

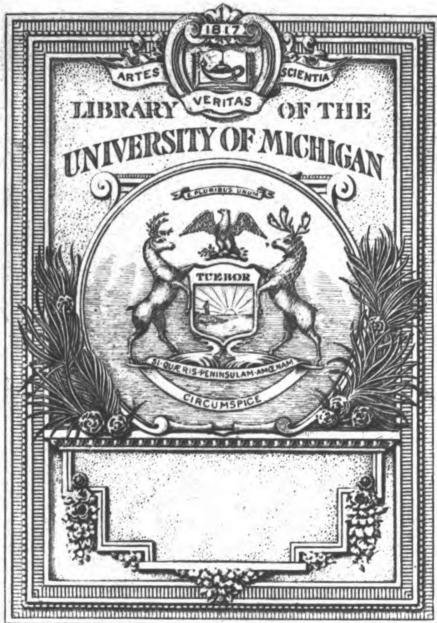

Monuments of the early church

Walter Lowrie



MONUMENTS
OF
THE EARLY CHURCH

BY

WALTER LOWRIE, M.A.

LATE FELLOW OF THE AMERICAN SCHOOL OF CLASSICAL
STUDIES AT ROME

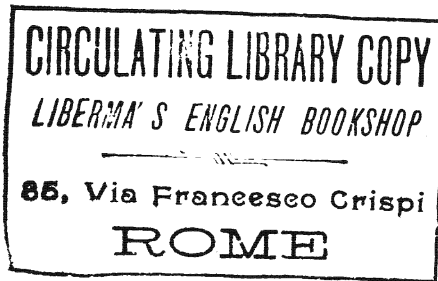

New York

THE MACMILLAN COMPANY

LONDON: MACMILLAN & CO., LTD.

1906

All rights reserved



**COPYRIGHT, 1901,
BY THE MACMILLAN COMPANY.**

Set up and electrotyped. Published October, 1901.
Reprinted December, 1906.

Norwood Press
J. S. Cushing & Co. — Berwick & Smith Co.
Norwood, Mass., U. S. A.

1000 P. 6.
1000 P. 6.

PREFACE

THIS volume is designed to give a general view of the monuments of the early Church, comprising in its scope all branches of Christian art and archæology, and treating each of them as completely as is possible within the limits of a handbook.

It is designed also, in behalf of students who may wish to pursue the subject further, to provide a general *introduction* to the archæology of the early Christian period. To this end it is hoped that the Bibliography will be found useful.

This book deals expressly with the *monumental* remains of Christian antiquity, and only incidentally with the early literature which illustrates the same period and the same subjects. It gives a detailed exposition of many of the most representative monuments, especially of those which are reproduced in the accompanying illustrations. There is included only so much of a more general nature as is necessary to define the point of view from which the monuments of early Christian art must be regarded, or to summarize the historical inferences which may be drawn from them.

The author has confined himself scrupulously to the well-defined and soundly assured results of this study, and has endeavored to eliminate questions of a controversial character.

The period covered by this study extends from the second to the sixth century inclusive. The interest of this period to the secular student lies in the fact that it represents the last phase of Græco-Roman art and civilization, and reveals at the same time a new artistic impulse which, after remaining dormant for centuries, was destined to germinate in another soil and appear again in the more familiar art of the Middle Ages. The religious interest of the period is of course still

greater, whether to those who trace back to it their religious forms and customs through the medium of the Middle Ages, or to those who refer for their inspiration more directly to the early Church.

It is obvious that so compendious a work as this must rely upon the conclusions of scholars who have devoted themselves specially to one or another of the departments which are herein treated. To speak only of writers still living, the author is glad to express his obligation to Mgr. Joseph Wilpert for all that concerns early Christian painting, as also in the matter of civil and ecclesiastical dress; to Professor Orazio Marucchi for the latest study of the Roman catacombs; to Professor G. Dehio for the study of the Christian basilicas; to M. Auguste Choisy for the analysis of Byzantine architecture; to Dr. Heinrich Holtzinger for Christian architecture in general; to Dr. R. Forrer for the study of textile art; and to all who have kindly consented to the reproduction of their illustrations. He is under obligation also to Mr. Charles R. Morey, Fellow of the American School of Classical Studies in Rome, for kind assistance in reading the proofs.

PRINCETON, N.J.,
April, 1901.

TABLE OF CONTENTS

I. INTRODUCTION

	PAGE
Relation of Christian to Classic Art	1
Formal Decline of Art in the Early Christian Period	4
Attitude of the Church toward Art	5
Limits of the Early Christian Period	6
Classification of Monuments	7
Distribution of Monuments	8
Relation to Literary Sources	11
History of the Study	17

II. CHRISTIAN CEMETERIES

GENERAL DESCRIPTION OF THE CATACOMBS	23
Nomenclature	23
Plan	29
The Catacombs and the Arenaria	31
Exaggerated Idea of their Extent	32
Actual Location and Extent	33
THE FOSSORS	36
THE CATACOMBS AND THE TITLES	37
THE CHRISTIAN MODE OF BURIAL	40
WORSHIP IN THE CATACOMBS	43
CONSTRUCTIONS ABOVE GROUND	47
Public Character of the Catacombs	47
The Area and its Buildings	48
Surface Burial	50
THE AGAPE	50
LEGAL TENURE OF THE CEMETERIES	53
The Sepulchre in Roman Law	53
Private Tenure	54
Corporate Tenure — the Burial Societies	56
INSCRIPTIONS	62
Epitaphs	63
The Poems of Damascus	74
HISTORY OF THE CATACOMBS AFTER THE FOURTH CENTURY	77

III. CHRISTIAN ARCHITECTURE

	PAGE
INTRODUCTION	83
A. THE BASILICA	
Meaning of the Name	89
VARIOUS VIEWS OF ITS ORIGIN	91
A Deliberate Invention	91
Derived from the Civil Basilica	92
Earlier than Constantine	93
Derived from the <i>Schola</i>	94
Derived from the Private House	94
From the Palace Architecture	97
From the Common House	97
ORIGIN IN THE ATRIUM OF THE LATE ROMAN HOUSE	98
Peristyle and Atrium	98
Analogies with the Basilica	100
FUNDAMENTAL CHARACTERISTICS OF THE BASILICA	101
Classical Elements	102
Internal Perspective	104
DESCRIPTION OF THE BASILICA	105
Plan	105
Vestibule	106
Nave	107
Columns and Capitals	108
Architrave and Archivolt	109
Pillars	111
Galleries	112
Windows	113
Doors	115
Roof	116
Ceiling	117
Decoration	119
Presbyterium	121
Transept	124
Prothesis and Diaconicon	126
Exterior	128
Façade	129
Syrian Architecture	130

B. THE CENTRAL TYPE

	PAGE
In General	131
Round or Polygonal Buildings	135
SIMPLE PLAN	135
COMPOSITE PLAN	139
The Dome from a Square Base	147
CROSS-SHAPED PLAN	147
OBLONG PLAN	153
S. Sophia	153

C. FURNITURE OF THE CHURCH

ALTAR AND CONFESSIO	159
CIBORIUM	167
CHANCELS	168
ICONOSTASIS	170
CATHEDRA	172
AMBONS	174
BAPTISTERY FURNITURE	175

D. POSITION AND SURROUNDINGS

ORIENTATION	176
ATRIUM AND PERIBOLOS	178
Cantharus	179
Propylaion	180
ADJOINING BUILDINGS	182

IV. PICTORIAL ART

INTRODUCTION	185
------------------------	-----

A. EARLY CHRISTIAN PAINTING

(Being the frescos of the catacombs and early Christian symbolism in general.)

INTRODUCTION	187
(Technic, divisions of the subject, character and employment of early Christian fresco.)	
EARLY CHRISTIAN SYMBOLISM	193

	PAGE
SYMBOLS OF DELIVERANCE	198
THE ORANS	201
OLD TESTAMENT CHARACTERS	204
Adam and Eve	204
Noah	205
Moses	206
Jonah	207
Abraham and Isaac	208
Daniel	209
Susanna	210
The Three Children and the Three Magi	211
THE MIRACLES OF CHRIST	213
Lazarus	213
The Blind Man	213
The Woman with the Issue	213
The Paralytic	214
The Multiplication of the Loaves	214
THE GOOD SHEPHERD	214
THE CELESTIAL BANQUET.	221
THE EUCHARISTIC BANQUET	223
THE FISH	232
THE CROSS AND THE MONOGRAM	236
THE VIRGIN MARY	245

B. SCULPTURE

INTRODUCTION	247
Character of the Monuments	247
Sculpture in East and West	248
Themes New and Old	249
Portrait Types of Peter and Paul	251
SARCOPHAGI	252
In General	252
The Jonah Sarcophagus in the Lateran	256
The Sarcophagus from S. Paul's	257
Other Sarcophagi in the Lateran	263
Sarcophagus of Junius Bassus	264
The Similar Sarcophagus in the Lateran	265
The Sarcophagi of Ravenna	268
THE DOORS OF S. SABINA AT ROME	270
THE CRUCIFIXION	276

TABLE OF CONTENTS

xi

	PAGE
IVORY CARVING	279
In General	279
The Box at Brescia	281
A Diptych at Florence	285
Cathedra of Maximianus	285
Gospel Cover from Murano	288
STATUES	289

C. MOSAICS

INTRODUCTION	292
The Study limited to Church Decoration	292
Technic of Floor, Wall, and Ceiling Mosaics	293
THE CONSTANTINIAN MOSAICS	297
S. Costanza	297
The Churches of Rome, S. Peter's	300
The Vine Pattern	301
THEMES OF APSIDAL DECORATION	302
THE APSIDAL MOSAIC OF S. PUDENZIANA	304
APSIDAL MOSAICS OF THE FIFTH AND SIXTH CENTURIES	311
S. Paul's, SS. Cosma and Damiano, S. Lorenzo, S. Vitale.	
HISTORICAL SUBJECTS	319
S. Maria Maggiore — Arch and Nave, S. Apollinare Nuovo.	
MOSAICS OF THE FIFTH CENTURY AT RAVENNA	329

D. MINIATURES

Introduction	333
The Paris Psalter	335
The Joshua Roll	335
The Vienna Genesis	337
Codex Rossanensis	338
Cosmas Indikopleustes	339
The Cotton Bible and the Cambridge Evangeliar	339

V. THE MINOR ARTS

EUCCHARISTIC VESSELS	343
LAMPS	347
CENSERS	353
DIVERS OBJECTS	354
Medals, Amulets, Ampullæ, Lead and Silver Objects.	

	PAGE
GLASS	357
Engraved Glass, Cut Glass, <i>vasa diatreta</i> , Gold Glass.	
THE TEXTILE ART	362
Lack of a Thorough Study of Classical Textiles	363
Account of the Discoveries in Egypt	364
Study of the Egyptian Finds	365
Execution, Material, Color.	
Tapestry	370
Three Periods of Design	371
Early Classical Tapestry	371
Deterioration in the Fourth Century	373
The Byzantine Period, Christian Themes, etc.	374
Importance of these Designs in Relation to Contemporary Art	377
Altar Cloths and Curtains	377

VI. CIVIL AND ECCLESIASTICAL DRESS

IN GENERAL	383
SUBORDINATE ELEMENTS OF DRESS, — Head-dress, Foot-gear,	
Breeches	386
THE TUNIC	389
THE DALMATIC	394
THE PENULA (CHASUBLE)	396
THE CLAMYS	399
THE LACERNA-BYRRUS	400
THE TOGA	401
THE PALLIUM AND THE PALLIUM SCARF	403
THE STOLE AND THE MANIPLE	410

APPENDICES

SELECT BIBLIOGRAPHY	415
INDEX	427

LIST OF ILLUSTRATIONS

FIG.	PAGE
1. Plan of part of the catacomb of Domitilla Marucchi, <i>Éléments d'Archéologie Chrétienne</i> , Tome 2.	24
2. A cubiculum in the catacomb of Callistus, one of the so-called sacrament chapels Reber, <i>Kunstgeschichte</i> .	26
3. Capella greca in the catacomb of Priscilla Wilpert, <i>Fractio Panis</i> .	28
4. Section of the catacomb of Callistus De Rossi, <i>Roma Sotterranea</i> .	31
5. Crypt of S. Cæcilia, catacomb of Callistus De Rossi, <i>Roma Sotterranea</i> .	33
6. A crypt in Cyrene Garrucci, <i>Storia dell'Arte</i> .	34
7. Fresco of the arcosolium of the fossor Diogenes, S. Callistus Garrucci, <i>Storia dell'Arte</i> .	36
8. A sarcophagus from the catacomb of Priscilla Wilpert, <i>Fractio Panis</i> .	41
9. Lead coffin from Phœnicia Garrucci, <i>Storia dell'Arte</i> .	42
10. Papal crypt in S. Callistus, restored De Rossi, <i>Roma Sotterranea</i> .	45
11. An arcosolium in the catacomb of Cyriaca <i>Bull. crist.</i>	48
12. Tombstone with graffito in Museo Kircheriano Wilpert, <i>Fractio Panis</i> .	51
13. Fresco in a crypt in Cyrene Garrucci, <i>Storia dell'Arte</i> .	55
14. Decoration in stucco, ceiling of a crypt Garrucci, <i>Storia dell'Arte</i> .	57
15. An orans, detail of a fresco in S. Priscilla Wilpert, <i>Gottgeweihten Jungfrauen</i> .	60
16. Sarcophagus of Livia Primitiva Garrucci, <i>Storia dell'Arte</i> .	62

FIG.	PAGE
17. Sarcophagus Garrucci, <i>Storia dell' Arte</i> .	63
18. Tombstone with graffito in the Lateran Photograph.	64
19. Tombstone in the catacomb of Domitilla Wilpert, <i>Fractio Panis</i> .	68
20. Fragment of the monument of Abercius Wilpert, <i>Fractio Panis</i> .	70
21. Loculus of a martyr in S. Domitilla De Rossi, <i>Bull. crist.</i>	71
22. The martyrdom of S. Achilleus, stone relief Garrucci, <i>Storia dell' Arte</i> .	74
23. Inscription by Pope Damasus in the papal crypt Grisar, <i>Analecta</i> .	75
24. Crypt of S. Januarius, Catacomb of Pretextatus Garrucci, <i>Storia dell' Arte</i> .	76
25. Plans of typical Greek and Roman houses Dehio and v. Bezold, <i>Baukunst</i> .	99
26. Plans of basilicas Dehio and v. Bezold, <i>Baukunst</i> .	102, 103
27. Plans of basilicas Dehio and v. Bezold, <i>Baukunst</i> .	104, 105
28. Plans of basilicas Dehio and v. Bezold, <i>Baukunst</i> .	107
29. Plan of old S. Peter's Reber, <i>Kunstgeschichte</i> .	109
30. View of old S. Peter's Kraus, <i>Geschichte der Kunst</i> .	110
31. Church in Babuda, Syria De Vogüé, <i>Syrie Centrale</i> .	111
32. Basilica in Turmanin, Syria, (façade restored) De Vogüé, <i>Syrie Centrale</i> .	112
33. Basilica in Turmanin, Syria, (apsidal end) De Vogüé, <i>Syrie Centrale</i> .	114
34. Basilica in Ruweha, Syria, (longitudinal section) De Vogüé, <i>Syrie Centrale</i> .	116
35. Basilica in Kalb-Luseh, Syria, (section) De Vogüé, <i>Syrie Centrale</i> .	117
36. Cathedral of Torcello, (interior) Holtzinger, <i>Allchristliche Architektur</i> .	119
37. S. Apollinare Nuovo, Ravenna, (interior) Lübke, <i>Grundriss</i> .	121

FIG.	PAGE
38. S. Maria in Cosmedin. Rome, (interior restored)	122
Giovenale, <i>S. Maria in Cosmedin</i> .	
39. Cathedral of Parenzo	125
Photograph.	
40. Apse of the basilica Severiana, Naples	127
De Rossi, <i>Bull. crist.</i>	
41. Restored basilica of S. Paul, Rome, (interior)	128
Photograph.	
42. Stone windows	130
Various sources.	
43. Plans of buildings of central type, simple plan	135
Dehio and v. Bezold and others.	
44. Plans of buildings of central type, composite plan	138, 139
Dehio and v. Bezold and others.	
45. Early Christian capitals	140, 141
Holtzinger, <i>Altchristliche Architektur</i> .	
46. Church of S. George, Ezra, Syria, (longitudinal section)	144
De Vogüé, <i>Syrie Centrale</i> .	
47. Plans of Byzantine churches	145
Dehio and v. Bezold, <i>Baukunst</i> .	
48. S. Vitale, Ravenna, (interior)	146
Photograph.	
49. The mausoleum of Galla Placidia, Ravenna, (exterior)	148
Photograph.	
50. The mausoleum of Galla Placidia, Ravenna, (interior)	149
Photograph.	
51. The church of S. Sophia, Constantinople, (interior)	154
Photograph.	
52. Plans of S. Sophia and the basilica of Maxentius	155
Dehio and v. Bezold, <i>Baukunst</i> .	
53. The mausoleum of Theodoric, Ravenna	157
Lübke, <i>Grundriss</i> .	
54. Altar from S. Quénin	159
De Fleury, <i>La Messe</i> .	
55. Altar with confessio in S. Giorgio in Velabro, Rome	161
Holtzinger, <i>Altchristliche Architektur</i> .	
56. Altar with fenestella in S. Alessandro, Rome	162
De Fleury, <i>La Messe</i> .	
57. Chancels of fourth and fifth centuries, Rome	169
Mazzanti, <i>Scultura ornamentale</i> .	
58. Chancel in S. Clemente, Rome	170
De Fleury, <i>La Messe</i> .	

FIG.	PAGE
59. Ambon in Thessalonica De Fleury, <i>La Messe</i> .	174
60. Cantharus formerly in atrium of S. Peter's De Rossi, <i>Bull. crist.</i>	179
61. Basilica with peribolos in Ruweha, Syria De Vogüé, <i>Syrie Centrale</i> .	181
62. Complex of church buildings at el Barah, Syria De Vogüé, <i>Syrie Centrale</i> .	182
63. Church of S. Simon Stylites, Kalat-Seman, Syria De Vogüé, <i>Syrie Centrale</i> .	183
64. Orans in palla, fresco in S. Callistus Wilpert, <i>Gewändung der Christen</i> .	202
65. Orans in dalmatic, fresco in S. Callistus Wilpert, <i>Gewändung der Christen</i> .	203
66. Orans in girdled tunic, fresco in the catacomb of Thrason Wilpert, <i>Gewändung der Christen</i> .	204
67. The vindication of Susanna, fresco in S. Callistus Wilpert, <i>Sacramentscapellen</i> .	210
68. The Epiphany, fresco in the catacomb of SS. Petrus and Marcellinus Wilpert, <i>Ein Cyclus christologischer Gemälde</i> .	211
69. The Good Shepherd, ceiling fresco in the catacomb of SS. Petrus and Marcellinus Wilpert, <i>Gewändung der Christen</i> .	216
70. Veneranda and S. Petronilla, fresco in S. Domitilla Wilpert, <i>Gewändung</i> .	222
71. Christ consecrating the Eucharist, fresco in one of the Sacra- ment Chapels, S. Callistus Wilpert, <i>Sacramentscapellen</i> .	224
72. Christ and the woman at the well of Samaria, fresco in one of the Sacrament Chapels, S. Callistus Wilpert, <i>Sacramentscapellen</i> .	225
73. Baptism and the Eucharist, fresco in one of the Sacrament Chapels, S. Callistus Wilpert, <i>Sacramentscapellen</i> .	226
74. "The breaking of bread," fresco in the Capella greca. S. Pris- cilla Wilpert, <i>Fractio Panis</i> .	228
75. The mystic fish, fresco in the crypt of Lucina Marucchi, <i>Éléments d'Archéologie Chrétienne</i> .	230, 231
76. Carved gems Garrucci, <i>Storia dell'Arte</i> .	233

LIST OF ILLUSTRATIONS

xvii

FIG.	PAGE
77. Carved gems Garrucci, <i>Storia dell' Arte</i> .	234
78. Carved rings Garrucci, <i>Storia dell' Arte</i> .	235
79. Coin of Apamea Garrucci, <i>Storia dell' Arte</i> .	237
80. Various forms of the cross and the Constantinian monogram	238
81. Coins of Constantine Garrucci, <i>Storia dell' Arte</i> .	240, 241
82. Coins of Nepotianus and Galla Placidia Garrucci, <i>Storia dell' Arte</i> .	242, 243
83. Crux gemmata, fresco in the catacomb of Pontianus Kraus, <i>Geschichte der Kunst</i> .	244
84. The Virgin and Child, fresco in S. Priscilla Wilpert, <i>Gewändung</i> .	245
85. A virgin taking the veil, fresco in S. Priscilla Wilpert, <i>Gottgeweihten Jungfrauen</i> .	246
86. Lid of a sarcophagus in the Lateran Photograph.	248
87. Lid of a sarcophagus in the Lateran Garrucci, <i>Storia dell' Arte</i> .	249
88. Fragment of a sarcophagus from S. Callistus <i>Bull. crist.</i>	250
89. Lid of a sarcophagus in the Lateran Garrucci, <i>Storia dell' Arte</i> .	250
90. SS. Peter and Paul, bronze medal in the Vatican Garrucci, <i>Storia dell' Arte</i> .	251
91. SS. Paul and Peter, bronze medal in the Vatican Garrucci, <i>Storia dell' Arte</i> .	251
92. An orans, relief on a screen Wilpert, <i>Gottgeweihten Jungfrauen</i> .	253
93. Sarcophagus in the Lateran Museum Photograph.	254
94. Sarcophagus in the Lateran Museum Photograph.	255
95. Sarcophagus from S. Paul's, now in the Lateran Photograph.	256
96. End of a sarcophagus in the Lateran Museum Beissel, <i>Bilder aus der Geschichte der Altch. Kunst</i> .	257
97. Elijah, fragment of a sarcophagus in the Lateran Photograph.	258

FIG.	PAGE
98. Sarcophagus in the Lateran Museum Photograph.	260
99. Sarcophagus in the Lateran Museum Photograph.	261
100. Sarcophagus of Junius Bassus <i>Röm. Quartalschrift.</i>	262
101. Details of the sarcophagus of Junius Bassus Beissel, <i>Bilder aus der Geschichte der Altchr. Kunst.</i>	264, 265
102. Sarcophagus in the Lateran Museum Photograph.	267
103. Sarcophagus of Theodore, Bishop of Ravenna Photograph.	268
104. Sarcophagus in Ravenna Photograph.	269
105, 106. Parts of the wooden doors of S. Sabina, Rome Photograph.	270, 271
107. The Ascension, panel of the doors of S. Sabina Photograph.	274
108. The Crucifixion, panel of the doors of S. Sabina Grisar, <i>Analecta.</i>	277
109. Ivory box in the British Museum Garrucci, <i>Storia dell'Arte.</i>	279
110. Sculpture in ivory at Treves Garrucci, <i>Storia dell'Arte.</i>	280
111. Part of ivory box of Brescia Photograph.	282
112. Part of ivory box of Brescia Photograph.	283
113. Ivory diptych in Florence Photograph.	284
114. Ivory cathedra of Maximianus at Ravenna Photograph.	286
115. Details from the cathedra of Maximianus Photograph.	287
116. Ivory Gospel cover, Ravenna Photograph.	288
117. Statue of the Good Shepherd in the Lateran Museum Photograph.	289
118. Statue of S. Hippolytus in the Lateran Museum Photograph.	290
119. Bronze statue of S. Peter in the Vatican Photograph.	291

FIG.	PAGE
120. Mosaic pavement of apse, Ancona	294
<i>Bull. crist.</i>	
121. Section of mosaic pavement in Parenzo	295
Lohde.	
122. Marble incrustation in S. Sabina	296
De Rossi, <i>Mosaici</i> .	
123. Inscription in mosaic, S. Sabina	296
De Rossi, <i>Mosaici</i> .	
124. Portrait in mosaic, catacomb of Cyriaca	297
De Rossi, <i>Mosaici</i> .	
125. Mosaic decoration of ring vault in S. Costanza	298, 299
De Rossi, <i>Mosaici</i> .	
126. Sketch of the mosaics of the dome, S. Costanza	300
Garrucci, <i>Storia dell'Arte</i> .	
127. Apsidal mosaic in S. Pudenziana, Rome	306
De Rossi, <i>Mosaici</i> .	
128. Plan of Jerusalem, part of mosaic pavement of a church at Madaba, Palestine	307
Marucchi, in <i>Nuovo Bull. crist.</i>	
129. Apsidal mosaic in SS. Cosma and Damiano, Rome	312
De Rossi, <i>Mosaici</i> .	
130. Mosaic of the arch of S. Lorenzo, Rome	313
De Rossi, <i>Mosaici</i> .	
131. Mosaic in S. Apollinare in Classe	314
Photograph.	
132. The sacrifices of Abel and Melchisedek, mosaic in S. Vitale, Ravenna	314
Photograph.	
133. Abraham entertaining the angels, mosaic in S. Vitale	315
Photograph.	
134. The Emperor Justinian carrying a votive paten, mosaic in S. Vitale	316
Photograph.	
135. The Empress Theodora carrying a votive chalice, mosaic in S. Vitale	318
Photograph.	
136. Mosaic of the arch of S. Maria Maggiore, Rome	320, 321
De Rossi, <i>Mosaici</i> .	
137. Mosaics in the nave of S. Maria Maggiore, Rome	322, 323
De Rossi, <i>Mosaici</i> .	
138. Christ enthroned, with angels and saints, mosaic in S. Apolli- nare Nuovo, Ravenna	324, 325
Photograph.	

FIG.	PAGE
139. Virgin and Child, with angels, Magi, and saints, mosaic in S. Apollinare Nuovo, Ravenna	326, 327
Photograph.	
140. S. Luke, mosaic in S. Vitale, Ravenna	328
Photograph.	
141. The Good Shepherd, mosaic in the mausoleum of Galla Placidia, Ravenna	330
Photograph.	
142. S. Ursicinus, mosaic in S. Apollinare in Classe, Ravenna	331
Photograph.	
143. Palace of Theodoric, mosaic in S. Apollinare Nuovo, Ravenna	332
Photograph.	
144. Mosaic in S. George, Thessalonica	332
Texier and Pullen, <i>L'Architecture Byzantine</i> .	
145. Joshua and the Gibeonites, miniature from the Joshua Roll of the Vatican	333
Græven, in <i>L'Arte</i> .	
146. Joshua and the men of Ai, miniature from the Joshua Roll of the Vatican	334
Græven, in <i>L'Arte</i> .	
147. Pharaoh's feast and Rebecca at the well, miniatures from the Vienna Genesis	336, 337
Hartell and Wickoff, <i>Die Wiener Genesis</i> .	
148. David, miniature from a Greek Psalter in Paris	338
Hartell and Wickoff, <i>Die Wiener Genesis</i> .	
149. Censers	346
De Fleury, <i>La Messe</i> .	
150. Terra-cotta lamps	348
Garrucci, <i>Storia dell'Arte</i> .	
151. Martyr exposed to a lion, terra-cotta lamp	349
<i>Bull. crist.</i>	
152. Terra-cotta lamp in the form of a fish	350
Garrucci, <i>Storia dell'Arte</i> .	
153. Bronze lamp in the form of a basilica	350
Garrucci, <i>Storia dell'Arte</i> .	
154. Bronze lamp in the form of a sheep	351
Garrucci, <i>Storia dell'Arte</i> .	
155. Jonah under the gourd, bronze lamp	355
Garrucci, <i>Storia dell'Arte</i> .	
156. Lead cup with reliefs, from Carthage	356
Garrucci, <i>Storia dell'Arte</i> .	

FIG.		PAGE
157.	Lead cup from Carthage, reliefs displayed Garrucci, <i>Storia dell'Arte.</i>	356
158.	Metal ampulla in Monza Garrucci, <i>Storia dell'Arte.</i>	356
159.	Bronze medal Garrucci, <i>Storia dell'Arte.</i>	357
160.	Fragment of cut-glass vessel representing Biblical subjects <i>Bull. crist.</i>	358
161.	Silver box from Africa <i>Bull. crist.</i>	360, 361
162.	The Good Shepherd, three gold-glasses Garrucci, <i>Storia dell'Arte.</i>	362
163.	Daniel and Bel, Adam and Eve, gold-glasses Garrucci, <i>Storia dell'Arte.</i>	363
164.	Jonah, two gold-glasses Garrucci, <i>Storia dell'Arte.</i>	364
165.	Fish under a gourd — Jonah as a type of Christ, a gold-glass Garrucci, <i>Storia dell'Arte.</i>	365
166.	Daniel and Bel, gold-glass Garrucci, <i>Storia dell'Arte.</i>	365
167.	Family portraits, gold-glasses Garrucci, <i>Storia dell'Arte.</i>	366
168.	A cycle of miracles depicted on a gold-glass Garrucci, <i>Storia dell'Arte.</i>	367
169.	Representation of a master carpenter, a gold-glass Garrucci, <i>Storia dell'Arte.</i>	368
170.	Segmenta, classical designs in tapestry Forrer, <i>Frühchristlichen Alterthümer.</i>	371
171.	The Church and the Empire united in the suppression of evil, woven silk design Forrer, <i>Frühchristlichen Alterthümer.</i>	372
172.	Virgin and Child, segmentum in tapestry Forrer, <i>Frühchristlichen Alterthümer.</i>	373
173.	The eye, design in tapestry Forrer, <i>Frühchristlichen Alterthümer.</i>	374
174.	The Egyptian cross, part of a clavus in tapestry Forrer, <i>Frühchristlichen Alterthümer.</i>	374
175.	Reconstruction of a curtain Swadoba, <i>Archäologische Ehrengabe.</i>	375
176.	Curtain in the Victoria Albert Museum Photograph.	376

FIG.	PAGE
177. Part of a clavus in silk embroidery	378
<i>Forrer, Frühchristlichen Alterthümer.</i>	
178. Details of a scarf in silk embroidery	379
<i>Forrer, Frühchristlichen Alterthümer.</i>	
179. Portrait in tapestry	380
<i>Forrer, Frühchristlichen Alterthümer.</i>	
180. Pope Sixtus I. and the Bishop Optatus, fresco in the catacomb of Callistus	397
<i>Wilpert, Un Capitolo della Storia del Vestiario.</i>	
181. Mosaic in the chapel of S. Venantius, Lateran Baptistery	404, 405
<i>De Rossi, Mosaici.</i>	
182* Linen maniple from Achmim	412
<i>Forrer, Frühchristlichen Alterthümer.</i>	

MONUMENTS
OF THE EARLY CHURCH

*A HANDBOOK OF CHRISTIAN
ARCHÆOLOGY*

I

INTRODUCTION

It would be but a bald definition of archæology to say that it is the study of ancient monuments. Like every other branch of history its ultimate interest is not the documents with which it deals, but the human story to which they bear witness. The story of many ancient peoples must be traced chiefly, if not solely, in their monumental remains, and the historian can ill afford to dispense with archæology, be the literary records never so plenty. Far from being the dullest branch of history, archæology is one of the most interesting, for it serves to illuminate precisely the most intimate and familiar aspects of ancient life, depicting them most vividly and most concretely.

The archæology of the early Christian period is not essentially different from any other branch of the study, though it is, of course, marked by problems and peculiarities quite its own. The most distinctive peculiarity which need be noticed is this, that it is not engaged with the totality of the monuments of any people or of any period, but solely with those which bear expressly the stamp of Christian inspiration. Christianity was not conterminous with any race, and the existence of the Church within the Empire did not signify the propagation of foreign art and custom in the midst of the regnant Classical civilization. Already with the second century — the period with which the monumental study of Christianity begins — the gentile element was so thoroughly predominant in the Church that we need not look for the traditions of Jewish custom except in matters most intimately associated with religion. The Jew had no art to hand on to the Christian, nor any architecture. The last temple at Jerusalem was a Classic building, as the first had been a Phœnician. Moreover, the Jew throughout the Empire was

already as much of a cosmopolitan as he is to-day. A certain aloofness from popular gentile life, prescribed by his religion and his moral code, must not blind us to the thoroughness of his tincture with classical civilization—he spoke in its language, he thought in its philosophy, he clothed himself in its dress. The emperors were not slow to recognize in the Hellenistic Jew an apt exponent of the imperial ideal, and they accorded him corresponding privileges. In the case of the Jewish Christians, as we see already in the Apostolic age, the ties of race and the barriers of racial exclusiveness were still further dissolved, and in the case of the gentile Christians they did not exist at all—they stood apart from their fellow-citizens only in matters which regarded religion and morality.

In general, one can hardly exaggerate the Roman's success (building, indeed, in part upon the work of the Greek) in impressing upon the world, not only the administrative régime of the Empire, but the whole complex of Classical civilization: it was in the fulness of time Christ came and the Apostles preached. The Church was a phenomenon of the Empire, and in time of persecution no less than in the era of triumph belonged essentially to it. To say that the Church grew out of the Græco-Roman civilization (as though transcending it), or grew up within it (as an isolated entity), would be misleading; the Church must be recognized as a very part of that antique classical civilization, and only by inwardly appropriating—not by adoption but by natural inheritance—the fundamental terms of its life and thought, was it able in spirit to transform it.

If one were bent upon the reconstruction in its totality of Christian life in the Classical period, the monuments which are reckoned to the part of Classical archæology would constitute data no less important than those which bear expressly a Christian character. And though we must here make complete abstraction of the common elements of Classical life, we cannot ignore the fact that the art which was the most distinctively Christian in spirit was none the less Classic in form. It was simply inevitable that all forms of decorative and pictorial art, of sculpture and architecture, should be adopted by the Christian as he found them ready to his hand. We see how thoroughly he belonged to his age when we

note with how little scruple he accepted them. He was concerned in the first instance only to eliminate such current themes as were expressly idolatrous or immoral, or to select such as could be given a Christian interpretation. This was followed, of course, by the development of themes properly Christian; but even in this work the Christian artist could no more divest himself of the formal traditions of Classic art — nor had he any more reason to do so — than in using the Classic languages he could dissociate himself from the fundamental modes of Classic thought.

There was no doubt also a formal progression upon the old lines; but the antique traditions were so soon broken off in the general collapse of Roman civilization that we are left without any sound basis for the speculation as to whether, or in how far, Christian art with a free and interrupted development might finally have transcended the traditional forms. This speculation, at any rate, does not concern us here. We shall not trace the old traditions through the petrified forms of Byzantine art, where they proved impotent for any scope beyond symbolism and decoration. It shall be left to the reader, with the monuments which are here put before him, to reckon the influence of Classical Christian art upon art Mediæval: this influence is to be traced rather in the selection of themes and in the arrangement of scenes than in spirit and technic. The Renaissance, which returned for its inspiration Classic art, had no relation whatever (except through the Mediæval tradition) with the Christian phase of that art; its monuments were already hidden or ignored.

This Classical Christian art proved no less adequate to the expression of Christian themes, and deserves no less truly the title of Christian art, than did any which was developed later and on Christian soil. This art has long been completely unknown, and not even yet is it popularly appreciated. Yet it remains more intelligible to the modern mind, it stands closer to us in sympathy, than does the art which stands nearer in time, developed during the Middle Ages by men of our own stock and under influences exclusively Christian. Classic art, even in this its Christian phase, reflects, in its lucid ideal and definite presentation, the moderation and balance which were characteristic of Classical civilization and thought. There is

fundamentally but one art and one reason; not a Christian art and a Christian reason. The proof that Christian theology was expressed in forms of Greek philosophy has been accounted to the discredit of the Church. On the contrary, it was the signal advantage of Christianity that it could from the beginning express itself in the forms of Greek art and in the terms of Greek thought; for it was true art and right reason. The normal authority which we ascribe to the early age of the Church is justified not only by the fact that it stood close to the origin of the faith and constituted the first expression of Christianity in the world, but also by the fact that it was the expression of Classical culture. The pagan Classical age is one against which many serious charges may be brought. One may be by no means disposed to recognize the legitimacy of the customs and theologies which sprang up on that soil. But one can hardly refuse to recognize that it was an age which was marked, as no other has been, by the general dissemination of just criteria of reason. It is a matter of no slight advantage that the philosophic claims of Christianity were first expressed in the Greek language, and, therefore, in terms intelligible to the world — in terms which then were comprehensible to disciples of Plato, of Aristotle, and of Zeno, and which remain intelligible for all times.

One must recognize in early Christian art two qualities which are not commonly thought of as compatible in the same subject: it was an art at once nascent and decadent. In many respects it was full grown when born, and its decline dates from its beginning. The highest expression which art attained in the Roman Empire was reached in the time of Trajan and Hadrian. Its decline during the next two centuries is measured upon the Arch of Constantine by the difference between the sculptured reliefs taken from the demolished Arch of Trajan and those which the first Christian emperor had executed expressly for his own monument. Within two centuries more art lay almost prostrate. We have not, therefore, in the case of Christian art, to look for the rude essays which we associate with all beginning, the effort, with little skill, to match the idea with the appropriate form. On the other hand, we cannot trace in it the keen progress upward which

constitutes the special charm of the study of early periods of art. Christian art began — so far as we can trace its monuments — with the end of the first century, that is with the most flourishing period of imperial art. It found its forms furnished ready to hand. The earliest Christian artists were technically the best; their skill declined with the general collapse of Roman art and culture.

The monuments reveal just such use and appreciation of art in the Church as might be expected of gentiles who were bred to a taste for it and found in their new religion no express veto against it. Apart, however, from the extant monuments, and relying solely upon the scant references in literature, one would hardly form a just conception of the Christian employment of art in the second and third centuries. One might be disposed rather to credit the opinion that the early Church set its face resolutely against its religious use, and that the artistic activity of the fourth century, to which the literature as well as the monuments bear witness, was a sign of the worldly corruption of the Church under imperial favor. This view was so confidently held in Protestant circles, and especially in England, that for a long time credence was refused to the discoveries of early Christian art in the Roman catacombs. It was a view which rested fundamentally upon a strong religious prejudice; but it seemed none the less to have some justification in history. For it seemed not unreasonable to presume that the Mosaic prohibition of pictorial art must have been observed in the Church as it was in Islam, there being the same reason for it in the keen struggle with surrounding idolatry. And, in fact, the few literary references to art which we have (in Tertullian, Clement of Alexandria, and Irenæus), though they do not express a condemnation of it, suggest distinctly the suspicion of its abuse.

The Spanish Synod of Elvira (306 A.D.), with its prohibition of the pictorial representation of the divine Persons in the churches (can. 36), has been taken for conclusive evidence of the general attitude of the Church. Eusebius of Cæsarea, — in other respects no enemy of art, — writing, in reference to a picture of Christ, to Constantia, sister of Constantine the Great, suggests the scruple that strangers, seeing such representations, might suppose that the Christians carry about their

god in a picture like the idolaters. It is likely that the same fear of misunderstanding prompted the canon of Elvira; and for the faithful themselves there may have been no little danger in the painting of "that which is worshipped and adored" upon the walls of the churches.

This utterance, however, does not represent the general attitude of the Church, which continued with little or no scruple (so far as monuments reveal) to employ pictorial art for the representation of religious themes and of the divine Persons. The monuments show us, too, that we have not to think of a strict observance of the Second Commandment even on the part of the Hellenistic Jews. One of the Jewish catacombs in Rome contains decoration in fresco representing animal forms such as are found in the Christian cemeteries. There is similar decoration in the Jewish cemetery at Carthage; and in Tunis the mosaic pavement of a synagogue is entirely in Classic design, with garlands, fishes, and birds. We may admit that such Jewish Christian communities as the Ebionites probably respected the mosaic prohibition. It is not unlikely that among the Christians a severe sect like the Montanists held aloof from art. There were voices raised against its religious use, or abuse, both before and after the iconoclastic Eastern emperors. But the enthusiasm with which art was cultivated by the Catholic Church is sufficiently demonstrated by the monuments themselves, or even by the examples which are illustrated in this book.

It is from no point of view an easy matter to fix the limits of the early Christian period, although the question is simplified when we regard it with exclusive reference to the history of art, and recognize that the theme of our study is Classic art as it was employed by Christians for the expression of Christian ideals. From this point of view it is plain that early Christian art ends long before Mediæval art begins. Between the two there intervenes a period of about two centuries, a true middle age, in which Classic art was no longer and Mediæval art was not yet. It adds little to our information to follow through this period the merely static survival of Classic forms in the Byzantine Empire; and it is in no sense germane to our topic to study the purely barbaric art of the Anglo-Saxons,

Celts, or Lombards. Practically, our study begins with the earliest extant monuments of a strictly Christian character, that is with the end of the first century, and it closes with the development of Byzantine architecture before the end of the sixth. It must be remarked, however, that no single department of our study covers the whole of this period: each branch of art had in some respects an independent history and a separate fate, originating later or terminating earlier than the limiting dates which are here assigned to early Christian art in general.

The precise limits of the period are of the less importance to our present study because it is rather on the plane of description than of narrative, being interested not so much to trace the origins of Classical Christian art, nor to follow its decay, as to portray it in its perfection.

There is needed here, by way of introduction, no more than the briefest survey of the various classes of monuments with which we have to deal.

The early Christian painting which has been preserved to us is found almost exclusively in the Roman catacombs: it therefore belongs to the earliest part of our period, and may be presumed to have a more or less immediate reference to death — or rather to the Christian hopes which illuminated it. The themes of later painting — especially in the decoration of the churches — can be inferred from the mosaics. On the other hand, light is thrown upon the study of the mosaics by the latest branch of painting which we have to consider, namely, the miniature illustrations of the Bible text. The catacombs themselves, quite apart from the monuments of art which they contain, constitute a testimony of the highest importance both for the early age during which they were in practical use and for the later in which they had become objects of veneration. It lay obviously in the nature of the case that the art of sculpture was not utilized as soon as painting for the representation of Christian themes. It is represented principally by the sarcophagi, which are most abundant for the fourth and fifth centuries, and were produced until the seventh, when artistic skill sank below the level demanded for figured work. The same period is represented, and the same history of decline is repeated, in ivory and metal work. In general the minor

arts followed the Peace of the Church, but the manufacture of gold-glass commenced toward the end of the third century. The discoveries in Egyptian burying-grounds enable us to follow the technic of the textile industry from the second century to the Mahometan conquest; but there were no distinctively Christian designs till the age of the Church's prosperity. In architecture there remain but few monuments earlier than the Constantinian age. The churches built during the reign of Constantine have been destroyed or remodelled. The following century, however, furnishes many complete examples. With the reign of Justinian in the sixth century there was prodigious activity in the building of churches, and many edifices have been preserved. Specially notable in this period is the development of the central type of architecture.

The history of mosaic art follows closely that of architecture, of which it was the handmaid. The mosaic decoration has, however, often been preserved when the strictly architectural features of the church have been transformed out of all recognition.

Such, in the most general terms, are the monuments which we have to study. But it must be remembered that to the archæologist each monument has a many-sided interest; a mosaic painting, for instance, may be studied as a part of church decoration, or as an example of pictorial art, or for its illustration of ancient costume, of early church doctrine, or of ecclesiastical use.

Local differences in art due to racial traditions can be but barely noticed in this book. They have not as yet been sufficiently studied; in many cases where we might expect to note them the monuments are too rare to furnish the necessary evidence. In general the monuments do not allow us to forget that they all belong — in spite of incidental peculiarities — to the broadly disseminated culture of the Roman Empire.

It is in the East especially we might expect to notice the influence of earlier art; it is there, too, we might expect the greater abundance of monuments; for it was the East — especially Asia Minor, Syria, and Egypt — which was the most flourishing seat of Christianity in the third century and even later. But, as a matter of fact, it is particularly in the East

that the monuments have been either most completely destroyed or least explored. Christian art in the East fell victim finally to the iconoclastic spirit of Islam. Valuable monuments of early architecture have been here and there preserved by their adoption as mosques, particularly in Constantinople, Thessalonica, and Jerusalem. But already pictured art had suffered much from iconoclastic zeal in the Church itself. Many of the pictures which are venerated in Italy as original portraits or miraculous images (*acheiropoeta*) of Christ and of the Virgin belong to the Byzantine art of the seventh century and were, doubtless, transported for preservation.

To this general destruction Syria forms an important exception, especially in view of its architectural remains. The conquest of Islam left the greater part of it a desert, and owing to the admirable character of its masonry (and to the fact that little or no wood was used) it furnishes the most numerous and the most perfect examples of the domestic and ecclesiastical architecture of the third and fourth centuries; and not only in its architecture, but in its carved reliefs, it bears witness to a national Syrian school, which probably had a wider influence than any other local art upon the surrounding peoples.

The Holy Land — especially Jerusalem and Bethlehem, but in general the whole of Palestine — was a resort of pious pilgrimage and the site of many churches of imperial foundation, due first to Constantine and his mother Helena, and later to Justinian. Scanty remains are still left of some of these churches, though the Crusaders in their zeal for rebuilding showed little respect for ancient monuments.

We might expect in Egypt a very strong influence upon art from the ancient national traditions and the ancient monuments. As a matter of fact, the Coptic churches have been either so thoroughly destroyed or so fundamentally altered that hardly more of the original than the ground plan can now be described and the textiles and small objects found in the graves present very little which is distinctive.

Asia Minor has as yet been insufficiently explored. Archaeological study will naturally follow in the wake of the German commercial exploitation of the country, and there is reason to hope for finds of great importance. How much may survive Mahometan occupation we see in the case of North Africa,

where French colonization has brought to light many important monuments of architecture, sculpture, and the minor arts.

But this brings us already to the West, where the monuments are in general more common, or better known, and where destruction has been due chiefly to perverse activity in restoration. On the borders of the Empire monuments belonging strictly to our period are for the most part very scarce. In England they are almost exclusively confined to mosaic pavements, especially at Trempton and Horkstow. In Spain they are represented chiefly by sarcophagi; in France by sarcophagi (at Arles), by a few churches which are almost entirely rebuilt, and by rare specimens of the minor arts. In Germany, Treves is specially interesting for three cemeteries (one of them under ground); numerous small objects and inscriptions have been found also in the Rhine country. Outside of Italy it is the northern coast of the Adriatic (Dalmatia and Istria), with its purely Latin colonies, which proves the greatest activity in artistic production, especially toward the sixth century. Here are found architectural monuments which have lately been well studied by scholars native to the region who are peculiarly zealous for their classical traditions.

But it is Italy itself, and preëminently Rome and its vicinity, which furnishes the greatest number of monuments — indeed, the majority of all which have been found. In Rome the very activity of ecclesiastical life, the fact that no period has been altogether lacking in additions and reconstructions, has contributed to the destruction of the monuments; but it has also served to present an almost unbroken sequence representing nearly every department of Christian art. If the monuments of the Middle Ages (both early and late) have been almost totally annihilated by the scorn of the Renaissance for what it counted an age of barbarism, the earlier monuments have fared somewhat better. The student is, indeed, likely to be disappointed at first, for what is left requires much patient hunting out and piecing together; but, after all, there are sufficient monuments in the way of architecture and mosaics to represent at least intelligibly the period of Byzantine influence, the more strictly Roman style of the fifth century, and even the Constantinian foundations. Sculpture is fully represented throughout this period by sarcophagi, by the wooden doors of

S. Sabina, and by minor objects. For the earlier period it is Rome alone, with its catacombs, which provides the key for the appreciation of the development of Christian art, and of the spirit with which it was employed by the Church.

Sicily is interesting for its cemeteries, especially the catacomb of S. Giovanni at Syracuse. Naples also has its primitive catacomb of S. Gennaro, and in the Campagna there are other cemeteries of less interest.

In the North, Milan furnishes sarcophagi, ivory carvings, and churches of the sixth century (very much altered); and Ravenna, with its churches, mosaics, and sarcophagi, splendidly testifies to the artistic interest and skill which marked both the Gothic and the Byzantine rule at the turn of the fifth and sixth centuries.

In enumerating the monuments which specially distinguish each place and period, it has not been convenient to speak of inscriptions, because they are to be found throughout the whole field. It is, however, in Rome and Italy that they are by far the most numerous; the inscriptions of Gaul stand next in importance. In the East they still, for the most part, await discovery. All but a small fraction of our Christian inscriptions are sepulchral.

It need not be said that the study of the early history of the Church is not dependent solely upon monuments, nor that the study of archæology itself is chiefly illuminated by documentary evidence. It was not a barbarous, but a literary age; and whatever of the literature of the Church — or more especially its official records — may have been destroyed by persecution, the stable basis of its history is still a literary one. But the archæological study of the monumental remains is only the more fruitful for being less than indispensable; its problems are more readily and more surely solved, since it is hardly ever left without some word of interpretation from contemporary writers. The literary sources which contribute to fix our conceptions of Christian archæology cannot, however, be mentioned in this work; it is enough that we present here the sources of monumental evidence. It goes without saying that the works of the Fathers and the History of Eusebius, for example, are indispensable for any study of our

subject, and even for the appreciation of its monuments. The comparatively few passages which may be quoted in this book do not by any means reveal the extent to which the early authors must be depended upon in formulating the conclusions of this science.

But there is one class of writings which stands in so close a relation to archæological study, and is of so little importance apart from it, that the student may need a special introduction, if but a brief one.

It is necessary to pass over with a mere word a class of documents which were of inestimable importance to de Rossi and to earlier students for the location and exploration of the catacombs, because the discovery to which they conduce has been all but definitely accomplished. I refer to the Roman martyrologies (the most important is that which is associated with the name of S. Jerome), which are liturgical lists giving the day of the annual celebration of the death, deposition, or translation of the saints who were commemorated by the Church, naming also the cemetery in which the body reposed. It is the last item which gives to the martyrologies their topographical value in the work of locating the catacombs and ascribing to them their proper names. The *Lives of the Saints* had a like use, notwithstanding that of the few which are strictly authentic none belong to Rome. It was de Rossi's generous faith which enabled him to draw even from late traditions a profit which most of the scholars of his time would have been too sceptical to look for. The results of his work justified his belief, and he was able by monumental evidence to reconstruct in some measure the genuine tradition contained in the *Lives* with which he had to deal (e.g. that of S. Cecilia), subjecting them to a criticism which was impossible on purely literary lines. Comparatively few of the *Lives*, of course, could be subjected to this test, and for the most of them we must remain without any such criteria for distinguishing the false from the true. But in the proof that in the *Lives* which have been accounted most hopelessly corrupt we may look for some substantial basis of fact, lies one of the most important general results of de Rossi's work, for it cannot but modify the general sceptical attitude toward ecclesiastical tradition.

Another class of documents, the pilgrim Itineraries, proved

of still more value for the topography of the catacombs. They were intended in most cases, not only as a record of the pilgrim's visit, but as a guide to others who might follow him; and it was with this view the pilgrims were so precise in describing the order and in marking the location of the monuments which they visited.

In Rome the pilgrims were interested chiefly in the tombs of the saints and the *memoriæ* which were erected over them, all of which (with the exception of the house of the fourth-century martyrs John and Paul) were without the walls. In Palestine interest centred, of course, in the sites connected with our Lord's life and the Constantinian structures which marked them. For Rome the itineraries are furnished us exclusively by German and English pilgrims. There are two in a Ms. of Salzburg: the first of them recounts a pilgrimage made shortly after the pontificate of Honorius I. (625-638), and the second belongs approximately to the same date. About the end of the same century, but hardly less valuable topographically, comes the Itinerary of William of Malmesbury; and early in the century following, one which was found in a codex of the monastery of Einsiedeln.

Earlier and of still greater interest — though they describe later monuments — are the accounts of pilgrimage to Palestine. The itinerary of the pilgrims from Bordeaux to Jerusalem (fifth century) has been long known. The *Peregrinatio Silviæ* (supposed to be S. Sylvia of Aquitaine) has been recently discovered, and is the most interesting of its class. This is a description by a lady of Southern Gaul of her visit to the Holy Places of Palestine in the fourth century. It was written for the instruction of her "sisters," that is, doubtless, the members of her religious community. These itineraries describe the Holy Land as it was embellished by the constructions of Constantine; there are two others of later date which describe the buildings of Justinian. To this must be added the description of the holy places of Palestine by the abbot Adamnanus, of the early part of the eighth century.

Even more closely related to archæology is the Roman *Liber Pontificalis*. It is a brief record of the official acts of the popes, — ceasing however to be brief when it reaches the popes of the latter part of the sixth century. It was evidently not

all of it written at one time; the later lives at least were added one by one by contemporary scribes. The first part of the work, as Duchesne would have it, probably extended only to the middle of the short rule of Silverius (536-537), and was therefore composed by a contemporary writer. Some would date the original composition a century later; but they would not thereby seriously affect its value to the archæologist. For, serious as are the historical blunders of the first part, it contains one element which could have been derived only from the official records of the Church, that is, the account of the construction of churches by popes and emperors and of the gifts which were made for their adornment. This is all given with such precision of detail — with number, weight, and measure — that it argues an author who, however ill equipped for the task of an historian, had at his service official records which extended back to the time of Constantine. Among the most interesting notices are those of the gifts of that emperor.

The *Liber Pontificalis* of Ravenna is the work of a single author, the Abbot Agnellus, in the early part of the ninth century. Agnellus had no such minute records at his disposal as had the author of the Roman work, but on the other hand he had a special talent for his task. He may be said to be the first Christian archæologist; it was by the study of the monuments of his city that he was able to piece out its history, and the documents which assisted him in his labor were chiefly the metrical inscriptions which were preserved in the churches.

The inscriptions which Agnellus records — in part dedicatory, in part descriptive of works of art — belong to a class of documents more strictly literary than those we have hitherto considered. The Christian poets, like the Greek, often chose for their theme the famous work of some artist, and exhibited their skill in its description.

This sort of poetry was current both in the East and in the West, but with marked differences of type. In the East it followed the Classical models. The Epigrams of Paulus Silentiarius are copied after the Greek form, as is also his poem descriptive of S. Sophia. This latter work was highly lauded by contemporaries, and it was claimed that a reader might get from it as vivid an impression of the church as if he had actually seen it. Procopius of Cæsarea described in prose the buildings of

Justinian, giving us a more exact and detailed account of the building operations of that emperor than Eusebius gives us (in his *Life and Eulogy*) of the churches of Constantine.

In the West, we have, first, the metrical inscriptions which Pope Damasus (366–384) erected in the catacombs in honor of the martyrs. They were frequently copied by the pilgrims, and in that way many of them have been preserved to us, though it seems that they never were gathered into one edition as were the poems of Prudentius. They belong so properly to our monumental study that they must be treated more at length elsewhere, for in the exploration of the catacombs a number of the original inscriptions have been brought to light.

With Prudentius, at the end of the fourth century, we come to a type of descriptive poetry which belongs exclusively to the West and constitutes a development altogether peculiar to Christianity and highly significant of the spirit of Christian art. It is the so-called *titulus*, a type of poetry which is related to the Greek epigram, but at the same time sharply contrasted with it. Classic art in its perfection strove after a purely formal effect upon the beholder, that is to say, its chief interest lay, not in its substantial import, but in its external form. This aim was completely summed up in the expression of the beautiful. Intimately related to the spirit of Greek art was the Greek epigram, which sought in language a clever and pointed expression of the effect which the work of art was intended to produce. The epigram was often inscribed upon the base of a statue, but the statue was none the less essentially independent of it, for its effect was purely formal and it needed no interpreting word. On the other hand we see in Christian art a spirit which was ever intent upon seeing behind the veil. In Christian art from the very first—in its early symbolical themes no less than in its later and more obviously didactic development—it was not the form but the thought which predominated; and the Christian work was characteristically accompanied not by the epigram with its clever expression of the formal effect, but by the title (*titulus*) which summed up no less tersely the substantial point of the narrative or dogma which the picture would represent. The *titulus* was usually inscribed under a picture, but it had precisely the same character when it was inscribed over a door, upon the altar, or

referred to the whole church—in any case it was intended to express the essential significance of the object. The *titulus* had a long history in the Church, and it was continued finally in a prose form quite through the Middle Ages, or until with the Renaissance the interest in the formal effect of art became predominant, and—it must also be said—art became better able to tell its own tale.

In the *Peristephanon* of Prudentius we have descriptions of the pictures of the Martyrium of S. Cassianus in Imola (the ancient Forum Corneli) and of the Martyrium of S. Hippolytus at Rome near S. Lorenzo. In his *Dittochæon* we see exemplified a characteristic of Christian art which we shall have several occasions to notice in the monuments. The name is compounded of two Greek words (*διττός* — *οχή*) and means double nutriment. The titles were evidently composed for actual inscription, and they represent a parallel series of pictures taken from the Old and New Testaments. A similar typological cycle from both the Old and the New Testaments is that of Helpidius Rusticus of the sixth century.

Even more interesting are the poems of Paulinus of Nola (353–431). In his letter to Sulpicius Severus of Primuliacum in Gaul he rebukes his friend for his too friendly act in painting his (Paulinus's) portrait in the refectory together with that of S. Martin, and he proposes the choice of two titles which would obviate the sacrilege by pointing the contrast between the saint and the sinner. The same letter contains dedications for the baptistery and the basilica which his friend was building, and gives the *tituli* of his own church of S. Felix at Nola. We have also from S. Paulinus a poem descriptive of the basilica of S. Felix; and another letter contains a poetical description of the basilica which he was building at Fundi.

We have literary record of the *tituli* of some of the churches of North Italy of the fifth century: those ascribed to S. Ambrose, and those referred falsely to Claudian. Also in Gaul for the basilica of S. Martin at Tours (about 460), and for the Cathedral of Tours as recorded by Venantius Fortunatus about 565. S. Gregory of Tours (+ 594), in his *Historia Francorum*, gives a prose description of the basilica of S. Martin and of the basilica of Namantius in Clermont.

The literature which has here been referred to as especially

illustrative of Christian archæology can most of it be found in the relative volumes of the *Quellenschriften für Kunstgeschichte* (cf. Bibliography).

The history of the study of Christian archæology need be given here only in the briefest terms: its present status is fairly represented by the Bibliography which is given in the Appendix.

The beginnings of a truly monumental study of Christian history are indissolubly associated with the exploration of the Roman catacombs. In 1578 a general interest was awakened by the accidental discovery of a single chamber of one of the catacombs which had lain buried for centuries. This furnished an impetus to study, and early in the seventeenth century two Dutchmen, L'Heureux and de Winghe, wrote works upon the catacombs and upon early Christian art in general which showed careful observation and a fairly just appreciation of the monuments. These works would have constituted a hopeful beginning for the study, if only they could have gained the attention of scholars, but as a matter of fact they were not even published.

The real beginning of the exploration and of the appreciation of the catacombs was made by Bosio, who after many discoveries, after many years of familiarity with the catacombs and a close and fruitful study of their contents, left his work incomplete and unpublished at his death in 1614. It was published, however, in 1632, under the title *Roma Sotterranea*, by Severano and in a Latin edition by Aringhi in 1651-1659. How great was Bosio's merit one can best judge from de Rossi's frequent expressions of obligation to him. He had recognized the right method for the study and exploration of the catacombs, and he only just failed to make the important discoveries which the world now owes to his successor de Rossi.

During the seventeenth century Christian archæology continued to be chiefly occupied with the catacombs and their contents, but without being able to avail itself of the impetus of Bosio's work for new discovery. No substantial progress was made in this line even in the eighteenth century, nor indeed until the discoveries of de Rossi in our own time. For the eighteenth century, however, the works of Boldetti and Bottari served to keep alive an interest in the subject, and already by

the end of the preceding century Ciampini had widened the field by studying early mosaics and the churches of Constantinian foundation. Up to the nineteenth century the field of discovery was almost exclusively confined to Rome, and the origin and significance of the catacombs and their contents was a fertile ground of dispute between Roman Catholics and Protestants.

With the nineteenth century the development of the study has been significant in many respects. A real appreciation of early Christian art was perhaps impossible before Classical art itself was understood, that is before the development of Classical archæology. At all events, our study has followed the development of that science and has had the advantage of its well-established method. The field of investigation has at the same time been broadened so that substantial contributions are made from all sides and from many lands, though Rome, as the chief storehouse of monuments, remains also the most important centre of study. The study in this its later phase has been marked not only by a scientific method, but by a scientific spirit which has for the most part risen quite above the interests of sectarian polemics.

It was through the work of Giovanni Battista de Rossi that Christian archæology first assumed its modern form and importance: it was he who first made it a science. Equipped with everything which was needed to furnish him for the work, with solid learning, and with zeal and ingenuity no less remarkable, he followed out a rigid method which led not only to the discovery of the catacombs, but to a just appreciation of their historical significance. It was a work of new discovery, inasmuch as a great part of the limited region of the catacombs known to Bosio had been again lost track of. Even the catacombs which were already known had not been correctly identified by their ancient names; they could not, therefore, be brought into relation with the history and traditions of the Church, and their testimony was almost exclusively limited to the obvious facts which met the eye. There were defects in Bosio's method which, small as they were, quite baffled his pursuit; and for all his patient investigation he found none of the sepulchres of the historically renowned heroes of the faith. On principle he avoided all regions of the catacombs which

showed traces of late masonry and painting: this seemed to him an obvious sign that the region and its tombs must be of late date. De Rossi, on the other hand, recognized that the decoration and construction which belonged to a time when the catacombs had ceased to be places of burial must indicate the neighborhood of tombs which were venerated from the fourth to the seventh century. It was at that time new stairways were constructed and the corridors were enlarged to give easy access to the historic chambers, which themselves were amplified and decorated as an expression of the popular cult which was accorded the martyrs.

In locating and distinguishing the catacombs, in assigning to the different regions their date, and in prescribing the method which must be followed in their study, de Rossi accomplished an indispensable work which perhaps no one else was fitted to do. This, however, was but the ground work; the most interesting part of his study, the important fruit which he drew from it, consists in the lines of connection which he traced—ingeniously combining many mere hints into a sound argument—between the monuments of the catacombs and the general history of the Church and of the Empire. His peculiar talent for the work is especially shown by the genealogical puzzles which he unravelled, connecting the different catacombs, or their individual tombs, with historical families of Christian or pagan fame. Such arguments, however, are in their very nature so dependent upon minute detail that not even a specimen can be presented in this book. And in general it must be said that the soundness of de Rossi's results, the accuracy of his method, and the candor of his judgment, cannot be fairly judged except from his own works in full—not even from the English condensation of his work by Northcote and Brownlow. The disparagement and distrust which de Rossi encountered in England and America was due to a merely second-hand acquaintance with his work which gave an inadequate idea of the cogency of his arguments. In all that is fundamental to the study of the catacombs his work deserves the highest confidence. The catacombs have not yet been completely explored; but what remains may be discovered (it is chiefly a question of expense) by the light which he has furnished. The four great volumes

of *Roma Sotterranea* hardly represent the half of his published studies of the subject. The studies and discoveries in the catacombs since the date of that publication are about to be edited by his surviving disciples as a continuation of *Roma Sotterranea*.

As regards the frescos of the catacombs de Rossi's opinion has less value. In the reproduction of the pictures he did not avail himself of the accurate photo-mechanical processes which were at his disposal, and his copyists were not always trustworthy. He himself lacked the keen appreciation of art which is requisite in a critic, and even in the interpretation of the subjects his judgment was often astray and has been corrected by his disciples. This lack in de Rossi's work is completely supplied by Joseph Wilpert, who has already published some works on the subject, and is about to give a complete presentation of the pictures of the catacombs in a work which for the accuracy of its reproductions of the frescos and for the scholarly worth of the studies upon them is sure to be recognized as the final work on the subject.

Marucchi, another of the immediate disciples of de Rossi, is likewise engaged in carrying on his master's work; two others whose work was very important, Armellini and Stevenson, have recently died.

But de Rossi's influence was not confined to the circle of his personal scholars, nor to the department of study with which his name is specially associated. Even in the study of the catacombs he was obliged to deal with almost every subject which interests the archæology of the early Christian centuries. The Roman monuments which he discovered and illustrated presented for the first time such a sequence as made it possible to understand early Christian art in the order of its development, and they constitute as it were a standard scale for the judgment of the date and value of all kindred objects wherever they may be found. De Rossi's great work on the Christian mosaics of Rome is only a striking example of the breadth of his activity in this field. To the study of almost every branch of Christian archæology he imparted a new impulse; in some departments he first laid the foundation. None of the scholars who have followed him can fail to recognize their debt.

But fundamental as de Rossi's work was, it was only a symptom of a general revival of the study of early Christian monuments and art. Already by the end of the last century there was an awakening to the worth of Mediæval art, especially of architecture; and the interest gradually extended back to the early period. In Italy and contemporary with de Rossi, Raffaelle Garrucci planned a *corpus* of the monument of early Christian art and carried it out very creditably. In France, nearer the beginning of the century, Seroux d'Agincourt made a similar publication of Christian monuments, covering less completely a more extended period. Early Christian art found in Raoul Rochette a sharp but mistaken critic who stimulated research by the very temerity of his views. Toward the end of the century again, Rohault de Fleury labored at the reproduction of Christian monuments, illustrating however only selected themes, and following them out through the Middle Ages. His son, Georges de Fleury, is engaged in revising his father's work and in continuing it on the same lines. Edmond le Blant, working under the inspiration of de Rossi, not only furnished new material by the publication of the inscriptions and sarcophagi of Gaul, but suggested new points of view for the appreciation of early Christian art in general. The abbé Duchesne has done valuable work in this field, though he is better known for his liturgical studies. Franz Xaver Kraus, though he has added nothing material to the study, has done very much to popularize it among the Roman Catholics of Germany.

Among German Protestants the first really monumental study of the early Christian period begins with Ferdinand Piper, who, quite independent of de Rossi, inaugurated in Berlin an interesting museum of Christian antiquities, and in several large works laid down a programme for the study which has had great influence in Germany and some effect even in England and America. Of the newer school Victor Schultze has been the most prominent leader. He has done a considerable service in stimulating interest and work in this field. A number of students have devoted themselves to the study, and in general the students of early Christian literature have showed appreciation of the importance of archæology. The predominance of a polemic interest, and the zeal for novel interpreta-

tions, has not affected favorably the value of their results. Ficker has been editing a series of studies by younger scholars: monographs which present a detailed account of a limited theme and possess sometimes a certain value. Finally, it is to Germany we owe the most solid as well as the most numerous studies upon early Christian architecture; G. Dehio and H. Holtzinger are especially to be mentioned in this connection.

It is natural that the British archæologists should be chiefly interested in the monuments which are furnished by their own land — belonging to a period and a type quite distinct from the Classical art we are here studying. But how generously the Continental studies have been appreciated and utilized in England, may be seen conspicuously in the production of Smith and Cheetham's *Dictionary of Christian Antiquities*, and particularly in the fact that so many competent scholars could be enlisted in the work.

With the widening of the field of discovery Roman scholarship is losing something of the preponderance of authority which it has hitherto enjoyed; and British and American explorers are among the first in exploiting the outlying regions which may be expected to yield valuable monuments for our study. For example, the Palestine Exploration has incidentally proved very valuable also for the discovery of Christian monuments.

Strictly in the line of archæology are the valuable researches of Professor Ramsay, which are published in his *Cities and Bishoprics of Phrygia*; and it is to be regretted that his geographical studies have too little relation to art to be noticed in this book. In his *St. Paul the Roman Citizen* he shows what may be done through archæology to illuminate even the history of the Apostles — a service which must be of special interest to Protestant theology. He has brought to light, however, a number of inscriptions of which we can take cognizance, for among them is the most interesting of all Christian epitaphs.

II

CHRISTIAN CEMETERIES

GENERAL DESCRIPTION OF THE ROMAN CATACOMBS

THE word "catacomb" has a curious history and a very doubtful etymology; de Rossi takes it to be a hybrid word, half Greek and half Latin, meaning "next the sepulchres" — *accubitorium* is a late Latin word for tomb. The great number of tombs on the *via Appia* is supposed to account for this appellation, although they were so frequent along all the principal roads that one hardly sees why this name should have been used to distinguish one very limited region. But whatever was the original significance of the name, its further history is sufficiently clear. The word does not appear before the end of the third century, and then not as the name of a cemetery, but as a topographical designation (*ad catacumbas*) — like many of the popular names for different quarters of the suburbs (*ad ursum pileatum, ad clivum cucumeris, etc.*) — for a special region along the *via Appia* about the second mile from the present walls. In process of time the name became expressly associated with one of the cemeteries along that road, that of S. Sebastian. This cemetery was one of the very few which were known and accessible after the eighth century. With it the pilgrims confused the traditions of the more important cemeteries near the *Appia*, and in the ninth century the name which was proper to this cemetery began to be employed for all underground burying places indiscriminately.

The name which was original to, and distinctive of, the Christian burial places was cemetery (*cœmeterium* — *κομητήριον*). It is sufficiently indicative of the Christian hope, for it signifies a sleeping place. It denotes a whole congeries of tombs rather than a single sepulchre, though it has this latter meaning in the very rare instances of its pagan use. It was

equally apt to denote a surface burying place or one beneath the ground. There was no special designation for the whole complex of the underground cemetery; particular areas, especially the chambers which included the tomb of a martyr, were called *cryptæ*; ordinary chambers, *cubicula*; the Classical name *hypogeum* denoted especially an isolated and private sepulchral chamber. The name *ambulacrum* is given by archaeologists to the corridors, though there is no evidence of its ancient use.

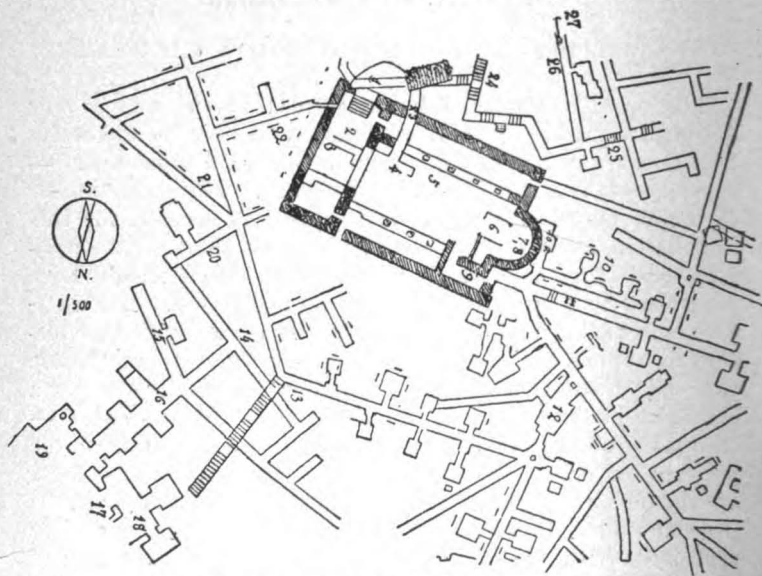

FIG. 1. — Plan of part of the catacomb of Domitilla.

It is these narrow corridors or galleries, extending often to great length and crossing at every angle, which are the characteristic feature of the Roman catacombs, and give the impression not only of boundless extent, but of hopeless intricacy (Fig. 1). In Rome the average width is less than a yard; the height is almost always above that of a man, and not infrequently very much greater. In the catacomb of S. Gennaro at Naples the harder quality of the tufa permitted a very much greater width (from three to ten yards), and the limestone in

which S. Giovanni at Syracuse is excavated permitted corridors and *cubicula* of a width which has no example in Rome.

It is along the walls of these corridors that the tombs were excavated; the name given them was *sepulcrum* or *locus*, though the archæologists have adopted the diminutive term *loculus*. The tomb is merely an oblong niche cut in the wall, just wide and deep enough to receive the body. As the whole wall space was utilized to the uttermost, the general appearance is that of a series of shelves (Figs. 2, 4, 5). Graves were sometimes made under the floor itself. Odd spaces too short for adults were often utilized for the *loculi* of children. The body was sometimes embalmed in Oriental fashion; but in general it was simply clothed in a tunic and winding sheet, and covered with a coating of plaster. This covering of plaster was probably more effective than anything else in preserving the air of the catacombs from contamination, though the *locus* itself was also tightly sealed with a plate of stone (Fig. 18), or by several tiles (Fig. 21). It was upon this covering the inscription was cut or painted. In case there was no inscription some common article belonging to the deceased or to his family was pressed into the soft plaster and served to identify the tomb. A more distinguished place of burial was afforded by the *arcosolium* (Fig. 11), in which the opening was made, not from the side, but from above, and usually under an arch. This style of tomb permitted the burial of several bodies side by side; such a *locus* was described as *bisomus*, *trisomus*, etc., according as there were places for two, three, or more bodies. The arch and the wall above and below the tomb being plastered, afforded room for painting, and apart from this there is rarely any decoration in the corridors.

Here and there, generally in groups, there open out from the corridors chambers of various size and shape (*cubicula*), which were designed as family burying places (Figs. 2, 5). In general they were intended to be readily accessible; the attachments for the wooden doors are sometimes to be seen. But in one case, at S. Domitilla, the entrance is by a hole at some elevation from the ground, which was permanently closed by a stone, after the likeness of our Lord's tomb. These chambers are of very various shape and size: square, rectangular, polygonal. There is a very important round *cubiculum*,

crowned by the shaft of a *luminarium*, in the region of S. Sotere in S. Callistus. The ceiling is sometimes flat, sometimes domed. The sepulchres — either the common *locus* or the *arcosolium* — are excavated in the walls of the *cubiculum* in the same way as in the corridors; or, if sarcophagi are used, they are ranged against the walls or accommodated in niches.

Other crypts, though used likewise for burial, seem to have been designed expressly for the celebration of Christian wor-

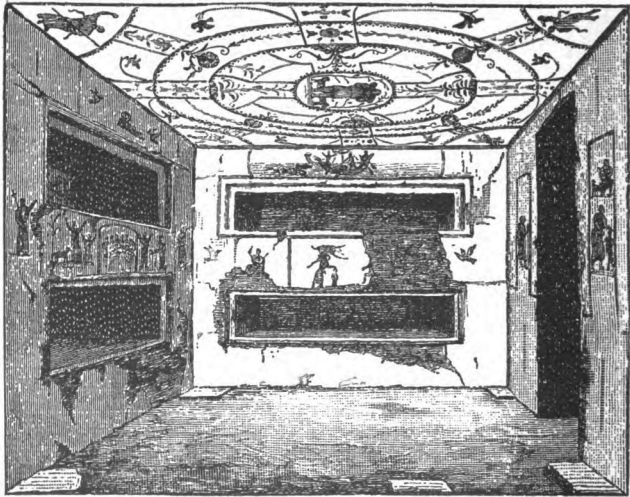

FIG. 2. — A *cubiculum* in the catacomb of Callistus, one of the so-called sacrament chapels. Third century.

ship — particularly, one must suppose, of the eucharist. Notwithstanding their limited size, they are rightly regarded as subterranean chapels intended for a more or less public use. They open generally with a broad entrance upon the corridor, so that a number of worshippers might have been accommodated in the latter. The accommodation was sometimes still further increased by a second chapel opening directly opposite the principal one; it is supposed that this was occupied by the women. An example of such a double chapel is the crypt of Miltiades in S. Callistus; it retains traces of the stone bench which ran around the wall. One of the most ample and com-

plete of these subterranean basilicas is a crypt in the Ostrian cemetery which is provided with a presbytery architecturally separated from the nave, ending with an apse, an elevated seat for the bishop, and a lower bench for the presbyters. Here there are also lateral niches for the sacred utensils, and on the other side of the corridor there is a corresponding chamber for the women. The earliest of these chapels (ascribed to the beginning of the second century), and the most interesting in point of decoration, is the so-called *Capella greca* (Fig. 3) in S. Priscilla. These crypts and chapels were not infrequently adorned architecturally with columns, capitals and cornices worked in the tufa walls or done in marble; but more commonly with painted decoration alone.

These early chapels, which are marked by great simplicity in the means of decoration, must be distinguished from those which were constructed after the peace of the church, when the crypt of every famous martyr was transformed into a resort for pilgrims and a place of public worship. To this end they were sometimes enlarged (Fig. 5), often adorned with marble and furnished with an episcopal chair, with altar and *ciborium*, and with everything necessary for the celebration of the eucharist (Fig. 10). The neighboring corridors were enlarged and strengthened with brickwork, and not infrequently a special stairway was constructed to give ready access to the sacred spot. With the increasing desire for burial near the saints — *ad martyres* — corridors were cut and *loculi* accommodated on all sides, so that the primitive aspect of the region was seriously altered. This transformation of the historical crypts was due above all to Pope Damascus, who embellished them also with his metrical inscriptions.

Burial in the catacombs ceased in the year 410 with the invasion of Alaric. This fact, which has been proved by de Rossi, affords an important limit for the dating of both frescos and inscriptions. The frescos which were added in the fifth, sixth and seventh centuries adorn exclusively the tombs of the martyrs, and they stand in sharp contrast with the more primitive work. All of these signs of a late age in the reconstruction and decoration of the martyrs' tombs led Bosio and other early explorers to avoid the very regions which historically and artistically constitute the points of greatest interest,

and often prove to be the centre of the original excavation. The pilgrims have left records of their visits in the *graffiti*—



FIG. 3. — The *Capella greca* in the catacomb of Priscilla. Middle of the second century.

names or exclamations scratched upon the plaster — which are often of great importance, and may serve even to identify the crypts in which they are found.

Many of the catacombs are quite simple in plan. Those at Syracuse have ample and regular galleries flanked by large *cubicula*; they are excavated on a single level, which lies only slightly below the surface. Hardly more complex in construction is the catacomb of S. Gennaro at Naples. One broad corridor runs from end to end of the hill under which the catacomb is constructed; close to it along its whole length runs a narrower passage; and from these there diverge at right angles and at close intervals short galleries or *cubicula*. The smallest of the Roman catacombs, that of S. Valentine, is even more simple. It is excavated in a hill which is practically the extension of the Pincian along the *via Flaminia*. The galleries were cut straight back from the steep hillside. The crypt of S. Valentine (martyred in the reign of Claudius II., Gothicus) opened directly upon the road, and behind it there was excavated later a large chamber for religious services in honor of the martyrs who were buried on the spot, and a few broad and regular galleries for the accommodation of the tombs of those who would be buried *ad sanctos*. On a higher level there is a more extensive excavation, but one which is still quite simple in plan: the low, narrow galleries cross one another usually at right angles. One usually speaks of a descent into the catacombs, and an epitaph reveals that an early name for the stairways was *catabaticum* (descent); but in this case one must *ascend* along the face of the hill. And the case is by no means unique, for the cemeteries were commonly excavated in a hillside, or at least under a distinct rise of ground. This choice was fixed by the necessity of avoiding dampness and serious inundation from rain water. It was therefore possible to enter the cemeteries by a passage sloping gradually back from the surface. The long steep stairs which descend directly from above belong for the most part to the period after Constantine and were constructed to furnish direct access to the crypts of the martyrs.

But after all, for the Roman catacombs simplicity of structure is the rare exception. Not only to one who is wandering in their mazes, but even to one who studies their plan, they seem involved in an inextricable confusion. This apparent confusion is, however, explained, if not entirely resolved, when one detects the fact that several cemeterial areas originally

distinct were later united in a single complex. The primary excavation was probably obvious enough in plan; the irregularity of the galleries which meet at various angles was due to the later necessity of utilizing all available space. For the catacombs were not (according to the popular idea) illicit excavations, unknown to the law, and therefore unrestricted in extent. They were distinctly circumscribed by the boundaries of the superficial area allotted to them; they were not free, either in the earlier or the later period, to extend under neighboring property whether public or private. Hence there were express limitations to the agglomeration of separate cemeteries; the catacombs of Pretextatus and Callistus had only the *via Appia* between them, but they were never joined in any way. No less absolute were the natural restrictions; for the galleries could be conveniently constructed only in a special quality of tufa, and in case the catacombs lay under the slopes of different hills it was likely that communications could not be made without descending to a level which would be frequently inundated by water. There are obvious difficulties in the strict observation underground of the legal limits imposed: one knows little of the Roman methods of mensuration; but it seems probable from the plans of the catacombs even as we now have them that the first galleries along the level selected were constructed all the way around the area which was at the disposal of the cemetery. The limits were thus plainly marked, and subsequent galleries ran roughly parallel to them. The level was easily maintained by following the stratifications of the tufa.

The impression of complexity in the Roman catacombs is very greatly increased by the fact that they are seldom confined to one level; in the catacomb of Callistus there are as many as six different levels of excavation (Fig. 4). This, of course, was prescribed by the necessity of utilizing all the available room within the limits imposed by the superficial area. But to this vertical extension of the excavation there were also natural limits due to the water level and the nature of the soil. The possibility of carrying out such excavations as surprise us in the catacombs is due to the geological character of the Roman campagna.

The great plain which surrounds Rome is almost entirely composed of a volcanic tufa—a mixture of pumice stone and sand. It exhibits different characters according as these elements appear in various proportions; but in general the different sorts of tufa are sufficiently distinguished by three classes: the lithoid tufa (*peperino*), which was employed for the wall of Servius Tullius and is still used for construction; the granular tufa; and the sand (*pozzolana*), which gives to Roman mortar and cement its tenacious character. It was in the

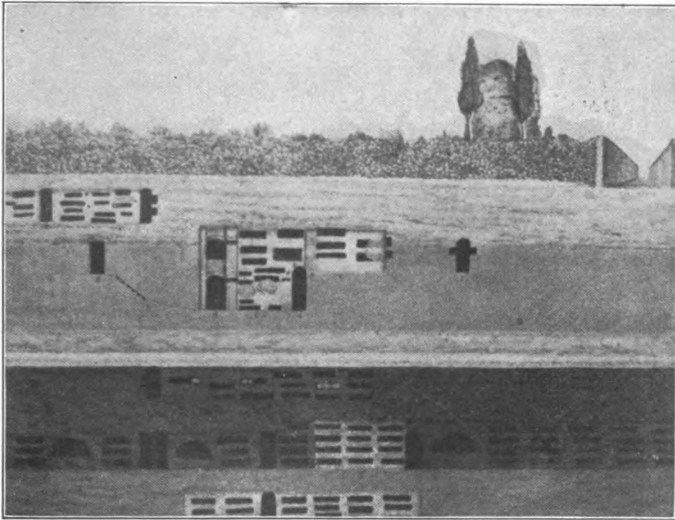

FIG. 4.—Section of the catacomb of Callistus.

granular tufa the catacombs were excavated; the lithoid presented insuperable difficulties to the excavation of narrow passages, and in the sand a vertical wall could have been maintained only by a facing of brick. This difference in the character of the soil imposed natural limits to the extension of the catacombs either laterally or vertically; and it explains in part why the excavations on one level were more extensive than on another, for not all qualities even of the granular tufa were equally apt for the purpose.

We see from the above how unreasonable was the denial of

the Christian origin of these huge excavations, or the opinion that they are merely Roman sand pits (*arenaria*) utilized by the Christians; for of the different sorts of tufa the granular alone had no value as a material, and the Romans had, therefore, no object in quarrying it. The fact is that the literary sources of history had not prepared us to accept such testimony as the catacombs bore to the numerical and also to the material and organized strength of the Church during the age of persecution. It must be confessed that there was a certain suggestion for the sand-pit theory in the fact that *crypta arenaria* was not an uncommon designation for the underground cemeteries. There was, of course, a certain similarity between the two, but the differences also are very plainly marked. It was a practical requisition that the galleries of the *arenaria* should be broad enough for several laborers to work abreast, as broad, in fact, as the safe support of the roof would allow: the galleries of the catacombs on the contrary were broad enough only for passage in single file. It is true, however, that *arenaria* are frequently found in connection with the cemeteries — whether they were accidentally entered, or constructed on purpose to provide room for the worthless material excavated from the catacombs. It is evidently for this latter purpose that the floors of the *arenaria* were often pierced by wells which descended to the galleries of the catacomb which lay below. For the removal of such material and for the provision of light and air the stairways were generally insufficient, and perpendicular shafts (*luminaria*) were opened directly from the surface and pierced sometimes through several floors of the catacomb. There is no doubt that in times of acute persecution — as for example in the third century when the catacombs were confiscated and their ordinary entrances watched — the Christians availed themselves of the *arenaria* for secret access to their cemeteries, and, on occasion, for worship and refuge.

Equally at fault is the popular exaggeration of the extent and significance of these Christian excavations. The idea is still current in Italy amongst the people that the catacombs surrounded the city with an uninterrupted network; and that they were connected by underground passages, on the one hand

with the basilicas within the walls, and on the other, with the mountains and the coast. Underlying all such representations is the notion that the whole system of excavation was secret, that it was intended not only for purposes of burial, but as a refuge for a hunted sect, as the ordinary place of meeting and worship and even of abode. That such notions conflict with the facts is evident from what has already been said; it remains now to observe more in detail the actual ex-

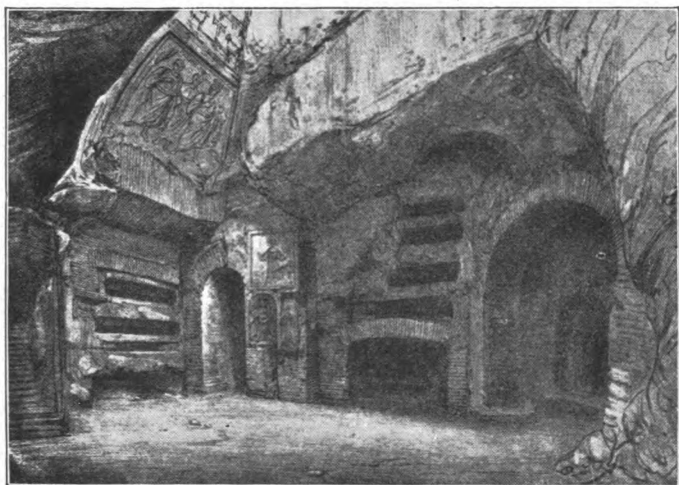

FIG. 5. — Crypt of S. Caecilia, catacomb of Callistus. Third century.

tent, the true use, and the legal status of the Christian cemeteries.

The location and distribution of the Roman catacombs was determined in part by natural, in part by historical considerations. As to the historical factor, we know only in general that the cemeteries of the first, and even of the second century must have been located within the suburban properties and usually in connection with the family tombs of noble or wealthy converts to the faith. Pagan tombs were built along all the public roads which diverged from Rome; but they were especially numerous and especially notable along the *via*

D

Appia, and it was along this road, or generally in this region, that a number of the greatest of the Christian cemeteries were located. The location of the Christian cemeteries in this region may have been due in part to the popularity of burial along the *via Appia*; but it is to be noted also that the Jewish colony was from the first established in the corresponding quarter of the city, and that Jewish catacombs have been found in this same region. A considerable majority of the catacombs were located along the roads which left the city on the southwest and west;

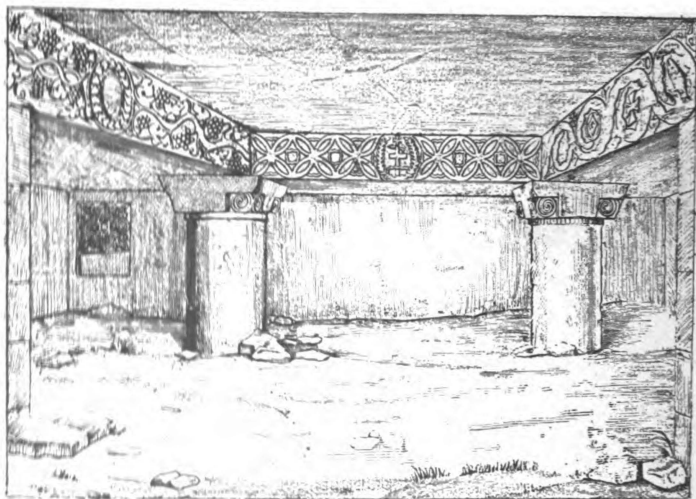

FIG. 6. — A crypt in Cyrene.

that is, from the Aventine and Trastevere quarters, which were the poorest and most crowded of the city. Along the *Appia* were the cemeteries of Balbina, Callistus, Pretextatus, and *ad Catacumbas* (S. Sebastian); on the *via Ardeatina*, the whole complex which is represented by the cemetery of Domitilla, the most extensive of all the catacombs; on the *via Ostiensis*, the cemetery of Lucina (the burial place of S. Paul), as well as those of Commodilla, of Thecla, and of Zeno; on the *via Portuensis*, of Pontianus and of Pope Felix; on the *via Aurelia*, the cemeteries of Pancratius, of Processus and Mar-

tinianus, and of Calepodius. The Vatican cemetery, the burial place of S. Peter, was on the *via Cornelia*, which, though it was directed to the north, was in immediate communication with the Trastevere. One must be careful, however, not to exaggerate the predominance of the cemeteries which were accessible from this side of the city. To the east of the *Appia* we find on the *via Latina* three cemeteries which are of but small importance; on the *via Labicana*, the important cemetery of Petrus and Marcellinus, and two others. On the slope which faces the Sabine hills we find some of the most important of the catacombs: on the *via Tiburtina*, that of Cyriaca (S. Lorenzo), and on the opposite side of the road the cemetery of Hippolytus; on the *via Nomentana*, the cemetery of S. Agnes, and the Ostrian cemetery; on the *via Salaria nova* the cemetery of Priscilla, and three of less importance; and there are three also on the *Salaria vetus*. On the *via Flaminia* there is only the third century cemetery of S. Valentine. Of these cemeteries that of S. Callistus alone is completely excavated; the sites of some are not precisely known; and the cemeteries of the Vatican and of Lucina have been completely destroyed by the great basilicas which have been erected over them in honor of the Apostles.

The Roman law forbade burial within the walls of the city. It was the Servian wall which marked the limit during the period when most of the catacombs were founded. The Aurelian wall was built about a mile beyond it, and the fact that no Christian cemeteries are found within this circuit proves that by the end of the first century the suburbs were too closely inhabited to leave room for burial within the first mile. The outside limit was determined by considerations of convenience, and as a matter of fact none of the Roman catacombs are found beyond the third mile. Those which lie at a greater distance belonged to the villages of the Campagna.

We have already seen in brief what were the natural requirements to be sought in choosing the site of a catacomb; the conditions of a well-drained surface and of a proper quality of tufa were so obvious that Michele Stefano de Rossi, who brought to the aid of his brother's work his own knowledge as geologist and engineer, was often able, by determining where a catacomb ought to be, to discover where it actually was. To

Michele Stefano de Rossi is also due a careful computation of the total length of the galleries of the catacombs; it is founded upon a calculation of the average development of the galleries under a given square area of surface, and it gives as result something over 550 miles. So great an extension of the galleries was rendered possible by the several levels of excavation which were worked at depths of from eight to twenty-five yards beneath the surface.

THE FOSSORS

Such vast works as are represented by the Roman catacombs were not executed at haphazard; they demanded some skilled



FIG. 7. — *Arcosolium* of the fossor Diogenes, a fresco in the catacomb of Callistus. Third century.

direction, not only for the selection of sites, but for the constant extension of the excavation. And in fact the excavators—*fossores*—constituted a sort of guild. To them was committed the preparation of the dead for burial, as well as their actual interment; but to their office there attached none of the ignominy which made contemptible the name of those who performed

similar functions in the pagan community—the *vespillones*. On the contrary, they were proud of their title and inscribed it upon their tombs as a mark of dignity and merit. In the third century the fossors were actually reckoned among the clergy as the lowest grade; and in the fourth it appears (from several inscriptions which speak of tombs bought from fossors) that they had the general control of the cemeteries. On the tombstones are often represented the tools of the fossor, and in the frescos, the fossor at work (Fig. 7). How far the fossors of the several cemeteries were united by their craft we have no clear indication. It is to be noted, however, that the

different catacombs, for all their similarity, are marked by certain differences which indicate not only a separate history, but an independent tradition in the style of decoration.

THE CATACOMBS AND THE TITLES

Besides the fossors, there must have been a higher authority charged with the general superintendence of the catacombs. During the earliest period, while the cemeteries were still private property and represented an extension of the family tomb to include those who were of the same family in the faith, we can only represent to ourselves that they were held at the disposition of the noble owners. But when, with the beginning of the third century, they became virtually, if not legally, the corporate property of the Church, we cannot but think of them in some strict relation to the regular ecclesiastical organization. And, in fact, Hippolytus, in his *Philosophumena*, reports that about the year 197 the Roman Bishop Zephyrinus appointed his deacon Callistus to the charge of the "cemetery." This is evidently the cemetery which still bears the name of Callistus, though he himself was not buried there; and it is not difficult to see why this cemetery in particular should depend directly from the bishop, for it had become — after the cemetery of the Vatican ceased to be used for this purpose — the ordinary place of burial for the heads of the Roman Church. We have evidence for the continuance of this relation about a century later in an inscription which recounts that a deacon of Marcellinus, with permission of that pope, prepared for himself in the cemetery of Callistus a double *cubiculum* with *arcosolia* and *lucernarium*. On the other hand, in the neighboring cemetery of Domitilla there was found the following inscription: ALEXIVS ET CAPRIOLA FECERVNT SE VIVI IVSSV ARCHELAI ET DVLCITI PRESBB; that is to say, a certain husband and wife constructed this tomb in their lifetime with permission of the Presbyters Archelaus and Dulcitus, who evidently exercised the chief authority over this cemetery. They were probably presbyters of the *Titulus Fasciolæ*, the parish church within the walls, with which a number of epitaphs distinctly connect this cemetery, the same church which has borne the name of

SS. Nereus and Achilleus, since in the ninth century the bodies of these saints were removed thither from the cemetery of Domitilla.

De Rossi has been able from inscriptions to establish the connection between several of the cemeteries and particular titles of the city, and the suggestion is obvious enough that each parish church had its corresponding cemetery. This arrangement may very well have been observed from the beginning. Some of the titles are as old as the earliest use of a private house for Christian worship. The *Domus Ecclesiæ* took its special title from the name of the owner: — *Domus* or *Titulus Pudentis* (*Ecclesia Pudentiana* as it was called later), *Praxedis*, *Equitii*, etc. While the church was accommodated in the house of a wealthy benefactor, the cemeteries may have been excavated under his suburban villa, and the community which worshipped in that title would naturally be the one to use the cemetery associated with it.

In the *Liber Pontificalis* it is recorded of Fabianus (shortly after Callistus): *Hic regiones divisit diaconibus et multas fabricas per cœmeteria fieri iussit.* Of the cemeterial buildings we shall have to speak later; as to the deacons, it is well known that the Roman Church maintained the number seven, in imitation of the "seven" who were originally appointed in Jerusalem. By reason of the fewness of their number and their close relation to the bishop they enjoyed an authority which exceeded that of the presbyters, and the successor to the episcopate was usually taken from their number. The civil regions of Rome were fourteen; to each of the seven diaconal establishments, which were designed to administer to the temporal wants of the Church, there must have been allotted two of the civil regions. The titles of the city were twenty-five in number in the third century — roughly two of them to every civil region. That they were charged not only with spiritual care of the people and with the more obvious parochial duties, but with the administration of the cemeteries, we can infer from a notice in the *Liber Pontificalis* concerning Pope Marcellus, at the very end of the period of persecution: *XXV titulos in urbe Romana constituit quasi dioceses, propter baptismum et pœnitentiam multorum qui convertebantur ex paganis, et propter sepulturas martyrum.* "He instituted in the city of Rome

twenty-five titles as parishes, for the baptism and penitence of the many who were converted from the pagans, and for the burial of the martyrs." There are reckoned thirty-two public cemeteries for Rome, — a number which precisely corresponds with the sum of the twenty-five titles and the seven deaconries. It is not necessary to suppose a strict uniformity in the distribution of the cemeteries, in such wise that the smallest congregations had each one and the largest had no more; but there is sufficient proof of a general distribution amongst the titles. Dionysius reorganized the cemeterial administration (according to the *Liber Pontificalis*) after Gallienus had revoked the edict of his father which had prohibited meetings in the cemeteries: *Hic presbyteris ecclesias divisit et cœmeteria et parochias et dioceses constituit.*

We learn that there were commonly two priests attached to each title. Of these, one alone was the proper titular, and the other his subordinate; — as we learn from a letter of S. Cyprian: *Felix qui presbyterium subministrabat sub Decimo.* The same system was maintained in Rome in the time of Pope Damasus (as we learn from a passage by S. Ambrose, on 1 Tim. 3): *Nunc autem septem diaconos esse oportet et aliquantos presbyteros ut bini sint per ecclesias* — that there be two priests for each church. This dual number of priests for each parish is explained by the relation of the titular basilica to the basilica which was connected with the cemetery. The number of Roman churches early in the third century is indicated in a passage of Optatus Milevitanus, in which he says that among the forty or more basilicas the Donatists had no place where they might meet. According to the testimony of Eusebius the Roman Church had in the time of Cornelius forty-six priests — a number which very well corresponds with the "forty or more basilicas." Besides the twenty-five titles there were, therefore, something like twenty-one cemeterial basilicas which were in the charge of the parochial clergy, who took their titles, however, not from the cemeteries, but from the basilicas within the city. So much for the administration of the catacombs; the question of their legal tenure (a matter of even greater interest) must be treated at large in another place. The light which the study of the catacombs throws upon the administration of the Roman Church has more than a merely

local interest, for from the first it was the Church in the Capitol of the Empire which constituted the norm of ecclesiastical government.

THE CHRISTIAN MODE OF BURIAL

There is one question which poses itself almost at the very mention of the catacombs: Why did the Christians resort to a mode of burial so different from the prevalent custom of the Græco-Roman world? There is certainly a problem here which demands some explanation; but before all, one's first idea of the singularity of the Christian mode of burial must suffer considerable reduction: all the catacombs are not Christian, nor were all the Christian cemeteries subterranean. Even in Rome the Vatican cemetery, which must have been used by the Church since the burial of S. Peter, was chiefly on the surface; the nature of the rock did not admit of deep excavation, the bodies were deposited in trenches after the same manner as is customary to-day, or the sarcophagi were left exposed above the surface of the soil. Throughout the Roman cemeteries, burial on the surface rapidly overtook during the fourth century, and by the beginning of the fifth it had quite superseded, burial in the catacombs.

In the East generally, where inhumation was commonly practised, the Christian converts found in their creed no reason to modify essentially the mode of interment or the type of cemetery which was traditional to their particular race or nation. In Egypt during the Roman rule the mode of burial for pagan and Christian alike was of the simplest possible: the body was merely buried in the dry sand, dressed in common garb, and without sarcophagus, coffin, or shroud. In Syria, according to national tradition, the character of the tombs was very various. The commonest was a plain sarcophagus, all of it buried except its rooflike lid, or a similar lid covering a rock-hewn trench. But there were also chamber tombs hewn in the rock and faced with a Greek porch or other architectural ornament. The most characteristic Syrian type of sepulchre was the *tegurium*, a pyramidal roof supported above a sarcophagus by four pillars. In North Africa Christian burial was always, so far as we know, in the surface soil. Surface cemeteries were not uncommon in Italy; the most extensive remains

are at Portogruaro (Julia Concordia); curious is the arrangement of the great stone sarcophagi in groups of ten and twelve. In the Northern countries the open air cemeteries greatly predominated, — in France, in the Rhine country, in Dalmatia, and in Istria. It would be going too far afield to describe the various forms which the Christian tomb exhibits in different lands. Such an account would almost constitute a treatise upon ancient modes of sepulture, for the Christians generally continued without scruple the customs of burial to which they were used as gentiles.

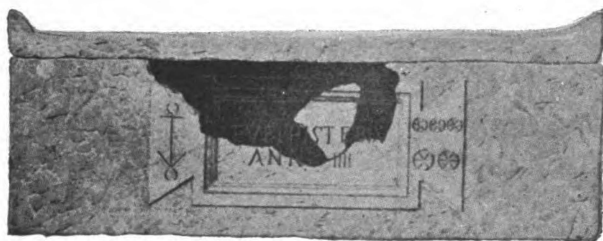

FIG. 8. — Sarcophagus in the catacomb of Priscilla. Second century.

On the other hand, catacombs are not confined to Rome and Italy; they are found in the Rhine country, *e.g.* at Cologne and in other lands. Subterranean burial was probably regarded as the most specifically Christian mode of interment.

It is particularly in the centres of Græco-Roman civilization, where cremation prevailed, that the Christian mode of burial seems in sharpest contrast with gentile custom. There is no doubt that the practice of inhumation was prescribed by the new faith and obligatory upon all the faithful; with a naïve conception of the doctrine of the Resurrection cremation seemed irreconcilable. There was also a strong repulsion to burial amongst heathen. It was therefore in the nature of the case that Christians must be buried, and that they must be buried together. As for the matter of burial, it was by no means unknown even among the Romans. In the Laws of the Twelve Tables burial and burning were both contemplated, and burial was mentioned first. Some of the great Roman families — like the Scipios — maintained the early tradition, burying their dead in sarcophagi in the family crypt surmounted by a monument.

In the third century the custom of inhumation rapidly spread — whether through the influence of Christian example, or through the popular adoption of Oriental cults and fashions.

From this period date the richly carved pagan sarcophagi. Rome therefore preserved in some measure the traditions of underground burial which were derived immediately from the Etruscans. The Etruscan tombs, with their numerous chambers and their sculptured and painted decoration, present a most striking analogy to the Christian catacombs. But these tombs were derived in turn from the Phœnician custom, which was disseminated widely — and no doubt especially in Judea — by this active merchant people.

The nearest analogy to the Christian catacombs is furnished by the underground cemeteries of the Jews, which have been discovered at Rome. One of these on the *via Appia* is accessible to the public and may conveniently be visited along with the catacombs of Callistus and Domitilla. One will notice certain differences of construction, such as distinguish even the different Christian catacombs from one another; but there is the same arrangement of galleries and *cubicula*, the same method of accommodating the tombs, the same decoration in paint and plaster; and in general, except for the presence of Jewish formulas and symbols and for the absence of Christian, one would see no reason to distinguish them from



FIG. 9. — Lead coffin from Salda, Phœnicia. Fourth century.

Christian cemeteries of the Roman type. They can none of them claim so ancient a foundation as the Christian; but they suggest nevertheless, and plainly enough, that the origin of the Christian mode of burial is to be sought in Jewish custom. It

is not unreasonable to credit in particular a considerable influence to the memory of the rock-hewn tomb in which the body of our Lord was laid.

We must recognize that the Christian catacombs when compared with pagan monuments of similar character present no essential difference of type: it is only by reason of their great extent that they strike us as something altogether strange and unparalleled. The original Christian *hypogeum* (the nucleus of all the catacombs) consisted in a group of crypts connected by short galleries, and its likeness to Etruscan and Oriental tombs is so obvious that the question of origin need hardly be raised. The way of subterranean burial having once been struck out, the subsequent complexity and extent followed as a matter of course upon the rapid increase of the Church. De Rossi has observed that no essential distinction can be drawn between the Christian catacombs on the one hand, and Phœnician, Etruscan, and Jewish tombs on the other; except that in the former the tombs were always sealed so as to permit visits to the cemetery, while in the latter they were always open.

WORSHIP IN THE CATACOMBS

This single peculiarity of the Christian cemetery is to be referred to the custom of holding religious services within the crypts, not only at the time of the deposition of the body, but on the anniversary of the death or burial. S. Augustine says expressly that the eucharistic sacrifice was offered at the tomb, and he mentions it in particular at the deposition of his mother. Among the crypts of the catacombs there are many which cannot but be recognized as veritable underground chapels, which were evidently constructed expressly for worship, even though they were incidentally utilized for burial, or primarily represented the tomb of a saint.

Mention has already been made of a chapel of the third century in the Ostrian cemetery which presents substantially the scheme of the church edifice as it appeared after the Peace of the Church. There we see the apse and the apsidal arch, with the episcopal chair in the centre and the presbyters' bench on each side. We have to suppose that a wooden altar was placed before the chair. The presbytery is distinctly sepa-

rated from the nave by the pillars which support the arch. The chair carved in tufa is a peculiarity of the *ostrianum*, and it is repeated there very frequently. In case there is no apse, or the apse is occupied by a tomb of the *arcosolium* type, the chair is found beside the tomb (the stone covering of which probably served for the holy table), or it is located at the middle of the side wall. The arrangement of these chapels seems to indicate that the custom of celebrating the Eucharist was already substantially developed as it is at present; that the presbyter alone stood (or perhaps sat) at the holy table, and the communicants approached it only at the moment of communion.

In some of the earlier chapels, however, we seem to have a witness to more primitive custom. For example, the so-called *capella greca* (Fig. 3), which belongs to the beginning of the second century, though it terminates in an apse and has two deep lateral apses in the form of a transept, has no special seat for the priest or bishop. One will hardly be inclined to lay any stress upon the cross shape which the chapel actually presents, for the apses are nothing more than broad tombs *ad arcosolium*, and there is no distinct place indicated for altar, presbytery, or nave. Besides the rich decoration there is only one thing which distinctly marks it as a place for public worship; that is, the tufa bench which runs along one side and is practically continued on another by the surface of the tomb under the central apse. One must imagine a wooden table carried in upon occasion, and one cannot but see in this whole disposition an arrangement for the seating of the communicants at the eucharistic table according to the earliest Christian custom at the breaking of bread. And, in fact, on the arch of the central apse, Wilpert has lately discovered, by removing the calcarious deposit which covered the wall, an eucharistic scene (Fig. 74) which may very well represent what the artist himself had witnessed in this chapel (see p. 227).

When the custom which we see portrayed in this picture had to be abandoned on account of the multitude of communicants, and the congregation could no longer sit about a common table, it is natural to suppose that the priest retained his old position, seated beside the tomb (as is indicated by the chairs of the

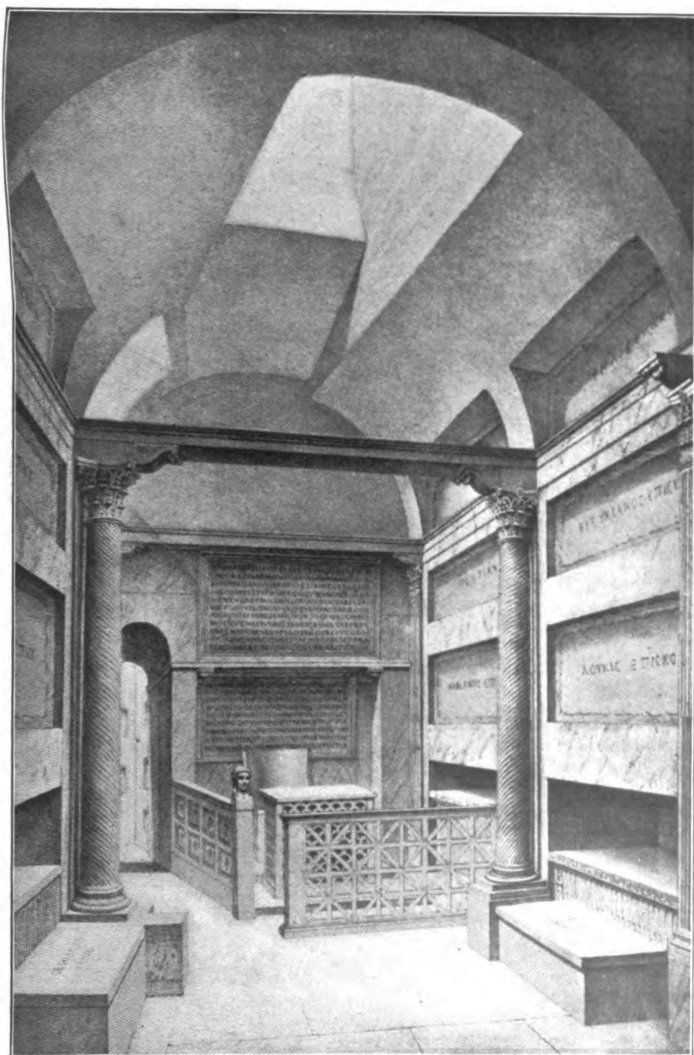

FIG. 10. — Papal crypt in the catacomb of Callistus. Restored as it was in the fourth century.

ostrianum), and not standing, according to the later fashion, with his back to the people. It has been commonly claimed, and too readily allowed, that all the tombs *ad arcosolium* were expressly constructed, or at least commonly used, for the celebration of the Eucharist. In olden time they were supposed to be the mark of a martyr's grave. In view of the modern practice which has reduced the altar of the church to a mere shelf against the wall, this supposition seems natural enough. But in an age when the primitive conception of the altar as the common table was still preserved, when the very position of the altar between the priest and the people still expressed this idea, the eucharistic use of these so-called table tombs, in the manner which is commonly supposed, is very far from obvious. Furthermore, the frequent and practically private Eucharists which this view implies are hardly to be reconciled with the jealousy of the Roman bishop for his prerogative as the proper dispenser of the Eucharist—a jealousy which went so far that the consecration of the Eucharist was not allowed even in the churches, without the presence of the express mandate of the bishop, and the congregations were obliged to wait for the consecrated elements which were carried to them by the deacons from the episcopal altar. There were doubtless private services in the catacombs,—in the family *cubicula*, and at the burial of the humblest disciple,—but it is to be supposed that the services in the chapels, and more particularly at the graves of the martyrs, had distinctly a public character, and was representative of the whole Church, even if but few worshippers could convene. The episcopal chair (for example in such a chapel as that we have described in the Ostrian cemetery) clearly implies the bishop's presence.

The catacombs were therefore used, and in a measure expressly constructed, for public as well as for private worship. But the extent of their public use has been singularly exaggerated, in clear contradiction to the witness of the monuments themselves. It is popularly supposed that they were a regular resort for the assembly of the Church during the centuries of persecution. But as a matter of fact few of the chapels could accommodate as many as fifty persons, and even if we take account of the neighboring corridors and *cubicula* the

number of worshippers could hardly exceed one hundred, while the catacombs themselves prove that the membership of the Roman Church in the third century was counted by the tens of thousands. We shall see in another place that the pictured decoration of the catacombs referred predominantly, if not exclusively, to the themes which were associated with death or rather with the Christian hope which illuminated it. And it must be recognized that the religious services which were ordinarily held in the subterranean chapels were expressly associated with the funeral offices and with the memory of the departed. One can, indeed, readily imagine that the catacombs proved often a safe and welcome resort in seasons of severe persecution when public worship may have been impossible elsewhere, and there is good reason to credit the accounts of such meetings, as they are reported in the lives of the saints, though this use was doubtless exceptional.

CONSTRUCTIONS ABOVE GROUND

The notion that the Church adopted subterranean burial to protect the tombs from the desecration they must have suffered had they been publicly known, or to hide from the state the names or numbers of its members, rests upon a complete ignorance of the sacred protection which was accorded by the Roman law to every sepulchre, and it stands opposed to the fact that the catacombs were, in fact, not secret. The confiscation of the Christian cemeteries under Valerian (258) and Diocletian (303), and their subsequent restitution under Gallienus and Maxentius, as well as the edict of Milan (313), which restored to the Christians ("*ad jus corporis eorum*") the churches and cemeteries which belonged to them, proves that the catacombs were not only known to the authorities, but also clearly recognized as the corporate property of the Church. Nor was there, indeed, any attempt to hide the catacombs; the original entrances (a number of which have been rediscovered) faced the public roads, and each façade doubtless bore an inscription indicating the extent of the cemetery and the name of the owner of the property.

The area must have been marked by distinct boundaries and devoted to the cemeterial structures which Christian as well

as pagan custom required as adjuncts to the tomb. There is nothing to inform us by what term the Christians in Rome distinguished the superficial area from their subterranean excavations; the word "cemetery" referred equally to both. It is this broad significance of the word which has given rise to the notion that the Christians sometimes actually retired to live in the catacombs. The *Liber Pontificalis*, in the life of Liberius, says: *eodem tempore* (Constantius) *misit et revocavit Liberium de cœmeterio beatæ Agnes ubi sedebat*; and in the life of



FIG. 11. — Arcosolium with frescos in the catacomb of Cyriaca.

Boniface I., *habitavit Bonifacius in cœmeterio sanctæ Felicitatis martiris via Salaria*. By dwelling "in the cemetery" is evidently meant, in some house connected with the cemeterial chapels or basilicas, or perhaps in the villa under which the cemetery may have been originally excavated.

In Africa the superficial cemetery was called an *area*. In several places in Italy the name *hortus* (garden) was applied to the cemeteries, and this word is sufficiently suggestive of the appearance of the place. The area was surrounded by a hedge or wall, and it was planted with cypresses and en-

livened with flowers as are the cemeteries of to-day. Traces of the wall have been discovered at S. Callistus, and the wall about the cemetery of Cyriaca *in agro Verano* (which is the present *campo santo* of Rome) was adorned in part by porches on its inner side. Even if these constructions are subsequent to the Peace of the Church, they no doubt represent substantially the early mode of marking the boundaries of the *hortus*.

Within the garden were constructed a number of buildings for various uses. Among them were the *cellæ* or *memoriæ* of the martyrs, which in some respects took the place of the monumental tombs of the pagans. They were, however, intended rather for use than for display; and they were specially adapted for worship or for the celebration of the funeral agape. Above the cemetery of Callistus two chapels of this character still exist, and one of them has lately been restored. They each have three apses, which was a common feature of the cemeterial chapel. After the Peace of the Church, great basilicas were erected above all the cemeteries, in honor of the Apostles and martyrs who were buried below. Besides the Apostolic basilicas, those of S. Lorenzo, S. Sebastian, and S. Agnes have alone been continuously in use; but the basilica of S. Petronilla has recently been discovered and restored, and enough remains of others to mark at least their position and plan.

The basilica erected in the fourth century in memory of S. Valentine presents an interesting peculiarity: as the steepness of the hill made it impossible to include the tomb of the saint within the church, the body was removed and placed under the altar of the church, which was built beneath the hill. This is perhaps the only instance of the translation of a body during the fourth century; so great scruple was felt about disturbing the body of a saint that the cemeterial basilica had often to be half buried in the earth (as is S. Agnes and S. Petronilla), cutting through several floors of the catacomb in order to accommodate the altar immediately above the tomb. But the most striking peculiarity in this case is the imitation catacomb constructed beneath the church. The tribune was raised about four feet above the nave, and behind the front wall of this platform there was constructed a narrow gallery (like those of the catacombs, but lined with marble) which

might be entered at either end by a descent of a few steps from the side aisles. In the middle of this corridor and directly beneath the altar was a small crypt in which reposed the body of the martyr. This monument throws a most interesting light upon the history of the crypt or *confessio* which is so marked a feature of Italian churches (see p. 164).

With the reign of Constantine burial in the subterranean cemeteries began to grow less and less frequent, and with the invasion of Alaric (410) it ceased altogether. The tombs which were constructed in the surface soil were at Rome predominately of a single type: a narrow trench lined with brick, and often deep enough to contain ten bodies laid one above another and separated by plates of stone. Such graves have been discovered above many of the Roman cemeteries: at S. Callistus they may be seen grouped about the chapel of S. Sixtus. From this it was an easy step to burial within the atrium of the cemeterial basilicas; and when, by reason of the barbarian invasions, the surface cemeteries without the walls were exposed to outrage, the city churches became the centres of new cemeteries; — and all the more readily because the city itself was in large measure depopulated.

THE AGAPE

But to return again to the cemeteries of an earlier age, before the Peace of the Church. The cemeterial gardens contained not only buildings designed for a distinctly religious use, but also halls for the agape, habitations for the curators, fossors, etc. The pagan burying places contained (beside the monument, or perhaps within it) rooms for various uses, and chiefly the hall or *schola* for the funeral feasts, which were celebrated annually and were provided for by an endowment which was inalienable like the monument itself. The Christians, too, had in the funeral agape a custom which demanded just such rooms, and it is probable that the earliest buildings connected with the catacombs were designed for this purpose. The original vestibules (as for instance that of S. Priscilla) may very well have served this use. The vestibule of the Flavian *hypogeum* (S. Domitilla), belonging to the first century, constitutes, however, an unique instance of a room obviously constructed for the

agape. The large *triclinium* retains traces of the stone bench which once surrounded it. A smaller room at the end is decorated in fresco, and was occupied — we may suppose — by the family. Adjoining it is the kitchen, in which were found various utensils and large amphoræ for the wine. At the other end is a well and a cistern. This hall is only in part underground; it is constructed of the finest brickwork, with an ornamental façade covering the approach to the cemetery, and it had originally a richer front upon the road.

The Christian agape presents an interesting study, and one link in its history is only to be explained by the monuments of the catacombs.

The agape was the earliest form in which Christian charity was manifested toward the poor of the Church; it was a feast in which all, rich and poor, shared alike from the common stock. It was originally the supper which preceded the Eucharist. Various grave disorders, con-



FIG. 12. — Tombstone with graffito, in the Museo Kircheriano.

nected with the agape, but especially the breach of the principle of charity and brotherhood, obliged S. Paul to regulate the eucharistic practice of the Corinthian Church. We may suppose that his settlement of the matter amounted to a definite separation of the Eucharist from the agape, though the change was not accomplished everywhere at the same time. The agape continued to maintain its place as an ordinary feature of the celebration of the Lord's Day; but in consequence of this separation, the Eucharist was celebrated early in the morning and the agape in the evening. The letter of Pliny to the Emperor Trajan about the Christians of Bithynia helps us to realize how, under stress of the suspicion of the Imperial authorities, the celebration of the agape as an ordinary function of the Church had to be relinquished.

And we can readily represent to ourselves how it might still be legally continued as a funeral feast at the cemeteries, since association for this object was permitted by Roman law. At all events, the agape as we know it after the second century had become distinctly a funeral feast, and it is not unlikely that the pagan practice had some influence in determining its form as well as insuring its continuance. Its similarity to the Roman *silicernium* was, indeed, very great; and it is not to be wondered that pagan writers drew attention to the fact. The differences, however, were also well marked; and the Christian apologists were prompt to point them out. S. Augustine, in reply to Faustus the Manichean, says, "Our agapes feed the poor"—a testimony which proves that the feast had not lost its original character as a charity. By the fifth century the *refrigerium*, which in the agape was provided for the poor, was accounted a suffrage for the spiritual *refrigerium* of the departed in whose memory the feast was given. The agapes which were celebrated on the feasts of the martyrs were provided at the expense of the Church or by the offerings of the devout. In the case of private persons an annual agape was often established by a bequest of the deceased or celebrated at the expense of his family.

We have seen that the custom was continued to the time of S. Augustine; but it suffered serious change in form, and was attended by grave abuses which finally led to its abolition. Julian the Apostate was obliged to acknowledge the moral difference between the pagan and the Christian custom. But S. Augustine, referring to the agapes which were daily celebrated in the atrium of S. Peter's, says that there were daily examples of drunkenness; and in another place he exclaims, "Now drunkards persecute the martyrs with cups, whom then the mad persecuted with stones." Nevertheless the feasting of the poor was continued at S. Peter's, in a hall specially appropriated to the purpose, till the destruction of the old basilica. Probably by the end of the fifth century the agape had become dissociated from the cemeteries, and again associated in a certain way with the Eucharist at the martyrs' festivals in the basilicas. With this change it had quite lost its early form. In Africa, in the time of S. Augustine, it was the custom upon the festivals to deposit at the graves of the martyrs, or by their

altars in the basilicas, gifts of bread, wine, and other food to be distributed to the poor. His mother, S. Monica, at the first festival which occurred after her arrival at Milan, went early in the morning to the church with her basket filled with the pious gifts she had been accustomed to offer in Africa, not knowing that S. Ambrose had abolished the custom. The *ostiarius* forbade her entrance into the church; "and henceforth," as S. Augustine says, "she carried to the tombs of the martyrs, instead of a basket of fruit, a heart full of pure desires." The example of S. Ambrose was soon followed everywhere; but a vestige of the agape still remains in the offerings in kind or in money which is made for the poor at the celebration of the Eucharist.

LEGAL TENURE OF THE CEMETERIES

The funeral agapes are closely connected with another question of even deeper interest and of broader significance for the understanding of the legal position and organization of the Church during the centuries of persecution. That is, the question as to the nature of the tenure of church property, which de Rossi would solve — so far at least as the cemeteries are concerned — by the hypothesis that the Church was organized, and by law recognized, as a burial society, and as such enjoyed legal protection at the same time that it was as a religious society prohibited.

Before examining this theory it is well to take account of the private tenure of church property, which probably continued till the end of the second century. The Roman law, which sanctioned the slaughter of the Christian martyrs, rigorously protected their tombs. No formality was required, nor any priestly consecration, to put a tomb under the protection of the law. The legal maxim was: *Religiosum locum unusquisque sua voluntate facit, dum mortuum infert in locum suum* ("Each of his own will constitutes a religious spot when he introduces in his property a dead body"). The few square feet of ground which covered the grave were by this mere act set apart from the rest of the property as a *locus religiosus*, which might not be in any wise alienated from the use to which it was dedicated. It was not thereby constituted strictly a *locus sacer*, which demanded a special consecration, but it was nevertheless placed under the

tutelage of the Pontifex Maximus, whose permission was required for any change in its disposition. The punishment attached to violation of a sepulchre was deportation to an island, or forced labor in the state mines, according to the social rank of the offender. The same protection which was accorded to the grave itself was extended to the monument which adorned it, to the surrounding ground which was allotted to it, to the buildings devoted to the funeral feasts, and to any other property annexed to it for its maintenance. It was common to indicate upon the *cippi* which marked the boundaries, or in the inscription of the monument itself, the extent of the ground which was devoted to the tomb. The formula was: *in fronte pedes XV in agro pedes XII*—“along the road 15 feet, in depth (in the field) 12 feet.” The destination of the monument was also expressly stated in the inscription. For example, *sibi et suis*—“for self and family”; or, “for himself and his freedmen”; or, for those who stood in any given relation to the proprietor. The tomb was commonly a family monument; and, with the restrictions which have been noted, it constituted a family property for the burial of succeeding generations.

It is easy to realize how a wealthy Christian, who gave his house within the city for the worship of the Church, might receive the bodies of the early martyrs in his private tomb, and without relinquishing his private tenure of the property might allow it to be recognized as the burial-place for all the brethren who worshipped in his house. Such was in fact the tenure by which church property was held till about the beginning of the third century. The great extent of the cemeteries was not inconsistent with private ownership. The area attached to pagan tombs was sometimes considerable, and the Christian practice of subterranean excavation reduced the necessity for great superficial extension. It is calculated that the primitive nucleus of S. Callistus—that is the part attached to the crypt of Lucina—lay under an area which measured only 100 feet *in fronte* and 180 *in agro*; and yet in this region there can still be counted 800 sepulchres.

It is not unlikely that some of the cemeteries may have been held by private title throughout the whole period of persecution. This supposition has been relied upon to explain the fact that

about the end of the third century the cemetery of Callistus suddenly ceased to be used as the burial-place of the popes, who, beginning with Marcellinus, were buried instead in the cemetery of Priscilla. Marcellinus suffered martyrdom in the year 304, the year following the edict of Diocletian which confiscated the corporate property of the Church. The papal cemetery of Callistus must have been the first to be struck by this act, and burial in it must have been rendered at once impossible. On the other hand, one may readily conceive that the cemetery of Priscilla may have continued to be held in



FIG. 13. — Fresco in a crypt in Cyrene.

private title by the family of Pudens, or by the Acilii Glabiriones, and was exempted from confiscation. There, at all events, Marcellinus was buried, and other tombs dating from the same period of confiscation have been discovered.

The primitive titles by which all the cemeteries were known throughout the age of persecution were the personal or family names of the original possessors; it was not till after the Peace of the Church that they were designated by the names of the principal martyrs who were buried in them. A topographical designation was often employed for the catacombs, and served to confuse still further their nomenclature. For

example, the *Cœmeterium Pontiani* (the name of the founder) took the name of SS. Abdon and Sennen, or (the topographical designation) *ad ursum pileatum*; the primitive title of the cemetery in which S. Peter found burial is unknown, and the place is best known even to-day by the topographical name *in Vaticano*.

As long as the churches and cemeteries were held in private title their legal status was perfectly obvious. Nor is there any problem raised by the undoubted fact that *after* the Peace of the Church all ecclesiastical goods were recognized as the corporate property of the Church and were held as such by the bishop. But already during the age of persecution church property had generally ceased to be held in private hands, as is proved by the edicts of confiscation and by other evidence which has been mentioned above. And it seems as if the tenure of church property was then precisely the same as we know it after the fourth century; for when after confiscation it was returned to the Church, the imperial edict designated the bishops as the holders of it. The same state of affairs is proved not only for Rome and Italy, but for the provinces; and it commenced with the beginning of the third century. It must be admitted that, under whatever fiction the property was held, it was actually recognized by the State as the property of the Church. This does indeed pose a very serious problem: How was it possible that the State recognized the Christian community as a legal entity and protected it in the possession of its property, while the Church, as a religious institution, was prohibited, and even the individual profession of Christianity was punished by death? Whatever may be the explanation, the fact itself cannot but put in a new light the situation of the Church under the Empire; and if the catacombs furnish monumental proof of numerous martyrdoms and of persecutions of which there is no other evidence, they also serve to prove that the Church must have enjoyed long periods of prosperity and of immunity from attack, during which, though it remained in law an illicit religion, it was shielded by the executive.

The hypothesis which de Rossi has proposed to account for the legal status of the cemeteries has been so readily and so widely accepted that it requires a presentation at some length.

In brief, however, it is simply this: that in order to obtain legal protection in the possession of its property the Church had itself recognized in law as a burial society. The position of pagan burial societies under the Empire was remarkable, indeed unique, and much has been learned about them from inscriptions. The burial societies, as first organized toward the end of the Republic, had a purely practical aim. The

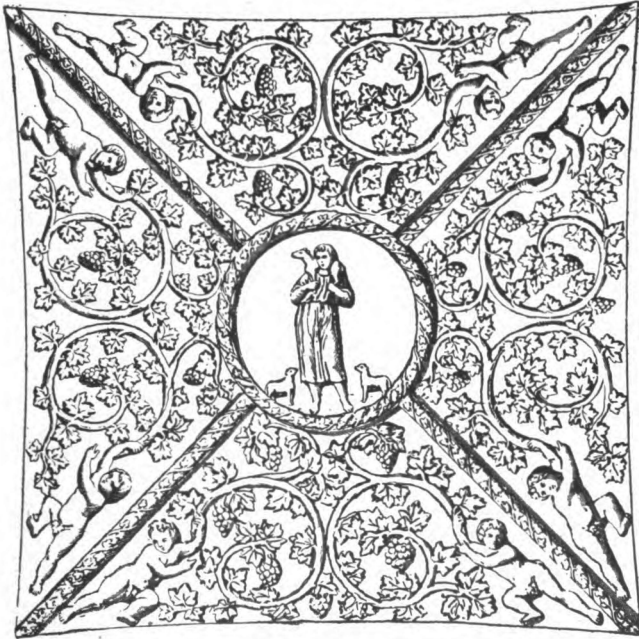

FIG. 14. — Decoration in stucco, ceiling of a crypt near the *via Latina*.

poorer classes, who were unable to provide a family tomb, were obliged to resort to coöperation to insure a place for their ashes and to meet the expense of the funeral. The members of these societies paid monthly dues and were assured a niche in the common columbarium. Special donations established funeral feasts upon the anniversaries of the death of the benefactors. These organizations had sometimes a broader scope, being practically mutual benefit societies; and, as they met

regularly for the transaction of business and for the celebration of the funeral feasts, they must always have established an important social bond between the members. The membership was composed of the slaves of a particular estate, of the artisans of a particular trade, or of people who were associated in some equally natural way. Such societies were frequently founded by the donation of a piece of ground, or of a tomb, on the part of some wealthy benefactor. Before the second century the burial societies had seldom any expressly religious associations: they were designated by the name of the patron, or by a description of their membership. But about the time of Hadrian they began to assume a religious character, being sometimes designated by the names of the particular divinities to whose cult they were devoted.

The burial societies must be regarded as an instance of a general tendency which was showed in the organization of trade guilds and associations of various sorts among the poorer classes. Such guilds became common in the latter years of the Republic, and they greatly increased under the Empire and with the growth of tyranny. The meetings of all such guilds were at first liberally allowed; but from the reign of Trajan they were jealously regarded as possible centres of political sedition, and the right of meeting (*jus cœundi*) was denied to all save the funeral societies. Until the end of the second century even this single exception extended only to the burial societies of the Capital; Septimius Severus permitted them throughout the Empire. The members (*sodales*) were allowed not only to organize for the purpose of procuring a common burial-place; but — as a necessary means to this end — to meet monthly within the city for the conduct of their business and the collection of the monthly dues, which were deposited in a common chest (*arca*). The societies were governed by their own statutes (*lex collegii*) under the public law. An interesting set of statutes of this sort was discovered in 1816 at *Lanuvium* (Civita Lavinia). It is the constitution of a *collegium* of slaves established in the year 136. After naming the date of foundation and the place of reunion, it fixes the monthly dues (which like the offerings of the Christians were not only in money but in kind), establishes fines and penalties (among them the refusal of burial to such as had committed suicide,

and to such also as had not paid their dues), it gives even the *menu* of the funeral feasts and a list of the dates upon which they were regularly to be held. This *ordo cœnarum* is given in the following form:—

VIII idus Martias Cæsenni . . . patris.

* * * * *

V kal. Dec. natali Antinoi.

* * * * *

XIX Kal Ian natali Cæsenni Rufini patroni municipi.

If, as de Rossi remarks, we substitute for these names a Callistus, an Agnes, a Cæcilia, we have the primitive list of the minor Christian festivals.

One cannot fail to observe how close in many respects was the parallel between some of the practices of the Church and those of the burial societies. De Rossi has drawn attention to the coincidence between the language of Tertullian and the rescript of Septimius Severus, "But it is permitted to the poor to pay monthly dues, provided they meet but once a month";—so far the Digest (XLVII. 22, No. 1). In much the same terms Tertullian (*Apol.* 39) says of the Christians, "Each one contributes his due upon a certain day of the month, or as much as he will, if he is willing to give anything, and if he is able."

The hypothesis of de Rossi seems to be confirmed by a Christian inscription which was found in Algiers near the site of the ancient Cæsarea Mauritanea:—

AREAM AT (ad) SEPVL CRA CVL TOR VERBI CONTVLIT
ET CELLAM STRVXIT SVIS CVNCTIS SVMP TIBVS
ECLESIE SANCTÆ HANC RELIQVIT MEMORIAM
SALVETE FRATRES PVRO CORDE ET SIMPLICI
EVELPIVS VOS SATOS SANCTO SPIRITV

ECLESIA FRATRVM HVNC RESTITVIT TITVLVM • M • A • I • SEV-
ERIANI C • V • EX ING • ASTERI.

According to this, a Christian, Evelpius, "a worshipper of the Word," had founded a sepulchral *area*, with a chapel (*cella*)

constructed within its limits, which he leaves to the "holy Church." The inscription having been broken, the community restored it. *Ecclesia fratrum* ("Church of the brethren") might then have been the name of the burial society which is supposed to have stood for the Church; or perhaps it was called "*Collegium cultorum Verbi.*"

Another argument is found in the so-called Philocalian catalogue, which contains, among other things, the dates of the burial of the Roman popes from 254 to 354 — a list which seems to have been derived from the same source as the parallel catalogue of the prefects of Rome, which must have been extracted under Liberius from the Archives of the city. We know that the burial societies, in order to obtain legal recognition, had to present to the authorities the name of their presiding officer, which in the case of the Christian communities was of course the bishop. It has been argued, therefore, that the Archives preserved the names of the bishops of Rome as the presidents of the Christian burial society. It is not claimed that the Church throughout the Empire was represented as a single society; it is rather supposed that the Christian community in each city constituted a particular society (or perhaps several), and gave the authorities no reason to suspect the ties which bound them together.



FIG. 15. — Orans in dalmatic, tunic, and veil. Catacomb of Priscilla. Third century.

For the reason that this hypothesis has been so generally accepted, and in particular because it has been made the basis for the most fantastic attempts to derive the very organization of the Church from the norm of the *collegia tenuiorum*, it is necessary to call attention to the fact that it is still an hypothesis, and that, plausible as it is, it is not definitely

proved either by literary or monumental evidence. So far as the catacombs are concerned, they have hardly any bearing upon the subject, except to suggest the problem which this theory is intended to solve.

Duchesne objects to this theory that it is neither sufficiently proven, nor in itself altogether plausible. He finds it easier to believe that the Church was able through the tolerance of such emperors as Commodus to possess its collective property in its own name. He suggests that even if it could be established that the registers of the prefecture had been consulted for the consular dates of the "depositions" of the popes, it would follow only that the prefecture recognized the Christian community and its chiefs, and not that it recognized them under the fiction of a burial society. "In order that the churches could have been made to accept a fiction such as that which would have transformed them officially into burial societies, it would have been necessary: 1st, that they had been willing, which is neither proved nor easily reconcilable with the horror of Tertullian¹ and of S. Cyprian² for this sort of fraternity; 2d, that the police had consented to ignore the fact that the matter really concerned the Christian community. This appears difficult enough. A burial society was an association of a rather small number of persons; the church of a great city, as of Rome, Alexandria, Antioch, and Carthage, must have numbered in the third century thirty, forty, or fifty thousand members. How can one imagine S. Fabian, S. Cyprian, S. Dionysius of Alexandria, going to be registered at the prefecture as head of a college of '*cultores Verbi*' composed of fifty thousand persons, associated with a view to procuring decent burial? It seems more natural to believe that if after the death of Marcus Aurelius the Christian communities enjoyed long intervals of peace, if they succeeded in possessing real property of a conspicuous nature and considerable value, it is because they were tolerated and even recognized, without any legal fiction, as churches, as religious societies. Of legal fictions, of burial societies, of mysterious titles, the documents give neither testimony nor suspicion."³

¹ *Apol.* 39.

² *Ep. de Basilide et Martiali.*

³ *Les origines chrétiennes*, c. XXIII., § IV.

INSCRIPTIONS

To give an adequate account of early Christian epigraphy within the limits of a half dozen pages is, of course, an impossible task ; it amounts simply to dismissing the subject in the fewest possible words. It is proposed to give here an account — only in the most general terms, and with but few examples — of the distinctive characteristics of Christian sepulchral inscriptions, of the several classes into which they may be divided, and of the sort of information one may expect to derive from their study. For further and more detailed information one may conveniently consult Marucchi's *Éléments d'Archéologie chrétienne*, the first volume of which devotes a disproportionately long section to this subject. The more fundamental sources are given in the Bibliography.



FIG. 16.—Sarcophagus of *Livia Primitiva*, found in the Vatican cemetery, now in the Louvre. Second century.

The first distinction which must be marked is that between the original titles and epitaphs, and the later metrical inscriptions with which Damasus and his imitators adorned the tombs of the martyrs and signalized their deeds. Of the first class it is convenient to distinguish between such as present only the simplest data, a name, a date, or some merely conventional formula; and such as, with richer content and more characteristic form, throw light upon dogma, or upon the conditions of the civil and religious life. The earliest Christian epitaphs are very brief, and one can seldom derive from them important inferences about ecclesiastical dogma or custom. This characteristic brevity detracts considerably from their importance as sources of information; and the student needs to be warned that early Christian epitaphs are commonly appealed to far too loosely in proof of the prevalence of this

or that doctrine or custom, as though it made no substantial difference whether they were proved for the second, the third, or the fourth century. We have to rely upon the inscriptions of the early period for the proof of the existence of certain customs; but when it is a question of dogma or ritual the very point at issue is usually the ascertainment of the *earliest* date to which they may be ascribed within this period, and epitaphs which cannot be securely assigned even to an approximate date ought not to be used except in mere illustration of doctrines and practices which are otherwise attested for the age in question.

Most of the more elaborate inscriptions are late, but it does not follow that all simple inscriptions are early, for brevity was the rule throughout the history of the catacombs. It has already been mentioned that many tombs were without name, and were distinguished only by the familiar possessions of the deceased which were pressed into the fresh plaster. It was also in the fresh plaster that the friends sometimes scratched the date of the "deposition" of the body.

This custom of indicating the day of the month upon which burial took place, and this name for the act of burial, — *depositio*, *depositus* (*κατάθεσις*), contracted, D., D.P., etc. — are peculiar to Christian inscriptions, and characterize all but the very earliest. The word "deposition" expresses the hope which illuminated the Christian burial; it indicates the committal to the earth of a treasure which shall be restored. The term of life of the defunct was indicated according to pagan custom: *Vixit annis . . . , mensibus . . . , diebus . . .* (V . A . . . M . . . D . . .). From the third century this datum was often given with less precision: *Vixit annis plus minus . . .* (Q . VIX . AN . P . M . XXX). The name was commonly accompanied by these formulas only; or also by the name of the person dedicating the monument, by some affectionate epithet (*filio dulcissimo*), or by some exclamation denoting the Christian hope for the departed — *in pace* (*ἐν εἰρήνῃ*), *in Deo*, *in Cristo*. Such exclamations were the



FIG. 17. — Saréophagus from the Vatican cemetery.

earliest adjunct to the mere name which alone marks the tombs of the most primitive period. They were expressed also by the symbols of the dove, the anchor, the fish, and later by the so-called Constantinian monogram.

The three names which were characteristic of Roman citizenship (*prænomen*, *gentilitium*, and *cognomen*) had begun to fall into disuse with the end of the first century, and their presence upon Christian monuments denotes a very high antiquity. The *prænomen* was generally dropped, and still more commonly a single name appears, sometimes of a strictly Roman character, sometimes of Eastern, or barbarian derivation, denoting a Jewish or perhaps a servile origin. Some of them are evidently names taken in baptism, with a Christian signification or association. *Petrus* occurs several times in Rome in the second



FIG. 18. — Tombstone, with graffito representing the raising of Lazarus, in the Lateran Museum.

century, *Petronilla* is associated by tradition with the first, *Paulus* also occurs, and later *Maria*. Such names as *Martyrius*, *Adeodatus*, *Evangelius*, are evidently of Christian formation; so also are a considerable number of names expressing humility, — as *Projecticius*, *Fimus*, *Stercorius*, — which one encounters already by the end of the third century. The names *Fides*, *Spes*, *Agape*, *Eirene*, etc., are very ancient; and the name *Lucina* — which probably denotes the illumination received in baptism — is associated with the burial-place of S. Paul and with the earliest nucleus of the cemetery of Callistus.

How much historical significance may lie in the simplest inscriptions — even in a mere name — one can judge fairly only by consulting de Rossi's own minute studies, which, for all their subtlety, approve themselves anything but rash. It is

especially for the early period, in the case of purely Roman names, and by reason of the rigorous system of personal and family nomenclature which the Romans used, that such arguments can be securely drawn. The very title of the cemetery of Domitilla is sufficient to connect it with the imperial Flavian family. Domitilla (feminine diminutive) was a common cognomen in this family; it corresponded to the masculine Domitianus. It is known that in the first century a vast estate (*predi amarantiana* — now corrupted to *Tor Marancia*), in which this cemetery is situated, belonged to a branch of this family. The cemetery itself brings the proof that it was, as a matter of fact, to the Christian branch of the family it belonged. A pagan *stele* was found there which records that the family tomb which it marked was obtained EX INDULGENTIA FLAVIÆ DOMITILLÆ. Another reads: FLAVIÆ DOMITILLÆ divi VESPASIANI NEPTIS EIVS BENEFICIO HOC SEPVLCHRVM MEIS LIBERTIS LIBERTABVS POSUI. Among the Christian epitaphs of the cemetery there are a number of names of the Flavian *gens*; for example:—

ΦΑ. CABEINOC KAI TITIANH ΑΔΕΑΦΟΙ.

That is, "Flavius Sabinus and Titiana, brother and sister." All of this renders plausible the form in which de Rossi completes a mere fragment which appears to have belonged to the inscription placed over the entrance of the cemetery:—

Sepulc R V M

Flavi O R V M ..

At all events, there is no doubt that as early as the first century this was the burial-place of the Christian members of the imperial Flavian house. These mere names suffice to connect this cemetery with the illustrious converts of the *gens Flavia* whom the Church could already count within the Apostolic age. It has been suspected, from the language in which Tacitus describes him (*mitem virum abhorrentem a sanguine et cædibus*), that Titus Flavius Sabinus, elder brother of the Emperor T. Flavius Vespasianus, was the first of the family to be converted to Christianity. He was for the first time Prætor in 64 under Nero, and it is certain that as a duty of

F

his office he must have examined into the causes of the Christians who were executed for their religion. During the thirty years of absolute peace and tranquillity which the Church enjoyed after the death of Nero there is no mention of Christians of this name. The relation of the family to Christianity becomes first publicly known by reason of the persecution of Domitian, and it is attested by pagan as well as by Christian historians. The first to fall a victim was the Consul Titus Flavius Clemens, son of the above-mentioned T. Flavius Sabinus and first cousin of the Emperor. While Clemens was beheaded, his wife, Flavia Domitilla, niece of Domitian, and another Flavia Domitilla, who was a niece of Clemens, were exiled to the islands of Pandataria and Ponza. In explanation of these harsh measures, it must be supposed that Domitian considered the profession of this strange religion by members of his own family a proof of political disaffection. It suggests food for the imagination to reflect that but for this outbreak of suspicion a Christian emperor might have occupied the throne of the Cæsars before the end of the first century; for it was the two sons of Clemens and Domitilla whom Domitian had adopted as his successors, changing their names to Vespasianus and Domitianus.

The memory of the Flavian converts and martyrs has been preserved in the Church and hardly needed the confirmation of the monuments. But another illustrious convert and martyr of the first century is known as such only through inscriptions discovered in the cemetery of Priscilla. Manius Acilius Glabrio, Consul in 91 with Trajan and head of one of the noblest Roman families, was also put to death by Domitian. He was made to fight with a bear or a lion, and, proving victorious in this contest, was beheaded. Though no memory was preserved in the Church that he died a Christian, yet the terms in which Suetonius records the charge which was brought against him and other members of consular and senatorial rank who suffered with him (*molitores rerum novarum*) has led several historians to suspect that they were martyrs for the Faith. That the Acilii Glabrones were Christians was put beyond a doubt in 1889 when, in the central and primitive region of the cemetery of Priscilla, there was discovered an extensive and richly ornamented *hypogeum* which contained fifteen inscriptions in Latin

and Greek of members of this family. Originally there must have been more, for the epitaph of the Consul himself is missing; the very richness of the marble decoration specially marked this crypt for destruction, and only fragments of the sarcophagi and their inscriptions remain. One of them reads:—

αΚΙΑΙΟC ΡΟΥΦΙΝΟC
ζΗΧΗC ΕΝ ΘΕΩ

Acilius Rufinus live in God—a sure sign of the Christian character of the sepulchre. Another reads:—

M ACILIUS V . . .
C . V .
et PRISCILLA C . .

Manius Acilius vir clarissimus (et) Priscilla clarissima (femina). The title *clarissimus vir* leaves no doubt that this personage of senatorial rank belonged to the family of the consul who was put to death under Domitian. The name Priscilla suggests a relationship with the family of the senator Pudens from whose wife Priscilla the cemetery took its name. In this cemetery were likewise buried that Aquila and Priscilla (Prisca) who were companions of S. Paul, and the site of whose house upon the Aventine is marked by the church of S. Prisca (*contraction* for Priscilla). Their common use of the name Priscilla, together with the fact that both families were buried in the same cemetery, suggests some close tie between the family of the tent-maker upon the Aventine and the senatorial family of the Esquiline.

There is something to be learned from the very brevity of the early inscriptions; there is argument to be drawn from their silence. During the first four centuries of the Church no single mention is made of a slave, and but rarely of a freedman, among the thousands of inscriptions of the catacombs—justifying the Christian boast that master and slave recognized their equality in the Church. In a later time the inscriptions occasionally record the manumission of slaves in suffrage of the departed.

In contrast to the pagan custom, even the noblest of the Christians recounted none of the honors of their offices and

rank, except that the initials V. C. (*vir clarissimus*), C. F. (*clarissima femina*), were not uncommonly inscribed to indicate membership in the senatorial order. The Christian attitude was that of looking forward beyond the tomb, rather than back over the course of earthly honor and success; *recessit a sæculo* became a familiar formula in the fourth century. In the third and fourth centuries the profession of the defunct was often mentioned in the inscription or indicated by picturing the tools of his trade. We have in general in the catacombs a thorough vindication of Tertullian's boast¹ that



FIG. 19. — Tombstone in the catacomb of Domitilla.

the Christians were to be found in every rank and in every profession.

Nothing could be more simple than the epitaphs of the Roman bishops in the papal crypt at S. Callistus. The earliest which have been preserved in this crypt are those of Anteros (236) and Fabianus (250):—

ANTEPΩC · EIII (Anteros, bishop).

ΦABIANOC · EIII · M̄P (Fabianus, bishop, martyr).

The inscriptions of this crypt prove that Greek was still the official language of the Roman Church.

The next pope, Cornelius, was buried in a distant region of the same cemetery, the very region, in fact which seems in origin to have been the property of the Cornelii and the

¹ *Apol.* 37.

Cæcili. This probably explains the fact that the epitaph of this pope is not in the official language of the Church, but in Latin :—

CORNELIVS · MARTYR
EP

The word “martyr” here is original ; on the epitaph of Fabianus, however, it was a subsequent addition.

Most of the very early inscriptions in the Roman catacombs were in Greek, and the same language persisted here and there to a comparatively late period. Greek inscriptions were sometimes written in Latin characters, and Latin sometimes in Greek. The very general traits of Christian epigraphy which can here be noticed serve as well for the Greek as for the Latin, for the East as for the West. It seems not unlikely, however, that early inscriptions in the Orient may have been more elaborate than those of the same period which we know in Rome. The earliest inscriptions of the East have not been preserved ; but the epitaph of Abercius (Fig. 20), which is translated in another place (p. 235), belongs to the middle of the second century, and is one of the most elaborate and interesting of all Christian inscriptions. It is inscribed upon a *stèle* of the common pagan form. The use of the *stèle* or *cippus* was not altogether rare in the Church, although the vast majority of inscriptions are upon plaques of stone. Despite their pagan significance, the initials D · M · (*Dis manibus*) are sometimes found upon Christian tombs ; partly because the plaques were thus inscribed as they were bought at the shops, and partly, perhaps, because they were so much the ordinary sign of a tomb that their more specific significance was forgot. B. M. (*bonæ memoriæ*) was sometimes substituted in a later age.

In point of orthography de Rossi distinguishes two classes of the primitive Roman inscriptions : those painted in red (in Pompeian fashion), which are characteristic of S. Priscilla ; and those cut in the stone, which are elsewhere almost universal. The orthography is for the most part careless, and after the second century there begin to appear frequent mistakes which reflect the popular pronunciation and the popular idiom.

Even in the concise terms of the early epitaphs there sometimes lies a clear testimony to early dogma. In the third cen-

tury a greater fulness and variety appears. There are a number of prayers, particularly in Greek, which suggest a liturgical origin. Metrical inscriptions are rare until the fourth century; the earliest examples of them are commonly brief, and show a dependence upon, if not an actual quotation from, the Classical poets. But there are also inscriptions in *quasi*

versus, a variety of verse invented by Commodian, a Christian poet of the third century. It is not of much interest

to record that the inscriptions, early and late, testify to belief in God, in Christ as God, in the

Holy Spirit, and in the Resurrection; it would be a matter

of startling consequence if they did not. Of more importance

are the references to baptism, particularly

the baptism of infants; and to the widows and

virgins of the Church.

But of all the dogmatic notices which are furnished by the inscriptions,

none have so sympathetic an interest, and

none are likely to be accounted of so great importance,

as those which illustrate the custom of prayer to and for the

departed. We may distinguish

three classes: those which contain a prayer for the peace of the departed; those which petition the prayers of the departed

in behalf of those who remain below — these two being frequently combined; and those which call upon all who read the inscription to pray for the person whom it commemorates.

Such forms are found with comparative frequency after the middle of the second century.

To another class belong the appeals for the intercession of the martyrs. It was hardly before the fourth century that the

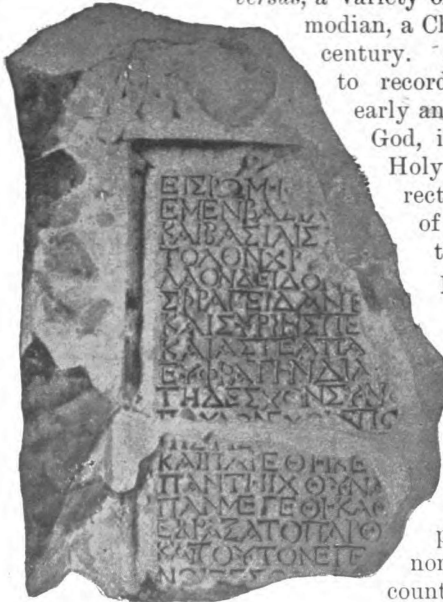

FIG. 20. — Fragment of sepulchral stele of Abercius, found in Hieropolis, now in the Vatican. Second century.

martyrs were regarded as advocates before God for the souls of the departed. For this period, however, the popularity of the view is proved, not only by inscriptions, but by some of the paintings of the catacombs which represent the soul introduced into heaven by the saints, and the same theme appears later in the mosaics of the basilicas. It is in this cult of the martyrs we find the roots of the later doctrine of the saints; in the official recognition of martyrdom, and in the special efficacy which was attributed to the martyr's intercession, we have the essential factors of the mediæval doctrine. It was this conception of the martyrs as advocates in the Judgment which made



FIG. 21. — Loculus of a martyr, closed with tiles, catacomb of Domitilla.

burial near them seem so desirable. The following inscriptions are of the fourth century: —

CVIQVE PRO VITAE SVAE TESTIMONIO
SANCTI MARTYRES APVD DEVM ET CRISTVM
ERVNT ADVOCATI
(Cemetery of Cyriaca.)

DOMINA BASILLA COM
MANDAMVS TIBI CRES
CENTINVS ET MICINA
FILIA NOSTRA CRESCEN . . .
QVE VIXIT MENS X . ET DES . .
(Cemetery of Basilla.)

Domina (*dominus*) was the title given to martyrs. The latter inscription reads: "O lady Basilla, we commit to thee Crescens, and our tiny daughter Crescens (tia) who lived 10 months and . . . days."

Another, from Aquileia,

MARTYRES . SANCTI
IN . MENTE . HAVITE
MARIA

reads, "Holy martyrs, remember Mary."

But to return to the earlier forms which regard all the faithful departed without distinction: I have spoken of them as a sympathetic subject of study, because they are so human, so naïve, and spring so promptly from the heart. The prayer for a place of refreshment, of light and peace, of rest in God, in behalf of the departed soul, was impossible from the standpoint of the pagan, simply because the other world was not conceived in such terms. To the Christian, on the other hand, these were the ideas which were naturally associated with the death of the believer; and if there was nothing in the Christian teaching which positively required such prayers, there could at least be no more solid objection brought against them than the claim that they were superfluous. What more natural, however, than that the Christian hope for the dead should at the very tomb itself be expressed as a prayer? What more natural than that such prayers should appear upon the tombstones before ever they were formulated in the liturgies, and before the doctrine of a purgatory of pain had turned their glad confidence into a tearful and doubtful supplication? The simple exclamations we have here to record bear evidence of being the fruit, not of any clear doctrinal conception, but of a popular and natural fantasy.

. . vIBAS
IN PACE ET PETE
PRO NOBIS

"Live in peace! and pray for us," reads an ancient inscription in S. Domitilla. The following, of the fourth century, gives the theological ground which justifies such a prayer to the dead, "Pray for us because we know that thou art in Christ":—

GENTIANVS FIDELIS IN PACE QVI VIX
 IT ANNIS XXI MENS VIII DIES
 XVI ET IN ORATIONES TVIS
 ROGES PRO NOBIS QVIA SCIMUS TE IN CHRISTUM¹

(Lat. mus. VIII. 15.)

That prayer for the dead was not associated with harrowing doubt about their fate we see, for example, in an early Greek inscription in S. Domitilla, which at the same time demands the prayer of the departed in behalf of the surviving friends:—

ZHCAIC · EN · KQ · KAI · EPQTA · YIEP · HMQN.

“Mayest thou live in the Lord! and pray for us.” This is simply the realization of the communion of saints.

Of the third or fourth century is the following:—

ANATOLIVS FILIO BENEMERENTI FECIT
 QVI VIXIT ANNIS VII MENSIS VII DIE
 BVS XX ISPIRITVS TVVS BENE REQUIES
 CAT IN DEO PETAS PRO SORORE TVA

(Lat. mus. VIII. 19.)

“Thy spirit rest in God: pray for thy sister.”

The demand for prayer in behalf of one's own soul seems to manifest a too anxious solicitude about one's fate; but it is found as early as the end of the second century in the epitaph of the Phrygian bishop, Abercius, written by himself (page 234). The following metrical inscription from S. Priscilla belongs probably to the fourth century:—

EVCHARIS · EST · MATER · PIVS · ET · PATER · EST . . .
 VOS · PRECOR · O FRATRES · ORARE · HVC · QVANDO ·
 VENITIS
 ET · PRECIBVS · TOTIS · PATREM · NATVMQVE · ROGATIS
 SIT · VESTRAE · MENTIS · AGAPES · CARAE · MEMINISSE
 VT · DEVS · OMNIPOTENS · AGAPEN · IN · SAECVLA ·
 SERVET

¹ The name of Christ is represented by the monogram.

There is unfortunately but little space left to treat of the inscriptions with which Damasus adorned the tombs of the martyrs. They deserve more attention than can here be given them. They are interesting, not only as a type of Christian poetry which was admired by contemporaries and frequently copied in succeeding centuries, and because of the beautiful and characteristic letters in which they were cut; but for the



FIG. 22. — Martyrdom of S. Achilleus, relief upon one of the columns which supported the ciborium in the basilica of S. Petronilla. Fourth century.

fact that they reveal several pages of the history of the martyrs which but for them would be absolutely unknown, that they testify clearly to the character of the cult which was rendered to the martyrs in the fourth century, and that they make it possible to identify in each cemetery the position of the most venerated tombs. There was no cemetery at Rome which had not at least one such inscription, and still others were placed in the cemeterial basilicas and chapels. Most of the original inscriptions have totally perished, many of them at the hands of the Goths; but the text of about forty of them has been preserved through the copies made by the pilgrims. In consequence of this lucky preservation a mere fragment of the original marble suffices for the

restoration of the whole inscription and serves often to fix its original location.

The accompanying illustration (Fig. 23) shows a marble which S. Damasus placed at the end of the crypt of the popes (Fig. 10); it is now restored to its original place and is almost complete, although recomposed from one hundred and twenty-five minute fragments into which it was broken. I give here the translation, which must suffice for an example of Damasus's poems: "Here, if you inquire, lies crowded together a throng of the righteous, the venerable tombs hold the bodies of the

saints, their lofty spirits the palace of heaven took to itself. Here the companions of Sixtus who bore trophies from the enemy; here a number of the leaders who ministered at the altars of Christ; here is placed the priest who lived in long peace; here the holy confessors whom Greece sent; here young men and boys, old men and their pure descendants, who chose to keep their virgin modesty. Here, I confess, I Damasus wished to deposit my body, but I feared to disturb the holy ashes of the righteous." It is not unreasonable to suppose that a "throng" of martyrs were often buried in a single tomb, particularly such as suffered together in the same

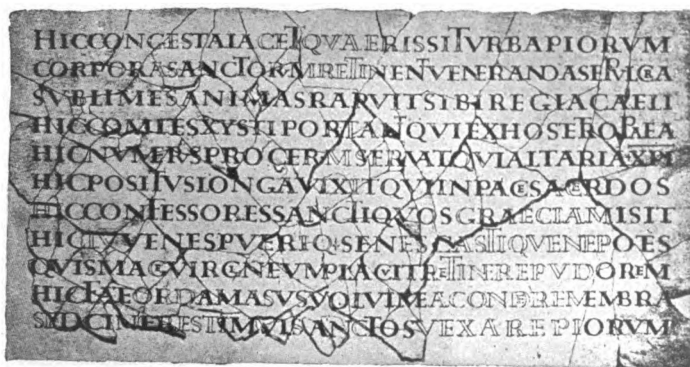

FIG. 23. — An inscription by Pope Damasus in the papal crypt, catacomb of Callistus. Fourth century.

persecution. In the case of such as were burned or thrown to the beasts, often only very small portions of their bodies could be recovered. Sixtus II. and his companions in martyrdom are here mentioned, although Damasus set up in this same crypt a special inscription in his honor. Those "who ministered at the altars of Christ" are probably unnamed deacons and presbyters; and the "sacerdos" of the next verse may refer to the Roman bishops who were buried here (using the singular for the class), though de Rossi understands Miltiades, who was the first pope to enjoy the peace given by Constantine. The "confessors" from Greece are unknown, but they may have been Hippolytus and his companions.

The last lines seem intended as a rebuke to those who disturbed the bodies of the martyrs in their zeal to be buried near them.

Damasus was in fact buried in a little basilica connected with the cemetery of Domitilla, in which he prepared also the tombs of his mother and sister. For himself and for them he composed inscriptions. This chapel has not yet been discovered, but a small fragment of an inscription found near the church of SS. Cosma e Damiano was recognized by de Rossi as belonging to Damasus's inscription to his sister, the



FIG. 24. — Decoration of the crypt of S. Januarius, catacomb of Prætextatus. Third century.

text of which was known. This piece was again lost, and has been rediscovered in the course of the excavation of the Forum. It awakens surprise that it is not inscribed in the customary Damasian letters; but this is explained by the fact that the sister died before Damasus became pope and before he had adopted the type of letter which is associated with his name.

De Rossi has traced the author of these beautiful letters, which though frequently imitated in a later age were never precisely copied. On the marble which contains the inscription to S. Eusebius, discovered in S. Callistus, there is at each end a line of smaller letters which read from top to bottom: *Damasis Pappæ cultor atque amatot Furius Dionysius Filocalus scripsit* — “Furius Dionysius Filocalus the reverer and lover of

Pope Damasus wrote it." This famous personage was the secretary of Damasus. In this inscription one is struck not only by the false spelling, but by the character of the letters, which in fact are only a distant imitation of the Damasian. This is explained by the fact that the original inscription had been broken, and was restored again about the end of the sixth century, perhaps by Pope Vigilius; it was then cut on the back of an inscription of Caracalla.

The interesting inscription which has been translated above is enough to show that Damasus was not a great poet; his verses are not always regular, and he shows a lack of invention in his frequent repetition of favorite words and phrases, many of them taken from Virgil. But his style was accounted elegant by Jerome (*elegans in versibus scribendis*), and he seems to have been a conscientious historian. The historical researches which he must have made about the martyrs were doubtless facilitated by the fact that he was archivist of the Roman church before he was made pope.

In the composition of metrical inscriptions Damasus had imitators even among the popes. Many such inscriptions were in dedication of basilicas; some of them we shall have occasion to notice in connection with the mosaics. Suffice it to say here that with the end of the sixth century poverty and ignorance had become so general that hardly any inscriptions were produced, except the rude epitaphs of popes or of other rulers.

HISTORY OF THE CATACOMBS AFTER THE FOURTH CENTURY

In the foregoing description of the Roman catacombs, and in the treatment of the problems which they raise, enough of their history has been introduced to give a fair conception of the earliest period, which illustrates specially the spirit of Christian brotherhood in the extension of the privilege of the family sepulchre to all who were of the same family in the faith. Enough has been said of the second period to reveal the extent and character of Church organization in the third century; enough also of the third period to illustrate the growing cult of the martyrs. It only remains to give a brief account of the last period of their history, which, though a long one, has little

to register but the various stages of their abandonment till their very sites became unknown.

De Rossi has proved that the custom of burying in the surface cemeteries above the catacombs had made such progress by the last quarter of the fourth century that only a third of the burials were subterranean. The desire for burial near the martyrs found a natural obstacle in the limits of the space which could be utilized. A Roman epitaph of the year 381 speaks of a Christian who for her great merit obtained a sepulchre in the abode of the saints, which many desired but few obtained: . . . *quae pro tanta MERITA ACCEPIT sepulchrum intra LIMINA SANTORUM quod multi cupiunt ET RARI ACCIPIUNT*. From the year 400 to 409 there are almost no inscriptions proving subterranean burial; and with the capture of the city by Alaric in 410 burial in the catacombs ceased altogether. This date is memorable as well for ecclesiastical as for political history. "In one single city the whole world perished," exclaimed S. Jerome when the news of the fall of Rome reached him in far-off Palestine. As the beginning of the barbarian inroads which laid low the whole civilization of the West, it has a special importance in the study of Christian art; in the history of the catacombs it marks the most definite crisis. This did not, however, mark the abandonment of the cemeteries above the catacombs, which must already have reached a considerable size; it was probably not till near the end of the sixth century that the law of the Twelve Tables forbidding burial within the walls ceased to be generally regarded. By this time the population of Rome had so much diminished that there remained no practical objection to intramural cemeteries. Even to-day a considerable part of the area within the Aurelian walls is occupied only by ruins or by vineyards; in the sixth century the greater part of the city must have been quite deserted, or at least left to the farmer. One of the earliest of the cemeteries in the city was established on the Esquiline near the church of S. Bibiana; another near S. Cosimato in Trastevere. Soon each of the parish churches became the centre of a parochial burying-ground.

But to return to the beginning of the fifth century. The disuse of the catacombs for burial by no means signified their abandonment. The pious veneration of the martyrs'

tombs is witnessed by frescos as late as the seventh century. Lamps burned perpetually before the tombs of the most famous saints, and pillars surmounted by a broad bowl of pottery or glass for the floating wicks are still to be seen in the catacombs and serve to designate the crypts which were once the resort of pilgrims. The descriptions which Jerome¹ and Prudentius² give of visits to the catacombs in the fourth century picture them as they remained for three centuries more. Notwithstanding the successive incursions of barbarians from the fifth to the seventh century, the popes did their utmost to preserve "the crown of martyrs" which encircled Rome. Pope Vigilus (537-555) was especially active in restoring the inscriptions of Damasus and in repairing other ravages which had been wrought by the Goths. Of John III. (561-574), the *Libet Pontificalis* records, *amavit et restauravit cœmeteria sanctorum martyrum*. From the same source we learn that this pope established out of the Lateran revenues a weekly gift of oil for every cemetery, and laid again upon each of the urban titles the obligation to send a priest every Lord's Day to the catacombs for the celebration of the Eucharist — a custom which was continued to the end of the seventh century.³ The seventh century was the period of the great pilgrimages from the North to which we owe the Itineraries. Pilgrimages had been common since the fourth century, but they were of a private character; and it was not till the eighth century that the cult of relics led to the violation of tombs and the desecration of the bodies of the saints. Any mention which is made of relics before that time refers to a more innocent custom, chiefly the custom of carrying away some of the oil from the lamps which burned before the tomb of a saint, though in general any object — a handkerchief for instance — which was brought into contact with the tomb acquired the properties of a relic, and such relics were often carried to a great distance for the consecration of a new church.

But the relics most usually carried away were little vials (*ampullæ*) containing some of the oil from the lamp which burned before the tomb of a saint. The traffic in the oil *ampullæ* was by no means confined to Rome; it was a custom

¹ In *Ezech.* 12: 40.

³ *Lib. Pont. in Sergio*, I. 1.

² *Peresteph.* XI.

almost universal. The *ampullæ* were made of glass, clay, or metal, ornamented with Christian subjects in relief (see p. 355, Fig. 54). The *ampullæ* which were carried from the tomb of S. Mennas in Egypt were spread by pilgrims all over the world. But the most interesting collection is that which was made in the time of Gregory the Great (590-604) by the "Abbot" John, who was sent to Rome by the Lombard Queen Theodelinda to ask relics for her cathedral at Monza. John executed his mission with care; upon a parchment attached to each vial he wrote the name of the saint from before whose tomb the oil was taken, and made, besides, a list on parchment of the whole collection. Originally there were more than seventy *ampullæ* in this collection; many of them are still preserved in the cathedral; and so likewise is the original draft of the list, which, as it follows precisely the order in which the tombs were visited, proved to be of the highest topographical value in the rediscovery of the catacombs.

The Roman Church was more conservative than any of the churches of the East in the respect which was shown to the inviolability of the tomb and in the refusal to disturb the bodies of the saints. It is certain that up to the middle of the seventh century no bodies were transferred within the walls, for the Itineraries mention SS. John and Paul (see p. 166) as the only martyrs who were to be visited within the city: "*In urbe Roma beatorum martyrum corpora Johannis et Pauli tantum quiescunt.*" Indeed the fifth and sixth centuries witnessed a notable development of the buildings above the catacombs. It was in this period that the greater basilicas (*basilicæ majore*) were erected over many of the tombs, sometimes incorporating the *basilica ad corpus* of Constantinian foundation. It was in connection with these basilicas that the first translations occurred. Honorius I. (625-638) changed the position of several of the tombs; but only from the crypt underground to the basilica above. With this period the Itineraries begin to speak of the martyrs *deorsum* in distinction from those *in basilica sursum*. The first bodies to be transferred within the city were taken from the suburban towns: those of SS. Primus and Felicianus from Nomentum in 648, and those of Beatrice and Faustinus from Porto in 682.

But with the eighth century the Campagna became so thor-

oughly deserted and so unsafe that even the basilicas could not be preserved, and then began the wholesale translation of the bodies of the saints to the basilicas of the city. In 757 Paul I. transported a great multitude of relics to the church of S. Silvestro in Capite, which he had just built on the site of his family mansion. His successors, however, did not imitate his example; Hadrian I. endeavored on the contrary to restore the suburban cemeteries. But Pascal I. effected the greatest translation of martyrs' relics which was ever made, removing in 817 the bodies of no less than twenty-three hundred martyrs to the church of S. Praxede. An inscription on marble in which he commemorated this event is still preserved in the church; it gives the name of each martyr, the cemetery from which each group was taken, and the part of the church in which they were buried. Leo IV. so thoroughly completed this work that, by the middle of the ninth century, the catacombs were totally despoiled of the treasures which attracted pilgrims and worshippers, and before long they had fallen not only into dilapidation, but into oblivion. Those of S. Lawrence, S. Pancras, S. Sebastian, and S. Valentine were the only ones which continued longer to be known and venerated, and that only because of the monasteries with which they were connected.

The translation of the relics of the saints was accompanied by a ruthless destruction of the cemeteries which surpassed anything they had ever suffered at the hands of Lombards, Goths, or Vandals. But after all, the bodies of the saints were saved by this official translation from a far worse violation to which they were already exposed at the hands of private though licensed venders of relics. The names of several of these relic-mongers have been preserved in history. One of the most celebrated was the deacon Deusdona, who seems to have had charge of the cemetery of SS. Pietro e Marcellino, and who took advantage of his position to sell the bodies of the martyrs in Germany. It was chiefly with the northern countries that this commerce was carried on; those who sought relics were no longer satisfied as of old with simple memorials carried from the tombs of the saints, they must have parts, however minute, of their very bodies.

With the oblivion into which all but a few of the cemeteries fell, there grew up the most hopeless confusion even in the

reminiscence of them. The great cemeteries of the *via Appia* and the *via Ardeatina* were popularly identified with the single cemetery which remained accessible, that of S. Sebastian; and in the same way those of the *via Tiburtina* were confused with the cemetery of S. Lawrence (S. Cyriaca). It was this confusion more than anything else which baffled all attempts at their rediscovery, till in our own time the puzzle was unravelled by the genius of Giovanni Battista de Rossi.

III

CHRISTIAN ARCHITECTURE

WHAT has been said in the Introduction (p. 1 *seq.*) about the dependence of Christian upon Classic art is nowhere more pertinent than in the case of Christian architecture. Early Christian architecture has often been accounted an original and significant development of the nascent Christian civilization. The architectural innovations which have been ascribed to the early Church have been reckoned to its credit or to its discredit, according as one was minded to see in them a pregnant seed of subsequent architectural development, or merely an unjustifiable and unintelligent employment of the constituent elements of Greek architecture. As a matter of fact the Church deserves neither praise nor blame on this score; from a technical point of view it was responsible for no architectural innovations; it brought to the world a new conception of religion and a new impulse toward morality, but it brought no new art teaching and no novel architecture. Christian architecture, more than any other province of art, was dependent for its forms and for its methods upon Roman, Greek, and Oriental traditions; and it was regulated in its development by two prime factors which were both of them extraneous to Christianity: by the tendency, early noticeable in Rome, and culminating about the end of the third century, to deal freely with the constituent elements of Greek architecture without reference to their original symbolism; and by the poverty of means which in the decline of the Roman Empire made monumental architecture of the earlier Roman type (vaulted halls of great area) impossible, and prescribed economic methods of construction. We shall see subsequently to what extent the shape, the construction, and the decoration of the Christian house of worship were due to causes within the Church itself;

but such innovation as there was hardly involved any technical development.

To speak at all of development in relation to early church architecture is somewhat paradoxical, for — to judge by existing monuments — it seems as if it had rather been created. This observation is true, at least, of the West and more particularly of the basilica. In the East, or under Eastern influence, there was one marked development, in the construction of the dome upon a polygonal — more especially a quadrangular — base, a development which culminated under the reign of Justinian in the construction of S. Sophia, combining the dome with the oblong quadrangular plan of the basilica. In the case of the so-called Christian basilica, there was no considerable variety within well-defined limits; but only such variety as existed from the beginning. It seems as if the Christian type of basilica sprang at once and fully developed into existence with the Peace of the Church, as a product of Constantine's zeal for church building. Such as it then was in the earliest examples which are either recorded or preserved, such it remained without substantial change for a period much longer than we are here obliged to study in connection with any of the other arts. The same type prevailed throughout the West from the fourth to the eighth century, and in some regions for two centuries longer. So long a period of arrested development it would be hard to parallel except in the history of Egypt or China. This long permanence of the basilica type proves the impotence of artistic invention which prevailed after the decay of the Roman Empire; but it proves also the thorough fitness of this type for the need which it was designed to satisfy. This observation is substantiated by the fact that the principal constituents of the basilica (the nave with aisles, the transept, the projecting sanctuary, and the clearstory) have been incorporated in every subsequent type of church architecture.

The fact is, however, that the admirable appropriateness of the basilica as it first comes to light in the buildings of Constantine, and its substantial uniformity throughout the whole Empire, suggest that it did not come suddenly into existence, as the invention of an emperor or his architect, but that it must have had a long, though unrecorded, development during

the centuries of persecution. What that history was, we can only conjecture, lacking the explicit testimony of early monuments; the following section, however, will present the reasons for believing that the general plan of the basilica was determined by the custom of worship in the private house. But, whatever was the course of development during the age of persecution, it is obvious that it must have been thoroughly within the traditions of Roman architecture, for the erection even of church buildings, previous to the fourth century, must have been commonly in the hands of pagan artisans. Technically speaking, the preparatory development of the Christian basilica is not a part of the history of Christian architecture, but of Roman. We can, therefore, the more readily dispense with a technical study of the architectural elements which enter into the Christian basilica, and all the more because such a treatment would comport neither with the character of this handbook, nor with the space here at command.

The fact that the individual elements which enter into the architectural complex, known as the basilica, were for the most part of Greek origin, only serves to point the contrast between Christian architecture and the Greek, to reveal the gap which exists between, let us say, the Parthenon and S. Paul's. It is the history of Roman architecture which bridges this gap. It may be well to sketch here, in brief terms and with special reference to the points immediately at issue, the course of this development. The effort of Greek architecture was concentrated upon a single task, the construction of the temple. The scheme of the temple was almost invariable. In base, it was rectangular and generally oblong. The Greek cult demanded a single room of no very considerable dimensions for the housing of the image. This room was easily furnished through the roof with light and air; it was adorned in front, or on all sides, by a colonnade. The worshippers and the altar both had their place without, and it was, therefore, on the outside that the architectural decoration was chiefly expended. The architectural scheme which was devised was perfectly suitable for the object in view, and it was suitable for hardly any other. Alexandria began the free application of Greek forms to public buildings of various sorts, and Rome carried on the same process with even greater freedom and

with greater resultant variety. In the construction of their temples, the Romans adhered more or less strictly to the principles of Greek architecture, which was well known in Italy before Roman times. They added, indeed, the round temple with circular colonnade, but even this was in keeping with the Greek principles of construction. For all other uses (in the construction of private or imperial palaces and villas, of public halls of justice, and of public places of amusement, such as baths, theatres, and amphitheatres) the Romans dealt with the Greek forms exclusively in a decorative interest and with little or no heed to the constructive symbolism which the Greeks always rigidly observed. This tendency culminated with the decline of the Western Empire and particularly under the reigns of Diocletian and Constantine; and freedom in the treatment of the elements of Greek architecture was therefore the natural heritage of the Church in the fourth century.

Whatever regret the purist is disposed to feel at this defection from strict architectural principle, and whatever blame he is inclined to mete out to the architects of the late imperial and the early Christian period must be diminished by the reflection that with the Parthenon Greek architecture had already reached its perfection, so that further progress along the same lines was no longer possible; that a more complex civilization demanded an architectural solution for buildings of a very different character; and that the combinations resorted to resulted in forms which were noble in themselves and were pregnant with all the developments which have marked the history of European architecture. Roman architecture developed chiefly by the elaboration of one principle which was unknown to the Greeks, and which had greater architectural worth, or at least greater potentiality for variety of application and for colossal construction, than any principle employed by them, namely, the principle of the arch — including the vault and dome. The development of these elements was the original contribution of Roman architecture, and the further development of the dome — especially its adaptation to a polygonal (most characteristically a quadrilateral) base was the sole contribution of the early Christian period.

The Roman solution of the problem of the dome was inadequate, because it was not capable of universal application; it

demanded the unlimited resources and the colossal engineering of the undivided Empire, and it depended in part upon the unique quality of Roman cement. The Roman vault and dome was moulded upon a temporary wooden support in a concrete of cement and stone; the character of the volcanic sand and stone abundant about Rome (*pozzolana* and *tufa*) made great thickness of concrete consistent with lightness; and the whole mass solidified so thoroughly that it practically constituted a monolith with almost no thrust. In the Byzantine Empire the preparatory support of timber was commonly unavailable, and the material of construction was brick, or in some regions hewn stone. Under the constraint of building both vaults and domes in free space and without support, brick was the material most naturally employed. Various ingenious devices of construction were resorted to, but they need not be enumerated here, inasmuch as they affected but little the appearance of the finished work. It is very necessary to observe, however, that the whole disposition of the building was conditioned by the necessity of providing a nice system of counterbalances to meet the thrust of the dome. The vault had a subordinate importance in early Christian architecture, but it became the essential feature of the Romanesque, and was developed under a new inspiration into the Gothic. The dome, on the other hand, was the most characteristic feature of Byzantine architecture, and the domed basilica represents the crowning and unsurpassed achievement of the early Christian period.

The use of the vault and dome had from the beginning a revolutionary effect upon Classic architecture, inasmuch as it tended necessarily to transfer the architectural emphasis from the outside of the building to the inside. In Christian architecture this tendency was carried to its extreme; the exterior form of the Byzantine domed churches was arbitrary, and it commonly masked the interior disposition of the structure.

The type of building which we are accustomed to associate expressly with the name "basilica," the type which was all but universal in the West, and predominant even in the East, made almost no use of the vault and none at all of the dome (apart from the half dome of the apse); the feature which has been accounted most characteristic of it is to be traced to

the Roman use of the arch. It was the employment of the arch which first made it natural to support a wall upon pillars, or upon an arcade with niched recesses. Characteristic of Roman architecture was the use of the engaged column as a mere ornament upon the face of a pillar. The engaged column played no important part in early Christian architecture, but it became of the highest importance in the development of the Gothic and entered then for the first time into dynamic relation with the building. From the support of the wall by an arcade it is a conceivable step—though it must be owned a long one—to its support by a colonnade. This was a procedure unknown to the Greek, and the step was not taken by the Roman till the third century A.D. The colonnade was originally designed to support only the architrave, or beam, upon which rested the timbers of the roof. In its earliest use for the support of a wall the architrave was retained with arches above it, either visible or disguised, to relieve its centre of weight. In the final stage of the development the architrave disappeared, and the arches rested immediately upon the capitals, or upon broader blocks inserted between. But though the architrave disappeared,—so far as its practical purpose was concerned,—the entablature was retained, being curved to follow the course of the arch. This development has been accounted the chief innovation of early Christian architecture, but it had already been carried out on purely Roman monuments, the best known of which is the palace of Diocletian at Spoleto. This was anything but a solid method of construction, and it is open to criticism from many points of view; but it must not be forgotten that we owe to it some of the most graceful creations of early Christian, Mahometan, and Renaissance architecture.

Although the elements which enter into early Christian architecture have thus to be traced back to Roman precedents, the triumph of Christianity did involve a revolution even in the sphere of architecture, for it again concentrated architectural effort (as in Greece) upon the solution of one chief problem, the church. Palaces and other secular buildings were of small importance in comparison; it was upon church construction that the zeal of the secular powers as well as the religious was chiefly intent. The Christian temple, unlike the Greek, was designed

to house and inspire a congregation gathered within it, not to attract the gaze of worshippers without. It was, if so loose an expression may be allowed, the Greek temple turned outside in.

Although we have to confess that early church architecture owed so little to Christian invention, its claim to be called Christian cannot reasonably be denied. It has often been claimed for Gothic architecture that it is the only type which can properly be called Christian; and this designation is denied to early church architecture on the ground that it is but a reflection, though faint and somewhat confused, of Classic forms. Gothic architecture was unquestionably a most original development of the Germanic spirit under the impulse of Christianity; but, in a strict use of the term, no type of architecture can lay claim to the name "Christian"; Christianity has fundamentally nothing to do with it. The invidious comparison ought not to be raised; it derives its force from the mistaken notion that the scheme of the Christian basilica was literally copied from the Roman judicial basilica, — if indeed the halls of justice were not bodily ceded to the Church. The comparison loses much of its point when it is reflected that even Gothic architecture is derived from the Roman vault construction enlivened by the introduction of the Mahometan pointed arch. The Christian basilica has been consecrated by centuries of Christian worship; it has not been surpassed, perhaps hardly equalled, in point of suitability to the various requirements of the Church's service; and if the origin of its most characteristic features is to be traced back to the private house and to the simple cult of the disciples who gathered there during the age of persecution, no Christian monument is more venerable, none more inseparably associated with the history of the Church.

A. THE BASILICA

The word "basilica" denoted originally anything kingly or lordly. Applied to a building, it suggested especially grandeur of proportion. The civil basilicas which were built by the emperors served not only as halls of justice, but for all the uses — political, commercial, and social — for which we employ our assembly halls, bourses, and market places. The greater

patricians of Rome had their private basilicas for social gatherings and business of state. The term came to have a significance almost as broad as our word "hall." Although many of the basilicas, and particularly the most sumptuous of them, had an oblong rectangular plan, and were divided longitudinally by rows of columns or pillars, this was not true of all, and even buildings which conformed to the general type exhibited a radical divergence in the fact that the middle might be either covered or uncovered. The name, in fact, did not characterize a distinct type of building, nor did it specify any particular employment of it. The choice of this name for the Christian house of worship was doubtless due to its very general and rather colorless use among the Romans; they could employ it in intercourse with the heathen without suspicion, and yet for the faithful it must have had a deeper significance, reminding them of the great King (*βασιλεύς*) whose house it was. The word "basilica" was radically synonymous with *dominicum* (house of the Lord), largely used in the West for the church building, and with the corresponding Greek word *kyriakon*, from which is derived our word "church." The Christian use of the word denoted specifically a house of worship, but it did not specify, any more than did the heathen, a particular type of building. Domed and round churches, as well as the oblong wooden-roofed buildings which we are accustomed to associate exclusively with the name, were anciently called basilicas. For example, Sulpicius Severus relates that Helena erected "basilicas" on the sites of the Lord's Passion, of his Resurrection, and of his Ascension; and yet the Church of the Holy Sepulchre and that upon the Mount of Olives were round structures. That the name came to be expressly associated with one type of church building was altogether natural, inasmuch as this was the original type, a type which was all but universal in the West, which remained predominant even in the East, and became absolutely normal for the church architecture of all subsequent periods. Some modern writers would extend the name "basilica" even to the Romanesque churches, which are similar to the earlier type chiefly in ground plan. It is important to recognize the kinship of these two styles, but for the sake of clearness it is convenient to adhere to the narrower and more

popular use of the name "basilica," limiting it to the early Christian period and excluding all round churches and all domed and vaulted structures.

Expressed in the briefest terms, the characteristics of the basilica are: an oblong rectangular ground plan divided longitudinally into three or five aisles by rows of columns (or pillars) which support a wooden roof, the roof above the middle aisle (the nave) being raised so much above the side aisles that the windows in its supporting walls admit air and light (constituting a clearstory); a half circular presbytery or sanctuary surmounted by a half dome (the apse), projecting beyond the rectangular plan, facing the nave, with which it corresponds in width, and adjoining it either immediately, or with the intervention of a transverse aisle (the transept) of the same height as the nave.

The minor features of the basilica were subject to considerable variation according to the taste of the architect, or to local exigencies and traditions; there were occasional exceptions even to this general scheme, which will have to be noticed in due place; but the fixed elements of the basilical scheme decidedly outweigh the variable, and the uniformity of the basilica throughout the whole Empire is one of the first and most significant facts which confront us in this study.

The origin of this type of building has of late years been the subject of much study and of much controversy; as a consequence, it is now possible to give, at least in general terms, an account which will do justice to the various considerations which have divided opinion. The minds of scholars were once satisfied with a very easy solution which referred it to the invention of one of the architects of the Emperor Constantine. This notion was based at least upon the just observation that the Christian basilica, as it first appears in the extensive building operations of Constantine, appears at once in perfect completeness, neither needing nor receiving any architectural improvement in the whole course of the four centuries which followed. But this fact is rather a proof that the whole of its development lay before Constantine, so that when the Church emerged from persecution into the light of imperial favor the tentative stages were already passed, the type of

building suited to its needs was already worked out and already fixed. Creations so stable do not spring all at once into existence; this view, which must be emphatically rejected, is only less absurd than the opinion, current only fifty years ago, which ascribed the Cologne Cathedral, and the origin of Gothic architecture in general, to the invention of some unknown architect dwelling at Cologne.

Another view, which till recently was the dominant one, ignores the peculiarity of the Christian building and considers it merely a copy of the civil basilica. The theory is that with the triumph of the Church a great number of the civil basilicas were turned over to Christian use and thus established a traditional type of church architecture. In point of fact there is no record of any civil basilica being made over to the Church, and such an alienation of public property is on the face of it far from probable if one reflects that they were needed for the purposes of civil and social life after the triumph of the Church just as much as they were before. It need hardly be said that it is the identity of name which suggests this opinion, and the account which has just been given of the pagan and Christian use of the name "basilica" suffices to show how little force there is in the suggestion. The theory is especially weak in that it ignores the diversity of the civil basilicas, and takes too little account of the most striking characteristic of the Christian type, namely, its uniformity. Even if all the elements which enter into the Christian basilica are to be found here and there in the civil, it still remains to be explained when and how the Church selected and combined the forms which peculiarly suited her use and fixed them in an unalterable tradition.

This is not to say that there is no instruction to be got from the comparison of the Christian with the pagan basilica; there was, as a matter of course, great similarity between buildings which originated under the same architectural influences and which were alike designed as halls of assembly. Whatever account one may give of the origin of the type of building which became fixed as the normal scheme of the Christian house of worship, it cannot be supposed that the Christians ignored the solutions which Roman architecture furnished for problems which were substantially the same as their own.

It is sufficient to acknowledge thus in a general way a certain dependence of the Christian basilica upon the pagan; the attempt to carry out a detailed comparison is at any rate rendered futile by the defectiveness of our knowledge of the civil basilica. We know well only the greater basilicas of Rome, and we know even them hardly well enough to determine with confidence the method of roofing and lighting, — a crucial point when it is a question of comparison with the Christian type. There is at least one feature of the Christian basilica which, so far as we know, is without example in the civil, that is, the transept. The transept, it is true, was only an occasional feature of the basilica, but it has a characteristic significance because it is specially prominent in the earliest buildings and in the greatest; as, for instance, S. Peter's, S. Paul's, and S. Maria Maggiore. It has further to be noted that, even in the case of features which were more or less frequent in the civil basilica but invariable in the Christian (as the aisles and the apsidal extension), we are prompted to seek elsewhere for the conditions of development.

From whatever point we start, we come back to the necessity of seeking the conclusive stages of the development of the Christian basilica *before* the Peace of the Church. It is the traditional misconception of the condition of the Church during the first three centuries which explains the prevalent indisposition to seek the origin of the basilica within that period. The idea that throughout all of this period Christians were a prey to almost unceasing persecutions, that they were under the necessity of concealing the existence of their religion, or at least their adherence to it, effectually excludes the notion that they could then have been engaged in developing the main lines of the church building, or, indeed, that they could have had any church buildings in the strict sense of the word. The account which has already been given in connection with the catacombs (p. 53 *seq.*) of the corporate property of the Church during the ages of persecution, and in particular of the possession of numerous church edifices which were publicly known and officially recognized as such, puts another light upon the situation and not only leaves room for the supposition of such development as is here in question, but positively demands it.

It must be confessed that the fact of a long preparatory history of church architecture is far more soundly assured than any of the particular theories which pretend to trace it in detail. It is probable that there are extant no church edifices earlier than the reign of Constantine; the last and greatest of the persecutions sufficiently accounts for their disappearance. In the lack of monumental evidence we are relegated to conjecture. Of the early subterranean chapels of the catacombs the most we can say is that they seem to point to a gradual development of the church edifice along lines which lead directly to the form which appears in the fourth century; but they give us no information about its origin.

There may be mentioned by way of example—and chiefly because from a German source it has been popularized in English—the theory which would derive the basilica from the school building (*schola*). This theory has hardly anything in its favor except the suggestion of S. Paul's example at Ephesus: "disputing daily in the school of one Tyrannus."¹ It is not unlikely that this precedent was frequently repeated, but only as one of a variety of expedients to find a place for Christian assembly. This theory breaks down utterly in view of the fact that, little as we know of the ancient *schola*, it seems to be probable that it did not conform to any settled type and in no case very greatly resembled the basilica. A common, and obviously a very convenient, disposition for the schoolroom was an oblong rectangular plan with an apse or exedra at the end; but it had no division into aisles by a colonnade, and had consequently no clearstory; the basilica, on the other hand, was never without them.

Certainly the most attractive theory of the development of the basilica which could be advanced is that which refers its origin to the private house, and the Apostolic custom of gathering there for worship. Whereas in the Holy Scriptures there is but once reference made to the use of a school as a hall for preaching, there is very frequent reference to worship—in particular to the celebration of the Lord's Supper—in the private house, and it is evident that even in the apostolic age certain houses were distinguished as the habitual resort of the Church.² We have every reason to believe that the Lord's

¹ Acts xix. 9.

² Rom. xvi. 3-5.

Supper was, during the Apostolic age, and indeed through the first quarter of the second century, celebrated invariably in a private house. This was altogether natural in the case of a sacrament which was in its institution — still more obviously in its prototype, the Passover — a household meal, and represented the Church in terms of the family.

That the dwelling-house was the regular place for the celebration of the Eucharist throughout the first stadium of the development of the Eucharistic cultus is especially important in this connection, because the practices and ritual which centred in the Eucharist have always been one of the chief factors regulative of church architecture, and nowhere more obviously than in the case of the basilica. We gather from Justin Martyr's account of the celebration of the Eucharist that, by the middle of the second century, it had been separated from the agape and united with the ordinary morning service of exhortation and prayer. There is no reason to suppose that it ceased to be celebrated in the private house, but Justin's account seems to presume that a house which was used every Sunday for an assembly of the Christians of the whole town, and of the outlying districts, — if not for daily service, — must have been set apart exclusively to the use of the Church. From this time on we meet with the expressions *domus dei*, *domus columbæ*, or simply *ecclesia*, used by Christian authors in such a way as leaves no doubt that they refer to houses consecrated exclusively to Christian worship.

The extension to the Church of the Roman institution of patronage (see p. 54 *seq.*), which was so highly important for the history of the catacombs, was presumably of no less importance for the history of the house of worship. It enables us to realize the relation of the wealthy disciple to the brethren whom he accommodated in his dwelling, and to understand the status of the property when it was relinquished to the exclusive use of the Church.

A congregation which was accustomed to worship in the chief room of a dwelling-house would be prompted to make but few changes when the property was put exclusively at their disposition, and even in the construction of a new building they would be likely to adhere to the familiar plan. We may suppose that the earliest churches were either actually

dwelling-houses which had been adapted and perhaps enlarged for Christian worship, or new buildings which preserved both without and within substantially the appearance of the private house. The forms of Christian worship—particularly in the celebration of the Eucharist—were developed in the private house, and they were not easily to be divorced from the architectural arrangement to which they had there been accommodated. If we must recognize that the scheme of the basilica was prescribed by the necessities of the Christian cultus, we must recognize that the cultus was in turn determined in part by the arrangement of the private house.

It is probable that the state of affairs just now sketched broadly characterized the Church as late as the beginning of the third century. So far we may reasonably claim to be on historic ground; conjecture begins when we seek to bridge the gap between the third and the fourth centuries. To state the case briefly, at the end of the first century—probably at the end of the second—we leave the Christians worshipping in the private house; early in the fourth we find them in the fully developed basilica. There is here a strong presumption that the peculiarities of the latter house of worship are to be traced to the former; that is to say, that the basilica is the product of a continuous development out of the data furnished by the Roman dwelling-house, under the concurrent influence of various types of public architecture. The disparity in point of size between the great basilicas and the ordinary dwelling-house must not be allowed to weigh against this presumption, for the scheme of the basilica was singularly independent of size, and remained the same for very small buildings as for very great. It may seem at first sight as though the disparity were equally marked in point of architectural arrangement; but as a matter of fact, there are numerous and very striking analogies between the basilica and the atrium of the Roman house. It is important to notice that the points of comparison which may be instituted do not, either singly or altogether, constitute a proof of an actual relation between the basilica and the house; but they do constitute a highly interesting corroboration of the presumption which is here posited, and it is strictly in this light they must be estimated. The presumption that the basilica is in some way or another a devel-

opment from the dwelling-house is far stronger than the proof of any particular theory designed to trace this development along specific lines. This derivation of the basilica has been for some time the dominant theory in Germany, and it has rapidly come into favor elsewhere. The general proposition is not to be prejudiced by the discrepancy of the theories which refer now to this and now to that special part of the dwelling as the seed of the basilica, nor by the instability of certain overelaborate efforts to trace the derivation and development in detail.

The first application of this theory was still fettered by the accident of the name, and sought the origin of the Christian basilica in the basilicas which, according to Vitruvius,¹ were attached to the palaces of the greater nobility, especially of those who held a public magistracy, "because both public councils and private judgments and decisions had often to take place in their houses." With the possible exception of the house but just now brought to light under the church of S. Cæcilia in Trastevere, the whole extent of Roman excavations fails to reveal a single instance of such private basilicas as an adjunct of any but imperial palaces. It does not appear from Vitruvius's account that it was an invariable feature even of the greater houses, still less that it was characterized by any uniform style of architecture. It was precisely in respect to palace and villa architecture that there was allowed the greatest liberty of invention; the one point, however, which most broadly characterized it was the fact that it was vaulted architecture,—it stood, therefore, in the greatest conceivable contrast to the Christian basilica. Besides, the presumption which we have raised in favor of the derivation of the basilica from the private house of wealthy disciples by no means extends to the palaces of the greater aristocracy. It is not conceivable that any considerable number of such houses could have been put at the disposition of the Church during the centuries of persecution.

It is the ordinary dwelling of the well-to-do citizen, the typical Roman house, to which we must look as the customary place of assembly for the early Church; it is only to such an house we can hope to trace the history of the basilica. One of

¹ *De Architectura*, VI. 8.

the principal factors to be explained is the uniformity of the church edifice throughout the Empire. This is not so much a reflection of the corporate unity of the Church — for schismatical bodies clung to the same type of church edifice — as it is an evidence of a common origin in the dwelling-house, and of the uniformity of the better class of dwelling-houses in all the chief centres of Roman influence. It is not necessary to speak of the Syrian or the Egyptian house, or of other national peculiarities; it is enough for our purpose that either the Greek or the Roman type of dwelling, or a combination of the two, was common throughout the Empire. The large “upper room,” which is frequently mentioned in the New Testament as the place of meeting of the Church, was a peculiarity of Syrian house architecture, and it has no relation to either the Greek or Roman house.

In the Greek or Roman house there was respectively but one room — the peristyle or the atrium — which could have served for Christian assemblies. The Greek peristyle (Fig. 25, *a*) was an open court surrounded on three sides by a covered colonnade about which the various rooms for public or private use were irregularly disposed. Opposite the doorway, and opening in full width upon the court, was a large covered room — the *prostas* — which was marked by the presence of the altar and hearth as the place of chief dignity and as the centre of the family life. The atrium of the early Italian house (*atrium testudinatum*) was very different: it also was a large rectangular room surrounded by small sleeping-chambers and work-rooms; but it was covered, together with the rest of the house, by a single gable roof. It had its *tablinum*, precisely corresponding to the Greek *prostas*, but it had also a peculiarity in two similar rooms — the *alæ* — which flanked the *tablinum* and opened at right angles to it, with their full width upon the atrium, and extended in depth to the outer walls of the house. This was originally a device for giving light to the women who worked about the hearth in the depth of the atrium, which was but poorly lighted by the door, and especially so when the front of the house was occupied by shops. This device was effective only in the case of an isolated house; when the towns became crowded and the houses immediately adjoined one another, the windows could no longer be introduced in the *alæ*, and light

and air had to be introduced by giving up the gabled roof and sloping it downward from all sides toward the atrium (*atrium tuscanicum*, Fig. 25, *b*), till it ended with a rectangular opening above a great water basin (the *compluvium*). The *alæ*, however, had become so incorporated with family customs—they were in particular the place for the portraits of the family ancestors—that they remained an established constituent of the Roman house. This is of especial interest because it alone seems to explain the transept of the Christian basilica, and to explain also why this feature appears only in Rome, or in lands directly under Roman influence.

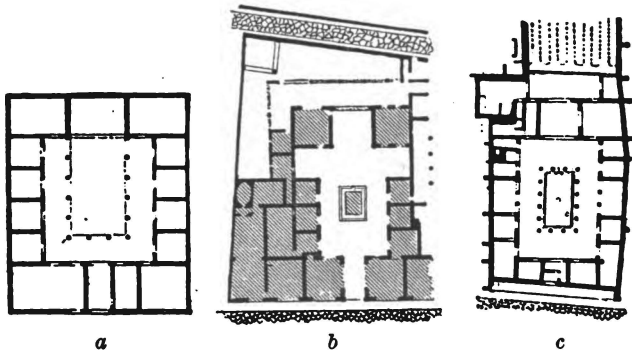

FIG. 25. — Plans of Greek and Roman houses.

a, Greek house: peristyle and prosta. *b*, Roman house: atrium, *alæ*, and tablinum.
c, Roman house: peristyle—atrium.

The old type of Roman house was with the beginning of the Empire relegated exclusively to the country; with it we have nothing to do, since the propagation of the Christian faith was confined almost exclusively to the great cities. We have here to do especially with the atrium as it was embellished through the influence of the Greek peristyle. The rich required a larger house, and this was effected in either of two ways: by extending it in depth by the addition of a peristyle; or by transforming the atrium in imitation of the peristyle. The simplest improvement of the atrium was effected by supporting the roof by four columns at the corners of the impluvium; a more elegant device was that of surrounding the impluvium with a

colonnade on three or four sides. The latter arrangement permitted the enlargement of the central open space to any extent that might be desired, and the consequent multiplication of the surrounding rooms. It is especially this type of house to which we must refer the origin of the basilica. In the example here given of it (Fig. 25, c) the *alæ* are transposed from their proper place, evidently on account of the exigencies of rebuilding in a restricted space. The syncretism of the Empire made this transformation very natural and very common in all large towns. There is therefore very little substantial difference between the theory of Victor Schultze, who derives the basilica from the peristyle, and that of Dehio, who derives it from the atrium; the peristyle was in the East the only room available for Christian gatherings; in the West the atrium transformed into a peristyle was the most natural choice.

It only remains to point out some of the more striking analogies between the basilica and the chief room of the dwelling-house. The *tablinum* was, obviously, the place which would be occupied by the presiding officers of the Church; by very ancient tradition it was marked as the room not only of social honor, but of a certain religious reverence. It cannot appear strange that in the basilica this room assumed an apsidal form, since this was a motive so exceedingly common in all Roman architecture of a monumental character. Between the *tablinum* and the open part of the atrium stood an ornamental stone table, the only reminder of the sacred hearth. It is a very striking fact that this is precisely the position of the holy table in the basilica; when we take into account the similarity of many of these tables with the most ancient altars (see Fig. 54), we can hardly fail to admit a close relation between them. A peculiarity connected with early Christian worship — one which had a great effect upon the architecture, inasmuch as it exacted a strict adherence to the three-aisle scheme — was the location of the faithful in the side aisles and transept, rather than in the nave, which was more commodious, better provided with light, and distinctly more convenient both for seeing and hearing. Strange as this custom is, it seems to have its explanation in the fact that the nave corresponds to the open court of the atrium, which was unprotected from the weather and, therefore, constituted the least desirable room. The choir was

naturally grouped in front of the altar; when the whole room came to be roofed their place was extended well down the nave, the rest of which was occupied by the catechumens.

We must suppose that in adapting the atrium to the use of a church one of the first cares of the Christians would be to roof it completely. Allowing for a provision of light and air—the house, it must be remembered, was enclosed on both sides by contiguous buildings—this could be accomplished substantially in but one way: by raising a roof above the central aisle (the open court) high enough to admit light from the sides, necessarily changing at the same time the slope of the side roofs. This, which is the well-known and invariable solution of the basilicas for lighting and ventilation, may perhaps have been already foreshadowed by its occasional use for the protection of the private house against the cold; at all events, it was a device sufficiently frequent in Roman architecture, and was probably resorted to in the case of some of the civil basilicas.

The proportional lengthening of the plan in the development of the basilica was due to the obvious conditions of this type of structure: it might be extended to any desired length without change of scheme, while very great extension in breadth required an additional pair of colonnades. Purely artistic considerations—the desire for horizontal lines of perspective converging at the altar—worked as obviously in the same direction. The omission of the colonnades on the short sides of the basilica is one of the points which is not explained by the architecture of the private house. It is to be remarked, however, that in the peristyle there was usually no row of columns in front of the *prostas*, and that in the atrium of similar form the same rule was frequently followed. Finally, in the light brick construction of the Christian basilica, which was so sharply in contrast to Roman usage in the construction of public buildings, in the almost total absence of architectural decoration on the exterior, and in the frequent lack of windows in the side walls, it is not unreasonable to see a reminiscence of its origin in the private house.

Hitherto our attention has been directed chiefly to the early preparatory history of the basilica; we have now to study it in its complete development, as it appears immediately after

the Peace of the Church in the buildings of Constantine, and as it remained till after the eighth century. Though we have traced the general scheme of the basilica to an origin far back in the age of persecution, it is not to be denied that the triumph of the Church and the reign of Constantine did constitute an epoch, and the most critical epoch, in its history. We can hardly call it a turning-point, because the line of development was not substantially deflected; but it is unquestionable that up to that time the church edifice must have been very modest both in point of size and of decoration, and that it

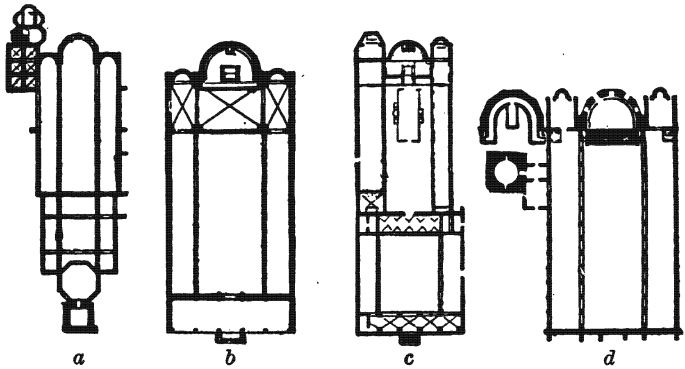

FIG. 26. — Plans

a, Cathedral of Porenzo. *b*, S. Pietro in Vincelli, Rome. *c*, S. Clemente, Rome.
d, S. Apollinare in Classe.

assumed then, for the first time, monumental proportions and a lavish wealth of decoration which enabled it to vie with the temples of the Classical religion, which was still entrenched in popular custom, and to attract and hold minds which were unaffected by the deeper influences of Christianity. In this final stage of its development the basilica naturally drew upon all forms of Roman architecture and art which were compatible with its general scheme.

Christian dependence upon Classical forms of architecture was rendered more direct in certain details by the frequent employment of fragments of disused buildings, — particularly columns, capitals, architraves, and cornices. The adaptation to a church use of pagan temples, or even civil buildings, was

very seldom resorted to; but the pillage of disused buildings—a piece of vandalism which was begun by the Romans themselves—was very common after the fourth century and was carried on with immeasurable and increasing destruction throughout the Middle Ages. Rome was, of course, the richest field for such pillage, and the object of it was chiefly the great store of marble which was there accumulated. The early Christian period was advantageously distinguished by the fact

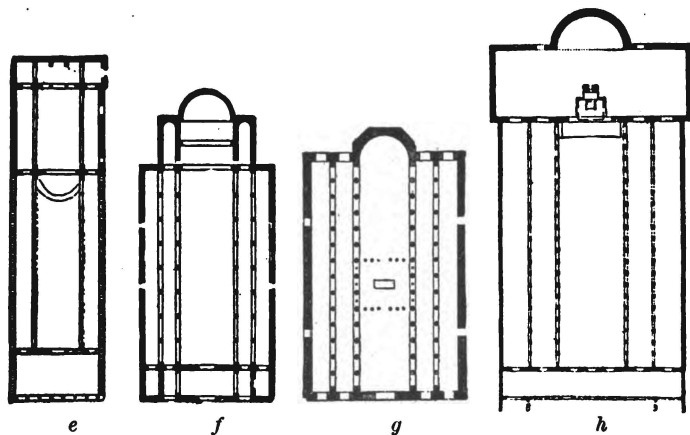

of Basilicas.

e, S. Lorenzo, Rome.

f, Basilica, in Suweda, Syria.
h, S. Paul's, Rome.

g, Basilica Ursiana, Ravenna.

that it could appreciate the productions of Classic art and use them in their original form, while in a later age they were regarded simply as a quarry for rough materials.

The popular notion which ascribes to the early Church the wanton destruction of ancient monuments out of a radical opposition to art and a hatred of everything connected with the pagan religion, is very far from being justified. As a matter of fact the temples were most of them in use in Rome long after the recognition of Christianity as the religion of the Empire, and when they were finally closed they were long kept in repair at the expense of the Christian state as the chief glory of the city.

Almost all the individual forms which entered into the basil-

ica were Classical, and although taken as a whole the basilica violated the principles of classical construction by ignoring the proper constructive symbolism of each part, it is nevertheless true that one of its most important formative principles—the horizontal perspective formed by parallel colonnades—was thoroughly Classical in spirit. This principle was brought to more forceful expression in Christian architecture because it was brought into relation with a ruling religious idea. Church architecture is necessarily internal architecture; the idea which has most fundamentally inspired it is the communion of saints—the Christian temple is the house of the congregation. This communion was concretely represented by the altar, which by ancient tradition was fixed between the clergy

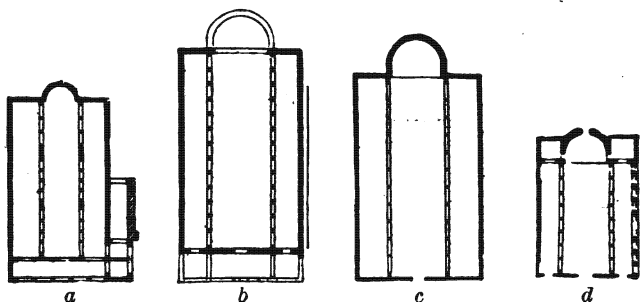
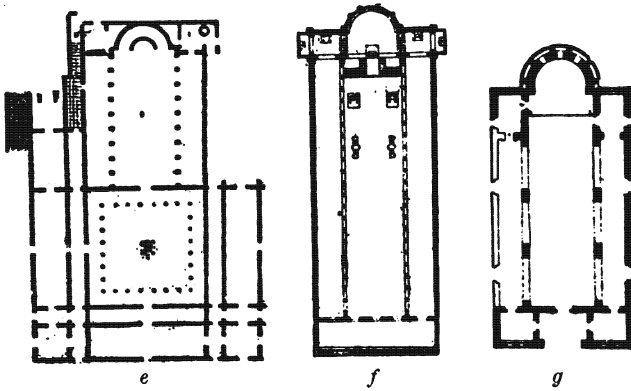

FIG. 27. — Plans

a, S. Maria in Cosmedin, Rome. *b*, S. Apollinare Nuovo, Ravenna. *c*, S. Agata, Ravenna. *d*, S. Spirito, Ravenna.

and the people,—that is, close to one end of the basilica and on the middle axis, so that toward it the horizontal lines which were emphasized by the long parallel colonnades seemed to converge. In Gothic architecture this motive was modified but not lost. There is certainly a difference to be observed in this respect between the Gothic cathedral and the early basilica, but not so blunt a contrast as is commonly drawn; for even in the Gothic the perpendicular lines, strongly as they are marked, remain subordinate to the horizontal. In the round churches, and in domed churches of every description, there was a very different architectural principle at work; for there the principal axis was central and vertical. It seems hardly just to say

that the Christian cult *could* not accommodate itself to this type of church by transferring the liturgical centre to the principal axis of the building — that is, by placing the altar in the middle of the room. But it certainly did not do so; and as long as the altar was kept near the periphery of the building there was a discord between the perpendicular axis of the architecture and the horizontal liturgical axis. We see from this why it is that the scheme of the basilica has remained a normal and regulative factor in church architecture, and why it must remain so just so long as the altar retains its traditional position in the



of Basilicas.

e, Xenodochium of Pammachius, Porto. f, S. Maria Maggiore, Rome. g, Basilica in Kalb-Luseh, Syria.

building, and the Eucharist its same high dignity in the Church. The most successful solution of domed architecture as applied to the church adapted itself to this exigency by adopting substantially the ground plan of the basilica.

In plan, the basilica was marked by two principal divisions: the great rectangular hall, which was the room of the laity, and the apse, which was the place of the clergy. To this must be added a vestibule, which in the East appears as a definite architectural feature of the building (the *narthex*), while the same purpose was served in the West by the adjoining portico of the atrium (see p. 178). The vestibule was the place for

the penitents, of whom, as is well known, there were many grades. There were many grades and kinds also within the church, each to be distinguished from the other, if not actually divided. The catechumens, I suppose, were usually admitted to the rear of the nave; the faithful occupied the side aisles, the men on the right side of the entrance and the women on the left; those who were held in chief honor in the congregation, as the widows and virgins, and those who on account of their age or social position were entitled to peculiar regard, had their place in the forward end of the aisles or in the transept; the different orders of the clergy were in turn distinguished among themselves, the bishop had his seat in the middle of the apsidal circle, the presbyters were seated on either side of him and at a lower level, the deacons stood near the altar, and the inferior clergy had their place with the choir in the nave. All of these minor divisions were not marked architecturally, but generally only by chancels (p. 168) or curtains (p. 377), yet even by this the effect of architectural unity must have been seriously marred. Architecturally, even the three principal divisions—between the clergy and the laity and the unbaptized or excommunicate—were not distinctly enough marked, or rather the spaces which they marked off became in time inadequate for the several classes for which they were designed, so that both a part of the clergy and a part of the unbaptized encroached upon the nave.

Fundamentally the basilica constituted a single room in which priests and people gathered in common worship about the common altar. According to a strict application of church symbolism the unbaptized were not to be admitted within this room; a place was provided for them without the doors in the atrium or in the narthex, an exception being made, however, in favor of the catechumens. The atrium was a square open court surrounded by a portico (Figs. 26, *a* and *c*, 27 *e*, 29, 30). With the fifth century it became infrequent, particularly in the East; but even in case it was removed, the portico adjoining the church was generally retained, or in rebuilding it was imitated, till late in the Middle Ages (Figs. 26, *b* and *e*, 27, *a*). In the East this narrow vestibule was architecturally incorporated with the church (Figs. 26, *f*, 27, *g*, 31, 52), and was called the narthex. The narthex, when attached to round or polygonal buildings (churches,

baptisteries, or mausoleums), terminated at each end in an apse (Figs. 44, *d*, *e*, and 49). In Syria, where the atrium had never been in use to hinder the effect of the façade, the narthex received an architectural solution (Fig. 32) which had a marked influence — through the Crusades — upon the mediæval church façade in Europe. The vestibule opened into the church by at least as many doors as there were aisles. We must suppose that of the penitents only the “wailers” were kept here, for the “hearers” could have heard the lections and the sermon only in case they were admitted within the church.

The great body of the church, the room of the congregation, was divided by colonnades into aisles, which were always odd in number (three or five), as the colonnades were of course

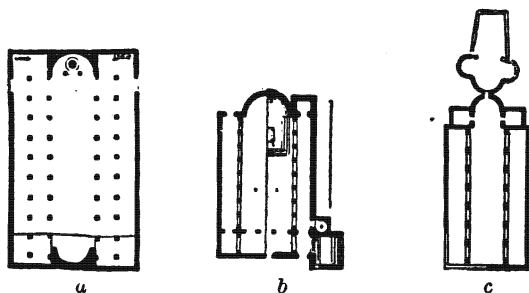

FIG. 28. — Plans of Basilicas.

a, Basilica of S. Reparatus, Orléansville, Africa. *b*, S. Agnese, Rome. *c*, S. Sinfiorosa near Rome.

even. The width of each of the side aisles was about half that of the middle. The five-aisle system was rare, and was only adapted to the greater basilicas; even in this case the united width of the two side aisles remained below that of the middle. The width of the aisles was determined by technical considerations, depending especially upon the strength of the roof beams. The height of the basilica was insignificant in proportion to its breadth; the predominance of the horizontal lines was thus thoroughly preserved. The total width of the basilica very much exceeded its height; but of more importance for the interior effect was the fact that the height of each aisle (including the nave) surpassed its breadth only by a

small fraction — $\frac{1}{8}$ to $\frac{2}{7}$. The height also was conditioned by technical considerations, namely, by the strength of the colonnades which supported the walls. Thin and light as the brick walls were, they had but an unstable support in the columns, which were the characteristic and almost invariable feature of the basilica.

This departure from Roman tradition — the adoption of the column instead of the pillar as a wall support — we have traced to its origin in the Roman house; and it is not difficult to detect the influences which conduced to its perpetuation. In the first place it effected a sufficient division of the room without too much marring its unity or interfering with the transmission of sight and sound; another consideration was the artistic delight which was felt in the form and material; while by no means least was the ease with which columns and capitals could be procured from ruined buildings. For the Constantinian basilicas the columns were expressly made; but later it became common to use old columns, and those of different orders and of different lengths were sometimes united in the same colonnade. The columns — except those which were taken from ancient monuments — were rarely channelled; the skill to make them was doubtless lacking, but there entered also into consideration the effect of the rich glass mosaics which covered the walls, for nothing harmonized so well with this as the tone of the smooth polished marble and its broad reflection of the light.

The mosaic decoration had its effect also upon the capitals: beautiful Classical capitals were sometimes employed in the basilicas and even made expressly for them; but the rich golds and purples of the mosaics with their glints of reflected light rendered somewhat vague and ineffective their sharp outlines, and the tendency which culminated in the Byzantine capital was toward a simple treatment in low relief, without detail, or an intricate surface design deeply perforated so as to present a broad effect of light and shade. A general change in the shape of the capital was due to the disuse of the architrave and the substitution of the arch (archivolt) resting directly upon the capital. The corners of the Greek capitals were ill-fitted to support this sort of pressure; the Byzantine capital assumed generally a very simple and solid shape, it was square

at the top and tapered conically to meet the circular head of the column. It presented therefore four smooth surfaces for the low relief decoration which was the only type of stone carving then practised. When the wall was constructed of stone the two arches which sprang from the capital demanded a broader base, and in this case the capital had to be oblong with bracket-like extensions on either side. One of the peculiarities of Byzantine architecture, and one which was strictly limited to it, grew out of this same necessity; it consisted in interposing a sort of second capital as the immediate support of the arch, a nearly cubical block of stone which was tapered slightly at the bottom. This received a decoration similar to that of the capital, though generally less elaborate (see Fig. 45).

The architrave fell more and more into disuse after the fourth century; it lingered longest in places like Rome, where the people were accustomed to the lines of Classic architecture, and where, it may be added, this member might be taken ready made from disused buildings. In S. Peter's, which was a basilica of five aisles, the central colonnades were surmounted by the architrave, the second rows

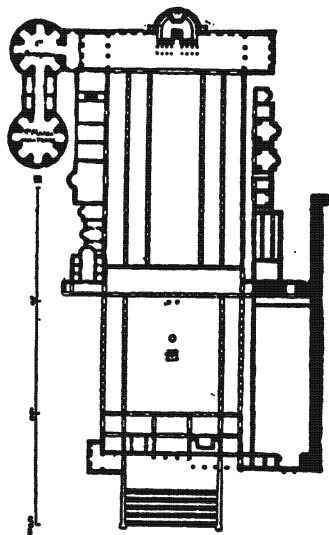

FIG. 2). — Plan of old St. Peter's.

by the archivolt; but it is doubtful if this arrangement dates from the original construction. The architrave was used in S. Maria Maggiore; the archivolt, in S. Paul's. The architraves in S. Lorenzo outside of Rome are taken from an ancient monument. Even after its general disuse as the support of a wall, the architrave continued in general use for a variety of purposes, and especially to bind together a row of columns (*cf.* Figs. 36, 38).

The substitution of the archivolt in this connection did not comport thoroughly with the horizontal principle of this archi-

ecture; but as the columns were very close together the arches were insignificant, and at any rate the horizontal line was strongly maintained by a cornice, if not also by a frieze. The panels of mosaic, or fresco (Fig. 38), or still more signally the procession of saints such as decorates the wall of S. Apollinare Nuovo at Ravenna (Fig. 37), conduced to the same effect. Structurally there was not much to choose between these two types, for if the architrave proved a poor support for the wall, the thrust of the arches tended to dislocate the columns. The arch had this advantage, however, that it permitted a greater

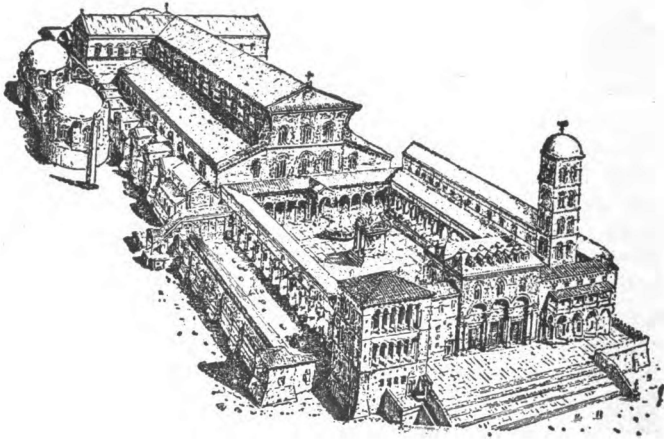

FIG. 30. — The old basilica of S. Peter's, Rome.

interval between the columns, and consequently a freer prospect from the aisles. This, as time went on, became of ever greater importance, for ancient columns became rare and new ones more difficult to make.

As a rule the interval between the columns was small in the beginning and greater in the later period; it is specially great in the churches of Ravenna. This was carried no farther, however, than the limits prescribed by the dimensions of the Classical shaft. Further progress toward the unification of the room of the congregation was possible only by the use of the pillar, which, affording a more solid base, permitted the construction of a broader arch.

In the early Christian period the pillar was seldom substituted for the column except in Central Syria. Its use in Syria was due in part to the lack of ancient columns to draw upon, but still more to the fact that, no wood being available, the construction was exclusively of stone, and consequently too heavy to be supported upon columns of Classical proportions. In one type of Syrian church three broad arches on either side of the nave replaced the colonnade (Fig. 34). In one section of the country, where wood was so scarce that even the roof had to be made of stone, the pillars of the nave served as support for great transverse arches which spanned each of the three aisles at such close intervals that plates of stone could be laid across from one to another to form the roof.

Even in Syria, however, most of the churches conformed to the common type. Elsewhere pillars were sparingly used, and with evident disdain. The only basilicas in the West which

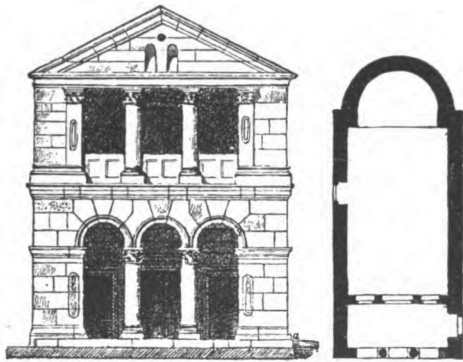

FIG. 81. — Church of Pabuda, Syria.

are known to have been built with pillars are the basilica at Orléansville (Fig. 28, *a*), S. Sinfiorosa (Fig. 28, *c*), the basilica attached to the Xenodochium at Porto (Fig. 27, *e*) and the older basilica of S. Felix at Nola for which S. Paulinus substituted one with columns.¹ They sometimes appear interchangeably with the columns of the nave (Fig. 38), evidently to insure greater stability; in some cases at least they are the result of rebuilding. In the case of a transept, pillars were always used to support the arch which divided it from the nave. In the later development of dome architecture pillars became the chief structural support, while the column retained hardly more than a decorative importance. In the basilicas the height of the

¹ *Poem 28* : v. 200 : *nam steterant vasto deformibus agmine pilis.*

architrave (or archivolt) varied from about $\frac{4}{10}$ to $\frac{5}{10}$ of the total height of the clearstory wall.

A peculiarity of the East was the construction of galleries over the side aisles and opening upon the nave; the walls above them were in turn supported by lower arcades. This was apparently a common feature of the civil basilicas, but in the West at least it was not originally employed in the Christian. Even in the East it was probably not used in the beginning;

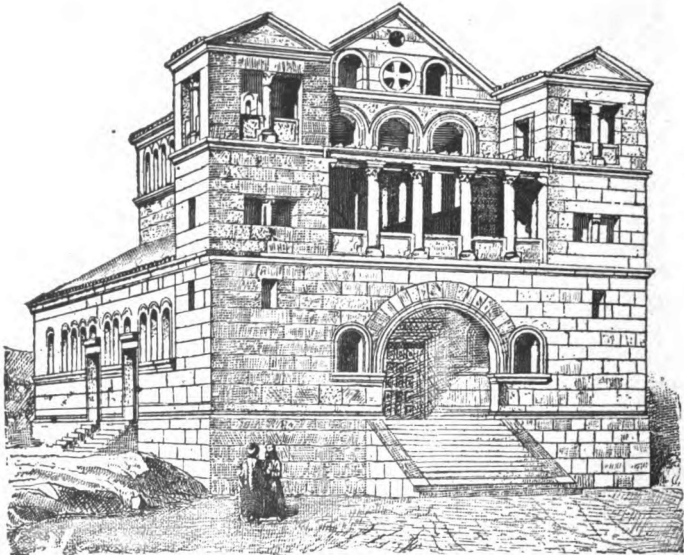

FIG. 32. — Basilica in Turmanin, Syria (restoration of façade).

at all events the Syrian and Palestinian churches almost without exception have but one story. Elsewhere, however, the two-story scheme became the rule in the course of the sixth century, — especially in domed structures, where it was more in keeping with the architectural lines of the building (Fig. 46). As employed in the basilica it had a tendency to raise the line of vision above the altar. The basilicas of Ravenna were in this respect uninfluenced by Byzantine custom; only the polygonal church of S. Vitale was constructed with galleries. The

galleries which appear in Roman basilicas (S. Lorenzo, S. Agnese, S. Cecilia, and SS. Nereo ed Achilleo) belong to the period (sixth to ninth centuries) during which Rome was subject to Byzantine influence. The galleries were apportioned to the women, and it seems probable that the stricter separation of the sexes in the East was the chief reason for their employment.

Even in case a basilica was provided with galleries, the clear-story walls rose still above them (with rare exceptions, which were probably due to reconstruction), for the direct admission of light to the nave. As a general rule, the windows corresponded to the intercolumniations of the colonnade. They became, therefore, less frequent as in the course of time the intercolumniations were made greater; but in any case they were much more frequent than the taste of a later age demanded, for it became the custom in the Middle Ages to wall up every alternate window. The same intervals were observed in the clearstory walls of the transept. There were generally three windows in the façade, — or a double row of three, — and the same *under* the gables of the transept. *In* the gables there were commonly no windows, because of the flat ceiling of the basilica. In Syria the window aperture was often rectangular; but even there it was more commonly closed above by an arch, and this was the almost invariable custom elsewhere. In case windows were introduced in the walls of the aisles, they were placed at much rarer intervals. It is remarked as a point of contrast between the basilicas of Rome and of Ravenna, that the former — at least the more notable of them — had no windows in the side walls, as had the latter. The Roman basilicas were also without windows in the apse, while elsewhere, especially in later constructions, they were usual, generally to the number of three. This is probably to be connected with the fact that the earliest and greatest basilicas of Rome, which served as patterns for the rest, had the apse directed toward the west, while later custom prescribed an easterly direction (see p. 176).

Small window openings were sometimes closed only by shutters, as a protection against cold or rain. Ancient stone shutters, moving upon hinges, are still preserved in Central Syria. But in general the windows were closed by a latticework of metal, or by thin plates of stone — often translucent marble or ala-

baster — which were closely perforated with small apertures composing a more or less ornamental pattern (Figs. 42, 153). A window at Grado, which is here illustrated, exemplifies a method of making such plates at small expense, for, though apparently of stone, it is actually of cement, and was formed in a mould. The small apertures in the window plates were sometimes filled with glass, clear or colored; or with some translucent stone, as in the case of the early windows of S. Lorenzo, which are incorporated with the mosaic of the triumphal arch (Fig. 130); but they were usually left open, allowing ingress to air as well as light. The smallness of the aper-



FIG. 33. — Basilica in Turmanin, Syria.

tures sufficed to protect the interior from rain, and they divided the broad shafts of light into scattered beams, which were particularly favorable for the effect of the mosaics.

The basilicas were very clearly lighted in comparison to most of the Gothic churches; the obstruction to the light which was offered by the stone window plates was compensated by the frequency of the windows, and still more by the reflection on all sides, from the polished surfaces of marble and from the bright glass mosaic, which at once increased and softened the light of the building. The cathedral of Monreale near Palermo, though a late mediæval building, gives a more perfect notion than does any other monument of the effect of early Christian decoration in marble and mosaic. In this

church one cannot but recognize that the effect would be enhanced if, for the broad windows of clear glass, there were substituted perforated marble plates of the ancient type. It must be recognized, too, that colored glass, such as filled the windows of the late Gothic churches, would have interfered in some measure with the definite color scheme of the mosaics. In fact, the means resorted to for lighting the early churches was far from being imperfect; and not the least of its advantages was that it insured purity of air and good ventilation without causing strong draughts in the lower part of the church.

The introduction of windows in the lower wall of the apse did not have a good effect. They would hardly have been used except for the symbolical interest which attached to the rising sun shining upon the morning Eucharist. The mosaics themselves are the proper illumination of the apse, and the play of reflected light upon the rounded or spherical surfaces of the apse is one of its singular attractions. This effect was enhanced by the multitude of little lamps which often adorned the altar room, but it could only be marred by direct shafts of light piercing the wall.

The doors of the basilica were commonly limited to the façade. The middle door leading into the nave was greater than those which flanked it, and the leaves of this door especially were a favorite field for decoration. Notable are the carved wood doors of S. Sabina in Rome (Figs. 105, 106) and of the cloister of S. Catharine on Mt. Sinai. Bronze doors from Classical buildings were employed, as in the Lateran Baptistery (from the Baths of Caracalla) and in the church of SS. Cosma e Damiano (formerly Temple of Romulus). Bronze doors, as they were made in the Christian period, commonly consisted of thin plates of metal supported upon wood, as, for instance, the doors of S. Sophia, which are still in part preserved. Such doors were generally decorated with a purely architectural ornamentation. Honorius I. decorated the middle door of S. Peter's with 975 pounds of silver, and inscribed a long Latin inscription upon each leaf. Richly ornamented stone doors are found in Central Syria. Entrances upon the sides of the church were not common except in Syria, since the front alone of the church was usually free.

The roof of the basilica was of wood. The only exception

is constituted by some of the Syrian churches above mentioned; but the churches of Central Syria stand so thoroughly apart and by themselves that they deserve a separate treatment and a fuller one than can be given here. For adequate information about this interesting architecture, one must refer to the work of de Vogüé.¹ In the basilicas, therefore, East and West, — and in Syria wherever wood was to be had, — a low gable roof surmounted the nave and transept, and a shed roof of the same angle covered the aisles. The commonest covering for the roof was, of course, terra-cotta tiles. At Ravenna colored glazed tiles were sometimes employed, and patterns were formed by them. The roof of great churches was often covered with lead, but the noblest material for this purpose was bronze. Hono-

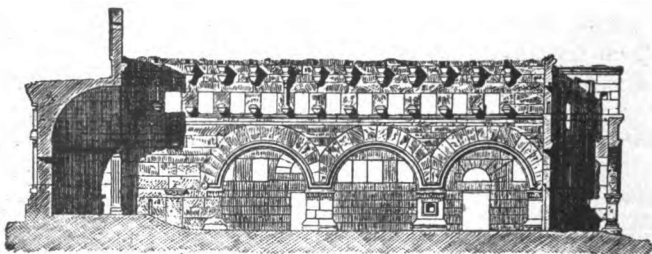

FIG. 84. — Longitudinal section of basilica in Ruweha, Syria.

rius I. had the roof of S. Peter's covered with bronze tiles.² The bronze tiles of the Constantinian church of the Apostles at Constantinople were gilt, so that in the sunlight they nearly blinded the beholder.³

It is probable that in the basilicas of Central Syria the roof and its supports were visible from below. That these basilicas were not ceiled, but were open clear to the roof, is proved especially by the windows which appear in the gable, sometimes a round window divided into four compartments by a cross, a precursor of the rose window. It has been commonly supposed that the basilicas of the West were often, if not regularly, covered in the same way. This notion is due solely to the fact that in the restorations which were undertaken in the

¹ See Bibliography.

² *Lib. Pont., Vita Honor.*

³ Eusebius, *Vita Const.* IV. 58.

Middle Ages the flat ceiling was not retained, because it was no longer in keeping with the lines to which people had become accustomed in Romanesque and Gothic churches. It cannot be denied that this scheme was often rendered very attractive — as in S. Miniato and in the cathedral of Monreale — by the rich designs in color with which the rafters were painted. But there remains no doubt that the general rule prescribed a flat ceiling for the ancient basilica, as well above the aisles as above the nave; and it is probable that this rule was subject to no other exception than that mentioned above.

In this respect the architecture of the basilica was influenced, not only by a Classic tradition, but by two considerations, the one artistic and the other practical, which attached themselves directly to the religious use of the building. Artistically it was of great importance that the eye should not be tempted to stray up among the rafters of the roof and

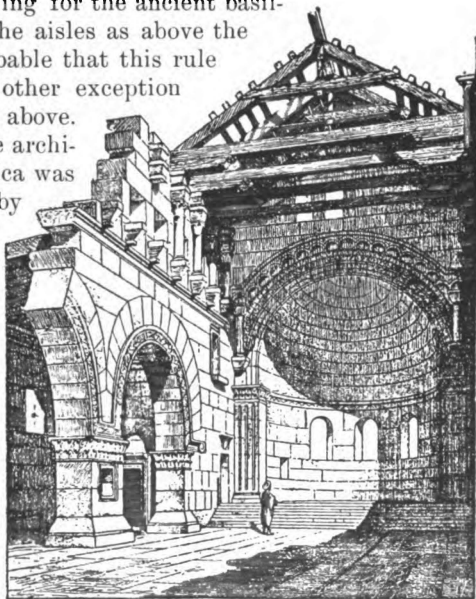

FIG. 35. — Basilica in Kalb-Luseh, Syria.

away from the apse and the altar, toward which all the chief lines of the building led; in maintaining the horizontal lines of the basilica no feature had so decisive an influence as the ceiling. Practically, it was of no less importance that the building should be acoustically adapted to its use as an auditorium. No other established type of church building has ever so thoroughly fulfilled this requirement, nor ever seriously aimed to do so. The character of church worship in the Middle Ages rendered this a question of minor consideration;

but in the early period it was, as it has come to be again in the Protestant churches, a matter of supreme importance. Even for the intoning of the prayers and the chanting of the Psalms a good acoustic quality was a desideratum, but besides that, it must be remembered that the long lections and the sermon constituted a very important part of the Eucharistic celebration in the early Church. During the earlier part of our period the bishop was accustomed to address the congregation from his seat in the apse; but in the course of the fifth century, the great size of the basilicas, as well as the interposition of the ciborium between the cathedra and the nave, naturally prompted the practice of preaching from one of the lectors' pulpits in the body of the church.

The flat ceiling of the basilica was supported by heavy beams extending from wall to wall and crossed at right angles by longitudinal beams which formed with them square or oblong spaces for deeply recessed panelling. It appears from ancient texts that various styles of panelling were in use, but that the most usual was the style traditional to the Greek temple, known as *lacunaria*. The ceiling was richly decorated in color and gold. Some ceilings are spoken of as entirely covered with gold, and when gold was used it must of course have dominated over any other decoration; but it is obvious that the effect of the gold would be enhanced by some contrast in color, and in this case it is natural to suppose that the beams would be principally decorated in gold and the recessed panels in color — dark blue and red. Some of the descriptions of early ceilings are very enthusiastic: Eusebius, describing the Constantinian church of the Holy Sepulchre, says that the golden ceiling reflected the whole temple as in a sea of light. The numerous windows which were immediately under the ceiling must have added much to its effect, and the ceiling in turn must have contributed greatly to the lighting of the whole building. Owing to the perishable material, no ancient ceiling has been preserved. The *Liber Pontificalis* frequently recounts the restoration of the ceiling timbers. But the restorations were often accomplished piecemeal, and they may be supposed to have followed often the ancient pattern.

The decoration of the floor and walls is treated in the chapter on Mosaic (page 295); it need be described here only so far

as is necessary in furnishing once for all a general impression of the basilica. The floor, in accordance with Roman custom, was finished in stone mosaic, predominantly in light-colored marble. The side walls and the recess of the apse, up to or above a man's height, were lined with colored marbles composed in large geometrical patterns (*opus sectile*). The rest of the wall space was covered with mosaic pictures, which during the early part of the fourth century were executed with natural stones, afterward with cubes of colored glass, in many



FIG. 36. — Cathedral of Torcello. Seventh century.

tints, but usually upon a background of purple or gold. Where means failed for the execution of pictures in mosaic, they were done in fresco, and in one way or another the whole surface of the brick wall was covered and concealed, as the traditions of Roman construction demanded. There was no effort to represent in the decoration the structural purpose of the wall; above the cornice, or the frieze, the structural symbolism was entirely ignored; the wall was treated merely as a screen which enclosed the room, with complete abstraction of the fact that it actually supported the weight of the roof. In the Byzantine domed architecture there was the same freedom in the treatment of the wall merely as a field for pictorial decoration.

This has often been accounted a serious defect in early Christian architecture; it stands in specially strong contrast to the strictly organic treatment of the Gothic. This practice and this conception of the wall were nevertheless thoroughly in accord with Greek traditions, indeed with the early traditions of the Aryan race. The wall, in fact, constitutes but a poor support; if it happen to serve as such, nothing better can be done with it than to ignore the fact. The comparison with the Gothic is not to the point, for in the developed style the wall practically disappeared, or rather was represented by the colored glass windows.

Most of the wall space was portioned out into rectangular fields convenient for the Biblical scenes or other religious themes which were to be represented. There was no fixed rule, such as obtained in later Byzantine times, for the location in different parts of the church of the several themes which were represented. But, in general, historical pictures (literal Biblical illustrations) adorned the nave, while the great symbolical subjects were in the neighborhood of the altar. The half dome termination of the apse was invariably the place for the principal theme; its spherical surface was singularly favorable for the best effects of the lustrous glass mosaic. On the curved but perpendicular wall below it there was often room for another subject. As the height of the apse was considerably less than that of the ceiling, and its breadth generally less than that of the nave, it intersected the wall of the church in a great arch (the apsidal arch) which provided a space hardly less eligible for a single grand theme. It was under this arch that the altar was located; or, in case there was a transept, under a second arch (the triumphal arch, according to a later terminology), of the same height and similarly decorated, which separated the transept from the nave. These two arches with the apse formed one complex as seen from the nave; the Apocalyptic visions which adorned them are the very triumph of the mosaic art. The apse and these neighboring arches contributed most essentially to the total effect of the basilica; they constituted the only variety which enlivened the monotonous lines of its architecture; it was at the triumphal arch the horizontal lines were first broken, and the gaze which was irresistibly drawn to the altar was then first bid to soar. This

complex of arch and apse, with the noble decoration which adorned it, constituted the crowning glory of the basilica; it deserves to be compared to the prospect which was enjoyed by the Greek worshippers, who stood without and gazed beyond the altar to the pediment of the temple.

Having already described the vestibule of the church and the room of the congregation, it remains only to speak of the room

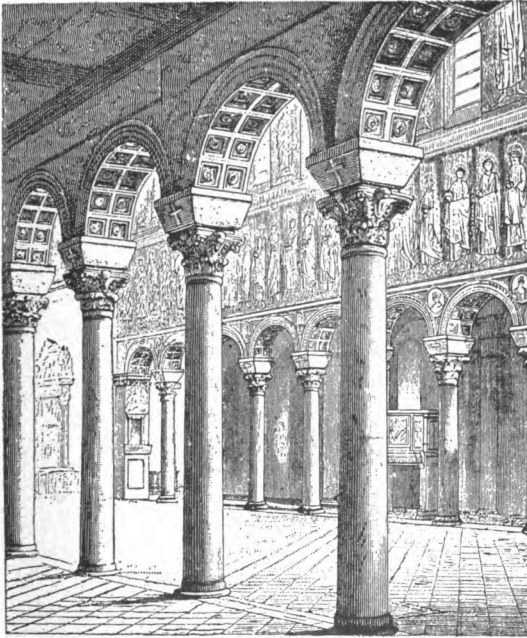

FIG. 37. — S. Apollinare Nuovo, Ravenna. Sixth century.

of the clergy. This part of the church was known by various names according as one or another aspect of it was present to the mind. The name *presbyterium* was given it as the place of the higher clergy; *apsis*, *exedra*, and *concha* refer to its form; *bema* refers to the fact that it was raised by several steps above the floor of the church; and *tribunal* (also *tribuna*), to its likeness to the platform occupied by the magistrates in the civil

basilica. A good deal that belongs to this topic has already been anticipated incidentally in the course of the preceding paragraphs ; still other subjects which one might expect to find treated here must be postponed, so far as any detailed descrip-



FIG. 38. — S. Maria in Cosmedin, Rome. Eighth century (restoration).

tion is concerned, to a later page, — all, that is, which belongs not so strictly to the architecture as to the furniture of the church, as the altar and its ciborium, the chancels, the pulpits, and the seats.

In this connection, however, attention needs to be called to

the architectural importance of the ciborium, or canopy, which surmounted the altar. The nearest analogy of the ciborium is to be found in the temple-like structure which frequently surmounted a tomb or covered a sarcophagus. The immediate suggestion of its use was obviously the desire to do honor to the altar by covering it, and by separating it ideally from the rest of the building. But, besides this, with the construction of great basilicas there arose an architectural necessity for this or for some similar device. The altar, no matter what might be the size of the church, retained always the same very limited dimensions. Of itself, therefore, it was ill fitted to constitute the architectural centre of a huge basilica; it needed then, as it has always needed, some architectural adjunct which might vary in size with the proportions of the building, and serve even in the greatest to mark the altar as the preëminent object of regard, as the centre and explanation of the liturgical order of the church. This was approximately the only solution which was possible so long as the bishop's throne remained in the middle of the apse and the celebrant faced the people from behind the altar. The reredos of the Gothic church was another solution under changed conditions. It can hardly be accounted so successful a one, since it afforded only a background and not a shrine for the altar, and was besides too closely incorporated with it.

It is evident that in the original disposition of the basilica the apse was intended to furnish sufficient room for all of the higher clergy. How thoroughly traditional this feature was, is proved by the tenacity with which it was conserved after it had ceased to correspond to the growing importance of the clergy and the increasing elaboration of the ritual. The room of the clergy was clearly circumscribed, and therefore the more expressly limited, by the fact that the half-circular floor of the apse was raised by two or three steps above that of the nave. The altar was commonly raised a few steps higher and stood in the middle of the chord of the apse; on either side of it were chancels which separated the room of the clergy from the rest of the basilica.

If this space was not actually too small to accommodate the number of clergy who might be present, it was still not large enough to comport with their dignity, or to distinguish clearly

the different orders. The want of a greater space must have been felt already before the end of the third century, that is, before the construction of any of the basilicas which we know. The fact that this want was not satisfied by any architectural innovation, — such, for example, as a deepening of the apsidal room after the manner of the Gothic choir, — but by the mere makeshift of extending the chancels into the nave and across the aisles, is attributed to the impotence of architectural invention in the early-Christian period. But it must be observed that, whereas the Gothic with its lofty pointed arches naturally invited the construction of deeply recessed spaces beyond the quadrangular plan, the lines of the basilica as distinctly forbade it. The round or polygonal churches which were constructed with dome and vault readily allowed of a deeply recessed apse (Figs. 49, 50), but in the basilica it must have destroyed the clear and noble effect of the half dome and arch, which we have but just now had occasion to praise as its chief architectural excellence.

The transept furnished an adequate solution for this need, although it was not developed expressly to meet it, but was derived, as we have seen, from a traditional feature of the Roman house, and was therefore limited to Rome and to the lands which were most directly under the influence of the Roman Church. The transept was as a rule somewhat narrower than the nave; the only exception is the transept of the Lateran, which is slightly wider. The lateral termination of the transept generally coincided with the wall of the aisles, and therefore did not interrupt the quadrangular plan of the basilica. The exceptional cases in which it extended slightly beyond this line belong, however, to the oldest and most important of the Roman basilicas, — S. Peter's, S. Paul's, and the Lateran (Figs. 26, *h*, 29), — and it was probably the great importance of these churches which contributed, together with purely architectural and symbolic considerations, to impress this scheme upon the Gothic cathedral. In a church which was provided with a transept, the altar was not located beneath the apsidal arch, but on the line which separated the transept from the nave, beneath the *arcus major*, as it was called in the *Liber Pontificalis*. This left between the altar and the apse ample space for the clergy, and in its wings provided accommodation for the altars of the

prothesis, upon which the offerings of the people were bestowed and from which the bread and wine for the Eucharist were taken. The whole of the transept, or at least the part reserved

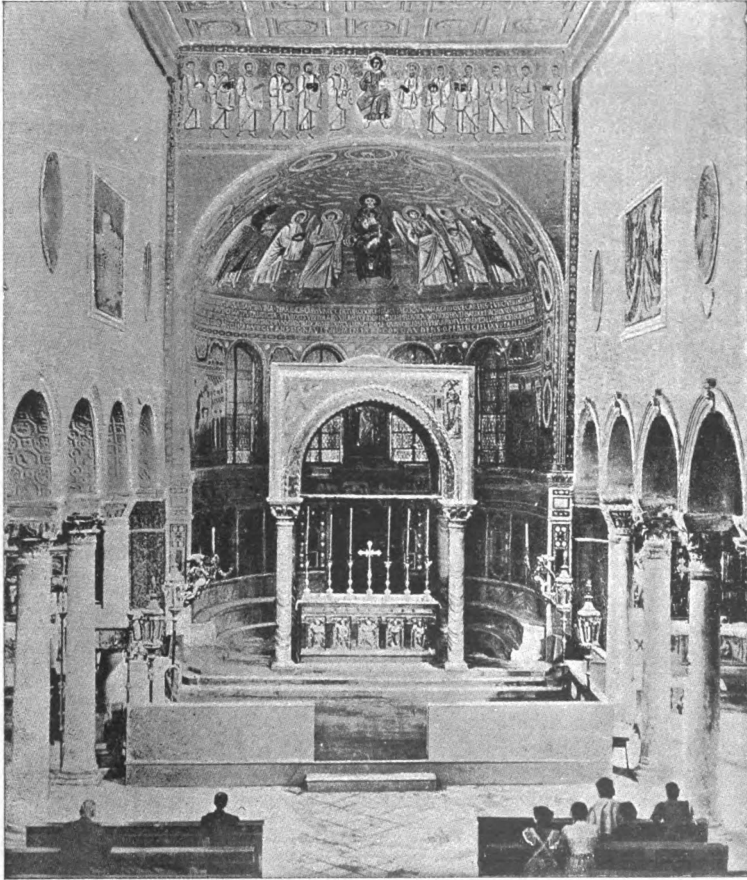

FIG. 39. — Cathedral of Parenzo. Sixth century.

to the clergy, was raised like the floor of the apse, and surrounded by chancels, sometimes also by rows of columns and curtains.

The altars of prothesis were obviously a necessary part of the furniture of the church so long as the offerings of the people were largely made in kind; a mere reminiscence of them is preserved in the credence upon which the Eucharistic elements are placed before they are carried to the altar. It appears that one table of prothesis often sufficed; but the separation of the sexes to the one side and the other of the church must as a rule have required one table at the end of each aisle, or, in case there was a transept, in each of its wings. The *Liber Pontificalis* records the gift by Constantine to the Lateran of "seven altars of purest silver weighing two hundred pounds each." This has been relied upon as a proof of the plurality of altars in that early age of the Church; but these silver altars were evidently nothing else than tables of prothesis, and they correspond, as Duchesne points out, to the number of deacons in the Roman Church. In case there was no transept, there was room found for these tables and for the services connected with them at each side of the apse at the extremities of the aisles, and this room was set apart merely by means of chancels and curtains. Remains of such chancels are still in place in the ancient basilica of S. Reparatus in Orléansville (Fig. 28, *a*).

In churches which were without the transept—as were many of the Roman basilicas, and all those of Ravenna and of the East—there was no means of enlarging the apsidal room; except by placing the altar some distance in front of the chord of the apse, and extending the platform and chancels correspondingly. But the Eastern Church found some compensation for the transept in the construction of two rooms which projected beyond the quadrangular plan, flanking the apse on either side and opening upon the side aisles (Figs. 26, *d* and *f*, 27, *d*, 33). Except in Central Syria the original shape of these rooms cannot often be established with certainty, for few parts of the church were liable to suffer so much from restoration. One of the rooms, called the *prothesis*, was intended to receive the offerings of the people; the other, the *diaconicon*, served, like the later sacristy, for keeping the church utensils and the sacred and liturgical books. The *diaconicon* was used for the vesting of the clergy, and to it the people also might resort to study the Scriptures. The latter fact is indicated by a *titulus* which Paulinus of Nola devised for the door:—

SI QUEM SANCTA TENET MEDITANDI IN LEGE VOLUNTAS,
HIC POTERIT RESIDENS SACRIS INTENDERE LIBRIS.

In plan the two rooms were identical, but the prothesis opened by a greater door into the church. There was sometimes a direct communication between the diaconicon and the presbyterium; but in the East there was never such a communica-

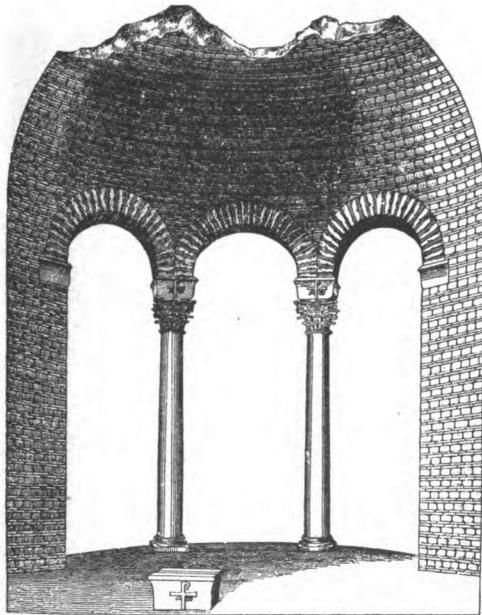

FIG. 40. — Apse of the basilica Severiana, Naples. Fourth century.

tion in the case of the prothesis, for one of the most impressive features of the Oriental ritual was the passage of the priests carrying the Eucharistic elements through the body of the church and in through the chancel doors to the presbyterium. There was no rule to establish upon which side of the church the prothesis and the diaconicon ought respectively to be placed.

In the course of time, as offerings in kind fell out of use and the other uses of the prothesis were conveniently served by the

diaconicon, which was commonly absorbed in a large sacristy, both of the rooms were often transformed into chapels for the side altars which came into use as a consequence of the cult of relics.

In external appearance the basilica stands in very disadvantageous contrast to all other types of Roman public architecture. The building material was almost invariably of brick,



FIG. 41. — S. Paul's, Rome, interior as recently restored.

and the brick construction after the second century of the Empire was of a very coarse character. Commonly as brick was used by the Romans, it was accounted too base a material to be exposed to view, and in all buildings of any pretension it was covered with marble, or hewn stone, or at least with plaster and paint. Although the Church followed this tradition so far as concerned the interior of the basilica, on the outside the bare brick wall was left exposed without any, or with the very least, attempt at architectural decoration. The justice

of the principle, however, was acknowledged by the fact that the façade was sometimes decorated, like the interior, with mosaic. It has to be remembered that, while the façade was freely visible from the atrium, the rest of the basilica was likely to be so completely surrounded by chapels, mausoleums, hospices, and schools (Fig. 55) that the exterior finish of the lower wall was not of prime importance; and the wall of the clearstory was to some extent enlivened by its close row of windows. It was by slight mouldings around the windows that the first step was made in Ravenna toward a decorative treatment of the brickwork. In Ravenna and in the East the apse was generally faced with a polygonal wall (Fig. 33); in Africa the apse and the adjoining rooms were often masked by a straight wall, — for a Syrian example see Fig. 61.

The best that can be said for the external appearance of the basilica is that it gave a perfectly frank and lucid idea of the interior disposition of the room. For the rest it revealed only too plainly its derivation from a private style of architecture. The lavish expenditure of costly decoration upon the interior stands in contrast not only to the bareness of the exterior, but to the exceeding cheapness of the construction. In the domed type of architecture the walls had of course to be much thicker, the construction was altogether much more costly, and even the exterior could not but have a greater architectural interest and variety. It was this type which continued the traditions of Roman public architecture; but the exterior followed the example of the basilica, and the bare brick walls had in some respects a worse effect, because they were meaningless, and masked the interior disposition of the building.

This rudeness was not altogether due to carelessness about the exterior effect, for there was a distinct effort to make at least the approach to the church — the façade, the atrium, and its porch — as attractive and imposing as possible. It was precisely the façade, however, which proved the most intractable feature of the exterior. From outside the atrium only the low gable and the clearstory wall were visible; from within, the case was not much better, for the portico with its close line of slender columns could in no way be reconciled with the sheer mass of the upper wall, unbroken save by a few windows. The problem of the façade was to be solved only by incorporating

the vestibule or portico more closely with the church, as was done with such signal effect in Central Syria.

But this brings us to another story: these churches of Central Syria — most of them of the fourth or fifth century — stand in the sharpest contrast to all other architecture of the early Christian period. Looking at such a façade as that which is represented in Fig. 32, it is hard to believe that it is not at least seven centuries later. In point of fact, we are compelled to believe that the early Norman churches in the neighborhood of the great crusading ports of Southern France and Apulia were directly inspired by these Syrian basilicas. Syria, it must be remembered, was one of the most flourishing centres of early Christian life, and it was not only in close contact with Greek

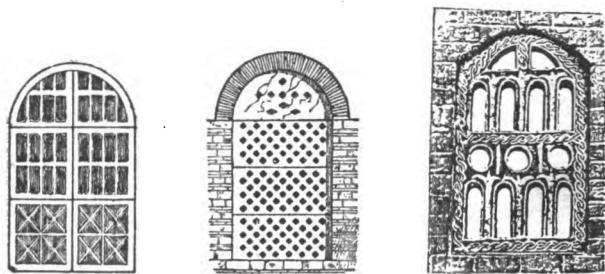

FIG. 42. — Stone windows.

and Roman civilization, but it inherited more fully than any other Christian land the traditions of Oriental art. It is altogether likely that Syrian architecture had a marked influence upon all neighboring lands — except Palestine, where all the great churches were due to the munificence of the Roman or Byzantine emperors. At all events its free and strong development of the theme which was presented by the basilica was not surpassed till the advent of the Gothic. From a decorative point of view the interior of the Syrian basilica was far less effective than the more usual type which we have been studying; it lacked the rich pictorial mosaics, and relied upon a strictly architectural decoration of the stone surface. From an architectural point of view it was incomparably stronger and more consistent, an advantage which was displayed even more conspicuously on the outside than within. It

is quite beyond our scope to do justice to the admirable character of its masonry and the detailed architectural decoration which did so much to ennoble its appearance; it is better frankly to omit this theme than to give the impression that it can be exhausted in a few words. But one word must be said about the façade, though it be only to direct attention to the characteristic scheme which is exemplified in Fig. 32. It will be seen that the chief features are: a free flight of steps leading through a broad arch into a vestibule, which is surmounted by an open loggia and flanked by two gabled towers which symmetrically balance the gable of the nave. The fundamental characteristic of this scheme consists in the two towers which mask the ends of the aisles and balance the clearstory; when this was given, all the rest was sufficiently obvious.

The church tower introduces a problem which is not altogether explained. It is not sure at what date it was first used for church bells; it is probable that its original purpose was defence. But whatever its purpose, it was common from the fifth century both in the East and West; and always, till late in the Middle Ages, it maintained its isolated position (Fig. 30). It was only in Syria that a pair of towers was employed, and only there that they were brought into organic relation with the façade.

B. THE CENTRAL TYPE

In the endeavor to give a total impression of the decorative as well as architectural effect of the basilica much has been said which applies equally well to the Byzantine domed churches. The ritual arrangements were the same in both cases, as were also the principles of decoration. There is left to consider merely the *structural conditions and architectural principles* which distinguished the round, polygonal, or domed structures, of various sorts, whether churches, baptisteries, or mausoleums. Even upon this express topic it has been necessary to anticipate incidentally a great deal which, having once been said, need not be repeated here.

By the central type of architecture no definite scheme of construction is indicated, but only the general principle of symmetrical—more strictly eurythmic—arrangement with reference to a central perpendicular axis. This principle is exemplified

as well in the round buildings which consisted of concentric colonnades covered by a conical roof (Fig. 44 *a, b, and c*), as in those, whether polygonal or round, which were surmounted by a dome. The dome, however, is the typical example of this principle, and, wherever it is employed, it exercises a strong centralizing effect. In the case of the mausoleum and the baptistery the eurythmic symmetry could be strictly observed, but it has already been remarked that, as applied to the church, it encountered an opposing principle in the horizontal axis which was exacted by the ritual, and in S. Sophia at Constantinople we have what has been called a compromise, though it is more properly a reconciliation, with the liturgical plan.

It is evident that, in turning from the study of the basilica to the central structure, we pass from a definite and invariable type to a congeries of types which were applied to divers uses and were even more various in their character; from a building which had no history and only a modicum of architecture we pass to the study of an intricate and original development on purely architectural lines. It is quite out of the question to treat here the many and important technical problems which this study suggests; for this the student must be referred especially to Choisy; *Histoire de l'Architecture*, Tome II. The earliest Christian examples of this class of architecture are those which were constructed at Rome, or by the Emperor Constantine under purely Roman influence at Jerusalem. But the development which we have to trace belongs exclusively to the Byzantine Empire, where invention and progress were still possible, owing not only to favorable political conditions and immunity from barbarian attack, but also and chiefly to the influence of the architectural traditions of the Orient. The development of Byzantine architecture culminated before the middle of the sixth century in the reign of Justinian. The various stages of this development are marked by buildings of a very high interest; its culmination in S. Sophia at Constantinople registers the highest limit attainable along these lines. This building was never imitated, but alongside of it the architects of Justinian developed another type — the church of the Apostles at Constantinople — which furnished the pattern for subsequent Byzantine architecture (example, S. Mark's at Venice). Justinian distinguished his reign not only by the devel-

opment of a distinct type of architecture, but by the great number of buildings which he erected, in Jerusalem, in Constantinople, and in many of the great cities of his Empire. In his zeal and munificence as a builder of churches he has not been equalled either before or since.

It must suffice to state here in the briefest terms the chief innovations which characterized the development of Byzantine architecture. It has already been stated that in Roman construction the vault and dome consisted of a thick bed of concrete which hardened into a monolith, exerting no lateral thrust, but requiring a heavy wall for its support. The technic of Byzantine construction was borrowed from the East; the use of brick made it possible to construct both vault and dome without the cost of a temporary support and with far less expenditure of constructive material and of manual labor. This change of technic had a far-reaching effect upon the architecture. On the one hand the comparative lightness of the dome permitted its support upon a lighter wall; or, what amounts to the same thing, the organic solution of the wall into a series of pillars (Fig. 47) which were connected above by arches, and gave free prospect and passage into a surrounding room (Fig. 48). On the other hand the lateral thrust which was developed required a nice adjustment of buttresses and balances, which — according to the traditions of ancient architecture — must be provided *within* the building and contribute to the interior space; that is to say, the thrust required the construction of a room, or rooms, surrounding the central chamber, and the use of free pillars made possible ready communication between the one and the other.

The most thorough attainable continuity between the central and the surrounding rooms was provided by reducing the number of the supporting pillars to four (Fig. 52). This introduced a square plan with which the round base of the dome corresponded only at four points, and those the weakest for support, namely, the centres of the four arches which connected the pillars. This difficulty was solved by the pendentive, which was the most characteristic invention of Byzantine architecture. The pendentive was a construction which filled out the angles between the square (or polygonal) plan and the circle of the dome: its surface formed a spherical triangle, one

side corresponding with the first course of the dome, the others following the supporting arches and concentrating the thrust upon the pillars (Fig. 51). The final development in dome construction consisted in erecting above the pendentives a cylindrical wall (the drum), which allowed room for window apertures without opening them in the dome itself. It is the dome with a drum which became the common type in later Byzantine architecture, and which was universally employed in the Renaissance; it contributed, however, more advantageously to the exterior than to the interior effect of the building.

So much variety and invention entered into the development of the Byzantine church that it is difficult clearly to trace its course. It is impossible to reduce this course to a single line of development; for it is evident that there contributed to its formation several distinct types which were contemporaneously in use at the very beginning of Christian architecture; and it is evident, moreover, that even in the final development these lines did not converge upon one point, but continued to reveal their several origins by the constitution of three distinct schemes—the polygonal, the cross-shaped, and the quadrangular. The influence which contributed to the formation of the quadrangular scheme was obviously the basilica. As to the equal-armed cross, that was an early and usual plan for a mausoleum or memorial. The round and polygonal buildings which date from the earliest period of Christian architecture were likewise intended for mausoleums and memorial shrines, and also for baptisteries. Throughout the fourth and fifth centuries the employment of the central type for the church proper—that is, the congregational house of worship—was exceedingly rare; it is reduced almost to the vanishing point when we exclude the buildings which were originally intended for mausoleums or memorials, and such as were directly imitated from them.

Of the round and polygonal buildings we have to distinguish two chief types according as the plan is simple or composite. Among those of composite plan we must distinguish again, with reference to the mode of roofing, between the buildings which consisted merely of concentric colonnades surmounted by a wooden roof, and those which were surmounted by a dome (supported by pillars or columns) and a ring-vault.

ROUND OR POLYGONAL BUILDINGS

SIMPLE PLAN

The simplest case is a cylindrical wall surmounted by a dome in the form of a half-sphere. The heavy dome construction of the Romans required a very thick supporting wall, which for economy of building material, as well as for purely artistic considerations, was broken by a series of niches. The Pantheon at Rome is the most colossal and altogether the noblest example of this type; the wall surface is diversified by eight great niches (including the door), alternately square and semicircular, with another row of niches above; but it becomes continuous again before it meets the dome. Light is admitted by a great opan in the centre of the dome. The great magnitude of the Pantheon made possible a special decorative feature which consisted in rows of columns in front of the niches, but the application of the general scheme was obviously quite independent of size.

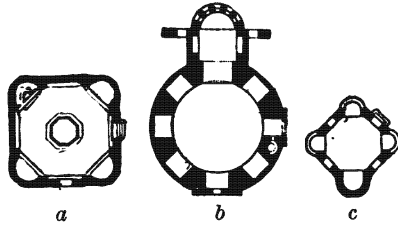

FIG. 43. — Plans of buildings of the central type. Simple plan.

a, Orthodox baptistery, Ravenna. b, S. George, Thessalonica. c, Arian baptistery, Ravenna.

Rooms of this type were constructed by the Romans as adjuncts to palaces, but more commonly as bath rooms and mausoleums. The Christians employed them for the same purposes, that is, as mausoleums and baptisteries. This type was manifestly appropriate to the mausoleum, not only on account of its shape, but on account of its monumental solidity. While in the construction of their churches the Christians showed a strange indifference about the solidity and endurance of the buildings, they seem to have shared the solicitude of the pagans for the eternal perpetuation of their tombs. The two round buildings which formerly adjoined S. Peter's (Fig. 30) were of this type, adorned with eight square niches, and they were probably constructed as mausoleums. One of them was in the eighth century dedicated to S. Petronilla; but it

was originally the mausoleum of the family of Theodosius, and it is probable that the other, dedicated to S. Andrew, had a like origin. Quite similar to these is S. George in Thessalonica (Fig. 43, *b*). Doubtless this too was originally a mausoleum, either Christian or pagan; for the presbyterium seems evidently to have been a later addition, connected with the building by breaking through one of the original niches.

Though such buildings were never constructed for use as churches, they were obviously very appropriate as baptisteries. The baptistery was essentially a bath room, and it naturally assumed the shape which was common for public and private baths among the Romans. The pool or basin occupied the centre, and there was sufficient room about it to accommodate the candidates, with their sponsors and the clergy; baptism, being essentially a personal and private sacrament, did not require the presence of the congregation. The altar had properly nothing to do with the baptistery, though in the East it was occasionally accommodated in one of the niches, or an exedra was even expressly constructed for it. Among the Romans the pool was commonly octagonal, and this became the almost invariable tradition in the Church. S. Ambrose attempted to attach a symbolical significance to the octagonal form;¹ and the fact that this form has been perpetuated in the mediæval (and modern) fonts is perhaps to be traced back ultimately to the Roman bath.

In the employment of deep niches in the thick wall (a constantly recurring feature of Roman construction) there lay the suggestion of a further development; the niches had only to be opened clear through the wall, and the central room was at once put in communication with surrounding rooms or with a corridor. This step was taken in the construction of the so-called temple of Minerva Medica at Rome; in this case ten niches open upon a circular corridor. From the imperfection of its construction the building is judged to be not earlier than the end of the third century. Close as it seems to stand to the Byzantine round church (Fig. 47), the relation was in fact not direct; the line of Byzantine development passed through other forms and was influenced by other examples. Equally outside the line of development is the great dome of the Baths of Cara-

¹ Gruter, *Thesaur. inscript.*, p. 1166.

calla, which was supported upon eight mighty piers; this example merely shows how natural was the deduction of the Byzantine type.

The mausoleum of Theodoric at Ravenna (Fig. 53) is hardly to be classed with any other Christian monument. It seems, however, to be a product of Syrian architecture. It contains two rooms, the lower of which is in the shape of a cross, while the upper is round. Externally it is ten-sided, surrounded by a platform which was originally covered, and it is surmounted by a colossal monolith.

It must now be noticed that there were, strictly speaking, no baptisteries with cylindrical walls such as we have been considering. This type was expressly imitated in early Christian baptisteries, but under changed structural conditions which modified the form of the room. One of the consequences of the brick construction which was employed in Christian architecture was a comparatively thin wall which did not admit of deep niches between its two surfaces. If the traditional niche decoration was to be retained in use, it could be accomplished only by the construction of apsidal additions projecting beyond the wall. That the niches were to be retained was practically assured by the fact that they were not only the essential decorative feature of this style, but served at the same time as buttresses to counteract the thrust which was developed by the dome under the new type of construction. Illustration of this is furnished by the two baptisteries of Ravenna. The plans (Fig. 43, *a* and *c*) show how the construction of four semicircular niches, with intervening wall spaces of equal width, transformed the interior into an octagon, while the exterior in the one case closely approached the form of a square, in the other suggests the form of a cross. It is evident that the construction of niches on the remaining four sides would have given an unsightly form to the exterior. The harmony of the interior was preserved by eight false arches which covered not only the niches, but the intervening walls, and rested upon engaged columns. The octagonal wall was carried up considerably above the summit of the niches in order to admit light beneath the dome. The diagonal section of such a building gives substantially the profile of the basilica, the high wall supporting the dome corresponding to

the clearstory; while, on the other hand, it also presages the drum of the developed Byzantine style.

This already leads us a step in the direction of the Byzantine round church. It would only be necessary to develop the structural symbolism which was indicated by the false arches and the columns which decorated the interior — that is to say, to support the dome upon real pillars, do away with the wall, and merely mark its place by rows of columns — and we should have the central hall of SS. Sergius and Bacchus. A similar plan, but with eight niches, would give the central hall of S. Vitale (Fig. 47). What is lacking here, however, is the surrounding room or corridor, which alone could furnish any sug-

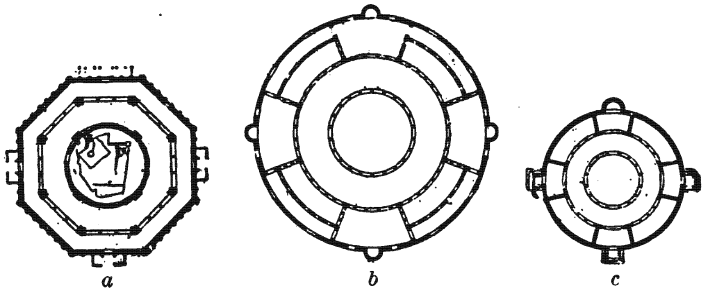

FIG. 44. — Plans of buildings of

a, Mosque of Omar, Jerusalem. *b*, S. Stefano Rotondo, Rome. *c*, Church of the Ascension, Jerusalem.

gestion or any reason for thus opening the niches. We have therefore to consider the influence of two other classes of buildings which were contemporaneous with the very beginnings of Christian architecture, and which served to accustom the eye to the perspective effects of concentric rows of pillars or columns. In this connection, however, we are already brought a step nearer S. Vitale by the octagonal church which Constantine constructed at Antioch. The account of Eusebius seems to represent that it was surrounded by deep niches, alternately square and semicircular, which were divided by galleries into upper and lower stories.

COMPOSITE PLAN

This topic comprises two distinct early types of building, besides the Byzantine polygonal type. The fundamental distinction between the two early types is that the first (Fig. 44, *a*, *b* and *c*) was roofed with wood, the second (Fig. 44, *d*, *e* and *f*) surmounted by dome and vault.

It cannot be claimed that the first type had any influence upon the development of the Byzantine style beyond the merely formal suggestion which was given by its concentric colonnades. In all other respects it stands at the farthest remove from the Byzantine style of construction, and in the closest relation to

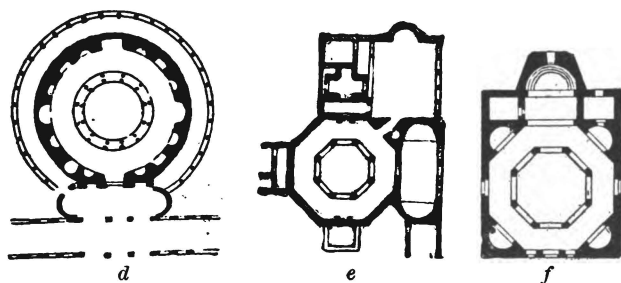

the central type. Composite plan.

d, S. Costanza, Rome. *e*, Lateran Baptistery. *f*, S. George, Ezra.

the basilica. Its fundamental features were: a circular (or polygonal) wall enclosing two or more concentric colonnades, each of which — like the colonnades of the basilica — supported a wall upon which rested the roof. The room within the central colonnade was sometimes completely or partially uncovered; and in this case the roof of the surrounding aisles had the shape of a truncated cone. In case the central room was covered, its walls were raised high above the aisles (like a clearstory) for the admission of windows, and surmounted by a conical roof. What has been said in reference to the basilica, about technic of construction, about wall decoration, ceiling, floor, columns, and arcades, applies equally here. Certain general similarities of scheme between this type and the basilica will also readily be noticed. But the attempt which has been made

to deduce it directly from the basilica rests upon a too fanciful comparison. On the other hand, it has not proved possible to trace this type to any example of classical architecture, unless it be the Marnion at Gaza. It emerges for the first time in the reign of Constantine, and may therefore be ascribed, if one will, to the Christian period, though hardly to any distinctive Christian influence. It seems more just to say that its origin is explained by the free inventiveness, the almost wanton liberty, which characterized Roman architecture at the beginning of the fourth century.

But whatever its origin, this type of building has a peculiar interest for Christian history, since it was employed by Constantine in the erection of the first great shrines which marked the holy places of Jerusalem. These buildings have all of

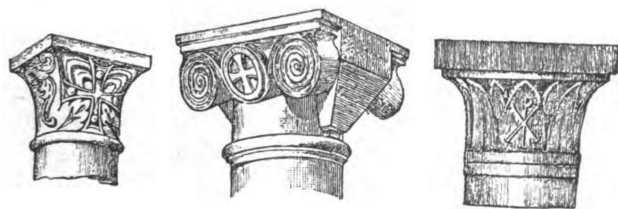

FIG. 45. — Early

them perished; we know them only from the descriptions of Eusebius and of mediæval pilgrims, and from the imitations to which churches of such fame naturally gave rise. The only churches of this sort which exist are S. Stefano Rotondo at Rome (Fig. 44, b), of the middle of the fifth century, and S. Angelo in Perugia, a reduced copy of it made about a century later and now half destroyed. S. Stefano has long stood as a riddle among the monuments of Roman architecture. Dehio with some plausibility attributes its erection to Placidia, and thus connects it with the church which her grandmother Eudoxia built at Jerusalem in honor of the proto-martyr Stephen and as her own mausoleum. This history brings it at once into relation with the memorial buildings of Constantinian foundation; it also explains how this type, which was expressly and appropriately designed for a

memorial, came, through the celebrity of Constantine's example, to be copied for this use not only, but also for use as a house of worship, for which it was quite unsuitable. That it was not originally intended as a substitute for the basilica, nor for the ordinary uses of church worship, is clearly shown by the fact that Constantine was not content with the erection of round shrines about the Holy Sepulchre and upon the spot whence our Lord ascended, but adjoined to each of them a great basilica. The round temples were doubtless used for private devotions and for extraordinary religious celebrations, but their most definite purpose was that of doing honor to a sacred spot and protecting it from profanation. They had therefore practically the same intention as the Greek *temenos*, and the central type was manifestly prescribed by this purpose.

In the year 326 Constantine erected the church of the Holy Sepulchre at Jerusalem. The sepulchre itself was enclosed



Christian Capitals.

within the inner colonnade of a round church of the general type just described. Eusebius gives a detailed but far from clear description of it, though the chief traits are tolerably well fixed. Its chief peculiarity was that it opened into a huge five-aisled basilica. It is supposed that the outer wall of the round building, after it had completed something more than half a circle, met the extended walls of the basilica and left therefore free communication between the two, equal to the whole width of the basilica. The round building was covered with a wooden roof which left part of the inner circle open to the sky. This shrine was most commonly called, not the church of the Sepulchre, but the *Anastasis*—the Resurrection. It was the round church which properly constituted the shrine; the basilica was added to it to accommodate the congregation. The whole edifice was destroyed in the year

614, by Chosroes II. of Persia, and only the round building was afterward restored. Together with other churches of Palestine, it was described, early in the eighth century, by the Scotch abbot, Adamnanus of Iona, who merely recounts what he had heard from the French pilgrim and bishop, Arculphus. This building was a number of times destroyed and restored, and finally the crusaders added again to it a rectangular church. The building was conserved in substantially the same form till a fire in the year 1808. The round church, altered as it was by Byzantine reconstructions, exercised a great influence upon late mediæval architecture.

The Constantinian church of the Ascension on the Mount of Olives has likewise suffered destruction, though Arculphus, at the end of the seventh century, still saw it in its original state. It likewise had a basilica annexed to it, but not in direct communication. Its central room was likewise unroofed, — and with manifest propriety, since it marked the spot whence our Lord had ascended into the heavens. Dehio reconstructs it as a round building like S. Stefano Rotondo (Fig. 44, *b* and *c*); but he admits that it may originally have been octagonal, as was the crusaders' restoration of it. This receives further support from the fact that the mosque of Omar (Fig. 44, *a*) is octagonal, and was probably imitated from it (cf. p. 310).

The mosque of Omar is not only a notable instance of this style, but one of the most remarkable monuments of all time. It was erected in the year 638, upon Mt. Moriah, on the site of the Jewish Temple. Although it was founded by an Arabian calif, to enshrine the rock from which Mahomet started for his flight through the heavens, it has many claims to consideration in a study of Christian architecture; it would deserve it, if merely for the fact that it was directly inspired by the Constantinian temples, and is the only existing monument which gives an adequate impression of the architectural possibilities of this style. Much has been disputed about its origin. De Vogüé's solution is in all probability the correct one, that it is a Byzantine building constructed by Byzantine architects, though for a Mahometan ruler. It is not unlikely that the roof was originally open at the centre — like the church of the Ascension, which in its purpose it so closely resembled, and which it may have followed as closely in pattern. About the

year 690, however, it was provided with a wooden dome of very remarkable construction. In decoration it is only in the dome that Arabic traits appear, the rest is purely Byzantine. In 1099 it came into the hands of the Christians, who founded here the order of Knights Templars. Standing as it did upon the platform of the Temple, it was popularly believed to be actually a part of the ancient Temple of the Jews, and it figures as such in the *Sposalizio* of Raphael. Having been copied in the first place from the churches of Constantine, it became in turn the pattern for the churches built by the Templars in Europe.

We have record of but one other round church in the neighborhood of Jerusalem; it was located in the Valley of Jehoshaphat, and commemorated the spot where the Virgin Mary remained between her death and her assumption. It is mentioned as early as the beginning of the fifth century.

Of the imitations which were made in early times of this type of memorial building, few have been preserved to us, or even recorded. Beyond what has already been said in regard to S. Stefano Rotondo (Fig. 44, *b*), and S. Angelo of Perugia, it need only be added that as these buildings were intended to be used as houses of congregational worship they were constructed with a clearstory and completely roofed. We learn from the Life of S. Willebald¹ that the church in which the Council of Nicæa was held was similar to the church of the Ascension on the Mount of Olives.

With the second type of round building, which we come now to consider, we return again to the cupola and vault construction, and we approach, therefore, more closely the line of development of Byzantine architecture. This type also emerges with the very beginnings of Christian architecture under Constantine. It seems, however, that it is to be referred directly to more ancient models; for though no classic buildings of the sort have been preserved (except probably the baptistery at Aix), the antiquarians of the Renaissance saw and described similar temples in the neighborhood of Rome. Constantine erected two such monuments at Rome (Fig. 44, *d* and *e*): one (S. Costanza), the mausoleum of his sister Constantia; the other, the baptistery of the Lateran. The scheme of both is essen-

¹ *Acta SS. O. S. B.*, *saec.* 3, P. II., p. 379.

tially the same, a central room formed by a circular or polygonal colonnade which supports a dome, and a surrounding corridor covered by a vault which serves as a buttress. The cupola of S. Costanza is supported by a circular colonnade composed of twelve pairs of columns; within this circle stood the huge sarcophagus of porphyry which is now in the Vatican Gallery. Both the cupola and the surrounding ring-vault were originally covered with mosaics (Figs. 125, 126), but only those of the vault have been preserved. The thick outer wall is enlivened within by niches, and without it was originally surrounded by an open colonnade. The baptistery is smaller and its construction lighter; both the colonnade and the external wall are octagonal, — the character of the cupola was altered in later times. This early building became the normal type for Christian baptisteries, and it remained so as long as a separate building was required for this use. It was obviously more appropriate to its purpose than was the round building of simple plan, for

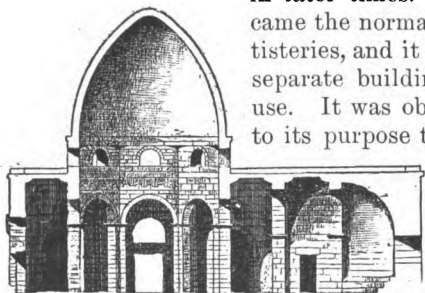

FIG. 46. — S. George, Ezra, Syria.

it not only provided a larger room, but architecturally separated the font from the assembly room.

These early buildings are obviously the direct prototype of a considerable class of round churches; for example, S. George at Ezra in Syria (Figs. 44 *f*, 46), built in 512, and the similar and contemporary church at Bosra. In the case of these Syrian churches the exigencies of stone construction account for the almost pointed profile of the dome. It can hardly be doubted that the typical Byzantine scheme (S. Vitale) was also strongly influenced by this example, although one of its features — the semicircular recesses and storied galleries — is to be referred more expressly to the development of the niche decoration which we have already studied as a characteristic of the round building of simple plan.

It is certain at all events that we have now before us all of the antique monuments which could have contributed to the

development of *S. Vitale*,—under the influence, it is always necessary to remember, of distinctive Byzantine principles of construction.

S. Vitale in Ravenna was erected during the reign of Justinian (begun in 526 and completed in 547). It would lead us too far to give a description of the building, beyond the few words which are necessary to render intelligible the plan and the interior view which are given in Figs. 47 and 48. The eight great pillars of the central room support an octagonal drum which is surmounted by the dome. The construction of the dome is peculiar: its core consists of terra-cotta pipes, fitted

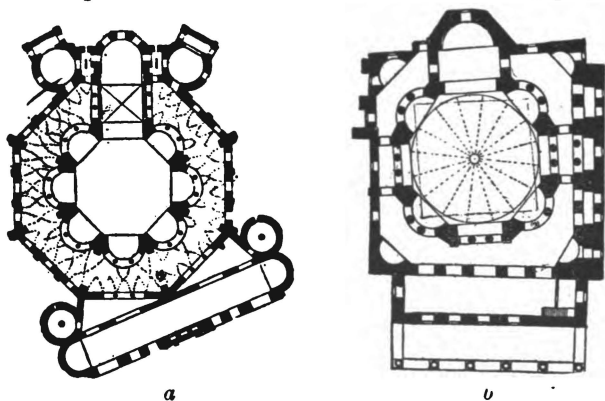

FIG. 47. — *a*, *S. Vitale*, Ravenna. *b*, *SS. Sergius and Bacchus*, Constantinople.

the one into the other, and extended spirally from the bottom to the top,—a construction which diminishes not only the weight but the thrust. The arched window openings in the drum serve to concentrate the weight upon the pillars, which are supported by buttresses extending beyond the surrounding corridor. The corridor is divided into an upper and a lower gallery (both of them vaulted), and the buttresses are pierced above and below by arches to permit free passage around the galleries. Seven niches surmounted by a half-dome intersect both the upper and the lower galleries; but as the walls of the niches are replaced by columns they permit free prospect from the galleries into the central room. Finally, the presbyterium and apse breaks the symmetry and completely interrupts the

L

galleries, extending with its adjoining rooms beyond the octagonal perimeter. The scheme, which is carefully and consequently thought out, is elaborate without being complicated; the constructive purpose of the several parts is obvious, and the effect is therefore restful and harmonious.

Essentially the same constructive scheme is repeated in SS. Sergius and Bacchus at Constantinople (Fig. 47), which was

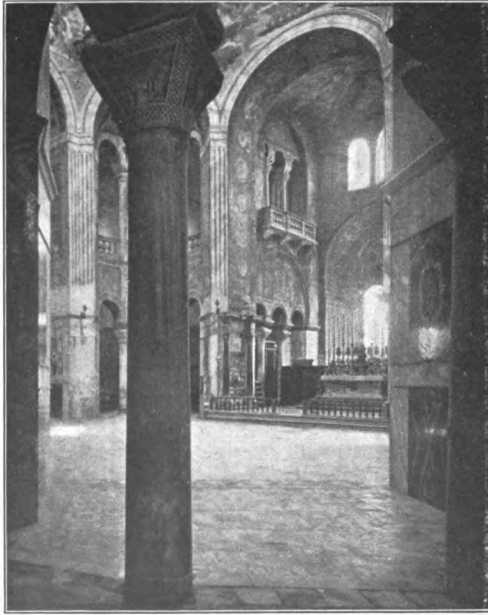

FIG. 48. — Interior of S. Vitale, Ravenna. Sixth century.

built about the same time. A very different effect is produced, however, by a change in a feature which is almost purely decorative, namely, in the niches. The niche opposite the apse and the central niche on either side of this line were suppressed by simply carrying the row of columns straight across from pillar to pillar, with the consequence of giving the room a distinct longitudinal direction,

and of permitting the inclusion of the whole room within a quadrangular wall. This shows the strong tendency in the Byzantine architecture of that time to accommodate the dome to the longitudinal room which was required by the ritual. S. Vitale, however, represents the consummation of the round type of church; and before we follow the Byzantine development upon other lines it is necessary to return again to the earliest period of Christian architecture and trace the influence of the cross-shaped plan.

THE DOME ON A SQUARE BASE

CROSS-SHAPED PLAN

Like the so-called transept of the basilica, the earliest examples in Christian architecture of a cross-shaped plan are to be referred to pagan prototypes, though in both cases the Christian symbolism furnished the suggestion which led to further development. Cross-shaped chambers were sufficiently common in Roman architecture; in the early Christian period they were commonly used as mausoleums or memorial chapels. There were two such rooms connected with the Lateran baptistery (one visible in Fig. 44 *e*) and a considerable number among the chapels which lined the sides of S. Peter's (Fig. 29). The type, however, which is most characteristic of Christian architecture consists in an oblong room terminating in a group of three apses united by a small dome. This was the usual type for the memorial chapels which were erected above the cemeteries. Two examples are preserved above the catacombs of Callistus, and one is attached to the small basilica of S. Sinforosa (Fig. 28, *c*). This so-called *apsis trichora* was employed by Paulinus for the presbyterium of the basilica which he built at Nola, in honor of S. Felix. This use, however, was exceptional, and it is not possible to say what influence this traditional form may have had in stimulating the development of a more distinctly marked cross plan.

There is at all events no doubt that this development was due chiefly to the symbolical interest of the form, and that it received a marked impulse from the discovery and veneration of the wood of the cross. In the case of large buildings, the application of a distinctly cross-shaped plan was practically so inconvenient that it could be due only to a symbolic motive. This scheme—two long and narrow halls intersecting one another at right angles—was of all central plans the most unsuitable to the Christian ritual; and such churches were, as a matter of fact, designed expressly as mausoleums or *memoriæ*. One of the greatest examples, and the best preserved, is the shrine (*Kalat-Seman*), which was erected around the column of S. Simon Stylites in Central Syria. It must have been built soon after 450. As may be seen from the plan

(Fig. 63), it consists of four great basilicas grouped in the shape of a cross around a central court, in the midst of which stands the column. The central court was uncovered, and there was, therefore, no attempt at bringing the four separate halls into a relation of close unity.

Most, if not all, the other churches of this type must, however, have been covered with a roof or dome at the intersection. Beyond the fact that it had the form of the Greek



FIG. 49. — Exterior.

The mausoleum of Galla

cross, nothing very clear is known about the church of the Apostles, which Constantine built at Constantinople as a mausoleum for himself and his family. It is probable that S. Ambrose took this as the model for the church which he built in Milan in 382 (originally dedicated to the Apostles, afterward to S. Nazarius); and if so, it is only another instance of the influence which famous memorial churches had upon the congregational church, in spite of their unsuitableness for this use. S. Nazario Grande at Milan was entirely rebuilt in the eleventh century, though it retains, with modifications, the cross form. S. Nazario e Celso at Ravenna, the mausoleum

of Galla Placidia (Figs. 49, 50), though of much smaller dimensions, is of the same type as the great church of S. Ambrose. The four vaulted arms are connected at the centre by a dome. The construction is poor, but the mosaic decoration is of the richest. This chapel originally stood in connection with a greater church—likewise cross-shaped—which was dedicated to the Holy Cross. S. Arculphus gives a plan of a cross-shaped church surrounding the well of Jacob in

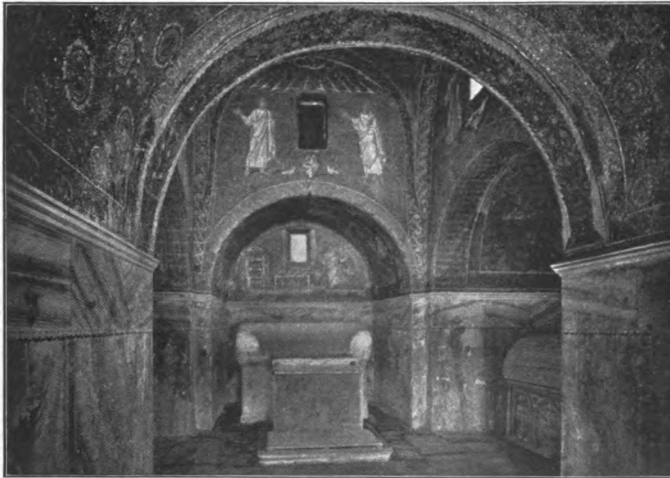

FIG. 50. — Interior.

Placidia, Ravenna. Fifth century.

Samaria. Finally, it may be mentioned that there are several baptisteries of this shape.

The Greek cross as it appears in Byzantine architecture takes a very different form: it is much less accentuated—that is, the four arms have less longitudinal extension in proportion to their breadth—and the angles which remain are partially or altogether absorbed by massively constructed rooms which serve as buttresses to the four central pillars. Within and without, the building was thus compacted into the unity of a single hall.

Different as this scheme is, it was not only potently influ-

enced, but essentially conditioned, by the less organic type which has been described above. An ostensible proof of this influence lies in the fact that Justinian, in rebuilding the Constantinian church of the Apostles, in Byzantine style, adhered to the form of the cross plan.¹

But before considering the forms which the Byzantine development actually took, it is necessary to note the elements which the cross form of itself essentially contributed to the solution of the problem presented by the use of the dome as the prominent feature of church architecture, — that is, the problem of harmonizing the vertical axis emphasized by the dome, with the horizontal axis required by the ritual.

To show how strongly this necessity was felt, one need only refer to the church of Irene at Constantinople, which reveals an exclusive preoccupation with the longitudinal direction: the side rooms are reduced to the width which was absolutely required by the buttressing system; the middle room is roofed by two domes, two broad vaults, and the half-dome of the apse, — with a result which is highly unsatisfactory, since the central disposition is completely lost, the vertical axes of the two domes are entirely ignored, and yet the longitudinal direction which is strongly marked in the plan encounters an obstacle in the ceiling.

The use of the cross form immediately introduced a factor which was of great advantage from the point of view of the ritual, namely, a square central room. The square room was practically attained in SS. Sergius and Bacchus as a development from S. Vitale. But the cross form, by reducing the supports of the dome to four pillars, opened the central room to the freest communication on four sides; and the four arms of the cross which were thus brought into the strictest unity with the dome balanced the importance of its vertical axis by two strongly marked horizontal axes which were in perfect harmony with it. That is to say, the eurythmic symmetry demanded by the central disposition was maintained, and at the same time the horizontal direction required by the ritual was clearly indicated. It may be said that this solution provided too much, since the transverse axis was not only not required by the ritual, but was in some measure discordant with it.

¹ Procopius: *de ædific. Just.* I. 4.

But the evil had to be accepted with the good, and although a compromise was possible by way of accentuating the importance of the longitudinal nave, the Byzantine architects kept this well within bounds, and rarely gave to the nave a length which was in marked disproportion to the transept.

The church of the Apostles which Justinian built to replace the earlier edifice of Constantine has disappeared like its predecessor. Procopius informs us that the longitudinal nave was greater than the two arms, "as the pattern of the cross required." He also informs us that the altar room and presbyterium were located at the intersection of the cross; and this is the only case in which we have any hint of such an adaptation of the ritual to the obvious requirement of the centralized plan. The long description which Procopius gives fails to furnish all the data we need for the reconstruction of the church; but Choisy is confident that we have close copies of it in two famous churches of the eleventh and twelfth centuries respectively, — S. Mark's at Venice and S. Front at Périgueux. Whether or not it may be referred to the age of Justinian, this type deserves notice as one of the most successful creations of Byzantine architecture. Its main characteristics can be briefly described. It is a system of five equal domes. The cross plan is strictly adhered to, but not accentuated. The building is distributed by heavy piers into five square rooms of equal dimensions, one in the centre and four constituting the arms of the cross. Each is surmounted by a dome, and there are thus three domes on each axis, preserving the symmetry and marking clearly the central disposition. The longitudinal nave is accentuated chiefly by the addition of the apse and the narthex. It may be presumed that in the church of Justinian there were galleries; and though galleries were not used in the West, S. Mark's has retained in their place, as a purely traditional and decorative feature, a narrow passageway supported by colonnades. The galleries were entirely dropped in S. Front, which was copied directly, not from the church of Justinian, but from S. Mark's.

The system of five domes was applicable only to very great churches. As most of the Byzantine churches of the Middle Ages were of exceedingly minute dimensions, they adopted a plan which was evidently derived from this, though it has only one dome. It is the type which is represented by the great

majority of Oriental churches throughout the Middle Ages. It was constituted by merely dispensing with so much of the cross arms as was covered by the four domes. This reduced all four arms to about the dimensions of the vaults which had separated the domes one from the other. By this change the breadth of the arms was made to exceed their length, and they were distinctly subordinated to the greater central room. The four piers of the dome, though they had a diminished weight to support, retained their previous dimensions, and completely filled out the small angular spaces of the cross plan, so that the plan externally became rectangular. Even in the original construction, the pillars had each been separated into four shafts, and now, with a lighter weight to support, the shaft facing the central room was often replaced by a column, by which means four small corner rooms were practically added to the hall,— or, what was of more importance, the short cross arms were put into closer relation with the nave and altar room. These four rooms were covered with spherical vaults, which were later (in the tenth century) developed into as many cupolas, one at each angle of the building. It became the fashion also to crown the narthex with three cupolas. It is this feature, namely the great number of cupolas, which gives to late Byzantine churches the external effect with which all are familiar. It may be remarked that the longitudinal direction was generally emphasized by the extension of the presbyterium ; this, however, was flanked by the two sacristies, so that all but the apse was included in the rectangular plan. The nave also was often emphasized, at the expense of the cross plan and of fundamental principles of symmetry, by rows of columns which separated it from the arms. This was the only motive borrowed from S. Sophia, and it was adopted with but little propriety. But this has already led us far beyond the limits of our period. It is a digression which proved especially tempting, because, upon the basis of the sixth-century development, it was possible in so few words to describe a type of architecture which has characterized so long a period of history, and characterizes to-day most of the churches of the East.

OBLONG PLAN

Hagia Sophia, "the Holy Wisdom," was built by Justinian in 537, upon the site of an ancient church of the same name which probably dated back to the time of Constantine. The names of the architects, Anthemius of Tralles and Isidor of Miletus, deserve to be remembered. SS. Sergius and Bacchus (Fig. 47) is usually taken to be the immediate prototype, or rather the next preceding step in the development. One can certainly note here a resemblance which is far closer than can be accounted for merely by the common principles of Byzantine construction. The resemblance is specially marked in the main room by the use of semicircular niches in combination with the straight colonnades of the side walls (Figs. 51, 52). The room under the dome may be said to be merely an elongation of the central room of SS. Sergius and Bacchus: that is approximately a square, this an oblong rectangle twice as long as it is broad. It becomes clear how essential this difference is when we observe that in S. Sophia the main room has ceased to be a *central* room surrounded by a corridor, and become instead a *middle* nave flanked by two aisles. In both cases the room was surrounded by eight piers; but in S. Sophia the dome itself was supported by only four of them. This tetra-style arrangement permitted a resort to the cross plan; and in fact the buttressing system provided on either side of the dome the rooms which might serve as the arms. This solution, however, was entirely ignored, and the side arms were architecturally shut off from the nave by a two-storied colonnade on each side. With this the central disposition and all effort after eurythmic symmetry were completely given up, notwithstanding that the plan of the building, exclusive of the narthex, was almost exactly square.

Dehio compares S. Sophia with the basilica of Maxentius, which represents the type of vaulted construction commonly used in the great Roman baths and in this instance applied to the civil basilica. The comparison of the plans (Fig. 52) is indeed sufficient to prove that, however important were the elements derived from contemporary Byzantine construction, the express aim of the architects was to adapt the essential feature of Byzantine architecture—the dome—to the funda-

mental scheme of the basilica. That the model which the architects had in mind was expressly the Christian basilica is shown also by the square atrium in front of the church. It has already been said that the atrium was rarely used in the East, and never in connection with the central type. This combination of the two current types of church architecture resulted in a type which differed equally from both; and it was accomplished by a device so thoroughly original that it



FIG. 51. — Interior of S. Sophia, Constantinople. Sixth century.

becomes superfluous to trace more minutely its relations with other types and earlier monuments.

With S. Sophia we are, strictly speaking, dealing no longer with the central type of architecture, though it is obvious why the subject must be treated under this head. In thus employing the dome to roof a hall of distinctly oblong proportions, its centralizing influence was not ignored, — it was modified. It was modified by the one device which is conceivably applicable to the case: by supplementing the dome with two half-domes of equal aperture at each end of the room. The two half-domes

were in a measure merged with the central dome by the spherical surfaces of the pendentives, and the effect of the whole ceiling was practically that of a long elliptical dome: that is to say, it no longer demanded an eurythmic symmetry; it demanded, on the contrary, a predominant emphasis upon the horizontal axis which corresponded with the dimensions of the room and comported with the ritual. The combination of these various spherical surfaces in the ceiling required, however, a corresponding variety in the plan of the room, and this was furnished by the four niches and the apse. It is evident that

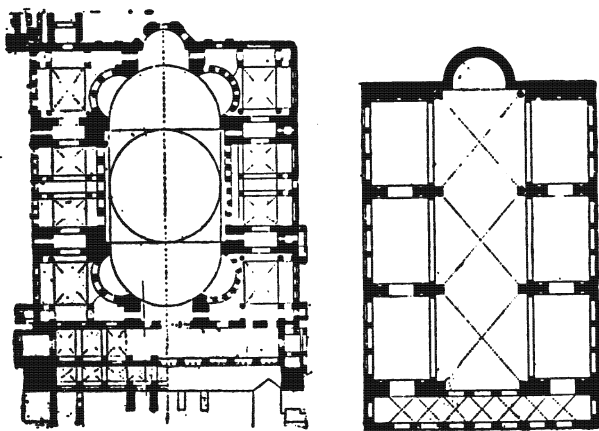

FIG. 52. — Plans of S. Sophia and of the basilica of Maxentius.

a perfectly regular plan, either rectangular or elliptical, would not have harmonized so well with the ceiling.

The consistent execution of the programme required that the dome should rest immediately upon the pendentives without the intervention of a drum, and that it should be constructed as flat as possible; it proved in fact too flat for stability. The buttressing system was very elaborately thought out, and with one exception it was thoroughly adequate. The half-domes were each supported by four piers, two of which they shared in common with the dome. They were amply buttressed at one end by two niches and the apse; at the other by the corresponding pair of niches and a double narthex. The

half-domes in their turn constituted a most effectual support upon two sides of the dome. The pendentives transmitted the weight and part of the thrust of the dome to four mighty piers which received the support of lateral buttresses of the full width of the aisle. The one weakness lay in the fact that a part of the lateral thrust of the dome had to be sustained by the great arches which supported it on either side, and they could oppose to it no resistance except such as was due to the comparatively slight thickness (five yards) which comported with their character. Twenty-two years after its building, a part of the dome fell during an earthquake. The dome was then immediately repaired, and from that time on the church has undergone frequent restorations, which, while leaving the nave substantially unchanged, have nearly transformed the exterior. The necessities of the case required a breach of one of the principles of Byzantine architecture, the erection of four huge *external* contreforts which rose high above the aisles, and were applied directly to the lateral support of the great arches.

The construction of S. Sophia was not only original, but bold. It was the first time so great a dome had been erected upon four piers; and the chief structural peculiarities of the building were not only without example in the past, but have remained without imitation since. Notwithstanding the restorations which it required, the fact that the building has endured for more than thirteen centuries is proof that the work was feasibly and strongly conceived. It was undoubtedly the culminating triumph of the Classical age of Byzantine architecture, though other types, the by-products of the same age, were found more available as patterns for a later time and for a decaying empire.

Originally, the decoration and furnishings of S. Sophia were the most splendid that have ever been lavished upon a Christian church, and the effect of the building doubtless justified the enthusiasm of its panegyrists. The golden altar, the presbytery, and the choir are now replaced by the inferior glories of the Moslem mosque; even the mosaics, so far as they represented distinctively Christian subjects, have been for the most part either destroyed or covered up. What remains, however, suffices for the imagination; and this is fortunately a type of

building which does not, like the basilica, depend for its effect chiefly upon its decoration.

Upon entering the building, the sombre light of the double vestibule serves to enhance the luminous splendors of the vast nave. Thanks to the disposition of the half-dome which spreads upward from above the entrance, the eye discovers at once the great cupola in its whole extent. At the same time the entire system of the vaults of the nave—the various

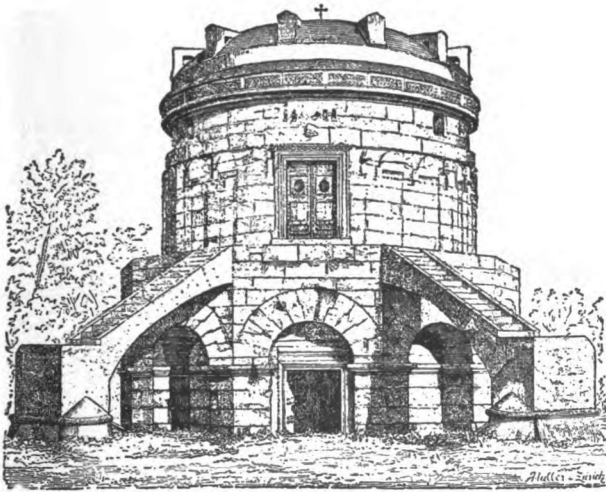

FIG. 53.—Mausoleum of Theodoric, Ravenna. Sixth century.

spherical surfaces so apt for mosaic decoration—is frankly exposed to view. In the prospect of the nave the double colonnades on either side serve to give something of the appearance and effect of the basilica. The numerous details fall naturally into three great divisions which are framed by the arches above. For all the elaboration, the governing lines produce an impression of simplicity, and the details are required to enhance one's appreciation of the vast size. The great dome has an aperture of nearly one hundred feet, the dimension of the half-domes and arches is the same; yet without the lateral colonnades nothing would indicate the

extraordinary sweep of the arches above them; they are needed to give the scale and to spare S. Sophia the questionable praise which has been given S. Peter's, — that there is nothing to intimate that it is huge.

The illumination is unusually generous; windows are pierced freely, not only in the high side walls, but in the half-domes, in the apse, and in the niches, while the crown of windows which illuminates the whole circumference of the dome seems to isolate it, as though it were suspended in the air. The four pillars which support the pendentives are hid behind the lateral galleries; one sees no more of them than the angle, but that suffices to reveal the presence of the mass of the buttress and to assure the eye. The work astonishes, yet at the first glance it explains itself. Never has stability and daring, the *éclat* of color and purity of lines, never has the genius of Rome and that of the Orient, been associated in a more astonishing and a more harmonious whole.

The preceding paragraph follows the language of Choisy almost closely enough to deserve inverted commas. I will here quote from him still more closely a sentence which applies to Byzantine architecture in general. After speaking of the simple geometrical relations which are to be traced in the monuments of this art, he adds¹: "It is not only the feeling of unity which one experiences at the view of a Byzantine interior, but also a sort of tranquillity and calm which is nothing else than the full satisfaction of the mind before a work where all the combinations of equilibrium are clearly apparent. The buildings of our Gothic architecture awaken a sort of inquietude and uneasiness which is due above all to the fact that the buttressing organs are projected outside; from within one does not at first view take account of the equilibrium. Quite different is the effect of the Byzantine constructions: the eye embraces at one glance the vault which covers the building and the contreforts which support it; it sees nothing which does not explain itself; it is the clearness of the art of Greece itself."

¹ *Hist. de l'Arch.* II., p. 34.

C. FURNITURE OF THE CHURCH

ALTAR AND CONFESSION

The preceding sections have several times furnished occasion to remark upon the central importance of the altar for the architecture as well as for the ritual of the church. In itself nothing could be more simple than this important piece of furniture. It was, as it was also commonly called, a table. In shape it was copied after patterns which were familiar in secular use; it consisted of a rectangular and only slightly oblong top supported by one, four, or occasionally five, legs. The Holy Table of the Church had as little resemblance to a

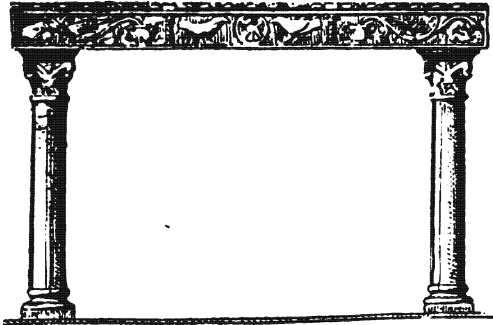

FIG. 54. — Altar of the fifth century, from S. Quénin, France.

pagan altar as the basilica had to a temple, or the statue of the Good Shepherd to an idol. We can well understand how the Romans could make and the Christians admit the reproach that they had “no altars, no temples, no images.”

This simple and natural shape the altar retained universally till well into the fifth century. The early altar was not so high and by no means so long as has been common in the West since the Middle Ages. From the beginning, stone as well as wooden altars were employed; the one stood in relation with the tables of the triclinium, the other with the ornamental stone table of the atrium.

The use of wooden altars is proved by early texts, and it is due only to the perishableness of the material that none have

survived. A wooden chest, decorated merely with a single cross upon the front, is venerated in the Lateran as the altar of S. Peter; but it can date no earlier than the age when the altar began to be used as a holder of relics. It is not mentioned before the eleventh century.

Gradually the Church came to discriminate in favor of altars of stone; this was very obviously on account of their more monumental character and greater durability. An edict purporting to be of Sylvester I. which forbids the use of wooden altars can hardly be regarded as genuine, since it rests solely upon the testimony of the *Breviarium Romanum* (eleventh century). Such a prohibition is, however, proved for Gaul at least by the twenty-sixth canon of the Council of Epaon (517); but the rule must have suffered occasional exceptions even after this period. Thanks to the durability of the material, several stone altars of the fifth century have been preserved, at least in part. The altar illustrated in Fig. 54 is from Southern France (S. Quénin, now at Vaison); it is ornamented with the eucharistic vine, while in the middle are two doves which approach the monogram of Christ. A similar altar plate from S. Marcel (Ardèche), now in the museum of S. Germain, represents six sheep on each side departing from the towns of Bethlehem and Jerusalem and approaching the monogram. An altar from Auriol in the south of France has on the front twelve doves and the monogram, and on the sides tendrils of the vine. This table is noteworthy for the fact that it is supported by a single stout pedestal. An altar which Galla Placidia found in S. Giovanni Evangelista in Ravenna was supported upon five legs, which were later supplanted by plates of stone when the altar assumed the form of a chest; the original legs have been in part preserved. Likewise of the fifth century, and perhaps earlier than any of these examples, are the mosaics of the cupola of the Orthodox Baptistery in Ravenna (S. Giovanni in fonte). They represent a stone altar of the simple table form supported upon four round legs or columns. Four times the design is repeated around the base of the dome, and on each altar rests an open book bearing the name of one of the Gospels. The custom of leaving the Gospels upon the altar finds witness elsewhere.

The change of form which the altar underwent in the sixth

century was due exclusively to the cult of relics, or rather to the new form that cult then took of enclosing the relics *within* the altar. In treating of the catacombs it has been shown that the Eucharist was early brought into close relation with the tombs of the martyrs; that it was celebrated either in the martyr's crypt and upon his tomb, or in a chapel directly above it. The great basilicas which Constantine and later emperors built above the tombs of the Apostles and martyrs were in thorough keeping with early traditions, and they were repeated everywhere throughout the Christian world. It was accounted a matter of prime importance that the altar be brought into

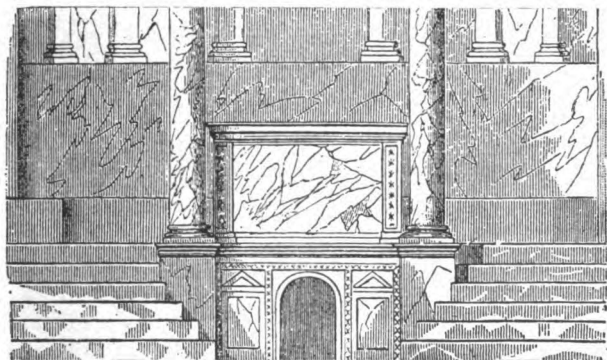

FIG. 55. — Altar with confessio, S. Giorgio in Velabro, Rome.

the closest possible relation with the tomb, or be located at least directly above it. To accomplish this end, hillsides were excavated and whole galleries of the catacombs were cut away. Many tombs had to be destroyed in reaching the grave of the martyr; but his resting-place was scrupulously respected, and except in the rarest cases the body was not moved even the few feet which might be required to bring it into the desired relation to the church, all considerations of convenience were subordinated to the aim of bringing the church to the body. In the most favorable case the floor of the presbyterium was brought to a level with the top of the tomb (sarcophagus, loculus, cubiculum, or whatever it might be); and since the altar stood usually upon the edge of a plat-

M

form which was raised by a few steps above the floor of the church, an opening in the wall of the platform beneath the altar afforded a view of the relics. The chamber surrounding the tomb, and the shaft or gallery through which it was put in relation with the altar, is called the *confessio*.

No part of the ancient churches has suffered more than the *confessio* from the pious zeal of reconstructors. Though no early example has remained unaltered, there are several mediæval constructions, like S. Giorgio in Velabro (Fig. 55), which

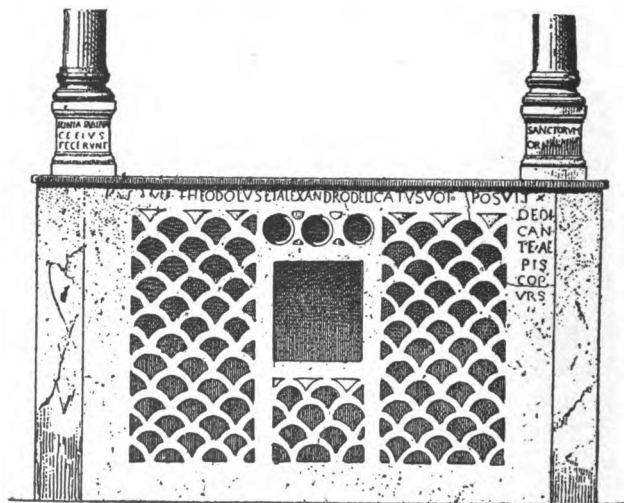

FIG. 56. — Altar with fenestella confessionis, in S. Alessandro, Rome. Fifth century.

exhibit substantially the early scheme. The opening into the *confessio* was closed by a grating of stone or metal — the *fenestella confessionis* — which allowed the worshippers a glimpse of the tomb. It is evident that this arrangement required no change in the table form of the altar. In the case, however, that the presbyterium was not raised above the level of the church, the fenestella had sometimes to be inserted between the legs of the altar, as in S. Alessandro at Rome (Fig. 56). This example furnishes an excellent illustration of a typical fenestella of an early and Classical pattern. The fenestella was provided with an orifice large enough to admit an arm ;

small objects, particularly handkerchiefs, introduced here and brought in contact with the sacred tomb acquired the character of relics (*brandea, palliola*). Any mention of the exportation of relics during the first five centuries must be understood to refer exclusively to such as these. This orifice was closed by costly doors — often of silver or gold — which were secured by a lock. The key itself was sometimes given as a relic; and de Rossi calls attention to the fact that in Italy keys are still given to children as amulets.

The bodies of both of the Apostles S. Peter and S. Paul lay deep beneath the floors of their respective basilicas, and were brought into relation with the altar by a vertical shaft similar to the luminaria of the catacombs. In the case of S. Peter's the shaft was twice interrupted by perforated plates, which were extended across it, — here called *cataractæ*. Objects deposited upon the lower plate gained extraordinary value as relics. This is proved by the request of Justinian. He had first begged portions of the bodies of the two Apostles for a church which he was building in their honor at Constantinople. When this request had been denied him by Pope Hormisdas, on the ground that the custom of separating the bodies of the saints was one unknown to the Romans, he asked that his relics might if it were possible be placed upon the lower plate (*ad cataractam secundam*). Constantine had surrounded the tombs of both the Apostles with cubical cases of wood covered with gold crosses in the form of the monogram of Christ, and since that time they had been rendered entirely inaccessible.

Constantine himself, however, followed a different plan in the construction of the confessio of S. Lawrence. In this case likewise the tomb and its cubiculum lay deep below the floor of the basilica, but it was rendered accessible by two stairways (*gradus ascensionis et descensionis*), which were doubtless entered at the corners of the apse. The grave itself Constantine surrounded with an apse, ornamented below with porphyry and covered above, in the half-dome, with silver; silver chancels enclosed it, and before it burned a gold lamp of ten wicks, a silver corona with fifty dolphins (lamps), and two bronze candelabra. In front of the tomb of the martyr was the instrument of his passion, a gridiron plated with silver. This confessio is already in this text called a crypt, but it was provided with

no altar besides that of the basilica above, nor did it serve as a model for later crypt constructions. On the contrary, the arrangement accorded so little with the early ideals that in the reconstruction of the basilica (probably by Leopardus about the end of the fourth century) the floor was sunk in order to bring the altar into closer relation with the grave.

It has been explained (p. 50) how the body of S. Valentine was made accessible by a gallery constructed in imitation of those of the catacombs. The type of gallery or crypt which was typical of later constructions is represented in the church of S. Pancrazio near Rome, and was probably due to Pope Honorius I. (625 - 638). It is a semicircular passage, entered at the corners of the apse and following its foundation wall; from the middle of this half-circle a straight horizontal gallery leads to the tomb. There are several examples of this type at Ravenna, and elsewhere in early churches, but it is doubtful whether they antedate the instance mentioned above. From this it is evidently but a short step to the excavation of a single large chamber under the presbyterium—the type of crypt which became characteristic of the Romanesque churches. Such a crypt often appears in mediæval reconstructions or imitations of ancient basilicas, with the consequence that the presbyterium is raised high above the nave.

In this connection may be mentioned a custom which occasionally introduced a novelty in the construction of the apse. It sometimes happened that a memorial basilica could not be built immediately above the tomb of the martyr, because the ground was already occupied by a venerable chapel which the builder scrupled to destroy. In this case the apse of the basilica was constructed upon a tangent to the apse of the earlier shrine, and a window was opened at the point where they met. A perforated stone window plate (*transenna*) here took the place of the fenestella, and enabled the worshippers in the greater church to glance beyond the altar and enjoy a glimpse of the martyr's chapel. An instance of this arrangement is the basilica of S. Sinforosa near Rome (Fig. 28, c).

Paulinus of Nola elaborated this idea in the construction of the new basilica of S. Felix. He opened arcades of three arches in the apses of both basilicas, leaving between them a covered court which served as entrance hall to the buildings.

The arcades were closed by transennæ, but Paulinus claimed that through them the worshippers in the new church could participate in the mass which was celebrated over the tomb of the martyr. This example seems to have led to numerous imitations. We have a contemporary instance of this construction in the recently discovered apse of the Basilica Severiana in Naples (Fig. 40). It seems to have been employed also with a merely decorative purpose in cases where there was no question of a martyr's tomb. S. Maria Maggiore, as reconstructed by Sixtus III. (432-440), seems to have had an apse which was put in communication with a surrounding gallery by means of such an arcade. At least this seems necessary to explain a curious reference which the *Liber Pontificalis* makes to this church in the life of Paschal I., where it is said that at the celebration of the mass the women stood behind the seat of the pontiff, so that he could say nothing to his assistants without being overheard by them. The room behind the apse seems in this case to have been used as a matroneum. An arcaded apse of this sort is illustrated by a bronze lamp of the fifth century (Fig. 153.)

It was naturally about the confessio and the altar that the costliest decoration was expended. There is frequent mention in the *Liber Pontificalis* of gifts of silver for the decoration of a confessio. Sixtus III. (432-440) persuaded the Emperor Valentinian to place as a votive offering above the confessio of S. Peter "a golden image with twelve doors and twelve Apostles and the Saviour adorned with precious gems." We have to understand that this was designed in relief with the Apostles and the Saviour framed in as many arcaded niches. The design was common upon the sarcophagi. Symmachus (498-514) placed the same design in silver above the confessio of S. Paul. Precisely where such a relief might be placed is not clear from the mere notice that it was *above* the confessio; it may have been attached to the perpendicular wall below the altar; but it is equally likely that it was in front of the altar and between its legs, constituting the earliest example of an antependium. Less is said than one might expect about costly materials being employed for the altar. Nothing is said about the great altar of the Lateran, though seven silver altars of prothesis are mentioned. It may be that reverence

for the traditional form of the altar served to perpetuate the use of stone, and the use of altar cloths had doubtless something to do with it. However, altars of precious metal are occasionally mentioned: for example, the altar which Constantine gave to S. Peter's was of silver plated with gold and adorned with four hundred gems, weighing altogether 350 pounds. Justinian gave a gold altar to the church of S. Sophia.

Whatever influence the early *confessio* may have had upon the shape of the altar, it was confined to the memorial churches without the city. It will be remembered that within the city limits burial was forbidden, and the congregational churches, the titles, were therefore without the *confessio*. The preservation of relics of a specially sacred character, such as the wood of the Holy Cross for which Constantine built the basilica of S. Croce, may have required the construction of an imitation *confessio*. Secondary relics such as have been described above needed no such elaborate care; at the most they were deposited in a cavity made in the plate of the altar, and they led to no change in its form.

The next stage in the development of the altar was due to the custom, which grew rapidly during the sixth century, of translating the bodies of the martyrs and depositing them within the churches of the city;—except in Rome, where no translations were made until after the middle of the eighth century. This often led to the construction of a true *confessio* or crypt; but more commonly the relics were deposited immediately beneath the plate of the altar. The reconstruction of the altar which this required was at first not very radical. The relics were enclosed within a stone cippus which closely imitated the heathen pattern. That is to say, it was a block of stone, roughly cubical in dimension, hollow within, and ornamented on the front by a doorway, like a miniature tomb. This was placed beneath the altar and constituted its chief support, though as its lateral dimension was smaller than that of the altar it did not entirely do away with the table legs. There are a number of examples of sixth-century altars of this character at Ravenna and elsewhere. In S. Giovanni Evangelista at Ravenna such a *confessio* was placed under an earlier table altar, and the space which intervened between it and the legs

of the table was enclosed with plates of marble. This leads directly to the final step, in which the altar was enclosed on all four sides by plates of stone and became a mere chest for the preservation of relics. It was not till the Middle Ages that it became customary to enclose a sarcophagus, or a fully extended body, within the altar, with a consequent lateral extension which corresponded to the length of the human figure.

The custom of erecting more than one altar in the church grew out of the cult of relics. Such altars came into use about the beginning of the fifth century, at first in side chapels, later in the church itself and even in the nave.

THE CIBORIUM

To protect and dignify the altar (see p. 104) a roof of square plan supported by four columns was often erected over it. The name *ciborium*—to be derived from *κιβώριον* a cup,—is explained by the form of roof which was commonly given it in the Orient: a cupola, like an inverted cup (Fig. 144). In the West, however, a steep conical or pyramidal roof seems to have been more common. The four supporting columns were placed at a sufficient distance from the altar to permit free passage around it. They were surmounted either by architraves upon which the roof directly rested, or by arches which were filled out at the corners so as to form a horizontal base for the roof. The character of the arch is illustrated by Fig. 39, but the roof generally rose very much higher than in this example. No ciboriums of the early period have been preserved entire, and they are but scantily illustrated in Christian art. We have evidence enough, however, chiefly in the way of descriptions, to establish securely the general traits as they have been given above. The earliest ciboriums we know date from the ninth century, and they still adhere to the ancient type. It was not till about the twelfth century that any novelty was introduced; at that time it became the fashion in Italy to support the roof above the architraves upon rows of colonnettes, giving it a much lighter and more graceful appearance than the earlier form could boast. In the early period the material was of wood, stone, bronze, or silver. It must suffice to mention a few of the most notable examples.

The *Liber Pontificalis* describes the ciborium which Constantine presented to the Lateran. The roof was of silver and weighed 2025 lbs. It is to be presumed that it was supported upon marble columns, and it is probably to be restored like the ciborium in Fig. 39; but the account is engrossed with the decoration and gives no hint of the fundamental form. In front was an image of the Saviour seated, five feet in height and weighing 120 pounds. There were then the twelve Apostles, likewise five feet in height, and weighing 90 pounds each. As symmetry requires, there were doubtless two Apostles at each side of the Saviour, and four upon each of the adjoining sides of the ciborium. On the opposite side, facing the apse, the Saviour was again represented, seated upon a throne, and at each side of him two angels holding rods in their hands. The roof was ceiled with gold. For the lamps which adorned it see p. 351.

This work of art was carried away by the hordes of Alaric in 410; but Sixtus III. (432-440) persuaded the Emperor Valentinian to erect a new ciborium, of which we know only that it was likewise of silver and weighed nearly as much as the old.

In the Basilica Ursiana in Ravenna the Bishop Victor (539-546) replaced an old wooden ciborium by one of silver weighing two thousand pounds, — presumably through the generosity of Justinian. In S. Sophia the columns as well as the roof of the ciborium were of silver; it is described at length and with enthusiasm by Paulus Silentarius. This work had the fortune to endure till the thirteenth century.

THE CHANCELS

Cancelus was the Latin word which was commonly used for the low screens which marked the separation of the presbyterium and choir from the rest of the church. In a later time the name came to be applied to the presbyterium itself — the chancel. Very few chancels of the early period have been preserved in place; we get, however, a clear idea of the normal arrangement in S. Clemente at Rome, where the sixth-century screens (Fig. 58) of the choir and presbyterium were simply removed from the lower church and set up in the twelfth-century church above. We get an equally good idea of the arrangement of

choir and presbyterium in S. Maria in Cosmedin at Rome (eighth century), where the marble chancels which had been employed for the pavement, or for other uses equally foreign to their purpose, have been judiciously restored to their original position (Fig. 38). A glance at the illustration will prove more satisfactory than a long description. In this case it will be noticed that the presbyterium extends some distance into the nave, and a few steps lead from the middle of it into the choir. In other cases, as in S. Clemente, the chancels of the presbyterium coincided with the chord of the apse, and the altar stood upon a line with them; the approaches had therefore to be

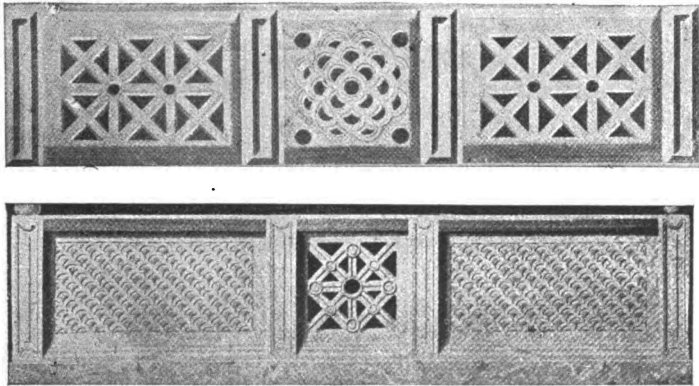

FIG. 57. — Chancels of the fourth and fifth centuries, reconstructed from fragments in the oratory of Equizio and in S. Lorenzo, Rome.

constructed on either side of the altar. In the illustration it will be noticed that the chancels of the presbyterium are surmounted by a light colonnade for the support of curtains. The choir too was sometimes provided with such a colonnade about its entire circumference. Here, as in S. Clemente, there are two ambons, or pulpits, at the sides of the choir. They were used for the singers and lectors, and later for the preacher; they differed in dignity and use, as they differed in form.

A very great number of ancient chancels, or fragments of them, have lately been brought to light in Rome; they had been contemptuously employed in the Middle Ages for wall and floor decoration. These finds inform us as completely as

we could wish about the form of the early Christian chancels, whether they were of stone, wood, or metal. During the fourth and fifth centuries they adhered closely to the patterns which had been long current in Rome, — that is to say, they were usually stiff geometrical designs in openwork, following the technic of metal. Fig. 57 shows a reconstruction of two chancels of this period from fragments found at Rome in the oratory of Equizio and in the church of S. Lorenzo. From the sixth to the ninth century the chancels received a new



FIG. 58. — Chancel in S. Clemente, Rome. Sixth century.

type of decoration, and became the chief field for such stone carving as was still practised, — that is, for the conventional designs in low relief which were copied from contemporary textile patterns (see p. 377). No other stone chancels have been preserved; but wooden ones are also recorded, and so are also chancels of bronze and silver. The most elaborate of all were doubtless the silver chancels which decorated the church of S. Sophia. Constantine employed chancels of gilded bronze in the church of the Apostles at Constantinople.

THE COLONNADE IN FRONT OF THE PRESBYTERIUM

A row of four or six great columns sometimes adorned the presbyterium. Their object seems to have been similar to that of the ciborium, to add dignity to the chief room of the church. They were not originally intended to mark the limits of the presbyterium, for they did not always coincide with it; still less were they designed for the support of curtains, or in any way to hide the altar from the people. It is probable that the earliest examples were simply decorative, and were not even connected by an architrave. It is from this ornamental

feature, however, that we have to trace the rood-screen of the Gothic churches on the one hand, and the iconostasis¹ of the Greek on the other.

In the round church of the Anastasis at Jerusalem Constantine erected twelve columns, corresponding to the number of the Apostles. From the notice that their capitals were surmounted by huge silver craters we are led to suppose that they were not connected by an architrave. Where they were placed or how they were arranged — whether in a circle or semicircle — does not appear.

We are, on the other hand, very clearly informed about both the character and the arrangement of the six white marble columns which (according to the *Liber Pontificalis*) Constantine brought from Greece and erected in the church of S. Peter. They are described as *columnas vitineas*, which alludes to their adornment with traceries of the vine, with birds and flowers — an example of the decadent taste of the age. Notwithstanding this account of their origin, there grew up in the Middle Ages a tradition that they were taken from the Temple at Jerusalem. It is mainly due to this tradition that they were preserved in the rebuilding of S. Peter's, some of them are employed to decorate the niches of the piers high up under the dome, and one is venerated in a side chapel where it can conveniently be studied. It is due to this tradition also that we have the familiar representation of them in Raphael's tapestry which pictures the healing of the impotent man at the door of the Temple. The position which these columns originally occupied in S. Peter's is exhibited in the well-known fresco (probably by Giulio Romano) in the *Sala di Constantino* in the Vatican. They stood in a row across the front of the presbyterium, at some distance behind the triumphal arch. This was probably their original position; but it is likely that originally they were not connected by an architrave; it seems at least as if the free position would comport better with Classical traditions. But at all events they were provided with an architrave as early as the time of Sergius III. (687–701); and Gregory III. (731–741) added another row of six

¹ The iconostasis is a solid screen of considerable height which separates the presbyterium from the nave. It is adorned with sacred pictures and pierced by a central door.

columns, fashioned in imitation of them and placed behind them.

A single colonnade of six columns is preserved in the cathedral of Torcello (Fig. 36); in this case, however, the choir as well as the presbyterium is included behind it. The horizontal beam which connected the columns offered a surface which was sometimes decorated like a frieze; it served as a support for lamps and chandeliers, and, after the seventh century, for large images, — images of silver happen to be mentioned most frequently. It is easy to see how the iconostasis was developed from this form. In the illustration above alluded to, it will be noticed that, between the chancels and the architrave, there is but little open space left; that too, it must be remembered, was often covered by curtains (see p. 378). As the Oriental Church permitted no images carved in the round, it was naturally disposed to make the most of the field which the screen offered for pictorial representations.

THE CATHEDRA

About the seating arrangements of the churches there is very little to be said. There are a few examples of a simple stone bench within the choir; more frequently the seat of the presbyters has been preserved, and that too was a stone bench constructed in a semicircle around the wall of the apse. Whatever dignity or adornment it had, it must have received from rich cushions and wall hangings.

The presbyters' bench was interrupted in the middle by the cathedra or throne of the bishop. To give the greater distinction to this seat, a niche was sometimes constructed for it in the apsidal wall (as in S. Balbina at Rome), it was sometimes surmounted by a baldachino of stone (as at Grado), and it was generally raised several steps higher than the benches which flanked it on either side. The cathedra itself was a chair of dignity, such as the Roman senators used on public occasions. Many of the earliest examples which we know were actually taken from pagan buildings, or at least bought in the public shops; it is especially the finest and the most graceful of them which are most obviously not of Christian origin. During the first five centuries one type of cathedra seems to have been all

but universal: a solid arm-chair with high rounded back carved out of a single block of marble. The famous statue of S. Hippolytus furnishes an early example of such a cathedra; in the illustration (Fig. 118) it is seen, unfortunately, only in face. Later the cathedra was often constructed upon the spot, built up of large blocks of stone. The decoration was generally of a simple character, and rarely of any great interest from the point of view of Christian art. For distinction, as well as for comfort, the cathedra must have relied largely upon its textile coverings, and in particular its cushion and stool.

The singular importance of the cathedra lay in the fact, that it was not only the bishop's seat, but also his pulpit. For it was the invariable custom in the Church, as it had been among the Jews, for the preacher or teacher to address the congregation from his seat. It will readily be understood that the traditional position of the cathedra, at the back of the apse, was not well chosen as a point whence the congregation of a great basilica might be addressed. The interposition of the ciborium, or of a colonnade in front of the presbyterium, rendered the position still more unsuitable. It is related that S. Chrysostom preached from the lectors' ambon in the nave, in order that he might be heard. It is probable that the bishop often used a portable cathedra which might be placed—at least during the sermon—near the chancels of the presbyterium. Such seems to have been the use of the ivory cathedra (Fig. 114) of Bishop Maximianus of Ravenna (546–556). The fact that it is sculptured behind, as well as before, proves that it was not intended to be set against the wall.

The chair which is venerated in Rome as the cathedra of S. Peter is a portable chair of wood (*sedia gestatoria*), of pagan origin, decorated with ivory reliefs representing mythological subjects. The history of the chair is unknown. It is in a ruinous condition, and was long ago enclosed in a heavy supporting frame.

The position of the congregation during the sermon was less uniform than that of the Bishop. In prayer they commonly stood with outstretched hands; kneeling was a more unusual, and distinctly a penitential, attitude. In certain regions, particularly in Africa and in Gaul, it remained the custom, at least as late as the fifth century, to stand during both the sermon

and the lections. In such cases it is evident that no seats were required for the people. On the other hand, we have proof, as early as the middle of the second century, that it was the more general custom of the Church to sit during the sermon. Seats, therefore, must have been provided for the people. The character of the mosaic floor proves that they were not a stationary part of the church furniture; but nothing more precise is to be learned about their character.

THE AMBON

While the bishop preached from the cathedra within the limits of the presbyterium, the lector read the Scriptures from a pulpit erected outside the presbyterium and nearer the people. From the fact

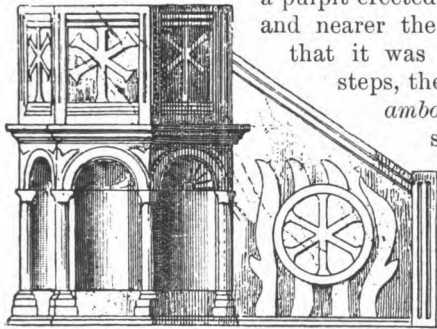

FIG. 59.—Ambon in Thessalonica. Fifth century.

that it was ascended by a flight of steps, the pulpit received the name *ambon* (*ἀναβαίνειν*); or from its shape and elevation it was called "the tower," *πύργος*. The ambon stood sometimes on the middle axis of the nave, sometimes to one side of it. Two ambons were frequently used to distinguish the Gospel from

the lections which were taken from the Old Testament and the Epistles. In this case, they flanked the choir or the presbyterium on either side, and were distinguished from one another by difference in size and ornamentation. The lectern of the Epistle ambon commonly faced the altar; that of the Gospel faced directly across the nave. The position of the two ambons, relative to the altar, was not fixed; the Gospel was read now from the right side, now from the left (see Fig. 38). The paschal candlestick, which seems to have come into use about the sixth century, stood beside the Gospel ambon. In shape the ambon was commonly round or octagonal (Fig. 59) with a solid balustrade, and with an approach of some half-dozen steps upon one or both sides. The double flight of stairs was

probably required for the singers, some of whom stood upon the ambon or its steps during the chants. At S. Sophia there was a single ambon in the middle of the nave. It was approached from the presbyterium by a raised passage, *σολεάς*, across which the clergy could move without hindrance from the crowd. This ambon was so great that the singers found room beneath it; above, it was crowned by a row of columns bearing lamps.

FURNITURE OF THE BAPTISTERY

The arrangement of the baptistery requires but brief notice. A flight of steps descended into the round or polygonal font (*piscina* or *fons*), which was sunk beneath the level of the floor, and sometimes raised also somewhat above it by a breastwork of stone. The font was surrounded by a row of columns which supported curtains to insure the most perfect privacy and decency during the immersion. The columns were united occasionally by archivolts, more frequently by architraves. The architraves were sometimes adorned by metrical inscriptions; the eight distiches in the Lateran baptistery are ascribed to Sixtus III. In the Lateran baptistery Constantine constructed a font of porphyry, covering with silver the outside of the breastwork, and the inside as far as the water line. In the middle of the font he erected a porphyry column supporting a golden viol ("where the candle is") weighing 52 pounds; there also incense was burnt at Easter time. Upon the rim of the font and pouring water into it was a golden lamb weighing 30 pounds. On the right of this a silver image of the Saviour five feet high and weighing 170 pounds. On the left a similar statue of John the Baptist, bearing the inscription: BEHOLD THE LAMB OF GOD, BEHOLD HIM WHO TAKETH AWAY THE SINS OF THE WORLD. There were besides this seven silver harts of 80 pounds each, likewise pouring water into the font. There is mentioned also a censor of gold, weighing 15 pounds, and adorned with 49 emeralds.¹

¹ *Lib. Pont.*, — *in vit. Sylvestri*.

D. POSITION AND SURROUNDINGS OF THE CHURCH

ORIENTATION

The Christians adopted for the orientation of their churches the direction precisely opposite to that of the pagan temples; that is, it was the apsidal end and not the front which was directed toward the east. From the earliest period of church building there was a disposition to give to the apse an easterly direction; this direction may even be said to have been prescribed, and a rule to this effect actually occurs as early as the middle of the third century in the *Apostolic Constitutions*.¹ Athanasius regarded it as an Apostolic ordinance that the church must face the east. Until the beginning of the Middle Ages, however, the rule was so far from being scrupulously observed that it suffered almost as many exceptions as it could boast instances. The direction of the street or the nature of the ground often interfered with a strict compliance with this rule, or even completely reversed the direction. The variety in the direction of the churches is specially great in Rome; nearly every point of the compass is there represented. S. Peter's has the apse on the west end, and it was evidently obliged to take this direction on account of the position of the Apostle's tomb with reference to the Vatican Hill. The first basilica built over the tomb of S. Paul had likewise its apse at the west end, and without any apparent reason. The greater basilica which supplanted it in 389 reversed the direction and complied with the rule. The direction of the street may account for the easterly position of the entrance in the case of S. Sebastiano and of SS. Nereo and Achilleo on the *via Appia*, and of S. Clemente and S. Maria in Dominica within the city. The Lateran basilica has the same direction, though the reason is not obvious. The westerly position of the apse seems to have been deliberately chosen in the case of S. Lorenzo fuori le mura. Some of the most important churches in Rome were directed toward various odd points of the compass, probably on account of the direction of the ancient streets. S. Maria Maggiore, S. Prassede, and S. Prudentiana are directed toward the northwest; S. Marco toward the north; S. Sabina, north

¹ Book II., c. 57.

east; and S. Agnese and S. Saba, southeast. The great basilica at Tyre, built in the beginning of the fourth century, was intentionally directed with its entrance toward the east, and its builder, Paulinus, constructed a high door expressly to admit the rays of the rising sun. The great basilica attached to the Anastasis in Jerusalem had likewise its entrance toward the east. The basilica of S. Felix at Nola had the apse at the west end; but Paulinus acknowledges that this was contrary to "the more usual custom," and he explains it by the necessity of bringing it into relation with the apse of the ancient chapel of the saint. Socrates relates that the chief church at Antioch had "an inverted direction" inasmuch as the altar was at the west end.

Turning from the exceptions to the rule, it is to be noted that in Ravenna, and in general wherever Byzantine influence was felt, the easterly direction of the apse was almost as strictly observed as it came to be in the Middle Ages. It was, however, very rarely that the church lay exactly east and west; there was a declination greater or less to one side or the other. It is a question whether this variety was due simply to accidental causes, the direction of the street, etc., or is to be referred to a symbolical purpose. The attempt has been made to prove the latter opinion by showing that the direction was chosen with reference to the point where the sun rose upon the date of the chief feast of the church in question, or upon one of the turning points of the year. The proof is too ingenious and too uncertain; but it is hardly open to doubt that it was not the true east but the position of the rising sun which imposed the direction. It has been remarked that in Ravenna, where the apse was at the east end, it was pierced by windows, whereas in Rome, where the chief churches had the apse at the west end, it was without them.

The numerous exceptions to the rule of the eastern apse have been taken to prove that the earlier rule in the West required the entrance, not the apse, to face the east, and that the custom which later became universal had its origin in the Orient. But when it is remarked that the most notable instances of this supposed Western rule are confined to churches which were built by Constantine or presumably under his influence—the Lateran, S. Peter's, S. Paul's, S. Lorenzo, the

Anastasis, the basilicas in Tyre and Antioch — it seems likely that this easterly direction of the entrance was a particular fancy of that emperor's. That Constantine may have had a strong prejudice upon a subject like this is not improbable, for it is known that even after he was converted to Christianity he retained many traces of his earlier sun worship.

ATRIUM AND PERIBOLOS

With exception of the memorial shrines which were erected over the tombs of the martyrs, the early Christian churches were almost invariably within the cities. As Christianity was, for a long time, confined almost exclusively to the greater centres of civilization, the churches had, for the most part, to be content with such scanty room as could be provided in densely populated towns. Like the private houses from which they traced their origin, the basilicas were commonly crowded in between surrounding buildings; or, even if more room was at their disposal, it was filled up with chapels, hospices, schools, and the whole complex of buildings which were required as adjuncts to the church. The effort was made, however, to secure a free space in front of the church, a quadrangular court paved with marble and surrounded on all four sides by porticos (Figs. 27, e, 29, 30). This was known by various names, in the West most commonly as the *atrium* or *quadriporticus*. The atrium was an almost invariable feature of the early basilicas in the West; in the East it was less commonly employed, and apparently as an imitation of the Western custom; after the fifth century it became everywhere less common, and only in rare cases was it imitated in the Middle Ages. The atrium provided a dignified entrance to the basilica, and at the same time protected it from the noise of the public streets. It was used for the instruction of the catechumens, for the feeding of the poor, and, doubtless, for many other of the purposes for which a cloister and court might serve. When burial within the city became customary it was the atrium which first provided room for it. The atrium itself was sometimes completely surrounded by subordinate buildings which the more effectually secluded the church. One may raise the query whether an atrium surrounded by buildings of either secular

or ecclesiastical use would not be an apt provision for the requirements of our modern life in great cities, where the old-fashioned churchyard is out of the question, and the noise of the streets is more than ever discomforting.

In the middle of this court there was as a rule a fountain of running water (the *cantharus*) for the symbolical purification of those who were about to enter the church. The washing was generally confined to the hands. This custom had its suggestion not only in the Old Testament and in the Jewish use, but in a practice which was invariably associated with the Classical temple. The symbolism was in itself so obvious that it hardly depended upon example or suggestion. These early fountains with their pure running water were vastly superior, from an æsthetic as well as an hygienic point of view, to the holy water basins of the Middle Ages. The fountain was generally provided with spring water by an aqueduct. No spring water being available for his basilica at Nola, Paulinus depended upon rain water, which he collected from the roof of the church. He describes this arrangement in one of his poems, and he glories in it as an example of humble reliance upon God's provision. Even in view of a dearth of water, he could console himself with the handsome appearance of the fountain and its ornaments. The fountain must have taken very various forms. The basin was commonly surrounded by a balustrade of sculptured marble; it was very frequently surmounted by an ornamental roof supported upon columns.

The most interesting ancient *cantharus* of which we have any notice was that which adorned the atrium of S. Peter's. It was erected by Symmachus (498-514) in substitution of an earlier and simpler one. The *cantharus* of Symmachus endured throughout the Middle Ages, but with the rebuilding of S. Peter's was brutally destroyed. The huge bronze pine cone which formed the centre of the fountain, and two of the bronze

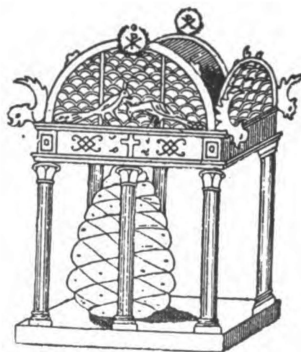

FIG. 60. — Bronze *cantharus* formerly in the atrium of S. Peter's.

peacocks which adorned the roof, are preserved in one of the courtyards of the Vatican Palace. It is supposed that the peacocks were taken from the mausoleum of Hadrian (Castel S. Angelo), and it is not unlikely that the cone too adorned the summit of that monument. Figure 60 gives a rough representation of this cantharus as it was shortly before its destruction. It is from a sketch of one of the earliest of Christian archæologists, the Dutchman, Philip de Winghe; valuable as it is, it does not accurately correspond with the descriptions we have of this interesting monument. According to the descriptions, the roof was of gilded bronze; the peacocks, the four dolphins at the corners, and the great cone were all likewise gilded. Eight porphyry columns supported the roof, and between them were marble chancels, each with two griffins carved upon it. A great fountain of water issued from the cone and played over its surface, falling into a square basin.

Where the atrium was lacking, as was generally the case in the Orient, the fountain — and in this case it must have been a smaller one — was placed in the vestibule. Figure 135 represents close by the church door a small basin upon a high pedestal, which was not unlike the holy water basin of the Middle Ages, except that it was supplied with running water.

Very rarely in the West, but more frequently in the Eastern provinces of the Empire, the church stood in the midst of a great court surrounded by a wall — the *peribolos*. The direct suggestion of the peribolos was the temenos which surrounded the Greek temple. A number of churches which were built upon the sites of ancient temples retained as a decoration the temenos which had surrounded the shrine. In the simplest case it was a mere wall (Fig. 61), but it was often adorned within by porticos. In any case it characterized only such churches as had considerable pretension to magnificence. A whole complex of church buildings was often included within its circuit; in many cases the wall may have been needed for defence.

One of the most important symbolical motives in church architecture is the broad and inviting doorway. This motive was first adequately developed in Gothic architecture; in the early period it was only the Central Syrian churches which expressed it in the design of the façade. The motive, however,

was by no means ignored by the early Church; but the presence of an atrium or peribolos required that the symbolical importance of the door be given its chief expression, not at the entrance of the church itself, but of the church precincts. The entrance of the atrium was in fact given very great importance, and like the propyls of the ancient temple, it constituted a building by itself, projecting beyond the walls of the precinct.

The high doorway which Paulinus built as an entrance to the peribolos of his church in Tyre was designed not only to admit the rays of the rising sun, but to allow those who passed before it a glimpse of the interior. The pious builder hoped by the striking elegance of the doorway to attract the adherents of the old religions and induce them to enter the church. A number of notable doorways are mentioned in

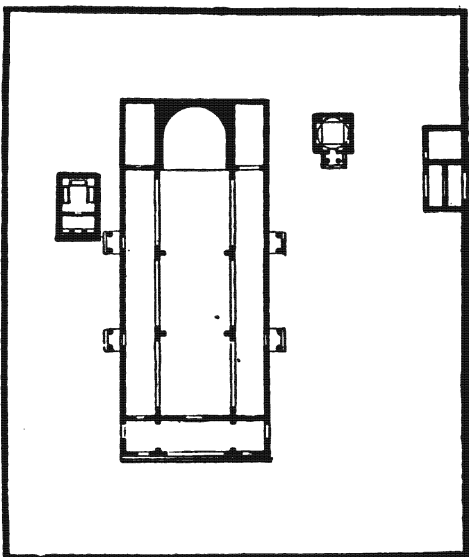

FIG. 61. — Basilica with peribolos in Ruweha, Syria.

early Christian literature, but except for mere vestiges of the foundations none of them have been preserved. The propyls of S. Peter's, as represented in Fig. 30, was a two-storied building with three doors, but it is not possible to decide how much of that structure may have been due to mediæval reconstruction. It appears, however, that the doorway usually comprised three entrances, as in this case.

ADJOINING BUILDINGS

The baptistery belonged only to the church of the bishop. It was never placed directly in connection with the church building, though it often adjoined the atrium. It had therefore a separate entrance and vestibule, and like the church it was frequently surrounded by chapels or oratories. A frequent adjunct of the baptistery was a hall where the candidates

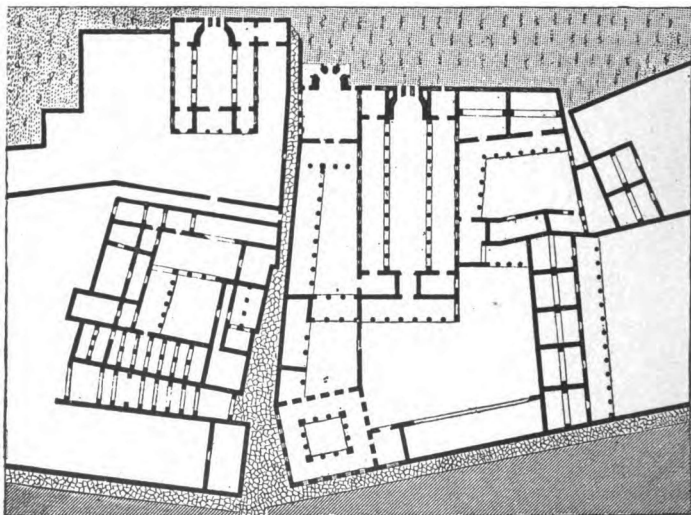

FIG. 62. — Complex of church buildings at El Barah, Syria.

received confirmation (*consignatio*) immediately after baptism and before entering the church.

It has already been remarked a number of times that the early churches were frequently surrounded by chapels. This is illustrated by the plan and the prospect of S. Peter's (Figs. 29, 30). The chapels on the south of this church opened directly into the side aisle; those on the north were separated from it by a narrow passage. The chapels or *cubicula* served two purposes; they were either used as mausoleums before burial in the churches was allowed, or else as places of retirement for pious meditation and the reading of the Scriptures.

An interesting adjunct of the church was the tower. Various were the uses to which the tower was put, and it is uncertain which use may have constituted the original or chief suggestion for its employment. It was only in Syria that towers were employed in pairs and brought into architectural relation with the church (Fig. 32). They were used there for the stairways which ascended to the upper galleries of the church; and they served as places of refuge in regions where there was

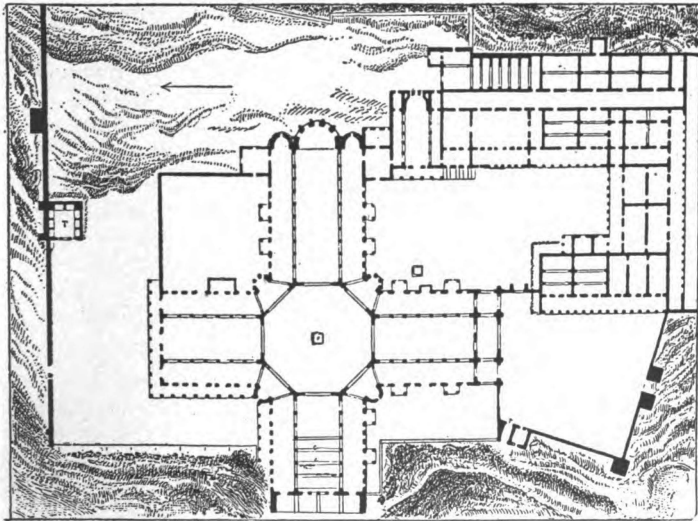

FIG. 68. — Memorial church of S. Simon Stylites, Kalat-Seman, Syria.

danger of sudden attack. In the West only a solitary tower was used, and it was never a part of the architectural scheme. The towers were either square or round in plan, and were divided into about a half-dozen low stories. The tower, however, was by no means a general necessity, and the majority of the churches remained without it. It is probable that in the West they were from the beginning employed for hanging bells; but the date of the introduction of church bells is as undetermined as that of the construction of towers. The ancient towers which remain in Rome and Ravenna are of mediæval

construction in the upper part, and even the bases give no certain clew to their date.

Several of the Syrian sites afford good examples of the complex of ecclesiastical buildings which often surrounded the church (Fig. 62). *Monasteria* seems to have been the name given to small chapels built in the vicinity of a greater church, particularly if they took the form of little basilicas. Next to the chapels the most important adjuncts of the church were the hospices for pilgrims or for the poor, hospitals, schools, baths, and the dwellings of the clergy. The hospice, or *xenodochium*, of Pammachius at Porto (Fig. 27, e) shows an orderly disposition of the buildings which was quite uncommon. It was chiefly in the case of the later monastic settlements in uncultivated and pagan lands that the whole complex of church buildings could readily be conformed to an ideal plan. The early buildings were, however, often very magnificently constructed, and they included rooms for a very great variety of purposes. Particularly impressive is the description of Constantine's church of the Apostles at Constantinople.¹

¹ Eusebius, *Vit. Const.* IV. 59.

IV

PICTORIAL ART

EARLY Christian pictorial art is here treated under three chief heads: Painting, Sculpture, and Mosaic. The early Christian painting which we have to consider is limited almost exclusively to the frescos of the Roman catacombs (early Bible miniatures are treated apart); the sculpture includes numerous sarcophagi, a few rare statues, and some interesting reliefs in wood and ivory; the mosaics *par excellence* are those which adorn the walls of the churches. One would hardly propose any other division than this, and yet it must be confessed that a classification of pictorial art which is based on the method of execution ceases to have any great importance when, as in the early Christian period, the content or thought of a picture predominates over the interests which attach to mere technic, to the greater or less success of execution, or to the medium even in which the work is wrought. This division, therefore, obvious as it is, cannot be adhered to strictly and exclusively; it is crossed here and there by a classification according to subjects, which requires sometimes the tracing of a single theme through all three branches of art.

This familiar and obvious division can, however, be the more reasonably retained, because it corresponds in a measure with three epochs of early Christian art, which were marked by the development of their own peculiar themes. Christian art of the second and third centuries is represented almost solely by the frescos of the catacombs, and the study of early Christian painting is chiefly concerned with this period, notwithstanding the fact that there are numerous catacomb frescos of the fourth century, and occasional examples of the art of every century down to the Middle Ages. The beginnings of Christian sculpture are to be traced back to the third century; but it was in the fourth century that it received its characteristic

development, and within the fourth and fifth are included almost all of the monuments which we have to study. Christian mosaic art was in its chief lines already developed in the fourth century; but it is to the fifth and sixth that the great majority of the monuments belong. The themes which were represented in the mosaics differed substantially from those which were current even in contemporary painting and sculpture. For the decoration of the church there was developed a new range of subjects, which were in part symbolical, and yet different from those which originated in sepulchral decoration; in part historical, and reflecting directly the examples of Scriptural illustration which were furnished by the Bible miniatures. It will be seen, therefore, that in following freely the division which is here chosen, it will be possible to take account of the divisions which refer to time and to those also which are based upon a classification of subjects.

There is another difficulty of method, which is due solely to the limited space at our disposal for the treatment of so large a subject. It is not possible here to allude to all even of the important monuments of early Christian art; it is possible to present only a representative selection of them. There is perhaps sufficient space for a general critique of early Christian art; but with this there would not be space enough for a liberal illustration of it by concrete examples. Inasmuch as the chief claim of archæology upon popular attention lies in the fact that it furnishes the most concrete material of history, it seems well in this instance to rest satisfied with what has been said in the Introduction in the way of a general account of the conditions and development of early Christian art, and to add here only so much of a theoretical nature as may be necessary for the appreciation of the point of view, and for the intelligent apprehension of the individual monuments. This chapter will therefore be mainly occupied with the task of describing a few of the most notable and representative monuments of early Christian art in the spheres of painting, sculpture, mosaic, and miniature. It is necessary, however, to explain somewhat at length the character of early Christian symbolism, and to treat with some degree of completeness a few of the principal subjects of early symbolic art — as, for example, the Good Shepherd and the fish.

So far as concerns the frescos of the Roman catacombs, the treatment is of necessity incomplete. The reproductions which have hitherto been made of the paintings of the catacombs are far from being exact or faithful. The opinions and theories which have been founded upon them reflect the same defects; much of the instruction which the art of the catacombs is capable of furnishing has not yet been brought to light, and some of the pictures which are best known are the theme of conflicting theories. Now, however, Monsignor Wilpert has ready for immediate publication a great work, the fruit of long labor, which is at once a complete study of all the paintings of the Roman catacombs in the spirit of the most candid and painstaking research, and a perfect illustration of them by means of the most exact processes of reproduction. This work will itself reveal much that is new; but, what is of still greater importance, it will put in the hands of all students the material for independent study. While expecting the publication of this book one would indeed be rash to venture beyond the commonplaces of this subject. For the illustrations of this section I have relied exclusively upon the pictures which Monsignor Wilpert has already published in several preliminary works.

A. EARLY CHRISTIAN PAINTING

BEING THE FRESCOS OF THE CATACOMBS, AND EARLY CHRISTIAN SYMBOLISM IN GENERAL

Almost all that need be said about the technic of early Christian painting—and indeed of sculpture too—is told in one word, when it is said that it passed by no single step beyond the formulas of Classical art, and that it followed that art in its rapid decline after the second century. Inasmuch, however, as the frescos of the Roman catacombs are almost the only examples preserved to us of the painting of the second and third centuries, it is in them chiefly that we have to trace the successive steps of the decline of this art. It may be that we derive from the catacombs an exaggerated idea of the impotence of late Classic art, for it must be observed that the execution of the catacomb frescos was from first to last exceed-

ingly sketchy, as was natural in the case of a decoration intended for small sepulchral chambers which were rarely visited and were visible only by artificial light. At the same time, rapid execution reveals perhaps as well as more studied work the training of the artist. The mere decoration of the catacombs demanded no more than a rough conventional design; the religious interest was satisfied with the bare indication of a well-known theme. In the later period the artist was content to fulfil the bare requirements; the artist of the earlier period rejoiced in picturesqueness of detail, in grace and naturalness of execution, the spontaneous expression of his skill. The decline in skill was so uniform and so uninterrupted that it enables one to determine approximately the date of most of the pictures. Hand in hand with this there went a growing carelessness even in the preparation of the plaster upon which the picture was to be painted, — as indeed in all the mechanical arts of building. The first impression of the paintings of the catacombs is rather one of uniformity, because in the general devastation the best are often reduced to the same state as the worst, and because, moreover, the color scheme is in all substantially the same — yellow, red, and green upon a white ground. But the farther one goes back the more careful were the color gradations; in the third and fourth centuries there was less and less attempt at gradation from one color or shade to another, and in later pictures which approach the Middle Ages the different parts of the figure were marked by the rude device of tracing with a line of black.

But all of this is of more interest to one who would follow the decline of Classic art than to us who are pursuing the rise and progress of the Christian. Of so little interest from our point of view are the technical formalities of execution, that some of the best-preserved pictures are of less importance than others which are now to be traced only by the help of the artist's preliminary outlines which were scratched in the fresh plaster. Many of the subjects which were represented in fresco were reproduced in the rude graffiti which were scratched upon the tombstones or upon the walls, and the manifest imperfection of this type of art hardly diminishes its interest. It will appear more plainly as we proceed that in early Christian art the substance was accounted of more importance than the

form; it is still more obviously true that *our* interest in these early monuments of art centres in the artist's purpose and thought rather than in the comparative success of his execution.

The history of Christian art, if we regard art solely with reference to its form, is divided into three periods. The first and second centuries represent the best period of Classical art under the Roman Empire. This, however, was but a faint reflection of Greek art of the best period; it will be remembered that the artists in Rome were for the most part Greeks, working under Roman influence and catering expressly to Roman taste. What was true of Rome in general was especially true of the Christian community, which was thoroughly cosmopolitan in its constitution and actually used the Greek tongue as its official language. The third and fourth centuries were a period of steady decline. The following centuries witness no check to this decadence, albeit they are characterized by a new feature, a certain stiffness and conventionality which was obviously due to a reaction from the side of the mosaic art, which was then fully developed in the decoration of the basilicas.

But if we turn rather to its material than to its formal aspects, we get another division of the history of early Christian art which is at once more definitely marked and more fundamental. To speak only of the first four centuries, we have first to consider a period, extending to some time in the early part of the second century, during which there was no Christian art properly so called, and the decoration employed by Christians was merely a selection of the more innocent themes of pagan art, to some of which a Christian symbolical sense might be attached. By the middle of the second century, however, we find an art as truly religious, as truly Christian, as any which was ever developed, and none the less Christian because it was couched in Classic form. It dealt already with a wide range of Biblical subjects, which, without any considerable extension, remained the staple of Christian art throughout the third century. There was from the first a typical fixity in the mode of representing these subjects, which did not interfere, however, with a rather astonishing liberty in certain other respects. The order of time in which these subjects emerged, and their relative popularity, can rarely be determined with

precision, and at all events it constitutes a study far too minute to be pursued here. It is sufficient for us here to regard them as a whole, and to note that they do actually display an unity of type which is due to the fact that they are stamped, expressed, and permeated by a certain mystic symbolism which was in many respects peculiar to the age of persecution, and seems to have lost its interest for the Church with the very beginning of triumph and prosperity. As a consequence of this, many of the subjects which were most familiar in the third century disappeared in the fourth, or were reproduced, especially in the sculpture of the sarcophagi, merely through the force of formal tradition.

With the fourth century, therefore, begins the third period of Christian art. It was characterized by a new type of symbolism which comported with the new trend of thought which was initiated by the triumph of the Church, as well as by a new use of art as it emerged from the catacombs and was employed for the decoration of the churches. It was a symbolism at once more obvious and more formally dogmatic than that of the older type; it may be said to be less profoundly religious and more ecclesiastical. During this period, however, symbolism no longer constituted the predominant, nor even the principal, interest of Christian art; it was supplanted by a purely didactic and historical treatment which dealt chiefly in the description of Biblical scenes. But what is peculiar to the development of the fourth and fifth centuries belongs primarily to the arts of mosaic and sculpture and will be treated under those heads. We have here to deal chiefly with the art which is represented by the early frescos of the catacombs, or more generally with the whole range of Christian symbolism as it was expressed during the age of persecution.

Inasmuch as early Christian painting is represented almost solely by the frescos of the catacombs, and more particularly the catacombs of Rome, we must take into consideration the query, whether, and to what extent, it is the expression of merely local traditions, and how far it was expressly designed for and limited to the use of sepulchral decoration.

Even as between one catacomb and another one may mark differences which are expressed both in formal treatment and in a preference for one or another group of subjects. They

were evidently due to the individuality of the artists who were employed. But these differences do not go very deep, the range of subjects was after all so limited, each theme was repeated over and over again so many times and with so much similarity of treatment, even among the small minority of Roman frescos which have been preserved, that we have reason probably to mourn no absolute loss of a new and singular theme among that great majority in Rome and elsewhere which have been destroyed. We learn from literary sources that the same symbolism was current throughout the Church, and it is not only the uniformity of art throughout the Empire, but still more the wonderful unity which bound together the Christian communities during the second and third centuries, which leads us to believe that the art of the Roman catacombs was the art of the Church.

We shall see that the themes which are represented in the art of the catacombs were in the main chosen with express reference to the purpose which they actually served, that is, as decoration appropriate to the grave. There is no reason to suppose that these same subjects were employed in the decoration of private houses, nor that beside this another cycle of Christian art was developed for the decoration of the earliest basilicas. We may, on the contrary, be quite sure that in point of decoration the house of a Christian differed from that of a pagan in no other respect than in the exclusion of the indecencies of Classic art. Even in the fourth century no new domestic decoration was developed; at the most—as in the house of SS. Giovanni e Paolo in Rome—the conventional Classic decoration was eked out by a few of the traditional pictures of the catacombs. As for the decoration of the basilicas, it appears very evident that it was first developed in the fourth century. Even the mosaic decoration of S. Costanza was hardly more than a selection from among the gracious and innocent themes of Classic art. It is more closely related to certain of the catacomb frescos of about the end of the first century—as in the earliest cubicula in S. Gennaro at Naples and the vestibule of S. Domitilla at Rome—than it is to any of later date. The earliest frescos of the catacombs, those which antedate the creation of a distinctive Christian art, have therefore a peculiar interest, inasmuch

as they may be taken to represent the character of decoration which the Christians preferred for their houses and for the early basilicas which were developed from them. These early frescos of the catacombs, like the mosaics of S. Costanza (Figs. 125, 126), reproduce with a merely decorative interest birds, fishes, and beasts, trees, garlands, and flowers, ornamental figures and busts, cupids and victories, and many mythological figures which were of too common a use to suggest expressly the pagan religion to which they traced their origin. Of these subjects there were some which gained a special popularity, because it was possible to attach to them a Christian symbolism; such, for example, were the vine, the dove, the peacock, the fish, and the fisherman, and even such mythological figures as Psyche and Orpheus.

But we must pass over this theme, we must confine ourselves here to that class of pictures which is beyond all doubt the most interesting, those, namely, which are distinctly symbolical, or at least religious, in character. There was a time when all the pictures of the catacombs were symbolically interpreted; there has lately, on the other hand, been much controversial zeal displayed in the attempt to reduce the symbolical to the fewest possible number of instances. If we dwell here almost exclusively upon religious and symbolical pictures, it is simply on account of their superior interest, and it is not to be taken as a sign that we would ignore the fact that there are others, beside the purely decorative themes just noticed, which have no religious reference at all. It is beyond a doubt that there are many purely *genre* pictures, representing especially the professional or domestic life of the deceased; it is true, too, that such pictures often throw an interesting light upon early manners and customs. It is only for lack of room that they must be dismissed with this bare notice, along with many subjects of an expressly religious character which cannot well be included under a few general heads which we can here study with some degree of completeness.

Before we pass to the study of any special themes it is necessary to consider the character of early Christian symbolism in general.

EARLY CHRISTIAN SYMBOLISM

It would hardly be necessary to discuss early Christian symbolism as a topic by itself and apart from the monuments which expressly illustrate its character, if it had not become a point of controversy more zealously contended than any other in the whole field of early Christian archæology, if the symbolical element in the art of the catacombs had not been fantastically exaggerated by some and unduly minimized by others. The point at issue, however, is not whether early Christian art was symbolical or not; but how far the symbolism extended, and what precisely was its character.

From Bosio down, the archæologists have commonly carried to so fanciful an extreme the symbolical interpretation of the pictures of the catacombs as to justify a sharp reaction. The reaction proves hardly less extreme, but it may be hoped that the controversy has now expired, leaving a substantial unanimity of opinion upon the principal points at issue. It may be remarked that de Rossi himself was not altogether a safe guide in matters pertaining to art, and his own immediate disciples have been prompt to make the needed retrenchments upon his teaching on this subject. A group of German Protestant writers who have lately attacked the Roman archæologists with some violence for their exaggerated interpretations of Christian art in the interest of Roman dogma, have perhaps had a sobering influence upon recent studies, though they were not justified in confusing all Roman archæologists with the extremists, and they were unfortunate in transforming the question into a doctrinal and denominational issue. It is of no interest to us to follow the history of the controversy, it is enough to state its results as affording a sound basis for our own interpretation of early art.

It must not be supposed that unanimous agreement is possible upon all the subjects of early Christian art, for in many instances the interpretation must be acknowledged to be at the best uncertain. It is not to be hoped that all will confine themselves to a fair interpretation of symbols which may be so easily wrested to the pious purpose of supporting the faith. But neither uncertainties of interpretation nor differences of opinion must be allowed to prejudice the fact that some sym-

bolism was actually intended by the artists and understood by those for whom they worked. It is of the nature of the pictorial symbol to be somewhat vague; therein lies its chief advantage over the more definite forms of speech, its suitability for the expression of themes — particularly religious notions — which evade the grasp of logical definition. It expresses, therefore, nothing with the definiteness of dogma, but in the freer terms of popular thought.

It is equally of the nature of the symbol that it is capable of more than one interpretation, that it attracts to itself an aggregation of kindred suggestions whereby it is progressively enriched. It has been sought to throw contempt upon any symbolical interpretation of Christian art by showing that the early writers attached divers significations to the same symbol. What this does prove is not that the art of the catacombs was not symbolical, but that it was subject, even in early times, to various interpretations. It does serve, however, as a caution against an arbitrary attribution of a fanciful and purely subjective symbolism to the early age of the Church. One is at perfect liberty for one's own delectation to attach whatever meaning one chooses to any symbol, ancient or modern; but it is altogether fallacious upon this ground to attribute to the early age of the Church doctrines and religious conceptions which are not indubitably expressed by the symbol, or in some other way clearly proven to have been current at that time.

It must be acknowledged that some of the Roman archæologists have extravagantly erred against this principle. From the pictures of the catacombs there is not so much to be learned about the dogmas of the early Church as has been supposed. They are chiefly interesting for the side lights which they throw upon the popular religious point of view and upon religious or ecclesiastical practices. The fundamental error of the interpreters lay in supposing that the art of the catacombs had a didactic purpose, that it was intended, like the historical pictures of the basilicas, for the instruction of the ignorant and unlettered. This idea is refuted by the very form of these pictures, which, if they are symbolical, are on that very account capable of expressing only that which was already familiar. It is equally inconsistent with the place where they were executed; for the cubicula of the catacombs were not

places of frequent, far less of public, resort. We must recognize the probability that the pictures of the catacombs were appropriate to the place, and that their symbolism had reference predominantly to the hopes which illumined the prospect of death.

It has been claimed that the decoration of the catacombs was strictly superintended by the clergy, that the hand of the artist was guided by the theologian; and it is sought thus to justify, not only the discovery of a definite dogmatic import in the single symbol, but the concatenation of the separate pictures of a single cubiculum or arcosolium into a complex system of theological ideas. But there is no reason for attributing to the early age of the Church the pedantic direction of art which is first proved in the case of the Byzantine Church in the eighth century. It is true that in the fifth century the bishops often personally directed the pictorial decoration of their churches, but the absence of any literary reference to Christian art during the first three centuries seems to prove that the ecclesiastical leaders had but little interest in it, that it grew up, therefore, in response to a popular demand and for the expression of popular ideas. Early Christian art is all the more important on this account, for we already know from their writings what the ecclesiastical leaders thought, and we desire very much to learn what notions were current among the people. We shall find that early Christian symbolism had a deep and mystical import, but that it by no means constituted a learned and technical system. One must be on one's guard against weaving into a system any series of pictures which happen to be painted upon the same wall or in the same chamber; they must be presumed to be separate unless they are connected by some range of ideas at once obvious and simple. A deeply thought out connection may, however, undoubtedly be traced in a number of instances, and especially in the so-called Sacrament Chapels of the catacomb of Callistus.

The proof that early Christian art was in fact symbolical is at once clearly displayed when we ask ourselves the question, Why do we find a monotonous repetition of an exceedingly narrow choice of Biblical subjects, to the total neglect of hosts of others which were no less important, no less familiar in

Christian instruction, no less dramatic and picturesque? There is no possible answer, except that their choice was determined by symbolical considerations. The symbolical employment of art by the early Church is rendered antecedently probable by two considerations: first, by the fact that Roman art had, by the beginning of the second century and under the influence of Oriental cults, assumed largely a symbolical character, especially in the decoration of sarcophagi; second, by the common use in the Church of allegorical interpretations of Scripture. Alexandria, whose influence was paramount in the field of allegory, is likely to have had a leading part in fixing the character of the symbolism of Christian art.

The character of this symbolism is best shown by the study of particular instances. What it is necessary to remark here is the effect which the exclusive symbolic interest had upon the execution of art. It is to this we have to attribute the absence of picturesque traits, indifference to such realistic effects as even late Roman art was able to compass, and carelessness about literal agreement with the terms of the Scriptural account. The subjects dealt with were familiar to all; the artist could afford to abbreviate description, and in depicting the chief dramatic moment he relied upon the imagination of the beholder to supply the whole scene. A man floating in a chest served to recall the story of Noah as an instance of divine deliverance. Christ touching with a rod a basket of bread recalled the miraculous multiplication of the loaves and symbolized the Eucharist. The story of Jonah was commonly represented in three scenes; but even when it was abbreviated to one, that quite sufficed for the purpose of the symbolism. The artists could not have been ignorant that according to S. John's Gospel the face of Lazarus was covered with a napkin and his tomb was closed by a stone door; yet he is invariably represented with uncovered face standing under an open tegurium; — for some reason or another this mode of representation was adopted, and since everybody understood its meaning, the artist had no need to seek a more accurate expression. No one could suppose that the ark of Noah was a cubical chest too small to contain a single person; but that was the traditional form, it demanded very little room, and the symbolism which was involved was as well

expressed by that as it would have been had the artist stretched his invention to depict a boat which was capable of containing all the beasts of the field and all the fowls of the air.

All of this is precisely what might be expected if the situation be fully taken into view. The beginnings of pictorial art have always been symbolical, at least in the sense that more is suggested than a rude art is able to depict. All art is apt to strive toward the attainment of realistic representation, or, in other words, toward illusion. But with this attainment it at once loses a certain power which lay in its early suggestion. The crude wooden idols of archaic Greek art and the black Byzantine Madonnas of the seventh century were worshipped with a religious ardor which no marble of Praxiteles, nor any canvas of Raphael, ever evoked. The archaic smile of the early Greek image might suggest a divine benignity; the perfect art of Greece could represent all that is gracious and noble in the human countenance, but by its very perfection it closed the way to all ulterior suggestion. Religious art is fundamentally symbolical, at least in the sense that it relies upon suggestion, because it deals with things which cannot be depicted. Christian art was predominantly symbolical until the Renaissance; it cannot be denied that with the skill it then attained it lost much of its religious character. In this case the value of early crude suggestion was in a measure offset by the power of depicting the human face as it was moulded and inspired by Christian motives and by the Christian life.

At the commencement of the Christian period Classical art was, indeed, unable to express this lofty moral ideal — life had only begun to furnish the models for it. But it was very well able to depict with striking realism the common objects of nature and the common scenes of life. Only a little earlier the artists had boasted of their skill to delude the eye. If Christian art did not take full advantage of the skill which was actually at its command, this was due to the fact that it was intent upon other things, upon the expression of conceptions for which mere skill of hand availed nothing. It was bound to ignore the possibilities of realism, of the descriptive and picturesque in art, and to rely upon suggestion and symbol. When early Christian painting and sculpture displays a care

for artistic symmetry, for picturesque detail, for realistic precision, it is the spontaneous expression of the artistic instinct which demanded its rights; all this was not required of the artist, and it is not to be wondered that it was often lacking. From this it will be apparent why it was that Christianity interposed no obstacle to the decline of Classic art: it put no premium upon artistic skill; it subordinated technical excellence to the interest of the religious symbol.

SYMBOLS OF DIVINE DELIVERANCE

In the introduction to his *Étude sur les sarcophages chrétiens de la ville d'Arles*, Le Blant had the credit of suggesting a theory which has been very promptly and very widely accepted by students of Christian archæology. The theory was suggested expressly to account for the subjects which were sculptured upon the sarcophagi, but it applies quite as well to the frescos of the catacombs. It has the advantage of explaining many of the themes of early Christian art from a single point of view, and of referring them to a distinctly funereal symbolism, which expressed the Christian trust in the divine might which was able to deliver the soul even from death and the grave.

Starting with the observation that the phraseology of many early epitaphs seemed to be derived from the liturgy of the Church, the suggestion lay very near that the pictorial themes also might have been inspired from the same source. It proved, in fact, very easy to show a relation between the themes of Christian sepulchral art and the funeral liturgies, which is altogether too complete and too precise to be fortuitous. Le Blant referred especially to the prayers in the Roman Breviary which commend the soul to God in the hour of death.¹ After a long litany come the following supplications:—

Receive, O Lord, thy servant into the place of salvation which he may hope of thy mercy.

Deliver, O Lord, the soul of thy servant from the pains of hell, etc.

Deliver, O Lord, his soul as thou didst deliver Enoch and Elijah from the common death of the world.

Deliver, O Lord, his soul as thou didst deliver Noah from the deluge.

¹ *Ordo commendationis animæ, quando infirmus est in extremis.*

Deliver, O Lord, his soul as thou didst deliver Isaac from sacrifice and from the hand of his father Abraham.

And so the prayer continues with the same formula, mentioning the deliverance of Daniel from the den of lions, of the Three Children from the burning fiery furnace and from the hand of the wicked king, Abraham from Ur of the Chaldees, Job from his sufferings, Lot from Sodom and from the flame of fire, Moses from the hand of Pharaoh, king of the Egyptians, Susanna from false accusation, David from the hand of King Saul and from the hand of Goliath, Peter and Paul from prison, and Thecla from horrible torture.

It is remarkable that among these examples of signal divine deliverance there are very few subjects which are not represented in early Christian art, and they are such as did not lend themselves to pictorial treatment—as the deliverance of Enoch and the departure of Abraham from Ur. On the other hand, this list includes almost all of the Old Testament subjects which were employed in sepulchral art. Many of these subjects are repeated in other prayers which are connected with the Roman funeral liturgies, and it is to be remarked that Lazarus and Jonah, omitted here, are elsewhere added to the list. They are here omitted, one may suppose, because they are most expressly types of the resurrection, whereas this is a prayer for deliverance from bodily death. It has to be acknowledged that these prayers are not to be traced to any texts which are earlier than the ninth century, and although in substance they doubtless are very much earlier, it would be rash to refer them to a date as early as the fourth century, and still more so to suppose that they served as the text for the earliest examples of Christian art in the second century. They are, in fact, to be regarded rather as a concurrent witness with the art of the catacombs to the strength of a type of thought which was exceedingly familiar in early Christian literature and is to be traced back to the second century.

This theory was put upon a much broader and a sounder basis by Victor Schultze, who sought out analogies even more complete in early Christian literature, and proved the broad currency of the argument which was drawn from signal examples of divine deliverance and from the miracles of Christ, in proof of the power of God to deliver the soul from sin and

from death. He shows also that the Scriptures themselves often furnish the hint which marks some of these subjects as typical of the deliverance of the soul from death, and he notes that the language of the Psalter obviously encouraged this mode of thought. Le Blant himself referred to an engraved glass cup of the fifth century found at Podgoritza (see p. 357), which groups together a considerable number of these subjects and accompanies some of them by inscriptions which seem like an echo of these ancient prayers. Schultze quotes as the Classical example a passage from the *Apostolic Constitutions*:¹ "He who raised Lazarus on the fourth day and the daughter of Jairus and the son of the widow, and rose also himself; who after three days brought forth Jonah living and unharmed from the belly of the whale, and the three children from the furnace of Babylon, and Daniel from the mouth of lions, shall not lack power to raise us also. He who raised the paralytic, and healed him who had the withered hand, and restored the lacking faculty to him who was born blind, the same shall raise us also. He who with five loaves and two fishes fed five thousand and had twelve baskets over, and who changed the water into wine, and who sent the stater which he took out of the mouth of the fish to those who demanded tribute by the hand of me Peter, the same shall also raise the dead."²

In these texts there are included the majority of the subjects, which were commonly employed in the adornment of the catacombs and of the sarcophagi, and there can be no doubt that it was this argument of deliverance from death by the almighty power of God which accounts for the selection of these signal instances of deliverance and their monotonous repetition in early Christian art. The relation of these scriptural instances to the personal hope for departed friends is sometimes made very obvious by the substitution of the figure of the departed in the place of the Biblical character. As an epitome of this whole series of representations we must regard the orans, the female figure with arms outstretched in prayer, which symbolized the soul of the deceased. One is left to wonder why the capital instance of this whole argument—the resurrection of Christ,

¹ Book V. 7.

² For other texts quoted by Schultze the student is referred to his *Archäologische studien*, p. 15 seq., and *Archäologie der altchristlichen Kunst*, p. 181.

which the Scriptures treat as the most immediate proof of the resurrection of his followers—appeared so rarely in early Christian art, and not at all until the fourth century. It is to be noted that some of these subjects appear first on the sarcophagi.

This theory must not, however, be held to account for all of the symbolical art of the catacombs, nor must we suppose that this art had all of it a funereal reference. The subjects even of the cycle which we have just considered had some of them, in addition, a very different symbolical import. It is not to be doubted, for example, that the multiplication of the loaves was also a symbol of the Eucharist. On the other hand, there were many subjects quite outside this cycle which from different points of view brought their own contributions to the symbolism of the tomb. Such was the figure of the Good Shepherd, a many-sided symbol in which the funereal reference was at least incidental. Such, too, were most of the symbols which Christian art inherited from the pagan. Orpheus, the peacock, the phoenix, the dolphin, etc., were already, in Classic art, employed as sepulchral symbols and connected by mythology with the fate of the soul after death.

We have now to consider in detail the artistic expression of the more important subjects included in the cycle of divine deliverance and miracle. It will be convenient to study here, once for all, the expression which was given them in sculpture as well as in painting.

THE ORANS

The name *orans*, or *orant*, designates a figure in the attitude of prayer, with arms outstretched in the manner which was common to both Jews and Gentiles, and was accounted by the Church particularly significant, because it recalled the position of the Saviour upon the cross. Portraits of the departed were, in the art of the catacombs, generally represented in this attitude (Figs. 85, 124). We can readily understand why the Old Testament characters which are taken as examples of divine deliverance were also commonly represented in the posture of prayer. The Scripture itself furnished the suggestion, recording the prayer of Jonah and the song of the Three Children.

Noah, upon his deliverance, immediately offered a sacrifice of thanksgiving; and the attitude of prayer was no less appropriate to Isaac delivered from sacrifice, to Daniel among the lions, and to Susanna accused by the elders.

But though we may apply the name "orans" in a general sense to portraits of the deceased and to representations of Biblical characters, it is used more specifically to denote the artistic symbol of the souls of the faithful departed. It is not



FIG. 64. — Orans in palla, fresco in the crypt of Lucina. Second century.

always possible to draw a sharp line of distinction between the portrait orans and this symbolical abstraction. Whole families, men and women and children, were sometimes portrayed in this posture upon the wall of the tomb where their bodies reposed. Even where there was no attempt at a portrait, the distinction of sex was sometimes observed. But the great majority of orants were quite impersonal in their traits, and equally so, whether they constituted part of the adornment of the ceiling, and represented the disembodied soul in general, or were brought into immediate relation with a particular tomb. The proof of the symbolical character of the orans lies in the fact that it was

generally represented by a female figure, without regard to the sex of the deceased. So, for example, we find often a female figure painted above a tomb when the inscription denotes a man. An early lead medal in the Vatican Museum represents the martyrdom of S. Lawrence and depicts a female figure rising from the body of the saint to receive the martyr's crown. In the *Acts of SS. Petrus and Marcellinus*: "The executioner testified that he saw their souls issue from their bodies in the form of young virgins, who were adorned with gold and gems and clad in shining garments, and were carried to heaven by the hand of angels." It is impossible with any candor to

deny the symbolical significance of the orans. The attitude of prayer comported with the situation of the soul at the moment of death: it represented at once thanksgiving for deliverance from death, and supplication of God's merciful judgment. The purely abstract symbol was not a development out of the portrait orans, for it appears among the earliest types of Christian art. Upon the ceiling of the crypt of



FIG. 65. — Orans with dalmatic and veil, catacomb of Callistus. Third century.

Lucina, which was decorated early in the second century, an orans of a thoroughly hieratic type (Fig. 64) is twice represented, alternating with the figure of the Good Shepherd. In this case, the figure is clothed in the palla. But it is the posture and sex, not the costume, which denotes the orans. The costume, in fact, varied, and it registers the changes of female fashion in dress, from century to century (Figs. 64, 65, 66). It will readily be seen that the Old Testament heroes of

deliverance who were represented in this posture, were thereby brought into relation with this symbolism, and their significance as types of the resurrection was made more abundantly plain.



FIG. 66. — Orans with girdled tunic and veil, fresco in the catacomb of Thrasion. Fourth century.

The orans of the catacomb frescos was reproduced in the sculptures of the sarcophagi. This symbol had no doubt its influence upon the mediæval representation of the soul as a diminutive body issuing from the mouth of the dying to be received by angels, or by demons, as the case demanded.

OLD TESTAMENT CHARACTERS

It must be borne in mind that we have here to do solely with the Old Testament characters who were regarded as types of deliverance from death. But though we have this symbolism primarily in view, we shall not neglect to consider other symbolical notions which were associated with these same subjects.

It is doubtful whether Adam and Eve properly belong to this cycle, or what precisely their significance may be in Christian art. They appeared very early in the catacombs of S. Gennaro at Naples, where they were associated with the mythological decoration of an early crypt. But at Rome the subject did not become popular till the fourth century, after which time it was employed very frequently upon the sarcophagi and upon the gold-glasses. The creation of man is represented but three times; the best-known example is upon a sarcophagus in the Lateran (Fig. 95). The theme commonly chosen is the temptation: in the midst is the tree with the serpent coiled about it, and on either hand stand Adam and

Eve, endeavoring to hide their nakedness with a leaf. Very commonly the man and woman are accompanied by the symbols of their respective labor: a sheaf of wheat represents the work of the husbandman, a lamb signifies the woman's work of weaving (Fig. 100). In some cases (Figs. 95, 98) the figure of Christ appears between them, allotting to each their labor. Eve appears sometimes upon the gold-glasses with hair richly dressed, and wearing bracelets and arm bands (Fig. 163). Several sarcophagi represent the exclusion from paradise.

The subject of Noah appeared as early as the end of the first century, and it was frequently employed in the art of the catacombs during the second and third. The earliest instance is in the vestibule of the catacomb of Domitilla, where, however, the only vestige of the picture which remains is the dove bearing the olive branch.

The subject was so simple in its treatment, and it was repeated with so little variation, that it requires few words of description. The representation is in the highest degree abbreviated: Noah stands alone and in the posture of an orans in a small cubical chest which floats upon the waves, while the dove flies toward him with the olive branch. In only one instance, a sarcophagus in Treves, is the whole family represented in the ark, with various birds and beasts. Sometimes a lad, or even a female orans, appears in the place of Noah, more clearly indicating the typical character of the subject.

It is very curious that the ark is represented in this same form on a coin of Septimius Severus stamped in Apamea in Phrygia (Fig. 79). In this case Noah and his wife are twice depicted, at one moment receiving the dove in the ark, in another standing upon the land and offering a prayer of thanksgiving for deliverance. It has been shown that there was a strong Jewish colony in this town, and the fact that it lay under the shadow of Mt. Ararat suggested this theme.

It is not unlikely that the form which is here given to the ark was suggested by some prototype in Classical art, perhaps by the chest in which Danaë and Perseus were set adrift. There is nothing in the monuments themselves to indicate whether any other symbolism was intended beyond that which we have traced. But it is not to be forgotten that in the first Epistle of S. Peter the ark is treated as a symbol of baptism,

and that Tertullian, elaborating this figure, made the ark a symbol of the Church.

The dove and the olive branch — or the olive branch alone — became a still more abbreviated symbol of deliverance and of peace.

We have seen that Moses' deliverance from the hand of Pharaoh was one of the subjects which appears in the liturgies as a type of the resurrection. There is evidently no single dramatic incident which expressed this deliverance; various episodes of Moses' life, however, were frequently depicted in fresco and sculpture. His colloquy with God at the burning bush was conventionally abbreviated almost beyond recognition; even the bush was dispensed with, and Moses appears with one foot raised upon a rock bending over to take off his shoe. This, according to Wilpert, stands for the believer who prepares after death to appear before the presence of God. Especially common on the sarcophagi was the scene in which Moses receives the tables of the Law from a hand stretched out of a cloud. Most frequent of all, and especially in the art of the catacombs, was the striking of water from the rock. The mode of representation was practically the same in painting and in sculpture; it is illustrated in Fig. 96, and at the lower right-hand corner of two sarcophagi which are shown in Figs. 95 and 98. On the sarcophagi this subject often balanced the resurrection of Lazarus. This was doubtless due chiefly to the desire for symmetry; but it can hardly be doubted that Moses was regarded as a type of Christ, as the water also was a symbol of baptism.

It is claimed by Roman archæologists that in the fourth century Moses was represented with the facial traits which were traditionally ascribed to Peter. A gold-glass in the Vatican which represents the striking of water from the rock is inscribed with the name *Petrus*. The artisans who made such wares frequently fell into error in attaching names to the subjects which they represented; but as this is not the only instance in which the name of Peter is attached to the figure of Moses, it is probable that a parallel was sometimes drawn between the chief of the Apostles and the chief figure of Jewish history.

No subject was so popular in the art of the catacombs as the

story of *Jonah*. It not only furnished the most striking symbol of the resurrection, and one which Christ himself appealed to, but it provided the best field for the exercise of the artist's fantasy. There are about forty instances of it among the paintings, and it was repeated also in sculpture, although in the latter case it presented manifest difficulties. The artistic expression of this theme was subject to a good deal of variety in detail, but the sarcophagus illustrated in Fig. 94 shows substantially the mode in which it was treated both in fresco and in sculpture (see also Fig. 164).

The story was represented in three scenes: the first was that in which the prophet was cast out of the ship into the mouth of the sea monster; in the second he is cast up by the monster upon the land; and in the third he reposes under the gourd. It will be observed that the monster is not a fish, but one of the fabulous dragons which were common in Roman art; it is probably most closely related to the dragon from which *Andromeda* was delivered. This theme, too, was sometimes abbreviated by dropping one or more of the three scenes; or space was economized, as in Fig. 98, by crowding the scenes so together that *Jonah* is spit out by the monster directly under the gourd. It is remarkable, however, that the scene which is generally retained and often quite alone (Fig. 155) is that in which the prophet rests under the gourd. It is evident that this was the most essential feature of the symbolism, and we have therefore to recognize that the original significance of the gourd, according to the text, was neglected, and the naked figure of *Jonah* reposing under its shade was regarded as a symbol of the soul in the joy of paradise after being delivered from the dangers and the pains of death. It is to be remarked that even under the gourd *Jonah* is always represented naked. That he should be so represented when cast into the sea was altogether natural, but the story furnishes no reason for it in the case of his sleep under the gourd, since that followed upon his successful preaching to the *Ninevites*. It seems probable that the nakedness was in this case altogether in the interest of the symbol, to represent the ideal state of bliss in paradise. The posture suggests *Endymion*.

When one considers the great number of nude or half-nude figures in Classic art, one cannot but be struck with their rarity

among the Christian monuments. There was certainly no rigid scruple against the art of the nude, but there was as little predilection for it. Eve was the only nude female figure known to early Christian art. Susanna was represented clothed, not surprised at her bath, as the artists of the Renaissance delighted to depict her. Daniel was generally, though not always, naked; Adam and Jonah were always so. We have to add to this, occasional pictures of Tobias, or of a fisherman, several representations of Isaac sacrificed, and of the vision of Ezekiel, one of the martyrdom of Isaiah, one of Christ baptized, and two of Christ upon the cross. These rare representations of the nude are interesting, especially in sculpture, as affording a gauge of the technical capacity of art; they prove what it was still capable of in the fourth century, and how utterly impotent it had become by the fifth.

A subject equally familiar in the catacombs and on the sarcophagi was the sacrifice of Isaac. The moment commonly represented is that in which Abraham stands ready with a knife to slay his son, who with hands bound kneels upon or beside an altar. A hand from heaven arrests the act, and the ram appears to replace the sacrifice. The mode in which this subject was represented is shown in the upper left-hand corner of the sarcophagus of Junius Bassus (Fig. 100). It was very often balanced by the receiving of the Law, as in Fig. 99. This, we have seen, was one of the symbols of deliverance. It is well known that the subject was also regarded as typical of the sacrifice of Christ, but how far this idea was associated with the artistic expression of the theme we have no means of knowing. It seems, however, that this must have been in the mind of the artist who in the third century represented this theme in connection with the Eucharistic symbols in the Sacrament Chapels of S. Callistus, and it certainly was intended in the sixth-century mosaic of S. Vitale (Fig. 133).

Still more common was the subject of Daniel among the lions. It appears for the first time at the end of the first century in the vestibule of S. Domitilla. The picture represents a young man clad in a short tunic, with arms extended in prayer and eyes raised to heaven, while a lion approaches on either side. With this early example, the form was already fixed, as it appears constantly in the frescos and in sculpture

(Figs. 95, 98, 99, 100),—only, as was remarked above, the figure of Daniel was commonly naked. Generally the prophet Habakkuk appears at his side offering him bread,—a whole loaf, not bread broken into pottage, as the story has it. As the loaf is often marked with the cross (Fig. 98), it seems evident that it had a mystic reference to the Eucharist. The great popularity of this subject was probably due to the fact that it represented the fate of so many Christian martyrs. The manner in which the martyrs were exposed to the beasts in the Roman amphitheatre sometimes influenced the mode in which the subject of Daniel was depicted. It is not certain whether the clay lamp illustrated in Fig. 151 represents Daniel or a Christian martyr; but it is evident that it represents realistically the manner in which Christians were actually exposed to the lions. In Fig. 160, which illustrates a fragment of a cut-glass vase of the early part of the fourth century, there appears at the right a part of just such a platform as is shown in the previous figure; and the intention here is evidently to represent Daniel, for Habakkuk appears above, while on the left is the sacrifice of Isaac, and below the Israelites marching through the desert with their eyes fixed upon the cloud of fire.

Another scene in which Daniel frequently appears is that in which he slew the dragon (Figs. 163, 166). The dragon is represented in a form similar to the serpent which tempted Eve.

One may readily notice how closely some of the other examples of deliverance correspond with forms of martyrdom which were actually suffered by the Christians. It was only in this indirect way that scenes of Christian martyrdom were depicted, for in the first three centuries there were no express representations of such themes. Scenes of pain and of horror were altogether foreign to the spirit of early Christian art. We shall have occasion to notice later that representations of our Lord's Passion do not appear before the fifth century and were altogether exceedingly rare throughout the early period. The earliest representation of a martyrdom belongs to the latter part of the fourth century; it is found on a fragment of one of the columns of the ciborium of the basilica of SS. Nereus and Achilleus (Fig. 22). It represents Achilleus standing with hands bound behind him ready to receive upon his neck the executioner's sword. In the background is the cross sur-

mounted by the crown. Another scene was painted about the same time in the house of SS. Giovanni e Paolo in Rome : three martyrs are kneeling blindfold upon the ground, while the executioners stand behind ready to strike with the sword. Beside these there are almost no other such scenes within our period.

Closely related to Daniel were the stories of Susanna and of the Three Children in the furnace. Susanna was often represented standing like an orans between the two



FIG. 67. — Susanna and the elders judged by Daniel, fresco in the catacomb of Callistus. Second century.

accusing elders. Sometimes Daniel appears as judge and deliverer (Fig. 67). In the *Capella greca* in S. Priscilla the story is depicted with unusual dramatic interest and in several scenes. In the cemetery of Pretextatus there is a painting which represents a lamb between two wolves, and the inscription

informs us that we have before us Susanna and the elders.

Far more frequent both in the frescos and on the sarcophagi were the Three Children of Babylon. They are commonly represented standing in the attitude of prayer amidst the flames of a furnace which is fed below by an attendant. Sometimes a fourth person, evidently the Lord, appears in their midst. They are always clothed in the Phrygian costume, which was used in Roman art to denote the inhabitants of the extreme Orient. This was probably the suggestion which led to their association with the Three Magi from the East who followed the star to Bethlehem, for they also were represented in the same costume.

This brings before us a curious, but characteristic trait of early Christian symbolism; for these two subjects were not only compared, but in a certain sense confused, in art. This appears in many instances upon the sarcophagi, and always in substantially the form which is illustrated in Fig. 89. In this case the Three Children are represented in the act of refusing to worship the image of Nebuchadnezzar. On the other side the Magi, similarly clad, offer their gifts to the infant Jesus. It will be noticed that the Three Children turning away from the image are pointing to a star, and are thus brought into still



FIG. 68. — Visit of the Magi, fresco in the catacomb of Petrus and Marcellinus. Third century.

closer relation with the Magi. One point of connection was doubtless the refusal of the Magi to listen to Herod's command. But besides this there was a deeper thought, for Nebuchadnezzar was regarded as the type of the persecuting emperors, and it will be seen how admirably balanced these two subjects are when it is remembered that it was the refusal to worship the emperor instead of Christ which was the Christians' chief offence against the State, and the cause of the majority of martyrdoms. The star to which the Three Children point represents the true worship as opposed to idolatry, for it is the symbol of Christ. The star was conventionally represented by three lines intersecting at equal angles, and in this figure the Christians saw at once a symbol of the cross

and the initial letters of the name Ἰησοῦς Χριστός. This form of monogram appears long before Constantine, and we may suppose that the Constantinian monogram was suggested by it. On one sarcophagus the star to which the Three Children point has the form of the Constantinian monogram.

It is not unlikely that the number of the Magi was fixed chiefly with reference to this association. This is at least more probable than that it was due to the number of gifts which they bore—gold, frankincense, and myrrh. The subject of the Magi was a very common one in the catacombs as well as in sculpture and mosaic. The number three appears in the earliest instance—the *Capella greca* in S. Priscilla (Fig. 3). But very commonly an even number of Magi were represented for the sake of symmetry—two (Fig. 68), four, or in one instance six. The number three became definitely fixed in the fourth century, and it was invariable on the sarcophagi and in the mosaics (Fig. 139). In Fig. 86 the wise men and a shepherd appear together at the manger, where the ox and the ass which are mentioned in an apocryphal Gospel have also their place. It is as an incident to the story of the Magi that we have the earliest representations of the Virgin and Child. It is probable that this subject was then understood, as it certainly was later, to represent the calling of the Gentiles.

There were no other Old Testament subjects so frequently depicted as those which we have just studied. Lack of space prohibits the particular consideration of more of them here, though some will be noticed incidentally as they appear in sculpture. David with his sling appears in but one fresco, Job is seldom represented in the catacombs, only once the translation of Elijah, though several times on sarcophagi (Fig. 97). Tobias with his fish is represented graphically in the catacomb of Thrason; on the other hand the vision of Ezekiel, which was peculiarly appropriate to sepulchral decoration, does not appear at all in the catacombs, and only a few times on the sarcophagi. This very nearly exhausts the types of deliverance so far as they were drawn from the Old Testament. We have now to consider the miracles of Christ from this same point of view.

THE MIRACLES OF CHRIST

In the art of the catacombs a somewhat arbitrary selection was made of the miracles of Christ; some themes were repeated again and again, while others found only here and there a chance notice. It must suffice to notice here the subjects which were the most common, and, important as they were, they require but few words of description. It is necessary here again to rely for illustrations chiefly upon the sarcophagi; the scenes were treated with equal simplicity and with like abbreviation in the frescos.

The raising of Lazarus was the most important of these subjects, since it most directly testified to the power of God to raise the dead at the resurrection. The form is always substantially the same (Figs. 18 and 95, upper right-hand corner): Lazarus wrapped like a mummy stands erect in the entrance of a temple-like tomb, and Christ stretches toward him the rod which symbolizes his power. It is to be observed that in almost all of the representations of his miracles Christ, like Moses, carries a magic wand or rod. Since the motive was a symbolical and not an historical one, this miracle stood for others of like character. The raising of the widow's son does not appear in the art of the catacombs. As the artists were interested (especially in the case of the sarcophagi) in crowding as many subjects as possible in a small space, a specimen of each *kind* of miracle sufficed.

So it was in the case of the healing of the blind. Christ is represented placing his finger upon the eyes of a single blind man (Fig. 98), but which particular act of healing this was the artist had no interest in specifying. According to a well-established principle of Classic art, subordinate personages, such as those who were craving Christ's assistance, were represented in minute proportions, and the blind men look consequently like little children. Christ's gesture in healing the blind man has been sometimes misunderstood, and the scene has been misinterpreted as a representation of Christ blessing little children, — a subject which, strange as it may appear, never occurs in early Christian art.

A female figure, often exceedingly minute, crouching at the feet of Christ and touching his garment or his hand, is the

woman who was healed of an issue of blood (Figs. 95, 96). Equally simple, but more distinctly characterized, was the figure of the paralytic. It was very common both in the frescos and on the sarcophagi, but there happens to be no illustration of it in this book, except on a gold-glass (Fig. 168), which groups together a number of the subjects which we have just been studying.¹ To represent this miracle nothing more was necessary than the figure of a man carrying his bed. There is nothing to denote whether it was the man healed at Capernaum, or him of the pool Bethesda; it probably was intended to represent both at once. The multiplication of the loaves and fishes was in the catacombs represented in various ways which we shall have occasion to study later; on the sarcophagi the treatment is stereotyped: Christ stretches out his rod over the baskets, or he touches with his hands the bread and fishes which are presented to him by two Apostles (Fig. 95). In the transformation of the water into wine he touches with his rod the waterpots (Fig. 95). These two miracles had more especially a relation to the Eucharist, and they will be noticed again in another place.

In Fig. 72 Christ is represented with the Samaritan woman at the well; and the same scene is several times reproduced in fresco and in sculpture.

THE GOOD SHEPHERD

There were various myths current in early times, and commonly believed, about miraculous portraits of Christ. There was, in the first place, the napkin with the impression of his own face which our Lord himself was supposed to have sent to Abgar, king of Edessa. Closely related to that was the Veronica portrait, about which there were divers traditions. As no one any longer supposes that these were actual portraits, their sole interest lies in the proof that the effort was actually made in early times to produce an ideal representation of the face of Christ. In the loss of these pictures it remains impossible to determine whether or not they had any influence in the determination of the type of head which was commonly

¹ After the paralytic comes Moses striking the rock, then the sacrifice of Isaac, Adam and Eve, and the raising of Lazarus.

represented in the fifth century. The presumption is that they had not, and that there was no fixed tradition to hamper the artists in the expression of their own ideal, for this varied freely, and was marked by three distinct types which belong to the fourth, the fifth, and the sixth centuries respectively. Historically attested are the images of Christ (made of glass, gold, or silver) which one of the Gnostic sects venerated along with images of the philosophers Pythagoras, Plato, and Aristotle. And it is known that the Emperor Alexander Severus placed in his *lararium* and honored with sacrifice the images — probably medallions — of Christ, of Abraham, and of Orpheus. In neither of these cases is there any suspicion of a portrait. Of more importance is Eusebius's account of the bronze statue in *Cæsarea Philippi*. It represented the standing figure of a man clothed in the *pallium* and stretching out his hand to a woman who kneeled at his feet. There is no doubt that at the beginning of the fourth century this was regarded as a representation of the Lord, and that it was believed to have been erected out of gratitude to him by the woman whom he had healed of an issue of blood. This derivation of the statue is commonly rejected by historians, and it is explained rather as the statue of an emperor receiving the submission of a province. But it is difficult to believe that Eusebius, who himself saw the statue, could have failed to detect in it so common a theme of Roman art as the statue of an emperor. The statue was removed from its public position by Maximinus Daza out of hatred to Christianity, and was finally destroyed by Julian. It is hardly to be thought that these emperors could have mistaken its true character, if it were actually of pagan origin; and there must remain at least the suspicion that the tradition was correct.

When we turn from mythical or historical accounts to the existing monuments of early art, the spirit in which the early Church regarded the representations of Christ seems obvious and unequivocal. There were not only no representations which had any suggestion of realism or of portraiture, but till the middle of the fourth century not even an idealistic conception seems to have been so much as attempted. In the earliest cases in which our Lord appears he is depicted as an infant in the arms of his mother, and it is evident that he appears only as an inci-

dent to the scene — as in the visit of the Magi, etc. It may be said, too, that in the representations of the miracles his presence was equally incidental; it was required to determine the subject, just as the presence of God in the Old Testament wonders was symbolized by the hand stretched from heaven. In this case the artists implicitly intimated that they had no intention of representing Christ as he actually was, or as the Church might like to conceive him. They represented him



FIG. 69. — The Good Shepherd, fresco decoration of a ceiling in the catacomb of Petrus and Marcellinus. Third century.

under the figure of a very young man, beardless, and without any such marked personal traits as were early ascribed to Peter and Paul. The figure of Christ is, in fact, to be distinguished only by the situation in which he is represented — the performance of his miracles — and by the pallium, in which generally only he and the Apostles and Moses were clad.

But beside these incidental expressions it is evident that the Church did desire an artistic representation of Christ, and that this was attained in the symbolical figure of the Good Shep-

herd. This, it is well known, was one of the commonest figures in early Christian art; and from the second to the fourth century it was beyond comparison the most favorite representation of Christ. It appears for the first time in the early part of the second century in the crypt of Lucina; and later very frequently in frescos, on sarcophagi, and as an independent statue, upon gold-glass, upon rings, upon medals, and in almost every branch of art. Nothing could have comported better than this symbol with the spirit of early Christian art, and the mode in which it was treated was highly characteristic. When this subject is represented in our modern art the character of the shepherd is but a slender disguise; it may be denoted by nothing more than by the fact that he carries a lamb and has the shepherd's crook, while for the rest it is the ideal face and figure with which we are accustomed to depict Jesus in all the scenes of his earthly life. There was nothing like this in the art of the catacombs; the symbol was frankly carried out, — it was a symbol and no whit more. The insufficiency of art to portray in realistic terms the figure of the God-man was clearly recognized, as we have seen, and this feeling was frankly expressed by a form of representation which could not even suggest the idea of a physical likeness. What was represented in the catacombs was just such a shepherd as might be seen in the *campagna* about Rome, a beardless lad of some sixteen years, clad in the short sleeveless tunic of the laborer, with his right shoulder bare, sometimes with feet and legs bare also, sometimes with shoes and stout leggins. There was a perfect realism about the representation, and yet at the same time a certain idyllic graciousness — it has been not unjustly called an hieratic trait — which distinguishes it from the same subject as it appeared in pagan art. The statue in the Lateran is altogether the finest example of the Good Shepherd (Fig. 117): with both hands he holds a sheep upon his shoulders; one shoulder is quite bare, for he wears the *tunica exomis*, which is girded up to the knees, as it commonly was; at his side he carries the shepherd's scrip. The gold-glasses which are given in Fig. 162 show common varieties of the subject, and illustrate different ways of holding the sheep. They exhibit also the short cape which seems to have been a familiar feature of the shepherd's attire. In two instances the shepherd has leggins; in one,

the feet and legs are bare. The head is always bare. As here, so also in the other art of the catacombs (Figs. 12, 13, 14, 16, 17, 69), the figure was often balanced by two or more sheep at the shepherd's feet. It will be noticed that in one of these gold-glasses the shepherd is not pictured carrying back the wounded sheep to the fold, but is sitting and tending his flock. Representations of the shepherd tending his flock occur some twenty times in the catacombs, in frescos and *graffiti*. In Fig. 19, for example, he is represented with his shepherd's staff in his hand, seated under a tree and playing upon the pipes, while the single sheep in the scene looks attentively up at him.

Nothing could be plainer than this symbolism, nothing more gracious and touching. This whole range of meaning was expressed by our Lord himself,¹ and it was appreciated in its fullest extent in early art. But there can be no doubt that, in the catacombs and upon the sarcophagi, the figure of the Good Shepherd had especially a sepulchral reference. It represented, of course, the faithful care of the divine Shepherd in seeking the souls which had strayed into sin, and bearing them back to his Church; but it also represented his power to bear aloft to his heavenly kingdom the soul which was wounded, weary, and bruised with the struggle here below. This was suggested by the familiar words of the Twenty-third Psalm: "Though I walk through the valley of the shadow of death I shall fear no evil, for thou art with me, thy rod and thy staff they comfort me." And this reference is expressed plainly in many of the prayers of the Church, for example, in "the prayer after burial" of the Gelasian Sacramentary: "Let us pray God to grant that the deceased, carried upon the shoulders of the Good Shepherd, may enjoy the fellowship of the saints."

A somewhat different symbolism is expressed by the pictures which represent the shepherd playing upon the syrinx and herding the sheep. It was not the parable of the Lost Sheep which was reflected in this theme, but the richer symbolism which was expressed by the speech recorded in S. John's Gospel, according to which the shepherd protects his sheep from the wolf, so that they can safely go in and out and find pasture; he calls them by name and they know his voice and follow him, but a stranger will they not follow, for they know

¹ John x. 1-27; xxi. 15-17; Matt. xv. 24; Luke xv. 4, 5.

not the voice of strangers. It is this image which is expressed in the epitaph of Abercius (see p. 235). The fulness with which the Church appropriated this symbolism is strikingly shown by the fact that the figure of Orpheus was occasionally represented in place of the Good Shepherd. That the representation of Orpheus was not an unthinking repetition of a subject which was common in pagan art, is placed beyond a doubt by the fact that it occurs in the central medallion of the ceiling, that is, in the place which was especially appropriated to the Good Shepherd. It will be remembered that Orpheus too was a shepherd. In the catacombs, as in Classic art, he is represented in Phrygian costume; he sits surrounded by his sheep, or by various birds and beasts, which listen attentively to the music of his lyre. It is impossible not to recognize that it was the intention of those early artists to associate with the Good Shepherd the loftiest moral myth which was known to the pagan world, to represent under the figure of Orpheus the compelling music of Christ's voice, which drew all men after him and closed their ears to the song of the Sirens. It must be remarked that the scene of Orpheus and the Sirens does not occur in early Christian art, though that other fable of Ulysses binding himself to the mast is represented several times upon the sarcophagi (Fig. 88). But this was not the only nor the most express symbolism which gave the figure of Orpheus a place in the decoration of the Christian cemetery. In Classic art, also, Orpheus belonged to the funereal cycle, for it was fabled that through the power of his music he alone had been able to penetrate into the lower world and lead up from Hades a human soul.

The symbolism which was attached to the sheep was a very simple one in the early centuries. Of the sheep which was carried upon the shoulder of the Good Shepherd enough has been said. The fact that it is sometimes a kid instead of a lamb is probably not significant. It is not till the fourth century that Christ is represented dividing the sheep from the goats (Fig. 87). The sheep which he tends and feeds represent either his flock on earth, or faithful souls in heaven. The latter sense is expressed by several paintings in which behind the sheep the figures of the blessed dead are represented in the posture of prayer. In the *cripta delle pecorelle* in S. Callis-

tus the Good Shepherd is represented surrounded by a number of sheep, and in the midst of them stand two men who stretch out their hands to drink of the water which abundantly flows from the rock on either side. Here the shepherd is depicted refreshing the souls in heaven with the water of life. On a sarcophagus in the Lateran the Good Shepherd is surrounded by twelve sheep, and behind each of them stands an Apostle.

After the fourth century the twelve sheep were very commonly used to represent the Apostles, especially in the mosaics; but the symbolism of the Good Shepherd rapidly fell out of favor and was replaced by the mystic lamb of the Apocalypse. In the mausoleum of Galla Placidia there is a mosaic of the fifth century which again represents the Good Shepherd (Fig. 141), but in a manner which reminds one of our modern art. It is no longer properly a shepherd, but an idealized figure of Christ adorned with the nimbus, and carrying a cross. It is strange to note how early and how completely the old symbolism disappeared, never to be revived again in Christian art.

But before leaving this subject we have still to trace another trait of symbolism which was associated with the Good Shepherd in its earliest representations. I refer to the milk with which the shepherd nourishes his sheep. This was represented by the jug or pail which he carries sometimes at his side (Fig. 78). The importance of this apparently trivial detail is shown by the fact that the sheep and the pail of milk sometimes appear apart from the shepherd. In the crypt of Lucina two sheep are represented on either side of a rustic altar of stone on which rests the jug of milk and the shepherd's staff. There are somewhat similar representations in the catacomb of Domitilla and in the house of SS. Giovanni e Paolo. This is so delicate a symbol, and it is so remote from the terms of modern thought, that its sense could hardly have been understood but for an explanation which is furnished in the *Acts of S. Perpetua*, which was written in the early years of the third century. It describes a vision of the saint in these words: "I mounted and beheld a garden of vast extent, and in the midst of this garden a man seated, having white hair and the dress of a shepherd, milking sheep: and standing round about him thousands of men clothed in white. And he raised his head and looked at me, and said to me: Thou art welcome, my

daughter. And he called me and he gave me some of the warm milk which he had just drawn, and I received it with folded hands and I ate it: and all about me said, Amen. And at the sound of the voice I awaked, with an indescribable taste of sweet in my mouth." From this it is evident that the jug of milk carried by the Good Shepherd is a mystic symbol of the Eucharist.

The favorite representations of heaven or of paradise during the first three centuries, as we see from the vision of S. Perpetua, were in terms of the pastoral symbol. The olive tree serves here to denote the celestial garden, as the palm tree does in the art of the following centuries.

THE CELESTIAL BANQUET

A more definite representation of the refreshment of the soul in heaven was given by the pictures of the celestial banquet. The idea was obviously suggested by many of our Lord's sayings, and its representation in Christian art was perhaps facilitated by the fact that it had been a favorite theme in some of the pagan religions. The earliest example is in the vestibule of S. Domitilla. It represents two persons seated before a small table upon which fish and bread are displayed; an attendant stands ready to minister to them. The whole is so realistic that it might be taken for a scene of everyday life—perhaps for a funeral agape—were it not for the mystic fish upon the table. Most of these scenes belong to a single region of the catacomb of SS. Pietro e Marcellino, and are probably to be dated about the end of the third century. There are five of these pictures still discernible, and they have a striking similarity which proves either the hand of the same artist or at least a common influence. They represent a family feast in which parents and children are seated about a semicircular table in front of which is a tripod bearing the mystic fish. Above the figures of two of the party are inscribed the commands which they are supposed to be addressing to the two maid-servants, "Peace, bring me warm water," "Love, fill my glass" (IRENE DA CALDA; AGAPE MISCE MI). A painting of the same period in an arcosolium of the Ostrian cemetery represents the parable of the Wise Virgins.

The scene is divided in two by an orans: on the right are the five Virgins holding lighted torches; on the left they all appear seated at the marriage feast. The same parable is represented again in the fourth-century fresco of the cemetery of Cyriaca. In this case Christ with the nimbus appears in the middle; on the left are five Virgins with lighted torches, while the five others on the right have their torches lowered



FIG. 70. — Veneranda introduced into paradise by S. Petronilla, fresco in the catacomb of Domitilla. Fourth century.

and extinguished. It is probable that both paintings marked the tombs of consecrated virgins.

The introduction into heaven through the kind offices of a saintly "advocate" was sometimes represented in the third century; it became a more common theme in the fourth, and was perpetuated in the apsidal mosaics of the basilicas. A picture of the fourth century in the catacomb of Domitilla (Fig. 70) represents a certain Veneranda introduced into

paradise by S. Petronilla, whose tomb was near this spot. At the feet of the saint is a box containing the rolls of the Scripture; above it is an open book.

THE EUCHARISTIC BANQUET

The miraculous multiplication of the loaves and fishes was pictured very frequently in the catacombs, but in very various ways. This theme owed its great popularity to the fact that it stood as a symbol of the Eucharist, — a symbol which was suggested by Christ himself in the address which S. John reports after the miracle. A third-century fresco in the *cripta delle pecorelle* in S. Callistus represents it in the same manner as was common on the sarcophagi: Christ stretches out his hands to bless the loaves and fishes which are presented to him by two Apostles; on the ground stand six baskets filled with the fragments which remained. The figure of Christ has here been destroyed in order to construct a niche for a lamp, but his position and gesture were evidently the same as in Fig. 95 and on other sarcophagi. The gesture is important, for it is doubtless the same as that which was commonly used in the consecration of the Eucharist. In a picture of the latter part of the second century in one of the Sacrament Chapels of S. Callistus (Fig. 71) Christ is represented with right arm and shoulder bare—that is, clad in the philosopher's mantle—stretching his hand toward the bread and fish which are supported upon a tripod. An orans standing by clearly expresses the soul which has departed from this world comforted with the Eucharist and confident in the almighty power of Christ.

There were very many ways in which this subject was abbreviated; it became a mere hieroglyph as it was treated in the *graffiti* of the gravestones; the five loaves and the two fishes alone sufficed to represent at once the miracle and the sacrament. A second-century sarcophagus of travertine in the catacomb of S. Priscilla is adorned simply with five loaves on one side of the epitaph and an anchor on the other. Two fish and five loaves appear upon a tombstone which is preserved at Modena; a similar monument is preserved in the Kircherian museum at Rome; and one of the tiles covering a *loculus* in S. Priscilla has upon it two loaves moulded in mortar, — evi-

dently a fragment of this same theme. On this last monument and on the epitaph at Modena the breads are marked with a cross, as they are also in several frescos which represent the seven baskets. On the sarcophagus above mentioned and on the Roman epitaph they are marked by three lines crossing each other obliquely, which was a current symbol of the cross. Two terra-cotta lamps from Salona which represent the same



FIG. 71. — Fresco of the third century, in one of the Sacrament Chapels, catacomb of Callistus. Christ, clad in the philosopher's pallium, consecrates the fish and bread (symbol of the Eucharist); an orans stands beside the tripod.

theme have the breads marked with the Constantinian monogram.

But we must postpone other abbreviations of this theme till we come to consider the symbol of the fish. We are here engaged with the scenes which represent the banquet of the multitude. The most notable examples are in the Sacrament Chapels of S. Callistus. These so-called chapels are in reality ordinary cubicula which are notable only for the subtilty of their symbolical frescos. The name is due to the fashion which till lately has been prevalent of interpreting these frescos as symbols of all the seven sacraments of the Roman

Church. It is now recognized that only baptism and the Eucharist are there expressed, and these subjects appear so often in the catacombs that they constitute no reason for giving so distinctive a name to these chambers. There are six cubicula usually reckoned to this group; Wilpert ascribes the first three of them to the same artist and to the latter part of



FIG. 72. — Christ and the Samaritan woman at Jacob's well. Fresco in one of the Sacrament Chapels in the catacomb of Callistus. Third century.

the second century; and the others, which are on a higher level, to the century following.

The chief interest lies in the first group, and it is to be regretted that we cannot study in detail the numerous subjects which appear on their walls and ceilings, nor trace the deeply planned scheme which connects them. The scheme of decoration is substantially the same in all three chambers, in each the sym-

bols of baptism and of the Eucharist are represented. In the third chamber is represented Christ's miracle, the multiplication

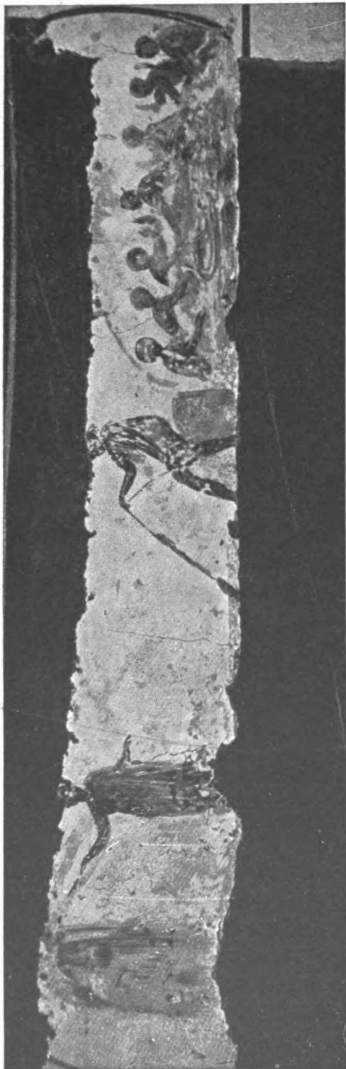

FIG. 73. — Fresco of the third century, in one of the Sacrament Chapels, catacomb of Callistus. Moses (Christ) striking the rock; the apostolic fisherman; the meal of the seven by the Lake of Tiberias, — symbols of baptism and the Eucharist.

of the loaves and fishes (Fig. 71), and to the left of it the feeding of the multitude, a theme which was thoroughly conventionalized in early Christian art. As the whole multitude could not be pictured, it sufficed to represent seven men seated at a table upon which were placed the loaves and fishes, and about which were arranged the seven baskets. The same scene was depicted in the first chamber. In both these cases, and in all others where this subject is represented, the men are clad in tunics. But in the second chamber, with but slight change of treatment, a different subject was represented, the meal of the seven disciples at the sea of Tiberias, when after his resurrection the Lord met them and put before them bread and fish. In this representation (Fig. 73) the seven baskets are naturally omitted, and the disciples, as fishermen, are depicted naked. It may be that the num-

ber of the disciples on this occasion accounts for the appearance of just seven figures in all similar representations of banquets. In this illustration, alongside of the fishermen at table, there is represented the apostolic fisherman drawing a fish out of the mystic water which Moses strikes from the rock. In this way the symbol of baptism is brought into connection with the symbol of the Eucharist. In the same chamber the baptism of a disciple is expressly represented; in the third chamber we have the baptism of Christ in the Jordan, and out of the water thus sanctified by Christ, the fisherman is represented drawing his fish.

It is here possible only to allude to another banquet which was employed as a symbol of the Eucharist, namely the wedding feast at Cana where Christ turned the water into wine. The symbol is a very obvious one.

It is to be presumed that the artist who decorated these chambers was acquainted with the symbolism of the fish, which was so popular in that age. But it must be observed that the pictures themselves do not prove it, nor do the briefer symbols of this miracle which we have considered above. All of the pictures of the fish which we have hitherto considered are based upon the scriptural account, and are sufficiently explained by it. We see that the fish symbol, even if it was originally suggested by the famous acrostic, must have been profoundly influenced by the artistic employment of the themes which we have just studied.

We have now to consider a picture to which Wilpert gives the name *Fractio Panis* — “The Breaking of Bread.” It adorns the wall above one of the great arcosolia in the *Capella greca* in the catacomb of S. Priscilla, and like the rest of the decoration of that crypt it belongs to the first decades of the second century. It will be seen that in its general scheme this picture (Fig. 74) resembles those which we have just studied; there are seven persons seated at a table upon which are two plates with the five loaves and the two fishes. On the wall space at each side the seven baskets are depicted (Fig. 3). These, however, are the only symbolical traits; for the rest, it was evidently intended for a realistic representation of the Lord’s Supper as it was celebrated in the catacombs, and especially in this very crypt. It is not the meal of the seven dis-

ciples, for we can distinguish that the third figure from the right represents a woman. Nor is it the feast of the multi-



FIG. 74.— "The Breaking of Bread," fresco of the first half of the second century, in the *Capella greca*, catacomb of Priscilla, representing a celebration of the Eucharist.

tude, for there also only men are represented. We can dimly descry upon the table a simple mug with two handles, which is highly interesting as an illustration of the practical style of chalice which was used in the catacombs, but still more so because it establishes beyond a doubt that this picture was intended as a representation of the Eucharist. The five men who face the beholder are clad in the tunic; the man who is represented in profile is distinguished by a beard and wears, apparently, both tunic and pallium, which was the dress ascribed in early art to ecclesiastical personages of rank. Whether he is bishop or presbyter, there can be no doubt that he is the president of this feast, and in fact he is depicted graphically in the very act of breaking with some show of force a large loaf of bread. The picture, therefore, represents the solemn act which gave to this feast the name which was so often used in the New Testament—"the breaking of bread."

There are realistic traits in this picture which suggest very strongly the probability that the artist intended to represent the Eucharist as he had actually seen it celebrated in the catacombs. It is in itself quite probable that even after the early custom of sitting around a common table had become impossible in the churches, it was still observed among the small groups of people who gathered in the cemeteries to commemorate their dead. The stone bench along the wall of this crypt (Fig. 3) and the apse-like arcosolium at the end prove that it was expressly intended as a place of worship, and more particularly for the celebration of the Eucharist. It is obvious that the chief tomb was beneath the apse, yet notwithstanding the place was broad enough for several bodies, the grave which is actually excavated there is hardly large enough for a year-old child. Wilpert supposes very reasonably that this small cavity contained the scanty relics of a martyr. At all events, it is the stone which covered this tomb which must have been used as the altar, and as the proper position of the bishop was at the back of the apse, we have in this an explanation of the curious fact that the feet of the bishop are upon a level with the chalice.

Of the rest of the decoration of this crypt, though it is among the most complete and interesting in the catacombs, we can stop to remark only that the representations which we find

here of Daniel and Susanna, and of the resurrection of Lazarus, prove that in the first decades of the second century the last chapters of the Book of Daniel were regarded as Scripture, and that the artist was acquainted with the Gospel of S. John.

In the civil museum at Leghorn there is an ivory pyx from Carthage, of about the fourth century, which, among other subjects, represents the feeding of the multitude. Christ is seated, and he stretches out his hands to bless the bread and fishes which are brought to him. On either side Apostles are hurrying away, carrying in the lap of their robes the miraculous food to the hungry multitude. In the early Church the deacons

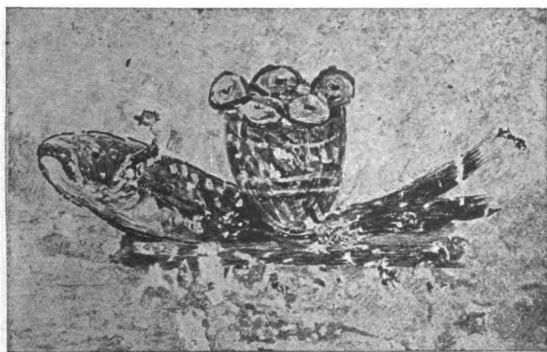

FIG. 75. — Fragment of a fresco of the middle of the second century, in the crypt of Lucina, containing loaves of bread

carried the consecrated bread to the congregation, and it is evident that the artist wished to point the comparison between the service of the Apostles upon this occasion and that of the deacons in the Church.

Of about the same age as the *Fractio Panis* is the fresco representing the two fish (Fig. 75) in the crypt of Lucina, the oldest part of the catacomb of Callistus. These interesting figures are only a remnant of a larger composition, which was originally painted between them, and is now destroyed. There can be no doubt that it represented the Eucharistic banquet under one or another of the forms which we have already studied. But how complete is the symbolism of these two ter-

minal figures alone! Beside each fish is placed a basket full of bread, and through the wickerwork of the basket one can detect by its red color a glass of wine. The baskets, like the fish, were an abbreviation of the miraculous feeding of the multitude, but the wine was added expressly with reference to the Eucharist. It is known that glass chalices were in use; it may be that the basket too had not merely a symbolical suggestion. It seems as if Jerome were commenting on this picture when, mentioning the meanest utensils which could be used for the Eucharist, he says: "No one is so rich as he who carries the body of Christ in a wicker basket, and his blood in



catacomb of Callistus. It symbolizes the Eucharist, representing two fish, with baskets and a glass of wine.

a cup of glass." The symbolism of the fish comes to clearer expression in this picture: the fish is Christ, it is he who offers this food, and the food he offers is himself. This picture and the *Fractio Panis* are the earliest monuments in which the fish occurs.

We have not far to seek for the association of ideas which made these symbols of the Eucharist so popular in Christian cemeteries. Christ himself said, "He that eateth my flesh and drinketh my blood hath eternal life, and I will raise him up at the last day." Eternal life and the Eucharist are two ideas which for the Church are inseparable. In the short liturgy in the Teaching of the Twelve Apostles the Eucharist is expressly

regarded as the nourishment for eternal life, and this idea is often associated with it in early Christian literature. S. Ignatius calls the Eucharist "the medicament of immortality, the antidote of death," and Clement of Alexandria, "the provender of eternal life."

THE FISH

We have already traced the fish symbol in its connection with the feeding of the multitude. But, whatever its origin, it is certain that the symbol owed its popularity chiefly to the famous acrostic which formed the Greek word for fish—**ΙΧΘΥΣ**—out of the initial letters of the five words which described the title of our Lord, Ἰησοῦς Χριστός Θεοῦ Υἱός Σωτήρ (Jesus Christ Son of God Saviour). This made of the fish—whether pictured or written—a mystic symbol of Christ himself. We do not know definitely when or where this acrostic was invented. But it is probable that it was current in the early years of the second century, and that in all the symbolical representations of the Eucharist which we have studied we have to read this deeper meaning, and recognize the suggestion, that the food which Christ provides for his Church is Himself. Prosper of Aquitaine speaks of Christ as "giving himself as food to the disciples by the seashore, and offering himself to the whole world as *Ichthus*." The earliest case in which the fish occurs in connection with the anchor—the symbol of hope—is on the sarcophagus of Livia Primitiva (Fig. 16), about the middle of the second century. Toward the end of the second century it became common to represent two fishes, one on each side of the anchor, for the sake of symmetry, and perhaps with a reminiscence of the two fishes of the miracle. This formed the hieroglyph for the epitaph which was so common in the early centuries, **SPES IN CHRISTO**—hope on Christ.

The fish appears during the first four centuries in a very great variety of forms and upon all sorts of monuments, not only in cemeterial art, but upon amulets, carved stones, and rings. Clement of Alexandria counselled Christians, if they were to wear rings, to wear them upon the little finger of the left hand where they would not impede one's labor, and to engrave upon them the Christian symbols, the fish and the dove, the anchor, the lyre, and the ship. The fish often appears

in the form of the dolphin, and the frequency of this form is due to the fact that the dolphin was a common decorative feature in Classic art. It was regarded as an animal especially friendly to man, and it gained a sepulchral symbolism from the fable that it carried the souls of the departed to the islands of the blessed. In Classical art hardly any subject was more common than scenes of fishing, which were employed in a purely decorative interest. Similar scenes repeated in Christian art were undoubtedly regarded as symbolical (Fig. 126). We have seen that the common fisherman stood for the apostolic fisher of men, for the fish represented not only Christ, but his disciples as well. Tertullian says: "We little fish, after the image of our Ichthus Jesus Christ, are born in the water, nor otherwise than swimming in the water are we safe." We see from



FIG. 76. — Carved gems of the second or third century.

this that the fish symbolized baptism, and we have to read this meaning in the picture of the fisherman in the Sacrament Chapels. It was not only the fish cooked and served upon the table which symbolized Christ, but the live fish swimming about in the water. Speaking of the multitude who were fed with the five loaves and the two fishes, Paulinus of Nola says of Christ that "he himself is the true bread and the fish of living water" — *panis ipse verus et aquæ vivæ piscis Christus*. An early carved gem (Fig. 76) represents a ship, the symbol of the Church, supported by the fish, and with the doves of peace perched upon its mast and stern. It further represents, as a typical parallel to this, Christ supporting Peter upon the water. The gem which is placed beside this in the illustration groups together many of the elements of early symbolism. The perch which supports the dove represents the cross;

between that and the Good Shepherd the cross is again represented by the mast of a ship, and on the other side by the anchor with two fish beside it, the cross appearing again in the letter X below; with the three other letters which are scattered about (the I above the anchor, the C inverted, and the @ without the cross-bar) we spell the word IX@YC ("fish"). In Fig. 77 we have four representations of this symbol. In Fig. 78 we have the Ichthus, the Good Shepherd, the anchor, and the ship. Figure 165 is a curious bit of symbolism; instead of Jonah, who was the type of Christ and the Resurrection, we see the fish resting under the gourd.

The whole of this symbolism is summed up in an epitaph of the third or fourth century of a certain Pectorius of Autun. The epitaph begins with a metrical composition which was probably much older. It is an acrostic, the first letter of each line forming the word Ichthus. "Divine race of the heavenly Ichthus, receive with pious heart among mortals the immortal



FIG. 77. — Early Christian seals or carved gems, — the fish symbol.

spring of divinely cleansing waters; refresh your soul, my friend, with the perennial waters of the wisdom which maketh rich; receive the delicious food of the Saviour of saints; eat, hungry one, holding Ichthus in thy two hands."

Of far higher importance for the illustration of this symbol, and indeed of the whole character of early symbolism, is the famous metrical epitaph of Abercius of Hieropolis, which both Lightfoot and de Rossi reckoned among the most important of early Christian inscriptions. Abercius has been identified as the bishop of Hieropolis, a small town in Phrygia. He lived in the latter part of the second century, and the journey to Rome which he mentions was probably made in the time of the Antonines. The inscription was known only in manuscript till Dr. Ramsay, in his first expedition to Phrygia, discovered the monument of a certain Alexander, dated in the year 216, which repeated several lines of the inscription of his fellow-

citizen Abercius. On his second journey he was fortunate enough to find two large fragments of the monument of Abercius himself, and they are now in the Vatican. The stone was nearly cubical in shape — the common form of the funeral *stèle* — and the inscription was engraved on three sides. One of the fragments is illustrated in Fig. 20. It reads as follows:—

“I, a citizen of an elect city, in my lifetime have erected this monument, to have where to place my body when time shall require it.

“My name is Abercius, a disciple of the holy Shepherd who feeds his sheep upon the hills and plains, who has great



FIG. 78. — Early Christian seals and rings. — the cross, the fish, the shepherd, the anchor, and the ship.

eyes which see through all, who taught me the sure learning of life, and sent me to Rome to see the royal city and the queen clad in a golden robe and with golden shoes. There I saw a people who had the gleaming seal. I saw also the plains of Syria and all cities, Nisibis, beyond the Euphrates. Everywhere I found fellow-believers, Paul . . . ; everywhere was Faith my guide, and gave me everywhere for food the Ichthus from the spring, the great, the pure, which the spotless Virgin caught and ever puts before the Friends to eat; she has also delicious wine, and she offers wine mixed with water together

with bread. I, Abercius, dictated this to be written in my presence, and in fact in the seventy-second year of my life. Let every sharer in my confession who understands this pray for Abercius.

“No man may lay another in my grave; but if it be done, he must pay to the Roman treasury two thousand gold pieces, and to my dear native city Hieropolis a thousand gold pieces.”

Abercius recognized that the mystic symbolism of his inscription would be understood only by fellow-believers. The enigmatical character of his language is due partly to the fact that he speaks of baptism and the Eucharist, which were the subjects chiefly guarded by the secret discipline of the Church in the second century. From what we have already studied we can recognize the appropriateness of this mention of the Eucharist in an epitaph, its relation to eternal life and the resurrection. But it was also connected very naturally with the account of his journey, for it was the custom to offer the Eucharist to a visiting bishop in sign of communion with him and with his church. Faith was his guide, for without that the Eucharist could not be received. He speaks of Christ as the fish, and having begun with the symbol he carries it out by referring to the Virgin Mother as one who *caught* the fish. He speaks of her also, strangely enough, as the one who offers this food to the “friends.” Under the figure of the queen clad in gold he refers to the Roman Church. The Christian people of Rome had “the gleaming seal”; it is well known that baptism was commonly spoken of under the figure of a seal. It is very interesting to observe that already in that age he found everywhere fellow-believers, everywhere recognition of the unity of the Church in the communion of the Eucharist, which was celebrated everywhere in substantially the same way, and particularly by the use of wine mixed with water.

THE CROSS AND THE MONOGRAM

Never has the sign of the cross been held in higher estimation than it was in the first centuries of the Church. Some of the early Christian writers dwelt at length upon the religious symbolism involved in the cross; they traced it in the commonest objects, in the letter T, in the mast and yards of

the ship, in the crosspiece of the anchor, in the trophy, in the attitude of prayer, and they sought out more remote analogies in the very constitution of nature itself. We have already had occasion to note the presence of the dissimulated cross, as it is called, on early monuments. Besides this, it is well known how frequently this sign was used as a gesture, not only in ecclesiastical functions, but in private life. In the latter half of the second century, to judge from Tertullian's account, this gesture was employed more commonly than in any subsequent period. He says, "At every action which we begin, in coming in and going out, when we clothe ourselves, or put on our shoes, when we bathe, when we seat ourselves at table, at lamplight-



FIG. 79. — A coin of Apamea, Phrygia, representing Noah and the ark, reign of Septimius Severus.

ing, on going to bed, we trace on the forehead the sign of the cross."

With all this it cannot but strike us with astonishment that an undisguised representation of the cross is rarely found in early Christian art. De Rossi could point to but one instance before the time of Constantine, and it remained exceedingly rare for more than a century after that. The only explanation that can be given of this fact is that the early Christians felt a particular distaste for the representation of the instrument which was still commonly in use, like our gallows, for the punishment of felons, as they showed in general a reluctance to depict our Lord's humiliation and passion. We can understand very well to what ridicule the public use of the cross would have exposed them. We have indeed a striking instance of pagan ridicule, in the crucifix with the ass's head from the

Palatine, which was rudely scratched on the wall of the pages' quarters attached to one of the imperial palaces. In front of the crucifix is a figure in the attitude of adoration, and the inscription reads, "Alexamenos adores God." The picture belongs to the end of the second century, and strangely enough it is the earliest representation of the crucifixion.

Since the cross does not appear even upon Christian monuments of the second and third centuries, it is futile to follow those who attempt to trace it to a pre-Christian origin. There were in use, among almost all peoples, religious symbols which had a more or less close likeness to the cross. The analogy is for the most part very easily explained, for the cross is the cosmic symbol of the four quarters of the earth or of the universe.

The Christians saw in these pagan symbols a mystic presage of the Gospel, but the only one of which they made any use during the second and third centuries was the swastica (Fig.



Fig. 80. — Various forms of the

swastica (Fig. 80, a), an ancient Oriental symbol, which was commonly used in the West for purely decorative purposes. The *fossor* represented in Fig. 7 has the corners of his tunic ornamented with it, and it was used not infrequently in the early tapestries.

The so-called Nile key (Fig. 80, k), which was one of the most ancient religious symbols of Egypt, was sometimes employed on Egyptian tapestries after the fifth century (Figs. 174, 175). The Christians found in it a special appropriateness because it was the Egyptian symbol of life, and it is well known that, of all the various notions which attached themselves to the Christian cross, none were so common, nor so fundamental, as that which regarded it as the tree of life. This notion appears early in Christian art. In a fresco of the fourth century in S. Callistus the cross, still dissimulated, is represented under the figure of a green tree with two horizontal branches under which there stand two doves. The triumphal cross, as it was depicted in the mosaics of the basilicas after the eighth century, was not only studded with jewels, but burgeoning with flowers. The cross which is painted in the vestibule of the cemetery of Pontianus

(Fig. 83) is evidently copied from the art of the basilicas. It is quite possible that the Egyptian symbol had an additional interest from the fact that it combined the cross and the wreath, which—like the crown with us—represented the triumph which followed martyrdom. The wreath appears above the cross in Fig. 22, but it was more common for the cross to be framed within the wreath, and it must not be supposed that this was done in a purely decorative interest. The Constantinian monogram was usually framed in this way, and that, too, it must be remembered, was regarded as a representation of the cross. In Fig. 175 the monogram is framed in the circle of the Nile key.

The equal-armed cross appears not infrequently upon coins before the Christian period, but merely as a monetary sign. It is probably due to this fact that it appears upon Constantinian coins (Fig. 81, *a*) before it was common elsewhere.



Constantinian monogram and the cross.

There is reason to believe that the Constantinian monogram owed its origin in part to a pagan religious symbol, the sun-wheel. The three forms in which the Constantinian monogram or cross is represented are shown in Fig. 80, *d*, *e*, and *f*; of these the first was the earliest and the most common. It was commonly surrounded by a circle or wreath. The sun-wheel is represented in the last figure of the same illustration; it was drawn perhaps as frequently with but three intersecting lines, like the earliest monogram without the loop of the letter P. The supposition that there was a connection between these two symbols does not rest chiefly upon their formal likeness, but upon the proofs which are gathered from one side and another to the effect that Constantine, before the vision which turned him to Christianity, was interested in the sun-worship of the Mithras cult, and continued to confuse the ideas of the two religions. It will be remembered that of all the pagan religions, it was the Mithras cult which competed most seriously with Christianity, and that, as a matter of fact, very curious analogies were to be traced between the two. One of these

points of likeness was the fact that, as worshippers of the sun, they observed the same feast day as the Christians. Constantine's edict forbidding the transaction of public business upon Sunday seems to reflect the Mithraic mode of speech rather than the Christian, for he calls it "the ancient and venerable day of the sun." One of Constantine's coins (Fig. 81, *a*) represents the sun standing between two stars, one of which is in the shape of the cross. The inscription reads: *Soli invicto comiti*. The title *invictus* (unconquered) given to the sun was peculiar to the Mithraic cult; it alludes to the principal festival of that religion — from which we derive our Christmas — when at the winter solstice the sun proves himself unconquered by the winter and begins to renew his power. A little later, on a



FIG. 81. — Four coins of

coin of Nepotianus (Fig. 82, *b*), the monogram is represented between two stars and would seem to stand for the sun.

About the sign which Constantine saw in the sky there is some confusion, because it is not well understood that the monogram was actually intended to represent the cross, and that whenever during the Constantinian age a monument is spoken of as a cross, it may generally be presumed to be in the shape of the monogram. When it is said that Constantine saw a cross in the sky, it is evidently the monogram that is meant, for the monogram was undoubtedly intended to represent what he had seen. There is very strong probability that what he saw was connected in some way with the sun — some unusual and striking effect of the sun's rays — and the chief enigma which remains is, how he came to associate this portent with a Christianity which made of its cross so great a secret.

No one has been able to suggest a satisfactory account of the word *labarum*, which was used to denote the military standards adorned with the Constantinian cross. In no other way was the official adoption of the Christian religion so plainly marked

as in the use of the Christian emblem for the standards of the army. The standards of the different legions were distinguished from one another. Several varieties of them are illustrated upon the coins of Constantine (Fig. 81, *b*, *c*, and *d*). The first one here illustrated shows the monogram surmounting a banner upon which are three dots, which represent the portraits of the emperor and his sons. In the second instance the imperial portraits are arranged in a vertical order along the staff, and it is not the monogram, but the equal-armed cross which is framed above. On the third coin the monogram appears in a similar frame. On a coin of Nepotianus the figure of Rome is represented holding the globe of the world, which is surmounted by the monogram. In Fig. 81, *b*, the



Constantine the Great.

staff of the standard transfixes a serpent. This represents Christ treading upon the serpent, or more generally Christianity triumphing over iniquity. One of the rings illustrated in Fig. 78 represents a serpent coiled about the base of the cross; but notwithstanding its great similarity in form to the preceding, it seems to represent a different idea. The two doves which accompany the serpent and the word *salus* written beneath suggest the bronze serpent of Moses. We have Constantine's idea expressed again, and more fully, in two pictures woven in silk (Fig. 171). This monument comes from Achmim in Egypt, and it is ascribed to the fifth or sixth century. Above is represented the imperial eagle, attacking an evil beast; below, Christ slaying the dragon. Christ holds his cross in his left hand, and in his right a spear which is marked with a cross at its handle. The dragon is represented as a crocodile, after analogies in Egyptian art. The picture plainly represents the Empire and the Church united in the suppression of evil. It is strange to find upon so ancient a monument the expression of an idea which was destined to

R

become at once the greatest and the most disturbing ideal of European history.

The Constantinian symbol was very early accompanied by the letters Alpha and Omega, so that this sign came to signify not only Christ's Name and his Passion, but his Divinity. In Fig. 103 one may see two different types of the monogram with these two letters; the third type of the monogram, without the letters, appears in Fig. 104. On a lead sarcophagus from Phœnicia (Fig. 9) the monogram is surrounded by the letters of the word *Ichthus*. In the Christian Museum of the Vatican, there is a large representation of the monogram in ivory, framed in a horseshoe instead of the wreath.

From the very introduction of this emblem it became at once exceedingly common throughout the Empire, and it serves as one of the readiest marks for distinguishing the date



FIG. 82. — Coins of Nepotianus,

of early Christian monuments. Strange to say, it almost as quickly passed out of use. It is rare to find it in Rome later than the fatal year 410. It was from the first a symbol of triumph, and it ill befitted the sad condition of Rome after its capture by the Goths. The cross then came into use in its realistic form, and the type of monogram which most closely resembled this (Fig. 80, *f*) remained latest in use. In the Orient, on the other hand, the original monogram survived much longer.

The supposition that Constantine merely adopted a symbol which was already common among the Christians finds no support in the monuments, for there is nothing to show that before his time these two letters were ever combined as an emblem of Christ. They do appear, however, though very rarely, as an abbreviation. The name Jesus was sometimes abbreviated by writing only the first two letters, IH. Likewise, the two initials of the name Jesus Christ, IX, were com-

bined as in Fig. 80, *b*; and Fig. 80, *c* shows how the first two letters of the name Christ were occasionally combined. The important distinction which has to be made is, that these signs were never used alone, but only in the course of an inscription and as a true abbreviation. There is, however, a difference between the abbreviation and the monogram (Fig. 80, *c* and *d*) which is not generally remarked: in the abbreviation the letter X stands upright, in the Constantinian monogram it lies on its side, and the figure has, therefore, greater symmetry.

About the fifth century there came about a change in the form of the monogram concerning which no adequate explanation has been offered. Instead of completing the letter *Rho* (*P*), the loop was not brought around to meet the staff, but terminated instead in an outward curve, so that the figure was not unlike a shepherd's crook. It has been supposed that this was in-



Eudoxia, and Galla Placidia.

tended to represent the Roman letter *R*, which corresponded to the Greek *P*; but this purpose was certainly not very clearly indicated, and it does not explain the fact that this form occurs most frequently upon monuments of Greek-speaking lands.

When we come to consider the undisguised cross, if we may so call it, we cannot but feel surprise that even the discovery of the true cross did not, in any noticeable degree, encourage the use of this symbol in art. It remained very rare till the fifth century. It must be understood that it was only the equal-armed cross (Fig. 80, *g*) which was in use either in East or West. The name, Greek cross, is a complete misnomer, so far as the early period is concerned; it indicates a distinction which was not marked before the Middle Ages. De Vogüé suggests that the earliest example of the so-called Latin cross (Fig. 80, *h*) is perhaps one which he found carved over the door of a fourth-century Syrian dwelling; at all events its use

was rare before the fifth century, and the mosaic in S. Pudentiana (Fig. 127) is one of the few examples we can point to.

The equal-armed cross, it must be observed, was not a strictly realistic representation of the instrument of our Lord's Passion, for a cross of that shape was probably never actually used. There is no doubt that the cross as commonly used had the shape of the *patibulum* (Fig. 80, *i*). An upright stake with a transverse bar above it was all that was practically required. Just because it was the ordinary instrument of punishment it

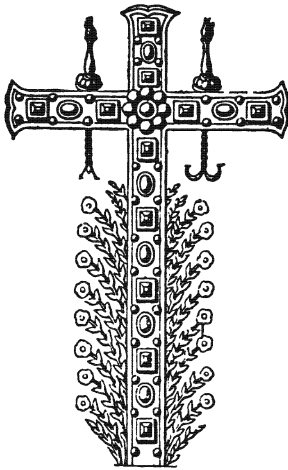

FIG. 88. — *Cruz gemmata*, fresco in the catacomb of Pontianus. Eighth century.

was very rarely represented in Christian art, although, as we have seen, objects of similar form, like the letter T, were taken as symbols of it. In the case of our Lord's crucifixion a short staff must have been nailed above the *patibulum* to support the superscription, and this, of course, gives us the Latin cross. The cross upon which S. Andrew is fabled to have suffered has the form of the letter X (Fig. 80, *j*). Such a cross was undoubtedly used, but it is rarely depicted upon Christian monuments. The common use of the Latin cross dates from the sixth century. It is specially noticeable on the monuments of the Arian Gothic rule at Ravenna. It seems to have grown out of the use of processional crosses and the representa-

tions of the cross in the form of a staff which were already common in the fifth century (Fig. 110). Such a cross is carried by Christ himself (Figs. 109, 141), and by Apostles and saints (Fig. 130); and it was the special attribute of S. Peter (Fig. 104). It is evident that there was no intention of realism in this elongation of the staff; but it is probable that it was from this that the mediæval artists got the idea that in our Lord's crucifixion he was elevated high above the ground, a conception which by no means corresponds with the representations of the crucifixion in early Christian art (see p. 276).

THE VIRGIN MARY

Attention has already been drawn to the pictures which represent the Virgin in connection with the visit of the Magi. Other scenes in which the Virgin occurs are rare in the catacombs. There is a very much damaged fresco in the catacomb of Priscilla which is supposed to represent the Annunciation. The instance is doubtful, though the fact that the figure which is taken to represent the angel is without wings is no proof against it, for angels were not represented with wings during the first three centuries. It may be remarked, in passing, that many of the early winged angels follow closely the type of victories. A distinctively Christian type of angel was developed in the mosaics of the basilicas (Figs. 138, 139), but winged figures first became really popular in the crude Lombard art of the early Middle Ages.



FIG. 84. — Virgin and Child, with a prophet, who points to a star, fresco in the catacomb of Priscilla. Middle of the second century.

The Annunciation is represented on the arch of S. Maria Maggiore, and upon the end of a fifth century sarcophagus in Ravenna. In the latter case the Virgin is represented spinning, according to one of the apocryphal accounts. On the other side of the same sarcophagus is represented her meeting with Elizabeth.

Fig. 84 illustrates a very interesting fresco in S. Priscilla of about the middle of the second century. It is sadly damaged, yet it is still notable for the grace of its composition; it sug-

gests one of Raphael's Madonnas, and prompts the curious reflection that in the long interval between that unknown painter and the Italian artists of the early Renaissance there



FIG. 85. — Fresco of the third century, in the catacomb of Priscilla. A bishop veiling a consecrated virgin, the same virgin as Priscilla, the Virgin Mary with the Child.

was, perhaps, no one who could draw such a group. It will be noticed that the man, who is clad in the philosopher's pallium, is pointing to a star. It is not perfectly clear what the picture represents, but the man is commonly taken to be a prophet foretelling the birth of Christ, and he is identified as Isaiah or as Balaam.

Another highly interesting picture is illustrated in Fig. 85; it is from the same cemetery, but it belongs to the following century. The woman standing in the middle in the posture of the orans represents, it is supposed, a consecrated virgin who was buried in this tomb. It is supposed with good reason that the scene in the background, at the left, represents her consecration to the virginal life. The virgin holds the veil in her hand, while the bishop, who sits in his cathedra and is assisted by his deacon, admonishes her by pointing to the Blessed Virgin as the pattern of her life.

B. SCULPTURE

Christian sculpture hardly existed before the fourth century. The gloom of the catacombs was not favorable to it; and, besides, carved sarcophagi were articles of luxury which were within the means of few Christians, and were to be acquired only in pagan shops. The nearest approach to sculpture which we commonly find are designs engraved on stone — *graffiti* — which might be wrought upon the spot; or statues and reliefs which represented themes, the Christian meaning of which was hidden (like the Good Shepherd), and which might, therefore, be executed in the public studios. With the fourth century, the public recognition of Christianity, the increased wealth of the Church, and above all the growing custom of burial above ground encouraged the use of sculptured sarcophagi. The sarcophagi constituted the chief exponent of Christian art in sculpture, though there are numerous examples of reliefs in ivory (chiefly diptychs, Gospel covers, and boxes for the preservation of relics), and we have the record of important works in gold and silver (in relief and in the round) which once ornamented the basilicas.

With the first emergence of Christian sculpture in the fourth century, the art was already at a low ebb. It is probable that

the attitude of the Eastern churches was from the beginning hostile to sculpture. The iconoclastic spirit which was ultimately destined to become an important factor in the definitive separation of the East and West was very early manifested, and it is not likely that we have lost many important monuments of sculpture (sarcophagi, etc.) among the ruined and unexplored cities of the Orient. In Central Syria, where the architectural monuments are so admirably preserved, we find almost no statuary and but few figured reliefs; the art of sculpture was there almost entirely confined to decorative designs in low relief. In Constantinople figures in low relief were at all times permitted without offence, and a fair skill was preserved in ivory carving and in bronze moulding until the Middle Ages.

In the West the monuments do not lead us to suppose that the art was discouraged by religious opposition; but there the



FIG. 86. — Lid of a sarcophagus in the Lateran Museum. Fourth century. The Epiphany — three Magi and a shepherd visiting the infant Jesus.

social conditions were unfavorable to its development or preservation. We see from the clumsy reliefs of the arch of Constantine how little necessity there is to attribute the decadence of art to Christian indifference. If imperial patronage could accomplish nothing better, we have rather reason for astonishment that even private monuments of a later date sometimes exhibit greater skill. Statues in the round were very rare. From the literary records we have to judge that they were more often executed in gold and silver than in stone. And it may very well be that the costliness of the material was meant to compensate for rudeness of form. The art decayed rapidly in the fifth century, and it is useless to expect any good examples of it later than the sixth. Rude repetitions of early sarcophagi and ivories were, however, made from time to time, carrying down to the Middle Ages, if not the technic, at least

some of the general artistic motives of the early period. We have to consider chiefly the Roman school of sculpture. In the West the provincial peculiarities of style were too slight to be worthy of mention in so general a treatment. We see from the sarcophagi that in Africa the art of sculpture followed closely the Roman traditions. The same is true of the sculptural school of Provence, of which Arles was the centre; other parts of Gaul which had less close relations with Rome show greater divergence, especially in the choice of subjects. In Ravenna the arts of sculpture and mosaic enjoyed a revival which lasted from the middle of the fifth to the middle of the sixth century. This requires special notice. We can, however, take no account of the crude beginnings of art among the Lombards, Celts, and Goths.

The themes which were developed in the art of the catacombs were, for the most part, perpetuated upon the sarcoph-



FIG. 87. — Lid of a sarcophagus in the Lateran Museum. Christ dividing the sheep from the goats.

agi, where their sepulchral symbolism was equally in place; even in other monuments, in which the interest was wholly historical, the force of the tradition was clearly apparent. At the same time, in the decoration both of sarcophagi and of other monuments, the range of subjects was very much extended. This was chiefly due to the historical and didactic interest which then began to make itself felt in Christian art. This new interest reflected the character of the religious instruction of that period, as represented by the Biblical commentaries and homilies which then began to form the stock of ecclesiastical literature. These new themes of art are too various to be readily classified, and they can be noticed only incidentally in the course of the description of some of the most notable monuments. Here it is necessary to mention only the fact that to our Lord's miracles, and to the other scenes in which he was represented in the early art of the catacombs, there

were added several scenes connected with his Passion. Christ appears also in certain symbolical representations which were new to the art of the fourth century and very different from the funereal themes which we have been studying. These new themes constituted what may be called an ecclesiastical symbolism: they represent Christ enthroned in the midst of his



FIG. 88. — Fragment of a sarcophagus from the catacomb of Callistus. Ulysses and the Sirens.

Apostles, committing to them, as the official representatives of the Church, his Gospel and his Law; or receiving the homage of saints and martyrs who come to lay their crowns before him. These themes belong properly to the decoration of the basilicas, and they will be studied more particularly under the head of mo-



FIG. 89. — Lid of a sarcophagus. Fourth century. The Three Children refusing to worship the image of Nebuchadnezzar: the star proves that they represent likewise the three Magi refusing to obey Herod; at the right the Magi offer their gifts to Jesus.

saics. They were, however, not improperly reproduced upon the sarcophagi, since their eschatological reference was very plain.

One of the minor characteristics of the art of the fourth century was an interest in portraiture, of which there are hardly any examples earlier. Almost all of the portraits in the catacombs belong to that century, and the portrait busts which were common on the sarcophagi still exhibit something of the Roman genius for this branch of art. In the century following there was commenced in the basilica of S. Paul the interesting series of portraits or idealizations of the bishops of Rome, and a century later this example was followed at Ravenna in a series of portraits of the bishops of that city.

We may consider here, for lack of a more appropriate place, the distinctive treatment which was accorded in art to the two chief Apostles, Peter and Paul. Apart from the ideal representations of Christ which were developed after the fourth century, there was no attempt at individualizing any of the Biblical characters except S. Peter and S. Paul. They alone of the Apostles had been in Rome, and there is certainly not excluded the possibility that a reminiscence of their personal appearance may have been preserved. It is evident, however, that the frequency



FIG. 90. — Bronze medal, SS. Peter and Paul. Fourth century.

with which these two Apostles are represented together, constituted a practical necessity for distinguishing them, which did not exist in the case of other characters. On the sarcophagi alone they are represented some twenty-four times, with or without the rest of the Twelve, on either side of the enthroned Christ. In the same way they are frequently depicted in the mosaics. On the gold-glasses, only these two Apostles were generally represented. It was necessary in all these cases to distinguish them by their facial types. They were distinguished till a comparatively late date by no conventional attributes: S. Peter did not carry the cross, nor the key, till the fifth century; S. Paul was not given the sword till the tenth. There was, however, a general, though not invariable, convention of representing Paul on the right and Peter on the left of Christ.



FIG. 91. — Bronze medal, SS. Paul and Peter. Third century.

In all of the representations the two Apostles are plainly

distinguished by very different physical types, which became thoroughly fixed in early Christian art, and have been substantially retained through all subsequent developments. These characterizations of the Apostles were so uniformly followed, and may be traced back to so early a date, as to suggest the possibility that they originated in veritable portraits. An admirable bronze medal (Fig. 91), now in the Christian Museum of the Vatican, represents the heads of the two Apostles with extraordinary vigor, and with the evident intention of either repeating or creating a portrait type. It was found early in the eighteenth century by Boldetti in the catacomb of Domitilla. De Rossi ascribes it to the second century, and at all events it is hardly to be put later than the third. Another bronze medal (Fig. 90) in the Vatican illustrates the cruder representations of the fourth century; this elongated type of face was especially common on the gold-glasses. In the better specimens of sculpture and mosaic the portraits of the Apostles closely approach the type of the earlier medal. If these are not actually portraits of Peter and Paul, they are certainly very admirable idealizations. There is great vigor, albeit a certain physical coarseness, in the round head of Peter set upon a thick neck. This Apostle is further distinguished from S. Paul by his short, curly locks and close-clipped beard. Paul's is the intellectual head: a high straight forehead, made more prominent by his baldness, and a great frontal angle. The most serious objection one can raise to these portraits is that they are not Jewish types. But they are highly interesting even as idealizations, and all the more so because they constitute the most striking instance of the continuous influence of early Christian ideals in art.

SARCOPHAGI

Even after the Peace of the Church, Christians were often satisfied to procure their sarcophagi from pagan shops; it was enough if the decoration were of a neutral character, or that it had at least no express associations with paganism. It is to be observed, moreover, that the decoration even of the Christian sarcophagi was more strongly influenced by the Classical traditions than was any other branch of Christian art. The

artisans, it would appear, must often have been strangely confused between their old and their new religion. It must be remembered, however, that many figures which had originally a definite religious significance were so constantly employed as mere elements of decoration that they lost their expressly pagan significance for the popular consciousness. There are very few sarcophagi on which one has not to remark the influence of the Classical models: in the cupids or victories which support the epitaph or the portraits of the deceased, in the Medusa heads, in the huge masks which compose the corners of the lid, in the Dioscuri, in the genii which represent the seasons, or hold an inverted torch, in the personifications of the heavens, the winds, the rivers, the sea, and the mountains, in the marine monsters, in the Tritons blowing the shell, in the lions devouring some animal, in the griffons, the mythical guardians of the tomb, or in the scenes of the chase and of rustic life.

The Classical tradition is no less apparent in the constant effort after symmetry and an harmonious grouping of the composition. Some have attempted to trace a doctrinal symbolism in the arrangement of the subjects upon the sarcophagi; but it must be confessed that in general the desire for symmetry was the ruling motive in the composition, and next to that we have to rank the zeal to crowd as many subjects as possible into a small field — a procedure which was sadly subversive of classic taste. Finally, it is to be remarked that the Christian sarcophagi, like the Classic, were usually embellished by color or gilding, though the traces of it have generally quite disappeared.

Even ornamental sarcophagi did not require a figured decoration over the whole front. Very many of them were ornamented by undulating channels (Fig. 16), called *strigils*, from their likeness to the instrument with which the athletes scraped the oil and sand from their bodies after exercise in



FIG. 92. — An orans. Relief on a sarcophagus.

the gymnasium. Other conventional patterns were borrowed from the designs which were common for chancels (Fig. 92). Room was usually left in the middle of the field for the representation of an orans, or a Good Shepherd, or merely for the inscription.

Perhaps the most ancient of the strictly Christian sarcophagi is that of Livia Primitiva (Fig. 16), which was found near the tomb of S. Peter, and belongs probably to the second century. The Good Shepherd, the fish, and the anchor which decorate it are not sculptured in relief, but merely engraved upon the surface. Figure 93 illustrates an early sarcophagus which is to be ascribed with probability to the third century, or



Fig. 93.—Sarcophagus in the Lateran Museum. Third century. The Good Shepherd repeated three times in the midst of a vintage of genii.

not later than the early years of the fourth. There is nothing distinctively Christian in the design, and it may very well have been made by a pagan artist. Of the three shepherds which appear on it, the middle one is bearded. As in this instance, the figure of the Good Shepherd often served to introduce scenes of rustic life, for which Classical art furnished ready models. Here we have a vintage gathered by genii, a common scene in pagan art, and one which was capable of interpretation in a Christian sense. This became a favorite theme in the reign of Constantine. The great porphyry sarcophagus of Constantia (now in the Vatican Museum) has a decoration of this character, though of much less lively and graceful design; and the same theme is repeated in a very charming manner in the mosaics which adorned the ceiling of her mausoleum (Fig. 125). Of all Christian sarcophagi the most

thoroughly Classical, both in execution and design, are two of the third century in the Lateran Museum, which are numbered respectively 163 and 181 in that collection. The first is divided laterally into three sections. In the middle stands a defunct matron between SS. Peter and Paul; at both ends is represented the Good Shepherd carrying a lamb on his shoulders. In the second there is no division into compartments; at the ends are seated a man and a woman, each accompanied by two other persons of the same sex representing the company of the saints in paradise, and both of them are looking toward the Good Shepherd, who occupies the middle of the composition.

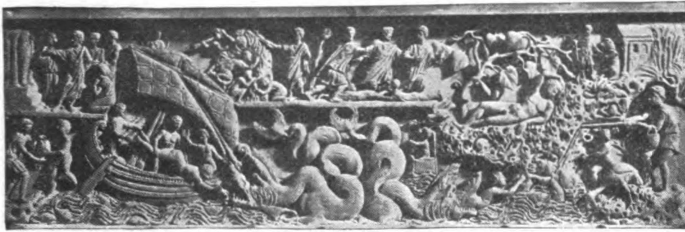

FIG. 94. — Sarcophagus in the Lateran Museum. Fourth century. Two fishermen, three scenes from the story of Jonah, Noah in the ark, the raising of Lazarus, the water from the rock, Moses assailed by the Hebrews, the Good Shepherd.

It was very rarely that the artists were content to adorn a sarcophagus with a single theme. The crossing of the Red Sea lent itself most readily to this purpose; and many of the details of the representation recall the scenes of combat which appear upon pagan tombs. It is most commonly upon the lids that we find the representation of a single subject; and owing to this, the composition of the lid is often more graceful than that of the sarcophagus itself. In the Roman type the lid was nearly flat, or with a low gable at the end, and it left a narrow field in front for sculpture. A number of lids containing one or two subjects are illustrated in Figs. 86–89. The fewer subjects the artist attempted to include in his design, the nearer it was likely to approach the grace of the pagan prototypes. But it early became the custom to crowd the subjects so closely together that the general effect was very much impaired.

The three scenes, for example, which illustrate the story of Jonah might very well have been allowed to occupy the whole field. But we see in Fig. 94 how the artist has utilized every inch of space for additional symbols. He takes advantage of the water which was needed for Jonah's sea to represent various sorts of fish, and two fishermen, each accompanied by a naked lad. Behind the monster he depicts Noah floating



FIG. 95. — Sarcophagus in the Lateran Museum, formerly in S. Paul's. Fourth or fifth century. The Holy Trinity and the creation of man, the Logos between Adam and Eve, the miracle at Cana, multiplication of the loaves and fishes, raising of Lazarus, the Epiphany, healing of the blind, Daniel among the lions fed by Habakkuk, the denial of Peter, arrest of Moses (Peter), Moses (Peter) striking the rock.

in his ark and receiving the olive branch from the dove. He takes advantage of the grassy slope upon which Jonah reclines beneath his gourd to represent a pastoral scene, the Good Shepherd gathering his sheep into the fold — which is here depicted in the form of a church. The wind and the sun are represented by human figures as in Classical prototypes. The subject would seem to defy the principle of symmetry, but in this composition there is striking proof of the strength of this tendency. One will notice that admirable balance is combined with variety in the central portion of the field; at the ends, the symmetry is more pronounced; below, the two fishermen balance one another; and above, the ecclesiastical fold is set over against the temple-like tomb of Lazarus.

The figure kneeling at the foot of Christ in this illustration represents the woman whom he healed of the issue of blood. It is not improbable that this figure, which occurs very frequently, stands generally for the Canaanitish woman, for Mary Magdalene, and for all the women in whom the Lord showed his grace and power; just as the figure of the blind man epitomizes all his works of healing upon men. The next



FIG. 96.—End of a sarcophagus in the Lateran Museum. Fourth century. Moses with the tables of the Law, the water from the rock, the woman with the issue, churches of Jerusalem in background.

scene is that of Moses striking the rock, to which the thirsty Hebrews rush to drink. The last is Moses assaulted by the Hebrews.

We note in the above instance a division of the field into two zones—a principle which was usually carried out much more rigidly in order to allow of the representation of the greatest possible number of figures.

The common arrangement is well illustrated in Fig. 95, a sarcophagus of the fourth century, which was once in S. Paul's

and is now in the Lateran Museum. We see here that the effort after symmetry has resulted in a monotonous uniformity. The attitude of the individual figures is good, but the general effect is impaired by crowding. In this case the faces are very roughly finished. It may be noticed, by the way, that the busts of the deceased couple are only blocked out, and that the lid has received neither carving nor inscription. We have in this an intimation of the fact that the sarcophagi were not generally made to order, but selected out of the general stock of a studio, ready made except for the inscription and portraits which had to be added after the purchase. In this case, for



FIG. 97.—Fragment of a sarcophagus in the Lateran Museum. Fourth century. Elijah giving his mantle to Elisha, the sons of the prophets and the bear.

some reason or another, neither the portraits nor the inscription were executed.

The centre of the composition is plainly marked by the shell, which contains the busts of the deceased, and is supported by two little cupids; and below, by the group of Daniel between the lions, to whom Habakkuk offers a loaf of bread. The figures which here and elsewhere appear in the background have no significance, and are added only to fill out the space. There is in this case an unusually strict symmetry of arrangement between the upper and the lower zone. Moses striking the rock corresponds to the raising of Lazarus. At the other end God is seated upon a throne, — or rather a *cathedra velata*, — and below, seated upon a similar *cathedra* (without a covering),

the Virgin and Child receive the adoration of the Magi. The figure behind the Virgin may be taken to be Joseph. Above, a similar figure stands behind the throne of God and another in front of it. These figures must be taken to represent the Trinity, although the subject is absolutely unique in Christian art. They might be supposed to be merely accessory figures designed to fill up the background, like those which we have already noticed, were it not that the front figure is coöperating with God by laying his hand upon the head of Eve who has just been formed. This evidently represents the Holy Spirit, and symbolizes the breathing into man the breath ("spirit") of life. Just as in Christ's attitude in blessing the loaves and fishes we see the gesture which was used in the consecration of the eucharistic elements, so here we see the gesture which was used in the Church, in confirmation, in ordination, or in any bestowal of spiritual gifts. Representations of God the Father are exceedingly infrequent in early Christian art, and they are almost exclusively confined to the rare scenes which depict the creation of man. We have absolutely no other representation of the Holy Ghost, except under the symbol of the dove. The scene next in order is a more common one: Christ, the Logos, standing between Adam and Eve and apportioning to them their respective labors—represented by the sheep and the sheaf of wheat. This scene symbolizes also the promise of redemption which was made to our first parents. The fall is represented by the serpent coiled about the tree. Christ is here represented beardless and young, with long locks, just as he appears in the scenes which represent his earthly life, and in contrast to the aged bearded persons who represent the Trinity in the first scene. Next in order come the symbols of the Eucharist: the turning of the water into wine, and the multiplication of the loaves and fishes. Immediately associated with this is the raising of Lazarus, the symbol of the resurrection. At the feet of Christ kneels the woman with an issue.

Next to the Magi is the healing of the blind man, then Daniel, and then Christ foretelling to Peter his denial. The cock clearly designates this scene. The gesture which Peter makes with his hand to his chin indicated perplexity; Pilate's attitude of mind is commonly expressed in the same way.

Christ's gesture in this scene is that which is commonly called the Roman benediction, with the fourth and little finger closed and the others open. The position of the fingers is the same in the act of creation and in the healing of the blind. But in this instance we see that it is not a gesture of blessing, but simply the accompaniment of his address. We learn, in fact, from Christian and pagan monuments, that this was the commonest gesture in oratory, and it was, therefore, quite naturally, though only incidentally, used in the address of benediction. Many of the ancient pictures of Christ — particularly in the mosaics — have been taken to represent him in the act of benediction when they really denote simply the gesture of address.



FIG. 98. — Sarcophagus in the Lateran Museum. Fourth century. The raising of Lazarus, multiplication of the loaves and fishes, sacrifice of Isaac, healing of the blind, denial of Peter, the Logos between Adam and Eve, Moses taking off his shoes, the woman with the issue, the miracle of Cana, Jonah, Daniel between the lions, arrest of Moses, water from the rock.

The so-called Greek benediction, in which the thumb and third finger are crossed in the palm and the other three fingers open, was likewise a common gesture in oratory, and it was only in the course of the Middle Ages that it became distinctive of the Eastern Church and confined to the act of benediction.

It is strange that the fall of Peter was represented so often upon Roman monuments. The special interest of this scene probably lay in the fact that it afforded a justification of the Catholic practice — hotly contested by certain sectarians — of readmitting to the Church through penance those who had lapsed by the denial of their religion in order to escape martyr-

dom. This cannot be intended, at all events, as a derogation of Peter's primacy, which was generally recognized in the fourth century and is here very characteristically expressed in the following scenes. These scenes represent Moses assaulted by the rebellious Hebrews, and finally satisfying their demands by striking water from the rock. The Hebrews are here as usual distinguished by their flat caps and their pantaloons. But it is claimed that Moses in these two instances represents Peter, and it is remarked that the faces of these three figures precisely correspond. The argument from mere resemblance is but a



FIG. 99. — Sarcophagus in the Lateran Museum. Fourth century. The raising of Lazarus, denial of Peter, Moses receiving the Law, sacrifice of Isaac, Christ before Pilate, the water from the rock, Daniel between the lions, an obscure subject, the paralytic carrying his bed, healing of the blind, multiplication of the loaves and fishes.

weak one in this case, where the execution is so rough and all the figures are so much alike; but we have already seen that Peter is elsewhere expressly identified with Moses striking the rock, and the only adequate explanation we can suggest for the frequent repetition of the Hebrews' assault upon Moses is that it represents at the same time the arrest of Peter at Rome. The Scriptures do not record that the Hebrews ever took violent hold of Moses. On the other hand it is evident that the arrest of Peter, which is represented in Fig. 100 (second subject from the left above), closely corresponds with this scene. It will be remembered that Christ foretold to Peter not only his denial but his martyrdom, saying, "When thou art old, thou

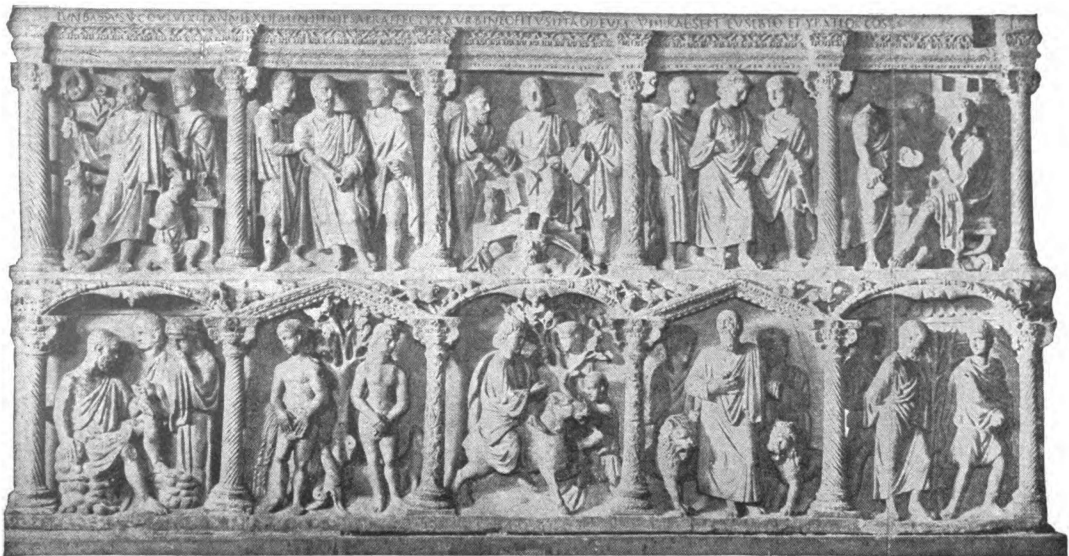

FIG. 100. — Sarcophagus of Junius Bassus (†850), in the crypt of the Vatican. Sacrifice of Isaac, arrest of Peter, Christ enthroned above the heavens, Christ led before Pilate, Job, Adam and Eve, Christ entering Jerusalem, Daniel, Paul led to execution.

shalt stretch forth thy hands, and another shall gird thee, and carry thee whither thou wouldest not." There is marked ap-

propriateness in representing here the martyrdom of Peter with which he atoned for his denial. In the next scene, as the official representative of the Church, as the rock upon which it was founded, he refreshes the world with the floods of baptism which flow from that other rock, which is Christ.

Reviewing briefly the principal ideas of this sarcophagus, we have: the divine Trinity, the creation of man, his fall and the promise of the Redeemer; the sacrament of the Eucharist and the resurrection, the calling of the Gentiles, and the constitution of the Apostolic Church which renews the sinful race through baptism.

It must be confessed that no other sarcophagus shows so profound a connection of ideas. It is certain that the artists themselves had often no conception of the deeper ideas which underlay the themes which they repeated, and we are usually left in doubt whether there is any intelligent connection to be traced between the subjects which are closely strung together, or whether the arrangement is due wholly to hazard.

Figure 98 illustrates a sarcophagus which is closely related to the preceding; it is very much better executed, but the arrangement seems to be entirely arbitrary and unreflecting. It will be sufficient to enumerate briefly the subjects: the raising of Lazarus, the multiplication of the loaves, the sacrifice of Isaac, the healing of the blind, Peter's denial, the Logos between Adam and Eve, Moses taking off his shoes, the woman with the issue, the water pots of Cana, the three incidents of Jonah's story in one composite scene, Daniel among the lions (Habakkuk offers him a loaf marked with the cross), the assault upon Moses, the water from the rock. It will be noticed how many accessory personages appear in the background.

In Fig. 99 the figures are more freely spaced and much better disposed. It is necessary here to mention only the subjects which have not appeared in the preceding illustrations. It may be remarked that Moses receiving the Law and Abraham sacrificing his son are often represented, as here, on either side of the busts of the deceased. This enabled the artist to utilize the small angles above the shell for the hand of God which intervenes in both of these cases. It was usually by a mere hand or arm stretched from a cloud that the pres-

ence of God was represented, and the artist was relieved of the necessity of depicting the deity in human form. This symbol evidently reflects the familiar language of the Psalms: "the hand of God," "the arm of the Lord." The scene below the busts has not been adequately explained. It seems to represent a prophet reading a roll, which a Jew would take from him, while another is spying upon him through the branches of a tree. Next to this on the right is the paralytic carrying his bed. In the upper right-hand corner we have a scene which appears first in the art of the sarcophagi; it represents Christ before Pilate. Christ stands in the background accompanied by a soldier. In front stands a servant pouring water from a pitcher — the basin has been broken off the small table upon which it stood. Pilate is represented washing his hands of "the blood of this just person." Pilate himself is seated with an assessor upon the judgment seat; he has an air of

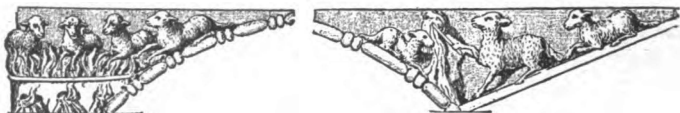

Fig. 101. — Details from the sarcophagus of Junius Bassus. Christ, in the form of a lamb, multiplying the loaves,

great perplexity and indecision. The Gospels make no mention of the presence of an assessor; it is simply taken for granted by the artists, because it was customary in Roman judicial procedure.

A decided improvement upon the type of sarcophagus we have just been studying is effected by separating the different subjects by a row of columns, arcades, or niches. This is illustrated by the celebrated sarcophagus of Junius Bassus (Fig. 100), a Prefect of Rome who died in the year 350. In point of execution it is the noblest of all Christian sarcophagi; the illustration is necessarily imperfect because the sarcophagus stands in the crypt of the Vatican and in a position where it is difficult to photograph it. The first scene is one with which we are already familiar — the sacrifice of Isaac. The next represents the arrest of S. Peter; it is clearly identified by the traditional type of the Apostle. At the lower corner to the right is the scene which corresponds to this, S. Paul led

to his execution. The high reeds which appear in the background of this scene very well correspond with the swampy character of the region about the Tre Fontane where S. Paul was beheaded. The two compartments above represent Christ before Pilate. He also, like Peter, is conducted by two soldiers, but he is not bound, and they do him no violence. It is evident that even when the Church began to represent these scenes connected with Christ's Passion there was still a great reluctance about depicting him in any humiliating position. He was still represented in the gracious aspect of a young and beardless youth, and usually with long curly locks. The type was evidently derived from the pictures of the Good Shepherd. Here, as always, he stands freely and majestically before Pilate, who himself seems to feel condemned by his prisoner.

On another sarcophagus in the Lateran of about the same date, this and other scenes of Christ's Passion are represented in the

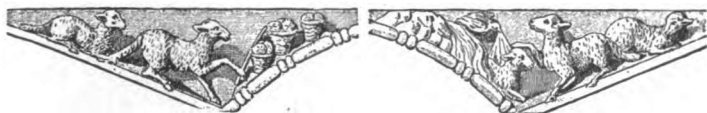

appears among the Three Children in the furnace, Christ striking water from the rock, baptized by John in the Jordan.

same spirit. A soldier places the crown of thorns upon his head as though he were crowning an emperor, and the way of the cross is represented by a scene in which a soldier and Simon the Cyrenean alone appear. This stands in the strongest contrast to the spirit of Mediæval art and of the Mediæval religion which delighted in scenes of horror and strove especially to stir the feelings by depicting vividly every detail of Christ's sufferings. It is not till later that we shall have occasion to mention the crucifixion, but on this sarcophagus it is symbolized by a bare cross, upon the arms of which are perched two doves supporting a great wreath or crown which frames the triumphant monogram. Below the cross sleep the two soldiers who guarded the tomb. In this we have symbolized at once the crucifixion, the burial, the resurrection, and the ascension.

But to return to the sarcophagus of Junius Bassus; in the middle of the composition we have, below, Christ's triumphal

entry into Jerusalem; one man is casting his garment in the way, and another is breaking off the bough of a tree. Above, Christ sits enthroned above the heavens, giving the charge of his Church to the two Apostles. Heaven is here personified as in Classic art, by an old man holding his garment above his head. It only remains to mention the scene in the left-hand corner; it represents Job upon the ash heap, his wife is offering him a loaf of bread on the end of a stick, while she holds her garment over her nose.

The niches of the lower zone are admirably designed; every alternate niche is finished above in the form of a shell; this ornament was common in Classic architecture; but here the design is unusual, for it passes by insensible gradations into the wings and head of a dove. In the six spandrels between the niches an unique and very interesting series of symbols is introduced. Four of the subjects are illustrated on a larger scale in Fig. 101. They represent Christ under the figure of the lamb: in the first he is joining three other lambs in the fiery furnace; in the second he is striking with his rod the water from the rock, the well of living waters with which he refreshes his disciples; in the third, he is baptized by John in the Jordan; two other niches contain the raising of Lazarus and the receiving of the Law.

This is the first time we have encountered this new trait of symbolism, according to which Christ is no longer the shepherd but the sheep. This symbolism belonged first and foremost to the apsidal mosaics of the basilicas, which in this, as in most other respects, were inspired by the Apocalypse. The mystic lamb—the *agnus dei*—stands upon the mount out of which issue the four streams of paradise, which are the four Gospels. He is often accompanied by twelve lambs representing the Apostles, issuing from the towns of Jerusalem and Bethlehem (Fig. 129). This symbol gained a firm hold in the fourth century, and it no doubt had an influence in supplanting the Good Shepherd. It was not till the fifth century that the lamb was represented with the nimbus and the cross.

A similar sarcophagus of about the same date as that of Junius Bassus is illustrated in Fig. 102. By the reduction of the colonnade to a single story and by the diminution of the number of figures it gains much, both in beauty and in clear-

ness of meaning. The greater number of subjects on the sarcophagus of Junius Bassus embarrass one's judgment; here where there are but three themes the meaning is clear, and we see that Abraham's sacrifice of his son typifies the Passion of Christ, and for this reason is placed opposite the judgment of Pilate, while the central subject depicts Christ after his resurrection. With this clearly established, we are bound to read back the same meaning into the other sarcophagus, with a presumption that its other scenes, too, were thoughtfully chosen. And in fact, it is sufficiently clear that the scenes which represent the martyrdom of S. Peter and of S. Paul have their place there as illustrations of suffering in likeness to that of Christ,



FIG. 102. — Sarcophagus in the Lateran Museum. Fourth century. Sacrifice of Isaac, Christ, enthroned, giving the new Law to his Apostles, Christ before Pilate.

while Daniel typifies both martyrdom and deliverance. Christ's triumphal entry into Jerusalem on the way to his Passion is evidently compared with his glory in the Jerusalem which is above. Job is often represented by the Fathers as a type of Christ for his suffering and patience. Adam and Eve typify the fall which required redemption. It may be that it is as the just man Job is here represented, in contrast to the first parents who brought sin into the world.

Very common are the sarcophagi upon which Christ is represented enthroned between the Apostles, although, as it has been said, this theme belongs especially to the art of the basilicas. Sometimes all twelve of the Apostles appear, either in a close row, or divided by niches. Sometimes from under the feet of Christ there gush the four streams of paradise.

It remains only to remark the peculiarities of the fifth cen-

tury sarcophagi of Ravenna (Figs. 103, 104). They are distinguished by their rounded lids, which are frequently decorated

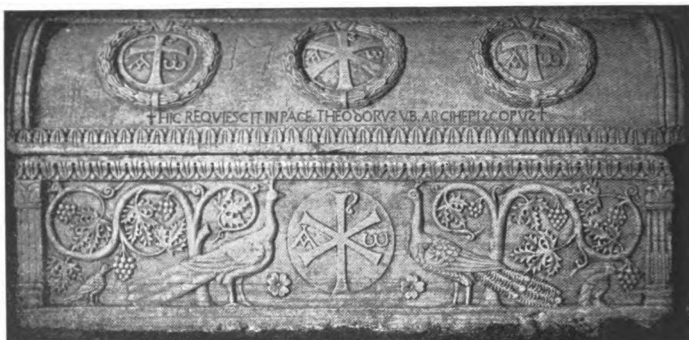

Fig. 103. — Sarcophagus of Theodore, bishop of Ravenna. Fifth century.

by crosses or monograms. It may also be observed that they are more frequently decorated at the ends than are the Roman sarcophagi. The aim in general is more expressly decorative, and they are consequently never overcrowded with figures. The principle of symmetry comes out here more strongly than ever, both in the strictly ornamental and in the figured designs. The subjects which belong to the early cycle of the catacombs never appear; in their stead are either historical subjects or the symbolical themes of the basilicas. Figure 104 repeats a theme which is common for the apse, or for the apsidal arch. It represents again Christ enthroned between the Apostles, but with a difference which belongs to the fifth century. S. Peter approaches with his key and cross, and S. Paul on the right hand receives from Christ a roll which symbolizes his commission as Apostle, or, it may be, his reception of the new Law. It is well known that in the fourth century, if not earlier, the Gospel came to be regarded as the new Law, and it is not unlikely that the scenes which represent S. Paul receiving a roll from the hand of Christ were intended to express a parallel to the reception of the Law of the Old Covenant by Moses. On this sarcophagus, besides the chief Apostles, two others stand acclaiming Christ, and two martyrs hasten to lay their crowns at his feet. The crowns,

the roll which S. Paul holds, the cross and the key of S. Peter, are carried in napkins. It was customary in the Church to veil one's hands, either with a napkin or with the skirts of one's



FIG. 104. — Sarcophagus in Ravenna. Fifth century. Christ, enthroned, giving the Law to Peter and Paul, two Apostles hailing him, two martyrs offering their crowns.

garment, in holding any sacred object. The custom was derived from pagan usage; the edicts of the emperor, for example, were thus received.

NOTE.—The first volume of Venturi's important work, *Storia dell' Arte italiana*, was unfortunately issued too late to permit the incorporation of any of its valuable suggestions in the text of this volume. But there is one monument which demands some mention, and deserves far more attention than can be given it in this note. I refer to the two front columns of the ciborium of S. Mark's, in Venice, which, since Venturi's convincing vindication of their antiquity, must be accounted among the most important monuments of early Christian sculpture. Each column is covered with figures representing stories from the Gospels. The figures are disposed in nine zones, between which runs an inscription. In each zone are nine figures, separated by colonettes surmounted by archivolts, after the manner which was common on the sarcophagi. It is mainly on account of the character of the inscription that this monument has been ascribed to a late period of the Middle Ages. The inscription, however, is not contemporary with the carving; it is proved to be an addition of a later age by the fact that it does not always designate correctly the events depicted. When this is recognized, the monument is seen at once in its proper relation to early Christian art. Venturi ascribes it to the early part of the sixth century. It is not unlikely that it originated in Istria. It was evidently the work of a skilful cutter of sarcophagi. It may be accounted the last important work of early Christian sculpture in stone. It is interesting, moreover, for the many traits it derives from the apocryphal Gospels, and for its proof of the influence of the pseudo-Dionysius upon pictorial art, though we have here only the first steps toward a discrimination between the different classes of angelic beings.

THE DOORS OF S. SABINA

Of early sculpture in wood it is perfectly natural that only very few, and for the most part only unimportant examples have been preserved. But there is one exception,—the cypress wood



FIG. 105. — Some of the panels on the left side of the wooden doors of S. Sabina, Rome. Fifth century. The Ascension, a symbolical representation of the Church, the denial of Peter, Habakkuk carried by the angel to Babylon, crossing the Red Sea, the ascent of Elijah.

doors of the church of S. Sabina upon the Aventine at Rome (Figs. 105–108); and this exception constitutes one of the most valuable monuments of early Christian art. This church, as the mosaic inscription informs us (Fig. 123), was built in the beginning of the fifth century (under Celestine I.) by a presbyter of Rome of Illyrian birth by the name of Peter. It is probable that the carved panels of the doors date from the foundation of the church. The border is later, and of a different wood. Only a part of each of the leaves is shown in Figs. 105, 106, and that is, unfortunately, on too small a scale to give any

adequate idea of the subjects treated. Originally there were twenty-eight carved panels, twelve of them large and sixteen small. Of these only eight of the large and ten of the small ones are left, while the other spaces are blank. The panels which remain have suffered some damage, as well as some unfortunate restorations which are difficult to detect on account of the thick varnish with which the whole door has been covered. The wonder is, however, that so much should be preserved and in so good a condition. Although it is the main door of the church, it happens to be protected by a vestibule. Many of the carvings are executed with great spirit and show remarkable invention. Many of the themes appear here for the first time, and several of those which are old appear here in a new form. This monument may have had an influ-



FIG. 106. — Some of the panels on the right side of the wooden doors of *S. Sabina*. Miracles of Christ, miracles of Moses in the desert, Christ appearing to Thomas, to the women in the garden, the call of Moses, a symbolical representation of the Empire.

ence upon the moulded designs of the bronze doors which became the fashion in the early Middle Ages; but so far as we know it seems to stand as much apart from succeeding art as from all which went before.

The originality of these carvings is so great that there is serious difficulty in interpreting them, and inasmuch as there is uncertainty about some, we may content ourselves with the consideration of a few of the most interesting.

Too many of the panels have been lost to permit us to judge securely whether they did originally, as is commonly supposed, constitute one of those parallels between the Old and the New Testament (a dittochaon, so-called) of which we have literary record (see p. 16) but no example among extant monuments of the early period. The panels have undoubtedly been transposed out of the original order, but between some of them there is parallelism striking enough to assure us that they must once have been placed side by side, and in other cases the missing complement is clearly suggested. It is difficult, however, to believe that the parallel was consistently carried through; the three small panels, for instance, which depict our Lord's appearances after his resurrection could hardly have been matched out of the Old Testament.

The series, as we now have it, begins with the history of Moses. On one large panel is represented his call; below, he is tending the flock of Jethro; above, he is taking off his shoes in the presence of the angel who speaks to him out of the burning bush; and at the top he is receiving his commission from God. On another large panel is represented the departure from Egypt: Moses pleads with Pharaoh and changes his rod into a serpent; the Israelites pass through the Red Sea, in which Pharaoh's host is engulfed, and march after the pillar of fire. The miracles of Moses are represented on a large panel in four sections: Moses stands above, talking with God; below, are two scenes representing in each case three persons around a table, commonly interpreted as the feeding with manna and with the quails; at the bottom Moses strikes the rock. To this evidently enough corresponds the panel which represents three of the miracles of Christ: the turning of water into wine, the multiplication of the loaves, and a subject which is interpreted as the healing of the blind

man. The ascension of Elijah is very admirably represented on a large panel: the prophet, mounting in the chariot, is received by an angel; below, Elisha receives his mantle, while two "sons of the prophets" throw themselves upon the ground in terror. To this corresponds the ascension of Christ, who is received into the clouds by three angels, while the Apostles are left gazing up in amazement. Of other Old Testament scenes we have only a single small panel left; it represents the angel transporting to Babylon the prophet Habakkuk by a lock of his hair¹—a subject which suggests the loss of other representations connected with the story of Daniel, probably Susanna and the Three Children. To this last subject there corresponds the familiar parallel of the Magi on a small panel. One small panel is supposed to represent the Transfiguration.

It is certain that other scenes relating to Christ's life have been lost, but there is fortunately preserved to us the end of the series, from the judgment before Pilate to the glorification of Christ in heaven. A number of these subjects appear here for the first time, and have therefore a very extraordinary interest. A small panel represents Pilate washing his hands, while Christ departs for Calvary, with Simon bearing the cross. Another small panel represents Christ before Caiaphas — a subject which is new to us. The denial of Peter is represented by itself. The Crucifixion is represented on a small panel, and so far as we know this is the first time it appears in Christian art. We have perhaps to suppose that a representation of the Resurrection has been lost. But we have on three small panels, the appearance of the angel to the two women at the tomb, Christ appearing to two women in a garden, and to the disciples in the upper room — probably to Thomas. Behind the head of the risen Christ is a nimbus formed by the monogram between the letters A and Ω. This perhaps explains the origin of the rayed nimbus.

The theme which is altogether the most striking of the whole series (a conception as admirable as it is novel) is represented on a larger scale in Fig. 107. In the upper part of the composition stands Christ in triumphal attitude. He stretches forth his right hand with a gesture which expresses

¹ Daniel xiv. 32-35.

at once address and command; in his left he holds an open scroll upon which are the letters of the word *IXΘYC*. He has the simple nimbus, and on each side of him are inscribed the

letters *A* and *Ω*.

The figure of Christ is framed in a great wreath which is supported by the four symbols of the Evangelists. The Saviour is here represented above the sun, the moon, the stars, and the vault of heaven; below stands a veiled woman in the attitude of prayer, the personification of the Church militant, and above her head the two Apostles hold a wreath in which is framed the cross. The office of the Apostles is to hold before the eyes of the Church Christ's cross, as the example for her life and as the only way through which she can receive the crown. But we



FIG. 107.—A panel from the doors of S. Sabina. The Apostles directing the gaze of the Church to Christ in the heavens.

notice here a strange feature: the staff of the cross is elongated upward, tapering like a tongue of flame. It points straight to a star, but it points on beyond this, above the heavens, to the divine Ichthus, Jesus Christ Son of God and Saviour, who is glorified by the Evangelists, the Alpha and

Omega, forever elevated above the heavens, but remaining forever the only teacher, the only Lord of his Church, which prayerfully gazes up to him *through the cross*.

There remains but one other composition to consider; it is the large panel at the lower right-hand corner of the right leaf as shown in Fig. 106. This has been taken to represent the appearance of the angel to Zacharias in the temple; but one can see at a glance how poorly it corresponds to the Biblical account of this event; and as this is a subject nowhere else represented in early Christian art, we have the less reason to expect it here. The cross plainly indicates a Christian building, and the person who stands in front of this palace, basilica, or church (whichever it may be) is not a priest, nor an ecclesiastic, for he wears the *paludamentum*, which was the dress of the emperor or of imperial officers. The preceding panel represented the Church; it seems as if this were designed as a parallel to it, representing the Empire. This collocation of ideas was very familiar in that age (see p. 241); the Church and the Empire were regarded as the two inseparable constituents of Christendom. The introduction of an angel in this connection is certainly a very striking fact, but it is not out of keeping with the ideas of that age. The Christian emperor as the protector of the Church was under the special tutelage of heaven. In this case the angel is not represented as addressing the emperor, but as furnishing him with celestial escort. The figures below, divided into two groups, represent the multitude acclaiming the emperor. The higher group represents the nobles, clad in the toga *contabulata*; the lower represents the plebs, clad in the *pænula*. This scene has great likeness to the *acclamatio* upon the arch of Constantine; the emperor, the nobles, and the plebs are in both cases clothed in precisely the same way. The theme is a symbolical one, and we need not, therefore, think of any particular emperor, but only of the imperial office in general.

One cannot be struck with the novelty of the themes which we encounter upon the doors of S. Sabina. This monument is in many respects unique, but it stands out here in stronger contrast because we have passed at one step from the art of the catacombs and of the sarcophagi with its sepulchral symbolism, to the art of the basilicas with its broader range of interest, its

more varied choice of subjects, and its expressly didactic aim. We see that Christian symbolism did not here come suddenly to a stop, though it changed its form and became more expressive. It dealt henceforth less in hieroglyphic emblems, and more in the lofty spiritual similitudes which were inspired by the Scripture itself, in particular with the symbols of the church and of the heavenly Jerusalem which were drawn from the Apocalypse. Whether it was symbolical or historical, the art of the basilicas was always frankly didactic. It was the historical interest, however, which chiefly contributed to enlarge the range of Christian art. The monuments which we have still to study, whether in sculpture, or in mosaic, or in miniature, introduced many more themes than we can conveniently deal with. We have now come to a point where the products of Christian art can no longer be conveniently grouped under a half-dozen heads.

THE CRUCIFIXION

The Crucifixion scene on the doors of S. Sabina (Fig. 108) demands a special consideration, in order that we may institute a comparison with the very few other monuments of the same sort which are to be found among the remains of early Christian art. This theme has for us an interest altogether out of proportion to the rarity of its occurrence in early art, for in the art of the Middle Ages it became, we may surely say, the principal theme, and one is curious to see what expression was given to it in the early age.

Most important of all is the fact that the subject was never represented before the fifth century, and one who objects to it now may enjoy the confidence that he is in harmony with the sentiment and tradition of four centuries and more of the Catholic Church. There is no reason to suppose that earlier monuments existed of which we no longer have the trace, for the earliest reference in literature to a picture of the Crucifixion is in the middle of the sixth century, and it is not till the very end of that century there is mention of a carved image of it—this in an account by Gregory of Tours, to the effect that in a church at Narbonne there was a crucifix which gave offence on account of its nakedness.

Though the Crucifixion on the door of S. Sabina is the earli-

est we know, one can hardly say that it is the beginning of a line of development; the subject was so rare for at least a century after, that no tradition was established. It is certainly treated in an unique way in this monument. The background represents the wall of Jerusalem, and denotes that the Crucifixion was without the city. Christ is placed between the two thieves, who are represented much smaller than he. They are all three naked but for the scantiest loin cloth. Curiously

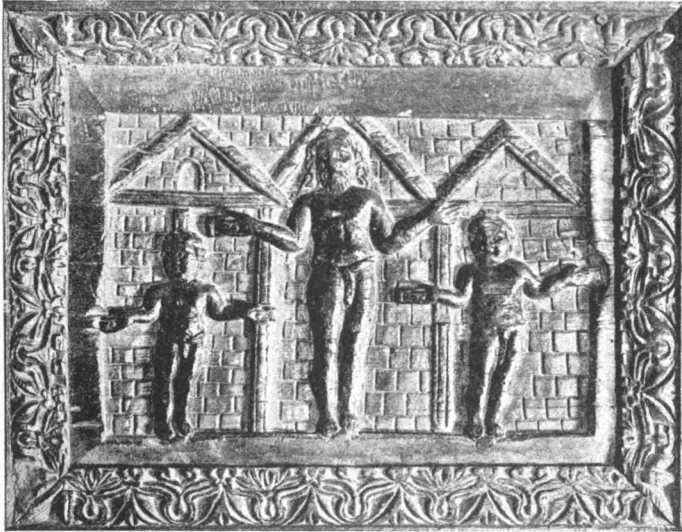

FIG. 108. — A panel from the doors of S. Sabina. The Crucifixion.

enough, there is no cross, though the hands of all are nailed to small blocks of wood. The feet are not nailed. There must have been some reason for merely hinting at the cross in this way, but it is puzzling to account for it.

It may have something to do with another strange feature which we have to observe, namely, the position of the arms; they all three stand in the position of the orans. One cannot readily suppose that this position was given them for lack of room, nor that there was any trait of realism in it. It is strange, on the other hand, to find Christ represented as an

orans, and the same attitude ascribed to both thieves. The posture of the orans suggested especially the petition of the soul for God's forgiveness and mercy. Christ is not commonly represented in this attitude; a rare if not the solitary exception is constituted by one of the representations of his baptism in the catacomb of S. Callistus. It is expressly mentioned that Christ prayed when he was baptized, and it may be that here his prayer from the cross is symbolized in this attitude. There is very little further we need remark in this picture. The figures are exceedingly ill-drawn; Christ has long hair and a beard, and his eyes are open. It is a characteristic trait of the early pictures of the Crucifixion (up to the twelfth century) that they represent Christ alive. The artists had not left so far behind them the cheerful traditions of earlier art that they could take delight in the harrowing suggestions of this subject.

A fresco of the Crucifixion was found in the house of SS. Giovanni e Paolo, and it, too, is supposed to belong to the fifth century. If so, it is our earliest painting of the subject; but unfortunately it was in a seriously damaged state when first excavated, and it has now almost entirely disappeared.

The next representation of this subject is on an ivory box in the British Museum (Fig. 109). This box can hardly be placed later than the fifth century, but we may note a certain advance upon the type represented by the doors of S. Sabina, especially in the introduction of some of the features which became traditional in later art. Christ is young and beardless, he has the nimbus, and the superscription REX IUD (*æorum*) appears above the cross. He is again naked but for the loin cloth, his eyes are open, and his feet are neither nailed nor bound. His arms, however, are stretched out horizontally, as in all the Mediæval representations. This position strictly demands a support for the feet, the *suppedaneum*, which appears in later representations and even in the earliest of all, the crucifix of the Palatine (p. 237). In the crucifix of S. Sabina, the *suppedaneum* may be indicated by the border of the panel. Such a support is however lacking here, though the body is raised some distance above the ground. The two thieves do not appear in this representation, but beneath the cross stand S. John and the Virgin. Near by, Judas hangs from a tree,

with his big bag of money spilt out beneath him; on the other side is a Jew, who still reviles Christ.

The three other subjects which are represented on this box are also interesting. This is the earliest monument on which Christ is represented carrying his cross; he goes out from the presence of Pilate and passes Peter, who has just denied him and sits crouched over a brazier. The two soldiers sleep-



FIG. 109. — An ivory box in the British Museum. Fourth or fifth century. Christ leaves the praetorium bearing his cross, the denial of Peter, the Crucifixion, Judas' death, the two women at the open tomb, Christ convincing Thomas.

ing before the empty tomb is the subject of another panel; and the last represents Thomas thrusting his finger into Christ's side. A representation of the Crucifixion in tapestry is illustrated in Fig. 178. Christ is here clothed in a long garment. The sun and moon appear on either side. The work belongs to the sixth or seventh century.

IVORY CARVING

It is quite natural that more examples should have been preserved of carving upon ivory than of any other class of monu-

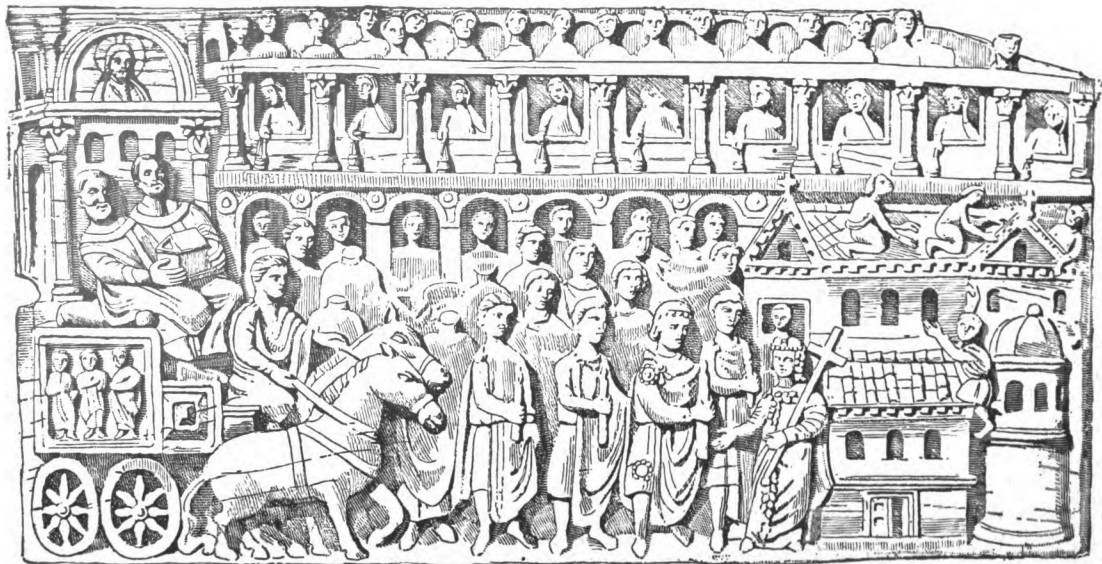

FIG. 110. — An Ivory relief at Treves. Fifth century. Two bishops are carrying a relic to a church, they are preceded by an emperor and courtiers bearing candles, and they are welcomed by an empress bearing a cross. The spectators in the upper windows of the palace swing censers.

ments except sarcophagi. It is equally natural that we should find works of rare delicacy of treatment among them. Only a few examples can here be mentioned or illustrated, and it is not necessary to pause to discuss the technic of this art. It followed the decline of all other branches of early art; but it served perhaps more than any other except Biblical miniatures to carry down the traditions of Classic art to the Middle Ages. There is no century which is not represented at least by rude copies of early models. The ivories of the early period are most of them to be ascribed to Rome, Milan, Ravenna, or Constantinople. This affords at least a general classification and marks certain differences in style. The first three names stand also for a chronological order; after the capture of Rome in 410 Milan became the seat of government and the centre of arts in Italy, to be superseded in the West only by Ravenna. It will be instructive to describe in detail two of the most important ivories in order to show how rapidly the range of subjects was extended after the Peace of the Church.

The first is the celebrated box preserved at Brescia (Figs. 111, 112). This box is in fragments; the five decorated sides are now laid together in the shape of a cross. The work is attributed to the fourth century, and the execution is far more perfect than one might expect even at that date. No other example of early Christian art can equal it in point of artistic beauty and skill. The aim of the artist is more exclusively decorative than in the case of any work we have hitherto considered. He has chosen what themes he pleased out of the early cycle, and he has freely invented new ones to match the spaces he had to fill, grouping them as proved most convenient. We must suppose that for the historical scenes he already found some patterns in Biblical miniatures or in mosaics.

We may notice in the first place that around the rim of the box were disposed medallions of Christ and fourteen Apostles. The head of Christ is just above the lock of the box; he is represented as a lad, and several of the Apostles are not much older. The narrow friezes at the bottom and top of each panel contain subjects from the Old Testament; the larger fields represent chiefly subjects from the life of Christ. At the top (Fig. 111) is Jesus in the Garden of Gethsemane, the betrayal of Judas, and the denial of Peter, Christ before Annas and



FIG. 111. — Top and two sides of an ivory box at Brescia. Fourth century. The large fields contain subjects from the New Testament; the borders, subjects from the Old; the medallions represent Christ and the Apostles.

Caiaphas, and before Pilate. The large field below represents Christ with two disciples beside some lake or river, the hand of God extended from heaven in witness to his Son; and then the history of Ananias and Sapphira. Following again the history of Christ, we have the healing of the woman with the issue, Christ instructing the disciples in the upper room (or preaching in the synagogue at Nazareth), Christ as the Good Shepherd defending the sheep while the hireling fleeth. In Fig. 112 we go back to earlier episodes: the raising of Peter's

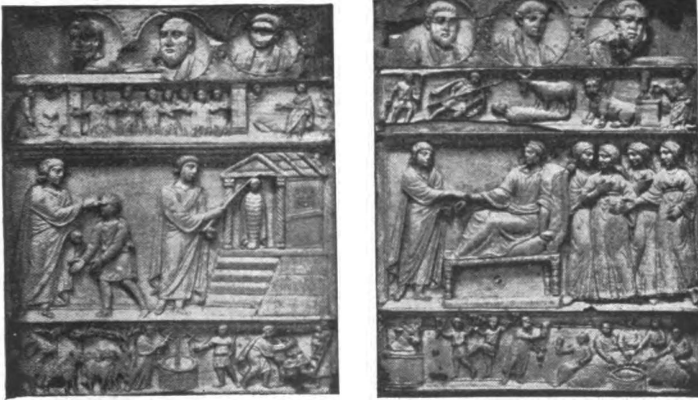

FIG. 112. — The two ends of the box at Brescia.

wife's mother, the healing of the blind man, and the raising of Lazarus.

The Old Testament story begins with the lower frieze at the right of this same plate: Jacob's dream (represented by an angel climbing a ladder), Jacob wrestling with the angel, Jacob watering the flocks of Rachel. In the frieze above we have Moses taking off his shoes; and on the other side his reception of the Law; in the middle there are represented the Three Children in the furnace — in the background are *four* more figures, representing the moment when the angel joined them. The story of Moses is continued below at the left with the worship of the Golden Calf, and a banquet in which five persons are seated at a table on which are loaves and a fish — probably the manna as a symbol of the Eucharist. Above is David slay-

ing Goliath, the prophet who was slain by the lion (represented as a mummy), and the hand of Jeroboam dried up as he put it forth from the altar. The uppermost frieze in Fig. 111 represents an orans, Jonah under the gourd, and Daniel feeding the dragon. The next below returns to the story of Moses :



FIG. 118. — Ivory diptych in Florence. Fifth century. S. Paul instructing his disciples, S. Paul at Malta, shaking the viper from his hand, Publius and his father, the sick brought to S. Paul for healing, Adam in Eden.

Moses found among the bulrushes, the slaying of the Egyptian, another banquet of five persons — probably the Passover. On the border to the right is Judas hung upon a tree : on the other side, a tower, the symbol of the Church or the New Jerusalem, according to one of the visions of Hermas. Below, Jonah and the monster ; on the border, the fish and the cock ; and at the

bottom, Susanna surprised at her bath, the judgment of Daniel, and Daniel among the lions. On this small box there are in all forty-one subjects besides the fifteen medallions; a considerable number of them appear here for the first time.

It must suffice to give one example of the fifth century ivories, — a diptych at Florence (Fig. 113) which belongs perhaps to the school of Milan. One side represents S. Paul as teacher, seated upon a chair among his disciples. Below is the scene at Malta where he casts off the serpent from his hand into the fire. Publius is dressed like a Roman official, but his father appears in the garb of the "barbarians" of the place. At the bottom, the father of Publius whom Paul had healed of a fever directs other sick folk to him. This work is well executed for its time, but we can distinctly enough note the decadence which marks the half century or so which intervened between this and the box of Brescia. The other side of the diptych, however, is thoroughly Classic in its traits, and this is doubtless to be attributed to the fact that the artist had some Classic model for this theme.

The revival of art at Ravenna furnishes us with a number of ivories. The most noteworthy is the ivory cathedra of Maximianus (Fig. 114,), bishop of Ravenna, before the middle of the sixth century. Its most admirable feature is the vine pattern which adorns the front and is employed with somewhat less delicacy for all the borders. The vine springs from a vase guarded by two lions and is continued on the upper frieze; it is gracefully enlivened by all sorts of birds and beasts. In the midst of it is the monogram of MAXIMIANOS EP (iscopos) — a form of puzzle which was especially popular in that age. The five figures in front represent the Baptist and the four Evangelists. In the conventionality of the drapery, and in a certain exaggeration of the attitudes, we have a suggestion of the traits which were to become so prominent in later Byzantine art. It is not unlikely that the front of the chair was executed by Byzantine artists. Another hand appears, however, in the historical subjects which adorn it. The back contained twenty-four scenes from the life of the Virgin and of Christ; some of them have been lost, and still others are scattered in various public and private collections. No scenes of the Passion were represented; the scenes from

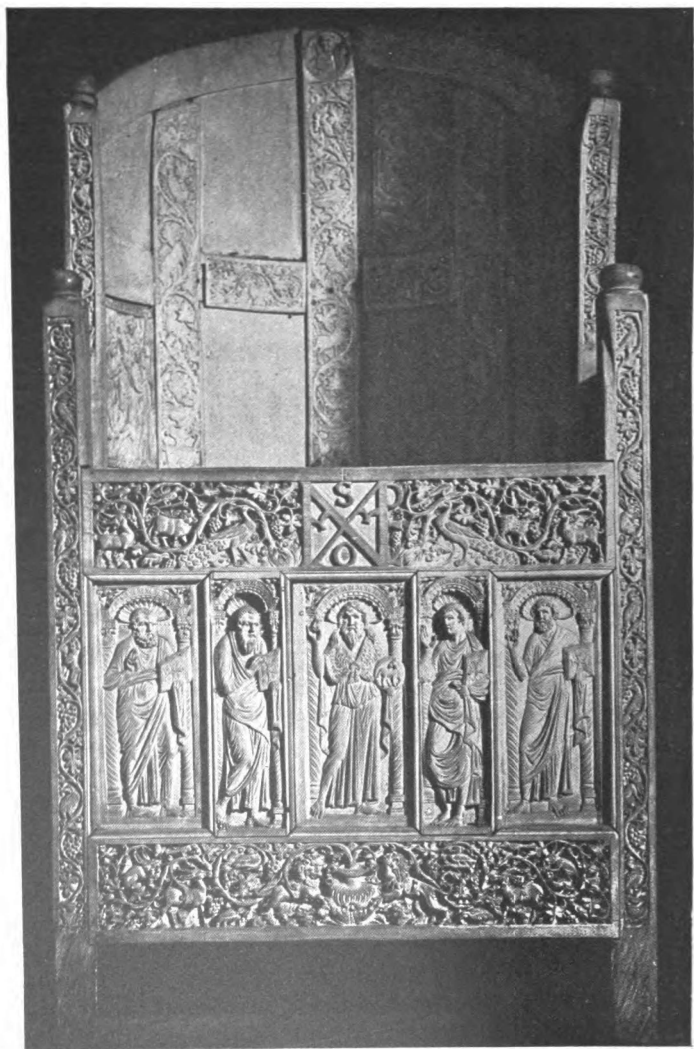

FIG. 114. — Ivory cathedra of Maximianus, bishop of Ravenna. About 550 A.D. John the Baptist and the four Evangelists.

the life of the Virgin show the influence of the apocryphal Gospels on early art, and present for the first time some of the subjects which were to become popular in the Middle Ages.



FIG. 115. — The story of Joseph; example of carving on the back of the cathedra of Maximilianus.

On the sides the story of Joseph is related in ten scenes. Two of them are illustrated in Fig. 115: in the lower scene Joseph is let down into the well while his brothers stain his coat with blood; above, Jacob tears his hair at the sight of Joseph's

bloody coat. These figures show great rudeness of execution, but at the same time a certain barbarous vigor which looks more like the forceful beginnings of a new art than the de-



FIG. 116. — Ivory Gospel cover from Murano, now at Ravenna. Sixth or seventh century. Christ enthroned amidst the Apostles, the Three Children in the furnace, the story of Jonah, the healing of the blind, the raising of Lazarus, healing of a demoniac, healing of the paralytic.

cadence of an old. They suggest the reflection that many hopeful revivals of art must have been rendered abortive by the frequent supervention of political calamities.

A Gospel cover from Murano (Fig. 116), now at Ravenna,

illustrates the irretrievable decadence of the seventh century, and at the same time the perpetuation of the old themes. One will recognize at once the healing of the blind man, of the demoniac, of the paralytic, and the raising of Lazarus. Christ's rod has assumed the form of the cross; it is the sceptre of the early European kings. In the centre Christ is enthroned between the Apostles. Below are the Three Children in the furnace; an angel enters and stills the flames with the cross. At the bottom we have the story of Jonah.

NOTE. — There is plausible proof that the so-called cathedra of Maximianus at Ravenna is the same which is mentioned in the chronicle of John the Deacon as a gift from the Doge Pietro Orseolo to the Emperor Otto III. during his residence in that city. If such is the case, both the date and the origin of the chair are undetermined by historical evidence. On account of the excellence of its workmanship, Venturi prefers to ascribe it to the early part of the fifth century, and he suggests that it may have been made for a Maximianus who was Bishop of Constantinople at that time. He argues, moreover, from the image of S. John the Baptist, which adorns the front of it, that it may have been designed originally for a baptistery.

STATUARY

From the great rarity of the monuments of early Christian statuary which have been preserved to us, we may judge that throughout this period and in all parts of the Church the prejudice against images was chiefly directed against this branch of art. It was a tradition inherited from the Jews, it was strongly enforced by the Old Testa-



FIG. 117. — Statue of the Good Shepherd, in the Lateran Museum. Probably third century.

ment, and it doubtless corresponded with a real danger of idolatrous misconception on the part of Gentile converts. We have several times had occasion to notice the statues of precious metal which Constantine and others erected in the basilicas. Owing to the value of their material none of these have been

preserved to us. It is probable that before Constantine there were no religious statues except those of the Good Shepherd.

Figure 117 illustrates a statue of the Good Shepherd belonging to the third century, found in the catacomb of Callistus; it is altogether the most gracious representation of this symbol which exists, though a number have been found at Rome and even in the Orient.

In the Metropolitan Museum in New York there is a representation of the story of Jonah, executed in marble on an unusually large scale, partly in relief and partly in the round—a style of treatment which is without parallel in

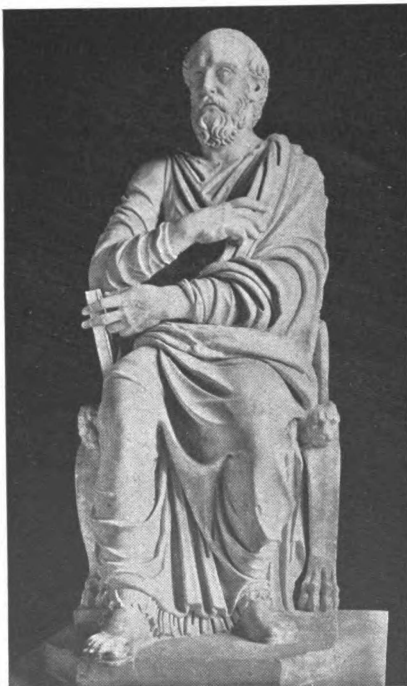

FIG. 118. — Statue of S. Hippolytus, in the Lateran Museum. First years of the third century.

early Christian art. This monument was found near the site of ancient Tarsus, and it belongs to the third or fourth century.

There could at no time have been any objection, on religious grounds, to portrait statues. The statue of Hippolytus (Fig. 118) was undoubtedly executed during the very first years of the third century, that is, immediately after his death. On one

side of his cathedra is engraved his computation of the Easter cycle, which soon after his death was discovered to be erroneous, and after that would hardly have been commemorated with such honor. On the other side is engraved a list of his works. The head and shoulders are restored, the remainder is antique, and it compares well with the best monuments of Roman art.

Of greater interest is the famous bronze statue of S. Peter (Fig. 119) which is now worshipped in the Vatican. The chair, and, of course, the nimbus, are modern; the rest is antique. Peter, like Hippolytus, wears the pallium; it is not so gracefully disposed, but it nevertheless indicates an age when this garment was still understood. The attitude is stiff but noble, and it appears as though the artist intended to give an impression of hieratic dignity. The severity is evidently intentional; it is marked



FIG. 119. — Bronze statue of S. Peter, in the Vatican. Probably sixth century.

especially by the rigidity of the neck, by the deep lines of the face, and by the stiffness of the right arm.

The earliest record that we have of this work is in the last quarter of the fifteenth century, and this fact has left room for the most divergent hypotheses concerning its origin. One tradition represents that it was the statue of Jupiter Capitolinus, and that by the addition of the keys and the substitution

of the head it was changed into an image of S. Peter, by Leo the Great, about the middle of the fifth century. This view is no longer held; on grounds of style it is impossible; that it was originally a Christian work is proved by the fact that both the keys and the head are integral parts of the statue. Many have lately accepted the view that it is a work of the early Renaissance (thirteenth century), perhaps by Arnolfo di Cambio. The vigor of the statue is supposed to indicate the rude virility of a new art rather than the decadence of an old. But no statue of the Renaissance can be compared with this for genuine understanding of the Classic dress, and the work is rather to be attributed to the end of the fifth, or the beginning of the sixth, century. It exhibits, it must be confessed, a skill which we should not expect in any artist of that time.

A marble statue of S. Peter in the crypt of the Vatican is almost equally a subject of dispute. The attitude is closely similar, but it is not a copy of the above. Here, again, opinions differ as to whether it is an original Christian work, or an adaptation of a consular statue.

C. MOSAICS

In taking up the subject of Christian mosaics we have to do almost exclusively with the decoration of the basilicas.

This is not to say that the Christians made no use of mosaics elsewhere. Figure 124, for instance, illustrates a portrait mosaic of the first half of the fourth century, found in the catacomb of Cyriaca, and now in the Chigi library. Earlier mosaics, employed for simple decorative patterns, are also found in the catacombs; in Africa it was customary, in the fourth century, to adorn the covers of sarcophagi with mosaic; and this art was of course made use of for the floors and walls of the Christian houses, as it was for the pagan. In the case of floor mosaics, however, we have seldom to think of any expressly Christian designs; and the rare instances of cemeterial mosaics are for the most part a mere reflection of the decoration of the churches.

It is not to be supposed, on the other hand, that the basilicas were never decorated in fresco instead of mosaic. It is astonishing that in an age of material decline the Church should

have adopted the most costly means of decoration that has ever been employed, and that so great a number of churches received mosaic decoration. We may say that mosaic painting was the rule, and that the rule required every bit of wall to be covered by mosaic incrustation of one sort or another. It is evident, too, that the great symbolical themes which adorned the apse could not have been developed except as the expression of this art. It is certain that without it we should have been left in ignorance of the character of church decoration in the early period. But we are compelled to suppose that poorer churches, and those which lay at a distance from the great centres of culture, had to content themselves with an execution in fresco in imitation of the mosaics of the metropolitan basilicas.

The mosaic art is, roughly speaking, contemporary with the Christian period. It need not be said, however, that the first stage of its development had nothing whatever to do with Christianity and was exclusively under Classical influence. It was as a covering for the floor that mosaics were first introduced and most commonly used. They were constructed of small cubes of marble of various colors, though very commonly limited to white and black. Geometrical designs predominated, representations of birds and beasts and intricate floral devices were common, and one need not be reminded of the elaborate pictorial compositions which were executed with the most consummate skill. Mosaics were more rarely employed for wall and ceiling, and it was generally the simpler designs in black and white which were used. For the lower walls particularly the Romans under the Empire employed incrustations of marble cut in blocks of various sizes and shapes and arranged in purely conventional patterns. It is not important for our purpose to distinguish the different kinds of stone mosaic in use among the Romans. The great variety and the sheer amount of costly foreign marble which was brought to Rome during the first three centuries almost exceeds belief. It formed a mine which has not yet been exhausted.

About the end of the third century glass mosaic came into use. The cubes for this work were readily obtained, and in just the color and dimension required, by drawing a mass of colored glass paste into long pencils which were then chopped into small sections. By this means it was possible also to

attain the rich effects in gold which are so prominent a feature of most of the Christian mosaics. To achieve this the cubes had simply to be covered with gold leaf protected by a film of glass.

This glass mosaic was occasionally used by the Romans for the decoration of niches and small wall surfaces; but it did

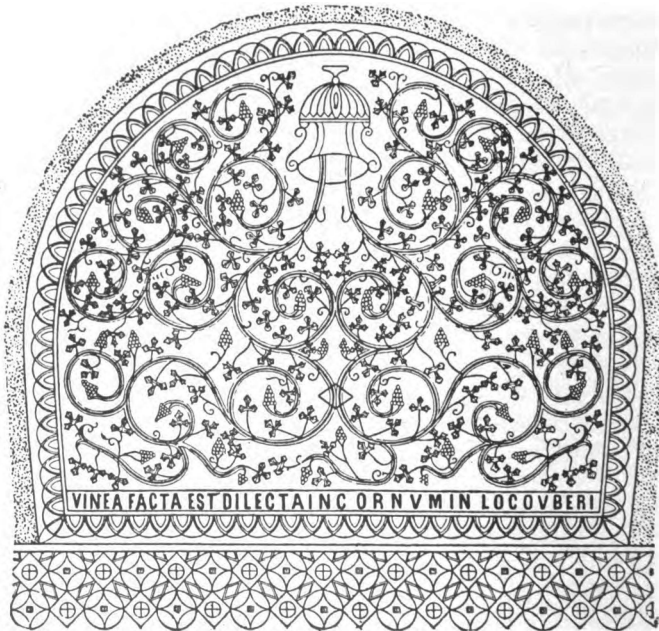

FIG. 120. — Apsidal pavement in Ancona. Fourth or fifth century.

not tend to supersede the frescos and stucco reliefs which were the traditional decoration of Roman walls and ceilings. It was first in the Constantinian age and in the decoration of the Christian basilicas that it supplanted painting and received the high development of which it was capable. Figured mosaics in stone were employed occasionally for wall decoration even in the fourth century, but mosaic in glass was then the characteristic type, and it very soon became the exclusive one. This may very well be called a Christian art, for, though its

beginnings lay outside of Christian influence, it attained in the Church a development which is altogether without comparison in pagan times. In this it was the only great technical art which received any new impetus and development from the Church; and it constitutes altogether the noblest, as it was also the most monumental, expression of Christian art. It is the art which shows most fully the impress of the Christian spirit. Notwithstanding the retention of innumerable decorative elements which were traditional in the Classical mosaics, the art of the basilicas dealt substantially in new themes and attained a nobility and grandeur of expression which is altogether without parallel in the art of Greece or Rome.

The floor mosaics are a subject of minor interest. They followed very closely their Roman prototypes, with the incidental introduction of Christian emblems, — as the vine in an apsidal pavement at Ancona (Fig. 120), and the fish in the purely conventional design of the pavement at Parenzo (Fig. 121). Inscriptions in the pavement were not uncommon, and sometimes the names of those who had contributed to the expenses of the work were commemorated in it. In another



FIG. 121. — Section of mosaic pavement in the cathedral of Parenzo. Sixth century.

place we shall have occasion to refer to a curious mosaic floor in a sixth century church at Madaba in Palestine, which represents a map of the Holy Land, with the cities of Bethlehem and Jerusalem (Fig. 128) on a larger scale. Very few early pavements are preserved; in Italy especially they were somewhat contemptuously destroyed to make way for the Cosmati work which was popular in the twelfth century.

The marble incrustation of the walls followed closely the Classical models. The general character may readily be understood from a single example which is very perfectly preserved in the church of S. Sabina at Rome (Fig. 122). In this case

the work adorns the wall space just above the colonnade. It was more commonly employed for the lower walls of the aisles and of the apse.

We may mention in this connection mosaic inscriptions, since they do not belong to pictorial art. Figure 123 illustrates the

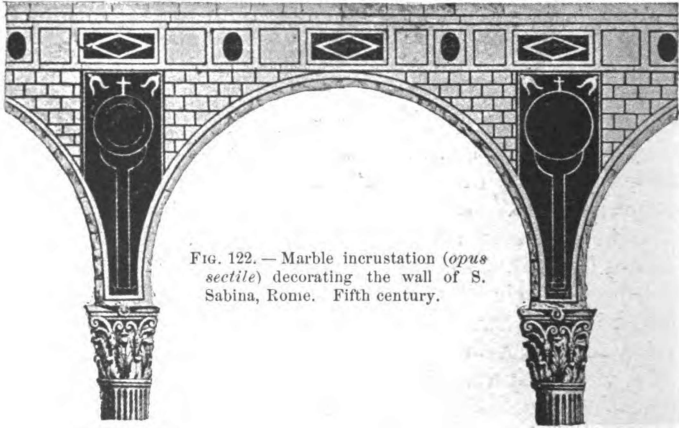

FIG. 122. — Marble incrustation (*opus sectile*) decorating the wall of S. Sabina, Rome. Fifth century.

dedicatory inscription — a metrical *titulus* — of S. Sabina. It is especially interesting on account of the two female figures, under which one reads, *ECLESIA EX CIRCUMCISIONE*, and *ECLESIA EX GENTIBUS*. Over these personifications



FIG. 123. — Dedicatory *titulus* in mosaic, S. Sabina. Fifth century.

of the Church from the circumcision and the Church from among the gentiles, the figures of the Apostles Peter and Paul were originally represented, and above these were the symbols of the Evangelists. This inscription is on the wall opposite the apse. More common are inscriptions under the apsidal

mosaic, or upon the arch. The historical compositions of the nave were often accompanied by an explanatory inscription, or "title," in mosaic.

THE CONSTANTINIAN MOSAICS

The mosaics with which Constantine ornamented the temples of his new faith represent a period of transition; they



FIG. 124. — Portrait mosaic from the catacomb of Cyriaca, now in the Chigi Palace. Fourth century.

contain numerous elements drawn from Classic art and from the early Christian cycle, but they appear at the same time to have struck out very definitely upon the lines which characterized all subsequent developments of apsidal decoration. The transitional style is best represented by S. Costanza; but it must be borne in mind, as an explanation of the character of the subjects, that this was a mausoleum and not a church.

We have already had occasion to compare the mosaics of the ring-vault (Fig. 125) with the earliest decoration of the catacombs. They were divided into eleven compartments, with only six substantially different designs, all of them of a purely decorative character.

The rest of the decoration has almost completely disappeared; we know it only from drawings by d'Ollanda, and by the detailed description which Ugonio gave of it after a visit to the mausoleum in the year 1594. The walls, including the drum of the dome, were superbly adorned with precious marbles. Figure 126 shows a drawing of part of the mosaic of the dome, which must have been one of the most graceful compositions of which we have any record. The river which was continued around the base of the design was enlivened by all sorts of aquatic birds, and by cupids sailing about on rafts and boats, a theme which was very common in pagan villas and baths, and which was continued in Christian mosaics down to the Renaissance.

The lower zone of the mosaic was divided into twelve compartments by as many caryatids, which, by a graceful transition, terminated in a cluster of acanthus stems, supporting in turn smaller caryatids, which framed more compartments, and finally interlaced at the center of the dome. The subjects which were depicted in these compartments were partly obliterated even in Ugonio's time, but he has described nine of the larger ones, of which the first four are included in our drawing. They were: Tobias and his fish, the elders accusing



FIG. 125. — Mosaic decoration of two sections of the ring.

Susanna, the judgment of Daniel, the sacrifice of Cain and Abel, Moses striking the rock, Elijah and the priests of Baal, and the sacrifice of Abraham.

So far, all of this decoration might equally well have appeared in the earlier art of the catacombs. But it seems that in the fifteen niches by which the wall was broken, and in a small spherical vault which interrupted the ring-vault just opposite the entrance, there was employed a type of decoration which was more distinctive of the age of Constantine. The

decoration of thirteen of the niches seems to have been very simple, to judge by the traces which are found in one of them of stars upon a white ground surrounding the Constantinian monogram. But the two large lateral niches still possess

mosaics which present some of the principal features of the apsidal decoration of the basilicas. It is certain that they have been atrociously disfigured by successive res-



vault of the Mausoleum of S. Costanza, Rome. Fourth century.

tations, so that one can base no judgment upon their style, nor be altogether confident in attributing them to Constantine. But it seems unlikely that such decoration could have been added to the mausoleum after his time. One of these mosaics represents God the Father, with the simple nimbus, seated upon the globe of the world in the midst of ten palms, which represent heaven, giving the law to Moses. It appears that God the Father was more frequently represented in the Constantinian age than afterward; and this observation agrees very well with the barely disguised paganism of that emperor's religion. The

corresponding mosaic represents Christ standing upon the mystic mountain, from which flow the four streams of paradise; two sheep approach him on each side from the towns of Jerusalem and Bethlehem, beside which grow two palms. The two chief Apostles also approach Christ, and Peter receives from him the new law. Though a comparison was often thus drawn between the old and the new Law, we see here that the fundamental distinction between them was also recognized, for upon the scroll which the Lord hands to Peter is inscribed



FIG. 126. — Mosaic of fourth century, decorating the dome of S. Costanza. After a drawing by d'Ollanda.

DOMINUS PACEM DAT — the new law comes in the guise of a gift, not of a requisition. According to Ugonio the mosaic of the spherical vault represented Christ seated in the midst of the Apostles, with a female figure on either side, and below, the *agnus dei* accompanied by the sheep.

We are left in a good deal of obscurity about the mosaics with which Constantine decorated the churches of Rome. They are merely mentioned in the *Liber Pontificalis* and first described in documents of a much later age. We do not know how early the façade of the Vatican basilica received its mosaic decoration. At the time of its destruction it had three zones of figures: Christ between the Virgin and S. Peter, ac-

accompanied by the symbols of the four Evangelists; then the Evangelists themselves between the windows; and below, the four and twenty elders holding up their crowns to Christ. The upper part of this composition is known to have undergone numerous changes. In a restoration by Leo I. the *agnus dei* was depicted in the place afterward occupied by Christ in the centre of the picture. It is not certain that any part of the composition can be referred to the time of Constantine.

There is more probability that the apsidal mosaics were substantially of Constantinian origin. These venerable monuments perished with the reconstruction of the church and are only known from ancient descriptions. In the apse Christ was seated upon a throne between SS. Peter and Paul. Palms framed the scene above, and at the bottom was the divine Lamb upon the mountain, toward which moved the twelve sheep from the towns of Bethlehem and Jerusalem. On the triumphal arch Christ had on his left S. Peter and on his right the Emperor Constantine — offering perhaps the model of his church.

A thick acanthus stem, prolonged in regular convolutions like the vine, and bearing vine leaves, was a favorite type of decoration under Constantine. It adorned the sarcophagus of his sister; and it received in the following century a very characteristic and beautiful application in the decoration of the apse. It may be suspected that this design originated in the time of Constantine, though there are actually no existent examples of it in mosaic earlier than the end of the fourth century. The earliest example is in one of the apses of what was once the vestibule of the Lateran baptistery, now the chapel of S. Venantius. One who has once seen it will not easily forget the effect of the large and supple convolutions of rich foliage against the luminous purple background. An admirable example of this type is to be seen in the apse of S. Maria Maggiore: the central part of this decoration is certainly due to the early Renaissance, but it is not unlikely that the vine pattern was ancient and was distorted to make room for the figure of the Virgin. Another well-known example is the apse of S. Clemente, which is likewise a late work.

THEMES OF THE APSIDAL DECORATION

More characteristic of the apsidal decoration, and far more common, was the grand symbolical theme which represented Christ enthroned in the glory of the new Jerusalem, and the whole range of subjects which naturally accompanied this. All of these subjects may be considered as a whole, because, though they are not all represented upon any one monument, nor even upon the rare monuments which are preserved to us from any one period, there is reason to suppose that they were all developed early in the fourth century, and it is certain at least that the fundamental principles of apsidal decoration were then thoroughly established upon lines which did not suffer any essential change throughout the early period, and which are to be traced even through the Middle Ages. The idea which determined their character was the desire to direct the mind to the divine object of Christian worship and enable the worshippers below to realize in vivid terms their communion with the saints in heaven, or to depict the adoration of the saints and angels in heaven as the counterpart of the worship of the Church on earth.

These representations, as is natural, were chiefly inspired by the Apocalypse, which represented the New Jerusalem, the Church triumphant in heaven, as at once the pattern and the reflection of the Church militant. It is interesting to note this unquestioning reliance upon the Apocalypse at a time when its canonicity was seriously questioned in influential quarters. The centre of the composition is always Christ, enthroned in glory among his holy angels, among his Apostles, among his saints and martyrs. The Apocalypse furnished the form for all of these themes; it suggested the four and twenty elders who laid their crowns at Christ's feet, the four angelic beasts which symbolized the Evangelists, the martyrs beneath the altar, the four rivers of paradise which issued from beneath the throne, and the divine Lamb which is represented on a throne, before which is the book with the seven seals and on each side the seven candlesticks. It is from the earlier pastoral symbolism we have to derive the twelve sheep which issue from the towns of Jerusalem and Bethlehem. The symbols of the Trinity are completed by the hand of God which

appears out of the cloud at the summit of the apse, holding the crown of eternal recompense, and by the dove which rains influence upon the Church. The cross also appears, not the symbol of suffering and humiliation, but the cross triumphal, the tree of life which was in the midst of the garden. All of these subjects — Apostles, Evangelists, martyrs, the sacrificial Lamb, the cross, the dove — served to connect the scene with the Church on earth. This connection was rendered still more real by historic martyrs, designated by name or by their symbols, approaching to offer their crowns to Christ; and by the figure of the founder of the church, who though still living is represented in the midst of the heavenly company, offering a small model of his church, the symbol of the gift which he dedicates here below.

This decoration was generally confined to the apse, and to the apsidal, or the triumphal arch. The nave was chiefly utilized for historical scenes illustrative of the Biblical narrative. But the figures of Evangelists, Apostles, and Prophets, were often depicted in the spaces between the windows; and in S. Apollinare Nuovo at Ravenna a continuous composition like a broad frieze connected the whole of the nave with the symbolical theme of the apse, displaying in long line the martyrs — virgins and matrons on one side, and men on the other — offering their crowns to Christ and to the Virgin.

In the poetical *titulus* which he composed for the apse of the basilica of S. Felix at Nola, S. Paulinus furnishes us with a profound commentary upon apsidal decoration in general. "The Trinity gleams in its full mystery: Christ is represented in the form of a lamb; the voice of the Father thunders from heaven; and, through the dove, the Holy Spirit is poured out. The cross is encompassed by a circle of light as by a crown. The crown of this crown are the Apostles themselves, who are represented by a choir of doves. The divine unity of the Trinity is summarized in Christ. The Trinity has at the same time its own emblems: God is represented by the Paternal voice, and by the Spirit; the cross and the lamb denote the Holy Victim. The purple background and the palms indicate royalty and triumph. Upon the rock He stands who is the Rock of the Church, from which flow the four murmuring springs, the Evangelists, living rivers of Christ."

In contrast to the profound symbolism of the apse, the walls of the nave were decorated with hunting and fishing scenes; Paulinus confesses that he had here to stoop to the tastes of the people.

The technic of mosaic was admirably adapted to the representation of such grand symbolical themes as have just been described. The execution of Biblical scenes was not always so fortunate; they must often have been copied directly from miniatures, and the multiplication of details and the effort after realism seriously interfered with the clear effect required. In general, it may be said, however, that there was very little disposition to strive after realistic illusion, or to imitate the technic of painting. Particularly after the fourth century, we notice a striking boldness of treatment, which was due in part to incapacity for fine designing and minute gradations in color; but it was a defect which proved in many ways to the advantage of the art. Nothing, in fact, was more important than simple design and strong relief. The figures were hardly more than outlined, and yet they stood out against the gold or purple background with a plastic grace and force. It is only by a *tour de force* that this art can be made to portray in realistic terms the objects which meet the eye; its true force lies in its suggestion; it translates everything into an atmosphere which is clearly superhuman; it was adapted, as no other art was, to the suggestion of the heavenly themes which can by no means be depicted.

But above all, and always, this art was supremely decorative. It was unrivalled for its wealth of color, and for its glinting reflections of light, as from the surface of rippled water. For all the emphasis which is given to the sacred themes which alone we have space to consider, it must not be forgot that the purely decorative elements which were carried down by an unbroken tradition from Classic art constituted at all times an important feature of Christian mosaics.

APSIDAL MOSAIC OF S. PUDENZIANA

When we come to trace out, in the monuments which have been preserved to us, the general principles of apsidal decoration which we have sketched above, it must be remembered

that they are preserved only in part, here the mosaic of an apse, there of an arch, each of them perhaps mutilated, and we must piece these fragments together if we would imagine the total effect of such decoration. It need hardly be said that it is still more rare to find a monument which gives any idea of the whole decoration of the church, nave as well as apse, historical and symbolical themes alike.

The oldest, and altogether the noblest of the apsidal mosaics is that which decorates the church which is supposed to be built on the property, perhaps above the house, of the senator Pudens, whom tradition represents as the host and friend of S. Peter, who was likely the Pudens referred to by S. Paul. Whatever may have been the date of the original foundation of the church, it is known to have been rebuilt, or at least remodelled, in the time of Siricius (384–399). At that time a certain Leopardus, who was titular presbyter of the church, dedicated the mosaic, which is illustrated in Fig. 127. The dedicatory inscription of Leopardus perished in 1588,—in a transformation of the church which irreparably mutilated the apse, cutting off completely the lower zone, and suppressing a wide strip around the whole circumference of the mosaic. The mosaic has also suffered restoration; but, with all, it retains most of its original traits, and puts before us more than one subject of singular interest.

In the centre of the composition Christ is seated upon the rich cushions of a throne of gold studded with gems. His vesture likewise is of gold, and he has a simple golden nimbus. Above him is Mount Calvary, with its triumphal cross of gold adorned with jewels. Christ is in the attitude of the teacher, making a gesture of proclamation with his right hand, while in his left he holds an open book, on which is inscribed *DOMINUS CONSERVATOR ECCLESIE PUDENTIANÆ*. There is no doubt that the church was originally called by the name of Pudens; the feminine adjective which is used in the inscription explains how there arose the popular notion that the church was dedicated to S. Pudentiana, who was one of the daughters of the senator. The women who approach Christ with their crowns may be the senator's two daughters, Praxede and Pudentiana; but it is equally likely that they are personifications of the Church of the circumcision and the Church of



FIG. 127. — Apsidal mosaic of S. Pudenziana, Rome. End of the fourth century. Christ is enthroned in the midst of the Apostles in the New Jerusalem; Calvary and its cross is behind him, and the symbols of the Evangelists above; the buildings represent Jerusalem as it then was.

the Gentiles, like the figures which we saw in the church of *S. Sabina*. *S. Paul* is on the right hand of *Christ*, and *S. Peter* on the left, as inscriptions beneath them signify. The figures of the remaining Apostles have been very much curtailed, and one on each side has been entirely cut off, by the vandalism which has been mentioned. The Apostles occupy a lower bench which corresponds exactly to the position of the presbyters with relation to the bishop's cathedra. A small bit of the mosaic beneath the throne of *Christ* is still preserved (not shown in this picture); it represents the divine

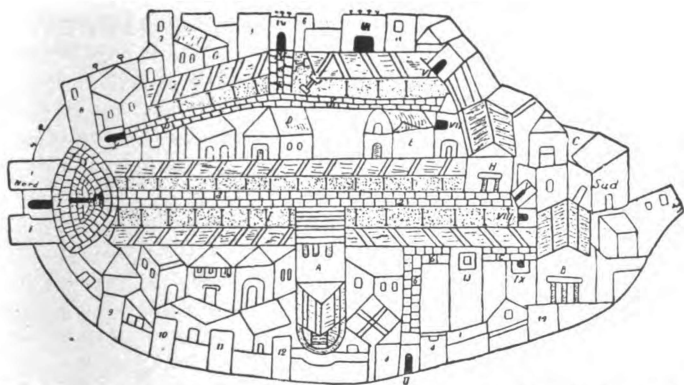

FIG. 128. — Plan of Jerusalem. Part of a map of Palestine, executed in colored marble for the pavement of a sixth-century church at Madaba, Palestine.

Lamb with the nimbus, standing upon the mountain, and above him the dove shedding down the beams of inspiration. We have to suppose that the part of the lower zone, which has been destroyed represented the twelve sheep, issuing from the sacred cities of Jerusalem and Bethlehem. And we may suppose, too, that the symbols of the Trinity were completed by the hand of God, holding the crown above the cross. The four symbols of the Evangelists have a grandeur which has seldom been excelled.

This is the only apsidal mosaic which has been preserved to us from the fourth century. Its style of execution is very far superior to any others which we have. With what has already been said, the essential significance of the picture is

very clear. It remains only to call attention to the buildings which form the background. They have an appearance of realism which contrasts strongly with the merely imaginary and impossible architectural creations which appear in later mosaics. De Rossi supposed, therefore, that they may have represented well-known buildings of ancient Rome.

A better suggestion has lately been made, and one which puts the whole symbolism of the picture in a new and interesting light. This suggestion was due to the discovery, in a small church at Madaba in Palestine, of a mosaic floor which represents with various colored marbles the map of the Holy Land, with the cities of Bethlehem and Jerusalem on a larger scale. Figure 128 gives, on a small scale and without the assistance of the colors, an idea of the panorama map of Jerusalem. It will be noticed that it does not adhere strictly to any one system, either to perspective or to plan. It is a curious production, but it is of very great interest for the topography of Jerusalem in the middle of the sixth century.

This map was expressly designed to show the sites of the churches of Jerusalem as they appeared after Justinian had completed his colossal work of church construction. Those who are learned in the topography of Jerusalem claim to recognize most of these sites. As our present purpose is a comparison with the mosaic of S. Pudenziana, we are specially interested in the aspect of the city at the end of the fourth century, that is, particularly with the shrines of Constantinian foundation.

The walls are here represented as they were extended after the time of Constantine to include the shrines which that emperor erected upon Mount Calvary in memory of the Lord's Passion and Resurrection. The principal topographical feature of the city is the broad street, flanked by covered colonnades, which intersects it from north to south. This street starts at the north from a great square in the middle of which stands a column. The neighboring gate flanked by two towers is now called the gate of Damascus, but the Arabian name, *Bab-el-'amud* (gate of the column), preserves a reminiscence of the column, although it has now disappeared. The three small gates at the other end of the street lead toward the southwest to Mount Zion, and toward the southeast to the base

of Mount Moriah. The building marked *B* just outside gate IX. corresponds to the basilica erected by Justinian on the site of the *Cenacolo* on Mount Zion, called *Mater ecclesiarum*. Above this a sort of tower, marked *C*, is supposed to represent the basilica of the Presentation, which was greatly enlarged by Justinian and is now a mosque. Gate II., the only one on the west, is the Joppa gate. On the eastern side of the city and parallel to the main thoroughfare is another long street with a colonnade on only one side. From about the middle of it a street proceeds directly east to gate IV. It is supposed that the arch of the *Ecce homo*, seen by S. Anthony in the sixth century, was located at the entrance to this street; and directly opposite is the building which is taken to be the Prætorium. Gate III., which stands next toward the south, was the *porta aurea*. It was the gate of ingress to the Temple of Solomon, which was located at a little distance to the southwest. The road which issued from it led to the Mount of Olives, where Constantine built the church of the Ascension.

The group of buildings in which we are chiefly interested is that which lies just west of the middle of the main street and covers Mount Calvary. These buildings are all ascribed to Constantine. The enumeration of them which is given by Eusebius and S. Silvia corresponds very well with the map. A great flight of steps (mentioned by several early pilgrims) leads up from the street to the basilica (the Martyrium) which was erected upon the site of the Crucifixion. The basilica is plainly distinguished by its three doors and gable roof. Behind it, and half hidden by it, is the round church of the Anastasis with which it was connected. The accounts speak, in no very clear terms, of an "atrium" which included the spot where the Holy Cross was discovered. This appears to be indicated by the quadrangle which is intersected by a cross.

Turning without more ado to the explanation of the mosaic, the first and most striking point of comparison is the colonnade. It appears as if the artist intended to represent the Lord enthroned in the midst of Jerusalem—the new and heavenly Jerusalem, be it understood, but represented in terms of the Christian city as it then was. Surely no better place could have been chosen for the throne of Christ than the middle of the main street, in front of the imposing colonnade

and the stairway which led up to Calvary. If we suppose that Christ is represented facing the east, we have in its true position behind him the rugged top of Calvary surmounted by the cross. It is significant that this is the first representation we have of the cross as an element of prime importance in a picture. We have to note that the symbolical and topographical interest of the artist conflict at this point. For it is evident that he wished to represent the buildings which covered Calvary, but was unable strictly to combine this aim with his representation of the cross. He locates them, however, approximately in the right position and at the just elevation, the Anastasis at the left and the Martyrium partly behind the mountain. The crenelated walls of the city appear at intervals in the background.

On the right there is a similar group, a polygonal church, apparently with an attached basilica which is in the same way partly hidden behind the mountain. This suggests the church of the Ascension, which was, we have reason to believe (p. 142), a polygonal building. This was located on the Mount of Olives, and its introduction here would, of course, be a violent departure from the topographical arrangement. But the composition is preëminently a symbolical one, and in introducing into the picture representations of the chief churches of Jerusalem the artist was under no necessity of cumbering himself about topographical accuracy. We can well understand, on the other hand, why he should wish to group about Calvary the great Constantinian shrines which commemorated the Crucifixion, the Resurrection, and the Ascension. It is to be remarked that the building which is here taken to be the church of the Ascension has its roof tilted forward as though expressly to display the opening in the centre of it which was one of the most significant characteristics of the building.

There is another monument in Rome which is supposed to represent these same churches. It is the relief on the end of a sarcophagus in the Lateran (Fig. 96) which represents Moses striking the rock, and Christ healing the woman with the issue. Jerusalem was not the scene of either of these events; but it is not in itself improbable that Jerusalem was taken as an artistic background to represent in a general way the Holy

Land. At any rate we have here, apparently, two basilicas, and attached to them two round churches. In this case, it must be confessed, we have no polygonal building, and the basilicas are without clearstories.

APSIDAL MOSAICS OF THE FIFTH AND SIXTH CENTURIES

Of the mosaic decoration of S. Paul's, which was executed under Leo I., toward the middle of the fifth century, there remains only the triumphal arch, and that is almost entirely the work of the restorers after the fire which destroyed the church. The original theme, however, is preserved. In the centre is the bust of the Saviour surrounded by a great nimbus. Close by are two adoring angels, and below are the four-and-twenty elders offering him their crowns. The symbols of the Evangelists are disposed in a row at the top. The inscription above reads:—

THEODOSIUS CEPIT, PERFECIT ONORIUS AULAM
DOCTORIS MUNDI SACRATAM CORPORE PAULI.

There are other fifth-century mosaics in Rome which deserve attention, but in this place, where we are following the characteristic theme of apsidal decoration, we have to descend to the sixth century for the next monument. The apsidal mosaic of SS. Cosma and Damiano (Fig. 129) was executed under Felix IV. (526–530). This work shows the influence upon art of that new race, the Gothic barbarians of the North, which had already become dominant in political affairs. The faces are of a type never found in classic art; they have a certain almost savage forcefulness, which, together with the colossal size of the figures and the statuesque majesty with which they stand out against the dark blue background, produces an effect which cannot readily be forgot. Christ stands upon a shimmering path of cloud; out of the rosy clouds above his head the hand of God was originally extended with the crown of recompense (now destroyed by a window opening). Christ alone has the nimbus; he wears a white tunic and pallium stiffly embroidered with gold; the right hand is stretched out with a gesture of proclamation, the left holds a scroll. The

face of Christ presents a type which we have not hitherto seen; his hair falls beneath his shoulders, he wears a full beard; the face is longer and older than usual, and has an expression which is severe without being harsh. The face of S. Paul, who stands on the right, is also more characteristically marked than usual. The two Apostles are presenting to Christ the physicians Cosmas and Damianus, martyrs of Media and patrons of this church. At the right is the figure of S. Theo-



FIG. 129. — Apsidal mosaic of SS. Cosma and Damiano, Rome. Sixth century. Christ stands upon the clouds of heaven, Peter and Paul introduce the Median martyrs, Cosmas and Damianus, patrons of the church, together with S. Theodore and Felix IV., the founder of the church.

dore, likewise offering his crown to Christ; and on the left is represented Pope Felix (restored) offering the model of the church which he here dedicates. On either side are the traditional palms; upon one of them is perched the phoenix, the bird of immortality, with a rayed nimbus about its head. This figure, which is hardly visible in the illustration, is close to the right hand of Christ. Below is represented the Lamb with the nimbus, standing upon the mountain. The four streams are here named: Geon, Fyson, Tigris, Eufрата. The twelve sheep issue as usual from Bethlehem and Jerusalem.

The arch above, which has unfortunately been largely de-

stroyed, represented Apocalyptic scenes; in the centre a medallion with azure ground represented the mystic Lamb lying upon an altar and surmounted by a cross, with the book of the seven seals at his feet; on each side are the lighted candlesticks; four angels approach him through the clouds; and finally there were the symbols of the Evangelists—two of which have been destroyed. Of the four-and-twenty elders who stood below nothing remains but two arms extending their crowns.

A half century later, under Pelagius II. (579–590), was executed the mosaic decoration of S. Lorenzo. Of this nothing is left but the mosaic of the arch (Fig. 130). On the right hand of Christ are S. Peter, S. Lawrence, Pelagius offering the model of the church which he had restored, and the town of Jerusa-

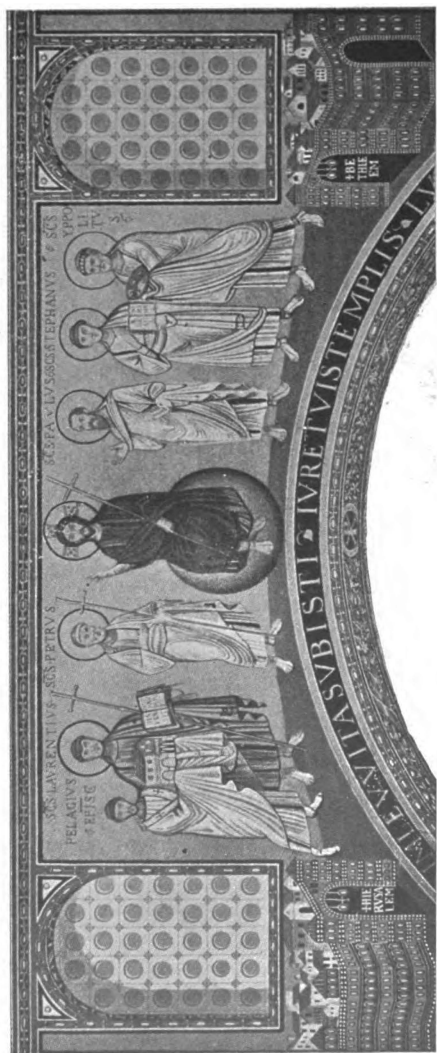

FIG. 130. — A paidal arch of S. Lorenzo, Rome. Fifth century. Christ seated upon the globe of the world, between the Apostles Peter and Paul, S. Lawrence, S. Stephen, S. Hippolytus, and Pope Pelagius, the founder of the church.

S. Paul, S. Stephen, S. Hippolytus, and finally the town of Bethlehem. The position of the Apostles is here the reverse

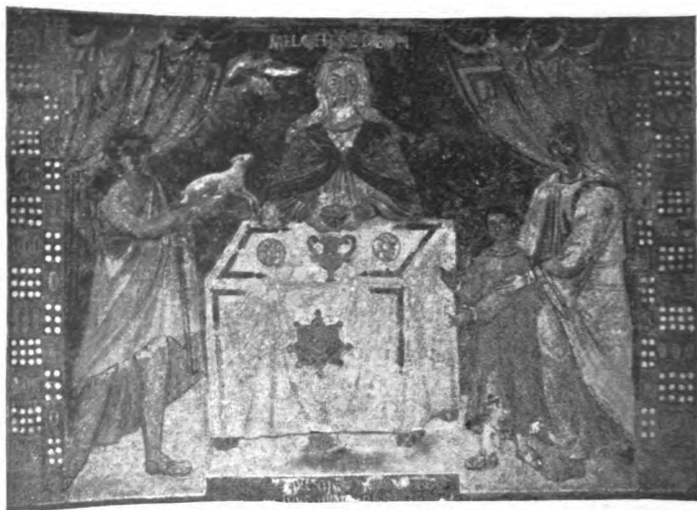

FIG. 131. — Mosaic in S. Apollinare in Classe, near Ravenna. Seventh century. A representation of the Christian altar, with the sacrifices of Abel, Melchizedek, and Abraham.

of the usual order; it is Paul who usually stands on the right, and Peter on the left. Bethlehem is always on the side



FIG. 132. — Mosaic in S. Vitale, Ravenna. Sixth century. A representation of the Christian altar with the sacrifices of Abel and Melchizedek.

of S. Paul, and Jerusalem on that of S. Peter; for they represent respectively the Churches of the Gentiles and of the

Jews,—Bethlehem being the town to which the Magi came bearing the homage of the Gentiles. Above these towns are two windows of alabaster and glass, which had been used in the earlier building and were incorporated here simply as a decoration. All of the figures except Pelagius have the nimbus; the nimbus of Christ has the cross inscribed in it. Christ is seated upon the globe of the world, but his figure corresponds ill with the dignity of his position. We have here what is perhaps the earliest example of an ascetic representation of Christ; it is marked by the thin face and pointed beard, as well as by the sombre coloring of his garments. This reflects the rapid progress of monasticism in the West during the sixth century.

One other example of apsidal decoration must suffice; that takes us to Ravenna and introduces us to the style of decoration which was appropriate to the enlarged apsidal room of the domed churches. The church of *S. Vitale* was built and its decoration completed during the reign of Justinian. It represents, therefore, Byzantine art in the latest phase of its development within the period which we have here to study. We see, however, that it was not yet differentiated from the art of the West, except by its purer preservation of Classical style. It retained a suppleness of form and a richness of ornamentation which are not to be found for more than a century previ-



FIG. 188.—Mosaic in *S. Vitale*, Ravenna. Sixth century. Abraham entertaining the angels, the sacrifice of Isaac.

ous in the mosaics of Rome. The great dome of this church is without mosaic decoration; it is only the presbyterium we

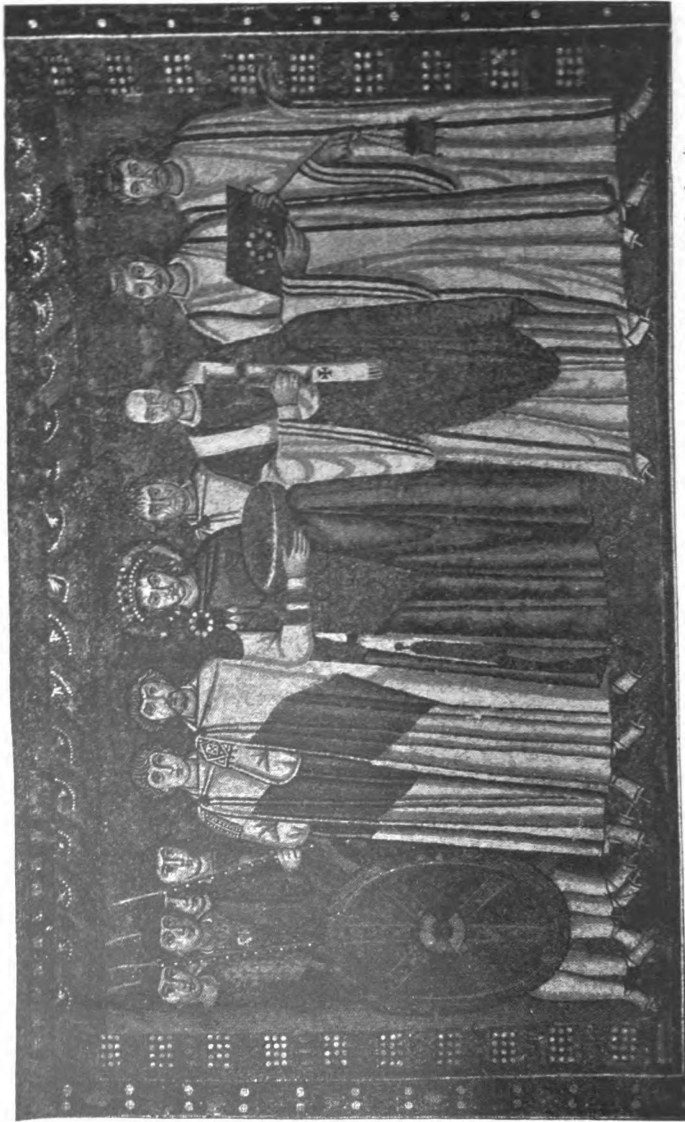

FIG. 184. — Mosaic in S. Vitale, Ravenna. Sixth century. Justinian carrying a votive paten to the church.

have to study. It will be remembered that the presbyterium of this church was deeply recessed. On the arch which separated it from the main room were the medallions of the twelve Apostles and of SS. Gervasius and Protasius, and in the middle the medallion of Christ. The great vault of the presbyterium is adorned with green foliage upon a ground of gold, and by four admirable angels supporting with outstretched arms a medallion in which is represented the divine Lamb, the symbol of the Eucharistic sacrifice. On the walls immediately below we have a decoration which is of secondary importance, but highly interesting for its style: angels supporting the monogram of Christ, the figures of Isaiah and Jeremiah, scenes from the life of Moses, and the four Evangelists with their symbols (Fig. 140). Below is represented a theme which we have not hitherto encountered, though it is one which is very appropriate for the altar room: in two lunettes are grouped together the Old Testament types of the Eucharist. One (Fig. 133) represents Abraham's three angelic guests; they are seated under the oak of Mamre at a plain wooden table without a cloth, upon which are three loaves marked with the cross. The patriarch has his loins girded to serve them, and carries on a platter the calf which he has killed; Sarah stands listening in the doorway. On the other side of the table Abraham is about to sacrifice his son Isaac; he is stopped by the hand of God, and the lamb which was to be the substitute stands at his feet. In this instance he is clothed in the white tunic and pallium; in the former instance in a short tunic of dark color. The opposite lunette (Fig. 132) more expressly represents the typical application to the Eucharist by depicting in the middle the Christian altar. It is a stone table supported upon four legs, and covered first with a heavy woollen cloth of dark color, and above with a white linen cloth fringed at the edge and adorned with the customary embroidery. Upon it stands the chalice and two loaves. Melchizedek offers up to God a similar loaf. He wears shoes, a loose tunic with a broad border and a sash, and a long mantle which is fastened at the breast — it was the dress of Oriental kings. His palace appears in the background. On the other side Abel, in the dress of a shepherd, issues from his simple cabin and presents his lamb as an acceptable sacrifice to God.

This theme was represented again, about a century later, in very similar fashion in S. Apollinare in Classe (Fig. 131).



FIG. 135. — Mosaic in S. Vitale, Ravenna. Sixth century. The Empress Theodora carrying a votive chalice to the church.

Here we have Abel, Abraham, and Melchizedek all grouped about the altar, which in this case is supported upon five legs and has only the linen cover.

But to return to S. Vitale. It is in the apse we have the most marked expression of Greek or Byzantine art. Christ, young and beardless, is seated upon the globe of the world; in his left hand is a book, and with his right he holds out the crown of recompense to his followers. On each side stands a majestic angel, with black hair bound with a white fillet. Beyond on the right stands S. Vitale dressed like an officer of the court, and on the left is the Bishop Ecclesius offering the model of the church.

Flanking the apse on each side are two compositions which have nothing in common with the themes which we have studied. On the left (Fig. 134) the Emperor Justinian is represented carrying a votive paten as a gift to the church. He is preceded by his clergy, one deacon carrying a censer, another the book of the gospels, while the bishop holds a cross; there follow officers of the court and soldiers. On the right (Fig. 135) is the Empress Theodora with her courtiers and ladies; she is carrying as her gift a large chalice, and is just on the point of entering the door of the church.

HISTORICAL SUBJECTS

It must not be supposed that all apsidal mosaics were symbolical and Apocalyptic, nor on the other hand that symbolical subjects were confined to the apse. We have the most famous example of an historical treatment on the great arch of S. Maria Maggiore at Rome (Fig. 136). The character of the mosaic was peculiarly appropriate to this church, for it was the earliest and the greatest basilica in the West to be dedicated to the Virgin, and it was closely associated with the story of Jesus' birth by the fact that it had under its floor a crypt in imitation of the cave and manger of the church at Bethlehem.

The mosaic of the arch is due to Sixtus III. (432-440). The inscription at the summit reads briefly: SIXTUS EPISCOPUS PLEBI DEI—"Sixtus, the bishop, to the people of God." Above the inscription (not shown in the illustration) there is a mere compendium of the Apocalyptic decoration: a medallion

with gold ground frames a jewelled throne with rich cushions upon which is placed a wreath and a cross; on each side are the two Apostles and the symbols of the Evangelists. At the

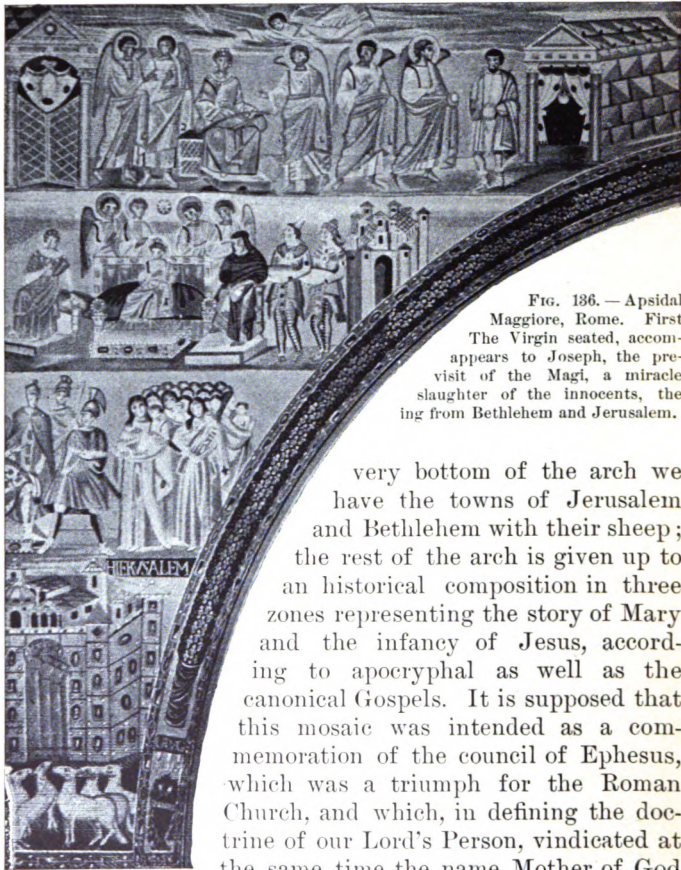

FIG. 136. — Apsidal Maggiore, Rome. First The Virgin seated, accompanied to Joseph, the pre-visit of the Magi, a miracle slaughter of the innocents, the ing from Bethlehem and Jerusalem.

very bottom of the arch we have the towns of Jerusalem and Bethlehem with their sheep; the rest of the arch is given up to an historical composition in three zones representing the story of Mary and the infancy of Jesus, according to apocryphal as well as the canonical Gospels. It is supposed that this mosaic was intended as a commemoration of the council of Ephesus, which was a triumph for the Roman Church, and which, in defining the doctrine of our Lord's Person, vindicated at the same time the name Mother of God

for the Virgin, and gave an impetus to representations of her story in art.

Beginning at the left and with the uppermost zone: Mary richly attired is seated spinning before her house; the dove and the angel Gabriel at once descend toward her, and in the

next instant Gabriel is represented standing before her and delivering his message. On the other side of the Virgin are the two angels whom God sent to be her guard; they appear

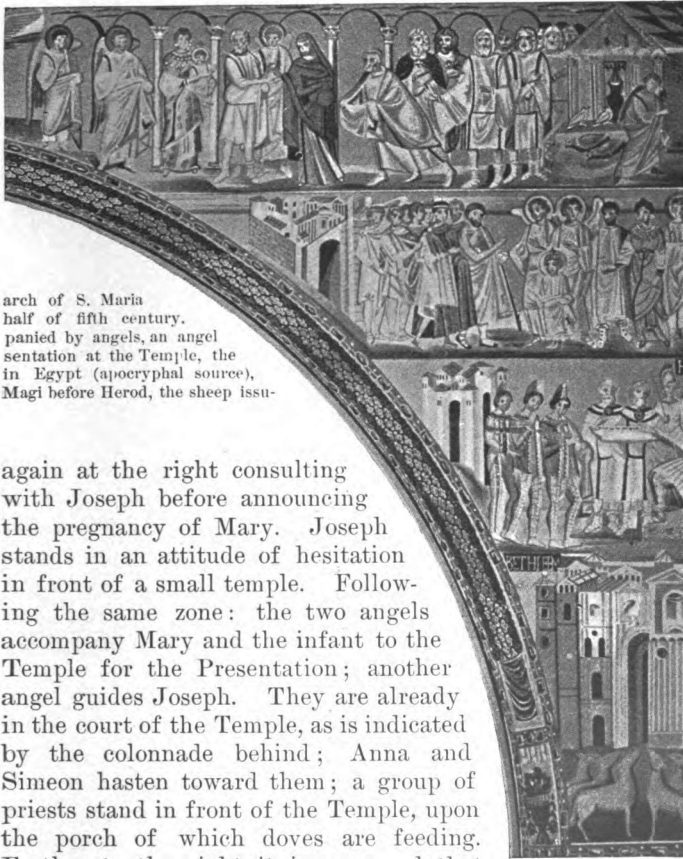

arch of *S. Maria*
half of fifth century.
panied by angels, an angel
sentation at the Temple, the
in Egypt (apocryphal source),
Magi before Herod, the sheep issu-

again at the right consulting with Joseph before announcing the pregnancy of Mary. Joseph stands in an attitude of hesitation in front of a small temple. Following the same zone: the two angels accompany Mary and the infant to the Temple for the Presentation; another angel guides Joseph. They are already in the court of the Temple, as is indicated by the colonnade behind; Anna and Simeon hasten toward them; a group of priests stand in front of the Temple, upon the porch of which doves are feeding. Farther to the right it is supposed that the flight into Egypt was represented, of which only the figure of an angel and part of that of the Virgin are visible. The mosaic has been partially destroyed on both sides, but more particularly on this. The next zone represents the adoration of the Magi: the infant Jesus is seated upon a great throne;

Y

he has a nimbus surmounted by a small cross, and above him is the star. Four angels stand behind him, and on each side of the throne two women, one young and the other old — perhaps Mary and the nurse. Only two of the Magi appear, but the other was probably represented at the other side and has been cut off with the mutilation of the mosaic. On the other side is represented a scene taken from one of the apocryphal Gospels, according to which on the arrival of the Divine Infant at a certain town in Egypt all the idols fell down, and the people and their king came out and worshipped him. The Nile is indicated in the picture by a blue streak in the background. The next zone represents on one side the massacre of the innocents, and on the other the Magi before Herod. An Oriental influence is shown in this mosaic by the extravagant richness of the costumes and architecture. Mary is dressed like an empress, and her humble home at Nazareth is a palace.



The capture of Jericho.

FIG. 137. — Specimens of the historical mosaics above the

It is probable that the mosaics which adorn the nave of this church belong to the preceding century, — that is to the first foundation of the church by Liberius. They are arranged in small contiguous compartments above the straight epistyle on each side of the central aisle, and also on the wall above the door. There were originally forty compartments, of which six were destroyed by the arches which were constructed before

two side chapels, while others have been replaced by modern paintings or mosaics. On the left hand are depicted episodes in the history of the patriarchs; on the right the story of Moses and Joshua. Figure 137 represents two of the subjects: the fall of Jericho, and Joshua commanding the sun to stand still. Both of these subjects have a high dramatic interest; but very often the choice seems to have been made without

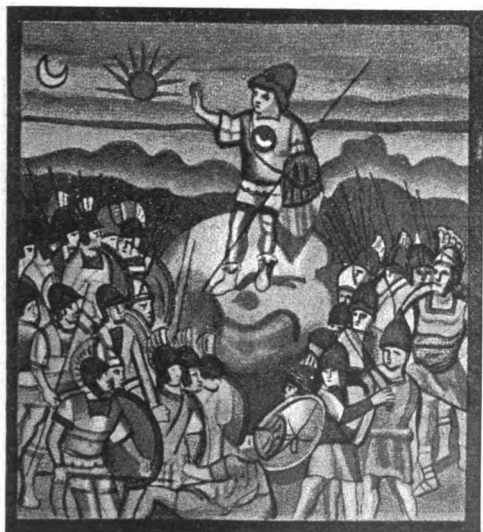

Joshua commanding the sun.

nave of *S. Maria Maggiore*, Rome. Fourth century.

reference to the importance of the theme, or to its dramatic possibilities. The artist seems to have picked out his subjects at random from an illustrated Bible. It was the fashion of the early miniatures to follow closely the narrative, with an illustration for the principal theme of every page. Many of these mosaics are quite incomprehensible without a minute acquaintance with the Pentateuch. Their

chief interest lies in the fact that they give us an idea of the character of the earliest illustrated Bibles. They suggest interesting comparisons with some of the early miniature manuscripts, particularly with the Joshua Roll of the Vatican.

Above these ancient mosaics, between the windows of the clearstory wall, there was once represented a procession of martyrs with the instruments of their torture under their feet.

For the next, indeed for the only other example of a series of Biblical illustrations which has been preserved to us from among the many which once adorned the naves of the churches,

we must turn to the church of S. Apollinare Nuovo at Ravenna, (Fig. 37). This church is a monument of the Gothic rule, and though the decoration was executed by the Greek or Roman artists who were naturally attracted to the seat of government, it affords a striking testimony to Theodoric's enlightened patronage of art. It was erected about the year 500 as the Arian cathedral, and when in the year 570 it was reconsecrated for Catholic worship, it is not likely that the mosaic decoration suffered any addition or any change. In later times the apsi-

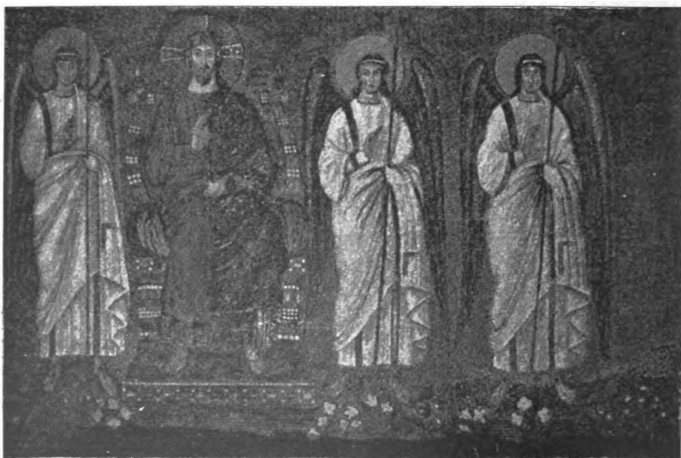

FIG. 138. — Part of a long mosaic frieze on the right wall of the nave of S. Apollinare Nuovo, enthroned between

dal mosaics have been barbarously superseded by modern stucco and paint; but we have still in the nave the most complete example of church decoration which has been preserved to us from the early period. It is not unlike the decoration of S. Maria Maggiore, only the relations are reversed; the Biblical illustrations, which deal exclusively with the life of Christ, are arranged in small compartments above each of the windows, and the procession of saints constitutes a continuous frieze immediately above the colonnade. Between the windows stand the white-robed figures of Apostles and prophets.

Nothing could be more effective or more appropriate for the

decoration of the clearstory wall than the long procession of martyrs which issue from the cities of Classis and Ravenna, and approach on the one side the enthroned Christ, and on the other the infant Jesus and his Mother. On the left, the women's side of the church, is a long line of twenty-two female martyrs led by the Three Magi (Fig. 139) to the Virgin and Child, who are enthroned between four angels. The martyrs are all clothed alike in a white stola and in a rich palla embroidered with gold and pearls; their brows are encircled by



Ravenna. Sixth century. A procession of martyrs offering their crowns to Christ, who is four angels.

a coronet from which depends a long white veil, with one corner of which they veil their hands in carrying the crown which they come to lay at the feet of Christ. They march in close rank, barely separated from one another by palms and lilies; they are distinguished only by the names which are written above them, *S. Agnes* alone is accompanied by her attribute, the lamb. This composition, as well as that which represents twenty-six male figures on the other side of the nave, has been criticised for its monotony; but this, which might well be accounted a defect in any other place, is here thoroughly in keeping with the monotonous line of columns

below, and conspires with them to carry the eye on to the centre of worship in the apse. The procession of male martyrs (Fig. 138), on the right side of the nave, approaches Christ enthroned between four angels; the martyrs are here also distinguished only by their names; they carry their crowns in the lap of the pallium, and they are separated by palms. The nimbus of the martyrs consists of a circle of light, that of the



FIG. 139. — Part of a long mosaic frieze on the left wall of the nave of S. Apollinare Nuovo, showing the martyrs carrying their crowns to the

angels and of the Virgin is a solid disk; in the nimbus of Christ is inscribed the cross.

The picture of Christ, with oval face and pointed beard, is exceedingly interesting; it is here for the first time that we see depicted the type which characterized most of the subsequent representations. It is an admirable idealization, combining harmoniously the traits of gentleness and majesty. The mediæval representations fell distinctly below it, they err by an exaggeration of the traits of harshness or of suffering; it was not till the Renaissance that this early attempt at the idealization of the God-man was again equalled.

Important as this mosaic is for its decorative effect, it is far surpassed in iconographical interest by the small panels next

the roof which represent scenes from the life of Christ. On the left hand are represented the miracles and the parables of Christ in thirteen panels; on the right, thirteen episodes of his Passion. It is not possible to describe in detail this important series; a bare list of the subjects treated is, however, not without interest, since it is the most complete illustration of the life of Christ which we have in early Christian art: 1,



Ravenna. Sixth century. A procession of female martyrs, led by the three Magi, offering infant Christ and the Virgin.

the healing of the paralytic (Matt. ix. 2-7); 2, the healing of one possessed (Luke viii. 27-32); 3, the healing of the paralytic of Capernaum (Mark ii. 3-12); 4, the separation of the sheep from the goats (Matt. xxvi. 33); 5, the widow's mite (Mark xii. 42); 6, the Pharisee and the publican at the Temple (Luke xviii. 10-14); 7, the resurrection of Lazarus (John xi. 38-44); 8, Jesus and the Samaritan woman (John iv. 7); 9, the woman with the issue of blood (Matt. ix. 20-22); 10, the healing of two blind men (Matt. ix. 27-30); 11, the miraculous draught of fishes (Luke v. 6); 12, the multiplication of the five loaves and the two fishes (Matt. xiv. 15-21); 13, the multiplication of the seven loaves and the few fishes (Matt. xv. 32-38); 14, the Last Supper (Matt. xxvi. 20); 15, Jesus on the Mount of

Olives (Matt. xxvi. 39); 16, the kiss of Judas (Matt. xxvi. 49); 17, the arrest of Jesus (Matt. xxvi. 50); 18, Jesus before Caiaphas (Matt. xxvi. 64); 19, the prediction of Peter's denial (Matt. xxvi. 34); 20, the denial of Peter (Matt. xxvi. 69); 21, Judas returning the thirty pieces of silver (Matt. xxvii. 3); 22, Jesus



FIG. 140. — S. Luke, mosaic in S. Vitale, Ravenna. Sixth century.

before Pilate (Matt. xxvii. 11); 23, the way to Calvary (Matt. xxvii. 32); 24, the women at the sepulchre (Matt. xxviii. 5); 25, Jesus appearing to the Apostles (Matt. xxviii. 17); 26, Jesus appearing to the two disciples on the road to Emmaus (Luke xxiv. 15).

There are a number of subjects in this list, particularly in the latter series, which here emerge for the first time in Christian art. From the list itself it is evident, and still more from the mode of representation, that the interest is purely an historical and didactic one; this series is an example of the "Bible of the Poor," designed to instruct the illiterate in the principal facts of the Gospel history. Whether or not these pictures were copied from Biblical miniatures, they are very different in point of execution

from the historical series in S. Maria Maggiore; the compositions are better adapted to the mosaic art; even though the panels are of smaller dimensions and are placed at a greater distance from the eye, they are more readily intelligible; the figures stand out in statuesque boldness, and the details are duly subordinated. Many of the pictures, especially of the first series, are plainly influenced by the types which were current in Christian sculpture. A single disciple, as upon the

sarcophagi, usually accompanies Christ in the scenes which represent his miracles. This is not a representation of *S. Peter*, nor of any one of the Apostles who were most constantly in his company, but, by a principle which was well recognized in Classical art, the single figure stands syncretically for the whole company of the Apostles. This device was here of great importance, for it enabled the artist to depict the scenes with greater clearness and simplicity, and to represent the principal figures distinctly and in large proportions. The fact that half the subjects here refer to the Lord's Passion cannot be taken to prove a greater interest in this theme, but they show that the early reluctance to represent it in art was passing away. Even here, however, it is to be noticed that the subjects which represent our Lord's physical agony—the scourging, the scoffing, the crucifixion—are not depicted.

Of the whole decoration of the church nothing is so thoroughly classical as the figures of prophets and Apostles between the windows. We could wish that other works of Theodoric's able artists were preserved to us, particularly those which once adorned his palace. The palace is depicted in one of the mosaics in this church (Fig. 143); but its decoration of marble and mosaic was carried away by Charlemagne to decorate his imperial residence at Aix-la-Chapelle.

MOSAICS OF THE FIFTH CENTURY AT RAVENNA

A great number of churches at Ravenna received elaborate mosaic decoration during the Gothic rule, but only fragments have been preserved. Fairly complete are the mosaics of the Arian baptistery (*S. Maria in Cosmedin*), but they are nothing more than a rude imitation of the magnificent decoration of the Orthodox baptistery (*S. Giovanni in Fonte*), erected in the early years of the fifth century under the Empress Galla Placidia. In this beautiful monument the marble incrustations of the lower walls have been lost, but the mosaics are fairly well preserved; they are very finely designed, and they have a special interest in the fact that they constitute one of the few examples we have of the early decoration of a dome, another being *S. George in Thessalonica*, the mosaics of which (Fig. 144) have been ascribed to the time of Justinian, but are possi-

bly much later. Above the first order of arcades are eight admirable figures of prophets; they are surrounded by a graceful foliage design, and with their shining white garments they stand out in strong contrast against the dark blue ground. Similar figures in stucco appear above in the niches which alternate with the windows. At the top of these niches are small fields of mosaic which represent a variety of subjects, some of them taken from the earliest cycle of the catacombs. The mosaics of the dome consist of two concentric zones surrounding a central medallion. The first zone repeats



FIG. 141.—The Good Shepherd, mosaic in the mausoleum of Galla Placidia, Ravenna. Fifth century.

four times the same theme: an ornamental arcade, in the midst of which is an altar supporting an open Gospel, and on each side a rich throne. Alternating with this and four times repeated is a large throne in a niche. The second and broader zone represents the Twelve Apostles marching with their crowns in their hands. The central medallion contains an admirable representation of the Baptism of Christ in the Jordan.

Another monument of the same age is (Fig. 50) the mausoleum of Galla Placidia (SS. Nazario e Celso), which still contains the sarcophagus of that empress, as well as that of Constantius III., her second husband, and of her brother Honorius. It is a building of rude construction, but on account of the complete preservation of its mosaics its decorative effect is

very rich, and it gives a more striking impression than any other ancient monument of the decorative capacities of the mosaic art. The decoration is simple and the effect is due chiefly to the richness of the color; the walls are covered with plain slabs of polished marble; the mosaics of the vault are executed in a purely conventional pattern; only the end walls are decorated with figured designs. Figure 141 represents the Good Shepherd in the midst of his flock. This theme reminds us that we have here again a case of sepulchral decoration; but how different it is from the Good Shepherd of the catacombs! It is still the youthful, beardless type of Christ which is here represented; but here he is clothed in imperial purple, his head is surrounded by the nimbus, and his shepherd's rod is the cross. Opposite this is a representation of S. Lawrence: with a cross upon his shoulder and an open book in his hand he joyfully hastens to his martyrdom, which is represented by a fiery gridiron. An open cupboard containing books, above which one can read the names of the four Gospels, suggests the source whence he derived his faith and his courage.

In S. Vitale we have already studied the chief example of the mosaics of the Exarchate which superseded the Gothic kingdom. The last mosaics of Ravenna were those of S. Apollinare in Classe, which were begun in the sixth century, but not finished until the latter part of the seventh. This was an age of full decadence, and it lies beyond the limits which we



FIG. 142.—S. Ursicinus, bishop of Ravenna, mosaic in S. Apollinare in Classe. Sixth century.

have set for our study. The apsidal mosaics repeat the Apocalyptic themes with which we have become familiar, but with variations which prove a decadence in thought as well as in

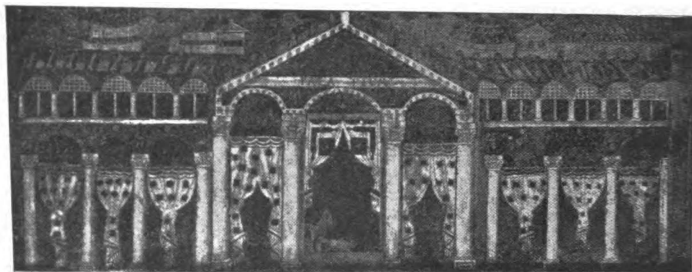

FIG. 143. — Palace of Theodoric, mosaic in S. Apollinare Nuovo, Ravenna. Sixth century.

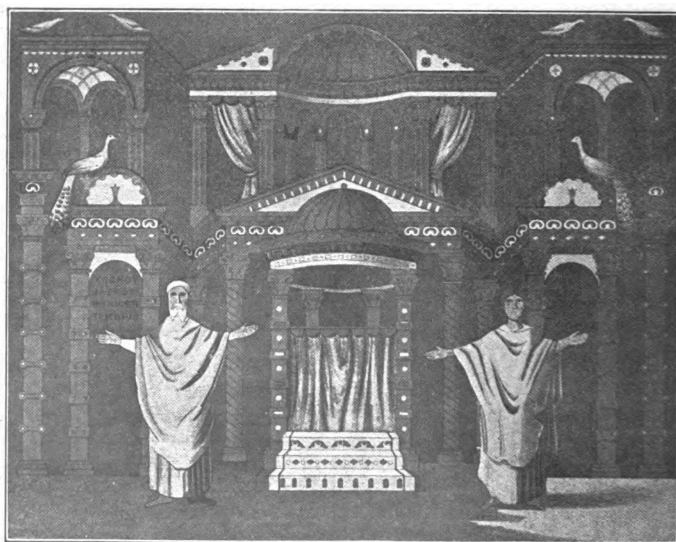

FIG. 144. — Mosaic in S. George, Thessalonica. An altar and ciborium, with curtain drawn; before it, in the attitude of prayer, stand a man and a woman clad in the pænula.

skill. The most interesting feature of the decoration of this church is the series of medallion portraits of the bishops of Ravenna, which are arranged in long line above the colonnade. They are an imitation of the portraits of the popes at S. Paul's at Rome. Figure 142 represents one of the bishops which are depicted between the windows of the apsidal wall. This, like the seventh-century mosaic in the Lateran baptistery (Fig. 181), is illustrated here more expressly as an example of the costume of the period.

D. MINIATURES

It is only quite lately that the subject of early Biblical miniatures has received serious attention, and there is yet a good



FIG. 145.—Miniature from the Joshua Roll of the Vatican. Fifth century. Joshua and ambassadors of Gibeon, in two scenes.

deal of difference of opinion about the date and origin of the earliest illustrated manuscripts. The art of miniature illustration was practised before the Christian era, and even after the fourth century it continued to be employed for Classical authors as well as for the Bible and ecclesiastical books. In a sense it may be called, however, a Christian art, for it first came into general use in the fourth century as applied to the Bible. The substitution of the codex for the roll was largely due to the use of the Christian Scriptures as books of reference, and this change in itself must have served to encourage, or at least facilitate, the illustration of manuscripts. The development of this art was, however, more positively due to the growing interest in the interpretation of the Biblical text. It is not likely that in the early period the whole Bible was ever

illustrated; at all events we have examples only of particular sections of the Scriptures, as, for instance, the Pentateuch and the Gospels.

The art of Biblical miniature painting has a history of a thousand years, and in all of that long period it suffered less change than any other art. Nevertheless, the early miniature painting was distinguished in many ways from that which prevailed during the Middle Ages. The aim of the latter was chiefly decorative, and it was closely incorporated with the text; the



FIG. 146. — Miniature from the Joshua Roll of the Vatican. Fifth century: Joshua and the men of Ai.

illustrations were incidental to the embellishment of a title-page, of an initial letter, or of the margin. Of the early illustrated manuscripts none so closely approaches this mode of treatment as the Gospel codex executed by a Syrian monk, Rabulas, in the sixth century. In particular, the architectural decoration which frames the Eusebian Canons, which are incorporated in this codex, seems to be the model of many of the decorative manuscripts of the Middle Ages. There is, in fact, good reason to suppose that the manuscripts which were copied and illuminated in the schools of Charlemagne, and which set the fashion for all later work, were directly derived from Syrian originals.

In general, however, the early miniatures were separated from the text, although they constituted a continuous comment upon it. Their aim was strictly illustrative, and it is worthy of remark that, notwithstanding the prevalence of allegorical interpretation, the pictorial illustrations of the Bible clung closely to the natural and historical sense of the story.

The determination of the date of the early miniatures is embarrassed by the fact that they were more readily, and in fact more frequently, copied than any other class of early monuments. We have, for example, in Fig. 148 an illustration from a Greek psalter in Paris which is proved by the text to belong to the eleventh century, while the miniatures are strikingly Classical in style, and are doubtless accurately copied from originals of the fourth or fifth century. The illustration here given represents in idyllic fashion the royal shepherd and psalmist, David. At his side is a female figure personifying "Harmony"; below is represented "Mount Bethlehem" under the figure of an aged man. Such allegorical personifications were common in Classical art, but still more frequently employed in Byzantine, and they may be taken, perhaps, to indicate a Byzantine origin for these miniatures.

The Vienna Genesis and the Joshua Roll of the Vatican may be taken to represent the earliest type of Biblical miniatures. The first belongs to the fourth or fifth century, the latter probably to the fifth. But even if their date were placed lower, their importance would remain substantially the same, and they could only be understood as copies of a manuscript of very early date.

The Joshua manuscript is the only instance we have of an illustrated roll; the form serves to explain the close relation of the illustrations to the text, particularly the fact that they constitute a running accompaniment of the narrative and reflect its most minute incidents. The roll contains twenty-three illustrations; one cannot say separate illustrations, for they are not framed apart, but are so closely continuous that they constitute, as it were, a moving picture. For example, in Fig. 145 we have the story of Joshua's dealings with the men of Gibeon (Josh. ix. 3-27). Above at the left are the fraudulent ambassadors starting out with their old sacks and rent wine-skins and battered raiment, as though they had

journeyed from a far country (vv. 3-5). Below they are presenting themselves to Joshua and the men of Israel (vv. 5-15); the city of Gibeon is personified above by the reclining figure with the horn of plenty. Between this and the next scene there is an interval of three days; Joshua and the host have already reached the city of Gibeon (which appears on the right), and discovered the fraud of the ambassadors; he calls them before him and decrees the perpetual servitude of the



The diverse fortune of Pharaoh's butler and baker.

FIG. 147. — Miniatures from the Vienna

Gibeonites to the Children of Israel (vv. 16-27). Figure 146 represents the return of Joshua's messengers from Ai (Josh. vii. 3).

The illustration of a codex was manifestly more convenient; the miniatures might occupy a whole page, or be placed below the text, but in any case they constituted each of them a distinct and separate subject, and the artist was at liberty to select from the narrative such themes as pleased his fancy or suited his talent.

The mosaics illustrating Genesis and Joshua in S. Maria Maggiore remind one of the Joshua Roll, but they are distin-

guished from it by the fact that they are framed in separate panels and each scene developed for itself. They follow the incidents of the narrative as closely and as indiscriminatingly as the Joshua Roll, but they could only have been copied from the miniatures of a codex.

The Vienna Genesis is an example of an illustrated codex which shows a characteristic selection on the part of the artist. It contains forty-eight pictures upon twenty-six leaves, and the artist has selected pleasing and idyllic themes to the exclusion



Rebecca at the well — the well personified in Classic fashion by a female figure.

Genesis. Fourth or fifth century.

of all scenes of stir and strife. The traditions of Classic art are especially marked in this work, as one may see from the two illustrations which are here given (Fig. 147). The first represents the contrasted fates of Pharaoh's butler and baker (Gen. xl. 20-22): the monarch reclines at table in the place of honor with three members of his court; behind stands an officer, while in front musicians are playing, and the fortunate butler, restored to favor, approaches to serve him. Outside, in fulfilment of Joseph's prediction, the baker is hanged upon a tree and the birds devour his flesh. The second illustration represents the meeting of Rebecca and Eliezer at the

z

well (Gen. xxiv. 10-18). The well is personified by the half-naked woman with a water jar. A colonnaded walk extends from the city of Nahor to the well, and along it Rebecca is



FIG. 148. — David playing the harp; from a Greek Psalter in Paris. Eleventh century copy of fourth century original.

approaching; in the next moment she is offering water from her jar to Eliezer.

If the art of miniature influenced the early mosaics, it was no less influenced in turn by them, and this influence became more and more marked after the sixth century. It is perhaps to be traced in the Rabulas Codex above mentioned. It is very clearly marked in the Codex Rossanensis of the sixth century.

It is especially observable in the forty figures of prophets which adorn this codex; and in the eighteen pictures from the New Testament it appears, not only in a certain simplicity of treatment which belongs to the mosaic art, but in the lofty idealistic conception of Christ. The influence of the mosaics is even more clear in the strange work called *The Christian Topography* of Cosmas Indicopleustes (Indian traveller). The author had made journeys as a merchant to distant parts of the earth, and he composed his book as a monk in one of the monasteries on Sinai in the year 547. It is an attempt to derive from Biblical sources a Christian physical geography, in opposition to the Ptolemaic system. Its Biblical illustrations are introduced in a purely allegorical interest; they are representations of patriarchs, kings, and prophets, regarded as types of Christ. It is a production of high artistic worth.

The Cotton Bible in the British Museum is to be compared with the Vienna Genesis, but it appears to be of very much later date. A certain rudeness of execution suggests barbarian influence, and though doubtless copied from older patterns, it is probably not earlier than the sixth century. From the Cotton Bible, or its original, were copied many of the mosaics in S. Mark's at Venice. The Cambridge Evangeliar belongs, perhaps, to the same century, but it stands in closer relation to the art of the Middle Ages.

V

THE MINOR ARTS

THE pictorial element of art has been already expressly studied in the last chapter; but it still remains for us to consider the purely decorative element, and in some measure to study over again pictorial art in its decorative aspect.

It is not art in its highest phases, but art in its merely decorative uses — in the production of dress, utensils, furniture, in short, the whole paraphernalia of public and private life — which represents in the most vivid and intimate terms the civilization of a people or of an epoch. It is not the rare artistic genius, but the common artistic taste, which reveals the tone of any civilization. To realize the character of Christian civilization in the Classic period, one must piece together innumerable minute studies of the common articles of use and luxury which gave color to public and private life. This constitutes at once the most interesting and the most difficult labor of archæology, for it supposes not only the summing up of the great mass of archæological results, but a rare imaginative construction of them.

Such a task is by no means to be undertaken here: to speak of “the Christian civilization within the Classical period” is to imply that in all material aspects the Christian civilization was identical with the Classical, and the portrayal of the familiar aspects of home and public life must be frankly left to Classical archæology. The patrician house of the martyrs John and Paul on the Cælian hill proves how thoroughly the Christian life of the fourth century was expressed in the terms of the Classical culture. The decoration of the house was in the main just what one might expect to find in the home of a pagan; even the decoration which was borrowed from Christian cemeterial art was employed in a purely Classical fashion.

In the following centuries there was a marked decline in

Classical taste and in the means of gratifying it; the unbridled gorgeousness of Oriental decoration influenced most of the decorative arts, even in Rome and the Western provinces, and supplanted the Greek ideals of simplicity, measure, and refinement of form and color.

As was to be expected in the general decline of the arts, hardly any new technical process marks the development of Christian civilization, — except in the Byzantine Empire, and during a period which is excluded from the scope of this handbook. The textile industry constitutes a marked exception, and it is consequently treated somewhat at length at the end of this chapter, while a whole chapter is devoted to Christian dress.

An industry of minor importance is that which is represented by the gold-glass, a technic which produced figured designs upon glass by means of gold-leaf. As this seems to have been almost exclusively a Christian product, it may be reckoned especially to our province.

For the rest, it must suffice here to mention objects which are distinctly ecclesiastical, or at least distinctly religious, in use or decoration. The character and costliness of church decoration is highly significant of the Christian reverence for the house of worship. The particular items of church furniture illustrate various liturgical practices, and they commonly serve to explain the development of our modern ecclesiastical utensils and adornment. In the chapter on Architecture we have already considered the stationary and strictly architectural elements of church furniture. We have now to speak, not of the altar, but of the embroidered altar cloths and of the Eucharistic vessels; not of the cathedra, the chancels, and the ciborium, but of the hangings which decorated them, or served to mark more distinctly the divisions of the church; of the lamps which illuminated the edifice, of the crowns and other votive offerings which embellished it, and, in the last place, of the ecclesiastical vestments.

Here more than in any other part of our study we are left to the testimony of literary sources. It is but natural that very few such monuments have survived; the textiles were in themselves perishable, and works of art in gold and silver were a standing temptation to the cupidity of plunderers, or to the exigencies of the owners. Enough, however, has been

left to furnish helpful analogies for the reconstruction of the various articles of church furniture which are mentioned in the texts. Reconstructions have often been attempted of the works of art which are dryly enumerated by the Roman *Liber Pontificalis*, or described with poetic fervor by Paulinus of Nola and Procopius. The drawings published by de Fleury in *La Messe* may be mentioned as especially successful.

Truly astonishing are the accounts of the rich gifts presented by emperors and popes to the great basilicas of Rome, of Constantinople, and of the Holy Land. Such accounts have met with no little scepticism; but the sources are reliable, and a just appreciation of the wealth which was concentrated at Rome during the Empire suffices to render them credible. Notwithstanding the partition of the Empire and the terrible calamities which overtook the Eternal City, it remains in some sort a mystery how that great hoard of gold and silver was finally dispersed and actually lost to Europe. Now that it is gone, there remains nothing which brings home to us so vividly the wealth of Imperial Rome as the countless store of precious marbles, fetched from every corner of the earth, and found to-day, not only amid the ruins of public buildings, but strewn over the whole Campagna, and wherever a Roman nobleman had his seat. The monuments not only substantiate the literary picture of the luxury of the Empire, but they prove that the wealth was not concentrated solely in the hands of the state or of the emperor. This distribution of imperial wealth in private holdings constituted a reservoir which could not suddenly be exhausted. Rome still remained rich after the seat of Empire was transferred to the East; time after time she paid her ransom in gold and silver; until the Middle Ages there appeared always to be enough gold to replace, after pillage, the decoration of the tombs of the Apostles, and the furniture of the churches. In Rome it was the cathedral of the bishop (the Lateran), and the memorial basilicas of the two Apostles, which were the recipients of the most costly donations. It must be remembered that the churches and the church ceremonies replaced the temples and the civic pomps upon which Rome had been accustomed to lavish treasure. The ascetic trend which was so strong in the fifth and sixth centuries was influential in simplifying the

private lives of many wealthy Christians, but it evidently had little or no tendency to check the lavish decoration of the house of God. In Constantinople and Ravenna the building and decoration of churches, like the management of church affairs, constituted one of the absorbing interests of the civil rulers. In the Holy Land the pious example of Constantine and Helena was followed by other emperors, notably by Justinian. Other churches, the objects of civil or provincial pride, must have vied with these imperial foundations; and the lesser churches, in proportion to their means, with a less perfect art and less noble materials, must have followed the lead and fashion of the greater.

EUCCHARISTIC VESSELS

Thoroughly in accord with the simplicity of our Lord's institution, the simplest vessels, the commonest cup and dish, were deemed sufficient for the celebration of the Eucharist. Vessels of glass, of the baser metals, or even of wood, were, in fact, used by poor churches till late in the Middle Ages. Figure 75 represents the Eucharistic bread in a basket and the Eucharistic wine in a cup of glass. The basket is here symbolical, it represents Christ's miraculous multiplication of the loaves; but it seems to have been put occasionally to the use which is here illustrated. S. Jerome says, "No one is so rich as he who carries the body of Christ in a basket of osiers and his blood in a cup of glass." At the same time these words imply that vessels of so mean a character were not the rule. It was natural that simplicity should not be scorned, but it was equally natural that Christians should express their sense of the dignity of the sacrament by providing worthier vessels according to their means; and the provision of gold and silver vessels must have been easier for the Church in the early period (notwithstanding persecution) than it came to be in the Middle Ages. Golden chalices and patens (sometimes adorned with gems) are, in fact, mentioned very early. Glass, however, seems to have been in very common use in the early period for the paten as well as the chalice; the fine effect and great popularity of gold leaf decoration upon glass doubtless encouraged the use of this material.

The earliest chalice represented in Christian art is the simple two-handed mug which is dimly to be described in Fig. 74. It appears to have been a very common vessel indeed, but in shape it was thoroughly practical. On the other hand, the vessel which appears upon the altar in two mosaics of Ravenna (Figs. 131, 132) is purely ornamental, and seems to meet none of the requirements of practical use, though it was this form of vase — the Classical *cantharus* — which figured commonly, indeed almost invariably, as the symbol of the Eucharist. Such a vase appears very frequently in Christian art, especially in the low reliefs in stone from the sixth to the ninth century, and in tapestry designs of the same period. Its symbolic significance is plainly marked by the vine which springs out of it, by the two harts which approach it on either side panting to quench their thirst with the water of life, and by the peacocks which symbolize its potency for immortality. It has accordingly been supposed — notwithstanding the difficulty of drinking out of such a vase — that this was the common shape of the Eucharistic chalice during the early period. The *cantharus* may very well have constituted a part of the altar furniture; either as a crater for mixing the wine and water, or as a pitcher for the reception of the whole of the consecrated wine, symbolizing the unity of the cup even when the wine was administered in several chalices. There is good reason, however, to doubt that it was ever used directly in administering the wine to the people; and its frequent employment as a symbol seems to be explained by the fact that it was a conventional decorative motive which the Church borrowed from ancient art and to which it attached its own meaning. The representations in which this vase figures in Christian art are plainly fashioned after an ancient Oriental design which was current in Classical times. This design originally represented the sacred Assyrian tree and its animal guardians; in Christian art the symbolic vine was substituted for the Assyrian Tree of Life, the vase in which it grew was elevated to the chief motive, and instead of the griffins, the panthers or the lions which guarded it, the gentler animals, representing the Christian disciples, approached it to drink. The popularity of this design is due to the fact that it was a common pattern of textile stuffs (which were always inspired by the East), and that

the textile embroideries afforded the only models which were generally available for decorative art at the beginning of the Middle Ages. The ornamental cantharus was therefore a traditional motive which was simply left unaltered in Christian art.

At all events, the earliest chalices which have survived were substantially of the same form as our own, to which also the earliest realistic representations in pictorial art agree. In general terms, it was a bowl supported by a slender stem upon a flat base. The most notable point of difference from the modern chalice was its greater size. Both size and shape may be seen in the mosaic (Fig. 135) which represents the Empress Theodora bearing a votive chalice adorned with pearls and other stones, to the church of S. Vitale. It is to be noted that this mosaic is of the same date as those which represent the cantharus upon the altar. The parallel mosaic (Fig. 134) represents Justinian carrying the votive paten. It will be seen that the ancient paten was much larger than the type to which we are now accustomed. All of the Eucharistic vessels had to be of a considerable size, for throughout the early Christian period it was customary for all the Christians who were present to commune, and it is evident, too, that the consumption was greater than at present. The paten here represented is a great flat bowl, and this shape appears to have been universal till late in the Middle Ages.

In Fig. 74 there is no paten represented, unless it be by the plate upon which the fish lies. In that picture the bishop is depicted in the act of breaking, with some effort, a large flat loaf. The size and character of the bread used in early times was various. It may be that the large flat loaf was always in use in the East as it is to-day. Small loaves, such as are represented in Fig. 75, appear invariably in the representations of Christ's miracle. They commonly appear (as in Fig. 101) marked with the cross, and just such little Eucharistic breads are represented — in *graffito* or in relief — upon several tombstones in the catacombs (Fig. 8). These small rolls were apparently the commonest form for Eucharistic breads during the first four centuries in Rome. They were not unlike our ordinary breakfast rolls; it was in fact just such bread as the Romans commonly used, and the cross was merely the acci-

dental result of folding up the corners to make it round. Though this cross was not confined to Eucharistic use, it was undoubtedly regarded as symbolical by the Christians, and probably suggested the custom of stamping the Eucharistic loaf expressly with numerous crosses and with various symbolical devices,—a custom which prevailed, at least in the East, as early as the sixth century. The loaves which are represented in Fig. 133 appear to be intentionally marked with the cross; those of Figs. 131, 132, are of a very elaborate pattern.

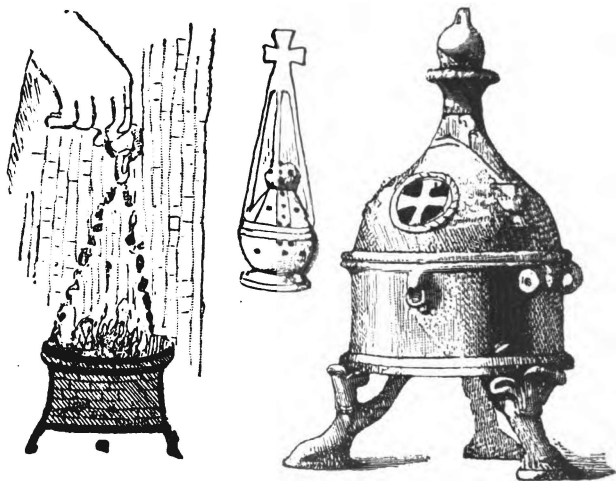

FIG. 149. — Censers of fifth and sixth centuries.

The size of both paten and chalice may be roughly estimated from the weight, which the *Liber Pontificalis* is always more careful to give than it is to describe the artistic execution. For example, among the gifts which Constantine presented to the Lateran, there were, according to this text, “7 patens of gold weighing each 30 pounds; 16 patens of silver weighing each 30 pounds.” Of the chalices, the text distinguishes “40 minor chalices of purest gold weighing each 1 pound,” from “50 minor ministerial chalices weighing each 2 pounds,” without mentioning any greater chalices. The chalices given to S. Peter were, however, of greater size and value. There were “3 golden chalices with emeralds and jacinths, each having 45

gems and weighing 12 pounds." There were, besides, "20 silver chalices each weighing 10 pounds." In this case the paten, too, was more costly: "a golden paten with a tower (!), of purest gold, with a dove, adorned with emeralds, and jacinths, and 215 pearls, weighing 30 pounds; 5 patens of silver weighing each 15 pounds." This must suffice by way of example; the use of jewelled chalices was by no means confined to imperial foundations, nor even to metropolitan churches. Patens were used also to hold consecrated oil, for Constantine presented to the church at Ostia a single *patenam argenteam chrismalem* weighing ten pounds. They probably served also to receive the donations of the people on the tables of prothesis. The mention of the golden patens presented to the Lateran follows immediately upon the mention of the seven silver altars of prothesis, and the same number is probably to be understood in the case of the patens. At all events, there were seven golden *scyphoi* (broad-mouthed mixing vessels) each weighing ten pounds, which could only have served for the reception of the wine (and oil) offered by the people. The *scyphus* seems to have been a necessary element of the church furniture; there were also in the Lateran twenty silver *scyphoi* of fifteen pounds each. There is mentioned "a single scyphus of coral, adorned on all sides with gems and lined with gold." This weighed twenty pounds and three ounces, was probably shaped like the cantharus of Figs. 131, 132, and was designed for the great altar, to hold the Eucharistic wine which was poured thence into the "*calices ministeriales*." The *ama* (or *amula*), a narrow-necked pitcher, was equally indispensable, and must have served to hold the wine and the water which were to be mixed at the Eucharist, perhaps also for the water with which the priest washed his hands. In the Lateran there were "2 amas of purest gold, weighing each 50 pounds and holding 3 *medemi*" (about 35 gallons); and "20 silver amas, each weighing 10 pounds and holding a single *medemnus*" (about 11½ gallons).

LAMPS

No class of Christian antiquities is represented by such an abundance of examples as the cheap clay lamps ornamented with the Constantinian monogram, or by some distinctively

Christian symbol or scene. The ordinary shape of the clay lamp is shown in Figs. 150, 151. It was simply the common Classical lamp, and it is distinguished as Christian solely by the themes which decorate it; the great majority of the lamps found in the catacombs are distinguished by no such mark. They were objects of the meanest value and consequently produced in the greatest abundance; the stamped designs which decorated them hardly added to their expense. Their preservation in such number is therefore readily accounted for, given a



FIG. 150. — Terra-cotta lamps with Christian symbols.

material which was at once valueless and incorruptible. Their chief interest lies in the ocular proof which they furnish of the prevalent custom of ornamenting the commonest household utensils with Christian devices. Ornamental boxes, which from the religious character of their decoration have been supposed to be intended for the reservation of the host or for the conservation of relics, are quite as likely intended for a lady's jewels or some other domestic use. It is recognized that scriptural scenes embroidered upon garments do not prove a sacred use. One of the wine jars found in the cellar of the house of SS. John and Paul on the Cælian is marked by the Christian manufacturer with the Constantinian monogram. This is

merely by way of example, to draw attention to a marked trait of early Christian life; people did not show shyness about their religion. Christian devices do not, however, appear upon clay lamps till near the end of the third century, and then but rarely. They are most common in the fifth. But even after the peace of the Church the great majority of the lamps used by Christians were still decorated with subjects which had no religious significance, taken from common life, or even from pagan myths.

Much more rare, but at the same time more interesting, are the bronze lamps of Christian origin. The forms which they assumed are meagrely illustrated by Figs. 152, 153, and 154. It is to be presumed that lamps of this sort were for the most part intended merely for household use. They show the elaborate art, or artifice, which was employed to adapt Christian themes and symbols to



FIG. 151. — Terra-cotta lamp representing a martyr exposed to a lion.

decorative ends; and they help us in some measure to picture the great chandeliers of gold and silver which decorated the churches.

It is, however, a far cry from these little bronze lamps to the costly works of art which have perished and are commemorated only by the texts. No other elements of early church decoration and furnishing give such an impression of luxury and magnificence as the devices for artificial illumination which are described in early texts. It is by no means easy to reconstruct the various forms of chandelier which are briefly enumerated in the *Liber Pontificalis*. The names by which they are denoted give no certain idea of their character, and

the Classical analogies — *e.g.* the bronze and silver chandeliers found at Pompeii — represent only very inadequately the more sumptuous works which are here indicated. Of the great *corona* with its pendent lamps which illuminated the church of S. Felix at Nola, Paulinus gives an enthusiastic and detailed description; yet the reconstructions of it are insecure and con-

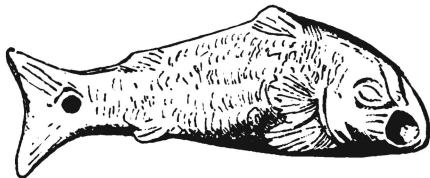

FIG. 152. — Terra-cotta lamp.

tradiictory. This *corona* apparently encircled a great cross, and both supported pendent lamps. A fresco in the catacombs (Fig. 83) shows how the cross was used in the fifth century to support lamps or candles. In the fourth century, when the cross was not yet represented in realistic form, the Constantinian monogram was used in the same way, as is shown by a monument preserved in the Vatican Museum. Lamps in the form of a fish must have been more common than existing monuments would lead us to suppose (see the clay fish represented in Fig. 152); many of the pendent lamps which Constantine presented to the Lateran were in the form of the dolphin. Astonishing is the number of lamps which Constantine presented to the Lateran basilica.

There were no less than 174 chandeliers and candlesticks of the most various sorts. De Fleury has reckoned that altogether they furnished 8730 separate lights. The ideal of the ancients was

not the attainment of the maximum power of illumination, but the impression of beauty produced by an arrangement of various sorts of lamps and various qualities of flame. By the sheer intensity of artificial light one can turn the night into day and outdo the sun; by an artistic arrangement of small lamps and candles which are barely sufficient to overcome the darkness, one can rival the beauty of the starry heavens.

The lamps given to the Lateran (*Basilica Constantiniana*) are

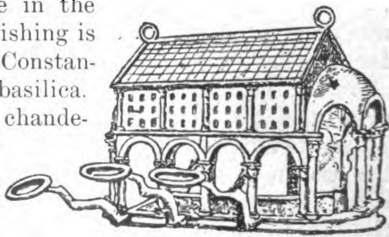

FIG. 153. — Bronze lamp in form of a basilica. Fifth century.

thus enumerated by the *Liber Pontificalis*: "A chandelier (*farus*) of purest gold which hung under the ciborium (*fastidium*, see p. 157) with 50 dolphins of purest gold, weighing 50 pounds, with chains which weighed 25 pounds." This was probably in the shape of a great crown, from which the single lamps (the dolphins) were suspended. Under the four arches of the ciborium there hung "4 crowns of purest gold, with 20 dolphins, weighing each 15 pounds."

"A chandelier (*farus cantharus*) of purest gold before the altar, in which burned genuine nard, with 80 dolphins, weighing 30 pounds. A silver chandelier (*farus cantharus*) with 20 dolphins, where there burned genuine nard." *Farus* denotes in general a chandelier; the *farus cantharus* seems to have been either an upright lamp-holder resting



FIG. 154. — Bronze lamp.

upon the floor, or some sort of corona suspended from the ceiling. One must picture a great cantharus with many wicks, or one great flame, surrounded by a crown which supported the pendent lamps. In the nave of the Lateran there were 45 such lamps of silver (without mention of pendants) each weighing 30 pounds. The cantharus could obviously be used alone; a pendent lamp of this sort was later called *butro*. The *gabatha* was a dish-shaped lamp for floating wicks. In the right aisle of the basilica there were 40 silver chandeliers each weighing 20 pounds, and in the left, 25 of the same weight. In the nave (*in gremio*) of the basilica there were also "50 silver chandeliers for holding candles (*cantara cirostata*) each

weighing 20 pounds." Whether they stood upon the floor, or hung from the ceiling, is not stated; nor whether they supported one or more candles. At all events, there were seven candelabra which did certainly rest upon the floor, one in front of each of seven altars (see p. 126). They were of copper inlaid with reliefs in silver representing the prophets, they were ten feet high, and they weighed each three hundred pounds. Mentioned in this connection, and apparently designed to contain oil for the lamps, are "3 measures (*Metretas*) of purest silver, weighing each 300 pounds and holding more than 115 gallons (*medemnos X*)."

It will be noticed that, while both candles and lamps were used, the lamps had the preference, and they only were used in the immediate neighborhood of the altar. This distinction holds good for all of the early period. On the altar itself there were no lights; as the celebrant faced the people, they would have been an incumbrance. About the tenth century the candle carried by the acolyte was sometimes placed temporarily on the altar for the convenience of the celebrant (his position with respect to the people having been changed); but it was not till later that it became a permanent feature of the altar furniture. The altar was nevertheless brightly illuminated, and plainly marked as the centre of attention, by the lamps which hung from the ciborium. In the Lateran, as we have seen, there were at least one hundred and thirty lights pendent from the ciborium (supposing each dolphin bore but one wick), and one hundred lamps burned in front of the altar, in the nave. Not to speak of the beauty of the olive oil light itself, the artistic possibilities of small pendent lamps are far superior to any effect which can be produced by the modern candles upon the reredos.

A silver box of the fifth century from Numidia (Fig. 161) bears upon its lid the representation of an orans between two tall candlesticks. This is interesting, not only as a rare illustration of an ancient candlestick, but because it reveals the symbolical meaning which was attached to lights in the early Church. Lights represented the glories of paradise; the orans — which perhaps stands for some saint whose relics were treasured in this box — is thus pictured in bliss. This meaning is further expressed by the mountain upon which she

stands, and out of which gush the four rivers of paradise. Candles or torches were for the Christians, as for the pagans, an invariable accompaniment of funeral processions. This was a perfectly natural use, since Classical custom encouraged burial at night; and it was even more strictly necessary in the case of the Christians, who buried in the catacombs. With less reason the use was extended to all religious processions, whether by day or night. They were doubtless carried in the litany processions which became so common in the fifth century, and portable lights must from this time on have been the common accompaniment of processions in the churches. Candles are carried by courtiers or civil officials in a procession which conveys some relic to the cathedral of Treves, as depicted in an ivory carving of the fifth century (Fig. 110).

It may be mentioned here that costly crowns, which were merely decorative and supported no lamps, were a common form of votive offering after the fifth century.

CENSERS

Another custom which was originally associated with processions, in particular with funeral processions, was the use of incense. How early incense may have been used by the Church it is not possible to fix with precision; the monuments in particular have very little evidence to offer on the subject. But the fact that so little is said of it even after the date at which it is known to have been in use, proves at once how naturally it must have been adopted as an obvious concomitant of the funeral, and how little significance must have been attached to it in relation to worship. In connection with funerals its utilitarian convenience is especially obvious, and as a matter of fact it seems to have been thus used by the pagans without any symbolical reference. It had also, however, among the pagans a distinctly religious use, and it is difficult to suppose that it could have been regarded as a feature of Christian worship as long as pagan customs remained a lively menace to the Church or even a vivid recollection. On the other hand, the high regard showed for incense in the Scriptures, and its use in Jewish worship, must have tended to

overcome such scruple. At all events, it was used in the churches as early as the fourth century, though apparently on æsthetic grounds, like the burning of scented nard in the lamps. Constantine presented to S. Peter's "a censer (*tymiamaterium*) of purest gold, adorned on all sides with gems to the number of 60, weighing 15 pounds," — it is hardly to be decided whether this was a swinging censer or a stationary one. It is clear that the use of censers, like the use of portable lights, passed from funerals to processions of all sorts, and so finally to processions within the church. Censers are not carried in the procession which is represented in Fig. 110, but they are swung by the on-lookers from the windows of the palace. A censer is carried by a deacon (Fig. 134) in the procession which Justinian makes to S. Vitale. This censer is represented on a larger scale in Fig. 149. The second figure on this plate reproduces the shape of the censers which appear in Fig. 110; the third figure represents a bronze censer preserved at Mannheim; it is probably of the same date. There are no earlier representations of censers in Christian art.

DIVERS OBJECTS

One of the subjects which properly belongs to this chapter — that of rings and carved stones — it has been found convenient to treat in relation to Christian symbolism in general (p. 234). Work in ivory, so far as it belongs to pictorial art, has been considered in the previous chapter; for the rest, the small objects in ivory found in the tombs have no artistic, and but small archæological, interest. Coins with Christian emblems have already been mentioned (p. 239), as well as two medals representing the heads of the chief Apostles (p. 251, Figs. 90, 91).

Medals of devotion decorated with Christian symbols constitute the only class of amulets which have any artistic interest. Their likeness to the *bullæ* of the pagans is sufficiently obvious. They early came into use, together with other forms of amulets, and their use increased rapidly after the peace of the Church. Figure 159 represents a bronze medal, which is not later than the fourth century; the subjects which appear on it belong to the earliest cycle of Christian art. In the midst is

the Good Shepherd; above, Adam and Eve; then Jonah under his gourd, the sacrifice of Isaac, Moses striking the rock, the two other Jonah scenes, Susanna, Daniel, and Noah.

The use of oil *ampullæ* has been described in another place (p. 80); the *ampullæ* themselves are invariably very rude productions in terra-cotta, metal, or glass, but they are usually ornamented and have a considerable iconographical interest. They are only less numerous than Christian lamps. Incomparably the most common are those which were brought by pilgrims from the tomb of S. Mennas, near Alexandria, and are found all over Europe. They bear an image of the saint kneeling between two kneeling camels — suggested by the legend that a camel of his own accord drew the bier of S. Mennas to the tomb. The *ampullæ* usually bore the image and symbols of the saint from whose tomb the oil was taken. Figure 158 represents a metal *ampulla* of the sixth century from Monza, which contained oil from the holy places of Jerusalem, and is, therefore, decorated with scenes representing the Crucifixion, the Resurrection, and the Ascension.

The lead coffin illustrated in Fig. 9 is a good example of a common sort of metal work of the fourth century. A fifth century reliquary from Numidia, illustrated by Fig. 161, is an example of a higher class of work; it is the more rare because it is of silver; its decoration is borrowed from the mosaics of the basilicas. A lead cup from Carthage (Figs.



FIG. 155. — Bronze lamp, Jonah under the gourd.



FIG. 156. — Lead cup from ancient Carthage. Fifth century. A mixture of Christian and pagan designs.

156, 157) of the same or the following century is interesting chiefly as an illustration of the mingling of Christian and pagan subjects, which witnesses to the impotence of decadent art to cut itself loose from earlier models. In this case the decoration consists of small plaques of lead soldered upon the cup. Work in enamel, executed in very various ways, was common in Greece, but fell out of favor in the



FIG. 157. — Designs of the above cup displayed.

Roman period (probably because figured glasswork was preferred); and Christian examples of it are rare and of slight



FIG. 158. — Metal ampulla in Monza. Sixth century.

importance till the Byzantine revival, which lies beyond our limits. In the fifth century began the use of small crosses as amulets; processional crosses came into use about the same time; the altar cross was not used within our period.

GLASS

Early Christian glass technic demands special attention. The industry was closely contemporary with Christianity and made rapid progress during the first centuries. Glass was a rarity in the time of Augustus, but the quantity which was found in the catacombs proves that it had become fairly abundant by the fourth century. It is not necessary, however, to speak of the plain glass vessels, which were of course the most abundant; and only a word need be said about the cut and engraved glass.

The simplest decoration upon glass was made by tracing patterns in line with a point—*graffiti* on glass. This was usually freehand work, rapidly and carelessly executed. The scenes which serve for this decoration are taken from Classical mythology, from everyday life, or from among the common subjects of Christian art. One of the most interesting examples of this art—though barbarously rude in workmanship—is a cup found in Podgoritza in Albania, and now in the Museum of Saint Petersburg. Its interest lies in the fact that it brings together most of the important scenes which constitute the early Biblical cycle of the catacombs.

A very much superior technic consisted in deep cutting and modelling with the wheel. The patterns used were seldom merely conventional; the work, therefore, required great skill, and there are no good examples of it after the third century. When the designs were cut on the inside of the glass they were sometimes lined with a color, or with gold-leaf, giving the effect of enamel. Cut sufficiently deep from the outer surface, they gave a charming effect of transparency. An example of this latter sort is given by Fig. 160, which represents a fragment



FIG. 159. — Bronze medal of the fourth century, with Christian symbols.

of a cylindrical vase of the shape which the Romans called *miliaria* ; it belongs to the early part of the fourth century, and it evidently represented a considerable number of Biblical subjects, — the three subjects which are preserved are distinctly original both in selection and execution.



FIG. 160. — Fragment of a cut-glass vessel of the fourth century. Vestiges of the sacrifice of Isaac, Daniel among the lions, the Israelites following the pillar of fire.

The most elaborate and most beautiful products of the glass industry were what is called the *vasa diatreta*, carved in relief through superimposed layers of differently colored glass, with the effect of a cameo. The most perfect specimen of this art is the Portland vase in the British Museum. In the Christian period this refined art produced only works of minor importance; the difficulty of the technic, particularly the danger of shattering one of the layers of glass, gave rise to imitations which were made by soldering upon the surface small figures already cut out of colored glass. A beautiful glass of this sort was found in a cemetery at Treves; on a white ground tinged with light blue of varying intensity there is a row of fish and two rows of marine shell-fish. Whether this was properly of Christian or of pagan manufacture, the Christian interpretation of the design is evident enough.

It is, however, the so-called gold-glass which is most expressly — indeed, almost exclusively — associated with Christian art. It seems

to have had its origin about the middle of the third century, and the art was hardly continued beyond the fourth. Most of the examples preserved have been found in the Roman catacombs, where it was the fashion to press them (merely as a mark of identification) upon the fresh plaster which closed

the *loculus*. The hardening of the plaster preserved them, or preserved at least the round plate which formed the bottom of the glass, and which was the field principally used for decoration. It is rare that a whole glass of this sort has been preserved, and it has been a matter of dispute to what sort of vessel these round plates appertained. They were commonly of two sorts: a deep saucer, and a tall cup or drinking glass, probably in matched pairs. It is doubtful whether the glasses found in the catacombs were whole when they were attached to the plaster, and not rather mere fragments which had already served their term of use in the household, and were no longer serviceable except as marks of identification. It is certain, at any rate, that very small disks (Figs. 165, 166) which were soldered on to the glass, and constituted almost the sole decoration employed for the broad margin of saucers, were also used as charms or ornaments, for they have been found surrounded by a band of gold, in order that they might be suspended from the neck. The drinking glasses were chiefly ornamented at the bottom. The technic consisted in engraving upon a gold-leaf attached to the glass, and afterwards protecting it by a glass film. The engraving was executed with a point, commonly in mere outline, but sometimes with a careful shading and modelling, which was occasionally enhanced by the use of colors. The finest specimens, however, were designed by minute dots, as in a mezzotint engraving.

This seems to have been a local Roman art practised in pagan shops (perhaps even in Jewish) before it was adopted by Christianity. There are, in fact, a number of glasses which represent mythological subjects or purely pagan themes, and the Jewish origin of others is clearly proved by representations of the seven-branched candlesticks and of the Ark of the Covenant. Christian themes are, however, much more numerous and more varied, and it is evident that these glasses were manufactured in Christian shops before the time of Constantine. As this art flourished before as well as after the Peace of the Church, it represented subjects which belonged to both the earlier and the later cycle, borrowing, on the one hand, from the catacomb frescos, and, on the other, from the mosaics of the basilicas. The Good Shepherd was frequently represented at the bottom of a drinking glass (Fig. 162). Tertullian refers

reproachfully to the use of Eucharistic chalices in which was painted the image of the Good Shepherd;¹ and though we have no reason to suppose that this art of gold-glass was so ancient, a similar style of decoration must evidently have been in use, and notwithstanding this gold-glass ware never presents the form proper to the chalice, the suggestion that vessels so decorated were used for the Eucharist is too natural to be put aside. The subjects are predominantly religious. A common device for the decoration of a cup was manifestly copied from



FIG. 161. — Silver box from Africa. Fourth or fifth century. On the lid, an orans between harts slaking their thirst at the four streams of Paradise (the

the ceiling decoration of the catacombs; it consists of a central medallion surrounded by radiating compartments which contain representations of Old and New Testament miracles. In Fig. 168 the subjects are crowded together, and the divisions are barely marked; this seems to reflect the influence of the sarcophagi. The imitation of the mosaics was not less close; in this case there was a horizontal division, the scene above representing the half dome of the apse, that below, the wall. The religious subjects which appear upon the gold-glasses have been sufficiently noticed under Pictorial Art.

There appears, however, upon the gold-glasses another range

¹ *De Pudicitia*, 7, 10.

of subjects — partly religious and partly secular — which is far more characteristic of them, and which seems to indicate their use. *Genre* pictures, which were rare in the catacombs, were especially common upon the gold-glasses. The commonest themes were representations of a married pair, or of a family group (Fig. 167), accompanied usually by the names of the couple, and almost always by a toast. *Pie zeses* (drink! live!) was the usual toast; *zeses* — a mere transliteration from the Greek — was more common than the Latin *vivas*. A married



two candlesticks; on one side, the Agnus Dei and the Apostolic sheep; on the other, two Gospels), which spring from beneath the monogram of Christ

couple, greeted with this toast, appears in the midst of the religious scenes depicted in Fig. 168. A similar toast (*Dignitas amicorum pie zeses*) was inscribed about the picture of Adam and Eve in Fig. 163. In this case Eve is adorned with bracelets, a necklace, and an artificial head-dress; it is probable that this scene was commonly, though not very aptly, chosen to represent married felicity. A toast in Greek appears also upon the third glass representing the Good Shepherd, in Fig. 162, and from innumerable examples of the same sort it is evident that the religious as well as the secular representations were meant to adorn the glasses which were used for mere family feasts. They were doubtless prepared as gifts for wed-

dings, birthdays, and all sorts of family festivals. A common toast was, "Take a crown, drink, and live." Crowns of leaves or flowers were commonly used at Christian feasts, notwithstanding their pagan associations. Figure 167 represents a small figure placing wreaths upon the heads of a husband and wife; such a figure is sometimes designated by name in the inscription as *Christus*. Figure 169 hails with a toast an overseer, "Dædalius, your hope [is in Christ]. Drink. Live."

The commonest subjects of all are the images of popular Roman saints. *Maria* appears frequently between *Petrus* and *Paulus*; and among the Roman martyrs — the Apostles excepted — Agnes was by far the most popular. Eighty out of the three

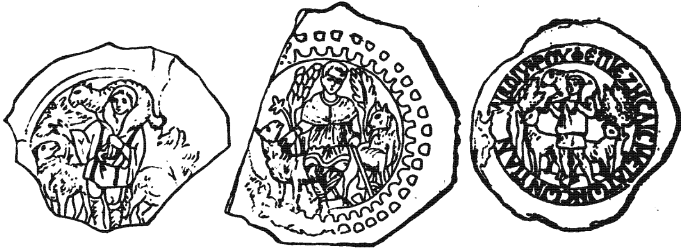

FIG. 162. — Fragments of three gold-glasses of the third or fourth century. The Good Shepherd in the different attitudes.

hundred glasses published by Garrucci contain representations of SS. Peter and Paul. When we think of the Christian agapes, and above all of the anniversary feasts in memory of the martyrs, we can realize how many occasions of a more or less religious nature the Christians had to use drinking glasses, and we can understand the selection of such ornament.

THE TEXTILE ART

Of all the arts, it is the textile which stands in the closest and most necessary relation to human life. It is a matter of course that in Classical and in early Christian literature there are innumerable references to it; there are names denoting the texture and color of textile stuff, descriptions more or less detailed of its decoration, and indications of its use. But

such fabrics were among the most perishable of all the materials used in the arts; and without the preservation of the stuffs themselves, the names, familiar and clear as they were to the ancients, are almost without significance to us, and the descriptions hardly avail to describe them. What significance are we to attach, for instance, to the many names denoting various shades of "purple"; or to the terms descriptive of different qualities of silk; or to the accounts of figured stuffs, when we do not know by what method of embroidery they were executed, or whether it was by embroidery at all? Long and fruitless study has proved how thoroughly impossible it is



FIG. 163. — Fragments of two gold-glasses. Daniel slaying Bel, Adam and Eve.

to come to any clear idea about these matters so long as monumental evidence is entirely lacking. Painted representations of clothing, hangings, etc., have constituted until lately almost the only sort of monumental evidence which threw any light upon Classic textiles; and considering the character of most of the paintings which have been preserved to us, and the ruinous condition in which they have been transmitted, that evidence is very far from being complete or even reliable. Lately, however, there have been discovered in Egypt almost inexhaustible treasures of textile stuffs; and the examples which are now distributed among most of the great museums of the world are probably sufficient to illustrate every term which is used in this connection in Classic and early Christian literature. Unfortunately, the value of this great store of information is still

only potential; the study of its relation to Classical literature, or to Classical art and life, has hardly yet been begun. This chapter is the poorer for the lack of such a study, which is here referred to as a rewarding subject of investigation.

These Egyptian finds, however, bear upon their very face, and quite apart from their relation to Classical texts, a clear witness to almost all phases of this important art, as it was practised from the third century to the seventh. Any one who is acquainted with the art of weaving can detect by an inspection of these fabrics the technical processes which were employed in the manufacture of them; but the most important evidence which they offer is quite on the surface and is obvious to

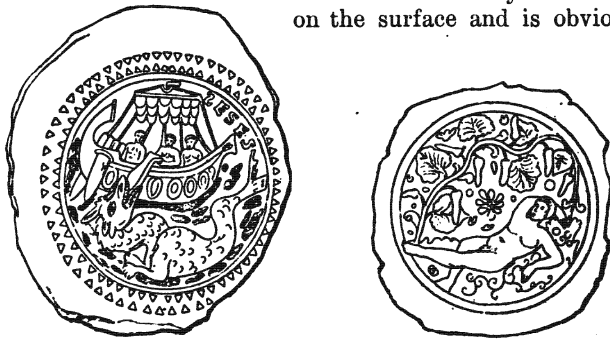

FIG. 164. — Fragments of two gold-glasses. The story of Jonah.

the mere layman. They show at a glance the material, the texture, the quality, the colors, and the forms, which characterized ancient textiles. They serve in particular to put vividly before us the character of one of the most important features of the decoration of the churches: the curtains, altar coverings, etc. It is this consideration especially which concerns us here; but it will be necessary first to describe generally and briefly the character of these finds, and it may be well also to give some account of their discovery and study.

The first finds were made as early as the beginning of this century in the neighborhood of Sakkarah; in 1801 a tunic came into the possession of the Louvre, and other textiles from the same source were later collected in Turin, and in the British Museum. There was, however, no methodical exploration of

the site, and it is only within the last fifteen years that an overwhelming abundance of material has been furnished by the burial-ground of Achmim. Achmim (a name variously transliterated), in upper Egypt on the right bank of the Nile, was the ancient Egyptian Chemmis — in Ptolemaic times Panopolis — renowned for its sculptors and masons as well as for its linen weaving. This site has already been exhausted; unfortunately not by intelligent exploration, but by indiscriminate pillage by the Arabs, who not only took no thought to preserve intact the contents of separate graves, but were commonly indifferent to the preservation of individual garments in their integrity. They frequently contented themselves with stripping off the colored embroideries and silks for which they were confident of finding a market. This was perhaps one of the richest sites, but it is by no means the only one; a few



FIG. 165.



FIG. 166.

other burying-grounds have already been explored with some success. Particularly worthy of note are the explorations of the burying-ground of Antinoë, begun in 1897 by the Musée Guimet of Paris, and completed in 1898 with the coöperation of the Chamber of Commerce of Lyons. These excavations were very fruitful, and they were of course conducted under the best scientific direction. The finds of the year 1898 were exhibited for a month in Paris, and then divided between the two subscribing parties. They illustrate very well the Classical textiles, and are a good basis for comparison with modern products; but they are not very rich in distinctively Christian patterns.

These Egyptian finds have been studied in a slight monograph by Gerspach, director of the Gobelins. His professional judgment upon the technic of the art — upon the processes of weaving, dyeing, and embroidery — is of course especially valuable. They have been studied from a much broader and more

thoroughly archæological point of view by Dr. R. Forrer; his numerous works (the most important of which are named in the Bibliography) are profusely illustrated, chiefly in color. Forrer's works refer almost exclusively to his own collection, which is a thoroughly representative one and forms an excellent basis for study. It has a special interest for our purpose, because it is the collection richest in distinctively Christian embroideries.

These excavations reveal a very simple mode of burial, which remained the same from the third to the seventh century. The body, after the slightest process of embalming, was clothed in the best garments, bound to a cypress bed, and without coffin or shroud buried at a depth of some five feet in the dry sand.



FIG. 167. — Fragments of two gold-glasses. Family groups.

The textiles which are found in these graves are therefore almost exclusively garments; properly studied they would furnish a complete picture of the dress of all classes throughout this long period. In continuation of the pagan custom, minor objects of various sorts were placed in the graves; they sometimes denote the profession of the defunct. One cannot but marvel at the perfect preservation of all the various textiles found in these graves; it is due merely to the exceeding dryness of the sand. Whether they be of linen, cotton, silk, or wool, they are many of them still sound and fit for use, preserving their color as well as their texture. Parts have often been disintegrated by the corruption of the body; dyed woollen threads of certain colors (particularly red) have been neatly eaten out by worms; but the greatest destruction was left to be wrought by the Arab excavators.

Gerspach affirms upon the evidence of these finds that almost every product known to modern textile art was produced in great perfection by the ancients. To quote this judgment, which is strikingly borne out by the facts, is sufficient excuse for not attempting here either to describe or to enumerate the various kinds of fabrics which are now brought to light. An



FIG. 168. — Gold-glasses. Healing of the paralytic, raising of Lazarus, Adam and Eve, the sacrifice of Isaac, the water from the rock.

overwhelming proportion of the material is of linen or cotton. A colder country might naturally be expected to show a greater proportion of woollen garments; even here, however, the weight and warmth of the woollen garments was sometimes extraordinary, and the linen was frequently woven like Turkish toweling (rough only on one side, however), producing tunics and palliums of considerable warmth. The curtain illustrated in

Fig. 176 is of this texture. Cotton is sometimes woven in the manner of Canton flannel; or, with the same mode of weaving, a warmer garment and a more beautiful surface was produced by a woof of fine glossy wool. For great warmth and protection against rain — one can hardly account for such garments in Egypt — a pure felt was used, or a felt beaten into



FIG. 169. — A gold-glass. Inscribed upon it is a toast to a certain Dædalus, apparently a superintendent or owner of a carpenter shop.

a heavy woollen texture. Light textures were, however, the rule, though they have rarely been so well preserved. Linen was woven with great regularity and sometimes with exceeding fineness; very light cotton tunics were common; and even light transparent woollen fabrics were made, to be used as veils, for example.

Silk was from first to last exceedingly rare; even among strictly decorative stuffs it exists only in the proportion of

about one to one hundred. How rare it actually was under the Roman Empire we can judge from the mention of two tunics of half silk (*subsericus*) given to Claudius by Valerian and Gallienus. Elagabalus (218-222) was the first to wear clothes of pure silk (*holosericus*). At a later time, however, silk certainly became much more common in Rome than the cemetery of a provincial Egyptian town would give any idea of. As we find it there, it was mainly employed in small patches (*segmenta*) for the adornment of commoner fabrics. In the third and fourth centuries it was generally in solid colors, or with a changeable surface (evidently, therefore, dyed in the thread); the ancients were sufficiently delighted by the natural sheen of the material. It is not unlikely that such silk was woven in the extreme Orient; it was always too thin for any but mere decorative purposes. The Egyptian weavers resorted to various devices for economizing this rare substance. In the case of a light woollen veil in Forrer's collection, the border is decorated by threads of silk shot through the woollen mesh. Another device resorted to consisted in winding linen threads with fine strands of silk, so that when woven they gave on both sides the effects of pure silk fabric. It is probable that in these two methods we have the distinction which the Romans marked by *subsericus* and *tramosericus*, though it is not easy to determine which was which. The Romans made a further distinction between *sericus* and *holosericus*.

Patterns woven in silk became common later — perhaps as early as the fourth century. The silk was sometimes woven in the shape of a *clavus* with round or lanceolate finial, all ready to be attached to the garment. A piece of such a *clavus* (probably fifth century) is shown in Fig. 171. The figures are in cream-white, the natural color of the silk, against a silver-gray ground. Silk *embroidery* (Figs. 172, 177-179) did not come into common use till the fifth century and under Byzantine influence.

Linen was rarely dyed, and it was frequently unbleached. The dyeing of cotton was more common; it was dyed especially a brick-red with tannin and iron. In the later period it was also printed in patterns. It was of course the wool which was most frequently and most richly dyed, always, however, in solid colors except where it was adorned with embroideries.

It is well known that the pallium, like the toga, was usually white, and decorated only at the corners; palliums both of cotton and of wool woven in broad stripes of bright colors appear among our finds, but this was hardly a general fashion, as this garment fell into disuse too early to be seriously affected by the growing taste for striking effects in colors. Women continued to use the palla much later, and it came to be decorated over its whole surface with a diapered pattern. The dalmatic was frequently adorned in the same way. The pænula, on the other hand, was always of a solid color, usually dyed in some shade of "purple," though the natural chestnut-brown of some of the Caucasian wools was also retained. Its sole decoration was a fringe.

The richest dyes, however, were not commonly lavished upon the whole piece of cloth; the choicest products of the dyers' craft appear only in the small patches of tapestry or embroidery (*clavus, segmentum, gammadia, paragauda*) which showed like gems against the meaner fabric which they decorated. It has to be remarked as a peculiarity of the ancient use of textiles in decoration that the commonest fabrics (plain linen or wool) were used where we should expect the richest; for instance, for the curtains of palaces and churches. The whole was given character by the borders (*paragaudæ*) and *segmenta* of tapestry or silk which adorned it.

TAPESTRY

The chief interest of this study centres in the decorative patches above mentioned; they were necessarily costly and had often considerable artistic worth. The most surprising revelation of these Egyptian finds is the fact that this decoration was commonly not wrought in any of the stitches which are classed as embroidery, but in tapestry. The tapestry was always in wool upon a linen backing; it was wrought precisely like the early Flemish tapestries and the modern Gobelins, upon an upright frame worked from behind. As used upon a linen garment, this decoration could be woven into the fabric; upon cotton and wool it was always *appliqué*, as it was also frequently upon linen. Lasting longer than the cloth which it ornamented, it could readily be transferred to a new garment.

In considering either the colors or the patterns of these tapestries, we have to note a marked difference between the Classical and the Byzantine periods, with the fourth century as a period of transition. It need hardly be said that all distinctively Christian designs belong to the later period.

Nothing reveals more clearly the refinement of Classical taste than moderation in the use of color; it was not variety of color which was prized, but the sheer beauty of a single dye. Comparison with the best Gobelin dyes shows that the ancient colors, even after fourteen hundred years, are less readily faded by the sun. In the early period the tapestries were almost always

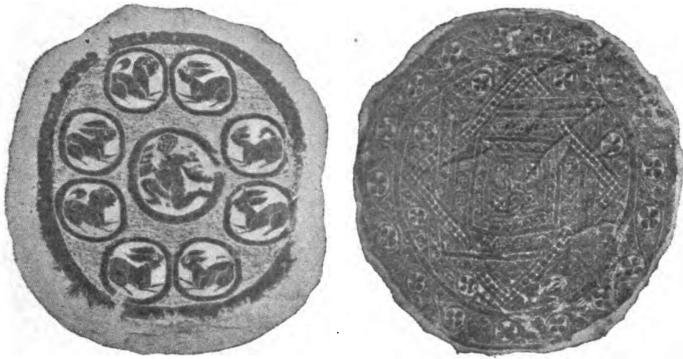

FIG. 170. — Segments for the adornment of a garment from Achmim, Classical designs in tapestry current from the second to the fourth century.

wrought in a single color, in one of the numerous shades classed as purple, — varying from dark carmine red, reddish brown, violet to dark blue or black, — some of which, as is well known, were more peculiarly prized and valuable. The pattern was pricked out by white linen thread; it was always quite intricate, though the general effect was simple. The designs were for the most part geometrical, combined with conventionalized vegetable forms; animal figures were introduced within the frame of the main design. Figure 170 is the only illustration here given of Classical *segmenta*. More ambitious pieces often represented a mythological scene. These pieces are sometimes remarkable for accuracy of design; various colors were

sometimes used in elaborately figured tapestries, but always with great sobriety. It was the *segmentum*, rather than the narrow clavus, which gave scope for artistic treatment. In general outline the *segmenta* were generally square or round; but various shapes were used, and for the centre of a cover



FIG. 171. — A piece of figured silk from Achmim. About sixth century. The eagle slaying an evil beast, Christ slaying the dragon (a crocodile), — symbolizing the Church and the Empire united in the suppression of evil.

or curtain a star-shaped figure, composed of superimposed squares, was especially common. The way in which these pieces were employed in the decoration of garments is described in the following chapter. Their use upon curtains, table covers, etc., was similar, and is very simply described; they were generally placed only in the centre and at the corners. Figure 176 represents a curtain of about the third century — plain tapestry of brown purple wool upon linen. The angular figures which here decorate the corners are very common; they were called *gammadice* from their resemblance to the Greek *gamma*. *Segmenta* in the shape of a cross, or with the design of the Constantinian monogram, were often used in the Christian period upon garments, curtains, and altar cloths. The letters which are frequently represented in early art as decorating the corners of the pallium were doubtless executed in tapestry *appliqué*; it is useless to seek in them any significance

beyond the mere purpose of adornment. Figure 175 shows a more elaborate curtain of an expressly Christian design; it betrays a later period, which demanded a decoration covering more or less completely the whole surface. The curtains represented in the fifth-century mosaics of Ravenna (Figs. 135, 143) are decorated by *segmenta*, but at close intervals over the

whole surface; on the other hand, Figs. 131, 132, and 142 repeat the simpler Classical design.

Classical simplicity in the use of the *segmentum* and its kindred forms endured, in fact, throughout the whole period with which we have to deal. The change which we have to note is chiefly in the tapestry itself. In the fourth century there was some deterioration in color, but still more in point of accuracy of design. The same patterns were followed, but with an increasing coarseness in the execution of the geometrical designs, and hardness and conventionality in the treatment of animal forms. The decadent taste of the fifth and following centuries found compensation for crudeness of design in a lavish use of colors; not only were there a great variety of new colors employed, but they were used in vivid combinations. This was undoubtedly the effect of Oriental influence, which made itself felt even before the formation of the Byzantine Empire.

Side by side with the traditional Classical patterns there



FIG. 172. — Segmentum in tapestry from Achmim. About seventh century. Virgin and Child with an angel.

came into common use designs of purely Oriental character, evidently copied from imported fabrics, but in various ways modified to suit the requirements of Classic art, or adapted to the expression of Christian symbolism. The sacred tree of Assyria with its animal guardians is only an example of such expressly Oriental motives (see p. 344). It was at the same time and under the same influence that the custom gained currency of decorating the whole surface with small patterns. For this a great variety of devices were employed; but none were more common than the four designs which were to become so popular in tenth-century Byzantine stuffs, as they were also on the textiles used in Western Europe after the Crusades,

and which we now naturally associate with our playing cards: that is, the lozenge, the heart, the trefoil, and the leaf,—or diamonds, hearts, clubs, and spades. These figures had, it is true, no special point of contact with Christian symbolism, but they were so commonly used in the sixth century that a combination of them would have seemed by no means out of place in ecclesiastical embroidery.

It was hardly before the fifth century that Biblical scenes were represented upon the tapestries as we find them in Egypt. As early as the fourth century, however, literary sources refer to such works, and Asterius, Bishop of Amasea, rebuked wealthy Christians for adorning their clothes with pictures of Christ and his disciples, and with scenes representing his miracles.

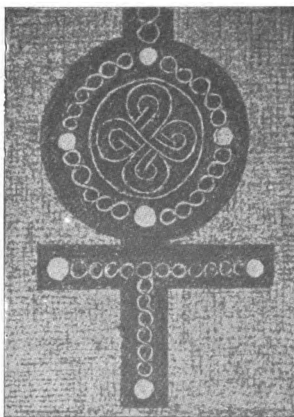

FIG. 174. —The Egyptian cross, part of a clavus in tapestry.

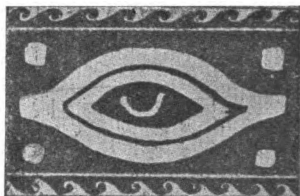

FIG. 178. —Tapestry from Achmim. Symbol of the divine omniscience.

It is not till the eighth century that the *Liber Pontificalis* expressly notices such scenes. By the time the representation of Christian themes in tapestry had become common, the art was so far decayed that the designs are confused, and often hardly intelligible, the effect depending chiefly upon the brightness of the colors. It helped the case somewhat that at about the same time (fifth century) silk embroidery became common (in Chinese flat stitch—what the Romans called feather stitch); there are many interesting examples of it (Figs. 172, 177, and 178), but none which can be called truly artistic. Figure 178 represents an unique object in Forrer's collection, which is interesting quite apart from the technic of the silk embroideries which adorn it. It is a narrow scarf of fine linen, nearly two and a half yards long, adorned with nine silk embroideries, and twelve

patches (crosses, squares, and lozenges) of plain silk, all of them *appliqué*. Forrer takes it to be an episcopal pallium of the sixth century. It may belong quite as well to the seventh century, and it is hard to believe that it was actually intended for a pallium, which, even in the East, has never had any other ornament than crosses.

It might, perhaps, have been a stole; and, at all events, the religious subjects which decorate it suggest an ecclesiastical use. The three examples which are here given of these embroideries represent the raising of Lazarus, the Crucifixion, and Mary Magdalene with the angel at the tomb. They are worked upon a reddish black ground in carmine red, golden yellow, light blue, white, and green. Of the other six pieces, two represent angels, others, Christ enthroned, Christ as an orans, Christ instructing a disciple, Christ healing the blind man.

Other Christian scenes which Forrer enumerates in his collection are: Joseph the patriarch (of special interest to the Egyptians), Elijah ascending in the chariot, the messengers carrying the grapes of Eshcol, Daniel among the lions, and the sacrifice of Isaac, from the Old Testament; and from the New, the Annunciation, the meeting of Mary with Elisabeth (Fig. 177), Mary holding the child Jesus (Fig. 172),



FIG. 175. — Reconstruction of a curtain — woolen tapestry on a linen ground. Fourth to sixth century.

the Magi (very frequent), the flight into Egypt, Christ healing the paralytic, the raising of Lazarus, the entrance into Jerusalem, the Resurrection, and the Good Shepherd. Orants and saints are frequently figured. The commonest animal symbols are the fish, the dove, the lamb, the hart, the hare, the fowl, and the peacock.

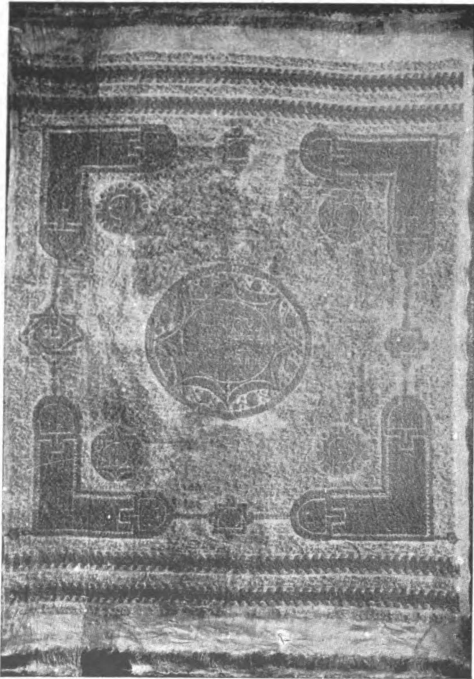

FIG. 176. — Curtain in the Victoria Albert Museum, London. Perhaps third century.

Gold embroidery is but rarely found in the Egyptian graves. It was, however, a very ancient art; it was much used in Rome under the Empire, and just subsequent to our period it was in frequent use in the decoration of the greater basilicas. In particular, the cross which ornamented the centre of the altar cloth — that is, of the frontal — was often worked in gold, and sometimes embellished with pearls. Early gold embroidery (as we learn from the few fragments which have been

preserved) was wrought with fine threads of pure gold; later, recourse was had to the method which is now common — wrapping a stout linen thread with strips of parchment or paper coated with gold-leaf. One gets an idea of the rich and heavy character of Roman embroidery in gold from the representations of the *toga picta* upon the consular diptychs.

The special interest of all these textile designs lies in the

fact that they do not represent merely the local traditions and the local art of a little town in Upper Egypt, but the cosmopolitan art and custom of the Empire (see p. 2). There is hardly anything which reveals more clearly the unity of custom under the Empire than the fact that the same garments were worn and the same patterns prevailed in the heart of the Empire and in its extremest provinces. The factories of Achmim were doubtless intended to supply more than a local trade; they must have received orders from Rome, and with the orders the Classical patterns which were to be executed. It is this which explains the uniformity of textile work throughout the Empire, and the subversion — as we see in the case of Egypt — of the traditions of local art. Among all the Egyptian textiles there is hardly anything of a purely Egyptian character. The Oriental patterns which were later introduced were no less cosmopolitan, for Oriental fashions gained acceptance everywhere.

Notwithstanding its decline in taste and execution, textile embroidery in all its branches had a rapid material expansion in the fifth and sixth centuries; in the decay — the extinction almost — of other branches of pictorial art, designs in tapestry were more commonly used and more broadly disseminated than ever, and they constituted the only patterns which were sure to be at hand in all parts of the Empire to guide the artisans who were engaged in the production of the conventional low reliefs in stone, which, from the fifth to the ninth century, were the commonest monumental expression of decorative art. The inspiration and origin of these stone reliefs has long been sought, and from various quarters. It is a notable fact that almost every one of these low-relief designs which is not distinctly derived from an architectural motive can be matched by textile patterns either of Classical or of Oriental origin; and their inspiration from this source can hardly now be questioned.

ALTAR CLOTHS AND CHURCH CURTAINS

The foregoing may give an idea of the nature of the textile stuffs which were employed in the decoration of the churches. Figures 131, 132, 142, and 143 show that Classical patterns were the rule for curtains and altar cloths even as late as the sixth

century. When we read of Biblical scenes depicted upon them, we have to recognize that they must, in general, have been, like those found in Egypt, of small compass, constituting mere details of the decoration. It remains merely to describe the manner of the employment of curtains and coverings in the churches.

In Classical times textile fabrics had as large a use in the furnishing of the private house as they have with us, and their use in the basilicas is mainly to be explained by the customs of private life. They were used in the houses for cushions and stools, as coverings for seats, for tables and for the wall, as curtains for the street doors, and as canopies to shield the atrium from the sun. But beside this, curtains were generally used instead of doors within the house, and also between the columns of the colonnade which shielded the sides of the atrium. All of these uses were repeated in the church: there was the stool and cushion for the cathedra of the bishop, coverings for the seats of the clergy, and for the wall behind them, coverings for the altar and for the tables, curtains for the doors of the church and of the sacristies; and, most important of all, the curtains which were hung between the nave and the aisles, before the presbytery, and around the ciborium. This lavish use of curtains was doubtless encouraged by the fact that they were common among the Romans as well for public as for private use, and were, in particular, an important feature of the decoration of the temples. The *Liber Pontificalis* clearly enough indicates both the lavishness of their employment, and the manner of their use, in the Roman basilicas during the eighth and ninth centuries. Though the employment of hangings seems to have had a considerable development about this time, the use was by no means new. Quite the same use of them is proved for the fifth century by the *Charta Cornutiana* (see below), which has the additional interest of describing the furnishing,



FIG. 177. — Part of a clavus in silk embroidery, from Achmim. Seventh century.

nner of their use, in the Roman basilicas during the eighth and ninth centuries. Though the employment of hangings seems to have had a considerable development about this time, the use was by no means new. Quite the same use of them is proved for the fifth century by the *Charta Cornutiana* (see below), which has the additional interest of describing the furnishing,

not of a metropolitan basilica, but of a country church. The use of hangings must, in fact, have been fairly well fixed as early as the fourth century; it corresponded to the requirements of the liturgies of that period. They became so necessary an accessory of church worship, of the Eucharistic service especially, that it is to be wondered that the Western Church was ultimately able so completely to dispense with them, and with the elaborate divisions between different classes of worshippers which they marked. The credit of discarding all of this paraphernalia, as well as for the abbreviation and simplification of



FIG. 178. — Some details of a scarf (stole?) of the seventh century. Linen with silk embroidery and patches of silk *appliqué*. The raising of Lazarus, the Crucifixion, Mary Magdalene at the sepulchre.

the Mass itself, is not due (as is lightly asserted) to the "practical genius of Rome," which had fallen completely under the sway of Oriental custom, but to the Northern peoples, particularly the Franks, to whom is due the character of Mediæval civilization, and from whom Rome herself had finally to borrow the very text of her liturgy.

The *Charta Cornutiiana* above mentioned is a document of very great interest to Christian archæology.¹ It is a deed of gift drawn up in the year 471 in favor of a village church in the neighborhood of Tivoli, near Rome. The donor, Flavius Valila, called Theodorus, bestows a piece of ground, silver utensils to the weight of about 54½ Roman pounds, bronze

¹ Printed by Duchesne in the introduction to the *Liber Pontificalis*.

chandeliers, and three sets of curtains (of silk, half silk, and linen), for high festivals, ordinary feasts, and week days. The *Charta Cornutiana* distinguishes covers and hangings. The covers (*pallea*, *mafortes*) were used upon the altar, upon the graves of the saints, and upon the tables. The hangings (*vela*) were used for all the purposes above enumerated. The various colors of "purple" (including green and a yellowish or whitish purple) are distinguished with a precision which argues a Classic refinement of taste hardly to be expected in that age.



Fig. 179. — Portrait in tapestry, from Achmim. About sixth century.

There are no ancient monuments which show so clearly the character of the early altar coverings as the sixth and seventh century mosaics of Ravenna, represented by Figs. 131 and 132. The altar here is a table standing upon four legs; it is covered on all sides by a white linen cloth, of which only the top and front are decorated. Figure 132 (sixth century) de-

picts a heavier and darker cover under the linen. The decoration is precisely such as we have found among the Egyptian textiles; it corresponds closely to that of the curtain illustrated in Fig. 176, and to a table cover from Egypt which is preserved in the museum at Vienna. We may see in these textile designs the origin of many of the stone reliefs of the subsequent period; for when the altar assumed a box form, by the insertion of plates of stone between the legs, the design common upon the altar covers was transferred to the stone, and this simple decoration was just as naturally extended to the screens of the choir and presbytery (Fig. 58).

Of far more importance are the curtains. The use of curtains at the doors (Fig. 135) is a matter which requires little comment. On the other hand, their use between the columns of the ciborium (Fig. 144), to hide from the people the most solemn acts of the Eucharistic celebration, appears strange to us, though it was thoroughly in keeping with the early ritual. The practice must have been all but universal, and probably as early as the fourth century. At all events, the earliest ciboria which have been preserved show arrangements for attaching curtain rods.

But this was only a single feature of an elaborate system for excluding the different ranks of the clergy and of the people from direct participation in the highest functions of the liturgy. In many churches of the fifth century which have preserved their ancient columns, one can still see the holes in the columns of the nave (on the nave side and above nine feet from the floor) for the insertion of curtain rods. Their position on the nave side was due to the fact that it was in the aisles the need of room was most felt, for it was there the laity stood, the men on the right and the women on the left. The fact that the aisles rather than the nave was allotted to the people is one of the indications that the church in the house was the pattern of the basilica, for the nave corresponds to the open and unprotected atrium. The use of curtains in this place seems likewise to reflect the custom of the private house. In the front of the nave, occupying about half of it, the choir and lectors — that is, the inferior clergy — had their place, which was architecturally marked by screens. Before them, across the whole front of the presbytery, was another row of curtains, depending from the columns which surmounted the balustrade of the sanctuary. Behind the choir was the place allotted to the various classes of catechumens, and still farther back, in the vestibule or without the door, were the penitents. We have to suppose, therefore, that another curtain was stretched across the nave in front of the catechumens, and that this was closed earlier than any of the others — unless we are to suppose that they had a position of greater dignity and privilege than even the baptized members of the church! This division of the nave is in some churches indicated by pillars which interrupt the lateral colonnades in front of and behind the choir

(Fig. 38). At a later period of the service we have to suppose that the curtains of the aisles were allowed to fall, cutting off the faithful from a view of the altar — a free space between the curtains and the architrave or arch still admitted light to the aisles. Afterward were closed the curtains which separated the choir from the sanctuary, and finally, the curtains of the ciborium. The way in which the curtains were hung — more particularly the way in which they were drawn — is very well illustrated by Fig. 143. In situations where freedom of passage was not required, they were simply knotted in the middle; in the doorways they were double and were drawn to each side by cords. In Fig. 143 a single curtain in a doorway is first knotted and then fastened to the door post.

Something of this mystery in ritual is still maintained in the Eastern Church; the Armenians use a curtain which is drawn across the front of the presbytery at the beginning of the Canon; in the Greek and Russian churches the curtain is replaced by the iconostasis, with curtains to close the central door.

Among the textile furnishings of the church no mention has been made of carpets, simply because there is no mention made of them in early texts. The mosaic floor amply satisfied all requirements of adornment.

VI

CIVIL AND ECCLESIASTICAL DRESS

THIS chapter has to do with the ordinary civil dress of the Christians during the first six centuries, as well as with the dress which toward the end of this period distinguished in some measure the clergy from the people, and which, persisting without essential change throughout all the changes in popular fashions of dress, became the distinctive liturgical garb of the Middle Ages. Ecclesiastical vestments cannot be understood apart from the study of the common elements of Roman civil dress out of which they sprung, and the traditions of which they continued. The two subjects are bound together still more closely by the fact that the distinction between the clergy and the people on the one hand, and between the different ranks of the clergy on the other, hardly became marked in the dress before the sixth century, and that not even then, nor for a long while to come, was the everyday dress of the clergy distinguished from that which they wore in the ministrations of the Church.

The Romans were accustomed to mark certain distinctions in rank by variety in dress, that is, by some special cut or adornment of the simple and universal constituents of Classic dress, rather than by the exclusive use of a particular garment. With the increasing luxury of the Empire, and with the change and variety of the fashions which were introduced, the early distinctions became more and more difficult to observe. But this very development of new types of dress, and the general introduction in the third century of Oriental garments which were entirely foreign to Roman use, constituted the basis for new and more thoroughgoing distinctions between the different ranks and professions. The law tried in various ways, and for the most part in vain, to regulate the use of new and foreign garments; and finally the sumptuary law of the

year 382 prescribed minutely the garments which might be worn by different classes, both indoors and out.

The Christians, of course, wore the same dress as the pagans. And as for the officers of the Church, there is no reason to suppose that they were distinguished from the people by any essential difference in dress until the middle, or more probably the end, of the fifth century. We have to suppose merely that the higher clergy, and especially the bishops, adopted in general a style of dress which comported with their social dignity.

However, by the end of the fifth century, under the influence of the Byzantine spirit of minute classification which prescribed a uniform for almost all classes in the Empire, clerical dress became distinctly and permanently fixed in its chief lines, marking the distinctions between the different orders of the clergy as well as between clergy and people. It became then such as we see it in the mosaics of the middle of the sixth century in Ravenna, and in those of a century later in the Lateran baptistery in Rome.

It must not be supposed, however, that this was a distinctively sacred dress, appropriated exclusively to priestly ministrations in the Church: it was the uniform of a particular class in the community — the clergy — who were thus distinguished just in the same way as were the courtiers, the soldiers, and other officers of the Empire who are represented on the same monuments. And though the clerical dress was then fixed upon lines which have been maintained without essential change to the present day, it was not at first so thoroughly distinctive as one might suppose; for it is clear that the chief garments of which it was composed — that is, the tunic, the pænula, and the dalmatic — were still, and for a long time continued to be, in common use. It must have been merely minor differences of shape, the conservation of an antique fashion, which marked the distinction of clerical dress at the end of the period which we have to study. It does not lie within the scope of this handbook to follow the modifications of this dress through the Middle Ages, still less to note the additions which were made to it. Such as we find the clerical dress at the end of our period, such it remained without substantial change. This persistence of the Classical mode of

dress is an interesting proof of the force of religious conservatism. Changes there undoubtedly were, but not so much in the form of the garments as in the whole conception of the significance of ecclesiastical vestments. They became more distinctive as the fashion of civil life adopted an entirely different costume. They acquired a new and sacred significance as the clergy themselves adopted for ordinary use a costume more consonant with the fashion of the times, and relegated the traditional dress exclusively to the sacred functions of the Church. And with this, as they ceased to be virtual garments for protection against rain and cold, their shape in some degree was altered, and their material and the character of their adornment were adapted to the new situation.

Such, in the most general terms, is the account of the origin and development of ecclesiastical vestments. The origin of every vestment of the Church was a perfectly natural and historical one. The symbolical explanations which from the ninth century were commonly given of them — of their very colors, fringes, and ornaments — have nothing whatever to do with their actual development. Such symbolism was, from the first, not only very elaborate and forced, but very various and contradictory: it was a case in which every one felt at liberty to please himself. But the explanations of the archæologist have commonly been hardly more to the point. There is no branch of Christian archæology in which there has reigned so much error, so much confusion and contradiction, as in the history of vestments. As a starting-point, the ecclesiastical vestments are thoroughly known in the form which they had assumed by the end of the Middle Ages. The error which has foiled most attempts to trace them back to their origins has been due, in part to a blind reliance upon the mediæval explanation and valuation of them, and in part to the preconceived notion that they are all alike to be traced back to primitive custom and to a primitive discrimination between religious and secular dress, or, as it used to be claimed, to the dress of the Jewish priesthood. But even when the problem has been approached with a fair appreciation of its terms, a detailed explanation of the origin of each vestment remained impossible as long as the testimony of the monuments, at least those of the early period, was all but ignored, and even the

common elements of Classical dress were but vaguely understood.

Wilpert¹ is the first who has made serious use of one of the most important sources of information upon our study, the paintings of the catacombs. They enable us to follow the history of dress from the beginning of the Christian period down to the Middle Ages. Their testimony is the more valuable because pagan paintings are so rare for the second, third, and fourth centuries. It is supplemented, however, even for this period, by both pagan and Christian sculpture; for a latter period, by the mosaics; and for the period which lies just beyond the range of our study, by the miniatures of liturgical manuscripts. The rich store of textiles lately found in Egypt, which has already been described in the previous chapter, is another source of information which is by itself sufficient to put before us an almost complete picture of the dress common in the Empire from the second to the seventh century. What has already been said on this score will serve to give an idea of the material, texture, color, and still more definitely of the adornment, of the several garments which we have now to study in detail.

Before taking up in detail the principal garments of the Classical period which explain the origin of the liturgical vestments of the Church, it is necessary to devote a few words to several important but subordinate elements of dress, both Classic and barbaric, which are represented on the monuments illustrated in this book.

It is well known that, according to Greek and Roman custom, men commonly wore no head-dress. In the act of sacrifice they covered the head with the border of the pallium or toga, and in the same way, perhaps, they protected themselves against the rain. It was only those who were especially exposed to the sun — as fishermen, farm laborers, and messengers — who wore a broad-brimmed hat (*petasus*) such as that with which Mercury is represented. A mere skullcap is worn by the fisherman on a sarcophagus in the Lateran (Fig. 94).

A head-dress of some sort was, however, worn by most of the barbarian peoples to the north and to the east of the Em-

¹In his *Capitolo di storia del vestiario*, and *Die Gewandung der Christen*, to which the present chapter is much indebted.

pire. On the Christian sarcophagi, in scenes from New and Old Testament alike, the Jews are distinguished by a close-fitting brimless cap (Figs. 95, 99). The same sort of cap was worn by some of the races of the North of Europe, and by two fossors as represented in frescos of the catacombs. This was the *pilleus* (πίλος), made of felt, leather, or wool, and used by those who were exposed to stress of weather, or by old men. S. Jerome, in thanking Paulinus of Antioch for the gift of such a cap, speaks of it as intended to warm his aged head.¹

For mere protection against the weather, nothing more was required than the hood which was attached both to the *pænula* and to the *birrus*. It is from this latter garment the monkish costume was probably derived — therefore also the academic gown and hood.

The most notable head-dress of ancient times was the Phrygian cap. Something similar, but rather formless and without decoration, was worn by the Dacians and Germans, as they are represented upon Roman monuments. The real Phrygian cap was conventionally used in Roman art to represent the costume of the extreme Orient. The Three Children and the Magi are therefore always represented in Phrygian garb (Figs. 68, 86, 89), as Daniel also often is. The Phrygian cap has a special interest in the history of ecclesiastical vestments; for, though no cap appears within our period as a part of the clerical dress, and though the development of a bonnet as the special insignium of the bishop belongs to the Middle Ages, it is from this pattern all such head-gear was derived, whether it be the episcopal mitre, the papal tiara, or the doge's hat.

For women, on the other hand, it was as much required by Græco-Roman custom that they should appear with head covered, as it was that men should be bareheaded. In early times the woman covered her head simply with the border of the *palla*. For greater convenience the veil was later introduced. There are a number of veils among the finds at Achmim which accord perfectly with the representations in the frescos of the catacombs (Figs. 15, 65, 66, 68, 70, 84, 124, 139). The veil was a rectangular cloth, — those from Achmim are of wool very lightly woven, — broad enough to cover the top and back of the head, and long enough to hang down for some distance

¹ Ep. 85, Migne XXII. 754.

in front of the shoulders on each side. The veil was properly the sign of the matron, but already in the third century it was used in the Church in the ceremony of dedicating a Christian virgin to God (Fig. 85). Among the pictures of the catacombs which represent a veiled woman it is usually impossible to decide whether the artist would designate the deceased as a matron or as a dedicated virgin; the inscriptions, which alone could indicate, have for the most part been destroyed.

The Classical foot-gear is seldom represented with enough precision either on Christian or pagan monuments to give an adequate idea of its character. The distinction most readily noticed is that between the sandal (*solea*, *σανδάλιον*) which went commonly with the pallium, and the shoe (*calceus*) which went specially with the toga and denoted the dignity of the Roman citizen. For women, modesty strictly prescribed the shoe. It has never been possible to understand the distinctions between the many different kinds of shoe which were in use and which are referred to in Latin literature, till the recent finds in Egypt (particularly the excavations which were conducted at Antinoë at the expense of the Musée Guimet of Paris and the Chamber of Commerce of Lyons), which have brought to light a great number of shoes of all periods, and illustrate unexpectedly the perfection of ancient leather work. These finds have not yet been seriously studied, and at all events they cannot detain us here. That other sorts of foot covering were common among the lower classes we see in the pictures of the Good Shepherd, who is represented with long heavy stockings which serve at the same time as shoes, or else with leggins made of a narrow band of cloth wound about the lower leg and fastened beneath the knee (Figs. 69, 162).

An article of apparel which must always be understood as accompanying the Classical dress was the breech-cloth (*cinctus*, *περίζωμα*), or the loin cloth (*ventrale*, *κοιλιάδεσμος*). Without at least such a garment, the law forbade any appearance in public; and when it is reported that certain martyrs were thrown naked to the wild beasts, it is still to be presumed that this garment was retained. The first garment was the more scanty, and was the same for men and for women. The clothing of the Baptist is limited to this in one of the pictures of the Sacrament Chapels, as is that of Daniel in several frescos of the fourth century.

The *ventrale* was a broad band of cloth so adjusted that the ends hung down before. In Classic art it was mostly attributed to fishermen; Tobias wears it in a fresco in the cemetery of Thrason.¹ Christ also wears it in some of the representations of the crucifixion (Figs. 108, 109).

The Romans expressly associated trousers (*braccæ*) with the costume of the barbarians. Very loose trousers tied at the ankle were worn by the Germanic tribes as represented on the Roman monuments. The Jews were represented on the Christian sarcophagi in a similar garment (Figs. 95, 99). A close-fitting pantaloon reaching to the ankle was a peculiarity of the Phrygian costume (Figs. 68, 86, 89, 139). But notwithstanding the prejudice against this article of dress, it became common in Rome in the third century, and was worn even by the emperors; at the end of the fourth a special law of Arcadius and Honorius prohibited its use within the city. Though this barbarous garment is the precursor of modern male attire, it needs no more notice here, as it has no relation to the development of ecclesiastical dress.

THE TUNIC

The composition of ancient dress is fundamentally a very simple matter. Out of an oblong piece of cloth, preferably of wool, taken just as it comes from the loom, and without any cutting, ripping, or stitching, one can reproduce completely the ancient costume, which was substantially the same for both men and women. The only fundamental distinction to be drawn is that between the under and the outer garment, and they both are formed from such a piece of cloth merely by a different manner of applying it and attaching it to the body. The under garment was closely fitting and securely attached, — later it came to be sewed. The outer garment was merely thrown about the body. They may be called respectively shirt and cloak — the most general terms to designate them in Greek were *ἔνδυμα* and *ἐπίβλημα*, or *χιτών* and *ἱμάτιον*.²

This describes as aptly the early Roman dress as the Greek.

¹ Garrucci, *Storia*, II. tav. 73, 2.

² Alex. Conze, *Die Antike Gewandung*, in *Teirichs Blätter f. Kunstgewerbe*, 1875, p. 62 *seq.*

Its application to the toga and pallium is at once evident; it is not so clear that it accounts for the different forms of the tunic or shirt. But, in fact, in its original form, the tunic (*tunica*, χιτὼν) was merely such a strip of cloth as has been described, of a width corresponding to the height of the person or the style of the garment (that is as it ended at or below the knee), and of a length just sufficient to wrap once around the body below the arms; — what is here called the length was of course the smallest dimension in the case of the *tunica talaris*. It might be fastened by two fibulæ above the shoulders, and again under the right arm, that is, on the side where the two extreme edges met. Substitute for the pins permanent stitches, and the garment had distinctly the form of a shirt without sleeves. The tunic of the laboring classes, particularly of slaves, commonly omitted one of these fastenings, leaving the right shoulder bare and the arm free. Such a garment was called *tunica exomis* (ἐξωμίς); it is represented in the catacombs as the dress of the fossors, and of the Good Shepherd in the earliest pictures (Figs. 19, 117, cf. 131, 132). The tunic was usually girdled (*tunica cincta*), and if the girdle might for convenience be laid aside in the house, respectability required that it be worn in public. In this matter, however, custom differed; the ungirdled tunic was the common habit in Africa, and was used sometimes in Rome under the Empire, where almost every foreign custom was represented. The *tunica laticlavata*, worn by senators, was properly ungirdled. The girdled tunic was both larger and longer than the ungirdled, to allow for the laps and folds, which must be arranged with much nicety — especially having a care that the *clavus* descend straight. The length of the tunic was regulated by the girdle; it must reach in front a little below the knees, and behind as far as the calves of the leg. Soldiers wore it shorter, and women longer, — down to the ankles (Figs. 7, 12, 66, 132, 133, 169).

The tunic was the indoor garment of the Roman; by itself it answered very well the practical requirements of dress, and to appear with it in public was counted, not indecent, but merely undignified. It took the place at once of our shirt and coat. It was usually of wool; or in Southern countries of linen, as in a later period it came to be frequently in Rome itself. Under it was commonly worn (besides a loin cloth or short

hose) a second tunic, or undershirt, of linen. S. Augustine, it is especially noted, wore a woollen undershirt. Augustus, with a still greater solicitude for his health, clothed himself in winter with a heavy toga, four tunics, an undershirt, a woollen chest cloth, short hose, and leggins. This was an abnormal case; but it shows, nevertheless, that the need of clothing was much more strongly felt by the Romans than the multitude of naked and half-naked statues would lead one to suppose.

Linen tunics were seldom colored, as the material does not readily take a dye. Those which are found in Egypt are commonly unbleached. We learn from literary references that it was the linen tunic especially which was adopted in the ministrations of the Church, at least by the fourth century. But whether of linen or of wool, it was commonly pure white. This color is the natural symbol of purity and light, and the New Testament itself expressly associates it with the dress of the saints in heaven. In the catacomb frescos, however, this symbolism is observed only in the case of the male figures, or more strictly the sacred personages, who were clad in pallium and tunic. In other cases the tunics are usually painted a yellowish or reddish brown, of a lighter shade, but of substantially the same coloring, as the dalmatic and the pænula. Far more exact and reliable information about the actual color of the garments is to be derived from the Egyptian finds. As has been said, most of the tunics found in Egypt were of linen; but even the woollen ones were in shades light enough to mark a strong contrast with the purple decorations, that is, with the clavus or with the border. The finest coloring is found in the tapestry decorations of the garments; the garments themselves were frequently of the natural color—yellow or brown—of the finer wools. During the Roman period the dyed garments, like the tapestry, were almost always in one or another of the various shades which were known as purple—dark carmine red, dark reddish brown, or shades which ran from violet to dark blue. By the fourth century, the Oriental luxury in color prevailed over the refined classic taste with the introduction of countless shades and combinations. Though the garment was still usually of one solid color, the tunic and dalmatic were not infrequently embroidered all over, or stamped, with flowers or

conventional designs. The purple toga embroidered with gold was the special insignium of the consul.

But the characteristic decoration of the tunic, and later of the dalmatic, was the *clavus*—a strip which crossed each shoulder and descended both before and behind as far as the bottom of the garment. Already in the previous chapter enough has been said of the character of the embroidery, or rather tapestry, which constituted the *clavus* (p. 372). It is well known that the narrow *clavus* was worn by knights, and the broad *clavus* by senators; but these distinctions of rank could hardly have been rigidly observed in the Christian period, for the narrow *clavus* at least was the usual adornment of the tunics which are found in Egypt, and after the fourth century female characters are frequently represented in the art of the catacombs with the broad *clavus*. For the first three centuries, too, it was invariably of purple; so that even this color did not mark very definitely distinctions of rank. The form of *clavus* which we find most commonly on the Egyptian textiles, instead of extending to the seam, ended with some appropriate terminal ornament about the middle of the garment. Still later it became even shorter; it took in fact an entirely different character, extending barely to the breast, and terminating with a round or leaf-shaped finial. In this ornament we have the so-called *lorum*, which represented the straps for the support of the soldier's cuirass; it was, therefore, used only on male garments, and, like our shoulder straps, was a sign of rank, different grades being distinguished by the number of the stripes (*tunicæ monolores, dilores, trilores, etc.*). The dalmatic, which later came into fashion and covered the tunic, was simply a different variety of the same garment, and the characteristic decoration of the tunic, which was no longer visible, was readily transferred to it. In revenge, the tunic became more richly ornamented at the borders, which were still visible; that is, about the neck, about the wrists, and at the bottom. The *segmentum* (Figs. 170, 172, 179, 181), was a round, square, or irregular figure in tapestry applied at the lower corners of the tunic (afterward to the dalmatic) and above the shoulders. The *segmentum*, in this form or in the shape of a letter, constituted the only ornament of the *pallium*; it was used only at the four corners (Figs. 135, 138). These ornaments have

an interest in the history of church vestments only as they survived as the decoration of the dalmatic; the tunic as it was worn in the sixth century was often figured all over with a small design regularly repeated, but it retained none of its earlier characteristic adornment except the embroidered border.

Under the Empire the tunic was generally worn with sleeves, usually loose and covering no more than the upper arm. The tight, long sleeves reaching to the wrist was an Oriental fashion (therefore worn by the Magi, etc., Figs. 68, 95, 132). It was regarded as effeminate by the Romans, but it came, nevertheless, into common use before the third century. To the long sleeves there usually corresponded the long tunic (*tunica talaris*), reaching to the ankles. This was likewise accounted effeminate by the Romans at the end of the Republic, as it was properly the woman's dress; but despite this contempt it was represented as the garment of gods and heroes, and under the Empire it seems to have been accounted a dress of special dignity. This was so at all events in the fourth century, for on the arch of Constantine the Emperor and his court are represented in the long tunic, while the short tunic is the dress of the people. In the second-century fresco in S. Priscilla which represents the Breaking of Bread the bishop or presbyter wears under the pallium the *tunica talaris* with long sleeves (Fig. 74); and the famous statue of S. Hippolytus (Fig. 118), which was executed at the beginning of the third, reproduces the same dress. The tunic, substantially with the same form and with the same decoration, was the dress alike of pagan and Christian, of clergy and laity; but to judge by the above instances it would seem as if the tunic of the higher clergy may very early have been differentiated from the common dress in the single respect that it was longer. Long it certainly was for all the clergy alike after the fourth century (Figs. 134, 142), for the long tunic was then the dress of the better classes. This was the form it retained during the Byzantine period, and it suffered no modification till late in the Middle Ages.

Both literary references and the mosaics represent that the tunic which was worn in the ministrations of the Church—whether of linen or of wool—was commonly white. The name "alb" (*alba*, — *tunica alba*) it bore from an early time, though it was only in the late Middle Ages that the adjective quite

superseded the noun. Though S. Jerome writes that "the holy religion has one dress for divine service and another for everyday use," he cannot be supposed to intend any difference in form. This is proved, quite apart from the monuments, by the rules which it was found necessary to make till well into the Middle Ages against the use of the everyday tunic in the services of the Church, as well as against the use of the liturgical tunic apart from such services. The difference must have been a very slight one, much like that between our Sunday and our workday clothes. In fact Jerome himself declares explicitly how he would have the difference understood, when he says in the same connection: "that we ought not to enter the holy of holies with everyday clothes, but with a clean conscience and with clean clothes to administer the sacraments of the Lord."¹

THE DALMATIC

The dalmatic (*dalmatica*, *δαλματική*) is substantially nothing more than a particular variety of the ungirdled tunic. It was not, however, one of the original Roman garments, but, as its name indicates, a foreign importation. The Dalmatians were in Classical times, as they are now, famous for the rich and skilful decoration of their garments. It is interesting to observe that they have preserved the same technic of figured tapestry which we have studied in connection with the Egyptian textiles. The dalmatic was, therefore, from the first a richly ornamented garment; it not only took over the characteristic ornaments of the tunic, but its whole surface was frequently woven or embroidered in design. The tunic which was especially associated with the dalmatic was the long-sleeved *tunica talaris*. The dalmatic as it was worn by men extended barely below the knees, leaving visible the bottom of the tunic; its large neck opening and short loose sleeves left also the sleeves and collar of the tunic visible, so that both garments can be recognized at once in pictorial representations. The woman's dalmatic reached to the ankles (Fig. 15), and after the fourth century even to the ground; the sleeves were larger and sometimes fringed. Just as in the case of the tunic, the male costume was finally assimilated to the female, not only in length,

¹In *Ezech.* 13:44.

but in the exaggerated largeness of the sleeves. It is this late form of dalmatic which is represented as the clerical dress in the mosaics of the sixth and seventh centuries, and such it remained throughout the Middle Ages (Figs. 134, 142, 181). The one feature of the dalmatic which was not subject to change was the purple clavus, which extended both before and behind as far as the seam. The clerical dalmatic was usually white.

The dalmatic came into use in Rome about the end of the second century; it is specially remarked that Commodus appeared with it in public, and the imperial example must soon have found many imitators. It was particularly well adapted for the rich decoration which became the fashion of dress in the third century, for, though distinctly an outer garment, to be laid aside in the house, it was by no means a storm coat; over it could be worn in cold or wet weather the toga, the pallium, the pænula, or the lacerna. So, for instance, on the consular diptychs the *toga picta* is worn over a richly embroidered dalmatic; and in the episcopal dress the dalmatic was worn under the pænula. The earliest example of the latter is furnished by the figure of S. Ambrose in a mosaic in Milan, which must have been executed immediately after his death (397), and which is the earliest representation of a bishop which exists. We have later examples in the mosaics of Ravenna (Figs. 134, 142, cf. 181) and in the fresco at the tomb of Pope Cornelius (Fig. 180).

The dalmatic might be of linen or of wool. The material perhaps varied with the season, but to judge by the garments preserved in Egypt it was much more commonly of linen, which was often woven heavy enough even for a cold climate. In the case of a linen garment the figured decoration in tapestry was woven into the cloth itself, whereas upon a woollen garment it was merely *appliqué*.

The earliest monuments which picture the dalmatic as the dress of the deacons are the mosaics of Ravenna of the middle of the sixth century. It is probable that it was much earlier appropriated to this order. The *Liber Pontificalis* ascribes to Sylvester the regulation that deacons should wear the dalmatic in the church. This testimony is not of much force, though it is not inherently improbable. In the *Life of S. Cæsarius of*

Arles it is related that on the occasion of the visit of the saint to Rome there was given to him by Pope Symmachus (498-519) the privilege of wearing the pallium, and to his deacons that of wearing the dalmatic, as was the custom in the Roman Church. From this it appears that at the latest about the turn of the fifth and sixth centuries the dalmatic was worn by the deacons of Rome, and the monuments above referred to prove that it must very soon after this have been generally adopted. We have seen that it was also worn by bishops; in this case it was somewhat shorter and more nearly after the early pattern. So general was its use by the bishops that S. Isidor of Seville actually calls it the "priestly tunic" (*tunica sacerdotalis candida cum clavis ex purpura*). The word *sacerdotalis* may here possibly include presbyters. Walfried Strabo relates that in his time the dalmatic was worn even by "some priests," but this could only have been by way of exception and in the case of persons who occupied posts of special dignity.

PÆNULA — CHASUBLE

Between the forms of shirt which we have already studied and the different forms of mantle which we have still to consider, stands the *pænula* (*φαινόλης, φενόλης, φαινόλιον*, — later *casula*, chasuble). It presents a somewhat striking contrast to the early type of classical dress; it seems probable, however, that it was not a foreign importation, but a development out of some common garment of the laboring classes. It was distinctly an outer garment, or more expressly a storm cloak. It was made of heavy woollen cloth — more rarely of leather. Originally it may have been, like the pallium or the early toga, a rectangular blanket; but, instead of being wrapped about the body, the head was thrust through a hole in the middle of it, and the body was snugly covered up as under a little cabin (*casula*). It was commonly broad enough to cover the shoulders, and long enough to reach below the knees before and behind. It was manifestly a most practical rain cloak, and precisely such a mantle is now commonly worn by tourists in the Alps. A number of *pænulas* of this form have been found in the graves of Achmim; and the same form, but with considerable variety in respect both to width and length, is repre-

sented on some of the classical monuments. This type is similar to the "fiddle-back" chasuble of the late Roman use, or still more closely to the Benedictine scapular. But the form used by the clergy after the fifth century — and we may suppose that it was the same which was common to all the higher classes — had a much more dignified appearance. It was round or elliptical in shape, falling down on each side well over the arms, the same shape, in fine, which was used in the Church throughout the Middle Ages.

The Roman monuments represent numerous varieties of the pænula which need not be

particularly described here, since they have no relation to the specifically clerical type. The various cuts of pænula which are represented as the soldiers' dress may have been distinctive of different regiments. The pænula commonly worn by the



FIG. 180. — Pope S. Sixtus and the Bishop Optatus (clothed in long-sleeved tunic, dalmatic, pænula, and sacred pallium). fresco above the tomb of Pope Cornelius, in S. Callistus. Sixth century.

lower classes in the fourth century barely covered the shoulders, and narrowed to a point at the bottom. A type which Wilpert calls the "baroque" pænula is witnessed to in ancient times only by the frescos of the catacombs; it is very long and full behind, but the front part is reduced to a small triangle which barely covers the breast. Curiously enough, a similar form appears to have been in use, at least occasionally, in the eleventh century, for it is represented in a picture of this date in the lower church of S. Clement. The Roman monuments lead one to suppose that the pænula was ordinarily provided with a hood (*cucullus*). This was a natural adjunct to a rain cloak; and it is equally natural that the Egyptian pænula is without it. Even after the garment became a mere liturgical symbol, a vestige of the hood was preserved in the adornment—just as it is on the cope.

The pænula was always dark in color; the paintings of the catacombs, the mosaics, and literary references agree in showing that it was usually a chestnut-brown. The Egyptian pænulas are commonly brown or purple. It was usually of a solid color and without ornament, though the narrow rectangular form was occasionally adorned with the clavus.

The pænula must have come into common use before the beginning of the Christian era. It was, at first, not a garment for ordinary use, but expressly for rain and for travel. It is not strange therefore to find that it was worn by S. Paul,¹ who was always on a journey. We learn from the author of the book *De Oratoribus* that about the middle of the first century it was something quite new for it to be worn instead of the toga by advocates in the forum. Not even the zeal for the conservation of the old customs could hinder its popular adoption, and by the fourth century it had superseded for all practical uses the toga and the pallium. The sumptuary law of 382 permits its use even by senators, though in the conduct of all public business they must still wear the official toga. The pænula of the clergy could have differed at the most only in cut from that worn by the people.

It was certainly the full, round pænula which was worn in the church and out of which was developed the Eucharistic vestment, as we see in the mosaic portrait of S. Ambrose (cf.

¹2 Tim. iv. 13.

p. 395). We have a still more weighty testimony in the incident which is related by Sulpicius Severus¹ about S. Martin of Tours (†397). This is the familiar story of the beggar to whom S. Martin gave his shirt. But, besides illustrating the charity of the saint, it informs us that he was accustomed to celebrate the Eucharist in a tunic and *amphibalus* — that is, the broad round pænula. What is actually related is, “The saint, without the poor man seeing it, drew out his tunic from under the amphibalus and sent him away clothed.” Such a feat could have been accomplished secretly only under a mantle of this sort, and it is evident that it could be accomplished at all only in case the tunic were fastened above the shoulders by means of pins, according to the earlier fashion (see p. 390). That this was the shape of the pænula in the sixth and seventh centuries is abundantly clear even from the examples which are furnished in this book of the paintings of the catacombs (Fig. 180), and from the mosaics of Ravenna (Figs. 134, 142) and the Lateran Baptistery (Fig. 181).

The pænula was worn by women as well as by men (Fig. 144).

THE CHLAMYS

Before describing the characteristic Classical mantles, the pallium and the toga, which it will be necessary to discuss at greater length, it is well to dispose of the two Oriental mantles which were introduced into Rome in imperial times: In the first place, of the *chlamys*, a Phrygian cloak, which is frequently represented on the Christian monuments, though it never formed a part of the ecclesiastical dress. In the second place, of the *lacerna* or *birrus*, which is but rarely represented on our monuments, though it finally, in an advanced period of the Middle Ages, developed into an ecclesiastical vestment — namely, the cope.

The *chlamys* (*χλαμύς*, *sagum*, *paludamentum*) was distinguished from the pallium merely by its smaller size and by the manner in which it was worn: namely, by bringing together two corners of the oblong piece of cloth over the right shoulder and fastening them there by means of a clasp-pin. It was especially a soldiers' cloak; and this explains the fact that it

¹ *Dialog.* 2, 1.

was with a scarlet "chlamys"¹ the Saviour was clad by the mocking soldiers; — it was precisely the garment which the soldiers might be expected to have at hand. But the chlamys was also used in civil life (Fig. 169), and it survived, though in a much longer form, in the Byzantine court dress (Figs. 134, 181). It was originally an Oriental (Phrygian) garment, and therefore appears in the representations of the Magi (Figs. 68, 89) and of Orpheus. As a soldiers' cloak, it is worn by the Israelites in some of the later frescos which depict the miracles in the wilderness.

The long chlamys — called *paludamentum* — was worn, not only by courtiers, but by the emperor, the purple color being distinctive of the latter (Fig. 134). The large square patch on the front of it was called the *tablion*. This garment was worn by no women except the empress.

LACERNA — BIRRUS

Another foreign mantle, the *lacerna*, was introduced from Asia into the Roman army by Lucullus. It was worn by army officers for storm or travel; it appears even to have been worn outside the toga as a dust or rain cloak. But in spite of such use it was distinctly an article of luxury, and it was regarded often as a sign of reprehensible elegance in dress. We know that it was a woollen garment of dark color but peculiarly light in weight; it was fringed at the bottom, and in the West it was sometimes provided with a hood. Unlike the chlamys, it was fastened, not at the shoulder, but in front of the breast by a strap with two buttons, or by a round breastpin; that is, it was worn just as a shawl is, and the Persian shawl was probably the pattern and origin of it. So worn, it descended below the hips, though in later use it came to be very considerably lengthened. The only certain representation of the *lacerna* in the catacombs is a sixth-century fresco in the cemetery of Pontianus. It adorns the tomb of the Persian saints, Abdon and Sennen, and it represents the saints in their national costume. It is also worn by Melchizedec in two of the mosaics at Ravenna (Figs. 131, 132).

The *lacerna* is sometimes identified with the *birrus*. Though

¹ Matt. 27 : 28.

they must have had the same form, they probably did not have the same origin. The birrus was a heavy winter garment, and it is likely that it was always provided with a hood. With the decay of the Western Empire such shawls naturally ceased to be imported from the far East; as they became articles of home manufacture the difference between the lacerna and birrus must have disappeared, and the first garment must have lost its character of exotic luxury. It is only thus one can explain the fact that such a garment became later a very mean dress indeed, and is represented in mediæval miniatures as the habit of monks and nuns. It had another history in the Church, however, for it was developed in the Middle Ages into an ecclesiastical vestment, the cope (*cappa, pluviale*). As the name *pluviale* indicates, it was a rain cloak, as the chasuble also was in the beginning. It could not have come into use as an ecclesiastical vestment till the pænula (chasuble) had ceased to be a practical garment, and no longer furnished sufficient protection against the cold and inclement weather which might be encountered during the processions and other functions held out of doors. This development lies, however, entirely beyond our period. There are no pictorial representations of the cope in ecclesiastical use earlier than the eleventh century. It retained its fringe till the fourteenth century; a mere vestige of the hood it still retains in its conventional decoration.

THE TOGA

The characteristic outer garment of the Roman was the toga. It was the distinctive dress of the Roman citizen, and stood for the exclusive privilege of the ruling class; whereas the pallium, which was the dress of all peoples of Greek stock, and was in use throughout the East wherever the Greek culture was felt, represented the cosmopolitan aspect of the Empire. It is probable that the toga was originally, like the pallium, a mere rectangular strip of white woollen cloth used just as it came from the loom. Under the Empire, however, when the mode of arranging the toga became a matter of serious importance and was accounted almost a fine art, its cut varied considerably with the fashion. Under the early Empire it seems to have had the form of an ellipse, from eight to ten feet in its

smaller diameter and nearly twice as much in its greater. Before it was put on it was folded double along its greater axis ; then one end was thrown from behind over the left shoulder, and allowed to fall in front almost to the ground. The length which remained behind, equal to about twice the human height, was drawn from under the right arm in front of the body and again thrown over the left shoulder, where it was fastened by the *nodus*. The real labor, however, began at this point, in arranging the folds of the *sinus* and adjusting the whole garment according to the mode.

Dignified as this garment was, it was very far from being practical, and it was no doubt the cumbrousness of the toga which prompted the use of the dalmatic and the pænula. Even in the second century it seems to have gone out of common use in Italy outside of Rome. By the fourth century it was no longer worn by the people, nor even by the magistrates except in the exercise of public functions. At the end of this century it was prescribed as the public dress of the senators ; at a later period its use was limited to the consul, and with the last consul it disappeared. The toga which survived the fourth century was, therefore, not the plain white garment of the people, but the *prætexta* of the senators, which was distinguished by a broad purple border, and the late consular toga, which was made entirely of purple silk heavily embroidered in gold.

During the course of this history the toga underwent very marked changes. It is supposed that in the second century it was cut in the form of a half circle, though without any striking change in the mode in which it was worn. But already by the beginning of the third century it was subjected to a system of plaiting or folding (*contabulatio*) which quite altered its character. This change began with an artificial folding of the part of the toga which was drawn across the breast, so that it was made to assume the appearance of a mere flat band (*tabula*) of barely a foot in width (Fig. 98). This *contabulatio* was finally extended to the end which hung down before the left shoulder, and indeed to the whole course which the toga originally followed, so that the body was not clothed, but merely wrapped once about with a narrow band. The result was that it had to be wrapped around once again, unfolded

and in its natural fulness, and the end, instead of being thrown again over the left shoulder reposed upon the left forearm. Such a development was favored by the fact that the toga was no longer practically required as an outer garment, since the dalmatic, or even the pænula, was worn under it.

Such is the form the toga had assumed as we see it on the reliefs of the arch of Constantine, or more clearly on the early consular diptychs. The latest diptychs represent a further change in the mode of wearing it, which was probably due to the exceeding stiffness of the embroidery in gold and precious stones which decorated the so-called *toga picta* of the consuls. When with the last consul it ceased to be worn in the West, it survived in the Byzantine court as one of the imperial insignia, the *lorum*. This, however, was nothing more than a vestige of the original toga, a mere scarf thrown across the shoulders.

It would be altogether aside from our purpose to describe in more detail the last developments of the toga, for it is a garment which has but slight claim upon our notice in this connection. Though it was, of course, worn by many Christians in Rome, it was never a distinctively Christian dress, and has no relation to any of the ecclesiastical vestments. In the pictures of the catacombs the toga has hitherto been recognized in but one instance. This fact is doubtless surprising, but it is explained by what is said in the next section about the pallium and the preference of the Christians for it. The brief remarks which have been here dedicated to the toga have been made expressly for the purpose of illustrating the fashion of the *contabulatio*, which was applied also to other garments, and explains—according to Wilpert—the origin of the sacred pallium of the bishops and the stole of the priests and deacons.

THE PALLIUM

While the toga was the badge of the Roman citizen, the pallium represented the cosmopolitan aspect of the Empire. Though originally it was the distinctive Greek mantle, its use was finally disseminated as broadly as the Greek civilization; and, worn without the tunic, it became especially the badge of learning and philosophy. It was, therefore, clearly more apt

than the toga, the badge of national privilege, to express the cosmopolitan spirit of Christianity; and the fact that it was worn by Christ and his Apostles, and in a certain sense sanctified by such use, constituted, no doubt, an additional explanation of the Christian preference for it. In comparison



Two soldiers in tunic and paludamentum (adorned with the tablion). S. Asterius, priest, in dark tunic and pænula, S. Anastasius (cleric?) in white tunic and yellow pallium.

FIG. 181. — Mosaic in the Chapel of S. Venantius, Lateran

to the toga it was a very simple garment; convenience and utility are bound to count for something even in the question of dress, and it is therefore not strange that the pallium partly superseded the toga even in Rome itself. On the other hand, the still greater convenience of the dalmatic and the pænula accounts for the subsequent disappearance of both toga and

pallium, or rather their transformation into mere ornaments and insignia.

The pallium, like the toga, was a woollen garment, usually white. It was without decoration, except at the four corners, which were ornamented by designs in tapestry. The pallium



S. Maurus, bishop, in white tunic and dalmatic, dark panula, and sacred pallium; S. Septimus, deacon, in white tunic and dalmatic, again two soldiers, or courtiers.

Baptistery. Middle of the seventh century.

was merely a rectangular piece of cloth, three times as long as broad, and it was wrapped about the body in a very simple and natural manner. It was commonly worn as follows: one-third of the stuff hung down in front of the left shoulder to the knee and enveloped the upper arm; the remaining two-thirds was drawn across the back, under the right arm, and

across the front (enveloping the whole body to the ankles), and again thrown over the left shoulder, where it had to be fastened with a pin, or simply over the left fore arm (Figs. 96, 118, 119, 140).

The pallium was commonly worn over the tunic, but the philosophers expressed the simplicity of their life by wearing it without a tunic, leaving the right shoulder bare after the manner of the *tunica exomis*. It was so worn by Justin Martyr and several other Christian teachers, and it is occasionally attributed in the pictures of the catacombs to sacred persons; namely, to Moses (Fig. 73), Isaiah (Fig. 84), and Christ (Fig 71).

The high estimation in which the pallium was held by the Church is sufficiently indicated by Tertullian's remarkable tractate, *De Pallio*. Half in earnest and half in jest, with his characteristic exaggeration, he exalts the superiority of the pallium at the expense of the toga. Whereas the toga was worn by all sorts of evil men, the pallium clothes especially men of learning — "Every liberal study is covered by my four angles," he makes the pallium boast. He addresses himself to his Carthaginian fellow-citizens without distinction of religion, and it is only at the end that he gives expression to his Christian profession in bestowing upon the pallium the last meed of praise: "Rejoice, O pallium, and be glad, a better philosophy has taken thee into her service since thou hast begun to clothe the Christians."

Still more significant of the Christian preference for the pallium, and of its prevalence in the Church, is the fact that the toga is but once represented among all the pictures of the catacombs, whereas the pallium appears very frequently from the beginning of the second century until the fourth, and was employed by the artists in representing Biblical and sacred characters, even after it had ceased to be actually used in common life. In the catacomb paintings Christ and the Apostles are always represented with the pallium, Moses usually is, and frequently Abraham. It is the usual dress of Biblical characters, with the exception of those which symbolize the faithful departed (Daniel, Noah, Job, etc.). The pallium represented official dignity in the Church, and was not ascribed in Christian art to the ordinary layman.

The woman's mantle was not essentially different from the

man's; the *palla* was similar to the pallium, but of a lighter texture. In Classical times the border of the *palla* was drawn over the head for a veil. The veiling of the woman's head was no less prescribed by Christian custom, but in Christian times a separate veil-cloth was commonly used. Wilpert shows that the *palla* was affected by the fashion of *contabulatio* in much the same way as the toga. This is proved by a number of Roman statues, and the first stage of the process (which affected only the end which depended in front) is illustrated by the dress of Veneranda in Fig. 70.

THE PALLIUM SCARF

Between the ancient Greek pallium and the collar which is worn by Roman archbishops there would seem to be nothing in common but the name. The name, however, naturally suggests that there was a substantial relation between them, and Wilpert's first and most fundamental contribution to the study of ecclesiastical dress consists in the proof that the pallium scarf was derived from the pallium mantle. To judge fairly Wilpert's position one must refer to his own statement of the case in *Un capitolo di storia del vestiario*; only a brief abstract of his argument can be given here. A number of links in the chain of monumental evidence are lacking, and the proposition is therefore incapable of rigid demonstration; but Wilpert's presentation of the case is conclusive enough to insure general assent.

Wilpert was not led into this theory merely by the suggestion which was furnished by the common name. His studies in the catacombs led him to the discovery of the high and almost sacred estimation in which the pallium was held in the early centuries of the Church, as evidenced by Christian art. This raised the presumption that the garment which had been appropriated in a peculiar manner as the Christian dress, which had been worn by Christ and his Apostles, and was attributed in Christian art only to the most sacred Biblical characters, would not be lightly discarded. From a practical point of view, however, it had been rendered superfluous by the introduction of the wide *pænula*. The fashion of *contabulatio* which transformed the *palla* and the toga suggests the means by which

the pallium also might have been retained in its place of honor, though serving a merely emblematic use. In fact, given the prevalence of this fashion, and supposing that there was a disposition to retain the pallium in addition to the pænula, it could only have ended by becoming just such a scarf as we find in use in the sixth century. That is to say, it could only be worn as *pallium contabulatum* over the pænula. This had as a consequence a slight alteration in the manner in which it was worn; as the broad pænula did not permit the *pallium contabulatum* to be passed under the right arm, it had to be carried across the right shoulder. It lay, therefore, across both shoulders, and it is very aptly called by the Greeks *ᾠμοφόριον*. The pallium scarf was worn in the following manner: the mantle being folded into a strip, one end was thrown from behind over the left shoulder, so that about a third was allowed to hang down before; another third was carried in a deep curved line across the back to the right shoulder, and thence in a similar curve across the breast to the left shoulder, allowing the remaining third to hang straight down the back. In order to hold it all in place it had to be fastened to the pænula by three pins—at the back and front and upon the left shoulder.

A further confirmation of the close relation between the mantle and the scarf consists in the fact that the latter has always been made of the same common material, namely, white wool; and that till the seventh century its sole decoration consisted in two black crosses at its extremities. The two crosses correspond exactly to the conventional decoration in tapestry which was applied to the four corners of the mantle—only two of them would of course be visible when the mantle was folded. It has already been remarked that letters very often appear as a decoration for the corners of the pallium. In the catacomb of Thrason there is a fresco of the fourth century representing Moses with a pallium which is decorated at the corner by a cross. One may reasonably suppose that after the fourth century the cross must have been very commonly used in this way. Wilpert has shown by experiment that a light woollen pallium may readily be folded in the form of a scarf with precisely the effect which it has in the representations of the sixth century.

The episcopal pallium is represented in its original form in

the cemeterial fresco of the middle of the sixth century which is given in Fig. 180. It is several times represented in the same form upon the mosaics of Ravenna, and when in the case of these mosaics the crosses are multiplied beyond the original number, the anacronism must be ascribed to the restorer. During the seventh century the pallium ceased to be folded and became a mere strip of cloth of single thickness. It also suffered a marked change in the manner in which it was worn. To avoid the necessity of pinning it to the dress, it was made simply in the form of a circle with long pendants before and behind. It was ornamented at the same time with more numerous crosses. Late in the Middle Ages the pendants were so much curtailed that only a vestige of them remained. Yet, notwithstanding such fundamental changes, the Roman pallium remains a signal example of the persistence of ancient custom, for not only is it still made of white wool and ornamented solely with crosses, but—without any consciousness of the reason—it is made with a double thickness above the left shoulder, over which the original mantle was twice thrown. The Oriental pallium, which has remained nearer to the original in form, has departed farther from it in material and decoration; its material is generally silk, and though it is still ornamented solely with crosses, it is covered with them from end to end.

The earliest reference to the episcopal pallium is by S. Isidor of Pelusium († 440), who already finds in it the symbol of the spiritual authority and watchfulness which the bishop, in imitation of the Good Shepherd, exercises over his flock. He informs us also that at the Eucharist, when the moment came for reading the Gospel, the bishop was accustomed to lay aside the pallium, as then the Lord himself, the chief shepherd, spoke directly to his people. This symbolical interpretation, and still more the liturgical practice which is here instanced, presuppose that the pallium must have been in use for at least a considerable time. Wilpert supposes that the Christian use of such a scarf influenced the sumptuary law of 382, which prescribed a *pallium discolor* (evidently a mere scarf) as the badge of civil officials.

S. Isidor speaks of the pallium as a badge common to all bishops,—as indeed it was in the East. In the West it has

been regarded since an early time as a distinction which could be conferred solely by the Pope, and since the ninth century it has been limited to metropolitans. It is doubtful, however, whether even in the West it represented originally a distinction of the Roman bishops, and not rather a usurpation of common rights.

THE STOLE AND THE MANIPLE

The fashion of *contabulatio* furnishes again the explanation of the development of the stole and maniple, as ornamental insignia of office, from the towel or napkin which was the natural adjunct of the practical and somewhat material service which characterized the office of deacon. Here again the Christian monuments fail to furnish any illustration of the unfolded towel upon the shoulder of the deacon, or of the stages of development between that and the narrow band of cloth as we know it to-day. On the other hand, pagan monuments offer sufficiently full illustration of such a towel borne upon the left shoulder of *camilli* (youths who ministered at the sacrifices) and *delicati* (table servants), and of the *contabulatio* which this *mantele* or *linteum* underwent, notwithstanding its strictly practical purpose. A considerable number of these monuments are reproduced and studied in Wilpert's work. (*Un capitolo di storia del vestiario*, Pt. II.) They present a striking analogy to the stole; they reveal that the *linteum*, which during the early period of the Empire was on one side rough (*villosum* — perhaps like Turkish towelling), was later made of fine linen, which permitted it to be neatly folded, though it never quite lost its practical utility, as did the stole.

Such a towel was evidently demanded by the deacon's service, which in the early period was of a far more material character than it is to-day. Part of the support of the clergy consisted in offerings in kind, which were received by the deacon, and out of which he had to separate the bread and the wine for the Eucharist. At the Eucharist itself the utensils which had to be cleaned were much larger, as the consumption was much greater than at present, and then as now the deacon had to reach the celebrant the water and towel for the washing of his hands. The fashion of *contabulatio* sufficiently explains the development of the scarf from the towel, and like the towel it

continued to be worn, in all churches except the Roman, upon the left shoulder. Already by the end of the fourth century it seems to have become a mere liturgical distinction, for the council of Laodicea forbade its use to subdeacons and the inferior clergy, notwithstanding that the more menial parts of the deacons' service had actually been devolved upon the subdeacons. As a matter of fact, a special cloth suitable to his service was provided also for the subdeacon. A miniature of the tenth century in the pontifical of Archbishop Landulfus of Beneventum represents the ordination of subdeacons, who receive from the bishop the chalice and paten, and from the archdeacon a pitcher and bowl. The accompanying rubric states that they also receive from the archdeacon what the picture fails to represent, namely, a napkin (*manutergium*).

The name stole, which was not used within our period and can hardly be said to have been in general use before the eleventh century, has done more than anything else to obscure the origin of this vestment. Its proper title is *orarium*, a name which was merely transliterated into Greek (*ὠράριον*). It is derived, not from *orare* (to pray), but from *os* (the mouth); it is a name therefore which obviously indicates the character of this towel. The two earliest church writers who mention this vestment are S. Isidor of Pelusium (*Ep.* I. 136) and the author of the sermon (ascribed to S. Chrysostom) *In parabolam de filio prodigo*. They both call it *ὀθόνη*, *linteum*, which corresponds to our towel. It was worn by deacons upon the left shoulder; the one likens it to the towel with which our Saviour washed the Apostles' feet, the other sees in it a likeness to the angel's wings.

The stole worn by presbyters and bishops had another origin, and one which explains the different modes in which it was worn. It also was called *orarium* by the Latins, but by the Greeks, more significantly, *περιτραχήλιον*, *ἐπιτραχήλιον*. Unlike the *linteum*, it was of white wool or colored silk; it naturally took the form of a scarf, and it must originally have been worn, as it is to-day, around the neck and under the chasuble, for it was properly a neck-cloth. One must remember that the dalmatic and the pænula had apertures too broad to afford any protection to the neck, and that even the tunic was without a collar. It is evident that it must often have been necessary to

protect the neck from the cold, and it appears, too, that a sense of decency, or at least of dignity, prescribed that the neck be covered. A neck-scarf was not an uncommon element of dress

about the end of the Empire, and from that is derived the *orarium* of presbyters and bishops. When the deacon's *orarium* had become a mere ornamental scarf, it differed from that of the presbyter only in the mode in which it was worn, and consequently in the ordination of priests it was only necessary to alter its position. The earliest representation of the episcopal stole is offered by a mosaic of the first half of the sixth century at Ravenna. Presbyters generally wore the stole in the same manner as the bishops; the practice of crossing it upon the breast is ancient, but did not come into general use till a late period.

The monuments prove that the commoner mode of carrying the serving towel was upon the left shoulder; but that was manifestly not the only way it could be carried, and the monuments also show it carried over the forearm. This very natural diversity in the mode of carrying the napkin or towel explains the origin of the maniple, which was at first worn exclusively by the Roman deacons, afterward extended to the superior orders, and finally came into general use throughout the West. The Roman deacons did not wear the stole till the Middle Ages; they had in the dalmatic a dress which sufficiently distinguished their office. But for their practical ministry they needed the *orarium* no less than the deacons of other churches, and they actually carried it, according to a disposition which may have been purely accidental, not upon the shoulder, but upon the forearm. The *Libër Pontificalis* recounts that Sylvester (314-335) prescribed that the deacons in the church must cover the left hand (or forearm) with the *pallium linostimum*—evidently a napkin or towel. A similar



FIG. 182. — Maniple (or stole) of linen from Achmim.

order is ascribed to Zosimus (417–418). Whatever bishop may have fixed this custom, whatever negligence on the part of the deacons may have occasioned such an order, or whatever may have been the reason for the designation of this particular mode, the fact of importance is that the Roman deacons bore the *orarium* upon the left forearm or in the hand, and this explains the fact that no single monument represents them carrying it, like other deacons, upon the shoulder.

The name, the manner in which it was carried, and the use of the *pallium linostimum* unite in proving that it had nothing in common with the *mappa* with which the Emperor and the higher officials gave the sign for the games. For the first centuries we must distinguish it also from the *mappa* in the sense of our handkerchief, — a distinction which must, however, have early disappeared. The older Roman *Ordines* call it *mappula* and *sestace*; the mediæval liturgists, commonly *sudarium* (sweat cloth), which corresponds rather to our handkerchief than to the napkin, and already supposes a change in the purpose and employment of the *pallium linostimum*. When it had once become a sort of handkerchief it was naturally no longer limited to the deacons; documents of the ninth and tenth centuries represent it in the hands of the Pope, of the bishops, priests, and subdeacons.

The *sudarium* retained its practical purpose longer than the stole. It also, however, was folded, and finally became a mere strip, changing at the same time its material, though it was not till the twelfth century that it ceased everywhere to be more than a mere badge.

In the East, where the deacons have always worn the *orarium* upon the shoulder, the maniple naturally never came into use. But anciently an embroidered handkerchief, ἐγγεῖριον, was carried at the girdle.

APPENDICES

SELECT BIBLIOGRAPHY

ANCIENT TEXTS ILLUSTRATIVE OF THE CHRISTIAN MONUMENTS

The most valuable discussion of the bearing of this whole class of literature upon archæology is found in the first volume of DE ROSSI: *Roma Sotterranea* (see below);— in particular the text and a critical valuation of the pilgrims' itineraries and kindred documents bearing upon Roman topography and chronology. This is briefly recapitulated (with omission of the texts) in NORTHCOTE and BROWNLOW'S condensation of de Rossi's work.

DUCHESNE: *Liber Pontificalis*, 2 vols., fol., Paris, 1886–92; the first volume discusses the archæological value, not only of this text, but of many kindred documents. *Origines du Culte chrétien*, by the same author, especially the second edition, 8vo, Paris, 1898, reproduces and comments upon many apposite texts— not all of them merely liturgical.

A different class of documents, of more strictly literary character— including especially poetical descriptions of monuments— is treated at length in the first volume of GARRUCCI: *Storia dell' Arte cristiana* (see below). Many of these texts are presented conveniently in the 8vo volumes of the series of *Quellenschriften für Kunstgeschichte u. s. w.*;— especially in UNGER: *Quellen der byzantischen Kunstgeschichte*, No. XII. of the series, Vienna, 1878. RICHTER: the same title, but dealing exclusively with Constantinople, No. VIII. of the *Neue Folge*, 1897. VON SCHLOSSER: *Quellenbuch zur Kunstgeschichte des abendländischen Mittelalters, Neue Folge*, VII., 1896. MÜNTZ: *Les Sources de l'archéologie chrétienne (Mélanges de l'École française de Rome, 1888)* gives a convenient conspectus of this class of literature.

Liber Pontificalis Ecclesiæ Ravennæ, ed. Bacchini, Modena, 1708.

Inscriptions

DE ROSSI: *Inscriptiones christianæ urbis Romæ*, 3 vols., fol., Rome, 1861–88. A summary of the same by NORTHCOTE: *Epitaphs of the Catacombs*, 8vo, London, 1878. EDM. LE BLANT: *Inscriptions chrétiennes de*

la Gaule, 2 vols., fol., Paris, 1856; *Nouveau Rucueil des Inscriptions chrétiennes de la Gaule*, 1 vol., Paris, 1892. By the same author: *Manuel d'Epigraphie chrétienne d'après les marbres de la Gaule*, 12mo, Paris, 1869. These volumes, besides giving the text of the inscriptions, provide a general introduction to the subject, and a discussion of the bearing of the inscriptions upon history and art.

Many early Christian inscriptions of the West are included in the *Corpus Inscr. Lat.* Christian inscriptions in Greek, belonging to both East and West, are included between the Nos. 8606 and 9893 in Vol. IV. fasc. 2 of БӖCKH: *Corpus Inscr. Græcarum*. A separate volume has been planned for the Christian inscriptions in Latin, under the auspices of the French School at Rome, and in Greek, under the French School at Athens. KRAUS has collected the Christian inscriptions of the Rhine province; ALIMER and TERREHASSE, those of Viennæ; KÜNSTLE, in the *Tübinger theologische Quartalschrift*, 1885, has commented upon those of North Africa. The poems of S. Damasus have been lately published by IHM: *Damasi Epigrammata (Anthologiæ Latinæ Supplementa)*, 8vo, 1895.

FOR THE HISTORY OF THE STUDY OF CHRISTIAN MONUMENTS

It will suffice to refer to BOSIO: *Roma Sotterranea*, fol., ed. of SEVERANO, Rome, 1632; ed. of ARINGHI, Rome, 1651. BOLDETTI: *Osservazioni sopra i cimiteri dei SS. martiri*, etc., 2 vols., fol., Rome, 1720. BOTTARI: *Sculture e pitture sagre*, etc., 3 vols., fol., Rome, 1737-54. CIAMPINI: *Vetera monumenta*, etc., 3 vols., fol., Rome, 1747. D'AGINCOURT: *Histoire de l'Art par les Monuments*, 6 vols., fol., Paris, 1823; German ed., 1840.

FUNDAMENTAL AND GENERAL WORKS

Works of Giovanni Battista de Rossi

Occupying the first place in importance is his *Roma Sotterranea*, 4 vols., fol., Rome, 1864-77. The early part of this work was abridged by DE RICHEMONT: *Les Nouvelles Études sur les Catacombes*, Paris, 1870. The same work was much more admirably done in English by NORTHCOTE and BROWNLOW: *Roma Sotterranea*, 1 vol., 8vo, London, 1870; and this was immediately translated into French by ALLARD, into German by KRAUS, and into Swedish by CENTERWALL—unfortunately before the English authors, following the progress of de Rossi's work, had brought out a second edition, much enlarged, in 2 vols., 1878-79.

De Rossi's work was uncompleted at his death, in 1894, and supplementary volumes were planned by his brother, M. S. DE ROSSI, and

his immediate scholars, ARMELLINI, STEVENSON, and MARUCCHI. The first three of these scholars have died in the midst of their labor, but the first volume is promised within a year. Besides gathering up the scattered results of de Rossi's work (as contained especially in the *Bullettino d' archeologia cristiana*, which he started in 1863, and of which, until his death, he was editor and chief contributor), it is to include all the later results of exploration and study. In connection with this work, though in separate volumes (with a German as well as an Italian edition), WILPERT will furnish a complete and entirely original publication of the frescos of the Roman catacombs, with an exhaustive study of them. His accurate reproductions will put for the first time before the student who cannot be in Rome, or, being there, cannot study the pictures at first hand, the data for an independent judgment of the art of the catacombs.

Another work of de Rossi's, dealing with another period and another sphere, is *Mosaici cristiani e saggi dei pavimenti delle chiese di Roma anteriore al secolo XV.*, begun in 1870 and issued in several sections in folio, Rome. His *Inscriptiones* have been noted above; his scattered works cannot be cited here—two years before his death there was published a list of them including 195 numbers. The importance of his work cannot be overestimated; in his study of the catacombs themselves he was obliged to deal, and he dealt in a luminous manner, with almost every department of early Christian art; by his rigorous method he laid the foundation for the study; and his conclusions, with unimportant reservations, which are for the most part noticed by his own scholars, are universally accepted.

Encyclopædia

MARTIGNY: *Dictionnaire des antiquités chrétiennes*, 2d ed., Paris, 1877, 3d ed., 1880. SMITH and CHEETHAM: *Dictionary of Christian Antiquities*, 2 vols., London, 1875-93. KRAUS (Franz Xaver): *Real-Encyclopædie der christlichen Alterthümer*, 2 vols., Freiburg im Breisgau, 1882-86. Of these, the English publication is the most worthy, the French is the least valuable.

Under this class we may perhaps still refer to the great work of BINGHAM: *Antiquities of the Christian Church*, 8 vols., 4to, London, 1708-22, 2d ed., 1726, Latin ed., 1724, new Eng. ed., Oxford, 1870, 9 vols. Though as good as ignoring the monuments, its convenient classification of a wealth of literary references gives it a lasting value. We see, however, how greatly these same subjects are illuminated by a study of the monuments, when we turn to the work of AUGUSTI: *Denkwürdigkeiten aus der christlichen Archäologie*, 12 vols., 4to, Leipsic, 1817 *seq.*, and *Handbuch der christlichen Archäologie*, 3 vols., 8vo, Leipsic, 1836-37;— though even these works are not strictly in line with modern monumental study.

Current Reviews

Much of the current literature is to be sought in reviews of a general character, dealing with history, archæology, architecture, or art. Only such can be mentioned here as are devoted expressly, either in whole or in part, to Christian archæology.

Revue de l'Art chrétien, Lille and Paris, since 1857; *L'Arte*, Rome, since 1897; *Bullettino di archeologia cristiana*, Rome, since 1863, now under the name of *Nuovo Bullettino*; *Römische Quartalschrift für christliche Alterthumskunde*, Rome, since 1887.

Introduction

Roma Sotterranea is by all means the most *practical* introduction to this subject. The first volume of Garrucci's *Storia* (mentioned below), in which he treats of the "Teoria" of early Christian art, deserves far more appreciation than it receives from those who turn to his volumes chiefly for the illustrations. But of introductions in the stricter sense, the most considerable is the work of Ferd. PIPER: *Einleitung in die monumentale Theologie*, 1 (large) vol., 8vo, Gotha, 1867. This work lays down an elaborate theoretical programme for the study of the subject; it has had a great influence in Germany, and it deserves attention, though the student is likely to find it too abstract.

Of the introductions which are constructed upon the same lines as this present handbook (in that they cover schematically the whole range of the study) those which deserve mention are the following:—

REUSENS: *Elements de l'Archéologie chrétienne*, 2 vols., 8vo, Louvain, 2d ed., 1885-86. It is much used in Roman Catholic schools, but it does not cover the subject with even formal completeness, and in the treatment of the early period especially it shows a great lack of critical discrimination.

A. PÉRATÉ: *L'Archéologie chrétienne*, 12mo, Paris, 1892 (*Bibliothèque de l'enseignement des Beaux-Arts*). He was the first to accomplish the task which is attempted in this present handbook; and, within the limits set him by the series in which it appears, he accomplished it admirably. The book is, in the first place, readable, and being written *con amore*, it cannot fail to interest. But beneath the simplicity of the exposition there is—what is less readily noticed—a thorough grasp of the subject, and the clearest distribution of the material. It is a charming book, by far the most popular that has been written on the subject, yet it proves a sound knowledge and a rare critical faculty.

VICTOR SCHULTZE: *Archäologie der altchristlichen Kunst*, 8vo, Munich, 1895. This is a more laborious work than the above, and less charming, but by reason of its copious notes and references it may prove more useful to students.

Franz Xaver KRAUS: *Geschichte der christlichen Kunst*, 2 vols., 4to, Freiburg im Breisgau, 1896-97. It is the first volume only which concerns our period. This work is devised upon a larger scale than either of the above; but it is less handy and less exact.

Mariano ARMELLINI: *Lezioni di Archeologia cristiana*, 8vo, Rome, 1898, being a posthumous publication of his lectures, without illustrations and badly planned.

Orazio MARUCCHI: *Éléments d'Archéologie chrétienne*, 3 vols., 8vo, Rome and Paris, 1890 — the third volume has not yet appeared. This is not only the most recent but the most valuable work of this class. The author's life-long occupation with the monuments of early Christian Rome enables him to speak with authority, and he has also the talent of clear arrangement and exposition. The work is, however, restricted to Roman antiquities; the second volume is a topographical guide to the Roman catacombs; the third is to be a guide to the principal churches of Rome; and the first is more than one-third of it allotted to two themes (Roman inscriptions and the relation of Church and State during the first four centuries), — a disproportion which is to be regretted, because it excludes subjects more proper to an introduction and prohibits the book from fulfilling altogether the expectation which is suggested by its title. The citation of the itineraries is handy.

C. W. BENNETT: *Christian Archæology*, 8vo, Cincinnati, 1888, is the only work in English which need be mentioned under this head.

Miscellaneous

Only a few works can conveniently be cited under this vague title: —

Two collections of essays published in honor of de Rossi's seventieth birthday in 1892 — *Mélanges de l'École française de Rome*, and *Archäologische Ehrengabe* (de Waal, editor); Stephan BEISSER: *Bilder aus der Geschichte der altchristlichen Kunst und Liturgie in Italien*, 8vo, Freiburg im Breisgau, 1899; and, finally, GRISAR: *Analecta Romana*, Rome, 4to, 1899. This last valuable and interesting work gathers up a number of the author's occasional articles, and, with another volume which is soon to appear, constitutes a supplement to his *Geschichte Roms und der Päpste im Mittelalter* (a work which makes the largest use of archæological sources), 3 vols., 8vo, Rome, 1899-1900; also in Italian.

THE CATACOMBS

As the principal works dealing with the catacombs have already been mentioned, it remains to cite here only a few works such as have little or no bearing beyond this subject. It must be remembered that, so far at

least as the Roman catacombs are concerned, none of these can have any value independent of de Rossi's work ; it is, therefore, of the less consequence that some of the least worthy productions are here omitted. PERRET : *Les Catacombes de Rome*, 6 vols., fol., Paris, 1855, — *édition de luxe*, but the text is insignificant and the plates fantastic. ROLLER : *Les Catacombes de Rome*, Paris, 2 vols., fol., 1881 ; — provided with pretty photographic reproductions, which, however, are not accurate enough to afford a sound basis for study. Victor SCHULTZE : *Die Katakomben*, 8vo, Leipsic, 1882. MARRIOTT : *The Testimony of the Catacombs*, 8vo, London, 1870, — an attack upon the work of Northcote and Brownlow. SCOTT : *The Catacombs at Rome*, 12mo, 1st ed., London, 1860, 2d ed. 1873, — a well-conceived set of lectures to working-men, on the early Christian period, as illustrated by the catacombs. ARMELLINI : *Le catacombe romane*, 8vo, Rome, 1880 ; and *Gli antichi cimiteri cristiani di Roma e d' Italia*, 8vo, Rome, 1893.

ARCHITECTURE

There is but one book which covers the whole subject of early Christian architecture, and deals with it exclusively, H. HOLTZINGER : *Die altchristliche Architektur*, 8vo, Stuttgart, 1889 ; 2d part, 1899. The book is an admirable one. It is especially to be commended for its citation of the references in early Christian literature, and for the completeness with which it discusses all the questions subsidiary to church architecture ; as, for example, the exterior adjuncts of the church edifice, and the interior furnishings required by the cultus. See also the general works of Schultze and of Kraus, above mentioned ; they both treat the subject of architecture at considerable length.

DEHIO and VON BEZOLD : *Die kirchliche Baukunst des Abendlandes*, 2 vols., 8vo, and several volumes of plates in folio, Stuttgart, 1884-99. The patient and prolonged labor of the authors has collected a mass of material which renders their book quite indispensable. It is only the first book of their first volume, and a part of the first *Lieferung* of plates, which concerns our period. Their limitation to Western architecture explains their preoccupation with the development of the basilical type.

Other works which deal with the development of the basilica may be cited without comment, although they represent divers conflicting theories.

ZESTERMAN : *Die antiken und die christlichen Basiliken*, Leipsic, 1847.

MESMER : *Ueber den Ursprung, die Entwicklung, und Bedeutung der Basilika in der christliche Baukunst*, Leipsic, 1854.

WEINGÄRTNER : *Ursprung und Entwicklung des christlichen Kirchengebäudes*, Leipsic, 1858.

MOTHES: *Die Basilikenform bei den Christen der ersten Jahrhunderte*, Leipsic, 1865.

RICHTER: *Der Ursprung der abendländ. Kirchengebäude*, Vienna, 1878.

SCHULTZE: the same title; in the *Christliche Kunstblatt*, 1882.

LANGE: *Haus und Halle*, Leipsic, 1885.

G. B. BROWN: *From Schola to Cathedral*, Edinburg, 1886.

CROSTAROSA: *Le basiliche cristiane*, Rome, 1892.

KIRSCH: *Das christl. Kultusgebäude im Alterthume*, Cologne, 1893.

G. CLASSE: *Basiliques et Mosâiques chrétiennes*, 2 vols., 4to, Paris, 1893.

The volume on early Christian architecture furnished by ESSENWEIN for DURM's series of handbooks on *Die Baustile*, has been rewritten for the same series by HOLTZINGER.

AUGUSTE CHOISY: *Histoire de l'Architecture*, 2 vols., 8vo, Paris, 1899. In this general work it is only the first part of the second volume which deals with our period. Throughout the whole of it, the author's keen perception and clear exposition of fundamental architectural morphology is almost beyond praise. Treating the development of architectural forms throughout the whole historic period, he dwells naturally with predilection upon the one substantially original motive which is to be credited to the early Christian period — the Byzantine dome construction.

Other works which deal specially with Byzantine architecture are:—

COUCHARD: *Églises byzantines en Grèce*, 1 vol., fol., Paris, 1842; *Voyage en Grèce*, 1 vol., fol., Paris, 1847.

SALZENBERG: *Altchristliche Baudenkmäler Constantinopels*, 1 vol., fol., Berlin, 1855.

DE VOGÜÉ: *Les Églises de la Terre Sainte*, Paris, 1860.

TEXIER and PULLAN: *L'Architecture byzantine*, 1 vol., fol. (French and English editions), London, 1864.

CHOISY: *L'art de bâtir chez les Byzantines*, 1 vol., fol., Paris, 1883.

GOSSET: *Les Cupoles d'Orient et d'Occident*, 1 vol., fol., Paris, 1889.

Representing special regions, we have, in the first place, the unique and indispensable work of—

DE VOGÜÉ: *Syrie Centrale*, 1 vol., 4to, of text and one of plates, Paris, 1865-77.

VON QUAST: *Altchristliche Bauwerke von Ravenna*, fol., Berlin, 1842.

SCHWARZE: *Untersuchungen über die äussere Entwicklung der africanischen Kirche, mit besonderer Verwertung der archäologischen Funde*, Göttingen, 1892.

BUTLER: *Ancient Coptic Churches of Egypt*, 2 vols., 8vo, Oxford, 1884.

JACKSON: *Dalmatia, the Quarnero, and Istria*, 3 vols., 8vo, London, 1887.

ARMELLINI: *Le Chiese di Roma*, 8vo, Rome, 2d ed., 1891.

MULLOOLY: *Saint Clement*, 8vo, Rome, 1873.

Padre GERMANO: *La Casa dei SS. Giovanni e Paolo*, 8vo, Rome, 1894.

WIELAND: *Ein Ausflug ins altchristliche Africa*, 8vo, Stuttgart and Vienna, 1900.

BARNES: *St. Peter in Rome*, 8vo, London, 1900.

J. Rohault DE FLEURY: *Saint Pierre*, 4to, Paris, 1899.

RICCI: *Ravenna e i suoi dintorni*, Ravenna, 1897.

PICTORIAL ART

In General, with Special Reference to Painting, Interpretation, and Iconography

Raff. GARRUCCI: *Storia dell' Arte cristiana*, 6 vols., fol., Rome, 1873-81. This great work, which covers the entire field of early Christian pictorial art, is the product of learning as well as labor. On account of its illustrations, it must remain quite indispensable to the student of this subject till the same ground has been covered with equal completeness by photographic reproductions.

Rohault DE FLEURY: *La Messe*, 8 vols., fol., Paris, 1883-89; *L'Évangile*, fol., Tours, 1874. These volumes, though dealing neither so exclusively nor so completely with the monuments of our period, constitute a valuable storehouse of illustration.

On a very different plane are the works of WILPERT, which are limited in scope to the study and reproduction of the paintings of the catacombs. His books are mentioned here among those of a more general character, because those which have yet appeared are but the introduction to a greater work (to come out as a continuation of de Rossi's—see above), which will cover completely the art of the catacombs. His admirable photographic reproductions of the frescos are matched by the value of his studies upon them, which are at once the most solid and the most illuminating which have been published. No study of the subject should be thought of without reference to these works. The author enjoys the advantage—more rare in the case of those who write on this subject than one would suppose—of direct acquaintance with the monuments,—and not only that, but a long and exclusive devotion to their study. The more considerable of his works which remain to be mentioned under this topic are: *Principienfragen der christlichen Archäologie*, small vol., 4to, 1889; *Die Katakombengemälde und ihre alten Copien*, 1891; *Ein cyclus christologischer Gemälde aus der Katakombe der heiligen Petrus und Marcellinus*, 1891; *Die gottgeweihten Jungfrauen*, 1892; *Fractio Panis*

1895; French ed., 1896; — all in small folio, published at Freiburg im Breisgau. *Die Malereien der Sacramentscapellen*, 4to, 1897.

A. VENTURI: *Storia dell' Arte italiana*, Vol. I., large 8vo, Milan, 1901. Five more volumes are to follow, but it is the first only which concerns our period, dealing with Christian art from its origin to the time of Justinian. It is the most complete, the most luminous, and the most authoritative work which has yet been published on this subject, and it will prove especially valuable to those who are interested in tracing the influence of early Christian art through the Middle Ages. The work is richly illustrated.

F. R. SALMON: *Histoire de l'Art chrétien aux dix premiers Siècles*, Paris, 1891, a sumptuous book, though but sparsely and poorly illustrated, with a treatment which is readable but not fundamental. CURTIS: *History of Christian Art*, 12mo, London, 1893, — an excellent popular treatment, published by the Society for the Propagation of Christian Knowledge. DIDRON: *Inconographie chrétienne*, 2 vols., 8vo, Paris, 1843 (also Eng. ed., Bohn's Library, London, 1886). Like Mrs. JAMESON, in her deservedly popular handbooks, this author touches the early period only as a point of departure. Likewise, HULME: *Symbolism in Christian Art*, London, 1892, has not set himself to understand the peculiarity of the early period.

Raoul ROCHETTE: *Sur l'Origine des types imitatifs qui constituent l'art du Christianisme*, Paris, 1834. This author, by the publication of certain startling propositions (untenable, at least in their original form), had the credit of starting an instructive discussion on the origin of early art forms. Ferd. PIPER: *Mythologie und Symbolik der christlichen Kunst*, 2 vols., 8vo, Weimar, 1847. This work has had a strong influence upon the whole school of German Protestant writers. MÜNTZ: *Études sur l'histoire de la peinture et de l'iconographie chrétiennes*, 8vo, Paris, 1886. DETZEL: *Christliche Ikonographie*, 8vo, Paris, 1894. The last two are excellent books. J. Romilly ALLEN: *Christian Symbolism in Great Britain and Ireland*, 8vo, London, 1887. Margaret STOKES: *Early Christian Art in Ireland*, London, 1888; and Jos. ANDERSON: *Early Christian Times in Scotland*, Edinburgh, 1891. No other books on Celtic art are mentioned, because they do not properly belong to our subject.

The following monographs may be mentioned without comment: —

HASENCLEVER: *Der altchristliche Gräberschmuck*, 8vo, Braunsch., 1886.

BECKER: *Die Wandgemälde der römische Katakomben*, 8vo, 1888.

ACHELIS: *Das Symbol des Fishes*, 8vo, Marburg, 1888.

MITIUS: *Jonas auf den Denkmälern des christlichen Alterthums*, 8vo, Freiburg im Breisgau, 1897.

VOPEL: *Die altchristliche Goldgläser*, 8vo, Freiburg im Breisgau, 1899.

LIELL: *Die Darstellungen der allerseligsten Jungfrau auf den Kunstdenkmalern der Katakomben*, 8vo, 1887.

FICKER: *Darstellung der Apostel in der christlichen Kunst*, 8vo, Leipzig, 1887.

SCHMID: *Die Darstellung der Geburt Christi in der bildenden Kunst*, 8vo, Stuttgart, 1890.

PALMER: *Early Christian Symbolism*, fol., 1885 — mostly plates, which are inaccurate; text worthless.

FARRAR: *Christ in Art*, 8vo, 1895 — uncritical.

KAUFMANN: *Die Auferstehungsglaube in altchrist. Kunst*, fol., 1900.

ZÜCKLER: *The Cross of Christ*, Eng. trans., 8vo, 1877.

SEYMOUR: *The Cross in Tradition, History, and Art*, 8vo, 1898.

R. FORRER Ü MÜLLER: *Kreuz und Kreuzigung Christi in ihrer Kunstentwicklung*, 4to, Strassburg in Elsass, 1894.

Sculpture

LE BLANT: *Les Sarcophages de la ville d'Arles*, 1 vol., fol., Paris, 1878; *Les Sarcophages inédits de la Gaule*, 1 vol., fol., Paris, 1886. Both of these are most valuable works, as well for the text (which deals also with the general problems of Christian art), as for the illustrations.

GROUSSET: *Étude des Sarcophages chrétiens de Rome*, Paris, 1885.

FICKER: *Die altchristliche Bildwerke im christlichen Museum des Laterans*, 12mo, Leipzig, 1890 — a handy catalogue.

KONDAKOFF: *Les Sculptures de la Porte de Sainte Sabine (Revue archéologique)*, 1877.

BERTHIER: *La Porte de Sainte Sabine*, 4to, Freiburg im Schweiz, 1890. For the same subject, see in Grisar's *Analecta* (above mentioned).

WIEGAND: *Das altchristliche Hauptportal an der Kirche der hl. Sabina*, Trier, 1900.

WESTWOOD: *A Descriptive Catalogue of the Fictile Ivories in the South Kensington Museum*, London, 1876.

MASKELL: *Description of the Ivories in the South Kensington Museum*, London, 1872.

STUHLFAUTH: *Die altchristliche Elfenbeinplastik*, Freiburg in Breisgau, 1896.

MAZZANTI: *La Scultura ornamentale romana nei bassi tempi*, 4to, Rome, 1896.

ZIMMERMAN: *Oberitalisches Plastic in frühen und hohen Mittelalter*, 4to, 1897.

CATTANEO: *L' Architettura dal secolo VI. al mille circa*, 8vo, Venice, 1889. English trans., London, 1890 (also in French). This work, notwithstanding its title, has much the same scope as the last two.

DE WAAL: *Der Sarcophag des Junius Bassus*, fol., Rome, 1900.

Mosaic

DE ROSSI: *Mosaici cristiani e saggi dei pavimenti delle chiese di Roma anteriori al secolo XV.*, Rome, issued in several folio sections, beginning with 1870.

GERSPACH: *La Mosaïque*, Paris, 1891 (*Bibliothèque de l'Enseignement des Beaux-Arts*).

APPELL: *Christian Mosaic Pictures*, London, 1877.

RICHTER: *Die Mosaiken von Ravenna*, Vienna, 1878.

DIEHL: *Ravenne*, 4to, Paris, 1886.

AINALOV: *Mosaiken der IV. u. V. Jahrhunderts*, 8vo, 1895.

Miniatures

HARTELL and WICKOFF: *Die Wiener Genesis*, 1 vol., fol., Vienna, 1895, — an admirable comparative study, which must serve as the foundation for the study of early miniatures.

STRZYGOWSKI: *Die Kalenderbilder des Chronographen*, Berlin, 1888.

HANS GRAEVEN: *Il Rotolo di Josua* (in *L'Arte*, 1898, pp. 221-23).

BEISSEL: *Vaticanische Miniaturen*, 4to, Freiburg im Breisgau, 1893.

GEHARDT and HARNACK: *Evangeliorum codex purpureus Rossanensis*, Leipsic, 1880.

HASELOFF: *Codex purpureus Rossanensis*, Leipsic, 1898.

MIDDLETON: *Illuminated Manuscripts of Classical and Medieval Times*, Cambridge, 1892.

Byzantine Art

BAYET: *L'Art Byzantin*, Paris, 1883 (*Bibliothèque de l'Enseignement des Beaux-Arts*); *Recherches pour servir à l'histoire de la peinture et de la sculpture chrétienne en Orient avant les Iconoclastes*, Paris, 1879.

KONDAKOFF: *Histoire de l'art byzantin considéré principalement dans les miniatures*, 2 vols., 4to, Paris, 1886-91.

STRZYGOWSKI: *Byzantische Denkmäler; Der Etschmiadzin-Evangeliar*, 1 vol., fol., Vienna, 1891; *Byzantische Wasserbehälter von Konstantinopel*, 1 vol., fol., 1893. Numerous works of the same author are to be found in the reviews of Byzantine art.

THE MINOR ARTS

GERSPACH: *La Verrerie*, 1885; *Les Tapisseries coptes* — both in the *Bibliothèque de l'Enseignement des Beaux-Arts*. Paris.

RIEGL: *Die ägyptischen Textilfunde im k. k. österreichischen Museum*, Vienna, 1889.

FORRER: *Die Gräber- und Textilfunde von Achmim-Panopolis*, 4to, 1891; *Die römischen und byzantinischen Seidentextilien aus dem Gräberfelde von A.-P.*, 4to, 1891; *Die frühchristlichen Alterthümer aus dem Gräberfelde von A.-P.*, 4to, 1893; *Die Zeugdrucke der byzantinischen, romanischen, gothischen und spätern Kunstepochen*, 4to, 1894.

The works of this author, with their abundant illustrations, give a most satisfactory account of the early textiles (third to sixth century) which have lately been found in such great quantity and in such perfect preservation in several Egyptian burial-grounds. They are published in Strassburg in Elsass.

KARABACEK: *Katalog der Th. Graff'schen Funde in Aegypten*, Vienna, 1883.

AL. RIEGL: *Die ägyptische Textilfunde im k. k. österr. Museum*, Vienna, 1889.

VESTIARY

MARRIOTT: *Vestiarium Christianum*, 8vo, London, 1868,—a learned English work which, like all others of its time, fails to understand the first stage of the development.

BRAUN: *Die priesterlichen Gewänder des Abendlandes*, Freiburg im Breisgau, 1898; *Die pontificalen Gewänder des Abendlandes*, 1898.

GRISAR: Cap. XII. of his *Analecta Romana*, Rome, 1899.

WILPERT: *Die Gewandung der Christen in den ersten Jahrhunderten*, Cologne, 1898; *Un capitolo di storia del vestiario*, fol., Part I., 1898; Part II., 1899, Rome.

This last work of Wilpert's has for the first time put the study of the origins of distinctive ecclesiastical vestments upon a sound archæological basis.

INDEX ¹

- Abel, 299, 317.
 Abercius inscription, 234 *seq.*
 Abraham, 208, 317.
 Acanthus, 254, 298.
 Acilii Glabrones, 66.
 Adam and Eve, 204 *seq.*, 259.
 Adamnanus, 142.
 Africa, 9.
Agape, 50 *seq.*
 d'Agincourt, 21.
 Agnellus, 14.
 Aisles, 107.
 Alb (*tunica alba*), 393.
 Altar, 46, 105, 123, 126, 159 *seq.*
 cloths, 377 *seq.*
Ama, or *amula*, 347.
Ambon, 174.
Ambulacrum, 24.
Amphibalus, 399; see Chasuble.
Ampula, 79, 355.
 Ananias and Saphira, 283.
Anastasis, church of, 141, 171, 177 *seq.*,
 309 *seq.*
 Anchor, 64.
 Angels, 269 note, 321 *seq.*, 326.
 Annas and Caiaphas, 282.
 Annunciation, 245.
 Antinœ (Egypt), textiles, 365.
 Antioch, Constantinian church, 138,
 177 *seq.*
 Apocalypse, 302.
 Apocryphal Gospels, influence of, 287,
 320.
 Apostles, 267, 303, 307.
 Apse (*apsis*), 121, 123.
Apsis trichora, 147.
 Arch, 88.
 apsidal and triumphal, 120, 124.
 Archæology, history of Christian, 17
 seq.
 Architecture, 83 *seq.*; cf. Contents, pp.
 viii. and ix.
 Architrave and archivolt, 109 *seq.*
 Archulphus, 142.
Arcosolium, 25.
Arcus major, 124.
Area, 47 *seq.*
Arenarium, 32.
 Armellini, 20.
 Ascension, 237.
 church of, 142, 310.
 Asia Minor, 9.
Atrium, of private house, 98.
 of basilica, 105, 106, 178.
 Auriol (France), altar, 160.
A-w, 242, 236 *seq.*; see Monogram.
 Banquet, see Celestial, and Eucharis-
 tic Banquet.
 Baptism, symbols of, 227; see Fish.
 of Jesus, 330.
 Baptisteries, 136, 137, 175.
 Basilica, Christian, 87, 88, 89 *seq.*; cf.
 Contents, p. viii.
 civil, 92.
 of Maxentius, 153.
 private, 97.
Bema, 121.
 Benediction, gesture of, 260.
 Bethlehem, symbol of, 314.
Birrus, 400.
 le Blant, 21.
 Bosio, 17, 18.
Braccæ, 389.
Brandeia, 163.
 Breech-cloth, 389.

¹ N.B. The Table of Contents, pp. vii.-xii., is itself a topical index; it has been arranged with great care to this end, and in many cases it will be found more convenient for reference than the alphabetical index, which is not designed to supplant it.

- Burial, 40 *seq.*, 366.
 on the surface, 78.
 societies, 57 *seq.*
- Cain and Abel, 299.
Calceus, 388.
Cancelus, see Chancels.
 Candles, 352, 353.
 Canopy, see *Ciborium*.
Cantharus, a fountain, 179 *seq.*
 a chalice, see Eucharistic Vessels.
 a lamp, 351.
 Cap, 387.
Capella greca, 44, 227 *seq.*
 Capitals, 108 *seq.*
Catabaticum, 29.
 Catacombs, 23 *seq.*; see Cemeteries.
Cataracta, 162.
Cathedra, 172 *seq.*
 Ceiling, 116 *seq.*
 Celestial banquet, 221 *seq.*
Cella, 49.
 Cemeterial chapels, 49.
 Cemeteries, 23 *seq.*; cf. Contents, p. vii.
 individual, see under Rome, etc.
 Censers, 353 *seq.*
 Chalice, see Eucharistic Vessels.
 Chancels, 168.
 Chapels, 49, 182.
 in the catacombs, 26 *seq.*, 43 *seq.*
Charta cornutiiana, 379.
 Chasuble (*casula*), 396 *seq.*
 Cheetham, 22.
Chlamys (*χλαμύς*), 399 *seq.*
 Choir, 168 *seq.*
 Churches, in general, 89 *seq.*; see
 Basilica.
 Byzantine, 147 *seq.*
 round, 135 *seq.*; cf. Contents, p. ix.
 individual, see under Rome, etc.
Ciborium, 123, 167.
Cinctus, 388.
Cippus, 166; see *Stele*.
Clavus, 369, 372, 392.
 Clearstory, 113.
 Clermont, basilica of Namantius, 16.
Cœmeterium, 23.
 Coins, 205, 240 *seq.*
Collegia tenuiorum, 60.
 Cologne, cemetery, 41.
 Colonnade in front of altar, 170 *seq.*
- Color of textiles, 371, 373.
 Columns, 108.
Concha, 121; see Apse.
Confessio, 50, 162 *seq.*
 Constantinian monogram, 236 *seq.*,
 299.
 Constantinople,
 Irene, church of, 150.
 SS. Apostles, 132, 148, 150 *seq.*
 SS. Sergius and Bacchus, 138, 146.
 S. Sophia, 15, 132, 152 *seq.*, 166, 168,
 170, 175.
Contabulatio, 402 *seq.*, 407 *seq.*, 410
seq.
 Cope (*cappa*), 399, 401.
 Cross, representations of, 236 *seq.*
 as a gesture, 237.
 dissimulated, 236.
 Cross-shaped churches, 147 *seq.*
 Crown (*corona*), 350, 351, 353.
 Crucifixion, 176 *seq.* 276
Cubiculum, 24 *seq.*
 Curtains, 377 *seq.*
- Dalmatia and Istria, 10.
 Dalmatic, 394 *seq.*
 Damascus, 15.
 inscriptions of, 74 *seq.*
 Daniel, 208 *seq.*
 David, 212, 283.
 Decadence of art, 4 *seq.*, 188, 248.
 Dehio, 22.
Depositio, 63.
Diaconicon, 126, 128.
Dittochæon, 16, 272.
 Dome, 86, 87; and cf. Contents, p.
 ix.
Dominicum, 90.
 Doors, 114.
 of S. Sabina, 270 *seq.*
 Dove, 64, 303.
 Dress, 383; cf. Contents, p. xii.
 Duchesne, 14, 21.
 Dyeing, 369 *seq.*
- ἐγχείριον*, 413.
 Egypt, 10.
 Elders, the four and twenty, 311.
 Elijah, 212, 299.
 England, 10.
 Entablature, curved, 88.
 Etruscan tombs, 42.

- Eucharist, 43, 44, 46, 50, 51, 94 *seq.*,
 105, 259, 317.
 Eucharistic banquet, 223 *seq.*
 breads, 224, 346.
 vessels, 343 *seq.*
 Eusebius, 15.
 Evangelists, 285, 303.
 Ezekiel, 212.
 Ezra (Syria), Church of S. George, 144.

 Façade, 129.
Farus, 351.
Fenestella, 162.
 Ficker, 22.
 Fish symbol, 230, 231, 232 *seq.*
 Flavian gens, 65.
 de Fleury, 21.
Fons, 175.
 Forrer, 366.
*Fossore*s, 36.
 Fountain, 179 *seq.*
Fractio Panis, 227 *seq.*
 France, 10.
 Funeral agape, 50 *seq.*

Gabatha, 351.
 Galleries of churches, 112.
 of catacombs, 24.
Gammadia, 372.
 Garrucci, 21.
Genre subjects, 361.
 Germany, 10.
 Gesture of benediction, 260.
 of consecration, 259.
 of ordination, 259.
 Gethsemane, 281.
 Girdle, 390.
 Glass, 357.
 cut and engraved, 357.
 God the Father, 299.
 Gold embroidery, 376.
 Gold-glass, 358 *seq.*
 Good Shepherd, 214 *seq.*, 290, 331.
 Grado, cathedral, 172.
Graffiti, on glass, 357.
 on plaster, 28.
 on stone, 188, 247.
 Gregory of Tours, 16.

 Habakkuk, 209.
 Hand of God, 264.
 Hat, 386.

 Head-dress, 386 *seq.*
 Helpidius Rusticus, 16.
 l'Heureux, 17.
 Hippolytus, 290.
 Holtzinger, 22.
 Holy Ghost, 259, 303.
 Hood, 387, 398.
Hortus, 48.
 House, Greek and Roman private, 97
 seq.
 Christian private, 191.
Hypogeum, 24, 43.

Ichthus, 232.
Iconostasis, 171, 382.
 Imola, Martyrium of Cassianus, 16.
 Inhumation, 40.
 Inscription of Abercius, 234 *seq.*
 Inscriptions, 62 *seq.*
 of Damasus, 74 *seq.*
 Isaac, 208.
 Istria, see Dalmatia.
 Italy, 10, 11.
 Itineraries, 12, 13.
 Ivories, 278, 279 *seq.*; cf. Contents,
 p. xi.

 Jacob, 283, 287.
 Jerusalem, symbols of, 314.
 Church of S. Stephen, 140.
 Church of the Ascension, 90, 142,
 310.
 Church of the Holy Sepulchre (An-
 astasis), 90, 141, 171, 177 *seq.*,
 309 *seq.*
 Church of the Martyrium, 90, 309
 seq.
 Church of the Virgin in the Valley
 of Jehoshaphat, 143.
 Mosque of Omar, 142.
 Job, 267.
 John the Baptist, 285.
 Jonah, 206 *seq.*, 290.
 Joseph, 287.
 Joshua, 323, 336.
 Judas, 278, 284.
 Junius Bassus, sarcophagus, 264 *seq.*
 Justinian, 319.

 Kalat-Seman (Syria), 147 *seq.*
 Kraus, 21.
Kyriakon, 90.

- Labarum*, 240.
Lacerna, 400.
Lacunar, 118.
 Lamb, as symbol of Christ, 266, 313.
Lamps, 347 *seq.*
 S. Laurence, 331.
 Lazarus, 413.
 Lead objects, 356.
 Legal status of Christian cemeteries,
 53 *seq.*
Leggins, 388.
Liber Pontificalis, of Ravenna, 14.
 of Rome, 13 *seq.*
Linteum, 410.
Lives of the Saints, 12.
 Livia Primitiva, sarcophagus, 254.
Locus (loculus), 25.
 Loin-cloth, see Breech-cloth.
 Lord's Supper, see Eucharist.
Lorum, Byzantine, 403.
 Roman, 392.
Luminarium, 32.

 Madaba (Palestine), floor mosaic, 348.
Mafortes, 380.
 Magi, 210 *seq.*
 Maniple, 412 *seq.*
Mantele, 410.
Manutergium, 411.
 Map of Jerusalem, 308.
Mappa, 413.
Mappula, 413.
 Marble incrustation, 295.
 S. Marcel (France), altar, 160.
 Martyrdom, representations of, 209.
 Martyrologies, 12.
 Martyrs, 27, 71 *seq.*, 78.
 Marucchi, 20.
 Mary the Virgin, 245 *seq.*, 320 *seq.*
 Medals, 354.
 Melchizedek, 317.
Memoria, 13, 49.
 Metrical inscriptions, 70.
 Milan, SS. Nazario e Celso, 148.
 Miniatures, 333 *seq.*: cf. Contents.
 p. xi.
 Miracles of Christ, 213 *seq.*
 of Old Testament, 198 *seq.*
 Mitre, 387.
Monasterium, 184.
 Monogram, Constantinian, 236 *seq.*
 Monza, 80.

 Mosaics, 118 *seq.*, 292 *seq.*: cf. Con-
 tents, p. xi.
 Moses, 206, 272, 283.
 Multiplication of loaves and fishes,
 214.

 Names, 64.
 Naples, Basilica Severiana, 165.
 Catacomb of S. Gennaro, 24, 29.
 Narthex, 105, 107.
 Nicea, church, 143.
 Niche, 136.
 Nile key, 238.
 Noah, 206.
Nodus, 402.
 Nola, Church of S. Felix, 16, 111, 147,
 164, 177, 179.
 lamps, 350.
 mosaics, 303.
 Northcote and Brownlow, 19.
 Nude figures, 207 *seq.*

ὠμοφόριον, 408.
Opus sectile, 119.
Orans, 201 *seq.*
Orarium (ὠράριον), 411.
 Orientation, 176 *seq.*
 Orleansville, S. Reparatus, 111, 126.

Pænula (φαινόλης), 396 *seq.*
 Pagan themes in Christian art, 191.
 Palestine, 9.
Palla, 407.
Pallea, 380.
Palliola, 163.
Pallium, 403 *seq.*
 scarf, 407 *seq.*
Paludamentum, 400.
 Parenzo, cathedral pavement, 295.
 Passion of Christ, 273.
 Paten, see Eucharistic Vessels.
Patenam chrismalem, 347.
Patibulum, 244.
 Paul, 251 *seq.*, 264, 268, 285.
 Paulinus of Nola, 16.
 Tyre, 177, 181.
 Paulus Silentarius, 14.
Peperino, 31.
Peribolos, 180.
περιζώμα, 388.
 Personification, 335, 338.
 of the Church, 296, 300, 305.

- Perugia, S. Angelo, 140, 143.
Petasus, 386.
 Peter, 206, 260 *seq.*, 268, 291.
 Peter's wife's mother, 283.
 Philocalian catalogue, 60.
 Philocalus, 76.
 Phrygian cap, 387.
 Pilate 259, 264, 265, 273.
 Pilgrimages, 79
 Pillars, 111.
Pilleus, 387.
 Piper, Ferdinand, 21.
Piscina, 175.
Pluviale, 401.
 Porto, Xenodochium, 111, 148.
 Portogruaro, cemetery, 41.
 Portraits of Christ, 214 *seq.*, 326.
 of Peter and Paul, 251 *seq.*
 of S. Ambrose, 395.
 Portraiture, 250, 292.
Pozzolana, 31.
 Prayers to and for the dead, 72.
Presbyterium, 121.
 Private house, decoration of, 191.
 Procopius, 14.
 Prophets, 324, 330.
Propylaon, 180.
Prostas, 98.
Prothesis, 125 *seq.*
 Prudentius, 15.
 Pulpit (*ὑψυγος*), see *Ambon*.
 Purple, 371, 391
- Ramsay, 22.
- RAVENNA, churches,
 Basilica Ursiana, 168.
 mausoleum of Galla Placidia, 149,
 330 *seq.*
 mausoleum of Theodoric, 137.
 S. Apollinare in Classe, mosaics,
 118, 331, 333.
 S. Apollinare Nuovo, 110; mosaics,
 324 *seq.*
 S. Croce, 147.
 S. Giovanni in fonte (Orthodox bap-
 tistery), 137; mosaics, 160, 329.
 S. Maria in Cosmedin (Arian bap-
 tistery), 137; mosaics, 329.
 S. Vitale, 112, 138, 145; mosaics,
 315 *seq.*
- Refrigerium*, 52.
 Relics, 79 *seq.*, 163.
- Rivers of paradise, 298, 300, 303.
 Rochette, Raoul, 21.
 Roman law, protecting tombs, 53.
- ROME, cemeteries,
 Jewish, 42.
 Ostrianum, 27, 43.
 S. Agnese, 48.
 S. Callisto, 30, 54, 147.
 S. Cyriaca (S. Lorenzo), 49, 81.
 S. Domitilla, 50, 65 *seq.*
 S. Felicitas, 48.
 S. Hippolytus, 16.
 S. Pancrazio, 81.
 SS. Pietro e Marcellino, 81.
 S. Priscilla, 44, 50, 55, 66 *seq.*
 S. Sebastiano (*ad catacumbas*),
 23, 81.
 S. Valentino, 29, 49, 81.
 Vaticano, 40.
- ROME, churches,
 Lateran baptistery, 144, 147; mo-
 saics, 301.
 S. Agnese, 49, 113, 177.
 S. Alessandro, 162.
 S. Balbina, 172.
 S. Cæcilia, 97, 113.
 S. Clemente, 168, 176.
 S. Costanza, 143 *seq.*; mosaics, 297
 seq.
 S. Georgio in Velabro, 162.
 S. Giovanni in Laterano, 115, 124,
 168, 176; vessels, 346 *seq.*; lamps,
 350 *seq.*
 S. Maria in Cosmedin, 169.
 S. Maria Maggiore, 109, 165, 176;
 mosaics, 301, 319 *seq.*
 S. Pancrazio, 164.
 S. Paolo, 109, 124, 165, 176 *seq.*;
 mosaics, 301, 319 *seq.*
 S. Pietro in Vaticano, 109, 116, 124,
 147, 165 *seq.*, 171, 176 *seq.*; mo-
 saics, 300 *seq.*; Eucharistic ves-
 sels, 346 *seq.*
 S. Petronilla, 49, 113, 176.
 S. Prassede, 81, 176.
 S. Prisca, 67.
 S. Pudenziana, 38, 176; mosaics,
 304 *seq.*
 S. Sabina, 115, 170 *seq.*, 176; doors,
 270 *seq.*; mosaics, 295 *seq.*
 S. Sebastiano, 49, 176.
 S. Sinfiorosa, 111, 147, 164.

- ROME, churches,**
 S. Stefano, 140, 142 *seq.*
 S. Valentino, 49, 164.
 SS. Cosma e Damiano, 115; mosaics, 311.
 SS. Giovanni e Paolo, 13, 80.
 SS. Nereo ed Achilleo (S. Petronilla), 49, 113, 176.
- Roof,** 115 *seq.*
 de Rossi, Giovanni Battista, 12, 18 *seq.*
 M. S., 36.
- Sacrament Chapels (S. Callistus),**
 224.
- Sacraments, see** Baptism and Eucharist.
- Sagum,* 399 *seq.*
 Saints, 27, 71 *seq.*, 78 *seq.*
 Samaria, church at Jacob's Well, 149.
 Sandals, 388.
 Sarcophagus, 40, 249, 252 *seq.*
 Sceptre, 289.
 Schola, 94.
 Schultze, Victor, 21.
 Sculpture, 247 *seq.*; cf. Contents, p. x.
Scyphos, 347.
Segmentum, 372, 392.
Sestace, 413.
 Sheep, symbols of the faithful and of the Apostles, 219 *seq.*
 Shoes, 388.
 Sicily, 11.
 Silk, 369.
 Simon the Cyrenean, 273.
Sinus, 402.
Solea, 388.
 Spain, 10.
 Statues, 168, 289 *seq.*
Stele, 69; see *Cippus.*
 Stevenson, 20.
 Stole, 410 *seq.*
 Stucco, 294.
Sudarium, 413.
Suppedaneum, 278.
 Susanna, 210.
 Swastica, 238.
 Symbolism, 193 *seq.*, 250.
 Symmetry, 253.
- Syracuse, catacomb of S. Giovanni, 11, 25.
 Syria, Central, 9, 116, 130 *seq.*
- Tablinum,* 100.
 Tapestry, 370 *seq.*; cf. Contents, p. xii.
Tegurium, 40.
 Textiles, 362 *seq.*; cf. Contents, p. xii.
 Theodora, 319.
 Theodoric, mausoleum, 137.
 Thessalonica, S. George, 136.
 Three Children of Babylon, 210.
 Titles (ecclesiastical), 37 *seq.*
Titulus (poetical), 15 *seq.*, 303.
 Tobias, 212, 298.
 Toga, 401 *seq.*
 Topographical names of catacombs, 55.
 Torcello, cathedral, 172.
 Towers, 183 *seq.*
 Transenna, 164.
 Transept, 93, 124.
 Translation of relics, 81.
 Trench tombs, 50.
 Treves, cemetery, 10.
Tribuna, tribunale, 121.
Triclinium, 51.
 Trinity, 269, 303.
 Trousers, 389.
Tufa, 31.
 Tunic (*tunica talaris, exomis, cincta*), 390 *seq.*
 Tyre, basilica, 177 *seq.*, 181.
- Vaison (France), altar, 160.
Vasa diatreta, 358.
 Vault, 86, 87.
 Veil, 387.
Ventrale, 388.
 Vintage scenes — vine symbol, 254.
 Virgin, see Mary.
 Virgins, consecrated, 247.
 de Vogüé, 116.
- Wedding at Cana, 227.
 Wilpert, 17.
 Windows, 113 *seq.*
 de Winghe, 17.
 Worship in the catacombs, 43 *seq.*

