

INTRODUCTION TO PERMACULTURE

BY BILL MOLLISON

Pamphlet I in the Permaculture Design Course Series

PUBLISHED BY

YANKEE PERMACULTURE

Barking Frogs Permaculture Center

Publisher and Distributor of Permaculture Publications

POB 52, Sparr FL 32192-0052 USA.

Email: YankeePerm@aol.com

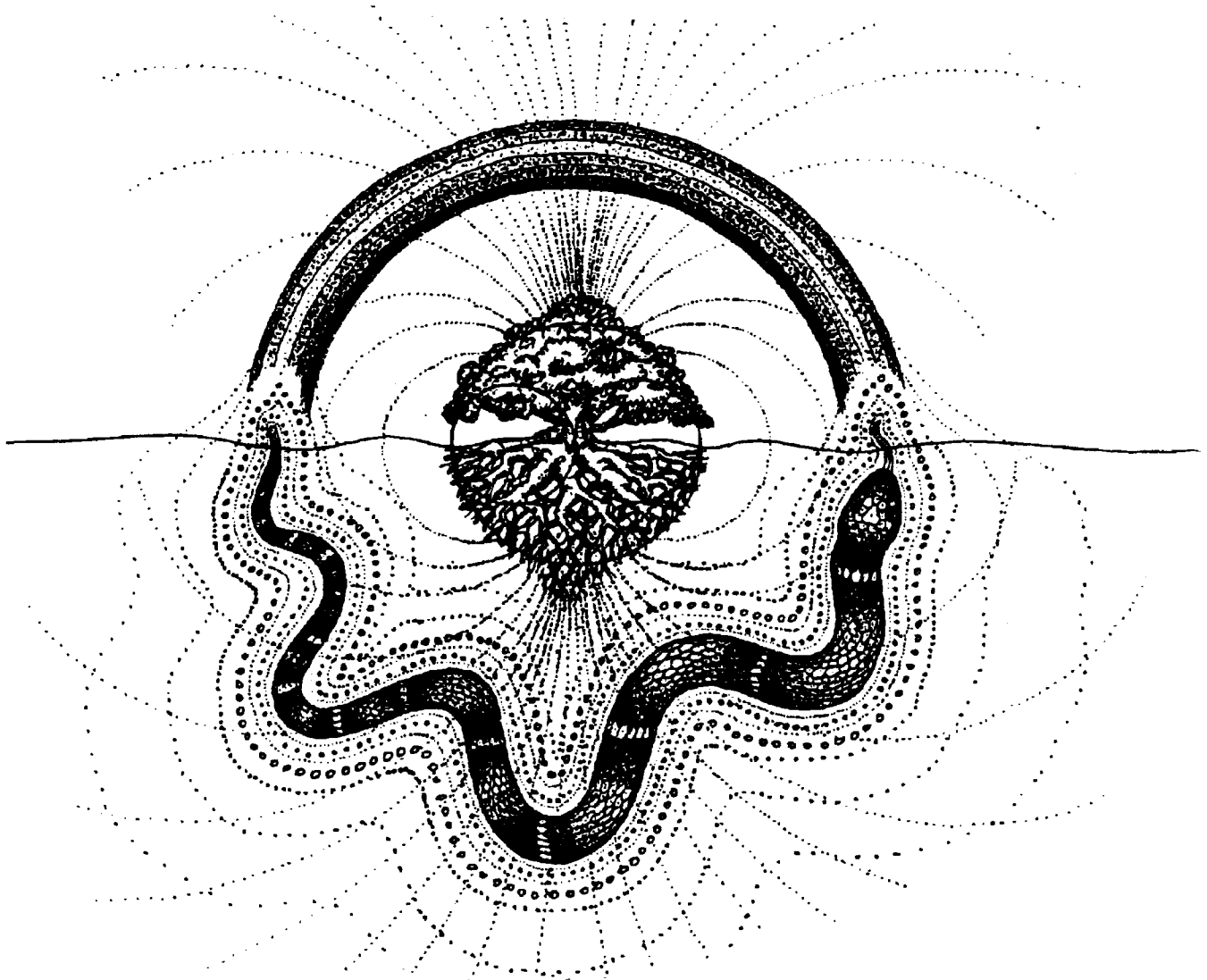

Edited from the Transcript of the Permaculture Design Course
The Rural Education Center, Wilton, NH USA 1981

Reproduction of this Pamphlet Is Free and Encouraged

AN INTRODUCTION TO PERMACULTURE

This is the first in a series of 15 pamphlets based on the 1981 Permaculture Design Course given by Bill Mollison at The Rural Education Center, Wilton, New Hampshire, USA. Elizabeth Beyor, without compensation, transcribed tape recordings of the course and subsequently edited them into the 15 pamphlets. Thelma Snell typed all 15 pamphlets and laid-out most of them. Lisa Barnes contributed illustrations to pamphlets II, IX, and XI. Bill Mollison edited the pamphlets for accuracy and style, as did I, their publisher, Dan Hemenway. I also performed computer typesetting for this edition. After about 10 years of using Thelma's typescript, we were able to offer a typeset version, which is at once more compact, saving trees and money, and more readable. Now we also offer the pamphlets in electronic form, so that they may be read directly by computer without use of any paper, saving more trees. This edition has been slightly re-edited to make it more readable, accurate, and up-to-date.

In deference to the monumental tasks of love in this work, often painstaking, always careful and caring, and with Bill Mollison's consent, I have placed these pamphlets in the public domain. Their reproduction is free to all and encouraged. Credit, above all to Bill Mollison and secondly to Yankee Permaculture, is proper and appreciated.

We have rough Spanish translations of a few Permaculture Design Course Pamphlets, some French translations, and some German translations. To obtain the latest list of translations we have available, order Permaculture Paper #27 from the Yankee Permaculture order form. This is our list of special order documents. Volunteer translators are needed, particularly for Spanish versions. Since these pamphlets are in the public domain, we expect that there are translations of which we have not heard. If you encounter any, please let us know.

Through the efforts of volunteers, we have placed this survey of permaculture in the public domain, supplementing the copyrighted material that is available. Just as we encourage you to reproduce these pamphlets, we urge you to respect the copyright of other permaculture books and publications. Always request permission to reproduce copyrighted material. Always abide by the decision of the copyright holder.

Volunteers are still greatly needed in all phases of our permaculture work. We hope that these pamphlets encourage you to join the champions of Earth, our mother, whether you call your work permaculture, something else, or no particular name at all. And if you wish to pursue permaculture, please note that we offer a large selection of permaculture publications, a journal, a correspondence Permaculture Design Course, and that we are also available to deliver lectures, lead workshops, and teach Permaculture Design Courses anywhere in the world.

To purchase any of these pamphlets on computer disk, please consult our order form.

For our Mother, the Earth,
Dan Hemenway. Sparr, Florida, USA, January 2001.

Ninth edition.

Permaculture Design Course Pamphlet Series	Quantity	Price
Complete Set of 15 Pamphlets. Bill Mollison. \$35 (on paper)	\$35.00 SET	___ \$ _____
Complete Set for computer, by email or as disks. Individually, add \$5 ea. to prices below.	\$50.00 SETFD	___ \$ _____
I An Introduction to Permaculture. (Price reduced 3/22/94.)	\$3.50 I	___ \$ _____
II Permaculture in Humid Landscapes.	\$7.50 II	___ \$ _____
III Permaculture in Arid Landscapes,	\$3.75 III	___ \$ _____
IV Permaculture on Low Islands. (See V for combined price.)	IV	___ \$ _____
V Permaculture on High Islands. (IV, V, & VI offered as one pamphlet.)	\$2.50 V	___ \$ _____
VI Permaculture on Granitic Landscapes. (See V for combined price.)	VI	___ \$ _____
VII Permaculture for Fire Control. (See XV for combined price.)	VII	___ \$ _____
VIII Designing for Permaculture.	\$8.50 VIII	___ \$ _____
IX Permaculture Techniques.	\$8.50 IX	___ \$ _____
X Forests in Permaculture.	\$6.25 X	___ \$ _____
XI Water in Permaculture.	\$3.75 XI	___ \$ _____
XII Permaculture for Urban Areas & Urban-Rural Linkages.	\$3.00 XII	___ \$ _____
XIII The Permaculture Community.	\$2.00 XIII	___ \$ _____
XIV The Permaculture Alternative.	\$2.50 XIV	___ \$ _____
XV Permaculture for Millionaires.	\$2.50 XV	___ \$ _____

All funds must be in US dollars in a check drawn on a US bank or by International Postal Money order. Make checks payable to: "Yankee Permaculture." Make postal money orders payable to: "Dan or Cynthia Hemenway."

For all Yankee Permaculture publications, please add US\$5 plus 10% postage & handling for shipments to the US and 20% for shipments to other countries.

Prices subject to change without notice.

Check our web site at <http://barkingfrogspc.tripod.com/frames.html>

Introduction

by Andrew Jeeves, 1981

Permaculture started in 1975 or 1976 as a public interest when Bill was talking about it to a friend who had a friend who was a radio interviewer on the national, government run, radio station in Melbourne. Bill was asked whether he wanted to do a talk-back program at this radio station. So he did. It turned out to be the most interesting talk-back program they had ever had.

The board was just lit up for the rest of the day. People were asking what it was about and where could they get more information.

Bill, at that time, had a manuscript that he had been working on, just ideas. He thought now was the time to publish something because there was so much information needed. He had at least three thousand letters coming to him saying, "Where can I get more about this?"

At that time, David Holmgren was writing a thesis at the University about permaculture, working together with Bill who was directing his research. So they got the thesis together, Bill added some more, and they rushed together a book which turned into *Permaculture One*. Twenty-five thousand copies were printed. Within three years they were out of print.

Out of that came a group of people wanting to get together to talk about permaculture. They decided to set up an association. The *Quarterly* now has about three thousand direct subscribers. [Now known as *The International Permaculture Journal*, it has ceased publication, at least temporarily. However, there are quite a few active permaculture publications around the world. -ED]

Regional permaculture groups started. People get together once a month or every two weeks to talk about permaculture. Maybe they get something going politically or set up a bioregional association to let each other know what is going on regionally. They are swapping plants, and mapping species of trees in the bush which are good bearers of nuts, and operating a seed exchange, that sort of thing. Thirty-six of those groups in Australia arose in the first four years. Everywhere we hold a workshop, a group usually forms and starts doing something. Every one of those groups seems to be performing a different function.

About two years ago, Bill decided that *Permaculture Two* needed to come out because there was more information. There was also a need to update a lot of the material in *Permaculture One* and change the emphasis from theory to something more practical. We got the manuscript together that Bill had written.

It was pretty haphazard. I went to stay with the editor of the *Quarterly* and we put it together and edited it some more. Then we had thirty thousand of those printed. This book is now reprinted.

Bill came over here to America last year, just lecturing and going from place to place with a few books and selling them, and scraping the money together so he could get to the next place, not really having much money, buying a van in California for \$700 to get across here. It was during that really hot summer and the van died. Bill was stuck out in the middle of nowhere, dead van, and wondering whether this was all worth it?

Then he went to the Futures Conference in Toronto. There were probably 1500 people there. They gave him a little spot, and he gave a talk about permaculture. Someone asked him whether he would like to talk again. He said, "Yeah, ok." There were 700 people at the next meeting. And he was asked to talk again, and there was a bigger crowd. Bill was one of the main finishing lecturers. When things seem to fall down a bit, and no one knew where to go on from there, Bill got up and started talking, and everyone was going, "Wow! Listen to this guy!"

After Bill's trip across the USA, a few groups of people decided that they wanted to hold some more workshops. One of these was The Rural Education Center. And here we are. It probably depends on you as much as it does on us, now.

UPDATE, June, 2001.

Much more has been published and otherwise shaped since 1981, when the above words were spoken. Much of this information is available from Yankee Permaculture, POB 52, Sparr FL 332192-0052 USA. It includes:

The International Permaculture Solutions Journal. TIPS Journal, which succeeds TIPSY, our former yearbook, contains updates on the environmental crisis, practical information on plants and animals of use in permaculture, introductory articles on the basics of permaculture, articles on aspects of permaculture design, extensive letters to the editor, book reviews, and many other items of relevance. Back issues of TIPS and TIPSY are available and remain the best sources of information on many of the subjects that they cover. Some offprints are available.

TRIP-*The Resources of International Permaculture*. TRIP is a directory of groups and key individuals working on issues of concern in permaculture--not only permaculture groups and publications, but also those in bioregionalism, green politics, environmentalism, genetic preservation, appropriate technology, forest concerns, and so forth. Formerly part of TIPSY, TRIP is now in its eighth edition. It contains addresses of approximately 2000 groups worldwide. TRIP is also available on computer disk. Special searches of TRIP may be arranged. And TRIP in print now includes an update service to keep readers up to date until the next entirely new edition.

YANKEE PERMACULTURE also publishes more than 30 permaculture papers, and of course the 15 Permaculture Design Course Pamphlets. Yankee Permaculture also produces for sale the slide/script presentations used to teach the **Elfin Permaculture Design Course** and offers readings for a Permaculture Design Correspondence Course, also in conjunction with Elfin Permaculture. Increasingly, our documents are available on computer disk as well as in print.

Elfin Permaculture annually presents an online Permaculture Design Course taught via email.

Permaculture Quarterly gave up on the schedule implied by that title and has become *International Permaculture Journal*, which has suspended publication at this writing. *The Permaculture Activist*, POB 1209, Black Mountain NC 28711-1209, USA. The *Activist* is a newsletter for English-speaking permaculturists in North America and Hawaii and is just about the best single source of listings of permaculture training programs in these regions.

Bill Mollison published two more very important books, *Permaculture: A Designers' Manual* and *Introduction to Permaculture* both available from Yankee Permaculture.

Contact Dan Hemenway, Elfin Permaculture, Barking Frogs Permaculture Center, POB 52, Sparr FL 32192 USA about hosting a permaculture design course or about consulting and design services. The email address is Barking-FrogsPC@aol.com Always include a SASE or international return mail coupons with letters and, if possible, enclosed a contribution for time and expenses, when requesting information from a permaculture group.

Contributions of time, money and/or other resources are welcome.

THE TERRIBLE TIME OF DAY

by Bill Mollison, 1981

I don't think anybody has summarized what is happening on the face of the Earth.

In order to change our ways, we seem to need to terrify ourselves, anticipating tidal waves and catastrophes. Now those things may come off, and the San Andreas fault may shift. But we can't do much about that. What is really happening is something for which we, as human beings, are personally responsible. It is very general. Almost everything we say applies everywhere.

The real systems that are beginning to fail are the soils, forests, the atmosphere, and nutrient cycles. It is we who are responsible for that. We haven't evolved anywhere in the west (and I doubt very much elsewhere except in tribal areas) any sustainable systems in agriculture or forestry. We don't have a system. Let's look at what is happening.

Forests

Forests have been found to be far more important in the oxygen cycle than we ever suspected. We used to think oceans were the most important element. They are not. Not only are they not very important, contributing probably less than 8% of the oxygen in atmospheric recycling, but many are beginning to be oxygen-consuming. If we release much more mercury into the seas, the ocean will be oxygen-consuming. The balance is changing. Therefore, it is mainly the forests that we depend on to preserve us from anarchic condition.

Of the forests, some are critically important, like the evergreen forests, of which there are two extensive systems. One is equatorial, multispecies; and the other, cool evergreen forests of the Russian tundra and the southern evergreen forests. Rain forests are critically important in the oxygen cycle, and in atmospheric stability.

The forests also provide a very large amount of our precipitation. When you cut the forest from ridges, you can observe the rainfall itself fall between 10% and 30%, which you could probably tolerate. What you don't see happen is that precipitation may fall over 86%, the rainfall being only a small fraction of the total precipitation. It is quite possible on quiet, clear nights with no cloud, no rainfall recorded anywhere on any gauges, to have a major precipitation in forest systems. It is particularly true of maritime climates. But it is also true of all climates. Therefore it is possible to very rapidly produce semi-desert conditions simply by clearing trees from ridge top. This is being done at a great rate.

It is the character of forests to moderate everything. Forests moderate excessive cold and heat, excessive run-off, excessive pollution. As forests are removed, immoderate extremes arrive. And of course, it is the forests that create soils. Forests are one of very few soil-creating systems.

What is happening to forests? We use a great many forest products in a very temporary way - paper and particularly newspaper. The demand has become excessive. At present, we are cutting one million hectares per annum in excess of planting. But in any one month, that can rapidly change. Last month, for instance, that doubled because of clearing of the Mississippi bottom land forests for soy beans.

Of all the forests that we ever had, as little as 2% remain in Europe. I don't think there is a tree in Europe that doesn't exist because of the tolerance of man or that hasn't been planted by man. There is no such thing as a primeval European forests. As little as 8% remain in South America. And 15%, I think, is a general figure in other areas. So we have already destroyed the majority of forests, and we are working on a rather minor remnant. Cutting rates vary, depending on the management practices. But in general, even in the best managed forests, we have a constant loss of 4%, giving 25 more years to go. But in fact, what we observe throughout Southwest Asia and in South America, and throughout the Third World, and wherever multinationals can obtain ownership of forests in the Western

world, is about 100% loss. It is a "cut and run" system.

We have long been lulled into a very false sense of security by reassurances that the logging companies are planting eight trees for a tree cut. What we are really interested in is biomass. When you take something out of the forest in excess of 150 tons and put something back which doesn't weigh much more than 10 ounces, you are not in any way preserving biomass.

What are the uses to which we put forests? The major uses are as newsprint and packaging material. Even the few remaining primeval forests are being cut for this. Forests that had never seen the footsteps of man, that had never experienced any human interference, are being cut for newsprint. Those are forests in which the trees may be 200 feet to the first branch, gigantic cathedrals. They are being chipped. There are trees in Tasmania much taller than your redwoods. These are being cut and shipped out as chips. So, for the most part, we are degrading the primeval forests to the lowest possible use.

That has effects at the other end of the system. Waste products from forests are killing large areas of the sea. The main reason why the Baltic and Mediterranean and the coast off New York have become oxygen-consuming is that we are carpeting the sea bottom with forest products. There are, broadly speaking, about 12,000 billion tons of carbon dioxide being released annually by the death of forests. We are dependant on the forests to lock up the carbon dioxide. In destroying forests, we are destroying the system which should be helping us. We are working on a remnant of the system. It is the last remnant which is being eroded.

Climate

The effects of this on world climate are becoming apparent both in the composition of the atmosphere and in the inability of the atmosphere to buffer changes. In any month now, we will break the world weather records in some way. In my home town, we are very isolated and buffered by ocean and forest. But we had in succession the windiest, the driest, and the wettest month in history, in two hundred years of recording. So really what's happening in the world climate is not that it is tending toward the greenhouse effect; it is not that it is tending toward the ice age; it is starting now to fluctuate so wildly that it is totally unpredictable as to which heat barrier you will crack. But when you crack it, you will crack it an extreme and you will crack it very suddenly. It will be a sudden change. Until then, we will experience immense variability in climate. That is what is happening.

We can just go cutting along, and in maybe twelve more years we won't have any forests.

There is still another factor. It would be bad enough if it were just our cutting that is killing forests. But since the 1920's, and with increasing frequency, we have been losing species from forest to a whole succession of pathogens. It started with things like chestnut blight. Chestnuts were 80% of the forests that they occupied. So a single species dropping out may represent enormous biomass, enormous biological reserve, and a very important tree. Richard St. Barbe Baker pointed out that the trees that are going are those with the greatest leaf area per unit. First chestnuts, with maybe sixty acres of leaf area per tree. Then the elms, running at about forty. Now the beeches are going, and the oaks, the eucalypts in Australia and Tasmania. Even the needle leaf trees in Japan are failing. The Japanese coniferous forests are going at a fantastic rate. So are the Canadian shield forests and the Russian forests.

The Phasmid Conspiracy

Now we come to a thing called the phasmid conspiracy. Each forest varies in each country in that its elms, its chestnuts, its poplars, its firs, are subject to attack by specific pathogens. Insects are taking some sort of cauterizing measures. The American reaction would be to spray; the British reaction would be to fell and burn; and in Australia, the reaction is to say: "Aah, what the Hell! It's going to be gone next year; let it go!"

Really, is it these diseases? What are the diseases? Phasmids are responsible for the death of eucalypts. There is the cinnamon fungus. In elms, it's the Dutch elm disease. In the poplars, it's the rust. And in the firs, it's also rust. Do you think that any of these diseases are killing the forest?

What I think we are looking at is a carcass. The forest is a dying system on which the decomposers are beginning to feed. If you know forests very well, you know that you can go out this morning and strike a tree with an axe. That's it. Or touch it with the edge of a bulldozer, or bump it with your car. Then, if you sit patiently by that tree, within three days you will see that maybe twenty insects and other decomposers and "pests" have visited the injury. The tree is already doomed. What attracts them is the smell from the dying tree. We have noticed that in Australia. Just injure trees to see what happens. The phasmids come. The phasmid detects the smell of this. The tree has become its food tree, and it comes to feed.

So insects are not the **cause** of the death of forests. The cause of the death of forests is multiple insult. We point to some bug and say: "That bug did it." It is much better if you can blame somebody else. You all know that. So we blame the bug. It is a conspiracy, really, to blame the bugs. But the real reason the trees are failing is that there have been profound changes in the amount of light penetrating the forest, in pollutants, and in acid rain fallout. People, not bugs, are killing the forests.

Soils

As far as we can make out, we have lost 50% of the soils we have ever had before 1950. We have been measuring pretty well since 1950. And we have lost another 30% of the soils that remain. Now this is as true of the Third World as it is in the Western World.

The rate at which soils are created is at about four tons per annum per acre - much less in dry areas. Soils are created by the fall of rain and the action of plants. The rate varies. In the desert, they are being created at a much lesser rate. But in these humid climates, at about four tons per acre. If you don't lose any more than four tons of soil per acre per annum, you are on a break-even.

But let us look at the usual thing. In Australia, we lose about 27 tons of soil per cultivated acre per annum. You do a lot better than that in America, however. Where you grow corn, you can lose as much as 400 tons per acre per annum. While the average may be twenty, it will go as high as 400 or 500 tons. So we are not doing too well. In Canada, they are measuring the humus loss, and that is about the same. There, they are running out of humus. In the prairies, where they started with good humic soils, they are now down to a mineral soil base.

Here is something that should be of interest to each of us. For every head of population - whether you are an American or an East Indian - if you are a grain eater, it now costs about 12 tons of soil per person per year for us to eat grain. All this loss is a result of tillage. As long as you are tilling, you are losing. At the rate at which we are losing soils, we don't see that we will have agricultural soils within a decade.

Apart from the soils that we lose directly by tillage, we are losing enormous quantities of soils to what is called desertification. In the state of Victoria, in Australia, we lose 800,000 acres this year to salt. That means not only a loss of soils which are tilled, but also a loss of the soils that we don't till.

Deforestation Causes Soil Loss

Now the main reason for disappearance of soils is the cutting of forest. And almost always the cutting of the forest is remote from where the soil is lost. That is, you can do nothing if your soil starts to turn salty here, because the reason lies way up the watershed, maybe a thousand miles away. We are now starting to get soil salting in humid climates in Australia. It is becoming a "factor out of place." It is no longer only occurring in deserts. It occurs in quite humid, winter-wet climates. How did this happen?

It is not a simple process, but it is easily understood. The rain, as it falls on hills and penetrates forests, has a net down-

ward transfer. If we remove forests, we now have a net evaporation loss. Forests transmit clean water downward, and they release clean water into the atmosphere. This net downward transfer carries with it the salts which are an inevitable part of that additional four tons of soil per acre which is produced from breakdown of rocks. These salts normally travel on out in deep leads. They are not surface systems. Fresh water runs from the surface and soaks down. Even in humid climates, we have much saltier water at depth than we have on the surface. This is because the trees act as pumps to keep the leads low.

If we cut the trees down, the deep leads rise at a measurable rate, and they are rising measurably across enormous areas in America, Africa and Australia. When they are up to about three feet below the surface, the trees start to die of "phasmids." And when they are up to about 18 inches below the surface, other crops start to die. When they reach the surface, they evaporate and the soil visibly goes to salt. Then the Australian government starts providing free pumps to farmers and they start pumping out the salt water. Where can they discard the water they pump out? Big problem!

The next step is to have concrete delivered, so now water diverted from the rivers soaks into the soil while they are pumping the salt water off to the sea. And they have to be doing that forever. You now want a thousand thousand pumps. At the same time that the government is supplying pumps to farmers, it is leasing additional wood-chipping licenses to the multinationals, who are doing very well. They are selling pumps on one hand and wood chips on the other. It is a happy circumstance for some people, but a catastrophe for the Earth.

Most people, however, aren't doing very well at all. So we are losing soils and increasing desert at a simply terrifying rate. And that is without any plowing for agriculture. You ask if the analysts of the multinational firms are aware of these problems? No, they have degrees in economics and business management and all sorts of irrelevant areas.

Mining is also a major factor in salting on a local basis, and has accounted on its own for the loss of whole hardwood forests in areas of Western Australia and no doubt elsewhere. Mining brings up a lot of residues which are evaporated on the surface.

Highways, Cities and Wells

The largest single factor in Britain causing loss of soils is the construction of highways. It is also a major factor in America. In Britain, I think that there is a mile of highway for every square mile of surface. And highways are being rapidly extended on the supposition that you will never need the soil and that highways will enable you to increase energy use. Highways account for the permanent loss of soils, as do cities.

Cities are located on the 11% of very good soils of the Earth. Canada is an interesting example, where cities are liable to obliterate the top quality soils, without any other factor, and in this decade, leaving agriculturalists to move on to less sustainable situations. At the same time, we are calling for at least sustained production, and in some cases an increase of production, on the soils that remain. As the loss of agricultural soils is largely due to the excess application of energy - mechanical energy and also chemical energy - then the fact that we are attempting to sustain productivity on the remaining soils means that the rate of loss must increase due to the fact that we use more and more energy on less and less surface.

Other factors work for loss of soils. In the arid southwest of this country, there is a sort of cut and run agriculture in which you sink a bore [drill a well] and pump up semi-saline water to annual cultivated crop. You keep this up for four years. By then the surface is heavily mineralized and you must seek another area and sink another bore, which results in a sort of carpeting destruction. You can see it. There are two or three good years, then returns fall below economic level. The soils are usually glued together with carbonates and they give up. pH rises by about two points per annum. You might start at pH 8 and rapidly go to pH 11. It is then that you pull out.

We look now at wind deflection of soils. This has brought about failure of the inland soils in America. There are soils blowing out to Los Angeles and falling as red rain. Soils from Central Australia marginal areas fall on the cities as a sort of finely diluted mud, measurable at 12 tons per acre per day. Wind is a major factor in soil loss. The drier it gets, the more wind becomes the factor that we look to.

We don't have to look any further than the soil, or any further than the forest, to see a finite world. I think we can say with confidence that we don't have a sustainable agriculture anywhere in the world, or a sustainable forestry.

Water

Let us move now to water. Even a decade ago, somebody said that water would become the world's rarest mineral. The water table everywhere is now falling rapidly. These are very ancient systems we are playing with. Many of them are about 40,000 years in evolution. No longer is there any way you can get cheap surface water. If you could, Los Angeles would buy it and use it. A major factor in this is the way we seal everything over in cities and towns. We don't get any recharge of soil water. We seal over huge areas with highways. We don't return water to the water table at all. As soon as water is in a river or creek it is gone. It is on its way to the sea, or it is evaporated on the desert salt pan. The flowing river is not really a very useful thing. It is on the way out.

There are two very critical areas for water. One is within cities. The other is on the edge of deserts. Both are running into real trouble. Encroaching deserts are killing some millions of people now in Africa. It is visible from the air as migrations of herds and people out of the Sahara.

One of the dangers has been the long term disposal of atomic waste in the deep waters. Some of these are beginning to seep through the Sacramento Valley. You had better start counting the radioactivity coming in the water table in Maine, New Jersey and California, and, I have an idea, in lots of other places as well.

Industry has simply used deep bores to put dangerous wastes into the water table with the result that large areas of this water table have become unpotable. I think Boston has ceased to use its ground water. And you'll never be able to use it again. There will be no way you will ever clean that foul water.

In many towns and cities now, water is running at 700 parts per million dissolved salts, which is at about the limit of the tolerance of the human kidney. At 1100 parts per million, you would experience fainting, accumulation of water in the tissues, all sorts of problems. Most deaths from that commonly occur in the cities, in Perth and Adelaide in Australia, in Los Angeles. In all these areas, perhaps, we shouldn't be using water for drinking. It's ok to shower in, although in Atlanta, the chlorine alone almost asphyxiates you when you shower. PCB's are a cause of sterility. I think about 20% of American males are now sterile by age 20.

The fact that water is becoming a scarce resource is manifestly ridiculous, because roughly half a million gallons fall on this roof right here annually. But you could be very short of water here soon unless you build tanks or surface storages to catch the water.

Now, of course the loss of trees has a pronounced effect on this increased scarcity of water in cycle. The water is not cycling. We are losing water on the surface of the Earth. I think that 97% of water is locked up at all times and only 3% goes into any cycling at all. We are reducing that very rapidly.

There are yet other factors. There is industrial pollution. There is a desperate scramble for energy sources, whether they are wood, coal, oil or atomic power. These are all really dangerous things to use in terms of the general life system. We are going toward real trouble. The danger is mainly in the end result - what comes out of the process, what goes up the chimneys. But in the case of wood, it is also the fact that you destroy a tree.

Chemicals. What can you say about them? Most every

broad-scale release of chemicals has unforeseen and long term results. These chemicals include DDT, PCB's, dioxin and chlorine.

A Desperate Future

At the very least, we have a desperate future. Our children may never believe that we had surplus food. It is mainly because of utterly ridiculous things. The entire output of atomic power in the United States is exactly equivalent to the requirements of the clothes-drying machines.

I literally can't stand being on the American highway. To me it is almost like being in a prison of madness. I can stand the background; but I can't stand the highways in Canada or here. Driving like crazy people. Where are they going? And why are so many of them going in that direction? They are all fleeing something. I would like to inquire what is in those trucks that are tearing down the road. Is it something of no use at all? Or something which is present where it is going? And often I have seen trucks, apparently carrying identical cargo, going in opposite directions, carting it here and there. The drivers tell me that they are carrying widgets.

Now all of this, including the energy problem, is what we have to tackle at once. It can be done. It is possible. It is possible to make restitution. We might as well be trying to do something about it as not. We will never get anywhere if we don't do anything. The great temptation, and one in which the academic takes total refuge, is to gather more evidence. I mean, do we need any more evidence? Or is it time to cease taking evidence and to start remedial action on the evidence already in? In 1950, it was time to stop taking evidence and start remedial action. But the temptation is always to gather more evidence. Too many people waste their lives gathering evidence. Moreover, as we get more evidence, we see that things are worse than they had appeared to be.

THE INTERNATIONAL PERMACULTURE
SOLUTIONS JOURNAL
P.O. Box 52, Sparr FL32192-0052 USA
DAN HEMENWAY, EDITOR & PUBLISHER
CYNTHIA BAXTER HEMENWAY ASSOCIATE EDITOR

Many of us are painfully aware of the severity of catastrophic ecological decline worldwide. *The International Permaculture Solutions Journal* delivers information, ideas and discussion to provide Earth-healing tools or to promote their development. Information that is practical, detailed and hard to find elsewhere often turns up on "TIPS" pages.

Who Writes for TIPS?

Many TIPS writers are tops in the movement: Bill Mollison, Jim Duke, Bill McLarney, and our editor Dan Hemenway, for example. Others are people who have been quietly working on their own. They all have something important to say.

What Does TIPS Cover?

TIPS issues often follow a specific theme. Presently we have a series of issues on aspects of developing sustainable food systems. After that will be a series on "Permaculture Design: The Process and the Product," and then a series on appropriate technology in permaculture. And of course each issue contains articles outside the theme as well--matters too important to wait. Eclectic book reviews, fascinating letters to the editor, informative illustrations, & easy-to-use format are hallmarks of our publication.

DESIGN FOR REMEDIAL ACTION

When we design for permanence, we go generally toward forests, permanent pastures, lakes and ponds, and non-tillage agriculture. That is our business. Until we get more clues as to what will be sustainable, that is what we have to play with.

Industrial water can be supplied from roofs. Settlements can use that water. America is simply sort of tanks. Now there are different sorts of tanks. One is the kind you put under the downspout from the roof of your house. Tanks of another sort are the cheap tanks - earth tanks. Absolutely no problem. Always enough water for all our uses - fresh water, which we presently let go into the sea.

We have three ways of water storage. We can store it in the soils; we can store it in surface earth tanks, and we can store it in sealed catchments. For an agricultural situation, we will use the soils. For domestic situations, we will use earth tanks. They are very much cheaper. For every 5,000 gallons we can store in concrete tanks, we can store 250,000 in Earth tanks at the same cost.

We have legal and financial strategies. We can convert locally into far more self-reliant bioregions. The people who are doing that are adding greenhouses to their houses and doing their own gardening. There is an immense conversion going on. That's where we start, dealing with an acre.

Now the thing that we have ignored, not only turned our backs on but often fled from, is conversion of high level investment capital to these low energy systems. There are a whole set of strategies to do so that we are assembling as an "Earth banks" service. Some of these strategies will benefit our social happiness as well.

The only way we can do things fast is by making the least number of moves in the fastest possible time, and by very rapid delegation of work to people. There is no hope that we can get this done in the next five years if we keep it to ourselves. Therefore, I have come here to break the monopoly of the elite alternative in America. We have got to let experts loose on the ground. We need hundreds and hundreds of them. We don't want at any time to patent anything or to keep any information to ourselves, not even keep our jobs to ourselves. The time for that is gone. What we are involved in is a cooperative, not a competitive, system. There are a very few of us operating at this end of the system, therefore we have to act in a very efficient way in order to create the greatest amount of change in the shortest period of time.

I think we have an ethic here: **to stop admiring the people who have money.** There has to be a big ethical change. It is an interesting time to be living in. The big twist we have to make is away from our educational system. All the methodologies and principles we use arose as a result of observation of natural systems, and are stated in a **passive** way. The mind twist that has to be made to create permaculture is to realize that you can get hold of that and **do** it. We have to make our knowledge **active.** We have to move from a passive to an active thought level.

" Agriculture is a destructive system."

What are the strategies by which we don't need agriculture? Agriculture is a destructive system. Well, we need a lot more **gardeners.** Gardeners are the most productive, most hands-on sort of agriculturists. They always have been. There never has been any debate about it. When you make a farm big, you just accept a suddenly lower productivity and yield, but less people get it. That is why it is economically "efficient." When you talk about efficient farming of this order, you are talking about **dollars.** When you reduce the size of the owned landscape, providing you don't reduce the lots to less than a quarter of an acre, the agricultural productivity goes up. You get a lot of arguments to the effect that breaking up large farms into five acre blocks is uneconomic. Five acre blocks are. One to one-quarter acre blocks are not. They are highly productive.

Now **gardeners**...How many gardeners are there in the Unit-

ed States? Fifty-three percent of households now garden. They garden only 600 square feet on the average. They make something like \$1.50 a square foot. These household gardeners are producing 18% of the food in the United States, at a value almost equivalent to total agriculture.

Now let's look at Russia. The peasant farmer, on a half-acre to an acre, is producing some 84% of the food. The state farms, which occupy most of the agricultural land, produce the remainder. But the state farms are not doing their job. They have a 6% deficit, which is shipped in from Canada or the United States. The glamorous agriculture, the large scale, broad scale agriculture, is not the agriculture that is producing the food.

We are now down to about 20 basic foods. The day of soybeans is probably arriving. You can make just about anything out of soybeans.

Control of Seeds

I don't think that there are very many seed companies left in the world that don't belong to a consortium of not more than 10 companies. It is certainly true in Australia. The seed is now being grown for and distributed by the multi-nationals. Can you buy a non-hybrid corn in the United States? Here and there. In Australia, we can't. But we do have one seed company. It is called Self-Reliance Seed Company in Stanley, Tasmania. Maybe we have two.

[Self-Reliant Seeds is now defunct, but it was replaced by Phoenix seeds, also of Tasmania. Ed.]

The next move of the large seed-growing consortiums was to have been seed-patenting legislation. At this point, a lot of people started to get a bit suspicious. The patenting of biological materials was a slightly suspicious move. Then the World Council of Churches looked into the situation and produced Seeds of the Earth. The cat was out of the bag. So there has been a general ground-level revolt against takeover of a basic resource. Kent Whealy's Seed Savers Exchange is just one of these moves.

But one thing this may have taught is that you can't run away from systems. Holing up in two acres out in the New England forests isn't going to get you out of the system unless you are into a seed-growing operation and know exactly what you're doing. Most people do not. If you are training yourself to be a good gardener, there are still certain areas you just haven't got into, and seed growing is one of them. In one valley in Tasmania, among a group of hippies living there, you might find 50 Ph.D.s. Most of them are sitting home knitting or weaving or running around getting blackberries, just leaving it to the really ruthless people to get on with what they are doing. We must involve **all** our skills to organize life forces, not just a few.

In the permaculture garden, we must deal with the question of ways in which elements are to be placed. Some of these elements are manurial or energy-exchange systems for other elements; others are defensive elements that protect other plants in a whole set of ways; and some act as trellis systems for others or provide shade. So there are physical relationships involved and there are whole sets of rules that govern why certain elements are put together. And we understand some of these rules. A lot of them are quite obvious.

Diversity

Diversity isn't involved so much with the **number** of elements in a system as it is with the number of **functional connections** between these elements. Diversity is not the number of things, but the number of ways in which things work. This really is the direction in which permaculture thinking is headed. I was sitting up one evening, studying how many connections are made by putting just two elements together, a greenhouse and a chicken coop. I think I came up with 129 sorts of beneficial connections. So what we are really talking about is not some grandiose complication of 3,000 species on a site.

It would be nice to make 3,000 **connections** between 30 species or 30 elements, with those connections defined as be-

ing beneficial or non-beneficial. You can see hundreds of examples, particularly in social groups, where diverse interests are not necessarily beneficial. Diversity of itself doesn't give you any stability or advantage.

So what we are setting up is a sort of **guild** of things that work harmoniously together. There are rules to follow on placement within the area. There are rules that have to do with orientation, with zonation, and with the interactions. There are whole sets of principles which govern why we put things together and why things work.

The agriculture departments have defined agricultural land. What they mean is land which can be tilled. But I don't see **any** landscape as being non-agricultural. There is a whole hierarchy of productivity in landscape, and it all can be used for production. So there are really two strategies for our consideration in agriculture. One is to find out what is the minimum level to which we can reduce agricultural practice, and to go about that. Another is to find the level at which we can increase the use of land termed non-agricultural for agricultural products. There are all sorts of new games to be played. I am literally amazed how little these forests in America are used for sustained productive purposes, as forests.

Principles

Let us look at the sets of principles that govern these systems. These principles, rules and directives are based on the study of natural systems. Axioms are established principles or self-evident truths. A principle is a basic truth, a rule of conduct, a way to proceed. A law is a statement of fact backed up by a set of hypotheses which have proved to be correct or tenable. Theses and hypotheses are ideas offered up for proof or discussion. There are also rules and laws laid down which are neither rules or laws. They do not pay much attention to defining how they got there. Now I have evolved a set of directives which say: "Here is a good way to proceed." It doesn't have anything to do with laws or rules, just principles.

Energy, Source, and Sink

We deal with the Earth, which has a fairly constant energy input from other parts of the universe. We are dealing with energy which has a renewable source, the sun. [Not true—the sun is using itself up. However it will expand and consume the Earth before it ceases to be a source of the shorter wavelengths. - DH] Between the source and the sink is where we intervene. The more useful storages to which we can direct energy between the source and the sink, the better we are as designers. So what we are up to is making an efficient set of storages that are useful to man [sic.]. Some of these storages may be useful in the creation of other storages. The amount of complexity we can build into that flow, the amount that we can direct to useable storages in order to hold back energy until we start to use it, that's where the skill of the designer lies. Furthermore, a lot of energies unusable in a mechanical sense are usable in the biological sense. So we need biological as well as mechanical storages.

Energy can be transferred from one form to another, but it cannot disappear or be destroyed or created. So we have a choice in the type of flow that we allow through the system. We can determine whether it is stored or whether we let it leave.

That is the choice we have with water, with rainfall. We can store it or we can let it leave; and if we let it leave, it becomes unavailable to us.

If we would recover it, there is a lot of work to making it available again. Engineers go down to the valley, because everybody can see there is water down in the valley. So they put a block in the valley and the water backs up behind it and you have water, a big lake down in the valley where it is least useful. Where it came from was up on the hills. Had the engineers stored the water where it came from, then they could have run it through all sorts of systems before they let it escape into the valley. The closer to the source that we can intervene, the greater use is the network that we can set up. So we edge up close to the

source to start to intervene in the flow. It's not the amount of rainfall that counts, it is the number of duties we induce that water to perform that counts.

Not all energy that goes into the system is efficient. Whenever we change the line of energy, we lose a little. No matter how well we design, we must always lose a bit.

A lot depends on the maintenance of the global biological-chemical cycle of essential elements, particularly carbon, nitrogen, oxygen, sulphur and phosphorous. We are worried about some of these cycles.

The probability of the extinction of a species is greatest when the density is very high or very low. There is a density dependence. You can see how high density is a dangerous thing for species because of very rapid transmission of plague resulting from the exhaustion of critical elements upon which the species depends. It is more difficult to see how very low densities are also critical situations. The factor of number is a factor ignored by most communes or communities.

"The probability of the extinction of a species is greatest when the density is very high or very low."

I don't think we know of any society of man whose continuance depends on their own genetic health that can exist below 300 in population, and not even at that number without very rigorous genetic control. We are breeding for extinction in several areas. High density populations often also start to include an enormous range of genetic disasters or mutations.

It is possible to make small changes in a general system to bring about a higher chance of survival of the elements of the system, or high yield within the system. There is an horrific statement called the over-run thesis which says: "Our ability to change the face of the Earth increases at a faster rate than our ability to foresee the consequences of that change."

And there is the life-ethic thesis, which says that living organisms and living systems are not only **means** but **ends**. In addition to their value to man, or their instrumental value to human beings, they have an intrinsic worth which we don't allow them. That a tree is something of value **in itself**, even if it has no value to us, that notion is a pretty foreign sort of thought to us. That it is alive and functioning is what is important.

Resources

Resources are something you can feed into a system and increase its productivity, or its yield, or the number of useful storages. But if you continue beyond that point of productivity, then the system itself collapses. And that comes down to the statement that any integrated system can only accept that amount of energy that it can productively use. So you can over-manure anything, over-heat anything; you can over-plow anything. Whether we are talking about money or manure, you can put too much of it in. What then happens is first you start to get less and less increase in yield and then more and more increase in a lethal factor. You can't continue to pour in more of the same thing and get a continued increase in yield.

A friend of mine went to Hong Kong. He ran a sort of energy budget on the city, paying a lot of attention to agriculture. He told me that the older Chinese agriculture (weeding by hand) produced, under very intensive conditions, using natural manures, about three times as much energy as it consumed. Then they modernized, utilizing small tractors, artificial fertilizer, and weeded by little hot jet flames. I think he said that they put 800% more energy in and got a 15% increase in yield. And then as they continued to pour in more energy, the yield decreased. By now they are into the same kick that we have. They only get 4% to 6% of that energy out again.

So agriculture went from an energy productive to an energy consuming system, just as the sea has gone from being oxygen producing to oxygen consuming, all because we are putting too much nutrient into it. You can do it to a pond very quickly and to a nation or a continent more slowly.

Then there are categories of resources that are of a totally different sort. There are resources which are unaffected by use. You can look at a beautiful view all day and it really doesn't affect the view. Information is such a resource. [But information is preserved by use. -DH]

There is another category of things that is interesting in that they **increase** if you use them. The more you use them, the more that they increase. Some forms of browse fall into that category. Some categories of animals and plants increase each other by interaction, and some other categories of resource also do that. And some resources, particularly quick turnover resources, simply decrease if you don't use them. Annual grass is a good example. If not used, the amount of annual grass in the system decreases. To some extent, so does firewood in a fire-prone situation. It accumulates as a fuel for wild-fire when all of it is consumed at once.

But most resources lie in the category of resources that need to be **managed** to maintain them. They are those which decrease if used. We will call them finite resources.

There is still another category made up of resources that, if you use them, decrease everything else. We have a good example of that in uranium or plutonium. Plutonium in use tends to lay waste to other resources and some of those uses are horrific. Things like dioxins, if used as a resource, start to decrease the general resource.

So resources have a sort of hierarchy of management and a hierarchy of being beneficial or not beneficial. Most of the things that make us happy either are very manageable or there are plenty of them. There are a few things which we think we need, but which make us miserable.

I think we can pollute with time, and I expect that we can, also, with diversity. Just by putting a lot of things together, we might reach the stage where we pollute the system simply with diversity.

Petrol (gasoline) is a resource which has created disorder in Western society. I can't think when someone last productively used a gallon of gasoline. Nearly all of it is used non-productively. I used a pint or two once to destroy a nest of bull ants to which I am allergic. As far as I was concerned, that was productive. I also do not know of a case in tractor economy where a machine produces more energy than it uses. You have to take the oil out of the ground, you have to refine it, you have to ship it. You argue that petrol fueled the jet upon which I traveled when I came over here. Right. But I came over here just so that you wouldn't have to go over there. It is true that petrol has some present uses - what I call restitutive uses. But generally speaking, the use of gasoline has resulted in terrible disorder. It reaches right into the social structure.

Chaos is really the opposite of harmony. It is conflicting competition and individualism. When everything is in chaos, if there are two or three of you going in one direction, you have to win, hands down, for everything else is really falling to pieces. So maybe we will win; maybe we are seizing an historic opportunity.

When we design, I keep coming back to what we **do**. We have a two-fold job: to recommend only the energies that are productive, energies that are not harmful, and to attempt to build harmony into functional organization, to pick up the pieces and make harmonious order.

We should not confuse order and tidiness. Tidiness is something that happens when you have frontal brain damage. You get very tidy. Tidiness is symptomatic of brain damage. Creativity, on the other hand, is symptomatic of a fairly whole brain, and is usually a disordered affair. The tolerance for disorder is one of the very few healthy signs in life. If you can tolerate disorder, you are probably healthy. Creativity is seldom tidy.

"Tidiness is symptomatic of brain damage."

Tidiness is like the painting of that straight up and down American with his fork and his straight rows. The British gar-

den is a sign of extraordinary tidiness and functional disorder. You can measure it easily, but it doesn't yield much. What we want is creative disorder. I repeat, it is not the number of elements in a system that is important, but the degree of functional organization of those elements - beneficial functions.

Yield is the sum of useful energy stores. It is the sum of energy conserved and generated in systems. It is never just **product** yield, not the number of pounds of tomatoes, or pounds of fish, or of acorns - which is the normal way people have of measuring yield - but it is the sum of the energy in useful storages. Yield is a function of design, and it is theoretically unlimited. That is, I haven't seen a system where we can't, by better design, increase the yield.

As the design itself is a function of our understanding of the system, so does the yield also depend upon the degree to which we understand things. It is the intellect that decides all these things, rather than any extrinsic factors. I am not quite sure what the intellect is. I have put it as our ability to understand, which may not be intellectual but empathetical.

Between the source and the sink, diversity increases: energy stores may increase and organizational complexity may increase. Our job is to convert those pauses in the flux of some of those categories into beneficial resources. It is the number of niches in a system that will allow a number of species and varieties to co-survive. It is the woodpecker's hole within the forest.

Now, again, the number of niches in a system depends on the design of the system. So now we have come to the active case. In situations which should be saturated with species, and with yield, we can make a vast difference by seeing where we can create more space, often by very small movements. [After first seeing where the unfilled niches, the empty spaces, exist, and filling them. Temperate ecosystems, in particular, often are incomplete.-DH] The numbers of pairs of pigeons breeding on a cliff depends on the number of ledges. It is easy to increase the ledges. Often, what is holding down a yield isn't the basic factor of food. In fact, food ceilings are very rare things to bump. It is some other factor totally unrelated to food. There are tons of food [acorns] around this environment [Wilton, New Hampshire], with nothing eating them.

What we must do is to see how things work, how different things work.

Tribal lore prescribes that one should only carry out necessary acts, that non-necessitous behavior tends to be very destructive. The rest follows. Therefore, one apologizes for whatever one has to do and does it. But you don't see people doing unnecessary acts.

Some time around 1952, I had a house in the bush, and I thought, as a curious thing to do, I wouldn't cut down a tree unless I had to. I never had to. But we could also live in the bush and cut trees down. Unfortunately, if you have money, it is hard not to. You are always doing something because you have to get rid of that money. Like petrol.

As I see it, tribal myth was a way to teach care of the environment. I believe that we are involved in a more complicated game than we had previously thought.

If you put fish and a set of algae in a pond, and one of those algae is particularly delicious, the fish chomp on the delicious algae until there are none of those left. Thus they disfavor them. Then the other algae, not palatable to the fish, increase, thereby controlling the fish, starving the fish out. Fish eats algae; algae destroys fish.

We let cattle go on landscapes, and the landscapes respond. The cattle disfavor plants that they like and thereby produce a system of plants that they don't like. That closes the landscape off to cattle. Some of those plants are poisonous to cattle. Time and time and time again, this is what we observe, that the landscape responds.

There is a response within the landscape against damaging things. I don't know how it works against one of these coal ma-

chines that chew up the Earth, but it probably has a long-term response, which may be acid rain. So, you don't push something without it sort of pushes back. We are into all this mechanical physics, which says that every action has an equal and opposite reaction. But the Chinese say, "No, that's not true." If you kick a living system, it kicks back harder. Its reaction is often unfairly oppressive. You might simply push someone out the door. That person re-enters with a pitch fork, not just pushing back in, but ready to poke holes in you.

Now there are different sorts of acts. There are necessitous acts and harmful acts. But there are also beneficial acts. And that gives us another hypothesis - that you probably will get more good back than you design. And this seems also to be true. What has probably been happening from the beginning of a consciously designed system is that when we put three elements in conjunction so that they are pretty harmonious, other beneficial results come out that we **didn't** design. Now that has happened almost without exception.

This is something that isn't being taught: that once we have done one thing correctly it goes on and it proceeds to do a lot of other things by itself. This seems to be happening. So it looks like there is something going on there, and it is very hard to analyze. Sometimes, you make a single move, simple and right, which you intend to be beneficial, and you discover, if you stand back and observe it and leave it alone, that it goes on and gives you maybe another 10 benefits which you didn't count on. Then, if you look into it closely, although you put it together for a single reason - you had reasoned it out - you see that once you did that, there were 12 or 15 other reasons why you should have done it. I think we all know examples of this.

When somebody clamped the greenhouse onto the front of the house instead of standing it out there in the sun, he may have done it for a single reason, to heat the house, perhaps, or simply to make it easier to tend it. But then lots of other good things came out of that.

We are not quite sure what they are doing, but the aboriginal groups go around polishing up their country with little ceremonies. They are fairly secretive about what they do, but certainly they are doing a little countryside adjustment. They have to do a little ceremony to keep the springs flowing along certain a mountainside. We laugh at them. We know those springs will flow whether they have a ceremony there or not. But if we take their religions away, the springs will stop flowing. You don't talk to idiots about advanced concepts. Anyway, they won't tell us much about what they know. I suppose they would worry about what we would do with the information.

So here is another whole way of thinking about things which I think we would find very productive, because it is a usable way to summarize a lot of things. We can make principles out of it, if we like. **"Everything works both ways,"** is one of them. **"If you do something right, it will do a lot more right itself,"** is another.

Now we have arguments as to whether we start from principles and to the real world, or - as I try to proceed - we go to the real world and get to principles. Do we look at what is really happening and sit down under a tree and think: "Well something like that is going on out here."? Or do we start going into nature and try to understand what is happening and then go to the garden? We have this argument about which way you proceed: Philosophy to garden or garden to philosophy. I think that there are people traveling both ways, people coming from the abstract to the garden and people coming from the garden to the abstract. Most of us are coming up out of the garden and heading towards the philosophy. A few have been up to the temple and are coming down to the garden.

I think, again, in our general education, and particularly in our primary education, that we get an awful lot of static phenomena taught to us, and cross sectional phenomena. But we are not taught interactive processes, and we are not taught much about the resonance of things. The real world that we live in is in constant flux. Things are on their way somewhere all the

time. There isn't such a thing as a quiet picture of a natural phenomenon. Everything is on its way to other phases. Yet we teach things as sort of rigid truths. We are culturally blocked. It is because it is a scientific culture; we try to measure everything. There are different ways of coming at things. I can't handle symbols; some people cannot handle numbers; some cannot handle dimension. This is why it is beneficial to associate in small groups, just to try to bring different lights on the same truths, trying to comprehend the different shadows of reality. This dynamic is lacking in education.

There is something we ought to be sitting on the floor and talking about a lot. There is this harmonic that, if we could get hold of it, would give us a lot of understanding, a lot of control over events. Our job is to put things in the right place and then let them rip. **But to get one in the right place, we have to have a lot of information about it.** Anything we are trying to place, whether it is a building or a tree or an animal or a road or a structure or a person, we have to know these things about it. We have to know its intrinsic functions, what is natural for it to do, the things it can't help doing by virtue of just being itself, being alive. Some animals and plants must spawn and they do that in different ways. Then there are things that we can categorize as yield, which we might be interested in. These may be of two or three levels or natures. There are what we might call direct yields. Chickens lay eggs. Then perhaps there are yields which are derived, secondary, or processed yields. Chicken manure will yield methane. And we have to know what the different yields are.

It also pays to know how elements function. They have behaviors, things that they do. They walk around or they sway about. They have **properties**. They will or will not reflect light. They have properties by reason of what they are. They have a color. They behave. They have a whole set of interactions and stimulus-response behaviors. Behaviors are short-term and long-term, too. Too often we comment on the short-term behavior of things, which isn't how they behave in the long term. Our science, and particularly psychology, suffers a great deal by not looking at the long-term behavior.

Now if we knew enough, if we had enough information, then a lot of these things could be listed for each element in the system, each entity. And then we could make a tremendous amount of design use of it. But they are not the things that are being listed as knowledge about the entities. You can obtain knowledge of almost anything about a tree except these things. Bad luck! Very little is known about the properties of a tree. As to the yield, it may be almost unknowable. I once tried to find out how people have used walnut trees. I found out that there is a people who base their whole culture on the walnut; other people may base their culture on bamboo. Or you can just take the walnuts by themselves. It is up to you.

If you have a fair idea of what is known about something, then you are able to place it so that it can function, so that its intrinsic function is possible to it. Then it will give its yields and its secondary yields can be taken advantage of, and it will behave in a friendly way because we put it near to things that are beneficial to it.

There is an enormous difference between the way we make a design in permaculture and the way an agriculturist would make it. Really, what we are up to is trying to let things function in a natural way.



PERMACULTURE IN HUMID LANDSCAPES

BY BILL MOLLISON

Pamphlet II in the Permaculture Design Course Series

PUBLISHED BY

YANKEE PERMACULTURE

Publisher and Distributor of Permaculture Publications

Barking Frogs Permaculture Center

P.O. Box 52, Sparr FL 32192-0052 USA

Email: YankeePerm@aol.com

<http://www.permaculture.net/~EPTA/Hemenway.htm>

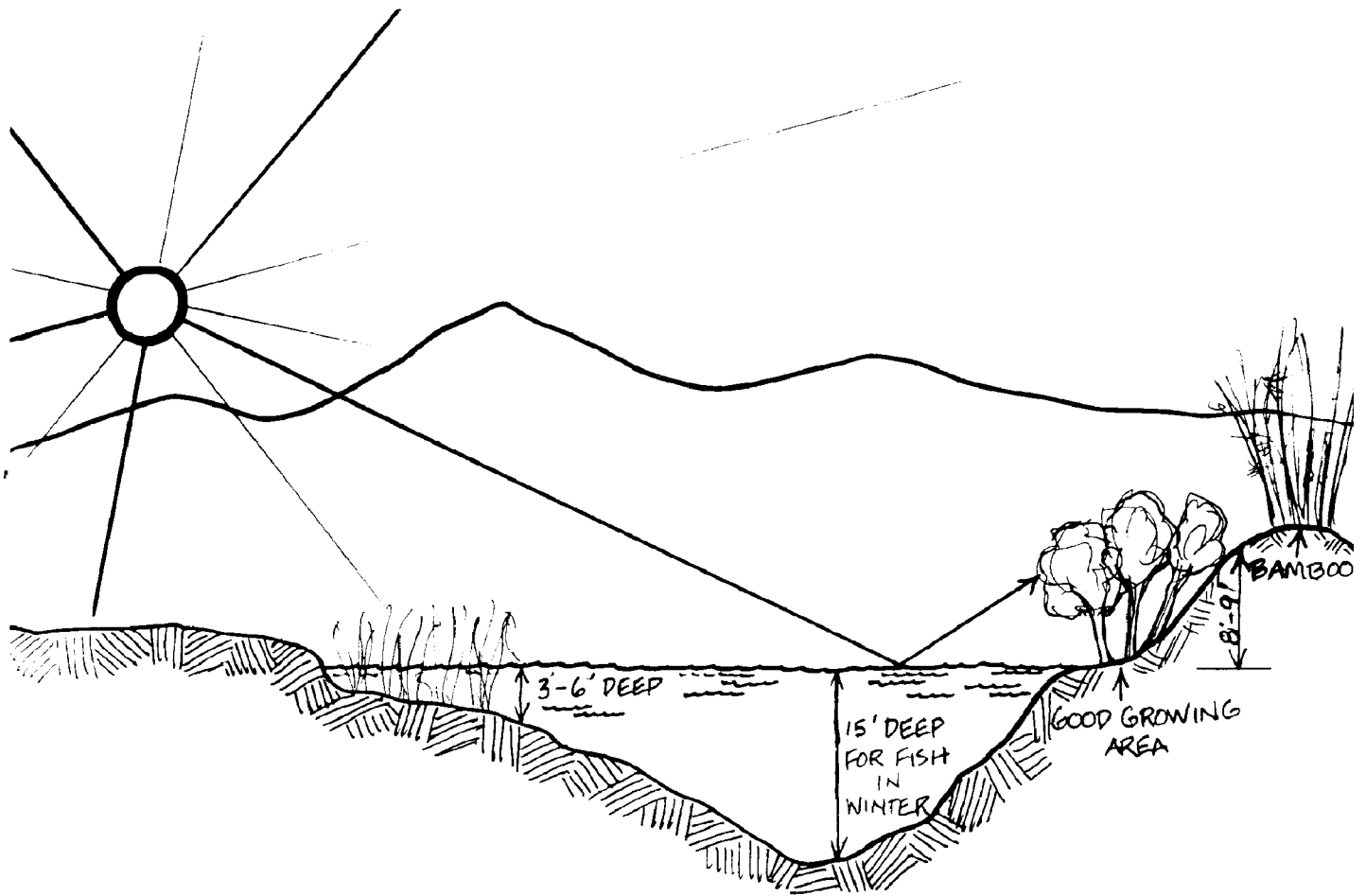

Edited from the Transcript of the Permaculture Design Course
The Rural Education Center, Wilton, NH USA 1981
Reproduction of this Pamphlet Is Free and Encouraged

PERMACULTURE IN HUMID LANDSCAPES

This is the second in a series of 15 pamphlets based on the 1981 Permaculture Design Course given by Bill Mollison at The Rural Education Center, Wilton, New Hampshire, USA. Elizabeth Beyor, without compensation, transcribed the tape recordings of the course and subsequently edited the transcripts into 15 pamphlets. Later, Thelma Snell produced the typescript for all pamphlets. Lisa Barnes laid out and made mechanicals of the original editions in addition to producing the artwork retained in this edition. More recently, Meara Culligan entered all 15 pamphlets onto computer disk, permitting use of easier-to-read typefaces. From time to time, we have added some further light editing to increase the readability of the pamphlets.

In deference to the monumental task of love represented by Bill's assembly of the Permaculture Design Course, and by the subsequent volunteer efforts leading to these pamphlets, Yankee Permaculture has placed them in the public domain. Their reproduction is free to all and highly encouraged.

The pamphlets are now available on computer disk, individually or as a set. See our order form for details.

We have some pamphlets translated into Spanish, French and German. Volunteers are now needed to complete these translations and to translate these pamphlets into other languages. Yankee Permaculture continues to depend on volunteers for all of our publications. To help, contact us at the address on the cover.

For Mother Earth

Dan & Cynthia Hemenway, Sparr, Florida, June, 2001.

Third edition

Permaculture Design Course Pamphlet Series		Quantity	Price
Complete Set of 15 Pamphlets. Bill Mollison. \$35	\$35.00	SET	___ \$ _____
Complete Set on Disk	\$50.00	SETFD	___ \$ _____
I An Introduction to Permaculture. (Updated resources.)	\$3.50	I	___ \$ _____
II Permaculture in Humid Landscapes.	\$7.50	II	___ \$ _____
III Permaculture in Arid Landscapes,	\$3.75	III	___ \$ _____
IV Permaculture on Low Islands. (See V for combined price.)		IV	___ \$ _____
V Permaculture on High Islands. (IV, V, & VI offered as one pamphlet.)	\$2.50	V	___ \$ _____
VI Permaculture on Granitic Landscapes. (See V for combined price.)		VI	___ \$ _____
VII Permaculture for Fire Control. (See XV for combined price.)		VII	___ \$ _____
VIII Designing for Permaculture.	\$8.50	VIII	___ \$ _____
IX Permaculture Techniques. (New material added, new edition)	\$8.50	IX	___ \$ _____
X Forests in Permaculture.	\$6.25	X	___ \$ _____
XI Water in Permaculture.	\$3.75	XI	___ \$ _____
XII Permaculture for Urban Areas & Urban-Rural Linkages. With New Resource List	\$3.00	XII	___ \$ _____
XIII The Permaculture Community.	\$2.00	XIII	___ \$ _____
XIV The Permaculture Alternative.	\$2.50	XIV	___ \$ _____
XV Permaculture for Millionaires.	\$2.50	XV	___ \$ _____
Postage & handling. \$5 plus 10 % to the US, 20% elsewhere.			
TOTAL			US\$ _____

All funds must be in US dollars in a check drawn on a US bank or by International Postal Money order. Make checks payable to: "Yankee Permaculture." Make postal money orders payable to: "Dan or Cynthia Hemenway."

For all Yankee Permaculture publications, please add US\$5.00 plus 10% postage & handling for shipments to the US and 20% for shipments to other countries. There is a surcharge for payment by electronic deposit. Inquire for details.

Prices subject to change without notice.

The category we are in now is humid landscapes, which means a rainfall of more than 30 inches. Our thesis is the storage of this water on the landscape. The important part is that America is not doing it.

The humid landscape is water controlled, and unless it is an extremely new landscape- volcanic or newly faulted--it has softly rounded outlines. When you are walking up the valley, or walking on the ridge, observe that there is a rounded 'S' shaped profile to the hills.

Where the landscape turns from convex to concave occurs a critical point that we call a keypoint.*

The main valley is the main flow, with many little creeks entering. At the valley head where these creeks start, we locate the major keypoint. From there on, the keyline starts to fall from one in 1,000 to one in 2,000 below contour. The dams we make in the lower valleys will be slightly lower at each point. They will not be at the keypoint.

Rain falling on the hilltop runs off. The paths described by single raindrops, wherever they fall, are similar in that they cross contours at right angles, because that is the shortest drop between two contours. Water takes the shortest path across the landscape from where it falls to where it hits the river line. It is along this path that raindrops are doing their thing. As soon as they are in the river valley, they are off to the sea.

It is possible to locate the keypoint from a contour map. Find where the contours start to spread. That is the keypoint.

Having found the keypoint, we can now treat the whole landscape as if it were a roof and a tank. In a fairly descending line, falling gently away

*Bill's treatment of keyline differs significantly from that of P. A. Yeomans, originator of the keyline plan. For a more detailed and more accurate treatment of keyline, see *Water for Every Farm--Yeomans Keyline Plan*, an updated version of Yeomans' work available from Yankee Permaculture at the address on the cover.

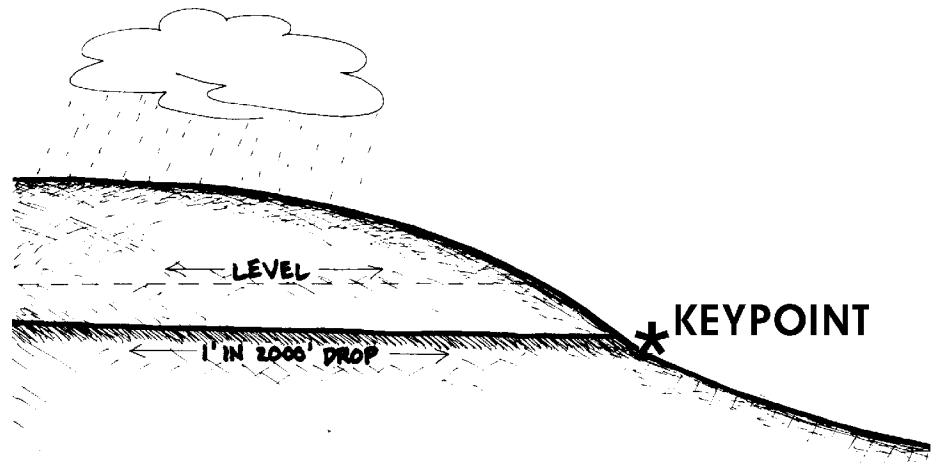

Having found the keypoint, we can now treat the whole landscape as if it were a roof and a tank.

from the horizontal, we put in a groove around the hill. This is the highest point at which we can work with mechanical tools. Above that, it is too steep. We make a little shelf around the hill leading to the keypoint. No matter where this water was going, we have now started to divert it, bringing it right around the hill to the keypoint. In effect, we have put a gutter around our roof, a very gently falling gutter. We started at the keypoint and extended a line that we lifted one foot at every 2,000 feet. We want to create a very, very gentle fall. Water just moves along it, and that is all. We have directed the water to our keypoint.

At the keypoint, we put a little dam; for it is the highest point in the profile of the valley that we can eco-

nomically store water. It is a rather deep little dam, and we need a fair amount of Earth to build it. It is not the most economical dam that we will have, but it gathers all the water from the top of the hill to that point. We can make that keypoint dam as large as we can afford. It will enable us at any time of the year to run water right around this contour and let it fall on any area that we want. We lead the water out through the wall of the dam, either by siphon or a lock-pipe, allowing it to enter a contour drain. We control the flow in the drain by a sheet of canvas or plastic, fastening it like a flag to a very light plastic pipe. A chain attaches to the other end of the flag, serving as a weight. We may peg that flag down within the drain, holding back the flow until the

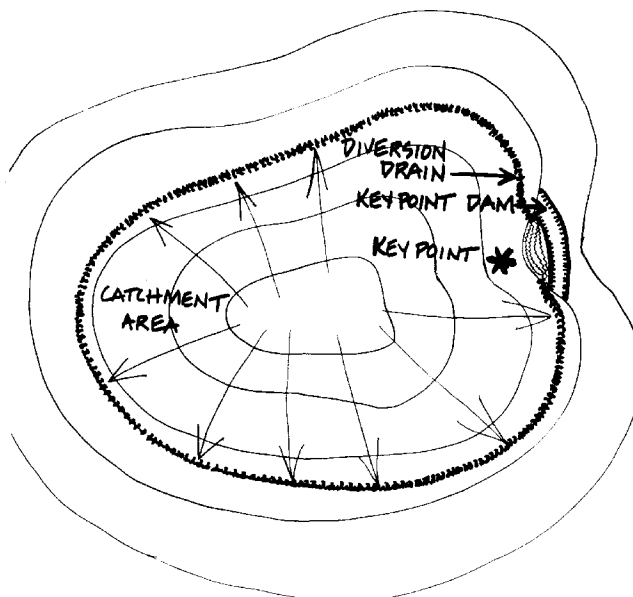

All runoff from above the diversion drain is collected at the keypoint. This can be directed from an irrigation channel to any other point below. Slopes of these channels range from 1:200 to 1:2000.

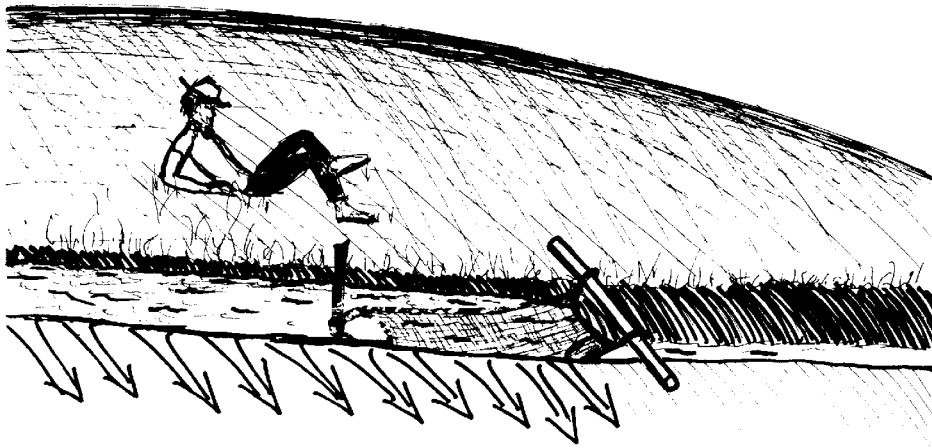

"One person can water hundreds of acres this way with no effort at all."

drain has filled behind the flag. Then the water spills over, sheeting down across the hillside. About twice a year, in summer, this will usually be enough to keep the countryside very green.

If you want to put out a bush fire you just walk backwards with the flag, and you douse the whole hillside. One person can water hundreds of acres this way with no effort at all. It is very light work. No pumps.

For very large dams, holding five or six million gallons, you merely put a sliding gate or lock-pipe in the dam wall, generally about 18 inches square. This water will flow out about as fast as you can walk, walking fairly slowly. The drain being filled will follow you along. The most restful way to irrigate a large area in this way is to have two people and two flags. We peg here, and our friend goes 100 feet ahead and pegs. When we have soaked our part of the field, we just pull our flag, and our water flows on to his flag.

The depth of your ditch depends on the size of your dam. If you have a 5,000 gallon dam and a little garden, a small market garden, you can have a small ditch, and you can control the flow just by putting a spade in it.

Alternately, you can have something as big as a lake, for which you will need a large lock pipe with a big wheel on it, and the ditch itself may be half the size of this room. This will require a fair size flag. In this situation, we may be trying to irrigate 2,000 or 3,000 acres a day.

On large property, taking in a whole watershed, we may go on constructing further dams on a descending contour. Away we go, dam to dam to dam, falling all the way on this one to two thousand keyline. As long as your main dam is the highest, you can come down to all the little valleys, taking in both sides of the watershed. The keypoint should fall to both sides of the watershed. In the next valley, the dam is a little lower, and the next one a little lower. As for the river, it will flow quite continuously. The more storage you have on the hills, the longer that river will flow in summer.

You can also find situations in which one side of the valley is very, very steep, and the other side very gentle. In this case, it is possible to put storages on the gentler slope.

Sometimes, again, the keypoint is well up-slope on very gentle, low sloping country.

What we are up to is taking water off non-agricultural land, and preferably forested land, collecting the water and the snow melt that has filtered through this forest. We don't want to cultivate those upper slopes. They are too steep, and they shouldn't be cultivated. Depending on your soil, don't cultivate beyond a 19 degree slope. You can get guidance on this from your local soils people. Generally, the sandier it gets, the less slope you will cultivate. With clay, you might get away with cultivating at 20 degrees probably once or twice.

The keypoint decides not only the most economical place to start to

catch the water; it also defines the point above which you should probably consider forestry, while using the land below for irrigated pasture, croplands, orchards, or even irrigated forest. If you are dealing with a fairly wild forest of walnut and other nuts, it is very useful to be able to pour water on just about the time you are going to harvest. Then all your husks split and the nuts drop out. Below the keypoint lies the potential for cultivation.

All this that I have been giving you is just a model. I don't expect the



countryside to be like that, for here we may have rocks and falls and trees, and maybe a small pasture--but just as a model, that is the way we would do it.

The slope with which we are working varies between sand and clay. Even with sand, if the drop is one foot in 2,000, we hardly shift a grain of sand in these ditches. We ran an eight mile ditch recently in northeast Tasmania. We got five or six miles along with one of these ditches--it was in the summertime and it hadn't rained for months--and there came a light, misty rain. We walked back a couple of miles and the ditch was running in the sand. It had been a guess, sort of a bet. We were doing it with a backhoe. It was just in sand, and it worked. We filled the first dam on the first day of light rain.

Here you are saying, you have rocks all over the place. Yet, it is very easy to go around outside them, or to bank up on outside of them. If they are as big as this room, run the ditch to the rock, let it drop down the side of the rock, pick it up at the bottom and go on. It is easy to go around a rock, just go around it and backhoe it. It may only need to be a little ditch, maybe just six inches deep.

The best way to answer your questions of how big this ditch needs to be is perhaps this way: The aboriginal people put mutton bird in casks. These people have an extraordinary dry sense of humor. They had a man from Sydney come down from a television team. He was interviewing an old friend of mine, a man named Devony Brown, and he was treating him as a simple-minded idiot, which Mr. Brown is not. He said, "Mr. Brown, you cut your birds, and you split your birds, and you put them in a barrel." And he said, "How many birds do you get in a barrel?"

"Well, oh, well, now," he says, "a small barrel, we don't get many, but you get me a big barrel and I'll get you a bloody lot of bird in it."

So does this answer your questions at all?

Look, if we are opening a valve on a 5,000,000 gallon dam, and we are getting rid of two and a half million gallons of water that day, we want a very big ditch--right? If we are opening a valve in a 2,000 gallon Earth tank at the top of somebody's back yard, we just want a trickle through the garden.

There is another way to construct a ditch that makes a fantastic landscape. That is to make the ditch a lake. Just go along and make a very broad ditch, and widen it wherever it is easy, and let the whole ditch fill with water, and your ditch is also a storage lake. I have seen it done once. It really makes something of the landscape.

There is a point, perhaps beyond five or six million gallons, that you are out of agricultural storages and into civil work. That will be valley dams. They will be subject to floods. We do not worry about floods with these little storages. While they may impound much water, they are very low dams. If they break, a six inch flood rushes out for two hundred feet. We design only with the sort of dams that you would feel quite confident about constructing. You are not about to put in a dam that is going to flood the next five or six villages down the stream, that will require concrete

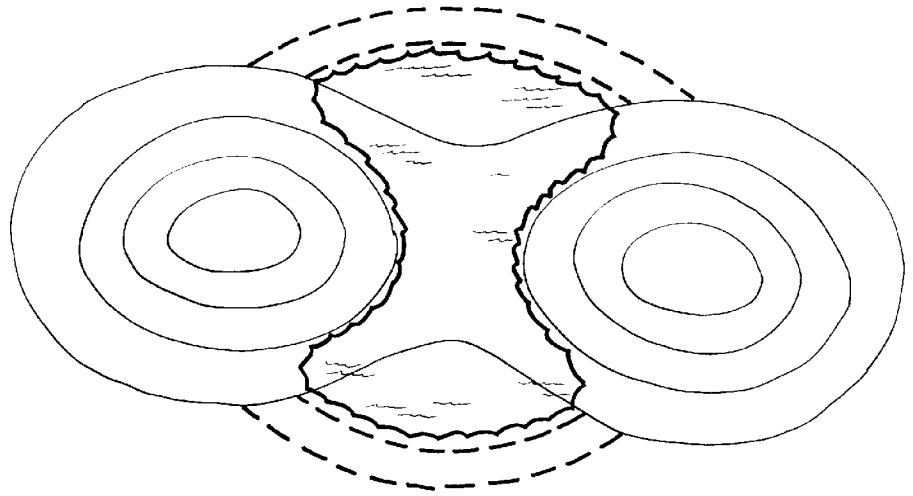

"By making walls on either side...of the saddle, we can obviously get very large and very high water storages. These are the highest water storages you can get on any property.

spillways and chutes and all that.

Here on these wooded slopes, though you encounter rocks, bracken, and trees, you look and you can see that there are ditches out there right now in operation. It is up to you to find those ditches and determine how they are made, and who made them, and where they go. There are storages out there. I want you to find those storages and determine what they will do. This is early springtime. There are little ditches flowing all day long out there, carrying off snow melt. You call them roads. Just look and see how far those roads are diverting water around the landscape. You know, the driving of a vehicle around the keyline will bring the water to the dam. We should use the keyline system as our road system.

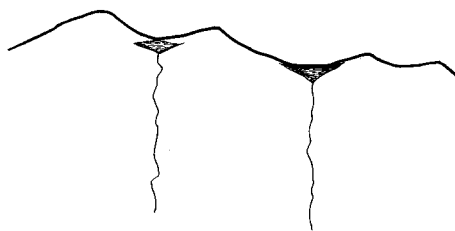

Just go and have a look at the roads right here. See where this road collects the water and where it drops it, and see where it takes it from.

You are asking me why people didn't think of this keyline system earlier? Common sense is an uncommon quality.

Now we go back to the top profile. This time we will be dealing with the hill profile itself. What we have been discussing so far is the valley profile. Any dams worth making in valleys are keypoint dams. The other dams, which we will now discuss, won't be in valleys.

Here is a typical profile of ridge tops, a sky-line profile. What I consider now is the little saddles in the ridges. Some of them are not so little. These saddles often mark points of weakness in the landscape, which may be massive, solid rock. The saddles mark those places where the rivers start coming down on both sides of the ridge. These rivers, obviously, have above them very large catchments. By making walls on either side, or perhaps on but one side of the saddle, we can obviously get very large and very high water storages. These are the highest water storages you can get on any property. These are real power storages. You may get one, or you might be able to get a whole series of these high storages on a single property.

Let us consider what these storages would be useful for. They are marvelous places for your house water supply. It might be possible to generate electricity with them. If we had a very broad saddle, maybe 300 feet wide, we would just have to make two wide semi-circular bowls on the side of the saddle. We would have a sheet

of water running across the saddle, and could run a hydro-electric stream off that. With this perched 400 feet above one friend's garden beds--a 400 foot fall is the maximum that you can get thick walled plastic pipe to hold at that--when the tap is opened at the bottom, you should see the sprinklers! You can stage the pressure down. You need not bring it down at 400 foot pressure. You can bring it down 200 feet, put a stop valve on a tiny tank, maybe a 100 gallon tank that you carry up on your back, and start again from that little tank and bring it down the last 200 feet.

These are excellent storages for intermittent mechanical power, for operating a turbine, supplying mechanical power for grinding or for a sawmill. You can operate a washing machine. In Australia, we have a washing machine, one of our best. It looks like a concrete mixer and runs off a very simple little gizmo. There is also a spin dryer that works on a little water jet. When you have 100 feet of fall and a little jet and a small turbine, it is simply your tap adjustment that becomes your speed adjustment.

There are other reasons for these high dams. Up there where it may be a fairly arid landscape in summer, you will find that the complexity of wildlife and the number of species, the number of seed-eating birds like grouse and quail rise sharply once you have these small storages up high. Wild chicks of seed eating birds need water daily, within 24 hours. These little storages are very enriching. These little saddle dams, which sometimes occur naturally, are great places for wild life.

Another important use for these high storages is to run sprinklers in a fire protection system. Two sprinklers will cover your two precious acres. When fire comes, if you have a single tap to twist and the thing runs for half an hour, you are out of trouble. So all you need, really, is 1,200 gallons up there.

Those saddle dams are pretty per-

manent. Even the natural ones are there for thousands of years. What's more, these are often filling when you have very little water down below. They fill faster than the lower dams. We are going to get a lot of energy back out of them, for, remember, you will not be pumping water anymore. The energy required to set up this system is what I call restitutorial mechanics; we use it just once.

Now we will go to the subject of contour dams .

For this, we choose the least sloping site. We build an Earth wall, and we run our diversion drains as usual. These contour dams can perch on the knoll of a hill, where it dwindles out.

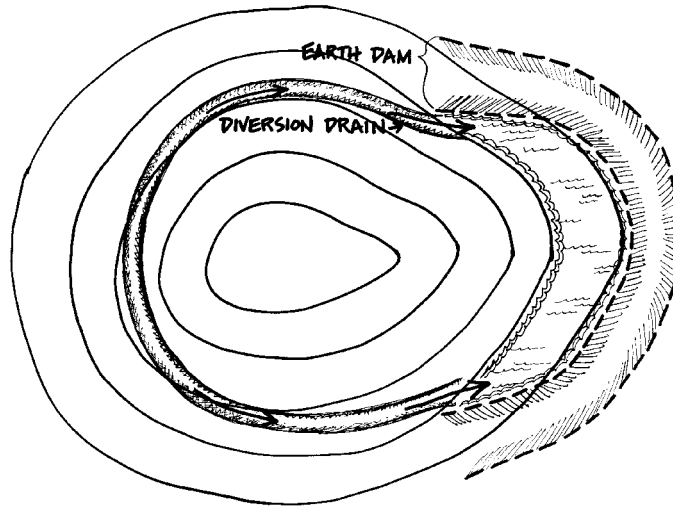

" The contour dam is a shallow dam with a large surface area."

The contour dam is a shallow dam with a large surface area. It will be a very, very cheap dam. For the amount of Earth moved, we are going to get a lot more water. So if there is any flattish area up high, even if we have to hand-cut out diversion drains for a hundred yards with shovels--you don't need a big diversion drain--we will get water way up there.

These dams have two or three effects. There is significant increase in the water table in the surrounding area because these dams all leak a little bit, and because you are running the water around those diversion drains, you get a better absorption. What we are doing is giving the water far more time on the landscape. We have decreased the rush-off of water.

You know, when it rains heavily, our storages fill first. So we have buffered the erosion by taking the first shock of water. After that, these dams continue to give to the water table as the water table dries out, so they are moderating systems. That's why throughout Australia the authorities encourage you to build as many of these small dams as you can build. It means that down in the large storages, the power storages, there will be far more constant flow of water and the chances of flooding mitigate.

These dams will stand up to any amount of rainfall, because they simply overflow. You put in a normal spillway, and when you put a spillway in, you always contour it away from the dam and grade it out so what you get is a sheet flow over it. Now you bring it out as a broad ditch and runs it along on contour, gradually letting the ditch taper out to nothing. We often plant the spilldown area with shrubs.

From the skyline of the landscape, we have observed the natural path of water. We diverted it to cheap storage points. With very cheap, extraordinarily cheap earthworks, we have stored that water permanently, and we have stored it for different

uses at different levels. It should be obvious to you that the high water should be water for cleanest use, and that as water comes downhill we can afford to let it become contaminated more and more with manurial pollutants for crops and with humic acid from forests.

We have set many priorities for our client. First, we get his domestic water supply for the house. We ought to do that before he ever starts mixing his concrete. We then look after the garden, the intensive garden; and then, lastly, we look after the extensive agricultural system.

This applies to people with larger properties. At present, we are doing the grand scale. We will put 13% to 15% of his landscape under water, if

we can get it, and more if he chooses an aquatic crop.

You are asking how I define the "grand scale?" It depends upon whether you are an Australian, a Texan, or a New Hampshire man. In New Hampshire, 140 acres is a grand scale; in Texas, or in the Northern Territory of Australia, 5,000 square miles is reasonably modest property. In large, dry areas you are dealing with total catchments, total river systems. On an area up there in Northern Australia, there are five mountain ranges and five rivers, starting way up in the hills and ending with crocodiles down in the estuary. There we have gobs of landscape to play around on. Usually we are dealing with areas larger than fifty acres. In this highly dissected country, little catchments may lie within modest properties.

In setting the water in the landscape, we also establish the placement of a number of other elements. If the first decision that we make is to control the water in the landscape, then the functions that it serves, the uses to which we put it, decide the subsequent placements, and the thing really does start to become harmonious.

We have talked a lot about Type One Errors, which a designer must avoid. One of those is the house on the hill, which I call the Berchtesgarten syndrome. You have heard of Adolph Schickelgruber, the famous paper hanger of the 1930's? He later became reasonably well off, and built a great concrete blockhouse on top of a crag, where, as far as I know, he could have perished of thirst. I don't know what his eventual fate was. Anyway, there is this urge among some people to get as high as you can, and look out upon things. Many clients

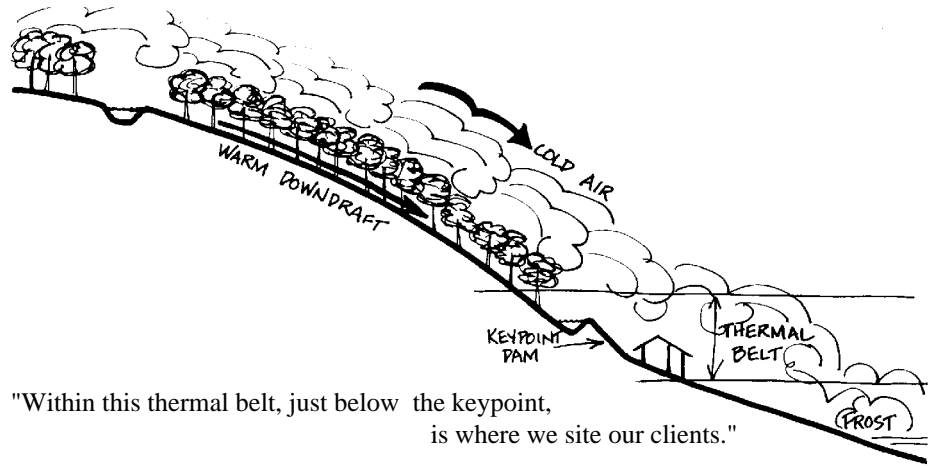

have this syndrome, and you have to fight these illnesses.

Your forest, properly, starts at the ridge top and comes down to the key point. This forested area has another factor going for it. It is your thermal belt. Let us look at the pattern of frost. If you can look at it from the air on a foggy day, you will see how it works, for the fog will imitate the frost. Here are your frosts moving across the ridge top. Occasionally a glob of it detaches and rolls downhill. Frost is not water; frost is treacle. Pour treacle on the landscape, and very stiff treacle at that. That is how frost and cold air behave. Frost does not behave like a stream flow; it behaves like fog. Frost moves out over the tree tops, pushing the warm air down. There is a warm thermal belt between the frost above the key point and the valley floor below.

As these gobs of frost move into the upper area of the forest that, even when it is a deciduous forest, still holds a lot of insulated water. It pushes the warm air out at the bottom. That air is several degrees warmer than the air entering at the top of the forest. Within this thermal belt, just below the key point, is where we tend to site our client. In that way, he has a racing start on thermal efficiency. It is the area where the first buds of spring break out, where the phenomenological calendar says that if you race up and down the hills, this is the best place to get started early in the spring. This is also the last area of autumn, where productivity disappears. So, it

is a long season area. If you walk from there any night up to the crags above, you will go through a zone of decreasing temperature. With an evergreen forest above the keyline, even in snow, you will experience a warm down draft within the thermal belt.

If we put in a high meadow up there, it will probably frost, and so will the trees up at that level. You will see the rime on them there. We won't get that degree of frost down here in the thermal belt. We will be several degrees warmer.

There are several thousand reasons for avoiding the temptation to site a dwelling way up on the ridge top. Down below the key point, the clean water is above us, and the house is below that water. Another thing, fire sweeps with fantastic rapidity uphill, and good-bye Berchtesgarten, because you have two fronts hitting you from both sides at once. You have nowhere to go. Fire moves quickly through the forest above us. Yet, we very easily controlled it at as this lower site.

Once we have set the water system, even if we never fully construct it, we retain the potential for its construction. The rest of the system is set, too.

Let us come down now to another area for water storage. This is where we start to really store the great bulk of the water we are going to store, and we don't store it in the dams, we store it in the soils.

We hop on a little light tractor attached to our Wallace soil conditioner and we start to comb parallel to the

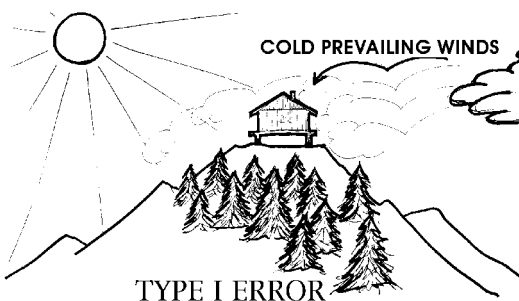

keyline. We comb the soils out. Of course, if you have forest below the keyline, this treatment won't be necessary, because the forest will be doing all that. The forest is driving down roots and they are rotting; it is putting little sticks on the landscape, and it is holding water up, and it is laying down duff. Let us say this is going to be agricultural land, so this is how we will proceed. If it is now agricultural and we are going to make it orchard or mixed forest, then we still proceed like this.

We now begin to create the greatest reservoir that we will have on the farm. This is the billion-gallon reservoir. It is the soil. You won't see any of this water, but it will be there. We just continue to comb the soil out, moving parallel to the keyline. As we do so, we provide greater soil storage of water closer to the ridges. This is just a technique to get the water out of the valley, back on to the high places.

The Wallace soil conditioner is a very simple farmer's machine, very rugged. It has a disc that runs along the soil and cuts it. It is very sharp, of excellent steel. This is followed by a shank that has a shoe at the base. You don't need to go more than 9 inches deep in the soil. The disc cuts through the soil, the shank follows the slit. The shoe widens the slit at its base. You shouldn't see more than a couple of teaspoonsful of Earth emerge along that opening. A very light tractor will do the job.

We are creating these thousands of grooves, running faintly across slope. Starting up on contour at one in two thousand, any water flowing on this landscape initially follows these million little drains. As heavy rain falls, these fill to capacity. Then, the water overflows and descends to also charge fully the grooves below. Water is very quickly absorbed. Just look at the amount of absorption surface in a conditioned soil as against the original soil. The original soil was sloping downhill, probably compacted by cattle, probably further compacted by

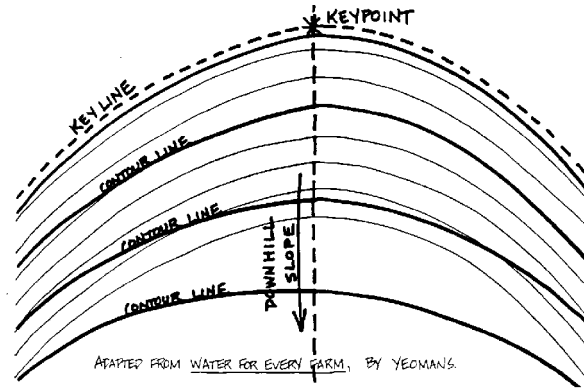

"We comb parallel to the keyline."

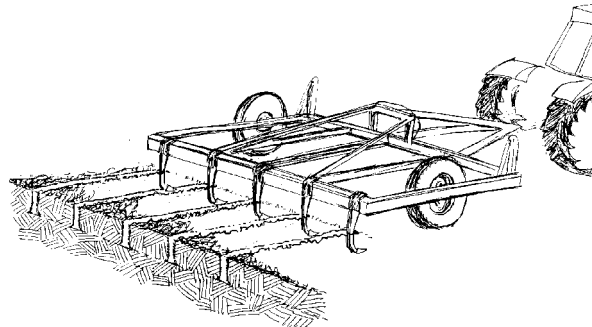

"We start to create the greatest reservoir that we will have on the farm."

tractors, and the water was running off. Now your little holes are absorbing that water. When it gets down here, it starts moving out underground. So it can't evaporate--the sun can't get at it.

Now we are starting to get soils which contain water to at least 9 inches depth. Those soils will absorb water roughly at about one inch per foot as interstitial water. So we start to hold the majority of normal rainfall within the farm. Interstitial water will continue on down and gradually go out the streams, but that may be at a very, very slow rate. Somewhere, you know, it may move out there at a distance of less than 10 feet a day, or in some areas, 20 feet in a year.

The Wallace soil conditioner is unlike a subsoiler, which is a tool of cultivation, and brings an enormous amount of Earth up on top. In spite of its ruggedness, the Wallace soil conditioner is very sophisticated, and it is designed to do exactly what I have described. It is designed to store water within the soil. Your subsoilers are not designed for this, neither are your chisel plows. We have done football fields with these soil conditioners

and the next day then went out and played football.

What we are after is storing water. Once we treat the soil in this way, we never have to repeat it, unless we restock heavily with cattle for a couple of years, or run it over to and fro with tractors. It is the ideal tool to rehabilitate eroded soils, soils that we never intend to put back under cattle, soils that we want to devote to new uses, those places we want to reforest as quickly as possible with the highest chance of success.

Now there are a few conditions in which you don't use the soil conditioner. One is in very free sandy soils. Nor do you use it in forested landscapes, and of course you don't use it where maybe 90% of the soil is rock. Apart from that, in all other conditions, use it. Use your keyline as your base line to start your conditioning.

We will now describe how you start the keyline out. You use a Bunyip level, which is made up of about 80 feet of half inch hose. At either end it has clear, stiff plastic uprights inserted into it. These are rigidly fixed to two stakes. Fill the hose with water. Then bring these two stakes together and mark off a level point on them. Here they stand right together. We have the base of these stakes on a firm, level platform, and mark off the level. Drive a stake here at the keypoint. One now walks 80 feet around the hill and puts the stake up or down the hill until the water reaches that level, and drives in the marker. If we want a one in 2,000 contour drop, we bring it down in proportion to whatever distance we walked. Now all it takes is two kids to run keylines all over the landscape. They can do it in half an hour with this sophisticated bit of equipment invented by the ancient Chinese and originally made of pig's guts, but adaptable to modern materials. It is called the Bunyip level. You start at your knoll, or you descend across the landscape on your keyline. Or you strike a dead level thing for a

swale, which we have not discussed yet.

If you don't have anyone around, and don't have any levels, you hop on your tractor, back as hard as you can into the valley, and then start driving gently around the hill, and continue on parallel to that situation. There is no need to fuss about it at all. We are not talking about anything very complicated, because all you want is for that water to travel maximum distance.

You can make wet spots on ridges. Geoff Wallace does a little half moon right up in a very steep little valley. He gets his tractor up there, combs out to the ridges, and puts a clump of trees on the ridge, so the trees are irrigated on the ridge points.

The results of the conditioning of soil are, first, a fantastic amount of water storage within the landscape; second, a soil temperature in winter that may be as much as 25 degrees Fahrenheit above that of the surrounding soils. Wet soil is an enormous heat mass, but you also have much air space in those soils. Conditioned soils commonly average 19 degrees Fahrenheit above the surrounding soil temperatures. It is frequent to see a field that has been soil conditioned unfrosted in a series of frosted fields, because very often it is just that 15 degrees to 19 degrees difference. So soil conditioning sharply decreases frost. Therefore it increases your growing season at both ends of the growing year. Trees will make a faster growth. Olives, that would maybe bear in 17 or 18 years, will normally bear within three years in conditioned soil. It pays to wait even two years or three years until this happened before you plant trees. You are still further ahead than if you planted first in compacted soils. You get roots following those lines right down into those little triangles, and then off themselves and going on further down, again making channels for water for even further penetration. We are not interested in going beyond a depth of nine inches. We can create that within a year from sub-soil. Seeds wash into those little crevices and germinate along those little ridg-

es. The plow has an attachment, a little seed box that just drips seeds at pre-regulated rates into those crevices, and you can go from pasture into millet, or pasture into wheat right away. And you haven't cultivated. You can go from pasture into pumpkins, if you want to.

Before you do this, it is a good idea to mow or graze the area flat, then use your soil conditioner.

If it is a stubborn soil, really compacted, you only go down to four inches. Then you will see in these lines a very rigorous increased grass, which you let come out, and either take off as hay, or mow and lay flat, or graze off. Then you recondition down to about nine inches. After you proceed either directly into crop or into orchard, or you start normal grazing sequences, which you continue for two years, or until you dig down and find that the results of conditioning have disappeared and your pasture is starting to degrade. Then you recondition your pasture. In normally strong soil, you wouldn't need to do that more than once every three or four years under quite heavy grazing. On football fields, you only need to do it every two or three years, and that is heavy compaction. You can see it is not a frequent treatment. In orchards, you don't need to regraze your orchard, because you are getting root depth from trees and root channels deep down in the Earth.

In some soils, you get hard pan, mostly as the result of the application of superphosphate and a high evaporation rate. When you put superphosphate on top, the rain carries it down to certain depths; then summer comes and the moisture evaporates and an insoluble tri-calcium phosphate forms in a concrete block 15 inches down. It is all right to use phosphate rock on calcareous soils, but not superphosphate. Those soils should never have superphosphate applied to them. That is a no-no. We will get into that in the tropical section. Superphosphate is a no-no on tropical calcium soils. It is a type one error. Superphosphate your atoll and you will concrete it. We will try to point out these type one errors

as we go along. We just did one. The Berchtesgarten syndrome is a type one error. Once you have made that error, everything else you attempt will remain difficult forever. You invite a high energy situation for your client in perpetuity. They are always going to be in trouble. A little camp in the woods is another type one error. You can feel those errors in your bones. You are asking, How about building a house on a valley floor? There is nothing wrong with it if you want to make a specialty of freezing things. If that is what you want, then just down the valley, put a big belt of pine trees across it, and you can live in a refrigerator all your life, summer and winter. It is Eskimo ideal. If you must adapt an Eskimo to southern Minnesota, that's where you put him. For us sunny people, that is not the place. There are valley sites, however, which we will get to later, which we deliberately choose.

Now back to the subject of water in landscape. We store most of our water in our soil. We can get it there in two ways. If you have poor clients who can't afford this soil conditioner, we can get water in there with radishes. I mean large radishes, the daikon radish. We use the same system. We slash, and we broadcast our daikon. The Daikon radishes spike our soil to about two feet. We never need to pull them because they are biennial and rot. If the area is too steep to use the soil conditioner, we use Daikon radish. We accomplish it biologically. Or we can plant real pioneer species of trees like your western red cedar, and they spike the soil. They are very good soil spikes. They start this process. If we have a very large area compacted, and we want to get into some crop or other, we can use that mechanical method. We might have to make a hole and put in a handful of compost with our radish so that it can get a start. If we are dealing with a very small area, we might dig holes and put little logs in and plant our vegetables where the logs are rotting under the ground. We can do all sorts of things like that. We can get it done.

What we are up to is opening the soil

again, bringing it back to its forest absorption capacity, and we do it. Our main aim is to store the water in the soil. You can see now what happens when we let water drain, that irrigation drain, out across conditioned soil. It encounters a series of ribbed systems that run it out and store it up.

Now let us move on down to the lower slopes. As the grade decreases, so the amount of water stored per Earth moved starts to increase. Any impoundments we make lower down are very cheap, and, as you now know, there is no need to go into the valleys to make them on any level area. We can make them on the point of a ridge, and that may be flatter than the valley floor. This has an advantage in that we don't have a flood-rush over our dam walls. It is an easy situation where we have a diversion drain running from higher up, pooling on the ridge, and maybe running back into the next valley.

There is only one rule about the efficiency of dams. That is, the flatter the floor that you are flooding, the more water you get for dollars spent. It doesn't matter where that is, on an open field, or on a ridge, or in a valley floor. So when you are looking to large storage, you walk the valley floor and find where it levels. At the point where it starts to level, you often find that it tightly constricts, and you will find the logical valley dam site. Again, you are the best tool in determining this.

It is a pleasant time of the year to

do it now, because there is water trickling through the landscape.

Where it speeds up, that is where you are going to have to move a lot more dirt. Where it is moving slowly, that is the floor of your dam. Where it starts to speed up, that is where your dam wall will go. At this time of year, just when everything is melting, you can follow all the trickles across the landscape and work these little things out.

We will go now to your lower dams. They lie below your fields, below your animal houses, below your house, but maybe just below, because they are good for energy. They may be of very little use at all in this respect. Occasionally, though, they may be useful for turning mill wheels below. They may be useful in that with enough flow we can put a hydraulic pump, a hydraulic ram on, and lift domestic water up 10 feet for every foot of the fall. They may be useful for high volume, low flow energies, particularly if we are putting them across creeks. These are your old mill dams, mill ponds. They lie all around this district. There is one just up the road, and another one just down the road. They move big masses slowly by weight of water. However, for the most part, the energy low dams supply is not much good to us, so they are the last dams we install.

However, these are our production dams. Here we produce the highest amount of yield from water. They are the best dams for our fish and our

wild life and water chestnuts, crayfish, all those little creatures. They do best down in these low dams because there is a nutrient flow into the dam of dissolved solids. Water that looks perfectly clear may carry a heavy weight of dissolved solids. You will find on analysis, more mass eroded from the hillside in clear water than you find in dirty water. Now the idea is to catch these nutrients in a biological net. We want to seize the nutrients, the dissolved solids in the water, the calcium, etc., without employing some high technology apparatus, and get these nutrients back on to the land.

You can do this by putting fodder plants in these ponds, algae, mussels, and snails. They will absorb that calcium and fix it, and you can get it back out again in the form of duck manure, fish, and wild rice. In this way, you are using very efficient little biological machines, working at the molecular level, straining out the nutrients before the nutrients leave your property.

The ideal situation is, starting with clean high dams, gradually dirty the water up with manurial nutrients--keep your ducks on a slowing flow into some of these ponds, wash your pig manure into some of them--then start putting this water through your wetland plant systems. You will be getting a high plant growth, which you take off. Then run the water on through other systems, and let it grow clean again. The water that you finally re-

Valley Profiles

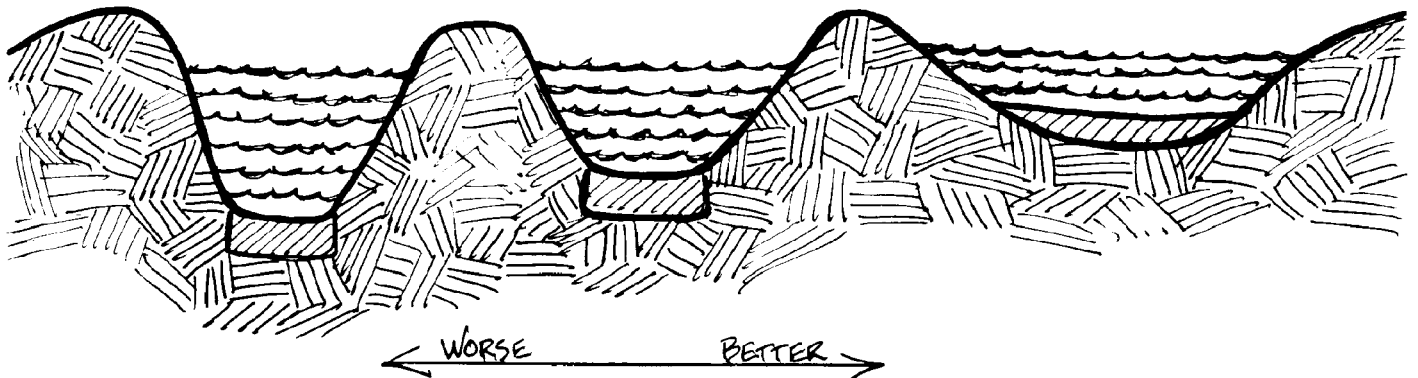

"The flatter the floor that you flood, the more water that you get for dollars spent."

lease into streams, the water that leaves your property, will be clean water.

Now you may not have the space to do all that, but, believe me, you don't need much space. In a mini-system we can do all that from here to the window. In clump, clump, clump, I can take you through a rice patch or a very high nutrient demand patch, or the taro patch; next, and algae-eating fish; into a rice patch; into a mussel pond with watercress. Now what we have is fairly clean water running out. Then you can let it go off. You can do all that in a space the size of this room.

In many places, of course, the key-line system is not an applicable way to treat your water. These are places in the Ozarks where people are sitting up in little headwater valleys, away above any keyline. They are sitting on tiny plateaus. They call it a cove.

Now you ask me, "What is the least slope you can put this biological net to use on?" There is no such thing as a least slope. We have country at home that has a three inch fall in a quarter of a mile. That is a least slope, and you can still use this system perfectly well on that. At that point you can swale it. You can actually go below the surface, dig out ponds that are below grade, that do not perch on top of the ground at all. The main volume is below the surface.

Just to summarize, I will run through it again. We first gathered clean water at the highest point for domestic uses. We added nutrients to water that we ran through our plant system; then we ran it off into marsh, carrying food from the natural productivity system to the trout; after converting nutrients to biological forms, we release clean water back into the stream. We can accomplish all this within a vertical drop of six feet, going from zone to zone to zone. So we are not talking necessarily about giant systems--we can be talking about real little systems. Once you have worked out a technique for this form of landscape, you will find yourself hitting this situation repeatedly. It is the classical humid landscape.

You will be recognizing it everywhere; you will be spotting saddle dams out of your car windows.

Right around here, and north and south of here, and increasingly as we go north toward Canada, you have very low grade landscapes with ice built bottoms, that have very slow water movement through them. They are basically marsh land. They are very cheap water storage systems, very cheap marsh systems. Very low walls give you very extensive ponds. Keep your eye out for that kind of landscape. It is often very cheap land because cattle can't move around in the marshes, and the hills may be quite dry. Where people can't run cattle, land is sometimes cheap. If you can buy that land, you can get miles of water for very little Earth moved. The best design decision, then, is to go into aquatic production, because the site suits to that, not to dry land production of cattle or corn. We spot those sites for clients who want to rear fish or trout or wild rice, or something else. There are also occasional sites where you have a basalt dike across the landscape, which in geological times formed an ancient lake. Then the waters broke through the dike at one point and the river went on out, and what you have left is an extensive marsh with a very narrow exit and very steep shallows to the exit.

The value of these high lake systems, saddle dams, and high meadows is well known. They afforded the traditional rich summer pastures used extensively in Switzerland and all cold climates as summer grazing meadows. Here is an excellent reason for opening up the flat ridges there. As you get closer to the coast, increasingly alkaline conditions commonly occur. Then you get a copper deficiency in animals. Their hoofs fall off; they aren't thrifty; they get lame quickly. Just shifting them temporarily up to those mountain pastures is good husbandry. All the young people go up with the herds to little huts. Everybody loves that move. These are really delightful times. If properly surrounded and broken up by trees,

these are relatively warm. These are very valuable high meadows, and they are valuable for wild life. They break up the canopy of the forest and give essential edge conditions for high productivity.

So the landscape, I believe, dictates in a very logical fashion how you treat it. If you just ruminate on this profile and its thermal advantages, its water advantages, its seasonal advantages, then I don't see any difficulty at all in coming to a set of totally logical decisions about how you begin to treat it, or where you had best place your client within it, or where you would advise him to undertake various sorts of endeavors. As a designer, you will have one last set of resolutions to make, and that will be to increase or decrease the various elements of this landscape according to your client's wishes. If, as typically happens, he hasn't a clue, you dictate the proportional break-up, always maximizing water and forest, because that still leaves the opportunity open for him to decrease them at any later date.

I will now deal briefly with minor form of water storage at great heights that can be hand constructed, called dieu-pond. These are very interesting and semi-mystical small catchments, dotting the British landscape. Mainly monasteries constructed these little catchments. They are said to be fed by 'dieu." It is the god Himself that sends down the rain.

Now they are normally sited where there is a mini-catchment, maybe a little cup-shaped area in the hill. They are hand dug, and therefore not machine compacted. They are often clay tamped. But they need not be. They can be dug in perfectly good holding conditions. Moreover, the material removed from them is laid out on the catchment so that we have the least vegetation there, and consequently a greater run-off into the dieu-pond. Dieu-ponds never dry up. They can range from about three feet to a maximum of about 20 feet in diameter. Two or three people can dig a dieu-pond in a day. Nothing to digging holes. You are laughing? Well, any-

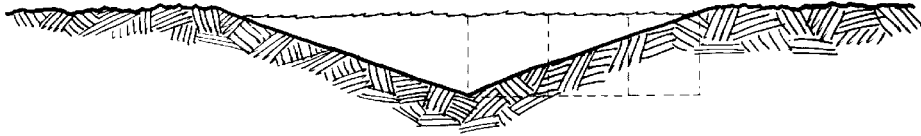

3:1 Dieu-Pond Slope

way, they dig this little hole so that its walls are three to one, which is about the resting angle of normally strong soil. Now the reason they don't dry up is that as they evaporate, the surface area decreases. They will always have some water. These ponds are the traditional high country watering points for stock. They do need cleaning out occasionally, because that little point at the bottom does fill with silt and leaves. It is an infrequent renewal. In very low summer periods, it pays to hop in there and drag the leaves out.

It is necessary to give the animals a stone access, or walk them into it on the low side. They will of themselves cause some collapse of the edges of it. For normally humid uplands, this is an eternal water supply, depending only on the number of stock watering it.

The builders of these dieu-ponds would never tell anybody how to build them. Old dieu-pond builders used to pass their secret one to the other.

The secret is, you taper it. I never knew how they worked until I took physics. I just knew they worked. I have seen them all around the world—little sloppy catchments. They work because they don't evaporate easily, and they fill from rainfall.

To the ordinary person, they look rather marvelous because there is no run-in, no streams, no springs, and here is a little pond of water. Today, we would hack one out with a backhoe, if not up to using a pick and shovel.

It is very likely that in future times low humid bottom lands, which have the lowest potential for soil loss, particularly if treated in some of the ways we will be discussing, will be the most valuable agricultural land. These areas may be in production long after we have lost all sorts of other soils. This is also where eroded soil accumulates. So those low-lying lands have a large amount of resilience. The only reason why we will be continuing

to farm the lowlands is that we will probably be continuing to erode the uplands. Therefore, these are important areas. Very often, our design may keep them out of permanent uses into croplands. You may not see a tree crop that is appropriate to them; and you can often reserve them for main crop purposes. They are important areas, and becoming increasingly important.

We need to deal briefly now with mini-terraces. We may, at times have to site the client where we don't want to. You have clients, quite affluent people, who buy site unseen, subdivisional areas. It often becomes necessary to establish a terraced system for the garden.

Design this in a series of planting areas of about waist height, two feet wide at the top, and maybe three or four feet at the base. The base of each tier is a walkway about 12 inches wide. Mulch the walkway and put mulch on the terraces as needed. We don't recommend more than three or four growing tiers in a series, and we don't recommend that they be any more than about forty feet long.

Your client is on this slope, digging in, living up there. He has his chickens above his garden, and the chickens are kicking the mulch downhill, giving him good mulch for his little terraces.

The terraces are along the hill. We let moisture flow down in very fine discharges on these paths. We only permit him three or four terraces, and we don't let them come in a line, we stagger them so that we get a staggering of runoff of excess water. It comes off at separate points, so we get several little runoffs spreading over quite an area of hillside. We will

keep the area just below our three or four terraces vegetated with permanent shrubberies, small fruits, brambles, and pumpkins, and things like that. The little terraced ridges are hand-patted and shaped so that the water does not run out of this area very easily. Rain falls, and there is no runoff over these 40-foot ledges.

Now the client can still be in trouble, especially the lady client. The ladies carry all the water. They have to get water on to these high sites with no chance of a catchment up hill, unless they have a friend and neighbor. You, as a designer, can give them two water sources. You can provide for a

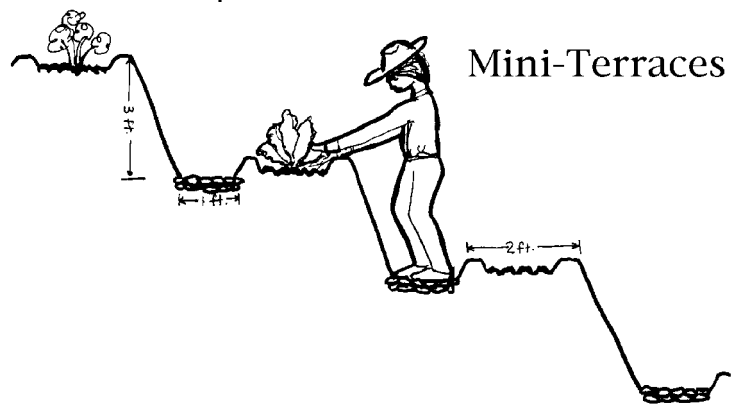

catchment tank for water collected from the roof of his house.

Now from our water holding system we dig a little diversion drain and run it very gently across the hill, and maybe even drop a little bit of down pipe in it, directing the water on the trenches. We are not going to get a silt flow, because we have this area mulched, and when the water leaves, we make it run off on an uncultivated site. All the principles are exactly the same as in our keyline structure. We are still running little high keyline dams for him, but everything is small, and his garden is small, but it is productive, very productive!

There are two ways of managing chickens in this situation. You can put the chicken house down at the bottom near the terraces, or you can put it up at the top and the chickens will kick this mulch down to where it stops against this bottom fence. That will be the place from which we collect the mulch for the garden. This is what I

call the kickdown system. We plant this area with chicken forage trees to hold the slope.

Now we will go to a relatively brief discussion of terraces and paddy field.

You can make those on slopes as steep as you like. You can do a Nepalese terrace, you know, in which you get a square foot for every 10 feet you terrace; but normally you make them on easy slopes. I looked out of our bus once in Nepal. We were turning a corner and the back wheels were hanging over here, and there was about a 3,000 foot drop. Out there were two little terraces. There was a gentleman standing on one foot, a hoe on his shoulder, looking up at me. Oh, God, I thought. All he has to do is to lean back! Also, not far away there was a tree growing up like that, and a big branch hanging out over empty space--no terrace below. There was a little girl on the road, and she ran up the trunk of the tree and sat on the branch without hanging on. My God! I can't stand to look at that! Forget those.

What we will discuss now are broad diversion and irrigation drains. You work right in them to see-saw your water across landscape. You usually have a little lip on the outer slope.

The drains fall across slope, and they may be very irregular in their width. There is no need to make them regular. We may be leading these diversion drains from a nearby creek, letting this trickle of water into them. We take this trickle of water and lead it into an agricultural situation.

This is not European gardening. You won't find anything about this in the British gardening book, because it is not straight, but has wavy edges on it; and it just isn't traditional.

Take a brisk look through world literature on the subject, and you will find 60 to 80 common, very high yielding plants that grow in marsh or water. One whole group that may be of interest is the bee forages that grow in or near water. We will deal with them later, when we go into aquaculture.

On more gentle slopes than those upon which we constructed our mini-

terraces, we can indulge ourselves in water terraces, much more simply constructed. We can set up nutrient flow systems that are catching, introducing, and removing nutrients at different points in the cycle, using land animals for nutrient input, and the land plants to mop up the last of the nutrients in the water, while water plants and water animals do their parts in the cycle. We are into slightly different games here than those which we will talk about in aquaculture.

Another thing that you can recommend to clients as very pleasant work is water gardening. You can go into this form of terracing, or into dry terraces fairly fast. They are relatively easy to make and are very stable situations as far as soil loss goes.

Now we will consider the mechanics involved. On very low slopes, where we want to make diversion drains and channels, and in deserts, we make use of a thing called a spinner, which is simply a very large wheel ripping around behind a tractor. This wheel has little cups on it, and you just drive across the landscape and this wheel revolves and chews out a gentle channel and throws the dirt way up here, so there are no banks. The ultimate result is a sort of drain through which the water runs along, not really visible on the landscape except in low-lying conditions. You can drive vehicles and tractors across the landscape and they just enter and leave it without a great deal of fuss.

The width of the drain depends on how big your spinner wheel is, normally maybe four feet wide, and a foot deep. These are very gentle drains for low slope systems. On steeper slopes, the most common form of drain is made by using a tilted blade. The tractor goes on slope here, and blade is on tilt so that it will scrape with a very gentle back slope, and that gives a little wall of Earth on the outside. If it is wide enough, it is also your road, contour road, and it can be grassed. If you have much land and a great big project, and you are meeting all sorts of slopes, including

steep slopes, you might even backhoe, or drag line one of these out.

It is handy to put a fence on the upper side, if you are going to fence, so that you can use relatively low fencing.

These are things called delvers, which resemble joined double plows, which can be towed behind bulldozers. They have two wings behind them, and they throw out a V-shaped drain, while the soil is spread out to the sides by the wings. They are low-slope systems. These delvers are sometimes mounted on graders, and you grade across the landscape, delving away at the same time. Graders can be used to grade out low profile drains. So, well, you use whatever machinery you have. For very small systems, you can use just a single furrow plow, turning out a turf; and you can double plow. The farmer can travel along the hillside with his chisel plow or his soil conditioner. Then, fixing a light blade on the tractor, follow along removing the loosened soil. This is a system that is useful when we are dealing with horticulture.

It is normal to grass the spinner drains, just as part of the field.

We will go to dam wall construction.

This is something you need to know, without ever having to do it.

For dams up to six or eight feet high--these are small walls--you don't fuss too much. You give it about two and one-half to one slope; on the rear side, three to one. You make a very broad crown. That's your dam. The broad top should enable whatever construction machinery you need to roll along it. It should be over a car-width wide. You can have a little bulldozer running back and forth while the big one scrapes it up. Avoid including rocks in the soil you use to build your dam. Rocks don't shrink and expand like other materials, and they make for many leaks. So when you strike rocks, bump those to one side. Tamp every foot of your wall as you build it up, using your machines to roll backwards and forwards, so that you have a rammed Earth wall. Up to eight feet, nothing much is going to happen to that. So it is fairly non-fussy.

What we have done is to remove the top soil, get rid of all the sticks and duff. If there is good clay soil underneath, we push this up, roll it down, push it up, roll it down, roll it backwards and forwards as we go. That's it! You can drive across these dams. You will normally use them as low valley crossings, or to drive across gullies.

Your spillways need to be broad. You have your dam across the valley. You cut a spillway into the solid part of the hill, wind it out along contour, letting it shallow out and fail. You don't bring it around down below. If you are going in towards a continuous stream flow, you might very well do one of two things. You can either bring it out and pipe it down here and give that a splash area, or you can put a pipe in the system, an overflow pipe, which you lead out. These are small systems that we can handle in several ways. That is your typical dam.

When you come to building a dam 200 feet long and 20 feet wide, you have to do all this very cautiously. You make a trench here at the base of your dam site. You go down four or five feet until you strike very good clay at the bottom, then you start rolling. You pack that and the whole core of the dam with selected clay.

Otherwise, the procedure is the same as for smaller dams. You do this, and hope for the best! The larger dam is a more serious job. The height of the back of the slope may be about eight feet, with an eight foot down wall. If you run into dry rock, you can lay it on the wall where you would expect some wave splash, if it is a shallow containment. Keep rocks out of your dam structure. On larger dams, you don't want any leaks. Line the whole vertical center right to the top with good clay. That will be a totally impermeable dam. Most soils, however, will roll down to an impermeable soil. If we are working in a granitic country, with coarse sand, we are not going to get a dam unless we do this core. The core stops the water, and this is what gives the dam stability.

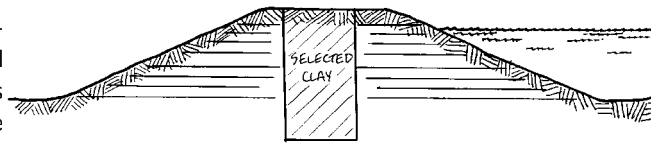

Batter slope cross section
for dams over eight feet high.
"You pack the whole core of the dam with selected clay"

That is how you make dams that stand above the surface. Many dams don't. There are many different sorts of dams. This is a barrier dam that goes across the valley. These are dams that run along contours. They are usually rolled Earth dams, and they are called contour dams. These are the ones you build up on knolls and slopes. Then there are dams below grade. On very flat lands, the way to hold water that runs in is to excavate the dam out, and throw the soil up. They are more properly called tanks--Earth tanks. A spinner drain might lead into one of these Earth tanks, so that a very gentle flow is coming in below ground level. There is no way that these things will ever bust out.

likely to get much vegetation except right at the edge. The steep bank of Earth at the rear, which can be eight or nine feet high, can have trees in front of it. You are in a tropical climate there. If you want to be fancy, you can glass that off and you

will have a fantastic situation, with winter reflection of sun giving maybe as much as 60% additional heat. You will have absorption of direct sunlight--a good heat-up situation. If you want to put bamboo up on top of your Earth bank, you have maybe as much as 60% to 63% additional heat. The Earth bank itself stores heat.

There are two basic forms of bamboo. One is called monopodial, and one is called sympodial. Most of the bamboos are monopodial and form clumps. Sympodial bamboos are more or less runner bamboos. You can put them in here and they go out under the road and come out on the other side. Nobody uses sympodial bamboos because they are all small bamboos, seldom

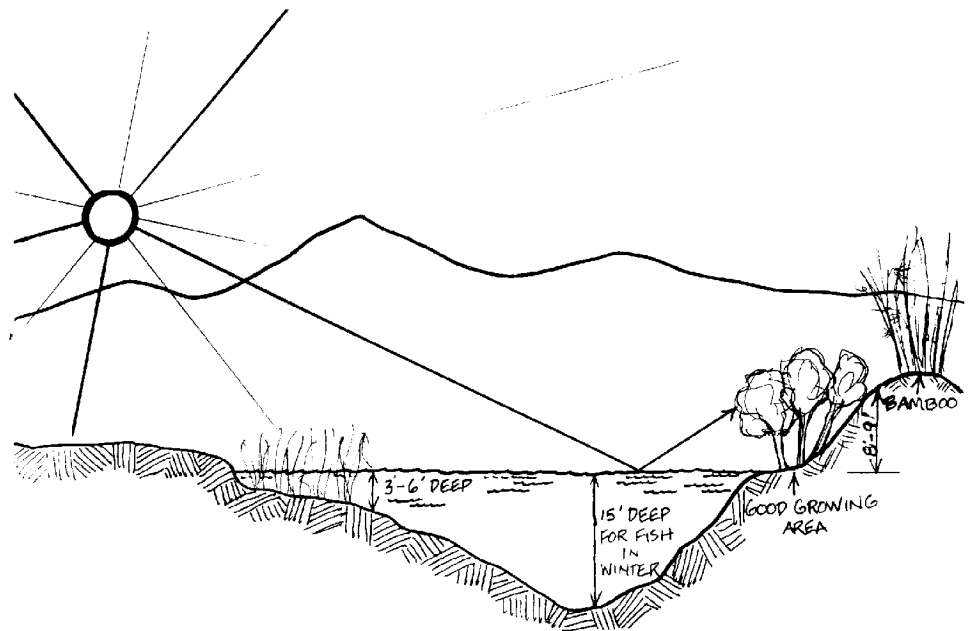

Now when you are building Earth tanks, you can do all sorts of interesting things. You can sharply pile-up the removed soil to create a sun trap. When your pond fills, you have a good growing situation. Animals can come into this. You can pave that section with stone, if you want to. The deep edge is very abrupt, and you are un-

exceeding five feet in height. They are good for making arrows. So if you don't need arrows, forget them.

Now the monopodial bamboos are gigantic bamboos, sixty to eighty feet high. Some have big trunks on them. They are slow growing, with nice tender edible shoots. They never become rampant. A monopodial bamboo will

form a clump as large as this room if no one is eating off it. If you are eating it, it won't be very big at all, because you eat the shoots.

If we are only going to grow plants in it, we can make our Earth tank about three to six feet deep. If we are going to hold fish in it, we need to kettle them out a little area, a fifteen foot hole somewhere, which you can backhoe in. It only needs to be a couple of feet wide and maybe six feet long for about fifty fish. Your pond does need that additional depth unless you are going to stock it with fish.

These Earth tanks fill from diversion drains. There's no need to find a spring for your water source. We just take a whole big runoff section. You can normally ignore springs in favor of an excellent, cheap site. Of course if a spring comes sited well, that is, if it is at the back of a plateau, we could run a very cheap contour dam and tie in the spring, and we would have a double hit. If the spring is on a steep slope, then you would need a contour plow. In that case, I would simply ignore the spring and bring the water round in contour to the dam. At the spring, you could do something quite different, which is the small, usual spring house with a small tank in it, something totally different from the large storage. If you are lucky, and your spring is above your diversion drain, you can bring it in to the dam. If you have a stream running through your Earth tank, it will just give a slow circulation to it.

Sometimes you will need to use pumps while the bulldozer is going, if you are down below the water surface. We have to use them intertidally, too, when you have to put in 12 hours of fast work--otherwise, glub. When you are digging these, you move your days around to night, if you are digging a big one. And sometimes it rains.

Lock pipes, you can purchase. Those flags you fit in the ditches, you can make them out of a bit of pipe and canvas, and a piece of dog chain. Sprinklers you can buy commercially.

On a flat site you can grade up a wall and get maybe 20 acres of water

when it rains, which rapidly dries off.

You can put a little concrete sill in your wall and have a sliding door, called a floodgate, which you can pull up and let all those twenty acres of water out into a chiseled two or three acre area. The floodgate is just like a board in a groove, a simple little thing. You can make those by hand. They all leak a little bit. Expect everything to leak a little bit. Even those lock pipes leak a little. That is normal. Dams leak a little.

We may run this water through our irrigation channel only twice a year, or something like that. Most of the time we let the water go, and therefore we have a normal spillway over the dam.

A dam may have these four things: a diversion channel leading in, an irrigation channel leading away, some device for releasing the water--either a lock pipe or a siphon over the top--and a spillway.

Now when you come to look at the dams--and we will look at a few on this site--the spillway may not go past the dam at all. We might be working on a site in which we have undulating country. We might take a spillway from the back of the dam and lead it into the next valley. There are all sorts of games we can play.

Contour dams are very cheap, no-fuss dams. They are dams in which the actual dam follows the contour and then swings back to ground level.

Basically, the construction is the same as for other dams, but usually you put contour dams on pretty flat land, and you grade them up pretty quickly. They may be six feet high. It doesn't matter if you get a bit of grass or rock in them sometimes. They can be a little rougher. Just roll them down tightly and they will hold.

There are all sorts of reasons for little mini-ponds. Never neglect the little pond. When you are planting steep slopes with trees, you might put a little well at the end of your paths. On a steep slope, it pays to dig these little wells, and line them with plastic, or drop a tire in, which is the quickest. Then when you have to water the slope, you are always carry-

ing a small amount of water down hill instead of a lot of water uphill.

Another use for mini-systems is when you go to broadscale quail or pheasants. You drop these little ponds through the landscape every 150 feet or so. Just make little holes.

If you have a lot of pear trees, you may want to rear frogs to get rid of pear slugs. You then place these little ponds all over the system.

Well, we have covered the keyline concept, and in with that falls all your lower slope control. And you have this bold idea of storing water right up on the top of the hills.

Only as a last resort do you dam the valleys. You only do that in emergencies, or for the creation of productive systems. Large-surface, relatively shallow, easily constructed, cheap lower productive dams are very good!

In dry areas, and in areas where you are growing very intensively, you might design some form of drip irrigation. Drip irrigation systems are very modest with water. For high value tree crops, they are critically important for establishment, but probably not thereafter.

There is another form of water control that is very interesting, given that we have some water uphill, and given that we have established an orchard on the hillside down below our glasshouse, which is bermed into the hillside directly above the orchard. We will grade little shelves almost on true contour all the way down, at about 40-foot spacing, which is about correct for orchard trees. Down the hill we go, grading these little platforms out and leaving the area in between them in grass. We will then plant our little trees in the outer edge of our swale. We have a pipe from our water source, which is uphill, and we bring it down and stop it.

We can lay a hose in these systems, or we can do another thing that is interesting. We can bury a pipe that comes up in the next system below for reverse siphoning. We can have these little reverse siphons going all the way down the slope. In that way we only need to run the hose in up here. The water enters the highest

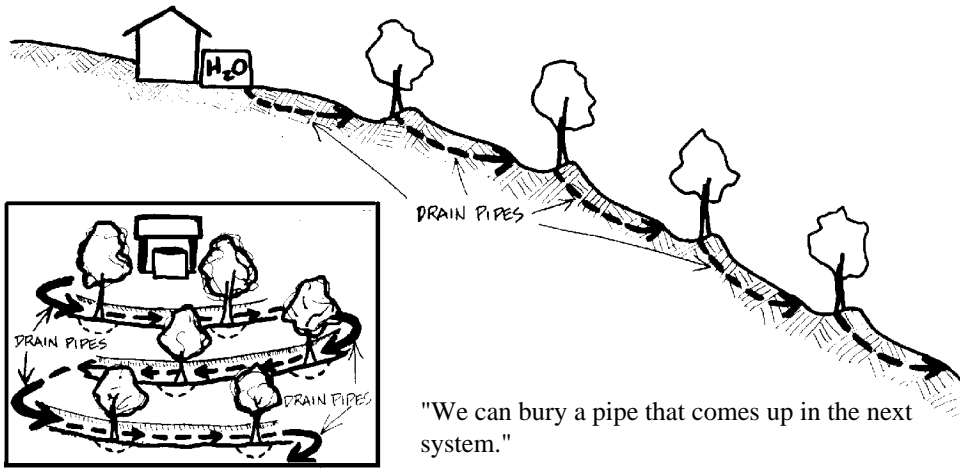

swale; it runs along and soaks up all the Earth, then enters the reverse siphon and runs down to the next level, and so on. One person can water hundreds of trees in about an hour.

Then you can do something very interesting. You can plant this swale to a highly nutritious crop, such as white clover. Then you mow the grass strip and throw all the grass on the swale. When it is looking all rich and good, you run along and regrade it, bringing that rich top soil up to your trees. Your trees will get bigger. You grade again, cutting it back a little bit. You do it two or three times. By that time, you have a great mound of black Earth, tree roots growing in it, and a well-defined walking platform that you can walk along, and an easy watering system. No problem with that one.

You stagger your trees down slope. You should also alternate species, putting your narrow leafed species up at the top--peaches and apricots--and your broad leafed species down below, because it is getting wetter all the way down.

That is a very easy way to run an orchard, and a very easy way to set it up. That is real Chinese style, building up the richness in your paths, and then scrape your paths off and put that around your plants. But always keep your stems free. You also have a nice little garden path in which to set your ladders for picking. It's a generally sensible little set-up.

When you get to very flat land with hardly any fall, you can make a trench, a side channel down the side

of the field. The side channel has a little fall to it. We block off the side channel at intervals, and through these blocks we put short pieces of four to six inch pipes. We have a plug with a handle on it that fits into those pipes. When we let the water go into this side channel, it fills up to the first block, which we have plugged so that the water cannot go beyond this barrier. We have also done something else. Leading out through the side wall of this main drain, we have many little two inch pipes directing water into our field. Our side drain conducts water through these little pipes out into graded channels running down the lengths of that field. There are trees on little banks between the channels. Again, this area has been planted with grains, and can be graded up to either bank. So we have banks made up of loads of clover and topsoil, with trees on them.

When all those little pipes are conducting water down over the first section of our field, we pull the plugs from the first barrier, and plug the second barrier. When that section of the field saturates, we move our plugs down to the next area. There can be four or five or even six or seven of these little two inch pipes leading the water in an even flow from the main drain to the irrigation channel. We can irrigate hundreds of trees with very little effort. That's for flat lands.

If we want switching systems, we put in another one of these barriers, and we just pull the plugs and let the water go down. We can direct water

around contours, and along to other flat fields. It is a cheap, simple system, consisting of many short lengths of pipe and plugs that you carry with you.

This is not a trickle-flow system. The whole thing is running like blazes. When we need to irrigate, we go up and open our floodgate, and the main water channel comes down and hits that little channel, and we stop it here and it fills up, floods out; then we move on and the next section fills up and floods out, and so on. You let a lot of water go, and you thoroughly soak it. Then you plug the whole thing up by closing down your floodgates.

You can dig those trenches with a little crawler tractor, just a small machine, or you can do it with shovels. The best way to dig a trench with shovels is to use two men. You get a very broad shovel, with one man on it. Around the neck of the shovel, just above the blade, you put a rope, and then you put a toggle on the end of the rope. One man puts the shovel in and the other pulls, and you get a rocking motion up. They can throw up banks about as fast as we can walk, very easily, no arm strain. One man is just moving sideways and putting the shovel in the ground, the other pulls, and away you go. Little Earth banks appear right across the country just like that. If you have to empty a load of gravel and have no dump truck, use that method, with one man standing on the ground pulling, and another just putting the shovel down in the middle. Painless. That is the way the Turks and Afghans contour enormous acreages of very shallow country. They will build and rebuild those contours every year, miles of them, just a couple of men. Ho! Ho! Ab-do!

One of the advantages of the keyline that very few persons see is that if you have a diversion drain above your fields and household systems, that works just as efficiently to remove excess water in winter as it does to direct water into your drains. A well-keylined and combed landscape that has been soil conditioned doesn't get boggy in winter and doesn't get dry in summer. People forget that the same

drain that diverts water off the hillside also prevents bog situations and seepage situations below. Once your storages are full and your soil is charged, you can direct a winter runoff into a creek if you want to. You can take it off the landscape through this system, just as easily as putting it on. We often run a descending diversion around the valley slope just to keep the drain bottom dry in winter. The same diversion drain, plugged, will irrigate the valley in summer.

Now when you are wandering around with this diversion drain, bringing it down to your dam, and taking an irrigation canal out of your dam, if you come to a little gully or something, you can easily make a little pond there as you go. It is quite easy to do that.

Another way to go about bringing more water into the landscape, storing water on the land, is to run broad swales. This has a particular application in urban areas. A swale is a critical technology for winter-wet America that is not much used. It is also a very useful technology to use when laying out forests.

You cut shallow blade trenches on true contours, with no movement of water along the trenches. The trenches are quite broad, hardly ever less than four feet wide, and often much wider. You wouldn't do this on a steep slope, just a moderate to shallow slope system. You walk it out along

the pegs; the bulldozer follows you. If you strike clay, leave it narrow, or else deepen it. As a rule, in clay, deepen your swale in profile, and in sandy and gravelly places, widen it.

Along the swale, where you think it will hold, you have little ponds in clay. Where you think it will soak into the ground, you widen the whole water system so the surface area is large. Rain, particularly storms, comes down the swales, too. The water finds your widened areas, which are free, and soaks in, and thus charges your ground water instead of going down the hill and off the property. In three or four years, you will have 17 to 20 feet of fully charged soil. Your forest, just above your swale, is alive and has access to this water. Your forest will be alive when your neighbor's ground water has flowed away out of sight.

If you ever have the chance to design a suburb in a place where there is a semi-dry climate and storms, particularly summer storms, sudden rain rushes, this is how you do it: You run a hard-top road, swales, little bridges, houses that are back to back, footpaths, down pipes. This whole system is swales, with double rows of houses sitting between the swales. All the roof run-off is going into the swales, and all the road run-off is going into the swales. There is no gutting, no curbs. The swales sometimes pass under the roads.

An immense variety of treatment is possible, such as little block stepping stones across swales, little rocks across swales, little graveled areas, little ponds in swales, frogs croaking. You set your trees out along the swale edge, but not in front of the

house, not on the sunny side of the

houses. It can be a remarkable environment! The swales are probably never less than two feet deep, very gently shoaled edges on them, great places for children to run in the storms and hop into them. Then when the storm ceases, the water, because you have broadened the swale at places, seeps away within a day or so. The swales will then contain water only in the over-deepened clay areas, the little ponds that we made.

This system exists nowhere that I know of except in the village project at Davis, California. Here they sit on a plain near Sacramento, and because of swales the place is an oasis in a desert of disaster. Nothing quite like Davis has ever happened in America, and is not likely to happen until we get out on the ground, 300 or 400 of us.

The trouble with America is that these things that people have been doing have been just with their own homes, keeping it to themselves. In Davis, you have the benefits of design orientation. A whole set of low-energy systems are demonstrated there. More of your urban areas should be permeable to rain so your street trees would remain healthy.

Ordinarily these urban swales will end up nowhere--start nowhere and end up nowhere. However, if you do think there are going to be very catastrophic rains, then you can lead the end of the swale out of the situation into a more normal drainage system. But in moderate rainfalls, the swale can hold it all. The efficiency of the absorption in swales increases as they age and as trees grow along them, because the trees penetrate the subsurface and carry water down. I think Davis initially absorbed about 40% of its water, then 85%, and now 100%.

Now it is absorbing water from off-site into its swales. It collects runoff from off-site and gets rid of it on its site. So that is very good. The older the swales get, and the more the tree roots penetrate down into the swale, the better they get rid of water.

These swales do not have to be renewed. I think possibly if they decayed badly, you would probably have

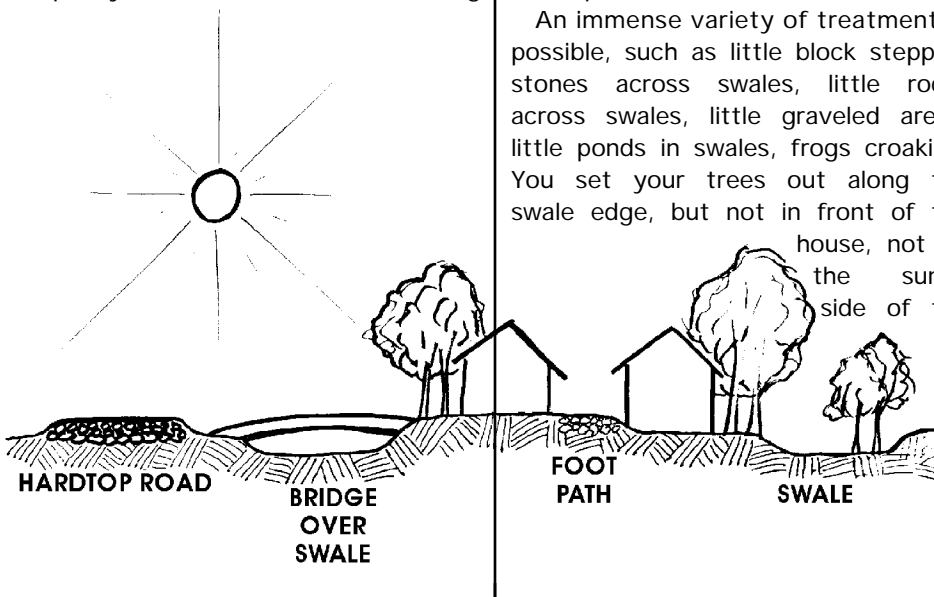

"Swales have a particular application in urban areas."

to just chew them a bit, but it is not a big job. You could do it with a couple of kids and a spade. No work repairing drainpipes; no pipes; no gutters; no curbs--cheap!

Swales can also be quite useful growing situations. You might be able to raise ginseng up here in the swales. Your swales are obviously ideal sites for certain useful plants that like this moist, rich, highly mulched situation. Blueberries! You swale below a pine forest, grow blueberries in the swales. There are many techniques you can use with water in landscapes.

There are other good reasons for constructing swales. In a forest, many leaves will arrive in that swale, and they rot quickly there. It is a moist site. Your little salamanders run around in there. You can deliberately add to the leaves in the swale. It is a long composting system on site. Occasionally, you can take from the swale for the garden.

Swales greatly decrease the risk of forest fire because they collect a lot of fuel and rot it very quickly. Swales make for a far more moist forest than existed before. It is amazing how few trees you have to remove to run a swale in an existing forest. However, it is a good idea to swale a forest before you plant it as a forest. Some trees can stand in the swales.

Another reason for swales is that you are in an isolated place and there is no chance that you are going to be able to go out with your Land Rover and bring in mulch material for your garden, you can swale out from your garden, and mulch into your swales.

Now you decide the sort of mulch you bring in, because you plant trees above the swale to give you the mulch you want. We get alkaline mulch from western cedar, acid mulch from oaks, and so on. So you treat your garden from a continuing input from the mature system, thus reversing the axiom that maturity exploits immaturity. We make immaturity exploit maturity, because maturity is exploitable. It is also a great accumulator. Left alone, the forest will exploit the garden; but with us in control, the garden can exploit the forest.

I will show you an unusual technique, just throw this one in. You will discover these situations. Here is a little house that looks like a granite boulder. Its occupant is a rock freak. We have rock freaks in Australia, houses that just disappear in the rocks, and they look like a rock. All around this great granitic dome there is 40 feet of course sand, so good-bye water. You also have all sorts of granitic slabs and surfaces. So you run chicken wire around your granite, and go around with some cement and sand, constructing gutters, and you lead them into tanks. We have done a lot of this. Some of those granite slabs are big. You bring the water down, and put your tank at the bottom. You have to be able to use your eyes. You look at that slab and say, "A roof! a roof! and it is uphill." No keyline is possible, but in these conditions building concrete works well.

Suppose you dig a little Earth dam up on a hill. It rains. Nothing happens. It keeps on raining. Nothing happens. You have a dry hole. Bad luck!

A friend of mine had an open underground stream that ran like fury. He hired contractors to dig a dam. It should have worked. But he went a foot too deep, and--glub. You can't predict these things.

Well, you now have two or three things you can do. What we have up here on the hillside is a big hole. We have a dry place. So we put a couple of sills there, and raise a roof, and pour a floor. We are in business. Nice place! Good barn, good storage, cheap! The only thing you have to make is a roof. It's a good place for cattle in winter. Haul in your hay. Trap door right up here, throw your hay down, wheel it out. Take advantage of having a dry hole.

Now, change the scene: The hole fills, either because you pump water in, or there comes a rainstorm. So it is not a real dry hole. Stand by the bank and throw in three packages of water dynamite. Boom! It bumps the bank, and any cracks in rocks are sealed with great water pressure.

You might do it two or three times. That is fast, and often works.

Next scene: You have a dry hole? Just leave it dry. There are all sorts of uses for dry holes. In dry climates, you can hop down in them and mulch them, and they are shady, an extra good growing situation.

Or you can do something else. When you see you are getting a fair amount of leakage, you can strew rich hay all around the edges of your pond. When the water turns green with algae, if there is a leak through cracks in the clay, the algae glue it up. You are gleying it, but with algae.

But in midsummer it dries out. Didn't work. So now we are getting down toward the final solution. We put green sappy material right across it, six inches thick. We gather the mowings from the golf course, and anything we can obtain. We pack it down. We chip green leaves and sappy material, second cut hay. We cover all this with sand or plastic or old carpets or a combination of all of those. Then it starts to ferment. You can find out when it does, because it is slimy. As soon as it goes slimy, you fill it with water and it fills without any trouble, and will never leak again. It is called gley. The only reason why it might not work is if you didn't do it properly. So you then go at it again, and find the spots you didn't do properly, and do it properly right there, because the rest of it is permanent.

If it is a very big area and you have a very rich client, you run across it with bentonite, which is a clay that swells up to 14 times. You spread a bit and roll it in hard, and then you fill it. That seals it. But it is costly. This is by far the most satisfactory solution.

There are many solutions that plug small holes, such as a sheet of plastic, or concrete. But gley is the best solution. You can make a dam in a gravel pit with it.

You would be lucky to dig a very dry hole, because usually it is on a slope. You can ordinarily get an entry out at slope level. Roofing it is easy.

Nice and sound-proof in there. There was a big one that a friend of mine made. It should have worked, but it didn't. He stuck in sides to it and

turned it into an indoor auditorium. You can get in there with a rock band and not annoy anybody.

Once you set the water systems, you also have set a lot of other systems. Wherever possible, your fencing and your access roads naturally follow your water systems, and can be well integrated. Both assist the water systems.

If you are wandering around with a curvilinear fence, you run a series of approximate short fences, because the only fence you can build is a straight fence. So your fences, and your tracks, your on-farm tracks, all follow that system. Then, if you do that, your animal tracks turn into keyline tracks because they follow the fences, and animals will also have beneficial effects on run-off. If you don't do that, then your animals always walk anti-keyline. They always walk ridge down to valley, and animals can become a major erosive influence. If you set your fences valley to slope, your animals walk your fences, and all their tracks will keyline where you can't get.

Everything follows from that. Your forests follow. Your forests grow above those channels. They are themselves very water-conserving and insure steady water-flow systems.

Your forests that are of high value, your constructed forests, are below those lines. You can irrigate these. There are special sets of trees that may go on the ridges, very hardy trees that don't need irrigation. You will need to determine for your area its ridge-top planting set of hardy, drought-proof trees.

So far, we have only been talking about the water characteristics of your system. I would like to look more closely now at any one dam that we build, and see what structures we need within it to have a biological input into the dam. There are only about three or four things we would need to do. Say that we put in a six foot valley dam for a lake. We pegged it all out before, so we knew exactly where that shoreline would be, and we may have logged it out before we built the dam.

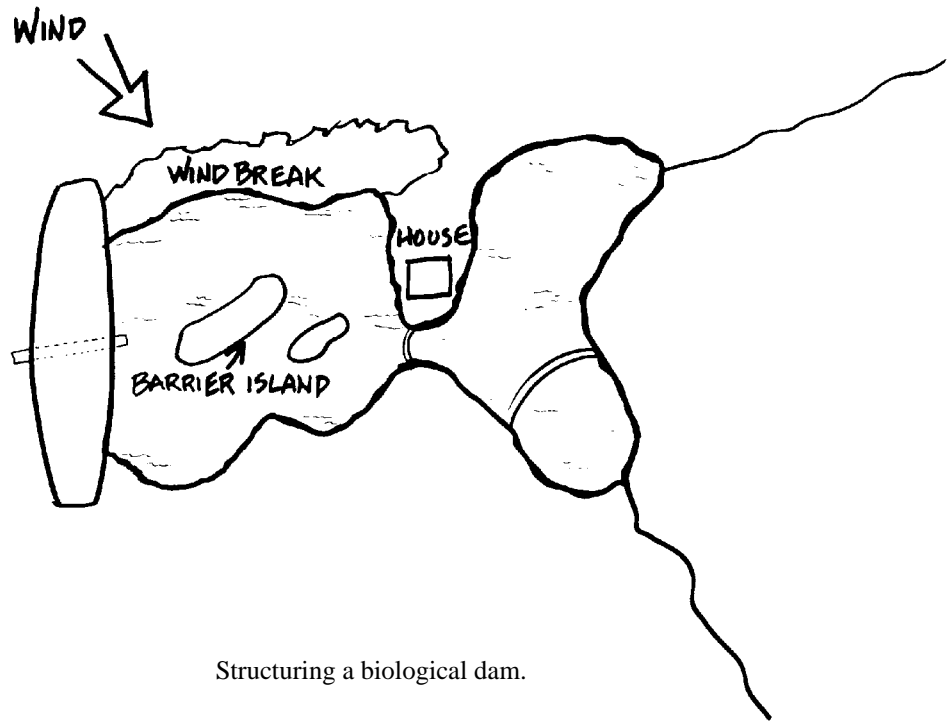

Structuring a biological dam.

We take some of our excavation material and make an island in our lake. If we have fierce winds across water, we make a barrier islands, so that we have a quiet patch of water in front of it. When we put our island in the lake, we have increased our shoreline. We may, if it is a bad fire site, in an area where people keep getting burned out every four years, put our client out here on a peninsula in the lake. We might do that for other reasons, too. We give him a deck out there and a little dinghy. Instead of leaving all our shoreline as a gradual shelving system, we might grade in here, making somewhat extensive, but constant-level marshes.

If we know that we are going to be drawing quite a lot of water down from this, if we know that we might pull four feet off it sometimes, then before we make the main dam, we throw up low dams across easily dammed sections that flood at high water. In this way, even when the other water is four feet down, these dams hold and preserve the shoreline flora. Many small animals that live along the shore continue to have refuge. As the water rises again, it covers the whole area.

What we have done in there is to play around with the edge of the

catchment, make shallows and barriers and islands--all sorts of useful things. You can put little pillared cottages out on those islands, little contemplative places, quiet spots, little retreats. You can put little stepping stones out to those places. We have done that.

Put in some underwater stones. This makes it a very lively place. Water birds nest on those islands. They are fox-free, except in winter, when they are not nesting. The shelving along the edges gives a very broad planting spectrum. You can align those shelves at different levels, specifically for certain plants, eighteen inches to three feet for wild rice. You can make marshes by grading off, away from the edge of the dam. Those marshes come out of little low mud walls, so that they marsh up.

If your dam fails, you still have your marsh for arrowheads and other duck fodder. If you do all that first, then flood the situation, you have created something that looks very good.

When you draw off water, your island sticks out a bit higher. Your shallows are mud-dammed, almost at water level, so that the main water rises over them a bit, going through them in pipes near the surface, and

when it falls, your little mud walls come out and hold the shallows. You don't bother about sub-surface dams where you have constant level productive water. Your larger fish can't get into some places that are too shallow and too weedy. They provide refuge for quite a lot of fry. We intend to make a biologically active system out of our water storages.

What we are giving you is classic solutions, ideas that you will have to adapt to individual circumstances.

Slopes give us a very great advantage, and I pay a lot of attention to slopes, to how a system can be laid out on slopes. When we have this gravitational advantage, it is possible to do all sorts of things.

This is a section of a ridge, and there is a ridge running along. We could put a little saddle dam here, and it would collect water from all around the higher area. People often go to

hills and mountains because it is a romantic place where they can look out on the world down below. They want to be up there. You can use larger shelves to get people down a little below the ridge. You can get water to them from the saddle dam above. You can also use shelves for their garden.

Some of their wastes can add to that system. You can run off water to orchards further down. Then when you get down deep here into these valley systems, you can create wet forests, we will call them, that will block fire out, keep it from running up slope easily.

You have water control on slope, and you have fire control on slope. Get your clients to build their storage units up high, units that themselves do not use water, or use very little water--the garages and the barns and the workshops. We don't have to supply these buildings with water, but

their roofs can supply very cheap tank water. Put all tanks up on the slope above house roof level, if you can get them up there. You never fill a tank from a house roof, if you can avoid doing so. Of course, on the other hand, a friendly neighbor might do that, add a tank to his roof for the benefit of somebody further down hill.

That can happen. There might be some cases where we supply them with water better than they could supply themselves.

The diversion drain falls to the saddle; the road probably falls out to the slope; the garden should fall out from the saddle, so the water comes down from the saddle to the garden. So you must decide which inclination you give these various shelves as you work down the slope. It is obvious that if we can get water doing its work down slope and across slope, we are in a good position.

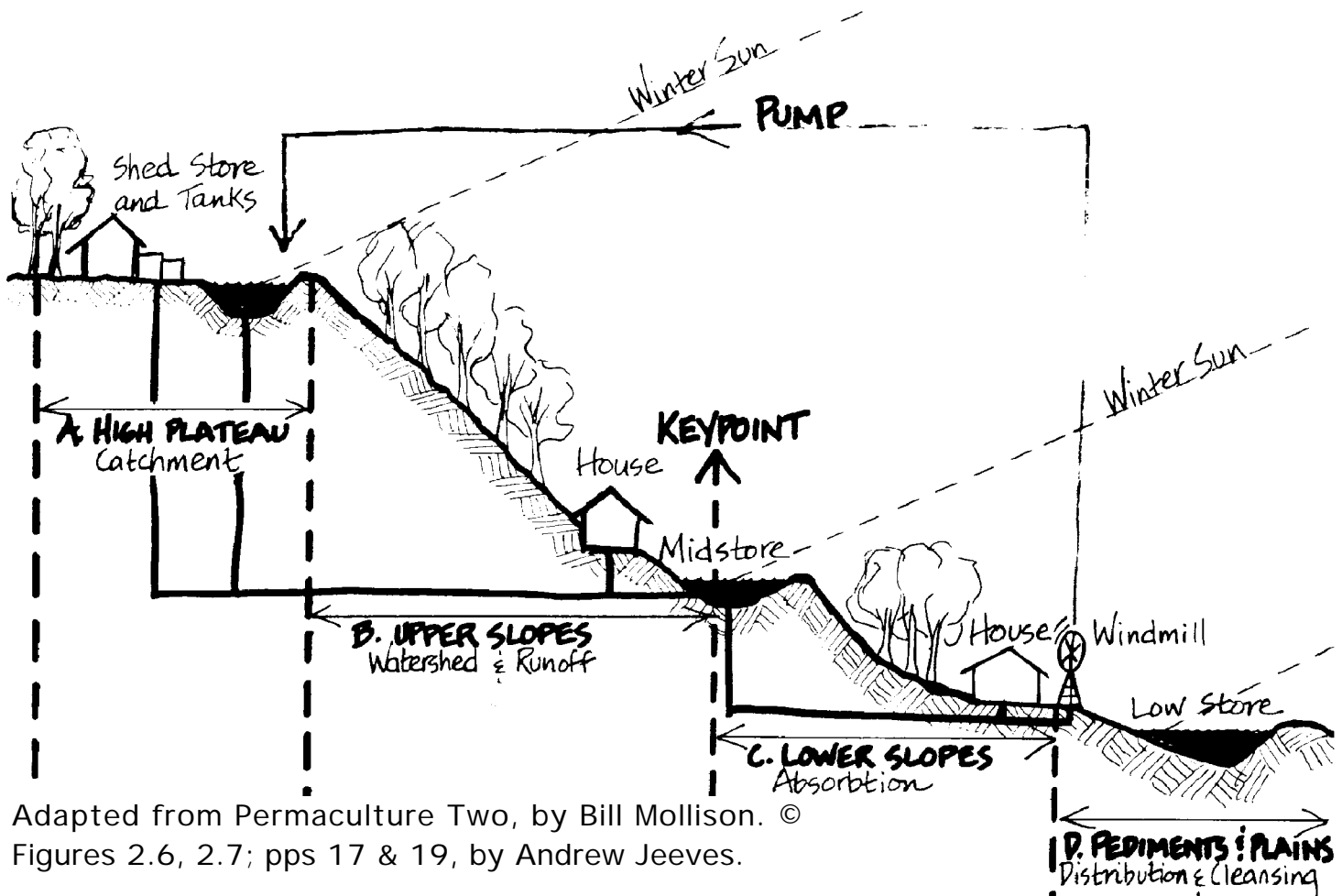

Adapted from Permaculture Two, by Bill Mollison. ©

Figures 2.6, 2.7; pps 17 & 19, by Andrew Jeeves.

"Slopes give us a very great advantage."

For reasons I could never fathom, you often see hot water or hot air collection systems on the roof. In level country, the good place for a hot water collector is below the sill level, so the thing thermo-siphons inside the system. You can clean it easily.

There is not much more chance of it being broken than the window itself. And it is low. Hot air systems also come down slope. I have friends who have set up large collectors on slope in front of their house, and bring hot air in low. Your hot air systems should go down slope, and low. Your water systems go up and run around.

You use all these techniques on slope. You must think it out, think which way the road will slant and for what reasons, and which way the gardens will slant, where your diversion drains must go in, what must come out, and so on.

If our slope is not an extreme slope, we can put a pond right here in front of the house. That is a great advantage. It is also a fire barrier, and it is a light reflector; it also makes for a pleasant environment. I think here we might attach glasshouses. We should examine each site to see if we couldn't also put a productive pond just in front of the attached glasshouse. The pond will provide additional heat buffering. It has the ability to absorb all but 15% of summer sunlight, while absorbing very little winter sunlight, and reflecting most of the winter sunlight into the living situation. A pond is a beautiful, automatic, self-regulating heating surface.

Where you can't get ponds, and you still want the effect of low winter light bounced up into the house, you can use white gravel, and highly reflective surfaces there. Snow is excellent!

On stony and steep slopes where you can't possibly run shelves along them, not even shallow shelves, you go to very small scale systems.

Here is a slope that we will describe as net and pan. You set up very shallow guide lines for drainage. You can hand cut the drains. You clear the slope of vegetation at the junctions, and make little flat planting platforms.

The intervals between these little platforms are those that would normally separate trees, squashed up a bit, because the advantage of slope is

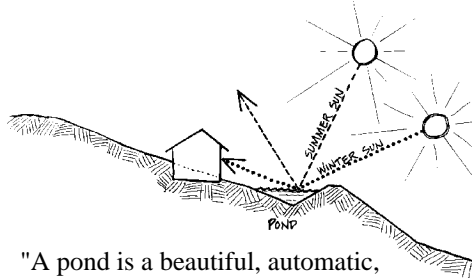

"A pond is a beautiful, automatic, self-regulating, heating surface."

at tree crowns stack much better towards the light. You will get a lot more trees on a steep slope than you will get on flat land. Dribbles of water come down these drains, gathering in these pans that are absorbing overflow. It is, again, a small scale system. You can't run it on a very large scale, and you will have to interrupt it with planting bands. It is particularly effective in very rocky country that you would normally not use for orchards.

A group of five or six of us did a fairly large orchard in three days on a little system like this. We cut little flats in the slope, which we put a tree on, and we had a little water roll around it, soaking in. When it overflows, it comes down and soaks in.

Place your narrow leafed fruit trees here, and broader leafed species down there. There are exceptions to that. The fig is an exception. We put the fig higher because it is far more drought resistant. There are a few, but not many, narrow leafed

trees that are high water demanding. You put the really drought resistant species up here. It has a secondary effect, too. Many of those drought resistant species are very good mulch providers. If you go high on the slope and put in tamarisks, and some of the pines that grow on the ridges, you get a good mulch layer to bring down hill.

After a few years, you can let your irrigation system decay, because your trees are established and probably don't need much water, or you can keep some of these maintained, depending upon conditions.

Arrange to have barn and loads coming into the barn on a level above the house. Have your animal accommodations up here. The wastes are thrown out here and rolled down to your annual garden system below. Your banks that are collecting water from the roof of your barn will provide a gravity flow system for the house and garden below.

Tanks themselves can be useful structurally. You can bury them to get them out of the way, or build over them; but you can also use them as quite bold structures. Often we trellis off them so that in summer you can be sitting under a trellis shade with a central ivy-covered tank that gives you a real cool place, real nice for hot climates.

Tanks can be structurally integrated into barns. In some areas, large tanks can be the base of the buildings. Buildings placed high on the slope can take tanks below them. The water will be used on lower areas, to which it runs down by gravity flow.

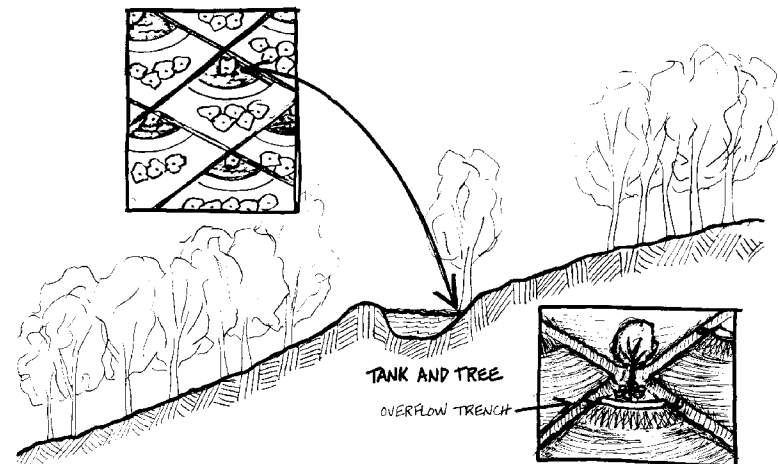

A net and pan slope.

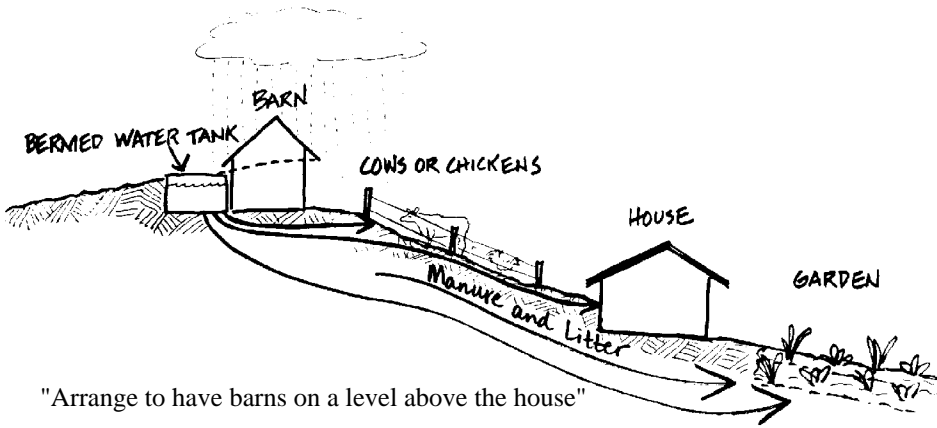

"Arrange to have barns on a level above the house"

One of the advantages of locating chickens above the garden site is that the chickens will provide mulch waste for your garden, which can be easily brought down. That mulch will be already shredded. Chickens are shredding machines, and they also remove the seeds. So by the time your mulch has come to your garden it has received added nutrient, the weed seeds have been removed, and it is shredded.

It is mainly used right in the garden. You can also take it through a water system below the garden again, or within the garden. The idea is to strip the nutrients out the way down, getting a product for it. In this kind of system, your nutrients are falling down. You use your slope. How often you go to places and see all of this completely in reverse, and people are working hard because of that, pushing wheelbarrows uphill and carrying mulch uphill, carrying water uphill.

On slopes, fire will always travel uphill fast. Water, roads, Earth walls, stone walls, and short grazing systems toward the downhill sector are all fire defenses. Only in rare circumstances do you need to be really worried about hot downhill fires.

The way that we set up all these systems also suits fire control. A dam with an Earth bank is good fire control. A high access road is also good fire control. So once you get people correctly placed on the slope, and the elements correctly placed around them, you again find that you have done a lot more for other conditions, such as fire safety, than you had originally planned.

You might have planned that dam just for biological production. It works also as a fire barrier. You might not have planned for it to work for fire except to provide water. You will find it has high radiation defense because of its Earth wall, and so on.

Start to get things right and they get real right. That is the reason we put that rain forest in right at the base of the slope in the valleys.

In steep valleys low down, very steep valleys that you are not going to get to work in, and in which you don't put dams, you can, nevertheless, bring small drains out of the creek. They are usually hand made, or light machine herringbone systems that pull water out of the creek and drop it down the banks. You can set up rain forests very fast if you can saturate that valley with ferns and mosses. Once your rain forest is established, it becomes self-perpetuating. It holds its own water. Again, you can let those little diversion systems decay. So try to get your major advantages out of slope; don't let a slope go without using it.

Engineers generally want to dam a valley, put in a monstrous pond. That is their solution. Yet we have been able to set up these high water gravity flow systems without any trouble at all. Electrical pumps are one of the first things to go in a fire. A characteristic of fire on site is that you have no water unless you have gravity flow.

We will leave the hills now and look at some house situations on very flat lands. We will move out into the plains--300 acres, two foot drop.

There is no way out here that we can get all the advantages we had on the hills. I will describe a site plan that we designed. You could see all over that country for miles. Here, water is always stored below ground in tanks.

When I arrived on the scene, the excavating had already been done. The Earth was piled in four great heaps around the edges of the hole. That's a normal situation. It wasn't very aesthetic, not very pleasing. I said, "Where will we put the house?"

For a while, it didn't look very hopeful.

We first determined the directions from which summer cooling winds would be coming in, winter cold winds, and summer hot winds. In any westerly belt, the cold winds come from off sun, while hot winds come from on sun, from middle interior.

Depending on which side the continent lies, they will come from the Northeast or the Northwest. In your case, here in New England, hot winds come from the Southwest. Cooling winds will come in at about 45 degrees from the coastal summer winds. For each site, that set of characteristics is very easily determined. Any old timer will tell you. For the site itself, you then look for any deflection of that system.

So we brought the man back in, and got him to reorganize his Earth. We located his house so that it would have all the advantages of pond reflection, be sheltered from the south westerlies and from the hot winds, which would have to pass across water and through vegetation, because we planted the banks. For the cooling winds, we have a good brisk circulation going by Earth banks around the whole system. We don't have any noise on that site. It is very private.

So what I want to say about flat lands is that, rather than paying so much attention to the water and water surface, let us have a look at the Earth we move, at what we can do with Earth bank.

The fastest way to run a windbreak is to grade up Earth bank and swale. Rise a four to six foot Earth bank and

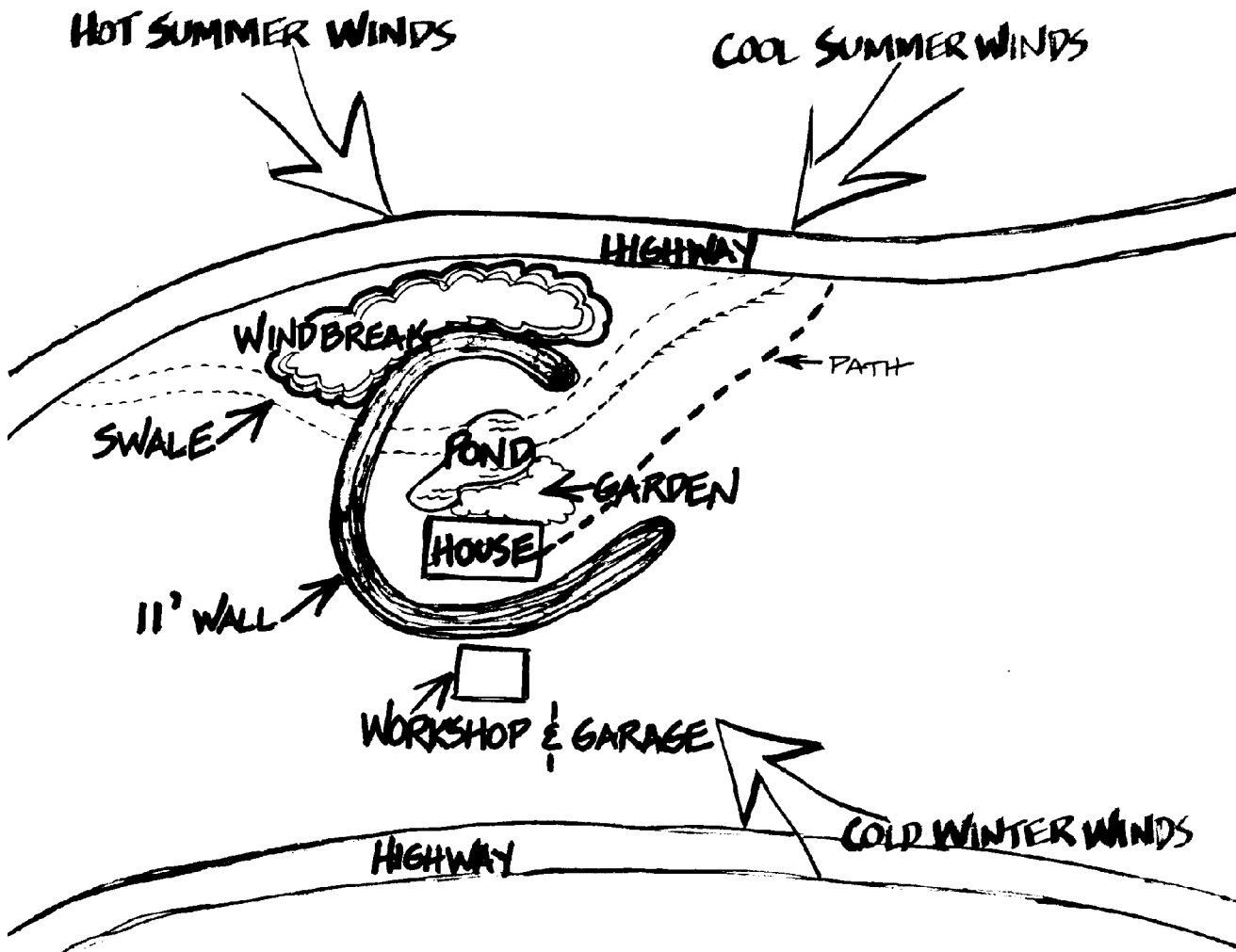

"We don't have any noise on that site. It is very private."

start your planting work. The swale works perfectly well. The fall here was very minute across the site.

We did a diversion off our roadway. The water came in and around the pond and went out again. Part of the annual garden is water garden. Access from the living area to workshops and vehicle areas comes in through the bank.

We planned for a single story house surrounded by Earth bank, and a tall barn with water tank. That is the solution to the water problem in flat lands. You have to make your slopes, throw up your roofs, and throw up your tanks, while you keep your house low. Or, you can put up a high dwelling, but these upper rooms must be bedrooms, and the lower rooms, your service rooms. In that case, the house roof also becomes of uses as a water collector. That is an elegant site now, a highly admired site.

Don't be frightened to use Earth

bank in flat landscapes. You can use water effectively for cooling. Flat areas are often hot. In general, you can use Earth banks in two ways. They give you a racing start in windbreaks; and they provide a very good livestock shelter with quick growing plantings on top. Those plants can be things like pampas grass and bamboos.

Earth banks are excellent radiation shields from fire, and they will decrease noise, particularly traffic noise.

There is one main rule to follow. From the crown of the road to the top of the Earth bank, we want to deflect in a straight line so that we clear the roof of the house. Vegetation does not do a lot for noise reduction unless you can get a hundred meters of it. It takes a lot of vegetation to absorb noise. Street noise is just like that. A well-insulated house with an Earth bank protection can be near a fairly noisy system and be quite quiet.

Achieving privacy and insulation against noise can really be a problem in some flat areas.

In flat land, you often find fairly eroded gullies with little steep banks. I will tell you of another real situation. It was a flat site, eroded gully. There is only one place to build here to get away from fairly noisy conditions. The client had made a dam across the gully with provision for draining it. What we did was use a backhoe to dig a cave under the house site. He built his house over the top of

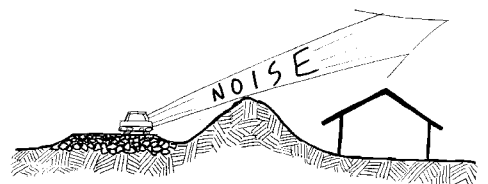

this cave. The cave extended beyond the house at both ends. It opened out to the pond at water level. We just trellised the top of it there.

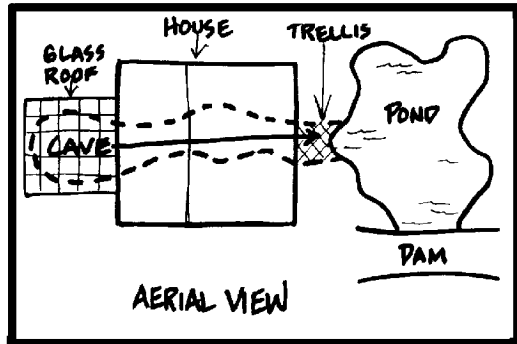
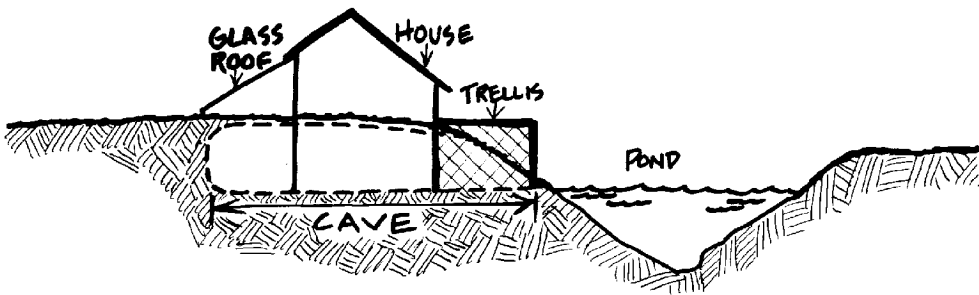

"He built his house over the top of this cave."

Then at the other end of our cave, we glassed the top of it, making it integral with the house structure. It was very cheap to do, and very quickly done, because it was an alluvial plain. So he now has an underground glass house in which we also made a shower.

He is proposing to grow bananas there. The cave end next to the pond is his cold cave. So he has good heat control. He can bring heat up through the ducts anywhere within the structure. The cool end of the cave is good for storage of root vegetables.

The whole thing opens out on the deck above, under the trellis, overlooking the water. His cave is dry as a chip inside. It is about a foot above the dam level. It is a beautiful place in the summer time, down, out of everybody's sight, by your own little lake, on your own deck, which you enter through your cave.

So in flatlands, you can do excavation on site in all sorts of ways.

We had another site, an excellent wild site, with a lot of excellent trees and other growth. But it was a very bad site for water. After a rain, you could see little twigs and leaves up against things. We designed a below-grade Earth tank, a lake. There was a lot of excavated dirt with which we made a peninsula into the water, about 9 feet above grade level.

We put his house, which was two story, up on this high peninsula. This is a high fire frequency site, with a fire about every fifth or eighth year. So we put the client on this peninsula. We got him up high enough so that from the second story he has a good view of the mountains. Surrounded on three sides by water, he has all the advantages of light reflection. As he is a good fisherman, we put fish in his pond.

We ran two very low Earth banks to deflect the down-flow of flooding rains away from the garden site. We directed all the water from off site into the dam site. When this water is flowing across landscape, it brings a lot of silt and mulch. These Earth banks we have thrown up accumulate leaf and silt that we transfer as mulch to the garden. That works very well. It is good mulching material and very cheap.

An enormous amount of water diverts through these Earth banks, flushing out the lake. Water diverts from the garden at the same time that silt and mulching materials deposit at the outside of the garden wall. The flotsam stops here and defends the dam from silting up.

The client has a couple of hundred acres. We restricted this whole thing to about two acres. He only wanted a small garden. He is a very good gar-

dener. He is also the director of parks and gardens in Melbourne, and a landscape architect. He hired me to fix this place up.

This man wanted a windmill, a rather odd thing with all this water coming down across the site. Still, he wanted a windmill. He got a windmill. He was sort of fanatic about windmills.

I pointed out to him, though, that we could at any time raise the Earth bank with a tank in it, and we could run water off his roof for him. He knows that. He just wanted a windmill. He liked it. He sits and looks out of his window at his windmill.

His sole purpose in choosing a two story house was that he wanted to see mountains, which were on the shade side. So he had to get up above the trees. It gets very hot there in summer. We gave him a shaded veranda on his second story where he can sit and look at the mountains in the summertime. This gets him up above the trees, rather than clearing trees to obtain a view. A two-story house is a very efficient structure for insulation.

Here are three totally different solutions to flatland situations. One solution defends from noise, and does something for privacy and cooling. The second one deals with a situation near a gully in a flatland. We gave the client an interesting house with low heat and a cool place to go in the summer. In this last situation, we gave our client a very sophisticated system of water control, plus a mulch collecting system. I can't tell you how to deal with flatlands in any general way. Just study the flora and see what your client wants, and what the problems are, whether privacy, noise, water, whatever. You can build up a whole set of solutions, and you have plenty with which to do it.

* For more precise definitions of the terms used in the Keyline Method, we recommend a careful reading of the latest edition of *Water for Every Farm...* by P. A. Yeomans, available from Yankee Permaculture.

PERMACULTURE IN ARID LANDSCAPES

BY BILL MOLLISON

Pamphlet III in the Permaculture Design Course Series

PUBLISHED BY

YANKEE PERMACULTURE

Publisher and Distributor of Permaculture Publications

P.O. Box 52, Sparr FL 32192-2052 USA

Email: YankeePerm@aol.com

<http://barkingfrogspc.tripod.com/frames.html>

or

<http://www.permaculture.net/~EPTA/Hemenway.htm>

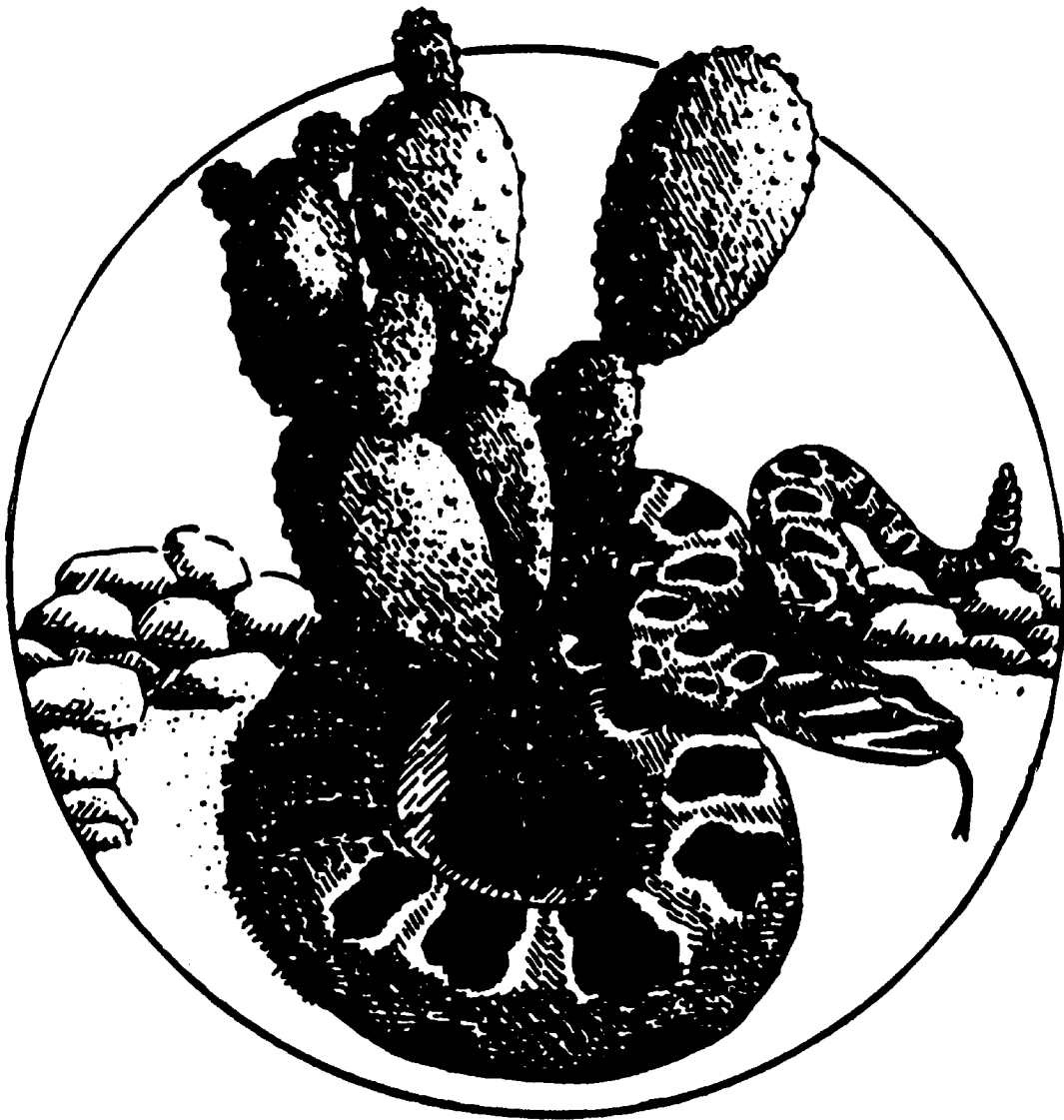

Edited from the Transcript of the Permaculture Design Course
The Rural Education Center, Wilton, NH USA 1981

Reproduction of this Pamphlet Is Free and Encouraged

PERMACULTURE IN ARID LANDSCAPES

This is the third in a series of 15 pamphlets based on the 1981 Permaculture Design Course given by Bill Mollison at The Rural Education Center, Wilton, New Hampshire, USA. Elizabeth Beyor, without compensation, undertook the transcription of tape recordings of the course and subsequent editing of the transcripts into 15 pamphlets. Later, Thelma Snell produced the typescript for all pamphlets. Dawn Shiner produced the drawings for this pamphlet, again without compensation. Lisa Barnes laid out and made mechanicals of the original editions. More recently, Meara Culligan entered all 15 pamphlets onto computer disk. I have since added some further light editing to increase the readability of the pamphlets. In deference to the monumental task of love represented by Bill's assembly of the Permaculture Design Course, and by the subsequent volunteer efforts leading to these pamphlets, Yankee Permaculture has placed them in the public domain. Their reproduction is free to all and highly encouraged. The pamphlets are now available on computer disk. Send a SASE or 2 international return mail coupons with an address label for details.

We have some pamphlets translated into Spanish, French and German. Volunteers are now needed to complete these translations and to translate these pamphlets into other languages. Yankee Permaculture continues to depend on volunteers for all of our publications. To help, contact us at the address on the cover.

For Mother Earth

Dan Hemenway, Dahlonega, Georgia, December, 1994.

Third edition

Permaculture Design Course Pamphlet Series

	Quantity	Price
Complete Set of 15 Pamphlets. Bill Mollison. \$35 (Price reduced 9/1/94)	SET _____	\$ _____
Complete Set on 3.5" Floppy Disk (MS Word for Mac, inquire about other formats) NEW!	SETFD _____	\$ _____
I An Introduction to Permaculture. (Price reduced 3/22/94.)	I _____	\$ _____
II Permaculture in Humid Landscapes.	II _____	\$ _____
III Permaculture in Arid Landscapes,	III _____	\$ _____
IV Permaculture on Low Islands. (See V for combined price.)	IV _____	
V Permaculture on High Islands. (IV, V, & VI offered as one pamphlet.)	V _____	\$ _____
VI Permaculture on Granitic Landscapes. (See V for combined price.)	VI _____	
VII Permaculture for Fire Control. (See XV for combined price.)	VII _____	
VIII Designing for Permaculture.	VIII _____	\$ _____
IX Permaculture Techniques.	IX _____	\$ _____
X Forests in Permaculture.	X _____	\$ _____
XI Water in Permaculture.	XI _____	\$ _____
XII Permaculture for Urban Areas & Urban-Rural Linkages.	XII _____	\$ _____
XIII The Permaculture Community.	XIII _____	\$ _____
XIV The Permaculture Alternative.	XIV _____	\$ _____
XV Permaculture for Millionaires.	XV _____	\$ _____

All funds must be in US dollars in a check drawn on a US bank or by International Postal Money order. Make checks payable to: "Yankee Permaculture." Make postal money orders payable to: "Dan or Cynthia Hemenway."

Our minimum order is US\$10. Add \$5 plus 10% postage & handling for shipments to the US and 20% for shipments to other countries.

Prices subject to change without notice.

Permaculture in Arid Landscapes- III

In the classic arid landscape, there are two erosion levels. There is a receding scarp, traveling geologically backwards. There is a down-drop of the scarp, a back slope, and then a slope to the back-slope. Scarp is a very sharp place. Out in the desert we see buttes, residual bits of scarp left behind as the scarp retreats. Sometimes they connect to pediment. Sometimes they stand alone out in the plain. They may rise to a height of 40 to 400 feet. The Grand Canyon, a mile in depth, presents a big profile. These scarps and remains of scarps occur in sequences across the desert. It is the only profile you have in large areas of the desert.

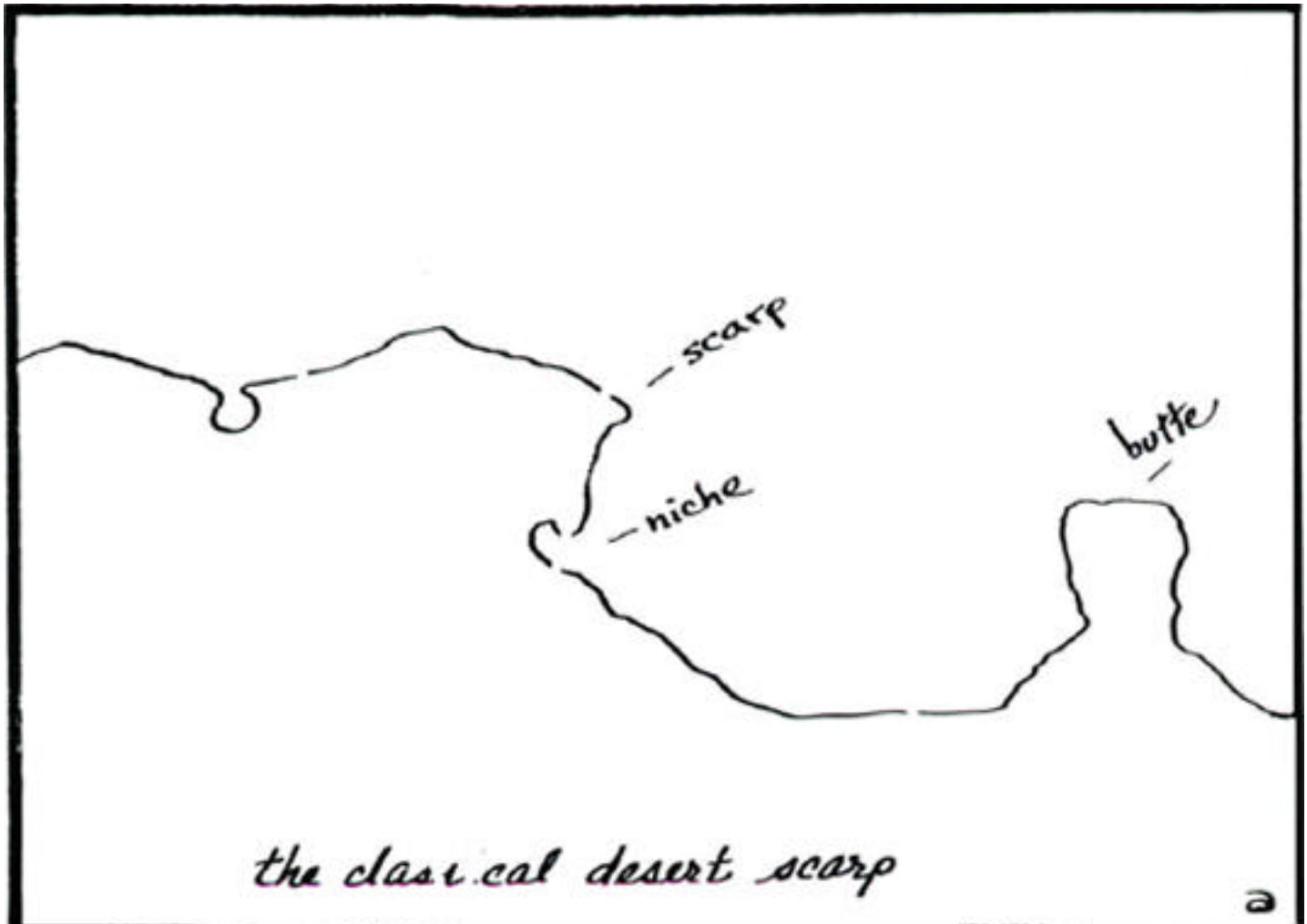

There is only one place to live in the desert where the sun is beaming down on this whole situation. At the bottom of the scarp there is always a notch, just before the pediment descends, caused by the splash of water falling from the top of the scarp. When water hits the pediment, it splashes and cuts that notch in there at the base of the scarp. Scarps in deserts usually consist of fairly soft rock. No matter what the original rock was, they get down to aluminum oxides, ferric oxides, and as they erode, an iron crust forms a hard red laterite cap. This capping is usually only about six inches thick. It covers the top of the scarp across the desert uplands and buttes. The rest of the scarp is of fairly soft material. Most desert rocks carve easily. In Anatolia, Turkey, southern Iran and Egypt, people have carved their way into the desert rock. This is fairly soft rock that will harden on exposure to air. It is possible with quite primitive tools to hew out a reasonable lot of dwellings in these scarps. The American Indians of the southwest desert areas have long made their homes in these scarps, and in those little niches at the foot of the scarp. Their dwellings may nestle right

in under the summer overhang, but the winter sun can get in. Regardless, once you are 16 feet into the rock, your temperature variation is practically nil. So that is where you live.

The dwelling in the desert properly sits under the cliff. In hot deserts, it will always be on the shade side. In cold deserts, situate dwellings where the summer sun will miss the dwellings and winter sun will enter.

It is very dry in under there, even in rain. The only rain that comes over, comes off that runoff at the front of the cliff. You can cut gutters along the top of the cliff to redirect the rain, to stop the rain running off the front of the cliffs.

When it rains in the desert, it usually rains cats and dogs. It rains fishes and toads, too, and the water holes fill up with frogs and fish. Where rain water pours off those escarpments, there may be waterfalls, and the water pours down into a sort of swale that runs behind the scarp and then pours over the wadis, picking up an enormous load of sand, especially in the floors of these wadis. The water then surges out onto the desert floor. Obviously, it very quickly disperses. Yet when com-

Permaculture Design Course Pamphlet III - Permaculture in Arid Landscapes

ing down the constricted wadis, it is often three to six feet high.

This water soaks into the wadi soil. For a little while the surrounding vegetation reflects that. These places often support a quite reasonable vegetation, with trees growing in there, desert pines and hardy acacias. These will be quite green and quite large trees.



"The most satisfactory place to locate a village is...up on the cliffs within the box canyon."

The most satisfactory place to locate a village is in these box canyons, up in cliffs within the box canyons. The advantage of this location is that a single fence across the entrance to the canyon often will keep out all large feral animals.

In the Australian desert there are camels that came in with a group of people we called Afghans. They actually weren't Afghans; they came from the Pakistani side of the Khyber pass. These people brought camels in to carry packs inland to the miners. Eventually they put a train in, which they named the Afghan. It runs up to Alice Springs. This train put all the Afghans out of business, so they settled down and married aboriginal women. You now find these Arabian aborigines all over the desert. They have all gone wild, too. Likewise, the camels went wild. There are thousands of those camels, and the bad ones are big bulls. They are dangerous animals. There are many dangerous animals in the desert, but the bull camels – and there are thousands of them out there – are very short tempered things.

So you put a fence across the entrance to the wadi. The people live inside, within the safety zone. All around the wadi rise these very abrupt cliffs. Canyons are usually rather narrow. Those box canyons may be 300 to 400 yards wide. The pediments come up off the floor and slope up to meet the cliffs. One box canyon will often have little box canyons going off it. At the bottom is a little trickle of water and the pediments meeting almost like a "V". The original drainage would have been coming to the front, where it found weakness lines, cutting back from the front and drawing the drainage into these weak-

ness lines. They are often like that, almost like right angle fractures to each other. The process starts to cut the pediment up and eventually cuts off these residuals. They get detached and start to get lower and lower until they crumble to pieces. Most of the rock loosens up during the freezing and heating that goes on in the desert. Then it rains, and a whole lot of the loose stuff just rushes off out and distributes on the plain. The water in the desert shifts immense tonnages, because it falls as sudden and very heavy showers.

One time 12 hippies persuaded me under duress to go with them out to an area in West Australia. We went out there in a gigantic old van. We were 700 miles away from the last outpost, which wasn't much anyhow. It was a windmill. They reckoned they were going to settle out there. They were getting 700 square miles for \$30,000, and they thought it was a good bargain. So here we were, running around in those trackless wastes in this old van. We settled in and probed around trying to find water.

The doves and the seed eating birds of the desert must drink and, if you follow them, you may find water. They were flying out of this particular wadi one day and we went back. Instead of finding water down in the wadi, where we spent a day or two looking, we found it when we got up in the scarp, at the place just before where these streams during the rain will fall over the edge. They swirl. That makes these water holes up on the scarp. That is the rule for this sort of desert. It is characteristic of the American desert as well. The water is up here just before the drop off. Sometimes you find holes full of sand up there that you can dig out, and there will be water in them. Sand will store water about 50% of its bulk. In sand, it is possible to store water without it evaporating. You can make a tank and fill it up with sand, and the water in between the sand grains is quite good. It can't evaporate, and other things can't get to it to drink it, so it is a good safe way to store water.

We found free water on that escarpment. We spent most of the day sitting in this water. After 11 o'clock in the morning, the desert is a very hostile environment for man.

Nevertheless, desert vegetation grows very quickly if it is possible to get water to the plants. The soils are unexploited; they are all fresh mineral, every sort of mineral, tons of it. When you get water, the growth response is very fast. Out there, you would get fruiting grapes from a cutting within 15 months, and large amounts too. The sorts of things to grow out there are citrus and grapes. Apricots are typical desert plants; so are pistachios and almonds. Most of the normal vegetable crops can grow in the desert, particularly the melon crops. All deserts have natural melons. The Australian desert has one called the paddy melon. Within two miles of settlements, where people have been growing watermelons and cantaloupes, you find things that are half paddy melon and half cantaloupe. They get to be all sorts of sizes and shapes, but whatever they look like, they taste like paddy melons – bitter!

So, given water, the growth potential is great. When the water comes into the wadis, it soaks away very quickly after its initial rush. For a while, the soils are very saturated, and that water lasts a long time. There may be damp soils there for a couple of years after a rain. That is the place to grow dates. In such soaked desert sands, vegetation reaches its maximum.

In the American southwest, piñon pines provide a staple food for the Indians. In a good year, a family of Indians can gather 60 bushels of pine nuts a day.

There are only certain situations in which the water is sufficient, the catchment large enough to be sufficiently reliable to support a small group of people and a modest agriculture. The limiting factor in the desert is not food. By no means is it food; it is water. You can't increase water where people don't believe in making drastic changes to the environment.

However, it is very simple to cut drain systems here on these high mesas and get the water at head, above the wadi

Permaculture Design Course Pamphlet III - Permaculture in Arid Landscapes

floor. Or water very easily siphons over the edge of the wadi. Or one can just drill down to the water and turn a tap on. Even with a limited amount of escarpment above the house height, clean water can be collected for showers.

I think the only way you could collect enough water to maintain an extensive agriculture would be by a set of silt traps, and a fairly formal dam that would make possible a small permanent lagoon. I have seen a couple of places that have developed permanent lagoons, naturally, in very large wadis. They have been quite permanent, because the trees look as though they have been there for a long time. So it is necessary to take advantage of all the natural features of the desert.

You get your client up off the wadi floor, but down off the escarpment. The escarpment is just not agriculture country; it is hard iron rock. Any gardening that can take place must take place here at a lower level, and it has to be walled against flood. The small gardens must be walled. The trees are all right. Trees don't mind flood. A limited tree agriculture, with a great number of species, is possible here.

All desert peoples dry their food. On the opposite scarp, catching the hot sun, drying rooms can be cut, and things desiccate very quickly. Dates, dried apricots, and other long storage items like desert nuts are mainstays of desert people.

There are some very simple ecologies in deserts. In the North African desert the whole ecology is basically the date, the melon, the goat, and coffee, with the goat eating the melon, the date and the desert scrub. That is a total life system. It is a sort of six species ecology, and it will run for thousands of years. Everything you need is there. You have to ferment a few things, make a goat cheese.

Also plentiful in the desert is a whole group of seed eating birds, mainly pigeons and doves, but also an interesting set of quail. The desert will go to rest for years as seed and capsules. There is a huge production of seed.

There is one other storage form in deserts, and that is enormous tubers. The desert produces huge tubers, often from legumes. There is an enormous storage organ on a legume called yala – I don't know if it even has a botanical name – and it weighs 300 to 400 pounds. It lives in the dunes. Maybe for seven years nothing happens. Then it rains, and the yala pushes up and spreads out perhaps 200 yards of desert, a great green plant. It is a green legume with a pea flower. It has abundant seed. It dies back, pulls in and disappears about six feet under the sand. The aborigines find them by psychic divination. I think it has to be psychic divination. Anyhow, if I can get them to look for a yala for me, they will look around a dune and sing and edge about, edge about, edge about. Then they will dig a hole and hit it. Whether it is memory as to where the vine was, or whether there is some trace of it in the surface patterns of the dune, I can't find out, because I can't talk to them except in broken English. They eat these tubers, but they don't eat them very often. There are not many of them, and they tend to leave them for hard times. In the meantime, they eat many other things, including insects. There is a lot of food in the desert. You never run short of food. The essential scarce ingredient is water.

If we bore in the desert, we find good water when we bore close to the pediment. There is still activity through it, though perhaps very slow, and not much salinity. The further out in the plain we bore, salinity increases. Typically, you may go from about 200 or 300 parts per million of salt, which is quite low and non-detectable, to 1,100 parts per million, even only a mile off the scarp. You can't use that water. So with modern gear, we can put in windmills somewhere close to the scarp, so that the threat of absolute lack of water is fairly easily removed from those local areas. However, you would not bother much with windmills unless the natural water systems were exhausted. It is not a thing we could use continuously. We should not use it for making lawns or flushing toilets.

You must do a lot of water conservation. You can make brushwood fences, slightly reinforced, and plant low diversion banks across the wadi and out on to the desert so that you get absorption pans set up.

In Permaculture II we have shown a different form of desert, with siphons going from one of these absorption pans to another. In rain, when one area fills, it will siphon to the next, and in this way, when we have fully charged the soils within one impoundment, any surplus water will siphon to the next, and charge it until that place is finished. In light rains, we might only get three of those impoundments fully soaked. When I went out there on a particular trip, we had 27 inches of rain, of which we got four inches in one day. That desert has a 10 inch average rainfall. So there is no meaning to desert rainfall. It hadn't rained for three years before that, and then 27 inches. That is how you get an average of 10 inches.

You can take those systems out as far as you like, so that some of them are infrequently irrigated. You would then put your hardiest plants at the furthest distance, and your softest, most water-demanding plants toward the water source. The great secret of growing plants in the desert is some form of drip irrigation, which can be very primitive, or very sophisticated. The primitive form is something like an ostrich egg with a single hole bored in it very near the plant. Water leaks from the bottom in little drips. It can also be as primitive as an old one-gallon wine flagon, of which many litter the desert around the camps. This is filled and inverted. The water drips through a small hole in the cap. It can be as sophisticated as a modern Israeli drip irrigation line.

If you listen carefully to St. Barbe Baker, you will hear him say that even three or four stones around a tree in the desert make a difference between survival and non-survival. Nobody quite knows why stone-mulch works. There are two schools of thought. I agree with both. If you put a pile of stones in the desert, it is often moist below them. The aborigines use stones in pits to collect moisture. They have little clay basins under them. Aborigines don't often reveal their desert sources, particularly of emergency water. You have to know exactly where they are, and push a straw down them and suck the water. Never is this water stored as visible water. Down in these pits below the rocks, it is usually moist. Two reasons have been given. One is that the rocks gain heat rapidly by day, becoming relatively hotter than the soil. They draw up water from the surrounding soil, creating a more rapid evaporation of the soil at that place. By night, they chill more rapidly than the surrounding sand. They are measurably cooler. Sometimes in the desert nights there is a positive humidity, and any moisture at all condenses within these rocks and drips into the sand. So probably both factors are operating. It is possible to plant a fig or some other tree and rock mulch it, and the tree seems to do very well. The desert figs, in their natural habitat, are always in these loose rock or boulder piles. Citrus also does very well in rock piles. So stone mulch is a valuable strategy.

Mulch of any sort is very plentiful in the desert. The aborigines thatch the water holes with quite a thick spinifex cover, just free of the water surface, just above it. They also thatch their desert day shelters thickly with spinifex. There is an enormous amount of mulch in all deserts except the dune deserts, which are rare anyway. Most deserts have a lot of vegetation. Mostly, it breaks up and blows around. You can trap it easily on fences. Many desert plants distribute themselves by releasing whole seed heads that ball across the desert. These settle against fences. You can easily accumulate very large quantities of mulch this way. All desert plants, notably the casuarinas and many of the pines, also deposit very large quantities of mulch. There is no getting out of mulching in the deserts. If you don't mulch, the pH of the soil on which you drip or put minute quantities of water rapidly rises and becomes toxic to plants. If you are dripping into mulch, there is a buffering from humic acids

Permaculture Design Course Pamphlet III - Permaculture in Arid Landscapes

that indefinitely prevents that fast pH rise.

You have to have a relatively large area of desert – maybe three acres – to furnish a sufficient quantity of mulch for a tenth of an acre, or a quarter of an acre. One of the tactics employed in deserts is to plant high mulch production species as barrier plants in windbreaks on banks. It is necessary to plant these banks to hold them all. One of the best plants for that is the tamarisk. This produces a very large amount of mulch. Other mulch producing plants are casuarinas and, of course, the desert pines. You can set tamarisk in the desert as live sticks, after three days soaking in water. Just push the sticks in and away they grow. Many of the casuarinas propagate in this way. They have very deep rooting systems. A whole group of useful plants is the mesquites. Roots may penetrate to over a hundred feet, which, near wadis, is really below the permanent water table. So many of the really deep rooted desert plants have no lack of water, and could probably transpire quite freely. The mesquites give a very heavy pod production.

A neglected group of plants that the western world hasn't looked at is the cacti. Some of the cacti have long been in cultivation, and produce very high quality agricultural products. Some of them have probably been continuously selected for at least four or five thousand years. This is true of the fruiting cacti. There is another group of cacti that produce abundant small fruits, very like strawberries. There is a cactus that produces little edible buttons. There are the prickly pears, which belong to the opuntia group. They came by way of the Spanish into Southern Europe, and are now common elements in Italian and Greek gardens, often used as hedgerows. They are variable in quality, but if you poke around in traditional Italian settlements, as we have in Adelaide, Australia, and Melbourne suburbs, you will find a whole range of seed-growing opuntia that produces a large fig-like fruit in the hundreds. The plates of the opuntia are perfectly good vegetables, rapidly propagated. They also make quite good barrier plants. This is one of the barrier plants you recommend for deserts. Both the opuntia and the mesquite will stop large, hooved animals.

We have actually used the desert burrs, which are manifold. Every time you come out of the desert, you have to throw your thongs away. They are interpenetrated by sharp spines that eventually work through. You can use those burrs to carpet around isolated plantings, to prevent things like jackrabbits from approaching trees. You can plant desert defenses in what I call guerrilla planting strategies, a rock crevice defended by burrs and other spiny plants.

We have a series of adapted plants and animals and people who get along well in these conditions. All the desert peoples have developed quite specific vegetables. There is no lack of plant life and animal life for a restricted settlement. But there is an absolute lack of water, and you must look forward to three year storages.

Like other environments, it is very easy to rapidly increase the animal resources in the desert. For every one of these caves that we artificially construct, we will get an occupant. Homing pigeons and even domesticated pigeons are originally desert rock pigeons. You will see them at home in dry India and in dry Iran, living in those little holes in the rocks. You will see them on sea coasts and wherever there are any eroded rock holes. All you have to do is chisel more rock holes to get more pigeons, because there is just any amount of seeds in the desert, and there is enough water for animals with such light demand. So pigeons are number one desert domestic livestock.

Some of you may have seen pictures of the pigeon habitats built in Egypt. They are grandiose things, like little castles, all penetrated with thousands of holes, and enormous quantities of pigeons live in these pigeon castles. Pigeon manure is the best desert fertilizer. It is the highest market value manure we know. The Egyptians make the nesting hole big enough to lay

two eggs, but to hold one young, so as they grow, one is pushed out and falls. Anyone can go and pick up all the fallen one. The other one grows. So the nests also are self-cleaning systems. All the wastes and the spare pigeons drop outside. There are also the eggs that may be harvested. One great advantage of growing pigeons in the desert is that, because of their nesting habits, they are almost predator-free, except for some hawks, and hawks are not very plentiful. So pigeons are a good and useful resource.

Another food source of the desert is the reptiles. They are to the desert what fish are to the coastal dwellers. Many names in the desert reflect this. We have things called sand mullets; but they are reptiles. Reptiles are large and plentiful because the second thing that is enormously common and widespread in deserts is insects, some of them nocturnal, but many are diurnal. So you have a lot of insectivorous animals. Again, the number of reptiles per unit area is determined by the scant shade provided by chance perched rocks or crevices. It is not determined by available food. So just by providing rock shelter, you can step up the number of reptiles. In some deserts the shade is so restricted, and crevices are so restricted, that thousands of reptiles may gather to over-winter in single rock piles. For instance, the rock piles are notorious places for rattlers to hibernate, maybe hundreds of them, into single crevice situations.

In Australia, we have very large lizards. They will sit and look at you for a long time, and if you make a move, they take off and hit 40 miles an hour on their hind legs. The road runner has nothing on them. They just blur. You can't believe it. All you see is just a little trail of sand sinking back into the desert.

The problems of the desert are obvious. One of those problems is the transportation of cargo. Camels are obvious pack animals, but nobody with any knowledge of camels wants anything much to do with them. They dribble on you, and nibble at you, run away, kick you, kneel on you, grab you by your appurtenances and shake you about. Bull camels are very savage animals, seldom very tame; and although the females are quite good, the bulls can get interested in them, and just when you are off on the female camel, the bull charges in and you get mixed up in the whole business. No place to be, I can tell you.

So one way out of that, I think, is to sail the deserts. I proposed to my hippie friends that we build an enormous trampoline with wheels, very large wheels, and hoist ourselves and roll softly across the desert under sail. Most deserts have steady winds, low, but steady. We worked out the actual proposal, but never found the \$30,000, or we might have been off and gone. Bad luck. Not a good design. We worked out a route that we could sail cross-wind, and I was looking forward to rolling down the desert under a great desert moon with a gang of hippies and aborigines and drinking cactus juice. But it never happened. It might happen yet. We could reactivate the idea when we grow rich.

I don't know of a desert that doesn't have a termite problem. The termite is to the desert what the worm is to the humid lands. The termite is your primary decomposer. Termites can be a major problem in the deserts. There are very few major problems. Lack of water and termites would be your two foremost problems. Termites must exist in covert ways. Chickens may be a useful factor in allowing us to grow some things because they scratch around, uncover and eagerly seek out termites. The termites are usually in little mud tunnels that the chickens very easily kick to pieces. We also think that this flooding system, no matter how infrequent, will do a lot to destroy termites in the cultivated area. We have observed that they are not very plentiful where we have had a couple of inundations. We think this may have collapsed their little mud tunnels and drowned a few of them. However, they do reinfest, because they are flying adults. There are certain trees we can't grow because they destroy them. This is rather sad, in that

Permaculture Design Course Pamphlet III - Permaculture in Arid Landscapes

some of the suitable trees such as carob are choice termite food. They love carob. They attack the living tree. So termite resistance in the desert is a primary factor to work for.

If you look at dry gardens, the marigold is a prime feature of those gardens. In even semi-arid situations, throughout Southwest Asia and in the Indian Deccan, you will see marigolds in the native gardens where they serve as a protection against eelworms (nematodes).

These things of very ancient usage sometimes become customs, incorporated into the religions of people. The cow in India is treated as a holy animal, for only the cow can convert the monsoon grasses into cooking fuels. The people of India simply cannot afford to eat the cow. Nearly 90% of the domestic fuel in rural India is dried cow manure. Throughout the whole nation, perhaps as much as 70% of the total cooking fuel is cow dung. So the cow has to be kept alive until it drops. In India, you have to be kind to the cow.

We might depend on the termites for a general turnover in the system from which we are drawing mulch and seed, but we must keep them out of our garden, and out of our orange trees. So we could run chickens around the marigolds. All these strategies are very simple. We mulch, and we rock mulch, and we are very conservative about water, and we don't stretch our system beyond the capacity of our water supply to carry through a three year drought.

Around our little tight life-capsule, our wadi, we also have a more widely distributed, easily available set of food, like the sand pines and the dates. Sometimes dates will grow for two or three miles out.

In very dry areas, we must give a lot of attention to the high shade. We can construct high trellises with termite proof wood like black locust or honey locust. We can trellis all our grapes, melons, and vine crops, using a lot of mulch at the base. Under the trellis we can grow our normal vegetables, because they won't stand the summer heat, and they get plenty of light through the trellis.

In the ground, we can put a moisture barrier, vertical plastic sheets dug into trenches that are refilled. It would be best if these penetrate at least three feet or even more. It could also be a clay tamped barrier, if you could have no plastic. Then the drip irrigation that we use has no lateral transfer out of that small system. That is critical. Put this barrier right around the garden. Then the water we put on here stays within the garden and travels up and down.

The barrier around, mulch within, and a trellis over it – that is the desert garden.

The aborigines make little shelters that are heavily thatched, shade shelters that they can sit beneath. When they renew their thatch, the old thatch serves as mulch – a sort of thatch to mulch, thatch to mulch situation. They also sweep the desert, using brooms, and run up little lines of these sweepings in the form of mounds. Around all aboriginal camps there is a little mounded mulch line. Discarded seeds lie under that mulch. So when it rains, food comes up in the mulch lines. They also sweep under their favorite trees, bringing mulch to the drip lines. They thatch and mulch over water; and they mulch over damp sand to retain moisture within it.

There are only two sorts of deserts in which people live. Only in rains do people cross the great expanses of flat deserts to oases. The oases are mainly wind deflected hollows. People don't live out there much. They live in these niches in the desert, as does almost everything else. These niches may go for seven or eight hundred miles across the desert. There is no lack of them.

The second form of desert is the desert with residuals. Great rocks stick out of the desert, great domes, very hard, and in this case not all soft, usually granite, almost non-erodible. Also, slabs come out and plunge under. There are many of these deserts throughout the world.

The desert with perhaps an average 10 inch irregular rainfall, if you have 400 acres of granite slab, the 40 acres directly surrounding it gets the equivalent of one hundred inches of rain, because none of that rain can soak onto the granite; it just runs straight off, and for hours after a rain it will just go on pouring off these slabs. Often there are depressions in these slabs in which to create little rock dams which can be very clean water dams.

At the edges of the mountain sections of these deserts, the hard rock mountains, there are innumerable opportunities to erect small dams. Desert dams are built of rock and cement. We don't build with earth wall in the desert. You can also blast out rock holes. These little rock wall dams get you right out of trouble. It is not difficult to store 100,000 gallons in these rock dams. You can build little rock diversion drains out of just a few inches of molded concrete, or little low stonewalls, and bring two or three of those cross channels into one.

You want a run-off area twenty times the area cultivated. So if you want to live on an acre, you will need a 20-acre run-off. It is possible also to create that run-off by sealing surface, to bituminize, or concrete a surface area, for run-off.

The desert is a pleasant but tight environment. The basic requirements are really very simple; the results very rewarding; the growth and production of plants are excellent.

As a designer, you are involved in strategy planning. You are going to sit at home for maybe eight weeks and work out a single truckload of provisions for three hippies, to last them about 18 months. These hippies will be moving out into the desert with a radio. They are a small pioneer group of hippies. They will be eating their dates and getting their plants in, and long before 15 months, they will have a solid vegetable garden base. Then they will be ready for more permanent people to move in to manage the heavier work systems. You, as a designer, impart the strategy and management, which is as important as the end result.

Increasingly, these days you will find yourself designing for a client group. Most people don't want that very solitary existence out on the land, just two of you sitting there, maybe scrapping and tearing each other to pieces. Many people enjoy a social relationship to others. So when a person gets a 200 acre section of land, he is looking for ways to share that land. That is what we often get involved in, designing where others would go, what functions they would take up, and how they would relate as a group. There are many non-sensical strategies like, "Let's all come together and live in this house and share everything." ...a recipe for disaster for most of us.

Observation is essential to good designing. Look around in the desert for trees that have a lot of drop. Then move this kind of tree in as your windbreak and mulch provider. Look at how water itself is stored in nature. If you find a two mile lagoon, ask what made that lagoon. If you look hard, you might find that it was a single rock intruding into a sandy river bed. The river has to whistle around it and carry a heavier load. It is possible to copy that very simple strategy for scour-hole production, just by building those dikes to make water self-deflect. It is also possible to make winds deflate a hollow.

When you have a full water table, that is permanent water. On the edges of arid lands, some of these simple strategies encourage natural forces to do the digging. The Papago Indians, instead of using walls across the wadis, have used guard walls and brushwood to hold the flood waters on the flood plain until it soaks in, instead of just coming across the plain and then running away. The Egyptians also did this, allowing flood waters to lay silt across their fields. It was a disaster for Egypt that the Aswan high dam was built. It is a temporary event. It will fill up and turn into marsh and the water will come over the top again. But while it is there, it is a nuisance. Dams in deserts that are not at headwaters will fill up. The normal valley dams simply fill with silt because there is no vegetation to hold the

Permaculture Design Course Pamphlet III - Permaculture in Arid Landscapes

country. The very definition of arid lands is that there is bare soil between plants. So you can use deflection walls, light dams to make scour holes. Observe what happens in nature and then imitate it, adapt strategies that have already evolved accidentally.

With your windmill, you return water to the system. Desert winds are seldom storms; they are always soft winds because of the immense buffering of the continent, and always fairly constant winds. A 20 to 25 foot-diameter windmill will return 25,000 gallons of water a day. That supplies a settlement of about five hundred people.

On escarpments and on any residual hills you have a very abrupt frost cut-off line, and it does not fluctuate more than six feet. It will frost up to that line, and above it, it won't. So put a little tank up there and do drip irrigation around the area below. Within a vertical distance of 20 feet you can go from water lilies to walnuts. Shade can adjust the intensity of the frosts. You can run all sorts of little mini-systems from hard frosting, which some plants require, to no-frost tropical environments, right on the same hillside. On some of the hills around central Australia where we deliberately did this, we had our perennial tomatoes up above the frost line, and the normal annuals, the peppers and melons down below.

The broadscale strategies of desert planting interest us, because one of our big jobs in the world is to start to replant the deserts. The largest area of global degradation that occurs each year is the increase in deserts. Therefore, it would seem to me that the biggest job we have as a group of environmental designers, is to start to decrease that effect. Even small belts of trees have an amazing down-wind effect in the desert, and you don't have to be grandiose. Five hundred yards or a thousand yards of tree belt, if we can get it established, will moisturize the air down-wind for quite a distance. I think this is partly due to down-wind transpiring, and partly because we are getting a better return to atmosphere of some of the ground water. Certainly the effects become manifest soon after you start a system going.

Obviously, we should start from up-wind. We look at the constancy of the wind, and we start from the up-wind sector, carrying moisture before us into the desert. That is what is happening in Morocco and other areas. That is the strategy.

Another strategy is to seize these headwaters and stop much of the water from running off and disappearing into evaporation pans, alkali flats. Alkali is the Arabic term for sodium, potassium, potash. We start at the top of the headwaters with our system, up in the hills. You might follow the desert streams back and find yourself in an exotic, semi-humid environment. That is where you start, and you start reforestation down from there. That rapidly chases the water out into the desert, clean water, flowing water. It can happen quite rapidly. Reforest the watershed and follow the water that is generated out into the desert.

A third and obvious ploy is to use your oasis and these scattered and multitudinous settlements along escarpments as nucleated areas from which we start zoning out. Here, the main problem is the control of feral and hooved animals. Settle a few hippies around the water holes. Keep hooved animals away from the general plantings. The excessive number of goats, camels, donkeys, pigs, and cattle contributes to the spread of deserts. Twenty thousand horses is an enormous load for the landscape to carry.

Just the factor of having built a camp will often create an almost closed forest around the camp. We see these settlements with camp dogs that chase away wild animals, and around them there is a green patch.

So there are your three attack systems that you can use as broad strategies.

There is one other strategy. Papanek made a thing that was an imitation of a desert plant in plastic. He invented a plastic

spiral with an encapsulated seed, along with some nutrient. This is designed to be dropped from airplanes. It imitates the desert seed as it hits the sand. As the wind blows, it bores in. Papanek has made thousands of these, which he proposes to fly over the desert with planes and bore all these seeds into the sand so the animals don't get them. Then when it rains, they germinate. Most desert seeds have a little thing like a bit of blotting paper on them that shrivels down. When you put water on it, it fills up. This is a little seed reservoir for water; and it is enough for the radical of the seed to start on down. While that is a great idea, its success would depend on there being a way to control browsers that would come in to destroy that new growth.

So you use a dog-hippie approach, a broadscale approach, an up-wind approach, and a headwater approach. All of these are quite valid approaches. All can generate water and vegetation locally, which also seems to generate water downhill. There is plenty of room out there in the desert, for all of us.

As the desert encroaches, the farmer starts to fail. You can see this right before your eyes, right across the whole area from Yugoslavia right through to Thailand and southward through Africa. The agriculturist is fighting a battle he can't win. As the water starts to dry up, and the animals encroach on the gardens, the poorer people who cannot fence start to lose ground to the animals. It is then that the herdsmen increase. As the herdsmen increase, so does the number of animals. When the herding economy becomes the main economy, that is just before the flash-out. After that, there is nothing but long migration and extinction and thin animals, and dying herdsmen staring towards the sunset. This is happening in front of your eyes in Africa. Herds are not appropriate in semi-arid regions. Hooved animals in particular are totally inappropriate.

Let us look at another feature of the desert, dunes and dune country. Dunes have water tables in them. Dune bases and dune heights are good places to start vegetation. The problem is that dunes move. By patterning your vegetation, you can increase or decrease your sand movement. The Chinese approach is typically Chinese. They bring rice mats into the desert. Back in the rice fields there are thousands of people weaving mats. They roll them up in enormous rolls and load them onto the railway carriages, and the carriages move them into the desert. There they cover the desert with rice mats. Through these mats they plant large trees, tamarisks and some of the Australian acacias. They have these trees growing in baskets full of humus - big four man baskets. They cut holes in the mats and drop these enormous baskets in - instant forest in the desert. These are desert trees and all they want is this racing start. Then they begin to generate water. It looks good. They probably have all these trees on standby, and then when there is a heavy rain, then they take them out, stick them in, and the trees follow the water table down.

Fences and basketry barriers are essential to stop the drifting of sand, particularly at the oasis. They need not be big fences. The essential thing is that the enclosures be small. Keep the enclosures down to about 100 feet square. You can't have very large enclosed areas or the sand will start moving. Keep the kids home from school and get them sticking little stick fences on 50 foot squares, then you rapidly can stabilize sand across hundreds of yards around a settlement, and start to work into forest, which will be totally stable. These little stick fences should be about 60% penetrable. They can be made out of thorn branches just stuck in little squares. They will stop sand advance. You shouldn't make very tight fences. They should have 40% or more gap.

Deserts may be peculiarly suited to aquaculture. A settlement in a desert is basically an island. The Australian continent is basically an atoll. People live on its perimeter. Its central lagoon is desert, and the oases within the lagoon are islands. So

Permaculture Design Course Pamphlet III - Permaculture in Arid Landscapes

it is possible to do rather bold things in the desert, to experiment with plants and animal species in an aquaculture in ways that you probably wouldn't dare to try within general river systems. In these isolated desert situations there is no way they are going to get out of there. If you have a five mile lagoon within a landscape of desert, it is probably one of the richest potential aquaculture areas, given a sufficient volume of water.

There is a thorny mesquite that the Western Australians have proclaimed a noxious plant. The reason for this is that it is successful in the desert. It has started to carpet parts of Western Australia. Now we wouldn't look on it as noxious. It has been declared noxious because out there the cattle holdings are so large that nobody ever has really domesticated stock. There are no fences. You might say to a grazer, "How many cattle have you got?"

"Well, I dunno. Had a couple of fairly good years, could be 27,000 in there."

They try to round them up with helicopters. But the cattle have got used to the helicopters, and they stand under trees. So they try to get them with hard-biting dogs. The cattle have gotten used to the dogs and horses. They are hard to move. When they get into this thorny mesquite, there is no way you are going to muster them at all. You can't get horses in there, and the dogs won't bring them out, and the helicopters won't bring them out. So the reason that this desert growth is noxious is that you can't get the cattle out of it. All this is ridiculous. It has a good foliage drop and a stabilizing influence on the desert. As long as your attention is on cattle, it is noxious. But it is really good for the landscape, while cattle are not good for the landscape. Anyhow, the graziers are dying out, because they can't afford the petrol to keep helicopters running.

We can introduce things into the desert that are rampant. Initially, what we want in the desert is a state of rampancy, and what we should go for is rampancy of plant materials in the desert - rampant, fast-breeding things. We had a prickly pear invasion in North Queensland in the dry-summer area, and the whole understory turned to prickly pear. The cattle were shut out by the prickly pear, so a second good forest started up in the prickly pears. But they got rid of the prickly pear so that the cattle could get back in. People just don't think out the very long range effects of rampancy. The long term effects of plant rampancy have been beneficial.

Well, we could experiment with many aquacultures in there. The desert is poor in aquatic species. All desert aquatic species are highly adapted. The frogs and the fish aestivate. They fill themselves up with water, dive into the mud, make a little mud bowl and live in it. You can dig them up and carry them around. There are many of these little bowls. The aborigines stick a sharp-pointed straw in and suck the water from them. You can cut a little red brick out of an old water pan, take it home with you in a plastic bag and put it in an aquarium and everything breaks out. Great lakes fill up, temporarily. It may be a five year lake. The lake fills up with fish, too. In the water holes there will be gigantic tadpoles, because when they turn into frogs, they have to be pretty big frogs. A little frog would dry up. At these water holes there are all sorts of birds. Sea birds will be arriving and sort of looking at you and waiting before they start walking down to the water and drinking.

So you can move in lagoon rushes; you can move in water lilies; you can move in root crop in marshes; you can move in fish; you can move in mussels; you can move in crayfish; and you can try all sorts of experiments and mixtures and get away with it in there. So when we come to our section on aquaculture, all things we will be saying there will really apply to permanent desert holes.



The International Permaculture Solutions Journal

P.O. Box 52

Sparr FL 32192-0052 USA

Dan Hemenway, Editor & Publisher
Cynthia Hemenway, Associate Editor

*A journal on the leading edge of
permaculture
to provide practical ideas and tools
to live in harmony with the Earth.*

Many of us are painfully aware of the severity of catastrophic ecological decline worldwide. **The International Permaculture Solutions Journal** delivers information, ideas and discussion to provide Earth-healing tools or to promote their development. Information that is practical, detailed and hard to find elsewhere often turns up on "TIPS" pages.

Who Writes for TIPS?

Many TIPS writers are tops in the movement: Bill Mollison, Jim Duke, Bill McLarney, and our editor Dan Hemenway, for example. Others are people who have been quietly working on their own. They all have something important to say.

What Does TIPS Cover?

TIPS issues often follow a specific theme. Presently we have a series of issues on aspects of developing sustainable food systems. After that will be a series on "Permaculture Design: The Process and the Product," and then a series on appropriate technology in permaculture. Of course each issue contains articles outside the theme--matters too important to wait. Eclectic book reviews, fascinating letters to the editor, informative illustrations, & easy-to-use format are hallmarks of our publication.

What Does TIPS Cost?

Subscriptions postpaid are US\$27.50 for USA addresses and US\$30.00 elsewhere. Each volume includes about 100 pages, typically delivered in four issues.

IV, V, & VI

PERMACULTURE ON LOW ISLANDS PERMACULTURE ON HIGH ISLANDS PERMACULTURE ON GRANITIC LANDSCAPES

BY BILL MOLLISON

Pamphlets IV, V, & VI in the Permaculture Design Course Series

PUBLISHED BY

YANKEE PERMACULTURE

Publisher and Distributor of Permaculture Publications

Barking Frogs Permaculture Center

P.O. Box 52, Sparr FL 32198-0052 USA

Email: YankeePerm@aol.com

<http://barkingfrogspc.tripod.com/frames.html>

or

<http://www.permaculture.net/~EPTA/Hemenway.htm>

These are the fourth, fifth and sixth in a series of 15 pamphlets based on the 1981 Permaculture Design Course given by Bill Mollison at The Rural Education Center, Wilton, New Hampshire, USA. Elizabeth Beyor, without compensation, undertook the transcription of tape recordings of the course and subsequent editing of the transcripts into 15 pamphlets. Later, Thelma Snell produced the typescript for all pamphlets and produced the drawings for these three pamphlets, again without compensation. Lisa Barnes laid out and made mechanicals of the original editions. More recently, Meara Culligan entered all 15 pamphlets onto computer disk. In the last few editions, I have added some further light editing to increase the readability of the pamphlets. In deference to the monumental task of love represented by Bill's assembly of the Permaculture Design Course, and by the subsequent volunteer efforts leading to these pamphlets, Yankee Permaculture has placed them in the public domain. Their reproduction is free to all and highly encouraged. The pamphlets are now available on computer disk, individually or as a set. See our order form for details.

We have some pamphlets translated into Spanish, French and German. Volunteers are now needed to complete these translations and to translate these pamphlets into other languages. Yankee Permaculture continues to depend on volunteers for all of our publications. To help, contact us at the address on the cover.

For Mother Earth

Dan Hemenway, Sparr, Florida, June, 2001.

Fifth edition

Edited from the Transcript of the Permaculture Design Course
The Rural Education Center, Wilton, NH USA 1981

Reproduction of this Pamphlet Is Free and Encouraged

Permaculture on Low Islands - IV

A special arid condition exists on low islands. This is because islands, small islands in particular, even the islands in Boston Harbor, have very little water catchment and finite water storage. Of course, all water storage is finite, but some storages are more limited than others.

There are two classes of islands. These are low islands and high islands. Their origins are totally different. The low islands are residual islands. The high islands are volcanic islands or they are granitic islands, either resulting from recent volcanic activity or from folding of the ocean bed, bringing up granites.

All islands are in process of development and change. Often volcanoes come up, making new islands, islands marching off down the slopes and back into the sea again. Islands are appearing and disappearing in those volcanic areas. Many people have actually seen islands appear and disappear. It has happened in recent times. Islands are temporary events, and for a variety of reasons. But some islands have more permanence than others.

Inasmuch as islands have a limited catchment, what really happens in the low islands is that the fresh water sits on top of a salt-water base. You can actually measure the available fresh water. The top level of the water is often only three to five feet below the surface, and its bottom level only four or five feet below that. If you know the area of the island, you can work out the actual number of gallons of fresh water coming in, and the storage within the water table. Islands can be tropical paradises if a lot of people don't go piling in on them. If they do, it will soon be necessary to use seawater to drink, or start bringing in water. And the plants will die if the fresh water within the water table is drawn off and the water table is allowed to fill up with salt water.

You must not pollute this water table. Here, the dry toilet becomes a real necessity. You can't run even two or three septic tanks into that water table on a small island.

Conditions of aridity exist mainly on the low islands with a finite water storage. There, one must be very efficient about using water. You must employ a whole set of strategies. I have worked as a designer in these particular conditions. The demand for designers in the atoll marine islands is very, very high. We can't begin to fill that demand.



Fig. 1-IV. "The atoll is basically a series of small islands around a closed lagoon, and the cay, which may be right beside it, is a small island surrounded by ocean"

The atoll is basically a series of small islands around a closed lagoon; and the cay, which may be right beside it, is a small island surrounded by ocean. The atolls are circular islands and a few little sand patches, just starting to be islands.

Atolls are composed of coral and sand, with an accumulation of biomass brought in by sea birds and migratory animals. The sea makes the island, really. These are calcareous islands,

these islands are mined for phosphates. In fact, all phosphates, no matter in what mineral structure they occur, have this derivation. They are accumulations of the manure of sea birds that have been feeding on sea animals.

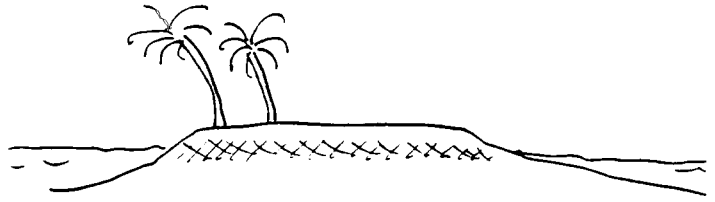

Fig. 2-IV. "The combination of phosphates and calcareous sands results in the formation in the soil of a layer of concrete about 18 inches down."

The combination of those phosphates and the calcareous sands forms the soil, which is free sand, and somewhat of a layer of "concrete" about 18 inches down. This concrete (calcium triphosphate) layer has various names. We will call it platen to differentiate it from another layer we will be discussing later in our study of tropical areas. This layer of platen varies in depth from maybe nine inches to two or three feet thick. It is often quite level on top, but of variable depth below. This has an effect on the water table. Rain penetrates very little. The rain tends to follow this platen layer out and run off, and is thereby lost to storage on the island. Thus, only a very shallow-rooted agriculture is possible.

So how did all these low islands get these big trees, like coconut, growing on them? The answer is, almost exclusively, by human intervention. The coconuts have no trouble establishing on the high islands, which often lack platen because they do not have the calcium build-up that the low islands have. But, nearly always, whenever these trees appear on the low islands, they get there by human agency. Both the ancient and the modern Polynesian sagas document this well.

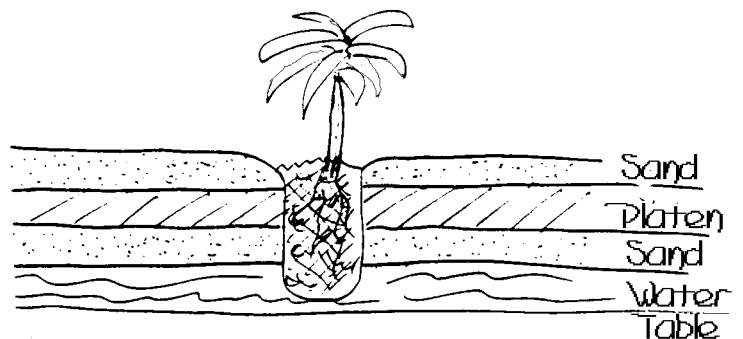

Fig. 3-IV. "The tree keeps the platen open."

To start getting a foothold on these islands, it is necessary to shovel away the layer of sand and break up the platen below it, getting through to what is a rather brackish groundwater. Then, everything you can get in the way of humus, you put in that hole. When your hole is filling up, you put a tree in, preferably a coconut. The tree keeps the platen open. So, down from the tree trunk and around its circumference, the platen is cracked and permeable to rain. The tree sets up its own little ground water system. Then, to establish more trees, you go about this again and again.

Permaculture Design Course Pamphlet IV - Permaculture on Low Islands

Start the process of vegetation on these islands in this way. A lot of vegetation occurs naturally, such as various grasses, and queer little twisted plants, which can sometimes be peculiar to the island. However, to get a productive forest started, you are in for this platen smashing.

Now we will move to the magical ring garden. You all know that circles, like pyramids, have tremendous life forces and surges of energy. Here is the ideal place to use them. Break up the platen and take it away. Heap up the sand around the edge. Fill up your circle with mulch and plant your vegetable crop in the mulch, putting a single drip system into the center. This makes a very successful island garden -- circle gardening. The fairies can dance around it.

Because drip-water normally will extend laterally about two to two and a half feet, you would probably have a maximum effective diameter of about four to five feet. If we make our hole deep enough -- and it need not be a deep hole -- it is also touching the water table at the base of the humus, and there is a "wick watering" system as well.

It is no good removing all the top sand, smashing up the platen and throwing it away, replacing the platen with mulch, and putting sand back over the mulch. A new layer of platen will reform above the mulch within twelve months. If you want to make a lot of concrete, that would be the way. You could smash it up every 12 months, take it away and make stone walls out of it.

Once you have started these drainage holes through the platen, the water rapidly turns quite fresh. When you first come on a calcareous island that has never been inhabited, then it is your trees and your first few plants that start the fresh water process. It will pay to put a lot of effort into those. Make some quite large holes, bring in canoe loads of mulch. The whole process, once you have started it off, will continue on its own.

We plant the inner edge of our ring garden with cabbages and peas and beans. We might put in a few more arid plants just on the outside or, we would put a circle of reinforcing wire into it, and grow cucumbers and beans up on this.

If we look at the geometry of what we have done, we may find that we have been pretty clever. Within a four foot circle we may have put twelve running feet of row crop within reach of a single drip point. That would be smart work, very efficient use of space.

What we don't want to do on an arid coral atoll is to set up a system of sprinklers. Before the water hit the ground, we would lose much of it to the hot wind. We would also lose water in surface evaporation. In addition, this would accelerate the formation of platen below the surface. So instead of using sprinkler systems, we make what is basically a large wick, composed of fibrous organic material. Then we start a small pipe or tap just going drip, drip, drip into our wick at the top. And we drip, drip at the center. By adjusting the drip rate, we can get this area fairly saturated. That water reaches out to the roots of the plants.

The center of your little ring garden is a very pleasant place to sit, so leave a few empty spots. You can sit surrounded by plants. Nobody can see you, and you are eating well.

Then it is up to you, for I have never really analyzed this -- I don't know whether you would go on making circle patterns, or whether you would make some linear patterns. The main thing, though, is to decrease the area of pathway, and concentrate the number of linear feet you are going to get in around the least number of drip points. It may be a matter of hose efficiency. I don't know; It is a subject that might require spending a couple of hours just working out a pattern.

However you design it, it is a garden that still needs application of mulch, and it needs watering. So, look at the linear efficiencies, and look at the fairies running around the edge of your rings, and the power surges going on around there!

Whether we are looking at an island in the bay out here, or at a calcareous island, we can't use septic tanks. The reason is that we are dealing with a very small water catchment system. We can't pump industrial wastes into an island water table. You have to govern the use of the surface with respect for the storages. On atoll systems, you have to store water as surface water.

It is possible to make small gley ponds, lined with leaves of papaw, grapes, banana -- anything that ferments very fast. Then pump it full of water from the ground well. You can thus double the amount of water that you have in that particular profile.

To keep sandy banks from collapsing, take coconut logs and line the banks with them. Once you have vegetation in this system, you are not so worried about instability of the banks.

A question that intrigued me was, "What would you ever grow in a pond on a coral atoll?" Because here is your fringing reef. You already have crayfish, fish - any amount of good seafood. I think probably the best thing to grow would be some aquatic plant food, something not common to the islands, also some rather exotic fresh water food such as prawns. Raise some ducks to feed the prawns via the algae cycle. If you are going to recommend water holes to seashore people who are already eating a lot of fish food, they probably don't want to grow fish in that area. I think if there are plenty of fish and plenty of shell fish, perhaps I would like some prawns and some of the very many varieties of tropical water crop that are high nutrient.

We can do something else. We can take the water out of our water hole. Go down very close to the water table, and you can grow semi-aquatics here, while growing plants of different root penetration just off the banks. That looks good and works well. Put some tubers up there on the bank, and other plants of different water demand down here.

It is quite possible for a pond to grow its own gley. Then allow it to fill gradually and grade the banks up, so that you turn it from a dry hole to a sealed pond by the process of a crop, which you grow within the pond and roll down.

Another obvious and very plentiful source of water is any and all small roofs. Some of the water can be stored high up off the ground in above-ground tanks.

If your client insists on having septic tanks, the best thing to do is to put them right at the perimeter of the island. The general flow of water is outward, unless your water usage is exceeding the fresh water fall.

Arrange your settlement on the periphery of the island, and draw water from central areas. Even so, if you use an excessive amount of water, the sea enters the edges, quickly signified by the death of trees from the effects of salt. You will also have a reverse flow of those pollutants. If there are too many people on an island, then the beaches become unusable because of the pollutants dashing up in the sparkling green waters.

So for these low islands, you have grow-hole technology: there is a pit, wick-watering gardening technology; there is gley technology for collecting free surface water, and for creating a growing situation. There is a roof catchment, and surface storage in tanks. And with this peripheral housing idea, you will be keeping your waste from the main water lanes. But to build up a large village at the center of your island could be a disastrous technique. You have to think your way through these situations all the time.

Permaculture Design Course Pamphlet IV - Permaculture on Low Islands

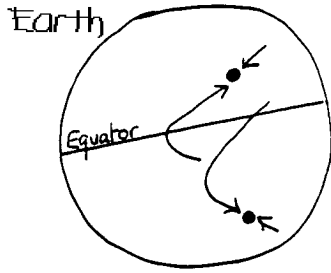

Fig. 4-IV. "On all oceanic islands we have two sets of winds."

On all oceanic islands, whether low islands or high islands, we have two sets of wind, and two periods of calm. We have spring-autumn periods of calm, and we have winter-summer winds. For the most part, these winds are either northeast-southwest, or northwest-southeast. Winds of many land situations don't differ a great deal, but islands are usually of this nature. So you have wind-break problems and erosion problems.

You have to be careful not to lose your island to erosion. It is quite possible to lose islands in this way. From the air, I have observed in these bays out here that waves are in the process of wiping out islands. Waves never cease to attack. Where the winds sweep on shore with waves, the process of erosion proceeds very rapidly. We can lose these islands because we let this wind attack directly.

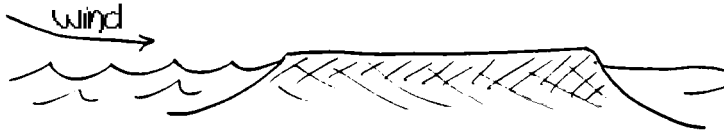

Fig. 5-IV. "It is quite possible to lose islands to erosion."

This process can be diverted by some change, like a little tree on the shoreline deflecting the winds upward. As the number of trees increases, the wind deflects and the trees begin to win out against the sea. A whole set of plants can become established along the shoreline, actually stopping the force of wave erosion.

The highest that vegetation can build an island is to about six feet -- vegetation alone -- so don't tamper with this shoreline vegetation. Or, if you tamper with it, you better have other defenses ready. You could deliberately tamper with this vegetation, let the sea come inside your island, create a harbor effect, but then you should have very good, previously-built defenses around your

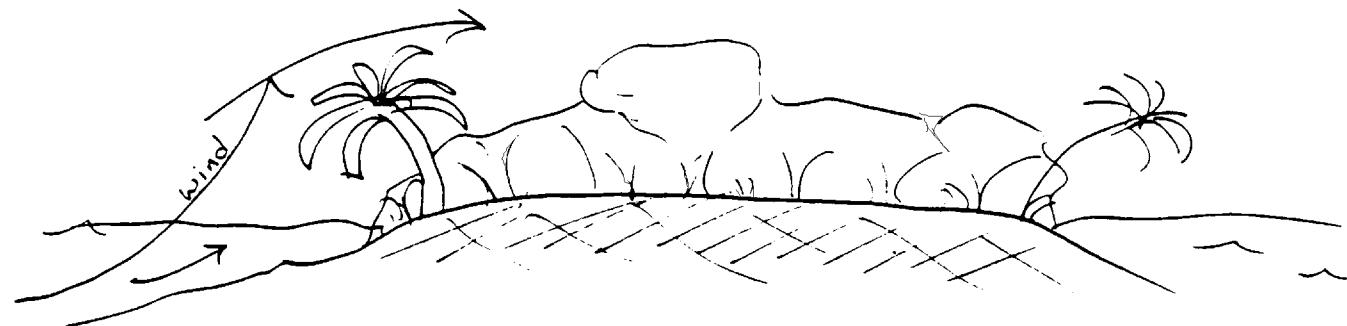

Fig. 6-IV. "As the number of trees increases, the wind is deflected and the trees begin to win over the sea."

harbor area. If you remove a strip of this deflecting vegetation, you have much broader wave running inland and coming with much greater force, because it is in a streamlined wind. Whenever the force of the wind lifts over vegetation, you get a low pressure coming in and the waves break further out and run much less up the beach. Don't muck around on these two very critical shorelines.

Remove the trees to make an airstrip, and you will have the sea come marching in across your airstrip, cutting it to pieces. Disaster. It will be hard to put that island back again. Contain an airstrip within vegetation, preferably at an angle to the winds. It is good to have trees alongside the airstrip and to keep your coastline intact. Then, when you drop below your tree level, you can land. The main thing is to preserve coastline vegetation at the ends of the air strip.

Atolls mainly need windbreaks on the outside areas. Atolls and cays have very different conditions of sea surrounding them. Cays have fairly turbulent seas around them; while the atolls have very quiet and shallow seas within them. Large regions of the internal lagoons are shallow, and are revealed at high tide. These are very rich growing areas; they have some land nutrient input from rainfall. So they are very productive. They have large fish -- sharks, rays, barracuda, schools of fish, mullet. Some atolls are really in a fish farm situation.

Mangroves occur within those atolls, though in some they are absent, because they have been utilized as firewood, or perhaps they just never got established there. But you can bring them in and they will quickly carry out the island into the lagoon. You can accomplish this in two ways. You can either put mangroves along raised barriers, which you make from logs and sand, forming further fish-trap enclosures, which may increase the fish population. There are plants that stand right here on the shoreline on which the waves break. Basically, there are three genera -- *Pemphis*, *Tournefortia*, and *Scaevola*. These are plants that will stand there in the sea, maybe growing about fifteen feet high. Behind them, you put a set of very tall plants. Where climate permits, you would use one of the palms. And it is possible to use the date palm. You don't ordinarily think of the date palm as being an island palm, but rather an oasis palm. But when you re-think the matter, you will see the basic conditions are very similar. We should be trying a lot more things, such as mangroves inland in the deserts. We should try many of our coastal species in the desert, and a lot more of our desert species on the coast.

It was an accidental occurrence that started some date palms growing on the Hawaiian coast. A Catholic priest on the Hawaiian Islands was eating a package of dates sent by a supporter. He discarded the pits, which sprouted and grew and took off along the coast just as well as the coconut palm.

Permaculture Design Course Pamphlet IV - Permaculture on Low Islands

You are not going to get much bearing from the front line trees on an island coast. They are principally useful as a windbreak. The next line will give some yield; and from the third line of trees -- that's within fifty feet -- you will start to get a normal yield. The palms are very good along the coastline.

In cold climates, you may be setting out *Coprosma*. They will stand right on the coast. *Coprosma repens*, bayberries, will stand well towards the forefront, but not quite as far forward as these others. The New Zealand mirrorbush is another one. There is the beach plum, *Prunus maritima*. There are others such as *Prunus catalonica*, *Rosa rugosa*. They grow right on the beach. Just make sure, though, that the trees you bring in are growing on oceanic beaches. Many things will grow on the coastline of sheltered water, but will not take that front-line oceanic assault.

Now there is another set of front line plants that are for the main part needle-leaf plants. There is the whole group of *Casuarina*, tamarix, Monterey pine, and a great plant with wide climatic range, the Norfolk Island pine, and the Monterey cypress.

You are not looking for yield here. You are looking more to the mulch potential of this set of trees, because these trees stand front on the ocean, the first to receive the winds from the sea. They are the front-line species. Of course, you can mix them up. You can put a row of palms and needle leaves and broad leaves. There are a very few thick-leafed plants. The sea grape is one.

There is a very small group of plants that will not take any salt at all on their leaves. Some of these seem to be large nut trees. Chestnut does not like salt at all; and I don't think walnuts are real fond of salt on their leaves. Almonds, peaches, apricots, apples, have to be somewhat sheltered. The pistachio doesn't want salt at all.

Of all the vegetables I know of, none of them suffer badly from salt. Many grow near the sea.

So you put in a coastal defense system and maybe extend your island into your lagoon system. You might as well use these extensions for other reasons. They might incidentally be fish traps, rearing systems. Warn your client of the drastic results of hacking off the foreshore vegetation to get a better view. Re-establishing a coastline is very difficult once erosion has started. Watch your water balances. Recommend minimal use, and see that you get maximum surface storage. Maintain potential surface storage at all times.

Islands can be interesting experimental stations. Some weird animals have developed on island, such as the giant tortoises, the big ones that you can sit on. They are great lawn mowers, and very good at converting table scraps into fertilizer. A herd of giant tortoises is an excellent thing to have lumbering about in the undergrowth, cleaning up the old fallen coconuts. There is a whole series of land crabs that do quite a lot of work on islands as compost shredders and insectivores. They find insect larvae and consume them. They lessen wood beetle infestation. Pigs can be useful on islands, and they are fairly easily controlled. Ducks do well, and chickens.

You have to look at your nitrogen turnover on islands. Put in some nitrogenous species. There are many island legumes. Some of them are vines, ground vines; some are little trees; some are tall trees.

You can eat the leaves, the flowers, and the pods of the horse-radish tree, the *Moringa*. It is nice to have in the garden -- a vegetable hedge. It is quite a tall little tree. It grows to 20 or 30 feet.

So you look after the nutrients within the garden systems, you look after the windbreaks. You set out central gardening, and, on low islands, peripheral occupational zones to decrease the risk of contamination of the water table.

We would probably have to bring in worms, and bring in a handful of compost to get all our little bacterial and fungal and algae forms onto the island, because we can be starting from a sterile environment. We should bring in a handful of soil with almost every plant we bring in. These plants have soil associates. The nitrogen-fixing bacteria for legumes are not necessarily going to be there. There are also some varieties of trees that won't grow from seed unless started in their own soil.

Finally, a further word on mangroves with respect to their importance for the whole global nutrient cycle... Mangrove is a generic term for estuarial forest plants and the genera are drawn for the main part from sub-tropical and tropical rain plants, such as *Sonnerata*, *Rhizophodia*, *Aegiceras* and *Nipa*, in the palms. The *Nipa* palms are mangroves. *Avicenna* is another mangrove -- one that comes all the way to latitude forty. All of these have twisty stems and leathery leaves, and they stand out in these quiet tidal waters. As a system, they are very productive. I think perhaps the mangroves have the highest biomass turnover of any system. *Aegicera* is a superb honey plant, responsible for most of the tropical honey of good quality.

They all lay a very thick leaf mulch in the sea amongst their roots, which turns into a nice loose mud which people detest. So they cut down the mangroves, and get washed away when they do it. You can always put little walkways out into the mangroves, two planks wide, you know, if you have to walk through there.

You say that the bald cypress will tolerate tidal water? Well, then, there you have another mangrove. More species come in as you go up river in mixtures of sea and fresh water.

They all lay down this really rich leaf mulch, which goes through several animals like shrimps, little anthropoids, diatoms. That leaf is really used. The whole food chain starts within these seas. It is an area that is responsible for most of the offshore shrimp fisheries. The mangrove jacks and quite specific fish are associated with the mangrove stands. Mangroves are very enriching systems. They should be heavily encouraged and widely distributed. Instead, they are everywhere being degraded and filled in and drained and chopped. Then everyone wonders why fish are getting scarce.

The mangrove palms are useful, too. They have either some useful fruits, some honey yields, or some stem products. Some of the mangroves have very durable woods and timbers. Some have edible, if not particularly delicious, fruits. However, their real value is in the enormous life-turnover in the system. The mangroves are great places for crocodiles. There is nothing quite comparable to moving through the mangroves in a canoe at two miles an hour, with a 40 foot crocodile bellowing behind, who can touch 30 miles an hour if he speeds up. There are alligators in mangroves, and little fish that spit at you and bug their eyes. There are whole hosts of organisms ripping around in there, all of enormous value to the nutrient cycle.

And there we will leave the low islands, the atoll with its quiet lagoon, and the sun sinking slowly in the West.



Permaculture on High Islands - V



Fig. 1. "High islands have a wet slope and a dry slope."

Islands, whether or not they are volcanic, if they are over a thousand feet high, often have clouds. They will have a very humid top on them, and sub-humid slopes. There will be a wet slope and a dry slope, because seasonally you get winds -- summer winds and winter winds.

If the island is more than five degrees off the equator, it will have a dry and a wet side. The wet side will be pretty wet, so that the humid area comes down slope on one side, while the dry side may be quite dry. The water table is high; the catchment potentially good.

Fresh water often travels out beyond the island and bubbles up in the sea. Typically, around the island and off the coasts, there are fresh water springs below sea level. They are quite visible; they look like sort of shimmer in the water as it bubbles out of crevices, and you can drink from these springs. They are known to the peoples who do much diving.

We will take a look now at a high island in Hawaii. This island is half volcano. The other half blew up. Because of the high humidity of the air passing across all islands, there is quite a heavy rainfall over this area where winds rise, peak and fall. As the winds pass across and come down the opposite side of the island, they assist in the drying-out of that side. The winds, lose moisture as they entered the wet side of the island, heat up as they descend, and then have greater evaporative power. They are also working on a lower pressure system.

Back to the wet side, this is a wet area, and will be rain forest. If we do not intervene, the rain forest will slowly extend down, and so will the clouds, to lower and lower levels, in some cases, extend to the water line, even on the dry side. The whole island then becomes totally wet. What really happens is the wetness descends in the trees at ground level.

I have a little book, given to me by someone as I left Hawaii, called "Memories of Molokai", written by one of the descendants of the missionaries. This man grew up there. He says that fields that were dry grasslands when he was a boy are now wet and marshy forested areas. People now alive can remember the descent of the mists as the forest has extended. They remember when the mist was one thousand feet high, higher than it is today. You really observe a positive, fast response when forests take over. The amount of water generated on high islands is relevant to the amount of forest on those islands. Historically, springs have either dried up, or recommenced to flow, depending on whether the forest is extending, or being removed.

You can play around with the water, play around with forests, on these high islands. High islands lend to high-ridge storage of

water, following the model we studied in the keyline system. We can direct water from catchment to catchment to catchment.

High islands are also good sources of wind and sun and water power. The ancient Hawaiians applied these principles.

Now we will look at the ancient Hawaiian land division. As we look down on the island, we can see that there are natural volcanic run-off patterns, and river systems. The Hawaiian land subdivision followed the ridges between the valleys. It followed the natural division of the island, which was from the mountain ridge to the surrounding reef, including the section of lagoon between the shoreline and the river, and, in fact, extending over the reef. This was the Ohana division of the islands. It was a good division, arrived at, no doubt, after a whole series of extinctions and reinvasions, over some thousands of years. These very logical districts imparted control of the entire watershed from its origins to its discharge into the sea and beyond.

The Hawaiians independently invented the keyline system. They put a massive stonewall at the keyline and led the water from the upper valleys out to the ridges. They took it back to the valleys and out to the ridges at a lower level, then back to the valleys, and that was their taro lands. These keyline systems still exist. You can walk out the keyline and examine those terraces, sometimes cyclopean, built of enormous stones.

They are forested from keyline up, and they confined foot traffic to the ridge tops -- very sensible people.

Forests were taboo areas, because they were the source of water. They were used very carefully for essential purposes. Where the human and forest nutrient eventually reached the sea, they enclosed the area with rock wall. Within this enclosure, in three days' time, the sea will grab all nutrients and somehow fix them. In that case, it is the form of algae. In those enclosed ponds they raised millions of pounds of mullet. So they turned run-off nutrients into fish and ate the fish. Then, back up on the hillside, in the paddy field, the process started all over again. Real good. That quite stable ecology supported many thousands of people.

Well, we soon fixed that. A few missionaries and a few cattle, a touch of disease -- we set it all to rights, cutting up the system, building condominiums. The whole nutrient flow now goes into the sea. All the fish traps filled and became solid earth systems. There may be fewer people living on the islands now, and the islands themselves are far less able to afford them a living. Production is starting to decline rapidly. Righteous, but not smart.

We could re-institute the Ohana division, except that Ohana is a word in which the people are an integral part of the division. If you belonged to an Ohana, you belonged to a valley and a set of fields and a fish pond and a reef section. They guarded right out to the reef and over the reef by building underwater structures. Thus they created reef structures for additional fish shelter. The people were an integral part of this whole system. The Ohana is a totality. I think it to be a nice concept. Its watershed, its people, its nutrient flow, its animals, everything, is a single, indivisible unit. Perhaps we could seize the headwaters here and start Ohanaing downhill.

That is a very nice system. You can go and examine what remains of it. Amazingly, there are those taro patches right on the nose of the ridges because they keylined right out to there. They keylined a little steeper than we do, because they did it by hand, and their little gutters were often stone lined. These gutters run out to quite amazingly steep ridges, right out to the points of the ridges where it was flatter. They grew taro in the paddy fields on

Permaculture Design Course Pamphlet V - Permaculture on High Islands

those ridge points. You really can't better their system. You might change the elements of it. Taro is not for all of us. Poi is not an ideal food. It is pink and gluey, and tastes frankly of acid. But I have friends who dearly love it.

They did extraordinarily well in establishing the integrity and the nutrient flow in that system. It is all there, just waiting to be revived. On very exposed dry sites, they used tiny rock walls, little rock mulch walls in amazingly intricate cross-wind patterns, sometimes only ten feet apart. Behind those they grew dryland crop, like sweet potato. They also grew a dryland fern out there for mulch.

You can do no better than to study the ancient technology of the Hawaiian gardener. For what limited species he had at his command, he was a superb technician and an excellent designer. I wonder at and admire his works, which are totally ignored by the current population. This patterning is all over the landscape. When you look at it with a permaculture eye, it doesn't take you long to work out what they are up to.

Not that the modern Hawaiian can reinterpret that. While some of the old Hawaiians still use it, they are very old. If we could have really looked at the culture before we converted it, we could have learned a lot. There is only one bit of hope. The Hawaiians are buying back the islands. I think they might win if we keep marijuana illegal.

Now this is your technique in the high islands. Keep your upland slopes forested. Your island dictates the sort of forest. If your island is high enough -- two thousand feet high -- you have gained (in latitude) maybe seven to twelve degrees. So you can descend from plum and deciduous species, which have sufficient chilling up there, to ultra-tropical, equatorial species at sea level. You can play all sorts of climate games downhill. Low light tolerance trees go up here, too, because they are almost always mists around the higher area.

Mist often curiously reproduces the whole shape of the island in the air above it. This is typical of all islands. Often, coming from the sea, you can see the cloud that belongs to your island; you can recognize that cloud straight-away. That is the island you are approaching. After a while, you come upon its solid counterpart. The Maori described New Zealand as the land of the long white cloud. It is a long island.

In certain of the Hawaiian Islands, and many other high islands, it is quite typical to find valleys that have no sunlight all day. Those valleys are in eternal shadow. There is no solar evaporation in there, only transpiration by plants. The vegetation on that side, away from the sun, steeply descends to sea level as a rain forest. It is not much good fighting that. You might as well turn it into the sort of rain forest that you approve of. The rain forest works its way down the hillside by means of soil storage of water. It creates really wet soil conditions. As the forest comes down, it creates additional precipitation. The forest really sends its own water down at ground level, regardless of transpiration. The forest condensation and its protection of the soil from evaporation win over transpiration. Given that we have constant humidity, the forest always beats rainfall in terms of water storage.

But when the loggers headed into these forests for sandalwood, when the graziers came and burned up to the ridges, the clouds were pushed right up those ridges. Then they attacked the growth on the ridges for charcoal, and the ridges are drying up. They further propose to attack the higher levels, to clear the area off for their electric generators!

There are special problems related to the placement of housing on islands. These problems are currently, but temporarily, overlooked by the new island people. Opposite to streams, on tropical islands, fringing coral reefs will disappear, because the coral won't stand fresh water. Therefore, these openings in the fringing reef are normal entries for vessels into the harbors. They occur naturally. Or you can blast some out, if you feel brave enough to see what happens after that.

Oceanic islands, inevitably, at some period in their history, experience tidal waves. If the tidal wave doesn't slow up on the reef, the valley with no reef offshore acts as a funnel, and the tidal wave sweeps into it with ever-increasing velocity and ever increasing bore. These are particularly dangerous valleys for settlement in the lower parts of the valley, and the Hawaiians treated them as not even cultivation areas. They grew tree crop in them, mainly coconut. The coconut trees did a lot to decrease the wave velocity up the valley. So you must keep your client out of there.

Unfortunately, Sheraton Hotels and a few other people don't know about that. They are sitting right there. The periodicity of tidal waves is about twelve to fifteen years. So we will see a lot of disappearance of white America on the Hawaiian Islands before too long.

Going inland from the shoreline, you are safe enough at the first elevation, if you have a sub-ridge within the major valley. It is usual for a tidal wave to penetrate more than a half mile inshore. The Hawaiians also perch themselves up off the valley floor, on the sides of the valleys in case of reawakening volcanism. Volcanism is always accompanied by torrential rains and enormous and very rapid mud flows. People don't want to be in the path of that flow, which may descend with a speed of four hundred miles an hour. So they build their homes up here off the valley floor, and in from the valley mouth. Where there is a fringing reef, you can creep closer to the coast. You just might get a twelve foot wave instead of a hundred foot wave. Europeans settled tightly on the coast. They are just in between two tidal wave episodes. One happened not long back, and very probably there will be another one soon.

Ash flows, mud flows, flows down wadis, landslides, which come down these volcanic hillsides, dictate that you get on a point of a lower ridge. While this is a nice place in any locality, it is almost dictated by necessity on oceanic islands.

The other factor to be considered on oceanic islands is the cyclone. Therefore wind shelter becomes important, and particular attention must be paid to house construction. Earthquakes and mud slides, but particularly earthquakes, dictate that you reduce the mass of your house to the minimal. It would be best, particularly in tropical islands, if the house were made out of paper or light matting.

As a designer, the last thing you check out before you leave is to be certain that you haven't left some unfortunate client to a certain death. The paths of mud flows, the paths of tidal waves, the paths of cyclone damage, are all known if you make local inquiries. Look for traces and effects that show you where not to be when these events occur. So, having done all the rest of your planning, you had best be sure that you have put your client where he will have a maximum chance of getting out of any of these situations.



Permaculture on Granitic Landscapes - VI

Granitic landscapes are somewhat like the residual desert -- slab landscapes with a lot of rocks. This landscape presents peculiar problems. Typically, there may be a hundred feet of permeable sand. Your chances of any significant storage of water anywhere in that landscape is very slight.

Yet millions of people live on those landscapes. The entire Perth plain of Australia is of this nature. It has about a two hundred foot depth of clean sand. You can't keep water on it. You may water it forever and the water just goes down and down. You can mulch it and the mulch is gone. A thick mulch is gone in six months. It just gets washed down into the sand. There is nothing to stop it. Mulch just breaks down into little particles and acids and flows on down between sand. It washes right down to wherever the water table happens to be at the time. All organic materials are washed down.

Near ancient rivers you will find people living on these plains -- plains extending out from large granitic areas, not subject to glaciation, and along major rivers that have receded, drying up a bit.

The water source is often bored wells. But that water is finite, and the usual story applies. Once you might have needed to bore to a depth of 20 feet. Now it is necessary to make a 2,000-foot bore, while the water is getting saltier and saltier the further you go down, because there is a natural stratification. There are different salt layers that have hard alkali. The ground water, the fresh water is flowing over the top of saltier water. As the fresh water is pumped off, the bore must go ever deeper and the water gets more expensive and saltier.

So small gley ponds, tanks, and very modest bore water use are requirements for the survival situation. Your garden area should probably be completely lined with plastic sheeting. You then can mulch, and humic acid at least will reach the roots of your plants. Your garden will then be sort of an underground tank.

It is necessary to treat the granitic landscape very much like the desert situation, even though the area may be reasonably humid.

Trees do well in this landscape, though I don't quite know why. So place a big accent on tree crop as a replacement for annual crop.

There can be no lawns. Lawns are total disasters. It takes 90 inches of water a year to maintain a lawn on siliceous sands. You may put on eight feet of water to keep your lawn alive, but there will be huge evaporative loss of water.

Around these rocks and dunes there may be numerous microclimates. You may be able to go from dates to strawberries.

Because of the reflectivity of granite, there are light and heat benefits. Incorporating the mass of these granite rocks into buildings is good strategy. It can be either under glass, or just incorporated under shade houses and used as evaporative cooling systems. It is sometimes possible to dig a rock out and incorporate that rock in the house.

There was a woman in Sydney who got sick of builders, and she set about designing her own house -- typical woman. So she headed for the rocks. What she has is nice rocks coming out in the bedroom, rock coming up through the walls into the living room. She has good evaporating cooling systems, little keylines running all over, covered with moss and ferns -- good permaculture design. It is a good idea, you see, to accept these natural



"You can mulch right on top of rocks."

features as part of the house. Glassed in, rocks are amazingly efficient heat stores, very cheap.

Working your way around this rocky landscape, you come upon all kinds of run-offs. You can put little blocks on the shelving areas and mulch there, right on the rock. You can mulch right on top of rocks and right beside the rock below, and get good little run-off systems going into those pockets. In the crevices, granite flakes off, and you find large sheets of that which you can lay out with a bit of assistance from a crowbar, and you can fill that area with mulch and make a growing area there.

You can grow on both sides of your rock in the shade, and in the semi-shade, in the morning sun and in the afternoon sun. Morning sun is the sun for the production of leaf; afternoon sun ripens. These are really interestingly detailed habitats, and you can almost sense what plants will grow in any of these pockets of mulch on rock, just by moving around in the system.

I have a friend who had about four acres of this granitic soil and four acres of dirt that he started to play with. His granitic area is slowly becoming far more productive than the other four acres of promising agricultural soil. He was using the stones for ripening and all sorts of things.

By playing around in there, you can have a lot of fun, and create a really attractive environment. You see a pile of rocks down here, a lot of niches in there, good tomato and cucumber spots, places for vines to grow and climb on rock instead of fencing. There are banks and little shaded areas for strawberries, and on and on and on and on.

But it is hard to deal with that area out where there is no rock base. A modest gley pond, run-off tanks, bores, windmills. Deep siliceous sands are hard to deal with, and shouldn't be crowded up and settled. Tree crops are a vital factor in sustaining agriculture on siliceous sands. Nearly all the palms, many of the fruits, figs, grapes -- all those do quite well there with minimal work.

I have often wondered about the potential of a below-garden gley system. Dig off the earth, put a green mat layer in, and then return the earth. I don't know whether it would work. It might.

I'm not saying exactly what you can do around a situation of this sort. When you walk in there, you should be able to work out quite a lot that you can do. I would stick in little olives and date palms and grapes and raspberries and strawberries and marigolds all around in amongst these rocks, and direct little runnels to places -- lots of detail work. Nice! There is nothing like an old rocky river bed or a pile of stones to work in! A pile of logs is great -- big logs, I mean, a huge amount of niches, and a great potential. Just start people cleaning up the country. **111**

PERMACULTURE FOR FIRE CONTROL & PERMACULTURE FOR MILLIONAIRES BY BILL MOLLISON

Pamphlets VII & XV in the Permaculture Design Course Series

PUBLISHED BY
YANKEE PERMACULTURE
Barking Frogs Permaculture Center
Publisher and Distributor of Permaculture Publications
P.O. Box 52, Sparr FL 32192-0052 USA
YankeePerm@aol.com
<http://barkingfrogspc.tripod.com/frames.html>

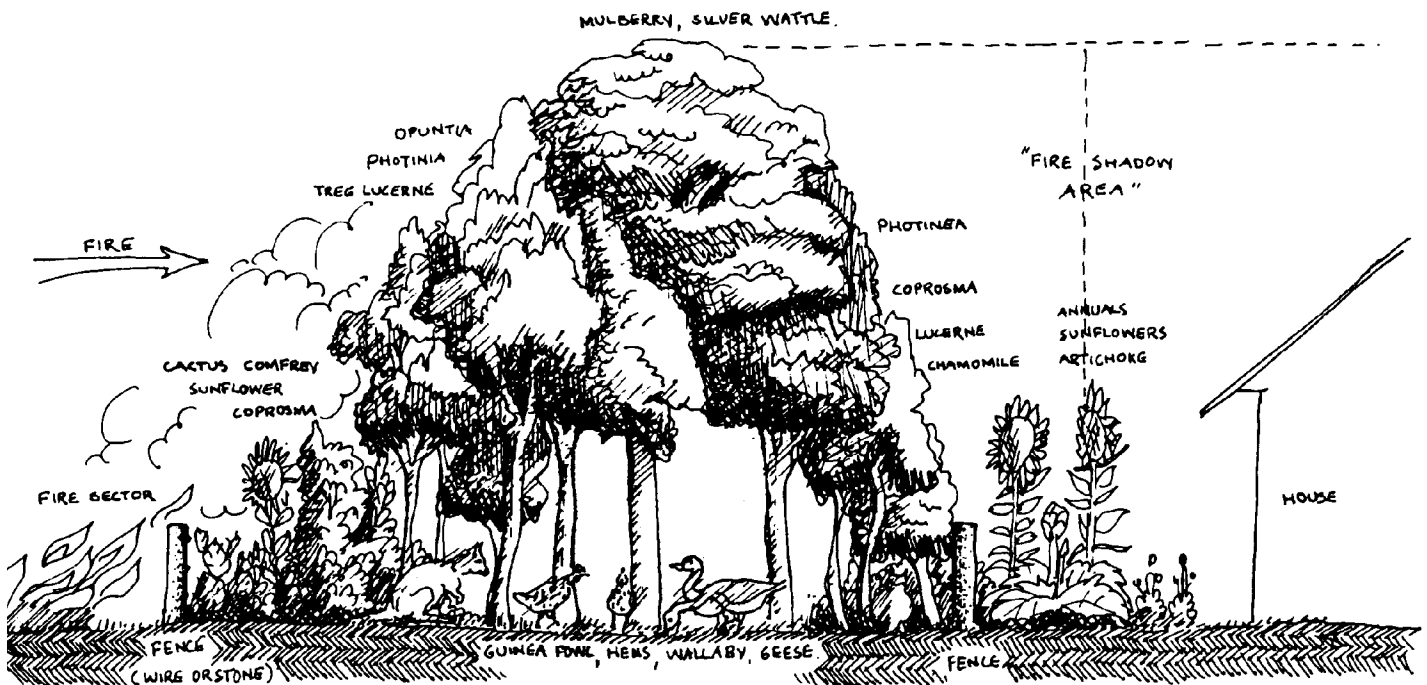

Illustration from *Permaculture Two*, © Bill Mollison, 1979, all rights reserved. Reprinted with permission.

Edited From The Transcript Of The Permaculture Design Course
The Rural Education Center, Wilton, NH USA 1981

Reproduction of this pamphlet is free and encouraged.

Permaculture for Fire Control Permaculture for Millionaires

These are the seventh and fifteenth in a series of 15 pamphlets based on the 1981 Permaculture Design given by Bill Mollison at The Rural Education Center, Wilton, New Hampshire, USA. Elizabeth Beyor, without compensation, undertook the transcription of tape recordings of the course and subsequent editing of the transcripts into 15 pamphlets. Later, Thelma Snell produced the typescript for all pamphlets. Lisa Barnes laid out and made mechanicals of the original editions. More recently, Meara Culligan entered all 15 pamphlets onto computer disk. I have added some further light editing to increase the readability of the pamphlets. In deference to the monumental task of love represented by Bill's assembly of the Permaculture Design Course, and by the subsequent volunteer efforts leading to these pamphlets, Yankee Permaculture has placed them in the public domain. Their reproduction is free to all and highly encouraged. The pamphlets are now available on electronic media. See our order form or Yankee Permaculture Special Order Paper #27 for details.

We have some pamphlets translated into Spanish, French and German. Volunteers are now needed to complete these translations and to translate these pamphlets into other languages. Yankee Permaculture continues to depend on volunteers for all of our publications. To help, contact us at the address on the cover.

For Mother Earth

Dan Hemenway, Sparr, Florida, USA, June, 2001.

Sixth edition

Permaculture Design Course Pamphlet Series

	Quantity	Price
Complete Set of 15 Pamphlets. Bill Mollison. \$35 (Price reduced 9/1/94)	SET _____	\$ _____
Electronic Edition	SETFD _____	\$ _____
I An Introduction to Permaculture. (Price reduced 3/22/94.)	I _____	\$ _____
II Permaculture in Humid Landscapes.	II _____	\$ _____
III Permaculture in Arid Landscapes,	III _____	\$ _____
IV Permaculture on Low Islands. (See V for combined price.)	IV _____	\$ _____
V Permaculture on High Islands. (IV, V, & VI offered as one pamphlet.)	V _____	\$ _____
VI Permaculture on Granitic Landscapes. (See V for combined price.)	VI _____	\$ _____
VII Permaculture for Fire Control. (See XV for combined price.)	VII _____	\$ _____
VIII Designing for Permaculture.	VIII _____	\$ _____
IX Permaculture Techniques.	IX _____	\$ _____
X Forests in Permaculture.	X _____	\$ _____
XI Water in Permaculture.	XI _____	\$ _____
XII Permaculture for Urban Areas & Urban-Rural Linkages.	XII _____	\$ _____
XIII The Permaculture Community.	XIII _____	\$ _____
XIV The Permaculture Alternative.	XIV _____	\$ _____
XV Permaculture for Millionaires.	XV _____	\$ _____

All funds must be in US dollars in a check drawn on a US bank or by International Postal Money order. Make checks payable to: "Yankee Permaculture." Make postal money orders payable to: "Dan or Cynthia Hemenway." Minimum order, \$10 + p&h.

For all Yankee Permaculture publications, please add \$5 plus 10% postage & handling for shipments to the US and 20% for shipments to other countries.

Prices subject to change without notice.

Permaculture for Fire Control - VII

Fire in a landscape is a subject that I want to treat very seriously. It is a common hazard.

Fire has a periodicity specific to the site. This fire periodicity depends on two factors: First, the rate that fuel accumulates on site. This is a critical factor. The second factor is the amount of moisture contained on site. Any ridge top is far more fire prone than its valley systems. Typically, the vegetation of ridge tops may even be fire-dependent, with species that germinate well after fire burns the ridges. In the valley, on the other hand, you may get species that may be killed by fire, but which burn very suddenly. While ridges are more fire-prone than their adjoining valleys, so are the sun-facing sites more fire prone than their shaded slopes.

It is possible to work out the fire periodicity on site by examining the cross-section cut of an old tree in the area, or even from historical records of fire in the area. With a rainfall of 30 to 40 inches, a catastrophic fire will occur about every 25 or 30 years. I am not talking about a local spot fire. I am talking about a fire that races through a large area.

A lot can be done to change that cycle. Advantage is gained if it can be delayed even one period. The less a site burns, the less it is likely to burn, because there will be more humus and more moisture incorporated into the site. On the other hand, the more it burns, the more likely it is to burn again soon. This is because fire removes a lot of moisture-retaining humus and kills a lot more than it consumes, resulting in a fire prone litter build-up. So the periodicity can change to a very short term if an area continues to burn. Areas that naturally experience fire every thirtieth year will burn every eighth or tenth year, once they are being burned at shorter intervals. Fire is a very destructive influence.

In permaculture landscapes, there are sequences of defense that you must throw up. What you must do is reduce fuel. That must be the primary strategy. You can do this by creating non-fuel surfaces, such as roads and ponds, by constructing swales and doing pit mulching, and reducing fuel by means of browsing or grazing.

It is very simple to protect the house site. You only need a hundred feet of non-fuel systems between the house and the forest. That is not very far; it is a raking job. Select plant species for this area that have fire-resistant characteristics, such as very high ash content, a very high water content, very low total bulk, and which grow densely. The ice plants, the Coprosmas, some of the thick-leaf evergreen plants, whose litter decomposes very fast, have leaves that are highly nutritious and don't last very long on the ground. A list of plant species useful for fire control in any area varies with the climate. Fire departments in fire-prone areas are often able to make recommendations.

Some trees, particularly the pines, and many of the leaf species, are litter accumulators. They form a hard and volatile litter that simply builds up and carries very large ground fire. Do not use plants to the fire danger side – the downhill side – which have high volatile oil content. Eucalypts are a positive no-no, and so are pine trees. Both are to some extent fire weeds. Both carry cones and hard fruits that often don't open until fires. After fires, you will see a widespread covering of new growth from the seed of these trees. That is what they are waiting for, a fire to enable them to extend their range a little.

So you halt fires by working from the valleys upward with plantings of low fuel vegetation. Re-establish the rain forest that would be on the site if it did not burn. Bring in a lot of species that naturally occur in the valleys.

Now let us look at the fire itself. What does the fire do? It doesn't burn much. It burns a few leaves, and perhaps buildings in its path. The real danger of fire is radiation. Four hundred feet before a fire, your hair catches alight. Two hundred feet, your body starts to split and your fat catches alight. At 100 feet, you are a torch. Radiation kills birds hundreds of feet from the fire. They just fall out of the air. Fire kills pigs very quickly. They don't stand radiation. Goats survive quite well. They just lean into it. And human beings are good at surviving a fire because they dodge about and hide behind shadows.

So we need to throw fire shadows over the central part of the system that contains our client. We do it with earth banks, and we do it with trees like willows and poplars that have high water content and that throw out a black cloud of steam. They don't let radiation through. So on many sites that you will design, where fire will be a future hazard, you pay a lot of attention to setting up fire-protection. In California, almost every plant depends on fire, and all have high oils, because they have been selected through a long history of fires. Greece was once a land of wet rain forests, with enormous oak and columnar beeches. It has become a skeleton of its former self, and its fire frequency is up and up. Now you really can't burn Greece because the dirt is burned, the plants are burned, the hills are burned, the rocks slip down hill and you can't burn rocks. The whole of the Mediterranean and much of North Africa has reached this condition.

What we must do is start reversing the process. If your client is in that chaparral, then you must pay particular attention to fire protection. You will have to give him somewhere to go to when a fire comes. You really can't save him on the surface. So you dig a T-shaped or L-shaped pit and earth it all up. It can be a length of road conduit, earthed over. Then your clients can hop underground and wait it out. When they are out of the radiation, they are out of trouble. In Coventry and other areas that were burnt in war, there were fire storms. Standing in a fire shelter, I have watched the glass pouring out of the windows in my car. It is hot out there, you think. It melts out the bearings in your car. You can't drive. Always duck behind things in a fire. Just get out of the radiation. And keep your mouth shut. Don't breathe. Otherwise, your lungs burn out. So if you don't breathe until you get behind things, you are all right. The main thing is not to be in direct radiation. Often you can dig a fire shelter into a bank with a backhoe. In some areas, this work of a few minutes may be the critical factor for survival.

Otherwise, give good advice to your clients: "Go behind the house and sit down 'til the front of the house is alright. Then walk around to the front of the house, because the fire will have gone past." Instruct clients about the need for litter reduction on the ground. Give them good instruction in pit mulching and swaleing. If you have a very bad fire site, construct a few big swales, and cover the swales with old carpet so that you get a very fast rot down. Put in a whole lot of plants that are quite fire-proof. You can stand behind a Coprosma, and you don't even feel the fire, just a hot steam bath.

You can take advantage of the normal attributes of the raking animals, such as chickens. They break up that ground litter and mix it with oxygen so that it really breaks down. Short grazers, such as sheep and wallaby, on the fire side, will reduce the standing litter to one inch, and you will not need to worry about ground fire.

Just experimentally, I have lit around mulches, and they are not a risk. Sawdust, too, is good safe mulch. Actually, you may get a half inch fire across the top. It starts to smolder burn,

Permaculture Design Course Pamphlet VII - Permaculture for Fire Control

but it doesn't go anywhere. It can be quickly put out. You don't need to worry about mulches.

The primary protection in fire is to have good sprinklers down hill. If you can turn on a couple of those, you can sit on the front verandah and enjoy the sight of water pouring over the landscape before the fire gets there. I've seen water from the fireman's hose coming six feet from the nozzle and going up in the air as steam. If, before a fire gets there, you've turned your sprinklers on, and the ground is wet, the fire won't cross that ground. If the fire is already there when you put the sprinklers on, then the water doesn't get very far out of the sprinkler. So you must start your defenses before the fire.

Sprinkler systems on roofs are very critical. A house is lost when ashes fall all over the roof, slide down it, prop against chimneys and fill gutters. The wind is blowing; the heat returns in under the roof and catches tar paper and insulation, and starts burning from the ceiling under the roofing. That is the way 99% of houses ignite.

The safest houses in fire are wooden. They have a 13 to 15 percent higher survival than stone or brick, which is a surprise, of course. In analysis of some houses of equal risk that didn't survive, the brick outnumbered wood. Almost without exception, stone houses are taken by fire. Stone transmits heat rapidly to the inner surfaces. Bricks are equally fast heat transmitters. You can burn a wood house with a blow torch if you go around catching it in a lot of places. But a wooden house is very resistant. Basically, wooden houses won't transmit heat through the fabric, and their drafting systems are better than in brick houses. White painted wooden houses, and paint generally, anything that will reflect radiation, is a protection.

When you are planning for fire, you must specify the use of screens and fire hardware mesh, so that large particles cannot enter the house system. The gutters should also be screened. Wherever you are experiencing snow, fire, or heavy leaf drop on the roof, it becomes necessary to put a rolled-under section on the bottom edge of the roof, and put the gutter back under, below that. Leaves will fall off. They can't get in the gutter. Snow will slide off. When snow melts, the melt will go into the gutter. Fire ash will slide down and fall off. It won't get caught in the gutter, either. That is a good device, and it can be fitted to existing roofs.

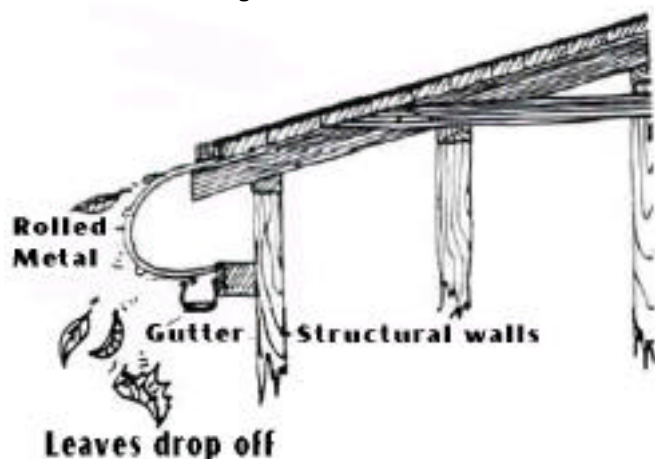

Rolled Roof Section

Illustration from *Permaculture II* by Bill Mollison, © 1979, all rights reserved.. Published by Tagari, 31 Rulla Rd., Sisters Creek TAS 73215 AUSTRALIA
Reproduced with permission.

Put a monsoon sprinkler on the ridge of the roof. It is only going to operate for a short period while the ash is falling. It will be the most sensible fixture that you can put on a house. The tap to it should be outside. Turn it on, and the whole house is being washed down for an essential half hour. The roof is continually washed, and the gutters are flowing. For this, you will need a gravity system, and it needs to be yours, because if it is part of a public system, every body will be drawing on it, and, likely, the system will be inadequate.

You must say to your client, "Well, look, we will give you a few simple specifics in housing design, and you must watch how you lay out your roads and ponds. That will give you a much better chance of survival." Also, advise your client about how to proceed in case of fire.

Fire builds up to high intensity about 2:00 to 3:00 p.m. Inevitably, the people at home are people with young children. Mostly, they won't have a vehicle. They are a vulnerable group, and they must be told what to do. If the fire comes from this side, they have to stand here with their woolies on, woolen jackets, blankets over them, and a bucket of water so that wool won't burn. Then go into this little shelter that we have provided and have a drink of water. We should try to get water in there. It's worth it. Just walk in there and sit down, and leave your woolen blanket in the water. Dig that shelter into a little hill just at the back of the house, normally away from the fire, on the slope. Go maybe six feet deep. Open your back door, and hop down into your little root cellar, which is also a fire shelter. We must look after the people in ways like that.

Advise people never to jump into water in fire. That is another no-no. There is no oxygen left in the water and they will faint straight away. It is like painting somebody's body. We breathe a lot through our skins. The fish already are dying from oxygen loss before fires ever get there. The people in the water will faint and drown. So jumping in the pond is a no-no.

In some areas, we will totally ignore this whole business, because for most of their history, those areas never burned. The prospects of a sweeping fire are remote.

Even in humid climates, high forested areas in the continental interior are not invulnerable to fire. When things dry up, and the wind whips about at 50 to 60 miles an hour, just a backfire from a car can set the whole area aflame. Fire travels about 400 miles an hour. There is no running away from it; no driving away from it. When fire starts, it spirals up, and increases in breadth at the base. You will be looking up at the sky, and there is half of somebody's house, way ahead of the fire – an incredible sight. You will be looking up at a blue sky, an upstream of smoke, and there goes that burning house, a great fire in the sky. Then it drops. At that point another spiral starts up. These big spirals go up, taking everything that is burning with them, then drop it out, to start new spirals. A fire will cover a thousand square miles in an hour. So most people who are in it are in it. You can't go away from it. You have to just hold your place and sit it out. Don't start running. Don't try to run ahead of it. You have more chance of surviving a fire if you run straight at it. If you run away from it you are dead. You have to just hold your place and sit it out. Don't start running. You can't drive your car, because the petrol will evaporate. Unlike Hollywood, gas tanks never blow up; cars never catch alight; only the tires do.

The sensible thing to do with high explosives, like drums of fuel and the like, is to store them away from a living situation, have them in separate sheds, a bit dispersed. When one ignites, it doesn't ignite the others.

Permaculture Design Course Pamphlet VII - Permaculture for Fire Control

Don't put your poor client at the head of a converging valley in the saddle. Don't put your client where you would normally put an efficient windmill. Don't put him where the ridges converge. No, no!

I witnessed an example of landscape architecture in an Australian fire-prone site. I was driving by this place, and I looked at this house – I couldn't believe it! There was an acre of fire-promoting vegetation just across the way, converging eucalyptus trees with pampas grass. It had been constructed by a landscape architect. While the aesthetics were reasonable; the function could be fatal.

So in my mind, function always comes first, then aesthetics. A good function is often a very pleasing aesthetic. He could have had a couple fire banks up the driveway. We could have had given him a pond and, just below it, a Coprosma hedge.

Construct the pond in front of the house, with your road beside it. The bank of the pond should rise toward the fire side. You will find that there isn't any conflict between good fire control and good placement of your elements. But if you don't have the initial planning, all sorts of things can go wrong.

Permaculture for Millionaires - XV

I am going to give you an anecdote.

When I was in Toronto at the Futures Conference, one thing I discovered was that the people critically interested in futures are those people who are making large investments. It wasn't a meeting of hippies. Hippies were in the two percent minority. This was the heart of Harbor Castle Hilton Hotel. I was in a pair of thongs, the only barefoot slopping in there. Here were investment bankers mobilizing their capital, some of their principals – not often many of their principals. These are people who deal in futures. Every businessman has a little clique around him. He has long term friends. If you meet one businessman, you have contacted somewhere between ten and twenty, intimates who are commonly ringing up and are doing deals, and who have had long associations. They are old friends.

I was one of the few people there who were giving anything positive. I think I was the only person there who was giving any indication of a future that you might be able to control. There were people there who were proposing ideas out of my control and, I'm sure, out of yours. There were proposals for a future that would need a huge amount of plumbing, technological fix. Whereas, I was indicating futures well within every man's capacity.

I gave them the example of Babassu palm.

It is within every investor's capacity to organize the development of fuel supplies from biological materials. I gave them the example of the Babassu palm. The Babassu palm grows under the worst conditions on the exposed coast of India. These palms produce a high sugar sap. It comes down to a harvest of about ten to twelve thousand liters of fuel per acre annually. And they can be heavily intercropped. They furnish very good shade cover for intercrop; and there are vast areas in India in eroded seaside condition where these palms can grow. Besides, the palms give – and for centuries have given – a very large proportion of the building and thatch and carpeting material. So the situation is ideal, really, for an enormous energy production coupled with food, and the material for people to build their own dwellings. For they are building entire buildings out of thatch, and they are appropriate dwellings, because that thatch is absolutely water tight, low mass, and ideal for that climate. It is extraordinarily good for dwellings.

So we can do this. It is certain that we can put in something better than an oil well for an indefinite period, and with far less investment capital. Now there are dozens of these situations where we can operate, and they lie in all sorts of energy realms, including things like buffalo gourds and yellow trees in deserts, which are eventually going to out produce an oil well.

So people were listening pretty hard. What we want to do is to enable these people to take what they want out – the palm juice – and to provide a base level living for thousands more people. The processing is fairly minor. Intercropping within the whole situation would make the palms healthier, and the people living in there and attending this operation would get all the secondary and other spin-offs.

I am trying to sell the rich the idea of commonwork.

What I am trying to sell the rich is the idea of commonwork. It is functional stacking. The original meaning of the word is to put one painting on top of another. It is like laying on colors. What we are laying on is functions.

Now, for instance, if we get a large company to lease a large part of the Indian foreshore from the state of Maharashtra and the start a Babassu palm production system, we would pay close attention to the ground. What we would set up would be an excellent sugar-palm production. This would be rich valley soil, and we would get a little keyline dam system going up along there. I worked out that sugar-palm system so the whole thing would be automatic harvest. No labor in harvesting except cutting the flower stems because the liquid is your saps. All we do is set up a whole system on an uphill slope and run it all down to one point. Then, in here, we would have other functions within the toddy sugar-palm system. There would be good places to live; they can graze cattle; they can take green-leaf *Desmodium*; they can take production from a bean crop, to the advantage of the health of the toddy palm. We can get in honey production, too.

All the investor wants is to earn a return.

We then have people who are looking after the toddy palms. We produce a crop. We produce honey. We practice aquaculture. The investor can let all of these go. All the investor wants is to earn a return from the alcohol production capacity of the site. All the other people own these other capacities. You would be surprised how many non-interfering overlays you can get on a site—overlays that will hold families in good health while maintaining an unending alcohol production.

Now the investor is not objecting to this, because he didn't want a fish production capacity; he didn't want a bee production capacity, and he didn't want grain crops. So these are the sort of propositions which businessmen are very willing to discuss. They don't even need to own the site. What they need to own then, is the right to the alcohol. As Gulbenkian says, "Let the meek inherit the Earth, just so long as I have the mineral rights."

Permaculture Design Course Pamphlet XV - Permaculture for Millionaires

So what is the logical way to go about this? Put the site into the Permaculture Institute. Then everybody receives the eternal right to that part of production in which they are interested. The Permaculture Institute holds and manages rights. Now that's a good proposition! Because what are they getting? Very low overhead, enriched crops, marvelous appearance in the eyes of the world – Look what we're doing here! Everybody is doing exactly what they want to do. Here are happy people who are keeping their situation healthy, and which some supervising designer, probably on site, trained in permaculture principles, is making sure it's working. Every one of those palm trees takes little vanilla orchids. So the permaculture designer starts stacking in, and he gives the care of the vanilla orchids to yet another group.

The rich don't have anybody to tell them what to do.

I see no reason for that not to happen. But what the rich don't have is anybody who can tell them what to do. I pointed out that they are not immune from acid rain; they are not immune from environmental disaster. They have no real desire to be moving among dead lakes, in a world that the wood chipper has stripped of the last of its forests, a world in which humankind is stranded on a naked rock. They own that they worry about it. But there is no leadership. They don't know where to look for leaders. They are thinking of funding schools to train people to be leaders. There is nobody to tell them what to do about the environment, how to handle this situation, give a businesslike, reasonable proposition. Nor is it possible to link to the alternative, because the alternative is not businesslike. The alternative has set up no structures that can integrate with ours. Now we have a structure. Here it is.

They understood. They can work in there with their banks; they can work in there with their investments. We can give spare lands over to them, of which we have several million acres that we are not using for this or that.

So we were the first people they ever met who were really alternative, really had ideas, really could suggest how they could invest their money, and who had a structure to which they could link. They just can't be running around themselves as individuals, or sending out people to try to find out how to link to the movements that are going on, and how to work with those movements to make a beneficial interface.

Dirty money!

Now there are those who say to us, "Don't go with them, it's dirty money." But then, there they are and here we are. We haven't 10 years to sort it out. It's war, or it's cooperation. For me it's going to be cooperation because war doesn't work. Opposition doesn't work. War replaces one lot of oppressors with another lot of oppressors.

There's no opposition.

There is no opposition in high echelons. So don't go looking for opposition; there is none. There is a high capacity for information gathering very rapidly. If we have data on acid rain, they can get it quicker. It's just that they had never thought to look. You give them that data, and say, "Go check it for yourself. Don't believe me." Do you know, this group can have it checked in maybe four days and get a high impact statement that is absolutely frightening? All they need to do is tell their very bright secretary to do it, and she, maybe, has a degree in biochemistry. She taps that acid rain, man, and brrrrrrrrrrrr.....

I said, "Look, I don't want you to believe me, but I tell you what – I'll give you four areas to look at and let you make up your own mind as to whether you have a future. Look at soils, forests,

pollution, and acid rain. You look there." We are not meeting any opposition. What we are looking at is complete acceptance, acceptance of a real situation with a methodology to which the investor can link. That's the whole situation. That's the sort of methodology we are working out for them. It is a valid methodology.

Companies are basically immortal. You can talk to a company about putting in a 70-year investment. They look at very long term investments.

Because you just can't turn off all coal production, there are two ways you can work on it. One is suppression of pollutants, and the other one is very rapid generation of a vast resource to replace coal. That's got to be biological. Frankly, I also think that we must go toward the decrease of energy use. You might be moving toward a rapid development of biological resources and at the same time assisting in the decrease of energy use.

When we get to the end of that cycle, maybe nobody is making much money; but look at the money Corning is going to make out of your attached greenhouses. So you can spot in these futures, and these are real futures. Capital can be switched to energy decreasing modes; no problem doing that.

Nobody is informed.

But the investor doesn't always have good advisor in these fields, either. Their own people are unequipped to advise. They are mainly graduates of economic schools and management schools. Those who employ them are for the main part people who inherited money. So nobody is informed. As soon as their vision widens to a comprehension of the future, they may say, "Where can I use what I've got?" or "Where do I fit into this?"

However, there is one problem. It's easy at the top to get these agreements, but that person usually has a set of underlings who get on with the actual work. Now that's where you strike trouble. It's exactly at the level of implementation that you strike trouble, because underlings are in the sort of desperate financial position where they are always looking out for their own corner. They don't want some parts of change, because there is no corner for them, no way they can continue to carry out the sort of operations to which they have become accustomed. For this reason, it is the principals, rather than the underlings, who must become involved in large scale permaculture conversion.

Yet they must have assistance. What we need is thousands of qualified permaculture designers, capable of handling the implementation and managerial aspects. To set up these permaculture systems on a scale of two or three million dollars investment capital, or two or three billion dollar investment capital risk, will take many designers full time for many years to adjust it and tune it and extend it.

It is worth doing something that size, for that is going to be effective as an example. The investor will be able to say, "Look! This year we have water in, and we have apricots growing around the water, and there are now ten families living here that weren't here before. This water stimulates the growth of palm trees. In seven years time we may be getting crops off here and here and here. Just look at what we are going to get!

And we are seven years ahead of everybody else!" It is a 10,000-liter an acre business, every year. With 500 acres of that –What's that worth compared to a liter of petrol? You have a \$5,000-an-acre business. So 500 acres of that is a 2.5-million-dollar proposition, and there are thousands of acres of it –thousands of acres with presently not another thing on

Permaculture Design Course Pamphlet XV - Permaculture for Millionaires

them except starving people, a few dying cattle, and a few pariah dogs.

Although it might be possible to shift 10, 20, 30-million dollars capital across within a month or two, who, who is going to oversee it? For this, you don't want some inspired person who wants to do good. You want a thoroughly competent person who knows exactly what to do. So we are trying to train inspired people to become competent. You can't train competent people to become inspired; but, again, we might well just do that, too.

Now there are many, many of these propositions that are of great interest to me. There are large areas of waste land, of desert, and all of which have a fantastic potential for production. In the Australian desert, land can be purchased at maybe \$120,000 for a 700 square miles, or \$200,000 for 1,000 square miles. In such areas there are probably 500 miles of excellent date washes, without anything else. Again, an enormous output of sugars. And that still leaves most of your area really untouched.

At the same time, an equal part of the investment capital should be directed toward energy use. Do you know what we need in deserts? We need sail freighters. We could sail any desert in freighters, and large freighters, too. All we need is a hundred foot wide strip which is sown down. All deserts have constant winds of 15 miles an hour, blowing all the time, and enormous loads could be sailed across the desert and straight to the coast. Everything produced in the desert is self-stored. It is in dry storage. So at the same time they are developing date production, we want them to be building the technology that cuts out the 600-gallon diesel engine tank, and the highway, and the truck – these things consume a lot more energy than is necessary.

It doesn't worry me if the investor doubles his money, providing we can go on doing what we are doing, providing they leave behind a huge number of people in charge of the land. In the end, you see, what you have is levels of function. All the investor buys is the product in which he is interested. The rest of it is the people's. That is all an investor is interested in when investing in an oil well – just the oil.

The cheapest way to make a profit out of a forest might be to go and cut it down, chip it and leave. That's happening. It is happening because people aren't persuaded that such a course is a deadly action. So information becomes vital. It is necessary to get this turned off. The man going to Borneo, wood chipping it and running, isn't usually an associate of these investors. They are simply providing money at interest to fund his operation. They are handling his account. When the people providing money for these operations become convinced that this sort of thing must stop, they can take that man out of there within two or three months, just by slowing down and drying up the flow of money. They can stop that operation without doing anything that is illegal, no marches, no fuss. Now that is all possible. Even the Mafia has to route money through financial systems. If you have a lot of allies within those financial systems, then you can stop certain operations much faster than you can running around and sitting down in front of chain-linked fences and getting arrested. But there must be a lot more of us at it. What we're in for is a persuasion job.

Put my thongs under the bed.

Some of us find all this enormously terrifying. It can throw a person into totally unaccustomed conditions. You're up 28 floors off the ground. Everybody is dressed smart and rushing in all directions, talking millions of dollars like mere pennies.

The butler asked me, did I want to have my clothes laid out? I said, "Yea, put my thongs under the bed." That sort of thing is going on. You have private planes running you to and fro. I wanted to have a look at some palm trees. The plane is chartered to take me flying up the valley and land me, collect me some seeds, and bring me back.

We can link to any multinational.

These people must become sold on what we are doing, must become excited about this sort of thing, convinced that it is a good thing. The beauty of it is that we have a system set up by which we can link to any multinational. Now you can take on amateurish methodologies that do not work and have no outreach at all. Or you can take on a methodology that they know, and which suits their financial and money transfer operation extraordinarily well. That means large money for operations there in India. And the spin-off benefits from those operations they can pass on to the people of India.

The world is made up of two sorts of people that I approve of. There are people who stay home and look after their house – I approve of those. And there are the people who are world-shakers. I approve of those, too. What we are dealing with here is the world-shakers.

We shouldn't be running around on the face of the Earth doing silly things. We should be centering in so that in two years time when you look at the globe, see what we are doing on the globe, it will look as if a lot of nuclei are all joining up. Everybody will be enjoying this. The financiers will be enjoying it; the people in the occupancy will be enjoying it; we will be enjoying it. It seems to me that this is where many of us ought to be heading if we have any capacity at all.

All that we want is to rapidly get reforestation back on the Earth.

There are these very large cattle and sheep ranching operations, and, being scarcely financial, they are cheap. The people who started up those ranches got the land for nothing, or for a shilling an acre, or ten cents an acre. They stocked them with half wild cattle. The sod went off, trodden into the ground. To buy that land now, with 400,000 cattle on it, you will never make money. So what we must see in property is a totally different function. It is essential to get all the cattle off those properties. In all of Australia, they probably don't produce as many cattle as in Essex in England. Thousands of cattle die for every one harvested, and if the market is no good, they don't harvest. We need to get these very large areas under control and very quickly. In one of those areas it would take ten of us to even see half of it, let alone direct operations.

Show that it can be done.

Our job is to make resolutions in conflict, to set up social meetings between people who have ideas and skills, and people who have the power to move things. Let's get a large section of these arid lands, sell the commonwork idea and get cracking out there on real arid land agriculture that counts on its own rainfall to make production. Show that it can be done. Then we've done a good thing. We give them all their money back. They have good real estate that we have substantially improved, and we have happy people all over the place carrying out functions. I have two Australian aborigines who are superb desert nurserymen. That's the sort of consultants we want on those jobs.



DESIGNING FOR PERMACULTURE

BY BILL MOLLISON

Pamphlet VIII in the Permaculture Design Course Series
Edited from Transcript of the Permaculture Design Course,
The Rural Education Center, Wilton NH USA, 1981

PUBLISHED BY

YANKEE PERMACULTURE

Publisher and Distributor of Permaculture Publications

Barking Frogs Permaculture Center

P.O. Box 52, Sparr FL 32192-0052 USA

Email: YankeePerm@aol.com

<http://barkingfrogspc.tripod.com/frames.html>

<http://www.permaculture.net/~EPTA/Hemenway.htm>

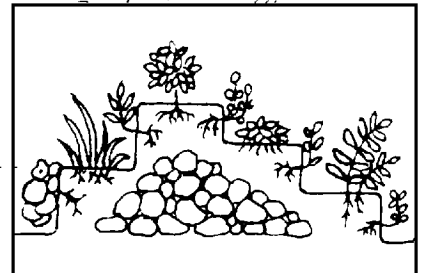
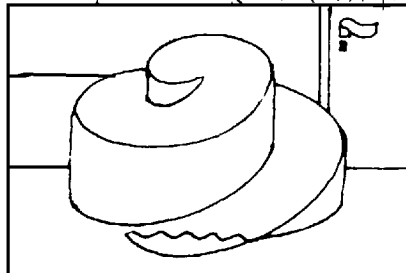
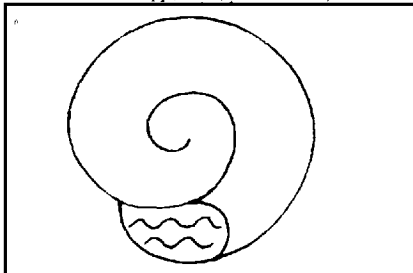

Designing for Permaculture

This is the eighth in a series of 15 pamphlets based on the 1981 Permaculture Design Course given by Bill Mollison at The Rural Education Center, Wilton, New Hampshire, USA. Elizabeth Beyor, without compensation, undertook the transcription of tape recordings of the course and subsequent editing of the transcripts into 15 pamphlets. Subsequently, Thelma Snell produced the original typescript for all pamphlets in this series. Later, Meara Culligan entered the pamphlets on computer disk from which we have re-edited this edition. In deference to the monumental task of love represented by Bill's assembly of the Permaculture Design Course, and by the other volunteer efforts leading to this pamphlet, Yankee Permaculture has placed it in the public domain. The reproduction of *Designing for Permaculture* is free to all and highly encouraged. The Permaculture Design Course Pamphlet Series is now also available in electronic formats.

Translations of some of these pamphlets into some other languages are available. Order permaculture paper #27 from the Yankee Permaculture order form for an up-to-date list. Volunteers are now needed to translate these pamphlets into other languages. We are happy to hear from volunteers in any capacity. Yankee Permaculture continues to depend on volunteers for all of our publications. If you want to help, contact us at the address on the cover.

For Mother Earth

Dan & Cynthia Hemenway, Sparr, Florida, USA, June, 2001, Fourth Edition

Permaculture Design Course Pamphlet Series	Quantity	Price
Complete Set of 15 Pamphlets. Bill Mollison. \$35	\$35.00	SET _____ \$ _____
Complete Set, Electronic Edition (disk or email)	\$50.00	SETFD _____ \$ _____
I An Introduction to Permaculture. (Updated resources.)	\$3.50	I _____ \$ _____
II Permaculture in Humid Landscapes.	\$7.50	II _____ \$ _____
III Permaculture in Arid Landscapes.	\$3.75	III _____ \$ _____
IV Permaculture on Low Islands. (See V for combined price.)		IV _____
V Permaculture on High Islands. (IV, V, & VI offered as one pamphlet.)	\$2.50	V _____ \$ _____
VI Permaculture on Granitic Landscapes. (See V for combined price.)		VI _____
VII Permaculture for Fire Control. (See XV for combined price.)		VII _____
VIII Designing for Permaculture. (New material added, new edition)	\$8.50	VIII _____ \$ _____
IX Permaculture Techniques. (New material added, new edition)	\$8.50	IX _____ \$ _____
X Forests in Permaculture.	\$6.25	X _____ \$ _____
XI Water in Permaculture.	\$3.75	XI _____ \$ _____
XII Permaculture for Urban Areas & Urban-Rural Linkages. [With New Resource List]	\$3.00	XII _____ \$ _____
XIII The Permaculture Community.	\$2.00	XIII _____ \$ _____
XIV The Permaculture Alternative.	\$2.50	XIV _____ \$ _____
XV Permaculture for Millionaires.	\$2.50	XV _____ \$ _____
SUBTOTAL (Minimum order, US\$5.00)		\$ _____
Postage & Handling US addresses add \$10 plus 10% of first \$250 of order. Elsewhere add 20 %.		\$ _____
Contributions to supply literature requested by "Third World" groups, grade school students, etc.....		\$ _____
Other Contributions (Scholarship fund, Tree Tithe, "Third World" courses, etc. Please specify).....		\$ _____
TOTAL		\$ _____
Enclosed is my check or money order payable to Yankee Permaculture		\$ _____

A service charge will be assessed for correspondence on orders that are underpaid or unclear. Because of exorbitant bank fees to exchange non-U.S. currency into U.S. dollars, we can only accept payment by check drawn on a U.S. bank or by International Postal Money Order in U.S. dollars. **IMPORTANT--**Make postal money orders payable exactly as follows: "Dan or Cynthia Hemenway." The U.S. Post office may refuse to cash money orders payable to Yankee Permaculture!

A SERVICE CHARGE of at least \$25.00 will be assessed for returned checks. We do not carry accounts--payment must accompany order.

TREE TITHE: As of January 1, 1985, all Yankee Permaculture publications carry in their price a **Tree Tithe**. We set aside this money for re-planting trees to compensate for those cut to make the paper that we use. Contributions to the Tree Tithe Fund are accepted.

For full terms, see the complete Yankee Permaculture Order Form.

Designing for Permaculture – Bill Mollison

In this paper, Bill Mollison talks about training people to produce permaculture designs for others. This is an important approach. My own priority is to train people to produce their own designs and to train particularly gifted people to teach this skill to others. Permaculture can, potentially, solve the world environmental crisis. However, I believe that this can happen only if people everywhere integrate permaculture into what stands for their own culture and apply permaculture principles daily. Specialists who charge professional fees (rightly in my view) can be a small part of the solution. However, if that is what permaculture becomes predominantly, then permaculture will become, alas, part of the problem. Empowerment, not control, should be our goal. I believe that diversity of strategies, both empowering people directly to produce their own permaculture designs and providing professional assistance for more difficult design problems, are necessary for permaculture to reach its objective—a nurturing human habitation within the Earth's ecosystems.—Dan Hemenway

PROFESSIONAL PERMACULTURE DESIGNERS' ETHICS

1. As a group of designers, we cooperate; we do not compete.
2. We do not duplicate each other's work. As far as possible, we create and use individual designs.
3. We care for our clients and are responsible to them.
4. The end to which we are working is the reforestation of the Earth and the restoration of its soils to health.
5. We care for the environment and wildlife. In all our design work, we side with that "super client," Gaia, which is an old Greek word for the Mother Earth Goddess. Earth was conceived of then as a living, thinking organism, a biological entity.
6. We seek the best, the most appropriate energy paths, utilizing appropriate energy.
7. We recycle at the highest level possible. Everything can be a resource. You must know how to use it. Use what you have. Try to make the least change produce the most effect.
8. A final ethic that we practice in our community in Tasmania is that we divest ourselves of everything surplus to our needs. But we don't ask you to do that.

THE ROLE OF THE PROFESSIONAL DESIGNER

As designers, your function is to know where to place things, and why. It is not your function to tell people how to garden, or how to build a house, or how to build a dam, although you may comment on all those things. Your function as a designer is to place things in the environment, and place them in such a way that you use their multiple functions, that you create low energy inputs for high yield and stability.

At the same time, your role is that of a creative observer. You must learn to observe nature, to recognize how to develop potential uses so that humans may benefit.

As designers, we try to build implementation groups, regional people who we can recommend to carry out the designs.

BUSINESS PRACTICES

We ask you to work for a year or two before you submit an application to the Permaculture Institute for a design diploma.¹

Design Course Training

We hope that, within a couple of years, teams from these design groups will get together and train more designers and implementers and run workshops to involve more people.

We offer scholarships in every course, and they are of this nature: If a person wants to work as a designer without charge, we do not charge him for the course; but he still has to pay the host group their basic cost. We will take one or two of those persons in every course. However, should the person start to charge for his work he should pay the fee to the people who trained him. We expect you to contact indigenous groups to inform them that such a course is scheduled, and that one or two scholarships are offered. If the course includes as many as 30 people, you can afford to take four people on a scholarship basis.

Presently, we are short of women as designers, and we need to compensate that deficiency, so half of design course participants must be women. Make it perfectly clear to all applicants that you are running the course for people who intend to become designers. Otherwise, you are wasting your time and theirs. This is heavy stuff; it is critical. While rural backgrounds are not necessary, it is essential that people have discipline and experience. Leave it to the hosting group to select from the applicants, making their selection on this basis.

I believe it is wisest to open some design courses to post-graduate students only; so in that way you will get economists

and business management people. We are going to need all those skills.²

I want to emphasize that we should not be expecting our children to change the world. Unless we do it, our children do not have a world to change.

Finding Work

Conduct weekend workshops, from which jobs will come. Lecture. Write articles for local journals. Only when you are established, with a back-up team, should you advertise as permaculture designers. Start modestly and gain experience before you find yourself with more work than you can handle!

² After working with Mollison's recommendations for some time, we found it useful to modify the approach as follows. First, hosts are **required** to recruit at least half women students. After encouraging indigenous people to attend, scholarships are used to assist in recruiting women, where payment is a barrier. In this way, some of the male/female balance in the permaculture movement is redressed. (In the US, and I suspect elsewhere, women typically earn two-thirds the pay for men yet often have the principal responsibility for rearing children as well.) All hosts are **required** to offer free or affordable child care at our courses. Again due to the imbalance factor, disadvantaged minorities also receive scholarship preference. We aim for one full scholarship for each six paid tuitions (or two half-scholarships, etc.) Almost always, we split the tuition evenly with hosts. The host can give as many scholarships as desired from his/her half, of course, and nominates people to receive our share of scholarships. We make the final decision on these. For more details, send at least US\$10 to Yankee Permaculture at the address on the cover. Ask for the Elfin Permaculture full design course packet for hosts including scholarship information. Elfin Permaculture also offers a 10-day design intensive to qualify people to design their own homes. This has proven very effective. Because it offers far more design experience than is possible in our three-week Permaculture Design Course, which covers many topics, it has also proven useful as a preparation for the design course or for post-graduate work with advanced design assignments. We also find that a weekend workshop, Friday night through Sunday afternoon, is very useful, mainly because it is short enough for everyone to find time to attend but long enough to permit student design experience.

¹ Contact the Permaculture Institute at POB 1, Tyalgum NSW 2484 AUSTRALIA. Other groups, including Elfin Permaculture at the address on the cover, have since qualified to certify designers.

Charges for Design Jobs

In general, we suggest that you charge for any work. However, almost without exception, you can organize a free job in the context of a paid job. Do the free work when you are in the area for paid job, thereby keeping your own cost down.

We tie our rates to those of local landscape architects. You have the individual right to set your fees. This discussion comes from our own past experience. It is usual to quote a price for a job, unless it is a job involving much work over a long time, in which case you might want to work on an hourly basis. Set down exactly what and how you do charge.

We have charged a daily rate for a normal job, which is up to about 40 acres, one day on site, and a typed, documented, and illustrated report later. The report would run about 15 to 20 pages.³ The text should contain numerous small pictures, little details. Refer to books. We always finish every report with an invitation to the client to inquire further at no cost. Whenever we have second thoughts on our design, we inform the client in a letter.

When you get into a big job, over 100 acres, and they want a detailed design, you have to start quoting on a time basis. You may find that you want to do group work on the larger properties.

A pre-design report on any big job consists of outlining what is generally possible, and how you can be of help in the future doing intensive designs for specific areas. Never go into a big job and attempt to do the total design immediately. Give the client a brief from which he can decide how to proceed. You can figure the design cost at 1 1/2% to 2% of the total investment that the client will need to make in implementing design. Determine how much the client proposes to spend on improvements, and figure your fee at 1% to 2% of that amount. You can quote on that basis. You usually charge about \$35 per hour for professional permaculture design work.⁴

You may develop village projects, such as in Davis, California. Perhaps you can do a pre-design for the group, pre-directions for people moving into the settlement. Later, you⁵ might produce individual designs for the people moving in.

There is another service that we can offer: a sheet of principles for people to hand to the architect who is planning to build their house. Also, we may assist the client in finding an architect to handle a special kind of structure.

Start a network, linking resource people—horticulture, architecture, agricultural engineering, realty agent, public relations, office people.

Finding Property for a Client

You may be asked to find property for a client. The first criterion, and extremely important, is that the client have his own water supply potential on site. The second criterion is that the site suits what the client wants to do. The third criterion is that the site in its present usage has been undervalued. The fourth criterion is that the site preferably be multi-titled, or without limitations on the kind of structures you can build, and the number of people you can accommodate. Sometimes you can get property that runs into town sites that will permit you to place 20 or more people on an area. The fifth criterion is that you must know that for your client you can improve that property to a high level. Land that has been strip-mined is a good example. The sixth criterion is that we do not select land for a client that has been valued for sub-division, because that is the highest price, unless you see a particular resource there that

³ We find that our reports often can run much longer than this. An Elfin Permaculture design report includes the design proper, a reference section or bibliography, a resource section, and an appendix. See the sample outline at the back of this paper.

⁴ This figure was based on 1981 conditions. It is now a fair starting price for beginning designers.

⁵ A pre-design for a community is very similar to a set of zoning regulations in our experience. - DH

has been overlooked in assessing the land's value. Finally, when you look for land for a client, you want to persuade the client to share your concern for the rehabilitation of the property.

There is a further reason why multiple titles are useful. The area may need a nursery. We might then site the nursery on a small title, so that somebody is in there involved in improving the place.

The charge for finding land is usually 1/2% of the purchase price of the property, just to find the property, plus an additional 1 1/2% on purchase, if they buy the property. You can figure the cost at about \$400 a week plus expenses.⁶

Keep a very keen eye on the local labor condition and the local market for particular land uses. This is different from the service offered by a real estate agent. You will be finding for a particular client a particular property, and cheaper than he can do it on his own. You charge the client, rather than, as in the case of a real estate agent, the seller of the property. It is not necessary to deal with a real estate agent, if you find the property and are able to contract for the purchase of it yourself. However, if you start to deal through a real estate agent, ethically, you continue to do so.

We have just begun to work as developers. There are villages that we are developing now; but our priority is to train more designers, because we do not have enough people to cope with all that work.

Energy budgeting and resource inventory are other services that you can offer. You will have to investigate your own price structure. I can think of many other services into which we could go. Soon, we should be the developers. We just don't have that power yet.

We want to acquire and preserve wild areas. whenever you travel and work and read, think of how to change large areas, such as dry lands, from cattle and sheep usage, which is destroying the land, to really productive areas. It might be as simple as the growing of aloe vera, which on a hundred acres is of greater value than sheep raising on 10,000 acres. When you get an idea, then you start to look for a client with the land, or you may start to look for someone who will buy the land to demonstrate such a revolutionary usage. You want to establish much of your design work as a demonstration site in some manner.

Have a good relationship with real estate people. I believe least 80% of the real estate agents support what we are doing. It would be good to print hand-outs for real estate agents, telling them about permaculture.

Managing Land

The management of land may require a couple of months a year. We charge \$2,000 to \$5,000 a year, depending on the amount of work required. Many people own land on which they do not live, and which may be in some use. They want somebody just to keep an eye on the property. Real estate people in Australia earn an income from managing maybe as many as 50 local properties. They perform services such as buying in and selling stock. They arrange harvests; arrange markets. They charge a flat rate for these services. Often you might oversee five properties for one client. He would have to pay a resident manager a salary of about \$15,000 a year. You can offer a frequent visit proposition where your fares are paid, at a charge of perhaps only \$5,000 a year, and you can oversee three, four, or five of those properties.

But as a trained designer, that takes you right out. As fast as we train designers, we lose designers. If we act as managers, we will never have enough designers in the district! Some will go into long term urban development; some will be taken into management, and there are many other places where designers are disappearing, fixed into some on-going situation. Education is one of these.

⁶ Based on 1981 conditions.

REPORT WRITING

Methodology

1. Collect all data: the client's requirements, maps, local regulations.
2. Analyze the client's problems.
3. Recognize those permaculture principles that fit this particular situation and can be applied to the problems.
4. Apply permaculture principles specifically to the problems involved.

5. Design solutions in the form of edges, patterning, increased functional relationships.
6. Check everything over to make sure this solution adequately meets all the client's needs, takes care of all problems. Once you have covered everything, you can write the report.

General Description of Site

Begin with a brief general description of the site and its placement in the region. This includes a very brief description of orientation of site, existing vegetation, existing water, soils.

Then draw a main map, with site broken into identifiable areas to be treated in detail later.

Themes that Affect the Whole Site

It would be logical next to deal with themes such as Fire Protection, for example, describing steps the client will need to take to protect against the hazards of fire.

Another theme might have to do with Legal Issues pertaining to the client: as an example, the possible advantages of trusts, land trusts, a non-profit organization.

Community Involvement would be a theme in the case of a client who would like to start a community on the site and needs help getting things together. You can recommend ways and means for getting people there, and for involving the local community.

Another theme, for a client contemplating going into a commercial crop, would be the Local Market Situation.

In some cases, Wild Life Control or Mosquito Control might be applicable themes.

After having dealt with general themes, proceed to:

Details of the Areas

You have, at the outset, defined the site as to zones. In writing your report, do not refer to specific zones in the same way that we refer to them in this course. Simply locate the areas, such as house site, intensive garden, etc. First, define each site by name. Then you may give to each separately identified site a location number, so that you have a map with each of these little areas numbered.

In your report, starting at the location you have numbered (1), work through each area, developing your design in depth. The first one will nearly always be the house site and the intensive garden area, because that is where the client ordinarily should be working first.

Principles of House Design

If the client does not have a house already built, this section should include a quick description of energy requirements and recommendations of certain types of architecture. If you know a good builder, you could recommend one.

If there is an existing structure, you can make retrofit recommendations, involving climate amelioration with glass houses, shade houses, trellising, vines, earth banks, windbreaks, perhaps ponds in the garden.

Define where the garden goes, including space for small fruits. However, you do not need to go into specific gardening technique. You can refer to books on the subject and suggest that there are methods of gardening which save energy. List all book references in a Bibliography at the end of the report.

You may need to discuss the possibility of collecting rain water from the roof, and therefore suggest locating a tank or barn roof at a higher level so water can move by gravity flow downhill to the house and garden area.

Again, treat water as a theme, if your design includes many issues throughout the site pertaining to water.

You then go to the next area, which may be the orchard, or a small chicken forest forage system. If it is an orchard, you describe the planting systems, the management systems, and how to bring animals into the orchard.

The Report

In this way, you go through each area, dealing in detail with each of the problems the area involves.

You will find that drawings probably will help people to understand what you want to describe. You may need drawings similar to those in Permaculture II illustrating horseshoe-shaped windbreaks. You should define the species in the windbreak. It may be useful to make some drawings of fencing layouts. You may want to do an enlarged drawing of a specific area, such as zone 1 and the intensive garden.

Standard Designs

You will probably can slip some standard designs into your report, writing bridging pieces. You often can develop your own standard designs for a variety of situations. If you send them in to us, we will print them. You will get an author's margin for each one sold. If you are a good designer, you might go into the business of doing standard designs for a living. Standard designs can deal with architectural themes as well as landscaping and agricultural design. Construction of an ice-house could be one example.

You will be getting towards the end of your report.

Bibliography

When you have treated in detail all the themes and each of the individual areas, compile a bibliography. This will include all books that you have referred to in the report, plus others that may be relevant to the design.

You will need to become familiar with these books and keep abreast of new ones. It would help if some person in the consultancy group could be an information collector, making it a practice to run through the latest books.

A Plant List

Your report should include a documented plant list. You will need to be careful in your recommendations, avoid including plants that are illegal in that region or that could become rampant on the site.

Initially you will need to get together a personal filing system for plants and animals, with information about each. You may need, on occasion, to make a specific list for a specific job, which may take a fair amount of research. You should familiarize yourself with local people who are a source of information on plant and animal species.

A Resource List

This should include a list of people in the area who perhaps can help the client. This might include other clients for whom you have completed design jobs, whose properties they might visit, just to see what is happening.

You will need a list of resources for hardware, with reference to tools and technologies they will be need.

It is well to remember, as you do initial designs in an area, that it would be useful to establish people as suppliers of ma-

⁷ .Several permaculture publishers, including Yankee Permaculture, will publish standard designs. You can require a per-copy royalty or a standard 10% royalty. See the Yankee Permaculture Order Form and the Yankee Permaculture Special Order Form (Yankee Permaculture Paper #27 on the back of our regular order form) for a listing of available standard designs, species lists, etc.

⁸ Since this 1981 statement, I have heard of no-one who has made a living writing standard designs. They are, however, a modest income supplement and avoid having to reinvent the wheel each time a new designer tackles a problem.

materials for further design jobs. A nursery would be very useful in this way.

Priority Staging/Cost Analysis

You will need to know how much money the client has to spend, and what he wants to ultimately accomplish. You will show him where to start, and approximately what it is going to cost, and work through everything in that way. You must never omit this, never hand this report to the client with all these lovely ideas, while he has no idea where to start, what to do first. You need to outline the best way to go about things.

There is something else that you may want to do, though it isn't always necessary: that is, to outline a management policy

specific to permaculture, dealing with the succession of plants, succession, and how the client can speed things by time stacking. This is something that usually fits in at the end of the a report.

In your conclusion, make it clear that you do not guarantee anything in this report since many conditions can change because you are dealing with natural phenomena and changing environmental and market situations.

Assure the client that you will answer further questions at no extra charge. Ask him to feel free to write at any time, and indicate also that you will try to visit him occasionally, just to see how things are going.

Type-One Errors

Even an experienced designer can make errors. Keep a check-list and go over it frequently.

Error 1: Undertaking a design job for people whose aims are environmentally destructive, for example, a group that wants to hack out a hole in the forest for themselves. When approached by such people, you should always side with the super-client—the environment. More often than not, though, the people you are dealing with are really good people.

Error 2: Not telling your client the reasons for your recommendations. You must always explain why you have recommended, for example, putting this drain in there, which you may have designed to carry grey water to some particular secondary use.

Error 3: The recommendation of a difficult technology, beyond the client's ability to handle.

Error 4: Not supplying adequate management data, sufficient directions about how to run the place after the client gets it going. For example, the orchard needs specific management strategy, as does changing over from one system to another.

Error 5: Writing a report with a depersonalized approach. Your reporting style should be direct, friendly, and fairly personal.

Error 6: Failing to be specific, employing expressions that are loose and vague, like "fairly large."

Error 7: Poor patterning. Very carefully think through those edges and the link-ups between the different patterns incorporated in your design.

Error 8: Failing to recommend essential pre-treatments. For example, explain how the client should condition his soil for the uses that you recommend.

Error 9: Recommending the use of plant species illegal in that area.

Error 10: Failing to fully define the resources that are on site, and to explain how they can be useful. That, of course, involves your ability to see them.

DESIGN WORK

Though our immediate interest is the client, people are merely a temporary event on the site. Our real, underlying interest is the site itself, though we may not choose to tell everyone that. So we try to persuade our client to use good management principles. We have a marriage to make between the client and the site, by means of the design itself. What we are trying to do, really, is to design for the site itself a reasonable future.

It is essential to find out what your client's resources are. There are two or three categories of resources to which we need to attend. The client has skill resources, and experience resources. He has material resource and capital. We need to know the client fairly well, to sit down with the client or client group, and find out all about them, and specifically what they want. It is probable that they want a certain set of things, which might be cows, pigs, turkeys, chickens, and orchards. Try to find out all those things.

Learn about the lifestyle that the client group envisage. It may be one of partial self-reliance; or of some form of production on site; or simply some degree of self-reliance, which may be food only. Determine whether they want economic independence, or whether they are quite happy with their jobs, or whether they have the capacity to make an income on the site, even in a remote location. There are people who have this capacity. A good example is a potter. The client's main income, then, would be from an activity not really related to the site. The client's skills, then, comprise one set of resources.

Another set of resources are on the site itself. Many of these may not have been seen by the client to be resources. This is where you come in. This is where you have the opportunity to earn your fee, perhaps repaying your client several

times over. If you are good at seeing the site's resources, then you have earned your fee.

Those resources vary. There may be rampant plant species on the site, as in the case of a city farm of 18 acres that is covered with fennel. Your client could clear the fennel and start doing something on the site. But if you read up on fennel, as I did when I encountered such a site, you will find that just a simple steam distillation process makes fennel valuable. Fennel has a fraction, very easily separated, which is the basis for licorice. The site was already "planted" to a very high value crop that would finance the development of the rest of the site. If you fail to see that, then you have missed your opportunity; you have just thrown most of your income away at the outset. If you do see it, not only can the client process his fennel, but he can buy more, and become a fennel processing center for the area. While there is nothing wrong with clearing the fennel to start an orchard, he might as well use it as he clears it. You, as an employed designer, need to show this to the client.¹⁰

There are varied categories of resources on site. This is where your field observations come in. Are there grasshoppers? Are they a resource?

You need to have at least some basic knowledge of herbs. Perhaps there is a resource there.

Sometimes below swamps and marshes there is a high value, bluish clay. The peats themselves in swamps are a product of high value. If you are going to dam an area, you might decide whether you are going to leave six inches of peat on the bottom, or three feet of it. What is the point of leaving three feet of peat in a dam site? You might as well take two feet of it out and leave six inches as your pond floor.

⁹ Elfin Permaculture has developed a 20+ page *Permaculture Design Client Survey*, available as Yankee Permaculture Paper #21, that provides most of the questions that should be asked of the client about preferences, resources and site conditions. It is available for license to other permaculture designers.

¹⁰ For example, see Yankee Permaculture Paper #34, the *Kudzu Utilization Concept Paper*.

So you observe the property, looking for mosses and peat, for weeds and herbs and insect life. The site might even contain some salable seed. These are your Earth Resources.

Look for unlimited resources with profit potential. Are there sources of salable energy on the site? Is there a 100-foot all-year round flow of falls, or can you give your client that? Can your client sit at home munching his self-reliance carrots while the electric meter ticks in the opposite direction and the money flows in? Can he sell clean water, which is fast becoming the world's rarest mineral? Is there water on site that can be metered down-hill to other groups? Does your client have an excellent wind site? Is it worthwhile to forget farming and erect a wind energy system that enables him to sell power at wholesale? Is usable wood rotting or going to burn in the next bush fire?

If any of these things is there, then you give your clients their living. So be careful that you do not overlook the energy potential of the site.

We have found that in four years we can grow commercial balsa from seedlings. This was the first balsa plantation in Australia. A three-year old balsa tree is worth about \$5,000.

Aloe vera is a burn ointment that retails in pots.

Get your client to put a little bit of capital that he was perhaps planning to put into a fence, or something else which he doesn't need, into the development of some income-producing enterprise.

This is the way you report. You talk with the clients, examine the site, then go home and spent a few days looking through literature or writing to a research librarian for information, for example, on fennel.

Another resource may be eucalyptus oil, which is worth \$100 a gallon. But within that gallon there are three one-ounce fractions worth \$1,000 an ounce. So with a second small step of fractional distillation in a tiny amount, using a one gallon still, you are \$3,000 ahead. An apparatus that costs you \$600 will pay for itself in the first distillation.

I had a client in India, the state government piggery, which raises pigs on 64 acres, spreading manure all over those 64 acres. There is so much of it that it kills everything. Yet they had a huge pig feed bill, for they fed the pigs grain. As I walked down the road, I could see breadfruit falling from the trees. They needed to plant those 64 acres to breadfruit and feed the breadfruit to the pigs, increasing the amount of valuable food for the neighborhood. Moreover, the government gets a cheap hog. I also suggested that they give the local farmers breadfruit trees and a pig, on a buy-back basis.

Look at forest management. If ever a fire sweeps across the site, it will remove hundreds of tons of biomass. Whether we remove it for some use, or whether we let it lie there to burn in a catastrophic fire, that is a debate. When you take out dead wood, you don't drop the soil 12 inches, as a fire will. It is well to remember also that we will be doing other forest management things: swaleing, and providing for the growing of more biomass, a lot more biomass. We will be putting a lot more energy through this forest than before. You can allow the forest to remain, as at present, at a crowded standstill, with a slight accretion value; or you can manage it to produce much more biomass.

The client may not see some of the site's resources., Meanwhile, he employs himself with little enterprises that bring him only a few dollars a year.

There are Earth resources: there are plant resources; and there are energy resources on the site. Water is a mineral that is salable. You see all the city health freaks staggering upstairs with two great bottles of water that they bought from some farmer. So if your client has a source of good water, he may be able to sell the water. He can analyze the water before he sells it. Around here, where you get all this acid rain, to sell water would be selling acid.

The site may hold yet other resources. You have to keep your eyes open. They could be animal resources, invertebrate or vertebrate. You must keep an eye out for what might be good there that isn't presently there. That site might be the greatest unplanted goldenseal farm in the country.

I characterize another set of resources as social resources. Does the site lend itself to seminar and teaching work? - To recreation? This depends on the location of the site and on available facilities.

So what can the site produce? All the better if that is a unique production. As a tropical crop, quinine, particularly that cultivated quinine from Java, with about 8% actual quinine in the bark, can be a valuable crop because all other forms of malarial control are failing, and quinine is coming back with a thump.

If the site suits some particular easily processed plant species of unique value, then maybe your client can grow a different cash crop than he had originally planned.

As an example, I turned the site of one client into water. I didn't leave much land surface except the area where he set his house. He went into Australia's first aquatic nursery. He can sell seed and plants and people can come and look at it.

Don't worry about being able to identify each of these plants. The world is full of botanists and horticulturists. All you have to do is design. You don't have to be a botanist; you don't have to be a bulldozer driver; you don't have to be a fence builder; you don't have to be an architect. What the designer has to do is look at the relationships.

This is a big job, becoming aware of site resources. I warn you, it is better to go around the site and contemplate it on your own. Make it absolutely plain to people that you must have a few hours on your own. You might use a spade. Look at the quality of the peat. You might find a bit of good clay. If you do, recommend to your client that he show it to a potter. The potter will give him the characteristics of the clay. That is what happened to us. We bought a 40-acre swamp, and we found that we had two feet of peat, and under the peat was a blue clay. We took it to a potter. He spun it on the wheel and it produced beautiful urns. He said, "I will pay you \$6 a bag for that, and so will anybody." We had a clay mine that we didn't buy as a clay mine.

Make sure that if some resource is there, particularly wind power, that your client takes out a permit to exploit the resource on his own land. In America, the multinationals are getting wind power into the same category as mining resources. So if you have a good wind site and they find it, they could stake it out. So get your client to stake it out. It costs little to do this. The same goes for his clay. Get him to take out the miner's rights to his clay. That is part of your report work. It is your job to find out what has to be licensed in order to exploit it. Does he need a license to sell water from his land? I doubt it. If he is on his own hillside, he probably owns that water. Be sure to find out. If he doesn't, he had better take out a right to the water on his land before he gets bypassed. Clients on the seashore need special rights to collect seaweeds or driftwood, or shells. That is why you should have a good lawyer to see that there are no covenants on land when you buy it, or when your client buys it, or when you recommend that he buys it.

A recent client of mine found that he had a gold mine as well as another mine on his property that he thought was just a hole in the ground. They were chartered by the mines department and he had been subject to leases in past times; but the leases had lapsed. Your client might care to do a little part time gold mining, while making his pond. Or he might make a hanging garden in his quarry—another wonder of Ninevah.

Assemble your various resources—Earth resources; biological resources—plants, animals, and insect life; the energy resources of wind, water, wood, oil, and gas; and the social resources that might need rights. You will earn your fee.

If people choose not to live from their land, just point out the value of the available resources, and that somebody else might care to lease them. The client, in any event, might care to take out the rights to the resources on his property.

We have another category to look at, and that is a category frequently missed by consultants—resources extrinsic to the site, resources that lie in the district. There are the resources of market, or maybe the resources of waste products, or the resources of certain unfulfilled demands in the area. There might be a need for such an item as a soil conditioner. You must point out these resources to your client.

A district may lack various things, such as hardware for which there may already be a demand. Obviously, this country around here is short of tanks. If it is a question of agency instead of manufacture, next year anyone selling tanks could be well off. Just print a pamphlet and leave one here and there; you don't have to have a tank. Sell three, then you get one free. The same arrangement may be responsible for selling certain other equipment useful for permaculture establishment. At least, have the distributor's rights; also, if possible, the manufacturing rights.

The district may produce wastes useful to your client. As you come and go to the job, you ask about these matters.

If you have done all that, you really have earned your fee without any design work at all. We are looking out for the site, increasing the number of ways in which the site stores energy, increasing soil productivity, and building soil fertility, rather than taking it out. If you make a client happy while you are doing that, good. If your client won't go along with some of these things, you can tell him that he wants somebody else, like the agriculture department, or a forestry commissioner, who will tell him how to cut his forest. You are not about to tell him how to cut his forest down. We have an ethic. We work on certain ethical basis.

If you get a rich client, watch it! Keep your mouth shut until you get things together and can present your report properly, and that's very good advice!

I went with one of my friends, who was a designer, to look at a design he had been working on only a few days before. He said to his client, "You should really have a diversion drain down here to increase this water output." His client immediately got out his bulldozer and charged uphill at about 25 degrees and put an incredibly bad canal around the hill. Keep your mouth shut. If it is a rich client, it must be done instantly! Just keep quiet until you get out of there and tell him how to do it properly. Otherwise, he may do it badly.

So you are ready for designing, and where do you start? First, you get your property boundaries set. On a big property, you might have to fly the bounds. Photography isn't much good to you. Maps aren't really, either, except to find out where you are going, or if you want records. It is really just a matter of playing around on your own. The most important step is to experience the site. You are your own best compound tool. You have senses for judging wind and temperature and evaporation and slope. You have eyes. Observation is your best tool. Experience is your second best tool. After that, apply other tools. It might be useful to suggest to your client that he start to make his own plans and decide upon some priorities.

Having determined the property boundaries, you may be in one of two positions. There may be certain things in place, in which case you have to work around them. You are then into a retrofit design. Your most difficult retrofit job is often right around dwellings and buildings, where most of the energy is burned. If you are asked to design a farm, you might point out to your client that you could save him much more money by starting around his house. Spend a day crawling under the foundations and poking about, and leave his farm alone, because his house is costing him much more than his farm. This case is typical.

But if you find yourself in the second position, where nothing has yet happened, it is a very happy state of affairs.

If nothing has yet happened, focus on to how to bring access into the site¹¹. Where there are already access roads, determine who maintains them, whether, if you make a road, it will be publicly maintained. Design the access to minimize upkeep. A misplaced road into the site will cost more over time than almost anything else, including the house itself. If you design access according to keyline principles, even if you have another mile to go in your initial road, the maintenance of the road will be so light that you may save thousands of dollars. A road should run very gently across slope and do little turns on plateaus. The access road should run up the center of ridges, right on the top of ridges, so that it can drain. Often this is the only possible place to locate a road in rough country. There are occasionally good valley roads, running along rivers, but they need fairly high maintenance. The designer must pay much attention to access. It is there that you can save your client much money. Be sure to explain to the client why you are doing it that way.

Always finish your access upgrade to the dwelling, no matter if you have to drop it a little to run it upgrade to the house. There are various reasons for this. Most access roads that descend to the house carry water down around the house area, and it is always a nuisance. When your car battery is flat, there is nothing like being able to get a gravity roll. In a winter climate, it is good to have a road in the sun. You will have less shoveling to do. An access road can do all those things and still protect against fire. You can plant to stop snow drifting. Those are small points to which you must attend.

Placing access is your first move.

Then you locate the house site, or sites, if this involves a group of people. In a community design, stress in your report that the free selection of the house sites is just not acceptable. When a mob of hippies moves into a colony, half of them head for the ridge-top and sit right in the saddle dam, and the rest of them move into the bush. These two sites are type-one errors.

If several houses be constructed on a site, as in the case of a land trust where possibly 10 people will build homes, advise them that a designer should select those sites and connect them with access roads. Otherwise, the results will be the sort of thing we typically strike. I can give you a real example. A mob of hippies bought a big valley a few miles long. There was public access to the site. Every hippie either headed for the ridge, or else down below somewhere, and there were a succession of roads going up and down the slope. They should have built on a mid-slope position, with a single access road only about a third as long and indefinitely sustainable. All these roads that they built are already starting to gully out. You don't have the right to do that to land. Nobody has the right to do that to land.

We would designate sun-facing sites all the way along this road, sites that are totally private and totally serviceable from single water, single road systems. You must suggest to clients that these house spots be marked, and people have only to select from the marked sites.

There are criteria for the selection of the house site.

Consider the thermal position. Keep the house site away from the fire tunnels. A house on a ridge in a valley is very badly situated. The valley funnels wind, and the ridge catches it. Get your client off that ridge—just below the ridge. He will lose very little in view. Just get him from that top. On the other hand, it is not a bad site on a ridge where there is a minor ridge between two major ridges. When you are backing into the mountains looking out to the sun, you know, sitting on a little ridge between two ridges is ideal. That is a typical Appalachian site. You will see that time and again.

¹¹ I find that it is useful to first identify water resources and flows, then to site access, dwellings, and land uses.--DH

Look at these figures. Sixty per cent of the energy efficiency is lost just by being exposed. That applies even to your solar heat collector. It is only 40% efficient when high winds blow across it. Most of the heat simply blows away. Don't position a giant house on a bare ridge top. A place like that changes hands every four years, because nobody can stand the misery and the energy expense. If a place is a happy place, it very rarely changes hands, maybe three or four times in 200 years. The miserably sited place turns over very quickly. As a rule, the fewer trees around it, the oftener it resells. Lack of trees is a miserable thing for cattle and people.

So map out your access, pick your house site, and then look at your client's list of things the he wants to do. After you have pointed out resources, people might want to abandon some of these choices in favor of some new enterprise.

Now lay out the water systems. Try to lay out the water, access, and house sites as a single entity. Everything else will fit into that. You need not worry much about the details if you get this right.

There are two type-one errors—very bad errors—to avoid. One is to site your client on these ridges, or in wind tunnels, or in fire funnels. The other one is to put people in the bush, to make a tiny clearing in the bush and locate a house in there. From the moment people move to the site, they experience terrible conflict.

Our clients are usually very conservation minded people. They like squirrels and chipmunks and beavers. They don't ordinarily shoot them all day long. As soon as we locate a client in the scrub, we make him a very attractive target for all the local animal and bird population. They are racing for his pumpkins.

What happens? The woodchucks go there. So he has to kill the woodchucks. He didn't want to do that. What's more, he will kill woodchucks all his life. It's true. He has to shoot wallabies, kill woodchucks, go out with a club and beat possums on the head. Yet he is a gentle vegetarian soul. The animals are badly killed and mangled so the client gets a guilt complex. He heads back to town because he can't stand it. He has to leave it to somebody else to carry out this bloodthirsty business, all because you put him in the bush!

Perhaps he has a nice white pine by the fence, and he can't grow anything within 40 feet of it. So is he going to starve or kill the white pine? He is going to kill the white pine. Gradually, the site begins to look like a bit of penicillin in the middle of bacteria. Everything around gets murdered. The client turns into the usual redneck. For what turns a person into a redneck is constant killing. You can turn a gentle conservationist into a real rough person. **You** did it. That's **your** fault. Or, if it was somebody else who did it, then you have a retrofit job on your hands.

While it is a type-one error to site a client on a ridge top, subject to fire and cold, and often without water, you must also be careful not to put him where the next catastrophe is going to destroy him—mud flows, or volcanoes. Verify that you didn't do that. You should have this check-list before you when you write reports. These errors are very serious.

If you are asked to design for a site that is completely wooded, first have a long heart-to-heart talk with the client. See if it wouldn't be more sensible for him to buy certain foods from neighbors. See whether he really wants to clear garden space there. If he does, you might as well clear it. But point out to him that he can provide all his food from a very tight situation, such as a large attached glasshouse plus a fully enclosed and electric-fenced eighth of an acre. Suggest that he go in for highly intensive gardening.

There are places in Australia called conservation areas. In one, all 385 titles in the area are owned by groups with a single aim. They limit themselves to one eighth of an acre to live by, and they do it. So it means the whole area is a gigantic wildlife area with thousands of kangaroo and wallaby and pos-

sum. Each person who comes there—now by law—has to exist on an eighth of an acre. It can be done. Much food may be produced under glass. There are then no worries about bears and raccoons. Indeed, a tight situation may not be much more expensive than an extensive one.

You might also try to persuade the client to make money out of the forest and buy in his food. If not, go ahead and clear an acre of forest, and make sure the material cleared is used to the highest advantage.

Zones

The human dwelling is the core of the design. That design might be for a settlement, a village, a town, a house, or a modest cave under the rock.

Around that core, we specify zones. These zones are not really concentric circles. You can indicate them as you like, but what I want to point out is that they are not bounded. It is a convenient, abstract way to deal with distances from the core of the design. Zones in a permaculture design represent places where you are more frequently or less frequently present. I call them zone one, two, three, etc., for purposes of identification. While I have seen people attempt to build those zones with circular fences, we did not do the design like that! Of course, it works perfectly well that way. But that is not really what we do.

I am talking about the distance from the core of the design. That which is farthest should require the least number of visits. The least-visited place around this house may be just below this window. It is more distant than the place in front of the barn. We go to the barn every day, twice a day, to milk cows. We probably go there for two or three other reasons as well. So, really, that patch of country in front of the barn is much closer to us than that bit of ground under this window. There is often a little bit of your house somewhere that you hardly ever see. Any of you who own a quarter of an acre can define maybe an eighth of it that you hardly ever visit. You may go there once a year. If you own 200 acres, there will be a large amount of it on which your foot never falls.

Zone one is the place where you are always present, where you make daily visits. It is around the entries to your house, and along the pathways between your house and any other object that you visit frequently. Clearly define those zone one areas. You place in them small plants, small animals, and those high energy, high production units that comprise the most important elements of self-reliance. The annuals there are in constant turnover, high demand, and the perennials there yield constantly. Keep there small animals that require care—the calves, chickens and ducklings. The more attention they must have, the closer you bring them. It's that simple. If you design this consciously, it is amazing how much more the site produces.

I often tell people to just imagine a big clump of parsley 20 feet away. You've made soup. You look out, it is raining, and you are in your floppy slippers, curlers in your hair. There is no way you are setting out to cover those 20 feet out and 20 feet back. So you do not get the harvest. That happens frequently. You plant so many things that you never harvest, and that do not get the attention they require because they are not under your eye.

It is true with the greenhouse. It is a bright morning. The day is just beginning to warm, and nobody has opened the vents. The seedlings start to cook, all because the greenhouse is way down there, a hundred yards from where anybody walks.

This zone one area doesn't really extend any more than 20 or 30 feet from the foundation of the house, and not from all the foundation. What we are really talking about is a little area that does not ever reach around to the back of the house. It's very close. From that, you get most of your food. If you have any sense, you get all your food except a couple of items from there.

It is nice to have a couple of little ponds in zone one, little four foot ponds, and one of those very close to a path. That's the one with the watercress. That is a pond from which you can take pounds and pounds of food.

It is full of tadpoles. This is frog city. Five or six gallons of tadpoles, and brother, you have many friends. It is really easy too, to select the frog you want. If you want frogs in the top of the trees, you take the frog eggs from the water surface. If you want frogs in the cabbages, you take eggs from mid-water; and if you want frogs running around in your mulch eating slugs, you have to scrape your pond bottom.

The reason is this: Your high life tadpoles, your tree frog tadpoles, are those tadpoles that are free swimmers, and tadpoles stratify in the water as the frogs stratify in the environment. Those tree frog tadpoles are buoyant, they will not sink. The frogs that burrow and scrub around in the leaf litter, have sinking tadpoles¹². They have to swim hard to rise in the water, and don't very often do so. They live in the pond as the frogs live on land, down in the mulch. So you just make your decisions.

If you send children out after tadpoles, they only bring in high-living frogs, because they never get down to these bottom tadpoles. Those tadpoles in the base have heavily pigmented tails, and the frogs also are heavily pigmented frogs. These tadpoles have changeable colors and so do the frogs. They adopt the color of their surroundings. Big tree frogs climb maybe 80 feet from the ground. Medium size tree frogs occupy the shrubs and bushes, and little tree frogs are the ones that sit in your cabbages.

Within zone one, if you are doing mulch gardening, it is fully mulched. There is no bare soil. If you are a triple deep digger, it is fully made into beds. All those methods produce good vegetables. We will not make you choose a method. It depends upon what suits you. I'm lazy—full mulch suits me. You are vigorous, triple digging suits you. Triple digging suits you now because you are young. Full mulching, you will grow into. So technique is not a fixed thing. It is something appropriate to occasion, to sources, to age, inclination and conviction. Mostly, it's a case of conviction. Well, it doesn't hurt to let people have their convictions sometimes—if they are harmless convictions.

That's the annual garden. There are really two classes of plants in the annual garden—those that you continually pick, or pick frequently and those that you harvest once or just a few times. The first group includes mainly the soft herbs, and the things that are yielding frequently, like broccoli, parsley, and most of the salad greens. If you don't cut the heads from broccoli, you lose production. If you have a broccoli around the corner, often half of it goes to seed before you get to it.

The other class of vegetable you eliminate when you do harvest them. They are your tubers, roots, head vegetables. Celery falls in between, depending on your habits. We always put celery on the paths, because we always just take two stalks. I never in my life used more than two stalks of celery at a time. I know people who grow celery in bunches and cut it right off. To them, celery is a head plant. To me it is a plucking plant. Those things you pluck closely follow your pathways; those things you cut off lay behind them. There is nothing more stupid than wading through a patch of cabbages to get to parsley, and nothing more logical than bordering paths with parsley, so that you never tread into the other area except maybe once or twice in its life. Design where your plants are to go, so your garden can be fully mulched with high turnover, mainly annuals, some perennials, some biennials.

This garden is under constant invasion. It is very attractive to weeds and running things. So once you have decided its borders, you might very well border it. Select border plants from those that do not permit invaders to penetrate them. You may still leave little areas unplanned, into which people can extend, if

they want, or into which they put things that are aesthetically important.

In zone two, unless you have extraordinary resources, there is no way that you are going to continue a fully mulched garden. Two of us mulchers went to Orange Bathurst Agricultural College and laid two different mulch gardens for the agricultural students to look at, and to weigh and measure against their clean-till gardens. Ours was so good that the vegetables tasted better than theirs, produced a lot more. One chap went home and applied nine acres of it!

It is a common thing for people to build a house and then hunt for a garden site. Having found a place for a garden, they make one there. They build a glass house somewhere, and their chicken house. By this time they are worn out. They have to cart their manure to the garden. They lay out an orchard somewhere, and they are desperately trying to get it pruned. They didn't ever have enough time or sufficient understanding to enable them to put anything together.

People will have a little house on a residential block, surrounded by flowers and lawn and shrubbery. Behind the house, way back in a corner, hidden by some discreet trellis, they burn things and cultivate a modest vegetable garden.

You recognize that pattern. It is so universal that to move a cabbage to this lawn is a cause for total neighborhood consternation. A man in Tasmania moved four cabbages out on his nature strip. The council sent two trucks and seven men and had them removed. The truck pulled up, the men hopped out, took long handled shovels, dug out his cabbages, threw a couple in each of the trucks, stood there for a while and had a couple of cigarettes. That act of defiance by one citizen was formally wiped out with a great show of force. To plant cabbages on the nature strip was just indecent of him, totally indecent.

Why should it be indecent to make practical use of the fore half of your property or around your house where people can see it? Why is it low status to use that area? The condition really has one origin, and that is peculiar to England and to the whole British landscape ethic. The British tradition has produced the whole profession of landscape designers in the English speaking world, and much of the non-English speaking world. Where landscape gardeners have never existed, this separation doesn't exist. What you are really looking at here is a tiny little British country estate, designed for people who had servants. The tradition has moved right into the cities, and right down to quarter acre patches. It has become a cultural status symbol to present a non-productive facade.

Lawns are interesting. Remember, there were lawns before there were lawnmowers. In India there are lawns today where there are no lawnmowers. I took a photograph of the lawn being cut on the Taj Mahal. Thirty-six widows moved forward on their knees, cutting the grass with their little knives. Lawn is a salute to power.

The nuclear family these days is smaller, yet the house is bigger. The childless couple are flat out keeping up with this situation. As well as being the lord and lady of the house, they are often the sole caretakers of the whole property. They are in an awful trap, really. They don't use any of that lawn. They don't have any time to go out there and enjoy it. This is the whole basis of landscape architecture. It is a symbol of status.

Well, many people have started to ignore it. I have a friend who has brought the whole design forward in front of his house, and it has spilled out onto the council strip. Out in the street you are wading through pumpkins. Another instance—I was walking up a street in Perth one day, and suddenly in one corner the whole area came to life. Beans and peas and all sorts of vines were growing along the footpaths and up the trees. It looked like a real Eden in this desert of status.

In the Davis village project you have a very beautiful landscape, with nearly 90% of it of some use. But not quite all of it. We don't need to have everything to be utilitarian. There is no

¹². This probably does not apply to tadpoles everywhere. - DH

reason why we shouldn't have daffodils and cabbages growing together. The gladiola can be a genuine companion plant in an onion bed, so put onions with gladiolas, instead of planning gladioli in the front garden and onions in the back. Marigolds are good to have all through the place. So are nasturtiums, because of their root interference with anything that looks like white fly. They have a communal root interchange with things like tomatoes. When you pull your flowers out of your vegetable garden, up goes your pest problem. Well, we are the pioneers of the new ethic.

In warmer climates, we may even have a lemon tree in zone one. The lemon tree is a daily crop, a constantly used food. So is the lime tree. In the tropics, and even in Tasmania, people use some limes every day.

We must remember to include some access in zone one, and space for dumping organic matter, whether for compost or mulch. We want the space for it reserved, and perhaps screened from view.

I suggest that this zone be bordered and blocked from surrounding areas for several reasons. One is that we want it to be a very sheltered area because it has the highest energy flow-through, and it can provide practically the total food supply. The second reason is that we don't want crabgrass coming in here. So we must decide what row of plants we can put into the border. There are some desirable characteristics we are seeking. They could very well be fireproof. It would be good if they were dark underneath, and if they themselves were highly adapted to low light condition while under them nothing would grow. They should also have some use within zone one, as well as serving some function in zone two. Within zone two they might serve as forage. But in zone one we want manures for our garden.

You might fence zone one, particularly where there is any chance of conflict with animals. A very easy protection, and the cheapest, is a netted fence with an underground layer and a single electric wire standing four inches above the top of it on the outside. I don't know any predator that will get past that, underground, above ground, or climbing. Barriers two feet underground stop most burrowers. When you are not dealing with burrowers, put a layer of fencing on the ground outside and put a rock on that. Use one inch mesh. Inch-and-a-quarter mesh is too large. Chipmunks and baby rabbits will go through it. A three foot fence should be adequate for all but deer. For deer, you would need a higher fence.

We need well-defined criteria for zone one barrier plants. They should be good wind defenses that won't burn and do not allow much understory. Some of the sunflowers and the Jerusalem artichoke planted in a band about four feet wide are suitable. They establish very quickly. They do the job the year you plant them. The Siberian pea tree as a hedge would be a good barrier plant. As you clip it, you can lay the clippings directly in your annual garden as a mulch. We use *Coprosma repens* (New Zealand mirror plant).

Start your border inside the fence. With browsers on the outside, it provides a high value product for browsing animals, so we don't need to bother clipping on the outside. Clipping inside, we get a high potash-nitrogen mulch that rots quickly in the garden. We can trench it where we will be growing beans and peas, or we can just lay it under our mulch.

We plant a wind barrier along the opposite sector from the sun, so there is no need to worry about shade from these plants. It pays to run smaller permanent shelters within the garden, too. I believe the Jerusalem artichoke, the Siberian pea tree and comfrey perhaps best meet our criteria. We want a plant that is soft, easily pruned, nitrogenous, high potash, and preferably alkaline. Given that set of conditions, you will find maybe 50 plants for that barrier. These plants must be a total barrier, permitting no other vegetation to grow under them, because we want a non-weeding situation. The only weeds that grow are a few dandelions, which we permit, and a couple of

bunches of clover, just for teas and salads. We don't have any other weeds in zone one.

Zone one is tightly controlled, weed free. I also like it to be absolutely dig free. Mainly, we eat it. Finish zone one with well placed, irregular entries, which may be cross-wind trellised. You can work it out real sweet, so that you can go through it on a slant, across wind. All this is critically important to the production within zone one.

Through this first zone, leave spaces for expansion. Zone one can expand or contract, depending on your back problems, your age, and the number of children you harbor. Your client may start out wanting a big garden now, then progress to wanting a small garden toward the end of his life. His perennial garden is then bearing. Permaculture designs adjust it to your age. Your yield increases while your digging decreases.

Zone two is not fully mulched. It may contain main crop gardens. They shouldn't be in that little area of annual garden. Here grow crops that you much use, much store, maybe only have a single harvest, maybe only visit three times to fully harvest. Stick a few tomatoes in zone one, but when you are putting in 50 plants, you are not going out every day and pick them, you are going to go through them two or three times, and eventually pull the whole plant, hang it inside and let it finish ripening. Your winter-keeping squash will go in zone two, while your zucchini and your patty-pan squash go quite close to the parsley. You are always nipping them. You could run through any plant list and quickly assign each of them to their functional zones. Zone two might be row-cropped. It need not be mulched. If you have a lot of free mulch, then mulch it. If you haven't, clean cultivate it.

You could put strawberries in zone two. You also could put some in zone one. Asparagus definitely goes in zone two. It has a very short season. You might not run this barrier hedge until after you had gone beyond your asparagus beds and a couple of other things that might require mulch.¹³

The purposes of the zones is to design distances properly. When you do this, it just pays hundreds of times over. Every time I break my own rules—and I do—I'm sorry. Zone one is for lettuce, spinach, green beans, pole beans—the things you are picking every day and bringing in and going out for. It should have lots and lots of parsley. I've never seen anybody with enough parsley.

Raspberries I would put in zone two, perhaps 40 feet away. You are there every day in season, so they are still not far away.¹⁴

Pumpkins could grow anywhere. I've grown them a mile away at the edge of a swamp, which happened to be a nice spot. They stream through the trees.

Blueberries, in small numbers, are domestic crop. Fifty blueberry plants approaches commercial scale. Two hundred strawberry plants edges towards a commercial crop. You will

¹³ . Design asparagus in connection with other crops. For example, it works well with tomatoes, which are a suitable companion crop, or cucurbits, which will climb on the fronds. Asparagus benefits from ducks and chickens, which eat the asparagus beetle add fertilizer. Ducks keep mulch relatively undisturbed, a benefit on sloped beds, while chickens will shred and scratch mulch on flat beds, keeping weeds from interfering. If the asparagus bed is just sunward of a plum orchard or thicket, poultry can be held in the plums until just asparagus cutting is over and the shoots have toughened, as poultry also control plum pests, especially early in the season. A plum thicket is excellent cover for chickens if pursued by predators. Poultry manure greatly increases asparagus yields. A good design might arrange poultry fence, gates, asparagus, and plums to permit poultry forage, tomatoes, or cucurbits in asparagus, in rotation or according to management needs. - DH

¹⁴ . Raspberries are an edge species. Specifically, red raspberries suit dry, sunny edges while black raspberries like partially or lightly shaded edges in well drained soil over moisture. Both work very well in poultry forages and either could be added to the asparagus design suggested above, forming an edge between the asparagus and plums or even a skirt around mature plum trees. Once the client indicates the species to include in the design, the properties of the species, site and climate indicate the correct arrangements. - DH

have plenty of buckets to give away. Beyond that, you would have to start selling them, and be putting in eight or 10 hours a week on strawberries.

You have to think all this out, if you are going to design this in detail.

Get some area under glass. Whether you are designing for retrofit, or new construction, attach the kitchen to glass house with a connecting entrance. Provide a direct view from the dish washing area into the glass house. Put some life into your glass house—a covey of little quail—so that you are not looking at a static situation. Quail come and go—sometimes they take dust baths. Frogs will climb the kitchen window. If you have to stand somewhere doing tedious work, it is awful just to be looking at a blank wall. While looking into this highly interesting design, you don't mind the work at all. We've been able to arrange this in almost every house we've had a hand in designing. I like it. When I return to those places. I always look through those windows. Put a little soft turtle—not snapping turtles—in the pond. They disappear in the mulch, then come back to the pond. When there is something alive nearby, it gives a good feeling. A little turtle living in mulch will eat worms and slugs. Turtles are good little things to have in there. And you can't beat a gecko. The average gecko is designed for glass houses. He will go anywhere in a glass house, upside down, downside up, round about.¹⁵

Whenever possible, zone two should include the range of some high manurial animals like chickens. House them at the edge of zone one, or very close to it. We are deliberately exploiting a larger system (zone two) to enrich a smaller one (zone one). We do it through the medium of an animal collector.

If your client is on a hillside, and he intends to milk goats, you can use that expanded-mesh flooring in both the chicken and goat houses. You can walk on it. That is very good material, too, to use in mud situations, along entries into the house. Just lay eight feet of that. The mud falls under.

We advise our clients never to dig these animal shelters into the hillside, but project them out, and put in a mesh floor. Look what's on the edge of zone one! When you are working in a cabbage patch, you can grab your rake, reach under the chicken house and pull out manure. That works very well. We have designed several of these. Everybody has been very pleased with them. They always have dry, stored manure and shredded bedding ready to be transferred to the garden.

These animals range in zone two. For milk goats, it is easy to bring a corridor into zone two, with a range in zone three. Edge the corridor with *Rosa rugosa*, which is a good milk goat plant. Planted just outside a coarse mesh fence, the goats will be doing all the pruning as they come through the corridor. It is often possible to have chickens and ducks contained within zone two. Because they require daily attention, we bring the housing of those small domestic animals, and even the milk cow as close as we can. You can bring it very close without much problem. You can bring it right here where we will be using the manures and we won't have carting problems. The pig, I would usually stock to the back in zone two. In confined quarters, pigs can get a bit messy. It depends on how much range you have. When pigs run on grass,¹⁶ they're very clean animals, and can bed close to zone one.

¹⁵ . When we first lived in Florida [USA], I positioned my desk so that I looked out into the garden. Just incidental to doing my office work, I learned far more about interactions between my garden and the surrounding trees and jungle than ever I could in any other way. A key to permaculture is that we experience the inner zones intensely, thereby improving our chances of making the right moves in the small area where we do the most living. -- DH.

¹⁶ . Locate feeder pigs so that they can be released in zone 1 and 2 gardens in the fall. Temporary fence lightly staked in place with a strand of electric inside, about six inches from the ground, will confine them to the intended area. The stock fence need only slow them down so that they get the electric shock, which pigs detest. They will not only clean up crop residue, but eat grubs,

Zone two contains the pruned orchard, the main crops, spot-mulched crops, thin spread compost, rather than heavily applied mulch, lightly, rather than heavily manured crops. Zone two contains the foods that comprise the bulk of the storage goods of the client group, along with many additional elements, products from small animals. The outer zone is designed to bring the high turnover nutrient to the high turnover zone.

When we collect acorns and bring them in to the chickens, they provide high value manure, and high value mulch. Nut husk mulch is of high value. It is usually alkaline, and high in calcium content. So we gather thinly from the outer zones material that is recycled by the animals for use in the zone one area.

So far, in dealing with zonation, we haven't said anything about how we swivel these systems. We start in to play with them. We set elements on discs and spin the discs to see how they fit. I'm not going to start spinning the discs just yet. You can begin to list the elements: limited mulch, orchard main crop, and purely domestic animals, of which there aren't very many. The Chinese may limit themselves to the duck and the pig. We will include the chicken. In Asia, the quail will be included; in South America, the guinea pig. Western Europe and perhaps New Zealand might bring in geese. The pigeons would be important in many countries. If you look at the old names on maps, you will see that pigeons used to be an element in this culture. Where cot or cote is a part of the place name, there were pigeons.

We are creating a biological funnel. We are deliberately creating a nutrient vortex. We are bending the rules. Everything farms for itself, does exactly the same thing that we are doing. Animals do the same. The Emu may have been among the very first agriculturists. Look at the beaver. The beaver knows what he is doing.

These zones really do have imaginary borders. If you want to bring a milk cow into zone two, it might extend out to two acres. It is still a very limited area. It would be limited to a maximum of two acres. Anybody who is really controlling an acre is feeding many people. No doubt about that.

Did you ever, at any time in your life, make the mistake of plowing four acres and putting it down to vegetables? I did that. I hopped on my brand new tractor, ripped 12 acres of beautiful soil, bought large armfuls of seed and planted the whole 12 acres on my own. I only saw about an acre of it after that. I grew rich and fed hundreds of people on an acre of it.

So two acres is enough. It contains quite a variety of elements, elements that make life worth living, like the patch of apples, and the eggs from our chickens. If you fully develop these two acres, you have a very productive unit.

Some people live in financial self-sufficiency on an eighth of an acre. Other people need 500 acres. The multi-nationalists would need several million acres, scattered around the world.

If you think it out, you can earn a livelihood on a very tiny area. There is a man near Melbourne who provides the parsley for the town, which is about the size of Boston. Around Boston, you rarely see parsley, except little bits laying on the sides of plates, strewn on butcher shop meats, little bits of it within the salad, placed here and there. Much of it is not eaten. I always eat mine, but some people just leave it on their plate. So every day, each day of the year, this man harvests two boxes full of parsley and he makes a good living out of it.

slugs, snails, witchgrass (quack grass) and probably other stoloniferous grasses. Pigs are the quickest way to eradicate Jerusalem artichoke and will quickly destroy asparagus, so fence judiciously. Pigs do not stink, but if they are fed garbage, the portions they do not eat can stink badly. In cool fall weather, the odor is less so the pigs can be moved conveniently closer. If started in spring, by fall they are eating a great deal and produce a corresponding amount of manure. The result is weed and pest free soil fertilized and lightly cultivated by rooting, ready for spring planting. Pigs are also useful in pastures where they selectively root out thistle and some other pasture weeds and in orchards after harvest, where they glean drops that could otherwise harbor pests over winter. Mollison describes **Pig Raising and Free Range Forage Species** in Yankee Permaculture Paper 19. Elfin Permaculture Consultancy has additional experience in using pigs in permaculture designs.

There is another person who was a clerk in the city. An eight-acre farm in the hills, with a modest little house, was for sale. The previous owner had died. The city clerk had just enough money to put the deposit down on this property. He wanted to get out of the city, yet he was terrified to get out. This property was just at the limit where he could drive to his job. So he bought the property on a Tuesday, and went to work on Wednesday, Thursday and Friday. On Friday, when he came home, he looked around the garden. It looked pretty wild. There was nothing much that he could see to eat in there. So he determined to clean this garden so that he could get organized. He arose in the morning, took his tools, and was about to make a hole in this horrible mess, when a gentleman walked in, well dressed in a suit. The gentleman said, "Can I cut my flowers?"

The man asked, "Who are you?"

The gentleman said, "Well, I am an undertaker, and I had an arrangement with the former owner to get our flowers here each weekend."

So the gentleman gave him a check for \$50 and wandered into that mess and came out with armsfull of flowers. That happened three times that weekend. This city clerk never went to work again. The previous owner had established a system so that every month of the year there were flowers. He died rich.

How much does it require to get out of the city? It all depends on how clever you are at discovering the needs in the surrounding area. You might just grow water chestnuts. It is up to your ingenuity. You can think big and have a thousand head of cattle, or 2,000 chickens. Or you can make a very good living and go around the world once a year on half an acre.

So it is up to you. If you want to enlarge that glass house and become a neighborhood supplier of certain essentials, then you wouldn't even need half an acre. If you want to go into the market against the beef growers, you make a big investment. But if you want to go into your own small market situation, you need very little.

One gross error that we have all made is to try to occupy too much land, and not really develop any of this land we have. A casual glance around this place here will show you that at least 90% of the resources are un-used, 10% partly used, and less than 1% used in any effective way. So you have two approaches. If you care for it foot by foot, you are high and dry long before anybody that tackles it on the broad scale. Not only does almost everything you do work, and everything you plant survive, if you treat it that way, fully occupying the area, you don't need to extend very far. But in broadscale orchards and hedgerows, the amount of success decreases as you extend. You will be putting much money into something that is not going to work anyhow. So, as designers, stress this nuclear approach.

We can point out on the site areas to reserve for vital uses, so that we won't be putting the future pond site by the house to some other purpose. We won't plant it to trees, but will prepare it for its eventual use.

The borders we need to establish will become apparent as we start to analyze the activities that the design requires. There will be many borders, not as simple as that one bordering the zone one garden. These have many criteria.

Beyond that, we come to zone three, which is just a name, of course. Here, we design unpruned fruit and nut production, with a high proportion of seedlings. We go into the management of existing resources. It is in this zone that the Portuguese graft onto existing oaks, or existing vines, or even wild vines. We start to adopt infrequent management strategies right along with our intensive cultivation strategy. We devise all sorts of self-harvesting systems. We use different techniques. We are into adjustment rather than ordering. We drop many of our power plays and become more sophisticated.

The animals within zone three verge on the non-domesticated. The animals themselves take on a different life style. You start to select species that are more self-caring. Most sheep

are not domesticated animals, and can go within this zone. Milk sheep come closer in; the wool sheep go further out. Beyond that, there are only certain things we might bring into this zone. We might bring in water; and we might bring in firewood and structural timbers. It comes down to what your client wants, what he thinks is basic, and what he can handle. There may be clients who want to rear deer as their main activity. In that case, you shift zone three inwards, because the client doesn't want much of that zone two function.

You can bring a corridor of zone four right to the house, allowing you to feed deer at your back door. I like wallabies right where I can sit and talk to them.

It is easier to bring in birds, because gardens, shrubs, and trees attract them. For clients who are so very fortunate as to have a beaver dam or some wallaby or deer, you can often lead these wild elements to the house or very close to it.¹⁷ You can attract them with plants or surplus nutrient, deciding which of those elements are appropriate. If you want to bring in a porcupine, you do an entirely different design than if you want to bring in a snapping turtle. For snapping turtles, you might need a canal coming in there, and many spare chickens running along the side of it. Then you'll get snapping turtles.

I had a client who had 8,000 acres. Every place he looked on that property, he could see a suitable place for a house. He couldn't make up his mind. So he asked me to help him decide. Within these 8,000 acres was a marsh, a low lying area. I said, "What will you do with that marsh?"

He said, "Drain it, and sow it down to pasture "

Well, we had a fire problem in the area, so I didn't want those swamps drained. With a very low Earth wall, maybe three or four feet, we created a lake from the marsh, and a little house on this lake. Running right to the side of the house, we have lawns that are swan-wombat lawns, quite thick with swan and wombat. This at least gives the impression that he is a gentleman of leisure, with his green lawns stretching out along the lake shore. His lawnmowers are these wild elements.

He is tickled pink with this, really pleased with it all. Had we not used these elements, he would have extinguished them.

I have come fresh from another and opposite example. Andrew and I were employed by a vegetarian community that had several thousand acres. The site of that community was the only opening in the forest. These people don't eat animals, and they don't fence against them. They were trying to grow vegetables in there, and attempting to grow nut trees.

This environment attracted everything that ever ate vegetables. From that great forest came kangaroos, emus, wombats, dingoes, cockatoos. I need not go any further, because you haven't a single thing left—not an apple, a nut, a lettuce plant, or a pumpkin. They hired people to poison and kill those animals. All around their settlement, over a very large area of forest, there was nothing but death. All because they are vegetarians, there are now thousands of carcasses rotting in that bush.

What I am asking you to do is to take the opposite approach, guard the garden area and control some of the elements that enter into it, and let the other things live.

Well, I think we may have had an influence on them. We gave them a set of tactics, showed them how to use these animals advantageously for fire safety and for other considerations. They needn't eat them, but they could let them live.

They have plenty of money, so they can bring in guarded corridors. Around their caravan sites and camps they can have any number of wallaby. There was an area down the road that had done this, achieving total fire control, just from wallaby

¹⁷ . Beaver may prove a little difficult to control in this manner. They may decide to build dams in very inconvenient places or they might move from the neighborhood, despite the expense of attracting them, as they practice long term rotations from dam site to dam site. Moreover, if they are successfully attracted, they may cut down trees that are important to the design. Not only do they cut their food trees, but they ring and kill non-food trees to favor those that they do eat. I know of no tree species that is safe from them. -- DH.

alone. Wallabies are very short grazers. Wombats are even shorter grazers. The average wombat hardly eats anything above an inch high.

That was an eerie place. I just felt awful in it. I had never been in such a bad place. There was a feel of death.

Dogs are bad. Many vegetarians have dogs. I was in a vegetarian community once where they had 36 people and 82 dogs. There is a lot of this in the world, I can tell you. I don't know what you would call it, but I think it is schizophrenia.

When people get hung up on some belief and try to impose that belief on the environment, they are forced to some horrific solutions. Imagine what it would be like in 10 years with that process continuing!

Here are situations where you intervene. Here you have to make that marriage between what the client wants and what the environment wants, looking out for the environment before you look after your client. Keep the swan, protect the emu, and still look after your client. You might have to do it with useful corridors.

I have probably completed some 800 designs. I always bring these wallabies in as lawnmowers; or deer, as sumac pruners; squirrels, as acorn gatherers. When clients begin to see how it works, they then start to value this other tribe, whereas before, they warred against it; they killed it. **Your business is to adjust the site to the client's requirements, while protecting the site.**

Extrinsic energies, energies coming into the site, need to be defined for each site regarding direction, intensity and frequency. Evaluate these things. If both intensity and frequency are low, you might not even consider them. If one is intense, if you get a high frequency or high intensity at low frequency, you take note. It is up to you to define the number of those influences that affect a center.

Sunlight and heat enter. This is a direct radiation. There is the flow of cold air or hot air masses across the country. Look to the transfer of colds—the lateral transfer of colds that travel across the surface, cold wind from the other way. You get a brisk south westerly wind hitting the side of the mountain and coming around due east on this side. Every time you get a south westerly wind, you get a screaming easterly. When you visit the site, you will learn about it. Forget the local weatherman. He's has his station two miles away. It is 100 feet from anything, and not near any hills. He is making abstract observations that don't apply to anybody in the district. On the site, right on that particular site, there is evidence of climatic long-time influences. Note these things.

The site itself tells you what happens there. I find it very difficult to work from maps. I might modify them very little when I get to the site, but I prefer to put the maps aside and go and look at the place.

There are cold winds coming in and hot winds coming in. We can use them in various ways. We can use them to cool, or we can use them to heat. Also, we can use them to neither cool nor heat. We can use a cold wind to generate enough energy to offset its cool. It is necessary to think in several different ways about each of these extrinsic energies.

You can make a perfectly good freezer with the sun, and a perfectly good heater with the wind. You make heat from wind using a simple device—a vertical axis windmill that stirs the water kettle inside the house. It has a kettle with fixed vanes. The force of the wind creates a tremendous turbulence. It generates heat. The colder it blows, the hotter it gets. Canadians use this technique¹⁸.

There is another device that somebody described the other day. Hot desert winds may be used for cooling. Raise a wind-

dodger, a little sail to bring the wind down to where you have pots full of water with wicks. The hotter the wind blows, the faster there is uprise of water in the wicks. This has a profound cooling effect.

Because there is a cold wind, it doesn't mean you need to be cold. Inside a closed situation, you take energy from another situation and make it work. You may use that energy to cool something; or you may use it to heat something. Define these energies, the intensities and frequencies, and then manage them.

In the summer there is a wind off the hot wind, which is itself a refreshing breeze. It is a low intensity, steady breeze, which is the one we use for cooling. Summer brings the fire-catastrophe wind, which is a continental interior wind. We have a sector for cold winds, because cold wind comes in and backs around. In this region right here, you are in a circulation cell. You can see that the winds start to circle in steadily from that sector. In setting your defenses, you must treat the whole sector.

Depending on how much room you have, bring your access in to the side of the house site, so that it is possible to defend the house site from that wind path created by your access. It is a type one error to place our client's house site on the edge of the property. Sometimes you don't have a choice, but if it is possible, move him in a bit.

Define considerations such things as wind, fire, and sun, as well as noise, privacy, views and aspects. People in flatlands appreciate the view of a distant mountain peak. They like to watch the light changing on it. Views are a component of the design. To obtain the desired view, you can move the site of the house up or down. You can give your client a pleasant look-out on the roof.

A retired sea captain will have a house with a bridge deck above. It will always have a telescope on it, and there will be a flagpole. When a few of these people settle around one area, it becomes the architectural norm of the area. Every home is patterned after that of the retired sea captain. It is cold and miserable on the flying bridge. You will want your pea jacket on, and you will need to be pacing back and forth just to keep warm. You will have the cook coming up and down, bringing you hot cocoa. All that escapes most people when they build this kind of house.

Your hardy open-water skipper has an open deck up here as well. There he is—he's happy now. He's got his wheelhouse. When storms come, he goes up to his wheelhouse, gets out on the open deck, because he really has to con it then. He's just making sure no rocks come up in the middle of the night.

The worst problem is the one with the wind-view conflict. You get even a small hole through vegetation, and it gives you quite a draft, even when you have no severe wind problems. Leaving a gate open into a garden is very destructive.

A view is something that a person looks at when he first moves in, and when visitors come for the first time. He points out, and says, "It is a fantastic view."

They say, "Ah, it is, isn't it?"

Sometimes I say to my client, "I will throw your windbreak around your house, and I am going to build you a little retreat up here. It is going to have a little cupola in it with space for a few chairs. Make an expedition to the view." Clients like that idea. We make them travel to zone three to look at the view. It's a short trip, and it gets them out. They really look at it when they go there for that purpose.

I moved into a really fantastic spot once. I had picked it out from a map. I was looking down on the mountain from two or three thousand feet above. The cold wind came screaming over. There was a big forest behind. I had a grand panorama, could see the islands around. There are just miles of islands. I built a little lookout there, just to go there and look at that panorama, and kept my dwelling in a sheltered, cozy spot.

¹⁸ ..See Yankee Permaculture Paper #14, *Village Power Generation & Energy Conservation* by Bill Mollison for details on this and other energy ideas mentioned in this paper. For treatment of basic energy design concepts and lists of suppliers and other resources for North America, see paper #13, *Domestic Energy*, by Mollison. et al.

So you have solutions. They should be multiple. You may want to remind your client that it will never be the distant view that he will be always looking at. He will be looking at the quail in the glass house. He will spend much of his time looking at the near view, the detail, such as a bird-feeding table.

The best view to provide for a child, or an elderly person, or a sick person, is to put bird-attracting shrubs right against the window of their room. A friend of mine, a professor of botany, had a fuchsia that came half way up his window, and the birds worked there. He wrote more papers on the interaction of birds and flowers than he did on botany.

Well, I think we may have dealt with some of the view conflict problems. If we haven't solved everything to our client's satisfaction, we may have given him enough alternatives to get him fairly well looked after.

Consider the fire sector. There are obvious fire-immune elements in the zonation that you can place to intercept fire: mud crops, mulched garden, roads, short grazers, summer-green systems, low-litter plants. What you swing around and interpose toward the wind may be the very same set-up that you use to feed the pigs. Your windbreak could be a tall forest of marsh species. On rises, where there are no high hills on the other side of them, you may have to build a very high radiation break very close to the house. Where winters are long and cold, we might come tightly in with pines, or some columnar green species, to keep the house warm. You might put them tightly against the house and then start zoning out farther. They will be mulch-productive and they can be a place of winter refuge for birds and animals

For every element we place, we make it work in as many functions as possible. These are the ironclad rules of design. If you have those rules right, anybody, anywhere, can point to any element you place, and ask, "Why did you put that there?" and you have answers. "Because it collects manure, because it keeps the grass down, because it defends against fire." **A designer must have answers or he is not a designer.**

To some extent we are working on a three-dimensional system. The elevation of the sun, the slope of the surface, the flow of water, of air, all affect where we place things. All the elements must be used to the greatest benefit.

Besides length, breadth, depth and elevation, we have yet another element to consider—the time element. You must plan for evolution in the design. You can and should have quite an input into the orientation and the decision as to surfaces in and around dwellings. Because you know the whole site pattern, you should work with architects. Some of you here are architects. Interaction between the designer and the architect is a fruitful interaction.

In the time aspect, it always pays to set priorities. No client has unlimited resources. Therefore, you must set the criteria for the client's priorities. Try to persuade the client, no matter what his wishes, to install energy-productive systems first; second, or concurrently, energy-conserving systems; last, those that consume energy. We should design for caloric efficiency. Given that you have this as a theoretical layout, and a place to start, you can proceed with some competence, as you start throwing these wheels and sectors out.

The great difficulty in any design is determining where to start. We give you two or three good starting places. You can start a water lay-out. Then select a house site. Around the house site you start these wheels and spokes. That is a good, straightforward approach. Last, look at special features on the site, like a big rock on the seepage area, or a growth of sumac. When you consider these features, view them as resources. We can always build them into the design. People are always drying marshes, and digging rocks and getting rid of them. Just to save our client all that work, find some way to use their special characteristics. That is design.

Edge

I move to a topic that fascinates me and to which I have given much thought. I call it edge. First, I want to define an edge. Where things join, there are edges. Those edges can be more or less complex. An edge is the interface. It is that steel-strong film, the surface between the water and the air; it's that zone around a soil particle to which water bonds with such fantastic force. It's the shoreline between land and water. It is the interface between forest and grassland. It is the scrub, which you can differentiate from grassland. It is the area between the frost and non-frost level on a hillside. It is the border of the desert.

Its characteristics are common to all those crossings. Everything I know of pauses there. I have never seen anybody with any sensibility walk straight from the forest onto the plain, or straight from the plain to the forest. Edge gives everything pause. Everything spends some time there. Further, in natural systems we find within edge a kind of species or productivity that sharply increases, and potential interactions increase. Therefore the energy flux is greater through the edge.

To realize the effects of this, look at those extraordinarily rich areas called reefs that divide the abyss from the atoll. All good agricultural scientists never gather samples from the edge. They will discard the first two meters and walk into the crop and sample within crop. Why? Because edge figures are often biased toward much higher production. The truth, according to agriculturists, lies only within the center. There are beneficent and non-beneficent edges. If we are agricultural scientists, we don't measure the yield of this windbreak. When unlike systems are butted against one another, one or both might measure a drop in yield. But, generally, we agree that the edge is very rich because it has species of one or the other medium plus species unique to itself.

We wouldn't do very well growing a tomato crop against a pine forest. Yet, a blueberry crop might grow well there. About all that there is not much doubt. There are many areas in which results have been measured, though I don't know of any book that has put it all together.

Edges enrich species and their interactions. In tidal marshes and in mangroves and in barrier reefs and at light edges, the interaction, the standing crop, the energy flux and yield are all greater. Therefore, by increasing the amount of edge in the design we probably can increase total energy flux. So we say to the agricultural scientist, "Why take the lesser yield? Why don't you just take that edge into account, increase the edge and double the yield?" But the scientific mind doesn't work like that. It works on a per-acre basis. However, it doesn't stop us from working like that.

So far, we have been looking at species and yields, diversity and energy flux. I will tell you how I came to look at edge this way.

Whenever I would go through central Australia and spend some time around the aboriginal camps, I would see the women doing things that, for reasons I couldn't define, fascinated me. They were working with all sorts of pigments and all sorts of media to produce very elaborate patterns. The Pitjantjatjara women do much of it. These patterns are on windows and on dresses. When the women are sitting about telling stories, they make these patterns.

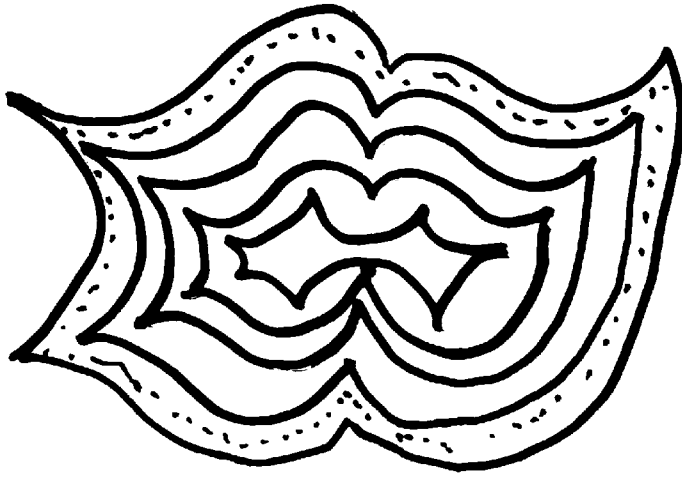

A basic part of the aboriginal society's belief is that women once knew everything, and that men had no knowledge. This is also the belief of the Celts. Men were in a stage of ignorance and greatly dependent, because the women only doled out bits of the results of their knowledge, never the processes. By a brave kind of raid into a section of celebration, the men were able to take a few important ceremonial objects. By observing the ceremony, they were able to seize a modicum of knowledge—not much of it, but all that they have.

The men in the aboriginal tribe to whom I can talk, and who are permitted to tell me things, can't tell me anything about this. The women, to whom I cannot talk very well, can't tell me much about this because there is a lot about it that is none of my business. This is women's business. The men don't know anything about it. They know about some other things, very different patterns; but they don't have any knowledge about this. I couldn't learn anything from the aboriginal men, and the aboriginal women said they are just their pattern, the pattern of stories, old stories. That's it for them. No more explanation.

One day I took off in a light plane to go north. We got lost in the desert. The pilot was nervous and we were wandering all over the place. From the moment we took off in this light plane my worries were over, because I saw at once that these patterns the Pitjantjatjara women are making are the patterns of the desert. I just went on with my camera, picking up variations on the women's patterns.

What the women were doing, and what they knew they were doing, was to describe aspects of desert ecology in terms of story and myth. These are ecological maps. They are accurate—the spacings are precise. One woman talking to another woman a great distance away can send her to a single stone and a single salt pan at a distance, to a place where the other woman had never been and she will accurately locate it.

The aborigines would say that I had an unfair advantage when I went up in a plane. They can't do that. They have to go up on escarpments and look out on the patterns. Once I made the connection, I made a second jump in their estimation to what they call another 'revelationary level.' It was only about five days later that I was sitting with them and they brought a pattern out and I got it straight away, and I pointed to something and I said, "Women's camp." They said a word, and I said, "What is that?"

They said, "I think you are wise beyond most white men."

If you can get this grip on what these people are doing, you will see that it is representational of their whole life. You have to look first to the environment, the patterning of the environment, and then revelation after revelation follows.

So I was very happy with that, and that gave me much thought. Not only are the hills like that, and the plains like that, but I have since then looked at some of the beautifully illus-

trated books published here in America, and many of them have photographs taken from the air. There are many places where these patterns exist. In the Pitjantjatjara country, the celebration, the way, and the pattern are indistinguishable things—a totality. The women have charge of most of the celebratory powers. The men have those parts that they pinched, and which the women bridge. There are always those areas where everyone joins in.

If you go to any part of tribal country, no matter where it is, there isn't any place where somebody isn't in charge of it. You have to make inquiry, "Who do I have to ask about this?"

They will say to you, "In that section, it will be that woman in that skin."

She will come there and talk to you about this. I will say to her, "Can I plant a tree up there?"

She will say, "Can't even go up there."

or

"Yes, you can plant some trees here."

Somebody is in charge of all of it. Nobody is in charge of the totality; and everybody has a bit—which is interesting structuring when you think about it.

About 12 months later, I was driving to Albany, in West Australia. A friend, Dennis McCarthy, was with me. We were covering 180 miles a day and talking. I said to him, "Edge, McCarthy!" We were passing something that made me think about it.

McCarthy didn't say anything for about 20 minutes, and then he said, "Edge harmonics, Mollison."

I said, "Why ever did you say that?" He said, "Because I am a mathematician, and edge harmonics has been my study."

I said, "McCarthy, I don't know why I think this, but I suddenly think you said something very important."

In my life, and probably in yours, we go along and nothing happens—intellectually nothing happens. You come to the end of what you can do, and you are on a plateau. Then you get a feeling, just as if you are going to sneeze, a feeling that you have accumulated many insights and that something else is going to happen. Again you plateau. I thought about edge harmonics. I thought back straight-away to these patterns. I thought, "I'm nearly there."

So I said, "We come to edge from a different way. We come to edge from its geometry, from its structural characteristics, and we get out of that straight-line idea."

When you look at the patterns of the desert, or the tundra, or the villi in your intestines, or the surface of your brain, you can see that every time we take an area from here and put it there, moving in an even harmonic about that edge, though we haven't altered the area, we have enormously increased the edge. So, if you like, without taking any cows out of the paddock, we can induce an enormous yield at the edge of the paddock. Without reducing the oxygen surface of the pond, we can give it as many times more edge as we care to do.

The harmonics of the edge may decide how much genetic material exchanges between sections of the media, or across the edge. It decides matters such as shelter. It decides the productivity of the edge itself. We're on to something.

This verges on something else. Refer to my classical humid landscape profile [Pamphlet II]. This is a harmonic, and often an almost endlessly repeated harmonic, and it contains potential.

I figure that this horizontal elaboration of edge is what life forms do when that vertical elaboration is not possible. This is true of biochemical harmonic. This is also the case with a bio-physical harmonic.

When one thing is no longer possible, then something else occurs. You will see that an increasing component of this results in a decreasing component of that. Both systems yield, but one yields in another modality. So I'm wondering here what entropy is, or whether entropy is even permitted? If that stops and that starts, then we haven't stopped being at work.

Maybe you will form that into a rigorous explanation. But I know with absolute certainty, over a whole range of phenomena, and from my own investigation into math, that the boundary condition is critically important to many things. We pay too little attention to the boundary condition. We have here a very powerful tool. We should use that tool in design. Where it does not cost a lot, it might benefit us greatly to produce this type of edge condition. Sometimes, we might have to work out how to use it; and, sometimes, we cannot get it. Sometimes, we have a choice whether we do a simple, unelaborated design, or whether we elaborate it.

Imagine a surface in which, although the surface is equipotential, its components differ. Imagine we make a dead flat surface, some of which is salt, some of which is clay, and some of which is ice, and so on. Then we subject it to heat and light and various influences. It begins to move in different ways, and in the movement it will draw apart, and get together, and some of it will push at other parts of it. What results is that things start fitting into certain harmonics, depending on the degree of difference, the type of differences, the type of inputs and the things that happen to it. Sometimes it rains on it; and sometimes it dries out; sometimes it goes into little cracks: bits of it leave other bits. After much time has passed, it may take up some resolutions. Those resolutions now represent different chemical gradients across the surface. Of those chemical gradients, we get different biological components—more or less salt, more or less clay, and so on. Those start to elaborate the pattern with little dots and specks. Things like spin effects occur in discreet clumps in a certain zone—¹⁹islands in your harmonic. These start to elaborate another pattern.

It has given me another perspective on edge that I am still throwing around in my mind. I'm not sure that I really have any good grip on it, but I know it's there. The first level of revelation has arrived. I know it's there, and know why it's there, but I don't know how to handle it very well. It was there all the time. I hadn't seen it to be there; but now I do.

Take the blueberry as an example. It appears to grow at the edge of clearings in pine forest. We may have a client who has come through agricultural college. He wants to grow a lot of blueberries, which are going to be his commercial crop. Leave it to him to grow the blueberries, and he will clear his area, his pine forest and his pasture, and set out his blueberries as open row crop. I've seen it done. If we can persuade him to loop his rows of blueberries through his plantings of pines, and run his pastures into there, then we might get him the equivalent of an acre of blueberries on a quarter acre, and probably ²⁰double the yield of the blueberries.

When asks me, "How much land do I need for strawberries?" The true answer is, "I can't possibly imagine; I haven't had a go at it yet."²¹

¹⁹ This is exactly what I have observed in the small patches of remnant prairie that I have been able to visit. While the land can be essentially flat, with little potential energy, life itself creates a dancing mosaic of edges, grasses, forbs, legumes in numerous species and varied stages of growth. This dance moves through time—as one species matures and goes to seed or rest, others emerge. Both in shape and in kind, the patterns unfold their complex harmonies as the seasons proceed. Probably any natural system achieves this level of intricacy and inter-related harmony, given sufficient eons of evolution. Mollison's proposal that we emulate such masterpieces of life and time is humbling. We haven't a chance to even begin properly unless we save every bit of the extant systems that have escaped the bulldozer mentality of Western society. We need these bits as teachers.

²⁰ In designing pastures with blueberries, be aware that ruminants eat blueberry bushes. Established blueberry bushes thrive with hogs or poultry. Both eat fallen fruit, likely to be infested with larvae, and encourage production in other ways. Clearly Bill's comments about blueberries are speculative and not to be confused with recommendations.--DH

²¹ Unlike blueberries, strawberries are not an edge species. Wild strawberries grow in open fields. As an early succession plant that grows in depleted soils, they may be at a temporal edge, but that's not the sort of edge discussed here. --DH

I had some box-thorn clumps that were a couple hundred years old. I went through them with my slash hook, doing things to them. Going from a 35-pace diameter clump, I ended up with 286 paces of edge, and I still had the clump practically intact. I then went along planting the edge and experimenting. I found that I had also designed a fantastic number of climates. I had cold winds there, and I had hot, salty winds here. I had shaded, dry, cold, salty, hot, and wet areas. I had an enormous amount of potential within that box-thorn clump. I did this just before I came away on this last trip. I had only started to work on it.

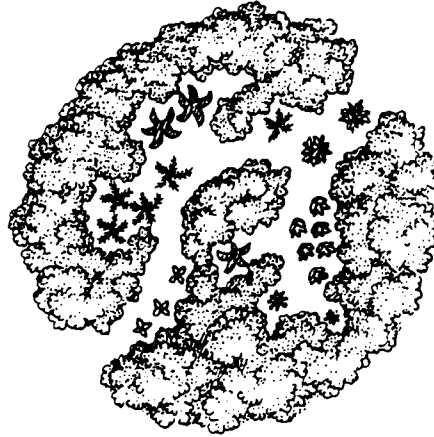

We can't grow avocados because of the hot salty winds. I said to myself, "I will put a few avocado patches in here—I might even be able to grow bananas." I didn't know, but I said, "This feels like bananas to me." At the edge that was very hot, I planted avocado. It lived all right; but I had it in a desert environment, where the rain was shut off. I would have to bring water to them or plant a desert species of avocado. Just as I was starting to get sophisticated, to work out where I had done things wrong, as I was beginning to experience the situation, I left, and haven't been back. The last time I saw my banana, it was unfurling; but I don't know whether it was unfurling any bananas or not. It was over a thousand miles south of banana country. That thorn bush had a banana hole in it all right.

Microclimate in the box-thorn clump

We are establishing an unmeasurable situation. We wouldn't say, "How much yield in an area?" I don't know. I have not wiggled around enough in here yet. I'm just lifting that idea, and I don't know how far I have lifted it. I think when it comes to doing what we must do, we can't devise suitable measuring tools for it. **You, yourself, are everything you need.**

I'm beginning to believe that rectilinear mathematics might have partly determined agriculture. If you establish something and then attempt to measure it, you are going to set up a grid. That is an easy way to deal with it. You set it up to measure such things as yield. When you have given your results, you have put your pattern on it, and people go right ahead spawning out thousands of these patterns.²²

What we are dealing with is things that have predictive inferences only in a dynamic situation. The blueberries and the

²² This follows the most basic principle of design: **Energy follows existing patterns.** If we design rectilinear patterns, we get simple, linear interactions. If we lay down a monocrop (equipotential, as Bill puts it), we create a ground state, no pattern, and energy transactions are minimal. Rarely is a rectilinear pattern optimum. If we wish to conserve energy (minimize flows), a spherical or round design element is required, e.g. a geodesic dome to shelter an artificial environment. When we want to amplify energy exchanges, we begin with something like a sine wave. Superimposed sine waves create the edge harmonics or, on a flat plane, moiré patterns (a cross section harmonic). Referring back to the prairie, this soon becomes too complex to think about. I believe that our intuitive faculties, most particularly our aesthetic sense, enable us to make modest steps toward the harmonics of natural systems. I believe that we are lost if we design mainly from our analytic faculty. This serves us well later, though, when we need to evaluate how well we have done on a small scale before applying our intuitive designs to a large territory. --DH

pinus march into the field, and into the ponds. Once we observe the way things accumulate, possibly we can predict how much will accumulate, and from where, and in what time.

Learn to wander a bit through that landscape, which is how Mike Corbett led the bulldozer into his new settlement at Davis. He marched ahead of the blade, and he said to the bulldozer driver, "We are going to make swales. I don't know how to do it, so let it be!" The whole settlement is patterned on Corbett's wander on foot, stopping sometimes to look at the Earth, and then marching on, wandering through, looking back. That has been an extraordinarily effective wander. Many energies have come out of that little wander. So what I am saying to you is, do a drunken walk through your site, if nothing else. The flatter your site, the more appropriate is the drunken walk. That's no way to string fences, but within the site, once the boundaries are set, you can elaborate these things in this manner.

I don't want to leave this area alone I keep toying with it. It gives me lots of wonder.

In any case, I have designed with it. There are two ways that you can use it. You can carve it into the existing structure, or, if no structure pre-exists, you can superimpose it. I think we may arrive at something that looks like a scarp, the way a scarp ends up once it starts to retreat. A scarp doesn't retreat in line; it is intricately broken, throwing out ledges, pinching off islands, the desert buttes and towers. This situation is very easy to maintain because that is the way Nature would be doing it. Too often, you get a corps of land engineers who will hop down through the desert and straighten everything out, make it right. Now the desert is in trouble; because it really didn't want that. Eventually, it breaks that constraint, breaks like a wild horse and plunges. Where we have structures, if we imitate the flux, we will get a much more easily maintained design, as well as having all these advantages of edge harmonics.

The botanists cannot tell you any of these things that we want to know. What is the harmonic of tea-trees along a swamp? That is why we have to write our own species index. Nothing published is going to be of use to us. We are not interested in the number of nuts per square foot.

There is God, giving an actual report on what He [sic] did. In the beginning there was nothing. The Earth was void. So what He did was strike off differences, to say, "There are waters above, and waters beneath." Before He did this, there was no difference. But now He has done it. He has divided the waters above from the waters below. Now He can place any number of events. He has a place in the void where He can start. As Almighty, He can make the rules. Any event that takes place on an equipotential surface will leave stresses in the media, and the media will rush to relieve stresses. Media interacting with media through the event will create an end event-like that! It looks like a tree! So from then on, a series of phenomena result.

Now we take over. We are doing this. We can start at any point on the sphere (Earth), and the results show at any opposite point on that sphere. It is becoming predictable. This part of a root system feeds this part of a tree crown.

So here is another way of thinking about things, particularly about the thrust of the event into the media. If you look at many trees, you see them spiraling through the landscape. Starting at the point of germination, they advance through the hills and into the sea. That enables you to read landscapes as to origin. It enables you to place anything that lies within such a place accurately. Think about a tree in terms of how suited it is to the environment in which you place it. You link what was previously a set of disparate phenomena in different disciplines into a single theoretical framework. **It is pattern recognition.**

Pattern Recognition

That is why certain things bug you and keep nibbling at the edge of your consciousness. You keep plateauing along, accumulating more examples. Then it impacts, and you get that

"about to sneeze" feeling. The examples are getting so numerous that you are about to recognize the pattern. People have tried to assemble a set of patterns. Very few of those people present us with the heart of the pattern, that which fits together all the circumstances.

The only reason why you have to prune apple trees is that they mature too fast. The trees fruit too early and cannot support the weight of the fruit. Therefore you might care to adjust things so that you no longer have to prune. You do that by working away on one or another of these media. You can make it more difficult or less difficult here or there. Once you get that adjustment right, you are going to know how to do it. Furthermore, as soon as you look at a situation, you can immediately read from the tree itself whether somebody has work to do there or not.

These are tools for creating edges. I am not much interested in laying around worshipping these tools or in putting them on charts and admiring them. I am very interested in going out there and working with them, imperfect though I find them initially. The more you work with them, the better they work for you.

I was lying in bed one night looking at the ceiling, and I was figuring—the problem with these patterns is that they are all two-dimensional: they don't end in the air or go down into the ground. The image of a sea shell came to me. Well, shells assume that shape for a reason. It efficiently stacks much digestion into a little space. So I thought, "Well, why don't we make our gardens go up in the air and down in the ground?" We never think of that. We get the string and rake everything out and make it level, and we do all the patterns on the flat, and if the garden wasn't level to start with, we soon level it.

A ziggurat is a holy spiral that ascends a tower. You can see them all over the Persian plains. Some of them function as brick kilns. But some of them are holy places. Get a paper and cut a spiral in it, then lift it at the center. Up comes this little flat part. To prop it, you have to make little rough walls to keep your path in the air. Make a little rock cairn, and then wind the spirals up around the cairn. The next day I went out to the garden and built a ziggurat about six feet across at the base. I said to myself, "Why should it not go on burrowing down in the Earth, too?" It would give a completely different environment. The end of it could hold water. I built the whole thing in an afternoon.

²³ . In my observation, apple trees do not require pruning on the forest edge, particularly the shade edge (the north edge in the Northern Hemisphere.) Apple trees growing on the north sides of forests, or city buildings for that matter, never overproduce. Of course, because we want heavy production, we place them where they will overproduce, in the open. The point that Bill makes throughout these pamphlets is that we care more about total production of the entire design than about individual yield per tree. If the tree grows at a north edge, or surrounded by forest that has overtaken it, it needs no pruning or fertilizer. The main job is to collect the apples. The yield per tree is low compared to a commercial orchard. The yield per hour of labor or dollars of management input is exceedingly high, however, by the same comparison. As a component of forest or shelter belt that has its own yield and justification, the yield per unit area is infinite because we have taken up no extra space. (Any number divided by zero is infinity). Note that observing the apple tree in a wild state gives us one more design option. Not everyone has a forest or shelter belt. An elderly person may not want to climb apple trees at the edge of a forest to harvest, but find that a small, espalier tree growing up the face of his or her house is very suitable. While the actual labor per apple is high, the time may be incidental to other activities, such as enjoying the garden, watching over infant grandchildren playing in a sandbox, or simply pinched going out to the mail box and back. The labor is very light. And if it is not taken from other activities, but merely done incidental to other activities, the actual lost time in labor is zero, again an infinite yield per hour lost to preferred activities. Furthermore, if one enjoys caring for an apple tree, possibly a pleached arbor over a back door walk to an outdoor eating area, the labor is actually a yield, **so long as we design the amount of work required within the limits of pleasure.** - DH.

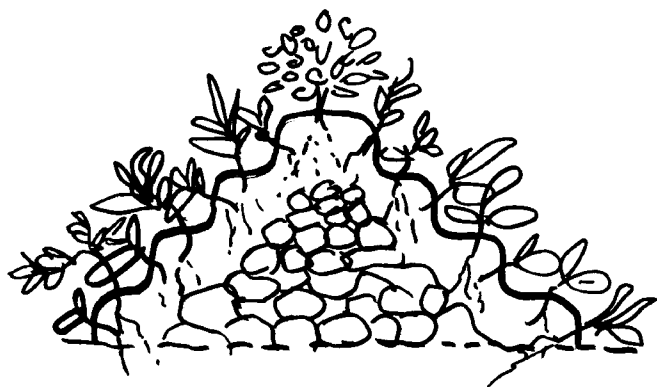

you start to draw winds, like the winds that circle around the house, you have started a pattern that may logically be continued. You will find that you have designed other conditions that you can favorably use.

The aborigines were taught European gardening. As soon as supervision was withdrawn, their gardens began a subtle change. I regret that I never made a drawing of one of those gardens. It was made of little mounds, little lips, and looking down on it, you could see patterns there that took on all sorts of totemic shapes. I was delighted with it. I thought I never saw anything so non-European. It was growing very well, too.

As for the garden, the only Earth shaping they had done was in terms of ceremony. They have many ceremonial stone patterns. If you show them how to grow vegetables and don't impress a shape on them, away they go into their totemic patterning, because that is the only way they have ever shaped the Earth. I should have made a plan of that garden. You have all seen that model of an herb garden from Findhorn, with its spokes and circles. You come in here from geometry. Another place to come in from is time. All of these things are different dimensions of stacking. There are truly three dimensions, which are totally different elements. You have the primitive beginnings of time stacking when you put lettuce under pole beans, and get the lettuce out before the pole beans shade the lettuce.

There are far more sophisticated ways to slide the time scale into overlapping frames. Fukuoka deals with time stacking. What we observe in Nature is a set of successional elements. The whole jargon of ecology deals with what happens as time accumulates.

The British devised a system of high farming in which they divided pastures after the animals had been on them a few years. The proper rotation was, I think, every seven years. The pasture was plowed and put into a high nutrient demand crop, a green crop or something, followed by a grain crop, followed by a root crop, followed by maybe even a fallow year. It was then returned to grazing. That was a sustainable agriculture. It took them seven years. They got a variable crop out of it. This requires a band leader and an orchestra. They had to have a farm history, somebody who knew the system and was prepared to continue it. It all presumed continuity on the land, which is what everybody used to assume happened.

That system didn't really do anything much about time. It is a matter of technique, rather than time. What Fukuoka did was to lift these years and set them on top of each other. He didn't have to fallow, because he never removed the main part of the crop from the soil. He stacked his legumes with his grains, with his ducks, and with his frogs. He set his livestock in his crop at certain times instead of having a livestock site and a crop site. He stacked different crops together. He went one step further. He started the next crop before the last crop was finished. Besides pushing sequences on top of each other, he also pushed sequences into each other. In monsoon lands, they have grasses that grow right to the ceiling of this room. They dry and fall. At that point, the cattlemen burn them. Those grasses form a massive amount of material as they lie thick on the ground. The crowns and roots are there below the ground, ready to sprout with the next rain. Just before the rains, a permaculturist in South Queensland ran across the whole area with a roller and sowed it to rye. This produced an enormous rye crop in country where it would be hopeless to cultivate that land to grow rye. With cultivation, he would have lost all the dirt as soon as it rained. Moreover, he would never have defeated that horrible complex of plants with rye. He had read Fukuoka. He was perfectly happy with the rye crop. I suggested that he go into millet, after his rye, roll the rye down and plant millet.

All of this is very new. Fukuoka's book was published [in English] in November, 1978; it was reviewed and got on the market by 1979. People started to understand it by 1980. It is 1981.



I had designed a variety of micro-climates, shaded and semi-shaded niches here and there, and bright, hot sunny places to the west and east. It is now a pretty little bed. It probably pays to use fairly permanent plants in this kind of bed. It is superbly adapted for culinary herbs. You have different drainages from group to group, different heats and shade. Well, about four months after I built it, I suddenly realized what an idiot I was. I found I had forgotten that I had two surfaces. It is possible also to grow out the sides of it, as well as on the flat. I tried to compute how many feet I've got into this. I think it is about 51 feet of row, which is quite a lot. There are no inter-row problems. You get much parsley and chives and thyme, with a little rosemary on top, and tarragon and other things down a little way. Maybe two of them would contain enough varieties to satisfy the most finicky cook. It could have all the herbs you commonly use.

It fits neatly outside the door, and is aesthetic. For the pond, just split open a plastic bag, put it in the bottom and fill it with dirt. You can grow a lot of watercress there.

I was really pleased with that. It condensed space, it reduced intercrop, cut down plant competition. Every plant has plenty of root space and plenty of climbing space. And it relieved the awful monotony of the flattened out landscape.

Another example is a circle-garden. I think we should pay a lot more attention to the advantages of these geometries, and the appropriateness of them. I wouldn't advise anyone to go spiraling all over their garden, or circling all over their garden, or wandering all over their garden. I think there are both appropriate and inappropriate geometries. I merely wanted to point out to you the elegance of that open spiral in a flatland situation.

When you play with a site design, play with patterns. I believe one may play mainly with curvilinear patterns. Because, when

²⁴ . Note that the spiral garden increases edge and edge effect, amplifying the potential for diversity. The circle garden decreases edge, so that the garden can be watered from a single drip point in the center. There are other effects, such as wind interaction, as well. -- DH.

In Australia, in permaculture associations, there are ever so many of these grain crops going. They are working at these stacking strategies—grass to rye and quackgrass to wheat, and all that. We haven't finished figuring out these stacking strate-

gies. These are just some of the aids towards it. I have trouble understanding what some of them are. There are many other things out there I don't understand.



Elfin Permaculture

P.O. Box 2052, Ocala FL 34478-2052 USA

Email: YankeePerm@aol.com

ELFIN PERMACULTURE DESIGN AND CONSULTING SERVICES

What Does an Elfin Permaculture Design Do?

A permaculture design helps people develop the specific lifestyle they wish to live in a specific place. Permaculture design clients typically are environmentally concerned people seeking increased self-reliance. The design is a written report of recommendations for achieving specific goals such as energy independence, food self-reliance, alternative incomes and so forth. The report compares the stated goals, preferences and resources of the residents with the potential and ecological needs of the site.

The design provides the residents with a plan by which they can meet their objectives by constructive development of the site as a whole system. In fact, the design process and the design itself are based on the principles by which Nature designs her ecosystems to efficiently utilize conditions of soil, moisture, climate, sun, orientation and available species to make most efficient use of them and produce as much life as possible both in quantity and in diversity.

Permaculture designs take a wholistic approach--everything is connected to everything else in the design for maximum efficiency. Conservation of resources--the client's and Nature's --is the over-riding principle of permaculture design. Change for its own sake is avoided and designs strive to become increasingly self-regulating and self-maintaining as they mature.

How is the Design Prepared?

Suppose that you notify us that you want a permaculture design. First, you buy from our sister enterprise, Yankee Permaculture, a copy of our Permaculture Design Client Survey. This is about 18 pages of questions for you to answer as fully as possible.

Included in the purchase price is a review of your answers by the author, Dan Hemenway, Elfin Permaculture's lead designer. He will recommend how to proceed. If you decide to have a design prepared by us, we will interview everyone involved and also examine the site for which the design will be prepared. Based on what you want and what the site offers and needs, we will make our report.

What Topics are Covered in an Elfin Permaculture Design?

Elfin Permaculture designs begin with a review of who the clients are and what we understand them to require from the design, as well as a brief description of the design site itself. It is hoped that this detached narrative will give the client another perspective on his/her situation and goals. The balance of the report consists of design recommendations.

Topics routinely covered in Elfin Permaculture designs are:

- **Food and Nutrient Cycles.** Food production is almost always part of the design. Permaculture designs typically specify tree crops, unconventional gardening methods, and solar greenhouses as part of the domestic food production system. Aquaculture, bees, small stock, poultry, and other foraging animals are frequently included. Soil management is treated in this section, as is disposition of human wastes, development of forage systems, food preservation, and control of potential pests. For some clients, commercial food production and/or processing is designed.
- **Energy.** All relevant options for energy production are evaluated, typically including solar, wind, water power, biomass, and other biological forms of energy. Then we look at applications for energy such as transportation, space heating and/or cooling, cooking, hot water, food preservation, and operation of equipment. After describing relevant conservation measures, we detail specific proposals for utilizing available energy for the remaining work at hand.
- **Water.** With the availability of high quality fresh water in drastic decline worldwide, obtaining useful amounts of healthful water is of paramount concern in the permaculture design. Typical domestic designs include roof catchment systems. Designs for larger properties ordinarily provide for creation of ponds where runoff can be stored for gravity feed to the point of use. Systems for treating and using greywater and other contaminated water are often part of a permaculture design. The water portion of the design follows that described for energy above, first looking at the resources and then the needs. The design represents our best thinking on utilizing such resources responsibly. In some designs, excessive erosion or destructive flood waters require special treatment.
- **Shelter.** For existing housing, shelter recommendations of our designs detail retrofit for energy efficiency, food production, increase in quality living space, and housing of plants and animals appropriate to the needs and desires of the client. If new buildings are required, we often can recommend designs and construction methods which use local materials, preferably from the site. The designs for new buildings save money and energy compared with conventional approaches. Shelterbelt plantings, shade in hot weather and more efficient space utilization frequently result from design recommendations.
- **Hazards and Problems.** While hazards vary considerably from site to site, usually some of the following risks can be anticipated and protected against to a degree: extremes of weather, earthquake, tsunami or tidal wave, fire, pollution and human violence. Dangerous activities proposed by clients need to be addressed. These might be use of toxic substances, unfortunately common in the practice of many crafts (e.g. chromium in leather work), or physical activities on site. For example, one set of clients proposed retiring to the country after a lifetime of professional work and urban living, and cutting their own firewood. The risk of injury to unskilled, unfit people in the very dangerous work of felling trees is about 100%. We expressed concern and proposed alternatives.
- **Special Treatments.** Often, a client will have a specific goal which is best treated in its own section of the design. One client had a wetlands which could not be "developed" for environmental reasons. He wanted to get a personal benefit from it nonetheless. We designed a use strategy that improved the water storage and purification function of the wetlands, protected adjacent wetlands, and gave him some direct yields.

- **Economics.** Design implementation usually costs money. Permaculture designs achieve their goals while staying within the means of the client. Almost everyone needs a certain amount of income. Our designs develop income when needed and provide ways to pay for the design implementation when needed. Often a special interest or skill of the client can earn money utilizing the site's resources.

- **Staging.** Elfin Permaculture designs specify the sequence in which to implement the design recommendations and, where relevant, how long each step should take. This enables us to use one aspect of the design to prepare the way for the next, permits generating resources to implement the design as we go along, and avoids the confusion and overload of trying to implement the entire design at once. Also, we believe that life-style changes are best undertaken in manageable steps so that the skills and behaviors required are comfortably mastered before the next step is undertaken.

What Skills and Training are Needed to Develop a Permaculture Design for My Home?

No new skills or training is needed to implement any properly prepared permaculture design, except those which you have indicated an interest or willingness to develop during the interview or in the survey. The design is intended to work with the client as s/he is and the site as it is with no forced changes on either part. Techniques, management strategies, products and resources which may not be readily available are all detailed in an extensive set of appendices to the design, including a bibliography for reading on specific topics, a list of people and organizations who can provide skills, information or other resources you will need, a list of suppliers of plants and products not commonly available and so forth. Our goal is to recommend practical measures which the client can actually perform in a reasonable time. Appendices also furnish background information relevant to specific design recommendations where this is the most practical way to provide it, species lists, and generic "standard designs" for problems which are common enough so that it is more useful to develop a general design solution rather than treat it in the highly customized design report.

What Living Situations Call for a Permaculture Design?

Our design experience includes urban, suburban and rural situations, large properties and small, and even rented properties. We have design experience in almost all climatic regimes from the humid tropics to frigid climates in northern Ontario, Canada, and in maritime, humid, and semi-arid climates. **The main requirement for a permaculture design is to want one--**to intend a lifestyle that grows increasingly self-reliant while increasingly benefiting the Earth.

Then Do You Think Everyone Should Commission a Permaculture Design?

No! Whenever possible we recommend that the person(s) who want(s) a permaculture design learn to produce their own design. We offer a three week Permaculture Design Course, the basic introduction for people who wish to work in the permaculture movement, and a 10-day workshop, expressly for people to acquire skills to use permaculture in their own lives. Either is suitable training. We do not host these programs ourselves but wait until some individual or group wants one sufficiently enough to do the work and risk the money to host one. Permaculture is a self-reliance movement. Often someone who wants a design will host a course or workshop on their site and get not only input from the instructor but also from the students who undertake a design for the site as the major activity of the program. Only when attending or hosting a workshop or course is impractical do we recommend our professional design services. Financially, it is much cheaper to host a course, even if it loses a bit of money (and it could earn money), than to contract for a design. Sometimes a person who received introductory design training will engage us on a consultant basis to help with one component of the design where experience is critical. They then incorporate our advice into their design.

What Kind of Consulting Work Do You Do?

We can consult on any of the areas commonly treated in the design. (See above.) Besides siting a house on the property, we think the most useful consulting work we do is to help people evaluate real estate to buy. By obtaining and completing the Permaculture Design Client Survey, many design problems "solve themselves" as the correct course of action becomes self-evident when the survey questions are answered. Elfin Permaculture is also available to do specialized design work and research for other permaculture designers.

How are Your Fees Based?

All design work by Elfin Permaculture begins when the client completes the Permaculture Design Client Survey. If the design job is very simple, we can quote a design fee on the insights provided by the Survey responses. Otherwise, we defer our quotation until after the client interview and site visit. These are charged at consulting rates, which can be deducted from the full design fee if the client decides to proceed with a full permaculture design. At this writing, the minimum fee for any design work is US\$1,000 plus direct expenses. Large and complex designs can be done in stages whereby an overall design is prepared in broad detail and very specific design recommendations are prepared as needed prior to implementation of that portion of the design. If we do not think that we can save you money through our design services over a reasonable time, we will recommend another approach.

Does a Permaculture Design Replace Architectural and Engineering Work?

No. Permaculture supplements these other types of design when they are required. Whenever possible, it is helpful to have architects and engineers work in collaboration with the permaculture designer.

Who Does Elfin Permaculture Design Work?

Dan Hemenway, founder of Elfin Permaculture, and Cynthia Baxter Hemenway, work as a husband/wife partnership in Elfin Permaculture Designs. Dan, who does much of the design work, has taught permaculture design in a number of countries in North America, Europe, Asia, and the Pacific Islands. He holds five diplomas from the International Permaculture Institute in Australia, operated a homestead self-reliant in food and energy for a decade and has professional experience in food production and alternative energy projects. Dan has been active in permaculture since 1981, Cynthia since 1988. She is a wholistic health practitioner and a Certified Nurse Midwife, activities that she integrates with permaculture. Dan and Cynthia have practiced permaculture in their own lives in Massachusetts, Ontario, Kansas, Florida and Georgia where they have lived. In addition, Elfin Permaculture Associates, an informal group of cooperating permaculture designers, provides us with expertise in areas of health and health care, venture economics, engineering and sustainable energy. From time to time, trainees in Elfin Permaculture's Advanced Permaculture Training (APT) program may provide input to designs under Dan's supervision.

THE CONTENTS PAGES THAT FOLLOW ARE TAKEN FROM AN ACTUAL DESIGN.
THEY REPRESENT A SAMPLE OF TOPICS TREATED.

C O N T E N T S

CHAPT. 1: INTRODUCTION.	
CHAPT. 2: CLIENT, GOALS & RESOURCES.	
	2, a. Building.
	2, b. Energy.
	2, c. Water & Sanitation
	2, d. Site
CHAPT. 3: COMMUNITY	
CHAPT. 4: CLIMATE	
CHAPT. 5: DESIGN GOALS	
CHAPT. 6: FOOD, CROPS, AND NUTRIENT CYCLES	
	6, a. Composting Toilet
	6, b. Vermicomposting
	6, c. Gardens
	6, d. Woody plantings
	6d, i. Poultry Yard.
	6d, ii. Primary Poultry Forage
	6d, iii. Extensive Poultry Forage
	6, e. Poultry
	6, f. Bees
	6, g. Greenhouse, Windows & Aquaculture
	6, h. Considerations and Techniques for this
Site	
	6h, i. Rock Pockets, Container
Plantings & Soil-Less Media	
	6h, ii. Pruning
	6h, iii. Cloudy Climate
	6h, iv. Mulch
	6h, v. Rootstock.
	6, i. Bare Spot.
	6, j. Remineralization.
	6, k. Aquaculture.
CHAPT. 7: ENERGY	
	7, a. Energy Conservation
	7, b. Windbreaks
	7b, i. First Stage--The Windbreak on
the North Boundary	
	7b, ii. Second Stage--The Windbreak
on the North Boundary	
	7b, iii. Third Stage--The Windbreak on
the North Boundary	
	7b, iv. First Stage--The Windbreak on
the West Boundary	
	b, v. Second Stage--The Windbreak
on the West Boundary	
	b, vi. Third Stage--The Windbreak on
the West Boundary	
	7, c. Space Heating
	7c, i. Solar
	7c, ii. Wind.
	7c, iii. Wood
	7, d. Greenhouse
	7, e. Cooking
	7, f. Hot Water
	7, g. Refrigeration
	7, h. Transportation and Access
CHAPT. 8: WATER	
	8, a. Catchment
	8, b. Secondary Catchment
	8, c. Supply Plumbing
	8, d. Greywater

CHAPT. 9: SHELTER	
	9, a. Greenhouse & Chicken Coop.
	9a, i. Glazing
	9a, ii. Greenhouse & Chicken Coop
Ventilation	
	9a, iii. Thermal Mass.
	9a, iv. Plumbing.
	9a, v. Greenhouse General Layout
	9a, vi. Deck/Upper Greenhouse
	9a, vii. Poultry Shelter--General Layout
	9a, viii. Poultry Yards--Layout and
Access	
	9, b. Summer Kitchen.
	9, c. Front Porch
	9, d. Woodshed
	9, e. Hallway and Stairwell
	9, f. South Room
	9f, i. Loft
	9f, ii. New Window
	9, g. Cellar.
	9g, i. Enclosure for Kiln
	9g, ii. Root Cellar
	9g, iii. Mushroom Production
CHAPT. 10: HAZARDS	
	10, a. People
	10, b. Fire
	10, c. Cold
	10c, i. Severe Cold
	10c, ii. Blizzards
	10c, iii. Ice Storms.
	10, d. Pollution
	10d, i. From External Sources
	10d, ii. From Crafts Activities
CHAPT. 11: ECONOMICS	
CHAPT. 12: STAGING	

APPENDIX I: SPECIES AND VARIETY LIST
APPENDIX II: HARDY GRAPE VARIETIES .
APPENDIX III: FIVE-NEEDED PINES
APPENDIX IV: CONTAINER PLANT LIST
APPENDIX V: BIBLIOGRAPHY
APPENDIX VI: RESOURCES
APPENDIX VII: SUPPLIER LIST
APPENDIX VIII: SOLAR AND WIND ENERGY
APPENDIX IX: WOOD HEAT
APPENDIX X: NUTRIENT SOURCES
APPENDIX XI: PERMACULTURE CLIENT DESIGN SURVEY
APPENDIX XII: CLIMATIC DATA
APPENDIX XIII: ENERGY CONSERVATION
APPENDIX XIV: MISCELLANEOUS TECHNICAL DATA

NOTE: Permaculture designs for sites in a wide range of latitudes from tropics to extreme cold are offered in our special order catalog, listed as Permaculture Paper No. 27 in the Yankee Permaculture Order Form.

© COPYRIGHT, 1991-96, DAN & CYNTHIA HEMENWAY, *Elfin Permaculture*, Ocala FL 34478-2052 USA. All rights reserved.

Forest Ecosystem Rescue Network (FERN)

We offer two FERN programs:

- **A weekend workshop**, or better a weekend conference, forms a FERN chapter. We prefer to serve as catalyst to local folks to define the local problem, set an agenda, and initiate a strategy.
- **Slide/lectures**. We have three bodies of slides. 1) Fate of Our Forests overview. Documents various causes of forest loss in both temperate and tropical regions, with emphasis on "decline" of temperate forests. Discussion follows on what the people present can do to improve the situation. 2) Temperate tree decline. A rather brute-force lesson in identifying trees and forests in decline, including photographs from Germany, the US, Canada and some other countries. We usually use at least two trays of slides in this presentation, and everyone who sits through it recognizes tree decline when they see it thereafter. It is very motivating. Our most effective volunteers recruited themselves following this presentation. 3) We also have a body of slides showing healthy forests. When possible, we follow "2)" above with the healthy forest slides, mixing in some more decline slides well into the program to establish the contrast between sick and healthy forest. Once people see what a forest should look like, they are even more able to recognize a sick forest.

Permaculture Programs

Lectures. We offer a very effective slide/lecture presentation that establishes some of the environmental problems that required the development of permaculture and some of the principles we use in permaculture design to address these problems. It ends with examples of permaculture design. No limit on number of attendees.

One Day Workshop. We arrive at the site a day or so early and develop some basic permaculture design ideas that can be communicated in a lecture format. When the participants arrive, we first review some basic permaculture principles and concepts, and then take a site walk. Following the site walk, we begin to flesh out the initial concepts for the permaculture design for the place. It is useful to make our basic lecture (described above) available the evening before a one-day workshop for people who want to make the most of this very fast exposure to the permaculture process. Limit: 40 attendees.

Weekend Workshop. This is our most effective short program. (While normally given on a weekend as the name implies, it can be given any two days in succession.) It begins with our introductory slide presentation Friday night, followed by discussion. The next morning, we explore basic principles of permaculture design. After lunch we have a field walk. (So far very much like the one-day workshop).

Elfin Permaculture

P. O. Box 52

Sparr FL 32192-0052 USA

Email: Permacltur@aol.com

Lectures, Workshops, and Courses Brief Descriptions

Then we divide the participants into teams. They prepare the draft design for the place, meet back in class from time to time to check progress, coordinate among the teams, and impart any special information that they may need. Participants are encouraged to sign up for the team for which they are least qualified, and then to solicit information needed for their part of the design from other participants, with the instructor the consultant of last resort. The instructor has spent time before the workshop developing a design approach to the site. He leads the design process when the teams might otherwise bog down. By Sunday afternoon, participants present the first draft of a permaculture design. We have surprisingly good carry-through into the subsequent lives of participants with permaculture concepts following a week-end workshop. Maximum enrollment: 25.

10-Day Permaculture Design

Intensive. This workshop effectively helps people achieve beginning competence at permaculture design. It is so effective, that we recommend it as a supplement to the full Permaculture Design Course, which covers much more information but presents less opportunity for design experience. In the 10-day program, participants work night and day for 10 days on a permaculture design for the workshop site. (...or one very nearby, if necessary.) The intensive begins with the standard weekend workshop format, allowing opportunity for some people to attend the initial weekend if we are not able to fill the 10-day program. Over the balance of the week, participants refine and revise the draft design produced in the first weekend. They draft a full permaculture design report that addresses shelter, energy, food, nutrient cycles, health, aesthetics, economics, community and other factors involved in helping the residents of the site meet their goals while nurturing the ecosystem around them. Class work during the week consists of presentations by the instructor, and by knowledgeable participants, on subjects necessary to complete the design. Topics vary according to problems and resources uncovered as the design process unfolds. The instructor brings all the outlines and slides and other materials needed to teach the full, three-week permaculture design course, selecting from these to meet the needs of the group. Design work is often impressive. Class meets Friday through Sunday of the following week. Maximum enrollment: 30.

Two-Week Workshop. This program resembles the 10-day intensive, except that it begins on a Monday and therefore does not include a weekend workshop at its inception. The two-week workshop can be less intensive than the 10-day program, making the longer workshop more suitable where most participants will be commuting and therefore less likely to work every night on the design project. Alternately, the two-week program is very successful as an intensive experience when we give the workshop in translation. Even though the amount of material imparted in the classroom is about the same, the longer time in which to work with the information helps people better integrate concepts and apply them better to their design project. Class meets Monday through Saturday for two weeks. Maximum enrollment: 30.

Permaculture Design Course. This three-week program (five or six weeks in translation) carries certification as a permaculture design trainee for successful students. The program is intensive and inclusive, surveying a wide range of information and concepts necessary to successfully practice permaculture. It includes class work, a student design project, slide presentations, presentations by the students, and extensive slides and other audio-visual materials. A four-week version covers the topic: Permaculture Design for Communities. (Certification is the same.) Maximum enrollment: 30. Elfin Permaculture also offers a Correspondence Permaculture Design Course and an annual Permaculture Design Course Online.

Advanced Permaculture Training (APT) Programs. Elfin Permaculture offers the same range of formats for advanced permaculture, open exclusively to graduates of a Permaculture Design Course. Emphasis is on personal design work and teaching permaculture. We do not encourage permaculture design for others as a career, however we will assist any design course graduate to hone his/her design skills. We develop APT program outlines on a case-by-case basis. APT also offers individualized guided programs of one to four years for design course graduates.

Our permaculture programs are described in more detail in information sheets, listed on the back of the Yankee Permaculture order form. The shorter programs usually draw participants mainly from the immediate area while programs of 10 days and longer draw from the region and usually attract some people from distant places. While promotion is mainly the host's responsibility, we can support your promotion in various ways, particularly if programs are booked with ample lead time. We consider a program to be scheduled when we have received a deposit reserving the date. Order for a current list of fees and terms from the Information Sheets on the back of the Yankee Permaculture Order form.

PERMACULTURE TECHNIQUES

BY BILL MOLLISON

Pamphlet IX in the Permaculture Design Course Series

PUBLISHED BY

YANKEE PERMACULTURE

Publisher and Distributor of Permaculture Publications

Barking Frogs Permaculture Center

P.O. Box 52, Sparr FL 32192-0052 USA

YankeePerm@aol.com

<http://barkingfrogspc.tripod.com/frames.html>

or

<http://www.permaculture.net/~EPTA/Hemenway.htm>



ZONE 1

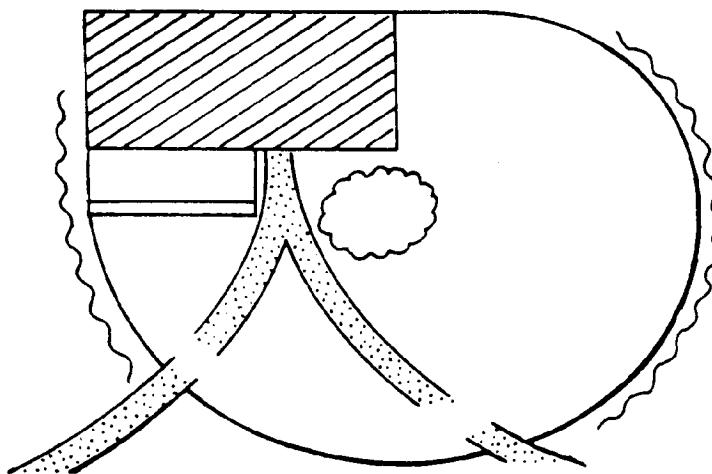
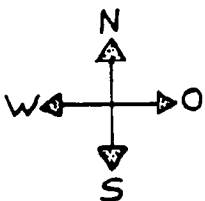

PERMACULTURE DESIGN COURSE PAMPHLET IX--PERMACULTURE TECHNIQUES

This is the ninth in a series of 15 pamphlets based on the 1981 Permaculture Design Course given by Bill Mollison at The Rural Education Center, Wilton, New Hampshire, USA. Elizabeth Beyor, without compensation, undertook the transcription of tape recordings of the course and subsequent editing of the transcripts into 15 pamphlets. Later, Thelma Snell produced the typescript for all pamphlets again without compensation. Lisa Barnes laid out and made mechanicals of the original editions, and provided many of the drawings. More recently, Meara Culligan entered all 15 pamphlets onto computer disk. I have since added further light editing to increase the readability of the pamphlets. Cynthia Baxter Hemenway spent many hours copyediting the new editions. In deference to the monumental task of love represented by Bill's assembly of the Permaculture Design Course, and by the subsequent volunteer efforts leading to these pamphlets, Yankee Permaculture has placed them in the public domain. Their reproduction is free to all and highly encouraged. The pamphlets are now available in electronic form as a set.

We have some pamphlets translated into Spanish, French and German. Volunteers are now needed to complete these translations and to translate these pamphlets into other languages. Yankee Permaculture continues to depend on volunteers for all of our publications. To help, contact us at the address on the cover.

For Mother Earth

Dan Hemenway, Sparr, Florida, July, 2001.

Third edition

		Quantity	Price
Complete Set of 15 Pamphlets. Bill Mollison. \$35 (Price reduced 9/1/94)	\$35.00	SET	\$ _____
Complete Set on 3.5" Floppy Disk (MS Word for Mac, inquire about other formats) NEW!	\$50.00	SETFD	\$ _____
I An Introduction to Permaculture. (Price reduced 3/22/94.)	\$3.50	I	\$ _____
II Permaculture in Humid Landscapes.	\$7.50	II	\$ _____
III Permaculture in Arid Landscapes,	\$3.75	III	\$ _____
IV Permaculture on Low Islands. (See V for combined price.)		IV	
V Permaculture on High Islands. (IV, V, & VI offered as one pamphlet.)	\$2.50	V	\$ _____
VI Permaculture on Granitic Landscapes. (See V for combined price.)		VI	
VII Permaculture for Fire Control. (See XV for combined price.)		VII	
VIII Designing for Permaculture.	\$8.50	VIII	\$ _____
IX Permaculture Techniques.	\$8.50	IX	\$ _____
X Forests in Permaculture.	\$6.25	X	\$ _____
XI Water in Permaculture.	\$3.75	XI	\$ _____
XII Permaculture for Urban Areas & Urban-Rural Linkages.	\$3.00	XII	\$ _____
XIII The Permaculture Community.	\$2.00	XIII	\$ _____
XIV The Permaculture Alternative.	\$2.50	XIV	\$ _____
XV Permaculture for Millionaires.	\$2.50	XV	\$ _____

All funds must be in US dollars in a check drawn on a US bank or by International Postal Money order. Make checks payable to: "Yankee Permaculture." Make postal money orders payable to: "Dan or Cynthia Hemenway." There is a minimum charge of \$10.00 before p&h.

For all Yankee Permaculture publications, please add \$5 plus 10% postage & handling for shipments to the US and 20% for shipments to other countries.

Prices subject to change without notice.

PLANNING IN ZONE ONE

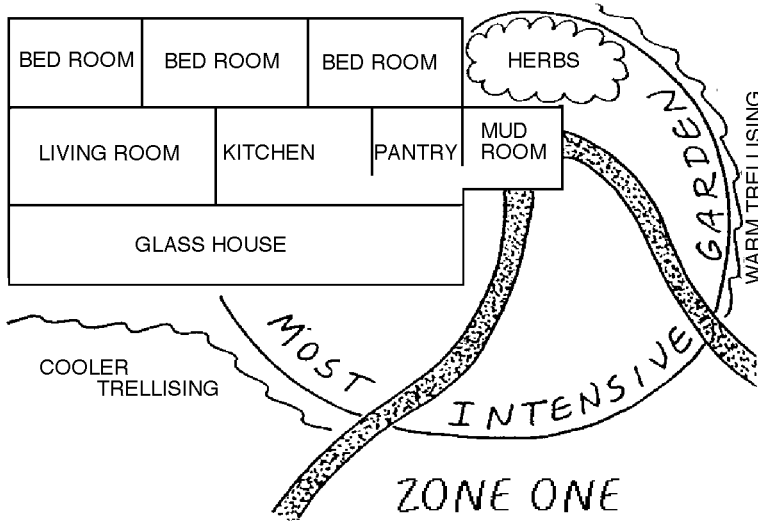
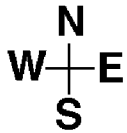

You are very likely to do more zone one planning than anything else. If your architects are half way capable, and often they are not, what you have is a set up something like this.

You have mud room, pantry, kitchen, living room, bed, bed, bed--or bed, bed, bed upstairs, each with an *en suite* toilet, of course!

The set-up of the house has to be like this for the functions to follow the zone. You can't depart very much from it. You can play around with ins and outs, jog it in, extend it out, screen it, trellis it; but, basically, your set-up is like that. It is the only efficient set-up. Yet, you are very likely to find kitchens on the north side, living rooms on the north side, and beds on the south, where you can't sleep at night because of the heat.

But let's assume we've had some say in the layout here, and often we do.

In that case, the most intensive garden section is around the garden entries. In there, place a little herb spiral, and then a great mass of parsley. You can't have too much parsley. Chives also go here. They are your two critical herbs. Garlic is a crop that you pull at the end of the summer, and it can go in just everywhere

that nothing else fits. If you have a hole, put in a clove of garlic, and that's it. Then plot the common herbs--there are only three or four of them. They are tarragon, thyme, rosemary and sage. That's it. Add a couple of pots of mint. Dill does well here and there throughout the garden. If you only gather the seed, it doesn't have to be close to the door.

There are three or four sorts of chives, the Chinese chives, the ordinary chives with the little purple top, and the fine-leaf blue ones. They are all worth planting. They have slightly different yields in time.

As for parsley, what I do is start a bed of it going, and let that go to seed. I start a bed the following year. Then I pepper the heads all over the place, so that I get parsley throughout everything. I just take the heads and shake them out all over the garden. I throw it out where I want it to grow. I use it as mulch. So parsley is thickish. Once you get parsley thick, you never have to worry about it again. You always get parsley thick where you had a parsley bed.

Our winter is not as severe as yours. What we have been doing successfully is to put out our bell

peppers in pots -- at least six or eight of them. Prune them in the fall and bring them in over the winter, and put them out again in the spring. You will have big, strong plants. We have had them going five years.

You will have worked out pathways out of this system, where you come from parking, paths to the barn, wherever you come and go. Take a section of this tract, and start to zone your plants along that track. Then start putting your beds in. Afterward, this will get messy in the ideal Permaculture garden. You can start putting crops in rows in there, rows of lettuce, rows of cabbage, your plucking herbs, the plants you are continually pulling from, that are long standing. They may include celery, a minor quantity of tomatoes, New Zealand spinach, broccoli, zucchini and patty-pan squash. Typically, you have a path with some chives or celery. Put celery here, too. Scatter chard along there, because it stands a long time. Peppers and tomatoes go further along. Radishes are a catch crop everywhere. Everything has radishes planted with it.

I don't think it is worth growing anything but trellising peas and beans.

Now your common root crops go further out, except, occasionally, things like beets from which you take some greens. Then comes the main crop, which will include the winter keeping squashes, corn, some carrots, main crop onions, parsnips, long

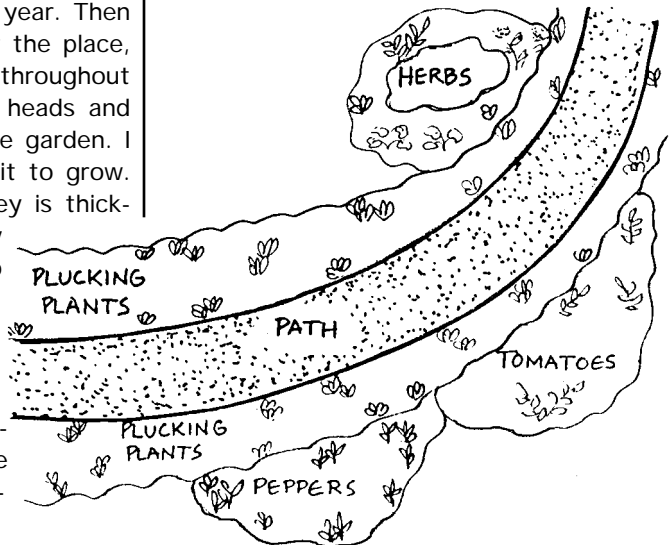

Pamphlet IX Permaculture Techniques Page 2.

term cabbages. I always put a nasturtium in here and there. The leaves are tasty in salad.

By summer, the Jerusalem artichoke is really up and out of the ground, forming a quick barrier hedge. Within the garden, you will have a few oddities scattered here and there. Cucumbers are part of the trellising system, and probably need to be on the hot side. There will be other things that can go on the cool side, like those scarlet runner beans. They are just about the best beans in the world.

You can establish conditions for a particular plant, or plants, and you keep that plant going in this spot year after year.

If you are dealing with a really small garden, it will pay you to set up a straw-box of potatoes, which is permanent. Board up an area something like eight feet by five feet. Throw some straw or seaweed into it. Set your potatoes 9" x 9". Scatter a bit of ashes on, then fill up the box with straw, and let your client just pick potatoes from the straw. Some will grow green on top. Just push them down underneath. Keep the whole thing ticking all the time. No soil, no bottom. Poles make a very good frame. The bark rots off and adds nutrient. Never use much sawdust, unless it is quite scattered. It tends to cut off all the air. If you put in much leaf material, it mats, and you get an anaerobic condition. Use the same straw-box every year for your potatoes. We have had potatoes growing for 12 years in straw boxes. Some of the people I know, for as long as I can remember, have had their straw beds of potatoes. It doesn't matter if it is on concrete.

Near that, you grow a couple of comfrey plants, because for later plantings you should always include a comfrey leaf. Pick a comfrey leaf, put your potato in it, wrap it up, put it under the straw, and that is your potash and nutrients. Another thing you grow near the potato box is a little pot of mint to cook with your potato. As you are picking your potato, you pick your mint. Grow it in a pot to

keep it from spreading.

The base of your straw box is a good environment for horseradish, which is a good companion plant for potatoes. You can make a special place for your horseradish. Get four old broken earthenware pots and sink them in the ground, leaving them out a little bit at the top. Every year, you refill these with good Earth and stick your horseradish root in it. Otherwise, you can't dig your horseradish. It grows straight, is easy to break, and very easy to lift.

Now let me tell you about composting as against mulch. Every time you compost, you decrease the nutrients, sometimes to one 20th of the original. Usually, though, you get about a 12th of the nutrient out of compost that you get out of mulch. So what have you done by composting? You have worked hard to decrease the nutrients badly. Most of them go into the air. Composting consumes them. We want to get right out of composting. We want to get back into sheet mulching. In composting, you are taking a lot of material, putting it into a small place, and letting the whole of the decomposition activity happen under hot conditions which can be appropriate for some things. When you mulch, you are spreading those materials and letting the process occur much more slowly on the surface of the soil. Any leach loss goes into the soil, and the general level of activity spreads across the whole of it. By the time the mulch has reduced to compost, most of the action has finished. If you want to get maximum value out of what you have, sheet mulch it. If you want to increase your nutrient base, do it efficiently.

There are some items that are good to compost, but you need a very, very small amount of compost, maybe a cubic yard, a four cubic foot box. That's for a king size gardener. For an average household, they need one of those drums. Just strew a little bit of compost on the seed bed, a little bit in seed trays, a little bit in your glass house. That is all you need. Most compost that you eventually get comes off your box of mulch. It incorporates

into the Earth's surface.

Nearly everything we measure in compost is less than what we measure in the soil after sheet mulching. What you tend to have is a hyper-rich area around your compost heap, but you do not have that on your garden when you apply compost.

The best thing to do with mulch is to put it somewhere dry until you need it. If you are piling up leaves, pile them up underneath pine trees. They stay dry there, undecomposed. I mulch up to two-inch thick branches. Just lay them between the peas and the mulch. I use all the large bark sheets off trees. This creates a thick mulched area where you are going to put in plants. You can't put small seeds in a thick mulch.

Kitchen wastes can go directly to the garden. Just pick up a handful of mulch, scatter the garbage around a bit and put the mulch back. In winter, I freeze kitchen wastes into blocks. You can take a lot of tea leaves out and put it on the mulch and go back the next morning and they will have disappeared. It is the same with banana peels. I just take fat out and pour it on the ground.

Deal with weeds the same as with kitchen wastes. They lift out easily, even docks. I reverse them so their roots are in the air. Lift up the straw and drop it back on the top of the weed. I let those weeds grow big, too. They're good.

If you dig this material into your soil, you'll rob the soil of nitrogen. If you mulch with it, you will never see nitrogen deficiency. Your mulch is permeated with 70% nitrogen. Everything that wants nitrogen takes it right out of the air. The soils with this acid rain are getting nitric acids falling on them.

Worm manure, which is the highest tonnage per acre, is the best manure. Again, that's a good reason for not composting. Instead of the material burning down in the composting bin, the worms are eating it all over the surface, and you have a lot of worm manure. It takes three days, probably, in most gardens for worm cast to completely cover the layer of saw-

dust. You are getting high nitrogen, high potash, high phosphate. Worm castings test alkaline, which might be of interest to you, so that your mulch stratification after two or three years may go from a pH 6 to pH 3, if you are using some pine needles. What you have is a stratification of pH. If somebody says, "What pH have you got?", you say, "Everything." You will find plants putting out feeder roots at completely different levels, and you will find high alkaline and high acid plants side by side.

You have mussels in your creek. You can scatter the shells under your mulch and slowly they will all disappear. It takes three years. They just disappear on demand. I mulch oyster shells, scallop shells, pine needles, seaweed, hay, straw. We mulch some tin cans, particularly around our citrus.

Algae, a lot of lawn clippings, a lot of hops- these things get slimy. Don't apply a thick mulch of anything that is wet. You will get good gley, but it is not good for your garden. It must have air. Hay should first be put through chicken pens; straw you put straight on.

Now what you do is set up proper, permanent, well-designed small systems for each plant you are going to grow. If you are going to grow cucumbers, you make these holes, put up a wire mesh cylinder, about four feet high, and it's permanent, and you always grow your cucumbers there. You work all this out. In the general garden, you do a sort of spot rotation. Wherever you are manuring, as in cucumbers, potatoes, and things like your asparagus bed, you never rotate. For tomatoes, rotation is disadvantageous. Tomatoes grow better on the same spot. So you set up a permanent tomato bed. You treat each vegetable as a design problem.

In any community situation, it is a very good idea to give responsibility to different individuals for different areas. As an example, I never re-plant leeks. I let a certain number of them go to seed, then I take the bulbs off and set them straight out. I just did this before I left. Then some well-

intentioned idiot comes into your garden and pulls your leeks out because they are running to seed. So you are two years behind again. They pull your lettuce out because it is going to seed. Of course, that is why you had it growing there. They plant something over the top of an area that you had pre-planted and were waiting for it to come up. So you are a long way behind. You can be up to four years behind; and if they destroy something you have been working on over a long time, they can set back 10 years of work.

If you can point out what you are doing, and if you have a very sympathetic friend and you work closely together, that's all right too. If you break functions up, one person attending to the compost, the other doing the planting, it is possible to work together over the same spot. However, it should be in different functions, one measuring and supplying, the other doing the actual structuring.

If you are going to mulch, you plant a quick-maturing lettuce leaf seed. You seed down an area and just put out seedlings. If you are growing seedlings in trays, just seize the opportunity to put them in anywhere.

Hay is full of seeds. You don't want to throw those seeds in your garden. So undo your bales of hay in your chicken run. The chickens can eat the seed. They also help to shred the hay, and add some manurial coating. After they have kicked it all over the place, you fork it out and put it on as mulch. If you are mulching in this way, maybe you won't need much manure.

In the future, we will become more sophisticated about mulch, and will be growing certain trees for their mulch. I am yet not certain which ones. We know some of them. We know some produce an alkaline mulch, some acid, and some have high potash, and some a nitrogen leaf litter.

It is the work of a few months study to determine which ones suit a particular site. In the dessert, we grow tamarisk and casuarina for their mulch. All bark is high in calcium.

If the area where you want to start your garden has heavy wet clay, you are in a happy situation. You are in for real trouble where there is siliceous sand. Clay is fantastic for water retention. Because you are mulching, your roots are well up in surface area, and don't have to encounter the clay. The clay holds enormous quantities of water. Sturdy clay gardens make the best mulch gardens.

If you wish to start a garden on lawn, just go straight on to it. At home, we have people who keep mulching across their lawn. This year, you decide that a bit of lawn is going to be a garden, so you mulch straight across it, and in a small handful of soil you plant all your little plants through the mulch. Put your potatoes at the base, and go straight into garden.

If you want to convert a lawn, it's a day's work. You never dig it. Here is one way to do it: You get a number of old tick mattresses. Take them home and just flop them on to the lawn. Cut little holes in these mattresses and drop potatoes through them. Put a handful of hay over them and that's all there is to it.

You work things out for each plant. There are certain crops that are traditionally planted with corn. Throughout the whole of Yugoslavia and southern Europe, and where there is a hot summer sun, corn goes with cucur-

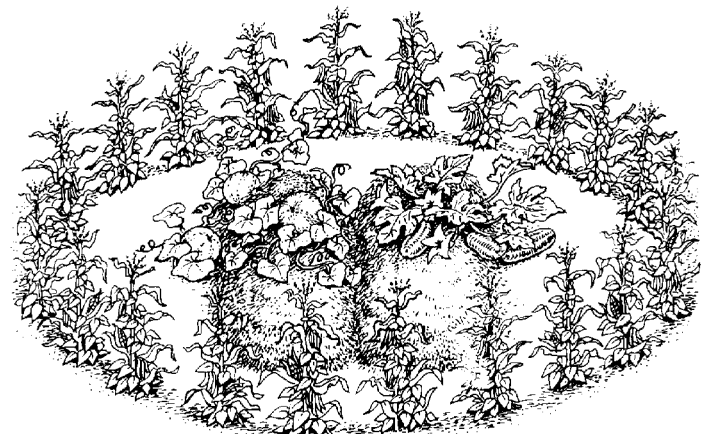

bits. In the cornfields of southern Europe, manure and compost is shoveled off oxcarts in random little mounds three feet in diameter and two feet high. These little garden compost heaps may run right over a hundred acre area. Corn is planted in rows. But in these mounds they put runner pumpkins, melons, watermelons, and all sorts of cucurbits. The corn comes up and is harvested and the melons drop off. They are sitting all over the field like a million footballs.

Climbing beans are a second group of companion plants to corn. There may very well be others. In the event you are growing sweet corn, and are not interested in the cobs drying off, you will have to go out and get them. You also have to pick the beans. How are you going to wade through that crop?

Work out a band of corn about four feet across, hollow in the middle. In there, put your manure pile and plant your cucurbits. This way, you have also set up what is basically an edge. Plant your beans around it. Now you can pick all the corn and beans, and when it is time to harvest the pumpkins, your corn is finished up and you can get to them. That is a rich little area there, and you can keep it for your corn patch. If some of the beans get away, there is your bean seed. If some of your corn gets away, there is your corn seed.

The tomato won't stand the wind. It doesn't like it at all. So it needs a little shelter around it. It needs to be a south-facing shelter. Grow Jerusalem artichokes around the outside. They are well up before the tomatoes are in trouble with the wind. You can stake the tomatoes, if you want to.

Basil and parsley are good companion plants for tomatoes. So plant some parsley in there and quite a lot of basil in the hot spots. Your basil goes in on the south facing edge. Parsley doesn't care, it can go on the cold edge.

For white fly, we want nasturtium, which gives the essential root contact. There is an all-yellow, bunching nasturtium that doesn't run; it is a small plant and a fixed species. You

can put a few in among your tomatoes.

If you worry about eelworm (nematodes) in tomato, you will need marigolds--*Tagetes minuta*. Gooseberries are good for the control of specific tomato pests. So if you want to grow a few gooseberries, do that just outside, on the cool side of the tires.

We have our basil on the hot side, parsley on the cool side, marigolds in random little clumps, windbreak of Jerusalem artichoke, and cool wide windbreak of gooseberries. That is a good tomato production system.

As we close up in the autumn, we take some good tomatoes and put them whole under mulch. You get about 200 plants at each spot. This enclosure is thick with seedlings. Every remaining tomato is just remulched annually.

When I started my bed, I just brought a carpet out, mulched the top of it, and planted tomatoes in little mounds on top of the total. Plastic superphosphate bags, cut in half, slipped over four sticks, made a greenhouse for the newly transplanted tomato.

Never re-buy your tomato seed. I never bought but one lot of tomato seed. When you throw your tomatoes under mulch, there is always the starting of your main crop tomato. Tomatoes from these seedlings always ripen in time.

If you pinch out the tomato axil shoots and plant them right away, you can also have a whole succession of plants going. At the end of the session, if you have a good tomato plant, take its axil shoots out, plant these in peat pots and put them in the glass house. In the spring, you can plant them out.

We give our plants their culinary associates, which have a secondary effect of being weed barriers. When you go for your tomatoes, you get some basil and parsley right in the same basket.

If you want to put a couple of comfrey plants out there, do it. A comfrey leaf under the mulch near the root of your tomato will supply potash.

Try to deal with each thing in your annual garden system. Set up a system for your area, tune it up. Then write up a standard design, which can be printed and tucked in with every subsequent report, when it suits. It would suit an acre garden; it would not suit a 20-acre garden. You won't have to keep on telling people how to grow their tomatoes.

I will continue to insist that a pond, probably central, in some of these non-eroded areas is worth its place. A little pond in the herb spot is worth its place. After just a little bit of research, and going on data that is already extracted, we can find a great many very high yielding pond plants. These plants are in fairly constant production, because they are in a constant environment. Some of those belong in the annual garden. They belong in the high turnover garden. Some of the perennial pond plants belong in the annual garden of course.

So put in a couple of small ponds, perhaps four feet across and 18 inches deep. Some of them filled with about 12 inches of soil, and some of them filled with about four or five inches of soil.

A pond that size will turn out about two hundred or three hundred frogs about twice a summer. The tadpoles live in the pond, and the frogs live in the cabbages, lettuces, and mulch. They return to the pond and you must make a place for them to get out. A good sort of pond is one that is slightly higher than the surrounding soil level, built up and paved with stones. We put sweet alyssum and thyme and garlic between the stones. The alyssum trails into the edge of the water, and the little frogs climb out on it. Another thing you can do is to build up a little stone pile in the pond. Frogs will drown if they can't get out of ponds, so let them have a way out.

Mosquito control is accomplished in two ways. I always put a bit of garlic around the pond and just squeeze the bulbs out into it. That is the best. That kills the larva. Just float off your garlic oils. It's about 100% kill. The garlic doesn't kill tadpoles. The tadpoles eat some mosquitoes, but they

are not a control measure. The second mosquito control measure is backswimmers. They, again, don't affect the tadpoles. Backswimmers fly in. If they don't, go and get them and put them in--not the big ones, not assassin bugs, but backswimmers. We have mosquito control standard design that we have never printed up. It was written by a Ph.D. in mosquito control. Garlic is a lot more efficient than oil, and it leaves other organisms.

Ponds can be constructed from old stock tanks, an old bath, or, it's what you have. You can also make them on site, brick up the sides, plaster them inside. All sorts of variations are possible. In some areas where we work, we just dig a pond in the clay, and get a rammer and just ram it in.

Hot exposures around the house are good trellising situations. Trellis can effectively contribute to climate control. Use trellis right around to the kitchen windows. It should be deciduous trellis, up in summer and gone in winter: hops, grapes, runner beans. The hop is a noble vine, excellent for light pillows for children. It puts them off to sleep without a whimper, and a child can not choke on a hop pillow.

You don't want a cold wind across your house. You can control that with trellis. We continue our trellis systems, but for different reasons. Now we can go to evergreen climbers.

Use aromatic plants around the entry--honeysuckles, jasmine, lilac. A garden should smell like a garden. It is pleasant to step out on a quiet evening into good smells. Stick some lily of the valley among your chives, right near the door. The formal entry should be visually pleasing, but also work in some things that need that reflection off the walls. It may be a good place for a few peppers.

There is a whole category of plants that will live in shade, but they won't yield as understory. Nearly all the small fruits will do reasonably well in the shade pattern of a small tree. The raspberry and strawberry bed will go there, and black currants, if you are permitted to grow them. Gooseberries do perfectly well in shade, particularly the green gooseberry group.

If you are dealing with a retrofit on a brick house, give them ivy on the north facing walls. It makes a difference. It is 40% efficient against heat escape, and it cuts that wind drag against the wall right out. It also preserves the wall marvelously. A brick wall under ivy is in much better condition after a hundred years than it would be without it. This does not apply to wood, just to brick. However, if you want to go to the trouble of putting up a trellis just out from your wood walls, you can use ivy on the trellis. It will still the air flow. Many people won't go to that sort of trouble, so you can use trellising systems.

It is a very good idea, though, just to back up your trellis with something permanent, so that the trellis becomes a permanent part of the garden. If you are going to use stone, use something that comes above the stone that is not stone, because stone causes high turbulence. If you are going to use stone walling, pick flat stones and give it 40% penetrability. Have lots of holes right through it--not for the lower two feet, but thereafter. It is much better to soften a stone wall with a plant that is higher than the wall and softish; otherwise you get real turbulence, low pressure zones, quick evaporation--all the things you don't want.

Trellising can be horizontal as well as vertical. Often when you retrofit you can use horizontal trellising very effectively. You will be trying to prevent excess summer heating. Horizontal trellising is the way to go about that. On the horizontal trellis you will need summer green crops, winter deciduous crops. It is easy to adjust a trellis to cut out the summer sun and let the winter sun right in. As soon as you get to deserts, you can start to use the horizontal trellis as your major trellis. A horizontal trellis placed close in against the house gives a place to go when the weather gets bad. There are little animals that might come in there: pigeons, quail, rabbits in hutches, doves and pigeons in lofts; bees. Bees are best put up above pedestrian traffic, up on a

shelf, so they are flying out above your head.

Then you must think where your weed barriers, paths, car park, entry, and mulch dump with go. The access paths will probably be established.

Once you have the garden set up into those little productive units, then your work is routine, easily achieved, almost self-done. The potatoes keep on potatoing, the tomatoes keep on tomatoing; your corn is an established system that continues to produce.

If our design is for an eighth acre with a large building on it, we would need to throw out all low yielding plants, such as globe artichokes, which take up a square meter and give three teaspoonsful of food. However, if we move out into a quarter acre, we could include a few low-yielding plants here and there. In limited space don't use sunflower, use Jerusalem artichoke. The Jerusalem artichoke is a really high yielding plant compared to sunflowers.

Into this area of permanent, undisturbed garden will come your little hedgerows. Fennel and other perennial umbelliferae ought to be dotted here and there for their value to wasps. Other things to build in around there are things that we have previously discussed, the weed barriers, the fire barrier plants, little permanent places where wrens can nest and wasps can winter over. Put in the sort of fruits you would normally be picking frequently, some of your raspberries and everbearing strawberries. Because they flower all year, I always put a few fuchsias outside the bedroom window. They are nice to look at when you first look out in the morning.

You can sit down and take a vegetable list from any good vegetable book and throw half of them out and put the rest of them in here. List the ones you are going to put in here, and exactly where you are going to put them. Your glass house space is reserved and structured. It can wrap around a bit. We don't put any west windows in the glass house. Those are insulated walls. There is absolutely no (net) gain from windows in those walls. We

use them as storage walls, a heat base.

Look at your house. If you have a thousand foot hill on the west, swing the whole glasshouse to mid-sky; forget about due south, come to mid-sky. Don't be so silly as to take a house and align it due south, when from 3 p.m. there is not going to be any sun on it, because your sun time is from eight to three. So put it in the middle of the sun time.

MOLLISON'S SOLUTIONS TO ENERGY PROBLEMS

You build a glass house front as a focusing system. Then you beg, buy or borrow sun reflecting mirror systems and place them under the eaves so the focus is about eight feet off the ground out front of the house, and there's your driveway. You run your car under there, put a magnet on it and bring it up into focus and it melts. You have a hole in the ground and a copper pipe around the hole. Your car melts and drips in this hole. That's at the end of autumn. Then you cover the hole up, and this copper pipe heats all your house and your hot water, and that runs all winter because you have molten metal down there. I reckon that is the solution to the American energy dilemma. Melt your car.

I do think, though, we could build houses that would of themselves be enormous energy collecting surfaces. We accidentally got it in Australia with an office building five stories

high, which has these blind windows, copper glazed, or gold glazed windows. Its focal point is about 15 feet above the heads of pedestrians. You have a column of hot air just constantly ascending and the cold air is just rushing in and going up. Very rapidly, they didn't like the bottom floors.

I have other solutions to your energy dilemma. The best one is this. You have a stone used by the Indians--soapstone--with a fantastic thermal capacity. Heat it up, put it inside the house structure where we need it most to cook and to heat the house. We will lead a little tube into it and plug it in. Any sunny day that you are running low, we will come along with our pickup truck and we will take out of our pickup truck a big fold-out focusing mirror. We will fire that heat back into your soapstone block. We have our meter. We will read the amount of calories we give you, and make it a little bit cheaper than oil. Now that is practical, easily done.

It seems to me that the technological society seems to be looking for the technological solution, whereas this isn't really a high technology solution. It is more like an old Indian trick. The Indian used to stick a slab of it up top of the communal fire and cart it back somewhere where they wanted to cook, and cook on it. They cooked on it for a couple of hours, then carried it back on a couple of green branches. I reckon that is a non-polluting system that is eminent-

ly practical, easily applied. Imagine a block of that in your glass house.

Do you want me to digress for a minute? I will give you another free invention, called "Mollison's sliding infinity parabolic calculator." I was the man that made the 35¢-Geiger counter. The sun, infinity, parabolic ray--it came to me. I took it down to the physics professors. They swore and cursed. There is always a mechanical solution, always a simple solution. Do you want to throw a proper bamboo screen up at the right curve? No problem. I will give you a few more inventions that are critical Permaculture inventions.

"Mollison's ultra-sophisticated, cheap, fast, solar heater." This invention came to me as I was walking along the beach at Molokai in my thongs, looking at the golf course. I thought I would head up into the bush to look at some date trees. I took off my thongs and started wandering across the sand. My feet started to cook. I was hopping from foot to foot. In agony, I put my thongs back on, and thought: My feet would cook here. The black sand was intolerably hot.

So what you do is run water pipes through a box of black sand. If your sand isn't black, you blacken it. Put some glass on top of it. What you have is something far more efficient than these metal collectors. You have a fantastic transmission of heat, endless hot water, at no cost.

You want another invention?

"Mollison's third world endless ni-

Mollison's Sliding Infinity Parabolic Calculator

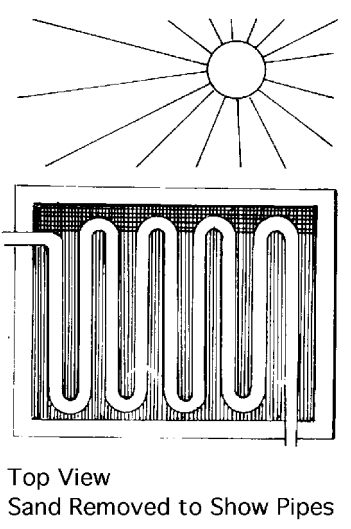
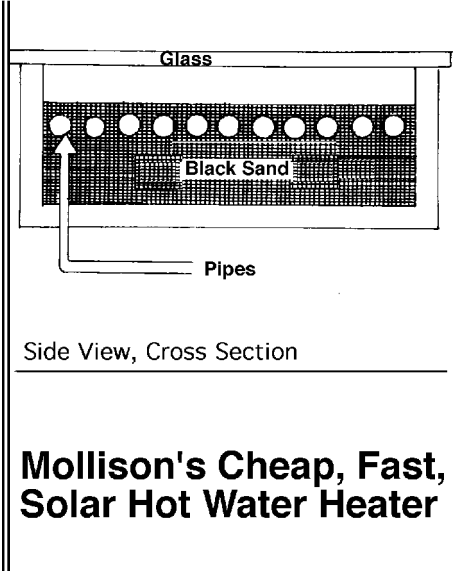
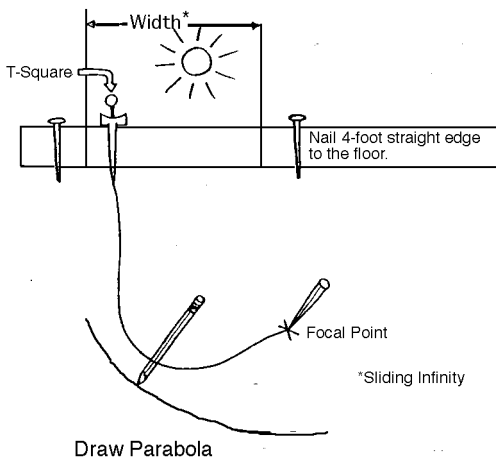



Mollison's Third World Endless Nitrogen Supply System

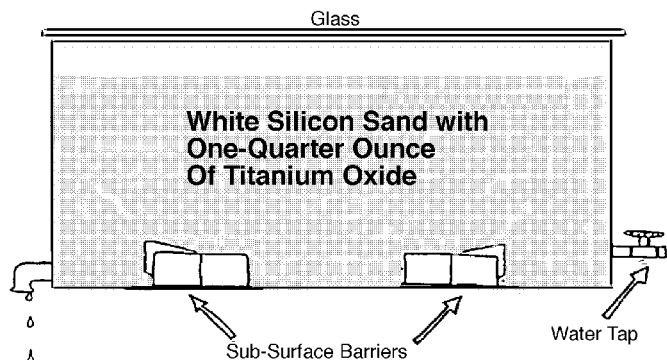

trogen fertilizer supply system." You will need a sand box, with a trickle-in system of water, and a couple of sub-surface barriers to make the water dodge about. Fill the box with white sand and about a quarter ounce of titanium oxide (a common paint pigment). In the presence of sunlight, titanium oxide catalyzes atmospheric nitrogen into ammonia, endlessly. You don't use up any sand or titanium oxide in this reaction. It is a catalytic reaction. Ammonia is highly water soluble. You run this ammonia solution off and cork the system up again. You don't run it continuously, because you don't want an algae buildup in the sand. You just flush out the system with water. Water your garden with it. Endless nitrogen fertilizer. If you have a situation where you want to plant in sand dunes, use a pound or two of titanium oxide. You will quickly establish plants in the sand, because nitrogen is continually produced after a rain. This solution is carried down into the sand. If you are going to lay down a clover patch on a sand dune, this is how you do it.

What I am saying is that everywhere around us, in the natural condition, these factories are working. That black sand has been cooking and dehydrating materials for ages. Just get a fish, split it, put it between two banana leaves, put it out there on the beach. Dehydrated fish. No flies. You can cook in it. That's better than your \$3,000 metal collectors. Those things are applicable everywhere. Good per-

maculture technology.

You are asking me whether people use titanium oxide to create this reaction? No, they don't. They just haven't thought of it. In chemical abstracts, around 1977, a researcher noted this, and then went to a discussion of the whole atmospheric circulation. One of the mysteries of the atmosphere is that it has an excess of ammonia.

They have never accounted for it. When he considered the amount of dunes and deserts in the world, he said, "This is it!" Where do we get titanium oxide from? Sands. So he calculated it. Three acres of desert under this system would supply as much as a commercial fertilizer plant.

But we are not really interested in three acres of desert. We are interested in three square feet in some peasant's garden in Guatemala, or somewhere else. I obtained a bottle of titanium oxide for our village. I never got any more of it. You can buy it by the pound if you want to. It is a common filler in white paint, after they got rid of lead. In the deserts, his nitrogen evaporates into the atmosphere. That's why it is there. Rain occasionally carries it down. That's why deserts grow plants. That's why you can start into a system in a desert without necessarily starting off with nitrogen fixing plants.

But, look! I have no time to try anything. I just know that it works. I never tried that black sand box as a water heater, but I did a dance across the beach and I was persuaded.

My home is a good example of a place where it is always working. It has a basaltic coastline with many little steam holes in the basalt. Some are quite big. The sea is crashing in here, and the waves drifting inland, and it is also raining at times. So what really happens is that in these black basalt holes, you get seawater evaporating. What you have in those holes is a high saline solution, twice

the amount of sea salt. When it rains, the rain water sits on it. So you get fresh water sitting on salt water. You can't dip your hand into that pool. It is a total sky focuser, a lens. The whole sky of light is focusing into this hole. Down there in that hole you have a high heat capacity solution that, you will note, is insulated at the top by water, which is a good insulator. So heat gathers in there, and it 's in basalt. All this is hot.

If you look in there, it is fascinating. You have a hot saline alga growing in there, violent looking stuff. You have different layers of mosquito larvae, belonging to different species of mosquito, but which are quite specific to that stratum. This demonstrates how common those sites must have been, over ages of time, when species have adapted just to that particular condition. It is real interesting.

If I were to make one, I would make it out of black concrete and I would put a straw right around it. Cook your spuds down in there.

Again, the body is a sensor. If you are playing around with a situation and you find a peculiar condition, you know, where your finger suddenly gets burned, or your feet get cooked, take note, take note! You think, as you are cooking away at the base, Eureka!

Everywhere, all this is happening naturally. A civil engineer on Molokai has a thermometer stuck in this beach, and he is busy with the idea. We could build these black sand heat collectors on top of people's water tanks. You wouldn't even need a glass top of it.

Well, well, well, where were we? We were just concluding planning in zone one. Parabolic house--that's how we got there. Right on the edge of zone one, you can recommend growing multi-graft fruit, a mini-orchard. There is some validity in cordon fruit--just single cordons, perhaps four feet long, each one a different apple. It's whip graft here. Just a little cordon fence made up of five sorts of apples. There's a man in California that has set up a cordon system in his back yard. He gets bushels and bushels of apples out of a tiny back yard. He

grows 150 varieties. That is an extraordinarily high-value quarter acre. Dwarf fruit trees are very good in this zone, particularly peaches and citrus. This is the only area where I would recommend this. I would go to the cordon for pear and apple, and to the dwarfs for most the rest.

THE GREENHOUSE

While we are still in zone one, we might look inside the glass house. This glass house is adjusted to use the reflection of the winter snow. It would not have to be the winter snow, though; it could be white quartzite.

As soon as that system is a little larger, we put up two or three glass houses for different reasons. It seems to me that the glass house is a very sensible thing. However, they are not being sensibly used. Often, they are only used to extend the season with the same crops you would in any case grow in your garden and store. You want a minimal amount of that sort of crop in your glass house. Maybe just one of the glass houses you build will have that crop. One alone should supply enough winter greens.

Now what other sort of crops would be appropriate? There are really two groups. There is a set of critical species, and there is an income set.

One of the reasons that we are a heavy load on other parts of the world is that we keep turning their peasant economies into production economies for species out of our climate range, and much of our food is of that sort. Many spices and beverages fall into that category. Although some of them are beginning to be home grown, they need a high labor input. I have a list that I have extracted for Tasmania, which I thought out very carefully, and which you can think out for your area, which isn't so very different. Just look through your grocery list and your shelves. Maybe you use 20 fresh ginger roots a year. You put a green ginger root in a small tub and away it grows. You have a continuous ginger supply. You might--and I would doubt it--eat as many as 20 pineapples a year. This is another plant that is very easily grown, not only within

the glass house, but within the house. It was the ordinary sort of indoor plant of the 1850's in England.

The pineapple needs a little technique. It needs ethylene to set fruit. Apples produce ethylene. You have to enclose the pineapple with an apple. Have a few apples ready as the pineapple flowers. Put them down at the base of the plant. Another thing you might do is to plant a single dandelion plant in a pot nearby, because it has constant ethylene production.

Vanilla is a fairly hardy orchid. It will grow up the rear wall of any greenhouse, any place that has some heat in it.

Cinnamon is a very easily propagated tree that grows from cuttings, and it coppices. When you cut a cinnamon stick off, you get four more. It is a two-year cycle crop. In a pot, it takes up about a square foot in a glass house. You can produce cinnamon for everybody in your area with one pot. Cinnamon is a very common roadside plant of the near tropics. You can distill the leaves for cinnamon oils. The leaves are a very high value fertilizer. It's a useful little plant.

Tea is a small shrub, which is a *Camellia*, a fairly cold-hardy shrub. In the tropics, it is a high altitude shrub. It is better as a green tea, but you can ferment it. Again, one plant gives you all the *Camellia* tea you want. It will grow in the open up to a latitude of about 40 degrees. Wherever *Camellias* grow, you can grow tea.

Coffee is a very shade tolerant indoor shrub that has beautiful flowers and a nice aroma. It will live in offices quite well, in just a well-lighted office, under fairly artificial light conditions. It bears heavy crops of berries. You can eat the berries. Spit out pits and take them home and roast them. You will get pounds and pounds of coffee berries off a single plant. It is a kind of weed tree of the shade.

To the extent that we import tea, coffee, cinnamon and ginger, we lay waste to a lot of distant peasant economies, cutting into their available land, using their land to grow this food for us, rather than growing food

for themselves. We do that just so we can have non-food items.

So I think it is time we built some glasshouses to produce these items ourselves, and take our weight off other people. If somebody grows five or six tea plants in their glasshouse, they will have enough tea to supply 20 or 30 households. If you grow cinnamon, you can grow enough for 100 households. These are species that I think we are morally obligated to grow in some of our animal heated or solar heated glasshouses.

In inland Australia, where I put in two story glasshouses, there is no problem with growing bananas. Two banana plants would normally supply all the bananas that you would use for a family. You can get the necessary height in two ways. One is to build a single story glass house and drop the floor of it a story to make room for these tall plants. The other way is to build a two-story glass house. It is very effective, however, to drop it a story below ground, providing it is drained. It is good heat buffer, and your plants will get up to the light fast enough. You could grow vanilla beans and bananas in a pit glass house with just one story at ground level. Grow the dwarf cavendish banana. [There are several other dwarf varieties such as Raja Puri, Dwarf Orinoco, etc. Also, beware of severe thermal stratification problems in 2-story greenhouses. One story with dwarfs performs much better. --DH]

Turmeric is equally easy to grow.

There are many opportunities at present for deriving an income from plants grown in the glass house. The highest return is from flowers, bulbs, ferns and indoor plants. But you might profitably grow vanilla beans. These have to be hand pollinated. You do it with a feather. You really have to make but three trips to the vanilla bean, one to cut it and bend it down, one to pollinate it when it flowers, and one to clip the beans. You sweat the beans in a woolen blanket, and that's it. One plant gives you hundreds of beans. It is a better commercial crop than tomatoes. It is up to your ingenuity, really.

The alienation of third world land from food production is increasing. So if you can start into these crops, you will be doing a good job. Most of them are vegetatively reproduced.

The banana sends up four shoots. Give these to your friends. Cut off your spice plant and stick it in the ground, and off it grows. So will the papaw [papaya]. Anyhow, papaws are really self-seeding. They will come up all over the place. In cool areas they last for 30 or 40 years; whereas, in the real tropics, a papaw only lives for about four years.

So I would think about this aspect of glass house production. You have an opportunity to provide more than cabbages, you know. You can be supplying foods otherwise that you bring from a great distance at a great human cost.

I haven't given much thought to the interior of the glass house. It would be good to do so. I can simply point out to you that there are strategies. Quail are good inside the glass house. They keep cockroaches and whitefly down. Bring them into the house to clean up cockroaches periodically. The ideal nesting place for quail is under the curve of a pineapple plant. They will eat tiny insects; they eat whitefly.

Run a pipe from the outside pond to a small pond inside the glass house. Fish will come in and overwinter in the glass house.

I had a thought about taro production. Taro is a very ordinary root crop. It grows in water. But it is no use trying to grow it where it is frozen. So we can move our four or five taro plants indoors.

One critical plant that must be moved in is the *Azolla*, a nitrogen-fixing fern that grows on water. So we bring *Azolla* in, and, grateful plant that it is, it starts spreading all over within a week or two. There are 18 species of *Azolla*. They run right up to the Canadian border and right down to the equator. Sometimes it's red; most species are green.

Everything in the greenhouse is waste high. Underneath is rubble. So why not put a pond there? One thing

that does well rooted in a pond is salable bulbs. Suspend them on mesh above the water.

I'll tell you what my friend does in Melbourne. He rents people's swimming pools and grows all of his spring bulbs in them before they start using the pools for swimming. He grows them on rafts.

Retrofit a swimming pool for biological production, with blueberry edges and frogs.

I don't feel we have got very excited about glasshouses yet. We have the technology. We have the uses right, the construction right, and we have started to get some of the crops right. But I think we have a long way to go. It should not take us long; but still, we have a long way to go.

KEEPING THE ANNUALS PERENNIAL

You may be able to get a system going so that there is no reason to buy seed again. Keep little bits of purple ribbon right by the door, and tie a piece of it around the plant you don't want to pull. Everyone should know what the sign is.

Just keep bringing the seeds in, or even hanging the plants up to dry without ever shelling them out. I think this is becoming critically important to us all.

You have, maybe, eight species of non cross-pollinating squash. If you are smart, you settle on a really satisfactory long-keeping pumpkin, a good cucumber, and agree with your friends that they set seed of one of a slightly different group. There is a perennial squash that just does not cross pollinate; it is quite a different species. There is a wide variety of species of squash--Chinese and Japanese. You have a very large selection. You could grow nine sorts of squash that are not going to worry each other. We have dealt with pinching out the axillary shoots of tomatoes and peppers and bringing them in over winter, either under glass or just as a sill plant.

Leeks should be permanent in the system. You should let some go to

seed and plant from bulbs all around the base, then sell the seed to someone else.

If you don't already know how to cross cut your cabbage stems, start in. Cut your cabbage, cross cut the stem, and you get four good little heads growing off that. I've gone further. I have cut right through, let the heads spread out, separate the four things and replant them as plants.

Celery is an interesting plant. It is a perennial plant, not an annual. In all Tasmanian gardens, they still have the perennial variety. Just keep pulling bunches off the side of it.

The trade has made annuals of many perennials because they are into seed production. I have found a wild lovage in Tasmania that tastes as celery and that is perennial.

With many plants, I just take the seed heads and shake them all over the garden in autumn. They fall through the mulch. I get celery, parsley, lettuces, and all that, coming up at random. It is very wasteful of seed. The same amount of seed would sell for \$20. I am trying to shortcut this whole business of buying seed, growing and purchasing seedlings, transplanting them out, cutting off the whole plant at harvest, and buying more seed every year. We are trying to get plants suited to the site, and reduce the seed packet buying as much as we can.

In Tasmania, we have found that we get many apple seedlings from apple pips that have been tossed out along roadsides. Every seedling apple we grow is a good apple, so we never bother to graft. They are already heavily selected apples, and we grow them from seed. All the deciduous trees that we have were imported. There are no wild apple species.

We got a frost resistant orange from pips. Nectarines are always good from pips. Lemon will take frost. So will mandarin oranges. I've been running around New South Wales when all the mandarins were frosted to the ground. Break them off the ground, and their skins would be stuck on the ground. These trees don't mind frosting up of a night, a few degrees below.

A seed bed should be incorporated into the annual garden--a little five square meter place for putting out seedlings. You want them coming all the time.

We save almost all the seeds of the fruit we eat, the pips. We let them dry, just along the windowsills. At the end of summer, when we have accumulated many of them, we pack them in sawdust and put them outside in a box. The rains fall on them and the frosts attack them. From then on, we start lifting the sawdust up and looking at it, and as soon as shoots start to peep out, we start putting them out all over the place. They are on their way. The more fruit you eat, the more fruit you grow. You catch up with yourself in about seven years.

FORAGE SYSTEMS AND ANIMALS IN ZONE TWO

Never in the history of the world has anybody designed and implemented animal forage systems.

White mulberry as chicken forage is as good as a double crop of grain. It is 17% protein. The mulberry crop is a very good chicken food for the period of bearing in which it occurs, and beyond it; because the chickens are getting seed long after the mulberries are gone. You can put in quite large mulberry plants from cuttings. You can put in four foot cuttings of about one and one half inch diameter. In the first autumn, take a rooting, and you can get several trees. You can completely fill the area and be into full mulberry production next year. In the United States, you have one of the very best black mulberries in the world. Two or three varieties will extend your harvest season.

The hawthorn group are great winter forage. So is the mountain ash.

When we come to the period of summer drought, we look to greens--to comfrey, cleavers, and any amount of chard. There are gardeners at home who grow more chard for their chickens than they grow for themselves. In this part of your garden you might have some throw-overs, like chard, or weeds.

Really, what we should look to carry us through a drought would be the Siberian pea tree. They are common here; and they are very good nitrogen fixers, producing a lot of seed. The peasants of Siberia fed their poultry on this tree alone. This sort of seed is always there. The chickens will go on and off it. They don't pay it much attention when they are chasing mulberries. And they eat a lot of greens in the summer. But at some periods when maybe there is no other seed, they hit it. It is doing handy things for them, like growing sprouts on its own.

With an acre of black locust, which is your best fence post material, you may look forward to a 10,000 pound drop, minimal. Just outside this acre, you have a little Fukuoka plot producing another 2,000 pounds of grain, in case we made some wrong guesses in here.

Wherever there's frost heave, and we want to stabilize the soil, we drop some sunflower seed in mud balls so the birds don't eat them. You have lots of opportunity with frost heave. Sow those little patches to clover or sunflower seed.

Now you can bring tubers in; you can bring in some Jerusalem artichoke.

Say we have a half acre of this--as a modest estimate, you may have 5,000 pounds of chicken forage in there, much higher in protein value than wheat, and a much more variable food. This would keep 40 chickens a year.

We have certain advantages here. We will have straw yards where we can grow lots of grain, by alternating a couple of yards to chickens. We have 5,000 pounds of fodder, at present, there. This would keep chickens for seven months a year. No need to go threshing and bagging your grains. You hang the sheaves up. The chickens will do all the husking and the threshing. Now that is without considering the forages and grasses, and the insects in this situation. I reckon we might have at least another 2,000 or 3,000 pounds of just protein.

Just before you plant, let the chickens and ducks in to dig out the slugs and clean up the ground. They won't get many of the seeds. Slugs and worms are much more delicious.

If we want to set up a new sort of chicken farm, we separate the chicken houses by about 150 feet. If you want to make it 200 feet, go right ahead. That's as far as a group of chickens range. You won't get any mixing up of the flocks.

Here's another fact for you. If you don't run any more than 400 chickens to an acre, you still have an entire herb and regrowth, with no bare soil. Four hundred is about the break even point. Three hundred is all right. It is good not to exceed 80 per flock. They are happier with about 50 to 60 per flock. It suits their social conditions best. You will need about five roosters to the flock, otherwise, the hens wander. So on an acre of ground you can set out four sorts of 60-chicken flocks, running roosters. You can have four entirely different breeds of chicken. The heavy breeds lay better in winter. The light breeds are spring and summer layers. For details, consult your chicken fancier, not your poultryman. You have good fanciers in America. You have a pheasant society; you have a duck fancier--all those ecological bandits. They are sort of oil millionaires. Five acres under wire. They go out and pinch very rare ducks off everybody, and escape illegally, if necessary, in their own yachts. They are nuts.

By calculations I have made at home, I have enough food on there for 800 chickens now, off the shrub growth. That's based on something more than intuition. It's based on an actual plot. Now, I don't want to put 800 chickens on there, because I don't want bare ground.

Your conditions are different, because you have a winter close-down period, and you have some of your food in store. So grow more sunflowers, or whatever, but not all sunflowers, because if the chickens get too much sunflower seed, their feathers drop out. That's because there is too much oil in their body, and the feath-

ers are very loosely attached in their sockets.

We wouldn't argue but that we are going to get cheaper eggs. We wouldn't argue but that we probably are going to get healthier chickens. Certainly I wouldn't argue but that we are going to get happier chickens, because what you have is a chicken out there really doing its own thing. We don't seem to get much disease in these chickens. They seem to maintain good health and they lay until they die. It's not one of these three-year systems. They often die at roost, having laid the day before. Some of them go six years in this. So no need to kill the layers. It is a cheap system. You can bring out a cart of eggs every day, and they don't cost a lot.

Get the system going with very large cuttings and pot planted things. Chickens cannot disturb little plants if you get them going in wire mesh, mulch or brush piles. Later in the season, when we get it going, we can load the area with two hundred chickens. In a few seasons of tuning and adjusting, we can bring it right up here to where we want it.

A pasture with above 400 chickens will show two effects. The amount of nitrogen starts to weaken the pasture, and the chickens will probably eat it out.

What we are really setting out is a much stronger root system than pasture, and we are setting up leaf mulch. It doesn't all have to be chicken food in there. Chinese chestnuts and hazelnuts can go in there. You will double and quadruple your yield of hazelnuts. What we have in there is high nitrogen demand, high commercial value crop dotted through the area. Chickens are cutting down the grass competition, and they are also eating the windfalls from apples and other fruits. So it is a chicken-orchard: chicken plus orchard, including vine crop.

A grain-fed animal itself keeps four chickens on just the grain in manure. Ducks with sheep are excellent. Ducks eat two things fatal to sheep: One is shallow water snails that carry fluke, and they also eat the fluke eggs. It

doesn't hurt ducks or infest ducks. Ducks don't compete with the sheep. So in this way, you set up a high hygienic situation. The same goes for chickens and grain-eating herbivores. The chickens don't just eat grain. They eat encysted parasite eggs. Anything that has died, an animal that has been run over on the highway, just hang it up in the chicken run, convert it into larvae. That will sharply reduce the flies in your area, because these larvae will drop into the chicken pen and be eaten before they can hatch flies. Ducks are great fly catchers, too. If you bait the flies in, ducks will catch many of them. We can bring insects in to them by planting insect attracting plants.

Chickens with plum and cherries sharply reduce crawling, flying pests. All the pests that go into the soil and re-emerge are sharply reduced.

With chickens given the shelter of trees, the depredation situation is practically nil.

What we are doing here is playing a new game, which nobody has ever played. They have played little bits of this game here and there. The people of Siberia and the tundra have played a little bit of it. In West Australia you can identify the old chicken yards by the fact that they contain the Canary Island tree lucerne, which, among the old timers, was the number one chicken seed forage. You can find every old Tasmanian pig sty, because it will contain oak trees. The British brought their oaks with their pigs and their poultry--sensible people! Now all that remains of the pig sty is the ancient oak trees. The pigs are over there being fed grain, and the oaks are over here with nobody feeding on them. Because the grandchildren of these people went to the university and got educated, they found out from the agricultural department how to grow pigs. The old systems all went into decay. But there remained little bits of it.

I think it is good to run our chickens with the other animals. Then we have animal heat and the enormous heat of the decomposition of manures out there in the barn. If we build a glass

house around it, we can use the heat; and if we use the methane, and the ammonia, and the CO₂, then it is starting to look very good.

You want a few piles of quartzite gravel in range; and you will need broken shell. The crushed shells of fresh water mussels are good for that.

In North America you have a large continent with large marshes. You had a large wildfowl population. Your country has wildfowl-specific forages. You had your turkey ranges, your pigeon ranges, and your duck ranges. Among these enormous forage ranges, there are going to be critical forage species, very good ones. Long ago, we should have started using these systems, and not have been relying on the wheat fields to produce disease-stricken cows and poultry. I simply point out your grand opportunities here. If you go back and read the accounts of your early explorers, you will find that as they were coming up the river, they weren't looking at a flock of ducks every half mile; they were looking at ducks by the thousands. They were looking at flocks of passenger pigeons that darkened the sky from dawn to evening. There was a lot more nobility in the environment then. Just imagine the transfer of phosphates across this country.

We can take some of the native animals like the turkey, and start to manage those forests into turkey ranges, or we can bring in other species closely allied. In these wildlife forages we find many of the pioneer plants, the plants that step out into the grassland, plants that are not fussy, do not require all the mulching and harrowing and digging. They prepare the site for your following plants. I would pioneer with bird ranges across the country, and transfer into larger tree species.

If you have existing forest of low-forage species, you can adjust maybe five acres of it one way, five acres of it another way. You have great opportunities. You have no establishment problem. All you have is tuning problems. You worry about what vines to put up those oak trees. Where there

are no forests, our concern is how we are going to get the oak tree up there.

Sixty per cent of the world's grains are fed to livestock. In the United States, not only are you doing that, but you are bringing in something like 100% of the produce of the South American fisheries. You are importing an enormous amount of protein from overseas. America does not feed the world. The peasant farmer of the third world feeds the world, including America. All the fish concentrate, the entire crop from the Chilean coast, comes into America as animal feed. That alone makes America a net importer of protein. They had put in a fish concentrate factory on our east coast in Tasmania. Certain whole fish stocks were wiped out this way.

We credit *Melaleuca*, which grows in most climates, with attracting about 60 per cent of our inland fish food. This grows all along our inland waterways. It attracts a great variety of honey-loving beetles and moths. So we can bring insects in. We can bias the whole situation toward the desired product. At the same time, we are not stuck on that product--the fish, the chicken, the duck. We can move into mulberry jam, apples. I have seen hazelnuts growing inside and outside a chicken pen. Inside the chicken pen, the bushes are about three times as big, and they have at least twice the amount of leaves per cubic foot, as compared with the ones outside the pen. The nut crops easily quadruple the ones outside the pens.

I suspect that we removed an enormous amount of biomass from this landscape when we took away the chisel plow--the marmots, gophers, moles; when we took away the free-flying pigeons. They were our phosphate mobilizers. The forest produced them and sent them out, saying "Feed me." In this way, the forest attracted the phosphate to itself. The animals are the mobile part of the forest, an aspect of the trees. Those birds are planting those trees; they are gardening those trees. You cannot take them away and expect to have a healthy forest. You can't. You can't have a healthy society, either. What you

have is unhealthy plants, because their essential mobile components are missing. The animals are needed. I think when we start to balance these systems, you will see it reflected in tree health and tree growth. You may even see a big tree again one day.

I have seen an English walnut growing in a chicken pen, an old chicken pen, not now active, between one and two hundred feet across the crown, and still only 60 feet high, and that tree is only 120 years old. It yields bags and bags of walnuts. These trees around here don't look as if they are ever going to be big. They will get sick before they get big.

You have conditions here that are good for ground birds. There are all sorts of places to start up these activities, to create the little ecological islands. I don't think we need 70 per cent of this corn. If we could work out these little alternative systems, there would be no need for carting in all of this protein.

There is a film that we have seen in Australia; you may have seen it here. It shows the fishing operation of Chile, which has a desert coast. Off the coast, there are islands that were very high nitrate islands and phosphate. Here the westerly drift comes up, and with it billions of fish. Those fish are being taken and processed into fish protein concentrate for U.S. pigs.

Under the conveyor belt that goes from the holds of the fishing vessels up to the fish factories is a God-awful mess; and for a while you can't figure out what is happening. All you can see is arms and wings. It is the peasant women and the pelicans fighting for dropped fish, because both are starving. The pelicans are invading towns 200 miles inland, fighting with people for the remaining food that there is. That film indicates something is bloody awful.

So I think we must go into forage systems seriously. These forage forest situations are fantastic fire control situations. We usually have a high growth rate, really good plants, very little ground cover, hardly any litter accumulation. Because there is more

nitrogen going into this forest through its animal populations, there is a very rapid break down of litter. It would be reasonable to choose hardy animals and these pioneer forage species to prepare for the following forest.

Time and gain I have set up a situation, and then discovered that this ecology is working, and I hadn't realized it until I designed it. Somebody had been in there before, a good Designer!

Yet it is not quite the same old game we have to play. We have to play a new game. We are not into the game of shoving the continents together, and pulling them apart, arranging all sorts of new combinations, just to see what happens.

We have been impoverishing the globe, and we are into the greatest, most intensive phase of impoverishment right now. We know that as a result we are going to wipe out tens of thousands of plant and animal species. Whole elements are dropping out of ecologies everywhere.

The only way we can begin to make amends for that is to bring other elements into those ecologies, in an attempt to restore their function. The chestnuts were 80 per cent of the forest cover. They are gone, killed. What do we put back? What amends are we going to make to every animal dependent on that forest cover? Are you going to make amends with the Chinese chestnuts, or what are we going to do? Acid rain will knock out many of the species in northeast America. We may not be able to get those species back in that area, but we have to make amends. We have the potential to enrich the system. The chances are more than equal that we can enrich it.

Some of you keep returning to the rationale that there is an inherent danger involved in introducing plants not native to an area. I have a rationale, too. I use only native plants; they are native to the planet Earth. I am using indigenous plants; they are indigenous to this part of the Universe.

Speciation is not something that is happening all the time. I believe that

many of our systems are becoming time-saturated. I believe that too much time can accumulate in this system. It closes up. A forest that is rich, complex, with many other things in it, gradually evolves into a big old closed system, dominated by a few species. It is a bit like a free economy society that has resulted in a few old savage people accumulating everything. The die-off starts at the bottom, and you lose a lot of genetic diversity. Then it's the time to overturn it. Any social system that lasts too long seems to get time polluted--chronically ill.

There is a man who had a 14-year-old sow. He fed it a lot of good things, including apples. He had pigs before her. About 17 years ago, in the corner of the pig pen there was a blackberry clump. An apple tree started there, and up it came. Then the apples started to fall, and the pigs got into the blackberries and moved them out, ripped them all out and left the apple tree. This fellow was a man of great sagacity. He went out and got a lot of apple trees, waded into the middle of his blackberries and planted trees in every blackberry clump he could find. He also planted peaches and quinces and figs and pears. He had a lot of blackberry on his farm; he was in fairly heavy rainfall foothill country. Blackberries there are not the weak undersized things you see around here. They are violently rampant blackberries. They will fill gullies and be level across the top of them with the hills. The water flows down below. So he waded in and put in a grafted sometimes, but often seedling trees.

What happens in this situation is that the tree grows straight up to the light. It doesn't make any low branches. It grows very fast. It is the fastest growing situation you can find for fruit trees. The tree doesn't have any branches for maybe nine feet, and then it crowns out. When the apples start to fall, there will not be enough of them to attract anything except three or four rabbits, and they eat them. Then, in a couple of seasons, maybe, a lot of apples start to fall,

and they start smelling good and getting lost in the blackberries and fermenting. At that point the cattle can't stand it. They wade into the blackberries up to their chest, picking out apples, and they tread heavy on the blackberries. Then the tree gets bigger, and it drops 30 bushels of apples. It is now partially shading the blackberries out. It also becomes absolutely impossible for the cattle to stay out. They smash the blackberries flat, and you have this gigantic apple tree with the big thick trunk, eight feet clear of branches. One of those trees is 70 feet across, and 60 feet high, yielding 70 bushels of apples. The cattle get about 40 bushels, and you can pick 30. At just 17 years old, it's a phenomenal tree.

I don't know whether you can imagine this farm; but you should see it. It has patches of eucalyptus and wattles, and here and there a gigantic fig tree, a gigantic apple tree, and an enormous pear tree. Twelve pear trees growing under similar conditions yield almost seven tons of fruit per tree. They are big. They are approaching 160 feet high. There is a flood plain with blackberries there, and these pear trees haven't any brambles at all under them. You can get on your ladder and pick the first 20 feet. The rest, from there on up, drop to the sheep and cattle.

I keep seeing this happening all the time. I thought, Of course! Here is the old European forest, in which lived the white ox, the old European white ox. On the edge of that forest, sneaking out into the plains, step after step, is the bramble. On the edge of this forest, the only place where it is doing any good, is the apple. Its fruit falls into the brambles. The seedlings come up and begin fruiting. Then comes the white ox. He comes and rescues the forest. That is how the forest advanced. Here comes your little boar out of the forest, rooting around in the blackberries for apples, and they will change the soil condition. They will make a high manurial situation, and will stimulate this edge growth of plants. Then on the forest will go, with apples out in front of it.

You will find this happening like that all over the place. Geoff Wallace is doing this deliberately. He has run completely out of blackberries, wiped blackberries right off his property.

The main value of blackberry to tree is that it prevents grass competition at the roots. Grasses produce chemicals hostile to trees. There is a fight on between grassland and trees. Fire helps the grasses; brambles help the trees. Hence there is a whole conflict of pioneer species in grasslands. The bramble is really continually mulching the tree, keeping its root system free of grass. The tree grows much better there than in an open situation. A secondary effect is that the bramble growth pre-prunes the tree to a standard, prevents low branching, and the tree crowns out into a really classical old British type crown--round, with a strong trunk. By the time the bramble is smashed, the bark is coming up from the root of the tree. It has all been timed. We couldn't have designed it better.

Somebody designed that for us. I just keep on this way, discovering something; then I go and have a look. It was there anyhow. After the forest is gone, when we are trying to grow the apple tree away from the forest, without the cattle, without the pigs, without the blackberries, we are going to have a lot of apple trees that are very unhealthy. In California, a lot of iris and fennel grow under apple trees. What you are looking for now is the tree's garden, the situation in which the tree can stand against the grass and still be very healthy. Now these are an interesting group of plants. Their main characteristic is that they are not surface fibrous-rooted plants. They do not set up that mat that intercepts light, rain, and prevents the percolation of water.

The nasturtium and any of the root thistles are very good plants. They are tap-rooted, large-leafed. They are clumped or have feathery fronds. Those are the sort of plants that do well under trees. You can design the apple garden, in which the apple will thrive according to its shade and sun requirements. If you start planting

this garden with your apples, you get healthy, fast growing, non-cultivated trees.

We are building up a set of plants from which we can derive characteristics that will enable us to add plants with specific traits. These are very good grass barrier plants with a very fast rotting leaf crop, quick turnover plants. You can start to garden your orchard over with these species. At home, daffodils often grow under apple trees. You may want to sell daffodils and apples; or you may want to sell fennel and apples.

Go and take a look at where the mulberry, the fig, the pear, the apple and the quince have survived the ebb and flow of human settlement. Work out the characteristics of the understory. You are seeking a tree with about a nine to 12 inch incremental growth annually, continuously self-pruning at the crown, so that branches are not overlaying and smashing, and the fruit will not be small and crowded. In the blackberry patch, the tree is protected until it starts to bear. When the blackberries are removed, growth slows .

Another remarkable sight is avocados about 60 to 80 feet high, bearing three to four tons per tree. They have a lot of cattle manure under them, because cattle love avocados.

You are looking under the tree that you are scoring, and you are setting as an ideal that the tree makes the amount of increment a year that it would make if we are actively pruning. But you wouldn't be pruning. Instead, you might put a wedge of grass under it, and let that prune it back. You would disfavor growth just a bit.

At Tagari, we've been only two years on site, and I don't spend much time at home. When I am there, I'm out stacking Russell lupines, comfrey, thistles, and bamboo in under my orchard. I'm trying to bring in more nasturtium. We are not inviting cattle into our orchard. We are doing the gardening there.

Some of these situations are appropriate for chickens for forages; some are appropriate for garden productivity; and some may also be appropriate

for wildlife or domesticated stock. We want a whole set of these gardens, isolated from one another.

Another good thing under trees is a proportion of slab stone. I don't know how much of the surface should be covered with slab. It may be the stone slab is doing the pruning. Stone slab is ideal watering--instant run-off. It is not going to absorb and of the rainfall. It is high worm cast--all the characteristics that we want.

Now for the fig, the rock pile is the perfect condition. I feel that by adding or removing more stone, we could prune those trees, because that is a very manageable proportion of the ground cover. If we want to lengthen the shoots, put stone on.

There are biological books that will give you the perching characteristics of birds. Most all open country birds require perches. All insectivores are perchers. Put a bird perch by that little tree and you will find instant mobilization of the insects around that point, and a substantial fall of phosphate there. It will make a difference. We have done it, and those trees where we have done it are healthy; and the trees where we have not done it are not. Those birds are eating seeds and insects and providing phosphorus for the tree. We throw these perches away after the tree is up and providing its own perching situation.

In a tropical location, there is a person who has done a beautiful thing. His trees are lychee trees, and grasses are really hostile to lychee trees. Those trees in grass will die. He put at the base of each tree a little five gallon can with a hole in it, and in each can he put four guinea pigs. Guinea pigs run around under the grass for a very good reason: There are a lot of owls. Those guinea pigs would leave one stick in a hundred of grass. They build up a high and low litter. They manure the tree. They cut most of the grass off, allowing free water penetration. All his trees with guinea pigs are doing very well. Now here is a cheap cultivation method. He has an army of guinea pigs there working for him, and it costs him very little. Yet he gets a very high growth rate in his

lychees. During the four years that they have been working, those guinea pigs are about to make a millionaire out of him. So that is another applied plant-animal relationship that is a governing relationship.

Occasionally a python comes through. He lowers the guinea pig population. But guinea pigs breed up. Well, pythons are harmless, really.

It's that sort of situation that we are trying to set up. We are attempting to beat the grasses against the forest, preferably in a productive way.

THE BEE

I don't know about America, but in Australia flowering is unpredictable, and forests are being rapidly reduced to islands of plants. The average beekeeper knocks out well over a thousand kilometers a week. Some do 1500 a week, just shifting bees and getting water to them, traveling to them, and carrying off the honey. It has already reached the point where, if beekeepers stayed home and started planting forage systems, they would be infinitely better off.

There is a whole set of bee forages. They range from useful crop, such as rape and buckwheat, to marshland trees, the water tupelo, and marshland plants such as purple loosestrife and *Caltha*, the marsh marigold. There are very reliable honey trees, such as basswood, *Tilia americana*. There are many basswoods, not confined to America. The *Tilia* are elsewhere called lime trees. Purple loosestrife is a problem to marshes, but if it is there, it is good bee fodder. If you have it around you here, you might as well be using it as bee fodder. The Tasmanian leatherwood might grow in this climate. It has a super-high-quality honey. It has the interesting characteristic that the cherry laurel has. It produces nectar from its leaves, and from its flowers. Leatherwood has very active leaf nectaries. Just before the end of the season, empty the hives out and carry them into the leatherwood, and they will put out 100 pounds of honey every

three days. Leatherwood will grow up with the forest and flower in it at crown, or flower as an interface. It is an indigenous species in Tasmania. This plant is a really fine tree in itself. It is good wood, a fine forest, a beautiful tree, and an incredible bee plant. In a two mile range it is customary to put in about 150 to 200 hives. Within this range, every one of these hives puts out 100 pounds of honey every three days, and all the time. Here, you would probably be lucky to hit 60 pounds in a season, unless you have a lot of *Tilia*. Leatherwood is an evergreen that grows in wet, snowy forests. It flowers the last of the season, mid-January with us. So it is going to be mid-July here.

What happens to a tree when it is moved from Australia to North America? It keeps its wits about it. It operates on day lengths as usual. We have shipped everything down, and it all grows. You send us autumn fruits from these oaks; we put them in and they don't drop till autumn. If it is springtime, we just plant them right away. Often we just give them a chill factor and plant them.

If you are planting for bees, there are a few rules. You plant a lot of the forage together. Clump your forages. It is not good to dot these things about the landscape. If you are going to put in leatherwoods, put 30 of them together in 10 different places. Put them in full sunlight, or on the sunny side of the situation. Don't put them near the hive. Keep them at least 100 yards or more from the hives. If you put them closer, the bees won't work them. I don't know why this is, but they don't. It is impossible to have too much low hedgerow between your hive sites and your forage sites. I mean as low as four feet. This enables the bees to work in unfavorable conditions. In very bad weather, the bees fly along the very low hedgerows that lead to the forage systems. These hedgerows are windbreaks, so they might as well be productive. Start out with thyme, rosemary, or whatever, and go on to low forage.

Wetland plants are excellent bee plants. People with wetlands might

profitably go into apiary work. Conventional hives are built to shift bees around. Now we could re-think bee-hiving altogether, given that we don't have to lift hives around. I imagine what we might build is the bee barn, in which we pay far less attention to the weatherproofing and insulating individual hives. We would insulate the whole structure and have a whole set of exits for bees. We would work inside it and have a high light escape to which we can switch off. We unload, store, and process inside. So the whole operation becomes a sedentary operation with a sliding in and out of our bee clothes. You always put in a bee processing shed that steps down. Because honey is heavy stuff, your extractor has to be no more than waist level, and your storage drums below. Honey is a flow-down thing. That shed is always a step-down system--three levels.

You say that in Czechoslovakia they are using this sort of system! I didn't know it already existed! I had to reinvent it! Great!

We must pay attention to the fitting out of pollen traps in the beehives. There are periods when they can be used, and periods when they are not used. Bee pollen is the best tree-grown flour for protein we can get. So we are right out of grain growing. The plants are already growing that grain, and it's hull-less. It has many good minerals, and is high in protein. You get as much pollen as you do honey. If you get 60 pounds of honey, you get 60 pounds of pollen. So it looks as if we might just shift right out of our grain growing situation. From a hundred hives, you will get pollen way beyond our individual needs.

Now we can figure that about 60 hives is a family's living. Moreover, those bees and the apiarist and his family are advantageous to any other system. They increase the apple crop; they increase the buckwheat; they increase the seed set in our gardens.

Again, we are into an interesting thing. We can go from crop and annuals into perennials in a staged system, which keeps our flow constant. We don't have to start with *Tilia*

americana. We would wait four years before we can get a blossom on it. So, we start with rape, buckwheat, sun-flowers, and all the other good things. There is a manifold system we can play with.

It is easy to choose your mid-season and late-flow plants. The flowering periods are generally known. Your beekeeper certainly knows them. The whole thing we are trying to do is to bring the food to the animals.

CATTLE FORAGE

It is very impressive to look at an ancient pasture, of which there are not many in the world. It is like going out and looking at the unplowed prairie. There are a few in Yugoslavia, and in other southern European countries where it hasn't been their habit to plow all the land. I took a picture of about two square meters of pasture on which I can count 18 flowering plants; but there are many not in flower. Some of those pastures would have some 30 or 40 species of plants per square meter. It is a pleasant day watching a cow going through those pastures. It is totally different from the grab and eat, grab and eat thing. The cow seeks her way through this complex. Inevitably, as she eats a good clover, she gets a mouthful, or half her mouth full of a bad tasting thing. So you have an interesting effect. Cattle are unlikely to browse that pasture severely, because many plants are protecting others, and many semi-dangerous, or semi-poisonous plants are in with the preferred plants. Newman Turner, whose books have recently been reprinted, points out in *Fertility Pastures* that whether she likes it or not, the cow takes her medicines all the time. The cows in those pastures are shiny and glossy and have nice washed noses and luminous eyes. The herdsmen go with them. They just sit with them. It's a pleasant occupation.

Most of the people who handle their own cattle never use dogs or horses or chase the cattle. Whenever they want to change 3,000 head, they yell "Comeon cow!" and all the cows put

their heads down and follow him through into the next field.

Another friend of mine owns 700 acres. He is an organic gardener and a renowned pasturist. He hasn't used super-phosphate for 17 years. The health of his cattle's has improved out of sight.

Now you get all sorts of problems with over-fertilization of grasslands. You get infertility; you get a rather pulpy kidney; you get many diseases as a result of locking up certain elements. The cattle look peaked. They chew on barns. They eat trees. They obviously suffer from lack of elements.

New Zealand, much more than Australia, is looking very much to tree crops for cattle pasturage--to willows and poplars, and some eucalyptus. Cattle love the bark of these trees. It is quite possible to have enclosures of maybe five acres of tree leaves, which is much better than having a barn full of hay.

If you want fat cows, you plant rye grass and clover, but you will still get cows with worms and cows with deficiency symptoms. Newman Turner recommends a whole lot of perennial herbs that should be put along hedgerows. We know, for instance, that when cows can just browse along hazel tips and buds, the butterfat content in milk increases, and the cows are healthier. Cows will always eat some comfrey, though it is not a preferred plant.

You can go nutty about something like comfrey or dandelions. But as a component in food, these things are good. Some people were urging on everybody to feed their children, chickens, horses and cows on comfrey, until another gentleman said, "Look, be careful!"

Once a nut starts urging nutrition on someone, they are going to do it. They get their blenders down and start drinking green glue. It's stupid! Of course it is possible, under certain conditions, to damage the liver. So there has been a note of caution sounded. Nobody has found that comfrey will kill you; we are already certain it won't. Everybody I know

eats comfrey and a few borage leaves, and we put borage leaves in our drinks. The main thing is, don't go to your garden and eat comfrey as your main food, like a lot of those people were doing. It is not the complete food; nothing is. Everything you do like that is stupid. The next thing you know, somebody will start the great cucumber scandal--the cucumber diet. If you eat a hundred things, you are not very likely to die of it; and you will get everything you ever need. What you don't need, you spit out. The point is, in a varied diet you add a component where that component was short. Chicory is a marvelous plant for cattle.

A friend of mine in rural Tasmania has 8,000 acres. He plants about 500 acres a year. He doesn't buy clover and grass seed. He buys the weed seed. He gets the dandelion and the thistles. He got a pasture chicory from France. His pastures are remarkable pastures. There is grass and clover, but at a very low rate. He sows clover at about one and a half pounds per acre, and some of the grasses. But the main part is herbal pasture. He gets his herb seed from other people's weeds. His cattle look fantastic. These are very successful pastures. He has never cultivated more than one and a half inches deep, just scratches the soil and dribbles the seed along. He doesn't own any machinery. He contracts a man in with a soil scratcher and a seeder, and does the rest on foot. You turn the cattle in on it; they can bite down and smash it about. Turn them out, and it all comes out again.

Let's have a look at the actual cycle of pastures in a climate which goes through the year, even though it does have a hard winter. Let's look at an annual grass. It carries on to midsummer, falls away, has a blip in autumn and falls away, and comes up in the spring. It is mid-spring before the herbs start. Their peak is summer. The perennials to some extent duplicate this. They hang on much later in the summer. They collapse a bit, and they have a better winter fodder value. The perennial grasses are better

grasses for winter. If we are going to raise the whole carrying capacity, we store the spring and summer excess, using haymaking as a strategy. However, these perennial pastures, which are of more value for that than the annual pastures, are quite critical as to the time when their food value is good. The dry stalks of the grasses when the seed is gone are really poor feed, just cellulose. The only way a ruminant can deal with cellulose is by additional input of two things: urea and molasses (sugar and a high nitrogen). Farmers in the dry marginal area float a half-full 40 gallon drum in a trough made from a from a 55 gallon drum cut in half lengthwise. In the trough made from the larger drum, there is a mixture of molasses and urea. The cattle lick this from the floating drum that turns within the mixture. It tastes horrible. They actually detest it. However, that supplies them with the basics that the bacteria in the ruminant require to break down cellulose.

If you put that out, you can feed your cattle on sawdust, newspapers, and cardboard. People do. They often bring loads of sawdust or any kind of cellulose they can get. Feedlots in the American West feed newspaper and urea. That's the American beef. You are eating your own newspapers, and a lot of bad news, too! They get the urea from chicken manure--6% chicken manure with molasses. It is the molasses that gets the bacteria active.

The sugar pod group, the mesquites, the honey locusts, carobs, and the sugary tips of such trees as striped maple, will help cattle take advantage of the dry perennial grasses. In a winter climate, the demand is really for carbohydrate fuels. So you design oaks and chestnuts. What you then find, to your surprise, is that this is the way it works. You don't have to design it in. God did that. Cattle grew up to take advantage of what was actually seasonal.

There are plants like Tagasaste and Coprosma--evergreen and highly nutritious plants that go all year. Even though you let the cattle browse

them, while they don't respond as fast over winter as they do in other seasons, they still regrow again. So you have three strategies, then, with these cattle and deer and goats and sheep. One is, instead of just relying on annual pastures, have areas of permanent, high-mineral mobilization herbs throughout all your pastures--dandelion, chicory, comfrey. Have evergreens, standing, high-nutrition tree crop within forage range that the cattle will coppice. Have high-sugar summer pods that will carry cattle through the semi-arid seasons. This group is critically important to range capacity. Also, you must have a winter high carbohydrate source--large nuts and acorns.

These are the truly perennial components--the fruit of trees that stand in pasture.

In Sholto Douglas' book on forest farming, he describes an experiment in which he took part in East Africa, growing carob trees in big baskets, planting them out on an East African cattle range. The carrying capacity of the range went from one cow to 12 acres to 12 cows to an acre.

Let's face it, what happens is, you add correct components at the right time of the year. If animals are eating carob pods, they can then eat dry grass and utilize it.

One of the people in west Australia has milking goats. He feeds each goat three carob pods per day. He has one carob tree and it maintains eight goats for the year. It is not a particularly high yielding carob tree; it is 17 years old. What's more, he doesn't pick up all the pods; he just picks up enough pods to give his goats three a day, they can go out and chomp on very rough forage--and the forage is very rough indeed where he is, for he is on a laterite cap. These goats milk well and do very well.

So it is obvious that if you have a food, which is a concentrate, and of which a small amount will allow the sheep or cattle to satisfactorily process range plants, then you lift the range capacity very abruptly.

The willows and poplars are good cattle-forage. If you are dealing with

goats, you have to go into self-defended plants. That is where you use mesquite and honey locust instead of carob or apple. Apple is a good sugar plant. The plum is a good sugar plant. Plums are good summer browse. However, you can't let goats into plum or apple.

The British orchards used to have massive trees, not a branch up to eight or 10 feet, and then a big crown. Cattle and horses could run around underneath them, quietly fermenting their own alcohol in their stomachs.

There are the root crops, too. If you can't grow oats, grow turnips and fodder beets. So you have swap-offs. Unless you are in severe conditions, in which winter comes crashing down on you, there is absolutely no need to go into hay pressing and baling.

The dreaded pampas grass is ideal shading grass. Instead of shearing the sheep and turning them out into a barren landscape, you put them in three acres of pampas, and the survival rates are about the same as if you put them in insulated sheds. You need places for animals to shelter at critical periods. So you must plant dense shelter. The losses of milk or meat products can reach 20% in unsheltered environments. Cattle and sheep are simply unthrifty where they can't get shelter. You all have a mental image of cattle and horses standing back to the cold winds and just shivering away. They will lose eight or 10 pounds in a bad day. They look so miserable. They are miserable. So design a dense shading or shelter block, and I don't mean just a hedgerow. It must be a big clump of dense trees, or tall grasses. Many forage plants, once they mature, protect themselves. Another thing, cattle plant all those plants, particularly sugar pod plants. If you read your propagation manuals, you will see: "Treat this seed with sulfuric acid, hot water, chip it, or grind it." When cattle eat honey locust pods, they chip and grind the seeds. They can't break them, because they are too tough for their teeth. These seeds immerse in an acid bath in the cow's stomach, heat for a

time, get packaged in manure, and are usually placed in a little hole that is stamped out near water. That's the best place to get your honey locust seed from--right from the back of the cow. Those seeds have 90% to 100% germination. So the way to plant your range is to feed the animals going on to the range with those pods. They plant the range. In the Hawaiian Islands, in Australia, and in Argentina, cattle mainly propagate their own range plants.

When you look closely, you will see that each animal, whether it is a turkey or a bluejay, extends its own garden. Bluejays, being slightly short of connections in the brain, often put 50 to 60 acorns in somewhere, and forget where they put them. They plant acorns quite well. Squirrels accumulate nuts in places they often don't remember. By stuffing a few acorns down into a rotting log, they kick the oak forest along quite well. Nearly every animal is at work planting its own garden, shifting its own materials about in a forgetful and sloppy manner. Humans plant melons, apples, tomatoes--all sorts of things.

There is no point in trying to push cattle beyond their range. The sensible thing is to swap over into moose or reindeer, and as soon as you get to below 18 inches rainfall, go to black buffalo, antelope, or gazelles. Antelope range is on those dry savannas. In America, you had a higher stocking rate with your natural animals. There were the buffalo, and add white tail deer, the ground hogs, and prairie dogs. You had single colonies of prairie dogs a hundred miles in diameter. These were your chisel plows, and a mighty chisel plow. The high plains in Kenya, with scattered bunch grass and acacias, had maybe 20 common herds, all of which were perfectly good beef. Now people get the chain saw out and whack all the trees down, fence it all off, plow it, sow it down to high yielding pasture or perennial rye and white clover, and put up a lot of buildings. They bring in highly selected Hereford or King Ranch crosses and start running them. What they have is one-60th of the yield that

they had before they went to that trouble.

That's exactly what's happened here in America. If you do your sums on your passenger pigeons and your mar-mots and your prairie dogs and your white tail deer, you will have 10 to 20 times the yield that you presently have in a stable situation, and your standing crop was enormously greater. We are not very intelligent. You had a situation in which you had a full on herd of swan, duck, deer, quail, turkey. Now if you had started to manage this situation, to maintain it, you would have been well below food ceilings.

What you have to do now is to encourage the smaller animals, because you now have property cut up by fences. Buffalo can't move with their seasons; therefore they can't maintain the bunch grasses. Their habit was to act to maintain their pasture. Cattle have a place. Cattle are forest animals. They are not pasture animals. You have to chase them out on to pastures. Really, cattle belong in cool forest swamplands. They love it. In summer, they spend all their time up to their bellies out in swamps, eating the swamp grasses. In winter they will come back into the forest edges.

That is where we got them from. That was their habit--the white ox of the forests of northern Europe. We are talking here of beef cattle. Dairy cattle are much more highly evolved than most beef cattle. I think, though, that we consume too much milk and dairy products for too long. It has a place for a while.

If you let an animal go into a range where there is highly preferred food, it eats the highly preferred food and leaves less and less of it. This is particularly true if you stock a range heavily.

If we have a pond in which we put a fish that breeds up--say a large-mouthed bass--and that pond has a certain capacity, as the fish breed up, you can get 100 one-pound fish, 200 half-pound fish, 400 quarter-pound fish. At one-quarter pound, they are hardly pan fish. At this point, your pond is heavily overstocked. One rule

of fishing is never throw a small fish back. Always throw it over your shoulder to your chickens. Always return the large breeding fish, and eat the medium sized fish. Don't ever throw little fish back into the water; throw them up the bank.

We have trout in Tasmania in heavily fished waters, where the legal limit for trout is seven and one half inches. These trout breed and die at seven and one quarter inches. You have deer population in the United States, where you are allowed to shoot antlered deer, and the only kind of deer you have left are antlerless. We have heavily fished lobster populations that originally had reasonably slender foreparts and a rostrum. The legal measure was four and one quarter inches, point to point. It must have been a rostral fish. Now, nearly all our crayfish do not have rostrums, and those that do are still undersized.

This is like putting an electric wire across the street, set at five feet, two inches. If you are more than five feet, two inches, it cuts you off. It isn't long before everybody is five feet, one and a half inches, or else very tall people who are walking doubled over.

What we really need to do with any sedentary population of animals is to leave the large, fast-growers. We don't need a minimum size; what we need is a maximum size. We need to leave the very large, successful, healthy, fast-growing animals. Eat the young and half-grown animals. If people started eating cows and bulls and leaving the calves, they would be in a ridiculous position. The thing to do with crayfish is to make pots that only catch small crayfish and then you will always have tons of crayfish.

If you want to fill this pond up with fish, put in your bluegill or whatever, and there will be a million little fish, and the pond goes out of fishing. Put a screen across the pond, and put a couple of brown trout or a pike or two in there. They will keep those little fish out of the system, because the small fish can swim through to the pike. That is sort of reverse escape-

ment. You can't let those pike into that pond, but we can let the little fish in to the pike, and you will always have pan fish in the pond. When they get too big to get through to the pike, they are right for us. You set that limit by putting in a two and one-quarter or two and tree-quarter inch mesh. Anything that can't go through a two and one-quarter inch mesh is good enough for you.

Now we have a chicken range. Hawks like chickens. If we are going to breed chickens, put a very thorny, brambly patch in each range in which we permit hens to raise chicks. We will get a high proportion of chickens from that. At home, we have a bush called the African boxthorn. It reaches the ground; it has millions of spines, and they go straight through your boots. Even cats can't prey within boxthorn. Dogs have no hope; they can't get within the crown.

Cats, if they get in there, want to move real slow. Chickens just slip through it fast, because they have little hard scaly legs. So escapement governs populations there; it protects breeders. You must give the same protection to highly selected foods. You have to put them in protected positions. Cut limbs with slash-hooks, and throw a patch of them on the ground in an animal's range, and put in a tree. Your food plant gets up and growing before the animal can get at it. That's exactly what Geoff Wallace did with his apple trees.

Some plants grow their own thorns, have their own protection; but many don't, so we must give it to them. So wherever we are dealing with range, and range management, we always have to think of this as a factor. We have to give our preferred animals some chance of not reducing their range, and a place to escape from predators.

I want to talk briefly about animals that are not normally considered in systems. I will just give you a few examples, so that you can get an idea of the range.

On the Hawaiian Islands, and only on the Hawaiian Islands, there is a sea mollusk that comes crawling up into

the fast streams. It is real good eating. There is no other mollusk that I know of anywhere else in the world that lives in hot streams, crawling over rocks, browsing on algae and converting it into good food. It exists only on a few islands. But it is obviously transferable to that particular sort of niche, and could be a food source.

The coconut crab does all that shredding work and provides a lot of insect control.

The slender blue-tongue lizard eats slugs--nothing else, just slugs.

The whole group of tiliqua in Australia are snail eaters. There are desert snail eaters, sub-tropical snail eaters, and cool to cold temperate snail eating lizards.

Then the geckos as a group are very good little pest controllers for glass houses.

We have mentioned the frogs and some of their characteristics that are beneficial in the control of quite specific pests that are otherwise chemically controlled.

Get the woodpecker on the bark, and the bantams under the trees, and the coddling moth incidence drops down to its usual about 1%.

A specific orchard pig, the Gloucester, is bred as an orchard forager. That's its place. The little wallaby, which are short browsers and live in dark thickets, maintain fantastic lawn systems. They are very soft in the system. They don't worry plants over 24 inches high. Geese are very similar, but a little harder than the wallabies when it comes to doing sward under nut trees. Geese-and-walnuts is an ancient combination.

The ideal farm: Sit there looking at your geese, and looking at your walnuts. Once a year you clip both of them (the geese, twice a year).

Some of the large land tortoises in sub-tropical or semi-tropical areas are short browsers and fast growers. They put on about 40 pounds in two or three years. They roll your lawns while they crop them. A herd of land tortoises would be much better for the grand Taj Mahal than 34 widows

on their knees, cutting the grass with little knives. Turtles are easily controlled. Fencing is minimal.

Tasmania has perhaps 60 species of a strange little thing called a phreatocid, a pedestrian amphipod. It has a circular body section, and it walks slowly just below the mud and leaf surfaces. They are primarily decomposers in cold waters. They will be active all the time. Under the ice, they will be chomping up leaves. They don't occur anywhere else in the world except right down on the tip of South America. They are an Antarctic edge species; they follow the ice caps up and down. The only place they can do that is in Tasmania and a little bit of South America. They have also adapted. Some of them have come down the mountains a bit. In the Devonian ice age, you had them over here. You find them as fossil.

Where they exist, they are a major food of the introduced trout. Trout eat far more insect here in America. In Tasmania, they may eat 20% insect and 80% phreatocid to trout, skipping a whole lot of intermediate steps.

Again, in Tasmania, because it is an oceanic island, because it is the remnant of an old continent, we have extraordinarily large fresh water limpets. These occur only in one lake, and they are the only ones of their sort. They are cold water limpets and, again, a major food of fish in the waters where they occur, where there are rocky bottoms on the lakes. They are algae browsers, and where they occur, there is a very fast conversion to fish protein.

Now if we, at least on paper, figure some of the possible short cuts through the trophic pyramid, we always look for our primary decomposer, the algae browser groups, the diatom eaters. That's why grey mullet is such a fantastically important fish. It browses diatoms and it weighs 15 pounds. For brown trout, we begin with leaf algae, go to zooplankton, diatom, shrimp, and then up to another whole group of cold water fishes, the galaxid fish, then the trout. We will give it a 10 factor. It takes 10,000 pounds of leaf to make a pound of

brown trout.

But if we go from leaf to phreatocid to brown trout, we only need 100 pounds of leaf to produce a pound of brown trout. So we get a hundred times more brown trout by way of the phreatocid food chain. Every time you go up a trophic step, the conversion consumes nine parts of every 10 of your food. Therefore, what we should be actively seeking out is these short-cuts, and particularly the large, low-level decomposers, chomping on leaf and algae and diatoms.

The role of the mussels is in phosphate fixation, and in calcium fixation. Now in your area, you should not eat those. It is better than you get that phosphate and calcium stopped before it goes to the sea, because it is phosphate and calcium that you are low on around here.

The phreatocid is really too valuable to eat because it may be the only thing we can use to get those leaves mobile again. It would be like eating all the worms out of your field.

I am pointing out that if you don't start maintaining these systems, you are in real trouble, and many of these things will be wiped out. Let us not pussy-foot around. There are enormous processes of destruction. As far as we know now, in the Adirondacks there is no more cycling of nutrient. You better get busy and find an acid decomposer, and quickly. What's gone is gone. What we are trying to do is accommodate millions of people in places where a degraded and degrading environment can support but thousands. We must make pretty smart moves. Other than that, we can continue pussy-footing around until the whole system falls on your head.

What I am saying is that we should look far more closely at the functions of animals that are not normally considered as integral parts of constructed or even agricultural or aquatic systems, and see what particular value, what particular niche they might occupy to increase the number of useful nets in the energy flux. The phreatocid is a fine example. We have many, many species of them,

because in the Devonian there were billions of phreatocides of varied sorts. Their pH range, too, is enormous. They did not come towards high alkali. They go towards high acid. The normal data reading in some of our rivers is pH 3.5. It is too acid for mollusks.

Consider your guard animals, too--animals that give adequate alarms to other animals--guinea fowl for example. They are great for spotting practically any danger, and their alarms work for your other domestic poultry.

PRUNING SYSTEMS

You only prune very close to houses, or on very small properties. You all know of ordinary cut pruning: A very low tree; keep the thing going out as a low open situation. It is a good form of pruning for light, for easy picking,

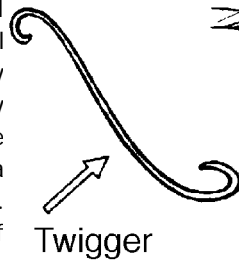

for easy handling of pest control, and so on. It would be a fairly normal thing to do. It is the form of pruning that most nurserymen can show you. It varies from place to place, and from species to species. But as a general method, it is perfectly adequate. Props between these branches keep them spread. You just pull a branch out when it is young and prop it into position to keep it spread. The main thing is to decrease the number of joints that are sharp, and to increase those in the main stem that come out fairly broad. These are the strongest ones. The idea is to force that branch out from the tree like that when it is young. It will be much stronger.

One additional thing, looking down on that tree as a system, we are apt to find that apples, pears, and most things are biennial bearing, so that you have heavy on, heavy off years. Now what you do is this: Think of the tree crown as divided into three sections. Start to prune around the tree, pruning heavily, lightly, and not at

all, on your three separate sections. Then next year, the section that was previously lightly pruned gets heavily pruned. The unpruned section gets a light pruning, and the heavily pruned gets no pruning at all. You will find then that you don't have a biennial bearing tree any more, and can fairly competently predict the amount of fruit per annum that you will get. What you will get is a fair number of small fruit on the unpruned portion, a small number of large fruit on the heavily pruned portion, a small num-

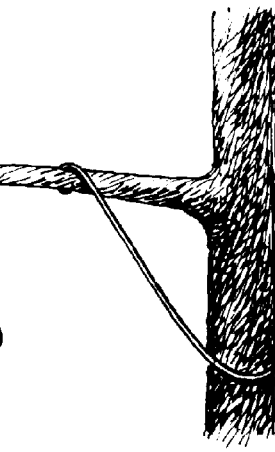

ber of large fruit on the heavily pruned portion, and the most fruit, of medium size, on your lightly pruned portion. This cuts the pruning down, as you can see, to less than half the cuts you used to make. Moreover, it makes your crop far more predictable, so that you can govern the market much better, or even light domestic demand. In total, you get slightly more fruit than as if you let the thing run biennially. So you don't lose any fruit. But you get a variety of sizes.

If you are going to make this the central tree in beds, you can also follow in the beds a rotation around it, so that you are treating your bed sections on thirds as well; and you garden from high demand, to medium demand, to root crop, to high demand. You mulch on thirds: heavy mulch, light mulch, no mulch. You sort of make for yourself a little wheel that you keep spinning. There is no reason not to have that tree in the center of a garden plot, with its rosemary and

other plant associates under it, many of which are specifically chosen to be the host species for wasps, which help the garden situation.

Now we go into zone two. Here you would not even bother to prune peaches, except to cut out dead wood, because the least pruning you give the whole group of peaches, cherries, and apricots, the better. The only reason you prune is to cut out dead wood and die-back, and to start branches around them. In zone two, continue to prune the pear and apple groups, and very vigorous, tall growing trees.

This is how you do it. Let the stem grow to two or three feet high. Then you select four buds at right angles to each other, and you tie them down to the stem, using a thing called a twigger. Looking down the stem, you are going to have four

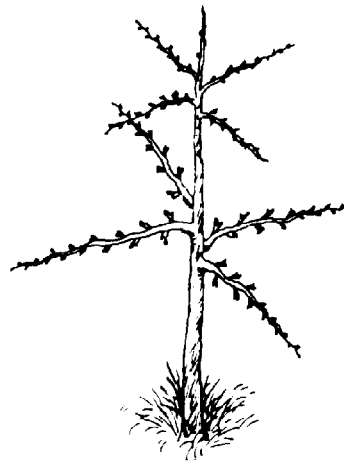

branches set out at right angles to each other, spread out to maybe fifteen inches. Tie these down. Then let the stem grow on two feet clear, rubbing out any branches that come, and do it again. In 18 months to two years, you usually have a couple of those done. About the time you have done it four times, you won't have any main trunk left. You have taken the tree right out.

What you have now is a tree very thick at the butt, tapering very suddenly, a very strong thing. We are talking here about powerful trees that normally grow strongly and which would otherwise get very high on you.

We stop them from getting high; we suddenly pinch them off.

It is almost impossible to break those branches with fruit load. They are very powerful. Once you have it like that, you never bother with it again. Just cut off any water shoots. It is an immensely strong and durable tree that will last many years. You take out the branches after the first

season's growth but sometimes you need to adjust them for part of the next season. What you have is 16 leaders; for each of these side branches is also a leader. So the tree is quite happy. It doesn't attempt to get away from the pattern. It gets fatter, produces more buds, but it doesn't break out of that pattern. Eventually, all these leaders turn into very large systems. Broadly speaking, there is very little pruning to this tree. It is a little-cared-for tree. Just use this method on large pears, apples, and plums that are very vigorous. It is cheaper to buy from the nurseryman a whip-graft tree the first year and start doing what you want.

The zone three form of tree is even simpler. There is only one thing to do. You see this all over Britain: Drive a very strong large stake and tie it up for eight feet, or plant it in the back of the bush and keep the trunk completely free of branches for eight feet. It takes four or five years. Then let it go, and it matures very rapidly into a very dome. You never prune that; you never even look at it. It will stand animals browsing around it and under it and through it, quite heavy animals.

So what you really have is three sorts of trees, all the same species. One needs a fair bit of attention, giving very predictable yields; the second one needs very little attention, yielding biennially. The last one gives a huge amount of apples or pears of a much smaller size, but it takes no work at all.

Now another thing I would tend to do in the outer zones is to go from

grafted to seedling trees. It's too far to get to in the summer, and particularly in spring. Drive down the roadsides and mark all the apple seedlings this winter. Go back in spring and find out from the flower what variety they are. In mid-winter, go and lift them out of the roadside hedgerows. They would eventually only be graded out or smashed down by the road crew. We plant those trees out, sometimes by the hundreds. People keep throwing apples out of cars and renewing the stock. Good plums, too. You root prune and top prune, and if you are going to put it in near the dwelling, you graft. If you are going to put it farther out, just plant it out there, put a stake in it, take five branches off, and up grows its leader.

Anything we have grown from seed gives us a very good fruit. We only want a whole lot of fruit, good fruit.

In summary, around our fruit trees, we put in crops that will give secondary yields, maybe commercial yields. That ranges from flowers to edible products. Put in crops that will support the foraging animals, reduce pests, and increase manure. Bring in the right animals. Put in structures like the little ponds and rock piles that will invite the right animals. Put in flat rock to decrease grass competition, and to stop soil compaction. And, finally, put in the plant's culinary associates.

Notes from the Editor

I'd like to elaborate on some of the topics Bill addresses here and in a few places disagree. One of the topics that I'd most like to comment on is the use of poultry in permaculture systems.

- Bill's designs for poultry escapement will not work in most of the Western Hemisphere because we have a predator that is unreasonably competent, the raccoon. Moreover, unlike most wild animal species, the raccoon will slaughter as many chickens as possible, just for fun.

Raccoons swim very well. Islands will not protect poultry. Waterfowl are among their favorite victims. They can climb fences, dig under them, or simply unlatch gates and walk in. They can turn door knobs, un-hook hook-and-eye catches and slide barrel bolts, though they need a way to reach these devices. If deep water is present, raccoons will drown dogs 10 to 20 times their size.

In this environment, poultry must be secure at night, when raccoons are active. Fortunately, raccoons are good to eat. Never trap a raccoon and release it, however, as it will never be fooled by that type trap again and will be an intractable problem for you and/or others. Raccoons are lazy and will walk into box traps to get husked corn, even if there is a cornfield nearby. In fact, they will go for the husked corn right in the cornfield itself. Barrel traps are reputed to work, but I've never encountered a raccoon stupid enough to go into one. If you want to try, put a cull hen at the bottom of an open 55 gal. drum. Place a plank leading from a ground up to the open top of the drum. Supposedly, the raccoon will go up the plank and jump in to get at the chicken. It can't get out.

If you hear a raccoon struggle in a trap, do not wait until morning to deal with it. Other raccoons will work to help it escape and often they succeed, particularly in live traps which otherwise minimize suffering of the animals.

- In addition to the seed, chickens eat Caragana leaves. The same is true for honey locust leaves, and probably those of other useful tree crop forage plants. If they are set out in the chicken run, be sure to protect them thoroughly. Otherwise, they can be planted a foot or more outside the fence. When the plants are large enough to tolerate loss of leaves up to two or three feet from the ground, you can move the fence back to include them in the range. Or just let the chickens out.

Geese, though they eat mainly grass, are death to seedling and sapling trees. They will ring the bark from them and kill them. Probably they are protecting their own forage. Once trees and shrubs are too tough for this damage, geese effectively suppress grass competition.

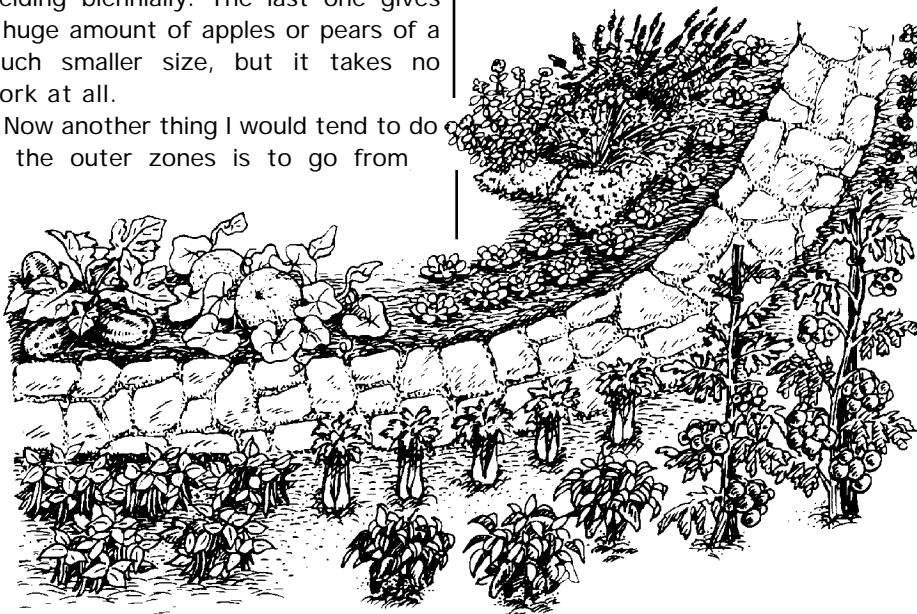

For more detailed information on poultry forage, see The International Permaculture Seed Yearbook (TIPSY) #2, which features a special poultry forage section. The same issue also has a bee forage section, with lists and ratings of bee forage plants.

If you are interested in Caragana, in particular, TIPSY #1 carries a very good article on that genus by Thelma Snell. Thelma's piece is probably the best that has been written in English. (Most material on Caragana is in Russian.)

Vol. 1, No. 3 of The International Permaculture Solutions (TIPS) Journal contains an extensive survey of methods for managing soil in permaculture systems. Readers of this pamphlet may be especially interested in my comments on using chickens in conjunction with mulch. In temperate climates, chickens are let into the mulch before and after annual crops are grown. In tropical situations, they are rotated. I have observed that chickens get most of their food from the invertebrates that live in mulch. I suspect that chickens also eat raw compost.

An ideal plant for poultry forages is the black raspberry (*Rubus occidentalis*), at least in regions where raspberries are native. (Brambles can be rampant and should not be introduced as exotics.) The tip-layering black raspberries provide excellent cover for brooding hens, and they escape the depredations of racoons and skunks **while nesting**. Once chicks are hatched, steps must be taken to protect the family at night. Where tip-layering blackberries grow, these may be even more effective. *Rubus* does very well in conjunction with chickens.

Black raspberries spontaneously associated with umbrella-shaped fruit trees such as apples, growing at the drip line where they are very productive. As Bill notes regarding blackberries, they benefit the tree. Of course, there is more to it than he goes into, having to do with the ability of the blackberries to suppress grass, mobilize trace elements, and attract various kinds of animal life, from soil dwellers to birds. Raspberries do the same, though not as robustly. Chickens fit these systems well. They take the lower berries, about eight inches above their height (they jump), but leave the ones easiest for people to pick. They get some berries, but you get more than if they were not there. A happy chicken is a wonderful asset.

- Watch out for Bill's admonition to mulch clay. It is easily overdone. The interface can be too moist, causing an anaerobic souring of soil and mulch that promotes diseases that, for example, kill tomato plants. Sandy soil greatly benefits from mulch because far less moisture is lost to evaporation. Sandy soil does not

hold nutrients well, so the propensity of plants to feed at the mulch/soil boundary enables crops to take nutrient as it is released, before it leaches out of reach. Plan crop densities to fully utilize this release. It will take some experimentation with specific conditions, including mulch type.

Seaweed is a particularly valuable mulch for sandy and coarse soils because it forms a gel that holds moisture between soil particles. Grass clippings, which could not be used on other soils because they form a gley, suit sandy soils almost as well.

- Note that there is one major drawback to mulch. In fall, mulch holds heat in the soil. On clear nights, particularly when there is a sudden temperature drop, even hardy plants such as broccoli will receive frost damage because the soil heat is unavailable to them. Annual plants must be mulched completely over their tops during cold snaps, to mitigate this effect. (Old bedspreads are easier to remove in the daytime than ordinary mulch.)

The effect is mainly with lower annuals. Trees reach past the effective benefit of soil radiation. They benefit from having soil temperatures more stable due to the insulating effects of mulch. Roots grow longer into the season and chance of frost heave is much less.

- With Jerusalem artichokes, be aware that they are allelopathic—they poison some other plants as do all other types or sunflowers. They can also be difficult to exterminate from a place, unless you have access to pigs. Pigs love them, can smell them underground, and, released in an unwanted patch **after tubers have formed**, they eliminate these plants entirely.

- Pigs control grubs, slugs, and even poison snakes when let to forage in a garden after harvest. They are easily contained by electric fence, just inside a lightweight temporary woven wire fence. (The temporary fence slows them, and the electric repels them.)

By the way, you can also keep racoons from an area by putting a strand of electric fence about four inches above the top strand of woven wire. They climb the wire fence, which is perfectly grounded, and then reach for the top, electric strand. Zowie! They aren't seriously hurt physically, but they may never return. This is very effective.

Back to the pigs, they can be let in closer gardens as the cool weather closes them down. Cool weather means fewer smells. Pigs smell only when overcrowded or fed kinds of garbage they won't eat. (It's the garbage that smells.) They completely eliminate witch (quack) grass and other rampant grass weeds. They root

out and eat the stolons, underground stems by which the grasses spread. Pig foraging is an excellent rotation in the permaculture garden.

Of course, they also do good things in the orchard/tree crops situation. As Bill points out, they will brave those brambles that have been doing other jobs for us, and get the fallen fruit from them. This prevents pests from overwintering in the fruit, and of course feeds the pigs. Pigs can fatten on fruit as well as on corn, but they need a lot more fruit. Bill has written a special paper on pig forage, available as Yankee Permaculture Paper #19, Pig Raising and Free Range Forage Species.

- If you are following Bill's advice on how to prune your tomatoes, make sure that they are indeterminate varieties, not determinate varieties. The first just keep on growing until something kills them. The determinate types (sometimes called bush varieties) have only so many shoots. If you remove shoots, you cut yield. Don't prune determinate tomatoes. They are good for dense plantings and have a high yield per unit area. Indeterminate tomatoes lend to trellising in various systems and have more design and companion planting potential.

- Use alyssum around your plants to attract the "beneficial" insects that require pollen and nectar in their adult stages. It is perfect, and blossoms over a very long period.

- Bill says, don't feed sunflowers to chickens because they make the feathers fall out easily. Thelma Snell, reading this after initiation into the joys of chicken plucking, suggested that we should save our sunflower seed to feed to those chickens we are about to slaughter. It will make the feather removal operation much easier! That's permaculture thinking folks. Just stand limitations on their heads to create opportunities.

- **Other Yankee Permaculture publications related to permaculture techniques discussed here include:**

- YPC 5. Useful Climbing Plants. Mollison.

- YPC 16. Gardening Articles, by Dan Hemenway, reprints.

- YPC 20. Circle Garden Patterns, Webb & Hemenway.

- YPC 30. Articles about soil by Dan Hemenway, reprints.

- YPC 31. Plants for Use In Permaculture in the Tropics, Frank Martin.

- YPC 36. Patiofarming in the Tropics and Subtropics by Frank Martin.

And all Yankee Permaculture journal issues, which are packed full of practical information that will make permaculture techniques work better.

Yankee Permaculture's address is on the cover of this pamphlet.

FORESTS IN PERMACULTURE

BY BILL MOLLISON

Pamphlet X in the Permaculture Design Course Series

PUBLISHED BY
YANKEE PERMACULTURE

Publisher and Distributor of Permaculture Publications

P.O. Box 52, Sparr FL 32192-0052 USA

YankeePerm@aol.com

<http://barkingfrogspc.tripod.com/frames.html>

<http://www.permaculture.net/~EPTA/Hemenway.htm>



Edited From The Transcript Of The Permaculture Design Course
The Rural Education Center, Wilton, NH USA 1981

Reproduction of this pamphlet is free and encouraged.

Forests in Permaculture

This is the tenth in a series of 15 pamphlets based on the 1981 Permaculture Design given by Bill Mollison at The Rural Education Center, Wilton, New Hampshire, USA. Elizabeth Beyor, without compensation, undertook the transcription of tape recordings of the course and subsequent editing of the transcripts into 15 pamphlets. Later, Thelma Snell produced the typescript for all pamphlets. Lisa Barnes laid out and made mechanicals of the original editions. More recently, Meara Culligan entered all 15 pamphlets onto computer disk. From time to time, I have added some further light editing to increase the readability of the pamphlets. In deference to the monumental task of love represented by Bill's assembly of the Permaculture Design Course, and by the subsequent volunteer efforts leading to these pamphlets, Yankee Permaculture has placed them in the public domain. Their reproduction is free to all and highly encouraged. The pamphlets are now available on computer disk, individually or as a set. Send a SASE or 2 international return mail coupons with an address label for details.

We have some pamphlets translated into Spanish, French and German. Volunteers are now needed to complete these translations and to translate these pamphlets into other languages. Yankee Permaculture continues to depend on volunteers for all of our publications. To help, contact us at the address on the cover.

For Mother Earth
 Dan Hemenway, Sparr, Florida, July, 2001

Sixth edition (minor editing, 7/27/01)

	Quantity	Price
Complete Set of 15 Pamphlets. Bill Mollison. \$35 (Price reduced 9/1/94)	\$35.00	SET ___ \$ _____
Complete Set on 3.5" Floppy Disk PDF files [Adobe Acrobat]	\$35.00	SET ___ \$ _____
Other computer programs, \$50 [\$10 per step if we have to translate for your program]	\$50.00	FD ___ \$ _____
I An Introduction to Permaculture. (Price reduced 3/22/94.)	\$3.50	I ___ \$ _____
II Permaculture in Humid Landscapes.	\$7.50	II ___ \$ _____
III Permaculture in Arid Landscapes,	\$3.75	III ___ \$ _____
IV Permaculture on Low Islands. (See V for combined price.)		IV
V Permaculture on High Islands. (IV, V, & VI offered as one pamphlet.)	\$2.50	V ___ \$ _____
VI Permaculture on Granitic Landscapes. (See V for combined price.)		VI
VII Permaculture for Fire Control. (See XV for combined price.)		VII
VIII Designing for Permaculture.	\$8.50	VIII ___ \$ _____
IX Permaculture Techniques.	\$8.50	IX ___ \$ _____
X Forests in Permaculture.	\$6.25	X ___ \$ _____
XI Water in Permaculture.	\$3.75	XI ___ \$ _____
XII Permaculture for Urban Areas & Urban-Rural Linkages.	\$3.00	XII ___ \$ _____
XIII The Permaculture Community.	\$2.00	XIII ___ \$ _____
XIV The Permaculture Alternative.	\$2.50	XIV ___ \$ _____
XV Permaculture for Millionaires.	\$2.50	XV ___ \$ _____

All funds must be in US dollars in a check drawn on a US bank or by International Postal Money order. Make checks payable to: "Yankee Permaculture." Make postal money orders payable to: "Dan or Cynthia Hemenway." There is a minimum order of \$10.00.

For all Yankee Permaculture publications, please add \$5 + 10% postage & handling for shipments to the US and +20% for shipments to other countries.

Prices subject to change without notice.

X - FORESTS IN PERMACULTURE

There are two aspects to forests: one is the composition of the forest, and the other is the set of intrinsic reasons for the forest's existence. Only when we have concerned ourselves with both aspects can we begin to learn how to manage a particular forest system. There are different management strategies for timber, and coppice, and fruit. There is no single management procedure. There may be a dozen. There is no reason why you shouldn't manage any single forest as many as a dozen different ways for totally different reasons.

Of the forests that you can define, there are probably these types: There is the forest that has a right to exist. Maybe it is a ridge top and steep slope forest, a forest that, because of its intrinsic value, we shouldn't think of trying to manage. The job they are doing is enormous. They are doing a lot for the whole of the country. When you get to the brow of the hill and start going down to the beaver pond, from that brow to the beaver pond is holy forest. You can bury your dead in it. Close your dead in the trees, so that the forest is dedicated. There's that sort of forest. Shall we call it the essential forest?

Then there are food forests—food for man. We can call them orchards, but there are other types also.

There is a forest for fuel production. Now here is where you can get really smart. Fuel is not necessarily wood.

Then there are forage forests. The elements of forage convert to other usable stores. This type of forest is for the use of other species besides man.

There is no need to think about these forests in blocks. These elements of a forest can inextricably mix in a sort of patchwork situation. Then, some, like bee forages, need to be clumped, for cross pollination, etc.

Then there is a whole class of structural forests that are not fuel forests. Bamboo is a good example.

Our management strategies will differ concerning the elements of the forest. The forest breaks down into functional assemblies. Then it breaks down for individual elements of the forest. The forest is a canopy. We should perhaps regard it as a complex organism, rather than as a collection of trees and animals. It's just a mighty great organism. You don't look upon your bladder as being something separate from your body. How could you pull the blue jays out of the forest and say they are not forest, but this tree is forest? Down here and up there are physical and functional interconnections in which the elements inextricably bind.

I went into one of these forests to look at scrub wallabies. I found it impossible to look at scrub wallaby without its 38 to 40 critically related species, of which some were plants and others are animals. Scrub wallaby had predators, competitors, parasites, food, poisons. You can't pull the wallaby out of that mess. You just have to open out your eyes, and your understanding too.

We have species functioning around forest openings, species that are edge species, species that are detached elements, pioneers. So we have edge species; we have within-stand species; and we have species of the central forest. The forest is always in stage. It is never at standstill. Even on its own, it is not at standstill. It is marching up and down or round about. It is always in dynamic change.

We, therefore, recognize some stages, some serial staging, and some positioning in the forest. We use many of those edge species and pioneer species. When we construct a forest, we should pay attention to these rules, to the elements that best serve at these places.

Thus, we have functional divisions and we have movement divisions within the forest. When you look at the forest, it is all going on out there; it is all happening.

It is very interesting to look at the structure of language. Take the Oxford or the Webster's dictionary and strip out all the words in common usage in the dictionary that have anything to do with the landscape. You will find that you have hundreds, if not thousands, of sea qualifications—seacoasts, headlands, bays, estuaries, tides, etc.; you have a reasonable set of words to do with open areas and level plains; and you have a very, very minor vocabulary to attempt to explain a forest. That's us.

Shift to the vocabulary of the Eskimo and you will find that he has a mass of words to describe conditions of snow and ice, sea and sea ice, but practically none at all which have to do with the forest.

This leads me to conclude that we never did pay much attention to these forests. We don't have an easy vocabulary to explain some of the things that we know are happening in the forest.

We don't seem to be forest people. Bad luck for the forest. We are coastal people, sea people, and riverside people.

Food Forests

So let's have a look at food forests. Two things about them may be of interest to us. One is yield. The other is equivalencies.

One interesting characteristic of the forest is that it doesn't fluctuate very much in its nutritional elements. Once you have measured up the proportion of sugar in the tree, you can propagate that tree, and are very likely to get those proportions. This is highly untrue for crops. Your grandfather was eating wheat at 17% protein, and you are eating wheat at 4% protein. All you have to do is throw a bit more nitrate on the ground and you have knocked out your lysine, or whatever—the little bit that was in there—and the wheat drops to an effective 2% protein. Those annual short-term crops are widely variable in nutritional yield. If you put high nitrate fertilizers on wheat and other grain crops, which you have to do once your soil is depleted, then one or two of the amino acids are not formed. I don't know why that is. Certainly there must be a pathway block somewhere.

Now what can we say about this? I think we can say that many tree species fulfill all our requirements for food. These are equivalent to foods that we would otherwise grow as row crops. This is particularly true of the tropics. We didn't design it this way. Any group that tries to sustain life in the tropics has to stick with trees that are all deep-rooted perennial systems. It is there that the nutrients cycle. This gets less true as we go toward cool, temperate, humid lands, where soil itself might hold much nutrient.

Nevertheless, if we look very closely at the total available food equivalence in trees, for example, we find that it is possible to go directly to that tree and eat its flowers and leaves. It is a salad tree. As you go toward the tropics, those trees start to proliferate, so that the necessity for 'green crop' is much less in the tropics; a few other trees are high value green-forage crop for man. The mulberry feeds many insects as well as silkworms and fish. Silkworm manure is good manure. Much conversion can be done from mulberry into agriculture. Fish feed directly on the mulberries that you plant beside the ponds. We should look amongst the trees and see how many of this type of green leaf trees would properly form a close-in trimmed or governed hedgerow for leaf production—a modest amount of it in northern climates, but in warmer climates, an immodest amount.

The drumstick tree, the old *Moringa olifera* is just a common hedgerow around the annual gardens throughout the tropics. Eat the flowers, leaves, and the fruits. So blind are we

Permaculture Design Course Pamphlet X - Forests in Permaculture

that we don't often see these trees as a part of other people's gardens. We would see them as a hedgerow, rather than as an integral part of the garden.

Why did we neglect plants that produce all our food needs—the trees—in favor of clearing? Why did we ever start wheat in these quantities when we had forests that would out produce any wheat crop at those equivalencies—food as good, if not better, than wheat?

I'll tell you why. There have been two great factors responsible for the assault on the trees. One great loss of forest has been for war, particularly in the era of wooden vessels, which believe me, didn't end at least until the Second World War, during which vast numbers of wooden vessels were rammed and sunk. Moreover, we had a wooden airplane precursor, the Mosquito bomber. Most of the highly selected forests of Europe went out as armadas before the Industrial Revolution. It was in the early part of the Industrial Revolution that we cut trees for charcoal. That caused great loss of forest everywhere the Industrial Revolution reached. The tree, whatever its yield, was ignored for the fact that it produced charcoal. It was only when the supply of trees caved in that people started making a transfer to coal. Eventually, of course, petrol came. Petrol came along because of the urgent need to find fuel to continue the Industrial Revolution.

The people who came to this country came from a society already well into the Iron Age. If you want to look at the frontier of the Iron Age today, just look at where forests remain in the Third World. There they are—charcoal burners smelting iron. When they started mining, they used huge amounts of wood for smelting operations, and enormous amounts underground.

Who is shipping the wood out? Who is using it? Wood from the people who have forests is being shipped to people who used to have them.

The old Irish are always lamenting the death of the trees. The little black Irish were the forest people. Their oaks went to the British. The big ginger Irish were up on the hill slopes. They were meat eaters, closer to the ice, and less in the forests—big knees, big eyebrows, bit fat fingers, ginger hair, and they eat meat. They have short intestinal tracts, and can't deal with much vegetation.

The trouble is, once you've done the damage, you grow up in this naked landscape, and you think you belong in the fields. Once the damage is done, we grow accustomed to the damage. Our children are now growing up accustomed to extreme damage. That is the normality, to perpetuate the damage.

We are in a third period of waste today, the paper period. Every hippie you know is going to start a newsletter. Once, every hippie wanted to build a boat, sail across the sea, get some cattle and settle down. Now he wants to print a newspaper.

The Dark Ages were ages of forest culture. The information that remains about those times suggests that the trees were highly valued, highly selected, had high yields. You paid for the use of land based on the richness of the tree crop. From the forest, they derived all their bread, all their butter. The butter was made out of beechnuts—highly selected beechnuts. There are still casks and casks of beechnut butter in Europe, buried in the peat, still in good condition. All the bread and cakes in Tuscany and Sardinia and a few other places are still made from chestnuts. Corsican muffins are made of chestnuts, not wheat flour. All the bread was made from the trees, and all the butter was made from the trees. There are your basics.

In your American southwest, the pinon pine nut is a staple Indian food. In one day a family of six can gather thirty bushels of pine nuts, and that's a year's supply. In South America, six *Auracaria* trees support a family of Indians. Those great supports are a source of staple food. One white oak, in its year, will

provide staple food for about six families. A good old American chestnut—how many pounds did we get off one of those trees? At least four or five hundred pounds. There's a couple of families' food for a year, with no hacking and digging and sowing and reaping and threshing. Just dash out in autumn, gather the nuts and stack them away. There are still hoards of acorns in America in the ground. Occasionally people find them. These are hoards put down in old times and never used, never needed. Maybe somebody put five pounds of sweet acorns down in a bog, and when we dry the bog and start to plow, boom! ...acorns sprout up everywhere! They still germinate.

There is a whole list of trees that grow from the tropics to up past here, that can supply a staple food for man. Now don't get the idea that I don't want you to eat rice and wheat. A small patch of that you can have, if you are really stuck on grain forage.

When the forests were managed for their yield and their food equivalence, they were highly managed. Now there are only a few remnants of this in the world, in Portugal, and southern France. In Portugal, you can still find highly selected, highly managed oak trees, often grafted, and olives. The pigs and the goats and the people live together in a very simple little 4,000-yard area in which nobody is racking around with plows. In that economic situation, there is no need for an industrial revolution.

A few of these tree ecologies still remain up on steep mountain slopes, where it has been difficult to get up there to cut the trees down for boat building and industrial uses. The whole of Europe, Poland, and the northern areas once were managed for a tree crop, and the forest supplied all the needs of the people.

When populations were reasonably small, the food forests of the aborigines represented a resource in which the last thing ever thought of was a food shortage. A shortage of food was a situation just impossible to imagine. Forests were stable, and they were self-perpetuating. Those forests were doing many other things besides feeding people. Those weren't little squatly pruned trees, pleached trees. They were enormous trees. The pears would have been trees of two hundred and three hundred feet. The apples would have been enormous edge trees and semi-isolated trees. The oaks were really enormous.

You can still see a few forests of this nature in the world, but not many. In Australia, we have primeval forests. You can go into some of those forests and stand there and you just can't believe what you see. You might be standing in five hundred-weight of nutmeg—this is one tree. You get uphill a bit in these rain-forests and you start to run into bunya pines. Those bunya pines have 40-pound cones. The bunya is a tall tree. They go up a couple of hundred feet. Those cones would squash a cow. They fall with audible thumps all over the place. You only have to squat down there, lay down beside your cone and pick out that bunya seed—very good eating, too. The potato yams are there—you are up to your eyes in food. There is no way you need to go looking for food. There are large numbers of edible leaves and plums. Those forests have plums not even related to *Prunus*. They are all over the place. That is the sort of condition in which we can imagine that people once lived. Certainly, under these conditions there is no danger of losing soils and water and all the other accessory things. There is no danger of losing forests, because people who gather their food from the forest are in the business of propagating forests. There are enormous ranges of these food forests for which processing technology has been long forgotten. Many foods that are not food to us, in former times were staples.

Now, however, we can play new games, and we can make new assemblies of food forests. There are not one of those fo-

Permaculture Design Course Pamphlet X - Forests in Permaculture

rests that are around us now that do not have all the secondary characteristics of forests: They are soil maintaining, moisture maintaining; they produce good wood—there's nothing wrong with apple wood. The forest also produces many other species, plant and animal, that provide food.

In a wood economy, a wood ecology, the houses were great. I was in a house in Wales that was nearly 900 years old, a good solid old house. I stuck my pocket knife in the oak and it was like iron, black. It was built in an old Irish enclave in Wales when it was then in the forest. At present, it has some other little homes around it. It was a little forest village. The house was built out of oak beams and filled with stones. Everything that made up that house came directly out of that forest. When your oak is not yielding too well, or has grown too old, or lightning hits it, there's a house. Some of the trees standing in Tasmania will make six ordinary homes, and it will provide firewood for them for 12 years—that's from an individual tree. Just one tree will house six families and give them their firewood for 12 years. The houses will last forever, or until they burn down.

In the tropics, it is possible to be food self sufficient from trees within two or three years. You start with things like bananas and papaya, and go on to a huge variety of fruits and nuts. There are lots of staples, too, like a coconut. Back about the 1940's, the coconut was fully used. "The Pacific Islands Year Book" gives 467 by-products around a tree like that. Breadfruit produces so much food that it becomes incredibly wasteful! The breadfruit is quick to propagate, and easy to grow.

I will tell you a little story. There is a man named Cliff Adam, living in a group of islands with about 40,000 people. Cliff got a grant from the United Nations to collect some food plants that might suit the area. They gave him \$136,000. So he took off in his plane and kept sending home parcels. He left two or three friends there who kept planting all these trees. He sent back some 600 sorts of mango, 30 or 40 sorts of breadfruit, all sorts of guava, and so on. When he got back home, he then moved them out in rows on 68 acres near the shoreline. Then he got another 135 acres from the government, up on the hills. So he set out all these trees. About three or four years later, he had all sorts of cassava and all sorts of yams and taros that you could imagine. He said to me, "I am in a very embarrassing position."

I said, "What is wrong?"

He said, "Well I shipped this crop in that wasn't growing here traditionally." This was really a coconut economy. He shipped all these plants in, and he set them out as trials. So he said, "The problem is, what I was going to do was this: give the farmers different sorts of mangos, breadfruit trees, and all that, and I have been doing it; but already the production from my two hundred acres would feed the island, and that's experimental production. I am in the embarrassing position where, as agricultural research and nutrition officer, I am already alone responsible." He said to me, "What am I going to do?"

I said, "I dunno."

This is a difficulty wherever people undertake this sort of assembly. You haven't gotten very far along the road, maybe four to seven years along the road, when you've grown so much food the whole thing gets rather embarrassing, and if you are the agricultural officer of a small country, you could probably feed the country on the experimental plots. What's embarrassing is that there are dozens of small farmers. Values fall. They are not going to have any money any more.

So this is the problem in tropical areas. It is true for India. Our assessment of India is that there are six billion acres unplanted, planted to nothing. You can see it all over India. There is nothing on it. Yet India is starving on these little rice plots in the valleys, making a virtue out of it. The problem is that when

we plant the land, people quickly become food self-sufficient. If you plant on an extended basis, then the whole structure of the economy is affected. What if nobody wants to trade or buy food? What if no one has to bother with it anymore? So there are problems. They are problems of a different order than the problems that we think we have. That has happened to several people who have tackled it seriously within the last five years.

There is another man who's pushing his food jungle just out of habit. He doesn't have to make money. He has an income from property—not much, but enough. A few years ago he started to build out the edge of a rain forest, moving out into the grasslands. He went about 30 yards, assembling trees. He has some 600 species of tropical trees. As soon as he had his trees going, he started to put in vines and epiphytes. By the second or third year, when I saw him, he was over his head in food. All around there was the sounds of food thudding to the ground. Now he's just gotten cracking. He had just assembled his species, and already he was in the embarrassing position where he could feed the whole coastline around him for miles. But he was still going on.

He developed some very interesting techniques. He used coconuts like a hand grenade. He would run out along the ridges into the grasslands, heaving coconuts down to the creeks. Boom! Boom! Of about every hundred, about four would take root and start up. He threw hundreds. So a person can run through the landscape bombing it with food.

He established his food pioneers, then grew coffee, cocoa, tea, grapefruit, mango—just about anything you might name.

Many of those fruits had never grown in Australia before. They are all doing right well, including a packet of brazil nuts that he bought and put in. They all came up, so he bought four thousand and put them in, and they all were coming up. So he put all those out, along with as many coconut trees as he could heave in.

It could be exactly the same in India. You could run all over India and just throw a food carpet across the whole continent. India is basically an unplanted continent, the world's largest empty space, as far as I can see. Yet people are dying of starvation. The problem is the economy, and land ownership. You don't have a food problem. I don't think you will ever have a food problem. If you seriously started this roll away stuff, started to roll all over that place, you wouldn't get very far before you would have an embarrassing amount of food. In a money economy, it's all right only while nobody else is doing it. But what if everybody started doing it? Terrifying thought!

Now the position is already being faced in some small communities where there is such a surplus of food that there is no real economy in food at all.

Take the great North American continent. If you put coconuts where there is now nothing, but where coconuts would grow—if we were to run around down there establishing three or four million coconut trees that would be yield in four years' time—you couldn't sell coconuts any more. You say, in Florida, coconuts are now all being wiped out by a disease? Hmhmhm.

Let's then have a look at a typical Indian situation—a few thousand miles of Indian road. Taxis are speeding down it; donkeys, and people; thousands of people walking up the sides of it. The main highways out of the cities are at least one hundred fifty yards wide, I would say. They run for hundreds of miles. I was setting off from central Bombay, trucking down the road. All along the road there were people starving and begging. The whole roadside area is rich with grasses that they feed the buffalo. Suppose that you plant coconuts just off the road, so they do not worry the traffic, and put papaws under the coconuts—papaws are good understory—and you can grow lots of other

Permaculture Design Course Pamphlet X - Forests in Permaculture

commercial crop between. Then you have food strips maybe 300 to 400 miles long, running out of Bombay in all directions. Enough food would grow there for the whole city of Bombay, where people are dying of starvation. You could do it within 18 months. We could put in bananas. India is the most heavily manured, unplanted farm in the world. She is six inches deep in human manure any time of the day or night—blood and bones, but much just ordinary manure. It would just grow into an instant food forest. In 12 months, people wouldn't have to go marching up and down the road going to work, would they? They could just sit at home and weave things and talk to each other.

Moreover, these are non-cooking foods. So it solves another gigantic Indian problem—the need to cut the forests to cook their grains. The reason that they are in deep trouble is that they have gone to grains and pulses, which is an end ecology. It is the last game you play before oblivion. The cooking times are horrific. To make edible some of the pulses, you must cook them for six hours, particularly the soybean. The consumption of fuel to cook soybeans is absolutely horrific, enormously in excess of the food value you obtain from soybeans. We can say the same of rice. To sustain a soybean or rice or wheat economy, you need a vast amount of external fuel just to make it viable as a food. India is running out of the fuel to cook her food because she chose the foods that you have to cook.

There is also the guava, and the mango, and the limes. We could set up a full island of nutrition along those highways with just five or six species, and you would lack nothing. With the coconut, the banana and the papaw, you have a complete diet. India was once a jungle; the people were jungle people, and in the times that we can remember, the Ganges plain was a jungle. They were not eating all this pulse and rice then. These foods came in as the jungles were cleared. As this annual food base expanded, what once was jungle became the fuel base for cooking. They were thrown into this position where they needed an enormous natural fuel reserve. In Kabul, for instance, the forest has retreated 85 kilometers within the last five to eight years. Only the last remnant of jungle forest remains, and there is not one part of it that is not under heavy attack for fuel.

This is your last act. Ninety-eight percent of this stuff is presently being cooked on dung. Therefore the fields are not being manured. That is the last act, and they are well into that one. In areas where they have been into it for a long enough time, there is no longer any food production. So the whole dilemma is right there in front of you.

The big error was to go toward a grain crop instead of towards a tree crop. Yet within India you have the best tree crop research institute in the world. That institute covers a few acres. You will find people there who know more about the coconut palm, its cultivation and its uses than maybe anywhere else in the world. Many areas of the world now grow coconuts and guava from that research station. India has the best, most carefully chosen, most carefully cultivated varieties of guava. The same goes for the lime, and the papaya.

These are frustrated people. The problem with that kind of game is the same problem—land ownership. The problem is that it threatens too much of the other economy. The whole question in everybody's mind is, "If we plant these fruit trees here—and we can do it tomorrow—and everybody's eating, what do we live on? How do we manage to pay the rent? How do we do that?"

A gentleman called Barry Slowgrove, who had the good fortune not to have had any experience in nutrition or in agriculture, an electronics man, and a business man, got sick in South Africa about ten years ago. His doctor told him to go and

eat fruits and nuts, and only those that had been produced organically. So he ran around to see what he could get. He couldn't find such things. So he began looking for books that described their nurture. He picked out a set of fruits and nuts that for every month of the year gave him a complete food.

Then he sold his electronics business—he had branches all over. He got a couple of million dollars. Then he set out all of these trees, the actual varieties that he knew, and all others that were analyzed. He set up a 12-month tree nutrition program in a nursery. He never had a nursery before. He read in areas that we would never dream of reading, such as the root temperature of avocados. He went on with nutritional analysis, doing the annual cycle. He found some amazing things about the annual cycle of nutrients in the case of the avocado—the oil goes from 6% to 40%, and it all depends on the stage at which you eat them. He planted them all. Then he set them out.

He had six African assistants. By the fourth year from go, they and their families and he, himself, were eating 12 months of the year on a non-cook basis. After that, he set up an organization called "Trees Unlimited," and he sold whole nutrition, whole-year nursery kits, plus the implementation, to anyone who wanted it. Everybody who bought it got a guaranteed year-around uncooked food supply at top nutrition.

Then he came running over to Australia and said, "I want to do it here, and I am going to set up that nursery over here and then sell everybody in Australia these kits." He said, "I've got it worked out from temperate to tropical cool."

He handed his nursery system over to an institute. He does not have any personal part in it now. He is just running around trying to get everybody to adopt his system. He says, "This is it! This is it! This is the solution to everything—no more fuel problems, no more cooking problems, no one on bad nutrition, you know, quick to do."

Now his technique is absolutely fantastic. He uses different colors of plastic for root temperature. He has different shading systems for different ages of trees. He goes out and sells his program. Then says, "OK, I'll get it going." He comes in and he bores all the holes where he is going to put trees on the property. He transfers the soil from the holes into pots. He takes the pots back to the nursery. He blocks all the little holes that he took soil from with his cans, which numbers to correspond with numbers on the pots, so that the soil in the pot has the same number as its hole. He goes and treats that potted soil in a variety of very interesting ways. He uses, for instance, sodium salts where you don't have enough water. He uses those in the soil because the plants need them, just as you do. He uses a seaweed gel; he uses more in sandy soils, and very little, if any, in clay. So the plants grow in the soil they are going back to, treating that soil. Now as they respond to that, he runs back to the hole, and he treats the area around the hole. When he has the hole ticking over, and the plant ticking over, he comes in, and in one day he puts the whole orchard in. The plants are already very high, and he advises you to water them once, when he puts them in, and never again.

I think Slowgrove's approach is extremely interesting. He went about it as a businessman would, totally unlike any approach that you ever heard of; he just went at it. He made it succeed. He systematized the whole thing. He made a lot of money at it. I mean, he made another few million dollars while he was doing it. You should see his tree catalog. It is something to see.

Slowgrove took an interesting road. He took the soil from the area in which the trees were to be planted, instead of using made-up nursery soil. He grew that tree in its own soil. He went through many simple sequences of treatment. He had the subspecies and the varieties that suited the climate anyhow. Then

Permaculture Design Course Pamphlet X - Forests in Permaculture

he amended the soil with a minimal amount of treatment, and likewise treated the area where the tree would grow. He used sodium salts and seaweed concentrate with the whole idea of cutting the need for watering down to a minimum.

What he didn't do, though, was to put any companion plants with these trees. He was just laying them out in rows. He was really zonked out by Permaculture Two, or it may have been Permaculture One, that another businessman had bought and which was on sale at the airports in Australia (These books just travel on their own all over the world, see!) This other businessman came running up to Slowgrove, because he had bought Slowgrove's trees and said, "Look at that!" Then Slowgrove realized he had left all the understory out, and had not used any of the design features of the system.

However, what he had done already was of excellent use. His whole purpose was human nutrition. He runs around the world eating fruits and nuts and he looks perfectly fit to me, and reasonably happy.

While he tackled an extraordinarily wide range of environments, he didn't tackle anything like New England or Canada. Quite obviously, you had people living here in heavily forested country and looking fit. That was also true of Canada. However, those people weren't eating entirely from tree crops; they were eating a lot of meats, and the further north one goes, the less do you see people dependent on vegetation.

I point out to you, though, that the total food supply was enormously above the requirements of the population. That food supply was above what it is today. If you make a comparison of the American livestock of the early invasion period with American domestic livestock today, you just had an enormously greater biomass in livestock. You know you had a far greater biomass in trees. So you had a lot more food on the ground in the days of the Indians than you have in the days of the whites. Now you have a lot more whites on the ground.

If you live like a European, you cannot garden like an Indian. No way. You're in problems. People who are simply plowing under native trees, then paving the area over with highways and cities, are blocking their ability to produce food.

Food forests, wherever they are tried, work extraordinarily well. There is a reasonably short delay between bringing trees in and taking their fruits off, but that delay is not critical because what you plant them into is a crop situation, as it is now. You go on cropping between them until you are swapping off what is now annual and biennial crop for tree crop, and even then you can go on cropping for quite a long while and take both.

In India, at the government pig killing station—the only Hindus that don't eat meat are a very small group; nearly all Hindus eat a little meat—well, this government pig-killing station is run by Hindus for Hindus. They raise pigs as they were taught by advisors, some of whom were Australians. They raise them on crushed grains. They have 68 acres around this piggery. But they haven't been taught what to do with pig manure. So they have a lot of little men with wheelbarrows carrying it out and dumping it all over those 68 acres.

About a quarter of a mile away there are some beautiful breadfruit trees, dropping breadfruit—a lot more breadfruit than anyone would ever need to feed all the pigs they've got. So I suggested to them that they combine this breadfruit situation with papaya. You can't bring banana in because you can't run pigs in the banana, but they had plenty of people there, if they wanted to, they could bring banana in, and carry the banana to the pigs.

So we worked out what to do, and as far as I know they started doing it. Now they could run all that pig operation and a lot more than a pig operation on 68 acres. I said to them, "And

the next step is to take this and the pigs, little pigs, and start to give it as a kit to lots of other farmers. Then you just do the killing for them and processing, or whatever." As far as I know, they have started that. They can easily kit out a whole district from such a center—not just with its fruits, but with its meat base as well. They just hadn't thought of it. First, because they called in Western piggery experts, and second, because not one of the persons on the staff was a forester or fruit and nut person, or biologist. They were all technicians.

They were delighted. Now, not the person running it, but the second person, is an experienced forester, and he is getting on with this. They have very good foresters in India.

Those grains that they fed to the pigs came from Indian gardens, which amounts to a reduction downwards to one-tenth of its former food value. However, within eighteen months they should be a net exporter of fruit and pigs, which is a very rapid and resounding sort of change.

It is exactly the same with the government milking shed, and buffalo growing. They have people running around carrying grass, feeding all those buffalo.

Cliff Adam had tackled this, too, much to his own horror. Talk about growing livestock! Cliff had put in an acre of a thing called elephant grass, quick growing stuff, grows about four feet high. It looks like sugar cane, and it's not far off sugar cane. Between the rows of elephant grass, he grew a tree called leucaena that many of you will have heard about. Under those trees he grew annual plants. He put in an acre of this. He had cows in a modern dairy. It was just like any barn except that instead of storing food, he was cutting the food and feeding the cows and milking them in the barn. He was running ten cows to the acre. He said, "I was going to extend to 10 acres, but this won't do. I will supply the entire milk of these islands, and what is the point? What I'm really here for is to tell farmers how to do it."

I said to him, "Well, I'll tell you another thing you can do. There's a lot of room for comfrey in there, and comfrey doesn't care if you are walking up and down on it. You will get five cuts a year off that."

He washes all the manure from the dairy down on a very simple row flowing system, back into the crop. So he has a wheel running in which he has ten cows to the acre with these two crops. The cows look good. They have been running about two years on this. He eliminated artificial fertilizer from the system. So what he has is a real full-on, high production dairy system in the tropics. He doesn't take the cows to the pasture; he takes the pasture to the cows. If you look at the field, there is short leucaena—it just marches across the field. The whole field is bordered with coconuts, which are superb to the situation—lots of shelter and plenty of coconuts.

Only a little bit of capital and a little bit of land are needed to evolve these very simple systems of high intensity production. The best butter in the tropics, however, isn't butter; it is avocado. By a long, long way, it is much better than butter. There are many solutions for food forests—amazingly fast, amazingly simple solutions—and in forest forage, too, as we have just thrown in there.

Now the application of these systems is not confined to tropical areas. Using modern nursery techniques, we can get an initial year or two years in the nursery, while doing the ground preparation in the field. In the nursery, we can get the ordinary cold-temperate fruit and the nut trees to a stage that, in the field alone, they probably wouldn't reach in eight years. We can ship container specimens the year before they yield. So just by the application of good nursery technology and accelerated growth in the nursery, and then a field preparation, you can lead very quickly into it. The establishment and use of non-cook

Permaculture Design Course Pamphlet X - Forests in Permaculture

food forests is pretty simple. Cooking, by the way, is the major fuel use in the third world. So, you would never go into an island situation and advise them to put in a rice plot—never! That would be the end of the island. Cut more trees to cook the rice, to extend the rice, to cut more tree.

I don't expect you could find a more conservative set of eaters in the world than the average Australian. It is meat and potatoes country, with the highest per capita consumption of meat in the world, except Argentina. But that is changing rapidly. What now appears in the shops is large quantities of avocado and other fruits, and nuts. Formerly, they were never produced or even offered for sale locally. People are rapidly adopting them. I don't think there is any problem in changing people's food habits. I haven't been into a part of the world where a gardener doesn't leap on a packet of new seed, if you will give it to him.

Just say, "Look, I got something for you here, it's a brand new plant."

"Looks good. What will I do with it?"

"Stick it in and stand back, you know?"

"Good!"

I think the very interesting thing about the permaculture approach is that it predicates that you are going to be on reduced fuel consumption for cooking. I can't see any reason for using fuels for much of anything at all.

While I don't pretend to be a nurseryman—we've just started working in this area—I am very interested in Slowgrove's approach, and we are using some of his techniques. I have friends who are nurserymen, and they are carefully monitoring trees now. They find that by adjustment of shade and nutrients they can get probably four or five times the growth that we used to get in old open bed nursery conditions. They sell very large trees now in a very short time. Other nursery developments also are revolutionary, techniques such as cloning by root tip, single cell generation of plants. If we learn of a rare seed, we get one into Australia, and send it to a friend in Adelaide. He starts the seed. He starts from the root tip. One seed is enough to start a whole bunch of plants going. It's really the most rewarding domestic technique, to look after your plants and get them going in a sheltered and ideal environment. Meanwhile, you are working outside where they are going to go, to bring that environment up to optimal growing conditions. While you do that, you can be cropping the area and using it for purposes that might very well be manuring it. Then you move these trees out into the situation. It's not a broad scale technique; but as a domestic technique, setting up a family in food, it is a very good technique.

Slowgrove said that if you want to do a lot of this, if you want to do 4,000 acres for a community, first, start the nursery running while you get out on to the ground. He had set up a sort of nursery kit. We did that, too, in central Australia with the aborigines. We set up a small nursery kit, all of which fitted on the back of the truck. So when a group of aborigines goes to an outstation, they take their own nurseryman, who has been through a course of training and knows the nursery business. The nursery has everything with it. It has its own drip lines and sprinklers and shade house. They set up the nursery at the camp, and then they fill out as much as they want to around the area. It is really simple, because you give them a bundle of tamarisk sticks in water, and after they get them, they stick them in the sand, and they have tamarisk going. Then you give them a bundle of grape cuttings suited to their area, and they may have twenty varieties of grape cuttings. They get those going, and then away they go.

That nurseryman only needs to train for a couple of months. He is a tribal nurseryman, while he is needed. That nursery is

built out of reinforcing mesh. It has a lot of grapes in it, and oranges, and all these goodies. They like their own foods, too, but they like these additional foods. There is absolutely no barrier to getting them to eat these foods.

All over India, you see big notices with Ghandi's name on them. Those notices carry one of old Mahatma's sort of instructions. They say that if every Indian planted a tree every year, the whole continent would be in very good order. They say it in Hindi; they say it in English. The trouble is, you can trudge for endless miles and you won't find a nursery or even a tree seed available. There isn't any. If you set up a nursery, you would rapidly become very rich, because all the people in India would come and get trees. They want trees; but there are no nurseries. There is not one nursery listed in the Yellow Pages in Bombay. (You can't get anyone on the phone there, but there are Yellow Pages.) So India could easily be revegetated, but it hasn't any trees for sale, not to anybody.

A group of interesting people in Bombay studied successful and non-successful undertakings. They found the most successful attempt to do anything to improve conditions within a village was made by a local farmer. He used a combination of very hard control and common sense. First, the problem was that there was a lot of disease in the village, and it affected his workers. So he forbade his workers to wash their clothes in the spring water on his farm. So they had to change their ways rapidly. They came downhill to wash their clothes instead of drinking the washing water. Thus he wiped out disease on his farm. Then he thought he would like to grow limes, because there was a big demand for limes, but none growing in the district. So he started a small nursery to grow limes. He grew rich by selling from the nursery, and he turned into a nurseryman, and enlarged his acreages. What he accomplished was a very simple thing locally, not a big deal. This was the most successful change in the village. There have been millions of dollars and thousand of Europeans coming and going with all sorts of free things, most having absolutely no effect, or no lasting effect.

But the real problem in India is land ownership. So maybe you will have to become a land owner to change things.

For a food forest, you must pay attention to the edge and to the species. Most trees bear on crown, but not all trees will stand within the clump. Some must remain on the edge. So when you set the thing up, you differentiate the crown bearers that are also edge species from the crown bearers that will stand within. These include the large nut trees. It is probably sensible to set your forest off with bark yielders and close planting in the interior of it, coming out. Then thin the forest for crown yields, then for edge yields. That way you have a structural forest within the food forest. It may be better to place your structural timber forest, as the core. As soon as we get a diameter of over 100 feet, we start to think of the center as maybe being structural. Then think about breaking the crowns and taking some edge in as a lake or something, and then starting again. That's the design.

However, within the tropical region we don't have to worry here, because we have stem bearers. Tropical forests, as soon as you get into there, you are into cocoa and all sorts of other trees, and into palms that are crown bearing. In the temperate forests, this is not the usual case.

Your oaks bear quite well within the canopy. So you can treat oaks as a forage and structural timber within the canopy. The way to get a really good mixed forest—and what most people don't do—is to put in a forest at very small intervals, with some species as little as three by three feet, but nearly any species as little as nine by nine, and put them in as seedlings. That forces them into a fast upright growth with a good trunk. You do modest trunk trimming, and you wait for bearing to start, and it

Permaculture Design Course Pamphlet X - Forests in Permaculture

will start with small trees. Then you might select for early bearings, easy nut crackability, low tannin, whatever. Start to cut out the trees that don't come up to your expectations, but that already have good trunk length. Then, keep on cutting them out until what you end up with is a good tree with excellent bearing potential on several characteristics, and then you let it develop the crown. The ideal way to go about it is in a graded way. It doesn't take so long either.

It wasn't more than a decade ago that some people bought an island and set it up—a very overcrowded island—with black walnut, because it was an investment thing. They were going to go along into the veneer trade. Well, black walnuts started to drop walnuts, and they found some really excellent walnuts among them. So they started to free these good walnuts. Now they are making a packet out of walnuts; they don't even know if they are going to bother with the veneer trade. They are heavily into a crushed nut business.

When you begin to get your trees established, then you can move in species like your striped maple and other useful plants. You might find it would be a good idea to put some grapes, or perhaps some other useful vine on some of them. One thing for sure, in fig country, as soon as figs are up and bearing, have a grape standing out there on the trellis, and when your fig is big enough, just lead your grape into the fig and then stop pruning it for good, because the grape reaches the crown of the fig and is wind pruned, and you just forget pruning it anymore. You do exactly the same with elm, black walnut, and blackwood—Tasmanian blackwood. They are all carrying grapes, and the grapes bear as heavily as they would if you pruned them. Because, in fact, they are pruned. No grapes can get out past the crown. I was standing by one of those trees down in West Australia, a fig tree. They were harvesting fig, grapes, fig, grapes. For grapes, obviously what you need is a tree of limited height, so that is a nice combination.

Structural Forests

The strongest structural timber is growing round timber, uncut timber. You have species that are pioneer or edge species. Black locust is a very good example of this in America. It's a tree that is pioneering. It's a good soil builder. As fence posts, it is a very durable wood. It has the highest impact loading strength of any timber known. The black locust is the traditional mallet head. Therefore what you have is probably the best designed structural poles existing. We find black locust posts that have been setting ninety to one hundred years, and they are still near maximum strength. I don't know what you are paying for fence posts, but it's heading up towards \$5 and \$8 in Australia for six foot posts. You can put in those stems at 4,000 to 5,000 per acre, and you don't wait very long for a fence post. It's only about four to six years. And it coppices. That is another good thing about the black locust. The more you cut, the more you get. They also provide quite good chicken forage. In this way, they ideally suit to stocking with chickens. That will increase the nutrient level of that forest.

Another wood that has numerous domestic uses is bamboo. With bamboo you are not so fast into crop, unless you can persuade someone to let you break up their clump and dig out the root masses. Otherwise, you have to wait to develop your clumps of bamboo. It is generally 10 years before you can cut it. Bamboo very easily propagates. Mostly it is vegetatively propagated. There are two to four bamboos suited to the North American climate that are heavy seeders. These are useful for feeding wild life, but they are not particularly suitable structural bamboo. I don't know of any structural bamboos that are annual seeders. Even small bamboo, however, is useful for gardens. There is a large bamboo that I think may grow easily up here. It grows to about 60 feet, with a diameter of about four inches.

You can look them up, probably in Boston.

You could use many thousands of clumps of that throughout New England. It is good for cups and knives and plates, gutters, and down pipes, and reinforcement of concrete. You have to follow the rules. You have to cut it at two to four years of age, dry it for about eight months, and then when used as reinforcement in concrete it is two-thirds the strength of steel. The comparison is per diameter. If you use inch bamboo where you would use one-quarter inch steel, you get a lot more strength. It has the advantage over steel, of course, in that it doesn't rust in concrete. It is a much better reinforcement if you treat it carefully. It bonds better in concrete. It has many additional uses. Bamboo shoots are excellent food. Fortunately, they can be eaten raw. So the bamboo is an excellent structural tree, as well as a food source. {There is some risk of cyanide poisoning from uncooked bamboo shoots. I've eaten small amounts of sweet shoots with no ill effects, though. -DH}

Let's take another—the cedar—your eastern red cedar. It's a good structural tree, a good pioneer tree. It naturally starts to disappear into the forest that succeeds it. That's the time to take it, as soon as it starts to become eclipsed by the next succession. Tamarisk is another good structural tree—excellent. There is a short list in Permaculture Two of the trees that are really worthwhile to set out by thousands for structural work, particularly for pole and fencing timbers. *Arbor vitae* belongs on this list. We could make a much more extensive list. Many of these long duration trees weren't recorded there. So when you are planting for a client, and he has the room for it, give him a considerable edge of structural timber for a thousand year future. All the better if those timbers are pioneer species.

You might want to buffer the large nut trees from the round fruit trees. Put maybe a 20- to 30-foot planting of other trees in, Acacias or something else. These trees that must be buffered against have a root exudate, which is a mixture of creosols that kills out the species that are pioneering. That is how they increase against the edge. This whole group—Juglandaceae—hickories, pecans, walnuts (*Juglans*, meaning the balls of Jove)—put out that excretion. The large fruit trees that bear at the edge, must have a buffer forest between them and the central forest of large nut trees. The mulberry is a very good buffer tree because it stands right in against those nut trees with no sign of loss of crop, and the mulberry will stand right against fruit trees without impairing their crop. The elderberry is another excellent buffer. They snuggle up to both those groups. The black locust is another good buffering tree.

There are two sorts of structural forests. You can manage, of course, for saw log. That is what everybody is urging you to do, because of the huge spin-offs to other people in saw logging. However, a round pole is of far more use to you or your client. A very limited amount of saw log is needed—only a small number of trees that you may need to rebuild your house, unless you are really interested in building houses for many other people. What we would have to weigh is how that use would compare with the trees' other uses in the forest.

So you have pole timbers and plank timbers. Management for these is different. You know how to manage for plank timber, or any forester can tell you, or there are books that will tell you. You pick out a true sort of tree with a clear trunk, and you free it a bit and look after it.

There are two ways to cut your forest. One is to continually fell the largest trees. When they come up to a certain diameter, you cut them. That gives you a continual production of round timbers in that forest. The other way to manage the forest is to cut out all the small and weak trees. The first method is a continual-product pole forest. The second, is an eventual-product forage forest. Now why not do some of both, if you are

Permaculture Design Course Pamphlet X - Forests in Permaculture

dealing with anything more than seven or eight acres of forest? If you manage timber for pole timber, and it is all posts of high duration, you are farther ahead on money value than you would be waiting 40 years for a plank.

I think you will find poles being used in construction much more commonly than in the past, particularly for accessory buildings. Australians now build houses in which they use about nine two-inch poles to build an entire framework. Then they just fill them in. There are many of those houses now being built. The whole structure is made of poles and then just filled in with mud, brick, stone, or whatever. The whole house framework costs around \$800. The building stands on its poles, and is filled in with mud, wattling, board, or chicken wire and cement. Chicken wire and cement are great building materials. Some beautiful homes are chicken wire and cement homes.

Now let us look at coppice in terms of structural forests. A whole set of plants is cut-and-come-again. We have mentioned black locust. Willows, poplars, ashes are all plants that you run as coppice. They are useful for furniture, handles, basketry. Your classical coppicing tree is the willow.

There are different reasons why you might coppice. You might for the bark, or for the timber, or for the forage. If you coppice for forage, you start your coppice above cow level, but to coppice for basketry, you can start below ground level. What you use is striped willow. You bury it in a good wet site as billets in rows. It shoots up and you coppice it again. You wouldn't get away with that with your cow in there. The Tasmanian basket makers, who are to the fifth generation in basketry, used this method. They have just a little patch of it, a half acre right outside their door, and they manure it and look after it.

I think that also ought to be used a lot more as a forage. Consider a quarter acre of that sort of coppice, something the cows will really rip into. You just have it ready so you can turn your cattle in and take them out, watching the amount of damage done. In some extensive cattle areas, if you have five or six acres of that sort of fodder locked up, it would carry you right through droughts. You can either cut it and throw it over, or let the cattle in, depending on how much damage you observe.

If you want to keep a stump from coppicing, the simplest thing to do is to throw something over the stump, a piece of carpet. Just exclude light from the stump. Cut a hole in the stump and put a little road salt in it.

For woven fences, you use hazel, oak, or ash. All of those are used.

What is poplar used for? It is good forage, good splitting, and good for inside work. It is not much good for outside use because it doesn't last long. You can't go into bent-wood chairs, or whatever, with it.

Another good tree, which is not American, is the tea-tree. It grows very thick. You can hardly get your hand in between the stems of it. It weaves well. We make all our baskets and all our lobster traps out of it. It has a high value oil in the leaves, so when you cut your tea trees, you also distill the heads. These tea trees are long lasting in fences. They last thirty to forty years. It sells 30 cents a stick at present. You don't put the butts in the ground. You use the sticks to fill in between black locust posts and rails. They will be there for 50 years as a fence or trellis. I put a row of rocks under them and stand them on the rocks. They hang there indefinitely. Those trees grow very fast. In five years you are ready for another cut. The oil that you distill from the heads gives them a double value.

I would like to discuss at some length the American forest as we now see its potential for management. I think if we go about its management very carefully, we will find that it is a high value standing system. I think there are two or three ways we can go about its management.

There are already pole stands of reasonable value with very few large trees. We can keep that part of the forest as pole stands and start to look at how we could use the poles. There are big areas of birch pole. I would use white birch plantings as reflective species in design in the district. I would make it coppice, too.

Let's look at what we have in the forest. We have many dying young trees. They are over-run eastern red cedars and understory trees that were beaten to the crown. They really represent only one thing—firewood.

If we put in a dry distillation tank, which is just a simple brick system—there are quite a few models, for the French use them quite a lot—we would get charcoal, methane, creosote, methanol—all of that. We would still have a readily saleable fuel as charcoal. There is a lot of forest right here on this place, and nearly any of it worth more than a cord of wood. After distillation, you still have charcoal left, which is an excellent cooking fuel. So it would be advantageous to go into dry distillation.

One of the very first illustrations in Permaculture One is a diagram of how you could use that wood for a whole lot of products. The whole system is pretty low technology. You needn't release all your flue gases. Send your flue gases through pond water and get calcium carbonate. Precipitate it out and throw it on your fields. Throw it back in the lake. It releases a very clean gas to the environment, and you can recover methane. Now that would be a good way to use those dead and dying trees in the forest.

Your priorities in the forest at any time are to cut the trunks that are lying on the ground away from your live tree trunks. These are the ones which in fire scar the base of the living trees. The first tree you cut up on the ground is the one lying against the other trees. That is true still of many chestnuts. Old chestnut logs are often lodged against big standing trees. They don't seem to rot very quickly. Now in North Carolina, there is a lot of chestnut wood lying around. The reason it is good to move this material out, rather than leaving it there to rot is that, in North Carolina, for instance, it would never get to rot because the fire frequency is relatively high. What will happen is that all those ground fuels and any standing dead fuels will burn out. I think in most forests that ultimately is the plight of many cords of wood. It just simply goes in wildfire. At present, without knowing any more, I think it would be better to take those out for fuel. They are more than firewood. Dry distillation could be combined with the heating of homes, because we are going to get surplus heat from it.

What I am looking at is trees that have lost their bark already. Throughout the forest, there are many very old trees on their feet, still alive. Now we can leave those standing if we find occupancy in them of wild life and birds. Also, whenever we cut up old trees, we are going to get many hollow limbs. I think we should sell those as nest boxes. We should also fit them into the forest to increase the number of hole sites for squirrels and other forest animals, but particularly for the birds. Probably the reason there are so few birds in the forest is the lack of good nest sites. If we analyze what birds we have, we might find out we are missing on many of the hole nesters. At least we can put those hollow logs up as nests and try them out. It is not much trouble to refit hollow logs. You have good books on bird nest boxes and critical entrance sizes, etc.

If you put your nest boxes out in the open, you are going to get sparrows. We are more interested in the birds that nest within the woods. Sparrows don't fly very far into the woods to nest. I think we should be selling these nest boxes. It always saddens me to see hollow logs burned, good sound hollow logs. You can leave some of them in the forest; you can leave them standing upright, and flat down, and they will get occupied all

Permaculture Design Course Pamphlet X - Forests in Permaculture

right. We could leave the few in there that are riddled with holes, and there are but a few of them. They are not going to take up much space.

Then we should look at three or four management strategies in the forest. First, we need to lay out the end uses of their products. We have a whole set of bark, leaf, oil, and medicine products within these forests. We should attempt a crude economic analysis of the end product values. We might be very sorry if we were reducing some of that material to charcoal. Nevertheless, we do have to heat presently with wood. The best way to do that, I figure, would be to build a dry distillation basement system. You load a container lined with brick, and you close it off. You light a fire underneath it. The wood inside can't combust, and your fire is still a twiggy fire. You steam everything out of it, all the juices, and it cooks. You cook that wood to charcoal, you bake it. Up come volumes of gas. Methane comes off. You can use 4% of your methane to pump the rest of it down to bottles, or you can pump it through a pipe into a gasometer. Then you pump the rest of the gasses along. Lime water will soak up the CO₂, so you run these gases out in the open air or through a pond, and that cools them, and out comes your creosote, etc. You are into other sorts of games from then on. You get methane out of methanol. That cools rapidly in water. You close it up in a steel drum and lock it in.

In the old method of making charcoal, they covered it with mud, and they didn't collect any gases. They wasted most of the biomass. All the gases went to air. The French used to brick up a double area, one that was for the fire, and the other cooked the timber in it.

This system would supply all the gas for cooking and a great hot mass down below the house with which to heat the living area. We can take any amount of hot water off that. We have creosote for painting and proofing our planks. We can turn a black or silver birch into a non-rot product by creosote soak. And we have methanol to run the tractor on. I would like to see somebody set it up. Perhaps we have the practical situation for it right here.

Inner zones need to be far more productive in human and animal forages. So we decide which of these elements we will build into the animal forage systems. That will determine which elements of the forest we will favor, and which we will weaken, and in what direction we will steer the forest. We should look closely at the forest around here for their high potential for increased forage for man and animal. Their value as windbreak is also desperately important. If we were to go on clearing the forests without replanting close-in, wind stress would cut productivity on site. So we must manage for close-in windbreak. We next manage for human and domestic species forages.

Let's look at white pine. If we close up an area with white birch and put white pine behind, it might create a micro-habitat for food production, because we have a reflective system. We might screen with white birch near gardens.

We should be managing this near section of the forest for greatly increased productivity within the center of the site. So what we are managing toward is those high forage-drop species, such as oak and cherry and apple. We remove selectively and we replant or encourage selectively. If we are managing that area for oak drop, we can also do it in such a way that we are looking forward to maybe very long term, occasional oak tree cut.

In a large design, you may be selecting four or five house sites. Some of those can be in the open and some in the forest. Where do we want the forester? We want him in the forest. The one who takes care of the livestock needs to be near to the barn. Break your house sites up according to the functions of the half dozen people living and working on the site. The ad-

ministrators need to be closer. You have gardeners; you have nurserymen; you have foresters. A large forested area should take five families in forest product. It does not mean you necessarily have to have five houses in the forest. Some people might come in to be foresters. Or they might be living in a group situation.

Out there in that further zone of forest, we start to break up secondary and tertiary uses. We might try a few structural forests in close, or a few bamboo clumps—bring them in. Maybe they are still working like those birches are for secondary reason of shelter. Out here we might find a place that is very promising for future plank timbers. We need a plank forest. These areas all have to be managed differently. Some of them are already progressing towards what we want. The uses for which we manage a forest should not conflict with further foraging of wild life.

Maybe in every area we will find a patch of forest that should really be for itself. We must always try to keep these places, because they are going to be doing things that may help us a lot out here, that may stop us from doing silly things out here later. We might be doing the wrong thing out here for the long term. Instead of taking out the trees for firewood, we might find that what the falling and rotting trees are doing in there is essential. So then we stop. These undisturbed areas can act as a control. Also, parts of the site really may be too dangerous to disturb, to constantly manage. You may find that these are very beautiful places. What do we want to bugger around in there for? We don't have to. We have a vast excess of this resource. We could leave some of it alone.

We have to decide what we can get out of the American forest, what are really valuable products. Our aims should be to leave as much of the biomass in the situation as possible, and to take out the smaller, highest value products. Seed is a good example. The forester here on this site should be a very busy person.

It is essential first to determine what the forest products are, then to look to what's happening in the market. What's the price of acetone? We know the value of some things, like methane. We don't have to worry about who is going to buy that. All our cooking gas is in that forest. Two technologies will extract it. One consists of composting the twigs, and the other is just good distillation technology. Both give us volumes of methane.

We must not forget that we have to trim our white oak to maximize its value, and therefore we are going to get trimmings. We have to use them somehow. We don't want a triangle of trimmings lying between the trees or all over the ground. That is a bad situation for fire. We can pile the brush into heaps. Brush piles are a good winter shelter for a whole host of animals. So also is your firewood, your cordwood, if left in the woods, not brought in. It will be full of lizards and salamanders. They live in this year's pile. The next year, you must build another pile for them.

While there are other potentialities in the woods, I think determining what they are is a job that should be tackled on site. There is a lot of work to be done here. The largest design problem in these wooded areas is the management problem.

One strategy for forest management now starting up in North Carolina sounds good to me. They assemble people who are in touch with the forest. They say, "OK, as an individual, I can't supply enough beech for this order, but as a group we can." They also, share tools and equipment.

Everybody is urging them to manage the forest to burn. We know this is true, for why else are they making all these stoves and things?

Permaculture Design Course Pamphlet X - Forests in Permaculture

Forests & The Atmosphere

I want to discuss briefly what the forest is doing to the atmosphere. I will start off with one statement: Whatever it's doing, it is very, very complicated. It is not simple.

Let's take wind—what the forest is doing to wind. Wind completely disappears in an effective forest within a thousand meters. The forest is swallowing it. It is absorbing the total force of even gale force winds within a thousand meters, except at the crown, where winds still continue to have some effect. I am not certain that we have an adequate explanation of what that energy becomes. I believe it may be wood. If we anchor the trees, the stem diameter remains constant, whereas if we move them, the stem diameter rapidly increases. So it may be that wind aids transpiration, or pumping, or cell production or something. Certainly, the energy of the wind is being converted within the forest to something; I'm not quite sure what. The forest is certainly using the wind, and I, for one, never heard any adequate explanation how that happens, nor have I seen anything written on it.

The forest forces 60% of the wind up. That starts a process. Now when the wind goes up, you get a high pressure on the windward side, and decreased evaporation, and at the same time the face of the forest towards the wind catches a lot more rain than the other side. That is just simply observable. So it is wetter there. When the wind goes up, it does cause an increase in rainfall. The rainfall increases between 15% and 20%. That has been measured in Holland and Sweden. When we cut the forest, the actual rainfall in the region decreases in a set of figures lying between 10% and 30%.

Then there is a secondary effect. When forest forces wind up, it goes into sidewise spiraling, that causes belts of rain across the direction of the wind. Little patches of rain go on for several tree lengths past the trees, so that at intervals of five tree lengths rain increases in a belt transverse to the wind. So you get wet, dry, wet, dry past tree belts. The descending winds past the forest are warmer, less humid and turbulent, and often cause drying out. Some people think those pressure changes in the air have the greatest effect on soil moisture. It is a fact that the low pressure belt, produces higher evaporation, and occasionally a rain shower on the leeward side of the forest. The forest has other effects on the wind about which I will not go into detail, like reducing the wind, or warming the wind, and so on.

I doubt if you go a thousand feet within the forest you will experience any wind at all. As for a tree belt, if it is to be effective, we need to have about five trees wide, although a single belt at 40% penetrability has an effect as a wind break. When only about 40% of the wind passes through a tree belt, the wind diminishes rapidly within 100 to 200 meters. It becomes negligible. Around a plant stand, to the wind itself, I wouldn't trim. If you trim, it might cause a wind tunnel below the trees, which is a little miserable for animals. The idea of a hedge row is that it does come to the ground, or starts above the stone wall or something.

The wind carries dust, and it carries humidity. Without any rain, that is, on a foggy night with air moving into the forest it will, within a hundred meters, reduce the humidity in the air by about 50%. This is called positive interception. I believe this to be a major factor in all coastal forests, and on ridges within fifty miles of the coast. If we have air coming off the sea that is very humid, and particularly night air blowing into these forests, all you see is a constant dripping of moisture within the forest, even if there is no cloud in the sky.

That occurs in an individual garden. A lady named Marjorie Spear has a garden in which it rains constantly all night, every night, when it doesn't rain anywhere else in the district, where

there are no trees to intercept this humid air. I think that what happens is that the air is relatively warm and leaves relatively cold. By the time the night winds strike the tree, the leaves are sensibly cool, and the moisture precipitates out rapidly on the myriad leaf surfaces. An individual tree has many acres of leaves. Moisture doesn't precipitate out on grasslands, except as dew. Yet, within the forest there are millions of gallons that come down. In Tasmania, up to 60% of our total precipitation is put down to this effect. Only 14% of that water falls as rain—trees catch 86%. Now we are a coastal island, a small island only a couple hundred miles across. Screens put up to imitate trees create high precipitation.

When you are cutting trees down, you won't notice the rain gauges over 15%, but you only have 14% of your moisture left. Now I think that is a critical factor for all coastal mountain ranges, for the first mountain inland from the coast. So that's what the forest is doing to the wind and to the humidity in the wind.

As for particles carried by the wind—and again, I'm talking about a hundred meters of forest—they are reduced sometimes to about a quarter of their previous occurrences in the air mass. We are talking about the dust and the other particles. Now as this may represent tons of particles, particularly if the winds have blown across soils and over industrially polluted areas, this means that the forest entraps much material. That leads me to suspect, and many people to state, that there is no shortage of any mineral or any element anywhere, because it is all on the move, particularly off seacoasts. It is being netted by the forests. It might be a slow process. Mineral might be used and fixed as fast as it is netted. But this really happens.

Conversely, when we come to organic particles—I am talking about pollens, bacteria, and some oil droplets that are being released by the forest—we get a reverse effect. What's happening is that the forests absorb tons of inorganic materials and release tons of organic materials. I was reading about the early voyagers approaching this continent in the Spring. Gigantic white pine forests grew here. Up to 80 miles out in the Atlantic, pollen coated the decks of the vessels. The voyagers thought it was sulfur. They talked of gigantic sulfurous rains. The whole sea was yellow with pollen. They thought there were volcanic eruptions ahead of them; they advanced with trepidation towards these shores, into these yellow skies. Imagine the biomass on the move there!

The organic particles are far more effective precipitation nuclei than the inorganic particles. We suspect that they are the important factors in atmospheric precipitation. So that is another effect of forests—they give off nuclei upon which raindrops condense. So while forests are taking inorganic particles out of the system, they are releasing organic particles that go on in the air stream and therefore are available for condensation of rain further inland. About 60% of inland rain falls from forest clouds, not sea clouds.

Let us not deceive ourselves. Clean air contains an awful lot of stuff. Just lying on your back with a good pair of binoculars will persuade you that there is a lot of matter on the move up there. Tying nets through it will persuade you more, and putting up little traps will persuade you even more. There is a lot happening up there. Forests are a big factor.

What else is the forest doing? We will move to rainfall. Rain falls on the sea, the land, and the forest. On the sea, it simply cycles back again. I don't know what its effects are. It probably has some effect on plankton production. On the land, where it falls on the forests, the canopy absorbs almost all its energy. A big energy transaction goes on right on the canopy. The mechanical energy is almost all absorbed. Within any reasonable size forest in leaf, even a violent thunderstorm doesn't come

Permaculture Design Course Pamphlet X - Forests in Permaculture

into the forest as anything but a fine mist. I am talking about tons of water and thousands of pounds of kinetic energy. This just dissipates in the crown. This has a couple of obvious effects. This water never hits the Earth, so any erosion from that pelting rain, which is an enormous force, just doesn't happen within forests. The crown absorbs that energy. Then, if the rain is light, no water reaches the ground. It is quite possible in light rain for the top of the forest to absorb the total rainfall. That is easily seen on roads. In a reasonable light rain, under the trees the roads are dry. That water never does get to the ground, and is evaporated off the crown. That causes a profound cooling effect. Energy transactions of all sorts are taking place on the crown of trees. There is frictional slowing; there is impact absorption; the winds are being tangled and stopped; and this rain is being evaporated. So many energy transactions go on up there.

These transactions aren't going on very much below the crown; therefore the amount of energy being absorbed and dissipated on the Earth's surface is much less under forests. You get very little erosion in forest. If it rains modestly or heavily, the crown becomes saturated and water comes on down in a whole variety of ways. Some trees funnel water down the bark channels. Ten or 20 times the actual amount of rainfall will run down just around the stem. Other trees pass it down around the crown itself, as a circular rainfall. In a mixed forest, rain falls every which way—some dripping outward, some running down under the branches, some funneling down the crevices of the trees. I just went into your forest the other day when it was snowing, and every tree was intercepting snow in a totally different fashion. The crystalline structure of snow and the shape it meets interact.

Let us think for a minute about something else. Eighty-six percent of the mass of that forest is water. Ninety-six percent of its leaves and twigs are water. That is an enormous weight on the Earth. That is a lot of water. It is an Earth load of tremendous mass. Really, the forest is a whole lot of vertical tanks. Some of them are very big tanks. I believe that we can load and unload the crust of the Earth in such a way that it will cause Earth movements. We know that quite modest dams will cause local earthquakes. We failed to see the forest as the enormous water mass that it is. I think if you want the continents to rise and fall and fracture and bugger around, then you can accomplish it by unloading the land of its forests. Play around with this water mass enough, and you will get it to happen. I think we unloaded a huge weight off continents when we removed our forests. I think we are dealing with more weight here than anybody has ever acknowledged or tried to measure.

Branches will break off trees, either in fierce gales, or at other times on very dead, still, humid nights. When the trees can't transpire, the enormous weight of the leaf water just smashes the branches down. That is the time not to be in the forest—on still, misty nights. With no warning, just bang! Crash! Big branches fall on those nights. The trees can't support their own weight, any more than they can support the weight of fruit. Fruit is 96% water.

So a forest also sponges-up this water. But not always, I feel, through its roots. Much of it enters the tree through its leaves. There is a tremendous direct leaf absorption of moisture and of substances in solution. So it isn't just the roots that are at work taking in nutrient; it is also the leaves. The leaves also manufacture these nutrients as they pass inward into the tree. So the forest builds a lot of water into its mass.

The rest of the water, not absorbed by the trees, gets down to the ground. Here the litter and humus of the forest floor await it. No more water seeps down until the floor fully charges. That represents quite another mass of water. There may

be six inches to a foot of water held in the landscape, but nothing moves the floor saturates. Then the water seeps into the mineral soils below the humus soils. Even down there, every foot of soil will hold an inch of rain. So if you have 30 inches of dirt, then a 3-inch rainfall won't move at all out of that forest situation. In between interception, absorption, the humus absorption and three feet of dirt, no water moves. Nothing is flowing. Thirty inches is minimal. Sometimes up to 60 inches of rain will be held because we have good deep dirt. It percolates so easily because it follows old root traces. Forest soils are totally bored out by old roots that have rotted out. They form all sorts of conduits to deeper levels of soils. Within the forests we don't get any significant evaporation of this through-fall of water. We are not going to lose much of this water through evaporation.

Let us look at the soil below the forest. First, the particles absorb all they can. Then water bonds tightly with each little particle. Clay, particularly, binds water very tightly. This surface tension effect comes into operation. Now when that has happened, the spaces between the particles, in which this effect doesn't occur, also will fill with water, and that water will start to percolate down. On it goes downward. Two fates await it. It can transpire, and the trees can bring it back out of the reservoir and into the air again, thus recharging the air with humidity. That air blows onward. Now that is a very fast effect. Even a modest line of trees up on a desert causes some rain downward. Trees transpire ground water most on hot days. This heavy evaporative transpiration increases the humidity of the region. When night falls, this may reprecipitate downwind. Water is flung in all directions. It is stopped and stored.

Then, when this system is full and when there is any slope, and there is always slope, some water may start to run off. On the floor of the forest, there is no such thing as a straight run-off system. Twigs and leaves and debris accumulate in immense amounts. Therefore, water persists longer in the landscape. Run-off is very, very slow in forests. If you follow a trickle, it performs some weird convolutions getting through the forest. It meets fallen logs, trunks, leaves, leaves that bank up and turn it. These impediments repeatedly halt the water. Its time on landscape is great through a forest as compared to the open, where it just goes whist! In the forest, it is impeded and impeded and impeded. In the open, the water runs off, and the rivers rise.

If you want to increase run-off into catchment, cut the forest, and for a very short term your reservoir fills faster with every rain. So the engineers reason, "Let's cut the forest to increase the run-off." They actually diminish the rainfall, drop the total water falling on the whole area to roughly 70% of what it was before.

Evaporation does not occur from the soil surface below the forest, because it is the roots deep down below that draw the water in and take it back up. The travel direction of water entering the forest is always downwards, and only upward as pure water that releases to the atmosphere. In a forest, water never travels upward again to the surface of the soil for evaporation. We therefore get no salting, no upward migration of salts to the soil of the forest. Then the water that was further down enters shattered rock and deep leads, maybe old buried river beds, and finds its way out into the streams.

As salts come up into the trees as essential nutrients, they are fixed in the forest. After you cut the forest, even if the streams continue to run clear, they contain enormous amounts of dissolved salts. We may be getting more tonnage running off cut-over forest land as dissolved salts than we get in actual silts. We have measured that in Tasmania. Tons of essential material, particularly calcium, washes from the forest

Permaculture Design Course Pamphlet X - Forests in Permaculture

when it has been cut. The forests were holding all of these minerals. They collected them, held them, turned them round and round and round in its usage. When you cut the forest, and there is nothing to hold them, these minerals go into the runoff. They go into the streams and flow to the sea. Much work unravels there, because the forest only slowly accumulated that calcium.

Now the other thing that the forest does to precipitation is that it catches snow and brings it to rest within the forest. The difference in melt period between snow outside and inside the forest is quite large. A forest probably delays melt at least a month. So really what the forest is doing is taking all the winter's precipitation that accumulated as snow and ice, holding it, and releasing it at a much slower rate over a longer period than would be the case without that forest. If we have just pastures and open ground, that winter snow will melt extremely quickly, and cause sudden flooding.

What does the forest do to sunlight? The forest enters into energy transactions with light. We can't treat any tree, or any forest as a mass. It is a collection of individuals that do individual things to light. One obvious interaction resulting in energy exchanges occurs with sumacs. Look at the sumac. A light wind blows on a sunny day. The sumac turns from an absorber into a reflector. Suddenly its whole light-energy balance changes. It uses one energy to change its effect on another energy. It is in constant energy balancing.

I believe that trees have two or three methods by which they govern their energy intakes. One would be used by the aspen. The aspen is doing something with the wind on an energy basis, and when it's not doing it with the wind, it has an orientation basis that it is doing something with the sun. The ivy are certainly doing something with the orientation surface to sunlight all the time. They are governing to a constant. Other trees have shiny underleaves with matte-covered top leaves, and they do a trade-off, a wind trade-off.

In some forests in Tasmania, we cannot measure light in depths of the forest. There is total light interception. You don't have those forests here, but we have them. You can descend into the blackest midnight in the forests. You have to take torches down there in brilliant daylight. In Tasmania, you can go down 200 feet into some of these valleys and there is no measurable light down there. The forest totally intercepts ultra violet and passes through more of the red light, so that you have a different quality of light within the forest. Dark trees become radiators. The birches are reflectors. In the reflector species, the tree itself doesn't get much heat. In some species the tree becomes the heat store, and the heat storage system. It is 86% water heat storage. Even on very bitter nights in Tasmania, where we have thick forests above, we get a warm down-draft. What is happening is that the cold air is entering the upper parts of the forest, and there is a slow down-draft, and it is a slow down-draft through thousands of enormous water storages that have been absorbing heat all day.

Some of these mechanisms are so effective that a relatively small plant in an office deals with all the carbon dioxide problems in that office, and many of the carbon monoxide problems as well. We just need to know a lot more about this, because it is absolutely certain that, if we knew more about it, we could completely change the atmosphere of some of these buildings very favorably in terms of energy balances, and particularly in terms of health of the occupants. I suspect that we need to find out a lot more about what happens within the solar glass house, and that information is going to have a fairly beneficial effect on us.

The quality of air moving through the forests changes. The amount of negative ions increases sharply in the air stream,

and most of the gases that are obnoxious to us are absorbed very efficiently. Negative ions are also excellent precipitator, which might account for the fact that much of the dust disappears in forests. There is nothing like a negative ion environment to cause clumping and precipitation. Negative ions will take cigarette smoke out of the air very efficiently in quite a large room. So will a small amount of trees.

Again, it is an error to suppose the forest stops at the soil surface. It doesn't. At least 40% of its mass is below the surface. So probably many of the figures we have thrown in here are in any case wrong because none of them are applying to the root. When a forester talks about the weight of a forest on Earth, he probably is not giving us the weight of a tree plus its roots. They estimate 5,000 cubic feet of wood in this tree, therefore 4,600 cubic feet of water. I believe they forgot the roots. Those roots are enormous storage organs. They are busy at work doing other things in the soil. We need to know what those roots are doing. We know they are on the move. They throw up whole masses towards the surface and pull them back, while they throw others down. They do it all seasonally. They live and die within the soil, leaving all sorts of channels and pathways open, which is going to greatly affect water. What's going on within those roots? Once we get below the top of the ground, we are in a whole new mystery zone. Certainly tree roots are breaking down primary rock material.

For all these reasons, and many that I haven't mentioned, because I consider them to be far too complex, forests are really worthwhile to just leave in place and really have a good look at, because mankind has never studied these forests. It wasn't until the 1950's that anybody I know of looked back through the rainfall records, and cutting record, and started to do some of the sums.

I will give you a statement that I am certain about: By the removal of ridge forests alone, we can produce deserts in any climate. By the removal of forests alone, we can remove soils. Now I am certain that the removal of the forest has been the main cause of the collapse of nations. Because when the forests go they just haven't the water, the soil, or the climate quality to sustain human life thereafter. So maybe we had better start to prize the forests a bit and to discover, not how to live without them, but how to live with them.

Before I leave, I want to say a little more about tree establishment. We have already talked a little bit about the nursery.

It may be necessary, particularly in sandy soils, to add basic nutrients. This may be necessary on acid soils and on alkaline soils. Sometimes it pays to use a little bit of superphosphate in sands and dunes. Zinc, iron, and most minerals are locked up by high calcium, and you won't get many tree species going unless you have a little bit of assistance.

I think the question of manuring trees has been taken very seriously by the forestry commissions. They are getting three and four times the growth rates from trees with one handful of superphosphate in sand. But additional superphosphate doesn't do any good at all, as usual.

Teaspoons & Butter Knives

Two old ladies north of Sydney evolved a system for re-establishing native forest in a national park on an area widely overrun by introduced exotic weeds and things. In short, the method they pursued was this: Given a very large area in which you want to change the nature of the forest, do it as a set of nuclei that are densely planted. Don't try to do it as a scatter of individual plants. This is really extremely important. Plant a small area, maybe half the size of this room, densely and close it out, weed out anything you don't want and turn the roots up, patch up the soil where you disturb it somehow with mulch and rally tightly established nuclei in defined areas. The placing of in-

Permaculture Design Course Pamphlet X - Forests in Permaculture

dividual elements really isn't going to get you anywhere, or it is going to get you somewhere very, very slowly. When you put in nuclei and work from the perimeter of the nuclei, it is amazing how fast you can change the situation. What happens is your ecology, or whatever it is, helps itself, because your assembly is an entire one. I think it is more important to do this than to do anything else. That is something that if we fail to do it, we will fail.

There is one class of trees for which we need to compile a list. They are the trees that will stand alone in grassland or hostile areas. They are pioneer trees. It will pay you to just stop and look at pioneer species wherever you are, and just pop them down on your list, because they all have a set of characteristics in common. They don't mind grass competition. They are very hardy. They are drought resistant. They change the nature of the soil towards forest soils. These trees range from acacias—of which there are hundreds, and they are all nitrogen fixers—to western and eastern red cedars.

If you have good pioneer species suitable to a site that people eventually want to change into a forest, run over it with pioneers while they are thinking about it. Then they can go into whatever they want from there, cutting down the pioneer species as a manurial crop for their forest.

There is nothing wrong with western red cedar and eastern red cedar as a crop either. They are both useful as a crop while pioneering and reducing other competitors before forest establishment.

You have to do this to defeat grasslands. Then you may start your multinuclei approach. To get things back to a previous situation, on land that has been invaded, you do precisely the same. You start with the little groups of natives that remain, and get them in there to throw out exotics. Mend your holes with mulch, or with another plant that is native, and work outward from that.

Those two old ladies, using only spoons—two spoons and a couple of blunt table knives—re-established some 1,500 acres of native Australian bush in a badly managed forest. When they started, they were about 68 years old. They finished when they were 75. They wrote a little pamphlet about what they had done. They said, "Begin where most of the things are that you want. Then go in there with little knives and spoons and take out all the strangers. Encourage the others, and just patch up the damage." They did minimal damage and just kept rolling the edges out, and I am told that it is really a remarkable area now that it is free of exotics—tall groves. It is north of Sydney in one of the parks.

Basically, this is also an approach used by Marjorie Spear, another woman past 80, though she did the opposite thing. She took a degraded and smashed-up native forest, really smashed it up, and expanded a totally exotic food forest into it in precisely the same way, by setting up a whole set of small, very densely planted nuclei, and taking the edges on out.

If you forget this particular point, you will scatter your resources, and many of your species will perish because they haven't their associates with them.

In sand wastes, we have been using the technique of burying all metallic domestic wastes, mulching, and then planting the perimeter. It seems to be working OK. You get gradual release of iron and zinc from old cans. Just fill a sand hole with this junk, layer it with humus, because it is not available unless there is humic acid, and then plant around it. I have many plants down in that sort of situation now, but I haven't been back lately. In soils, it is often a pH adjustment that is wrong, rather than an absolutely missing element, except in sands, where you are likely to have missing elements.

Righto! We have finished forests.

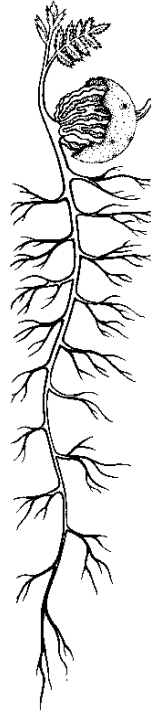

**THE INTERNATIONAL
PERMACULTURE
SOLUTIONS JOURNAL**
P.O. Box 52
Sparr FL 32192-0052 USA
DAN HEMENWAY
EDITOR & PUBLISHER
CYNTHIA BAXTER HEMENWAY
ASSOCIATE EDITOR
YankeePerm@aol.com

Many of us are painfully aware of the severity of catastrophic ecological decline worldwide. *The International Permaculture Solutions Journal* delivers information, ideas and discussion to provide Earth-healing tools or to promote their development. Information that is practical, detailed and hard to find elsewhere often turns up on "TIPS" pages.

Who Writes for TIPS?

Many TIPS writers are tops in the movement: Bill Molison, Jim Duke, Bill McLarney, and our editor Dan Hemenway, for example. Others are people who have been quietly working on their own. They all have something important to say.

What Does TIPS Cover?

TIPS issues often follow a specific theme. Presently we have a series of issues on aspects of developing sustainable food systems. After that will be a series on "Permaculture Design: The Process and the Product," and then a series on appropriate technology in permaculture. And of course each issue contains articles outside the theme as well—matters too important to wait. Eclectic book reviews, fascinating letters to the editor, informative illustrations, & easy-to-use format are hallmarks of our publication.

What Does TIPS Cost?

Subscriptions postpaid are US\$27.50 for USA addresses and US\$30.00 elsewhere. Each subscription includes about 100 pages per volume, typically delivered in four issues.

A Yankee Permaculture Publication.

Permaculture Design Course Pamphlet X - Forests in Permaculture

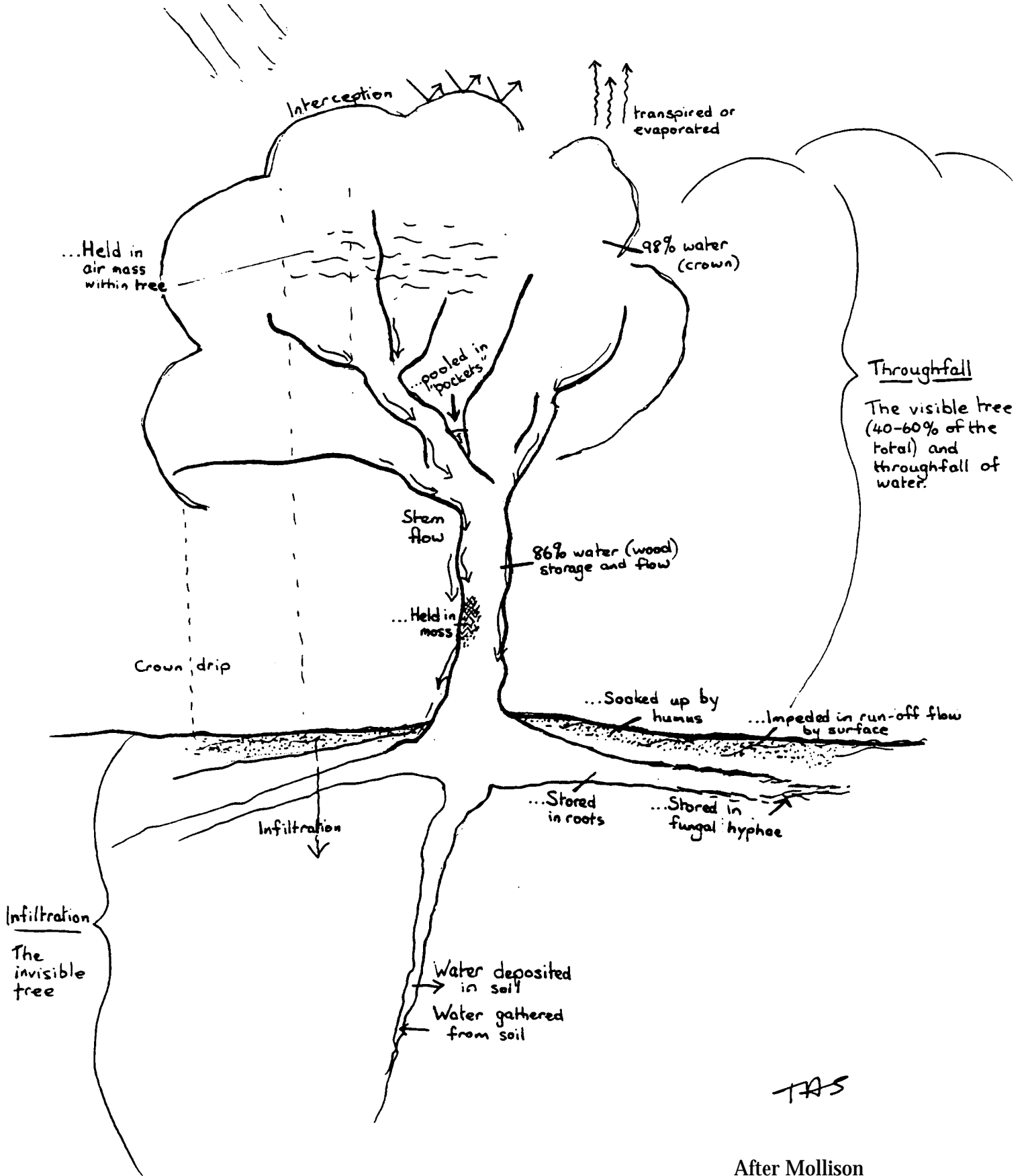

After Mollison

WATER IN PERMACULTURE

BY BILL MOLLISON

Pamphlet XI in the Permaculture Design Course Series
 Edited from Transcript of the Permaculture Design Course,
 The Rural Education Center, Wilton NH USA, 1981

PUBLISHED BY

YANKEE PERMACULTURE

Publisher and Distributor of Permaculture Publications

P.O. Box 52, Sparr FL 32192-0052 USA

Email: YankeePerm@aol.com

<http://barkingfrogspc.tripod.com/frames.html>

or

<http://www.permaculture.net/~EPTA/Hemenway.htm>

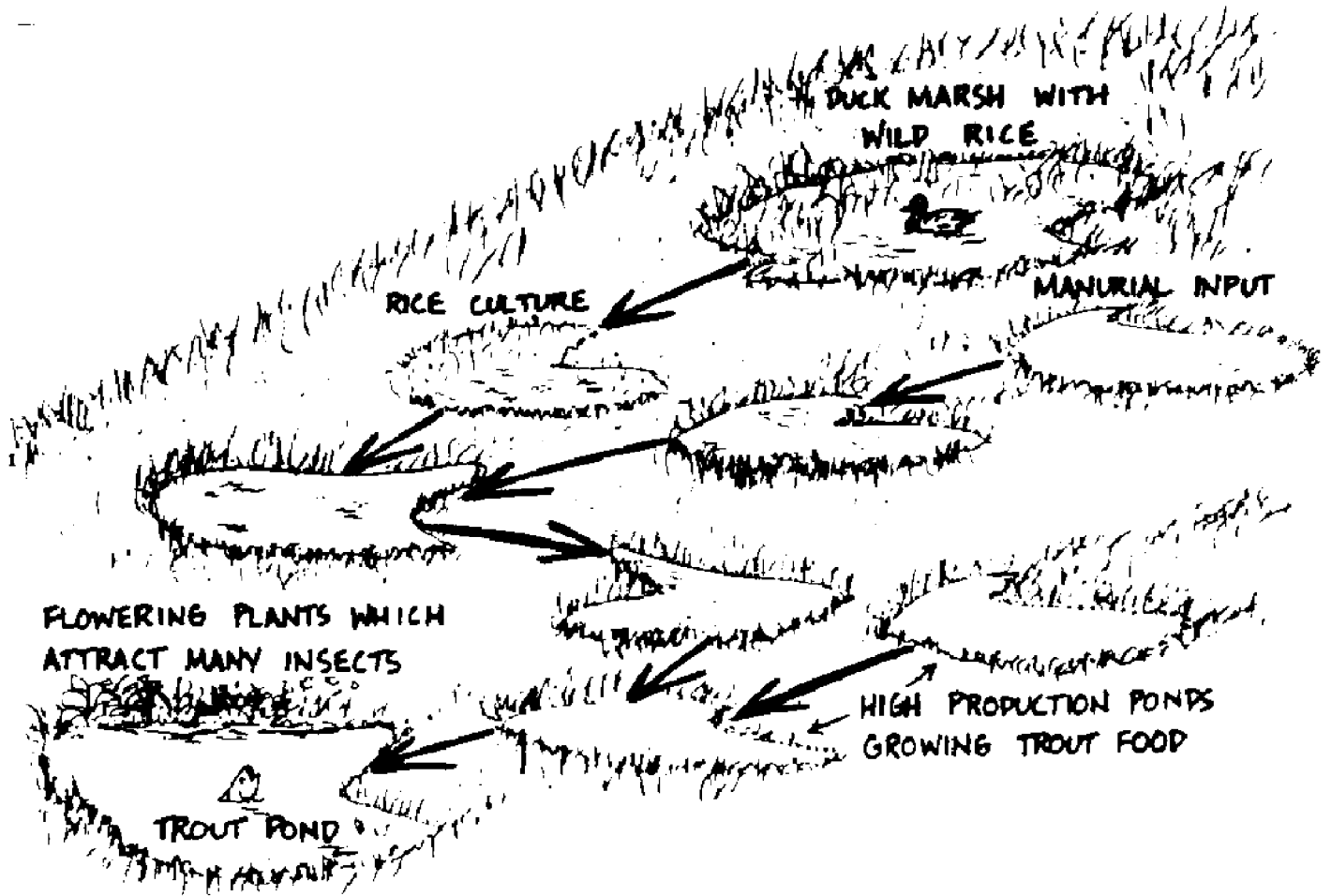

These pamphlets have been placed in the public domain. Reproduction is free to all and is encouraged. Credit to Yankee Permaculture is appreciated. Contact Yankee permaculture for a list of other permaculture publications. Please send us translations of these pamphlets into other languages.

Water in Permaculture

This is the eleventh in a series of 15 pamphlets based on the 1981 Permaculture Design Course given by Bill Mollison at The Rural Education Center, Wilton, New Hampshire, USA. Elizabeth Beyor, without compensation, undertook the transcription of tape recordings of the course and subsequent editing of the transcripts into 15 pamphlets. Thelma Snell produced the original typescript for all pamphlets in this series and Lisa Barnes drew illustrations for some pamphlets, including this one, again without compensation. Later, Meara Culligan entered the text to computer disk. I have lightly edited this pamphlet for readability. In deference to the monumental task of love represented by Bill's assembly of the Permaculture Design Course, and by the subsequent volunteer efforts leading to this pamphlet, Yankee Permaculture has placed it in the public domain. The reproduction of Water in Permaculture is free to all and highly encouraged.

Translations of a few pamphlets into some other languages are available. Order permaculture paper #27 from the Yankee Permaculture order form for an up-to-date list. Volunteers are now needed to translate these pamphlets into other languages. And Yankee Permaculture continues to depend on volunteers for all of our publications. If you want to help, contact us at the address on the cover.

For Mother Earth

Dan & Cynthia Hemenway, Sparr, Florida USA. July, 2001

Fourth Edition

Permaculture Design Course Pamphlet Series		Quantity	Price
Complete Set of 15 Pamphlets. Bill Mollison. \$35 (Price reduced 9/1/94)	\$35.00	SET	\$ _____
Complete Set on 3.5" Floppy Disk (MS Word for Mac, inquire about other formats) NEW!	\$50.00	SETFD	\$ _____
I An Introduction to Permaculture.	\$3.50	I	\$ _____
II Permaculture in Humid Landscapes.	\$7.50	II	\$ _____
III Permaculture in Arid Landscapes.	\$3.75	III	\$ _____
IV Permaculture on Low Islands. (See V for combined price.)		IV	
V Permaculture on High Islands. (IV, V, & VI offered as one pamphlet.)	\$2.50	V	\$ _____
VI Permaculture on Granitic Landscapes. (See V for combined price.)		VI	
VII Permaculture for Fire Control (See XY for combined price.)		VII	
VIII Designing for Permaculture.	\$8.50	VIII	\$ _____
IX Permaculture Techniques.	\$8.50	IX	\$ _____
X Forests in Permaculture.	\$6.25	X	\$ _____
XI Water in Permaculture.	\$3.75	XI	\$ _____
XII Permaculture for Urban Areas & Urban-Rural Linkages.	\$3.00	XII	\$ _____
XIII The Permaculture Community.	\$2.00	XIII	\$ _____
XIV The Permaculture Alternative.	\$2.50	XIV	\$ _____
XY Permaculture for Millionaires.	\$2.50	XY	\$ _____

The minimum order, before computing p&h, is \$10. Postage & handling is an additional US\$5 + 10% in the US, +20% elsewhere. Prices subject to change without notice.

We regret that we can accept payment only in US funds by postal money order or checks drawn on a US bank.

See our regular order form for more details.

WATER IN PERMACULTURE

Almost all of the water on the earth is not moving. It is in the oceans or it is in the ice caps. I think 75% of all fresh water is unavailable. Of that fresh water in the world, there are only tiny amounts in lakes, ponds, soils, rivers and in the atmosphere. In total, less than 1% of that water moves. That's the amount that we have to work with.

The world mean average rainfall is 33.8 inches. Of the atmospheric water, 77% falls on the oceans, 23% on the land. Of the 23% falling on the land, 16 parts transpire or evaporate, leaving seven parts to run off and end in the ocean. Of the 7% runoff, 84% goes into the ocean and returns to the cycle.

The land, in addition to the rainfall, gets seven parts of its water from horizontal advection. That is where forests intervene.

This is a very simplified, generally accepted sort of model. The one real application we can make locally is in providing surface storage and soil storage of water. If we establish forests, we store a lot of water in the forests, too.

We can't do much about the rivers; and we can't do much about the atmospheric water. But, to me, it is clear that most of the world needs much more surface storage at greater heights than usual, not just in the low valleys. We need to reduce runoff. We can store water in soils that have been treated with the Wallace plow, and by constructing swales. Throughout urban areas, swales seem very appropriate.

It is the water available to us that decides what sort of plants we grow. While the average is 34 inches of rainfall, such figures are really meaningless, particularly during a plant's establishment. We must buffer extremes, particularly those drought extremes that seem to be happening more and more.

It is simply no good recommending plants to people, or designing orchards, unless you have cared for the water supply. Give them the ability to water at least twice in the summer. You must make absolutely certain that you have designed water storage so they can get water—either off site, somehow, or on the site—in the plant's establishment phases.

Seaweed and seaweed concentrates do a lot for water storage, working as jell in the soils. In the very dry soils, you can recommend the use of dried seaweed, powders and seaweed concentrates, to greatly assist water storage and plant resistance to wilt. Basically, it works on the surface film itself.

In our previous discussions of water storage, including the keyline system, we simply regarded it as reserve water supply. While in most places, ponds are made for cattle and stock watering, we design the water storages in themselves as highly productive systems.

We can get books on fish culture, but there are very few, if any, books on plant aquaculture. Do you know of any? Plants that grow in water are just a neglected part of aquaculture. Yet, as on land, we are going to get more yield out of those plants than we get from animals.

The water level of lakes and ponds changes from summer to winter, furnishing a variety of sites for aquatic plants that run from the water surface to rooted vegetation to marginal vegetation. Quite a few swamp trees can live here. In fact, they must not live more than 20 feet from the edge of water, yet never in the water. One of those is bamboo. Bamboos won't take sodden conditions. They live up on fairly well-drained soil, but they will send feeder roots down to water. Many such tree species grow well in wetland margins.

Within the water there are hummocks which are either exposed or not exposed. Many plants, like the bald cypress in Florida, live on hummocks or even develop hummocks. How they develop them, nobody is quite sure. Plants on these big bogs grow in little islands, too. The weight of the trees depresses the bog so that they become moated.

Whole sets of plants, including trees will grow out reed mats. We had a lake we called the lagoon of islands. It was just many

moated islands with trees—maybe hundreds of islands. The hydro-electric commission dammed it, flooded it up. It is now a sheet of clear water. Official vandalism! That area was not meant for storage. It was a beautiful habitat.

Intertidally, or between levels, there is another set of plants. They have certain characteristics. They die down, either in summer or in winter, depending on the sort of pond. They then rest as rhizomata or tussock systems.

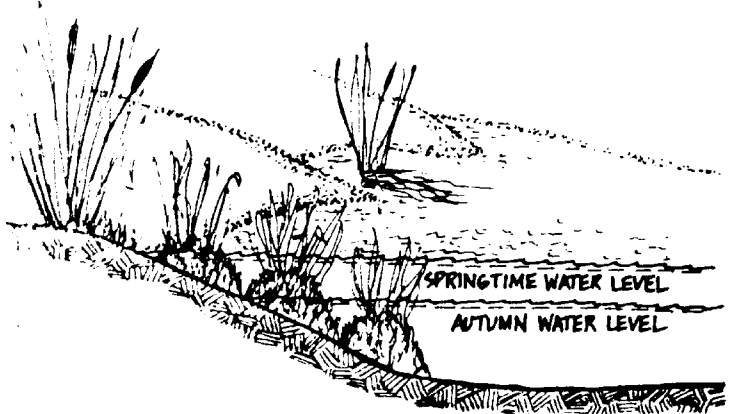

This is a very rich area and therefore difficult to manage. If a plant gets out of control there, there is nothing worse than to try to eradicate that plant from the situation. You want to be very careful about what edge plants you put in.

When I talk to you about this edge effect, I want to instill in you that you can maximize edges by creating islands and peninsulas. As you design a pond, decide what sort of edges you will put in it. If there are trees to be planted, plant them as a buffer, so that rushes are blocked from extension on to lawn. Decide upon your edges and put them in. If you get them in fast enough, then you won't get a completely rush-ridden pond of one species.

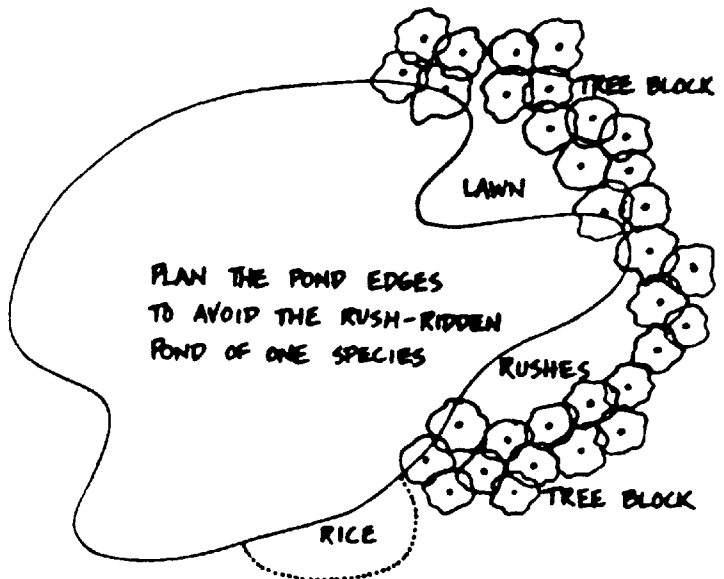

Different species of rushes and reeds serve varied uses. From these you get real heavy crops. That is where papyrus grows, and a whole group of things that are good for paper and fodder. That is where the reed for mats and the cattails grow.

My advice to the ordinary small homeowner is to put those cattails in the annual garden in a tiny little pond, and to cut off the tops to stop them from seeding. Keep them out of the main

water storages. However, their seed can blow in at any time, and you have to pounce on them as soon as they start. Otherwise, they close off that marginal surface. Chinese water chestnuts, which are fairly hardy, grow there. They form large tubers, and so does *Cyperus esculentis*, the earth nut. This, again, is a rush [sedge].

Certain trees grow here where the water table is very shallow. The water table on these banks is only three or four feet down. This is a poplar spot or a willow spot.

Some swamp trees produce the most durable woods in the world, and some of them are the lightest woods in the world. I think *Leiteria*, the American genus, is the world's lightest wood, much lighter than balsa. They hold water in the stems. A lot of them have air cells throughout their stems and root systems. This is how they manage to live in water. They store oxygen as air in the plants themselves.

Other plants that you know very well are the arrowheads, the duck potatoes, an important wildfowl food. The *Triglochin* come up and lie along the surface, bearing heavy seed heads. These are eaten rather like leeks. They look like leeks, and you can treat them like leeks. *Sagittaria*, the duck potato, has at least 80 species and a wide climate range. It grows way up past here and way south of here.

Wild rice is a very important plant, if not for you, at least for all of your ducks. You have to put that seed into mud balls and throw it into your ponds. The seeds do not have a long air-storage life. Water plants often have seeds that are fat, squashy things, that fall from the plants, sink, and take root. Some are different, though, and will blow for miles like thistle. They bob around in the water. A few get eaten by ducks. They sink before the winter, and then take root in the bottom in springtime. *Zizania* (wild rice) is one of those. There are also a tropical *Zizania*. *Zizania* grows from the coast of Florida way up to central Canada. It grows in still lagoons, slow flowing rivers, oxbows—that sort of situation. It doesn't like fast water, but it likes a bit of movement through the water, either wind induced or flow induced, and it likes a depth of 18 inches to three feet. You would probably do best to choose your seed from a situation that approximates that which you are going to be planting.

I see no reason at all why, instead of thinking ponds, you shouldn't think bogs, and create a hundred square yards of bog, and go into a special crop like the distillation of *Calamus* for oils. Forget about the pond, just fill it up with *Calamus*.

Phragmites is the super, plu-perfect thatch. Thatch of *Phragmites* lasts 40 to 60 years. It is as good as any roof. The only one that would last longer is a turf roof. Slate roofs always crack, scale off and piddle down.

Close to the water's edge, in soaked soils, there will be fly catching plants—venus fly trap plants, pitcher plants, sundews, picking tiny little things out of the air and fastening them into the plants. When you come out into the water, you can have a few plants which root, come up, and float on top. They include all your so-called water lilies. The best way to plant those is to take a bag of manuring materials, tuck it into a good old tire, punch the tire in two or three places, and push it out with the water lily root buried in the bag inside the tire. It will come out of the tire and be out of the bag and constrained by the tire. You can always get it out again as a pond plant, and harvest it easily. That works well.¹

Many of these deeper rooted species can be planted by putting them in clay balls containing as much nutrient as you wish to wrap with them. Just drop them in. Weight them with a stone if you want to: clay ball, stone, and a bit of horse manure with your seeds.

This is where the lotus lives. Some of the lotus have popcorn seeds. You may gather the seeds and pop them. There are many things that are good for popping, but we don't pop them. However, other people often do.

Here, which may be only three or four feet out, you also have the most important floating species, *Trapa*, which runs from very cool to equatorial climate. The Chinese water chestnut lives here as a mud rush. The Indian water chestnut is a floating chestnut with an anchor, anchoring the stems. The chestnut floats. It is a beautiful sight in India to see ladies floating big bronze bowls along in front of them, picking the water chestnuts. You need skilled people, because you can't walk through the rows; they have to walk rather slowly through the stems, so they don't tear them off. It is a graceful and pleasant summer occupation. But no splashing and kicking about in there, because it will knock the stems to pieces. No hanky-panky or monkey business.

Beyond that, and beyond six to nine foot depth, the only thing we are much interested in is either a continuation of our good old fern *Azolla*, or duck weed, on the surface. *Azolla* and duck weeds are both useful. The dreaded water hyacinth can be used, and used well, in restricted locations to clear up pollution. In warm climates, this plant is bad in large slow rivers. Here we want algae production, which practically ceases at 12 feet deep. The only reason we would want a space 12 to 15 feet deep in a pond is to allow fish to escape low oxygen, and high or low temperature conditions.

We are interested in algae bloom out here. When a white painted disc disappears at a depth of about two and a half feet, obliterated in a soft green water, you have a really well-manured pond. If the disk blacks out at about a foot, the pond is over-manured. If the disk can be seen at five feet, the pond is not well-manured—you need to throw in more chicken manure to increase the bloom. If we are interested in the production of shrimps, prawns, yabbies, fish, or whatever, we want a well-manured pond with a soft green bloom.

Certain fish browse algae. Even the rainbow trout has gill rakers that enable it to collect algae and zooplankton. The brown trout lacks this feature.

With trees and bee plants, we use 200 species across all climates. I have no doubt there are 2,000 species that are of great use to us, many of them not entering into any catalog of plants because it just is not our habit of recent years to go splashing around in water getting our food. I guess the reason might be that most gardening ideas come from Britain. The British never get wet. If they get wet, it is to mid-shin, their trousers rolled up. That is probably the reason we never evolved these systems.

If you want a productive pond, you might very well incorporate it as a normal part of the garden. Further, I would say that a very small area, six feet in diameter, is well worth having as a production pond, with these elements in it. These are as good vegetables as any land vegetables. Watercress and cattails are two good examples.

In Australia, we have concrete tanks anywhere from five to 25,000 gallons. You buy them off the shelf. We have stock ponds of all sorts, little concrete ponds. The most handy one only costs \$40. It is a very good little production pond. I got a sheet metal mold and rolled two molds for a six foot pond, two feet deep.

1. Because tires contain cadmium, an extremely toxic element, we usually delete Mollison's reference to various uses he finds for them. In this case, we left the reference in, assuming that the reader can find another way to do the same job.

2. In my experience in North American greenhouses, toads (*Buffo spp.*) control slugs and cut worms well as all these are nocturnal. Bull frogs were of little value, probably because they feed in daylight when those pests are not active.

I am becoming convinced that you need frogs in your glass-house because I think they are going to deal with a lot of those slow moving things. They are plu-perfect slug eaters.²

I am going to repeat some things that I have been throwing out offhand. The pH in ponds is between 6 and 8, that is, it is 100 to 200 times lower in acid than most garden soils. Good garden soil will go from pH 5 to 6.5. It is common to lime ponds. Lime them when you make them. Lime the whole base of the new pond. Then, just check the pH of the pond. Most things in the pond like lime. It is quite different from land culture in that respect. So keep checking on this pH. It is good in this climate to water your plants with limey pond.

The ideal structure for a pond is a sloping floor or a step floor. You should be able to fully drain it. It is even better if you are able to drain it into another pond and take it through a dry-land cycle. After a few years as a pond, it will carry dryland crops three to four years without further manuring. One reason for this is the fantastic ability of the mud and the mud surface to fix passing nutrients from the water. One of the elements in those nutrients is the diatoms, which you can't see. The other one is fresh water mussels. Mussels pump nitrogen and phosphorus into the mud. They will filter about 200 gallons of water per day per mussel. The mussel draws from the water all of the little living forms and particle and shoots them out and buries them. It lives there on the mud surface and just has it's top lip out. It injects these nutrients into the mud floor of the pond. It lowers phosphorus in the whole system. Of all other plants, animals, seeds, anything, the mussels are the superior phosphorus fixer. So I consider it a valuable part of the pond to be harvested only modestly for chicken grit.

When you drain the pond for the dry cycle, shift most of the animals into another forage pond. Don't go to dry land culture unless you have at least one other pond to transfer your old pond waters into, together with your critical species.

It is good for intensively cultivated ponds to go through a dry stage. In the dry cycle, grow the heavy feeders in the first year, then taper off and finish with a modest crop. Then roll it down and re-flood it. Once your pond is held in gley, the gley itself goes down in the soil quite a ways and perpetuates itself. You have to start that fermenting process, but you don't have to continue it. If I had a delicate pond sitting on top of a sand dune, in no way would I play on it after I had gleyed it. Just use your sense.

It is possible to go out into a perfectly stable lagoon, dig a couple of post holes, and your lagoon runs out. Just punch the gley in a sufficient number of places to a sufficient depth and the whole thing drains. Ponds do obliterate in time. The ponds that most commonly obliterate are shallow ponds, made from fairly loose fill material. There are ponds, however, that don't obliterate in a millennia. Most of the operating ponds we would put up here on this site would be there many, many years later, and the ponds in our hills would also be there.

You will never see a pond obliterate, though, in your lifetime. The only way you will see that is to make a barrier dam in the desert. As soon as you fill a watercourse in a dessert, it will percolate nicely as a sand dune. A lot of the ponds built in Arizona are barrier ponds across water courses. They simply fill up with detritus. With the sort of ponds we are making, if there is any risk of that, what you do is use your pond as your source of manure. Cut the muck out and spread it on your fields. That is often done. These ponds are great places for trapping all of those things that are good to throw on the ground. [It is also possible to build silt traps to harvest these materials before the water enters the pond, prolonging its life. - DH]

Mussels don't hurt plants nor do shrimps or prawns. We have fresh water shrimp that are very good harvesters of algae, including diatoms. They are a prime step from diatoms to fish. As you get sub-tropical, these shrimp are big enough for

human food. The little arthropods that we are talking about, the phreatocids, are harmless to plants. They eat the decaying matter from the plants, and keep the stems clean. They don't chew the stems. They don't eat green plants, nor do shrimp. There are some mollusks that we don't want in there: the spiral mollusks eat plants. On the other hand, some are large enough to eat. If you want to go into snail production - God forbid! - you would go into those. Otherwise, exclude spiral mollusks. If they get on top of you, the dry land cycle and the ducks will finish them.

Don't let children bring snails into your ponds because they eat green plants, and they can wipe out a pond. The crawfishes usually don't compete with fish and don't harm them. Try to get crawfish with restricted burrowing capacity. We have one called the yabbie. He is a long tunneler. He may go 25 feet. He might start on the inside wall of your dam and come out on the outside wall! Surprise, surprise! He comes out with great speed. But we have other crawfish, and so do you.

One of them that makes a restricted burrow. In fact, the best habitat for these species is beer cans. So we throw in a clutch of the beer cans tied to a cork or a ping pong ball. Throw out the ping pong ball. Draw 20 beer cans and take out 20 large size crawfish. Then sink your beer cans again. That's a slow way to do it. A fast way to make a little trap is with a ramp and slope. They go up the ramp and hop into the trap. In Australia, the cultivation of crawfish is becoming rather common, and some hundreds of acres of flat, previously non-productive land is under aquaculture.

The crawfish is a fantastic inland resource. They have them in Chicago. You should have them here. I don't know if anybody grows them here. We worked it out. A Scotch biologist figures that 30 quarter-acre ponds in marine culture would keep a family, supplying an income of \$20,000 to \$30,000.³

Crawfish like ponds that are about three feet deep, and they like brush piles. Piles of limbs in the water can save them from getting eaten by predators. The traditional way that the Hawaiians and the Japanese fertilize their ponds is by doing exactly what the beaver does, letting bark and limbs rot in the ponds. You don't spread it over your pond, just put it on the edge where you are not cultivating.

Another real good thing to do around ponds is to strew bales of hay around the edge, both to seal ponds and to get diatoms working. Strew it half in and half out around the edge, kick it in if it rots off. Diatoms like hay. Often you can feed little fish by having a bowl of hay and water, and dipping the water out of the bowl and feeding it to the fish. What you are actually putting in is little flagellates and diatoms. They drift around in the air. There is no need to put them in there. They are in all water. Just scatter the hay around the edge, and kick a little more in. Ducks will add manure to it.

You can figure on eight ducks to a quarter acre. But the more ducks you put on, the more manure you get. Ducks give you an additional crop, and they greatly assist the turnover of the energy in the pond. It is possible to make provision for the ducks somewhere in that food cycle. Wild rice is good in this situation because it comes up in the vegetative stage, and it grows well above the duck. You harvest what you want. It has a three week dropping period. You gather it for four or five days, and the rest of it falls. It is superb duck food.

We have a lot of foxes and dogs that chase ducks. If you haven't got a pond big enough for an island, put a fence into the water; top net it—that is essential. Put your duck shed back of that. The ducks will come out of this shed into the water and swim and browse and go back there to sleep. They know to do this from night one on. They don't want foxes either. Islands are good, though. But if it is murderous to ducks where you are, maybe you can't keep ducks.

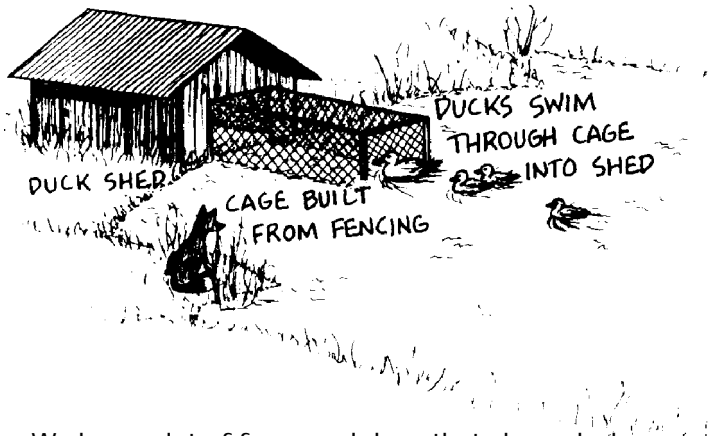

We have a lot of foxes and dogs that chase ducks.

Pond edges are good blueberry areas. Mints are invasive, but very productive. Another purpose for the pond might be to grow mints, particularly black mint. You don't need many acres of that. Two or three could bring you \$70,000. You distill mint to menthol. It is good to grow mint if you are dairying and have dairy outwash. From that, you get powerful blooms of mint. So you might try a mint marsh for that black peppermint and do simple steam distillations. Mint is such a strong growing plant that it quickly exhausts even ponds. It will get pretty woody after a few years. In cold climates, it has a rest period, and you can re-manure. You can put it on edges; but because it is laterally invasive, I would put a couple of bushes on either side of where I was going to put mint—dense bushes to keep it in its little patch.

A good place for bamboo is back from your ponds. They look great.

I won't go into a discussion of the fish you might place in your pond, because you have to know your local laws about fish. Catfish look like an obviously good pond fish because they are very low on the chain feeders, way down on the trophic ladder. And they are good eating. I wouldn't go past them to trout, unless you are real keen on trout.

If you are in the happy opportunity where you spot a hundred acres with a 15-foot wide outlet, land that used to be marsh, and somebody is selling it cheap, grab it. Stock it with trout. You can retire instantly, because just by net fishing, not manuring or anything, you will have a continual trout supply.

A man bought a cattle property. That land was jumping with grasshoppers, absolutely covered with grasshoppers. He was in a grasshopper that erupts annually. He was pretty despondent about growing cattle. The grasshoppers would remove everything. He built a pond. I said, "What's in your pond?"

He said, "Let's have a look." He threw in a net and pulled out an eight pound trout.

I said, "How long have these been here?"

He said, "Twelve months."

I said, "You are nutty! You have bulldozers and this great valley, and you're going to grow cattle?"

He said, "Now I got you right!"

I said, "Hills covered with grasshoppers!"

He put over a hundred acres into a big trout pond, and he just simply retired. He doesn't have to figure around feeding those trout and adjusting them. He has a hundred acres of this trout pond.

Trout are in beaver ponds. As long as they have that escape, shaded by a few trees, they don't demand a lot. They can take it a bit warmer or a bit colder than you think. They are optimal over 60 degrees Fahrenheit, but lower than that, they are still pretty active. Trout are an extensive fish. So if you have an extensive area under water, grow trout. But intensive trout are a curse, because you have fine adjustments to make, and it is a nuisance.

As large a yield as anyone knows of for the home farm is from blueberries and mulberries on the edge of the pond. Mulberries are great feed for stock in water, as well as on land. White mulberries are used extensively throughout the ponds and paddies of Asia for their leaf and fruit as feed. We want careful adjustment of maybe 20 species of plants and small animals low on the trophic ladder. That includes the shrimps, yabbies, crayfish, catfish, edge plants, pond plants, and ducks.

You can do little pond designs at home, with perhaps ducks for their eggs, and wild rice. Always include those mussels as decomposers.

There is a whole group of American grain plants that are ideal for ponds, marsh grasses with heavy seed yield for ducks.

Wherever you build your pond, don't forget its other functions: barrier functions, fencing functions. Often a long pond in the valley saves you a half a mile of fences. The pond has reflection functions and fire protection functions. It's a heat store. It usually becomes a recreational area. Put a big rock by the side of a deep area where children can safely dive. The pond has water cleaning functions. It efficiently collects in its mud essential nutrients. I believe the Chinese would say that the main value of their canals and ponds is for manuring their fields.

Sewage should be turned out into a marsh, not a pond. In that marsh, grow your mints, your bog plants. They have phenomenal sewage demand. But in this climate, send your sewage into a holding pond. Then let it seep through a marsh that can grow into trees. When it has passed through that, it has no solids left at all. It still holds a lot of dissolved nutrients, mainly phosphates and nitrates. You can let that go into your pond. You need a holding pond, because in winter the marsh plants are dormant and cannot purify water.

There is a Swiss study which might interest you. One of the plants which they mention is rush, *Scirpus validus*. They found this to be the most efficient water cleanser. One of my designs was for a town of 8,000 people, for which I did a sewage disposal, saving \$30,000 a year in engineering work, and about the equivalent amount annually for fuels. The town is pleased with it. I turned it into an industrial base for the town, an employment system, through mint and bamboo. This was originally done on 50 acres; but the town has purchased an additional 1,500 acres and turned it into further raw materials. Also, I allowed for water fowl, and put underwater shelving into it. It has been so successful, that when I last heard of it, it had vast numbers of black swans and teal. While up in Canberra, they put in a \$700,000 sewage cleaning plant which produces poisonous water. They make no apologies or anything for doing this.

Just give me a bulldozer and a sloping site. As for San Francisco, I could do their whole town. As it is, all they are doing is covering the sea floor with silt. It is horrible!

If we are just dealing with water culture, I believe that what we should do is set up single culture systems that flow one to

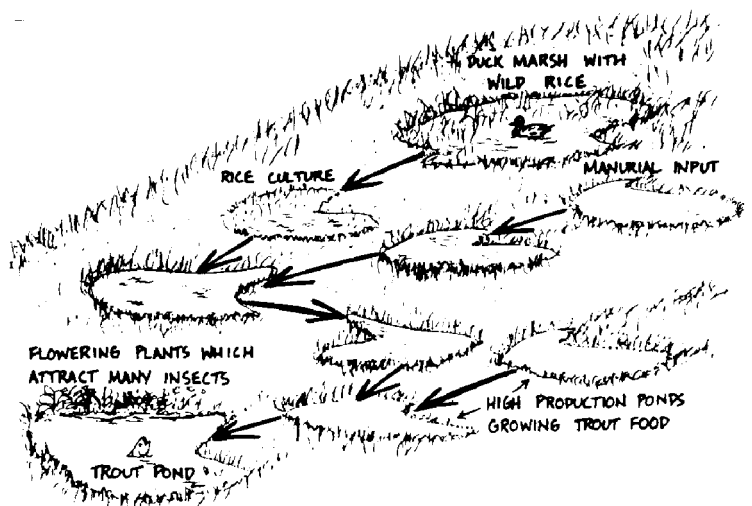

the other, and we should design for them. Make a duck marsh with mussels, perhaps, and wild rice, an 18-inch deep flat pond. From there, we can go to ordinary rice crop, or paddy crop. From either of these, we can go to shrimp ponds that don't contain trout, or to a pond with any invertebrate that trout like. We are enriching the water, using some of it in crop, turning some of it into shrimp, and these ponds trickle to the trout pond, inevitably carrying shrimp on migration.

In Australia, there is a place that has an enormous clay base. It doesn't breed trout. Every year they stock thousands of trout and they grow well. Those trout eat a little fish called smelt. The smelt is found at one site, a quarry in which it can breed. The main food of the trout is the smelt which lives in this tiny quarry.

If we get production of tiny things that continually flow into a trout pond, we could greatly relieve the need to feed the trout, and maybe abolish it.

You have a lamp that attracts a lot of bugs, an ultraviolet lamp, the patio light. Place a lamp of this sort over the pond, with a little fan in it, so that when insects come flying to it, the down draft hits them and they go straight into the water. With that sort of setup, you could do without manure input for crops. Have a few small ponds at different pH's, which suit small forage animals, some of which, in this case can be snails. These ponds would have trickle systems into the main pond where we harvest trout. Meanwhile, from the other ponds we take wild rice, rice, duck eggs.

It is polyculture, but not in the sense that we have it all in together. Some crops may not, in fact, grow with others, because we are adjusting totally different pH's. We might find a little phreatoid, or something—a real good trout food—that will go in a low pH. Meanwhile, we might heavily lime another pond for mollusk production. With their food flowing to them, the trout are perfectly happy. Maybe a few forage ponds around fish are the way to feed fish. There is no way the trout can come up the trickles, which are through little grilles. So what is coming down, they get, but they can't get at the sources.

Some little fast breeding fish, like stickleback, breed by millions, and, given certain high algae conditions, can be converted into trout. If you put them into a total polyculture, they would short-circuit the whole system. I think we've have many skilled games to play in aquaculture, interesting games too.

There were a lot of hippies at a conference. They had colored tents all over the place. I noticed that there were a lot of grasshoppers on the yellow tent. So I figured it would be good if you could float a big yellow balloon out here in the pond, just beyond the normal grasshopper's leap. They can see yellow and they will leap for it.⁴

Now, folks, we are going to take permaculture right out into the sea. We don't stop permaculturing at the shore lines. Down we go into the tide, the rocky main shore line, the main marshland, and the tidal marsh.

Tide ranges can run from two to 27 feet. The tide range that we need is really less than one foot. In some cases tides may occur only once a day. Tides are real weird things. Around the coast of America, you will be able to determine your tide ranges, and there are also tide tables. Twenty-seven feet—something like that—for the Bay of Fundy, Darwin, and many other places.

Those mud traps, of which you find many in Tasmania, are very ancient. Nobody has any record of them ever being built. They are quite possibly aboriginal. The Maoris have many. The other Polynesians also built them. They are simple tide traps, stone walls that don't quite reach the surface at high tide. They are about six inches below the surface. Fish swim over them at high tide. The tide drops six inches, and they are still quite happy in this lagoon. When they try to swim out, they find the tide has gone out through the rocks. These traps work best at night,

which is why most people think they don't work. When you go to look at them by day, there is often not much left in them, but at night they are often full of fish.

Another good thing to do is to make a pond two or three feet deep in this tidal area, because fish otherwise will strand and turn into sea gull food. You will often find a client whose land includes some salt flat, even if the government has struck off a hundred foot tide reserve, above the high tide mark, as they frequently do. You will often find that back from that, for hundreds of yards, you have salt marsh. You can put a simple channel through that reserve area, if a channel doesn't already exist, just by driving backwards and forwards with your tractor for a while. The tide runs into these salt marshes in any case. It is possible, between tides, to dig inland ponds. There are only a few rules. They must have about a three-to-one side slope, a real gentle side slope. Then the rocks fall, and you can throw them up on the tide side to stop the sea winds coming in. Put some salt-resistant shrubs around your pond, and lead your water in through the channel. You could fill a pond with the next tide, if you wish. Then, depending on how deep that channel is—and you can regulate it by shifting a board up or down—you can give it a three inch, or six inch, or one foot tide range twice daily over that pond. It is the cheapest swimming pool you can build anybody, and self-flushing. It is always warm. It is inland. You can shelter it. The tide brings only a few inches of water over the warm water.

A variety of organisms, particularly oysters and mussels, grow best when their location is at 60% air exposure. For any kind of oyster, your local fisheries guide will tell you what air to water exposure is ideal. Broadly speaking, above that exposure you get much less meats, while below it, immersed, you get much more shell. But at the ideal exposure you get a modest amount of shell with a lot of meat. So if you have an oyster enthusiast, you can actually set him up with a situation in which he can raft or support oysters inland, which is much easier than having them out in the tide land, and which is self-governed to give them all ideal exposure. It is possible for a client to make a lot of money breeding oysters, selling off the spat.

If he has access to a lot of broken pot, he can set up a lobster city. Lobsters will not tolerate another lobster in the same hole. They will lose legs and things. Often you find that there is some fish processing somewhere, usually with waste product that you can feed to lobsters in these stacks. It amounts to the growing of a marine animal inland.

Another thing you can grow there is sponges. You can also grow flounder, if you can feed them. Lobsters and oysters are pretty immune from predation. But with the flounder and other fish, you might strike cormorant problems. Cormorants can be converted to fish food by hanging a five and a half inch net well off the bottom. It will drown them and fish will eat them. But you only do this when you are into intense fish production. Ponds in these areas offer no protection for fish. If you have any shelter, as soon as a cormorant hits the water, the fish takes for shelter. The cormorant might get one, but he doesn't get many. But in an open pond situation, he will murder a lot. You can bring the growth of lobsters to a standstill in dense populations, so that none will exceed three and a quarter inch carapace, simply because the density of lobsters is enormous.

Let's look at the inlet. You can bring the tide in, maybe with banks supported by concrete. You can slide boards in, adjusting your tide range. You can also have funnels leading in so the sea comes in through funnels at night. A lot of small fish enter. Small round fish can't get back out again. You can bring a lot of fish into your ponds continually, with every tide. If you have a predator fish or lobsters in there, you can just keep them in food. Now I'll give a couple of instances of the human brain at

4. Not all yellows are created equal. Insects use prismatic eyes to see colors, including yellow, as bands of the spectrum. People do see this "spectral yellow" as yellow. We also see mixtures of the red and green portions of the spectrum as yellow, whereas insects would see red plus green, not a composite color. For insect traps, use either a known "spectral yellow" or perform tests with insects. Seeing the trap as yellow is inconclusive.

work. They want a sea pond for the breeding of oyster spat. So what do they do? They go 50 feet above sea level, dig out dams, and pump sea water up 50 feet. They are doing that in Tasmania. Or they go into the sea and build a wall out at tremendous maintenance cost.

If you get hold of these saltings, and there are thousands of acres of them, you have the best goose grazing areas you ever saw.

Now what do you have in the way of plants for here? For salt flat tidal range, you have front line plants, the mangroves, if you are in a hot enough climate. On these salt marshes, you have various little fat plants at your grass roots. *Salicornia* is a great goose fodder. This is real goose country, where I think a lot of our domestic geese breeds come from. If you want to go into a very small industry, you can make *Salicornia* pickles, which sell well in England. A host of little plants out here are quite useful. You can plant here salt marsh honey plants. Sea lavender is a very good honey plant. There is an interesting plant, *Spartina*. It is called cord grass, used for weaving those fancy seat chairs. The old timers made cord from it. But it is far more important than that. *Spartina* is a heavy seed producer, and it is also a great forage crop for geese, and the base food for most of the cool water fish. No *Spartina*, no bluefish. It is a nurse ground for the young and their food. The bluefish industry depends on the *Spartina* and the *Spartina* depends on there never being an oil spill. So I advise you to collect some *Spartina* seed and send it down to me as rapidly as possible. After the next oil spill, I will send you back some *Spartina* seed, at a very minimal cost. It is a northern hemisphere plant. That environment is totally unoccupied in the southern hemisphere. It doesn't have a plant in it. Without *Spartina*, you don't have quahaugs either, because your quahog zone comes in here. We don't have quahaugs because we don't have *Spartina*.

When we come down into the sea grasses, it is very interesting. They are the *Zostera* and the *Posidonia*, the eel grasses. These are basic sea foods. They absorb nutrients quickly. I think it has been calculated that if you put a bag of super-phosphate out to them, in three days they will have absorbed all of it. When composted for about 10 days, they are the best insulation material you can get. They shed all their upper part, which comes ashore by the tons, either in autumn or early summer, depending on what variety they are. They heat up like fury when you pile them on your carts. The composting process burns out a lot of things that are on sea grasses that otherwise stink, while it leaves the frame of the sea grass. It is a chocolate color, fibrous stuff. As an insulation material, it doesn't have any of the risks of the mineral fibers. And they last forever. You can use that for garden mulch, but not where there are cattle, because they eat it. Put it straight on and forget about salt, unless you are in a location with below 20 inch rainfall. Put it on sopping wet.

Possibly, in this whole estuary the eelgrass will only blow ashore at one place. This is probable. But it is easily caught on fences.

It will be necessary to investigate your client's title. Ancient grant titles extend to low tide. There are still some in the United States. Titles which are not grants, but freehold—they are not Crown charters—will go to high tide. Modern titles may be set back 100 or so feet from the beach which has been converted into beach reserve. At the same time you can get, under lease, access to the intertidal zone. It is not difficult, and is very cheap. At least in Australia, everybody has the right, no matter who leases the area, to take a single eelgrass load. It is real good stuff and it is free to you. If you don't collect it, it either blows inland or wisps out, a silica skeleton that just helps to build up the beach plants a bit, while the rest of it breaks up and returns as mud into the channels and goes back to the sea. It probably fertilizes the sea further out. We have enough of this stuff in the world to insulate the world, safely. When you convert it to insulation you have put it to permanent use, at a big energy savings.

Another thing about these little sub-tidal fences and screens for collecting long-shore drift is that other things arrive here: broken up shell, sometimes by tons.

I was on an island recently that was originally very low pH and has an acidic soil. They have been carting limestone onto it by boat for I don't know how long. They built a jetty with stone base, and they are still carting limestone in on this jetty. Yet I looked over the side of this jetty, and by my best estimate, there might be 1,100 tons of broken shell there, which is just limestone. Shell, itself, is salable in 50 pound bags to any responsible chicken keeper. It is quite expensive. It is a continually renewable resource of good lime for fields.

These little longshore drift traps can collect many things. If you look closely at natural things in this tide range, like a log that washed ashore, or an old wreck, or an old boat moldering away there, and you walk around and study it, you find that the tide comes in and out, and the longshore drift builds up. A deep and permanent pond forms there, and a shallow permanent pond in front of it. Nobody had to dig those, and nobody has to maintain them. All you have to do is to direct the tide into these scour-hole situations. They are excellent growing ponds.

Again, if you have the right title, or lease title, you can put in simple barrier systems, which may be fences or logs, or anything you can drag there. You can produce permanent ponds. You don't have to dig or maintain them. One thing that grows in there is octopus. If you simply provide the pots for them, they are occupied. At low tide they are ponds; at high tide, they are slightly flooded. Octopus have no place to rest in this whole situation, and it is full of little mollusks. They can't dig caves in there. They would like to be there because they eat mollusks. When you give them a pond, they have a place to breed. If you put pots in there—ordinary clay pots—each pot has an octopus in it. When the tide comes in, these hundreds of octopus come out of their pots and go out and eat shellfish. They come home and go back into the pot at low tide.

They will do this as soon as you provide pots. I don't know where they come from. They apparently have just been swimming all over those browsing lands, looking for somewhere to live. It is a good octopus growing situation. It is also a very good place for growing sponges.

Now you can start to play around. There can be barrier fences, drift fences, pond scour holes. We can design for ourselves a complicated system which scours water and is self-maintaining, and brings in broken shells. You just combine a series of fairly natural drift events into a complex of fish trap, scour hole and growing situation.

It is enjoyable working around down there. We do a lot of it in miniature to start with, taking little logs down and watching the effect, building little fences. Then when you feel as though you are getting it right, scale them up. Always be looking along the shoreline at what is really happening. Observe when something happens—where a reef runs out, or a log strands—because there are lots of forces at work, and lots of material on the move all the way along here. You can bring it to where you want it.

I believe also that it would be very productive to run the same thing that we would run in large dams, what I call sub-surface dams. This would permit some of the waters, just for a while, to remain as quite water. I believe we could create large *Zostera* fields intertidally. The condition required for *Zostera* is a period of still water, not too much run of tide. I think that we could greatly increase the productivity of intertidal sand flows by installing shallow still-water systems. This I do know: in a tidal river that fills at high tide, where a natural barrier occurs in it, like a stone dike, that area will be full of *Zostera* and full of fish. It is very simple to duplicate that system by constructing leaky walls, just rubble walls. These are not dams. On open coastlines, you don't find *Zostera*. When the *Zostera* get mussels attached to them, and shrimp move into there, a whole series of events start to take place. It is a fascinating area to play with, that salt marsh to low tide.

We don't stop there; and we don't stop at this intertidal place, because certainly the Hawaiians kept on gardening right out into the reefs. So did the Irish. The Irish set out what they call fields. The fields are simply rows of stone across hard bottom. You can handle very large boulders in the sea. You come in along side of them, draw them on to boats, float them out, and roll them off. You can place them easily in the sea. They grow enormous quantities of desirable seaweeds on those fields. Many of those Irish fields are not harvested any more; but some are. They are visible from air, enormous acreages under water.

I went to Donegal and poked around on the barrens. I saw some very interesting things there. They make tiny little stone-walled fields. I said, "Why don't you enlarge these fields?"

They answered, "Because the smaller field produces more than the larger one."

I said, "Why?"

They said, "It is warmer."

You could feel the radiant heat from those walls.

They deliberately made their fields smaller and increased their productivity.

They also used the tide a lot. They cut the kelp, tie a big rope around it and pull it up, 10 or 12 tons of kelp on the move. They bring it in on the tide, right into the bog channels. When the tide goes out, there it is, right on the shore. They load donkeys and and away they go with the kelp. They can handle great weights in the water. All over the coast, you will see little hollow mounds. They fill these with kelp stems, which they stack and dry like firewood. They fire them with peat, and get the potash from the kelp stems for their fields. The fronds they lay down as mulch. It is a marginal existence, the only way they can exist, but it is quite enjoyable actually. They eat a lot of dulse and other seaweeds chopped in their porridge.

You can extend your aquaculture systems into estuaries. You can do beautiful swap-offs in estuaries, too. You can take cold water, fresh water, warm salt water from them. In estuaries, in adjoining ponds with totally different salinity grading, you can grow everything from trout to grey mullet to eels, because you have an intake of fresh water up there, as well as twice daily intake of warm salt water. So we can continue to design even onward and outward.

Another thing that I have seen working very well is very large raft culture. When the Irish salmon runs were good, they didn't worry about culturing salmon. Now two things have happened. Their authorities "improved" their rivers. Their idea of improving rivers was to get a bulldozer down the bed of the river. That destroyed all the old salmon weirs. Now salmon weirs are little log and rock constructions across the river. They oxygenated the water. The engineers did away with them, and the oxygen levels dropped. The salmon were wiped out. The Japanese got efficient with their gill nets at sea. They would catch nearly all the salmon bred in Ireland. So the Irish, not to be outdone, bring the salmon inshore and release them into giant floating rafts, moored in quiet tidal areas behind islands. They produce an amazing amount of salmon there in big flooded nets.

So you can go into rafting. I should mention at this point that rafts are applicable across the whole of the aquatic systems: tiny little ones on tiny little ponds for insect attractants; larger ones to grow plants at a fixed root level, including pot plants. Water culture is highly developed in southwest Asia. A raft remains constant and level, and you can set pots in rafts so that your plants are at the same depth at all times. One thing you can grow well on rafts is daffodils. You can set them out on chicken wire. Each little space holds a daffodil bulb, and its roots are just in the water. If it is a high nutrient water, you get a lot of daffodils. Vegetable crops could be grown on rafts, and they can grow rock cultures, mussels, oysters, and algae. It would be a good way to grow algae. You can make a ring, and a big net, and grow fish within the sea in that net system. The Irish had very large rings, and they walk boards around them, with four foot fences so the salmon couldn't jump out.

You can do large scale transfer of sea birds in nesting cycle, by keeping adults until the nesting cycle begins on part of the coast. A mutton-bird is a critically important food of the Tasmanians. You can keep the adults like chickens until they nest. When you release them, they return to the nest, and then you start a whole new colony. To some degree, you can do the same with seals. You have to kidnap the young seal, before they can swim, when they are not being fed, and they all start a new seal colony, too. So it is possible to colonize an abandoned area. Seal are critically important to inshore fisheries. The loss of seal dropped the inshore fisheries right down. What apparently happened was that the seals ate mainly spiny and whitefish, which have a high manurial turnover on the *Zostera* bed which, in turn, supports high quality food fish. When you kill off the seals, you kill off your manurial system. There are connections there that nobody ever made. They simply killed the seals for fur, and destroyed the inshore fisheries.

Another thing that nobody has made much use of except one man I know is the sea as a source of phosphate. Phosphate is carried by birds. Sea birds like islands, and specific roosting places. Look at a flock of gulls and cormorants roosting on an old bridgework. You will see quite species-specific roosts. You can make very attractive roosting systems by creating roosts on platforms in the sea or on islands. Well, this man built a platform with multiple roosts on a desert coast off west Africa. The platform was the size of a football field, with concrete pylons. He spent a lot of money doing it. And he was the subject of great laughter. He's gathered so much phosphate off that area that he's annually a millionaire, and he's laughing. He gathers it both as a liquid when rain falls, which he pipes ashore and evaporates on the shoreline, and as a solid which is shoveled into bags. Basically, he has reconstituted a phosphate island.

There are many phosphate islands in the world that are being mined, but very few that are being created. The potential for creating a small phosphate island serving a small village is a very simple affair, providing you look at your roosting situation. Two hundred terns always roosting in the right place will entirely supply maybe an island or a village. Phosphate is one of the critically lacking minerals in the Third World. Wherever you can get that organized, in a lake, or by the sea, or on the land, it is a good thing to have done. The Dutch build specific bat roosts throughout their fields, which control mosquitoes and give them a critical manure. You will see those bat roosts in the flatlands in Holland, slatted like racks for drying towels. These are ideal bat roosts. The insectivores hang from them. Their manure is carefully collected and carefully distributed. So the sea and lakes are good places for collecting phosphates. If you can achieve something like that, you will be making a better strike than anybody else for local self-sufficiency.

You know now about Spirulina, the hippie food additive. Spirulina is an algae. It can be simply produced in tanks under continuous production system. Spirulina desalinate water. A modest plant will desalinate 10,000 gallons of water a day, producing that much fresh water from salt or brackish water. Once it starts to produce fresh water, you can mix it with hyper-saline water coming in and put it back again through the tanks. It has a higher BTU than coal, if you want to use it as a fuel. It is about 86% total protein, of which 68% is a complete protein. It has no cellulose, so it is almost entirely digestible. In summer, it will give three crops a day. It is presently greatly over-priced, selling for about \$30 a pound, dried. It should cost one and a half cents.

It will clean up sewage water; it will clean up grey water. You can feed it to your ducks and pigs, or turn it into a powder and eat it yourself. There is no need to eat the stuff. I merely propose this as part of aquaculture. It is very promising, I think. But I'm not going to do it. It is not my style of garden.

In places where you will be designing in arid lands, perhaps just summer arid lands, you will find people who are short of garden water and who have showers and sinks going into underground drains. Shunting systems can be installed, using a

simple standard double mouth fitting, and gray water can then be run directly into mulch. This has been done successfully in dozens of places with summer arid areas where I have designed. Shower water is immediately taken up by plants.

Grey water can be recycled through glass houses. It releases its heat in there. A sensible thing to do is to put your shower in the glass house. You can shunt this relatively clean water directly to the gardens.

I previously described for you that half-pipe open on one side, designed to lead water from toilets directly to tree crop, and which won't become blocked by roots. I think this is really a sane and safe way to dispose of sewage. While I think there is nothing at all wrong with the flush toilet, I do think there is something awfully wrong with Los Angeles—a crazy excess of everything, including the flush toilet.

This tile drains useful where we can get sufficient domestic water from uphill to run a flush toilet, and where we can grow trees on the outrun. I think it is an extraordinarily safe system. It has been on a long trial. It is now produced from standard plastic material. What size? If you use a lot of water, make a big drain. It falls at the normal drain-fall. About every four feet it has a two inch piece that fastens the bottom of the sections together. These act like little dams that slow the water, so that little ponds form continually behind them. This half pipe is placed upside down in an earth trench. It is buried in earth, but it is open on the bottom. It doesn't have stone on it or under it. It can even be laid in clay. You then plant trees beside it, even invasive trees, and away they grow. The man who made it originally made it out of half pipe and molded those little dams in it. Put it down below the frost line. It holds the water up as it goes along until absorption takes it out.

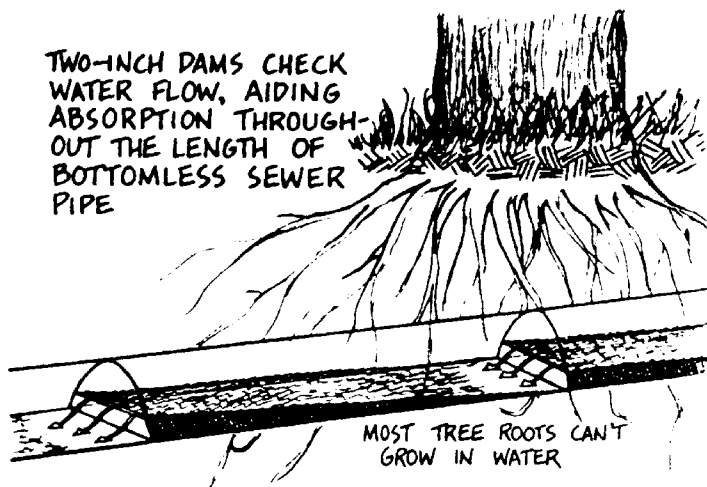

It works. Round pipes don't work, because they get invaded by roots. They will fill up with poplars and eucalyptus root. Leach fields work for a while, but these devices seem to work indefinitely.

The more you play with water, or walk on landscape where you can play with water, the more fascinating things you'll see that you can do. I do believe that if we really studied what the beavers are doing, we would already see some very smart work, just on flatlands. They are not building just one dam, they are building several dams, for all different reasons, and they are building little canals and bog places, and they are doing water control—pretty good little fellows!

Here is something we have done on flood plains. If you have a row of trees along a river bank, which you often do have—willows and poplars, you will notice that there is seldom more than four trees tilted over, until the next one is upright. I have not seen many flood plains that

would push more than four trees down in a row. And they go on growing. The fifth tree usually has the full upright height of the tree. Casuarinas, willows, poplars, all withstand flood.

You can plant in two ways. In both cases, you start at right angles to the bank and do a nice taper towards the river. That way, you will create a scourhole lagoon in the river, which is a very handy thing, providing a low water area for fish. If you can pick a place where it is not rocky, you can create a permanent lagoon. You can bring in detritus, collect firewood, also collect a substantial amount of mulch. You can have a place that doesn't collect anything, but which does give some silt. So floods can provide you with a lot of wood, a lot of mulch, and a lot of silt.

This silt is a good place for a crop like asparagus. It likes an annual dressing of silt. In Australia, it is a channel weed—it grows in the irrigation channels. It is four feet down with its roots.

In Australia, poplars grow to 90 feet high. Saw them off at the butt, dig an eight foot hole and lay them straight in position. A 90-foot hedge. It works. You grow your willows to sort of 30 feet high, saw them off, and plunk them in a hole. As long as you have them anchored, they'll grow. There are nurseries that will sell them to you at about 60 or 80 feet. Canadians would be transplanting at least 50 foot poplars, wouldn't they? No roots, just saw them off. Then you get another one that comes from the roots. That's why you run that nursery. You can take a 90 foot poplar and make two 45-foot poplars. You could take a 90 foot poplar and make three 30-foot poplars.

Now a word on very large dams such as the Aswan or any of those dams. They are mostly negative in their effect. All studies show that they reduce the fertility of the river below them by trapping the silt. They often sharply increase disease, and particularly in tropical lands, because the country is not scoured by floods. They always change the fisheries below. In Australia, for instance, they completely wipe out some species of fish for miles downstream because of the cold water released from the base of these dams. They have a very low biological use. They give rise to centralized power systems and, inevitably, to polluting industries at the other end of the usage chain. Generally speaking, they are a disaster.

So we are mainly in favor of reasonably small impoundments.

There is always a nuisance damming the waterways. You have to pay a lot of attention to your spillway systems, and those dams may flood. But they have their uses. However, it is the last place to go for a dam.

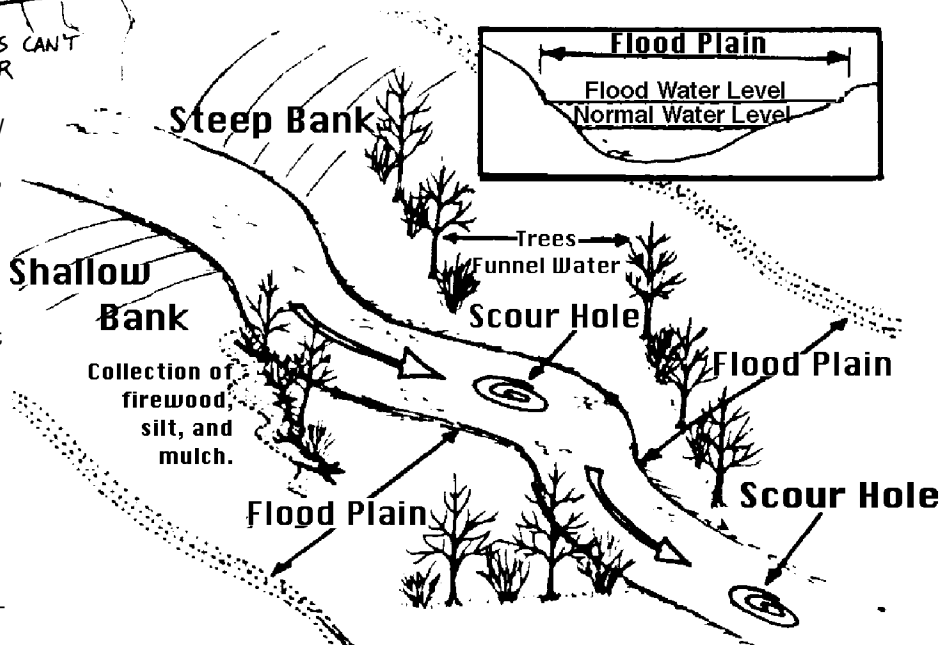

**PERMACULTURE IN URBAN AREAS
& URBAN-RURAL LINKS**

BY BILL MOLLISON

Pamphlet XII in the Permaculture Design Course Series

PUBLISHED BY

YANKEE PERMACULTURE

Publisher and Distributor of Permaculture Publications

P.O. Box 52, Sparr FL 32192-0052 USA

Email: YankeePerm@aol.com

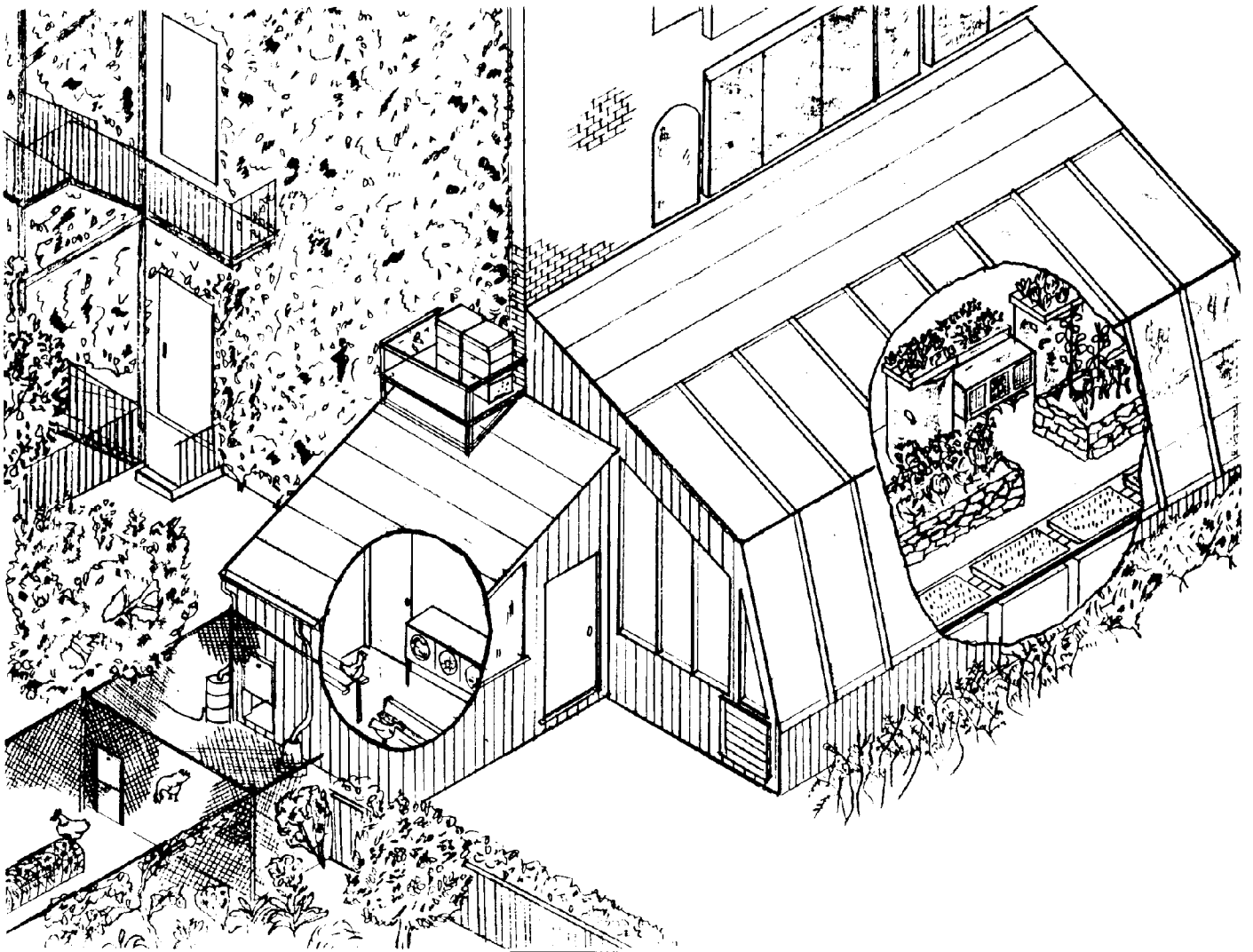

**Edited from the Transcript of the Permaculture Design Course
The Rural Education Center, Wilton, NH USA 1981
(Resource list updated August, 1995)
Reproduction of this Pamphlet Is Free and Encouraged**

PERMACULTURE FOR URBAN AREAS & URBAN-RURAL LINKS

This is the twelfth in a series of 15 pamphlets based on the 1981 Permaculture Design Course given by Bill Mollison at The Rural Education Center, Wilton, New Hampshire, USA. Elizabeth Beyor, without compensation, transcribed the tape recordings of the course and subsequently edited the transcripts into 15 pamphlets. Later, Thelma Snell produced the typescript for all pamphlets. Lisa Barnes laid-out and made mechanicals of the original editions. More recently, Meara Culligan entered all 15 pamphlets onto computer disk, permitting use of easier-to-read typefaces. At each juncture, I have added some further light editing to increase the readability of the pamphlets.

In deference to the monumental task of love represented by Bill's assembly of the Permaculture Design Course, and by the subsequent volunteer efforts leading to these pamphlets, Yankee Permaculture has placed them in the public domain. Their reproduction is free to all and highly encouraged.

The pamphlets are now available on floppy disk, individually or as a set, or via email as a pdf file. Send a SASE or two international return mail coupons with an address label for details.

We have some pamphlets translated into Spanish, French and German. Volunteers are now needed to complete these translations and to translate these pamphlets into other languages. Yankee Permaculture continues to depend on volunteers for all of our publications. To help, contact us at the address on the cover.

For Mother Earth

Dan Hemenway, Sparr, Florida. USA, August, 2001

Fifth edition

Permaculture Design Course Pamphlet Series		Quantity	Price
Complete Set of 15 Pamphlets. Bill Mollison. \$35	\$35.00	SET	\$ _____
Electronic Edition, \$35 as PDF files or \$50 in other formats. Individually, double the print price.	\$50.00	SETPD	\$ _____
I An Introduction to Permaculture. (Updated resources.)	\$3.50	I	\$ _____
II Permaculture in Humid Landscapes.	\$7.50	II	\$ _____
III Permaculture in Arid Landscapes,	\$3.75	III	\$ _____
IV Permaculture on Low Islands. (See V for combined price.)		IV	
V Permaculture on High Islands. (IV, V, & VI offered as one pamphlet.)	\$2.50	V	\$ _____
VI Permaculture on Granitic Landscapes. (See V for combined price.)		VI	
VII Permaculture for Fire Control. (See XV for combined price.)		VII	
VIII Designing for Permaculture. (New material added, new edition)	\$8.50	VIII	\$ _____
IX Permaculture Techniques.(New material added, new edition)	\$8.50	IX	\$ _____
X Forests in Permaculture.	\$6.25	X	\$ _____
XI Water in Permaculture.	\$3.75	XI	\$ _____
XII Permaculture for Urban Areas & Urban-Rural Linkages.[With New Resource List]	\$3.00	XII	\$ _____
XIII The Permaculture Community.	\$2.00	XIII	\$ _____
XIV The Permaculture Alternative.	\$2.50	XIV	\$ _____
XV Permaculture for Millionaires.	\$2.50	XV	\$ _____
SUBTOTAL (Minimum order, US\$5.00).....			\$ _____
Postage & Handling US addresses add \$5 +10% of first \$200 of order. Elsewhere add 20 %.			\$ _____
Contributions to supply literature requested by "Third World" groups, grade school students, etc.....			\$ _____
Other Contributions (Scholarship fund, Tree Tithe, "Third World" courses, etc. Please specify).....			\$ _____
TOTAL			\$ _____

Enclosed is my check or money order payable to Yankee Permaculture **MINIMUM TOTAL, US\$10.00.....** \$ _____

A service charge will be assessed for correspondence on orders which are underpaid or unclear. Because of exorbitant bank fees to exchange non-U.S. currency into U.S. dollars, we can only accept payment by check drawn on a U.S. bank or by International Postal Money Order in U.S. dollars. **IMPORTANT--**Make postal money orders payable exactly as follows: "Dan or Cynthia Hemenway." The U.S. Post office may refuse to cash money orders payable to Yankee Permaculture!
A SERVICE CHARGE of at least \$15.00 will be assessed for returned checks. We do not carry accounts--payment must accompany order.
TREE TITHE: As of January 1, 1985, all Yankee Permaculture publications carry in their price a **Tree Tithe**. We set aside this money for re-planting trees to compensate for those cut to make the paper that we use. Contributions to the Tree Tithe Fund are accepted.
 For full terms, see the complete Yankee Permaculture Order Form.

Prices subject to change without notice.

Price list updated 8/2/01

Permaculture for Urban Areas & Urban-Rural Links

The urban scene is very interesting. As far as design goes, we apply very much the same principles in tiny areas that we were applying to larger areas. In the urban areas, you may have very little growing space. Then your main strategy is the choice of plants.

It is here that we must start to throw out slow bearing and low yielding plants, and perhaps start to abandon things like bush peas and bush beans. Go to trellises. Attend to trellising, because your vertical dimension is your greatest area.

Trellis as much as you can, if space is very restricted. If you have tall walls, you can trellis up and produce a lot of crop on vertical surface. You can do modest turf roofing on little roofs for herbs and things.

Often enough, because of the arrangement of old houses, where you don't have much southern exposure, the only strategy is to put a glasshouse within the roof. While it can grow some things, it is basically a heating system. It needs to be an active system; you will have to use fans. You just take the air down to the heat store. So you will need to go climbing around and looking within the roof, under floor spaces, and under stair spaces, and be prepared to use much trellis material.

You often can use reflecting surfaces to good effect – old mirrors and aluminum foil will light up dark corners. A friend of mine haunted a mirror place, and got hundreds of strips of mirror that he put to use on a tiny house. The whole house was half as big as this room, with a tiny yard. He built up a fantastic reflector down on that yard. He reflected a lot of light back into the shade situation. Apart from that, there isn't a lot you can do.

The vegetables you plant will be lettuce, zucchini, and peppers – those long-producing, high-yielding things. Encourage the use of as much glassed-in area as you can for the obvious reason that you get far more continuity in production, and far more controllable production. Do much shielding from wind.

In urban areas where buildings are brick or masonry, ivy is a very important shade plant, and it provides good external insulation. Where you cannot put up a little evergreen hedge to guard from cold wind, grow ivy on the wall. Let it grow thick. Our findings are that where you have a spring and autumn season in a highly variable climate, ivy alone can prevent 70% of the heat gain in the house. It is not quite as efficient at preventing radiant heat escape. It is only as good as 40% at that. What it does is check that rapid lateral flow of cold north-westerly winds that would otherwise go screaming along the walls.

If you are going to use trellises on wooden walls, you need to organize it out

from the walls. Box your trellis in and stop the wind that way.

As a designer, you will spend as much time laying out one of those small urban systems as you will a hundred acres, because it is far more careful work that you are up to. In the urban setting, lot size is critical. A suburb with lots not more than a half acre and not much less than a quarter acre can produce 28% more than the same amount of crop land that the suburb occupies. If you give people too much land, they tend to put it into lawns; and if you don't give them enough, they tend not to garden. The average quarter-acre lot seems to be an ideal lot size to produce gardens.

You can get poultry on a quarter-acre suburban lot. Don't recommend roosters, or peacocks.

The main thing to encourage in the city is a set of social strategies. There are many city people who cannot get direct access to land. I will run through those systems that we know of that are working. Probably you know about others.

The first one would be the allotment system, normally one-eighth acre plots. You can get access to these either through the community gardening organizations in America, or public lands in Britain.

Within Britain, they have a system that is a post office listing of people who want land, and opposite, a listing of people who have land. It is public. It is posted up in the post offices. You can go in and write up whether you want land, or you can write up whether you have land. What it has successfully done is match up many youngish gardeners with a lot of older people who are no longer able to keep their allotments or yards in order. It is generally an unspoken thing, as most things are in Britain, that if you are using somebody's garden, you don't pay rental, but you give them some vegetables. That is generally the way it operates. That system has been extraordinarily successful in locating land within the city for garden usage. Some landlords with an itinerant group of people prefer to let the garden of that house to a permanent resident nearby.

In Australia, much of the land reverts to the local authorities because absentee owners don't pay the rates and taxes. To locate these blocks of land, you must go to the local authority. We have done this. Then we bring in trucks and do a heavy planting over it. We make little paths, and put in water and sprinklers and hoses. Then in a ceremony, at which the mayor is often present, we donate it to the surrounding house owners. We give it to them as a food park. We hand them a sprinkler and a gladiolus, and everybody shakes hands. And we invite the press. You will find then that they keep that gar-

den very well. Not one of those garden projects has failed.

You first have to find the land that the council owns. It is usually a neglected, boarded up lot. Ask the local people if they would like it. None of them ever say, "No." Then you go in and do the initial landscaping, because in poor neighborhoods they often have not the resources for this. We do stone block beds, and paths. The council often instructs their employees to drop off additional sawdust for paths, or leaves for mulch. Then we have a day we all landscape it – council, residents, anybody else who is a garden freak. We plant it up, and then we present it to them. Everybody has a good time – cook a few chickens.

You have to work with the local authority. They often are pleased to get rid of those areas. The property still belongs to your local councils; but, in effect, it has been given to the residents. There is no formal handing over of title; but if they tried to take it back, they would be voted out of office, so they just leave it with the residents. I have been back to see four of those places that I was involved in, and after three or four years they all still look good. I have been told by the councils, too, that they are very successful. This is right in the middle of an industrial urban neighborhood area.

The director of parks and gardens in that area is a permaculturist, and many of the gardeners in the city are, too. Instead of planting out all the trees that the council hands them, they grow potted trees that look as if they are decorative trees but, in fact, bear much edible fruit. Throughout the whole city of Melbourne, many fruit trees are now going in along streets and in parklands.

The garden club works very well. It is particularly suitable to low income groups who are really strapped, like high-rise people. It has to have an organizer, somebody devoted to it. The garden club operates very well in the Netherlands and places where land is very tight.

As an organizer, you get a large group of people to buy a farm with quite formally issued shares, fairly cheap. You can buy a \$100,000 farm with a hundred \$1,000 shares, \$100 down, and the rest on time. You will have to negotiate the whole thing. It must always be accessible by public route. That is critical when people aren't well off. It must be where they can get to it by train or bus. You have to dicker with the local authorities; but you can often put overnight camps on it, and central toilet facilities.

Most people will move out there on Friday nights to spend the weekends. I've known camps of little caravans or small sheds that people make up from what they can salvage in the city.

Permaculture for Urban Areas & Urban-Rural Links - Page 2

You can then design the whole farm to include some forest, some lakes, some fishing, and then many allotments. It is often opened to the public to stroll through. They tend to grow quite a lot of flowers as well as vegetables, so they are quite pleasant places. That has been very successful.

Farm link is happening in the state of Victoria and is also operating in Japan. You link a small grower to 20 or 30 families in the city on a personal basis. They guarantee to buy his crop, and he guarantees to try to meet their needs in production. They meet and plan for the whole year. He tries to give them accurate estimates of crop harvesting times. They make a little schedule so they will be prepared to get all their apricots when they are ready, and get their peas and freeze them. That way, he will not be running in with these things at some time when they are not ready to take care of them. So the whole thing is discussed and mapped out for the year. It gives the farmer better than the wholesale price, and it gives the urban people something less than retail price. Everybody benefits. [Mollison describes her what has become the CSA system.]

It is very common for those people to assist with labor at critical periods, and the farmer can easily arrange that, so that he can prepare to plant or hill up potatoes, or harvest on weekends. They arrange weekend work schedules. This labor is credited to those who work.

Another thing that has been happening in Australia is that the farmer is often able to provide mulch to urban gardeners, and they are often able to buy things for the farmer. They are on the spot to get spare parts for him, or to send out a grocery order for him, so that he is not under the necessity of visiting town and getting lost, and wasting hours just getting a single bolt. They can make these purchases and get them to him quickly. Everybody benefits.

It has gone beyond that with some of our people. They have built small shelters out on the farms for these people to come for family holidays. Again, there is a charge, but it is a very reasonable charge, much less than they would pay to go on holidays elsewhere, and they have a personal interest in the farm. They help with tree planting. That is working out very well. The Victorian government set it up, intending that the urban people should get some idea of the difficulties facing the farmer in terms of climate and crop, and it largely took off on its own. It is working to cut out the middleman and the markets, which the government never intended.

It's precisely the same way in Japan. So far as I know, it works very well

there. Many people in the city are not full-on gardeners; they don't have access to land. For these people, this is a good strategy. We call it farm link.

In one case, a certain scout group that camps on a farmer's property does all the tree planting. An adult education group also has a single farm link where they go for all their educational requirements, and they are housed there. As a result the housing has been improving all the time. Their money helps to improve their accommodations.

We are running a close thing to it ourselves. We have friends in Melbourne who come over for summer holidays so their children can enjoy the beaches. They help us, to help pay for their accommodations, and accommodate us in the same way in Melbourne. So we have an urban-country link.

We have found that one of the things that urban groups can do for farmers is to assist in legal and accounting procedures for the farm. The British have another thing going called Working Weekends on Organic Farms [WWOOF]. That is extraordinarily popular. It is going on both in Australia and Britain. About 68% of the people want to break out from the city and town, but are often very uncertain about their abilities. Working weekends on an organic farm gives them the opportunity to visit with people who are already out, and find out how to put up fence, cut firewood, plant crops, harvest crops, and service machinery. That works very well. They pay to go and work and learn. Traveling around, we have come upon several farms whose major solid income is from accommodating city people. Most of the people come during the children's holidays. The farmer has a little trout stream for fish, and he supplies firewood at no charge. The visitors help him with herding. I think this urban-rural work exchange is something we should work on. [WWOOF now operates in many countries.]

There are surpluses of material by building sites. A scouting group in town can often locate glass, good solid fencing, building materials, doors and windows, just at scrap prices. These are expensive in any rural area. So we find there are many beneficial linkages possible.

Another fast building thing, which is now widespread, is the food cooperative. Initially, they were just a good strategy within town. I think there are 40,000 of them here in the United States. They are strong and fairly well organized, too. Each of them commonly involves four to five hundred people. Some of those food coops are now buying a farm and putting a manager on it. There needs to be a key person who says, OK, this coop is going to own a farm and grow its own vegetables,

and I'll find the manager and I'll find the farm and I'll find out about the financing.

In urban areas, I always find myself working more on strategy than I do on designs. It takes a little while to find land, but it's always there. The last one we designed was an 18-acre city farm in Melbourne. An unemployed group supply hardware or work. It is sort of a demonstration site for city people to come and see what works. Here is where you get to use urban sheet mulch. They will design and build attached glasshouses. There is an empty factory nearby where these kids can construct the frames. They can plant for you a complete herb garden. They will supply the plants and plant it for you. The idea of this group is to demonstrate a whole range of things which people can use within the city. This makes them a retailer of other people's hardware. They sell everything from stock ponds to windmills. The people of Melbourne Rural Institute of Technology, who are architects and engineers, are cooperating on it.

The core group is a sort of permaculture association in that district, and we ourselves were the designers. We have those 18 acres full up with design systems. Some of it is park walkway for the public. It is part of a large parkway we are now developing. There is a large picnic area where people can drive in and just eat. A perfectly ordinary house on the site that is being retrofitted. There are two or three little ponds. All sorts of demonstrations are going on there.

The city farm in Britain is slightly different, very tiny, and right in the city. What they are really aiming to do is to hold a very wide range of common farm animals under perfectly ordinary conditions. They have milk cows being milked and giving birth to calves, and goats and geese. This is more so that city children have something to look at which gives them some relationship to reality. There are 46 of these city farms. They all occupy very deprived areas where children have never been on a farm in their lives. Those children are there just gaping at cows being milked, and piglets suckling.

If they didn't have any rates and taxes, they would be a little economic unit, because they produce milk and cheeses and some spare stock. They also grow rabbits, worm beds and such things. They are very busy places. A lot of very tough youngsters run around there, mucking out and doing chores. These places could be self-supporting, but they do need the wage of a manager. Many of the city farms of London are voluntarily staffed.

But they don't quite make it financially. They are not an economic farm unit. They have to buy in their feed. They haven't

Permaculture for Urban Areas & Urban-Rural Links - Page 3

enough land, ever, to produce it. Most of the British city farms were originally urban dairies. They just bought feed and sold fresh milk. They have been squeezed out by the price of land. They were economic units until the price of land started going up. In 1982, they were 85% self-funded by local sales and services.

In Australia, a friend of ours went around the city looking at all the chestnut trees and selecting good chestnut trees for grafting. He suddenly realized he had looked at three or four thousand chestnut trees. So! There were already a lot of chestnuts in the city! He then went around to the owners and offered them a wholesale price for their chestnuts, which in Australia is \$2 a pound. They were all quite happy, because hardly any of them wanted more than a couple of buckets of chestnuts, while their trees produced hundreds of pounds. I first met him when he was up into the second year gathering chestnuts, and he had sold \$70,000 worth of chestnuts that year, retail, which enabled him to buy a farm and start grafting chestnuts. Then he started to sell grafted chestnuts. He had a selection of thousands of trees to graft from. He has now developed the most successful grafting techniques in the town, and he is selling his grafted chestnut trees off at \$15 each. I suggested to him that he also freeze a large quantity of selected seed.

He has made a special study of grafting. You graft chestnut according to the color of the nuts. There are dark brown and light tan and medium tan nuts. It is no good trying to graft a dark brown nut tree onto a light tan stock. So he sets out all his stock from dark brown nuts from his good dark brown trees, and he grafts to them. His success rate just went out of sight. That was something that nobody had ever taught him, and I don't think it has ever been recorded. He selects good seed, that he knows produces good chestnuts. He sells it to us cheap, and everybody can grow nuts at home.

Further, this man is suggesting to people who have room that they plant a chestnut tree. He gives them the tree, providing they contract their excess nuts to him. He has no trouble if people move, in talking to the next owner and saying, "I'll buy your chestnuts."

He has made a specialty of the chestnut. Yet, he started off without ever owning a chestnut tree. He is presently very well off.

Within the city of Melbourne, and within the city of San Francisco, there are about half a million citrus trees in people's back yards. Most of that fruit falls to the ground. In San Francisco, Jamie Jobb

has started collecting this unwanted fruit. He gives it away.

In the city of Adelaide, there is a man running 9,000 sheep, which is a very respectable amount of sheep.

Each of these sheep rents out at \$6 a week. He will place the sheep in your overgrown yard or somewhere at \$6 a week. He shears it and drenches it. He owns a shearing shed in the suburbs, and a pickup truck and trailer, and he goes around and brings them in lots of one hundred or two hundred, shears them, and goes back out and drops them off again. The demand exceeds his supply.

Adelaide, and many of our areas, do not allow homeowners to have wild grass because of the fire hazard. It is quite expensive in rough ground to have someone mow and clean it up. So this man leads sheep in to reduce that fire danger. They get a sheep for a week at a price they would pay a man for an hour. And a sheep working for you in this situation does a lot more than a man. It is up to the property owner to fence the sheep.

This is an entirely different urban strategy. You look upon the city as a farm that already exists. It has very large areas for grazing. It always has plenty of surplus fruits and nuts, and all you have to do is organize it.

Another thing that is happening within cities is the group cooperative processing units. Australian immigrants – the Greeks and Italians – buy and install presses and vats for wine. You weigh in your grapes, and you can either get your grape juice back or take a proportion of the vat wines. That is quite a jolly affair. Throughout Australia, there are nut growers coops with centralized cleaning and packaging machinery.

We have hardly touched upon this whole subject. I believe that well-off people who can afford to put in processing machinery, and put it on rental in their district, should do so. Then everybody has access to a grain grinder locally. It should be the same for distillation, steam distillation, fine oil separations, oil fraction separation. We are urging this upon individual clients. We have some of these projects under way now. People need to press olives. It is a couple of hours work. They need to press their sunflower seeds.

In Yugoslavia, in the foyer of every town hall in small towns, there is an enormous large brass thing big, nearly two stories high. That is the town still. People bring in their plums. They are weighed in, and then the local council, or city council, issues slivovitz (plum brandy) in proportion to what you brought. The town distills it for you. If you have a bag of potatoes that are going off, you run it in to a fermenting center. They know the equivalent and you get that much alcohol

fuel, paying only for the distillation. All these things must be local, of course, must be within fifty kilometers, normal movement range.

In 1979, in Germany, as a result of some years of research delegated to universities and to agricultural departments in Europe, there was a conference on future agricultural trends. They came up with 17 findings, of which the first three were these: They saw a return to small farms, particularly specialized farms from a half acre to fifteen acres. I, myself, have seen some of these farms, and they are doing right well. A 12-acre farm, working on just organic grape juice, grosses about \$70,000 a year. They saw an increasing demand for self-pick and wayside sales. There is already a strong trend toward that. They foresaw that organically produced products would be the only products on demand in the future.

Agricultural college people from Australia and Canada, the United States and Europe attended that conference. However, the work was done in Hamburg, Germany. This cheered me up, because I feel as though it is sort of heading in the right direction: Small farms, organic products, and self-marketing systems.

There are aspects of this that might interest us as permaculture designers. Let us consider the self-pick sales. The ones that I have seen in operation suffer the most from people. They still pay well. The most successful one I've seen is a very simple set-up in Britain, a small-fruit production. It had gooseberries, strawberries, loganberries and black and red currants. They had much broader intercrop spacing than is usually the case, and they had made quite large mounds upon which the fruit grew. Those gooseberries were all right. No worry about people knocking the plants about. But they were moving out of raspberries. Strawberries also come in for a lot of trampling, but their strawberries were coping with it because they were mounded up and well mulched with sawdust. Although the crop density was low, the returns were very high. You could eat all you wanted to. People, in fact, don't eat much fruit. They are not very apt to get down two pints of strawberries, and they pick six and pay for six. You don't take into account that they have eaten two. This has been very successful. But there are design aspects to it that we should probably try to get at.

For the small farmer, the farmers' market is very good. The problems with these are mostly organizational. It pays the farmers to control the market space. Wherever they haven't done so, the rentals are always jacked up until the small general farmer can't afford it, and

Permaculture for Urban Areas & Urban-Rural Links - Page 4

the whole market turns into a commercial operation trucked in, which is not what any of the local farmers wanted it to be. The necessary strategy is to get hold of the space, either by ownership or long-term lease. We have found one of the best things is to buy a set of old warehouses, then turn it over to marketing groups.

On most weekends between 9:00 a.m. and 3:00 p.m., people with a stall would take in between \$300 and \$400. For many small farmers, that is a sufficient income. I have friends who have completely built their house from this kind of market income. One or the other of a couple can run the market, and the other one can hold a job, or can work on the farm.

Farmers' markets in Tasmania are open one day, either Saturdays or Sundays. They are held in the cities, of which we have only two, and in the country towns. They are regional markets. They deal with a very broad range of merchandise. They deal with handicrafts, seedlings, small poultry and small animals, settings of eggs, as well as eggs, old clothes, breads, baking products, preserves, jams, fresh herbs and dried herbs, and some are really into things like soaps and shampoos. Oils, essential oils, rubbing oils, massage oils, and there are always a few religious groups in there. Bands are playing and there are hot drink stalls. Now that's a very good income. We made about \$600 one weekend just with hot soups and things at the markets, and with strawberries and cream and coffee. They are great places that you can set up to assist the local people in their endeavors to make a viable economy in rural areas.

The wayside stalls, largely, are never manned. Now this is the way to get rid of main crop. You can put a mountain of pumpkins out there and they go off a few at a time, so you get rid of many of them. Wayside stands usually operate on the honesty system. They have a slot box for people to put the money in.

Sometimes people take the money, but very few people take the product. It is just not worth manning wayside stalls. You put your produce out in handy \$1, \$2 and \$5 lots, and put slots in the table for people to drop the money into. The closer you get to town, the more likely you are to get your money box cleaned out. The wayside stall is for main crop. You might put in four acres of pumpkins. You won't get rid of them at a farmers' market very easily, but you will get rid of them at wayside stands. Wayside stands can also operate as shared enterprises, because they run all the week, and not everybody has a stall on a good traffic lane. So what you try to do is get joint leasing of a site

that somebody owns, giving them a small income, and you can dump your products there, under some understanding with the person who owns the site. That is commonly done.

Another excellent way to sell is door to door. The best way to sell door to door is not in town; it is in the country. Much larger quantities are purchased per home in the country than in town. In town, people don't buy large quantities of food. I have never made less than maybe \$300 a day, door to door. I used to do door to door every day. You get many cups of tea, bread and butter, and interesting conversations. Providing you can be fairly regular, you do right well. They want to see you on Thursday, and they want some idea about what you might have.

It was in 1951 that I was running a market garden and door to door sales on my own. I made thousands of dollars. I just did it for a year—very boring business, making money. It is! It was 1951 when I grew a crop of sweet corn. I had about an acre of it. It went very well. I put it in a basket and went around with it, and people said, "What's this stuff? What do you do with it?" Nobody knew what it was. I just knew what it was myself. It was the first year in which it was grown in Australia. So what we did was wrap it up - - and this is what you must do with all new crop - we wrapped it up in a sheet of recipes and gave it away in a pair of ears. So if you get a very new crop, you should give the first lot away, and with recipes. When we first started baking, we gave little loaves of bread away. When we came back with sweet corn, we had no trouble whatever selling all we could produce. We even sold enough for people to freeze.

How do you set your prices? We always sold for less than the retail price in town. Many people go for a premium price on organic products. I don't think that is very fair, because it costs us less to produce, and when people are getting benefited for less cost, you can get rid of as much as you like. If you want more than \$400 or \$500 a week, you are off your head.

It was here in this market garden that I made my gross error. I laid down 12 acres of market garden on my own. I never saw eight acres of it. What a person forgets is the picking and pulling of it. I just invited people to come in and harvest the rest of it, because I never even saw it. I had an old Farmall tractor and just laid the whole lot down. But I never thought it all out; I was just picking for months and months. I had good moist cropland, good humus, a drained swamp. What all this means is that you should be recommending to your clients ways in which they can make their living, and you

should have a full knowledge of these strategies.

I've noted here, and increasingly, that farmers are drawing more of their living from really social involvement, by running field days, offering recreational and sports holidays, or riding or trail facilities, by temporarily keeping people's horses or cattle. Most farms in Tasmania that are next to wilderness areas are doing very well. They offer accommodations and run some riding horses, with long trail roads. There aren't many of them, and they are always overbooked.

As designers, we should adopt the pioneering approach with our first designs, our first clients in any area. Try to stimulate them to take on the nursery function. We have people all over Australia now involved in single species or multi-species production. We have bamboo nurseries under way, aquatic nurseries under way, quail supplies under way, pigeon breeders. If you get your early clients to undertake this sort of function, then you can continually be recommending them as sources of supply to later clients.

In an area with many grasshoppers, a guinea fowl breeder does very well. You can recommend guinea fowl to everybody. The same holds true for soil conditioners like the Wallace plow. If your early client can afford to do so, he should buy this tool. Then you continue to recommend him to later clients. In Permaculture Quarterly, we have a listing of all suppliers in district for all those items. Within 12 months to two years after you have started consultancy work, you should find that there is no trouble getting any species that you need, while at present, you don't even know where to start.

Along with your own clientele, who are largely suppliers, you are also able to locate suppliers within local garden groups. You can soon get a listing of people who will supply these oddities.

We also try, within district, to set up non-competitive client operations. We encourage people to concentrate more on what grows well on their property, and for others to leave the growing of that crop to them - let them grow this crop for the whole district. Imagine, for instance, that you have a very suitable patch for grain production - 12 acres. Tell all the other people around the district that so and so will produce the grain, while they get on with vegetables, or with fruit.

This is the very opposite of what has been happening under the agricultural department. They will fill a whole valley up with apple growers. They all go broke together, and they all boom together. What we should try to do is to seek out

Permaculture for Urban Areas & Urban-Rural Links - Page 5

something that is not in district for a farm that is very suitable for it, and a person who wants to grow it, and tell others to get on with something else that is not there. That is really regional self-sufficiency.

As a local consultant and designer, you can have a lot of influence.

Grain production suits humid area flatlands that are easily watered, and there is not much of that sort of land in any district. So those people would normally be raising more grain. I recommend to them that they go ahead and put grain there, then everybody else can get or-

chards on slopes. What you are really trying to do is plan the region, as well as the client's farm. You are setting it up as non-competitive systems in which somebody, because they are producing most of the grain, has a market in the district.

Just a final word about the clients that you meet. Often they may be retired, steel workers or electronics people, for example. Very often you can recommend ways they can make use of their professional capacities. An itinerant accountant is a handy person to find. If your client is an itinerant accountant, you can recommend him to other clients. As

permaculture designers, your job is more than to attend to the physical layout of the farm; it also extends to the services that the client might render to the whole district. As an instance, I was very interested in the fact that the man who collected chestnuts had separated from these trees several really good seed trees. We advertised his seed in the *Permaculture Quarterly*. He told me that has been worth \$30,000 to him in seed orders, not only within Australia, but outside Australia. One touch like that, and maybe you have earned your fee 60 times over.

Resource List

The following groups and publications are selected from our directory, **TRIP** (The Resources of International Permaculture), Volume VI. For a more complete, updated listing, you can obtain **TRIP** in print or on disk from Yankee Permaculture. Please nominate other groups to be included in this list. This list was generated on: 3/6/99

City Farmer

Office of Urban Agriculture
318 Homer St. #801

Vancouver BC V6B 2V3 CANADA

Publications include: *Urban Home Composting: Rodent-Resistant Bins and Environmental Health Standards*, *Gardening with People with Disabilities*, *School Garden Guidelines: How to Teach Children about Nutrition and the Environment*, and a color urban gardens poster.

FarmFolk/CityFolk Society

#208 - 2211 W. 4th Ave.

Vancouver BC V6K 4S2 CANADA

Green Guerrillas, Inc.

625 Broadway, 9th Fl
NY NY 10012 USA

Urban Harvest

(Former Dow School Bldg, 1900 Kane)

POB 980460

Houston TX 77098-0460 USA

"Building Healthy Communities Through Gardens and Orchards"

Urban Environment Laboratory

POB 1943

Providence RI 02912 USA

Hartford Food System

509 Wethersfield Ave.

Hartford CT 06114 USA

EarthRight Institute

POB 1185

Norwich VT 05055 -1185 USA

Environmental hot line for Northern New England (USA), 800 639-1552. Municipal energy-planning handbooks, fact sheets, etc. Environmental information, education and referral.

International Society of Arboriculture *Catalog of Curricula in Arboriculture & Urban Forestry*

POB GG

Savoy IL 61874-1033 USA

Publications include: *Social Aspects of Urban Forestry*, *The Landscape Below Ground*, *Trees and Overhead Electric Wires*, and *New Careers in Arboriculture*.

National Assn. for Urban Studies

Streetwise

Brighton Polytechnic

68 Grand Parade Brighton BN2 2JY

UNITED KINGDOM

Greentown Group

Urban Studies Center

553 Silbury Rd.

Central Milton Keynes Bucks MK9 3AR

UNITED KINGDOM

Neighbourhood Use of Buildings & Space - NUBS

John Knights, Director

15 Wilkin St. London NW5 UNITED KINGDOM

"Voluntary groups taking local initiatives are not usually in a position to employ the architectural and planning help they may need because traditional architectural practices are often not geared to cope with the particular problems of the voluntary sector. Without proper architectural drawings, and planning advice and realistic costings a voluntary group is unlikely to receive the financial support it needs from the Local Authority or potential donor. "NUBS was established in 1975 to help overcome these problems. Since then it has worked with over 90 voluntary groups, providing a unique service, developing their embryonic ideas for using the derelict land and buildings which litter the Inner City areas of our cities."

Toronto Food Policy Council

277 Victoria St. Rm. 203

Toronto ON M5B 1W1 CANADA

Henry George Foundation

Land & Liberty

177 Vauxhall Bridge Rd.

London SW1V 1EU UNITED KINGDOM

Promotes "...the economic and political philosophy of Henry George. ... He saw that mankind's fundamental economic and social dilemma was "How to apportion the land?" 2:37:30 PM Henry George saw that the solution was simply to permit individuals to lease the land from the state upon payment of an annual ground rent equivalent to at least 5% of the value of the land while at the same time reducing the taxes that weigh on enterprise. The Foundation conducts research into the application of Henry George's economics to present day economic and social problems. It maintains a library...and publishes a range of literature..., holds meetings and conferences, and campaigns to bring Henry George's philosophy before a wider public."

Urban Agriculture Network

Urban Development Unit

United Nations Urban Development

Programme

One UN Plaza, DC1-2080

NY NY 10017 USA

International Water and Sanitation Centre

WHO

POB 93190

2509 AD The Hague NETHERLANDS

"IRC has a publication series, a documentation unit, and works in developing countries [sic.]."

Center for Neighborhood Technology

Neighborhood Works, The

2125 W North Ave Chicago IL 60647 USA

Agricultural Initiative

Center for Citizen Initiatives - CCI

3283 Sacramento St.

San Francisco CA 94115 USA

Promotes self-sufficiency and increased food production in the former Soviet Union through rooftop gardens, small-scale agricultural enterprises, etc.

Permaculture for Urban Areas & Urban-Rural Links - Page 6

Green City Program

Green City Calendar

c/o Sabrina Merlo, Planet Drum Found.
POB 31251
San Francisco CA 94131 USA

Arboricultural Journal

A B Academic Publishers
POB 42
Bicester Oxon OX6 7NW UNITED KINGDOM
Summaries in French and Spanish. Urban forestry.

Arboricultural Association

Arboricultural Journal

Journal of Urban Forestry

Ampfield House
Ampfield, Romsey Hampshire SO51 9PA
UNITED KINGDOM

Urban Environment Centre, The

16 Howland Rd.
Toronto ON M4K 2Z6 CANADA

Urban Ecology Australia Inc.

Centre for Urban Ecology
83 Halifax St. Adelaide SA 5000 AUSTRALIA
Ecological city. Formerly listed as The Halifax Project.

National Federation of City Farms

The Greenhouse
Hereford St Bedminster Bristol BS3 4NA
UNITED KINGDOM

An extensive network of urban food systems (both plants & animals) set up and managed by local communities.

American Community Gardening Assn. - ACGA

Community Greening Review

325 Chestnut St.
Philadelphia PA 19106-2777 USA
Volunteers & professionals "promote gardening and greening in urban, suburban, and rural America."

Center for Urban Education about Sustainable Agriculture - CUESA

The Bay Area Urban Gardening and Greening Directory

1417 Josephine St. Berkeley CA 94703 USA
"...lists over 100 projects and organizations in the San Francisco area doing work in areas such as farmers' markets, community gardens, horticultural job training, and children's gardens.

New York City Street Tree Consortium

44 Worth St. The Mezzanine
NY NY 10013 USA
Street tree care training, pruning course.

Wave Hill

675 W 252 St.
Bronx NY 10471 USA
Urban reforestation.

Center for Sustainability

133 Willard Bldg.
Univ. Park PA 16802 USA

GREEN Institute, The

1433 E Franklin Ave. #7B
Minneapolis MN 55404-2135 USA
Programs include an "ecoindustrial" park, a "business incubator," an urban environmental learning center, materials exchange and reuse, and energy technology.

Projeto Aldeia Global

Rua da República - 71
Novo Hamburgo RS 93315540 BRAZIL
A non profit organization dedicated to support the development of Eco-Villages.

Parks Council, The

457 Madison Ave.
NY NY 10007 USA
Protect & enhance parks, open space, shore.

Operation Greenthumb

NYC Dept. General Services
49 Chambers St. Rm. 1020
NY NY 10007 USA
"Land Reclamation Program" turns vacant lots into meadows. "Provides free technical & design assistance, fencing, tools, lumber, soil, fruit trees, shrubs, special assistance to educational garden projects." Publishes resource list of other New York City gardening support groups.

Open Space Greening Program

Council on Environment, NYC
51 Chambers St.
NY NY 10007 USA
Advice and workshops on gardening. Garden reference library. Tool & book lending library. Green Bank Program provides matching funds.

Open Space Institute, The

666 Broadway 9th Fl.
NY NY 10012 USA

Bronx Green-Up Program

NY Botanical Garden, Watson Bldg. Rm. 317
200 St. & Southern Blvd.
Bronx NY 10458 USA
Technical assistance, resource referrals, training program, truck service for garden materials, free soil & plants when available. Bronx sites only.

Bronx Frontier Development Corp.

851 Barretto St.
Bronx NY 10474 USA
Urban composting. Demonstration garden. Limited technical help on gardening. Bronx-based groups can pick up one free load of compost or wood chips.

Magnolia Tree Earth Center

677 Lafayette Ave.
Brooklyn NY 11216 USA

Horticultural technical assistance. Workshops for school children.

Neighborhood Open Space Coalition

71 W 23rd St. #508
NY NY 10010-4102 USA

American Forestry Association

Urban Forests

American Forests

POB 2000 Washington DC 20013 USA

Urban Agriculture Network, The

1711 Lamont St. NW
Washington DC 20010-2601 USA
More than 6,500 NGOs in 65 countries networking around the issue of urban food production.

Urban Options

Attn: LeRoy Harvey
405 Grove St.
E Lansing MI 48823 USA
"We have an energy & environmental demonstration house and information center."

Urban Forest Institute

Box 415
Honaunau HI 96726 USA

Seattle Tilth Association

4649 Sunnyside N Rm 1
Seattle WA 98103 USA
Trains composting teachers, operates demonstration compost system, gardens, greenhouse. Produces printed guides to establish similar programs in other areas and distributes slide shows. Publishes monthly newsletter and several Northwest (USA) gardening books.

Institute for Sustainable Cities

485 Leatherfern Pl.
Sanibel FL 33957 USA
"Developing strategies for environmentally sound, socially just urban redevelopment. Key areas: urban farming, sustainable transportation; proximity policies, urban wildlife, community economics."

Permaculture in Action

c/o Jeremy Burnham
POB 235 Noordhoek 7985 SOUTH AFRICA
"...offers training & support in permaculture and 'city villages' around Southern Africa, including Malawi and Namibia."

Permakultur Austria

Permakultur

c/o Inst. für Freiraumgestaltung & Landschaftspflege, Abbeitsbereich Freiraum
Univ. für Bodenkultur Wien
Peter Jordan-Straße 82
A-1190 Vienna AUSTRIA
"Our purpose is to support permaculture and its application in Austria. We offer consultancy, lectures, introductory and design courses, a seed

Permaculture for Urban Areas & Urban-Rural Links - Page 7

service, library, book sale and a plant exchange. We have...sub groups working on bioregional development and urban permaculture. [We have] started...our first demonstration sites. We translate and publish texts relevant to permaculture and we publish a quarterly newsletter. People joining this work are highly welcome."

Vancouver Permaculture Network

Attn: Harold Waldock
9641 139th St.
Surrey BC V3T 5H3 CANADA
Alternate address: Siobhan Ryan: 3721 Beatrice street Vancouver. Vancouver Permaculture Network hosts PC courses, has now a regular meeting scheduled at Cotton Wood Gardens

Environmental Building News

Environmental Building Design

Alex Wilson, Editor & Publisher
28 Birge St.
Brattleboro VT 05301 USA
Bimonthly newsletter on environmentally responsible building for builders and designers.

IMAGO

IMAGO News

553 Enright Ave.
Cincinnati OH 45205 USA

Eco-Home

Ecolution

Attn: Julia Russell
4344 Russell Ave.
Los Angeles CA 90027 USA
"Demonstration home of urban, ecological living. Tours."

Earth Connection

EC News

370 Neeb Rd.
Cincinnati OH 45233-5101 USA
"...a place where people from all over...can...learn about solar design construction, water conservation, and other measures to help us all live more 'lightly' on this magnificent Earth, as well as to probe the deep spiritual meaning of eco-sensitive living."

Sustainable Resources Center, The;

Urban Lands Program

Urban Gardener

1916 2nd Ave. S
Minneapolis MN 55403 USA
A non-profit involved in energy, land and food issues and community gardens in the Twin Cities.

Urban Ecology

Urban Ecologist, The

405 14th St. #701
Oakland CA 94612-2706 USA
Excellent information!

Permaculture Institute of New Zealand - PINZ

POB 56-107, Dominion Rd.
Auckland 1003 NEW ZEALAND

Center for Popular Economics

POB 785
Amherst MA 01004 USA
"Economics education for activists."

Trust for Public Land - NYC Land Project - TPL

Mid-Atlantic Regional Office
666 Broadway 9th Fl.
NY NY 10012 USA
Legal support for community garden preservation.

Boston Urban Gardeners - BUG

46 Chestnut Ave.
Jamaica Plain MA 02130-0192 USA

Los Angeles Eco-Village

Los Angeles Eco-Village News

3551 White House Pl.
Los Angeles CA 90004 USA
An urban ecovillage.

Biological Urban Gardening Services - BUGS

BUGS Flyer - The Voice of Ecological Horticulture.

POB 76 Citrus Heights CA 95611-0076 USA
"an international membership organization devoted to reducing/eliminating the use of synthetic chemicals (pesticides and fertilizers) in urban landscapes. The major service BUGS provides to its members is education through our quarterly newsletter and catalog of educational brochures dealing with ecological horticulture." Quarterly newsletter.

Center for Urban Horticulture

Miller Library, Univ. of Washington
Box 354115
Seattle WA 98195-4115 USA
"...research, teaching, and public service concerning the selection, management, and role of plants and of ecosystems in urban landscapes."

San Francisco League of Urban Gardening - SLUG

2088 Oakdale Ave
San Francisco CA 94124 USA

Shelterforce

National Housing Institute
439 Main St. #311
Orange NJ 07050-1523 USA
"Nat'l cross-disciplinary mag. for community development activists."

Permaculture Implementation Guild of Seattle - PIGS

POB 45472
Seattle WA 98145-5472 USA

Permaculture Community Action - Worknet

104 Bridlewood Blvd
Agincourt ON M1T1R1 CANADA

This has been a fairly selective listing. For more leads, see TRIP directory.

The Permaculture Community

BY BILL MOLLISON

Pamphlet XIII in the Permaculture Design Course Series**PUBLISHED BY****YANKEE PERMACULTURE****Publisher and Distributor of Permaculture Publications****P.O. Box 52, Sparr FL 32192-0052 USA**

YankeePerm@aol.com

This is the thirteenth in a series of 15 pamphlets based on the 1981 Permaculture Design Course given by Bill Mollison at The Rural Education Center, Wilton, New Hampshire, USA. Elizabeth Beyor, without compensation, undertook the transcription of tape recordings of the course and subsequent editing of the transcripts into 15 pamphlets. Later, Thelma Snell produced the typescript for all pamphlets and produced the drawings for these three pamphlets, again without compensation. Lisa Barnes laid out and made mechanicals of the original editions. More recently, Meara Culligan entered all 15 pamphlets onto computer disk. From time to time, I have added some further light editing to increase the readability of the pamphlets. In deference to the monumental task of love represented by Bill's assembly of the Permaculture Design Course, and by the subsequent volunteer efforts leading to these pamphlets, Yankee Permaculture has placed them in the public domain. Their reproduction is free to all and highly encouraged. The pamphlets are now available on computer disk, individually or as a set. Send a SASE or 2 international return mail coupons with an address label for details.

We have some pamphlets translated into Spanish, French and German. Volunteers are now needed to complete these translations and to translate these pamphlets into other languages. Yankee Permaculture continues to depend on volunteers for all of our publications. To help, contact us at the address on the cover.

For Mother Earth

Dan Hemenway, Sparr, Florida, August, 2001.

Fifth edition

**Edited From The Transcript Of The Permaculture Design Course
The Rural Education Center, Wilton, NH USA 1981****Reproduction of This Pamphlet Is Free and Encouraged**

The subject we want to go into now is not just permaculture 1 as it applies to integrating elements within ecosystems in beneficial ways. It also applies to the whole question of funding and cooperation between community, government and business. Using the same methods that integrate the elements of a garden system, we can attain surprisingly similar benefits accruing to the whole social system. We design a maximum number of functional connections with a minimal amount of legal complexity. This model works. It is working in Australia, and it will work for America; it will work for Britain. There are legal details that differ from country to country, but, basically this model works everywhere outside the Communist world.

First of all, we have a group of people that can be defined as a community. It can be a community of designers, a community of people living in one house, or a community scattered over the face of the Earth. All they have to do is to agree to a set of principles and ethics that guide them. These ethics are Earth care, people care, and a final one of non-profiteering, of not accumulating wealth beyond one's needs.

We will now go to a description of the legal structure.

This community forms a company. This is a perfectly ordinary company such as it exists in all nations. Part of the function of all companies is to act as a trustee. That is all that this company does. It does not trade, nor does it take any cash flow in or out. It issues shares of one dollar to each member. All members can be directors of the company. Now this part of the structure is just the same as that which many people have: a land trust, or a land bank, or a research institute. There are many of them being formed.

The Permaculture Institute, which is the name of this company, exists to work in areas of health, education, and agriculture. That gives the company a total broad spectrum basis of acting. Then, under trust drawn up according to the laws of your country, it would be normal to add, "for the good of all Americans."

This is a publicly oriented trust. It confers advantages, not all of them applicable in all countries. Generally this trust offers these advantages:

- This Institute usually has immunity from land taxes and rates and local council and local government charges.
- It has all sorts of potential links with other institutes. For instance, in agriculture, it is automatically a member of the World Free Seed Exchange, and can get seed from anywhere in the world at no cost. The whole of the World Seed is open to that. That includes 4,600 institutes and some 680 botanical gardens.
- It can make links and do joint research with any other institute of its kind, with joint funding, or funding staff arrangements and so on.
- It is also in an insulated situation. If this fails, so do all schools, churches, and most other important public institutions and offices. For they, likewise, cannot afford to pay those sorts of costs. It is uncommon, almost unheard of, for this to be raided by government or anybody else. It is also the way the rich structure their own money flow systems. They always have this as an outlet. The Ford Foundation is an example.

Critical, and often missing from structures of this sort, is a second trust, not connected with the Institute Trust, although under the company's trusteeship. This second trust is a non-profit trading corporation. It occupies structures loaned to it by the Institute at no cost, because it funds the Institute. It is staffed free of charge by members of the community. So this is one company that owns no buildings, and employs no staff. It borrows from a political party, or a small external society, all its moveable fixtures, furnishings, and usable objects – tractors, vehicles, typewriters, desks, chairs. So it also has no chattels.

Political parties enjoy some unique privileges in Australia. They need not declare their income, nor their membership, nor do they pay traffic fines. Because they are not corporate, they pay no income tax.

So what we have is the community, the company, and two trusts, maybe supported by one or two other external factors.

At the Trading Trust, there is nobody and nothing at home. Within the Trading Trust no risk is incurred. This also is precisely the structure of some merchant banks throughout the world. There is no one at home. So they incur no risk whatsoever. Although it is a legal structure, it is not a corporate entity.

This Trading Trust registers several businesses in which it cares to deal. Good businesses are:

- Travel agencies, because a lot of people we know need to travel, and those who act as agents may get 15% discount, free tickets, or perhaps free flights around the world.
- A publishing company, because information is vital. It is something on which we live.
- A consultancy, as another means of transmitting information on a global scale - information transmitted by people.
- A real estate operation is often appropriate.
- And, in our case, a seed company, which is owned by the Trading Trust.

Now the Trading Trust can also enter into business-sharing arrangements. It can hold shares in, and take part in other operations, such as consumer co-ops, workers' co-ops, and unemployment co-ops; and it can hold residential shares in other seed companies, or seed growing operations; it can hold shares internationally; it can participate on an international basis in trading cooperation. Therefore the Trading Trust has a very broad potential for joining in cooperative money flow, just as the Institute has a very broad potential for joining in cooperative research flow, and informational flow.

These two trusts are not only tax immune, but donations to them are often tax deductible. That has to be established, however. The money can route through any other institute within the country that has tax deductibility. The usual charge for that is a 2-4% handling charge that remains in that trust. As an example, if you want to give something to the Permaculture Institute to give to the Threshold Foundation, we would keep 2% just to cover the cost of handling the transfers. So it is a tax deductible operation – not taxed, because nobody profits.

Money can come into the Trading Trust. Most of it came in by virtue of its own efforts, by businesses run by the Trading Trust itself. It comes in dribs, drabs, oddities, and occasionally, big lump sums. Money can come into the Trading Trust from government, and substantial amounts do. It comes in as normal business aids.

I will give you an example. Australia has a law that says that all businesses engaged in exporting are automatically remitted certain portions of all fares of exporters traveling overseas. The government regards consultancy and knowledge as an export. The reason the government provides these benefits is that isolated countries have to maintain a net inward cash flow for good balance of trade, and they offer a tremendous number of incentives to industries within that country likely to earn overseas dollars. If, year by year, our exports go up, then the amount to which they recompense us increases to a level of nearly 90%.

That is very nice for Australian exporters. If it costs us \$8,000 to go overseas on business related to consultancy, or educational exportation of permaculture, they will give us \$6,000 back.

Now if you are also a travel agent, you may receive from the plane company an additional discount on air fares, or, perhaps, a remission of the entire fare. In such a case, you may very well make a couple of thousand dollars on a world trip, just by traveling.

The exporter may also appoint agents in any country, to any number, to operate on its behalf; and the same thing applies for these agents. The agents of this exporter, in any country, flying into and from Australia, or from country to country, on behalf of this exporter, also get remission of those fares, plus

something the Australians don't get, a full remission of accommodation costs. 2

If I appoint you as my agent on the East coast of America, and I want you to fly to Australia, or I want you to fly to Japan, in connection with an export item such as a book, some seeds, some knowledge, or a consultancy job, I can then, having appointed you as an agent, pay your fares initially. Seventy-five percent of those fares will be returned to me, plus all the costs for accommodation and other normal associated costs. The law of one country, such as Australia, enables any individual within that country to assist individuals in other countries. That is now common.

So there is a fantastic amount of potential in that alone for shifting people around the face of the Earth at very little cost.

Every June, an accountant makes up the accounts, puts in a report to the Department of Trade and Industry, which issues our refund in November. When we are away, we just send all our tickets home in June. We have to show how much income we brought to Australia from our trips abroad, as a part of normal accounting. We submit these trading accounts to the department of Trade and Industry.

Money comes in largely from trading efforts, but also from government and these business aids.

There are other business aids. The Australian government funds and fully refunds on the development of any invention or device that might be salable. The whole cost of development, productivity development of any salable invention is fully refunded by the government. Now these are not things that you must apply for; they are free, automatic, government business aids. You don't have to be under any bureaucrat, you don't have to fill out any forms to clients, you just get it. These are normal channels, with a capital flow from government to business.

But I find in our case, by far the largest and most significant flow, is the flow from what people earn.

This Trading Trust is a non-profit corporation. It has to distribute all profits. It distributes them in four ways:

1. It gives by far the greater amount to the Research Institute, thus getting a double tax exemption, because for one thing, it isn't taxable, and in the second place, it is a tax deduction.

2. It also gives to public charity, or any charity of its choice, which is another tax deduction. That can be aboriginal ethnic groups, which we fund.

3. There is a minor flow to a political party as donations, that exactly equals the cost of typewriters, desks, vehicles and tractors. The political party chooses to spend the gifts it receives on these things.

4. Lastly – and this is a thin miserable stream – it gives some of its money to these people who work within the Trading Trust and their dependents. At present, for Tagari – I won't advise you to imitate this – it is \$21 per week. So last year, in a very large trading turnover, a sum of \$20,000 might have been taken out for perhaps 40 volunteer workers living in the community. Every man, woman and child in Tagari receives the same amount. We don't differentiate between sexes or ages. If that person is one year old or ninety, male or female, he gets \$21 a week, and that's it. From this amount these volunteer workers must buy their clothes and incidentals. Clothing is mostly from Vinnys Boutique (at Vincent de Paul Society), in Tagari – clothes for the poor. We just don't have any expenses. We are all working in the Trading Trust full time. It provides transport to and from the situation. It used to provide bulk food; now it doesn't. It provides free seeds. These people live below the minimum income level, so they do not pay tax.

Let me tell you, this group, of all the people in the whole of Australia, is the most heavily self-taxed group. All their money goes to the public. We pay the highest to the public tax of any group within Australia, because all our money, except a tiny amount, goes to the public. Once it crosses that boundary, we

can no longer use it or profit from it in any way. The Research Institute carries out work in health, education, and agriculture for the good of Australians. It can't employ anybody. No one can benefit personally from it.

The institute can sometimes help to people who wish to achieve something in line with our principles and ethics. There was a person who gave money to the Institute for the establishment of a child-birth center. We set up the Childbirth Institute in Queensland. She supplies an excellent staff that runs the childbirth center. They run it for the institute as part of its health program. It is for the public benefit. It would be fantastic if in this way we could set up many children's schools and child-birth centers!

Just occasionally, members of the public give substantial amounts of money to the Trading Trust. The largest sum we received was toward the seed company. There are certain trading operations you can enter into that are acts of defiance. Well-off people will often fund such acts of defiance, even when it is not tax deductible. The sum that we received allowed salaries to be paid to workers in the seed company. Some of those workers were members of the public; others were members of the Tagari community. These last (who are complete nuts!) only took \$21 a week as their pay and put the rest back into the Trading Trust.

But they may not be complete nuts. This group could have kept all the money and paid taxes on it, if it exceeded taxability. As I pointed out, they have hardly any need for money.

It is possible to set up trading operations that are totally non-capitalized. In the publishing trade, it is normal to ask for pre-orders, and invite large publishers, who give printing money before the book is printed. There are other industries of this sort that don't require capital. You don't need capital to start up a travel agency, a consultancy, or a real estate business. All you need is people qualified and willing to do it.

Let us consider another subject now – land. This is important to the function of the whole network and therefore has to be heavily insulated. Trading operations are not important. They can come and go. They are a nuisance.

The Institute, the public trust, will not take risks. All land donations go to the Trading Trust, not the Institute. The Trading Trust first pays all transfer costs. All part-owned properties lie in the risk area. Only fully owned property, and often those with some financing attached to them, pass into the Institute. Such land must also be heavily insulated from any claims against it from the outside, for the Institute cannot take risks, and will not accept properties that have any attachments on them.

Now within this area lie all real properties. Real property includes buildings, land, equipment, and rights. That is real property.

Property comes in through the trading departments in the form of copyrights and other things. Occasionally, the trading operation puts deposits on property such as land and houses; and when the property is fully paid off, passes it into the Institute, as a gift. Often a cooperative or community will give us a share in an enterprise, perhaps for a thousand dollars and a contour design job. That remains in the Trading Trust.

Land can come in from the public. It can come in from the government. Land can come from local government, land the local government does not want. Local government can launch city farms through this Institute. All this land comes in through the Trading Trust.

Now land accumulates, and can accumulate with extraordinary rapidity. There is absolutely no problem in 12 months in getting hold of several million dollars worth of land, no problem whatsoever in that. I mean hundreds of square miles of land. The problem is this: There is a lot of time and money involved in just passing that land in. What we really need is a volunteer group in the public to handle that. We have been offered large areas of land within Great Britain and France, and areas of Afri-

ca, and islands, and areas in Australia, in all its states- I mean 3 huge areas. There is absolutely no problem in getting all the land anybody is wanting, providing you have a group set up to deal with it. They can't because it costs time. They have to go look at the land, and all sorts of things are involved. Sometimes it costs this group \$4,000 or \$5,000 just to get the land in here. So it has given up taking any land that is not paying its own way in. They don't want your land unless you are doing the whole problem bit of putting it in here. Then, there is also the matter of finding somebody who wants it. That can happen. If nobody wants to live on it, we cannot handle it.

The sort of properties that come in may be warehouses, office buildings, inner urban, suburban, or rural areas, for preservation or for development. These properties can be distributed amongst the activities sponsored by the Trading Trust, or used for purposes of health, or as retreats, or given to schools for educational purposes. There are many reasons why lands come into the Institute.

All this land then goes out to the public, to communities, cooperatives, or little groups that form to administer it; or it may in some cases be a single individual. We can give these people either limited tenancy, life tenancy, life tenancy inheritable, or transferable and inheritable tenancy. Or they may simply occupy it as public land, land open to the public.

Also, the Institute's funding returns to the public in its activities for health, education and agriculture.

Houses, not paid off, that are in the Trading Trust, are rented out to members of the community. The rent is remitted if these people work within the Trading Trust. But if they leave it, then the rent is directly incurred, even though they may have donated the house. If rent is paid, it may, however, be returned to the householder for repairs, etc. Houses are either owned by the Institute and given to community members on life lease, inheritable, or transferable; or these houses may be held by the Trading Trust and occupied by community members under temporary lease until such time as all costs are paid off.

When you think about a community, you ask, What is it that the community really wants to do? It probably wants to make enough money to support itself. More important, it probably wants to do good works, because people who enter into a community often do so for the purpose of doing good works. It usually wants to cooperate with other communities who have similar goals. But how infrequently do these communities set up a legal structure that enables them to do any of these things, and to achieve them efficiently in a very short time?

A proper legal structure gives a community a wonderful opportunity to unite with other groups at all levels, to put out tendrils joints from trading operations, trade to trade, even to an individual isolated on a hillside, who can be appointed as an agent. It can deal with an individual isolate; it can deal with him so that both benefit. It can house, look after, and work with either an individual, a farm, a community, or another cooperative, and so on.

We have extraordinary close links at this level with an urban group who are discussing subsuming a similar structure. They don't need to go through the legal hassle to set it all up. They just join us as partners, or traders, or Institute people who serve as directors for their local area. This is a marvelous way to delegate responsibility to bioregions. It is also marvelous for an international set-up. It closely follows the merchant banking systems, that are themselves international, and it was designed and is advised by merchant bankers in Australia.

Incidentally, all its legal advice is free. The Australian legal profession makes no charge to public interest groups. In Australia, we have excellent international lawyers, and the lawyer association will send them free on our business. All legal offices in all capital cities are ours to use, free of cost. That gives us typist, offices, duplicating equipment, anywhere we like.

Much of our medical work and dental work is done at very

low charge, or no cost, by people who understand our position, who respect what we are doing.

In summary, we are a group of friends who agree to a set of principles and ethics. As people, we can have no power over any other person, over any capital or indeed over any material goods. So what we have divested ourselves of is power, only power. However, we have access to libraries, and to international travel, when it serves a useful purpose. We enjoy the best of foods, great company. We do right well, but only because people like us. We cannot, as individuals, force anyone to do anything, because we don't have any power over anybody. As a group, we exist only if people like us. Otherwise, we are broke, dead, unloved.



**THE INTERNATIONAL PERMACULTURE
SOLUTIONS JOURNAL**
P.O. Box 52, Sparr FL 32192 USA
DAN HEMENWAY
EDITOR & PUBLISHER
CYNTHIA BAXTER HEMENWAY ASSOCIATE EDITOR
Email: YankeePerm@aol.com

Many of us are painfully aware of the severity of catastrophic ecological decline worldwide. *The International Permaculture Solutions Journal* delivers information, ideas and discussion to provide Earth-healing tools or to promote their development. Information that is practical, detailed and hard to find elsewhere often turns up on "TIPS" pages.

Who Writes for TIPS?

Many TIPS writers are tops in the movement: Bill Mollison, Jim Duke, Bill McLarney, and our editor Dan Hemenway, for example. Others are people who have been quietly working on their own. They all have something important to say.

What Does TIPS Cover?

TIPS issues often follow a specific theme. Presently we have a series of issues on aspects of developing sustainable food systems. After that will be a series on "Permaculture Design: The Process and the Product," and then a series on appropriate technology in permaculture. And of course each issue contains articles outside the theme as well--matters too important to wait. Eclectic book reviews, fascinating letters to the editor, informative illustrations, & easy-to-use format are hallmarks of our publication.

What Does TIPS Cost?

Subscriptions postpaid are US\$32.50 for USA addresses and US\$35.00 elsewhere. Each subscription includes about 100 pages per volume, typically delivered in four issues.

THE PERMACULTURE ALTERNATIVE

BY BILL MOLLISON

Pamphlet XIV in the Permaculture Design Course Series
Edited from Transcript of the Permaculture Design Course
The Rural Education Center, Wilton NH USA, 1981

PUBLISHED BY

YANKEE PERMACULTURE

Publisher and Distributor of Permaculture Publications

P.O. Box 52, Sparr FL 32192-0052 USA

YankeePerm@aol.com

<http://barkingfrogspc.tripod.com/frames.html>

or

<http://www.permaculture.net/~EPTA/Hemenway.htm>

This space is reserved for art by a volunteer artist or a suitable public domain illustration. Please send us your suggestions.

The Permaculture Community

1

I grew up in a little village in which there were no rich people, nor any poor. You had no fear of starving, nor any hope of becoming rich. We were all on one social level. If you were without something, you never had to worry about whether you would eat or not. My family members were the bakers there. We just supplied bread at no charge to people who couldn't buy bread. That sort of thing went on all the time. Then money started to accumulate, and we got a totally detached class of people.

There are plenty of resources in the world for everybody. There is land, food -- everything. The fact that some of the people are trying to accumulate these resources is the reason for the problems we have today. This centralization of resources has extended to the centralization of energy, which is causing our acid rain; and the centralized control of transport, which has resulted in our freeways.

We are attempting to provide opportunities for people to come out of this system.

What went wrong with the whole alternative movement was that it didn't offer an alternative. I have spoken to many persons who have said, "I wish I could do what you are doing. Can you employ me?"

I would have to say, "No, I can't, because what I am in isn't employment."

Increasingly, though, I have been able to say, "While I cannot employ you, I can give you a job in which you can earn your way, and you can leave your present job right now." We have been able to do that lately.

So we provide an alternative. But I know of few cases where the alternative isn't struggling just to look after itself. In most cases, it is not even feeding itself. Our action, if it is vigorous, completely changes that.

We ask, "What is your present employment?"

He answers, "I'm in this travel agency."

"Great! You can earn your money with us as a travel agent."

You might also earn your money with us as an accountant, or something else. We are now able to offer more opportunities of that sort.

In Tagari, we are not becoming our town's employer. Instead, we are changing our status from that of employee to that of a sharer in enterpris-

es. What we are up to is providing the alternative for the person who would rather work with a jolly mob of people, laughing and giggling and packaging seed, and who know what they are up to, and who they are dealing with, and where the money goes.

Outside of what we are doing we haven't seen any great signs of an alternative appearing. Yet it is going to have to. I think the whole situation is ready for it. We just haven't thought of half the things we can do yet. Tagari handles a minute amount of enterprises because they are a minute community.

Most of the cities in Australia now have Permaculture associations. We have set up city farms. We get gifts of land into the Institute and transfer it to people within the cities, and so on. Many of those Permaculture people are heavily involved in work in the cities. On one hand, they are consultants; and on the other hand they participate in structuring the local social milieu. Some of them are working hard in the center of the town, and they won't come out.

So we want to support these people.

Anyone can begin a travel agency. Somebody right here can earn a living locally doing all that booking, and it would be very handy. Our consultants must do a lot of flying. How many are you flying to China? Twenty. What is it going to cost them in fares? Twenty people at \$2,000 is how much? The normal agency fee is about 15%. \$6,000 just to book their flight. To whom do we want to give that money? Give it to somebody who belongs to this group of people, where all the profit is not just going to the top, and never coming out anywhere in rural areas.

That is just an example of the hundreds of trips we must make. We are leaving here for directions north, south, east and west. Other people are coming here and leaving here. So we need a travel agent. But that is not a full time job. That keeps one of the people here digging the garden most of the time, and occasionally being a travel agent. What would you pay someone to take over the digging of your garden? \$7 an hour? As a travel agent, you may book for anyone, of course. Then, if the business grows, you can pay two gardeners and a travel agent.

Everything we have done, we did the hard

The Permaculture Community

2

way. We had to study to become a travel agent. Now if we had known a travel agent, we could have operated as a local office. But we didn't. We had to learn how to become a travel agent. If we had known a real estate agent, we could have opened a local office.

The real estate business, as a function of Permaculture, doesn't necessarily give us any additional ownership of land. But it gives us a measure of control over what happens across a lot of land. That is what we want to achieve.

I would like people in America to take greater advantage of this real estate business. Somewhere in the consultancy may be -- there often is -- a qualified real estate person, or a person who might know someone who is qualified, whom they can appoint as an agent. Then you could operate Permaculture real estate branch offices.

It was two years before we could start to become real estate agents. Now we have found six real estate agents who are living as hippies. So we can get one straight away. They had become sick of the business -- just selling graziers more land. So they got out and went to live in the bush. But they still qualify as real estate agents. Real estate agents can also manage properties, earning management fees, getting paid perhaps \$1,000 or \$2,000 a year just to manage the hiring, and to oversee the property. They don't take any risk. They just do the leasing and management of the properties. A local real estate agent can spend the most of his time digging the garden, and occasionally driving down the road just to see that nobody is bulldozing up the trees, and that people are pruning the orchards on time, and so on. There is quite a range of employment opportunity here.

We are going to need someone right here to manufacture Yeoman's plow. What you do is put the components out to three small manufacturers. Somebody makes the shoe, and somebody else makes the shank. A couple of kids who have nothing else to do, an unemployed group, makes the frame, and they do ten at a time. If they can make the shanks, good. Our manufacturer then bolts the parts together, and we order the plows from him. He prints up a little brochure on the plow, and appoints distributors. That is all there is to it.

Our designers become the distributors. All they need to carry about is these little brochures that they hand out to their clients. Whenever a plow is wanted, one is broken down and packaged through to the client.

If you get smart, you might do all the manufacturing of it yourself. If you don't want to make shoes and discs and things out of special steel, you contract that part out. You might care to send out a card just to see if anyone wants to pre-order such a plow. If you get ten pre-orders, then you contract parts for ten. I point out that everything we do can be started without any capital, or with very little capital.

How do you open a publishing business? You issue cards soliciting pre-orders, and you get your money in. You then spend all the money you get for pre-orders on printing. Remember that what you get for pre-orders is the retail price. So for every book you sell on pre-order, you will be able to print additional copies. What you have then is an additional supply of books, all yours, all paid for, after authors, editors, etc., get their percentage.

Our business is to teach people self-sufficiency. We do not handle anything that doesn't promote self-reliance. I don't see any necessity for any of our people to be running around looking for money. There is more money than we can handle right in these systems, if we manage them ourselves. But if we leave the management to others, there is none in it. In Australia, we have been able to distribute Permaculture Two through our own people. That is what we want to do.

Now what about seed and seed companies? Let me tell you about the Self-Reliance Seed Company [now replaced by Phoenix Seed Co.-Ed.]. It deals only in open-pollinated seeds. It deals only in varieties from which people can save their own seed. It will collect seed from anywhere in the world. If we ever set up a seed farm in Australia, we could get sprayed. So we must never set up a large seed farm. We break it up. What we want is for everybody here to say what seed they will grow, and what seed they will collect. What we are proposing to do is to print Self-reliance Seed Company envelopes to be issued with a rubber stamp that says, for example,

The Permaculture Community

3

Queen Anne's Lace. The grower requests 200 envelopes, and is sent the stamp and envelopes. The grower then collects the seed, fills the envelopes, and stamps them Queen Anne's Lace; and he receives what amounts to the price before retail. In this way the money returns to the grower, to the person who goes into the forest and collects the seed of the red oak. Nobody else gets a large margin. This person gets the grower's margin and the packager's margin.

You will need a seed cataloger, who is really a publisher. It is normal for seed companies to list three packet sizes. You want a good handful of seed for a person who has a big garden. For the urban gardener, you want 10 carefully selected seeds -- 10 zucchini, for example -- for the urban gardener wants only 10 seeds.

We are not putting other good seed companies out of business. What we want is our seed. We want pea tree seed; we want all the Chinese seeds, the medicinal herbs. In our catalog, we list those open-pollinated seed companies, such as Johnny's Selected Seeds and Kent Whealy's Seed Savers Exchange. Our catalog advertises their wares, free of charge. If they would list ours, that would be good, too. Then we might agree to break into different sections of the market. The seed that we want is Permaculture Seed.

Every seed company that ever starts has to buy seed to begin. So in the back of the catalog, you ask for growers to supply seed. You get into a garden movement, thereby involving many small growers. With very short-lived seeds, you give the collector's address, and the dates under which he will directly mail.

The other thing that can come out of this is seed exchanges, which are free. The only person who makes any money out of the seed exchange is the cataloger, who makes a charge for printing it up.

In the front of the catalog is a listing of the seed for sale, and in the back, is the Permaculture seed available as exchange. You only want one seed catalog for the United States. That really is a national job. I will tell you who wants to do packaging too -- that is the Watts' Self-Help Group.

The Institute can get free seed from anywhere in the world, but these seeds cannot be sold.

They can only be given to a grower for the purpose of starting his own supply. Then he can sell the seed from what he grows

Every seed we sell has instructions on how to save your own seed. We are selling self-reliance. What I hope will happen is that the seed exchange path will expand and expand, and that the selling aspect will reduce and reduce. There will always be a few people who want to buy their seed. I would hope that the amount we are putting out to the growers will reduce and reduce, so that eventually every plant wanted will be grown locally in the United States and elsewhere.

What we really want to do is to build up everywhere the important species for Permaculture, because there are many varieties we cannot get anywhere now. This catalog will list all the plants we ever want. These plants will be listed under Bee Forages, Chicken Forages, Cattle Forages, Deer Forages, Fireproof Plants, etc., and listed by zone.

You ask for a feed-back from the people getting the seed. If something is unsatisfactory, you inform the grower about what has happened. You just normally refund the full price of the packet, if it is unsatisfactory, and inform your grower. If your grower is a responsible person, he will refund you. If not, find another grower.

You know Thompson and Morgan Seed Company? They have about the largest seed catalog. Do you know what they operate out of? You say, probably a square block area? That's what I thought! They occupy a house smaller than any house around here, just a little old house, and little old ladies with spectacles are there in a tiny room. You can't get in there because there is just room for the lady and the chair. This place is beside the Essex Road, just out of London. I didn't believe it! I drove past it five times. I knew I was dealing with the world's largest international seed company, and I drove past it and parked, and eventually went to this little house to ask where it was, and that was it! There were bags of seeds in the porch, little old ladies everywhere. Children, during their school holidays were hired. That is (or was) the Thompson and Morgan Seed Company.

Because we are the middle class, people who have our wits about us, and who are well educat-

The Permaculture Community

4

ed, we have to initiate things and take action. Then we pass it off.

While perhaps we can't give you \$2,000 very often, we will give you the ability to earn a quarter of a million dollars fairly often. Then when you get too much action, you pass it off. You pass it off, because you see further places to go.

We decided as a policy, we would never give money away. Instead, we give enablements away. We will fund a college to teach an aboriginal gardener. We will not give the aborigines money. We will give orange trees to aborigines; we won't give them the money to buy orange trees. We give fishhooks, not fish. That is critically important. It is giving people self-reliance.

If you have someone who wants to start a Permaculture nursery, you can get the standard design on the nursery from us. Then you can build a standard for America. The nursery should be functional. The plants in the Permaculture section of the nursery should be placed in functional groups.

If you are setting up an aquaculture nursery, put a few tanks around your yard. If you throw the whole lot in the pond, you come out with one dominant species. So in the nursery, it is best to use stock ponds. On all the plants we sell, we indicate which is rampant, and how to deal with it.

Now what sort of hardware, and what sort of rights should we be looking for? We want good retrofit materials. So we are interested in glass, in ducting, in squirrel cage fans, and automatic opening vents, sealants, insulation. Look through the solar catalog. Pick out things that you think might be critically important in what we are doing and recommending to clients. Then go to the manufacturer and say, "Can I get distribution? would like distribution, prefer manufacture, but will be happy with retail."

Another sort of hardware that interests us is small processing hardware. Here is the big missing category. You can buy anything to produce anything you want, buy any little chipper, plow, seeder, bagger, but you can't find processing hardware. We want pressers, oil seed extractors, juicers, stills, dryers, all those things that are the real bases of self-sufficiency on a small site. Keep your eye out for things in this category.

In India, there are very good oil presses being

produced by a manufacturer who may own the rights to it. He just might be overjoyed if you would walk into his shop and say, "Send us three of these and give us the American rights." You would then find a casting firm, perhaps in the alternative. Then you would contract out the screws and things for turning to repetition engineers. Finally, you would assemble it and get it on the market here.

Then there are little things, little bits of handy gear like a twigger, which is a bit of bent wire. You can give the manufacturing of this to a small group in an urban center. What they have to do is keep cutting the wire off and bending it. It is very handy. Our Sheltered Workshops in Tasmania make it. You can make the first twigger. Make it work, then hand the twigger over to a little group as their item. We invented it and gave it to a shelter group. They were perfectly capable of doing that so there are little things like that which we call hand off. They can be listed in the back of the seed catalog.

Another thing we need is a good bench still, made up of ordinary glass -- pitted glass will do. We also need a field still that can be carried into a field and set up for the crude distillation of perhaps a ton of material, which will allow you to distill mint oils.

A husker-grinder is another essential item. I have never seen a really good one except the Ripple Flow. All these that we have are either very slow, heat-generating, or high-energy things. If Permaculture obtains the rights to the manufacture of the husker-grinder, we've gotten it for all of us. That's the important thing. We can start to manufacture it right away, everywhere, on a local basis.

Now the whole idea of this is that you don't produce something for export to India or to Australia. In every case, we make it our policy to manufacture within range of the users. Well-off clients should be encouraged to put in a facility for the district. There is no point in having 5,000 husking systems all going parallel to each other. There is no point in having Geoff Wallace's plow on every farm. It should be on hire for the district, because a person only wants it for half an hour, sometimes two hours.

We need grain cleaners, seed cleaners, both

The Permaculture Community

5

for threshing and cleaning. This is an item someone may need to reinvent.

Let's look at something else now. We went to Toyota and said, "We have 51 consultants in the field. We own 17 Toyotas. What kind of deal will you give us if we register these as a fleet, and then everybody transfers to Toyotas?" Toyota has a range of vehicles, and they run well under rough conditions. We also have a design engineering group capable of making things for those Toyotas that cut the petrol consumption, or other attachments that take alcohol-gas, or they can make anything you wish. Toyota offered us 15% off the list price. Then we went to the taxation people and they told us that the Institute didn't have to pay sales tax.

There is no hope we can set up a vehicle manufacturing plant. What we can do is set up an arrangement with a present manufacturer and start to replace the bits until we have replaced most of the parts we are interested in. We do the same things with a tractor, so that our tractors will not break down. For a client who is starting with grassland and wants to progress to forest, a small eight to 20 horse-power tractor is a useful tool. He can run over the grassland, making dumps where he is putting his trees, and working the grassland, building up rapidly to really rich tree soils.

So what you need is a hardware assessment and selection group to run the whole of that business. You are going to have a lot of designers in this country. These groups who go into the manufacturing and supplying of these items have a really wonderful opportunity for marketing something absolutely specific to the requirements of Permaculture. Tanks are another hardware item that seems to be lacking here in America. The most useful size is quite shallow. It is 15 to 18 inches deep, and four to six feet in diameter, reachable to the center. That size tank is extraordinarily useful. You can produce a condition suitable for bulb growing by just laying an inch of water over it, saturating the soil. You can set up a pond with six or twelve inches of soil. These tanks are constructed of precast concrete, which is the best material for this purpose. They do not need a drain hole. Once they are full of water, you can't move them. They will then weigh may-

be a thousand pounds. They are made easily from a mold. This would be a good product for a group of people to make. They are excellent as stock tanks -- for watering stock, small stock, or poultry. They can be ramped up for small stock. Catfish would grow in them, and tadpoles and little fish. If I were setting up an aquaculture nursery, I would set it up with 40 or 50 of these.

We have, among Tagari members, a split. We have a group of Luddites. Ludd was the leader of a group of men who went out with sledge hammers and broke up machinery. There are people in our group who have an instinctive distaste for computers. We have other people in our group who see a tremendous benefit in having computers. There is a package now you can get for \$300 that fits on your Apple computer. It is coupled with the ham idea. It requires a ham radio's license. Anywhere on the face of the globe these little units listen for each other. Any one of these can talk to any one of the others, or automatically shunt. If you want to talk to anybody, to ask a question, or make a transfer through deal or barter, you put the data into the computer and press a button and it goes out to this one which catches it and stores it. There need be no one at home. If you are there, it can handle your answers within two seconds. If you are not at home, it stores the information until you put the answer in, and then it goes back. This operates across Canada now.

If you want a bee plant list from the stored information, the list comes back, and the computer records the name of the person who asked for it. An automatic account comes up in their name. There is a charge for the service only. There is no paper work involved, no lists being mailed.

As an example, say that Bruce has agreed to handle the lists and has an Apple computer and one of these devices. You can phone in your order to the local person who also has this device, and you say, "Give me a bee list for an alkaline hillside facing south in Timbuktu." This person puts it through to Bruce's computer. You are identified as to who you are, and Bruce's computer sends the information back. The local person whom you contacted says, "Here it is." That should be within two seconds, because what you are asking for is stored. You have your list, and

The Permaculture Community

6

alongside your name in Bruce's computer comes up the fact that you have sent for that list. Therefore you are charged \$4. The charge comes back on your list, so you know what you owe. This is a very good way to trade and barter.

I had a message one night. I said, "Get your tape recorder." They got a tape recorder out and I gave them the whole story on seed patenting legislation in Australia and the way it was being edged in without anybody knowing. They relayed this tape to every state. It was also relayed to a group whose job is quick tape copying. They can do it in seconds. Then this group started mailing this information to all organic gardening groups, and we had Australia alerted the next morning. Thousands of notes were pouring in to politicians. We've that sort of organizational level in Australia, and have had for a long time.

We also have local radio programs that run regularly -- Permaculture half-hour programs -- and they are commonly reaching six to 12 million people weekly.

We are feared and respected, because we can bring the local government down, the state government. And we are prepared to do so. We jammed the parliamentary switchboard into Tasmania Parliament for a week, and they convened at midnight and changed legislation and got it out to us through radio because they couldn't get in or out by way of the lines to the Parliament house. It was for the purpose of stopping an evil substance from being sprayed over the farmlands from the air.

So what I'm telling you is if you do cooperate and stop chopping up the whole system into little bunches of people, which is a big feature of the American alternative, if you do speak with one voice, brother, you are a loud voice.

We have a Permaculture association that operates on a weekly schedule, linking up with six key points across the whole nation. You ring in to one of these key points if you have a message that you want to go out to the whole nation. We contact central, which sends the message out to all six key points, and all these key points have local dissemination groups. This is absolutely easy. It takes a person willing to spend one evening a week sitting in at the telephone and ringing all six points. He can jack them into each oth-

er. He rings and asks if there is anything you want to say to everybody that's that important, and you generally say, "Not tonight."

"OK. We have a message coming in for you...." The whole thing is dealt with within two hours. You don't use it for chatting.

Now you might have an important national message to go out, and you say, "Yes, to all stations this message ..." And that can go on tape and go out to all stations. In addition, our fast tape copying service group, called the Down to Earth Association will fast tape copy the message and send it to all members, who then get it to the local programs on all radio stations, and so it goes out to the man in the street that evening.

The specialty of the Down to Earth Association is working with media. Their tapes go to all sorts of people on both sides of the media -- on the government side of the media, and on the private side -- and these messages go out in their programs. They say, "We just got an interesting tape in which you might care to hear..." and it goes out to all the people in Melbourne. A lot of people tune into that station. It is Public Access. We have other people within such services and they can do other linking-calls.

The people who are voluntarily performing these services have to be persuaded. They have to be people like ourselves, who believe that what we are doing is ethical and good.

If we think something dangerous is going to happen, we have state emergency services. When that spray was coming, I rang the State Emergency Service and said, "I want you to put out a call for all pregnant women, all farms with animals, to stay indoors tomorrow."

They said, "Why?"

I said, "Here is why ... So you get all animals under cover over the whole state and all pregnant women under cover across whole state."

The State Emergency Service went into action. They cannot refuse to tell a population of a present danger. You do that a few times, and it becomes very embarrassing. Either they have to refuse to act, which is illegal; or if they act, it is very embarrassing. Those messages have to go out. These are tactics we have successfully used to shift whole national and state policy.

So we don't let something like seed legislation

The Permaculture Community

7

die. There are fighting groups set up in all Permaculture associations. Independently of the Permaculture association, as a result of the radio broadcasts, other people have set up fighting groups against these legislations.

Then we set up the act of defiance, the Self-Reliance Seed Company. Don't let it die. They give in, because it is too embarrassing, too public, too much voice, too much action against them. There is no use giving them information. That's just news. You give them the action basis.

Now you people here in this country are a set of individuals who are perfectly capable of operating in your own way. So I expect that you will get on with your jobs. That Bill Mollison happens to be anywhere doesn't matter. If he gets run over or drops out of sight in London, it is just another person. I don't want to be personally in charge of anything here. I would very much like you to adopt the attitude that you are forming a university of minds, a companionship; and I don't want any stratification happening in this network. That's what I want to say. Be sure to give people jobs, and be sure those jobs do not stratify. Our system will be superseded if it succeeds. It can go wrong if it succeeds, too. If that happens, other people will come and attack it and say they will be glad when we get out of it.

It looks as though what we are trying to do has to be done. I think it is awfully important. I can see in my life there is nothing else worth doing. I think it's life or death, and I'm hitting hard on the life side, if I can. That may be a hard decision for you to make, because it doesn't give you much. And I don't expect all of you to make that decision. But some of you may. The main thing we have to do is to get people within their own home country competent on their own ground, with a lot of support systems, right where they are.

Permaculture associations are spreading right into center of research and other establishments, and who knows what funnels out? There are Permaculture Associations all over Australia, and we didn't set more than about half of them up. They share species. They visit each other's places. They share housework cooperatives. Some of them who live in the city of Perth have identified every large useful tree in that city, found a fantastic resource of Permaculture value, found

things we didn't even know existed, such as dragon's blood trees and South African wild plums. They will conduct anyone on a tour of the city to show them those trees, so people can see what they look like. They collect seed from these trees. They have a free seed exchange between themselves. They are powerhouses. Some of these groups number over 200 people in quite small districts. Often from the ranks of those associations come the next designers. They carry out a fantastic number of functions; you can pass off an enormous amount of work to those people. One group produces the *Permaculture Quarterly*, and how they do it, I don't know. [*This has since failed. Ed.*] It is a very big job they are doing.

There are more than 30 associations sending newsletters in, and some of them have meetings that as many as 200 people commonly attend.

The Permaculture association has taken over some really downtrodden sheep country, and they have moved in on it with thousands of seeds. God only knows what they are doing.

Housework cooperatives have begun within one of the associations. Seven women with small children -- and some who went through that nearly went crazy on their own -- meet on Saturdays, and they absolutely bang, bang the house. They clean it from top to bottom. Then they go out and do the same with the garden. They do this on each person's place with small children. Now they find they have very little to do. It gives people with small children a slight break in complete madness.

You know, when you have three little kids you can never get that housework done, and it drives you crazy looking at it. They also do the same for people newly moved into the district. They go, the whole group -- there may be a hundred of them turn up -- and they just say, "What do you want done?" And they do it. They bring trailers and trucks and tractors, and clean up all the old cars, take them to the dump, stack the wood, make the place look good. Then they have a big party. All that is going on happily in the world.

So what we are trying to do is get a lot of nice people together. If somebody is not nice, you drop them out of a cooperative net. Really, in some ways, I wouldn't like to cross some of the

The Permaculture Community

8

Permaculture people, because some of the 70 toughest gangs in Watts cooperate with us.

Did I ever tell you about Watts? As the last thing, just before we close this section, let me tell you about Watts.

When I was in California talking to the Tree People, a reporter came in, a woman to interview me. She sounded scared about tomorrow. So I asked, "What are you going to be doing?"

She said, "I am going to interview a remarkable person down in Watts." I had heard of Watts she said, "I'm really scared about how I am going, to get in there, but, you know, I've got to go."

I said, "I'll go down with you. I don't mind."

And she said, "Oh, great! great! great!"

I said, "I'll throw myself in front of you and you can run, you know."

So down we went. It was about as we thought. There were a lot of gentlemen about, and ladies about, and it was a pretty tough looking place. We walked through something that made you feel as if you were coming past the executioner. It was like a place in London, a jewelry place where you go to sell a smuggled jewel, and you just pass a lot of heavies lying about with bulging pockets. They opened several doors, and little things opening and closing. As you are led in, your escape is cut off. Sitting in this place is a man called Barney Mull. He is a big Watts fellow. There he sits -- Barney. He said, "Come in!" All around the wall there are people who are wiping the skin from scars, holes in them, and big heavy pockets.

We got in there. We asked what this was?

He said he was a Bahai and that he had been a debt collector in Watts with a group of heavies, collecting rents from the people of Watts. That meant he had a group of agents under his control. He was collecting rentals, sometimes for churches and places that owned property in Watts. Then his family broke up, and he became an alcoholic. He lost his wife. When he became an alcoholic he became suicidal. He thought the best way to die was to walk into Watts, because he would surely die.

But while he was in the hospital as an alcoholic, a black doctor came and said to him, "Man, I got news for you, you get out of here or you are dead. If you come here and stay in as an alcohol-

ic, you are dead." And he said, "I'm going to get you out tonight." This black doctor got him out and sent him away, because he knew that where he was nearly all alcoholics died.

So he went down to Watts. He thought he would die in Watts, because what he had done in Watts preyed on his conscience. So he went down to Watts and he lay down in a little thing still there, a little porch in front of a square building that was deserted, locked, and nailed up, and the porch measurement was about five feet by eight. He lay in there for eight years drinking wine, and never getting out except to go across to the pub get more wine on his relief check and come back with his wine and drink. So he didn't buy any food.

But he didn't starve, because all the little children going around Watts, little toughies, many of them in gangs of five and that, used to break their sandwiches in half and feed him, sit down and give him bottles of pop, and give him an apple occasionally. The children of Watts fed him for eight years. So, while he was in terrible condition physically, he was still alive at the end of eight years.

One day he decided to stand up. He got up and stopped these little kids and he said, "Listen! I owe you my life! Now life means nothing to me," he says, "My life is yours, I give you my life. You gave me my life. It's yours." He said, "I will never take any risks with it; I'll never get married to anybody -- nothing. I belong to you, to you -- see?"

These were tough little mobs. I mean they control the streets And when the mob is full, My God, they're armed! So he said, "We are going to do something. What's wrong here?"

And they said, "Well, we haven't any money; we got nothin' to do."

So he got this little mob, and they took him over, and in effect elected him boss. The porch was his office for the next couple of years. He started the Watts Self-Help Group.

So then he sits down with his mob, and they decide to go take over the next street. This is a tough proposition. Gang war. He worked out a strategy, which he still uses. He fitted them out with different colored baseball caps and things so everybody can see each other and know exactly where they are in the district. They drive in

The Permaculture Community

9

fast in a green van, so they are right in the middle of the next gang's territory. They pile out. The war chiefs, the four of them in the yellow hats, go and stand with their back to a corner, looking at each other so everybody's back is covered all the way.

So he has a scouting team out. Then he sends out some little green hats, and the little green hats start walking down the street. Barney and some other heavies come around this way. Sure enough, the gang pounces and surrounds these little green-hatted kids. They got 'em. And at that point the yellow hats see where the action is, and they point in that direction so all the rest knows where it is, and they start to walk down this side of them. Barney is coming up the other side, and the little green hats are surrounded. Two lots of heavies are standing around the gang. Finally Barney said to them -- you see, everybody was standing there like this, and everybody's pockets were full of pistols, knives, shotguns -- he says, "OK, you're dead!" He says, "You're dead! We got'cha. You're dead." He said, "We came here to kill ya, and we're going to kill ya." And the little kids, stiff like this, 'cause they know they got guns in their backs and guns in front of them, guns on the other side, and they are out-manuevered. They recognized some of the yellow hat boys, 'cause they might be Chino, you know -- the real killers in the next block, or they might be from this site. So they start walking like this -- got to be as macho as they can.

So they all start walking up and down like this. And the gang chief walks up and down too, you see. So they come to a deal. He's going to send his top man in at night and they are going to negotiate a deal, because they are dead, and their lives are ours. We've killed 'em.

Slowly, Barney has taken over 70 gangs that run the whole bloody district, run the employment and they run the gardens. If you want war, we got war.

So this is the Watts Self-Help Group. You have never been amongst a more hellion movement in all your life.

Barney and I are going to meet them. We are going to sit in a whitewashed room with four windows and people in arms. Everything in view,

hands on the table. When the new gang chief comes in, he comes in with a shotgun and the darkness all around. He has his heavies behind him, and they got people across the street in cars. They check out every corner of that room to see that nobody is laying an ambush. And they throw all their scouts out to see they are not ambushed. They come in to start dealing. Or, they could open fire through the windows and kill us. That's their choice.

So they start dealing, and they go on dealing. You know, you're going to treat these people fairly. Fairness and openness are all they understand. And minding the boss on the line is all they understand, because they are getting shot every night. Maybe 46 cops go out just to wipe out seven of them. They got their knives when they go out, and they go out together with shotguns. The cops have determined this seven has to die tonight. So they are at war all the time. That's in Watts, in Los Angeles.

Want to come and help us? You already got to be dead before that, you see.

Oh, the newspaper reporter? Yes, she interviewed him and left, and Barney and I went on. And I took him out and introduced him to some Mexican groups whom I met independently -- they were walking up and down the street.

So, Barney doesn't drink any more, doesn't touch drink.

The firms around there have given him thousands of dollars. He counts it and then returns nearly all of it, and he has gone from 15% self-finance to 85% self-finance. He's gotten accountants working for him. All the firms would give him all their money to hold for them, because they can't operate unless they have money.

Did I see Watts tower?

Yea, but I was looking at a little porch near Watts tower, more than at Watts tower. I was looking at an area that was already taken over; I was looking at a lot of little gardens and green things.

Barney is dead. He was shot not long after I left there. But he had counted himself dead years before, and we must all count our-selves dead before we tackle real risks.