

THE FLYWIRE HOUSE

A case study in design against bushfire

David Holmgren



FOREWORD

Catastrophic bushfires have been an integral part of the history of European settlement in south eastern Australia. This provided a context for the inclusion of bushfire resistant house and landscape design as one of the elements that Bill Mollison and I brought together in *Permaculture One* in 1978. That pioneering work was directly influenced by Bill Mollison's then recent personal experience of surviving the great Tasmanian bushfires of 1967, in which he saved his own (not at all fire resistant) house and then saved several more nearby houses, while many more unattended ones burnt down. Another key theme in that early work was the recognition that the nutrient rich, forests of food producing tree species and appropriate livestock that were one outcome of permaculture design, were inherently less fire hazardous and even fire retardant compared to fuel rich sclerophyll forests dominated by eucalypts or pines.

The experiences of many during the 1983 Ash Wednesday fires as well as extensive research by CSIRO and others confirmed much of this integrated bushfire resistant design as reflecting the consensus of expert opinion. *Flywire House* embodies this bridge between permaculture as radical fringe innovation on the one hand and mainstream science and public policy on the other. The influence of the permaculture vision of the fire retardant food forest is moderated in the *Flywire House* design. Like the building design itself, the landscape design reflects the more conventional sensibilities of a mainstream audience that the original design project addressed. Secondly the low fertility clay soils prone to waterlogging in winter and hardsetting in summer were not likely to support a healthy high density of diverse food producing trees that form a close canopy forest with deep enough root systems to remain healthy and fire retardant in a severe drought such as the 82-83 Victorian drought that was regarded as a one in one hundred year event.

About the time *Flywire House* was published as a book (1991), the early predictions about global warming were suggesting greater intensity and frequency of bushfires being one of the prime consequences for southern Australia. At the time these

**This publication is based on a
joint project by
David Holmgren and Maggie Fooke**

Copyright © David Holmgren,
Holmgren Design Services,
Hepburn Springs, Victoria. 3461

Published by Nascimanere Pty Ltd, 1993
Box 59, Crystal Waters Permaculture Village,
MS16 Maleny, 4552 Australia

Typesetting by Trevor Angel Desktop Publishing,
PO Box 460, Maleny Qld 4552

Printed by Peter Rosendale, Airport Printers,
Third Ave., Mudjimba, Qld. 4564

National Library of Australia
Cataloguing in publication.
ISBN 0 9589585 3 X

This book is copyright. Apart from any fair dealing for the purposes of private study, research, criticism or review, as permitted under the Copyright Act, no part may be reproduced by any process without written permission.

eBook design and production Richard Telford. www.permacultureprinciples.com

warnings seems to speak of the middle of the next century but 18 years later after a decade of drought and increasing bushfire intensity and frequency, it seems like we are already well down the slide into the climate crisis. The fires of Black Saturday (7th Feb 2009) killed nearly 200 people, destroyed thousands of homes and burnt through nearly half a million hectares of forest and farmland. The causes of and responses to this great tragedy is now the subject of a Royal Commission.

In reviewing Flywire House 26 years after the original project, I feel confident that the principles and even most of the design details of this case study are still relevant and incorporate almost all the elements of current bushfire resistant design standards. What makes Flywire House unique in the bushfire design literature is that fire resistant principles emerge almost seamlessly from the wider permaculture design framework that aims to create a system that is productive, low impact and resilient. I believe the relatively conservative approach to landscape design with separate and distinct manageable vegetation systems is more fire resistant and more healthy than attempting to create the classic permaculture food forest of high density vegetation in a climate with dry windy summer conditions on very poor soils.

That being said, the question of what one would do differently is often most prominent in the reader's mind. Two specific technical points and two more general contextual ones come to mind at this point of reflection.

There is some evidence that the ceiling spaces of houses are a great source of ember ignition and that a cathedral ceiling is more fire resistant. In view of the limited experience of Australian builders (both owners and professionals) in tightly sealed construction, the flat ceiling shown in Flywire House might not be the best.

In landscape management, there is considerable evidence that thinning of dense eucalypt regrowth forest, significantly reduces likelihood and intensity of crown fires, as well as improve future timber values and diversity of ground cover native vegetation. Thinning to retain slightly less flammable eucalypt species in a small part of the forest closest to the house is included in the design, but I think a

continuous program of forest thinning to reduce fire hazard, improve ecological and future timber values and provide a constant supply of carbon neutral fuel should be an essential element of any bush property. Ironically I remember the reason for this particular omission was more political than technical in wanting to focus attention on the house and immediate landscape design as the primary focus of bushfire resistant design and not support the tendency to blame wider nature and default to cutting down trees (if necessary, all of them).

The more contextual doubts about this particular case study, concern the example of an individual house on a steep ridge property surrounded by native forest as a place of settlement. While I feel the design is still robust for the site, we need to acknowledge two points that undercut those permaculture aims for productive, low impact and resilient design.

Landscapes that are steep, low fertility and forested (especially with eucalyptus) are inherently vulnerable in ways that cannot be fully compensated by good design (or vegetation management) as well as being difficult places to maintain access, services including water supply and grow food. In a world of climate change and energy descent, these landscapes may go back to being forested and/or grazing landscapes without the rural residential development that has developed in the last half century.

Secondly single house rural property development with small family or household numbers of people who commute for work and other activities are inherently less sustainable, productive and resilient than clustered and shared (eco village and co-housing) developments where the function of bushfire resistant design and preparedness can be supported by the economies of scale and resilience that community provides. In the face of the unfolding climate/energy/economic crisis, more than ever we need to band together and co-operate to survive and thrive in an uncertain future.

David Holmgren Melliodora February 2009

THE CASE STUDY APPROACH

This design was done for a particular property (burnt out on Ash Wednesday) in the belief that hypothetical design without reference to a real set of site conditions and constraints is not likely to be practical. Bush fire resistant design involves integration of many elements and careful weighing of risk factor. The search for a universal design which suits all sites, people and situations is obviously impossible. What is possible is well designed examples of the application of universal principles.

The design was entered in Victorian section of the "Bushfire Resistant Homes Competition" run by the building materials company Boral following the Ash Wednesday fires of 1983. To meet the criteria of the competition, the design is aimed at the project home industry and their clients. However the scope of the design goes well beyond house construction to include site selection, landscape design, water supply and management within a sustainable development framework. Permaculture principles of multiple use, function redundancy and use of passive rather than active systems have been used to integrate solar design and intensive food gardens with design against fire.

The scope, detail and presentation of the design disqualified it for the Boral competition but it was used in an information display which the Victoria Department of Planning and Environment sent around to affected areas after the fires. (None of the design solutions produced by invited architects were deemed to have satisfied the fire resistant design criteria)

Elements of the landscape and water systems design have been implemented on the case study property and earthworks have been done on the proposed site for a passive solar, earth bermed house. Unfortunately the house has not been built.

Many of the elements of the design have been incorporated into my own house and property, developed since 1986. It is the subject of a complete permaculture case study book currently in preparation.

David Holmgren, Hepburn Springs 1991



Remains of a house burnt out on Ash Wednesday – Upper Beaconsfield case study property

FIRE BEHAVIOUR

Those of us who live in the bush must come to terms with the inevitability of periodic crown fires which will burn uncontrolled. Only a fundamental change in individual and community attitudes and actions will bring about a change in this situation.

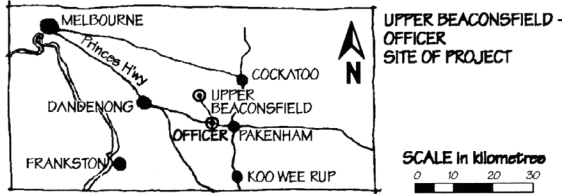

Bushfires which threaten life and property in the forested hill country around Melbourne can potentially occur any summer. The likelihood of a source (almost always human) starting a fire where fuel and weather conditions favour the development of crown fires is much lower.

However, once a crown fire occurs, fire fighting is reduced to taking advantage of improvements in weather conditions to contain the burn within accessible boundaries.

WHY ARE CROWN FIRES UNCONTROLLABLE?

A fire reaches the tree tops, or crown, via shrubs, smaller trees and low branches; it is then known as a crown fire. When enough fine plant material is together dry enough to support a fire of rapidly increasing intensity, other plants can be dried and add to the fire. With a strong, hot, dry wind any well established fire will move through forest burning all fine material from the ground to tree tops in a short time (minutes if not seconds). The rate of spread of the fire greatly increases and the radiant energy released during crown fires can exceed 40,000 kilowatts per metre of fire front. A gas fire of volatile oils may flash over tree tops ahead of the front. Turbulent gale force winds can occur in exposed positions throwing burning embers of bark, branches and leaves 100's of metres or kilometres. This intensity increases on steep ground with the fire front leaping to exposed ridges.

SEVERE FIRE RISK RESIDENTIAL LANDSCAPE IN HILLY BUSHLAND WITH ROADS ALONG RIDGES SEPARATED BY STEEP THICKLY FORESTED GULLIES

RIDGE TOPS EXPOSED TO INTENSE UPSLOPE FIRE WINDS FROM ALL DIRECTIONS

SMALL PADDOCKS OFTEN LIGHTLY GRAZED CAN CARRY A HOT FIRE INTO BUSH

HOUSES MOSTLY SITED ON MORE GENTLE SLOPES ON SADDLES & SPURS. BLOCKS 20 ACRES (8ha)

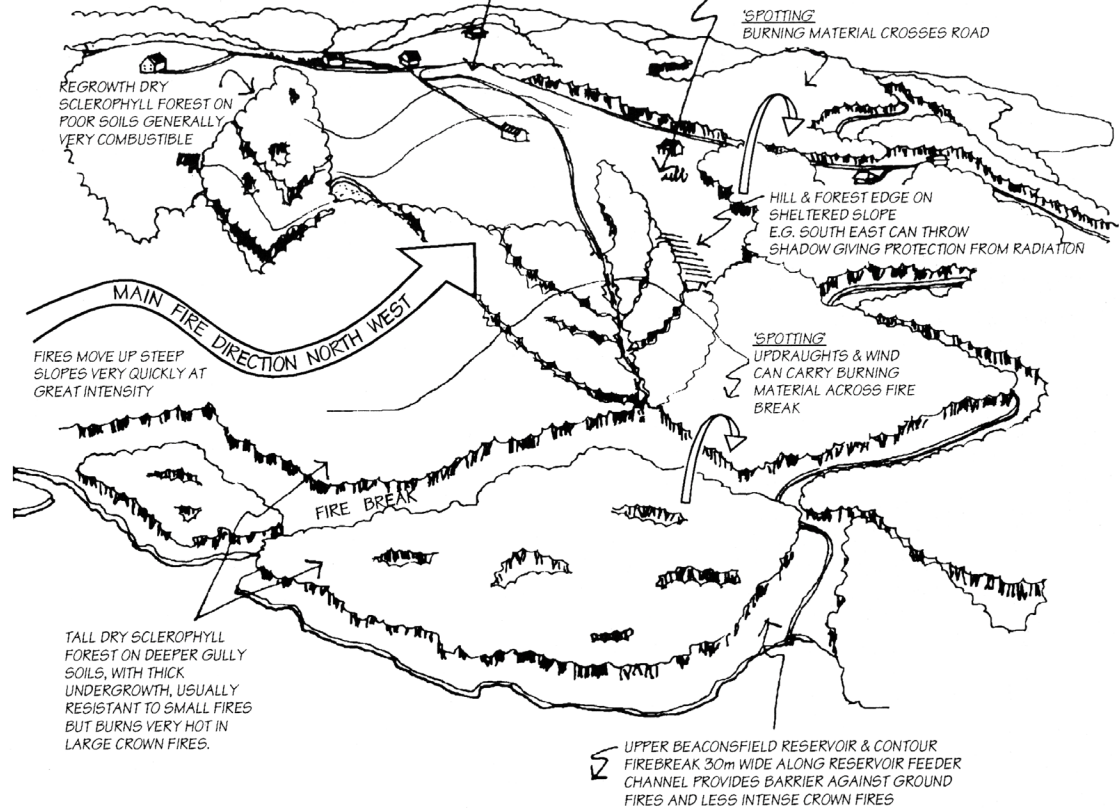

HOW A HOUSE BURNS

SOME COMMON MYTHS

* Houses explode due to pressure differences ahead of the fire front.

There is no evidence for this. Houses may appear to explode because of:

- Fire inside the building causing glass in windows to crack and fall outwards.
- The force of high velocity winds, sometimes with flying debris, causing structurally weakened houses to collapse.

* Timber houses are more likely to be destroyed than brick.

No! Well built light coloured weatherboard clad houses have better survival rates than dark coloured double brick.

* Metal structures are safer than wood in a fire.

No! Metal trusses and frames quickly lose strength when heated whereas wood remains sound until burnt through.

- Almost all houses destroyed by bushfires burn down after the passing of the fire front.
- People must assume that if widespread crown fires threaten many houses no firefighters will be available to help.
- The evacuation of residents by authorities is responsible for many houses being left to burn down and may endanger more lives than it saves.
- If a house is designed with some consideration of bushfire and if the residents have some basic action plan, the house is by far the safest place to stay.
- The best fire-designed house provides the material and psychological environment for residents to survive a severe fire storm and be in a position to extinguish any fire in or on the building after the front passes.
- Suitable maintenance by residents reinforces the efficiency of the design and provides psychological preparation and training for the day a bushfire threatens the property.

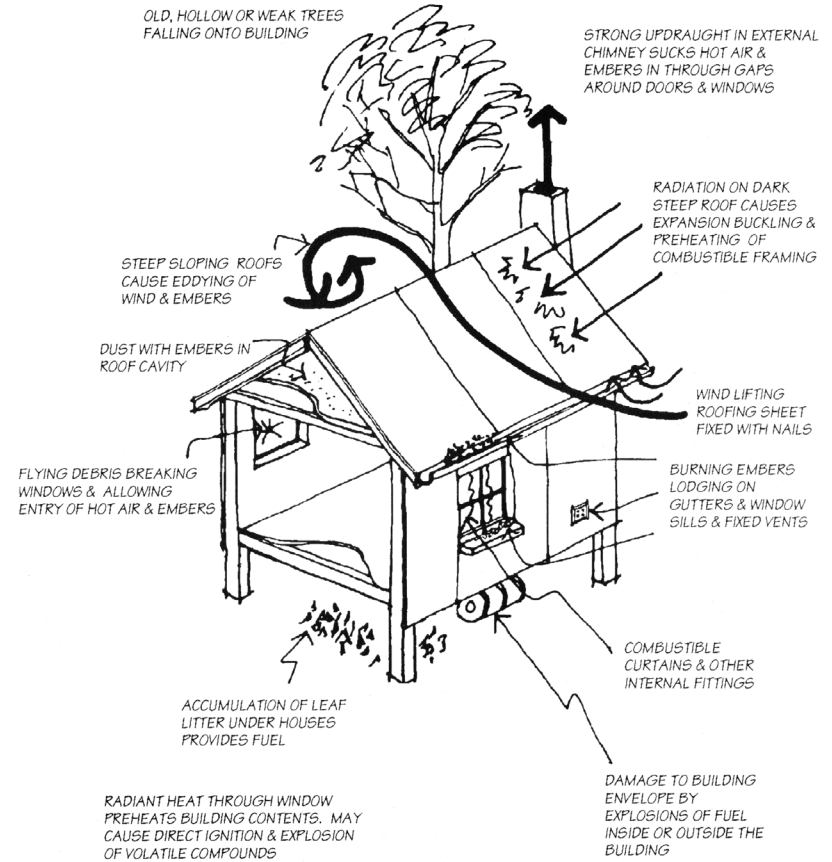

CHOOSING THE SITE

GENERAL ATTRIBUTES OF THIS PROPERTY

- + A public road that runs along the east side of the block giving access from a 'safe' side
- ++ The Upper Beaconsfield reservoir fire break, which is 50 m wide, provides four wheel-drive access along the western boundary
- + A proposed 4 million litre dam, shared with the neighbour across a common boundary; to utilise the best large water storage position with suitable clay and catchment area.
- + Rainfall 900 mm per annum
- + Excellent views
- Dry, shallow mudstone ridge soils support stunted, dry sclerophyll forest (a high fire risk forest as a result) – *Eucalyptus goniocalyx*, *E. dives*, *E. obliqua* (gullies) *E. cinerea* (most common)
- 70% of the land is steeper than 1:5
- The public road is steep, narrow, and gravelled. It is located on a high fire risk ridge with a dense fringe of native vegetation.
- Overhead powerlines are positioned along a road reserve in thick bush.
- A west facing spur running off the north-south ridge produces a very high fire risk site from all directions. It is an especially severe crown fire sector.
- The property was completely burnt on Ash Wednesday.



FIRE SECTOR

SLOPES SUITABLE FOR BUILDING

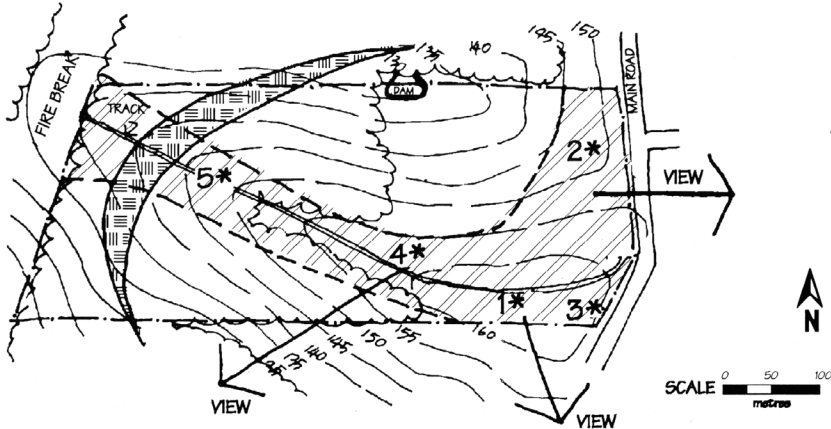

1* HILL TOP

- + EASY CONSTRUCTION (FLAT SITE)
- + GOOD PANORAMIC VIEWS
- SEVERE WIND EXPOSURE
- SEVERE FIRE EXPOSURE – ALL SIDES
- VERY SHALLOW STONY SOILS
- POOR GARDEN SITE, POOR GROWTH OF FIRE RESISTANT SPECIES
- DESPOILMENT OF SKYLINE
- HIGH HEAD FOR DIRECT PUMPING FROM DAM – NO GRAVITY FEED

3* S.E. ROAD EDGE

- + GOOD VIEWS
- + MODERATE FIRE RISK DUE TO SLIGHT SHELTER TO N.W. BUT EXPOSED TO FIRE UP PUBLIC ROAD (RECORDED ON ASH WEDNESDAY)
- + GENTLE SLOPES
- POOR SOLAR GAIN DUE TO ASPECT
- NO DOWN SLOPE FOR EFFLUENT
- POOR GARDEN, RIDGE SOILS
- CLOSE TO BOUNDARY & ROAD

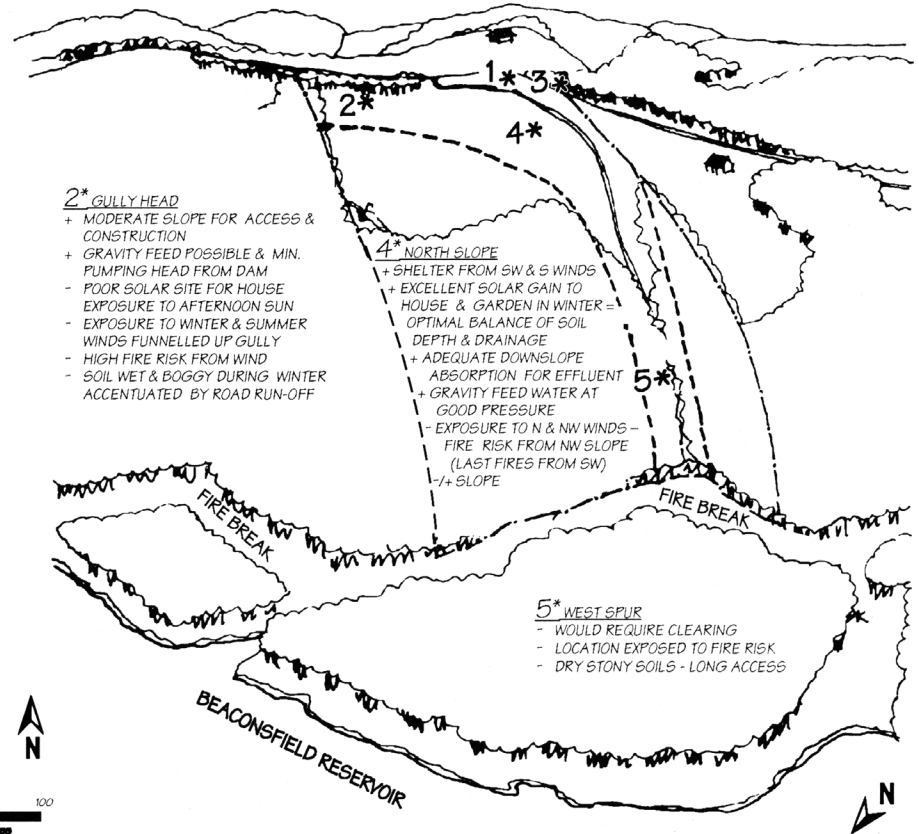

2* GULLY HEAD

- + MODERATE SLOPE FOR ACCESS & CONSTRUCTION
- + GRAVITY FEED POSSIBLE & MIN. PUMPING HEAD FROM DAM
- POOR SOLAR SITE FOR HOUSE EXPOSURE TO AFTERNOON SUN
- EXPOSURE TO WINTER & SUMMER WINDS FUNNELLED UP GULLY
- HIGH FIRE RISK FROM WIND
- SOIL WET & BOGGY DURING WINTER ACCENTUATED BY ROAD RUN-OFF

4* NORTH SLOPE

- + SHELTER FROM SW & S WINDS
- + EXCELLENT SOLAR GAIN TO HOUSE & GARDEN IN WINTER = OPTIMAL BALANCE OF SOIL DEPTH & DRAINAGE
- + ADEQUATE DOWNSLOPE ABSORPTION FOR EFFLUENT
- + GRAVITY FEED WATER AT GOOD PRESSURE
- EXPOSURE TO N & NW WINDS – FIRE RISK FROM NW SLOPE (LAST FIRES FROM SW)
- /+ SLOPE

5* WEST SPUR

- WOULD REQUIRE CLEARING
- LOCATION EXPOSED TO FIRE RISK
- DRY STONY SOILS - LONG ACCESS

SITE LAYOUT

FITTING THE HOUSE TO THE SITE

- A house constructed on a concrete slab and resting on a “bench” cut into the side of a hill, provides the best shelter from wind and fire. This form of construction is also cost effective and has the added advantage of having good thermal control characteristics.
- A long east-west axis maximises solar efficiency. The ideal building proportion (depth versus length) is 1.0 to 1.5 or more.
- By minimising the depth of the house, foundations can be positioned on the cut rather than fill portion of the excavated bench. Having a narrow bench also scars the landscape less; as it conforms more sympathetically with the surrounding hillside, and reduces vertical separation between the house and food garden. Split levels are not as appropriate to bushfire design.
- Structures such as a garage and shadehouse on the west side give the house shelter from afternoon sun.

ACCESS

- A graded gravel driveway, 5 m wide, runs on contour servicing the house and garage from the rear.
- A graded gravel low loop track, 2 m wide, provides access for firefighters and to the garden.
- No provision has been made for vehicle access from the house bench to the western side; thus avoiding the formation of a wind funnel through a break in the shelter hedge (see planting notes).
- The ridge track on a dry, well drained, natural surface provides: access to a header tank (see water notes page 8) and the dam feeder channel track; two wheel-drive access to the reservoir firebreak; a break against grass fires.
- The feeder channel provides two wheel-drive contour access to the dam and pump, and a fire break for low intensity fires including fuel reduction burns.
- Pedestrian access to the dam and pump by a path which follows the inside of a shelter hedge. The path has two gates.

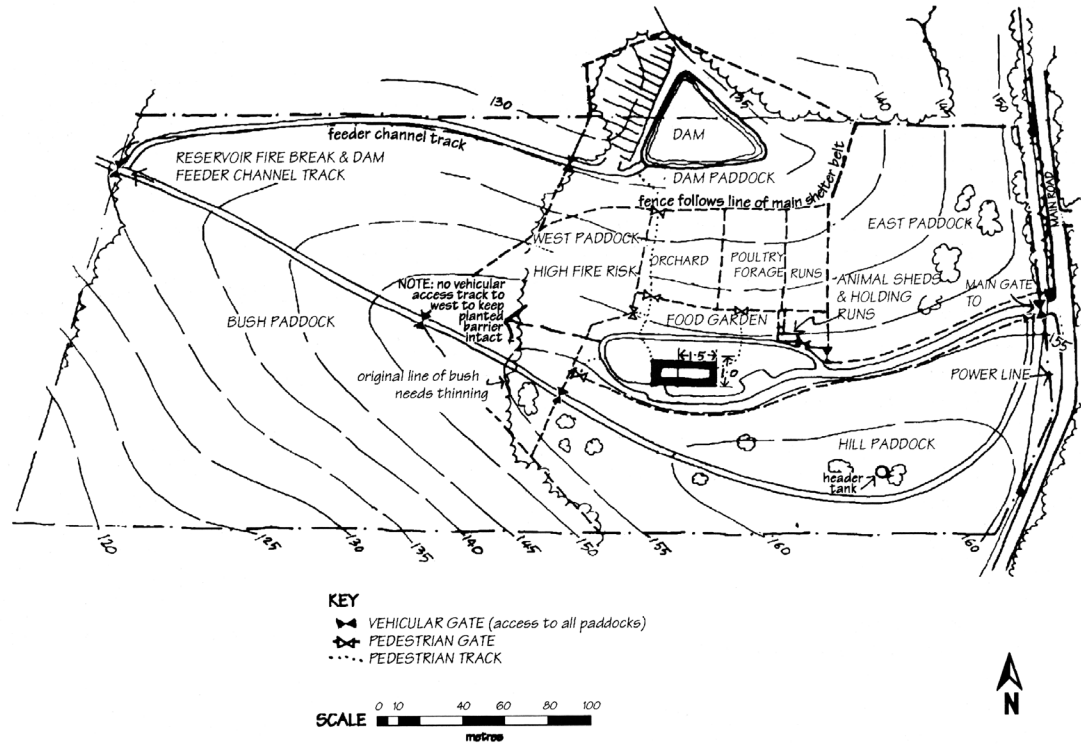

FENCING

- Steel posts are preferable to wood, and hardwood is preferable to softwood for fire resistance.
- Double fenced drive – only one gate between road and house.
- The house zone, which includes firebreak plantings and the food garden, has no dividing fences but has gates which lead directly out to all paddocks. These are accessible to both vehicles and pedestrians.

ANIMAL SHEDS

- The relatively high fire risk animal sheds and holding yard are to the east on the lower loop track (a relatively ‘safe’ bushfire risk area).

POWER LINES

- Overhead power lines are a source of bushfire and present a great danger to people during fires. The absence of trees along the access track reduces the risk. The cost of all powerlines laid underground needs to be seriously considered by the community.

BROAD SCALE PLANTING

FIRE RESISTANT SHELTER SPECIES

DESIRABLE CHARACTERISTICS.

1. Minimum fuel retention (dry leaves, twigs, bark).
2. Winter deciduous or rapidly decomposing leaf litter.
3. Foliage of low inflammability due to water content, chemical inhibitors.
4. Smooth non-flamable bark.
5. Wind fast in gale force conditions.
6. Well adapted to soil and site giving vigorous growth.
7. Dense foliage to catch burning embers and absorb radiation.

MAJOR ELEMENTS

SHELTER BELT

- A major fire/wind break approx 50 m from the house, to the north west, shelters the orchard, garden and house from summer winds by deflecting them up and over the site (wedge shaped profile).
- Allows penetration of winter sun through a deciduous canopy to the garden and orchard.
- Curved away from the house to the north east around contour to allow early morning winter sun to shine through to the house and views over the road.
- Acts as a filter strip for surface and ground water flows into the dam, provides animal forages.
- Deep rooted, fast growing trees will utilise deeper soils in addition to water and nutrients seeping through the soil from the orchard further up slope.

BUSH EDGE BELT

- This dense firebreak forms a continuation of the deciduous belt planted into the edge of parkland cleared bush in the secondary fire sector to west and south west.
- Native, evergreen drought-hardy trees and shrubs adapted to shallow ridge soils. The belt is sheltered by bush.

SOUTH WIND/FIRE BREAK

- Limited height (3 m) located on top of bank to deflect winds from the secondary fire sector to south-west, continues around access track to the north-west to prevent funnelling of north-westerly winds toward the house.
- Dense native evergreens, very drought-hardy, tolerant of stony soils, planted on a raised ridge of top soil; that also forms a surface drain for the house site.
- Ground covers planted along edge to cover bank.

NORTH WIND/FIRE BREAK

- Sunny, well drained bank.
- Limited height and width (2 m) to avoid clipping; which reduces fire resistance. Clipping increases dead wood (fuel) buildup in centre of plant and increases fire risk.
- Dense radiation shield and wind deflectors along edge of house bench.
- Continues around the play area and clothesline (1.5 m).
- Species selected for size to avoid clipping.

WOODLOT

- Timber and firewood species.
- A high fire risk shelter belt along the property boundary to the south. It widens to become a block planting in the south-east corner of the property (a low fire risk sector).



Forest burnt by crown fire on lower north-west slopes of the case study property.

BROAD SCALE PLANTING

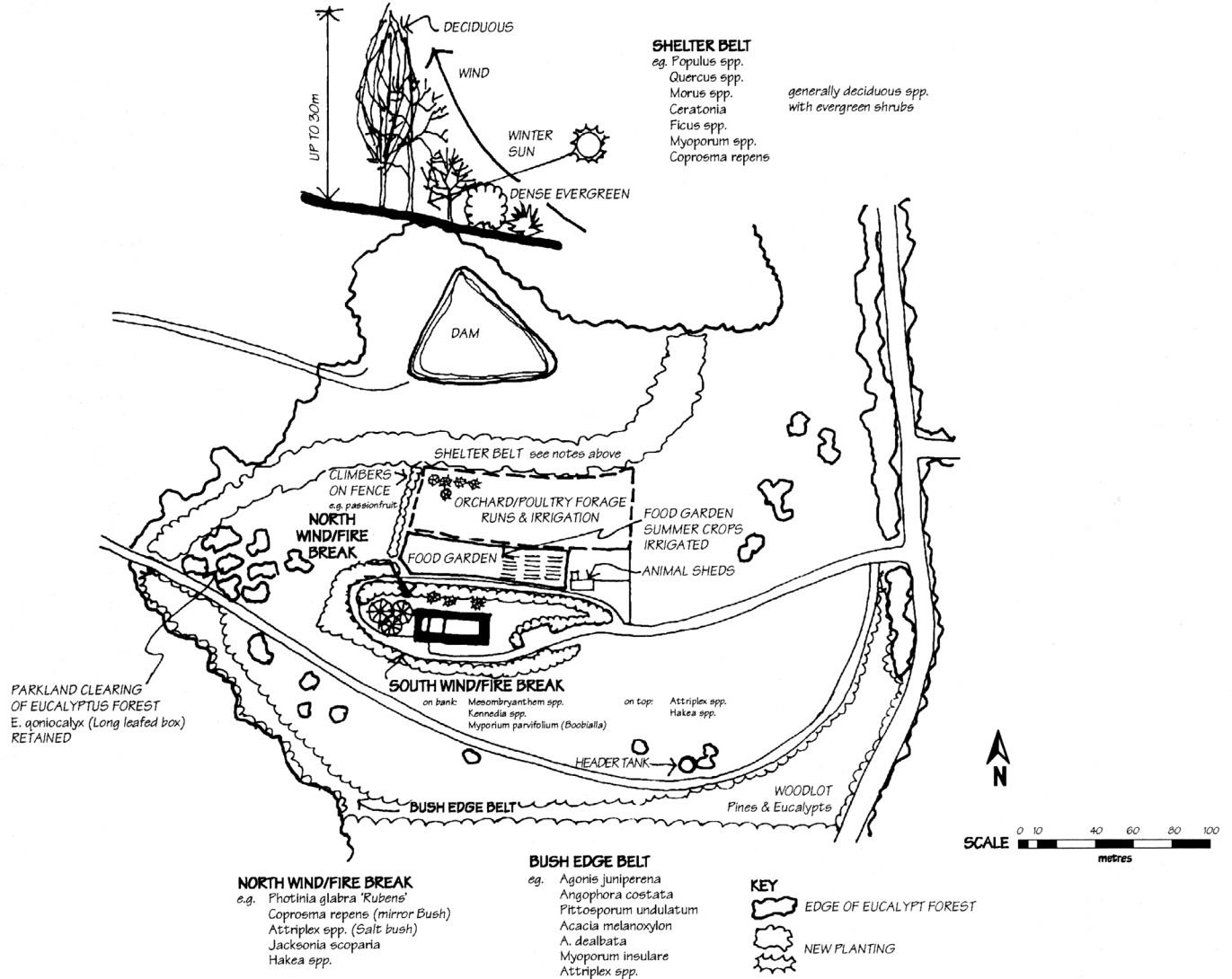

WATER & FIRE

The most important function of a water system is to provide an actively growing mantle of green through any and every summer. This is economically and technically more realistic than a 'fail-safe' system that provides huge volumes of water at high pressure during a firestorm.

ELEMENTS

- The optimum site in the storage catchment is used for a 4 million litre dam.
- A feeder channel doubles the natural catchment ensuring drought supply.
- A 10 hp diesel driven centrifugal pump.
- 50 mm polypipe line over a distance of 175 m from pump to tank.
- 22,500 l (5,000 gal.) concrete tank with an 8 m head above the house.
- Low pressure drop, Arkel disc type filter.
- 50 mm x 20 mm distribution manifold.
- 12 mm and 20 mm low pressure trickle irrigation circuits.
- 22,500 l (5,000 gal.) rainwater tank in the shadehouse.

DESIGN

- The shared dam and reliable long-life pump is affordable, unlike a self contained scheme. Pressure for firefighting or high pressure irrigation is also then available.
- The header tank provides a house and garden water supply of 14,500 l at reasonable pressure by gravity feed.
- The pump must be run every week or so in summer... inconvenient but this activity assures the pump is always in working order.
- 8,000 l held in reserve in the header tank guarantees some water under pressure for any conditions.
- By concentrating plumbing at the filter, accident risk is minimised, fault finding is assisted and any extension of the distribution system is simplified.
- The manifold and unbranched distribution lines ensure optimum flow and pressure to all outlets.
- The 20 mm threaded taps can also take a standard fire hose.
- The low pressure trickle system gives efficient watering to critical areas.
- The rainwater tank in the shadehouse provides potable water to a third tap in the kitchen and a low pressure gravity reserve of 12,500 l, available through a 50 mm threaded outlet behind the house. Visible and accessible to the fire truck driver.
- A 50 mm threaded outlet at the pump and header tank increase the flexibility of the system.
- A roof catchment of 300,000 l per annum is absorbed in a contour trench across the west paddock, providing green summer grass; which acts as a barrier to fire.
- The septic absorption trench feeds orchard trees; the effluent is well purified before reaching the dam.

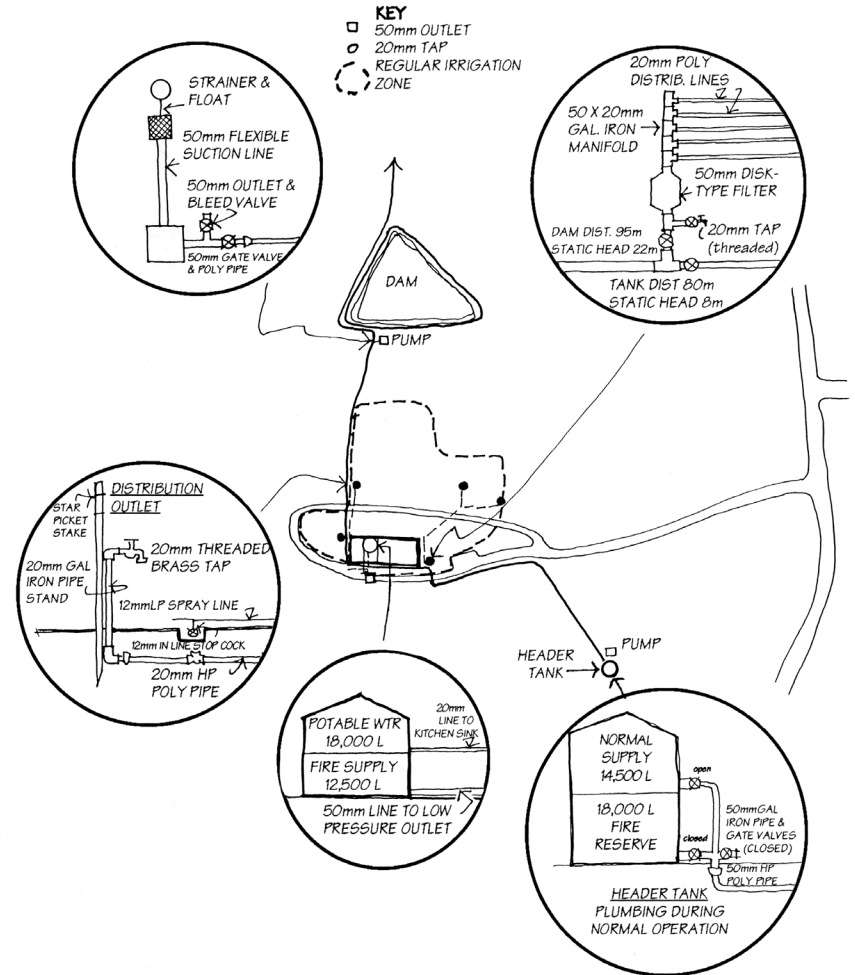

PLANTING & SERVICES

Actively growing fire resistant plants provide protection by absorbing burning debris, deflecting hot winds and throwing a radiation shadow. The radiation shadow is dramatically better than inert barriers as clouds of water vapour are given off when plants are heated.

PLANTING AROUND THE HOUSE

WEST – Large deciduous shade trees provide radiation and wind protection and continue the upward profile of shrubs. A mossy, shaded lawn is less flammable and minimises mowing.

- Trees; Oaks, Elm, Plane Trees

NORTH – High pruned medium sized deciduous trees with a frequently watered lawn below. Micro sprayer located along the firebreak and house eaves

- Trees; Pyrus (Pears) Prunus (Plums, Cherries)

EAST – An open lawn play area, kitchen herbs, deciduous vines grow on the pergola with micro sprayers in place.

- Vines; Chinese gooseberry, Wisteria, Lonicera

SOUTH – Low, shade loving shrubs and ground covers

- Ground Covers; Fuchsia, Myrtus

SHADEHOUSE – Moisture and shade loving plants such as ferns, mosses, liverworts and indoor plants

- *Ficus pumila* (creeping fig) over the concrete tank

FOOD GARDEN – On the north slope below the house, on deeper soils. Used as a major fire barrier. The food garden is exposed to full sun but sheltered from summer and winter winds.

SERVICES AROUND THE HOUSE

- **POWER** underground
- **GAS CYLINDERS** are located at the south-east corner of the house, and are protected from the east by a short wall. Safety valves point outwards.
- **WATER DISTRIBUTION** is via underground lines to galvanised iron stand pipes at: manifold south-east corner; north-west corner; garage; gate between the food-garden and west paddock; vegetable garden and animal shed to north-east.

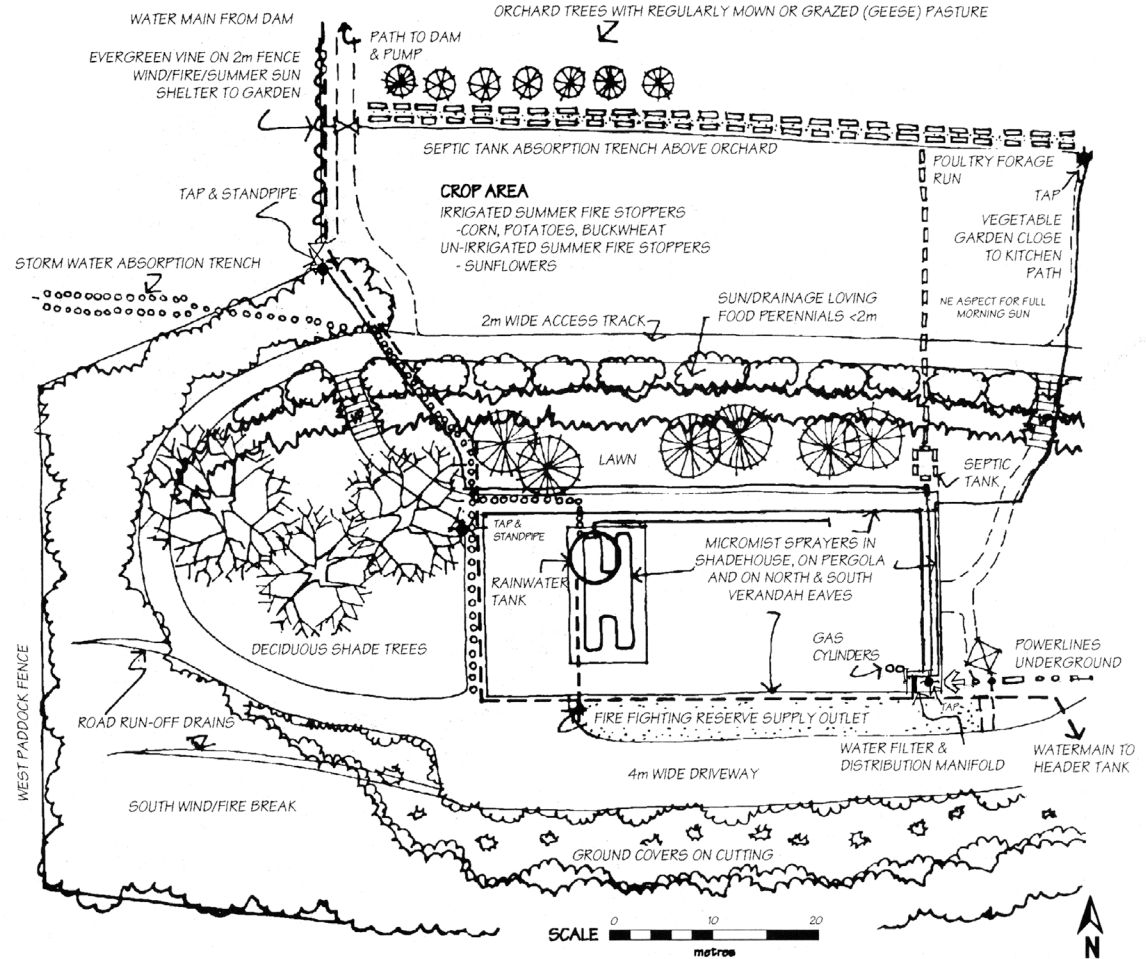

- **MICROSPRAYER** (above ground), lines: around house, shadehouse, pergola, front lawn, bank planting above garden access track and orchard trees.
- **STORMWATER** from the rainwater tank and southern roof is piped to the absorption trench in the west paddock – this water provides a green pick for stock, and a firebreak against grass fires.

- **RAINWATER TANK** provides potable water to kitchen and also provides a firefighting reserve. It has an obvious outlet and is easily accessible at the driveway edge.
- **ACCESS TRACK** above the food garden enables the unloading of mulch etc. The loop track is widened to 4 m here to allow for maximum fire truck mobility.

HOUSE DESIGN

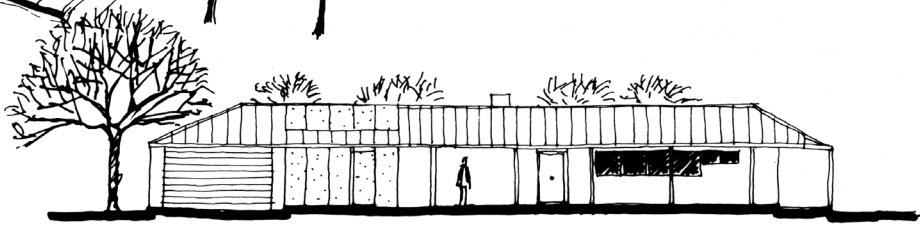
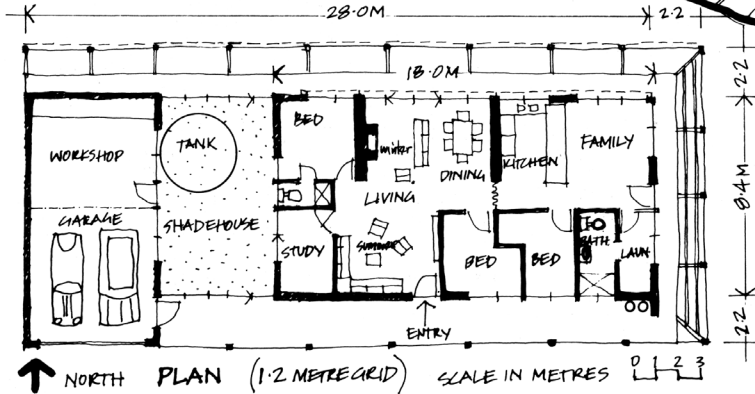
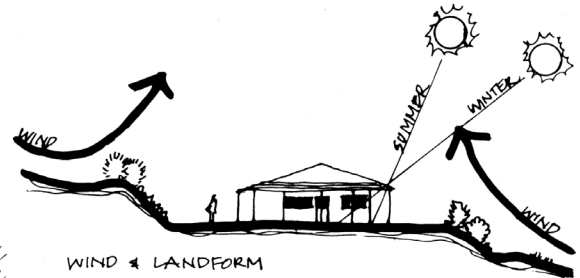
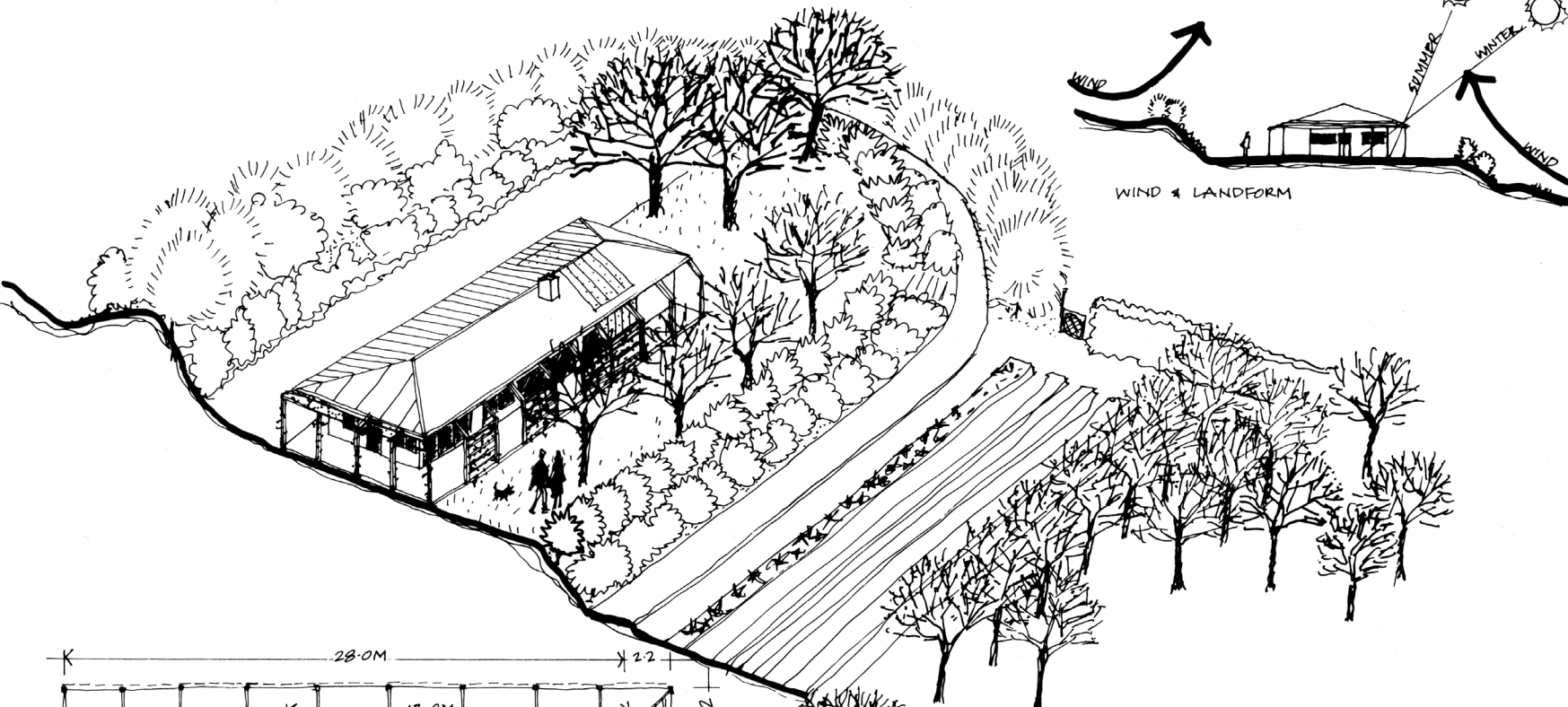

SOUTH ELEVATION

SCALE IN METRES 0 1 2 3

HOUSE DESIGN

'There is a very strong correlation between ... design principles for bushfire safety and ... energy conservation. These principles relate to the control of radiant heat (from sun and fires) and of air currents into and out of the house.'

Draft Dept. of Planning design and siting guidelines

As energy costs rise, it has become necessary for the building industry to work with designs which include full insulation and a standard of air sealing that has not generally been practised in Australia. Design for bushfire safety should not be excessively expensive once these practices are adopted.

PASSIVE SOLAR DESIGN is also dependent on these standards and has clearly been shown to be an efficient way to heat and cool dwellings as well as being compatible with a range of sites, styles and layouts. There is, however, a conflict between passive solar gain from north facing glass and bushfire safety. This design gives an example of how that conflict can be resolved. In the same way, the landscape design resolves the conflict between the benefits of north facing slopes for productive gardens, and their bushfire risk.

A gradual change between inside and outside living and working spaces is a basic principle of proficient house design. In rural dwellings outside work and leisure activities are as complex and vital as inside ones. In general, there is a conflict between the creation of halfway spaces (using for example: verandahs, decks, courtyards, pergolas and fences) and bushfire resistant design. Resolution of this conflict is essential.

THE DESIGN includes a full verandah on the south as an entry area/"farmhouse mudroom"/summer living area. The pergola on the east connects the family room to the main outside living/play area north-east of the house. The shadehouse provides a cool fly-free living space on hot summer days. The north glass wall includes large folding glass doors which open on to a sheltered, sunny, level paving and lawn area. The bushfire performance of these features is explained later.

The internal layout is fairly typical of project houses built for families. The rooms are rearranged without affecting internal function while retaining solar and bushfire performance.

The ensuite bathroom could be deleted to reduce cost.

The basic principles are:-

- Living zones mainly to the north.
- Children's rooms and family room separated from the adult living zone.
- Laundry and bathroom access also from outside work spaces.
- Living zone opens to both north & south verandahs.
- Design variation is simplified by there being a plan based on a 1.2 m grid. The basic design, illustrated, can be adjusted within the external framework.

SECTION NOT TO SCALE

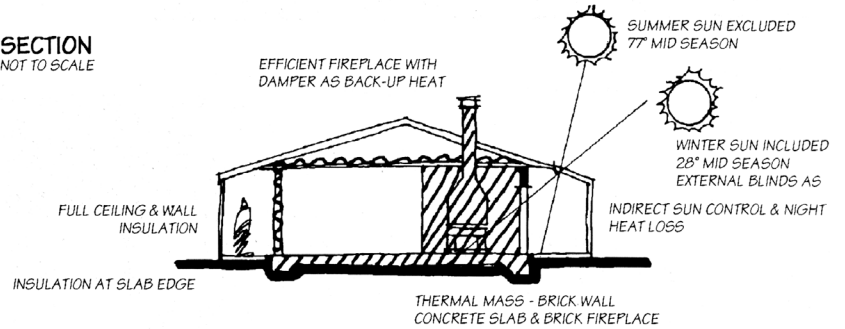

SOLAR DESIGN ELEMENTS

- Long rectangular shape oriented north.
- Correct eave overhang on north wall to allow full winter sun into building but exclude direct summer sun.
- A structure for shading the west wall against excess solar gain and east glazing against summer sun, but allowing full winter sun.
- Concrete slab floor – radiates heat (night) from radiation absorbed (day).
- Fully insulated and tight building envelope – no fixed venting. Stud construction, brick veneer, double brick and mudbrick are suitable.
- An efficient fireplace and walls to increase internal thermal mass.
- Adequate cross-flow venting to cool building after hot days, drawing air from an evaporative cooled external source (shadehouse).
- A system for insulating the north glazed wall against night-time losses and excessive indirect solar radiation in summer.

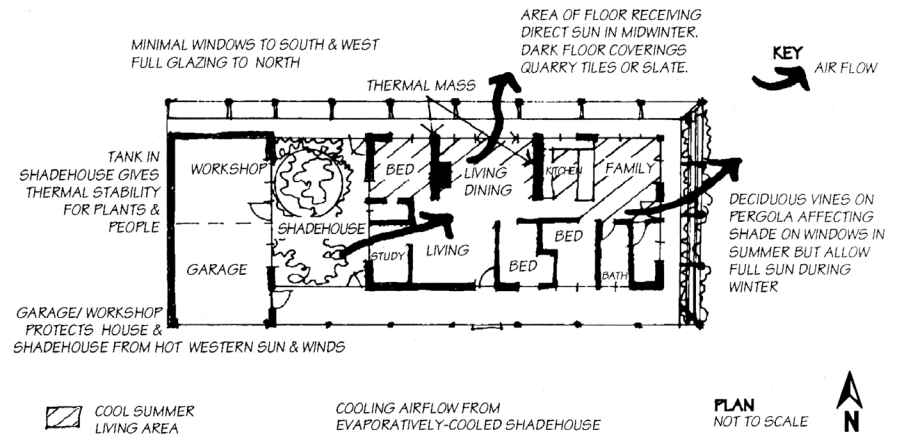

HOUSE DESIGN

No single feature guarantees the survival of the house in extreme conflagrations but the total design (with all construction details following) gives a good chance, even without the landscape design and proper maintenance.

On Ash Wednesday several houses were destroyed when people, in the course of firefighting, opened a door, allowing the entry of burning embers and superheated air, which ignited furnishings.

The design provides excellent halfway spaces for residents' safety and for firefighting efficiency. The east and south doors open onto relatively safe areas, while the west door from the study into the shadehouse is absolutely safe. From there, the garage/workshop, verandah and north terrace are accessible.

Interior furnishings include a minimum of plastics and other combustible materials. For example, wool rather than acrylics for carpets and curtains. (A secondary feature in bushfires but important in internal house fires.)

The location of the garage/workshop effectively isolates dangerous fuels and other highly inflammable chemicals from the house. The gas cylinders are in the safest accessible position. The stud wall protects them from possible heat from the east. However, it is not advisable to enclose them fully because the cylinders must be able to flare off. (The metal post, nearby, would fail but not adversely affect the verandah structure.)

WIND is a key factor in the loss of a majority of dwellings during severe fire storms. This point was well illustrated at Aireys Inlet on Ash Wednesday.

DESIGN FEATURES AGAINST THE EFFECTS OF WIND

- The low hip and gable roof provides optimal protection against lifting forces (worst on flat roofs) and wind turbulence (worst on steep roofs).
- The integration of house, shadehouse, garage/workshop and watertank in one structure, with minimal corners exposed to the fire sector in turn minimises eddying and funnelling but still achieves design criteria for inside/outside space. The south roof will have little uplift, while the garage restricts funnelling along its length.

- The north, south, and east eaves meet the walls at 90 degrees thus reducing eddies. There are no eaves on the west side.
- Leafless guttering eliminates the problem of wind blown leaves, especially from "summer deciduous" eucalypts, during long hot summers.
- No windows or doors in the garage facing west (worst fire direction for this site).
- A shutter system completely protects vulnerable north glazing against burning debris.
- Weldmesh and flywire protects the shadehouse from embers and debris.
- Internal fireplace with fully sealing damper.
- Slab-on-ground, of course, is of critical importance.

RADIATION during firestorms can preheat combustible parts of the building envelope and interior (through windows) making ignition by embers or even sparks a possibility.

DESIGN FEATURES FOR PROTECTION FROM RADIATION

- The north and west glazing is fully protected against radiation by shutters and the shadehouse.
- Less vulnerable east and south glass protected by firescreens and microsprayers (note: water vapour and metal flywire are excellent attenuators of infrared radiation)
- The microsprayers and lush fire resistant plants protect the shadehouse and pergolas.
- Reliability of the microsprayer circuits during a firestorm is good due to:
 1. The high standard of the supply, filtration and distribution system.
 2. Normally in use on extreme fire danger days for cooling and irrigation
 3. Carefully located above ground polypipe spray lines, when in use, will not melt
- Light coloured building envelope. All exposed metal, timber, A/C sheet and weatherboards should be gloss white or very light in colour. Roofing iron should be painted silver or white.
- The relatively dark, porous brick paving on the verandah and under the pergola absorbs water and heat.

SECTION THROUGH 'INTERNAL' WATER TANK
(INDICATING 1.2m CONSTRUCTION/PLANNING GRID)

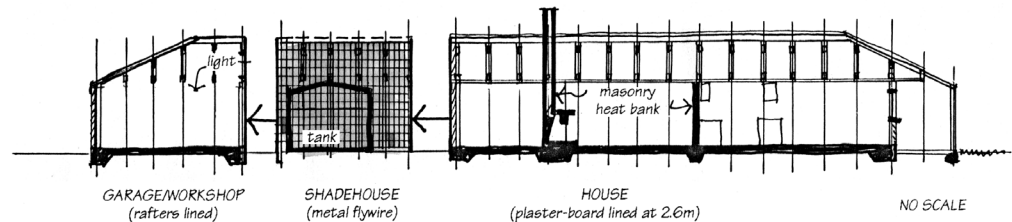

CONSTRUCTION

This house is an example of a balance of cost, client values, and bushfire safety. As a result the absolute best materials or techniques for bushfire safety have not always been chosen. In total the specifications are appropriate to this very high fire risk property. The philosophy behind construction does not assume the building could never catch fire, so less critical systems protect critical ones. The aim being to maintain the integrity of the building envelope. In the event of fire this building will not collapse or burn readily.

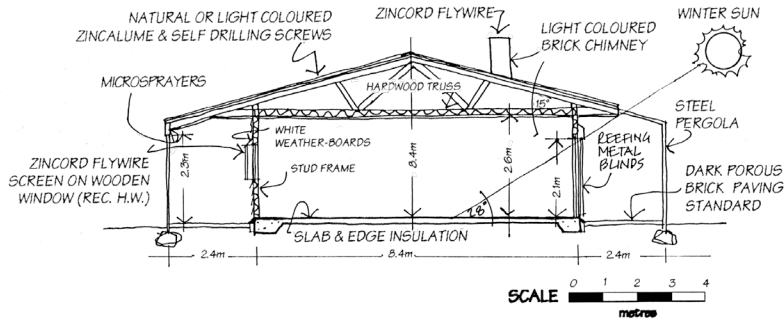

WINDOWS AND DOORS

- White painted hardwood frames are superior to softwood (less susceptible to chips and dents and have a higher ignition point) or aluminium (expands, dropping or cracking glass when overheated)
- Architraves should be cut to shape to fit weather boards.
- External metal screens (Zincord flywire) on south and east windows.
- Exterior reefing metal blinds covering northern glazing gives total security against radiation, embers and debris (not whole roofs!)... these are expensive but provide complete solar control, night time insulation and security against theft. 2.4 m panels will cover two windows or sliding door panels for a building grid of 1.2 m.
- Alternatively, well maintained (pruned annually) fire resistant deciduous vines grown on the vertical panels of the north pergola with Zincord flyscreens over glass and internal wool curtains with a reflective lining would work well.

EAVES

FASCIA – 50 mm thick fascia increases fire resistance.

GUTTER – Monier leafless gutter, well-proven, with round downpipes that can be blocked with tennis balls to fill gutters with water.

SPRAYLINES – 12 mm micro spray lines on north, south and east eaves (separate circuits) fixed on to the fascia under the gutter and inside pergola posts. Painted white, all joints secured and

clamped (standard). Stop cocks located underground in masonry boxes.

MICROSPRAYERS – 180 degree fan spray pattern, low output 20 l per hour microsprayers, 1.2 m apart.

STRUCTURE

STUD FRAME with a hip and gable trussed roof, on a slab to a 1.2 m grid modular design, using conventional construction. Timber trusses are superior to steel which loses strength when heated. Hardwood is preferred to softwood for its higher ignition point and lower heat output. Cantilevered trusses can support the verandah if the steel posts were to fail. Bottom plates are sealed on to the concrete slab using mastic.

PERGOLAS are steel – there is no threat to the house structure or envelope in the event of extreme heating. The wall frames are fixed to the slab with bolts, trusses to plates with straps (e.g. Pryda-Hurricane), and perlins to trusses by twist nails. Corrugated Zincalume roofing has an excellent record in fires (when light coloured). Hardwood weatherboard cladding (light coloured gloss paint critical on west wall). A/C sheet would also be suitable.

SECTION

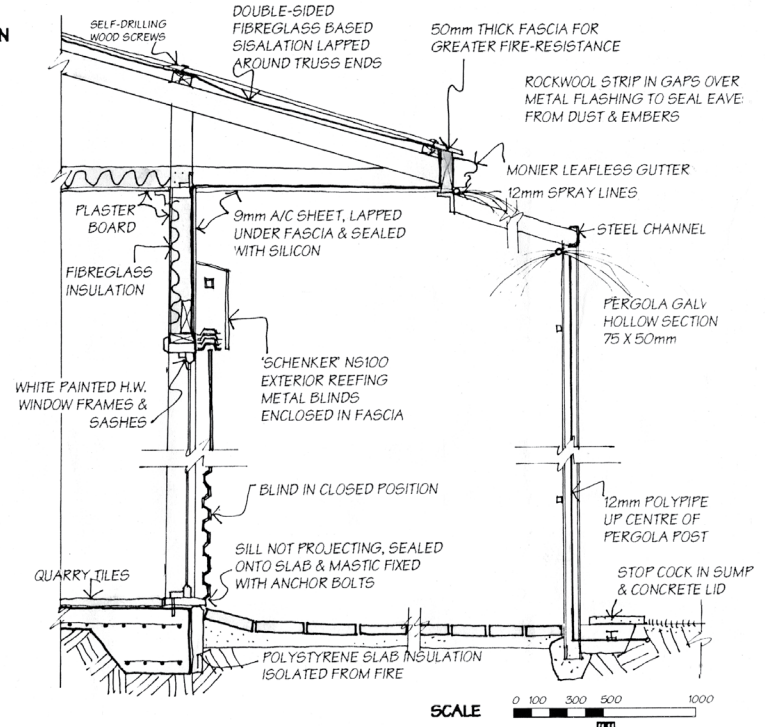

CONSTRUCTION



The shadehouse expresses the value of metal flywire in construction design against bushfire.

THE STRUCTURE – wooden purlins, trusses and stud frames preferably of a weather durable species (e.g Stringybark, Box, Tallowood, Jarrah, Red Gum) these harder species have a higher ignition point than ash species. Of course, all timber should be painted with gloss white. If Ash purlins and rafters were used, fire resistant paint would provide fire, but not weather, protection.

Galvanised mesh (F>18, 200 x 100 mm, 8 mm rod) fixed over purlins provides:- bracing; a walk-on surface; support for flywire. The flywire is 'Zincord' heavy duty galvanised security flywire, made from 0.25 mm wires on a 2 mm grid, fixed by roofing iron on all sides using rivetted metal strips and silicon mastic (mastic withstands 600°C). It is also fixed to the galvanised mesh.

The flywire will stop embers as well as flying debris without damage and attenuates radiation significantly. The tight surface will also shed leaves readily.

'Zincord' in aluminium frames fixed to the inside of studs and rafters provides a back up against the entry of embers should the layer be punctured by flying debris. This further attenuates radiation (fire and sun) and are removable for maintenance.

'Micromist' sprayers or 'Nann' misters at 1 m intervals attached to 12 mm polypipe fixed to the underside of the rafters will provide excellent fire protection to the structure as well as serve their normal functions (evaporative cooling and irrigation).

THE FIREPLACE should be dark brick inside (for solar gain) but light coloured above the roof to assist the function of the damper in preventing thermosyphoning.

For the garage opening a standard roller door should be adequate protection. The stud walls and roof should be sealed with sarking in the same manner as the house and lined with A/C sheet. The ceiling can be lined onto the rafters to give greater working height and storage.

The only windows which open into the shadehouse are safe, as are the west house windows. Given the relatively exposed (to sun and fire position and, if the workshop is used frequently, a great deal of highly combustible contents e.g. wood shavings, paints, glues, fuels) insulation of the roof, and north and west walls could be justified for fire safety and working comfort.

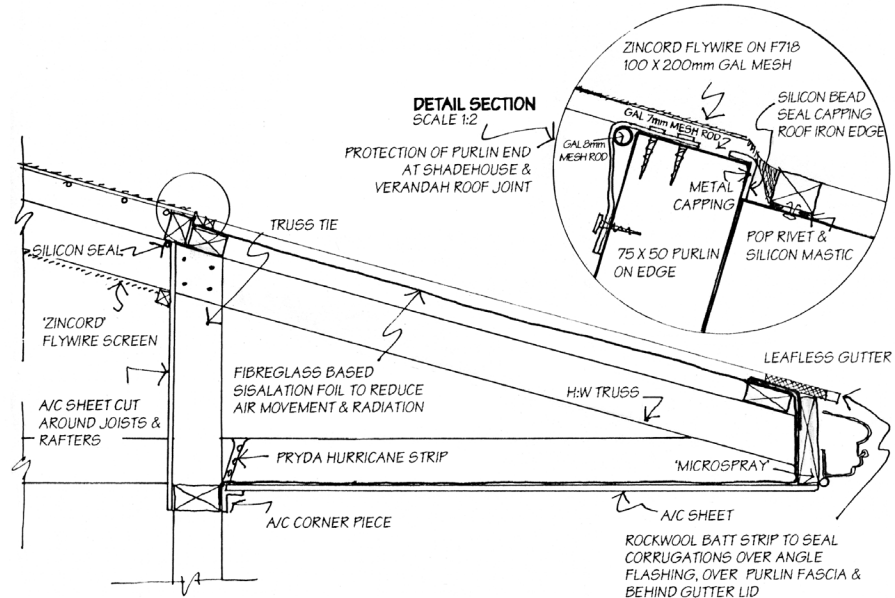

SECTION
SCALE 1:10
ISOLATION OF ENCLOSED
EAVE OF SHADEHOUSE

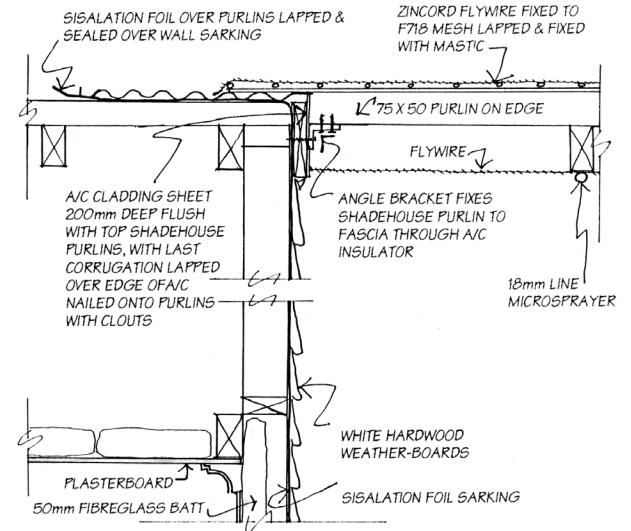

SECTION
SCALE 1:10

MANAGEMENT

A purely engineering approach to bushfire resistant house design is likely to fail because it is impossible to eliminate the 'human factor'. Alternatively, people can be seen as the key to the solution. The solution is at two levels which compliment each other.

Firstly, the management of the house and property can contribute greatly to bushfire safety. Secondly, the activity that this management involves can be psychological training for staying with the house and acting effectively and wisely to save it. The design is the basis of confident action, while property and house management is the expression of that confidence.

Maintenance and management against bushfire involves activities all year round. Most can be justified on other grounds and are part of a responsible householders' routine.

IN AUTUMN

Sealing around doors and windows checked for thermal efficiency. Bulk firewood should be stored adjacent to the animal sheds north-east of the house, with a cut and split supply stored in the workshop.

AUTUMN/WINTER

Rake litter in the tree belts and bush edges within the fire sector into contour ridges which catch run-off water and decompose enough not to be a fire hazard by summer. This is more labour intensive than cool burning but is safer and better for the soil.

SPRING

- Repaint any exposed woodwork.
- Plant main summer vegetables and crop plots.
- Check diesel pump (oil and fuel filters, water intake strainer and float).
- Clean disc filter (annually is adequate).
- Run pump for two hours while checking the whole irrigation system, especially microsprayers and drippers for blockages.
- Mow and mulch orchard grass while it is still green, or alternatively, keep the grass grazed by geese or other suitable livestock.

SUMMER

- Move stock into the west paddock before the grass cures (dries) and becomes unpalatable.
- Keep grazed all summer if sufficient grass growth is maintained.
- Check flywire screens for damage.
- Keep house, workshop and grounds tidy.
- Mulch with seaweed or other non combustibles.
- Use the irrigation system to give generous, deep but infrequent watering to the whole garden.

- Plough strips around paddocks and cut under garden trees and shrubs inaccessible to stock, once the grass has cured.
- Work out a check list for actions to be taken on extreme fire risk days and know what to do when a bushfire approaches.

EQUIPMENT OF VALUE ON THE FIRE-READY PROPERTY

- A fire extinguisher in the workshop (also important for internal fire)
- 20 mm diameter hoses with closable nozzles.
- Fire rake and knapsack sprayer for small fires in bush areas.
- A brush cutter for grass along fences and under trees.

The concept of the house as refuge to survive any fire has been emphasised as an important psychological factor in design. On our high risk site the house would live up to that expectation. However on some severe risk sites (e.g. steep north-west slopes, poor access, tall dry forest with old trees, poor water options) a different approach might be appropriate. The house may be dramatically destroyed, endangering life, though in most cases it would be useful to remain on site to extinguish the house after the fire front passes.

A simple fire shelter can solve this problem. A shelter may even be a necessity. Even though the decision to evacuate may have been made earlier, in the end, this may be impossible.

A fire shelter should be simple, strong, earth insulated with no through draughts possible and suitable for a dozen people to remain for 1/2 hour. In this case the fire shelter is sited in the bank of the house bench to the north-east of the kitchen door.

LOCATION PLAN

NO SCALE

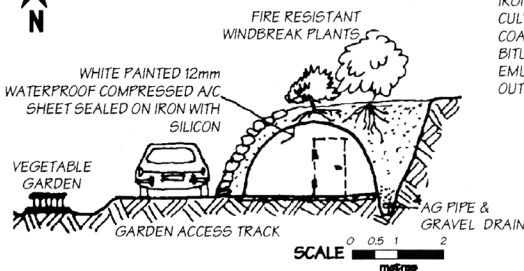
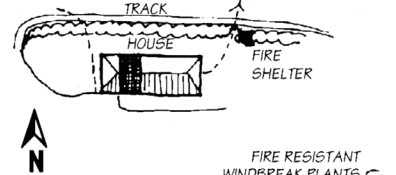

PLAN

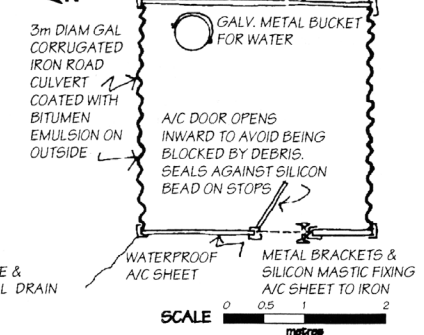

OTHER PUBLICATIONS BY DAVID HOLMGREN

