

\$5.00

HANDBOOK OF

Lost Wax or Investment Casting



By James E. Sopcak

HANDBOOK OF LOST WAX or INVESTMENT CASTING

A how-to-do manual that shows you
how to make the equipment you
will need as well as how to
use it to make patterns,
molds and castings for
jewelry and small
metal parts

By
JAMES E. SOPCAK



ISBN 0-935182-28-4
Copyright © 1986 Gem Guides Book Co.

Published by
Gem Guides Book Company
315 Cloverleaf Dr., Suite F
Baldwin Park, CA 91706

TABLE OF CONTENTS

PREFACE	4
An Introduction to Lost Wax or Investment Casting	4
Chapter 1	
How to Make a Vacuum Investment Mixer	6
Bill of Materials	9
Chapter 2	
How To Make A Burnout Oven	10
Bill of Materials	16
Chapter 3	
How To Make A Pressure Casting Machine	18
Bill of Materials	22
Chapter 4	
How To Make A Simple Wax Wire Extruder	23
Bill of Materials	24
Chapter 5	
How To Make Rubber Molds	26
Flask	28
Investing the Pattern	46
Making The Mold	29
Parting The Mold	29
Bill of Materials	30
Chapter 6	
How To Make A Wax Injector	31
Bill of Materials	36
Chapter 7	
How To Make Wax Patterns	37
Tools and Supplies	39
Chapter 8	
How To Invest Wax Patterns	43
Debubblizers	43
Flasks	43
Mixing Investment	45
Eliminating bubbles	45
Investing the Pattern	46
Finishing the Flask for Casting	47

Chapter 9

How To Burnout And Cast	48
Preparations	48
Temperature Controls	49
Preparing Metal	49
Determining Quantity of Metal	49
Handling Flask	50
Introducing and Melting Metal	50
Using The Pressure Casting Machine	51
Cooling and Removal of the Casting	52
Cleaning the Casting	52

Chapter 10

Rubber Molds and Duplicate Patterns	54
Rubber for Molds	54
Homemade Flask for Curing Rubber Molds	55
Loading the Rubber and Curing the Mold	56
Parting the Mold	56
Preparation of the Mold for Duplicate Patterns	57
Using the Wax Injector	58
Finishing Duplicate Wax Patterns	59
Appendix	60
Rubber Molds Without Vulcanizing by Frank Gemmel	60
Commercial Equipment	61

PREFACE

As often happens in periodical publication, one good article leads to another. Sometimes it leads to a whole series of articles that, taken as a whole, constitute a complete textbook of the subject. But a periodical's life is usually fleeting, even for the publisher. If a series is good, it is not long before back issues containing the material are exhausted and, for practical purposes, it is lost to many people, particularly newcomers who, generally, have the greatest need for its information. Such was the history of a series of articles on investment casting by James E. Sopcak which appeared in *Gems and Minerals Magazine* (now out of publication). When completed, they constituted a complete "course" in lost wax or investment casting of jewelry. Therefore, it was decided to publish this information in book form.

In this book you will find not only step-by-step instructions for making wax patterns, producing investment molds and casting but, what may be more important to many, chapters on how to make the equipment you will need. As mentioned, all of this information was originally published as a magazine series. To keep the cost within reach of everyone, the original type was used in this reprinting. As a result, you may find a few references to "next month" or "last month" that indicate periodical publication. But the meat of the material is affected not at all and you will find here what you need to know to start making your own jewelry castings.

An Introduction To LOST WAX or INVESTMENT CASTING

Because of the need for special equipment and a mistaken belief that it is a complicated process, too few amateurs have tried making investment castings for jewelry. Though it may sound complicated, it really is not. Any amateur with the desire can not only make good castings but can also construct most of the equipment he will need. It will be the purpose of this series of articles to show him how to do both.

Precision casting using expendable wax patterns was first developed by the dental profession. It was adopted by industry to cast complicated precision parts and the jewelry trade, which was quick to recognize its possibilities, climbed on the band wagon.

Essentially the process involves:

1. Making a wax pattern that is expendable,
2. Investing or encasing the pattern in a suitable refractory material that will:
A. Stand high heat; B. Reproduce every detail of the pattern in the form of a mold,

3. Burning out the pattern leaving a negative mold inside the investment material,

4. Casting by filling the mold with metal,

5. Recovering the casting by destroying the mold.

Because the wax pattern is completely "invested" in the mold and removed by burning or melting it out, the most complicated forms can be cast. It makes no difference if they have undercuts, reverse curves, or similar convolutions. And, since the mold is destroyed in removing the casting, there is no need to make a casting which will "draw" from the mold.

One meaning of the word "invest" is to surround or contain. The process gets its name from the fact that the pattern is completely surrounded or invested. The material used to make the mold is called "investment," hence, *investment casting*.

Since the wax pattern is expendable and burned out of the mold and, hence, lost, the name "lost wax" casting has also been used. Both names are synonymous

but "investment casting" is preferred and most books, articles, and catalogs use this term.

The Basic Materials

Actually, common paraffin can be used to make small patterns. However, a stronger, more stable wax should be used for larger and more complicated patterns. Special pattern wax is available from jewelry supply houses and its characteristics will be covered later. (*Note:* Should you decide to use paraffin, remember that it is highly flammable. Melt it in a double boiler and be very careful.)

The material for making the mold is called "investment." It is somewhat similar in appearance to casting plaster but is actually quite different. Ordinary plasters will not stand the heat required to burn out the pattern or cast molten metal. The most common investment material is a mixture of crystobalite (a high temperature silica mineral) and other ingredients. It is easy to use, highly refractive, and low enough in cost to make it economically practical.

Wax, investment, and silver, gold, or alloys are the basic materials needed.

Equipment

The cost of equipment has been one of the main deterrents to amateur use of the process. Many books build their instructions around rather costly casting machines, burnout ovens, electric vibrators and other equipment. These, or substitutes for them, are necessary. It is one of the purposes of this book to show how to make or acquire substitutes that are both satisfactory in performance and within the hobby budget.

Some mechanical experience is necessary to make this equipment - knowledge that many do-it-yourselfers possess. If you do not have this knowledge, perhaps a fellow craftsperson does, and will help you.

Among the equipment to be described, along with details for building it will be:

A *vacuum investment mixer* that eliminates air bubbles from the investment, one of the major sources of poor castings,

A *pressure casting machine* that is easy to make from parts available everywhere and which eliminates the need for an expensive centrifugal casting machine,

An easily made *burnout oven* that will give heat up to 1900° F. (and is also suitable for enamelling),

A homemade *wax injector* to be used with rubber molds to make duplicate patterns,

And a *wax extruder* that will simplify making wax wire forms that simplify making patterns for many types of jewelry.

All of this will be followed with detailed, step-by-step instructions for using the equipment and making investment castings. When the series is finished, you will have had a "course" that will have given you the knowledge and equipment you need to enjoy a relatively new and fascinating technique of the jewelry making art.

A Safety Note

When the author originally completed the projects covered in this book, we did not know that asbestos could cause cancer. Jewelry makers used it for a variety of purposes, as did the author in making the burnout oven, the pressure casting machine and the wax injector.

For a number of these tasks, and for lining casting flasks, he used sheet asbestos which he purchased from a plumbing supplier. Wherever this product was mentioned in the original text, we have substituted the words "asbestos substitute", for such a sheet material, in strip form, is available from casting equipment suppliers, such as Kerr/Sybron. It is called *Flask Liner* and is sold primarily to dental laboratories for flask lining.

Many jewelry makers still use asbestos in sheet and other forms (if they can find it), regardless of warnings about health hazards. We leave the choice to the reader as to whether to use a substitute or true asbestos, but if you choose the latter, please be aware that you must proceed at your own risk.

Investment Casting — Part 1

HOW TO MAKE A VACUUM INVESTMENT MIXER

An otherwise good casting is often made unuseable because air bubbles are present in the investment when the wax pattern is invested. When this happens, small globules appear on the surface of the casting. Though these can be removed sometimes, they normally detract from the detail of the piece and make finishing difficult.

Various methods have been used to eliminate bubbles, including "dehubblerers." These are essentially detergents that lower the surface tension of the mixture and allow air to escape more easily. Vibrators have also been used to "shake" the bubbles loose. But, by far, the most satisfactory method of eliminating bubbles is by mixing the investment in a vacuum. The problem is to obtain a vacuum in a suitable container while still being able to stir the mixture inside.

By lowering the pressure in a closed container to approximately 24 to 28

inches of vacuum and mixing the investment in this medium a bubble free mixture can be obtained. In order to attain the vacuum, one does not necessarily need an expensive vacuum pump. Most laboratory supply houses carry hydro aspirators which will produce the necessary vacuum from normal city water pressure of 30 pounds or more. An aspirator of this type should be moderately priced and can be obtained with adapters for direct attachment to a utility sink spigot.

With the aspirator illustrated the necessary vacuum can be attained in 20 to 30 seconds provided the container is well sealed and of moderate size. For the casting of rings and other jewelry mountings, a container or mixing bowl with a capacity of one to two cupfuls will be ample. The container should be sufficiently rigid to withstand the exterior atmospheric pressure, and should be a nonoxidizing metal or plastic. The vacuum mixer illustrated was made from a plastic sugar bowl purchased at a local dime store.

Because the size and shape of the mixing bowl that may be purchased will vary, we will, in general, outline the construction procedure, avoiding direct measurements where possible.

Actual construction of the mixer can begin by cutting or turning the brass cover plate to a diameter 1/16 inch larger than the outside diameter of the open end of the mixing bowl. This brass circle will become the cover. In the center of this circular brass piece, drill a 3/8 inch hole and 3/4 inch from the center drill a 5/16 inch hole. Into the 3/8 inch center hole solder (preferably silver solder for greater strength) the 3/8 inch outside diameter brass bushing. It should be flush with the bottom of the

cover plate. The off center hole should be tapped using a 1/8 inch NPT (National Pipe Thread) to accept the brass elbow. The threaded end of the elbow should be covered with pipe joint compound and tightened in place. The open end of this fitting should face the nearest outer edge of the circular brass cover.

Next the mixing paddle must be prepared to the inside contour of the mixing bowl, leaving about 1/16 inch clearance on all sides. A series of 1/4 inch holes should be drilled or punched into this paddle to provide better agitation of the investment. The 1/4 inch stainless steel rod should now be slotted, using a hack saw, to a depth of about 1 1/2 inches and the paddle soft soldered in place. The brass washer should also be soldered to the stainless steel rod to retain this assembly in position with relation to the depth of the mixing bowl. (See sketch.)

Cut and attach, using rubber cement, the gum rubber gasket to the brass cover plate. The gasket should be 3/4 inch wide with the outer diameter the same as the cover plate.

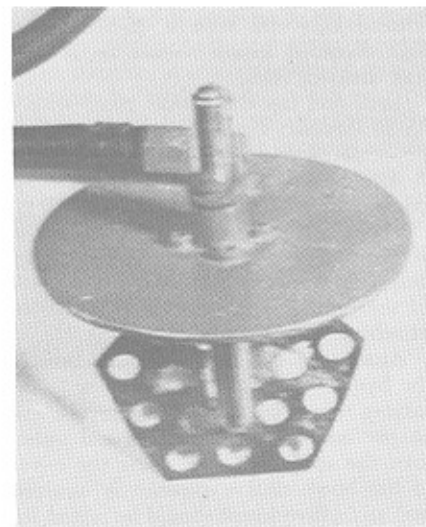

Assembled top of the mixer.

At this point the paddle should be assembled into the cover and checked to be sure the paddle does not bind in the mixing bowl. Cut off the stainless steel rod 3/8 inch above the bushing.

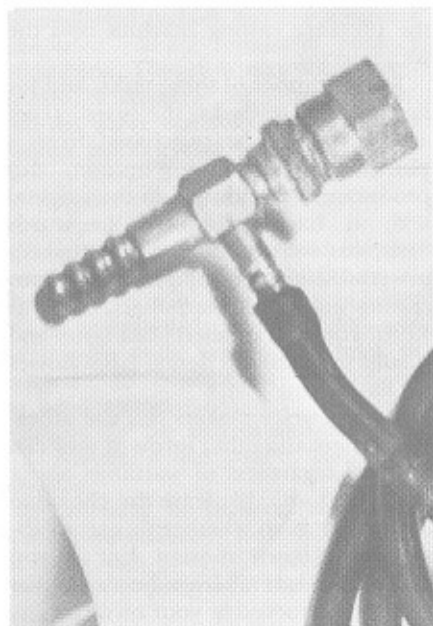

A hydro aspirator with fitting for a utility faucet.

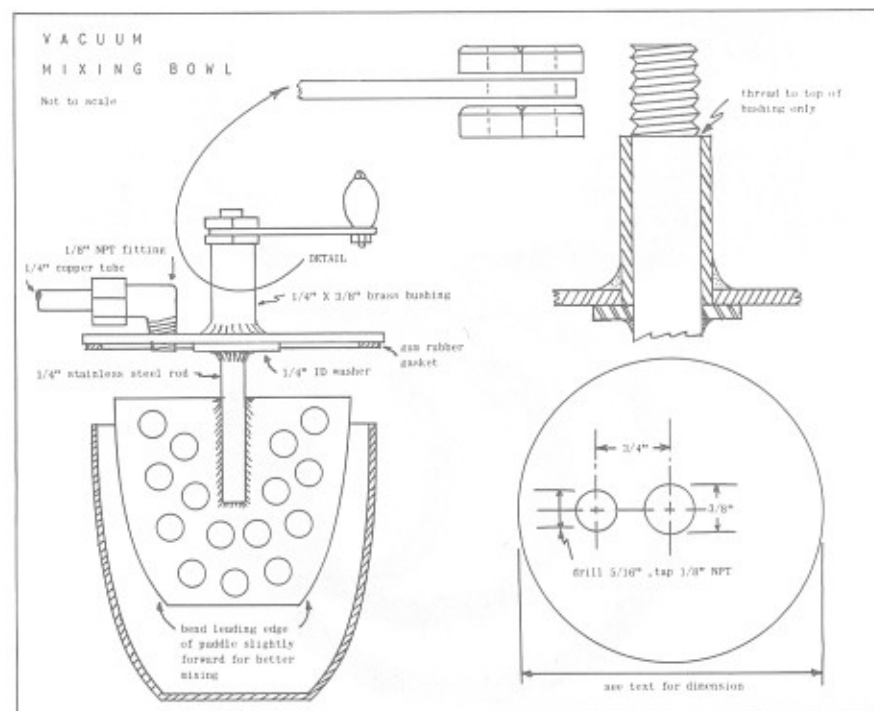

Thread this end with a $\frac{1}{4}$ -28 thread. The threaded length should be slightly less than $\frac{3}{8}$ inch.

Drill and tap the handle piece with a $\frac{1}{4}$ -28 thread. The threaded hole should be centered and $\frac{1}{2}$ inch from the end. A knob should be attached to the opposite end to form a crank.

The 1 inch piece of $\frac{1}{4}$ inch tubing is inserted into the compression fitting and the assembly tightened. The purpose of the tubing is to provide a means for attaching the vacuum hose.

Attach one end of the vacuum hose to the hydro aspirator and the other to the mixing bowl cover plate. Prepare the proper mixture of investment and water, turn the spigot on full, press the cover to the bowl until a vacuum is attained and mix. Investment should be mixed for

a minimum of 50 turns and/or 1 minute after full vacuum is attained.

For those not familiar with the principle of the hydro aspirator, a word of explanation may be in order. Simply stated, a low pressure area is formed by a stream of high velocity water passing over or around an open tube. This principle is incorporated in the aspirator illustrated and, by design, it is an efficient application. This method of attaining a vacuum is similar to the medicinal nasal aspirator.

In using the vacuum mixer, it is suggested that a predetermined amount of tap water be put into the mixing bowl. With a spatula or small spoon, small quantities of investment should then be added by sprinkling the dry investment onto the water. Enough time should be allowed between each addition to permit the investment to be absorbed into the water. When a small pile of dry investment begins to build on top of the liquid,

the proper water/investment ratio has been attained. With a little experimenting various consistencies of investment can be achieved in this manner. If thinner investment is needed for an intricate casting, the pile of dry investment should be small. A heavy casting of simple design may necessitate a thicker mixture. This method of determining water/investment ratio is not quite as time consuming as the weighing method and will reproduce results satisfactorily.

If a notation is made as to the amount of water used to prepare a given amount of investment, a water/casting-ring-size ratio can be established.

It has been found that approximately $1\frac{1}{4}$ ounces of water will produce sufficient investment to fill a casting ring 3 inches high and $1\frac{5}{8}$ inches in diameter. Using the above ratio as a starting point, a water/investment ratio can be compiled which will result in a minimum of wasted material.

Assembled parts of the vacuum investment mixer.

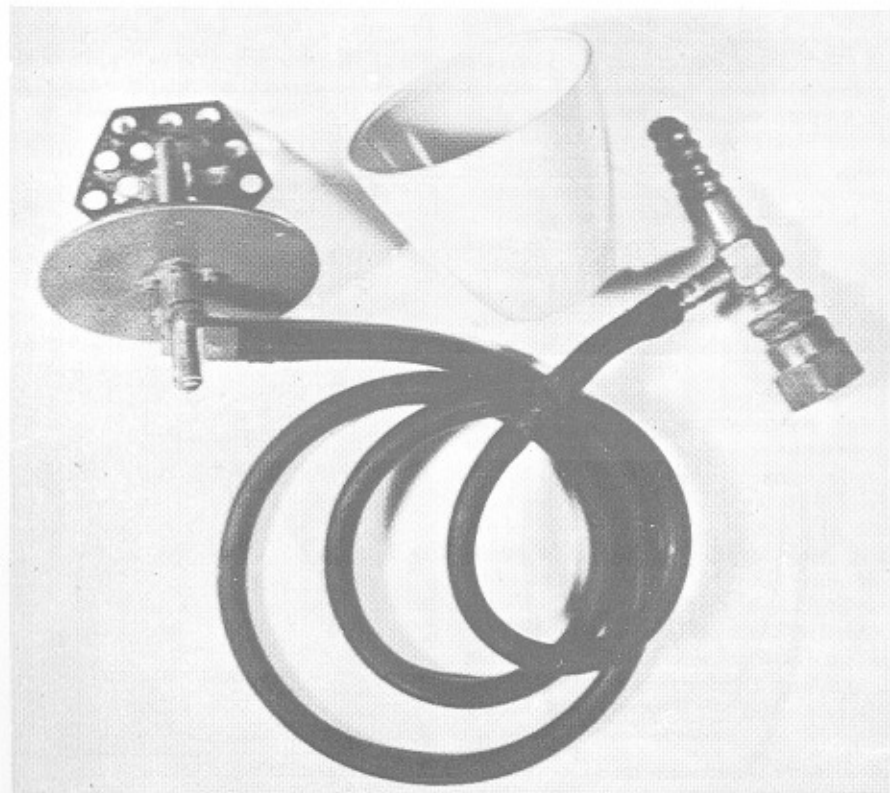

MATERIALS

- 1 pc. brass plate, $\frac{3}{16}$ " thick (see text for dimensions)
- 1 pc. $\frac{1}{4}$ " brass or stainless steel rod about 4"-5" long
- 1 pc. 22 to 26 gauge stainless steel sheet (see text for dimensions)
- 1 90° brass elbow, $\frac{1}{8}$ " NPT one end, $\frac{1}{4}$ " tube compression fitting on other end
- 1 brass bushing, $\frac{1}{4}$ " I.D., $\frac{3}{8}$ " O.D., $1\frac{1}{4}$ " long
- 1 pc. $\frac{1}{32}$ " to $\frac{1}{16}$ " soft gum rubber sheet (see text for dimension)
- 1 pc. $\frac{1}{4}$ "x1" copper tubing
- 1 pc. flat brass $\frac{1}{2}$ "x $\frac{1}{16}$ "x2"
- 1 knob for crank
- 1 pc. vacuum hose, $\frac{1}{4}$ " I.D. by 2' to 3'
- 1 brass washer $\frac{5}{8}$ "x $\frac{1}{4}$ "x $\frac{1}{16}$ "
- 2 hex machine nuts, $\frac{1}{4}$ -28
- 1 mixing bowl (see text for recommendation)
- 1 hydro aspirator (available at most laboratory supply houses. Only the lowest priced type is needed. If you cannot find a source, contact your local high school chemistry teacher, he should have a source from which he buys lab equipment. Or contact Central Scientific Corp., 1702 Irving Park Rd., Chicago 13, Ill.)

element does burn out, replacement is simple at a fraction of the cost of a commercial unit.

In addition to the burning-out of invested patterns, for lost wax casting, the oven can be used as a tempering oven for steel tools, heat treating stones, ceramics, enamelling and other similar applications. As a lark, the author once used the oven to produce a delicious baked apple. Your own imagination can certainly find other applications for this piece of equipment.

Construction is relatively simple and can begin by cutting the galvanized sheet to the required dimensions. Next the individual pieces should be laid out in anticipation of further cutting, folding and bending. You will note from the layout details that the areas that have been shaded out are to be removed. To produce neater looking corners, $\frac{1}{4}$ -inch holes have been drilled on centers at the intersections of the areas to be removed. These holes permit easier bending and

Parts used for making a burnout oven. The sheet metal parts have already been formed. Only three of the five firebricks are shown.

allow for the slight miscutting of angles. Refer to metal layout details for dimensions and areas to be removed.

Next, all pieces must be bent to 90° as indicated by an X on the metal layout detail sketch. If you have a sheet metal shop in your town, it is suggested that they be taken to the shop for bending. If a shop is not available, the bending can be done by clamping the pieces in a vise between two boards cut to the required length. Although bending the pieces in this manner is slightly more difficult, a neat bend can be achieved with a little care. The bending sequence should be given some thought prior to starting of any bends to avoid interference of one bend with another. This completes the metal portion of the oven.

Next refer to the sketch titled, "Brick and Coil Layout." Two firebricks are left whole, two bricks are cut to $5\frac{1}{2}$ inches long and one brick is cut exactly in half. All cuts can be made with a thin bladed hack saw. The two full length bricks will eventually be the top and bottom of the oven. The brick cut in half will furnish the two sides which contain the heating element. The $5\frac{1}{2}$ -

inch bricks will be the door and the back of the oven.

For those not familiar with this type of insulating firebrick, it should be pointed out that it is very soft and should be handled with care. A fingernail has sufficient hardness to gouge the brick. For this reason and its high temperature properties it was chosen for this project. This same type of insulating brick is normally used in some commercially made ovens. The brick is made by a number of suppliers and can be obtained to withstand various temperatures. For our purposes the 2300°F brick is sufficient and should be specified.

Take the two half bricks and, referring to the coil layout, route them to receive the heating element. The routed width should be slightly under the outside diameter of the Nichrome coil and sufficiently deep to contain the coil below the surface of the brick. Heating coil placement is not critical but should approximate the placement shown in the sketch and illustration.

If a drill press is available, the routing can be done by simply using a drill bit of the required diameter. The coil layout can be carefully outlined on the brick in soft pencil, the drill bit set to the required depth and the brick pushed into the revolving bit, following the pencil outline. If a drill press is not available, the routing can be done with a piece of round steel stock by pressing the end of the steel into the brick and using the rod as a scraper. Although this may seem difficult, the brick is relatively soft and can be compressed to dust with ease.

The door and back brick must also be routed to a depth of $\frac{1}{4}$ -inch along all four sides so that a portion of the brick protrudes into the oven openings for better heat retention. This can also be done on a drill press using a flat ended bit as a router or by carefully cutting and scraping away the excess material with a knife. Refer to the brick and coil layout for the width of these cuts.

Heating coil preparation comes next. Cut the coil exactly in half. This can be done by simply counting the number of coil loops and determining the midpoint. At both ends of each coil half, the coil must be straightened by stretch-

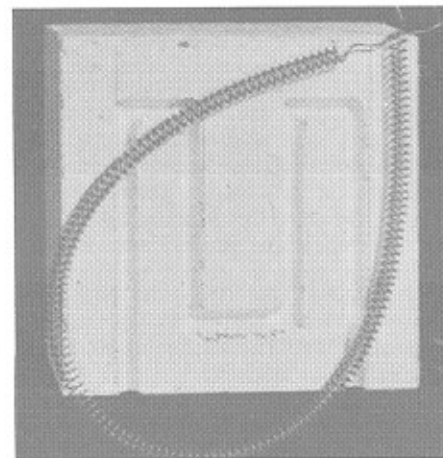

Half-bricks that form the sides of the oven. (Top) The brick routed to take the heating element and the heating element, stretched and ready for installation. (Bottom) Brick with the heating element in place.

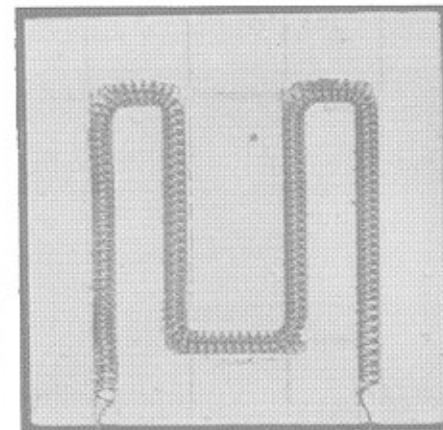

ing the coil loops taut so there is a 4-inch length of straight wire. The straightened ends will be fastened to the terminal screws at the back of the oven. About 6 to 8 straightened coils are sufficient to produce the above length. The total length of the routing should now be determined and each coil stretched to about one inch short of this length. Lay a yardstick on a flat table top, grasp both ends of one coil and stretch the coil using the yardstick as a guide. The dimension to which the coils return (they will spring back a little) should coincide

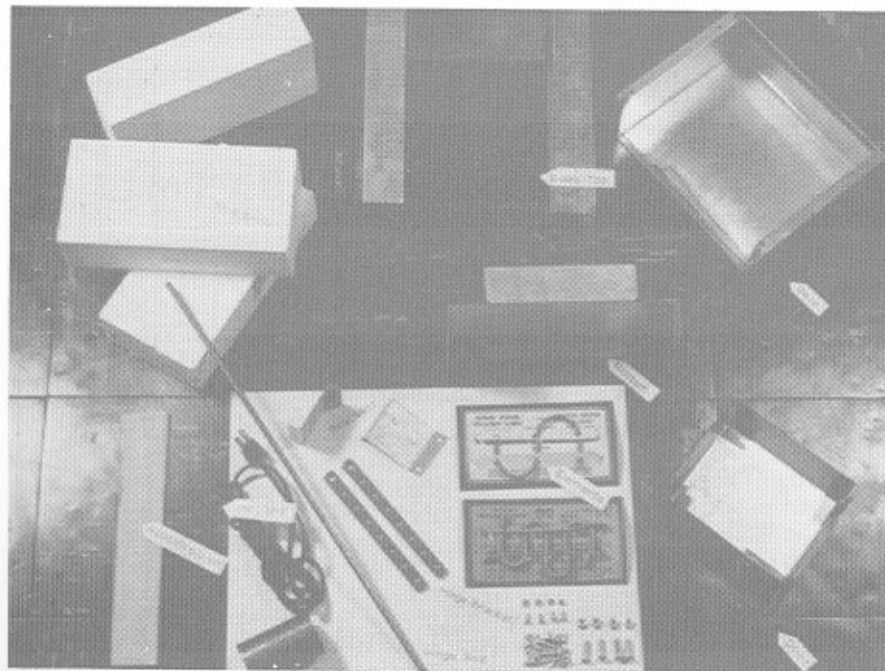

with the length needed as determined above. Starting $\frac{1}{4}$ -inch from the edge of the routed firebrick, press the coil into place. (See illustration.) Prepare staples $\frac{1}{2}$ -inch long with a radius of $\frac{1}{16}$ -inch and push these staples into the brick along the length of the Nichrome coil at strategic points to hold the coil in place. In locating the staples, be sure they are pressed *between* the individual coils so as not to short out any adjacent coils. Once the Nichrome wire has been heated, it will take a permanent set. The staples are used primarily to aid assembly.

You can now assemble the bottom, top and sides of the brick portion of the oven. Place one full brick on a solid flat surface. Position the two side bricks containing the heating elements flush with the front and side edges of the full brick and place the remaining full brick on the top of this assembly. (See sketch.) Prepare light, 4-inch pieces of stiff $\frac{1}{8}$ -inch diameter wire. Sharpen one end of each

piece to a point and drive two of these wires, as you would a nail, through each full brick into each side brick, both top and bottom. The wires should be located through the full brick so they will be driven into the middle of the side brick one inch from both the front and back edges of the assembly. This reinforcement of the brick assembly is needed to hold them together for subsequent assembly into the metal case. Pilot holes slightly under the diameter of the wire used can be drilled into the full brick. This aids in driving the wire into the side brick perpendicularly. By predrilling these holes the wire is less apt to be driven into the sides at an angle. The firebrick is soft enough to accept the wires without breaking, if driven carefully.

Slip the completed brick assembly into the formed metal case. Invert the case containing the assembled bricks so that it rests on its top. Locate and drill two holes through the outside of the metal case one inch from the front and back edges of the oven and centered with relation to the flange of the bottom piece. The bottom piece should be temporarily put in position to determine the locations of these holes. The holes should be the same size as the outside diameter of the sheet metal screws used. Again place the bottom piece in position and locate the drilled holes on the side flanges of the bottom piece. Remove the bottom piece and drill holes the root diameter of the screws at these locations. Assemble the bottom piece to the case using sheet metal screws.

For those not familiar with the use of sheet metal screws it may be well to state that this type of screw is to some degree self tapping. To fasten two pieces of light gauge metal, the outer piece of metal is drilled to the outside diameter of the sheet metal screw and the inner piece drilled to the root diameter of the screw. In this manner, the sheet metal screw will bring the two pieces together and hold them tightly.

Brick assembly prior to insertion into the metal case. The heating element is in place. (Upper) Section of brick morticed on one side to form the back and door of the oven. Two are required.

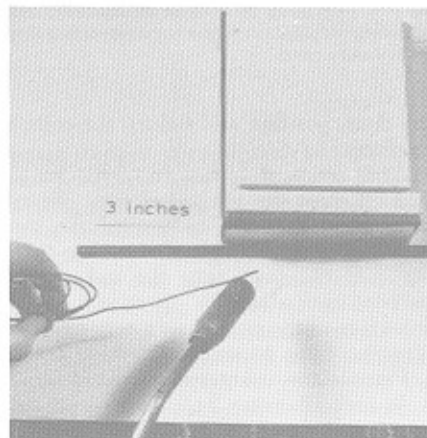
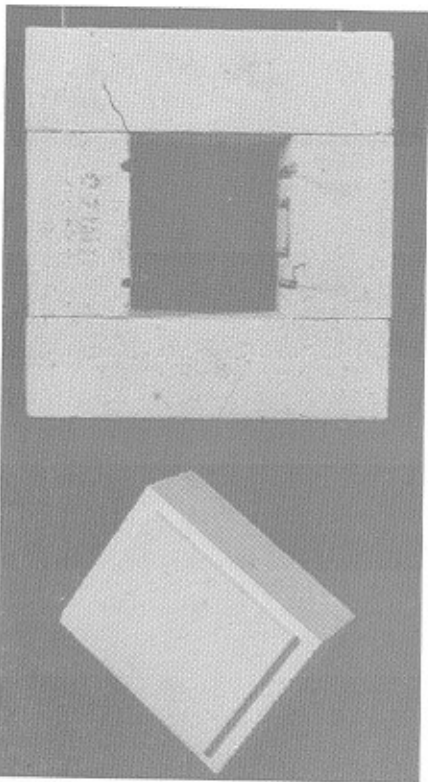

The position of the door and hinge rod for silver soldering them together. Place weights on the brick to prevent warping.

Take the two pieces of $2 \times 3\frac{1}{2}$ -inch sheet metal and bend them into a bracket for the terminal board. Bend a $\frac{1}{2}$ -inch flange on each 2-inch end in the directions indicated by the side view of the sketch. Drill the foot of the flanges for sheet metal screws and the tops to take 6-32 machine screws. Locate the foot holes on the sheet metal on the back of the oven so the bracket will just clear the back brick. These brackets and the terminal board form the clamp to hold the brick in place. Fasten the brackets in place with sheet metal screws.

From the remaining fire brick, cut a piece approximately $\frac{1}{2}$ " thick by 9" x $2\frac{1}{4}$ " to be used as a terminal board for the electrical connections at the rear of the oven (see illustration on page 16 - substituting the fire brick piece for the asbestos shingle shown). Attach this terminal board to the brackets, using four $6/32 \times \frac{3}{8}$ " machine screws. Prior to assembling the terminal board to the brackets, drill four holes as illustrated to accommodate four brass machine screws which will be the electrical terminal posts for the Nichrome wire elements, the line cord and the top connecting wire, all in series (see photo on page 16). Remaining brick can be cut into suitable

Side view showing installation of the door hinge.

pieces and used as trivets for your flasks during burnout.

The brass machine screws should now be inserted and the hex nuts tightened. Remove this assembly, place the back brick into position and reassemble. Care should be taken to avoid disturbing the Nichrome wire leads. Each Nichrome wire lead should reach one of the brass terminal posts.

At this point, all firebrick intersections, that is, the inside corners, should be filleted with a high temperature furnace cement. This can be done by spreading a fillet of cement with the tip of the index finger to form a $\frac{1}{4}$ -inch fillet radius.

By placing the metal door piece face down on an insulated surface, the $\frac{1}{4}$ -inch steel rod can be positioned and silver soldered in position. The end of the rod should extend three inches beyond the width of the door and should be flush with the face of the door. Weights or clamps should hold the door piece down against the insulated surface to prevent warping during soldering. Two 1-inch areas of silver solder, at each edge of the door and rod contact points, are sufficient to hold the door securely to the rod. Do not bend the rod now. Depending on your preference, the door handle can be either to the left or the right of the oven. You can tailor this feature to your own need.

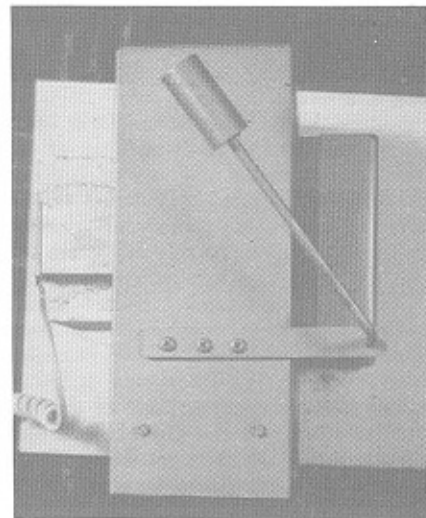

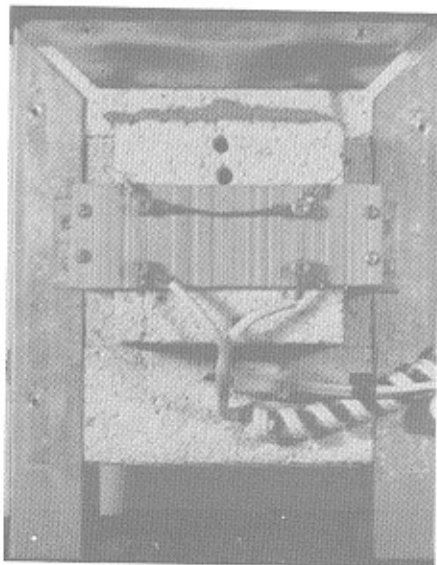

Rear of the oven with back cover removed, showing installation of the terminal board and heavy-duty cord.

the door, position and tighten the collars in place.

At a point, 2 inches from the hinge bracket, heat the hinge rod to a cherry red. Bend the rod up toward the top of the oven at an angle slightly less than 90°. At the same time the rod should be bent back about 35° as related to the front face of the oven. Use a concentrated pinpoint flame to achieve a sharp bend.

Prepare the counterweight by drilling a 1/4-inch diameter hole to a depth of approximately 2 inches. The counterweight can be secured to the end of the rod by an adhesive or a set screw. The counterweight can be made of any suitable round stock with sufficient weight to hold the door tightly closed.

Returning to the back of the oven, attach one Nichrome wire lead to each of the four bass terminal screws. Across the two upper screws a piece of heavy

Position the oven between two common bricks placed at the top and bottom of the oven so that the oven is level and the back bracket is held above the working surface of a workbench or table. Place the front door firebrick into the metal door piece and center this assembly on the oven with relation to the oven opening. Next drill 1/4-inch holes into the hinge bracket piece. These holes should be centered and 1/2-inch from the end of each piece. From the opposite end, drill three holes on 3/4-inch centers to accept sheet metal screws. Hang the two bracket pieces on the positioned door rod and locate the three screw holes on the sides of the metal case. Drill holes in the case to the root diameter of the sheet metal screws and assemble. The door can be opened and closed at this time to check any points of binding. Binding points can be relieved by further cutting away the firebrick.

Two 1/4-inch retaining collars should be used to keep the hinge rod from sliding back and forth. These retaining collars can be 1/4-20 hex nuts drilled to a full 1/4-inch opening. One of the hex nut faces on each nut should be drilled and tapped to accept a set screw. Place the retaining collars on the rod, one on each side of the hinge bracket. Center

BILL OF MATERIAL

- Galvanized iron sheet, 26 gauge
- 1 pc. 7 1/2"x32" (top & sides)
- 1 pc. 7 1/2"x8 1/2" (door)
- 1 pc. 6 1/2"x12" (bottom)
- 1 pc. 11"x15" (back cover) (light gauge)
- 2 pcs. 2"x3 1/4"
- 6 insulating firebrick, 2300°F, 9"x2 1/2"x4 1/2"
- 24 round head sheet metal screws, #6x3/4"
- 2 pcs. flat steel, 1/8"x1/2"x6"
- 1 pint high temperature furnace cement
- 1 heating element, Nichrome, coiled, 660 watts at 110 volts or 1000 watts at 110 volts
- 1 pc. round steel, 1/4"x18"
- 4 brass machine screws, round head, 10-24x3/4"
- 8 hex nuts, brass, 10-24
- 1 pc. round metal stock, any material, 1 1/2"x4" (for counterweight)
- 1 heavy duty line cord (type used on electric irons)
- 4 machine screws, round head, 6-32x1/4"
- 4 hex nuts, 6-32
- 1 power control, Type C.R.S., rated 660 watts or 1000 watts (minimum)*
- 1 pyrometer*
- 1 can, heat resistant lacquer or enamel*

*These parts are optional.

The two attractive models give scale to the burnout ovens.

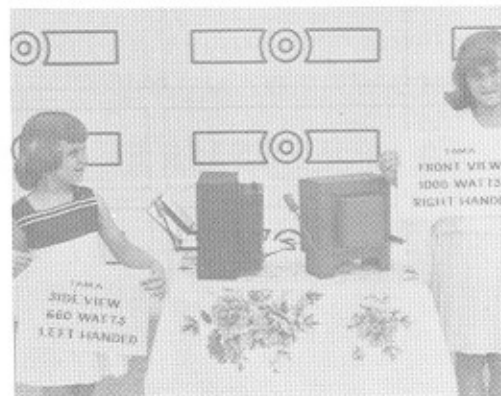

gauge copper wire should be attached, as a jumper, to give continuity to the two heating elements. To the bottom two brass terminals, attach the heavy duty line cord.

Position and affix the back cover using the remaining sheet metal screws. This completes the oven assembly except for painting. The new aerosol wrinkled finish paint in either black or grey gives the oven a professional touch and instructions for use are printed on the can.

If you elect to equip your oven with a pyrometer, the vent holes in the back cover can be used to pass the thermocouples through to the back firebrick and into the oven chamber. The pyrometer can be mounted on top the oven. In addition, a silicone controlled power rectifier of the proper wattage can be used in conjunction with this oven. By controlling the input of current, an infinite range of heat adjustment can be achieved over the range of either the 660 watt or the 1000 watt model.

A novel way of determining burnout temperature, if a pyrometer is not available, is to use an aluminum nail as a pyrometric sphere. The nail can be held upright in a ball of clay and the correct, reproducible temperature determined when the nail bends or melts. Most aluminum alloys melt at about 1200° which is also an optimum burnout temperature. If the aluminum nail method

is used as a heat indicator, it is suggested that the 660 watt model be built. This model has a slower and more gradual heat rise and the heat has more opportunity to soak through to the center of the invested pattern.

The author has found that burnout of a 1 1/2-inch diameter invested wax pattern can be completed in forty-five minutes, using the 660 watt model. Naturally, with a 1000 watt, controlled heat model, burnout can be accomplished much faster. With the investment setup (minimum one-half hour), the flask can be placed in the oven preheated to 900° and burnout accomplished in about twenty-five minutes. Trial and error will produce your own proven method and procedure.

Leftover firebrick pieces can be cut into slices 1/2-inch thick and used as trivets during burnout. Slots can be cut into these pieces to aid the free flow of wax from the invested pattern.

HOW TO MAKE

A PRESSURE CASTING MACHINE

In essence, lost wax or investment casting consists of investing a wax pattern, eliminating the wax through burn-out, and filling the resulting cavity with molten silver or gold under pressure. The necessary pressure can be achieved in a number of ways through centrifugal force, steam pressure, or air pressure. The method used here is air pressure, generated by a foot-powered tire pump.

The initial pressure necessary to force the molten metal into the cavity is five pounds. In theory, the metal should flow into the cavity without turbulence to prevent air from entering the cavity ahead of the metal. After about four seconds at five pounds pressure, a secondary load must be placed on the molten metal to achieve greater density. This secondary load can vary from 20 pounds up to 40 pounds pressure, depending on the density

desired and the intricacy of the pattern. By referring to the illustrations and the parts list, a general picture can be obtained as to the function and method of assembling the pressure casting machine.

Square steel tubing has been used for the working parts of the machine with a 3/16 or 1/4-inch steel plate for the base. Assembly can begin by cutting the square tubing to the required lengths to form the handle, the lever arm, the two uprights, and by cutting the base plate to the required dimensions. It would be well to mention at this point that if square tubing is not available, standard pipe and pipe fittings can be used and can produce similar results. Your own ingenuity in using this article as a basis for construction and dimensions can produce a casting machine using pipe instead of tubing.

The T shaped assembly which forms the handle and the lever arm are airtight, and act as an air reservoir for better control of pressure to the molten metal. After cutting all pieces to dimension, select the 5-inch length of square tubing which forms the handle. Both ends of this piece must be sealed by silver soldering filler blocks into the ends, being sure that the silver solder makes an airtight seal. A 1/4-inch hole must be drilled into this 5-inch piece to permit air to reach the handle. The 1/4-inch hole should be centered in relation to both ends and also centered across the width of the tubing.

Next the handle piece should be silver soldered to the end of the 9-inch lever arm, again being sure the solder joint is

The pressure casting machine with the arm raised and the flask in position. The concentric circles on the base aid in centering the flask under the pressure plate.

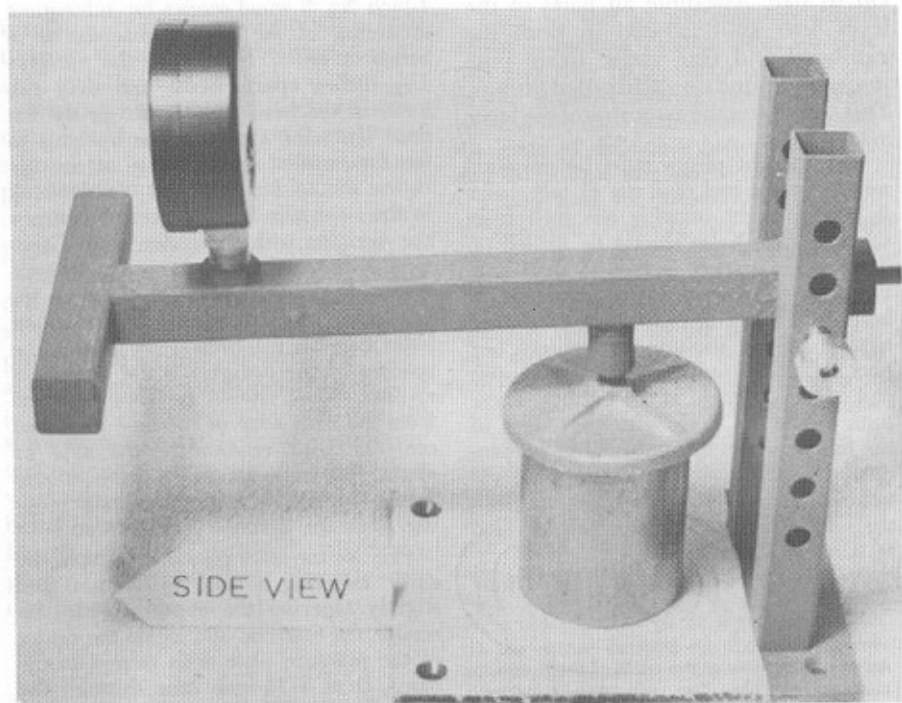
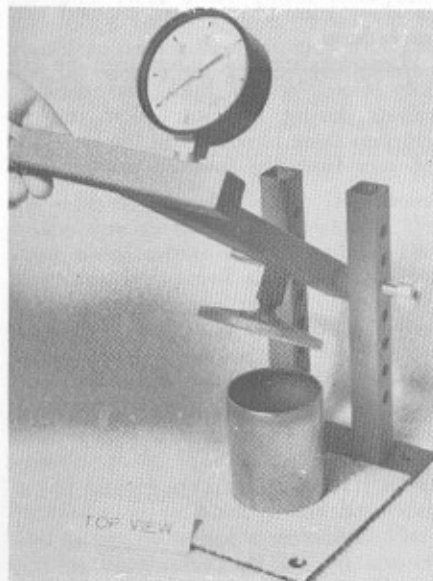

The completed pressure casting machine with a flask in position. The pressure plate on this machine is a casting but 1/4-inch sheet aluminum will serve as well. The swivel that joins the pressure plate to the arm allows the plate to adjust to the top of the flask even though it is slightly out of square.

airtight. The 1/4-inch hole in the handle piece should be centered and the hole should face into the open end of the lever arm, this will permit free passage of air into the handle. You should now have a T-shaped piece with the cross of the T sealed at both ends. Lay this piece flat and designate the top and bottom with relation to the final assembly.

Facilities must be provided in the lever arm to affix the air pressure gauge and the pressure plate. This can be done by soldering a reducer into the top and bottom of the lever arm which has been drilled to receive the reducers. The reducer for the air pressure gauge should be 1 inch from the handle end of the lever arm, on the top. The pressure plate reducer should be 6 inches from the handle end, and 4 inches from the opposite end of the lever arm, on the bottom. Both reducers should be centered

with relation to the width of the tubing.

The brass bushing should next be soldered into place by first drilling a 1/2-inch hole through both sides of the tubing parallel to the handle. The center of this hole should be 1 inch from the open end of the lever arm and centered with relation to the width of the tubing.

Center the brass bushing through the tubing and silver solder it in place. Through this bushing will pass the lever pin which acts as the fulcrum for the lever arm assembly.

Prepare the last filler block by drilling a 1/4-inch hole through the center and silver solder a 2-inch length of 1/4-inch copper tubing into this hole. Silver solder this assembly to the open end of the lever arm. The tubing will be attached to the hose from the foot pump which supplies air through the lever arm and the pressure plate to the molten metal.

The pressure plate is a 3-inch circular piece of 1/4-inch aluminum, drilled and tapped for 1/8" N.P.T. (National Pipe Thread). To this piece affix, with water glass (sodium silicate) as an adhesive, three layers of sheet asbestos substitute

cut to size. Assemble all parts of the lever arm as illustrated in both the exploded and side views, using pipe joint compound on all threaded fittings. This completes the assembly of the lever arm.

The upright pieces must be prepared next. Lay out and drill six $\frac{3}{8}$ -inch holes in each upright, starting one inch from the top. The holes should be drilled on $\frac{3}{4}$ -inch centers. It is best to drill both uprights together to insure alignment of holes when the uprights are assembled to the base. In addition, two $\frac{3}{8}$ -inch hex nuts must be silver soldered into the open end of each upright at the bottom. These nuts should be flush with the edges of the tubing so the uprights will be perpendicular when assembled to the base. If necessary, the ends of the uprights, with the nuts soldered in place, can be filed to achieve squareness.

Prepare the base piece by drilling four mounting holes at each corner to accept

1-inch No. 8 wood screws for subsequent mounting of the casting machine to a bench or table. Next space the uprights $1\frac{1}{2}$ inches apart, locate and drill two holes in the base plate to accept the flat head bolts for attaching the uprights to the base plate. The spacing of the uprights should be such that the bushing in the lever arm can be inserted between the uprights with some side play. Countersink the two holes from the bottom. Assemble the uprights into place on the base plate. Specific spacing for the above holes can be determined by trial. The spacing of the uprights is not extremely critical. They should be about $\frac{1}{2}$ -inch from the back edge of the base plate and centered with relation to the side or edges. All holes in the uprights should accept the $\frac{3}{8}$ -inch lever pin without binding. (See the assembled illustration.)

Prepare the lever pin, as illustrated, by silver soldering a knob to one end and slightly tapering the opposite end. Assemble the machine and locate the center of the pressure plate with respect to the base. Drill a $\frac{1}{4}$ -inch hole through the base plate at this point to permit passage of air. Cover the base plate with one layer of asbestos substitute as a heat

insulator, being sure to punch a hole through the asbestos substitute to coincide with the hole in the base plate.

With a compass, make a series of concentric circles, in pencil, on the asbestos substitute, using the hole in the base plate as a center. These circles will aid in centering the flask under the pressure plate when casting.

Paint the entire machine except for the areas covered with the asbestos substitute and attach the foot-powered tire pump. The wrinkle finish paints available in aerosol containers result in a professional-looking machine and, in some instances, can hide poor soldering techniques. Mount the machine at a workable height to a heavy table or bench. It may be necessary to add to the length of the hose supplied with the tire pump. This completes the pressure casting machine assembly.

Since we will go into complete details about investment casting later, now we will give only basic instructions for use of the pressure casting machine, highlighting the important steps and outlining the areas of difference between pressure and centrifugal casting.

Flasks used for pressure casting may be any type of tubing that has sufficient strength and which will withstand the burn-out temperatures. The top and bottom should be even and smooth, particularly the top, so the seal between it and the pressure plate on the machine can be maintained without having to apply excessive pressure on the handle.

The wax model should be sprued in the conventional manner using a wax sprue wire no larger than 10 gauge. If the wax model is of a size which would not permit complete filling of the cavity, additional sprues may be necessary. If additional sprues are used they should be gathered together at or about the center of the sprue former so that the investment will separate each sprue wire by at least $\frac{1}{32}$ inch.

The wax sprue wire and the wax model should be completely painted with a debubblizer, permitted to dry, rinsed, and again permitted to dry before investing.

The investing of the model is done in the conventional manner being sure that no air bubbles adhere to the wax model.

Prior to burn-out, the invested model should be permitted to set at least one half hour.

When the investment has set, a cavity must be reamed into the investment to facilitate the melting of the metal. This cavity should be a hemisphere approximately $\frac{1}{8}$ inch smaller in diameter than the inside diameter of the flask. A piece of sheet metal can be cut to this configuration and used as the reamer. The bottom of the invested flask should also be scraped slightly concave. (See illustration.)

The casting machine should be adjusted to the proper height of the flask through correct placement of the lever arm. Also set the pressure plate by pressing down on the lever arm with the flask in position.

Burn-out is accomplished at 1200°F

An exploded view of the parts of the pressure casting machine. The asbestos substitute cover for the base and the hole in the base are not shown. If a compressor is used for air pressure, the filler piece (under Reducer (1)) should have a $\frac{1}{4}$ " hole in it.

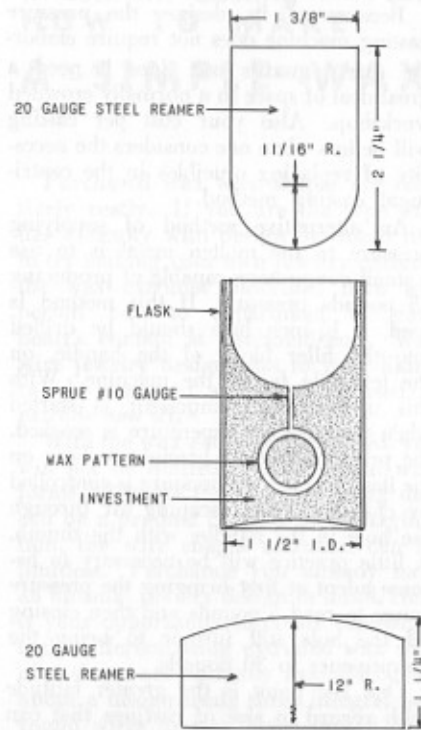
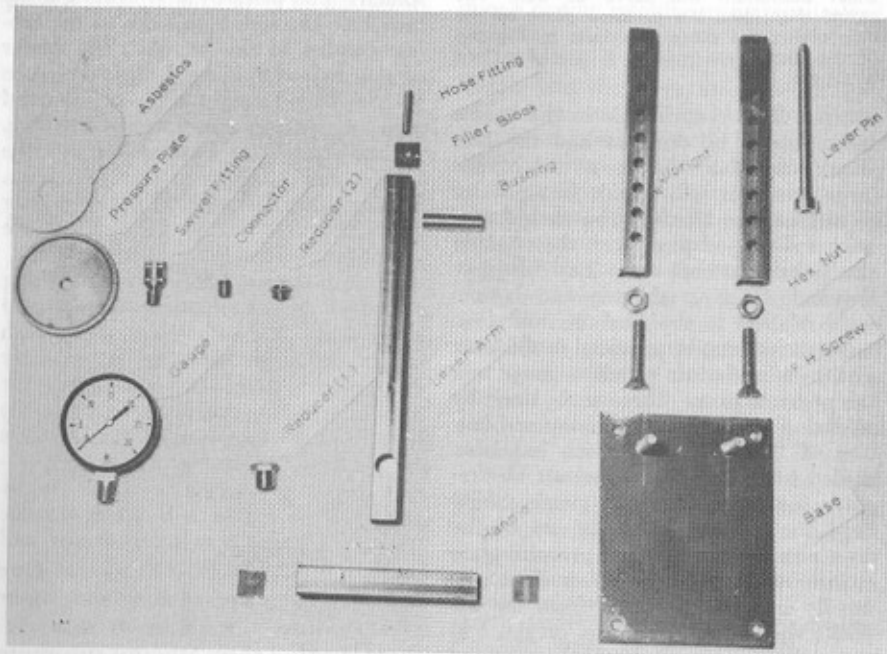

Cross section of a typical flask with reamers of sheet metal to form the top and bottom of the investment.

for a time sufficient to completely eliminate all wax residue. Complete burn-out for a man's ring normally takes one hour but this would depend on the wattage and size of the burn-out oven used.

When the investment is free of wax, the flask can be centered in the casting machine. The proper amount of metal should now be placed into the reamed cavity and the metal melted. No flux should be added to the metal until the metal is completely molten. After fluxing, the metal should be again heated until completely fluid. The exact temperature at which to cast the metal is a matter of trial and error but occurs at a point just under the temperature at which the metal begins to "spin." The author's first try was unsuccessful but I have had no difficulty since in determining the casting temperature.

The flame should now be removed from the metal and the lever arm and pressure plate brought to bear on the flask. Firm hard pressure should be applied. Immediately bring the air pressure to 4 to 6 pounds by pumping the foot pump. In approximately 2 to 4 seconds increase the air pressure to 20 to 40 pounds. The initial air pressure of 4 to 6 pounds is needed to gently force the metal into the cavity and the increased pressure is

needed to produce a dense casting. The increased pressure should be held for about 2 minutes or a sufficient length of time to permit the metal to solidify.

If you are perplexed at this point, it should be explained that the surface tension of the molten metal will not permit it to flow through the sprue until external pressure is applied. You will remember that we said the sprue should not exceed a 10 gauge wire size because if a larger sprue is used, some of the metal will flow prematurely and spoil the casting.

After a few minutes, pick up the flask with tongs and quench it in a container of water. Remove the casting, pickle and finish.

As mentioned previously, the pressure casting method and the casting machine outlined is capable of reproducing the most intricate castings. With this casting machine there is no chance of losing metal through unbalance, as is the case with centrifugal machines.

Because of its design, the pressure casting machine does not require elaborate safety guards nor does it need a great deal of space in a normally crowded workshop. Also your cost per casting will be less when one considers the necessity of replacing crucibles in the centrifugal casting method.

An alternative method of supplying pressure to the molten metal is to use a small compressor capable of producing 35 pounds pressure. If this method is used, a 1/4-inch hole should be drilled into the filler block of the handle, on the left side facing the machine. With this method the compressor is started when the casting temperature is reached, the pressure plate is brought to bear on the flask and the air pressure is controlled by closing off the escaping air through the hole in the handle, with the thumb. A little practice will be necessary to become adept at first bringing the pressure gauge to read 5 pounds and then closing off the hole still further to bring the air pressure to 30 pounds.

One last point is the greater latitude with regard to size of castings that can be produced with this casting machine. Flasks up to 5 inches in height and up to 3 inches in diameter can be used.

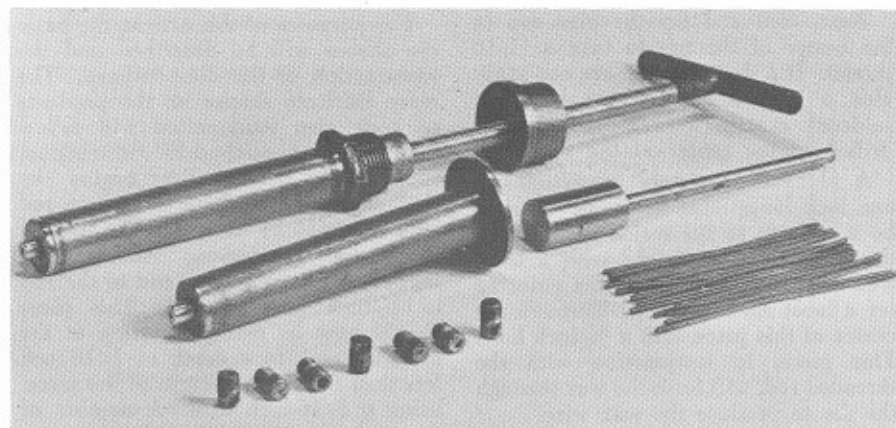

Two versions of the wax wire extruder. Top: The hand-operated extruder with the pipe cap unscrewed to show the assembly of the piston. Center: An extruder barrel with

the piston designed to be used under the quill of a drill press or an arbor press. Lower: A group of dies with a variety of shapes and some extruded wax wire made with the device.

Investment Casting — Part 4 HOW TO MAKE

A SIMPLE WAX WIRE EXTRUDER

Purchased wax wire shapes are relatively costly. If you are the type that has difficulty with design or would like to try making your own jewelry designs, the wax extruder described here will permit you to experiment to your heart's content at minimum cost. Wax wire jewelry designs not to your liking can be remelted and the wax used to extrude new wire.

With the wax extruder illustrated, you will not be limited to commercial wire forms. Because the wax extruding dies can be a product of your own imagination, the wire shapes extruded can be limitless. Perchance you already have an unusual jewelry design in mind. Here is your opportunity to create something truly different using extruded wax wire of a shape not normally available. How about a design using three integral half round wires or possibly a design combining three different sized triangular wax wires? Your own ingenuity and creativeness can be your guide.

The construction of the wax extruder can begin by sawing off the threaded portion of the 3/4-inch pipe. The inside diameter of this piece is approximately .824 inch and must be carefully filed to increase this to .875 inch or the outside diameter of the brass tubing. When you have removed sufficient metal from the inside of the threaded piece so that it just slips over the tubing, the thread can be silver soldered to the brass tube. Be sure this piece is a tight fit. If facilities are available a 7/8-inch metal drill can be used to enlarge the threaded pipe and eliminate the tedious filing.

A filler piece must now be silver soldered to the opposite end of the brass tube. This filler should be solderable material, either steel or brass, and at least 3/16-inch thick. The filler block should be filed to fit snugly into the inside of the tube and soldered flush with the edge of the tube. The filler piece after assembly should be drilled and tapped with a 5/16-24 thread.

BILL OF MATERIAL

- 30" — 1" square steel tube
- 1 pc. 9"; 1 pc. 5"; 2 pcs. 8"
- 1 pc. 3/16" or 1/4" sheet steel for base
- 3 pcs. 1/8"x1"x1" sheet steel for fillers
- 2 3/8"x1" flat head bolts
- 2 3/8" hex nuts (for above)
- 2 1/4"x1/8" N.P.T. reducers*
- 1 1/8" N.P.T. connector*
- 1 1/8" N.P.T. swivel fitting*
- 1 pc. 1/4"x3" flat aluminum or dural plate
- 1 pc. sheet asbestos substitute (see Safety Notes, pg. 5)
- 1 3/4" I.D. x 1/2" O.D. x 1 1/2" brass bushing
- 1 0-30 p.s.i. air pressure gauge with 1/8" N.P.T.
- 1 foot-operated tire pump
- 1 pc. 3/8"x3 1/2" round steel rod
- Miscellaneous: silver solder, flux, pipe joint compound, hose clamp.

*These materials normally available from electrical supply houses handling lamp parts.

Next, drill and tap the pipe cap in the center of the top to take a $\frac{3}{8}$ -16 thread. If a drill and tap are not available, a $\frac{3}{8}$ -inch hex nut can be silver soldered exactly over a $\frac{3}{8}$ -inch hole drilled in the center of the pipe cap.

A plunger or piston, approximately one inch long, must be made. It must be a snug fit to the inside diameter of the brass tube. A friend with a lathe would be most helpful at this point or try a local machine shop. Through the center of this piece drill a $\frac{3}{8}$ -inch hole. This piece, in conjunction with the threaded rod, will force the wax through the die to produce the wax wire.

To one end of an 8-inch length of the threaded rod, silver solder a $\frac{3}{8}$ -inch round bar, about 4 inches long. This will form a T handle. Assemble this piece through the threaded pipe cap and install the piston to the opposite end using three $\frac{3}{8}$ -inch hex nuts and two $\frac{3}{8}$ -inch washers. The two hex nuts on top of the piston should be locked together tightly. If you prefer one hex nut can be used but it should be silver soldered in place. This completes the body of the extruder.

Making the Dies

The more tedious and exacting portions of the wax extruder is the construction of the wax extruding dies. The dies used to extrude round wire are relatively simple to construct. The square, triangular, half round and double half round may take a little more effort but they are not outside the ability of the amateur.

BILL OF MATERIALS

- 1 pc. 1x1x3/16" steel or brass
- 1 3/4" pipe cap
- 1 pc. brass tube, 7/8" O.D., 6" long
- 1 3/4" close pipe nipple
- 1 pc. threaded rod, 3/8-16, 8" long
- 4 3/8-16 hex nuts
- 1 pc. 3/8" rod, 4" long
- 1 pc. round stock, 1" long, diameter to fit I.D. of barrel. See text.
- 1 pc. round brass rod, 5/16" dia. For dies. Length as required.
- 1 pc. brass flat stock, 1/16"x5/16". For dies. Length as required.

For purposes of this article, the basic die shapes will be described and the construction of the dies outlined. The more intricate shapes or the products of your own imagination will follow the same basic method of construction.

All dies construction begins by threading the end of the 5/16-inch rod with a 5/16-24 thread. The thread should be 1/4-inch long. After threading, cut off the threaded end of the rod to 1/2-inch long, overall. This piece should now be drilled, starting at the threaded end, to a depth of 1/16-inch less than the overall length of the piece, using a 3/16-inch drill. A number of these pieces can be made in preparation for various die forms.

Round Wire Dies

A hole of required size should be drilled on centers through the end of the die piece opposite the threaded end. This hole can be any diameter up to and including 3/16-inch. The holes should correspond to the various wax wire sizes desired. Combinations of round, integral wax wire shapes can also be made by drilling overlapping holes.

Other Die Shapes

Take a die piece prepared as above and scribe a line through the center of the end opposite the thread. With a fine cut flat file, file away half the diameter of the piece to a depth of 1/16-inch. Keep the file parallel to the diameter and square to the length of the piece. Using the 5/16-inch brass flat stock, cut a piece slightly over 5/16-inch long. Into this piece file the shape desired using square, round or triangular needle files. Center this piece with respect to the die piece and silver solder it in place. An infinite number of die shapes can be prepared in this manner.

Using the Extruder

The extrusion of the bulk wax into the various wire shapes is a relatively simple operation. Having charged the extruder with a length of bulk wax, select the die and assemble the extruder. Using a Bunsen burner or an alcohol lamp, heat the extruder over its full length by rotating it over the flame. Permit sufficient time to elapse between each heating to allow the heat to penetrate the entire mass. At a point just below

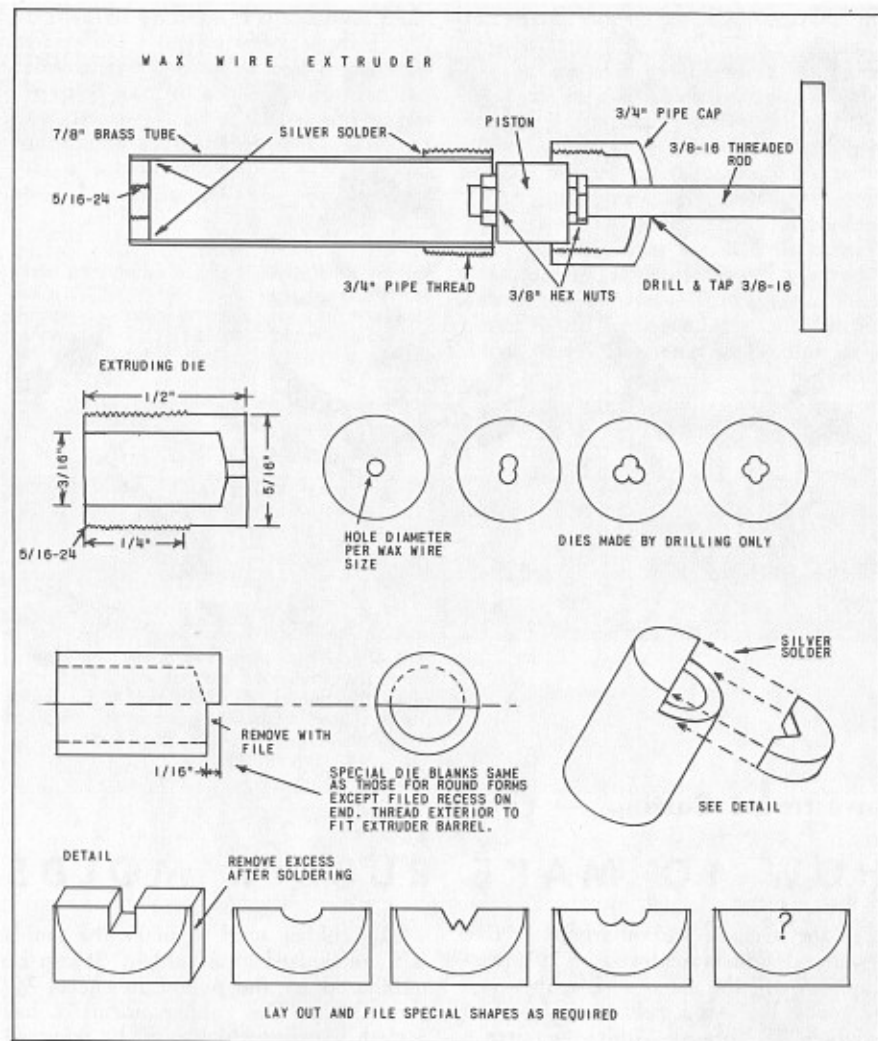

the temperature where the extruder becomes uncomfortable to hold, the wax can be extruded. Point the extruded wax toward the floor to permit gravity to straighten the wax wire. The beginning length of extruded wire will tend to curl. When a sufficient length has been extruded the weight will straighten the remainder. Permit the extruded wax to form a large coil, on the floor, allow time for the wax to harden, and then cut it into desired lengths.

The temperature required for wax extrusion is a matter of trial and error.

After a few tries you will be able to extrude without difficulty.

If a drill or arbor press is available, the wax extruder can be adapted to use this method. By replacing the thread on the tubing with a flange of sufficient diameter, the extruder can be placed into a hole in the drill press table and the quill used to apply pressure. With this method the threaded piston rod can also be replaced with a non-threaded rod. The pipe cap can also be eliminated. Both versions of the extruder are illustrated.

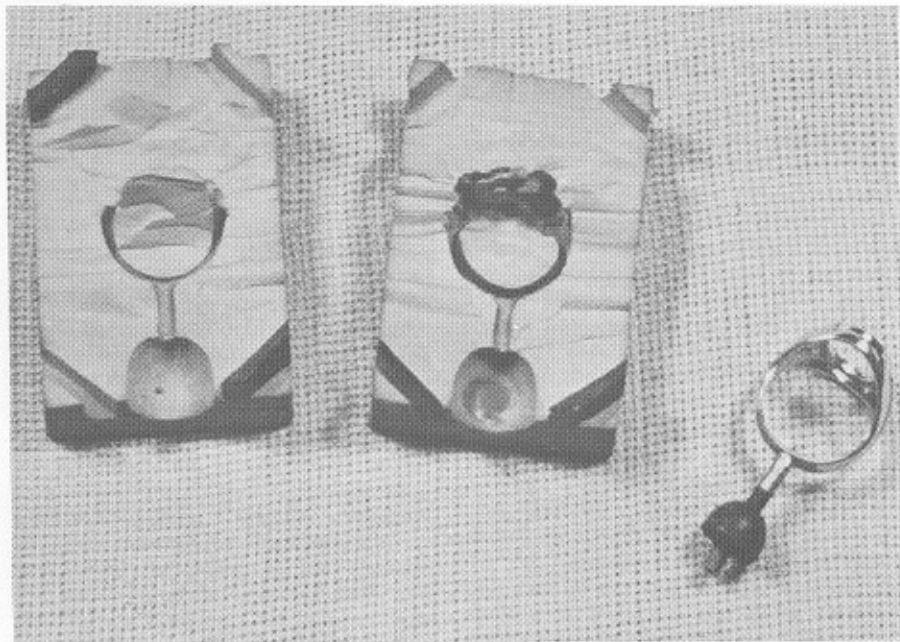

A rubber mold, parted to show the cavity. Note the four keys cut at each corner to align the halves. At the right is the metal pattern used to mold the cavity, complete with sprue and sprue button.

Investment Casting — Part 5

HOW TO MAKE RUBBER MOLDS

In the event a particularly attractive jewelry design is achieved or you need duplicates of the same design, they can be made by using rubber molds. An example is a bracelet which requires a number of links of the same design to achieve the necessary length. These can be the product of repetitive wax patterns made with a rubber mold. Through the use of this media it is only necessary to execute one metal pattern. Soft metals such as lead, pewter or tin-lead solders can be used as the master pattern material. They are all relatively easy to carve, file and engrave to create the first design. A rubber mold made with the master pattern can then produce wax patterns which can be used to cast additional pieces in more durable metals such as silver, gold, brass, and aluminum.

The rubber used to make the molds is unvulcanized gum rubber. It can be purchased by the pound in sheets $\frac{1}{8}$ -inch thick. The rubber normally has a cloth backing which must be removed before use. In addition, the rubber should be dipped into naphtha or benzine to remove any residue of oils. (Naphtha and benzine are very flammable. Handle with care at your own risk).

The materials needed to produce a rubber mold are the pattern, the unvulcanized rubber, a flask to contain the unvulcanized rubber and a means to apply pressure and heat.

Having already covered the subject of the rubber and the pattern, the next

item would be heat. Professional mold makers use a device which applies both pressure and controlled heat to the rubber filled flask to achieve vulcanization. This device is rather costly and unless you intend to make large numbers of rubber molds, your kitchen oven can be used satisfactorily. The heat required

to attain vulcanization is 300°F. for approximately 30 to 40 minutes, depending on the size of the mold. A mold $1 \times 1\frac{1}{2} \times 2$ inches which is an ideal size for rings and small jewelry pieces, takes 30 minutes at 300 degrees to cure. Larger molds will take relatively more time. Once you have established your mold size, trial and error will produce the proper time for repetitive results.

Parts and materials for vulcanizing rubber molds. The flask is shown between the clamping screws on one plate of the vulcanizing clamp. The other plate fits on top of this assembly and is held in place by the wing nuts.

One word of caution with regard to your kitchen oven — the internal temperature of the oven does not always agree with the oven dial setting. The heat required to produce vulcanization

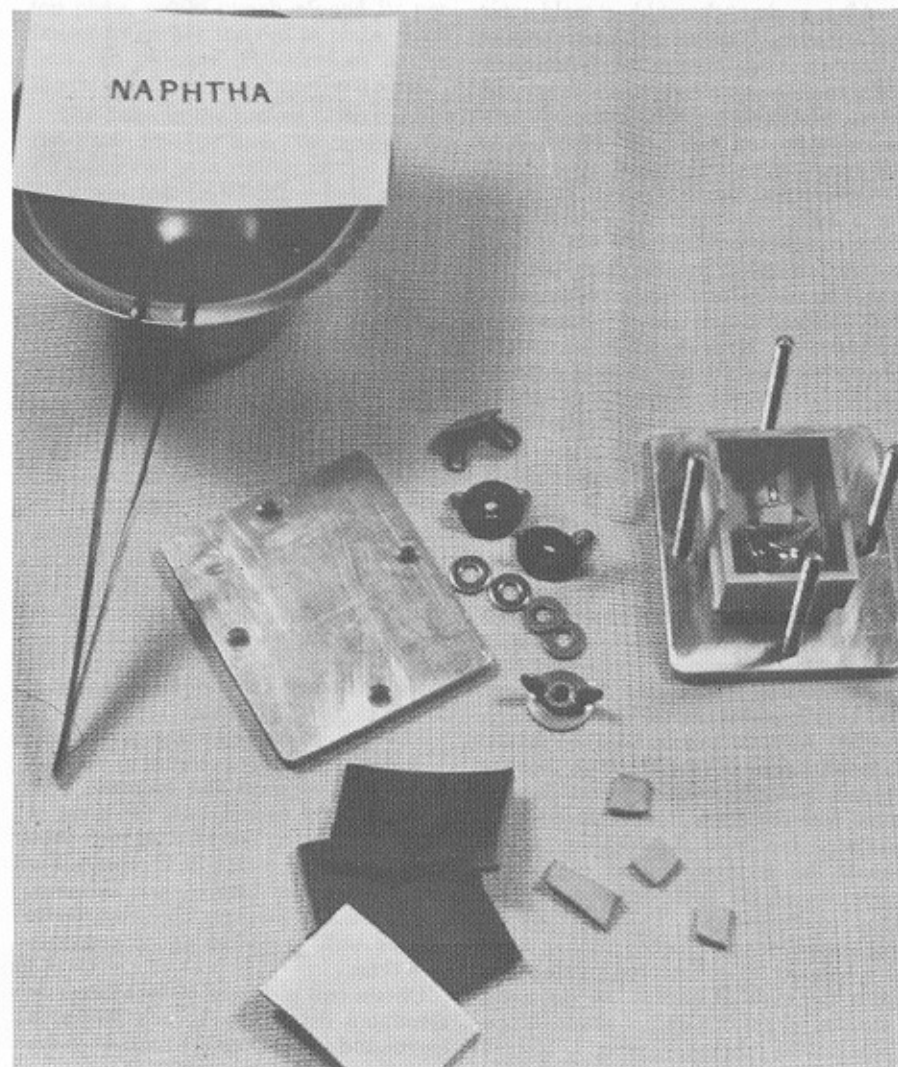

is critical within plus or minus 5°F. Preheat your oven for approximately 15 minutes prior to curing the rubber mold, then check and adjust the temperature accordingly. A small oven thermometer purchased at a local hardware store will suffice for temperature checking. If your rubber mold is not completely vulcanized, increase the time of curing. If the mold has a burnt appearance around the pattern, decrease the curing time. Again, establish the time necessary in conjunction with your mold size to attain vulcanization and use this time "forever more."

After curing, the rubber mold must be cooled in water to room temperature before cutting or parting. After removing the mold assembly from the oven, plunge the entire assembly into a bucket of tap water and permit it to remain submerged until completely cooled. Approximately a half hour will be a sufficient length of time to produce complete cooling. Do not attempt to part or cut a hot mold as this will result in uneven shrinkage and a faulty wax pattern.

A device must be made to contain the pattern and the rubber, plus a means to apply pressure during the heating cycle. The device illustrated is a simple way to achieve this end.

Flask

The rubber mold flask is a length of extruded, rectangular, aluminum tube stock cut and squared to the correct height. This material can normally be obtained from aluminum supply houses as cutoffs or from your local aluminum storm door and screen showroom. The flask illustrated measures 1 inch high by $1\frac{1}{2} \times 2$ inches in width and length inside. A $\frac{1}{8}$ -inch hole must be drilled into one end of the flask to hold a sprue piece. This hole should be centered with respect to both the height and width of the flask. In addition, a line should be scribed around the inside perimeter of the flask centered with respect to the height. This line will be duplicated in the finished rubber mold and will act as a centered cutting line when the mold is parted. In the event extruded aluminum is not attainable, a flask can be fabricated using 1/16-inch

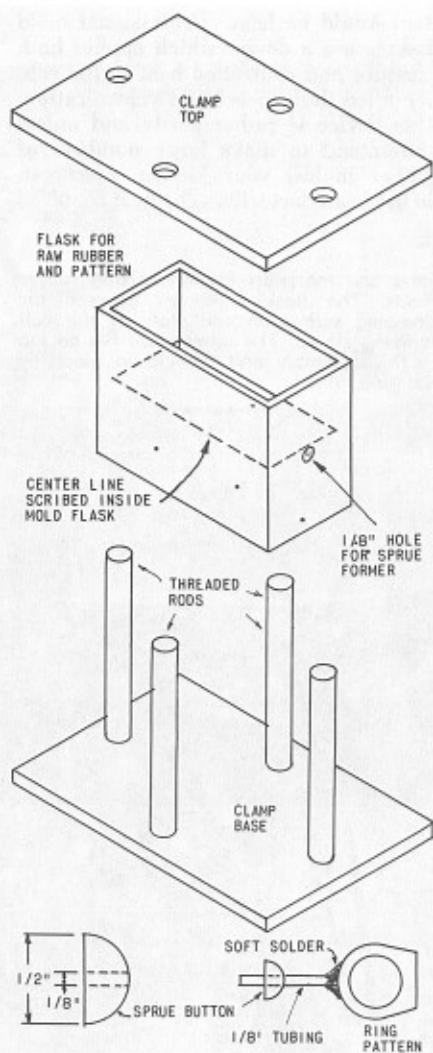

brass flat stock cut and silver soldered to the correct dimensions.

Pressure Device

A device to apply pressure to the rubber filled flask must also be made. This can simply be two $\frac{1}{4}$ -inch flat brass or aluminum plates, cut to size, with pressure applied by means of C clamps. For convenience and ease of use, however, the illustrated pressure applying device will be well worth the added construction time.

Obtain two pieces of $\frac{1}{4}$ -inch brass or aluminum flat stock, $\frac{3}{4}$ -inch larger in length and width than the outside of the

flask. With both pieces clamped together, drill four holes $\frac{3}{8}$ -inch from each outside edge and centered with respect to the length and width of the pieces. Use a No. 7 drill so one set of holes can be tapped with a $\frac{1}{4}$ -20 standard screw thread (N.C.). Designate one of these pieces as the top, the other as the bottom, and separate.

Thread the four holes in the top piece with $\frac{1}{4}$ -20 threads. Obtain and cut four $2\frac{1}{2}$ -inch lengths of $\frac{1}{4}$ -20 threaded rod and screw these into the threaded holes in the top piece. With one end of each threaded rod flush with the face of the top piece, center punch around its perimeter to anchor the rod in place. Lock nuts can be used if desired to anchor the threaded rod to the pressure plate.

The holes in the bottom plate must be redrilled to $\frac{1}{4}$ inch to accept the threaded rod as a sliding fit.

Obtain four $\frac{1}{4}$ -20 wing nuts and assemble the pressure device as illustrated.

Making a Mold

The actual making of a rubber mold consists of cutting a number of pieces of the sheet rubber to the inside dimensions of the flask. The exact number can be calculated. If $\frac{1}{8}$ -inch sheet rubber is used, divide $\frac{1}{8}$ into the flask height. As an example, a flask one inch high will require 8 pieces of sheet rubber cut to dimension.

Next sprue the pattern to a short length of $\frac{1}{8}$ -inch brass or copper tubing, affixing the sprue piece to the pattern with soft solder. Assemble the sprued pattern with the sprue button in place through the $\frac{1}{8}$ -inch hole in the flask. The pattern should be cen-

TO SEPARATE RUBBER MOLD, CUT ALONG HEAVY LINE IN DIRECTION OF ARROWS. DRAWING SHOWS ONLY ONE CORNER OF MOLD.

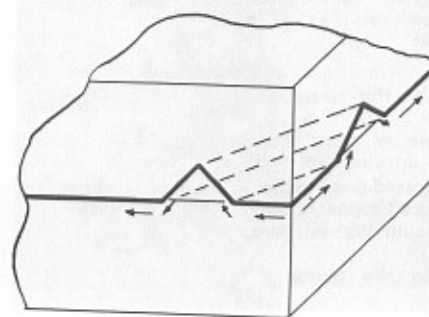

tered with relation to the width and length of the flask. Centering with respect to height will be automatic when the flask is packed with rubber.

Place the flask on a flat surface and pack half of the precut rubber pieces into one side of the flask. Place the pressure plate on top of the packed rubber and turn the assembly over. Pack the remaining half of the flask with rubber and put the other pressure plate into position. Screw on and tighten the wing nuts to compress the rubber into the flask. Place the entire assembly in a preheated oven and cure as outlined above. After about 5 minutes in the heated oven, the rubber will soften and begin to flow. At this time, again tighten the wing nuts until the pressure plates are in intimate contact with the rubber filled flask. Remove (hot; handle with care) and cool when curing is complete as outlined above.

Parting the Mold

The most exacting portion of making the rubber mold is the actual cutting or parting of the mold. Basically, the mold must be parted so that the wax pattern can be extracted with a minimum of difficulty. A little forethought prior to the actual cutting of the rubber will pay dividends when the time comes to remove the wax pattern. Studying the actual pattern and predetermining where the mold should be cut will aid greatly when the mold cutting begins.

To outline the various intricacies associated with rubber mold cutting would be much too lengthy for an article of this nature. We shall endeavor to explain and illustrate the cutting of a rubber mold for a man's ring. Adaptations of this method will permit the cutting of the other molds using the same basic techniques.

Begin by holding one corner of the rubber mold in a bench vise. Place the rubber mold into the vise in such a manner that it will be held along its entire width at the bottom edge. (See illustration.) With a sharp knife, cut across one corner, at the parting line, to a depth of $\frac{1}{8}$ inch then cut upward at a 45° angle and back down



A rubber mold clamped in a bench vise for parting. Below are two molds (four halves) that have already been parted. A sharp model maker's or art knife with a thin, razor-sharp blade was used to cut the rubber.

of the rubber mold. As the cutting progresses, continually pull the mold apart and proceed with further and deeper cuts. In order to cut the rubber easily, the rubber must be stretched prior to the application of the knife edge and the actual cutting of the rubber.

When the entire pattern has been reached around its outside perimeter, again stretch the rubber and cut the center portion of the rubber mold. This area would correspond to the center or finger portion of the ring. Finally, if the ring is a bezel setting, cut through just above the bezel seat to the outside of the pattern cavity. The mold should now be dusted with baby talc and the excess talc blown away. Be sure that the talc comes in contact with all cut and pattern surfaces of the mold in order to facilitate removal of the wax pattern.

Rubber molds need not be restricted to jewelry articles alone. Small, non-replaceable parts of almost anything can be duplicated in rubber and the wax patterns cast in brass or aluminum. If the part is broken, it need only be temporarily soldered together and a rubber mold made. The resulting casting will be as good as a new one.

BILL OF MATERIALS

- 2 pcs. 1/4" brass or aluminum sheet (see text)
- 1 length 14-20 threaded rod about 12" long
- 1 pc. extruded rectangular tube about 1 1/2"x2"x1 1/2" or sheet brass 1 1/2"x7"x 1/16" (see text)
- 4 1/4-20 wing nuts
- 1 length 1/8" copper tube (for sprue, see text)
- 1 pc. 1/2" brass or aluminum round stock for sprue buttons, (see drawing and text)
- 1 (or more) lbs 1/8" unvulcanized gum rubber (Available from jewelry craft suppliers, such as Bartlett & Co., 5 South Wabash Ave., Chicago, IL 60603)
- Dusting Talc, solder, X-Acto knife, naptha

Investment Casting — Part 6

HOW TO MAKE A WAX INJECTOR

Once a particularly attractive jewelry design has been executed in metal and a rubber mold is made, it becomes a simple matter to reproduce this design in wax. Although wax can be poured or centrifugally cast into the mold, a better, quicker method is to use a wax injector. Basically a wax injector consists of a heated pot to hold the liquid wax and a means to transport the wax, under pressure, to a rubber mold. Commercial models are available utilizing both air and hydraulic pressure with heat that is thermostatically controlled. Needless to say the commercial models are relatively costly.

The wax injector outlined here is, in general, quite similar to the commercial models. The molten wax is transported to the rubber mold by hydraulic pressure produced by a piston and cylinder arrangement. The temperature of the wax is controlled thermostatically, using a self-contained flat iron thermostat. The heat is produced elec-

Simulated use of the wax injector. The finger points to the pump plunger where pressure is applied to inject the wax into the rubber mold. Note the bag of dusting talc for dusting the interior of the molds, several rubber molds, and wax patterns.



trically by using resistance wire (nichrome).

The construction of the wax injector can begin by cutting off a 4 1/4-inch length of 3-inch diameter stainless steel or brass tubing. Next prepare a circular piece of 1/16-inch steel or brass the outside diameter of the tubing. Center this piece with respect to the tubing and either silver solder or soft solder it in place. This will form the bottom of the melting pot and should be fluid tight.

Cut strips of 3"-wide sheet asbestos substitute, 4 1/2" long (or make up width equivalent with what is available). Taking one at a time, dip a piece into water and apply it to the outside of the pot, covering the entire surface except for the bottom. When the asbestos substitute has thoroughly dried, trim off the excess from both top and bottom.

Next begin winding the nichrome wire around the pot, starting from the bot-

tom. Leave a 6-inch lead of nichrome wire at both top and bottom. Two thirds of the length of wire should be wound on the bottom half of the pot, the remaining one third on the top half. Because the concentration of wax will be at the bottom of the pot the greatest amount of heat must be generated in this area.

Be sure to space the nichrome wire so no two wires touch. The nichrome leads going to the thermostat and the line cord should be covered with radio type fiberglass spaghetti.

In the event you are unable to purchase the nichrome wire specified (ohms per foot), substitutions can be made. The wax melting pot, as designed, requires approximately 145 ohms resistance to produce 100 watts. To determine this, use a simple application of Ohm's law. To find the amperage neces-

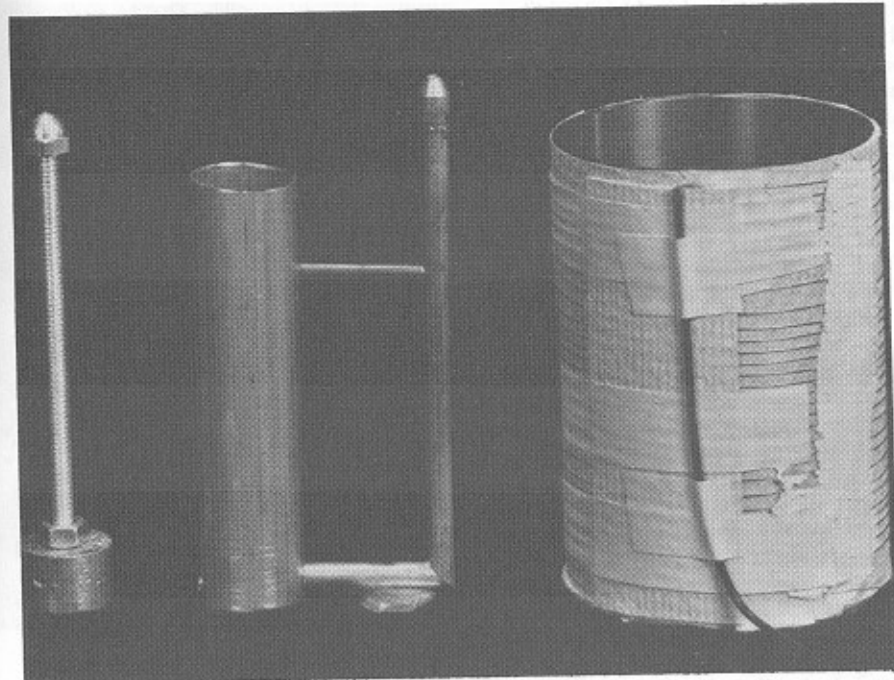

The working parts of the injector. Left, the piston with its piston rod. Center, the pump cylinder with assembled wax transfer tube and tip. Right the wax pot covered with asbestos substitute and wound with nichrome resistance wire to form the heating element.

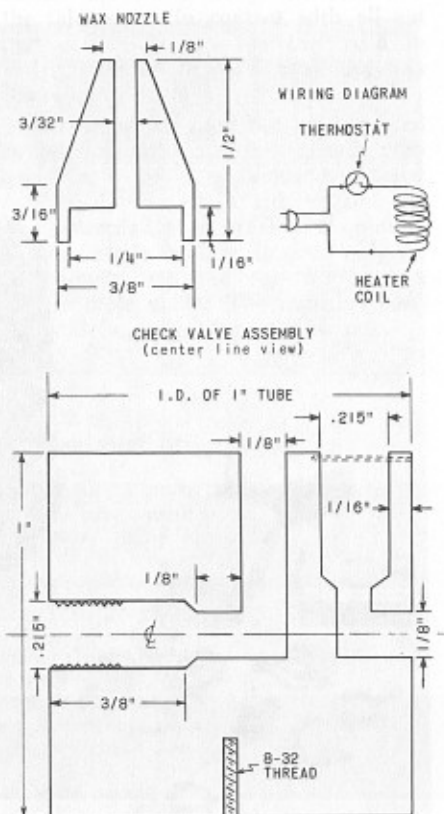
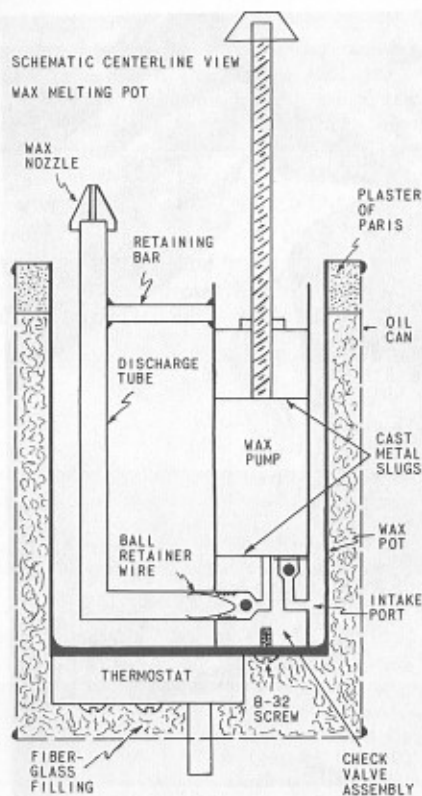

sary, divide the watts required into the volts. To determine the resistance needed, divide the amperes, derived from the above, into the volts. As an example: 120 volts divided into 100 watts equal .83 amperes. In like manner, .83 amperes divided into 120 volts equal 144 ohms of resistance. If the nichrome wire is rated at 5 ohms per foot, the amount necessary would be 144 ohms divided by 5 or 29 feet of wire to obtain 100 watts.

The thermostat must now be attached to the bottom of the pot. This can be done by centering the thermostat and locating the two mounting holes with respect to the bottom. Drill two corresponding holes with a number 29 drill (.138") and tap with an 8-32 thread. Coat the ends of the screws with gasket cement and attach the thermostat to the bottom of the pot. The two screws, when in place, should be flush with the bot-

tom, inside of the pot. The gasket cement is necessary to prevent leakage of the wax. Do not at this point attach the thermostat permanently.

Next take the 1" diameter brass tube and cut off a length of approximately 1 1/2". Square one end of this piece, which will be used as a mold. Mount the tube, base down, on a piece of sheet asbestos substitute by some means. Melt sufficient lead, tin-lead solder, or white metal to be able to pour two slugs of metal approximately 1" in height. The short piece of brass tubing should be coated with a light film of oil or petroleum jelly prior to pouring this metal. The two slugs thus made will be used for the piston and check valve assembly of the wax injector.

Taking one of the slugs you have cast, drill a .201" hole through the center. Tap this hole with a 1/4-20 national course thread. Cut off a 5-inch length of the threaded rod and screw this into the thread in the metal slug. Lock the rod in place with a 1/4-20 hex nut. This combined part is the piston

and piston rod assembly for the wax pump.

Take the remaining slug and scribe a line through the center of one end and down both sides. Refer to the details of the check valve assembly and drill holes as outlined. It is suggested that the $\frac{1}{8}$ " holes be drilled first and then redrilled with a larger drill. When the holes have been completed, set a ball bearing in each hole. Place a drift punch on top of the ball bearing and strike the punch smartly. This operation will tend to form the bottom of the hole to the ball bearing, thus providing a better seat. Tap the hole on the left of the diagram with a $\frac{1}{4}$ -28 national fine thread to a depth of $\frac{3}{16}$ inch.

The two holes on the side of the slug will be the intake and discharge ports for the molten wax. The smaller hole, to the right in the diagram, will be the intake port, the larger hole to the left will be the discharge port.

Taking next the remaining four-inch length of one-inch diameter brass tubing, drill two holes corresponding to the holes previously drilled in the check valve assembly. The check valve assembly should be flush with one end of the one-inch tubing. Make a wire retainer, as shown in the diagram, and assemble the check valve into the tubing, making sure the holes in the assembly are aligned with the holes in the tube. The intake ball should be in place when this portion is assembled.

Cut a piece of the $\frac{1}{4}$ -inch tubing at a 45 degree angle, the overall length of this piece should be $1\frac{1}{2}$ inches. The remaining length of $\frac{1}{4}$ -inch tubing, also with the 45 degree angle, should be silver soldered to the first piece at a 90 degree angle. Thread the short arm of the tubing with a $\frac{1}{4}$ -28 thread for a length of $\frac{3}{16}$ inches. Prior to assembling the brass tubing to the check valve assembly, place a U shaped piece of wire into the tubing to act as a retainer for the bearing ball. This piece of wire should keep the ball from seating into the end of the tubing. Assemble as illustrated with the discharge ball in place. A reinforcing bar must be soldered between the $\frac{1}{4}$ -inch and the 1-inch brass tube to keep the assembly

aligned and rigid. Care should be taken when soldering this bar not to overheat the wax pump and thus melt the previously installed check valve assembly.

Place this entire assembly into the wax melting pot. Cut off the $\frac{1}{4}$ -inch brass tubing approximately $\frac{3}{4}$ of an inch above the top edge of the wax pot. Prepare the nozzle, as illustrated, and soft solder it in place. Locate the center of the check valve assembly with respect to the melting pot. Drill a hole through the bottom of the pot to align with the threaded hole in the check valve assembly. Coat the bottom of the wax pump with a heavy layer of gasket cement and assemble the wax pump into the pot.

The thermostat can now be assembled to the bottom of the pot. One of the nichrome leads will go to one terminal of the thermostat, the remaining nichrome lead will go directly to the line cord. The remaining lead from the

Bottom view of the wax injector showing the wooden feet and thermostat knob. Note that the cover plate is soldered inside the case, slightly below the end, and that it is only "tacked" in several places so it can be easily removed if necessary. To the right is the top cover plate with holes for the injector nozzle and piston rod. Below is a rubber mold with two pieces of metal sheet used to hold it together while the wax is injected.

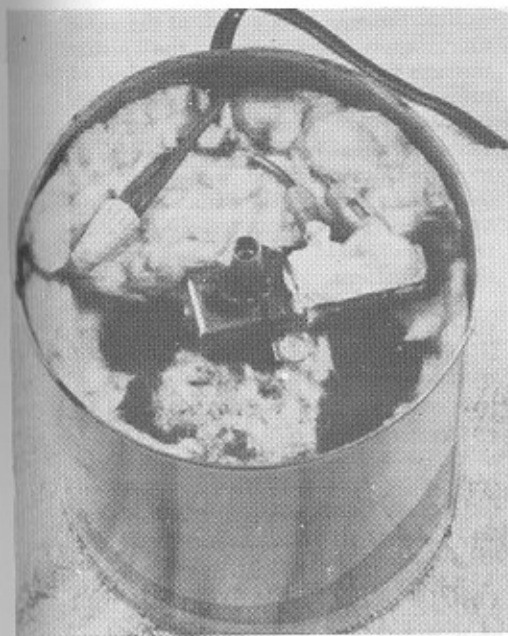
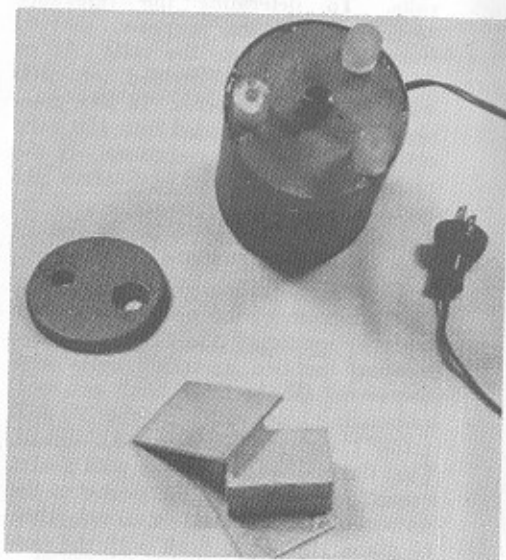

Bottom view of the wax injector with the base plate removed, showing the fiberglass insulation, thermostat, wiring, and position of the thermostat. The terminals of the thermostat have been covered with refractory cement for added electrical insulation.

line cord will be attached to the second terminal of the thermostat to complete the circuit.

Cut out both ends of a one-quart, composite oil can, or a metal can of the same size, and clean it thoroughly. Place the can on a flat surface and center the assembled wax melting pot, bottom side up, into the center of the can.

Begin packing loose fiberglass insulation between the melting pot and the inside of the oil can. Wear gloves and a dust mask when handling the fiberglass; work in a well-ventilated area and proceed at your own risk. Discard the gloves when the job is done.

Next cover the entire bottom of the wax melting pot with loose fiberglass except for the area around the thermostat. To prevent the loose fiberglass from entering the thermostat mechanism, make a U-shaped metal dam to retain the fiberglass. Cut a circular piece of 20 gauge galvanized iron which will

just fit into the inside of the oil can. Drill a $\frac{1}{2}$ " hole into this circular piece which will align with the adjusting shaft of the thermostat. Place the circular piece in position and epoxy it to the wall of the oil can around its perimeter (tack solder if you have a metal can). The circular piece should be just inside or below the bottom edge of the oil can. Prepare three small wooden legs from 1" dowel and secure these legs to the bottom of the assembly, using sheet metal screws.

Turn the entire assembly over. Again pack loose fiberglass insulation between the melting pot and the oil can. As the packing of the loose fiberglass insulation progresses, be sure that the leads coming from the nichrome wire are not touching either the melting pot, other nichrome windings, or the oil can. When the fiberglass insulation has been packed to within one-half-inch of the top of the oil can, fill the remaining void with plaster of Paris. When the plaster has dried thoroughly, paint the entire outside. Affix a pointed radio type knob to the thermostat shaft.

A cover must be made for the wax melting pot. This can be a circular piece of $\frac{1}{8}$ -inch masonite cut slightly larger than the outside diameter of the pot. Drill two $\frac{1}{2}$ -inch holes in the masonite to correspond with the piston rod and the wax discharge tube.

Fill the wax melting pot three-quarters full of broken pieces of wax. Set the thermostat completely counterclockwise. Plug in the line cord. Using a double receptacle, one for the wax injector and another for a lamp, move the thermostat setting slightly clockwise. When the lamp flickers, the heating coil of the melting pot has been energized. Turn the adjustment 10 to 15 degrees further clockwise. Observe the wax after about 15 minutes. If the wax has melted, insert a thermometer to obtain the wax temperature. If the wax has not begun to melt, advance the thermostat slightly clockwise. A point must be found on the thermostat setting where the wax will be held at approximately 158°F . Be sure to allow sufficient time between each adjustment of the thermostat to permit the entire contents to become

BILL OF MATERIALS

- 1 pc. brass or steel tube, 3" dia., 4 1/4" long
- 1 pc. brass tube, 1" dia., 5 1/2" long
- 1 pc. brass tube, 1/4" dia., 8" long
- 1 length nichrome wire, 5 to 9 ohms per foot. (See text for length.)
- 1 pc. asbestos substitute sheet - 3" wide, if possible.
- 2 5/32" bearing balls
- 1 composite, 1-qt. oil can or a metal can of same size. (A 1-qt. metal oil can was used for the original project, but these are hard to find today. The author advises that one of the laminated composite oil cans will suffice. If you can find a metal can of the same dimensions, it would be more durable).
- 1 pc. steel or brass plate 3 1/4" x 3 1/4" x 1/16"
- 1 line cord
- 1 flat iron thermostat (General Thermostat Corp., Model B-200, 1500 watt, 115-230 volt, AC only)
- 1 pc. threaded rod, 1/4"-20 x 5"
- 1 1/4"-20 hex nut
- 1 8-32 x 1/2" round head machine screw
- 1 pc. 3/8" brass rod, see text for length
- 2 6-32 machine screws
- Misc.: hard and soft solder, loose figerglass insulation, fiberglass spaghetti, casting lead, solder or white metal, plaster of Paris, paint.

heated. When the optimum temperature has been found, mark this point for future reference.

The actual making of a wax pattern is relatively simple. First the rubber mold must be powdered with baby talc to prevent the solidified wax pattern from sticking. Hold the rubber mold together with two 1/16-inch aluminum plates slightly larger than the mold. Press the opening of the rubber mold

against the wax nozzle and, at the same time, apply pressure to the piston through the piston rod. A great deal of pressure is not needed to force the wax into the rubber mold. Apply pressure for approximately 15 to 20 seconds. Remove the pressure from the pump, turn the rubber mold so the orifice is facing up, and permit the wax to solidify. Part the rubber mold carefully and remove the wax pattern.

The wax used for injecting is especially compounded for this purpose. Normally the working temperature of the wax is 158°F. But it is best to check with your supplier for confirmation of this temperature.

The wax injector outlined here will have a slight tendency to over shoot the nominal temperature setting when the wax first melts. The temperature of the wax will become stable when the entire mass of wax is molten. From this point, the wax injector is capable of a nearly stable temperature within plus or minus 2°F. for extended periods.

The wax injector illustrated and described has been used to make a multitude of wax patterns. Naturally, with any device of this type you may have difficulty with the first few wax patterns. However, after you become adept at powdering the rubber mold and applying the correct amount of wax pressure, no further difficulty should be encountered. Wax pattern sizes ranging from very small medallions and rings to large pendants and pins are within the scope of this wax injector.

Investment Casting — Part 7

HOW TO MAKE WAX PATTERNS

The casting of metals, in all likelihood, first occurred at some time in the long history of man as an accidental achievement. Possibly a rich piece of ore or placer deposit used to bank a fire resulted in bringing the metal to its molten state. The metal, having run into a cavity, could have been man's first recognition that a casting process was possible. Although this may be only a theory, it does seem to be logical as a beginning.

Regardless of the origin of casting, the process has evolved and refinement has brought it to its present state. With today's technology, castings are possible within tolerances of one thousandth of an inch or closer. Not generally known is the fact that your dentist is a master craftsman in the casting art. Gold inlays are made to exacting tolerances through the technique of *investment casting*. Industry uses investment casting techniques to produce a multitude of intricate mechanical parts which, without these processes, would require extensive machining at high cost.

Although the casting methods outlined here are simple adaptations, the basic principles of casting remain. Because of these simplified methods and the availability of the material, investment casting can become a most interesting and productive hobby. Using self-made tools and equipment, very satisfactory casting results can be achieved.

The prime area of investment casting to be covered is the casting of silver and gold jewelry. Rings, brooches, buckles and jewelry ornamentation can be produced by the handfoul once the casting processes have been mastered. You can use investment casting for other applications such as making small parts and fittings, also.

Casting, as with other forms of art, requires a knowledge of the basic step-by-step procedures in order to produce the desired results. The pictorial and written step-by-step procedure outlined can be a guide to your first successful casting. From this point, you can expand to design and reproduce articles of lasting beauty limited only by your own application and interest.

The basic technique described here is centered around the use of a self-made pressure casting machine. Although centrifugal casting is more popular, the centrifugal machine is more complex, expensive and difficult to use. Pressure casting, in addition to simplicity, need not be as elaborately safety guarded as a centrifugal machine. Also, pressure casting, as outlined, has an inherent safety factor as there is little if any risk of spilling molten metal. The metal is heated directly in the flask cavity and forced into the mold by air pressure. Centrifugal casting requires that the molten metal revolve at high speed to attain the needed casting pressure.

The process also involves the use of other homemade equipment. We shall start from the very beginning which is the preparation of wax for a pattern and follow through with each step necessary to complete a successful casting.

With this introduction in mind, let's begin.

Making a Wax Pattern

Sheet and wire wax can be purchased from most jewelry supply shops. The wax wire can also be made with a homemade wire extruder so we will start with instructions for making the wire.

We must first charge the wax extruder. Extruding wax is available from jewelry supply and casting supply houses. Wax comes in a variety of

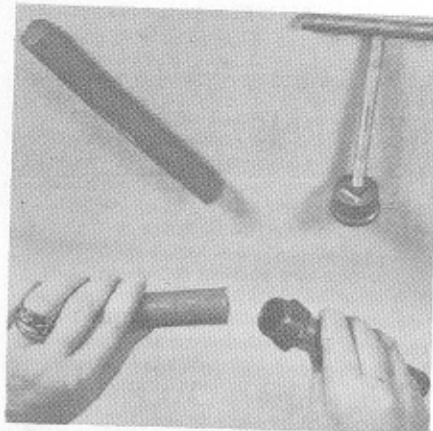

At a point just below where the wax extruder becomes uncomfortable to the touch, the wax should be ready for extrusion. Trial and error, from the beginning, will give the correct extruding temperature. Again, be sure the extruder is heated over its entire length and allow sufficient time for the heat to penetrate the entire mass of wax.

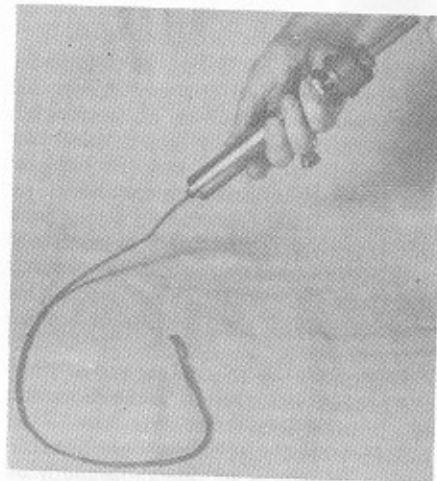

shapes and hardnesses such as blocks, sheets, rods, and wires. If you have made the wax extruder, order a rod that is just under the inside diameter of the extruder barrel. Specify the hardness and the diameter when you order. If rods of the right diameter are not available, you can use a tube of the same size as your extruder and melt and cast a rod of the right size.

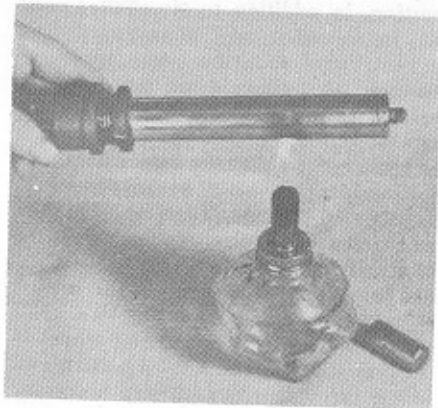

When the correct extruding temperature has been attained, hold the extruder, as illustrated, and begin applying pressure to the piston by turning the threaded piston rod. The beginning length of extruded wax will tend to curl. As more wax is extruded, the weight of this wax will straighten the remainder. Work from a standing position, permitting the extruded wax to form a large coil on the floor. In the event the wax cools during extrusion, reheat it and the extruder to the correct temperature.

If only small quantities of various extruded designs are needed, you can change the dies. Once you have extruded a sufficient length of any particular shape, cut the wax into workable lengths. Normally, lengths of four to five inches are sufficient for most designs and are easy to store. When the extruded wax has been cut into lengths, straighten any irregularities by rubbing with a wet finger or, in the case of square wax, pressing the pieces between two sheets of wet glass. It is best to have a number of extruded shapes on



hand so that when a particular shape is needed for a design, it will be available.

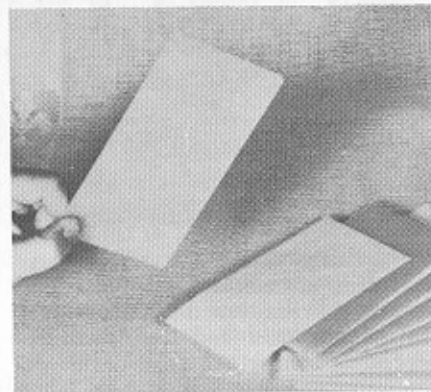

It is possible to make sheet wax by pouring a quantity of molten wax onto a lubricated sheet of glass. By placing another sheet of glass, spaced by wires of a given diameter and strategically placed, on top of the molten wax, it can be formed into sheets. The results are mediocre at best, so it is suggested that sheet wax be purchased. Sheet wax can be obtained in various hardnesses and thicknesses.

Tools and Supplies

The illustration shows but a few of the tools that can be used for working wax. Depending on the hardness of the wax and the ultimate design, the wax can be formed, scraped, cut, fused,



sanded, filed, pierced, formed or impressed into a positive or negative cavity for embossing. A portion of the joy of working in this media is the flexibility and ease with which the wax can be worked.

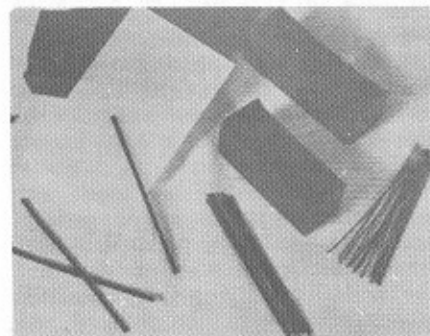

In addition to various wax wire shapes and sheet waxes, there are a number of other forms. Among these are hard carving wax. This wax yields readily to files and knives and can be sculptured into the most intricate designs and patterns. Also available is a sticky wax. This can be used to fasten the various shapes together.

By placing two pieces of wax together in intimate contact and applying heat to the joint with a heated probe (much like soft soldering), the waxes can be fused or welded together. This procedure is used when various com-

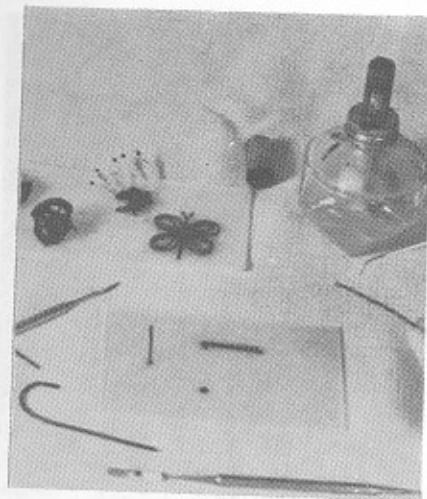

Design we shall leave to the individual. It is sufficient to say that, after the birth of an idea, the design should first be put on paper. Referring to this paper sketch, the various shapes of wax wire and sheet can be cut. Once the pieces have been cut, the actual fusing together and building up can begin. Through manipulation of the waxes, the design can take shape. Do not hesitate to try a design. Little can be lost except your patience and possibly a small amount of wax. Who knows, we may have another Cellini in our midst.

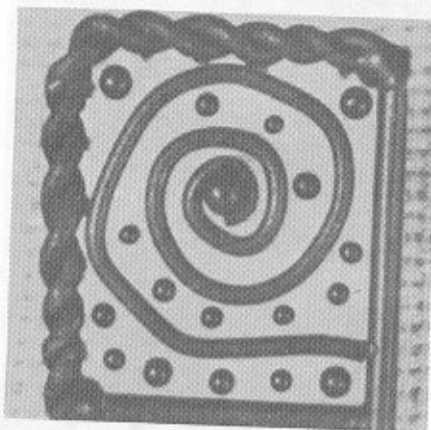

ponents are integrated to form a design.

Wax can be first melted and then applied in the desired location with a heated spatula. In this manner wax can be built up in anticipation of subsequent reworking or cutting. Wax working tools need not be purchased items. It is a simple matter to take a heavy gauge copper wire and insert a short length into a pre-drilled piece of wooden dowel. Once this has been done, the end of the copper wire can be shaped to either a cutting edge, a spatula, or a sharpened point.

If for some reason too much wax is removed in cutting or filing, it is again a simple matter to build up this area with molten wax as described above. Unlike carving in granite, the broken off nose can be replaced and recut when wax is used.

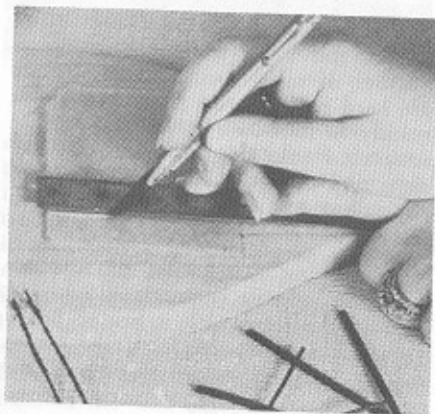

The design chosen for practice here has little if any aesthetic value. Its main purpose is to illustrate the various waxes that can be used and the procedures needed. Bordering two sides of this design are half round wax wire, with the two remaining sides bordered in twisted wax wire. The spiral radiating from the center is round wax wire and the dots are drops of molten wax fused into position. The entire design is built up on a piece of sheet wax.

If you find that the wax is too brittle to form into the shapes required, dip the pieces into a beaker of warm water. Be sure the water is not too warm as it can melt the wax. The wax should first be dipped into the warm water for only a few seconds, removed and tested for pliability. If the wax is still too brittle to conform to the shape, it can be redipped and tried again. A point will be reached when the wax becomes pliable enough to work satisfactorily.



Although not elaborate, our design does show how a wax design can be achieved. Note the ends of the twisted wire have been fused to the sheet wax. Although not apparent in the illustration, the half round and full round wax wires are fused to the sheet wax base with a pointed probe which had been heated in a flame. When connecting or fusing waxes, endeavor to place the fused area where it will not detract from the design and can be readily cleaned up in the finished casting.



Remembering that the metal casting will be no better than the wax pattern, extra care should be taken to clean up all fused and irregular areas. Remove any excess wax. Polish the accessible areas by holding the wax pattern under a stream of water while rubbing it with a nylon stocking stretched over the index finger. The action of the nylon in conjunction with the cold water tends to burnish and polish the wax. A few additional minutes spent in cleaning up the pattern will save many, many minutes when it comes time to polish the casting.

It is now time to attach the sprue. Choose a piece of extruded wax wire that is 10 gauge or slightly under in diameter. The wax wire diameter is

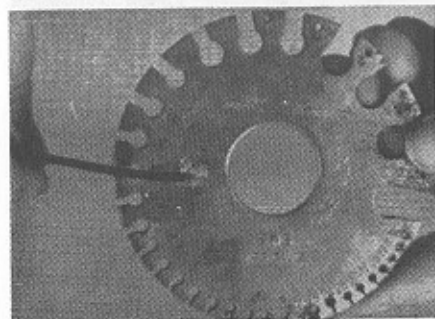

critical. If the sprue wire is too large, preflow of metal will occur. If the sprue wire is too small, there is the possibility of an incomplete casting. Cut off a piece of the wax wire 3/16-inch

longer than the radius of the flask which will be used. This will allow sufficient sprue length when the subsequent reaming operation takes place.

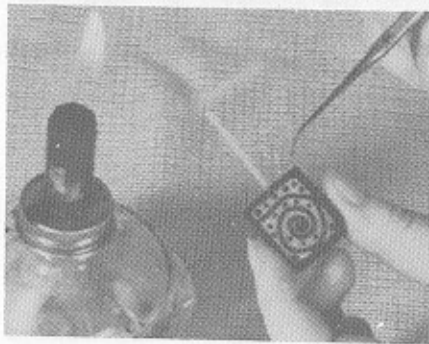

The sprue piece must be fixed to the pattern. This can be done by holding the sprue wire in intimate contact with the pattern and fusing the two pieces together. The heat can be applied to the joint with a pointed probe which has been heated over a flame. Be sure that the wax sprue wire is securely fused to the pattern to prevent subsequent loosening.

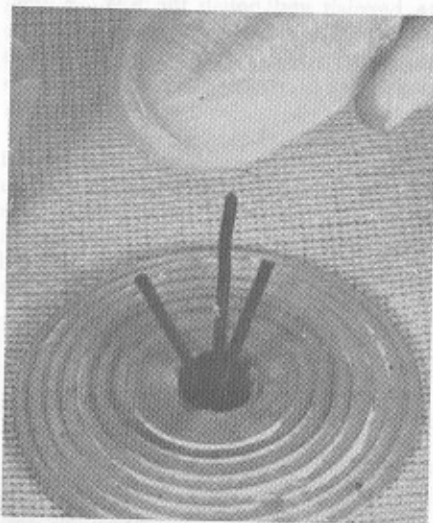

The picture shows the technique of using multiple sprues. If you have an unusually large wax pattern, multiple sprues may be necessary. Note that each sprue terminates at the center of the circular bottom plate and there is

a space between each sprue. This technique can also be used if more than one wax pattern is cast at one time. Instead of the one large wax pattern, each individual sprue could hold one ring. In this manner it is possible, depending on the size of the flask, to cast up to four or more rings or small patterns at one time.

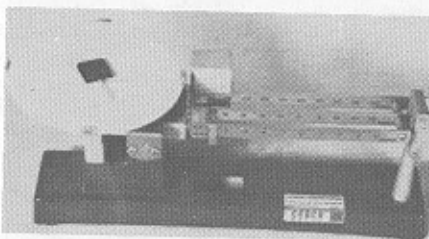

Once the sprue has been attached to the wax pattern, an exact weight must be obtained in order to determine the amount of metal necessary for the completed casting. Normally, the amount of silver necessary will be nine to ten times the weight of the wax. Gold, depending on the karat, will take from fourteen to sixteen times the weight of the wax. Simply weigh the wax pattern and multiply this by the factor necessary. Any reasonably accurate balance or scale can be used for this purpose.



The wax pattern with the attached sprue must now be attached to the circular plate or base. The plate can be almost any available material such as aluminum, brass, plastic, rubber, etc. The sprued pattern is attached by either fusing the sprue directly to the plate or by using sticky wax. Be sure that the sprued pattern is centered with relation to the disc.

The pattern is now ready for investing which is the process of actually making the mold in which the casting will be poured.

Investment Casting — Part 8 HOW TO INVEST WAX PATTERNS

To reduce surface tension on the wax pattern and sprue, a *debubbler* must be painted over all surfaces. Commercial debubblers are available. Equal parts of *tincture of green soap* and *hydrogen peroxide* make a very good debubbler. Flow on an ample coat of debubbler, making sure it wets all corners and undercuts. Set the sprued pattern aside and permit the debubbler to dry thoroughly.

When the debubbler has dried, rinse the pattern in a beaker of clean water. Observe the pattern to be sure the water wets all surfaces. If the water forms small globules on the surface of the pattern, repeat the debubbling procedure. Again permit the pattern to dry thoroughly, rinse, and inspect. If most of the debubbler is not rinsed from the pattern, an excessively heavy oxide will result on the finished casting.



A number of flasks should be prepared in anticipation of the various patterns which may be cast. The flasks

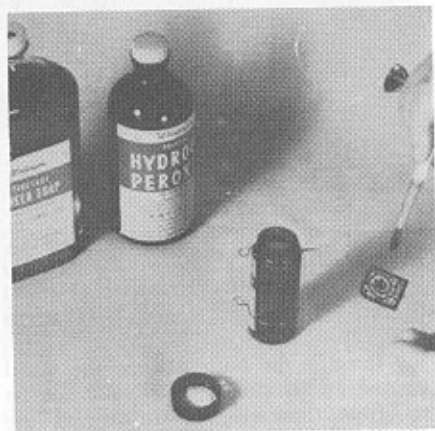

can be made from either brass or stainless steel tubing. It is best to cut a number of tubes varying approximately $\frac{1}{4}$ inch in height. A good supply of flasks would range from $1\frac{1}{2}$ to 3 inches in height. The diameter of the flasks should vary according to the size of the castings to be made.





Select a flask at least $\frac{1}{4}$ to $\frac{1}{2}$ inch larger in diameter than the overall width of the wax pattern. The flask should be from $\frac{3}{16}$ to $\frac{5}{16}$ inch higher than the sprued pattern. A sufficient amount of investment should cover the pattern to prevent the molten metal from breaking through the bottom when the metal is cast. This thickness should not be so great, however, as to prevent the free passage of gasses through the bottom of the invested flask.

Next cut strips of sheet asbestos substitute approximately $\frac{1}{4}$ " less than the height of the flask. Form these pieces over the outside of the flask to give them curvature. Insert enough pieces into the

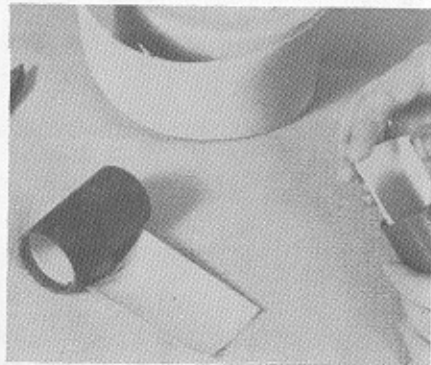

flask to cover the inside. A small amount of overlapping is permissible. The asbestos substitute is needed to absorb expansion of the investment during burnout. The pieces should be centered with relation to the height of the flask. The exposed areas, both top and bottom,

with no asbestos substitute covering, will act as locks to retain the investment within the flask when the flask is removed from the burnout oven and transported to the casting machine.



Dip the asbestos-substitute-lined flask into a beaker of water. Wetting the asbestos substitute is necessary to prevent excessive absorption of water from the investment. After the flask has been dipped, iron out with the index finger any air bubbles under the asbestos substitute. Set the flask aside and permit any excess water to drain.

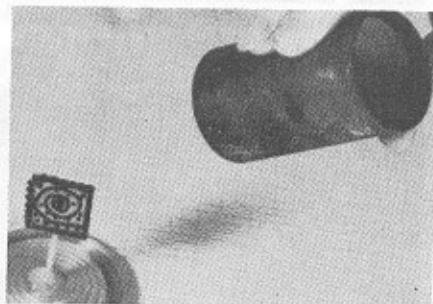

Place the asbestos-substitute-lined flask over the sprued pattern. Center it with relation to the wax pattern. The flask can be held in place with a small quantity of sticky wax around the bottom at the junction of the flask and base.

The next step is to mix the investment. If your flask is $1\frac{3}{4}$ inches high and $1\frac{1}{2}$ inches in diameter, measure out about one ounce of water at room temperature. Place the water into the mixing bowl. With a spatula, sprinkle the dry investment on the water. Sprin-

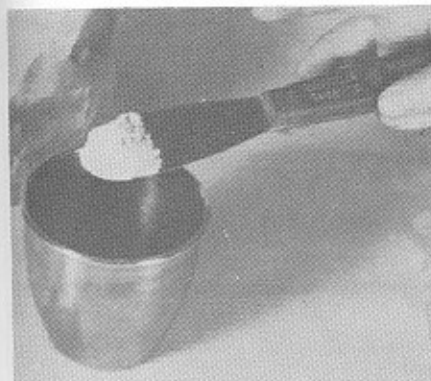

kle on only small amounts of the investment at a time. At first the water will absorb the investment and it will sink to the bottom. Eventually the dry investment will begin to build on top of the water.

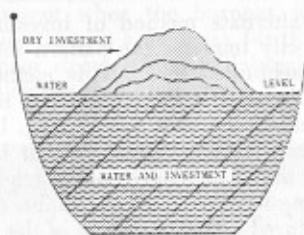

If the pattern is intricate and detailed, a thin mixture of investment will be needed. If the pattern is bulky, a thicker investment will be required. Although a thinner investment will more readily conform to an intricate pattern, it is inherently weaker. There is no hard-and-fast rule which can be used to determine the consistency. Begin with a consistency approximately that of a pancake mixture.



Next, mix the dry investment by hand to produce a homogeneous mixture. The dry investment will tend to adhere to the mixing paddle of the vacuum mixer if not completely mixed and this can result in a nonuniform investment.

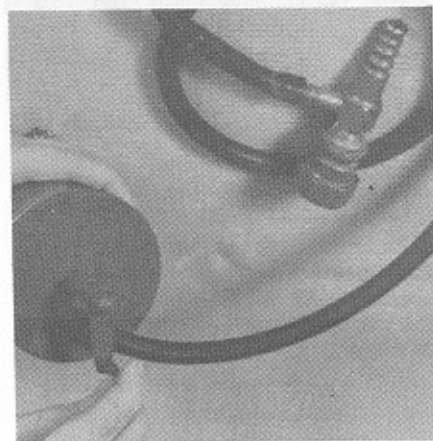

With the vacuum mixer assembled as shown, attach the hydro aspirator to a spigot. Turn the water on full. Press the top cover of the mixer against the bowl to create a vacuum inside. Place a thumb against the top and push upward, trying to raise the top. If the top cannot be raised when reasonable pressure is applied, it is assurance that the vacuum is being retained. Mix the investment for at least 50 turns of the handle. Occasionally tap the bowl assembly against a solid, flat surface to dislodge any dry investment adhering to the sides. When mixing is finished, pull the tube away from the aspirator. Do not simply turn off the water before pulling the tube away as residual vacuum in the bowl will tend to draw water into the mixture. Remove the top.

If a vacuum mixer is not available, the hand-mixed investment can be vibrated to dislodge air bubbles. The vibrator shown in the illustration is a foot massager that can be bought for a reasonable price. The purpose of vacuum mixing or vibrating is to remove all air bubbles captured in the mixed investment. After casting, air bubbles against the pattern will appear as nodules of metal. These can usually be removed with pliers but sometimes

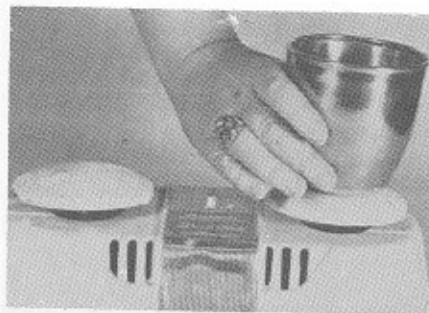

they are so firmly attached that an otherwise good casting is ruined.

Hold the flask containing the pattern and vibrate the investment into the flask as illustrated. Note that the thumb of the left hand is in intimate contact with the vibrator. The thumb acts as a dampening device for vibrations transmitted to the flask and prevents breaking the sprue or wax pattern. The cup containing the investment is placed directly on the vibrator and tilted forward until a steady stream of investment flows into the flask. When the flask is completely full of investment it should again be vibrated directly on top of the vibrator with the little finger acting as a cushion. This additional vibration is an added safety measure to be sure that no air bubbles have been captured in the investing process. Naturally, if a vibrator is not available, the investment can be poured directly into the flask.

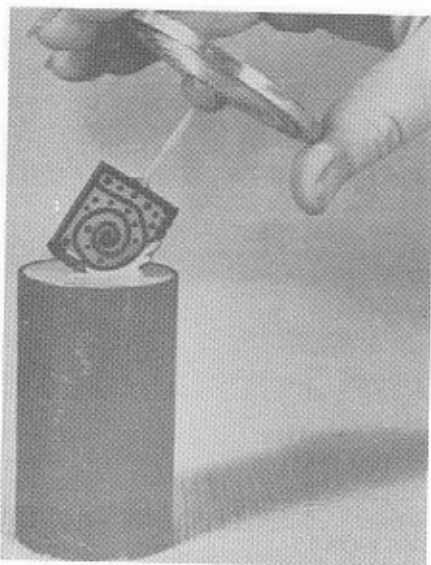
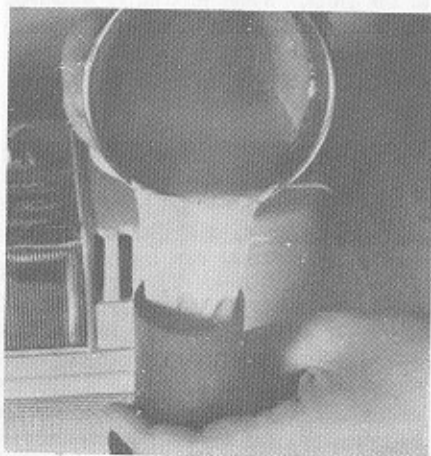

An alternate method of investing is to directly immerse the pattern into an investment-filled flask. This method is normally used if the pattern has severe undercuts, such as a domed ring. Using the example of a domed ring, it is apparent that, if the previous method of investing were used, an air bubble could be captured under the dome of the ring.

If the pattern is extremely intricate, it is often a good idea to paint the investment on with a small brush. In this manner the investment can be flowed into the most intricate cavities. The painting of the pattern is an added safety measure and can be used with either of the two investment methods outlined previously.

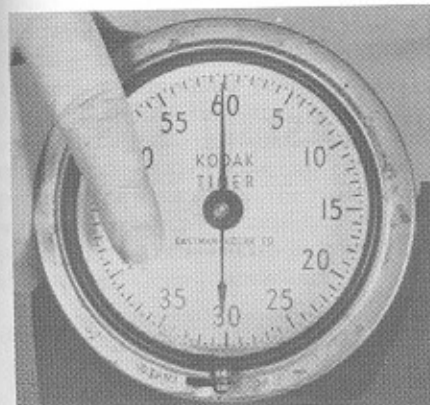
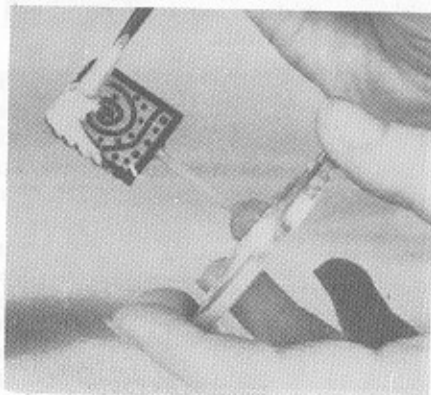

Set the invested flask containing the pattern to one side for a minimum of one-half hour. This is necessary in order to give the investment sufficient time to absorb any free water. If free water is present when the burnout schedule begins, there is a tendency for the water to form steam which will break down or distort the investment.

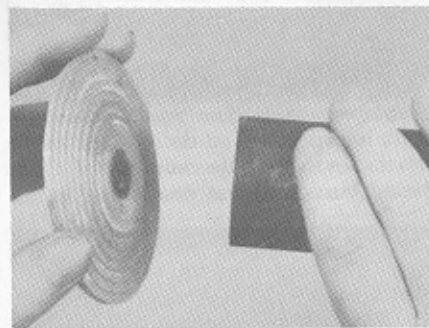

Remove the bottom plate from the flask with a twisting motion. The point at which the sprue attaches to the bottom plate will normally detach from the plate and be retained in the investment.

When the investment has set for one-half hour, it should be hard to the touch. With a sheet metal reamer approximately $\frac{1}{8}$ inch in diameter smaller than the inside diameter of the flask, ream a cavity into the investment. Use the wax sprue wire as a guide to center the reamer. Occasionally clean off the

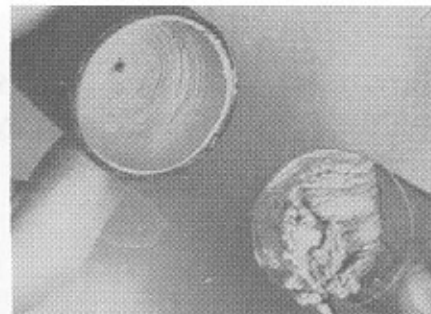

buildup of investment on the reamer. The reamed cavity will hold the casting metal after burnout.

Ream the bottom of the investment in the flask with a tool like that shown. The reamer should have a large radius so it will not cut too deeply into the investment. Reaming the top is neces-

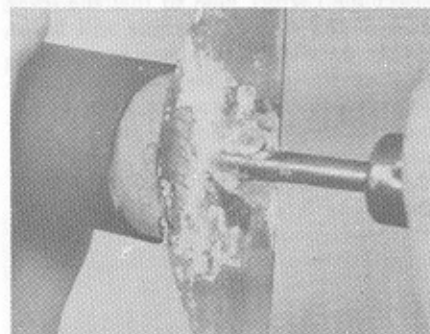

sary to provide a cavity in which to melt the metal. The bottom is reamed to assure that none of the investment projects below the flask so the rim will present a flat surface to the casting machine. The sketch shows the flask before and after reaming.

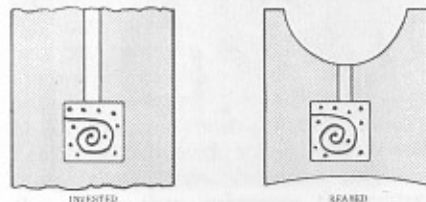

The pattern is now completely invested and ready for the burnout process.

Investment Casting — Part 9

HOW TO BURNOUT AND CAST

Since the actual casting must be made immediately after burning out the pattern, while the mold is still hot, burnout and casting are almost one continuous operation. So, the pressure casting machine must now be set to the correct height. Center the invested flask with respect to the base and the pressure plate. Remove the fulcrum pin and select the correct hole so that the lever arm of the casting machine will be as nearly parallel to the base as possible. Replace the pin. Press the lever arm down so that the pressure plate firmly contacts the flask. Release the pressure and repeat the pressure application to the flask a number of times. The pressure plate is attached to a swivel and may not completely seat with the first application of pressure. The casting machine is now adjusted to receive the first flask.

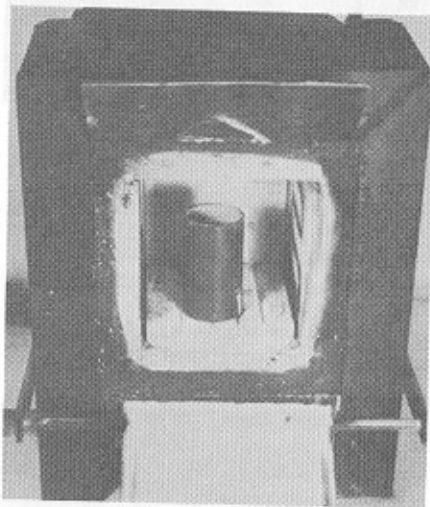

This is dependent on the wattage rating of the oven and the number of flasks being burned out at one time.

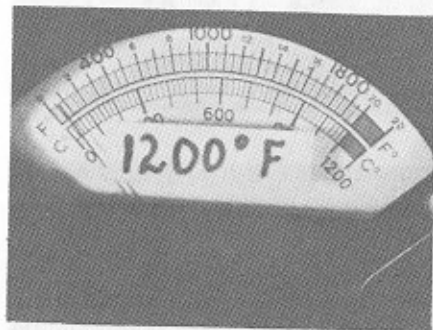

If your oven is equipped with a pyrometer, it is a simple matter to gradually bring the temperature to 1200°. Hold the temperature at 1200° for a period of 10 to 20 minutes. The initial heating of the flask should be with the sprue hole facing down. As the heat penetrates, the wax will become molten

and flow through the sprue hole onto the floor of the oven. When the sprue opening is completely devoid of wax, the flask should be turned over (use tongs and handle carefully) so that the sprue opening is facing up. In this position the gasses from the remaining wax can escape more readily. A completely burned out flask is indicated by the white, clean appearance of the investment or by looking down through the sprue hole into the cavity for the presence of visible red light (glow).

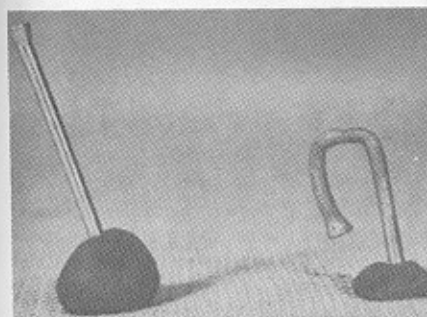

If a pyrometer is not available, a suitable temperature indicator can be made from an aluminum nail. Most aluminum alloys melt at approximately 1200°F. By placing the nail at a slight angle into a piece of clay, the nail can act as a pyrometric indicator. Place the nail close to the invested flask within the oven. When the nail bends, as illustrated, an internal heat of about 1200° has been attained. Because this method of determining heat is not quite as accurate as using a pyrometer, visual determination of the internal temperature of the flask becomes more important. Color vs temperature charts are available. Normally, the first indication of red appears at 900°F and dull red at 1100°F. The reason for visual determination of temperature within the cavity is to insure thorough penetration of the heat.

During the burnout operation, the metal for casting can be prepared. If new or virgin metal is to be used, go on to the next step. If you are using used or otherwise unclean gold or silver, the metal must be cleaned. This can be done by heating small quantities of metal on a

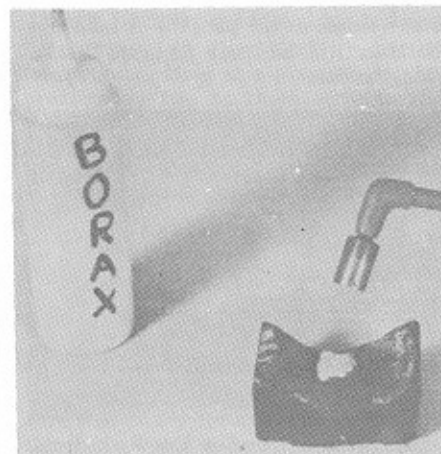

charcoal block to the melting point. Flux the metal thoroughly with borax and permit it to cool. Next pickle the metal in Sparex or other suitable pickling solution (check with your supplier). The metal used for casting must be absolutely clean or pits will result in the finished casting. A pinch of saltpeter added to the borax will help purify the molten metal.

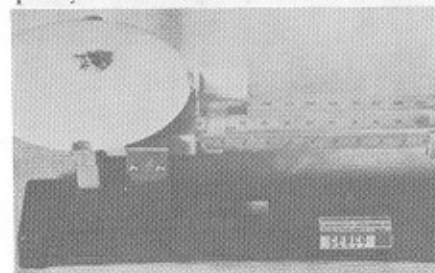

Weigh out sufficient metal for the casting. As stated previously, this will be nine times the weight of the wax pattern for silver, and 14 to 16 times the weight of the wax for gold. If a balance is not available, the amount can be determined volumetrically. Take a beaker with enough water in it to submerge the pattern. Note the height of the water, then submerge the pattern and note the point to which the water rises. Remove the pattern. Now add small quantities of metal until the water again rises to the same position it attained when the pattern was submerged. This amount of metal will contain the

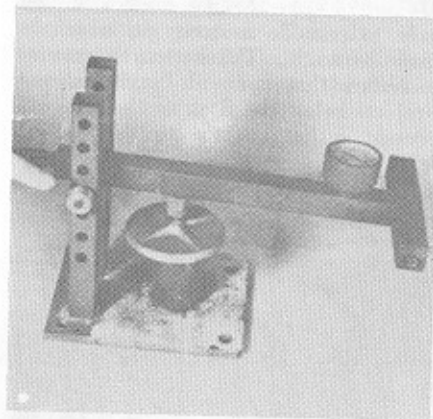

Place the invested flask into the burnout oven, sprue opening down. Close the door of the oven and turn on the switch. Normally, the burnout sequence takes in the neighborhood of one hour.

same volume as the pattern. A tall, thin container will be more accurate than a wide, flat one.

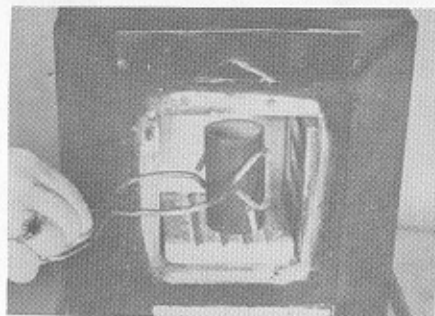

Using tongs, remove the flask from oven and immediately place it on the base of the casting machine. Be sure the flask is centered with respect to the pressure plate. The sprue opening should be facing up.

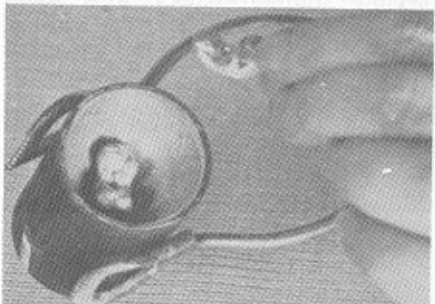

Place the preweighed metal into the cavity. Immediately begin heating the metal with a torch adjusted to a non-oxidizing flame.

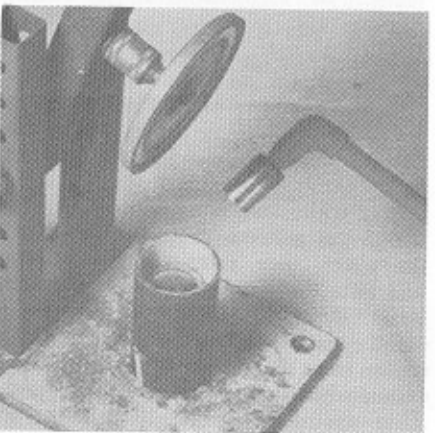

As the metal melts, it will form a molten ball in the center of the cavity. Remove the heat at this point.

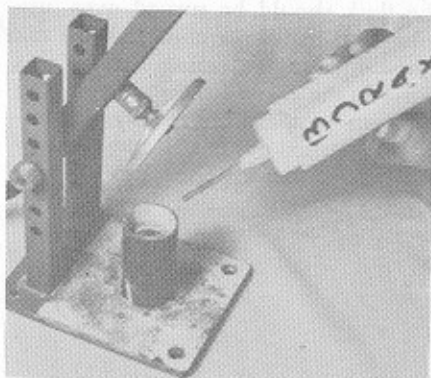

Quickly place a small amount of borax on top of the molten metal. This can best be done with a half filled, plastic bottle of borax. Squeeze the bottle gently and the escaping air will carry a small amount of borax to the metal. A large quantity of borax is not needed. The equivalent of $\frac{1}{4}$ teaspoon of borax is sufficient to cleanse the oxides and impurities from the molten metal. This operation of preheating, applying borax and reheating the metal should be done as quickly as possible to prevent excessive loss of heat from both the metal and the invested flask.

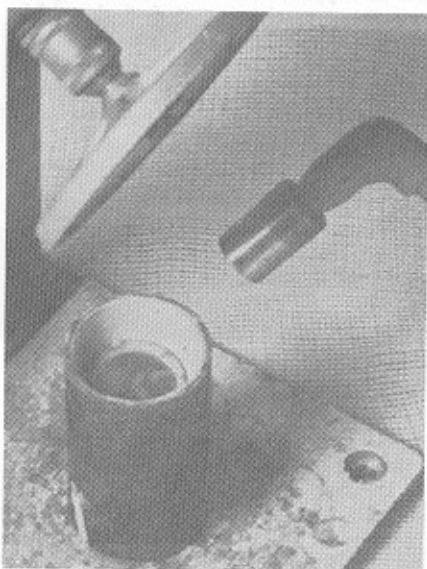

Again apply heat until the metal is completely molten. This will be evident when the metal attains a shiny, glass-like appearance. At this point, grasp the handle of the lever arm with your free hand. Remove the torch and quickly bring the pressure plate to bear on the top of the flask. If you are using the pressure casting machine we have described, be sure to place your thumb over the hole in the handle.



The pressure casting machine with a foot pump, set up to simulate the casting procedure.

Begin pumping the foot pump to bring the pressure to approximately five to ten pounds. Hold this pressure for approximately two to three seconds and then bring the pressure to from twenty to forty pounds. The higher pressure

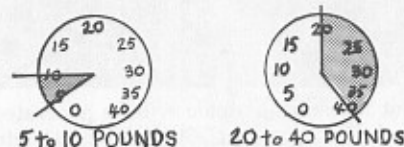

should be maintained for approximately two or three minutes. The initial pressure will gently force the metal through the sprue opening into the cavity. The higher pressure is necessary to attain density in the finished casting. Remove both the air pressure and the lever arm pressure from the flask. Permit the flask to cool for about five to ten minutes. At this point the casting operation has been completed.

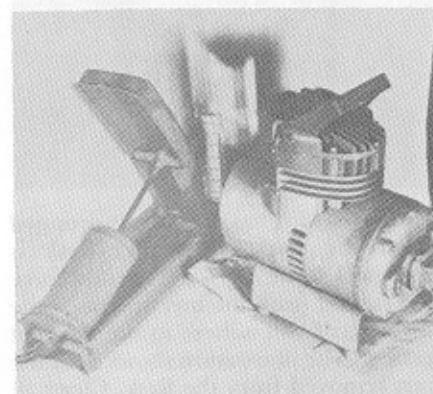

Pressure can be applied to the casting machine by either a foot pump or a compressor. The compressor, if used, should have a rating of twenty to thirty pounds of free air per minute and a capability of generating at least thirty pounds of pressure. The use of an air compressor will necessitate the modification outlined in the section on how to build a pressure casting machine.

After the initial cooling period, remove the flask from the casting machine using a pair of suitable tongs. Plunge the flask into a bucket of water at room temperature. As the water contacts the

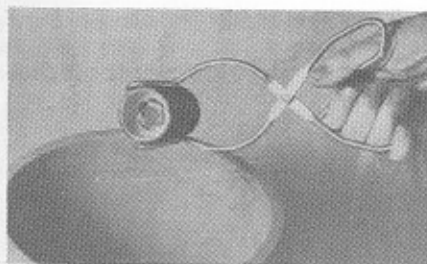

hot investment, steam will be generated and the investment will disintegrate into the water. Permit the flask to remain submerged until completely cooled.

With a stiff bristled brush and a good laundry soap, scrub the casting thoroughly to remove all traces of investment. Stubborn areas can be probed with a sharp nail to help remove the investment.

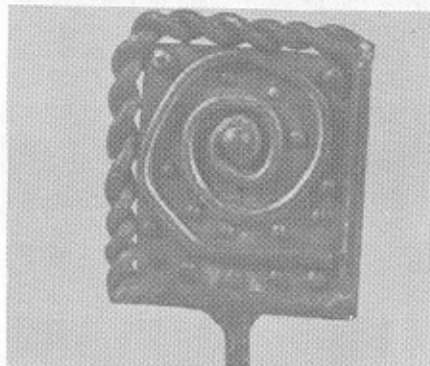

A completely scrubbed casting will look like the one illustrated. Note the heavy layer of oxide.

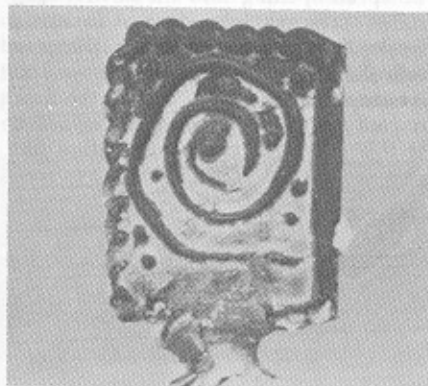

If the casting has not already dropped from the flask, when the flask is removed from the water, gently force the casting from the investment. Some investment will adhere to the finished casting. The illustration shows a casting just removed from the flask. Clean all investment and asbestos substitute from the flask in preparation for the next casting.

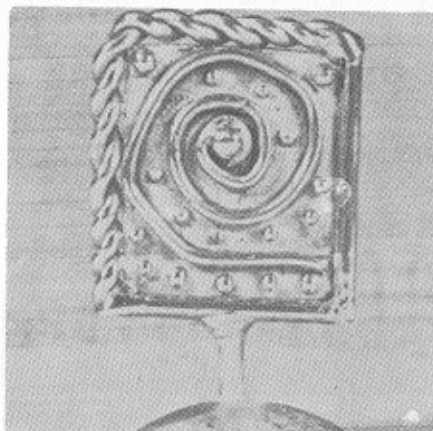

The casting must be pickled to remove the oxide. A commercial pickling solution, such as Sparex, may be used and is preferred by many. Or, you may do as some jewelry makers do and use a 10% solution of sulphuric acid in water. This solution is more dangerous than Sparex, but the author has found that it does a better job. Handle acid with great care and keep it out of the reach of children and pets. *Always pour acid into the water (NEVER the opposite) to prevent dangerous splattering.* Should any acid get onto the skin, wash immediately with copious amounts of

water and have any burns treated by a doctor. If acid ever gets in the eyes, hold your head under a spigot and thoroughly wash out the eyes, then get to a doctor or emergency room, taking along the acid container so that the medical people may see what they are dealing with.

Whatever solution you use, pickle the casting until all traces of oxide have been removed. The illustration shows the casting as it should appear after pickling and polishing.



Remove the sprue with either a saw or a suitable pair of nippers.

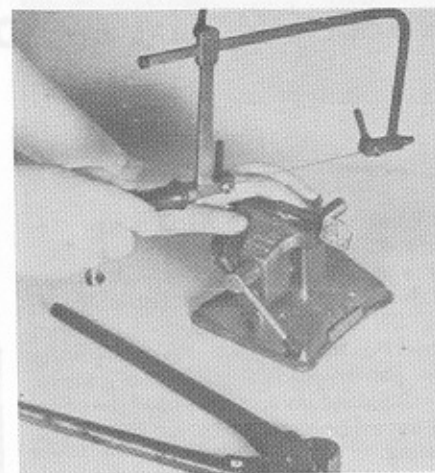

The casting is now completed. It is only necessary to affix the findings. If the casting is to be used to make a rubber mold, findings can also be attached at this point. Within certain limits, findings can be made an integral part of the rubber mold and the resulting wax pattern.

Investment Casting — Part 10

RUBBER MOLDS and DUPLICATE PATTERNS

When duplicates of a design are needed, additional duplicate wax patterns must be made. The easiest way to do this is to make a rubber mold, using the original casting as a pattern. From this mold any number of duplicate wax patterns can be made. Once made, the duplicate patterns are used the same as an original to make an investment casting.

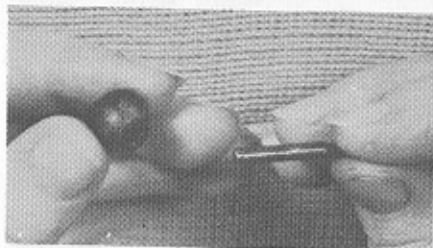

Making the rubber mold starts with obtaining a short length of brass or copper tubing, 1/8-inch in diameter. Also a sprue button must be made.

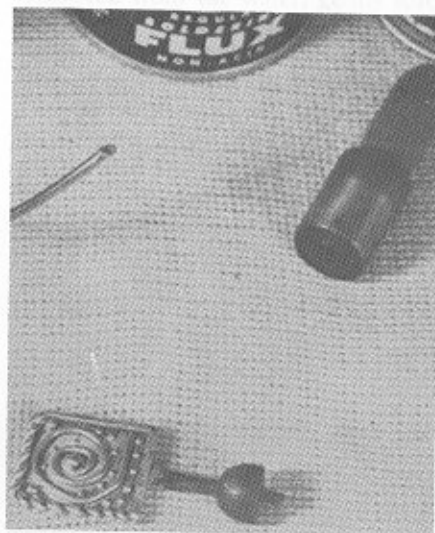

Soft solder the 1/8-inch brass tubing to the finished casting to form a sprue. Place the sprue into the opening of the sprue button.

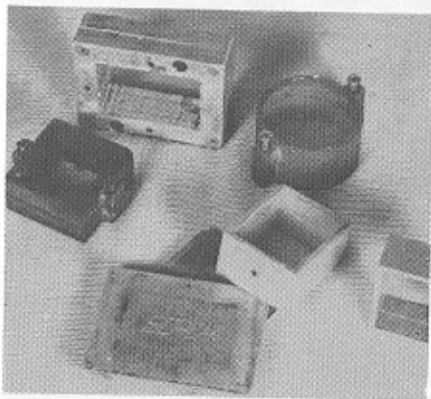

Select a rubber mold flask which will contain the metal pattern. There should be a minimum of 1/4-inch around all sides of the metal pattern. Less than 1/4-inch of rubber around the pattern may result in a deformed wax pattern in subsequent wax injection.

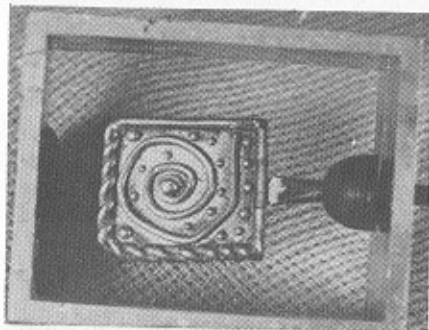

This shows the metal pattern in place in the rubber mold flask. Note that the pattern is centered with respect to the height and sides of the flask.

Precut a number of pieces of unvulcanized gum rubber the exact inside dimensions of the flask. Remove the protective covering from the pieces of rubber. Dip each piece of rubber into a beaker of either naphtha or white unleaded gasoline. (Both solutions are highly flammable. Use with great care and proceed at your own risk).

Drain the excess solvent by tapping the piece of rubber against the edge of the beaker. The solvent dip is necessary to remove any traces of oil or dirt from the unvulcanized rubber. Do not handle the rubber after dipping as this will deposit oil from the fingers. Unvulcanized rubber normally comes 1/8" thick. It is a simple matter to measure the height of the flask and predetermine the number of pieces needed. As an example, if the flask height is 1", eight pieces of rubber will be needed - four on each side of the pattern.

This shows the rubber-filled flask. All that remains to be done at this point is to place the top pressure plate over the four threaded studs and tighten the wing nuts in place.

As the wing nuts are tightened, the unvulcanized rubber will be compressed within the flask. Be sure to tighten the wing nuts securely.

Preheat your kitchen oven to a temperature of 300°F. Place the entire assembly into the oven and bake for 30 minutes.

The size of the rubber mold will determine the length of time necessary to obtain complete curing of the rubber. The temperature is constant at 300°F. If the rubber mold is overbaked there will be a tendency for the rubber to char or darken in the area of the pattern. If the rubber mold is undercured, the rubber will have a putty-like texture after cooling. Again, trial and error will establish the correct time for baking. If the rubber mold is underbaked, it can again be reheated to attain the desired results.

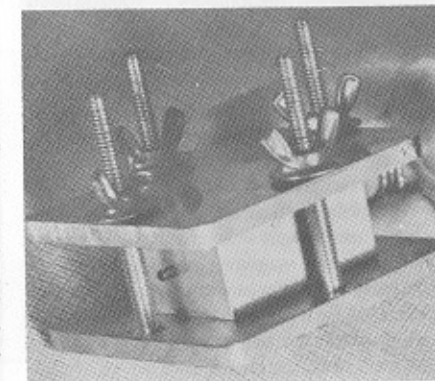
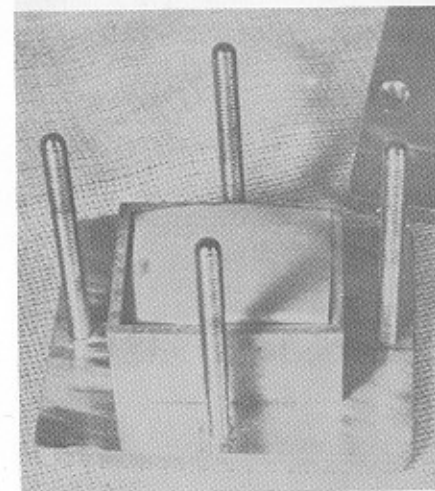

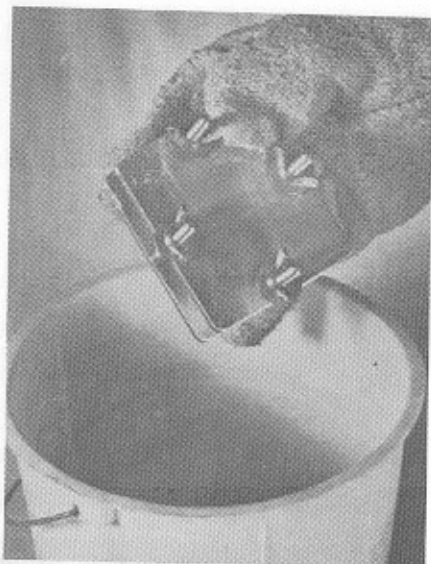

Remove the vulcanized rubber mold from the oven and cool in a bucket of cold water. The entire assembly should be placed into the water. Allow sufficient time to obtain complete cooling throughout the entire bulk of the rubber mold. Cooling normally takes from twenty to forty minutes.



Clamp one edge of the rubber mold in a vise. With a very sharp knife, cut diagonally across one corner, at the center line of the mold, to a depth of about $\frac{1}{8}$ inch. Cut upward at a 45° angle, again for about $\frac{1}{8}$ inch, and back down to the center line. Repeat this cutting at all four corners of the mold. When the rubber mold is completely parted, the mounds of rubber thus formed will act as locks to align the two halves.

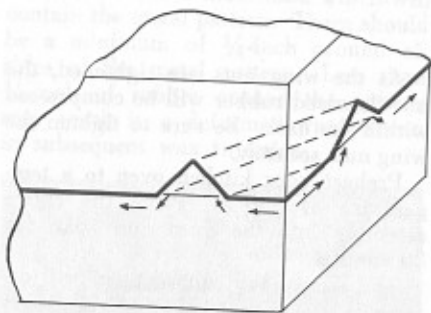

Once the locks have been cut, proceed to cut deeper into the rubber mold, starting from the sprue button and work down along the sprue until the pattern has been reached. Cut around the center line of the pattern for 180° or to the side of the rubber mold opposite the sprue. Always cut from the pattern to the outside of the mold. When the side opposite the sprue has been reached, again start cutting down the sprue on

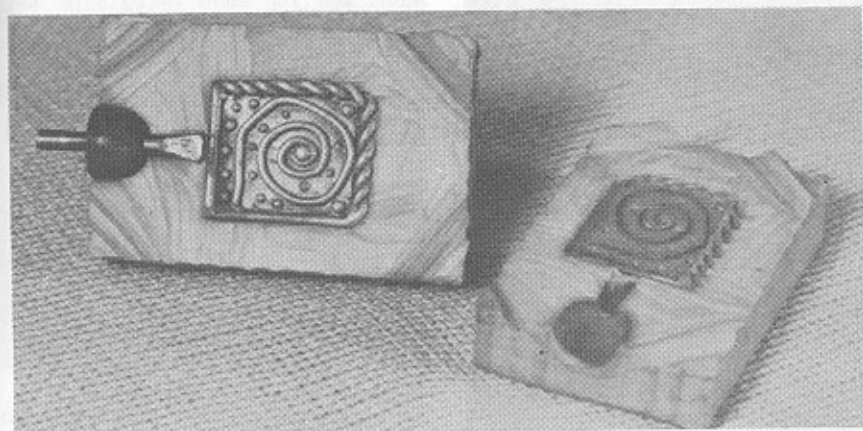

the other side of the mold. All cuts should be made with a slicing, continuous stroke. Each cut will result in a small irregularity in the surface of the rubber which will act as additional locks to align the two halves.

Here is the completely parted rubber mold with the pattern still in place. Note the rubber locks at all four corners. Other patterns will follow the same basic sequence of cutting. In the case of ring patterns, it will be necessary to first cut the rubber mold around the entire outside of the ring. When this has been done, the rubber can be stretched and the finger portion of the rubber mold cut through. If the ring pattern happens to be a bezel setting, cut across the bezel area just above the bezel seat.



Your collection of rubber molds will grow as more and more desirable patterns are made.



After parting the rubber mold, the half molds should be completely dusted with baby-type talcum powder. An efficient means of applying the talc is by using a plastic squeeze bottle, the opening of which has been covered with one or two layers of coarse muslin. Fill the squeeze bottle about half full of talc and apply muslin over the opening; screw the top in place. Holding the plastic bottle at a slight downward angle, squeeze the sides gently but quickly. The escaping air will carry a quantity of baby talc to the mold.



The illustration shows the vulcanized rubber mold containing the metal pattern as removed from the rubber mold flask. If you belong to a club where rubber molds are exchanged, it is a good idea to engrave one of the pressure plates with your name as a mirror image. After vulcanization, your name will appear on the rubber mold as an integral identification.

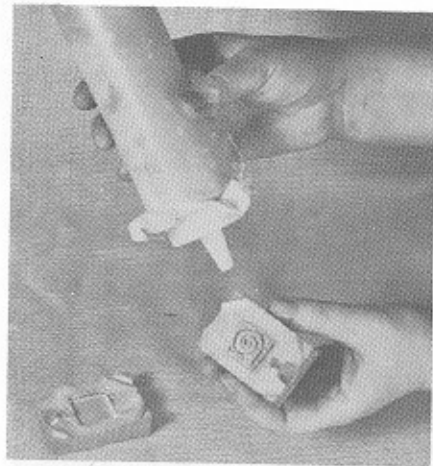

Again flex the mold to be sure that no undue amount of talc is being retained in the crevices or fine details of the rubber impression.

Once the thermostat of the wax injector has been stabilized to give 160°F wax temperature, it need only be switched on to again attain this temperature. Normally the attainment of the proper temperature takes about one-half to three-quarters of an hour. Wax which is too low in temperature will freeze before the rubber mold cavity is completely filled. Wax which is too high in temperature will result in undue shrinkage of the wax pattern.

Cover all cut surfaces of the rubber mold with a fine layer of talc. Next flex the mold to expose all pattern surfaces and cover these with talc. Remove the excess powder by tapping the mold sharply against a solid object.

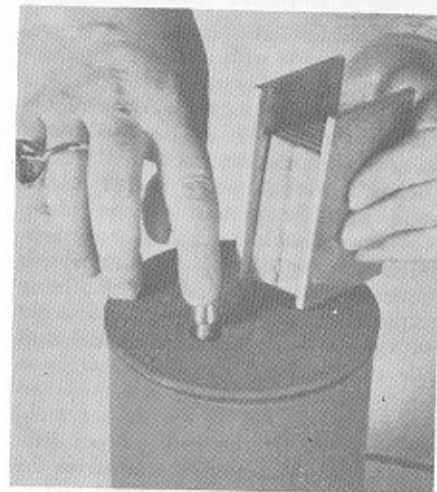
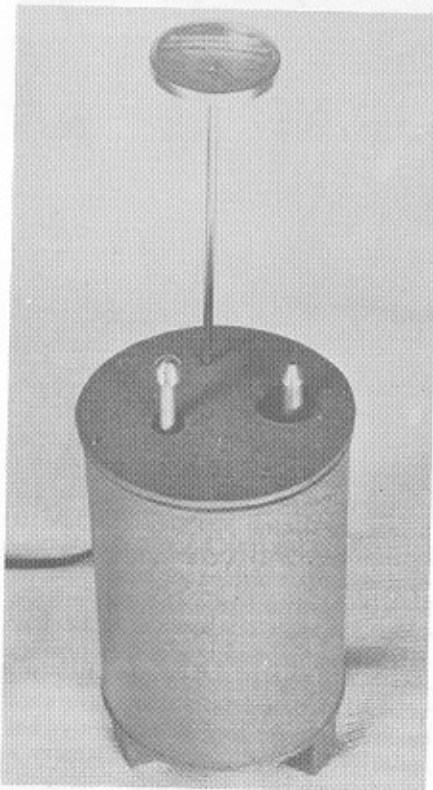

Place the rubber mold between two metal plates. Holding the mold as illustrated, place the sprue opening over the wax discharge nozzle of the wax injector. Next apply pressure to the piston rod with the finger. A gentle pressure is sufficient to force molten wax into the rubber mold cavity. Remove the finger pressure and lift the rubber mold away. While still applying pressure with the fingers to the metal plates, turn the rubber mold so that the sprue opening faces up. Hold the mold under pressure for about one to two minutes to permit the wax to solidify. Do not relieve the pressure from the mold as this will tend to increase the size of the cavity and result in a malformed wax pattern.



Part the mold carefully, starting from the sprue end. The parting should be done slowly to permit the rubber to flow or to have time to release from the undercuts. The single pattern in the illustration is the original metal pattern. The group below are wax reproductions. A rubber mold such as the one described can be used to produce hundreds of wax patterns.



To the right are wax patterns, to the left are finished and semifinished silver castings.

If the step-by-step sequence outlined is followed, there should be no difficulty in obtaining satisfactory castings. Normally, difficulties arise only if some portion of the casting sequence has been omitted or otherwise incompletely performed. In the event you do experience difficulty, a review of the casting sequence will often yield the solution. The casting sequence outlined, although not the ultimate, has been reduced time-wise to what may be considered the barest minimum.

If for some reason difficulty is experienced, the solution is usually one of applied logic. As an example, if the casting is pitted, this is the result of either dirty or unclean metal or in-

sufficient burnout. An incomplete casting may be the result of not enough heat to completely melt the metal or an insufficient amount of air pressure to quickly force the metal into the cavity.

Again, review the casting procedure if difficulties arise. If this does not yield a solution, identify the problem and record all possible contributing factors. Taking one variable at a time, eliminate the possibilities until the solution is found. Experience has been that most casting difficulties can be attributed to haste.

APPENDIX

How To Make — RUBBER MOLDS WITHOUT VULCANIZING

By Frank Gemmell

San Francisco Gem and Mineral Society

Because he thought that the method of making vulcanized rubber molds described in our series on investment casting was too complicated for the average hobbyist, Mr. Gemmell sent in this description of a simplified method which he uses. It requires no heat or vulcanizing. Though not as durable as vulcanized molds, the non-vulcanized variety can be used for a reasonable number of duplicate wax patterns. Our thanks to Mr. Gemmell for sharing his methods. Ed.

This method of making molds for duplicate wax patterns is quite simple, requiring no elaborate equipment, processing or heat treating (vulcanizing). The original pattern may be made of any convenient material such as wood, linoleum, metals, or plastic, anything except wax. The pattern, of course, must have a sprue attached so that a pouring orifice is molded into the mold.

Use a mold material such as *Pure Rubber Brushing Latex* which is obtainable in many art supply, hobby and plastic supply shops.

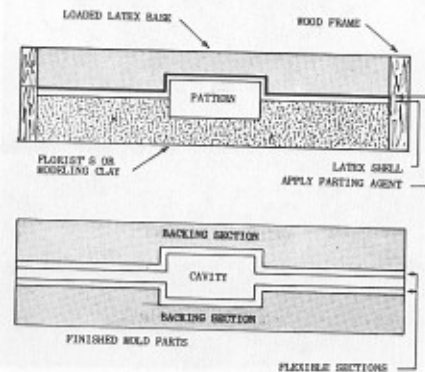

Step 1
Imbed the pattern to its halfway point in a block of florist's clay or modeling clay having a flat surface. This block of clay should be about 3" square, larger for larger patterns. Surround it with a wooden form extending about 3/8" above the pattern. Grease the inner surfaces of the wood form with vaseline. Now coat the entire surface of the pattern and the block of clay with four or five coats of the latex. Apply it with a brush. Drying time for each coat ranges from a half hour at elevated temperature (about 100°F) to two hours at room temperature.

When all coats are set and tack-free, brush on two coats of a parting agent, such as silicone, and let it dry. Next fill the area within the wood frame with latex which has been loaded with a very fine sawdust or some similar filler, brushing in successive coats that are no thicker than 1/8-inch. Thicker coats will take too long to cure. The loaded latex should be mixed as used as any that is left over will cure before you are ready for the next coat. The brush will wash out readily if washed immediately after each coat in running water. The

loaded latex may be mixed in any cup or glass as it will not adhere.

Step 2

When the first half is completely cured, remove the florists' or modeling clay, invert the whole in the wood frame so that the loaded latex section is now at the bottom. The upper surface, now exposed, is that which was against the florists' clay, with half of the pattern exposed. Now coat this entire surface with parting agent and proceed with:
1. The several coats of pure latex and,
2. The coats of loaded latex. *Be sure to apply the coats of parting agent between the two operations.*

If properly prepared, the mold will part readily for the removal of the pattern, and also the loaded sections will part from the thinner, pure latex, mold sections. The wooden frame will serve as a guide for reassembling the mold parts.

You now have a four-part mold. The two thin sections are sufficiently flexible to allow the removal of the wax patterns regardless of any undercuts, while the firmer sections, made of loaded latex, will be sufficiently firm to back up the thinner sections and hold them in place. The thin sections may be made thicker or thinner as experience dictates, depending on the intricacies of the original pattern.

Obviously, provision must be made in the wood frame to match the sprue opening for pouring the wax. This mold will stand warming to the temperature necessary to allow the wax to flow freely. It may sometimes be advisable to

make provision for clamping the mold together with C clamps.

Additional Notes

Latex is not a rubber cement, although for certain applications it does a good job, especially for temporary bonding to glass, such as wooden frames to contain plaster for intarsia. It is a liquid latex formulated for air curing. It is very commonly used for ceramic molds. While molds made in this manner lack the durability of vulcanized rubber, they are sufficiently durable for most amateur purposes. Latex molds have a shelf life of about two years before deterioration sets in.

The secret of using this system is in working out the optimum thickness of the shell section in relation to the particular pattern to be reproduced. The more intricate the pattern as regards undercuts, the thinner the shell should be. However, the thinner the shell, the more difficult it is to assemble the mold.

Any liquid or jellied parting agent containing silicone can be used to coat the sections. This can be supplied by ceramic shops or, possibly, by other types of craft outlets. The use of talc is not advisable since the latex must be brushed on, and this can disturb the powder and cancel its purpose.

The latex has also been used as an electrical insulator. But remember that it will loosen in contact with moisture and it is definitely NOT oil resistant. It is completely soluble in most light hydrocarbons such as gasoline, naphtha, benzene, xylol and similar solvents.

Commercial Equipment

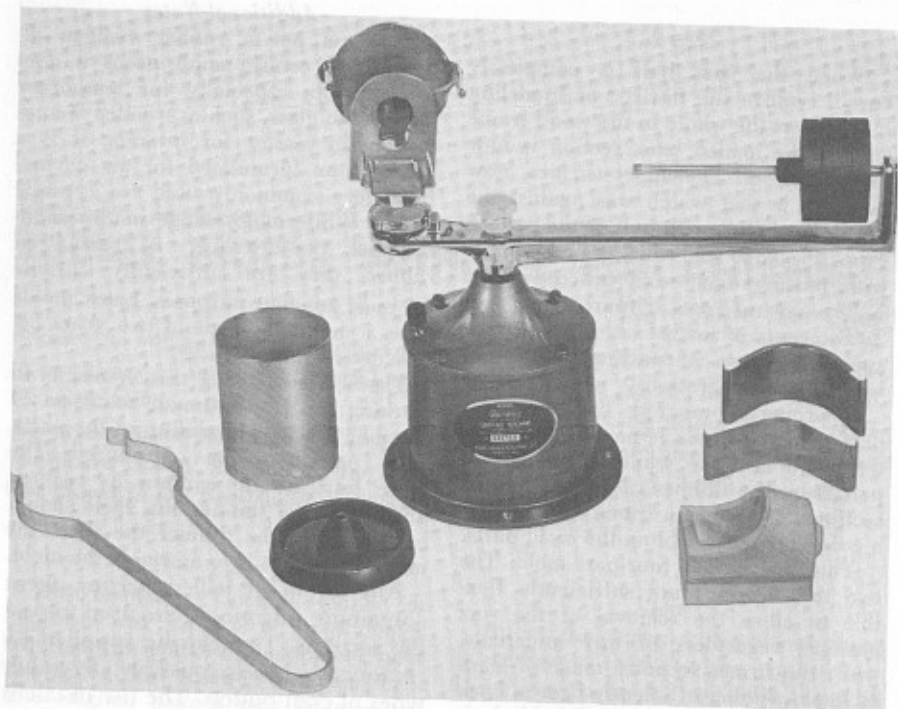

A centrifugal casting machine from Kerr Division of Sybron Corp. On this type of machine the molten metal is forced from a crucible into the mold cavity when the horizontal arm is allowed to rotate rapidly.

In addition to the equipment that you can make, as described in this book, there are tools, accessories and supplies to make your casting work easier and more versatile. And, if you decide that you would rather not build your own -- fine, ready-made casting machines, burnout ovens and other pieces of equipment are available. Such items, in a variety of models and types, are offered by rock shops and

The Vigor® Wax Designing Pen from B. Jadow and Sons, Inc. With a device such as this, modeling wax is kept in a fluid state in a reservoir and will flow from the tip on the handpiece when the craftsman operates the fingertip control. The model can then be built up. Also available from suppliers are electrically heated spatulas for "soldering", cutting and contouring wax.

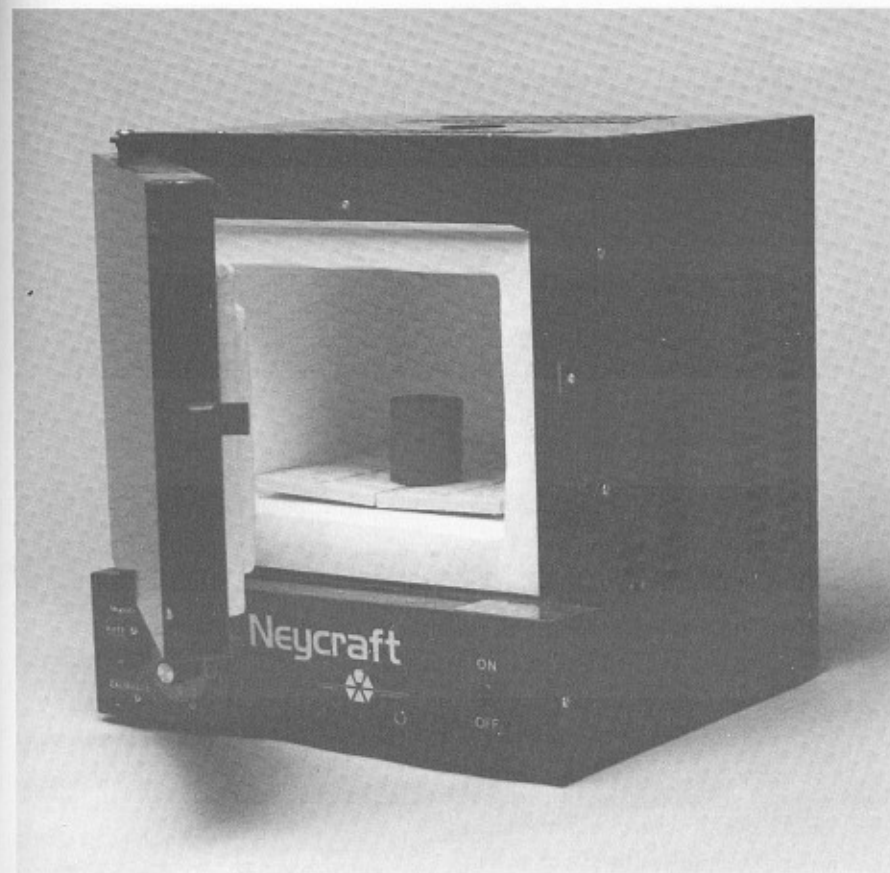
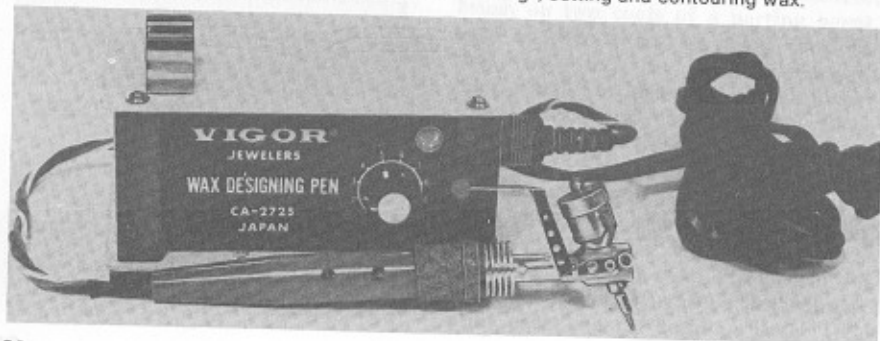

The Neycraft Fiber Furnace™ from the J.M. Ney Co. is among the variety of burnout ovens that are available to jewelry makers.

mail-order suppliers. Representative examples from the many types available are pictured here.

Predominant among casting machines are centrifugal and vacuum units. However, other types may come on the scene. Suppliers have offered a steam caster, consisting of a cap that houses a water-saturated gasket, which when clamped over a flask in which metal has been melted, forces the metal into the mold cavity by the steam

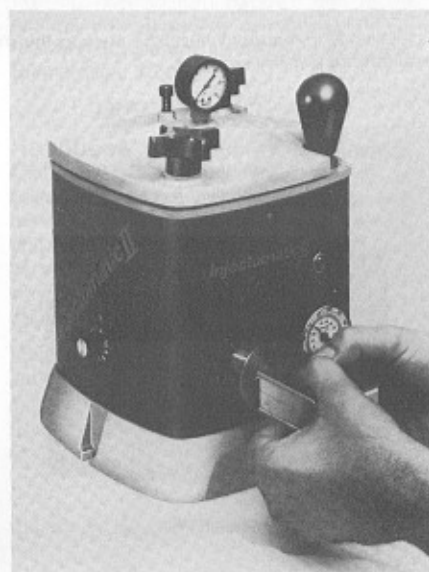

The Injectomatic II wax injector from Kerr Division of Sybron Corp. uses compressed air to deliver wax to a mold cavity.



Readymade investment vibrators, such as this Vigor® model from B. Jadow and Sons, Inc., are also available to jewelry workers.



pressure generated. A book was also published that told how to make such a caster.

For making wax models there is also a wide variety of tools. And, periodically, new devices are invented and offered, many of which make jewelry work easier and more efficient. Checking with jewelry craft suppliers, reading magazines for the hobby and trade, and visiting gem, jewelry and mineral hobby shows will reveal many possibilities.

Molten metal may also be introduced into the flask with a vacuum casting machine, such as the Vac-U-Cast from Swest, Inc.

OTHER GEMBOOKS

JEWELRY MAKING

Jewelry Making for Beginners, Soukup. Here is an easy-to-learn method for fabricating soldered jewelry pieces. All steps are clearly shown. Learn jewelry crafting with little investment of tools and no previous knowledge or experience. \$4.50

Jewelry Maker's Handbook, Geisinger. All techniques are shown step-by-step allowing the reader to follow along and create the projects in the book, then begin designing and fabricating originals. Profusely illustrated. \$5.95

Jewelry Craft Made Easy, French. For the hobbyist and professional craftsman who prefers purchasing already finished gemstones, mountings, and findings for assembling interesting jewelry. Detailed instructions and illustrations cover a wide variety of jewelry. \$5.95

How to Design Jewelry, Austin & Geisinger. Design is the element that adds something special to jewelry creations. The questions to design problems are answered here, and much information is given to help you fashion unique jewelry pieces. Illustrated. \$4.50

How to Make Wire Jewelry, Jenkins & Thrasher. Step-by-step instructions and illustrations show how to use inexpensive tools and supplies to make pins, pendants, chains, rings, bracelets, earrings, and novelties. \$5.00

How to Repair Jewelry, Phelps. Written by a professional jewelry repairman. Detailed step-by-step instructions show how to fix broken chains, replace lost parts, remove and reset gemstones, solder without removing gems, size rings, remodel old pieces and much more. \$5.00

GEM CUTTING

The Art of Gem Cutting, Dake. Tells how to buy rough stones, cut the gems, choose and use equipment. Gets the reader started on the right path and builds an interest in many phases of the hobby of gem cutting. \$5.50

Cabochon Cutting, Cox. Illustrations, photos, and detailed instructions show how to cut a cabochon. Answers all the questions from dopping to setting stones. \$4.50

Advanced Cabochon Cutting, Cox. Learn how to master special shaped cabochon cutting, assembled stones, star stones, and cat's eyes. Special sections on opal and jade. \$4.50

Facet Cutter's Handbook, Soukup. This book contains everything one needs to know in order to facet gemstones expertly. Includes twenty-two beautiful cuts. \$4.50

Handbook of Gemstone Carving, Wertz. Easy-to-follow book on carving gemstones with detailed instructions for carving flat work, carvings in the round, and portraits in stone. \$4.50

How to Use Diamond Abrasives, Riggle. How to cut cabochons and small flats using diamond abrasives. Subjects include trim sawing, slab sawing, grinding, dopping, smoothing, polishing, and equipment. Illustrated in color. \$5.00

How to Tumble Polish Gemstones, Wexler. How to turn pebbles and rough stones into sparkling jewels. Guide to tumbling equipment. Illustrated in color and B/W photos. \$5.00

MISCELLANEOUS

Handbook of Crystal & Mineral Collecting, Sanborn. You can find no better book to tell you about crystals and minerals, their physical properties, where and how to collect them, the different types of specimens, how they fit into different types of collections, methods of housing, and much, much more. \$3.50

How to Create With Horseshoe Nails, Link. Detailed illustrations help describe how to make a wide variety of art pieces from nails, including jewelry pieces, belts, art deco and interesting sculpture. \$2.25

AVAILABLE FROM YOUR DEALER
Prices are subject to change.