

AT MICROFICHE
REFERENCE
LIBRARY

A project of Volunteers in Asia

Handpumps Testing and Development: Progress Report
on Field and Laboratory Testing

by Saul Arlosoroff et. al.

Published by:

Publications Office
World Bank
1818 H Street N.W.
Washington D.C. 20433
USA

Available from:

same as above

Reproduced by permission.

Reproduction of this microfiche document in any
form is subject to the same restrictions as those
of the original document.

Rural Water Supply Handpumps Project

Handpumps Testing and Development: Progress Report on Field and Laboratory Testing

Saul Arlosoroff, David Grey, William Journey,
Andrew Karp, Otto Langenegger, Leif Rosenhall,
and Gerhard Tschannerl

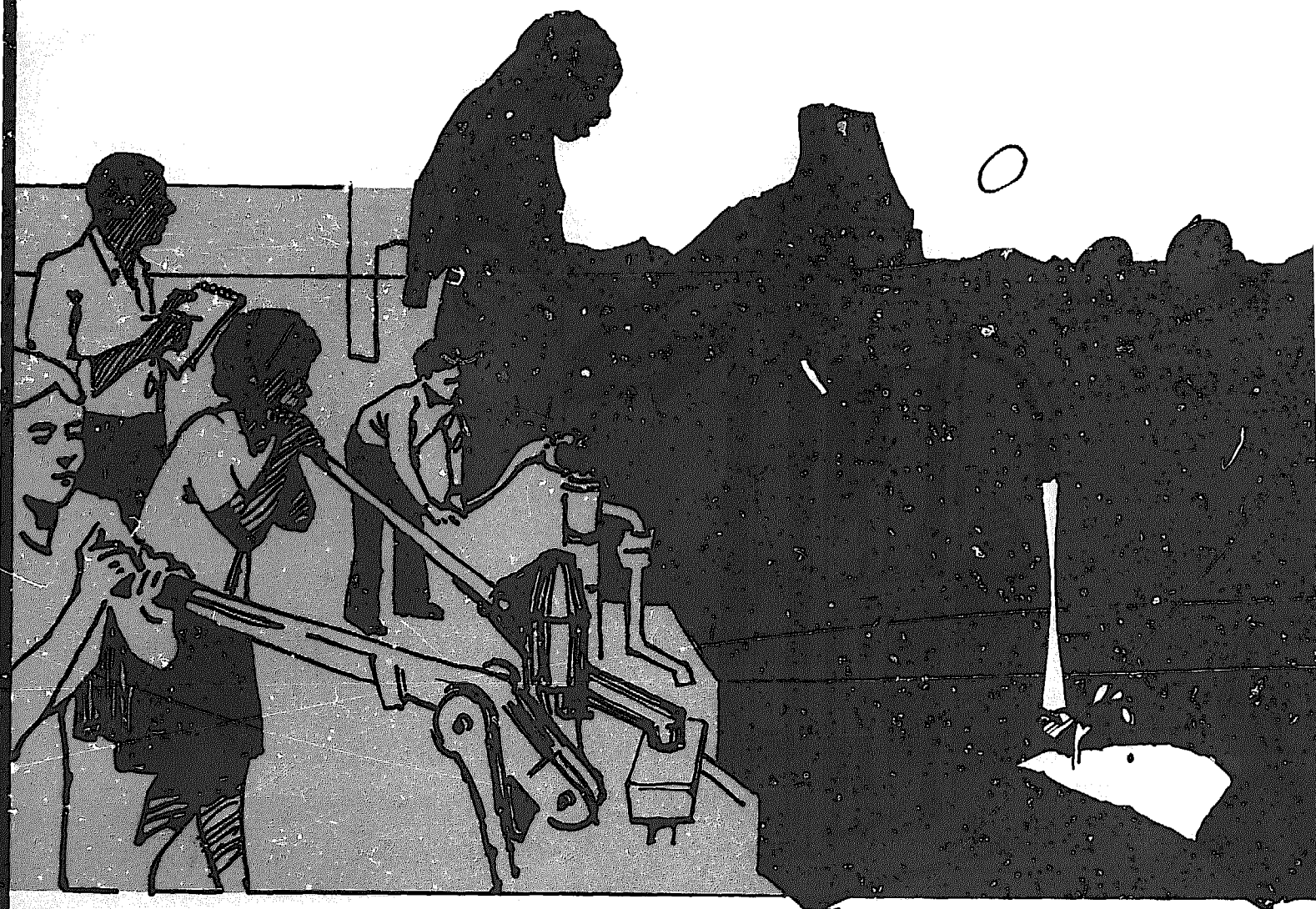

UNDP Project Management Report Number 4



A joint United Nations Development Program and World Bank contribution
to the International Drinking Water Supply and Sanitation Decade

WORLD BANK TECHNICAL PAPERS

- No. 1. Increasing Agricultural Productivity
- No. 2. A Model for the Development of a Self-help Water Supply Program
- No. 3. Ventilated Improved Pit Latrines: Recent Developments in Zimbabwe
- No. 4. The African Trypanosomiasis: Methods and Concepts of Control and Eradication in Relation to Development
- (No. 5.) Structural Changes in World Industry: A Quantitative Analysis of Recent Developments
- No. 6. Laboratory Evaluation of Hand-operated Water Pumps for Use in Developing Countries
- No. 7. Notes on the Design and Operation of Waste Stabilization Ponds in Warm Climates of Developing Countries
- No. 8. Institution Building for Traffic Management
- (No. 9.) Meeting the Needs of the Poor for Water Supply and Waste Disposal
- No. 10. Appraising Poultry Enterprises for Profitability: A Manual for Investors
- No. 11. Opportunities for Biological Control of Agricultural Pests in Developing Countries
- No. 12. Water Supply and Sanitation Project Preparation Handbook: Guidelines
- No. 13. Water Supply and Sanitation Project Preparation Handbook: Case Studies
- No. 14. Water Supply and Sanitation Project Preparation Handbook: Case Study
- (No. 15.) Sheep and Goats in Developing Countries: Their Present and Potential Role
- (No. 16.) Managing Elephant Depredation in Agricultural and Forestry Projects
- (No. 17.) Energy Efficiency and Fuel Substitution in the Cement Industry with Emphasis on Developing Countries
- No. 18. Urban Sanitation Planning Manual Based on the Jakarta Case Study
- No. 19. Laboratory Testing of Handpumps for Developing Countries: Final Technical Report
- No. 20. Water Quality in Hydroelectric Projects: Considerations for Planning in Tropical Forest Regions

() Indicates number assigned after publication.

(List continues on the inside back cover)

February 19, 1985

Dear Madam/Sir:

Subject: UNDP/World Bank Rural Water Supply Project for the Testing
and Technology Development of Handpumps (INT/81/026)

We have the pleasure of sending you the Fourth Report of the Global and Interregional Handpumps Project funded by UNDP and executed by the World Bank.

The Handpumps Project is part of the UN effort to achieve the goals of the International Water Supply and Sanitation Decade. These goals call for the provision of adequate drinking water for all people in developing countries. Handpumps installed in wells, where groundwater of appropriate quality is readily available, provide one of the simplest and least costly means of supplying drinking water to rural areas, and could also serve in the urban fringe suburbs of cities and towns.

The project consists of three phases: laboratory testing, field trials in seventeen developing countries, and the promotion of technological development of new types of handpumps that could be maintained at the village level and manufactured in developing countries.

This report reviews all Project activities and conclusions to date, concentrating on field work, but also summarizing laboratory activities. The report also reviews activities essential for the success of handpump programs, including community participation, caretaker training, and proper construction of wells and boreholes. These latter topics will be covered more thoroughly in future reports. To this end, we would be grateful to receive any information you could provide to us on maintenance costs, particularly related to the frequency of breakdowns and the type of maintenance system employed.

Comments on this report are most welcome.

Sincerely yours,

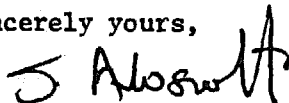

S. Arlosoroff, Chief
Applied Research & Technology
(UNDP Projects Management)
Water Supply & Urban Development Department

Enclosure

Rural Water Supply Handpumps Project

UNDP Project Management Report Number 4

RURAL WATER SUPPLY HANDPUMPS PROJECT

INT/81/026

The UNDP/World Bank project for laboratory and field testing and the technological development of handpumps for community water supply is aimed at promoting the use of suitable handpumps for groundwater extraction to meet the goals of the International Drinking Water Supply and Sanitation Decade. In the selection of pumps and in some cases their further development, consideration is given to their durability, capital as well as maintenance costs, suitability for village-level maintenance, and prospects for local manufacture.

Reports on handpumps testing and development are published periodically, at least once a year, for the duration of the project. The following reports have been published:

- Report No. 1. Laboratory Tests on Hand-Operated Water Pumps for Use in Developing Countries: Interim Report. 1982.
- Report No. 2. Laboratory Evaluation of Hand-Operated Water Pumps for Use in Developing Countries. 1983.
- Report No. 3. Laboratory Testing of Handpumps for Developing Countries: Final Technical Report. 1984.

WORLD BANK TECHNICAL PAPER NUMBER 29

Handpumps Testing and Development

Progress Report on Field and Laboratory Testing

Saul Arlosoroff, David Grey, William Journey,
Andrew Karp, Otto Langenegger, Leif Rosenhall,
and Gerhard Tschannerl

The World Bank
Washington, D.C., U.S.A.

Copyright © 1984
The International Bank for Reconstruction
and Development / THE WORLD BANK
1818 H Street, N.W.
Washington, D.C. 20433, U.S.A.

All rights reserved
Manufactured in the United States of America
First printing December 1984

This is a document published informally by the World Bank. In order that the information contained in it can be presented with the least possible delay, the typescript has not been prepared in accordance with the procedures appropriate to formal printed texts, and the World Bank accepts no responsibility for errors. The publication is supplied at a token charge to defray part of the cost of manufacture and distribution.

The World Bank does not accept responsibility for the views expressed herein, which are those of the author(s) and should not be attributed to the World Bank or to its affiliated organizations. The findings, interpretations, and conclusions are the results of research supported by the Bank; they do not necessarily represent official policy of the Bank. The designations employed, the presentation of material, and any maps used in this document are solely for the convenience of the reader and do not imply the expression of any opinion whatsoever on the part of the World Bank or its affiliates concerning the legal status of any country, territory, city, area, or of its authorities, or concerning the delimitation of its boundaries or national affiliation.

The full range of World Bank publications, both free and for sale, is described in the *Catalog of Publications*; the continuing research program is outlined in *Abstracts of Current Studies*. Both booklets are updated annually; the most recent edition of each is available without charge from the Publications Sales Unit, Department T, The World Bank, 1818 H Street, N.W., Washington, D.C. 20433, U.S.A., or from the European Office of the Bank, 66 avenue d'Iéna, 75116 Paris, France.

Saul Arlosoroff is chief; Gerhard Tschannerl senior project officer; Andrew Karp project officer; and David Grey, William Journey, Otto Langenegger, and Leif Rosenhall regional project officers with the Applied Research and Technology Unit of the Water Supply and Urban Development Department at the World Bank.

Library of Congress Cataloging in Publication Data

Main entry under title:

Handpumps testing and development.

(World Bank technical paper, ISSN 0253-7494 ; no. 29)
"Rural Water Supply Handpumps Project, INT/81/026"
1. Hand pumps--Testing. 2. Hand pumps--Developing
countries. I. Arlosoroff, Saul, 1930- . II. Series.
TJ903.H36 1984 621.6'4 84-19530
ISBN 0-8213-0410-0

ABSTRACT

The UNDP/World Bank Project for the Testing and Technological Development of Handpumps for Rural Water Supply is field testing a total of 2860 pumps of 76 pump types in 17 countries. The Project has also completed full tests of 23 pump models at the Consumers' Association Laboratory in the United Kingdom and plans more tests both in the U.K. and in laboratories elsewhere. Emphasis has been placed on the development of pumps which are suitable for "Village Level Operation and Maintenance" (VLOM).

The first three UNDP Project Management Reports concerned only laboratory testing. The current report reviews all Project activities and conclusions to date, concentrating on field work but also summarizing laboratory activities. It relates significant findings in the development and use of VLOM handpumps. The report also reviews activities essential for the success of rural and urban fringe handpump programs, including community participation, caretaker training, and proper construction of wells and boreholes.

Report annexes include a discussion of VLOM direct action handpumps and their design principles, a survey of existing handpumps in China, a set of field monitoring forms, and a sociocultural study for a handpump maintenance program in Eastern Africa.

The report is intended to provide developing country agencies and assistance organizations with information which will assist them in selecting appropriate pumps for given sets of conditions; the report also is intended to provide support to pump manufacturers and to initiate improvements in the quality of their products.

Condensé

Dans le cadre du Projet PNUD/Banque mondiale d'essais et de développement technique de pompes à motricité humaine pour l'alimentation en eau des régions rurales, un programme d'essais sur le terrain a été lancé dans 17 pays en vue de tester 2.860 pompes de 76 modèles différents. Vingt-trois modèles ont par ailleurs fait l'objet d'essais complets au Laboratoire d'essais et de recherche de l'association des consommateurs (Consumers Association Testing and Research: CATR) au Royaume-Uni, et d'autres tests de laboratoire seront effectués au Royaume-Uni et dans d'autres pays. L'objectif est notamment de mettre au point des pompes qui soient aptes à être facilement "Exploitées et entretenues au niveau du village" (pompes EENV).

Les trois premiers rapports de gestion du projet PNUD ne concernaient que les tests de laboratoire. Le rapport actuel - qui est en grande partie consacré aux opérations menées sur le terrain mais qui résume aussi les travaux de laboratoire - analyse toutes les activités du projet et les conclusions qui s'en dégagent. Il contient des observations intéressantes sur la mise au point et l'utilisation des pompes EENV à motricité humaine en zones rurales et à la périphérie des villes et il passe en revue les éléments essentiels au succès des programmes de pompes, notamment la participation de la communauté concernée, la formation des responsables des pompes et la construction de puits et de forage adéquats.

Les annexes du rapport comprennent une étude sur les pompes EENV à motricité humaine à entraînement direct et sur les principes de conception de ces pompes, un inventaire des pompes à motricité humaine existant en Chine, un jeu de formulaires pour le contrôle continu sur le terrain et une étude socio-culturelle pour un programme de maintenance de pompes en Afrique de l'Est.

Le rapport vise, d'une part, à fournir aux services et organismes d'aide des pays en développement des éléments d'appréciation qui les aideront à choisir les types d'appareils adéquats en fonction des conditions rencontrées et, d'autre part, à aider les fabricants de pompes et à amorcer des améliorations dans la qualité de leurs produits.

Extracto

El proyecto del PNUD-Banco Mundial de ensayos y tecnología de producción de bombas de mano para abastecimiento de agua a zonas rurales está poniendo a prueba aproximadamente un total de 2.860 bombas de 76 tipos en 17 países. Se han completado pruebas integrales de 23 modelos en el Laboratorio de la Asociación de Consumidores en el Reino Unido y se tiene previsto realizar más ensayos tanto en dicho país como en laboratorios en otros lugares del mundo. Se hace hincapié en la producción de Bombas de mano aptas para Operación y Mantenimiento a nivel de Poblado (BOMPO).

Los tres primeros informes sobre la gestión del proyecto del PNUD se relacionaban únicamente con las pruebas de laboratorio. El presente informe examina todas las actividades y las conclusiones del proyecto hasta la fecha, prestando especial atención a los trabajos en el terreno pero resumiendo también las actividades de laboratorio. Establece una relación entre los resultados más importantes de la producción y utilización de bombas de mano cuya operación y mantenimiento puedan realizarse en los poblados. En el informe también se examinan actividades esenciales para el éxito de los programas de bombas de mano en zonas rurales y periferias urbanas, entre ellas la participación de la comunidad, los programas de formación para los encargados del mantenimiento y la construcción apropiada de pozos excavados y pozos perforados.

Los anexos del informe incluyen una descripción de las BOMPO de accionamiento directo y sus principios de diseño, una encuesta sobre las bombas de mano existentes en China, una serie de formularios para la supervisión en el terreno y un estudio sociocultural relativo a un programa de mantenimiento de bombas de mano en Africa Oriental.

El informe tiene por finalidad proporcionar a los organismos de los países en desarrollo y organizaciones de asistencia información que les sería de utilidad en la selección de bombas de mano apropiadas para determinadas condiciones; el objetivo del informe es también brindar apoyo a los fabricantes de bombas de mano e iniciar mejoras en la calidad de sus respectivos productos.

DEDICATION

This report is dedicated to Oliver Murphy, in memory of his work and his commitment to this Project and its goals.

Oliver Murphy came to Tanzania from Ireland in 1980 as a volunteer to work with a mission in Mwanza on the construction of rural water supplies. He learned to speak Swahili fluently and to understand many of the problems facing Tanzania's rural population. He joined the UNDP/World Bank Handpumps Project in March 1983 and became the Tanzania Country Monitoring Engineer, based in Mtwara. He was greatly liked by Tanzanians and by all those with whom he worked; friendships extended from regional administrators to the multitude of Tanzanian children whom he regularly entertained.

Oliver tackled with vigor the task of installing a large number of handpumps and very quickly established a monitoring routine that required frequent travel away from Mtwara. After spending several days in the field collecting handpump monitoring data, he returned to Mtwara on the evening of November 18, 1983, and was killed in an automobile accident.

Oliver's death at the age of 26 brought sadness to all. He will be missed by his friends and colleagues everywhere. In a short time Oliver made a significant contribution to the Project, and his work benefitted people in many villages and contributed much to our understanding of effective ways to provide water to the needy in developing countries throughout the world.

CONTENTS

Preface	xi
Acknowledgements	xiii
List of Acronyms	xv
1. INTERREGIONAL OVERVIEW	
Background	1
Purpose of the Project	1
Methodology	3
Project Activities in Latin America - Bolivia.....	4
Village Level Operation and Maintenance (VLOM) Handpumps ..	5
"Software" Requirements	7
Borehole Construction	9
2. EASTERN AFRICA	
Introduction	20
Sudan	21
Malawi	27
Tanzania	34
Kenya	38
Conclusions	45
3. WESTERN AFRICA	
Introduction and Conclusions	47
Ghana	56
Ivory Coast	79
Mali	82
Niger	85
Burkina	86
4. EAST ASIA AND PACIFIC	
Introduction	97
China	99
Papua New Guinea	103
Philippines	107
Thailand	113
5. SOUTH ASIA	
Introduction	122
Bangladesh	122
India	133
Sri Lanka	143

6.	LABORATORY TESTING AND DEVELOPMENT	
	Introduction	149
	Handpump Testing	149
	Development and Manufacture of Water Flow Meters	161
	Development of Below-ground Components	162
	Development of Dry Bearing Systems for the Maldev	164
	Other Activities	169
	The Value of Laboratory Work	171
	Future Laboratory Work	172
7.	WHAT HAS BEEN LEARNED ABOUT HANDPUMP TECHNOLOGY	
	Handpump/Well System	173
	Quality Control in Manufacturing	175
	Handpump Design	176
	Low-lift Pumps	180
	High-lift Pumps	183
	Conclusions	185
ANNEX A.	THE CASE FOR DIRECT ACTION HANDPUMPS	187
ANNEX B.	THE ROWER PUMP	205
ANNEX C.	A SURVEY OF THE PRODUCTION AND USE OF HANDPUMPS IN CHINA ..	223
ANNEX D.	SOCIO-CULTURAL STUDY FOR A HANDPUMPS PROJECT IN KENYA	275
ANNEX E.	MONITORING FORMS	305
ANNEX F.	LABORATORY TEST RESULTS OF HANDPUMPS	
	Kardia	334
	Turni	346
	Mono Direct Drive	358
	Mono	372
	Sihilase	386

PREFACE

Recognizing the urgent need to provide people in developing countries with reasonably good access to safe water and to improve sanitation, the United Nations declared the 1980's to be the International Drinking Water Supply and Sanitation Decade. Member nations established an ambitious goal to provide adequate water supply to all people in these countries. To achieve this goal new or improved water supplies and sanitation facilities must be provided to at least 2,000 million people, most of whom live in rural areas.

Facing the present scarcity of development and aid funds, it is apparent that only low cost options for water supply and sanitation offer the possibility of a global solution. At cost reductions of 60 to 80 percent, handpump-based water supply systems can provide wider coverage and greater reliability than can be achieved with more sophisticated systems which offer higher levels of service.

Handpumps installed in dug wells or boreholes in areas where groundwater is available provide one of the simplest and least costly methods of supplying the rural population with water. However, despite all efforts in the past, a number of serious problems related to the effective large scale application of handpumps remained to be solved at the time the Decade began.

Among the activities of the Decade is Project INT/81/026 on Laboratory and Field Testing and Technological Development of Rural Water Supply Handpumps, funded by the United Nations Development Programme (UNDP), Division for Global and Interregional Projects. The World Bank, with responsibility assigned to the Water Supply and Urban Development Department, is the executing agency for the project.

The objective of the Project is to support the global effort to provide reliable, low-cost water supply systems to serve those in dire need of adequate sources of water in rural and urban fringe areas. This is to be achieved by promoting improved designs of handpumps which can be locally manufactured in developing countries, and which can be maintained and repaired by trained handpump repairers (VLOM pumps). Handpump design cannot be approached in isolation from the many interrelated factors needed for a handpump to provide a reliable community water supply. Therefore, the Project is also concerned with other aspects which are essential if a handpump program is to be successful, including economic, financial, social and institutional considerations, and improved borehole construction.

This is the fourth report of the Project. The three previous reports describe the results of laboratory tests on a wide range of handpumps, primarily with the aim of providing information about the production of more reliable handpumps to all interested manufacturers. As the laboratory tests progressed and the field trials were beginning to be set up, and as reactions from other institutions active in the Decade were received, it became clear that durability was not the only criterion of handpump design that had to be considered, and the VLOM concept gradually emerged. It is more fully explained in Chapter 1.

This report contains the interim results of the Program, including the field trials which are currently underway in 17 developing countries. Initial conclusions are discussed; these are intended as guidelines on how to select suitable handpumps based on country specific conditions and as a means to encourage design improvements and to achieve more widespread manufacture. Future reports will deal with the comparison between different handpumps, analyses of handpump and borehole performance, country-specific handpumps selection methodology, further results from field trials, laboratory tests of additional pumps, and other related subjects.

Among the future outputs of the project will be a financial analysis based on projected annual costs for maintenance and operation of a variety of maintenance systems for handpumps. For this purpose we would be grateful to receive any information on maintenance costs, particularly as related to the frequency of breakdowns and the type of maintenance system employed, obtained from field operations or tests organized by developing country governments, aid agencies, and others.

Comments on this report are most welcome.

Saul Arlosoroff, Chief
Applied Research and Technology,
Water Supply and Urban Development Department
The World Bank

ACKNOWLEDGMENTS

A large number of dedicated individuals and institutions throughout the world have contributed either directly or indirectly to the developments described in this report. We are very grateful to them all.

Institutionally, we thank the United Nations Development Programme (UNDP) for the direction, guidance, financing and promotion that it has given to the Project from its inception, and for the key role played by the senior staff of the UNDP Division of Global and Interregional Projects and the UNDP resident missions. We are also grateful to staff in the World Bank who have contributed to the development and wide application of handpumps for rural water supplies. Special thanks go to the United Nations Volunteers Organization, which has arranged for UNVs to be integrated into the Project serving in the essential positions of Country Monitoring Engineers. The following bilateral agencies provided support to the project: Canadian International Development Agency (CIDA); German Ministry for Economic Cooperation (BMZ) and German Agency for Technical Cooperation (GTZ), Federal Republic of Germany; Swiss Development Cooperation (SDC); Swedish International Development Authority (SIDA); FINNIDA, Finland; Ministry of Foreign Affairs, The Netherlands; and Danish International Development Agency (DANIDA).

Appreciation is also expressed to the Overseas Development Administration (ODA) of the United Kingdom for initiating and continuing to support the laboratory testing of handpumps, the procedures of which the Project has used as a basis for the laboratory aspect of its work, and to the Consumers' Association of the U.K. which has carried it out. Recognition goes to the International Development Research Centre (IDRC) of Canada for its support of pioneering work with direct action plastic handpumps. The work of the Mennonite Central Committee in Bangladesh has greatly contributed to the development of the Rower irrigation pump which led to the development of the TARA pump, and we are grateful for their permission to republish some of their reports in Annex B.

Special gratitude must be expressed to our UNICEF colleagues, whose handpump development and installation work, especially in India and Bangladesh, both prior to and within the Project, have had a world-wide impact on the development of better handpumps and their utilization.

The entire Project staff and the Project Advisory Committee, as well as members of the Consumers' Association, have contributed to this report. Its preparation was coordinated by Andrew Karp. The Project staff is composed as follows:

WORLD BANK HEADQUARTERS (WASHINGTON, D.C)

Saul Arlosoroff
Gerhard Tschannerl
Andrew Karp
Anthony Ramuglia
Nicholas Burnett
Robert Roche
Kedar Bryan

REGIONAL PROJECT OFFICERS

David Grey	Eastern Africa
William Journey	South Asia
Otto Langenegger	Western Africa
Leif Rosenhall	East Asia and Pacific

COUNTRY MONITORING ENGINEERS

San Shwe Aung	Malawi
Aung Chein	Sri Lanka
Gerry Clarke	Sudan
H.S. Fonseka	Kenya
Diawoye Guindo	Burkina
B.P. Joshi	Ghana II
Sampath Kumar	India
Thint Myat	Ghana I
Kyaw Myint	China
Kyaw Nyunt	Philippines
David Rowsome	Papua New Guinea
Khin Maung Than	Thailand
Roland Titus	Tanzania

LIST OF ACRONYMS

ABS	Acrylonitrile-butadiene-styrene (a plastic material)
ACEM-IC	Ateliers de construction électro mécanique de Côte d'Ivoire
AFVP	Association française des volontaires du progrès
AID	United States Agency for International Development
AIT	Asian Institute of Technology, Thailand
AMREF	African Medical Research Foundation, Kenya
ATDI	Appropriate Technology Development Institute, University of Lae, Papua New Guinea
BMZ	Bundesministerium für Wirtschaftliche Zusammenarbeit (German Ministry of Economic Cooperation), Federal Republic of Germany
BOAD	Banque ouest-africaine de développement (West African Development Bank)
BSP	Black steel pipe
CAAMS	Chinese Academy of Agricultural Mechanization Sciences
CATR (or CA)	Consumers' Association Testing and Research Laboratories, U.K.
CEAO	Communauté économique de l'Afrique de l'ouest (West African Economic Community)
CIDA	Canadian International Development Agency
CIEH	Comité interafricain d'études hydrauliques
CILSS	Comité permanent interétats de lutte contre la sécheresse dans le Sahel (Permanent Interstate Committee for Drought Control in the Sahel)
CME	Country Monitoring Engineer, Handpumps Project
CORDEOR	Corporación Regional de Desarrollo de Oruro (Oruro Regional Development Corporation), Bolivia
CORDEPO	Corporación Regional de Desarrollo de Potosí (Potosi Regional Development Corporation), Bolivia
CPHEEO	Central Public Health Environmental Engineering Organization, India
CTLO	Community Training and Liaison Officers (of KWAHO), Kenya

DANIDA Danish International Development Agency

DCH Direction centrale de l'hydraulique
(now called Direction de l'eau), Ivory Coast

DE Direction de l'eau, Ivory Coast

DLVW Department of Lands, Valuation and Water, Malawi

DNHE Direction nationale de l'hydraulique et de l'énergie,
Mali

DPHE Department Public Health Engineering, Bangladesh

EEC European Economic Community

EMAMA Entreprise malienne de maintenance, Mali

FED Fonds Européen de développement (European Development Fund)

FEME Fédération des églises et missions évangéliques, Burkina

FINNIDA Department of Development Assistance, Ministry of Foreign Affairs,
Finland

FOB Freight on board

FRG Federal Republic of Germany

GI Galvanized iron

GTZ Gesellschaft für Technische Zusammenarbeit (German Agency for
Technical Cooperation), Federal Republic of Germany

GWSC Ghana Water and Sewerage Corporation

HELVETAS Swiss Association for Technical Assistance

HER Direction de l'hydraulique et de l'équipement rural, Burkina

ICDDR,B International Centre for Diarrheal Disease Research, Bangladesh

IDRC International Development Research Centre, Canada

IDWSSD International Drinking Water Supply and Sanitation Decade

IRC International Reference Centre for Community Water Supply
and Sanitation

KfW Kreditanstalt für Wiederaufbau, Federal Republic of Germany

Kg-f Kilograms-force

KWAHO Kenya Water for Health Organization

MAJI	Ministry of Water and Energy, Tanzania
MAWTS	Mirpur Agricultural Workshop and Training School, Bangladesh
MCC	Mennonite Central Committee, Bangladesh
MOH	Ministry of Health, Thailand
MoWD	Ministry of Water Development, Kenya
MPWH	Ministry of Public Works and Highways, Philippines
NAW	National Administration for Water, Sudan
NEERI	National Environmental and Engineering Research Institute, India
NGO	Non-governmental organization
NORAD	Norwegian Agency for International Development
NWSDB	National Water Supply and Drainage Board, Sri Lanka
ODA	Overseas Development Administration, United Kingdom
OPE	Office of Project Execution, UNDP
PDA	Population and Community Development Center, Thailand
PE	Polyethylene (a plastic material)
PHED	Public Health Engineering Department, State of Orissa, India
PVC	Polyvinyl chloride (a plastic material)
RPO	Regional Project Officer, Handpumps Project
RWDC	Rural Waterworks Development Corporation, Philippines
RWSA	Rural Waterworks and Sanitation Association, Philippines
RWSD	Rural Water Supply Division, Ministry of Health, Thailand
SDC	Swiss Development Cooperation
SIDA	Swedish International Development Authority
SODECI	Société de distribution d'eau de la Côte d'Ivoire
TWAD	Tamil Nadu Water Supply and Drainage Board, State of Tamil Nadu, India
UNDP	United Nations Development Programme
UNICEF	United Nations Children's Fund

UNV United Nations Volunteer
UST University of Science and Technology, Ghana
VLOM Village Level Operation and Maintenance
WECO Western College of Arts and Applied Science, Kenya
WHO World Health Organization

CHAPTER 1

INTERREGIONAL OVERVIEW

A. BACKGROUND

It is estimated that more than 2,000 million people in the developing countries lack adequate supplies of safe water and adequate sanitation facilities.

The goals of the United Nations International Drinking Water Supply and Sanitation Decade include the provision of reasonable access to safe drinking water to all people in developing countries by the year 1990. The UNDP/World Bank Handpumps Project is part of the UN effort to achieve these goals. Handpumps installed in wells, where groundwater of appropriate quality is readily available, provide one of the simplest and least costly means of supplying drinking water to rural and urban fringe areas. Because of budget limitations, it is apparent that only such low cost options can lead to wide coverage of improved water supplies.

In the past, there have been serious problems with the poor performance and short working life of most handpumps used for community water supply. Some of these problems are associated with handpump design, selection, and quality of manufacture. Others are rooted either in the attitudes and behavior of handpump users or in the organization of handpump installation and maintenance programs. Review of a number of handpump projects indicates that handpump failure may be attributed to one or more of the following:

- (a) Lack of institutional infrastructure, proper maintenance, spare parts, trained repair personnel, and appropriate budgets.
- (b) Pumps which were not designed for continuous use by entire communities nor for repair and maintenance by villagers.
- (c) Improper borehole design and construction.

Until recently, data on evaluating and improving handpump performance, including the non-technological factors which influence it, were sparse and inconclusive. Likewise, there was also a lack of reliable data on the comparative performance of various handpumps. Over the past ten years there have been a number of handpump field tests, but the primary objective of most of these test programs was the development and testing of a particular pump rather than a systematic comparison between a variety of pumps and designs.

B. PURPOSE OF THE PROJECT

In response to the above problems, the UNDP and the World Bank undertook a project to test, evaluate and improve handpumps, and to promote the technological development of a new generation of pumps. The results of the Project will enable developing country governments and assistance agencies to obtain maximum benefits from the scarce funds available for rural and urban fringe water supplies. The Project is also providing data for the development



FIGURE 1-1 TRADITIONAL WATER SOURCE IN WEST AFRICA

The child fetching water from this open and contaminated water hole is among the more than 2,000 million rural people in the world who lack safe and convenient sources of water.

and manufacturing of simple, reliable handpumps which can be maintained and repaired by trained village handpump repairers (VLOM pumps) who live in the user community, and who require little or no outside help.

To date the Project has emphasized, but not been limited to, the development of more appropriate handpump technology, as it was found that the availability of a VLOM (Village Level Operation and Maintenance) technology was a prerequisite for the successful implementation of large scale village-level maintenance systems, and was therefore the most urgent of all the handpumps-related problems to be solved. Furthermore, although handpump technology must be suitable for specific local conditions, much handpump technology is transferable among countries. However, support systems for handpump projects, such as training and maintenance programs, will require modifications to adapt them to local physical, social, economic, and institutional conditions. Therefore, the Project is also involved in training and maintenance programs in a number of the countries in which it is operating and it will be increasingly involved with such issues in the future.

C. METHODOLOGY

Project work has so far consisted of three main activities: (1) laboratory testing, (2) field trials in 17 developing countries, and (3) assistance with the development of new types of handpumps that can be maintained at the village level and manufactured in developing countries. Recently the Project has also begun to provide technical assistance in borehole design and development because of its direct impact on handpump life and maintenance.

Full-scale comparative laboratory testing of 12 types of handpumps, sponsored by the British Overseas Development Administration (ODA), was carried out by the Consumers' Association Testing and Research Laboratories (CATR) of the United Kingdom in 1980. Since then, tests on an additional 23 pumps were completed,* bringing the total number of pump makes tested at CATR to 35. The final results of Laboratory tests on 18 pumps are published in Project Management Report Number 3, which also contains in an annex a summary of test results of the 12 pumps sponsored by ODA. The laboratory test results of five additional pumps are given in Annex F of this report.

The CATR laboratory tests include inspection of the pumps and their packaging, user assessments, and measurements of pump performance. This is followed by a 4,000-hour endurance test, abuse tests, and an engineering assessment with suggestions for design improvements. An evaluation of the pumps for local manufacture and ease of installation, maintenance, and repair is also carried out. Manufacturers are kept informed of the progress of their

* The tests on the first 18 pumps were funded entirely by the Handpumps Project. More recently manufacturers have contracted directly with CATR for testing their pumps, the results of which will be published as annexes to the regular reports of the Project.

pumps through the tests and discussions are held on any failures noted. More details on laboratory testing are contained in Chapter 6, "Laboratory Testing and Development".

The field testing of handpumps and related activities are taking place in 17 countries in Western Africa, Eastern Africa, South Asia, East Asia and Pacific, and Latin America and the Caribbean. This is done in collaboration with national and international institutions in each country, as shown in Table 1-1 at the end of this chapter. A total of about 70 pump models manufactured in 31 countries are included in the test program, as listed in Table 1-2.

In each country a Country Monitoring Engineer, who is usually a United Nations Volunteer, is assigned to monitor these trials. The CME observes, advises, and reports on the installation, operation, and maintenance of all Project pumps in his area, for which standard monitoring forms have been developed (see Annex E). He reports to a Regional Project Officer who supervises all Project activities in the region, averaging about four countries. Regional Project Officers are based in Nairobi for Eastern Africa, Abidjan for Western Africa, Bangkok for East Asia and Pacific, and Dhaka for South Asia. Latin American activities are managed from Project headquarters in Washington.

Although the field trials are still in progress, laboratory and field experience have resulted in both the modification and improvement of several pump models and the complete reassessment of several others. Discussion of each Region can be found in Chapters 2 through 5.

The nomenclature used in the report for describing some of the types of handpumps and their components is shown in Figure 1-3, on page 19 at the end of this chapter.

D. PROJECT ACTIVITIES IN LATIN AMERICA - BOLIVIA

The Project is preparing for field trials in the highlands of Bolivia to begin in late 1984. The objectives are to demonstrate and evaluate the suitability of low lift handpumps for domestic water supply and small scale irrigation of domestic, school, and community garden plots, to demonstrate and evaluate the suitability of deep-well handpumps for community water supplies where water is at a maximum depth of about 45 meters, to monitor the technical, social and cost aspects of at least 95 handpumps of different types (see Table 1-2), to train users in operation, maintenance, and sometimes installation of pumps, and to identify and demonstrate low-cost construction methods for low-discharge wells. Technical assistance to manufacturers in Latin America will be provided at a later stage.



NDPUMP DURING MAINTENANCE

em which can occur if below-ground
ge level operation and
rising main was being pulled up
tripod and pulley in order to
the borehole for maintenance. The
om the cable and fell. Fortun-
connected to the rising main caught
nted the entire rising main from
. A VLOM design eliminates the
because components at the bottom
surface without extracting the
ate hoisting equipment.



FIGURE 1-2 DAMAGE TO CONVENTIONAL HANDPUMP DURING MAINTENANCE

This illustration shows a major problem which can occur if below-ground components are not suitable for village level operation and maintenance. In the illustration the rising main was being pulled up with a cable connected to an overhead tripod and pulley in order to remove the cylinder at the bottom of the borehole for maintenance. The rising main accidentally broke loose from the cable and fell. Fortunately, the pipe clamp that had been connected to the rising main caught on the top of the pumpstand and prevented the entire rising main from falling to the bottom of the borehole. A VLOM design eliminates the possibility of this sort of accident, because components at the bottom of the borehole are brought up to the surface without extracting the entire rising main and without elaborate hoisting equipment.

Development of deep well handpumps suitable for village level operation and maintenance has been particularly difficult. Such pumps are especially needed for deep wells because of the difficulty of hoisting components of conventional pumps from great depths. However, it has been a major challenge to develop alternative VLOM components which are both reliably supported in the well during normal pump operation and which can be removed for maintenance without elaborate equipment or sophisticated skills. Nonetheless, significant progress has been made and is described in the sections of this report dealing with the field trials.

To achieve the potential benefits of VLOM pumps it is essential that appropriate training be provided for village handpump repairers and that spare parts be available to them. For long-term maintenance to succeed arrangements should be made for covering maintenance and repair expenses. It is essential that pump development be consonant with these activities.

The first handpump candidates for VLOM status have already begun to appear on the market. However, they still require modifications and cannot yet be categorized by the Project as being VLOM.*

Through both laboratory and field work the Project team and its associates throughout the world have learned a great deal about the design of handpumps, and this learning process is continuing. This subject is discussed in Chapter 7, which begins with a summary of important design considerations.

F. "SOFTWARE" REQUIREMENTS

The Project is involved in "software" activities related to infrastructural support, health education, and training in handpump maintenance and repair in a number of the countries where field trials are taking place. There is a good deal of variety in the nature of these activities and the Project's role in them, but in general there is an emphasis on maintenance systems including caretaker training. In the Ivory Coast the Project is about to begin an assessment of the maintenance system for handpumps and is assisting with developing improved caretaker training courses. In Malawi and Kenya the Project has undertaken case studies of rural water supply programs, and has supported training programs and community participation for water supply schemes. In Bangladesh the Project is

* Readers who are particularly interested in the technological development of VLOM handpumps, will find the following sections of this report to be informative:

- Chapter 2 - Discussion of Maldev/Afridev pump in Malawi
- Chapter 3 - Discussion of Volanta, Vergnet, and ASM pumps
- Chapter 5 - Section on "Experimental VLOM Version of the India Mark II"
- Chapter 5 - Section on "The TARA Pump"
- Chapter 7 - "What Has Been Learned About Handpump Technology"
- Annex A - "The Case for Direct Action Handpumps"
- Annex B - "The Rower Pump"

sponsoring a large study of the health impact of improved water supply, sanitation, and health education. In Thailand the Project is assisting with the training of local village volunteer caretakers, as part of a training and re-training program of the National Department of Health. In China the Project participated in a training course of handpump installers and repairers organized under its auspices.

The organizational, economic, and social factors required for a successful handpump program are wide-ranging and to a large degree country- and program-specific. The following general comments, however, should highlight the importance and variety of such non-technological factors and promote their consideration when handpump programs are planned and implemented.

- o If handpumps are to be properly installed, used, and maintained, then interrelated social, organizational, economic, and technical obstacles must be overcome.
- o Beginning with installation of handpumps, it is imperative that the beneficiary communities perceive the need for handpumps and that they relate to them as their property and as their responsibility to maintain. Selected members of the communities should learn as much as possible by participating in the planning and physical work of installing the pumps.
- o The appointment of local caretakers or repairers, who are adequately trained and who have adequate tools and spare parts, may represent the only practical and realistic solution to prompt and economical maintenance and repair of large numbers of handpumps. This requires a method of selecting village handpump repairers, an arrangement for training and local compensation for them, and a VLOM pump design which is conducive to maintenance without the need for sophisticated skills and equipment.
- o The strategy for doing this will vary from one area to another. However, failure to create and support a village based handpump infrastructure will result in either inoperative handpumps or the need for prohibitively expensive mobile repair-on-demand teams -- and, due to logistical difficulties, in all probability such mobile maintenance teams will not be able to respond promptly when needed.
- o Support for handpump maintenance must be institutionalized at the national, district, and village levels. Funding requirements must usually be addressed at the national level, where objectives must also be set, and where programming should be developed to achieve national water supply objectives. This may also include standardization of pump designs in order to increase and rationalize the availability of spare parts, to promote in-country manufacture by increasing the market for a particular pump model, and to facilitate training by restricting the variety of pumps to be installed.

- o It will frequently be most logical and efficient to base mobile pump installation teams at the district level within a country. Ideally village handpump repairer training courses should be organized at the sub-district level given the difficulties for trainees to travel too far or to be away from home for too long. This is especially true when the trainees are women.
- o At the village level one way to organize a program is for the villagers to accept final responsibility for pump maintenance and to organize themselves to collect fees to cover costs, to select and support the caretaker, and to resolve any conflicts associated with the handpump.
- o Installation of a handpump water supply can be a means to improved health as a component of a health "package." However, if maximum health benefits are to result, then a health education program on basic sanitation, including the proper use of water and food, will generally be required.
- o A frequent obstacle to timely pump maintenance and repair is the fact that water is usually collected by women and children, but handpump maintenance is usually done by men whether by a village handpump repairer or by a mobile maintenance team. Thus those responsible for repairing a pump when it is out of service are the people who may sense the need least. Also, many trained men will frequently be far from their villages, while women more typically stay closer to home. For these reasons, in many cases, women repairers should be appointed. In some areas resistance may be expected to an expanded role for women, but it is worthwhile to confront and overcome such resistance.

G. BOREHOLE CONSTRUCTION

The monitoring of handpumps in Eastern Africa has demonstrated that proper borehole construction is essential for extending the life of handpump components. Poor borehole construction can result in abrasive material in the well water; this in turn drastically reduces the life of the leather cup seals of the pump piston. In a field trial area in Malawi, where the average life of leather cup seals was previously only about five months, improved borehole construction and completion increased this life more than six-fold. After 30 months of operation almost all leather cup seals monitored in this field trial area were still functioning properly.

Improved borehole construction includes proper well screen design and setting, gravel pack size and emplacement, and well development techniques after drilling is completed. The increasing emphasis that the Project will place in the future on the role of the borehole will largely consist of documenting what impact on the well handpump system results from using different types of drilling rigs, different casings and screens, different borehole designs and completion techniques, etc., as well as their cost implications and their relationship to the institutional requirements of the successful and cost-effective delivery of handpump-based rural water supply schemes. The borehole component will receive greater emphasis once the present phase of field trials is completed. Following are preliminary conclusions and recommendations based on experience in Eastern Africa.

The design of an efficient borehole is much more complicated than putting a hole of intermediate depth and width in the ground and lining it with perforated casing if the rock formation is unconsolidated. It depends rather on a thorough understanding of the geology and the groundwater occurrence and movement. A good borehole will do its job effectively and economically for many years, while a poorly designed and constructed borehole will quickly become expensive to maintain and may eventually become unusable.

The drilling equipment and materials chosen for borehole construction should be as simple as possible and relatively inexpensive. The equipment must also fit together well, creating a balance in the relationship of each item in the assemblage. In the choice of the drilling rig itself, a wide range of options is available from hand-operated equipment to a large multi-purpose rig that can drill in almost any formation with great speed. The latter is usually imported and invariably requires expatriate specialists for operation and maintenance, along with expensive ancillary equipment. The choice of the rig must be made for the specific requirements of a handpump-based water supply project. Unless large well diameters and/or greater well depth are called for, simpler drilling equipment can be used which is operated and maintained by nationals and can work even under adverse conditions, such as during a severe rainy season. For drilling into unconsolidated and semi-consolidated formations, a cable-tool rig may be most appropriate.

The choice of the casing, screens and ancillary equipment is another critical factor in borehole construction. Frequently boreholes are either uncased or equipped with a steel pipe slotted with a welding torch, a hacksaw, or a circular saw blade. These slots are often too wide and too few, resulting in an inadequate open area in the slotted steel pipe. Other common problems with slotted steel pipe are its susceptibility to corrosion, its high cost in foreign exchange, long delivery time, and heavy weight. Commercially-available steel or PVC screens are an alternative solution, but suffer from some of the same drawbacks as slotted steel pipe.

A screen which has been used with increasing success is an in-country manufactured slotted PVC pipe. The slots are cut at right angles to the pipe axis with a hand operated device that has a battery of circular saw blades. The width of the blades as well as the slot length are chosen specifically for the requirements of particular boreholes. In Malawi some 200 PVC-lined boreholes were installed between 1980 and 1982 for both motor pumps and handpumps and have given trouble-free performance.

The ancillary equipment required with casing includes centralizers and a bottom cap. The latter prevents formation materials or gravel pack from entering inside the screen. Centralizers ensure that the screen is in the center of the borehole and that the gravel pack around the screen is uniform.

Other crucial elements of the borehole are its design and the principles of its construction. The hydrologist at the drilling site must determine the depth at which drilling is to be stopped. Drilling only as deep as necessary is one of the important features of cost-effective borehole design. While appropriate drilling depths are relatively easy to determine in alluvial strata, the decision is more difficult to make in basement rocks, and has to be guided by the level of the water table encountered, the hardness of the rock, and the results from the bailer test.

A gravel pack of the right grain size and properly applied around the well screen serves several purposes: it prevents fine material from entering the borehole where it could damage the pump or settle on the bottom, ultimately clogging the well; it allows the slots of the borehole screen to be larger; it reduces groundwater flow velocities immediately around the screen, reducing the head loss; and it prevents the formation from collapsing around the screen and casing by filling the space between the borehole wall and the lining pipe. The choice of grain size of the gravel pack must be made with a thorough knowledge of the specific hydrogeological conditions at the well. An important principle of borehole design is that the gravel pack size depends on the grain size of the aquifer, and the slots of the screen are designed according to the grain size of the pack, rather than the other way around.

After the gravel pack is in place, the borehole is properly developed to stabilize the gravel pack and the formation immediately adjacent to the borehole. Development removes suspended particles in the water, often increases the permeability near the borehole, and brings fine materials into the borehole that may later enter the well through normal pumping. The principle of development is to create much higher water entry velocities than occur during normal pumping. There are numerous techniques. Among them intermittent "overpumping" at fixed intervals until clear water is obtained has proven successful with PVC casings.

The final step in completing a well is the pumping test to determine whether the borehole has an adequate yield. The test is commonly carried out by gradually increasing the pumping rate while measuring the drawdown. If a well can sustain a yield of 1.0 liters/second it should be tested at that rate, otherwise at 0.75 liters/second, 0.5 liters/second, or at a minimum 0.25 liters/second. Boreholes that give less than 0.25 liters/second should be abandoned unless there is no alternative water source, as the handpump will lower the water level in the well down to the cylinder assembly during heavy use. It should be possible to avoid such a failure if proper care is taken during drilling to determine at what depth to stop drilling and to abandon a dry well before completion.

Table 1-1 Summary of Field Trials

Country	Collaborating Agencies	Activities in Addition to Handpump Testing
Bangladesh	Department of Public Health Engineering (DPHE) International Center for Diarrheal Disease Research (ICDDR) Mirapur Agricultural Workshop and Training School (MAWTS) Canadian International Development Agency (CIDA) UNICEF World Bank (credit)	Study of the effect of improved water supply, sanitation, and health education on the incidence of diarrheal disease; low lift plastic pump R&D and manufacturing.
Bolivia (in preparation)	Corporación Regional de Desarrollo de Potosí (CORDEPO) Corporación Regional de Desarrollo de Oruro (CORDEQR) EEC UNDP (Country Project)	Demonstration and testing of handpumps for community water supply and small scale irrigation.
Burkina	Direction de l'hydraulique et de l'équipement rural (HER) Ministry of Foreign Affairs, The Netherlands United States Agency for International Development (AID) Fonds Européen de développement (FED) UNICEF	Water quality testing and analysis.
China	Chinese Academy of Agricultural Mechanization Sciences (CAAMS) Ministry of Machine Building Industry Ministry of Health Ministry of Foreign Economic Relations & Trade Provincial Bureaus German Agency for Technical Cooperation (GTZ) German Ministry for Economic Cooperation (BMZ)	Establishment of two handpump testing laboratories; technical assistance in the manufacture of prototypes; training in hand-pump installation and maintenance; international workshops on low-cost rural water supply based on groundwater extraction with handpumps.
Ghana		
Field Trial Area I: Kumasi	Ghana Water and Sewerage Corporation (GWSC) Kreditanstalt für Wiederaufbau (KfW) German Ministry for Economic Cooperation (BMZ)	Water quality testing and analysis.
Field Trial Area II: Bolgatanga	Ghana Water and Sewerage Corporation (GWSC) Canadian International Development Agency (CIDA)	
India		
Field Trial Area I:	Central Public Health Environmental Engineering Organization (CPHEEO) Tamil Nadu Water Supply and Drainage Board (TWAD) Crown Agents Richardson and Cruddas (1972) Ltd. Wavin India Ltd. UNICEF	Field R&D of VLOM below-ground structure for India Mark II; active involvement of Indian manufacturers in R&D.
Field Trial Area II: Orissa	Central Public Health Environmental Engineering Organization (CPHEEO) Public Health Engineering Department (PHED) Danish International Development Agency (DANIDA) Richardson and Cruddas (1972) Ltd. Waving India Ltd.	
Ivory Coast	Direction de l'eau (DE) Société de distribution d'eau de la Côte d'Ivoire (SODECI) Communauté économique de l'Afrique de l'ouest (CEAO) Abi Industrie Canadian International Development Agency (CIDA) World Bank (Credit)	Training of repairers; demonstration of village-level maintenance systems; water quality testing and analysis.

Table 1-1 Summary of Field Trials (continued)

Country	Collaborating Agencies	Activities in Addition to Handpump Testing
Kenya	Ministry of Water Development (MoWD) Ministry of Health (MoH) Ministry of Social Services Kenya Water for Health Organization (KWAHO) Swedish International Development Authority (SIDA) Department of Development Assistance, Finland (FINNIDA) Danish International Development Agency (DANIDA) OPE (UNDP)	Implementation of a rural water supply project; demonstration of appropriate borehole design and construction; technical assistance to local manufacturers; village mobilization, training of caretakers, and an impact study in cooperation with the Women in the Decade Project (UNDP Project INT/83/003).
Malawi	Department of Lands, Valuation and Water (DLVW) Danish International Development Agency (DANIDA) ODA UNICEF UNDP	Technical assistance to handpump manufacturing, evaluation of effects of appropriate borehole design and construction, assistance with training of caretakers and maintenance assistants.
Mali	Direction nationale de l'hydraulique et de l'énergie (DNHE) Swiss Association for Technical Assistance (HELVETAS) Swiss Development Corporation (SDC)	Technical assistance to local manufacturing.
Niger	Ministry of Hydraulics Association Francaise des Volontaires du Progrès (AFVP) German Agency for Technical Cooperation (GTZ) German Ministry for Economic Cooperation (BMZ)	
Papua New Guinea	Appropriate Technology Development Institute (ATDI) Geological Survey Provincial Governments of Lae and Central Province	Technical assistance for the local manufacture of handpumps; demonstration of hand augering for well construction.
Philippines	Ministry of Public Works and Highways (MPWH) Rural Waterworks Development Corporation (RWDC) World Bank (Credit)	Testing of Robo well-screen.
Sri Lanka	National Water Supply and Drainage Board (NWSDB) German Agency for Technical Cooperation (GTZ) German Ministry for Economic Cooperation (BMZ) Canadian International Development Agency (CIDA)	Design improvements to the local Sihilase pump through laboratory testing; technical assistance to local production of pumps.
	Field Trial Area II Kalutara	
Sudan	National Administration for Water (NAW) UNICEF	Assisting the Training of village caretakers.
Tanzania	Ministry of Water and Energy (MAJI) Pinnwater Department of Development Assistance, Finland (FINNIDA)	Assistance with strategy formulations of rural water supply scheme, manufacture and demonstration of direct action pumps, caretaker training, establishment of maintenance system.
Thailand	Rural Water Supply Division (RWS, Ministry of Health)	Assistance with selection and training of caretakers; technical assistance to manufacturers of local pumps; testing of Robo well-screen.

Country of Manufacture	Pump														
China	SLB-80	41									1				
China	SYB-80	22									1				
China	SYB-100	25									*				
China	SY-81	17									1				
China	SW-2 (previously JI-1)	17									1				
China	Six types of irrigation pumps	18									1				
Ethiopia	Ethiopia Type EP 50														
Finland	Nira														
France	Vergnet									25					
France	Nepta														
Germany, Fed. Rep.	Kardla									12					
Germany, Fed. Rep.	Turni									12					
Germany, Fed. Rep.	Pb Mark II										19				
Honduras	Funyuaq (AID)										1				
Laboratory, U.K.											1				
Bangladesh															
Bolivia**															
Burkina															
China		41	22	25	17	17	18			12	12				
Ghana															
India															
Ivory Coast															
Kenya															
Malawi															
Mali															
Niger															
Papua New Guinea															
Philippines															
Sri Lanka															
Sudan															
Tanzania															
Thailand															
Totals		41	22	25	17	17	18	1	86	90	1	13	13	19	1

Country of Manufacture	Pump												
Laboratory, U.K.													28
Bangladesh													224
Bolivia**													95
Burkina													155
China													369
Ghana													450
India													140
Ivory Coast													86
Kenya													150
Malawi													201
Mali													25
Niger													80
Papua New Guinea													67
Philippines													216
Sri Lanka													130
Sudan													135
Tanzania													125
Thailand													192
Totals													2,868
Sweden	Petro	21											
Tanzania	Direct Action Prototype												
Thailand	Dempster Derivative		35	20	30	20	5	20		1	34		
Thailand	Lucky Derivative			20									
Thailand	Korat 608 A-1 (conventional)			31									
Thailand	Korat 608 C (modified)			20									
Thailand	PVC Deep			5									
Thailand	PVC Shallow			20									
United Kingdom	Consallen			26									
United Kingdom	Mono			33									
USA	Moyno			106									
Zimbabwe	Blair			122									
TOTALS													

* Handpumps tested in ODA Project.

** Additional pump types and quantities may be tested in Bolivia.

Figure 1-3
Handpump Nomenclature

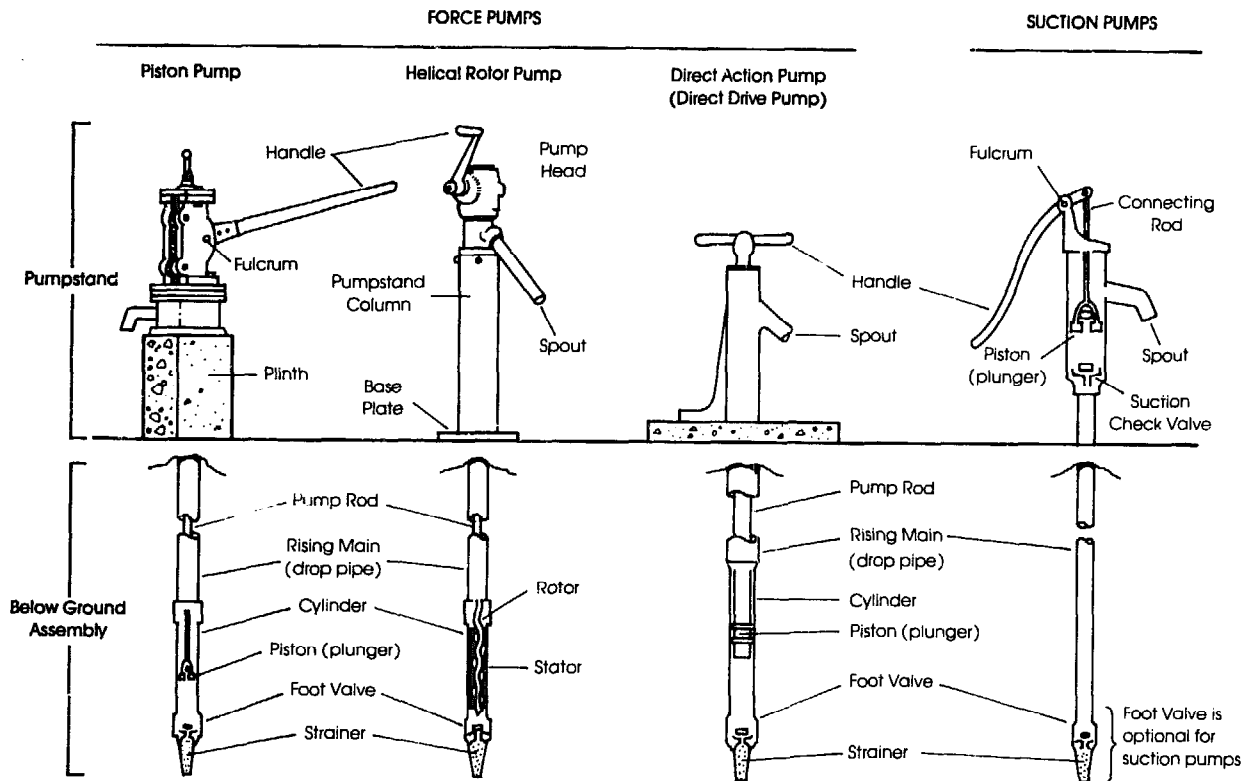

A suction pump is one where the piston (plunger) is located above ground, in the body of the pump. For practical purposes, the maximum operating depth to water table of this type of pump is about seven meters.

A force pump is one where the piston (plunger) or rotor is below water level, at the bottom of the rising main. Such pumps are self priming. The maximum operating depth is limited only by the durability of the pump and the strength of its operator.

CHAPTER 2

EASTERN AFRICA

A. INTRODUCTION

In the Eastern Africa Region few countries have been able to provide more than thirty percent of their rural population with potable water supplies and in many countries coverage is closer to ten percent. An improved water supply commonly is high on the list of priorities of development needs in many rural communities and water supply is an important issue in Eastern Africa. Due to constraints on the availability of both water resources and finance and to the need for technically simple and rapidly implemented water supply schemes, many countries in Eastern Africa are developing their groundwater resources by constructing dug and drilled wells equipped with handpumps. Major handpump programs have long been established in Uganda, Malawi and Zimbabwe. More recently such programs have begun in Ethiopia, Sudan, Tanzania and Zambia and are now getting underway in Kenya, Somalia and Lesotho. Many thousands of handpump wells have been constructed in the last ten years and hundreds of thousands more are planned. The role of the Project in increasing the dependability and reducing the cost of rural water supply projects utilizing handpumps is therefore very important in this Region.

The Project has field trials in four countries in the Region, as follows:

- o Kenya: The South Coast Handpumps Project (Msambweni Division, Kwale District, Coast Province) implemented by the Ministry of Water Development (Government of Kenya) with the assistance of staff from other line ministries, and direct guidance and assistance from the Project, with funds provided by SIDA channelled through UNDP/OPE (UNDP Project KEN/82/004).
- o Malawi: The Upper Livulezi Integrated Project for Rural Groundwater Supplies (Ntcheu District, Central Region), implemented by the Department of Lands, Valuation and Water (Malawi Government) with funds from DANIDA and UNICEF and technical assistance from ODA.
- o Sudan: The South Kordofan Rural Water Supply Project (based in Kadugli, South Kordofan Province), implemented by the National Administration for Water (Government of Sudan) with technical assistance and funding from UNICEF.
- o Tanzania: The Mtwara-Lindi Rural Water Supply Project (Mtwara and Lindi Regions), implemented by Finnwater (a Finnish Consulting Engineering Company) and funded by FINNIDA.

The Project also maintains contact with and occasionally advises on handpump-related activities in other countries in the Region.

The Project in Eastern Africa commenced in August 1981 when the first Regional Project Officer (RPO) took up his post based in Nairobi, Kenya. The present RPO assumed his post in February 1983. The Country Monitoring Engineer (CME) arrived in Kenya in June 1982, in Malawi in August 1982, in Tanzania in March 1983, and in Sudan in January 1984. An additional post is being created in Kenya for an Assistant Engineer who will be specifically responsible for the establishment of handpump manufacture in Kenya and who will also provide general support to the Regional Project Officer.

Quarterly visits typically are made by the RPO to the field trial areas in Malawi, Tanzania and Sudan. Because of the RPO's role in overall management of the Kenya Water Supply project, monthly visits usually are made to that area. The CMEs provide monthly reports based on monthly pump inspections. These include completed standard monitoring forms, breakdown reports and notes about observations and problems which were encountered. Major reports reviewing the field trial data are prepared jointly by the RPO and CME of the country concerned.

In the Eastern Africa Region the main activities of the Project team are the field testing of existing handpump models and the design and development of handpumps that can be manufactured locally and can be maintained at the village level. Other very important issues are also being addressed. These include sociocultural, institutional and economic aspects of simple rural water supply systems, technical aspects of water well design and construction, and the key issue of the organization of and payment for handpump maintenance. The RPO also works closely with the Eastern Africa Project Preparation Unit for Water Supply and Sanitation Investment Projects (UNDP/World Bank Project RAF/82/004) in joint activities in several countries. This collaboration is of mutual benefit to both projects. In the ensuing sections, more detailed descriptions are given of the country field trials in the Region.

B. SUDAN

1. Introduction

Sudan has a land area of over 1.5 million square kilometers and an estimated population of about 22 million people, of whom over 15 million live in rural areas. The country is characterized by harsh climatic conditions, and weak infrastructure which is aggravated by vast distances and poor roads. Rural water supplies are the responsibility of the National Administration for Water (NAW), which replaced the Rural Water Corporation in 1980. Until recently, there have been three main types of rural water supply systems:

- o Water yards consist of motor-pumped boreholes, storage tanks and standpipes within a fenced "yard". There are now over 3,000 water yards serving an average of 1,250 people each. Shortages of fuel and spare parts are persistent problems.
- o Hafirs are constructed in clay-lined valley floors and are filled by stream diversion in the wet season. There are over 800 hafirs serving

about 3,000 people each. Problems include large percolation and evaporation losses, high turbidity and almost unavoidable pollution.

- o Open dug wells from which water is raised with a rope and bucket. There are over 3,000 recorded wells. Problems of contamination have led NAW to initiate the protection of these wells by the installation of handpumps.

In recent years, several rural water supply projects have provided drilled wells equipped with handpumps. NAW has endorsed this and declared its aim to establish the manufacture of handpumps in Sudan. UNICEF is assisting NAW in two of the largest water projects, one in South Kordofan Province and one in Bar-el Ghazal Province. Both projects primarily provide drilled wells equipped with India Mark II handpumps. There are plans to install about 4,000 pumps in the two regions.

2. Field Trial Background

The Government of Sudan endorsed the Project in early 1982 and a proposal to integrate field trials with the UNICEF-assisted, NAW rural water supply project was drawn up in August 1982. The UNICEF/NAW project in South Kordofan was established by UNICEF in 1977, drilling started in 1978 and the project was handed over to NAW in 1982. UNICEF financial and technical support has continued.

The project's water supply activities include the rehabilitation of hafirs and the drilling of new wells, of which about 260 have been successfully completed. The wells primarily have been constructed by down-the-hole hammer drilling (the project now has 2 Atlas Copco Aquadrills) and, to a lesser extent, by cable-tool drilling. Depths of successful wells range from about 25 m to 85 m, with most between 35 m and 55 m deep. Static water levels range from near ground level to over 55 m, with the average being about 20 m. Almost all wells are fitted with India Mark II handpumps.

The relatively large size of some settlements, and the considerable distances and poor roads between settlements combine to make regular maintenance difficult and expensive. In addition, some handpumps provide for over a thousand people in villages which are inaccessible to mobile maintenance teams for several months during the wet season. For this reason, an intensive village handpump caretaker training program is now underway and it is hoped that much of the handpump maintenance will be done by those caretakers.

3. Field Trial Status

Due to the difficulties of handpump maintenance in South Kordofan, UNICEF was reluctant to introduce pumps other than the India Mark II for testing. It was initially agreed that various prototype down-hole components would be tested and a few Blair pumps would be introduced on hafir outlet wells (to reduce contamination from the use of buckets). Monitoring of these units would be undertaken by UNICEF and NAW staff. However, it was jointly decided that the Project would serve as an excellent testing ground for the standard

India Mark II due to the large number of users, the relatively deep water levels, and the harsh climate. For this expanded monitoring program a CME was recruited in January 1984.

Five Blair pumps were installed (2 on a dug well and 3 on a hafir outlet well) in March 1983. Thirty-four Deplechin Duba Tropic II handpumps, donated by the EEC, were received in Kadugli in mid-1983 and one was installed. Limited monitoring was carried out during the remainder of 1983 and early 1984. With the arrival of the new CME a firm monitoring plan has been proposed and new pumps are being installed. Photos of Blair and India Mark II handpumps are shown in Figures 2-1 and 2-2.

4. Field Trial Observations

As detailed monitoring has only recently commenced, no firm conclusions can yet be drawn. However, observations made on three missions to the project area indicate that the field trials will be a valuable test of handpumps under arduous conditions in Africa.

Long queues throughout the day and pump usage well into the night are common at many sites and are evidence of the large number of users per pump (over 1,000 in some cases). If a minimal service level (i.e. large number of people per pump) is to be adopted, then pumps need to be extremely robust (which can be said of the India Mark II) and either a mobile maintenance system must be extremely effective (which is unlikely to be achieved in South Kordofan due to the large distances and poor communications) or the villagers must be willing and able to repair their own handpumps. The potential success of the village maintenance training program is evidenced by the enthusiasm of the trainee caretakers. However, ability has yet to be proven and the India Mark II is a relatively difficult pump for people with little experience in the use of tools to maintain. If service levels of 400 to 500 people per handpump are to be employed, these are double the figures used in most countries in Eastern Africa and a greater incidence of breakdowns must therefore be expected.

The India Mark II pumps are popular, are being worked very hard and, in general, are performing well. However, a considerable percentage of those pumps visited in the field had problems, some of which were serious. Many cases were seen of wearing or even completely collapsed handle bearings, with resulting consequences including severely worn pump rods, pump rod guide bushings, handle levers, and handle quadrants as well as "peeled back" pumphead cases (see Figure 2-3). All of these problems are due to lateral handle movement resulting from worn bearings. It is likely that the cause of this bearing wear is the regular removal of the axle pin and its replacement (by hammering) through the bearings every time the pump is dismantled. This procedure is prescribed in the India Mark II installation and maintenance manual. However, it is not necessary to remove the axle pin -- except when the handle, bearings or pin itself need replacement -- and doing so will greatly reduce bearing life and accelerate pumphead destruction. Steps are being taken to have the manuals modified to reflect this very important point.



FIGURE 2-1 BLAIR PUMPS IN THE SUDAN

This direct action handpump was developed and manufactured in Zimbabwe. It is operated by moving the entire "walking stick" shaped discharge pipe up and down. To the left a second Blair pump is shown which was installed on the same wide diameter well; it is in its descended position where the discharge pipe rests when not in use.



FIGURE 2-2 INDIA MARK II HANDPUMP IN THE SUDAN

Following the installation of over 400,000 India Mark II pumps in India, UNICEF has begun to incorporate this sturdy pump in its projects in Africa.

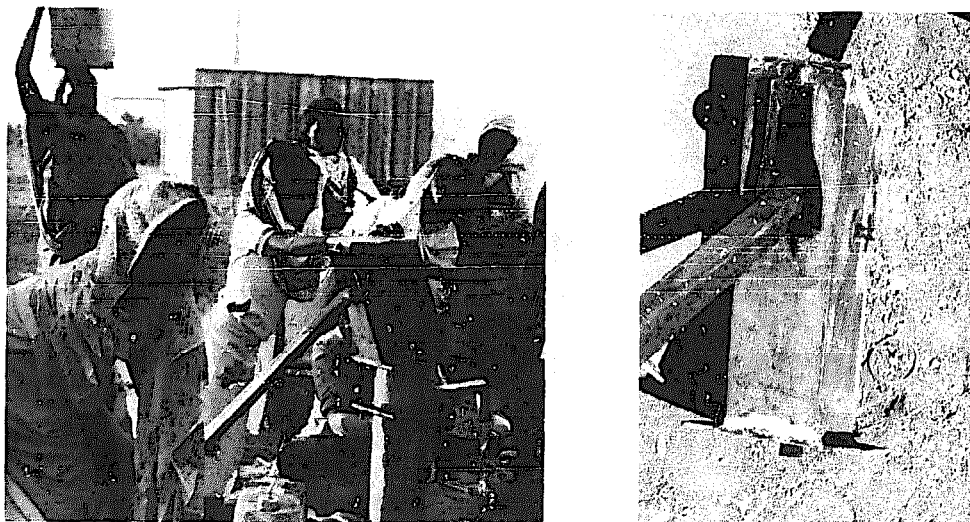

FIGURE 2-3 DAMAGED INDIA MARK II PUMPHEADS IN THE SUDAN

The damaged pump on the left is still working, and the pumphead on the right is awaiting reconditioning at a workshop. The pumps shown here have "peeled back" pumphead cases due to lateral handle movement resulting from worn bearings. It is likely that the cause of this bearing wear is the regular removal of the axle pin and its replacement (by hammering) through the bearings every time the pump is dismantled. This procedure is based on instructions in the India Mark II O & M manuals, although in fact it is not necessary to remove the axle pin except when the handle, bearings or the pin itself need replacement. The manuals are being modified to take account of this.

India Mark II handpumps were originally installed in the UNICEF assisted projects in the Sudan with Indian made brass type cylinders. Due to problems with cylinder distortion, 75-mm Dempster cylinders were purchased from the USA and installation of these started in April 1982. However, serious problems have been encountered with the Dempster cylinders due to plunger (piston) breakage, caused by all the valve cage ribs snapping. Between December 1982 and May 1984 there have been 131 such breakages occurring with 71 pumps (in December 1982 there were about 120 pumps installed and in May 1984 about 290 pumps installed). This has been the single biggest cause of handpump breakdown in the project and it is still uncertain why it is occurring. There is, however, no evidence of incorrect installation and the problem is being carefully studied. It is clear that these breakages have a feedback effect in that the repairs required have not always been well carried out, resulting in further damage to the pump (for example to the bearings).

Observation of maintenance crews in the field revealed that they were willing and hardworking but their poor use of tools (for example, using a pipe-wrench when a small spanner was needed) and lack of cleanliness (for example, replacing cup leathers without cleaning sand from a cylinder; even replacing a plunger without removing broken brass valve cage ribs) accelerate pump breakdown. These observations emphasize that poor installation and maintenance practice (by trained maintenance crews) is commonplace in many countries due to a lack of familiarity with tools and to a lack of appreciation of resulting accelerated pump failure rates. Two main points emerge, first pumps must be designed to minimize the need for tools and the problems that can be caused by the incorrect use of tools, and second few pumps can be considered suitable for full and effective maintenance by village caretakers, who will often have very little if any experience with the use of tools.

The Blair pumps (3 on a hafir outlet with a water level of 3-4 m and 2 on a dug well with a water level of 6-7 m) were installed in March 1983 and were working satisfactorily when visited by the RPO in April 1983. However, their acceptability was questionable due to relatively low yield and the problem of filling narrow-necked containers (plastic jerricans are the most commonly used containers in South Kordofan) with the Blair's moving rising-main. When next visited after the rains in October, one of the pumps at each site was not working due to broken head blocks and the users of the dug well were drawing water with buckets through a manhole.

5. Future Activities

The major activity in 1984 is the consolidation of the handpump monitoring program by the new CME. It has been agreed with NAW and UNICEF that the following pumps will be monitored, and installation is proceeding.

- 25 India Mark II pumps with standard Indian cylinders.
- 50 India Mark II pumps with Dempster cylinders
- 30 Duba Tropic II pumps
- 10 Vergnet pumps
- 20 Direct action pumps on hafir outlet wells
(including the 5 Blairs).

To assess the effects of varying levels of maintenance skills, care will be taken to ensure that some of the India Mark IIs will be maintained by the CME, others by the NAW mobile team and others by village caretakers. The CME will assist with monitoring the effectiveness of the village handpump caretaker training program, establishing a handpump reconditioning facility in the Kadugli workshop and improving maintenance practices. As prototype extractable down-hole components become available from current research and development in India and the United Kingdom, these will be made available for installation and testing in South Kordofan.

Additional support to the program may include detailed advice on well siting techniques, as the current failure rate in basement complex rocks is high, with about 50 percent of the holes drilled being dry. The questions of the use of remote sensing and geophysical techniques have been discussed and further action may be taken in 1984. Another issue raised by UNICEF is the question of borehole design, which is particularly relevant in Wau where much of the drilling is in sediments and rapid cup leather wear is a consequence of sand-pumping. A workshop on borehole design, to include details of well screen and gravel pack selection and installation and well development is being considered. There has been much discussion of the question of handpump manufacture in the Sudan, as the scale of planned handpump programs is considerable and local production would improve the availability of new units, replacement units, and spare parts. This issue is being given detailed attention in 1984.

6. Conclusions

The Sudan field trials provide a test of handpumps which are intensively used at relatively deep settings in harsh climatic conditions and which must be maintained by village caretakers. The problems of organizing maintenance underscore the need for pumps that can be maintained with little help from outside the village.

C. MALAWI

1. Introduction

Malawi is a small, landlocked country with a population of nearly 7 million people, of whom about 6 million live in rural areas. The population density is generally high and water resources, though not abundant, are adequately distributed. Malawi has a remarkable record of rural water supply development, characterized by the successful self-help gravity-fed piped water schemes that supply about 1 million people. By 1982, 5,000 boreholes serving about 1.25 million people and 2,000 dug wells serving about 250,000 people had been constructed. In 1981 a new program of integrated projects for rural groundwater supplies commenced. The projects provide water from dug and drilled wells equipped with handpumps and are planned and implemented by the staff of the Department of Lands Valuation and Water (DLVW), in close cooperation with the user communities. These projects can be described as being models and apply the techniques for community involvement that have been very successfully developed in the rural piped water program. The first

integrated project, the Upper Livulezi Project, which was implemented and largely completed in 1982, is the focus of Project activities in Malawi.

2. Field Trial Background

The Project was endorsed by the Government of Malawi in early 1981 and the cooperative program was agreed upon in April 1981. A pilot phase of the Upper Livulezi Integrated Project for Rural Groundwater Supplies was undertaken from March to July 1981, during which 34 wells (24 drilled and 10 dug) were completed and handpumps installed. The main project commenced in December 1981 and construction was completed in March 1983. During this period another 110 drilled wells and 50 dug wells were completed. Also, seven old drilled wells were rehabilitated and new pumps were installed. All the drilled wells were constructed with cable-tool rigs; their depths range from 10 to 46 m, with most being between 20 and 30 m. Estimated pumping water levels range from about 5 m to about 35 m, with most being between 15 and 25 m.

The project was implemented by DLVW with a considerable degree of community involvement and was co-funded by UNICEF and DANIDA, with additional assistance from ODA and UNDP. The integrated project concept is to provide water supplies by rehabilitating existing dug and drilled wells, hand digging new wells where water-levels are shallow, and drilling new wells where water levels are deep--all in an intensive program which provides complete coverage to one area at a time. Costs are kept low by keeping construction teams close together and using locally manufactured materials including handpumps and well screens. Furthermore, careful supervision of construction teams ensures that wells are no deeper than necessary and that little time is wasted waiting for instructions or materials. Well construction standards are good, with correctly designed well screens and gravel packs and careful installation and development. Most important, the integrated project seeks to involve the target population at all levels, (from the traditional leadership to the villagers themselves) and in all phases (planning, execution and maintenance).

3. Field Trial Status

Handpump installation in the Upper Livulezi Project started in February 1982. A Country Monitoring Engineer arrived in Malawi in September 1982 and immediately took up his post based in the Upper Livulezi Project headquarters in Kandeu. The following handpumps, serving about 45,000 people, are being monitored:

(a) High Lift:	94 Maldev pumps (of 2 types) 3 Afridev pumps 23 India Mark II pumps 14 Consallen pumps
(b) Low Lift:	57 Mark V pumps 10 Madzi/Blair pumps
Total:	201 pumps

4. Field Trial Observations

It is important to note the limitations of the Upper Livulezi Project as a location for a handpump testing program. First, the project is unusual in that the moderate service level (250 people to a borehole and 125 people to a dug well) means that most villages have several pumps and none of the pumps are subject to the extremely heavy use common in some countries. Second, the high level of community involvement both in construction and maintenance ensures a high level of commitment and care, so that vandalism and misuse (common problems in many handpump programs) are rare. Third, caretaker training has been effective: as a result, most of the Maldev pumps now receive regular monthly preventive maintenance by volunteer village caretakers (all of whom are women). Fourth, water levels are not deep, with only about 20 percent of the 134 high-lift pumps lifting from 20 meters or more and only one of them from over 30 meters. Finally, groundwater quality, almost without exception, is good throughout the project area, so that corrosion is not a problem. The Upper Livulezi Project is clearly a good project and one that should serve as a model for others. However, conditions are such that handpumps are not greatly stressed. Consequently, problems will not be accentuated and may not become quickly apparent, and thus it is not a particularly good test site for handpumps

Maldev Pump

The Maldev pump was designed and developed in Malawi and the Livulezi Project is its first real test. Development of the pumphead commenced during 1981, when a number of different prototypes were designed and built. In essence, the pumphead was designed from inception to be: easy to maintain, easy to manufacture in Malawi, sturdy, reliable at the pumping depths commonly encountered in the country (generally 15 to 30 m and rarely 30 to 60 m), and relatively low in cost. The pumphead is also designed to be part of a modular system, that is, it will fit on an India Mark II pedestal, it will hang steel or PVC rising main depending on the adapter used, and it can be used with a range of down-hole components. It can allow the removal of extractable valves and plungers through a simple access cover in the pumphead.

A total of five different down-hole assemblies are being tested with the Maldev pumpheads, two of which are more or less standard brass cylinder galvanized iron rising main, and galvanized iron pump rod combinations. The other four assemblies include various combinations of PVC rising main with PVC cylinders or brass lined PVC cylinders, plastic footvalves, and plungers.

The first group of 25 Maldev pumps was manufactured by a company in Lilongwe in early 1982 without any jigs and fixtures. Twenty-two of these were installed in the Upper Livulezi Project between April and June 1982. Many of these were seen to have faults at installation (e.g. poorly aligned handles and loose fitting bearings). From installation to mid-1984, 15 of these pumps had suffered breakdowns, all related to the fulcrum or hanger bearings. Seven of the pumpheads have been replaced by later production units. In May and June 1982 drawings were prepared for a full-scale production run, incorporating revised geometry and other significant improvements. An order for 150 units was awarded to a company in Blantyre, who took considerable trouble to manufacture jigs for pumphead assembly and to

provide quality control. The first production pumpheads were installed in the Upper Livulezi in September 1982. Of the 77 production Maldev pumpheads installed in the Upper Livulezi Project, 41 were installed in 1982 and by mid-1984 there had been 6 pumphead breakdowns, all occurring in 1984 and all related to the bearings.

Afridev Pump

The bearings used in the Maldev pumphead are sealed ball-races of the same size as those used in the India Mark II. It is estimated that the life of the bearings will be 2 to 4 years, assuming very careful quality control in pumphead manufacture and bearing installation. In view of the expected problems with ball-bearings, a modified pumphead, called the Afridev, was designed, with CATR assistance. The Afridev uses polymer bushes in place of ball races and is both easier to manufacture and to maintain. Three Afridev pumps are being monitored, one of which was installed in 1982 and two in 1983, and polymer bush wear is being regularly measured. Mild steel bearing counter-surfaces (pin surfaces) have corroded and resulted in fairly rapid wear of the unfilled polyacetal bushes which were used initially. Mineral-oil filled polyacetal bushes and corrosion-free counter bearing surfaces are now installed and being monitored. (See also Chapter 6, Section E: Development of a Dry Bearing System for the Maldev Pump.)

Consallen Pump

Consallen pumps, manufactured in the United Kingdom, were incorporated in the field trials because they appeared to be a promising design using corrosion-free materials. They had also performed well in laboratory tests. A total of 14 Consallen pumps have been monitored, of which 11 were installed between June and August 1982. By mid-1984, only one of these pumps had not broken down, and there had been 75 breakdowns with the remaining units. Four pumps have been replaced completely (3 by Maldevs and 1 by an India Mark II), leaving 10 being monitored. Over 70 percent of the breakdowns have been caused by broken ABS plastic rising mains. Six pumpheads required replacement due to fractured fulcrum support brackets. The monitoring results indicate that, in general, those pumps with a maximum pumping water level around 20 m or more break down often (every 2 weeks to 4 months) with the variation roughly depending on how busy they are. Those with water levels of 10-15 m show a full range of breakdowns (from every 2 months to not at all in 17 months), again broadly corresponding to how busy the pumps are. Although the results are not conclusive, it appears that the 1982 Consallen is inappropriate for use where pumping water levels exceed 15 m, and should probably not be used in a normal busy village location where pumping water levels are likely to exceed 10 m, if an interval of about 12 months between breakdowns is required. It is quite likely (but unsubstantiated) that at a pumping water level of 5 m the pump will be very reliable. However, at this head a much less expensive direct action unit may be equally reliable. The Consallen has not performed well in the tests so far and the results have been communicated to the manufacturer, who is energetically attempting to modify and improve the weak points identified so far. Five "1983" Consallen pumpheads incorporating many improvements were sent to Malawi in early 1984. No breakdowns have been recorded with these pumpheads.

India Mark II

The India Mark II handpump was chosen for the test program because of its outstanding reputation for reliability and its good performance in laboratory trials. To date, over 400,000 India Mark II handpumps have been made in India and are being operated in many countries. Twenty-five pumpheads and ten sets of down-hole assemblies were procured from INALSA in New Delhi through UNICEF. British leather buckets were specified as was quality control inspection by the Crown Agents. Twenty-three India Mark II handpumps are operating in the project, of which eight were installed in 1982 and 15 in the second half of 1983. Of these, only the eight installed in 1982 have standard India Mark II down-hole components and the remaining fifteen have the brass cylinder and galvanized iron rising mains and pump rods which normally are fitted to the standard Maldev pumphead.

Not one breakdown or repair has been recorded with an India Mark II pump since installation of the first unit in May of 1982; this record is excellent. There is little more that can be said about the performance of the India Mark II in the Malawi monitoring program: the pump has been without fault and is popular. However, the precision machining and tight quality control required in the manufacture of the unit means that it would be very difficult to manufacture in Malawi. Furthermore, when the pump does break down, it is not easy to maintain in its present form. (Development work being carried out in India may eventually result in a more easily maintained version of the India Mark II; see Chapter 5, Section C.)

Mark V

The Mark V shallow-lift (up to 6 m) handpump is a simple, inexpensive, easily installed and repaired, direct action pump with steel above-ground and PVC below-ground components. The pump rod is made from PVC pipe and is filled with air.

The development of low-lift direct action handpumps started in Malawi with the Mark I in 1975 and over 1,500 Mark V pumps have been manufactured in a DLVW workshop since July 1980. Fifty-seven Mark V pumps have been installed in the Livulezi Project between June 1981 and April 1983. However, monitoring data and maintenance records have only been systematically kept since April 1983.

In the fourteen-month period between April 1983 and June 1984, there were about 125 breakdowns of the Mark V pumps. About 80 percent of these breakdowns were due to a single cause: breakages of the PVC pump rod at the joint with the galvanized iron pipe of the "Tee" bar handle. This is a classic notch point in the PVC pipe, which has long been recognized as the weakest point in the pump. These breakdown rates clearly illustrate how weak a point it is.

It is clear that the breakage of PVC pump rods at the joints with the handle in the Mark V pump is a very serious problem which must be resolved as soon as possible. Overcoming the problem will result in a dramatic reduction in breakdowns. A design for an improved low-lift unit was prepared in late 1982. This design incorporated many of the features of the Mark V but

included modifications to overcome weak points and to reduce reliance on imported components. Several of these units were installed in the Upper Livulezi Project in early 1984 as replacements for particularly unreliable Mark V pumps. Because a direct action handpump would be suitable for use in up to 50 percent of the groundwater points to be constructed in Malawi in the next few years and because such pumps can be easily maintained, it is urgent that the weakest points of the Mark V be modified as soon as possible. Improvements of other components can be tackled with less urgency.

Madzi Pump

The Madzi pump is a low-lift handpump of innovative design which is being manufactured largely of PVC pipe by a company in Lilongwe. The pump was designed by the Blair Research Laboratory of the Ministry of Health in Zimbabwe and is being manufactured by Prodrite in Zimbabwe as the Blair pump. Now a modified version of it is also being made in Malawi, and this version is referred to as the Madzi pump. The major design feature is that the pump rising main also serves as the pump rod, with water discharging from the "walking stick" direct action handle. The pump has a smaller diameter plunger than the Mark V and can be used at somewhat greater depths, with 10 m probably being the effective maximum. The pump is easy to install and easy to maintain.

Ten Madzi pumps were installed between December 1982 and September 1983. Up to June 1984 there have been a total of 22 breakdowns affecting eight pumps. Most of the breakdowns have occurred at or near the connection between the PVC pump rod/rising main and the steel "walking stick" handle. Once again we can see that the major problem is caused by the notch point at the steel pipe to PVC pipe connection.

The Madzi pump has performed relatively well, although it would be a significant improvement if breakdowns were reduced to less than one a year in normal useage (125 users, 20-25 families). There is, however, a question regarding the acceptability of the pump in a project where well-designed concrete aprons are kept clean by proud users who find the Madzi pump "messy" compared to other pumps with which the users are familiar. In a more typical useage where there are not many other pumps for comparison, it is probable that acceptability would be less of a problem.

5. Other Activities

Manufacture of the Maldev high-lift pumphead, the Mark V shallow lift pump and the Madzi/Blair shallow lift pump are all well established in Malawi. The field trials have already identified problems with all these units that can be rectified and several specific design improvements have been proposed. If requested, the Project will support DLVW with a consultant who will assist in establishing efficient volume production of the Maldev pumphead, with the preparation of a full manufacturing manual. The manual will include pumphead drawings, material specifications, jig and fixture designs and drawings, production line layout (to include machinery and manpower requirements) and quality control requirements and inspection

procedures. However, before this can be carried out conclusions must be reached regarding several important design aspects - for example, the type of bearings to be used.

Village caretaker and maintenance extension staff training have both been assisted by the CME. These training programs appear to be having considerable impact. Almost all waterpoints are clean and well cared for (some after three years of use). Village caretakers are quick to demonstrate the use of their universal spanners which they use monthly to tighten nuts and bolts on the Maldev pumphead, and to show their caretaker diaries, properly filled in. Although this program is in its infancy and will not result in a total transfer of pump maintenance to the users, it is undoubtedly a major step in the right direction.

6. Future Plans

The first CME left Malawi at the completion of his contract in mid-July 1984. A replacement is being sought to undertake an assignment from mid-1984 to mid-1986. The main field trials will be completed in mid-1985. Thereafter, the Project will continue to support the manufacturing and quality control of both high-lift and low lift (direct-action) pump units. Support will also be given to the public-sector-backed maintenance system with its village based preventative and basic curative maintenance levels. This support will include assistance with cost control, training and spare parts distribution systems. An additional activity will be further evaluation of the impact of drilled and dug well design on handpump performance. A proposal has been made to DLVW that a National Rural Water Supply Handpump Engineer be appointed, to liaise with our project and eventually to oversee the procurement, installation, and maintenance of handpumps throughout Malawi.

7. Conclusions

Two main points emerge from the monitoring results. First, it is clear that with improved borehole design (well screen design and setting, gravel pack size and emplacement, and development techniques), life of leather cup seals has in most cases exceeded that normally encountered in Malawi. For example, 18 handpumps with new 3 inch cylinders and leather cup seals were installed in the Upper Livulezi Project in May and June 1981. All of these cylinders are still in use (attached to new pumpheads). Two of these cylinders had new leather cup seals fitted in December 1982 (after about 18 months' operation) and 2 had new leather cup seals fitted in November 1983 (after about 30 months of operation). The remaining 14 cylinders still had the original leather cups in mid-1984, about 3 years after installation. This compares to an average 5 month life of leather cup seals in Malawi, calculated from the annual number of seals replaced in about 5,000 boreholes. Thus, the importance of good borehole design in greatly reducing the below-ground maintenance requirements of handpumps cannot be over-emphasized. This applies particularly to the weathered basement aquifers of Malawi and, by inference, to unconsolidated and semi-consolidated formations elsewhere.

The second major observation is the relative success of the down-hole assemblies with PVC rising main and extractable footvalves and plungers. Approximately 25 down-hole assemblies with PVC rising mains and extractable foot valves and plungers are in use in Malawi, with the deepest setting at 27 m. All have 75-mm outer diameter, 67-mm inner diameter PVC rising main in 3-m sections which are solvent-cemented together. Some of these have 75-mm outer diameter, 63-mm inner diameter PVC pipe as cylinders; others have cylinders consisting of a brass tube sleeved into the PVC rising main. All use a compressed rubber cone to grip the PVC rising main at the pumphead. By mid-1984 these assemblies had been operating for up to one and a half years and no problems had been encountered with the PVC rising main, its support at the pumphead, or its solvent cement joints. Removal of the footvalve and plunger from these units is relatively quick and easy, and requires few tools. Results are not conclusive and the use of long strings of large diameter PVC clearly must be treated with considerable caution. Nonetheless, it appears that the down-hole assemblies under test, together with the Maldev pumpheads, are very close to the VLOM concept.

The handpump program in the Livulezi Project has demonstrated the benefits of careful monitoring in identifying problems in handpump design, operation, and maintenance. The need for carefully conducted field trials as an essential complement to laboratory tests also has been well established. The handpump design and development aspects of the program have been very important and have benefited greatly from monitoring feedback. The next stage of the testing program should be the consolidation of knowledge gained. The aim should be to reduce prototype diversity within the program so that decisions can be made on production designs of handpumps for local manufacture, which will be standards for the large integrated groundwater development program that is planned for the coming years.

D. TANZANIA

1. Introduction

Tanzania has a land area of about 0.9 million square kilometers and an estimated population of just over 20 million people of whom over 80 percent live in rural areas. For a number of reasons, the country has not been able to meet the ambitious targets for rural water supply coverage with piped supplies. Low-cost solutions, such as the construction by hand of wells to be equipped with handpumps, now play a major part in the national program. This program is being implemented largely in turn-key projects carried out by consultants and funded for by donor direct disbursement. It is estimated that about 40 percent of the rural population is served either through piped systems or wells equipped with handpumps.

2. Field Trial Background

The Government of Tanzania, through the Water Master Planning Coordination Unit of the Ministry of Water and Energy, first expressed interest in participating in the Project (then referred to as UNDP project GLO/79/010) at the end of 1980. Discussions regarding the integration of

field trials with a then current rural water supply project in Tanzania started in mid-1981. Various sites for the field trial were considered including the Dutch-funded project in Morogoro and the SIDA-funded project in Mwanza. A joint decision was finally made that the field trials should be conducted in the FINNIDA-funded Mtwara-Lindi Rural Water Supply Project. The handpump field trials were subsequently endorsed by the Treasury of the Government of Tanzania in August 1982.

Implementation of the Mtwara-Lindi Rural Water Supply Project started in 1978, following completion of a Water Master Plan in 1976. The project, executed by Finnwater, a Finnish consortium of Consulting Engineers, is providing rural water supplies through the construction of both piped systems and wells equipped with handpumps. Over 1,500 handpump wells had been constructed by the end of 1983, supplying over 360,000 people. The wells primarily are of two kinds. First, there are large diameter, concrete, ring-lined, dug wells which rarely exceed 5 m in diameter and which comprise over 70 percent of the total number of wells. Second, there are small diameter, hand-augered, screened and gravel-packed wells which do not exceed 14 m in depth. Pumping water levels average between 4 and 5 m and rarely exceed 8 m. Almost all handpumps in use are various models of the Nira pump, made in Finland. The other major types of handpumps in common use in Tanzania are the Kangaroo handpump and the SWN range of handpumps, all made in the Netherlands, with the exception of some local assembly.

3. Field Trial Status

The initial Country Monitoring Engineer took up his post in late March 1983 and by November 1983 had installed 102 pumps, as follows:

	<u>Installed</u>	<u>Planned</u>
New Nira (1983)	47	47
Old Nira	33	33
SWN 81	15	20
Kangaroo	4	5
Blair	3	20

Additional pumps planned to be installed, subject to Government approval, will include the India Mark II and the Maldev. These will be installed in deeper wells to be drilled in the western portion of the project area with a new drilling rig. Some additional direct action, low-lift units, possibly the Ethiopia BP50, Bangladesh TARA, or Malawi Mark V, may also be installed.

4. Field Trial Observations

Although the test pumps had only been operating from four to six months, by the end of 1983 many breakdowns were recorded. Seven breakdowns occurred among 80 Nira pumps, 9 breakdowns among 15 SWN 81 pumps (most due to rod breakdage at the rod hanger bearing), 3 breakdowns among 4 Kangaroo pumps (all due to broken spring guides - the units were replaced with modified pumps),



FIGURE 2-4 LOCAL DIRECT ACTION HANDPUMP IN TANZANIA

In an attempt to avoid frequent bearing and lever arm replacement in low-lift pumps installed by Finnwater in Tanzania, the pump head was removed and a T-handle fixed onto the pump rod to produce a direct action pump for trial. Users immediately accepted this modification and considered it to be an improvement. The pump shown here is being operated by a member of the Finnwater staff.

and 8 breakdowns among 11 Blair pumps (most due to fracturing of the PVC head block). Thus, the early expectation that very low pumping heads would result in few breakdowns of the handpumps under test proved to be wrong.

Discussions with the CME and Finnwater staff on the benefits of direct action pumps (see Annex A) resulted in the fabrication of a small number of units in their project workshops (Figure 2-4). There has been a good response from the users and careful monitoring of these units is planned.

5. Other Activities

Discussions have been held with staff of the Mechanical Engineering Department of the University of Dar-es-Salaam regarding the possibility of a cooperative program of design and small-scale laboratory testing of handpumps by the Department. The Department already has had several students undertake study projects on handpumps and the possibility of the Project providing support to the University is being considered. A particular subject of interest would be evaluation of several different direct action pump designs (for example, the Blair, Tara, Ethiopia BP50, and Malawi Mark V) for manufacture in Tanzania. A detailed survey would be needed to determine the local availability of materials, and alternatives (for example, wooden pump rods) could be investigated.

The Dutch-funded, DHV-implemented project, based in Morogoro, was visited by the RPO and CME in May 1983 and Morogoro staff accompanied the CME in a long field trip in Mtwara in October 1983. There is much that the Project can do to provide a link between the many bilateral rural water supply projects in Tanzania. This cooperative role would be of considerable value.

Following a request received at the end of 1983 from FINNIDA, Helsinki, the RPO took part in the evaluation and appraisal of the Mtwara-Lindi Rural Water Supply Project in March and April 1984. This is the largest rural water supply project in Tanzania.

6. Future Plans

The monitoring program started in earnest in August 1983 but was cut short by the death of the Country Monitoring Engineer, Oliver Murphy, in a vehicle accident in November 1983. A replacement CME will be in post in August 1984. In the interim, Finnwater has agreed to maintain a skeleton monitoring program. After the new CME arrives, it is hoped that the tests of direct action handpumps can be expanded, as it is possible that such pumps can be made in Tanzania without too high a foreign exchange component of raw or finished materials. Furthermore, these low-lift units would have widespread applicability in Tanzania and can be designed to be easy to manufacture.

The Ministry of Water and Energy has provisionally agreed to create the post of a National Rural Water Supply Handpumps Engineer within the Ministry. Such a position would enhance the Government's direct involvement in the handpump testing and development program.

7. Conclusions

In the early 1970's the Tanzanian Government declared a goal of providing potable water within a 400 m walking distance of every home by 1991. The achievement of this target is, however, constrained by the selection of suitable technologies and by the costs of both construction and maintenance. Many of the piped rural water supply systems are inoperative due to lack of fuel or spare parts. The current budget constraints further affect the Government's ability to operate and maintain these systems. Accordingly, handpumped groundwater supplies are seen as a possible solution. The identification of easily-maintained handpumps, the establishment of their manufacture in Tanzania, and the development of an appropriate maintenance system are fundamental to a successful national rural water supply program. Thus, the successful completion of the handpump testing project could have a major impact on Tanzania's rural water supply program.

E. KENYA

1. Introduction

Kenya has a land area of almost 570,000 square kilometers and an estimated population of about 18 million people, of whom over 15 million live in rural areas. Rural water supply development is the responsibility primarily of the Ministry of Water Development (MoWD), although as much as one half of the existing rural water supply facilities have been constructed by other agencies (e.g. non-governmental organizations, missions, etc.). It is estimated that about 15 percent of the rural population has been provided with improved water supplies mostly in the form of pumped and piped systems. However, a very high percentage of these systems operate at low operating efficiencies (i.e. percentage of operating schedule actually achieved) or are out of order. In recent years MoWD's policies for the provision of water to rural communities have been changing, with less emphasis being placed on the high capital and recurrent cost piped schemes and more emphasis on simpler, lower-cost, more community-based water supplies. MoWD has not, until recently, considered the use of wells equipped with handpumps as suitable for rural water supplies. The only major handpump programs in Kenya have been those of the Ministry of Health, which has constructed many wells in times of cholera epidemics. However, lack of attention to maintenance problems has resulted in few if any pumps working; consequently, many wells have been abandoned.

Three major handpump projects are currently underway in Kenya. These include a project in Western Province with FINNIDA assistance, which is being entirely implemented by an international consulting firm, and a program in Nyanza Province being implemented by a parastatal organization (the Lake Basin Development Authority) with the major assistance of an international consulting firm. The South Coast Handpumps Project represents a new approach by the Ministry of Water Development, for the Ministry will provide low-cost, point-source, rural water supplies to about 40,000 people in a program planned to have a high level of community involvement in decision-making, construction and maintenance. The project is being implemented by Kenyan staff of MoWD, working with leadership at the province, district, division, location, and

village levels; and with staff of the Ministries of Health and Social Services. The South Coast Handpumps Project is the focus in Kenya for the Project.

2. Field Trial Background

The Government of Kenya confirmed its intention to participate in the Project in May 1981. The South Coast area (Kwale District) was selected for the field trial area and it was agreed that 50 to 100 wells would be drilled and 100 to 150 existing open wells would be covered. All wells were then to be equipped with handpumps. In late 1981 SIDA agreed to provide funds, channelled through UNDP, for the project. The project document was signed by all parties in November 1982. Funds were released by SIDA to UNDP, New York in February 1983 and approval to incur expenditure was obtained from UNDP at the end of April 1983, under UNDP Project KEN/82/004. Mobilization began in June 1983. During the first two months of the project a base camp was constructed and well drilling started in earnest in September 1983.

Activities in Kenya are unique within the Handpumps Project because of the Project's direct involvement in the execution and in the provision of broad-based technical assistance to a full-scale rural water supply project of a kind never before implemented by MoWD. Design principles and methodology are being established as the project proceeds, including service-levels, waterpoint spacing, community involvement, site selection, well construction methods, apron designs, etc. Field trials, while an important component of the project, have taken second place during the early stages of the project.

The project has two Ross Surveyors which are lightweight site-investigation drilling rigs only capable of making shallow holes. By the middle of 1984, over 30 successful wells had been drilled with depths ranging from 18 to 45 m and water levels from 5 to 30 m. The aquifers in the project area are highly permeable, so drawdowns are very small, and the water is generally of excellent quality. Over 80 existing open dug wells have been located in the project area, of which about 50 are suitable for covering. Water levels in the wells range from a few meters to almost 30 m, with most between 10 and 20 m.

3. Field Trial Status

Handpump installation started in October 1983 and by the middle of 1984, 30 pumps had been installed including Petros, Niras, Vergnets, Maldevs, Afridevs, Blairs and India Mark IIs. Due to the importance of strong community support and involvement in the project and suspicions expressed by many villagers when the question of protecting existing open wells with covers and handpumps was discussed, it was decided that the wells would not be covered until people had become familiarized with the use of handpumps on new drilled wells and actually requested that pumps be installed on their traditional sources. For this reason, installation of pumps will be slow for the first year, with a target of fifty drilled wells. Thereafter it is hoped that additional pumps can be installed in the fifty existing dug wells, generally with two pumps per well. The proposed pumps for the monitoring program (and their country of manufacture) are as follows:

10	Blair	Zimbabwe	Low lift
20	Petro	Sweden	High lift
10	SWN 81	The Netherlands	" "
10	Volanta	The Netherlands	" "
10	Vergnet	France	" "
5	Maldev*	Malawi	" "
5	Maldev*	Kenya	" "
10	India Mark II	India	" "
5	India Mark II	Kenya	" "
5	Nira	Finland	" "
30	Afridev* prototype	Kenya	" "
30	Low lift prototypes	Kenya	Low lift

The wide range of pumps to be tested reflects the MoWD's desire to test most of the pumps currently being imported for projects in Kenya. It is hoped that all of these pumps will be installed by the end of 1984.

Several design variations to the Afridev pumphead have been made, many of which simplify manufacture. These include square section pumpheads, wooden bearings, acetal bearings, and concrete pedestals (instead of steel). Completely Kenyan manufactured prototypes have been installed with Kenyan made PVC rising main, cold drawn and galvanized pump rods, cast foot valves and extractable plungers, cup leathers, and pumpheads. (For more information on the Afridev see Section C 4 in this Chapter.)

The India Mark II also is locally manufactured and will be modified to facilitate maintenance. Photos of the Maldev handpump manufactured in Malawi, the modified Afridev pump made in Kenya, a Kenyan made India Mark II, and the Nira pump imported from Finland are provided in Figures 2-5 through 2-8.

4. Field Trial Observations and Related Activities

It is too early to draw conclusions on handpump performance from the field trials. Although installation of handpumps is an almost completely new activity for the professional and technical staff of the MoWD, progress made so far has shown that MoWD staff are well able to implement a handpump program on their own.

The geological formations of the project area comprise Quaternary and Tertiary sediments including corals, sands, silts, and clays. Drilling in these formations with light cable-tool rigs is not easy due to the presence of running sands and the need to use temporary casing. Initially several holes had to be abandoned and, even worse, temporary casing was lost in two holes. Such problems have been overcome by improved techniques and greater care. The fine sands of the aquifer necessitate very careful well design if a drilled well is to be a long term source of sand free water. In the early drilled

* See Section C of this chapter for the distinction between Maldev and Afridev.

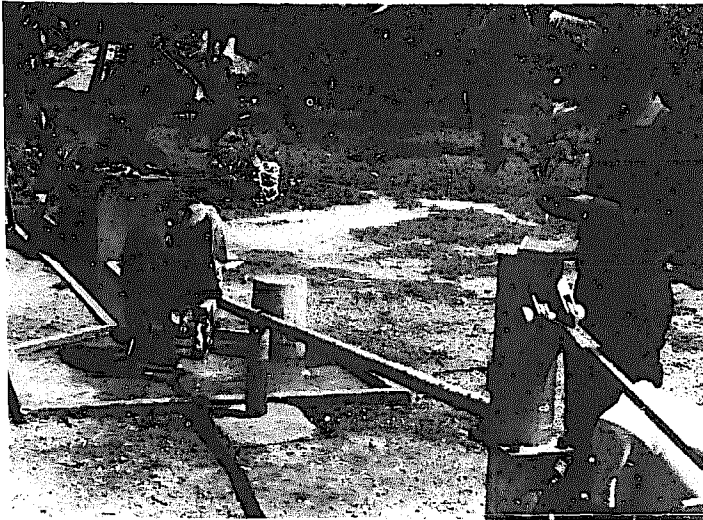

EV HANDPUMP IN KENYA

veloped and manufactured in Malawi. The Maldev is only
t may be connected to any of a variety of below-ground
by other manufacturers. The Project is assisting in
this already popular pumphead, and to develop VLOM
ponents for it which can be locally made.



TYPE AFRIDEV HANDPUMP IN KENYA

ufactured in Kenya, and is a modification of the MALDEV
in Malawi. A major difference is the use of polymer
ball races. A further change is the square cross-
pumphead. This square tube is manufactured as a standard
instead of the round one made in Malawi. This is an
availability of local materials can influence design.

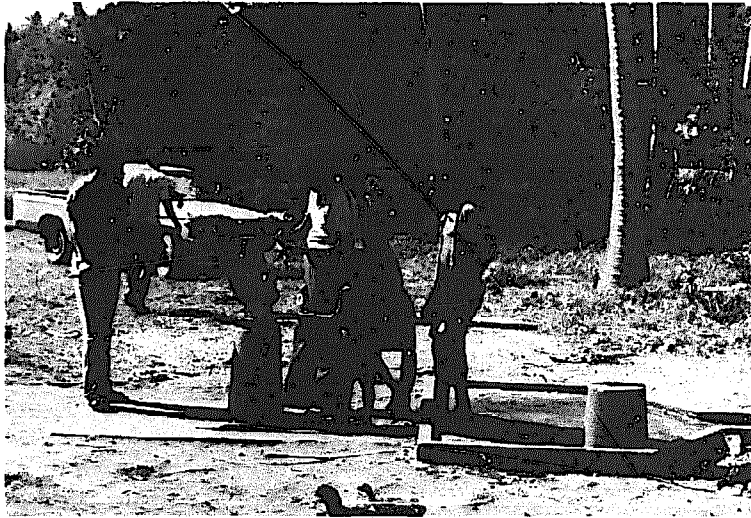

FIGURE 2-7 KENYAN-MADE MODIFIED INDIA MARK II PUMP

This Kenyan-made pump has two notable modifications from the standard India Mark II design. First, the pedestal is made of concrete instead of steel, in order to reduce the cost. Second, the discharge spout has been elongated in order to move water away from the pump. This helps keep the pump operating area dry and to minimize the possibility of sullage water entering the well.



FIGURE 2-8 NIRA HANDPUMP IN KENYA

The pump is made in Finland and has undergone several design modifications in recent years. This recent model is included in the field trials of handpumps in Kenya.

wells much trouble was encountered in obtaining sand-free holes, with several days of developing by air still yielding sandy water. This problem is faced in all existing boreholes in this aquifer. To overcome this problem, several courses of action were taken. First, after assessing the aquifer grain size grading, discussions with a PVC pipe extrusion company in Nairobi led to the production of good quality slotted pipe for use as well screening, with an open area of 8-10 percent and a slot size of 0.75 mm. Secondly, after a long search throughout the project area, coarse sand deposits were located in the project area and careful sieving was initiated to provide a gravel pack of 0.8 to 3 mm. A hand-operated rotating sieve has been manufactured to facilitate gravel pack production. Drilled wells are now carefully completed with casing and well screen of 110 mm outer diameter PVC pipe centralized in a 200-mm hole, surrounded by a carefully installed gravel pack. As a consequence, well development is a quick and easy operation, with sand free discharge obtained after a few hours. It is expected that pumps installed in these carefully-designed wells will have much longer plunger leather seal life than those installed in the first sand-pumping wells.

The project is conducting a handpump testing program here as it is in other countries. However, its primary aim in the South Coast is improvement of the quality and the quantity of water in an area where less than ten percent of the population have access to clean water supplies and where cholera outbreaks are frequent.

The social issues arising from the project are complex. The people of the area are of different ethnic groups and religions (Muslims and Christians). They are wary of external interventions because of previous poor experiences with failed schemes and broken promises of assistance. In recognition of these and other issues, which need to be understood if the people of the area are to be committed to the project and its long-term success, a sociocultural study was carried out by a Kenyan social anthropologist from the African Medical Research Foundation in June and July 1983. This was prior to well construction and during the period of water committee formation and well site location. The report has proved invaluable to the MoWD project team, none of whom have previous experience of community-based, rural water supply construction. The report is contained in Annex D.

As a direct follow-on to the report, a project was prepared with the Kenya Water for Health Organization (KWAHO), an NGO which focuses on simple, self-help water supplies and sanitation. In April 1984, KWAHO, with funding from the UN Women's Voluntary Fund, recruited two Kenyan Sociologists as Community Training and Liaison Officers (CTLOs) to work primarily in the South Coast Handpumps Project. The first role of the CTLOs is in community liaison which will provide a link between the community and project technicians. The CTLOs are assessing community needs, organizing community commitment to water supply improvements and long-term maintenance, and arranging for the project team to assist villages to build waterpoints when requested. Their second role is to establish training methods and materials and to run training programs related to water supply and sanitation, ranging from hygiene education to handpump maintenance.

5. Other Activities

The RPO has been involved in many activities in Kenya. This has included liaison with MoWD and Ministry of Health headquarters and regular participation as an observer in the National Action Committee for the Water Supply and Sanitation Decade.

Advisory support has been given to many other donors in the water supply sector. At the request of FINNIDA, the Regional Project Officer served as a member of the 1983 Appraisal Team for the FINNIDA-financed Western Province Rural Water Supply Project. The current phase of the project aims to provide water supplies to some 220,000 people, mostly from handpump wells. Support has been provided to the Netherlands Government with regard to reviewing their current pilot rural water supply project and assisting in the preparation of the proposed full-scale project in Nyanza Province. Again handpump wells will be a major component of the project. Detailed discussions with SIDA have led to the proposal that SIDA expand the South Coast Handpumps Project to a district or province wide program. The RPO is assisting with the preparation and appraisal of this project during 1984 and will assist with its supervision during implementation. Discussions were also held with officials of USAID, NORAD and CIDA regarding proposals for rural water supply development in Kenya, and liaison was maintained with many of the national and international NGOs operating in the water sector in Kenya.

The establishment of local manufacture of handpumps and well screens for rural water supply development in Kenya has been an important activity. There is considerable capability and interest in the private sector in handpump manufacture. Industries in Kenya are fully capable of manufacturing handpumps, but it must be decided which handpumps should be made and what is the potential home and export market. Several organizations (one college and five companies) across the country have made prototype handpumps for the South Coast Project, most of which will be tested. Units made so far include the India Mark II (made by Western College of Arts and Applied Science, WECO, in Kakamega), modified Maldev pumps, and modified Nira pumps. WECO, with technical assistance support from DANIDA, has been particularly helpful and, at the request of the RPO, DANIDA has provided a small grant for the manufacture of handpumps. By the end of 1984 it is hoped that the testing program in the South Coast Project will be sufficiently advanced to draw important conclusions for handpump manufacture in Kenya. This will require cooperation between the Government and all agencies working in the sector. It is hoped that the Project can play an important role in bringing about that cooperation.

6. Future Activities

The major future activity will be the continued support of the South Coast Handpumps Project and its possible development into a district-wide water supply and sanitation program. The handpump monitoring component will become more significant in the second half of 1984 and during 1985 it is hoped that handpump manufacture will be agreed upon and ready to commence on a substantial scale. The cooperation and coordination of government, donor agencies, NGOs and the private sector will be sought. As with the other countries in the Region, it is hoped that MoWD will appoint a National Rural Water Supply Handpumps Engineer.

The social aspects of rural water supplies will continue to be an important area of activity, including liaison with UNDP Project INT/83/003 (Women and the Water Decade) and continued close cooperation with NGOs in Kenya.

7. Conclusions

It is clear that the project can play an important role in promoting the development of groundwater using wells equipped with handpumps. The strength of the private sector, the aspirations of the rural population, the level of skills and the amount of cash circulating in rural areas all will assist in developing truly indigenous water supply systems with, for example, handpumps and their spares available in the marketplace.

F. CONCLUSIONS

No element of handpump programs can be singled out as the critical link, and the work in the Eastern Africa Region underscores the importance of a system approach to these programs. Program planning and design, well construction and completion, pump design and manufacture, community commitment and capability all play an important part in ensuring that the handpump is a reliable and safe source of water. Important factors which can affect the success of handpump projects include (1) locally manufactured handpumps with acceptable quality control, (2) easily repairable pumps requiring minimal mechanical skill and tools, (3) readily available spare parts, and (4) user understanding of the health benefits afforded by clean water and use of water for personal hygiene.

Of particular importance is the availability of spare parts which can be facilitated by local handpump manufacture. Accordingly, selection of a "best" pump (in terms of reliability and ergonomics) is not as important as the development of handpumps which can be made locally. The field trials must therefore be directed at identifying suitable handpumps for local manufacture. This underscores the development aspect of the trials and the need to maintain a "static" set of pumps on test as a baseline as well as a "dynamic" or evolving and improving set of pumps. Tests of several of the pumps in the Region are of this "dynamic" nature, including the Afridev and direct action pumps.

The importance of good drilled well design in reducing the frequency of handpump breakdowns has clearly been shown, first in the Malawi field trials and now in the Kenya trials. In general, drilled wells are at present inadequately designed in terms of well screens, gravel packs, and development techniques. The evidence points to the fact that, in unconsolidated or semi-consolidated formations, the life of the leather cup seals of the plunger can be increased many times if sand is prevented from entering the well by careful design and completion. The need for effective training in well design is clear. Also, the need for the development of programs for handpump caretaker training and health education is of major importance.

The Project team is part of a network of people in the Region working towards the common goal of providing dependable water supplies. Close cooperation is obviously essential. This is particularly so with the other UNDP regional and interregional projects in the sector which are being executed by the World Bank. These include the Project Preparation Unit (PPU) for Water Supply and Sanitation Projects (RAF/82/004) and the Technology Advisory Group (TAG) for the Development and Implementation of Low-Cost Sanitation Investment Projects. Project cooperation with PPU and TAG has led to a strong integrated team working together to assist governments and donors with rural water supply project planning and implementation. This cooperation clearly needs to be consolidated in the future. In order to facilitate this coordination, to meet the expanding role of the Project in the Region, and to undertake specific tasks such as establishment of handpump manufacture and quality control, additional staff are being recruited.

It is important to ensure that the Project has a lasting effect on the Region through the training of a group of nationals in the field trial countries (and ideally other countries) who will be responsible for the long-term implementation of the major handpump programs which are currently being planned. For this reason, a start has been made by proposing to the Governments of Kenya, Tanzania and Malawi that a post of National Rural Water Supply Handpumps Engineer be created. This Engineer will act as a liaison officer with the Project and as a result will become familiar with the broad range of rural water supply issues that are involved in successful handpump programs.

CHAPTER 3

WESTERN AFRICA

A. INTRODUCTION AND CONCLUSIONS

1. Project Background

Ghana, the Ivory Coast, Niger, and Burkina* were initially selected for the field tests in the Western Africa Region. The handpumps project was first proposed to the governments of these five countries in July 1981. Because joint activities had to be arranged for the field trials, the Project was also presented to several donors who already were involved in rural water supply projects in these countries. By the spring of 1982 agreements had been reached with all the parties on the locations of the field trials and on funding.

Preparations for an extension of the field trials in Ghana and the Ivory Coast (cofinanced by CIDA) and for a field trial in Mali (executed by Helvetas) began in the autumn of 1982.

A list of organizations participating in Project activities is provided in Table 1-1 and the types of pumps** being tested in the Western Africa Region are included Table 1-2.

2. Summary

More than 700 handpumps of 15 different makes are being field tested in seven areas of the Western Africa Region, including two areas in Ghana, two in the Ivory Coast, and one each in Mali, Niger, and Burkina. The field operation is progressing well in all five countries, and some important conclusions can already be drawn. The Project involves standard monitoring of handpumps as well as analysis of the water quality in the Region.

The results of the field operation thus far can be summarized as follows:

- o Each of the pumps being field tested has characteristic weak points that cause more or less frequent breakdowns. However, a given type of pump does not necessarily perform the same way in different situations. In other words, factors such as usage of handpumps (frequency and care), well characteristics, and maintenance system have considerable influence on the performance of handpumps.

* Formerly Upper Volta.

** The terms handpump and pump are used in this chapter interchangeably for both hand- and foot-operated pumps.

- o The percentage of broken pumps (that is, those not pumping water) in the field trials in the Region has ranged from 2 percent at a particular time in one of the field trial areas to 50 percent in another area. The normal failure rate is between 2 and 20 percent and an extreme of 50 percent is reported.
- o Several handpumps have been developed and are manufactured in the Western Africa Region. Some of these pumps were designed on the basis of VLOM (village-level operation and maintenance) principles even before this term was coined by the Project. Included among such pumps are the Vergnet, ASM (Abi-Vergnet), and Volanta.
- o Properly executed preventive maintenance has a notable impact on pump performance.
- o Factors such as well construction and development, pump installation, structure and organization of pump maintenance systems (including distribution of spare parts), and attitude of users greatly affect rural water supplies using handpumps.
- o Close attention should be paid to water quality when groundwater is being considered for use in rural water supply systems. In some areas of Western Africa the corrosiveness and the high iron concentration of groundwater in particular have caused some problems. It is clear that a good well and a good pump are not necessarily sufficient for a water point; the water must also be of acceptable quality to the users.
- o Village participation in the decision making process (for example, when a choice must be made between a borehole with handpump or an open dug well) is being emphasized more and more. Health education of the rural population and training of pump repairers and mechanics have become standard components of rural water supply projects in the Region.

3. Field Operations

In most of the test areas handpumps are being monitored by teams comprised of one Country Monitoring Engineer (usually a United Nations Volunteer), a local technician or mechanic, and a local driver. The monitoring teams are equipped with a vehicle, some tools, and technical equipment (stopwatch, metronome, bucket, force gauge, water-level indicator, spectrophotometer, pH-meter, electric conductivity meter, and thermometer). In addition to conducting the standard monitoring program outlined in the monitoring forms, the monitoring teams measure leakage and handle force, perform preventive maintenance, and test water quality by measuring temperature, turbidity, electric conductivity, pH, and levels of iron, oxygen, and nitrate.

The pumps in the field trials are monitored at intervals of about two months. The Country Monitoring Engineers prepare bimonthly progress reports containing the main field data and results.

4. Results of Field Trials

The Project field testing has clearly demonstrated that the performance of handpumps depends upon several factors. The main points are discussed in the following paragraphs.

Quality Control

The quality of materials and job execution are extremely important to good handpump performance. In many cases, however, insufficient attention is paid to this point in the field. Poor performance is often due to problems related to the material from which pump components are made, fabrication of components, pump installation, and well construction.

Material and Fabrication: The majority of pump failures are caused by material defects or poor workmanship in various pump components including pumping elements, rising mains, rods, bolts, and couplings. For example:

- o Breaking of rods, couplings, etc.,
- o Leakages due to defective couplings and corrosion,
- o Hard pumping and rod breakage due to inaccurate tolerances (rotor/stator).

Pump Installation: Many problems are related to lack of adequate care in the installation of handpumps, for example:

- o Disconnected pump rods, rising mains, etc. due to improper tightening of couplings, nuts and bolts,
- o Loosening of pump stands because of bad quality well pads (cracks in the concrete),
- o Hard pumping and/or extreme wear due to maladjustments or bad alignments of parts of the pumps,
- o Entering of dirt and polluted water into the well if pump stands are not properly sealed off, etc.

Well Construction: The following problems have been encountered in the field and have an adverse impact on handpump performance or durability:

- o Sand, silt and clay in groundwater (up to one volume percent of sandy-silty material has been measured in groundwater from boreholes equipped with handpumps).

- o Pump cylinders that are not immersed, or only partly immersed in water (probable causes for this are clogging of screens and gravel packs, insufficient well development, depletion of aquifers and water quality).

It is not sufficient to provide detailed information to be considered when constructing water points, particularly if such guidelines are not observed. To overcome problems related to poor workmanship, supervision--in other words quality control--is imperative, especially during well construction. More effort should be invested in supervision in order to assure maximum benefits from the large investments put into well drilling.

Pump Selection

Field experiences give evidence that only pumps with non-corrosive below ground components should be installed in areas where groundwater is corrosive. This conclusion is based not only on the reduced life expectancy of metal parts but also on the increased iron content of pumped water which is a serious nuisance in several parts of the Western Africa Region.

Handpump Performance in the Field

Some handpumps perform much better than others. Also, there is evidence to show that the performance of a given type of pump can differ significantly from area to area depending upon factors such as the maintenance system and attitude of pump users.

Preventive Maintenance

Results from the field, particularly from the Ghana Field Trial I (Kumasi), show that well-executed preventive maintenance can have a considerable effect on the performance of handpumps. The effect of preventive maintenance, however, varies with the type of handpump. For example, the Moyno pump is more affected by preventive maintenance than the India Mark II pump (at least during the first two years of operation).

Village Participation

The level of local participation varies widely in the Region. In some villages residents are not interested in a groundwater supply; while in others residents become actively involved in planning their water supply and later enthusiastically try to maintain their new handpumps. Although village participation is on the rise, there are still a few cases in which the lowest level of village participation--that is, acceptance of a drilled well with a handpump--has not been reached. When this happens the reason is in most cases connected with objections to the taste of the well water, related to a high iron content.

Water Quality

The quality of water plays an important role with regard to:

- o Technical aspects (corrosion, sand, silt, clay).
- o Acceptance by villagers (High iron concentrations can cause water to taste poorly, discolor food, stain laundry, etc.).

Potential water quality problems should be taken into account when planning rural water supply projects and not only after project completion. Pump selection, well type, and the approach to village participation may all have to be different when water quality problems are likely to be encountered.

Handpumps Used for Irrigation

In the field trial areas in Mali, Burkina, and Northern Ghana, more and more handpumps are being used to irrigate small vegetable gardens. Such small-scale irrigation can serve to supply villagers with vegetables all year round, as well as raise funds to cover the recurrent costs of the handpumps.

Amount of Handpump Use

Reliable information on the amount of handpump use is of great importance to the Project in evaluating pump performance data. It is also essential for planning purposes. Such data are being collected by use of water meters that have been installed on handpumps on an experimental basis.

5. Local Manufacture of Handpumps

The following handpumps have been at least partly designed and developed in the Region:

- o Abi Lever-operated conventional piston pump.
- o Vergnet Foot-operated hydraulic pump with diaphragm made in France.
- o ASM Lever-operated hydraulic pump, hybrid of Abi and Vergnet pumps.
- o Volanta Flywheel-operated pump with sealless piston, pump cylinder extractable through rising main.

Additional pumps designed in the Region include the UST and DESTA pumps, and possibly others. However, they are still in the prototype stage.

The main factors considered in the design of the pumps mentioned above, apart from the Abi pump, were the VLOM principles -- particularly the ease of maintenance (for example, whether the pump cylinders can be easily extracted from the wells) and the use of long-wearing parts (such as sealless pistons or

Table 3-1 Qualitative Classification of Handpumps in Terms of Conventional versus VLOM Pumps

Conventional	VLOM Features
Moyno	
India Mark II	
Abi	Abi modified
Monarch	
Deplechin	Deplechin modified
	ASM
	Vergnet
	Volanta

Note 1. This figure is intended to provide an overview of the general status of handpump technology in the Western Africa Region based on the VLOM features of pumps being field tested. The horizontal placement of the pumps represents a progression from conventional pumps with few if any VLOM features at the left to pumps which are more suitable for village level maintenance and repair at the right.

Note 2. The group of three which comes close to the VLOM concept (ASM, Vergnet and Volanta) has its origin in the Western Africa Region. It should be noted that somewhat greater progress has been made in achieving VLOM status with these three pumps when the lift is between 10 and 25 m than when the lift is greater than 25 meters.

hydraulic pumps). The three pumps that come closest to the VLOM concept are the ASM (Abi-Vergnet), Vergnet, and Volanta. A qualitative classification in terms of conventional versus VLOM principle for the pumps which are being tested on the field trial in the Western Africa is presented in Table 3-1.

The status of handpumps (as of May 1984) being manufactured in Western Africa is as follows:

Ghana

UST pumps:

- o Manufactured by the Department of Mechanical Engineering of the University of Science and Technology (UST) in Kumasi.
- o The pump is now in the prototype stage of development.

Ivory Coast

Abi and ASM Pumps:

- o Manufactured by Abidjan Industrie in Abidjan.
- o Abidjan Industrie began manufacturing the Abi pump in 1962.
- o The production line for the ASM (Abi-Vergnet) pump was started in 1981. The ASM pump consists of a pump stand made by Abidjan Industrie and below-ground components (cylinder and plastic hoses) of the Vergnet pump made in France.
- o The approximate numbers of pumps manufactured by Abidjan Industrie up to May 1984 are 12,000 Abi and 3,350 ASM.
- o Abidjan Industrie also is experimenting with a new version of the Abi pump called the Abi-MN which is expected to be ready for field testing in mid-1984. It will have an extractable piston (standard Abi cylinder made of brass, 60/68 mm diameter), plastic rising main (63/75 mm diameter), rods made of stainless steel, and a modified pump stand. The plastic rising mains are made in Abidjan.

Bourga Pump:

- o Manufactured by Ateliers de construction electro mecanique de Cote d'Ivoire (ACEM-IC) in Abidjan.
- o ACEM-IC began fabricating Bourga pumps in Spring 1984. The pump is designed by a French engineer who has been working in Western Africa for several years and who is manufacturing Bourga pumps in France.

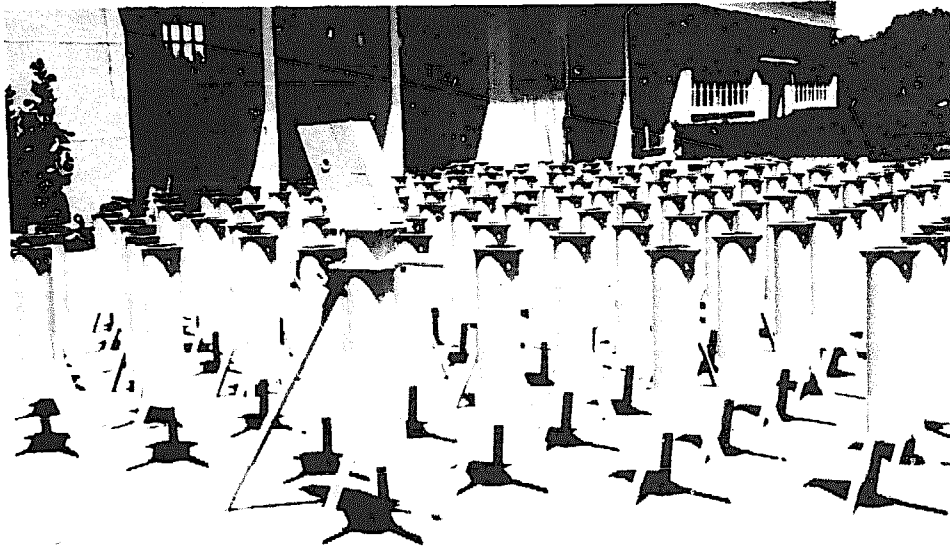

FIGURE 3-1 INDIA MARK II PUMPS MANUFACTURED IN MALI

The pump design was slightly modified from the Mark II Indian standard to use metric pipe sizes for cylinder dimensions.

Mali

India Mark II:

- o Manufactured by Entreprise malienne de maintenance (EMAMA) in Sikasso.
- o Planned yearly production capacity is 1,200 to 2,400 pumps.
- o The production line was started at the beginning of 1984. The pump made in Sikasso (see Figure 3-1) differs from the standard India Mark II pump made in India in the following ways:
 - The cylinders, three sizes, have standard metric dimensions (60, 80 and 100 mm inside diameters).
 - The cylinders are made of stainless steel instead of brass or brass-lined cast iron.
 - The pump stands are painted and rarely galvanized.
- o Apart from the cup seals, the parts made of brass of the 60-mm cylinder, e.g. valves, are interchangeable with the original 2-inch India Mark II pump cylinder.

Burkina

Volanta Pump:

- o Manufactured by the Catholic Mission Vocational Training Centre in Saaba, Ouagadougou.
- o About 200 Volanta pumps have been manufactured in Saaba for Burkina. The pump, which has been designed by a Dutch engineer, also is manufactured in The Netherlands. The first prototype was installed in Burkina in the spring of 1981.

DESTA Pump:

- o Manufactured by Departement energie solaire et technologie appropriée (DESTA) in Ouagadougou.
- o DESTA is part of a nongovernmental organization called Federation des eglises et missions evangeliques (FEME). It is manufactured out of semifabricated products that are available on the local market.

Remarks

The manufacture of handpumps in West Africa is receiving considerable attention. In addition to the manufacturers mentioned above, some others are capable of producing handpumps. Various possibilities are being studied. Also worth mentioning are the efforts put into this subject by regional

organizations such as CIEH, CILSS, Club du Sahel, Conseil de l'Entente and, in particular, CEAO and BOAD.

B. GHANA

1. Operation of Field Trials

Ghana has a surface area of 239,000 km². Its total population in 1981 was 12.1 million and its rural population was 7.7 million, or 64 percent of the total. Population density was 50.6 per km². In 1983 there were approximately 6,000 handpumps installed throughout the country.

Ghana Field Trial I (Kumasi)

The principal features of the first field trial being carried out in Ghana under this Project are as follows:

Counterparts:	Government Authority: GWSC Donor: KfW
Integrated into:	The Maintenance Unit of the 3,000 Well Drilling Program in southern and central Ghana.
Field Trial Area:	Ashanti Region
Base of Monitoring Team:	Kumasi
Pumps Monitored:	220 India Mark II (India/USA)* 55 Moyno (USA)
Well Characteristics:	Well depth--average 40 m (25 to 80 m)** Static water level--average 11.5 m (0 to 42 m)
Executed by:	Monitoring Team (1 CME, 1 GWSC technician, 1 GWSC driver)
Start:	January 1983

* India Mark II pumps from India equipped with Dempster cylinders made in the United States.

** Approximate figures.

Maintenance Structure:

The handpumps of the 3,000 Well Drilling Program are maintained and repaired by GWSC repair teams equipped with UNIMOG trucks and by inspection officers riding motorbikes. The inspection officers visit all the pumps regularly at intervals of about one to three months in order to perform preventive maintenance, to take care of minor repairs, and to report pump failures to the GWSC repair teams. (The use of inspection officers is still at the experimental stage.) Within the field trial area, similar tasks are performed by the project monitoring team.

Villagers do not share in maintenance costs. However, the training of local pump caretakers has been started.

Physical Characteristics:

The field trial is being conducted in the forest area of the southern part of central Ghana, which has a mean annual rainfall of 1,500 to 1,800 mm. The underlying rock structure consists mainly of granite, schist, and phyllite.

Dense villages are the dominant type of settlement in the rolling to undulating landscape of this area.

Remarks:

The 3,000 Well Drilling Program was completed at the end of 1983. It comprises 3,000 boreholes equipped with 2,250 India Mark II pumps (the pump heads, rods, and rising mains were made in India and the Dempster cylinders were made in the United States), and 750 Moyno 1V12 pumps manufactured in the USA.

Ghana Field Trial II (Bolgatanga)

The principal features of the second field trial initiated in Ghana are as follows:

Counterparts:	Government Authority: GWSC Donor: CIDA
Integrated into:	Maintenance/Stabilization Project
Field Trial Area:	Upper East Region (Bolgatanga and Navrongo districts)
Base of Monitoring Team:	Bolgatanga

Pumps to be Monitored: 70 Moyno (Canada)
50 Monarch (Canada)
25 Maldev pumpstands with Dempster
cylinders (Malawi/USA)
30 Volanta (Burkina)

Executed by: Monitoring Team
(1 CME, 1 GWSC technician, 1 GWSC driver)

Start: March 1984

Maintenance Structure: The handpumps of the Upper Regions are repaired and maintained by GWSC staff, who use trucks for major repairs, and motorbikes for minor repairs, preventive maintenance, and inspections. Most of the villages have pump caretakers who have received some initial training in maintaining handpumps.

A proposal for cofinancing the recurrent cost of handpump maintenance by the users has been prepared and will be considered in the near future.

Preventive maintenance on pumps within the field trial area is performed by the UNDP/World Bank Project monitoring team.

Physical characteristics: The field trial is situated in the savanna region of northern Ghana, which has a mean annual rainfall of 1,000 to 1,250 mm. Granite is the dominant rock type in this area and the landscape is rolling to undulating. The settlements are composed of widely scattered clusters of huts.

Remarks: The field trial is integrated into a CIDA-assisted project (1973-1980) that includes 2,500 boreholes equipped with various types of handpumps, mainly the Canadian Beatty (now GSW), Moyno and Monarch.

A project entitled the Water Utilization Project was started in 1978 to help the villagers maximize the benefits of the boreholes. This project included pump caretaker training, and community education and development.

A third CIDA-assisted project, the Upper Region Maintenance/Stabilization Project, was launched in 1982 to increase the operational reliability of water supplies.

2. Field Results - Kumasi

To date the results from field trials have been obtained primarily from Area I, Kumasi. In Area II, Bolgatanga, only a portion of the Moyno and Monarch pumps to be tested had recently been installed and monitoring begun. Two hundred and twenty India Mark II and 55 Moyno pumps are monitored in Field Trial Area I; the majority of the pumps were installed in the second half of 1982.

Defects of Handpumps

Defects of Handpumps Inside the Field Trial Area: Defects which occurred on India Mark II and Moyno handpumps between January 1983 and April 1984 are summarized in Figures 3-2 through 3-5. Comments:

- o Preventive maintenance is performed by the Project monitoring team whenever they monitor the pumps in about two month intervals. It consists of tightening nuts, bolts and screws, greasing chains and reporting defects to the repair teams. During each visit the causes of breakdowns (out of service) or poor performance are diagnosed.*
- o In Figures 3-3 and 3-4 the occurrence of poor performance and out of service defects are summarized for each of the first seven inspections. Normally defects noted by the monitoring team were repaired before

* Definitions of Defects:

- | | |
|----------------------|--|
| Out of Service: | The pump is not operational or no water is produced by pumping. |
| Poor performance: | The pump is functioning poorly because of a defect which must be repaired. |
| Pipe disconnected: | Rising main disconnected at a coupling. |
| Leakage: | No water discharged from pump within the first three strokes or revolutions after approximately 5 minutes without pumping, indicating water has leaked from the rising main (at the joints). |
| Piston seals worn: | More than 65 strokes (2.5 inch cylinder) or 100 strokes (2 inch cylinder) are needed to pump 16 liters at 50 strokes/minute. |
| Piston seals stiff: | The piston does not go down easily. This is reflected in the chain becoming slack on the handle up-stroke. |
| Rotor & stator worn: | More than 120 revolutions are needed to pump 16 liters at 50 revolutions/minute. |

FIGURE 3-2 INDIA MARK II PUMP DEFECTS
GHANA FIELD TRIAL AREA I

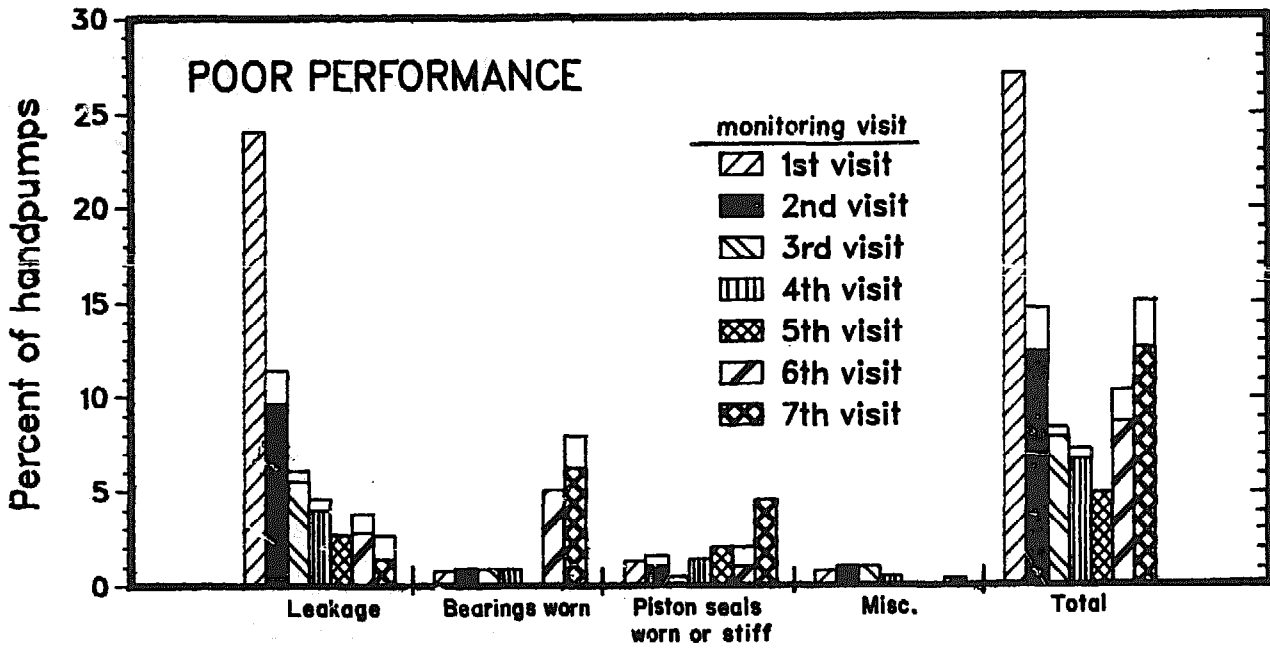
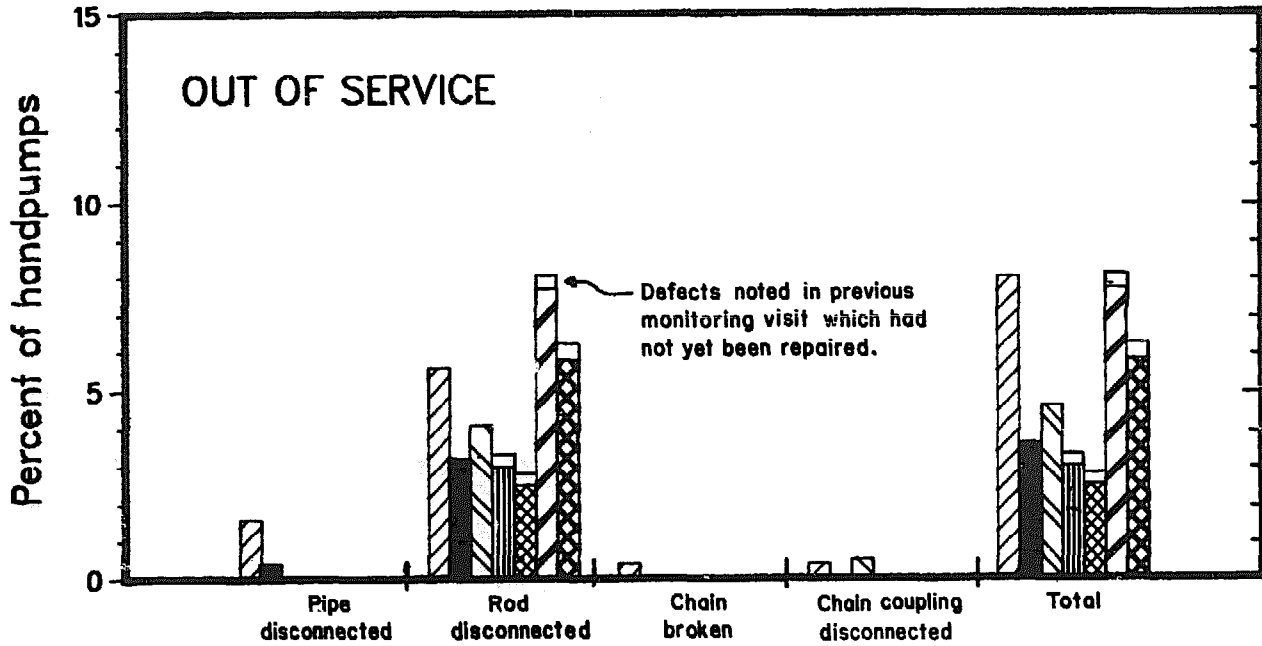

FIGURE 3-3 MOYNO PUMP DEFECTS
GHANA FIELD TRIAL AREA I

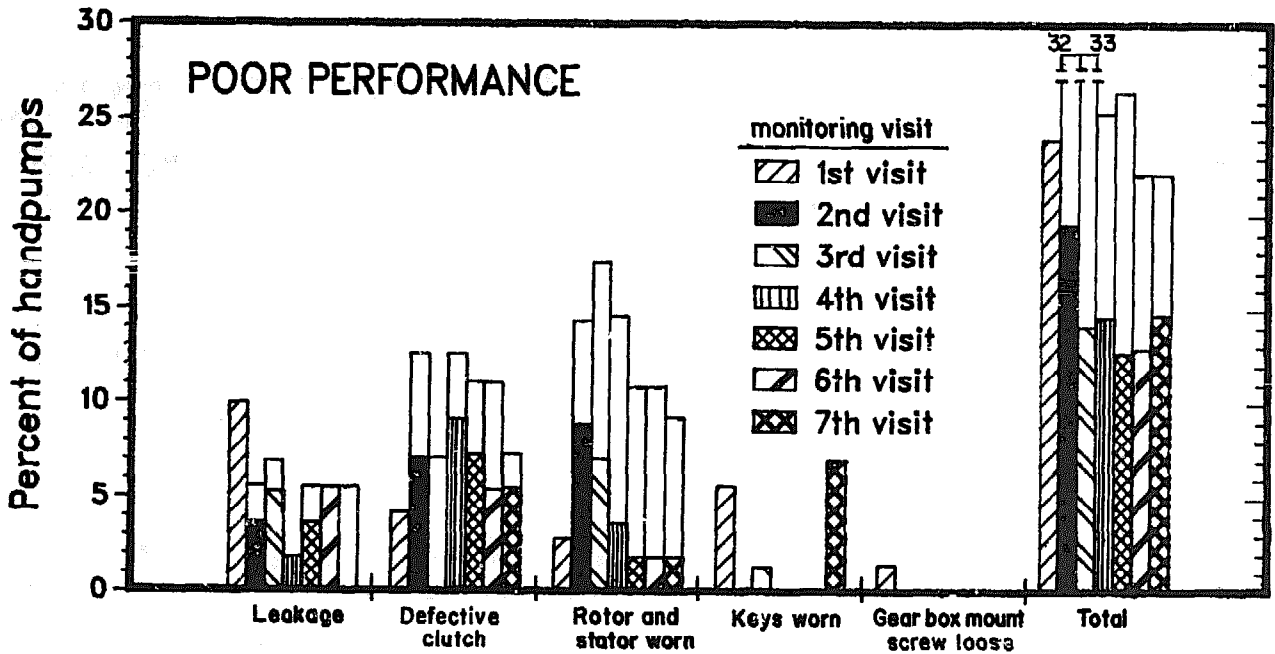
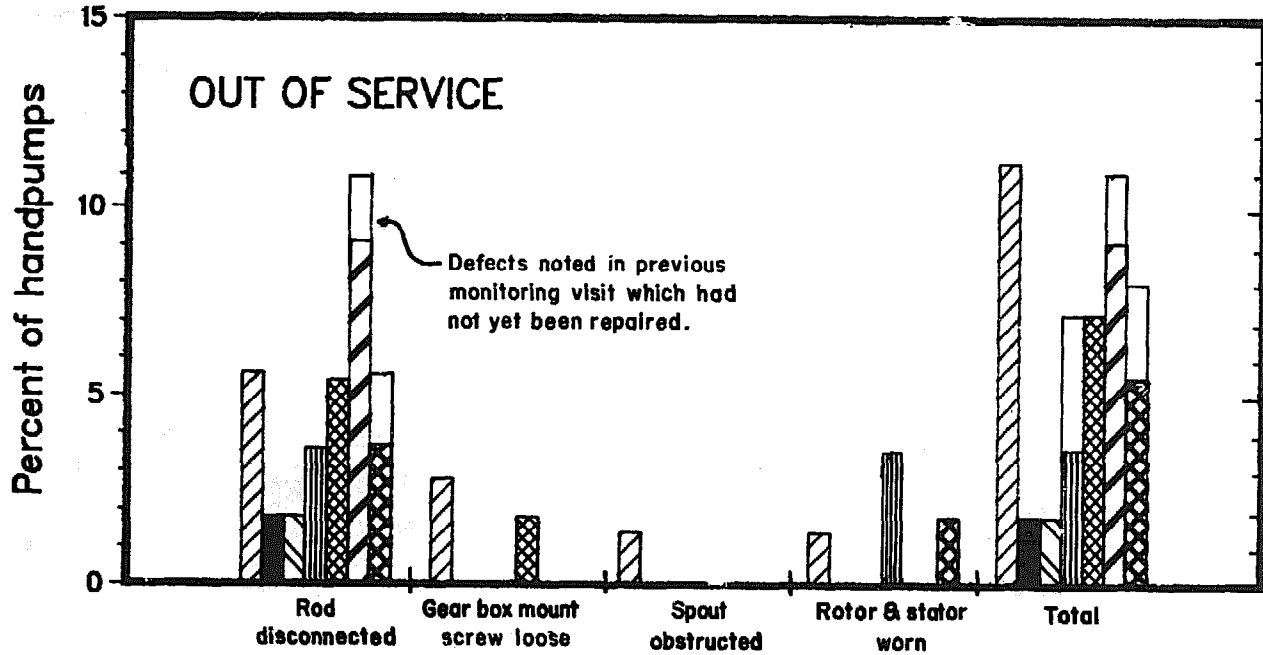

FIGURE 3-4 OUT OF SERVICE BREAKDOWNS VS. PUMP AGE
GHANA FIELD TRIAL AREA I

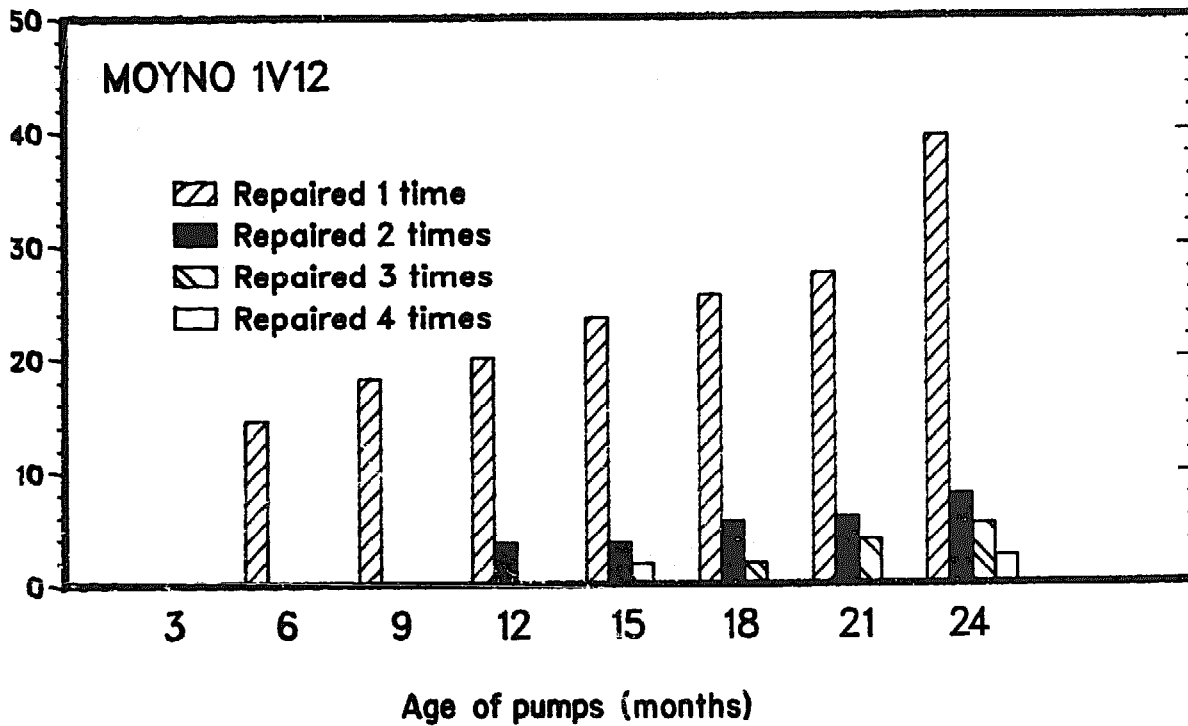
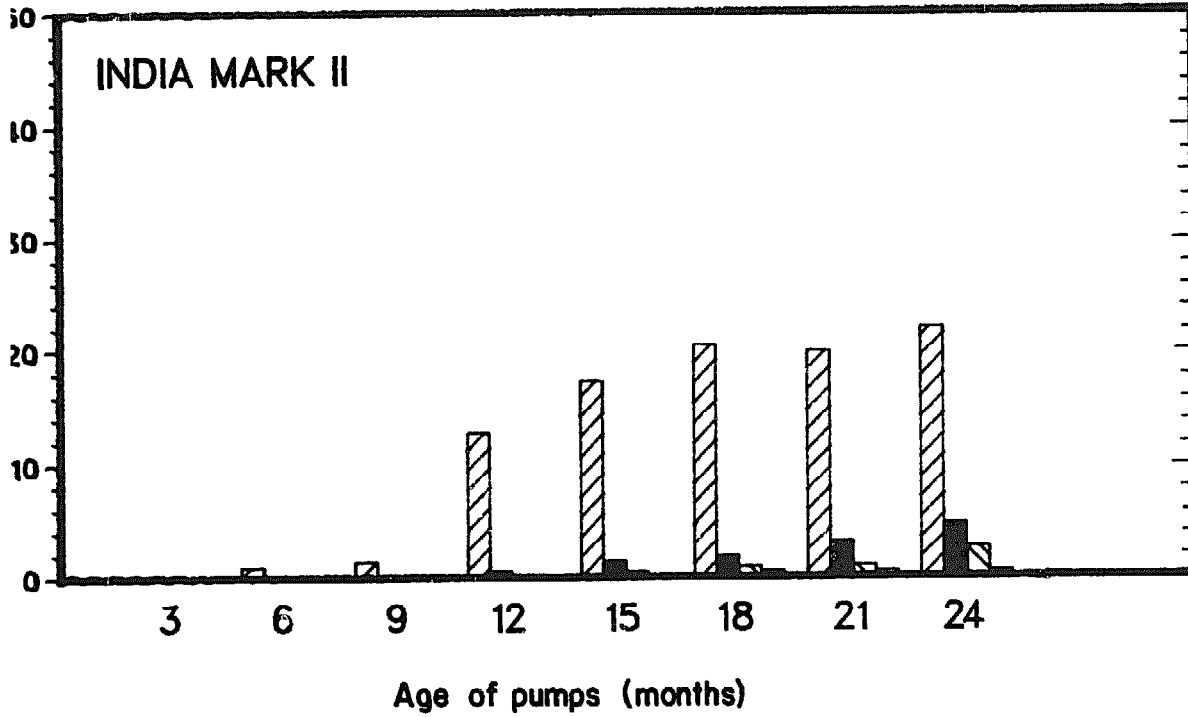
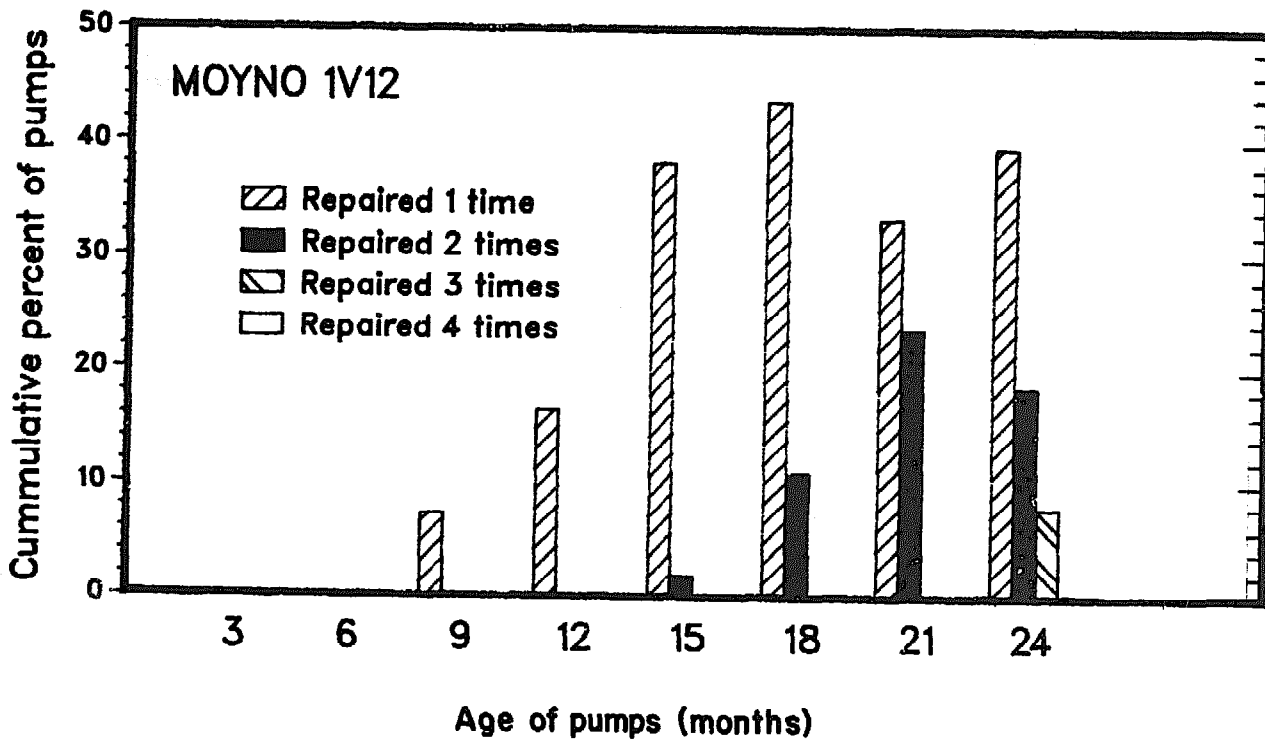
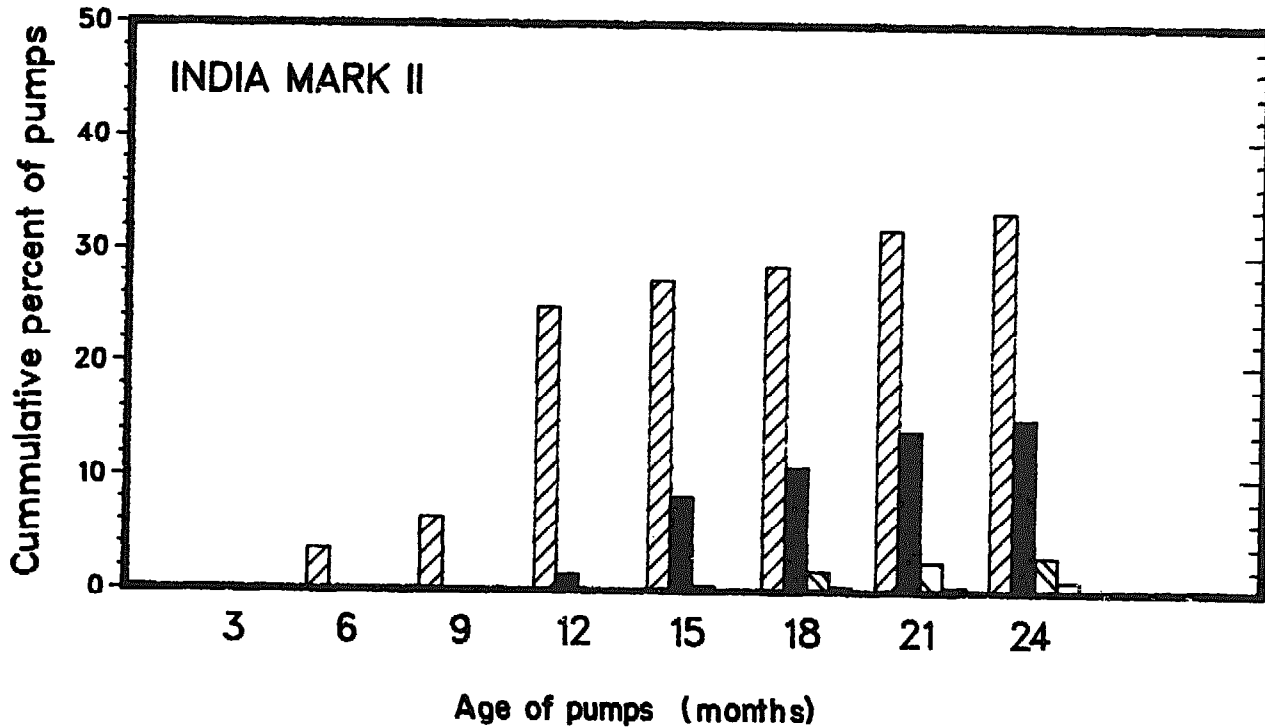

FIGURE 3-5 MINOR REPAIRS (POOR PERFORMANCE) VS. PUMP AGE
GHANA FIELD TRIAL AREA I



their next visit; those which were not are distinguished in the bar charts from those which were newly encountered. Also, it should be noted that the upper and lower bar charts in each figure have different vertical scales.

- o Pumps monitored in a given time interval were not of uniform ages because they were not installed simultaneously. It should also be noted that the first monitoring visit may have taken place several months after the pumps were installed.
- o Disconnected rods have caused most out of service defects for both types of pumps.
- o Leakage, mainly caused by loosened or defective couplings, in the rising main was a major poor performance defect for both, but especially for the India Mark II pumps and particularly at the beginning of the monitoring. This appears to be due to poor installation.
- o The typical failures of the Moyno pump are noted below. These have been or are being remedied. The nickel plating has been replaced by chrome plating; also the clutch, keys and screws have been redesigned by the manufacturer.
 - rotor/stator (scaling off the nickel plating of the rotors)
 - clutch (design too weak)
 - handle keys, gear box mounting screws (design too weak)
- o The major causes of poor performance and out of service defects for both pumps were related to below-ground components and apparently to poor installation.
- o The data in Figures 3-2 and 3-3 do not indicate significant differences regarding frequency of defects between the two pumps, if defects carried over from previous monitoring visits are not taken into account. However, when data is adjusted for pump age (see Figures 3-4 and 3-5) then significant differences between the two types of pumps begin to emerge.

Defects of Handpumps Outside the Field Trial Area: In Figure 3-6 and Table 3-2 results of defects of the handpumps of the field trial area are compared with defects of handpumps of a neighboring area. There are 72 India Mark II and 16 Moyno pumps in the neighboring area. Comments:

- o There are no significant differences with respect to the India Mark II pumps; however, the Moyno pumps show significant differences. In the neighboring area out of service defects are more than double and the percentage of pumps in good condition is only half, in comparison to the field trial area.
- o Preventive maintenance has not yet been started on a regular basis in the neighboring area.

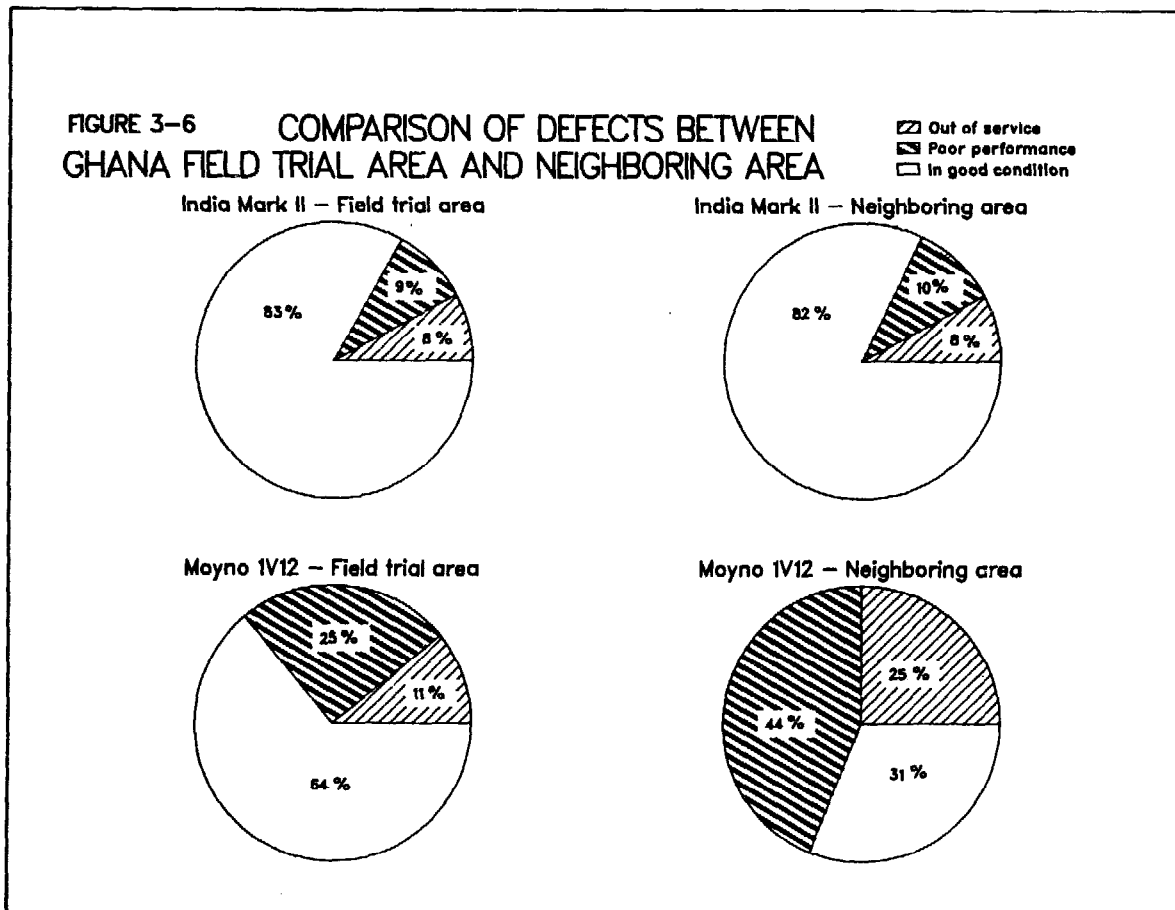

Table 3-2 Summary of Defects in an Area Neighboring the Ghana Field Trial Area

Number of handpumps needing repair (and corresponding percent of total)														
		Out of Service					Poor Performance							
Pump	Number of pumps inspected	Rod disconnected	Rod disconnected and bearings worn	Rod disconnected and defective clutch	Rotor and stator worn	Total	Leakage and bearings worn	Bearings worn	Piston seals worn	Rotor and stator worn	Too heavy to operate	Defective clutch	Total	Grand Total
India Mark II	72	5 (7%)	1 (1%)	-	-	6 (8%)	1 (1%)	3 (4%)	3 (4%)	-	-	-	7 (10%)	13 (18%)
Moyao	16	2 (13%)	-	1 (6%)	1 (6%)	4 (25%)	-	-	-	5 (31%)	1 (6%)	1 (6%)	7 (44%)	11 (69%)

Slackened Nuts and Bolts: Figure 3-7 shows that a high percentage of screws, nuts and bolts slacken on both the India Mark II and Moyno. In the case of the India Mark II a loose connecting rod lock nut can result in the chain becoming disconnected from the pump rod, and for the Moyno a loose handle screw can cause free play which damages the keyway where the handle connects to the gearbox. Handle free play as well as loosened gearbox mounting screws can allow the Moyno pump head to shake during use which in turn can severely damage the drive mechanism. The reason for this situation is that, in general, neither lock nuts nor spring washers are used.

FIGURE 3-7 LOOSE NUTS AND BOLTS VS. PUMP AGE

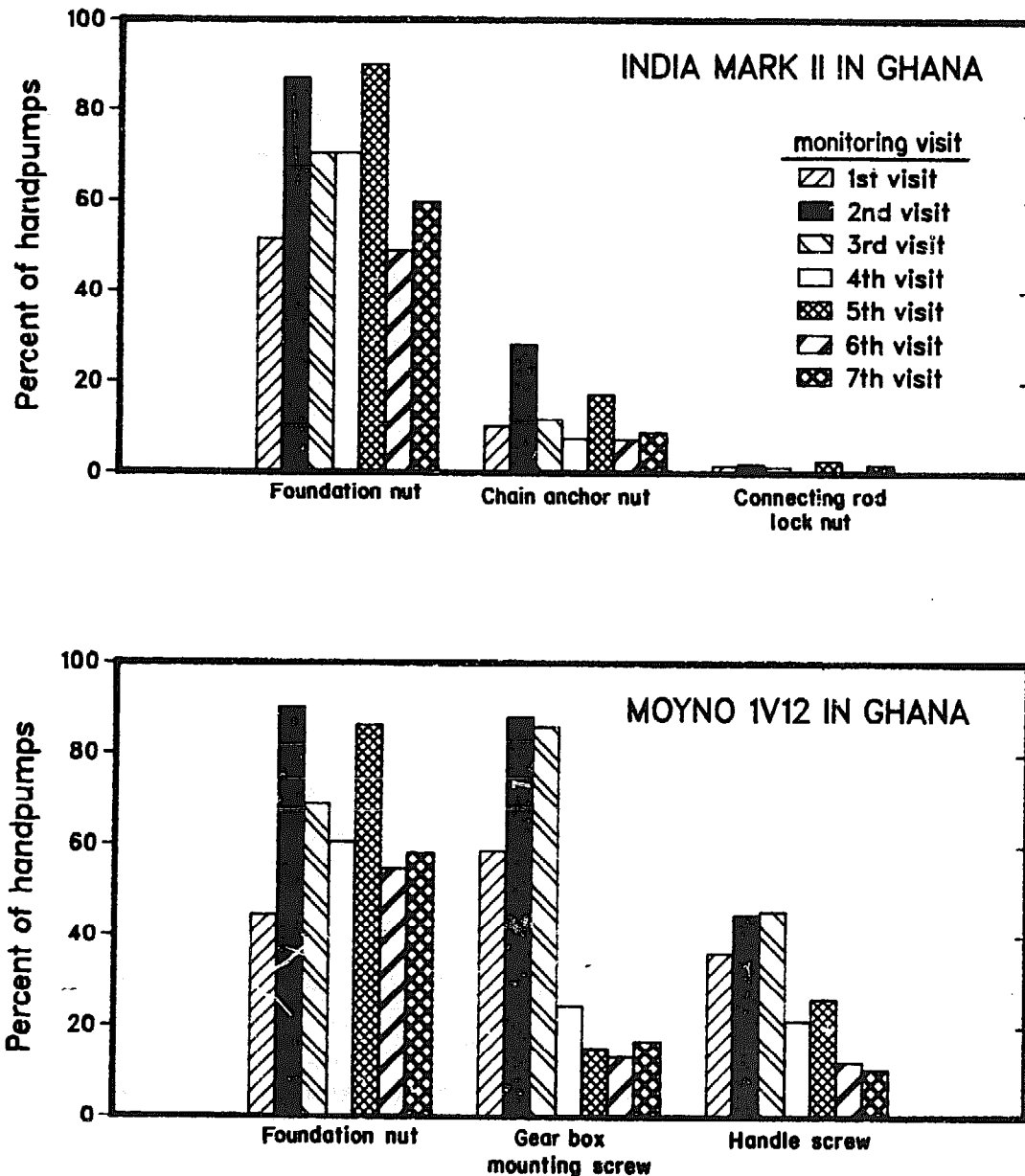

Table 3-3 Discharge and Volumetric Efficiency for India Mark II and Moyno Handpumps

Pump	30 strokes or revolutions per minute			50 strokes or revolutions per minute			70 strokes or revolutions per minute			
	Min	Max	Avg	Min	Max	Avg	Min	Max	Avg	
India Mark II (2.5 inch)	6.9	11.7	9.5	10.1	25.0	16.6	17.8	33.0	23.9	
Discharge rate (liters/min)	India Mark II (2 inch)	5.3	6.8	6.1	7.3	13.5	10.2	13.7	16.0	14.8
	Moyno 1V12	3.0	7.1	6.2	2.0	12.8	10.4	4.3	16.8	14.5
Discharge rate (liters/stroke or revolution)	India Mark II (2.5 inch)	0.23	0.39	0.32	0.20	0.48	0.33	0.25	0.47	0.34
	India Mark II (2 inch)	0.18	0.23	0.20	0.15	0.27	0.20	0.20	0.23	0.21
	Moyno 1V12	0.10	0.24	0.21	0.04	0.24	0.20	0.06	0.24	0.21
Volumetric Efficiency (percent)	India Mark II (2.5 inch)	72	122	99	63	147	102	80	147	106
	India Mark II (2 inch)	85	107	97	71	130	99	93	108	102
	Moyno 1V12	42	98	87	17	100	82	76	100	87

Note: Volumetric efficiency is defined as the ratio of the volume of water pumped per stroke to the volume swept by the piston. Due to the inertia of the water column on the up-stroke of the piston, more water can be lifted in one stroke than the volume swept by the cylinder. This raises the volumetric efficiency above 100 percent, especially for shallow water tables and greater pumping speeds.

Pump Performance: Table 3-3 contains the maximum, minimum and average volume flows at 30, 50 and 70 strokes or revolutions per minute as well as the volumetric efficiencies of the India Mark II (2 and 2.5 inch cylinders) and the Moyno 1V12. In Figure 3-8 the discharge rate of some India Mark II pumps with 2.5 inch cylinders is plotted versus the pumping depth.

FIGURE 3-8 DISCHARGE RATE PER STROKE VS. PUMPING DEPTH
INDIA MARK II PUMPS (2.5 INCH CYLINDER)
Ghana Field Trial Area I

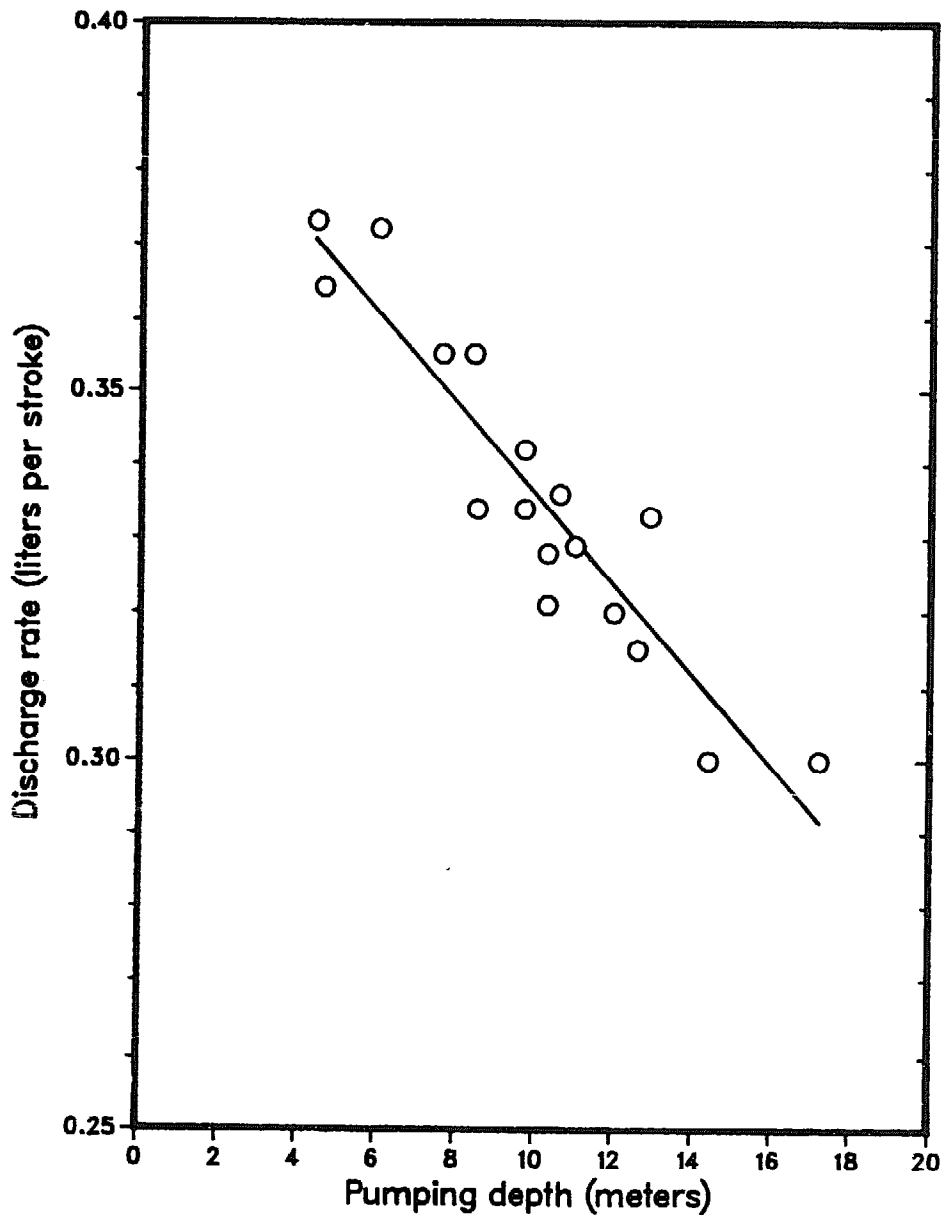

Volume Flow Versus Handle Speed: In Figure 3-9 volume flow curves versus the number of strokes per minute for the India Mark II and revolutions per minute for the Moyno 1V12 are plotted.

FIGURE 3-9 DISCHARGE RATE VS. HANDLE SPEED
INDIA MARK II AND MOYNO PUMPS
Ghana Field Trial Area I

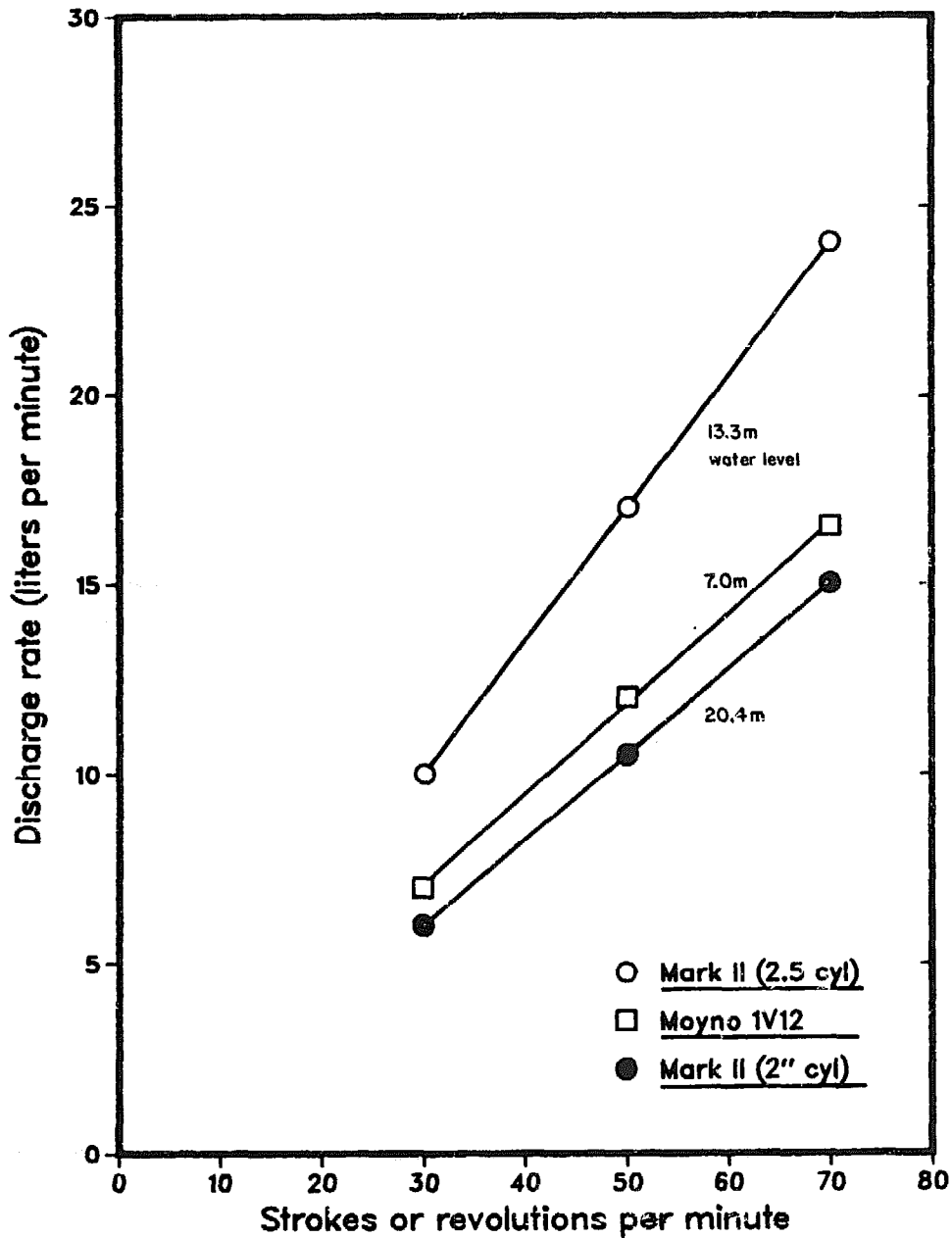

Theoretical and Field Measured Volume Flow and Handle Torque of Moyno 1V12 Pumps Versus Pumping Depth: In Figure 3-10 manufacturer and field measured volume flow and handle torque of Moyno 1V12 pumps are plotted versus the pumping depth. The manufacturer's values are taken from the Robbins & Myers data sheet 6/80 - 2 m and the field data have been calculated on the basis of force measurements. The field results correspond quite well with the data quoted by the manufacturer. Figure 3-11 presents the lever- and handle forces which are required to operate the India Mark II (2.5 inch) and Moyno 1V12 pumps respectively versus water level (pumping depth).

- o The graph shows the characteristics of the India Mark II and the Moyno pumps. These are based on different principles (that is, piston and helical rotor).
- o The extreme values of force required, expressed as a percentage of the mean values, are higher on the Moyno pump (about 45 percent) than on the India Mark II pump (about 30 percent).
- o The relatively wide force range of the Moyno pump is indicative of two problems related to the rotor/stator:
 - adjustment and tolerances
 - scaling of the nickel plating

Mechanical Efficiency: The mechanical efficiency of India Mark II (2.5 inch) and Moyno 1V12 pumps is depicted in Figure 3-12.

Repair Time for Below-ground Components: Typical repair procedures were timed for India Mark II, the Moyno, and the Volanta pumps. Most of the repair time was spent removing and reinstalling the piston, which, in the case of India Mark II and the Moyno, required the removal of the entire below-ground components, but in the case of the Volanta was far simpler. In all three cases the pump cylinders were at a depth of approximately 30 meters (27 meters for the Mark II, 32 for the Volanta, and 33 for the Moyno). It took about one hour for a skilled and experienced mobile maintenance crew to remove the cylinder from India Mark II and the Moyno, and another hour to replace it. On the Volanta the same operation took only five minutes for each step! Furthermore, no heavy tools were needed to work on the Volanta, whereas a tripod, pulley, spanners, and other tools had to be used on the other pumps.

FIGURE 3-10 DISCHARGE RATE AND HANDLE TORQUE VS. PUMPING DEPTH
MOYNO 1V12 PUMPS
Ghana Field Trial Area I

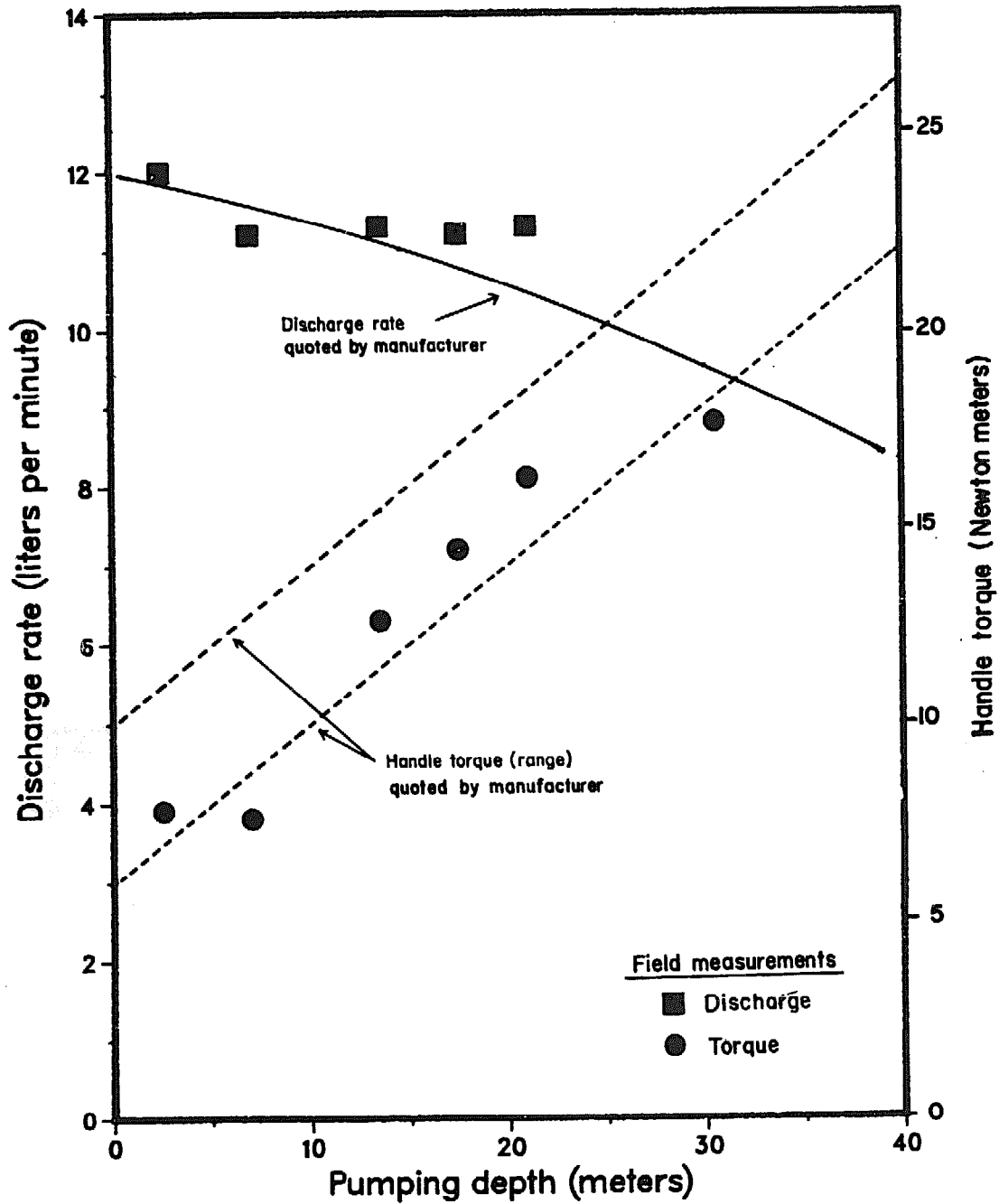

FIGURE 3-II LEVER AND HANDLE FORCES VS. PUMPING DEPTH
INDIA MARK II AND MOYNO IV12
Ghana Field Trial Area I

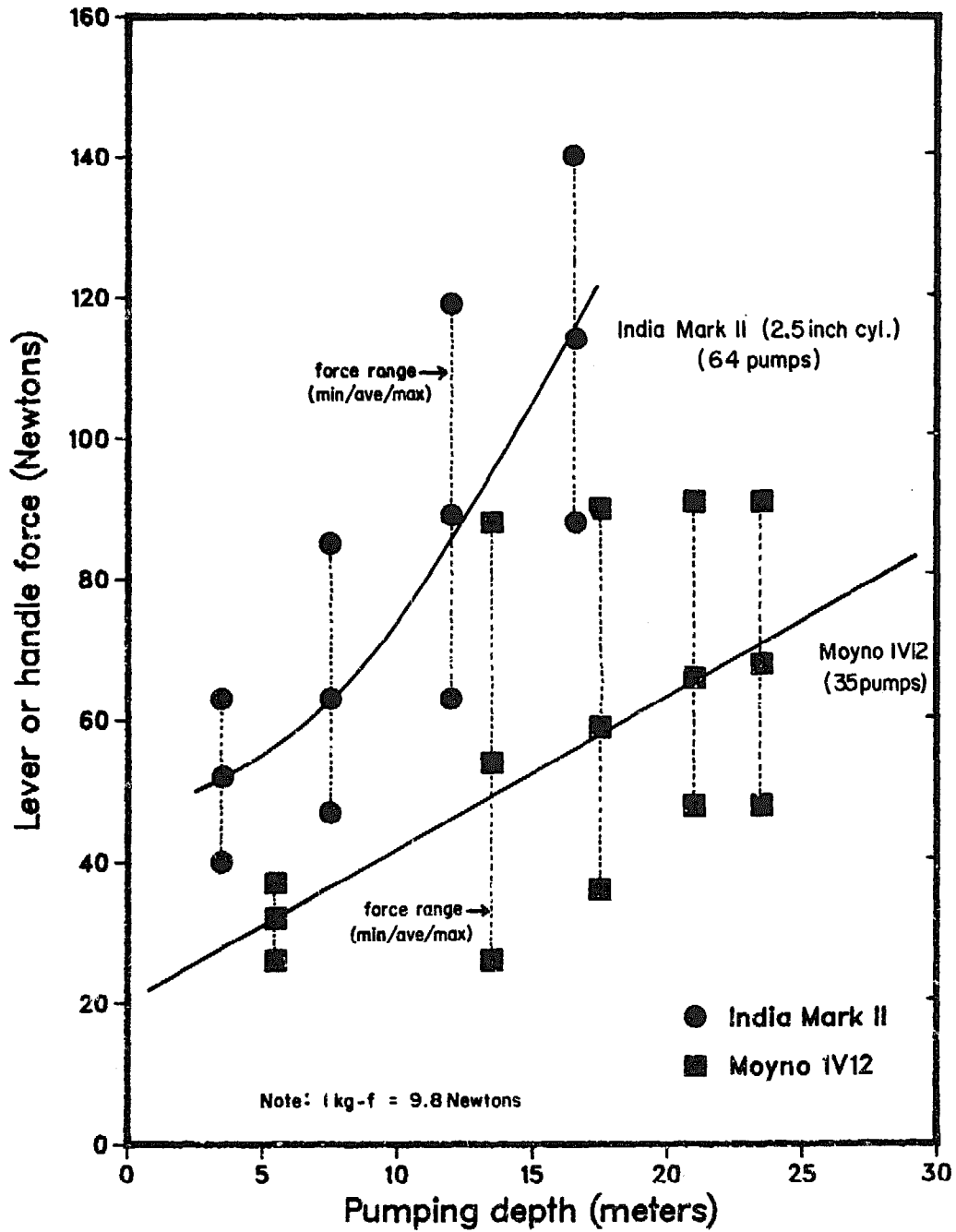
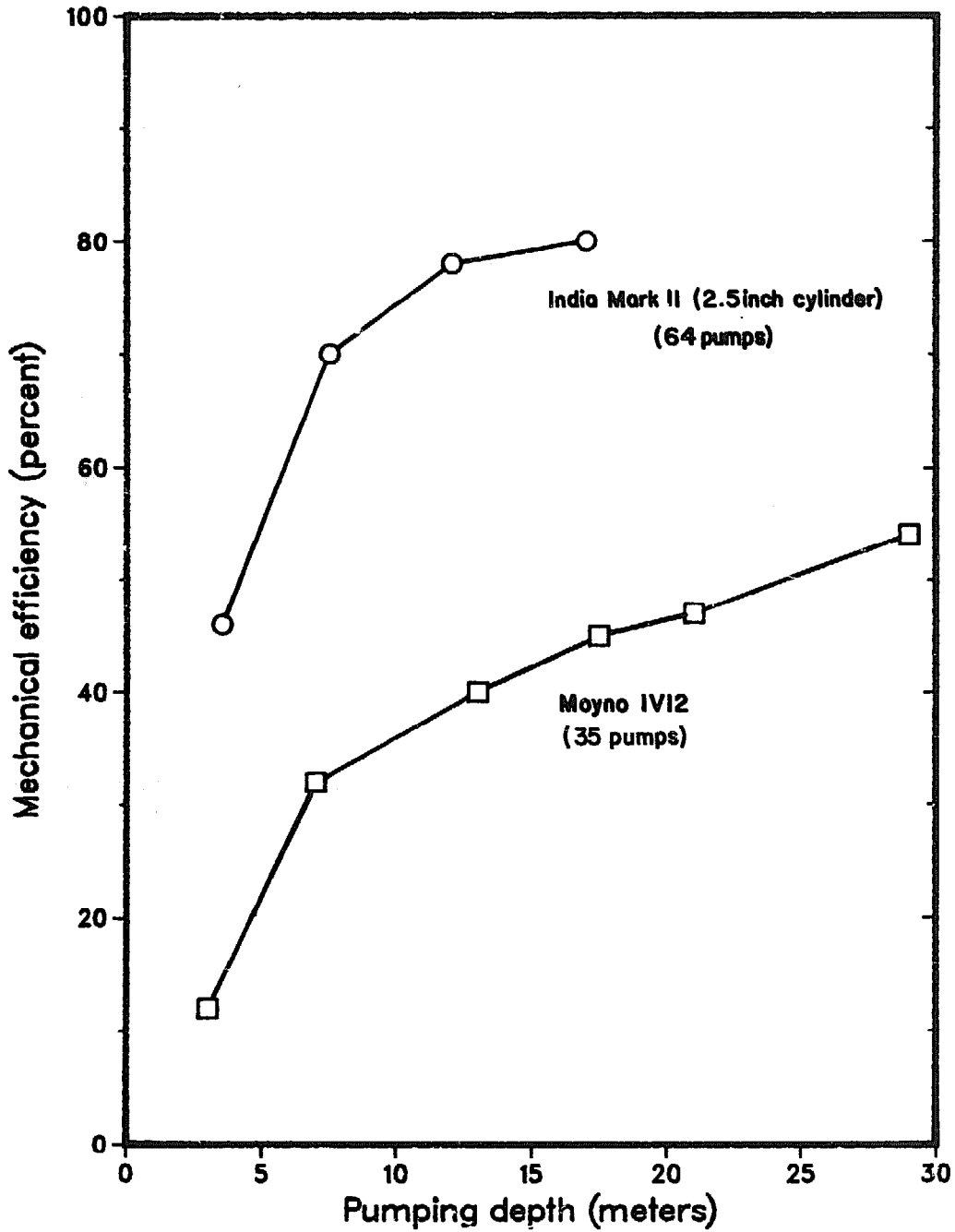

FIGURE 3-12 MECHANICAL EFFICIENCY VS. PUMPING DEPTH
INDIA MARK II (2.5 INCH CYLINDER) AND MOYNO IV12



Water Quality

Physical parameters: Temperature, turbidity, pH, and electric conductivity values in Ghana Field Trial I area are depicted in Figure 3-13. The temperature is in the range of 24 - 27°C with a mean of 25.3°C, which corresponds to mean air temperature. The median value of the other parameters were 6.0 for pH, about 150 micromhos/cm for electrical conductivity, and less than 10 FTU for turbidity.

Total iron: In most of the wells in this area the concentration of iron is far beyond the upper limit of 0.3 mg/l recommended by WHO, (WHO Guidelines for Drinking Water Quality, 1984) beyond which objectionable taste and staining of clothes may be experienced. Out of 124 analyses performed between August and October 1983, only three had less than 1.0 mg/l total iron, the others showed much higher concentrations (average of 18 in August-October 1983 and 12 mg/l in February-April 1984).

Investigations in Ghana Field Trial I area point to the following preliminary findings:

- o There are two sources of iron: the aquifer and the corrosion of pumps.
- o The iron concentration of the aquifer (groundwater) is, according to the classic theory, due to low pH, little or no dissolved oxygen (in a reducing environment), and high organic content. The luxuriant vegetation of the forest zone is probably the potential source of the organic material. This situation is unlike that in the savanna region of the northern areas. Another important factor with respect to the organic material, its decomposition, and transport to the aquifers, is the climate, particularly the rainfall pattern, which differs considerably in the forest and the savanna zones. The relation between ammonium (NH_4), which is an indicator of organic content, and total iron (see Figure 3-14) supports this.
- o The amount of iron contributed by corrosion varies and is particularly high in wells that are little used in which corroded material has had time to accumulate. This is clearly demonstrated in the example given in Figure 3-15, where the total iron concentration in well water dropped from about 18 mg/l down to 2.5 mg/l after several hours of pumping.
- o Under similar geological conditions and where pH is low in Niger and Burkina, the total iron content of groundwater is much lower than in the Ghana Field Trial Area I (Kumasi). Groundwater from open (dug) wells contains less total iron than groundwater from drilled wells. The content of dissolved oxygen in groundwater from dug wells is usually in the range of 2 to 3.5 mg/l (oxidizing environment), while concentrations in groundwater from boreholes is often less than 1 mg/l (reducing environment). The reason for this may be the contact of the water with the air in the open wells (natural aeration or artificial aeration while drawing water from the wells). This may also be related to the fact that drilled wells are usually deeper and thus produce water from lower levels of the aquifer, which may contain more iron.

Figure 3-13
Water Quality Parameters for Ghana Field Trial Area I

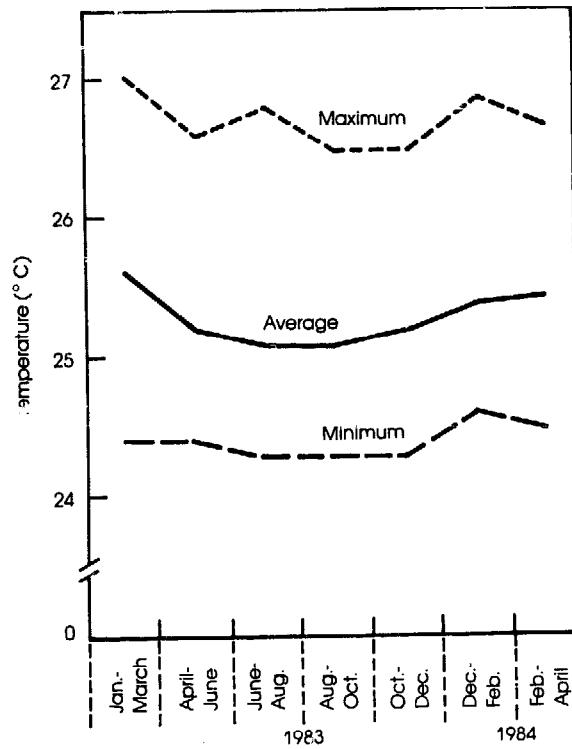
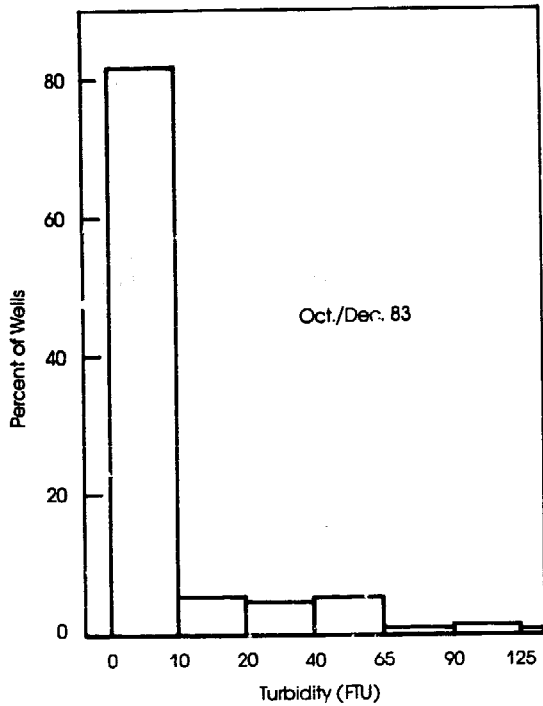
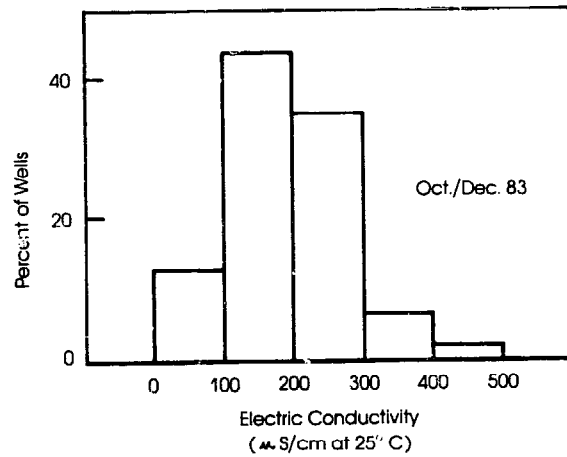
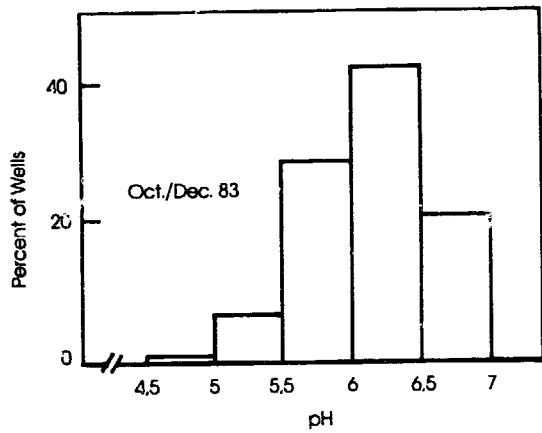

FIGURE 3-14 TOTAL IRON VS. AMMONIUM (ORGANICS)

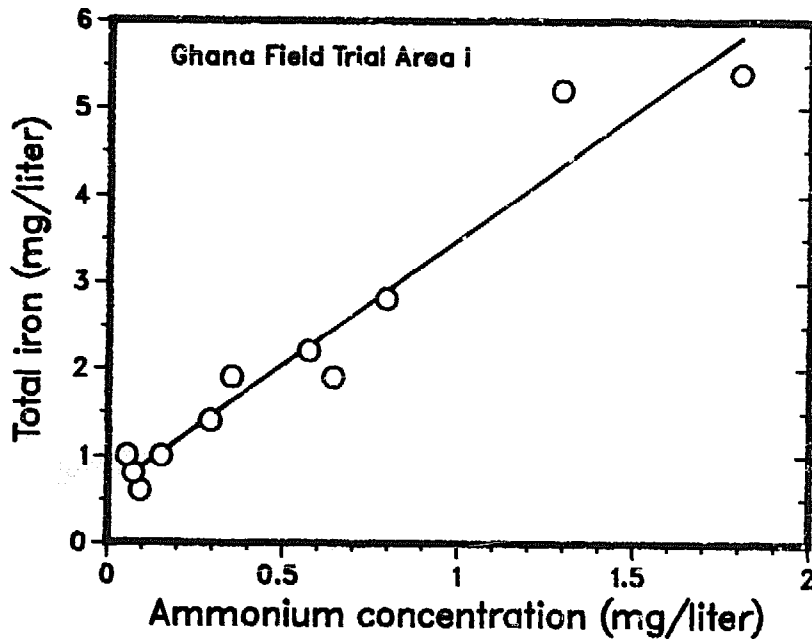
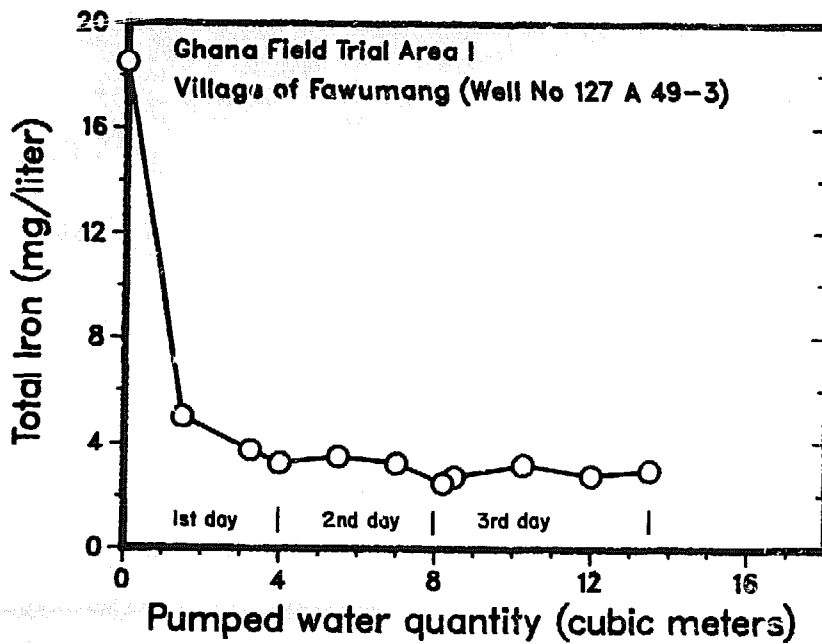

FIGURE 3-15 IRON CONCENTRATION VS. TIME WELL IN USE



- o The exposure of groundwater with a high iron content to air (in open receptacles or even stoppered sample bottles) reduces the iron concentration significantly, even within hours (see Figure 3-16).

Conclusion: Measurements of iron content in both drilled and dug wells and the results of aeration tests indicate that storage of groundwater for one to two days may be both an effective and simple solution to the iron problem. As a general rule, handpumps that have corrosive below-ground components should not be used where the groundwater is aggressive. Iron can be removed from water by means of simple techniques such as aeration and filtration. However, as long as the users of handpumps fail to maintain the pumps adequately, iron removal plants, even simple ones, are not recommended because they too, would require proper maintenance.

**FIGURE 3-16 IRON CONCENTRATION VS. AERATION TIME
Ghana Field Trial Area I**

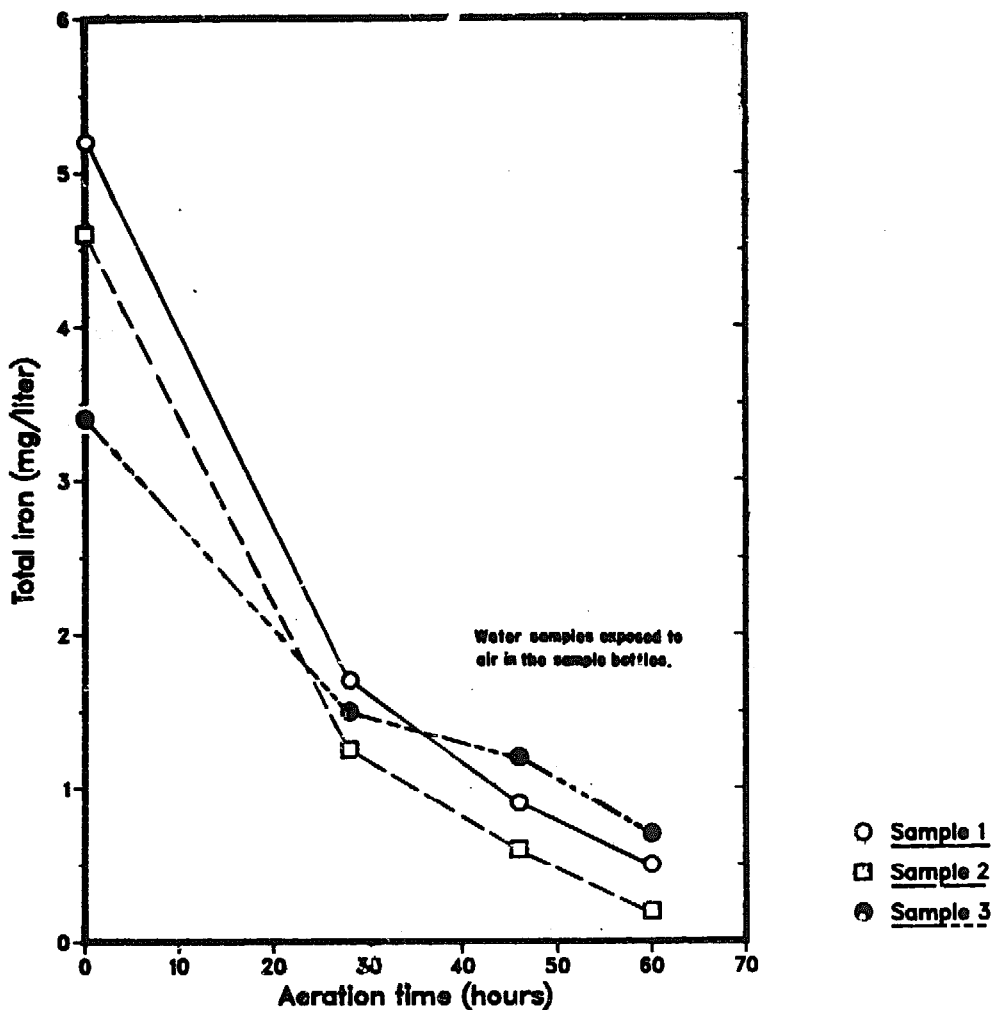

C. IVORY COAST

1. Operation of Field Trials

The Ivory Coast has a surface area of 322,000 km². Its total population in 1981 was 8.3 million and its rural population was 5.2 million, or 62 percent of the total. Population density is 25.7 per km². In 1983 there were approximately 10,000 handpumps installed throughout the country.

Ivory Coast Field Trial I (Man)

The principal features of the first field trial in this area are as follows:

Counterparts:	Government Authority: DCH (now DE) Donor: World Bank, CEAO
Integrated into:	Second Ivory Coast Water Supply Project (Rural Water Supply Component)
Field Trial Area:	Region of Man
Pumps Monitored:	20 ASM (Abi-Vergnet; Ivory Coast/France) 20 Abi (Ivory Coast) 20 Vergnet (France)*
Executed by:	Expert assigned by DCH, in cooperation with Handpumps Project
Start:	July 1983
Maintenance structure:	The government of the Ivory Coast has entered into a contract with a private company, SODECI, to maintain and repair the handpumps in the Ivory Coast.

The maintenance of handpumps is paid for by the villagers who are charged CFAF 55,000 (US \$137) per year. ** About 10,000 handpumps have already been installed throughout the country, and they serve approximately 75 percent of the rural population. The number of people served per pump varies greatly, but it averages about 400. Considerable effort is being put into the training of pump repairers and the

* Approximate numbers.

** This system of financing was introduced by the government in 1981.

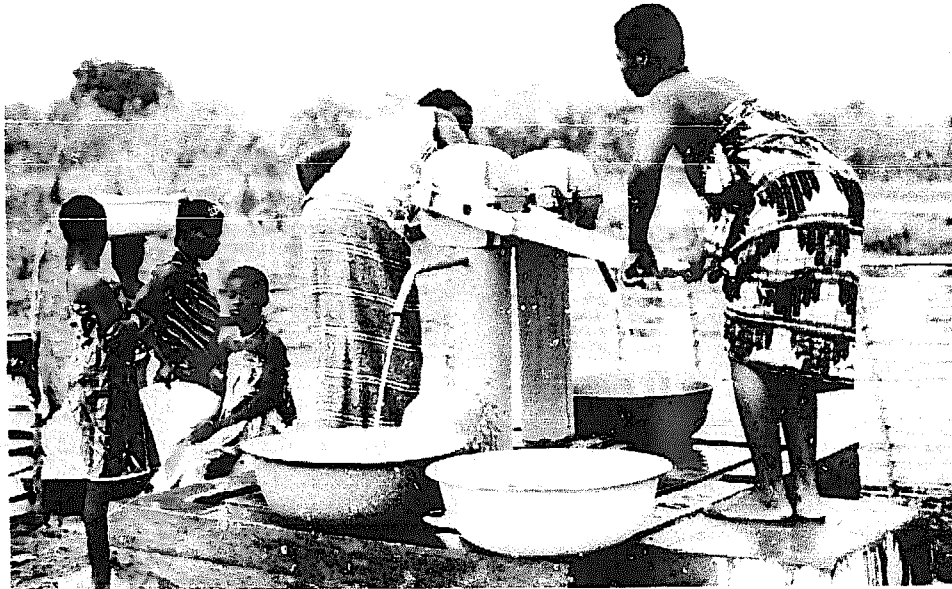

FIGURE 3-17 INSTALLATION OF TWO ASM PUMPS ON ONE WELL

The photo shows two ASM (Abi-Vergnet) handpumps installed in the same well. Such a double installation has several advantages, including shorter waiting lines for the users. The second pump provides a source of water when the first is out of service awaiting repair. Doubling the number of pumps will halve the use per pump and thus can double the time period between breakdowns and potentially can double the life of each pump. Clearly, it is less expensive to install two pumps on a single well than to construct twice as many wells. This is especially important in areas where well construction is the major cost of a rural water supply program. However, this can generally only be done when wide diameter wells are used (the Vergnet and ASM are two of the few pumps which permit installation of two pumps in a single borehole with a diameter of only 125 mm).

health and sanitation education of the rural population in order to reduce the maintenance cost of handpumps and to increase the benefits of water obtained from the boreholes equipped with handpumps.

Physical characteristics:

Man is located in the forest area in the center of the western part of the Ivory Coast. The mean annual rainfall is about 1,600 to 1,700 mm, and the topography is undulating to hilly and partly mountainous. The underlying rock consists of granite and migmatite. The typical settlement is the concentrated village.

Remarks:

The expert assigned by DCH to this field trial is especially involved in improving the ASM handpump, which is a hybrid of the locally manufactured Abi handpump and the foot-operated Vergnet pump made in France. The ASM handpump consists of the Abi pump stand and the Vergnet below ground components, and is often referred to as the Abi-Vergnet handpump. The installation of two ASM pumps on one well is shown in Figure 3-17.

Ivory Coast Field Trial II

Following are the principal features of this field trial:

Counterparts:

Government Authority: DCH (now DE)
Donor: CIDA

Field Trial Area:

Region of Man plus two additional areas to be selected.

Pumps monitored:

14 Moyno (Canada)
12 PEK (Canada)

Executed by:

Consulting firm in co-operation with government authorities, SODECI, and the Handpumps Project.

Start:

Anticipated in mid-1984

Remarks:

The main objective of this field trial is to train pump caretakers and provide health and sanitary education for villagers. Field testing of handpumps is being carried out to a limited extent and is expected to be integrated into the Field Trial I (Man).

2. Results

Field tests in the Ivory Coast Field Trial I (Man) area have concentrated mainly on technical aspects related to improving the ASM pump for the Ivory Coast. The manufacture of the ASM pump began in 1981, and by May 1984 about 3,350 pumps had been manufactured and installed mainly in the Ivory Coast (2,200), Benin (850), Burkina (100), and Mali (200). Some improvements are needed to make the ASM pump more reliable. The original reason for combining the below-ground components of the foot-operated Vergnet pump (hydraulic pump) with the pumphead of the lever-operated Abi pump was to take advantage of the best features of both pumps.

The elements that need to be improved or redesigned are:

- o The primary plunger and cylinder in the pump stand
- o The handle (weight, simplification, enlargement of bearing areas)
- o Bearings
- o The connection of the primary plunger rod to the handle

Both field and laboratory tests support this finding. It is anticipated that cooperation between the expert in charge of the Ivory Coast Field Trial Man and the manufacturer, together with the contributions of CATR and SODECI, will result in an improved ASM handpump that will be reliable and easy to maintain on the village level.

D. MALI

1. Operation of Field Trials

The surface area of Mali is 1,240,000 km². Its total population in 1981 was 7.2 million and its rural population was 5.8 million, or 80 percent of the total. Population density was 5.8 per km². In 1983 there were approximately 1,500 handpumps installed throughout the country.

The following are the principal features of the field trial in Mali:

Counterparts:	Government Authority: DNHE Donors: Swiss Government, Helvetas
Integrated into:	Helvetas Well Drilling Project
Field Trial Area:	Districts of Bougouni, Yanfolila, Kolondieba
Base of Monitoring Team:	Bougouni
Pumps Monitored:	25 Vergnet (France)
Executed by:	Helvetas project staff

Start: December 1983

Maintenance structure: The handpumps (Figure 3-18) are repaired and maintained by village and local mechanics. The maintenance costs are borne by the villagers, who also contribute to the purchase and installation of the pumps.

The distribution of spare parts and the cost of spares and repairs are handled by the project.

Physical Characteristics: The field trial area is located in the savanna zone of southern Mali, which has a mean annual rainfall of approximately 1,300 mm. Granite is the dominant rock type and the topography is flat to rolling. Villages are the typical form of rural settlement.

Remarks: During the first phase of the Helvetas project, which was terminated in mid-1983, 320 successful boreholes were drilled. Since then the project has been extended into a second phase.

Helvetas has been testing a number of different types of pumps (Vergnet, Vergnet Pneuride, Abi, ASM, Bourga Simplex, VL 2000, India Mark II, Briau Nepta, Deplechin Tropic VII, Moyno, Pulsa, Consallen).

As a result of these tests, Helvetas is installing mainly the Vergnet pump, which is easy to maintain at the village level, is relatively reliable, and little affected by corrosion.

Helvetas focuses primarily on village participation, health and sanitary education, village-level maintenance and operation of handpumps, community development, and small-plot irrigation schemes.



FIGURE 3-18 VERGNET FOOT-PUMP IN MALI

This French-made foot-operated pump is popular in some parts of Western Africa, where more than 14,000 have been installed. In the photo two youngsters are jointly operating the pump, with each placing one foot on the pedal. They have placed stones next to the pump on which each places his other foot.

E. NIGER

1. Operation of Field Trials

The surface area of Niger is 1,260,000 km². Its total population in 1981 was 5.5 million and its rural population was 4.8 million, or 87 percent of the total. Population density was 4.3 per km². In June 1981 there were approximately 375 handpumps installed throughout the country.

The following are the principal features of the field trial in this area:

Counterparts: Government Authority: Ministry of Hydraulics
Donors: GTZ, AFVP

Integrated into: 200 Dug Well Project in the Department of Niamey

Field Trial Area: Districts of Filingue, Quallam and Kollo

Base of Monitoring Team: Niamey

Pumps Monitored: 40 Deplechin (Belgium)
40 India Mark II (India)

Executed by: GTZ, with assistance from AFVP

Start: May 1983

Maintenance Structure: The policy of the government is that the recurrent costs of maintaining and repairing handpumps as well as replacing those that are worn out are to be financed by the villagers.

Maintenance is beginning to be performed by village pump caretakers and local mechanics (artisans). The distribution of spare parts is to be assured by the pump manufacturers through a distribution network. The system is still in the initial stages.

Physical Characteristics: The field trial area is situated north and northeast of Niamey and extends to the northern-most point of the Western Africa Region. The mean annual rainfall of the savanna zone in this area is in the range of 500 to 700 mm. Sedimentary rocks (sandstone, siltstone) are abundant and are partly covered by dunes. Settled farmers live in villages in the area, but it is also frequented by herdsmen with their cattle.

Remarks:

The Niger field trial is unique within the Region because the pumps to be monitored are being installed on large-diameter dug wells (one Deplechin and one India Mark II pump are being installed on each well.)

The field trial is being executed by GTZ in cooperation with the AFVP volunteer program and includes well-selection, mobilization of villagers, pump installation, and training of pump caretakers and mechanics. The first pumps were installed in February 1984 and all 80 pumps are expected to be in place by the end of 1984.

2. Results

The tasks added to pump monitoring in Niger, such as pump installation, pump caretaker training, and so on, have been extremely time-consuming and have caused delays in the start of the field tests. Well selection has been difficult because relatively few dug wells comply with the selection criteria (water depth in the well, acceptance by villagers, use, location, access, etc.). However, the results that will be gained from the Niger field trial are of interest in that two types of conventional pumps are being installed on the same well—India Mark II (lever-operated pump) and Deplechin (flywheel-operated pump)—and the results compared. In addition, handpumps are being installed on large-diameter dug wells using rising mains made of steel and plastic. Furthermore, pump caretakers and local mechanics will be trained, and the distribution of spare parts is being monitored. The acceptance of pumps by villagers and their participation in the program is another important factor to be monitored in Niger.

F. BURKINA

1. Operation of Field Trials

The surface area of Burkina is 274,000 km². The total population in 1981 was 7.1 million and the rural population was 6.5 million, or 71 percent of the total. Population density was 25.9 per km². In 1982 there were approximately 1,500 handpumps installed throughout the country.

The following are the principal features of the field trial in this area:

Counterparts:

- (a) Government Authority: HER
- (b) Donor: Dutch Government
- (c) Cooperation: FED, UNICEF, USAID

Integrated into:

- Dutch Project Volta Noire (Dedougou)
- USAID Project (Bobo Dioulasso)
- UNICEF Project (Ouagadougou)
- FED Project (Ouahigouya)

Field Trial Area: Provinces of Bourkina, Passore, Moun-Hou
(Volanta pumps)
Province of Houet (Moyno pumps)
Province of Oubritenga
(India Mark II pumps)
Province of Yatenga (Vergnet pumps)

Base of Monitoring Team: Ouagadougou

Pumps Monitored: 50 Volanta (Burkina/The Netherlands)
50 Moyno (USA)
30 India Mark II (India)
25 Vergnet (France)

Well Characteristics:

<u>Volanta pumps</u>	
Well depth	36 m (16 to 59 m)
Static water level	15 m
Depth of pump cylinder	27 m (15 to 41 m)
<u>Moyno Pumps</u>	
Well depth	42 m (10 to 128 m)
Static water level	14 m
Depth of pump cylinder	30 m (9 to 59 m)
<u>India Mark II Pumps</u>	
Well depth	25 m (13 to 50 m)
Static water level	11 m
Depth of pump cylinder	21 m (12 to 30 m)

Vergnet Pumps*

Executed by: Monitoring Team
(1 CME, 1 HER mechanic, 1 HER driver)

Maintenance structure: The maintenance and repair of handpumps have been the responsibility of the government and rural water supply projects, respectively, with little or no village participation. Efforts are now being made to transfer the maintenance of handpumps, including the financing of the recurrent costs, to the villagers.

The structure of the FED project is considered to be a model. Within this project the handpumps are maintained and repaired by pump caretakers and village mechanics and are financed by the villagers.

* Because the Vergnet pump is just beginning to be monitored, insufficient field test results are available to provide meaningful summary data.



FIGURE 3-19 VOLANTA PUMP IN BURKINA

This deep set handpump is a candidate for VLOM classification. It is manufactured in both Burkina and The Netherlands and uses a rotary handle to drive a piston assembly. Its rising main is of a sufficient diameter so that the piston assembly can be pulled up through it for maintenance, without the need for special hoisting equipment. The Volanta pump in the photo has been equipped by the Project with a water meter in order to indicate the amount of use it receives.

The types of pumps used account for the different approaches that the projects in Burkina have adopted in maintaining handpumps. The FED project uses the Vergnet as their standard pump and the Dutch project uses the Volanta pump, both of which are suitable for village-level maintenance. On the other hand, the pumps installed in the USAID (Moyno) and UNICEF (India Mark II) projects are not as suitable for village repair as are TOM pumps, at least in the below-ground structure. One of Volanta pumps tested in Burkina is shown in Figure 3-19.

Physical Characteristics: The field trial area comprises four zones in the savanna zone which has a mean annual rainfall between 1,200 to 1,400 mm (Bobo Dioulasso) and 700 to 900 mm (Ouahigouya). The topography is flat to undulating except for an escarpment in the area of Bobo Dioulasso. The dominant rocks in the field trial area are granite, migmatite, volcanic sediments, and sandstone. In Ouahigouya the settlements consist of scattered villages, while concentrated villages are typical in the other areas.

2. Results

Condition of Handpumps

The condition of Moyno, Volanta, and India Mark II pumps monitored between February 1983 and March 1984 in the Burkina test area is depicted in Figure 3-20. The average well depth, static water level, and installation depth of the pump in the three pump areas differ as follows:

Moyno pumps: The defects responsible for poor performance decreased significantly from about 40 percent to 20 percent over the period of time considered. The number of pumps in good condition increased from about 40 percent to over 60 percent, and the out-of-order defects have dropped below 10 percent during the same period. Two factors probably account for this change:

- o Replacement of worn out rotors and stators.
- o Impact of the project monitoring team (reporting of pump failures).

The out-of-order defects found on Moyno pumps in this field trial are comparable to those reported from the Ghana Field Trial I.

FIGURE 3-20 CONDITION OF PUMPS IN BURKINA
(FEBRUARY 1983 TO MARCH 1984)

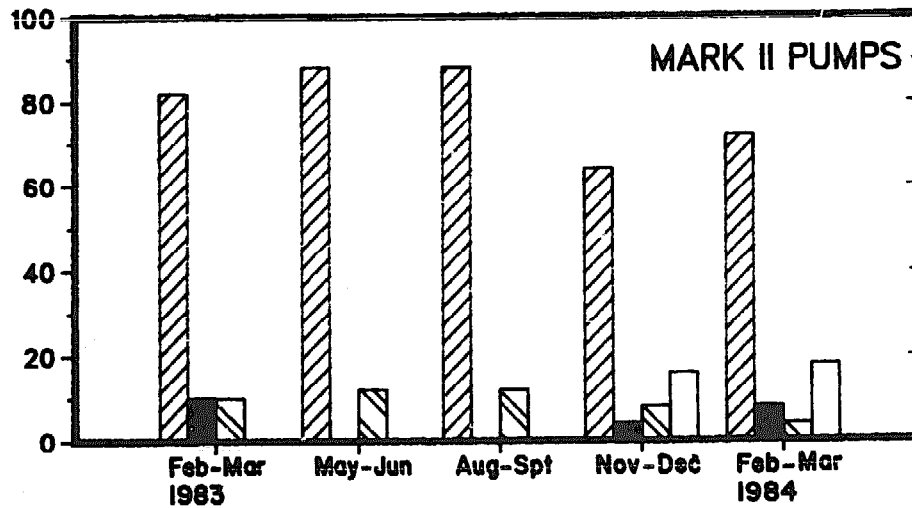
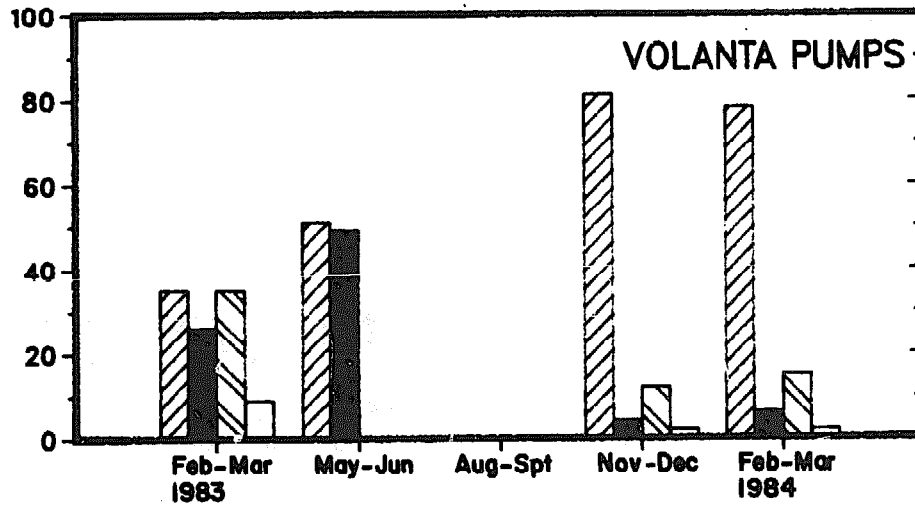
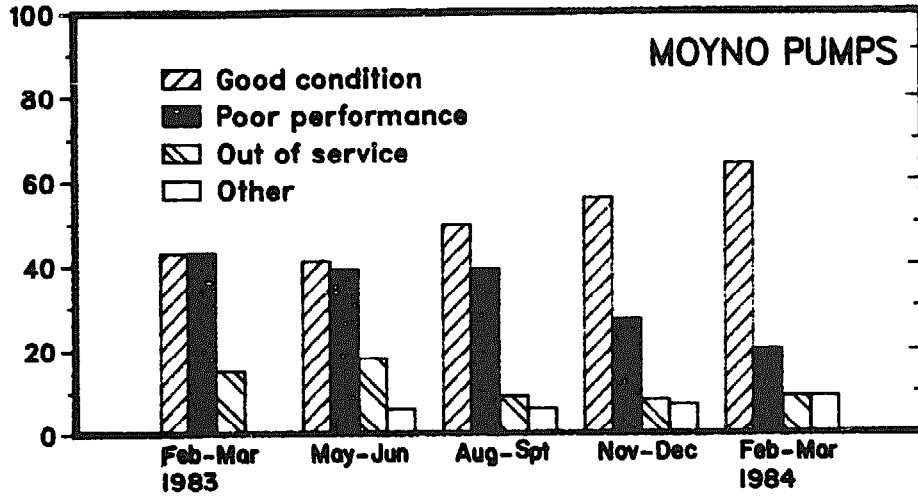

Volanta pumps: There are two reasons for the relatively poor performance of the Volanta pumps during the first two monitoring visits:

- o The pumps were still equipped with cables and most of the rising mains had threaded joints.
- o The maintenance system for these pumps had not been adequately set up.

During the monitoring period the cables were replaced by rods and the rising mains were solvent cemented. The main failures of the Volanta pumps were broken cables and leakage due to cracked and badly joined plastic rising mains (defective threads). Field experience with the Volanta pump now indicates that the main causes of failure have been removed; no major design changes are anticipated.

India Mark II pumps: The India Mark II pumps have performed well. The failures that have occurred are similar to those in the Ghana Field Trial I.

Pump Performance

Discharge rate: The maximum, minimum and average discharge rates at 30, 50 and 70 strokes or revolutions per minute during the monitoring visits between February and March 1984 are presented in Table 3-4. Average discharge rates for the Moyno, Volanta and India Mark II also are plotted in Figure 3-21. The discharge rates of the India Mark II (2-1/2-inch cylinder) and the Volanta pumps are about the same. The average and the maximum discharge rates of the India Mark II and Moyno pumps correspond to those measured in the Ghana Field Trial I during the same period.

Wear of Cup Seals and Scaling of Rotors: Figure 3-22 shows examples of how the wearing of cup seals (India Mark II) and scaling of rotors (Moyno) develop under unfavourable conditions.

Table 3-4 Discharge Rate Versus Handle Speed
for the Moyno, Volanta, and India Mark II Pumps

Pump	Discharge rate at 30 strokes or revolutions/minute			Discharge rate at 50 strokes or revolutions/minute			Discharge rate at 70 strokes or revolutions/minute		
	(lpm)			(lpm)			(lpm)		
	Max	Min	Ave	Max	Min	Ave	Max	Min	Ave
Moyno 1V1	8.3	0.7	6.6	14.1	1.0	10.6	19.8	0.8	14.2
Volanta	16.8	1.6	8.1	27.7	3.0	14.9	36.0	2.2	21.2
India Mark II (2.5 inch)	11.6	4.1	10.6	26.7	3.8	17.7	30.0	9.5	23.8

Note: lpm = liters per minute

FIGURE 3-21 DISCHARGE RATE VS. STROKES PER MINUTE
BURKINA FIELD TRIAL

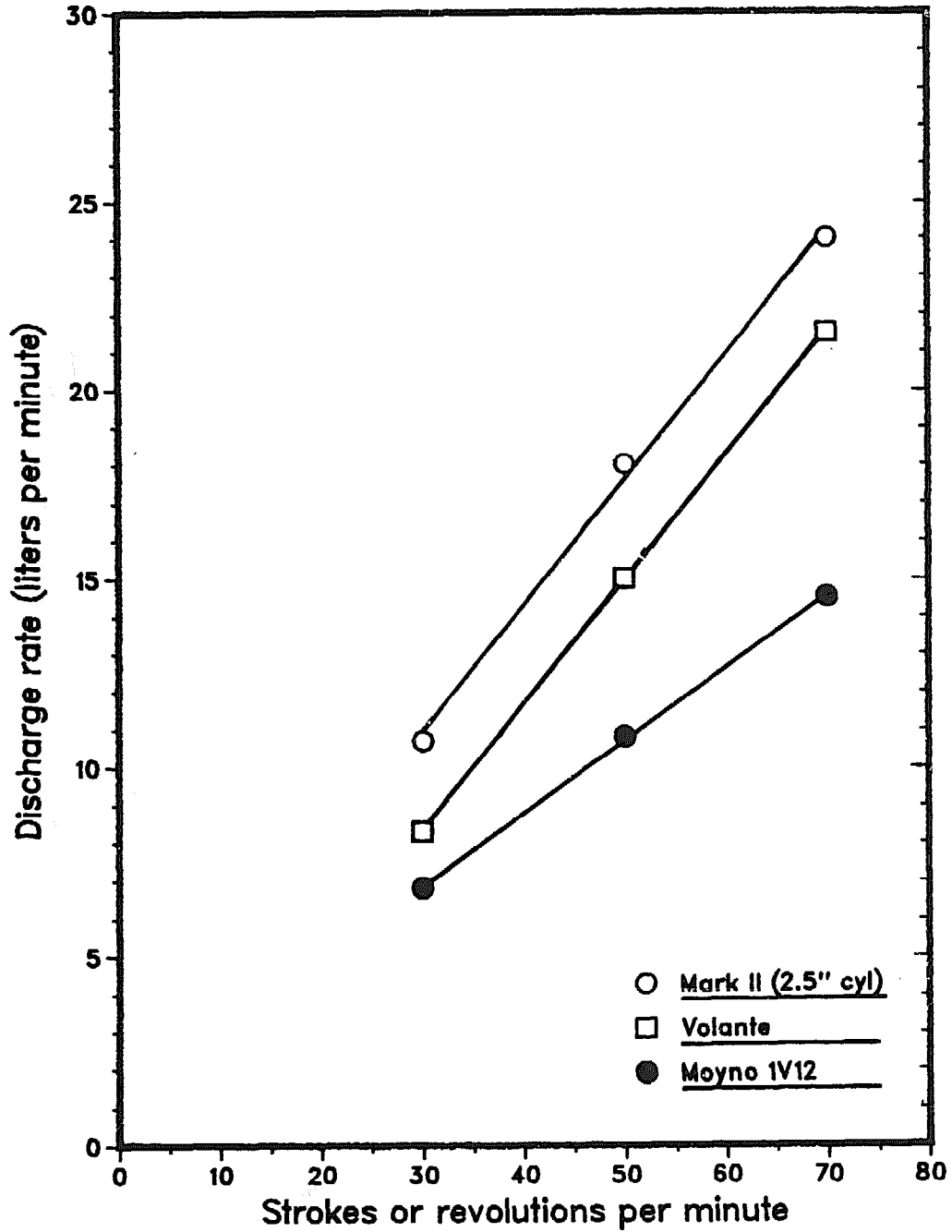
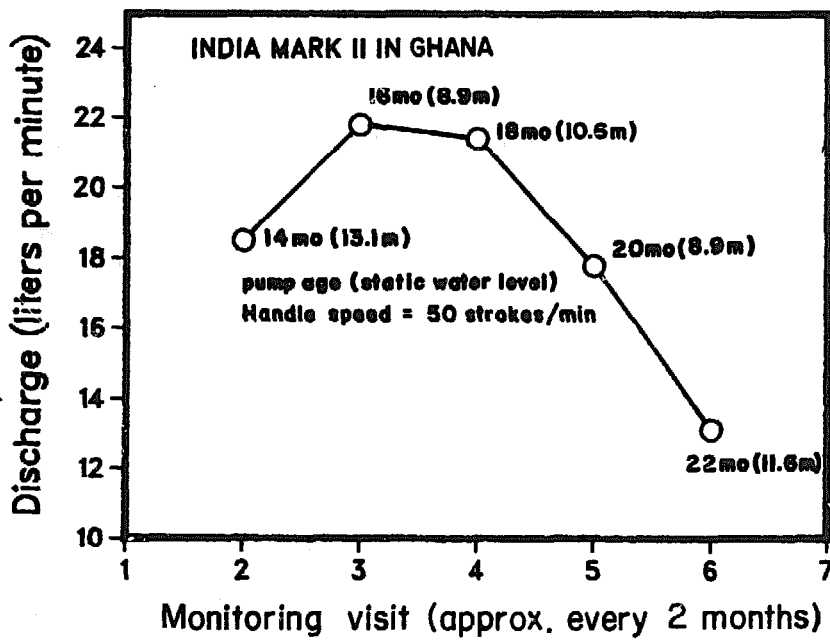
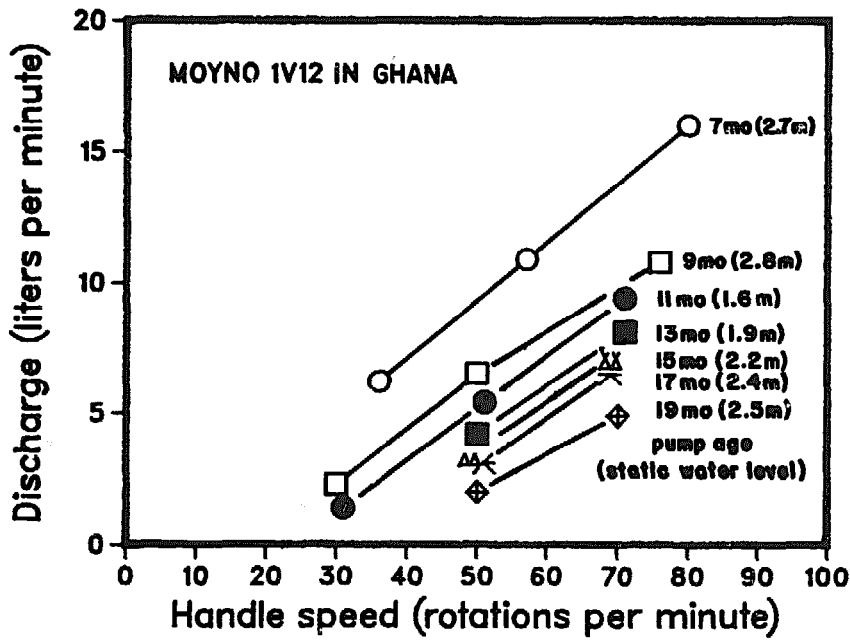

FIGURE 3-22 DISCHARGE RATE VS. HANDLE SPEED AND AGE



Water Quality

In Table 3-5 the temperature, pH, turbidity and iron content are summarized for the three areas in which there are Moyno, Volanta and India Mark II pumps. The data were collected from August to September 1983 (end of the rainy season) and from February to March 1984 (dry season). Related comments include:

- o The extreme groundwater temperatures are 28 and 32°C with an average of approximately 30°C. This is about 5°C higher than the temperatures in the Ghana Field Trial I (Kumasi).

An interesting point is that there is an inversion of the seasonal variations between the two field trials. In the savanna region (Burkina), the groundwater temperature is higher during the rainy season than during the dry season, while the opposite is the case in the forest area (Ghana).

- o The pH varies slightly between the three areas of the Moyno, Volanta and India Mark II pumps with averages between pH 6 and 6.8. The percentage of wells with pH lower than or equal to 6.5 is as follows (February - March 1984):

Moyno	64 percent
Volanta	33 percent
India Mark II	54 percent

- o There are notable seasonal differences in turbidity in the water pumped with Moyno and India Mark II pumps. Both show higher turbidities during the rainy season. The reason for this might be the wells (type, quality/condition), particularly since both boreholes and dug wells are equipped with handpumps. It is relevant to mention that Moyno pumps in the field trial areas have been more frequently installed on dug wells than other pumps have been.
- o The iron concentration in the three areas is between nil and 3 mg/l, with an average of 0.8 mg/l. The water pumped with Volanta pumps has the least iron content (0.2 mg/l). The main reason for this is most likely the fact that the Volanta pump is not, or is only slightly, corrosive (using plastic rising mains and non-corrosive metals).

Table 3-5 Water Quality Parameters in Burkina Faso

Pump	Date	Temperature (°C)			pH			Turbidity (FTU)			Total Iron (mg/l)		
		Max	Min	Avg	Max	Min	Avg	Max	Min	Avg	Max	Min	Avg
Moyno 1V12	Aug- Sept 1983	31.6	28.0	29.7	7.9	5.4	6.5	330	0	25	3.0	0.02	1.4
	Feb- March 1984	30.4	28.0	29.3	7.6	5.1	6.2	43	0	5	NA	NA	NA
Volanta	Aug- Sept 1983	32.0	29.6	31.1	7.8	5.4	6.5	43	0	2	1.9	0.01	0.2
	Feb- March 1984	32.0	28.2	30.6	7.9	5.7	6.8	51	0	6	NA	NA	NA
India Mark II (2.5 inch)	Aug- Sept 1983	31.4	30.2	30.8	6.8	5.3	6.3	130	0	12	1.9	0.05	0.8
	Feb- March 1984	30.8	28.8	30.3	7.0	5.9	6.0	20	0	4	NA	NA	NA

Note: Temperature, pH, turbidity and total iron measurements of groundwater taken at Moyno, Volanta, and India Mark II pumps in August-September 1983 (rainy season) and February-March 1984 (dry season).

Number of samples: Moyno (45), Volanta (42), India Mark II (26).
Results quoted as: Maximum (Max), Minimum (Min), Average (Avg)

CHAPTER 4

EAST ASIA AND PACIFIC

A. INTRODUCTION

The UNDP/World Bank Project in the East Asia and Pacific Region operates in the Peoples Republic of China, Papua New Guinea, the Philippines, and Thailand. The Regional Project Officer is stationed at the World Bank Office in Bangkok and assumed his duties in July 1983.

It is planned that a total of 813 pumps will be field or laboratory tested in the Region. As shown in Table 4-1, 65 percent of these will be locally manufactured. For a complete list of pump types to be tested in each of the four countries see Table 1-2 in Chapter 1.

Table 4-1 . Number of Pumps in East Asia and Pacific Region

Country	Imported Pumps	Local Pumps	Total Pumps
China	202	167	369
Papua New Guinea	22	45	67
Philippines	56	160	216
Thailand	31	130	161
Total	311	502	813

In the East Asia and Pacific Region there are few conclusive results so far because of the short period that monitoring has taken place in this Region, although there are some preliminary results related to design of locally made pumps, pump breakdowns during field trials, and water quality problems.

As shown in Table 4-2, most of the locally-made handpumps were installed in Thailand, the Philippines and in Papua New Guinea by the end of 1983 and the monitoring was in full swing by the beginning of 1984. In China most locally-made pumps were installed by mid-1984. The arrival of the foreign-made pumps in the Philippines, China and Thailand took longer than expected and their installation is expected to be completed only by the end of 1984.

Table 4-2 Work Plan for 1984 for East Asia and Pacific

Activities	Jan	Feb	Mar	Apr	May	Jun	Jul	Aug	Spt	Oct	Nov	Dec
<u>CHINA</u>												
Lab Beijing				Construction			Installation		Testing			
Lab Hunan			Modify		Installation			Testing				
Local Pumps		Installation						Field Trials				
Foreign Pumps										Installation		
<u>THAILAND</u>												
Local Pumps	Installation						Field Trials					
Foreign Pumps							Installation		Field Trials			
<u>PHILIPPINES</u>												
Local Pumps				Installation			Field Trials					
Foreign Pumps										Installation		
<u>PNG</u>												
Local Pumps	Field Trials											

The construction of a handpump testing laboratory in Beijing was completed in mid-1984 and another laboratory in China, located in Changsha, has been expanded to test primarily low-lift irrigation pumps. The Workshop on Handpumps and Their Application in Water Supply and Sanitation, jointly organized by the Ministry of Machine Building Industry, the World Bank and UNDP was held in China in August 1984, followed by the meeting of the project's Advisory Panel. The proceedings of the workshop will be published as Management Report Number 5.

The primary emphasis of the Project in this region is to improve the design and local manufacture of handpumps for shallow as well as deep water tables. A variety of locally-made pumps already exists, that in some cases can be improved in both design and quality for greater durability. Several local manufacturers have already responded by improving their products or by beginning the manufacture of handpumps. Pumps brought in from outside the Region will demonstrate some novel design features related to the VLOM concept and may lead to the establishment of joint ventures in local manufacturing. The study and demonstration of proper borehole construction is also included.

B. CHINA

Project activities in China are taking place against the following background:

- o The potential number of future handpump users, estimated at over 550 million persons, is larger than that in any other country.
- o Prior to the commencement of Project work in China, deep-well (i.e. non-suction type) handpumps were not commonly used.
- o A large variety of locally manufactured suction type handpumps are in use in China, and prior to Project activities there was no central source of information about them nor were any laboratory or field data available for comparing their performance.
- o The development of the plastics industry is uneven in China, and there is a potential for the Project to assist with improving the manufacturing capability related to handpump components which could be made of plastic.
- o The Project is assisting with the establishment of two handpump testing laboratories in China, drawing on the experience of the laboratory of the Consumers' Association Testing and Research (CATR) facility in the United Kingdom.

The Project activities in China include not only field testing but also the establishment of the two above-mentioned handpump testing laboratories. The purpose is to develop locally-manufactured handpumps by transferring the experiences and developments related to handpumps in other countries and by using this as a base from which further development can take place within China itself. A coordinated and objective comparison will be made in China of the performance of both locally made and imported handpumps. The Project will also support improvements in design and manufacturing of handpumps.

Immediately after the signing of the cooperation agreement in April 1983 for handpumps testing in China, a survey of Chinese handpumps was made by the Chinese Academy of Agricultural Mechanization Sciences (CAAMS), a translation of which is included in this report as Annex C. In September 1983 a team of Chinese engineers went on a study tour of the Consumers' Association Testing and Research Laboratories in England, when two Chinese-made handpumps were tested for demonstration purposes at CATR. They also visited pump manufacturers and other institutions in both the United Kingdom and the Federal Republic of Germany.

As described on the following pages, the Project is now preparing to test 49 pumps in two laboratories in China and to field test 320 pumps representing 22 pump models.

Table 4-3 Pumps Tested in China

Pump	Country of Origin	Quantity	Application	Utilization	Method of Operation
Mono	U.K.	10	Deep	Drinking	Hand/Rotary
Mark II	India	34	Deep	Drinking	Hand/Piston
Maldev	Malawi	34	Deep	Drinking	Hand/Piston
TARA	Bangladesh	44	Intermediate	Drinking	Hand/Piston
Blair	Zimbabwe	34	Shallow	Drinking	Hand/Piston
Consallen	U.K.	12*	Deep	Drinking	Hand/Piston
Kardia	F.R.G.	12	Deep	Drinking	Hand/Piston
Turni	F.R.G.	12	Deep	Drinking	Hand/Rotary
Rower	Bangladesh	5	Shallow	Irrigation	Hand/Piston
Treadle	Bangladesh	5	Shallow	Irrigation	Hand/Piston
SYB-80	China	22	Shallow	Drinking	Hand/Piston
SYB-100	China	25	Shallow	Drinking	Hand/Piston
SY-81	China	17	Shallow	Drinking	Hand/Piston
Rotary	China	27	Intermediate	Drinking	Hand/Rotary
Diaphragm	China	3	Shallow	Irrigation	hand/Diaphragm
MB-290	China	3	Shallow	Irrigation	Hand/Diaphragm
1-1/2SB	China	3	Shallow	Irrigation	Foot/Centrifugal
402 Jinshan	China	3	Shallow	Irrigation	Foot/Bicycle
Peijang	China	3	Shallow	Irrigation	Foot/Pedal
4D120	China	3	Shallow	Irrigation	Animal/Piston
SM-2	China	17	Shallow	Drinking	Hand/Diaphragm
SLB-80	China	41	Deep	Drinking	N.A.
Total		369**			

* The order for Consallen pumps has been delayed while the manufacturer is making some design modifications.

** The total of 369 pumps includes 8 spares of foreign origin.

1. Participating National Organizations

In China, the principal counterpart is the Chinese Academy of Agricultural Mechanization Science (CAAMS) in Beijing, which is responsible for all activities of the Project in the country. The second counterpart is the Hunan Research Institute of Agricultural Machinery in Changsha (Hunan Province), whose main task is the modification of an existing laboratory to accommodate the testing of Chinese and foreign made low-lift water supply and irrigation pumps. The third counterparts are the local authorities implementing the field trials. In Jincheng County (Shanxi Province) a special office for the field trials has been established with seven full-time employees within the Water Resources Bureau. In Changsha and Wangsheng Counties in Hunan Province the responsible authority for the field trials is the Hunan Public Health Bureau. Whenever necessary, the Hunan Research Institute of Agricultural Machinery provides assistance. On the national level, the Ministry of Machine Building Industry and the Patriotic Health Campaign Committee (Ministry of Health) provide overall coordination. The brigades in each county are directly responsible for the maintenance of the pumps. The Project has conducted training courses for the brigade handpump caretakers.

2. Pump Models and Quantities

The Survey of Chinese Handpumps includes a large variety of shallow-well suction pumps using piston, centrifugal, and diaphragm designs, some for water supply and some for irrigation. However, it was found that no deep-well handpumps were in use in China. Another significant finding was that all existing Chinese made pumps are made of metal. As a result of Project activities, two deep-well pumps are now being manufactured in China: the SLB-80 and the Rotary pump.

A total of 369 pumps will be field-tested over at least eight months. This will include 167 Chinese made pumps and 202 pumps of foreign origin, including eight pumps of foreign origin to serve as spares. The pump makes and summary information about them are presented in Table 4-3.

All of the pump models which are included in the China field trials will also undergo laboratory testing. A total of 31 high and low lift pumps, representing 13 different models, will be tested in the laboratory in Beijing. The construction of this laboratory began in March 1984 and was completed in June 1984. Eighteen low-lift pumps, representing nine models, will be tested in an existing laboratory in Changsha, Hunan Province, which is being modified and expanded for this work.

3. Site Selection

Up to now only existing open wells have been used for the field trials, although it is intended that wells would be either drilled or hand dug. Since the static water level is high throughout Hunan Province, all deep-well pumps such as the India Mark II will be allocated to Shanxi Province, where the static water level varies depending on location from 6 to 35 m or deeper.

There have been 312 sites identified. Of these, 150 are in Hunan Province, with static water levels between 0 and 10 meters. In Shanxi Province 162 sites have been selected, 52 of which have static water levels between 20 and 35 meters, and the remaining 110 have levels between 10 and 25 meters.

4. Pump Installation

The installation of the Chinese made pumps began in February 1984. Installation of pumps of foreign origin is planned for the last half of 1984.

5. Monitoring

The Project Country Monitoring Engineer is responsible for the monitoring of the approximately 162 pumps scattered over 12 communes in Jincheng County and also for supervising the monitoring of another approximately 150 pumps carried out by the Hunan Research Institute of Agricultural Machinery in Changsha and Wangsheng Counties. He is part of an office provided and especially established for the Project by the Water Resources Bureau in Jincheng City, Shanxi Province.

The field monitoring of Chinese-made pumps began in April 1984, and monitoring of foreign-made pumps is scheduled to begin in late 1984. Tests in the Chinese laboratories will begin in the second half of 1984.

6. Results

The newly developed deep well SLB-80 piston handpump has performed poorly in the field, mainly because it is a new product. Shearing of handle bolts through excessive wear is one of the more serious problems. The other deep well pump, which is also a new design but of the rotary type, has gone through a similar experience, with the flow rate dropping rapidly, almost day by day. Other problems are cracked gear boxes and unthreading of rising mains. The Project has suspended the installation of more of these pumps until necessary design changes have taken place. In September 1984 the manufacturers will receive technical assistance in this regard by a foreign consultant provided by the Project. This will in all likelihood also call for the discontinuation of the manufacture of certain unsuitable pump designs.

Recent field results have indicated that problems are being encountered with the SYB-80 and SY-81 suction pumps as well as the SM-2 diaphragm pump. Because of the fundamental nature of the problems with the SM-2 diaphragm pump (rubber diaphragm and general weak design) it will probably be removed from the field trials. Early problems with the SYB suction pump were solved by modifying the bearings and providing a longer handle. Performance is now good and the pump is well accepted by the villagers.

The Project will install twenty water meters of local design to monitor the usage of the pumps. In the meantime, one typical suction pump installation of an SY-81 in Jincheng, was surveyed for one full day on June 28, 1984. The number of villagers carrying water was recorded as 198, which was less than one-third of normal because people were busy with harvesting.

Table 4-4 shows preliminary averages of performance characteristics collected from five SM-2 diaphragm pumps, ten SYB-80 suction pumps, five SY-81 suction pumps and five SYB-100 suction pumps.

Table 4-4 Performance Data for Chinese-Made Pumps*

Pump	Static Water Level (m)	Average** Volumetric Efficiency (%)	Average Flow rate (l/min)	Handle Lever Ratio	Date of Installation
SM-2	3.56	107%	40	1:7.5	Apr 84
SYB-80	3.05	107%	33	1:5.0	May 84
SYB-81	2.52	112%	37	1:5.5	May 84
SYB-100	2.12	108%	48	1:4.5	May-84

* Performance was measured while pumping at the rate of 40 strokes/minute.

** See Table 3-3 for definition and explanation.

C. PAPUA NEW GUINEA

1. Participating National Organizations

The main Project counterpart in Papua New Guinea is the Appropriate Technology Development Institute (ATDI) of the Papua New Guinea University of Technology, Lae, Morobe Province.

While ATDI is coordinating the project, the actual implementation is carried out in Morobe Province in the Markham Valley and the coastal areas of the province by the local government in Lae, partly by the Department of Health and partly by the Department of Works and Supply. The maintenance of the pumps in the Project is the responsibility of the Department of Works and Supply at the request of the ATDI coordinator.

In addition to the work which is formally part of the Project in Morobe Province, other work is being done in the Central Province in Port Moresby by a hydrogeologist working with the Department of Minerals and Energy.

2. Pump Makes and Quantities

In Papua New Guinea only locally-available pumps are being tested, as follows:

Table 4-5 Pumps Tested in Papua New Guinea

Pump	Country of Origin	Quantity	Application	Remarks
MVP-Pump	PNG	25	Shallow	Blair Pump derivative made in Lae, PNG
Onga	Czechoslovakia	22	Made in Shallow	Imported via Australia
GSVWP	PNG	20	Shallow	Blair pump derivative made in Port Moresby
Total		67		

The local derivative of the Blair pump is made almost entirely of standard Australian PVC pipe fittings. Because at least thirty percent of the populated area in Papua New Guinea is suitable for low-lift pumps, the local derivative of the Blair pump is a potentially advantageous alternative to the suction pumps of Japanese origin such as the Fuji, Kawamoto, and Rocket with which there have been some performance problems. The same applies to the Lucky suction pump made in Taiwan. It is, therefore, encouraging to see that the local derivative of the Blair pump is gaining ground, with a possible export of technology to the Solomon Islands, Fiji Islands, and Vanuatu Island in the South Pacific.

3. Site Selection

In the Markham Valley in Morobe Province, 47 handpump sites were selected by the end of 1983. In addition, at least twenty sites will be provided by the Department of Minerals and Energy in the Central Province, Port Moresby, which will provide information for the Project although they are not explicitly mentioned in the Project agreement.

Province	Number of Sites	Static Water Level
Morobe	47	6m
Central*	20	6m
Total	67	

* Handpump sites in the Central Province are informally available for field testing.

Existing wells are used at the sites in Morobe Province, but all of the locations in Central Province have new tube wells drilled by hand augering and bailing.

4. Installation of Pumps

All 25 locally-made Blair derivative pumps (inside cylinder diameter 40 mm) had been installed by early February 1984. Two Onga suction pumps (cylinder diameter 90 mm), which had been previously installed, were selected for testing.

The tests and development of a different locally-made Blair derivative pump in the Central Province by the Department of Minerals and Energy has yielded some valuable results. A local derivative of the Blair pump has been developed based on designs provided by the Project. To date, 20 locally-made, modified derivatives of the Blair pump have been installed and are being monitored.

It had been planned that hand augering, which was successfully employed in Central Province, would also be used in Morobe Province to drill additional wells. It was found, however, during trials in April 1984 that the existence of large boulders in the alluvial material makes hand augering with light equipment unsuitable for that part of the country. Tests with heavy hand augering equipment in October likewise proved unsuccessful.

5. Monitoring

In Morobe Province, a Canadian Research Engineer working within the Department of Works and Supply at the Provincial Office in Lae has been appointed Country Monitoring Engineer. In Central Province monitoring is being done by a hydrogeologist from the Geological Survey.

6. Results

The volumetric efficiency of the Blair derivative improved greatly following replacement of the original foot valves: when measured in January 1984 shortly after most of the foot valves were changed, the average

volumetric efficiency of three pumps which did not have new foot valves was 60 percent, and the average volumetric efficiency of 21 pumps which had new foot valves was 89 percent. When measured again in June 1984, the drop in average volumetric efficiency was less than 10 percent. This performance is encouraging and the Blair derivative is beginning to win back the villagers' confidence, which was lost when foot valves on the old version were malfunctioning. The villagers at Wampit, for example have beaten well worn paths to the Blair pump installed at the school site and have asked for a pump of their own. The average volumetric efficiency of two Onga pumps which were measured fell slightly from 86 percent in January 1984 to 80 percent in June 1984.

Had spare parts been required for the Blair derivative, such as piston and cylinder valves, procurement problems would likely have been encountered. There has been a shortage of PVC 25 x 20mm reducer couplings and brass washers in Lae. A special order to Port Moresby by the ATDI for the reducer coupling has resulted in the receipt of coupling with the same nominal dimensions, but different external and internal diameters, making it very difficult to properly seat the brass washer. The brass washers had to be specially machined in Lae at a cost of US\$3.75 per washer. This points to the need to have an agency responsible for stocking spare parts, as for example the Health Department, perhaps utilizing their rural health centers throughout the province as distribution points.

The Blair derivative pump manufactured at the Village Technology Foundry in Lae has not been successful and the production was terminated in late November 1983, having produced only 10 pumps. A number of problems were identified such as:

- o Dislocation of the brass pin at the foot valve.
- o The glass marble used as a ball check valve became wedged between the pin and the inside surface of the bushing.
- o Cracking of the galvanized iron spout pipe.
- o Cracks in the well cover emanating from the anchor bolts.
- o A lack of spare parts in stock.
- o Wearing of the brass pin in the foot valve.
- o Inadequate base mounting.

Because of repeated problems with the Lae design of the Blair derivative pump, it was decided to adapt the design used in Central Province. A production line was established at the Health Department's workshop in Lae. All 25 required Blair derivative pumps of that design were assembled and their monitoring will begin shortly.

D. PHILIPPINES

In the Philippines the Project is monitoring the performance of both locally-manufactured and imported handpumps, with pumping depths ranging from 0 to 45 meters. Most of the existing locally produced pumps are actually hybrids of local pump heads combined with pistons and cylinders imported from Japan. However, the Project has brought about the local production of a complete Blair derivative pump including head, cylinder, and piston, with its design based on the Central Province version from Papua New Guinea. Installation of pumps began only in late 1983, and therefore results from the monitoring are not anticipated until late 1984.

1. Participating National Organizations

In the Philippines, the main counterpart is the Ministry of Public Works and Highways (MPWH). In order for the Ministry to handle the increased activities in the International Drinking Water Supply and Sanitation Decade, a special Project Management Office for rural water supply was established in 1981, which also deals with international agencies.

The Rural Water Works Development Corporation (RWDC) within the Ministry of Human Settlement is forming Rural Waterworks and Sanitation Associations (RWSA) for every village receiving handpumps. These associations will be responsible for maintenance.

The activities of the Handpumps Project in the Philippines are in some respects complementary to the First Rural Water Supply and Sanitation Loan provided by the World Bank. MPWH and RWDC are constructing wells and installing handpumps as part of a project covered by the loan, while the Country Monitoring Engineer of the Handpumps Project provides technical assistance in site selection and pump installation. He also monitors the handpumps and reports the results to MPWH, RWDC, and the manufacturers.

Four provinces, all in the vicinity of Metro Manila, are involved in the Handpumps Project.

UNICEF will install two Mono pumps (U.K.) and four Blair pumps in Bulacan Province and requested the Project to test the pumps, which was agreed.

2. Pump Makes and Quantities

The pump makes and characteristics are presented in Table 4-6. The first three pumps are of foreign origin and constitute 25 percent of the pumps to be tested in the Philippines. All of these pumps are of the reciprocating type and are used to supply drinking water. A summary of key specifications of pumps being tested in the Philippines are summarized in Table 4-7.

The handpump industry in the Philippines is, to a large extent, relying on imported cylinders from Japan while the pump heads in most cases are locally made. A Philippine PVC extruding company, Neltex, was selected to manufacture the thirty Blair derivative pumps.

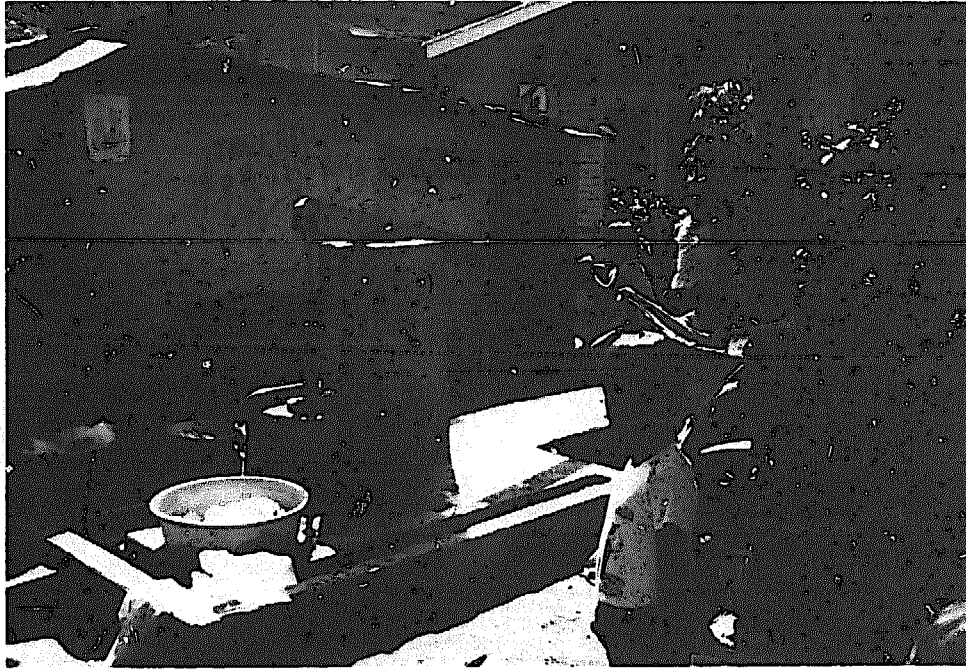

Figure 4-1 LOCAL HANDPUMP IN THE PHILIPPINES

This pump type was developed and has been manufactured in the Philippines for more than 20 years. The Project will ultimately monitor 50 such pumps.

Table 4-6 Pumps Tested in the Philippines

Pump	Country of Origin	Quantity	Application	Remarks
Mark II	India	15	Deep	—
Maldev	Malawi	15	Deep	India Mark II Cylinder
Maldev	Malawi	20	Deep	Eureka Cylinder
Local Blair Derivative	Philippines	30	Shallow	—
Jetmatic	Philippines	30	Shallow	Roboscreen
Local Pumphead	Philippines	45	Deep	Eureka cylinder
Local Pumphead	Philippines	55	Deep	Takasago cylinder
Mono	U.K.	2	Deep	Purchased by UNICEF
Blair	Zimbabwe	4	Shallow	Purchased by UNICEF
Total		216		

Table 4-7 Key Data on Pumps Tested in the Philippines

Pump	Stroke Length	Cylinder Diameter	Swept Volume	Rising Main Diameter	Pump Rod Diameter	Pumphead Unit Price
	(m)	(mm)	(l/stroke)	(mm)	(mm)	(1984 US\$)
Jetmatic	178	100	1.24	—	—	26
Eureka	254	46	0.38	50	10	77
Takasago	356	57	0.82	64	16	177 imported 255 local
Blair Derivative	610	38	0.63	38	19	105

Site Selection

The site selection was completed by the end of 1983, providing for an increase in the number of sites from 150 to 160 to include more locally available pumps. With the exception of a few shallow wells, all wells provided to the project are new tube wells drilled by the percussion method in some cases equipped with a PVC Robo well screen. The site selection is as follows:

Province	Number of Sites	Static Water Level
Batangas	61	10-45m
Bulacan	47	1-12m
Pampanga	47	0-24m
Nueva Ecija	41	9-18m
Total	216	

Installation of Pumps

The rate of handpump installation has recently been accelerated because of the arrival of a Japanese made percussion rig (diesel), which added considerable capacity to the manual percussion drilling method employed. By the end of 1984, 144 hand pumps were installed which corresponds to ninety percent of the total planned. All locally made pumps are expected to be installed by the end of 1984, including thirty locally made Blair derivative pumps. The foreign made pumps are due for arrival before the end of 1984 and will be completed by early 1985.

Monitoring

A Country Monitoring Engineer assumed his duty in September 1983 in Metro Manila. Three digital and three chemical water flow monitors as well as twenty imported water meters which were purchased locally were installed in the summer of 1984. Both the digital and chemical monitors failed whereas the other meters have worked well.

Results

In Batangas Province the static water level can be as much as 100-m deep. In such cases, a 2 1/4 inch Tagasago cylinder and a heavy duty local pump head fitted with a wooden handle as long as 4.9 m are used. The long handle reduces the required handle force to a manageable level but makes it very difficult for children to use since they are too short to reach the handle. Table 4-8 shows the calculated force which must be applied to the large wooden handle based on conditions at three different locations. In Arumahan the handle force on the rod which must be applied to lift water is approximately 150 kg-f. However, the 15:1 mechanical advantage obtained with a 4.9-m long

handle reduces the required handle force to about 23 kg-f. The large wooden handle handpump has become well accepted in the Philippines and the introduction of India Mark II and Maldev later on this year may not have the impact found in other countries.

Table 4-8 Philippine Local Pumphead: Calculated Handle Force

Location	Handle Length (m)	Mechanical Advantage Ratio	Static Water Level (m)	Cylinder Setting (m)	Rod Weight (Kg-f)	Hydraulic Force (Kg-f)	Total* Force (Kg-f)	Force on Handle (Kg-f)
Bago	3.7	1:11	34	61	95	86	181	16
Sabang	4.3	1:13	48	67	104	123	227	17
Arumahan	4.9	1:15	82	91	142	210	352	23

* Total force is the sum of the rod weight to the depth of the cylinder setting plus the hydraulic force down on the piston due to the column of water in the rising main. Mechanical and hydraulic friction, which are minor factors, are not included.

Only limited maintenance has been necessary, and pumps are generally working well. The most common repair and maintenance required is the replacement of the leather cup seals on Tagasago and Eureka cylinders (every four to six months) in spite of the fairly low utilization of the pumps (average two to four hours daily). The incorporation of water meters will add a new and important dimension to the program insofar as it will allow a distinction to be made between heavily-used and lightly-used wells and the suspected relationship of use to the frequency of breakdown. Many of the newly installed pumps are equipped with gravel packed Roboscreen and it will be interesting to observe the frequency of worn out leather cup seals at those sites in comparison with other wells.

Some progress has been made in the design of a locally manufactured Blair derivative pump. Standard fittings have been identified for piston and valve components, similar in assembly to the PNG design, but not to the quality standard of the Australian fittings. A few Blair derivative pumps were installed using as casing and screening either galvanized iron pipe with stainless steel spear point, or the standard PVC 110-mm class C pipe with the matching Robo well screen. Ease of repair and maintenance was demonstrated as

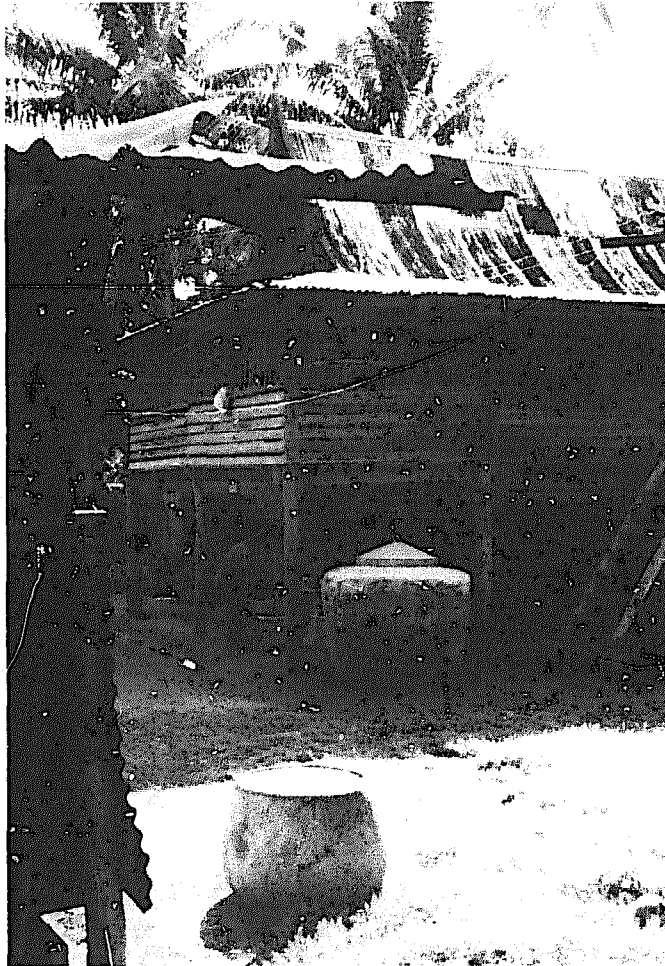

FIGURE 4-2 RAINWATER COLLECTION TANK

The widespread use of rainwater collection tanks in rural Thailand and easy access to surface waters may account for the relatively low use of handpumps in the country. Also, groundwater is not always readily accepted for drinking and cooking because of its objectionable taste which is likely due to a high iron content.

well as the simplicity and operation of the pump. Certain modifications to the mounting bush are required to allow easy adaption to galvanized iron and PVC casing. The Blair Derivative is not fully accepted by the villagers who prefer to use the popular Jetmatic suction pump.

The 1-1/3 inch diameter Roboscreen has proven difficult to install with the drive and force method commonly used in the Philippines. Four-inch Roboscreen has been installed and properly gravel packed in approximately 50 eight-inch boreholes monitored by the Project. Reduced wear on leather cup seals is expected in these.

E. THAILAND

The objective of the Project has been the field testing of several handpumps of both local and foreign manufacture in both deep and shallow wells. In addition, the locally made Korat Conventional pump has been laboratory tested in the United Kingdom by the Project (described in UNDP Project Management Report Number 3), and has subsequently been modified partly as a result of the laboratory tests.

In general the pumps being monitored in Thailand have been subjected to much less stress than those monitored by the Project in other countries. This is because of the low numbers of people using each pump, minimal pumping heads due to high water tables, the widespread use of rainwater collection systems for much of the year in preference to pumps, and in some areas the presence of objectionable tastes, color, and odor in the groundwater which further discourages use of the pumps.

1. Participating National Organizations

The main counterpart is the Division of Rural Water Supply within the Department of Health. The Division has assigned the Saraburi region to the Handpumps Project. The pumps are distributed over four provinces: Saraburi, Lopburi, Singburi and Nakorn Nayok Provinces. The installation and repair of the pumps is the responsibility of the Division of Rural Water Supply regional office in Saraburi. The Provincial Water Supply Division, Public Works Department, provided the Dempster derivative pumps.

The responsibility for maintenance lies with the local authorities immediately after installation, and a village handpump caretaker is appointed.

2. Pump Models and Quantities

In Thailand, 110 locally-made pumps are being tested and testing of 11 foreign-made pumps will soon begin. The pump makes and summary information are given in Table 4-9, with the first five pumps being of foreign origin and all pumps being used for domestic water supply.

Table 4-9 Pumps Tested in Thailand

Pump	Country of Origin	Quantity	Application	Method of Operation
Mono	U.K.	1	Deep	Rotary
TARA	Bangladesh	3	Intermediate	Piston
Blair	Zimbabwe	3	Shallow	Piston
Maldev	Malawi	2	Deep	Piston
Mark V	Malawi	10	Shallow	Piston
Mark II	India	2	Shallow	Piston
PEK	Canada	10	Deep	Piston
Korat Conventional	Thailand	30	Deep	Piston
Korat Modified	Thailand	20	Deep	Piston
Lucky Derivative	Thailand	20	Shallow	Piston
Dempster Derivative	Thailand	35	Deep	Piston
PVC Shallow	Thailand	20	Shallow	Piston
PVC Deep	Thailand	5	Deep	Piston
Total		161		

3. Site Selection

In Thailand, a country with severe flooding problems for more than four months of the year, deep static water levels are found only in a few areas. In some cases, the static water level is at ground level.

The Korat Modified Pump is a modification of the Korat Conventional Pump where the rack and pinion has been replaced by a chain and quadrant to allow the gravity return of the rod/piston assembly. This idea was developed by the Division of Rural Water Supply based on the design of the India Mark II, a good example of technical cooperation between developing countries.

Originally it was planned to have all sites selected near the Saraburi Office in the Saraburi Province but the search for deep static water levels led to an expansion to Lopburi and Singburi Provinces as well as to Nakorn Nayok Province. In April 1984 it was decided to expand the field testing to include the dry Khon Kaen Province in northeastern Thailand. In most cases, existing wells were chosen, thereby limiting to a large extent the possibilities for the installation and testing of the Robo well screen. The site selection has been finalized as follows:

Table 4-10 Sites Selected for Pump Monitoring in Thailand

Province	Number of Sites	Static Water Level
Khon Kaen	40	10-30 m
Saraburi	91	10-15 m
Singburi	20	2- 8 m
Nakorn Nayok	6	10 m
Lopburi	4	15 m
Total	161	

4. Pump Installation

In Thailand 105 of the 161 pumps are currently undergoing field trials. The first pumps were installed in May 1983, including the thirty Korat pumps. Twenty Lucky suction pumps were installed in July 1983, and twenty Dempster derivative pumps were installed in October and November 1983. The twenty PVC shallow-well pumps were selected from among pumps already installed by the counterpart agency without the participation of the Project.

A Mono pump was contributed free-of-charge by the manufacturer in the United Kingdom and was installed in January 1984. A second Mono pump will be tested by the Department of Mineral Resources, using Project monitoring forms. A third Mono pump will be tested by a Thai-Australian Village Water Supply Project in northeastern Thailand, again using Project monitoring forms. The last two Mono pumps were installed in January 1984.

5. Monitoring

In Thailand, the Country Monitoring Engineer assumed his duties in March 1983. He is stationed in Saraburi and is monitoring the installed pumps. Nineteen digital and chemical water flow monitors have been installed and eight additional flow monitors will be installed on pump makes yet to be decided. It has proved difficult to equip the Dempster pump with water monitors because of the thickness of the cast iron wall.

6. Results

A summary of the breakdowns which occurred in the period of July 1983 to June 1984 is shown in Table 4-11. These results are further divided into failure types in Table 4-12. Average performance data for 25 Korat Conventional, 15 Korat Modified, 25 Dempster derivative, 20 PVC shallow and 20 Lucky pumps is provided in Table 4-13.

Table 4-11 Record of Handpump Breakdowns in Thailand
July 1983 - June 1984

Monitoring Period	Pump Type	Above-ground components	Below-ground components	Total number of repairs	Number of pumps installed
13 Months	Korat Conventional	12	15	27	25
13 Months	Korat Modified	7	6	13	15
11 Months	Lucky	17	13	30	20
9 Months	Dempster Derivative	7	-	7	25
8 Months	PVC Shallow	6	1	7	20

Both the Korat Conventional and Korat Modified pumps have breakdown rates more or less equally distributed between above- and below-ground components. However, a significant improvement has occurred on the modified version of the Korat pump (i.e. changed from positive return to gravity return), for breakdowns have required only a minimum of repair. Accordingly, the Korat Modified pump appears to be the most promising high-lift pump that will be suitable for standardization.

Table 4-12 Types of Handpump Failures in Thailand
(as of June 30, 1984)

Types of Failure	Number of Failures
<u>Above Ground Components</u>	
Korat Conventional Pump	
- Failure of threads of the gear connecting rod	3
- Breakage of handle	2
Korat Modified Pump	
- Breakage of handle	3
- Grease cup missing	4
Dempster Derivative Pump	
- Breakage of fulcrum link	5
- Disconnection of flat bar and round bar	2
- Breakage of flat bar	1
Lucky Pump	
- Cracked pump base	2
- Breakage of valve spindle	2
- Stainless steel sleeve torn out	4
- Cracked pump body (barrel)	6
- Rubber seal worn out	3
- Breakage of hose adapter	1
- Breakage of fulcrum link	1
- Failure of the threads of connecting rod	2
PVC Shallow Pump	
- Leather cups worn out	5
- Suction valve failure	2
- Failure of the threads of connecting rod	1
- Pump piston assembly failure	1
- Leaking of riser pipe	1
Mono Pump	
- Self locking device of the gearing system inside the drive head jammed	1
<u>Below Ground Components</u>	
- Leakage of foot valve	27
- Leakage of pump cylinder	9
- Leakage of riser pipe	3
- Failure at pumping rod connection	1
- Leather cup stuck and/or shrinkage	2

Table 4-13 Performance Data for Pumps Tested in Thailand

	Korat Conv.	Korat Modified	Lucky	Dempster Derivative	PVC Shallow
Maximum stroke (mm)	114	127	203	216	279
Inside diameter of cylinder (mm)	76.2	76.2	103	76.2	76.2
Maximum swept volume (liters)	0.52	0.58	1.70	0.98	1.27
Pumping rate ² (strokes/minute)	30	30	30	30	30
Cylinder setting (meters)	12.9	15.2	NA ¹	13.3	NA ¹
Mechanical advantage	10.0	10.0	8.0	5.0	3.2
Calculated flow rate ³ (Liters/minute)	15.6	17.4	51.0	29.4	38.1
Actual flow rate ⁴ (liters/minute)	13.6	15.0	30.0	27.3	33.3
Volumetric efficiency (%)	87	86	59	93	87

- 1) Not applicable (because the cylinders of these suction pumps are within the above-ground pump bodies).
- 2) The setting of the pumping rate at 30 strokes per minute may have to be changed for the Lucky and PVC shallow well pumps. It has been found in the field that the villagers prefer to pump at the rate of about 40 strokes per minute.
- 3) When pumping at the rate of 30 strokes per minute, the theoretical flow rate is equal to the swept volume per stroke multiplied by 30.
- 4) The actual flow rate was determined by counting the number of strokes required to pump 20 liters of water. This was done while pumping at the rate of 30 strokes per minute and while using the maximum stroke length. Under these conditions, if N is defined as the number of strokes required to pump 20 liters, and Q is the actual flow rate (liters per minute), then $Q = 30 \times 20/N$.

The locally made Lucky suction pump, generally speaking, is of poor quality and has proven to be maintenance intensive with serious breakdowns. The alternative to this metal pump would be the locally made PVC suction pump, but after only 5 months of field testing, several breakdowns have been reported, with worn leather cups being the most common cause. There is need for a low lift PVC pump of different design, and much hope is placed on the TARA, BLAIR and MARK V handpumps which will soon be introduced for testing. Existing PVC extruders and pump manufacturers are ready for pilot production, should the project present a good design.

Difficulties were encountered with the PVC deep-well pump designed by the Mechanical Engineering Department of the Chulalongkorn University, Bangkok. The number of pumps to be installed was first reduced from twenty to five and then discontinued. These problems were primarily due to the suction and discharge check valves whose flaps were molded from hard synthetic rubber; the flaps created a flow constriction which allowed very little water to pass. Also, the inner surface of the rubber seal was supported by a metal expanding ring, which was an extension of the piston plate. This had the effect of making the rubber seal incompressible. With poor quality PVC, the piston either got stuck or was very hard to move. Only one out of the five pumps installed had any discharge, and then with only 26 percent volumetric efficiency.

It is interesting to note that not a single leather cup has needed to be replaced on the deep well Korat and Dempster pumps. This appears to be primarily due to low handpump usage for, on average, pumps are used only ten minutes per day during the wet season and sixty minutes per day during the dry season. Minimal leather cup wear may also be attributable to the small amount of abrasive material found in the well water. This is notable because most deep wells are constructed with machine slotted metal casing without gravel packing and in no case has Roboscreen been used.

Spring activated foot valves are used for the Korat and Lucky pumps, whereas ordinary foot valves are used for the Dempster pumps. The monitoring has shown that eighty percent of all below-ground breakdowns are due to leaking spring-activated foot valves, whereas in no case has the ordinary foot valve used with Dempster pumps failed. The problem with the spring-activated foot valve was due to fatigue of the brass pin which locks the brass foot valve spring. At present, the smaller end of the brass wire is used as a locking pin; this has reduced the failure rate considerably.

Experience with flow meters indicates that the digital flow monitors are not reliable. This is due to the fact that water and moisture enter the watch module and the body of the monitor, and to the fact that sediment builds up between the electrodes causing the time to advance even when the pump is not in use. For this reason, two 1-1/2 inch Kent water meters (piston type) and eight 1/2 inch Asahi locally made water meters (turbine type) are being tried. The results are very good for the 1-1/2 inch meter but the price (US\$150) is prohibitive. The 1/2 inch is also accurate but reduces the discharge by approximately twenty percent on the Korat pump. It is too early to judge the chemical flow monitors because of the extremely low utilization of the handpumps in the wet season.

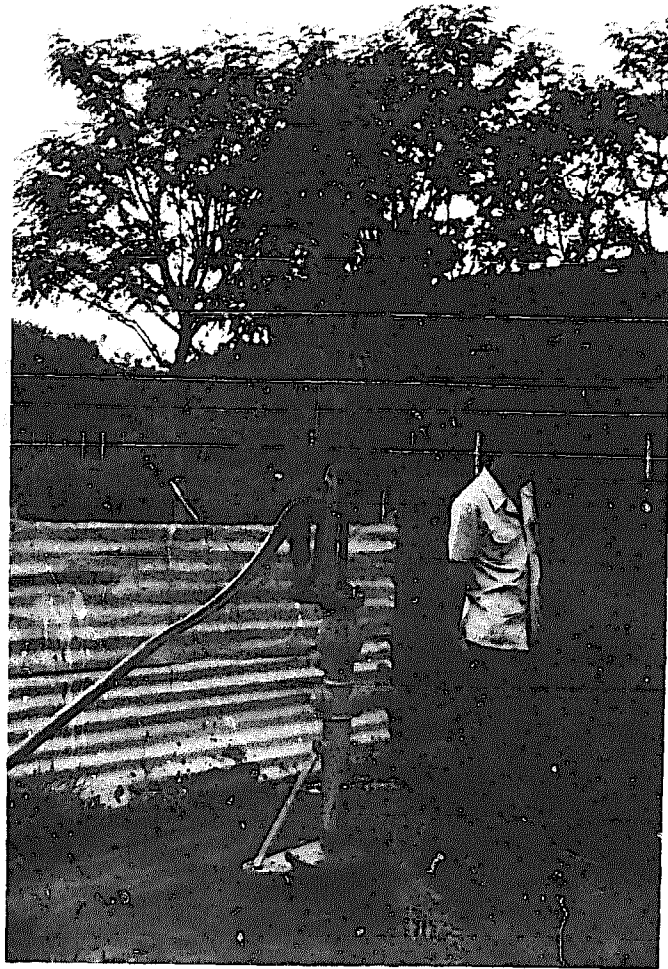

FIGURE 4-3 DEMPSTER DERIVATIVE PUMP

This Dempster derivative pump is manufactured and used in Thailand, and is one of the pumps being monitored by the Project.

The 15 water flow monitors installed in October 1983 (middle of the rainy season), indicate that the average daily utilization was only 25 minutes for 15 pumps monitored over 57 days or 390 litres per pump per day. Another four flow monitors also were installed in October 1983 and monitored over 49 days. The readings indicate that these pumps were utilized 50 minutes per day, producing 810 litres of water per day. There are indications that the flow monitors are not functioning properly, but the general conclusion still holds that the handpumps installed in Thailand on shallow water tables are used only for a short period every day.

During the rainy season, the utilization of the water from the handpump is extremely low. The water in the Saraburi Region has a very high iron concentration (no laboratory data are available but the smell and taste are significant) and, therefore, the villagers prefer to bring their water from individually constructed rainwater collection systems. A family cement jar normally contains 1,800 liters which provides drinking water during the entire rainy season plus one or two extra months. This phenomenon is very common in large areas of Thailand, especially in the northeast.

Even though the pump installations are fairly close (60 km radius) to the maintenance/repair workshop in Saraburi, the average waiting time for repair is six days for the Korat Modified pump. All pumps are attended by village handpump caretakers. In almost all cases, the caretaker is also a farmer and is rarely available at the pump when needed. Two women caretakers have been appointed to overcome this problem since mothers normally spend much of their time near home. It has been a great success so far and it is planned to appoint more women caretakers.

The caretakers are poorly equipped with maintenance tools and lubricating oil. Spare parts for below-ground components are often not in stock while adequate stock of spare parts for above ground components are kept at the store of the Saraburi Regional office. Manuals for all locally made pumps have now been prepared and printed. In spite of some shortcomings, the village-level caretakers in Thailand have been brought successfully into the handpumps maintenance system, which is an important but difficult step towards the implementation of VLOM.

As expected, the Lucky suction pump takes less time to repair with an average of 20 minutes per repair compared with 65 minutes for the Korat Conventional and 50 minutes for the Korat Modified.

CHAPTER 5

SOUTH ASIA

A. INTRODUCTION

In South Asia the Project is currently active in one area in Bangladesh, one in India, and two in Sri Lanka and is preparing for work in a second area in India. These areas are quite diverse in environmental, political, social, and economic conditions, most of which are important determinants in the choice of handpump technology, well construction techniques, and institutional arrangements for their support and maintenance.

Two participating countries, India and Bangladesh, have adopted official standards for specific locally-produced handpumps, while the third country, Sri Lanka, may adopt official standards for high lift and low lift pumps based on the current pump testing activities. India has a standard high lift pump, the Mark II, which the Project seeks to improve by creating a VLOM (Village Level Operation and Maintenance) version. India also wishes to develop a better low lift pump for possible standardization. Bangladesh has standardized on the No. 6 suction pump but has encouraged the development of a more widely applicable non-suction low lift pump.

B. BANGLADESH

1. Project Background

Bangladesh occupies the largest deltaic plain in the world, populated by approximately 100 million people. With a density of about 700 people per square kilometer it has the second highest population density in the world, ranking just after Java. Environmental sanitation is extremely poor, and for the four months of the year when the delta is inundated with surface water pathogens are spread throughout the environment creating still further hazardous health conditions. Mortality resulting from attacks of diarrheal diseases is unacceptably high, especially among children. According to a recent report by the Ministry of Health, "Diarrheal disease continues to be a major health problem in the country particularly for children under five. It is a major killer claiming more than 200,000 children annually."*

A major complication is that the groundwater table in Bangladesh appears to be lowering generally, putting suction pumps at risk of failure during the dry season. This is apparently due to the large scale extractions of groundwater for irrigation. About a half million suction handpumps have been provided by the government to rural areas, each serving about 150 users.

* "Morbidity and Mortality Survey on Diarrheal Diseases in the Rural Areas of Bangladesh," Ministry of Health, People's Republic of Bangladesh, December 1983.

The Bangladesh project is implemented by the International Centre for Diarrheal Disease Research with funding from CIDA, and the handpump component is supervised by the World Bank/UNDP Handpump Project. Local project objectives are twofold: the overall objective is to measure the effect on health of a package of environmental health interventions consisting of handpumps, latrines, and health education in a rural Bangladesh study population; the second objective is to test a simple, inexpensive VLOM low lift pump. The major indicator of success would be significant reductions in the incidence of diarrheal diseases. A sample of 200 experimental handpumps will be monitored over a period of three years. These include the No. 6 and the TARA. Latrine usage will be monitored, and the health education intervention will be refined periodically based on behavioral changes observed in the study population of 4,500. Diarrheal disease surveillance will be conducted in the study population and in a closely matched comparison population of the same size which will have received no interventions, and conclusions will be drawn about the efficacy of the group of interventions.

Pump site selection has been completed and pump installation began in June 1984, to be completed by the end of the year. Women caretakers will be trained to perform routine pump maintenance. Key engineering personnel have been appointed including an environmental engineer, an engineering supervisor in charge of test pump installation, and two mechanics to service the pumps.

The Project has also had the Consumers' Association laboratory in the United Kingdom test and evaluate three handpumps manufactured in Bangladesh: the Bangladesh New No. 6 pump,* the Rower pump (described in UNDP Project Management Report No. 3 and in Annex A of this report), and the TARA pump (laboratory testing is in progress).

2. TARA Pump Development

The Need for a Low-Lift Non-Suction Type Pump

Over 500,000 suction handpumps have been installed in Bangladesh over the past ten years in a national rural water supply program. Approximately 15 to 20 percent of all possible tubewell sites on the densely populated deltaic plain of Bangladesh have static water levels which are known to drop below eight meters at least part of the year, rendering suction pumps inoperable. A six meter average head prevails in Bangladesh, with an annual fluctuation of about two meters. Large-scale dry season groundwater extraction for irrigation is reported to lower the water table in nearby areas, affecting the suction handpumps installed there.

* The New No. 6 pump is a suction pump which is the national standard pump in Bangladesh, although development of a more widely applicable non-suction low lift pump is being encouraged by the Project. The New No. 6 pump is itself an improvement made in the late 1970's to the old Maya No. 6 pump (In Bangladesh, No. 6 designates a 3-1/2 inch cylinder diameter, about 90 mm). The laboratory test results are given in UNDP Project Management Report No. 3.



FIGURE 5-1 BANGLADESH NEW NO. 6 PUMP

Over 500,000 suction pumps have been installed in Bangladesh over the past ten years, most of which are of the New No. 6 type. It is robust, and the fact that all the moving parts except for the foot valve are located above-ground makes the pump easy to repair. But suction pumps used for domestic water supply have the general disadvantage that they often need priming (i.e. filling from the top before water can be pumped), which can introduce contamination into the well. An additional problem with the use of suction pumps in Bangladesh is that ground water levels have been decreasing over the years, and are more than eight meters below the surface (the approximate limit for suction pumps) at 15 to 20 percent of all possible tubewell sites in the country, at least in the dry season. For this reason a non-suction, direct action pump, known as the TARA, has been developed and is now being tested.

To address the growing problem of lifting water for domestic purposes in areas where suction pumps are inoperable or periodically run dry, the Government of Bangladesh, UNICEF, and the World Bank/UNDP Handpumps Project, in collaboration with the Mirpur Agricultural Workshop and Training School (MAWTS) in Bangladesh, are developing and testing a non-suction handpump known as the TARA* pump which has the potential to serve all areas in the delta of Bangladesh.

Status of TARA Pump Development

Forty TARA pumps were installed in stages in Bangladesh during 1983 and early 1984 and 50 were sent to UNICEF in Sri Lanka for field testing; TARA pumps will also be manufactured in India for testing in the State of Orissa. The TARA pump design has been revised over three generations of prototypes and will be brought to the production stage during the course of the Project.

Modifications to the original design include a larger diameter (2 inch) discharge spout, a larger diameter, thicker walled PVC pump rod, more robust pump rod connectors, a redesigned check valve, a shortened T-bar handle, and higher, thicker leather cup seals. A rubber top guide bush is being evaluated to replace the present wooden sleeved PVC model. Six tubewells failed as a result of silty aquifers, and third generation pumps were reinstalled on new tubewells. One of 12 first generation pumps is operating after one and one half years of heavy use. The remainder were retrofitted with second and third generation components.

Design Concept For a Low-Lift Direct Action Handpump

The TARA prototype pump is an attempt to meet VLOM criteria for the range of low lift handpump applications. At its most basic level, VLOM handpump would need to be simple enough for villagers to cope with routine maintenance and breakdowns. Dismantling and reassembling a VLOM pump ideally would be accomplished without tools and specialized skills.

Low lift pumping often evokes an image of a suction pump, otherwise known as a "shallow well pump," with its pumping elements located at the surface. Suction pumps are limited theoretically to a lift at sea level of 10 meters, but in practice this limit is usually reduced to little more than seven meters. However, the same pumping elements located below the water level could lift to a discharge level limited for all practical purposes by the amount of power available to move the piston upward and the structural limits of the pumping elements. A simpler handpump of adequate capacity can be designed without a lever by judicious choices of a relatively small cylinder diameter and relatively long stroke length and a light weight, high volume pump rod. Such a pump can be operated comfortably at a head of 5 to 20 meters and is called a "direct action low lift" handpump. ("Low lift" is a term proposed here to distinguish it from suction or "shallow well" pumps and from

* "TARA" means "star" in several North Indian languages.



FIGURE 5-2 TARA HANDPUMP

A first generation prototype TARA pump is being demonstrated in Bangladesh at the time of its introduction in 1982. This direct action pump has a high potential for providing the technology component of a low cost, easily maintainable system.

its higher lift cousins, known as "deep well" pumps.) Annex A presents information about the advantages and design principles of direct action handpumps.

TARA Pump Design

The TARA pump is designed to satisfy the VLOM objectives. A piston operates inside a cylinder and is connected to the steel pipe T-bar handle by sealed* PVC pipes which are solvent joined into a single member serving as the pump rod. The pumping elements (piston and check valve) may be removed for servicing by withdrawing the pump rod with the attached pumping elements through the rising main, which also functions as the pumping cylinder and, in the design for Bangladesh at least, the casing. Two threaded connectors, one joining the T-bar handle to the pump rod and the other joining the piston to the pump rod, may be taken apart and put together again by hand without tools.

The 54.3 mm inside diameter cylinder can hold 2.3 kg of water per meter, but when the 42.2 mm outside diameter PVC pump rod is inserted the effective weight which must be lifted is reduced to 1.3 kg-f/m (approximately 0.9 kg-f/m for the weight of water in the annulus plus 0.4 kg-f/m for the weight of the PVC rod). As discussed in Annex A, the buoyancy of the rod, which is filled with air, does not assist with lifting the rod, except for the buoyancy of the portion of the rod which extends below the level of the water table.

The pump operator must raise the handle with an upward force of about 1.3 kg-f/m of pumping head and lower it with a downward force of around 1 kg-f per meter of pump rod submergence to resubmerge the pump rod against buoyant upthrust (neglecting friction in both instances). At a head of 20 meters, 26 kg-f (plus force to overcome friction) is needed on the up-stroke and 13 kg-f (plus force to overcome friction) on the down-stroke. Figure B-2 in Annex A shows how the required handle force depends on the pumping head and the pump rod length. Most people can lift more than their own body weight with their leg and back muscles. Operating the TARA pump at a 15 to 20 meter head is easiest when the operator assists the beginning of the upstroke by using his legs.

Simplicity of design also correlates strongly with lower manufacturing costs, especially where opportunities exist to substitute mass produced items for specialty items. Economies of scale relate to the length of production runs and are inherent in items such as PVC and steel pipe and standard industrial fasteners. There are few specialty items in the TARA pump. They consist only of the piston and check valve assemblies and a non-standard bushing connecting the PVC rising main with the steel pump head. Therefore fabrication of the TARA pump is reduced to a minimal series of cutting, drilling, turning, fitting, and welding operations likely to be easily and cheaply done in developing countries. However, for a large-scale rural water

* The segments are isolated from one another by a PVC plug, or bulkhead. A leak at one joint would therefore not compromise another segment of the pump rod.

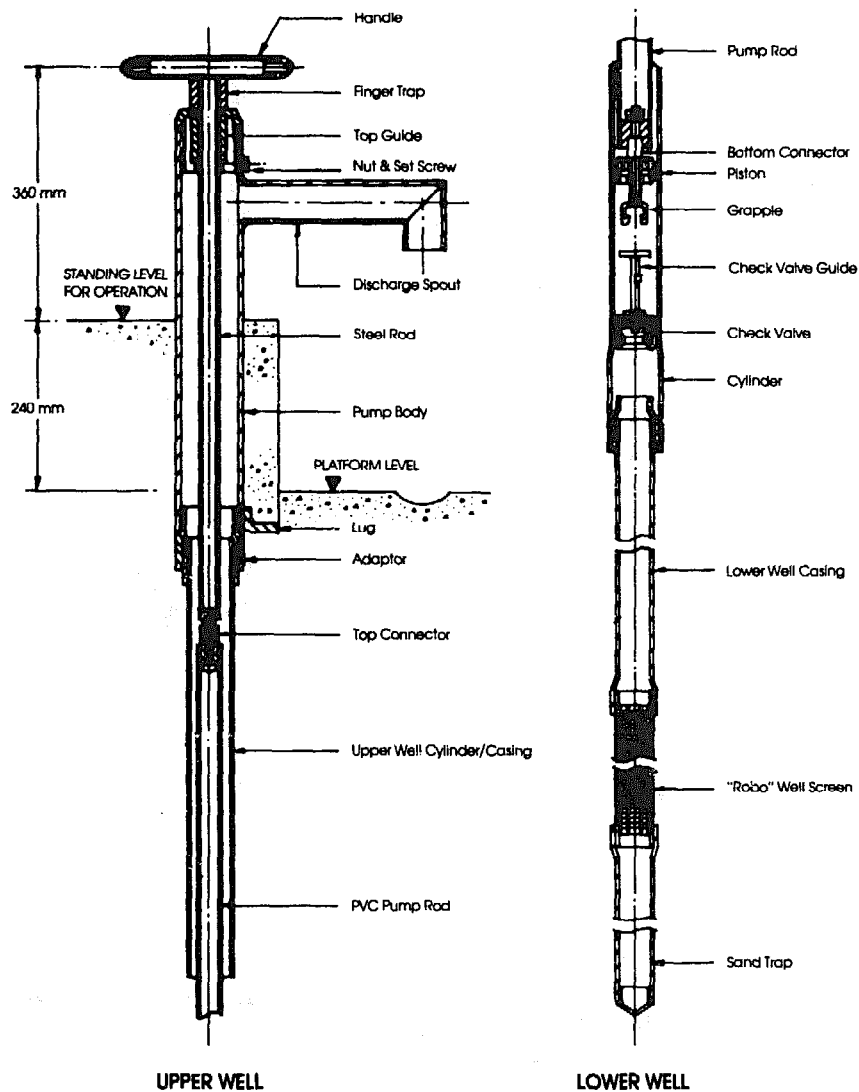

World Bank-26367

FIGURE 5-3 TARA HANDPUMP

This direct action pump, developed in Bangladesh, has characteristic features which make direct action pumps attractive for low-lift applications. A sturdy T-bar handle is fixed onto a hollow but sealed rising main which, except for the top section, is made of PVC pipe. This reduces the weight of the rod/cylinder assembly and distributes the pumping force more evenly between the up- and the down-stroke. The plunger --and foot valve if desired-- are extractable without removing the cylinder, which facilitates the replacement of parts that may wear more quickly. The rising main also serves as the well casing; this permits the construction of small-diameter boreholes at a considerable cost saving.

y project the specialty items may be adapted for rapid-rate production in industrial center or made in rural based workshops, depending on nationalities for the industrial sector.

The output capacity of the TARA pump is high compared to a suction pump the same swept volume, and unlike suction pumps it is not dependent on spheric pressure (which limits suction to a practical pumping head of seven meters) to push water up a delivery pipe. The stroke length is dependent on the size and/or preference of the user, delivering 0.23 liters each 10 cm of stroke (0.13 liters on the upstroke and 0.10 on the downstroke). A tall adult may choose a long stroke (40 cm results in 0.9 liters per cycle), while a child may manage a shorter one (15 cm results in 0.35 liters per cycle).

In field trials users had no complaints or adverse reactions to the novel method of operating the pump. Without coaching, users tended to use their legs to assist the beginning of the upstroke. Small children almost invariably used their legs for leverage and were observed using their full body weight to push the buoyant pump rod. Users liked the large platform, which is three times the area of the standard DPHE/UNICEF installations.

Incertainties

For the TARA pump to be suitable on a mass scale for rural water supply in Bangladesh it must survive heavy use over long periods of time without imposing demands on the already overextended public sector maintenance and repair personnel and budget. It follows, then, that the success of the pump will depend upon whether the users are able routinely to change valves and whether the other elements in the system, such as the pump rod, platform, and connectors can withstand years of use.

The PVC pipe rod is probably the most vulnerable element in the system. Design norms allow a cyclical axial pressure loading. (For example, in a water hammer system they allow for water hammer of 80 kg-f/square cm.) A force that is equivalent to three times the peak load on the pump rod is only 25 kg-f per square cm. However PVC is not an engineering polymer intended to be subjected to repeated longitudinal stress reversals. Failure due to fatigue before a distinct possibility. The question is after how many stress cycles and at what peak loads. The planned three years of field testing followed by accelerated fatigue testing in a laboratory should provide definitive answers. Meanwhile, alternatives are being investigated.

Buckling of the pump rod is apparent on the down-stroke, and abrasion appears on the pump rod. No doubt abrasion occurs on the rising main as well. Eventual perforation of the pump rod or weakening to the point of failure is possible. Guides on the pump rod are being considered to minimize buckling.

Costs

Table 5-1 below compares the installed costs of a TARA pump with the New No. 6 suction handpump, which is the standard pump in the Bangladesh national rural water supply program. The New No. 6 installation consists of a 1-1/2 inch diameter PVC tubewell, with one joint of GI pipe at the top. The TARA tubewell is a 2 inch x 1-1/2 inch diameter tubewell. For convenience, both tubewells are identical with the exception of the upper seven meters. It should be noted, however, that the suction pump cannot be used at 8 to 15 meters of head, while the TARA pump can. The additional cost for a 15 meter TARA pump would be US\$0.64/m or slightly more than US\$5.00.

Table 5-1 Comparison Between Installed Costs of TARA and New No. 6 Pumps at 8 Meter Lift on 50 Meter Tubewell

COMPONENT	TARA (US \$)	No. 6 (US \$)
Pump	33	26
Tubewell	95	103
Platform	30*	10
TOTAL	158	139

* The TARA platform is three times the size of the No. 6 platform.

Conclusions About The TARA Pump

A direct action, low-lift handpump of the TARA design is a viable concept with distinct advantages over conventional handpumps for use at pumping heads of up to 20 meters. The principal advantages are simple design and an extended range of lift. The TARA pump, as currently designed, is geometrically and ergonomically acceptable for low-lift pumping in the context in which it has so far been tested. The accompanying PVC tubewell is compatible with the labor intensive drilling technique indigenous to Bangladesh, the "sludger" method. Major problems with the system do not appear likely, except in the case of unknown fatigue resistance of the PVC pump rod. If PVC proves to be unacceptable, the substitution of appropriate materials could rectify the problem although at a somewhat increased cost. The TARA pump may be able to meet VLOM criteria if major problems do not occur with the PVC pump rod.

The case for direct action pumps appears to be strong, since conventional lever action piston handpumps appear to be fundamentally deficient in design concept; force multiplication drives are applied needlessly, as a consequence of choosing cylinder diameters larger than necessary; high mass piston control rods waste limited amounts of human power and complicate extraction of pumping

elements for servicing; more material is used to accommodate the greater weight of the larger diameter column of water, and larger boreholes are necessary to allow for the insertion of larger diameter cylinders which escalates drilling costs needlessly. Direct action handpumps, by comparison, are demonstrably simpler mechanical systems. A smaller diameter reduces the swept volume of the cylinder, but a longer stroke restores swept volume. The smaller diameter cylinder can be inserted into a smaller diameter borehole. Lighter weight, more easily extractable pumping elements can be used in direct action systems. Simple, direct action handpumps can be designed for pumping heads of up to 50 metres, but developing products for mass distribution will depend on identifying and solving the practical problems of such systems.

A more detailed discussion of the design principles of direct action handpumps is contained in Annex A.

3. Robo Well Screen

Robo* screen is a locally made well screen developed in 1977. It is an inexpensive PVC plastic product used to filter out sand while allowing passage of water into a tubewell. It is now produced in Bangladesh. One and one-half inch nominal diameter continuously slotted screen is made by MAWTS at the rate of 30 m/day. Slot sizes of 0.20 and 0.25 mm, with an open area of approximately 11 percent, are available at a sales price of Tk 92.5/m, or US\$3.75/m. Two meters are normally used per tubewell. Approximately 8,000 meters of Robo screen have been made so far.

4. Manufacture of Leather Cup Seals

Leather cup seals for piston handpumps have been used for hundreds of years. The cup seal is the part most frequently in need of replacement for most handpumps. The Project, together with UNICEF, collected information about leather cup seal processing and design norms, resulting in changes to the cup seal dimensions used in the first TARA pumps. Conclusions are that the most important variables affecting the working life of leather cup seals are the quality of tanning and selection of the correct portion of the hide.

The Mirpur Agricultural Workshop and Training School (MAWTS) experimented with leather processing techniques to produce a higher quality cup seal for use in the TARA and Rower pumps. UNICEF and the UNDP/World Bank Project provided information from manufacturers of leather seals and leather reagent suppliers. MAWTS experimented with both chrome tanned and vegetable tanned leather, using a variety of oils and waxes to impregnate the leather seals. Chrome tanned leather needed to be formed while hot and did not retain a proper shape during subsequent impregnation.

* Developed by Yaron Sternberg and Robert Knight, University of Maryland, under contract to the World Bank.

Cup seals of the following dimensions are manufactured:

outside diameter	53 mm
center hole	39 mm
height	17 mm
thickness	3 mm

Vegetable tanned leather from cattle or buffalo is split to 3 mm, plus or minus 0.2 mm. Round disks 83 mm in diameter are cut out and soaked for a period of not less than 20 minutes. After soaking, the leather must be soft and pliable. Cups are formed from the disks in a die with the hair side outwards and left to dry in the outer die ring for 72 hours. During the drying period the cups will shrink from an original outer diameter of 54 mm to 53 mm. If the cups are removed from the ring before 72 hours they will expand.

After forming and drying, the center hole is cut out on a lathe. The cups are clamped on a mandrel so that the center hole will run true with the outside diameter. Cutting speed should be approximately 300 meters per minute. The sealing edge is cut at 350 meters per minute on a lathe.

After cutting, the cups are soaked for 20 minutes in a mixture of 75 percent paraffin, 15 percent carnauba wax and 10 percent linseed oil at a temperature of 75-80 degrees Celsius. Small air bubbles will appear on the surface of the solution. When the bubbles disappear soaking is complete. Excessive wax is cleaned off by dipping the cups in linseed oil at 80 degrees Celsius. Cups are stored until use in cardboard cylinders 53 mm in diameter to prevent their opening up.

5. Development of a Poppet Valve for the Bangladesh New No. 6 Pump*

The leather check valve, a weighted flapper, of the New No. 6 pump tends to become brittle when stored and is prone to leakage when brittle. The Consumers' Association tests of the New No. 6 pump showed that performance suffered unnecessarily because of check valve leakage, and frequent priming (with water of dubious quality) is therefore required.

The Consumers' Association suggested that a poppet valve be considered as a replacement. A proposed design by UNICEF and UNDP/World Bank was discussed with the MAWTS design engineer. Requirements were that the poppet valve be compatible with existing pumps, both the New No. 6 and the Maya No. 6 which total several hundred thousand in Bangladesh, and that the poppet could be serviced without separating the pump head from the base plate. The MAWTS engineer refined the concept after a number of tests. A cage to limit valve lift was discarded since the cage required anchorage and extra material and would be serviceable only by separating the pump head and base plate.

* This discussion of poppet valves is abstracted from a report written by Kenneth Gibbs, Water Section Chief, UNICEF, Bangladesh.

Valve lift in the present prototype poppet valve is limited to 24 percent of the diameter of the valve port by lugs on the end of legs on the plastic valve, which is installed in the valve port by compressing the legs by hand and inserting the valve into the port. Plans are to lengthen and curve the legs inward to make insertion easier. A problem with the valve sticking open was noted in field tests when the nipple of the suction pipe is run up deeply into the base plate of old pumps. Slight changes in the legs are expected to remedy the problem. New pumps have deeper threads which do not cause valve jamming.

Valve weight is extremely important. Early tests on a valve of satisfactory geometry but light weight indicated valve bounce under medium lift conditions. Additional weight eliminated this characteristic.

The valve is sealed by a rubber washer cut from a tire inner tube, a material common in rural areas of Bangladesh and therefore likely to be a convenient source of replacement parts.

C. INDIA

1. Project Background

A handpump development and field testing project was organized by the Project in the state of Tamil Nadu in collaboration with the Tamil Nadu Water Supply and Drainage Board (TWAD), UNICEF, Richardson and Cruddas (1972) India Ltd., and Wavin India Ltd. The latter two organizations provide materials and prototype building services to the project. Crown Agents provides a monitoring engineer and administrative support.

Field testing is being done in Coimbatore district of the Tamil Nadu State. The sample will be comprised of 80 pumps. Fifty-five of the pumps are standard India Mark II deep well pumps, while 25 have either PVC rising mains or modified pumping elements or both. Installation of the first test pumps, 14 of which were fitted with water flow monitors and/or water meters, began in November 1983 and is to be completed by September 1984. The objectives of the field test project are to develop and test modifications to the India Mark II handpump which enable a trained caretaker to perform routine maintenance. If successful, a substantial recurrent cost burden could be removed from the public sector.

A second field test project has been proposed for the coastal plain of the State of Orissa. The Public Health Engineering Department (PHED) of Orissa, assisted by DANIDA, is undertaking a rural water supply project which includes handpumps. Project objectives include comparative testing of low lift pumps to identify simpler, more easily maintainable, and less expensive options than are currently available in India. DANIDA will be responsible for monitoring the test pumps, while PHED will install wells and maintain the pumps.

PHED has expressly ruled out the use of suction handpumps because of contamination risks entailed in priming and because of the poor quality of locally available suction pumps. Water levels are relatively high, and PHED

intends to compare Indian-made TARA pumps and Wavin TARA pumps to the present design of a modification to the India Mark II for low lifts. Jetting is the preferred drilling technique for small diameter tubewells in Orissa, but there may be potential for the less costly "sludger" technique used in Bangladesh. The project may begin in October 1984, pending clearance by the Government of India and DANIDA.

2. Experimental VLOM Version of India Mark II Pump

Major progress has been made in developing a Village Level Operation and Maintenance (VLOM) version of the already popular and robust India Mark II handpump. The importance of this cannot be overstated considering both the advantages of the VLOM concept and the fact that an estimated 100 million beneficiaries are served by the standard India Mark II, with 50,000 to 100,000 additional pumps being installed annually. As of mid-1984 more than 400,000 India Mark II pumps have been installed.

The Mark II VLOM designs, if adopted as standard, and the recommended support systems which are being developed, will be placed in the public domain and will be freely available to all interested parties. VLOM development work has been undertaken by UNICEF, the World Bank/UNDP Global Handpump Project, pump manufacturer Richardson and Cruddas (which is a "Government of India undertaking") and the PVC pipe manufacturer Wavin, India, Ltd. The specifications for the standard India Mark II are already in the public domain.

The VLOM version of the Mark II is being designed and tested for deep wells which will require up to 40 meters of rising main, and it is expected to operate beyond such depths. It is precisely in such deep wells that the VLOM approach is most important, but has until now been most difficult to achieve.

Objectives

The primary objective of the development of better components for the India Mark II is to preserve where possible the successful design standardization of the India Mark II while improving the maintainability of the system. The experimental components for the India handpump field test represent the consensus views of TWAD, UNICEF, Project staff, Richardson and Cruddas, Wavin, and a consultant to the Project who was one of the principal developers of the India Mark II handpump.

The development strategy may be summarized as follows:

- o Experimental below ground components are expected to be compatible with existing pump drive heads, so that eventual retrofitting of existing pumps will be feasible.
- o Experimental pumping elements are to be withdrawn to the surface by pulling the pump rod and piston--with or without the footvalve, as desired--through the rising main without lifting the rising main, whatever their other characteristics.

- o Modifications to existing components, where necessary, have been as minor as possible. The objective is to be able to incorporate existing stocks of spare parts and production tooling into succeeding generations of improved pumps.
- o Reduction in the number and cost of tools required for standard maintenance procedures in order to make it more affordable for a village caretaker to have a complete tool set.*

This strategy does not preclude more radical or innovative approaches, but is regarded as the strategy most compatible with the needs and stated objectives of the national water supply program.

Design Concept

The design concept utilizes the standard India Mark II pump head** and is designed to be installed in a 150 mm borehole. It has a 75 mm outside diameter PVC cylinder and rising main. The rising main is made from standard

* If the tool kit can be reduced to an affordable minimum so that each caretaker has a set and if the mechanical repair and maintenance procedures can be simplified, then village level maintenance by a trained caretaker with assistance from neighbors could not only hasten repair and maintenance but also reduce the recurrent costs of handpumps to manageable proportions. The sophistication of the tool kit required for the standard Mark II is illustrated by the following. The tools required for changing the cup seals or valves on the standard India Mark II (which involves lifting the 1-1/4 inch nominal diameter steel pipe rising main, pump rod and cylinder assembly) include: two stilson wrenches, one "slip" vise for holding the rising main, two lifting bars, one 12 mm socket wrench, one 10 mm socket wrench, two 19 mm open end wrenches, one 12 mm open end wrench, one 10 mm open end wrench, one pump rod vise, and one split ring to support the chain nut.

** Work has recently begun related to an experimental modification to the India Mark II pump head. The purpose of the modification is to reduce the number of tools and the time required for pump repairs, and to use easily-replacable plastic bearings at the fulcrum instead of the present ball bearings. With the experimental pump head and prototype VLOM down-hole components, standard repairs could be performed by a village caretaker and an assistant on a pump with a 30 to 40 meter setting, using only the following tools: one stilson wrench, two combination open end or box wrenches (one end 12 mm, the other end 10 mm), the two large standard 19 mm open end wrenches and one "hanger", either separate or built into the inspection cover. The minimal tool kit can deal with removal of the inspection cover, removal of the upper chain nut, removal of the plate in the floor of the drive head, pump rod connectors and replacement of leather cup seals.

PVC pipe with a 65 mm inside diameter, and the cylinder is made either from a brass sleeve inserted in the PVC pipe, or from a special PVC extrusion with greater wall thickness and a 63.5 mm inside diameter. Experiments are underway to verify if the rising main and cylinder must be supported from below by a bottom support which will lock into the casing using a simple trip system, supported by a secondary casing, or whether PVC rising mains may be suspended. Guides made of high density rubber will hold the rising main in position. The foot valve is made of brass, is removable, and snaps into a PVC component at the base of the cylinder. The standard India Mark II foot valve and piston have been modified to abruptly drain the water which is above them in the cylinder and rising main when they are connected for removal.

Status of Pump Development

At present the development work for below ground components is at the prototype stage. Various components are being field tested in 11 installations as of July 1984. Fourteen more experimental pumps will be installed by the end of September 1984 where static water levels range from 30 to 40 meters depth. Each test pump will serve approximately 250 to 500 people. A total of 25 experimental VLOM units will be monitored under the direction of the World Bank/UNDP Interregional Handpump Project, along with 55 standard India Mark II pumps, 50 of which have already been installed.

The experimental pumps installed so far have demonstrated that the time and effort required to retrieve the piston and foot valves from a cylinder at a 40 meter depth have been greatly reduced. Two men have been observed to do this job in one half hour, compared with three to four hours for the standard Mark II system, and they used about half the number of tools compared to the full set of specialized tools that it takes with the standard system. Furthermore, the task was easy. This is a tremendous improvement over the arduous process of retrieving the cylinder from a standard design pump, which requires lifting and unscrewing of all of the rising main and pump rod sections and involves the danger of losing one's grip and having the rising main and cylinder fall to the bottom of the borehole.

The first prototype extractable foot valves employed a leather cup seal as a static seal around the perimeter. This meant that as the piston and foot valve were pulled upward for retrieval, the column of water above them also had to be lifted. However, the latest prototype pistons and foot valves, when joined for extraction, allow the water column to be drained through the piston and around the periphery of the foot valve as it is lifted through the 65 mm inside diameter rising main. It should be an easy task for two people to remove the piston and foot valve for repairs, and no lifting equipment should be required. The only required tools will be open end spanners to open the couplings and one stilson pipe wrench to change the seals.

Extractable Foot Valves

All test pumps with large diameter PVC rising mains will have extractable foot valves because of the obvious advantage of not having to lift and cut the PVC rising main, rejoin the rising main, and adjust the length of the pump rod in order to service the foot valve. Photos of these prototype components are presented in Figure 5-5.

Two systems of capturing the foot valve assembly for removal and maintenance were built. One consists of a grapple attached to a follower cage of the piston and a T-bar conjugate piece attached to the foot valve as in the TARA pump, recently discarded because of the advantage of the water column drainage feature of the second version. The other consists of a threaded spigot on the follower plate of the piston which inserts into a socket on the foot valve cage. The foot valve is removed by lowering the piston onto the foot valve and rotating the piston to engage the threads. Square or knuckle threads are recommended. The advantage of the square thread system is that it is quite robust, while the knuckle thread system is much more compact and requires fewer components. A third system is being considered, which was developed by the Consumers' Association laboratory in the United Kingdom. It consists of a sleeve or cage enclosing a bar attached to the foot valve. The sleeve or cage reciprocates with the piston while the bar remains stationary. When the piston is withdrawn to the surface, the foot valve is automatically picked up. The only objection to this system is that in general the piston requires more frequent servicing than the foot valve, and it is prudent to leave a component in place undisturbed if it is functioning properly. Otherwise there would be a risk of inducing malfunction by disturbing it.

The first extractable foot valves installed by the project were made either from the standard 2-1/2 inch nominal (approximately 63.5 mm) diameter piston components or the 3 inch nominal diameter piston assembly with the diameter of the follower plate reduced to that of the 2-1/2 inch nominal diameter follower plate. A static seal was achieved using the standard piston cup seal. Seating of the foot valve is by means of a tapered cone on the bottom of the foot valve follower plate, which fits into a corresponding cone. The disadvantages of the first foot valve option were that it did not provide for dumping the column of water resting on the foot valve during extraction (assuming that the foot valve was intact) and the flow area of the valve was sub-optimal. For these reasons a second option was developed.

The second foot valve option is a "snap-in" arrangement. It consists of the standard India Mark II foot valve in a modified cage arrangement with a double convex tapered spigot below the follower plate of the foot valve. The double convex tapered spigot inserts into a PVC or polyethylene (PE) receiver ring with an interference fit, holding the foot valve in place against the upthrust of hydraulic friction and effecting a static seal. The interference fit requires a pressure of approximately 15 to 20 kg-f (33 to 44 pounds) to make it snap into place. The snap-in foot valve has a shaft extending from the upper cage to open the piston valve when the two are joined for extraction. This allows the column of water resting on the piston to drain through the piston and around the foot valve when it is pulled out of the receiver, so that maintenance personnel need only lift the weight of the pump rod and pumping elements (at a 40 meter setting, the weight is about 36 kg-f).



FIGURE 5-4 THE PROTOTYPE MODIFIED VLOM INDIA MARK II HANDPUMP

A VLOM version of the standard India Mark II pump is being developed and field tested in India which permits the extraction of the piston and, if desired, also the foot valve through an open cylinder. The last segment of the pump rod with attached piston and foot valve was extracted in less than an hour. The foot valve was connected to the piston for extraction by lowering the piston to the top of the check valve and rotating the pump rod clockwise.

With a lift of only 50 mm, the foot valve clears its seat and the resulting space between the foot valve outside diameter and the cylinder inside diameter allows movement of water around it and releases the head pressure from the column of water above. The foot valve can be lifted up by a screw connection to the piston, and when this is done a trip pin will also lift the piston valve into an open position and dump the head pressure through both components. This dumping of the pressure of the water column should allow retrieval of the two valves by one or two people, without the use of any special lifting tools.

Cylinders

The experimental cylinders are either brass lined or unlined PVC. Both materials are very smooth, and the former is the traditional material for deep well handpump cylinders. The brass sleeves are inserted into standard PVC pipe which has a 75 mm outside diameter and 65 mm inside diameter and which has been plasticized by heating. The PVC shrinks when cooled providing a tightly fitting protective encasement for the brass sleeve. The resulting unit may be solvent cemented directly to a PVC rising main above and a support pipe below. The process is simple and no problems were encountered. The resulting package is rigid, apparently robust, and marginally cheaper than the standard cast iron housing. The PVC cylinder must be a non-standard thick walled extrusion, since the standard India Mark II cylinder inside diameter is 63.5 mm. This poses no problem, however, and will not significantly affect overall system costs for the production of reasonably large quantities.

For the initial experimental pumping elements the foot valve seat was provided by a taper in either the brass sleeve or plain PVC pipe. However, a problem could arise if the taper on either brass or PVC is forced open during operation by valve pounding or polymer creep. If the taper were to give way the check valve could either become stuck or drop down the well. When the cylinder was slammed down on a table with the foot valve in place as a demonstration, the check valve was forced through the taper, although the taper was unsupported by PVC and had been reduced in length prior to the experiment. A more secure seat could be achieved by seating the foot valve body on a component with a snap-in arrangement to hold it in place against hydraulic upthrust. The snap-in attachment could be substituted for the lower cup seal on the foot valve, leaving the upper cup to effect the static seal, and the receiver could be substituted for the tapered valve seat. The foot valve receiver could be PVC solvent cemented to the lower part of the PVC cylinder or cylinder housing. This system would not disrupt the strategy of retaining standard components where possible, and would preclude potential problems with the present foot valve seating arrangement. The Project is testing this design, photos of which were shown in Figure 5-5.

To hold the rising main (which has a 75 mm outside diameter and 65 mm inside diameter) in place, a rubber conical compression grommet was made to fit around the upper end of the rising main and into a conjugate taper in a steel flange to be installed between the drive head and the water chamber. A rubber encased 4 mm thick shim fits on the top of the conical rubber grommet which is oriented with the taper pointing downward and compresses the grommet around the rising main when the four bolts which fasten the drive head to the water chamber are tightened. A tension test rig is being constructed to

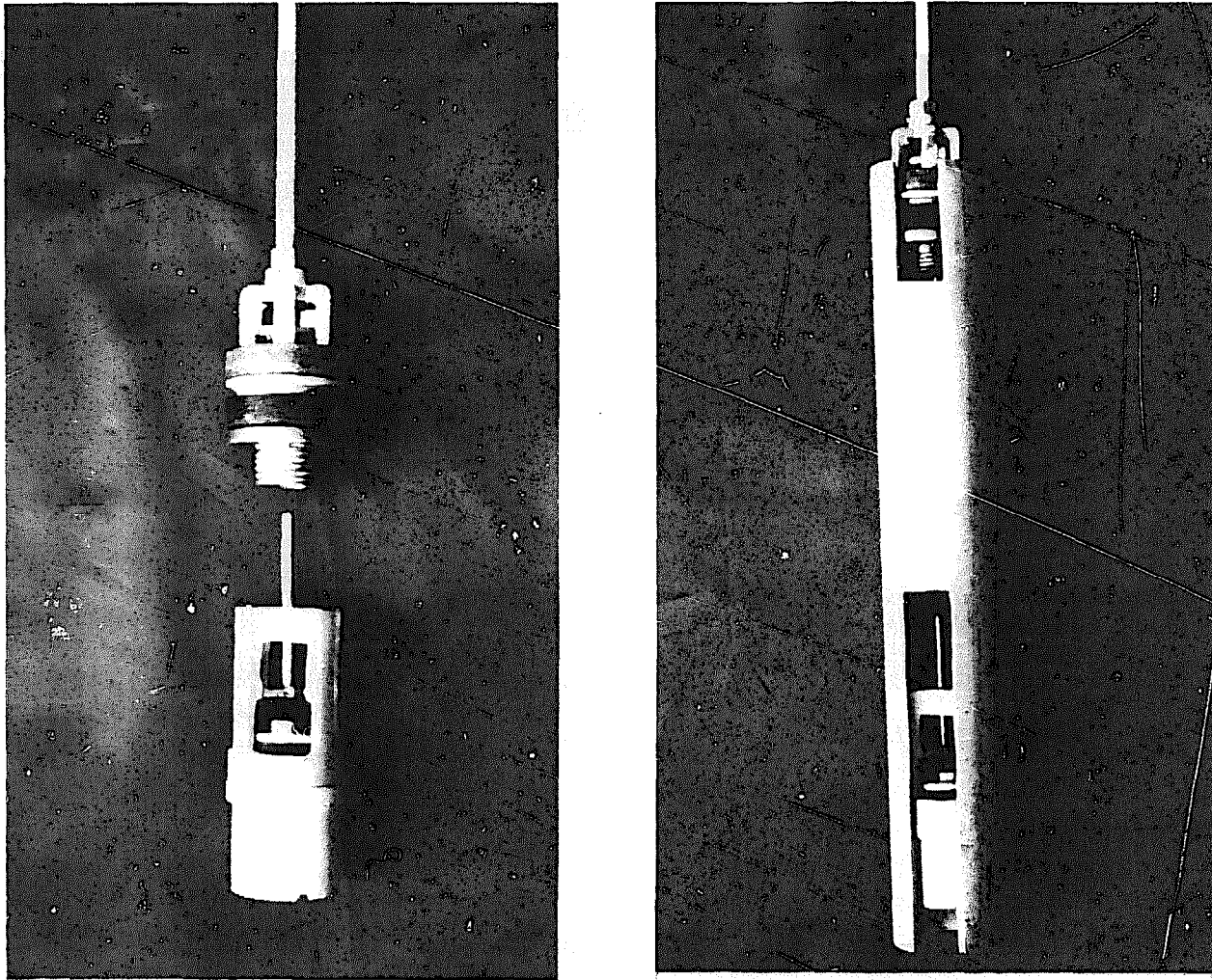

FIGURE 5-5 PROTOTYPE EXTRACTABLE PISTON AND FOOT VALVE FOR THE INDIA MARK II HANDPUMP

The photo on the left shows a prototype piston with an extractable foot valve below it. The foot valve can be removed by lowering the piston and screwing the piston follower plate into a socket on the foot valve cage and then lifting the two together. Note the trip pin protruding upwards from the foot valve. This pushes the piston valve open when the two are screwed together, thereby allowing the column of water in the rising main to drain, reducing the weight to be lifted when removing the piston. The foot valve shown is a "snap-in" design, as described in the text. The photo on the right shows the piston and foot valve in a PVC cylinder (the slots were cut for exhibition purposes).

measure the load that the rising main can take before slipping. For an extra measure of safety, a PVC ring can be solvent cemented on the 50 mm of rising main projecting into the water chamber. This will prevent the rising main from passing through the rubber grommet. The grommet will not bear significant tensile load if the rising main is supported from the bottom and may be able to withstand the load of a full rising main and the deflections caused by pumping. It is anticipated that the grommet will absorb shear forces generated by pumping and prevent failure of the top joint of the PVC rising main.

Rising Main Bottom Locking Device

Assuming that the PVC rising main will not survive without bottom support, then a stable platform is necessary on which to rest the weight of the full rising main. To provide an option for bottom support of the rising main, a bottom locking device was built.

The bottom support has a width of 140 mm when in a closed position for lowering into the well or for retrieval and has a maximum expansion of 160 mm suitable for boreholes with a 150 mm inner diameter casing. The cylinder assembly sits on the bottom support using an opposed taper principle with a four degree taper. The bottom support has a PVC plug taper and a polyethylene (PE) or high density rubber outside compressive ring.

The PE ring is held stationary for insertion and fixing by a cable. For removal the rising main is pulled sharply upward, which pulls the tapered cone out of the ring and relaxes the grip of the ring on the wall.

Tests indicate that the bottom support is able to support at least one metric tonne (this is about six times the weight of a 45 meter column of water in a 65 mm inside diameter rising main). Indications are that release of the bottom support lock would be easy, but this should only rarely be necessary because the piston and foot valve can be retrieved without removing the cylinder and rising main.

Unfortunately, the four opposed taper bottom support devices installed on experimental pumps have not performed consistently, and work is continuing on resolving the bottom support requirement.

Connection of Rising Main to Pump Head

The PVC riser pipe enters the pump head at the same location that the galvanized steel pipe enters the standard India Mark II which is through a hole in the pedestal to the water tank flanges. For the PVC rising main, a compression ring support has been added to this connecting point. This compression ring support has been tested for over one metric tonne, although the weight of the rising main will actually be supported by the previously described bottom support. A safety ring has been fixed to the rising main above the compression ring.

Rising Main Guides

High density rubber guide rings were installed every three meters to reduce deflection of the PVC rising main in the borehole during pumping. Since the rings take up most of the annular space, extracting the cable becomes a problem. It is likely that the cable should be permanently installed in each well.

Pump Rod Guides

Simple, snap-on rod guides of about 50 mm diameter are being tested. If the pump is operated with short, violent strokes there is a chance that the pump rod may contact the PVC rising main and abrade it. The rod guides may prevent contact. The test will examine whether this precaution is necessary.

Bearings

The two ball bearings used in the fulcrum of the India Mark II are pressed into the handle at the factory. However, it is difficult to install replacements in the field because of the absence of a press. The tendency is to use a hammer, which often damages the bearings and reduces their working life. Field testing of simple journal bearings of polyacetal plastic in Malawi has indicated that the material has the potential for becoming a substitute for ball bearings and would be hard to damage during installation in the field. If field tests in the future establish their superiority over ball bearings, they may be used to retrofit several hundred thousand existing pumps.

Cost

The cost for the Mark II VLOM system is slightly less than that for the standard India Mark II system. For a 40-meter depth, the down-the-hole VLOM components, including 75 mm PVC rising main, cylinder, guides, and bottom lock will cost approximately Rs 1,630 (US\$ 154) in India. This compares to the the cost of the standard India Mark II down-the-hole components, including a 1-1/4 inch BSP rising main with a brass cylinder, which is priced at Rs 1,760 (US\$166).

The use of a rising main made of 2-1/2 inch or 3 inch galvanized iron pipe was also considered but was rejected both because of the heavy work involved in installation and retrieval and because of its high price: 40 meters of 2-1/2 inch black steel pipe (BSP) would cost Rs 2,800 (US\$264), and 40 meters of 3 inch BSP would cost Rs 3,733 (US\$352) not including the cost of the cylinder.

D. SRI LANKA

1. Project Background

Sri Lanka is an island nation of 15 million people and two major ethnic groups. The northern part of the island is dry for most of the year while the southeastern portion has adequate rainfall. Since handpumps have only recently been introduced into Sri Lanka, the rural population is not accustomed to using them and generally prefers traditional open wells for bathing and drinking purposes. There is no national standardization of locally produced handpumps as yet.

Vavuniya

The National Water Supply and Drainage Board (NWSDB) of the Government of Sri Lanka has launched a rural water supply project consisting of 600 wells in the northern district of Vavuniya. Within this program the German Agency for Technical Cooperation (GTZ) is field testing handpumps. Sixty handpumps of four types are currently monitored in the project. They are the AID deep well pump, the Sihilase (Kandy) deep well pump (Sarvodaya deep well pump), two versions of the India Mark II (one manufactured in India by INALSA and the other by a Sri Lankan manufacturer), and second generation TARA pumps. Fifteen PEK pumps and two additional types of pumps by a German manufacturer, Preussag, have been ordered for testing in Vavuniya. The PEK is a direct action Canadian pump made almost entirely from polyurethane of various blends and is specified for use with a 25 meter head.

A deputy project manager was appointed by GTZ in September 1983. He supervises the locally-hired monitoring technician who repairs pumps and collects data from test pumps. He has been given the responsibility of developing a maintenance system to ensure long-term functioning of the pumps.

Kalutara

UNICEF manages handpump field testing in the Kalutara District as a part of their assistance to NWSDB. A country monitoring engineer, who is a United Nations Volunteer, is responsible for data collection and reporting under the supervision of UNICEF. There is a total of 125 pumps in the test sample consisting of six types of pumps. They include the India Mark II (standard India version), the India Mark II (Sri Lanka version), the AID (both deep well and suction models), the Sihilase, the Sarvodaya L-4, the Wasp, the TARA, and the Slimco. The test period has not been long enough for identifiable trends in handpump behavior to emerge.

2. Preliminary Comments on Handpumps in Sri Lanka

The following preliminary comments about handpumps in Sri Lanka are based on observations as of October 1983 and should not be considered definitive. Data collected during subsequent field testing will provide a sound basis for conclusions about the relative merits of various design features and recommendations to handpump manufacturers.

AID Deep Well Pump

Users of the AID deep-well handpump like its relatively high capacity compared to most other pumps. It seems also to be more aesthetically pleasing than other pumps. Finally, it is a local product made to reasonably good quality standards which is advantageous relative to imported pumps. However, it has serious deficiencies.

The AID deep-well handpump is a conventional cast iron handpump copied by the Somasiri foundry in Jaffna from a basic design developed by the Battelle Memorial Institute on behalf of AID in the late 1960's and later modified by the Georgia Institute of Technology also on behalf of AID. The deep-well pump stand has a cross-head to guide the pump rod thereby maintaining uniaxial reciprocating motion. Two outboard cast iron cleats on the crank pin slide up and down inside cast iron runners, with the fulcrum shaft mounted in a moveable fulcrum stand, which is itself pinned to the pump stand, so that it moves in an arc when the pump rod is moved up and down. The leverage system is exposed to the environment. This means that grease may become caked with dust and/or liquify under the heat of the sun and wash away in heavy rains. Exposed surfaces can thereby be abraded or corroded because of the absence of a protective shroud around the moving parts. Field test experience so far indicates that the leverage system needs frequent lubrication and is subject to rapid wear.

The small diameter rising main prevents removal of the pumping elements without also removing the rising main. This is a distinct disadvantage from the maintenance perspective. The 3 inch nominal diameter PVC cylinder is attached to a 1-1/2 inch diameter galvanized steel rising main by a threaded cap. PVC is a material noted for its sensitivity to notch failure, and the long-term viability of this joint is questionable. The check valve is a rubber hinged flapper attached to the bottom of the cylinder by two bolts, without an upper stop to control valve lift. At high operating speeds pump efficiency may be expected to suffer from excessive leakage due to late valve closure. The hinged joint is not ideal for longevity, since stress is concentrated at the hinge. The bolted attachment may be a source of valve failure either from detachment caused by vibration or corrosion. The low valve seat is subject to fouling from solids taken in from below but could be corrected by a higher valve seat. A rubber-faced poppet, with a lift yielding about 25 percent of the cross-sectional area of the cylinder, and a higher seat would be an improvement. The present valve has one distinct advantage, however, in that its mass is relatively low which reduces inertial forces during operation.

AID Suction Pump

The suction version of the AID pump is subject to the same disadvantages as the deep well pump with respect to the leverage system. It is easier to dismantle and reassemble because of the absence of a rising main. Essentially the same set of components is used to good advantage for both pumps, except for the rising main and deep well cylinder.

Sihilase (Kandy) Deep Well Pump (Sarvodaya Deep Well Pump)

In both the Kalutara and Vavuniya field test projects extensive maintenance is necessary to keep the Sihilase (Kandy) pumps operating. Project staff and users are becoming frustrated with the pump for that reason.

The Sihilase (or Kandy) pump derives in part from the IDRC-sponsored "Waterloo" low-lift plastic pump and the "open top" cylinder concept, in which the piston check valve may be withdrawn to the surface for servicing by pulling out the pump rod. The rising main of an "open top" system is necessarily as large or larger than the piston diameter. The rising main in the Sihilase pump is 3-inch nominal diameter PVC pipe. An extractable check valve is a logical feature to combine with a large diameter rising main. Otherwise the entire rising main has to be lifted to service the check valve. However, the Sihilase pump has a fixed foot valve which defeats part of the purpose of the open top concept and is a major flaw in the Sihilase pump design. The large diameter rising main is suspended by a clamp hanger. Experience in Bangladesh and India indicates that a PVC rising main should either be supported from the bottom to avoid shearing at the connection to the pump stand or should have a rubber compression fitting as the top connector to absorb shear forces. Rubber will absorb some of the deflections caused by vibrations during pumping.

The 24 mm outside diameter PVC pump rod has a 3 mm wall thickness. It is too small in diameter. During use it repeatedly expands and contracts in length and thereby wastes energy during pumping, especially at higher operating speeds. Repeated elongations, especially with large deflections, are likely to result in fatigue of the material. Both laboratory and field tests have demonstrated that pump rods made of PVC pipe should not be perforated to make a pinned mechanical joint, since stress concentrations at the perforation inevitably lead to cracking and failure. A larger diameter, thick walled PVC pipe with solvent joints or steel tubular rods would be an improvement to the Sihilase pump.

Valve lift on both the piston and foot valve is too high. The cup seal on the piston has a lip angled in the wrong direction. The high side (or the lip) should be outboard rather than inboard. One alternative would be to use the piston and an extractable foot valve from a locally made pump such as the AID pump corrected for valve lift in combination with the 3-inch nominal diameter PVC rising main.

The Sihilase pump has hardwood bearings on both the fulcrum and the connection between the handle and the rod with spare bearings built into the bearing blocks, which is probably a sound feature. However, they are not impregnated with oil and the projected area appears to be too small, since 1/2 inch nominal diameter shafts are used. Larger diameter shafts, such as 3/4 inch nominal diameter galvanized steel pipe in longer bearings, would make the leverage system more robust. The leverage system is covered with a sheet metal shroud attached to an angle iron frame which supports the bearing blocks. The shroud does not completely cover the concrete pump pedestal, allowing water to stand around the shroud bolts and lower part of the shroud. This promotes corrosion, making it very difficult to remove the shroud bolts. A larger shroud would drain water away from the bolts. A "clam shell" hinged shroud with one bolt or pin could be an improvement.

Slimco Deep Well Pump

The Slimco deep well pump made in Sri Lanka is a cast iron pump with a 100 mm diameter brass cylinder. The design closely resembles the Finnish made Nira pump. However, it has a major defect which must be remedied before UNICEF will agree to field test it. The pump rod is guided through a hole in the cast iron cover without a bushing and the movable fulcrum is without a stop. This means that the pump handle may be lowered to a position such that the rod will be bent against the guide hole making further pumping impossible. The cylinder is too large for a deep-well use. A maximum diameter of 75 mm is recommended. UNICEF plans to work with the foundry to improve the pump.

INALSA Suction Pump

The INALSA suction pump is an attractive pump made in India. It has a cast iron body (in which the cylinder hole is machined) and a mild steel head cover. The pump rod is guided through a brass bushing and the fulcrum stand is movable. Bearings are provided for all three shafts. The absence of an upper guide puts uneven pressure on the guide bushing, mostly on the side toward the handle. This feature can be expected to cause long-term problems. Frequent problems have been experienced with pump rods jamming in the bushing caused by slight misalignment of the head cover over the four bolt holes during attachment. However, it can be aligned properly by experimentation. The mild steel pump handle is sturdy and convenient to operate. The foot valve is a caged poppet. The cast iron cage rusts very quickly, however, imparting a disagreeable taste to the water.

Poor quality leather cup seals have been an important source of pump failure. The cup seals swell to an unacceptable degree and cause the piston to jam. The Indian Standards Institute quality standards for leather cup seals specify no more than a five percent increase in volume during prolonged soaking in water, but the seals furnished with this pump do not meet that standard. The National Water Supply and Drainage Board are reported to have responded to the problem by grinding down the walls of the stock cup seals to make them thinner. This procedure destroys the grain or structure of the leather thus weakening it and drastically reducing its working life.

INALSA India Mark II

The Indian made INALSA Mark II pumps which have been furnished to the Vavuniya project are not standard Mark II pumps. They do not have a chain and quadrant with a "pull down" pump rod but instead have a crank arrangement with a ball bearing. This causes the pump rod to be displaced laterally through an arc on both sides of the vertical axis of the well. It remains to be seen whether pump rod disconnections will develop as a result of metal fatigue at the connectors as happened with deep-well pumps in India before the advent of the chain and quadrant. Presumably this non-standard design is meant to be used for intermediate lifts up to 25 meters.

The same problem with piston jamming due to cup seal swelling is reported in the Kalutara project. However, it is more difficult to cope with, since the deep well pump is harder to dismantle and reassemble.

Sri Lanka Version of the India Mark II

Examples of a local version of the India Mark II were seen in Vavuniya, apparently copies of the INALSA non-standard version. Welding quality was uniformly poor. All surfaces were painted, rather than hot-dip galvanized. The bearings were of poor quality. No cylinders were examined, but it was reported that they were imported from India. GTZ has decided to phase them out of their water supply project. One approach to the quality control problem might be for a donor to finance the services of an Indian manufacturer of the India Mark II to introduce adequate quality standards to Government officials and to train the staff of a local manufacturer. A Sri Lankan agency could then take responsibility for enforcing quality norms.

Wasp Suction Pump

The Wasp suction pump is made in India and is a much improved but expensive version of the classic Maya cast iron suction pump common throughout the Indian subcontinent. UNICEF/India provided encouragement and technical assistance to the Wasp foundry in Bombay. The castings and machine work are excellent compared to its cousin, the Bangladesh New No. 6 pump. The pump rod operates through a brass movable guide bushing set into a slot in the head cover which protects the pump from debris while allowing the rod to move freely. The fasteners are very robust 5/8 inch (15.9 mm) galvanized bolts with lock nuts. The cylinder is a brass sleeve inserted into the cast iron pump body. The check valve is a robust poppet type. The cost, however, is three times that of the New No. 6.

The stroke of the piston in the Wasp pump is very short, about 100 mm maximum, compared to about 125 mm for the new No. 6 pump. However, to take advantage of the maximum stroke one must push the handle to an uncomfortably low position, while at the top of the stroke the handle is parallel to the ground. This is because the pump handle is curved excessively, resembling a shepherd's staff. If the pump rod shape were straightened, more stroke length would be available within the comfortable range for most people between the knee and slightly above the hip, rather than from the ankle to the knee. For small children the pump handle could be raised to shoulder height and the full body weight could be used in pumping. With this reservation, the Wasp pump is a commendable improvement of a pump, the Maya, which has needed improvement for many years.

Sarvodaya L-4 Intermediate Lift Pump

The Sarvodaya L-4 pump resulted from several years of experimentation with PVC plastic handpumps, much of it with International Development Research Centre (IDRC) support. It has a three inch nominal diameter PVC rising main which is used as the pump cylinder as well. The piston may be withdrawn through the rising main, but the foot valve is fixed. The pump stand is unusual: a PVC discharge spout is partially covered from above by a metal cover, allowing the spout to be removed without dismantling the mild steel welded pump stand. The leverage system consists of a steel pipe with a bearing housing welded on and a ball bearing system which is too loose in the housing and is not shielded. The fulcrum is attached to a clevis by the

fulcrum shaft. The base of the clevis is attached to the pump stand by means of a flange and two stove bolts. This is a very weak connection which is subject to constant stress reversals causing the connection to loosen which results in misalignment of the pump rod. The pump rod is 24 mm PVC pipe with pinned connections. Although the Sarvodaya L-4 is based on a good and simple concept, it has been modified and made more complex and thereby has lost much of its potential advantage.

Modified TARA Low-Lift Pump

Unlike the TARA pumps in Bangladesh, the 50 units supplied to UNICEF and GTZ in Sri Lanka will not be installed in alluvial soils which in Bangladesh consolidate around the PVC pipe serving as the cylinder/rising main/casing. In Sri Lanka they will be placed into large diameter excavated wells or drilled wells at least twice the outside diameter of the PVC rising main. This could be expected to cause the PVC rising main to break at the threaded connection to the 2-1/2 inch nominal (approximately 63.5 mm) diameter galvanized steel pump stand when it is subjected to deflections caused by pumping unless measures are taken to prevent it. Two techniques to resolve this problem will be tried. In the relatively shallow excavated wells in Kalutara the rising main will be attached to the concrete rings with galvanized steel wire with rubber strips protecting the rising main. In Vavuniya, excavated wells generally are deepened with a drilled hole in the center of the excavation. The project has available 5-inch nominal (approximately 127 mm) diameter PVC casing pipe used for surface casing. This pipe could be used as a casing pipe extending from the center of the concrete platform down to the hole in the rock and supported at the bottom of that hole. The TARA pump rising main will be inserted into the casing with guides to prevent deflections and the rising main will rest on the bottom of the hole. Intake ports will be drilled into the rising main about one meter above the bottom.

Third generation TARA pistons, foot valves, and pump rod connectors are much improved over the second generation TARA parts in the units supplied to Sri Lanka. Since they may be easily retrofitted after the pumps are installed, they will be manufactured in Bangladesh and sent to the two Sri Lanka projects.

CHAPTER 6

LABORATORY TESTING AND DEVELOPMENT

A. INTRODUCTION

In this chapter the main activities of the Consumers' Association Testing and Research (CATR) Laboratories are described. These include the testing of handpumps, the development and manufacture of water flow monitors, the development of below-ground components of plastic materials, and the development of dry bearing systems for the Malawi pump head. Brief comment is also provided on other activities, such as a study tour for Chinese engineers in handpump evaluation, and the design work on new bearing systems for the India Mark II handle. CATR also provides a brief overview of the value of laboratory work and discusses future activities, with particular reference to those projects having collaborative funding from the World Bank and the Overseas Development Administration of the United Kingdom.

B. HANDPUMP TESTING

1. Standard Handpump Test Procedure

The test procedure used for the UNDP/World Bank sponsored project was essentially the same as the one used to test twelve handpumps in the Overseas Development Administration tests between 1978 and 1980. This was done so that the results would be comparable. A list of all pumps which have been evaluated is provided in Table 6-1.

None of the pumps tested was satisfactory in every respect. All the designs represent some compromise between reliability, performance, ease of installation and maintenance, user convenience and so on.

The selection of the most appropriate pumps for community use depends on the local conditions. In different applications, particular pump characteristics will be of greater or lesser significance. It is therefore very important to define these conditions before deciding which pumps to use. However, for most applications, out of the 35 pumps tested by CATR, we would expect the choice to be made from the pumps listed in Table 6-2; they are presented by category in alphabetical order. Unless otherwise stated, laboratory tests were conducted for pumping heads up to 45 meters.

Table 6-1 List of Pumps Tested at Consumers' Association Laboratories

<u>Pump test</u>	<u>Pump</u>	<u>Country of Origin</u>
ODA Project	Abi	Ivory Coast
	Climax	United Kingdom
	Consallen	United Kingdom
	Tempster	USA
	Godwin	United Kingdom
	GSW (formerly Beatty)	Canada
	India Mark II	India
	Kangaroo	Netherlands
	Monarch	Canada
	Mono	United Kingdom
	Petro	Sweden
Vergnet	France	
Batch 1 (Reports 1,2,3)	Bandung	Indonesia
	Korat 608 A-1	Thailand
	Moyno IV 2.6	USA
	Nepta	France
	New No. 6	Bangladesh
	Nira AF-76	Finland
Batch 2 (Reports 1,2,3)	Dragon No. 2	Japan
	Ethiopia Type BP50	Ethiopia
	Jetmatic	Philippines
	Kenya	Kenya
	Sumber Banyu (AID)	Indonesia
	VEW A18	Austria
Batch 3 (Report 3)	ASM (Abi-Vergnet)	Ivory Coast
	Funymaq (AID)	Honduras
	Maldev	Malawi
	New Petro	Sweden
	Rower	Bangladesh
	Volanta	Netherlands
Batch 4 (Annex F)	Kardia	Federal Republic of Germany
	Mono direct action	South Africa
	Monolift	United Kingdom
	Sihilase	Sri Lanka
	Turni	Federal Republic of Germany
In Progress	GSW (new model)	Canada
	Monarch (new model)	Canada
	PEK	Canada
	TARA	Bangladesh

Table 6-2 Recommendations from the 35 Pumps Tested by CATR to Date

<u>CATEGORY A</u>	Pumps that have proved generally satisfactory in laboratory tests, which are in serial production and appear to be giving reasonable service in the field.
India Mark II	Reliable, robust and performs well, though good quality control in manufacturing is essential. It requires a reasonable level of skill to be maintained and is suitable for manufacture in some developing countries. VLOM below-ground assembly is under development.
Kardia	Reliable to depths of 30 m. Easy to maintain, with some potential for manufacture in developing countries.
Korat 608 A1	Reliable below ground, pumpstand less reliable but easy to maintain and repair. Potentially suitable for manufacture in developing countries with foundry skills, needs a small change to eliminate the safety hazard.
Maldev	Pumpstand only, designed for 2.5 inch uPVC or galvanised iron rising main and for ease of maintenance. Pumphead is robust and reliable and is suitable for manufacture in developing countries. Improved pumphead and VLOM below-ground assembly are under development.
Monolift	Robust and reliable, best suited for depths below 20 m where it offers a higher rate of delivery than other pumps using the same principle. Not suitable for manufacture in developing countries.
Rower	This low-lift irrigation pump is easy to manufacture, install and maintain in developing countries. It is a suction pump with a high rater of delivery but is not recommended for drinking water purposes.
Vergnet	Foot-operated pump with hydraulic connection between above- and below-ground parts. Reliable below-ground, less reliable above-ground. Limited potential for manufacture in developing countries.
Volanta	Easy to maintain. Cables were unreliable but manufacturer now supplies steel rods with hook-and-eye joints which are currently under test. Considerable potential for manufacture in developing countries.
<u>CATEGORY B</u>	Pumps reasonably successful in Laboratory tests but subsequently shown to have had problems in the field; manufacturers are taking action to overcome the difficulties. This group also includes pumps which have not reached the stage of serial production.
	Consallen, Ethiopia BP50, Moyno, Nira AF76, and Petro

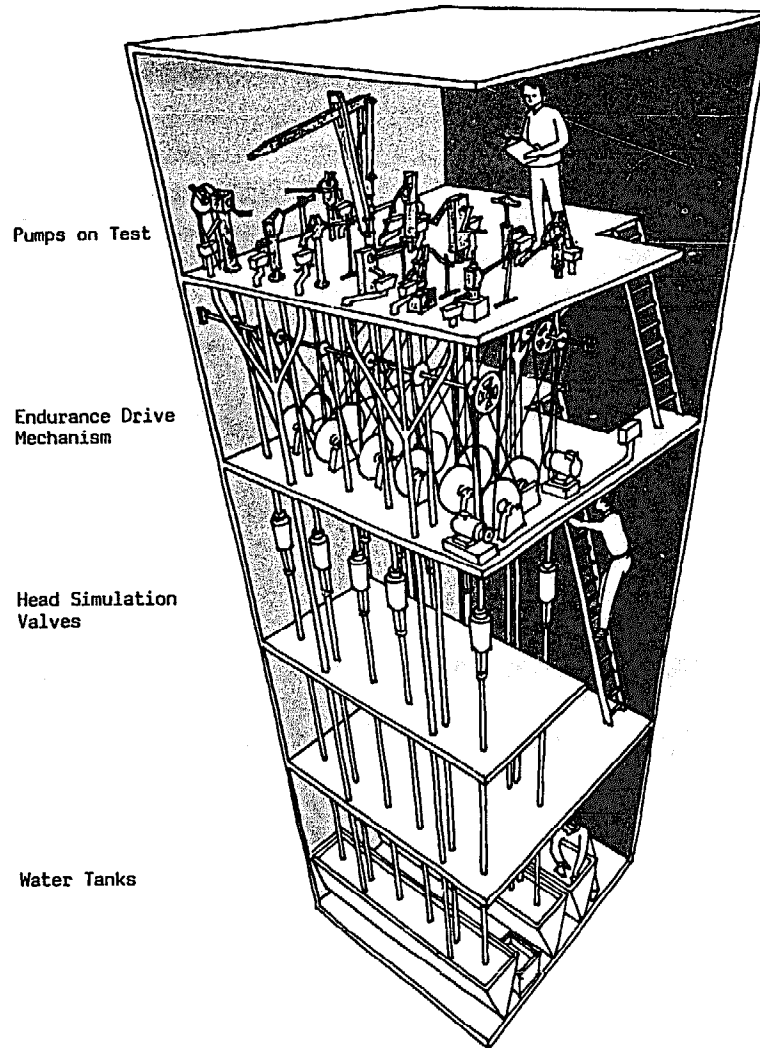

FIGURE 6-1 HANDPUMP TESTING TOWER

The floor of the pump chamber at the top is 7 meters above the water level in the tanks, the practical upper limit for suction pumps. High lift force pumps are fitted with head simulation valves so that tests can be carried out at various depths down to 45 meters.

The handpump testing tower is shown in Figure 6-1. The following detailed description of the test procedures indicates the breadth of the evaluation which is carried out.

Description

The test samples should be representative of the manufacturer's normal output. Wherever possible, sample pumps should be obtained through independent procurement agencies.

o Manufacturer or Agency

- Name and address of pump manufacturer and/or supplying agency

o Pump model and type

- Manufacturer's model reference
- High- or low-lift type
- Free discharge or delivery lift

o Cost

- FOB

Inspection

o Condition of pumps

- Whether in working order as received.
- Summary of defects on delivery.
- The pumps are dismantled and inspected for any visible defects. Further defects may come to light in the course of testing the pumps.

o Literature

- Whether supplied with pump or obtained from other sources.
- Assessment of clarity, accuracy and usefulness.

Weights and Measures

o Weights of principal components

- Pumpstand
- Cylinder
- Drop pipe per meter length
- Pump rods per meter length, including couplings

o Principal dimensions

- Nominal bore and stroke
- Nominal volume per stroke
- Usable cylinder length

o Cylinder bore diameter

- Comment only if bore finish is unsatisfactory

o Ergonomic measurements

- Measurements of handle and spout heights, angular movement and velocity ratio of handle, and description of exit water pattern.
- Where a pump is mounted on a plinth, some of the ergonomic measurements depend on the height of the plinth.
- When information is available, pumps are installed at their manufacturer's recommended height. When it is not, the pump is installed so that the midpoint of handle operation is as close as possible to 0.9 meters from floor level, subject to a maximum spout height of 0.6 meters. These preferred heights were suggested by previous user tests of handpumps.

Pump Performance

o Volume flow, work input and efficiency

- Measurements of volume flow, work input, and the efficiency of the pump are combined in a single test procedure. Strain gauges are attached to the pump handle to measure the applied forces, and a rotary potentiometer is fixed to the body of the pump will measure the angular movement.
- The outputs from the strain gauges and the potentiometer are fed, via an interface unit, to a microcomputer. The computer is programmed to record the data and calculate the work done by the operator of the pump. The computer compares this work done on the pump with the work done by the pump in raising water (the product of the weight of water raised and the head) in order to calculate the efficiency of the pump. The strain gauges and potentiometer are calibrated at the start of each test; the calibration procedure is built into the computer program.
- Low-lift pumps are tested at 7-meters head. High-lift pumps are tested at 3 heads: 7, 15 and 25 meters or 15, 25 and 45 meters depending on the specification of the pump.
- For each head, the pump is tested at three operating speeds, normally 30, 40 and 50 strokes or revolutions per minute. Where 50 strokes/min would be impractical or unrealistic, 20, 30 and 40 strokes/minute are used.

- For each test, the computer plots applied force on the handle against handle displacement. A typical result for a conventional reciprocating pump is illustrated in Figure 6-2.
- Successive strokes retrace the force/displacement loop. The area inside the loop represents the work done on the pump.

o Leakage

- Measurements of the volume of water leaking past the foot valve and measured for the same heads as the tests of volume flow, work input and efficiency.
- The leakage test is normally carried out by removing the cylinder and one length of drop pipe. The cylinder is filled with water and the open end of the drop pipe blocked off. The various heads are then simulated by injecting compressed air above the cylinder.

Figure 6-2
Work Required Per Pump Stroke

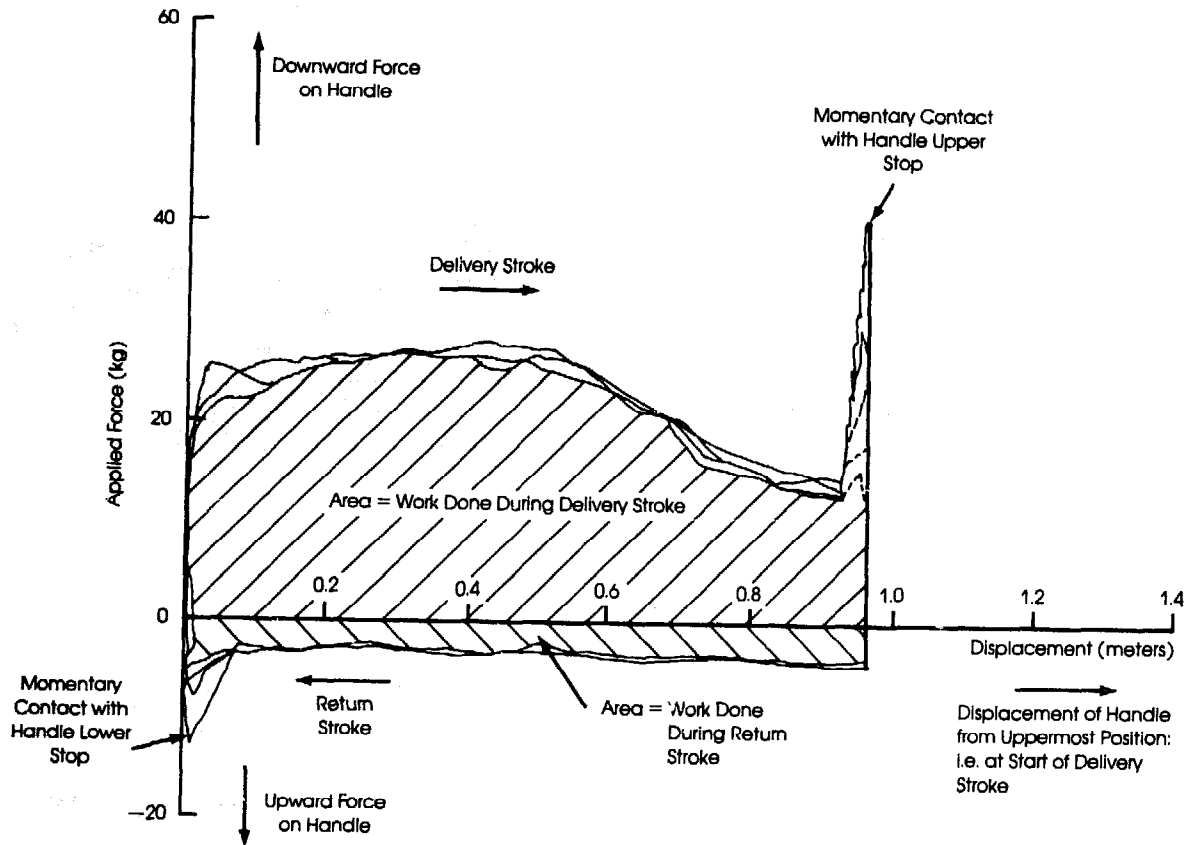

User Trial

A number of users are recruited. Most are women and children, of various heights and ages, with a small control group of adult men. Each user is given an opportunity to familiarize him/herself with the pump and to find their preferred method of operation. They are asked to fill a 10 liter container at their own pace. The number of strokes and time taken are noted. High-lift pumps are normally set at 20 meters depth.

o User comments and observation of users

- Each user is asked to fill out a short questionnaire to record his/her opinions of the ease of operation of the pump.
- Methodical observations of the relationships between pumps and people are made, reinforced by selective video recordings.

Endurance Test

The endurance test consists of two stages of 2000 hours each, with a check test of volume flow after the first stage. The pumps are mechanically driven, normally at 40 strokes or revolutions per minute, or the speed most appropriate to the pump design. The handles of the reciprocating pumps are driven in simple harmonic motion imposing no shock loads. The simulated depth is the maximum agreed with the manufacturer.

o Stage 1 - clean hard water, approximately 7.2 pH

o Stage 2 - hard water consisting of one gram per liter of Kieselguhr with a maximum of particle size 7.5 micrometers and one gram per liter of fine, sharp-sand particle size of between 75 and 500 micrometers is added. For stage 2 the water is agitated and daily checks are made to ensure the correct concentration of contaminants is maintained.

o Failure report - Any failure is examined and an assessment made of the probable cause, i.e., use of materials, design, bad quality control, or manufacture. Based on the cause of failures, suggestions for design improvements or for manufacturing changes are made.

Abuse Tests

o Handle Shock Loading where applicable.

- Controlled shocks are applied to the handle stops using impacts determined by an operator where the handle is allowed to travel with the normal level of effort onto the stops. Both high- and low- lift pumps are tested at a head of 7 meters, since for high-lift pumps the user is more likely to hit the handle on its stops when the pump is used at relatively shallow depths. The test is carried out using the normal endurance stroke speed at a rate appropriate for the type of pump. The test consists of 96,000 shocks for force pumps and 72,000 shocks for suction pumps, or until the pump fails.

o Impacts on pumpstand and handle

- Using a pendulum, impacts in steps of 100 Joules to a maximum of 500 Joules are applied on the center of the pumpstand.
- Using a pendulum, impacts in steps of 50 Joules to a maximum of 200 Joules are applied on the center of the pump handle.

Engineering Assessment

The pumps are dismantled. Each component is examined and the material and method of manufacture assessed, together with the degree of skill demanded and the standard of workmanship. These together with the experience gained in installing and maintaining the pumps form the basis of the overall assessment of suitability for manufacture and use in developing countries.

o Materials, manufacturing methods, etc.

- Identification of materials and manufacturing processes used for each component of the pump.
- Assessment of fitness for purpose of chosen materials and processes.

o Suitability for manufacture in developing countries

- Summary of manufacturing processes required, with assessments of the degree of skill demanded for each process.

o Ease of installation, maintenance, and repair

- Assessment of techniques, skills and equipment required.
- In assessing ease of installation, maintenance and repair, we consider the degree of technical competence demanded by the design and construction of the pump, and whether it could be repaired using indigenous materials.

o Resistance to contamination and abuse

- Assessment of sanitary sealing of both pumpstand and wellhead. Here the resistance of the pumpstand to accidental or deliberate contamination is considered and the likelihood of contamination of the well by surface water.
- Assessment of resistance to deliberate abuse, pilferage, impacts by domestic animals, etc. Resistance to abuse includes both the likely susceptibility of the pumpstand to impacts - from domestic animals, for example - and to pilferage or vandalism.

o Potential safety hazards

- Assessment of potential dangers of finger traps, insecure fastenings, projections, etc., to both pump users and bystanders.

o Suggested design improvements

- Suggestions for improvements in either pump design or manufacture, at minimal cost. It is hoped that these suggestions will stimulate a response from pump manufacturers.

Verdict

A summary of the principal good and bad features of the pump and its performance and comment on suitability for manufacture in developing country.

Reporting

- o The first interim report contains all information prior to the start of the endurance test - it is not a comprehensive report, but rather highlights the more important findings to date. It includes Data Checking Sheets, detailing the results for the particular pump. This gives manufacturers an opportunity to comment on the testing, and to question any of the results relating to their pumps. It is hoped that this approach will encourage a dialogue with manufacturers.
- o Contacts are made with the client as required where significant problems are encountered in endurance testing.
- o The final Technical Report includes full details of the pumps, test procedures, results, relevant drawings and photographs.

2. Pump Batches 1 and 2

The final summary report of assessments of the first twelve handpumps were published by the World Bank as UNDP Project Management Report No. 2 in March 1983. This work was funded by the World Bank/UNDP Handpumps Project.

There were nine high-lift pumps, two low-lift suction pumps and one low-lift force pump. None of the pumps was satisfactory in every respect, for all designs required some compromise between performance, reliability, ease of installation and maintenance. The preferred pumps were the Korat 608 from Thailand, the Moyno IV from USA, Briau Nepta from France, and the Nira AF76 from Finland. Of the low-lift pumps, the most interesting was the BP50 made in Ethiopia which is a direct action force pump and appears to be close to the VLOM concept. It is easy to install and maintain, self-priming, and therefore suitable for drinking water supply. Unfortunately it was not very robust but this might be overcome by further development work.

3. Pump Batch 3

The full technical report with all results for this batch of six pumps was published in mid-1984 by the World Bank as UNDP Project Management Report No. 3. This report also included the full technical details of tests carried out on the pumps in Batches 1 and 2.

In this group of six pumps, testing of four were funded by the World Bank: the Petro from Sweden, Rower from Bangladesh, the ASM (Abi-Vergnet) from the Ivory Coast, and the Maldev head from Malawi. Testing of one pump was funded by USAID - the Funymaq, made in Honduras, and the sixth pump was the Volanta whose testing was funded by the INSTO Foundation in Holland.

Petro - Sweden

This pump had originally been tested in the Overseas Development Administration series and was completely redesigned as a result of the laboratory tests. This model proved more reliable than the earlier one and only required one small modification. Subsequent work on the anchor fitting in PVC pipe has indicated potential problems in this type of well casing. However it appears that the anchor is satisfactory in mild steel well casing.

Rower - Bangladesh

This was a very easily manufactured, assembled and repaired suction pump, particularly suitable for irrigation purposes. It had high output (approximately 1.7 liters per stroke) and after 4000 hours of endurance testing, in spite of some wear, was producing nearly 1.4 liters per stroke. Testing has indicated that it fulfilled many of the VLOM criteria.

Abi-Vergnet ASM - Ivory Coast

The below ground element of the ASM, made in France, was very reliable in contrast to the pumphead, which was made in the Ivory Coast. The pumphead showed lack of quality control in manufacturing; the bearings used in its handle were of particularly poor quality. It was discovered during the early tests that the primary cylinder contained an unrepairable manufacturing fault. A replacement head was finally delivered which was better and also showed further modifications to the fixing arrangement of the primary rod to the handle.

Maldev head - Malawi

This is a robust and simple head but the ball races in the handle and the hanger were damaged during assembly of the head by the manufacturer. Subsequent work in both the laboratory and in the field on the replacement of ball races by dry bearing systems has indicated that potential savings in manufacturing costs and ease of maintenance in the field could be achieved. A new project, noted later, is underway to improve the reliability of these systems.

Funymaq (AID) - Honduras

Considerable problems exist with this pump due to lack of quality control in manufacturing. A similar model to this called the Sumber Banyu, manufactured in Indonesia, had been tested in Batch 2, and had also shown that proper quality control in manufacturing had not been exercised. The need for

careful quality control and/or inherent complexity of foundry technology may indicate that this design is not really suitable for production in a developing country.

Volanta - Holland

A number of areas of unreliability in the cylinders and cable connecting them to the pumphead were found during laboratory tests. The pump has been substantially modified in response to these analyses and also to information from the field where trials showed similar problems. The cable has now been replaced by steel rods with hook-and-eye connections. Two types of cylinders were tested and the glass fibre sealless type is now in production.

4. Pump Batch 4

The full technical report on the results of tests on these pumps is presented in Annex G of this report. Pumps in this batch included the Kardia and two versions of the Turni with different gear ratios in the heads. These pumps were manufactured by Preussag in the Federal Republic of Germany who funded the cost of the tests. The Monolift pump was manufactured by Mono UK, who funded the testing costs for this pump and the Mono Type 4 Direct Drive, made by Mono (South Africa). The testing of the Sihilase pump, manufactured in Sri Lanka, was funded by the World Bank.

Kardia - Federal Republic of Germany

This pump generally proved to be satisfactory and had only one or two minor problems which the manufacturer has overcome. It completed the endurance tests without breakdown. The below-ground assembly is lightweight.

Turni - Federal Republic of Germany

The Turni is a rotary positive displacement pump and was supplied with two "pumphead gearbox ratios". Although lower in output than pumps of a similar type, the manufacturer incorporated certain mechanical advantages which may make this design suitable for depths below 50 meters. They were both somewhat over-engineered although the foot valve failed during the course of the endurance test. There were problems where the high sand content used in the endurance test settled out on the rotor when the test rig was stopped. The pump would not then restart and the cylinder had to be removed and cleaned. This did not occur with the Monolift pump which employs a similar operating principle. Like the Moyno, the Turni uses a one-start rotor in a two-start stator.

Monolift - United Kingdom

This pump has a two-start rotor in a three-start stator and, at 0.3 liters per revolution, produced more water than either the Turni or the Moyno. Only one or two minor problems occurred with the handles and foot

valve which the manufacturers have remedied and nothing of significance occurred during the endurance test. The specification for the rubber used in the stator has now been broadened to make the pump suitable for ground water temperatures from 16 to 40°C. The pumpstand has been shortened and with the lower operating torque of the new pumping element, this pump is more suitable for children. A 2:1 gearing is now available as an option providing lower effort when operating from deeper settings.

Mono Type 4 Direct Drive - South Africa

The below-ground components are similar to the Monolift but the direct-drive low speed operation of this pump produces only about one third of the water per revolution compared with the Monolift. Various parts of the pump failed during the endurance test and design changes have been made to overcome a fault in the non-return clutch. Alterations to the operating height and form of the handle should make the pump easier and safer to use.

Sihilase - Sri Lanka

The foot valve and plunger required modification before this pump could be installed. Its efficiency was quite good at 20 meters but during the endurance test there were repeated breakages of the PVC pipe pumprod. This had to be replaced with steel rods in order to complete the endurance test.

In spite of this failure, the pump is considered to be worthy of further development for a maximum head of 15 meters because it contains a number of interesting VLOM design ideas, unfortunately let down by poor manufacturing and quality control.

5. Pump Batch 5

Pumps in this batch come mainly from Canada and include the PEK, Monarch, GSW, and TARA (Bangladesh). The PEK pump, having an innovative design and use of materials, was installed on the borehole at the laboratory before it was mounted in the test tower for a full test. The other two Canadian-made pumps were first compared with their earlier versions that previously were tested by CATR, and the full test results will be compared with the results of their predecessors tested in earlier batches (ODA 1979 and Batch 1). Some other manufacturers have sent prototype designs for initial assessment on the borehole to establish basic performance characteristics.

C. DEVELOPMENT AND MANUFACTURE OF WATER FLOW MONITORS

1. The Need

One of the most important elements in performing an economic analysis of rural water supplies is the knowledge of the amount of water extracted by each pump and the average daily usage. It may not be feasible to use standard water meters because it may not be practical to adapt the fittings to suit all the different handpump spout designs and materials. Also, for some spout

configurations the extension holding the meter might restrict output and cause overflowing internally. It was therefore desirable to develop alternative means for measuring these parameters.

2. The Flow Monitor

Consumers' Association funded the original development of an electronic water flow monitor which was universal in that it could be fitted into the pump body or the spout of any type of handpump through a simple drilled hole, it would not restrict the operation of the pump and it would provide the total time of operation of the pump from which the approximate quantity of water produced could be determined.

3. Pre-prototype Laboratory and Field Tests

The water flow monitors were produced and prototypes have completed 12 months testing in the laboratory and nine months field trial in Lesotho, Africa. Two systems were developed, both activated by the flow of water from the pump. One system is based on the use of the timing mechanism in a digital watch which totals the time of water flow from the pump. The second system is based on the ionization of a column of mercury. A small gap in a mercury column moves up a scale indicating the time water has flowed out of the pump.

The water flow monitor is calibrated for the particular pump so that the amount of water produced in the period of the test can be established to limits of approximately plus or minus 10 percent.

4. Further Field Tests

On the basis of the success of this work a further 200 flow monitors were ordered to be used in the field trials in both East Africa, India, Bangladesh, Sri Lanka and Thailand.

The components for the water flow monitors were ordered from outside suppliers and initial checks indicated flaws in nearly half of the mouldings.

In spite of further stringent checks on function and water ingress carried out on all of the monitors, reports from the field indicate that malfunctioning of some of these has occurred, mostly caused by moisture within the monitor. A manufacturer has now undertaken further development and complete water proofing of the components in conjunction with the World Bank Regional Project Officers.

D. THE DEVELOPMENT OF BELOW-GROUND COMPONENTS

1. Introduction

At the World Bank Advisory Panel Meeting in Braintree in October 1981, the Project Manager compared the characteristics of the conventional handpump with one designed for Village Level Operation and Maintenance (VLOM). The

comparison favored the VLOM pump in a number of areas, the most important being the maintenance aspect. Fuel is very scarce in developing countries and costs of running district maintenance teams are very high, particularly where heavy lifting tackle is required for repair work, which in turn needs four-wheeled drive trucks as transport.

It was considered therefore that the VLOM concept should take priority in the area of handpump development. From tests at our laboratories a number of potentially suitable pumpheads have been indentified which can be manufactured in developing countries relatively easily, but none of the pump cylinder designs was sufficiently reliable or could be made and easily maintained in developing countries. Few cylinders used plastics - materials which offer potential simplicity of design. Plastics are light and corrosion resistant and, if mass-produced by moulding or extrusion, they would be cheap and spares could be guaranteed to fit.

In Malawi there has been progress for some time in the development of a simple, robust handpump head, the "Maldev", using the available skills and facilities in Malawi. Work was done in conjunction with a local manufacturer to produce these pumpheads and then training courses were given for village pump caretakers. Improvements in the installation of handpumps were organized, pump platforms were upgraded and real improvements have emerged there in the rural community water supply.

2. Below-ground Assemblies

Basic problems existed with the maintenance of below-ground equipment which conventionally used galvanized mild steel rising main, steel rods and heavy metal cylinders and foot valves. These required a mobile team for repair and maintenance. The facilities for carrying out research on the use of plastics in below-ground assemblies were very restricted in Malawi. The Eastern Africa Regional Project Officer in Nairobi was asked for assistance. Some facilities for doing plastics machining were available in Kenya but these proved inadequate and CATR was approached for assistance.

3. Project Co-funding with ODA

The potential for the use of plastics in below-ground equipment is large, and the World Bank agreed to discuss co-funding of a project on this subject with ODA who had been involved in Malawi particularly on groundwater projects. The terms of reference for the project called for use of plastic materials which are available in developing countries. Also, the parts should be able to be produced simply, in large volume, and allow villagers to maintain the below-ground assemblies without special tools or heavy lifting gear.

4. Initial Design Concepts

The Project had produced some components in Kenya and had tried out some concepts in the field. Consequently, these designs formed the basis of CATR's original project. Discussions were held with manufacturers of plastic materials and a number of designs were developed. Prototypes based on three

of these designs were machined from solid bar stock and assessed on specially designed multi-station test rigs.

Machined samples were also sent out to Malawi and Kenya for testing and apart from showing a failure of the foot valve locking mechanism which had already been established in the laboratory tests, the units work satisfactorily.

One particular concept of a rolling diaphragm was of sufficient interest to the Research & Development Division of Dunlop Limited that they are now pursuing it further. Work is still continuing and it is hoped that prototype samples will soon be ready for testing.

The final designs which evolved from this development work were published in a laboratory report to the World Bank in October 1983, and these included a variety of foot valve extraction systems.

5. Prototype Manufacture

A continuation project was agreed between the World Bank and ODA to manufacture a prototype model to check that the components fitted together, and provide the toolmakers with essential information for mould tool design. This model was shown to members of the World Bank Project Management Team in January 1984. Further suggestions for areas of development were made and these have been undertaken. Toleranced drawings were sent to tool makers who have produced moulding tools and the first moulded parts have now been produced. Enough parts for 120 assemblies will be made for testing in the field and in the laboratory. The general assemblies of the designs are given in Figures 6-3 and 6-4.

E. DEVELOPMENT OF DRY BEARING SYSTEMS FOR THE MALDEV PUMPHEAD*

1. Introduction

When a prototype of the Maldev pumphead was received at the Consumer's Association Laboratories for assessment, there was some concern that the ball races had been damaged while being inserted into the handle and hanger positions. It was considered that ball races were not appropriate in this context, they may be able to be shielded from dust but they cannot be shielded from water, and are liable to rust. Also, unless they are fitted properly by a bearing press into a socket which has been carefully toleranced, their life will be shortened. It is also difficult to replace these ball races in the field, and damage to the replacement bearings may occur during installation.

* See Chapter 2, Section C for the distinction between the Maldev and the Afridev pumphead.

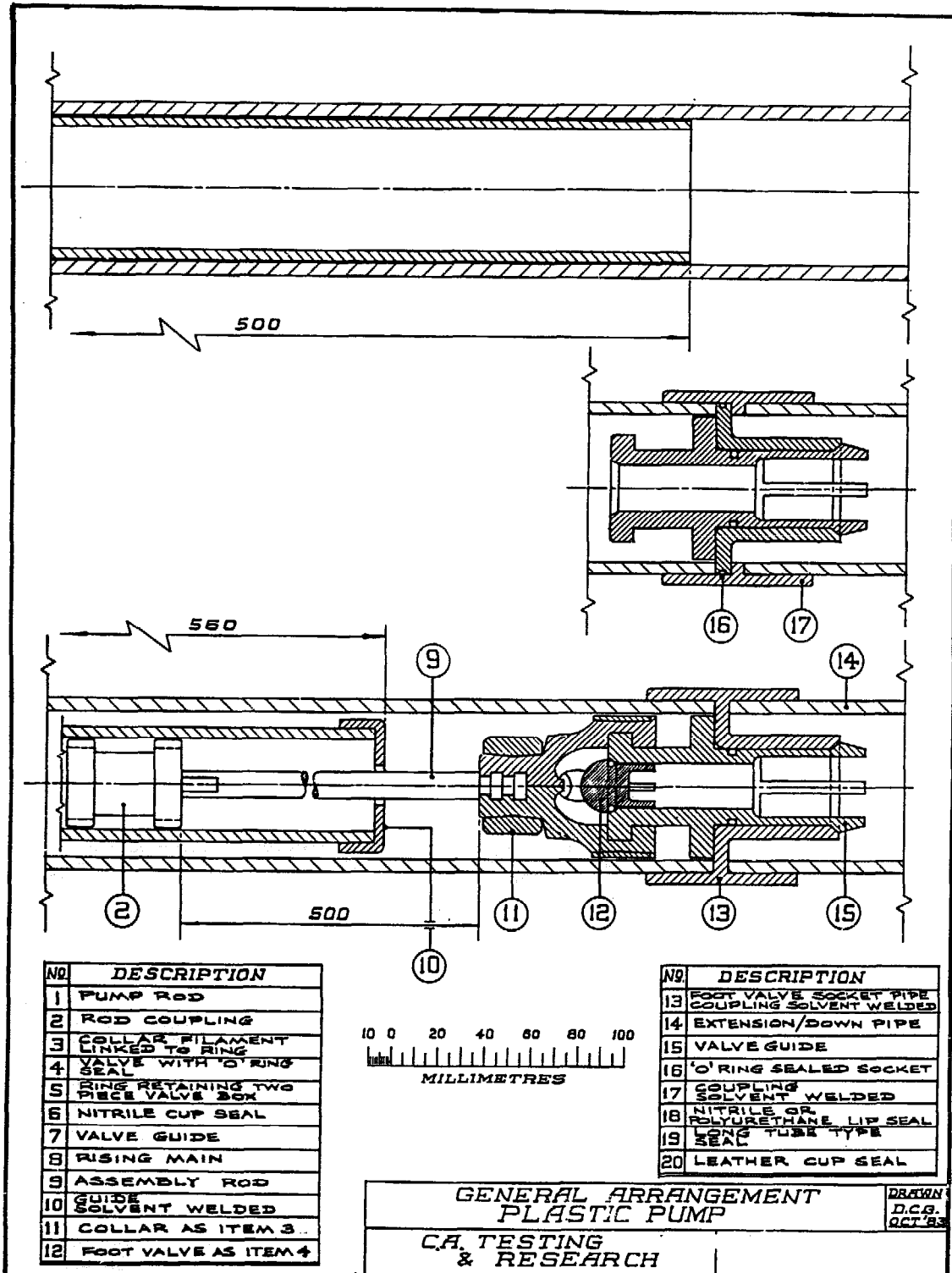

FIGURE 6-3 GENERAL ARRANGEMENT OF PLASTIC CYLINDER ASSEMBLY

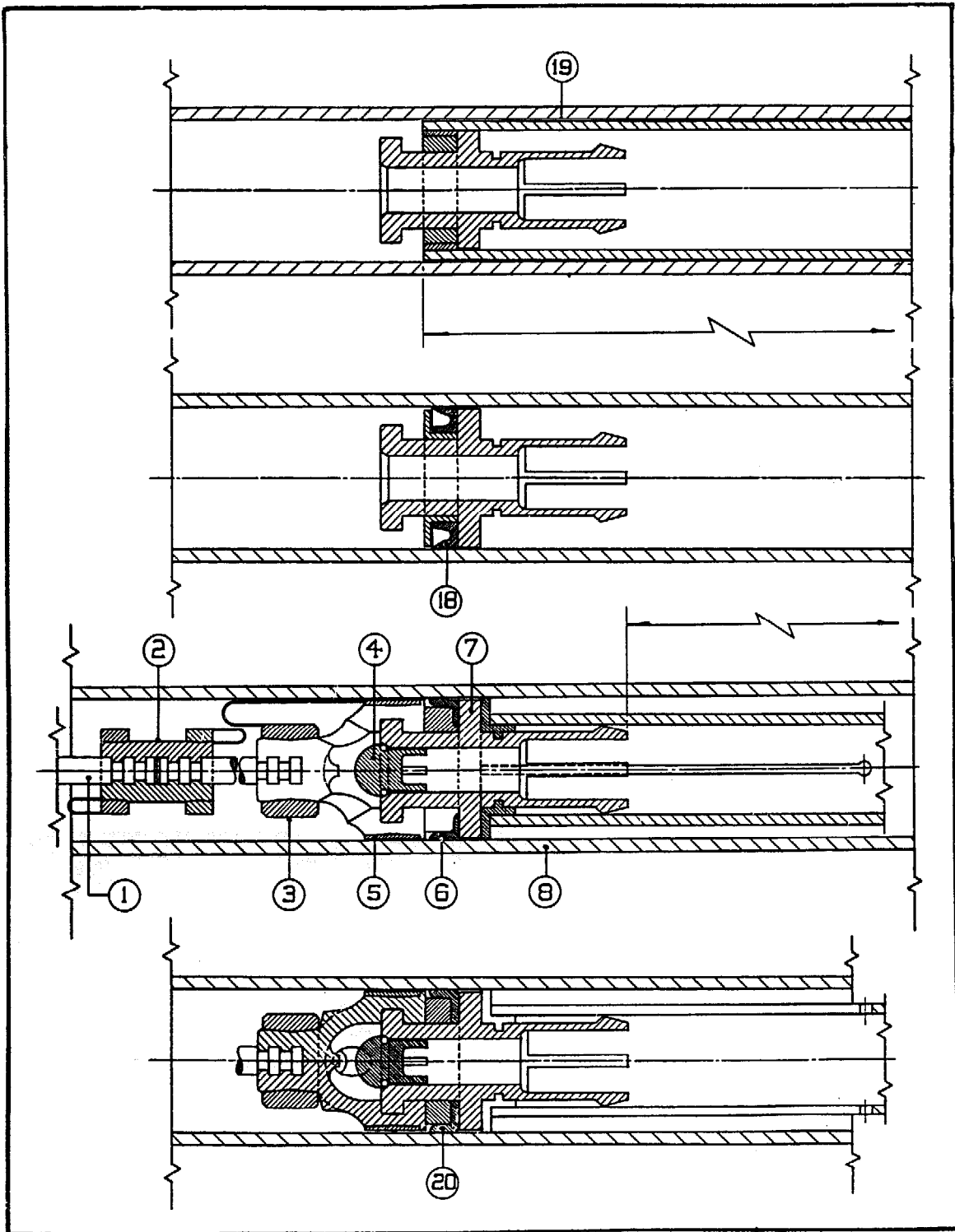

FIGURE 6-4 GENERAL ARRANGEMENT OF PLASTIC CYLINDER ASSEMBLY (continued)

One of the CATR technologists visiting Malawi for discussions on the below-ground component project suggested that a dry bearing system should be tried. Some components were machined and sent to the Kandeu Camp in Malawi that had a pump which was used for an average of about five hours per day by a village of some 250 people. These original prototype bearings endured for 20 months.

2. Project Proposal

The potential value of using a dry bearing system lay in the ease of maintenance or replacement by the villagers without having to resort to the use of special tools; its inherent low cost would enable spares to be kept in the village, simplify the design and reduce the production cost of the pumphead.

The proposal was to design a number of bearing options and carry out endurance testing on specially designed rigs, in order to identify which system should be field tested. Discussions were held with the National Centre for Tribology in the United Kingdom and with raw material manufacturers. Temperature test strips were sent to Africa and Bangladesh and placed inside pumpheads to obtain accurate details of temperatures that plastic materials would have to withstand. Temperatures up to 65°C were recorded.

3. Bearing Material

Acetal Copolymer was shown to be the best of the readily available plastics because it is strong, dimensionally stable and unaffected by water. It is also relatively easy to mould, cheap to replace, and parts can be very easily fitted by trained villagers. It was considered that a 9 to 12 month life might possibly be adequate if the pump could be repaired easily in the village, particularly if no special tools were required for replacement of the bearings. A twelve-month life for a bearing seems probable, if sufficient care is taken to use properly finished pins with the correct bearing system.

4. Endurance Testing in the Laboratory and the Field

The laboratory tests showed considerable promise from systems operating at a simulated depth of 45 meters in high ambient temperatures, and with exceptional side loads and high reciprocating forces.

Various combinations of fulcrum and hanger bearing housings were tested in the laboratory. These are shown in the upper photo in Figure 6-5. Bearing housings were either machined from mild-steel, solid bars or cut from stock, circular- or square-section, mild-steel tubing. Threaded rod connections were made from standard bolts which were modified by removing the head and cold-formed to a suitable angle, or from a set screw which was simply face welded to the hanger bearing housing. Acetal bearings (bushes) were machined from solid bars but designed to be suitable for moulding; bearings were either fixed or allowed to float relative to their housings, and in all cases were allowed to float relative to their pins.

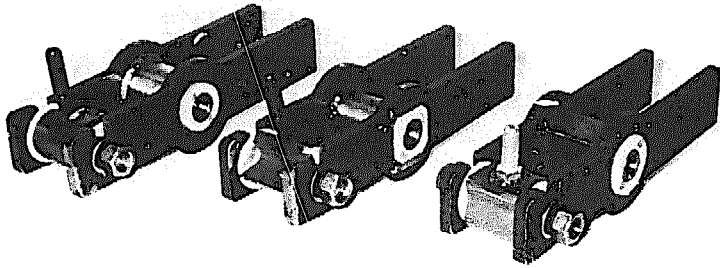

Three alternative
assembly designs

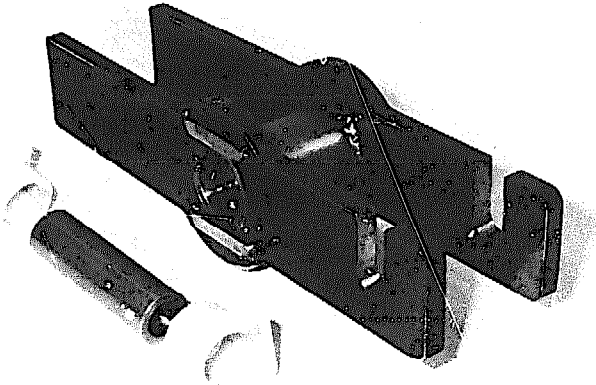

Fulcrum Assembly

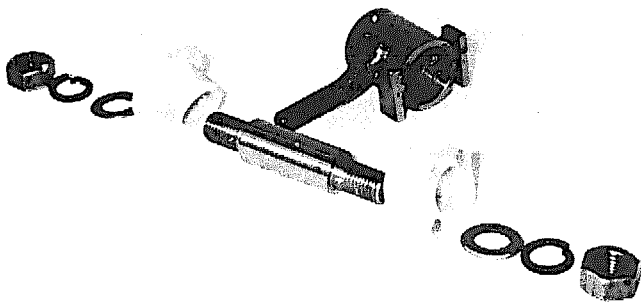

Hanger Assembly

FIGURE 6-5 FULCRUM AND HANGER ASSEMBLIES FOR ACETAL BEARINGS

Test results which principally affected the choice of recommended components were as follows: (i) acetal bearings which were allowed to float relative to their housing wore at about the same rate as those which were fixed, however, the wear was even around the circumference of the floating bearings, (2) square-section, hanger bearing housings ruptured along an edge, and (3) the threaded rod connection made from a modified bolt broke loose from the circular tubing several times whereas a rod connection made by face welding the head of a set screw to the circular hanger bearing housing worked satisfactorily.

Accordingly, the following design was recommended:

- o Fulcrum and hanger bearing housings should be made from stock, circular-section, cold-drawn, mild-steel tubing.
- o Threaded rod connections should be made from a standard set screw or bolt whose head is face welded to the hanger bearing housing.
- o Acetal bearings (bushes) should have circular sections with round flanges and can be identical for both the fulcrum and hanger bearings.

Fulcrum and hanger bearings similar to those shown in the middle and lower photos in Figure 6-5 were recommended as a result of the laboratory tests. A drawing of the recommended fulcrum and rod hanger assembly is shown in Figure 6-6.

For the first 12 months the bearings in the pump in Kandeu were kept lubricated and showed little wear. When the bearings were degreased the wear rate accelerated.

Some bearings have been fitted unlubricated into high use pumps at water depths of around 45 meters and the wear characteristics appear to be unsatisfactory. However further investigation has revealed two potential causes of failure. Very poor quality finished mild steel pins were used which probably accelerated this excessive wear, and unexpected corrosion of the surface of the bearing housing produced wear on the outside of the bearing. Both of these problems can be overcome by design modification and this is progressing.

If polyacetal dry bearing systems can be developed for these applications, then the production problems in the manufacture of the pumphead will be greatly simplified. Also, the village caretaker may be able to easily replace them in the field and to keep a stock of spares at a low cost.

F. OTHER ACTIVITIES

1. Study Tour for Chinese Engineers

In September 1983 a study tour was organized for six engineers from the Ministry of Machine Building Industry, the Chinese Academy of Agricultural Mechanization Sciences, and the Hunan Provincial Research Institute of Agricultural Machinery to discuss methods of handpump evaluation and development and to familiarize themselves with methods used in CA R

Figure 3-6
General Arrangement of Fulcrum and
Rod Hanger Assembly for Acetal Bearings
Modified Maldev Handpump — Afridev

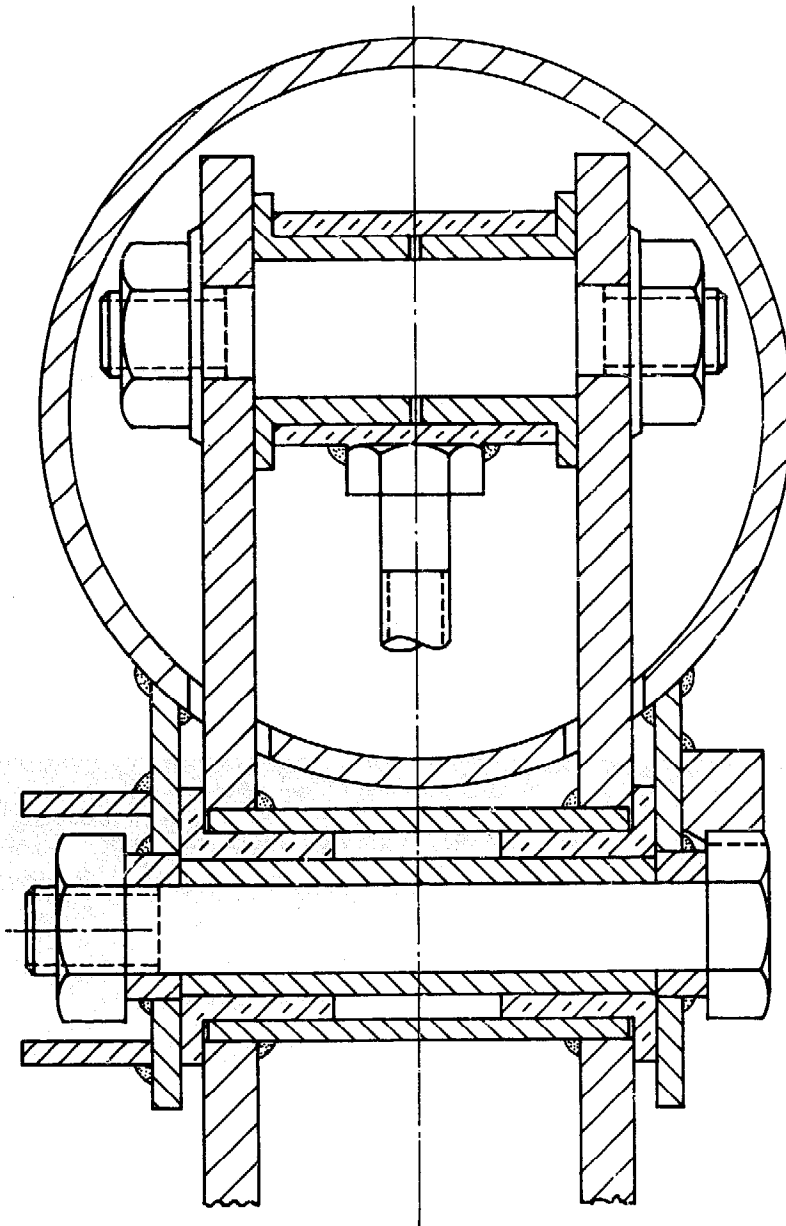

Finish: $0.4 \mu\text{m}/\text{Ra}$ or better
(Outside Diameter of
Bearing Pins & Spacers)

N.B. Axis of hanger
attachment shown
displaced through 90°

laboratories. It had been decided to establish two handpump testing facilities in China in order to help their own handpump manufacturers to improve their designs. CATR is assisting in the ordering of equipment for the performance and endurance tests, and further technical assistance will be provided when the pump testing facilities are operational.

2. India Mark II Handle Bearings

With over 400,000 India Mark II pumps now in use in India, there is a growing concern that the maintenance and repair of bearings will be a difficult undertaking. CATR has been asked to look at possible designs using acetal material which would allow the handle bearing to be replaced in the field inexpensively and without the need for special tools. This work is progressing.

G. THE VALUE OF LABORATORY WORK

1. Handpump Testing

It has become evident that many manufacturers do not have accurate data on the performance of their pumps at a variety of water depths. They are also ill-informed about field problems of their pumps and laboratory work has highlighted some potential areas of breakdown. Controlled testing in the laboratory is quicker, cheaper and more reliable than in uncontrolled field tests. This work has also provided information to purchasers of handpumps enabling them to decide on the one which is suitable for the location where it will be used.

Laboratory evaluation has also stimulated manufacturers to modify their designs to overcome flaws, thus ensuring better performance and longer life. This, of course, benefits consumers in developing countries.

2. Water Flow Monitors

Although problems now exist with these units, chiefly water entering the case, it is hoped that when minor modifications and improvements in installation are made, they will become a valuable tool--essential for proper analysis of handpumps under field conditions.

3. Plastic Below-ground Components

It is hoped that the new assemblies will replace existing metal high-lift cylinders at about one third of their cost and that they will be able to work down to at least 45 meters. In this respect it is noted that some of the concepts which are embodied in these designs contrast with designs which are manufactured elsewhere from PVC. However, it is believed that existing plastic units are only capable of supporting a low level of use where wells are relatively shallow.

4. Dry Bearing Systems

If these prove to be suitable for the Maldev pumphead (then renamed Afridev), it is probable that all other reciprocating pumps will benefit from the use of these systems. It is known that one pump manufacturer is already experimenting with acetal bearings. The maintenance problem with India Mark II pumps all using ball races in the handle is considerable, and the fitting of new ball races is proving difficult. A dry bearing suitable for this pump would produce a great saving in maintenance costs, enabling villagers to maintain their own pumps without having to wait for the arrival of a service technician.

H. FUTURE LABORATORY WORK

1. Handpumps

A number of manufacturers who are developing novel types of pumping units, many of which offer advantages, have contacted CATR regarding initial tests on the borehole. Laboratory testing provides a quick and accurate means of measuring the performance of the pump at a variety of pumping depths which can often indicate potential weaknesses. Because of the value this can play in handpump design it seems probable that manufacturers will continue to require this service for at least the next two to three years.

2. Plastic Below-ground Components

This work is to be continued with funding from the Overseas Development Administration as well as from The World Bank, and once results from the field trials of the first 100 or so units are available and can be analyzed for possible design modifications, these units could be mass produced in developing countries.

3. Dry Bearing Systems

The ODA is also interested in further examination of different materials and bearing designs and have agreed to share the cost with the World Bank in a project to investigate these possibilities.

4. Lightweight Pumprods

Direct action pumps such as the Ethiopia BP50 or the TARA pump in Bangladesh offer considerable advantages to both the manufacturers and possibly to the users. The Canadian PEK pump is similar, making use of a low mass, high volume rod to lift water from 50 meters. Before considering alternative materials and configurations for direct action pump rods, basic theoretical analysis on the operation of the systems is required. Again, the ODA will be collaborating with the World Bank to undertake research in this area.

Chapter 7

WHAT HAS BEEN LEARNED ABOUT HANDPUMP TECHNOLOGY

Following is a summary of the Project's experience to date with handpump technology for community-based rural water supplies. This will provide guidelines for planning and executing water supply schemes in developing countries and for the manufacturing and procurement of handpumps. It should be stressed again that the handpump itself, even though the main concern of this Project, is only part of a system which is comprised of the well, the handpump (and its installation and maintenance), and the infrastructure supporting the water supply scheme. This chapter deals first with the handpump/well system as a whole and then with handpump design.

The conclusions related to handpump technology which are discussed can be summarized as follows:

- o The subject of appropriate handpump technology is closely related to community participation.
- o The context in which the pump is to be used - the country, hydrogeology, settlement pattern, maintenance system, etc. - is critical in determining the most appropriate technology.
- o Training of repairers is essential, and the degree of such training will influence the choice of technology and vice versa.
- o Quality control in the manufacturing process is essential.
- o Good quality boreholes are critical to the life of pump components, because poorly developed boreholes may result in excessive amounts of abrasive material entering the well.
- o Pumps which were designed to be maintenance-free for several years have not lived up to the expectations under field conditions for a variety of reasons. It is therefore preferable to use "Village Level Operation and Maintenance" (VLOM) as an attainable criterion in pump design rather than "Free of Maintenance".
- o Use of interchangeable, common, low-cost, and expendable components, instead of specialty items, will facilitate repairs.
- o The design cycle required to develop a production model of a pump with demonstrated suitability for VLOM may take several years. New design ideas must therefore be screened before new production models are manufactured in large quantities.
- o The use of plastics for certain pump components offers the promise of lower costs, easier installation and maintenance, and corrosion resistance. This is particularly so for direct action pumps.

- o Non-reciprocating type pumps, such as diaphragm and helical rotor pumps, tend to be expensive and difficult to repair, but nonetheless have specific advantages in certain circumstances.
- o Standardization on only a few pump designs for a given country will facilitate local maintenance, the availability of spare parts to village handpump caretakers, and the manufacture of pumps in-country.
- o Design criteria are significantly different for low-lift and high-lift pumps, which are suitable for lifts of less than 15 meters and up to 45 meters, respectively (these criteria are presented in some detail in this chapter).
- o Direct action piston pumps, which are operated by pulling up and pushing down on a T-bar handle attached to the top of the pump rod, offer a great deal of promise, especially for low-lift conditions.

A. HANDPUMP/WELL SYSTEM

There are many ways to characterize the handpump/well system. From the point of view of project implementation the two main physical structures are the well and the handpump. The social setting in which the planning, construction, operation and maintenance take place is a vital factor which must in every instance be taken into account.

Certain aspects of the handpump/well system which had in the past often received insufficient attention have recently been highlighted in various forums, notably the importance of community participation in all phases of a project. This participation should start with planning of the project and should continue beyond pump installation with community involvement in maintenance and repair. Other institutional issues have been less publicized such as determining suitable organizational structures for well construction and handpump installation which make the best use of national capabilities while at the same time channeling funds, equipment, or skilled manpower contributed by external assistance agencies.

Pumps are selected for rural water supply schemes by using specific criteria, which depend on the context in which the pump is to be used, and generally vary from country to country or region to region. Criteria to be considered are the required reliability of the pump (are adequate alternative sources nearby in case the pump is out of service?), feasible frequency of maintenance (how often can the caretaker be expected to service the pump?), stand-by units or components, cost of the well, number of users, etc.

For example, the pump selection criteria would be quite different for the following two scenarios which represent two typical conditions. Scenario One applies to pumps suitable for many wells in the Sahelian region of West Africa, where the water table is deep, most drilling is done in hard rock in remote and dispersed locations, 500 users or more per well, with few if any alternative source (especially in the dry season), and low local manufacturing capability. This means that the cost of the well is high, the required reliability of the pump high, that the pump will be heavily used, and the

implied value of the pumped water is high. It calls for a very durable pump, possibly with a standby unit to be installed in case of a breakdown requiring a major repair. A stock of frequently used spares should be kept with the pump to avoid the expense and delay of bringing in spare parts from a long distance. The local caretaker must be well trained and well equipped because the cost of calling in a central maintenance team is very high (due to long distances and poor road conditions). These pumps will more often than not be imported.

Scenario Two applies to densely populated areas with shallow water tables, where access to traditional (polluted) sources are relatively easy. Each handpump serves a smaller number of people (say 50-200), and the total population to be served by a scheme is large. Cost savings for wells and pumps therefore critically affect the extent of service. With the larger number of pumps relatively close together, spare parts and back-up repair services can be more easily available, placing less of a demand for reliability on individual pumps. Both pumps and wells should therefore be low in cost, and pumps are likely to be locally manufactured. Bangladesh and Thailand are examples of countries where such conditions prevail.

B. QUALITY CONTROL IN MANUFACTURING

Quality control in manufacturing is of fundamental importance. The demands on a community handpump are such that even when the design is good, frequent malfunctions and breakdowns will occur if quality control is inadequate. Experience with the India Mark II pump is an example of how a good design (which is nonetheless fully suitable for village level maintenance) resulted in one of the most durable pumps available today, largely due to a combination of standardization of design and strict external quality control.

It should also be noted that the manufacture of pumps in cottage industry workshops has proven to be inadvisable because the production of interchangeable parts of consistently good quality can only be sustained in a well equipped and experienced manufacturing establishment. Nonetheless if such an establishment is responsible for the quality control of all pump components, it may be practical for the larger company to sub-contract the manufacture of these components to cottage industry shops. This has been done successfully by some of the major producers of the India Mark II pump, who assemble the pumps from components partly made in their own plant and partly made to their specifications by small workshops and thoroughly checked for quality.

Quality control increases the cost of the product but the higher capital cost results in higher reliability which in turn results in lower recurrent maintenance and repair costs.

C. HANDPUMP DESIGN

Differences in overall conditions notwithstanding, some general recommendations about handpump design can be made:

1. Maintenance-Free versus VLOM Pumps

It is unlikely that a pump can be developed which will in fact be free of maintenance for several years when installed and used in water supply projects. Several manufacturers had set themselves the ambitious target of developing pumps that require no maintenance for a period of several years, but no such pump has so far succeeded in practice. Even if a pump showed exceptional durability in laboratory tests, once installed in the field the overall reliability of the handpump/well system was in several instances drastically reduced. Examples of what has occurred in the field are sand in the well, chemically aggressive water, misalignment of the well, abusive operation of the pump, faulty installation or maintenance, and harsh environmental conditions (high temperatures, wind-blown sand, etc.). The performance and durability of the handpump can only be as good as the borehole in which it is installed. Attempts could be made to foresee some of these conditions and to control others through training and supervision, but it is virtually impossible to completely avoid them, and they significantly increase the need for pump repair. It is therefore being repeatedly stressed that adequate well construction is crucial to the success of handpumps.

Even if none of these adverse conditions are present, manufacturers find it very difficult to maintain a consistent quality even with adequate quality control in the factory. Small design improvements may be introduced that seem to have no side effects on the pump but which may in reality introduce the need for early repair or even replacement of a component in a whole series of pumps already installed in the field. For example an electrostatic plating process used in manufacturing a particular pump was changed; much later the pump was found to fail in corrosive well water. Even if the design remains unchanged, variations in the quality of the materials supplied to the manufacturer may induce new problems in the field where none existed before.

In the endeavor to create a high durability pump which is intended to be maintenance-free for a period of several years, the design of the pump tends to become relatively sophisticated, and this generally makes it impossible for village handpump caretakers to carry out repairs, makes the pump less suitable for local manufacture, and makes it relatively expensive.

2. Interchangeable Components

In a VLOM design, preference is given to common, low-cost, and expendable components rather than specialty items. In this way even the periodic repair by the caretaker necessitated by relatively rapid wear or deterioration of a part is acceptable--as long as the repairs are easily performed and there is no lasting damage to the pump. For example, the current design of the direct action Malawi Mark V pump features a column of wooden bushings as upper guides for the pump rod, and worn bushings get replaced simply by changing the order of the bushings on the rod so that another bushing in turn takes the load.

3. Length of Design Cycle

Even though handpump design may appear to be an easy task, to produce pumps that have demonstrated their suitability for VLOM under field conditions has been difficult. New design ideas are of course essential, especially in response to field test results, but they take an inordinately long time to be tested through to the final stages. Once a new design or a major modification has been designed, a few prototypes are produced for testing. Generally testing takes place first in the laboratory, but it may first take place directly in the field in rare cases where an experimental field situation can be found which causes a minimal disturbance to the water users in a particular area. Problems usually arise right away, which can in many cases be easily remedied through minor design or manufacturing changes. The process up to this point can easily take one year.

Before declaring the product successful, there must be extensive field trials in at least one project where the durability as well as the ease and cost of maintenance are observed. At this point the designer will usually want to make improvements which will reduce costs and simplify the manufacturing process, but care must be exercised because deviating significantly from the prototype may inadvertently introduce complications in the performance. Until reasonably definitive results from the extended field trials are available, another year may go by. Adequate field trials of a seemingly good idea can require as much as two years and considerable financial outlay. This underlines the need for careful selection of design ideas for eventual field testing.

4. Plastic Components

The introduction of plastic components as substitutes for metals for most rigid parts is a logical development for handpump design. The main advantages are cost reduction, corrosion resistance, and lighter weight, the latter making installation and maintenance easier. These characteristics are fundamentally important for the design of direct action pumps. Plastics are at the same time being introduced for deep-set handpumps and for well casings and screens. Even though very successfully employed in a number of handpump designs, experience in the near future will tell to what extent the use of plastics should be increased.

The designers of plastic components for handpumps have in most instances brought to bear mechanical engineering skills to plastics designs, rather than starting with a thorough knowledge of the characteristics of plastic materials. Often the material of a component was changed from metal to plastics, while its configuration remained nearly the same. Only a few designs based on plastic material principles have been developed. An example of how the mechanical engineering approach to plastics had led to a failure is the use of a harder material for the cylinder and a softer material for the piston seal, stemming from the design rule in mechanical engineering that the cheaper and more easily replaceable part should be the one to wear out first. When applied to cylinder assembly design in plastics, however, it produced the opposite result: abrasive particles suspended in the water

became embedded in the softer material and then acted like sand paper, wearing out the harder material first.*

User acceptance of plastic has in some places been slow because of the actual or suspected low durability of the materials. The introduction of plastics requires some changes in installation, operation, and maintenance procedures in the absence of which failures occur that could otherwise have been avoided.

5. Non-Reciprocating Pumps

The most commonly used pumps are of the reciprocating type, where a piston is moved up and down in a cylinder with the aid of a pump rod. Several non-reciprocating pumps also exist, some of which are very popular in a certain region or country. Examples are a hydraulic membrane pump and a rotary pump with helical stator and rotor (progressive cavity type). A popular make of the former is the Vergnet pump, and, of the latter, the Moyno and Mono pumps. The non-reciprocating designs have the disadvantage of a more difficult manufacturing process or more expensive configurations and materials for some (but not all) of the parts. They also put severe constraints on the feasibility of village-level maintenance, either because of the expense of spare parts or because of the difficulty of repairs. A partial exception to this is the Vergnet pump whose diaphragm is expensive but which can be relatively easily repaired by trained villagers.

Non-reciprocating pumps may, however, have specific advantages not generally given a high value, but essential in certain applications. Thus the Vergnet pump is very easy to extract even from greater depths and allows the installation of two pumps on one borehole, but a replacement diaphragm is relatively expensive. The rotary type may be less sensitive to particulate matter passing through the rotor. Rotary pumps (when manufactured with close attention and quality control) are said to have the advantage that wear, and therefore failure of the pump, tends to be gradual rather than sudden so the need for maintenance and repair can be more easily predicted. The relative importance of the advantages and disadvantages of such pumps depend upon local circumstances and proven performance in the field.

6. Standardization

When considering the purchase of handpumps for a rural water supply scheme in a particular country, often more than a dozen different pump types come under review. The use of several handpump designs in one country is initially desirable to demonstrate and test the comparative performance of different types for the users and the decision makers. Different assistance agencies may be involved with schemes in different provinces, introducing their own pump preferences. However, many pump types should coexist in a

* Donald Sharp and Michael Graham, eds, Village Handpump Technology, Ottawa, Canada, IDRC, 1982, p52.

country only in the initial phase. Ease of local maintenance, the availability of spare parts to village caretakers, and the desire to manufacture pumps in-country (possibly through joint ventures) are long-term interests which call for standardization on just a few designs. There will be rare cases where a country can standardize on one pump, but requirements are usually varied, calling for a few standard pump types in each country. The field trials now being conducted are designed to assist in this choice.

A first step towards standardization is to decide on a universal base plate in order to make different pump models easily interchangeable on the same boreholes. (The Ghana "3,000 Wells Program" is an example of this.)

The standardization in India on the Mark II pump provides an interesting precedent, motivated primarily by the need for strict quality control of a design found to be very durable in extended field trials in the late 1970's. Once the decision had been made to use this design, all other versions were eliminated from joint Government/UNICEF tenders. Subsequently over 400,000 units have been installed in India and are operating with a high degree of success. Some local mechanics have become so familiar with the pump that they can perform repairs on the below-ground structure which were previously considered possible only by a well-equipped mobile maintenance team. Standardization has also contributed to the low price of the pump in India.

7. Low-Lift and High-Lift Pumps

When considering recommendations for handpump designs, a fundamental consideration must be the range of pumping heads for which the pump is to be used. Designs are likely to be quite different for distinct ranges of head.

The UNDP/World Bank Handpumps Projects refers to low-lift pumps as those suitable for pumping heads of no more than about 15 meters. Suction pumps are a sub-set of low-lift pumps, and are able to lift water from a maximum of about seven meters. High-lift pumps are referred to as suitable for pumping heads of up to about 45 meters.*

In considering the pumping heads for which a pump is suitable, it is the water level rather than the well depth which is the main parameter. Furthermore, it is important to consider drawdown of the water table in low-yielding wells during prolonged pumping.

The design of pumps for heads greater than about 45 meters has received far less attention than that of pumps for lesser heads. Although the proportion of pumps used with heads of more than 45 meters is very small as

* These depth limitations should be taken only as rules of thumb; some low-lift pumps will undoubtedly perform well at 20-meter heads, and some high-lift pumps may be suitable for lifts greater than 45 meters. The main point is that from the experience gained so far it appears that low lifts are best served with direct action, hollow-rod pumps, and high lifts with lever-operated, open cylinder pumps.

compared to the total number of pumps world-wide, such extremely high-lift pumps are needed to serve some areas, notably the Sahel region of Africa. In principle, handpumps can operate with heads of as much as 90 meters, but at such depths borehole construction is very costly, pumps are costly, the water delivery rate is low given the limitations of human power that can be applied, repairs are frequent resulting from high stress on pump components, and repairs are difficult to below-ground pump components. Therefore the design of pumps for extreme pumping heads is a major challenge and may require some modifications to basic high-lift pump designs. These modifications may include stronger components, and in the case of reciprocating type pumps it may include a damped motion similar to that of a pendulum. Once VLOM pumps are developed and proven for lifts of up to 45 meters, the investigation of pumps for greater lifts should be given systematic attention.

D. LOW-LIFT PUMPS

For pumping heads of up to about 15 meters, direct action reciprocating pumps hold the promise of being the most suitable. These direct action pumps are operated by pushing down and pulling up on a T-bar handle attached directly to the pump rod, without the use of a lever. At present most pumps which are used at this depth range are either suction pumps (generally made of cast iron and capable of pumping only from heads less than about seven meters) or lever pumps which can also operate at greater heads. Many existing suction pumps approach VLOM insofar as they are easily maintained (with all the parts which are subject to wear being above ground--except in some cases the foot valve, if one is installed at the base of the rising main), have simple designs that can be made in most countries, are cheap, and are fairly robust (except for the pivots on the lever).

But suction pumps have serious disadvantages, which in the long run will limit their application. First, the need to prime the pump when the foot valve or suction check valve below the cylinder leaks (which frequently happens) is an unacceptable practice which introduces contamination into the well. A self-priming feature for suction pumps may reduce this problem, but so far none has been successfully implemented. Second, the depth limitation of about seven meters* seriously constrains the application of suction pumps, which is exacerbated by the fact that water tables are falling in many areas because of extensive groundwater extractions for irrigation or because of drought. Many suction pumps have already been abandoned because the water table fell to more than seven meters.

* The actual limit to the depth from which suction pumps can lift water is determined by the barometric pressure (which in turn depends upon the elevation above sea level), and leakage and hydraulic friction in the pump, drop pipe and foot valve. At sea level the maximum practical suction lift is about seven meters, but at 4,000 meters above sea level (such as on the Andean plateau of Latin America) it is reduced to about 4 meters.

Direct action pumps have no lever, thereby eliminating the mechanical advantage of a lever pump in relation to the piston rods as well as the counter-weight effect, both of which are exploited by lever pumps to lift water from greater depths. The pump rod of a direct action pump is instead operated directly with a T-bar handle mounted on top of the rod. This breakthrough in design was made possible by the use of light-weight materials such as plastics and aluminum, and was first introduced for practical application by the International Development Research Centre (IDRC) of Canada. Not only do these materials reduce the weight of the rod and plunger, but they also enable designers to use large-diameter, light-weight rods. Through the choice of the right materials and cylinder and rod diameters, direct action pumps can be designed such that the human force required for a given pumping head is similar to that for a lever pump. In other words, a person would have to work about as hard to pump a given amount of water from the same depth with either a lever pump or a direct action pump. This is further discussed in Annex A.

Examples of direct action pumps which are now being tested are the TARA (Bangladesh), Ethiopia BP50, Malawi Mark V, PEK (Canada), Blair (Zimbabwe), and the Rower irrigation pump (Bangladesh). The PEK, which has recently come on the market, has one model for a pumping head of up to 25 meters, and another for up to 50 meters. Even though performance data for several direct action pumps are only now being collected, the novel design features and choices of materials and dimensions show great promise.

The main advantages of direct action pumps are:

- o The elimination of pins and bearings for the lever does away with a major source of wear in lever-operated pumps.
- o The required borehole diameter can be smaller since the same volume of water can be lifted per stroke with a longer piston travel and smaller cylinder diameter. This can result in major savings in drilling costs.
- o The pump may be cheaper.
- o The piston can more easily be pulled out for repair since the piston rod assembly weighs very little and the top of the pump stand has no obstruction once the guide bush for the rod is removed.
- o The simpler design makes direct action pumps more suitable for manufacture in developing countries.

Sealless pistons are more likely to be applicable to direct action pumps than to lever-operated ones because of the higher speed of travel of the piston, but have not up to now demonstrated their clear superiority over pistons with various types of seals (some pumps which are not direct action such as the Volanta, have sealless pistons). Sealless pistons may prove to be most useful for pumping heads of less than about 10 meters, in which case an adequate clearance should be maintained between the piston and the cylinder wall for the free passage of any particles suspended in the water. The piston should not be made of soft material which would allow abrasive particles to get embedded.

The best choice of materials and key design dimensions for direct action low-lift pumps still remain to be determined. PVC, the most frequently used material up to now, may not be the best for certain components. The material for the rod is particularly critical, since the forces applied to it during pumping are quite complex. Hollow rods must maintain their airtight seal if they are to retain their low mass; connectors must not come loose or break.

Following are recommendations for some design features particularly applicable to direct action pumps, and which, except for the very last recommendation concerning the discharge spout, are also valid for some types of lever-operated, low- and high-lift pumps:

- o The pipe dimensions chosen should be as much as possible those of standard extrusion available in-country. This means that pump dimensions may have to vary from one country to another.
- o The foot valve and piston should not have a built-in link which would extract the foot valve every time the piston is pulled out. There are times when only the piston needs to be worked on, in which case it is better to leave the foot valve undisturbed. The bottom of the piston can be equipped with a hook or another "fishing" tool to pull out the foot valve when desired.
- o In areas where large cost savings can be obtained in alluvial soils from greatly reducing the borehole diameter, the rising main and the casing may be made one and the same. This is the case in Bangladesh, where low-cost boreholes constructed with the "sludger" method are fitted with the TARA pump, a direct action handpump. If the PVC cylinder demonstrates too short a working life, a metal sleeve may be inserted into the PVC casing pipe to provide an adequate lining for the inside cylinder wall.
- o The exposed above-ground elements of direct action pumps must be robust and sun and weather resistant.
- o If the rising main is separate from the casing in deep wells, the rising main may in many cases need to be supported. It also may be necessary to center the rods inside the rising main with spacer guides.
- o Some low-lift, direct action pumps need a larger diameter discharge spout than comparable lever pumps because they have less water storage volume inside the pump head. This may be in part offset by distributing the discharge of the water more evenly between the upstroke and the downstroke (accomplished by changing the rod and/or cylinder diameters; see Annex A).

E. HIGH-LIFT PUMPS

This section deals primarily with reciprocating pumps, because they are the most common throughout the world. As discussed above, other pump types have not shown themselves to be decisively superior, even though they have some specific advantages over reciprocating pumps which are highly valued in certain applications.

The purpose of a lever for reciprocating pumps is to provide a mechanical advantage as well as to counterbalance the weight of the rod, piston, and water column (the weight of the latter is carried only in the upstroke of the piston). It is best to use a modular approach to the design of the pump, separating into different modules the pump stand including the handle, the cylinder assembly including piston and foot valve, and the rod. Different designs of individual modules are to some extent interchangeable, so that the best modules can be combined to make a better overall handpump design. A modular approach allows the improvement of a particular module which has a shortcoming but is part of a pump which has been successful. An example of modular improvement is the current research and development effort with the India Mark II pump in India, where the pumpstand and the rod are left unchanged and modifications to the below-ground structure are being developed. The objective is to make the Mark II pump more suitable for village level maintenance through the introduction of an open cylinder with a removable piston and foot valve. Another example is the Maldev pumphead, which is a VLOM pumphead with no unique below-ground structure and which in the past has been used with below-ground components from other pumps.

Bearings are one of the weakest elements in the reciprocating pump, and cannot be avoided in a lever pump. The use of steel pins as fulcrums without bearings is to be avoided for community pumps. They wear rapidly and all too often damage the housing. Sealed, grease-packed, anti-friction bearings (ball bearings or other types) are a significant improvement and constitute the standard technology of the present generation of VLOM candidates. However, they have the disadvantage that, once worn out, they are difficult to replace in the field and are expensive. Because of the press fit on the outer race, the chance of damaging the bearing in the process is high with a resulting loss of durability. Polyacetal bearings, which consist of machined or injection-molded bushings, have recently been laboratory tested with encouraging results (see Chapter 6). Field tests are also under way, and the outcome is expected shortly.

It is often debated whether a cast iron or a welded steel design for the pump head is superior. Both are acceptable as long as a high quality of manufacturing is maintained. The choice depends on the manufacturing capability of the country concerned, the availability of raw materials, and the technology has previously been used for manufacturing handpumps. However, foundry technology is inherently more difficult than cutting and welding of mild steel products, and achieving adequate quality control with foundry work may be more difficult than with steel fabrication.

Following are recommendations for some design features for high-lift pumps:

- o The provision of an upper guide bushing in the pump head is undesirable unless a delivery head is needed to pump the water to a higher elevation, which is very rarely required. Such a bushing increases the number of parts in the pump head and tends to show excessive wear.
- o The piston and foot valve should be extractable through the pedestal without removal of the entire above-ground assembly of the pump. If they can be extracted through the head, it is even better for ease of maintenance.
- o Since in many areas of the world groundwater is corrosive, corrosion-resistant materials are desirable, such as brass, stainless steel, or plastics, especially for parts submerged in water.
- o To reduce the time spent on removing and replacing connecting rods during repair, the connectors should be easy to unfasten as well as secure when in operation. A rod dismantling and assembly procedure without tools would be the best. If threads are used, they should be of a large diameter to reduce the chance of cross-threading, a common occurrence, and should be of corrosion-resistant material to avoid seizing.
- o Cylinder walls could be made of PVC, which will wear in due course. By making the cylinder long enough, the setting of the piston can be changed (such as by removing short pre-assigned sections of the rod) several times, whenever needed. Such a cylinder could give a life of five years or more, depending on materials and whether the well is sand free. Brass or stainless steel interior sleeves inserted into the PVC pipe may however give better service by preventing the need for potentially faulty repair by the village caretakers when only PVC is used.
- o Correctly manufactured, high quality, leather cup seals have been very successful, while synthetic or natural rubber has not been sufficiently tested to permit an evaluation of their performance in relation to leather. A single seal on the piston may be sufficient, even for a lift of 50 meters. The advantages of two or more seals for these applications have not been demonstrated. Laboratory testing has shown that when double leather cup seals -- probably of low quality -- are used there is a tendency for the entire load to be carried by only one seal until it is worn and leaks badly, by which time the other seal has become so stiff that it does not seal properly.
- o For the manufacture of leather cup seals it is important to note that undersizing them is less of a problem than oversizing. Cup seals that are too large greatly increase the friction of the piston in the cylinder. Many pump failures have occurred due to oversized leathers, and it often took a long time to identify the cup seals as the source of the problem. Many rod breakages, bearing failures,

piston cage breakages, and possibly even housing breakages can be attributed to oversized leather cup seals. Other critical factors for leather manufacturing are the tanning process, the portion of the hide from which the cup seals are cut, and its impregnation. Good quality control is also essential for this item. (Manufacture of leather cup seals is discussed in Section B-4, Chapter 5 of this report.)

- o Too great a valve lift during the operation of the pump (for the piston valve as well as the foot valve) reduces the volumetric and mechanical efficiency and may create greater shocks. There is no advantage in the open area of the valve exceeding the area of the valve port. For poppet valves, for example, lift should be limited to 1/4 of the diameter of the port. Valves which create less of a hydraulic friction loss may need even a smaller lift. Metal ball valves are generally not recommended, since they tend to pound and damage the seat and cage.

F. CONCLUSIONS

In order to achieve widespread, sustained coverage of the rural and urban fringe populations, pump designs must be based on the VLOM principle. Only then will it be feasible to transform the maintenance system practiced in developing countries from a reliance on expensive motorized mobile teams of skilled mechanics paid with government funds to one where the village or a group of villages carries out and pays for pump maintenance and repair. Significant improvements in pump design have been made in this direction over the last few years, but no VLOM pump has reached the stage where it has become a production model with proven successful performance in field trials of adequate duration.

Each country using handpumps will at some time have to decide which pump types to use. This choice will rarely be a single pump type. Nonetheless, standardization on a small set of pump types must be achieved for the sake of facilitating the distribution of spare parts, exercising stringent quality control of manufacturing, and training installers and village repairers. The ease with which pumps can be locally manufactured (including joint ventures) will be an important consideration in this process. Joint ventures between established pump manufacturers in the industrial countries and their counterparts in the developing countries are an important component in the proposed cycle.

The country-wide pump choice will depend on a variety of factors determined by local conditions, such as the range of water table depths, availability of alternative water sources, in-country manufacturing capability, self-help potential in villages, and user acceptability of pump types. To arrive at a selection, the performance of different handpumps must be evaluated in relation to local requirements. Future Project reports will present laboratory and field test results in a manner which will help the concerned organizations to make this choice.

ANNEX A

THE CASE FOR DIRECT ACTION HANDPUMPS

This annex was written by William (Tim) Journey, Regional Project Officer for South Asia, and Andrew W. Karp, Project Officer at the World Bank headquarters in Washington D.C. It is hoped that this annex will stimulate discussion leading to optimal design of direct action handpumps. The authors welcome comments.

A. INTRODUCTION

Direct action (also known as direct drive) handpumps are defined as those for which the pump rod is operated directly, by means of a handle attached to it, without the mechanical advantage which conventional handpumps achieve by means of a lever arm or a gear box. This annex will limit itself to discussion of the most promising type of direct action handpump, which is a piston type and is operated by pulling up and pushing down on a T-bar handle attached to the top of the pump rod. Such pumps offer the potential of major cost savings because they require smaller diameter boreholes than are needed for conventional pumps. Because of their simplicity, they also tend to be easier to maintain and repair than conventional pumps, and are in many cases lower in price.

The direct action piston type handpumps which offer the most promise for a wide range of pumping heads have a light weight large diameter pump rod and a wide diameter plastic rising main; they can pump water on both the up and down strokes.* In this Annex the potential advantages of such direct action handpumps and their design principles are described.

To date the Project has done laboratory tests, summarized in Chapter 6 of this report, on two direct action piston pumps: the "Ethiopia", and the "Rower" (an irrigation pump developed in Bangladesh). Two more direct action pumps are scheduled for testing by the Project at the Consumers' Association Testing and Research Laboratory: the "PEK" (made in Canada) and the "TARA" (under development in Bangladesh and India and described in the South Asia section of this report). In addition to testing these specific pumps, the Project is undertaking research related to light weight direct action pump rods, including optimization of their dynamic behavior and the selection of suitable materials for their manufacture.

Because of their extreme mechanical simplicity, relatively low cost and relative ease of fabrication and maintenance, direct action handpumps potentially fulfill Village Level Operation and Maintenance (VLOM) objectives. Within the past fifteen years direct action handpumps have been developed for rural water supply and irrigation applications in several developing countries: Zimbabwe (several thousand Blair pumps have been made), Malawi (several thousand), Ethiopia (an estimated 1,000), Tanzania, Bangladesh and Sri Lanka. Also one (the PEK) has been developed in Canada. The IDRC "Waterloo" pump, which was designed specifically for fabrication in developing countries, had an important influence on the development of direct action handpumps.

Conventional piston handpump technology derives mostly from designs originating in the 19th Century, which themselves appear to represent simple improvements and substitutions of materials, retaining the geometry of earlier

* For pumping from lifts less than about 7 meters, even simpler direct action piston pumps can be advantageous (the Rower pump is an example of a simple direct action suction pump with a pump rod of a conventional small diameter).

pumps from medieval Europe. The piston diameter and stroke length of earlier pumps were apparently chosen according to two major considerations:

(1) compatibility with the power supply intended to drive them (water wheel, animal, wind or human) and (2) a limited selection of materials (mostly iron) and relatively crude production processes compared to the modern era. Force multiplication (leverage) was added as necessary, and dimensions adjusted to provide the best combination of capacity and operating speed within the limits of the power source.

Direct action handpumps are the simplest type of piston pump. They have relatively smaller cylinder diameters and longer stroke lengths than conventional lever drive handpumps. Their higher piston speeds reduce the need for highly efficient piston seals.

The elimination of a lever handle on direct action pumps results in several advantages. The force applied to the handle by the user is not multiplied as it would be with a lever, and therefore the pump rod is subjected to less force than it would be with conventional lever operated pumps (for a direct action pump to operate with such reduced force on the pump rod, the design must have a smaller diameter piston than would be used for a conventional lever operated pump).^{*} This in turn means that the rod is subject to less severe operating stresses and in turn permits the use of a greater variety of rod materials. Also, direct action pumps eliminate the disadvantage of the eccentric application of handle force which is necessary with lever pumps; this reduces the need for heavy-duty pump stands and strong fulcrums. Also, fulcrum bearings, which are a location of significant wear on conventional lever pumps, are not needed.

B. Down-Stroke Handle Force Requirements

During the down-stroke water is free to move through the check valve in the piston, and therefore for purposes of analysis of the down-stroke the piston almost doesn't exist. Thus, during the down-stroke, a light weight wide diameter pump rod will be buoyant relative to the water level in the rising main and the user will have to apply a downward force to overcome this buoyancy. The downward force required to overcome the buoyancy of the pump rod will be in direct proportion to the cross-sectional area of the pump rod and its weight. The application of this down-stroke force will be accompanied by the pumping of the volume of water which has been displaced as the rod is submerged further downward. The volume of water discharged on the down-stroke will be equal to the increase in the volume of rod submerged in the water in

* The smaller diameter piston of a direct action pump, which is required in order for it to operate with reduced force on the pump rod, also results in less volume of water being lifted for every centimeter that the rod is moved. This volume reduction is compensated for by the fact that the rod and piston of a direct action pump will move several times more distance per stroke than would the rod and piston of a typical lever operated pump, thereby lifting about the same quantity of water per stroke.

the rising main, which will be in proportion to the cross section of the rod at the point where it enters the water column, i.e. at the top of the rod.

It is interesting to note that the down-stroke force is in proportion to the length of the rod and is independent of the level of water in the well. For instance, if the cylinder, piston, and rod extend 5 meters below the water level in a given well, then the required down-stroke force will be greater than if they only extend 2 meters below the water level.

In summary, the down-stroke handle force is the sum of the forces required to overcome rod buoyancy and friction, minus the assistance provided by the weight of the rod and handle themselves. This can be calculated using the following formula:

Down-stroke handle force, $k-f =$

$$\begin{aligned} & [(\text{rod cross-section, cm}^2) \\ & \quad \times (\text{buoyancy of } 0.1 \text{ kg-f/cm}^2 \text{ per m of rod}) \\ & \quad \times (\text{total length of rod, m})] \\ & + [\text{friction force, kg-f}] \\ & - [\text{rod and handle weight, kg-f}] * \end{aligned}$$

C. Up-Stroke Handle Force Requirements

A handpump design axiom is that most of the force required to lift the piston is proportional to the horizontal cross-sectional area of the piston exposed to the column of water above it and to the pumping head (plus additional frictional forces and the weight of the pump rod itself). A common misconception is that the force required to lift the piston is proportional to the total weight of the column of water in the rising main. For instance, a 15 meter high column of water in the rising main will result in a pressure head of 15 meters, equivalent to $1.5 \text{ kg-force/cm}^2$. Thus the greater the piston area exposed to this pressure the greater the force required to lift the piston, regardless of the diameter of the rising main and the corresponding total weight of water in the rising main.

A more sophisticated analysis is needed to explain the case where the pump rod itself approaches the diameter of the cylinder, as in the case of typical direct action pumps. If the rod has a constant diameter all the way down to its connection with the piston, and the cylinder/rising main does not change diameter throughout its length, then the horizontal cross-sectional area of the piston exposed to the column of water is equal to that of the

* Rod and handle weight used in this equation refer to that measured in air (i.e. a rod with a mass of 1 Kg will have a weight of 1 Kg-f). The change in weight which occurs as a result of the rod being submerged in water is accounted for by the first term on the right side of the equation.

Figure A-1
Components of Two Typical Direct Action Handpumps

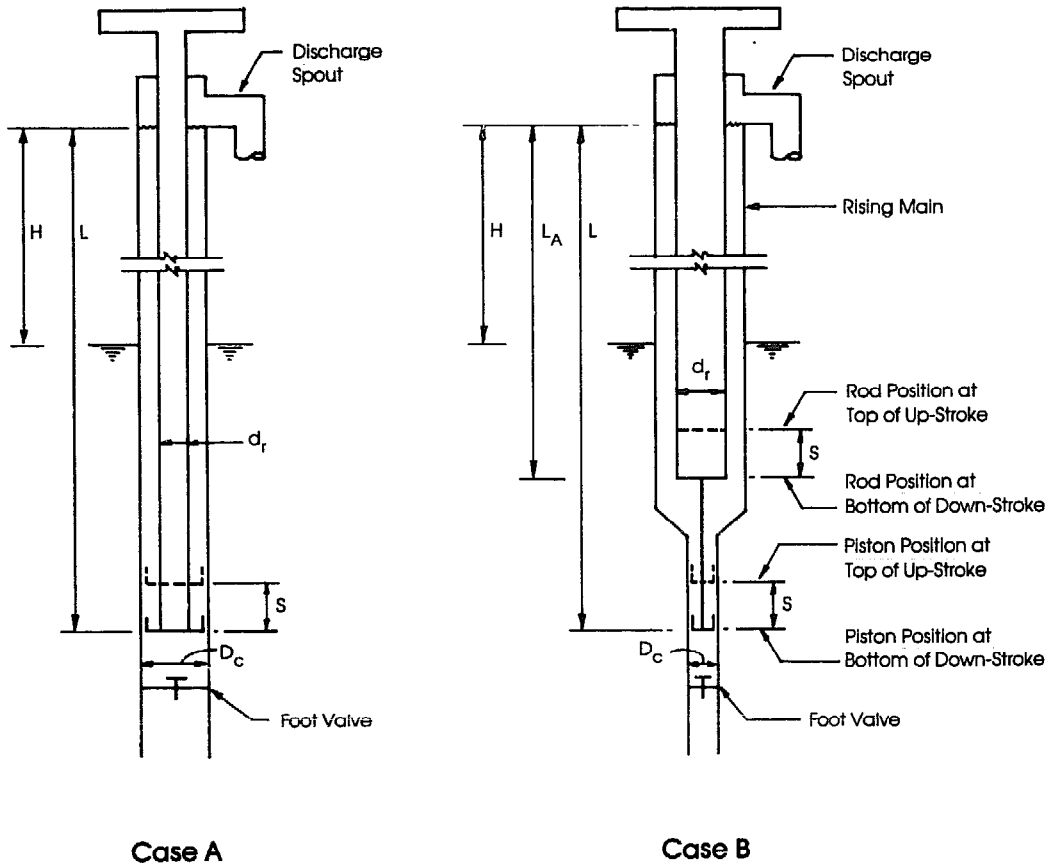

Case A: Cylinder diameter and rising main diameter are the same.
Rod diameter is constant over entire submerged length.

Case B: Cylinder diameter is not necessarily equal to rising main diameter.
Wide diameter portion of rod does not necessarily extend all the way
down to the the piston.

H = Pumping head, meters	D_c = Cylinder diameter, cm
S = Stroke length, cm	d_r = Rod diameter, cm
W_r = Rod weight, kg-f/m (weight when not submerged)	A_c = Cylinder area, cm^2 ($\pi d_r^2/4$)
W_h = Handle weight, kg-f	A_r = Rod area, cm^2 ($\pi d_r^2/4$)
L = Length of complete rod down to the piston, meters	F = Force to overcome friction, kg-f
L_A = Length of wide diameter portion of the pump rod, meters	

Note: For typical direct action handpumps either $L_A = L$ or else L is only slightly longer than L_A and the difference in lengths can be neglected for purposes of analyzing the operational forces of the pump. Therefore, in this annex, L is treated as being equal to L_A .

annulus between the pump rod and the inside cylinder wall. To illustrate the point, the outside diameter of the TARA pump rod is 42.2 mm and the inside diameter of the cylinder and rising main is 54.3 mm, resulting in an annulus cross-section of 9.2 square centimeters. A 15 meter head of water (1.5 kg-f/cm²) will result in a required lifting force of 13.8 kg-f to overcome the water head. In addition, 15 meters of pump rod for the TARA weighs 6 kg-f, and thus a total of 19.8 kg-f is required to lift the piston, neglecting friction and buoyancy effects, which are discussed later in this Annex.

Complicating the analysis further, a direct action pump may have a pump rod diameter greater than that of the piston, as illustrated in Case B of Figure A-1. The analysis for this case differs from the more typical case of a rod which is smaller than the piston in that the net lifting force required may possibly be negative, i.e., the rod and piston may be pushed upward by buoyancy. In this case the water pressure (1.5 kg-f/cm² when there is a 15 meter head of water) pressing up on the bottom of the rod and down on the piston is the same, but the bottom of the rod has a greater area than the piston and thus the upward force resulting from water pressure exceeds the downward force. Depending on the specific weight of the material of the rod, it is thus possible that the upward buoyancy force in this case will exceed the combined weight and downward pressure forces, and the rod could tend to move upward without the user applying any force to it. However, the upward movement is not accompanied by water discharge: The level of the water surface in the rising main will go down as the rod and piston go up. This is because the volume swept by the piston as it moves up (which is the volume of water it lifts with it) is less than the volume swept by the bottom of the pump rod. This creates space in the rising main into which water can flow.

Rod buoyancy considerations are perhaps the most misunderstood factors concerning the required operating force. This might best be visualized by thinking of the case where the piston has been lifted above the water level in the well. If the piston is lifted further the water below it will not assist in pushing up the piston, regardless of the rod weight relative to water, because the water level below the piston tends to move towards the same level as that in the surrounding well. To expect the buoyancy of the rod to pull itself up together with the piston attached to it and the water surrounding it, without the assistance of any water pressure below, is analogous to the idea of lifting oneself off the ground by pulling up on one's bootstraps. Pulling the piston further up will be the same situation as occurs in a suction pump, in which an adequate upward force must be applied by the handpump user to the piston to create the pressure differential which lifts the water.

The use of the term "buoyancy" in this context requires some clarification, especially as it applies to the up-stroke. On the down-stroke the rod moves THROUGH the column of water in the rising main, and the rod is in effect SUBMERGED or FLOATING (in the case of a light weight rod) in this column of water. Thus on the down-stroke the classic Archimedes principle can be applied which states that a submerged or floating object is buoyed up with a force equal to the weight of the fluid displaced by the object. However, on the up-stroke the situation requires further clarification, which will be described here for the simple case shown in Case A of Figure A-1. Here the water in the annulus between the rod and the inside of the rising main will move up at exactly the same velocity as the rod moves (assuming no leakage

through or around the piston). Thus the buoyancy of the rod RELATIVE to this annular column of water is irrelevant, because the rod is not free to move RELATIVE to this water. Instead what must be considered is the buoyancy of the system which is moving, and this system includes the rod and the annular column of water as if they were attached and were a unit. In order to determine the effect of buoyancy on the up-stroke handle force, what must be considered is the buoyancy of this system relative to the water level IN THE WELL (the water level outside the rising main) in which this system is partially submerged. The submerged portion of the volume of this system is in proportion to the length of the portion of the rod which is below the level of water IN THE WELL. Using the terms from Figure A-1 this length is equal to $(L - H)$. The buoyancy force on the system which is lifted on the upstroke will be equal to the weight of the water displaced by this system, which will be the weight of water with a volume equal to that of the portion of the rising main below the water level in the well, with a length of $(L - H)$. The NET upward force on the handle will be the difference between the buoyancy force of the submerged portion of the system being lifted (the portion below the level of water in the surrounding well) minus the weight of the entire system being lifted (the weight of the entire length L of rod and water in the rising main). For Case B of Figure A-1, and for other configurations which vary from the simple case described above for Case A, the analysis will be more complicated but will still involve consideration of buoyancy resulting from submergence relative to the level of water in the surrounding well.

The pump rod may appear (deceptively) to have a net lifting force even when none of it is submerged below the water in the surrounding well. This appearance results because if the pump rod and piston assembly are allowed to move freely without stops limiting their travel, then the rod will slowly rise of its own volition. However, closer observation will show that this movement occurs only until the bottom of the light-weight rod has approached the water level in the surrounding well, at which point an equilibrium position is reached in which the force down on the piston (rod weight plus hydrostatic force down on the top of the piston) is balanced by the buoyancy of the rod and piston assembly. After that, if the pump lacks a catch to stop the rod movement, the upward movement of the rod will continue but it will be slower and will no longer be accompanied by the discharge of water. This is because above that point, the rod only rises as water leaks around the piston seals to fill the space below it. The upper limit of this travel is the free floating level that the pump rod would have if there were no downward force on the piston due to the water within the rising main. Thus, to the degree that leakage occurs, and only at the rate that this leakage occurs, the rod buoyancy can lift it relative to the water column in the rising main. However, this buoyancy does not result in the discharge of water nor does it occur when the rod is being lifted more rapidly than water can leak around the seals.

In summary, the up-stroke handle force requirement can be calculated using the following equation:*

$$\begin{aligned} \text{Up-stroke handle force, kg-f} = & \\ & \text{weight of water in rising main} \\ & - \text{buoyancy force on the } \underline{\text{system}} \\ & + \text{weight of rod} \\ & + \text{force to overcome friction} \\ & + \text{handle weight} \end{aligned}$$

Using the nomenclature of Figure A-1, and noting that a column of water weighs 0.1 kg-f per cm^2 cross-section and per meter of height, this becomes:

$$\text{Up-stroke Force} = 0.1 \times (A_c - A_r) \times L - 0.1 \times A_c \times (L-H) + W_r L + F + W_h$$

which reduces to:

$$\text{Up-stroke Force} = 0.1 \times A_c \times H + W_r \times L - 0.1 \times A_r \times L + F + W_h$$

D. Handle Force versus Pump Rod Length

For a given water level and given rod and cylinder diameters, the further a wide diameter light weight pump rod and cylinder extend below the water level, the greater will be the required down-stroke force and the less will be the required up-stroke force. The amount added to the force in one direction will be exactly equal to the reduction to the force required in the other direction and thus the average of the up-stroke and down-stroke forces will not be affected.

This situation is very different from that of conventional piston pumps that have rods of negligible diameters; with such pumps water is pumped only on the piston up-stroke and the handle force is negligibly affected by the submergence of the rod below the water table.

A complete analysis of a typical direct action pump with a wide diameter light weight rod should include not only consideration of the pumping head, but also of the submergence of the rod below the water table. This is because it is generally preferable for users to apply a greater force on the down-

* The discussion and equations for handle force in this annex are based on the assumption that the wide diameter portion of the pump rod is of a constant diameter, as shown in either Case A or Case B of Figure A-1. If this is not the case, then the equations should use average rod cross-section.

stroke than on the up-stroke, and the submergence of the rod below the water table will affect the portion of the total work per cycle which must be done on each half of it. However, the particular pump design and lift conditions will determine if the cost of a special extension of the pump rod is justified in order to optimize the portion of the work done on the up and down strokes. For low lift applications such an extension may not be justified.

Figure A-2 illustrates the dramatic impact of the pump rod length on the required up-stroke handle force for the TARA pump, for pumping heads (depth from the surface down to the water table) of 10, 15, and 20 meters. For other pump designs it should be noted that the smaller the diameter of the bouyant rod, the less sensitive the handle force will be to the length of the rod.

E. Frictional Losses

A potentially important cause of friction in direct action pumps may result from the buckling of the pump rod which can occur when compressive forces are applied to it during the down-stroke. This buckling can cause rubbing of the rod against the wall of the rising main. The degree of buckling will depend upon the stiffness and length of the rod and upon the compressive force applied to it. For a specific pump design (i.e. for a specific rod material, diameter and wall thickness) the buckling will generally increase when the length of the rod is greater. Thus greater friction as a result of rod buckling may be expected with high lift direct action pumps than with low lift ones. Quantification of the amount of buckling and the resultant friction must await more experimental information.

Rod guides can minimize or eliminate buckling but the guides themselves will rub against the inside wall of the cylinder, and the tendency of the rod to buckle will increase the pressure of the guides against the walls and thus increase this friction. Nonetheless it can be expected that optimally spaced guides made of smooth abrasion resistant material will minimize the problem of friction caused by rod buckling. It can also be expected that the use of such rod guides will be of greater importance with high lift direct action pumps.

Valve geometry affects frictional losses and becomes a more complicated problem when space is limited, as in the case of typical direct action pumps. This is because of the conflicting requirements of large port area and high structural integrity of the piston assembly. Also, a one-to-one drive ratio results in higher piston speeds and a corresponding need for larger flow areas than a slower moving piston of the same diameter. Experimental evidence indicates that the ratio of valve port area to cylinder cross-sectional area is important* and for the valve type used in the TARA pump the ratio should be 1:3 at a piston speed on the order of 0.5 m/second.

* Goh Sing Yau, Malaysia in Village Handpump Technology: Research and Evaluation in Asia, Edited by Donald Sharp and Michael Graham, Ottawa; IDRC, 1982.

The pump rod must allow enough space between itself and the rising main to prevent significant hydraulic frictional losses. The smaller diameter piston used on direct action pumps require smaller diameter seals. These have less surface area in contact with the cylinder and therefore potentially have less friction. Also, the longer stroke of the direct action pump piston will spread out wear on the cylinder over the larger area of the wear path, extending the working life of the cylinder.

For preliminary conservative design purposes, it may be assumed that the total effect of friction is to add about 10 kg-f to the required handle force for the up-stroke and 7 kg-f for the down-stroke. For the TARA pump with a pumping head of 15 meters, this is equivalent to a mechanical efficiency of 67 percent. This is because the up-stroke force is increased from about 20 kg-f without friction to about 30 kg-f with friction, the down-stroke force is increased from 15 to 22 kg-f, and the mechanical efficiency will be in proportion to the average force without friction -- that is, $(20 + 15)/2$ divided by the average force with friction, $(30 + 22)/2$ -- which results in 67 percent.

A more optimistic design assumption would be that the total effect of friction is to add only about 4 kg-f to the required handle force for the up-stroke and about 2 kg-f for the down-stroke. Calculated in the same manner as in the preceding paragraph, this is equivalent to a mechanical efficiency of 85 percent for the TARA pump with a pumping head of 15 meters.

More field data and experience is needed to determine realistic assumptions for friction in direct action handpumps, and to develop designs which will minimize this friction. The Project is pursuing such investigations.

Figure A-2 illustrates the effect of friction and other factors on the required handle force.

F. Equations for Volume Pumped

The volume of water pumped on the down-stroke will be equal to the volume displaced by the pump rod:

$$\begin{aligned} \text{Liters per down-stroke} = & \\ & (\text{stroke length, cm}) \\ & \times (\text{upper rod cross-section, cm}^2) \\ & \times (0.001 \text{ liter/cm}^3) \end{aligned}$$

Figure A-2
Theoretical Handle Forces Versus
Pump Rod Length for the Tara Pump

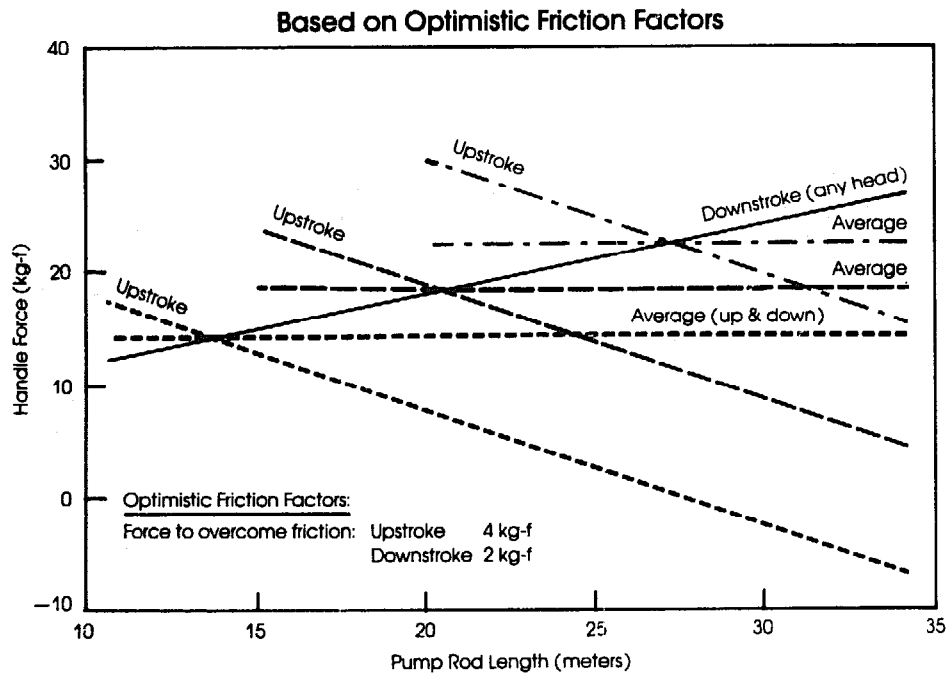
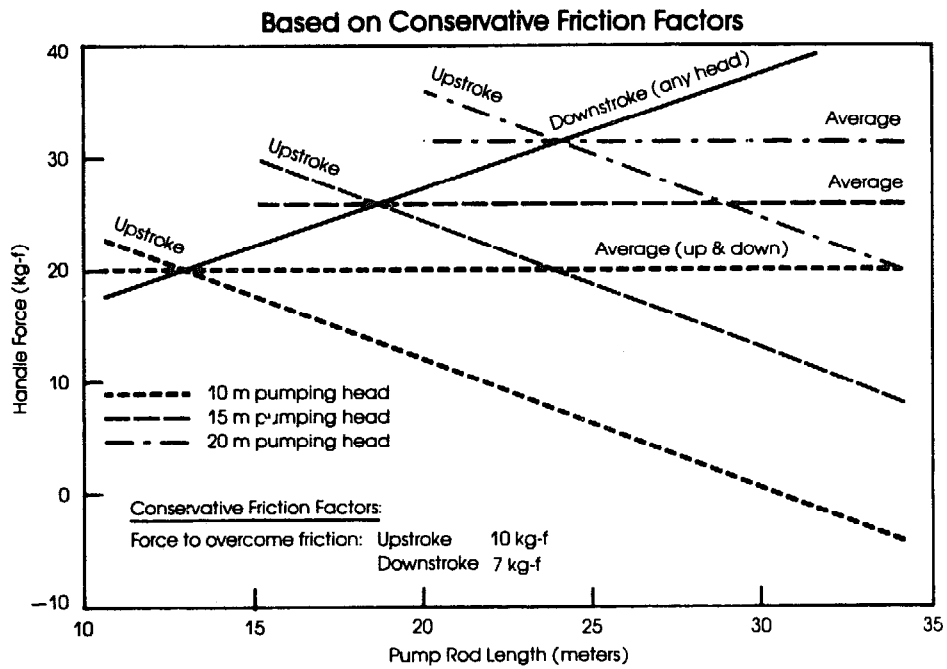

Note:

Practical application of the information presented in this figure is complicated by the fact that pumping heads will typically fluctuate with seasonal variations and pumping drawdown of the water table level.

The volume pumped on the up-stroke will be the difference between the volume swept by the piston and that swept by the pump rod:

$$\begin{aligned} \text{Liters per up-stroke} = & \\ & (\text{stroke length, cm}) \\ & \times [(\text{cylinder cross-section} - \text{rod cross-section, cm}^2)] \\ & \times (0.001 \text{ liter/cm}^3) \\ & - \text{leakage around piston seals} \end{aligned}$$

The total volume pumped per cycle (up-stroke plus down-stroke) is the sum of the above, and is independent of the rod diameter:

$$\begin{aligned} \text{Liters per cycle} = & \\ & (\text{stroke length, cm}) \\ & \times (\text{cylinder cross-section, cm}^2) \\ & \times (0.001 \text{ liter/cm}^3) \end{aligned}$$

G. Illustrative Applications of Direct-Action Handpump Principles

Figure A-3 illustrates how, at a given pumping head of 15 m, the required handle force is affected by both the rod length and various combinations of cylinder and rod diameters. The total water pumped per cycle and the sum of the up and down-stroke handle forces depend only on the cylinder diameter and are independent of the rod diameter. However, the rod diameter determines both the distribution of handle forces and the fraction of the water pumped on the up and down-strokes. An illustration of the use of this Figure is for a case where the pumping head is 15 meters and it is desired to use the TARA pump and to keep the up-stroke force below 20 kg-f. It can be concluded that the pump rod length will have to be at least 17.5 m (10.5 m below the water table) and that with this arrangement the required down-stroke force will also be about 20 kg-f. An alternative would be to use the Design B in the Figure. In this case the required up-stroke handle force could be reduced to about 14 kg-f with a rod length of 17.5 m, and the corresponding down-stroke force would be about 20 kg-f. However, there would be a reduction in the total water produced per stroke cycle, from 0.69 liters for the TARA design down to 0.55 liters for the Design B design.

It should be noted that there is not necessarily a constraint related to the need for a minimum annular space between the pump rod and the inside of the cylinder, because, as shown in Figure A-1 the rod does not need to extend into the cylinder at all. For practical purposes the annular constraint applies to the space between the rod and the rising main, and this will not be a problem if the rising main has a larger diameter than the cylinder. In pump designs which feature such a larger rising main diameter, the extra space facilitates the removal of the piston directly up the rising main for maintenance purposes.

Figure A-3
Theoretical Handle Forces Versus Pump Rod Length at a Pumping Head of 15 meters for Various Rod and Cylinder Diameters

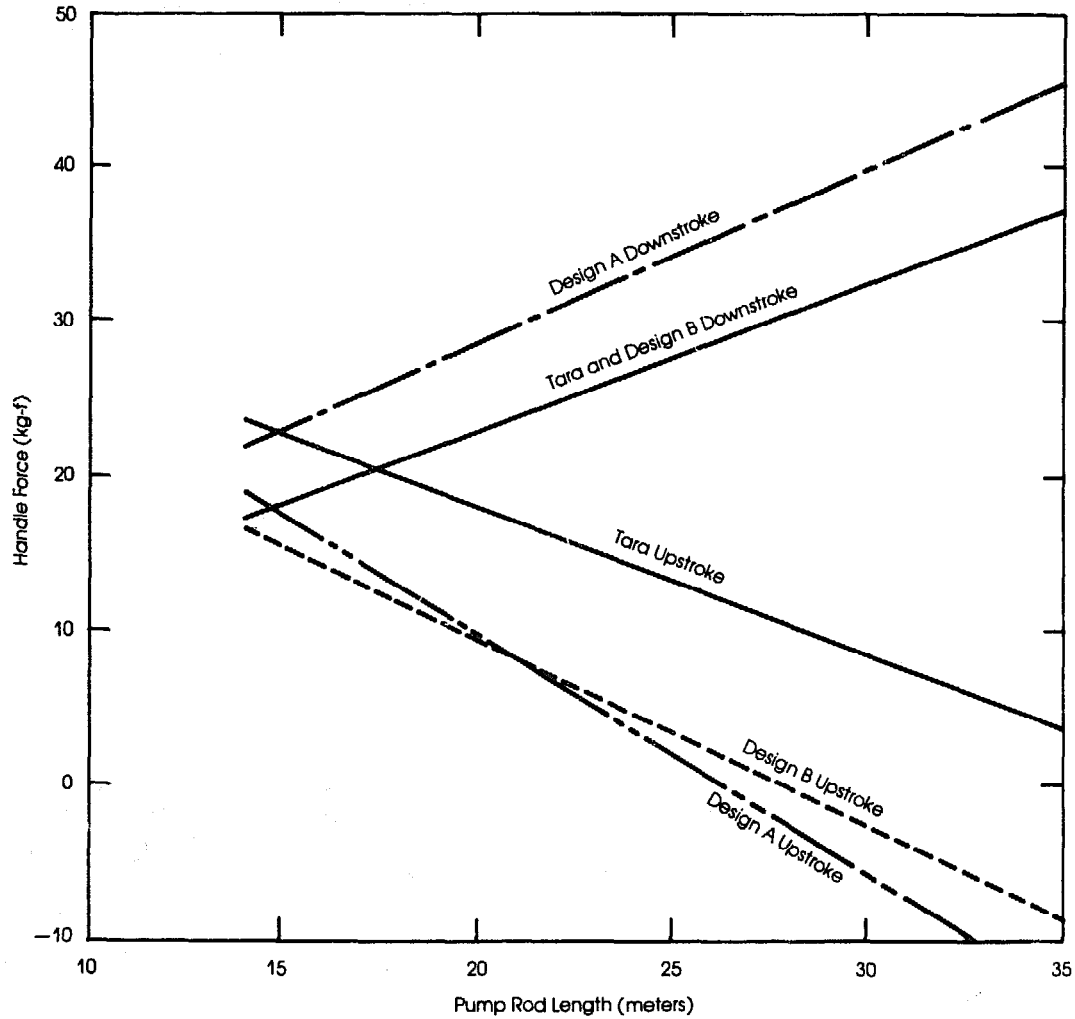

Notes: All handle forces shown in the above graph include an assumed force to overcome friction of 4 kg-f on the upstroke and 2 kg-f on the downstroke.

The stroke length has been assumed to be 300 mm.

Diameters and discharge per stroke are as follows:

	Rod Diam. (mm)	Cyl. Diam. (mm)	Liters/Stroke		
			Up	Down	Total
Tara	42.2	54.3	0.27	0.42	0.69
Design A	48.3	54.3	0.14	0.55	0.69
Design B	42.2	48.3	0.13	0.42	0.55

H. Pump Rod Design Parameters

A direct action system imposes special requirements on the pump rod which controls the piston movement. It should be relatively high in volume and relatively low in mass so that the balance between up and down forces may be approached and so that the net increase in power required to lift the mass of the rod is held to a minimum. The rod will move at higher speeds than that of a conventional lever pump, it will be subjected to compressive forces at a higher level than conventional rods, and may buckle, entailing high amplitude oscillations leading to contact between the rod and rising main. An ideal direct action rod would be the best compromise among the following characteristics: low mass, high volume, high stiffness, high tensile strength, low elasticity, and high abrasion resistance. A suitable light tube seems to be indicated, although other alternatives will be investigated. If the rod could be a single segment and flexible and strong enough, it could be bent over and played out on the ground during extraction. However, flexibility would conflict with the ideal of stiffness to prevent buckling. Connectors usually presuppose tools and may be vulnerable to uncoupling during operation or subject to failure caused by fatigue. Both the materials requirements and the dynamic behavior of direct action pumps will be investigated by the Project.

I. Volume Pumped versus Pumping Head

A handpump may be considered reasonably efficient if it has a mechanical efficiency above about 50 percent. For a given mechanical efficiency, the two predominant factors affecting the rate at which water is pumped will be the rate at which the user applies work to the pump (this rate is defined as "power" and is measured in units of watts) and the depth from which the water is pumped. For instance, if work is done at the same rate for two situations which differ only in that the pumping head for the first is 10 meters and that for the second is 20 meters, then exactly half the water will be pumped from 20 meters. In practice, this could result from the use of an identical pump which would require twice the handle force at 20 meters head than at 10 meters, which would tend to tire the user more at 20 meters and make him move the handle at half the speed and thus pump half the water. It also could result from reducing the cylinder diameter so that half the water is pumped per stroke but the handle force and power input is unchanged.

The rate at which a user can apply work to a pump will depend on a number of factors, including the strength of the user, the comfort and ergonomics of the pump, the length of time the user must continue to work (work can be done at a greater rate for short bursts of time), and climatic conditions. Nonetheless, a conservative estimate is that typical pump users can apply work at the rate of about 50 watts for extended pumping periods. Such extended periods will apply both to irrigation uses of handpumps and to pumping from substantial depths. For instance, to pump 20 liters from a depth of 45 meters will require about five minutes of continuous pumping if the user applies 50 watts of power and the pump has a mechanical efficiency of about 65 percent.

Figure A-4 illustrates the relationship between the rate at which water can be pumped and the pumping head.

Figure A-4
Pumping Rate Versus Pumping Head

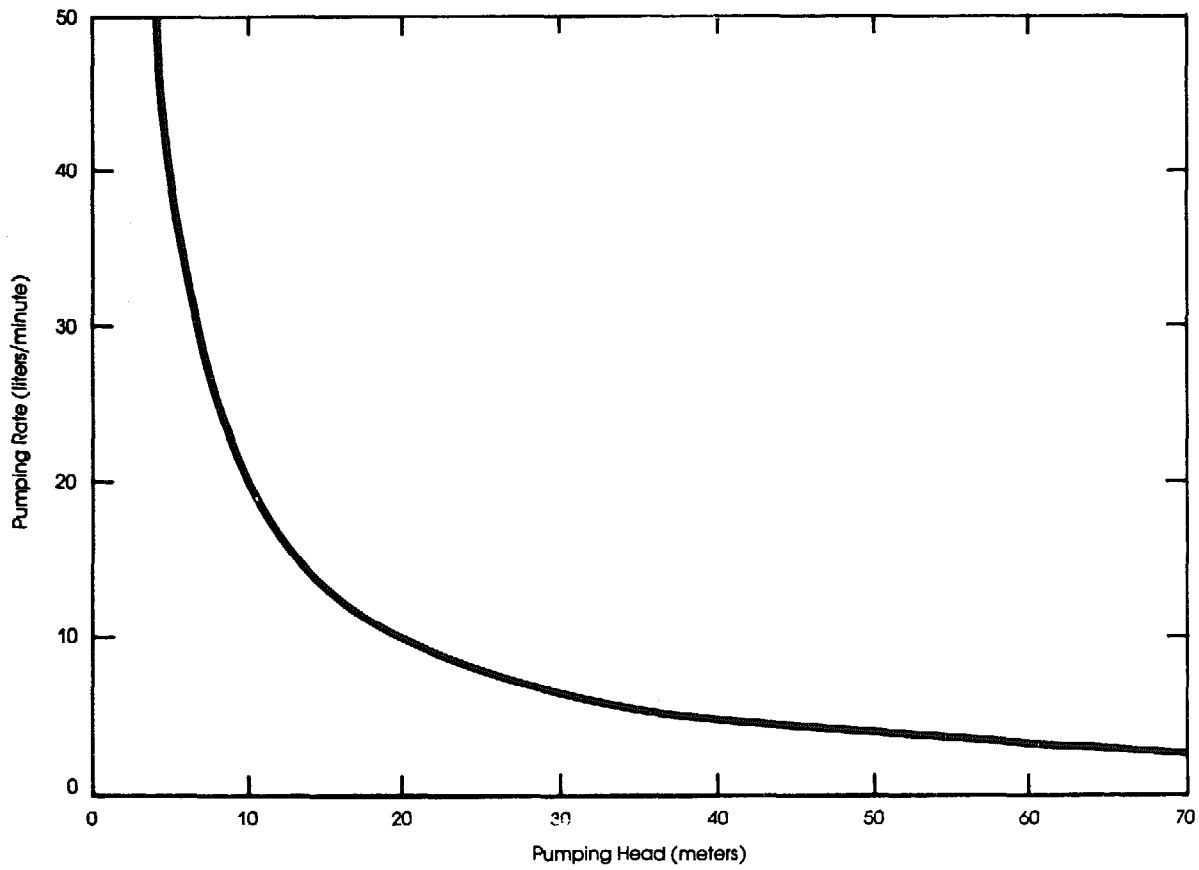

This graph applies to any handpump design, if the design is ergonomically comfortable for the application of about 50 watts of power, and if the mechanical efficiency is about 65%.

J. Conclusion

Conventional piston handpumps appear to have deficiencies in design concept compared to direct action pumps: force multiplication drives are needed as a consequence of choosing cylinder diameters larger than necessary; high mass piston control rods waste the small amounts of human power available and complicate extraction for servicing; more material is used to accommodate the greater weight of the large diameter column of water, and larger diameter boreholes are necessary to accommodate the larger diameter cylinders, escalating drilling costs needlessly.

Direct action pumps, by comparison, are simpler mechanical systems. A smaller diameter reduces the swept volume of the cylinder, but a longer stroke restores swept volume. A longer stroke results from eliminating the mechanical advantage of a lever. The smaller diameter cylinder can be inserted into a smaller diameter tubewell. Lighter weight, more easily extractable pumping elements can be used in direct action systems. Simpler mechanical systems reduce tool requirements for maintenance and simplify training of maintenance personnel.

It follows from the above discussion that simple direct action piston handpumps may contribute to improvements in performance in the rural water supply sector. However, mature products ready for mass application first must be developed. This will depend on identifying and solving the practical problems of such systems.

ANNEX B

THE ROWER PUMP

The Rower is a direct action handpump developed for low-lift irrigation applications in Bangladesh.

Following are three related reports about the Rower pump. These were written by the Mirpur Agricultural Workshop and Training School (MAWTS) and the Mennonite Central Committee.

These reports are reproduced here because the Rower is a widely used example of a new generation of direct action handpumps which offer many advantages based on their village level operation and maintenance (VLOM) characteristics including simple maintenance, low cost, and local manufacture. The general advantages and technical analysis of direct action handpumps are discussed in Annex A. The laboratory tests of the Rower pump are discussed in the Handpumps Project Management Report No. 3 and are summarized in Chapter 6 of this Report.

REPORT 1: THE ROWER PUMP

1. DESCRIPTION

The Rower pump is a manually operated reciprocating pump with a 2 inch nominal diameter PVC pipe as the pump cylinder. The piston inside the cylinder is operated by pulling and pushing directly on a T-handle at the end of the piston rod. The pump is installed at an inclined angle of 30° from the horizontal to the well in the ground through a "Y" connector piece. Moving the "T" shape handle in a rowing motion the farmer/operator thrusts the piston back and forth in the cylinder and draws water out of the tube well by means of suction. Use of a suction chamber is made to compensate for the velocity variation produced by the water column traveling in the well pipe, which provides a steadier upward flow of water in the ground pipe enabling the operator to make easier and smoother strokes. Compared with the conventional metal body lever pumps a person can pump significantly more water in a given time with the Rower pump at a suction lift of 15 to 25 feet (5 to 8 meters). The output difference increases with the increased lift, however, at 20 feet lift the output is about 0.8 liters per second (12 GPM) depending on the aquifer condition. The pump is easy to install and operating comfort is remarkable. The pump is being used for small scale irrigation by the farmers for various types of crops. Several types of the Rower pump have been produced and tested for various lifting height and cylinder sizes. Another successful version is the 3 inch diameter Rower pump suitable for low lifting of surface water up to a lift of 10 feet (3 meters) giving an output of about 2 liters per second.

2. TYPES OF ROWER PUMPS

Types	Maximum Lift	Recommended Maximum Working Lift	Discharge at Recommended Lift	Suitability
Rower pump 2 inch	26 ft (7.9 m)	20 ft (6.1 m)	0.8 liters/sec 13 gal/min	Tube well
Rower pump 2.5 inch	18 ft (5.5 m)	12 ft (3.7 m)	1.5 liters/sec 20 gal/min	Lifting water from dug well & tube well
Rower pump 3 inch	12 ft (3.7 m)	9 ft (2.7 m)	2.0 liters/sec 30 gal/min	Surface water lifting from pond, canal, river, etc.

Figure B-1
Water Discharge Versus Depth

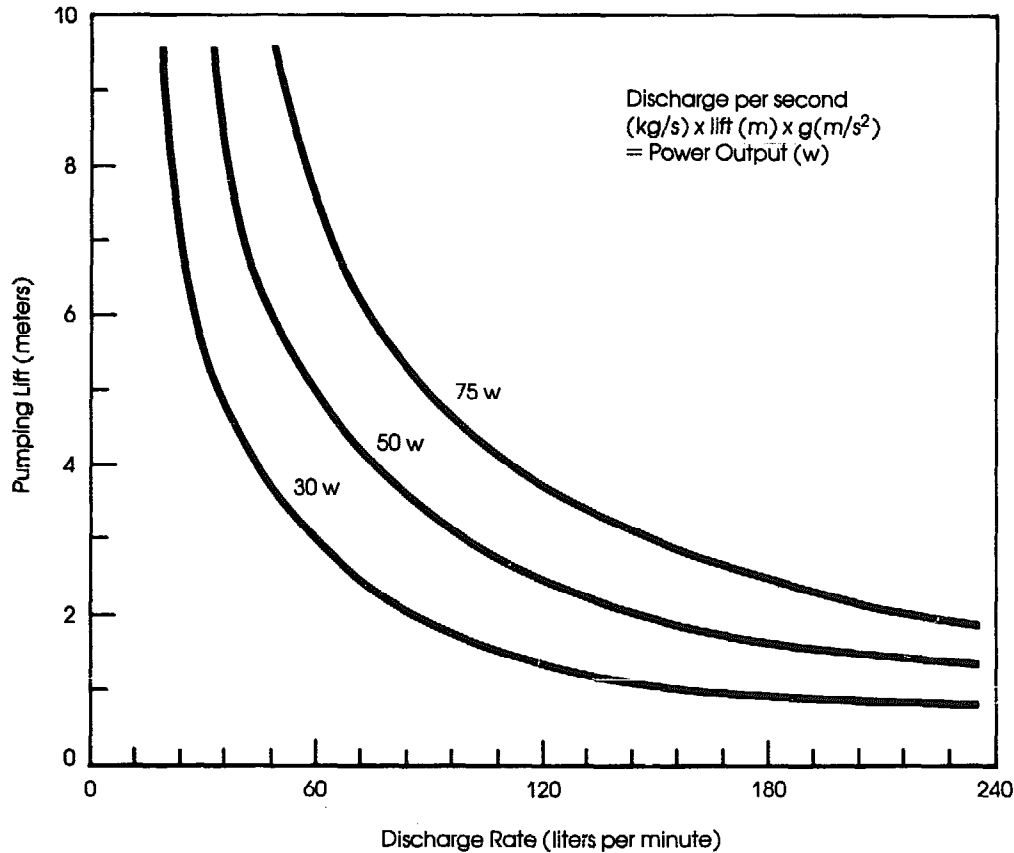

3. PERFORMANCE CHARACTERISTICS

During field trials carried out in various parts of Bangladesh, the performance of the two inch Rower pump has been found as indicated in the discharge graph shown for various power inputs by individuals while operating the pump. However, for an average healthy person operating the pump output over a period of eight hours of continuous operation in turn by two persons operating and resting is as indicated in the table:

2 Inch Rower Pump

<u>Lift Height</u>	<u>Discharge</u>
10 feet (3.0 m)	23.0 gpm (1.5 liters/sec)
15 feet (4.6 m)	20.0 gpm (1.3 liters/sec)
18 feet (5.5 m)	17.0 gpm (1.1 liters/sec)
20 feet (6.0 m)	12.5 gpm (0.8 liters/sec)

4. OPERATIONAL INSTRUCTION

4.1 Well

The well normally consists of 1-1/2 inch nominal diameter galvanized iron (G.I.) pipe or PVC pipe as found suitable, depth of the well would vary according to the ground condition from place to place. A screen/filter length of 12 feet (3.7 m) at the bottom of the well is generally recommended. In certain cases 6 foot (1.8 m) length may be sufficient. Fine sand condition would necessitate a gravel packing around the screen. Gravel packing must be well mixed and consist of required sand sizes. A cap is required at the bottom of the screen. The top end of well casing should be installed at a proper point so that the pump outlet will be 20 to 24 inches (51 to 61 cm) above the surface where the operator stands. This height assumes an adult operating the pump. For final placement of the well, pack the top of the casing pipe tightly, to prevent movement of the well during pumping action.

4.2 Installation of Pump

a) Inspect all the pump parts so that they function properly:

Foot valve seal should seat tightly inside the tapered end of the cylinder.

- Piston locking nut moderately tightened and lock ring correctly attached, assembly in correct order.
- Surge chamber collar properly sealed with rubber mounting coupler. Check coupling for required rigidity.

b) Installing pump cylinder to "Y" function piece:

- Use paint on the threads.
- Use pipe wrench to moderately tighten the cylinder to the junction "Y" piece.
- Turn the pump in the direction the farmer wishes to operate the pump.
- Check the angle of the pump against the horizontal ground and the comfortable angle should be about 30°.

c) Support for the inclined pump cylinder:

- Split a bamboo and tie it around the outside of the PVC pipe for sunlight protection and for stable support. Also fashion a bamboo or branch of tree to act as a vertical support directly under the pump cylinder about 1 foot from the end of the delivery spout. With wire or rope fasten these together. For additional rigidity and stability the pump can be completely buried in an earth mound.

Figure B-2
Sub-Assemblies of the Rower Pump

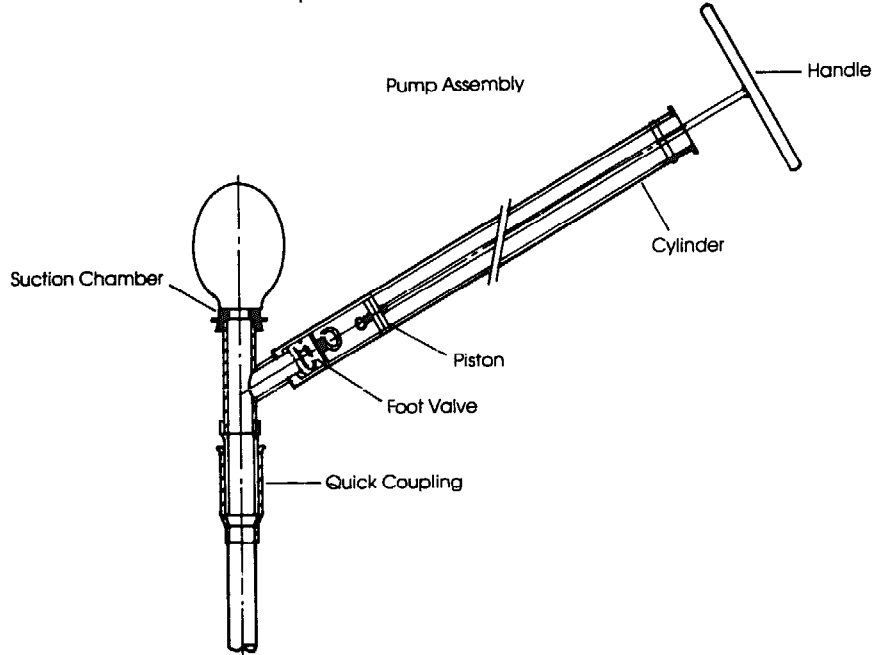
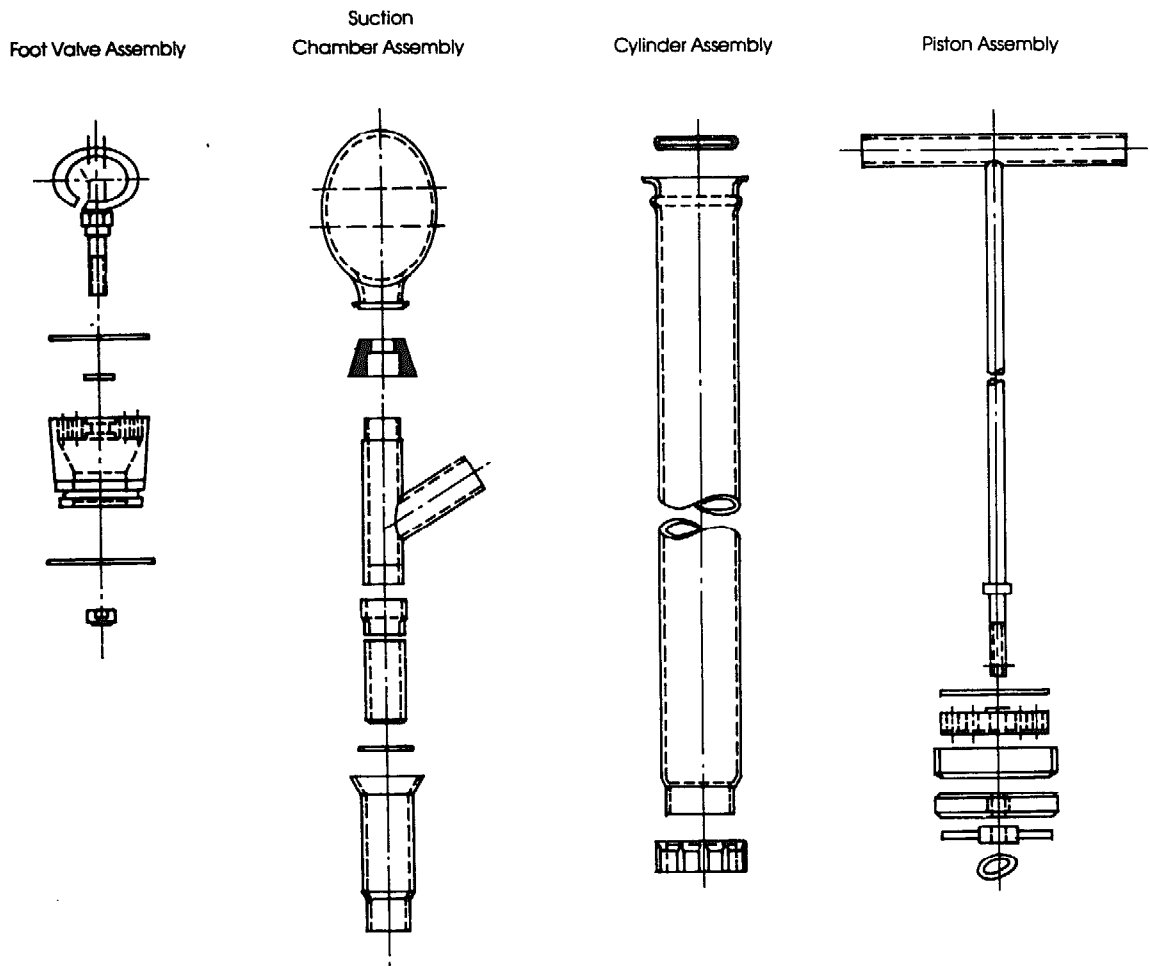

- d) Make a proper receiving area for water to fall. Approximately 3 foot (1 m) diameter area with small dike around the perimeter. If the user wishes the water can be conveyed by various means found suitable for different areas. Efforts should be made to prevent soil erosion around the pump specially at the delivery end.

4.3 Developing the Well

In order to lengthen the useful life of the well and the pump and allow for easy operation of the pump the following procedures are recommended:

Once the pump and well are completely installed begin to operate the pump, when water appears, stop and quickly remove the surge chamber from the pump allowing the water column to rush down into the well.

Repeat this procedure two to three times. Next start pumping water from the well with Rower pump till all dirty water ceases to come out. When water appears clean remove the surge chamber as before, as many times as necessary, till no more dirty water is discharged from the well. This procedure may have to be repeated several times before the well is satisfactorily developed.

4.4 Tools Required for Installation of the Pump

Pipe wrench and hacksaw blade (if PVC well is used). For normal operation hardly any tools are required.

5. REPAIR AND MAINTENANCE

The merit of the Rower pump lies in the very simple design used for its manufacture. The pump during its normal operation hardly requires any maintenance, and the components are very simple and spares may be easily replaced without use of any tools. Simplified maintenance is an important feature of this pump. Access to both piston and foot valve is quick and simple. They can be removed without dismantling the pump. The piston with the leather cup seal in the cylinder can be easily removed by pulling out the piston rod. A rod with a hook at one end and a ring at the other is used to both draw out the foot valve and slide it back again. If the pump loses its prime then the foot valve seals and sealing of the suction chamber around the coupling rubber piece should be checked for leakage. Different rubber seals used in the pump can be made from ordinary inner tubes and replaced. Other maintenance points are:

5.1 Leather Bucket

If the action of the piston becomes stiff usually it is found that the leather bucket has swollen and needs "shaving" to make it an easy slip fit.*

5.2 Rubber Piston Valve

If a replacement valve is required it must be tight fit around the piston rod, and cover all the holes in the aluminum plate.

5.3 Over Tightening of Locking Nut

Over tightening of the locking nut can result in cracking the aluminum plates. For this reason a washer is provided to facilitate tightening.

5.4 Bending of Piston Rod

If the piston rod is bent, it will result in excessive wear of the piston guide or the leather bucket. This condition must be avoided.

* Editor's comment: This statement has been included here because it is part of the original document provided by the Mennonite Central Committee. However, elsewhere, with other types of pumps, it has been found that the practice of "shaving" oversized leather buckets (leather cup seals) has drastically shortened their working life. The outside of the leather is its strongest part, and once shaven the remainder deteriorates rapidly. It is therefore important to provide original leather buckets which are undersized and will not need shaving. Buckets with a diameter about 1/16 inch (about 1.5 mm) smaller than the inside diameter of the cylinder have been found to work well elsewhere, with different pumps.

REPORT 2: ROWER PUMP INFORMATION
(Two-Inch Model)

INTRODUCTION

Groundwater conditions in many parts of Bangladesh are good enough to allow successful operation of above-ground, reciprocating piston handpumps. However, other parts of Bangladesh are not suitable. In those areas, the water level drops to 25 feet (8 m) or more in the dry season, not allowing traditional hand irrigation pumps to operate easily for irrigation.

The Rower Pump is designed to meet unfavorable groundwater conditions. This manually operated handpump produced in Bangladesh has features of relatively high water output, easy field maintenance, and low cost.

PUMP DESCRIPTION

The Rower Pump is simple, consisting of 15 disassembleable parts. The pump cylinder is a two inch PVC pipe mounted on the tubewell at 30 degrees from horizontal. The water flows through the upper end of the body as the piston rod is pushed and pulled. A one-directional "foot valve" is at the lower end of the body, by use of a suction chamber attached below the foot valve, water flows steadily, enabling a relatively easy and smooth pumping effort.

INSTALLATION

Necessary to pump operation is a proper installation. A good installation will increase pump life, enable efficient water output, and give the operator reasonable comfort. Two basic positions are recommended, but many variations from them are possible. The sitting position is suitable for prolonged operation. The pump is completely buried in the soil, leaving the mouth only a few inches above ground level. This installation is the least expensive, most resistant to theft, and can be covered for protection during seasonal flooding.

The second position, operating while standing can be used for irrigation as well as home purposes. The support under the cylinder is quite sufficient to prevent movement at the pump's base. The cylinder should be wrapped with bamboo. It is recommended to make the water receptacle and standing ramp of concrete. The two inch Rower Pump is installed with 1-1/2 inch nominal diameter tubewells. It can be used with galvanized iron (GI), plastic or bamboo pipe. Rural well drillers setting the pump in Comilla and Noakhali are required to take a 3 day training course including theory and practice, to bring their skills up to necessary levels.

IRRIGATION SUITABILITY

The Rower Pump is designed for irrigation. While it is especially useful for winter vegetables and wheat, many other crops can be irrigated. Given good conditions and high labor input, rice can be irrigated. With its field-

tested output (described below), the Rower Pump can produce in eight 5 hour days more than one inch of water over one acre of crop land.

PUMPING CHARACTERISTICS

The pump has been operated without cavitation at a 28 foot (8.5 m) water level. Irrigation can be done at 25 foot (7.6 m) water level. At more than 25 feet (7.6 m), the strength of the operator is the limiting factor.

Recent testing has illustrated the pump's advantages at higher water lifts. At water levels between five feet (1.5 m), the output varied from 15 to 10 US gallons per minute (0.9 to 0.6 liters/sec) respectively. These pumping capacities verify the pump's usefulness for manual irrigation in many areas of Bangladesh. The range of lift capacity is approximately eight feet (2.4 m) more than any other manual pump being manufactured in Bangladesh. Surveys of fielded pumps in Comilla and Noakhali, where the water levels occurred between 10 and 15 feet (3 to 4.5 m) and sand layers varied from coarse to fine, substantiated these test results. Actual pumping outputs there ranged from 11 to 12 U.S. gallons per minute (0.69 to 0.76 liters/sec).

PUMP MAINTENANCE

One important feature of the Rower Pump is its ease of maintenance. Tools are not needed for disassembly of the piston or foot valve. These can be repaired by hand. The piston assembly is attached to the bottom of the piston rod, and may be reached by pulling the piston completely out of the cylinder. To disassemble the piston, the support plate is unscrewed. The individual parts can then be slipped off the bolt.

The foot valve can be retrieved by use of a hooked rod supplied with the pump head. Both the rubber flap valve and the ring seal can be replaced by stretching them in and out of position. The PVC cylinder pump body is glued into place on the metal "Y" piece and should not be removed.

FIELD OPERATION RESULTS

During the 1980-81 rabi season, 500 pumps were marketed. These were marketed with PVC tubewells through local businessmen. The rate was subsidized at about 19 percent of actual cost. In the 1981-82 rabi season an additional 650 pumps were marketed, mostly through local businessmen, but this year at cost. The retail price was marked up to give the businessman a profit margin.

Following up on each season's sales were two surveys. First, an installation survey was conducted with each farmer immediately after his pump was fielded. Second, utilization surveys were conducted approximately on a

monthly basis with about 30 percent of the rower pump purchasers.* Below is a summary of some pertinent data from those surveys:

The pump was sold as an irrigation pump. Immediately after purchase over 90 percent of pump purchasers reported an intention to use the pump for irrigation. More than 80 percent of the pumps sampled were reported to have actually been used for irrigation. Over half of the sampled pumps were used significantly for domestic purposes (drinking, washing), a few of the users reported innovative uses such as for fish culturing, brick fields, and restaurant.

Installation surveys showed that two-thirds to three-fourths of the pump operators questioned were able to show that they could, in fact, carry out routine maintenance procedures on their pumps. Repeat visits showed over 95 percent being able to do so. Thus, the pump appears to be designed well for simple maintenance.

Good installation procedures did not appear to be conscientiously followed by the tubewell mistories as is suggested by several criteria. From the previous paragraph one reason can be deduced. Another: the water receiving area was not properly constructed. This indicates a need to pay much attention to the mistories training and the process by which they are made accountable for good work.

These sampled pumps used for irrigation during 1981-82 rabi season covered an average land area of one-half acre in the Noakhali and Comilla areas. A major crop was potato. However, many other crops were irrigated. In 1981, 27 different crops were discovered to have been irrigated by the Rower pump. A common practice noted is for a farmer to plant two or three short duration crops in succession on the same plot throughout the rabi season and early summer.

AVAILABILITY

The Rower Pump is manufactured by Mirpur Agricultural Workshop and Training School of Mirpur, Dhaka. Marketing inquiries should be directed to: Project Manager, Mirpur Agricultural Workshop and Training School, Section 12, Pallabi, Dhaka-16.

* Copy of Survey results available at Mennonite Central Committee, Box 785, Dhaka-2.

August 1982
Mennonite Central Committee, Dhaka
MAWTS, Mirpur, Dhaka

REPORT 3: TECHNICAL MANUAL - Two Inch Rower Pump

1. DESCRIPTION

The Rower Pump is a manually operated, reciprocating pump with two inch diameter PVC plastic pipe as the cylinder. The piston inside the cylinder is operated by pushing and pulling directly on a T-handle at the upper end of the piston rod. The pump is attached to the tube well at an angle of 30° from horizontal. Moving the piston back and forth in a rowing motion the farmer/operator draws water out of a tubewell by suction. Use is made of a vacuum chamber to damp the velocity variation in the moving water column that occurs due to the reciprocating piston. This damping effect makes it possible also to reduce stress on the operator since the water column accelerates at the beginning of each stroke at a lower rate than the piston.

The Rower pump is very simple. No extra tools are required for inspection and maintenance of the pump. Furthermore, maintenance is a simple task so that a farmer can easily check and service his own pump as needed. Primary maintenance would be expected on the piston on which a leather cup seal and a rubber valve flap are fixed, on less frequent occasions the foot valve may need to be examined. This has a rubber flap valve which is removed and replaced quite easily. The foot valve is extracted through the discharge end of the cylinder by the use of a retriever rod supplied with the pump.

2. PERFORMANCE CHARACTERISTICS

The Rower pump operates without cavitation up to about a 28 foot (8.5 m) pumping head where the pump is used for irrigation, a maximum 22 feet (6.7 m) pumping head is recommended due to limitations of operator strength and endurance. In locations where the source of water is an open well or where better tubewell conditions occur, the allowable water level under which the pump could operate satisfactorily for irrigation would be 25 feet (7.6 m). But if the tubewell does not produce water so easily this maximum water level would be proportionately less.

Assuming average conditions of a medium to fine sand layer, an adult operator and about a 15 foot (4.6 m) water level, one can expect this Rower pump to produce approximately 12 US gal/min (0.76 m liters per second) over extended period of operation. This output capacity would vary, of course, depending on the ground water conditions and development of the well. Depending on the type of installation the pump can be operated in a standing or sitting position.

The characteristic, nearly constant velocity of water in the tubewell with a Rower pump creates a favorable condition for the tubewell filter. When using the Rower pump the danger of damaging the tubewell filter is very small, even with especially fast pumping. Thus, it is not likely that the well will produce sand if the tubewell has been installed properly.

3. INSTALLATION PROCEDURE

WELL

The source of water for the two inch Rower pump is a tubewell. For this the pipe and filter/screen can consist of PVC plastic, galvanized iron (G.I.), bamboo or a combination of these. The tubewell should be installed by an experienced well driller using the best methods available within the financial means of the pump purchaser. In areas where the tapped aquifer consists of fine sand, it will be advantageous to bore a hole larger than the well pipe, allowing for oversized sand or gravel to be packed around the outside of the filter.

Proper installation of the Rower pump requires the top of the tubewell pipe to be positioned at the correct depth from ground level. Figures B-4 and B-5 show the dimensions for two alternative installation methods.

After the tubewell is positioned properly the top end should be packed very tightly with soil so that it will not move during the pumping operation.

PUMP

Push the surge chamber with the seal onto the Y-piece carefully so that it seals tightly, when fitted not more than 1/2 inch of the rubber seal will be visible. Attach the pump to the tubewell taking care to prevent any air leaks. The desirable direction of the pump with respect to the tubewell is one that considers the angle of the sun, location of irrigation fields, any available shade and other relevant factors.

INSTALLATION

Option - 1

Sitting Position: for irrigation purpose. If the pump will be used mostly for irrigation purposes and is not placed at a farmstead (bari) then the pump should be installed by the very simple, cheap and relatively secure method shown in Figure B-3. The dimensions indicated show that only a few inches of the discharge of the pump remain visible above ground level. Soil that is packed around the cylinder will prevent its movement during the pumping and will keep the cylinder positioned at the proper angle. A small amount of soil can be shaped to form a seat for the operator.

Option - 2

Standing Position: for irrigation and household uses. If the pump will have a significant amount of domestic use (drinking, cooking and washing) in addition to irrigation, the Rower pump should be installed according to the dimensions given in Figure B-4. For such uses, it will be important to have the pump placed at the correct height for a person to stand while operating. The platform on which the operator stands, and the receptacle where the water

Figure B-3
Rower Pump Installation for Irrigation

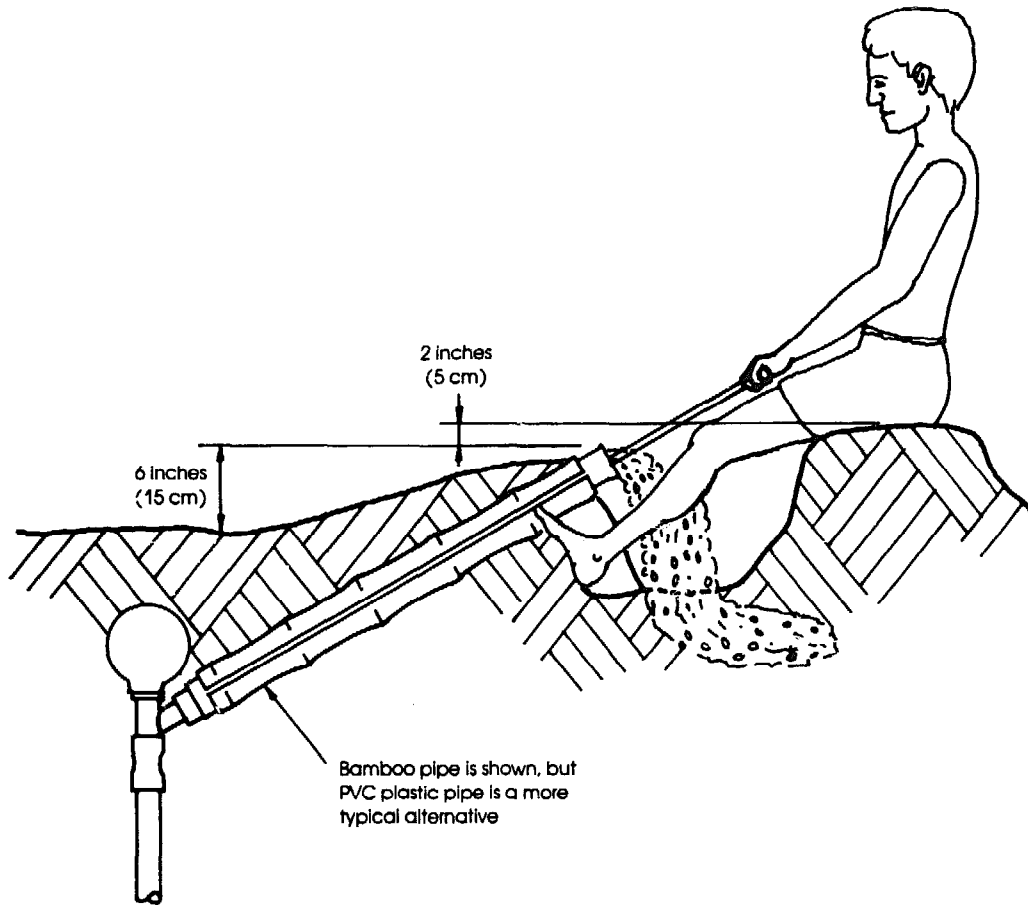
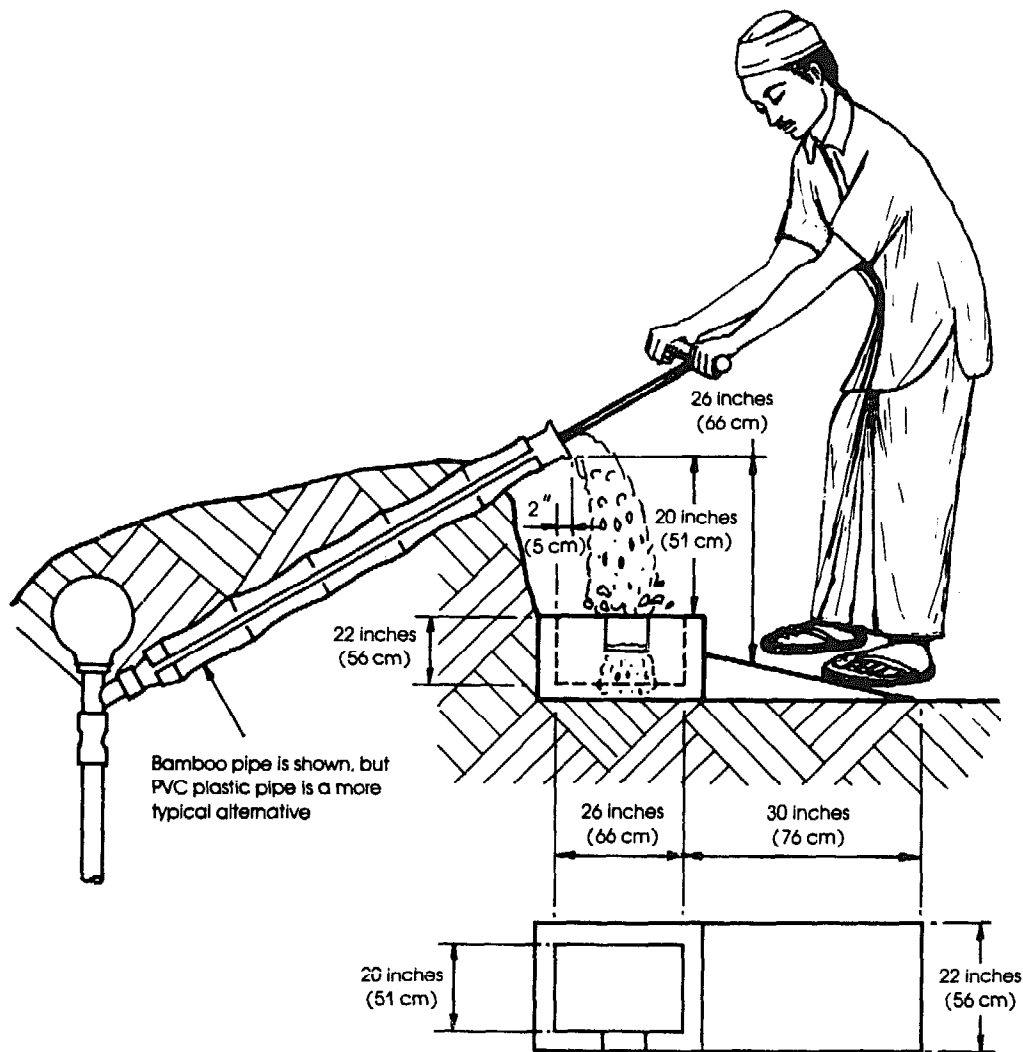

Figure B-4
Rower Pump Installation for Domestic Water Supply



falls should be of such construction as to prevent erosion. Soil should be packed around the complete pump as near to the discharge end as possible.

For both installation options, the operator platform should be positioned so that when the pump is being operated the piston rod does not rub the edges of the cylinder. Long-term exposure of the PVC cylinder to direct sunlight will damage the plastic. Any exposed parts of the cylinder should be wrapped loosely with bamboo strips or other suitable material.

A very important step in installing the well comes after placement of the pump head. The well must be cleaned out and developed properly. If the well driller has no method of his own, then use the following procedures; pump for five minutes, then remove the foot valve. After the water has drained, place the foot valve back in the cylinder. Repeat this until the water becomes clean. This procedure often requires up to an hour of pumping.

4. REPAIR AND MAINTENANCE

The piston has a leather cup seal that may need occasional replacement. This is easily accomplished by removing the locking pin and unscrewing the assembly from the piston rod. If the rubber valve is worn, it can also be easily replaced at this time.

The foot valve will rarely need to be removed from the cylinder. In case water does not stay in the cylinder very long it may be useful to examine the foot valve seals. The foot valve is removed by the use of the hook on the end of the retriever rod provided with each pump. Pull the valve out of the cylinder slowly. If either of the two rubber seals is damaged or for any reason needs to be replaced just slip off the old ones and fit the new one in place. The ring seal needs to sit flat and uniformly around the valve body.

If air bubbles come out of the cylinder together with the water after several minutes of pumping, there is probably an air leak that should be plugged. The most likely source of air leaks is improperly sealed threads. A damaged surge chamber could also give this problem. For threaded components use of quality paint will serve as a good sealant.

If the surge chamber must be removed for any reason, it is again installed easily by the use of soap and water on the rubber seal and the metal surface against which it will slide. First, place the rubber seal firmly and squarely in the mouth of the surge chamber. Then, with the two mating surfaces soapy and wet, push the chamber and the seal together completely onto the Y-piece while twisting the chamber in only one direction.

5. MECHANICS RESPONSIBILITIES

The Rower pump is designed so that the owner of the pump can accomplish his own repair and maintenance. Therefore, the mechanic who installs the pump has the responsibility to clearly instruct the pump owner or user in all aspects of the pump use and maintenance. The farmer needs to know how to use his pump, how to do any routine repair, where he can obtain spare parts, and where he can obtain general advice about irrigation methods with the use of the Rower pump.

The Rower pump is developed and manufactured by:

MIRPUR AGRICULTURAL WORKSHOP AND TRAINING SCHOOL, (MAWTS)
Mirpur Section 12, Pallabi
Dacca-16, Bangladesh
Telephone No. 38 25 44

MENNONITE CENTRAL COMMITTEE
1/1, Block "A" Mohammadpur
Dacca, Bangladesh
Telephone No. 31 70 65

ANNEX C

A SURVEY OF THE PRODUCTION AND USE OF HANDPUMPS IN CHINA

This Document is a translation of a report prepared by the Chinese Academy of Agricultural Mechanization Sciences (CAAMS), Beijing. The report summarizes information obtained in a nationwide survey of rural domestic water supplies and the production and use of water supply and irrigation handpumps in China. The survey was sponsored by the UNDP/World Bank Handpumps Project (INT/81/026). It was conducted in the first half of 1983 and the report was completed in August, 1983.

As part of the United Nations activities for its "International Drinking Water Supply and Sanitation Decade", the United Nations Development Program and the World Bank have set up a program for the laboratory and on-site testing of handpumps for potable water and human- and animal-driven pumps for irrigation in China. To facilitate the implementation of this program, we carried out a nationwide survey in 1983 of the production and use of handpumps for potable water and human- and animal-driven pumps for irrigation (hereinafter called simply handpumps) and potable water conditions, so that handpump research and development work can be more properly done in the future.

This survey was the responsibility of the Chinese Academy of Agricultural Mechanization Sciences, which brought together 14 engineers and technicians from farm machinery institutes in Hunan, Fujian, Shandong, Sichuan and other provinces, and from the Huhehot Animal Husbandry Machine Institute, the Shanghai Deep-Well Pump Plant, the Pinghu County Farm Machinery Plant, the Gaoping County Farm Machinery Plant and the Miyun County Farm Machinery Manufacture and Repair Plant (nine units in all), covering 25 provinces, municipalities and autonomous regions in China, excluding Tianjin, Ningxia, Qinghai, Tibet and Taiwan. In-depth surveys were done in 12 provinces, including Inner Mongolia, Shaanxi, Shanxi, Hebei, Shandong, Jiangsu, Zhejiang, Fujian, Hubei, Hunan and Sichuan, and in 81 cities and counties, including Huhehot, Changchun, Taiyuan, Jinan, Ulumuqi, Changsha, Fuzhou, Guangzhou, Jing County, Yunxiao, Tong'an, Xinjian, Taihe, Anfu, Anyue, etc., with visits to provincial and county machinery offices, water conservancy bureaus, patriotic health campaign organizations, epidemic prevention stations, commune production brigades, manufacturing plants and other user agencies, users and producers. Farm machinery institutes in 11 provinces, including Heilongjiang, Jilin, Liaoning, Gansu, Xinjiang, Henan, Anhui, Guangdong, Guangxi, Yunnan and Guizhou, organized provincial handpump surveys.

Before the survey began, the participating engineers and technicians were called to a conference to prepare a survey outline and determine survey methods and approaches. Upon completion of the survey, a conference was called in Beijing, where the survey report was prepared.

The Chinese Academy of Agricultural Mechanization Sciences also sent six engineers and technicians to Inner Mongolia, Shanxi, Hebei, Shandong, Jiangsu, Fujian, Jiangxi and Hunan in order to select on-site handpump test sites. The sites selected were in Jincheng County, Shanxi Province, and Changsha and Wangcheng Counties in Hunan. Local machinery offices, hydrology offices, patriotic health organizations, epidemic prevention stations and other agencies assigned mechanical engineers and hydraulic engineers to select test sites and test wells. A general prospecting survey was done of the county's groundwater and geological conditions, and chemical analysis of water quality was done. Shanxi's Jincheng County provided 263 test wells, including 67 shallow wells, 179 medium wells, and 17 deep wells, distributed over 15 communes, including Zhoucun, Zhoudi and Bagong. Changsha in Hunan provided

181 test wells, including 104 shallow wells and 77 deep wells, distributed over three towns and two communes in Changsha County and Wangcheng County. A summary of the survey is presented below.*

I. The Present Rural Potable Water Situation

China is a developing country that is vast in territory and has a huge population; its land area totals 9,600,000 km². The country has 30 provinces, municipalities and autonomous regions, with 247 cities, 2,085 counties and a population of over 930,000,000, 85 percent of which is rural.

China's natural conditions are quite complex, with fairly great differences from one region to another. Although there are a good many lakes and rivers, water resources nonetheless are still rather limited. Poor potable water conditions are a severe problem inherited from China's historical past. After the establishment of the Peoples Republic of China, the Chinese Government made a great effort to improve drinking water sanitation, and potable water facilities underwent considerable development. In 1981 China participated in activities marking the International Decade of Potable Water Supply and Environmental Sanitation; the State Council of China issued a document emphasizing the inclusion of water improvement work in national economic and social development planning and required that government agencies at all levels treat water improvement as an important issue for the living standards of the masses and vigorously promote further advances in water improvement work.

At the present time, piped water reaches 82.5 percent of urban dwellers; average water consumption is 130 liters per capita per day. As the people's standard of living has continued to rise, rural potable water facilities have also improved considerably. Through handpumps, central water supply stations and various other types of rural piped water supply systems, 350 million people constituting 40 percent of the rural population, now have water supply systems. Fifteen percent of all villages have piped water stations.

However, development of drinking water facilities has not been able to meet the people's needs. Around the country there are more than 16 million people in 26 cities who are not supplied with tap water, and in rural areas some 500 million people drink water that does not meet health standards; of this latter number, 40 million are short of water, 45 million drink high-fluorine water (distributed over more than 47,000 villages in 574 counties of 26 provinces, municipalities and autonomous regions), another 60 million drink brackish water, and in areas bordering the sea and river networks there are some 150 million who drink surface water polluted by human waste and farm chemicals.

* Translator's Note: A summary of the performance of all the handpumps which have been tested in China is provided in Appendix 1 of this annex. A collection of photos of these handpumps is provided in Appendix 2.

In Shandong, for example, only eight percent of the rural population drink piped water; the vast majority drink water from old wells which are severely polluted and, for the most part, do not meet national standards for potable water. There are also some three million people drinking high-fluoride water, and seven million drinking pond water, pit water and brackish water. At some 8,000 sites where conditions are good, efforts are being made to provide piped water by 1985, benefiting 16 million people and providing 20 percent of the rural population with running water. By 1990 there will be 30,000 - 35,000 sites in the province served by free running water, giving service to 50 percent of the rural population. In areas using high-fluoride water, efforts are being made to provide piped water by 1988. In other areas, another 2,000,000 hand-operated wells will be developed by 1985, providing water to 40 percent of the rural population.

Shanxi Province has a rural population of 20,000,000, most of whom drink river water and well water. Shanxi is one of China's important coal bases, and industrial pollution and the use of water by industry and mining have an effect on the water drunk in rural areas. The number of people drinking polluted water is as high as 2,150,000, and some 1,030,000 people have difficulty getting drinking water. Each year the provincial government invests 8,000,000 yuan* in rural water improvement, primarily for hand-operated mechanical wells, reservoirs, running water and other facilities.

Although Hunan Province has relatively abundant water resources, with more than 4,700 large and small rivers, and an annual water-consumption level that is 174 percent of the national average, in most areas river and pond water is used for drinking, and this water is severely polluted by human waste and farm chemicals. On the basis of surveys of the entire province, vigorous efforts are under way to install mechanical wells. In Changsha County, for example, 2,000 hand-operated mechanical wells and 2,020 small wells are being dug to provide 40 percent of the population with drinking water. In addition, in order to relieve the water shortage in western and southern Hunan, the government is investing more than 10,000,000 yuan annually on diversion works.

In Hubei Province, surveys in December 1980 and June 1981 found 836 sources of potable water in flatlands, hilly and mountainous as well as lake areas. The surveys showed that the structure of most wells is not very tight; they lack protection and are susceptible to pollution. The water contains quite a lot of iron and manganese, and the fluoride content is close to the maximum allowable level set in standards. Because the drinking water is contaminated, some endemic diseases have seriously affected people's daily lives and their physical well-being. According to 1981 statistics from the provincial Health Department, only 6,300,000-plus people in the whole province's rural areas (including county seats) have piped water; 82.5 percent of the rural population (33,000,000-plus) drink river, pond, pit and open well water. In recent years the Hunan provincial government has invested 1,000,000 yuan annually in water improvement, and the number of people drinking safe water is increasing gradually.

* Translator's Note: One Chinese yuan is equivalent to approximately US 50 cents.

The task of solving the problem of providing safe drinking water to 500 million peasants is indeed a difficult one. Thus, the Chinese government's water improvement effort comprises 20 to 25 percent of the worldwide effort of the "International Decade of Potable Water Supply and Environmental Sanitation".

At the present time, 300 million of the 500 million people living in areas of China requiring water improvement are in need of urgent relief. China's health agencies are planning to focus in 1985 on providing relief for areas along the coast, areas with waterway networks, high-fluoride areas, brackish-water areas and areas short of water. If relief is provided to 30-40 million people each year, as a goal, the drinking water problem of 100 million people will be solved within three years. If relief is provided to 50-60 million people annually from 1986 to 1990, virtually the entire rural population will have drinking water that meets health standards by 1990.

One way to solve the drinking water problem in rural areas is the use of handpumps. If 40 percent of the 500 million rural inhabitants are provided with handpumps, it will be possible to solve the drinking water problem; 20 percent of these pumps should be deep-well pumps and 80 percent should be shallow-well pumps. If one deep-well pump supplies drinking water for 200 people, and one shallow well provides drinking water for five people (in China, shallow-well pumps are used by individual households), within ten years China will require a minimum of 200,000 deep-well pumps and 32,000,000 shallow-well pumps.

II. Hand-Pump Production and Utilization

In the 1950's, after Liberation, new reforms and improvements in the traditional, manual-lift devices were instituted in China. In particular, in the past few years, since the implementation of co-production and responsibility systems and various rural economic policies, households have had an even greater need for small, multi-use pumps that are high in quality, low in cost, consume no oil or electricity and are run by human or animal power so as to meet the demands for rural potable water and small-plot irrigation. At present our energy sources are tightly stretched, and there is insufficient firewood, oil and electricity. This means that rural people must use human- and animal-operated pumps.

According to existing, incomplete statistics, the country now has more than 40 plants producing handpumps of 57 different types. Most of these - plants are county-level factories, and each plant produces from several hundred to upwards of a thousand pumps annually. Simple in structure and low in cost, many of them are well received by users. For the most part, they are used to provide drinking water, but to a certain extent, they also are used to irrigate fields.

According to their mode of operation, China's handpumps can be divided into hand and foot pedal pumps, or two-person pull and animal-driven types. In terms of working principle, handpumps include piston, diaphragm, and gear accelerating-centrifugal types. Their rate of flow varies from $1 \text{ m}^3/\text{hour}$ to $25 \text{ m}^3/\text{hour}$, with lifts of 2 m to 30 m and suction of 1.5 to 8 m.

Chinese handpumps come in the following models:

Handpumps

<u>Animal-Operated</u>		<u>Human-Operated</u>	
		<u>Hand</u>	<u>Pedal</u>
Triplex piston	Press	Piston (single, duplex)	Duplex piston
Four-plex piston		Diaphragm	Diaphragm
	Crank	Duplex piston	Centrifugal
		Centrifugal	
	Push-pull	Piston	
		Diaphragm	

1. Piston pumps. China's groundwater sources are unevenly distributed. In the South, they are relatively shallow, mostly less than 10 meters and generally from 3 to 5 meters. Water is deeper in the North, generally from 10 to 15 meters but as much as 100 meters in a few cases.

In terms of present utilization of handpumps, most are simplex piston pumps used for shallow groundwater to supply drinking water, with one pump per household or family; this type of pump provides safe, convenient and inexpensive water.

According to incomplete statistics from the areas surveyed, there are 16 plants producing this type of pump. For example, the Model SYB-80 handpump (see Figure 1) produced by the Farm Machinery Plant of Yunxiao County in Fujian Province has a flow rate of 2 m³/hour and a maximum suction of 7 meters; in the last two years 500 have been produced, and in 1983 it was planned that 2,000 would be produced. In 1982 this pump was selected as the recommended drinking-water pump in Fujian Province from among 14 prototypes of four pump models produced by eight different plants at the "Handpump Testing and Evaluation Conference" held in Fuzhou by the provincial Farm Machinery Bureau. After integration of the design, improvements were made in both performance and materials; it has been warmly received for its simple structure and low price.

The Model SY-81 handpump produced by the Dayu County Farm Machinery Plant in Jiangxi has a flow rate of 2.82 m³/hour, a maximum suction of 6 meters, and an overall lift of 8 meters. It has already undergone regional product appraisal; in the last two years 150 have been produced, and it is planned

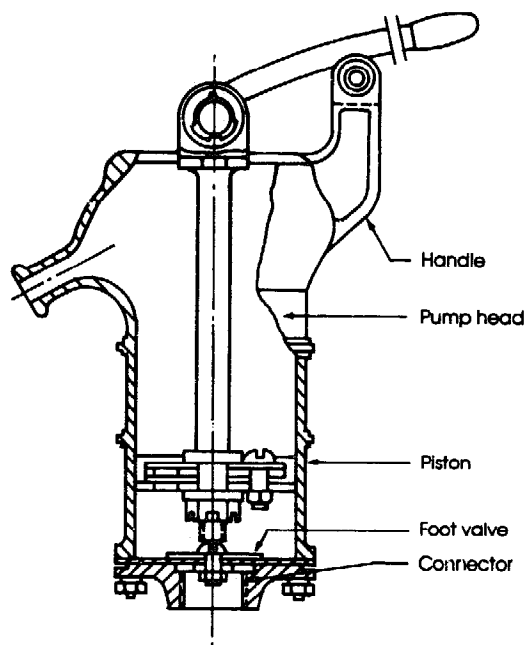

Fig. 1. Model SYB-80 Press Pump

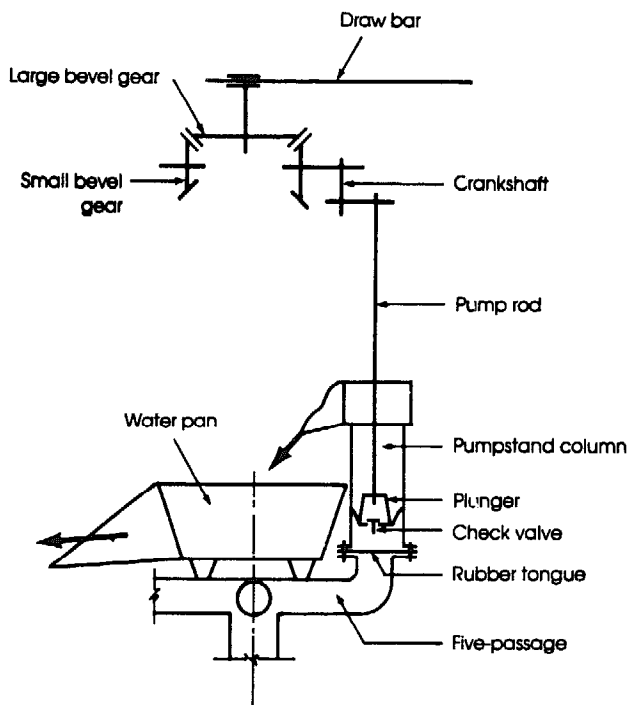

Fig. 2. Model 4D120 Fourplex Piston Pump

that 4,000 will be produced in 1983. At this year's Trade Fair sponsored by the National Farm Mechanization Service Bureau, quite a few users placed orders for it. This pump is simple in structure, light, fast, labor-saving, and convenient to move.

The Model SYB-100 handpump produced by the Changsha County Number 1 Light Machinery Plant in Hunan has a flow rate of $2.2 \text{ m}^3/\text{hour}$ and a maximum suction of 8 meters. In the last five years 4,000 have been produced, and it is planned that 1,500 will be produced in 1983. It is quite widely used for drinking water in rural areas. It has a rational structure and comes in a good selection of types; it has been well received with supply not able to keep up with demand.

Large diameter, simplex piston pumps are used to irrigate small plots of land. In the north, the Models D-100 and D-120, produced by the Jing County Dongfeng Farm Machinery Plant in Hebei, are more widely used; they have bores of 100 and 120 mm, a maximum suction of 7 meters, and flow rates of $2.5 \text{ m}^3/\text{hour}$ and $3 \text{ m}^3/\text{hour}$. In the last five years 8,000 have been produced, and in 1983 it is planned that 1,100 will be produced. People have been buying quite a few of these to irrigate wheat and vegetable plots. This plant also produces the Model 2D-120 two-person duplex piston pump and the Model 4D 120 animal-operated fourplex piston pump. In recent years 640 of the fourplex piston pumps have been produced (see Figure 2), and from January to April of 1983, 385 were produced; it has a flow rate of $4.5 \text{ m}^3/\text{hour}$ and a maximum suction of 8 meters. It is operated by one draft animal. Moreover, its location can be changed for watering during the spring dry season. Farmers have been lining up at the plant to buy the pump, and it has been impossible to keep up with demand. The pump's useful life needs to be increased somewhat.

The Farm Machinery Plant of Qing County, Hebei Province, also produces an animal-driven pump, the Model D 150-3 triplex piston pump (see Figure 3). Its flow rate is $5 \text{ m}^3/\text{hour}$, with a maximum suction of 8 meters. In the last two years 150 have been produced, and in 1983 it was planned that 500 would be produced. This pump is quite widely used, but its quality leaves room for improvement; it is technologically poor, with a short useful life.

In addition, there is the Fujiang Brand duplex piston pedal pump produced by the Number 1 Farm Machinery Plant of Suining County, Sichuan (see Figure 4). Last year more than 1,000 were produced, and this year it is planned that more than that will be produced. At present, supply cannot keep up with demand; people come from the neighboring counties of Shehong and Pengxi to buy these pumps; large quantities have been ordered, with each county requiring 5,000.

The use of handpumps is very widespread; according to incomplete statistics, in Shandong Province alone there are 2,740,000 handpumps benefiting more than 10 million people, or 18 percent of the rural population. In Hebei there are 1,250,000 handpumps benefiting more than 11 million people, or 24 percent of the rural population. In Hunan there are 3,400,000 handpumps, benefiting more than 28 million people, or 39 percent of the rural population. In Jilin, there are 400,000 handpumps, benefiting more than 2.1 million people, or 11 percent of the rural population.

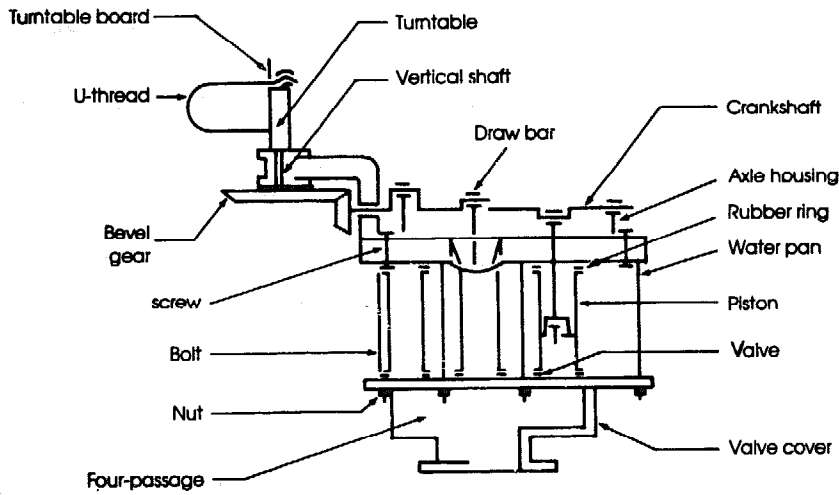

Fig. 3. Model D150-3 Triplex Piston Pump

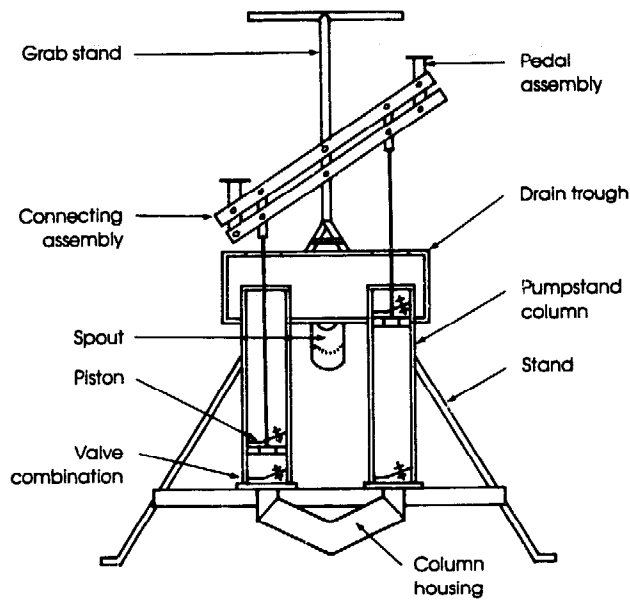

Fig. 4. Fujiang Man-Driven Pump

Shandong's Juye County has a total of 130,000 households, and there are already 54,000 handpumps. In Sichuan's Chongqing County, 90 percent of the rural population are using handpumps for drinking water. Tong'an County in Fujian has a population of 460,000; 400,000 drink well water from 5,000 wells. In the past, buckets were used to raise the water, and the water sources were easily polluted. In recent years handpumps have been steadily replacing buckets, and health conditions have greatly improved. There are now 1,780 handpumps, and it is forecast that in 1983 this number will exceed 2,000.

2. Diaphragm pumps. Another type of pump used for drinking water and irrigation is the hand- or pedal-operated diaphragm pump; there are eleven factories producing this type. For example, the diaphragm handpump, Model JL-1, produced by the Xinzheng Machinery Plant in Shanghai (see Figure 5), has a flow rate of 2 m³/hour and a maximum suction of 6 meters. For this type of pump, the handle causes the diaphragm to move up and down thereby causing the capacity of the pump to change; water enters through the intake valve and exits through the outlet valve.

It was planned that 500 would be produced in 1983; this product is die-cast from an aluminum alloy, with a cast-aluminum handle and a copper intake. These materials prevent rust and the pump is light in weight (only 3 kg), not bulky, structurally simple, and technologically advanced. It was tested at 0.1 horsepower, and the life of the diaphragm is 300,000 strokes. It is widely used for rural drinking water, in factories, and on boats.

Shandong's Water and Electricity Equipment Plant (Qufu County) produces a diaphragm handpump (see Figure 6) with a flow rate of 5-8 m³/hour and suction of 2-5 meters suitable for use in well and river irrigation. In the last two years more than 1,700 have been produced, and in May and June of 1983 some 1,000 orders were placed. It is sold as far away as Yantai, Linyi, Heze, Inner Mongolia, Henan, Jiangsu and Heilongjiang. Locally it is this pump that rural people buy the most, as it is very convenient to use and has a diaphragm life of more than 200,000 strokes.

Fujian's Model Selection Conference also evaluated the Model MB-290 pedal-type diaphragm pump produced by the Tong'an County Farm Machinery Plant. Its flow rate is 6 m³/hour, with a maximum suction of 6 meters. Last year 100 were produced, and this year it is planned to produce 500. After studying the results of tests on the effect of human power, a combination of hand, push-pull and pedal methods was adopted, increasing the pump's input power and taking full advantage of the effect of human power.

Hunan Province also called a model selection conference, and out of 13 models of handpumps, 10 were selected for 200 hours of performance and wear tests. Preliminary evaluations were made of three models for use in irrigation: the Model SB 300-3 produced by the Shandong County Number 2 Farm Machinery Plant, the Model SB 250-1.5 produced by the Qiyang County Farm

* Translator's note: The name of the JL-1 pump has been changed to SM-2 since this report was written.

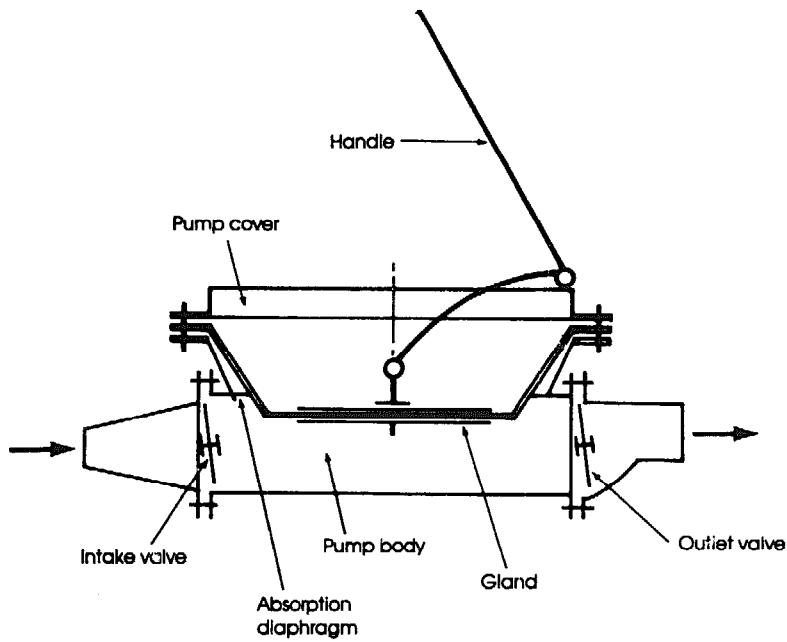

Fig. 5. Model JL-1 Diaphragm Hand Pump

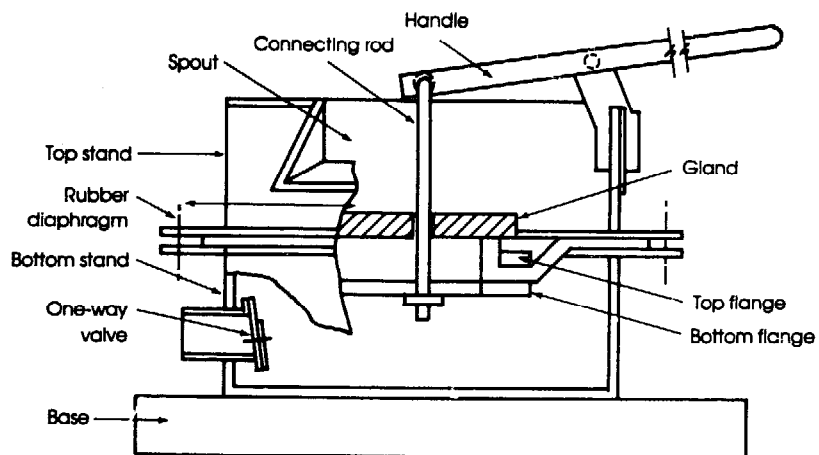

Fig. 6. Shandong Diaphragm Handpump

Machinery Plant, and the Changde Regional Farm Machinery Research Institute's Model SB 350-2 hand or pedal diaphragm pump. Input power and pump efficiency tests were also performed, the former generally being 0.1 - 0.3 kw and the latter between 30 and 48 percent.

3. Centrifugal pumps. In the South, the most commonly used pumps for irrigation are crank and pedal centrifugal pumps; there are seven plants producing this type. Most of these plants are in Sichuan, such as the Anyue County Farm Machinery Plant, which produces a pedal-type centrifugal pump, Model SB (see Figure 7), in 1-1/2-inch, 2-inch and 2-1/2-inch sizes. This pump uses gears to turn the centrifugal pump, raising water from a river's edge to be used in irrigation. The gearbox is placed on top of a frame so that it can be pedaled as a bicycle, moving the gears and the valve on the centrifuge. The flow rates are, respectively, 5 m³/hour, 8 m³/hour, and 12 m³/hour; lifts are 6 meters, 4 meters, and 2 meters; with a maximum suction of 3 meters, 1.5 meters, and 1 meter. In the past two years 1,500 have been produced, with 100 exported to Africa. It is planned that 3,000 will be produced in 1983. There are three quality grades for this pump--popular, medium and high-grade. This pump, which is used by individual households for irrigation, has been warmly received. The Rong County Water Pump Plant also produces crank-type centrifugal pumps and has already sold 5,000 of them; some 500 are being produced this year.

Some factories are working on comprehensive utilization, so that one pump can serve multiple purposes. For example, the Jinshan 402 B bicycle pump produced by the Zhenjiang Sprinkler Machine Plant in Jiangsu Province has a flow rate of 5 m³/hour and a lift of 3 meters; it is lightweight (3 kg) and is pedaled by one person (approximately 0.11 horsepower) and can be easily shifted from place to place. This pump has already been evaluated to go into production and about 2,000 are planned for this year. The rice-thresher pedal pump produced by the Lujiang Machinery Plant in Liling County, Hunan Province, mounts a centrifugal pump onto a rice thresher. Its flow rate is 10 m³/hour, with a lift of 2 meters. The thresher's cylinder can be used to store energy, thus reducing the amount of human labor expended and improving efficiency; it is extremely convenient to use and is an example of one machine providing multiple uses.

4. Double-acting piston pumps. Push-pull type, double-acting piston pumps for drinking water and sprinkler irrigation do not have one piston and two valves as do single-piston pumps, but rather one piston and four valves, as the piston is able to move water in alternating directions. For example, the Model TL-120 double-acting piston pump (see Figure 8) produced by the Dayu County Farm Machinery Plant in Jiangxi has a flow rate of 6.8 m³/hour, a lift of 13 meters, and a maximum suction of 7 meters. This product has already been certified and 10 have been produced; 1,000 are planned for 1983. At this year's National Farm Mechanization Service Company fair, many users sought to place orders for it. The Model 8SH-95 double-acting piston pumps produced by the Huimin Regional Farm Machinery Institute of Shandong has a flow rate of 3.6 m³/hour, a lift of 30 meters, and a maximum suction of 8 meters. It was certified regionally this year. This type of pump can also be used for rural drinking water, for sending water uphill, and for sprinkler irrigation.

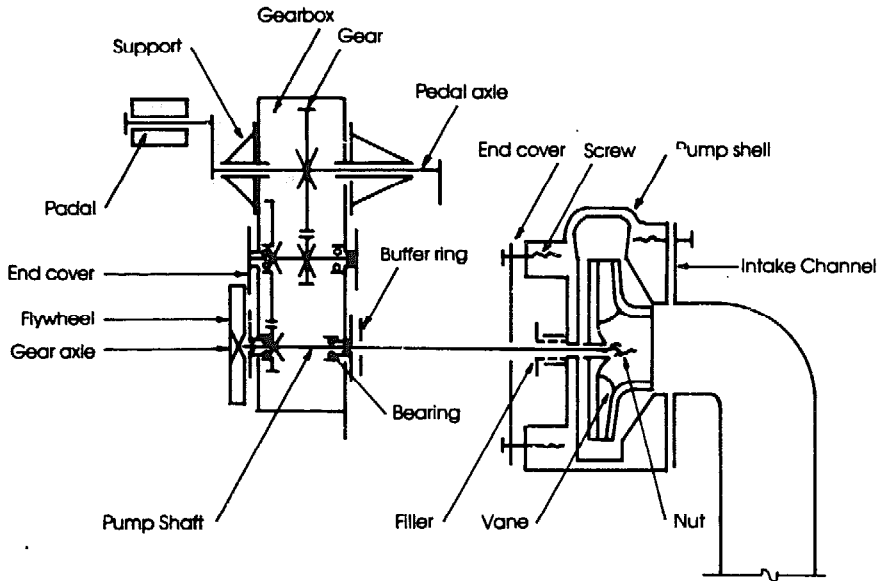

Fig. 7. Model SB Centrifugal Pedal Pump

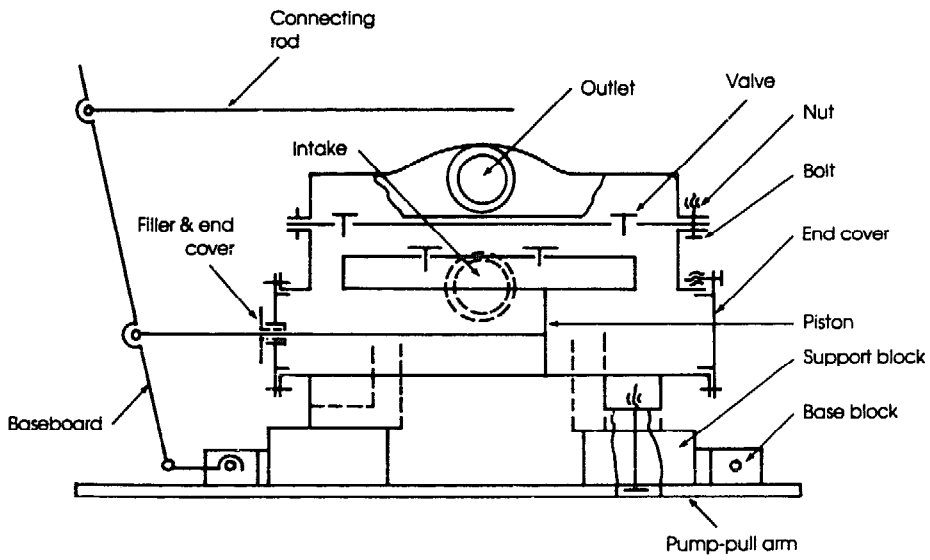

Fig. 8. Model TL-120 Double-Acting Piston Pump

5. Deep-set pumps. Deep-set pumps for drinking water are now being developed in China. At present, the Tai'an Water Pump Plant of Shandong, the Gaoping County Farm Machinery Plant of Shanxi and the Miyun County Farm Machinery Repair and Manufacturing Plant of Beijing are test-manufacturing the Model SLB 60 deep-well draw-bar pump (see Figure 9). It has a flow rate of 1.2 m³/hour and a lift of 20 meters. This pump's cylinder is seamless steel that is honed and has holes in it; the piston has a U-shaped cup leather and a spherical valve. The draw bar is cold-drawn or stainless steel, and the pump head is a seamless steel tube. The handle is copper-clad with round bearings to keep dust and pollution out of the pump head.

Another type of pump is the deep-well single-rotor bar pump (see Figure 10). It relies on the turning of a metal rotor inside a rubber bushing to raise water from inside a well to the surface. It has a flow rate of 0.6 m³/hour and a lift of 20 meters. This pump uses a carbon steel chrome-plated rotor and a stator consisting of seamless steel lined with rubber. The pump rod is cold-drawn steel or stainless steel, and the pump head is equipped with a pair of cone gears for crank drive to lift the water to the surface. The pump head is tightly sealed to prevent contamination. The cost of this pump is quite high, but it holds up very well and is convenient to use.

The Ministry of Water and Electricity's Inner Mongolian Hydraulic Science Institute is developing a wind- and man-driven, deep-well, single-rotor bar pump; this product has already undergone some 2,000 hours of wear tests and should be evaluated to go into production this year to help solve the problem of drinking water for people and animals in the northwest.

III. Future Development of Handpumps

The manufacture of handpump products in China is varied at present; quality is uneven, and strict controls are lacking. In particular, further improvements need to be made in terms of selection of material quality and useful life. The future for development of handpumps in China, a developing country with a huge rural population, is a vast one. The production of deep-well handpumps is not yet well developed, but it is urgently needed to provide water for people and animals. The Inner Mongolian Water Conservancy Agency reports that its stock-raising areas need approximately 4,000 handpumps each year. The water level in most wells is 10-30 meters, so the appearance of new deep-well pump products will, to a large extent, replace buckets and water carts and have a major impact on drinking water and irrigation in rural areas.

With the United Nations handpump testing program and BMW/GTZ of the Federal Republic of Germany, we are going to carry out model selection and improvement of China's existing handpumps and establish specifications and standards for Chinese products. While carrying on and developing China's traditional products, we will study the advanced technology of foreign products and design handpumps that are structurally simple, low in cost, long-lasting, reliable, compact, lightweight, easy to operate and simple to repair. This will provide relief for China's rural problems with drinking water and irrigation of small plots and will contribute to development of handpumps in developing countries and to technological cooperation.

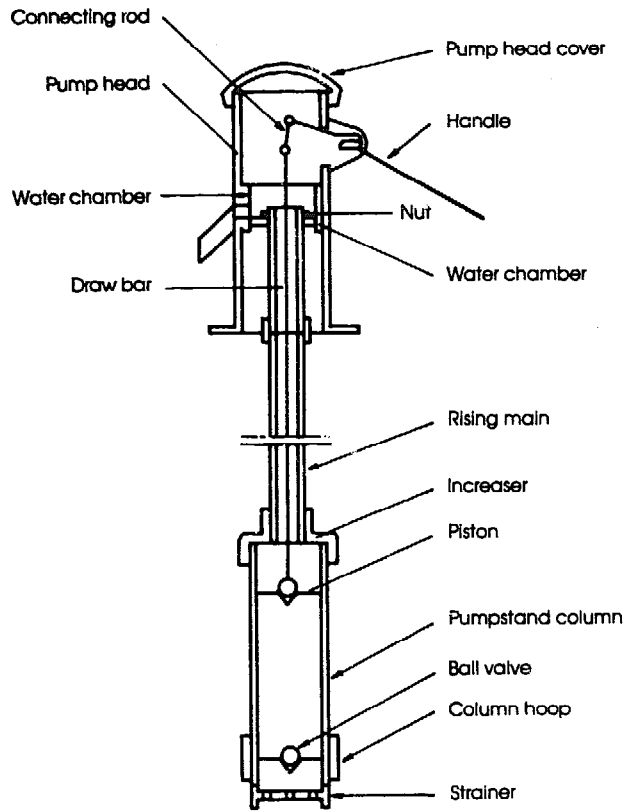

Fig. 9. Model SLB 60 Deep-well Draw-bar Pump

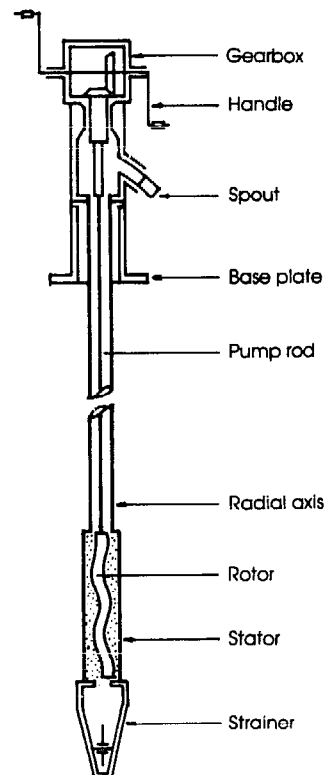

Fig. 10. Model Deep-well Rotary Pump

Appendix 1

Performance Characteristics of China's Handpumps

Performance Characteristics of China's Handpumps

Model	Type of pump	Flow (m ³ /hr)	Maximum suction head (m)	Total lift* (m)	Suction pipe diameter (inches)	Strokes per minute	Piston diameter (mm)	Stroke length (mm)	Number produced		Comments	
									Up to 1982	1983		
SY-81	Single piston	3	6		1	50	81		12	150	4,000	Certified, popular, light weight
JL-1**	Diaphragm	2	6		1.5	40			3	new	500	Certified, finely machined
SYB-80	Single piston	2	7		1		80	100	9.5	500	2,000	Certified, popular
SYB-100	Single piston	2.2	7		1.5	45	100		23	4,000	1,500	Popular, many produced
SB-100	Single piston	1.5	7			35-40			11.5			Popular, simple but good structure
SYB	Single piston	2	6		1.25				14	100		Poor quality
SB40-4	Single piston	1.2	7	20	1.5				16			Light, simple to operate, not durable
J-8.5	Single piston	1.3-1.6	7		1		80		11	730	1,500	Simple design, simple to operate
SJ-100	Single piston	2	7		1				10	1,000	1,000	Electric and hand powered
SYB-75	Single piston	4	7		3				9.5	3,000	1,500	Used for irrigation
SB-40-4	Single piston	1.56	7	20	1.5	20	100	180	20	trial		Good quality, complex design
SB	Single piston	2-3	7	25	1.5	25	96.5	178	21	trial		Good quality, complex design
D-150-1	Single piston	1.5-2	7		2				30	1,500	150	Many sold, simple to operate
D100	Single piston	2.5	7		1				12.5	740		Popular, used for household & irrigation
D120	Single piston	3	7		1.5				15	7,600	1,125	Popular, used for household & irrigation
2D120	Double piston	5.6	7		2				36	1,980	910	Popular, used for irrigation
4D120	Four piston Animal driven	4.5	7		2				91.5	640	385	Popular, used for irrigation
D-150-2	Double piston	3	7		2					2,000	400	Popular, many sold
D-150-3	Animal driven	5-8	7		2-3				73	150	500	Poor quality
SB95	Single piston	2-4	7		1	40	95	110	15	2,000		Popular, used for household & irrigation

Performance Characteristics of China's Handpumps (continued)

Model	Type of pump	Flow (m ³ /hr)	Maximum suction head (m)	Total lift [*] (m)	Suction pipe diameter (inches)	Strokes per minute	Piston diameter (mm)	Stroke length (mm)	Weight of pump head (Kg)	Number produced		Comments
										Up to 1982	1983	
SB120	Single piston	3.75	7		3	40	120	110	15	2,000		Popular, used for household & irrigation
SB140	Single piston	6.5	7		3	40	140	110	40	2,000		Popular, used for household & irrigation
SYB95	Single piston	2-4	7			40	95	150				Popular, standard quality
SB150	Double piston	6	7			40	150	100	40	trial		Relatively poor quality
SB120	Double piston (rotating shaft)	6.5	7			40	120	100	40	trial		Relatively poor quality
SB115	Double piston (foot pedal)	6.3	7			40	115	120	50	trial		Relatively poor quality
SB160	Double piston (aminal driven)	7	7			6	160	150		trial		Relatively poor quality
Peijiang	Double piston (foot pedal)	16	6		1.5				37	1,500	1,500	Popular, many sold
	Diaphragm	5-8	5-2		2				30	1,700	1,000	Popular
	Diaphragm	6-8	6-7			20-30	250	50	24.5			Popular, used for irrigation
SB300-3	Diaphragm	5.5-13.3	7			35-40			30	new product		Certified, production model selected
SB350-1.5	Diaphragm	13.3-25.5	1.2-2.5			32-48			30	new product		Certified, production model selected
SB350-2	Diaphragm	23	1.5-3.5			25-45				new product		Certified, production model selected
SG-55	Diaphragm	11	5.5		2				29	350	30	Popular
SP-Z-27	Diaphragm	4-6	6		3				48	15	100	Few made, initial results good
MB-290	Diaphragm	6-8	6		2				38	100	500	Tested for 500 hours
MB-290-Z	Diaphragm	10-15	6		2				47	trial		Operated by many methods
MB-200	Diaphragm	1.3	7		1				10	trial		Operated by many methods

Performance Characteristics of China's Handpumps (continued)

Model	Type of pump	Flow (m ³ /hr)	Maximum suction head (m)	Total lift* (m)	Suction pipe diameter (inches)	Strokes per minute	Piston diameter (mm)	Stroke length (mm)	Weight of pump head (Kg)	Number produced		Comments
										Up to 1982	1983	
SY-32	Centrifugal	4-6	5		1.5				12.5	4,890	300	Popular, many sold
	Centrifugal (2 person foot pedal)	5-8	2	3-5	3						100	Poor quality
1.5JB	Centrifugal (2 pers.ft.ped.)	5-8	3	6	1.5				35	1,480	3,000	Popular, many produced, exports to Africa
2JB	Centrifugal (2 pers.ft.ped.)	8-12	1.5	4	2				35		3,000	Popular, many produced, exports to Africa
2.5JB	Centrifugal (2 pers.ft.ped.)	12-17	1	2	2.5				35		3,000	Popular, many produced, exports to Africa
	Centrifugal (2 pers.ft.ped.)	12-25	3	5					30	200		Two person pump, popular simple to operate
Jinshan- 402B	Centrifugal (bicycle driven)	5	3	3		32			30	trial	2,000	Certified, popular, multi- purpose
	Centrifugal (2 pers.ft.ped.)	10-12	1.5-2	1.5-2					10			Inexpensive, simple to operate, multi-purpose
Jinyu	Centrifugal (foot pedal)	6.12	1.5	7.3	1.5, 2				15, 19			Attached to harvester, simple to operate, minimal effort
	Centrifugal (foot pedal)	6.12	6.3		1.5, 2	50			12.5, 18			Difficult to rotate
TL-120	Double acting piston (2 pers. push-pull)	6.8	7	13	2	50			44	10	1,000	Certified, popular, used for irrigation
8SH-95	Double acting piston (2 pers. push-pull)	3.6	7	30	1	40	95		37	6		Certified, used for irrigation including sprinklers

Performance Characteristics of China's Handpumps (continued)

Model	Type of pump	Flow (m ³ /hr)	Maximum suction head (m)	Total ¹ lift ^{**} (m)	Suction pipe diameter (inches)	Strokes per minute	Piston diameter (mm)	Stroke length (mm)	Weight of pump head (Kg)	Number produced		Comments
										Up to 1982	1983	
8SRP-110	Double acting piston (2 pers. push-pull)	4.6	7	20	1	40	110	100				Popular, used for irrigation
195	Single piston	3	7						11			Easy to move
SLB60	Single piston (lever bar)	1.2		20	1.25	40	60	200		new product		In great demand in N.W. part of country
SLB60	Single piston (lever bar)	1.2		20	1.25			200		new product		In great demand in N.W. part of country
SLB60	Single piston (lever bar)	1.2		20	1.25					new product		In great demand in N.W. part of country
	Single piston (lever bar)	0.6		20	1.5	40				new product		In great demand in N.W. part of country

* Translator's note: "Total lift" is used here to mean the suction lift plus the height from the piston to the discharge port.

** The name of the JL-1 pump has been changed to SM-2.

*** The SLB-60 (tested at the CATR laboratory in the United Kingdom) is no longer manufactured. It has been modified and is now called the SLB-80 and is manufactured in three different locations.

Appendix 2

· Photos of Existing Chinese Handpumps



Model SY-81
Type: Single Piston
Flow: 3 m³/hour
Suction: 6 m
Total lift: 8 m
Operation: One person press
Producer: Dayu County
Farm Machinery Plant,
Jiangxi Province, China

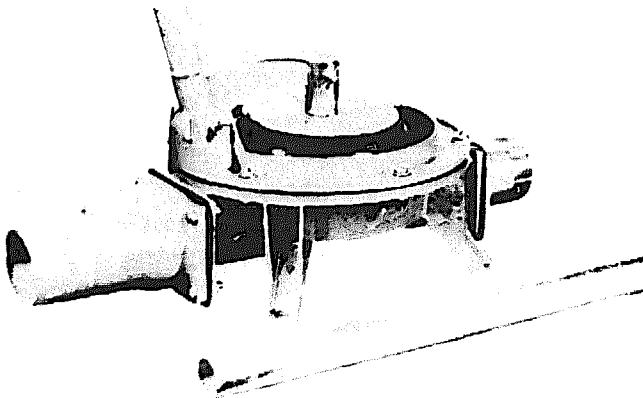

Model: JL-1
Type: Diaphragm
Flow: 2 m³/hour
Suction: 6 m
Total lift:
Operation: One person press
Producer:
Xinzheng Machinery Plant,
Shanghai, China



Model: SYB-80
Type: Single piston
Flow: 2 m³/hour
Suction: 7 m
Total lift:
Operation: One person press
Producer: Yunxiao County
Farm Machinery Plant,
Fujian, China

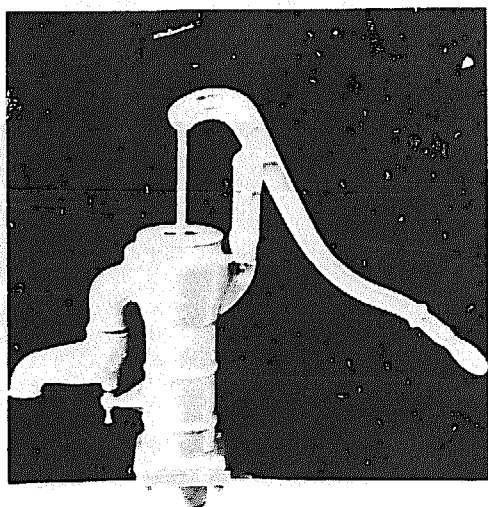

Model: SYB-100
Type: Single piston
Flow: 2.2 m³/hour
Suction: 7 m
Total lift:
Operation: One man press
Producer: Changsha County
Light Industry Machines
Plant, Hunan, China

SYB-100型手搖式吸水泵

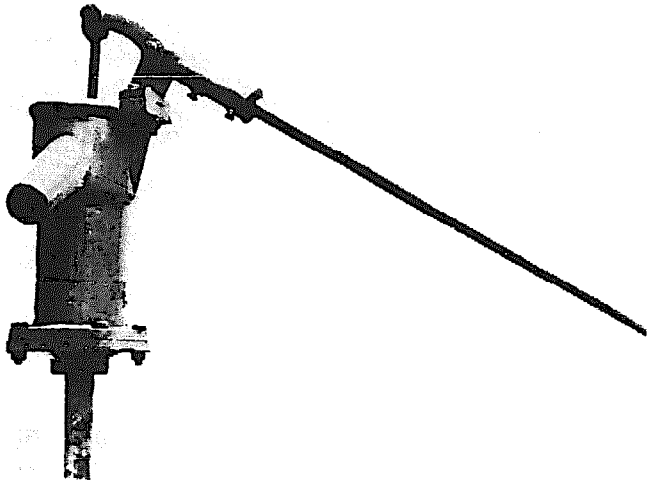

Model: SB-100
Type: Single piston
Flow: 1.5 m³/hour
Suction: 7 m
Total lift:
Operation: One person press
Producer: Xinjian County
Number 2 Machinery Plant,
Jiangxi Province, China

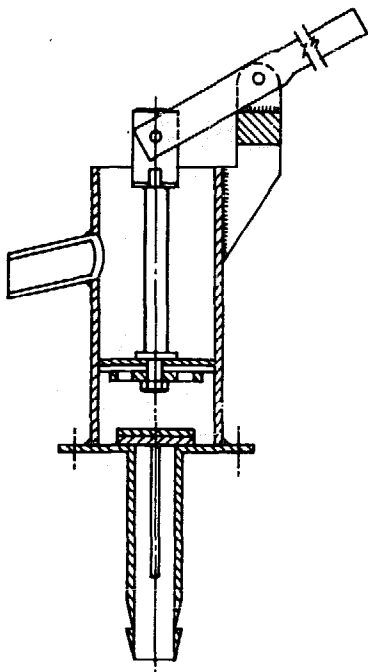

Model: SYB
Type: Single piston
Flow: 2 m³/hour
Suction: 7 m
Total lift:
Operation: One person press
Producer: Lanzhou
Agricultural Pumps Plant,
Gansu Province, China

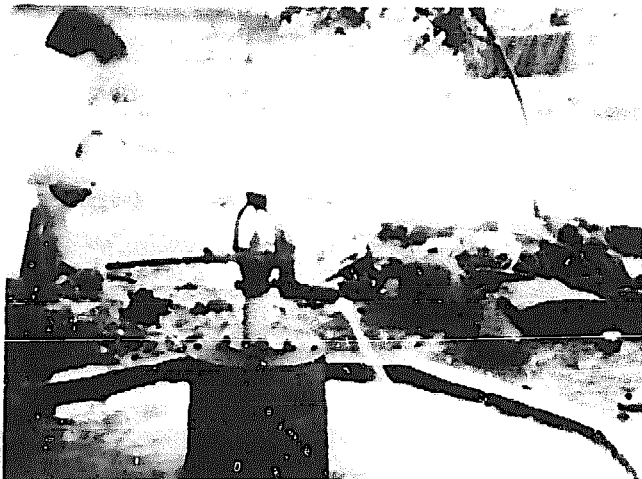

Model: SB40-4
Type: Single piston
Flow: 1.2 m³/hour
Suction: 7 m
Total lift: 20 m
Operation: One person press
Producer: Hua County
Machine Electricity Plant,
Guangdong Province, China

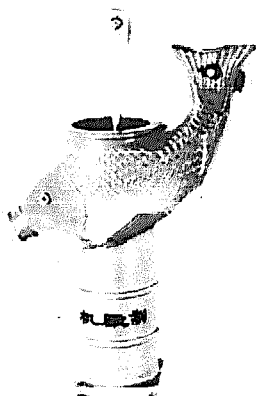

Model: J-8.5
Type: Single piston
Flow: 1.3-1.6 m³/hour
Suction: 7 m
Total lift: 7 m
Operation: One person press
Producer: Longhai County
Farm Machinery Institute,
Fujian Province, China

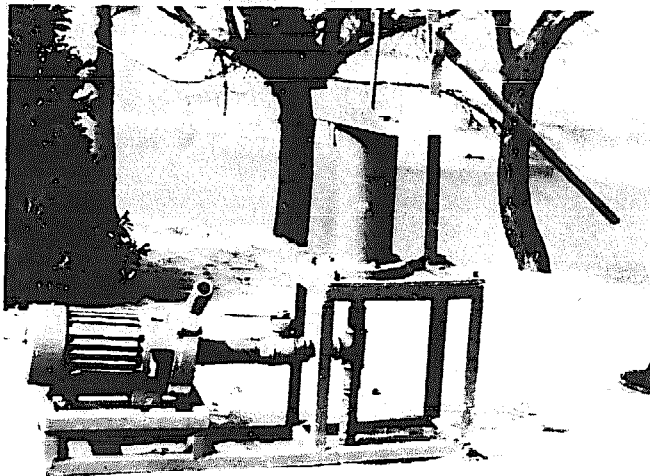

Model: SJ-100
Type: Single piston
Flow: 2 m³/hour
Suction: 7 m
Total lift:
Operation: One person press
Producer: Dongming County
Farm Machinery Plant,
Shandong Province, China

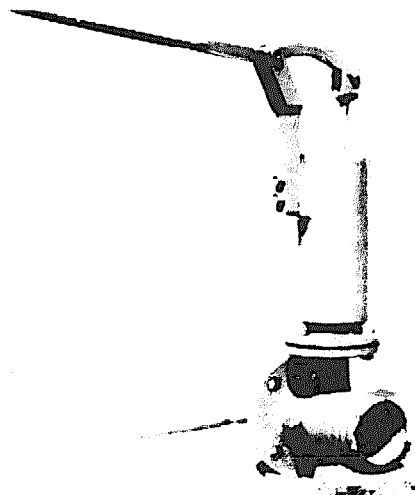

Model: SYB-75
Type: Single piston
Flow: 4 m³/hour
Suction: 7 m
Total lift:
Operation: One person press
Producer: Feicheng County
Sprinkler Irrigation Plant,
Shandong Province, China

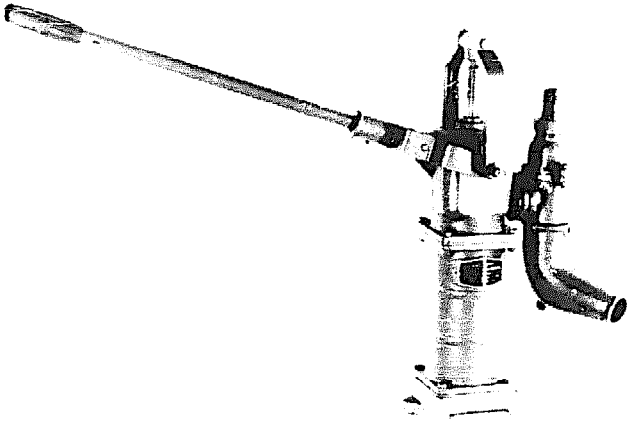

Model: SB-40-4
Type: Single piston
Flow: 1.56 m³/hour
Suction: 7 m
Total lift: 20 m
Operation: One person press
Producer: Xiangju County
Machinery Plant,
Zhejiang Province, China

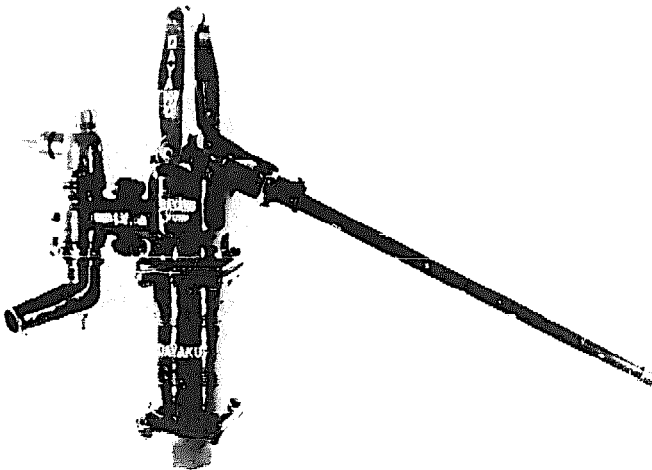

Model: SB
Type: Single piston
Flow: 2-3 m³/hour
Suction: 7 m
Total lift: 25 m
Operation: One person press
Producer: Qian'an County Pump Works,
Hebei Province, China

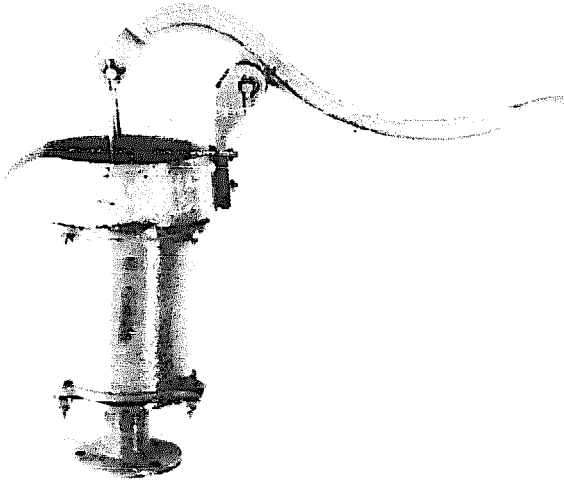

Model: D-150-1
Type: Single piston
Flow: 1.5-2 m³/hour
Suction: 7 m
Total lift:
Operation: One person press
Producer: Qing County
Farm Machinery Plant,
Hebei Province, China

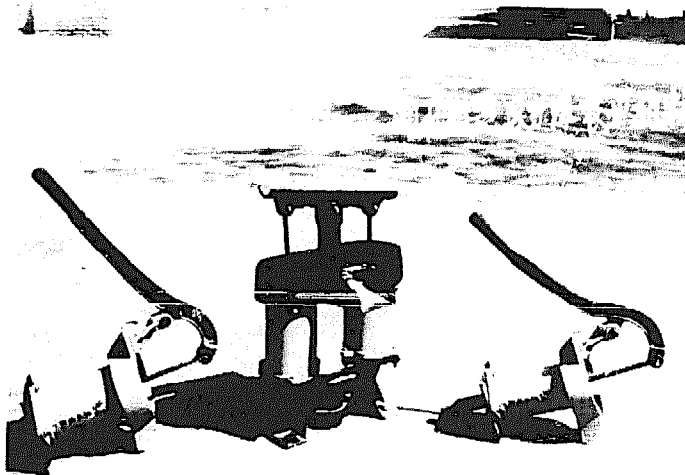

Model: D100
Type: Single piston
Flow: 2.5 m³/hour
Suction: 7 m
Total lift:
Operation: One person press
Producer: Jing County
Dongfeng Farm Machinery
Plant, Hebei Province, China

Similar to
Model D-100

Model: D120
Type: Single piston
Flow: 3 m³/hour
Suction: 7 m
Total lift:
Operation: One person press
Producer: Jing County
Dongfeng Farm Machinery
Plant, Hebei Province, China

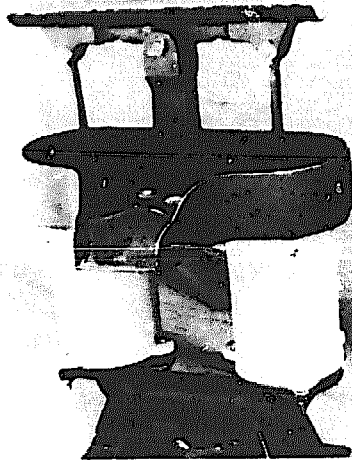

Model: ZD120
Type: Double piston
Flow: 5.6 m³/hour
Suction: 7 m
Total lift:
Operation: Two person press
Producer: Jing County
Dongfeng Farm Machinery
Plant, Hebei Province, China

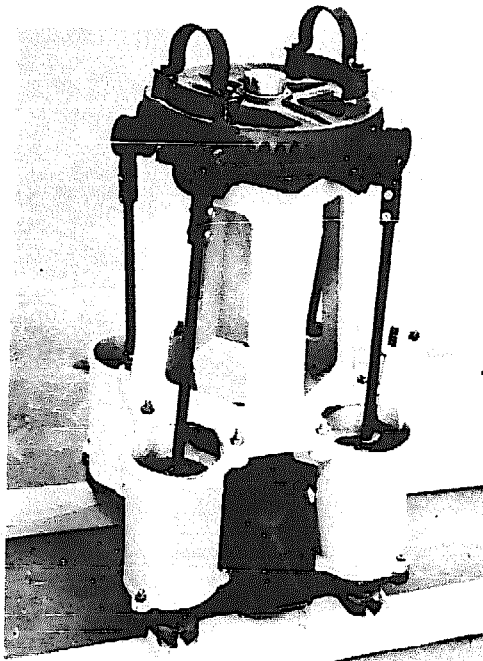

Model: 4D120
Type: Four piston
Flow: 4.5 m³/hour
Suction: 7 m
Total lift:
Operation: Draft animal
Producer: Jing County
Dongfeng Farm Machinery
Plant, Hebei Province, China

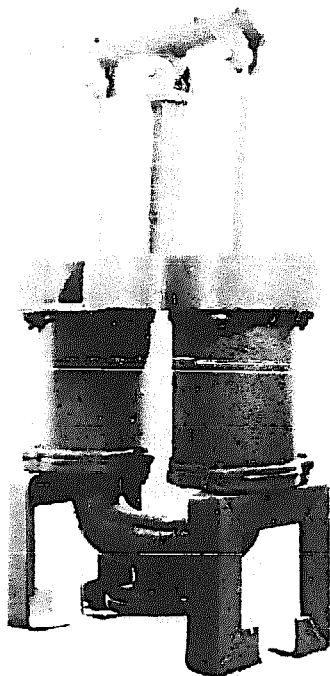

Model: D-150-2
Type: Double piston
Flow: 3 m³/hour
Suction: 7 m
Total lift:
Operation: Two men press
Producer: Qing County
Farm Machinery Plant,
Hebei Province, China

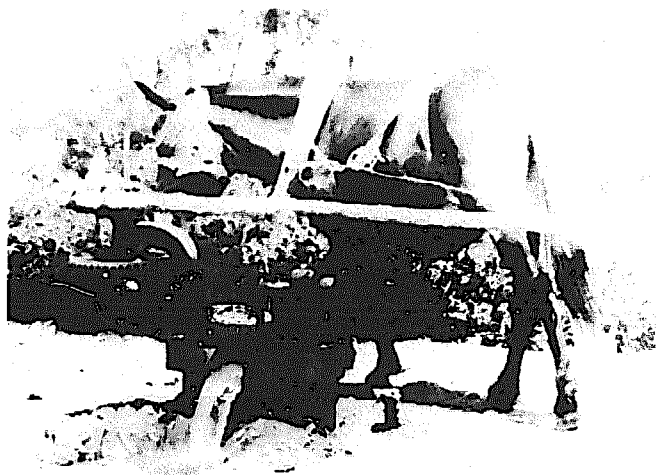

Model: D-150-3
Type: Triple piston
Flow: 5-8 m³/hour
Suction: 7 m
Total lift:
Operation: Draft animal
Producer: Qing County
Farm Machinery Plant,
Hebei Province, China

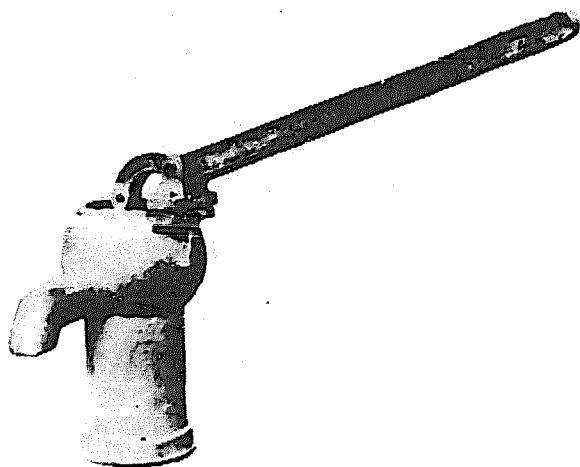

Model: SB95
Type: Single piston
Flow: 2-4 m³/hr
Suction: 7 m
Total lift:
Operation: One person press
Producer: Juye County
Farm Machinery Repair
and Manufacturing Plant,
Shandong Province, China

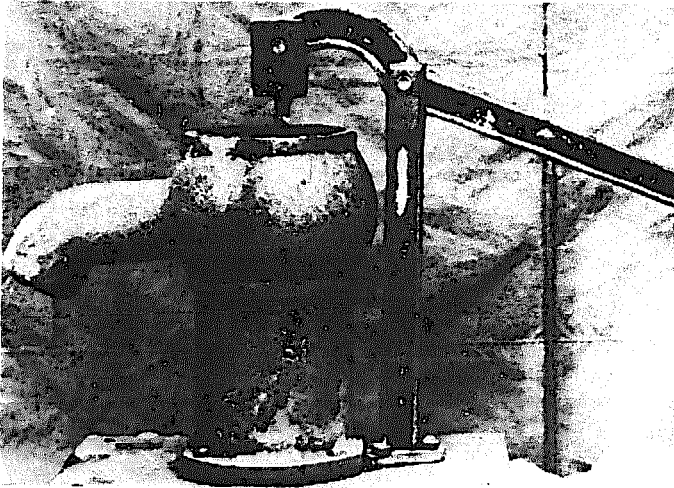

Model: SB-120
Type: Single piston
Flow: 3.75 m³/hour
Suction: 7 m
Total lift:
Operation: One person press
Producer: Juye County
Farm Machinery Repair and
Manufacturing Plant,
Shandong Province, China

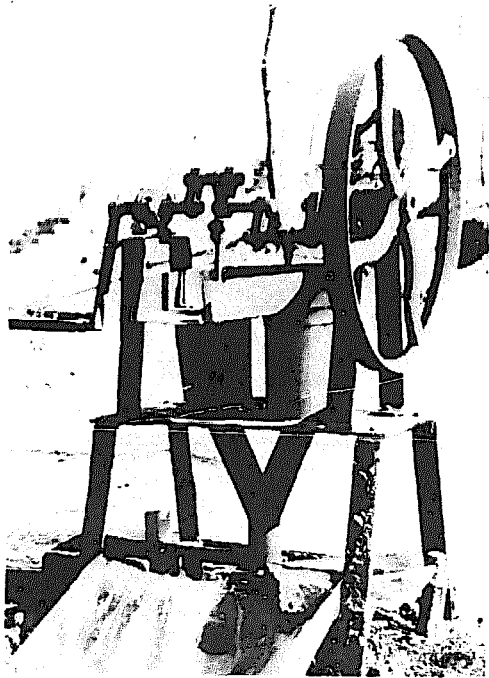

Model: SB-140
Type: Double piston
Flow: 6.5 m³/hour
Suction: 7 m
Total lift:
Operation: One person press
Producer: Juye County
Farm Machinery Repair and
Manufacturing Plant,
Shandong Province, China

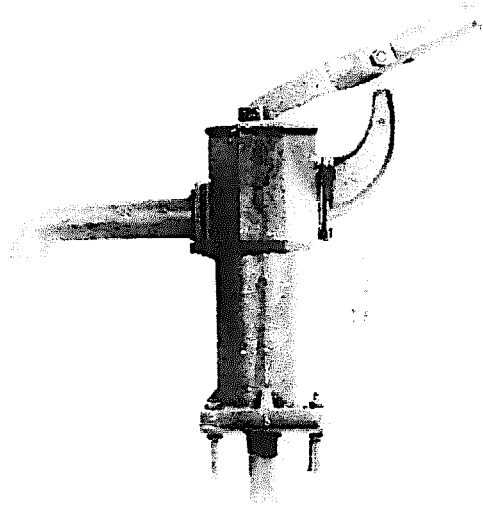

Model: SYB-95
Type: Single piston
Flow: 2-4 m³/hour
Suction: 7 m
Total lift:
Operation: One person press
Producer: Anqiu County
Farm Machinery Plant,
Shandong Province, China

Photo not available

Model: SB-150
Type: Double piston
Flow: 6 m³/hour
Suction: 7 m
Total lift:
Operation: Two person press
Producer: Juye County
Water Conservancy Bureau,
Shandong Province, China

Photo not available

Model: SB-120
Type: Double piston
Flow: 6.5 m³/hour
Suction: 7 m
Total lift:
Operation: One person crank
Producer: Juye County
Water Conservancy Bureau,
Shandong Province, China

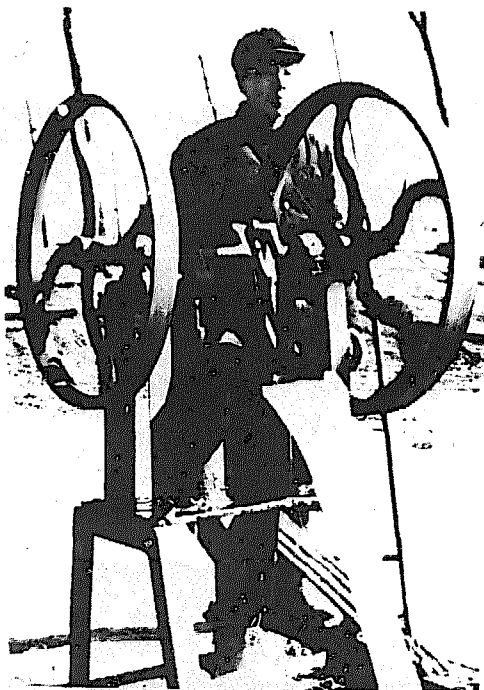

Model: SB-115
Type: Double piston
Flow: 6.3 m³/hour
Suction: 7 m
Total lift:
Operation: One person pedal
Producer: Juye County
Water Conservancy Bureau,
Shandong Province, China

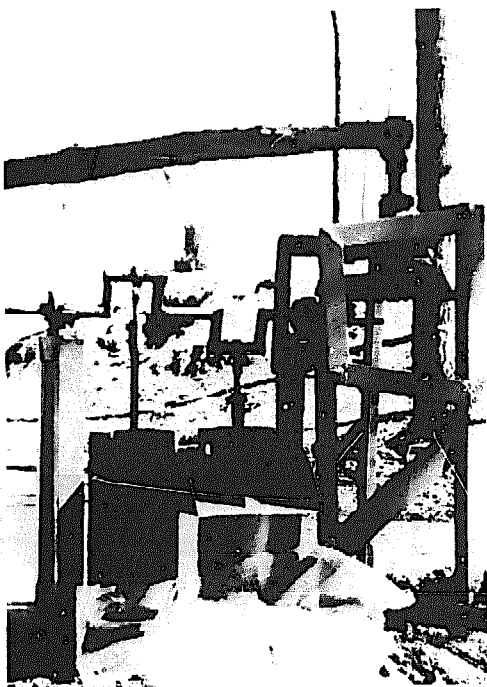

Model: SB-160
Type: Double piston
Flow: 7 m³/hour
Suction: 7 m
Total lift:
Operation: Draft animal
Producer: Juye County
Water Conservancy Bureau,
Shandong Province, China

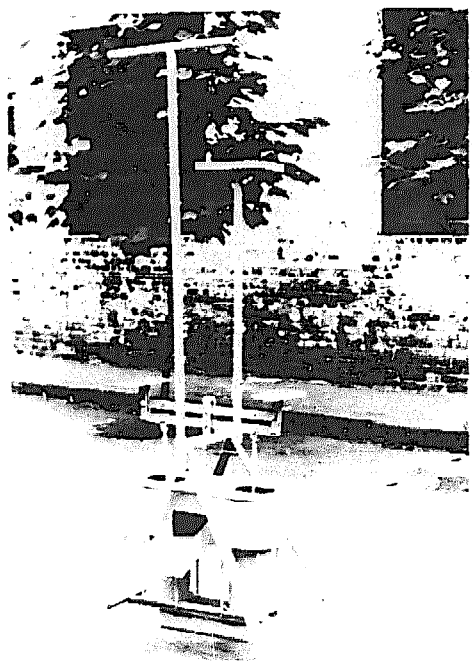

Model: Peijiang
Type: Double piston
Flow: 16 m³/hour
Suction: 6 m
Total lift:
Operation: One person pedal
Producer: Suining County
Farm Machinery Plant,
Sichuan Province, China

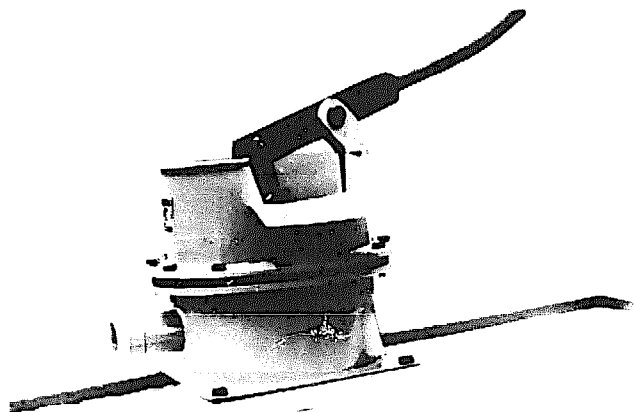

Model: Geme
Type: Diaphragm
Flow: 5-8 m³/hour
Suction: 5 m
Total lift:
Operation: One person press
Producer: Shandong Water
and Electricity Equipment
Plant (Qufu), Shandong
Province, China

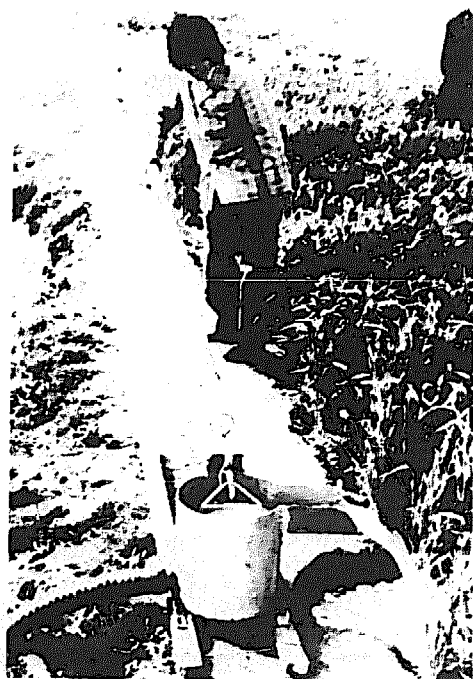

Model: Geme
Type: Diaphragm
Flow: 6-8 m³/hr
Suction: 6-7 m
Total lift:
Operation: One person press
Producer: Liangshan County
Water Conservancy Bureau,
Shandong Province, China

Photo not available

Model: SB300-3
Type: Diaphragm
Flow: 5.5-13.3 m³/hour
Suction: 7 m
Total lift:
Operation: One person press
Producer: Shaodong County
No. 2 Farm Machinery Plant,
Hunan Province, China

Photo not available

Model: SB350-1.5
Type: Diaphragm
Flow: 13.3-25.5 m³/hour
Suction: 1.2-2.5 m
Total lift:
Operation: One person press
Producer: Qiyang County
Machinery Plant,
Hunan Province, China

Photo not available

Model: SB350-2
Type: Diaphragm
Flow: 23 m³/hour
Suction: 1.5-3.5 m
Total lift:
Operation: One person press
Producer: Changde Regional
Farm Machinery Institute,
Hunan Province, China

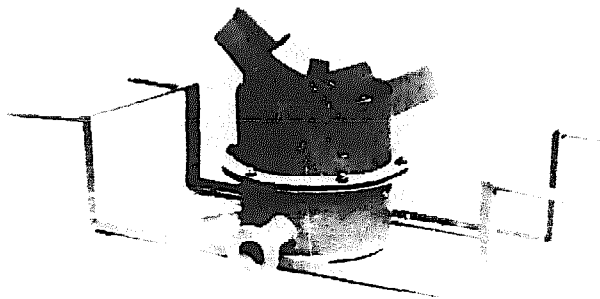

Model: SG-55
Type: Diaphragm
Flow: 11 m³/hour
Suction: 5.5 m
Total lift:
Operation: One person press
Producer: Tongliang County
Pump Works,
Sichuan Province, China

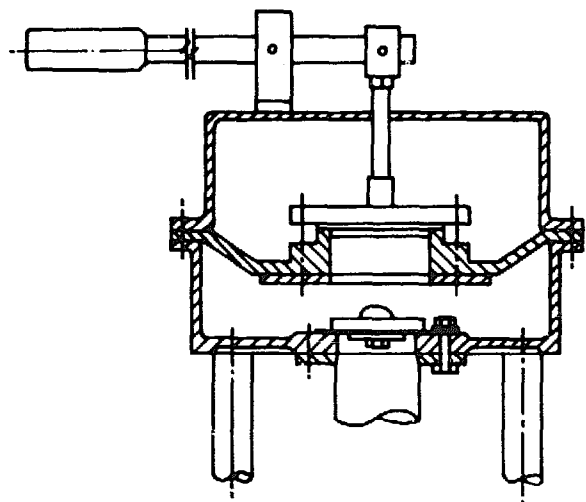

Model: SP-2-27
Type: Diaphragm
Flow: 4-6 m³/hour
Suction: 6 m
Total lift:
Operation: One person press
Producer: Jiangxi Machine
Industry School Factory,
Jiangxi Province, China

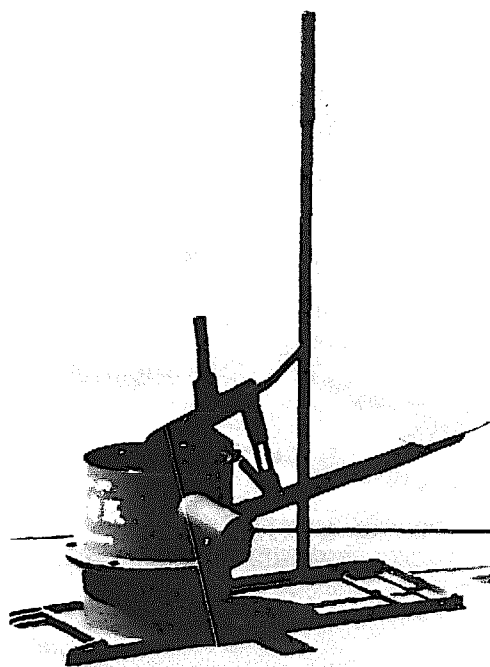

Model: MB-290
Type: Diaphragm
Flow: 6-8 m³/hour
Suction: 6 m
Total lift:
Operation: One person press
Producer: Tong'an County
Farm Machinery Plant,
Fujian Province, China

Similar to
Model MB-290

Model: MB-290-2
Type: Diaphragm
Flow: 10-15 m³/hour
Suction: 6 m
Total lift:
Operator: One person press
Producer: Tong'an County
Farm Machinery Plant,
Fujian Province, China

Similar to
Model MB-290

Model: MB-200
Type: Diaphragm
Flow: 1.3 m³/hour
Suction: 7 m
Total lift:
Operation: One person press
Producer: Tong'an County
Farm Machinery Plant,
Fujian Province, China

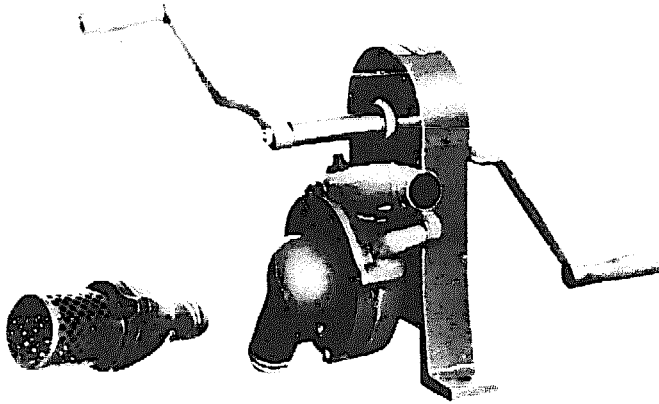

Model: SY-32
Type: Centrifugal
Flow: 4-6 m³/hour
Suction: 5 m
Total lift:
Operation: One person crank
Producer: Rong County Pump
Works, Sichuan Province

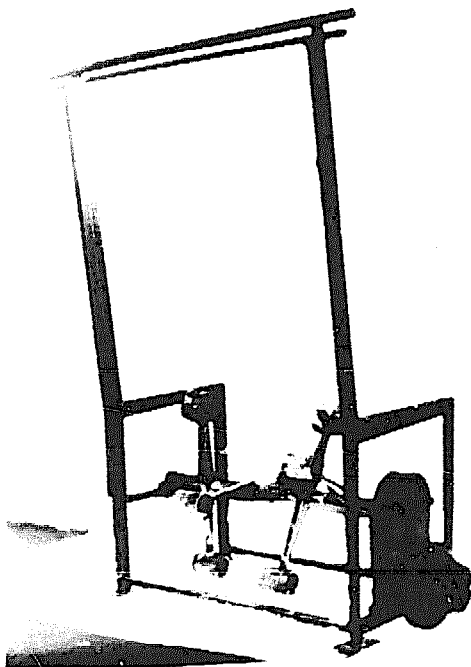

Model: Pedal pump
Type: Centrifugal
Flow: 5-8 m³/hour
Suction: 3 m
Total lift:
Operation: Two person pedal
Producer: Tongnan County
Farm Machinery Plant,
Sichuan Province, China

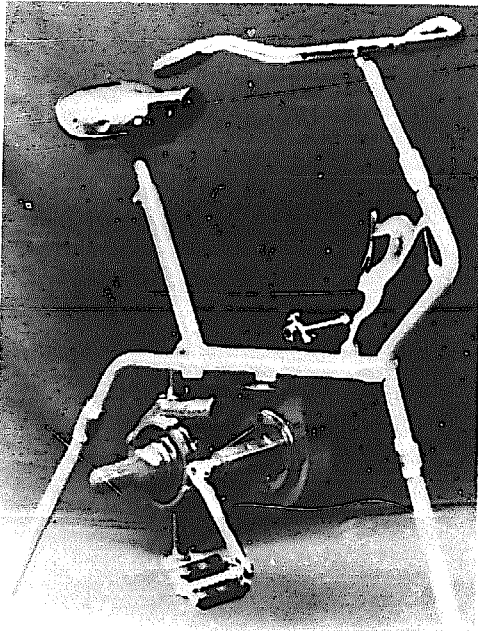

Model: 1-1/2-JB
Type: Centrifugal
Flow: 5-8 m³/hour
Suction: 3 m
Total lift: 6 m
Operation: One person pedal
Producer: Anyue County
Farm Machinery Plant,
Sichuan Province, China

Similar to
Model 1-1/2-JB

Model: 2JB
Type: Centrifugal
Flow: 8-12 m³/hour
Suction: 1.5 m
Total lift: 4 m
Operation: One person pedal
Producer: Anyue County
Farm Machinery Plant,
Sichuan Province, China

Similar to
Model 1-1/2-JB

Model: 2-1/2-JB
Type: Centrifugal
Flow: 12-17 m³/hour
Suction: 1 m
Total lift: 2 m
Operation: One person pedal
Producer: Anyue County
Farm Machinery Plant,
Sichuan Province, China

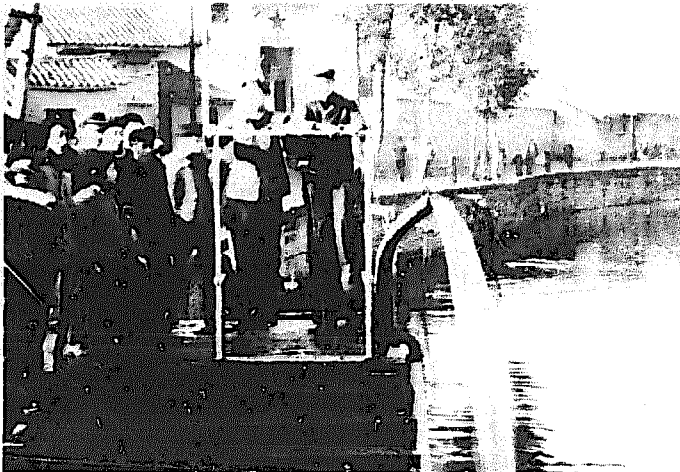

Model: Pedal pump
Type: Centrifugal
Flow: 12-25 m³/hour
Suction: 3 m
Total lift: 5 m
Operation: Two person pedal
Producer: Longchang County
Farm machinery Plant,
Sichuan Province, China

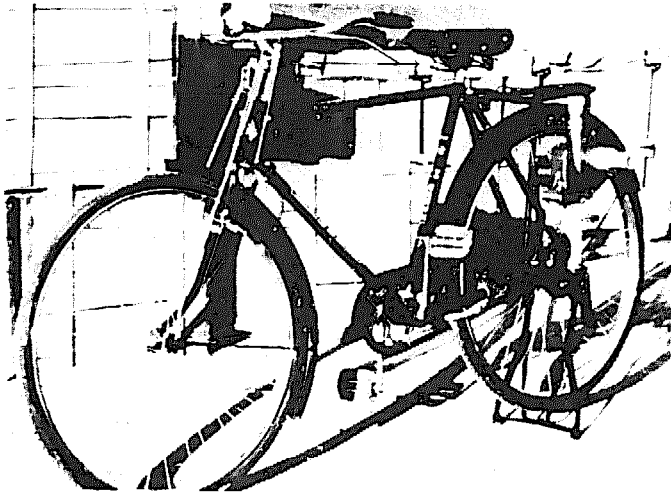

Model: Jinshan-402B
Type: Centrifugal
Flow: 5 m³/hour
Suction: 3 m
Total lift: 3 m
Operation: One person pedal
Producer: Zhenjiang
Sprinkler Plant,
Jiangsu Province, China

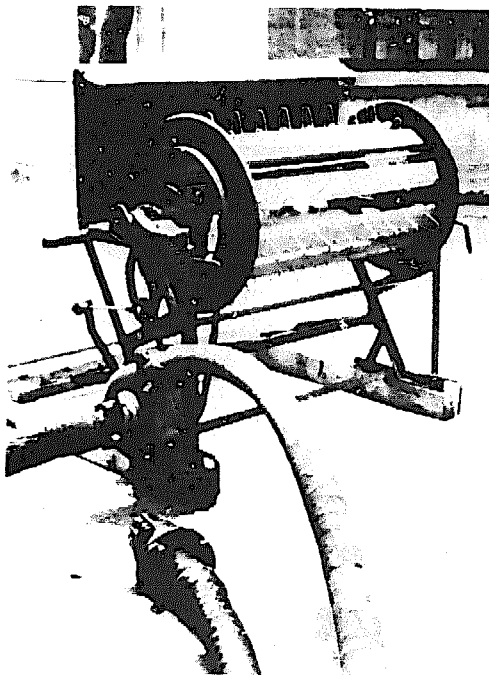

Model: Harvester pump
Type: Centrifugal
Flow: 10-12 m³/hour
Suction: 1.5-2 m
Total lift: 1.5-2 m
Operation: Two person pedal
Producer: Liling County
Lujiang Farm Machinery Plant,
Hunan Province, China



Model: Jinyu
Type: Centrifugal
Flow: 6.2 m³/hour
Suction: 1.5 m
Total lift: 7.3 m
Operation: One person pedal
Producer: Guangji Pump
Works, Hubei Province, China

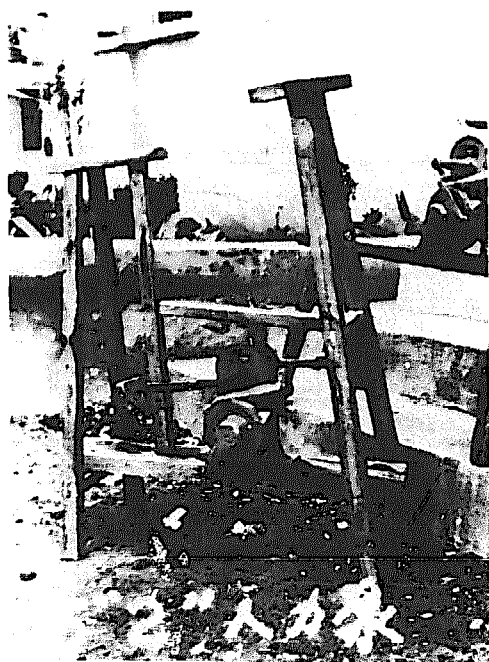

Model: Pedal pump
Type: Centrifugal
Flow: 6.12 m³/hour
Suction: 6.3 m
Total lift:
Operation: One person pedal
Producer: Xianning Regional
Farm Machinery Plant,
Hubei Province, China

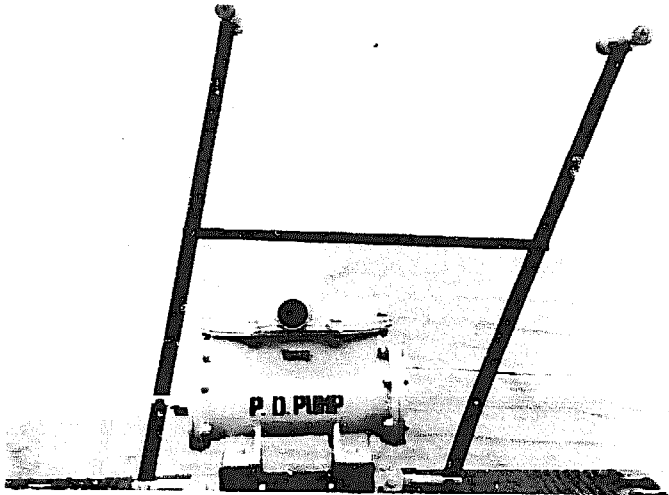

Model: TL-120
Type: Double piston
Flow: 6.8 m³/hour
Suction: 7 m
Total lift: 13 m
Operation: Two person
push-pull
Producer: Dayu County
Farm Machinery Plant,
Jiangxi Province, China

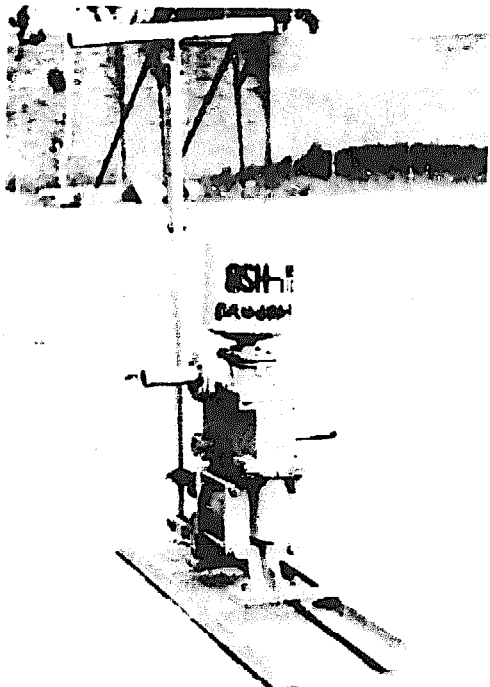

Model: 8SH-95
Type: Double piston
Flow: 6.8 m³/hour
Suction: 7 m
Total lift: 13 m
Operation: Two-man
push-pull
Producer: Huimin Regional
Farm Machinery Institute,
Shandong Province, China

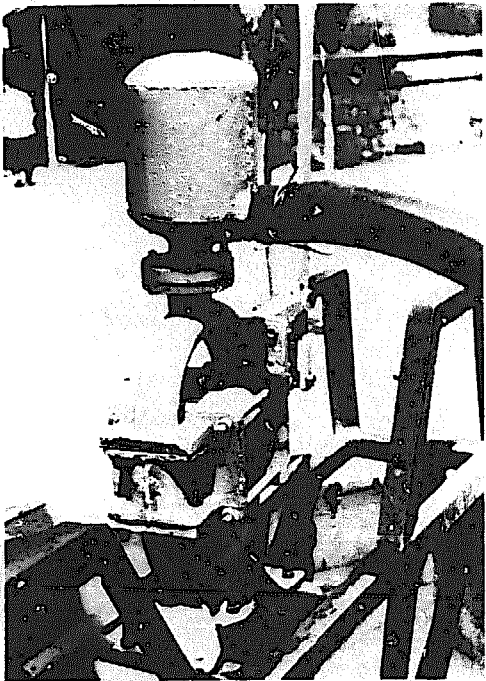

Model: 8SHF-110
Type: Double piston
Flow: 3.6 m³/hour
Suction: 7 m
Total lift: 30 m
Operation: Two person
push-pull
Producer: Tai'an Works,
Shandong Province, China

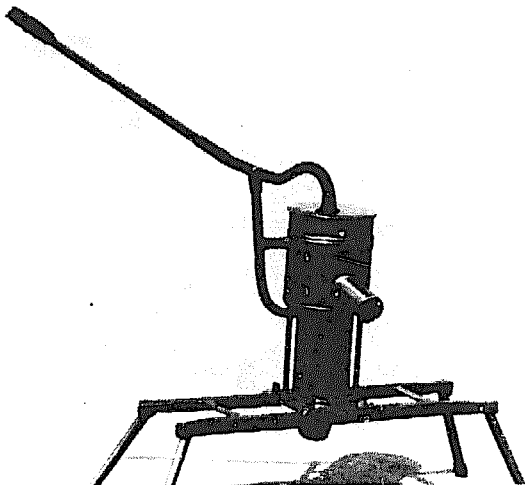

Model: 195
Type: Single piston
Flow: 3 m³/hour
Suction: 7 m
Total lift:
Operation: One person press
Producer: Xiapu County
Farm Machinery Institute,
Fujian Province, China

Photo not available

Model: SLB 60
Type: Hand draw-bar
Flow: 1.2 m³/hour
Suction:
Total lift: 20 m
Operation: One person press
Producer: Tai'an Pump Works,
Shandong Province, China

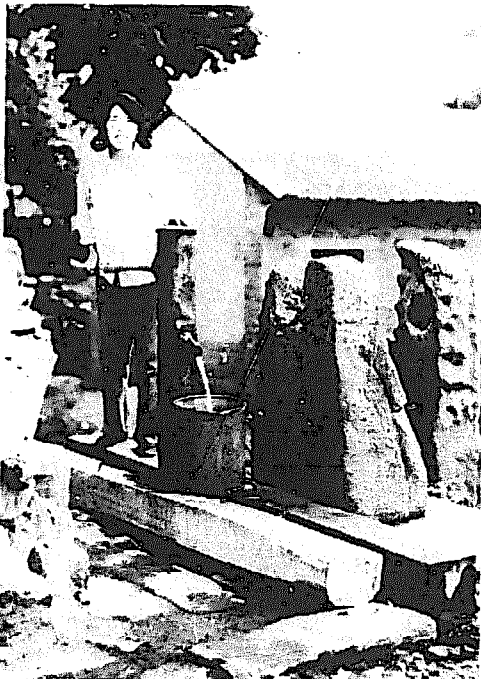

Model: SLB 60
Type: Hand draw bar
Flow: 1.2 m³/hour
Suction:
Total lift: 20 m
Operation: One person press
Producer: Gaoping County
Farm Machinery Plant,
Shanxi Province, China

Photo not available

Model: SLB 60
Type: Hand draw bar
Flow: 1.2 m³/hour
Suction:
Total lift: 20 m
Operation: One person press
Producer: Miyun County Farm
Machinery Repair and
Manufacturing Plant,
Beijing, China

Photo not available

Model: Crank pump
Type: Single bar
Flow: 0.6 m³/hour
Suction:
Total lift: 20 m
Operation: One person crank
Producer: Shanghai
Deep-Well Pump Works,
Shanghai, China

Photo not available

Model. Crank pump
Type: Single bar
Flow: 0.6 m³/hour
Suction:
Total lift: 20 m
Operation: One person crank
Producer: Pinghu County
Farm Machinery Plant,
Zhejiang province, China

ANNEX D

SOCIOCULTURAL STUDY FOR A HANDPUMPS PROJECT IN KENYA

In Kenya, as in many parts of the developing world, handpumped groundwater offers an appropriate and affordable initial source of potable water that can serve a considerable proportion of the rural population. Furthermore, the community itself can ensure the reliability of the supply by undertaking first-line maintenance. Only recently has this possibility been considered in Kenya. Because of the growing interest in this method of supplying water, the Ministry of Water Development has adopted a completely changed approach to the provision of rural water supplies in its South Coast Handpumps Project.

This project is being implemented by the Ministry of Water Development with the assistance of other ministries and in cooperation with the interregional UNDP/World Bank Rural Water Supply Handpumps Project. Funding is provided through the United Nations Development Programme by the Swedish International Development Authority. The project is considered to be a national exercise in the field testing and technological development of rural water supply handpumps. In cooperation with similar projects in many other countries, goals include identification of suitable handpumps for village-level maintenance, development of a methodology for their installation and maintenance and establishment of in-country manufacture.

Successful rural water supply projects are not easy to implement because of the delicate balance that must be achieved between the engineering and technical aspects and the often complex social aspects of planning, construction, operation, and maintenance. This report is concerned with community involvement in the project, a subject of paramount importance that so often is overlooked or taken for granted.

Conscious of the need to obtain community support for the project to ensure full involvement but uncertain how to proceed, we approached the African Medical Research Foundation (AMREF) in May 1983 to seek advice. With the support of AMREF's director, Ayuka Oendo, who was on the staff of the Health Behaviour Unit, was asked to undertake a sociocultural field study to guide the project in its dealings with the community and to prepare preliminary recommendations for the establishment of a community-based handpump maintenance system.

This report, based on Mr. Oendo's field work, is the product of considerable personal effort. It demonstrates the benefits of having a sociologist and engineer working together. We express our gratitude to Mr. Oendo and to AMREF for their support.

Mr. Oendo's September 1983 report is preceded by a June 1984 up-date by K.-K. Munguti and Rose Mulama of the South Coast Handpumps Project, Kenya.

David Grey, Regional Project Officer for Eastern Africa

UP-DATE

INTRODUCTION

The sociocultural study undertaken by Ayuka Oendo of AMREF in June 1983 gave a picture of villagers' attitudes to the proposed handpumped water supplies, prior to the commencement of project implementation but after project preparation activities, including committee formation, had been underway for several months. He pointed out that his study should have been carried out before project planning started, but though late, it has greatly helped, and led the project implementers to ask themselves some questions on the direction and future of their activities.

As the project has progressed, some internal adjustments have taken place. Now that nine months of project implementation have passed some changes in the social view have occurred and this note concerns these changes, as observed in villagers' attitudes to the project's activities. The following issues are discussed; land ownership, water committees, cash contribution, and attitudes to the covering of dug wells.

LAND

The question of land ownership of the surrounds of the pump has been everyone's concern. The issue was raised with the Kwale District Commissioner in May 1984, and suggestions made then have been taken up. Kenya Water for Health Organization (KWAHO) community training and liaison staff are in the process of preparing a legal land document to be signed by the landlords giving up the pump area to the community.

It is now the policy that the land question is discussed with the potential land donor. In this new approach the siting is done by the community and it is the people who decide where to have the borehole site. This way it becomes easier to tackle the land problem. It is no longer the problem of the community liaison team approaching the land owner to give up the piece of land; he is approached by the other villagers, and he knows the borehole and the surrounds will be community property. In villages where pumps have already been installed, a cautious approach is of course needed. However, even here it has been found that landlords have no objection to allowing the water to be used by the community. Legal surrender of that land to attain communal status is being discussed, and the most acceptable solution appears to be the attachment of the legal transfer document to the land title deeds.

WATER COMMITTEES

Initially, committees were formed by the surveying team, assisted by the Department of Social Services (Maambweni) and a Public Health Technician. These committees were formed on the spot and normally comprised those who turned up on the day of siting. In most of these committees the landlords tended to be the chairmen. The committees consisted of three or four people, some of whom were not even aware they were members when we approached them.

In recent meetings held by the community liaison team, committees have been reconstituted and, where non-existent, new ones have been formed. Some of these committees have taken up the pump issue very seriously. They have held meetings, taken minutes of all their discussions and have prepared their own regulations for their handpump. In the more organized areas, times for drawing water have been set, for instance between 6:00 a.m. and 8:00 p.m., with notices stating that children should not be seen playing around the pump especially in the evenings. It is believed the youths tend to misuse the pumps at night. Other committees have agreed that they need a lock for their pump to prevent misuse, and even suggested building structures over the pumps for protection. These ideas from the community are positive indicators that they have begun to view these facilities as their own, which is a major communication breakthrough.

The communities now know that the water sources are theirs and that they will need to care for them. The formation of effective water committees have thus been a very significant step forward in the project. All members have been elected in open meetings (as opposed to being appointed). They all know that the running of the water supply is entrusted to them, as opposed to a situation where they were nominated members listed in the project files, while being inactive in their villages.

The village chairmen (who assist the sub-chiefs in the villages) have been very cooperative. They sit in the committees in their area and there have been cases where they are also chairmen of the water committees. The committees normally consist of 9 people: 4 men and 5 women. The men have tended to be the elected chairmen, with women mostly being secretaries and treasurers. Women are major drawers of water and a majority in committees guarantees contact with the water facility. Where siting is going on the water committee is informed in the village with the help of the community liaison team. Only after this does the geologist visit the village to verify the site. This procedure has eased the work of the drilling team who now can count on the support of the community through the water committee, especially in providing some local labor to bring stones and water, etc.

CASH CONTRIBUTION

The subject of cash contributions for procurement of handpumps and their maintenance has been presented to the community. The response has been promising, which is another indication that villagers are prepared to take over the management of their pumps, provided the idea is discussed beforehand.

Two ways of collecting money have been discussed:

- (i) An agreement (this is for the committees to decide) could be reached starting now to have every household pay an initial amount. Many committees have said they think a monthly payment into their treasury might be appropriate.

Others felt that the time for cash contribution is after completion of maintenance training courses, when trainees come back to the village with a knowledge of the likely costs of maintenance. On this point too has arisen the question of the water vendors who draw

water from the pump in jerrycans for sale. It is generally considered that none should be asked to buy water from the pumps, but perhaps the water vendor who draws a lot of water might be asked to make contributions as a family. Some water committees have felt that the water vendor is making a living out of this, and hence may be allowed to draw water free as long as he lives in the village.

- (ii) There are frequently kitchen gardens situated at the end of the drainage channels, using waste water from the pumps. It has been thought that if the community cultivated that portion of land and planted some vegetables, they might raise enough money for maintenance. The idea has so far been taken up by two communities but it is still too early to comment on their progress.

The idea of using existing voluntary (self-help) groups could be a decisive factor in this aspect. In two of the villages, women's groups have undertaken to cultivate a garden near the pumps and sell the produce for the pump's maintenance. But not all women in the areas are members of these groups. This would mean there are families that do not work in the gardens and yet draw water from the pump.

What may happen is that women could solve this by allocating turns to work in the garden for those families that have no members in the group. In one of the places the women have decided to ask every woman to turn up for work on the agreed day, irrespective of whether they are group members or not.

COVERING OF DUG WELLS

When the project was being prepared, it appears from Mr. Oendo's report that well owners were informed that the project intended to cover their wells, without explanation or discussion. The result was resistance to the idea by several communities.

In May 1984 the community liaison team visited all the open wells in Msambweni Location. Discussions were held with every one of the communities around these wells. The health benefits of protected wells were explained to them. It was made clear that wells would only be covered at the specific request of the community.

Discussions revealed that there had been a negative experience with a few protected wells in the past and when the pumps broke down the villagers were unable to maintain them, and there was no alternative source of water. But recently there has been a protected well in the area in which one half of the slab can be lifted in case of a problem, so that people can draw water with buckets during a pump repair, or can enter the well to deepen it. The pump did in fact break down and the people lifted the slab and drew water using their traditional methods.

Mr. Oendo had indicated that well owners did not wish to have their wells covered. This view does not appear to exist any longer, partly because people have appreciated the water from pumps and partly because it is understood that people can gain access to the well by removing part of the slab, if the pumps break down and cannot easily be repaired.

CONCLUSION

As Mr. Oendo recommended in his report, a team of sociologists and extension workers is now attached to the project, and it is considered that the work of presenting the aim of the project clearly to the people will greatly assist in overcoming the difficulties mentioned in the report.

The major aim of the community liaison team is to guide the villagers to reach workable solutions that will not interrupt their way of life. It is paramount that the villagers know this, and every step is being taken to let them make as many decisions as possible pertaining to the use of their water. To keep up this vital work it is planned that by mid-July 1984, four more extension workers (to make a total of five) will be recruited from the area to strengthen the community liaison team.

Katua-Katui Munguti, Community Training and Liaison Officer
Rose Mulama, Assistant Community Training and Liaison Officer
South Coast Handpumps Project, Kenya
(Seconded from the Kenya Water for Health Organization)

June 1984

Sociocultural Study for the Establishment of a
Community-Based Handpump Maintenance Program in Kenya

Ayuka Oendo, African Medical Research Foundation (AMREF), September 1983

SUMMARY AND RECOMMENDATIONS

The South Coast Handpump Testing Project has three principal goals: (1) to improve the quality and number of water wells in an area that has experienced frequent outbreaks of cholera, (2) to test handpumps and, on the basis of their performance, institute appropriate modifications that would improve their performance and reliability, and (3) to develop a village level maintenance program. This project is expected to contribute toward the development of a national capability in establishing and managing handpump programs.

From the outset, it was recognized that for the community to receive the full benefit of the improved water services, and for the handpumps to be given the type of care and maintenance that would ensure long-term project success, community involvement had to be meaningful and had to be obtained at all stages: planning, implementation, operation, and maintenance.

Involving the Community

The main recommendations in this report are that the role of the community in the project should be expanded, and that the project should be integrated into the community structures with a view toward developing local control. This goal can be achieved by:

- (1) involving the community in a dialogue to identify and, where possible, incorporate its preferences;
- (2) defining with the community a role for them that is both practical and meaningful so that control of the project ultimately can be turned over to them;
- (3) assisting the community in the formation of village water committees and utilizing them in the establishment and management of the project; and
- (4) appointing a Community Liaison Officer to facilitate communication and productive relations among the participants in the project.

Model for Participation

The proposed participation model suggests roles for the community, the Administration, Government departments and voluntary agencies.

- (1) In the community, two groups need to be involved in the project:
 - (a) The village water committee is the most important group. The village chairman, both a respected member of the village and an officer of the Administration at the village level, is a key figure in the community and should be chairman of the water committee. The functions of the committee should include:
 - (i) participating in the selection of wells and borehole sites, and deciding on the ancillary facilities to be provided along with handpumps;
 - (ii) organizing the ownership and control of, or securing for public use the wells, their immediate surroundings, and access paths;
 - (iii) taking charge of the wells, boreholes, and handpumps and supervising their use; and
 - (iv) maintaining the handpumps and monitoring their performance and suitability for community needs.
 - (b) Women's groups need to be involved because they are the only formally organized voluntary groups, they most directly benefit from an improved supply, and they have the ability to raise limited funds. They can participate in the project by taking charge of the cleanliness of the water sources. They can also perform routine maintenance and use their funds for the purchase of needed spare parts.
- (2) Within the Administration, the Assistant Chiefs, the Chiefs, and the District Officer - personally or through district water committees - can supervise the performance of the various village water committees and address issues arising out of the project that are beyond the competence of local committees.
- (3) The Divisional Social Development Officer, can play an important role both in assisting the women's groups and in organizing the community to participate in the project. His assistance to the Community Liaison Officer, particularly during the absence of the latter, can contribute much to communication and improvement of relations among the participants.
- (4) The District Development Committee should be approached to take on the responsibility for supervising and coordinating this project along with the others in the area.
- (5) The role of the Project Coordinator should be to maintain communication and consult with community leaders. He would recommend to the Regional Project Officer (RPO) of the UNDP/World Bank Handpumps Project the appropriate changes and modifications in the project schedule and implementation in view of the prevailing community attitudes. With the RPO, he would approach the District

Officer and District Commissioner with a view toward involving their respective development committees in the project.

- (6) The Community Liaison Officer, with the assistance of the Divisional Social Development Officer (or the latter in the absence of the former), will maintain constant communication with the village leaders, Assistant Chiefs, and Chiefs so as to ensure a high level of community interest in the project. He will also routinely review the role of the community with community leaders in order to give them increasing responsibility, and to ensure the continued effectiveness of the water committees. He will keep the Project Coordinator and the RPO informed of the progress and changes in community involvement in the project.

Training for attendants

The community will select trainees for the handpump maintenance scheme. At least a few members of the village water committee and leaders of women's groups should be trained. The water committees should decide the status and remuneration, if necessary, of the attendants.

Ownership and control

Wells and borehole sites should be officially secured for public use either by purchasing them or by obtaining written guarantees from the owners that the sources will be always freely accessible to the public.

Additional inputs

An integrated approach is recommended so as to strengthen the project and to enable the community to reap maximum benefits from it.

- (1) Health education is needed in water handling, storage and use as well as in the disposal of excreta. The Kenya Water for Health Organization in conjunction with the Divisional Public Health Education Office can conduct an education program as part of this project. This information will be most usefully aimed at the village committees and women's groups.
- (2) Sanitation, particularly the technical problems in latrine construction and use, should be addressed. The Environmental Sanitation Unit of the African Medical Research Foundation, in conjunction with the Divisional Public Health Education Officer, can assist the community in this aspect of the project.
- (3) Women's groups need to be assisted both in diversifying and improving their economic activities, and in marketing their products. The Kenya Water for Health Organization, the Ministries of Social Services, Cooperative Development, Agriculture, and Live-stock Development can contribute toward strengthening these groups.

1. INTRODUCTION

1.1 The Study

Purpose and objectives

This study took place over a four-week period in June and July 1983. Its purpose was to find a way to involve local communities in the planning, installation, and the maintenance of handpumps. Before the members of a community will become involved in a project, they must first accept it. This means that they must understand the project and appreciate the benefits that will accrue from it. Part of this study, therefore, was aimed at finding out what and how much the community understood about the project. The study also explored aspects of the community organization that might affect the form of involvement that would be appropriate. These aspects include:

- (1) community leadership and organizational structures;
- (2) ethnic, religious, and economic factors important for voluntary communal involvement;
- (3) social and cultural attitudes toward water and voluntary labor;
- (4) economic needs and priorities, resources, and potential;
- (5) the status of water as a need and its availability;
- (6) self-help and other voluntary groups;
- (7) past and present external interventions with water projects and community attitudes toward them;
- (8) role and status of women and their involvement in community projects;
- (9) local technical skills; and
- (10) the status of health education in the community.

It was hoped that the study would lead to recommendations regarding:

- (1) the persons, groups, and organizations to be involved in the project;
- (2) the way in which the handpump project can be integrated into other community's projects and thereby place it in a context in which it can be maintained locally;
- (3) relations between water committees and project personnel that would maximize cooperation;
- (4) an effective role for women and women's groups in the project; and

- (5) the nature and level of continued involvement in the project by the Government and other agencies.

Methods used

The study consisted of informal, unstructured discussions and interviews with officers of the Administration, community leaders, influential and ordinary members of the community, officers of government departments at Southern Division Headquarters, and project personnel. Among the officers of the Administration, discussions were held with the District Officer in charge of the Division, the Chiefs of Msambweni and Diani Sublocations, and Assistant Chiefs of various sublocations.

Discussions with the village chairmen were particularly valuable, in that village chairmen play a dual role, both as the lowest level of administration who communicate government policies and wishes to the village members, and as normally respected members and authentic spokesmen for their villages. In addition, some other members of the community, either because of their age and experience or because of their education or wealth, are respected and their advice and support are often sought by village leaders. Discussions were held with these individuals sometimes alone, but often in the company of the village chairman.

Other members of the community whose ideas and opinions were sought were well "owners" and religious leaders at mosques. In meetings with leaders and members of women's groups, their activities, problems, capabilities, and potential were discussed. A meeting was held with leaders of seven women's groups in the Shimba Hills at Mafisini and two other meetings with leaders and members of the Kinondo Womens group and the Mwamba dza Hara Women's group. These meetings were also attended by the Social Development Officer and his assistants.

Long and detailed discussions were held with officers of the government departments at Msambweni, in particular with the Public Health Education Officer and his assistants, the Social Development Officer and a public health technician.

In preparation for this study, the Project Coordinator and Country Monitoring Engineer explained the immediate and long-term objectives of the project.

Problems

This study was handicapped by two problems: (1) the short period in which the study was to be done, and (2) the stage of project development at which it was carried out. Although the study had to be compressed into four weeks, a longer period would have been appropriate in view of the special problems that prevailed in the area. These problems were due to ethnic and cultural diversity, varying levels of need of water, previous experience (or lack of it) with handpumps, and the sheer size of the area covered by the project and the size of population involved.

Because time was limited, the study had to rely on organized and pre-arranged meetings. Although discussions were informal, the fact that they had to be "kept to the point" set the stage for possible distortion and gave the vocal minority an opportunity to dominate these meetings. In other words, there was not enough time to carry out adequate participant observation, which could have permitted insights beyond what was said in public meetings.

Carrying out the study at this stage in the development of the project presented particular problems in Diani Location. Although the community had already been involved indirectly through their leaders, involvement at the village level appeared to be inadequate. Although meetings with leaders at various levels had given them adequate information about the purpose and objectives of the project, their support and cooperation appear to have been insufficient to ensure the general goodwill of the community.

1.2 The Project Area

The people and the environment

The project area in the Southern Division consists of two locations -- Msambweni and Diani -- which have a combined population of over 50,000. The area covers 300 square kilometers and stretches from Ukunda in the northeast to Ramisi in the southwest, and from the coast to the Shimba Hills.

Most of the people in this area are Muslim Digo. Except for isolated individuals who have bought land in the area, the non-Muslim and non-Digo population is confined to the Shimba Hills, where a community of largely Christian Kamba has resided for the last 20 years.

Although land is individually owned, the Digo have not traditionally exercised land rights that preclude other people from sharing the land. Thus grazing is carried out almost indiscriminately (except for areas under crops) and individual rights to the produce from coconut, cashew, and mango trees are often not recognized. Similarly, free access to and utilization of facilities, like water sources, on private land is considered the natural right of every Digo. However, it is believed that infiltration by "up country" settlers in the area is beginning to have an effect on these attitudes, the reason being that these people have introduced the practice of fencing off their property. Among the Kamba in the Shimba Hills, private property is more dominant.

Rainfall in the project area is high and occurs every month of the year. The temperature and humidity also are high. This combination of factors leads to luxuriant vegetation, which grows in such profusion that it makes cultivation difficult. As a result, there is a marked preference for crops that do not require much tending and weeding. The major cash crops are coconuts, cashew nuts, mangoes, oranges, and biza. The main food crop is cassava. Other food crops include bananas, maize, beans, pulses, cowpeas, and rice. All these are grown on patches that can be weeded easily.

Other economic activities include fishing, petty trading, and masonry. The small but thriving handicraft industry depends largely on the tourist market. The predominant religion in this area is Muslim, except for the

mainly Christian population in the Shimba Hills. The numerous mosques in the villages are the center of worship and social activity. The traditional sense of brotherhood among the Digo is reinforced by the sense of community promoted by Islam. In fact, the two influences have been interconnected to such an extent that it is difficult to trace the origins of certain attitudes and practices. In the Digo tradition, for instance, everyone is guaranteed free access to and use of a water source. In addition, Islam teaches that to provide people with water is an act that has a reward in Paradise. The Digo thus consider it not only a duty, but a privilege to provide water for the community.

The role of women has similarly been affected by religious and cultural beliefs. The Digo women, it is claimed, used to be as economically and socially active as their upcountry counterparts. But with the Arab-Islamic teaching that shield women from public exposure and difficult manual tasks ("wives are not slaves") women have assumed a low social profile. Furthermore, they are only allowed to do household tasks that are not physically strenuous. Even within women's groups, men seem to take over the management of projects when they become large or require that other men become involved.

Community water needs and water availability

Despite the regular and heavy rainfall in this area, three factors have made water a felt need:

- (1) the religious requirements for personal cleanliness as a way of life and for ablutions prior to worship mean that easy access to water is necessary;
- (2) the reluctance to expose women to the public and the desire to protect them from hard physical work necessitate that water, which is normally collected by women, be available in sufficient quantities close to home; and
- (3) within the project area, there are two schemes supplying piped water, one to the Division headquarters, hospital, and village at Msambweni, and the other to the tourist hotels in Diani. The latter also provides piped water to a small portion of the local population. Although these schemes do not have the capacity for expansion, they have made people aware of the possibility of having piped water in their villages and have raised their aspirations accordingly.

As a result of the first two factors, there is a long tradition of well ownership and use in this area. Besides the many wells in the villages, some of them constructed as many as 100 years ago, practically every mosque has its own well. In addition, more wells are being constructed to provide water for the increasing population.

Piped water in Ukunda and Msambweni reaches a small number of people through water kiosks in centers along the main road. Many of these kiosks, run by licenced operators, are inefficient because of defaulting in payments

to the authorities. As a result, the water is frequently disconnected. Water is sold at the rate of 10 cents per 20 liters at the kiosks. It costs more, however, if bought from water vendors who use mikokoteni, or handcarts to transport it to villages farther away from the sources.

The unreliability of the kiosks and the fact that the people have to pay for the water has led them to rely heavily on open wells. In most parts of Msambweni and in the Shimba Hills, handpumps, therefore, have been accepted as an appropriate, if not ideal, solution. In the parts of Diani adjoining the Ukunda Water Scheme and sections of Msambweni which have had experience with hand-pumps, there is a feeling that handpumps are an inferior technology.

2. THE HANDPUMP TESTING PROJECT AND THE COMMUNITY

2.1 The Project

Choice of area

Two problems connected with the choice of this area for a field trial must be considered during implementation of the project and during analysis of results:

- (1) the field trial area does not have a shortage of water. In fact, the heavy rains falling throughout the year cause many to complain about too much rain! Thus traditional sources may be used in preference to new handpump wells; and
- (2) people in part of the field trial area have had the experience of two previous handpump projects that have failed. Because of the problems that this situation created, many opposed a water project involving handpumps, especially when they realized that their own wells would be covered. Also, in parts of the area, the existence of a piped water scheme nearby made handpumps more difficult to accept as handpumps were considered both troublesome and inferior.

2.2 The Community

Understanding of project objectives

Community understanding of the objectives of the project did not differ significantly from the aims stated above. It was understood that the government wanted to seal their wells and to install handpumps and that the purpose of this was to protect water from contamination. Although most agreed that the water might be contaminated and that some form of protection was needed, the reaction to the sealing of wells and installation of handpumps differed greatly.

Attitude toward project by community members

The differences between the communities can be attributed in part to their different experiences with handpumps and in part to varying levels of expectation. Those in the Msambweni location have had no previous experience with handpumps. Also, there are few piped water systems in their area; accordingly, such systems have little effect on people's expectations. Since these people depend entirely on open wells for their water, they regard handpumps as a welcome innovation. They see only the advantages of handpumps and the additional water sources created by new boreholes.

Those in the Diani Location, on the other hand, already have had experience with handpumps. UNICEF had established a handpump project there in 1964, during which five wells were dug by the community and were covered and fitted with handpumps. The pumps broke down after a few months, and because there were no spare parts or skilled people to repair them, the wells fell into disuse. For a period of time, water was collected with buckets through the manholes, but containers, objects, and sometimes small animals fell in and could not be removed as the manholes were too small to allow people to get into them. The covering blocks were too thick and tough and, in any case, people were not inclined to tamper with "Government" property. In time, the wells could not be used any more and the people were forced to dig new ones. Later, in 1978, the Australian government started a joint handpump project with the Government of Kenya. Seven wells, dug by the community, were covered and fitted with handpumps. After one year all had broken down and the community faced the same problem that had arisen with the UNICEF handpumps.

When the initial work of surveying and selecting wells for protection started in early 1983, the reaction in the area was one of anger and frustration. In particular, people were annoyed because they had not been consulted or given satisfactory explanation as to the intentions of the project. Their unanswered questions included:

- (a) "We have had handpumps before. How different are these pumps from the UNICEF and Australian pumps? Why try something that has been tried twice before and that failed? We don't want handpumps. What we want is water, and we have it."; and
- (b) "If the government is really interested in us having clean water, with our participation we should get piped water. But if they want to test their handpumps, why don't they dig their own wells?" They also regarded handpumps as inferior technology because there is a piped water supply at Ukunda and Diani. They think that handpumps are not only clumsy and undignified, but slow and wasteful of water.

Attitude toward project by leadership

The attitudes of the Chief and Assistant Chief in both locations, ironically, were opposed to those of their communities. In Diani Location, the Chief, in spite of his knowledge of the previous handpump failures and his peoples' opposition to them, was enthusiastic and cooperative. As a government administrator he considered it his duty to support government projects, even to the extent of arresting and punishing those not cooperating.

On the other hand, the Chief of Msambweni, in spite of his peoples' willingness, was reluctant to cooperate because:

- (1) he knew of the former UNICEF and Australian handpump failures and did not see that anything made this project different; and
- (2) he had formerly cooperated with government personnel, using his influence to get local people to castrate their bulls so that better quality herds could be developed by means of artificial insemination. Unfortunately, the livestock program could not be maintained. As a result, the Chief was ridiculed and humiliated in his area.

The Chief sees a similarity in these two experiences and thus is convinced that cooperating on such projects will result in ridicule and unpopularity. He therefore avoided meetings arranged to discuss the Project and refused to promote it.

2.3 Discussion

The project and the community

The project proposes to provide water on the basis of one borehole for every 250 people and one dug well for every 125 people, which is a reasonable service level. The community should be involved in decisions concerning the best location of boreholes and choice of the open wells to be protected. Basing decisions on these service levels and on technical criteria (such as diameters of wells and hydrogeologically suitable sites for boreholes) alone is certain to raise conflicts with community interests. For instance, it seems that people in this area prefer separate sources for watering animals. If the community is consulted and such a simple preference satisfied, it will increase community goodwill and support and will save project funds by constructing watering troughs at every well or borehole. Involving the community in the survey, and reconciling their preferences to the project constraints, would guarantee the project informed, active, and continued support.

The initial survey that selected wells for protection and sites for drilling boreholes, was a cause of happiness in areas where the water sources are more distant, and where the people did not have unsuccessful past experiences with handpumps. In other areas, the survey caused despair and suppressed anger. If certain points about the project had been explained adequately to the communities before the survey started, they would have had a better attitude toward the project. For example, the communities should have been told:

- (1) that several types of pumps were being tested in the area, that there was going to be careful monitoring to assess their dependability, and that those found to be unsuitable would be removed and replaced with those that had worked well;

- (2) that what they thought about the handpumps before installation was important and, where possible, their opinions and ideas would be incorporated. More importantly, that their experience with using the new handpumps was very important because user acceptance was what the project was all about;
- (3) that there was sufficient flexibility to incorporate their ideas, for example, with regard to the way the wells were to be sealed and aprons constructed; and
- (4) that the training of community members to maintain the handpumps was part of the program and repair kits and spares would be made available to those designated as caretakers for the handpumps.

Meetings and discussions with leaders and community members in Diani showed that an open discussion, in which their fears and objections were aired, could overcome much of their resistance. In fact, genuine interest in their suggestions caused people to actively come up with ideas on how the project could best be accomplished. It was satisfying to see how much responsibility and initiative the leaders were taking, once they were assured that their participation was fundamental to the project.

The appointment of village water committees at the time of the survey, though well intentioned and based upon sound principles, led to the creation of numerous tiny committees that had no authority and that placed well "owners" in a position that could jeopardize the rights of other village members to free access to water. This was due to the fact that the survey team appointed the well site "owner" as the chairman of the village water committee and the chairman was allowed to nominate all three other members of the committee.

Further, the firm tactics used in the survey and the appointment of committees would have been effective if (1) voluntary participation by the community was not needed at any stage of the project, and (2) the attitudes and involvement of the community were not going to influence the success of the project. These tactics were inappropriate in this case as voluntary and informed participation by the community was expected to form an integral part of the project. It is obvious that sensitivity is needed when dealing with a community that is expected to play a major role in a project.

Technology

If a technology is to be acceptable, the users must feel that it improves on, or is compatible with, what they believe is their level of development. Although handpumps clearly are an improvement on rope-and-bucket water collection now practiced in the project area, the failed handpumps in Diani and existing piped water supply systems have led some to believe that handpumps are an inferior technology. Expressions like "Why are you taking us back to the 1960s? We have already used handpumps and we are ready to move on to the next stage", or "It is undignified for our women to be struggling with handpumps while our neighbours just five kilometers away only need to turn a tap", or "With all that money, the government could bring water to some high point so that we could obtain, through our own efforts, piped water supplies

using gravity", or "Handpumps are a waste of money" indicate that in this particular section of the field trial area, handpumps were introduced without careful explanation and community acceptance.

As discussions with community members later proved, these objections were based mainly on lack of knowledge of the purpose and objectives of the project. The people had not understood that:

- (1) besides protecting the present sources, the project will also add new sources, thus improving the quality and increasing the number of wells available to them;
- (2) the limited piped water system serving tourist hotels in the area could not be expanded to serve them, nor was it possible in the near future for the government to establish a piped water system in the area;
- (3) the installation of handpumps does not preclude the establishment of a piped water system for, if funds become available, a piped water system could even be established on the basis of the wells and boreholes being constructed; and
- (4) a maintenance program would make the project fundamentally different from either the UNICEF or Australian projects.

Once these points were understood by the community, there was a marked change in attitude, and people were ready to offer suggestions as to how the projects could be carried out. Therefore, what makes a technology "appropriate" is as much a community's understanding, acceptance, and knowledge that it will improve their lives as it is simplicity and low cost.

3. FRAMEWORK FOR COMMUNITY-BASED HANDPUMP MAINTENANCE

3.1 Community organization and leadership

The Administration

Government administration, at the district level, is ordered hierarchically from the District Commissioner down to the village chairman. The District Commissioner is in charge of the entire district. The district is subdivided into divisions, which are the responsibility of District Officers. Locations, under Chiefs, constitute the divisions. Locations are subdivided into sublocations, which are under Assistant Chiefs. Village Chairmen are heads of villages and are responsible to the Assistant Chief.

Units Head Officer

District	District Commissioner
Division	District Officer
Location	Chief
Sublocation	Assistant Chief
Village	Village Chairman

All these officers are civil servants appointed by the President or Public Service Commission, but the position of the village chairman is ambiguous. This ambiguity arises out of his status and manner of appointment. The following points can be made about village chairmen:

- (1) as members and residents of the villages which they head, they have an intimate knowledge of the activities and attitudes in their villages. If they are courageous and articulate, they reflect accurately the views of village members;
- (2) they are "hired and fired" almost at the whim of the Chiefs and/or Assistant Chiefs. Although, in principle, several factors are taken into account before they are appointed, in practice this amounts to the chief or assistant chief deciding whether the chairman is "cooperative" or "effective";
- (3) being unpaid civil servants and often respected members of villages, they may privately (and sometimes publicly) take stands that contradict official policy. The fact that they are unpaid and recruited informally gives them a sense of not really being part of government administration, while the title of chairman and official recognition as village leader enable them to influence community attitudes and speak on behalf of the village;
- (4) knowing that their positions are dependent on the Chief's pleasure, some village members who have access to powerful offices and personalities defy or ignore them; however, the majority of village chairmen are effective and influential, deriving their power as much from formal government authority as from the fact that they are often well respected members of their villages. A number of them are also Islamic religious leaders at the village level.

The normal practice in dealing with the administration and the community has been to fully brief the top officer and obtain his support. Once this is done, orders are issued down the chain of command. The amount of information decreases with the length of the chain with the result that people at the village level often must obey directives they do not understand. Although this technique may be necessary from the administrative point of view, it may be counterproductive when community programs are involved. This is because such programs require that the community understands them and is supportive. Mere obedience is not enough.

At the lowest level, village chairmen are expected to implement directives, and, with the aid of Assistant Chiefs, deal with uncooperative elements. In practice, however, the village chairmen are less predictable. Being members of the villages they lead, they avoid carrying out unpopular directives. When there is no room for discussion, the attitudes of village chairmen range from indifference to half-hearted efforts. In some cases they even display open hostility. This makes village chairmen the most important level at which long discussions must be held and the people whose support must be won.

Government ministries and departments

Various government ministries and departments are involved in activities that, if utilized, could affect the success of a project. The Public Health Education unit has the capability and resources needed to ensure a lively community interest in a project. Similarly, the Social Development Unit, as part of its continual involvement in supporting self help activities and in providing social and recreational facilities, has the motivation and skills needed to mobilize and organize a community for effective participation. Existing development committees at sublocational, locational, divisional, and district levels have the structures and organization needed for the coordination and supervision of the project both at the implementation, and the operation and maintenance stages. However, special care should be taken to ensure that tactics are not too firm when dealing with local communities.

Religious leadership

Because Islam is widespread and deep-rooted in this area, mosques are a common feature in many villages. Religious leadership is important not only because the mosque is the hub of village life, but also because the mosque is a source of water for which the leader is directly responsible. Although religious leadership seems to exert only informal influence, the connection between religion, tradition, and formal village leadership is so intricate that it is often impossible to separate them. Around the Shimba Hills where Christianity is dominant, however, religion and religious leadership do not appear to be a major factor in community activities.

Voluntary (self-help) groups

There are no formally organized self-help groups that include both men and women in this area. Because of the difficulty that officials have experienced in organizing sustained self-help groups, they have opted for organization on the basis of projects. Consequently, projects like school and dispensary construction may elicit the participation of nearly everyone in a community.

Women's groups, however, proliferate and seem to be active in various spheres. Not only are they well organized, meeting and working on a regular basis, but they also fund community projects. These funds are raised from: members' contributions, payments for performed tasks, and the sale of group handicrafts and farm produce.

The activities of women's groups are geared toward generating incomes both for individual members and for investment in community projects. Such activities include the renovation of homes, the cultivation of members' farms, the payment of school fees for members' children, and the purchase of household goods on a rotating basis.

3.2 Water sources: ownership, management, and control

Wells are the main source of water in the field trial area. Even where water kiosks operate along the main road and in small centers, wells provide a standby source in case the piped supply to a kiosk fails. Open wells also provide a source of water for construction and for those in the community who cannot afford to purchase water from the kiosks. In most of this area, away from the main roads and the two centers, wells are the only sources of the water.

More than 50 percent of the wells are owned by individuals. "Ownership" in this sense is determined by the person who was responsible for its construction. In another sense, almost all wells are individually owned because "ownership" to the community means the "owner" of the land on which the well is situated. These individually owned wells have been constructed by the more wealthy members of the community through the services of well digging contractors.

Some wells have been dug by the community on an individual's land or on communal property. The "ownership" of such a well by the community does not differ from individual "ownership" since both are used freely. Wells at the mosque have been constructed either by wealthy individuals or by the community. The responsibility that "ownership" places upon an individual is to ensure that the well is in a good condition. When it is not, the "owner", with the cooperation of the village chairman, convenes a meeting of the male members of the village to plan ways to remedy the problem.

Traditionally, a water source and the access to it have always been free to the public, regardless of whom constructed the well or who "owns" the source. It is claimed that a Digo will not deny anyone access to water. However, the recent land demarcation and the emerging awareness of the fact that land is a limited resource might affect these attitudes. Already, among the non-Muslim Kamba in the Shimba Hills and where people from upcountry have bought land, difficulties have arisen with wells on private property.

4. PROPOSAL FOR PARTICIPATION

4.1 Role-Sharing in Implementation

The community can play an important role in ensuring the success of this project. At the local level, the village water committees should be the most important groups to be involved in the implementation of the project. Existing committees should be restructured to give them authority and wider representation. Each village should be given a free hand in deciding the size and composition of its committee; however, it should be recommended that the committee include one or more representatives from the relevant local women's groups. Ideally, the village water committee should include the village chairman, representatives of women's groups, and well site owners.

It is particularly important to involve women's groups because not only do women have the most direct interest in water supply, but they are the only functioning formally organized groups and they have access to funds. Women

also seem to be able to reach decisions with minimal dissent and to take action rapidly.

At the sublocational level, the creation of sublocational water committees, under the chairmanship of the Assistant Chief and comprising village chairmen and key village leaders, would help in dealing with problems arising out of the implementation of the project that cannot be solved at the village level. The Chief, Project Coordinator, and Community Liaison Officer should be ex-officio members of these committees.

The Project Coordinator should establish regular meetings with the Chiefs and the District Officer to keep them informed of the progress of the project. At the locational level, the Chiefs might want to form committees to oversee project activities. This, though less necessary than the village and sublocational committees, would give the project a sounder community base. The Chiefs and their assistants can decide on the composition and responsibilities of these committees, although the Project Coordinator and Community Liaison Officer should be ex-officio members.

At the Division level, the Project Coordinator should approach the District Officer to form a Project Committee or subcommittee to include heads of departments (Water Development, Health, Agriculture, Livestock, Cooperatives and Social Services). The Public Health Education Officer and the Divisional Social Development Officer also must be included. In the absence of this committee, the Project Coordinator should arrange to have regular informal meetings with these officers and seek to involve them in the project. For integration and coordination at a higher level, presentations should be made to the District Commissioner with a view to include the project among those coordinated by the District Development Committee.

The government departments that should be involved in the project are the Public Health Education Unit and the Department of Social Services. The Social Development Officer, already involved in organizing women's groups and other community projects, is uniquely equipped to assist in the formation of water committees. The Public Health Education Officer is also an important person, both because of his skills in community education and mobilization, and because of the opportunity it provides him to introduce health education at the earliest possible stage in the implementation of the project.

The Project Coordinator has the most important role to play since he must coordinate all the other participants. He will have to hold meetings with water committees, Village Chairmen, Assistant Chiefs, Chiefs, and the District Officers both to review the progress made and to discuss future activities.

4.2 Community-based operation and maintenance

The most important part of the project is the operation and maintenance stage. In a sense, community involvement at the implementation stage is only a preparation for this stage, for it is the effective operation and maintenance of the handpumps that will determine their usefulness.

Fortunately, the community and project planners agree that local caretakers should be responsible for the operation and maintenance of the handpumps. The selection and training of caretakers or attendants should start as soon as possible. The Village Chairman together with the village water committee must decide who should be trained and what should be the precise responsibilities of the caretakers. In making their selection, they should ask certain questions:

- (1) whether there is a possibility that the person might move out of the village for any reason for prolonged periods, and thus leave them without assistance;
- (2) what they propose to do if and when the person demands payment for his services;
- (3) is the person accessible, and available on short notice; and
- (4) whether the person has the ability and interest to learn to take care of the pump.

The village water committee will be responsible for the handpump(s) in the village, and the attendants are answerable to the committee. Therefore, it will be an advantage if the committee decides that all or some of the committee members should be trained to be attendants. Also, there are advantages in training local people who already have maintenance skills, such as auto mechanics and bicycle repairers. Finally, because women are effectively organized and most directly benefit from the water supply, they should be given careful consideration. Local selection of attendants will give the community the attitude that they own and control their handpumps. They will then be less inclined to blame the "government" for failure to repair a handpump which breaks down.

Regardless of who is selected to be the attendants, care should be taken to avoid making this skill the exclusive monopoly of only a few people. Depending on the numbers of trainees involved, the training sessions should be held either in villages or at some central place that will bring together attendants from adjacent villages who will be expected to use similar pumps. The purpose will be both to "demystify" the technology and to give as many people as possible the opportunity to know how the pump is put together, what could go wrong with it, and how faults can be rectified.

4.3 Proposed ownership and control of water sources

At present, it is not expected that any problems will arise with members of the community regarding the protection of wells, drilling of boreholes, or installation of handpumps. Well- and borehole-site owners will permit their land to be used because to them this means water will be closer to their homes. To the Muslim community, it also means the honor and privilege of providing the community with water.

Certain factors need to be taken into account, however, if maximum benefits are to be obtained from the project and the public permanently guaranteed free access to the water sources:

- (1) although access to and use of water sources is free at present, settler elements from upcountry and the continuing exercise of land demarcation are combining to raise awareness of exclusive land ownership rights. It is not certain what effect this will have on existing attitudes toward water as a public amenity;
- (2) the belief that it is a privilege and a religious act to "provide" people with water seems to stem from the fact that it is a demonstration of a person's devotion to God and goodwill toward his fellowman. If this project is carried out in such a way that the "owners" do not feel that their participation in providing water will give them spiritual and social credit, then it is not certain that their benevolence can be sustained for very long. They might feel that the handpumps are a foreign installation taking their land and inconveniencing them; and
- (3) the land demarcation exercise, coupled with growing population, has had the effect of emphasizing the limited nature of land. Since a substantial area may be required for a handpump, its immediate surroundings and access paths, the sacrifice is likely to appear to be too much for the "owners", especially if livestock watering troughs, cattle dips, and clothes washing facilities are included. In addition, if local women's groups decide to start vegetable gardens at the sources, the amount of land needed for each source may be up to half an acre. This would seem to be too much to expect owners to give freely.

It would appear that the best solution would be to purchase the required sites and obtain title deeds for them, or otherwise obtain written guarantees from the owners surrendering the sites and access paths to public use. After purchase, the sites would belong to the "government" but would be under the direct control of village water committees, which are headed by Village Chairmen and which include the site owners. In this way, the sites will become public property but the "owners" will be in positions of responsibility and will be continuously involved in matters related to the site. Although the "owners" will lose direct control of the sites, their continued interest in the sources is vital to their usefulness as they are the first people to know when anything goes wrong. Furthermore, the community regards the site owners as the "owners" and their interest can only be maintained if it is acknowledged that they have contributed to the welfare of their villages.

5. ADDITIONAL INPUTS

5.1 Health Education and Sanitation

Health education is needed both in water handling and excreta disposal practices. Although the handpumps will prevent contamination of well water, it is clear that without the requisite knowledge, contamination will still take place after collection.

Women, being most directly responsible for collecting and handling water for domestic use, are the appropriate target for health education efforts. Involving women's groups in this exercise will not only be more effective, but it also will strengthen them.

Excreta disposal is another issue that needs to be addressed. Because of Islamic influences, there are strong beliefs about personal and environmental cleanliness. For example, defecation is considered a private act and feces should not be left in public view. Private family latrines attached to or very close to individual houses are often exclusively used by the families owning them. On the other hand, male public latrines at mosques are intensively used by worshippers and village members.

Although bushes in this area could be, and sometimes are, used for defecation, latrines are preferred because of the practice of using water for anal cleansing. This is the reason why latrines are attached to houses, built in extensions to houses, or at least are close by. People who do not have latrines defecate in the shelter of bushes. They, however, walk as far away from their homes as possible both for privacy and so as not to defile the vicinity of their homes. In most cases, hoes are used to bury feces.

There are two main reasons why individuals do not construct latrines. The most important is that loose soils typically found in the area cause pits to collapse. The second problem is that the location of latrines and method of anal cleansing require that concrete slabs be used. The construction of concrete slabs, however, is still beyond the means of the majority of people. The next best alternative for males is the mosque latrine.

The majority of latrines in this area are quite clean. Some of them do have odors, but during inspections the writer found hardly any flies. Disinfectants were used in some latrines. The floors, though damp, were generally clean. The superstructures are made of the same materials as the houses -- that is mud and stone walls and a "makuti" roof.

While the problem of unsanitary water handling practices can be solved by health education, directed mainly at women, the excreta disposal problems can only be solved by technological means. With the assistance of various agencies, the techniques of supporting pit walls are being applied more widely, but it has not yet been made sufficiently inexpensive to be affordable to most people. Similarly, concrete slabs are more costly than many people can afford.

Another important step that could be taken to improve sanitation is the "demystification" of pit support and slab construction techniques. It appears that many people believe that it takes an "expert" to carry out such construction. Rather demystification could be accomplished by training as many local masons and builders as possible in the techniques of pit support and slab construction. An organization like African Medical Research Foundation could carry out this exercise. Meanwhile, the Kenyan Water for Health Organization could instruct women's groups in proper health practices. In either case, the assistance of the Community Development Officer and the Public Health Education Officer will be invaluable.

5.2 Women's Groups

Organization

Most women's groups act as small local mutual assistance groups. Their activities are often restricted to contributing funds to help members who are in need, or to performing domestic tasks for one another. However, with the encouragement and assistance from Social Services personnel, the groups organize themselves formally and attempt to diversify their activities.

Activities

The activities undertaken are related both to income-generation and to mutual-assistance. Mutual-assistance activities include:

- (1) paying school fees for members' children,
- (2) purchasing household goods for members,
- (3) tilling members' shambas, and
- (4) meeting hospital expenses and other emergencies.

The funds used in these activities are raised both by members' regular contributions and from the sale of handicrafts and produce from their farming activities. The income-generating activities include:

- (1) goat rearing,
- (2) poultry raising,
- (3) raising crops on a group basis, and
- (4) making handicrafts.

Discussion

As the women's groups are the only organized groups meeting and working together regularly, it will be important for them to be involved in the Handpump Project. The fact that they have funds is an added advantage. In the past, women's groups have used their funds in community projects, such as building nursery schools, renovating and improving primary school buildings, and in repairing and maintaining community wells. This, in addition to their direct interest in improved water supplies, makes it imperative for them to play an important role in the development and operation of the project. It is recommended that their involvement in the project should take the form of permanent representation in village water committees, and they should be assigned specific duties at the operation stage of the project. Such duties could include:

- (1) ensuring proper handling of the pumps by women and children while collecting water;

- (2) maintaining cleanliness around the handpumps and proper use of the site;
- (3) carrying out preventive maintenance of the handpumps and possibly some repairs; and
- (4) cultivating vegetable plots utilizing runoff water from the water points.

The Ministries of Agriculture and Livestock Development could assist the women's groups to utilize the handpump sites to start cattle dips, and to grow vegetable gardens. To strengthen the groups further, the Ministry of Cooperative Development or the Ministry of Culture and Social Services and other agencies could assist in securing markets for their products.

6. CONCLUSIONS

Despite inherent problems in the area selected for this project, not to mention the bottlenecks in starting it, significant advances toward its success have been made. Although the technical side of the project has started and community participation is lagging well behind, recognition of this gap has greatly increased the chances for success. However, the Project Coordinator must continue to be sensitive to and aware of the need for active and responsible community involvement. He will benefit considerably from the services of a social scientist with skills in community organization and mobilization. The scientist (referred to in this report as Community Liaison Officer), with the assistance of the Community Development Officer and the Public Health Technician, will assist the community in organizing its participation in the project and will facilitate communication between the community and the project personnel.

Certain modifications in the approach to the project are recommended. Principal among these is identification of local communities as official project participants. The decisions on which wells are to be protected, where the boreholes are to be located, and the timetable of the work should be based on discussion and compromise. The community should own the project before it is completed (that is, before the handpumps are installed). When the pumps are furnished, the community should participate in the assessment of the performance of the handpumps. The community can keep records not only of the specific characteristics of handpumps, but also of what the community considers to be their strengths and weaknesses. They can also keep an accurate record of the intensity and manner of handpump use.

The community should be consulted with regard to the particular handpump features that they think should be modified as a result of their earlier experience. Similarly, their ideas about the way wells are to be sealed should be given due consideration. This is particularly important because assurance is needed that they will not be deprived of water if the pump breaks down and cannot be quickly repaired.

Finally, even though it is recognized that the village is the most important level at which community involvement is to be sought, existing structures need to be involved and new ones created at different levels in order to make the project genuinely community based. A necessary step is to encourage the formation of water committees at sublocational, locational, and divisional levels. These committees will supervise and coordinate lower level activities and solve community-related problems that may arise during and after the implementation stage of the project. Efforts should be made at high levels to include the project in those that are supervised and coordinated by the District Development Committee. Also, government ministries and departments should use this project to introduce new ideas into the community and to improve their standard of living.

It is expected that the methods and principles developed in this project for a truly community-based rural water scheme (both for construction and maintenance) could contribute to the formation of a national policy for the large-scale implementation of similar projects throughout Kenya. The weaknesses in implementation, the resulting problems, and the solutions employed could provide invaluable lessons for those considering similar projects in other areas.

APPENDIX: PROPOSAL FOR COMMUNITY LIAISON OFFICER

Purpose

A Community Liaison Officer is needed in this project for two important reasons:

- (a) the personnel involved in the project at present are all technical people. Although they may support the idea of more community involvement, they are not equipped with the skills for community organization, and do not have sufficient time to become deeply involved in community activities; and
- (b) Government regulations do not allow unauthorized officers to address public meetings. This places serious constraints, unless the government designates an officer to the project for precisely this purpose.

Job Description

The officer should be a graduate in Social Sciences having experience in community work. He will work in conjunction with the Project Coordinator and the Country Monitoring Engineer. He will be responsible to the Project Coordinator and the Regional Project Officer.

Initially, the officer will need four weeks in the field and thereafter, one to two weeks out of every two months until the installation of handpumps is completed. During his absence, his responsibilities can be taken care of by the Community Development Officer. After handpump installation is complete, the Liaison Officer should spend one to two weeks in the area every three months until the Regional Project Officer is satisfied that the project is effectively in the hands of the community. On such field visits, he should meet with the village water committees and community leaders. In addition, he should brief the Regional Project Officer and write reports on the progress of the transfer of the control and management of the project to the community. In the reports he should suggest steps which can be taken to improve community relations and to encourage participation.

Detailed Terms of Reference

The Community Liaison Officer will:

- (1) help organize village water committees, and, without taking over the role of selection, ensure that all key persons and group representatives are included;
- (2) discuss with Chiefs and Assistant Chiefs the formation of committees at their respective levels and suggest appropriate appointments and responsibilities for them;

- (3) facilitate communication among the committees at various levels within the community on the one hand, and provide liaison with the Project Coordinator;
- (4) reconcile the community's objections and demands to the project objectives and constraints by:
 - (a) explaining to the community the plans and intentions of the project, and
 - (b) presenting community suggestions and recommendations to the Project Coordinator for consideration and possible incorporation;
- (5) keep the Project Coordinator and Regional Project Officer informed of changes in community attitudes and the effect these may have on the project;
- (6) suggest to the Project Corodinator appropriate relations between project personnel and the community;
- (7) help solve problems within village water committees and ensure their continued functioning; and
- (8) ensure transfer of responsibility to the community as the project progresses and ensure complete control by the community at the end of the implementation stage.

ANNEX E
MONITORING FORMS

This Annex contains the monitoring forms used by the Project for collecting information about pump use and performance in the field trials. These forms are accompanied by the instructions for their use.



WORLD BANK - UNDP INT/81/026
Rural Water Supply Handpumps Project
Field Trials



SHORT GUIDE TO MONITORING FORMS

<u>TYPES OF MONITORING FORMS</u>	<u>SOURCE OF INFORMATION</u>	<u>COMPLETED BY WHOM</u>
Form 1. Well and Pump Characteristics	Office	Monitor
Form 2. Site Inspection Report	Site visits	Monitor
Form 3. Repair and Maintenance Report	On site or workshop	Monitor
Form 4. Village Caretaker Log Book (no printed form)	Village	Village caretaker
Form 5. Social and Cultural Factors	Village	Anthropologist or monitor
Form 6. Maintenance Cost Data	Office	Monitor
Form 7. Water Supply Systems Cost Data	Office and field	Economist

INSTRUCTIONS TO THE USE OF THE MONITORING FORMS (SHORT VERSION)

GENERAL:

All lines and tables should be filled. Use the following codes for:

Not available	NA
Not applicable	/
Don't know	DN

For multiple choice answers (yes - no, etc.), the appropriate box is to be ticked .

FORM 1. WELL AND PUMP CHARACTERISTICS (Office information)

A1. Identification code. An eight-digit code, unique for each pump in the global field trials, consisting of the country code (two digits), the project code (one digit), the pump type code (two digits), and the pump serial number. This numbering is hierarchical (except for the pump type, which is global), whereby projects are numbered within each country from one to a maximum of nine, and the serial number starts from 1 for each country-project-pump type combination. The country codes are given in Annex I. Project: Code number (one - nine) of the project, donor, or executing agency. The numbering starts with "one" within each country. Pump type: Must correspond to Item E1 of Form 1. The two digit code should be unique for the global field trials. Major local variations or modifications should each be given a different number.

A2. Water point code. Optional. In some countries all the water points are coded.

B5. Static water level. Measured from ground level to water level at the time of well construction.

B6. Rock type. Generalized answer required, where possible in two parts - a rock type description, followed, if the material is unconsolidated, by a general description of grain size of the aquifer (i.e. where the screen intake is set).

- e.g. a) Alluvium - fine to medium sands
- b) Weathered gneiss - sandy, some clay
- c) Basalts - consolidated

B7. Well deepened or rehabilitated. Is relevant when the project takes an existing dried-up or disfunctional open or drilled well and deepens or rehabilitates it before installing a pump.

B9. Constructed by. Enter name of drilling team or foreman, and the agency or community, if drilling is not both carried out and funded by the rural water supply project.

DRILLED/DUG WELL SKETCH. This sketch is useful in that many important features of the well and pump can be shown. For a drilled well suitable scales would be:

- vertical (depth) - one space to 1m for 20m depth, one space to 1.5m for 30m depth, one space to 2m for 40m depth, etc.
- horizontal (diameter) - one space for 2.5cm (allowing up to 30cm).

For a dug well suitable scales would be:

- vertical (depth) - one space to 0.5m (up to 10 metres deep).
- horizontal (diameter) - one space to 25 cm (up to 3m wide).

The sketch will be best drawn using a heavy pencil or felt-tip pen.

C3 & C4. Slotted lining & gravel pack. This information is important for drilled wells in unconsolidated strata because it gives an indication of how effectively sand movement into the well will be prevented. Slot size is the width of the slot (probably between 0.5 - 2mm) and open area is the percentage of the slotted pipe open to water flow (calculated as the total area of slots divided by total pipe area). The d_{50} is the median* grain size of the gravel pack, which, if not available from the geologist or driller, could be approximated by estimating the average diameter of the gravel pack grains.

C5. Development. (a) Method. For example: none, overpumping, surging, air-lifting, jetting, etc. (c) Was sand-free discharge obtained after developing (or during pump test)?

C6. (c) Final pumping water level is measured at the end of the pumping test from ground level to water level.

C7. Sand trap refers to space provided on the bottom of the well (inside the casing, if one is installed) for sand to accumulate during regular pumping. If provided, measure well depth from ground level to bottom of well at the end of the pumping test.

C8. Water quality. This will help in assessing the corrosivity and acceptability of the water. A pH meter and a conductivity meter should be used, if available, as a minimum.

MASONRY SKETCH. A rough annotated sketch should be drawn of the pump surroundings, marking any features such as drain, soakaway, washing slab, and cattle trough. An approximate scale should be given.

* The size at which 1/2 the volume of the gravel pack has a larger grain size and the other 1/2 a smaller grain size.

D4. Drainage refers to the presence or absence of any structural measures or natural conditions which prevent the accumulation of water on the ground in the immediate vicinity of the well, such as an adequate slope, or a lip on the apron (with or without a short drain away from the well), a soakaway pit, etc.

D5. The question aims at determining (i) if an open well can be accessed manually in case of pump failure (but only with proper authorization, e.g. involving a lock or heavy weights to lift), and (ii) the chance of return flow of waste water into the well.

E6. Capacity. (a) Max stroke - the maximum travel of the rods (i.e. plunger). (b) Max swept volume - the max stroke multiplied by the internal cross-sectional area of the cylinder, given in litres.

(c) Theoretical performance - "A" is the standard volume of the container to be used in the pumping tests and has to be fixed for each country or project, e.g. 20 litres or 4 Imp. gal, or 4 U.S. gal, depending on the standard size of containers in the country. The theoretical performance is then computed by dividing A by (b), the max swept volume in litres, making sure that A has been converted into litres. Enter the value for A also in the footnote to Form 2 and in A3 on Form 2.

E7. Static water level. Measured at the time of pump installation.

E8. Seal material. Enter type of seal material between the pump's piston and cylinder (leather, rubber, PVC, etc.). If not applicable, enter a slash (/).

F1. Approximate population. The approximate population at the date of pump installation should be given. If a census figure or a projected population estimate is used, the date of the census or the projection should be given.

F2. Approximate area covered by houses in the village should be estimated from a map (if available and accurate) or approximated on the ground. If possible a VILLAGE SKETCH should be drawn and the approximate location of dug and drilled wells marked. Required is an indication, not an accurate map, to provide a feeling for the distances people walk to collect water.

F4. Estimate of number of households using this pump. If an approximation together with possible error (e.g. 50 \pm 10 people) can be made, this figure will be very useful. If not available, enter NA.

FORM 2. SITE INSPECTION REPORT

A line in this form is to be filled out each time the pump is visited. The first line in the table is used to record information collected during pump installation. One copy of this form is to be kept in the office and another taken to the field. The newly collected information is to be transcribed onto the office copy.

A. REFERENCE. Carried forward from Form 1. Theoretical performance is copied from Form 1, Item E6c.

Footnote *. "A" is the volume of the standard container used in the pumping tests, to be copied from Form 1, E6c. "B" is the pumping rate in strokes per minute, to be fixed for each type of pump (consult your Regional Project Officer).

B. MONITORING

B4. Well depth. The depth of the well should be measured whenever the pumping element is removed. The purpose is to determine the amount of sand accumulation in the well over time. The first measurement should be taken on the finished well before pump installation.

B5. Water Monitor. Reading is the reading of any monitor device or meter, if installed, to record water flow or frequency of use of the pump. Difference is the difference between the current and the previous reading. Difference per day is the difference divided by the number of days since the last visit.

B6. Performance. Actual performance, defined as the number of full strokes required to fill a standard container of size "A" at a constant pumping rate of "B" strokes per minute. (Note that the actual performance might depend on the pumping rate.) This gives a measure of changing seal and valve efficiency over time.

B7. Efficiency (A3/B6). Volumetric efficiency in percent, calculated by dividing the "theoretical performance" by the "actual performance."

B8. Condition of pump. The pump is either working well, working with only minor defects or in poor condition. The words "Good," "OK," and "Poor" should be used as subjective descriptions. If "Poor" is used, there should normally be an indication of why in Column 10, Preventive Maintenance, or Columns B11 - B13, Repair Code, Repair Done and Cause of Breakdown.

B9. Condition of surroundings. The sanitary conditions surrounding the well should similarly be subjectively described as "Good," "OK," or "Poor," or should be characterized as "well drained," "poorly drained," etc.

B10. Preventive maintenance. Any work that is carried out by the monitor, visiting team or village caretaker at the time of the site inspection should be noted, e.g. lubrication, bolt tightening, removing pebbles from the spout, digging a drainage ditch, etc. Details of the work done, who reported the failure (if other than the monitor), what was the cause, etc. should be recorded on the back of the form or on an attached sheet, specifying pump identification code, date and visit number (A1, B1, B2).

B11 - B13. If the pump needs repair (i.e. B8 "poor"), or was repaired or maintained since last visit, or is being repaired during the current visit, complete Form 3 and enter the repair code in Form 2, starting with No. 1 for the first repair of this specific pump, the nature of repair done, and the cause of breakdown. Otherwise enter "none" in B12.

FORM 3. REPAIR AND MAINTENANCE REPORT

This form is to be completed each time a repair or maintenance is carried out, including by the caretaker. This does not include minor adjustments by the monitor or the caretaker.

A. REFERENCE

A3. Repair code is the repair or maintenance number of a specific pump, beginning with "1" for the first repair or maintenance of this pump.

B. SEQUENCE OF EVENTS

B1. Reason for intervention. Breakdown and poor performance are reported events calling for a "repair," while scheduled maintenance is not preceded by a report.

B3. Dates. The relevant dates are to be entered; those not relevant are to be marked with an oblique line (/).

B4. Failure reported by, for example, the caretaker or headman to the project pump installation team, or the District Chairman. If the breakdown is observed by and repaired by the caretaker (see C5), both (b) and (c) should be answered with an oblique line (/).

C. REPAIR. Clearly distinguish for C1 to C5 between work done on site and work done in the workshop.

C2. Parts replaced. At times a whole section or even the entire pump may be replaced, or reconditioned with used parts. Record what was changed, and wherever possible the condition/wear of any used (second-hand) parts that are newly installed at this site.

C3. Tools used. Enter list of tools used (e.g. shearlegs, block and tackle, 2 shifting spanners, 2 pipe wrenches).

C4. Time taken to do repair. This is the actual time taken working on the pump, separated into on-site and workshop repairs (if carried out), not including delays while waiting for spares, etc., in total man-hours of the team.

C7. Type of vehicle(s). Specify the category (e.g. truck), the capacity (e.g. 3-ton), and, if known, the make and model number.

C8. (a) Round-trip distance per pump visit. Enter the actual distance traveled by the vehicle(s) per visit to this pump. If several pumps are visited in one trip (to inspect a reported failure, or for repair or maintenance), write down their number in C8(b) and divide the total round-trip distance traveled by the number of pumps visited.

C9. If the pumphead is opened up or removed during repairs, this may be the only chance to take a reading of the static water level and the well depth, both measured from ground level.

C10. Description of corroded, worn, damaged or broken parts. Give details and sketch (or attach photograph) if possible. This is very important if a good assessment of the pump's reliability is to be made and possible improvements to pump design suggested. Collect the discarded parts, including those replaced in the workshop, and store them in the office, properly labeled as to pump ID number, Repair Code, date, etc., for later thorough examination by senior engineers.

FORM 5: SOCIAL AND CULTURAL FACTORS

The data collection of the social and cultural aspects should be undertaken at least twice a year: in the rainy season and in the dry season. Ideally the interviews should be conducted by a female assistant since women/girls are more likely to talk frankly and fully with a woman. The persons selected for the interviews within each village should be randomly drawn and should preferably be a female head of household or a senior woman in the household. If possible the sample should consist of 10% of the total village population.

A. REFERENCE

A1. Identification code. Identical to Forms 1 - 3. If more than one test pump in the village, determine which pump the person interviewed uses, if any.

A2. Village. Carried over from the reference section of Form 1.

A3. Mother tongue. If there is more than 1 tribe/ethnic grouping within the country, specify the name of the tribal language spoken in the village (and the name of the tribe/tribes in the village, if different).

A4. Name of person interviewed. Give the full name, sex and age of person interviewed.

A5. Size of household refers to the number of people, regardless of age, permanently residing in the household under the care/supervision/economic dependance of the person interviewed.

B. USE CHARACTERISTICS

B2. Tick all relevant boxes.

B3. Amount of water collected (in litres or Imp. or U.S. gal per adult per trip).

B7. Reason for using other sources. In some countries people tend to use different water sources for different uses, such as drinking, cooking, bathing, etc. The person interviewed should therefore explain factors which affect their choice of source, for example payment, reliability, or social reasons.

B8. Water stored. Establishes whether water is stored in the container used for water collection or whether it is transferred to a separate storage container.

B9. Tick all relevant boxes.

B10. Purposes. The person interviewed should only be asked about her/his use within the last 24 hours. The questions here concern non-domestic use of water and may be related to income-generating activities for the household.

C. USER VIEWS

C1. Taste and appearance. The quality of water seems to some degree to influence the use of the pump for drinking and even more often for other water uses. Record the response given regardless of whether you agree with it or not.

C3. Alternative source when pump fails. Record which alternative source(s) is/are used by the respondent and his/her reaction to the water quality at the alternative source.

C4. User action when the pump is out of order. Record the respondent's account of what people do when the pump fails to operate.

* * *

Acknowledgements: The assistance of the Consumers' Association Testing and Research (CATR) and David Grey (then with the Overseas Development Administration in Malawi) in the preparation of the earlier drafts of the forms and this guide is gratefully acknowledged. Some ideas were also drawn from the International Development Research Center (IDRC) forms designed for handpump field testing in Asia

GT:kb

March 1, 1983

COUNTRY CODE

10. WEST AFRICA

- 11. Ivory Coast
- 12. Upper Volta
- 13. Ghana
- 14. Niger
- 15. Mali
- 16. Togo*

20. EAST AFRICA

- 21. Kenya
- 22. Malawi
- 23. Tanzania
- 24. Sudan
- 25. Zimbabwe*

30. SOUTH ASIA

- 31. Bangladesh
- 32. Sri Lanka
- 33. India
- 34. Pakistan*

40. EAST ASIA & PACIFIC

- 41. Thailand
- 42. China
- 43. Philippines
- 44. Papua New Guinea
- 45. Malaysia*

50. LATIN AMERICA & CARIBBEAN

- 51. Dominican Republic*
- 52. Paraguay*
- 53. Honduras*
- 54. Bolivia
- 55. Haiti*

* Countries outside UNDP/World Bank Project INT/81/026. Other countries may be added sequentially.

Instructions for the Use of Monitoring

Form 6: Maintenance Cost Data

GENERAL:

The purpose of this form is to help develop basic maintenance cost data for handpumps. This form, unlike the other basic monitoring forms, is to be returned to project headquarters for processing. Consequently some data which appears on the other monitoring forms which are not available at headquarters must be repeated. However, data that does not change from one Form 6 to the next need not be repeated on every form. In such cases, the standard "S" (see below) may be used.

On the forms, please use the following codes for:

Not Available	NA
Not Applicable	/
Don't Know	DN
Same as reported on previously completed copies of Form 6	S

A. Reference (Standard items identical to those on Form 3)

- A1. Identification Code: Standard eight-digit code used on all other forms. This will allow identification of particular characteristics (well type, depth, etc.) to be "called for" when required.
- A2. Water Point Code: Optional. In some countries the water points are coded.
- A3. Repair Code: The repair or maintenance number of a specific pump beginning with "1" for the first repair or maintenance of the pump. Should be the same as A3 of Form 3.

B. Maintenance Costs

- B1. Since Form 6 will be processed in the field without a copy being sent to headquarters, it is essential that some data be copied from Form 3. Date repair completed is necessary to permit conversions to another currency and grouping of data by time periods. Unit cost (or price) or parts should be current "market" price. If parts are contributed or subsidized estimate what local market cost would be and note that this is an estimate.
- B2. Note that there is a misprint; "wate" should be "wage". The average hourly wage rate would, mathematically, be the hourly wage of each person who worked on the pump, times the time each worked, totaled and divided by the total time worked. This detail probably is not necessary for each repair. An average for the "average" crew (including workshop crew when the pump workshop is involved) would be appropriate. In this context note that this should include total man-hours of the team involved, including personnel such as the driver who may not actually help repair the pump but who is getting paid as part of the crew. However, do not include delays while waiting for spares as part of the total man-hours of the team.
- B3. This information needs to be copied. Note that, for Form 3, instructions require that work done on site and work done in workshop be clearly distinguished.
- B4. This will require some investigation which, of course, need not be repeated for every repair. Fringe benefits should represent average additional social costs (above the basic wage) to account for such employee benefits as vacation, sick leave, medical coverage, retirement benefits, etc. Since these will probably be fairly constant over a wide range of wage rates in terms of a percentage of the basic wage rate, it will usually be simplest to express the cost in this way.
- B5. Support costs include such items as home office costs, supervision, etc. Do not include vehicle and equipment costs which are treated separately.
- B6. Estimated overhead costs for repairs carried out in the workshop should include amortization of the costs of workshop equipment and buildings. This may be estimated by dividing total estimated operating and depreciation costs of equipment and plant per year by the estimated number of man-hours which will be spent in the workshop on pump repair during the year. For example, take the following.

Capital Costs: (in constant dollars)

<u>Item</u>	<u>Present "Value"</u>	<u>Estimated Economic Life</u>	<u>Cost Per Year*</u>
Buildings	\$1 Million	20 years	\$50,000
Equipment	\$500,000	10 years	\$50,000

* Straight-line depreciation

Operating Cost: (in constant dollars)

Average operating cost per year (electricity, maintenance, etc.) (Exclude direct labor on pumps, but include shop maintenance labor, etc.) \$ 30,000

Total yearly capital & Operating costs \$130,000

Total man-hours directly spent on pump repairs (exclude shop maintenance, etc., shown under operating costs): 65,000

Shop overhead costs for workshop repairs would then be \$130,000/65,000 man-hours or \$2.00 per man-hour.

- NOTE:**
1. The estimated economic life should be based on how long the shop and/or equipment is expected to be able to provide a viable service in the future, not what its particular "age" may be now, (though that may well affect the estimate). That is to say, how long is it expected that the item will be able to provide a viable service? In this context economic life may well be less than physical life. For example, a particular tool may "last" 50 years, but be technologically obsolete in 10. Its economic life is, therefore, 10 years.

Remember, this is an estimate. Nobody is expected to be able to "know" when a new technology will make a piece of equipment obsolete. And in most cases, economic life will probably be effective physical life.

2. The "Present value" has been used instead of "Original cost". This has been done for two reasons. First, it may not be possible to determine what the original cost was --and if it was, it would be necessary to depreciate it from the original date of purchase. By using present value (do not take this to be "replacement value" in terms of a new piece of equipment) past depreciation is factored in. For example, an 8 year old piece of equipment may be selling new for, say, \$20,000 and have an estimated life of 10 years. This particular piece of equipment may have had very little use and be well maintained, so that its estimated (economic) life is an additional 8 years. It's present value could then be estimated at \$16,000.
- C3. Since not all of the maintenance crew will necessarily be engaged in specific pump repairs, it may be that the average hourly wage of the mobile crew as a whole will be different than that of the labor used for repair (question B2) which could also include someone not in the mobile crew. If average wage is the same, answer with "S".
- C6. This does not have to be repeated on every form. If equipment carried does not change mark a big "S" under item.



FORM NO. 1918
(2-83)

WORLD BANK - UNDP INT/81/026
Rural Water Supply Handpumps Project
Field Trials



FORM 1: WELL AND PUMP CHARACTERISTICS

A. REFERENCE

A1. Identification Code

Country

Project

Pump Type

Serial No.

A2. Water point code _____

A3. Region or district _____

A4. Village _____

A5. Map and grid reference _____

A6. Form completed by _____ Date _____

A7. Form checked by _____

B. WELL CONSTRUCTION

B1. Well type: Drilled Dug Other (specify) _____

B2. Construction dates (a) From _____ (b) To _____

B3. (a) Diameter (give units) _____ (b) Depth _____ m

B4. Depth at which water was first struck _____ m

B5. Static water level (a) Belowground _____ m (b) Date _____

B6. Rock type _____

B7. Well deepened or rehabilitated? Yes No Date _____

B8. Any problems encountered during construction? Yes No

Specify _____

B9. Constructed by (foreman/team) _____

Agency/Community _____

B10. Type of well construction equipment used _____

B11. Remarks

DRILLED/DUG WELL SKETCH

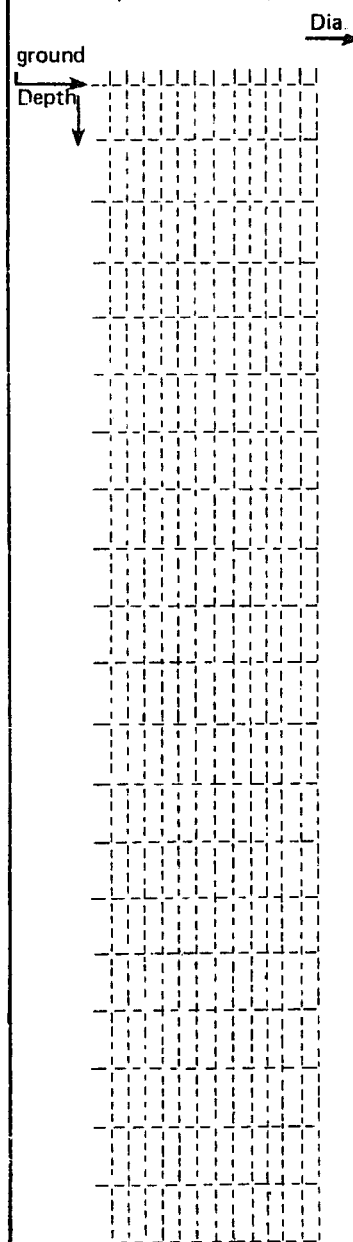

- Mark (a) depth (vertical) scale
- (b) diameter (horizontal) scale
- (c) hole depth and diameter
- (d) lining depth and diameter
- (e) location of plain and slotted lining
- (f) rising main depth and diameter
- (g) rods
- (h) cylinder location
- (i) static water level

C. WELL COMPLETION

	1		2		3		4		5	6
	DIAMETER (mm)		SETTING (m)		MATERIAL		MAKE			
	Interior	Exterior	From	To						
C1. Plain lining (casing)	(a)									
	(b)									
C2. Slotted lining (screen)	(a)									
	(b)									

23. Slotted lining (a) Slot size _____ mm (b) Open area _____ %

24. Gavel pack (a) d₅₀ _____ mm (b) Volume _____ m³

25. Development (a) Method _____ (b) Duration _____ hrs

(c) Sand-free discharge: Yes No

26. Pumping test (a) Duration _____ hrs (b) Yield _____ l/sec

(c) Final pumping water level (below ground) _____ m

7. Sand trap: Yes No Measured well depth _____ m

8. Water quality: (a) Conductivity _____ μS (b) pH _____

(Attach any other water quality information)

9. Chemical additives used in drilling? Yes No

Specify _____

MASONRY SKETCH OR PHOTO
(mark approx. scale or dimensions
and pump locations)

D. MASONRY WORK AND SURROUNDINGS

1. Apron Yes No D2. Washing slab Yes No D3. Cattle trough Yes No

2. Drainage: Good Bad Describe _____

For dug well: (a) Type of well cover _____

(b) Removable cover or lid? Yes No Describe access _____

Remarks

E. PUMP

E1. Manufacturer _____ Pump name _____ Model No. _____

E2. Installation (a) Date _____ (b) Time taken _____

(c) Installed by (foreman/team) _____

E3. Dimensions

	1	2	3	4	5
	MATERIAL	DIAMETER		UNIT LENGTH (m)	NO. OF LENGTHS
		Interior	Exterior		
(a) Rising Main					
(b) Rods					
(c) Cylinder					

E4. Distance from ground to bottom of pumping element (cylinder) _____ m E5. Pump lever ratio 1 : _____

E6. Capacity: (a) Max stroke _____ mm (b) Max swept volume _____ l

(c) Theoretical performance (A/E6b) _____ A = _____ l

E7. Static water level _____ m E8. Seal material _____

E9. Any problems encountered during or immediately following installation? Yes No

Specify _____

E10. Observed faults of the pump _____

E11. Remarks

F. VILLAGE

F1. Approximate population _____ No. of households _____

F2. Approximate area covered by houses _____

F3. Number of protected water points

	1	2
	EXISTING	PLANNED
(a) Drilled wells with handpumps		
(b) Dug wells with handpumps		
(c) Taps		
(d) Other (attach particulars)		

F4. Estimated no. of households using this handpump:

(a) Dry season _____ (b) Rainy season _____

F5. Village pump caretaker(s) Yes No

F6. Remarks

VILLAGE SKETCH (mark approx. scale)
x Dug well, o Drilled well



WORLD BANK – UNDP INT/81/026
Rural Water Supply Handpumps Project
Field Trials



FORM 2: SITE INSPECTION REPORT

A. REFERENCE

- A1. Identification code

--	--

--

--	--

--	--	--
- A2. Water point code _____
- A3. Theoretical performance (E6c) _____
- A4. Form completed by _____

B1	B2	B3	B4	B5			B6	B7	B8		B9	B10	B11			B12	B13
				Reading	Difference	Difference Per Day			Performance *	Efficiency (A3/B6)			Pump	Surroundings	Preventive Maintenance		
	Date	Static Water Level (m)	Well Depth (m)	WATER MONITOR					CONDITION OF			Preventive Maintenance	FROM FORM 3				
												Installation					
1																	
2																	
3																	
4																	
5																	
6																	
7																	
8																	
9																	
10																	
11																	
12																	

*Number of strokes to give "A" at "B" strokes per minute. A= _____ | (E6c), B= _____



FORM NO. 1920
(2-83)

WORLD BANK - UNDP INT/81/026
Rural Water Supply Handpumps Project
Field Trials



FORM 3: REPAIR AND MAINTENANCE REPORT

A. REFERENCE

A1. Identification Code

A2. Water point code _____

A3. Repair code _____

A4. Form completed by _____
Date _____

A5. Form checked by _____
Date _____

B. SEQUENCE OF EVENTS

B1. Reason for intervention: Breakdown Poor performance Scheduled maintenance

B2. Nature of failure _____

B3. Dates: (a) Failure occurred _____ (b) Failure reported _____
(c) Failure inspected _____ (d) Repair completed _____

B4. Failure reported (a) By whom _____ (b) To whom _____

B5. Failure inspected (a) By whom _____ (b) Action taken _____

C. REPAIR (Specify on-site or in workshop)

C1. Description of repair _____

C2. Parts replaced _____

C3. Tools used _____

C4. Time taken to do repair (man-hours) _____

C5. Repair carried out by _____

C6. Assistance from village caretaker(s): Yes No

C7. Type of vehicle(s) used _____

C8. (a) Round-trip distance per pump visit _____ km (b) Number of round trips _____

C9. (a) Static water level _____ m. (b) Measured well depth _____

C10. Description of corroded, worn, damaged or broken parts (add sketch or photograph)

C11. Remarks



FORM NO. 1925
(2-83)

WORLD BANK - UNDP INT/81/026
Rural Water Supply Handpumps Project
Field Trials



FORM 5: SOCIAL AND CULTURAL FACTORS

A. REFERENCE

A1. Identification Code

A2. Village _____

A3. Mother tongue (tribe) _____

A4. Name of person interviewed _____

Man Woman

A5. Size of household _____

A6. Interviewer _____

Date _____

B. USE CHARACTERISTICS

B1. Walking distance from household to pump _____ m

B2. Who collects water? Adult female Adult male

Children: Girls Ages _____ Boys Ages _____

B3. How much is collected in one trip (units)? _____

B4. How many trips are made? _____

B5. Usual number of users waiting at pump when you take water? _____

SEASON	MORNING	AFTERNOON
Dry		
Rainy		

SEASON	MORNING	AFTERNOON
Dry		
Rainy		

B6. Do you ever collect water from other sources? Yes No

SEASON	TYPE OF SOURCE	DISTANCE FROM HOUSEHOLD
Dry	1.	
	2.	
	3.	
Rainy	1.	
	2.	
	3.	

B7. Reason for using other sources and use of this water _____

B8. Water stored (in separate container)? Never Sometimes Regularly

Stored overnight? Yes No

B9. Water use at pump (other than carrying)? Yes No

Washing clothes Personal washing Full bath Washing food Washing utensils

Watering animals Other Specify _____

B10. Is water from pump used for following purposes?

WATER USE	DRY SEASON		RAINY SEASON	
	Yes	No	Yes	No
Beer brewing				
House building				
Watering livestock				
Watering plants				
Other				

C. USER VIEWS

C1. Comparison of taste and appearance of water (handpump vs. other sources) _____

C2. Any difficulties in using the pump? _____

C3. Alternative source and change in quantity fetched in case of pump failure _____

C4. User action when the pump is out of order (reporting, repair, etc.) _____

C5. How many households take water from the pump? _____

C6. Remarks

C. TRAVEL AND EQUIPMENT COSTS

- C1. Number of staff on mobile maintenance team _____
- C2. Travel time for this maintenance trip in hours and tenths of hours _____
- C3. Average hourly wage of mobile crew as a whole if different from B2, above _____
- C4. If more than one round trip is done for this maintenance, number of round trips (See C8b on Form 3) _____
- C5. Distance traveled per round-trip for this maintenance (See C6a on Form 3) _____ km
- C6. Cost of equipment carried by mobile crew (exclude the vehicle and replacement parts for pump)

QUANTITY	ITEM	PRESENT REPLACEMENT COST OF ITEM	EXPECTED LIFE (In Years)

C7. Type of road over which maintenance team traveled to perform this maintenance:

Paved _____ Gravel _____ Unpaved _____ Track _____
(If more than one type, indicate % of each)

C8. Type of vehicle(s) used (See C7 of Form 3) _____

C9. Remarks _____

March 20, 1984

FORM 7

FORM FOR COLLECTION OF COST DATA ON RURAL WATER SUPPLY HANDPUMPS

This form is designed to provide a basic framework for the collection of cost data from existing rural water handpumps which are used primarily to provide water for domestic use. It has been drafted with the knowledge that much of the data requested will only be available as order of magnitude estimates based on aggregates and that in some cases particular questions cannot realistically be answered. Nevertheless, informed estimates are better than the outright guesses which have often been the basis of the presently available data on handpump costs. Consequently, it is hoped that as many questions as can realistically be answered will be answered by the investigator with, as necessary, any appropriate caveats.

A. REFERENCE

Country	_____
Project	_____
Currency	_____
Approximate national per capita income	_____
Approximate per capita income in project area	_____
Population density (people/km ²) in project area	_____
Source of above data items	_____
Form completed by	Name: _____
	Title: _____
	Address: _____

Date form completed	_____

B. WELLS AND WATER USAGE

	Drilled	Dug	Total
Number of productive wells Range of depths (meters) Average depth (meters) Average depth from surface to mean water level (meters) Average expected life (years) Year(s) of construction e.g. 1981-83			
Average number of people using water from each well Average water consumption (litres per capita per day) Are the wells used: all year round : seasonally : if yes, which months Are other sources of water also used: all year round : seasonally : if yes, which months	Yes/No Yes/No Yes/No Yes/No	Yes/No Yes/No Yes/No Yes/No	
(a) Average construction cost of well: total : foreign component : local component ^(b) -labor other			
<u>OFFICE USE ONLY BELOW THIS LINE</u>			
Average US \$ construction cost of well: total : foreign component : local component Average 1984 US \$ construction cost of well: total : foreign component : local component			

(a) Divide total construction cost (excluding pumps and their installation) of both productive and non-productive wells by the number of productive wells. Include labor and material costs at market prices even if donated.

(b) "Local" refers to all non-foreign exchange costs.

C. PUMPS AND RELIABILITY

	A	B	C	D	E
Manufacturer/type Country of manufacture Number installed: total on drilled wells on dug wells Average number of pumps per well Average expected life (years) Year(s) of installation e.g. 1982					
Percentage of year the average pump is out of order Average number of breakdowns per pump per year Average time between pump breakdown and repair (days)					
Average ex-factory cost : total : foreign component : local component Average shipping cost from factory to well: total : foreign component : local component (a) Average cost of installing the pump: total : foreign component : local component - labor - other					
<u>OFFICE USE ONLY BELOW THIS LINE</u> Average US \$ cost of installed pump: total : foreign component : local component Average 1984 US \$ cost installed pump : total : foreign component : local component					

(a) Include labor and material costs at market prices even if donated.

D. MAINTENANCE SYSTEM

	Village Pump Caretakers	Regional Repairers	Motorized Mobile Maintenance Teams
e there? e they men (m) women (w) or both? w many pumps per caretaker, repairer, or mobile team?	Yes/No M/W/Both	Yes/No M/W/Both	Yes/No M/W/Both
their responsibilities include: preventive maintenance minor repairs major repairs all repairs breakdown notification health education other (specify) _____ _____ _____	Yes/No Yes/No Yes/No Yes/No Yes/No Yes/No Yes/No Yes/No Yes/No Yes/No	Yes/No Yes/No Yes/No Yes/No Yes/No Yes/No Yes/No Yes/No Yes/No Yes/No	Yes/No Yes/No Yes/No Yes/No Yes/No Yes/No Yes/No Yes/No Yes/No Yes/No
w many people on the motorized mobile team e they paid? w much they get a subsistence allowance? w much? o pays them?	X Yes/No per Yes/No per	X Yes/No per Yes/No per	Yes/No per Yes/No per
w do they travel? (foot, bicycle, motorbike, truck, etc.) by vehicle, what type? w many times per year do they visit each pump : regularly : in response to breakdowns (a) at is the average distance travelled per pump visit (km)			
are do they obtain spare parts? o pays for spare parts?			
<u>scribe briefly other important aspects of the maintenance system</u> <u>at have not been mentioned above</u>			

) e.g. if 4 pumps are visited in a journey of 100km, this is 25km.

E. RECURRENT COSTS

Indicate on this sheet the total annual costs of operating and maintaining the handpumps in this project.

	Total	Foreign Component	Local Component
(a) <u>Labor costs</u> (b) - project administration - motorized maintenance teams - regional repairers - subsistence allowances - village pump caretakers - other (specify) _____			
<u>Transport</u> - vehicle and mobile equipment depreciation - fuel and lubricants - vehicle spare parts and maintenance - other (specify) _____			
<u>Pump spare parts</u>			
(c) <u>Building depreciation</u>			
<u>Other (specify)</u> _____ _____ _____ _____			
Total annual recurrent costs Number of pumps Total annual recurrent cost per pump			
<u>OFFICE USE ONLY BELOW THIS LINE</u> Average US \$ recurrent cost per pump Average 1984 US \$ recurrent cost per pump Percentage: labor transport spare parts building depreciation other			

(a) Include all direct and indirect and social labor costs like pensions, medical and other insurance, housing subsidies, sick leave, vacations etc.

(b) Allocate appropriate portion of total project administration labor costs to pump operation and maintenance. This should include managers, workshop staff, garage staff, etc.

(c) Allocate appropriate portion of any project headquarters, workshops, garages and other buildings and their equipment to pump operation and maintenance.

F. VILLAGER PAYMENTS

1. Did/do the villagers (the pump users) contribute toward:

Contribution	Well Construction	Pump Installation	Pump Operation and Maintenance
<u>Land</u> for well site	Yes/No	X	X
<u>Cash</u> If yes: how much? : paid to whom?	Yes/No	Yes/No	Yes/No
<u>Materials</u> If yes, what?	Yes/No _____ _____ _____	Yes/No _____ _____ _____	X X X X
<u>Food</u> to workers	Yes/No	Yes/No	X
<u>Labor</u> If yes, how much?	Yes/No _____ _____	Yes/No _____ _____	Yes/No _____ _____

2. If the villagers contribute toward recurrent pump operation and maintenance costs, describe the system by which funds are collected in the village, how much is paid to whom for repairs, spare parts etc.

ANNEX F

LABORATORY TEST RESULTS OF HANDPUMPS: BATCH 4

Table 1: BRAND LIST OF PUMPS TESTED IN BATCH 4

Name/Model	Manufacturer/Supplier	Deep or Shallow Well	Price (US\$)* Approx	Country of Origin
Kardia	Preussag AG	Deep	841 ^a	West Germany
Turni	Preussag AG	Deep	1037 ^a	West Germany
Mono Direct Drive	Mono Pumps (Africa) Pty Ltd	Deep	599 ^a	South Africa
Monolift	Mono Pumps Ltd	Deep	477 ^a	England
Sihilase	Sarvodaya Machinешop	Deep [#]	150	Sri Lanka

* Cost if 50 purchased in one order

a Supplied complete for 20 m depth

20 m nominal maximum depth

Kardia Pump

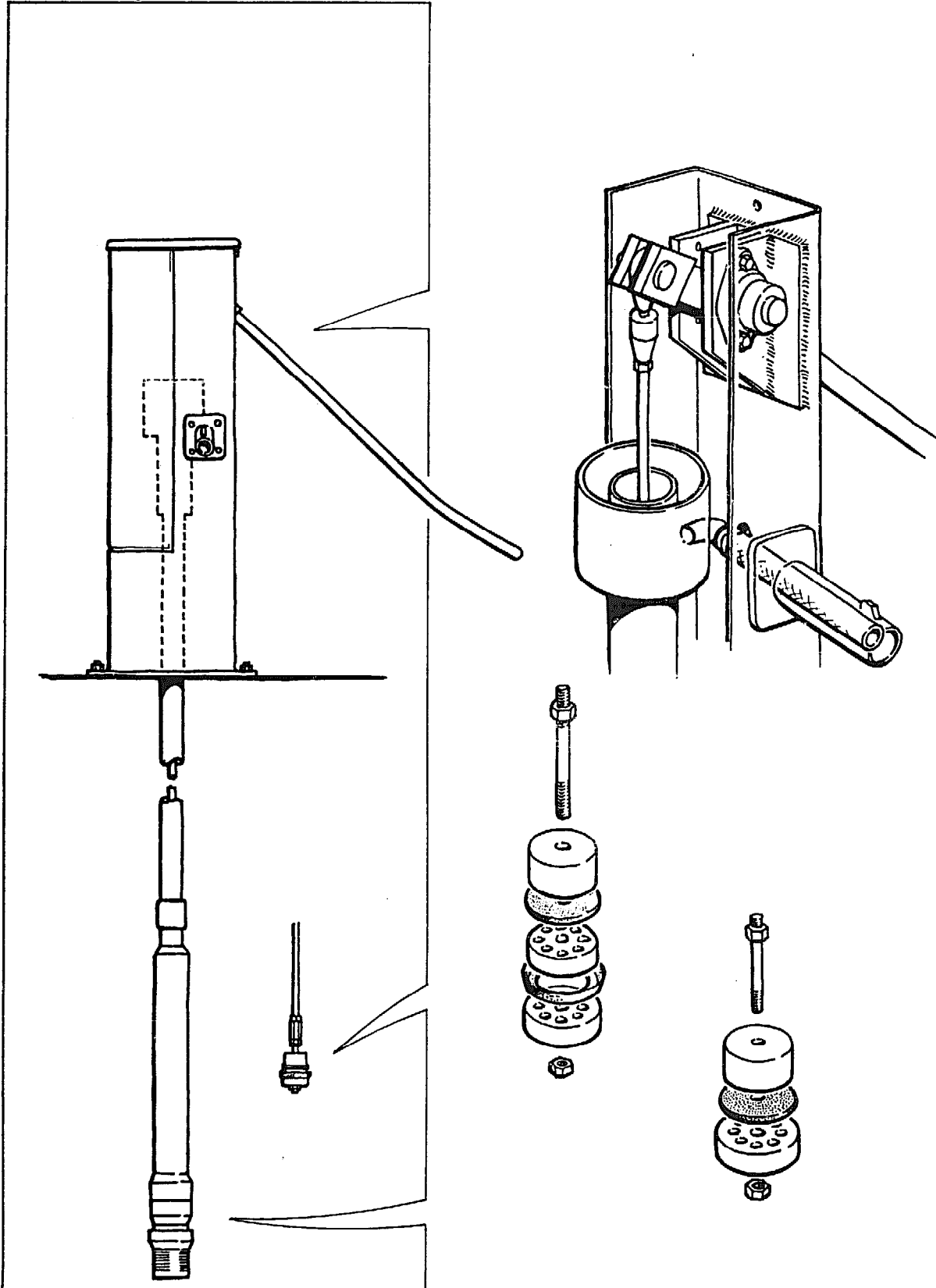

SBF-KARDIA HANDPUMP

1.1 Manufacturer

Preussag AG

1.2 Address

Moorbeerenweg 1,
Postfach 6009,
D-3150 Peine,
Federal Republic of Germany.

1.3 Description

The Kardia is a deep-well force pump with a conventional, reciprocating plunger action. The cylinder is a length of uPVC pipe. The plunger is fitted with a proprietary, moulded rubber lip seal which acts directly on the bore of the extruded uPVC pipe. The plunger and footvalve are similar in design, machined from uPVC and fitted with flat, rubber sealing washers. A short screen pipe is fitted below the footvalve assembly. The cylinder pipe is extruded by Preussag to their own specification. For installations at depths of 35 metres or more, the manufacturer suggests that two plunger seals may be fitted.

The uPVC rising main, manufactured by Preussag to their own specification is joined by threaded connections sealed with PTFE tape. The pump rod is stainless steel, with conventional brass tube-nut couplings.

The pumpstand is fabricated from steel sheet and sections, and hot-dip galvanised. The handle is a solid, stainless steel bar. The handle bearings are large, proprietary ball races in flanged housings. Inside the pumpstand, the rising main is attached to a delivery cup from which the water flows out through a short length of flexible hose inside the steel spout of the pumpstand.

1.3 Price

Approximately US \$900 including packing, complete for 20 m depth, lots of 50.

2. INSPECTION

2.1 Packaging

The pumps were packed in two long cases; one contained the pump, the other contained three lengths of PVC pipe and rods. The cases were lined with polythene sheet and the parts were wrapped in corrugated paper. The packaging was considered suitable for all transportation conditions, but the cases were large and difficult to man-handle.

2.2 Condition as Received

Both samples were received in working order.

2.3 Installation and Maintenance Information

An installation manual was provided with the test samples. The text was in English and the manual included several line drawings and photographs showing various stages of installation. The text was clear and concise.

3. WEIGHTS and MEASURES

3.1 Weights

Pump stand : 50.9 kg (including handle)
 Cylinder: 3.0 kg
 Rising Main (per m): 1.2 kg (including couplings)
 Pump Rod (per m): 0.7 kg (including sockets)

3.2 Dimensions

Nominal cylinder bore: 63 mm
 Actual pump stroke: 135 mm
 Nominal volume per stroke: 421 ml
 Rising main size: 1.5 in
 Pump rod diameter: 10 mm
 Maximum dia. of below-ground assembly: 84 mm

3.3 Cylinder Bores

No significant taper or ovality was found in either of the two samples.

The surface roughness (R_a) was measured in three places in a direction parallel to the cylinder axis.

SAMPLE	CYLINDER BORE	ROUGHNESS AVERAGE (um)			
		TEST 1	TEST 2	TEST 3	MEAN
1	Extruded uPVC	0.22	0.18	0.16	0.19
2	Extruded uPVC	0.20	0.18	0.18	0.19

Measured at 0.8 mm cut-off

3.4 Ergonomic Measurements

HANDLE HEIGHT		PLINTH HEIGHT (mm)	ANGULAR MOVEMENT of HANDLE (deg)	HANDLE LENGTH (mm)	VELOCITY RATIO of HANDLE	HEIGHT OF SPOUT (mm)
MAX. (mm)	MIN. (mm)					
1334	270	None	65	1000	8:1	513

4. ENGINEERING ASSESSMENT

4.1 Materials of Construction

COMPONENT	MATERIAL(S)
Pump stand	Sheet steel, hot-dip galvanised
Handle	Stainless steel
Rising main	uPVC
Pump Rod	Stainless steel with brass connectors
Cylinder	uPVC
Plunger body	uPVC
Cup seal	Proprietary rubber lip seal

4.2 Manufacturing Techniques

The manufacturing techniques required to make the pump are listed below:

Above-ground Assembly	Sheet metalwork Steel fabrication Simple machining of steel and uPVC uPVC fabrication
--------------------------	--

The use of proprietary bearing assemblies and the flexible plastic delivery hose simplify the manufacture of the pumpstand. Few processes are involved, but the pumpstand requires consistent high levels of skill and careful quality control. Nevertheless, it would be suitable for manufacture in many developing countries.

Below-ground Assembly	Simple machining of steel and uPVC manipulation and fabrication
--------------------------	--

The use of a proprietary seal simplifies the manufacture of the plunger, but requires that the cylinder bore is maintained within limits closer than those normally required for the bore of extruded uPVC pipes. Skill is needed in machining the components of the plunger and footvalve, and in manipulating the pipe to make the footvalve housing. The below-ground assembly would be suitable for manufacture in developing countries with the necessary skills and with established pipe extrusion facilities.

4.3 Ease of Installation, Maintenance and Repair

4.3.1 Ease of Installation

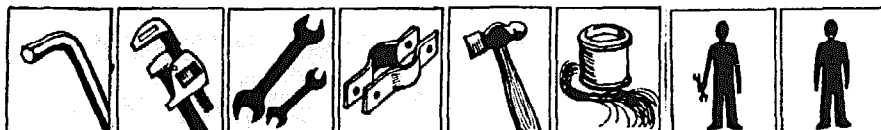

Lifting tackle is not required. Rising main and pump rod are supplied to length so that it should not be necessary to cut and thread the uppermost pump rod. All the tools and PTFE sealing tape were supplied by the manufacturer with the test samples.

4.3.2 Ease of Pumpstand Maintenance and Repair

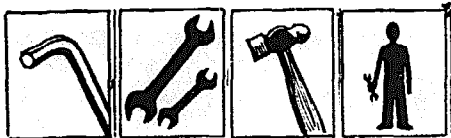

It is unlikely that the pumpstand will require frequent attention. The pumpstand may be suitable for village-level maintenance, but it will be essential that the tools supplied by the manufacturer are retained on-site.

4.3.3 Ease of Below-ground Maintenance and Repair

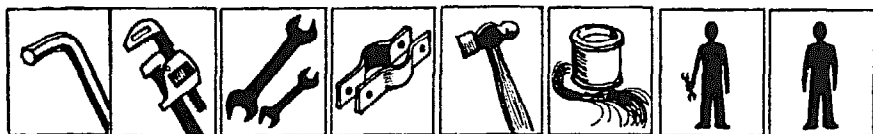

The lightness of the below-ground string will make it easy to extract without the need for lifting tackle, and it is not necessary to remove the pumpstand from the well-head. It may be suitable for village-level maintenance, but it will be essential that the tools supplied by the manufacturer are retained on-site.

4.4 Resistance to Contamination and Abuse

4.4.1 Resistance to Contamination

The pumpstand is adequately sealed against contamination, provided that the well casing is not cut flush at the well-head.

4.4.2 Likely Resistance to Abuse

The pumpstand might be damaged by impacts or heavy-handed usage. In the long term the handle and its mounting bracket may also be susceptible to fatigue.

4.5 Potential Safety Hazards

There are no safety hazards to operators of the pump. There are potential finger traps where the handle enters the body of the pumpstand, but these are in clear view of the pump operator and therefore unlikely to be dangerous.

4.6 Suggested Design Improvements

The plunger seals were marked as being designed for 62 mm diameter bore, but the cylinder bores averaged over 63 mm. The seals were not a good fit in the cylinders although the pump worked. It was suggested that either the internal diameter of the pipe should be reduced to 62 mm, or a larger seal should be used. The cylinder pipe is extruded by Preussag themselves, and we understand that current cylinders are made to 62 mm bore.

The brace inside the pumpstand body appeared to be designed to accept a support for the delivery cup; this was also shown as part no.10 on drawing 03-3390-2, but none was supplied. Additional support is neither necessary nor desirable and the holes in the brace should therefore be eliminated. This suggestion has been adopted by the manufacturer.

The pipe clamp slotted into recesses in the pumpstand body, retained by very small socket setscrews. These were difficult to remove and might easily be dropped down the well, and they should therefore be eliminated. We understand that the clamp is now welded into the pumpstand body.

The handle bracket should be enlarged so that the points of attachment are in the stiffest regions of the pumpstand body: see sketch, right.

It may be necessary to chamfer the edge of the bracket as shown below:

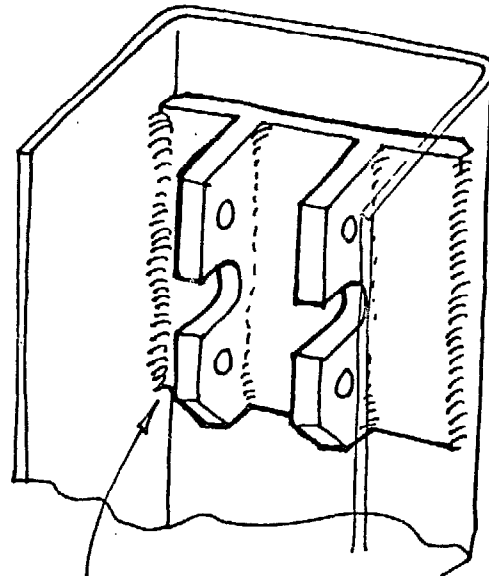
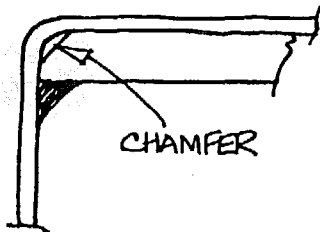

EXTEND BRACKET
WELD INTO CORNER OF
PUMPSTAND BODY

The handle shock load test results have shown the importance of adequate strength here. The handle might be modified as shown, right, to enable the condition of the weld to be monitored more readily and be stronger than the existing design. The manufacturer has recently improved the welding and added a securing bolt. The pivot pin need not be headed.

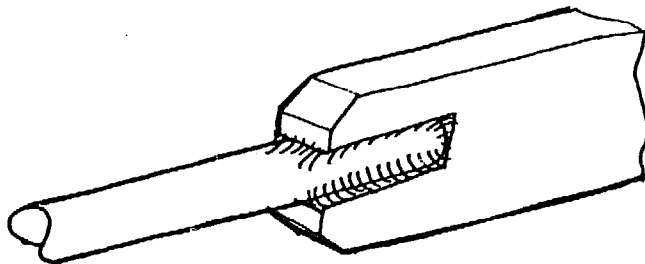

The manufacturer has introduced a number of other modifications:

A new jointing system for the rising main, using threaded collars as before, but with rubber washers to seal the ends of the pipes: the SBF KATUR-SYSTEM. A sample was supplied, and adequately sealed, hand-tight joints were easily achieved without tools. The manufacturer has also found these joints to be better in resisting long-term fatigue.

The delivery cup inside the pumpstand has been modified to allow easy adjustment between the lengths of the rising main and pump rod during installation. A deeper cup might also be beneficial to avoid any possibilities of water overflowing inside the pump body when the pump is operated energetically.

The baseplate has been increased from 5 mm to 10 mm thickness.

5. PUMP PERFORMANCE

5.1 Volume Flow, Work Input and Efficiency

A description of the test method may be found in the Test Procedure.

HEAD	7 metres			25 metres			40 metres		
Pumping Rate (strokes per min)	30	39	50	30	40	50	30	39	48
Vol/stroke (litres)	0.37	0.37	0.37	0.38	0.36	0.36	0.37	0.36	0.35
Work input/stroke (J)	68	76	82	116	110	113	182	186	184
Efficiency (per cent)	36	33	31	79	80	78	79	76	74

NB. The maximum depth recommended in the Manufacturer's specification is 40 m.

5.2 Leakage Test

No leakage was observed for heads of 25 or 40 metres. At 7 metres head, the footvalve leaked at a rate of 0.4 ml per minute.

6. USER TRIAL

Details of the organisation of this trial may be found in the Test Procedure.

Most users liked the smooth action of the pump, and smaller users in particular liked the moderate operating effort. Some users thought the rate of delivery was rather slow, however.

The handle height and movement appeared to be a good compromise between the requirements of short and tall users.

7. ENDURANCE

A detailed description of the endurance test method may be found in the Test Procedure. The pump was tested at 40 strokes per minute at 30 metres simulated head at the request of the manufacturer.

General Comments

The pump completed the 4000 hour endurance test with no failures. However, when the cylinder was dismantled for inspection at the end of the first 1000 hour stage, the cylinder and plunger seal were found to have been badly damaged. Further investigation showed that the anti-corrosion plating inside the Laboratory's head simulation valve had failed, and that corrosion debris had fallen into the cylinder. A new head simulation valve was fitted, and the cylinder and plunger seal were replaced. Such a problem would occur in the field only if similar debris were introduced through the pumpstand, and the design of the pumpstand makes this unlikely as long as the cover plate is always replaced after maintenance or repair.

The pump was generally in good condition at the end of the test, with no components apparently nearing the end of their working lives. Volume flow was consistent throughout, and the pump continued to perform well at the end of the test.

Breakdown Incidence

Breakdowns are shown in bold type

Hours:	1042	2096	3169	4213
Inspection and full performance test	Inspection and volume flow check Cylinder and plunger seal badly damaged by loose debris	Inspection and volume flow check	Inspection and volume flow check	Inspection and full performance test

Details of the Endurance Test

Breakdowns are shown in bold type

HOURS

1042 **INSPECTION** after 1st 1000 hours:

Cylinder bore and plunger seal badly damaged by debris caused by corrosion inside the Laboratory's head simulation valve. The cylinder and plunger seal were replaced.

Estimated amount of water pumped to "breakdown"... 0.9 million litres

2096 **INSPECTION** after 2nd 1000 hours:

- (a) Cylinder: signs of wear on centre holes of valve blocks on both plunger and footvalve, but both valves still serviceable.
- (b) Filter: partially blocked but easily cleared
- (c) Pumpstand: slight free play in joint at handle to pump rod connection
- (d) Corrosion: none

3169 **INSPECTION** after 3rd 1000 hours:

- (a) Cylinder: slightly more wear in valve blocks than at 2096 hours, but still serviceable.
- (b) Pumpstand: slightly more play than at 2096 hours in joint at handle to pump rod connection, but still serviceable.
- (c) Corrosion: none

HOURS

4213 FINAL INSPECTION

- (a) Cylinder: sand embedded in plunger seal; seal and cylinder wall scratched. Slight step in cylinder bore at top and bottom of plunger stroke. Centre holes of valve blocks in plunger and footvalve worn, but both still serviceable.
- (b) Filter: partially blocked but easily cleared.
- (c) Pumpstand: slightly more play than at earlier inspections in joint between handle and pump rod, but still serviceable.
- (d) Corrosion: none

Estimated total amount of water pumped in 4000 hours... 3.6 million litres

Strokes/minute	Volume flow tests at 30 m (litres)			Leakage tests at 7 m (ml/min)
	30	40	50	
New [1]	0.38	0.36	0.36	n/s
After 1000 hours	0.35	0.35	0.35	n/s
After 2000 hours	0.37	0.36	0.35	n/s
After 3000 hours	0.37	0.36	0.36	n/s
After 4000 hours [1]	0.40	0.39	0.39	n/s

[1] Volume flow results at 25 metres depth
 n/s = not significant: less than 0.1 ml per minute

Pump Performance after Endurance

HEAD	7 metres			25 metres			40 metres		
Pumping Rate (strokes per min)	29	38	47	29	38	46	30	38	47
Vol/stroke (litres)	0.40	0.39	0.39	0.40	0.39	0.39	0.39	0.39	0.39
Work input/stroke (J)	54	60	71	117	126	139	184	203	216
Efficiency (per cent)	49	43	37	82	75	68	82	75	69

These results cannot be compared directly with the original performance data, because the cylinder and plunger seal were replaced at the end of the first 1000 hour stage. However, the results show that the pump achieved consistent high levels of performance at the end of the endurance test.

8. ABUSE TESTS

8.1 Side Impact Tests

In the side impact test on the body of the pumpstand, the base distorted slightly at an impact of 200 Joules. At 300 Joules, the distortion was sufficient to affect the alignment of the rising main and the test was terminated. The manufacturer has subsequently increased the thickness of the base from 5 mm to 10 mm. In the test on the handle, the round bar portion of the handle bent at the inner end at an impact of 150 Joules. The handle was still serviceable, however, and there was no apparent damage to the handle bearings.

8.2 Handle Shock Test

The handle failed after 54,000 cycles at the welded joint between the round and rectangular sections.

9. VERDICT

A reliable handpump in which a conventional, plunger action has been realised using modern materials. The pumpstand and handle have recently been strengthened by the manufacturer. Easy to maintain and repair, and suitable for manufacture in some developing countries. Suitable for community water supply from depths down to 30 metres.

PUMP PERFORMANCE

CODE VA : KARDIA PUMP

Water Head 25 Metres --- Pumping Rate 40 Strokes/Minute
Total Weight of Water Raised 3.6kg
10 Strokes/Revolutions
Total Work Done On Pump 1107 Joules. (Rate 73.7 Watts)

Average Volume of Water .36 Litres per Stroke
Average Work Done on Pump 110 Joules per Stroke
Efficiency 80%

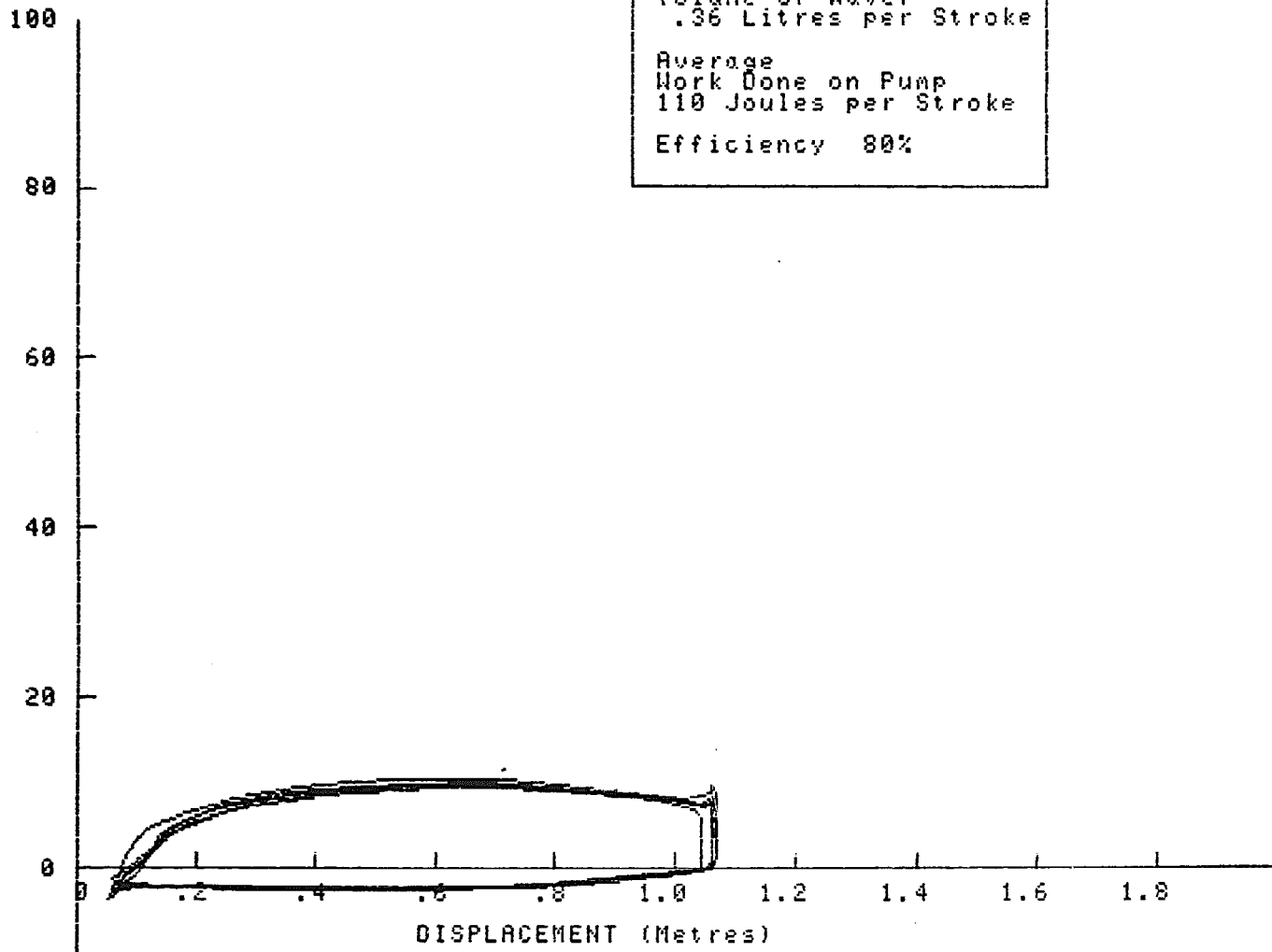

Water Temperature 12 deg C

PUMP PERFORMANCE

CODE VA : KARDIA PUMP

Water Head 40 Metres --- Pumping Rate 39 Strokes/Minute
Total Weight of Water Raised 3.6kG
10 Strokes/Revolutions
Total Work Done On Pump 1869 Joules. (Rate 122.4 Watts)

Average Volume of Water .36 Litres per Stroke
Average Work Done on Pump 186 Joules per Stroke
Efficiency 76%

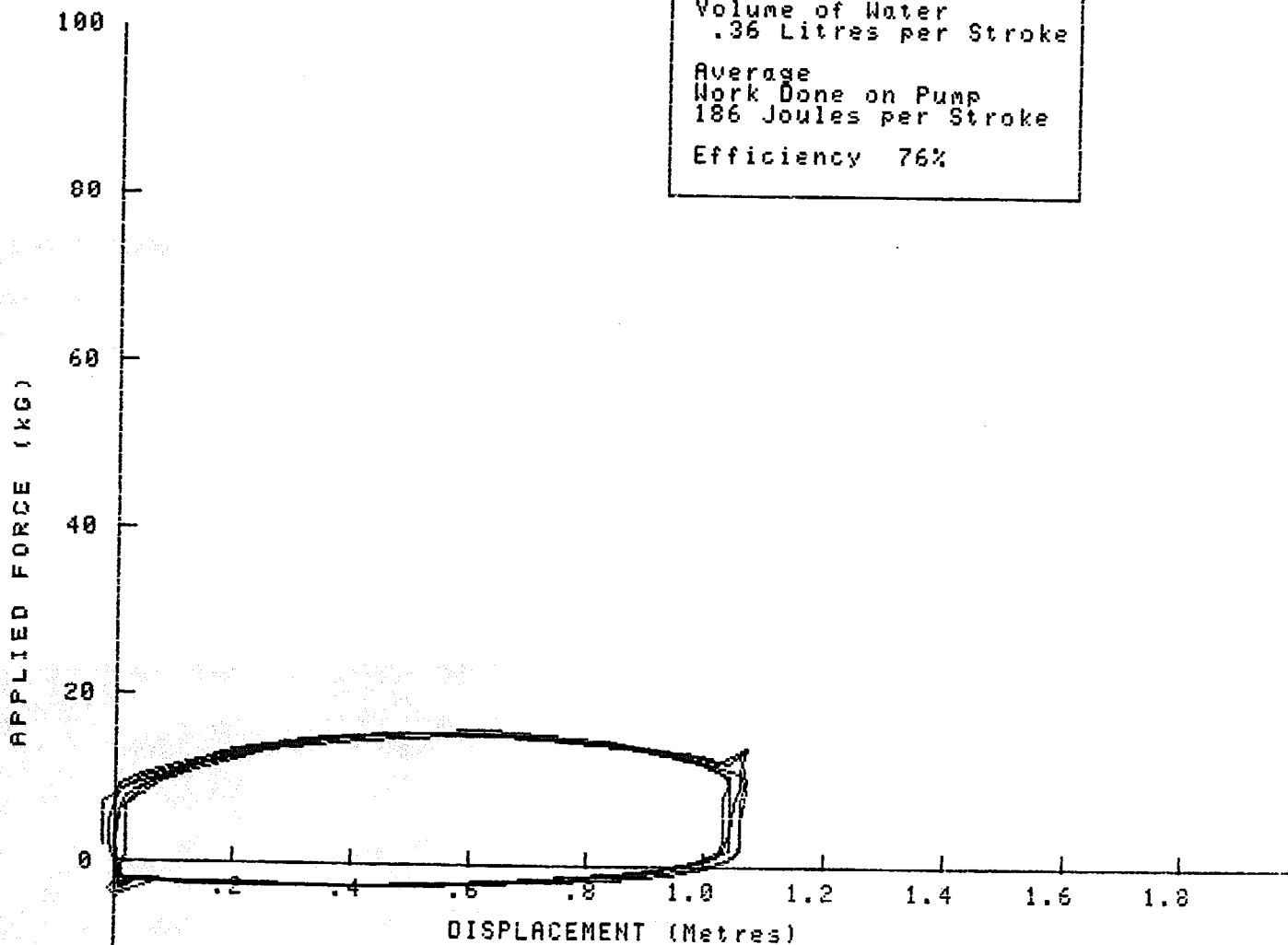

-40 Water Temperature 12 deg C

Turni Pump

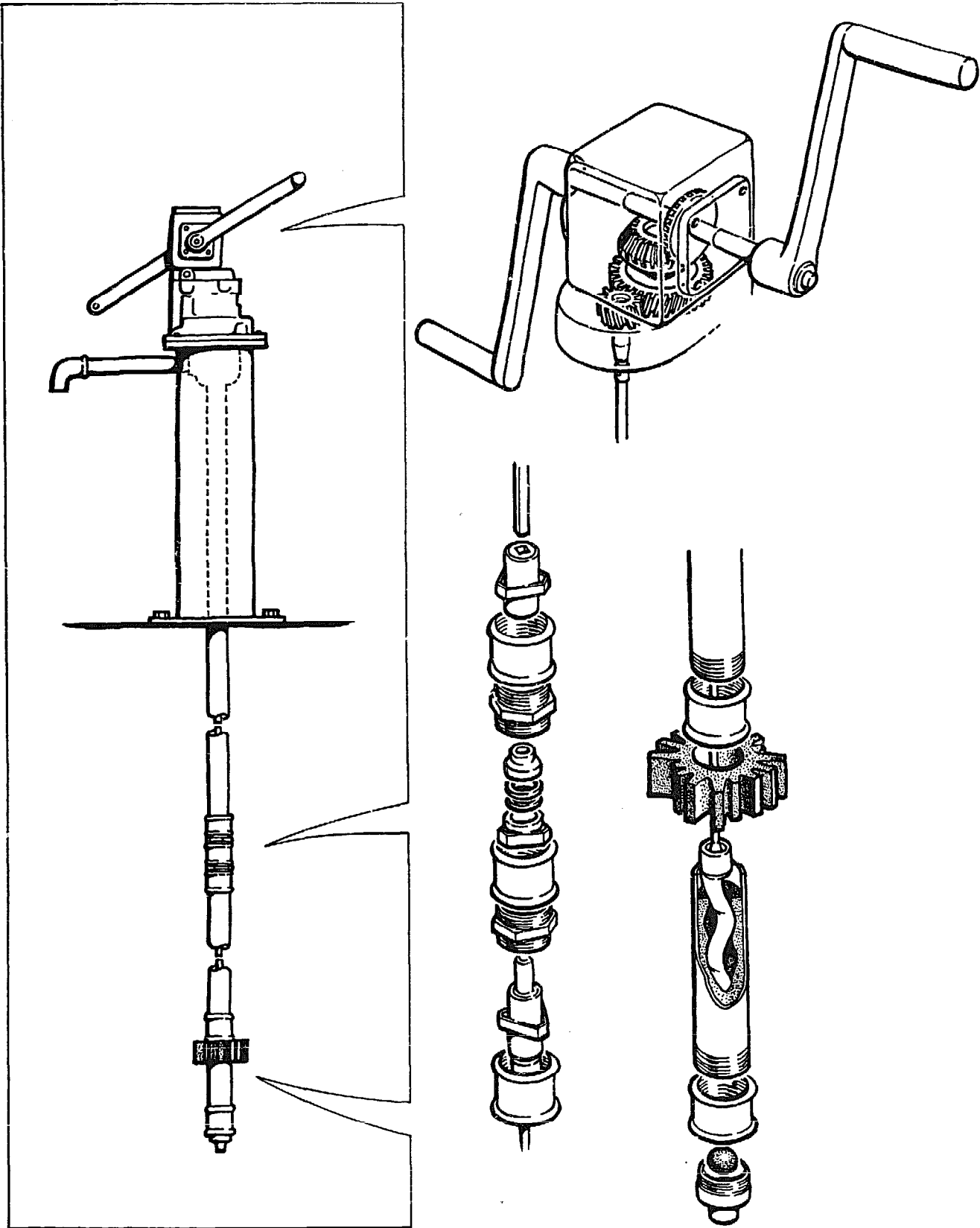

TURNI HANDPUMP

1.1 Manufacturer

Preussag AG

Address

Moorbeerenweg 1
Postfach 6009
D-3150 Peine
West Germany

1.2 Description

The Turni is a positive displacement force pump, with a helical, stainless steel rotor within a double-helical, elastomeric stator. Two versions were supplied, with pumping elements of different lengths and pumpstand gearbox ratios of 8.25 and 5.5 : 1 respectively.

The pumpstand consists of a self-contained gearbox supported by a galvanised, fabricated steel column. The gearbox housings are cast iron, and contain a train of four gears: two bevels forming a right-angle drive and two spur gears providing the output:input ratio. The gears are machined from steel and supported by proprietary ball races. Grease is used to lubricate the gear train.

The pumping elements are smaller than other handpumps using the same operating principle. The pumping elements for the 8.25 and 5.5 ratio versions are similar in diameter and pitch, but the 8.25 ratio version is considerably shorter.

The pump rods are square, and drive is transmitted through intermediate bearing assemblies at each rising main connection. These have square sockets to accept the ends of the pump rods, and each bearing supports the weight of the pump rod immediately above it. Therefore, the combined weight of the pump rods does not bear on the rotor, and the axial thrust generated by the helical pumping element is not transmitted through the pump rods.

The footvalve has a seat machined from a standard reducing nipple and uses a rubber ball as the valve.

1.3 Price

Approximately US \$1100 including packing, complete for 20 m depth, lots of 50.

2. INSPECTION

2.1 Packaging

All the parts were packed in wooden cases lined with wax paper and containing packs of silica gel. The pump cylinders were bolted into the cases, and small parts were secured by battens.

The pipes were delivered in two cases: one was packed with polystyrene chips, and the exposed pipe ends were covered with plastic caps; in the other case the pipes were secured by plastic foam. The packaging was considered suitable for all transportation conditions, but the cases were heavy and difficult to man-handle.

2.2 Condition as Received

On one of the 8.25 ratio samples, the pumpstand baseplate was buckled.

On one of the 5.5 ratio samples, lubricant was leaking from plugs on the gearbox cover plate.

When later dismantled for engineering assessment, one gearbox was found to have been incorrectly assembled, so that a bearing shim was damaged. Part of the shim was loose in the gearbox.

2.3 Installation and Maintenance Information

An installation manual was supplied with the test samples. The text was in German, but the various stages of installation were amply illustrated by many photographs. The manual is also available in English and a French translation is being prepared.

3. WEIGHTS and MEASURES

3.1 Weights

Pumpstand : 54.1 kg (including handles)
 Cylinder: 6.5 kg
 Rising Main (per m): 3.7 kg
 Pump Rod (per m): 0.9 kg

3.2 Dimensions

Rising main size: 1.5 inches
 Pump rod: 10 mm square
 Outside diameter of below-ground assembly: 60 mm

3.3 Cylinder Bores

Not applicable

3.4 Ergonomic Measurements

HANDLE HEIGHT		PLINTH HEIGHT (mm)	ANGULAR MOVEMENT of HANDLE (deg)	HANDLE LENGTH (mm)	VELOCITY RATIO of HANDLE	HEIGHT OF SPOUT (mm)
MAX. (mm)	MIN. (mm)					
1295	685	None	360	300	8.25 [1] or 5.5	590

[1] Ratio of gears in pumpstand gearbox

4. ENGINEERING ASSESSMENT

4.1 Materials of Construction

COMPONENT	MATERIAL(S)
Gearbox	Cast iron
Gear train	Steel
Handles	Forged steel
Spout	G.I. pipe
Pumpstand column	Steel
Rising main	G.I. pipe ^[1]
Pump rod	Square section steel bar
Rotor	Stainless steel
Stator	Elastomer

[1] SBF KATUR pipe system using modified PVC is also available.

4.2 Manufacturing Techniques

The techniques required to manufacture the pump are listed below:

Above-ground Assembly	Iron foundry Drop Forging Steel Fabrication Machining (milling, turning, slotting etc.) Gear cutting
--------------------------	--

The gearbox assembly demands complex, developed manufacturing skills supported by rigorous quality control. It would not be suitable for manufacture in a developing country.

Below-ground Assembly	Small-scale fabrication Specialised processes (pumping element)
--------------------------	--

The pumping element demands specialised manufacturing processes and rigorous quality control. It would not be suitable for manufacture in a developing country.

4.3 Ease of Installation, Maintenance and Repair

4.3.1 Ease of Installation

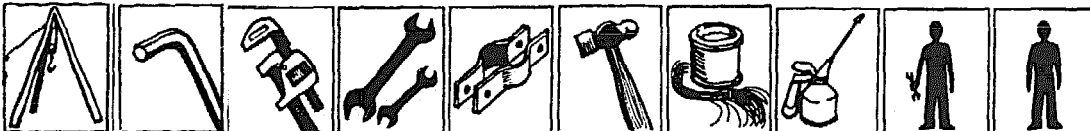

Lifting tackle is required, but the manufacturer offers a modified pumpstand column with a winch and a 4.5 metre upright, with a pulley at the top, to take the place of a tripod or sheerlegs. All the tools, sealing compound and lubricant were provided by the manufacturer with the test samples. The tools were of consistent high quality.

4.3.2 Ease of Pumpstand Maintenance

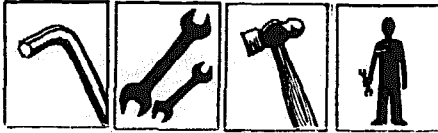

The gearbox should not require frequent attention. However, in the event of failure, manufacturer's spare parts are likely to be required, and considerable skill is required to re-assemble the gearbox. A replacement rather than maintenance routine would be more appropriate.

4.3.3 Ease of Below-ground Maintenance and Repair

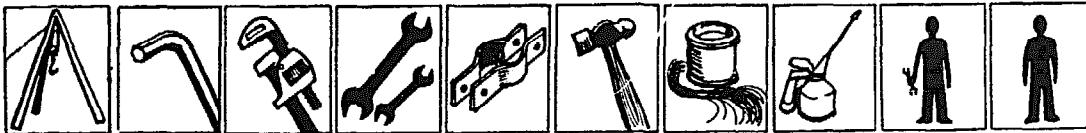

Extraction of the below-ground string requires removal of the gearbox from the pumpstand column, but there is no need to remove the column from the well-head. Lifting tackle will be required, but all the necessary tools would be available on-site if care is taken to retain the manufacturer's tool kit. However, any failure in the pumping element is likely to require manufacturer's spare parts, and it may be preferable to replace the entire pumping element as a unit.

4.4 Resistance to Contamination and Abuse

4.4.1 Resistance to Contamination

Good - the pump is adequately sealed against contamination by foreign matter or surface water.

4.4.2 Likely Resistance to Abuse

The pump is generally robust. There are many accessible fastenings on the pumpstand, but most are hexagonal socket screws and therefore unlikely to be susceptible to tampering or pilferage. Furthermore, these have been eliminated in the manufacturer's latest gearbox design.

4.5 Potential Safety Hazards

Components of the handgrips may become sharp as a result of wear. Otherwise, there are no potential safety hazards either to users of the pump or to bystanders.

4.6 Suggested Design Improvements

The elaborate ball joints above the pumping element might be replaced by simple slack joints. Alternatively, by using the inherent flexibility of the rod these joints might be eliminated.

At present, a 5mm diameter rollpin at 15mm diameter drives a 5mm solid pin at 16mm diameter, which drives an 8mm solid pin at 16mm diameter. These pins should be consistent throughout the driveline. The manufacturer has agreed to adopt this proposal.

In the endurance test, the pump tended to be difficult to re-start when the drive mechanism had been stopped for repairs to other pumps. The pumping element was removed and found to be clogged by sand. A suitable filter is now supplied by the manufacturer.

A drawing was supplied of a new gearbox housing. This was superior in many respects to the original, but:

- a) the bevel gear should abut a machined shoulder or a circlip and should not rely on the grub screw.
- b) the transfer gear pinion gear spigot appears to be rather small - the method of fitting is not clear from the drawing supplied.
- c) the opportunity has not been taken to reduce the separation of the handles and thereby make the pump easier to use by one person.

The manufacturer has incorporated these points in the latest design of the gearbox.

The manufacturer also now offers a modified pumpstand with integral lifting tackle -- see also 4.3.1 Ease of Installation.

5. PUMP PERFORMANCE

5.1 Volume Flow, Work Input and Efficiency

The test method is described in the test procedure. Both the 8.25 and 5.5 : 1 ratio pumps were tested.

5.1.1 Results for 8.25 ratio Pump

HEAD	7 metres			25 metres			45 metres		
Pumping Rate (revs per min)	30	40	48	30	39	48	33	41	51
Vol/rev (litres)	0.25	0.25	0.25	0.24	0.24	0.24	0.23	0.21	0.21
Work input/rev (J)	136	142	141	168	173	177	292	251	236
Efficiency (per cent)	12	11	12	34	33	35	34	37	39

A check test on the 8.25 ratio pump confirmed that volume flow was not affected by increasing the water temperature from 13.5 to 20°C.

5.1.2 Results for 5.5 ratio Pump

HEAD	7 metres			25 metres			45 metres		
Pumping Rate (revs per min)	29	39	51	27	39	50	30	39	50
Vol/rev (litres)	0.16	0.16	0.16	0.16	0.16	0.15	0.14	0.14	0.14
Work input/rev (J)	109	99	93	133	119	126	142	148	125
Efficiency (per cent)	10	11	12	28	32	29	42	42	49

5.2 Leakage Test

Both versions of the pump were tested. The measured leakage from the footvalve was not significant for either version, i.e. less than 0.1 ml per minute, at heads of 7, 25 and 45 metres.

6. USER TRIAL

Details of the organisation of this trial may be found in the Test Procedure. By agreement with the manufacturer, the 5.5 ratio version was installed for the user trial. Users criticised the low rate of delivery, but felt the effort required was less than for other pumps using the same operating principle. The wide separation of the handles made it awkward for all users, and impossible for small children, to use both handles simultaneously. Most users preferred to use one hand on each handle, though the long hand grips made it possible to use both hands on one side. Small children found it difficult to sustain the necessary operating force throughout each revolution.

The manufacturer has confirmed that it had not been envisaged in the design that a single user might work the pump by placing one hand on each handle. The handles are closer together in the latest gearbox design.

7. ENDURANCE

A detailed description of the endurance test method can be found in the Test Procedure.

General Comments

The 5.5 ratio version was installed for endurance testing. It was tested at 40 revs per minute at a simulated depth of 45 metres.

At the inspection after the first 1000 hours, the footvalve was found to leak badly due to uneven wear on the rubber ball. The valve was modified to decrease the included angle of the machined valve seat (to improve the seal against the rubber ball), and to improve the surface finish. This modification has been adopted by the manufacturer, and the material of the valve ball has been improved.

In the final stage of the endurance test, with sand added to the water in the ratio of 1 g per litre, the pump tended to be difficult to re-start when the drive mechanism had been stopped for repairs to other pumps. The pumping element was removed and found to be clogged by sand. Such problems did not occur in the previous stage, when the more finely divided Kieselguhr was added to the water. This suggests that a filter should be used to prevent sand or similar sized particles entering the footvalve.

The pump showed signs of wear at the end of the test, but remained in working order.

Breakdown Incidence

Breakdowns are shown in bold type.

Hours:	1042	2096	3169	4213
Inspection and full performance test	Inspection and volume flow check	Inspection and volume flow check	Inspection and volume flow check	Inspection and full performance test
	Footvalve Leaking Badly			

Details of the Endurance Test

HOURS

1042 INSPECTION after 1st 1000 hours:

- (a) Handle: slight free play in rotating sleeve
- (b) Gearbox: a good deal of grease had leaked out
- (c) Pumping element: rotor lightly marked, stator slightly scuffed
- (d) Footvalve: leaking at a rate of 9.5 ml/minute under a 7 metre head. The footvalve body had been made by machining a valve seat at an included angle of 90 degrees in a standard reducing nipple. The surface finish was poor. The footvalve seat was re-machined at an included angle of 80 degrees.

The rubber ball was shown to have worn unevenly.

Estimated amount of water pumped to breakdown... 0.4 million litres

2096 INSPECTION after 2nd 1000 hours:

- (a) Handle: no apparent increase in wear
- (b) Pumping element: rotor and stator slightly more marked than in inspection after 1042 hours
- (c) Footvalve: ball slightly marked by valve seat
- (d) No corrosion, but some scale on metal parts

HOURS

3169 INSPECTION after 3rd 1000 hours:

- (a) Handle: noticeable end float in rotating sleeve
- (b) Pumping element: signs of wear somewhat more pronounced than in previous inspections; some rubber deposited on rotor
- (c) Footvalve: seating marks on ball slightly more pronounced
- (d) Pump rod: worn on corners
- (e) Corrosion: small corrosion pits on pump rod

4213 FINAL INSPECTION

- (a) Handle: some free play in rotating sleeve but still serviceable
- (b) Pumping element: rotor worn, particularly at bottom end, with rubber deposited from stator; stator also worn.
- (c) Footvalve: more marked than at previous inspections but still serviceable
- (d) Pump rod: worn on corners and locally chipped
- (e) Corrosion: rust on pump rods where worn or damaged

Estimated total amount of water pumped in 4000 hours... 1.4 million litres

Revs/minute	<u>Volume flow tests at 45 m (litres)</u>			<u>Leakage tests at 7 m (ml/min)</u>
	30	40	50	
New	0.14	0.14	0.14	n/s
After 1000 hours	0.14	0.15	0.15	9.5 [1]
After 2000 hours	0.14	0.15	0.15	n/s
After 3000 hours	0.14	0.14	0.15	0.2
After 4000 hours	0.10	0.10	0.10	n/s

[1] The footvalve was modified in response to this result
n/s = not significant: less than 0.1 ml per minute

Pump Performance after Endurance

HEAD	7 metres			25 metres			45 metres		
Pumping Rate (revs per min)	29	38	48	30	38	47	30	38	48
Vol/rev (litres)	0.17	0.16	0.16	0.12	0.12	0.13	0.10	0.10	0.10
Work input/rev (J)	56	59	52	97	88	92	106	115	116
Efficiency (per cent)	20	19	21	29	34	34	39	39	39

If compared with the original performance data, these results show a reduction in volume flow at 25 and 45 metres, after endurance, suggesting wear of the rotor/stator.

8. ABUSE TESTS

8.1 Side Impact Tests

The pumpstand was undamaged by side impacts up to 500 joules on the body, and impacts up to 200 joules on the handle against the non-return clutch. The clutch slipped at the moment of impact but appeared to be undamaged. This non-return clutch has been replaced by a roller clutch in the latest gearbox.

8.2 Handle Shock Test

Not applicable.

9. VERDICT

A generally robust and reliable pump, though care is needed to prevent leakage from the foot valve and to exclude sand or similar sized particles. It is awkward to operate, particularly for children, and with a low rate of delivery, especially in the 5.5 ratio version, and therefore may only be suitable for community water supply from depths of 50 metres or so. However, the manufacturer has incorporated several changes, including a new gearbox with closer handles and alternative gear ratios.

Because the pump is complex and requires sophisticated manufacturing resources, it is not suitable for manufacture in developing countries.

PUMP PERFORMANCE

CODE VB : TURNI PUMP (8.25)

Water Head 25 Metres --- Pumping Rate 39 Strokes/Minute
Total Weight of Water Raised 2.2kg
9 Strokes/Revolutions
Total Work Done On Pump 1558 Joules. (Rate 111.5 Watts)

Average Volume of Water .24 Litres per Stroke
Average Work Done on Pump 173 Joules per Stroke
Efficiency 33%

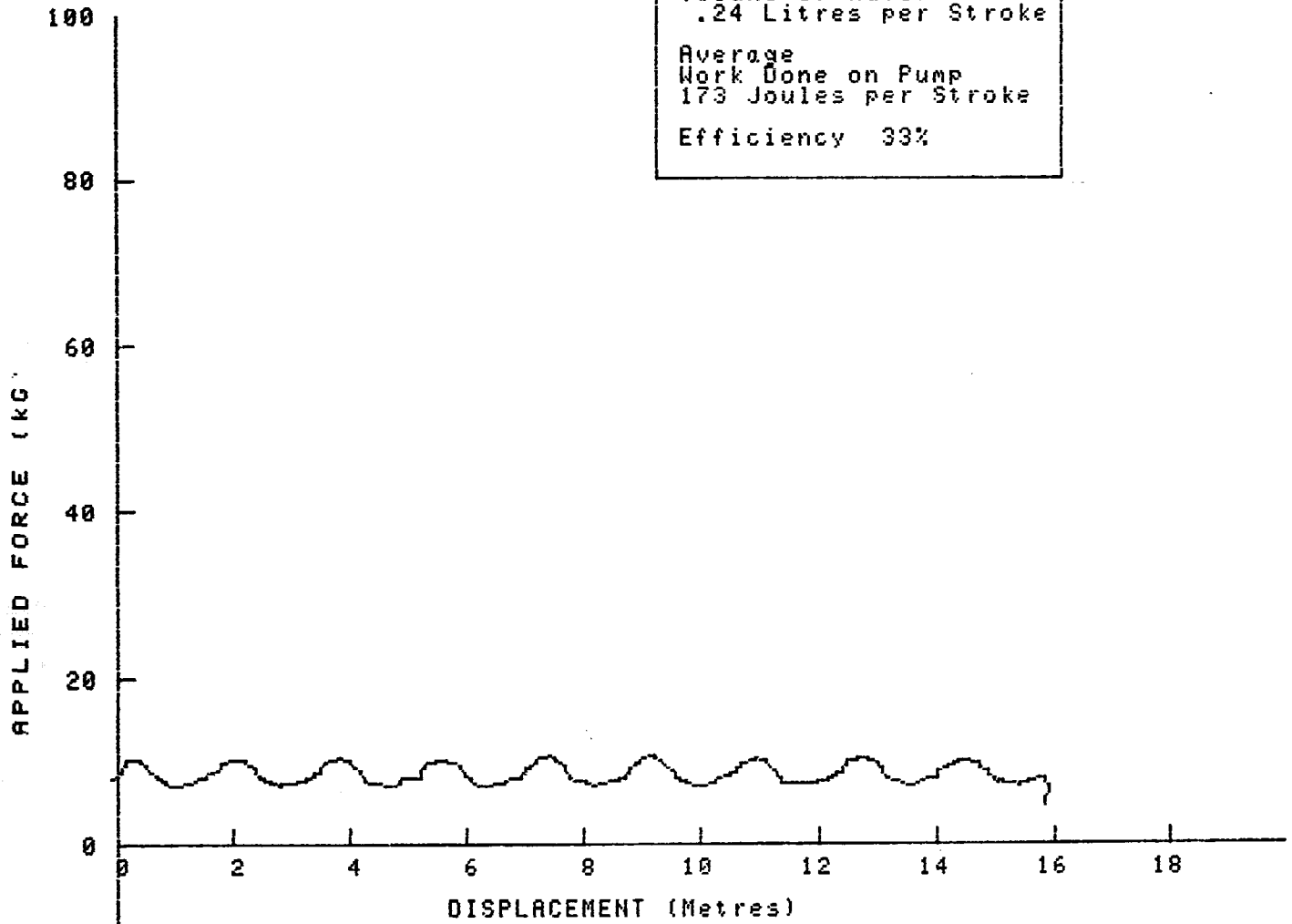

Water Temperature 13.5 deg C

PUMP PERFORMANCE

CODE VB : TURNI PUMP (8.25)

Water Head 45 Metres --- Pumping Rate 41 Strokes/Minute
Total Weight of Water Raised 1.9kG
9 Strokes/Revolutions
Total Work Done On Pump 2264 Joules. (Rate 173.5 Watts)

Average Volume of Water .21 Litres per Stroke
Average Work Done on Pump 251 Joules per Stroke
Efficiency .37%

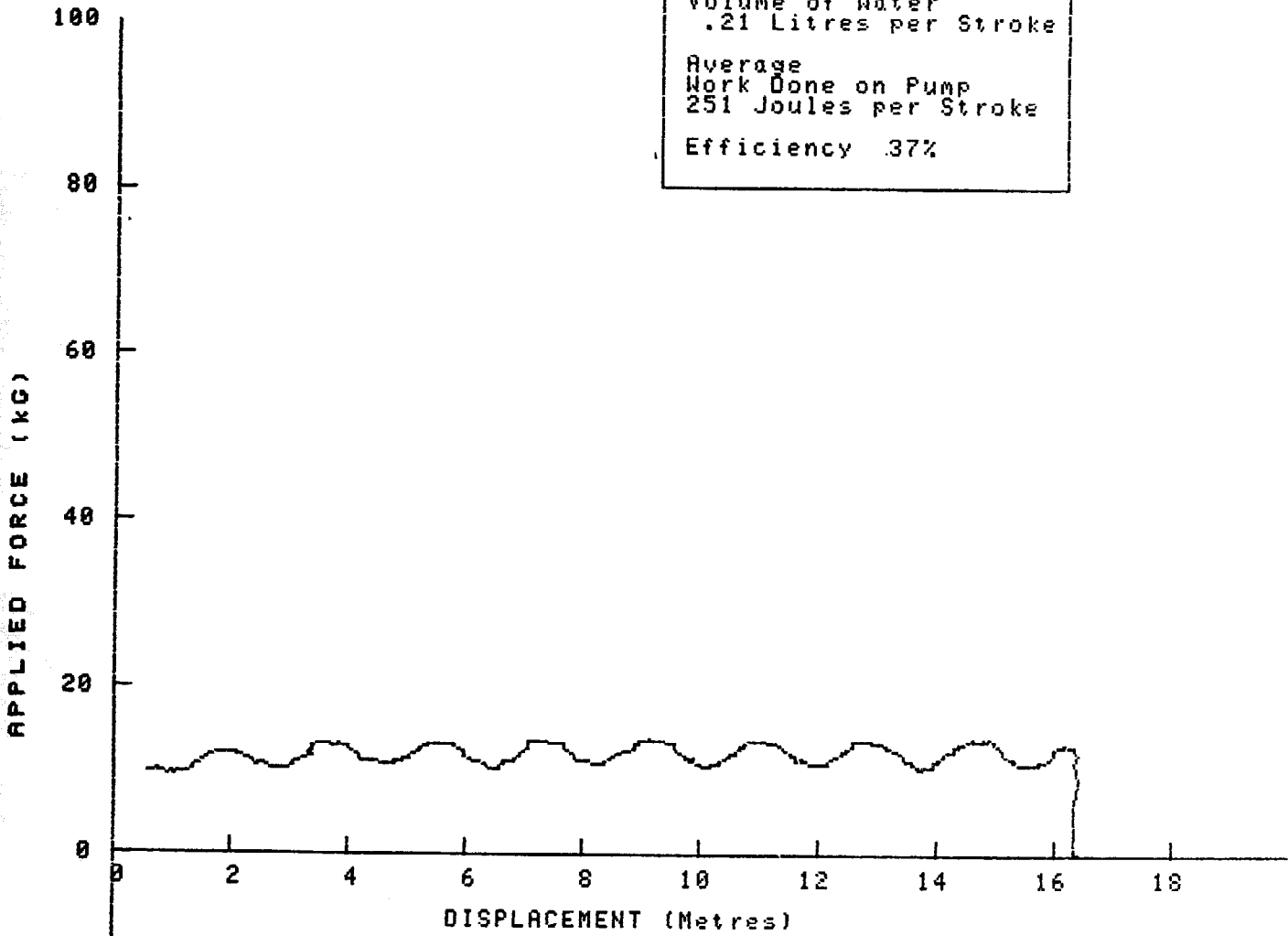

Water Temperature 19.5 deg C

Mono Direct Drive Pump

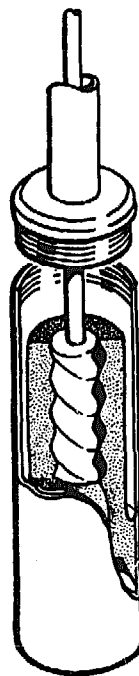
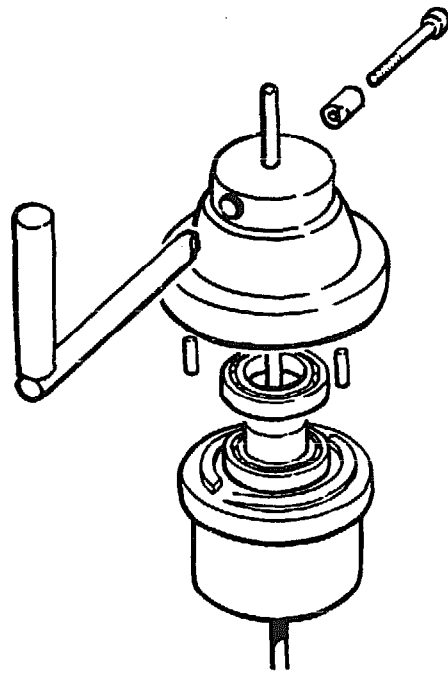
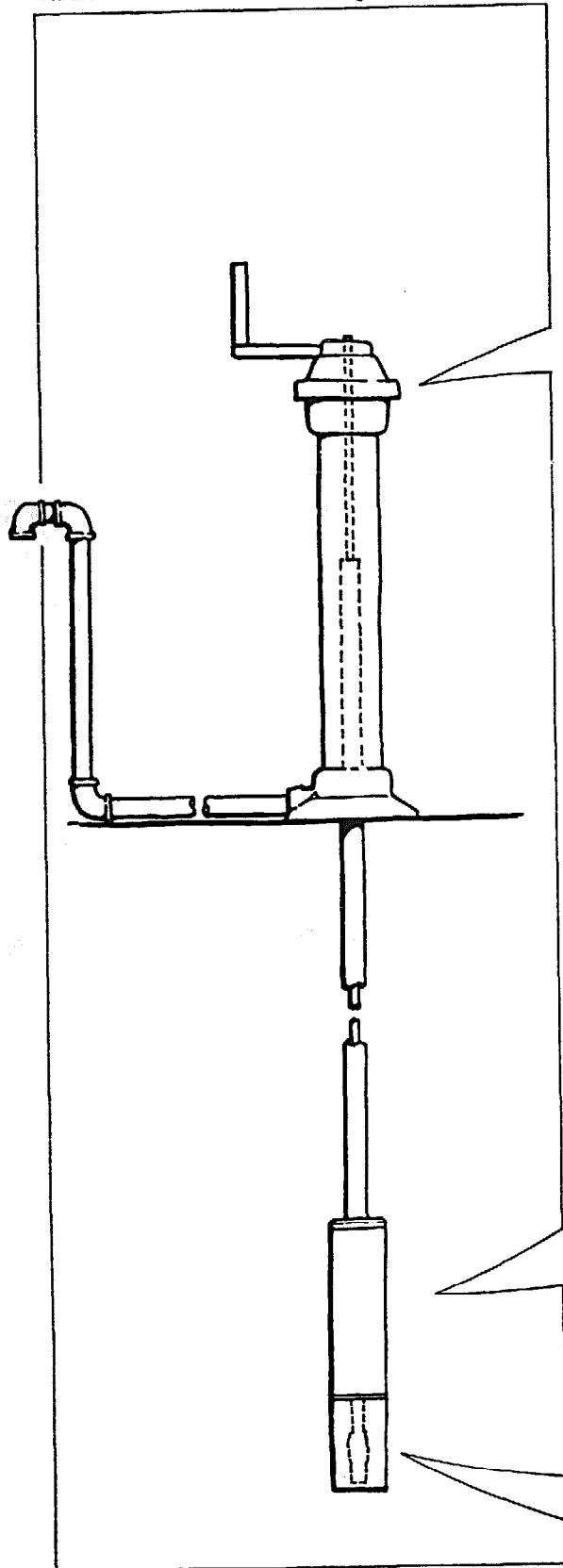

MONO DIRECT DRIVE TYPE 4

1.1 Manufacturer

Mono Pumps (Africa) Pty Ltd.

Address

13 Engwena Road
Sebenza
Edenvale 1610
Transvaal, South Africa

1.2 Description

The Type 4 handpump from Mono Pumps (Africa) is a deep-well force pump using the established Mono positive-displacement principle. A double-start helical steel rotor turns within a triple-start moulded elastomeric stator to provide the pumping action. Unlike other pumps using the same principle, however, no gears are used in the pumpstand: the handle is fixed directly to the top of the pump rod, giving direct drive.

The pumpstand top and base are of cast iron, with a column of steel tube between them. Two large sealed ball races support the rotating top cap. In the samples supplied, the outlet was at ground level, so that the water could be directed away from the pumpstand, as shown, while allowing the user to walk around the pump. The pump is also manufactured with a conventional spout on the side of the pumpstand body.

In the cylinder, the pressure of the head of water in the rising main is allowed to act on the outside of the elastomeric stator. The stator is thereby intended to be self-compensating for various installation depths.

1.3 Price

Approximately US \$600 (20 m depth)

2. INSPECTION

2.1 Packaging

Two heavy-duty cardboard boxes contained the pump parts, protected by polystyrene chips. A pack of silica gel was included in each box. The pipe lengths were packed in a wooden case.

The packing was considered suitable for all transportation conditions and arrived in good order after shipment from South Africa. However, the two cardboard boxes may deteriorate if they were stored in damp conditions.

2.2 Condition as Received

Both samples were received in working order. There was some surface rust on the rod sockets of the pumping elements.

2.3 Installation and Maintenance Information

Engineering drawings and a set of installation instructions were supplied with the test samples. The instructions were in English. They were comprehensive, generally straightforward, and supported by clear, simple illustrations.

3. WEIGHTS and MEASURES

3.1 Weights

Pumpstand:	39.5 kg (including handle)
Cylinder:	19.0 kg
Rising Main (per m):	2.5 kg (including socket)
Pump Rod (per m):	1.0 kg (including guide and socket)

3.2 Dimensions

Rising main size:	1 inch
Pump rod diameter:	12 mm
Outside diameter of below-ground assembly:	115 mm

3.3 Cylinder Bore

Not applicable

3.4 Ergonomic Measurements

HANDLE HEIGHT MAX ^[1] (mm)	HANDLE HEIGHT MIN ^[1] (mm)	PLATFORM HEIGHT (mm)	ANGULAR MOVEMENT OF HANDLE (degrees)	HANDLE LENGTH (mm)	VELOCITY RATIO OF HANDLE	HEIGHT OF SPOUT (mm)
1000	800	None	360	265	1:1	[2]

[1] Measured to the top and bottom of the hand-grip

[2] The spout is made up from standard GI pipe and fittings and can therefore be made to suit local conditions.

N.B The manufacturer has since reduced the overall height of the pumpstand by 200 mm and increased the length of the handgrip by 50 mm.

4. ENGINEERING ASSESSMENT

4.1 Materials of Construction

COMPONENT	MATERIAL(S)
Pumpstand	Cast iron base and cap, steel column and handle
Seals and bearings	Standard lip seal, standard sealed single row ball races
Stator	Elastomer
Rising main	GI pipe
Pump rods	Steel, with rolled threads
Rotor	Stainless steel
Footvalve	Cast gunmetal body, brass poppet, rubber washer

4.2 Manufacturing Techniques

The manufacturing techniques required to make the pump are listed below:

Above-ground	Iron foundry
Assembly	Machining - turning, milling, screwing etc.

The iron castings require well-developed foundry skills, and machining demands careful quality control to ensure the correct bearing fits for the rotating top cap. Specialised processes are not required, however, and the pumpstand might therefore be suitable for manufacture in some developing countries.

Below-ground	Gunmetal foundry
Assembly	Machining - turning, milling, screwing etc.
	Rubber moulding
	Specialised processes (pumping element)
	Fitting skills

The pumping element requires specialised manufacturing facilities and skills, both for the moulded rubber stator and the helical steel rotor. It would therefore not be suitable for manufacture in developing countries.

4.3 Ease of Installation, Maintenance and Repair

4.3.1 Ease of Installation

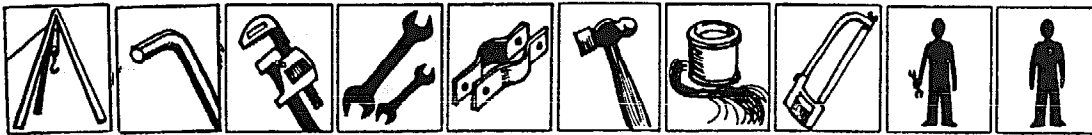

The manufacturer's instructions for installation list all the tools and equipment required for installation, including lifting tackle. The instructions are clear and comprehensive; installation should be straightforward provided the instructions are followed.

4.3.2 Ease of Pumpstand Maintenance and Repair

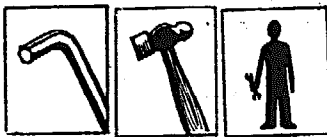

The ratchet mechanism in the rotating cap may be unreliable in the form supplied for testing. In other respects, the pumpstand should not require frequent attention. However, in time it will be necessary to replace the bearings for the rotating cap. This should be possible on-site, but care and some skill will be needed to avoid damage to the pumpstand. We understand that the manufacturer does not intend the pump to be suitable for village level maintenance.

4.3.3 Ease of Below-ground Maintenance and Repair

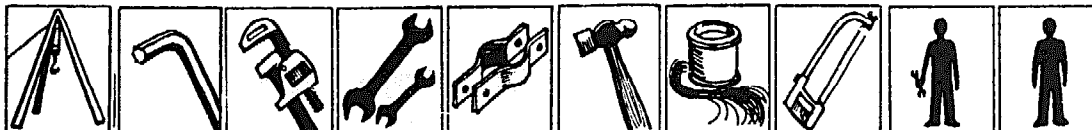

Lifting tackle will be required to extract the below-ground assembly. The pumping element is not intended to be dismantled on-site: all the threaded joints are sealed with epoxy resin during manufacture.

4.4 Resistance to Contamination and Abuse

4.4.1 Resistance to Contamination

Good - the pump is unlikely to be contaminated by either surface water or foreign matter.

4.4.2 Likely Resistance to Abuse

Good - the pumpstand is generally robust and is likely to resist accidental damage. The spout might be easily damaged, but it would also be easy to repair.

4.5 Potential Safety Hazards

Components of the rotating hand-grip may become sharp with wear.

4.6 Suggested Design Improvements

Footvalve:

- a) Remove the upper spigot, to simplify manufacture and assembly.
- b) Increase the length of the thread for attaching the sealing washer. Incorporate a shoulder or distance piece to control the compression of the washer. See sketch, right.

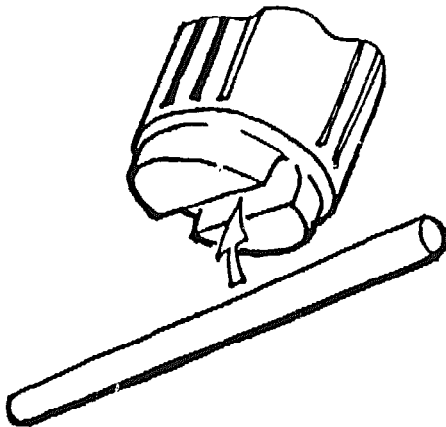
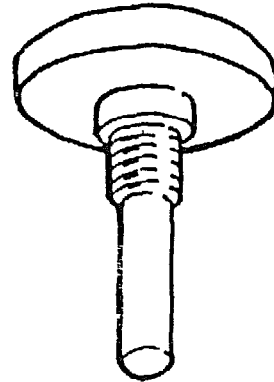

- c) The strainer/valve seat should incorporate some means of gripping for removal and replacement, e.g. spanner flats, or a slot in the base for a tommy bar. See sketch, left.

The machined steel nipple at the lower end of the pumping element could be replaced more cheaply by an iron or gunmetal casting, or could be replaced by a standard reducing nipple.

The pump top should be modified so that the non-return ratchet would come into operation only when the pump was turned backwards. It was necessary to remove the ratchet mechanism during the endurance test, because of rapid wear. The ratchet mechanism has since been redesigned by the manufacturer, and now incorporates steel balls.

In other pumps, plastic plain bearings have been shown to be viable alternatives to ball races for handle bearings, with substantial savings in cost and complexity of manufacture.

5. PUMP PERFORMANCE

5.1 Volume Flow, Work Input and Efficiency

The test method is described in the Test Procedure. In the ODA test in 1979/80, the performance of the Mono pump was found to be strongly influenced by water temperature. In agreement with the manufacturer, the performance of the direct drive pump was therefore tested in cool and warm water up to the maximum depth recommended of 40 metres.

5.1.1 Cool Water - 12 to 15°C

HEAD	7 metres					25 metres				40 metres			
Pumping Rate (revs per min)	30	45	69	102	125	29	50	70	99	31	49	68	95
Vol/rev (litres)	0.09	0.12	0.13	0.14	0.14	0.14	0.14	0.14	0.14	0.13	0.13	0.13	0.13
Work input/rev (J)	50	42	39	35	37	88	84	84	80	122	118	111	110
Efficiency (per cent)	12	19	22	27	25	38	41	40	43	40	43	46	46

5.1.2 Warm Water - 21°C

HEAD	7 metres				25 metres				40 metres			
Pumping Rate (revs per min)	30	51	72	99	32	51	70	96	33	49	69	97
Vol/rev (litres)	0.13	0.14	0.15	0.15	0.14	0.14	0.14	0.14	0.13	0.13	0.13	0.13
Work input/rev (J)	51	50	46	47	94	85	85	84	155	130	129	133
Efficiency (per cent)	16	18	22	21	36	40	40	40	31	37	38	37

There were few differences in pump performance with the two water temperatures. However, the volume delivered per revolution, at 7 metres head and low operating speeds, was greater at the higher temperature. At 40 metres head, the work input per revolution was greater at the higher temperature, yielding lower efficiencies.

5.2 Leakage Tests

No significant leakage from the foot valve was observed at heads of 7, 25 and 40 metres.

6. USER TRIAL

Details of the organisation of this trial may be found in the Test Procedure. Smaller users found the pump hard work at 20 metres, particularly because of the low rate of delivery. All users found the action awkward: it was difficult to sustain the required operating force throughout each revolution. Some users complained that the pump had an unpleasant feel, as though they were winding up a spring. When they released the handle, it sprang back sharply against the ratchet.

7. ENDURANCE

A detailed description of the endurance test method may be found in the Test Procedure.

General Comments

The pump was tested at 40 revolutions per minute and 40 metres head.

The pumpstand seized after 277 hours. The pins of the non-return ratchet had 'picked-up' on the ramps, causing the mechanism to seize. The unused ends of the pins were rounded and the ramps were re-furbished, but the pumpstand seized again after 3 hours. The pins were therefore removed, since the mechanical drive for endurance testing did not require a ratchet to prevent reverse rotation.

It was suggested to the manufacturer that the design might be improved by modifying the pump top so that the ratchet only came into operation when the pump was turned backwards. As supplied, the pins rose and fell repeatedly when the pump was turned in the forward direction. The manufacturer pointed out that this mechanism had been used successfully for many years with motor-driven pumps. It may be, however, that at the higher speeds of motor-driven pumps, the pins would be unlikely to fall onto the base of the ramps in the short time available, in contrast to their behaviour at hand-operated speeds. In response, the manufacturer has redesigned the ratchet mechanism.

Hardened pins were supplied by the manufacturer and fitted, but the pumpstand seized in 6 hours. The endurance test was therefore completed without the ratchet mechanism in operation.

Near the end of the second 1000 hour stage, the pumping element was worn out: no water was produced at 7 metres head for speeds less than 60 revs/minute, and at higher speeds the output was less than when new. The manufacturer suggested that the stator might have been chemically degraded as a result of hydrochloric acid being added to the water during the second stage to control the pH value.

A new pumping element was supplied, to complete the endurance test. At the end of the test the replacement element had completed 2000 hours. Considerable wear was apparent although during this period no hydrochloric acid was added. The pump produced no water when operated at 30 revs/minute.

Breakdown Incidence Failures are shown in bold type.

Hours:	1059	1669	1980	3026	4071
277	1182				
		Difficult to start Pump			
Non-return Ratchet Seized	Hardened Pins fitted to Ratchet but Failed in 6 hours		Pumping Element Worn Out		
Inspection and full performance	Inspection and volume flow check		Inspection and volume flow check: Pumping Element replaced	Inspection and volume flow check	Inspection and full performance test

Details of the Endurance Test

Failures are shown in bold type.

HOURS

277 Pump handle jammed: the pump top would not rotate, but it could be released by turning the handle a few degrees in the reverse direction. The ratchet pins had picked up on the ramps, causing the mechanism to seize.

The unused ends of the pins were rounded, the ramps were re-furbished and the pump was re-started. However, the pump jammed again after only 3 hours. The pins were therefore removed, since the mechanical drive for endurance testing did not require a ratchet to prevent reverse rotation. The manufacturer agreed to supply a set of hardened pins.

Estimated amount of water pumped to failure... less than 0.1 million litres

1059 INSPECTION after 1st 1000 hours:

- (a) Pumping element: not dismantled because all joints sealed with epoxy resin. A few spots of external rust.
- (b) Pumpstand: in good working order after removing ratchet pins.

1182 Hardened ratchet pins supplied by manufacturer and fitted to pump. Pump seized in 6 hours. Pins removed.

Estimated additional amount of water pumped to failure... 0.3 million litres

HOURS

1669 The pump was difficult to re-start after the test had stopped for repairs to another pump. The pumping element could not generate sufficient pressure to overcome the resistance of the head simulation valve. The pump was re-started by pressurising the pumping element with compressed air to improve the seal between the rotor and stator.

Estimated additional amount of water pumped to failure... 0.1 million litres

1980 Pumping element worn out. The pump could not be re-started after the machinery had been stopped for repairs to another pump.

In a volume flow check at 7 metres head, the pump produced no water at speeds less than 60 revs/min, and less than 0.1 litre per revolution even at 140 revs/minute.

The pumping element was inspected. The stator was worn, and there were local deposits of rubber on the rotor. The footvalve was damaged in the course of dismantling the pumping element. The pumpstand was in good working order, having removed the ratchet pins earlier. The pumping element was returned to the manufacturer for examination.

The manufacturer supplied a new pumping element and footvalve for the remainder of the endurance test. The manufacturer suggested that the pumping element had either run dry, which would not be possible as installed for testing, or the stator had been chemically degraded as a result of the hydrochloric acid added to the water to control the pH in the second 1000 hours (see Test Procedure).

Estimated additional amount of water pumped to failure... 0.1 million litres

3026 INSPECTION after 3rd 1000 hours:

- (a) Rotor: slightly scuffed and some rubber deposits at lower end
- (b) Stator: scuffed, and some scoring
- (c) Corrosion: spots of rust on cylinder end caps
- (d) Pumpstand: in good working order without ratchet pins

4071 FINAL INSPECTION:

- (a) Rotor: Some scratching and local deposition of rubber
- (b) Stator: scratched and locally polished
- (c) Filter: some sand had accumulated inside the filter
- (d) Corrosion: slightly more rust in cylinder end caps
- (e) Pumpstand: in good working order without ratchet pins

The replacement pumping element was worn after 2000 hours of endurance testing, and produced no water at an operating speed of 30 revs/minute (see below). The pumpstand remained serviceable after 4000 hours, but only after removing the ratchet pins in the early stages of the test.

Estimated total amount of water pumped in 4000 hours... 1.2 million litres

Revolutions/minute	Volume Flow Tests at 40m (litres)			Leakage Tests at 7m (ml/min)
	30	50	70	
Original unit:				
New	0.14	0.14	0.14	less than 0.1
After 1000 hours	0.12	0.12	0.13	less than 0.1
After 2000 hours	zero	zero	0.11	valve damaged
Replacement unit:				
New	0.11	0.12	0.12	less than 0.1
After 1000 hours (3rd phase)	0.10	0.12	0.12	less than 0.1
After 2000 hours (Final phase)	zero	0.11	0.12	less than 0.1

Pump Performance after Endurance

The performance test after endurance was carried out at one temperature only, 13.5°C, because in the test when new little difference was observed for different water temperatures.

HEAD	7 metres				25 metres				40 metres			
Rumping Rate (revs per min)	30	51	71	101	30	51	72	104	30	51	70	101
Vol/rev (litres)	zero	0.05	0.09	0.11	zero	0.12	0.13	0.13	zero	0.11	0.12	0.12
Work input/rev (J)	—	36	32	30	—	79	79	76	—	99	110	115
Efficiency (per cent)	—	10	18	25	—	36	39	43	—	43	42	40

These results should not be compared with the pump performance when new, because the two sets of data refer to different pumping elements. However, the volume flow check tests indicate reductions in the volume delivered per revolution at each 1000 hour interval.

8. ABUSE TESTS

8.1 Impact Tests

The pumpstand was undamaged by side impacts up to 500 joules. The handle was tested by impacts of up to 200 joules against the ratchet - the pump was undamaged. The pump absorbed the impacts by turning on the thread between the pump top and the pumpstand column.

8.2 Handle Shock Test

Not applicable.

9. VERDICT

This direct drive derivative of the Mono handpump is notably simpler than the parent design. The rate of delivery was low, however, and children found the pump difficult to handle. The endurance test indicated that it might be necessary to replace the pumping element regularly if the pump were used to supply a village community. However, failure is likely to be gradual rather than sudden, requiring the pump to be turned faster to achieve sufficient outflow.

The non-return ratchet in the pumpstand has been modified to reduce the rate of wear. The manufacturer has also reduced the height of the pumpstand by 200 mm and increased the length of the handgrip by 50 mm.

Not suitable for manufacture in developing countries, nor for village-level operation and maintenance. Considerable further development would be required to make the pump suitable for community water supply.

PUMP PERFORMANCE

CODE WA : MONO DIRECT DRIVE PUMP

Water Head 25 Metres --- Pumping Rate 51 Strokes/Minute
Total Weight of Water Raised 1.3kG
9 Strokes/Revolutions
Total Work Done On Pump 768 Joules. (Rate 72.2 Watts)

Average Volume of Water .14 Litres per Stroke
Average Work Done on Pump 85 Joules per Stroke
Efficiency 40%

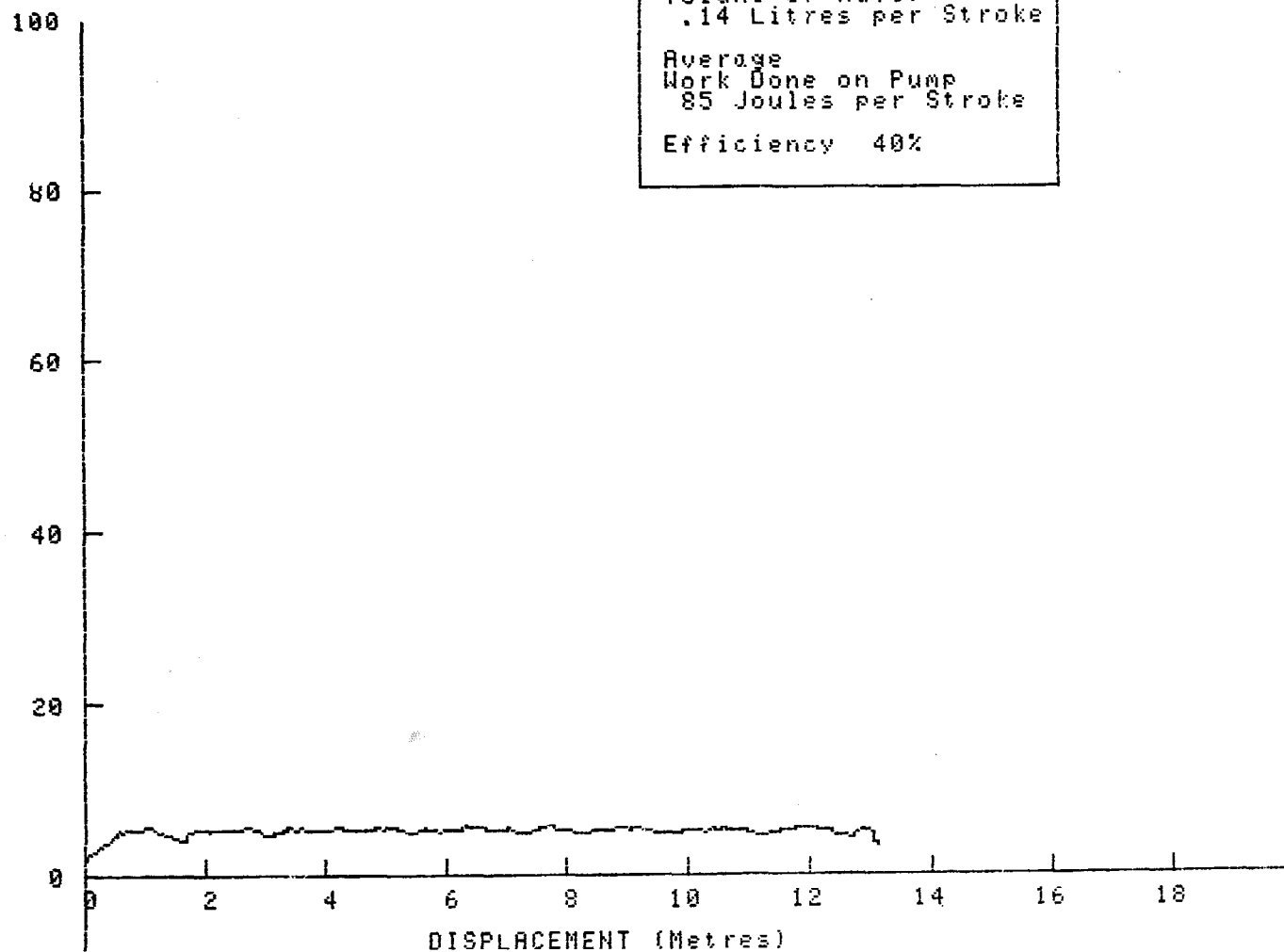

-40 Water Temperature 21 deg C

PUMP PERFORMANCE

CODE WA : MONO DIRECT DRIVE PUMP

Water Head 40 Metres --- Pumping Rate 49 Strokes/Minute
Total Weight of Water Raised 1.1kg
9 Strokes/Revolutions
Total Work Done On Pump 1174 Joules. (Rate 107.0 Watts)

Average Volume of Water .13 Litres per Stroke
Average Work Done on Pump 130 Joules per Stroke
Efficiency 37%

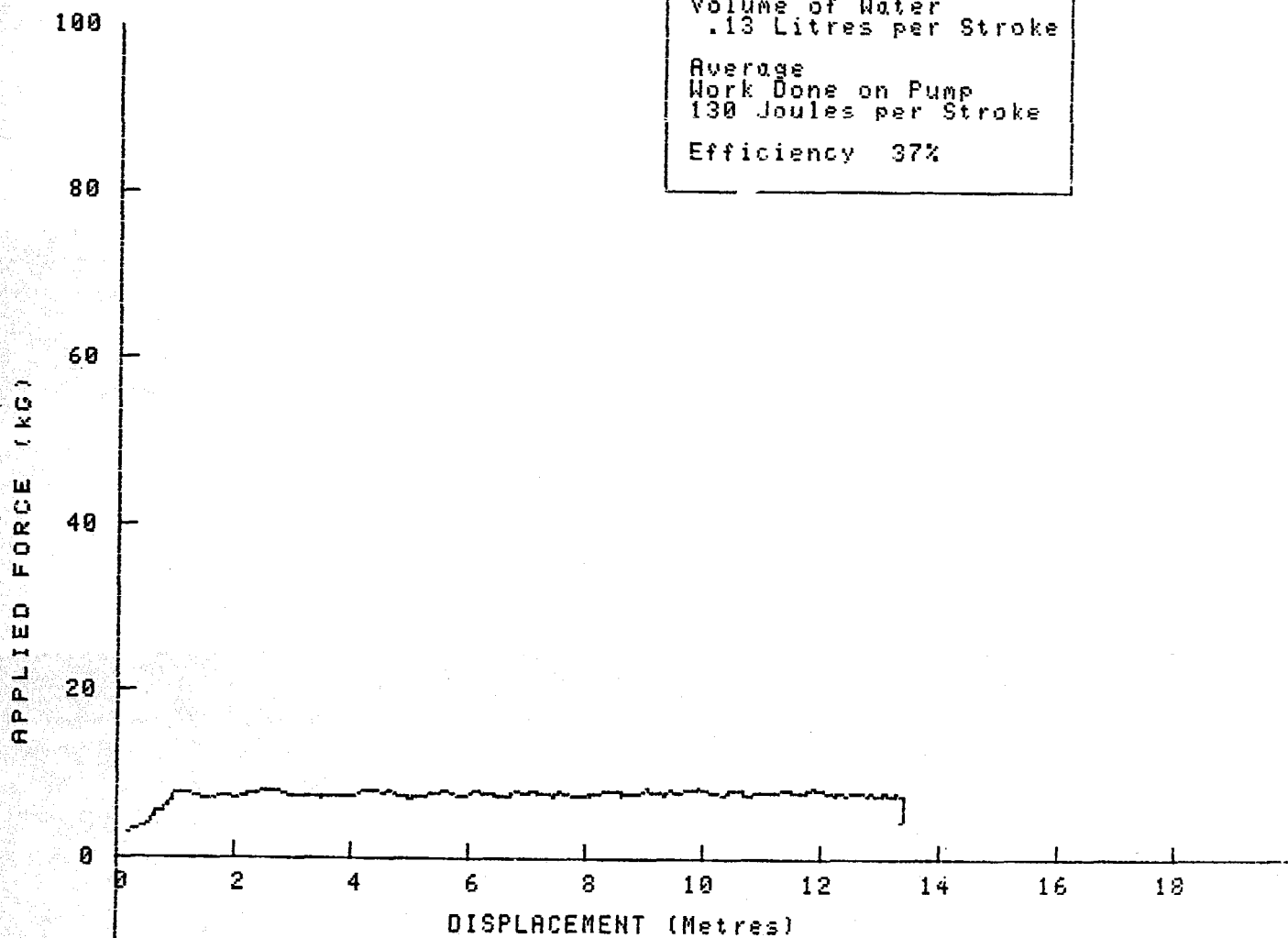

Water Temperature 21 deg C

Monolift Handpump

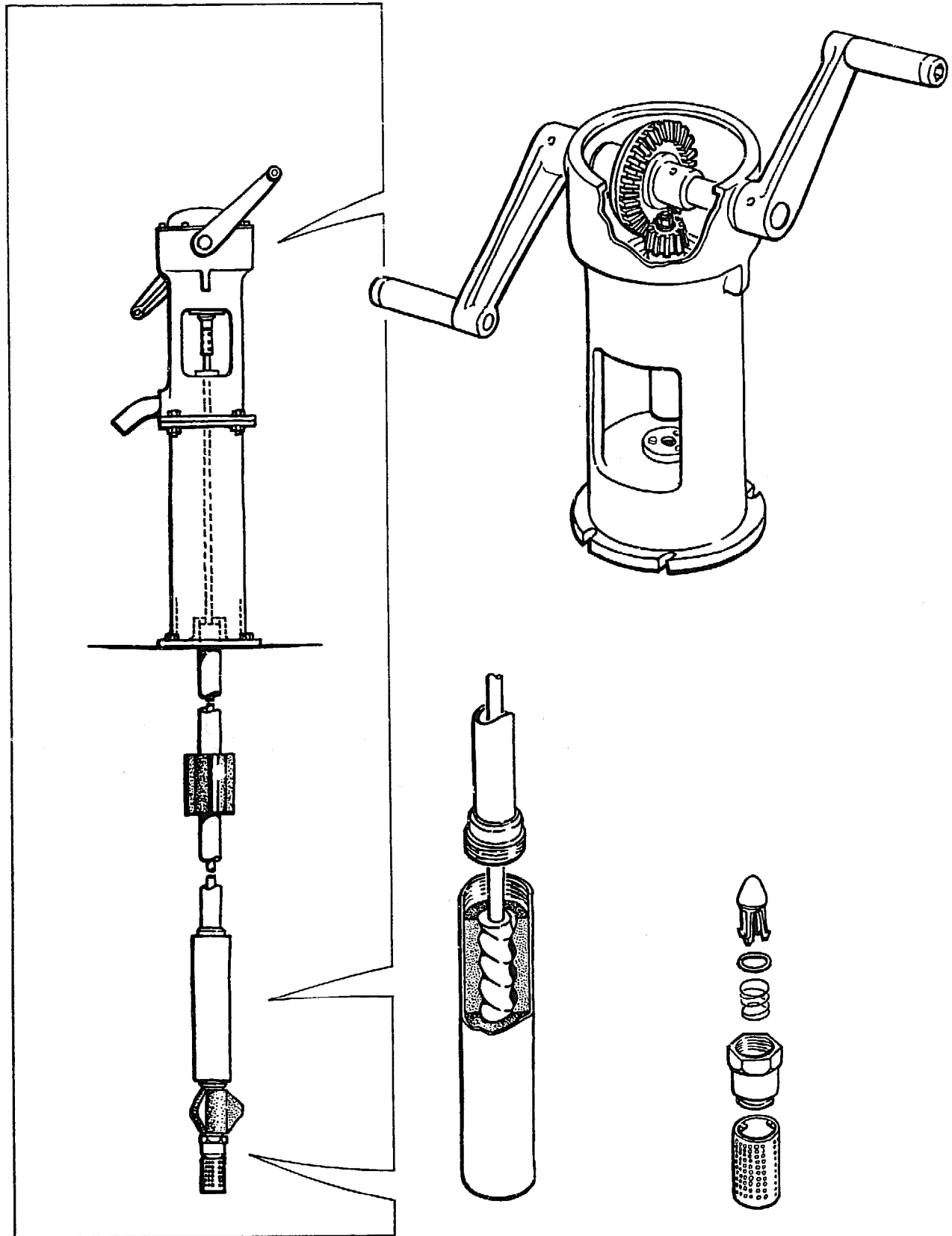

MONOLIFT HANDPUMP

1.1 Manufacturer

Mono Pumps Limited

Address

Arnfield Works
Martin Street
Audenshaw
Manchester M34 5JA
England

1.2 Description

The Monolift is a positive displacement handpump of the established Mono design, with a double helical steel rotor in a triple helical elastomeric stator. The pump is operated by a pair of rotary crank handles, driving through bevel gears. A ratchet mechanism ensures that the handles free-wheel when turned in the wrong direction. The gearbox and handle arms are cast iron. The handles have rotating steel handgrips. The pedestal is fabricated from steel tube and plate.

The samples supplied for testing represent a stage in a process of product development. In older Monolift pumps, the gears were steel and the gearbox contained a quantity of oil. In the test samples, the bevel gears had been machined from 'Nylatron', a thermoplastic, to remove the need for lubrication. Plastic plain bearings were used on the axle of the larger bevel gear, with proprietary ball races supporting the smaller, bevel gear.

The pumping elements were designed for use with water temperatures between 16 and 25°C. The original gunmetal and brass footvalve was replaced by a proprietary all-plastic footvalve, as shown, in the course of the endurance test: see section 5.2.

1.3 Price

Approximately US \$477 (cost per pump 50 off at 21 metres)

2. INSPECTION

2.1 Packaging

Components were packed in wooden cases lined with bitumastic paper. The pump heads and pedestals were in separate cases, all well packed. The pump rods, pumping elements and small parts were packed with relevant literature. 4 lengths of GI pipe were contained in an open-sided case.

The packaging was considered very suitable for all transportation conditions. The size and weight of the cases made them convenient for two men to handle. The G.I. pipes seemed over-protected.

2.2 Condition as Received

Pumpstand - the pinion bearings were loose in their housing in one sample. The threaded ends on three handle bolts were bent.

Pumping element - In one pumping element, the footvalve casting was porous and leaked under pressure, and the top joint also leaked. In the other pumping element, there were leaks from the top and bottom joints of the casing. The sealing faces of the footvalves were contaminated by paint.

2.3 Installation and Maintenance Information

Installation instructions, in English, and a set of engineering drawings, including isometric views, were supplied by the manufacturer. The instructions were generally clear and concise. Greater use of illustrations would make them more appropriate for use in developing countries.

3. WEIGHTS and MEASURES

3.1 Weights Pumpstand: 59.8 kg (including handle)
 Cylinder: 9.3 kg
 Rising Main (per m): 4.4 kg (including socket)
 Pump Rod (per m): 0.9 kg (including socket)

3.2 Dimensions Rising main size: 1.5 inch.
 Pump rod diameter: 12 mm
 Outside diameter of
 below-ground assembly: 87 mm

3.3 Cylinder Bores Not applicable

3.4 Ergonomic Measurements

HANDLE HEIGHT		PLINTH	ANGULAR	HANDLE	VELOCITY	HEIGHT
-----		HEIGHT	MOVEMENT	LENGTH	RATIO OF	OF
MAX	MIN		OF HANDLE		HANDLE	SPOUT
(mm)	(mm)	(mm)	(deg)	(mm)		(mm)
1270	772	[1]	360	250	3:1 [2]	585

[1] Supplied with steel pedestal - the pump does not require a plinth to be built up on the wellhead.

[2] Ratio of wheel to pinion in gearbox

4. ENGINEERING ASSESSMENT

4.1 Materials of Construction

COMPONENT	MATERIAL(S)
Pumpstand	Cast iron
Pedestal	Steel, fabricated
Seals and bearings	Standard lip seal and standard sealed ball races
Gears	'Nylatron'
Handles	Cast iron arms, steel handles
Spout	GI pipe
Rising main	GI pipe, high pressure quality
Pump rod	High-tensile steel, with stainless steel sections for rubber guides
Pumping element	Stainless steel rotor, elastomeric stator, mild steel casing
Footvalve	Originally gunmetal body with brass spindle and rubber washer - subsequently replaced by all-plastic proprietary valve with O-ring seal

4.2 Manufacturing Techniques

The techniques required to manufacture the pump are listed below:

Above-ground Assembly	Iron foundry Steel fabrication General machining Gear cutting
--------------------------	--

Good quality control is necessary to ensure accuracy in machining the castings. Mono intended that the cut gears would be replaced by plastic mouldings if the laboratory tests and concurrent field trials with prototype machined parts were successful. This would simplify the machining processes, but would add a requirement for plastic moulding. Well-developed iron foundry skills are required for the pumpstand castings. With moulded gears, the pumpstand might be manufactured in developing countries with appropriate foundry and machining skills.

Below-ground Assembly	Steel fabrication Thread rolling General machining Gunmetal foundry Specialised processes, for pumping element
--------------------------	--

Machining the double-helical steel rotor is a specialised process. The stator requires careful quality control over both the material and the moulding process. The pumping element would not be suitable for manufacture in a developing country.

4.3 Ease of Installation, Maintenance and Repair

4.3.1 Ease of Installation

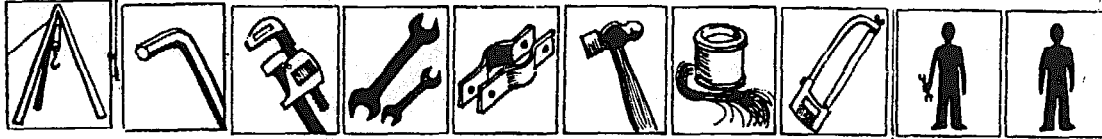

The manufacturer's instructions state that lifting tackle will be required for installations at 15 metres depth or more. The hexagon key and jointing compound were supplied with the test samples. The coupling at the pump head does not require the pump rod to be threaded.

4.3.2 Ease of Pumpstand Maintenance and Repair

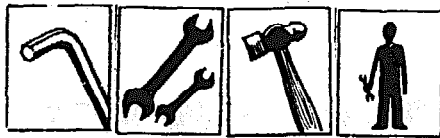

The gearboxes of the test samples were not oil-filled, eliminating this element of maintenance and a known cause of breakdowns in previous Mono handpumps when the oil was pilfered. Frequent attention to the pumpstand is unlikely to be required. Most repairs will demand manufacturer's spare parts.

4.3.3 Ease of Below-ground Maintenance and Repair

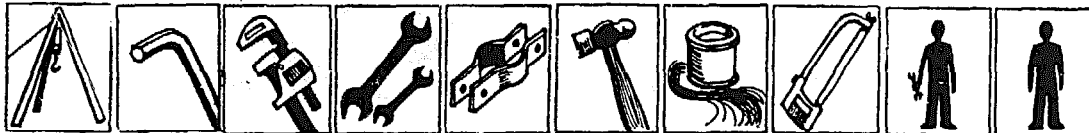

Frequent attention to the below-ground assembly is unlikely to be required, provided that the all-plastic footvalve is fitted. However, any repair requires the pumpstand to be removed from the well head, and then extraction of the entire below ground assembly. If the pumping element is at fault, then it must be replaced as a unit. In general, this pump demands an exchange rather than a maintenance routine.

4.4 Resistance to Contamination and Abuse

4.4.1 Resistance to Contamination

Good - the pumpstand is adequately sealed against contamination provided care is taken to seal the well head against ground water.

4.4.2 Likely resistance to Abuse

Fair - the pumpstand is robust, and most of the external fixings are socket screws and therefore secure. The bolts and nuts by which the drive head is attached to the pedestal are easily accessible, however.

4.5 Potential Safety Hazards

Components of the handgrips may become sharp as a result of wear. Otherwise, there are no potential safety hazards either to users of the pump or to bystanders.

4.6 Suggested Design Improvements

The cylinder end plugs should be replaced by standard reducing sockets, or a flange should be added to the existing turned component; see sketch, right.

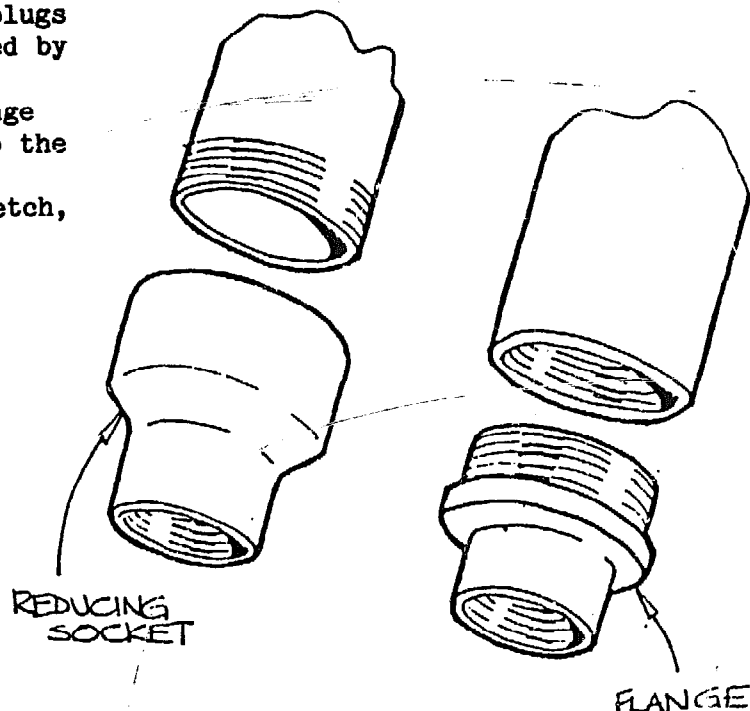

The steel hub of the 'Nylatron' gear wheel should be omitted. If the 'Nylatron' is not itself suitable as a bearing, then a bronze or cast iron bush should be used.

Rigid, smooth, non-rotating handles would be easier to make, would eliminate a potential safety hazard and may be acceptable in use.

5. PUMP PERFORMANCE

5.1 Volume Flow, Work Input and Efficiency

The test method is described in the Test Procedure. In the ODA test in 1979/80, the performance of the Mono pump was found to be strongly influenced by water temperature. The pumping elements supplied for this later test were intended for water temperatures between 16 and 25°C. Therefore, in agreement with the manufacturer, the pump performance was tested in cool and warm water.

5.1.1 Cool Water: 13 to 13.5°C

HEAD	7 metres			25 metres			45 metres		
Pumping Rate (revs per min)	29	39	49	30	38	46	30	41	49
Vol/rev (litres)	0.36	0.37	0.38	0.28	0.29	0.31	0.18	0.23	0.26
Work input/rev (J)	98	82	75	166	163	171	214	221	230
Efficiency (per cent)	25	30	34	40	43	45	37	46	49

5.1.2 Warm Water: 19 to 20.5°C

HEAD	7 metres			25 metres			45 metres		
Pumping Rate (revs per min)	31	41	52	31	41	51	33	42	49
Vol/rev (litres)	0.34	0.34	0.34	0.33	0.34	0.34	0.30	0.31	0.31
Work input/rev (J)	100	94	92	174	142	162	240	242	249
Efficiency (per cent)	23	24	25	46	58	51	55	56	55

For depths greater than 7 metres, greater volumes per revolution were obtained for water within the manufacturer's specified temperature range, particularly at 45 metres, yielding higher efficiencies.

5.2 Leakage Test

As originally supplied, both pumping elements leaked under pressure. In one, leaks were found at both ends of the steel casing. In the other, the cast gunmetal footvalve body was porous. The manufacturer therefore supplied a new, plastic foot valve to replace the original for endurance testing. With the new valve, no significant leakage was measured at heads of 7, 25 and 45 metres, i.e. the rate of leakage was less than 0.1 ml per minute.

6. USER TRIAL

Details of the organisation of this trial may be found in the Test Procedure. All users found the pump hard work at the simulated head of 20 metres. Many users thought the pump too high, especially children, and found it difficult to sustain the required effort throughout each revolution of the handles.

Even small 11-year-olds preferred to use the pump with one hand on each handle: they found the hand grips too short for both hands on one side, and could not sustain the necessary force as the handle went 'over centre'.

7. ENDURANCE

A detailed description of the endurance test method may be found in the Test Procedure.

General Comments

The pump was tested at 40 revolutions per minute at a simulated head of 45 metres.

Only one failure was observed in the endurance test. The pump was installed in accordance with the manufacturer's instructions, which did not call for lubrication of the rotating handgrips. After 97 hours, the handgrip was wearing rapidly, with the metal of the sleeve 'picking up' on the centre spindle. A new handle was fitted, with grease as a lubricant, and the problem did not recur in the remainder of the 4000 hours. We understand that the manufacturer now fits plastic rather than steel handgrips, though this modification was introduced to prevent the handgrips becoming uncomfortably hot under tropical sunlight.

The pump was in working order at the end of the test, and generally in good condition. The rotor showed signs of wear, and also the stator to a lesser extent, but the pumping element was still serviceable. There was an improvement in volume flow compared with the original performance tests.

Breakdown Incidence Failures are shown in bold type.

Hours:	1042	2096	3169	4213
97				
Handgrip Wearing Rapidly				
Inspection and full performance test	Inspection and volume flow check	Inspection and volume flow check	Inspection and volume flow check	Inspection and full performance test

Details of the Endurance Test

Failures are shown in bold type.

HOURS

97 **Rotating steel handgrip 'picking up' on centre spindle, causing rapid wear. The installation instructions do not call for the handgrips to be lubricated and they were therefore fitted as supplied, i.e. without lubrication.**

A new handle was fitted, with grease as a lubricant. The problem did not recur.

Estimated amount of water pumped to failure... less than 0.1 million litres

HOURS

1042 INSPECTION after 1st 1000 hours:

- (a) Pumping element: rubbing surfaces of rotor slightly marked, but both rotor and stator in good working order.
- (b) Footvalve in good working order.
- (c) Handgrip: little wear in rotating handgrip fitted after 97 hours.
- (d) Drive head: large bevel gear seized on axle, possibly caused by dried-out lubricant. It is unlikely that this fault would arise in the field, where users might be expected occasionally to free-wheel the handle in the reverse direction.

2096 INSPECTION after 2nd 1000 hours:

- (a) Pumping element: light scratches on rotor, and some rubber deposited on surface. Both stator and rotor in good working order.
- (b) Footvalve: in good working order.
- (c) Handgrip: little wear.
- (d) Drive head: gears in good working order.
- (e) Corrosion: pumping element end caps rusting.

3167 INSPECTION after 3rd 1000 hours:

- (a) Pumping element: rotor locally polished, elsewhere deposits of rubber from stator, but both stator and rotor in good working order.
- (b) Footvalve: in good working order.
- (c) Handgrip: little wear.
- (d) Drive head: Upper ball race loose in housing but outer race did not turn when under load.

4213 FINAL INSPECTION after 4th 1000 hours:

- (a) Pumping element: rotor scratched on outer surfaces of helix, with deposits of rubber from stator on inner surfaces, and signs of wear in stator, but rotor and stator still serviceable.
- (b) Footvalve: in good working order.
- (c) Handgrip: little wear.
- (d) Drive head: little end float in handle cross-shaft, indicating little wear in thrust washer and bevel gears. Handle bearings slightly worn. Upper ball race loose in housing but outer race did not turn under load.

Estimated total amount of water pumped in 4000 hours... 3 million litres

Revolutions/minute	Volume Flow Tests at 45m (litres)			Leakage Tests at 7m (ml/min)
	30	40	50	
New	0.30	0.31	0.31	less than 0.1
After 1000 hours	0.31	0.32	0.32	less than 0.1
After 2000 hours	0.38	0.38	0.38	0.2
After 3000 hours	0.38	0.38	0.38	less than 0.1
After 4000 hours	0.39	0.39	0.39	0.2

Pump Performance after Endurance

Cool Water: 10.5°C

HEAD	7 metres			25 metres			45 metres		
Pumping Rate (revs per min)	29	38	47	29	38	47	29	38	48
Vol/rev (litres)	0.39	0.39	0.39	0.34	0.35	0.36	0.31	0.32	0.33
Work input/rev (J)	108	113	111	192	206	210	239	261	277
Efficiency (per cent)	24	23	24	43	41	41	56	54	52

Warm Water: 21.5°C

HEAD	7 metres			25 metres			45 metres		
Pumping Rate (revs per min)	29	38	47	28	38	47	29	37	42
Vol/rev (litres)	0.39	0.39	0.39	0.39	0.39	0.39	0.39	0.39	0.39
Work input/rev (J)	150	151	146	207	207	230	264	262	262
Efficiency (per cent)	17	17	18	45	46	41	64	65	65

For depths greater than 7 metres, greater volumes per revolution were obtained for water within the manufacturer's specified temperature range, particularly at 45 metres depth, yielding higher efficiencies. This pattern is similar to the results when new, though the pump efficiencies after endurance were higher at 45 metres depth, similar at 25 metres depth and lower at 7 metres depth.

8. ABUSE TESTS

8.1 Side Impact Test

The pumpstand was undamaged by side impacts up to 500 joules. The handle impact test was not applicable to this pump.

8.2 Handle Abuse Test Not applicable

9. VERDICT

A robust and reliable handpump, potentially suitable for community water supply in developing countries. Best suited for depths greater than 20 metres, where the frictional losses in the pumping element are less significant. A known source of unreliability has been removed by doing away with the gearbox oil bath of previous models. With an output of approximately one third of a litre for each turn of the handle, the rate of delivery is considerably greater than other pumps using the same principle. The test sample was difficult for children to operate, but this would be improved by reducing the height of the pumpstand, and by reducing the friction between the rotor and stator. The manufacturer has implemented several modifications since the test samples were supplied, including shortening the pumpstand pedestal and modifying the pumping element to reduce the operating torque. The pump is also now offered with 2:1 ratio gears which should further reduce the effort though at the expense of discharge rate.

Although not suitable for manufacture in developing countries, or for village-level maintenance and repair, the Monolift is likely to be reliable in use.

PUMP PERFORMANCE

CODE WB: MONOLIFT PUMP

Water Head 25 Metres --- Pumping Rate 41 Strokes/Minute
Total Weight of Water Raised 3.1kg
9 Strokes/Revolutions
Total Work Done On Pump 1280 Joules. (Rate 96.4 Watts)

Average Volume of Water .34 Litres per Stroke
Average Work Done on Pump 142 Joules per Stroke
Efficiency 58%

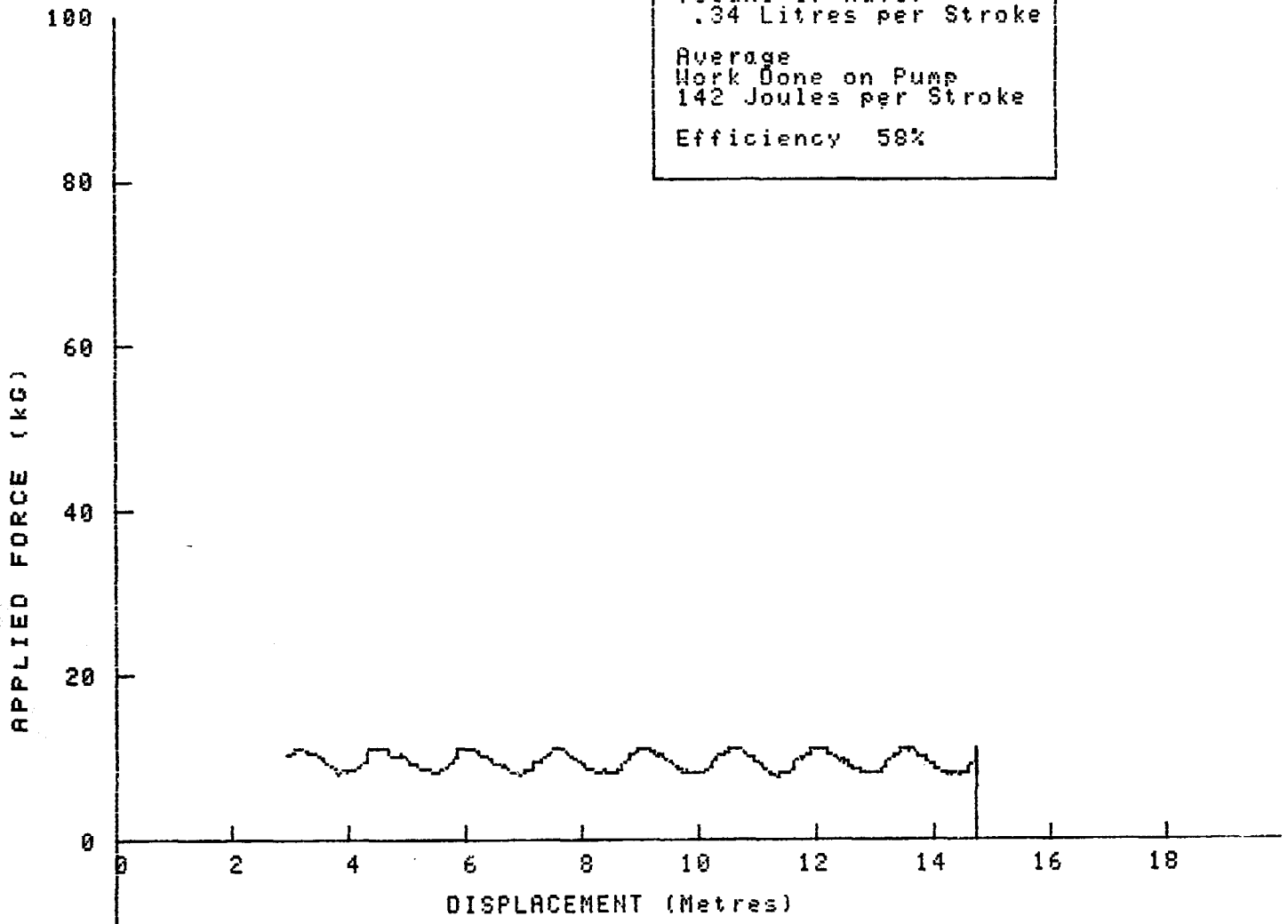

Water Temperature 19.5 deg C

PUMP PERFORMANCE

CODE WB: MONOLIFT PUMP

Water Head 45 Metres --- Pumping Rate 42 Strokes/Minute
Total Weight of Water Raised 2.8kg
9 Strokes/Revolutions
Total Work Done On Pump 2181 Joules. (Rate 171.4 Watts)

Average Volume of Water .31 Litres per Stroke
Average Work Done on Pump 242 Joules per Stroke
Efficiency 56%

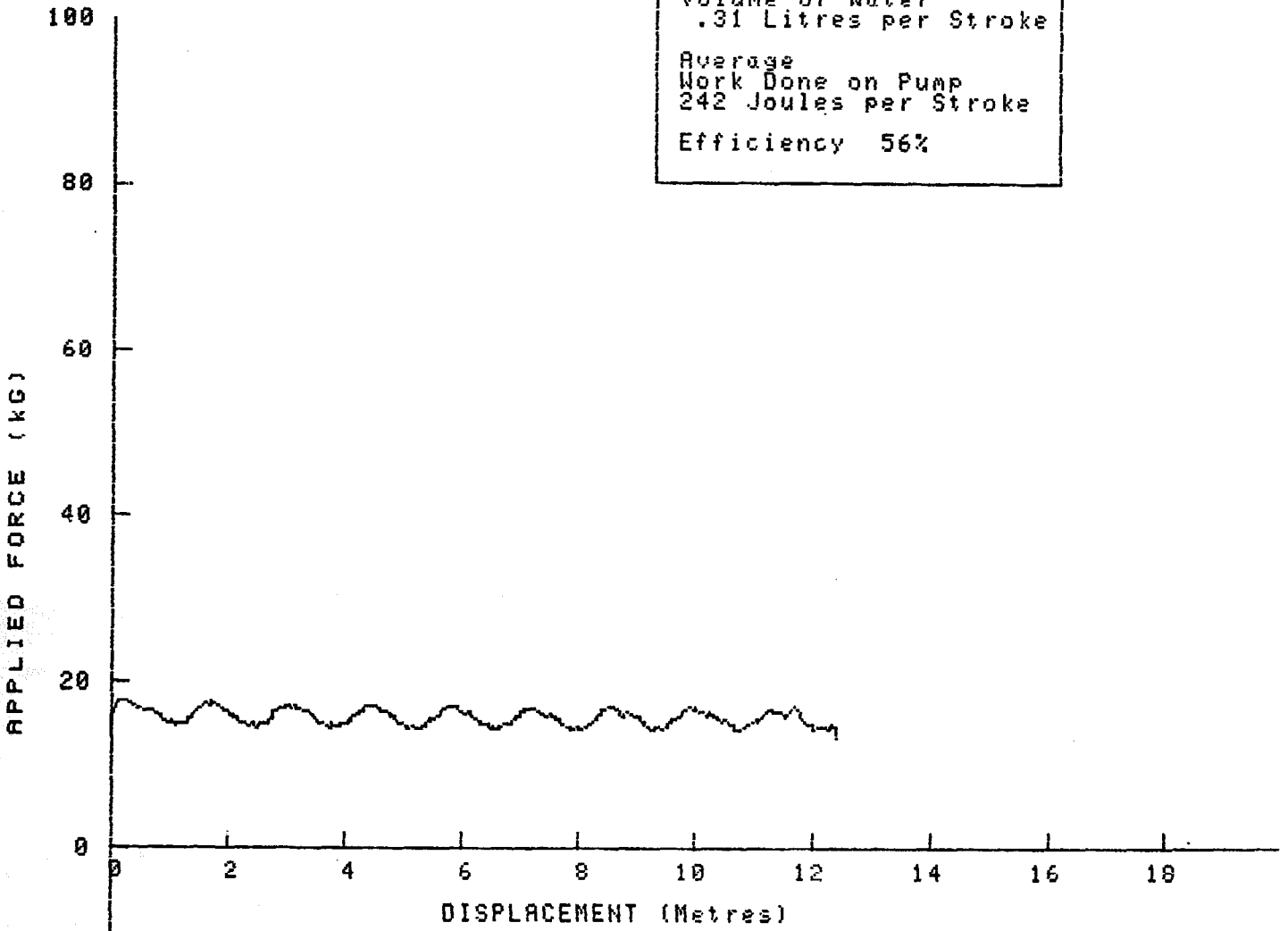

Water Temperature 20.5 deg C

Sihilase Pump

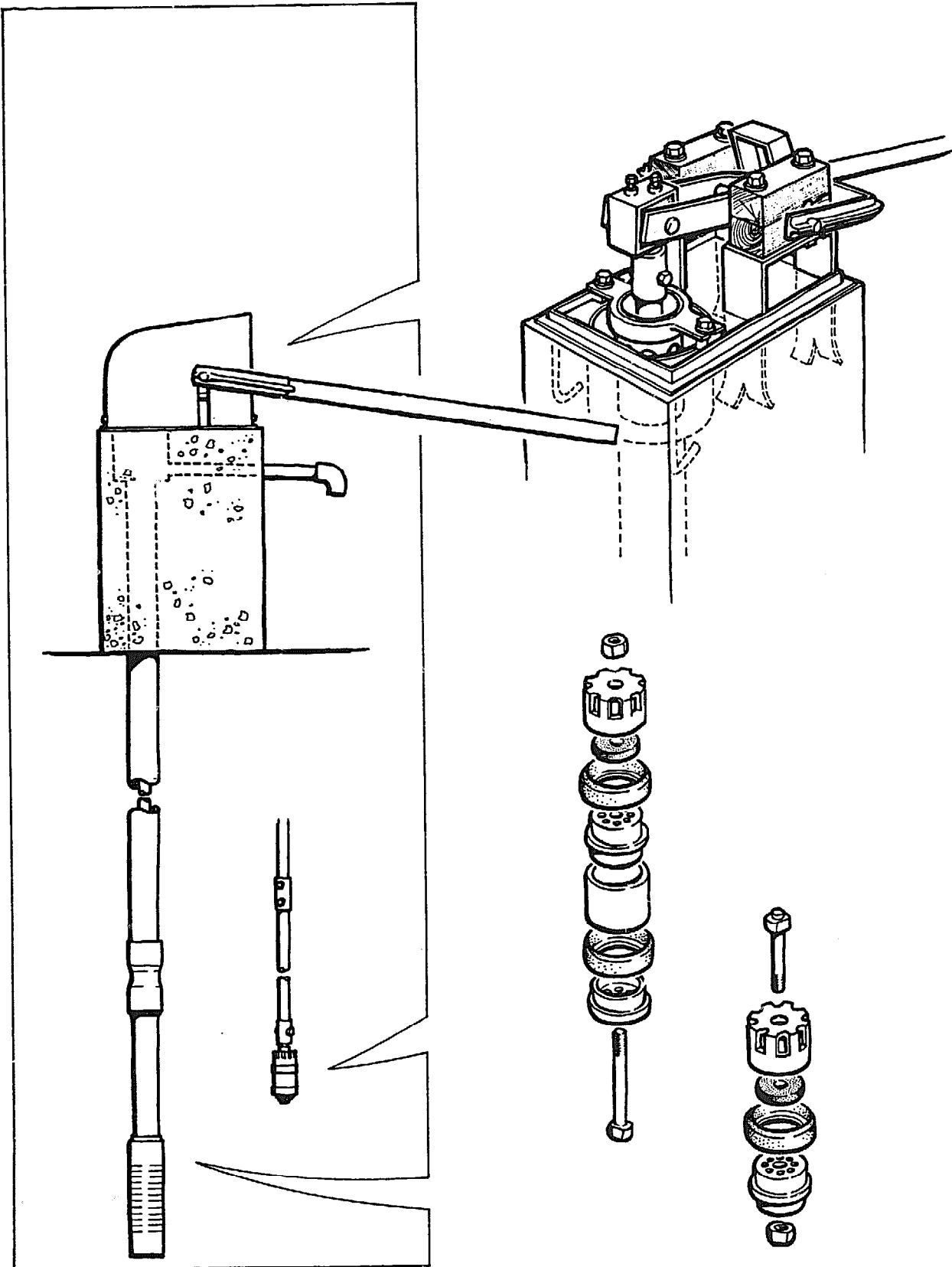

SIHILASE HANDPUMP

1.1 Manufacturer

Sarvodaya Machinshop

Address

Sarvodaya Kandy District Centre
Palletalawinna
Katugastota
Kandy
Sri Lanka

Supporting Agencies

SKAT
(Swiss Centre for
Appropriate Technology)
Varnbuelstrasse 14
CH-9000 St.Gallen
Switzerland

Helvetas
(Swiss Association for
Technical Assistance)
St.Moritzstrasse 15
Postfach 8042 Zurich
Switzerland

1.2 Description

The Sihilase is a reciprocating, plunger type, force pump, constructed from materials locally available in Sri Lanka. It is intended for a maximum depth of 20 metres. Extruded uPVC tube is used for the cylinder and rising main, in different sizes, and also for the pump rod.

The same components are used for both the plunger and footvalve. They are fabricated from sections of extruded uPVC pipe, using solvent cement. Where flat components are required, sections of large-bore uPVC pipe are cut and straightened. Leather seals are fitted. The valves have rubber sealing washers and brass centre spindles. The pump rods are connected by sleeves cut from uPVC pipe, secured by brass studs.

The pumpstand is set in a concrete block, cast on-site. The handle bearings are oil-impregnated hardwood, supported by a framework of mild steel. The handle is a mild steel tube. The top of the rising main discharges into a delivery cup, and the spout emerges from the concrete block beneath the handle.

1.3 Price

Approximately US \$150.00 in December, 1982

2. INITIAL INSPECTION

2.1 Packaging

The outer packaging consisted of two wooden crates, one containing the pipes, the other all remaining parts of the pumps. The pipes were packed in an open crate 2.75 m. long, each pipe supported separately by steel straps and wood. The crate containing the pump parts was packed with textile waste. The packaging was considered very suitable and the method of packing uPVC pipe was particularly good.

2.2 Condition as Received

- Initial Inspection:
1. The spouts were loose in both samples.
 2. In one sample, the outlet was not watertight.

A number of further defects came to light in the course of installation and testing:

Installation:

3. The handle limit stop did not restrain the handle at the upper end of the return stroke, even though the handle limit was bolted to the underside of the bearing frame. The handle struck the top of the rising main before the limit roller came into contact with the limit stop.
4. The handle pivot bearings were very tight on their shaft, causing excessive friction. The bearings were drilled out to a running fit.
5. The "front bearing", joining the handle to the top of the pump rod, was tight on its spindle. Both the bearing and the spindle were dressed with abrasive paper to reduce the working friction.
6. The "front bearing" was loose in its housing. It was secured by inserting two bolts through the weldnuts on the top of the housing. No suitable bolts were provided with the samples, and none are shown on the installation sketch provided, but the weldnuts appear to have been provided for this purpose.

Testing:

7. The plunger and foot valves were not functional as received. Insufficient clearance had been provided between the valve body and the sealing disc, so that the disc must lift 27mm to open: 6mm lift would be appropriate to match the size of the ports in the valve. If fully opened, the valves would be unlikely to close when the direction of action was reversed at the end of the stroke.

The valves were modified: the modifications are described in 4.6: Suggested Design Improvements. They improved the operation of the pump significantly, but did not eliminate the leakage from the footvalve.

8. Unacceptable levels of footvalve leakage were noted in the user trial and confirmed in the leakage test. The valve was leaking around the centre spindle, through a joint in the footvalve body. The spindle was sealed with silicone rubber compound.

2.3 Installation and Maintenance Information

A project report, an installation manual, in English, and an exploded installation diagram were supplied with the test samples. The installation manual was useful, but illustrations within the text would have been helpful. A drawing was also supplied of a fabricated steel pumpstand frame as an alternative to on-site cast concrete.

3. WEIGHTS and MEASURES

3.1 Weights

Pumpstand frame:	6.0 kg
Pumpstand :	18.5 kg (including handle)
Cylinder:	3.1 kg
Rising Main (per m):	2.3 kg (including sockets)
Pump Rod (per m):	0.3 kg (including sockets)

3.2 Dimensions

Nominal cylinder bore:	68 mm
Actual pump stroke:	115 mm
Nominal volume per stroke:	418 ml
Rising Main Size:	3.5 inch
Pump rod size (uPVC pipe):	1.0 inch
Outside diameter of below-ground assembly:	100 mm

3.3 Cylinder Bores

No significant taper or ovality was found in either of the two samples.

The surface roughness average (R_a) was measured in three places in a direction parallel to the cylinder axis.

SAMPLE	CYLINDER BORE	ROUGHNESS AVERAGE (μm)			
		TEST 1	TEST 2	TEST 3	MEAN
1	Extruded uPVC	1.2	1.0	1.0	1.1
2	Extruded uPVC	0.9	0.9	1.0	0.9

Measured at 0.25mm cut-off

3.4 Ergonomic Measurements

<u>HANDLE HEIGHT</u>		PLINTH HEIGHT (mm)	ANGULAR MOVEMENT OF HANDLE (deg)	HANDLE LENGTH (mm)	VELOCITY RATIO OF HANDLE	HEIGHT OF SPOUT (mm)
MAX [1] (mm)	MIN [1] (mm)					
1185	285	560 ^[2]	49	1000	7.1	480

[1] Unable to reach limit stops

[2] Height of cast concrete pumpstand body

4. ENGINEERING ASSESSMENT

4.1 Materials of Construction

Component	Material(s)
Pumpstand body/plinth	Cast concrete
Handle	Mild steel
Handle mounting frame and limit stop	Mild steel
Handle Bearings	Oil-impregnated hardwood
Cylinder, plunger body,) valve body, strainer,) rising main, pump rod) and spout)	uPVC
Rising main support	Galvanised steel
Pump rod connector bolts	Brass
Plunger and footvalve seals	Leather
Plunger and footvalve spindles	Brass
Valves	Rubber discs

4.2 Manufacturing Techniques

The techniques required to manufacture the pump are listed below:

Above-ground Assembly	Machining and fabrication of uPVC Steel fabrication Simple woodwork Concrete craft
Below-ground Assembly	Machining and fabrication of uPVC Simple machining of brass Leather forming

Simple processes are used throughout, but considerable skill and very careful attention to detail are needed to produce a satisfactory product. It would be suitable for manufacture in some developing countries.

4.3 Ease of Installation, Maintenance and Repair

4.3.1 Ease of Installation

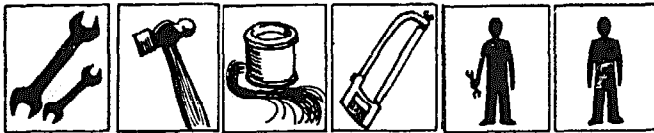

Lifting tackle is not required. Joints in the rising main are solvent cemented. The slotted intake tube must be screwed onto the cylinder, and the cylinder screwed into the rising main. Hand-tight joints are likely to be adequate if PTFE tape is used on the threads: if wrenches are used, they should be of a type which will not damage the surface of the uPVC.

4.3.2 Ease of Pumpstand Maintenance



The pumpstand is unlikely to require frequent routine maintenance. However, the handle may break in use and would be difficult to repair on-site. The handle bearings may be reversed to combat wear: two bearing holes are provided in each block.

4.3.3 Ease of Below-ground Maintenance



The below-ground assembly is likely to require frequent attention. The plunger and footvalve may be withdrawn from the well without removing the rising main. However, the most frequent problem in endurance testing was breakage of the pump rod, which would demand removal of the rising main. Even so, lifting tackle would not be required because of the light weight of the below-ground string.

4.4 Resistance to Contamination and Abuse

4.4.1 Resistance to Contamination

The use of a concrete plinth, cast in-situ, ensures an adequate well-head seal. The pumpstand is protected against contamination as long as the cover remains in place.

4.4.2 Resistance to Abuse

Poor - the handle is weak and likely to be broken by accidental impacts or heavy-handed usage. The pumpstand cover is flimsy and easily removed. None of the fixings is of a type designed to resist unauthorised tampering or pilferage.

4.5 Potential Safety Hazards

There are possible traps between the handle and the pumpstand body, but these are in full view of the user of the pump and therefore unlikely to be dangerous. There are no safety hazards to users of the pump.

4.6 Suggested Design Improvements

The handle should be strengthened to improve its durability under normal conditions of use, and to resist accidental impacts and abuse.

The tubular uPVC pump rod cannot withstand the forces induced by normal operation at 20 metres depth. A stronger material should be used or the maximum depth should be substantially reduced.

The valve body should be moulded or machined from one piece, or a seal should be added on the central spindle.

The valve cage on the foot valve and piston should be enlarged to allow room for water to pass between the valve and cage - this suggestion has been adopted.

Valve lift should be limited to approximately 6 mm by adding a spacer on the central spindle above the valve disc - this suggestion has been adopted.

Turning or moulding circular ridges on the seating face would assist in sealing the rubber or leather washer - this suggestion has been adopted.

5. PUMP PERFORMANCE

5.1 Volume Flow, Work Input and Efficiency

The test method is described in the Test Procedure.

HEAD	7 metres			20 metres		
Pumping rate (strokes/min)	30	38	50	38	39	50
Volume per stroke (litres)	0.34	0.35	0.35	0.31	0.29	0.32
Work input/stroke (joules)	63	67	69	115	117	126
Efficiency (per cent)	36	35	34	53	49	49

5.2 Leakage Test

The initial results were unacceptable, with leakage of more than 10 ml per minute. The valve seat was machined to raise circular ridges either side of the ports, to improve the seal against the rubber washer. This produced only a marginal improvement, as did replacing the thick rubber washer by a thin rubber or leather washer, also supplied with the test samples. Further investigation revealed that the valve was leaking around the centre spindle, through a solvent cemented joint in the valve body. The spindle was sealed using silicone rubber compound. The leakage was then measured at 0.4 ml per minute at 7 metres head and 1.4 ml per minute at 20 metres head.

6. USER TRIAL

Details of the organisation of this trial may be found in the Test Procedures.

Even small users found the pump too low, though many found it acceptable in other respects. Strong, vigorous users caused the delivery cup in the pumpstand to overflow.

7. ENDURANCE

General Comments

The pump was tested at 40 strokes per minute at a simulated head of 20 metres.

The pump was very unreliable. The tubular pump 'rod', of uPVC pipe, broke at a coupling after 289 hours. All the joints were re-made, using solvent cement to prevent all the load being taken by the brass coupling bolts. However, the tubular pump rod broke repeatedly. After 2603 hours, the original pipe was replaced by a larger diameter, thick-walled pipe, for which special connectors were made. This also broke, however, and was replaced in turn by 10 mm stainless steel pump rods after 3123 hours.

The handle broke after 2957 hours, and was repaired. It broke again after 4088 hours and after 4196 hours, at the end of the test.

The rising main within the pumpstand split after 1375 hours.

The cylinder was deeply scored by the top edge of the plunger, and by the nuts on the coupling to the pump rod. An annular guide was fitted to improve the alignment of the plunger. In spite of the damage to the cylinder bore, the pump continued to work, although the lower cup leather had to be replaced after 2109 hours, and the upper cup leather was found to be breaking up in the final inspection. The footvalve was affected by sand which lodged between the centre spindle and the valve disc, and thereby slowed down the action of the valve.

Breakdown Incidence

Breakdowns are shown in bold type

Hours:	1042		2109		3191		4196	
289	971	1375	1375	2552	2957	2999	4088	
				2562	2663	3123		
				2603	2634	2887		
	Pump rod broken		Rising main split	Pump rod broken: replaced by larger uPVC tube at 2603	Coupling broken	Handle broken		Handle broken
			Pump rod broken			Plunger seized	Pump rod broken: replaced by steel rods	Handle broken
					Coupling bolt broken			
Inspection and full performance test		Inspection and volume flow check	Inspection and volume flow check			Inspection and volume flow check	Inspection and full performance test	

Details of the Endurance Test

Breakdowns are shown in bold type

HOURS

- 289 Tubular pump rod broken at intermediate joint. All joints re-made using solvent cement in addition to brass studs, and reinforcing collars added at rod ends. Additional joint made using solvent cement only.
- 971 Tubular pump rod broken immediately below connection to handle: this joint had been reinforced by a solvent-cemented collar at 289 hours. Joint re-made using longer reinforcing collar.
- 1042 Inspection after 1st 1000 hours:
- (a) Pumpstand: slight wear in handle bearings
 - (b) Cylinder: in good working order
 - (c) No corrosion
- 1345 Tubular pump rod broken above joint with plunger - repaired with longer, solvent-cemented reinforcing collar.
- 1375 Rising main split within pumpstand - new section fitted.
- 2109 Inspection after 2nd 1000 hours:
- (a) Pumpstand: slightly more wear in handle bearings, but still serviceable
 - (b) Cylinder: lower seal broken; cylinder scored by top edge of plunger
 - (c) No corrosion
- 2552 Tubular pump rod broken - repaired at 2552 and 2562. After breakage at 2562 2603 hours, the original uPVC pipe was replaced by thick-wall uPVC pipe of a larger diameter. Metal connectors were fitted at the handle and plunger. A solvent-cemented, machined uPVC intermediate connector was also fitted.
- 2612 Machined uPVC connector broken - replaced by stronger uPVC component.
- 2634 Second machined uPVC connector broken - replaced.
- 2663 Brass bolt broken at connection of rod to plunger - replaced.
- 2887 Plunger seized - nuts on brass bolt at pump rod connection had scored cylinder wall: swarf had seized plunger - plunger top edge had also marked cylinder wall. Annular guide added to coupling to centralise plunger.
- 2957 Handle broken within T-section - repaired by welding.
- 2999 Pump rod broken - repaired at 2999 hours. After the break at 3123 hours 3123 the tubular uPVC was replaced by 10 mm stainless steel rod.

HOURS

3191 Inspection after 3rd 1000 hours:

- (a) Pumpstand: slightly more wear in handle bearings, but still serviceable - p pin at pump rod connection also worn
- (b) Cylinder: cylinder deeply scored by top edge of plunger, and by nuts on coupling bolt (see 2887 hours), but still working
- (c) No corrosion

4088 Handle broken within T-section - repaired by welding.

4196 Handle broken within T-section - end of test.

4196 Final Inspection:

- (a) Pumpstand: hardwood bearings for handle worn, but still in good working order - handle pivot pins also worn. Some wear of bush and pivot pin at connection with pump rod, but still serviceable.
- (b) Plunger: top seal damaged and breaking up.
- (c) Cylinder: deeply scored by top edge of plunger.
- (d) Footvalve: slow to close because sand particles lodged between centre spindle and sliding disc, causing partial loss of delivery from pump when operated at 40 strokes/minute or more. Once closed, the footvalve did not leak, however.
- (e) Filter: full of sand below slots.
- (f) No corrosion.

The estimated amount of water pumped between successive breakdowns varied from a few thousand litres to 0.6 million litres. The latter figure was achieved after the tubular uPVC pump 'rod' was replaced by 10 mm stainless steel rod.

Estimated total amount of water pumped in 4000 hours... 3 million litres

Strokes/min	Volume flow tests at 20 m (litres)			Leakage Tests at 7 m (ml/min)
	30	40	50	
New	0.31	0.29	0.32	0.4
After 1000 hours	0.28	0.29	0.29	3.2
After 2000 hours	0.33	0.34	0.35	3.0
After 3000 hours	0.20	0.24	0.25	2.0
After 4000 hours	0.25	0.25	0.26	n/s

n/s = not significant; i.e. less than 0.1 ml/minute

Pump Performance after Endurance

HEAD	7 metres			20 metres		
Pumping rate (strokes/min)	30	38	48	31	39	47
Volume per stroke (litres)	0.19	0.21	0.25	0.25	0.25	0.26
Work input/stroke (joules)	73	80	83	164	175	190
Efficiency (per cent)	18	17	20	29	28	27

These results show reductions in volume flow coupled with marked increases in work input, when compared to the results when new. The measured efficiencies are therefore substantially lower. These effects reflect the poor condition of the the leather cup seals and the cylinder bore, and the contamination of the footvalve by sand.

8. ABUSE TESTS

8.1 Impact Tests

The handle bent at an impact of 100 joules, and broke at 150 joules. The concrete block was not tested for impact resistance. In practice, the integrity of the concrete will depend on the materials and skills available when the pump is installed.

8.2 Handle Shock Test

This test was not carried out since the handle had broken on several occasions in the endurance test.

9. VERDICT

An ingenious design which makes use of the materials locally available in Sri Lanka. However, the samples supplied were not strong enough to withstand normal conditions of use for community water supply. In particular, the uPVC pipe used for the pump rod could not withstand normal pumping loads from 20 metres depth, and the handle was weak. Only simple manufacturing processes are demanded, but very careful attention to detail is essential to produce an adequate product.

In need of considerable re-development, but could form the basis of a low-cost pump suitable for manufacture in developing countries, with local maintenance and repair, for depths around 15 metres.

PUMP PERFORMANCE

CODE X : SIHILASE PUMP

Water Head 7 Metres --- Pumping Rate 38 Strokes/Minute
Total Weight of Water Raised 3.5kG
10 Strokes/Revolutions
Total Work Done On Pump 672 Joules. (Rate 42.1 Watts)

Average Volume of Water .35 Litres per Stroke
Average Work Done on Pump 67 Joules per Stroke
Efficiency 35%

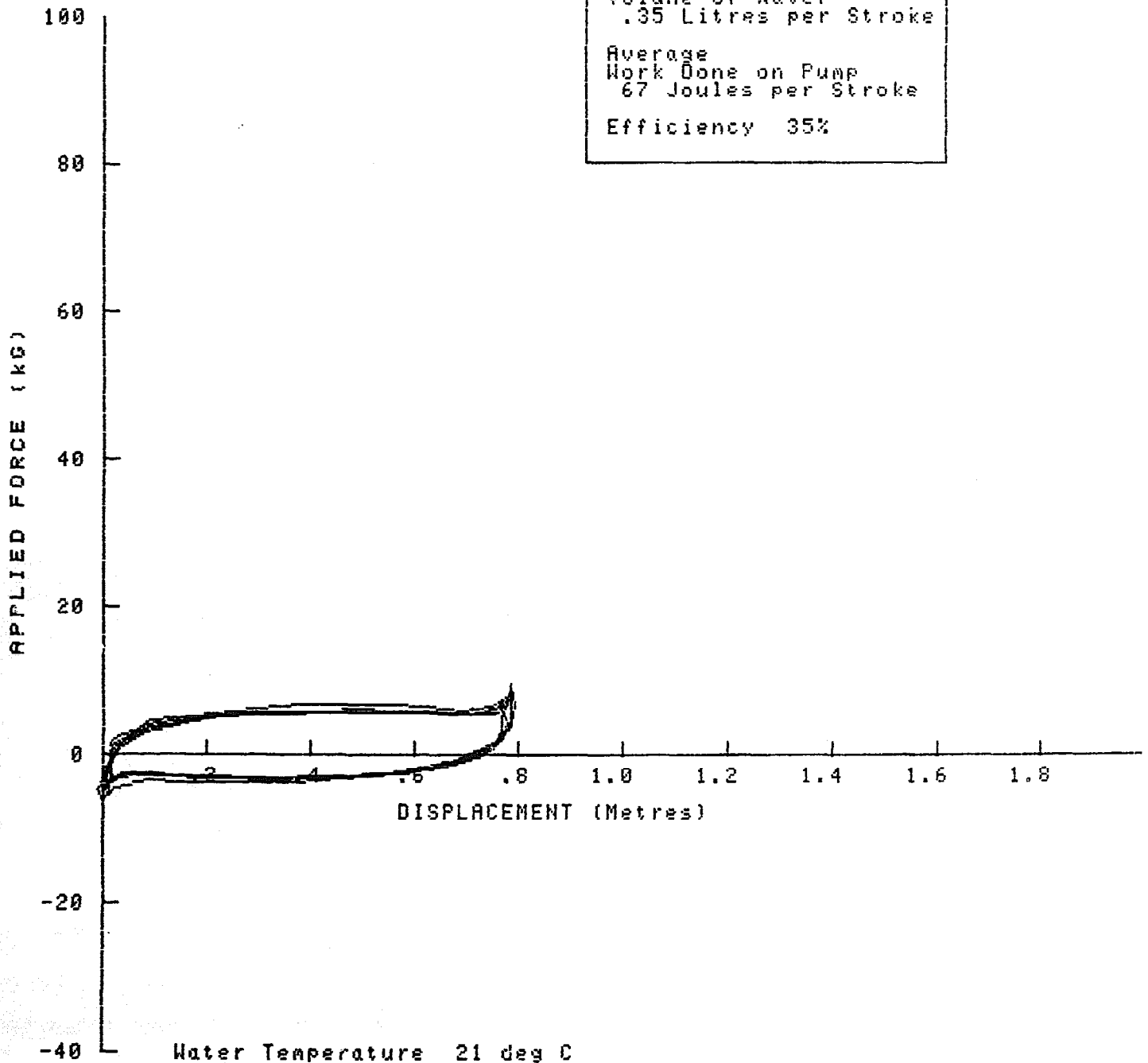

PUMP PERFORMANCE

CODE X : SIHILASE PUMP

Water Head 20 Metres --- Pumping Rate 39 Strokes/Minute
Total Weight of Water Raised 2.9kg
10 Strokes/Revolutions
Total Work Done On Pump 1176 Joules. (Rate 76.9 Watts)

Average Volume of Water .29 Litres per Stroke
Average Work Done on Pump 117 Joules per Stroke
Efficiency 49%

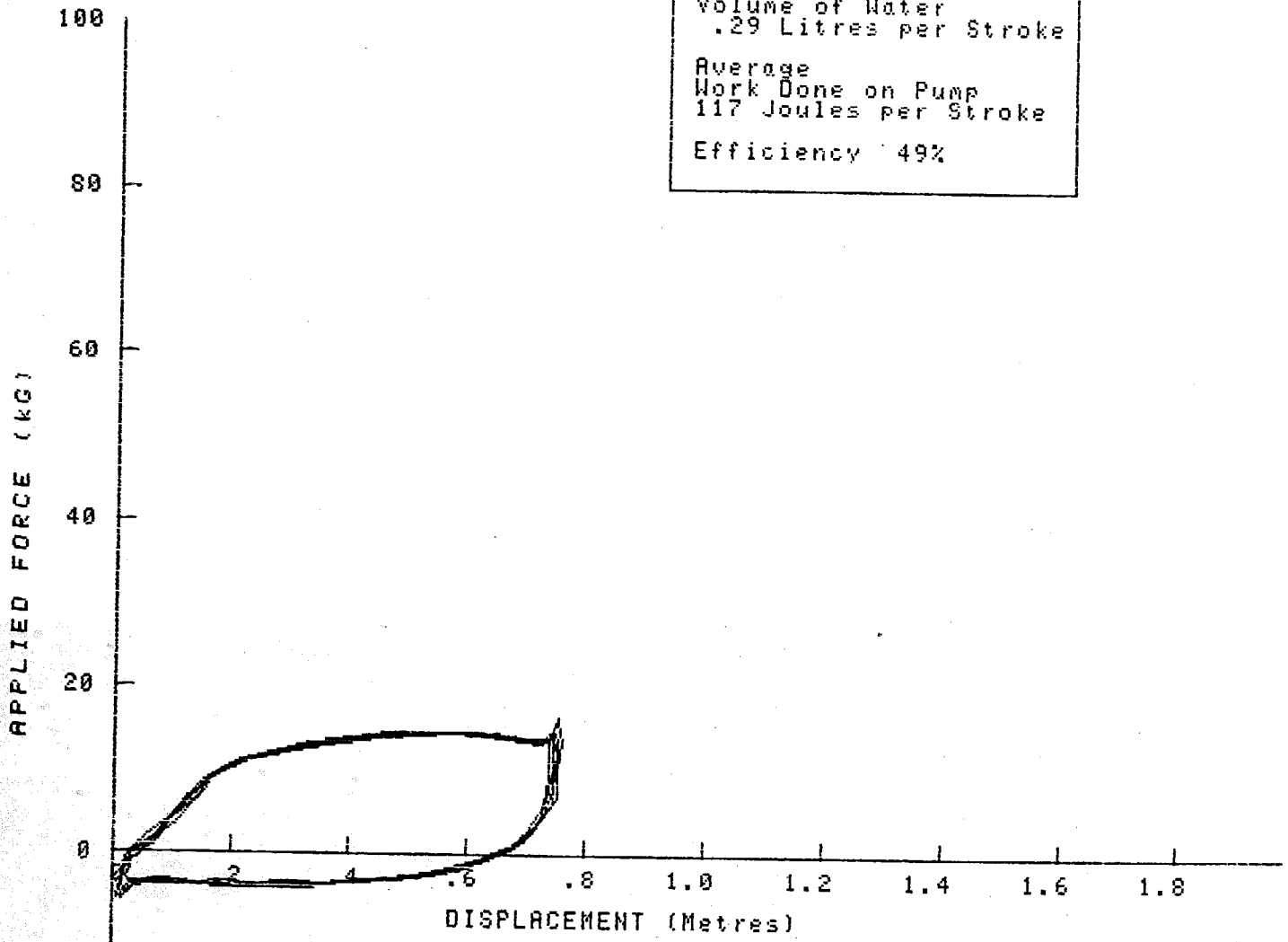

Water Temperature 21 deg C

World Bank Publications of Related Interest

Laboratory Evaluation of Hand-operated Pumps for Use in Developing Countries Consumers' Association Testing and Research Laboratory

An invaluable guide for selecting water pumps. Paper rates 12 pumps on basis of rigorous testing to determine their strengths and weaknesses. Pumps rated for packaging, condition as received, installation, maintenance, repair, and overall desirability.

Technical Paper No. 6. 1983. 89 pages.
ISBN 0-8213-0133-0. Stock No. BK 0133. \$3.

Laboratory Testing, Field Trials, and Technological Development

Contains results of laboratory tests carried out on twelve hand pumps for the World Bank and presents recommendations for improvements in performance, safety, and durability.

1982. 122 pages (including 3 appendixes).
Stock No. BK 9190. \$5.

Meeting the Needs of the Poor for Water Supply and Waste Disposal

Fredrick L. Golladay

Examines economic, political, social, and cultural obstacles to meeting the needs of low-income people for water supply and waste disposal. Proposes steps to reduce these obstacles. Notes that communities organize and manage resources to carry out activities that cannot be profitably undertaken by households. Proposes methods to facilitate the formation and operation of community organizations to carry out these functions.

Technical Paper No. 9. 1983. 66 pages.
ISBN 0-8213-0238-8. Stock No. BK 0238. \$3.

A Model for the Development of a Self-Help Water Supply Program

Colin Glennie

Presents one version of a practical model for developing, with high community participation, water supply programs in developing countries. Consideration is also given to sanitation program development and practi-

cal guidelines for program development are included. One of a series of informal Working Papers prepared by the Technology Advisory Group, established under UNDP's Global Project, executed by the World Bank.

Technical Paper No. 2. 1982. 45 pages (including 2 annexes, references).
ISBN 0-8213-0077-6. Stock No. BK 0077. \$3.

Municipal Water Supply Project Analysis: Case Studies

Frank H. Lamson-Scribner, Jr., and John Huang, editors

Eight case studies and fourteen exercises dealing with the water and wastewater disposal sector.

World Bank (EDI), 1977. 529 pages.
Stock No. IB-0655. \$8.50 paperback.

Notes on the Design and Operation of Waste Stabilization Ponds in Warm Climates of Developing Countries

J. P. Arthur

Practical design criteria for pond systems to fit various ambient temperature and reuse requirements, such as irrigation. Offers suggestions for start-up procedures, operation, and trouble shooting.

Technical Paper No. 7. 1983. 106 pages.
ISBN 0-8213-0137-3. Stock No. BK 0137. \$5.

Ventilated Improved Pit Latrines: Recent Developments in Zimbabwe

D. D. Mara and Peter R. Morgan

Describes designs and materials for latrines, one for peri-urban areas costing about US\$150, and a US\$8 version for rural areas. Some 20,000 of the ventilated pit latrines have been built in Zimbabwe. They have been found very effective in eliminating odors and controlling fly breeding.

Technical Paper No. 3. 1983. 48 pages.
ISBN 0-8213-0078-4. Stock No. BK 0078. \$3.

Village Water Supply

Describes technical aspects, costs, and institutional problems related to supplying water for domestic use in rural areas and proposes guidelines for future World Bank lending in this sector.

A World Bank Paper. 1976. 98 pages (including 4 annexes).

Stock Nos. BK 9099 (English), BK 9100 (French), BK 9044 (Spanish). \$5.

Village Water Supply: Economics and Policy in the Developing World

Robert J. Saunders and Jeremy J. Warford

Addresses the problem of potable water supply and waste disposal in rural areas of developing countries where the majority of the poor tend to be found. Emphasizes the economic, social, financial, and administrative issues that characterize village water supply and sanitation programs.

The Johns Hopkins University Press, 1976. 292 pages (including 4 appendixes, bibliography, index).

LC 76-11758. ISBN 0-8018-1876-1, Stock No. JH 1876, \$22.50 hardcover.

French: *L'alimentation en eau des communes rurales: economie et politique generale dans le monde en developpement. Economica, 1978.*

ISBN 2-7178-0022-0, Stock No. IB 0549, \$7.

Spanish: *Agua para zonas rurales y pobladors: economia y politica en el mundo en desarrollo. Editorial Tecnos, 1977*

ISBN 84-309-0708-4. Stock No. IB 0532. \$7.

Water Supply and Sanitation Project Preparation Handbook

The three companion volumes guide planners, engineers, and community development and public health specialists working in projects related to water and sanitation in developing countries and help users prepare project reports. Case studies illustrate each phase of project development: identification, prefeasibility, and feasibility. Suggests approaches and methods of project evaluation to guide project team members.

Volume 1: Guidelines

Brian Grover

Technical Paper No. 12. 1983. 190 pages.
ISBN 0-8213-0230-2. Stock No. BK 0230. \$5.

Volume 2: Case Studies— Identification Report for Port City, Immediate Improvement Project for Port City, Prefeasibility Report for Port City

Brian Grover, Nicholas Burnett, and Michael McGarry

Technical Paper No. 13. 1983. 352 pages.
ISBN 0-8213-0231-0. Stock No. BK 0231. \$15.

**Volume 3: Case Study—
Feasibility Report for Port City**
Brian Grover, Nicholas Burnett,
and Michael McGarry

*Technical Paper No. 14. 1983. 308 pages
ISBN 0-8213-0232-9. Stock No. BK 0232.
\$15. Stock No. BK 0367. 3-volume set:
\$25.*

**World Bank Studies in Water
Supply and Sanitation**

The United Nations has designated the 1980s as the International Drinking Water Supply and Sanitation Decade. Its goal is to provide two of the most fundamental human needs—safe water and sanitary disposal of human wastes—to all people. To help usher in this important period of international research and cooperation, the World Bank has published several volumes on appropriate technology for water supply and waste disposal systems in developing countries. Since the technology for supplying water is better understood, the emphasis in these volumes is on sanitation and waste reclamation technologies, their contributions to better health, and how they are affected by water service levels and the ability and willingness of communities to pay for the systems.

**Number 1: Appropriate
Sanitation Alternatives: A
Technical and Economic
Appraisal**

John M. Kalbermatten, DeAnne S. Julius, and Charles G. Gunnerson
This volume summarizes the technical, economic, environmental, health, and sociocultural findings of the World Bank's research program on appropriate sanitation alternatives and discusses the aspects of program planning that are necessary to implement these findings. It is directed primarily toward planning officials and sector policy advisers for developing countries.

*The Johns Hopkins University Press, 1982.
172 pages (including bibliography, index).
LC 80-8963. ISBN 0-8018-2578-4, Stock
No. JH 2578. \$12.95 paperback.*

**Number 2: Appropriate
Sanitation Alternatives: A
Planning and Design Manual**
John M. Kalbermatten, DeAnne S.
Julius, Charles G. Gunnerson, and
D. Duncan Mara

This manual presents the latest field results of the research, summarizes se-

lected portions of other publications on sanitation program planning, and describes the engineering details of alternative sanitation technologies and how they can be upgraded.

The Johns Hopkins University Press,
1982. 172 pages (including bibliog-
raphy, index).

*LC 80-8963. ISBN 0-8018-2584-9, Stock
No. JH 2584, \$15 paperback.*

**Number 3: Sanitation and
Disease: Health Aspects of
Wastewater Management**
Richard G. Feachem, David J.
Bradley, Hemda Garelick, and D.
Duncan Mara

Summarizes knowledge about excreta, night soil, and sewage and their effects on health. Describes the environmental characteristics of specific excreted pathogens and the epidemiology and control of the infections these pathogens cause.

*John Wiley and Sons (U.K.). 1983. 528
pages.*

*ISBN 0-471-90094-X. Stock No. IB 0558.
\$39.50 hardcover.*

**Appropriate Technology for
Water Supply and Sanitation**

The following volumes have been published in a less formal format. Some are abridgments of the three foregoing volumes.

**Volume 1: Technical and
Economic Options**

John M. Kalbermatten, DeAnne S. Julius, and Charles G. Gunnerson
Reports technical, economic, health, and social findings of the research project on "appropriate technology" and discusses the program planning necessary to implement technologies available to provide socially and environmentally acceptable low-cost water supply and waste disposal.

*1980. 122 pages (including bibliography),
Stock No. BK 9186. \$5.*

**Volume 1a: A Summary of
Technical and Economic
Options**

John M. Kalbermatten, DeAnne S. Julius, and Charles G. Gunnerson
A summary of the final report on appropriate technology for water supply and waste disposal in developing countries, a World Bank research project undertaken by the Energy, Water, and Telecommunications Department in 1976-1978.

*1980. 38 pages.
Stock No. BK 0049. \$3.*

**Volume 1b: Sanitation
Alternative for Low-Income
Communities—A Brief
Introduction**

D. Duncan Mara

Describes in nontechnical language the various low-cost sanitation technologies that are currently available for low-income communities in developing countries and presents a general methodology for low-cost sanitation program planning.

*1982. 48 pages.
Stock No. BK 9189. \$3.*

**Volume 3: Health Aspects of
Excreta and Sullage
Management—A State-of-the-
Art Review**

Richard G. Feachem, David J.
Bradley, Hemda Garelick, and D.
Duncan Mara

Provides information on the ways in which particular excreta disposal and reuse technologies affect the survival and dissemination of pathogens. It is intended for planners, engineers, economists, and health workers.

*1980. 303 pages (including 14 appendices,
references).*

Stock No. BK 9187. \$15.

**Volume 10: Night-soil
Composting**

Hillel I. Shuval, Charles G.
Gunnerson, and DeAnne S. Julius

Describes a safe, inexpensive treatment method for night-soil composting that is ideally suited for developing countries because of its simplicity in operation, limited need for mechanical equipment, low cost, and effectiveness in inactivating pathogens.

*1981. 81 pages (including bibliography, 2
appendices).*

Stock No. BK 9188. \$3.

**World Bank Research in Water
Supply and Sanitation—
Summary of Selected
Publications**

A bibliography summarizing the papers in the Water Supply and Sanitation Series, as well as the World Bank studies in Water Supply and Sanitation published for the World Bank by The Johns Hopkins University Press.

*1980.
Stock No. BK 9185. Free.*

*Prices subject to change without notice
and may vary by country.*

Distributors of World Bank Publications

ARGENTINA

Carlos Hirsch, SRL.
Attn: Ms. Monica Bustos
Florida 165 4° piso
Galeria Guemes
Buenos Aires 1307

AUSTRALIA, PAPUA NEW GUINEA, FIJI, SOLOMON ISLANDS, WESTERN SAMOA, AND VANUATU

The Australian Financial Review
Information Service (AFRIS)
Attn: Mr. David Jamieson
235-243 Jones Street
Broadway
Sydney, NSW 20001

BELGIUM

Publications des Nations Unies
Attn: Mr. Jean de Lannoy
av. du Roi 202
1060 Brussels

CANADA

Le Diffuseur
Attn: Mrs. Suzanne Vermette
C.P. 85, Boucherville J4B 5E6
Quebec

COSTA RICA

Libreria Trejos
Attn: Mr. Hugo Chamberlain
Calle 11-13, Av. Fernandez Guell
San Jose

DENMARK

Sanfundslitteratur
Attn: Mr. Wilfried Roloff
Rosenderns Alle 11
DK-1970 Copenhagen V.

EGYPT, Arab Republic of
Al Ahram
Al Galaa Street
Cairo

FINLAND

Akateeminen Kirjakauppa
Attn: Mr. Kari Litmanen
Keskuskatu 1, SF-00100
Helsinki 10

FRANCE

World Bank Publications
66, avenue d'Iéna
75116 Paris

GERMANY, Federal Republic of

UNO-Verlag
Attn: Mr. Joachim Krause
Simrockstrasse 23
D-5300 Bonn 1

HONG KONG, MACAU

Asia 2000 Ltd.
Attn: Ms. Gretchen Wearing Smith
6 Fl., 146 Prince Edward Road
Kowloon

INDIA

UBS Publishers' Distributors Ltd.
Attn: Mr. D.P. Veer
5 Ansari Road, Post Box 7015
New Delhi 110002
(Branch offices in Bombay, Bangalore,
Kanpur, Calcutta, and Madras)

INDONESIA

Pt. Indira Limited
Attn: Mr. Bambang Wahyudi
Jl. Dr. Sam Ratulangi No. 37
Jakarta Pusat

IRELAND

TDC Publishers
Attn: Mr. James Booth
12 North Frederick Street
Dublin 1

ITALY

Licosa Commissionaria Sansoni SPA

Attn: Mr. Giancarlo Bigazzi
Via Lamarmora 45
50121
Florence

JAPAN

Eastern Book Service
Attn: Mr. Terumasa Hirano
37-3, Hongo 3-Chome, Bunkyo-ku 113
Tokyo

KENYA

Africa Book Services (E.A.) Ltd.
Attn: Mr. M.B. Dar
P.O. Box 45245
Nairobi

KOREA, REPUBLIC OF

Pan Korea Book Corporation
Attn: Mr. Yoon-Sun Kim
P.O. Box 101, Kwanghwamun
Seoul

MALAYSIA

University of Malaya Cooperative
Bookshop Ltd.
Attn: Mr. Mohammed Fahim Htj
Yacob
P.O. Box 1127, Jalan Pantai Baru
Kuala Lumpur

MEXICO

INFOTEC
Attn: Mr. Jorge Cepeda
San Lorenzo 153-11, Col. del Valle,
Deleg. Benito Juarez
03100 Mexico, D.F.

MIDDLE EAST

Middle East Marketing Research
Bureau
Attn: Mr. George Vassilou
Mitsis Bldg. 3
Makarios III Avenue
Nicosia
Cyprus
(Branch offices in Bahrain, Greece,
Morocco, Kuwait, United Arab
Emirates, Jordan)

NETHERLANDS

MBE BV
Attn: Mr. Gerhard van Bussell
Noorderwal 38,
7241 BL Lochem

NORWAY

Johan Grundt Tanum A.S.
Attn: Ms. Randi Mikkelborg
P.O. Box 1177 Sentrum
Oslo 1

PANAMA

Ediciones Libreria Cultural Panamena
Attn: Mr. Luis Fernandez Fraguera R.
Av. 7, Espana 16
Panama Zone 1

PHILIPPINES

National Book Store
Attn: Mrs. Socorro C. Ramos
701 Rizal Avenue
Manila

PORTUGAL

Livraria Portugal
Attn: Mr. Antonio Alves Martins
Rua Do Carmo 70-74
1200
Lisbon

SAUDI ARABIA

Jarir Book Store
Attn: Mr. Akram Al-Agil
P.O. Box 3196
Riyadh

SINGAPORE, TAIWAN, BURMA

Information Publications Private, Ltd.
Attn: Ms. Janet David
02-06 1st Floor, Pei-Fu Industrial
Building
24 New Industrial Road
Singapore

SPAIN

Mundi-Prensa Libros, S.A.

Attn: Mr. J.M. Hernandez
Castello 37
Madrid

SRI LANKA AND THE MALDIVES

Lake House Bookshop
Attn: Mr. Victor Walatara
41 Wad Ramanayake Mawatha
Colombo 2

SWEDEN

ABCE Fritzes Kungl. Hovbokhandel
Attn: Mr. Eide Segerback
Regeringsgatan 12, Box 16356
S-103 27 Stockholm

SWITZERLAND

Librairie Payot
Attn: Mr. Henri de Perrot
6, rue Grenus
1211 Geneva

TANZANIA

Oxford University Press
Attn: Mr. Anthony Theobald
Maktaba Road, P.O. Box 5299
Dar es Salaam

THAILAND

Central Department Store, Head Office
Attn: Mrs. Ratana
306 Silom Road
Bangkok

Thailand Management Association
Attn: Mrs. Sunan
308 Silom Road
Bangkok

TUNISIA

Société Tunisienne de Diffusion
Attn: Mr. Shaheddine Ben Hamida
5 Avenue de Carthage
Tunis

TURKEY

Haset Kitapevi A.S.
Attn: Mr. Izzet Izerel
469, Istiklal Caddesi
Beyoglu-Istanbul

UNITED KINGDOM AND NORTHERN IRELAND

Microinfo Ltd.
Attn: Mr. Roy Selwyn
Newman Lane, P.O. Box 3
Alton, Hampshire GU34 2PG
England

UNITED STATES

The World Bank Book Store
600 19th Street, N.W.
Washington, D.C. 20433
(Postal address: P.O. Box 37525
Washington, D.C. 20013, U.S.A.)

Baker and Taylor Company
501 South Gladiola Avenue
Mornence, Illinois, 60954

380 Edison Way
Reno, Nevada, 89564
50 Kirby Avenue
Somerville, New Jersey, 08876
Commerce, Georgia 30599

Bernan Associates
9730-E George Palmer Highway
Lanham, Maryland, 20761

Blackwell North America, Inc.
1001 Fries Mill Road
Blackwood, New Jersey 08012

Sidney Kramer Books
1722 H Street, N.W.
Washington, D.C. 20006

United Nations Bookshop
United Nations Plaza
New York, N.Y. 10017

VENEZUELA

Libreria del Este
Attn: Mr. Juan Pericas
Avda Francisco de Miranda, no. 52
Edificio Galipan, Aptdo. 60.337
Caracas 1060-A

WORLD BANK TECHNICAL PAPERS (continued)

- No. 21. Industrial Restructuring: Issues and Experiences in Selected Developed Economies
- No. 22. Energy Efficiency in the Steel Industry with Emphasis on Developing Countries
- No. 23. The Twinning of Institutions: Its Use as a Technical Assistance Delivery System
- No. 24. World Sulphur Survey
- No. 25. Industrialization in Sub-Saharan Africa: Strategies and Performance
- No. 26. Small Enterprise Development: Economic Issues from African Experience
- No. 27. Farming Systems in Africa: The Great Lakes Highlands of Zaire, Rwanda, and Burundi
- No. 28. Technical Assistance and Aid Agency Staff: Alternative Techniques for Greater Effectiveness



The World Bank

Headquarters:

1818 H Street, N.W.
Washington, D.C. 20433, U.S.A.

Telephone: (202) 477-1234
Telex: WUI 64145 WORLDBANK
RCA 248423 WORLDBK
Cable address: INTBAFRAD
WASHINGTONDC

European Office:

66, avenue d'Iéna
75116 Paris, France

Telephone: (1) 723-54.21
Telex: 842-620628

Tokyo Office:

Kokusai Building
1-1, Marunouchi 3-chome
Chiyoda-ku, Tokyo 100, Japan

Telephone: (03) 214-5001
Telex: 781-26838



UNDP

New York:

United Nations Development Programme
1 United Nations Plaza
New York, New York 10017

Telephone: (212) 754-1234
Telex: 125980 (domestic)
232-422 (overseas)
Cable address: UNDEVPRO
NEW YORK

Geneva Office:

Palais des Nations
CH-1211 Geneva 10
Switzerland

Telephone: 98-84-00
98-58-50
Telex: (UNDP) 28.96.20 or (UN) 28.96.96
Cable address: UNDEVPRO
GENEVA (SWITZERLAND)

Tokyo Office:

Shin Aoyama Building
Room 2255
1-1, Minami-Aoyama 1-Chome
Minato-Ku
Tokyo 107, Japan

Telephone: 03-475-1619/20
Telex: J28 334
AB TKOP1 J28 334
Cable: UNDEVPRO
TOKYO (JAPAN)