

**AT** MICROFICHE  
REFERENCE  
LIBRARY

A project of Volunteers in Asia

The Backyard Mechanic (Volume 2)

Published by:

Superintendent of Documents  
Consumer Information Center  
P.O. Box 100  
Pueblo, Colorado 81002  
USA

Available from:

same as above

Reproduced by permission.

Reproduction of this microfiche document in any form is subject to the same restrictions as those of the original document.

★ THE ★  
BACK-YARD  
MECHANIC



Reprinted from

**DRIVER**

THE TRAFFIC SAFETY MAGAZINE for THE MILITARY DRIVER

# Table of Contents

|          |                                |    |
|----------|--------------------------------|----|
| Chap. 1  | Buying A Used Car              | 2  |
| Chap. 2  | Basic Tune-Up                  | 9  |
| Chap. 3  | Final Tuning                   | 15 |
| Chap. 4  | Drum Brakes                    | 21 |
| Chap. 5  | Brake Hydraulic Systems        | 27 |
| Chap. 6  | Power Brakes                   | 33 |
| Chap. 7  | Carburetor, Rebuild            | 39 |
| Chap. 8  | Air Conditioning               | 45 |
| Chap. 9  | Ignition Systems, Part 1       | 49 |
| Chap. 10 | Ignition Systems, Part 2       | 56 |
| Chap. 11 | Spark Plugs                    | 61 |
| Chap. 12 | Grease, Oil, And Filter Change | 67 |

**DRIVER**

THE  
TRAFFIC SAFETY MAGAZINE  
FOR THE  
MILITARY DRIVER



 An auto maintenance series designed to help the novice working at home, as well as to provide a few reminders for the experienced hobby-shop mechanic.

*Prepared and written by*

**SSgt Don Holt**

*with the*

*Air Force's DRIVER Magazine Staff,  
AFISC/SEDD, Norton AFB, CA 92409*



# BUYING A USED CAR



## Some Basic Tips on Selecting a Safe and Sound Used Car

For sale by the Superintendent of Documents,  
U.S. Government Printing Office  
Washington, D.C. 20402  
Stock No. 008-070-00406-2 / Catalog No. D 301.72/  
A:M46V.2

If you were thinking about a new car this fall, you probably ran right down to check out Detroit's latest offerings. And, unless you're still out cold from the shock of seeing the price stickers, you might have decided you're really interested in a late-model used car after all.

But with the price of used cars skyrocketing, you're going to make a pretty healthy investment in a used car—in fact you may spend about as much as you'd originally planned to drop on a new car. So now more than ever before it's important to shop carefully and get a good deal on a used car you really want.

When you're buying a new car you really don't have to worry too much about whether the car is safe and reliable. But with any used car it's important to make sure the car is in top condition for maximum driving safety and pleasure. So, with this article we'll offer some basic tips about buying a used car that should help you get all of the car you're paying for—whether you're in the market for a late-model car or just looking for a drive-around-town second car.

#### LATE-MODEL

When you're shopping for a late-model car the first thing you should do is decide what type, style or model car you really need and how much you can afford to spend. The "looking around for a good deal" approach you might use when shopping for a clunker isn't always the best bet for buying a late-model car. Remember that prices will most likely continue rising, so either by choice or necessity you may be

hanging onto this car for a few years and you might as well get a car you like.

#### MARKET

After evaluating your wants, needs and financial status, get a feel for the market on the car you're interested in. Your base credit union should be glad to give you the "blue book" price on any car, but the true going price is most accurately reflected in newspaper ads. So get a feel for price and availability on "your" car by scanning the papers before you're ready to buy.

When you're checking out the ads you'll probably see cars you're interested in listed by new car dealers, used car lots and private owners. So the logical question is where to buy? Well, each of the three possibilities has various advantages and disadvantages. But before we go any further we want to say one thing—DIAGNOSTICS!

#### DIAGNOSTIC TESTING

Buying a used car has become a whole lot easier and a lot less risky thanks to the development of scientific automotive test centers. And we feel that anybody who buys a used car without having it completely checked out by a reputable independent test center is only slightly short of crazy. Because along with indicating if the car is safe and sound by thoroughly checking the basics like the front-end, suspension system and brakes, diagnostic testing tells the exact tune and internal condition of the engine through electronic analysis.

Although a diagnostic test will run about \$15 or \$20, there's no way you

*continued*

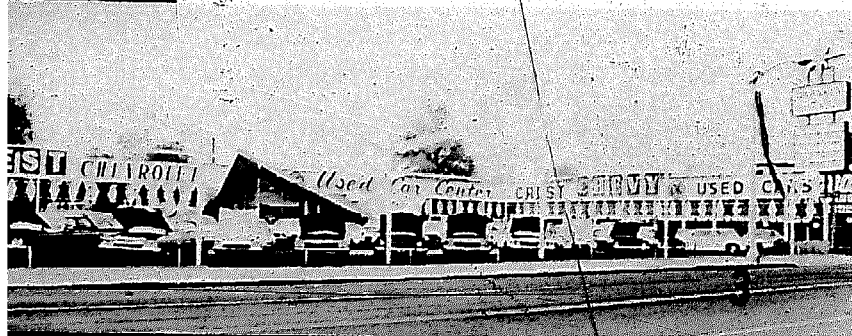

## BUYING A USED CAR

or a mechanic can do as thorough a job checking out a car for less money. And the small amount of money you spend having a car checked out now can save you a lot of bread, hassle, and disappointment in the future. Another advantage is that a diagnostic check will reveal the condition of many "small" items like headlight aim, battery charge and wheel balance that you might overlook or not be able to check. And having to have a lot of "minor" maintenance and adjustments after the sale can add up to make a good deal "not so good."

So now we're back to the question of where to buy a used car. Well, as previously mentioned, each of the possibilities has certain advantages and disadvantages that we'll run through briefly.

### NEW CAR DEALER

With a late-model car, it's generally pretty hard to go wrong buying from a franchised new car dealer. A car dealer keeps the best of his trade-ins for his used car lot and wholesales the not-so-cherry ones to used car dealers.

Although you're going to pay at least several hundred dollars more for a car at a dealer's lot, the car has probably been thoroughly checked and reconditioned by the dealer's service department before going on the lot. And in most cases you'll have some type of guarantee and the dealer's reputation (if he's a reputable dealer) backing up the car in case something does go wrong.

Most dealerships will also be glad to have the car checked out by an independent test center and provide you with the report or allow you to keep the car overnight to give it a thorough test drive and have it checked out on your own. Another big advantage is that most car dealerships will hold the car while you arrange financing. This way if you luck onto "your" car you don't have to worry about them selling it out from underneath you if somebody shows up with cash in hand.

### USED CAR DEALER

A reputable used car dealer generally offers about the same services as a new car dealer and you may be able to save a few bucks buying at a used car lot.

But in most cases a used car dealer doesn't have a service department and a used car that looks good may go right on the lot without being checked or serviced. So the main points to consider when buying from a used car dealer are can you have the car checked out before the purchase and does the dealer offer a guarantee that's worth anything?

### PRIVATE OWNERS

A lot of people in the used car market opt for buying from private owners, primarily because of the money they can save. Well, it's true that you can generally do better on price from a private owner—especially if he's in need of cash and willing to bargain for a quick sale. The main disadvantage to buying from a private owner is that you generally have to have cash in hand since the owner may be prone to sell to the first person who does. Also, a private owner may be reluctant to turn his car over to you to have it checked out for a variety of legitimate reasons. So you may be buying on a strictly "as-is" basis with no guarantee or real





Eyeball along all major body panels for ripples or body irregularities that mean the car has been pressed out after a smack. Check the rocker panels and behind the bumpers for rust.

The bounce test will give you a general idea of the condition of the shocks. If the car bounces a couple of times before returning to its original position when depressed, the shocks are worn.

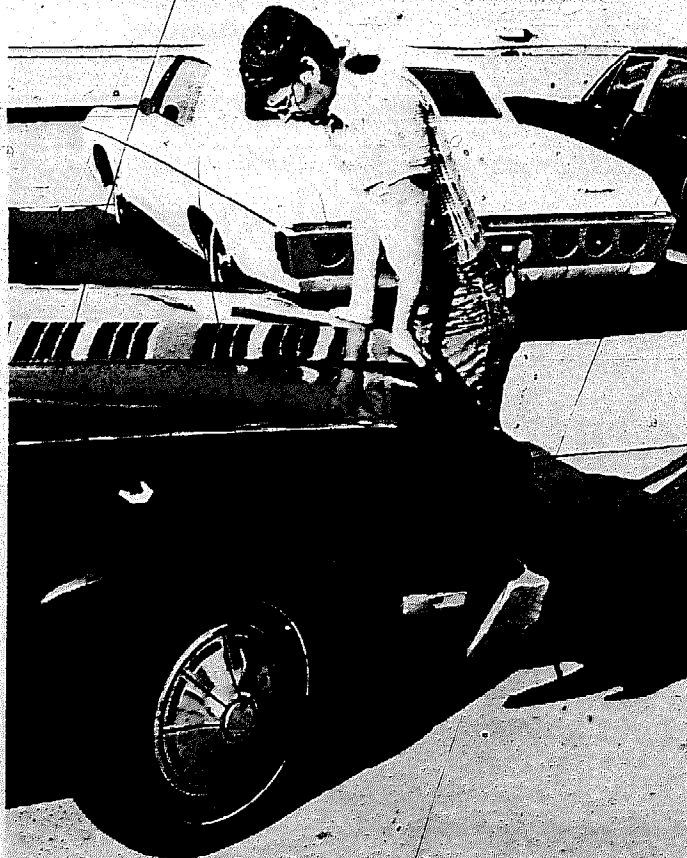

recourse if the car has problems. Of course if you're saving a bundle off the going price of the car you can afford to spend a bit on minor maintenance after the sale.

So, what this boils down to is that you weigh the advantages and disadvantages of each buying situation as they apply to you. But if at all possible, we recommend not buying a car that you have not had thoroughly checked out by an independent diagnostic center. And if you've never dealt with a diagnostic center, most American Automobile Association (AAA) offices keep a list of reputable diagnostic shops in their area.

But let's say for some reason you can't have the car checked out or you want to be sure you don't have a total lemon before spending the money on having the car tested. Well, there are some basic checks everyone can and should make before purchasing any used car.

Before we get into the mechanics of checking out a used car, however, we want to point out that this is where the basic strategies for buying a late-model car and a clunker vary. For instance, if you're checking out a late-model car and you discover some minor problems or a fairly major one you may want to write off the car—especially if you're going to have to pay top dollar for it. But, if you discover some problems and you're still interested in the car, these problems might provide some good bargaining points to encourage a private owner to drop his price a bit. Or, in the case of a dealer, you can be sure he guarantees to have these items repaired before the sale.

On the other hand when you're buying an older car—especially a clunker—you must expect the car isn't going to be in perfect condition. And since you're probably going to be buying from a private owner on as-is basis, it's important to check out the car thoroughly and weigh how much you're paying against how much it will cost to get the car in shape. Of course with a clunker your main concern will be whether the car is safe and reliable. So the items you'll be most concerned with are things like tires, brakes, steering, and engine performance.

*continued*



continued  
**BUYING A USED CAR**

So the following basic checks—while not to be considered complete by any means—should help make sure you don't buy a dog. One thing to keep in mind is that not all of these checks apply to a clunker as much as to a new car and vice versa. A final point concerns buying an imported car. Since some of the more exotic import cars may have weird idiosyncracies that you might not be aware of, it's not a bad idea to have an import car checked out by a foreign car mechanic.

#### **GENERAL CONDITION**

Begin checking out a car by simply walking around it looking for obvious defects such as cracked window glass. You should be able to get a good feel for whether the car had a hard life by simple observation. If the car has been sitting for awhile, be sure to check underneath it for splotches of liquid that indicate transmission, rear-end or cooling system leaks. Check the tailpipe: if it is oily or gunky, the engine has internal problems. Carefully eyeball all major body panels for ripples or irregularities that indicate the car has been pressed out after a crunch. A once-smacked car is best avoided since it could have suffered other damage in the crash.

When eyeing the body panels, it's a good idea to check the rocker panels for rust. Although it's rare on a late-model car, rust could be starting. On an older car rust may have been painted over so check the paint for pitting. Also check the splash guards behind each bumper for rust and crash damage—if the bumper brackets are new or welded you can assume the car was smacked quite hard.

#### **WHEELS AND TIRES**

Check the wheel rims for dents. A few dents are not uncommon during ordinary driving, but a lot of dents or especially large ones are a good sign the car was driven pretty hard. Naturally you'll want to check the tires for condition and tread depth as well as tread wear patterns. Uneven tread wear is important for a couple of reasons. First, it's a sure indication that you're

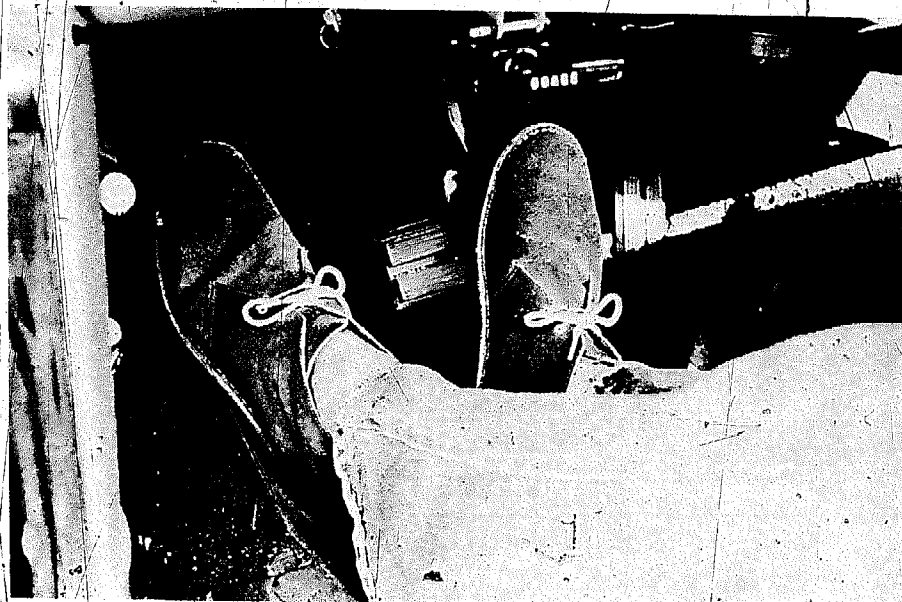

**Check brake hydraulic system** by holding down firmly on the pedal for thirty seconds. If the pedal stays firm the brake system is okay.

going to have to sink some money into front-end work and/or wheel balancing. Also the fact that the owner drove the car with the front-end out of alignment may indicate that he was a bit sloppy with other basic maintenance such as oil changes and lubes. Don't forget to open the trunk and make sure the spare tire holds air and the jack works properly—replacing these two essentials after the sale can make a good deal not so good.

#### **STEERING AND SUSPENSION**

Although it's a bit difficult to tell too much about the car's suspension system through casual observation, you can check the steering play and shock absorbers. Watch the front wheels while you slowly turn the steering wheel (engine on with power steering); there should not be more than two inches of play before the wheels turn. If there's excessive play you're in for a fairly costly adjustment or possibly more serious work. You can get a rough idea of the condition of the shocks by the bounce test. Push down on each end of the car and release it. If the car returns to its normal position in one smooth motion the shocks should be okay. If the car bounces a few times the shocks are probably worn. Also grab the top of each front wheel and pull firmly. A

little play is acceptable, but if there's a lot of give there may be suspension or wheel bearing problems. If possible, check underneath the car to see if the exhaust system is in good condition—not rusted, and if the car had a recent lube.

#### **UNDER HOOD**

The next step is opening the hood and having a look around. If the engine hasn't been cleaned, check for oil leaks. A lot of oil and gunk around the oil filler tube means internal engine problems. Pull the dipstick and look carefully for water droplets that indicate a blown head gasket and a very costly repair bill. If the oil is very dirty, the owner probably wasn't careful about regular maintenance.

#### **RADIATOR**

Check the radiator for any signs of repair that may mean an "overheated" engine. Remove the cap and check the coolant—if it's especially rusty and gunky you probably better look for another car. Also look carefully for any sign of oil in the coolant that would indicate a cracked block and a definite no-purchase.

Make sure the brake master cylinder is topped off and there are no signs of leaks around the unit. If the car has

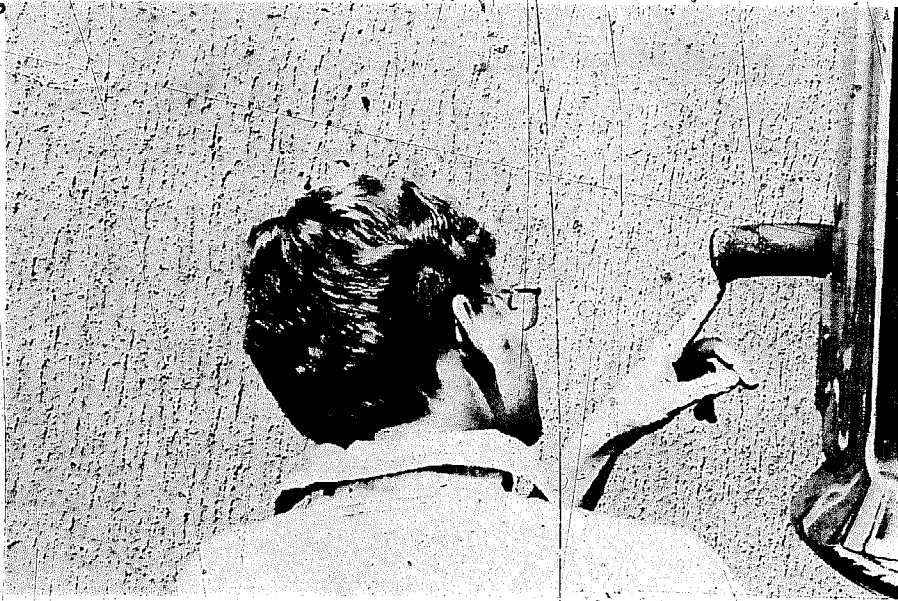

Tailpipe should be dry. If it is black, gunky or oily the engine probably has internal problems.

an automatic transmission, pull the transmission dipstick and check the color and condition of the fluid. It should be sparkly red. If it is orange, black, has carbon specks or smells like varnish the transmission is in definite need of an overhaul. Pull the PCV valve out and see if it clicks freely, if it does the owner probably kept up on

regular maintenance. Finally, just check around under the hood—is the battery clean, are the terminals and cables clean and uncorroded?

#### INSIDE

If things look good under the hood you can check out the inside of the car. First look for lube stickers on the inside

of the door post—the kind service stations put there to tell when the car was serviced. These may indicate how well the owner kept the car serviced (unless he did his own maintenance) and you might be able to match up the mileage on the odometer with that shown on the service stickers just to be sure the mileage figure is correct. Also, if you're buying from a lot, you might be able to get the previous owner's name off the lube stickers or perhaps you can find his name on an old credit card slip somewhere in the car. In any case, if you can find the previous owner's name you can give him a ring and ask him about the car.

Inside the car check all of the equipment and accessories to be sure they work. Items like the turn signals, heater and defroster are a must of course. Also, make sure the windows and doors open and close correctly. If the interior shows excessive wear, you can assume the car has had a lot of miles or at least hard ones.

Be sure to check the brake hydraulic system by holding down firmly on the pedal for at least thirty seconds—if the pedal stays firm, the hydraulic system is okay. On a manual transmission car,

*continued.*



continued

## BUYING A USED CAR

(near right)

**Pull oil dipstick** and look for water droplets that mean a blown head gasket.

(far right)

**Look in trunk** for operational jack and an inflated spare.

(near right)

**Remove radiator cap** (carefully release the pressure if the engine is hot) and check coolant condition. If it is especially rusty, scaly, or there is any oil in the coolant, forget the car. A new radiator or signs of radiator repairs probably means the car has been crunched or that it is an "overheater."

(far right)

**Check master cylinder** for fluid level and make sure there are no signs of leaks around the unit.

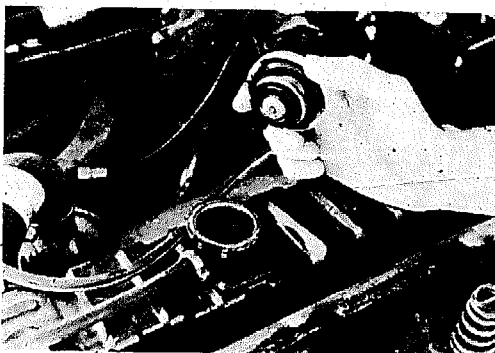

check to see that the clutch has no more than 1 inch of free play. A basic way to check the clutch is to put the car in gear, apply the emergency brake (engine running) and release the clutch—if the clutch is okay, the engine will stall when the clutch is released. Make sure you make this test in an open area, with no one in front of the car.

### TEST DRIVE

After checking out the inside of the car, you're ready for a test drive. Listen carefully when you crank the engine. The engine should start quickly and easily. After the engine warms a bit rev it a few times and check the color of the exhaust smoke. If the exhaust smoke is black you're in need of at least a carb adjustment. But if the exhaust smoke is blue there's a definite engine problem. Run the engine at various speeds and listen for misses, hesitations, or unusual noises. Any irregular engine operation is an indication that at least a tuneup is needed and it's a good rea-

son to have the car diagnosed or at least a compression check made to determine the internal condition of the engine.

After you get a feel for the car, head out for a deserted stretch of road where you can safely make some quick stops to check the brakes. On the way you can make a few acceleration tests to further check engine operation. From a standing start accelerate briskly and smoothly to about 50 mph. The car should accelerate without missing or making any unusual noises—check the rearview mirror for blue smoke while you're accelerating. Also be listening for any unusual mechanical noises like transmission clunks. Blue exhaust smoke or strange noises are good reasons to look for another car.

When you get to a nice stretch of deserted road where you can safely test the brakes, make some progressively harder stops. Make sure the car stops evenly and quickly without pulling, screeching, or making any unusual

noises. When you get the feel of the brakes, try locking them on for just an instant. If the brakes won't lock there's something wrong with them.

Finally, drive the car over various road surfaces to get a feel for ride comfort and noise levels. If the car drifts on the road or won't track straight down the road when you release your grasp from the wheel briefly, there's a definite alignment problem. If the wheels seem to bounce or hop you know they need to be balanced.

So, if the car rides and handles to your liking and everything else checked out, you may have just bought a new used car—congratulations. But, if things didn't check out just right, be prepared to look for another car or make sure the "deal" you're getting is saving you enough so you can afford to get the car in shape. And, if you just picked up a second-car clunker, check out this month's article on keeping up an oldie on page 16. Ⓞ

# Thompson BARGAIN BUGGIES

WE FIX ANYTHING!  
COMPLETE  
AUTO REPAIR

Thompson  
BARGAIN BUGG

Good buys from Thompson Guys

SERVIC





# THE BACKYARD MECHANIC

**R**ecently many people have gotten very tune conscious—not musically but mechanically. Fuel shortages and high gas prices make maximizing gas mileage the “in” thing. But many drivers still think there are super-trick ways of tuning a car to double the gas mileage.

Well, unfortunately there aren't any magic tricks or gadgets that will substantially increase fuel economy. The truth is that your car operates at best efficiency when it is tuned properly to specifications. So the real way to get maximum performance and gas mileage is to perform a thorough tuneup. But by “thorough” we mean more than just slapping in points and plugs—although this alone will usually improve performance.

A good tuneup can be broken down into three major steps that begin with an inspection of the basic systems, such as the fuel and electrical systems. Phase two is the actual tune-up step of replacing ignition parts. And the last step is making the ultra-important final settings and adjustments. We'll outline the basics of the first two steps here, and next month we'll cover the use of tuneup equipment for making the final adjustments.

The Backyard Mechanic is designed to serve as only a general guide to the maintenance topics discussed. Since basic procedures vary from car to car, a manual should be consulted when

performing any maintenance. And any jobs that the “backyard mechanic” feels are beyond his capabilities should be left to experts.

## GENERAL TUNEUP

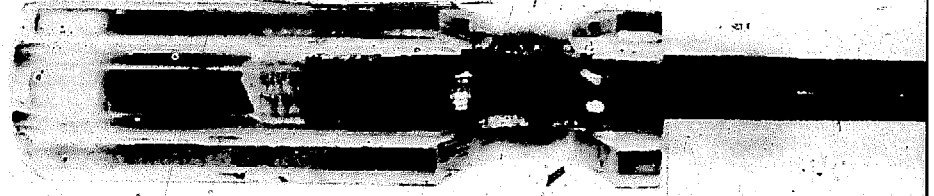

### GENERAL CHECKS

The first thing you should do before beginning a tuneup is glance through a manual to get a good idea of what you're going to do and what equipment and parts are needed. It's usually a good idea to pick up regularly replaced parts, such as filters, when they are on sale. But if you don't have replacement parts on hand, your best bet is waiting until you check things out before buying parts. This way you won't go out and pay for parts not really needed.

After checking a manual, the first step in a tuneup is a quick inspection of the basic components that affect reliability and performance. Some of the most important checks that require nothing more than a couple of minutes and common tools are listed below.

**Battery**—First, after removing any jewelry, pop off the battery filler caps and check to see that the water level is up to the fill line or over the plates in all cells. If the level is

low, bring it up with distilled water. Tap water is okay in an emergency.

Next make sure the battery case and terminals are clean. Corroded terminals should be cleaned with steel wool or a special cleaning tool, such as pictured. When removing the battery cables for cleaning, be sure to remove the ground cable first (the cable that runs to the car frame or engine—the negative cable on nearly all American cars and most imports). Connect the ground last when reinstalling the cables. A dirty battery case can be washed with baking soda solution and rinsed with clean water. Coat the tops of the cleaned battery terminals with petroleum jelly to help prevent corrosion. Finally, trace the positive battery cable to make sure all electrical connections are tight—especially at the starter.

**Air Filter**—A dirty air filter restricts air flow to the carburetor and causes it to burn more gas. So, a clean air filter is essential for best gas mileage. Most cars use a dis-

posable paper element filter available for around \$3 at stores. You can check the filter by holding it up to the sunlight or to a bright light bulb. If you can't see light coming through all the way around the filter, it should definitely be replaced.

**Gas Filter**—A plugged gas filter can stall your engine cold without warning. Since there's no way to check the filter, it should be replaced at every tuneup. There are two basic types of gas filters—the type used on most GM products (Rochester carbs) installs inside the carb. Most other cars use an in-line filter that clamps in the fuel line between the fuel pump and the carb.

The GM-type filter can be replaced by very carefully removing the fuel line at the carb while holding a rag under the line connection to catch leaking gasoline. When you remove the line note how the filter and spring insert in the filter housing so you can install the new filter correctly.



Special cleaning tool works best on corroded terminals.

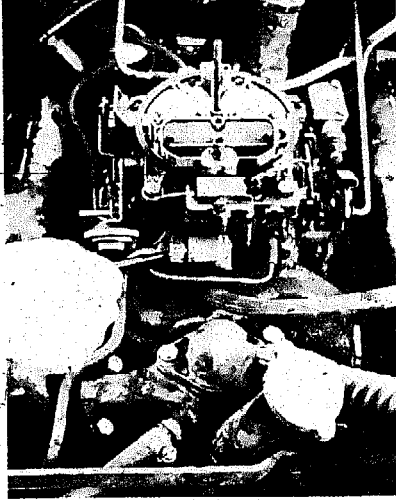

The gas filter fits inside the carb on most GM products. In-line filters are used on nearly all other cars.

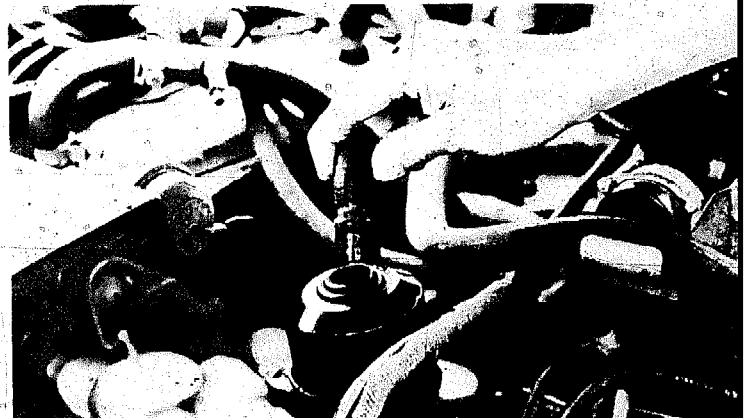
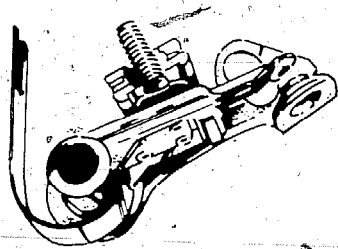
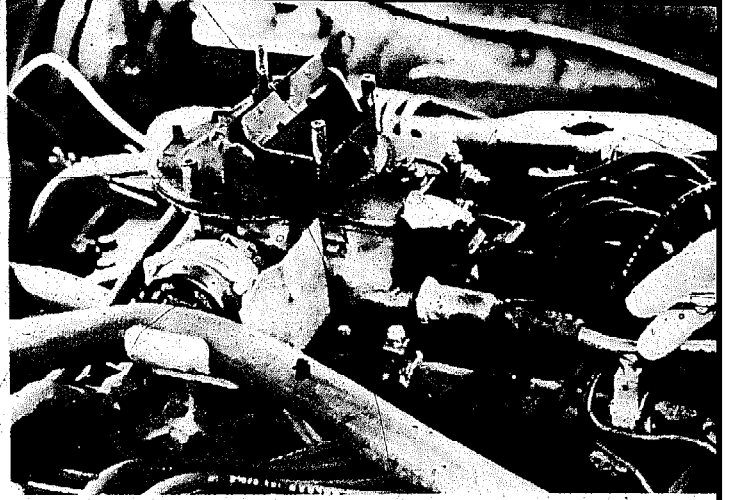

The PCV filter is located in the rocker arm cover or intake manifold on most cars and should be replaced at every tuneup.

The in-line filter either clamps into the fuel line or, on most Ford products, it screws into the carb with the fuel line clamped to the other end. The new filter can be clamped into place exactly as the old filter came out.

**Emission Systems**—Emission systems should be properly maintained to keep emissions down and performance up. The "Backyard Mechanic," Parts VII and VIII in the July and August DRIVERS, cover emission system checks. But during a tuneup your main concerns should be the PCV system and the heat riser and/or thermostatic air cleaner.

An easy way to check the PCV system is to place a sheet of paper over the oil filler neck. If the paper is pulled in by suction, the system is operating. Even if the system is operating this is the perfect time to install a new PCV valve—the valve should be replaced every 10,000 miles or so. To replace the valve simply locate it in the rocker arm

cover or intake manifold. Pull the old valve out of its rubber grommet and insert the new valve being sure it is properly seated in the grommet.

The heat riser is a simple valve that controls heating of the intake manifold by exhaust gases. If the valve sticks it causes all kinds of problems. Locate the heat riser on the exhaust pipe or crossover near the exhaust manifold and check it for free operation. A sticking valve can be freed with solvent.

Most cars since 1971 and many older model cars have a special thermostatically-controlled air cleaner instead of the heat riser. And a few cars still use both systems. If your car uses a thermo air cleaner there will be a hot air tube or pipe running from the exhaust manifold to the air cleaner intake. The previously mentioned "Backyard Mechanics" cover thermo air cleaner maintenance—but your primary concern should be checking to see that the heat tube is properly

connected at the air cleaner and manifold and that it's not leaking.

**Spark Plug Wires**—Plug wires are very frequently neglected items that can cause plenty of problems. Wires with cracked or damaged insulation should be replaced. The best way to install new wires is to buy a replacement kit designed for your car's engine. These kits come with wires pre-cut to the proper size. The only trick is replacing one wire at a time so you get the wires into the distributor cap correctly. If the wires are oil-soaked but not damaged they can be cleaned with solvent.

**Clean Carb**—At every tuneup, if not more frequently, a can of carb combustion chamber cleaner should be sprayed down the carb throat according to the instructions on the can. The outside of the carb—especially the choke plate and linkages—should also be sprayed clean with carb or choke solvent. Be sure the choke operates freely.

continued

continued

## THE BACKYARD MECHANIC

### TUNEUP

After checking out the mentioned items, as well as basics like the drive belts and the master cylinder reservoir, you're ready to get into the actual tuneup. The only tools you need in addition to ordinary hand tools are a plug gapping tool and feeler gauges—unless you have a GM product in which case you don't even need feeler gauges. Naturally you'll need spark plugs and a tuneup kit—these are discussed later.

Before beginning the tuneup, however, you should perform a compression check. Checking the compression tells you the internal condition of the engine—primarily what kind of shape the valves and piston rings are in. This check is important since an engine down on compression can't be very effectively tuned, and some engines can be damaged when run with burned valves.

In a future "Backyard Mechanic" we will feature an entire article on doing a thorough compression and cylinder balance test. But in the meantime, here is a very simple way to get a good idea of your engine's internal condition. Pull the coil wire out of the distributor and ground it to the firewall or engine. Then crank the engine over with the starter for about 20 seconds. If the engine cranks fairly evenly, the compression should be okay. But if there is a lot of variation in the cranking speed a complete compression check should be made.

### PLUGS

After checking the compression, the first ignition parts you'll want to replace are the spark plugs. But before running out to buy new plugs, it's a good idea to remove a couple of the old plugs and examine them to see if the fuel mixture is burning properly. If you have a four- or six-cylinder engine, removing the plugs should be a snap with a plug wrench or spark plug socket and ratchet. But if you have a V-8 or air conditioning, some of the plugs may be tricky to get to. Make a survey under the hood to see if you need any kind of special extensions or swivel adapters to get to the plugs.

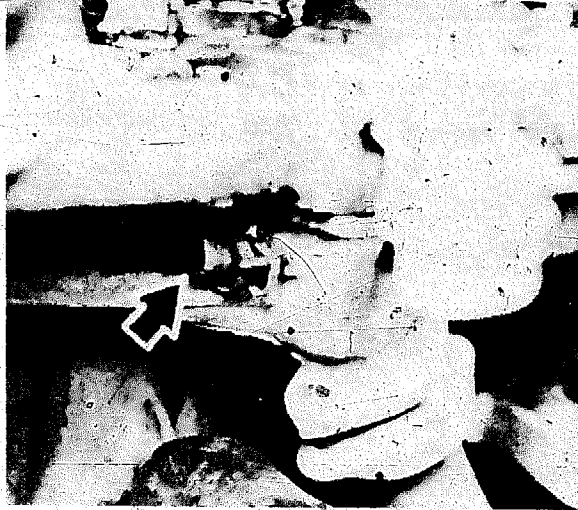

The heat riser used on most older cars is located near the exhaust manifold. It should be regularly doused with solvent to keep it operating freely. On cars with thermo air cleaners, make sure the heat tube or pipe is connected at the manifold and at the air cleaner.

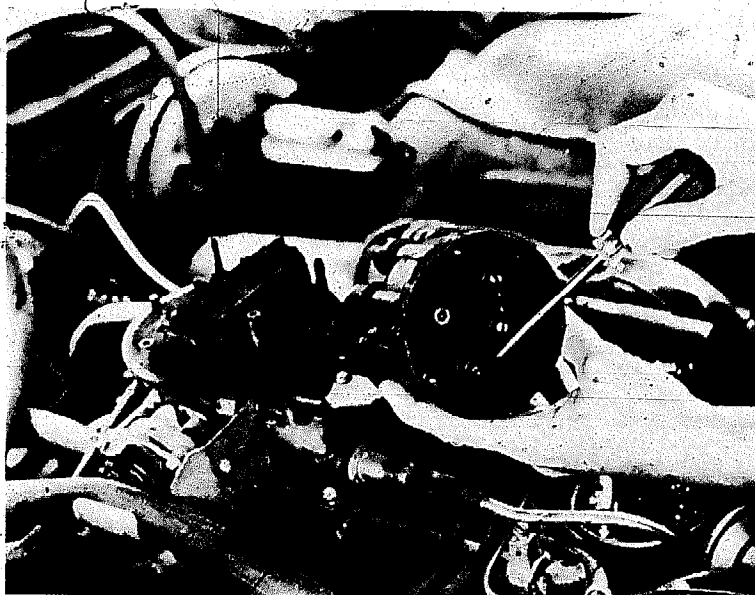

Light carbon deposits should be scraped off the distributor cap contacts. Heavy carbon build-up or cracks in the cap call for a new cap.

If you have compressed air available it's a good idea to blow out the plug depressions to keep junk from falling in the hole when the plug is removed. Pull off the wires on a couple of plugs and carefully remove the plugs. Since the removed plugs will be warm, grab them with a rag or leave them in the plug socket tool to inspect them. If the plugs have a crumbly chocolate-brown deposit, the engine is burning okay. But, if the plugs are black and oily, either the plug is burning too cold or oil is leaking into the combustion chambers and fouling the plugs—oil fouling is common with older engines that have worn piston rings. In either case a hotter burning plug should be used. On the other hand, a white powdery deposit means

the engine is burning too hot and colder burning plugs are definitely needed.

A good place to buy new plugs is at a discount store. But check the application charts very carefully to get the correct plug for your engine. Frequently the same size engine uses a different plug, depending on the year or horsepower rating of the engine. If you're changing to a different heat range plug, be especially careful. If you have trouble determining what plug to switch to, take one of the old plugs to a parts house and have them set you up with the right plug.

While picking up your plugs you can grab an ignition tuneup kit and you're set for your tuneup. The best way to go is with sealed kits that

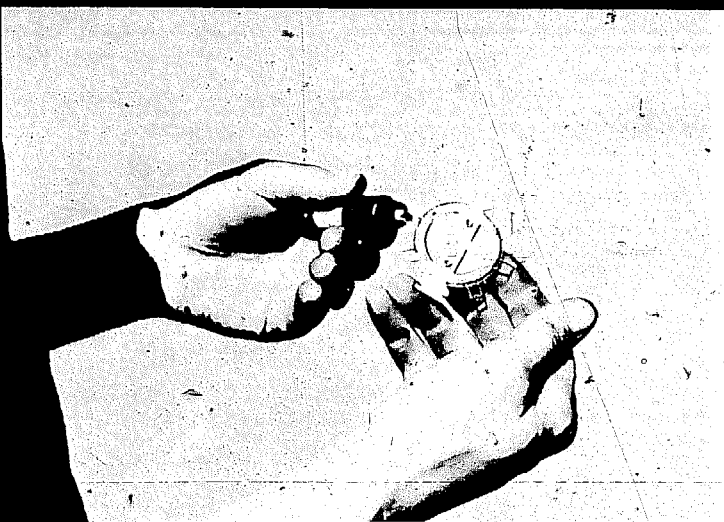

Removed spark plugs should be read for correct burn. New plugs should be gapped to specifications before installation.

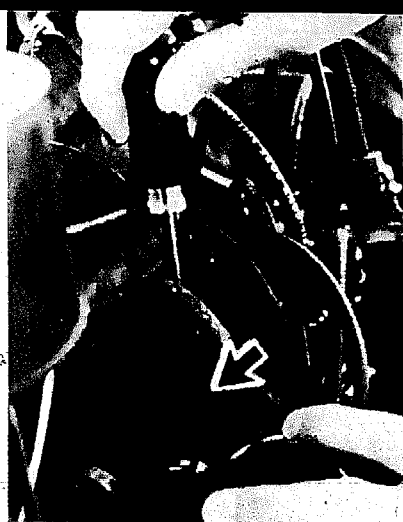

The distributor cap on most GM products is removed by turning the special lock screws until they release. Non-GM cars have caps held in place by external clips that are popped off with a screwdriver.



GM distributor. Rotor

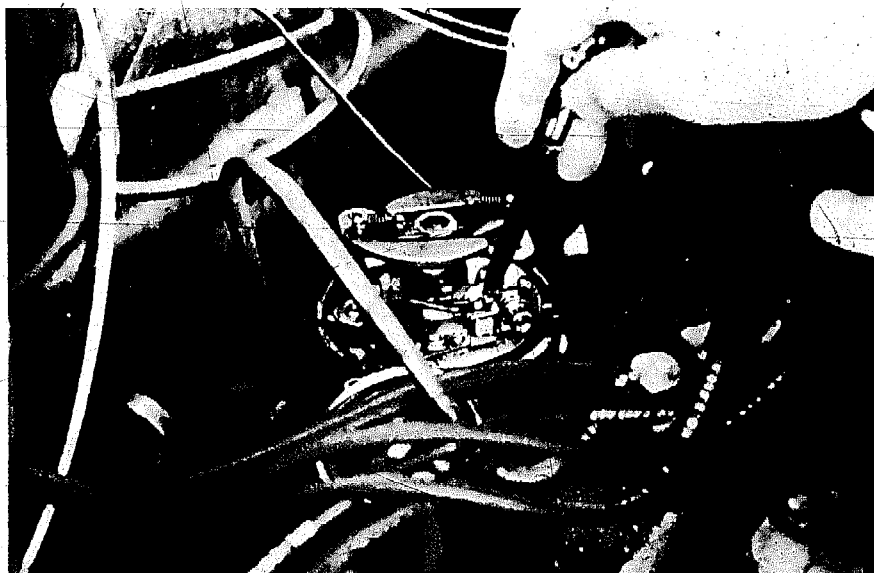

Condenser Points

contain a rotor, condenser, and points. Just be sure and get the correct kit for your car and engine. As with the plugs, the kits may differ for the same engine depending on the year or horsepower rating.

After figuring out how to remove all the plugs (if this is a problem on your engine) all you have to worry about is gapping the new plugs. Most plugs are pregapped at the factory, but double-check each plug with a gapping tool to be sure it's at the gap specified in your manual.

Replace the wire immediately on each new plug to prevent mix up. Install the plugs one at a time and snug

*continued*

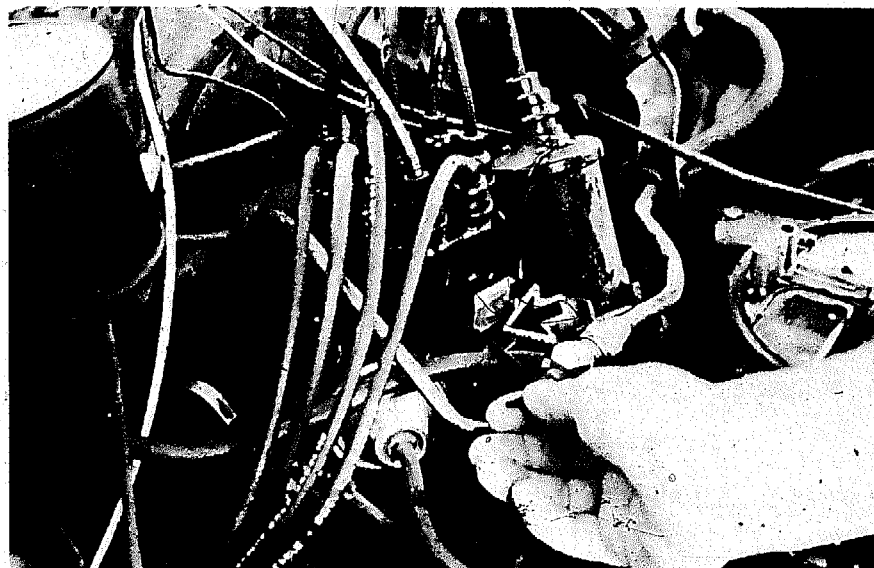

Adjusting access window on GM distributor.



continued  
THE BACKYARD MECHANIC

them finger tight before tightening them with a socket or torque wrench.

#### POINTS

After changing all the plugs you're ready to get into the distributor. Installing new ignition points and condenser are the only tricky parts of a tuneup—but even this job is simple if you work carefully. While some people recommend removing the distributor to work on it—you can avoid a lot of potential problems by leaving it in place and simply being careful.

The most important thing when replacing the ignition parts is not losing the small hold-down screws—especially not dropping them down into the distributor. Magnetized screwdrivers are a big help for this job.

When you're ready to replace the points, the first thing you'll need to do is remove the distributor cap. Most GM cars have caps with a special locking catch. To remove this type cap, simply use a screwdriver and turn the screw heads in the cap until the locks release (see photo). Most other type caps are held in place by external clips that can be popped off with a screwdriver.

Check the removed cap very carefully for cracks or excessive carbon deposits on the inside contacts. If either are found, a new cap should be installed. When installing the new cap make an accurate drawing of where the plug wires fit into the cap so you can install the new wires properly. If the wires do get crossed and the engine won't start or runs poorly, a service manual has a diagram of how the wires fit into the cap.

If the distributor cap is in good condition, gently scrape any carbon off the contacts with a screwdriver and spray out the inside of the cap with solvent. Wipe the cap clean with a rag and pull it out of your way.

There are basically two types of distributors and the procedure for installing and adjusting the points differs. We'll discuss the two types separately, beginning with the type used on nearly all GM products. The accompanying pictures should get you oriented if you've never replaced ignition parts.



Non-GM distributor. Rotor Points Condenser  
Note where wires connect.

#### GM DISTRIBUTORS

On a GM-type distributor the first thing you'll see with the distributor cap removed is a large round rotor held in place by two screws. Loosen the screws and lift the rotor straight up to remove it. Now the points and condenser should be visible (see photo), unless you have a window radio antenna in which case there will be a shield over the points that you simply pull off. Now you can see that the points and condenser are held in place by set screws. Also notice that there are two wires that attach to the points. Generally the wires fit in a clip and can be simply pulled loose. However, on some cars the wires are held in place by a small nut—you may need a small ignition wrench to loosen this nut. After removing the wires from the points, very carefully loosen the condenser, then the points by removing the hold-down screws. Lift the parts off the plate.

Spray the distributor plate with solvent and gently wipe it and the distributor cam clean. Then take the small tube of lubricant supplied with the tuneup kit and coat the cam with lube. Now you're ready to install the new condenser and points. Place the new condenser on the plate exactly as the old part came off and lock it down with the screw. Then place the points on the plate, being very sure

the guide hole on the points is positioned over the guide post. Tighten down the screw and hook the wires to the points. Since the point adjustment is made externally with a GM-type distributor, you can put in the new rotor and lock down the distributor cap. Now you're ready to fire up the engine and adjust the points.

Locate the adjusting access window on the distributor cap (see photo) and insert the allen wrench that comes with the tuneup kit. If the engine fails to start, turn the wrench one way, then the other until the engine fires. If the engine still fails to start, go back and doublecheck your work.

To adjust the points, with the engine running turn the adjusting wrench to the right (clockwise) until the engine starts to miss or dies. Then simply turn the wrench one-half turn back to the left. This should be the correct point gap setting. But the setting should also be checked with a dwell meter—this procedure will be covered next month.

#### OTHER TYPE DISTRIBUTORS

Installing and adjusting points on the other type distributor used on nearly all non-GM cars and on most import cars is basically the same except for the point adjustment. The accompanying pictures should clarify

the steps involved in working on this type distributor. With the distributor cap removed, the first thing you need to do is remove the rotor by pulling up on it. Then the condenser which may mount on the distributor plate or on the outside of the distributor housing can be removed. Next remove the points by loosening the screw and lifting the unit off. Clean the distributor plate and cam, then lube the cam as with the GM distributor. Install the new condenser and you're ready for the points. This is where the basic procedure differs.

Put the points in place, making sure the guide hole is over the guide post, and snug down the set screw. Don't tighten it all the way because you still have to adjust the points.

To adjust the points, you have to first get the point rubbing block on a lobe of the distributor cam (see photo). To do this, turn the engine by hand with the fan, or if your car has a clutch-operated fan you can have a buddy tap the starter until the rubbing block is on the peak of a cam lobe and the points are open.

Now with the points held open by the cam, carefully insert a clean feeler gauge of the correct size (your manual gives the gap spec) in between the points. Insert a screwdriver in the special adjusting slots (see photo) and adjust the gap until the gauge drags lightly when inserted in the gap. Then carefully tighten the set screw and double-check the gap. The gap frequently changes when the screw is tightened. Install the new rotor by lining up the guide inside the rotor with the groove on the cam and twist the rotor slightly until it slides all the way down on the cam. Re-install the distributor cap and you should be all set.

The engine should fire up. If not, go back and check your work—especially the point gap. If it's too narrow or too wide, the engine won't start. The points should also be checked with a dwell meter. As previously mentioned, this will be covered next month.

Now your car should run a whole lot better. But you're not finished yet. The final settings of point dwell, timing, and carburetion are what make the difference between a car that runs and one that runs great. So hang on 'til next month when we'll give you tips on super-tuning. ⊕

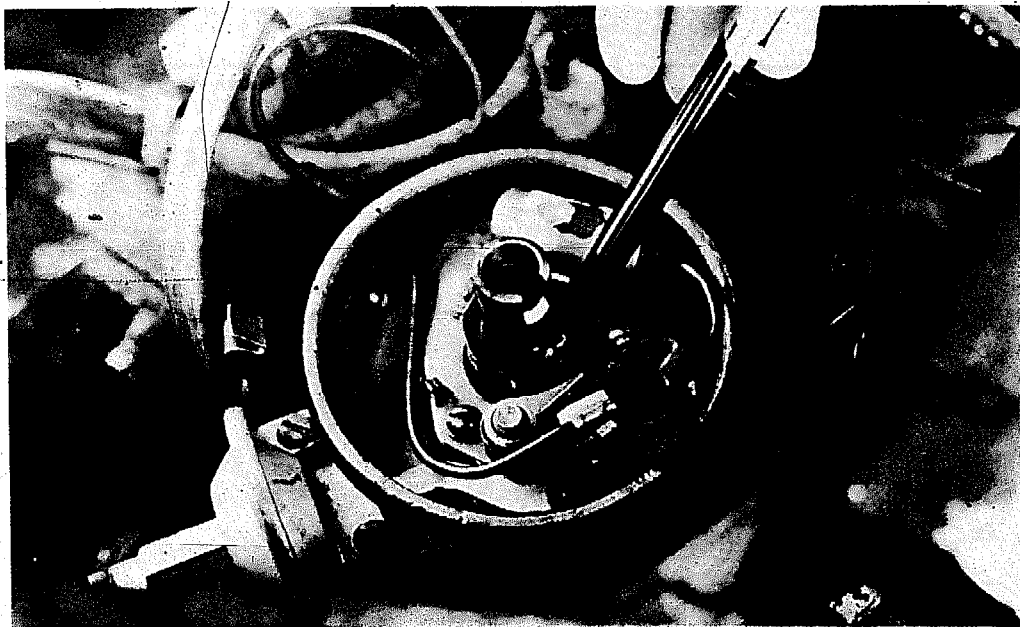

To adjust the point gap, the rubbing block must be on a high lobe of the distributor cam. Special rings that fit over the cam and hold the points open to the proper gap are available. These save the trouble of cranking the engine to get the rubbing block

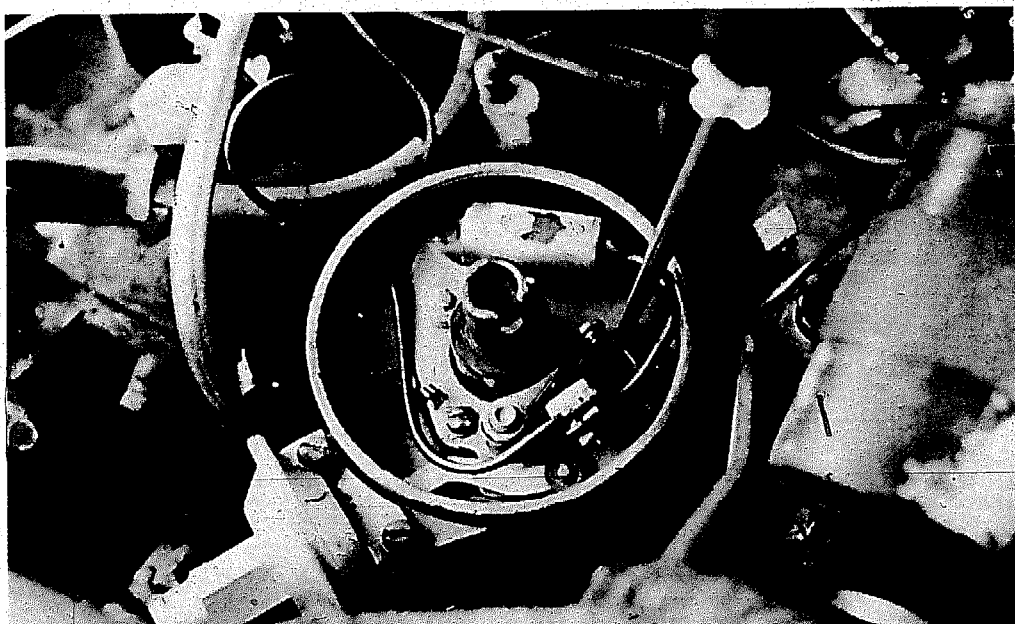
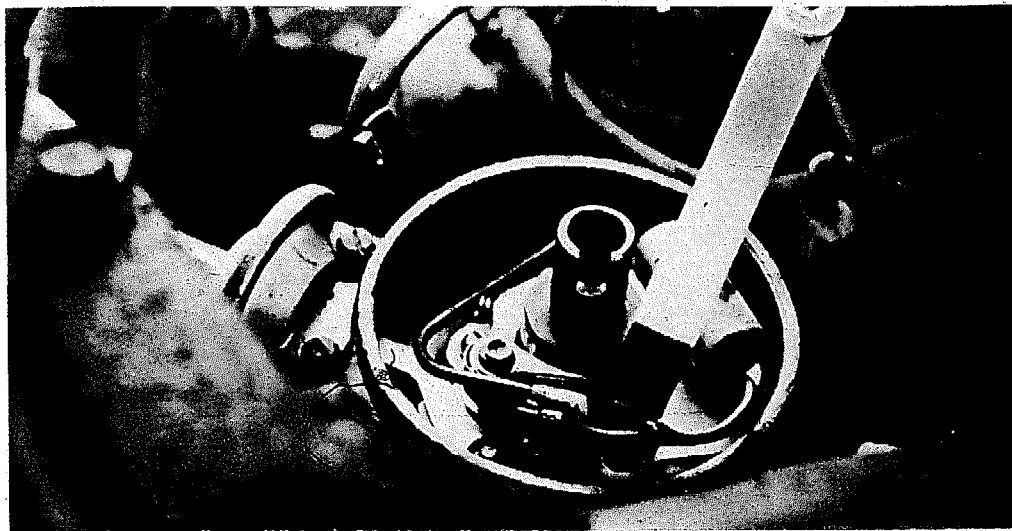

With the points held open by the cam, the gap can be adjusted to specifications with a feeler gauge. The gap is changed by inserting a screwdriver in the special adjustment slot.

# FINAL TUNING

Last month's "Backyard Mechanic" went through the basic tuneup steps of inspecting essential components and installing new ignition parts. However, we didn't get into the most important part of a general tuneup—the final adjustments. So this month we'll finish things off by outlining how to use the special tuneup equipment to make the final tune settings.

The main items you'll need for putting a super-tune on an engine are a dwellmeter, preferably a combination tach/dwell, and a timing light. This equipment is available at your base auto shop. But if you're really into "backyard mechanic," you can pick up the necessary equipment at a discount store for around \$25 and have your own home tuneup center.

Many stores carry special tuneup kits that contain the essential equipment. But, while these kits are handy, most of the less expensive ones come with the weak-flashing neon bulb timing light which is relatively inaccurate and very difficult to use. The

brighter-flashing power timing light is the only way to go as we'll explain later. So if you buy a complete tuneup kit be sure it has a power timing light—either A.C.- or D.C.-powered is okay, but the D.C. is handier. You might also consider buying the tuneup items individually since most discount and department stores regularly place tuneup equipment on sale. By watching the newspaper ads you can probably pick up a good-quality timing light and tach/dwell for about what you'd pay for a kit containing less accurate instruments.

### DWELL

The first step in final-tuning an engine is setting the dwell angle—this is basically just a more precise measurement of the point gap. By reading how long the points stay closed before opening (with the engine running), a dwellmeter tells exactly what the point gap is and allows for a more exact adjustment.

Some people think that if the points are set carefully with a feeler

gauge there's no reason to check the dwell. But this isn't true, as evidenced by the very existence of the dwellmeter. Generally if the points are set to specs with a gauge they'll be pretty close on the dwell—but not always. So checking the points with a dwellmeter should be part of every tuneup.

To use the dwellmeter all you have to do is attach one of the meter's leads at the coil and ground the other lead. Trace the wire that runs from the distributor to the coil. Clip the positive dwell lead (red clamp) to this terminal. If the terminal is covered with a special insulator boot, you won't be able to get a direct connection. In this case pull the boot up slightly and wrap one end of a straightened paper clip around the terminal and push the boot back down. Then clamp onto the free end of the clip to make your connection (see picture). Make sure the lead is not touching any other metal, then simply ground the other lead.

Next set the meter to dwell if it is a combination tach/dwell and flip

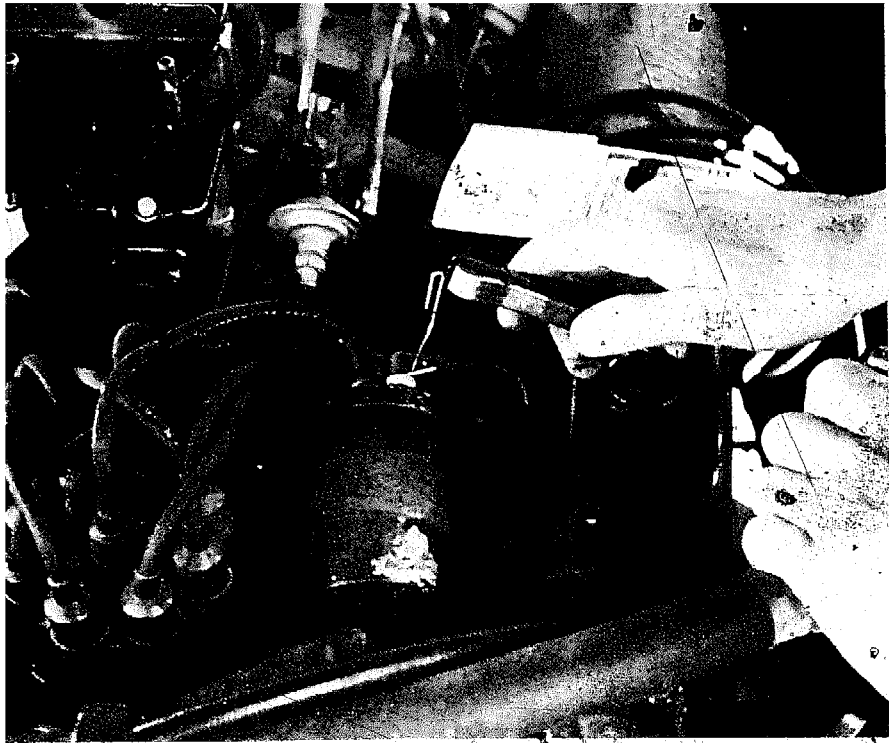

One lead of the dwellmeter hooks to the positive coil terminal. If the terminal is covered with an insulator boot, lift the boot slightly and wrap one end of a straightened paper clip around the terminal. Then clamp onto the paper clip.

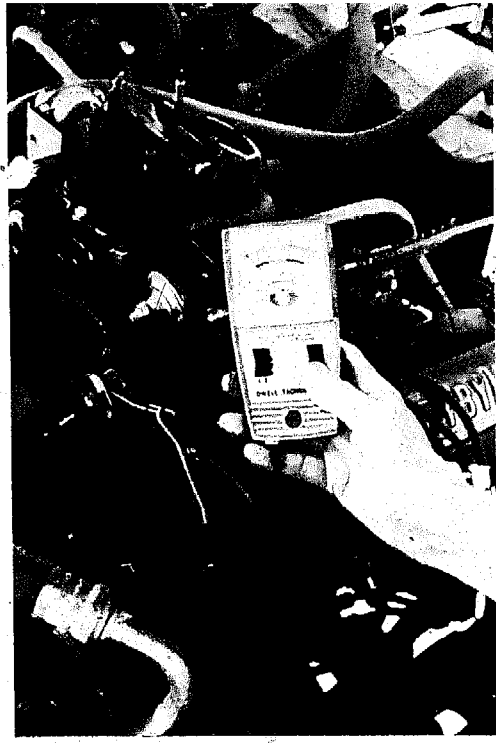

Before testing the engine, set the meter to either tach or dwell and to six or eight cylinder—whichever settings are appropriate. For a four-cylinder engine mentally double the eight cylinder reading.

the switch to either six or eight cylinder—whichever is appropriate (see picture). If you are testing a four-cylinder engine, set the selector on eight cylinder and mentally double the reading. After getting the meter hooked up and properly set, check a manual for the dwell spec on your engine. The dwell specification may be given as a single value or in the form of an acceptable range. For instance, the acceptable dwell might be given as 36° to 40°. In this case the best bet is to shoot for the middle of the range.

To check the dwell simply start the engine and take the reading—make sure the idle is reasonably close to the proper speed to insure a correct dwell reading. If the dwell angle is not to specs, the points need to be readjusted. Too high a dwell means the points are staying closed too long—the gap needs to be widened. A low dwell reading means the points are not staying closed long enough—the gap needs to be narrowed. The easiest way to remember this is that

if the dwell is too small the points should be made smaller.

Setting the dwell on a G.M. product with the external point adjustment is a snap. Simply insert the allen wrench into the adjusting nut and turn it until the dwell is right on. If the dwell is high, turn the nut clockwise to open the points. If the dwell is low, go counter-clockwise to close the points.

Adjusting the dwell on a non-G.M. distributor can be a pain since it's more of a trial-and-error procedure of adjusting the points until the correct dwell is obtained. However, with a helper you can cut out a lot of hassle. Remove the distributor cap and rotor and have your helper crank over the engine just long enough to get a reading on the meter. Then make the appropriate point gap adjustment—high reading wider gap, low reading narrower gap—and have him crank the engine again so you can check the new setting. Continue this procedure until you get an acceptable reading. Doing this prevents having

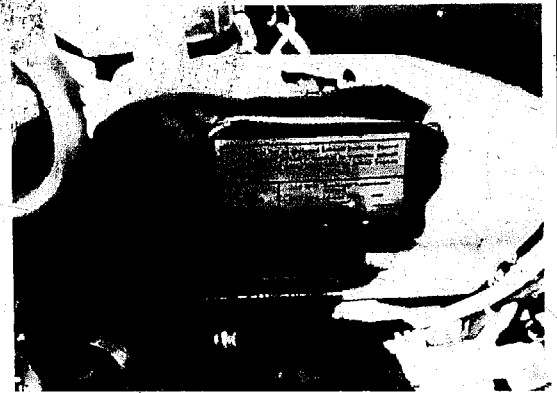

All cars since 1971 have the vital specifications contained on a special information plate in the engine compartment.

*continued*



continued

## THE BACKYARD MECHANIC

to adjust the points, reinstall the rotor and cap, and start the engine after each adjustment to check the dwell. You can also work this system by yourself with a remote starter switch.

### DWELL HOLD

After getting the dwell right on, you should perform a dwell hold test to check for a worn distributor. To do this simply increase engine speed slowly as you watch the dwell reading. If the reading increases more than 3 degrees as you increase idle speed to about 1500 rpm, the distributor is worn and should be replaced or thoroughly checked out by a mechanic. Also, if there is more than a slight variation in the dwell at idle, or if the points won't hold adjustment, you can be pretty sure the distributor is worn.

### CARBURETION

The next step in a final tune is setting the carburetor. On post-1971 cars all you really have to worry about is the idle speed. All 1971 and newer cars have the idle mixture preset at the factory and a special limiter cap installed over the adjusting screw. This cap prevents the screw from being turned more than one-half turn to help keep the engine operating within emission standards. It is strictly illegal to remove or tamper with this screw.

So on a newer car, locate the limiter cap(s) at the base of the carburetor and simply check to see that it is turned out as far as it will go. Locate the idle set screw at the throttle linkage or anti-dieseling solenoid and you're ready to set the idle. But you don't just adjust the screw until the idle is at the right speed on today's cars. Most newer cars require rather exotic methods of setting the idle speed. For instance, some cars have to have the idle set while they are idling in gear with the headlights and all accessories on. Always check a manual or the information plate in the engine compartment (see picture) for the correct idle speed and adjustment procedures.

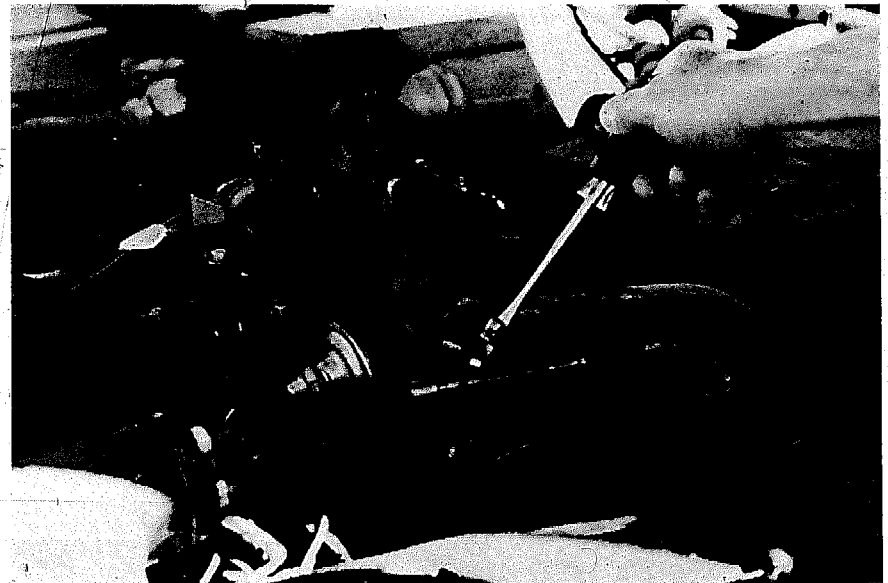
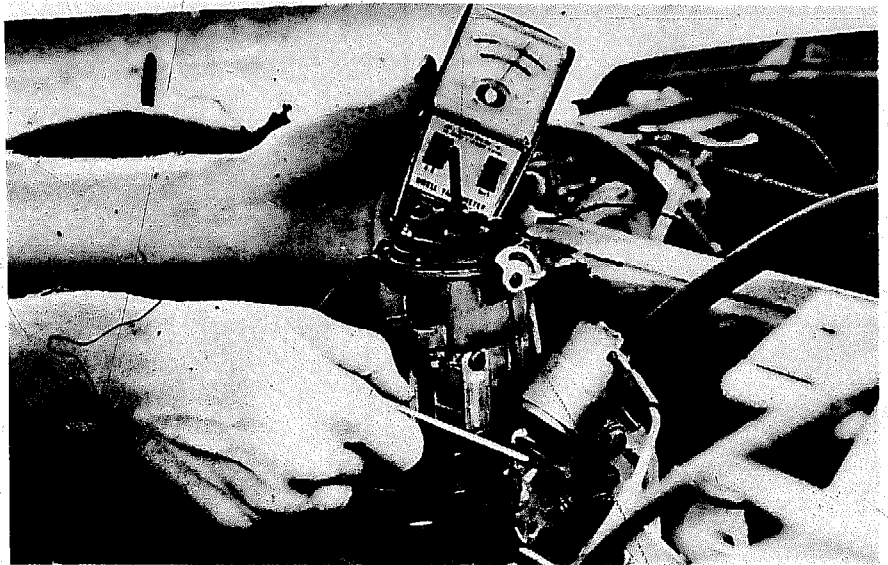

Hot idle speed is set at the solenoid or on the throttle linkage. Be sure to follow all specs and special procedures when setting idle.

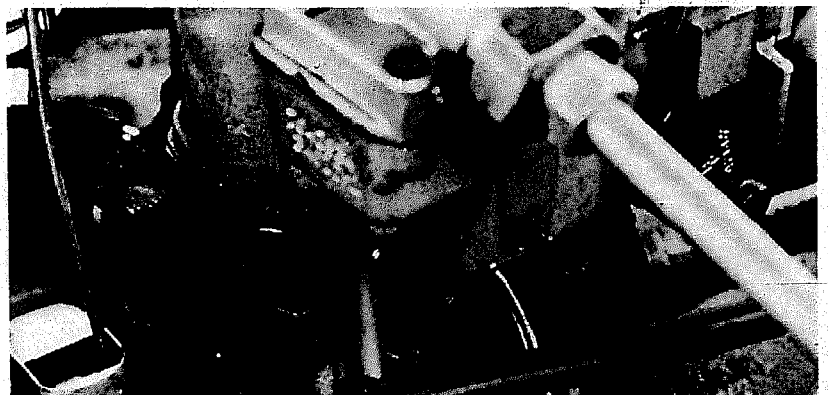

On cars newer than '71 the idle mixture does not require adjustment—the mixture is preset at the factory and special limiter caps placed over the adjusting screws. On older cars an acceptable mixture setting can be obtained using a tachometer (see text).

A couple of other points to remember are to be sure the engine is fully warm and off the fast idle cam when adjusting the curb idle. Also—if the idle is set with the air cleaner off—double check it with the cleaner unit in place. Finally, never try to smooth out the idle by turning the speed up—a higher idle just wastes gas and contributes to dieseling.

On a pre-1971 car you will probably need to set the idle mixture as well as the idle speed. A fairly good idle mixture setting can be made using the tachometer. Locate the mixture screw(s) at the base of the carb—one-barrel carbs have one mixture screw while two- and four-barrel carbs have two mixture screws. Turn the screw in until the idle roughens, then turn the screw out slowly until the highest possible tach reading is obtained. If there are two idle screws, repeat the procedure on the second screw. You may need to turn the idle speed down before adjusting the second screw as the engine may race when the first mixture is reset. With the mixture set, simply set the idle to the correct speed following the procedure shown in the manual. Once again be sure the engine is fully warmed and double-check the speed after installing the air cleaner.

#### TIMING

After setting the idle you're ready to make the final and most important adjustment—the ignition timing. A lot of people neglect timing because they think it is an involved job. Timing is critical on today's cars and should be set very carefully at every tuneup. But timing an engine is really very simple if you avoid the common mistakes of many backyard mechanics.

First of all, the neon bulb timing light is very difficult to use and barely adequate. These weak, flashing lights can be used only in a dark garage and then must be held right next to the timing marks. And on a lot of cars—newer cars especially—getting the light this close to the marks is a hassle and can be very dangerous

*continued*



The power timing light emits a very bright flash and is more accurate and easier to use than the simple neon bulb light.

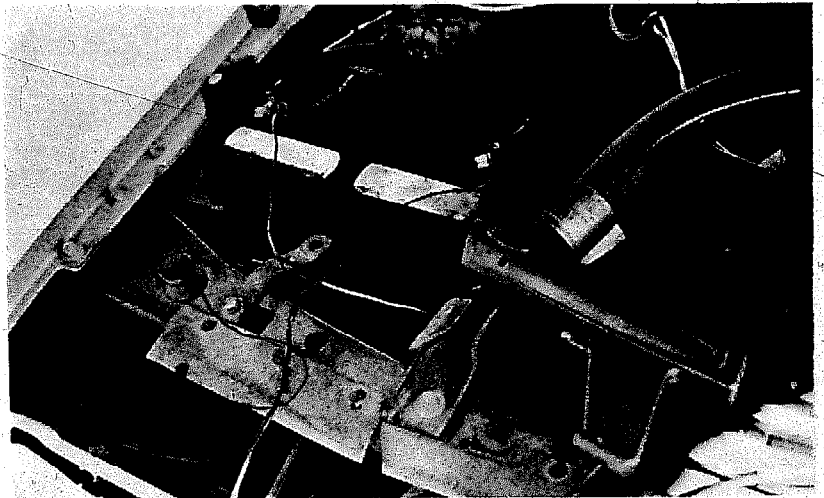

The most common power timing light is the D.C. type that simply attaches to the car battery. Hook the red lead to the positive battery terminal and the black lead to the negative terminal.

The third lead of the D.C. light simply inserts into the number one plug wire pick-up at the distributor cap. The plug wire is installed in the top of the connector to complete the circuit.

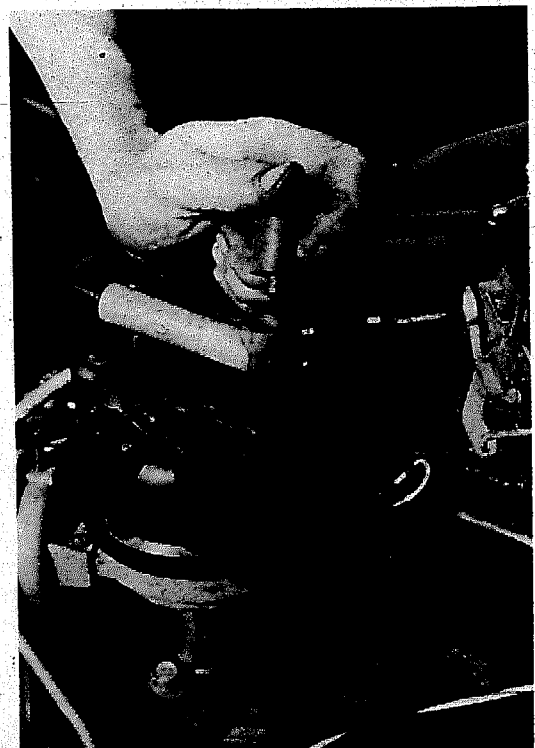

continued

## THE BACKYARD MECHANIC

since you risk getting the light's leads or your hands caught in the fan. So if you don't have a power light, your best bet is heading for the hobby shop and using a good light. You'll get a more accurate setting with a lot less trouble.

Hooking up a power timing light is quite simple. An A.C.-powered light (this type is pretty rare anymore) simply plugs into a standard household electrical outlet. The more common D.C.-powered light has two leads that connect to the battery. Attach the red lead to the positive battery terminal and the black lead to the negative terminal. Both type lights have a third lead that has a special connector that inserts into the number one cylinder plug wire pickup on the distributor cap.

A manual shows the location of the number one cylinder pickup at the distributor cap. On an in-line engine you can locate the number one plug wire from the first cylinder to the distributor cap. On a V-eight engine the number one cylinder may be either the first cylinder on the right or left bank—you'll have to check your manual.

After locating the number one plug wire, pull the plug wire out of the cap and install the timing light connector. Then reinstall the plug wire into the top of the connector (see picture).

The type and location of the timing marks varies considerably. However, most manuals have a diagram or a picture showing exactly what the marks look like and where they are located. So if you check a manual you shouldn't have any trouble finding the marks. But you may need to rotate the engine by hand or by tapping the starter until the marks become visible. Also, you'll probably have to clean the grease and grime off the marks with solvent so you can see them better.

The timing marks are generally located on the lower front pulley or on the vibration damper (below the fan). There is usually a stationary

timing pointer on the engine block and a series of timing marks on the pulley. But on some engines there is one mark on the pulley and the timing marks are stationary. Generally there will be a mark for TDC (top dead center) and a series of marks to the right of TDC indicating degrees before TDC and marks to the left indicating degrees after TDC. Most cars time before TDC so the marks to the right of the TDC line are what you will be concerned with.

After locating and cleaning the marks, very carefully make a neat line with white chalk or white enamel paint over the correct timing mark (given in your manual). This will

help you see the mark when the engine is running.

Start the engine and let it warm. The engine must be fully warmed and idling at the proper speed to set the timing. While the engine warms, check the manual or the information sticker to see if there are any special procedures for timing. Nearly all engines must be timed with the vacuum advance line removed at the distributor and plugged. The best way to plug the line is by attaching a vacuum gauge or inserting a golf tee in the end of the line.

With the engine warm and idling at the correct speed and the advance line plugged, aim the light carefully

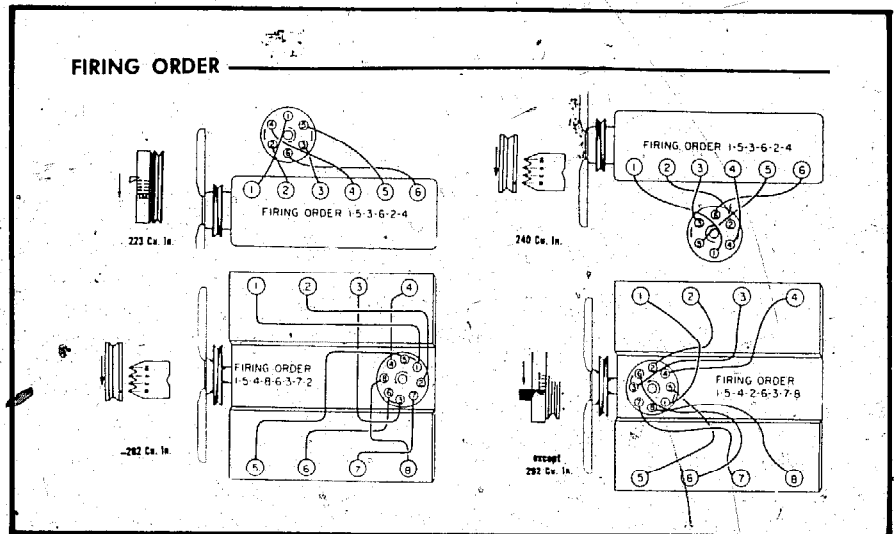

Check a manual for the type and location of the timing marks used on your car's engine—this varies greatly. Mark the correct timing lines with white chalk or paint to help make them visible.

at the timing marks. Not aiming the light properly is one of the primary causes of timing error—so be sure to keep the light at about a 45° angle and sight directly down the light.

The timing light will flash each time the number one cylinder fires and make the timing marks appear to stand still. The mark and timing pointer will align on each flash if the engine is in time. If they don't line up, you will have to adjust the timing by rotating the distributor. To do this you first have to loosen the clamp bolt that holds the distributor in place. On most older engines the bolt is easy to get to. However, on many newer engines the bolt is located be-

hind the distributor and you may need a special distributor wrench or a swivel attachment on a ratchet extension to get to the bolt.

To adjust the timing, simply rotate the distributor slowly until the timing mark and pointer align. Then carefully lock down the clamp bolt and double check the setting to be sure it didn't change when the distributor was tightened.

With the timing set you can test the mechanical advance by gradually increasing engine speed while aiming the timing light at the marks. If the advance is working, the timing mark will jump ahead. On older cars you can also check the vacuum advance

by reinstalling the vacuum line at the distributor. The timing mark should jump ahead slightly. On most cars since 1971 there is little or no vacuum advance at low speeds so you can't check the vacuum advance in this manner.

Now you're finally done. But go back and quickly double-check everything again just to be sure you've got the engine super-tuned for max performance and gas mileage. You might also consider going to a dyno tune shop to have your car's engine scoped and dynoed. For a modest price (around \$10) you can be doubly sure everything is working right and that your engine is super-tuned. ☺

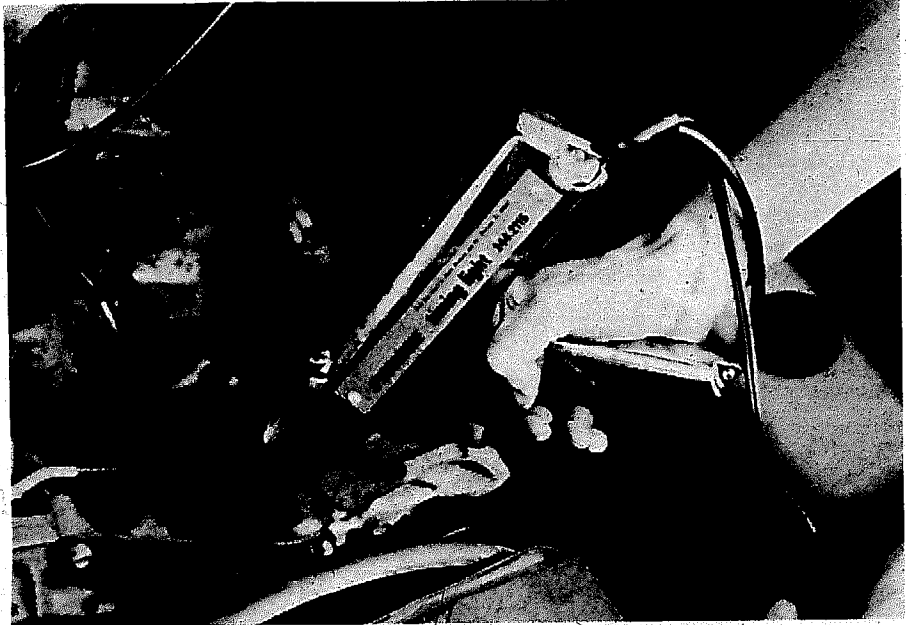

**Before timing the engine, remove the vacuum advance line at the distributor and plug it with a golf tee or a vacuum gauge. Then with the engine idling, aim the light carefully at the marks, keeping it at about a 45° angle. Not aiming the light carefully is one of the major causes of timing error.**

**If the timing is off, simply loosen distributor lock bolt and rotate distributor until the marks line up—then the engine is timed.**

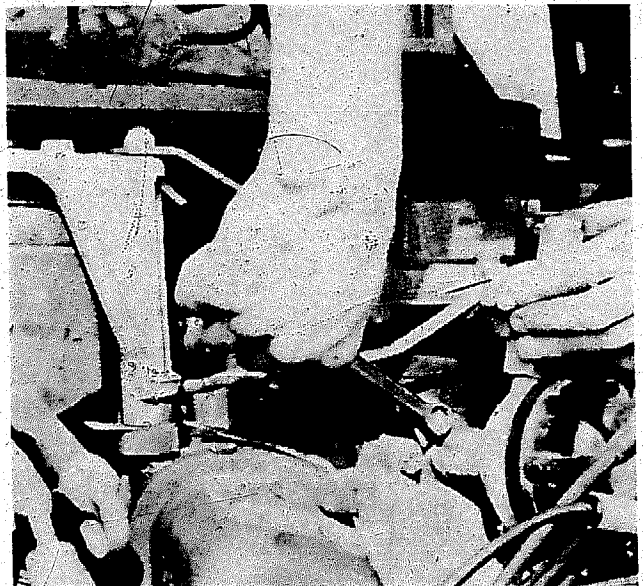

## THE BACK-YARD MECHANIC

# DRUM BRAKES

It's easy to up your stopping power

**B**rakes are the one part of a car that nearly every driver is concerned about. And its no wonder—losing your brakes would be traumatic at best. Although brake failures are quite rare with today's dual-master cylinder, heavy-duty brake systems, your car's brakes do require some basic care and maintenance to keep you stopping surely and safely.

The most common brake maintenance is checking the brake linings and/or pads for wear and replacing them when they are worn too thin. This is the subject we'll deal with in this *Backyard Mechanic*. Next time we'll pick up with some of the regular checks and service needed to keep your car's brake system doing its thing—like inspecting and bleeding the hydraulic system and checking the self adjusters.

### SIMPLE SYSTEM

Because brakes are one hundred per cent essential to driving, many backyard-type mechanics are leary of doing any brake system maintenance. But as we discovered in *The Backyard Mechanic Part V, May '73 DRIVER*, that dealt with disc brake service, brake systems are about as

simple as they are essential. While drum brake service can be a bit more involved than disc work, if you study a service manual and work carefully, you can easily and safely do a complete brake job at home with ordinary tools and equipment. In addition, you'll save a nice bundle of cash.

Since most newer cars are equipped with front disc brakes, we'll only be concerned with rear drum brakes here. However, the procedure for relining front drum brakes is basically the same as for rear brakes.\* So, if you have drum brakes all the way around, you shouldn't have any problems doing a complete brake job by following the basic procedures given here and in a service manual.

### WHEN TO RELINE

Your car usually lets you know when its brakes need help by not stopping like it should, by giving you less and less brake pedal to work with, and sometimes by issuing noisy warnings when you hit the brakes. But its

*continued*

\*The only real difference is the way the drums come off. *The Backyard Mechanic, Jan '74 DRIVER*, covers front drum removal and repacking of front wheel bearings—a job you'll want to do when you reline the brakes.



Backing Plate

Adjusting or  
Bottom Return  
Spring



# TYPICAL DRUM BRAKE

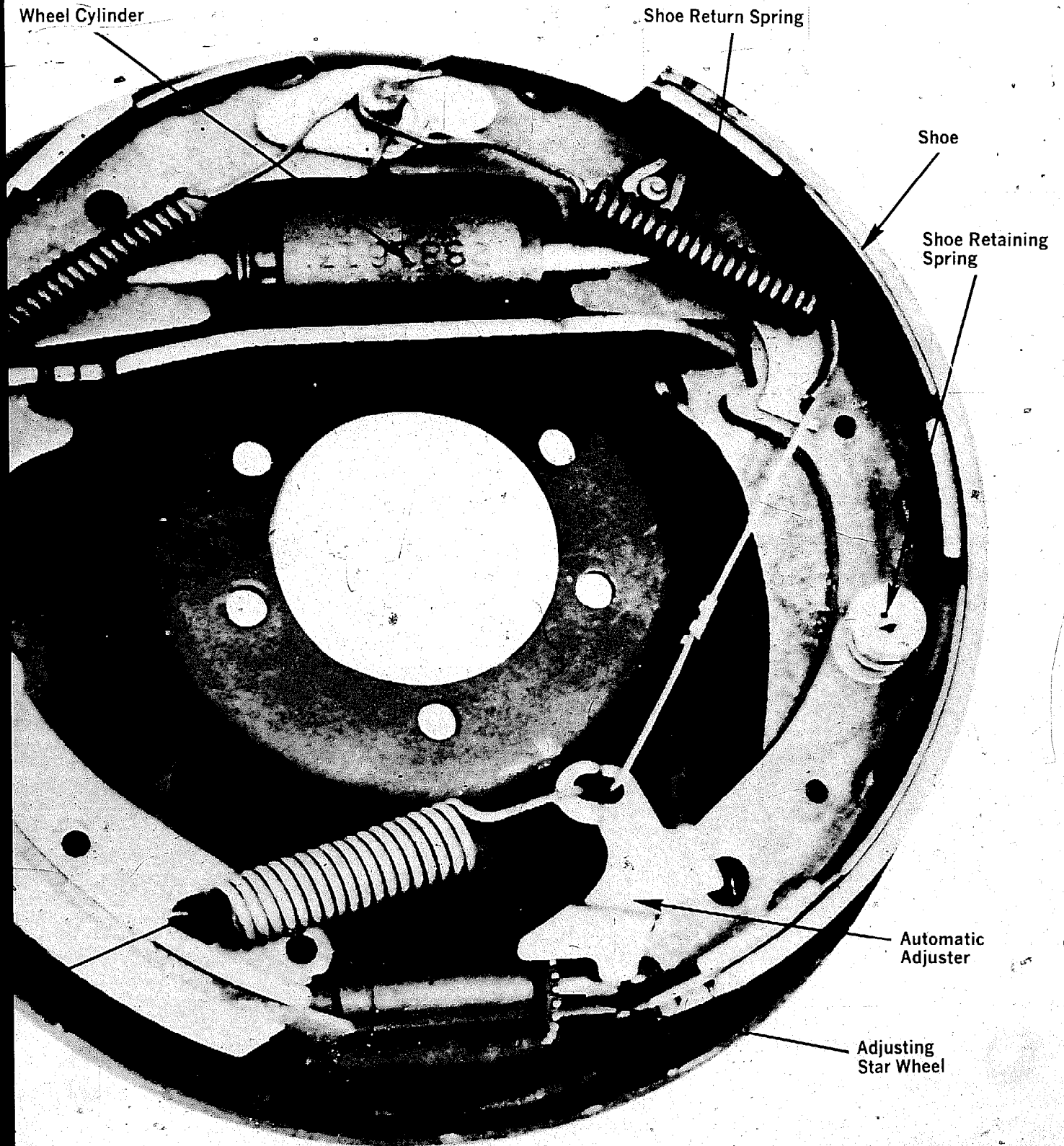

continued

## BACK-YARD MECHANIC

not a very safe nor economical idea to wait until the brakes are this far gone to replace the linings. In most cases, letting the linings wear extra-thin causes damage to the brake drum which could have been avoided or made less costly by timely replacement of the linings.

The best and only certain way to be sure of the condition of drum brakes is to regularly pull the drums and check the linings for thickness. The brake shoes should be replaced when the linings get down to less than 1/8-inch above the metal on bonded linings, or above the rivets and riveted shoes. If the linings are soaked with brake fluid you should also replace the shoes in addition to fixing the fluid leak.

It's usually recommended that brakes—both front and rear—be inspected at least every 10,000 miles. But rear brakes *normally* wear about twice as long as front brakes, and pulling the rear drums can be a hassle. So, if you know when the rear brakes were last relined or checked, you can get by with checking them every other time you inspect the front brakes. However, a faulty automatic adjuster, among other things, can cause the rear linings to go fast and put a dangerous strain on the front binders. So don't hesitate to pull the rear drums at the first sign of any brake problems.

### GETTING READY

Because pulling the rear drums can be a hassle you should be prepared to go ahead and do a complete brake job—if necessary—when you pull the drums. But since there's no way to tell exactly what parts and/or service are required (if any) before you pull the drums, the best bet is to check to be sure the local shop has parts for your car before you begin. You'll also need some transportation to get you to the shop to pick up any needed parts since you can't very well drive

The brake adjustment often has to be backed off to remove each drum. Locate the access slot (usually on the backing plate behind the brake assembly). While holding the self-adjuster lever away from the star wheel as shown in the diagram, turn the wheel with a brake adjusting spoon or screwdriver until the brake is completely backed off. Make sure the emergency brake is released when you loosen the brakes.

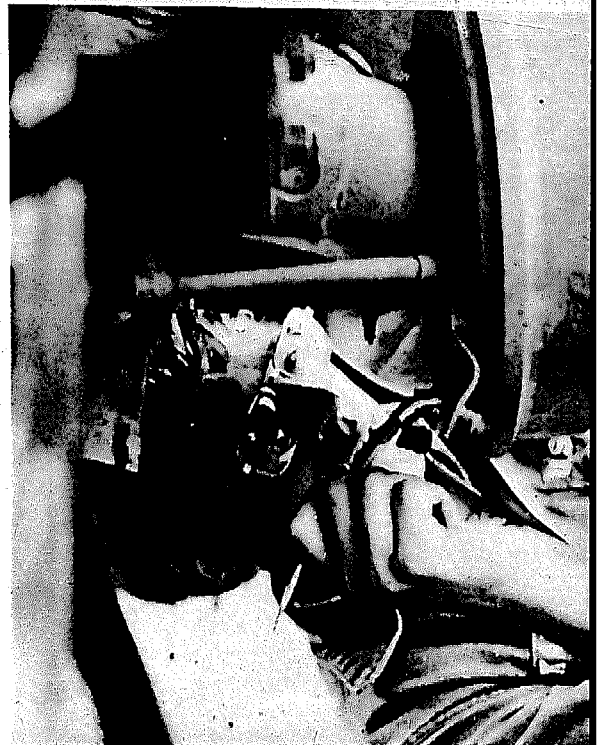

your car without the rear drums.

To finish your preparation, locate a machine shop that offers while-you-wait service in case you need to have the brake drums machined. Many base auto hobby shops have the special lathes and equipment needed for doing brake machine work. So, if you're not working at the hobby shop, you may be able to save some bread by having machine work done there.

When you've checked out the local parts house and machine shop you're set to begin. If you've got your tools and a clean surface to lay out parts on, all you need are some clean rags and denatured alcohol. You should also have some paper and pencil to make any sketches of the brake assembly needed to supplement the diagrams in your service manual. Some smart camera enthusiasts find a black and white Polaroid is the easiest way to make a foolproof record of how the assembled brake should look.

When you've got everything organized, chock the front wheels to keep the car from rolling and carefully raise the car's rear end just enough to get the wheels off the ground. Place safety stands securely under the car's frame. Remove both rear wheels and release the emergency brake. Finally, place a block of wood under the brake pedal to prevent accidentally depress-

ing the pedal—something which can cause real problems when the brakes are disassembled.

### REMOVING THE DRUMS

When you're ready to get into things, the first step is removing the brake drums. The same type drum brakes have been used on all American cars except Vega since 1970, and on most cars since 1966, so the procedure is basically the same for newer cars. Generally all that's required is backing off on the brake adjustment so the drums can be pulled free. To do this, first remove the rubber plugs that cover the brake access slots—usually located on the backing plate behind the brake assembly. Some cars may have a filled access slot that will have to be punched out to gain access to the adjuster.

Insert a brake adjusting tool (costs about 50 cents) or screwdriver in the slot. Then, while holding the automatic adjuster lever away from the star wheel with a small screwdriver, turn the adjuster up until the drum turns freely (see diagram). Give the adjuster four or five good turns to make sure the brakes are completely backed off.

If the drum won't budge after loosening the brakes, you may have to use a wheel puller. Check your

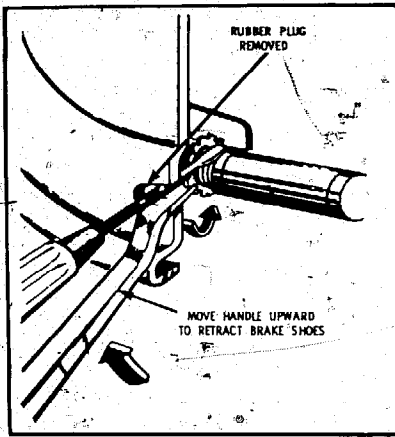

Brakes are adjusted by using brake spoon or screwdriver to turn star wheel on adjuster screw. Job is faster if self-adjusting lever is released as shown.

manual for the specs on your car. If a wheel puller is needed, you should be able to rent or borrow one from the parts house where you are getting your parts.

After removing both drums, immediately check the linings and drums for wear. If the linings are worn past  $\frac{1}{8}$ -inch, they should definitely be replaced. If there is plenty of lining, rough up the lining with fine sandpaper and clean the assembly with alcohol before reinstalling the drum. If replacement linings are needed, the

best bet is to stick with good-quality, asbestos-bonded brake shoes. While relined shoes are a little cheaper, your brakes are only as good as the linings. So the small amount saved on cheaper linings isn't worth your safety.

#### MACHINE WORK

The brake drums should be cleaned and checked for warping and heat discoloration. If the inside surface of the drums have grooves or scratches large enough to catch a fingernail, the drums should be "turned." Turning is

*continued*

The drum should slide off with the brakes released. However, on some cars a wheel puller may be required. Check your manual for the correct drum removal procedure using a wheel puller. Basically, you simply attach the puller to the drum (or lugs on some cars) and tighten the puller to release the drum.

Clean the removed drums with denatured alcohol and check the inner surfaces for wear. The drums should be relatively smooth—scratches large enough to catch a fingernail mean the drums should be taken to a shop to be turned. If the drums are warped or badly heat discolored, they should be replaced.

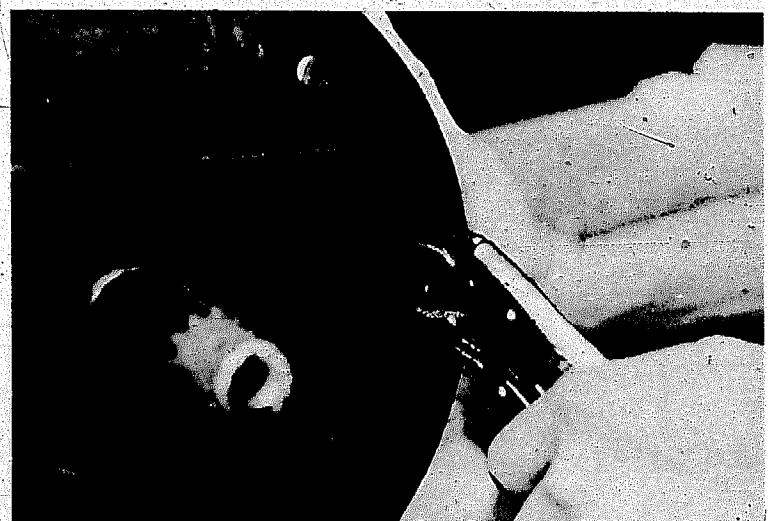
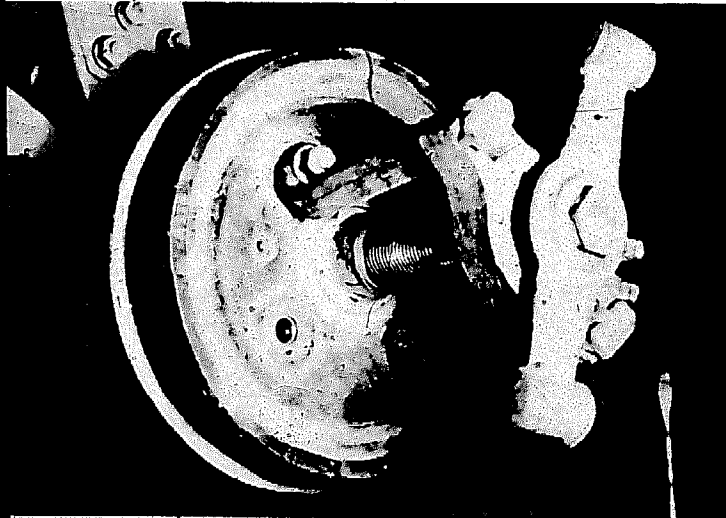

Check the brake linings for wear. The shoes must have at least  $\frac{1}{8}$ -inch of linings remaining above the metal or rivets to warrant leaving them in. If the linings are worn, begin removing them by using vise grips to release the retaining cap from the brake shoe retaining pins.

continued

## BACK-YARD MECHANIC

simply machining the inside of the drums to a smooth surface. However, since grinding the drums down until there is less than .60-inch of drum

thickness is a very dangerous practice, most drums can be turned only once, or twice at the most. If the drums have a sharp edge at the back of the braking surface, the drum has been

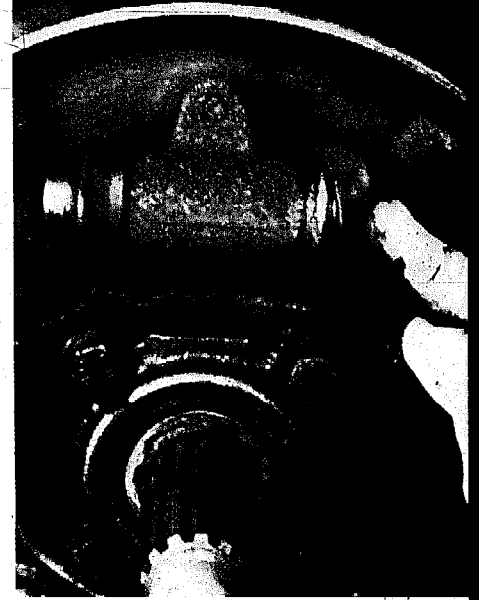
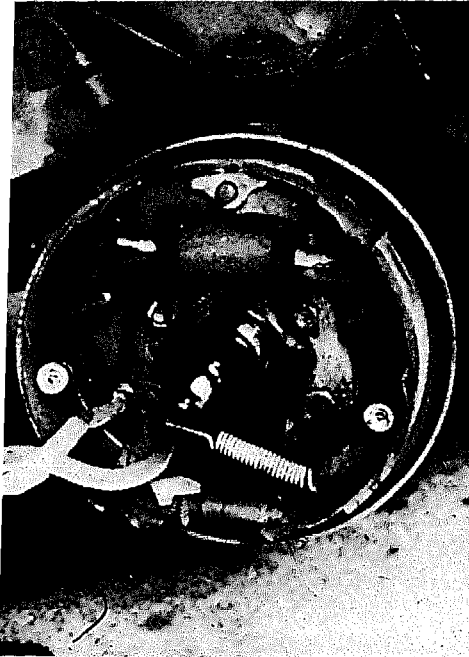

turned at least once—have the machine shop measure the drum carefully before turning it again. Most shops will give you a trade-in for your old drums if you need new ones.

If the brake drums need turning, be sure to have the new brake shoes arced. Arcing the linings is simply machining them so they fit the drum more closely. This eliminates the normal lining wear-in period. However, arcing is not necessary unless the drums are turned.

Using a special brake spring tool, carefully remove the primary and secondary return springs from the shoes. If you do not have the special spring tool, you can use vise grips to pop the springs off. But use extreme caution with either tool because the springs can pop loose at dangerously high velocities. Check the springs for wear and damage and place them in an appropriate container. If you've had problems with dragging or noisy brakes you might consider replacing these springs—especially if they are worn, corroded, or weak.

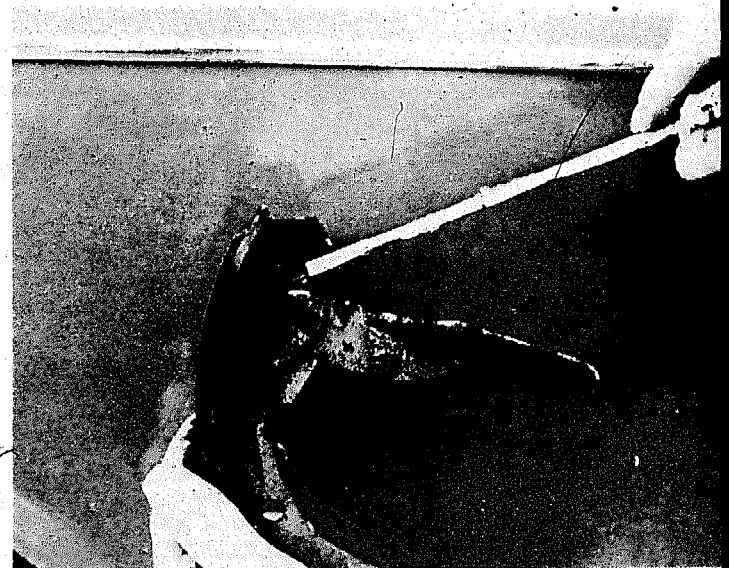
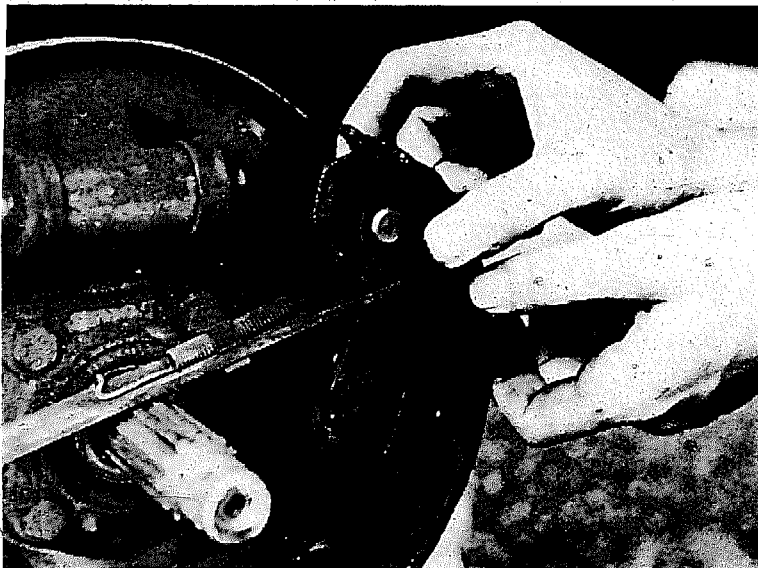

After removing the springs, carefully release the self-adjuster unit following the instructions in your manual. Next, release the parking brake cable and remove the old shoes. Disconnect the parking brake lever from the removed shoe so it can be installed on the new shoe. Screw out the star wheel adjuster assembly and apply grease or spray lubricant to the threads and reinstall it.

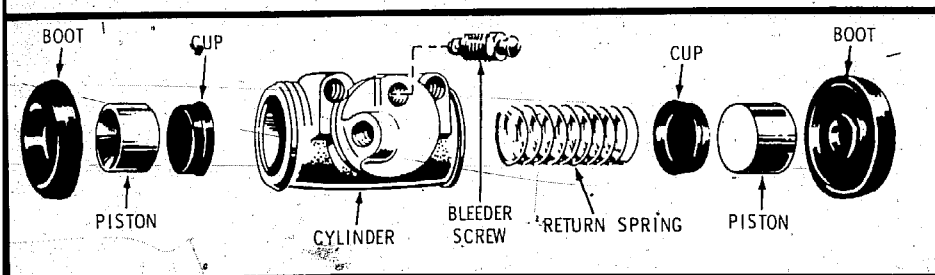

The wheel cylinders are critical since they expand the brake shoes to operate the brake. Check the cylinders for leaks by pulling back on the rubber cap. Any fluid inside the cylinder means the unit will have to be rebuilt or replaced. The cylinder can be rebuilt by simply installing the new parts included in a rebuilt kit. Easy-to-follow instructions come with the kit. However, wheel cylinders can only be rebuilt if the bores are in good condition. Light scratches can be cleaned with crocus cloth and a rag soaked with clean brake fluid. But deep gouges call for a new cylinder.

If the wheel cylinder is rebuilt or replaced, you will need to bleed the brake system to remove any air that entered when the cylinder was opened. This will be covered next month.

If the wheel cylinder is not leaking, or after it is rebuilt, tie cord around the cylinder pistons to prevent them from popping off accidentally and leaking in air. Then use a small broom and an alcohol-soaked rag to thoroughly clean the brake assembly.

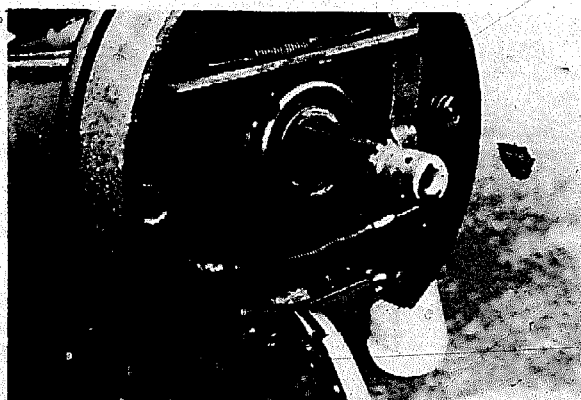
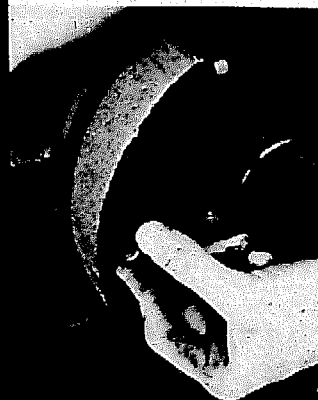

After cleaning the assembly and drum with alcohol, install the new brake shoes just as the old ones came out. Be sure to hook up the self-adjuster and parking brake cable properly. Make sure there isn't any brake fluid or oil on the new linings or drum, and double check the assembly with the diagrams in the service manual and the fully assembled brake. If everything is okay, expand the brake shoes by turning the adjuster wheel until the drum will just fit over the linings. You may have to centralize the shoes by hand to get the drum on. The shoes tend to move out of place without the drum to hold them.

Finally, when you pick up the new brake shoes, be sure to grab a couple of wheel cylinder repair kits. You may not need to rebuild the wheel cylinders, but you might as well have the kits handy just in case (this will be discussed later). The shop should also be glad to take back the kits if you don't use them.

When you've picked up the new brake shoes and had the drums turned (if necessary) you can finish the brake job in a matter of an hour or so. The rest of the job is a mechanical process as illustrated in the accompanying pictures. Just work carefully and slowly, following the procedures recommended in your manual. Be sure to work on one wheel at a time so you can use the properly assembled brake as a quick reference.

When everything is back together you can repeat the process on the other wheel.

With both wheels completed, have a buddy operate the brake pedal while you spin both drums by hand to be sure the brakes work. If they both check out, you can button everything up and go for a cautious test drive.

If there aren't any unusual noises and the braking action is good—you're all set. Go easy on the new linings for the first couple hundred miles to give them a chance to wear in—especially if they haven't been arced. You'll also need to adjust the brakes several times as they wear in.

The self adjusters should take care of the adjustments in the normal fashion—when you drive in reverse and apply the brakes. However, you may need to bring the adjustment up manually at first so the self adjusters can take over. To do this, simply use a brake adjusting spoon or screwdriver as you did before. Turn the adjusting star wheel (parking brake off) until the brake tightens up all the way. Then back off the adjustment until the wheel turns freely. Be sure to back off both brakes the same amount to equalize them. ☺



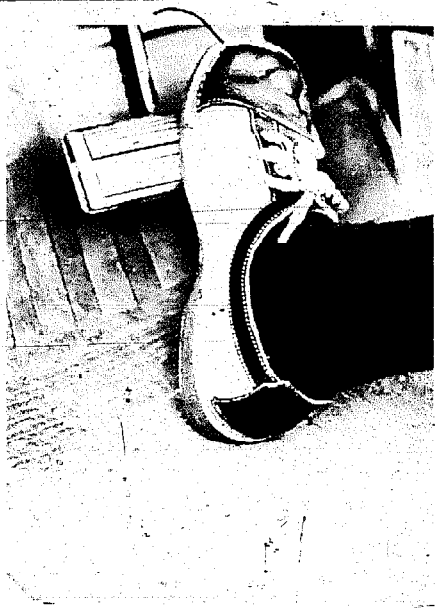

## THE BACKYARD MECHANIC

# BRAKE HYDRAULIC SYSTEM

**I**n our last "Backyard Mechanic" we covered relining drum brakes. However, we postponed until this month discussion of basic hydraulic system checks and maintenance needed to get your car's brakes in top condition and keep them that way. So we'll run through these jobs here, and next month we'll finish off brakes by covering power brake service.

These three articles, along with the "Backyard Mechanic" on disc brakes in the May '73 DRIVER, should have you covered for any routine brake service your car is likely to require. But as with any mechanical problems, if you have baffling brake trouble we recommend that you see your friendly mechanic or a good specialty shop.

### HYDRAULIC SYSTEM

Most people know that their brakes are hydraulically activated—even though they may not know exactly why or how. But the reason your brake system operates with fluid pressure involves a

basic law of hydraulics that is quite simple. Essentially, a fluid cannot be compressed by pressure and is therefore an excellent transfer medium (Fig. 1, page 24).

Since your car's brake system is basically an airtight network of cylinders and lines filled with fluid, what this means is that when you step on the brake pedal and create pressure in the system, the pressure has to go somewhere. If the brake system is in good working condition the pressure ends up at the wheel cylinders (or pistons on disc brakes), where it is relieved when the cylinders or pistons expand and force the brake linings against the drum or disc.

As long as you have brake lining and an airtight hydraulic system filled with fluid, you're going to stop. But if you have a leak in the system that allows the pressure to escape before it reaches the wheels, you won't stop so good. And if you lose enough fluid or get enough air in the system you won't stop at all

—as we've all seen on the tube when the bad guy drains the fluid from the master cylinder of the good guy's car.

### SYSTEM CHECK

So if you want to keep stopping you should check the hydraulic system regularly to be sure the fluid level is up and the system is not leaking. A quick and easy check is to simply depress the brake pedal and hold it down with plenty of force. If the pedal stays firm the system is okay. But if the pedal gradually sinks to the floor, there's a hydraulic leak somewhere. If your car has power brakes or vacuum-assist disc brakes (which most newer cars have) this check should be made both with the engine running and with the ignition off. When performing the test with the engine off, pump the brake pedal six or eight times to release the vacuum before holding the pedal down.

Any time the pedal fails to hold firm you should immediately find and repair the leak before it results in brake

*continued*

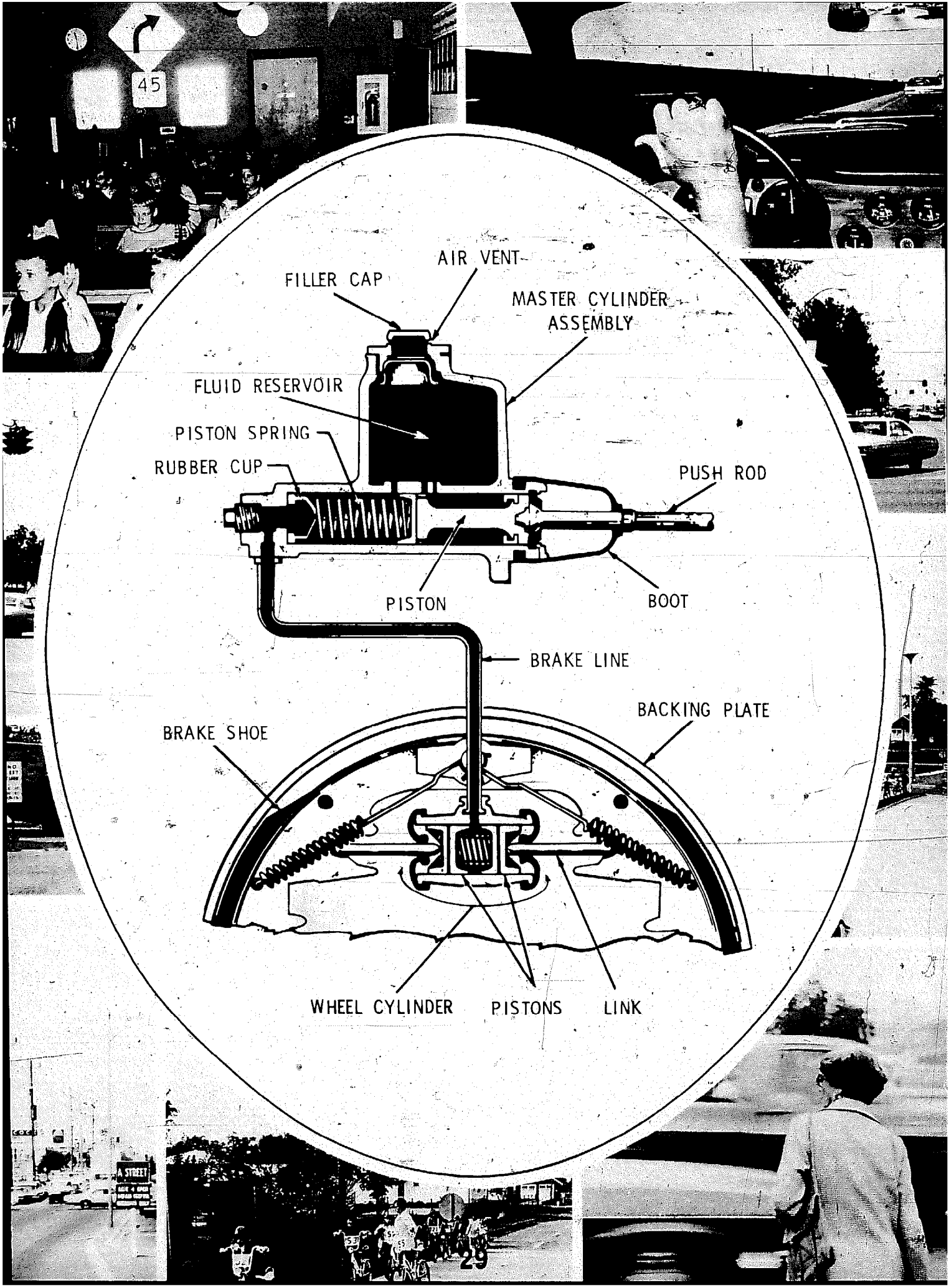
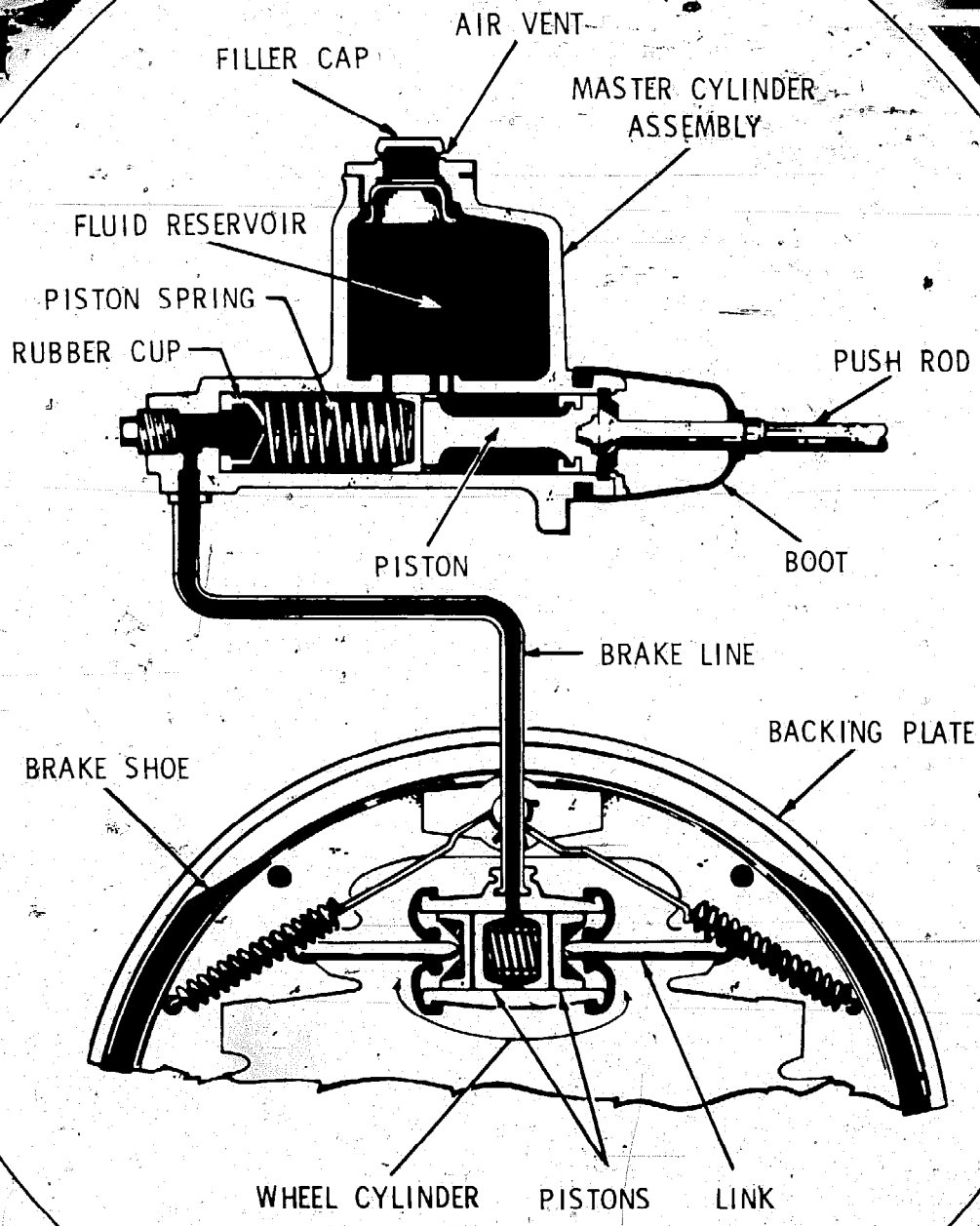

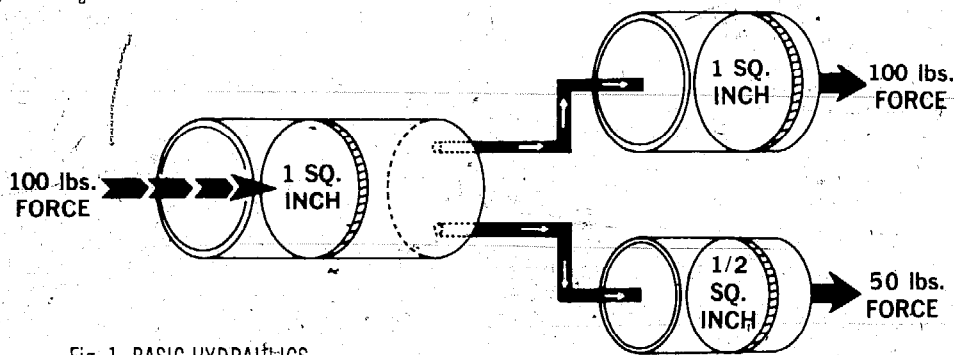

Fig. 1-BASIC HYDRAULICS

Principle of hydraulics illustrated. 100 lbs of force in the main cylinder is applied, such as your foot on the brake. This pressure is exerted equally in all directions, so there is 50 pounds of force against a cylinder with a 0.5 square inch bore, and 100 pounds against a cylinder with a one square inch bore.



Check the hydraulic system by depressing the brake pedal and holding it firmly. If the pedal stays up, the system is okay. But if the pedal sinks slowly to the floor there is a hydraulic leak.

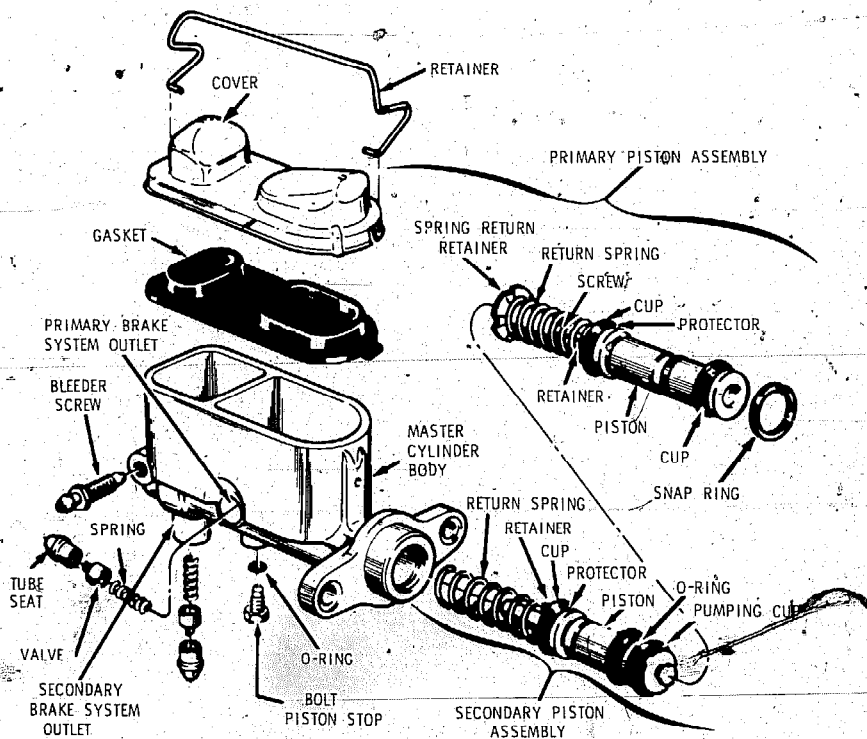
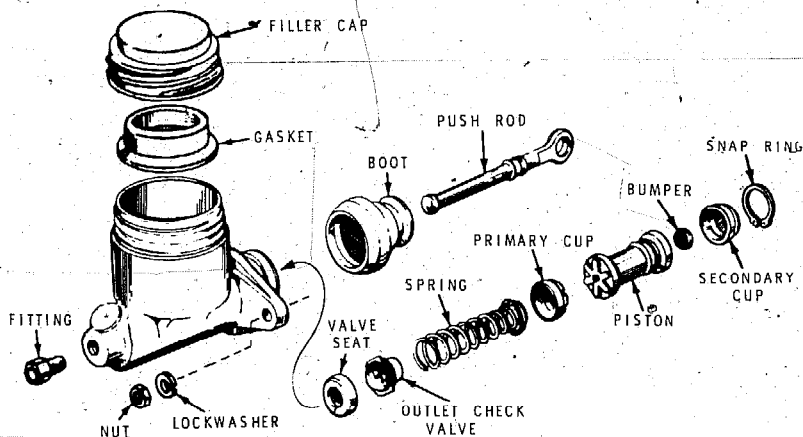

Fig. 2 MASTER CYLINDER DISASSEMBLY

To disassemble master cylinder, pull rubber boot and pushrod out, remove snap ring, and slide other parts out. Obviously, dual master has many more parts. For proper reassembly, note order in which yours/come out.

Fig. 3  
BASIC BRAKE BLEEDING

1. Clean the bleed screw at each wheel.
2. Attach a small rubber hose to one of the bleed screws and place the end in a container of brake fluid.
3. Top up the master cylinder with brake fluid. (Check often during bleeding). Pump up the brake pedal and hold.
4. Open the bleed screw about one-quarter turn, press the brake pedal to the floor, close the bleed screw and slowly release the pedal. Continue until no more air bubbles are forced from the cylinder on application of the brake pedal.
5. Repeat procedure on remaining wheel cylinders.

Master cylinders equipped with bleed screws may be bled independently. When bleeding the Bendix-type dual master cylinder it is necessary to solidly cap one reservoir section while bleeding the other to prevent pressure loss through the cap vent hole.

Disc brakes may be bled in the same manner as drum brakes, except that:

1. It usually requires a longer time to bleed a disc brake thoroughly.
2. The disc should be rotated to make sure the piston has returned to the un-applied position when bleeding is completed and the bleed screw is closed.



Check the master cylinder fluid reservoir regularly. Before popping the top, clean it thoroughly to keep gunk from contaminating the fluid. A low fluid level may mean a leak—inspect immediately.

failure. But even if the system checks out okay, it's a good idea to make a quick inspection of the hydraulic system as a preventive measure.

#### BRAKE LINES

Although the master cylinder seems like the most logical place to start a hydraulic system inspection your best bet is to begin with the brake lines. This way, if you have a leak it will be isolated to either the lines or the master cylinder immediately—the master cylinder sometimes appears to be leaking when it's not.

You should be able to check the brake lines without raising the vehicle if you don't mind grubbing on your back. But if you raise the car on stands or ramps to make the inspection easier, be doubly sure the supports are properly secured and the vehicle is chocked. And of course don't get any further under the vehicle than necessary, or stay under any longer than you have to.

If the brake line connections at the wheel are tight, check the back side of the tire and backing plate very carefully. Leaking wheel cylinders generally leave a telltale splotch of brake fluid here. Next, inspect the flexible hose that connects the main metal brake line to the brake, if your car has these type lines. The flexible hoses are subject to deterioration and should be replaced if they show any signs of leaking, are damaged, or even feel gummy. Because metal lines are tougher, many newer cars have done away with the flexible

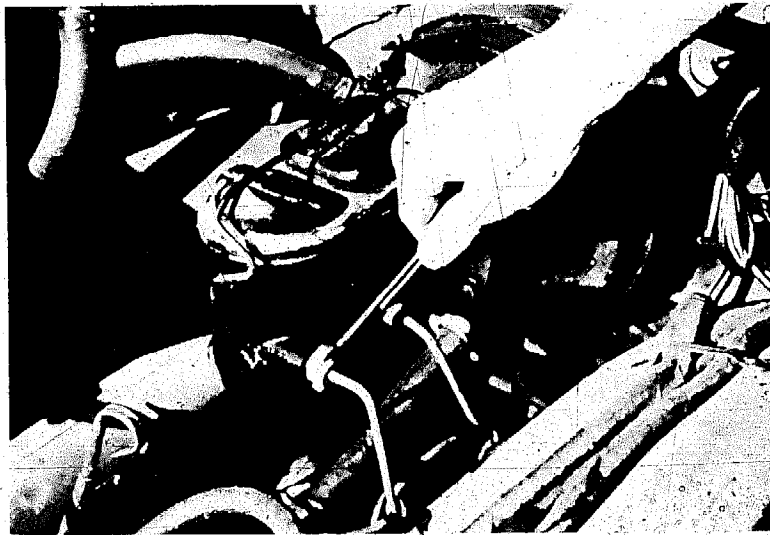

Remove the brake lines very carefully, when pulling the master cylinder.

connectors and use one-piece metal brake lines.

After checking the wheel area for fluid leaks, trace the length of metal line from each wheel to the master cylinder. The main lines should be inspected for leaking connections, dents, and signs of abrasion at points where the lines turn or bend around obstructions on the underside of the frame. If you don't spot any leaks along the brake lines, you can move on to the master cylinder.

#### MASTER CYLINDER

The master cylinder is the heart of the hydraulic system. It is located in the engine compartment opposite the driver and connected to the brake pedal by a special rod. The master cylinder initiates braking when the brake pedal is depressed by pushing out a piston inside the cylinder, exerting pressure that is transferred through the system.

#### MASTER CYLINDER CHECK

Generally, you'll know if the master cylinder fails since braking action will be greatly reduced, and on newer cars the pressure warning light on the dashboard should illuminate. But it's a good idea to check the unit for leaks when you check the fluid level in the reservoir.

The master cylinder reservoir should be checked regularly since fluid loss will indicate a leak in the system that you can track down and repair before it becomes serious. To check the fluid level, clean all gunk off the unit and then

simply pop the wire bracket (or whatever locking device is on the top) and remove the lid.

If the level is down only slightly, check the brake line connections and refill the reservoir with fluid and check the level again in a couple of days—some fluid loss is normal. Although it's not likely the fluid level could be very low without your being notified by inferior braking and/or an illuminated warning light, you might discover a leaky master cylinder. If the unit is leaking anywhere but the brake line connections it should be rebuilt or replaced.

#### REBUILD

Rebuilding a master cylinder is not at all the complicated job many people think. Even with today's dual-master cylinders, which have about twice as many parts as the old single units, rebuilding is just a matter of removing the old parts and sticking in the new ones that come with the rebuild kit. We won't go through the procedure here, but a service manual as well as the rebuild kit give step-by-step instructions. However, we will offer a few tips you might not pick up from the instructions.

First of all, a few master cylinders are best replaced with a factory rebuilt unit. A manual should specify if the master cylinder on your car is rebuildable—most are. The first step in removing the unit is usually disconnecting the

continued

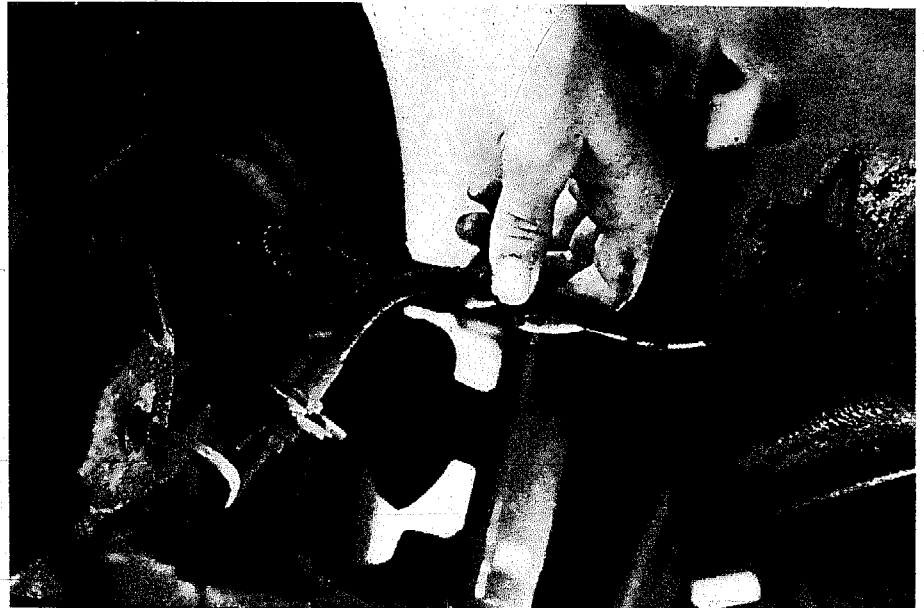
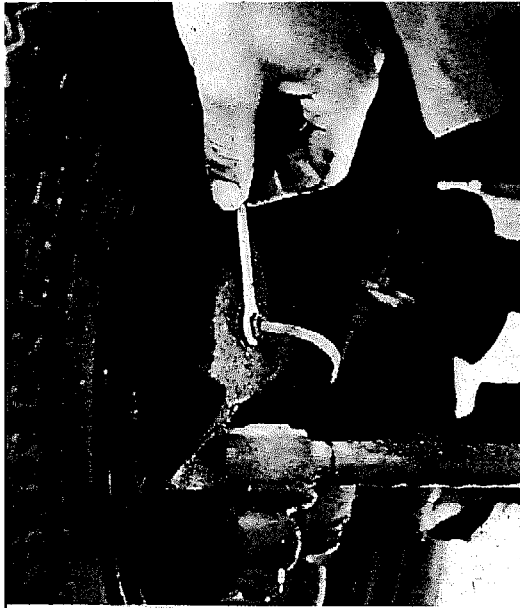

Check all brake line connections to be sure they're tight and not leaking. Trace the lines from the wheels to the master cylinder looking for leaks. Flexible-type connectors are especially vulnerable to deterioration and damage—inspect them extra carefully.

push rod at the brake pedal. However, on power-brake-equipped cars the push-rod generally activates the power assist and the rod *should not* be removed. Also, when removing the unit be very careful when disconnecting the brake lines. When you get the brake lines removed, all you have to do is pull the stoplight switch and unbolt the unit from the firewall or power unit.

Before disassembling the unit, clean it very thoroughly with alcohol. When you remove parts, clean each one in alcohol and lay it on a clean cloth in the order in which it was removed. Make sure the unit is clean on the inside and check the piston bore very carefully. The bore must be smooth and unmarred. If the bore is slightly damaged, you can probably clean it with crocus cloth—but if it is badly scoured it must be honed smooth, or the entire unit replaced. Finally, when reassembling the unit be extra clean. Carefully follow the instructions step by step and lubricate all installed parts with *clean* brake fluid. Figure 2 has blow ups of a single and dual master cylinder which will give you an idea of the parts involved. The master cylinder generally should be bled after being rebuilt—this will be covered later.

#### FLUID

One of the most common causes of poor braking is contaminated brake fluid. As previously mentioned, the hydraulic system operates on the principle that fluids are not compressible. So even a small amount of air (which is highly

compressible) in the system can seriously affect braking. The system should be bled whenever the brake pedal gets "spongy"—indicating contaminated fluid—or when the system is opened at the wheel cylinders or master cylinder during a brake job. But when you bleed the hydraulic system, it's a good idea to first flush the system with special brake system cleaner or denatured alcohol.

#### CLEANING

To flush the hydraulic system, you first need to bleed the fluid out of the master cylinder reservoir. Open the bleed screw(s) if the cylinder is so equipped, or loosen the brake lines at the unit. Have a buddy pump the brake pedal slowly but firmly while you catch the escaping fluid in a suitable container. Be sure not to let the fluid leak on the car—it can ruin the finish. When you've got most of the fluid out of the reservoir, tighten the bleed screw or brake line connections and you're ready to begin flushing.

Fill the master cylinder reservoir with cleaner or alcohol and go to the wheel closest to the master cylinder (usually the left front) and open the bleed screw on the backing plate behind the wheel. Here again you want to be sure to catch the escaping fluid. A length of rubber hose that fits over the bleed valve to carry the fluid to a container is a good idea. Also, you can use a special bleeding hose that has a valve in the end which doesn't allow air to bleed back in after the fluid escapes. These self-bleeders are available at any auto store for about \$2 and allow you to bleed the

entire system by yourself. They also make the job easier with a helper.

If you're using a bleed hose, just open the valve and pump the brake pedal slowly but firmly until the cleaning agent is expelled through the valve—then close the valve and follow the same procedure on all wheels until the entire system is purged of brake fluid.

If you're not using a bleeder hose, have your buddy depress the brake pedal while you open the bleed screw—he should tell you when the brake pedal is just about to the floor so you can close off the bleed screw to keep excess air from bleeding back in. Continue this procedure until the cleaner exits from the valve—then repeat the process on each wheel.

#### BLEEDING

When the system is flushed you can fill and bleed the system. The procedure is basically the same as with flushing the system but a bit of care must be exercised when bleeding out the air. First, bleed the cleaning agent out of the fluid reservoir. Then tighten all bleed valves and fill the master cylinder reservoir with clean brake fluid. Bleed the air from the master cylinder by opening the bleed screw (if so equipped) or loosening the brake line connections and pump the brake pedal until the escaping fluid doesn't make a sputtering sound. Close off the master cylinder connections and refill the reservoir.

Check a manual for the correct bleeding procedures and sequence for your car. Usually, brakes should be bled beginning with the wheel farthest from



continued

## THE BACKYARD MECHANIC

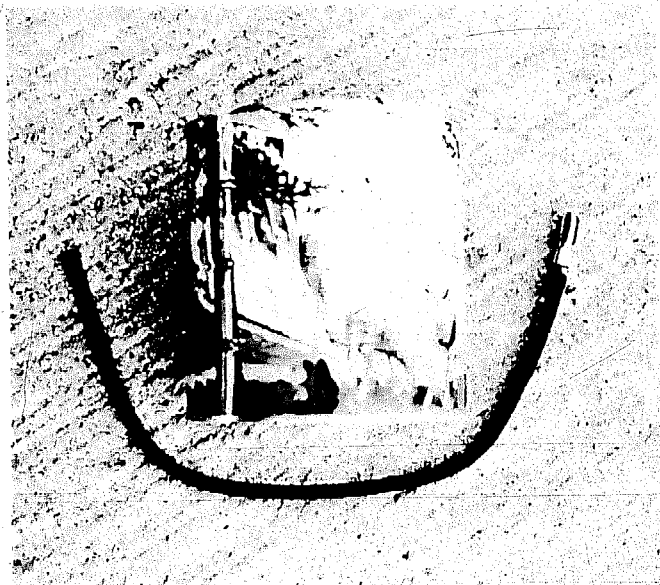

Brakes can be easily bled by one person using a special bleeding hose available at any auto supply store.

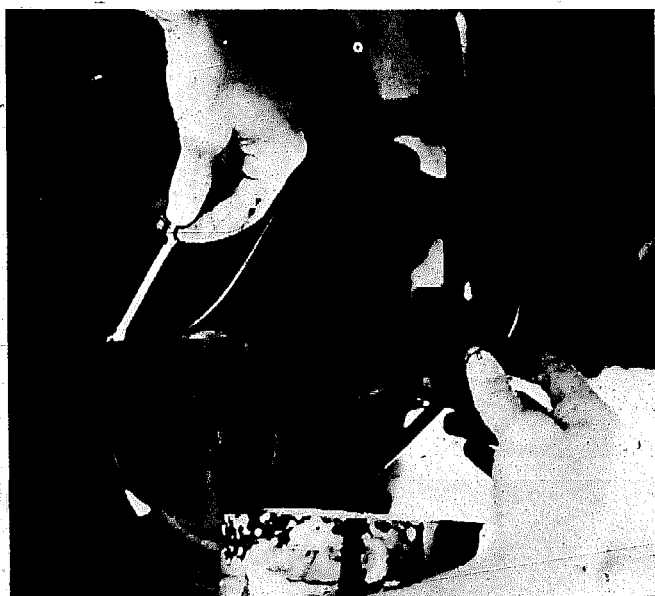

Bleeding can be done manually by opening and closing the bleed screw as someone pushes on the brake pedal. Special bleeding hoses have check valves that prevent air from bleeding back into the system and eliminate the need for opening and closing the bleed screw. The hose is installed on the bleed valve and the brake pedal pumped until the air is released from the system. Brake fluid should be bled into a container and thrown out—never use old brake fluid for any purpose.

the master cylinder, working to the wheel closest, but this varies. Begin bleeding by opening the bleed screw on the appropriate wheel a quarter of a turn. Have your buddy depress the brake pedal slowly (as before) letting you know when the pedal is near the floor so you can close off the screw. Continue holding pressure on the pedal and opening and closing the bleed screw until all the cleaning agent is removed

and a steady stream of fluid escapes. Now you're ready to bleed the air.

Following the same procedure of opening and closing the bleed screw while the brake pedal is depressed, listen as the fluid escapes through the bleed valve. When the fluid escapes without making a sputtering sound—the air is out of the line. This may take as many as a dozen openings and closings of the valve, so be patient.



Universal brake fluid is available. But top-quality heavy-duty fluid that fits the needs of your brake system is best.

After bleeding each brake, refill the master cylinder and replace the cap. Check the reservoir frequently while bleeding to be sure the level doesn't get low, which would allow air to be drawn in. Repeat the bleeding procedure on each wheel in sequence. If you are using a self-bleeder you don't have to worry about opening and closing the valve each time. Just install the hose, open the bleed valve and pump the brake pedal until the cleaning agent is expelled and you think the air is out. The special valve in the bleeder keeps air from bleeding back in.

When you've bled all four wheels the brake pedal should be up to the normal height, should not be spongy, and should hold pressure. If not, try the bleeding procedure again. If you're bleeding after relining the brakes, the pedal may not come up as you think it should if the brakes aren't properly adjusted. So check this before rebleeding the lines. Figure 3 outlines the basic steps for bleeding the brake system.

A few other hydraulic system problems you might encounter involve special proportioning and metering valves used in brake systems with front disc brakes and rear drums. We'll discuss these special devices as well as the pressure differential warning system in next month's power brake installment. ⊗

## THE BACK-YARD MECHANIC

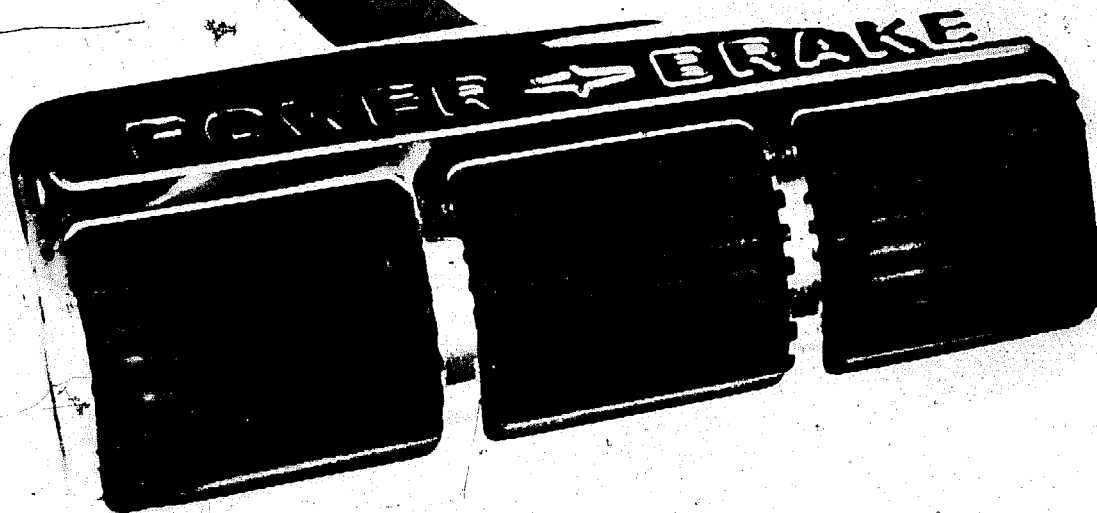

**A**s we threatened last month, we're finally going to finish off brakes in this "Backyard Mechanic." Last time when we discussed the brake hydraulic system, we didn't get to the special valves that are important parts of today's hydraulic systems. So we'll cover these devices briefly before wrapping up brakes with a discussion of power brake assist units.

### PRESSURE DIFFERENTIAL SYSTEM

Soon after the auto companies introduced dual-master cylinders to help prevent brake failures, they went one better with brake pressure differential warning systems. These devices are designed to activate the dashboard brake-failure warning light as soon as there is a loss of fluid pressure in the hydraulic system—either front or rear brakes.

Basically, the warning system is a piston assembly with the brake failure light switch attached to it. Fluid from the front and rear brake lines runs through the assembly and holds the piston centralized in its bore because there is equal pressure from

each line. If a leak develops in either system (front or rear) however, the fluid pressure decreases and the piston moves off center, triggering the warning light.

This system is great if you develop a hydraulic leak and the light lets you know about it. But as some of you may have discovered, other things can trigger the warning light. In many cases, opening and bleeding the brake system activates the light. And with some cars the lights have a bad habit of coming on when the front wheels are spin-balanced on the car, or for no apparent reason at all.

The first thing some people do if the warning light comes on when it shouldn't is just disconnect the light and forget about it. But the warning system is there for a purpose and having a disconnected light won't do you a lot of good if you do have a brake failure. So it's a very good idea to know how to centralize the piston to turn off the light without deactivating the system. In most cases, the job is easily done—check a manual for the simple step-by-step procedures for centralizing the warning valve on your car. Figure 1 also out-

lines the basic procedures for most cars.

### PROPORTIONING VALVE

On vehicles equipped with front disc brakes and conventional rear drums, a special proportioning valve maintains correct fluid pressure between the front and rear brakes to provide balanced braking. Although the proportioning valve rarely malfunctions, if unbalanced braking that's not attributable elsewhere develops, the inexpensive unit should be replaced. The valve is factory set and no attempt should be made at adjusting the old valve. To replace the valve, simply disconnect it from the brake line and carefully install the new valve making sure the opening marked "R" is toward the rear—not the front.

### METERING VALVES

Most cars with front disc brakes also have another special hydraulic valve called a metering valve. The metering valve is installed in the brake line to the front brakes (Fig. 2) and delays fluid pressure buildup to the front brakes until rear brake

## WARNING LIGHT SWITCH-OFF PROCEDURES

After repairing and bleeding any part of the hydraulic system the warning light may remain on because the pressure differential valve remains in the off-center position.

A. 1970—1973 Ford products, General Motors cars, Chrysler products and 1971—73 American Motors cars (disc brakes) have a self-centering valve. After repairs or bleeding is performed, center the valve by applying moderate pressure on the brake pedal. This will turn out the light.

B. To centralize the valve on 1967—69 Fords:

1. Switch the ignition on and bleed brakes.

2. If the front brake system was repaired or bled, a leak must be created

in the rear brake system and vice versa. Open the bleed screw at one rear brake and have an assistant press the brake pedal slowly until the light goes out. Quickly close the bleed screw.

3. Check brake fluid level and brake pedal height and firmness. Road test the car.

C. To centralize the valve on 1967—1970 (drum and disc) and 1971—1973 (drum only) American Motors cars:

1. Before repairing or bleeding the brakes, disconnect the switch terminal wire and remove the nylon switch terminal, contact plunger spring, and nylon plunger with contact.

2. If the light had come on and actuated the valve, spring pressure may hold the plunger. To release the plunger,

apply a small amount of brake pedal pressure.

NOTE: Location of the leak can be determined by the position of the plunger in its bore. The top of the plunger will lean to the side (front or rear) which has the low pressure.

3. Make the repair and bleed the brakes. Install the spring and plunger in the valve with the contact down.

4. Install the nylon terminal and connect the warning light wire to the terminal.

5. Replace the valve assembly if any fluid leaks from the center terminal opening while removing the terminal.

IMPORTANT: The switch assembly is non-serviceable, replace if faulty.

Fig. 1

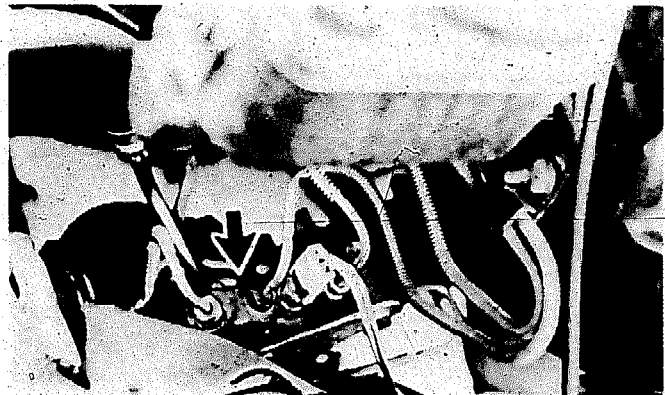

Most 1972 and newer cars have special units that combine the metering, proportioning, and brake failure warning valves into one assembly located near the master cylinder (arrow). Older cars have separate valves located in the brake lines.

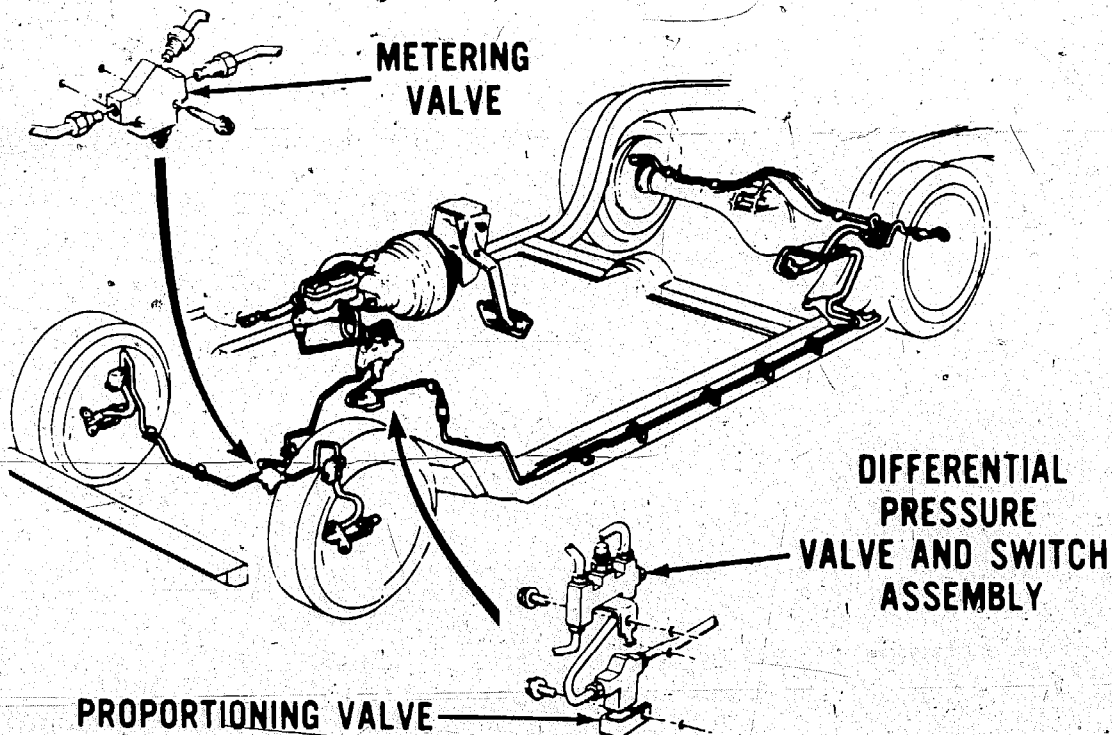

Fig. 2

continued

## THE BACKYARD MECHANIC

pressure is at the proper level. Like proportioning valves, metering valves rarely malfunction. However, if the metering valve is not operating properly, unusual stress is placed on the front brakes, reducing braking action and greatly increasing front brake wear.

Check the metering valve by applying the brakes very slowly (engine on). If the metering valve is operating there will be a slight change in pedal pressure at about one inch of pedal travel—it should feel like a slight bump. If the valve is not operating it can be easily replaced by disconnecting it from the brake line and carefully installing the new valve. The brakes should be bled after installing the new valve—as they should be any time the brake system is opened.

### COMBINATION VALVES

In 1971 General Motors introduced a valve that combines the warning system, proportioning, and metering functions all in one unit. Ford followed in 1972 with the same type unit and now most new cars utilize a combination-type valve. These combination valves are normally located at or near the master cylinder (check a manual for the location and specifics on your car). The entire unit must be replaced if any of the functions fail. Once again there isn't any trick to replacing this type unit—it's just a matter of disconnecting the brake lines and installing a new unit.

### POWER BRAKES

Power brakes and power-assist disc brakes are quite popular today. But most people who pay the extra money to get these options don't know that they aren't getting at all what they pay for. Actually, power brakes are nothing more than a standard hydraulic brake system with a vacuum assist unit between the brake pedal and the master cylinder to help you activate the brakes.

When you hit the brake pedal with power brakes, vacuum from the intake manifold pulls the assist unit piston forward which pushes on the master cylinder activating rod operating the brakes. The fact that you

are separated from the master cylinder by the vacuum unit is why you don't have as good a "feel" with power brakes as you do with manual brakes where the brake pedal is linked right to the master cylinder.

### OPERATION

Most power brake units consist basically of a piston, control valves, and a vacuum connection from the engine intake manifold. When your foot is off the brake and the vacuum unit is in the released position, the vacuum system-intake port is closed. A special atmospheric port remains open to allow air to pass from one side of the vacuum piston to the other. This maintains equal pressure on the piston and keeps it in the off position.

When you hit the brake, the atmospheric port closes and the vacuum port opens. Vacuum from the engine then sucks the unit piston forward against the master cylinder operating rod and actuates the brakes. If the power unit fails or the engine dies, there is usually enough vacuum remaining in the system to give you assisted braking for a few seconds. But after that you're going to have to use plenty of leg power.

The important thing to remember with power brakes is don't freak out if the power fails or the car dies. You can always stop a power-brake equipped car manually in a reasonable distance—you just have to put a lot of muscle on the brake pedal.

### SYSTEM COMPLICATED

Unlike many of today's automotive components that seem complicated but aren't, the power brake booster seems simple—but the mechanics aren't. So unless you're a certified brake mechanic and have all of the weird special tools required to do the job, there "ain't no way" you're going to rebuild or repair a power assist unit. The important thing is to know what basic checks to make before hustling down to the local brake shop when you have power brake problems. Nine out of ten times, power brake problems are caused by something very simple that the average person can easily take care of. So let's take a look at some of the basic checks you can make.

### SYSTEM CHECK OUT

To check the power unit's operation, shut off the engine and pump the

The power brake assist unit is located between the master cylinder and the fire wall. The vacuum check valve on this unit has a special connector where a vacuum gauge can be attached.

Pulling the vacuum line at the power assist and checking for suction is the first step in tracking down a power brake problem.

If there is vacuum at the assist but the unit does not work, the check valve may be malfunctioning. The valve can be pulled from the unit for inspection if care is used not to damage the mounting grommet or hose.

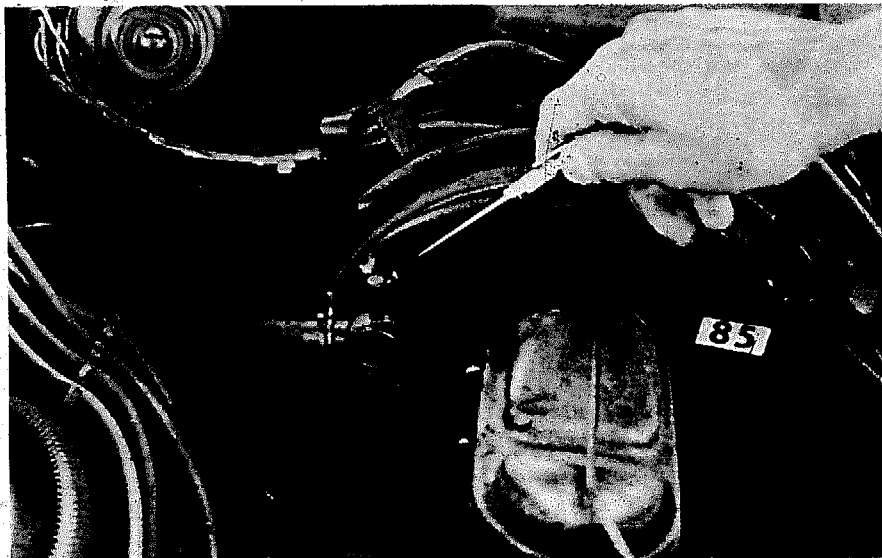

brake pedal about a dozen times to be sure and exhaust all vacuum from the system. Step on the brake pedal and hold it down firmly. Start the engine. If the vacuum unit is working, the brake pedal will move forward slightly as the engine starts. If the pedal stays hard and does not move, the vacuum unit is not functioning.

The first thing to do if the power unit is not working is to make sure it is getting vacuum from the engine. Pull the vacuum hose loose from the power unit (see picture) and place your thumb over the hose. There should be plenty of suction at the end of the hose with the engine idling. If the vacuum is weak, check the hose very carefully for leaks or kinks. Install a new hose if the old one is defective.

If the hose is okay and there is insufficient vacuum, check for vacuum at the intake manifold. Place your finger over the manifold vacuum port, or attach a vacuum gauge. The vacuum gauge should show at least 16 inches of mercury with the engine idling.

Although not very common, if vacuum is low at the intake manifold it's probably because of vacuum leaks. You can check for leaks by putting heavyweight oil on the joints at the carburetor base and intake manifold. If there is a leak, the oil will seal it temporarily and the engine speed will increase. Leaks can be repaired by tightening the bolts or installing new gaskets if necessary.

If there is plenty of vacuum at the hose but the booster unit still doesn't work, the vacuum check valve (see picture) is usually at fault. This valve is a common cause of power brake problems. The check valve is a one-way unit that allows air to be sucked out of the vacuum booster to operate the assist, but doesn't let air back in (vacuum out) when the engine is shut off. If the valve comes loose or fails, vacuum isn't maintained in the booster unit and the power assist can't operate.

Most check valves can be easily removed from the vacuum unit for inspection. Carefully pull (or unscrew) the valve from the unit and disconnect it from the vacuum line.

Test the valve by blowing through it one way and then the other. You

*continued*

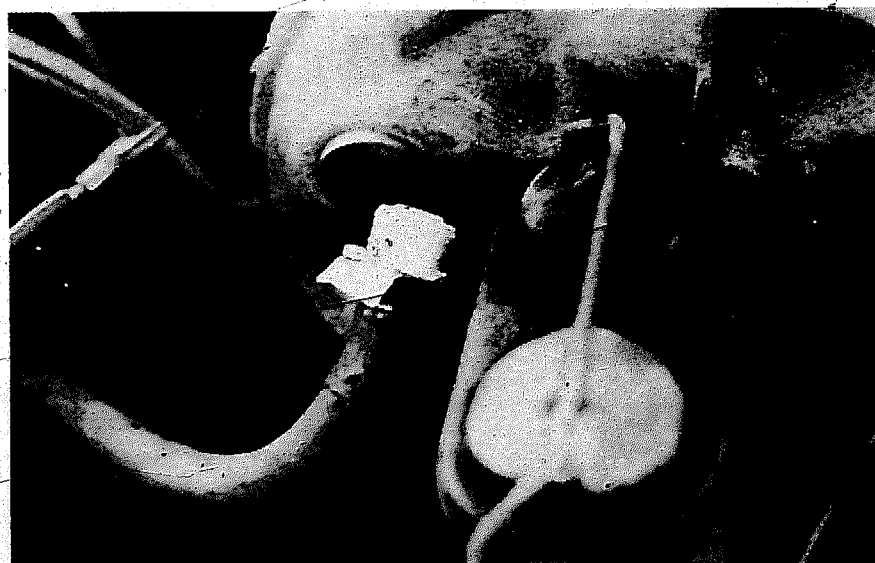
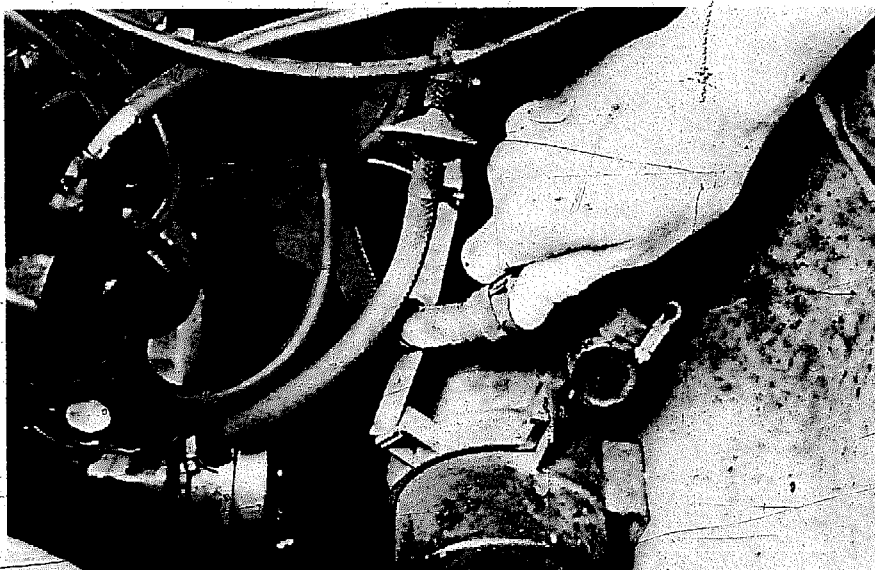





continued

## THE BACKYARD MECHANIC

should be able to blow through the end that inserts into the power unit, but not through the end that attaches to the vacuum line. Install a new valve if the old one is faulty, being sure to get the unit placed securely in its grommet.

If the valve is in good condition but the power unit doesn't operate, you better head for the local brake shop or pick up a factory-rebuilt power assist unit and bolt it on. As previously mentioned, power assists are hairy to rebuild and should always be replaced with a new or factory-rebuilt unit. A good service manual has the specs on this job for your car.

### REGULAR MAINTENANCE

Most power boost units have a filter to clean the air drawn into them. On a few boosters the unit is external and should be periodically removed and cleaned with alcohol—check your manual for the specs. However, most units have an internal filter that should be serviced when the booster is removed from the car.

One final check you can make on the power assist unit is making sure there is no brake fluid being sucked through the vacuum line into the in-

take manifold. Remove the vacuum hose that runs to the power assist at the manifold and run a pencil around the inside of the open end. If the pencil comes out wet, fluid is leaking past the vacuum cylinder piston. If so, the unit should be replaced. Fluid leaking into the engine will cause it to run poorly, and enough fluid can cause sticking valves and other serious engine problems. Before replacing the power unit, however, check the master cylinder very carefully for leaks. Fluid leaking into the vacuum unit from the master cylinder may be the cause of the excess fluid. In this case the master cylinder should be repaired or rebuilt.

A power brake-related check you should make when checking the brake adjustment is to make sure that the power unit is not causing the front brakes to drag. With the car's front end raised and properly supported (brakes properly adjusted), spin the wheels. Immediately start the engine but do not touch the brake pedal. The wheels should coast to a stop gradually and turn freely. If not, have the vacuum unit checked out by an expert. Figure 3 gives the procedure for checking the automatic adjusters on drum brakes. Ⓢ



The check valve is designed to let air out of the assist unit when the power brakes are operated, but close when vacuum stops. If the valve passes air freely from each direction, it's faulty.

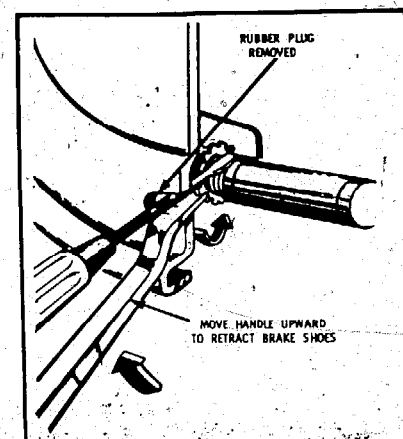

Fig. 3

### AUTOMATIC ADJUSTER CHECK

1. Raise the vehicle and support it properly with safety stands. Chock the wheels.
2. Loosen the brakes by holding the adjuster lever away from the starwheel and backing off the starwheel approximately 30 notches (see diagram).
3. Spin the wheel and brake drum in reverse and have a helper apply the brakes. The movement of the secondary shoe should pull the adjuster lever up, and when the brakes are released the lever should snap down and turn the starwheel.
4. If the automatic adjuster doesn't work, the drum must be removed and the adjuster components inspected carefully for breakage, wear, or improper installation.



Leaking brake fluid can be pulled into the engine through the vacuum line. Pull off the brake booster vacuum line at the manifold connection and check the inside of the line for fluid. If the line is wet, the brake assist or master cylinder (whichever is leaking) should be replaced to prevent engine damage.

The Backyard Mechanic is designed to serve as only a general guide to the maintenance topics discussed. Since basic procedures vary from car to car, a manual should be consulted when performing any maintenance. And any jobs that the "backyard mechanic" feels are beyond his capabilities should be left to experts.

---



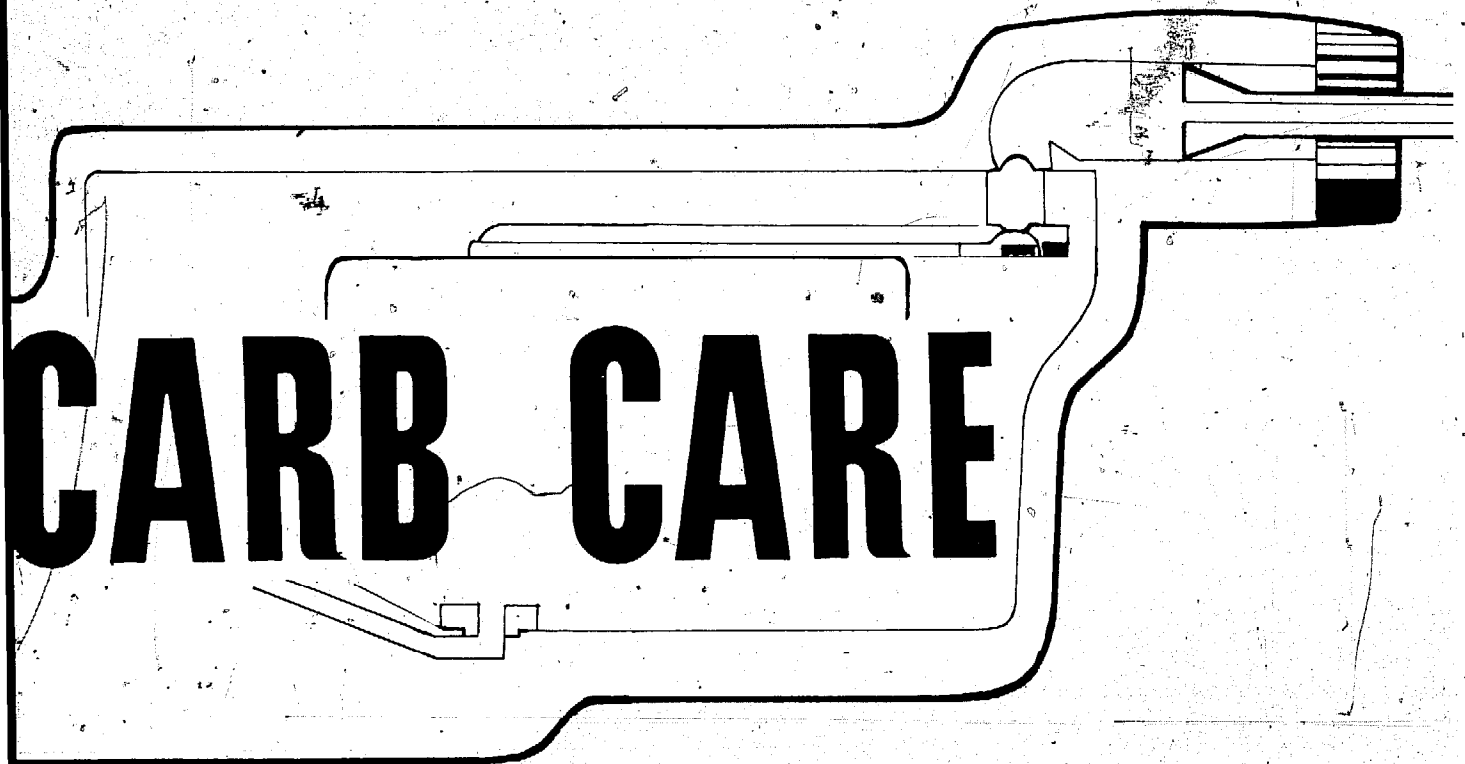

# CARB CARE

**A** few years ago a major oil company had a television commercial featuring a grimy character known as "Mr. Dirt." The purpose of the ad was to convince you to use their detergent gasoline to keep Mr. Dirt from doing his thing inside your car's engine. Well, whether or not that gasoline really helped to keep an engine clean, the fact remains that dirt is one of an engine's worst enemies.

Dirt and contaminants inside the engine are big contributors to engine wear. But where Mr. Dirt does his dirtiest work, or at least where you notice it most, is the place where the dirt enters—the carburetor. The list of problems caused by a dirty carb reads like the "Who's Who" of auto ailments. Everything from hard starting and lagging acceleration to stalling and—most important these days—excess emissions and poor gas mileage

are caused by a dirty or worn carb. So it's definitely a good idea to keep your carb clean and functioning properly for maximum performance and mileage and for lower emissions.

## FILTERS

Thanks to improved air and gas filters on today's cars, carbs stay a lot cleaner, and because they keep cleaner, they frequently last the life of the engine without major maintenance. So the very best way to keep your carb clean and doing its thing is to regularly replace these important filters. But even with regular filter replacement, some dirt and grime finds its way into the carb. And unless you periodically clean out this dirt, it can build up and eventually plug carb jets and passages, as well as cause the carb to wear. If this happens you've got a sick carburetor that may have to be disassembled to be thoroughly cleaned and

*continued*

continued.

## THE BACKYARD MECHANIC

possibly rebuilt or even replaced.

### CLEANERS

There are a couple of ways to remove accumulated gunk from a carburetor. The easiest method is to use a fuel system cleaner that is added to the gasoline. Just about every automotive products manufacturer makes this type cleaner that generally sells for less than \$1 a can. The products go by various names depending on the manufacturer, but they are all essentially the same. If you add a couple of cans of this type cleaner to the gasoline about every oil change it does a fairly good job of keeping the carb clean—especially if you start from the time the car is new. But this type cleaner is not really too efficient at cleaning out built-up dirt and varnish.

### CLEANING KIT

The most effective method of cleaning a carb (especially a gunky one) without removing it from the engine is to run solvent directly into the carb, using a special gravity-feed kit. These

inexpensive kits are available at most auto supply and discount houses and are quite simple to use.

After removing the air cleaner assembly, the first step in using the kit is to disconnect the gas line at the carb. After carefully disconnecting the line—being sure to catch escaping gasoline in a can or rag—block off the gas flow with the special block-off fitting provided with the kit. Then attach the flexible solvent hose to the gas inlet on the carb, using the correct size adapter from the kit. Install the other end of the hose to the can of solvent and suspend it from the underside of the hood.

Start the engine and run it at varying speeds so the solvent penetrates through all of the jets and passages. Every so often, briefly place your hand over the carb to block the air flow to help force the solvent through the carb. When all of the solvent has run through the carb the engine will die and the internal passages should be pretty well cleaned of gunk and varnish.

To finish the job right, carefully reconnect the fuel line, start the engine and spray a can of aerosol carb cleaner/decarbonizer down the throat of the carb following the instructions on the can. The outside surfaces of the carb—especially linkages—should al-

so be sprayed clean with choke solvent to keep things working right. Also check for any gasoline leaks from the carb or fuel line when you clean the outside.

### NOT FOR EVERYBODY

Now, if you've been having sick carb symptoms like poor performance and mileage and cleaning the carb didn't seem to help, you may be in need of a carburetor rebuild or replacement—that's providing you've carefully checked out all other areas that could be causing performance problems. Industry surveys show that car owners generally blame the carburetor for poor engine performance. However, about 80 per cent of the time other problems such as a plugged PCV system, a leaking manifold, or a bad valve are at fault. So thoroughly check all possible sources of performance problems before tearing into the carb. In the case of a malfunctioning carb, first check to see that the heat passages in the intake manifold near the base of the carb are clean. These passages (especially on Chevy V-8's) sometimes plug and cause carb problems. Also check to be sure the gasket between the manifold and carb is in good shape and the carb is tightened down—an air leak here or at the manifold could be

Fuel-system cleaners that are added to gas tank go by various product names. Regular use of this type cleaner helps keep the carb clean.

Gravity-feed kits are the best method of cleaning the inside of the carb.





causing trouble.

But before we go one step further we want to emphasize strongly that rebuilding is not for every carb, nor is it for every person.

Only a few years ago it used to be just about standard procedure to pull off the carb and rebuild it about every other tuneup. Well let's face it, in the last few years carburetors have gotten more complex; but at the same time they've gotten more reliable so they really don't need major maintenance as often if they're kept clean.

Also because of the complexity and the emission control restrictions, most regular mechanics do not attempt to rebuild many of today's carbs. In most cases it's easier and cheaper to simply remove a faulty carb and bolt on a new or factory-rebuilt unit. The same is also true for four-barrel carbs—many skilled mechanics find that it's easier to get a factory rebuild than trying to rework a complex four-barrel carb.

So the fact that "real" mechanics do not try to rebuild all carbs ought to tell you "backyard" mechanics something. Generally, if you've got carb problems with a post-1970 carb or with any four-barrel unit, you're probably better off getting a rebuilt one and installing it rather than fooling with the old carb. It's also illegal

for anyone but a certified mechanic to tamper with a newer carb in many cases.

#### WHEN?

So now you may be wondering just when should you rebuild a carburetor. Well the main candidates for carb rebuilds are older cars with one- and two-barrel carbs. If you're nursing along a car that's logged a lot of miles and is running a bit sick, probably the best investment you can make is a reworked carb—especially if you do the job yourself. Of course you want to be sure the carb is really what's giving you trouble.

If a sick carb is the problem, there's no reason why the average "backyard" mechanic can't pull off an older model one-barrel carb and completely rebuild it. Also, if you have a bit of experience with carbs and/or you work very carefully and follow instructions you should be able to handle a two-barrel carb.

As we mentioned previously, the post-1970 carbs are specially calibrated and equipped for reducing emissions and *should not* be tampered with. However, if you're having carb problems it's not a bad idea to remove the carb and give it a thorough cleaning and check for obvious problems like a punctured float. If the

carb still gives you trouble after it is cleaned and properly reinstalled, your best bet is heading for a good mechanic or replacing the carb.

#### REBUILD

Okay—let's say you have an older carb that's in need of a rebuild. The very first thing you should do is get a manual that outlines the job for your carb step-by-step. If you're not sure of yourself after checking out the procedure, don't do it. Save yourself time and trouble by getting a factory-rebuilt.

If you're confident you can handle the job, you can save a bundle by picking up a carb rebuild kit and doing the overhaul. However, there's a very important difference in the quality of the rebuild kits. The less expensive kits generally contain only a few new internal parts and new gaskets, but worst of all they usually have only sketchy instructions. The way to go is with the more expensive kit that contains all the parts needed to completely overhaul the carb, as well as complete instructions and the ultra-essential gauges for measuring the critical adjustments.

When you're buying a kit you have to be positive you get the correct one,

*continued*

Aerosol carb cleaners can be used to clean the outside of the carb and sprayed down the carb throat to clean the inside.

Be sure to get the best carb rebuild kits that contain all necessary parts, as well as complete instructions and the gauges needed for making the essential adjustments.

\*Most rebuild kits are designed for more than one model carb and usually contain more parts—especially gaskets—than are needed to rebuild any one carb. Especially for this reason, save every removed gasket and part so you can be sure you use the proper replacement part.

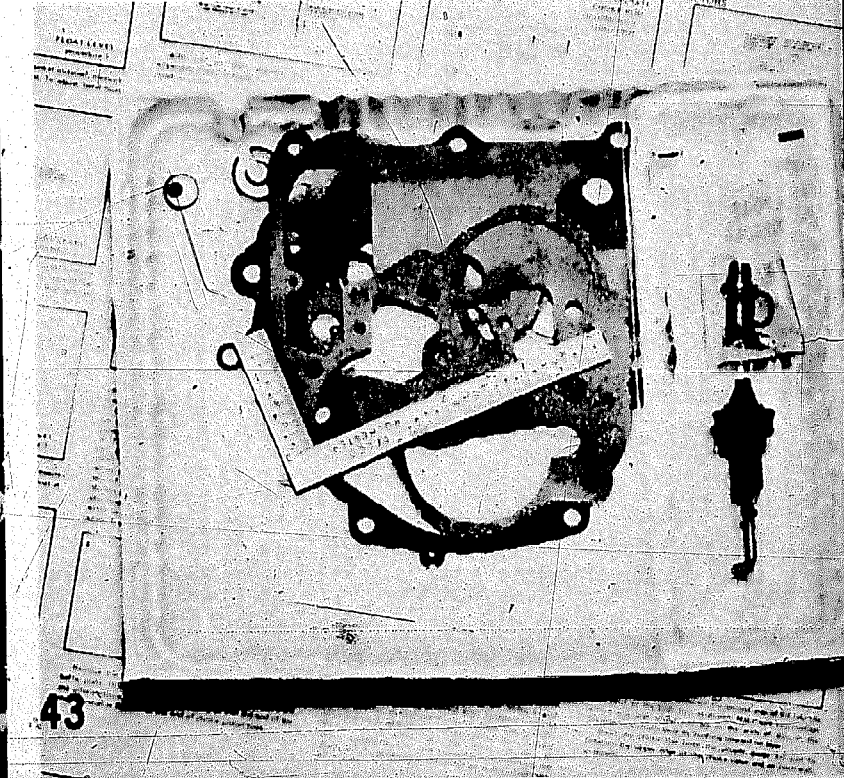
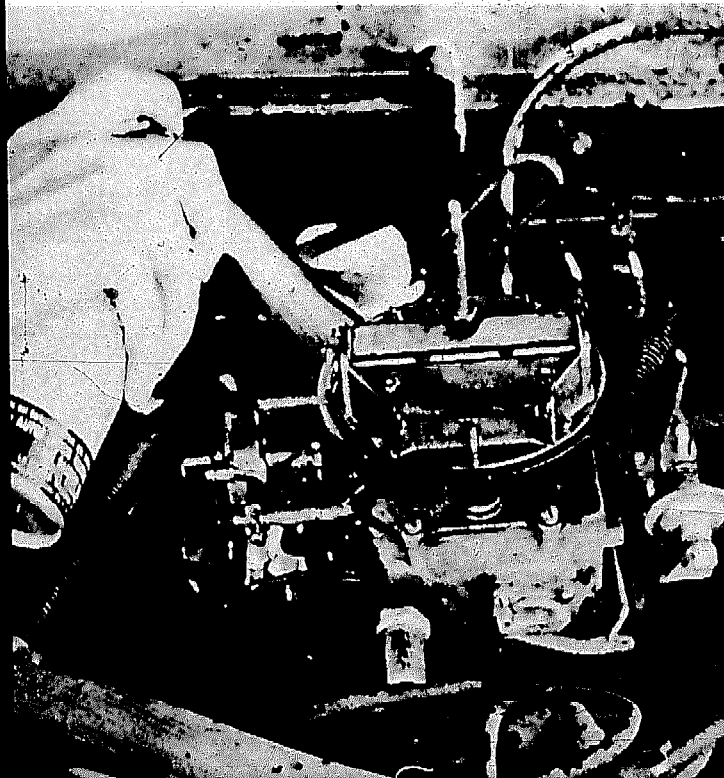

continued

## THE BACKYARD MECHANIC

since the kits vary for the same carb depending on the specific model. The best way to be sure is to get the number from the carburetor identification tag that's usually mounted on top of the carb. If there isn't a tag, you should be able to find an I.D. number somewhere on the carb.

When you pick up the rebuild kit, grab plenty of carb solvent for soaking the parts clean and you're about ready to go. Remember, never use gasoline for cleaning the carb since it is highly flammable. But also be careful with the carb solvent since it is very caustic and can burn your skin. The best bet is to try to keep the solvent off your hands as much as possible and always rinse the solvent off of your skin after long exposures to the solvent.

Besides common hand tools, the only other items you'll need are some clean rags, clean cans (such as coffee cans) to use for soaking tanks, and finally some sectioned pans—such as TV dinner trays—for organizing parts.

Before beginning to work there are a couple of final points to keep in

mind. First, don't forget to remove all jewelry and disconnect the negative battery cable (or positive cable on positive ground systems) to prevent any chance of a burn or explosion from a spark. Finally, to make the job a lot easier, thoroughly clean the outside of the carb with solvent before beginning.

The first step is disconnecting the fuel line, vacuum lines, and the linkages so the carb can be lifted off the manifold—never try to rebuild a carburetor on the engine. The important things are to be sure and use a container or a rag to catch the escaping gasoline when you disconnect the fuel line. Also be sure you know exactly how and where all of the linkages and vacuum lines attach. It's generally a good idea to take some polaroid shots or make some sketches to be sure you know how everything goes back on. You can also label each part as you remove it to help prevent any mixup.

After everything is disconnected from the carb, simply remove the nuts that hold the carb to the manifold and lift the carb off and place it on a clean working surface. Place a wadded-up rag in the manifold opening to prevent any foreign debris from getting inside the engine.

The next thing you want to do is carefully remove the top of the carburetor and remove the float by pulling the pin as shown in the picture. Gently shake the float near your ear—if you hear sloshing the float must be replaced. Plastic floats sometimes get soaked with gasoline and become too heavy. Check float by squeezing it lightly. If the float is okay set it aside and you can go on.

Another important consideration before you continue dismantling the carb are the special spring and ball assemblies that are used as metering systems in most carbs. Note exactly where and how these assemblies fit and be careful not to lose any of these small parts since they are rarely supplied in the rebuild kits. After checking out these special parts, you can continue the disassembly following the step-by-step instructions given with the kit and in a manual.

Since the different types and styles of carburetors vary greatly, we can't cover the entire rebuilding process here. However, we will generally outline some of the major steps using pictures of a Rochester two-barrel carb which is a rather common carb that is used on many GM products. Various carb rebuilding tips also accompany the following pics. Ⓢ

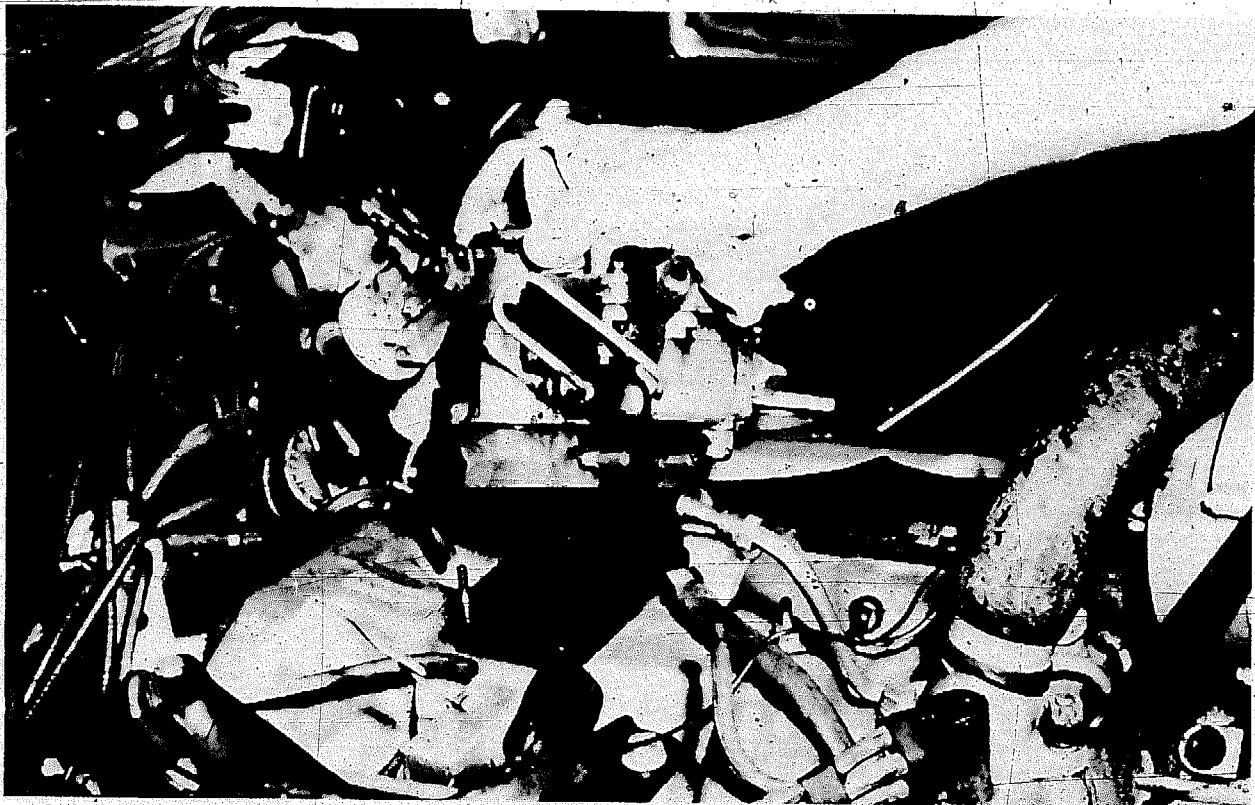

After all linkages and vacuum lines are carefully disconnected and marked for easy reassembly, the nuts holding the carb to the manifold can be removed and the carb lifted off the manifold.

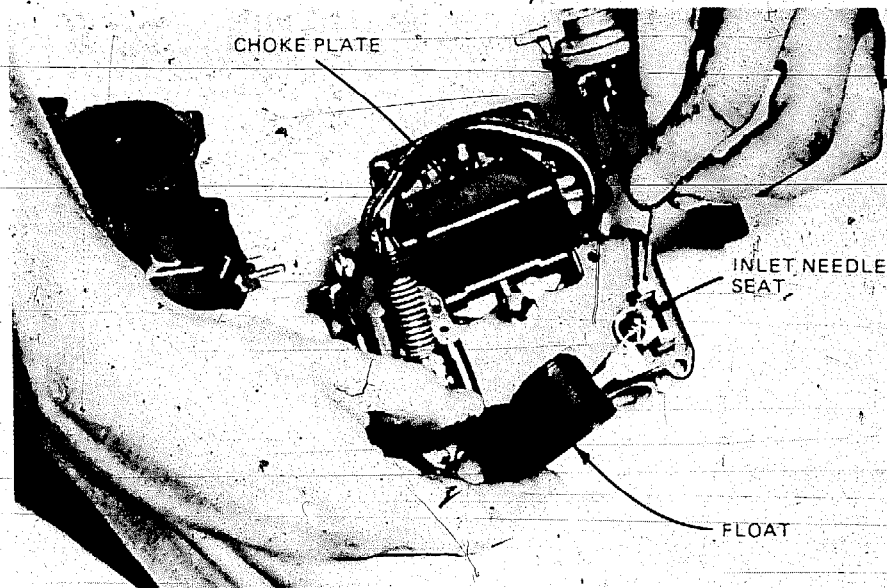
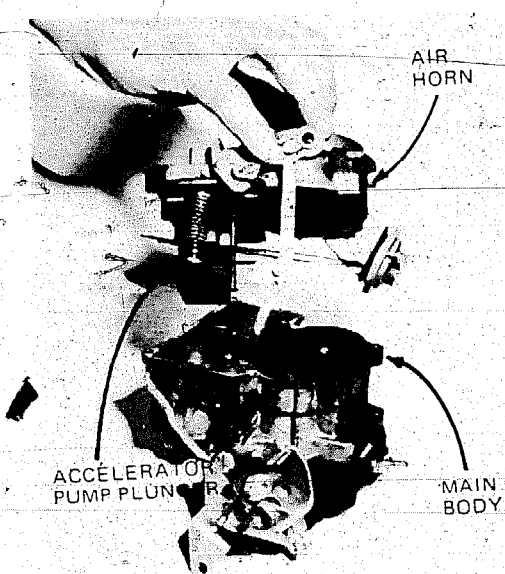

The first major step is removing the top of the carb (air horn) from the carb body. There is usually some linkages that must be unhooked to accomplish this. This is the time to locate small parts such as metering valves that can be easily lost.

*\*Don't get carried away when you're disassembling the carb. Follow the instructions step-by-step and don't tear down subassemblies unless specified in the instructions.*

Checking the float is a very important step. Remove it by pulling the retaining pin. Shake the float—if there's gas in it you need a new one. Remove the fuel inlet needle and seat and save them. Remove the accelerator pump and other air horn parts according to instructions.

*\*The accelerator pump is an important part that shoots gas into the carb under heavy demand. A worn pump is what causes lagging acceleration. Soak the new pump in light oil before installing it to be sure it seats correctly.*

*photos continued on next page*

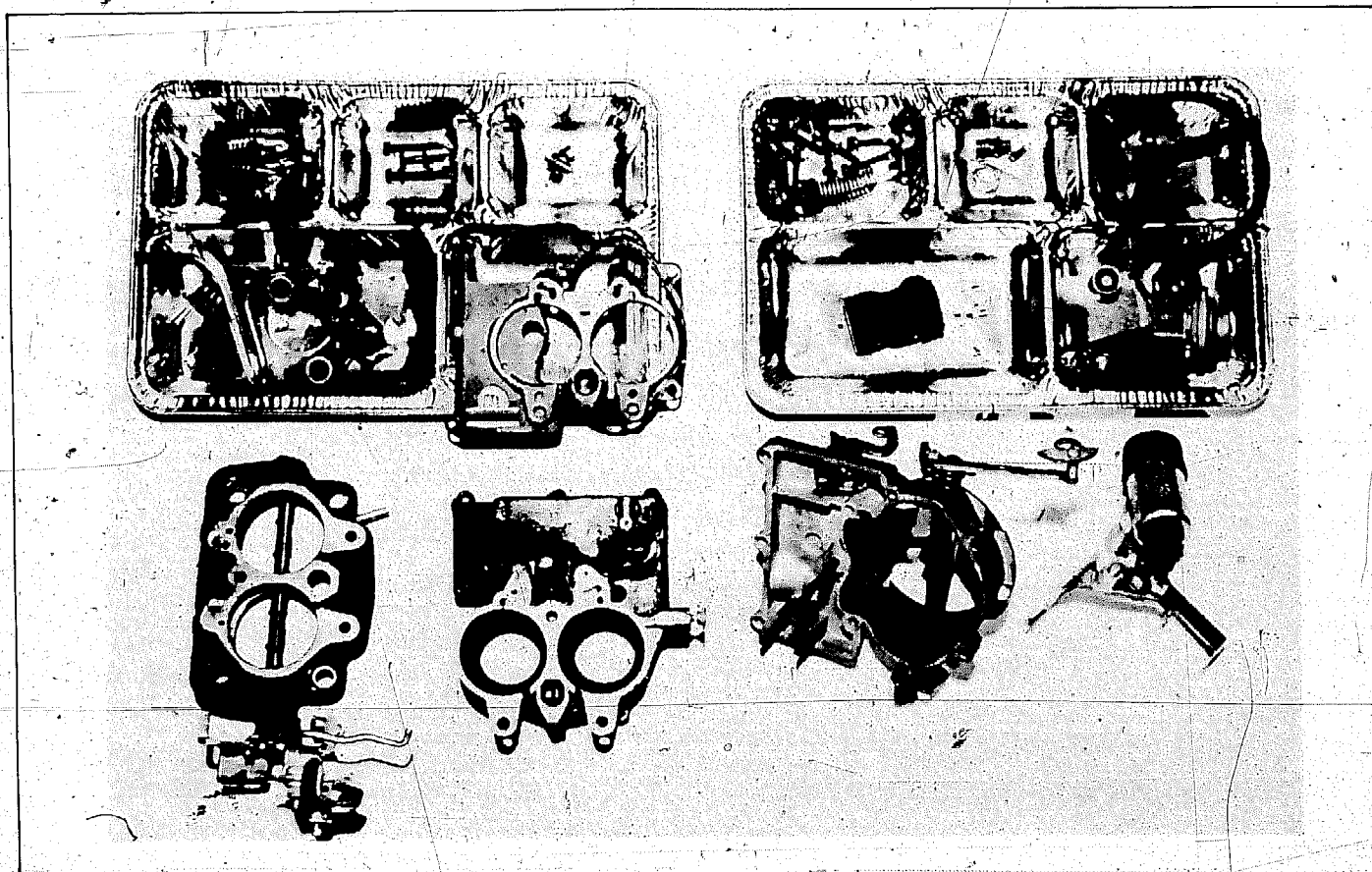

Finish disassembling the carb according to instructions and organize all removed parts and the new parts. As previously mentioned, you may have extra parts in the rebuild kit. This is a good time to match all the new parts with the removed ones and get things organized for the reassembly.

continued

## THE BACKYARD MECHANIC



Soak all major parts in carb solvent for at least 30 minutes. Do not place rubber, plastic, or any non-metal parts in solvent—they may disappear. These parts can be washed in solvent and rinsed clean. After all parts have soaked clean, rinse them thoroughly in water and let them air dry.

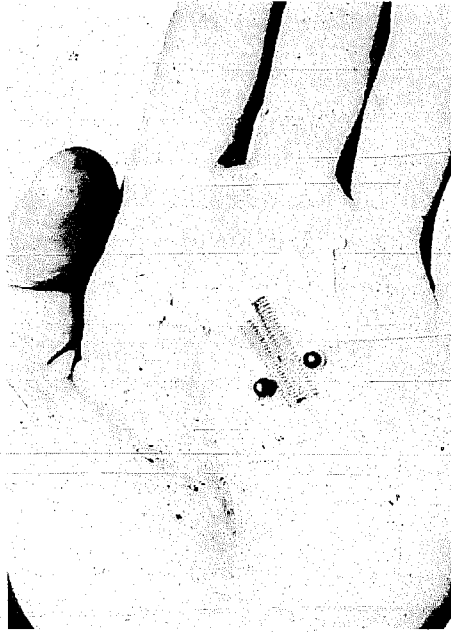

Here's a good example of why you should save all removed parts. This carb uses two sizes of balls which could be easily mixed. All new parts should be checked carefully against the removed parts before installation.

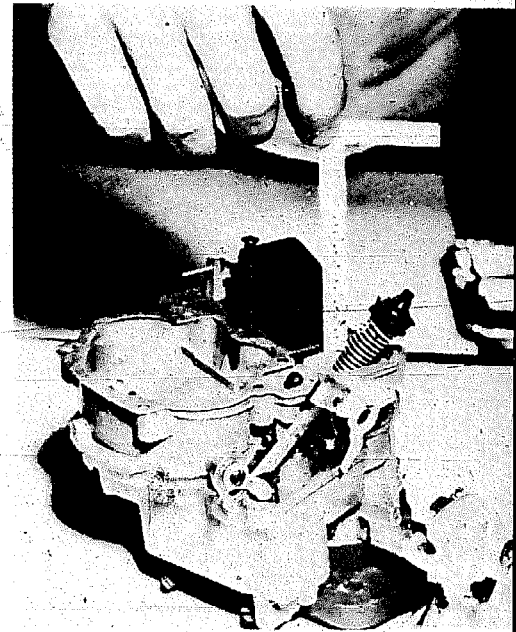

Reassemble the carb following instructions. Make all adjustments very carefully according to instructions—if you don't, all of your time and trouble has been wasted. Float level is one of the most important settings.

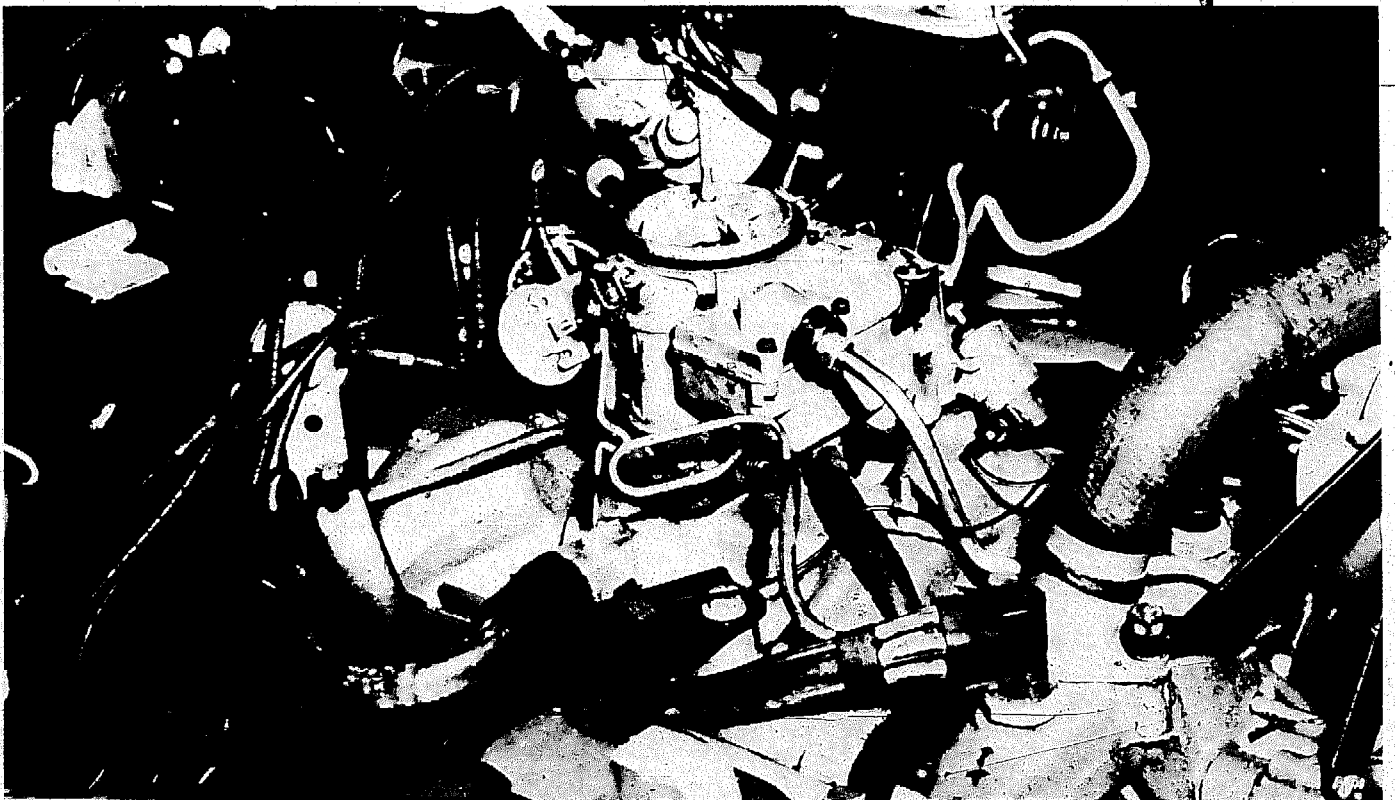

After installing reworked carb and hooking up all vacuum lines and linkages you can fire up the engine and adjust the fuel mixture and idle speed as specified in the manual.

*\*As soon as you get the engine running right, why not drive to a good shop and get the carb scientifically adjusted right on with the special analyzers? This will insure you're getting the best performance and mileage with the lowest emissions. After all the money you just saved by doing your own carb rebuild you can surely afford it.*



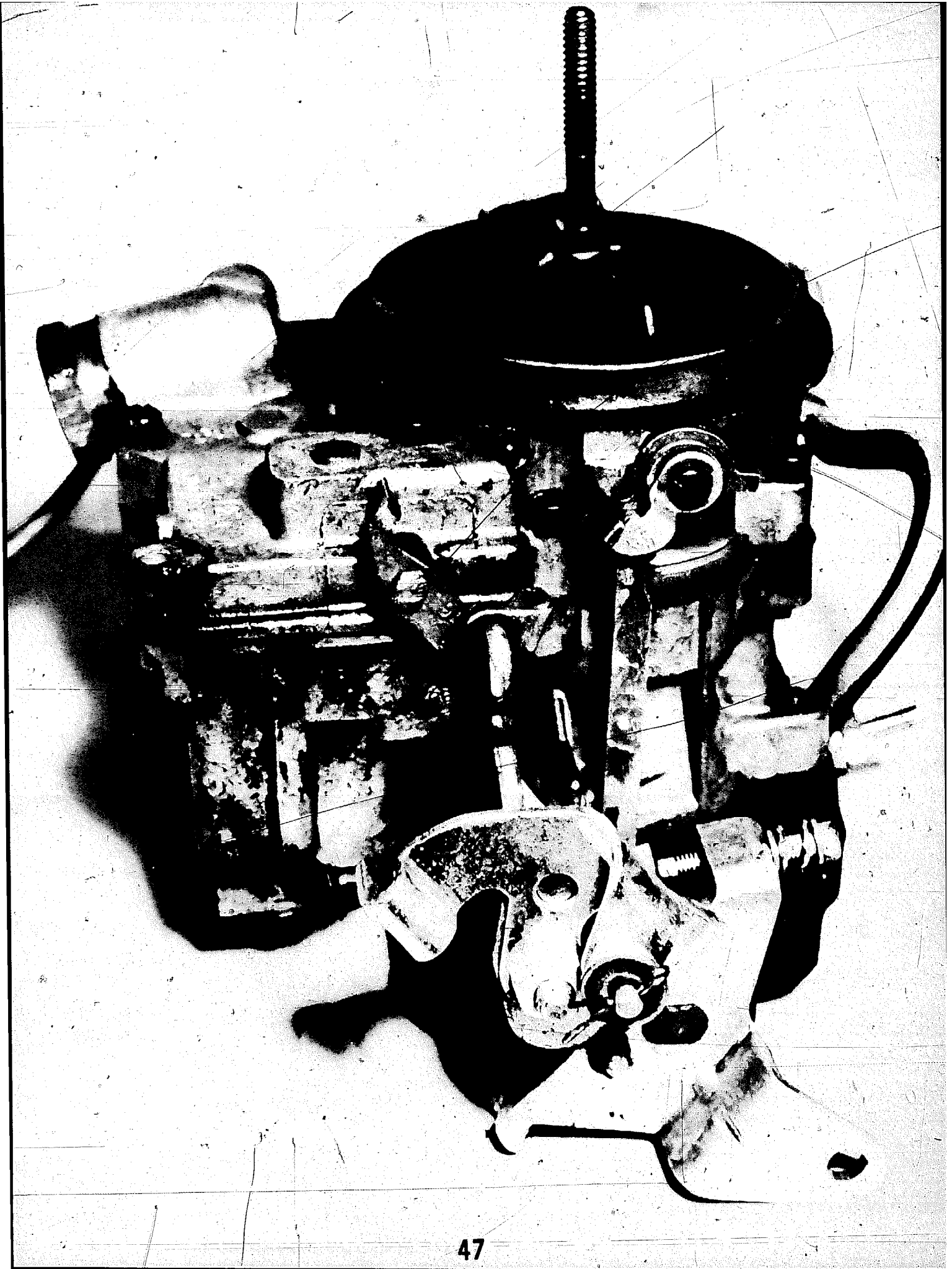



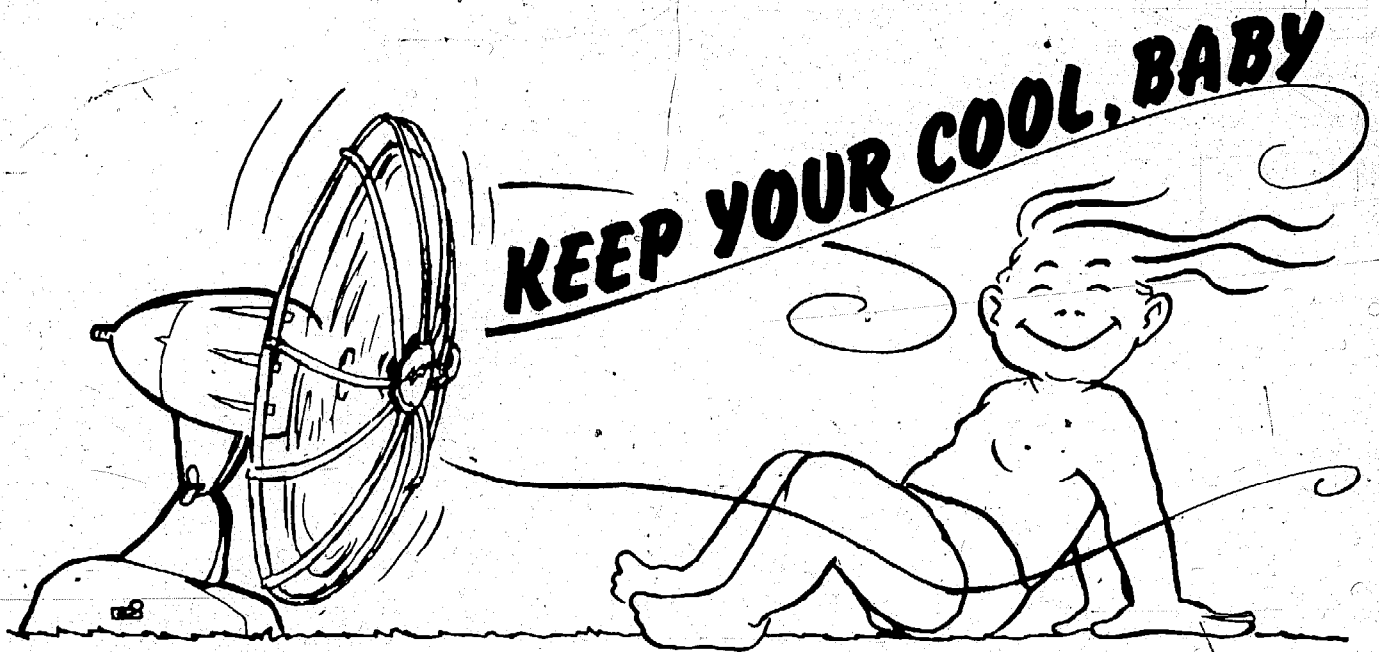

# AIR CONDITIONERS

**T**hose of you who are familiar with T.O.s know that during certain portions of any operation, there are little notes that read "caution" or "warning." Well, right up front, here's a *warning* about foolin' around with your auto air conditioner.

**WARNING . . . THE REFRIGERANT USED IN AIR CONDITIONING SYSTEMS IS HAZARDOUS. YOU CAN'T SEE, TASTE, OR SMELL IT, AND IT CAN'T BE READILY DETECTED. THIS REFRIGERANT BOILS AT -21 DEGREES FARENHEIT AND CAN SEVERELY INJURE YOU BY FREEZING. ALSO, IF IT COMES IN CONTACT WITH A HEAT SOURCE, IT CAN CHANGE FROM A LIQUID TO A HAZARDOUS GAS.**

Now that we've got the dire warnings out, let's take a look at your car's air conditioning system to see how it works, and maybe we can clear up a few malfunctions.

## OPERATING THEORY

An air conditioning (A/C) unit works on the simple principle that when a liquid is converted to a gas, it absorbs heat from its surroundings. Using an immense amount of logic, we see that when it's reconverted from a gaseous state back to a liquid, it gives up this heat.

In order to accomplish this feat of heat removal, we need several components.

They are the compressor, the condenser, the receiver, the expansion valve, the evaporator unit, and associated hoses and fittings.

As we go further into the a/c's operation, remember that what the a/c does is *remove* heat from the passenger compartment, not add cold. The first step in this chain is the compressor.

The compressor is nothing more than a pump which is driven by the crankshaft via a V-belt. It picks up a gaseous refrigerant from the evaporator inside the car and compresses it. Let's refer to this refrigerant (Freon) as R-12. The compressor uses an electro-magnetic clutch to permit it to be turned off when not needed.

The R-12 is metered into a cooling coil (evaporator), normally located inside the car on the firewall, at about 30 psi. The R-12 is in liquid form at this point. Its boiling point at 30 psi is just above the freezing point of water. The R-12 therefore tends to boil, absorbing heat from the coil.

A blower forces either inside or outside air, depending on the setting, through the evaporator. The air then passes into the passenger compartment through those little grilles (you know the ones we mean . . . those little grilles that no matter where you aim them, they still blow ashes from your cigarette or ash-tray all over the car). As the air passes through the evaporator, heat and moisture are removed.

The R-12 boils inside the evaporator and then passes into the compressor, as a gas, where its pressure is increased. R-12 pressure as it leaves the compressor is usually 200 psi.

The R-12 then enters the condenser, a heat exchanging coil resembling a radiator and usually located in front of the car's radiator. The high pressure caused by the compressor is put to work at this point and raises the boiling point of the R-12 to over 150 degrees F. When outside air is passed over the thin tubes and fins of the condenser, it cools and changes the R-12 back to a liquid, losing the heat it picked up from the interior of the car.

The liquified R-12 then enters the receiver (dryer), a small black tank located next to the condenser or on one of the fender wells. This unit has the job of separating liquid refrigerant from any gas that might have left the condenser, and also filters the refrigerant and absorbs any moisture it may contain. It incorporates a sight glass, in most systems, that allows the R-12 to be visually checked for the presence of bubbles. Remember this sight glass . . . it's invaluable in troubleshooting a/c problems.

R-12 then flows through a liquid line to the expansion valve. This valve is usually located near the evaporator, and usually on or near the firewall. The valve, shaped like a mushroom on some aftermarket systems, controls the flow of R-12

to the evaporator. It provides only the amount of flow that the evaporator can handle.

### SYSTEM TROUBLESHOOTING

#### CHECK COMPRESSOR BELTS . . .

Inspect belts for cracking, fraying, or glazing. Glazing can result from, and result in, slipping. A glazed belt will have a smooth, slippery surface where the belt contacts the pulley.

If the belt needs replacing, do so, being sure you use only the belt specified in your owners' manual. If your compressor is driven by multiple belts but only one is bad, replace both. Belt sets are exactly that . . . sets.

A. Replacing belts: Loosen the mounting bolts of the compressor and move the unit toward the fan so that the new belt may be installed without prying. Check first though, to see if you can replace the belt by loosening the idler pulleys instead of the compressor.

Tighten the belt by pulling the compressor away from the fan, prying it carefully with a breaker bar or, if the mount has a square hole, by applying torque on the mount with a socket drive.

Belts should be tightened so that there is no slack and so that they have a springy feel. Moderate thumb pressure should cause the belt to yield  $\frac{1}{2}$  to  $\frac{3}{4}$  inch for each 10 inches between pulleys. Tighten new belts slightly more to allow for belt stretch during break-in.

If the belts continue to slip, or are noisy, chances are that either the pulley is worn beyond limits, or you have the wrong belt.

B. Check compressor operation: The front portion of the clutch should remain stationary when the compressor is disengaged. If this portion of the clutch turns with the belt, the compressor is operating. With the a/c selectors switches "on," the clutch should be turning.

If the compressor is not running, be sure all a/c controls are set on full or max. Also consider that some of these lil' devils won't go on if the outside temperature is below 50 degrees F. If all switches are set and the weather is warm, the compressor should operate at least intermittently.

If the clutch still fails to engage, pull the wire that goes to the clutch and check for voltage with a voltmeter. If voltage is present, the clutch is faulty and must be replaced. If there is no voltage, trace the wiring back toward the ignition switch. If the wire leads to a frammis located on the receiver or firewall and electrically connected to the compressor, assume the frammis is a low-refrigerant protection switch. If you have voltage on the ignition side of the switch but not on the compressor side, the R-12 is low.

continued

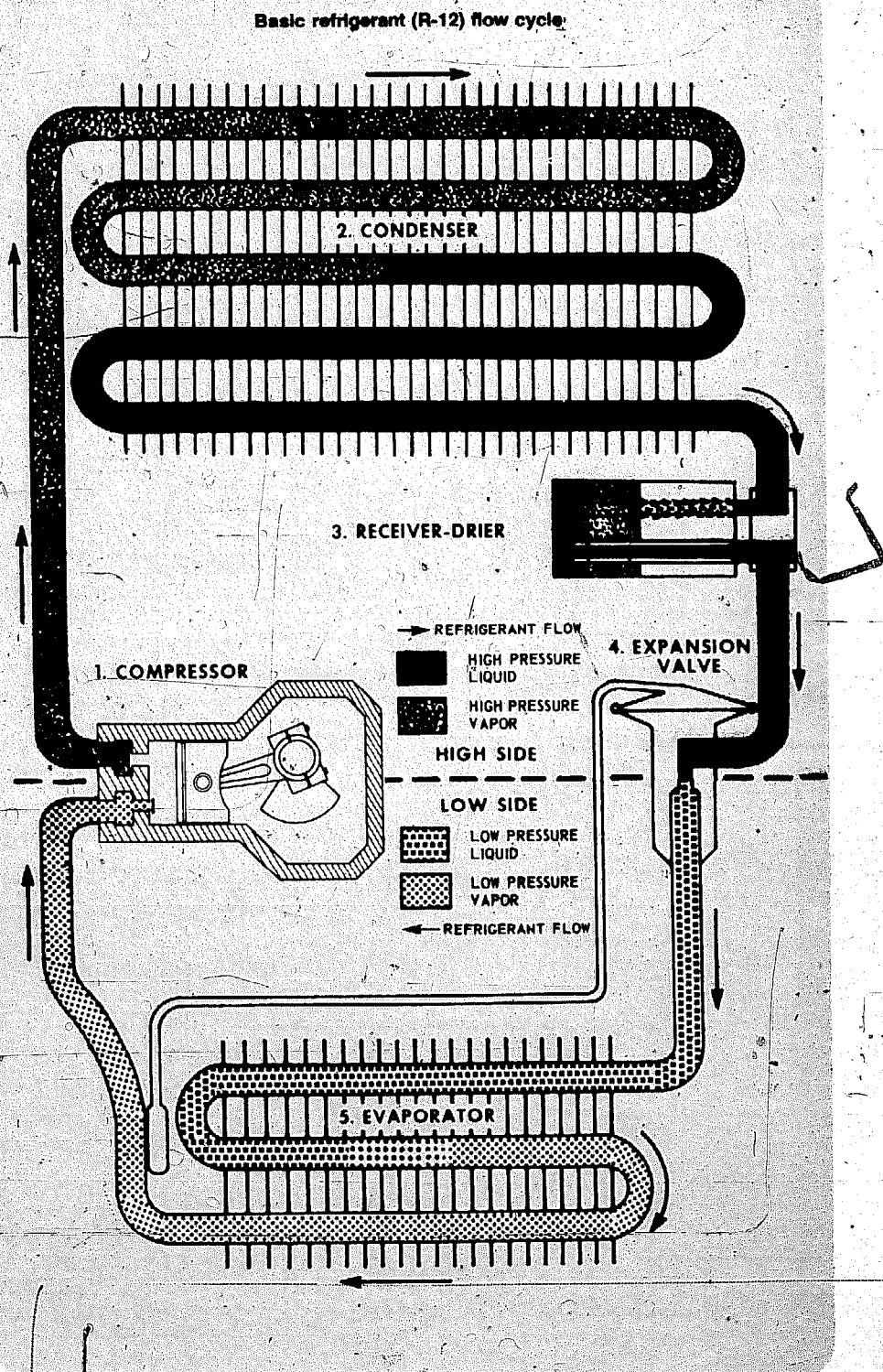

continued

## THE BACKYARD MECHANIC

If voltage is present at the compressor side, check wiring and connections back to the ignition switch. Check for a blown a/c fuse in the fuse block, or an inoperative thermostat (usually located behind the temp control knob).

C. Inspect condenser and fan: Check condenser for bent or damaged fins, and FOD. Straighten the fins as necessary, but be careful not to damage any of the tubes. Check the fan for bent blades or wobbling, and insure that it is not slipping due to worn belts. Remember that cooling system malfunctions can cause the a/c to function badly.

D. Leaks: R-12 leaks show up as oily film or substance on the various components because compressor oil is carried around the entire system along with the refrigerant. Look for oily spots on hoses and lines, and at joints. A small amount of oil on the front of the compressor is normal.

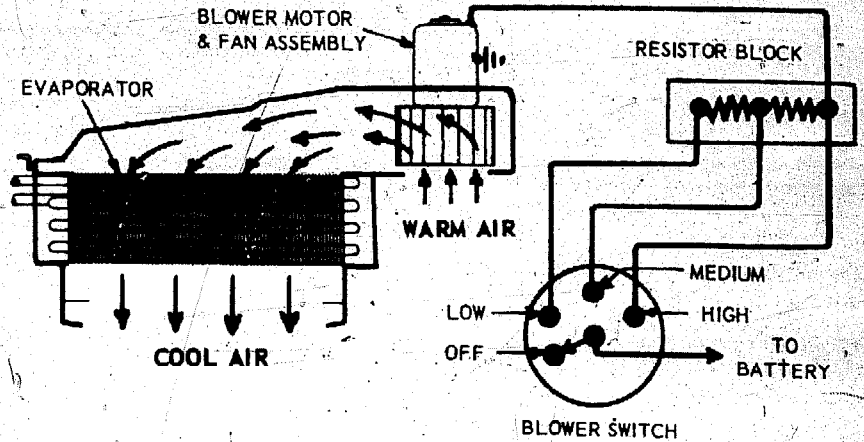

Blower motor and fan operation

**NOTE** . . . if you determine that your a/c is low on R-12 and wish to recharge it yourself with one of the kits on the market, please consider either having it done or asking your installation hobby shop for assistance. No matter what the labels on the kits say, you *should* have a gauge kit, a leak checker, and a purge kit to do the job right. By the time you've purchased two or three little cans of R-12 and the hose kit, you're only about three dollars away

from the price most a/c servicemen charge to do it. An added benefit of having a pro do it is that he can evacuate and dry your system while he's at it for little or no extra coin. If you still want to do it yourself, check with the hobby shop . . . most of them have at least the gauge kits. Trying to put two pounds of R-12 in a system that needs only 9 ounces cannot only be frustrating, but possibly dangerous.

Illustrations courtesy of Mitchell Manuals, Inc.

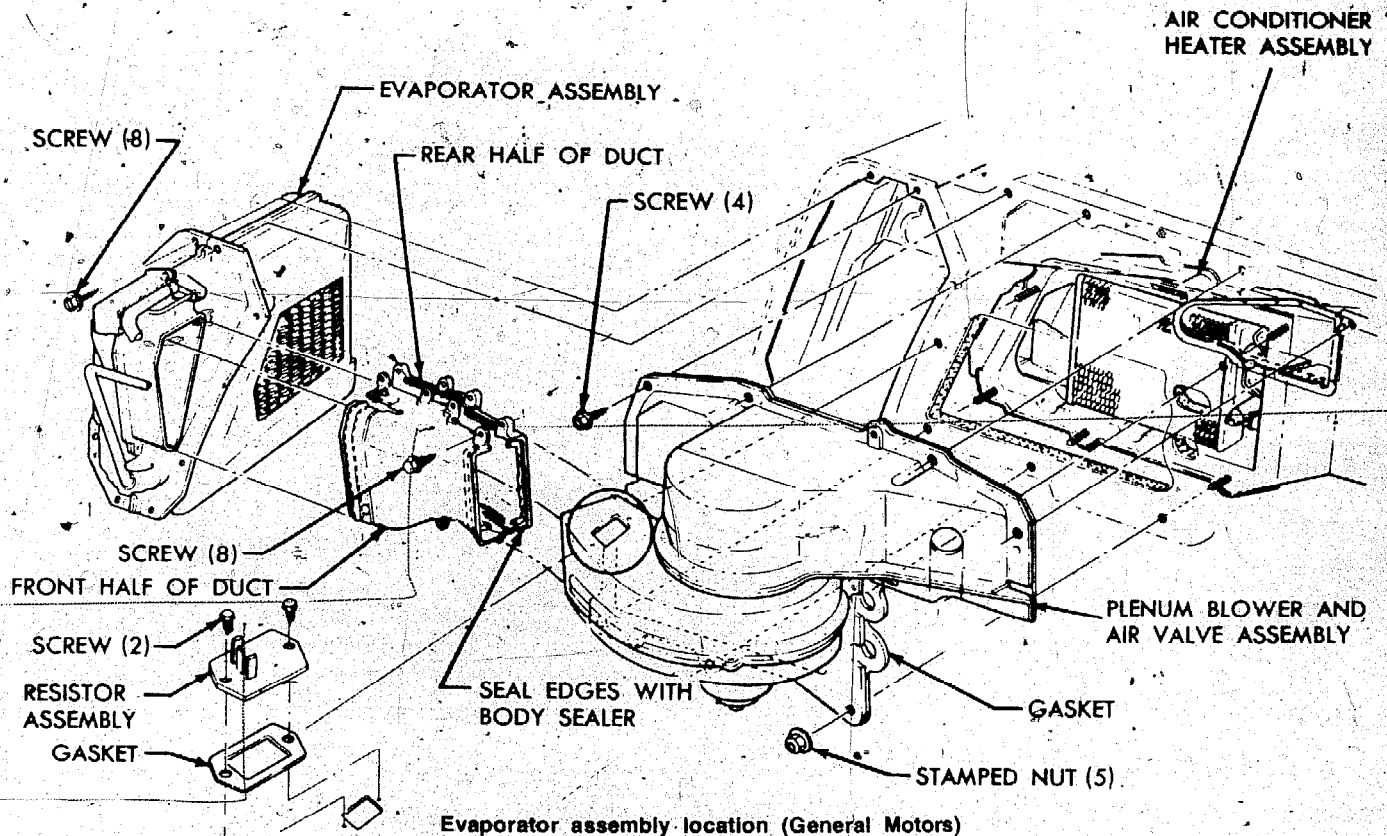

Evaporator assembly location (General Motors)

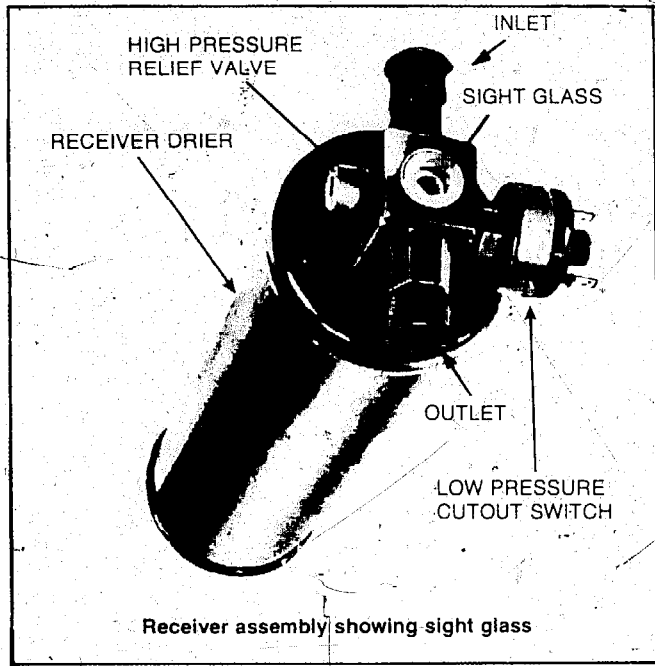
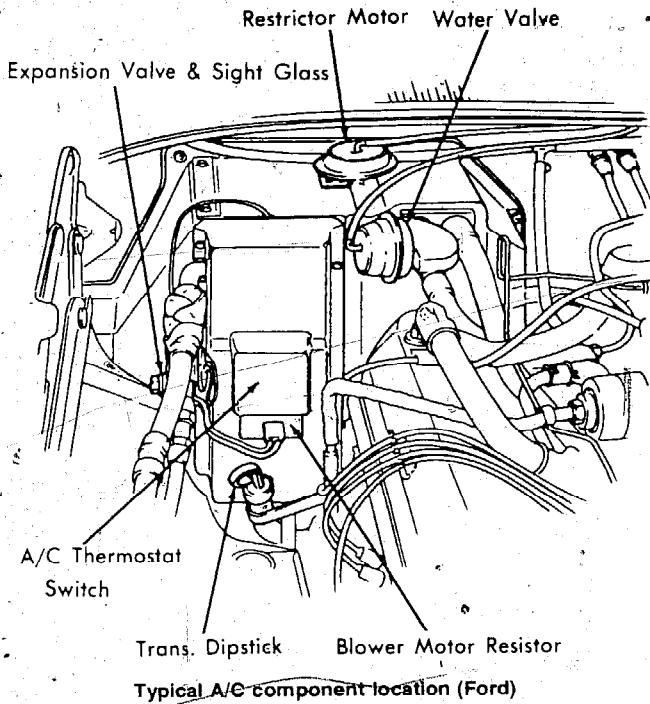

**E. Sight glass:** Start the engine and adjust idle speed up or set the idle cam on a higher notch. Locate the sight glass and remove any covers, and clean it with a rag (if the receiver is near the fan, use caution to insure the rag doesn't get caught in the fan). Have someone set a/c blower and controls at max and watch the sight glass. The glass should foam and then become clear. Unless the outside temperature is less than 70 degrees, the glass should become completely clear within a few minutes. A few bubbles will be present at the cooler temperatures even if the system is operating correctly. If a few bubbles appear at warmer temperatures, it indicates the system is slightly low on R-12 and should be leak-checked and recharged. If you see severe bubbling or the glass remains completely clear from startup, the system probably is very low and needs a charge. If the glass foams and then turns clear, go on to G.

**F. Line temperature:** Carefully feel along the tube that runs from the condenser to the expansion valve. It may be hot, so watch it. The line should be warm along its entire length. A drop in temperature indicates a clog at the point of the temperature drop. If the drop occurs at the receiver, the receiver will have to be replaced because it is clogged with moisture or dirt.

The main suction and discharge lines at the compressor should show a definite difference in temperature, one hot and one cold. If they feel about the same and the sight glass doesn't foam even at startup, the R-12 charge is probably completely gone.

**G. Blower performance:** Operate the system with the blower at high speed and the temp control set at the coldest setting. Engine should be at fast idle.

The temperature at the discharge vents will vary with the weather but most systems will maintain a comfortable temperature in all but the hottest weather. Above 90 degrees, expect a slight reduction in cooling.

If the outside temperature is normal and the a/c performance is still below normal, suspect the blower or temperature control system.

If the blower operates on all speeds and changes its speed when the blower control switch is moved, it's operational. If it operates on only one or two positions or speeds, suspect a faulty blower resistor. This gem is located (usually) in the engine compartment on the evaporator housing. Remove it and check for burning or shorting coils.

If the blower doesn't function at all, run a jumper wire from the positive battery terminal or the fuse block to the blower motor terminal. If it still doesn't run, check the ground strap.

If the system output is inadequate, even though the blower is good, the temperature control system may be the glitch. Have a buddy move the temperature control lever back and forth while you look under the dash for a moving control cable (when under hood or dash, remove rings, watches, bracelets). The cable operates either a water valve, or an air mixing door. If there is no apparent cable movement, but shifting the temp control knob has an effect on compressor operation, have the thermostat switch checked by your friendly a/c serviceperson.

If the lever is moving an air door or water valve, inspect the linkage to see if it is operating properly. The most common problem is an incorrect adjustment or a slipping adjusting screw. The adjustment is usually made on the clamp which holds the cable in place. Adjust the cable's position so that the door or water valve will move to its fully closed or maximum position just before the temperature control reaches its max travel. Where a vacuum-operated water valve is used to stop coolant flow through the heater core at maximum cooling only, check the vacuum line to the valve. If the line is not cracked or kinked, have the valve checked.

If the a/c works OK for 20 to 40 minutes and then begins to go away, the evaporator core is probably freezing up. The suction throttling valve or de-icing switch causes this and will have to be inspected or repaired by a qualified a/c person.

#### HOBBY SHOP?

Don't forget your installation hobby shop when you have a/c problems. Most shops have the a/c manuals you'll need, and many have skilled a/c technicians that can help guide you through the maze of wire and tubing.

Also, as with other Backyard Mechanic articles, we advise getting and using the correct shop manuals and safety equipment. A/C servicing can require safety goggles, insulated gloves, pressure gauge sets, and special pressure vessels and connections.

Don't be afraid of doing your own troubleshooting, but remember that major a/c repairs are best accomplished with a little qualified help. ☺

# IGNITION SYSTEMS

## The spark of life for your car

**I**gnition systems have come a long way from the red hot platinum tube used to ignite fuel in the early 1900s to today's breakerless ignition systems.

In this issue we'll cover late model coil ignition systems, and in the next issue we'll move on to the latest generation of high energy systems.

**A Quick History.** Until 1914, ignition sources were either the "hot tube" or the high or low tension magneto developed by Robert Bosch and Frederick Simms.

In late 1913, the first real improvement in ignition systems was developed by Charles Kettering at his Dayton Engineering Lab (later known as Delco) for use on the 1913 Cadillac.

This ignition system, still known today as the Kettering system, is the coil ignition system. It was used from about 1914 until the mid '70s and was the most accurate, compact and efficient ignition

system until the advent of the new generation systems.

**Ignition Basics.** The parts composing the Kettering, or coil ignition system, are the electrical energy source (battery), ignition coil, condenser, distributor, ignition switch, low and high tension wiring, and the spark plugs.

The ignition system is tasked with producing high voltage surges and then directing these surges to the correct spark plug at the correct time. The surges, or sparks, must be timed to arrive at the spark plug at an instant near the end of the piston compression stroke and in reference to the piston position. The spark from the spark plug then ignites the compressed fuel/air mixture, with the resulting explosion forcing the piston back down the cylinder and producing power.

The ignition system involves two individual circuits. One of these is the primary circuit composed of the ignition switch, primary winding of the ignition coil, distributor contact points, and condenser. The other is the secondary (or high voltage) circuit, including the secondary winding of the ignition coil, the high tension lead, distributor cap, rotor, and spark plugs.

When the ignition switch is closed, current flows through the primary circuit in this manner: battery, to and through primary winding of the ignition coil, to closed distributor contact points, to ground, and back to the battery. A multi-lobe cam on the rotating

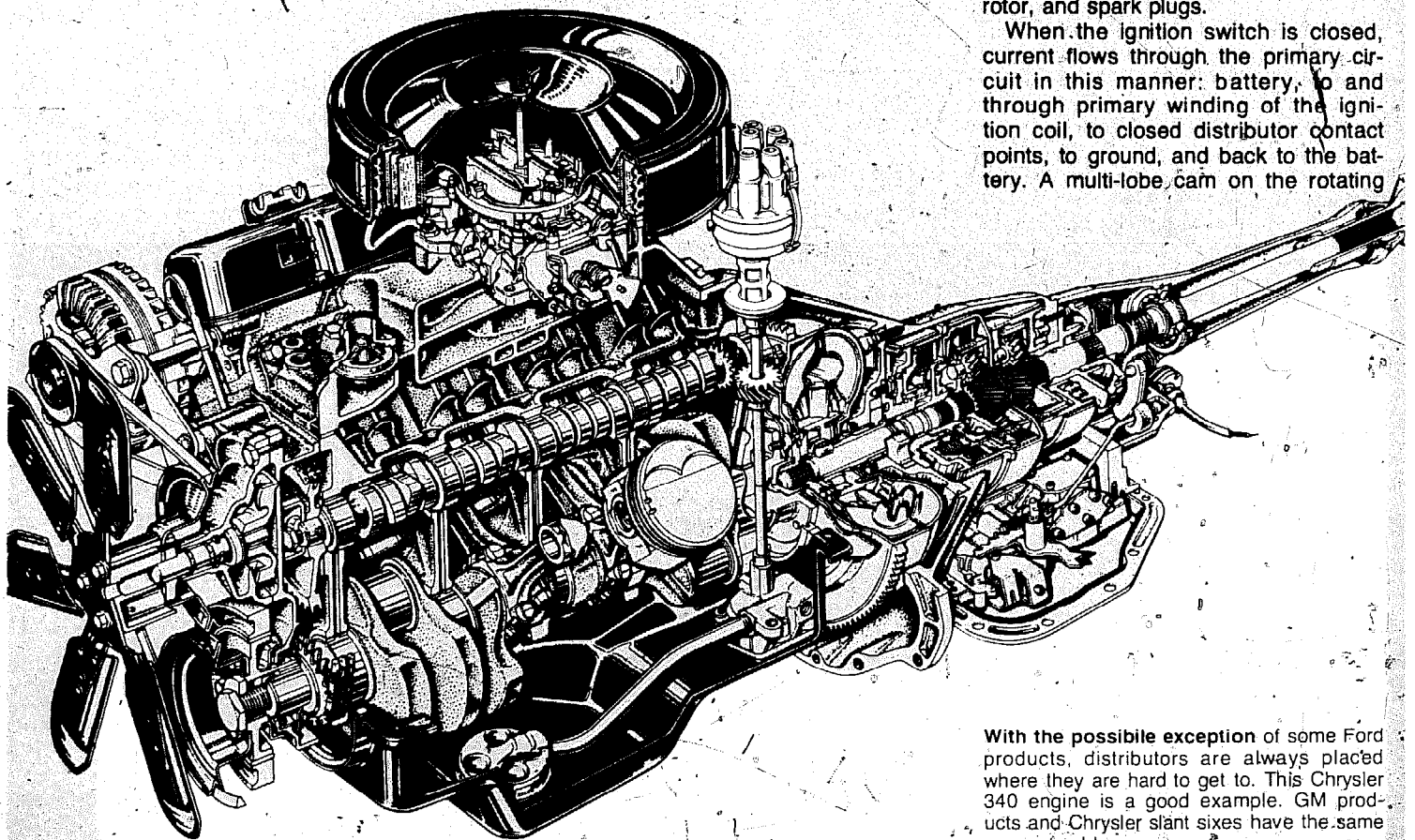

With the possible exception of some Ford products, distributors are always placed where they are hard to get to. This Chrysler 340 engine is a good example. GM products and Chrysler slant sixes have the same access problems.



# THE BACKYARD MECHANIC gets back to Basics

distributor shaft causes the contact points to open and close. When the points open, the current decreases rapidly in the primary winding of the ignition coil and a high voltage is *induced* in the coil's secondary winding (more about the phenomenon of *induction* later).

This induced high voltage flows through the distributor cap to the rotor, through the spark plug lead and to the spark plug. The voltage arcs from the center electrode of the plug to the ground or angle electrode, igniting the air/fuel mixture.

The secondary current flows from the coil secondary winding, across the distributor rotor gap and spark plug gap,

and back to the secondary winding through ground, the battery and the ignition switch. The contact points then reclose and the cycle repeats. The next-firing spark plug will then be the one connected to the distributor cap insert that is aligned with the rotor when the contact points separate. With the engine running, current flows through the coil primary calibrated resistance wire; the other lead connected between the coil and solenoid terminal is a bypass feature (more about this under COILS).

When the contacts separate, a high voltage is induced in the coil's primary winding. This voltage (about 250 volts) causes an arc to form across the con-

tact points. In order to quickly stop and control the primary current and prolong contact point life, a capacitor (called a condenser when installed in ignition systems) is electrically connected across the points.

**Distributor Function.** When you open the hood, one of the first things you see is a plastic device with a multitude of wires leaving the top and scattering around the engine in different directions. It's the distributor. Don't worry though, it's not as complicated as it looks.

A distributor has three basic functions. One is to open and close the low tension circuit between the battery and the coil so that the primary winding of the coil is supplied with intermittent surges, or

*Continued*

This pictorial of the Kettering ignition system illustrates that the system hasn't changed much since 1914. Detail improvements have been made, but components remain basically the same.

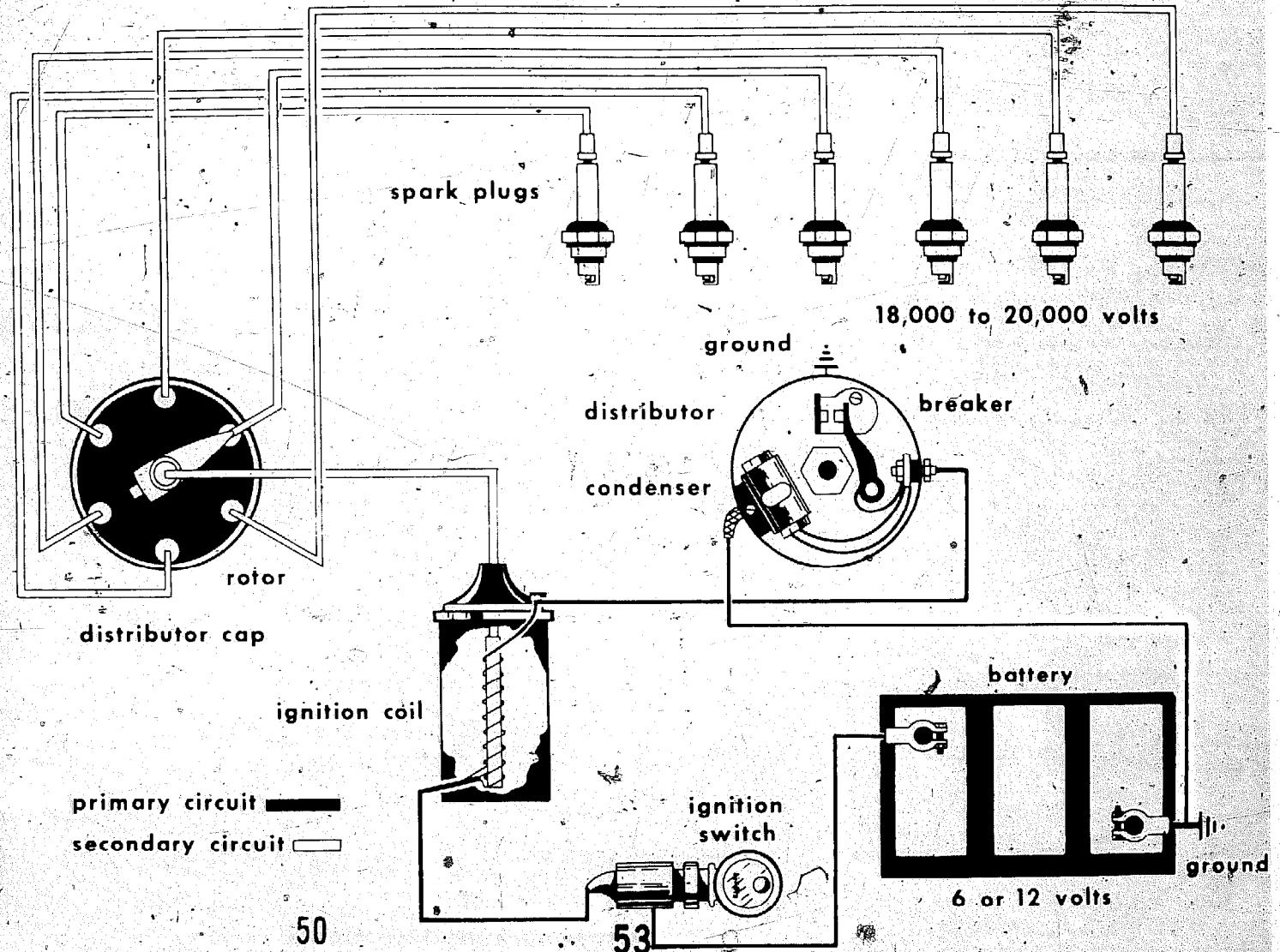

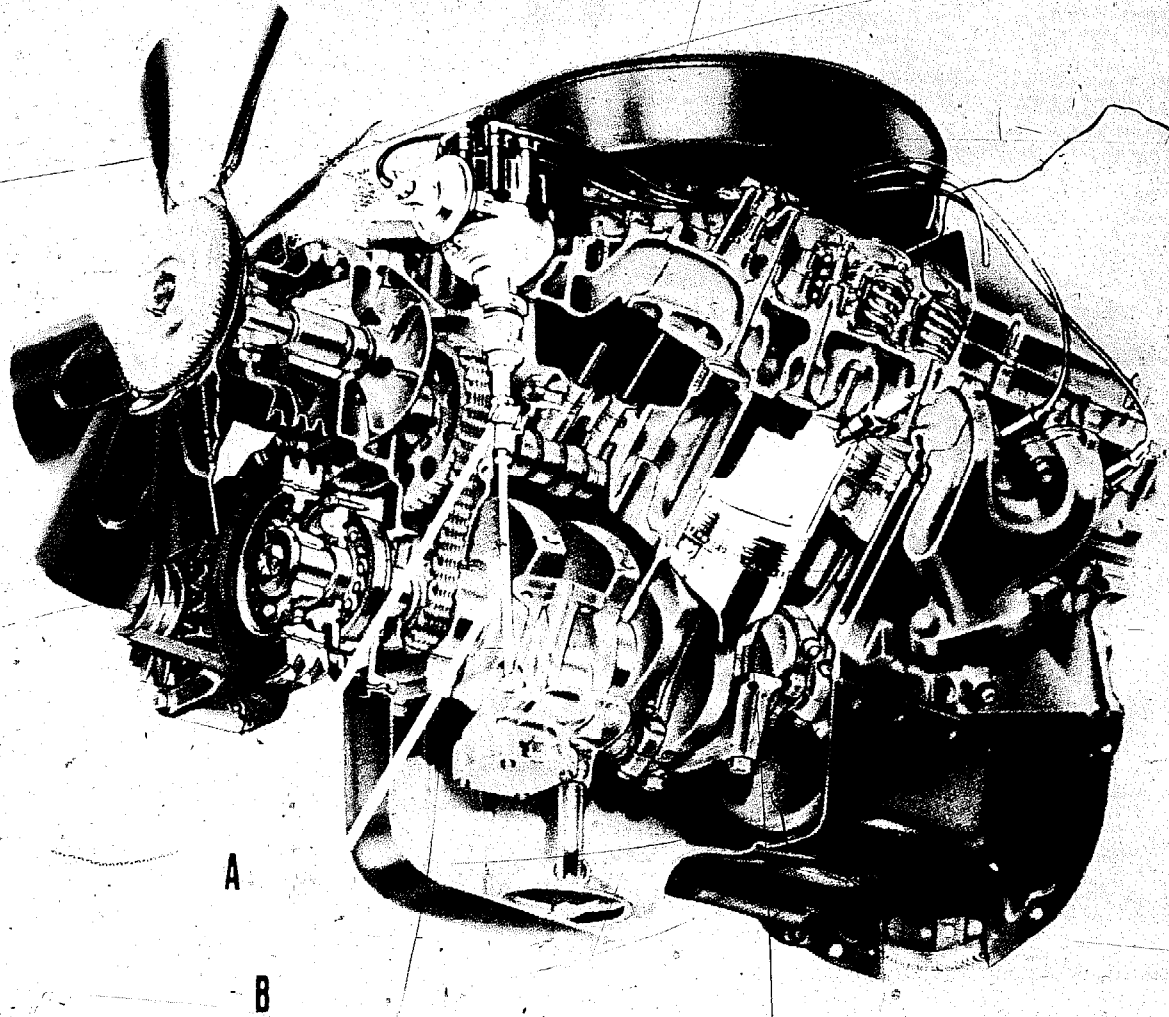

This cutaway reveals that, in some engines, the distributor has two functions. Drive for the distributor comes from gear on the camshaft (A) and distributor driveshaft has an extension (B) that is used to drive the oil pump.

(right)  
Cutaway of vacuum advance mechanism showing advance and retard diaphragms (more in text). (Courtesy Ford Motor Co.)

(below)  
Distributor for eight-cylinder car has eight lobes on cam, and shows slot used to index rotor, location of points and condenser.

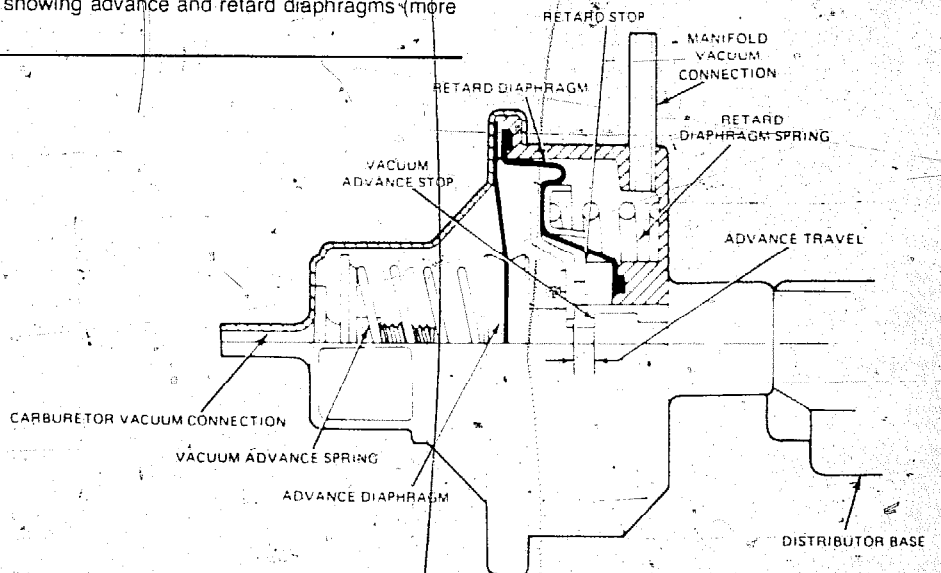
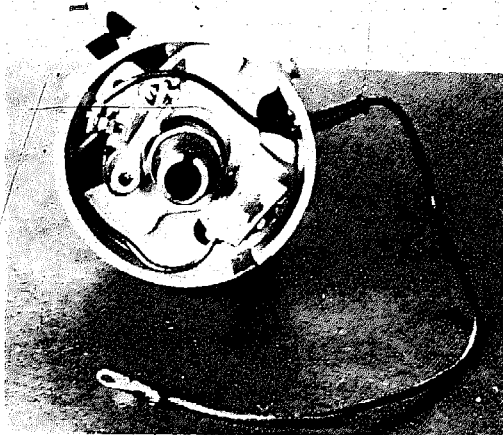

## the backyard mechanic

continued

spikes, of current. Each spike builds up a magnetic field within the coil. The distributor then opens its circuit so that the magnetic field will collapse and cause the coil's secondary windings to produce a high voltage surge (for more info, see Coils).

The second function is to time these voltage spikes with regard to engine requirements. This is accomplished by the centrifugal and/or vacuum spark advance mechanisms.

The last function is to distribute or direct the spikes through the rotor, cap, and high tension wiring to the spark plug that is ready to fire next.

The typical Kettering system distributor consists of a housing, drive shaft, centrifugal advance assembly, vacuum advance diaphragm and linkage, breaker plate assembly, condenser, rotor, and distributor cap.

The distributor cap, rotor, and high tension leads form the system which directs the high voltage impulses to the spark plugs in correct sequence.

The breaker plate assembly contains the breaker lever, the contact support, and the condenser. When the point cam attached to the distributor drive shaft rotates, each cam lobe contacts the breaker lever rubbing block and causes the points to separate, which in turn creates the voltage spikes mentioned earlier. With every breaker point cam revolution, one spark will be produced for each cylinder (remember though, since each cylinder fires at every other crankshaft revolution in a four-stroke engine, the distributor therefore rotates at half engine speed).

The distributor shaft and weight-base assembly is fitted with bearings and rotates inside the distributor shell or housing. Centrifugal advance weights are pivoted on studs in the weight base or on the bottom of the breaker plate, and are free to move away from the shaft and work against calibrated advance springs connected to the breaker cam assembly. The breaker cam assembly slip fits on the top of the shaft and rotates with the shaft, being driven by the weight springs activated by the advance weights.

Outward movement of the weights advances the cam assembly in relation to the shaft as engine speed increases (i.e., the more engine speed, the more the spark is "advanced") and therefore provides a means for the spark to arrive at the spark plug earlier than at low speed. Each engine model requires an individual spark advance "curve" to insure delivery of the spark at the right

instant for maximum power at all engine speeds.

An improvement in fuel economy on engines operating under part throttle conditions is realized by supplying additional spark advance. Vacuum advance mechanisms are provided for this purpose. Engine vacuum from the intake manifold is routed to a diaphragm connected to the breaker plate, and the breaker plate rotates to provide an earlier, or advanced, spark.

**Centrifugal Advance.** The centrifugal advance mechanism (weights and springs) times the high voltage spike produced by the ignition coil so that it is delivered to the plug at the correct time, as determined by engine speed.

When an engine is idling, the spark is timed to arrive at the plug just before the piston reaches the apex of its travel (TDC or top dead center). At higher engine speeds there is a shorter interval of time available for the fuel/air mixture to ignite and burn. Consequently, it's necessary to deliver the spark earlier in the combustion cycle to insure complete ignition and burning of the fuel.

The centrifugal advance mechanism, consisting of two weights and springs, determines the amount of the spark advance. The weights are thrown out (due to centrifugal force) against spring tension as the distributor shaft rotates with increased speed. The motion of the weights turns the breaker cam assembly so that the breaker cam is rotated in the direction of shaft rotation to an advanced position with respect to the distributor drive shaft. The higher the engine speed, the further the weights cause the cam to rotate, thus advancing the spark earlier into the combustion cycle.

**Vacuum Advance.** Since centrifugal advance isn't really effective at low engine speeds we must have another means of advancing the spark under conditions of low engine speeds or partial throttle openings. This low speed advance is accomplished by the vacuum advance system.

The vacuum advance mechanism has a spring-loaded diaphragm connected by linkage to the distributor breaker plate. The spring-loaded side of the diaphragm is air-tight, and is usually connected to an opening in the carburetor. This opening is on the atmospheric side of the throttle plate when the throttle is in the idling position. In this position, there is no vacuum.

When the throttle is partially opened, it swings past the opening of the vacuum port. Intake manifold vacuum can then

draw air from the air-tight chamber in the vacuum advance mechanism and this causes the diaphragm to be moved against the spring. This motion is transmitted by linkage to the breaker assembly. Total vacuum advance is governed by the amount of vacuum in the intake manifold, up to a limit imposed by the design of the diaphragm and linkage assembly.

**Dwell Angle.** Dwell, often referred to as contact angle or cam angle, is the number of degrees of cam rotation during which the points remain closed. It is during this period that the current in the primary coil winding increases. Although the cam angle may not change, the length of time the contacts remain closed decreases as engine speed increases. At higher engine speeds, the ignition coil primary current doesn't reach its maximum value in the short length of time the points are closed. In order to store the maximum amount of energy obtainable from the coil, and thereby obtain sufficient energy to fire the plug, a breaker lever assembly that will operate well at high speeds is necessary. The distributor is equipped with a special high-rate-of-break cam and a special high speed breaker lever which is capable of following the cam contours at high speeds without "bouncing." The high-rate-of-break cam separates the points faster for each degree of rotation and permits closing earlier, thus effectively increasing dwell.

**Condenser.** The ignition condenser is a capacitor consisting of a roll of two layers of thin metal foil separated by a thin sheet of insulation. This assembly is sealed in a small metal can with a flat washer providing a tight seal.

The high voltage induced in the coil primary winding causes the condenser plates to charge when the contacts first separate; the condenser then acts like a short circuit and current flows into the condenser to minimize arcing at the points.

**Coil.** The ignition system wouldn't be of much help if it didn't have high voltage to deliver to the plugs. In order to develop this high voltage, we rely on the ignition coil.

An ignition coil is essentially a pulse transformer that steps up the low voltage from the battery or alternator to a voltage high enough to ionize the spark plug gap and ignite the air/fuel mixture in the cylinder.

A typical coil is made up of a primary winding consisting of a few hundred turns of relatively large wire, and a secondary winding involving many

continued

# the backyard mechanic

continued

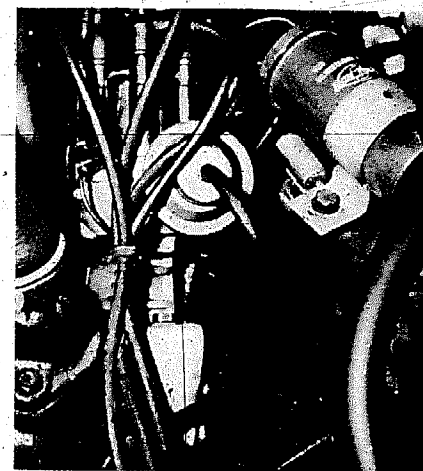
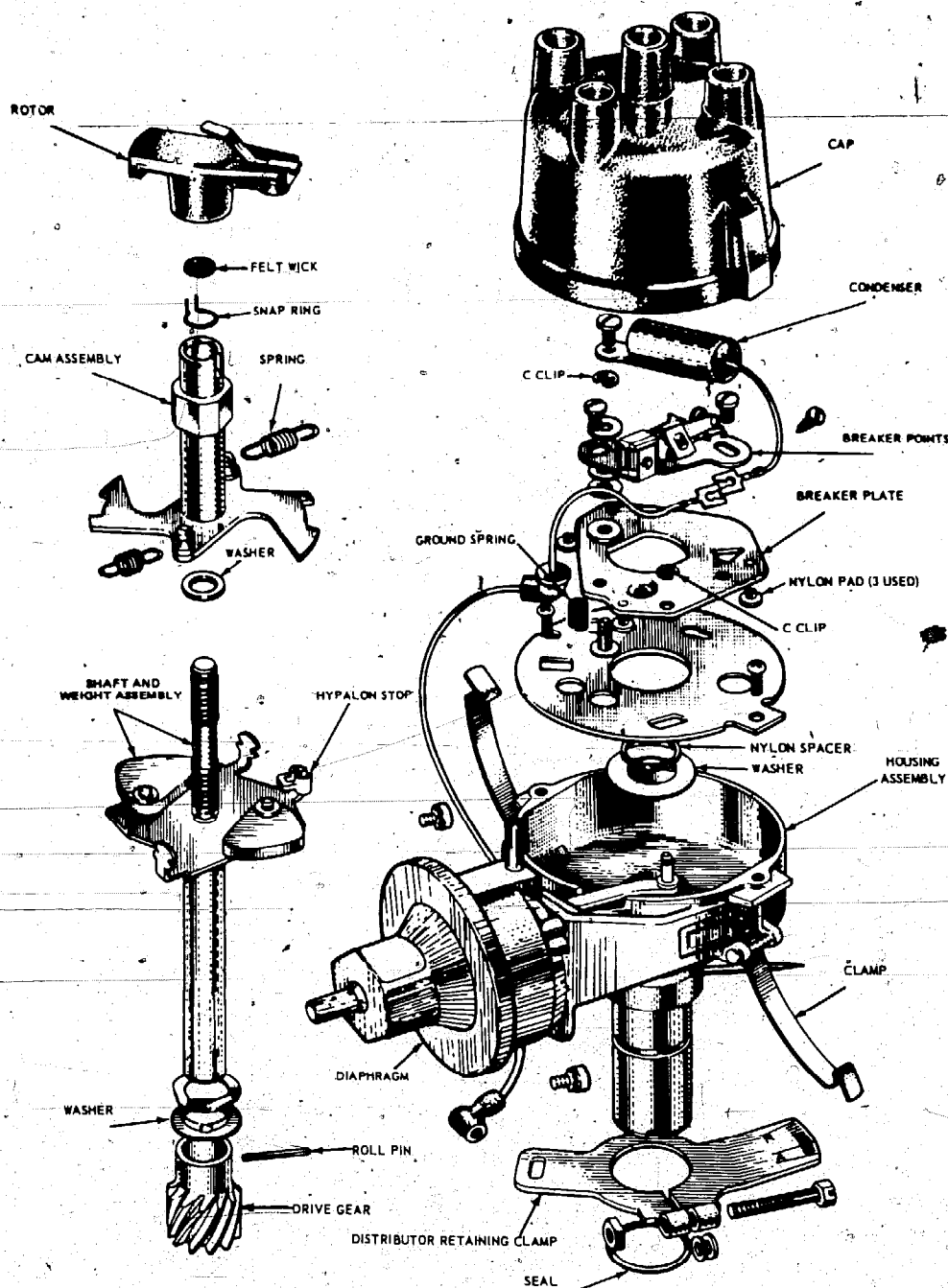

General relationship of distributor, vacuum advance mechanism, and ignition coil. White wedge-shaped object in center is distributor hold-down mechanism. When distributor timing must be changed (like during a tune-up) hold-down clamp must be loosened to allow distributor to be manually rotated.

(right) IPB (internal parts breakdown) of Pinto distributor gives general idea of configuration of most conventional distributors. Note use of small nylon pads under breaker plate to ease friction.

(Courtesy Ford Motor Co.)

thousands of turns of very small wire. These windings are assembled over a soft iron core and enclosed by a soft iron shell. This assembly is then fitted into a one-piece steel or aluminum shell which is then filled with oil and hermetically sealed by a coil cap of molded high-dielectric (insulating) material.

Coils are sealed to prevent entrance of moisture, which could cause coil failure. During manufacture, the coil case is filled with hot oil. As the oil

temperature decreases to room temperature, the oil contracts, thus allowing room for expansion when the coil heats up during normal operation. The oil also acts as an insulator to prevent voltage arc-over within the coil.

In an ignition system, sufficient primary circuit resistance must be present to protect the points from excessive arcing or burning. In some systems, part of this needed resistance may take the form of a separate resistor or cali-

brated resistance wire connected between the ignition switch and the coil primary terminal.

During cranking, most external resistances are bypassed to provide full battery power to the coil to aid in starting. The higher currents developed during cranking are not sufficient to cause point deterioration because of the short periods of time spent cranking. Also, the lowered battery voltage during cranking causes a lower primary current, so the resistor bypass feature is an offsetting feature. Bypassing the resistor with the engine operating will cause rapid deterioration and failure of the points.

**The Final Link.** The final link in the ignition chain is the spark plug. This device, which appears so simple externally, is actually so complicated in its operation and relation to engine performance that we're going to do a separate BYM for spark plugs. ⊕

Next month, we'll cover BEIs, HEIs, LEDs, and X-sistors . . . and we'll even explain what all those initials stand for! (DRIVER wishes to thank Mr. Joe Hallett of Action Auto Parts, San Bernardino, CA, for providing the distributors photographed for this article.)

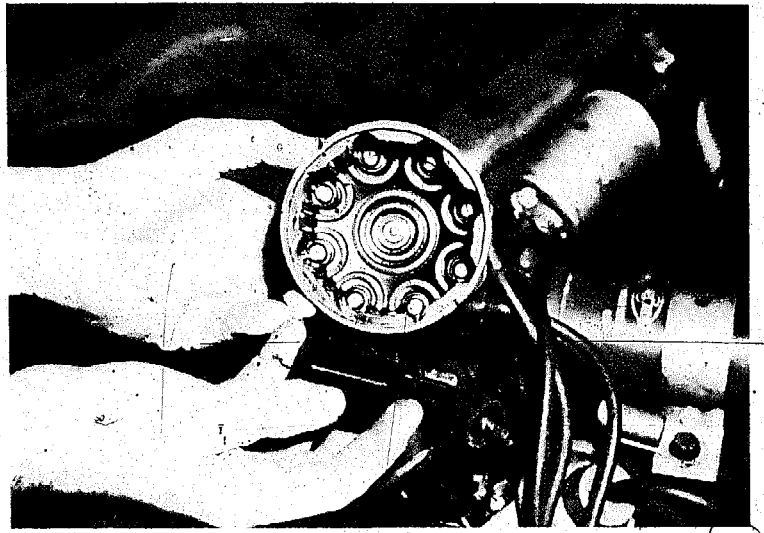
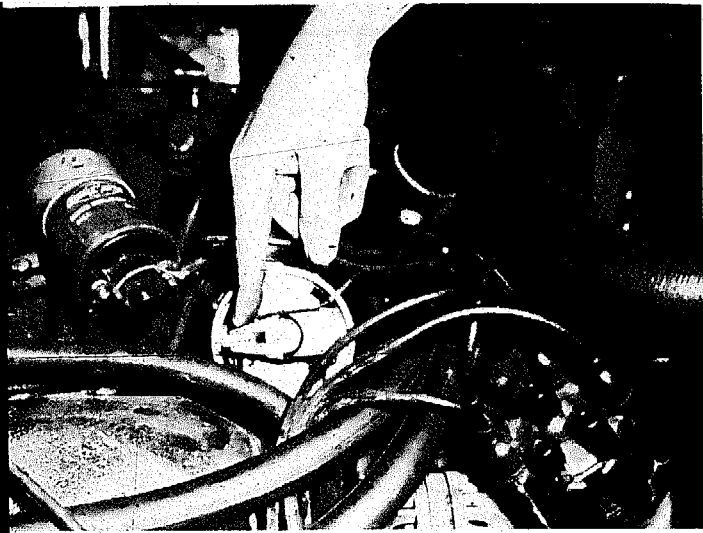

**left:** With distributor cap removed, the first thing you see is the rotor. Rotor contact end can become pitted with extended use, and contact spring piece on top may lose tension. Rotor is a slip fit on distributor shaft and will have an internal projection to match a slot on distributor drive shaft to insure correct orientation. **right:** Distributor cap should be checked occasionally for cracks and contact wear. A bad distributor drive shaft can wobble and allow the rotor to impact the metal contact points imbedded in the cap. The center graphite contact button may lose its spring-loading and not make sufficient contact with the rotor to insure complete ignition.

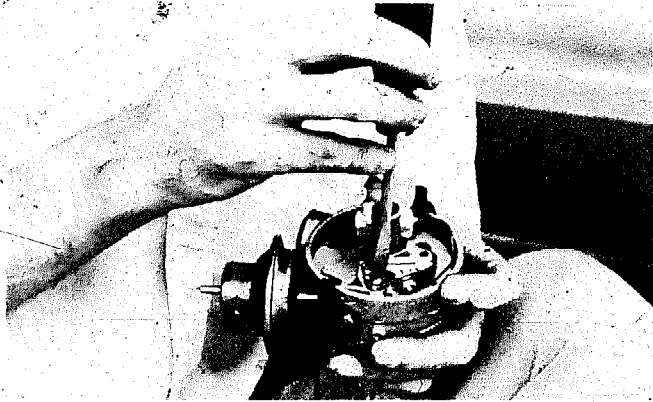

**left:** This is the easy way to change points! While we don't advise removing the distributor to change points, we do want to use this picture to point out that the screws that secure the points can be easily lost into one of the holes in the breaker plate and you will have to remove the distributor! **right:** All ignition coil connections should be tight and free of corrosion. Any dirt on terminals can cause some of the high voltage to "run off" and may result in insufficient voltage to the spark plugs.

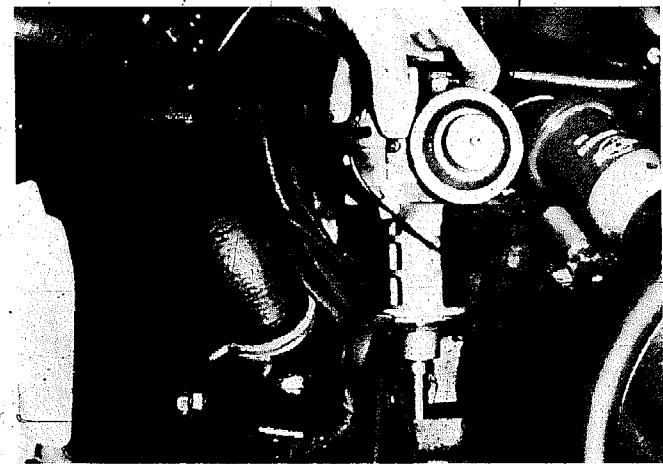
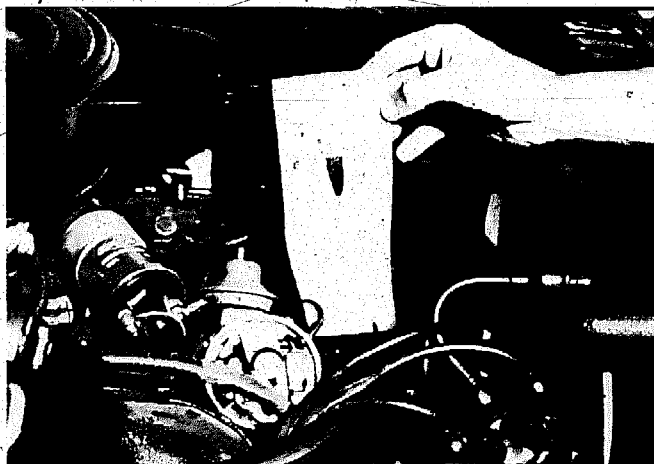

**left:** If, for some reason, you find it necessary to remove the distributor, first make an illustration like this. It shows the position of the rotor relative to some reference point like the vacuum advance. Since the distributor drive uses helical instead of straight cut gears, the shaft will rotate as it's removed. Unless you know the correct final rotor orientation (by your drawing) you probably won't get the distributor back in correctly. **right:** This is about the point where the drive gears will begin to mesh. As you go further in, shaft will turn. If you haven't made your drawing, you won't know where the rotor is supposed to be oriented. Also, in some cars, you won't be able to get the distributor all the way in because the drive shaft extension won't mate with the oil pump shaft correctly. Like we said, make that drawing *before* you pull that distributor!



# THE BACKYARD MECHANIC BACK TO BASICS

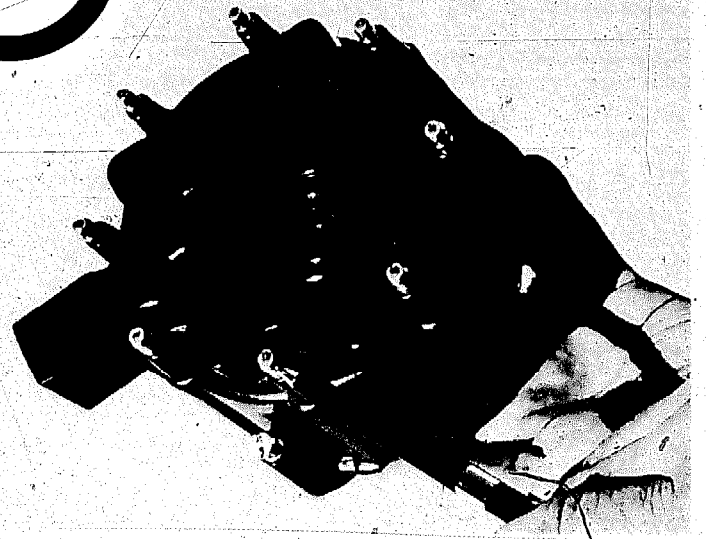
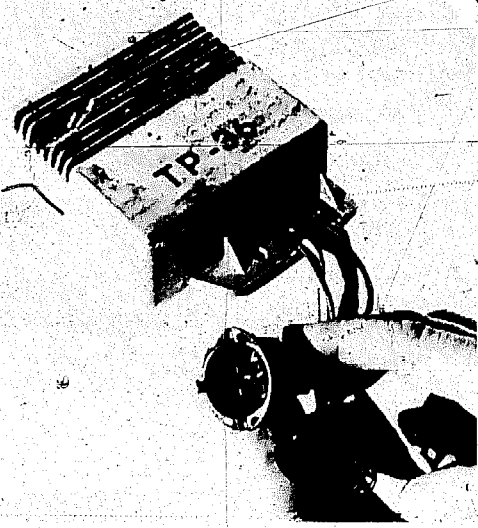

*left:* One nice thing about the new ignition systems is that it's pretty difficult to hook them up incorrectly after a component change. Ford Dura-Spark control module shows how spade-type male connectors and keyed connector housings are constructed to minimize assembly errors. *right:* GM HEI distributor cap is much changed from conventional cap. Large well in cap is where ignition coil goes, and projection on left is electrical connector. Pen points to new design of spark plug wire connectors.

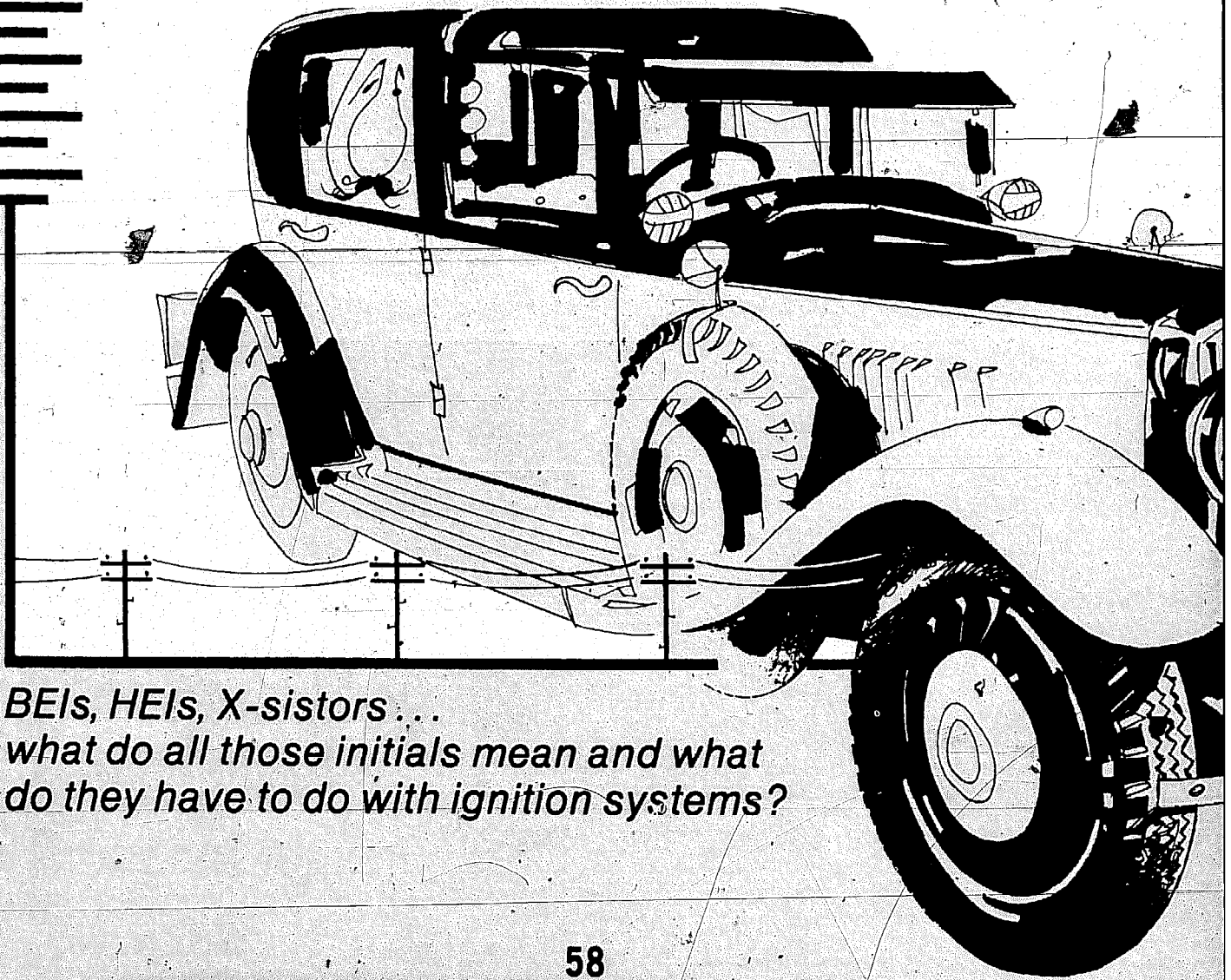
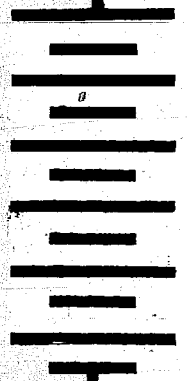

**BEIs, HEIs, X-sistors...**  
*what do all those initials mean and what do they have to do with ignition systems?*

In the last BYM Back to Basics, we covered the operation of the conventional, or Kettering, ignition system. We showed that the purpose of the ignition system was to develop high voltage, time the high voltage delivery with respect to engine speeds, and then direct the voltage to the correct spark plug.

Today's ignition systems accomplish exactly the same thing, but they do it with greater accuracy, higher speed, and, generally, less components.

**No Points.** It was long hoped that, eventually, an ignition system could be designed so that the contact points common to the Kettering system could be eliminated. The need to eliminate points was caused by several reasons. One, points wear out quite rapidly, considering the life of other automotive compo-

nents. Two, at higher engine speeds, conventional points tend to "bounce," that is, they stay in the open position when engine (and therefore distributor shaft) speeds are high . . . the points just do not have enough spring tension (or enough time) to close. Three, the rubbing block, a fiber device attached to the points, wears quite quickly. As it wears, dwell changes. Along with the change in dwell, rubbing block wear will not allow the points to open to the specified dimension and will cause them to burn more easily.

Early attempts to eliminate points resulted not in point elimination, but in reduced voltage carried by the points. Transistor ignitions solved the problem of point burning and wear, but didn't solve the other problems inherent in contact points.

The mid-sixties marked the beginning of the end for the Kettering ignition as we know it. New strides in electronic technology enabled manufacturers to develop breakerless, high-energy ignition systems that did away with the problems associated with conventional ignition systems.

Not only are the new ignition systems more reliable than conventional systems, they deliver higher energy levels, they are easier to work on, and they have become the first link in a chain (along with carburetion and exhaust) that will allow us to strangle harmful exhaust emissions.

**Transistor Ignition.** As we mentioned earlier, transistor (X-sistor) ignition was the first attempt to really improve the Kettering system. Transistor systems have some advantages to the Backyard Mechanic because they can be easily installed in any conventional system, and really do increase point life. A good aftermarket transistor system will also increase voltage levels and thereby more fully combust the fuel/air mixture with a resultant slight increase in power and mileage.

**How It Works.** A transistor is a small electronic device that controls current via the conductive properties of an element known as germanium. The word "transistor" originates from the term "to transfer resistance."

The transistor in an ignition system provides a means of furnishing greater current to the ignition coil with an accompanying larger secondary voltage for spark plug firing. At the same time, it supplies less current to the ignition contacts thereby prolonging their life. This whole deal is accomplished by using two interrelated primary ignition circuits whereas the Kettering system uses only one such circuit.

*continued*

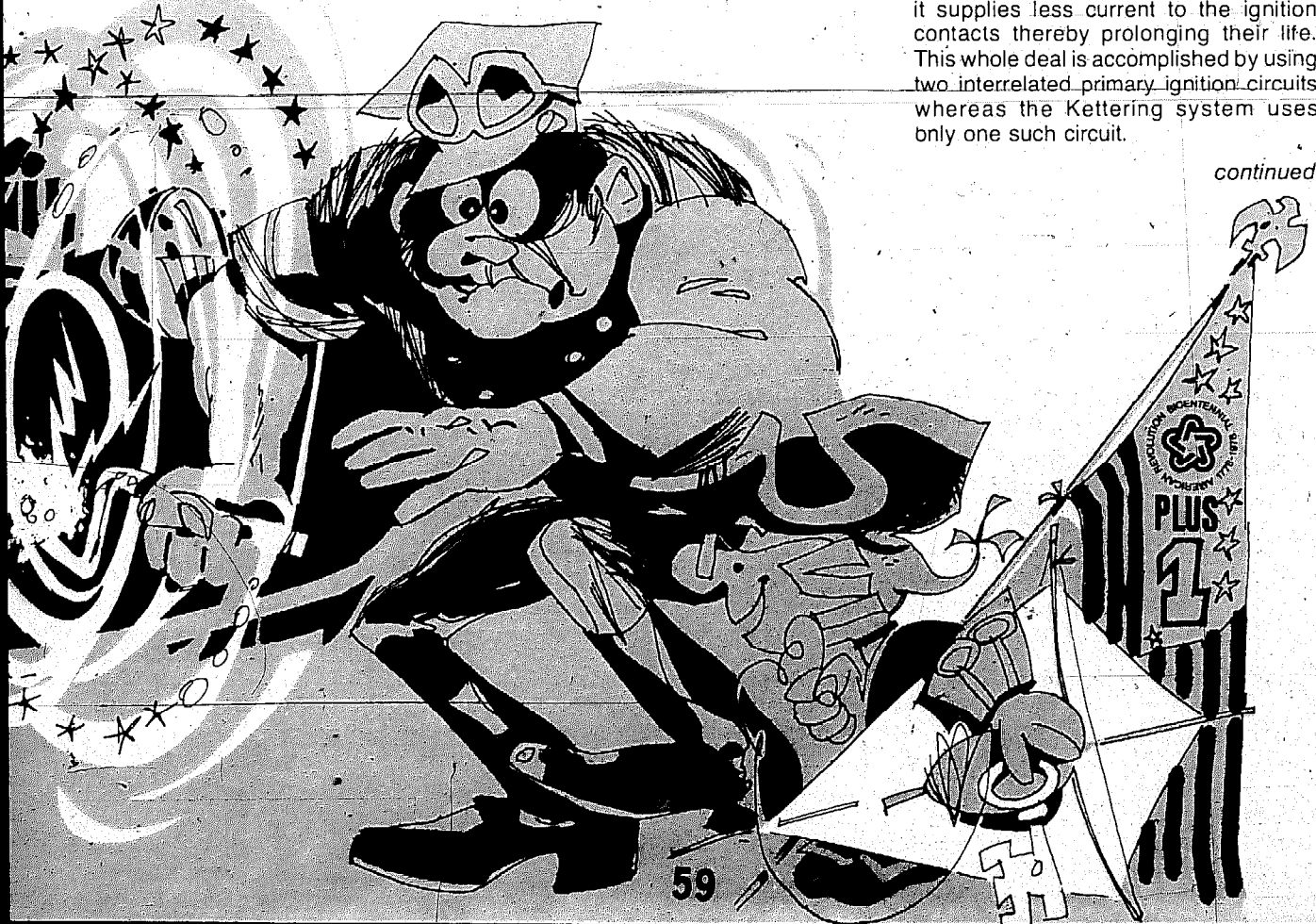

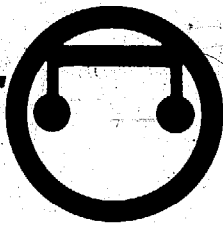

The system consists of a base circuit (low voltage *trigger* circuit), coil primary (collector) circuit (low voltage *primary* circuit), and a secondary (high voltage coil) circuit. Current will not flow in the primary circuit unless a current is flowing in the base circuit. A very small current in the base circuit allows a much larger current flow in the primary (collector) circuit.

In actual operation (see Fig. 1), a 1/2-amp current flows from the battery through the ignition contacts, a common .33 ohm resistor, the ignition switch, and back to the battery.

This small current flow (let's call it control current) permits a large 12-amp current to flow from the battery through the ignition coil, the .43 ohm collector resistor, the toroid, the transistor collector and emitter, the common .33 ohm resistor, the ignition switch, and back to the battery. Since this circuit supplies the power to the ignition coil, we refer to it as the power, or coil, circuit.

During the dwell, when the contact points are closed, current flows in both circuits. When the points begin to open, the collapsing magnetic field produced in the toroid sends a reverse pulse through the control circuit, stopping all electron flow in the control circuit. Because the control circuit triggers the power circuit, current stops in the power circuit, too.

This causes the magnetic field produced by the coil primary windings to collapse, and sends very high voltage (generated by inductance in the coil secondary) from the coil to the spark plugs. In addition, high voltage is also induced in the primary windings of the power circuit.

Normally, this would be sufficient to cause transistor destruction inasmuch as the induced voltage instantly rises above the load level of the transistor until it reaches the breakdown level of the zener diode. So, this is the reason we incorporate the condenser in the power circuit . . . it absorbs the high voltage current and keeps it within load limits until the zener protection level is reached. Discharge of the condenser voltage from zener level to system voltage takes place by reverse flow through the power circuit, except that the transistor is bypassed by the diode which freely passes this reverse current.

We then close the points and complete the cycle by causing current flow in the power circuit.

**Ford Dura-Spark.** In the Ford Dura-Spark solid-state system, the conventional breaker plate and cam assembly is replaced by a *magnetic* signal-generating system which detects the distributor shaft position and sends electrical pulses to a control module. The module switches off the flow of current to the coil primary windings, inducing the secondary windings to build up a high voltage charge which is then directed to the spark plugs as in a conventional system.

The control module contains timing circuits which then close the primary circuit, allowing it to build up a sufficient charge that will enable the secondary windings to produce the high voltage required to fire the next cylinder. In effect, this timing action sets the dwell. (Remember dwell? The period of time that the points in a Kettering

rotor or armature, driven by the distributor shaft, which rotates past the stationary pole piece of a pickup coil. The number of teeth on the armature correspond to the number of cylinders in the engine. A weak magnetic field is provided by a permanent magnet which is part of the pickup assembly.

As each tooth of the armature moves away from the permanent magnet, an electrical signal of opposite polarity is generated in the pickup coil (stator). As the armature tooth nears the magnet and moves away (as the distributor shaft rotates), the signals generated go from positive to negative; however, when the armature tooth and the stator tip are aligned, the signal is zero . . . between positive and negative.

This zero signal tells the control module to turn off, producing the same effect in the coil primary circuit as the opening and closing of contacts in a conventional ignition system; it "breaks" the primary circuit.

The sudden stoppage of current in the ignition coil primary windings causes the magnetic field to collapse and induces high voltage in the coil secondary.

As engine speed increases, the time span between alternations of current (the zero signal) decreases. In this way the control module knows when to open and close the primary circuit.

**NOTE:** Ford advises that the '77 Dura-Spark system uses a coil current regulator to provide a stall shut down feature. When the engine stalls, the module shuts off and locks. Unless the ignition switch is first turned to the start position, the module will not provide any spark.

Readers should also note that because of the increased high voltage, new spark plug wiring systems are being used. The most apparent difference is the larger diameter of the plug wires, up from 7 mm to 8 mm. Also, silicone

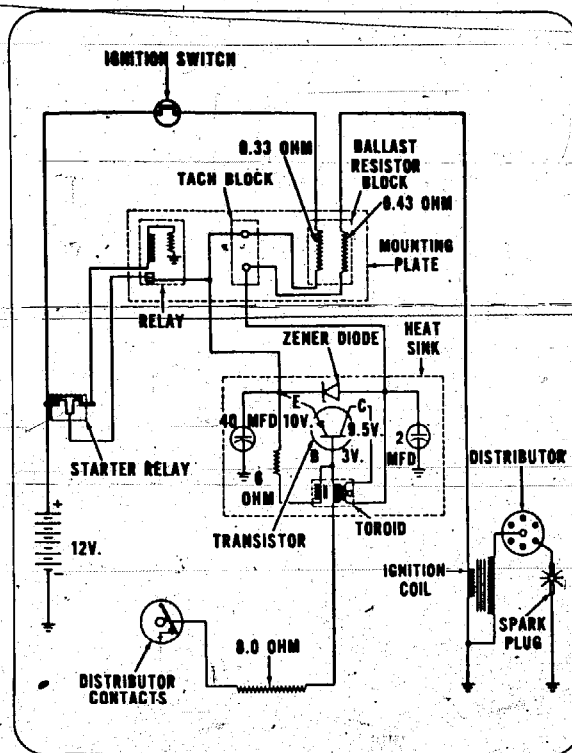

FIG. 1

Ford transistorized ignition system is explained in text. (Schematic courtesy of Ford Motor Co.)

system remain closed.) Because of the inherent stability of the control module, dwell adjustments will never be needed with the Dura-Spark system.

Signal-generating systems generally follow the pattern of a gear-shaped iron

continued

# the backyard mechanic

continued

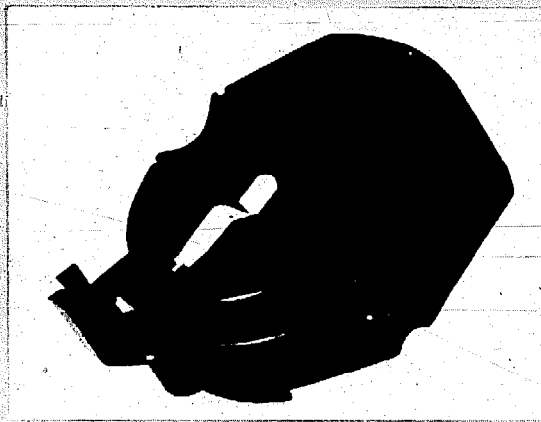
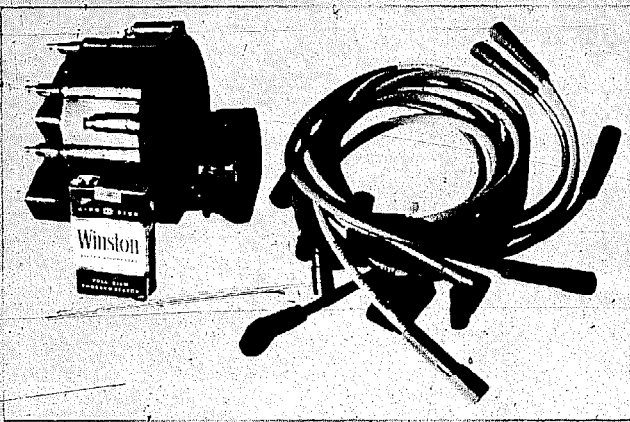

**Left:** Large size of GM HEI distributor cap is emphasized by cigarette pack. Plug wire size has been increased to 8mm and has female connectors on both ends. Female connectors are used to negate possibility of voltage leaks. **right:** Would you believe this is a rotor? Several users of this GM HEI rotor report that the upright portion may crack where it joins the main body. If your '77 runs rough, check for cracking of the upright.

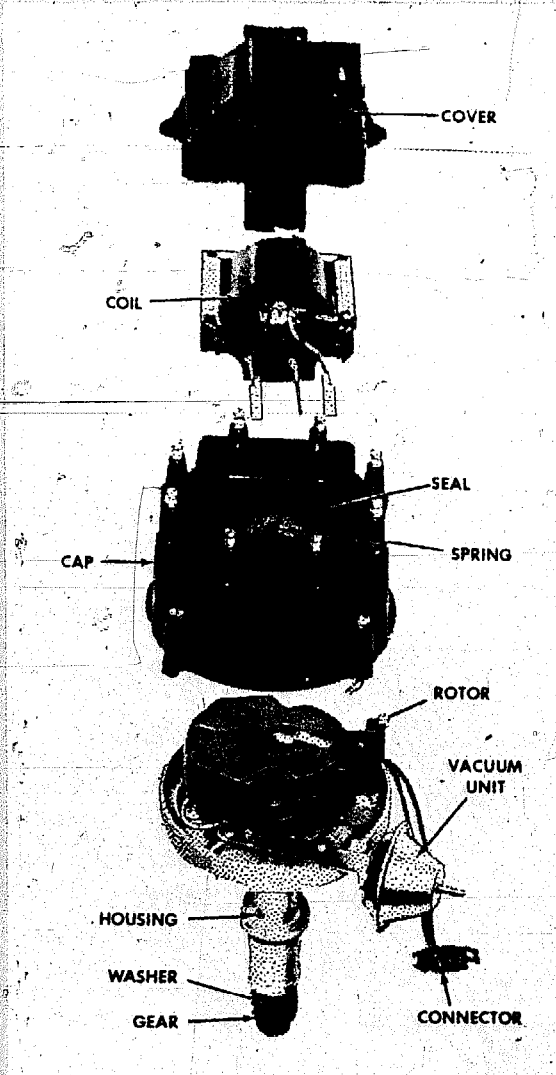

**Left:** Exploded view of GM HEI distributor shows how all main ignition components fit into housing. Design is efficient, compact, and easily serviced. (Courtesy of General Motors Corp.) **right:** Ford Dura-Spark armature and stator. Armature is gear-shaped toothed wheel, stator is plastic-encased magnet. Like other new systems, connectors are used to insure correct wiring.



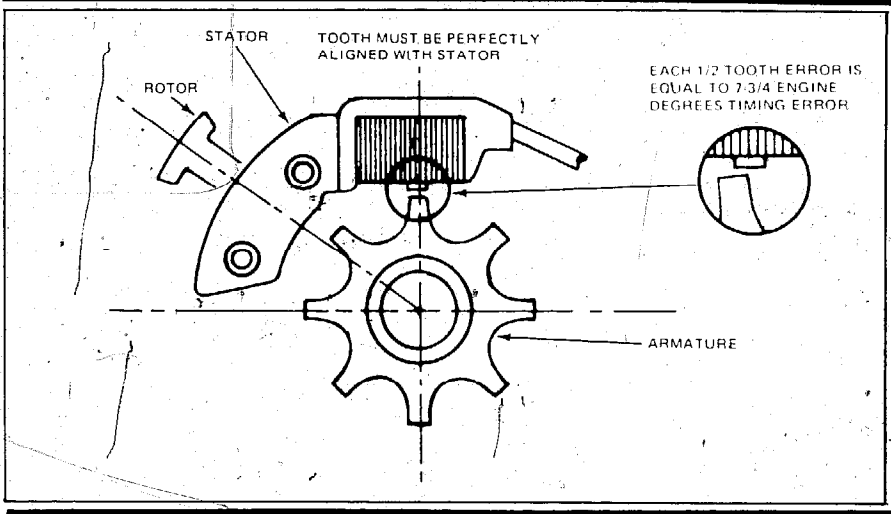
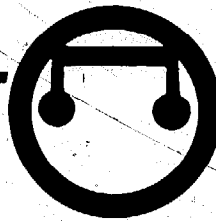

Static timing position of stator for eight-cylinder engine. Air gap between stator and armature must be adjusted when new stator is installed. Adjust air gap *only* with non-magnetic feeler gauge (brass or plastic).

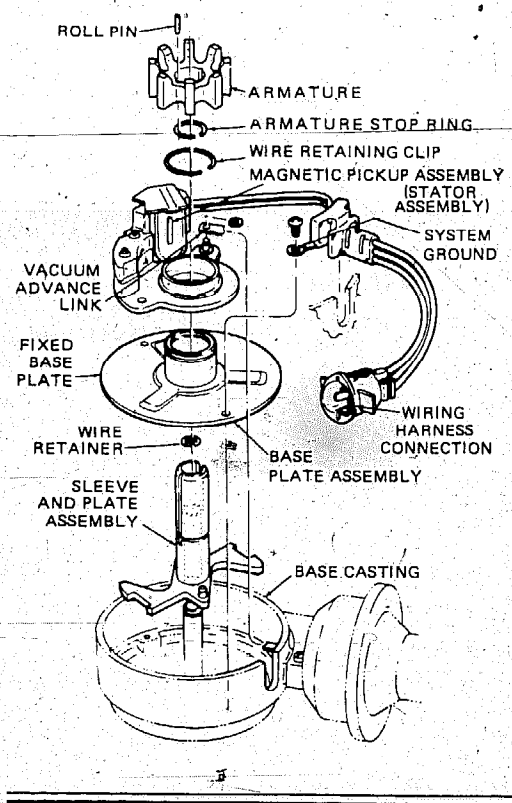

Exploded view of Ford Dura-Spark distributor shows simplicity of design.

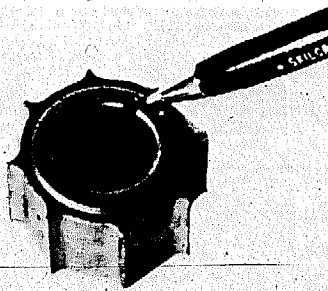

Armature for Ford system has two indexing grooves. Armature cannot be installed backwards or upside down, but indexing roll pin must be installed or armature will shift positions on distributor shaft.



Control module for Chrysler system is firewall mounted and has pin connectors for ease of replacement. U-shaped device is heat sink for transistor in center. Heat is the enemy of solid-state devices, so if a module goes bad rapidly, move the new one to a location not so near the engine, or where a flow of cooling air is available.

grease, either Dow 111 or GE CG627 is required wherever insulator areas "interface" (connect) with the distributor cap, coil, or plugs. This silicone grease is necessary to prevent high voltage runoff.

**Chevy HEI.** The Chevrolet High Energy Ignition was introduced in January 1974 and was used primarily on their high-performance models. It is similar to the Ford breakerless and other no-point systems in that the contact points are eliminated, and high voltage is "triggered" by an electronic signal, not by the making and breaking of conventional points.

The HEI system consists of a completely new and different distributor assembly that combines all the ignition components into one solid state electronic unit. The distributor housing, encloses the vacuum and centrifugal advance units, electronic module, pickup coil and pole piece (known in other systems as the stator and reluctor), timer core, capacitor, rotor, and distributor shaft. The distributor cap houses the ignition coil and is tasked with directing high voltage impulses to the spark plugs as in conventional systems.

A convenient tachometer (engine speed gauge) connection is incorporated in the wiring connector on the side of the distributor (except '77 models); however, it will activate only certain models of electric tachs . . . better check with your Chevy dealer before you buy a tach for this system. NOTE: The ta-



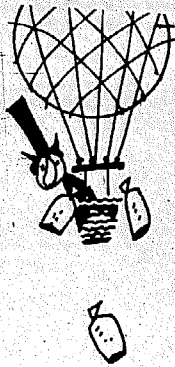

## GLOSSARY

chometer terminal on the distributor cap must *never* be grounded since grounding can damage the circuitry of the control module. When making compression checks, disconnect the ignition switch connector from the HEI system.

The wiring used with HEI is a carbon-impregnated fiber-glass conductor encased in an 8 mm silicone rubber jacket.

As in the Dura-Spark system, the HEI is magnetically controlled, so its theory of operation is the same.

**CDI.** One of the most popular aftermarket ignition systems is the CDI, or Capacitive Discharge Ignition. The CDI operational theory is extremely complicated and lengthy, so we won't go into it here. Suffice to say that CDIs are different in theory and produce different results than transistor or magnetically-controlled electronic ignitions. Magnetically-controlled ignitions produce a relatively long-lasting spark that gives complete combustion and therefore, low emissions. The CDIs produce a short-lived voltage of extremely high amplitude (40,000 volts +) that is capable of firing spark plugs under difficult conditions such as fouled plugs or extremely high compression.

Remember, in a CDI system the points are retained, but they carry far less current than they do in a Kettering system. Since the points carry less current, they encounter fewer problems than the conventional systems' points do.

CDIs employ a solid-state device to trigger the high voltage, and this trigger, or electronic switch, is called a silicone-controlled rectifier or SCR.

SCR operation as concerns CDIs is, again, very complex. If you wish to know more about the operation of CDIs, consult one of the reference works we've listed at the end of the article.

**Which One Is For You?** If you have a new car, of course the choice is already made for you. It is nearly impossible to attempt to convert the new HEI or Dura-Spark-equipped cars to operate with CDI or transistor ignition. In actuality, you would be dealing yourself a losing hand. The new systems are specifically designed for each car to work with other components of the emission control system, and those emission sys-

**Ballast:** A current-limiting element. A ballast resistor is a resistor used to limit the current and keep it under control.

**BEI:** Breakerless electronic ignition. Has no contact points.

**CDI:** Capacitive discharge ignition. Uses points, but points carry less current than Kettering system.

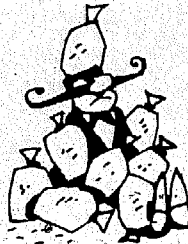

tems won't work with any contemporary aftermarket ignition system without an "extensive" rework.

If you own an older car with conventional Kettering ignition, then the aftermarket systems are for you. Transistor systems work well on the family car and are relatively inexpensive. CDIs cost more, but their performance is what you need if you have an older car or truck that has a slightly tired engine or that you use to carry or tow heavy loads.

In a future article, we'll give you the straight skinny on spark plugs and how they can really make or break the performance of any ignition system! ⚡

**NOTE:** There just isn't enough space in DRIVER to go into the whole operational theory of solid-state devices and associated circuits. If this article whets your appetite, or if some circuits are confusing, may we suggest the following reference works... most should be available at your post library.

*Practical Electricity* by R. G. Middleton (Audel)

*Transistor Technology* by Bridgers, Scaff, and Shive (Bell Lab Series)

*Electronics* by Robert Irving (A. Knopf)

*Semiconductor Fundamentals* by Seidman and Marshal (Wiley)

*Dictionary of Electrical Abbreviations* edited by D. H. Polson (Odyssey Press)

**Heat Sink:** A device used to absorb heat produced by electrical components. By releasing equipment heat to atmosphere, sink prevents overheating of heat-sensitive electrical components (like transistors).

**HEI:** High energy ignition.

**Reluctor:** The armature in breakerless ignition systems. In conjunction with a stator, it eliminates contact points.

**SCR:** Silicon controlled rectifier. A solid-state device similar to a transistor in that it provides a current path consisting of a solid material (silicon). Acts as electrical "switch."

**Stator:** Replaces contact points when used in conjunction with reluctor. Usually consists of a magnet imbedded in plastic, but may also be a light-sensitive device when used in an LED (light-emitting diode) triggered ignition.

**Toroid:** A small doughnut-shaped iron core around which coils of wire are wound similar to a transformer.

**Transistor:** A non-vacuum semiconductor combination of chemical elements used in electrical circuits in place of vacuum tubes. Requires only low voltage to operate.

**Zener Diode:** A voltage regulating device. Two-element semiconductor device used to control direction of current flow.

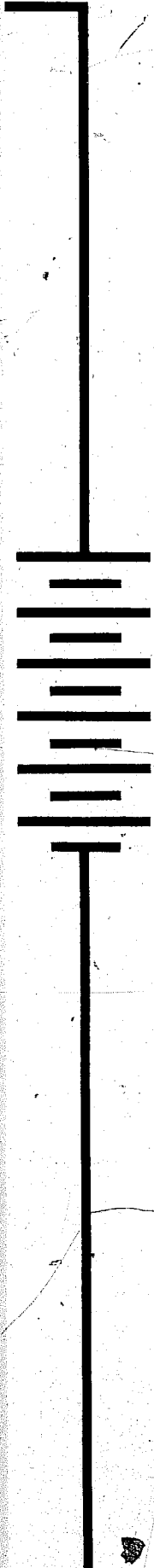

# the backyard mechanic

**W**e don't think too many people will quibble with the statement "The efficiency of any engine—indeed its ability to operate at all—is directly dependent on the ignition qualities of a small component that has no moving parts—the spark plug." That quote comes from Champion Spark Plug Co., and although plugs are their business and they may be a little biased about them, they are absolutely correct.

How important are spark plugs in relation to engine performance? Well, in a test conducted by Champion and certified by the United States Auto Club, gasoline mileage in as-is cars was measured and then measured again with a change of spark plugs being the only modification—the installation of new plugs resulted in a mileage increase of 4.92% at 35 mph and a 3.44% increase in a normal varying speed situation.

Just a plug change also resulted in a 38.16% improvement in HC emissions. A complete tune-up yielded a 66.37% improvement in HC emissions and an increase of 14.45% in mileage at 35 mph.

Pretty impressive statistics huh? Yes, and they illustrate that ignition systems in general can provide the most startling difference in engine performance when not operating correctly.

A spark plug is an electrically-operated mechanical device that is used in the cylinder head of an internal-combustion engine to ignite the fuel/air mixture inside the combustion chamber.

"How does it work?" We thought you'd ask that. It's very simple, really. The center electrode is insulated from the shell by a ceramic insulator such as porcelain. The side electrode is fastened to the plug shell which is grounded to the cylinder head. Current flows from the distributor, down the plug wires, to the center electrode. The current then flows down the center electrode and jumps the air gap to reach the side electrode. This produces a spark which ignites the air/fuel mixture in the cylinder.

Not much to it really . . . unless you consider that the terminal end may be ice-cold while the firing tip, only three inches away, is exposed to flame temperature in excess of 3000 degrees F;

## back to basics spark plugs

the plug must seal off the incredible pressures involved in combustion; and it must do all this millions of times in a highly corrosive atmosphere.

**Heat Range.** If you've been around any type of racing where engines are involved, no doubt you've heard a mechanic say, "Needs a hotter plug, Harry," or "Hey, Fred, a colder plug'll help keep your engine together at sustained speeds." What they are referring to is a plug's heat range; in other words, is it a hot plug or a cold plug?

A spark plug has to maintain an even flow of heat from its firing end to avoid becoming a source of preignition. At the same time, the spark plug has to run hot enough to burn off deposits formed by the combustion process and that can cause short-circuiting of the plug and subsequent misfiring.

*continued*

### Normal Combustion

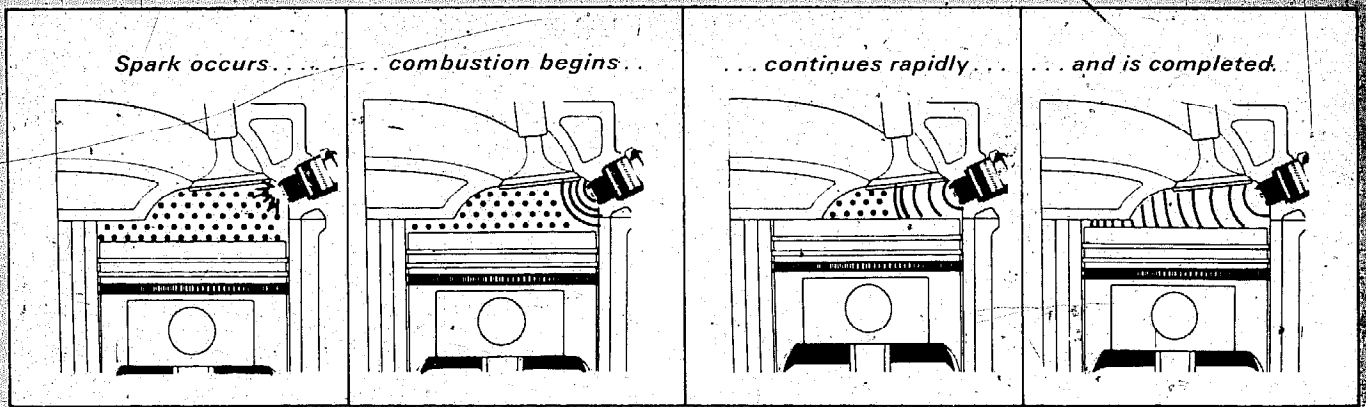

### Detonation

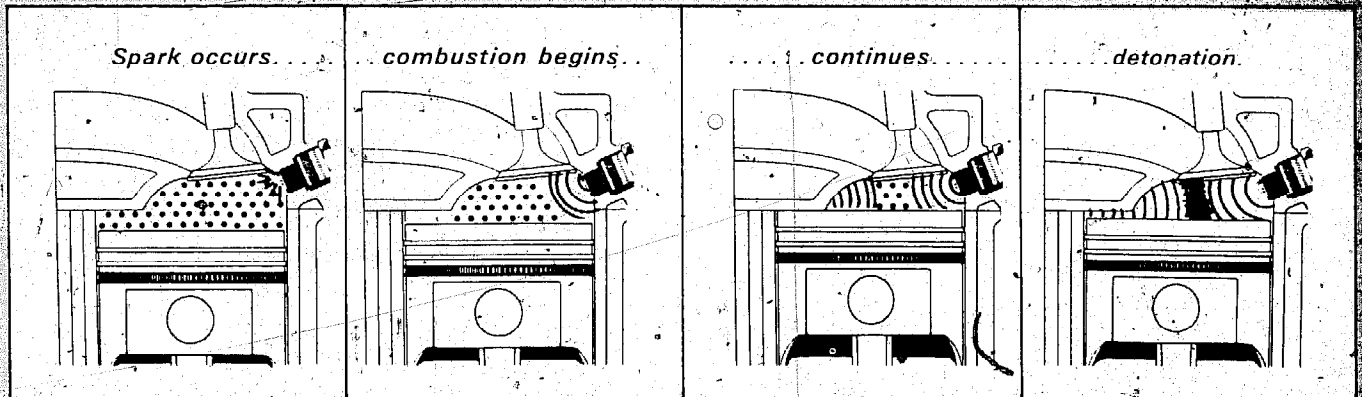

### Preignition

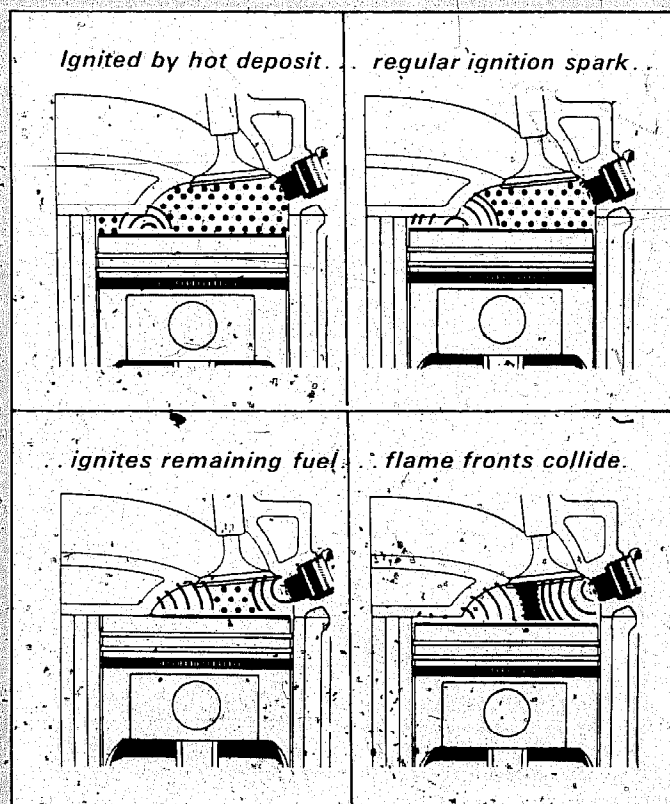

ROUNDED-EDGE  
WIDE GAP

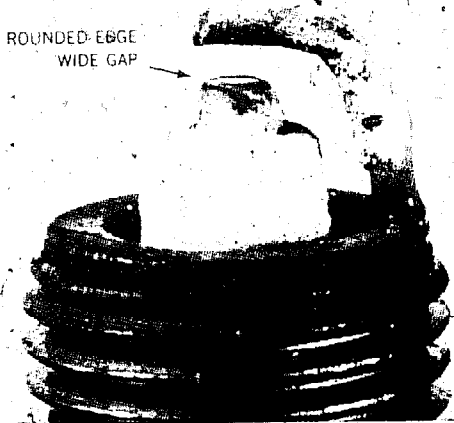

ROUNDED-EDGE



Notice how the used plug (left) and the plug that has only been regapped (center) are similar. By just regapping, you aren't really accomplishing anything. (right) A plug that has been abrasive-blasted and then regapped offers better performance than just regapping because the insulator deposits have been removed.

SHARP EDGE

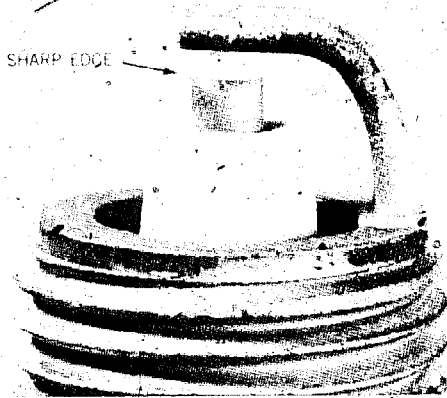

SHARP EDGE

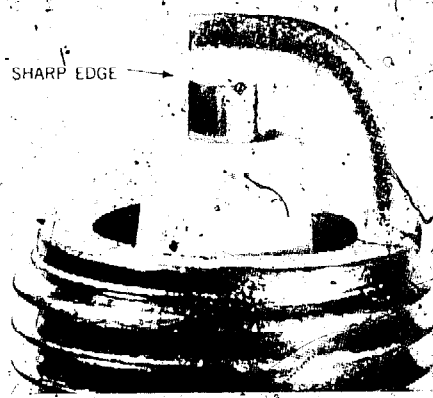

(left) After sand-blasting, regapping and filling plug is almost as good as new. (center) New plug. (right) The typical used plug is lightly crusted with deposits and will be light brown to grey in color with minimum electrode erosion.

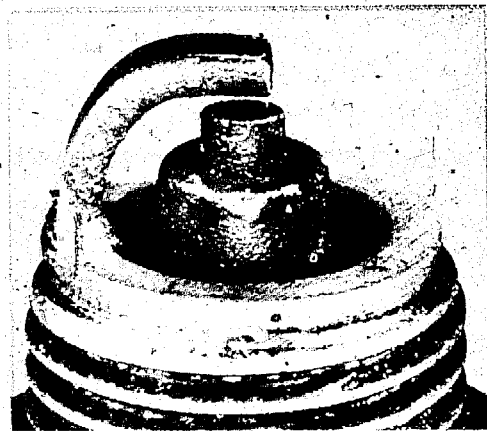

(left) Oil fouling indicates clogged oil return passages, bad rings, or clogged PCV valve. Hotter plug may relieve symptoms, but there will still be a mechanical problem in the engine. (center) Carbon fouled plug indicates rich mixture, weak ignition, clogged air cleaner, high float level, or sticky carb float. (right) Center electrode is too worn to allow regapping. Time for new plugs.

Chart 1

| Plug Thread | Iron Heads  | Aluminum Heads |
|-------------|-------------|----------------|
| 10 mm       | 14 lbs. ft. | 12 lbs. ft.    |
| 14 mm       | 30 lbs. ft. | 28 lbs. ft.    |
| 18 mm       | 34 lbs. ft. | 32 lbs. ft.    |
| 7/8 in.     | 37 lbs. ft. | 35 lbs. ft.    |



## the backyard mechanic

continued

Since each engine has different temperature characteristics, each engine must use plugs of a specific heat range. If performance parameters are radically changed from those originally envisioned for the engine, then the plug heat range must be altered.

The hottest part of the plug is the tip of the nose, the part that actually sits in the combustion chamber. Heat flows up through the insulator and down through the shell. The longer the heat path through the insulator and shell, the hotter the plug (and vice versa), because the amount of heat that flows decreases as the length of the path is increased. The "cold" plug, when used in an engine, has a tip which is actually colder than the tip of a "hot" plug. Thus, the cold plug is recommended when the car is driven at full-throttle most of the time. Unfortunately, this cold plug will tend to "foul" (become covered with misfire-causing deposits) at low speeds because it is not hot enough to burn off deposits. The fouling may be burned off if the period of low-speed driving is short, but long periods of operation will bake the deposits on and permit current to leak across the fouled insulator, especially during open throttle operations. Eventually, the deposits become heavy enough to allow all the current to flow through the deposits instead of across the air gap.

Conversely, the hot plug will not foul when driven at low speeds, but if it is driven continually at high speed it will become so hot that the tip of the insulator will burn away, as will portions of the electrode.

**Proper Plug Installation.** The spark plug gasket is an important factor in conducting the heat from the plug to the cylinder head. Unless plugs are properly tightened and gasket tension is correct, this heat flow may be interrupted. Spark plugs used on some cars (like FoMoCo products) do not use gaskets but rather the plug seat is tapered so that when installed the taper becomes the "gasket."

A cold plug may be ruined by excessive heat if driven hard when it's not tight, and if hot plugs are driven hard when not properly tightened, we guarantee they'll go out to lunch (usually somewhere between Blythe, California and Quartzite, Arizona).

After you've properly gapped the plugs to be installed (use a gapping tool or one of the gauges available from

manufacturers) try the following procedure for installing those plugs:

- Thoroughly clean the gasket seating space.

- Screw the plug in by hand as far as it will go.

- Carefully fit a deep socket of the proper size over the plug and pull on the wrench lightly until you feel the gasket beginning to compress.

- Slowly increase the pull on the wrench until you feel the resistance become stiff, indicating that the gasket has been fully compressed.

- Clean the ceramic insulator and top conductor with a dry, grease-free rag to prevent possible shorting.

You should always use a torque wrench when installing plugs, and install to the values listed in Chart 1. These figures are maximum readings and are based on clean and dry threads on plugs and in cylinder heads.

The final tightening of plugs in cast iron heads should be done with the engine at normal operating temperature. Torque plugs in aluminum heads with the engine cold (at room temp). Plug installation in aluminum heads requires care because of the ease with which the threads may be stripped. Easy does it.

**Mis-Fire or No-Fire.** Assuming that an engine has adequate compression, that fuel and air are mixed in the proper proportions, and that ignition timing and dwell are correct, ignition of the charge may occur any of several ways. Actual misfire may be due to lack of proper mixture in the cylinder. When the spark is lacking, however, it may be due to one of the following reasons:

**Tracking Ignition:** This occurs when the spark "jumps" from one deposit island to another and ignites the fuel charge at some point along the insulator nose. The charge does not actually misfire, but the effect is to retard ignition timing. Power and economy are affected *without* the driver being aware of the problem.

**Surface Ignition.** May occur when some surface in the combustion chamber becomes hot enough to ignite the fuel charge. Usually this occurs before the spark and is then called "pre-ignition." The source may be an overheated spark plug, valve surface, or glowing cylinder deposit. Normally, the driver is aware of the problem since the power loss it causes is very noticeable. Engine damage can also result from pre-ignition.

**Wide electrode gap:** The plugs' electrodes may be worn so badly that ignition voltage is insufficient to jump that of air gap. You can recondition a plug in this condition, but we don't advise it. A condition like this greatly increases emissions too, and several plugs in the same engine having this problem may cause catalytic converter overheating because of insufficient burning of fuel.

**Bridged gap:** Deposits may have bridged the electrode gap so that coil voltage is drained away without a spark occurring. Exhaust emissions are horrendous with this kind of plug problem, but the plug can usually be cleaned.

**Flashover:** Dirt or moisture, or a deteriorated "plug boot," can cause voltage to short over the outside of the insulator.

**Cracked insulator:** High voltage may short to ground through a cracked or broken insulator. Care taken during installation will eliminate most broken insulators. Don't cock the socket or wrench, and try to use a foam-lined plug socket during installation.

**Fouled plug:** Conductive deposits may form on the insulator surface and drain away ignition charge. Oil-fouling is the most common form of fouling and is sometimes cured by a change to a plug of a slightly hotter range.

**Plug Gap Adjustment.** Plug gap should be set or reset *only* by bending the side electrode. Don't exert pressure on either the center electrode or the insulator. When measuring gap on used plugs, use a pin-type gauge and not a feeler gauge, because irregularities in the electrode surface can cause incorrect readings. *Always* gap new plugs and *always* regap used plugs. . . . *use your tech manual* to get the *right* gap specs. . . . don't take your buddy's word for it.

**Coil Polarity.** If you pull the plugs out of an engine and the side electrode is heavily dished or scooped opposite the center electrode, chances are your coil polarity is wrong. Polarity should always be negative at the spark plug terminal because this considerably decreases voltage required for ignition. This is because of the higher operating temperature of the center electrode. . . . if you remember your high school physics, electrons will leave the hotter surface at lower voltage.

Check your coil. . . . the negative lead (marked "-") should always run from the coil to the distributor on vehicles with a negative-ground system.

continued



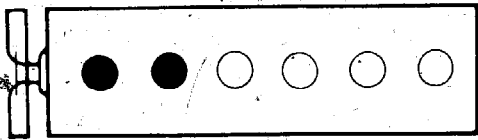

Fig. 1

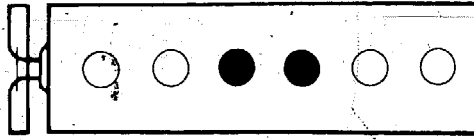

Fig. 2

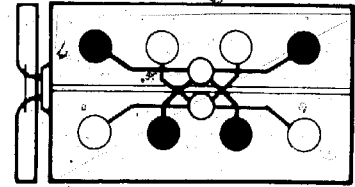

Fig. 3



Ash fouling may cause misfire. Could mean engine may need valve guide seal.

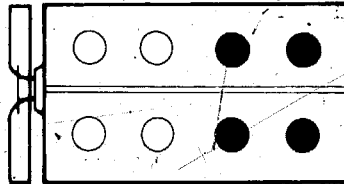

Fig. 4

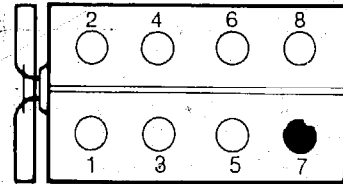

Fig. 5

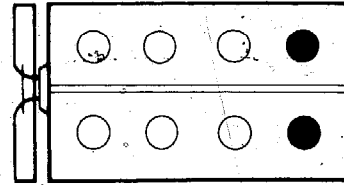
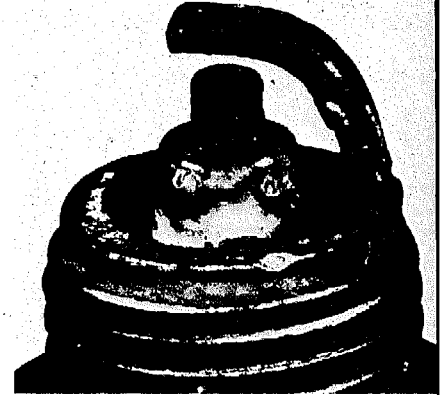
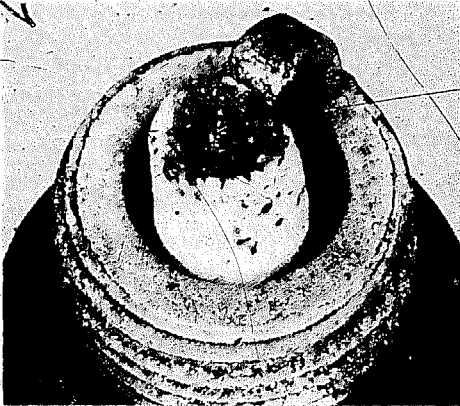

Fig. 6



(left) Caused by deposits loosened from hot piston top and splashing onto insulator. Just clean and regap. (center) Two-stroke motorcycle engines are most usually affected by gap bridging. Caused by dirty air filter or dirty piston top. (right) Insulator glazing occurs because of high heat in the combustion chamber. Try a plug that is one step colder.



Preignition is a no-no. It's caused by combustion chamber deposits which become incandescent and ignite fuel before the plug does. Other causes include piston scuffing, detonation, cross firing, or plug heat range too high.

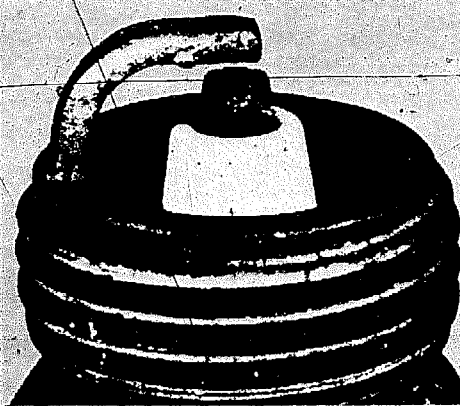

Overheated plugs have a blistered, white insulator and very few deposits. Check for correct plug heat range, overadvanced ignition timing, cooling system malfunction, leaking intake manifold, or sticking valves.

continued

**Cross Fire.** Although it is not a spark plug problem, cross fire is an ignition problem that can cause trouble. Cross fire, or induction leakage, can occur whenever ignition cables are grouped closely together and run in parallel for some distance. Cross fire isn't usually caused by faulty cable insulation but by the magnetic field which surrounds any high voltage conductor. The lead which is carrying high voltage at any given instant tends to induce voltage in an adjacent lead. Cross fire is most likely to occur between consecutive firing cylinders which are located close together in the engine block.

Cross fire can cause engine roughness and damaging preignition or detonation. So, even though it may not look pleasing, run your plug leads in a



**Detonation** can cause actual plug damage. To stop detonation try retarding the ignition slightly, using higher octane gasoline, and a richer mixture.

manner so that they won't run parallel for any distance, and separate plug wires for adjacent cylinders by placing them at opposite ends of the plug wire holder or loom.

**Troubleshooting With Plugs.** Champion Spark Plug Company notes that close examination of spark plugs can give you clues about the fitness of your engine. Just as important as the examination, though, is keeping the plugs in order according to their cylinder position. The location in the engine may help to locate a problem that otherwise might go undetected.

The diagrams in Chart 2 illustrate some of the problems in the engine which may be located by keeping the

plugs in the correct order. Telltale plugs are colored black if fouled and red to indicate an overheat.

Fig. 1 shows two adjacent fouled plugs in a six-cylinder engine. There's a good chance that this is due to a blown head gasket between the two cylinders.

Fig. 2 is drawn so that the two center plugs are fouled. This suggests that raw fuel is being "boiled" out of the carburetor into the intake manifold after the engine is shut off. If the engine is used for stop-start, short distance driving, the two center plugs may foul due to an overly rich "diet." Proper carburetor float level, good needle and seat seal, and the addition of a layer of insulation between the carb base and manifold can help relieve this "foul" problem.

An unbalanced carburetor may produce fouled plugs in an 8-cylinder engine as shown in Fig. 3. A good look at the fuel flow on this particular design (consult your Mitchell's or Motor Manuals) shows that if the right barrel was running rich, the cylinders it supplies would foul. The remaining four would show normal plugs.

Finding the back-four plugs overheated, as in Fig. 4, may indicate cooling problems. There's a good chance that a good cleaning of the cooling system would restore circulation to the rear of the engine.

One overheated plug (Fig. 5) can indicate a leak in the intake manifold near the location of the fouled cylinder. Also, check the firing order. If the overheated plug is the second of two adjacent, consecutive firing plugs, you could be the victim of cross fire.

Fig. 6 shows a condition you may see occasionally in larger V-8 engines used for light duty . . . the two rear plugs are oil-fouled. If the oil drain holes in the rear of the cylinder heads are clogged due to "sludge," excess oil may be pulled into the cylinders via the intake valve stems. This will probably be noticed in the two rear cylinders first, since the engine slants in that direction. High oil consumption and smoky exhaust when starting may accompany this condition.

**Cleaning Used Plugs.** To use or not to use . . . that is the question relative to used plugs. Electrode gaps wear away at the rate of .005 to .008 inch during a normal service life of 10,000 miles. Plugs should be replaced if they measure out of these limits. Renewal

should be performed only on those plugs suitable for further service, and the following procedures should be followed:

- Remove any oil deposits with a safety solvent and dry plugs thoroughly.
- Open the electrode gap wide enough to permit cleaning and filing.
- Use an abrasive cleaner (sand-blaster) to remove combustion deposits on both the electrodes and the insulator, and then use clean air (while wearing your safety goggles) to blow away all abrasive dust. Clean and dry the threads and connector terminal.
- File the electrode surfaces to restore clean, sharp edges.
- Reset gap (remember, bend only the side electrode).

Some people will condemn a plug if it does not spark in a plug tester at an air pressure equal to or greater than the engine's cranking pressure. WRONG! Air pressure as read on a plug tester has little relationship to engine cranking pressure. Why? The plug being tested is cold. In the engine, the electrodes operate at high temperature and require less voltage to fire than when cold.

The tester can't duplicate an air/fuel mixture. Neither does it take into consideration that a plug does not fire at maximum cylinder pressure but actually well ahead of TDC (top dead center).

If you are using a plug tester, follow the instructions to the letter and it will give you a good indication of the condition of the plug . . . don't throw out a good plug because you didn't follow directions.

**Not Any More.** Like the engine, the modern spark plug is a carefully engineered product combining highly specialized technology in ceramics, metallurgy, and precision manufacturing techniques. It's also very complicated in its function and theory, right?

Well, if you read this article, you should be a little less confused than before . . . and, after all, that's the theory behind the Backyard Mechanic Gets Back to the Basics! ☺

DRIVER wishes to thank the Technical Services Division of Champion Spark Plug Co. for allowing us to extract from their excellent technical briefs, and also for the majority of photos used in this article.

Hobby Shop Price About \$8.95  
Downtown Price About \$16.95  
Is your labor worth \$8 per hour?



## BACK TO BASICS...

**A**nyone who's ever been in the military has probably heard the term "preventive maintenance." It doesn't matter whether you're a dental technician, an aircraft crew chief, or a vehicle control officer, preventive maintenance is a concept you hear about and work with continually. The Army even has a monthly 64-page magazine called *PS, The Preventive Maintenance Monthly*. Why all the emphasis on PM? Because, over and over again, it has been proved that it works!

Preventive maintenance, in the form of a grease job and an oil-and-oil-filter change, is probably the best way to prolong the life of your vehicle's power plant and help insure that the engine won't go out to lunch when you need it most.

**Why Change?** Oil, like most other things, eventually wears out. The addi-

tion of aftermarket oil supplements may replenish some of the original chemical components, but they won't remove the accumulated acid, ash, moisture, or other contaminants that build up in motor oil over a period of time.

The oil filter can remove only so much of the accumulated junk before it, too, fails to function properly.

Why "change" chassis lubricants like you do oil? For the same reasons . . . grease "wears out" eventually, and becomes contaminated with foreign matter just the same as oil.

Since both chassis and engine parts are made up almost entirely of metal, they are subject to failure caused by contaminants in the lubrication. Abrasion, or the wearing away of the metal itself, is one problem. Another is the formation of deposits of foreign matter caused by the inability of dirty lubri-

cant to keep surfaces clean. A third problem is the failure of metal caused by the attack of acids formed by combustion or chemical reaction . . . acids that can be defeated only by removing the contaminated lubricant.

**How often?** One thing is certain — you won't hurt your engine by changing the oil too often. We at DRIVER feel that frequent changes of oil and filter are the keys to long engine life. With the exception of new cars using a reputable synthetic such as Mobil 1, we feel that 5000 miles is the longest your car should go without a change. In dusty areas of the country, 3000 is about the outside limit. And while you're at it, don't forget to check and change, if necessary, the fuel and air filters, too. Power brake systems often have an air filter, and automatic transmissions have a fluid filter . . . check 'em when you do your PM,

# THE BACKYARD MECHANIC

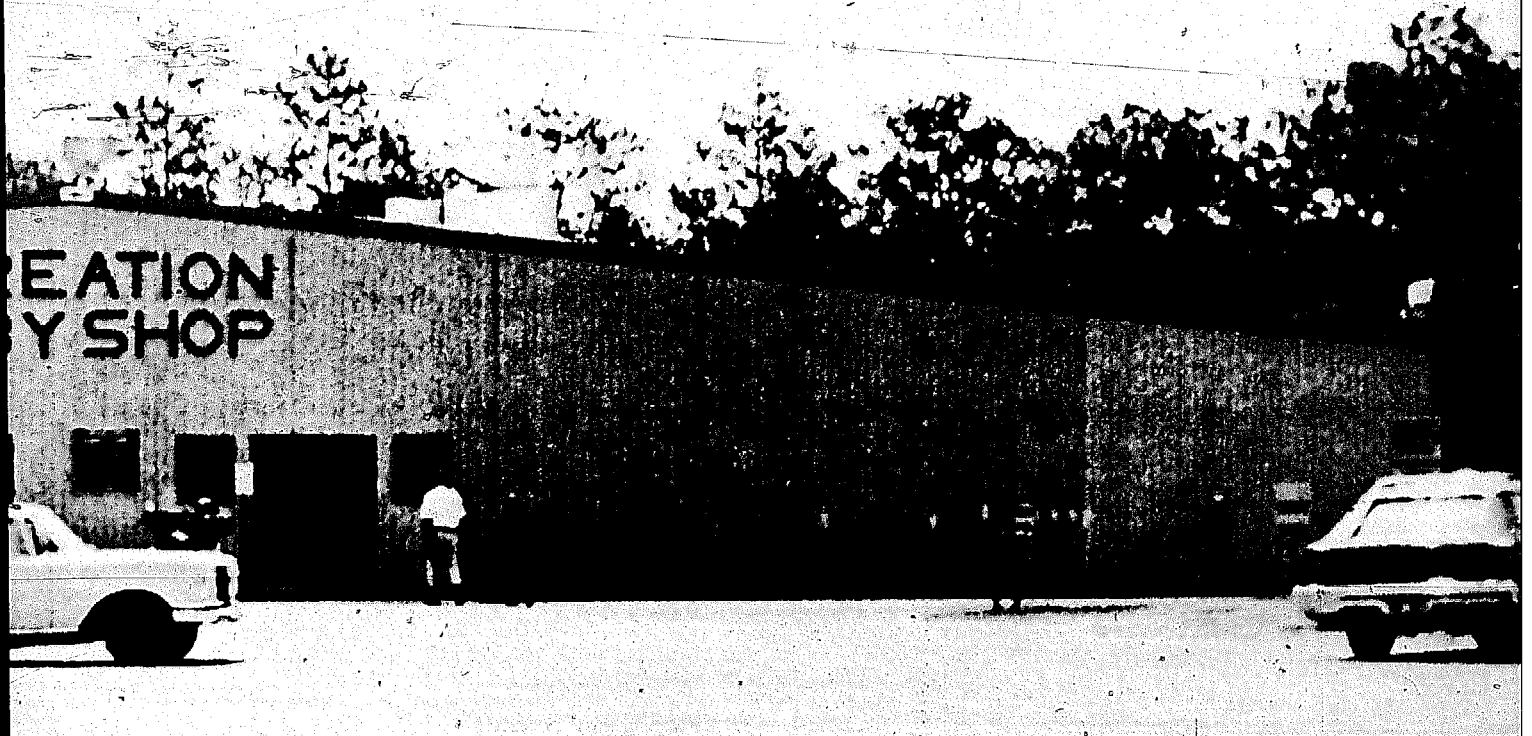

## Grease, Oil, and Filter

change 'em as needed, and we think you'll find that the cars of today will go an awfully long time before major maintenance is needed.

**Quality:** All oil cans are supposed to be labeled with a code which indicates the oil's service limitations. For pre-'71 cars, use oil graded at least SD (Service Deluxe). Newer cars require SE (Service Extreme) quality. Most premium-quality oil will provide adequate engine protection, so the choice of brands is personal preference. If you *do* decide, for some reason, to switch brands, be sure that you continue to use the same type (detergent or non-detergent) and rating (SE or SD) that you have been using.

Most good quality oil filters are about the same . . . but be sure that, whatever brand or type you choose, it meets the car manufacturer's specifications and warranty requirements.

Lately, we've seen the development of two-stage filters and filters with internal additive supplies. Both new types appear to be well-tested and reliable and seem to have gained acceptance with the professional racer crowd. These new-type filters are not too much more expensive than conventional filters, and the added protection they offer may be worth the increase in price over single-stage conventional filters.

**Additives:** Basically, if you use a high-quality oil and change it regularly, you don't need additives. Army studies indicate that the vast majority of those additives tested by the Army don't add much to oil performance, and they also want to remind you there is the possibility of a voided warranty if such a product is in use when certain types of engine failure occur.

**Get Going:** We hope we've convinced you that a grease job and an oil and

filter change are just what your car needs, so let's tag along with Belinda Jean Proietti of the DA section of AFISC as she trips on over to the Norton AFB Auto Hobby Shop.

"Lindy," a San Bernardino native, lists poetry, dancing and baseball as her hobbies, and tells us that she works on her own car most of the time . . . she watches her odometer carefully, so she'll know when a lube job and an oil-and-filter change are needed. This petite, attractive young woman proves you don't need to be male, or a professional mechanic, to take an interest in your car and its maintenance. Although we used our photographer's car for the pictures, we might add that Lindy's car is a VW with over 100,000 miles on it. She thinks that proves the value of preventive maintenance.

*continued*

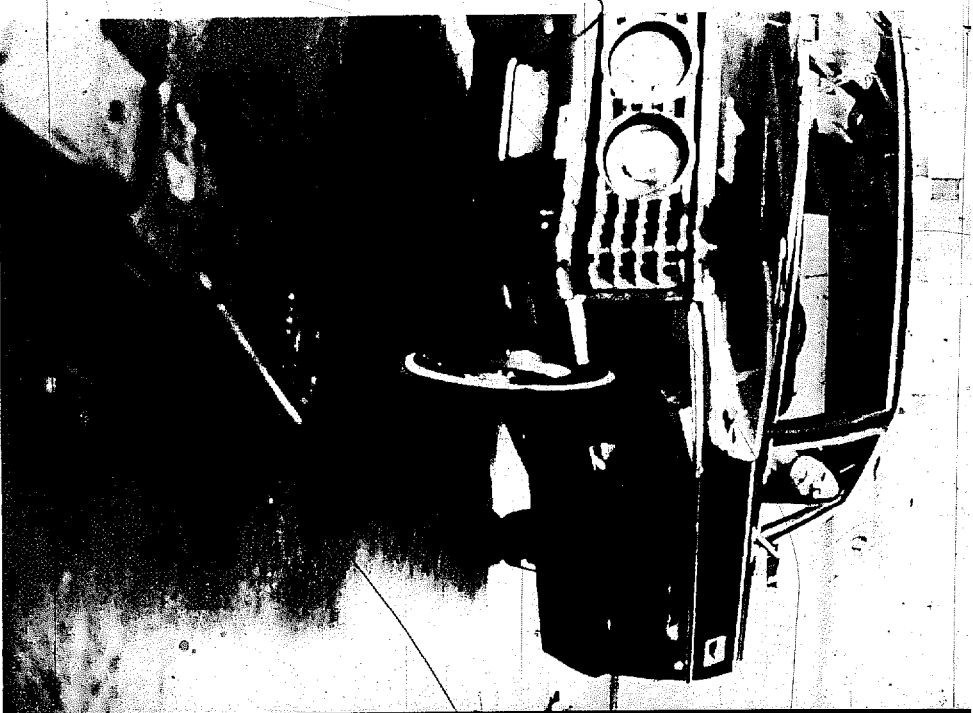
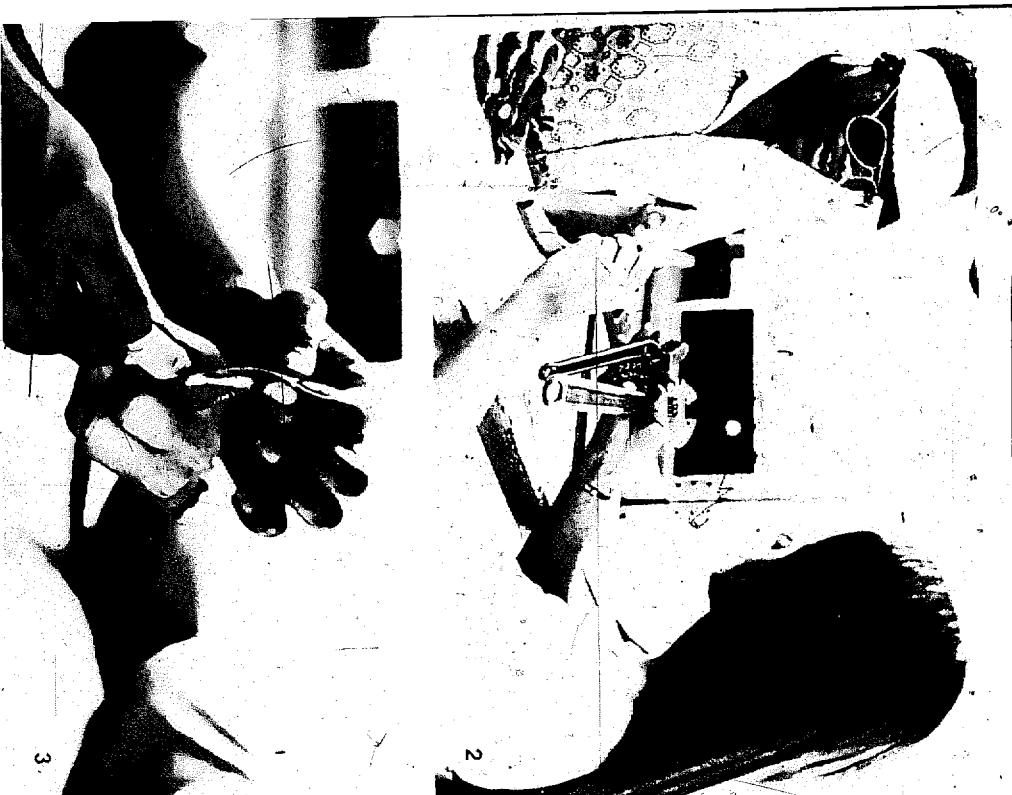





8



9

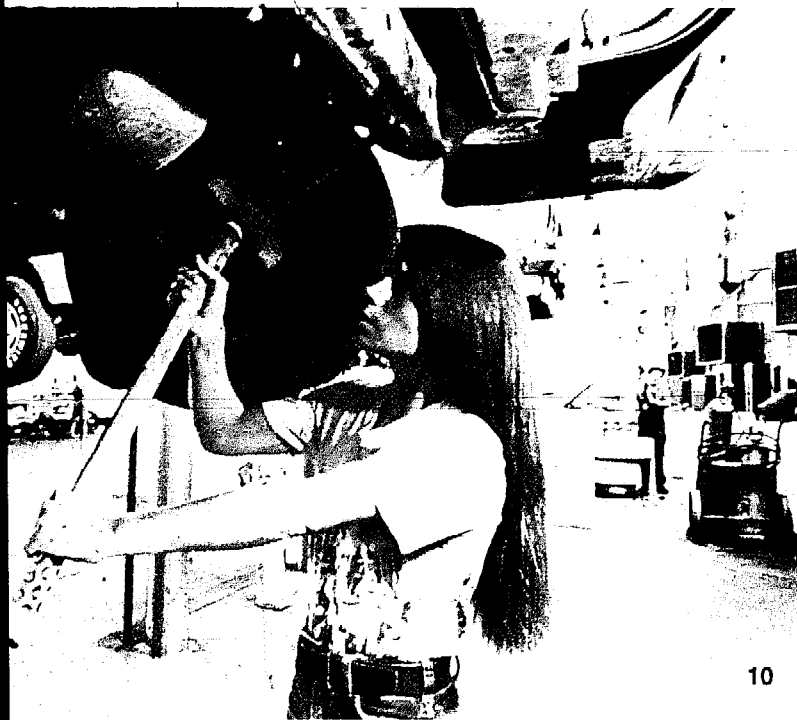

10



## the backyard mechanic

continued

1

**Belinda Jean "Lindy" Proletti signs in** at the Norton AFB Auto Hobby Shop . . . object: grease job, oil and filter.

2

**Lindy is assigned a lift**, and the tool crib manager gives her the tools necessary for the job . . . not a bad deal for 75 cents!

3

**Like many of us**, Lindy has a ring that has great sentimental value, and she doesn't want to remove it. A little duct tape eliminates the hazard, and her watch will come off before the car goes on the lift. If she was working around machinery, or if the engine was going to be running, she'd also pin her hair back and put on a scarf.

4

**Most hobby shops** have sales stores where you can buy your parts. Savings over downtown prices is usually considerable. Shop personnel can advise you on the correct grades of oil, too, if you're not quite sure what you need.

5

**It helps** to have a spotter when you put the car into the lift area . . . hobby shop employees will usually assist.

6

**Before** you put the lift arms under the car, check with a manual that shows the lift points. If you don't position the arms correctly, you can bend pieces or even crush a muffler or catalytic converter.

7

**Instructions** for operating the lift are usually placed near the controls. If it's your first time, or if you aren't sure about all the levers and valves, ask the hobby shop people to assist you.

8

**Once the car is on the lift** and the drain oil receptacle is in place, remove the oil drain plug from the oil pan. A word or two of caution: the oil will be hot, and so will the drain plug . . . you can burn fingertips easily. Also, note the direction in which the jaws of the crescent wrench are facing . . . if it's turned around, it may slip.

9

**Looks like she's doing it right** . . . Lindy's got plenty of light, the catch pan is in place, and she has a rag to hold onto the drain plug if it's too hot.

10

**While the oil is draining** from the pan, prepare to remove the oil filter. This gag photo shows how some people go overboard . . . yes, the filter will be tight, but that's why we use a filter wrench to remove it.

continued

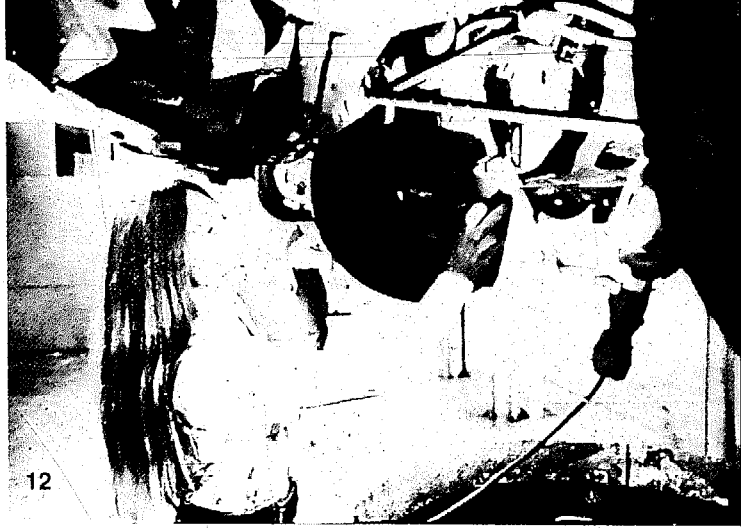

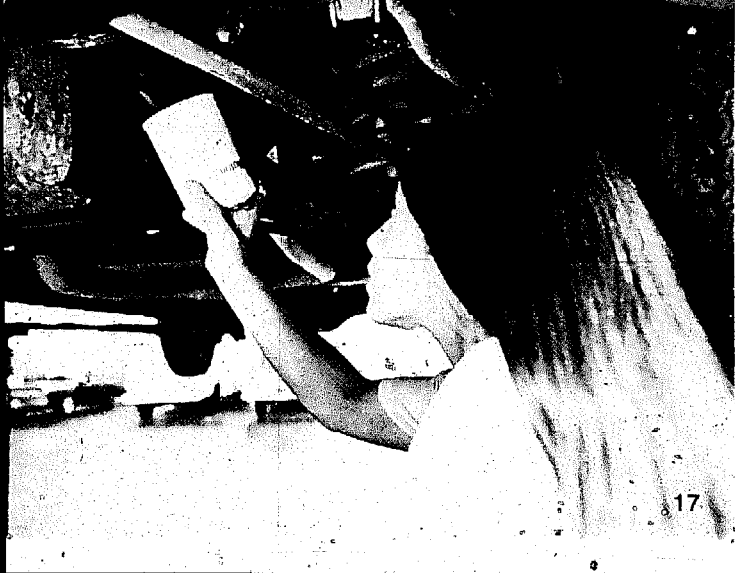

17



19



20

## the backyard mechanic

continued

11

The oil filter wrench usually takes the shape of a strap or chain that fits around the filter canister. There is only one way that is correct for filter wrench operation. If it slips, you know you have to turn it around.

12

After the filter is broken loose with the wrench, carefully remove the filter and let it down vertically. Again, the oil and filter will be hot, and spilled hot oil running down your arm is *not* fun. Use a rag, and plan ahead if you must get the filter out from above or behind obstructions.

13

As the oil continues to drain from the oil pan and filter mount, get the grease gun. Check the end to see that it's clear of dirt that can be forced into what you'll be greasing. Wipe the gun off with a rag so that it won't be so slippery. Try not to have your finger on the trigger as you inspect the end. Grease tastes lousy!

14

After studying your manual to determine where the grease fittings are, wipe the fittings clean, put the nozzle of the gun firmly over the fitting nipple and squeeze the trigger. If the car has plugs instead of fittings, go ahead and install fittings, but be sure to remove them and reinstall the plugs when the job is done.

15

This picture shows what happens if the nipple is clogged or if the gun is not held firmly enough against the fitting. Grease should seep out of the joint between the two components, not from around the gun nozzle. Resecure the gun to the fitting and try again. Fill fitting until grease just begins to poze out. Ball joints and other fittings with neoprene or rubber reservoirs should be filled till they are firm, and no more. Too much grease can rupture the reservoir.

16

Reinstall the oil pan drain plug. Then, prior to installing the new oil filter, wipe down the filter mount on the engine block and apply a thin film of oil or grease to the seal on the filter canister.

17

New filter goes in the way the old one came out. Instructions say "hand-tighten," but to be sure it doesn't leak, you need hands like Goliath . . . better to use the filter wrench and tighten "snugly," but don't go overboard and wrinkle the filter canister.

18

Check to be sure you're installing the proper grade and weight of oil for your car's needs.

19

Install the amount of oil called for in your owner's manual. Don't forget to reinstall oil filler cap and PCV or smog connections, if applicable.

20

Check oil level, fire up the car and check for leaks from filter and drain plug, turn car off and recheck oil level. Clean up your work area, return the tools, make a note of the odometer reading, and pat yourself on the back for a job well-done and quite a few bucks saved.

