

AT MICROFICHE
REFERENCE
LIBRARY
A project of Volunteers in Asia

The Self-Reliant Potter: Refractories and Kilns

By: Henrik Norsker

Published by: Friedr. Vieweg & Sohn
Verlagsgesellschaft mbH
Braunschweig, Germany

Available from: Deutsches Zentrum für Entwicklungstechnologien--GATE
in: Deutsche Gesellschaft für Technische Zusammenarbeit
(GTZ) GmbH
Postbox 5180
D-6236
Federal Republic of Germany
Tel: (0 61 96) 79-0

Reproduced with permission.

Reproduction of this microfiche document in any form is subject to the same restrictions as those of the original document.

Henrik Norsker

The Self-Reliant Potter: Refractories and Kilns



Vieweg

Deutsches Zentrum für Entwicklungstechnologien – GATE

Deutsches Zentrum für Entwicklungstechnologien – GATE – stands for German Appropriate Technology Exchange. It was founded in 1978 as a special division of the Deutsche Gesellschaft für Technische Zusammenarbeit (GTZ) GmbH.

GATE is a centre for the dissemination and promotion of appropriate technologies for developing countries.

GATE defines „Appropriate technologies“ as those which are suitable and acceptable in the light of economic, social and cultural criteria. They should contribute to socio-economic development whilst ensuring optimal utilization of resources and minimal detriment to the environment. Depending on the case at hand a traditional, intermediate or highly-developed can be the „appropriate“ one. GATE focusses its work on three key areas:

– *Technology Exchange*: Collecting, processing and disseminating information on technologies appropriate to the needs of the developing countries; ascertaining the technological requirements of Third World countries; support in the form of personnel, material and equipment to promote the development and adaptation of technologies for developing countries.

– *Research and Development*: Conducting and or promoting research and development work in appropriate technologies.

– *Cooperation in Technological Development*: Cooperation in the form of joint projects with relevant institutions in developing countries and in the Federal Republic of Germany.

For several years GATE has been an active supporter of the SATIS network (Socially Appropriate Technology Information Services) and has entered into cooperation agreements with a number of technology centres in Third World countries.

GATE offers a free information service on appropriate technologies for all public and private development institutions in developing countries, dealing with the development, adaptation, introduction and application of technologies.

Deutsche Gesellschaft für Technische Zusammenarbeit (GTZ) GmbH

The government-owned GTZ operates in the field of Technical Cooperation. 2200 German experts are working together with partners from about 100 countries of Africa, Asia and Latin America in projects covering practically every sector of agriculture, forestry, economic development, social services and institutional and material infrastructure. – The GTZ is commissioned to do this work both by the Government of the Federal Republic of Germany and by other government or semi-government authorities.

The GTZ activities encompass:

- appraisal, technical planning, control and supervision of technical cooperation projects commissioned by the Government of the Federal Republic or by other authorities
- providing an advisory service to other agencies also working on development projects
- the recruitment, selection, briefing, assignment, administration of expert personnel and their welfare and technical backstopping during their period of assignment
- provision of materials and equipment for projects, planning work, selection, purchasing and shipment to the developing countries
- management of all financial obligations to the partner-country.

Deutsches Zentrum für Entwicklungstechnologien – GATE
in: Deutsche Gesellschaft für Technische Zusammenarbeit (GTZ) GmbH
Postbox 5180
D-6236 Eschborn 1
Federal Republic of Germany
Tel.: (06196) 79-0 Telex: 41523-0 gtz d

Henrik Norsker

The Self-Reliant Potter: Refractories and Kilns

A Publication of
Deutsches Zentrum für Entwicklungstechnologien – GATE
in: Deutsche Gesellschaft für Technische Zusammenarbeit (GTZ) GmbH



Friedr. Vieweg & Sohn Braunschweig/Wiesbaden

The Author:

Henrik Norsker has been making pottery since 1970. He left his pottery workshop in Denmark in 1976 to establish a pottery school in a village in Tanzania. Since then he has continued working in developing countries with the promotion of modern pottery. Besides Tanzania he has been involved in ceramic projects in Nepal, India and Bangladesh. He is presently working on a pottery project in Burma.

CIP-Kurztitelaufnahme der Deutschen Bibliothek

Norsker, Henrik:

The self-reliant potter: refractories and kilns :
a publ. of Dt. Zentrum für Entwicklungs-
technologien - GATE in: Dt. Ges. für Techn.
Zusammenarbeit (GTZ) GmbH - Henrik Norsker.
Braunschweig ; Wiesbaden : Vieweg, 1987
ISBN 3-528-02031-8

All rights reserved.

© Deutsche Gesellschaft für Technische Zusammenarbeit (GTZ) GmbH, Eschborn 1987

Published by Friedr. Vieweg & Sohn Verlagsgesellschaft mbH, Braunschweig
Printed in the Federal Republic of Germany by Lengericher Handelsdruckerei, Lengerich

ISBN 3-528-02031-8

This book about how to construct and fire kilns addresses trainees and practising potters in developing countries. It intends to assist potters to become more self-reliant by providing advice on the optimum use of locally available raw materials and by explaining techniques which will help potters to increase their production and their income.

The first section of the book describes the whole sequence of producing refractory items. The second section deals with different kiln types and their functioning principles.

The various methods of constructing kilns are treated in a practical way with comprehensive illustrations. Finally instructions are provided on the loading and firing of kilns and on different methods of measuring temperature, including a thorough description of how potters can make their own pyrometric cones.



Deutsches Zentrum für Entwicklungstechnologien

ISBN 3-528-02031-8

tool

31.50

Stichting TOOL

Entrepôtdok 68a/69a,
1018 AD Amsterdam
The Netherlands.
Tel. (0)20-264409

Contents

Preface	7
1. Refractories	9
1.1 Introduction	9
1.2 Refractory raw materials	10
1.2.1 Kaolin	10
1.2.2 Fireclay	11
1.2.3 Aluminous materials	11
1.2.4 Bauxite	11
1.2.5 Laterite	11
1.2.6 Silimanite, kyanite, andalusite	12
1.2.7 Zircon	12
1.2.8 Silica	12
1.2.9 How to get refractory materials	13
1.3 Production of refractory items	14
1.3.1 Clay cleaning	14
1.3.2 Grog	15
1.4 Kiln furniture	19
1.4.1 Saggars and slabs	19
1.4.2 Thermal shock	20
1.4.3 Saggars	21
1.4.4 Shaping	21
1.4.5 Kiln shelves	26
1.4.6 Drying of saggars and slabs	27
1.4.7 Firing saggars	27
1.4.8 Glazed support	28
1.5 Firebricks	31
1.5.1 Solid bricks	31
1.5.2 Insulating firebricks	35
1.5.3 Acid bricks	36
1.5.4 Heavy firebricks	37
1.5.5 Mortars	38
1.6 Testing refractories	38
1.6.1 High temperature testing	39
1.6.2 Refractory materials and bodies	39
1.6.3 Refractory items	42
2. Kilns	43
2.1 Development of kilns	43
2.1.1 Bonfire kilns	43

2.1.2	Sinde up-draught kiln	46
2.1.3	Bangladesh up-draught kiln	46
2.1.4	Permanent up-draught kilns	47
2.1.5	European up-draught kilns	48
2.1.6	Down-draught kilns	50
2.1.7	Khurja kil	51
2.1.8	Mayangone kiln	53
2.1.9	Bujora down-draught	53
2.1.10	Cross-draught kilns	55
2.1.11	Tube kilns	57
2.1.12	Chinese chamber kiln	58
2.1.13	Champaknagar chamber kiln	58
2.1.14	Sumve cross-draught kiln	62
2.2	Choice of fuel	63
2.2.1	Firewood	64
2.2.2	Agricultural waste	67
2.2.3	Peat	68
2.2.4	Lignite	68
2.2.5	Coal	69
2.2.6	Oil products	70
2.3	Combustion and fireboxes	71
2.3.1	Combustion	71
2.3.2	Firewood firebox	73
2.3.3	Sawdust firebox	76
2.3.4	Coal fireboxes	78
2.3.5	Oil drip firing	82
2.3.6	Pressure burner system	85
2.4	Heat transfer and draught	88
2.4.1	Transfer of heat through air	88
2.4.2	Transfer of heat through solids	88
2.4.3	Transfer of heat by radiation	88
2.4.4	Natural draught	89
2.4.5	Flues	91
2.4.6	High altitude	91
2.5	Kiln construction	91
2.5.1	Site of the kiln	91
2.5.2	Foundation	91
2.5.3	Masonry	93
2.5.4	Floor and walls	94
2.5.5	Curved walls	95
2.5.6	Arches	95
2.5.7	Domes	99
2.5.8	Catenary arch	102
2.5.9	Arch construction without support	102
2.5.10	Expansion joints	104
2.5.11	Insulation	104

2.5.12	Maintenance of kilns	104
2.6	Loading and setting of the kiln	105
2.6.1	Loading biscuit firing	106
2.6.2	Loading glaze firing	107
2.7	Kiln firing	112
2.7.1	Biscuit firing	113
2.7.2	Glaze firing	116
2.8	Temperature measurement	119
2.8.1	Thermometers	119
2.8.2	Colour	119
2.8.3	Test draw	119
2.8.4	Cones	120
2.8.5	Pyrometer	121
2.8.6	Self-made cones	122
Appendix		126
Tables of weights and measures		126
Table of Seger cones		128
Table of Orton cones		128
Average properties and measures		129
Mohs' scale of hardness		130
Temperature conversion		131
Useful formulas		132
Bibliography		134

Preface

The idea of writing a ceramic book specifically to suit conditions in developing countries originated from my personal experience and associated problems whilst I was struggling to set up modern pottery production in a Tanzanian village ten years ago. When I was a potter in Denmark, ceramic raw materials and kiln refractories had only been a question of which supplier to contact whereas in Tanzania we had to find our own clay and glaze minerals, produce firebricks and kiln slabs, and construct the equipment locally. From that experience I realized the shortcomings of my former training and how difficult it was to extract appropriate technology from currently available ceramic literature. This literature mainly addresses itself to a market comprising amateurs, art potters and industrial engineers in developed countries. Generally, the hobby books are too basic and the engineering books are too advanced to be useful to most potters. The art potters' books provide a great deal of useful information. However, they do not cover all the fundamental problems facing the potter in a developing country, e.g. how to produce refractories.

The term self-reliant potter closely reflects the working conditions in which potters in many developing countries have to exist. Imported materials and equipment are virtually impossible to obtain and even the supply of resources within the country may be impractical due to poor logistics or difficulties with local government bureaucracies. Self-reliance is therefore not seen as an end in itself but as a means to ensure a profitable pottery production.

The aim of this book is not to enable somebody without practical pottery experience to start up modern pottery production on his own. The book is mainly written for the benefit of potters already involved with modern pottery, and for teachers and students involved with the growing number of pottery training centres and institutes in developing countries.

GATE is planning to publish more technical books on ceramic technology and these would cover the subjects of glazing, clay preparation and shaping methods. GATE invites users of this book to forward their comments and any suggestions regarding the planned future series of ceramic books.

Acknowledgments

A number of friends, potters and colleagues in Denmark, Tanzania, India, Nepal, Bangladesh and Burma have over the years participated in the process of establishing the raw materials for this book. I wish to thank them all for sharing with me the frustrations, disappointments and occasional triumphs of that process.

Knud Erik Asak initiated me to the art of kiln building and he has contributed a number of photographs and the design of the Champaknagar kiln.

Troels Kvorning has taught me the basics of pottery and has kindly let me use some of his photographs from Tanzania.

The technical details of the kerosene pressure burner are provided by James Danisch

who has also contributed to the book with helpful suggestions and photographs.

Kaung Kaung Oo has helped with working drawings for some of the kilns.

Peter Nauman has produced the majority of the drawings and has had the tedious task of correcting my English and proof-reading the manuscript.

The manuscript has been typed and retyped several times by Nan Win Moe.

Finally I owe thanks to my wife Tin Tin Moe for her encouragement and patience with the writing of the book.

My thanks to all of you.

Rangoon, 27th December 1985
Henrik Norsker

1. Refractories

1.1 Introduction

For the construction of kilns it is necessary to use bricks and mortars which will endure intense heat. For glaze firings it is also usually necessary to have materials for stacking pottery in the kiln chamber. Saggars, kiln shelves and props are examples of kiln furniture.

Industrial standard

By industrial standards a clay is called refractory when it does not soften below 1580 °C. However, in most cases we will have to be satisfied with clays that soften at a much lower temperature because real refractory clay may not be available or is too expensive. In any case, most potters will not bring their kiln above 1250 °C and will only maintain the maximum temperature for a short period.

Potter's refractory

For the purpose of this book the term refractory will cover clays and materials that are suitable to be used in a potter's kiln fired up to 1250 °C. In case the kiln is to be fired at a lower temperature, it might be possible to use ordinary building bricks and saggars made by less refined methods than those described below. However, the principles remain the same and the additional effort will often be rewarded by a longer life for the kiln and kiln furniture.

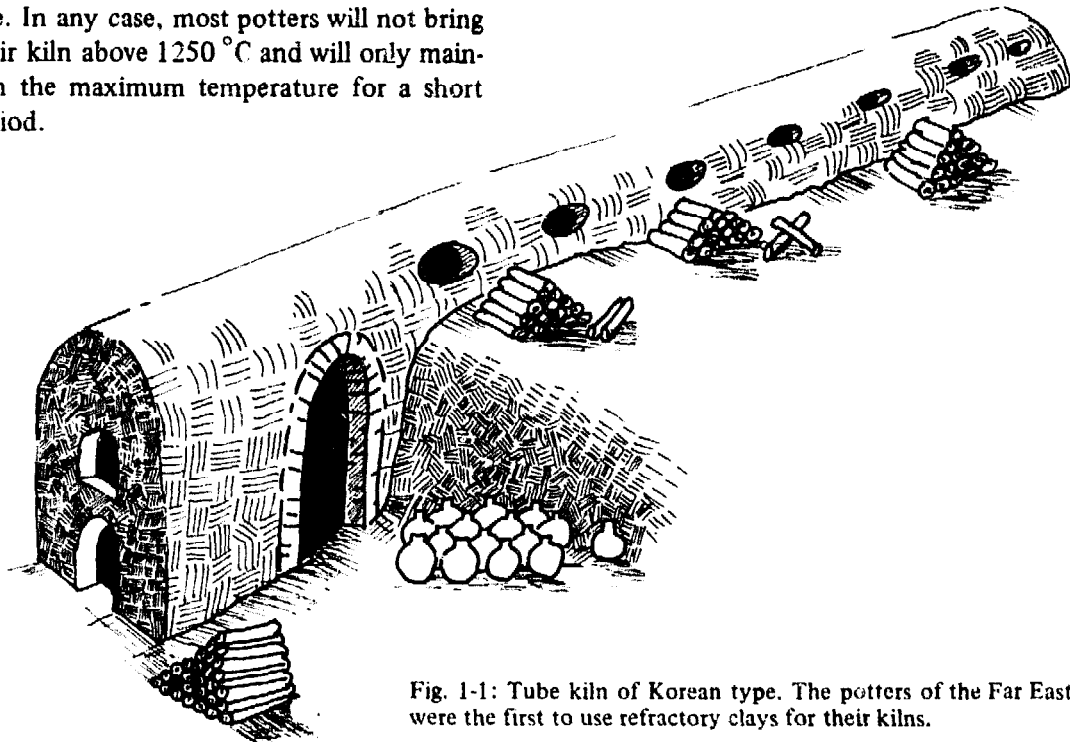

Fig. 1-1: Tube kiln of Korean type. The potters of the Far East were the first to use refractory clays for their kilns.

1.2 Refractory raw materials

In most cases refractory items for ordinary potteries will have to be made of clay.

1.2.1 Kaolin

Kaolin, also called China clay, is the best refractory clay type. A pure kaolin clay will not soften below 1750 °C. Kaolin has been created by the decomposition of feldspar (fig. 1-2).

Primary clay

Pure kaolin is found at the site of its parent rock (primary clay) and has not been mixed with impurities which would reduce its refractoriness and change its colour. Kaolin clays possess little plasticity due to their large clay particles.

Porcelain

Pure white burning kaolin is much in demand for making porcelain and is therefore expensive. However, for the production of refractory items, kaolin firing to a buff colour is acceptable.

Sand content

Often it is possible to find a local source of kaolin. It will normally be mixed with a con-

siderable amount of sand which is left behind when the parent rock has changed into clay. Sometimes only a small part of the parent rock is changed into clay and in other cases raw kaolin occurs in pockets amongst granite rocks. The raw kaolin is normally

a) Ancient times

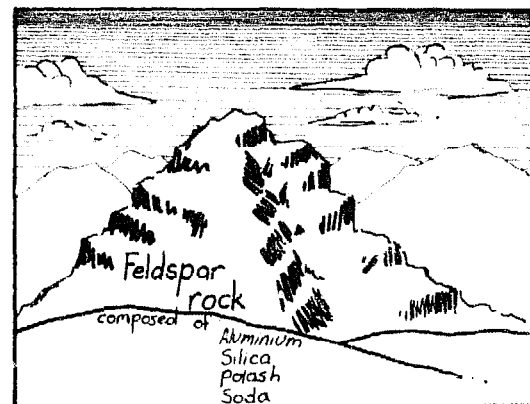

b) Ancient times - weathering

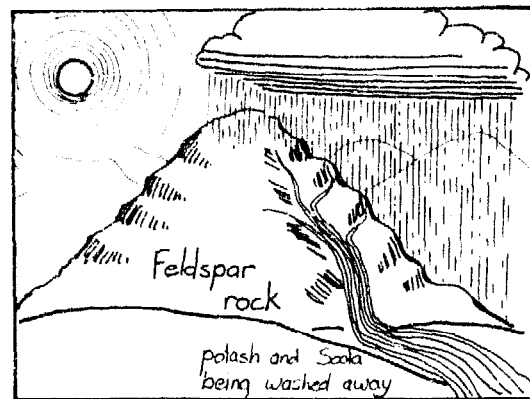

c) Today

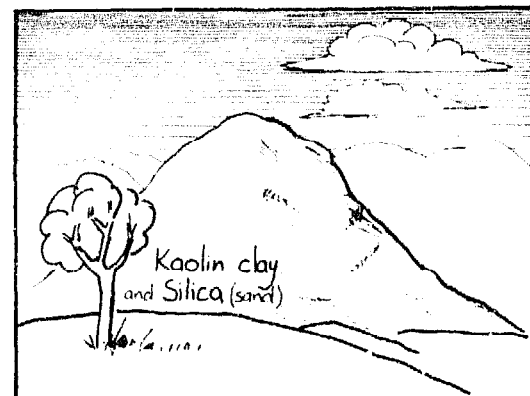
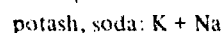
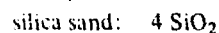
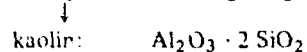
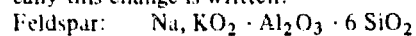

Fig. 1-2: Exposed to the action of weather the feldspar rock is slowly changed into clay. Chemically this change is written:



The potash and soda are washed away and add to the salt in the oceans.

white but some types of rock produce a pinkish colour which may still be a suitable refractory clay. Solid firebricks can often be made from raw unwashed kaolin. Kaolin is also used in the production of paper and rubber.

1.2.2 Fireclay

Fireclays are produced in the same way as kaolin but have been transported away from the location of the parent rock (secondary clay). Fireclays are also refractory, but often more plastic than kaolin. The colour of raw fireclays varies from white to yellow, brown or grey, and the sand content can be more than 50%.

Sometimes the term fireclay is used only for the clays lying below and between coal-seams. Such clays do not occur under all coal-seams and they might not always be refractory. However, there is a good chance of finding a suitable fireclay where coal-seams are located. Even under inferior coals such as lignite it is sometimes possible to find suitable clays.

1.2.3 Aluminous materials

Generally the more alumina in a refractory body the better is its refractoriness. So if alumina-rich materials are available at a reasonable price they should be added to the refractory body. The local institute of geology or mining should be approached about the availability of some of the following materials:

1.2.4 Bauxite

$\text{Al}_2\text{O}_3 \cdot \text{H}_2\text{O}$

melting point: 1600–1850 °C

density: 2.9 g/ml

hardness: 1–3

Bauxite is the raw material from which the metal aluminium is produced. It is found in many places though only a few deposits are utilized. Even deposits which are not suitable for aluminium production may be useful to the potter.

Bauxite grog

Red bauxite is less refractory than white or grey bauxite. The bauxite has no plasticity and needs a binding clay. The raw bauxite should be ground, mixed with 25% plastic clay, shaped in rough bricks which are fired to about 900 °C, and then crushed. This material can then be used as ordinary grog in a refractory body. A standard mixture is 75% bauxite grog and 25% fireclay. Bauxite grog can also be used as a substitute for a portion of the grog in the production of ordinary refractory bodies.

Calcination

The process described above of firing the rough bricks of bauxite is called calcination. The raw bauxite cannot be used without calcination (calcination at 700–900 °C; above 1000 °C bauxite becomes hard to grind) because it shrinks a lot during firing, giving off about 25% in water.

1.2.5 Laterite

In the tropics laterite soils are widespread. It is a reddish clayey material which hardens when exposed to air. Most laterites contain too much iron oxide and other impurities to be of use for refractory purposes. However, some purer forms of laterite can be used. Laterites vary a great deal and their usefulness has to be tested by experimental use. Bauxite is rather similar to laterites but has a higher aluminium content.

1.2.6 Silimanite, kyanite, andalusite

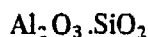

Melting point: 1850 °C

Density: 3.2–3.6 g/ml

Hardness: 6–7

Silimanite is found mainly in India while andalusite and kyanite are more widespread. Although these materials may cost too much for most potters, they are good refractory materials and produce long-lasting kiln shelves and saggars. In India some smaller potteries have started to use silimanite for their saggars and found this to be economical as it has extended the life of the saggars. The three materials are rather similar except that silimanite and andalusite can be used raw while kyanite needs to be calcinated above 1350 °C at which temperature it expands by 17%. (If intended for use below 1350 °C the calcination may be omitted.) The materials are non-plastic and can be used in mixtures as grog. A sagger body could be 60% silimanite, 30% fireclay and 10% plastic clay.

1.2.7 Zircon



Melting point: 2550 °C

Density: 4.2–4.7 g/ml

Hardness: 7–8

Zircon or zirconium silicate is commonly found as beach sand. As it is much heavier than normal sand, zircon has usually been separated from other sands by wave action. It is highly refractory and is useful in making special setters for tiles and plates. Bigger items such as saggars would, with the addition of zircon, become too expensive and heavy. When zircon is used to make press-moulded items, an addition of 10% fireclay is necessary, while items to be hand-moulded or thrown on the wheel need 30–40% clay. Zircon is very suitable for painting kiln

shelves and saggars. The kiln wash is made from either pure zircon mixed with water or with the addition of kaolin. The wash prevents glazed ware from sticking to the settings.

1.2.8 Silica



Melting point: 1710 °C

Density: 2.6 g/ml

Hardness: 7

Silica is found as part of rocks and clays and it is so common that it makes up 60% of all materials in the crust of the earth.

Occurrence

As a free mineral, not combined in clays and rocks, it occurs as quartz rock, silica sand, sandstone, flint pebble and as semi-precious stones such as agate, opal and jasper.

Refractory

The addition of silica makes a clay mixture more refractory. However, items exposed to sudden temperature changes should contain as little free silica as possible. Some forms of silica contract and expand suddenly at certain temperatures (fig. 1-3) and this causes the cracking of items such as kiln shelves and saggars. Firebricks for the kiln structure will be less exposed to sudden temperature changes and may contain some silica without giving problems.

Cost

For use in refractory bodies, quartz rock would be too costly and should be reserved for glaze-making. Silica sand is often more readily available and has the advantage that its particle size as found is suitable for immediate use. All sands contain silica in the form

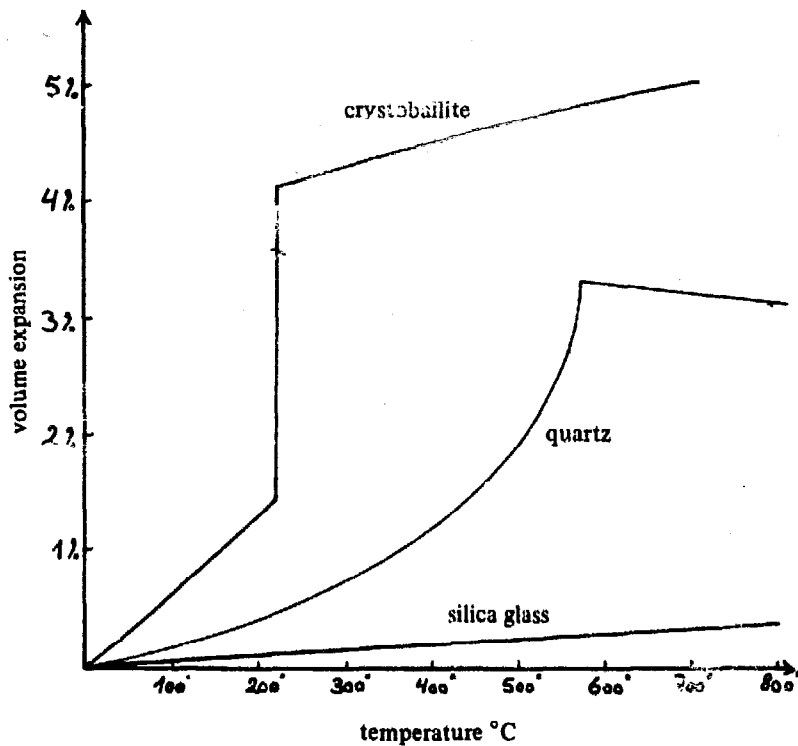

Fig. 1-3: Three forms of silica with different rates of expansion. The crystals of crystoballite expand suddenly at 220 °C and the quartz crystals expand suddenly at 573 °C. When silica has no crystal form as in silica glass or ash it expands evenly.

of small quartz crystals but a particular sand may contain many other minerals which may reduce its refractoriness. In general, the whiter the sand, the purer it is. White beach sand and the sand remaining from kaolin mining are the purest types of sand.

1.2.9 How to get refractory materials

Industries

Information about where to get materials may be obtained from existing ceramic industries, glass factories or cement factories which all need good refractory materials. Even if firebricks are available they might prove too expensive and in any case raw refractory clay will still be needed for the production of kiln shelves or saggars.

Geological institutes

Other sources of information are geological institutes and mining corporations but sometimes they are not well informed and are only concerned with big commercial deposits of high grade. Do not give up if they tell you that there is no refractory clay available. Clay sufficiently refractory for use up to 1200–1250 °C is quite common and there is a fair chance of finding some.

Surveying

In the end, potters may have to look for refractory materials themselves. Before starting to dig holes everywhere, ask local farmers and traditional potters if they know about a white or grey-coloured clay. A white clay is often already in use for other pur-

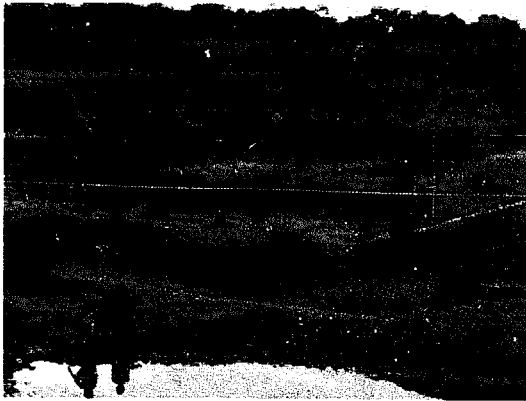

Fig. 1-4: Clay mining in Bangladesh

poses such as whitewashing houses. Also contact local well-sinkers who should have some knowledge of what soils are hidden below the surface. Apart from kaolin, fireclay and silica sand, which can usually be found locally, the other refractory materials listed above normally have to be purchased from a supplier.

1.3 Production of refractory items

1.3.1 Clay cleaning

Some refractory clays can be used as dug for the production of firebricks but usually, and especially for the production of slabs and saggars, the sand in the clay must be removed. Kaolin-type clays often contain more than 50% sand which should be removed at the site in order to save its transport cost to the pottery. Some deposits contain as little as 15% clay but it may still be feasible to wash out the clay. The removal of sand is done by adding water to the clay in a pond and stirring it until the clay is suspended in the water. The sand will settle first and the water clay mixture is transferred to another pond where the clay will settle more slowly. The stirring may be done mechanically or by hand; the principle is the same.

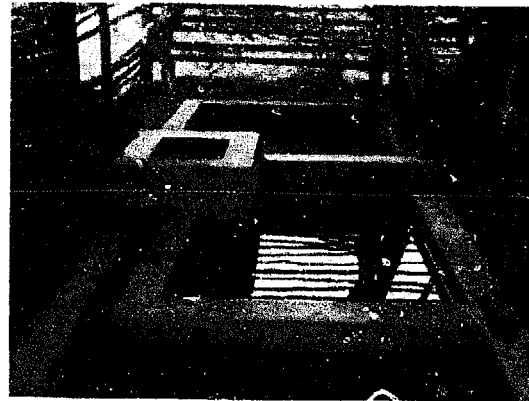

Fig. 1-5: The clay is stirred in the pond to the back. It is then poured through a screen into the small pit from where it runs to the two lower settling ponds.

Washing ponds

For the clay cleaning, two or more shallow ponds (for example 4 x 2 metres and $\frac{1}{2}$ metre deep) should be dug in the ground close to the clay source. The sides of the pond can be made of brickwork but simple wickerwork plastered with clay will do. The pond is half-filled with water and clay is added until the pond is filled. The raw clay is stirred with a shovel until all the clay particles are separated from the coarser sand. With coarser types of clays, like kaolin, the stirring may not take more than 30 minutes but with finer clay a longer period is needed and it may be necessary to let the mixture soak for a day. When no more lumps are left and the feel of the material at the bottom of the pond is no longer clayey but sandy, the clay slip mixture is transferred to the second pond. The slip can run by itself if the second pond is placed lower or it can be transferred with a bucket. In the latter case the slip could be poured through a screen into a small pit connected to the second pond. In the second pond the clay is left to settle. The rate of settling depends on the fineness of the clay. For highly plastic clays it may take weeks but for kaolin clays it will often take less than a day. After the clay has sett-



Fig. 1-6: After settling the washed kaolin clay is dried in the sun.

led the clear water on top should be run off cautiously without stirring the settled clay. The water can be reused by transferring it to the first pond by the help of a pump or by bucketing. The bucket or the pump inlet should not be dipped into the settling pond because that would stir the clay. Instead the surplus water should be conveyed to a small third pond from where it can be returned to the first pond. If there is a small stream nearby, the waste material can be used for making a small dam to provide water for the claywashing.

Washmill

For large quantities of clay an animal-powered washmill can be used (fig. 1-7). This can be operated continuously and raw clay can be added while the stirring is taking place. This addition will force clay slip to run off at the top. The raw clay will sink to the bottom where the action of the stirring blades will disintegrate it. The clay will become suspended in the water while the coarser materials remain at the bottom. The clay slip is then led into settling ponds through a screen. If a very pure clay is needed, the clay slip can be led through a grooved tray (fig. 1-7) where the grooves will retain the very fine sand. (This fine sand is likely to be mica

which is fusible compared to more refractory silica sand.) From time to time the tray should be turned upside down for cleaning and occasionally the washmill will have to be emptied of sand.

1.3.2 Grog

Grog is burned clay which has been crushed to grains of various sizes. It is used for making solid firebricks, saggars and slabs, etc. The grog is mixed with a plastic clay which binds it together. The additional firing and crushing make it more costly to use grog instead of raw clay but the benefits soon become obvious.

These are:

1. The firebricks or saggars are much less likely to crack with sudden changes of temperature.
2. They will better withstand loads without bending.
3. The tendency of spalling¹ is greatly reduced.
4. The drying shrinkage is reduced as less water is used in the clay and grog mixture.
5. Firing shrinkage is reduced because the grog has already been fired once. Generally the higher the content of grog the better the refractory properties, but shaping, especially of saggars, demands a certain plasticity.

Grog production

Grog is produced by firing lumps of raw clay in the kiln, or the raw clay can be formed into rough bricks, which are easier to set in the kiln. The clay used for making grog should be more refractory than the bond clay which binds the grog grains together. The grog clay should contain as little sand (free silica) as possible. A grog clay lacking

¹ The cracking of a firebrick due to temperature change is called spalling.

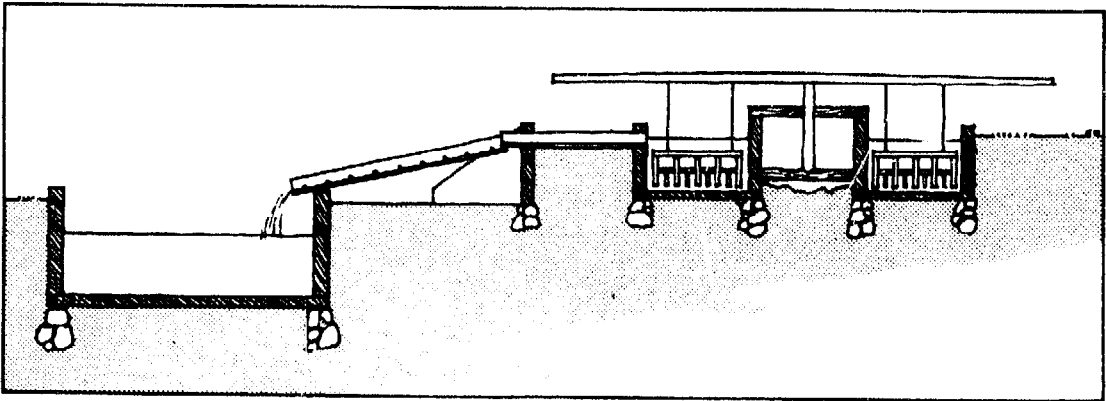
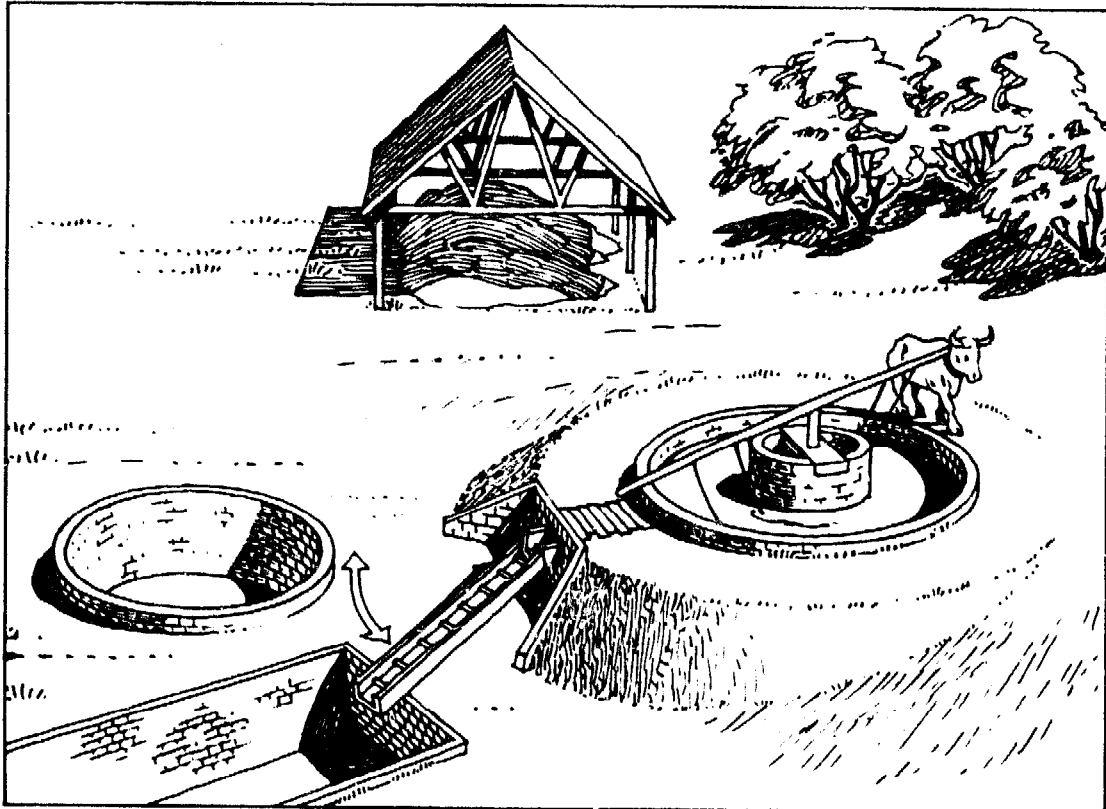

Fig. 1-7: Animal-powered washmill for clay cleaning. A grooved tray leads to the settling tanks.

plasticity will be difficult to form into rough bricks and will be troublesome to stack in the kiln. An addition of about 10% plastic clay will solve the problem. If possible the grog clay should be fired at a temperature which is higher than the temperature the

finished refractory items are likely to be used at later. However, this can be difficult for small potteries which cannot afford to build special kilns for grog and firebrick production. Alternatively, the grog bricks can be placed at the hottest spots in the kiln.



Fig. 1-8: A manual hammer for grog crushing

Broken saggars

When the pottery has been in production for some time broken saggars or kiln slabs and old firebricks should suffice for the grog production. However, care should be taken to remove any layer of ash slag or melted glaze as these materials will lower the melting point of the finished product.

Crushing

After firing, the grog is initially reduced by a hammer to lumps the size of about 5 cm. For the final crushing the hammer pictured in fig. 1-8 should be adequate for most smaller potteries. The hammer is operated by stepping on the shorter end of the lever and then left to fall by its own weight onto

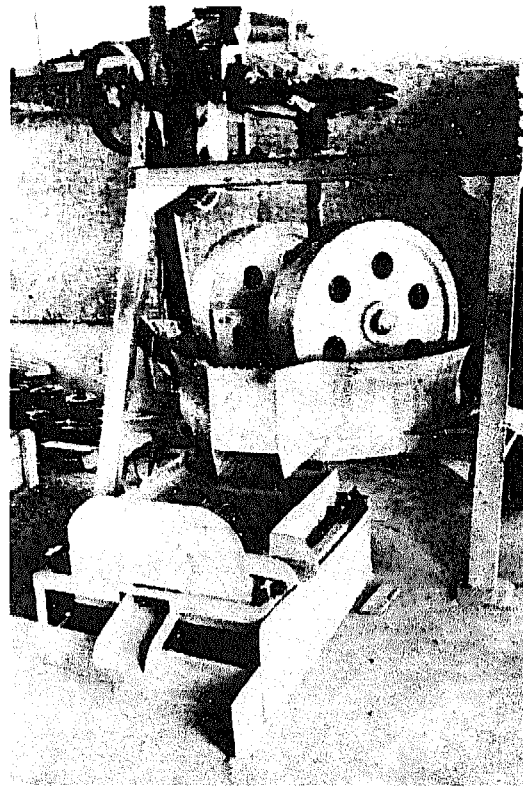

Fig. 1-9: A pan grinder supplied with a double-deck screen grades the crushed grog in two sizes.

the grog which is placed under the metal or stone hammer by a second person.

For bigger potteries a jaw roller, impact crushers or pan grinder (fig. 1-9) may prove more useful for crushing large amounts of grog. A hammer mill (fig. 1-10) designed for milling corn can be used by changing the screen and reinforcing the cage to withstand the abrasive action of the grog. Grog particles should be angular and plate-like rather than rounded. For these shapes a hammer mill is more suitable compared with the other machines.

Grog size

The size of grog should normally be between 1 mm and 5 mm. In general, fine grog mixtures tend to withstand loads better but are

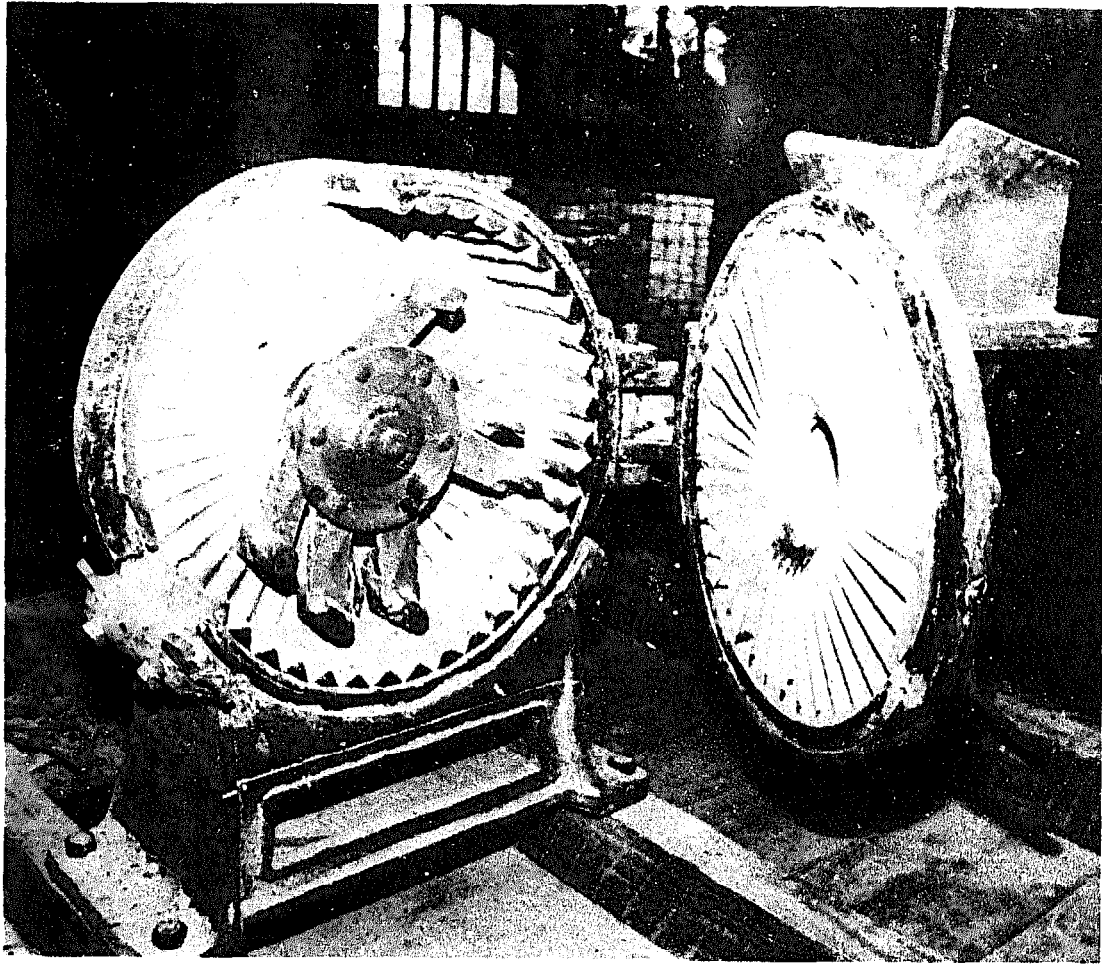

Fig. 1-10: The inside of a hammer mill. The hammers swing out when they rotate. The grog is fed through the centre hole to the right and leaves through a screen (removed) on the left.

more prone to cracking after repeated heatings. Therefore smaller items can be made with a higher proportion of fine grog while bigger items should contain a greater amount of coarse grog. Otherwise equal amounts of fine and coarse grog should be used.

Dust

In any case the grog should have the dust fraction removed. Dust will reduce the

plasticity, lower the melting point and it contains much free silica. The dust is best removed by washing.

Aluminous grog

Andalusite, silimanite, kyanite, bauxite and laterite minerals mentioned earlier can be substitutes for clay grog in the refractory mixtures described below. In clay mixtures these materials act in the same way as grog.

1.4 Kiln furniture

1.4.1 Saggars and slabs

Saggars are used for protecting the glazed ware against the action of flue gases and ashes from combustion of solid fuels, which otherwise might cause discolouration and give the glaze a rough surface where ash has settled on the ware. At higher firing temperatures firewood ash melts together with the

glaze and if the colour effect of the ash is acceptable an open setting with kiln shelves, also called slabs, is preferable. Saggars are heavier and take up more space compared to the same weight of kiln shelves. However, if the height of the setting is more than two metres a setting with kiln shelves tends to become too unstable while saggars can be stacked to above four metres. The same clay mixture can be used for both saggars and slabs though clay mixtures for kiln shelves need less plasticity.

Fig. 1-11: Saggars stacked 3 m high



Fig. 1-12: Open setting on kiln slabs in a kiln fired with wood to 1280 °C

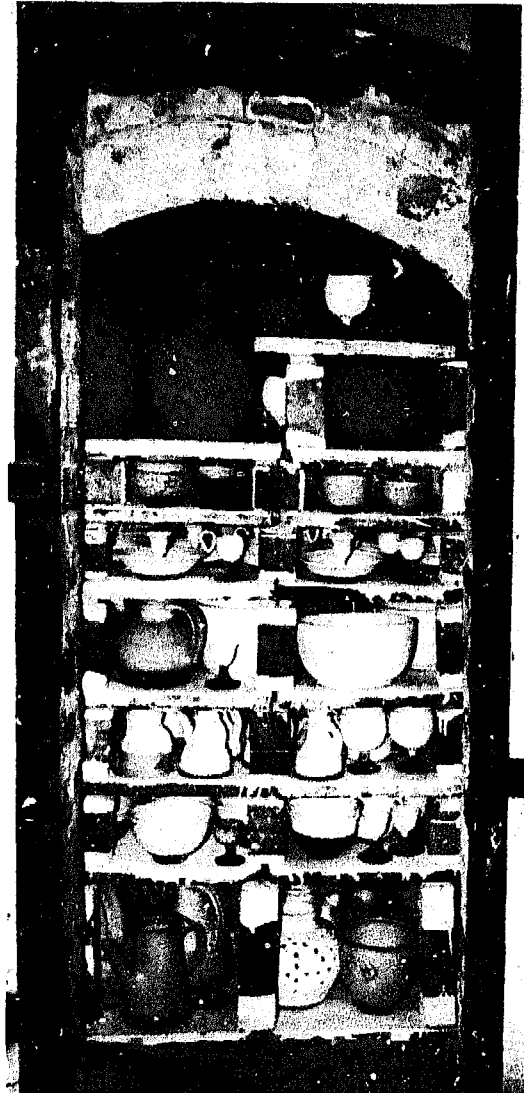

Grog content

As a rule of thumb the mixture should contain as much grog as the shaping technique allows. Normally that is 40–60% but it depends on the plasticity of the bond clay. It is unusual to find a clay being both highly plastic and refractory, and so usually the bond clay is made from a mixture of a stoneware clay or a vitrifiable plastic clay and a refractory clay such as kaolin. The bond clay should start to vitrify at a low temperature but should not soften before well above the firing temperature. The kaolin crystals in the clay start slowly to change into mullite crystals (fig. 1-13) above 1000 °C. Mullite grows into long needle-shaped crystals which form a lattice that will reinforce the fired clay in much the same way as iron bars in reinforced concrete. This lattice-work enables the kiln furniture to carry the load of the ware at high temperatures. The partly melted mass between the grog particles will enable the mullite crystals to grow freely. If the bond clay was too refractory the needle crystals could not grow properly and the slabs would bend. This can be seen from the fact that newly fired slabs tend to bend. However, after they are fired a few times

Fig. 1-13: Lattice-work of mullite crystals reinforces the fired clay. Kaolin crystals change gradually into mullite at high temperatures. The crystals are shown 100 000 times bigger than they really are.

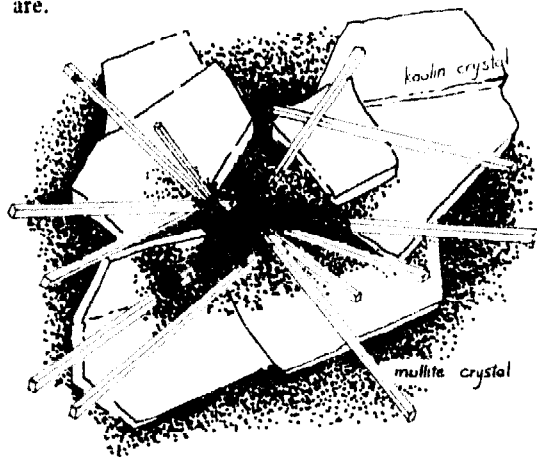

and the lattice-work is allowed time to grow they no longer bend.

As the right proportion of grog and bond clay depends on the quality of raw materials, firing temperature and shaping technique, the local potters will have to find their own recipe by trying a number of different mixtures.

Recipes

The following recipes are practical examples of saggar bodies: (parts in weight)

recipes	a	b	c
saggar clay	30	25	30
kaolin	15	15	30
grog	55	60	30

Bodies for making slabs can be made with a higher content of grog compared to bodies for saggar production.

1.4.2 Thermal shock

In most cases the potter will be more troubled with cracking of saggars or slabs than with fusion and softening of the kiln furniture. Due to their shape, saggars tend to crack more easily than slabs but the problem is often caused by the same problem, thermal shock.

Expansion

All materials expand when heated. Kiln furniture, ware and the kiln lining itself expand about 1% when heated to 1250 °C and will shrink again as the kiln cools. If the heating and cooling process is slow and even, all items in the kiln will expand or shrink at the same rate. However, if a saggar for example is heated or cooled from one side only, the two different sides of the saggar will expand at different rates. That will cause tension and the saggar could crack. Especially around 573 °C and 230 °C the heat-

ing and cooling should be done slowly (see p. 115 f.). The following can be done to reduce the problem of cracking:

1. Reduce the amount of sand (free silica) in the clay. Sand is not the only source of free silica. Clay produces free silica when heated above 1000 °C. Kaolin-type clay releases about 36 % whereas other clays as montmorillonites (bentonite) release up to 60 %. Thus a change of bond clay should be considered too.
2. Increase the amount of grog to make the fired body more porous. A porous body will more easily accommodate tensions than a dense body. Porosity of saggars should be 18–25% (see p. 42).
3. If the firing temperature is below 1250 °C an addition of 5–12% talc will improve resistance to thermal shock. Talc will reduce the melting point and therefore can be used only at lower temperatures. Talc is used for making cordierite bodies which have a high resistance to thermal shock. The formation of cordierite is difficult to achieve.
4. Biscuit-fire the kiln furniture.
5. Change the firing and cooling schedule to ensure slow change of temperature at 230 °C and 573 °C. One pottery found that saggars lasted 6–11 firings when cooling of the kiln took 24–72 hours. The same saggars lasted 50 or more times when the cooling took 168 hours (Searle, "Refractories" p. 575).

1.4.3 Saggars

Preparation of saggarr body

The different clays and grog are measured out according to the recipe. That can be done either by weight or by volume, whichever is more convenient. But take care to follow the same method each time so that the composition of the body does not vary. The grog should be wet before mixing with the clay. The clay and grog are spread out in

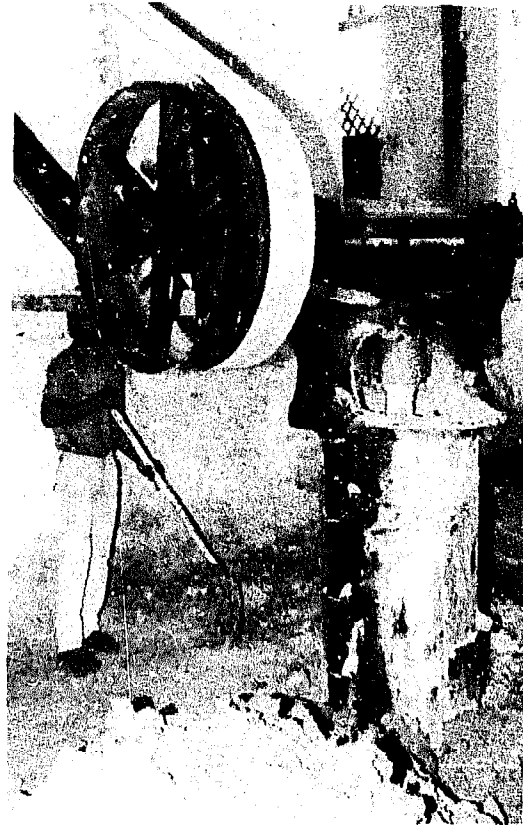

Fig. 1-14: Vertical pug mill for clay mixing. A similar pug mill can be powered by an ox.

alternate layers on top of each other. Each layer is watered as required. After one day the clay is soaked and the mixture is turned upside down with a hoe or spade or pugged in a pug mill. If necessary more water is added. It is then left to mature for two or more days while covered with plastic sheets or wet bags. Before shaping, the mixture is thoroughly kneaded either manually or in a pug mill.

1.4.4 Shaping

Saggarr shapes

The shape of the saggars should suit the size of ware and kiln to enable the packing to be as dense as possible. The shape is determined

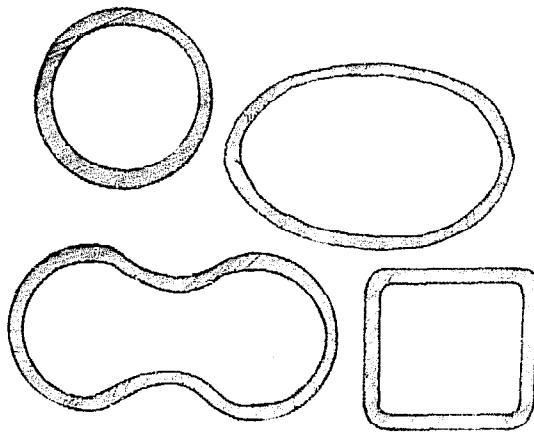

Fig. 1-15: Different shapes of saggars

by the forming method, i.e. throwing and jollying will produce only round saggars whereas with hand-moulding and slip-casting more shapes are possible.

Also, separate sides and bottoms will reduce the stress on the saggars due to thermal shock, but it demands accurate shaping.

Saggars can be made by five different methods: a) thrown on a wheel, b) jigger-jollying, c) hand-moulding, d) press-moulding and e) slip-casting.

a) Throwing

Saggars up to about 30 cm in diameter can be made by throwing on a wheel. The clay is placed on the wheel and beaten into a flat round shape of the required diameter. The inside of the saggar is then formed by beating the clay until the bottom has the right thickness (1.5–2 cm). The excess clay is now at the outer rim. A thick slurry of the same clay body is added and the clay at the rim is drawn up to form the wall of the saggar. The thickness of the wall should be even and the shape of the saggar cylindrical. The bottom is levelled and the diameter and height of the wall are checked with a ruler. The surface of the saggar is made smooth with a steel blade.

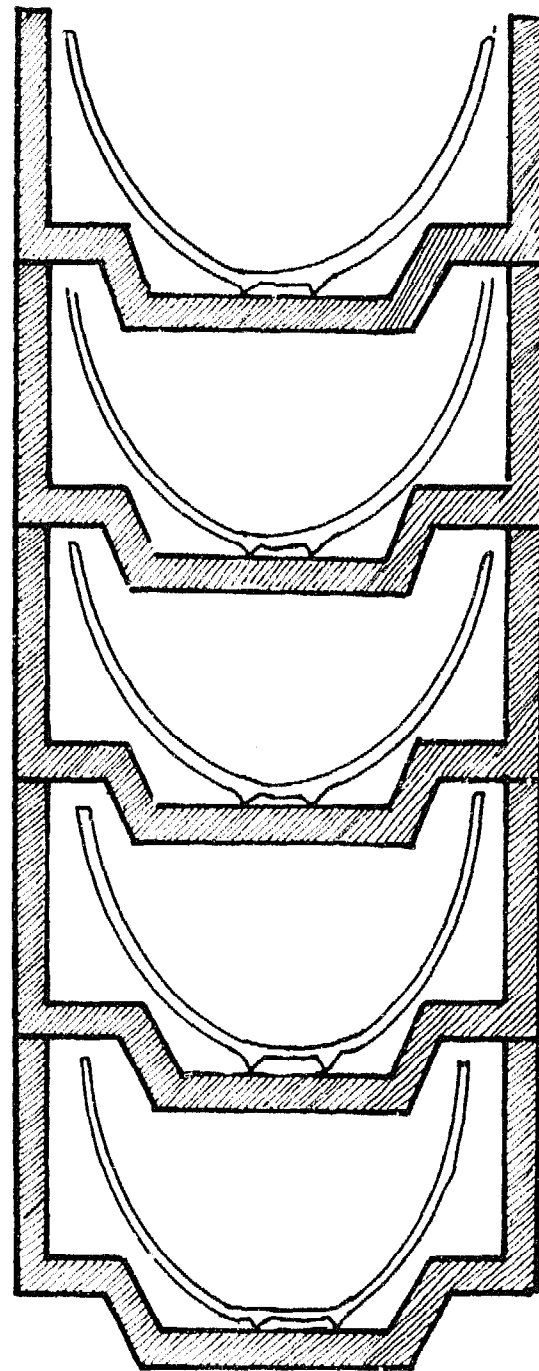

Fig. 1-16: Saggars shaped for dense setting of bowls

Saggars higher than about 10 cm cannot be thrown in one operation. After the saggar has stiffened more clay is coiled on top and the wall extended by further throwing.

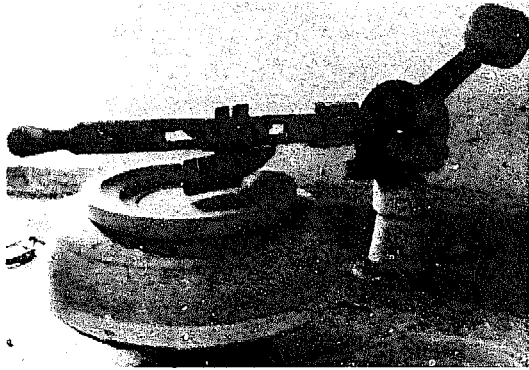
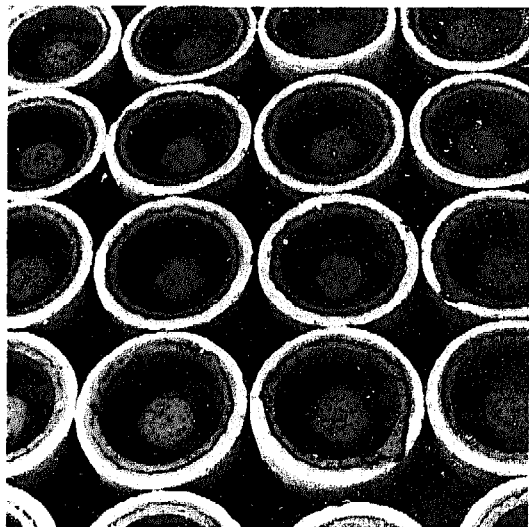

Fig. 1-17: Jolley machine with rotating plaster mould and template in this case for making plates

b) Jigger-jolleying

A saggar by this method is normally formed inside a rotating mould (jolleying) by the pressing of a template. This method is especially suitable for shaping of smaller saggars up to 20 cm in diameter. The saggars can be made into shapes which allow a dense setting. A normal potter's wheel can easily be equipped to work as a jigger-jolleying machine. The moulds are usually made of plaster of Paris but can also be made of clay burned below 900 °C to give the moulds

Fig. 1-18: Plaster moulds filled with drying saggars formed by jolleying



high porosity. The saggar clay should be softer than clay for throwing. The mould should be slightly wet before throwing the required amount of clay into it. The clay is pressed into shape by lowering the template. For bigger saggars it is necessary to press the clay out evenly inside the mould by hand before lowering the template. Excess clay is cut off at the rim and the mould is lifted off to be replaced by another.

Depending on the clay and the weather each mould can be used 2–4 times a day.

c) Hand-moulding

The saggar clay for hand-moulding should be stiff. An iron ring or frame slightly bigger than the bottom of the saggar is placed on a board. The board is dusted with fine grog and saggar clay is thrown into the frame and beaten out until it fills the frame. Excess clay is cut off by a wire and the frame is removed. The sides of the saggar are moulded

Fig. 1-19: Wooden mould for saggar-making

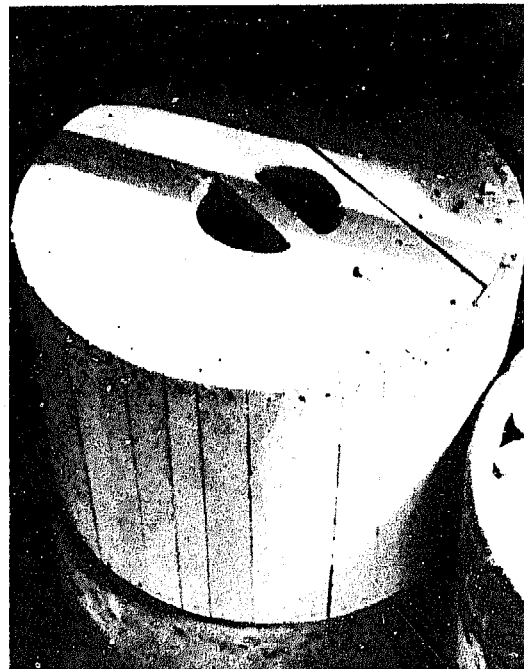

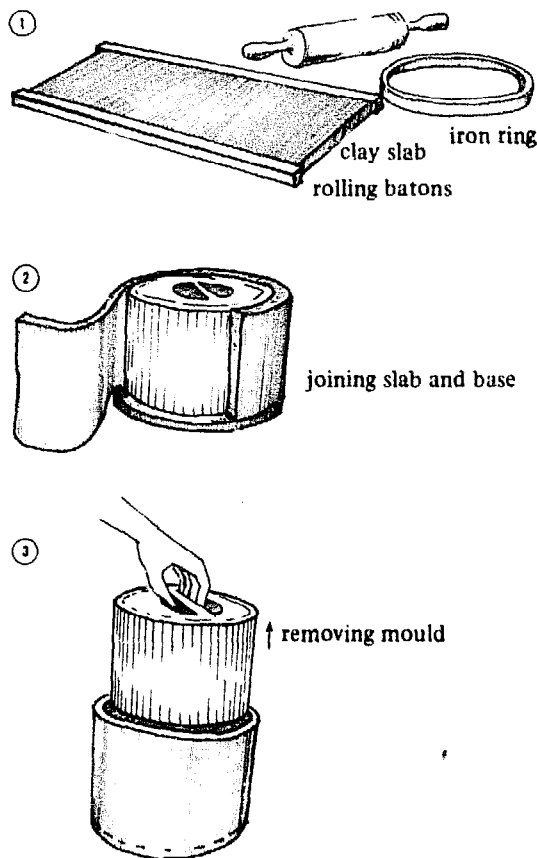

Fig. 1-20: Hand-moulding of a saggars

into a long slab of clay paste between two strips of wood fixed to a board. As before, the board is dusted and the clay is then beaten well and excess clay is cut off. This slab is then wrapped around a wooden mould or drum forming the inner shape of the saggars. The slab of clay paste can be moulded on top of a long piece of cloth which will support the clay while wrapping it around the drum. The ends of the strip are cut and kneaded together.

The drum and the clay are then placed on the previously prepared bottom which has been smeared at the joint with a clay slip. The sides and bottom are then kneaded together and excess clay at the bottom is cut off. This operation is best done on a revolving table.



Fig. 1-21: A saggars-moulding shop. On the table to the right the slabs of bottom and sides are beaten out. On the revolving table to the left the bottom and sides are joined and made smooth.

While the drum is still inside, the outer surface is made smooth with a steel blade or sponge. After removing the drum the inside is also made smooth. The saggars is left to stiffen a bit and is then turned over so that its bottom can be levelled and made smooth.

d) Press-moulding

Slabs and saggars can be pressed in a steel mould. Pressure is applied by a fly-wheel screw press which can be operated manually. Such presses are not very expensive (in India a manual saggars press in 1985 cost about \$ 1000) and produce saggars of a quality superior to hand-moulded saggars (although some saggars-makers claim that properly hand-made saggars are superior). The mould is greased with oil to ensure the proper release of the saggars. The quality is considerably improved by applying two or three extra tugs of the press. The mould should be slightly conical to enable release of the upper mould and the saggars, without distorting the clay sides. After a long period of use the mould may need machining to ensure a smooth conical surface.

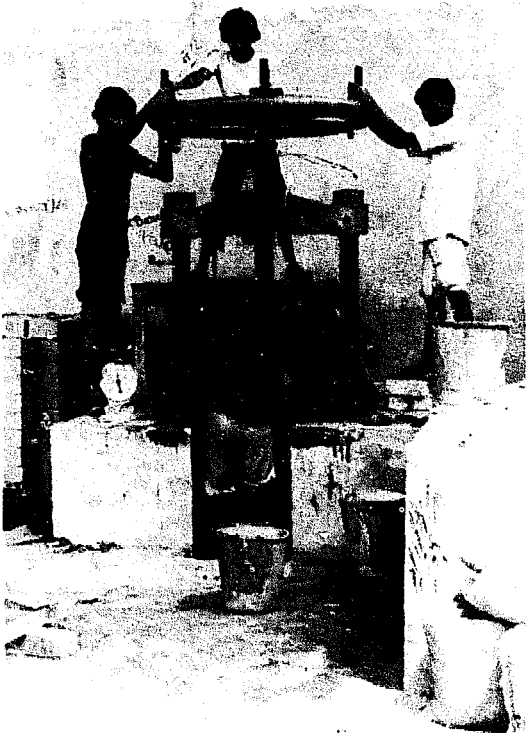

Fig. 1-22: Slabs, saggars and firebricks can be moulded in a fly-wheel press.



Fig. 1-23: Release of saggars from an electrically-powered fly-wheel press

e) Slip-casting

Slip-casting is done by pouring a clay slip into plaster of Paris moulds. The moulds will

absorb the water in the clay slip and the clay will harden. After some time the clay shape can be taken out. Saggars are normally cast in solid cast moulds (fig. 1-24).

Fig. 1-24: Plaster mould for solid slip-castings of saggars

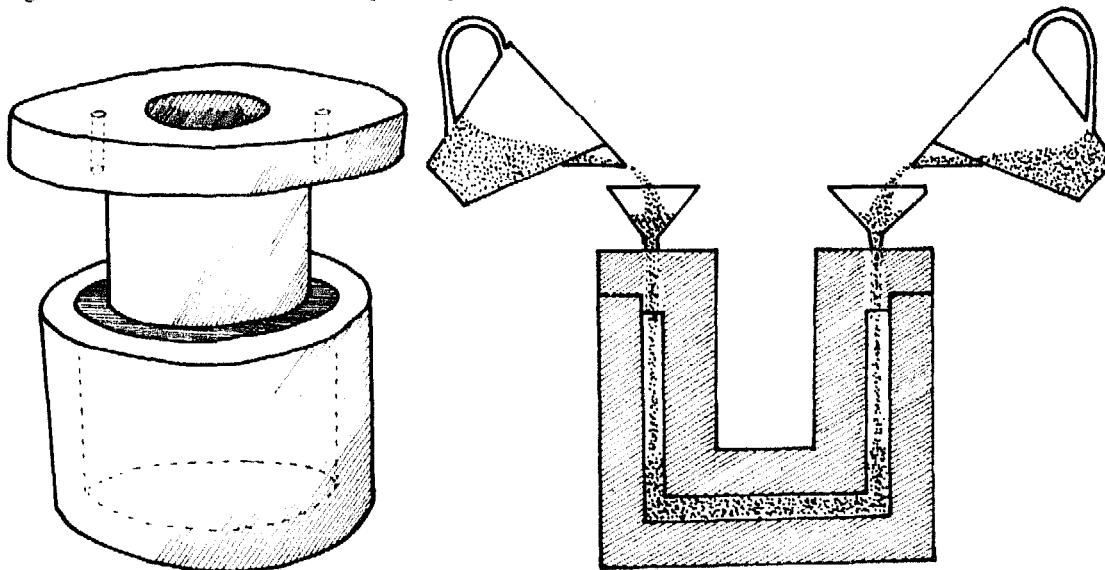

Slip-casting has the advantage that the shaping does not require plastic clay and so the mixture can contain a much higher proportion of grog compared to the other methods. Although the ceramic industry uses this method extensively, smaller potteries may experience difficulties due to the cost and availability of plaster. Furthermore, chemicals such as water glass or soda are needed for making the clay slip fluid with a water content equal to plastic clay (20–30%). Without these chemicals the water content needs to be 40–50%.

1.4.5 Kiln shelves

For an open setting, square flat kiln shelves, also called bats or slabs, are used. These are normally made by hand-moulding although they can also be press-moulded and slip-cast. Clay mixtures and clay preparation for hand-moulding are similar to those of saggar-making though a higher content of grog is permissible and the clay paste should contain less water (semi-dry).

Fig. 1-25: Kiln slabs used in a shuttle kiln



Forming

An iron or wooden frame having the shape and thickness of the finished bats is placed on a solid bench or on a concrete floor and is sprinkled with grog dust. The semi-dry clay paste is gradually added by starting at one end of the frame while beating the clay constantly with a wooden hammer. The stroke of the hammer should always have the same direction, opposite the direction of filling the frame. After filling the frame completely the surface is levelled by running a wooden stick on top of the frame. The surface is made smooth by a sponge and a steel blade used alternately. A plate fitting exactly inside the frame is placed on top of the slab while the frame is lifted off. The four sides of the clay slab are carefully made smooth and the slab is left to stiffen for about a day. It is then turned over and its bottom is made smooth.

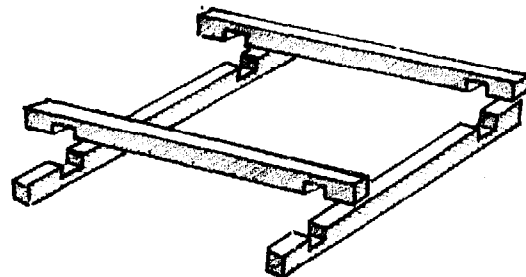

Fig. 1-26: Separable wooden frame for slab-making. The sticks have the thickness of the slab.

Thickness

The thickness and size of slabs depend on the quality of the raw materials and on the firing temperature. The higher the temperature, the thicker the slabs need to be to carry their load without bending. A slab measuring 30 x 30 cm should before drying have a thickness of 3–4 cm.

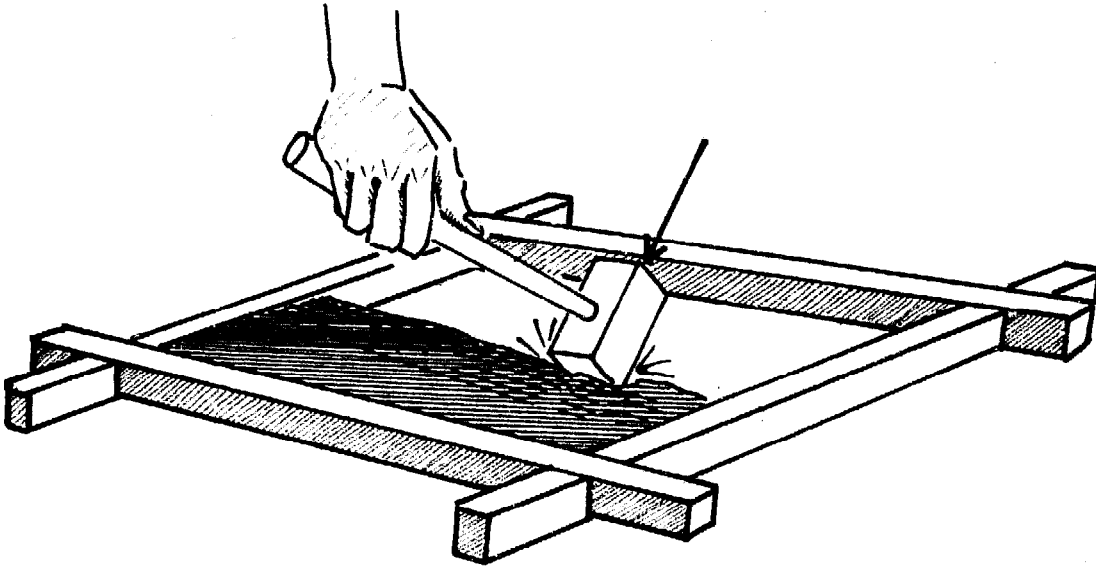

Fig. 1-27: Beginning at one end semi-dry clay is gradually filled into the frame while a wooden hammer compacts the clay with even strokes in one direction.

Firing of slabs

The slabs have to be fired once before being used. For the first firing the slabs should be fired while standing on their edge although at high temperatures they tend to warp if not supported from both sides. Alternatively they could be fired to about 1000 °C the first time. Normally slabs will bend during the first couple of firings. The remedy is to place the bent slabs with the bend upwards at the next firing. After a few firings the slabs will stop bending because reinforcing mullite crystals have formed (see p. 20).

1.4.6 Drying of saggars and slabs

Saggars and slabs should be carefully dried to avoid warping and cracking. Big saggars are particularly sensitive to stress caused by uneven drying. After stiffening sufficiently the saggars and slabs could be stacked two by two or more in order to slow the drying and reduce any tendency to warp. During dry seasons the items should be covered with plastic sheets. Saggars and slabs will crack if

the outer part sticks to the board or floor on which they rest but this can be prevented by dusting with grog or setting the saggars on paper.

1.4.7 Firing saggars

Saggars will last longer if they are fired empty the first time and to a higher temperature than they will be working under later.

Often potters will fire their green saggars on the upper layers in the kiln and they will be tempted to fill them with glazed ware too. The individual potter must try out both ways and decide for himself which is the more economical.

Sagger life

The potter should always record how many fresh saggars or slabs he fires at each firing so that he can control if the breakage of saggars or slabs becomes too high. Large saggars made from clay seldom last more than 4–6 firings up to 1250 °C. Provided a good-quality fireclay or kaolin is available for sagger-

making and the firing and cooling of the kiln is done carefully, a saggar life of 10–20 firings may be possible.

Slabs will normally withstand many more firings than saggars.

1.4.8 Glazed ware support

Various types of supports for the setting of glazed ware make it possible to place the pots more tightly in the kiln, thereby improving the firing economy. In the chapter "Loading and setting of the kiln" page 105 ff., a number of different supports are described.

Clay body

Supports such as spurs, thimbles and stilts are made by press-moulding. The body for this should be made from a fine-grained fire-clay or by mixing kaolin, silica sand and plastic clay in the following proportions:

kaolin	60
plastic clay	15
silica sand	25
(by weight)	

The clay body should be screened with a fine mesh sieve (80–100 mesh, see p. 127).



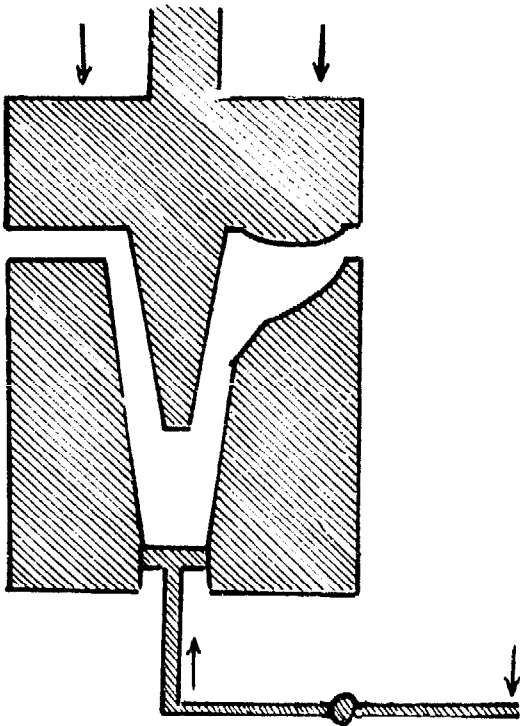
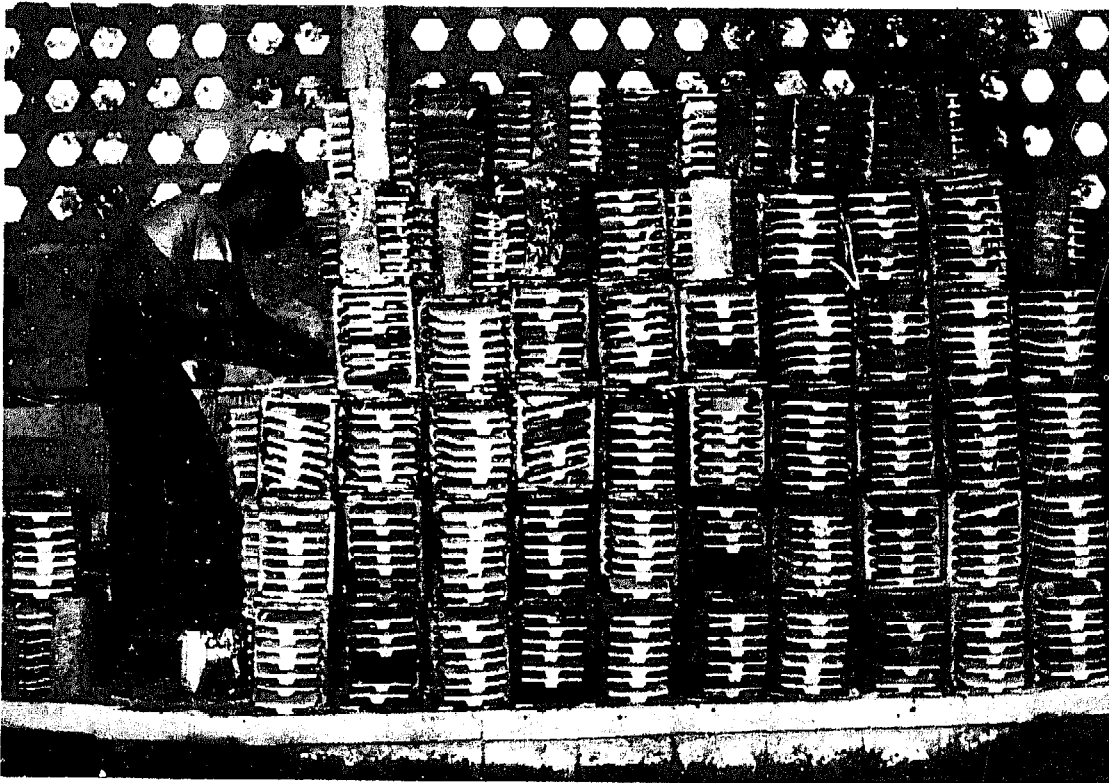

Fig. 1-29: Thimble press mould with ejector

Fig. 1-30: Tile setters for stacking glazed roofing tiles



Press-moulding

The clay body should be press-moulded in a semi-dry state with a water content of 10–15%. The higher the pressure applied in the mould the less water is needed. The mould could be made of mild steel or brass if a lever press as shown in fig. 1-28 is used. The mould should be made with a simple ejection device, which will push the finished item out of the mould. The mould should be greased with oil before each filling in order to ease the release of the press-moulded item. Alternatively oil could be mixed with the clay body. The mould could also be made of plaster or clay, but then less pressure should be applied.

Crank

Thimbles can be used for stacking flatware such as plates and tiles on top of each other

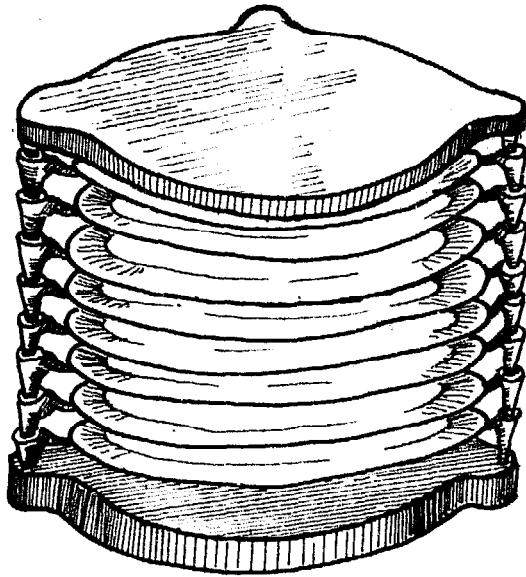

Fig. 1-31: Flat plates stacked tightly in a crank

as shown in fig. 1-31 provided that the flatware is made exactly same size.

A bottom and top plate each with three fixed sockets for the thimble pillars hold these together and the top plate also protects the ware from kiln dust. This kind of arrangement is called a crank and may hold 10–15 pieces. The top and bottom plates are made in a flat mould and formed in the same way as kiln slabs. A template should be made for measuring the exact position of the three thimble sockets, which are carved out afterwards.

Pan rings

Pan rings are used for stacking glazed plates and bowls on top of each other (fig. 1-32). The pots may rest on the pan rings with their rims upside down or they may hang on the pan rings resting on their rims (fig. 1-33).

Pan rings are made from clay bodies similar to those prescribed for kiln slabs or saggars. The pan rings can be stock-moulded in the same way as solid firebricks (p. 33), but ex-

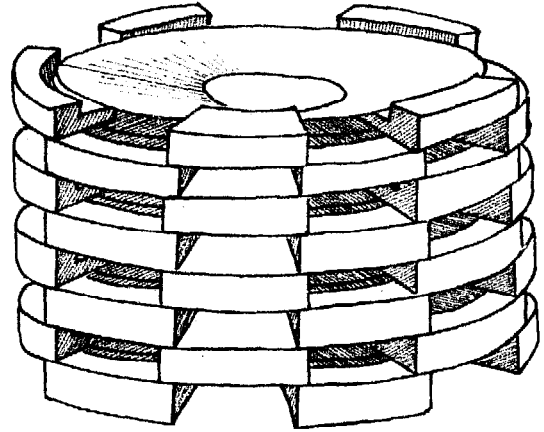

Fig. 1-32: Setting of pan rings for stacking plates and bowls

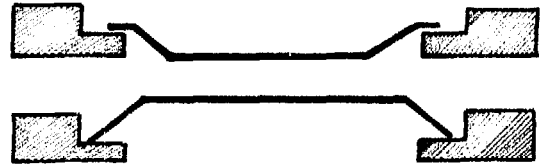

Fig. 1-33: Two different ways of setting the ware on pan rings

tra care is needed to ensure that the step of the pan ring is filled completely with clay and that the step does not break off when the pan ring is released from the mould¹. The curve of pan ring is made with a radius that fits the size of plates or bowls to be stacked.

Another method of forming pan rings is to place a thick coil of clay on a bat. The coil is laid as a ring with the desired diameter. This ring is then centred on the wheel and a template cut to the profile of the pan ring is used for shaping the ring. The ring is then cut into 8 or 12 pieces and left to dry².

The pan rings are fired and given the same kiln wash as other kiln furniture.

¹ This method is suggested by M. Cardew, "Pioneer Pottery", p. 162.

² This method is used and described by J.G. Judson, "Studio Potter Book", p. 272.

1.5 Firebricks

Firebricks are used for the construction of a potter's kiln and are also used in many other industries such as glass works, foundries and boilers. If the potters can successfully produce firebricks for their own kilns they may be able to earn extra income by selling firebricks to these other industries. Industry today uses a number of different types of firebricks according to specialized requirements, but this book will deal mainly with solid and insulating firebricks made from clay.

Solid firebricks are used for the fireboxes, chimney, bagwalls, floor and flue systems, while the kiln lining may be made of insulating firebricks.

1.5.1 Solid firebricks

Production of firebricks is less critical when compared to saggars because firebricks are not exposed to as sudden temperature changes and rough handling. Furthermore, the shaping of firebricks demands less plasticity from the clay. Some fireclays and kaolin clays can be used as dug, which is an economical method to produce solid firebricks, but grog may be a worthwhile addition to improve their refractory quality. The proportion of clay to grog will vary according to the plasticity of the clay and the conditions to which the firebricks will be exposed.

Fig. 1-34: Construction of a test kiln in Bhaktapur, Nepal. The insulating firebricks for the inner lining were fired in a pit firing.

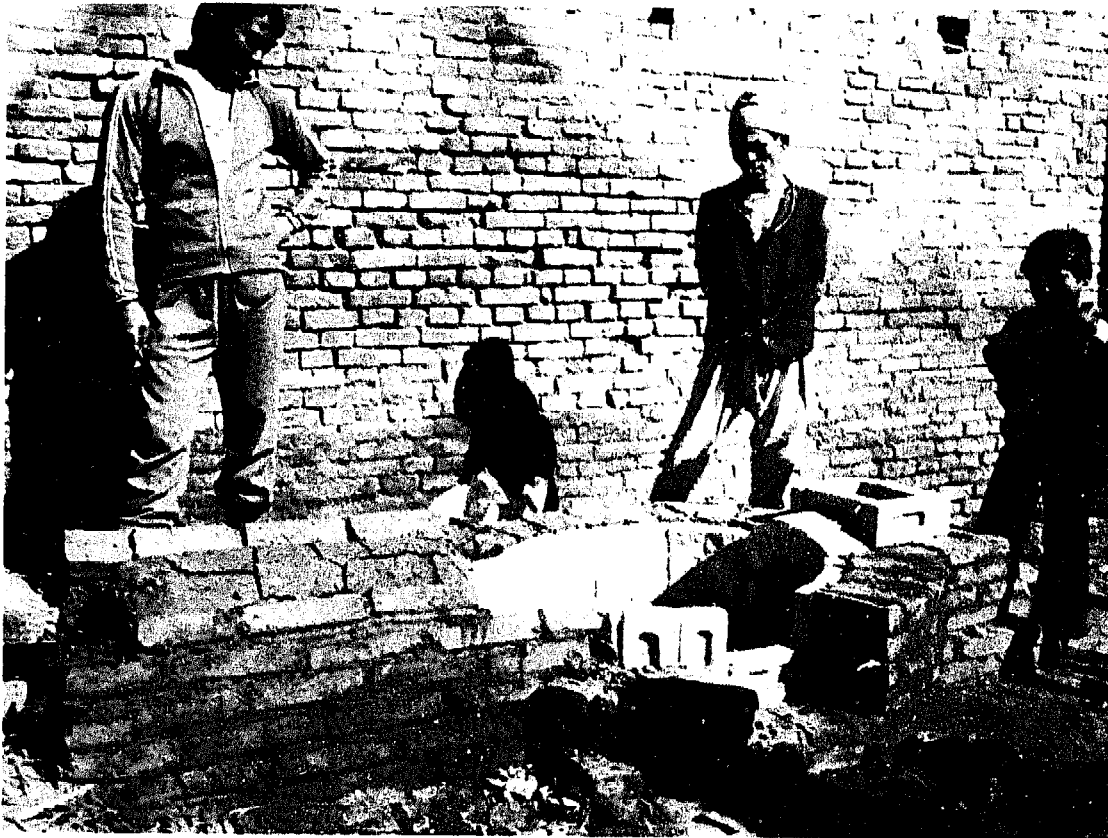

Two grades

The addition of grog increases the production cost and it may be preferable to produce two grades. For example, firebricks for fireboxes, grates and bagwalls can be made with the highest possible content of grog (60–80%) while the rest of the kiln can be made with less grog (20–40%). The same grading could also be used for the bond clay so that first-grade bond clay, which has had its sand fraction removed, will allow for a higher content of grog.

Bond clay

The clay binding the grog together should be less refractory than the grog. Otherwise the brick will become brittle after firing. But the bond clay should not vitrify excessively or fuse because if the firebrick becomes too dense it will tend to spall after long use though a high grog content will counterbalance this tendency. Often the best solution is mixing two different clays, e.g. a fusible stoneware clay with a fireclay or kaolin clay. The proportion will depend on the quality of the clays and the intended firing temperature.

8 solid firebrick recipes

	a	b	c	d	e
Fireclay	80	60	50	40	30
Fireclay grog	20	40	50	60	70
	f	g	h		
Stoneware clay	10	10	20		
Kaolin	30	40	40		
Kaolin grog	60	50	40		

(measured by weight)

The mixing and preparation of the clay and grog should be carried out as described for saggar bodies. However, the moulding of bricks demands much less plasticity and so the water content can be lower.

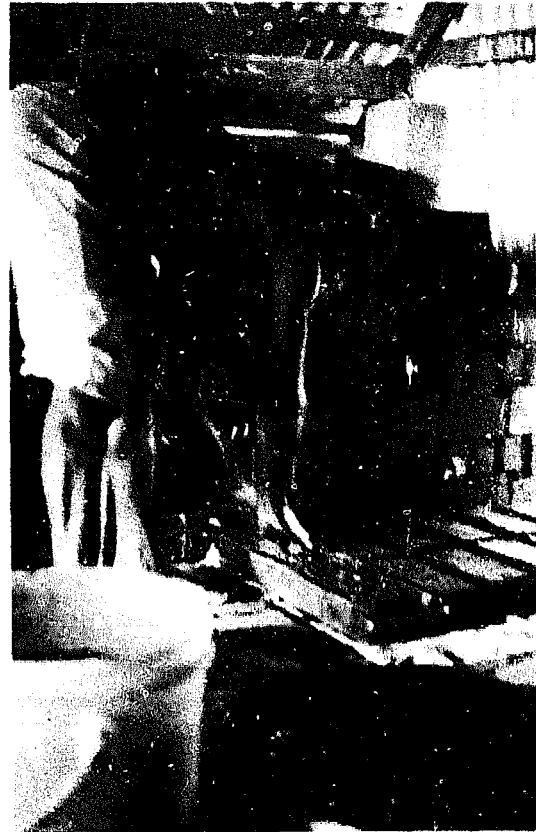
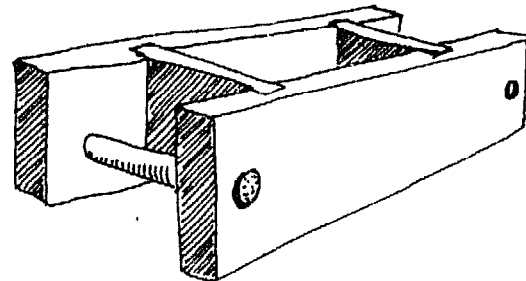

Fig. 1-35: Slop-moulding of bricks

Slop-moulding

Slop-moulding is done with a very soft clay paste. The mould frame is first dipped in water and then placed on a ground which has been levelled and dusted. The soft clay is forcefully filled into the mould and the top is levelled off by using a stick. The mould is then lifted and the brick is left to dry on the

Fig. 1-36: Slop-moulding frame



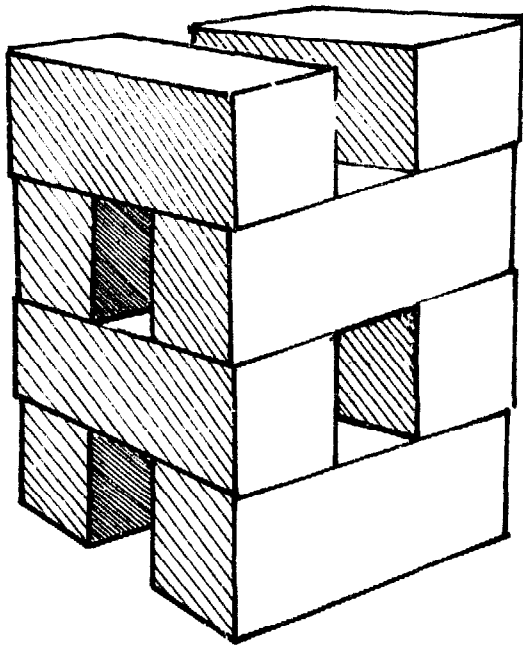

Fig. 1-37: Open stacking of firebricks for even drying

ground. At first the bricks will be too soft to handle but after a day or so they will be strong enough to stack for further drying. They should be stacked as shown in fig. 1-37 so that air can dry the bricks from all sides. The slop-moulding technique is very fast but the bricks will have irregular shapes. It is mainly used for common red bricks, which are also needed for the kiln construction.

Stock-moulding

Higher density, more accurate shapes and greater firing strength are achieved by stock-moulding. A stiff clay paste is used in this method. The mould has two pieces; the bottom of the mould, which is called a stock, is fixed to a solid table and the top piece, called a frame, fits loosely onto it (fig. 1-38). The inside of the brick mould should measure the size of the finished brick plus the total drying and firing shrinkage which can be determined from the testing of the firebrick mixture (p. 40 f.). The moulder should first

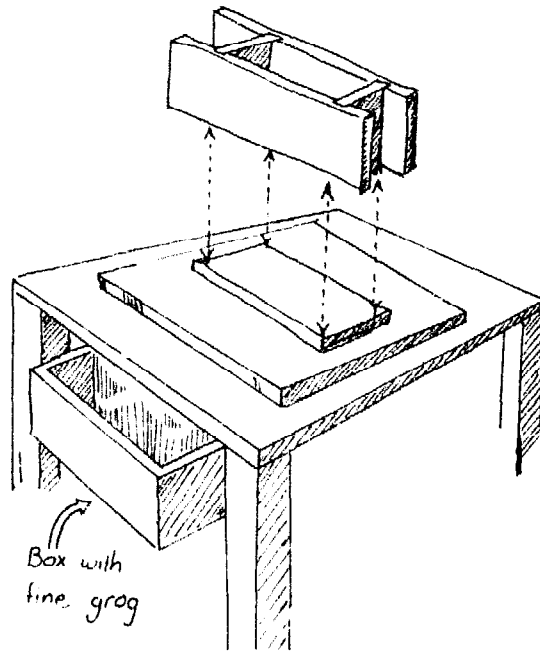

Fig. 1-38: Stock mould fixed to a solid table

Fig. 1-39: Separable frame for moulding with semi-dry clay mixtures. The clay is pounded repeatedly while being filled into the mould.



prepare a lump of clay by bumping it several times on the table, giving it a square form which is slightly bigger than the inside of the mould. From above the head the clay should be thrown with full force into the well dusted mould. The clay should fill all corners of the mould and is then levelled off at the top with a stick. The mould is then lifted, with the brick inside, and an assistant can carry the mould to the drying ground where it is emptied by gently knocking the mould. Normally the bricks can be placed on their edge immediately. For firebricks, dusting is done with fine grog and not sand.

Special shapes

Wedge and arch bricks are moulded like square bricks but in specially made frames. Small numbers of special shapes, such as

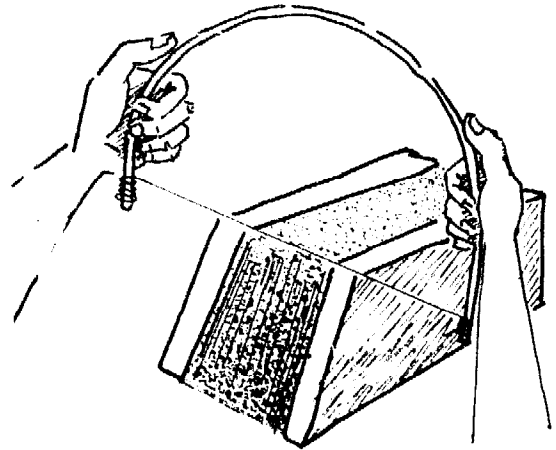
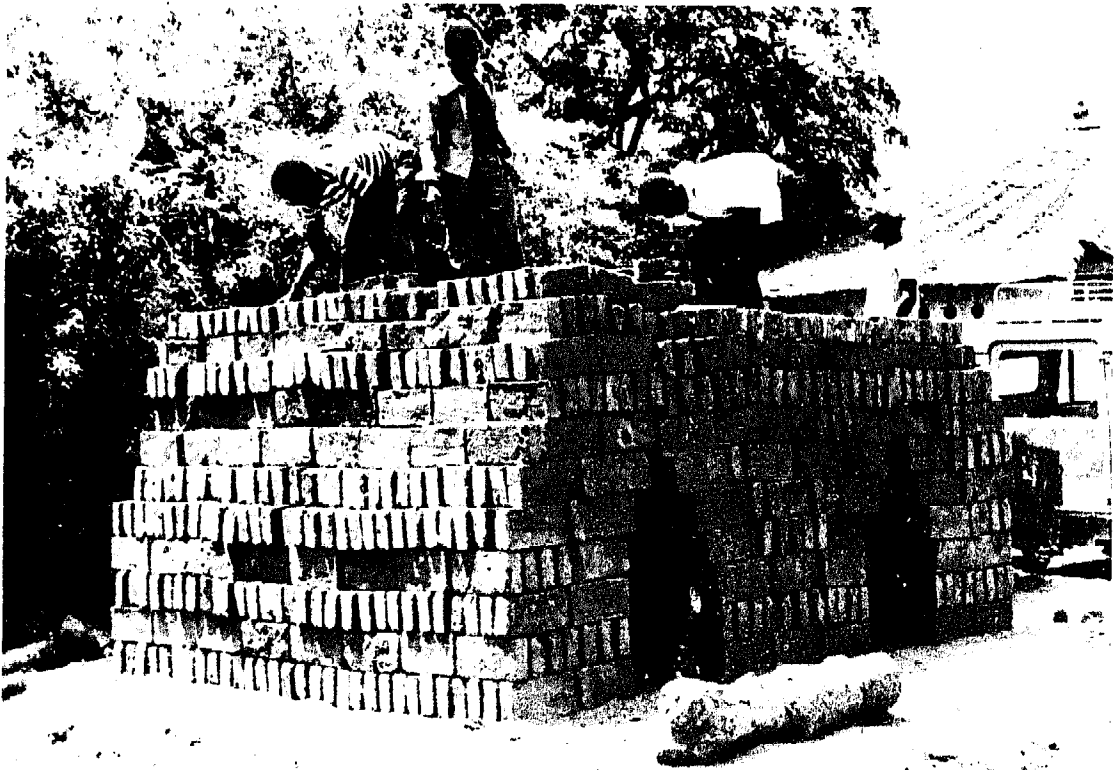

Fig. 1-40: Cutting of special shapes with the help of two templates

bricks for skewbacks or rounded bricks for flue channels, can be made by cutting freshly moulded square bricks. The square brick is placed between two templates of wood which have the desired profile, and a wire is

Fig. 1-41: Stacking bricks for firing in a clamp kiln. When all bricks are set the kiln is sealed with a plaster of clay and firing takes place in the two fireboxes.



then drawn along the templates, cutting the brick (fig. 1-40).

Firing solid firebricks

The problem in firing solid firebricks is that they should be fired at a higher temperature than the one at which they will be used later. (The same applies for insulating firebricks and kiln furniture.) If the pottery is already one that is in production then the bricks should be fired next to the bagwalls or in other hot spots in the kiln. In case no kiln is at hand, the bricks will need to be fired in a clamp kiln where the firing temperature will seldom exceed 900 °C.

Kilns made of these low-fired bricks will tend to crack more than usual. This is caused by the extra shrinkage of the firebricks when they, as part of the brickwork in the new kiln, are exposed to a much higher temperature.

1.5.2 Insulating firebricks

Insulating firebricks are made of a mixture of fireclay and sawdust. Other combustible materials such as coal, lignite, peat, rice husks, etc. can also be used as fillers and should be prepared like sawdust. The sawdust will burn away in the kiln and leave plenty of holes in the bricks. These holes make the bricks better heat insulators when they become part of a kiln because heat cannot pass through motionless air which is trapped in the holes. The insulating firebricks have several advantages over ordinary firebricks. These are:

1. Less heat escapes through the kiln walls.
2. Less fuel is needed to heat an insulating inner wall because it is less dense.
3. The surface of an insulating inner wall is hotter during firing and the increased glow increases the radiance of heat to the ware (p. 88).

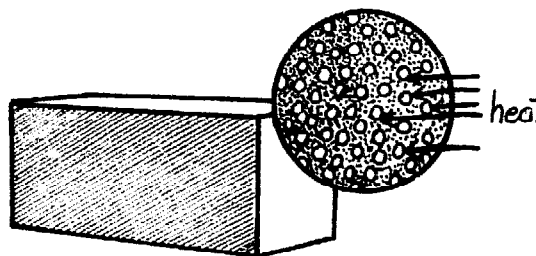

Fig. 1-42: Heat going through a sawdust insulating brick is stopped by all the pockets of air left by the burned out sawdust particles.

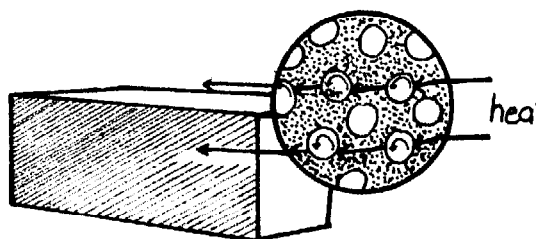

Fig. 1-43: If the insulating holes are too big the air inside the holes can rotate and thereby heat is transferred through the brick.

4. They are cheaper to make by using less clay and needing no grog.

For these reasons insulating firebricks should be used as much as possible. However, due to their open structure they are sensitive to slag attack and cannot be used in salt glazing kilns.

Insulating bricks will collapse at a lower temperature compared to grog firebricks made from the same clay.

Sawdust

The sawdust should be screened through a mesh of at least mosquito net size. (This is 16 mesh but 24–30 mesh is preferable.) If the particles are too big the resultant holes in the finished brick will allow the air inside to rotate, which means the air will transfer heat (fig. 1-43). On the other hand, dust-size particles should be avoided. Hardwood sawdust results in smaller pores than sawdust from softwood, but hardwood sawdust is not always available.

Bond clay

For a bond clay, the clay should be as refractory as possible especially if the bricks are for the inner lining. For a back-up insulation behind an inner lining inferior clay may be used. The clay should have good binding power so that it can take a lot of sawdust. The binding power of the clay can be improved by the removal of its sand by washing. A washed kaolin clay with the addition of 10–20% plastic clay often produces very good bricks.

Sawdust/clay mixtures

The more refractoriness and binding power the bond clay possesses, the more sawdust can be added to it. The potter will have to test a number of different mixtures and perhaps even different bond clays. Measured by volume the sawdust content will be about 40–60% with the remaining part bond clay. After adding water to the sawdust and clay, it should be mixed very thoroughly. The mixture is left a few days before moulding.

Moulding

Stock-moulding will produce more accurate shapes, but the sawdust tends to make the insulating bricks stick to the mould. The softer clay mixture used for slop-moulding is more easily released and the additional amount of water will also increase the porosity of the finished brick. The choice of moulding method could be made after letting the moulder try out both methods. Sawdust bricks take a long time to dry due to the great amount of water taken up by the sawdust. But the bricks will seldom crack during drying because the sawdust reinforces the clay body and gives the clay a very open structure.

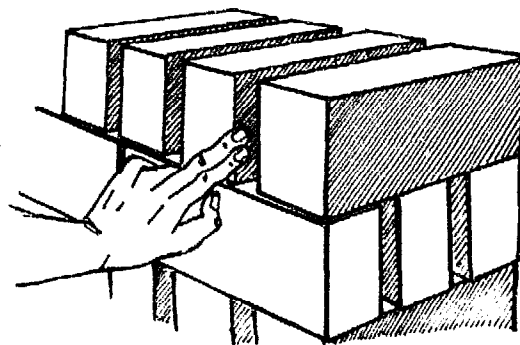

Fig. 1-44: Sawdust bricks are placed a finger's space apart during firing.

Firing

The bricks should be stacked in the kiln as shown in fig. 1-44. The burning out of the sawdust will raise the temperature rapidly and it will be necessary to stop adding fuel while the sawdust burns. Otherwise, the rapid increase of temperature will cause distortions in the bricks. The firing is easier to control if the sawdust bricks are fired in smaller quantities along with other ware.

1.5.3 Ash bricks

Silica in ash

Ash can be mixed with a bond clay to make insulating bricks for use with temperatures up to around 1100 °C. The refractory value of the finished bricks very much depends on the type of ash which is used. Ash of rice husks contains more than 90% silica and high silica contents are also found in ashes of rice straw and thatching grass¹.

Ash testing

Some ashes have high contents of minerals which lower the melting point. These are

¹ M. Cardew, *Pioneer Pottery*, p. 42.

useful in glazes but not in firebricks. It is necessary therefore to make practical tests with the ash in question before using it.

A mixture of four parts ash to one part clay (by volume) is a good starting point.

Ash washing

Ashes high in potash and soda should have these soluble minerals removed by washing so that they are less caustic to work with. The removal of soda and potash will also raise the melting point of the ash. The washing can be done by leaving the ash in a pit outside during the rain.

Amorphous silica

The silica in ash has no crystal forms like the silica found in sand and quartz rocks, and because of this it is called amorphous. The importance of this lack of crystals is that amorphous silica does not shrink or expand suddenly as does the silica with crystal form (see p. 12).

If ash bricks were made using a similar amount of silica but in the form of sand (crystal form), these bricks would be very prone to spalling or cracking due to sudden changes in temperature (thermal shock). The ash bricks using amorphous silica are much less likely to suffer these effects. The disadvantage with ash bricks is that the amorphous silica is much less refractory, and hence they are unsuitable for very high temperatures.

Low duty

Ash bricks may be used in low temperature kilns and as back-up insulation in high temperature kilns but in either case thorough testing is necessary before relying on a particular ash and clay mixture.

1.5.4 Hollow firebricks

Fig. 1-45 shows press-moulded firebricks with two hollow rooms. These rooms are filled with rice-husk ash during construction. The kiln seen in the picture is constructed from these bricks and is fired to 1250 °C. Due to the low thermal mass of the kiln lining, the kiln is very fuel-efficient. It has been developed by the Central Glass & Ceramic Research Institute of India with the aim of improving fuel economy of the round down-draught kilns at Khurja (p. 51).

Fig. 1-45: The hollow spaces of these firebricks are filled with rice husk ash. A prototype of a low thermal mass kiln developed at the Khurja Centre is seen behind the bricks.



1.5.5 Mortars

Mortars are used for joining firebricks in the kiln structure. They are also used for protective coatings of brickwork such as the lining of fireboxes. The mortars should resemble the bricks they join so that the joints and the bricks expand and shrink at the same rate during a firing cycle. To enable an easy laying of the bricks the mortar should be plastic.

Grog

Fine refractory grog (passing at least 24 mesh) should be used for reducing shrinkage in the joints. If the joints shrink too much they will fall out after only a few firings. Sand can also be used instead of grog, but too much sand will cause spalling of the joints. The amount of grog or sand depends on the bond clay, which may already contain sand. Usually grog makes up 50–65% of the mortar.

Bond clay

The bond clay could be the same as that used for making the bricks. The bond clay should be refractory, but it is better if the mortar is slightly fusible so that the joints will form a strong bond between the bricks. This can be achieved by adding a fusible plastic clay to the refractory bond clay. The exact amount of fusible clay depends on the firing temperature and if possible a few tests should be done. Normally 20–30% of the bond clay could be fusible clay, and the remaining part be similar to the refractory clay of the bricks.

Mortar recipes

The following recipes are examples measured in weight:

(a)	fireclay	40
	grog 40 mesh	60
(b)	kaolin	25
	stoneware clay	8
	grog 24 mesh	67
(c) ¹	sand	40
	grog	40
	stoneware clay	20
(d) ²	grog (or sand)	1
	fireclay	2

The mortar should be applied as thinly as possible. In case large gaps need to be filled by mortar it is better to add a lot of coarse grog.

Outer walls

The outer walls are laid with common red bricks and a mortar made of a normal clayey soil can be used for the outside. Where the walls will be exposed to rain, the joints should be pointed with a sand/lime mortar in the proportion of five parts sand to two parts lime.

1.6 Testing refractories

Bagwalls, flue linings or saggars that give in during firing may ruin both the kiln and the ware. To avoid these problems tests can be done to ensure that the materials will withstand the severe conditions to which they will be exposed during many cycles of firings. Therefore before trusting a refractory raw material or a refractory product, say a firebrick, some simple tests should be carried out. Simple tests of clay supplies can also tell us whether we get the clay we expected and which may have been paid for dearly.

¹ Japanese mortar quoted from F. Olsen "The Kiln Book" (p. 18)

² From D. Rhodes "Kilns" (p. 94)

1.6.1 High temperature testing

Ceramic institute

The first thing we want to know is: can the clay withstand high temperatures? For this, a kiln which can withstand temperatures of 1300–1400 °C would be ideal for testing. Few potters will have access to such a kiln, but a sample of the clay could be sent through local authorities to the national geological department or ceramic institute which will normally be interested in gaining information about suitable clay sources.

Production kiln

Quicker results could be obtained by firing the test piece in the flue, in front of the firebox, or on top of the bagwall of a potter's kiln. The temperature may not be 1300–1400 °C but it is most likely the highest temperature the material will have to withstand in practice.

Test kiln

In case no high temperature kiln is available, a small test kiln could be constructed. In extreme cases, where there are no proper refractories available for the construction of a test kiln, (this was once experienced by the author in Africa) the test kiln, built of the untried refractories and fired to as high a temperature as possible, becomes the test itself. A small test kiln is also useful for firing glaze and body tests and the one shown in fig. 1-46 is not expensive to construct. By changing the firebox arrangement it can be fired with firewood, oil or coal (p. 73–87).

1.6.2 Refractory materials and bodies

In most cases it will already have been established whether or not the type of clay in question is suitable for high temperatures and the individual potter or local pottery development centre will only need to check the

Fig. 1-46: Test kiln

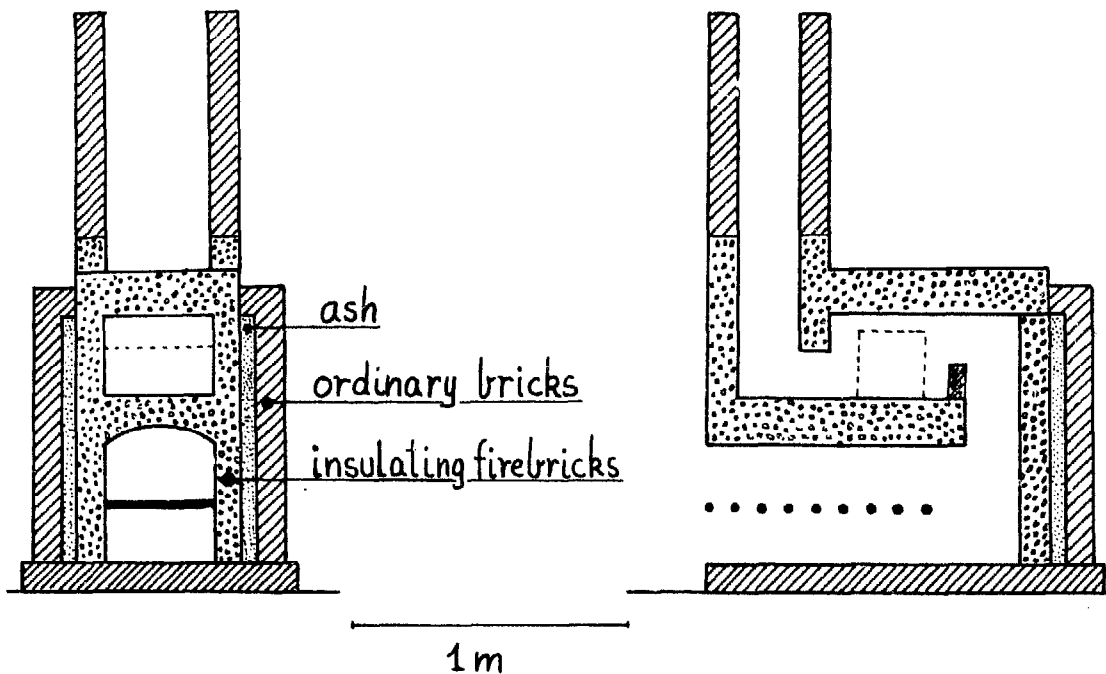

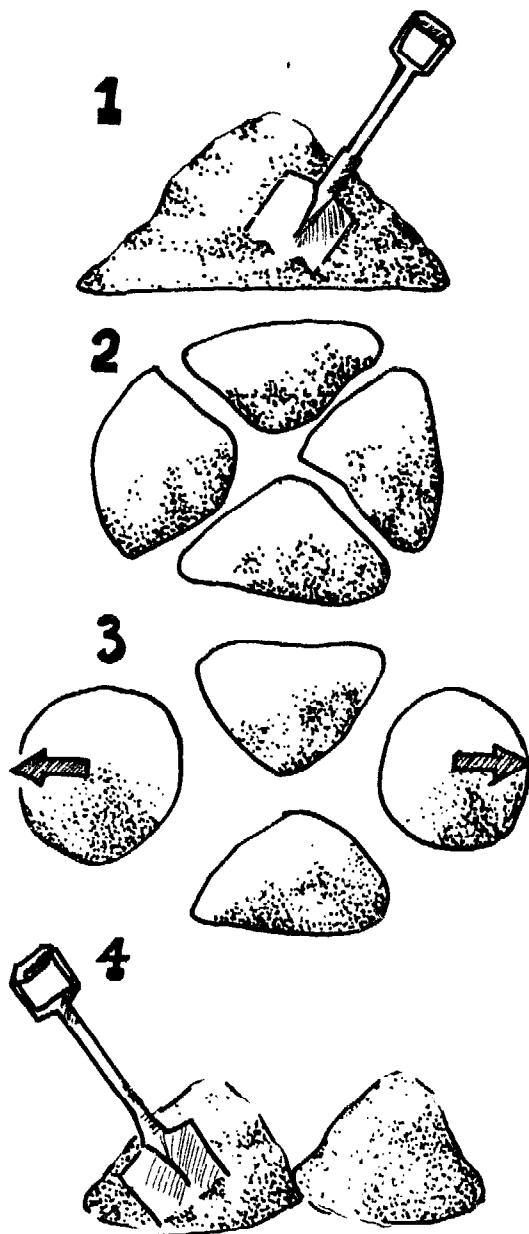
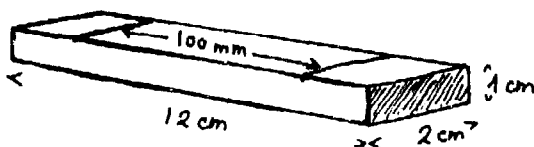

Fig. 1-47: The method of quartering: 1. The sample is mixed well. 2. It is then divided into four portions. 3. Two portions are removed. 4. The remaining two portions are mixed well and another cycle of quartering can start.

Fig. 1-48: Test bar for measuring shrinkage



quality of clay supply and refractory body mixtures. The following tests should be carried out with new batches of clay.

Sampling

The clay to be tested should be collected from at least four different places at the clay deposit or from where the clay has been dumped. The four samples of about equal size are mixed well on a swept concrete floor. The sampled clay is then divided into four equal portions. Two portions opposite each other are set aside and the other two are mixed thoroughly. This process of dividing and mixing should be repeated at least four times. This method is called quartering (fig. 1-47) and ensures that the final sample is representative of the bulk of the clay.

Moisture content

A sample of about 100 g is weighed on a scale. The weight W_m is recorded and the sample is heated to 110–200 °C for an hour so that all water evaporates. It is then put on the scale again immediately and the dry weight W_d recorded.

Moisture content in per cent

$$= \frac{W_m - W_d}{W_d} \times 100$$

When the clay is purchased by weight the moisture content shows how much water has been paid for. When weighing the clay according to recipes, excessive amounts of water in the clay should be compensated for.

Shrinking test

The clay is mixed with water to normal plasticity and 5–10 test bars measuring 1x2x 12 cm are formed. A wooden mould makes this job more easy. Two parallel lines exactly 100 mm apart are marked across all the test bars. While drying, the test bars should be turned over now and then in order to avoid

warping. When the test bars feel dry the distance between the two cross-lines are measured in mm on all bars and the amount of drying shrinkage is found:

Drying shrinkage in per cent

$$= \frac{100 - \text{Dry length}}{100} \times 100$$

As the distance was 100 mm the shrinkage in mm is equal to shrinkage in per cent. After firing the test bar to the highest temperature possible additional shrinkage is measured in mm and recorded as:

Firing shrinkage in per cent

$$= \frac{\text{Dry length} - \text{Fired length}}{\text{Dry length}} \times 100$$

Total shrinkage in per cent = $100 - \frac{\text{Fired length}}{\text{Dry length}} \times 100$

The drying shrinkage indicates to some degree the plasticity of the clay. A large drying shrinkage means that the plastic clay could absorb much water, which in turn indicates fine clay particles. The figure for drying shrinkage should be compared with figures of former supplies to see if the present batch is of the same quality.

The firing shrinkage indicates how fusible the clay is. A high shrinkage normally means a lower melting point. The total shrinkage of refractory bodies tells us how much bigger we should make our moulds. In case we want our slab to measure 30x30 cm and the total shrinkage of the clay/grog mixture is 8% then our mould frame should measure:

$$30 + \frac{30 \times 8}{100} \text{ cm} = 32.4 \text{ cm on each side.}$$

Softening point

The test bars are placed in the kiln as shown in fig. 1-49. The test bars should be supported so that the free span equals the distance between the cross-lines of the test bar. If possible cones should be placed next to the test bars to show the temperature. After firing the amount of bending is compared

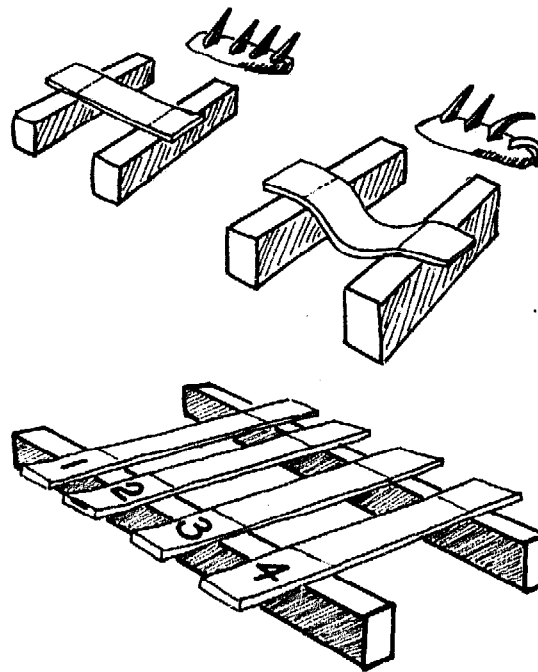

Fig. 1-49: Setting of test bars for firing. The bending of the bars is compared with the bending of cones.

with the cones and results from former tests. When testing a new clay the test bar should be placed so that it can be viewed through a spyhole and the approximate temperature at which bending starts is noted.

Pore water

After measuring drying shrinkage some of the test bars can be used for measuring the amount of pore water. Pore water is the water that is left in the clay after the water of plasticity has evaporated. The pore water will only leave the clay above 100 °C during the smoking period of biscuit firing (see p. 113).

First the weight, W_d , of the dry test bar is found and recorded and the test bar is heated to 110–200 °C for one hour. Immediately after that the test bar is weighed again, weight W_p is recorded and the percentage of pore water can be computed:

Pore water in per cent

$$= \frac{W_d - W_p}{W_p} \times 100$$

The pore water percentage expresses the fineness of the clay particles or the plasticity of the clay. The test is simple and is good for ensuring that new supplies of clay do not contain too much sand.

The following pore water contents are typical:

kaolin 1.5 %, fireclay 3.5 %, ball clay 6.1 %, brick clay 2.2 %, bentonite 14 %

Plasticity

The results of drying shrinkage and pore water content tests discussed above are an accurate indicator of a clay's plasticity. However, the first and most simple test for any potter is to wet a small portion of the clay in the palm of his hand and get the "feel" of it. The clay is rolled into a pencil shape and the more this "pencil" can be bent into a ring without rupturing, the more plastic the clay is.

Particle size

A quick test of new clay supplies can be done by making the clay into a thin slurry and screening it through one or more very fine sieves. A 200 mesh sieve holds back particles bigger than 0.0076 mm. The residue on the screen is dried and put on the scale. If the weight of this residue is called W_r and the dry weight of the total sample W_c ,

Size less 200 mesh in per cent

$$= \frac{W_c - W_r}{W_c} \times 100$$

This figure can be used to check the amount of sand in the clay. Some fine sand will pass a 200 mesh sieve, but for comparing the

quality of new batches of clay with former supplies it is accurate enough.

1.6.3 Refractory items

"Spalling count" test

Besides possessing refractoriness our refractory products such as firebricks and saggars should be able to withstand many cycles of heating and cooling without cracking or spalling. The ability to withstand thermal shocks is tested by heating a standard-size (appr. $23 \times 11.5 \times 6.5$ cm) firebrick to around 900°C . The hot firebrick is then picked out of the kiln and plunged into water of room temperature. This is repeated until half of the brick measured by weight has cracked away due to this shock treatment. If the brick can endure 10 cycles of such heating and cooling it is very satisfactory. The clay body for saggars or slabs is formed into bricks and tested in the same way.

Water absorption

If the clay body of saggars or bricks becomes too dense it will be more prone to cracking due to thermal shocks. The more dense a body is the less water it will absorb. So the density (or porosity) can be measured by soaking a piece of the fired clay body in water for at least 24 hours. It is then taken up and after its surface is wiped dry its weight, W_w , is found. The soaked test piece is then heated at $110\text{--}200^\circ\text{C}$ for one hour and its dry weight, W_d , is recorded. Porosity or more accurately the water absorption can be estimated.

Water absorption in per cent

$$= \frac{W_w - W_d}{W_d} \times 100$$

For saggars and slabs a figure of 18--25 % is reasonable.

2. Kilns

2.1 Development of kilns

A kiln may be described as an enclosure to contain heat. Potters use it to fire their pots and they have developed a countless number of different kiln types, each one reflecting the demands of local markets, tradition, skills and materials.

Even so the basics of all ceramic kilns are the same; heat is introduced into the enclosure surrounding the pots. Some heat is lost through the walls or is carried away with the combustion gases, but as more heat is introduced than escapes, the temperature rises and the pots will mature.

2.1.1 Bonfire kilns

The oldest type of kiln, dating back more than 10,000 years, is the bonfire kiln. These kilns are still widely used for firing tradi-

tional unglazed red ware (terracotta) because they are still the most suitable for small-scale production of low-fired pottery. This is due to the fact that no investment is needed for a permanent kiln, that the firing at most takes a few hours and that cheap and readily available fuels such as straw, grass and cowdung can be used.

Sukuma potters

The Sukuma women in Western Tanzania often use split roots of sisal as a fuel (fig. 2-2). The roots produce intense heat and the firing takes no more than half an hour. The pots are fired no higher than 700 °C. This is an advantage for pots made for cooking over an open fire because the clay has not started to sinter and its open structure can more easily adjust to the thermal shock of being put over a fire.

Fig. 2-1: Bonfire kiln

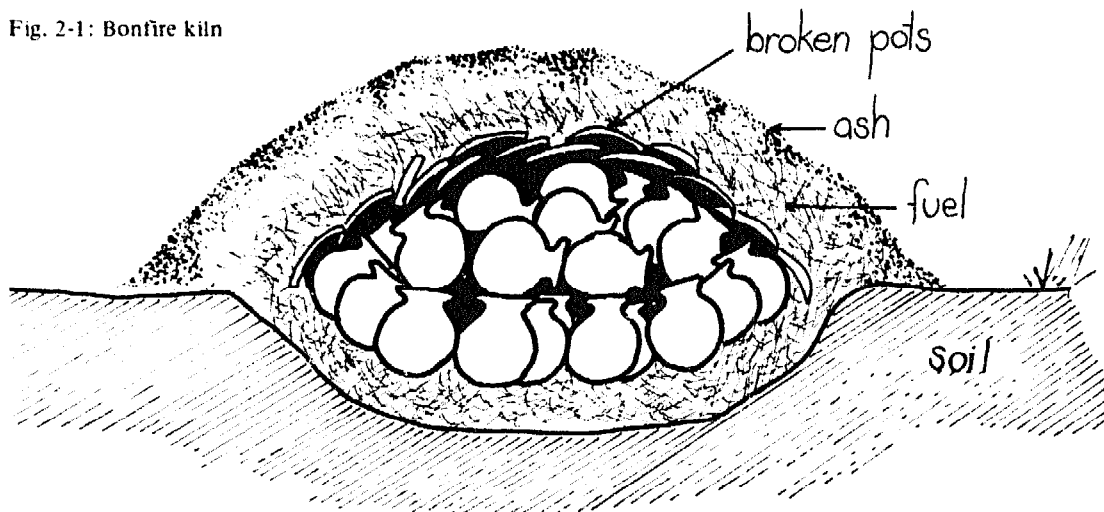



Fig. 2-2: Sukuma potters firing their pots with sisal roots in a bonfire kiln. Bujora, Tanzania.

Fig. 2-3: Bark "glaze" is applied to the still hot pots. ▷

The pots are dried in the sun the whole day so that moisture in the pots will not crack them when they are exposed to the sudden heat. The pots are raised a bit on a layer of broken pots and some sticks of sisal roots are placed in between. About two layers of roots are placed around the small heap of pots and set on fire. Another layer of roots is added during the fire and sometimes more where the fire consumes the roots too fast. Before the pots have cooled they are raked out of the smouldering fire and beaten with branches (fig. 2-3) dipped in a bark soup. The carbonaceous matter of the extract sticks to the pots and gives them a partly water-proof surface.





Fig. 2-4: Straw-fired kiln in Thimi, Nepal

Nepalese potter

In fig. 2-4 a potter in Nepal is preparing his kiln for firing. Behind him another kiln is opened and the pots are ready to be sold. The pots are stacked in a big heap with straw and in the lower part firewood in between. The pots are finally covered with straw, broken pots and an insulating layer of ash on top. Holes in the bottom of the kiln allow air for combustion to enter. The fire is lit in the bottom of the kiln and then gradually works its way through the heap. This kiln illustrates a development from the Sukuma kiln as it has the heat travelling up through the pots, vent holes making control of the fire possible and an insulating layer for better containment of the heat. Firing temperature may be 150 °C higher compared to the Sukuma kiln.

Fig. 2-5: Communal shed enables potters in Bhaktapur to produce pots during the monsoon in Nepal.

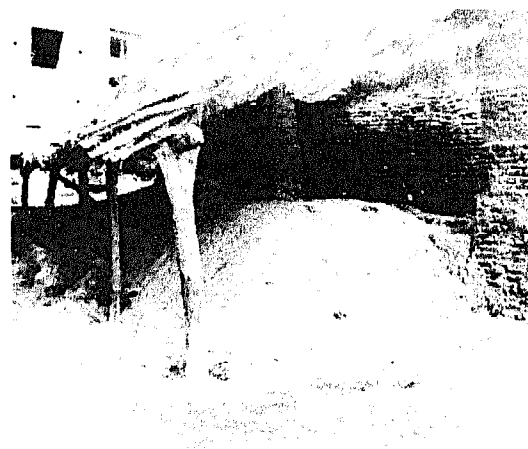



Fig. 2-6: This kiln is constructed with broken pots forming walls, fireboxes and flues. The first layer of green pots is stacked on top of the flue pots. Sinde, Burma.

2.1.2 Sinde up-draught kiln

The kiln of the Sinde potters (fig. 2-6) has no permanent structure. Four fireboxes, one on each side, are constructed by the setting of pots. A bottom layer of once-fired, partly broken pots works as flues through which heat from the fireboxes spreads to all corners. The green pots are stacked on top and other cracked pots are built into a kiln wall.

Fig. 2-7: Top layer of the Sinde kiln is laid.



Straw, pieces of broken pots and clay form the outer layer. Vent holes are left in the crown of the setting. Firing is carried out by stoking firewood in the four fireboxes. The combustion gases and heat go up through the setting and leave through the vent holes at the top. Kilns of this kind are called up-draught kilns. The use of fireboxes and flues, though simple, allows much better control of the firing. In the beginning a very small fire allows the pots to dry out completely and at the end of the firing heavy stoking will ensure a high temperature. The hot gases and flames from the fire circulate all over the kiln creating a more even temperature and utilizing the heat better.

2.1.3 Bangladesh up-draught kiln

In fig. 2-8 a simple up-draught kiln is nearly ready for firing. Once-fired pots are serving as a kiln wall as with the Sinde kiln, but this one has a permanent firebox dug out under the kiln. Fuel is cowdung stuck on bamboo sticks as this area, the western part of Bangladesh, has hardly any firewood to offer.

Fig. 2-8: Semi-permanent up-draught kiln in Rajshahi, Bangladesh. After smoking a layer of straw and mud is plastered on the outside.



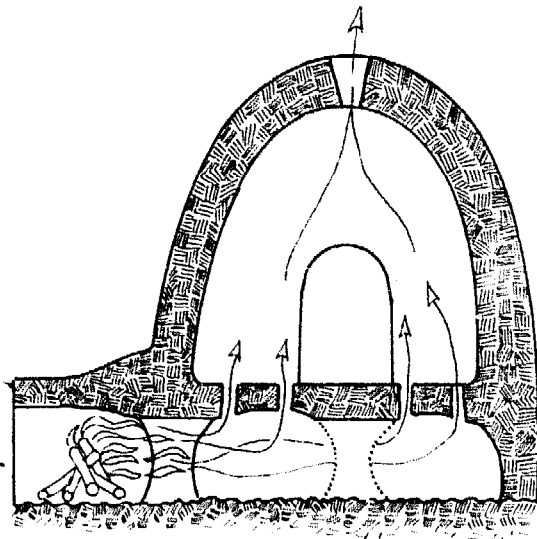
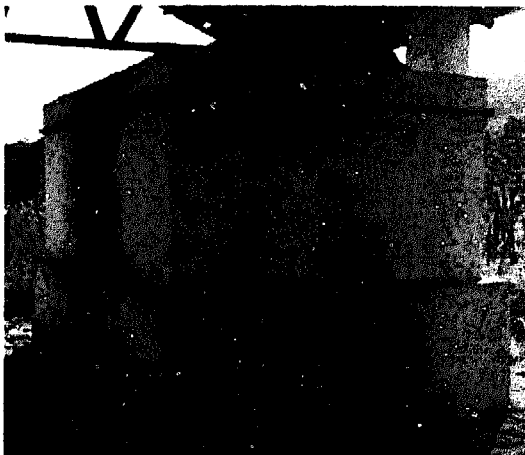

Fig. 2-9: Ancient up-draught kiln from Greece

2.1.4 Permanent up-draught kilns

In the Near East up-draught kilns with permanent outer walls were developed (fig. 2-9) and this type of kiln spread with migrating potters from Persia to India. It is still widely used and fig. 2-10 shows an improved type of up-draught kiln which was constructed by Indian advisers in Tanzania. Stoking is done through firemouths at two sides and the hot

Fig. 2-10: Square up-draught kiln, Singisi, Tanzania



gases enter the kiln chamber through the perforated floor and leave through holes in the crown. Great skill is needed when setting the ware so that space is left for the gases to pass in a way that ensures even temperatures. At cold spots more space is left so that more hot gases will pass there while the spots tending to overheat are stacked more densely. This kiln is fired to 900–1000 °C.

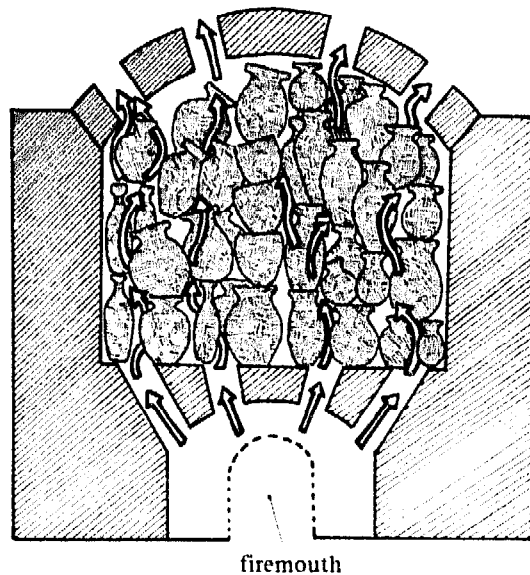

Fig. 2-11: Setting of pots in an up-draught kiln has to be done so that the hot gases rise evenly through the pots.

Glazed pots

The permanent structure makes packing of the kiln easier and the walls retain and reflect the heat better so that higher temperatures can be reached. The drawback, compared to the lighter kilns mentioned above, of the heavy kiln structure is that a great deal of fuel is used for heating the walls along with the pots. The permanent kiln chamber makes it possible to stack glazed pots properly and this may be the main reason for constructing a permanent kiln.

2.1.5 European up-draught kilns

The up-draught kiln originating in the Near East spread to Europe where it was further developed and reached its perfection with the bottle kilns (fig. 2-12). These kilns were widely used until the beginning of this century, when they were replaced by down-draught kilns. The bottle kilns could be fired up to 1300 °C. Dampers on top of the dome could be opened and closed for directing the draught. That enabled the skilled fireman to achieve fairly even temperatures. The ware was placed in saggars to protect it from the

Fig. 2-12: Bottle kiln with its innovations: chimney, firebricks and iron grates for burning coal

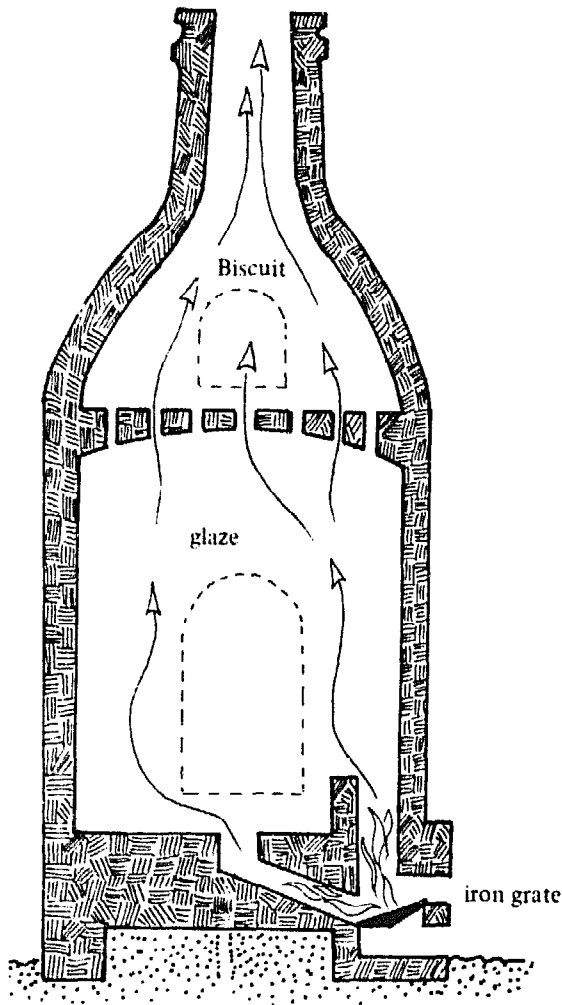

combustion gases. Often a biscuit chamber over the main chamber was added so that the otherwise wasted heat was used for biscuiting.

Refractories, grates, coal, chimney

These up-draught kilns were originally developed in Germany, by the beginning of the 17th century, in an attempt to produce porcelain which was then only produced in China. The 1300 °C needed for porcelain was reached by constructing the kiln with firebricks and by firing coal on cast-iron grates. The grates made it possible to speed up combustion of the fuel and reduce the intake of excess air. A chimney placed on top of the chamber creates the extra draught needed to draw combustion air through the grates.

Fig. 2-13: Cross-section of a hovel kiln

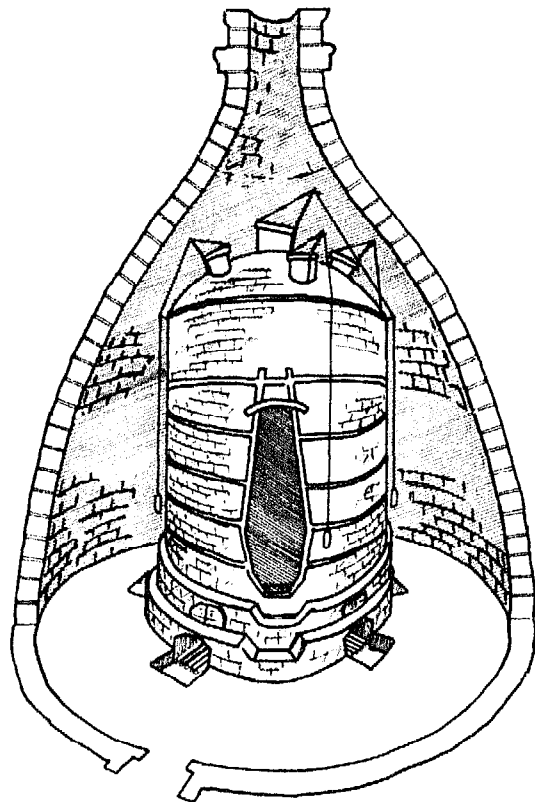

Hovel kiln

A variety of the bottle kiln is shown in fig. 2-13. It works in the same manner but a hovel encloses the kiln and protects it and the workers from the weather. The kiln itself was cheaper to construct as it did not need to carry the weight of the chimney and the hovel could be constructed entirely from common red bricks. The potteries of North Staffordshire, England, were famous for these kilns which literally dominated the skyline around Stoke-on-Trent. The hovels could be up to 21 m high.

Limitations of up-draught kilns

By the turn of the century the up-draught kiln was considered outdated. A ceramic expert Mr. E. Bourry¹ wrote: "Intermittent kilns with up-draught ought to be condem-

Fig. 2-14: Hovel kilns at Gladstone Pottery Museum, Stoke-on-Trent

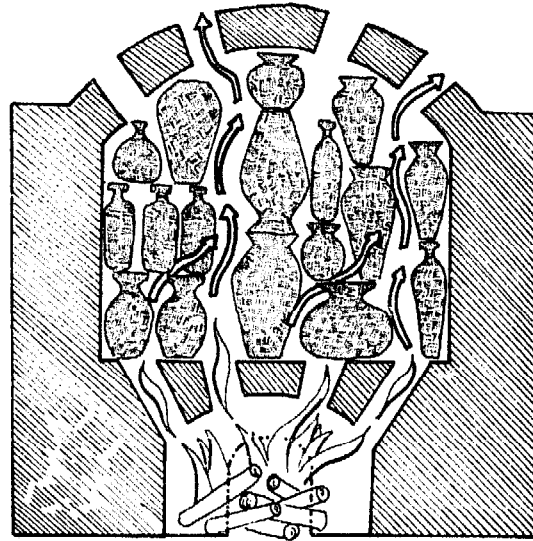

Fig. 2-15: Chimney effect creates hot spots in an up-draught kiln

ned. They have the double effect of being wasteful and giving an unequal distribution of heat . . . and only deserve to be forgotten."

The up-draught kiln is wasteful because the hot combustion gases rush too quickly through the kiln setting, so that the heat of the gases has little time to be transferred to the ware.

The bottom of an up-draught kiln tends to become hotter as the hot gases strike here first. Furthermore, in the setting of the ware some places will be more open and the hot gases will tend to pass that way. That makes these spots hotter whereby even more gases will be pulled that way just like a hot chimney pulls better than a cold one. The up-draught of the gases simply creates this tendency of making hot spots even hotter. These drawbacks led to the invention of down-draught kilns.

¹ "A Treatise on Ceramic Industries" by Emile Bourry, p. 211. It is still true except that in recent years up-draught kilns fired with gas and constructed with fibre refractories have been able to overcome these problems.

2.1.6 Down-draught kilns

In a down-draught kiln the hot gases from the fireboxes circulate to the top of the kiln chamber, are then pulled down through the setting and leave through flue holes in the floor. Under the floor flue channels lead to the chimney (fig. 2-16).

Even temperatures

Hot air rises so the downward draught of the hot combustion gases tends to avoid the hot spots and seeks out the cold spots

where the downward pull is stronger. In this way the draught will by itself even out temperature differences.

Bag walls

A wall, named a bagwall, at the inlet from the fireboxes directs the hot gases upward. In case the top of the setting tends to be too hot the height of the bagwalls is lowered and vice versa. Sometimes holes in the bag-wall help but the holes weaken the wall and it may collapse during firing.

Fig. 2-16: Down-draught kiln with flue channels under the floor

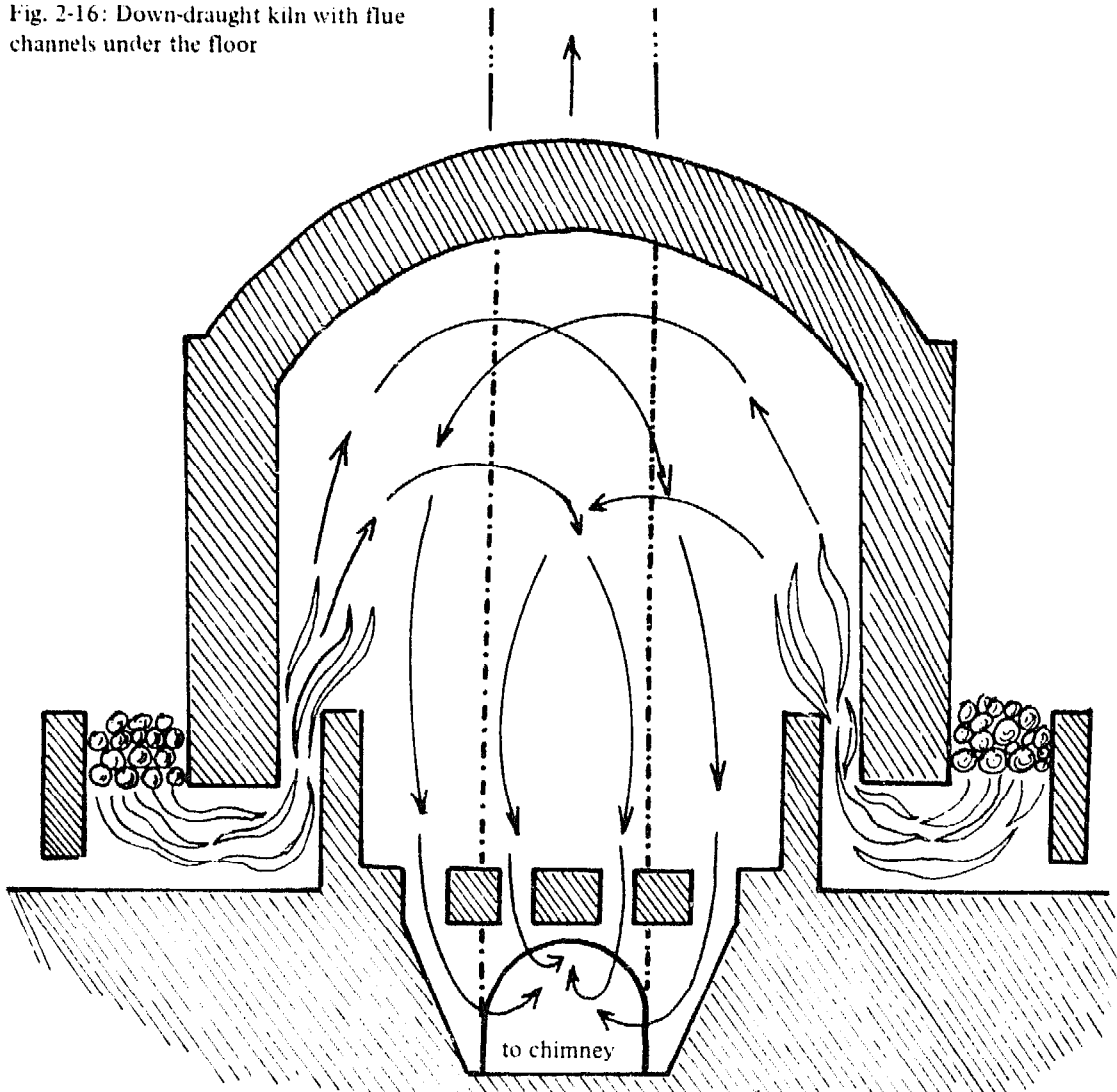

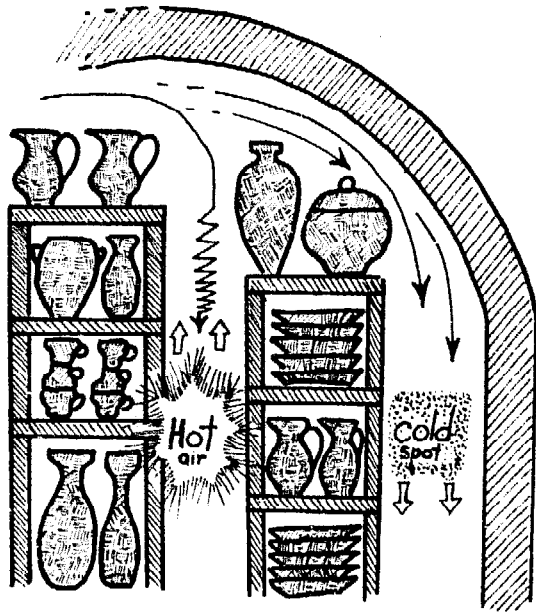

Fig. 2-17: The downward draught avoids the hot spots and seeks out the cold spots in the kiln setting.

Heat economy

The combustion gases spend a longer time inside the chamber, compared to the up-

draught kiln, simply because they have further to go. So more heat is transferred to the ware and consequently fuel is saved. As the hot gases leave the kiln chamber at ground level it is easier to let them pass through another chamber or several chambers before entering the chimney.

Chimney

A chimney for down-draught has to be tall to create a strong pull, which is required to force the heat downward especially if more chambers are added. The Bujora kiln (p. 53) has an up-draught biscuit chamber which at the same time serves as a chimney.

2.1.7 Khurja kiln

The Khurja kiln is a typical example of a coal-fired down-draught kiln of European design (fig. 2-18).

Fig. 2-18: Circular coal-fired down-draught kiln. Khurja, India.



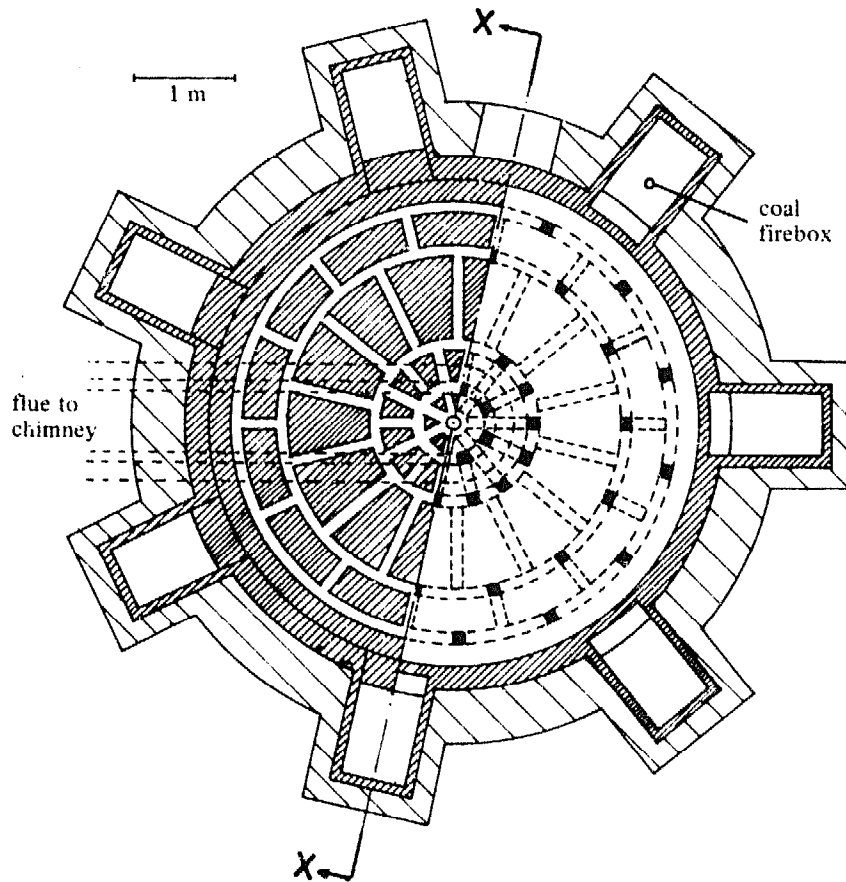
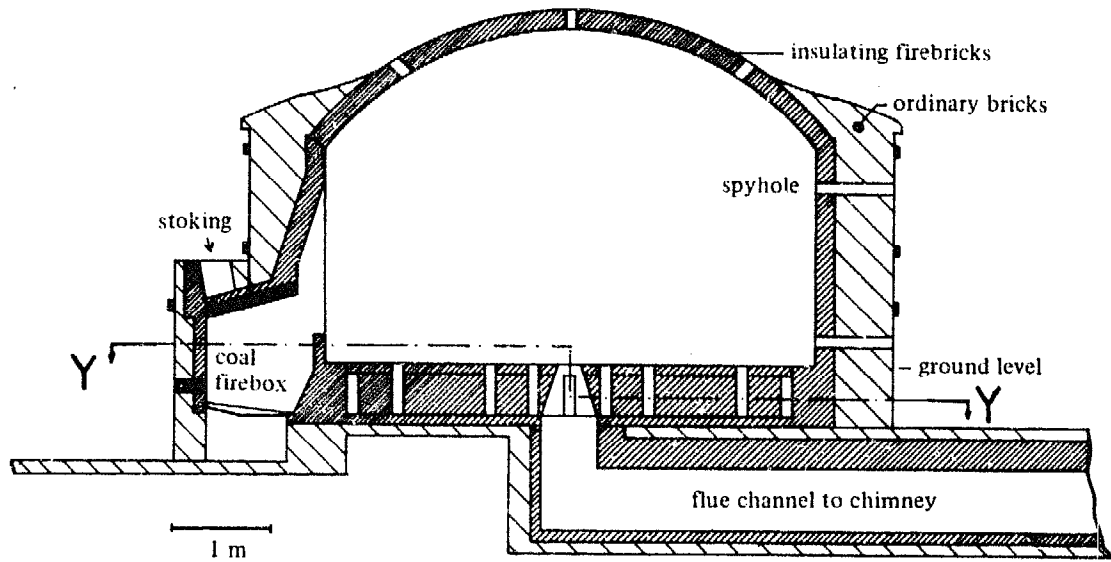

Fig. 2-19: Khurja down-draught kiln a) side elevation, b) ground elevation showing flue holes and channels. The details for this kiln have been obtained from "Status Report on Ceramic Industry at Khurja", published by Central Glass and Ceramic Research Institute, Calcutta, India.

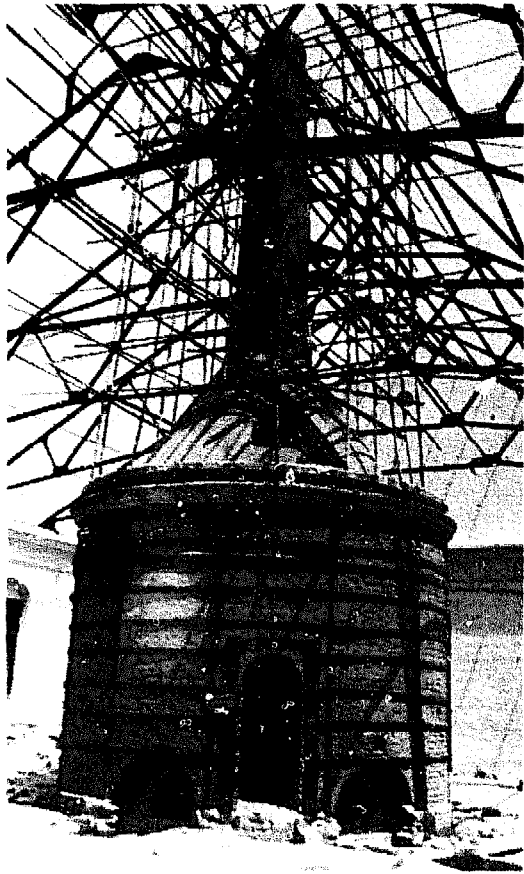

Fig. 2-20: 40 m³ down-draught kiln under reconstruction. Mayangone, Burma

2.1.8 Mayangone kiln

The kiln in fig. 2-20 was originally wood-fired but has recently been converted to oil. It was built in 1924 after a German design that has five flue channels in the wall. These help to transfer some of the heat of the flue gases back to the chamber through the wall (fig. 2-23). The outer kiln wall carries the weight of the top chamber and chimney and the kiln is reinforced with plenty of mild steel bands. The flue channel under the floor can be cleaned from the outside, which is a good idea. The kiln fires to cone 7 (1250 °C) and the temperature difference between top and bottom is with 1-1½ cones (30-50 °C).

2.1.9 Bujora down-draught

This kiln was constructed with a second chamber which works as an up-draught kiln and chimney. When the first chamber reaches 1240 °C the second chamber would be 800-900 °C which is sufficient for firing biscuit ware and common red bricks. The top third chamber can be used for calcining feldspar and quartz for glazes and clay bodies.

Chimney chamber

As firebricks, of which a normal chimney would be built, were made of kaolin which

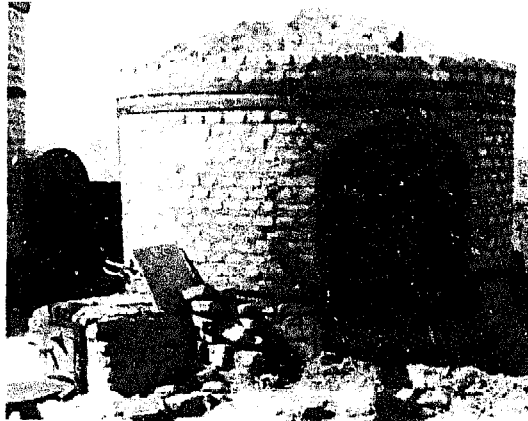
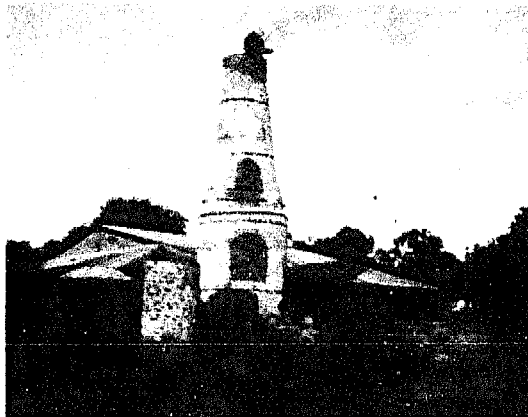

Fig. 2-21: First chamber of Bujora kiln. Water and oil pipes lead to the three fireboxes.

Fig. 2-22: The Bujora kiln seen from the other side with its chimney chamber to the right



was expensive, the chimney was expanded and turned into a second chamber. The wide inside diameter made it safe to build the chimney chamber of common bricks. In any case, a second chamber meant firing more ware for the same outlay. A drip-plate burner could be placed in the flue channel (fig. 2-24) between the two chambers so that the temperature of the second chamber could be raised further in case the waste heat of the stoneware firing was not sufficient. A small fire was lit in the flue channel in order to increase the pull of the chimney when starting a firing.

Fig. 2-23: The Mayangone kiln is made with flue channels in the walls.

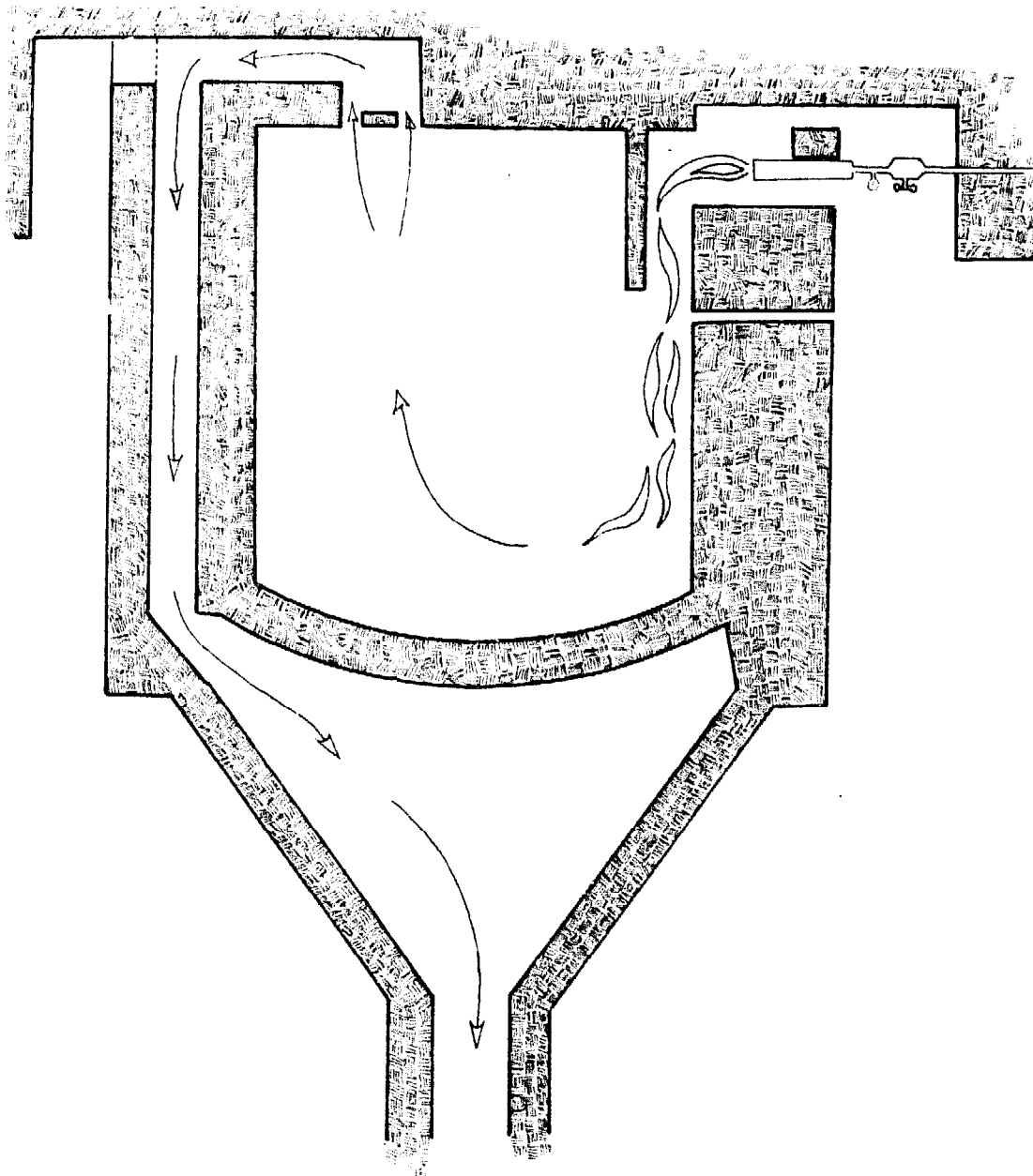
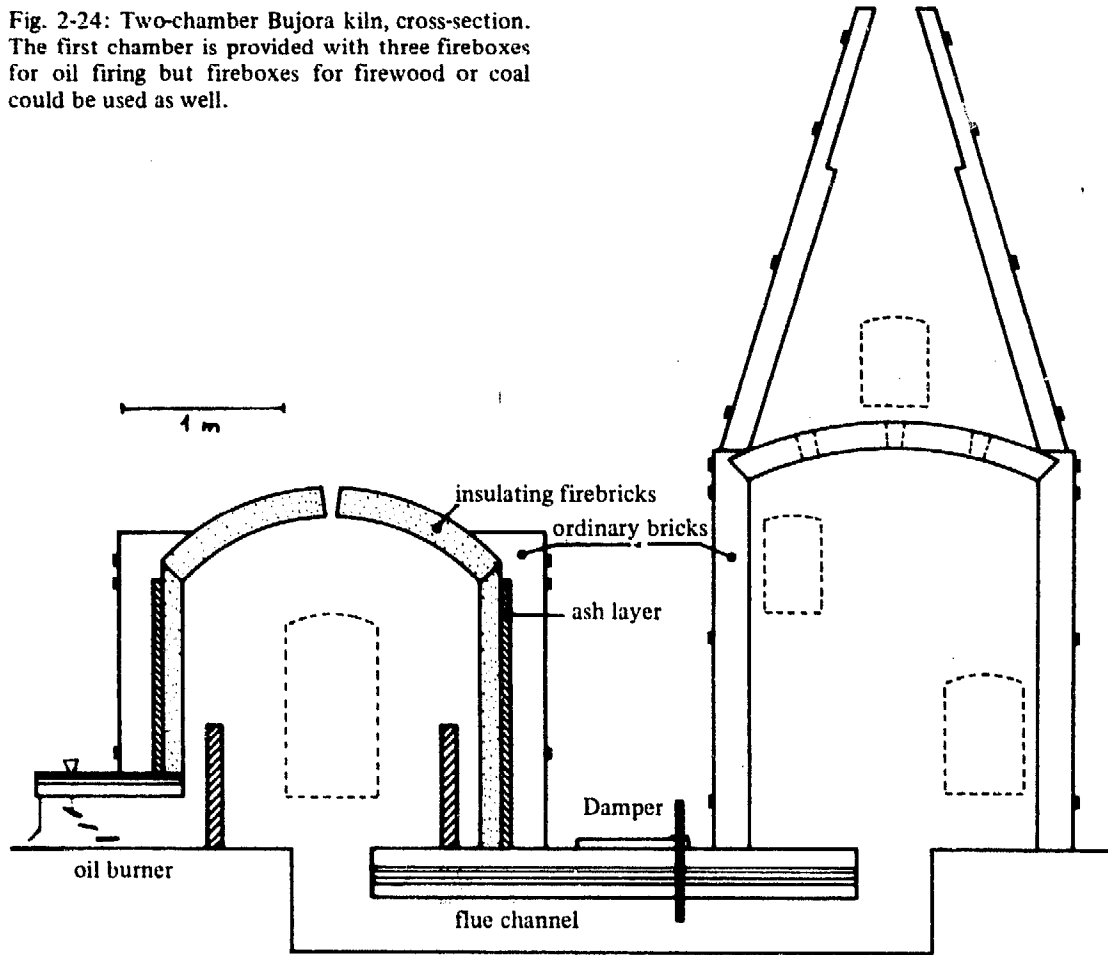

Fig. 2-24: Two-chamber Bujora kiln, cross-section. The first chamber is provided with three fireboxes for oil firing but fireboxes for firewood or coal could be used as well.



2.1.10 Cross-draught kilns

Cave kilns

The cross draught kiln originated in the Far East and as with the up-draught kiln this type of kiln must have developed gradually from the open bonfire. Potters found that by enclosing the fire higher temperatures could be reached; instead of building up a wall around the fire the potters hollowed out a cave into a bank of clay (fig. 2-25). The lower end served as a firebox and the hot gases were carried through the ware across the cave chamber and out through the flue hole. Cave kilns are not in use any more, but old kilns have been found by archaeologists.

Fig. 2-25: Cave kiln dug out of a clay bank

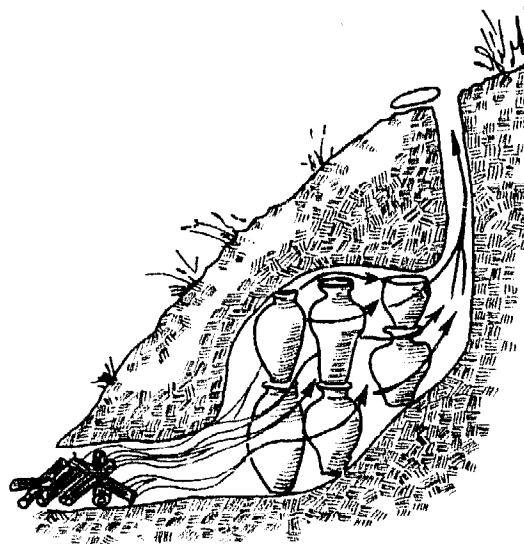



Fig. 2-26: Reconstruction of old cross-draught kiln in Thailand

Stoneware temperatures

Such simple kilns were capable of firing stoneware. The cross-draught through the ware transferred more heat to the ware compared to up-draught and the fully enclosed kiln chamber retained the heat well. The kiln developed into a variety of cross-

draught kilns. Fig. 2-26 shows a reconstruction of a kiln type which was used in Central Thailand 700 years ago for firing glazed stoneware, and similar kilns, though bigger, are still used throughout South-East Asia. Fig. 2-27 shows a wood-fired kiln used for firing celadon stoneware. It has no separate firebox, but the front part of the kiln is 0.5 m lower and serves as a fireplace. The floor for the setting of ware slants upward and the kiln chamber narrows towards the exit flue. That helps to create a more even firing temperature.

The faster the flow of hot air the more heat will be transferred to the pots. Close to the fireplace the air is hot but moves slowly, whereas towards the back the air is cooler but is moving faster due to the narrowing kiln chamber.

Some kilns of this type have stoking holes at the sides so that stoking is done here towards the end of the firing.

Fig. 2-27: Two wood-fired kilns seen from firebox side



2.1.11 Tube kilns

The cave kiln, supposedly, was made ever longer until it developed into the long sloping tube kiln about one thousand years ago. Tube kilns are up to 50 m long and are used for both earthenware and stoneware. On p. 92 a tube kiln is seen from the firebox end. The kiln chamber is a long uninterrupted tube with an exit on top. The tube is filled with pots, traditionally in an open setting, but now also with saggars (fig. 2-28). The fire is started in the firebox and the combustion gases go through the whole kiln to the top exit and transfer all of their heat to the ware on the way. When the lower section of the kiln has reached maturing temperature stoking into the tube is begun through side holes just above the matured section (see p. 71). The combustion air enters through the firebox and is very hot when it reaches the firing zone. In this way the firing zone slow-



Fig. 2-28: Saggars set in a tube kiln under repair

ly moves upward until the whole kiln is fired. When the upper section is fired the lower section has already been cooled considerably by the intake of combustion air. The difference in height of the exit flue and the inlet at the firebox is often enough to create sufficient draught through the kiln. However, some tube kilns have a low chimney as seen in fig. 2-29.

Fig. 2-29: Upper section of a tube kiln. An entrance is made for every 5 m. Stoking holes are seen at the side of the arch.

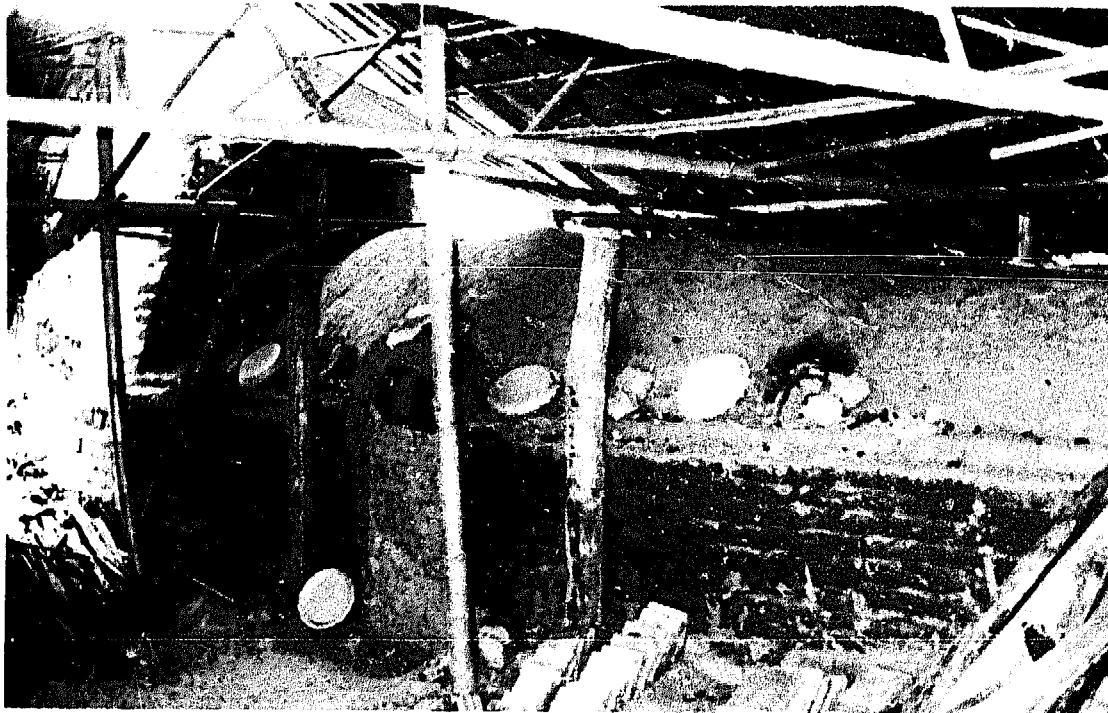
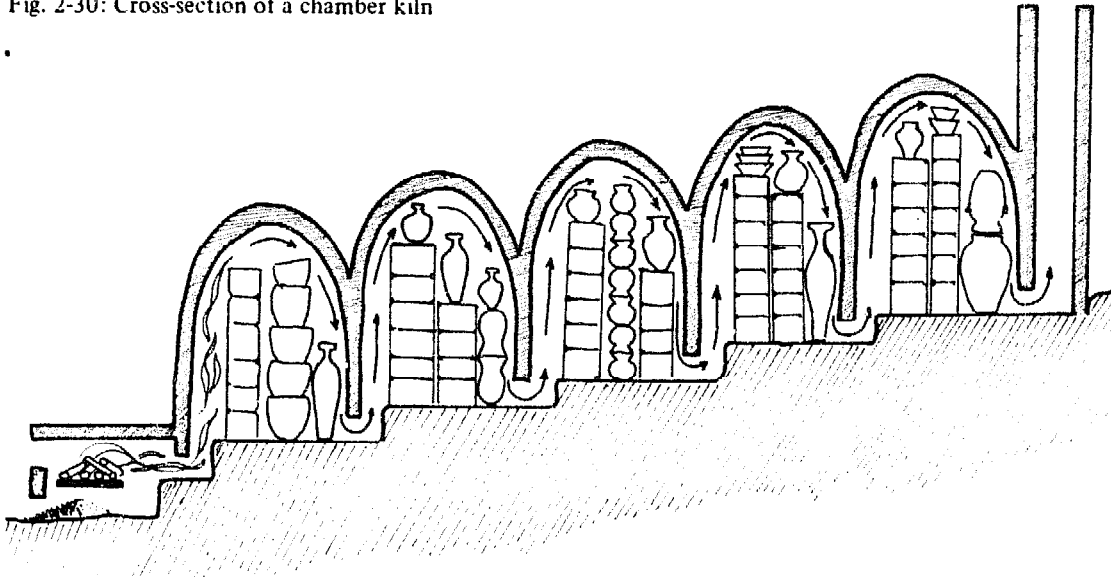

Fig. 2-30: Cross-section of a chamber kiln



2.1.12 Chinese chamber kiln

In China the tube kiln was further developed by breaking up the long tube into separate but connected chambers (fig. 2-30). The fire is started in the firebox and the first chamber is fired as other kilns. When the desired temperature is reached in the first chamber, say 1280 °C, the second may be around 1100 °C and the third around 700 °C. Firing is continued by side stoking in the second chamber through openings in the door. The temperature in the second chamber rises rapidly because the combustion air is preheated from passing through the first chamber. The preheated air is so hot that thin sticks of wood fed through the stoking holes burn instantly.

Setting

In each chamber a bagwall or saggars force the heat upwards after which it is drawn down through the setting and across to the exit flues leading into the next chamber. The draught is normally created by the upward slope of the kiln. The slope of a chamber

is about 20°. The Chinese chamber kilns could have up to eight chambers and would be stacked with ware produced by many individual potters. The largest kilns could be up to 400 m³ in total kiln space.

2.1.13 Champaknagar chamber kiln

Fig. 2-31 shows a three-chambered wood-fired kiln at a pottery school in Champaknagar in Bangladesh. Identical kilns are built by groups of students when they set up their own potteries. According to the size of the group kilns are built with two or three chambers and more chambers can be added later as the production increases.

Earthenware

The kilns are fired to 1100 °C with an open setting on kiln shelves. Each chamber is about 3.5 m³ and takes 600 mugs. Ordinary red bricks are used for construction throughout, but there are plans to provide the kilns with an inner lining of insulating firebricks in order to improve the fuel economy.



Fig. 2-31: Three-chambered wood-fired kiln under construction. The firebox to the right and the chimney at the other end are not yet ready. Champaknagar, Bangladesh.

Firing

The firing is started at midnight so that the last part of firing takes place during the day in order to minimize the risk of fire in the villages. The pots have been biscuit-fired by traditional kilns similar to the type shown in fig. 2-8 and so there is no need of a smoking fire. During the first three hours a layer of embers is built up in the firebox. After that firing is done at full rate until the temperature reaches 1100°C in the first chamber at 8–10 a.m. Three dampers in the bottom of the chimney are used for evening out temperature differences sidewise. The stoking is then moved up to the next chamber and the firewood is fed through stoke holes at both sides above the inlet from the lower chamber. Each additional chamber reaches 1100°C after about two hours' stoking.

Firewood

The first two chambers consume 2200 kg firewood and each additional chamber about 500 kg. Unfortunately the firewood is not properly seasoned so heat is wasted drying out the extra water in the firewood (p. 64 f.).

Fig. 2-32: Two-chambered kiln built with sun-dried bricks. Suvapur, Bangladesh.



Fig. 2-33: Two-chambered wood-fired kiln. Champaknagar, Bangladesh.

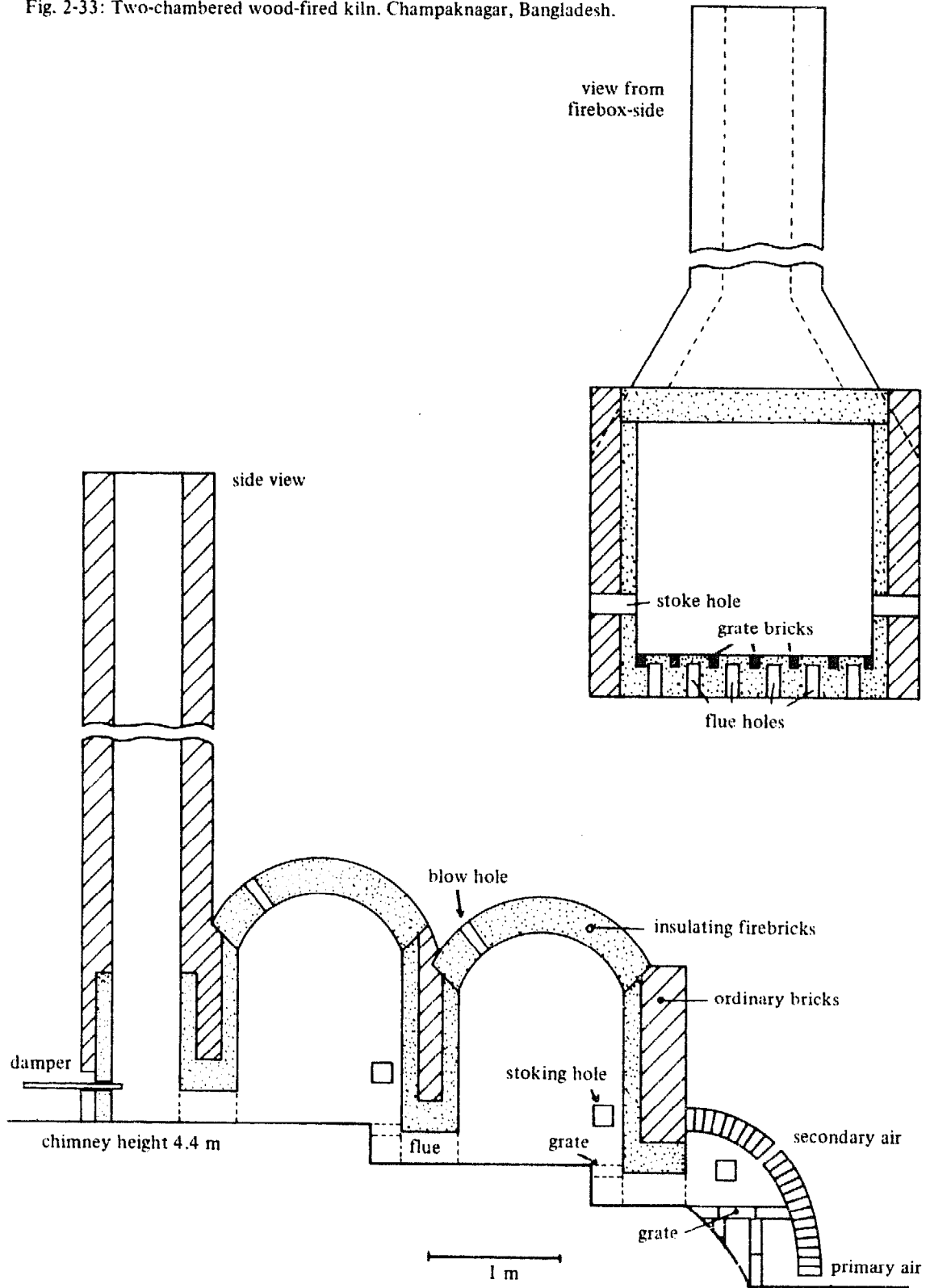

Extra chamber

The small extra cost of firing additional chambers makes it tempting to add several more. The additional chambers would also reduce the size of the chimney which is 4.4 m for the two-chamber version. However, a huge kiln capacity would also mean longer periods between firings and would mean that more space for storing pots awaiting firing would be needed. It may also be difficult to set aside enough money for the production costs in the longer time between making pots, firing and selling the finished ware.

Construction

It is better to start with a few chambers while the pottery workshop is starting up; later as production and confidence grow additional chambers can be added without much interruption to production. It is better to plan for future expansion when designing and constructing the kiln, so that sufficient

space is left to build on. In case the kiln is built on a slope it is easier to add extra chambers at the firebox end as the chimney is a larger structure to dismantle and reconstruct.

Firebox

The firebox shown in fig. 2-34 is made very wide because the unseasoned firewood has to spend longer time drying in the firebox compared to properly dried firewood. Other types of fireboxes as described under fireboxes (p. 73–87) can be used as well.

A more rational solution of course would be to season the firewood properly. However, small village potteries have no money to invest in a stock of firewood sufficient for drying 4–6 months. It is costly to be poor.

Self-supporting

The chamber kilns are constructed without any iron frame supports. The structure supports itself as the chambers lean onto each other.

Fig. 2-34: Champaknagar firebox

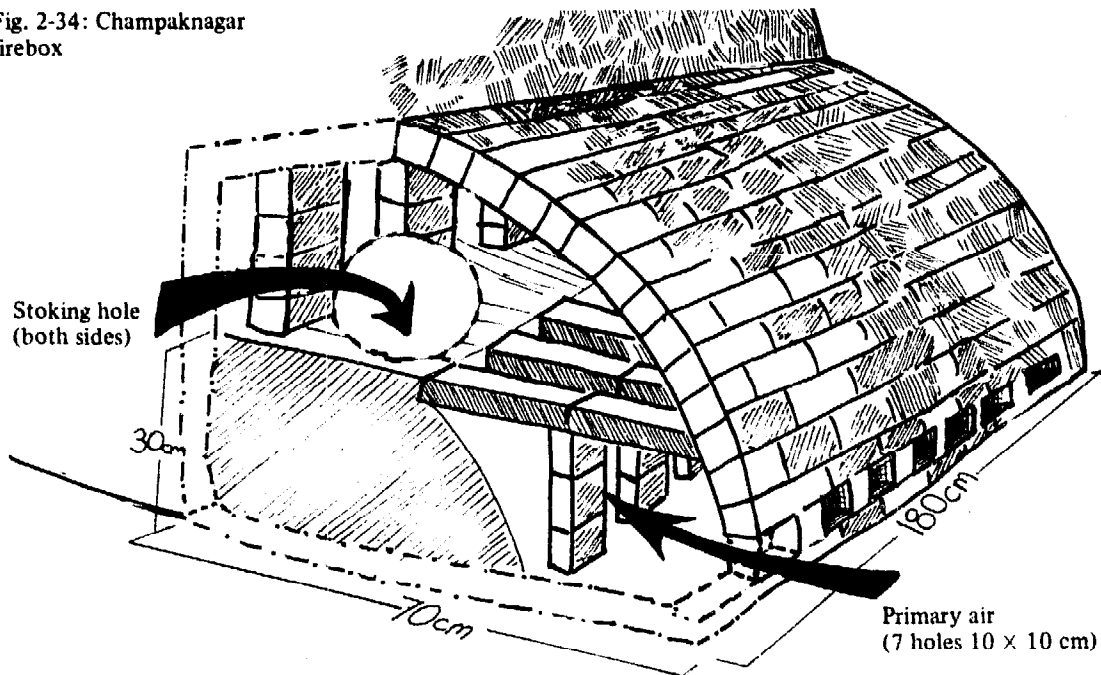

2.1.14 Sumve cross-draught kiln

The cross-draught principle of the chamber kiln is used in a small waste-oil-fired kiln constructed in a small village pottery in Sumve, Tanzania. The kiln is fired to 1250 °C and uses an open setting. It is constructed with self-made insulating firebricks with an outer wall of common bricks.

The chamber is constructed as a catenary arch (see p. 102) which makes the structure self-supporting. The capacity of the kiln is rather small but for newly started workshops it is fine. This kiln could be expanded by adding more chambers as is done in Cham-paknagar.

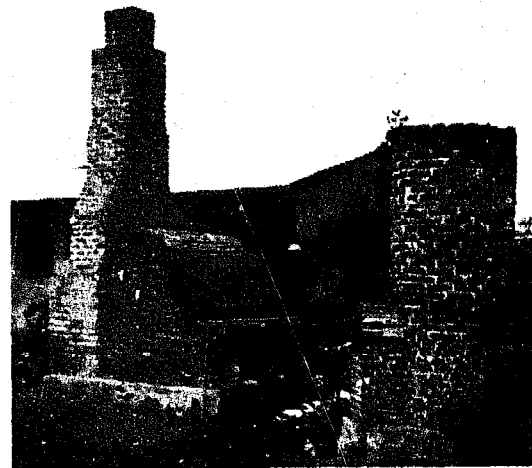
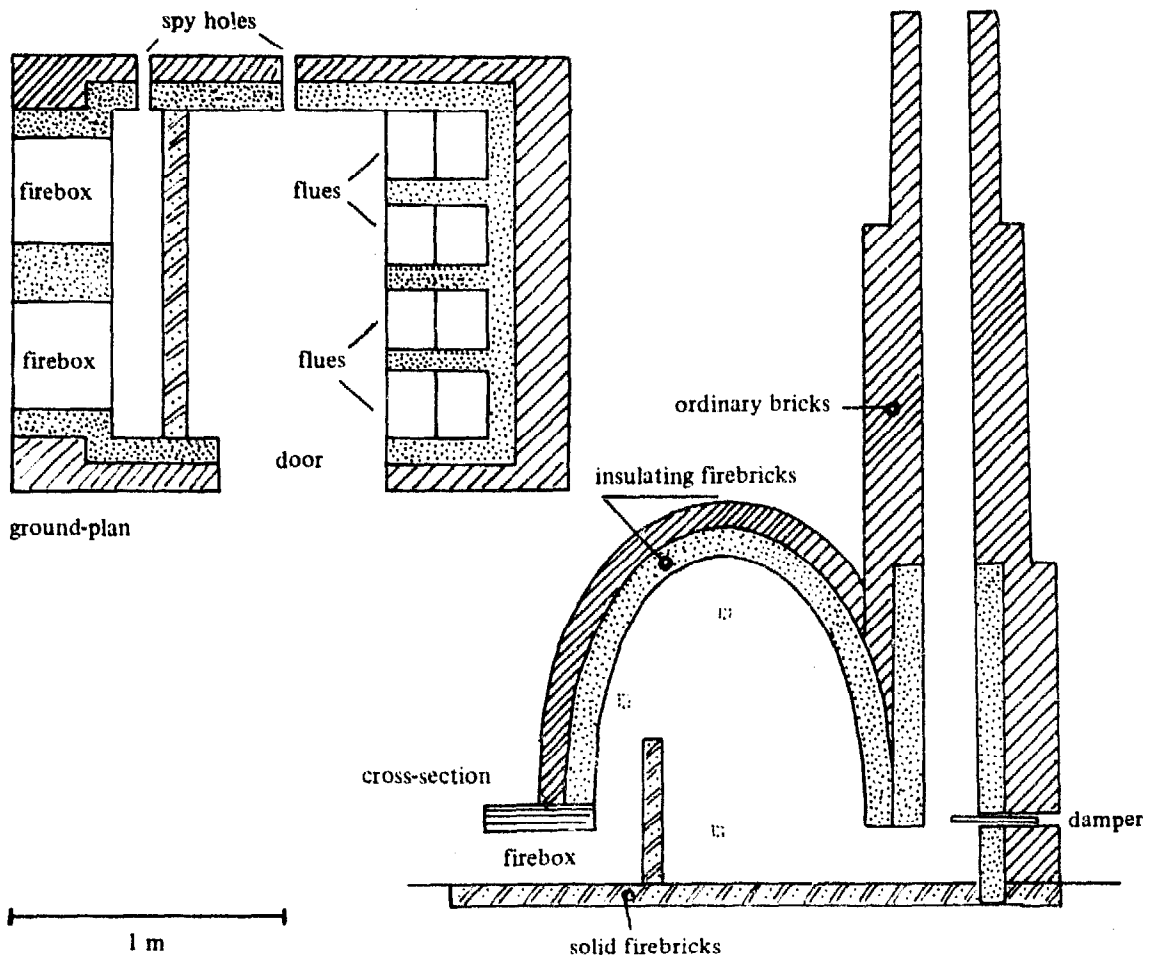

Fig. 2-35: Waste-oil-fired kiln in Sumve, Tanzania. To the right an oil heater.

Fig. 2-36: Stoneware kiln with about 1 m³ capacity (cross-draught kiln)



2.2 Choice of fuel

Nearly everywhere the cost of fuel for firing kilns is the single biggest cost of ceramic production. In some areas the cost of fuel simply rules out the production of modern pottery and only traditional pottery fired with agricultural waste materials is economically possible.

Kilns heated by gas or electricity will not be described here because these fuels are seldom available or their cost is prohibitive. (This might change in the future when big hydro-electric or natural gas projects will make these types of energy more easily available and cheaper.)

That leaves us with three main sources of fuel: firewood (and agricultural waste), coal and oil.

Cost and supply

In many areas only one type of fuel is available for potters. However, those fortunate enough to be able to choose from several types of fuel should consider which fuel will serve them the best by comparing (1) the cost of the fuels and (2) how reliable the supply is.

Total cost

The cost of transport and the time spent on buying the fuel needs to be added to the actual market price, e.g. sawdust may be very cheap at the sawmill but if this is 50 km

from the pottery the cost of hiring a lorry may make this fuel very expensive. Or in case coal can be bought from a government store the cost of employing a person to do the necessary paperwork, etc. will also add to the fuel cost. The different fuels have different heating values and this should also be taken into account, e.g. 1 kg of firewood may only produce half the heat of 1 kg of coal (see appendix).

Table 2-1 is an illustration of how to compare fuel costs. This comparison is based on the estimated fuel consumption for the firing of a two-chamber kiln of Champaknagar type. In this example firewood turned out to be the cheapest fuel, but if the source of coal had been closer it would have been less costly to transport and could in that case become the chosen fuel. The cost of coal in this example also includes \$ 12 for employing a person to acquire the necessary licence to purchase coal from a government store. In areas with a higher cost of labour, firewood would become more costly due to the heavy work involved with felling the trees and cutting the firewood.

Supply

A low-cost fuel which is seasonal or of unreliable supply may turn out to be costly due to delayed firings. These in turn will cause cuts in production and income. In order to secure a regular supply it may often be better to accept a higher cost of fuel than

Table 2-1

Fuel	Heat value	Fuel needed	Net price (US \$)	Transport (US \$)	Drying, storage, preparing, firing (US \$)	Total (US \$)
Firewood	3400 cal/g	2200 kg	52	30	12	94
Fuel oil	9000 cal/g	893 l	402	20	2	424
Waste oil	10100 cal/g	795 l	103	45	2	150
Coal	7720 cal/g	970 kg	48	80	14	142

suffer the results of an insecure supply. If the supply situation is difficult it is better to arrange fireboxes which can burn two or more different fuels. For example it is easy to place drip-plate burners in a firebox for coal or firewood. The additional cost of making two firing systems may be recovered in one or two firings.

2.2.1 Firewood

Formerly firewood was the main fuel all over the world but today in the industrialized part of the world firewood accounts for only 0.4% of fuel energy used, while in the developing world firewood still accounts for 25% of the energy used¹. In the poorest countries about 40% of the energy is from wood. That figure reflects the fact that oil products and coal are too expensive and often not available to the majority of people in the developing world. Therefore, many potters, especially those in rural areas, will continue to rely upon firewood for firing their kilns.

Ash colours

Firewood is easily capable of heating kilns beyond 1300 °C if desired, and it also produces long flames which help to even out the temperature inside the kiln. Firewood ash will not normally harm glazes, apart from slightly changing their colour. Some potters even try to promote this colour effect for its decorative quality. If this discolouration is not desired the ware should be fired in saggars.

¹ Arnold & Jongma "Fuel, Wood and Charcoal in Developing Countries" (FAO, Rome)

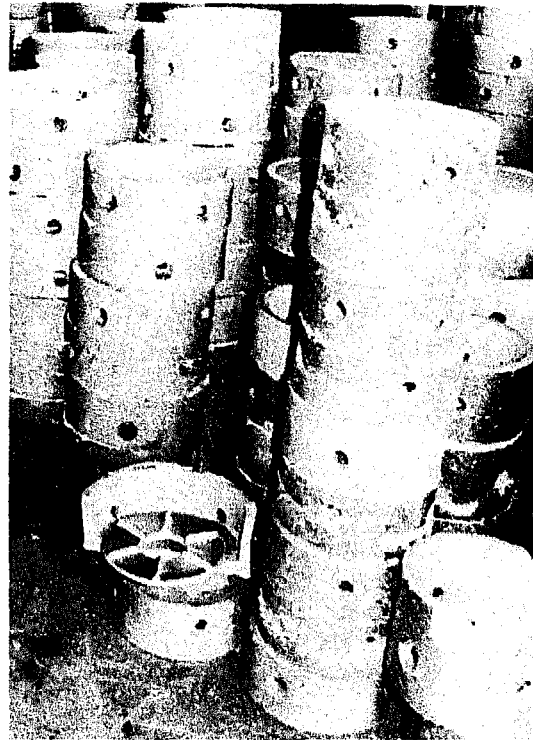

Fig. 2-37: These saggars are provided with holes that will allow the effect of ashes to reach the glazed ware.

Heat value

The softwoods such as fir and pine have slightly more heat value per kg compared to hardwoods such as teak and oak. The weight per volume of oak or teak is about double that of pine (see appendix).

The hardwoods burn more slowly while the light softwoods burn much faster and with longer flames. Usually hardwoods are burned in the initial stages of firing while softwoods are used near the end when a fast release of heat is needed to raise the temperature. The slower heat release of the hardwoods can be countered by splitting the wood into very thin sticks.

Water content

When wood is freshly cut it contains 30–50% water. Wood with so much water not

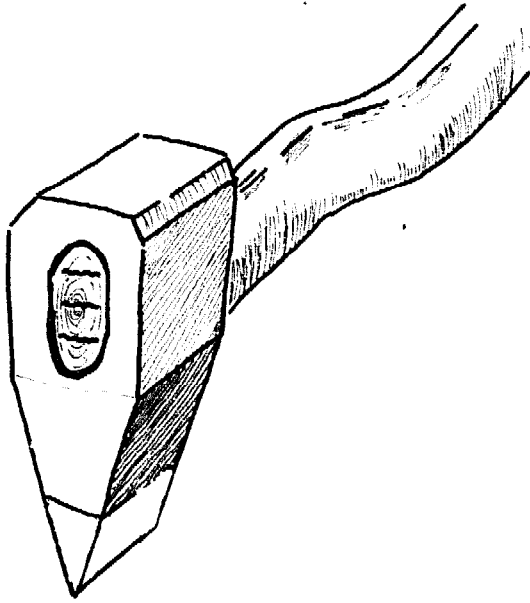
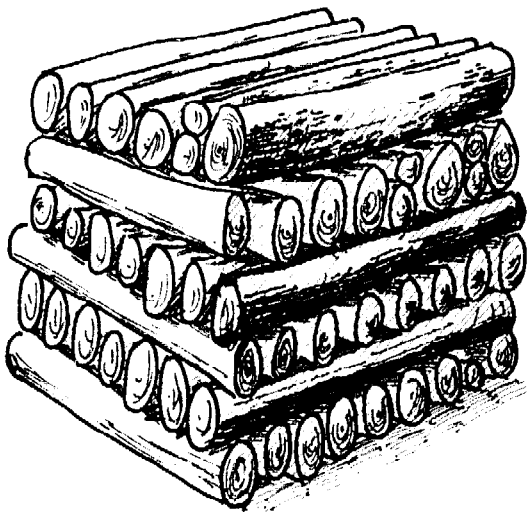

Fig 2-38: Special axe for splitting firewood. The axe does not cut the wood but splits it by impact. It is not suitable for splitting wood with long fibres.

only burns badly but a lot of the wood's energy will be used to turn the water into steam. The wood should be stored until it is completely dry on the surface as well as within. In temperate climates this will take a year while in tropical countries the firewood should be allowed to dry throughout a

Fig. 2-39: Firewood stacked so that air can pass easily through the stack and dry the wood



dry season. Properly dried firewood still contains 10–15% water.

Storing

The potter will need to keep a stock of firewood big enough to last for six months or one year depending on the prevailing climate. The three-chambered kiln from Champaknagar (p. 58 f.) uses about 2.3 tons to fire to 1100 °C. It is loaded with 1800 mugs and is fired nearly every third week and so a stock of 20 tons of firewood will be needed in this case. Some potters may be able to buy wood which is partly dried but one can never be sure of this and so it is better to buy fresh wood which is easier to split. When settling the price for the purchase of firewood by weight, take into account that the fresh wood weighs about 30% more than dry wood.

Normally it is much cheaper to buy large amounts of wood by the lorry-load. This also

Fig. 2-40: A solid chump of wood half-buried in the ground is the proper base for splitting firewood.



allows the potters to cut the wood into suitable sizes. The cutting and splitting of wood is much easier while it is still fresh. Sticks about 60 cm long and 3–5 cm thick are needed for the last hours of stoking, while thicker ones will be fine until then. Splitting the wood makes it dry faster as does stacking the long sticks so that air can pass through the pile. Bamboo is an excellent fuel although it is usually reserved for construction purposes.

Fire hazard

Potters often place the firewood for the next firing on top of, or on shelves, above the kiln during a firing (fig. 2-41). The heat from the kiln dries out the wood completely thereby further reducing the cooling effect of the moisture in the wood. However, great care must be taken to prevent the wood from catching fire.

Planting trees

In some areas there are large forests with plenty of trees and it may seem that there is no need to worry about a lack of wood for fuel. However, even potters in these areas may after only a short time find there is not enough firewood because the demand for wood is so great. The price of wood goes up as firewood is cut further and further away. A family uses about 4000 kg of firewood each year for cooking alone. Therefore, one single village may soon use all the trees in the nearby forest if no new trees are planted to replace the ones which were cut and burned for fuel. Even though the potter may face no trouble in getting firewood for the time being, these fortunate conditions are unlikely to last forever. If at all possible, potters should try to secure their source of firewood by planting their own trees.

In heavily populated regions land is scarce and expensive and so potters will be unable

Fig. 2-41: Split bamboo sticks are dried on top of a sloping tube kiln.



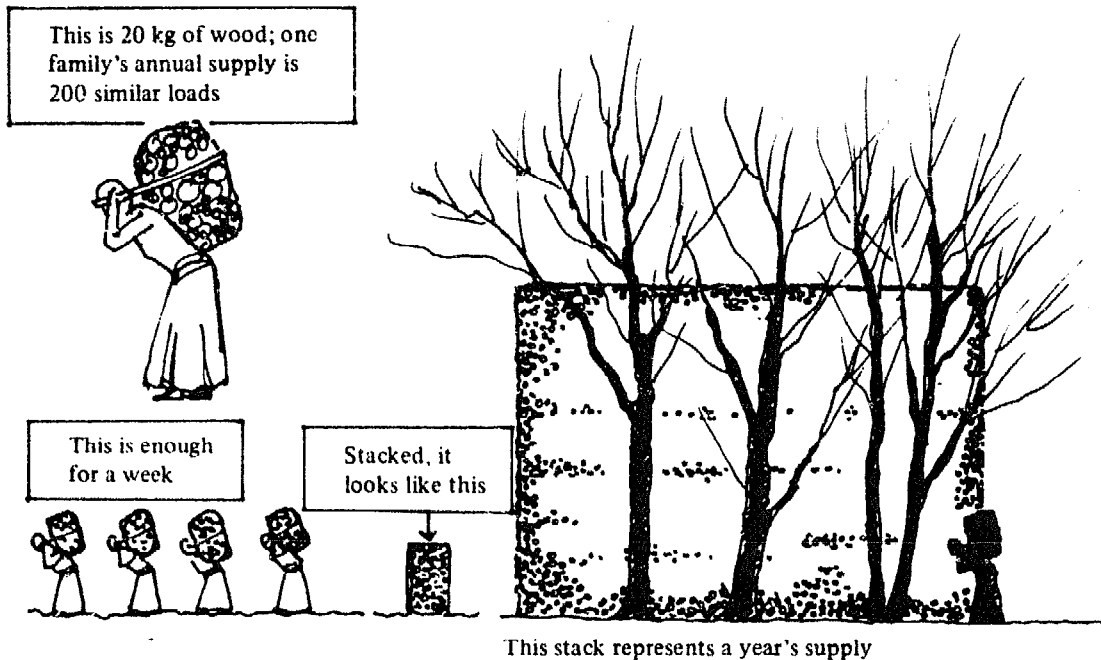

Fig. 2-42: The big stack represents a family's annual use of firewood for cooking (drawing from: Aprovecho-Institute, Fuel-Saving Cookstoves, GATE/Vieweg, 1984, p. 6).

to buy or lease land for growing trees. In other places, however, potters may through local authorities be able to lease fallow land where trees can be planted. Often local development authorities offer seedlings free of charge to villagers.

It may seem an overwhelming task to start planting a forest, but in fact the forest does not have to be very large. Where a three-chamber kiln like the one at Champaknagar is fired every three weeks it will consume 40 tons of firewood annually. According to some estimates¹ a forest covering 1–2 hectares of land will produce this amount of wood every year.

In tropical areas a tree such as a eucalyptus grows so fast that it can be cut for firewood after only two or three years. Some trees will shoot again from the stem after cutting and so the trouble of replanting is dispensed with.

The right choice of tree species for growing firewood depends on local climate and soils. All countries have a forestry department

which should be able to advise on which trees would be most suitable in a specific area².

2.2.2 Agricultural waste

All agricultural waste products are bulky fuels. They take up a lot of space compared to the amount of heat they release on burning. The main attraction of waste products is their cheapness, transportation often being the only cost. In some areas agricultural waste products are already used for cooking or as fuel by local industry, whilst in many other areas these by-products are just dumped and are free for use.

¹ 30 m³ of wood (solid volume) is the average annual production per hectare (100x100 m) for a well managed plantation. (FAO Report: RAS/80/001, Bangkok 1984).

² Further information can be obtained from: Coordinator, Wood Energy Programme, Forestry Department, FAO Rome, Via delle Terme di Caracalla, 01000 Rome, Italy.

Sawdust

Sawdust has the same heat value as the wood from which it was cut. It is an efficient fuel when used with the right firing system (p. 76). The main problem is to keep it dry because it soaks up moisture like a sponge.

Rice husks

Milling of 66 kg of paddy produces 10 kg of rice husks. The heat value is nearly as good as for sawdust but this fuel has a high ash content. Some rice mills burn the rice husks for steam-powering the mill and drying the rice hulls and so they may only have a little left over to sell.

Other vegetable waste

The following materials can be used during the initial firing of the kiln as an additional fuel:

- Peanut hulls; very bulky but have the same heat value per kg as wood.
- Bagasse; the crushed sugar cane after the sugar juice is extracted. 130 kg sugar produces 100 kg wet bagasse. The bagasse has to dry for a couple of months. With 15% moisture content it has a heat value close to firewood.
- Sisal; production of 1 kg sisal fibre leaves 30 kg waste which after drying is a usable fuel. The roots of the sisal plant also burn very well.
- Straw from growing paddy, corn, etc. is often used for firing traditional unglazed pottery and can be burned in the fireboxes of a pottery kiln provided the straw is tightly bundled.

2.2.3 Peat

Peat is a spongy mass of vegetable matter formed by the decomposition of ancient fo-

rests. Peat can be described as the first step in nature's production of coal. It is normally only covered by a thin layer of soil.

Winning

The peat contains about 90% water when it is dug or rather cut. The soft mass is cut into blocks (20x5x5 cm) which are first laid out on the ground for drying. As soon as the blocks can be handled they are stacked into piles in order to accelerate their drying. Drying may take several months and the air-dried peat blocks will contain 20–30% moisture. Winning of peat requires only manual labour and a few tools.

Heat value

The properties of peat are still close to those of firewood and peat can be burned on firewood grates although it needs slightly less secondary air compared to firewood. The heat value of air-dried peat is close to that of firewood.

2.2.4 Lignite

Lignite is the step between peat and real coal. Lignite may be brown or black and it still has a wooden-like structure. Some lignites are called brown coal. The lignites differ considerably in their moisture contents and heat values with some being close to peat and some resembling real coal.

Winning

Sometimes lignite or brown coal can be won on a small scale by individuals as is the case with peat. However, usually the lignite seams are covered with so much overburden that the winning has to be left to commercial mining corporations. Lignite can be burned on coal grates.

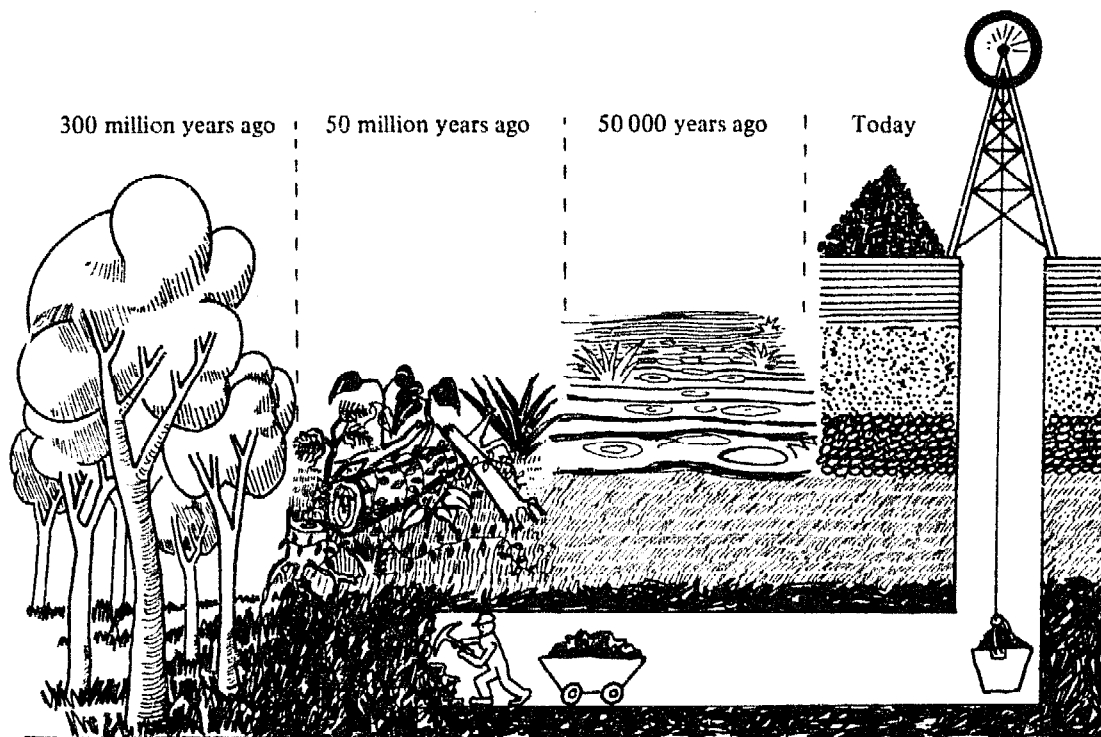

Fig. 2-43: Peat, lignite and coal are created by forests growing in ancient times. The starting point for coal formation is peat and as this is compacted more and more it is converted into lignite and finally into coal. Peat found today may be only a few thousand years old whereas lignite may be 50 million years old and coal up to 300 million years.

Storage

Lignite is very friable and is therefore especially likely to break up into small pieces if it is subjected to cycles of wetting and drying. Small fractions and dust cannot burn on the grates and so the lignite should be stored in a dry place.

2.2.5 Coal

Coal represents the last stage of the transformation of vegetable matter and the term coal covers a wide range of heat values and moisture contents. However, all coals have a higher heat value and have less volatile matter than the other solid fuels. Ash content varies from 1–20% on average.

Saggars

Due to the high sulphur content in coal, glazed ware has to be protected in saggars. The consumption of coal when firing ceramic ware in kilns depends on the size of kiln, the firing temperature and the setting type, but it varies roughly from 0.3–1.5 tons of coal per ton of ware.

Storage

Coal is more economical to buy in large quantities. So several potters may save money by buying their coal together. Coal does not need to be stored in a shed but should be laid on clean ground. Coal oxidizes slowly when exposed to air and this process will heat up the coal. This heating may

cause the coal to ignite by itself if it is piled in large heaps. The preventive rule is not to pile the coal higher than 2 m, smaller piles being less likely to ignite than big ones.

2.2.6 Oil products

Some countries have many different types of oil products while others only a few; therefore, only the most common are mentioned here. Petrol cannot be used for firing kilns because it burns explosively. Kerosene is an excellent fuel but is normally more expensive than other oil products though in some countries it is subsidized by the government. Diesel oil and light fuel oil are rather similar when used for firing. Fuel oil is a very powerful fuel with a heat value of about 30% above good coal. However, it is also the most expensive fuel and will in many cases not be economical for potters.

Waste oil

Waste oil is as powerful as fuel oil yet cheaper. Waste oil can be obtained from garages, bus and transport companies and railways which are left with a lot of lubrication oil after servicing their vehicles. In some countries the lubrication oil is recycled, whereas in others no use is made of it and so it can be obtained for a low price. Some power-generating plants produce large amounts of waste oil when cleaning heavy oil for their diesel engines. This type of waste oil has a high viscosity and is often mixed with water. Waste oil should be screened before use. A 16 or 24 mesh screen is fine enough for drip-plate burners.

Contaminants

Waste oil contains various contaminants reflecting its life as a lubricating oil in engines, gearboxes, etc. A drain oil from a

garage in Nevada¹ was found to contain the following contaminants listed as parts per million (ppm):

iron	50
copper	18
chrome	7
aluminium	7
lead	500
tin	5
silica	5

Some people regard burning of waste oil as a health hazard especially because of its lead content. However, the quoted amount of lead equals that in petrol while earthenware clay may contain more than 320 ppm and paper for candy-wrapping may contain as much as 7125 ppm. A potter firing with waste oil will be no less safe than if he had spent the day at the road side. At Bujora Pottery in Tanzania the waste oil gave a pleasant shine to the unglazed clay. This was probably due to the contaminants of the waste oil.

Pollution

Oil and especially waste oil are dirty to work with, and a more serious problem is that oil can cause great harm to the drinking water in the whole area if it is allowed to leak into the soil. Therefore, great care must be taken not to spill oil on the ground, and if this does occur, it should be cleaned immediately. If sawdust is always kept close by, it can be used to soak up the oil, and afterwards it can be used for preheating the fireboxes. The ground where screening and filling of the oil tank takes place should be covered by a layer of cement or bricks in order to prevent the oil leaking into the soil.

¹ D. Parks "A Potter's Guide to Raw Glazing and Oil Firing", p. 63



Fig. 2-44: Firing of a tube kiln in Thailand. An attendant stokes bamboo from each side.

2.3 Combustion and fireboxes

It is not possible to learn how to fire a kiln successfully from a book. That has to be done by participating in many, many firings as the firemaster's assistant. However, it is helpful to understand the basic principles involved in kiln firings.

2.3.1 Combustion

It is common knowledge that firewood burns as does charcoal, oil, coal and gas. The burning process is called combustion. All these fuels were originally green plants; firewood and charcoal are made from present-day trees but oil, coal and gas have originated from thick forests which covered the earth many hundreds of thousands of years ago.

Fig. 2-45: Wood (carbon) combines with air (oxygen) and heat is the result. ▶

Carbon and oxygen

When watching a small fire we notice that the firewood slowly disappears leaving a little ash and that the fire needs plenty of air. But what is behind the magic? Wood and other

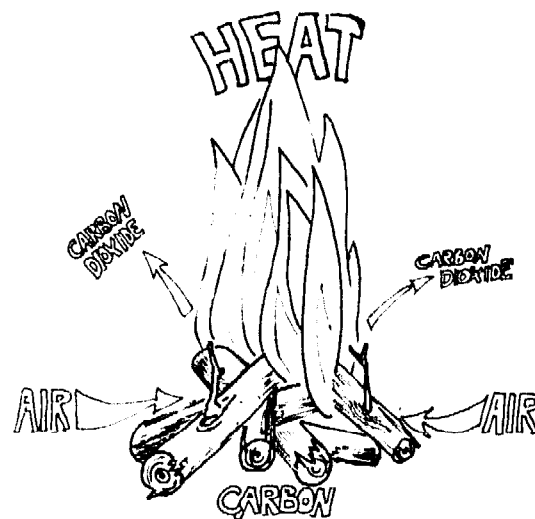

fuels are mainly made of a material called carbon and the burning process takes place when the carbon combines with the oxygen in the air and forms a new material called carbon dioxide. The process produces a lot of heat. The carbon dioxide escapes and only ash is left. Ash is the part of the fuel which cannot burn.

Flash point

When a piece of wood is heated, initially water and carbon dioxide are given off. Above 280 °C volatile gases in the wood are

given off. These gases will burn if they come into contact with open flames and this temperature is therefore named the flash point of wood. However, these gases will without open flames only burn at temperatures above 600 °C. This is called the ignition temperature. The temperature of wood flames are 1100 °C while fuel oil has a flame temperature of 2080 °C.

Solid, liquid, gas

Firewood and coal are solid matter while oil is liquid. However, the burning will only take place when carbon is in the form of gas. All materials exist in three different forms depending on the temperature. The three forms of water are well known (fig.

Fig. 2-46: Temperatures of flash point, ignition and flame of wood

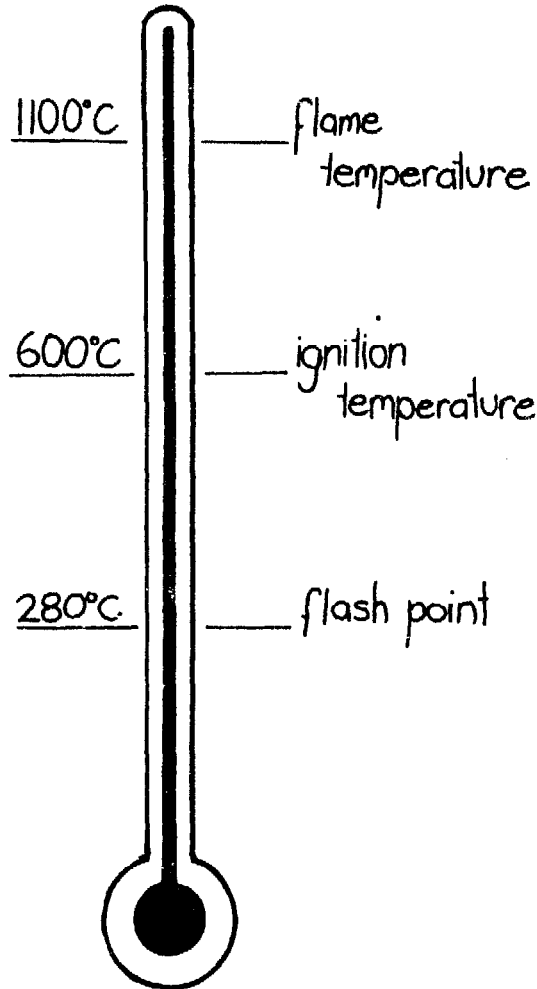
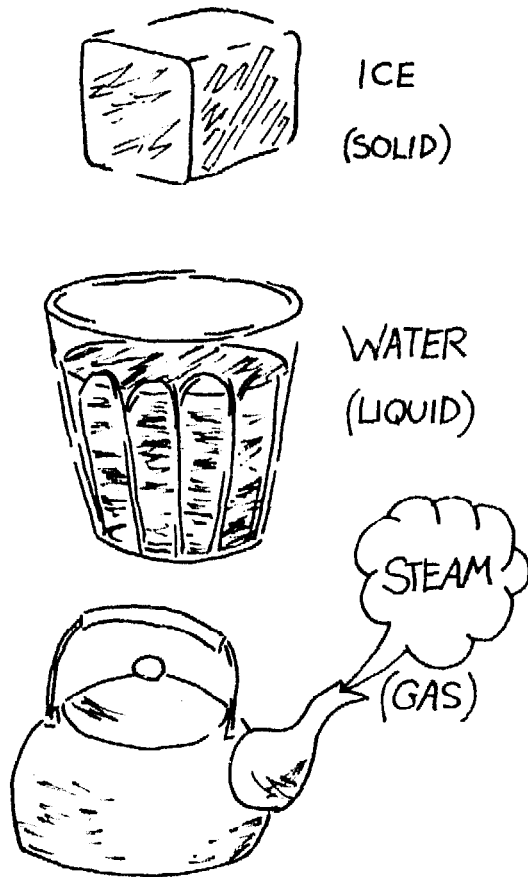

Fig. 2-47: Water in its three forms



2.47). So first we will have to turn our fuel into a gaseous form and then mix it with air. This is the job done in the fireboxes of pottery kilns and it is done differently according to the type of fuel. For the potter, mainly three types of fuel are of interest: firewood, coal and oil.

2.3.2 Firewood firebox

Firewood burns in two stages. When a new piece of wood is added to the fire, the wood will first give off volatile gases which will burn. (In wood the volatile gases amount to about 80% of the total mass, the remainder being in the form of fixed carbon (charcoal).) The flames of a fire are these burning gases and they will often not even touch the firewood. After the volatile gases have escaped only charcoal is left and it will burn with gentle blue flames.

In the ceramic kiln the two-stage burning takes place in the firebox which enables us to control the fire. The main problem is to

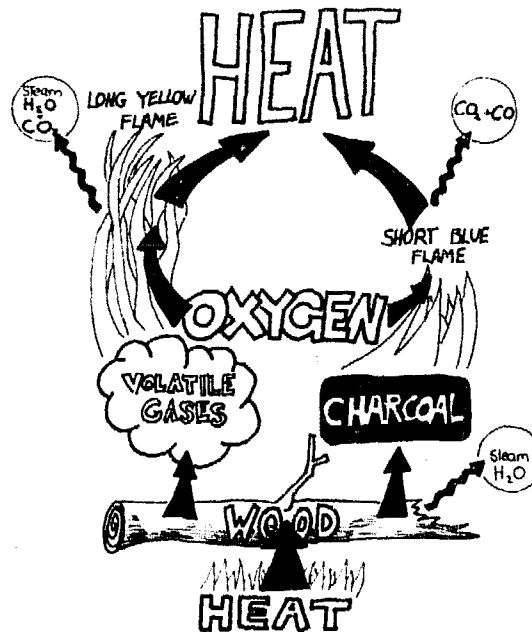
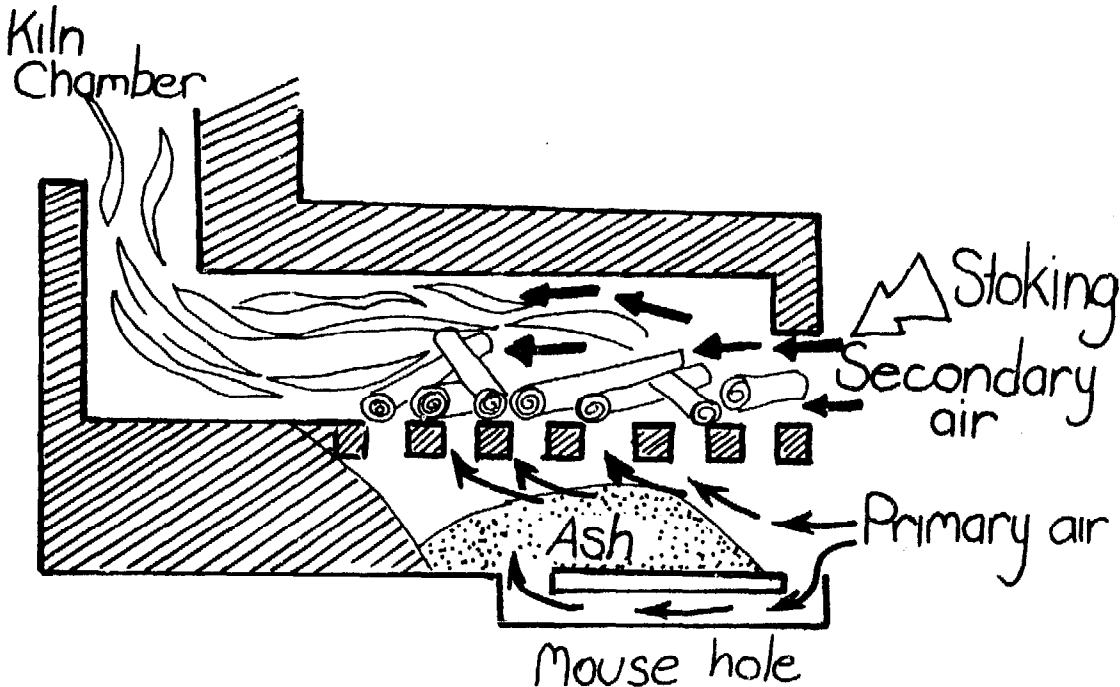

Fig. 2-48: Wood burns in two stages. The first, seen to the left, is the burning of the volatile gases. The second, seen to the right, is the burning of the charcoal.

ensure a good strong fire with just the right amount of air needed to combine with the carbon of the fuel. If we let in too little air

Fig. 2-49: Function of a wood firebox. The height of ash pit should equal the height above the grate.



some of the volatile carbon gas will go out of the chimney unburned which can be seen as black smoke. That means wasted firewood. If we let in too much air this excess air will cool the kiln. That too is a waste.

Primary/secondary air

In fig. 2-49 air enters at the bottom of the firebox, passes over the embers and goes through the grate. Reaching the firewood it helps to burn the carbon gas being released rapidly due to the high temperature inside the firebox. Most of this air, *primary air*, is used to burn the charcoal and often there will be too little air left for the volatile gases released from the firewood. *Secondary air* entering above the grate ensures complete combustion for these volatile gases. By thus dividing the air inlet less air is needed and thereby less cooling of the kiln takes place.

The volatile gases represent up to 30% of the heat value of the firewood. In case sufficient primary air passes the fuel the combustion will be complete, but it would mean an excess of air being 50–100% of the air used for combustion. This excess is reduced to 30–50% when secondary air completes the combustion.

Grate

The wood is spread out evenly on the grate so that air has easy access to it. For firewood the distance between the grates should be 15–20 cm so that the wood will fall into the ash pit as soon as it is nearly burned out. Otherwise it will block the access of primary air.

The grate can be made of iron bars but they will soon wear out and grates made of fireclay bars (fig. 2-50) are more durable. The ash pit should be as big as or bigger than the space above the grate because a thick layer of embers is needed to preheat the primary air.

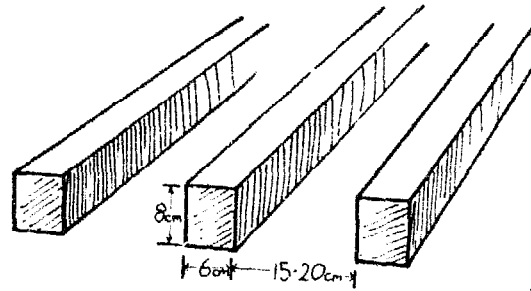

Fig. 2-50: Fireclay bars made as long solid firebricks

A mousehole letting air into the bottom of the ash pit can regulate the thickness of the ash pit. The grate for firewood should be about 15–25% of the floor area of the kiln chamber, the 15% sufficient for firings up to 1100 °C and the 25% for 1300 °C and above.

Firing technique

Firing is started in the ash pit with big pieces of firewood so that firing begins slowly and it also helps in building up a good layer of embers. Later the firewood is placed on the grate and the secondary air inlet is opened. A properly designed kiln should be easy to take up to about 1000 °C but in order to save fuel care should still be taken to control the inlet of air and keep a steady stoking going. From 1100 °C to 1250 °C the kiln needs full attention. After stoking flames will come out of the blow-holes on top of the kiln chamber and the atmosphere inside the kiln chamber will be cloudy. The stoking will cause the temperature to fall and the kiln will be in strong reduction (p. 116). While the wood burns the temperature will rise and the atmosphere inside will become clearer. As soon as the inside is clear, stoke again! This technique produces an oxidizing firing. Reducing firing is done by stoking as soon as the blowhole flames have gone. Another point is to keep the grate covered with a thin layer of firewood all the time. That way air

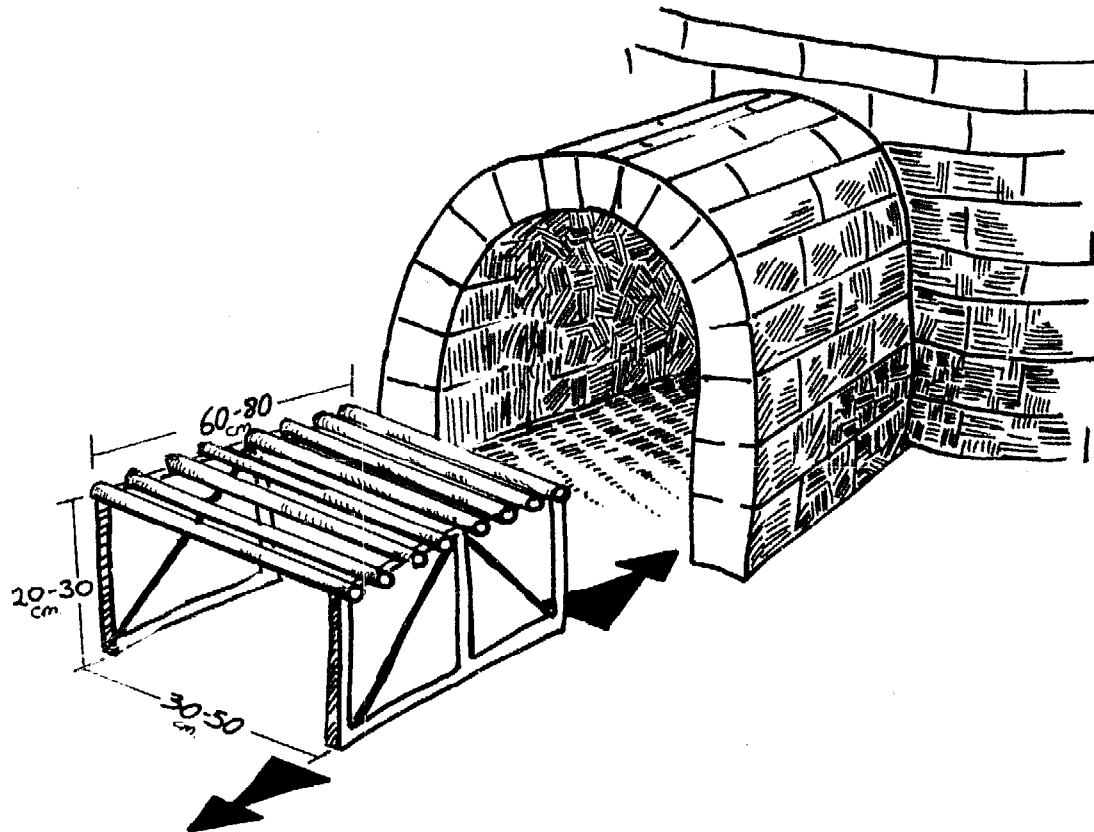

Fig. 2-51: Iron grates will last longer if they can be removed after firing has been finished (F. Olsen "The Kiln Book" fastfire wood kiln, p. 178).

is not rushing through the open space on the fire grate. This would cool the kiln; only ten minutes' neglect might cost an hour's extra firing. Near the end of the firing thinly split firewood is used. This burns very fast and stoking will need to be done almost continuously by throwing in pieces wherever wood has burned out. However, the last firewood split should have burned out before a new one is thrown on top of it, otherwise the firebox and the ash pit will become choked. Stoking is done through a small hole not allowing in excess air.

Hob firebox

Conventional fireboxes have the primary air supply under the grate and the secondary over it. The hob firebox works the other

way round (fig. 2-52). The firewood is fed from the top and the box over the hob can be filled up so that the firebox is kind of self-feeding.

Fig. 2-52: Hob firebox

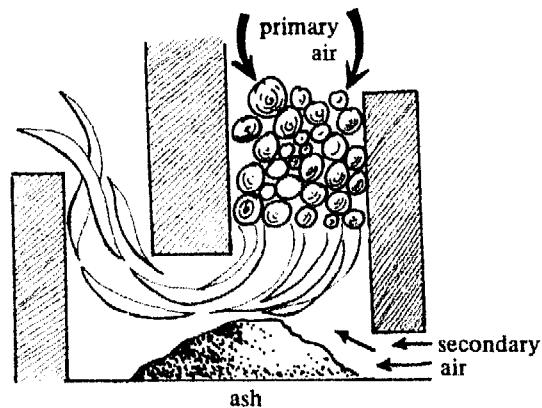

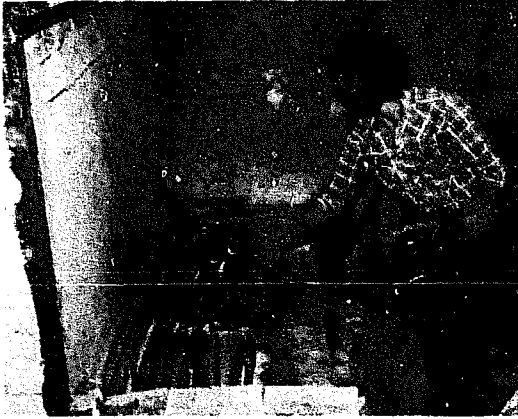

Fig. 2-53: Stoking a hob firebox

2.3.3 Sawdust firebox

Sawdust, rice husks and other agricultural waste materials need special firing systems. The problem is that this type of fuel is very bulky and if used in a conventional wood firebox it would block the grate and only burn slowly on the surface. One solution is to let the fuel fall onto the top of a steep cast-iron grate provided with a lot of small

Fig. 2-54: Grate for sawdust. The grate is set at an inclination of 50° . The sawdust is fed at top and should trickle down the grate.



steps where the fuel is burning (fig. 2-54). This system needs constant attention to ensure proper flow of the fuel evenly over the whole grate area. Otherwise areas without enough fuel will burn through and let in cold air. The system requires a rather big grate area compared to kiln size but can be used for smaller kilns fired up to 1000°C . (A grate measuring $40 \times 100\text{ cm}$ fired a 1 m^3 kiln to 1100°C with rice husks in eight hours consuming 650 kg husks.)

Sawdust injection

In this system sawdust is sucked into a centrifugal blower via a pipe system and sawdust mixed with air is then blown into a conventional firebox. The firing is started with ordinary firewood in order to slowly heat the kiln. After smoking is over and when there is plenty of coal in the firebox the blower is started. In the beginning the firing uses only a little sawdust and firewood will still be needed to ignite the sawdust. When the firebox bricks are glowing red firewood stoking is stopped and the flow of sawdust is gradually increased. A 1.7 m^3 kiln is quoted to use 3 m^3 sawdust to fire to 1300°C in 11 hours¹. For this kiln a 23 cm straight blade blower powered by a 0.3 HP electromotor running at 3400 rpm is used. The sawdust is fed to the suction pipe through a hopper (fig. 2-56) with an auger in the bottom. The sawdust has to be very dry, otherwise the firing will slow down and the fire may even be extinguished. In areas with no power supply the blower can be driven by a combustion engine and the auger in the hopper can either be connected to the engine by a v-belt or be driven manually.

¹ The sawdust system was developed by L.W. Baker, "Sawdust Injection Firing" *Ceramics Monthly*, September 1977, p. 45-47. Later Steven Howell, Johnson State College, Vermont, U.S.A., developed it further and constructed this kiln.

Fig. 2-55: Sawdust injection system

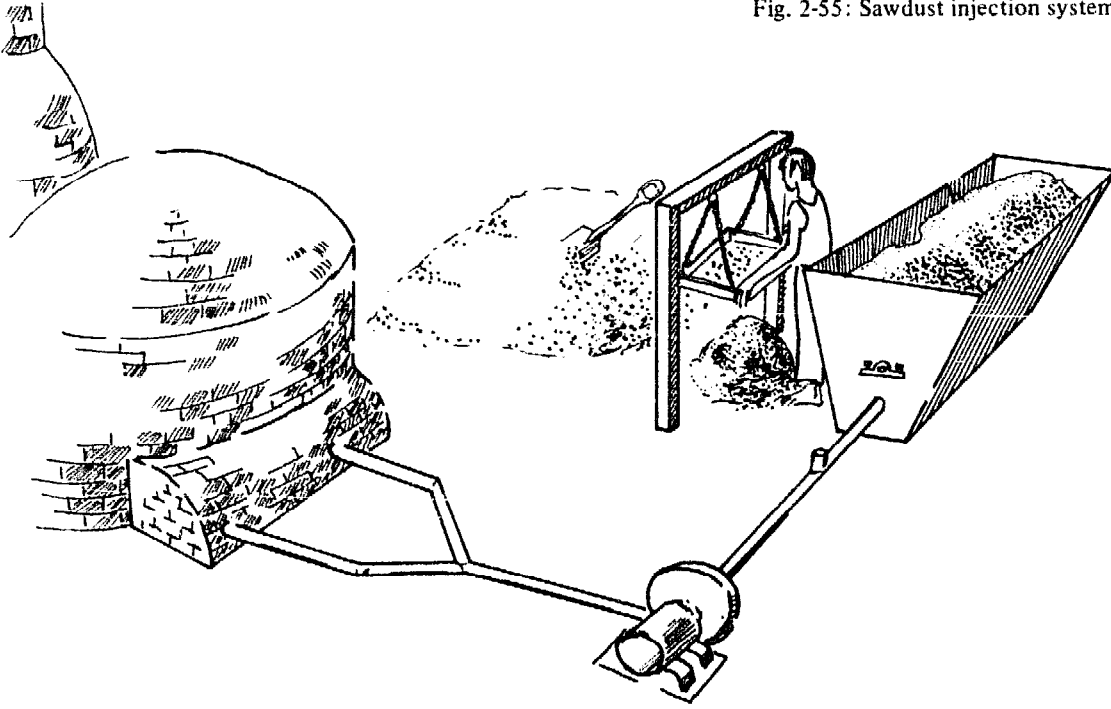

The sawdust burns very fast almost like liquid fuels. The ashes will not remain in the firebox but will be blown throughout the kiln. Some will settle on the walls and sag-gars and form a glaze and the rest will leave by the chimney. Firings to above 1250 °C may be done in open settings because the

ash will melt together with the glaze. Below 1250 °C the ash would produce a rough layer on the glazed ware.

A hole in the bottom of the chimney will help to provide air for burning up unburned sawdust. The sawdust burning produces a lot of sparks which may start a fire.

Fig. 2-56: Sawdust is fed to the suction pipe by a hopper. The speed of the auger can be used to regulate the sawdust intake.

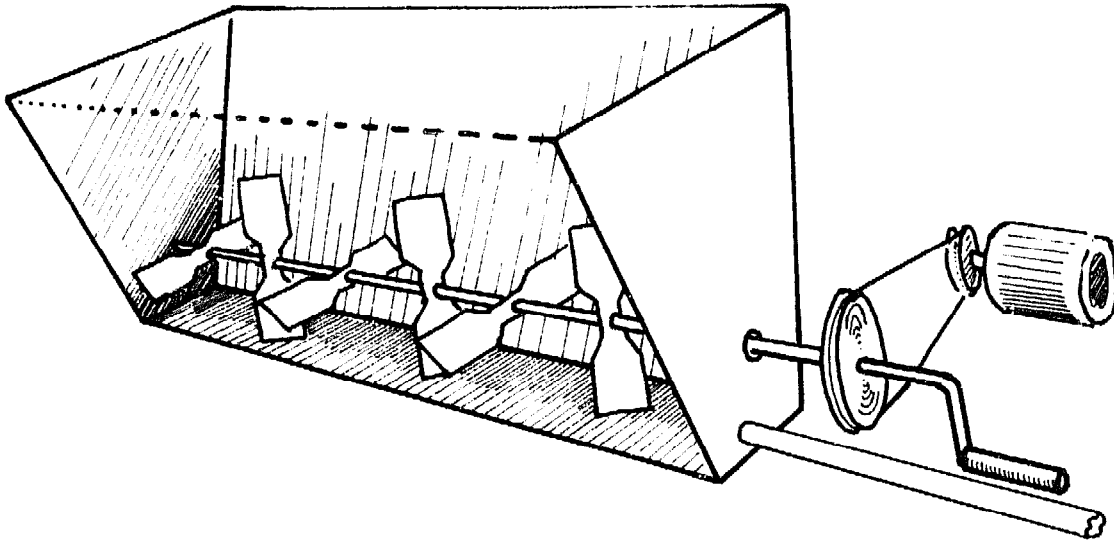
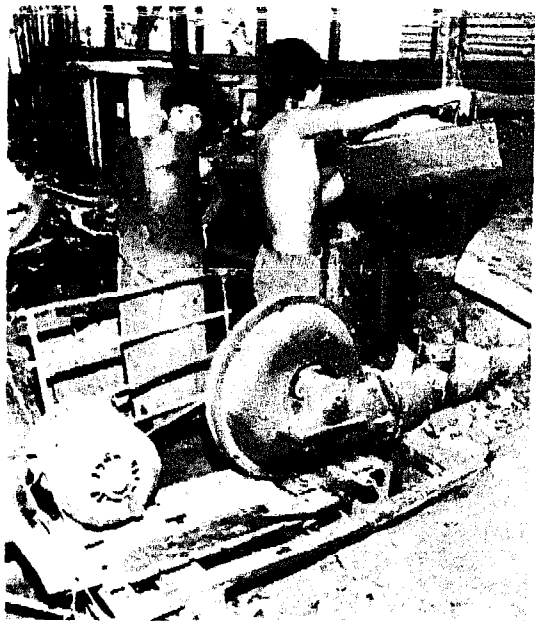



Fig. 2-57: The sawdust should be screened and dried before it is used.

Fig. 2-58: Sawdust burner with the intake of sawdust in front of blower



Sawdust burner

In fig. 2-58 a modification of the injection system is shown. The sawdust is fed into the blower pipe in front of the blower outlet. This system is simpler but needs constant attention to ensure that sawdust does not clog the outlet from sawdust funnel to blower pipe.

Rice husks

The above system has only been tested with sawdust but may also work with other agricultural waste products. Rice husks are rather similar to sawdust except that they have a slightly lower heating value and leave much more ash. The ash has a high silica content which makes it unsuitable for open setting glaze firings.

Straw

Straw and other agricultural waste materials can also be burned with the injection system. However, the straw has to be cut into small pieces. If the straw is dry that can be done in a hammer mill with a coarse sieve.

2.3.4 Coal fireboxes

Coal needs other types of fireboxes compared to wood mainly because coal has much less volatile matter and thus resembles the charcoal left after the volatile gases in wood have burned away. Fireboxes for coal-fired kilns are normally of the same size regardless of the size of the kiln. So bigger kilns simply have more fireboxes.

Grates

The grates are made of iron bars with 2.5–4 cm space in between. The bars are exposed to intense heat from the white-hot coals

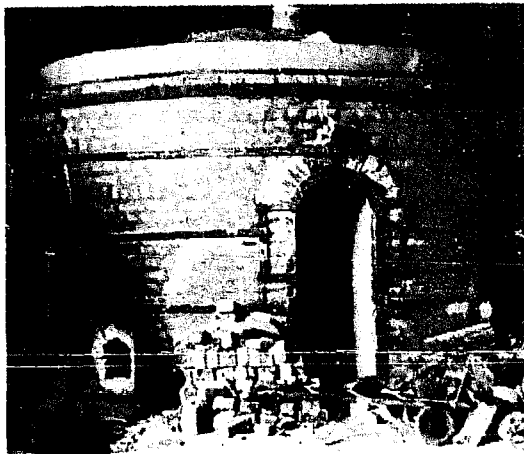

Fig. 2-59: Coal-fired down-draught kiln having its fireboxes inside the wall. Kanapur Village Pottery Institute, India.

and wear out quickly. The cost of renewing the grate bars is a big drawback of coal firing.

A water container placed in the ash pit will cool the bars. The resulting steam will dissociate into ions when passing the burning coal. This action cools the temperature of the burning coal without a corresponding loss of energy. At the same time the flames will

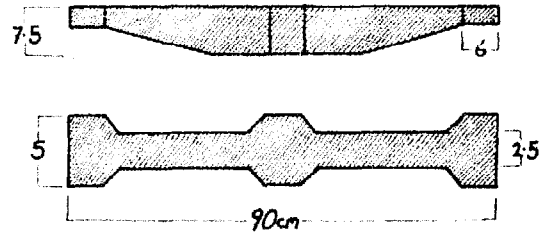

Fig. 2-60: Typical grate bars for coal. The thickened parts adjust the open space between the bars.

become longer and the coal is less likely to clinker.

The life of the iron bars will be much prolonged if they are designed to be removed as soon as the firing is stopped. Cast-iron bars are superior to mild steel bars.

Flat/inclined grates

Flat grates are mostly used for slow firings up to 1250 °C mainly in an oxidizing atmosphere. Inclined grates are used for porcelain and faster firings. (Inclination is usually 15–25° but there seems to be no fixed rule, e.g. lignite should be fired on inclined grates in-

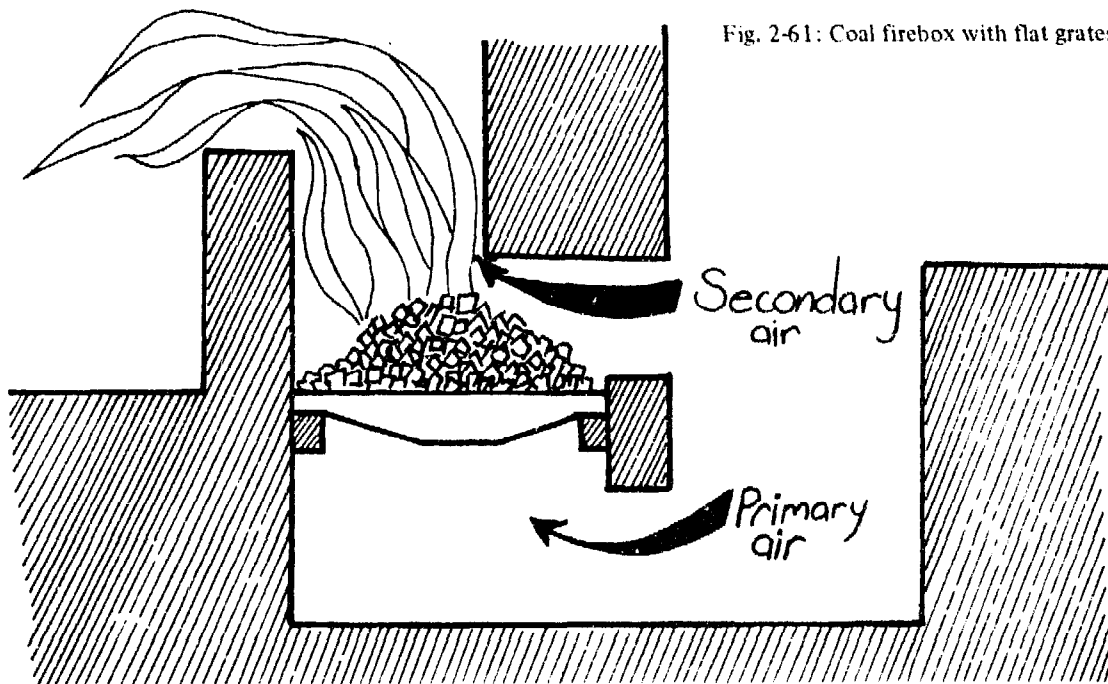

Fig. 2-61: Coal firebox with flat grates

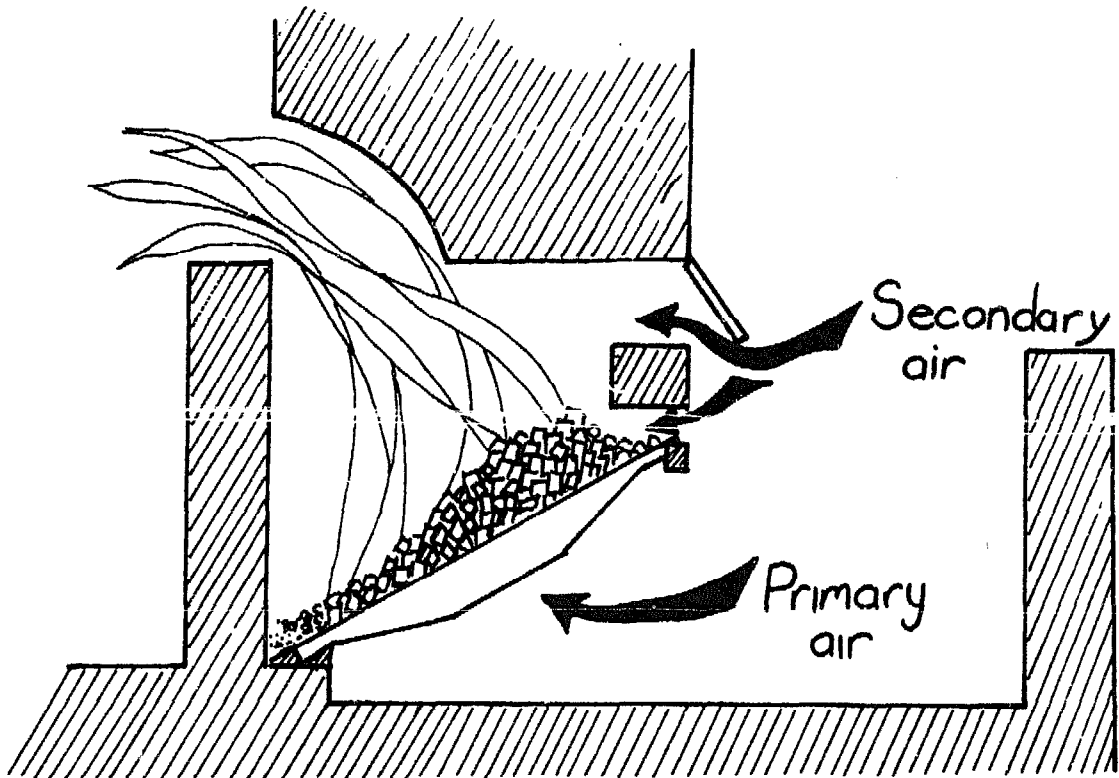
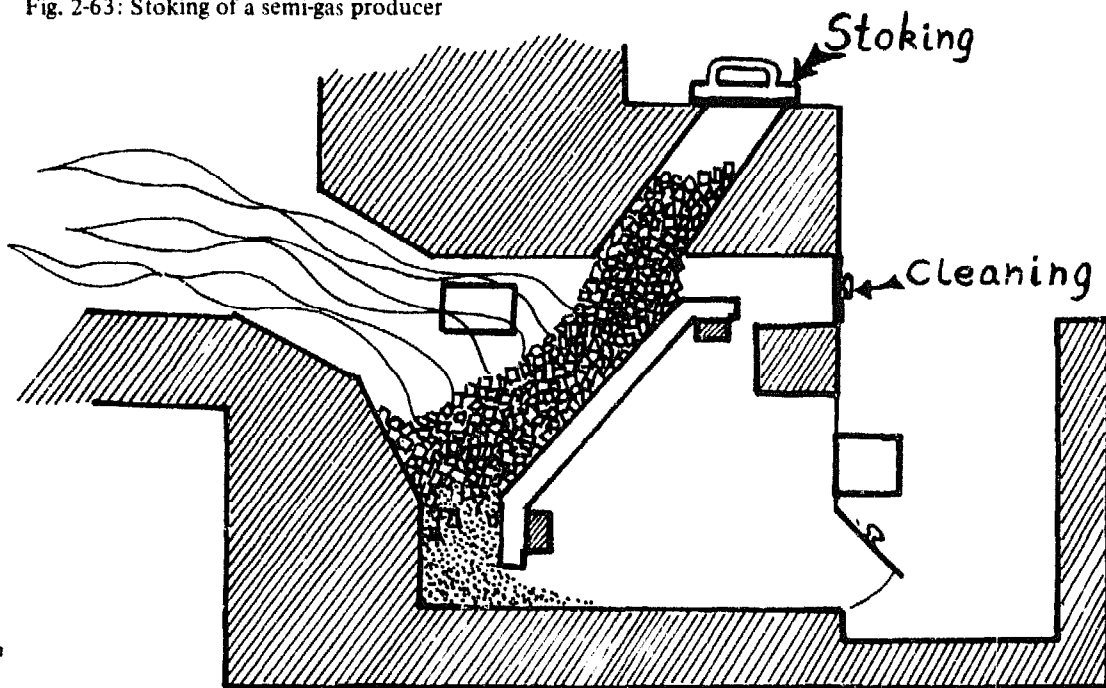

Fig. 2-62: Coal firebox similar to the ones seen in fig. 2-59. The firebox is within the outer wall of the kiln. Secondary air is regulated by opening of the stoking shutter and by placement of bricks just above the grate bars.

Fig. 2-63: Stoking of a semi-gas producer



stead of flat ones.) Types with steep inclination are called semi-gas producers because they are fired with a thick bed of coal which produces a lot of half-burned carbon gas. This gas is fully burned by an inlet of secondary air above the grate as in a firewood firing or inside the kiln in case long flames are desired.

Semi-gas producer

A semi-gas producer is shown in fig. 2-63. The inclination of the grate is 50° and stoking is simply done by filling coal until the grate is covered with a coal bed of the desired depth. At full firing the whole stoking channel can be kept full of coal which will slide down by itself. The problem with this type of grate is to fire at a slow rate. That can be overcome by covering the upper part of the grate with a clay slab during the initial slow rising of the temperature. As more intense fire is needed the slab can be drawn out.

Preheated air

Channels for secondary air are built into both sides of the firebox so that when the secondary air enters above the coal bed it is preheated (fig. 2-64). This will ensure a better combustion of the volatile gas, thereby adding to a better fuel economy.

Stoking

Primary air enters under the grate and if the coal bed is thicker than 10 cm, secondary air is needed too for complete combustion. There are two basic stoking techniques:

- (1) Frequent stokings are made to ensure that there is an even layer of coal all over the grate and that no place is burned through resulting in a rush of cold air entering the kiln.
- (2) Stokings are made by first pushing the burned coal to the back of the grate and then filling fresh coal in front.

The first method requires more experience and more frequent stokings whilst the latter

Fig. 2-64: Channels in the walls of the firebox preheat the secondary air.

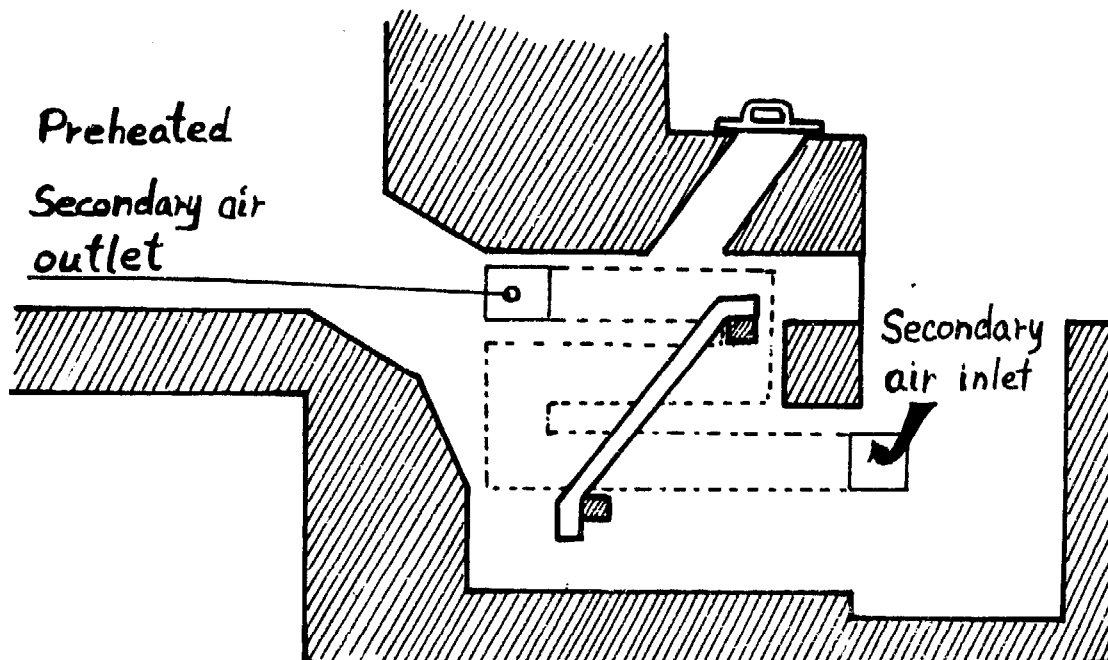

tends to be less economical because it allows too much cold air to rush through the grate during stoking. Every now and then clinkers have to be cleared from between the bars with the help of a bent iron rod, which is inserted from under the grate.

Alternate stoking

Each time stoking is done the temperature will drop as the fresh coal is heated and it will then gradually rise again. It is therefore better to stoke the fireboxes alternately at an even interval, i.e. say the kiln has four fireboxes and each needs stoking every hour then stoking should be done to one firebox in turn every 15 minutes instead of all four once every hour. The interval between stoking is judged by looking at the smoke from the chimney and at the coal bed on the grate. It depends on the type of grate and firing technique. If stoking technique (2) is used stoking is done every 1–1½ hours up to 900 °C, then every 45 minutes to 1 hour up to 1200 °C and finally every 30 minutes.

The most efficient combustion takes place when the burning rate is about 95–145 kg per 1 m² grate area per hour (Singer p. 908). The Khurja down-draught kiln burns on average 85 kg/m² per hour.

Firebox size

The grate area of each firebox is within 0.3–0.5 m². The length is normally 80–90 cm. The total grate area of all fireboxes should fall between 12% and 25% of the floor area of the kiln chamber¹. 12–15% would be sufficient in most cases, while 25% would be for fast firing and high temperature porcelain kilns. The top of the firebox arch should be around 80 cm above the grate. The lower

¹ F. Singer, "Industrial Ceramics", p. 911, quotes: grate area in m² should be 10 % of kiln chamber volume in m³.

part of the grate should be at least 50 cm above the floor of the ash pit.

Firebox location

The fireboxes should be spaced evenly around the kiln and the firebox may fit within the outer wall due to its small size. The closer to the kiln chamber the better and in the Khurja kiln (p. 51) the bagwall is made as a part of the inner wall, thus saving setting space. The number of fireboxes for a particular kiln is found by dividing the grate area of one firebox into the total desired grate area.

2.3.5 Oil drip firing

A simple and reliable drip firing system for oil can be made very cheaply. Oil is fed by gravity to a drip-plate burner and the air is supplied by the natural draught of the chimney. Forced air oil-burner systems are harder to construct and descriptions of such systems can be found in technical books (see bibliography).

As for all other firing systems the important thing is to change the fuel into its gaseous form so that it will ignite.

Fig. 2-65: Firebox for oil drip firing. The drip-plate burner is seen in front of the firebox. Pipes for oil and water are placed above the firebox.



Water and oil

Ignition can be aided by adding water to the oil in the following manner:

From a valve above the firebox the oil drips down onto a straw, which is fixed to another valve, from where a thin squirt of water runs along this straw (fig. 2-66). The straw breaks the surface tension of the water making many small drops which mix more easily with the oil. This mixture drips onto a set of three iron plates placed inside the firebox. In the initial stages of the firing the iron plates must be kept hot by a small fire. Hitting the hot plates the water will explosively turn into steam. This action will pulverize the oil into a mist which easily vaporizes and then burns. The system also works without water, but the energy spent on heating the water is negligible compared to the improved combustion of the oil.

Carbon clinker

Besides helping to atomize the oil the water also reduces the carbon clinker, which otherwise would build up on the iron plates during firing. The water works in the same way as for coal firing (p. 79) $C + H_2O = CO + H_2$. This action cools the plates thus reducing corrosion but the energy is given back again when the carbon oxide and hydrogen burn.

The amount of water is judged by watching the flame. It is normally about one part water to five parts oil.

Burner plates

The iron plates can be made from any type of scrap iron, but the plates should not be too thin otherwise they will wear out fast. The plates are either welded onto a frame as shown (fig. 2-66) or they are placed in

Fig. 2-66: Drip-plate burner

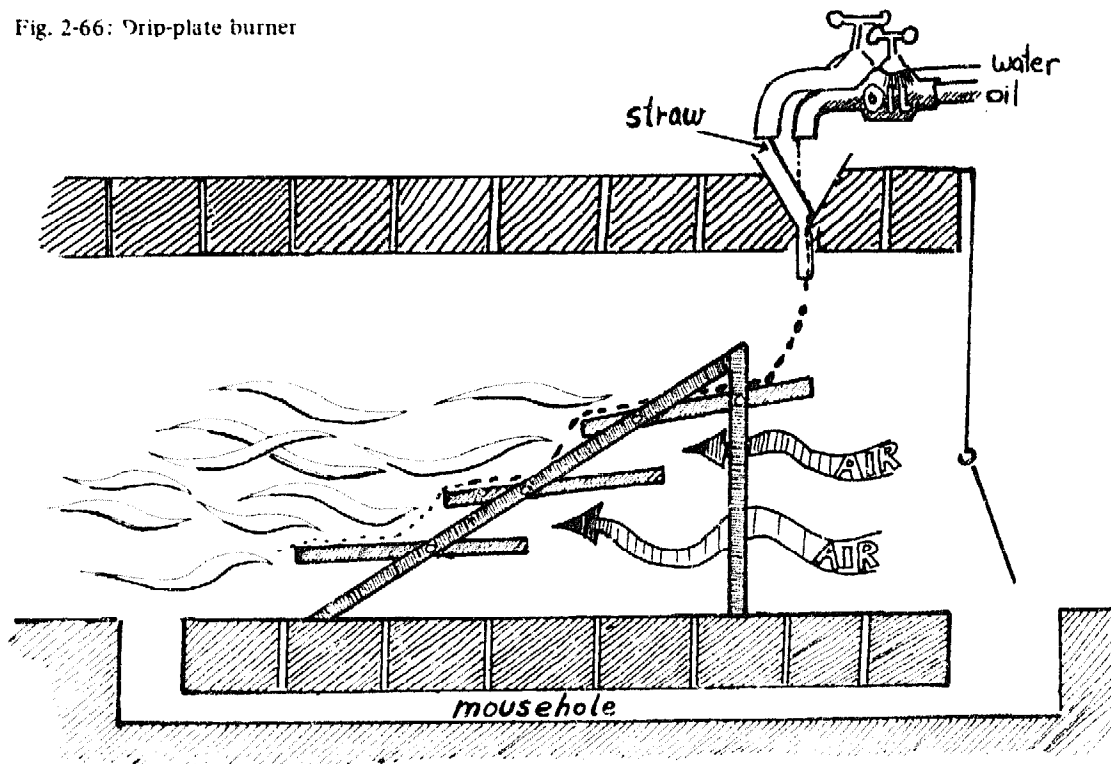

grooves in the brickwork of the firebox. The size of the plates is not crucial and the slope depends on the viscosity of the oil; a plate size of 10x20 cm and a slope angle of 15° are good starting points for experimentation. A gradually decreasing slope ensures that the oil burns on all plates and a raised edge will guide the oil flow onto the next plate.

The drip-plate burner can easily be installed in fireboxes of other fuels. However, ample space (at least 0.6 m) should be allowed in front of the burner because the oil flames are very fierce. The capacity of drip-plate burners equals that of fireboxes for wood and coal. However, if the kiln is intended to burn oil only, more drip-plate burners could be installed in order to have a more even heat in the kiln chamber.

Oil tank

The oil flows to the burners by gravity. Heavy fuel oil and waste oil have high visco-

Fig. 2-67: Oil tank for separation of water and heating of the fuel oil. In fig. 2-35 a photograph of such an oil tank is shown.

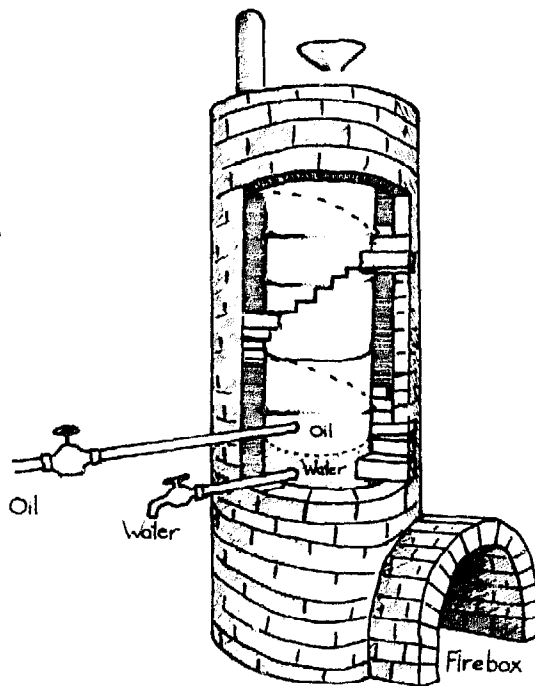

sity and will have to be heated to ensure a proper flow in the pipes. Waste oil often contains water and a heating system can be combined with de-watering. Two oil drums, welded together to form one long drum, are raised above a small firebox. Around the drum a chimney is made with an inside flue spiralling around the drum to the top. An outlet for water is made in the bottom of the drum and an outlet for oil is positioned about 0.5 m above the bottom.

Oil is pumped or filled into the drum through a sieve at the top. As water is heavier than oil the water will settle at the bottom of the drum and is tapped off now and then. Only a small fire is needed to keep the oil warm. The level of the oil should be at least 1.5 m above the taps at the burners.

Firing

A small wood fire is made in front of the burner plates. If it is a biscuit firing, smoking should be finished before starting oil firing as it will raise the temperature too fast. After about two hours the burner plates will be hot enough to start the oil firing, but the preheating fire should be kept going until the firebox is hot.

Without a preheating fire the oil firing will produce black smoke during the initial stages of firing the kiln.

In the beginning when only a little oil is dripping the fire will take place on the upper plate. Later, the oil will flow to all the plates and produce an intense white flame.

Fig. 2-68: Preheating of burner plates

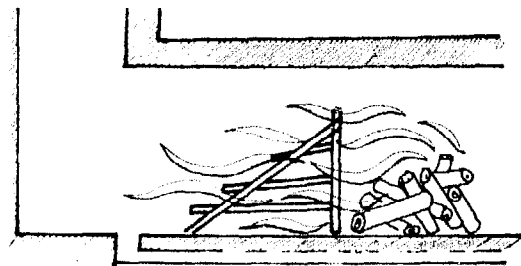

Take care that all the oil dripping onto the plates is ignited and that a pool of oil does not form in the bottom of the firebox. This could cause an explosive burning which may even blow out the fire. A mousehole ending in front of the burner will collect the excess oil and by watching the outside end of the mousehole (fig. 2-66) it is easy to discover excess oil flow. The mousehole works as an emergency reservoir and when the oil flow has been adjusted the excess oil harmlessly burns from the mousehole opening inside the firebox.

Additional fuel

In order to save oil the firing up to say 1100 °C can be carried out with cheaper fuels

e.g. firewood. The last stages of the firing up to say 1250 °C normally are the most difficult when firing with firewood. By changing to the powerful fuel oil, the last few hundred centigrades are easily reached.

2.3.6 Pressure burner system

This burner system is based on the same principle as the kerosene pressure stove, only expanded greatly in size (fig. 2-69). The burner is a double-walled cylinder of rolled steel, welded together and fitted with an orifice system. It works with kerosene, diesel oil and light fuel oil.

Fig. 2-69: Small pressure burner with a pressurized fuel tank. The pressure is obtained with a bicycle pump.

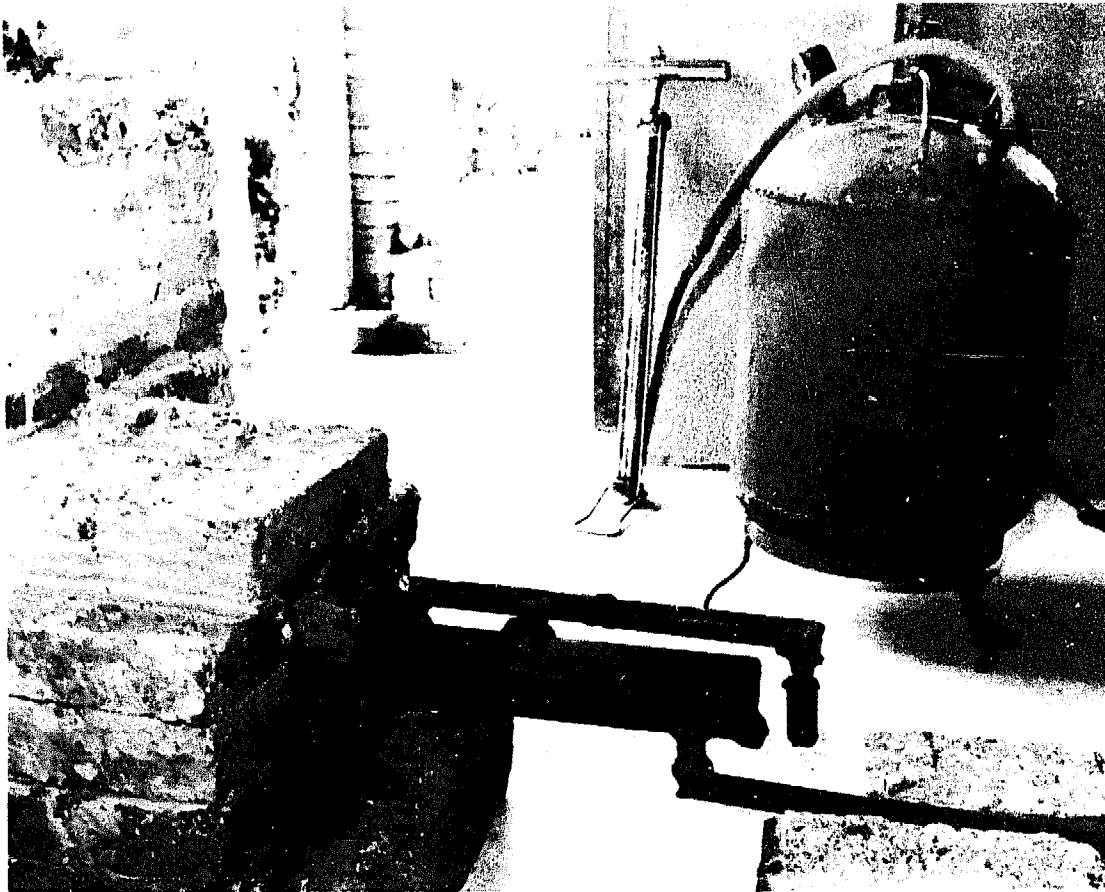

Function principle

The kerosene or oil is fed to the bottom of the double-walled chamber either by gravity or from a pressure tank. Initially the burner is heated by placing an oil-soaked rag or sawdust inside the cylinder. The heat will vaporize the fuel in the evaporation chamber and after a while the pressure of the oil gas will expel the vapours through the orifices (1.5 mm holes) at the rear of the burner. The oil gas is ignited by the burning rag and the burner is now operating. The flame of the gas from the orifices will heat up the evaporation chamber and the fuel valve can slowly be opened fully. The rate of firing is controlled by the valve at the oil pipe.

Back pressure

The oil has to be under a certain pressure to counteract the back pressure generated inside the evaporation chamber. Otherwise the vaporized oil gas will escape through the oil pipe instead of the orifices. The oil pipe is fitted to slope downward from the burner to prevent gas bubbles from entering and thereby blocking the oil pipe.

Large burner

For firing medium to large kilns it has been found that a burner with an inner diameter of 18 cm, 35 cm long and with 9×1.5 mm orifices is sufficient to heat $2-3 \text{ m}^3$ of kiln up to 1000°C . For this size of burner fuel can be gravity-fed from a minimum height of 4.5 m, which will be sufficient to counteract the back pressure in the burner.

Small burner

Small kilns can be fired with a version of the burner that has an inner diameter of 4 cm, length of 30 cm and a single 1.5 mm orifice. This size will be suitable for kilns up to 1 m^3 (1000°C). More burners can be added for each additional cubic meter of kiln volume. Because of greater back pressure generated in these small burners a pressurized fuel tank must be used. Since a 1 m^3 kiln can be fired to 1000°C using approximately 25 l kerosene, a 50 l tank pressurized with a bicycle pump to about atmosphere 3 will do. This burner can be scaled down by changing the 1.5 mm orifice with a 1 mm orifice.

Fig. 2-70: Large pressure burner

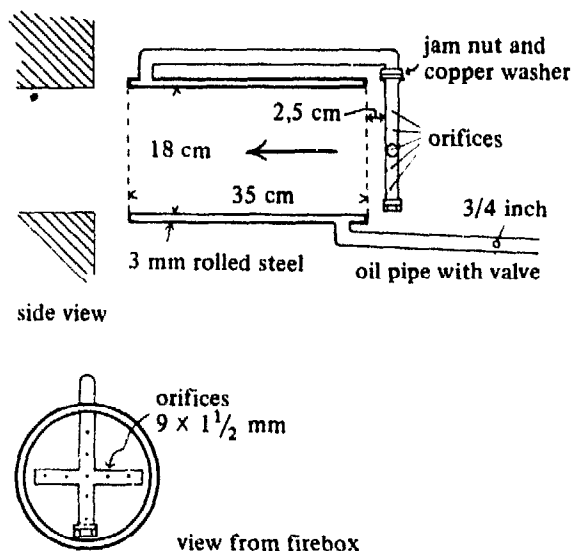

Chimney and firebox

Because the burner produces a flame under pressure, a large chimney is not required. Air for combustion is drawn into the burner by the venturi effect of the pressurized fuel gas. A simple up-draught kiln can function without any chimney while a cross-draught or down-draught type will need a low chimney to pull the combustion gases properly through the kiln setting. The burner is placed with a gap of 3-5 cm from the firebox inlet in order to let in secondary air. An opening in the kiln wall is sufficient but the flame should be allowed a free space of about 0.5 m in front of the burner. In general, several small burners will produce a more

even temperature compared to one large burner.

Carbonization

However, small pressure burners tend to become blocked by carbon deposits inside the cylindrical chamber, especially if the temperature in the chamber becomes too high. These carbon deposits are very difficult to remove and so it is best to avoid overheating the cylindrical chamber by leaving a sufficient gap between the burner outlet and the firebox opening and by ensuring an additional natural draught of air.

Kilns with additional draught, powered by a chimney, show little tendency to cause carbonization problems compared to chimneyless kilns.

The cylindrical chamber should have an airtight lid that will facilitate cleaning out minor deposits with petrol between firings.

Steam

Several successful firings have been done with a modified small pressure burner in Nepal. Oil was substituted for water so that steam was generated in the cylindrical chamber and this was forced out under high pressure through a single small orifice. The oil was fed in front of the steam orifice by a brass pipe where it would be vaporized and blown through the burner by the steam. A back pressure valve is needed between the burner and the pressurized water tank. Initial results indicate that fuel consumption equals that of a similar type of oil burner.

Fig. 2-71: 2 m³ down-draught shuttle kiln with four small pressure burners. Exit flue is in the bottom of the shuttle car.

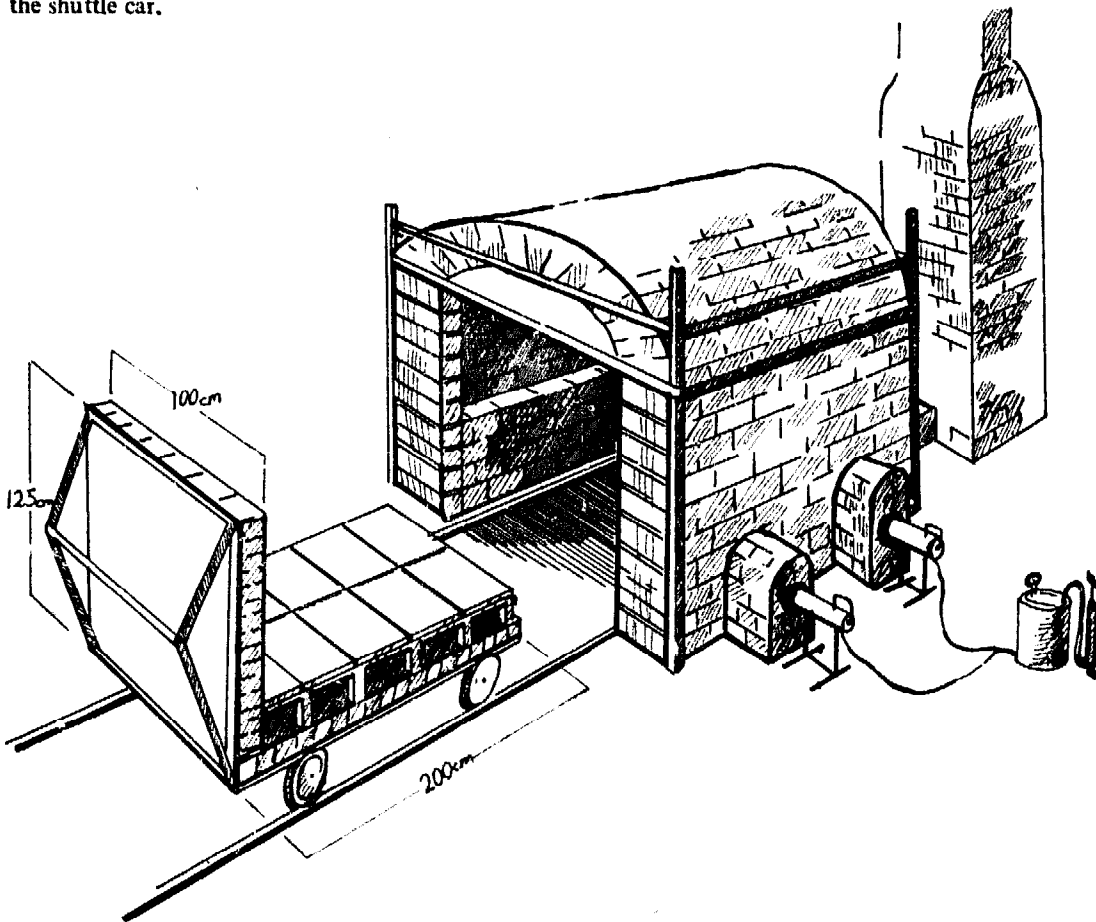

2.4 Heat transfer and draught

The hot combustion gases will, after leaving the fireboxes, pass through the kiln chamber on their way to the chimney. The more heat the combustion gases transfer to the ware while they pass, the more efficient is the firing. If the gases leaving through the top of the chimney are still very hot this means that a lot of heat or fuel is being lost. The transfer of heat takes place in three different ways:

2.4.1 Transfer of heat through air

Convection

Heat is transferred to the kiln walls and to the saggars or kiln setting when the hot gases from combustion pass through the kiln. Heat transferred in this manner by circulating air is called convection. Increasing the speed of the air (velocity) will result in the transfer of more heat.

Kiln setting

Just as a river will run fast where it is narrow and more slowly where it widens, air streams act in the same way. Therefore, a half-filled kiln with a lot of space between the saggars would fire badly. For an efficient firing the kiln should be set with many narrow passages through which the hot gases will pass quickly.

2.4.2 Transfer of heat through solids

Conduction

As the kiln setting becomes hot by heat transferred by convection this heat will also pass through the saggars walls and reach the pots inside. This transfer of heat through

solids is called conduction. Heat transferred by conduction will take some time and so the air outside the saggars will at first be hotter than inside where the pots are. This should be kept in mind when firing and is one reason for soaking the kiln at top temperature so that the temperature throughout the kiln will even out.

Kiln walls

Heat will also pass through the walls of the kiln and be wasted. The use of insulating firebricks for the inner wall will reduce this loss. The many small holes in insulating firebricks will reduce the passageways for the conduction of the heat. However, if the holes are too big the air inside the holes will have room to circulate and transfer the heat by convection (see fig. 1-43, p. 35). The weight of the insulating bricks is less than solid firebricks and so the fuel that would be needed to heat that weight difference is also saved.

2.4.3 Transfer of heat by radiation

Finally heat can also be transferred by radiation from a glowing surface. The sun transfers its heat to the earth by radiation. The more a surface is glowing the more heat it will transfer to its surroundings. At the end of a firing everything inside the kiln glows white-hot and will radiate a lot of heat. This radiation helps to even the temperature inside the kiln. The hotter parts will glow more and transfer heat to the cooler spots. A soaking period will give this radiation time to even out the temperature differences.

The insulating firebricks have here another advantage over solid firebricks; as less heat escapes through the insulating bricks their surface temperature will become higher and so they will radiate more heat back to the kiln setting.

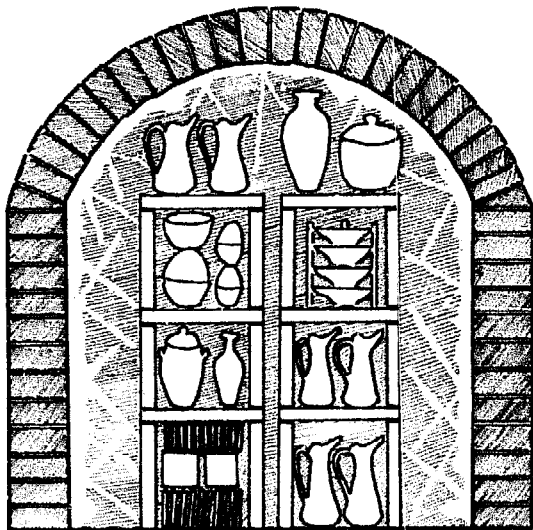

Fig. 2-72: At red heat the kiln walls will radiate heat back to the kiln setting.

Kiln wash

Some potters paint the inside of the kiln with a feldspar mixture which will melt and produce a shiny surface. This will add to the reflection and radiation of the kiln wall and will make a considerable difference especially in smaller kilns.

2.4.4 Natural draught

Chimney

One litre of hot air weighs less than one litre of cold air. So hot air will rise following the same law of nature that makes a piece of wood ascend when it is immersed in water. This law is used to produce a draught or pull of air in kilns by the help of a chimney. The column of hot air inside the kiln weighs less than a similar column of outside cooler air and this weight difference will produce a pull at the bottom of the chimney.

The force of the pull will increase with increasing height and volume of the chimney and with increasing temperature of the gases

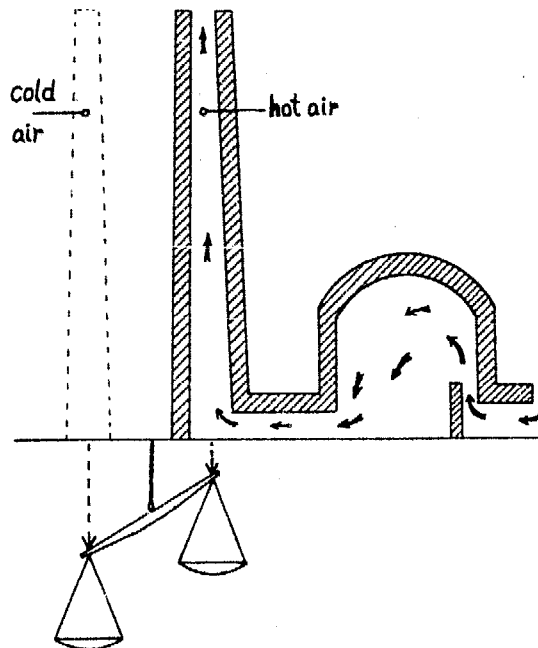

Fig. 2-73: The hot air in the chimney weighs much less than cold air of the same volume. The balance illustrates this weight difference.

inside the chimney. The maximum weight of gases is pulled through the chimney when the temperature of the gases is around 300 °C. With higher temperatures more volume of gases is passing but it weighs less.

The pull should be sufficient to create a good draught through the fireboxes and the kiln chamber.

Chimney dimensions

Some general rules exist for the dimensions of a chimney according to the size of the kiln. The following dimensions apply to high temperature firings and less height could be used for low temperature kilns:

3 m of chimney for every 1 m downward pull plus 1 m of chimney for every 3.5 m horizontal pull.

The height of chimney for the kiln in fig. 2-74 should be:

$$3 \times 2.2 + \frac{2 + 1.5}{3.5} = 7.6 \text{ m.}$$

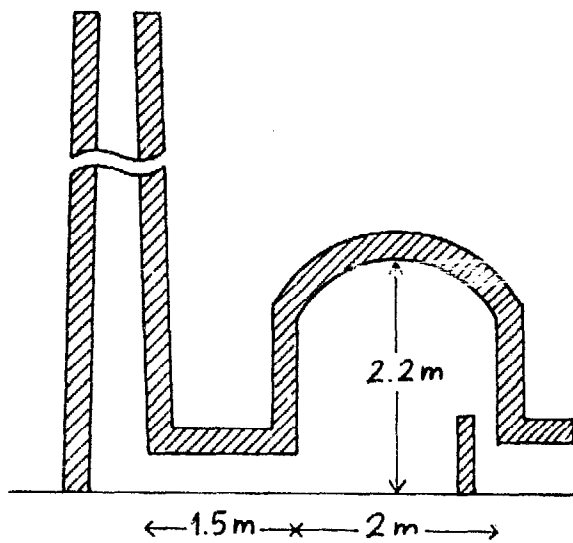

Fig. 2-74: Kiln with downward pull of 2.2 m and horizontal pull of 3.5 m

The bottom area of the chimney should be approximately 10% of the area of the kiln chamber.

Dampers

A slight tapering of the chimney at the top will increase the speed of the air passing through the kiln. However, too strong a pull will cause irregular heating. The pull can be regulated by the use of dampers or by making an opening at the bottom of the chimney through which cold air will be drawn in and cause the pull to slow down.

Velocity

The pull will be slow at the beginning of a firing but when the temperature in the chamber is around 1100 °C the speed (velocity) of gases through the kiln should be 1.2–1.5 m per second. This can be checked by throwing an oil-soaked rag into the firebox. The time taken for the black oil smoke to come out of the chimney should be noted. The total distance covered by the gases is

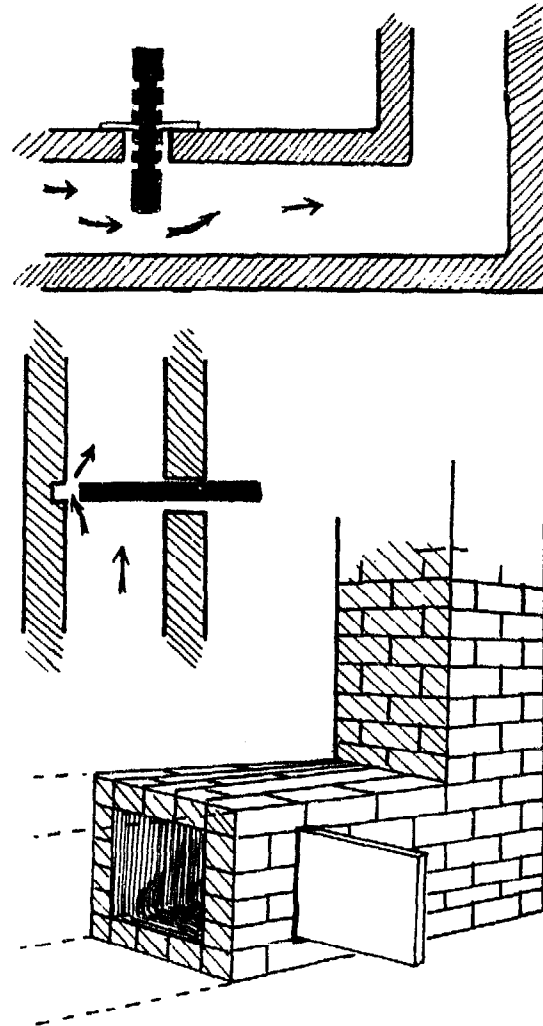

Fig. 2-75: Three different types of dampers. Dampers are placed between the outlet flue of the kiln and the chimney.

from the firebox up the kiln wall across the arch and down to the outlet flue¹.

$$\text{The speed of gases} = \frac{\text{distance in m}}{\text{seconds}}$$

The pull during wood firing is right when flames and smoke come out of the blow holes (a sign of back pressure) right after stoking. If there is no back pressure, dampers should be closed more to reduce the draught.

¹ This method is quoted from F. Olsen, "The Kiln Book", p. 53.

2.4.5 Flues

The openings or channels carrying the gases from the firebox to the kiln chamber (inlet) and from the chamber to the chimney (exit) are called flues. The size of inlet and exit flues should be of equal but generous size. One litre of air at 20 °C will expand to 4.5 litres when heated to 1250 °C and so the cold air entering through the primary and secondary air inlets needs 4.5 times larger openings after it has been heated in the firebox.

The size of the flues should be slightly bigger than the cross-section of the chimney. Another measure suggests that for each 1 m³ of kiln chamber there should be about 600 cm² flue area. In any case it is better to make the flue area too big because later when the kiln is finished it is easy to reduce the flue size but difficult to increase it.

2.4.6 High altitude

At high altitudes there is less oxygen in the air than at sea level. So kilns built in mountainous regions need to pull more air through the firebox for combustion of the same amount of fuel. Therefore, the height and diameter of chimney and size of flues should be made larger to allow for this extra air. Roughly the chimney and flue dimensions are expanded 1% for each 100 m altitude above sea level.

Example:

A kiln designed for sea level with a 6 m high chimney of 0.5 m diameter is to be constructed at an altitude of 1400 m.

New height of chimney = $6 + 6 \times 14\%$ m = 6.84 m

New diameter of chimney = $0.5 + 0.5 \times 14\%$ m = 0.57 m.

The added inside volume is nearly 50% in this case.

2.5 Kiln construction

2.5.1 Site of the kiln

The site of the kiln should be selected carefully. At some stages of the firing a lot of smoke will develop and sparks from the chimney could cause fires at nearby houses. If possible select a site for your kiln at a safe distance from neighbours. The kiln site should be dry and preferably levelled above the surroundings so that the kiln, its foundation and flue system will not come under water during rainy seasons. Ample space is needed around the kiln for stacking and drawing the ware, for storing saggars or kiln shelves and for storing fuel. Firewood is especially bulky (see fig. 2-76, p. 92).

2.5.2 Foundation

Construction of a kiln resembles that of a common house built of bricks. The bricklaying technique only differs a little and ordinary skilled masons will easily adapt themselves to the task. For larger kilns it is recommended to consult local building specialists (engineers, architects, masons) with experience in major constructions, particularly for assessing the size of proper foundations according to the type of soil and climate of the kiln site. In particular, foundations for chimneys above about six metres need a good foundation to ensure the chimney will not lean. Apart from the chimney only the supporting walls need foundations. The foundation should be exactly levelled by using a spirit-level. Levelling over larger distances can be done with a hose filled with water (fig. 2-77). A clear plastic hose is fitted to each end of the hose. So the level can be easily observed. Take care that no air bubbles are trapped inside the hose.

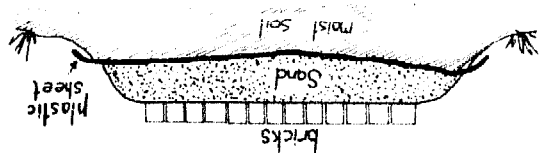

Fig. 2-79: Plastic sheets with a protective layer of sand work as a moisture seal.

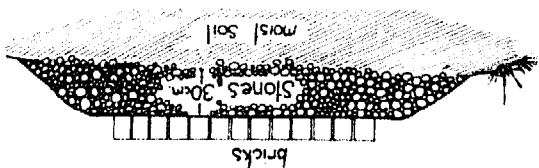

Fig. 2-78: A layer of stone pebbles seals off the moisture.

ken bricks) 30 cm thick and sealed with cement or common bricks on top (fig. 2-78). If available, plastic sheets with a top layer of about 0.5 m of sand may be cheaper to use (fig. 2-79).

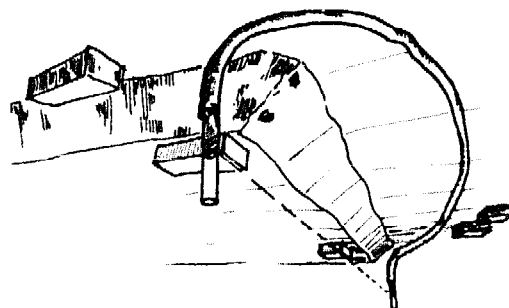
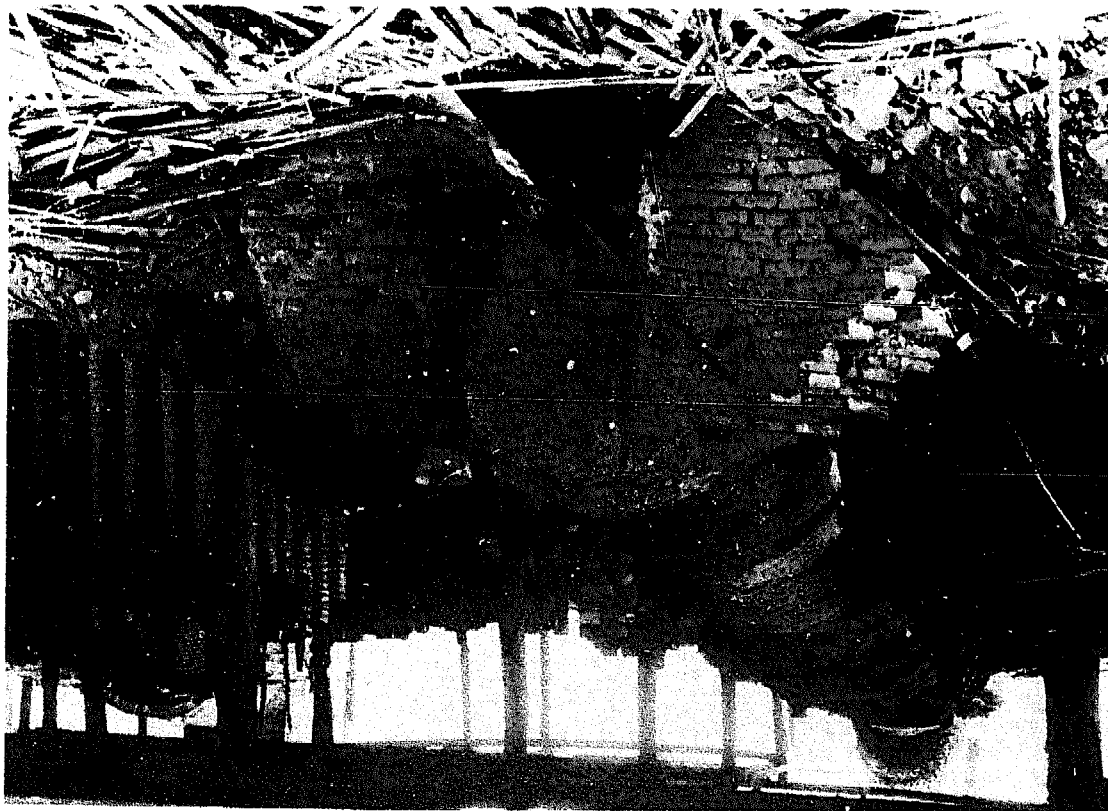

Fig. 2-77: Levelling of the foundation by the help of a hose

A damp-proof layer has to separate the kiln structure from the ground. Otherwise, moisture from the ground will slowly be absorbed by the brickwork and fuel will be wasted drying this moisture with every firing. This layer can consist of stone pebbles (not bro-

Damp-proof layer

Fig. 2-76: Chinese-type tube kiln in Thailand. Sagars and fuel fill up the space around the kiln.



2.5.3 Masonry

Mortar

The mortar (p. 38) should be mixed with water a day or two before use. Avoid any lumps and big pieces of grog. The consistency of the mortar should be soft, nearly slip-like. Some prefer to soak the firebricks in water before laying them. The joints are the weakest part of the structure and they should be as thin as possible. The mortar is not meant to stick the bricks together but

Fig. 2-80: Mortar is used for filling the spaces between irregularly shaped bricks.

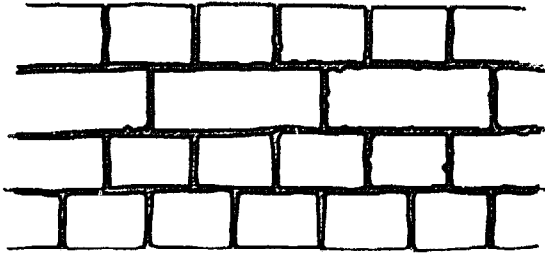
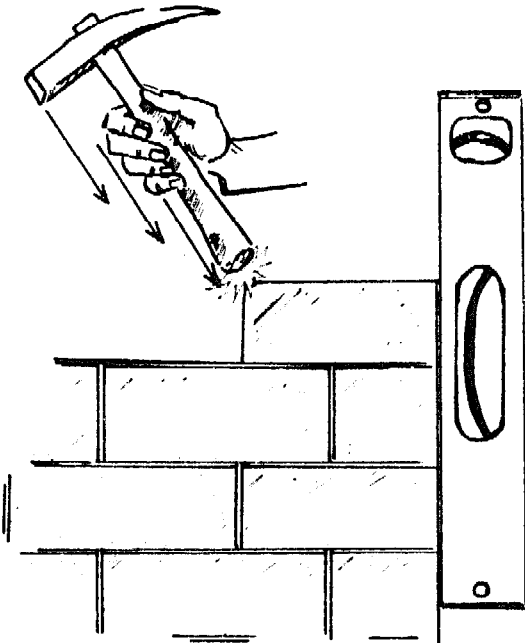

Fig. 2-81: Each brick should level vertically with the wall.



rather to provide a level bed for the bricks by filling up the space between irregularly shaped bricks (fig. 2-80).

Laying

The mortar is laid out with a trowel but only for one or two bricks at a time. Each brick is tapped into position with the trowel or hammer until it is in line (fig. 2-81). Immediately check its position with the spirit-level both vertically and horizontally and readjust if necessary by tapping lightly. In case adjustment is done later the brick and mortar should be removed and fresh soft mortar applied. The joints should also seal the kiln chamber. Therefore, be sure that the joints are completely filled with mortar.

Cutting

Cutting of firebricks is done with the claw of a brick hammer by tapping the brick all

Fig. 2-82: Cutting of firebricks

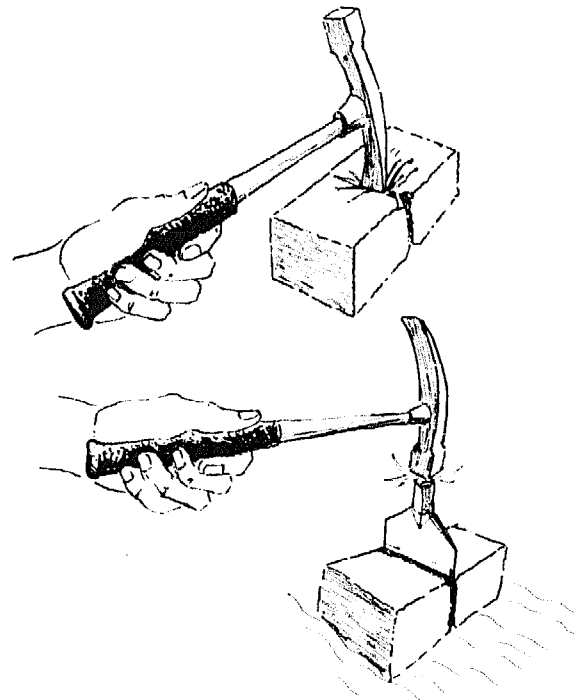

around along the line of the cut. After about two rounds of tapping the brick is given a sharp blow on the edge while resting in the hand or on a bed of sand. Some people prefer to use a brick chisel for the final blow. Insulating firebricks can also be cut by a saw though the saw will afterwards only be suitable for cutting bricks. Cutting by saw could be reserved for specially shaped bricks such as skewbacks and arch bricks.

2.5.4 Floor and walls

Normally the floor is laid last, but flue channels passing under the walls will need to be made at the same time as the foundations. The basic rule for bricklaying is that joints should never be in line but always be bridged by the next brick course. There are two basic bricklaying patterns: header course and stretcher course.

Header course

Header courses are laid across the wall, thereby only exposing the smallest face of the firebricks to the high temperature inside the kiln chamber. For our self-made firebricks, often possessing limited refractoriness, this is an advantage.

Fig. 2-83: Header course

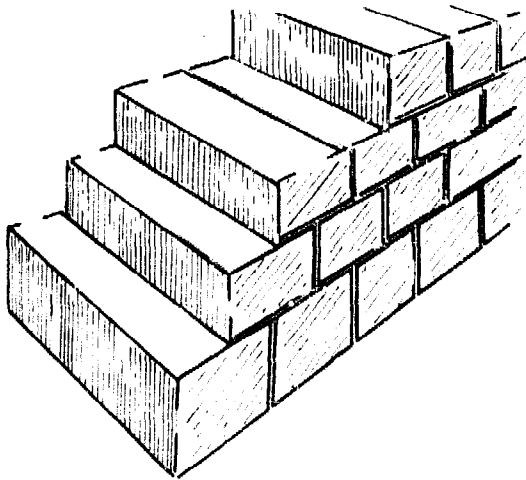

Fig. 2-84: Stretcher course

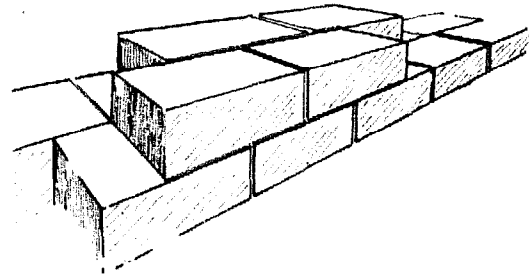

Fig. 2-85: One stretcher course for each three header courses

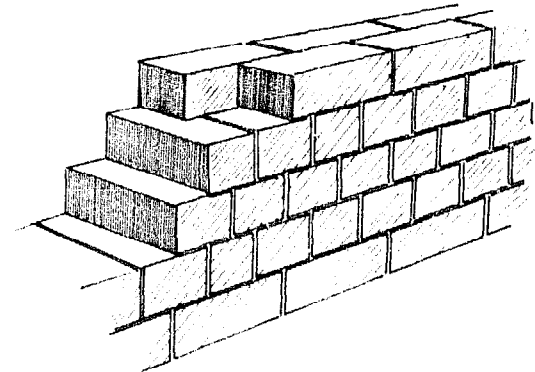

Fig. 2-86: Stretcher courses in a Chinese-type tube kiln



Stretcher course

Stretcher courses are laid along the wall, but for straight walls stretcher courses alone will only be strong enough for unsupported walls less one metre's height (bagwalls).

One stretcher course for each 3–4 header courses is suitable for 23 cm walls. A 23 cm wall is safe up to about 2 m height and a 34 cm wall is safe up to about 4 m.

2.5.5 Curved walls

Round kilns

Curved walls are found in circular kilns which have proved very durable. A circular inner lining can stand alone because the bricks are wedged together in the same fashion as an arch and will not fall into the kiln. So a curved wall does not need to be bonded with the outer wall. Instead a gap of about 5 cm can be left between the inner and outer wall. This gap can be filled with ash or a mixture of 70% sawdust and 30% clay (volume). A curved wall is laid in the same manner as a straight wall. Normally only header courses are used.

Fig. 2-87: Cross-cut of a circular kiln wall

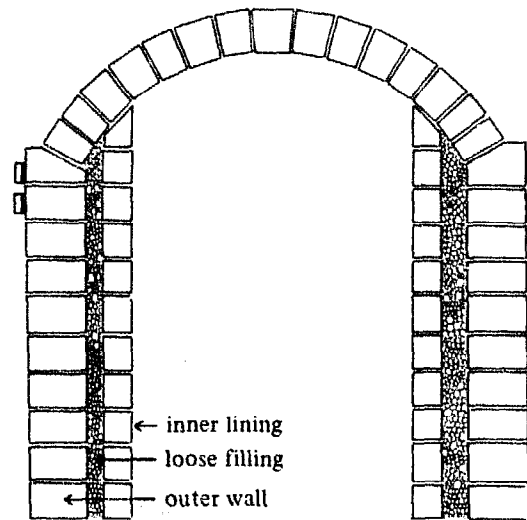
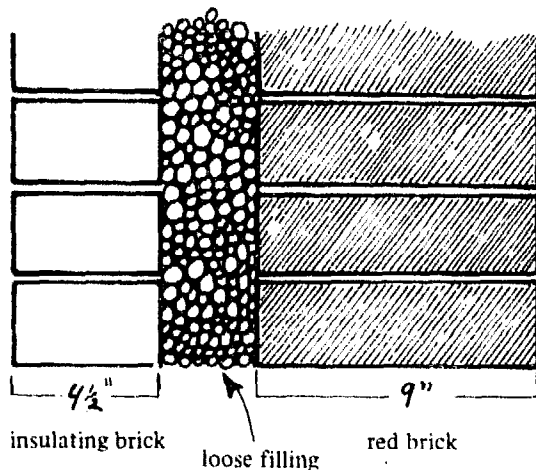

Fig. 2-88: The dome is resting on the outer wall.

Wall thickness

Circular kilns with diameters up to 2 metres are made with a 10 cm inner lining, 2–3 metres with 15 cm and above 3 metres with 23 cm. The inner lining should preferably not support the dome which instead is made to rest on the outer wall (fig. 2-88). That enables the wall to be replaced while leaving the dome in place and the wall, only carrying its own weight, can be made from light insulating bricks. The outer, dome-supporting wall should have twice the thickness of the inner lining and is made from ordinary red bricks laid in an ordinary mud/sand mortar.

2.5.6 Arches

Arches are used to bridge doors, flues and fireboxes and to form roofs for rectangular kiln chambers. Square bricks can be used for laying arches if the joints are filled properly. However, if available, tapered bricks are preferable as they produce a more durable arch. In case firebricks are self-made a number of tapered shapes should be made for the

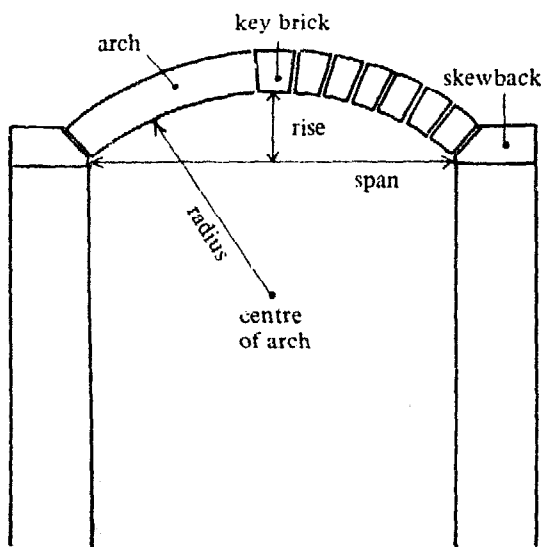
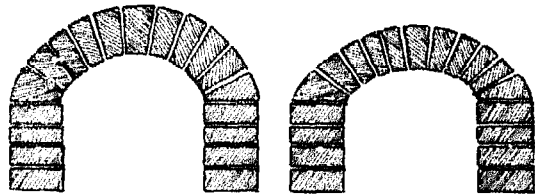

Fig. 2-89: Arch

construction of arches. The number of bricks and their degree of tapering can be calculated (see appendix). The main point is that the outer size of the arch bricks is bigger than the inner size so that each brick is prevented from falling in. That means the higher the rise of the arch the stronger it is. Normally a rise of 20 cm for each 100 cm span is reasonable for roofing kiln chambers. (12.5–25 cm rise per 100 cm span is within normal good practice.)

However, in fireboxes, especially for oil firing, the firebricks are under severe conditions and a rise nearly half of the span is advisable if the firebricks are of poor quality. The firebricks will shrink causing the arch to sink and especially the joints are exposed to the fluxing action of ashes.

Fig. 2-90: Firebox arch after construction, and later after firing shrinkage of the firebricks has taken place. The initial high rise saved the firebox arch from collapsing due to firing shrinkage.



Relieving arches

A relieving arch is used to remove the load from the main arch. Normally it is rarely used. However, the firebox shown in fig. 2-92 benefits from having a relieving arch above, which would carry the load of the kiln wall. A relieving arch also makes it easier to replace the bricks of the main arch when these wear out.

The important feature is the gap between the relieving and the main arch which ensures that no weight is being carried by the main arch. A loose filler, such as asbestos or a sawdust/clay mixture can be used to fill the gap.

Skewbacks

The arch is resting on a skewback at both ends. The weight of the arch is transferred to the walls through the skewbacks. These are made from square bricks cut to the proper angle (fig. 2-91). The skewbacks should be laid very carefully because if they fail the arch will come down.

Fig. 2-91: Skewbacks cut from square bricks

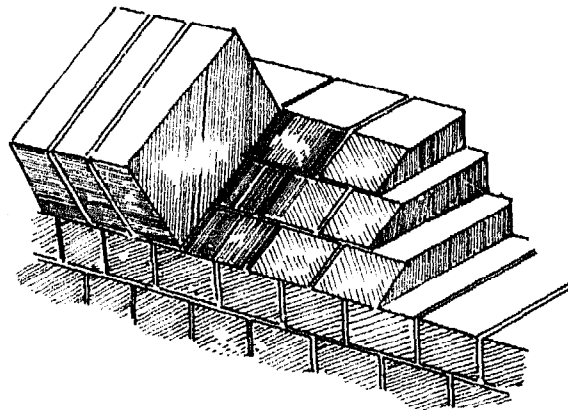

Arch frame

While the arch bricks are being laid, a support frame is needed. This is made of wood (fig.

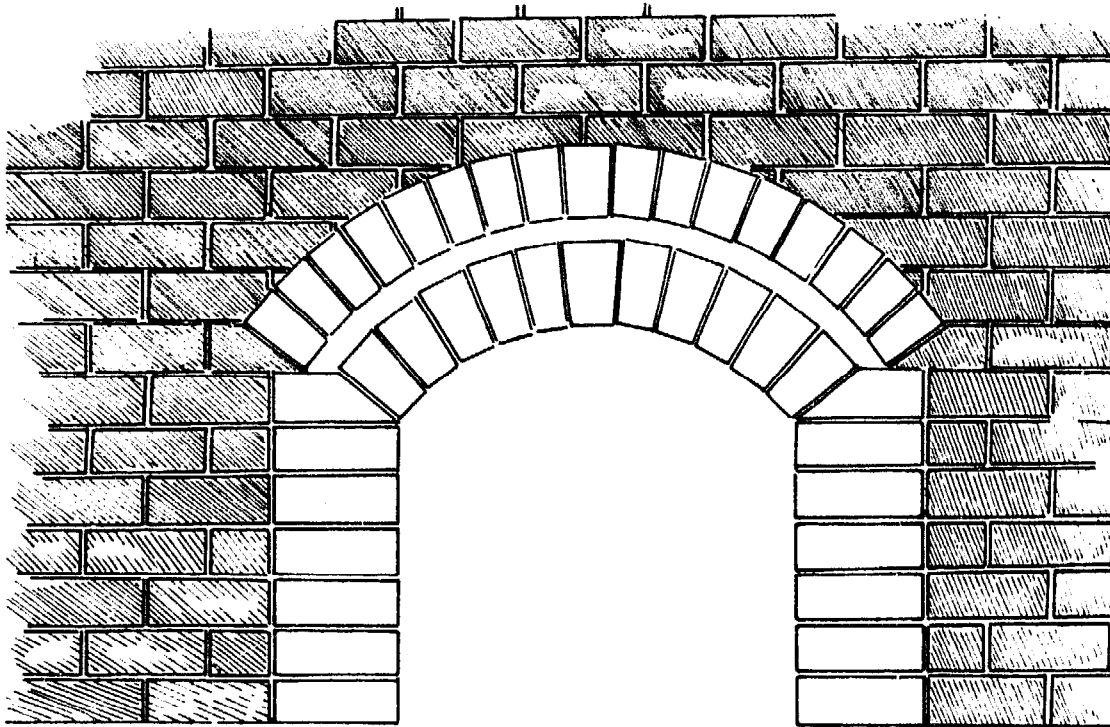

Fig. 2-92: Relieving arch

2-93). The frame is raised until its sides are level with the skewbacks.

Laying the arch (fig. 2-95)

Construction of the arch is started from both sides working towards the middle. Each brick should be placed so that it follows the

circle of the arch by pointing towards the centre of the circle. Extra care is needed to ensure that the joints are completely filled with mortar. This is done by applying a thin layer of mortar on both surfaces and after the brick is laid it is rubbed back and forth. With a hammer and a piece of wood the brick is given a few taps at the lower end. The bottom of the points should be as thin as possible. The outer part of the joints might be thicker depending on the tapering of the bricks. Thicker joints should have small pieces of broken firebricks forced in from above after the whole arch is laid.

Fig. 2-93: Arch support frame

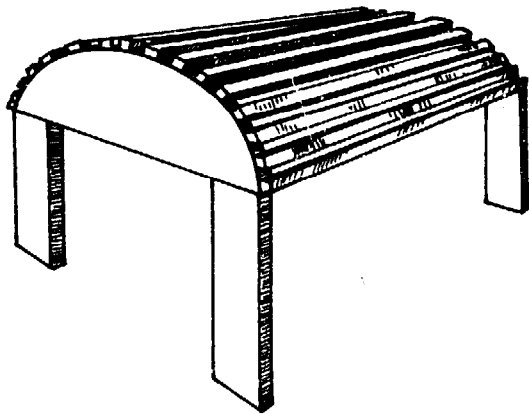

Fig. 2-94: Bottom of the joints should be as thin as possible.

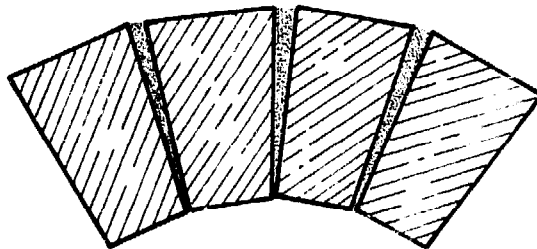
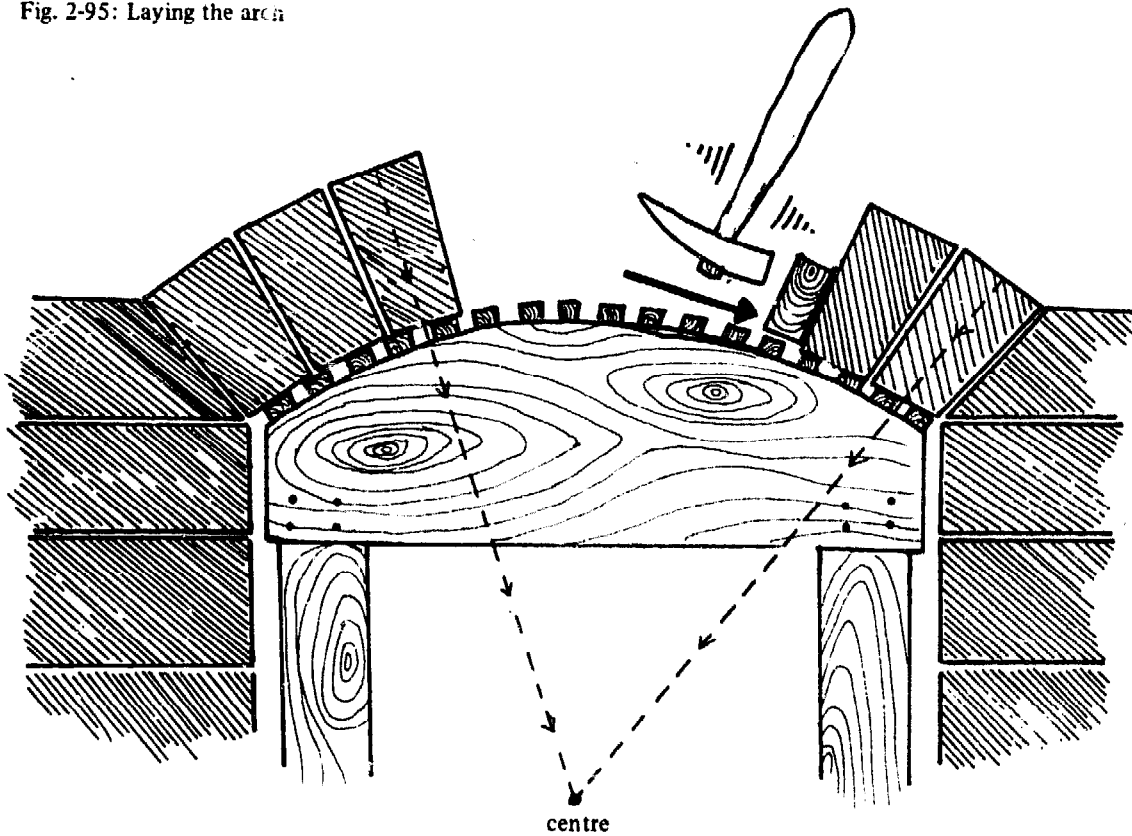

Fig. 2-95: Laying the arch



Square brick arch

In case no tapered bricks are at hand ordinary square bricks can be laid as shown (fig. 2-96), but at least the key brick should be tapering and should be forced below the other bricks. The square bricks are laid so that the upper one is resting a bit inside the corner of the lower one in order to prevent it from slipping out. A square brick arch will have thick outer joints and these should be filled with broken firebrick pieces.

Fig. 2-96: Square brick arch

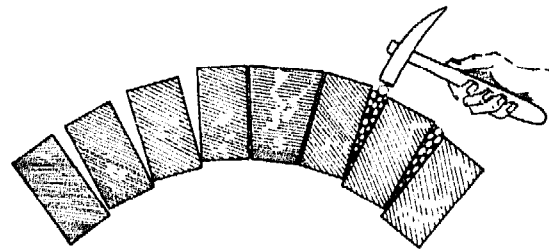
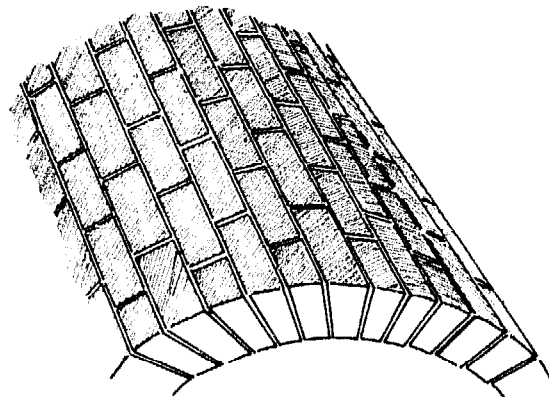

Fig. 2-97: Bonded arch

Bonded arch

As for all other brickwork the joints should, as far as possible, be broken as shown (fig. 2-97). In case one brick should fall out the bond will keep the arch from collapsing. When the key bricks are in place the wooden frame can be removed.



Arch spans and thickness

The thickness of the arch depends on the span and rise of the arch, the temperature of firing and the quality of the firebricks. The highest temperatures are reached at the outlet of the fireboxes and the arch here should be 23 cm thick. Generally, solid heavy firebrick arches spanning less than 1.5 m are laid with 12 cm thickness, up to 4 m spans 23 cm thickness and above that 34 cm is used. Insulating firebricks are lighter and thickness above 23 cm is not used for spans even above 5 m¹.

¹ Norton: "Refractories" p. 702

Fig. 2-98: Construction of a dome



2.5.7 Domes

Circular kilns are roofed with a dome. A dome is a more stable structure than an ordinary arch and requires no supporting frame for its construction. The radius and rise of the dome circle are calculated as for arches (see appendix). Domes are normally made with a rise of 20–25 cm per 100 cm span. A stick with the length of the radius and thickness of the dome is tied at the centre of the dome circle (see fig. 2-99) in such a way that it can move both around and up and down. Take care that the stick is really pivoting at the centre of the dome and that it will not become displaced during construction.

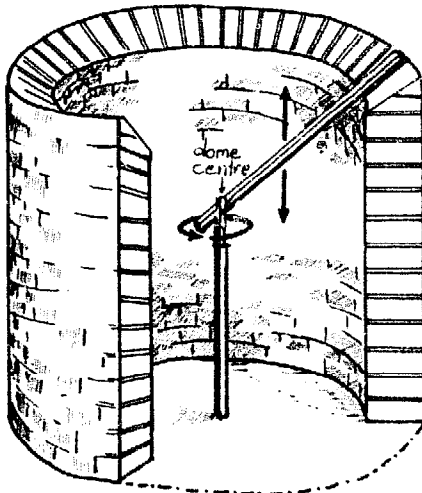

Fig. 2-99: Arrangement of dome ruler

Skewback

The skewbacks on top of the circular kiln wall are then laid with the guidance of the stick. The skewback bricks are laid as headers (fig. 2-100) cut to the proper angle.

Laying the dome

The laying of the first course of the dome is started by placing two bricks, also in header position, on the skewback. The joints should be as thin as possible. The stick is laid on top of each brick while tapping it into line with the stick and the lower edge of each brick should be in line with the mark on the stick (see fig. 2-98). Each brick will then be pointing towards the centre of the moveable stick. The stickiness of the mortar will prevent the bricks from slipping and as soon as more bricks are laid they will squeeze each other into place. The mason stands inside and works around until reaching the starting point (fig. 2-101). The last brick has to be cut so that the circle course of bricks interlocks tightly. A new course of bricks is laid in the same fashion taking care to overlap the joints of the former course. Each round of bricks will lock itself and there is not the same need for broken joints as with ordi-

Fig. 2-100: Skewbacks are laid as headers

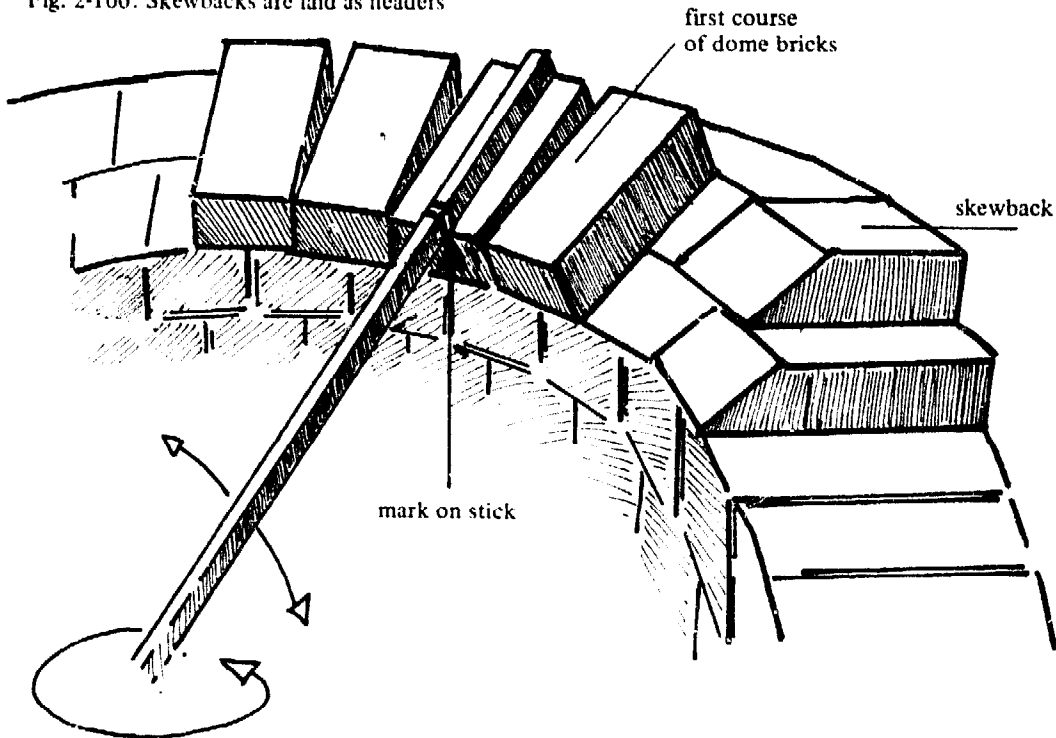



Fig. 2-101: Starting the dome of the Bujora kiln. Note the insulating loose layer between the inner firebrick lining and the outer wall. The bagwalls proved to be too high and were later cut in half.

Fig. 2-102: Only a few courses are still to be laid and each brick has to be cut to size.



nary arches. As the circle of brick courses becomes smaller the bricks should be cut slightly at the edges on the inner side in order to give better lock.

When the mortar is dry it is safe to walk on the dome and from the top all the joints should be gone over to ensure they are completely filled with mortar. Normally a vent hole is left in the centre of the dome. Domes can be constructed in similar ways for covering clay cellars or underground tanks for water. In that case a lime mortar is sufficient.

2.5.8 Catenary arch

The shape of a catenary arch is found by hanging a chain or heavy rope between the ends of the span so that the rope touches the top point of the required arch. The curve is copied onto a wooden board which is used to form a wooden frame. An arch with this shape is self-supporting and so steelwork is not needed. A catenary arch can be laid with square bricks.

Fig. 2-103: A chain forms the shape of a catenary arch.

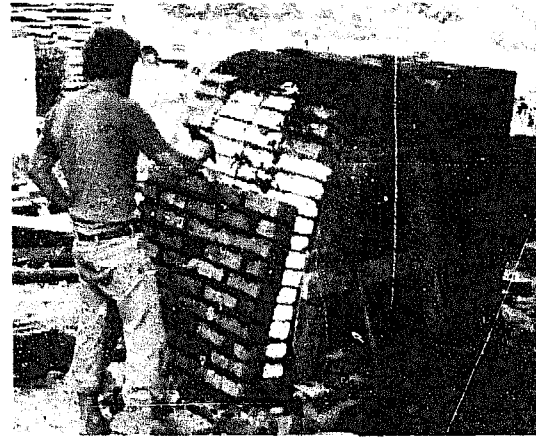
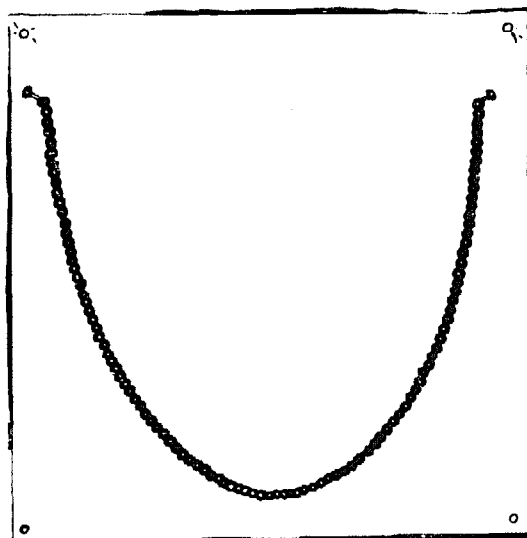

Fig. 2-104: Catenary arch under construction. Singisi, Tanzania.

2.5.9 Arch construction without support

An alternative method of arch construction which does not require a wooden support is suitable for catenary arches or arches with a high rise like barrel vaults.

In this method, the face of the arch is sloped back from the vertical and the vault develops from back to front by first laying a complete arch, one brick thick, then adding one full arch at a time. The initial slope of the arch is built up against the end wall of the kiln as shown in fig. 2-105.

Mortar

The mortar should be plastic so that its stickiness will prevent bricks from falling until the key brick is set. A simple bent wood or bamboo guide, made to the inside curve of the arch, keeps the curve uniform.

Brick shape

Ordinary square bricks can be used for this construction method. However, specially shaped bricks, which are thinner but wider than standard, will make construction easier. Bricks like this are used for the large stone-ware kiln shown in fig. 2-107.



Fig. 2-105: Construction of a catenary arch without support. Beginning of construction. Nepal.

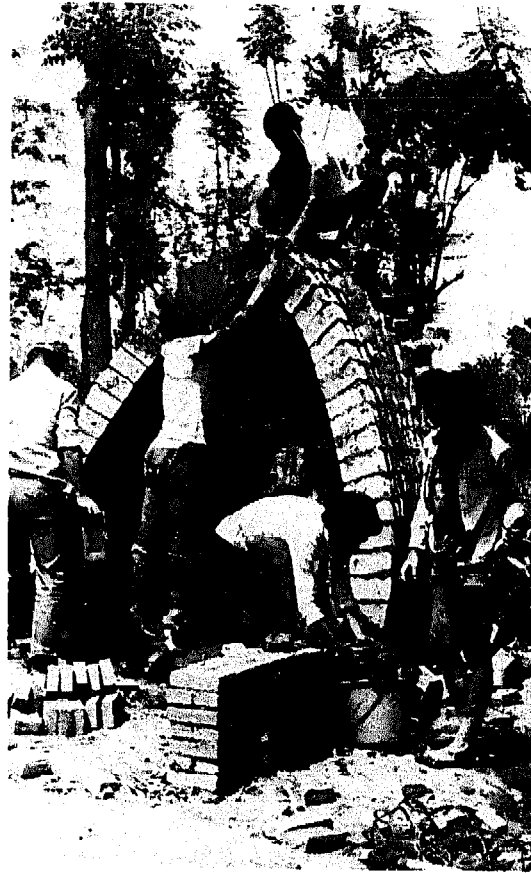
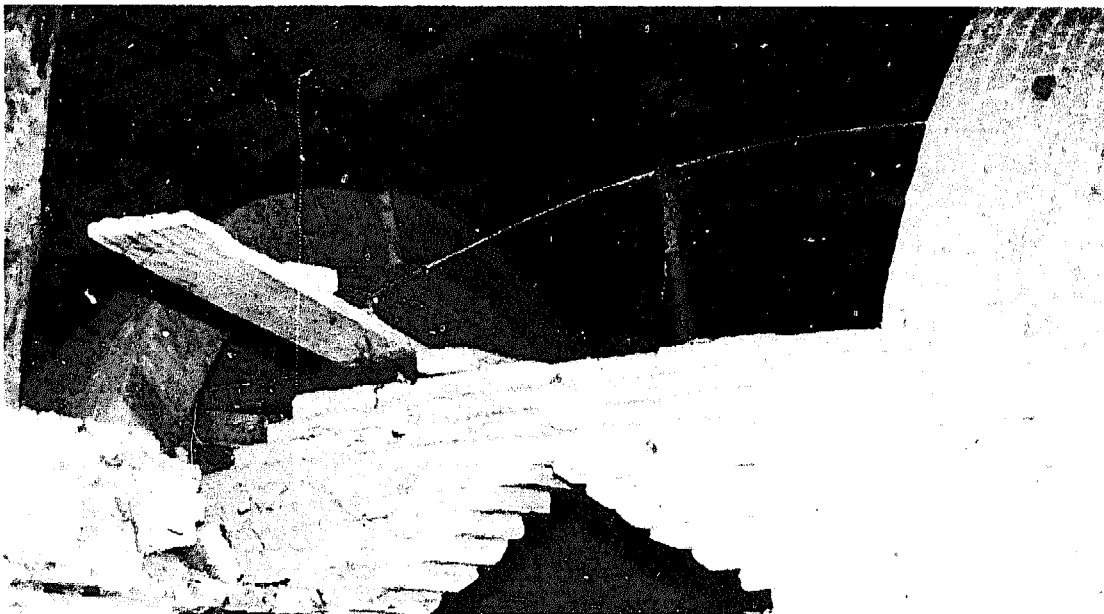

Fig. 2-106: Each row of arch bricks is completed at a time. Nepal.

Fig. 2-107: Bamboo guide keeps the curve uniform. Specially shaped bricks are used.



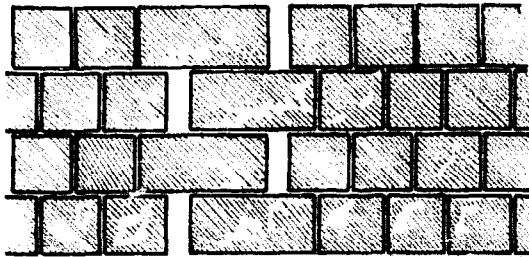
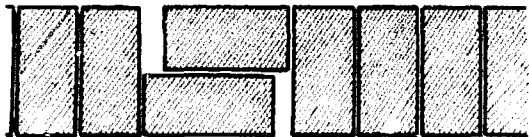

Fig. 2-108: Expansion joints in a kiln wall. Side elevation.

Fig. 2-109: The same expansion joints as in fig. 2-108 seen from the top of the wall



2.5.10 Expansion joints

The firebricks might expand 0.5–1% each time the kiln is fired and they will shrink again while cooling. In small kilns (1 m^3) this is of no concern but in bigger kilns the expansion might cause the wall to crack and bulge if the construction is made too tight. Joints, $\frac{1}{2}$ cm thick, are made without mortar for each 1 m length of wall. Such expansion joints are made starting from the corners in numbers according to the length of the wall.

Steelwork

However, the expansion joints are only needed for kilns firmly supported by steelwork. Free-standing kilns without steelwork will just expand as a whole and fall back again and circular kilns with an insulating layer will need no expansion joints. If the kilns are laid with self-made firebricks these will often shrink additionally during the first firings of the new kiln. Only if the firebricks have been fired at a much higher temperature will no more shrinkage occur. This additional shrinkage makes room for the normal ther-

mal expansion and therefore expansion joints can be omitted. In conclusion, expansion joints are only needed in big square kilns, laid with hard-fired bricks and supported by steelwork.

2.5.11 Insulation

During firing heat goes through the kiln wall and is lost. Heat goes through solid matter (conduction) but is stopped by air. Good heat insulation means as much air as possible but the air should be in small pockets, otherwise the air will rotate and thereby transfer the heat (convection). The most practical solution is an insulating firebrick wall backed up by ordinary bricks. In some cases a gap of about 5 cm can be left between the inner and outer wall. This gap can be filled with some very light loose materials.

Loose layer

This can be a mixture of (by volume) 30% plastic clay and 70% sawdust. The sawdust will slowly burn out leaving insulating airpockets. Ash is an even better insulator, but unless the ash has been calcined it will lose much of its volume after a few firings. A simple solution is to leave a few loose bricks in the top of the wall to allow for the refilling of ash. If a loose insulation is used spyholes and vent holes should be lined so that the insulation does not fill the holes. A similar loose layer can be laid on top of arches and a layer of flat tiles may be used to cover the insulation for protection.

2.5.12 Maintenance of kilns

Nearly all kilns show cracks after the first few firings and it does not mean that the

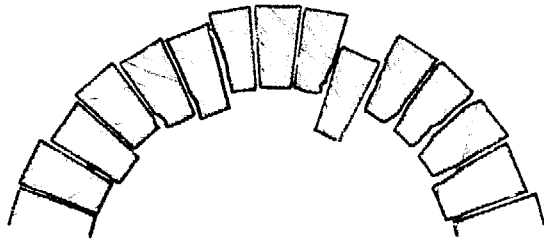

Fig. 2-110: Look out for bricks falling in and refill mortar in loose joints.

kiln is about to collapse. However, after each firing the condition of arches and dome should be inspected carefully for bricks beginning to sink in or for joints which have become loose or fallen out. These defects should be mended immediately to prevent the arch from collapsing. Flue channels, dampers and bagwalls should likewise be checked. It is an unnecessary waste of time and energy to stop a firing halfway through because a damper is blocking the draught or a bagwall has collapsed. The flue channels should be cleaned regularly.

Fig. 2-112: Drying pots in the sun



Fig. 2-111: Collapsed two-chamber kiln

2.6 Loading and setting of the kiln

Dry pots

When the raw pots are dry they are ready for firing. This can be checked by holding the pot to one's cheek; if any coolness is felt then it is not sufficiently dry to be fired safely.

The pots can be left in the sun for a day to ensure they are completely dry. Another method is to light a small fire in an empty kiln for half a day after which the pots are loaded and kept in the warm kiln overnight. The gentle heat remaining in the kiln walls will dry the pots and next morning the firing can start.

Biscuit/glaze firing

Some workshops glaze the raw pots and fire them only once while others prefer to fire the green pots without glaze (biscuit firing), then glaze the pots and fire them once more (glaze firing).

2.6.1 Loading biscuit firing

Before loading a kiln it is preferable to have $1\frac{1}{2}$ times the ware needed to fill the kiln. A wide selection of sizes and shapes makes it easier to fully utilize the kiln space. The same idea applies to glaze firings.

Stacking

Unglazed ware can be stacked on top of and

Fig. 2-113: Pots stacked for biscuit firing

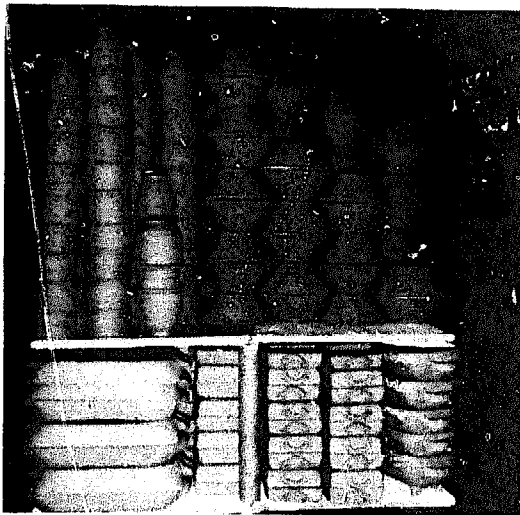

inside each other. However, around $700\text{ }^{\circ}\text{C}$ clay expands and then later it shrinks again. Therefore the pots should not be set tightly inside each other and a gap of at least 5 cm should be left between the pots and the top of the kiln. Cups, bowls and pitchers should be placed rim to rim and base to base. Tiles, saucers and other flatware will often show less breakage if placed vertically against each other.

Fig. 2-114: Stacking like this may cause breakage.

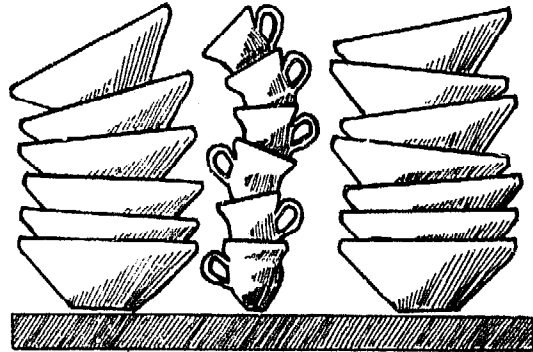

Fig. 2-115: Correct way of stacking

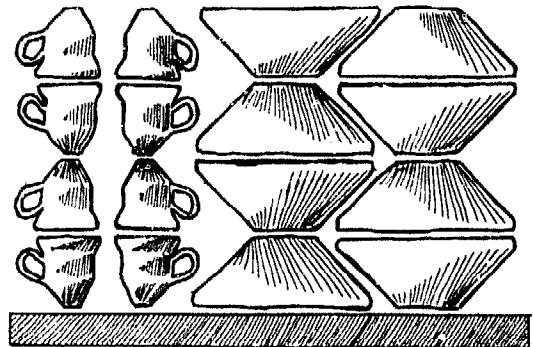
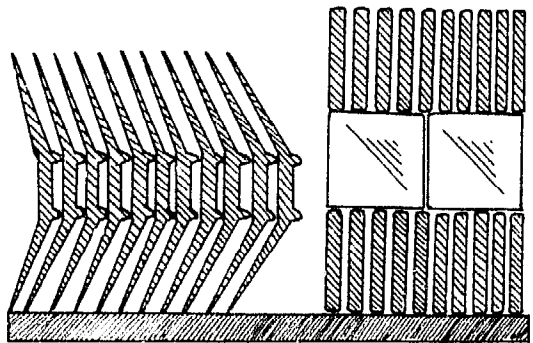

Fig. 2-116: Flatware is better stacked on edge.



Height of setting

The height of the stacked pots depends on the quality of the clay and the types of pots. The green strength of highly plastic clays is much greater than sandy clays and thin green pots will break before thick-walled ones. In case the pots cannot be stacked from bottom to top without breaking, the pots can be set in smaller stacks supported by kiln shelves resting on props (fig. 2-113). The same persons should always both load and draw the pots from the kiln so that they can learn from their mistakes.

Last check

While the pots are being placed in the kiln they should be given a last check. It is a waste to fire broken pieces and at this stage it may still be possible to correct a minor flaw in a pot before firing. This checking is needed to improve the quality and correct mistakes done during earlier production of the pots.

2.6.2 Loading glaze firing

Slabs or saggars?

A glazed pot will stick to anything it touches during firing so that pots will have to be

Fig. 2-117: Open setting of slabs combined with saggars

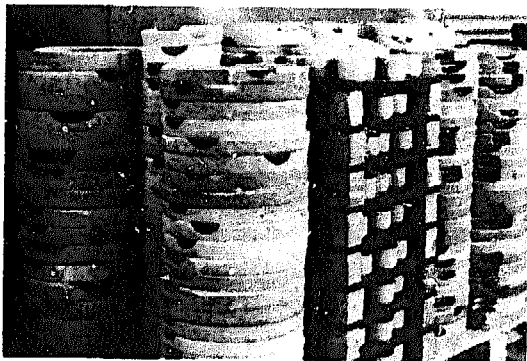

placed separately either on kiln slabs or in saggars.

Provided the glazed pots are not harmed by direct exposure to combustion gases and ashes, kiln shelves are the best solution. For the same space a kiln setting with slabs carries more pots compared to saggars, which are also much heavier. The ratio of kiln furniture to ware is about 4 : 1 for saggars but only 2 : 1 for slabs. Sometimes saggars are set as a bagwall (fig. 2-30) behind which kiln shelves are placed.

Kiln wash

Before setting, glaze droplets from previous glaze firings should be chipped off the slabs or saggars and these should then be given a refractory kiln wash. A suitable wash can be made from a powder of silica sand or quartz mixed with water and gum arabic or another glue. Another suitable kiln wash can be prepared with $\frac{1}{2}$ kaolin and $\frac{1}{2}$ silica powder mixed with water. Alumina, zirconium silicate and silimanite are excellent for high temperatures, though expensive and often not available.

Fig. 2-118: Stacking with thimbles

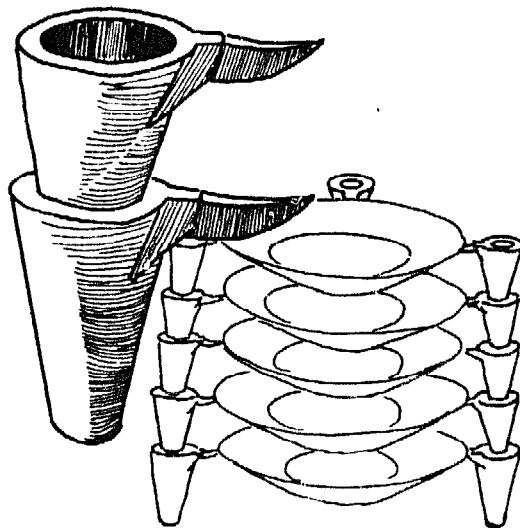

The kiln wash will prevent pots from sticking to the kiln furniture, which will also be less likely to stick to each other. Glazes accidentally running off the pots will also be easier to chip off after the firing. The wash can be painted on with an ordinary paint brush.

Lids

Pots with lids such as teapots and jars should be fired with the lid in place so that the lid and the pot will fit together after firing and the colours will be the same. This is especially important for high temperature firings. The faces of contact on the lid and the pot should be free of glaze and should be painted with a silica powder mixed with glue.

Sticking

The simplest way of placing glazed ware in the kiln is to remove any glaze from the foot of the pots and set the pots directly onto the shelf or saggar. However, at high temperature firings, especially when stoneware clays are used, the pots tend to stick to the kiln furniture. To avoid sticking one of the following methods should be used:

1. The pots can be set in sand, but care should be taken during setting to avoid knocking sand into the glazed ware on the shelf below.
2. A silica powder wash can be painted onto the feet of the pots.

Fig. 2-119: Freshly rolled balls are stuck to the pot and it is then set in the kiln.

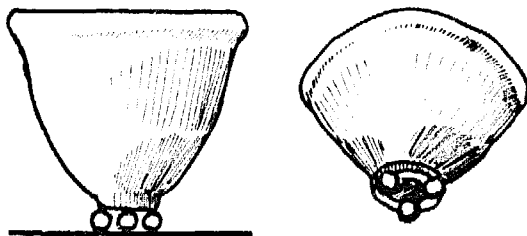

3. Small hand-made clay balls of $\frac{1}{2}$ kaolin and $\frac{1}{2}$ silica powder with the addition of a glue (a cheap flour of cassava, maize or the like works well) can be stuck onto the bottom of the pots before they are placed in saggars or on shelves. The balls are made just before setting is done (fig. 2-119).

Earthenware setting

Pots made from clay which does not soften or warp during firing can be supported on only a few points. Stilts and spurs are used for setting pots with glazed bottoms and they can also be used for placing glazed pots inside each other (fig. 2-120).

Flatware such as saucers, dinner plates or tiles can be placed vertically and supported at the top with thimbles (fig. 2-122). These can also be used for stacking bowls or plates horizontally in which case a cover for supporting the stack of thimbles is helpful (see page 29 f.). Bowls and plates could also be placed rim to rim and base to base if their

Fig. 2-120: Setting with stilts

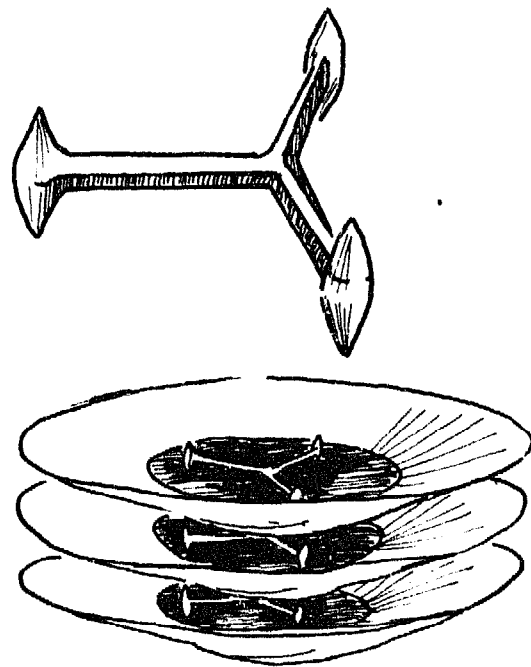

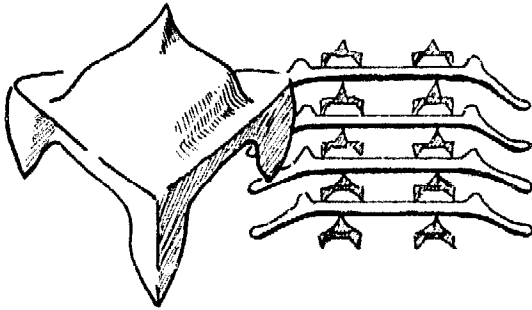
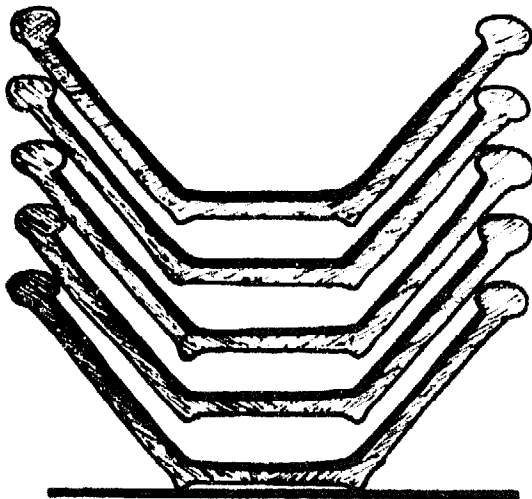

Fig. 2-121: Spurs resting on the unglazed bottom of the plates



Fig. 2-122: Thimbles used for setting tiles vertically in saggars

Fig. 2-123: Bowls only glazed inside can be stacked hanging inside each other.



rims and bottoms are left unglazed. If bowls are made to accurate measure and with a thick rim, they can also be stacked hanging inside each other (fig. 2-123).

"Kissing"

The glazed pots should be placed carefully 3–5 mm apart. This will prevent them from "kissing" each other when the glaze and clay expand during firing.

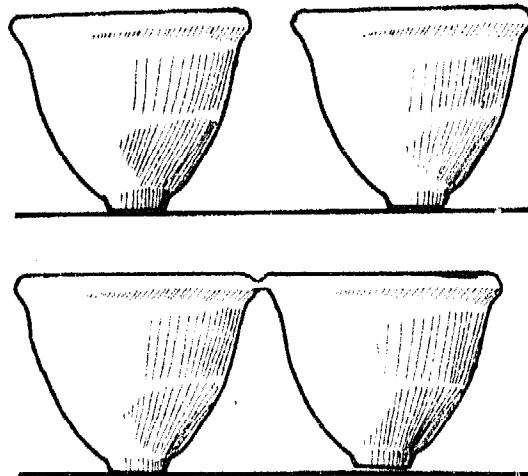

Fig. 2-124: Glazed pots should be placed 3–5 mm apart to prevent them from "kissing".

Cold spots

All kilns will have some cold spots, where the correct maturing glaze temperature is not reached. To gain maximum use of the kiln space and to avoid second-rate, under-fired ware being produced in these spots, a lower melting point glaze should be applied to pots which are to be stacked in these areas of the kiln. A good understanding of the kiln and careful stacking will ensure maximum results from each firing.

Saggars

Saggars are normally filled with glazed ware outside the kiln and stacked on top of each



Fig. 2-125: Cups are set in saggars outside the kiln.

other inside. Before placing the saggar its outside base should be dusted to prevent any dust settling on the glazed ware in the lower saggar. Each stack of saggars, called a bung, should be set straight and not rock. The bungs are set a bit apart to allow a proper draught through the setting and if the bungs are tall a few lumps of clay are squeezed into the gap between the bungs so that they form an interlocking bridge support for each other. In case the firing temperature is close to the softening point of the saggars special fireclay bars could be set between the bungs and the kiln wall for additional support (fig. 2-126).

A wad of clay laid on top of the saggar rim (fig. 2-127) will seal the saggar and provide a safer setting if the saggar rims and bottoms are not even. New green saggars should only be used for the upper 3-5 layers of saggars.

Fig. 2-126: Fireclay bar supports a bung of saggars.



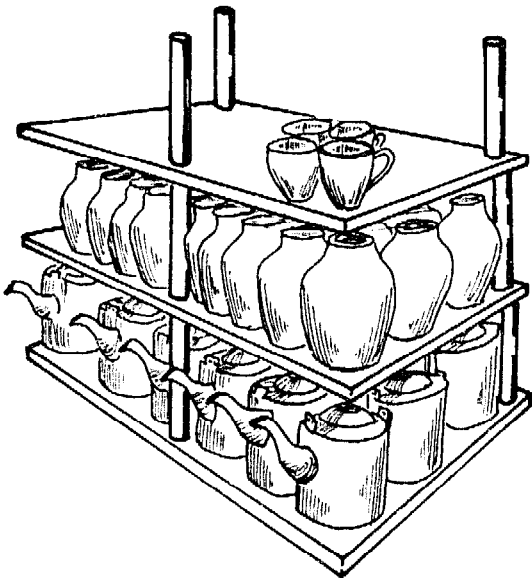

Fig. 2-127: Wads of clay are laid on top of the saggar rim.

Kiln slabs

The structure of kiln slabs and supporting props or firebricks is normally rebuilt with each new setting of ware. Each slab should be supported at three points only because it is unlikely to rest evenly on a four-point support and the slab would then be under tension, which could cause it to break. The kiln setting is placed layer by layer and it should be done evenly so that dense layers of (for example) cups are mixed with more open layers of larger pots. Having all cups

Fig. 2-128: Slabs should be supported at three points only if possible.



on one side and large pots on the other side of the kiln chamber could result in uneven firing temperatures. Slabs that sagged in the former firing are placed with their sag upwards in the next firing.

Door

The brickwork of the kiln door should have the same insulating quality as the wall of the kiln. Bricks are to be laid in a refractory mortar, which has a high proportion of sand in order to make it easy to break up the door afterwards. Spyholes should be left at the top and bottom of the door, with neatly fitting bricks provided for closing the holes.

Fig. 2-129: Bricking up the kiln door. Note the spyhole left at the bottom and that cones and test pieces are placed in saggars with their sides knocked out.

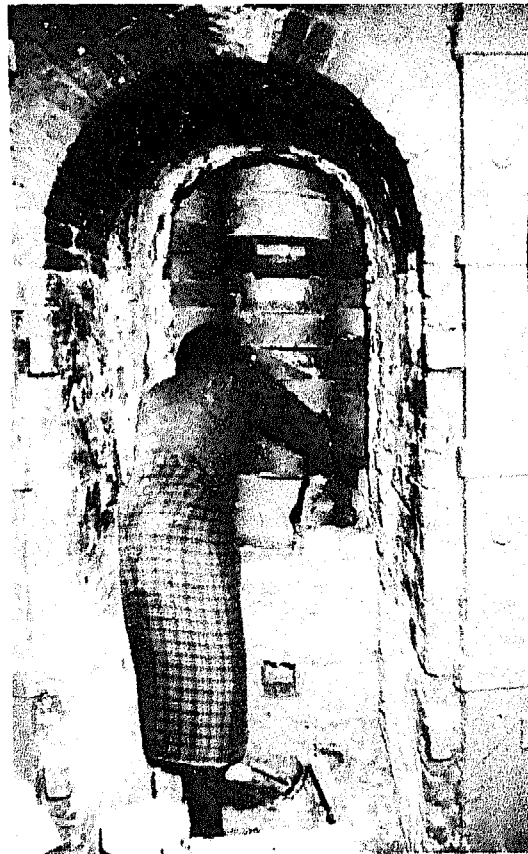

2.7 Kiln firing

The firing is the last step in the production of pottery and all of the potter's previous efforts during production may be either rewarded or ruined in this final process.

Firing routine

All potters feel excitement and anxiety when opening their kiln and inspecting the outcome of the firing. However, it is possible to reduce the anxiety once a successful firing routine has been developed. Each kiln has its own peculiarities and it often takes up to ten firings to break in a new kiln and learn its secrets. This should be done in a systematic way and recorded so that mistakes are not repeated and experience is gained from successes.

Firemaster

At each firing there should be only one person in charge, the firemaster. The firemaster supervises all work from setting the kiln, firing, cooling until drawing. All major decisions such as when smoking is over or when the firing is finished are taken by the firemaster. A kiln during firing needs constant attention, and even when using a convenient fuel such as oil the firing process must be carefully watched. When a kiln is fired with solid fuels such as coal or wood a steady stoking is needed. A good firemaster listens to the breathing of the firing and checks the conditions in the fireboxes and inside the chamber many times every hour.

Kiln log-book

Each firing should be recorded in detail in a log-book, so that afterwards it is possible to trace the reasons behind possible misfirings.

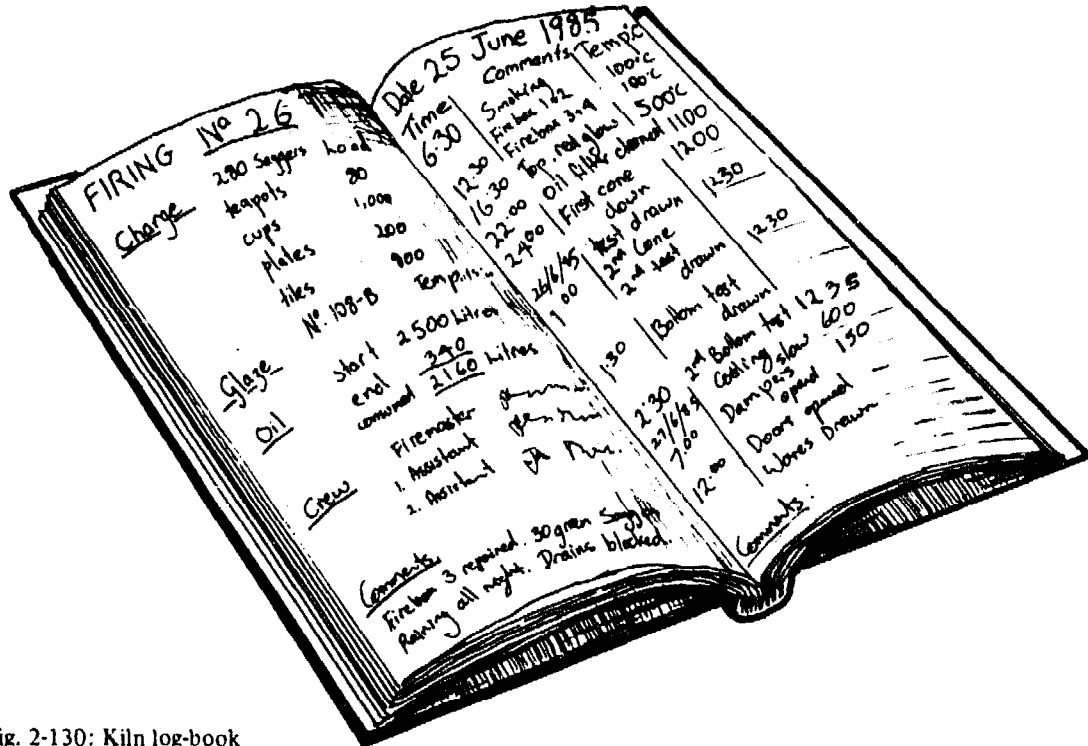

Fig. 2-130: Kiln log-book

The following things should be noted down:

- repairs or alterations carried out,
- number and type of ware in the kiln,
- pattern of setting of saggars, slabs and pots,
- condition of fuel (such as wet firewood),
- date and time of lighting fires in the different fireboxes,
- smoking time,
- start of real firing,
- stoking intervals and rise of temperature,
- bending of cones or drawing of test pieces,
- position of dampers and draught,
- condition in fireboxes during firing,
- finishing time,
- cooling time and time of opening spy-holes and kiln door,
- fuel consumption.

While the ware is being drawn, it should be noted where the different pots were placed in order to get a picture of where the kiln was too hot or too cold. Finally the ware could be rated as first-, second- and third-class and the estimated value of the fired pots should be recorded too.

After that the firemaster and the firing crew should discuss the outcome of their firing and they should try to pinpoint problems and decide upon how these problems could be solved at the next firing. Some of the problems may originate from an earlier stage in the pottery production.

Only by experience can a successful firing routine be established and this sort of practical understanding is difficult to gain from books. However, it is hoped that some of the instructions given here will be of use for the firing itself. This chapter deals with the general techniques of operating kilns. Information on how to stoke the fuel and operate the fireboxes is given in the previous chapter: Combustion and Fireboxes.

2.7.1 Biscuit firing

Smoking

Even if the pots felt dry when they were loaded into the kiln they will still hold some water. Pots are normally dried in the open air, but air always contains some water and during the rainy season the air can become very humid. The air left in the space between the clay particles contains the same amount of water as the air outside. This pore water will expand explosively if it turns to steam before leaving the pot.

Very plastic clay has small clay particles, which will only leave small openings for the pore water to escape through. Sand or grog added to such a clay will make big holes through which the water can more easily pass. Therefore, sand and grog will improve a clay which tends to crack during drying or smoking.

The pore water will only dry out when the pots are heated to temperatures of 50–100 °C inside the kiln. If this heating goes too fast the pore water will turn to steam before it can get out of the pots. The pressure of the steam will cause the pot to crack or even explode (fig. 2-131).

Therefore, a long period of very slow heating is needed until all of the pots are completely dry. This period is called smoking and it should count for approximate one third of total firing time. That means 3–12 hours or even more depending on the nature of clay, types of ware and size of kiln. The first firing of a new kiln could mean smoking for days to enable the kiln itself to completely dry out.

Vent holes

During smoking a very gentle fire is kept in a few or only one firebox and in the beginning this fire may even be placed outside the

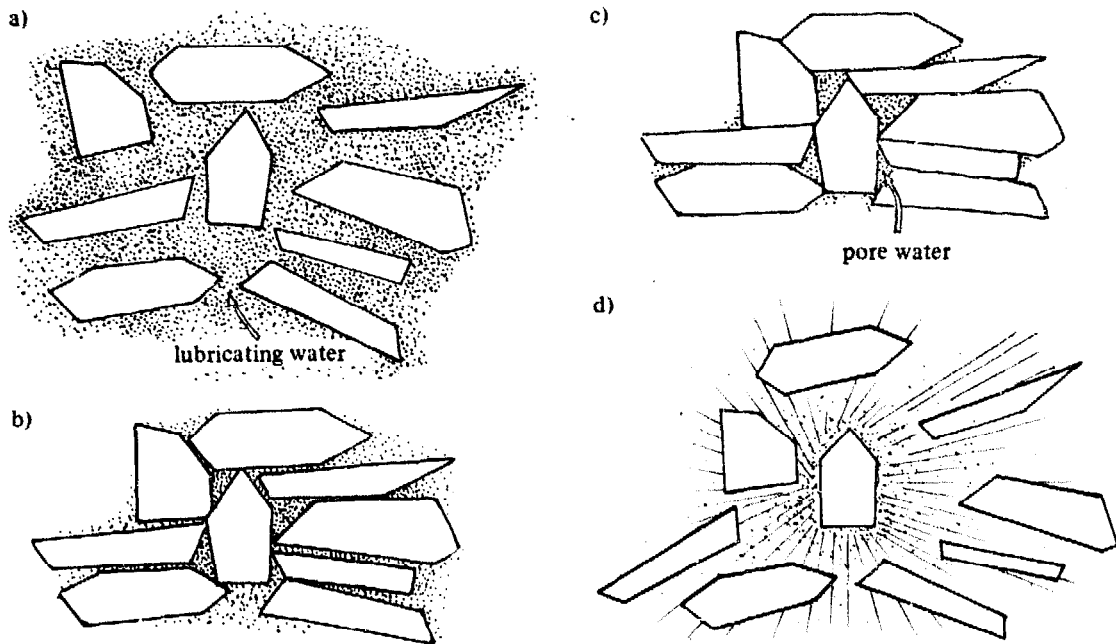

Fig. 2-131: Clay shown in four stages. The clay crystals are made 100 000 times larger than their real size.

- a) Plastic clay. Water surrounds all the clay crystals and these can move easily.
- b) Leatherhard clay. The clay crystals touch each other but there is still lubricating water in the clay.

- c) Air-dried clay. All the lubricating water has evaporated and only pore water remains between the clay crystals.
- d) The pore water turned to steam inside the clay and caused the clay to crack because the clay was heated to above 100 °C too suddenly.

firebox mouth (fig. 2-132). All spyholes and vent holes are left open during smoking to let out the resulting steam before it condenses at colder spots of the setting.

It must be emphasized: *Go slow*. The kiln will contain the result of weeks of hard work and it is very easy to ruin it at this stage.

Condensed water

The smoking period is finished when the air coming out of the spyholes contains only a little or no moisture. This can be tested by holding a piece of glass which is of room temperature in the air stream above the spyhole. If water forms (condenses) immediately on the glass smoking should be continued until only a little moisture is formed after holding the glass at the spyhole for a number of seconds.

Fig. 2-132: The fire is in this case kept outside the firebox until the water smoking period is over.



Ceramic change

The temperature inside the kiln on completion of smoking should be 120–200 °C and then the real firing can start. The spyholes and vent holes should be closed, and the firing time, from the end of smoking until a dark red colour is visible inside the kiln, should take more than four hours. Between 350–700 °C a ceramic change takes place, which permanently changes the plastic clay into something rock-like that can never again be softened by water and formed into a pot. The clay particles contain water in their crystal structure ($\text{Al}_2\text{O}_3 \cdot 2\text{SiO}_2 \cdot 2\text{H}_2\text{O}$). This chemically bound water is released from the crystal structure and changes the crystals so that they cannot go back to their former shape. This chemically bound water amounts to 14% of bone-dry clay and its release will normally not cause the pots to crack. But the free silica or sand in the body expands suddenly at 573 °C and both actions combined may cause problems.

The ceramic change is at its peak around 600 °C. Chemically bound water from within the clay particles is driven out and often white steam can be seen at the chimney at this point. If the firing goes too fast, around 600 °C this rapid release of water may also cause the pots to crack.

Burn-out

The carbon or vegetable matter in the clay will start to burn out when a red glow is reached, but the burning out will only be completed at around 900 °C. Clays containing a lot of carbon should be given a firing with excess air from 800–900 °C. A fast biscuit firing may close the surface of the clay before all the carbon gets out. This may later cause blistering of the glaze and the clay may even bloat at higher temperatures from the pressure of the trapped carbon gases.

A black core in a broken piece of a biscuit-fired pot is a sign of unburned carbon.

Top temperature

At around 800 °C the clay starts to harden. The clay hardens as soda, potash, lime and other impurities in the clay begin to melt, thereby glueing the clay particles together. This will give strength to the clay body and more so as the temperature rises. This process is called vitrification. Traditional pottery fired in pit kilns is only fired up to this temperature. Ceramic ware that is going to be glazed after a first firing is normally not fired higher than 900–1000 °C because the pots should remain porous for the application of glazes. Earthenware always has problems with crazing of its glazes. A higher biscuit firing reduces the problem but also increases the danger of overfiring the biscuit ware. For such firings the top temperature should be judged by the help of cones (p. 120) or by drawing a test piece and checking its ability to absorb water.

However, normally the firemaster can judge when the desired biscuit temperature is reached by the colour inside the kiln. Stoking is then stopped and when the inside is clear of combustion gases the dampers are closed.

Cooling

The air intake of the fireboxes, spyholes and vent holes should be sealed completely after firing and the kiln left to cool by itself. It is tempting to speed up cooling, but if the kiln is cooled too fast pots may crack. The clay contracts suddenly at 573 °C and if the cooling is uneven it will cause cracking. The free silica (quartz) of the clay changes its crystal shape suddenly at 573 °C. When heated free silica will expand and when it cools it shrinks again and this may cause cracking of the pots during cooling. During firing this



Fig. 2-133: Firing is over and the Champaknagar-type kiln has been sealed.

expansion does not cause problems as the clay is still very open and has room for this movement. These cracks may not become obvious until after the glaze firing as they may be very fine. The crack pattern will often look like a brick wall. Remedies are: a) to cool more slowly, b) to raise biscuit temperature slightly, c) to decrease the amount of free silica (sand) or substitute it with fine grog.

2.7.2 Glaze firing

If the ware has been biscuit-fired already there is no need for an extended water smoking, but the water from the glazing should be allowed to dry out slowly especially if the glaze shows a tendency to crawl. The glaze crawls away from rims or forms islands where the glaze has crawled away. This may be caused by firing the glazed pots before they have dried properly. The firing rate would normally be 100–150 °C per hour¹.

¹ F. Olsen, *The Kiln Book*, p. 131, describes firing to cone 10 (1300 °C) in four hours without problems. This is possible with some clays provided high-quality kiln slabs are used.

However, when firing large pots it is prudent to slow down the firing around 573 °C. Apart from this the firing can proceed at a steady rate until the maturing temperature of the glaze is reached.

Oxidizing/reducing

The mixture of gases inside the kiln affects both the clay and the glazes. A firing with excess amount of air intake (oxygen) is called oxidizing and a firing with too little air for complete combustion of the fuel is called reducing. The main difference between these two firing conditions is the change of colour in clay and glazes. For example, the metal iron has a grey or black colour but if it is exposed to air it turns to rust, which is red.

Fig. 2-134: Steady stoking is needed to raise the temperature.

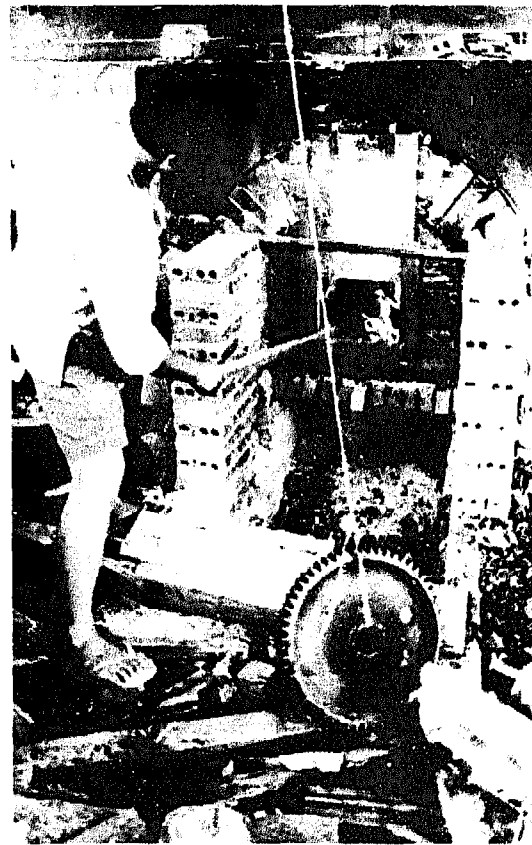

Rust is iron + oxygen or iron oxide and is present in most clays. A clay with a small iron oxide content will fire to a yellow or buff colour when the firing is kept oxidizing throughout, whereas it will turn to a grey colour if the fire is reducing. What happens is that the reduction firing produces a lot of half-burned carbon that has been starved of air. On its way through the kiln this carbon picks up the oxygen in the iron oxide and the "rust" is turned back to its original metal, iron, which is grey.

It is more economical to keep a lightly oxidizing or neutral firing throughout as a reduction firing means that some fuel is not being completely burned. If the special colour effect of a reduction firing is desired it should be done at the right time. For changing the colour of the glaze the reducing firing should be started at 100–150 °C below the maturing temperature of the glaze, whereas for changing the colour of the body reduction will only be effective before the covering glaze starts to melt.

The firing is kept oxidizing until the right temperature for reduction is reached. Reduction is then started by letting in less air at the fireboxes and by partly closing the dampers. Reduction is in process when flames come out of the spyholes. However, a heavy reduction is not needed and is a waste of fuel. For ware that has not been biscuit-fired reduction should not be started before the temperature is above 1000 °C when all carbon in the clay has been allowed to burn out.

Test draw

The firemaster should be able to judge the approximate temperature of the kiln by the colour of the glow inside. When this colour indicates that the maturing temperature is soon to be reached a test piece from the kiln should be drawn using a crooked iron rod (p. 119). The glazed test piece will show the con-

dition of the glazed ware inside the kiln. If the glaze surface is still rough the firing should be continued. From the look of the test piece the firemaster can judge when to draw the next test piece. It may be necessary to reduce or stop stoking while drawing and care should be taken to draw the tests quickly in order not to cool the kiln unnecessarily.

Soaking

Tests should be drawn both from the top and bottom part of the setting. If the temperature is uneven the maturing temperature should be kept for one or two hours, allowing the glaze all over the kiln to melt properly. Such a period is called soaking.

Cones

A set with three different bending temperatures of cones can provide a warning so that when the first cone bends it indicates that there is only 30 °C to go before reaching maturing temperature. If, for example, the cone at the bottom spyhole is not bending at the same time as the upper cone the firemaster can start stoking more slowly in order to allow the bottom temperature to catch up with the top. The maturing temperature is reached when the second cone bends. The last cone, with a bending temperature 30 °C above the maturing point, should not bend but gives the firemaster a warning in case the temperature should rise during the soaking period.

Finishing

When the firemaster, from the look of test draws and cones, feels confident that the glazes have matured the firing can be stopped. The stoking of fuel is stopped and the dampers are left open until the inside of the kiln is clear of combustion gases. The



Fig. 2-135: Saggars with finished cups are drawn from a hot kiln.

dampers are then closed completely and all spyholes and firebox inlets are sealed. In case iron grates or drip-plate burners have been used their life will be prolonged if they are pulled out at this stage. If the firing has been reducing then a period of 10–20 minutes oxidizing at the end will brighten the glazes without changing the reduction effect on the colour of the glaze.

Cooling

The kiln should be left to cool and only when the temperature is definitely below 200 °C can the door be opened. The temperature is low enough if it is possible to hold an arm inside the kiln for a short while. Too sudden a cooling will not only damage the ware but also the kiln structure and the saggars or kiln slabs.

Above 1100 °C a lot of free silica is formed in the clay body. Much of it will take the form of a crystal called crystoballite, which shrinks 3% at 230 °C during cooling. This shrinkage will cause many pots to crack if cooling is too sudden. These cracks will be long clean cracks of the body and the glaze

will have a sharp edge because at this low temperature the glaze had solidified when the body cracked.

The problem occurs often with stoneware, which is fired to 1250–1300 °C. Saggars and slabs may suffer even more because they have developed a higher content of crystoballite due to their many cycles of firings.

Fig. 2-136: Teacups are cleaned and graded after being drawn from the kiln.



Remedies are:

a) slower cooling around 230 °C (and 573 °C),

b) to reduce silica (sand) in the clay body by substituting grog,

c) to add more feldspar to the clay body. The feldspar will fuse together with the free silica and crystoballite and the resulting glass will not have sudden shrinkage points.

All potters are eager to see the result of their work but, if they cannot wait for the kiln to cool slowly, only broken pots may be the reward for their haste.

2.8 Temperature measurement

2.8.1 Thermometers

The temperature inside the kiln cannot be measured with ordinary mercury-in-glass thermometers above 550 °C. Thermometers may still be useful for measuring temperatures during smoking and cooling periods and they can be used to read the temperature of the flue gases in the chimney.

2.8.2 Colour

The colour inside the kiln is a good indicator of the temperature. The lowest visible red, which is visible only when it is dark outside

Colour of temperature	°C
Lowest visible red, night-time	470
Lowest visible red, daylight	550–650
Dark red – cherry red	650–750
Cherry red – bright cherry red	750–815
Bright cherry red – orange	815–900
Orange – yellow	900–1090
Yellow – light yellow	1090–1315
Light yellow – white	1315–1540
White – bluish white	1540

the kiln, is seen at 470 °C but during daylight a red colour may not be seen before around 600 °C. The higher the temperature, the brighter the colour becomes as shown in the table.

The experienced firemaster will be able to accurately judge the temperature by its colour. This skill is one of several additional senses developed during countless hours of tending firings and even a firemaster who is fortunate enough to have other more sophisticated measuring methods such as those described below should compare these with the colour reading before trusting them completely.

2.8.3 Test draw

Glazed test pieces made from the same clay body and with the same glaze as the rest of the ware fired in the kiln can be used to judge when the glaze has matured. The test pieces should be placed close to the spyholes from where they can be drawn out with the help of an iron rod (fig. 2-138). When the colour indicates that the firing is close to completion the firemaster draws a test piece and from the extent of fusion of the glaze the condition of the rest of the ware is revealed. The colour of the glaze though may differ from that of the finished ware. The test pieces can be shaped as rings (fig. 2-137) or can be small cups with a hole in the bottom for easy fetching.

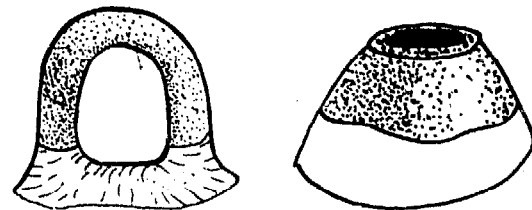

Fig. 2-137: Two examples of glazed test pieces: a ring of clay and a cup with its bottom pierced

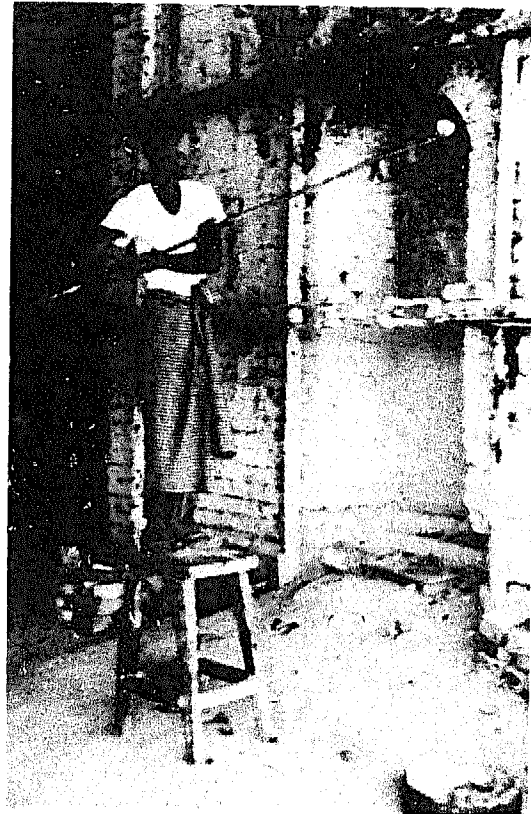

Fig. 2-138: Drawing a test cup through the spyhole with the help of an iron rod

2.8.4 Cones

Cones are slim three-sided pyramids 5–7 cm high and made from various mixtures of kaolin, feldspar, quartz, limestone and other minerals. The cones soften like clay and glazes and bend depending on the melting point of the mixture they are made from.

Commercial cones are available for measuring temperatures of 600–2000 °C within steps of about 20 °C. The cones have a printed number corresponding to their bending temperature (see table of cones in appendix).

Set of three cones

Cones are normally used in a set of three placed in front of a spyhole from where the firemaster can see them during firing. In the example (fig. 2-139) where the maturing of the glaze corresponds to the bending of

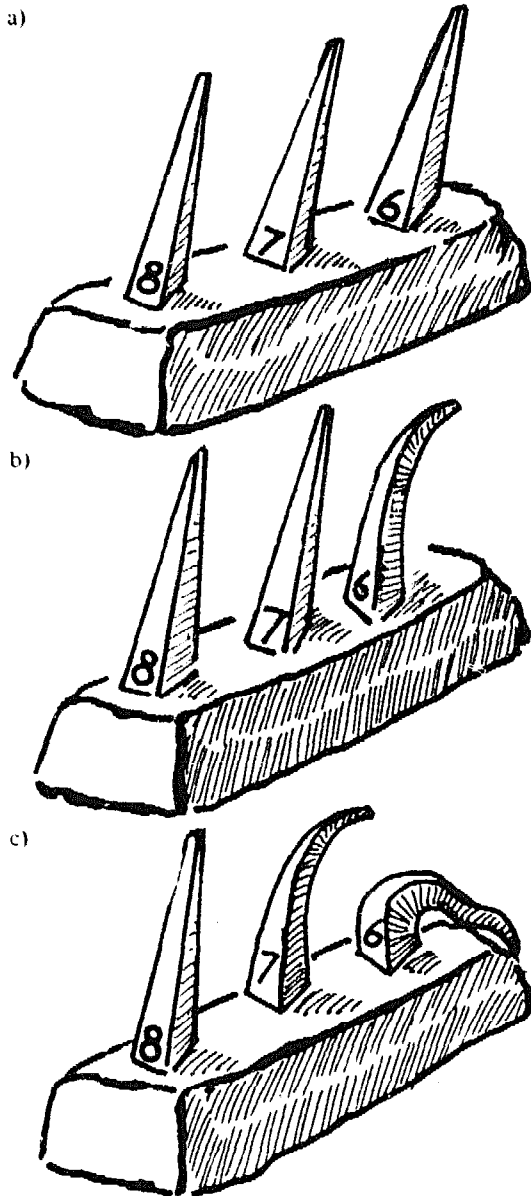

Fig. 2-139: Setting of cones
 a) Cones should be set similarly at each firing.
 b) Cone 6 has started to bend, warning the firemaster that the firing is soon to finish.
 c) Cone 7 is on its way down. When the tip of the cone touches the base the maturing temperature has been reached.

cone 7 (1230 °C) another one, a cone 6 (1200 °C), is placed in front of cone 7 so that the bending of cone 6 provides a warning. Behind cone 7 a cone 8 is placed which shows whether the kiln is overfired.

Setting of cones

The cones should be set in a well grogged clay at a slight angle and with the flat side of the pyramid away from the bending direction. The firemaster should make sure that the cones are set in the same way at each firing. They should not be placed too close to the spyhole, otherwise they will be cooled by air entering through the spyhole. Before firing the firemaster should look at the placement of the cones through the spyhole and remember their position for later. At temperatures above 1100 °C it can be very difficult to see the cones properly and one cone can easily be mistaken for another. It helps to watch the cones through a dark (smoked) piece of glass or through dark sunglasses.

Heat-work

Cones do not really measure temperatures but rather heat-work or the combined effect of heat and time. If cone 7, for example, is heated at about 250 °C per hour it will bend at 1230 °C but if heated at 50 °C per hour it may bend at only 1200 °C.

Cones with the same number but from different factories may not bend at the same temperature and so before cones from a new supplier are used they should be fired in the kiln alongside the old cones to make sure that they bend at the same time.

2.8.5 Pyrometer

A pyrometer reads the temperature directly by measuring the electric current which is produced in a thermocouple. The thermocouple is made from two wires of different materials which are joined at one end. This end is inserted into the kiln chamber where it is protected by a ceramic tube from corrosion (fig. 2-140).

Fig. 2-140: Pyrometer

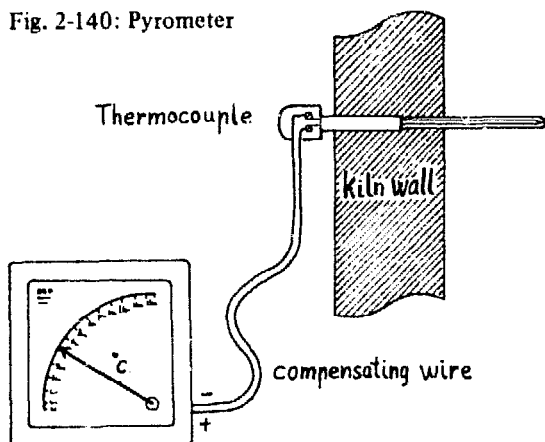

For temperatures up to 1100 °C the joined wires are made from 90% nickel + 10% chromium for the positive wire and 98% nickel + 2% aluminium for the negative wire.

These metals are usually cheap but for temperatures up to 1500 °C the two wires need to be made from very expensive materials: platinum (negative wire) and 87% platinum + 13% rodium (positive wire).

The wire leading from the thermocouple to the pyrometer is made from metals electrically similar to the ones used in the thermocouple and if ordinary wire is used the pyrometer will not be accurate.

A pyrometer shows the actual temperature and is able to show the firemaster how fast the temperature is rising as well as the rate of cooling. It is a very helpful instrument but is expensive and spare parts can be difficult to get. Therefore, its use in many countries will be limited to pottery training centres and bigger factories.

Warning

A firing should never be measured by a pyrometer only. The final judgement of when the firing is completed should still be based on cones or test draws. A pyrometer only shows the temperature and does not record the condition of clay and glazes as cones

and test draws do. Furthermore, a pyrometer may fail.

2.8.6 Self-made cones

Cones are made by a few large factories. These guarantee a consistent quality so that cones of the same number from the same factory should bend simultaneously even if their years of manufacture are years apart. This is only possible with a very strict control of raw materials and production. Even so, cones are inexpensive and so it would normally not make sense for potters to make cones themselves. However, in many remote areas, or where overseas imports are difficult, cones are often not available and potters could produce them in their own workshop.

Cone body

It takes patience to find the right mixture of clay, sand and melters (fluxes) which will bend at the desired temperature. The first problem is to get raw materials that do not differ much from batch to batch.

Clay

A pure kaolin clay which should contain the same proportion of sand and clay with each batch is the most reliable. Alternatively a stoneware clay or the plastic production clay of the workshop can be used. Clay with a high iron content is less suitable because the iron oxide acts as a melter in a reduction firing but not so in an oxidizing firing.

Silica

Silica sand or quartz is needed for adjusting the bending or softening temperature. The more silica, the higher the bending temperature. The sand particles also help to open

up the cone mixture so that it is less likely to crack during drying.

Melters

Melters (fluxes) which lower the bending temperature are added to the mixture of clay and sand. Melters such as feldspar, whiting (or limestone) and talc are sufficient for the higher temperatures above 1200 °C. Below that, melters such as borax or boric acid are added. Potash and soda can replace these if they are not available. Potash, soda, borax and boric acid are all soluble in water. When these materials are added directly to a moist cone body they will to some degree leach out of the cone body and settle on the surface of the cones. This will cause the cones to bend at higher temperatures than intended. The materials could be made insoluble by melting them together with the silica sand, feldspar, whiting and talc of the cone body and then, after crushing the resulting glass to a fine powder, adding this to the clay. That is a laborious process and a simpler method would be to mix and form the cones in a semi-dry state by adding a glue such as starch or gum arabic.

Cone mixtures

There are many factors determining the melting point of a ceramic mixture besides the proportion of the various materials in the mixture. Therefore, the cone body recipes given next column are only meant as a starting point for further experimenting.

Kaolin, whiting (limestone, chalk), talc and feldspar all contain silica in varying degrees. One kaolin clay may be very pure while another source may contain high amounts of silica sand. These recipes are based on pure kaolin while the recipes using stoneware clay have smaller amounts of silica sand in them to compensate for the sand in the stoneware clay.

<i>Cone 05a, 1000 °C</i>	
Potash feldspar	10
Talc	6
Kaolin	22
Quartz, silica sand	20
Whiting	8
Borax	34
Potash feldspar	8
Talc	6
Stoneware clay	29
Quartz, silica sand	16
Whiting	8
Borax	33
<i>Cone 1a, 1100 °C</i>	
Potash feldspar	18
Talc	3
Kaolin	22
Quartz, silica sand	32
Whiting	10
Borax	15
Potash feldspar	19
Talc	2
Stoneware clay	27
Quartz, silica sand	27
Whiting	10
Borax	15
<i>Cone 7, 1230 °C</i>	
Potash feldspar	27
Kaolin	17
Quartz, silica sand	44
Whiting	12
Potash feldspar	23
Stoneware clay	26
Quartz, silica sand	39
Whiting	12
All recipes by weight.	

A simpler solution is to make the cones from a mixture of the clay and the glaze used in the workshop.

Example of a mixture for cone 8, 1250 °C:

stoneware clay	22
glaze for 1250 °C	51
silica sand	27

(the glaze recipe: 4 feldspar, 3 quartz, 2 whiting, 1 kaolin)

Experimenting

A series of mixtures has to be tested before the right bending temperature is arrived at. The simplest way is to start with the recipes given above and vary the amount of clay and silica sand in, say, three steps of 5%. Cones of these three different mixtures are then fired in a normal production firing and through the spyhole an eye is kept on the bending of the cones. The bending is then compared with either the bending of commercial cones fired along with the self-made ones or with the state of the glaze on draw tests.

In case none of the cones bend, new mixtures should be made with less clay and silica sand but if the cones bend too soon more clay and silica sand should be added.

The test mixtures should be prepared as described and it is important to use the same raw materials and the same procedures during testing and also later when the actual cones are produced.

Preparation of cone mixtures

The clay, sand, feldspar, limestone or whiting should be sampled so that later, when a new batch of cones is to be made, it will be possible to obtain raw materials of similar quality. In all deposits of raw materials there will be a variation in particle size, sand content, etc. This variation can be reduced by taking samples from many different places in the deposit and mixing these thoroughly. A much

bigger portion than needed is collected and the amount required is divided from this by quartering (see testing, p. 39). All the materials are dried and screened (100 mesh) before weighing out the different amounts according to the recipe. This should be done before experimenting so that the same materials can be used for testing and production. After the materials are weighed they are mixed well and sieved (100 mesh) again. About 6 g material is needed for one cone.

Shaping of cones

The cone mixture is easier to shape if a starch or glue is added to the dry mixture together with water. If borax is used, the water content must be kept low. All cones must be of exactly the same shape. A mould is made of plaster, hardwood or iron according to the dimensions shown in fig. 2-141. The cones are three-sided pyramids with a triangular base. The base is cut so that it facilitates a setting angle of 70° with the horizontal.

To begin with, only a few cones are made and tested so that if these cones do not bend at the right time the rest of the mixture can be adjusted.

Fig. 2-141: Shape and dimension of cones

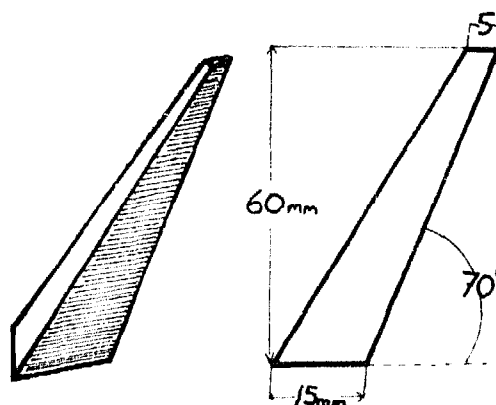

Biscuit

Then the whole mixture is shaped into cones and dried. If an organic glue such as starch or sugar syrup has been used it will with time go rotten, stink terribly and the cone made with it may be easily broken when handled. To prevent these problems the cones could be given a low temperature biscuit firing, ensuring they are all fired at the same time and at the same place in the kiln. However, it should be noted that a biscuit firing will slightly lower the final bending temperature of the cones. Cones which are bonded by an artificial glue can be stored without biscuiting.

New batch

Once the right mixture is established cones are easy to make. So it pays to make enough for several years of firings. Five hundred cones of about 6 g could be made from 3 kg of raw materials. Note down carefully how the cones are made and from which materials

so that when the first batch is finished a new batch of cones of the same bending temperature can be made. Remember that with cones it is important to expose them to the same conditions at each firing; setting should be at the same distance from spyholes and at the same angle. A new batch of cones should be made well in advance of finishing the old ones so that the bending temperature of the new cones can be tested in the kiln alongside the old cones.

Use of self-made cones

Self-made cones will not be as reliable as good-quality commercial cones and so test draws of glazed pieces should also be done. The cones will help to give the firemaster a warning of when to draw tests. They can also be placed at the top and bottom or front and back of the setting so that the firemaster can change the damper setting or slow the firing rate to compensate for temperature differences within the kiln chamber.

Appendix

Tables of weights and measures

Metric system:

1 kilometre, km	=	1000 metres, m	1 cubic metre, m ³	=	1000 litres, l
1 m	=	100 centimetres, cm	1 l	=	1000 cm ³ or ml
1 cm	=	10 millimetres, mm	1 ml	=	1000 mm ³
1 mm	=	1000 micron, μ	1 ton	=	1000 kilograms, kg
			1 kg	=	1000 grams, g
			1 g	=	1000 milligrams, mg

to convert:	to:	multiply metric by:	to convert:	to:	multiply UK & US by:
<i>length:</i>					
m	feet	3.280	feet	m	.305
m	inches	39.370	inches	m	.025
cm	inches	.394	inches	cm	2.54
mm	inches	.039	inches	mm	25.400
<i>area:</i>					
hectare	acres	2.471	acres	hectare	.405
m ²	sq. feet	10.764	sq. feet	m ²	.093
cm ²	sq. inches	.155	sq. inches	cm ²	6.451
<i>volume:</i>					
m ³	cu. feet	35.314	cu. feet	m ³	0.0283
m ³	cord (wood)	.276	cord	m ³	3.625
cm ³ (cc)	cu. inches	.061	cu. inches	cm ³ (cc)	16.387
l	cu. inches	61.020	cu. inches	l	.016
l	U.K. gallon	.219	U.K. gallon	l	4.546
l	U.S. gallon	.264	U.S. gallon	l	3.785
<i>weight:</i>					
kilograms	pounds	2.205	pounds	kilograms	.453
grams	ounces	0.035	ounces	grams	28.349

Table of sieve mesh sizes

The fineness of a sieve is measured as the number of threads that can be counted across one inch of sieve mesh. A number (6J, 80, 100 . . .) followed by "mesh" indicates the fineness of sieves.

The numbers in the first column correspond to threads per inch (2.54 cm) of sieve mesh according to British standard series. The second and third column show the maximum particle size, in mm and inch, that can pass through the sieve mesh.

B.s.s. number	size in mm	size in inch
5	3.355	0.1320
6	2.812	0.1107
7	2.410	0.0949
8	2.057	0.0810
10	1.676	0.0660
12	1.404	0.0553
14	1.203	0.0474
16	1.003	0.0395
18	0.853	0.0336
22	0.699	0.0275
25	0.600	0.0236
30	0.500	0.0197
36	0.422	0.0166
44	0.353	0.0139
52	0.295	0.0116
60	0.251	0.0099
72	0.211	0.0083
85	0.178	0.0070
100	0.152	0.0060
120	0.124	0.0049
150	0.104	0.0041
170	0.089	0.0035
200	0.076	0.0030
300	0.053	0.0021
350	0.043	0.0017

Table of geological particle grading (Wentworth-Udden Scale)

Particle	Size range
Boulder	above 256 mm
Cobble	64-256 mm
Pebble	4-64 mm
Gravel (granule)	2-4 mm
Sand	1/16-2 mm
Silt	1/256-1/16 mm
Clay	below 1/256 mm

Table of Seger cones

°C	°F	German, Staffordshire, French Cone No.	New "H" series Staffordshire Cone No.	°C	°F	German, Staffordshire, French Cone No.	New "H" series Staffordshire Cone No.
600	1112	022	H 022	1100	2012	1 a	H 1
625	1157		H 022 A	1110	2030		H 1 A
650	1202	021	H 021	1120	2048	2 a	H 2
670	1238	020	H 020	1130	2066		H 2 A
690	1274	019	H 019	1140	2084	3 a	H 3
710	1310	018	H 018	1150	2102		H 3 A
730	1346	017	H 017	1160	2120	4 a	H 4
750	1382	016	H 016	1170	2138		H 4 A
790	1454	015	H 015	1180	2156	5 a	H 5
815	1499	014 a	H 014	1190	2174		H 5 A
835	1535	013 a	H 013	1200	2192	6 a	H 6
855	1571	012 a	H 012	1215	2219		H 6 A
880	1616	011 a	H 011	1230	2246	7	H 7
900	1652	010 a	H 010	1240	2264		H 7 A
920	1688	09 a	H 09	1250	2282	8	H 8
940	1724	08 a	H 08	1260	2300		H 8 A
960	1760	07 a	H 07	1270	2318		H 8 B
970	1778		H 07 A	1280	2336	9	H 9
980	1796	06 a	H 06	1290	2354		H 9 A
990	1814		H 06 A	1300	2372	10	H 10
1000	1832	05 a	H 05	1310	2390		H 10 A
1010	1850		H 05 A	1320	2408	11	H 11
1020	1868	04 a	H 04	1350	2462	12	H 12
1030	1886		H 04 A	1380	2516	13	H 13
1040	1904	03 a	H 03	1410	2570	14	H 14
1050	1922		H 03 A	1435	2615	15	H 15
1060	1940	02 a	H 02	1460	2660	16	H 16
1070	1958		H 02 A	1480	2696	17	H 17
1080	1976	01 a	H 01	1500	2732	18	H 18
1090	1994		H 01 A	1520	2768	19	H 19

Table of Orton cones

(United States, Ohio, The E. Orton Jr. Ceramic Foundation)

Bending temperatures of large cones when heated at 150°/hour

°C	°F	Cone No.	°C	°F	Cone No.
600	1112	022	1120	2048	02
614	1137	021	1137	2079	01
635	1175	020	1154	2109	1
683	1261	019	1162	2124	2
717	1323	018	1168	2134	3
747	1377	017	1186	2167	4
792	1458	016	1196	2185	5
804	1479	015	1222	2232	6
838	1540	014	1240	2264	7
852	1566	013	1263	2305	8
884	1623	012	1280	2336	9
894	1641	011	1305	2381	10
894	1641	010	1315	2399	11
923	1693	09	1326	2419	12
955	1751	08	1346	2455	13
984	1803	07	1366	2491	14
999	1830	06	1431	2608	15
1046	1915	05	1473	2683	16
1060	1940	04	1485	1705	17
1101	2014	03	1506	2743	18

Note:

The temperatures indicated in these cone tables may not be the same as when the cones bend in the individual potter's kiln. Cones are not used for measuring temperatures but for indicating the condition of clay and glazes.