

**AT** MICROFICHE  
REFERENCE  
LIBRARY

A project of Volunteers in Asia

Making Building Blocks with the CINVA-Ram

Published by:

Volunteers in Technical Assistance  
1815 North Lynn St. Suite 200  
P.O. Box 12438  
Arlington, VA 22209 USA

Paper copies are \$ 2.50; a Spanish-language  
edition is available.

Available from:

Volunteers in Technical Assistance  
1815 North Lynn St. Suite 200  
P.O. Box 12438  
Arlington, VA 22209 USA

Reproduced by permission of Volunteers in  
Technical Assistance.

Reproduction of this microfiche document in any  
form is subject to the same restrictions as those  
of the original document.

VITA MANUAL

# MAKING BUILDING BLOCKS WITH THE CINVA-RAM

A SUPERVISOR'S MANUAL

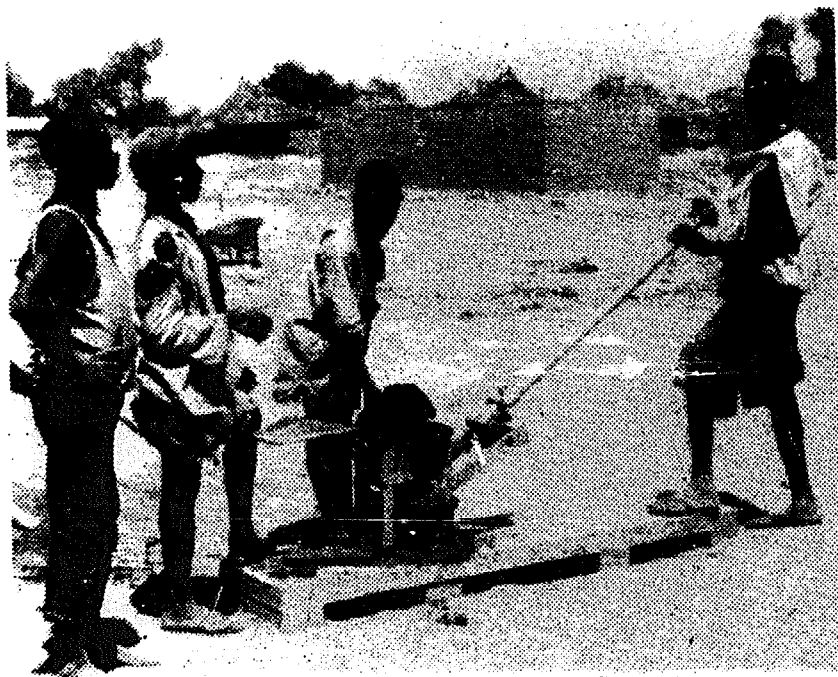

VM 1-11-66

NOTE TO THE READER: VITA's publications are compiled by VITA volunteers because they want to help people in developing areas. With your field experience, you are in a unique position of being able to increase the usefulness of this work by sharing what you have learned with the people who will use the publications in the future. You are strongly urged to complete the following questionnaire, tear it out and send it to:

VITA  
230 State Street  
Schenectady, N.Y. 12305  
U.S.A.

Date \_\_\_\_\_

Name \_\_\_\_\_ Agency \_\_\_\_\_

Address \_\_\_\_\_

\_\_\_\_\_

1. Is the material in this manual presented so that you can follow it to use the CINVA-Ram Block Press?
2. Have you followed it to use the machine?
3. Where do you find it unclear?
4. Where do you find it incomplete?
5. Where would more diagrams be helpful?
6. Have you made any improvements on the instructions contained in the manual? If so, please describe them including photographs or sketches if possible.
7. Would you suggest other publications which would be useful in your part of the world?

TABLE OF CONTENTS

	<u>Page</u>
I. INTRODUCTION . . . . .	1
II. EQUIPMENT . . . . .	3
III. TESTING FOR THE SUITABILITY OF THE SOIL. . . . .	4
IV. MAKING BLOCKS AND TILES. . . . .	6
V. BUILDING . . . . .	19
VI. REFERENCES . . . . .	19
VII. OTHER MACHINES FOR MAKING BLOCKS FROM STABILIZED EARTH . . . . .	20

This manual was compiled by VITA (Volunteers for International Technical Assistance) from material based on the experience of several field workers who have used the CINVA-Ram Block Press. It is hoped that the manual will make it easier to use the machine. VITA would appreciate receiving any criticisms or suggestions for improving the manual.

Volunteers for International  
Technical Assistance (VITA)  
230 State Street  
Schenectady, N.Y. 12305  
U.S.A.

1966

## I INTRODUCTION

1. Purpose This manual combines the experience of four men who used the CINVA-Ram Block Press and figured out answers, bit by bit, to the inevitable problems of detail as they came up day after day. This was the hard way to learn how to use the press; this handbook is intended to make it easier.
2. The Press The CINVA-Ram Block Press is a simple, low-cost, portable machine for making building blocks and tiles from common soil (see Fig. 1). The press, made entirely of steel, has a mold box in which a hand-operated piston compresses a slightly moistened mixture of soil and cement or lime. (An equipment list is on page 3.)

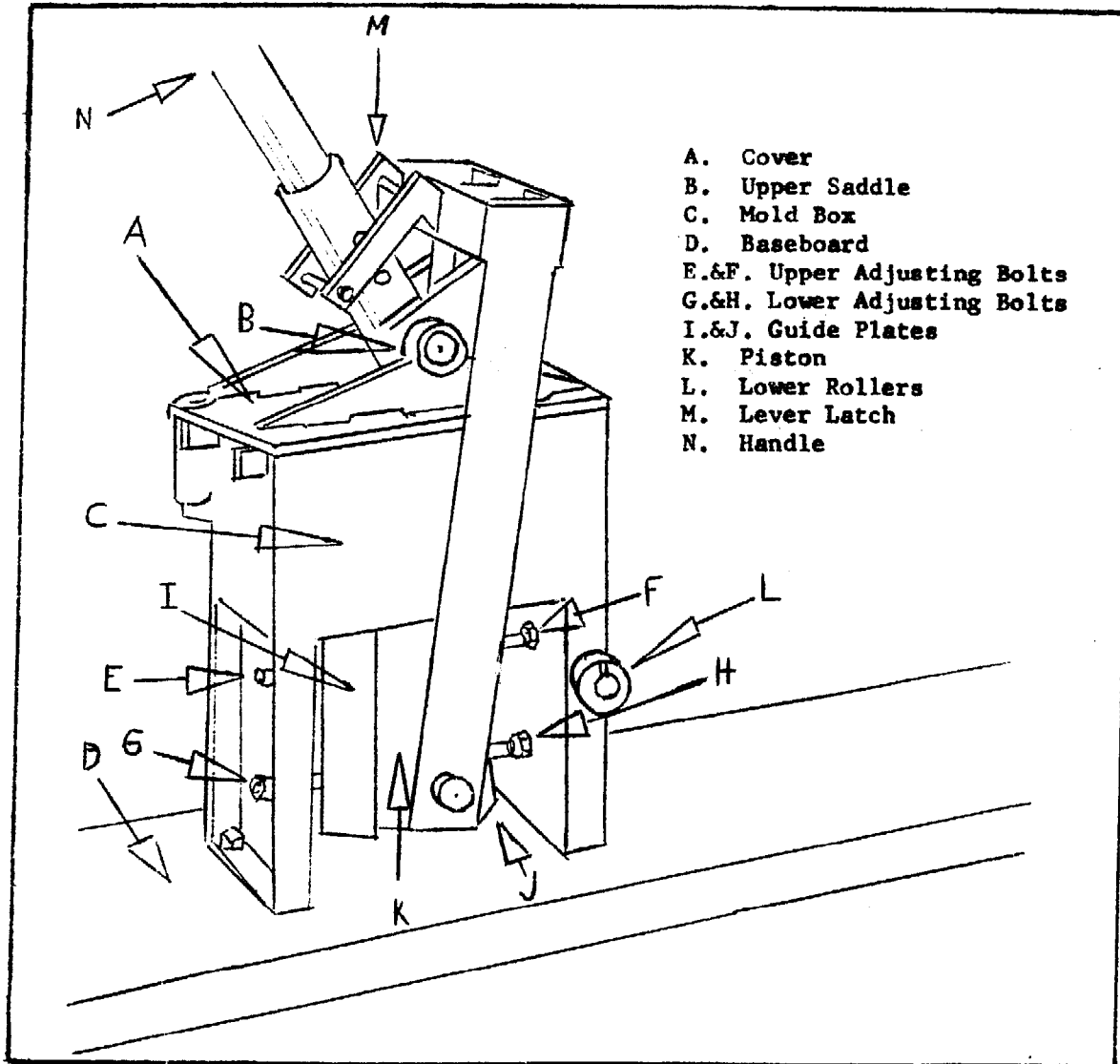

Fig. 1 - The CINVA-Ram Block Press and its Parts.

The press was developed as a tool for small individual or mutual self-help programs (see Fig. 2.) It was designed by Raul Ramirez, an engineer, at the Inter-American Housing Center (CINVA) of the Organization of American States in Bogota, Colombia.

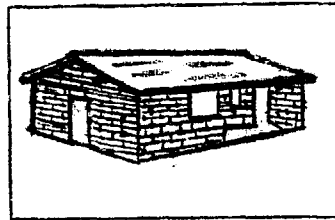

Fig. 2 - CINVA-Ram House.

3. Advantages CINVA-Ram blocks and tiles have many advantages over other building materials.
  - \*\* They are easier to make than concrete blocks: they can be removed immediately from the press and stacked for curing without the use of a pallet.
  - \*\* The cost of building material is greatly reduced, since most of the raw material comes from your own land.
  - \*\* Transportation costs are avoided, since the blocks are made near the construction site.
  - \*\* Depending on the quality of materials used, CINVA-Ram blocks can be superior to adobe and rammed earth which were used in buildings now 100 years old, still standing and in good condition.
  - \*\* The blocks are easily handled.
  - \*\* The blocks need no baking, since the curing process is completely natural.
  - \*\* The press makes variations of the block, adapted to the various phases of construction.
4. Note to the Field Worker When teaching people how to use the CINVA-Ram Block Press, make your instructions as simple and clear as possible. Do not quote from this manual, but master each phase of the operation so that you can teach it in your own words. Encourage the workers to take satisfaction from the completion of each step, every one of which is a move toward the final goal.
5. Soil testing, block production and the use of the blocks are all important, but they are less important than the will of the families to help themselves in building a home. This may well need to be awakened and supported by your words of encouragement and inspiration.
6. Try to make at least one person in the group familiar with the whole operation, so that the local community will possess the skill to carry on the work alone.

## II EQUIPMENT

### 7. CINVA-Ram Block Press

Weight:	140 lbs.
Height and base width:	10" X 16" X 20"
Application force of lever:	80 lbs.
Bearing Strength	200-500 psi
Size of block (3½" X 5½" X 11½")	lays up 4" X 6" X 12"
Size of tile (1½" X 5½" X 11½")	lays up 1½" X 6" X 12"
Average number of blocks or tiles can be made by two people per day:	300-500
Average number of blocks needed for a two-room house:	2500
Average number of blocks per 100 lbs of cement:	150

Inserts: Four different molds for producing different kinds  
of blocks and tiles.

Cost in United States: \$175 FOB in New York

AVAILABLE FROM: IBEC Housing Division  
30 Rockefeller Plaza  
New York, New York 10020

Attention: Mr. Robert F. Hayter

Metalibec Ltda.  
Apartado Aereo 233 - NAL 157  
Bucaramanga, Colombia  
South America

Materiel Industriel et Menager Japy  
6 Rue de Marignana  
Paris 8<sup>e</sup>, France

Frazer Engineering Company  
116 Tuam Street  
Christchurch, New Zealand



8. Other Equipment Needed

1 Wide-necked glass jar

$\frac{1}{4}$ -inch to  $\frac{3}{8}$ -inch (8 to 10 mm) mesh wire screen

Box, inside dimensions: 24 inches by  $1\frac{1}{2}$  inches by  $1\frac{1}{2}$  inches

Fine sieve

Suitable mixing boards - good sizes are 4 feet by 8 feet and 8 feet by 8 feet.

Bottomless measuring box

Bottomed measuring box

Shovel

Sprinkling can

Mounting board, at least 9 feet long, 8 inches wide and 2 inches thick.

4 Bolts, at least  $\frac{1}{2}$  inch in diameter and 3 inches long

8 Washers

III TESTING FOR THE SUITABILITY OF THE SOIL

9. Need for Testing Making blocks from stabilized earth is a simple process, but it will not be successful unless the soil is properly tested. It would be a serious mistake to treat this step lightly. Scarce money and labor could be wasted for an unsatisfactory result.
10. Soil is a variable and complex building material. Every sample is different from every other sample. But building blocks can be made successfully from a wide variety of soils.
11. Purpose of the Tests The tests described here will tell us:
- (1) How much sand and how much clay is in the soil to be used (Particle Determination Test and Compaction Test, paragraphs 16 and 17).
  - (2) How much cement or lime should be added (Box Test, paragraph 18).
12. Clay It is mainly the clay content which gives the mixture cohesion.
13. Stabilizer One of the important functions of the stabilizer is to reduce the change in the volume of the clay, which swells as it takes up water and then shrinks as it dries. Portland cement is the best

stabilizer, but slaked lime can also be used! In some areas, lime is readily available and cheaper than cement! With lime, a higher percentage is needed for stabilizing than with cement. Lime does not work well with all soils, however, careful experimentation is therefore necessary. Lime can often be used with excellent results in combination with cement. This cuts down on the amount of cement needed. But it is important to remember that lime dries more slowly and therefore needs a longer curing period. Tests have shown good results with 1/3 cement - 2/3 lime mixture.

14. Organic impurities Organic material is found in the surface layer of most soils. Soil used for block making should be reasonably free of organic matter, which hinders the setting and hardening of the cement, and results in weak blocks. Therefore, the top soil should not be used unless most organic material is removed.
15. Mixture A wide range of soils is suitable for making blocks. We want: (1) a good proportion of sand to form the body of the block; and (2) a certain amount of cohesive or plastic fine particles (clay) to bind the sand particles together. Good blocks can be made with even a small amount of clay, but there must always be some clay. If a small amount of stabilizer is enough, save on cost by reducing the amount used. Learn to find sand by testing, because soils commonly considered clay may contain a good percentage of sand.

#### Simplified Field Tests

16. Particle Determination Test This test analyzes the soil to find the ratio of sand to clay and/or silt.
  - (1) Pass the soil through a  $\frac{1}{2}$ -inch screen.
  - (2) Pour into a wide-necked jar enough soil to fill the jar half full.
  - (3) Fill the jar with water.
  - (4) Add 2 teaspoons of salt, to help the clay/silt particles settle faster.
  - (5) Shake the jar vigorously for 2 minutes.
  - (6) Set the jar on a level spot.

The soil should settle in about half an hour. The sand will settle quickly to the bottom. The clay/silt particles will settle last. Measure the layers to determine the ratio of sand and clay/silt (see Fig. 3).

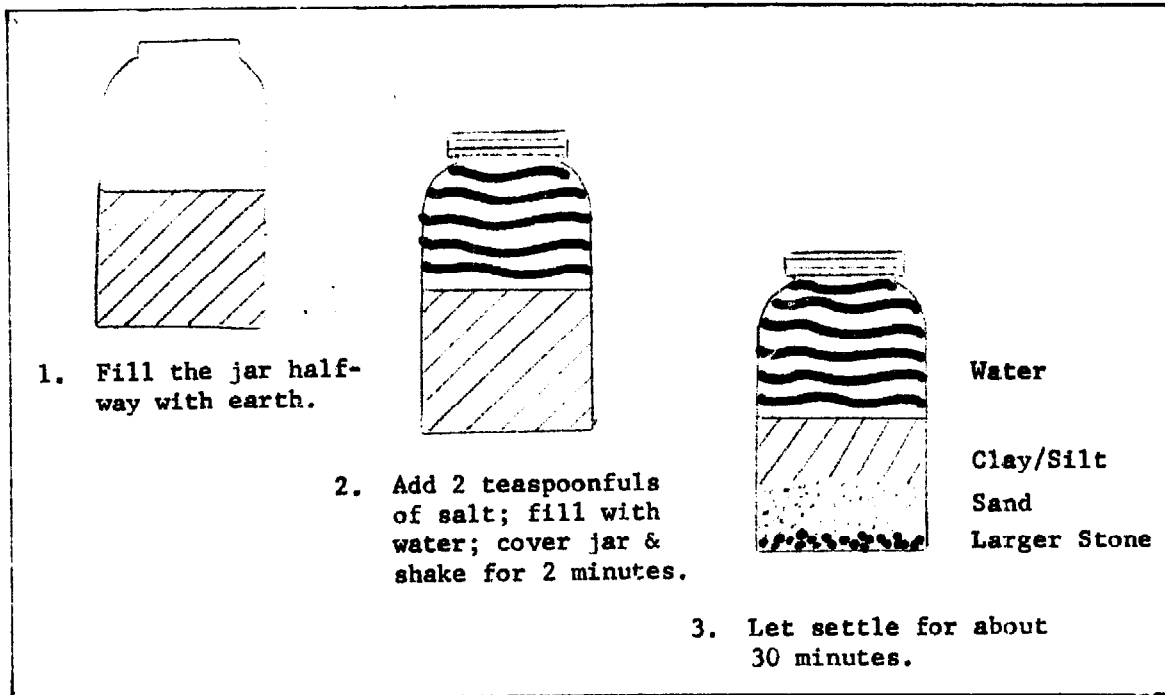

Fig. 3 - Particle Determination Test

Use soil that is at least one-third sand and between 5 and 30% clay/silt. If the soil at hand is not suitable, it can be made suitable by adding sand or clay. Record the percentages of sand and clay/silt in the soil used. This will help in deciding which soil makes the best blocks.

17. Compaction Test. This test indicates the packing quality of the earth, which depends on the percentage of clay in the sample.

- (1) Take a handful of dry, screened earth and moisten it until it is damp enough to form a ball when squeezed in the hand, but not so damp that it will leave more than a slight trace of water on the palm.
- (2) Drop the ball from a height of about three feet onto hard ground. If the ball breaks into a few smaller pieces, the packing quality is good to fair. If it disintegrates, the quality is poor.

18. Box Test The Box Test is a guide to the proper soil-cement ratio. It measures the shrinkage of soil which contains no stabilizer. The box should have these inside measurements: 24 inches X  $1\frac{1}{2}$  inches X  $1\frac{1}{2}$ " (see Fig. 4).

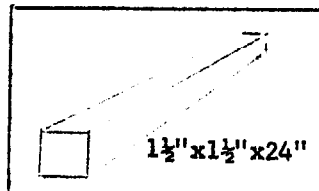

Fig. 4 - Box for Box Test.

- (1) Oil or grease the inside surfaces of the box thoroughly.
- (2) Pack the box well with moist soil (previously screened). The soil should be thoroughly moistened to pack well, but it should not be muddy.
- (3) Tamp, especially at the corners.
- (4) Smooth off the surface with a stick.
- (5) Place the box in the sun for three days or in the shade for seven days. It should be protected from rain.

19. Measure the contraction by pushing the soil to one end.

<u>Shrinkage</u>	<u>Cement to Soil Ratio</u>
Not over $\frac{1}{2}$ inch	1 part to 18 parts
Between $\frac{1}{2}$ inch and 1 inch	1 part to 16 parts
Between 1 inch and $1\frac{1}{2}$ inches	1 part to 14 parts
Between $1\frac{1}{2}$ inches and 2 inches	1 part to 12 parts

When lime is used instead of cement, use double the amount. Do not use the soil if it has many cracks (not just three or four); if it has arched up out of the box; or if it has shrunk more than two inches.

#### IV MAKING BLOCKS AND TILES

20. The proportion of cement and/or lime needed to stabilize the mixture has been determined by the Box Test.
21. The number of blocks and tiles needed should be calculated from the plans for walls and floors. Three blocks (laid flat) give one square foot of wall; two tiles give one square foot of flooring.
22. You may not be present during the block-making. Go through each step with the group doing the work until you are satisfied that the steps are clearly understood. Be generous with encouragement. Organize the physical layout of the steps of the operation as efficiently as possible. The movement of the operation should be a flow of work, with the fewest possible number of foot steps, toward the final stacking near the construction site in the following order:
  - (1) Digging and screening the soil
  - (2) Preparing the mixture

(3) Pressing the blocks

(4) Curing and stacking the blocks

23. Circumstances will not always permit a direct flow. Therefore, some forethought is needed to set up the best operation for your situation.

Digging and Screening

24. Digging. At the selected digging spot, strip the surface soil of all vegetation. If the vegetation is carefully removed and stored, it can be used later for planting around the completed house or for replanting the soil supply pit.
25. The amount of top soil which must be removed to avoid getting organic matter into the mixture, varies in different locations. It may go to a surprising depth of several feet - or it may not be necessary to remove any at all. Normally, six inches to a foot should be enough.
26. Generally, the soil gets sandier as the digging goes lower. Sandy soil with a low proportion of clay makes the best blocks. Sometimes a layer of clay sub-soil will be followed by very sandy soil; and combining the two in the screening or mixing steps will produce a stronger block.
27. If, as the digging goes lower, the pit produces soil which is not good for block-making, there is no choice but to widen the digging area.
28. The person supervising the work will probably not be present during the digging. Therefore, he should give a simple explanation of soil composition at the start of digging, so that any pronounced change in sand or clay content will be noticed.
29. In Case of Rain. In a period of alternating showers and sunshine, provision should be made to cover the pit (for example, with zinc sheets), so that work can continue immediately after the showers. Where surface water can run into the pit, put up a small retaining barrier of soil. The pile of screened soil should, of course, be protected by a covering which will shed most of the rain.

30. **Screening.** The soil should be screened through quarter-inch wire mesh (see Fig. 5).

Fig. 5 - Quarter-inch Wire Mesh, Actual Size.

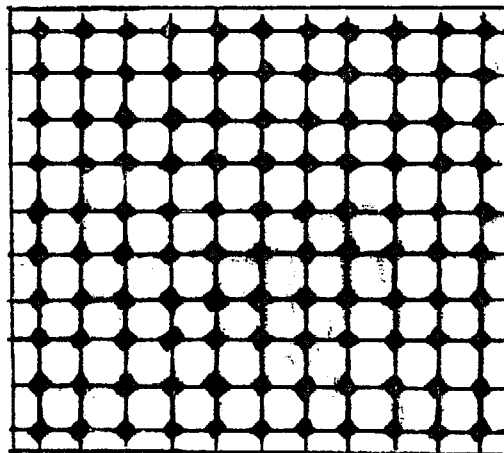

The screen should be mounted at a level where it can be shaken by hand without back-bending; for example, by suspending it from an overhead support (see Fig. 6). The screening operation is one where women and children can help in block making.



Fig. 6 - Screening the Soil

31. It is important to keep the CINVA-Ram operating steadily. It should not be idle while soil is being dug and screened.
32. Experience is needed to know how large a stock pile of screened earth is needed for different sized buildings. It can be estimated, since it will take up  $1 \frac{1}{2}$  to  $1 \frac{2}{3}$  times its volume in the compacted blocks.
33. **Preparing the Mixture.** The importance of thoroughness in both cement mixing and moisture mixing, two distinct steps in preparing the mixture, cannot be emphasized too strongly.
34. **Cement Mixing.** A suitable mixing board (good dimensions: 4 feet by 8 feet or 8 feet by 8 feet) is needed.
35. Measuring boxes whose sizes can be determined from the tests in paragraphs 16 - 19 can be very effective in making sure that the correct proportions of soil and cement are mixed.
- (1) Set a large bottomless measuring box on the mixing board.
  - (2) Fill it with soil and level off the top.
  - (3) Lift the box, leaving a measured pile of soil on the board. The soil should be spread out over the mixing board as the box is lifted.
  - (4) Use a smaller bottomed measuring box for a measured amount of cement. The cement should be emptied evenly over the soil.

(5) After the proper number of boxes are emptied on the mixing board, mix the cement and soil by turning it over with a shovel until it changes uniformly throughout to a different shade of color.

36. Do not use lumpy cement. Pass it through a fine screen; discard lumps which will not break up easily with the fingers and pass through the screen.

37. Moisture Mixing

- (1) Spread out the thoroughly mixed soil-cement mixture on the mixing board.
- (2) Add water with a sprinkling can, without making puddles (see Fig. 7).
- (3) Mix it thoroughly again, by turning it over with a shovel.

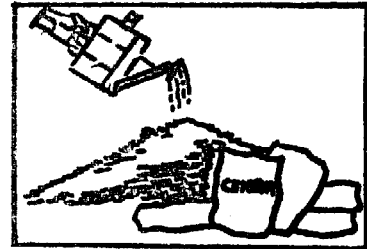

Fig. 7 - Moistening the Soil.

38. Keep the amount of water less than what seems to be enough. More water can be mixed in, but much time can be lost in getting rid of excess water.

39. With a little experimentation, it will be possible to calculate the amount of water for each mix. This will save the time it takes to make small additions of water and repeat the mixing process. It is important to remember that the mixture will look as though it is not moist enough.

40. Testing for the Correct Amount of Moisture. The correct amount of water is quickly learned through experience. To test it squeeze a handful of the mixture. (See Fig. 8.) If it is moist enough, it will keep the shape it is squeezed into. If dropped onto a hard surface from shoulder height, it should break into small fragments. The mixture is too moist if water is squeezed out of the top of the machine box when a block is pressed.



Fig. 8 - Determining the Dampness.

41. The mixture should be used within one hour after water has been added.

42. Pressing the Blocks. The first point that must be driven home to all operators of the CINVA-Ram is that they should not put too much strain on the machine when they press a block. Never should two men press on the handle to bring it down in making a block. Nor should anyone jump on the handle to force it down with repeated thrusts of his body. This point cannot be emphasized too strongly because such a strain will damage the machine.

43. Mounting the Machine. The CINVA-Ram Press (see Fig. 1) should be mounted on a board at least 9 feet long, 8 inches wide and 2 inches thick. A narrower board will let the press tip sideways; a shorter board will lift up at the ends, making it hard to get the right amount of pressure on the block; a thinner board will split under pressure.
44. The bolts should be at least one-half inch in diameter and three inches long. It is good to put washers under the heads of the bolts on the underside of the board - especially on the end of the press with the lower rollers, since this end receives the greatest pressure. The washers help to keep the bolt head from pulling through the board. If the heads do start to pull through, install larger washers immediately; the great strain put on a loosely mounted press can easily throw it out of adjustment and eventually break it.
45. Pressing.

- (1) Open the cover.
- (2) Make sure the piston is all the way down. If it is part way up, it will not be possible to get the correct amount of mixture into the box.

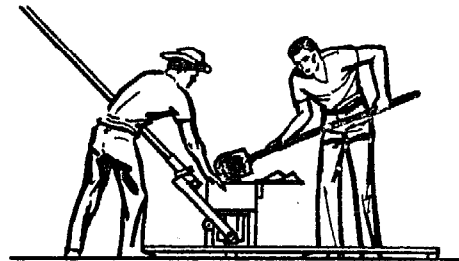

Fig. 9 - Filling the Box.

- (3) Dump the proper amount of soil-cement mixture into the box (see Fig. 9). The supervisor should determine the correct amount of mixture for each block - a measuring box can be used to make sure that the same amount is used each time. Uniformity in loading is absolutely necessary for producing uniform blocks.
- (4) Fill the corners of the box to the top, so that the corners of the finished block will be well pressed.
- (5) Press a bit in the corners with your fingers.
- (6) Replace the cover.
- (7) Move the lever to a vertical position; letting the lower rollers fall into place (see Fig. 10).
- (8) Disengage the lever latch.
- (9) Move the lever to a horizontal position on the side opposite the lower rollers

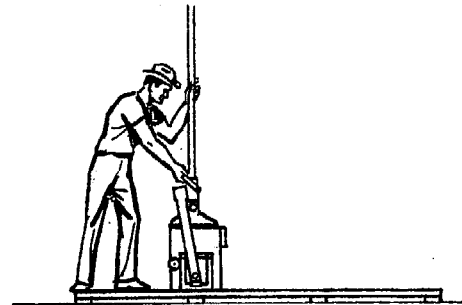

Fig. 10 - Raising the Lever.



(compression cycle) (see Fig. 11). If the right amount of mixture is used, one man of average weight should be able to move the lever down along with only two or three pushes. The lever must be lowered completely; otherwise, the block will be too thick, wasting material and producing a block which may be too thick to use.

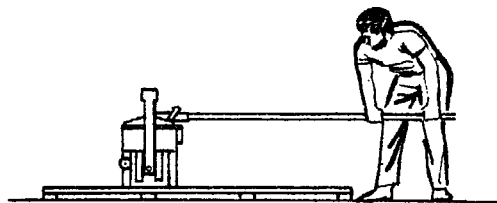

Fig. 11 - Lowering the Lever

- (10) Move the lever to a vertical position, engage the lever latch, and return the lever to its rest position on the lower rollers.
- (11) Open the cover (see Fig. 12).

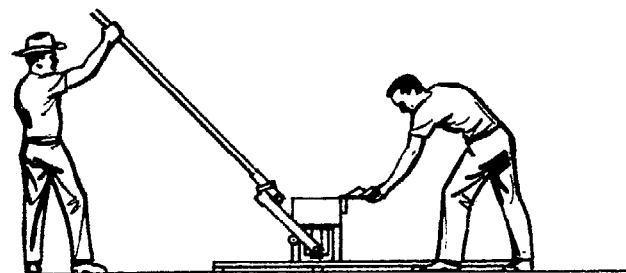

Fig. 12 - Returning the Lever to Rest Position and Opening the Mold Box.

- (12) Depress the lever steadily to eject the block (see Fig. 13). If the block is cracked or deformed, it should not be used. Read the instructions in paragraphs 52-61, Adjustments.

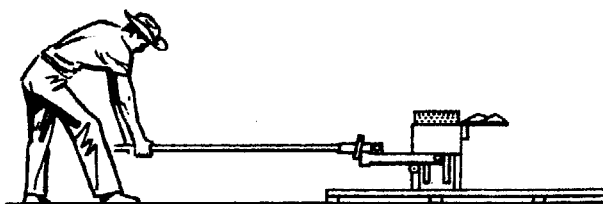

Fig. 13 - Ejecting the Block.

- (13) If the blocks are lifted from the machine and carried properly and carefully, and if the mixture is correct and the machine is in good adjustment, the blocks will not break easily.
  - (a) Press in on opposite ends of the block with the fingers closed, the thumbs in close to the fingers, and using part of the palms (see Fig. 14).

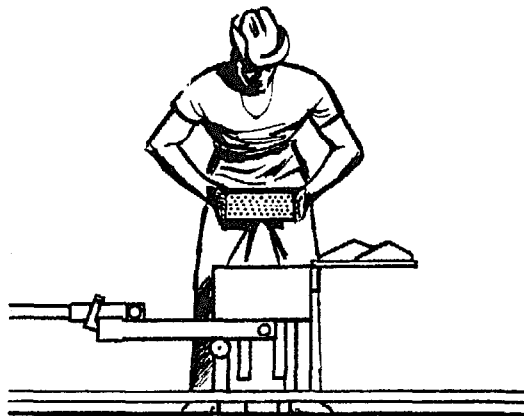

Fig. 14 - Removing the Block

(b) To set the brick down, tip it into place on its side.

46. Try to have at least two men operating the machine, because it is very time-consuming to have one man moving from one side of the machine to the other to press and eject. But it can be done by one man if only one is available. Four persons make an ideal team for pressing: one filling, one pressing, one ejecting, and one removing. A team of four can easily produce two blocks a minute if the mixture is prepared and close by.
47. Sticking. Some soils stick more than others. An occasional cleaning of the corners of the press box with a metal scraper may be necessary. The blocks should come out of the press with sharp corners. Sticking can be overcome by slightly moistening the points where it occurs with a bit of kerosene on a rag.
48. Rotating Jobs. On a job where there is enough labor to have all the steps - digging, screening, mixing, loading, pressing, ejecting, and carrying - going on at the same time, it is fair and good for morale to rotate the jobs every hour or so.

#### Maintenance and Repairs

49. Lubrication. All moving parts (rollers, pins, pressure plate, guide plates, piston's cylinder, bearings and supports of axles) should be well lubricated every four to eight hours with heavy oil or grease to insure smooth operation and cut down on wear (see Fig. 15).
50. Pins. The pins which secure the pivot shafts, compression yoke and rollers should be replaced when broken by the largest nails available, because they will last longer than the average cotter pin. If C-ring replacements are not available, broken C-rings can be replaced by wrapping a piece of wire in the groove.
51. Clean Surfaces. The inside of the box and the under surface of the cover must be kept clean.

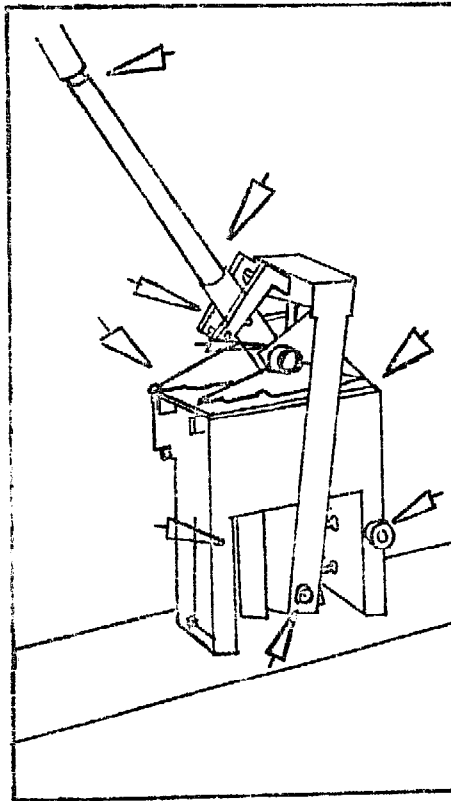

Fig. 15 - Lubrication Points

52. Adjustments. The CINVA-Ram press should not be tampered with unnecessarily, but the following suggestions may help if the press produces faulty blocks.
53. Breaks and Cracks. Breaks and cracks are caused by loose or incorrectly adjusted guideplates.
54. Side Breaks. (See Fig. 16.) Move the lower adjusting bolts (G and H) side-ways toward the high side of the break (see Fig. 1). If more adjustment is needed, move the upper adjusting bolts (E and F) toward the low side of the break. This can sometimes be done simply by hammering the bolt side-ways (with a piece of wood, so that the threads will not be damaged) rather than by loosening and tightening the nuts. After the bolts are hammered over, tighten the nuts.
55. End Breaks. (See Fig. 17.) Move the guide plate opposite the end where the break occurs inward by turning lower

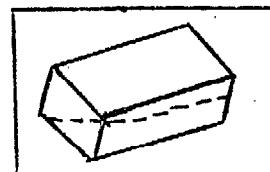

Fig. 16 - Side Break

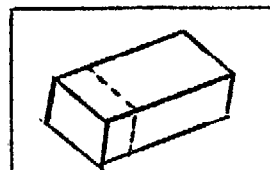

Fig. 17 - End Break

adjusting bolt G or H, depending on the guide plate to be moved (see Fig. 1). NOTE: Moving one end of a guide plate in one direction forces the other end of the same plate in the opposite direction. If this loosens the piston much at either the top or the bottom of the guide plate, the other end of the plate must be moved inward. The free play should be corrected because it will cause the piston to crack the blocks by compressing them in one direction in the compression cycle (with the upper saddle as the pivot point) and in another direction in the ejection cycle (with the lower rollers as the pivot point). Also, the guide plates must be tight enough against the piston to keep it from jerking and jumping upward at the end of the ejection cycle.

56. If end cracking is not stopped by tightening the plates against the piston, it may be necessary to tilt the guide plates and the piston, so that the pressure plate will be higher at the end which is cracking. This is done by moving the tops of both guide plates toward the cracked end.

57. Corner Breaks. A corner break is caused by a combination of a side break and an end break (see Fig. 18).

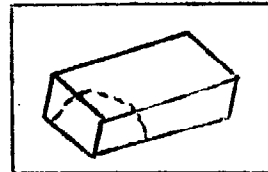

Fig. 18 - Corner Break

- (1) Fix the side crack by moving the bolts sideways, as in paragraph 54 (usually it is only necessary to move the bottom bolt on the end with the crack toward the side where the crack occurs).
- (2) Fix the end crack by moving the lower adjusting bolt opposite the cracking end inward against the piston, as in paragraph 55.

58. Tapering. Tapering is caused by incorrectly adjusted guide plates.

59. Side Taper. (See Fig. 19.) First move the guide plate on the thicker side outward; then move the other guide plate inward (see Fig. 1). The guide plates should be kept parallel to each other. Move both the tops and bottoms of both guide plates the same distance.

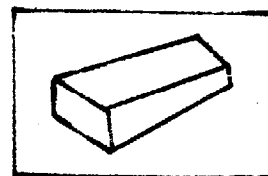

Fig. 19 - Side Taper

60. End Taper. (See Fig. 20.) Move the tops of both guide plates toward the thin end. Move the bottoms of both guide plates toward the thick end. (See Fig. 1). The tops should be moved as far in one direction as the bottoms are in the other.

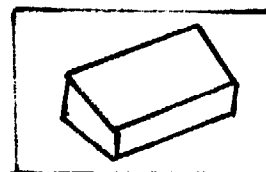

Fig. 20 - End Taper

61. Corner Taper. (See Fig. 21.) A corner taper (one corner thinner than the rest) is caused by a combination of a side taper and an end taper (see Fig. 1.) First, fix the side taper by moving the guide plates as in paragraph 59. Second, fix the end taper by moving the guide plates as in paragraph 60.

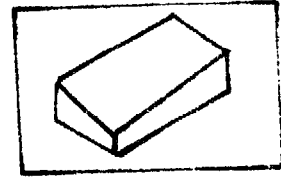
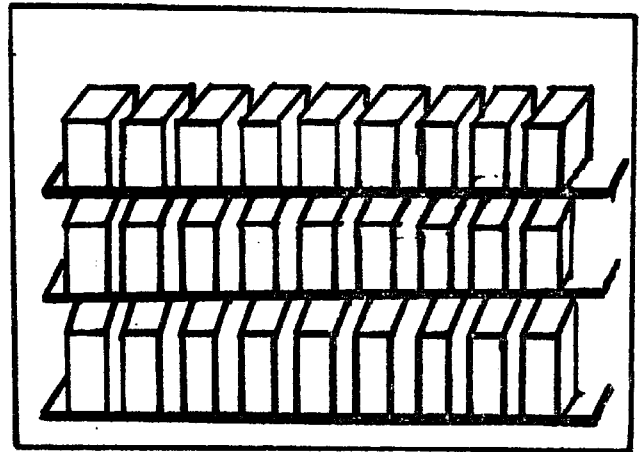

Fig. 21. - Corner Taper

62. Curing and Stacking the Blocks. The curing of the blocks is another important step which must be taken with care. To become careless at this point could ruin all the careful work that has gone before.

63. The moisture in the blocks must come out slowly and evenly.

64. The blocks should be laid on flat, unwarped, clean planks wide enough to support the full width of the blocks (see Fig. 22). If such boards are not available, the blocks should be placed on smooth ground covered with paper or leaves so that they will not be in direct contact with the ground.



65. The blocks should not be pushed into another position after being placed.

If it is necessary to move the blocks at this point when they are very weak, they should be carefully lifted and carefully placed again. If the blocks cannot be put inside or under a shelter, cover them with heavy paper. (Paper cement bags carefully opened and separated make excellent coverings.)

Fig. 22. - Blocks stacked for first 5-day cure.

If there is a shortage of storage space, the blocks can be stacked five rows high after three or four hours of drying - if they are very carefully handled.

66. The next day, the first operation is to move the blocks to make room for another day's production.
67. After the overnight drying, the blocks should still be protected from the weather because they must still cure slowly for four or five more days. Soaking will harm the blocks at this stage. Sunshine will make them cure too quickly, reducing their strength. In very hot climates, blocks should be kept moist during this period. In any climate, they should be prevented from curing too fast. For the first four days, they should be sprinkled lightly with water twice a day. If lime is used, double the curing time. The blocks can be restacked ten rows high on edge for the next curing period of 10 days. The blocks must not be stacked solidly; there should be a space of about an inch between blocks to let them cure properly. A good stacking arrangement

is three blocks side by side with an inch space between them crossed with three blocks above - alternating the direction of each layer (see Fig. 23).

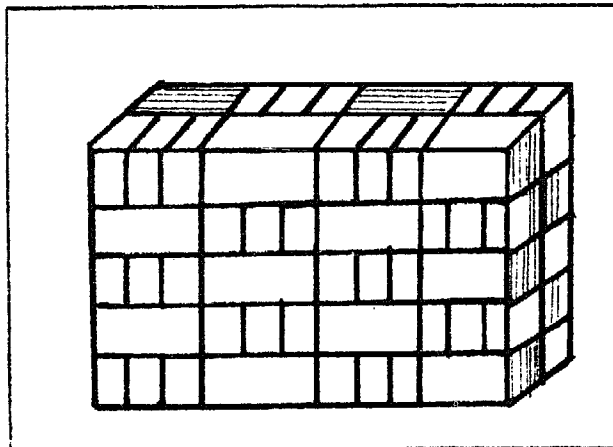

Fig. 23 - Blocks stacked for 10-day cure

68. In carrying out the curing process, try to be moving the blocks closer to the construction site.
69. Never underestimate the importance of careful curing.
70. Variations of Blocks, Floor Tiles. The CINVA-Ram press's box, when used without any inserts, produces a solid block 11-1/2 by 5-1/2 by 3-1/2 inches. Inserts for the box, which are included with the CINVA-Ram will change the size or shape of the blocks.
71. Frog. A wooden "frog" (see Fig. 24) is used in the box to produce a block with a partially hollow core. The advantage of this block is that it uses only four-fifths the mixture used in a regular block - reducing both cost and labor. These blocks are also ideal for designing patterns in walls using blocks laid on edge. The "frog" must be kept clean.
72. Some soils will stick to the wooden mold. A quick wipe with a kerosene-dampened rag will overcome this.
73. Blocks can be made with hollow cores running the whole length of the block, but this takes a little more time. The proper molds for these blocks have to be made (see Fig. 25), They do not come with the press. These blocks can be used where metal reinforcing rods are to be run through the laid blocks.

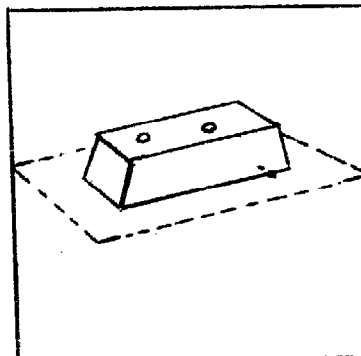

Fig. 24. - "Frog" Mold

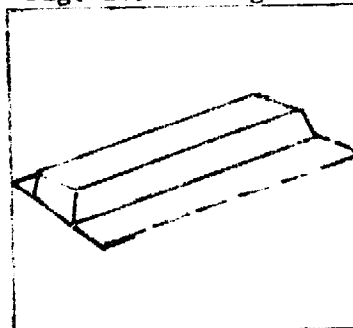

Fig. 25. - Block Length Mold

74. With a little experience, operators will become efficient in making these blocks.

75. Floor Tiles. Tiles produced with CINVA-Ram Block Press make inexpensive, attractive and durable flooring. The tile insert is a wooden block with a metal face (see Fig. 26). The wearing surface on the tile is made with a cement mixture.

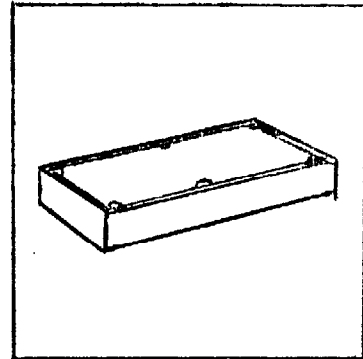

Fig. 26 - Tile Mold

- (1) Screen the sand for this mixture as finely as possible: the finer the sand, the smoother the tile face will be.
  - (2) Mix two parts sand with one part cement. Mineral coloring can be added to produce different colored tiles.
  - (3) Mix water with the sand cement mix, as in paragraphs 37-39.
  - (4) Place the tile-making insert in the box.
  - (5) Spread the mixture over the insert, to a depth of one-quarter to three-eighths of an inch.
  - (6) Add the soil-cement mixture to this, without completely filling the box. The two mixtures should be equally wet.
  - (7) The tile is then pressed and ejected in the same way as the blocks. (See paragraphs 45 and 46.)
76. A pallet is helpful in carrying the newly pressed tiles. The tiles, which are thinner than the blocks, are more easily damaged in handling. Cured or partly cured blocks can be used as pallets. The tiles are turned over when removed from the machine and cured face up. They can be carried on the insert to the curing spot if pallets are not used, and then inverted when placed down; but this operation is a little awkward and slows the tile-making.
77. It is extremely important that the tiles rest on a flat surface for the first day of curing. A bowed surface will make the tile sag to the bow and the tile will either cure in a warped shape or crack.
78. A different method of facing is to place a dry mixture of cement, sand and coloring into the box and then add a soil-cement mixture which is slightly wetter than usual. This saves the time it takes to make a wet mixture. It also spreads out easier on the insert.
79. The tile facing may stick to the insert. Rust on the metal face can cause this. If nothing else stops the sticking, put a sheet of plastic or a piece of heavy paper (one ply of paper cement bag will do) cut or torn to the size of the insert into box before filling. The plastic or paper can be peeled off the face of the pressed tile. One paper will last for about twenty tiles.

80. Curing and Stacking. Tiles are cured in the same way as the blocks, but they are stacked only two high, with the faces together.
81. Other inserts provided with the CINVA-Ram Block Press can be used to make I-shaped blocks, blocks for utility conduction, and lintel blocks (for placing door supports).
82. Testing the Blocks. The strength of the cured blocks should be tested. Most countries have a university which can test the blocks.

#### V. BUILDING

83. Mortar. The mortar joints between CINVA-Ram blocks and tiles should be one-half inch thick. Since the blocks are 11-1/2 x 5-1/2 x 3-1/2 inches, the building unit is 12 x 6 x 4 inches. In flooring, the 11-1/2 x 5-1/2 inch tiles plus the half inch mortar joint, make a unit of 12 x 6 inches.
84. The foundation for the blocks must be firm. Use a cement-sand mortar for the first two layers, to allow waterproofing.
85. The mortar recommended for the rest of the building is one part cement, two parts lime and nine parts of the same soil used to make the blocks. Lime is used because it forms a more plastic mortar; since it sets more slowly than cement, it is less likely to crack. The mortar should be a moist mixture which does not flow as freely as cement-sand mortar.
86. Surface Coating. Let the mortar dry for about a week. Then, using a narrow brush, paint all the joints with a thin cement wash which can be brushed into any fine cracks. Stir the cement wash frequently. Where large cracks develop they should be gouged out to hold a packing of soil-cement mortar. Wet the crack. Press the mortar in and smooth it off.
87. The blocks alone have an attractive finish but they can also be given this finish: after a day, paint all the exterior walls with a cement wash of about rich milk consistency. Work in the shade, keeping the cement wash well stirred. Three coats are recommended. The coats should be thin to keep from building up a crust of cement. Allow a day between each coat.
88. A lime wash can be applied to make the building waterproof. This usually needs to be done again every year.
89. A silicone base wash (clear in appearance) is an excellent water repellent for very rainy areas. In experiments, this solution has waterproofed blocks which were not coated with a cement wash. In areas above the frost line, experimentation should precede the use of CINVA-Ram blocks.

#### VI REFERENCES

90. (1) Manual for the Supervision of Self-Help Home Construction with Stabilized Earth Blocks Made with the CINVA-Ram Portable Block Press.



by Paul M. Campbell, FCH Company, Inc., Chicago. (Prepared for the Government of Jamaica in January 1959).

(2) Manual for Supervising Self-Help Home Construction with Stabilized Earth Blocks Made in the CINVA-Ram Machine, by Chris Ahrens, housing specialist, State of West Virginia Economic Opportunity Agency.

(3) CINVA-Ram Handbook, by John R. Hansen, volunteer in American Friends Service Committee Summer Project, July 1963, Patzicia, Guatemala.

(4) What is the CINVA-Ram Machine? by a Peace Corps Volunteer.

(5) Earthen Home Construction: A Field and Library Compilation with an Annotated Bibliography, by Lyle A. Wolfskill, Wayne A. Dunla and Bob M. Gallaway, Texas Transportation Institute, A. & M. College of Texas, Bulletin No. 18, March 1962.

(6) Earth for Homes, Ideas and Methods Exchange No. 22, U.S. Housing and Home Finance Agency, 3rd printing, revised, September 1963.

#### VII OTHER MACHINES FOR MAKING BLOCKS FROM STABILIZED EARTH

91. Landcrete, manufactured by Messrs. Landsborough Findlay (South Africa) Lts., Johannesburg, and Trans-Atlas Ltd., 15 Duke St., Dublin 2, Ireland. A well-designed hand-operated toggle press, sturdily constructed and simple to operate.
92. Winget, manufactured by Messrs. Winget Ltd., Rochester, England. A hydraulic press powered by a gasoline engine. The quality of the blocks produced is helped by high operating pressures, but the production rate is the same as that of a hand-operated machine.
93. Ellson Blockmaster, manufactured by Ellson Equipments (Pty.) Ltd., Johannesburg, South Africa. The machine uses a toggle switch lever system giving a constant length stroke which standardizes the thickness of the blocks.

If you need more information on the material in this manual or on other technical matters, VITA (Volunteers of International Technical Assistance) can send it to you. If you have specific questions, VITA can put you in contact with an expert who can answer them. VITA is an international association of scientists, engineers, technicians and businessmen who volunteer their spare time to consult on questions from persons in developing areas.

Simply send your request to:

VITA  
230 State Street  
Schenectady, N.Y. 12305  
U.S.A.

To help the VITA volunteer who answers your request, you should

1. Be quantitative -- give measurements, costs, materials available, sketches when possible.
2. Describe the best solution, if any, found nearby and any limiting cultural factors.
3. Indicate a deadline for action. You will hear directly from the VITA volunteer; keep in contact with him; inform the VITA Office if correspondence stops.