

AT MICROFICHE
REFERENCE
LIBRARY

A project of Volunteers in Asia

A Survey of the Possible Use of Windpower in
Thailand and the Philippines

by: William E. Heronemus

Published by:

United States Agency for International
Development
Washington, DC 20523 USA

Available from:

United States Agency for International
Development
Washington, DC 20523 USA

Reproduction of this microfiche document in any
form is subject to the same restrictions as those
of the original document.

"A SURVEY OF THE POSSIBLE USE OF WINDPOWER IN THAILAND
AND THE PHILIPPINES"

Prepared for the Department of State,
AID/TA/OST, at the Request
of H. A. Arnold, Director.

by

William E. Heronemus, Professor of Civil Engineering
University of Massachusetts (Amherst)

November 1974

Contract No. AID/ta-c-1143.

2. Summary

This work was performed in an attempt to answer the question: "Could windpower be used by the peasant farmer in Thailand or Philippines to improve the quality of his life?" It was found that windpower was being used to a very limited extent in Thailand to move water, thus relieving either a back-breaking manual labor task, or, a very expensive out-of-pocket expenditure for fuel for engine driven pumps. Some of the windpumpers in use are inexpensive enough that the individual farmer can own one; others brought in from the United States are too expensive for private ownership. No evidence of existing windpumping could be found in the Philippines.

Data were gathered descriptive of the Thai windpower resource, their irrigation system and water management plans and their current agriculture. It has been concluded that windpower could be very useful in expanding Thai agriculture. There are regions in which the winds are most productive: happily they are the same regions in which irrigation systems are most complete and the urge toward double-cropping and fertilization is well-founded. Thus, augmentation of double-cropping in the rich Chao Phya Delta - Central Plain region, using windpower at the individual farm level, or carefully integrated with irrigation systems "almost able" to provide water during the dry season, is given maximum emphasis. It is also suggested that windpower could cope with season-end droughts in the expanding agriculture areas of the Northeastern Region, and perhaps could serve to irrigate second crops, preferably crops other than rice. Then attention is turned to the possibility of using windpower along the mighty Mekong to lift out that water in large quantity, coping with a 15-meter level variation. Though little engineering

detail for such windpumpers is presented, the concept is set forth as worthy of serious discussion within the Mekong Committee, at least.

The need for better management of water, year around, brings with it the need for increasing quantities of fertilizer. A moderate-sized windpower system afloat in the Gulf of Thailand is proposed as a source of energy that could treble Thailand's 1973 fertilizer consumption, and which after construction would be totally independent of foreign inputs. At 1974 fertilizer prices, the system would be an economic bonanza to its owners.

Brief mention is made of the Philippines. The windpower resource there is richer than that of Thailand, and the motivation toward more intensive agriculture, double-cropping and fertilization, is abundantly clear. Windpower alone could relieve the Philippines considerably of her foreign exchange petroleum deficit. Windpower systems in the Philippines must be configured either to be housed in the paths of numerous tropical wind storms, or, must be strong enough to withstand such winds. Either is possible.

For both Thailand and the Philippines a quick look is taken at the possible use of the ocean thermal differences process, another solar driven energy process of great interest to the author. Both countries, the Philippines in particular, could base their economic future on expanding use of that process and could become giants amongst the LDC by so doing.

Solar energy, via windpower and ocean thermal differences, could give these two relatively poor nations economic advantages over any of the more highly industrialized western or eastern nations, if put to use shrewdly starting right now.

2. Table of Contents and List of Illustrations

	page
0. Cover Page	
1. Summary	1
2. Table of Contents and List of Illustrations	3
3. Introduction	7
4. Windpower Use in Thailand, Past and Present	11
5. The Winds and Related Resource Data for Thailand	21
6. Irrigation in the Chao Phya Delta Using Windpower and Commercially Available Windpumpers	25
7. Proposed New Wind Pumpers for Dry Season Irrigation in Thailand	37
8. On the Generation of Electricity by Windpower Over the Chao Phya Delta and Central Plain	52
9. On the Generation of Electricity by Windpower Over the Gulf of Thailand	53
10. Irrigation Via Windpower in the Philippines	57
11. The Ocean Thermal Differences Process, Thailand and Philippines: A Major Energy Possibility for the Future	59
12. Vertical Axis Wind Machines	62
13. Conclusions	66
14. Recommendations	70
15. References	73
16. Appendix 1: Monthly Velocity-Duration Curves, <u>Nakhon Sawan</u> , plus Energy Calculation Sheets, Showing Energy in a 6 Meter Diameter Swept Area at 10 Meter Axis Height. . .	1-1
17. Appendix 2: Monthly Velocity-Duration Curves, <u>Don Muang</u> , Pessimistic Curve Shape Versus Simplistic But Perhaps Optimistic Curve Shape.	2-1

page

18. Appendix 3: Analysis of an Improved 6 Meter Diameter Two-Bladed Thai Windmill Driving,
- (A) A Variable-Throw Crank Thence a Reciprocating Pump of Large Barrel Diameter,
- or
- (b) A Fixed-Throw Crank Thence a Reciprocating Pump of Moderate to Small Barrel Diameter. 3-1
19. Appendix 4: Analysis of Wood Construction Fan Mill Irrigation Pumps Using Reciprocating Pumps. 4-1
20. Appendix 5: A First Approximation of a Mekong Irrigation Pumper and Eastern Mekong Wind Pumped Irrigation System. 5-1
21. Appendix 6: A Proposed Program for Development of the Thai Windpower Resource and Other Asian Energy Resources. 6-1
22. Appendix 7: Chronology of Visit, List of Places Visited, and List of People Contacted 7-1

List of Illustrations

1. Figure 1. A Six-Sail Thailand Windmill as Used in the Salt Works (Bare Poles Condition).
2. Figure 2. The Drive Shaft and Gear of a Thai Water Ladder in Use in the Salt Works near Samut Songkhram.
3. Figure 3. A Two-Bladed Thai Windmill in Use for Water Pumping Near Don Muang.
4. Figure 4. Aloft Mechanism, Two-Bladed Thai Windmill .
5. Figure 5. Lower End of Chain Drive From Two-Bladed Thai Windmill, and Windmill Owner.
6. Figure 6. Thai Water Ladder Driven by a Two-Bladed Windmill.
7. Figure 7. An American Fan Mill, An Aermotor 12-Foot Diameter Wind Pumper near Petchaburi.
8. Figure 8. The Chao Phya Delta Wind Line.
9. Figure 9. A Comparison of Selected Shape, Velocity-Duration Curves, Against a Possible Less Energetic Shape, Both Drawn Through the Same Three Points at Wind Speeds 1 kt, 4 kts, and 12 kts.
10. Figure 10. A Comparison of Energy in the Wind at Two Stations on Opposite Sides of the Gulf of Thailand.
11. Figure 11. A Proposed Offshore Windpower System for the Gulf of Thailand.
12. Figure 12. A Two-Oil-Drum Vertical Axis Wind Pumper at IRRI, Los Banos, Philippines.
13. Figure 13. Another View of the IRRI Two-Oil-Drum Vertical Axis Wind Pumper.
14. Fig. 1-1 In App. 1, Velocity Duration Curves, Nakhon Sawan.
15. Fig. 2-1 In App. 2, Same as Fig. 9.
16. Fig. 2-2 In App. 2, Velocity Duration Curves, Don Muang (Optimistic)
17. Fig. 2-3 In App. 2, Velocity Duration Curves, Don Muang (Pessimistic)

18. Fig. 3-1 In App. 3, C_p vs. Tip Speed Ratio, Various Constant Values of Root Pitch, 2-Bladed Design.
19. Fig. 3-2 In App. 3, Thrust and Root Bending Moment vs. Tip Speed Ratio for Windspeed = 10 mph, 2-Bladed Thai Windmill.
20. Fig. 4-1 In App. 4, Fan Mill Characteristic
21. Fig. 4-2 In App. 4, Profile View, 30 Blade 6 Meter Dia. Fan Mill
22. Fig. 4-3 In App. 4, Plan View, 30 Blade 6 Meter Dia. Fan Mill
23. Fig. 4-4 In App. 4, Pole Matcher, 30 Blade 6 Meter Dia. Fan Mill
24. Fig. 5-1 In App. 5, The Eastern Mekong Wind Line
25. Fig. 5-2 In App. 5, Velocity-Duration Curves, Nakhon Phanom
26. Fig. 5-3 In App. 5, Velocity-Duration Curves, Mukdahan
27. Fig. 5-4 In App. 5, Velocity-Duration Curves, Ubon Ratchatani
28. Fig. 5-5 In App. 5, Velocity-Duration Curves, Mukdahan, Pessimistic Energetics.

3. Introduction.

Over the past several years it has become clear to many men that the supply of energy to less developed countries in the form of electricity generated in large central stations, distributed via national grids, is still many decades away from providing energy to the peasant farmers on whose shoulders and backs the economies of those countries squarely rest. The concept of supplying energy to those needing it most, the farmers, from one or more renewable solar energy processes, as a substitute for energy from fossil fueled, uranium fueled, or very large hydroelectric plants, is not at all new. The oldest of the solar energy processes, photosynthesis, has long provided almost all of the energy fuel available to those great masses, in the form of wood, fibre or burnable animal wastes, a resource whose recovery today in many parts of the world is the greatest contributor to exponential growth in soil erosion and desert expansion. The second oldest of the solar energy processes, windpower conversion, has been practiced in most parts of the world, but is used effectively today in rather limited areas of the world. There is also renewed interest in the practice of the low temperature photo-thermal process for the heating of water, distillation of water, and via heat engine cycles, for the production of shaft work.

The work reported herein was accomplished to answer the question "can windpower machines be used to help the lot of the Thai or Philippine farmer, and can those machines be acquired by the individual farmer within an annual income of about 150 U.S. dollars?"

The answer to that question is a qualified "yes." It was found that the Thai farmer of the Chao Phya Delta and Central Plain Regions has been using

wind driven pumps to lift water for irrigation. The salt workers along the two shores of the upper reaches of the Gulf of Thailand also use wind driven pumps to move the water from which they recover salt by evaporation. Those wind machines, in both instances, are acquired by individuals, held as personal property, and do include a considerable amount of cottage labor input on the part of those who own them. But, both the salt water and the irrigation water pumps of Thailand are rather sophisticated machines requiring the skill and tools of the millwright or wheelwright shops located in the larger cities. And very few of these machines are operable today, so one can not say that a number of persons are profiting from their use. The existing machines do serve a very useful function, and though grossly inefficient part by part, the entire system is well balanced and exhibits years, possibly centuries, of thoughtful evolution (though the author cannot claim to have established the date when those wind pumpers first appeared in Thailand).

The answer to the question must not be stated simply in terms of past or present, however. It appears that these farmers are in the last analysis the key to the provision of increased quantities of food (and favorable trade balance in the case of Thailand, because about one-third of all the foreign exchange is earned by selling a rice surplus) necessary to match the three percent population growth rate. So, can windpower machines help these farmers, to meet the productivity expansion expected of them for the future?

Increased agricultural productivity appears to have these requirements, in Thailand, at least:

- (a) There must be better control over the random droughts at beginning and end of the rainy season (April through November, more or less) which cause random and at times severe rice loss.

- (b) There will probably have to be a steady changeover to High Yield Varieties of rice, a change that is just beginning in Thailand; and those rice varieties require fertilizer.
- (c) There will have to be continued steady growth toward two-crops of rice per year, starting in the parts of Thailand most favorable, then expanding outward into less favorable regions. Double-cropping of rice requires at least these things:
- (1) Assured management of rain plus ground-water during the rainy season plus management of ground water in large quantity during the dry season. Rain management includes pumped drainage.
 - (2) Fertilizer for both crops.
 - (3) Replacement of water buffalo by machines, and the continued provision of fuel for those machines.
- (d) The first or second crop need not always be rice. There is much emphasis on increasing vegetable, fruit and upland-crop production. Water demand during the dry season for such crops may not be so great as that for rice, thus water lifting and management for rice during the rainy season but for crops other than rice during the dry season may be an easier task.
- (e) There is a desire to raise more meat and to increase maize (American corn) and soybean production to feed meat animals. There is a desire to raise more oil crops to increase protein supply.

Windpower using machines improved over the existing machines could contribute to the pumping of water called for by the above. Wind generated electricity could be used to manufacture nitrogenous fertilizer to support expanded productivity.

The question stated above will therefore be addressed in the frame of reference of an expanding future agriculture, an agriculture still based primarily on manual labor by peasant farmers in small family holdings or by farm families reduced to tenant or share-cropper status, but an agriculture which gradually sees those farmers raising two crops, diversified crops, from fertilized and irrigated fields. The preponderance of the report is addressed to the Thai situation, because very little time was available to collect and analyze data for the Philippines. The report will suggest how windpower could be used to:

- (a) prevent drought or late-planting in the rice seedling beds at the start of the rainy season.
- (b) prevent premature drying of the rice fields at the end of the rainy season.
- (c) increase existing and planned gravity irrigation capability during the dry season in the Chao Phya Delta where a large network of streams, canals, and ditches already make large quantities of ground water almost accessible for dry season irrigation, and provide some pumped drainage in that region during the rainy season.
- (d) provide modest amounts of irrigation during the dry season in the Northeastern Thailand region where shallow dug wells might be expected to provide sweet water within three meters of the surface.
- (e) provide large amounts of irrigation during both rainy and dry seasons along the Mekong River bank, extending perhaps 30 to 50 kilometers inland west of that bank, depending upon the ability of the State to increase the water distribution systems in that area.
- (f) manufacture fertilizer.

4. Windpower Use in Thailand, Past and Present

Numbers of six-sail wind machines are currently in use in the salt works around the northern shore of the Gulf of Thailand. The machines are of about 6 meters diameter and use bamboo spars, rope and wire to form a wheel which carries 6 triangular sails, each woven from rush or split bamboo.

Figure (1) shows such a machine. They are fixed in azimuth, rotating one way in the southwest monsoon and reversing direction in the northeast monsoon.

The windwheel axle is timber and each end is rounded to form a wood journal bearing which rests in a wood crotch. No lubrication is used. Power is transmitted by a chain of about one inch links which rides in a vee groove between the sides of a built-up wooden pulley wheel of about 30 cm diameter.

The chain is a western product, open-link steel chain. The chain also rides in a vee groove wooden pulley of about 120 cm diameter, built on one end of a pump drive shaft, shown in Figure (2) foreground. This wood shaft is about 4 m long and each end is terminated in a 3 cm diameter iron rod set into the wood and held by an iron hoop. The shaft has an eight tooth wooden paddle gear built into it in the best of wheel-wright tradition, spoked and banded.

This gear engages and drives the paddles of the water ladder type pump as can be seen in the background of Figure (2). The water ladder pump is a very

beautiful wood machine (some very modern metallic fasteners and plastic washers, including cotter keys, were evident in close-up inspection of the

Figure (2) water ladder) of carefully fitted parts which are able to "scrape"

water up an inclined trough, elevating it not in excess of one meter, and doing so at an efficiency as high as 50 percent (per AIT). None of the

pump is a cottage-industry product: it must be made by skilled artisans

possessing all the tools and knowledge of the wheelwright. It was said that these pumps are produced in small shops in Bangkok.

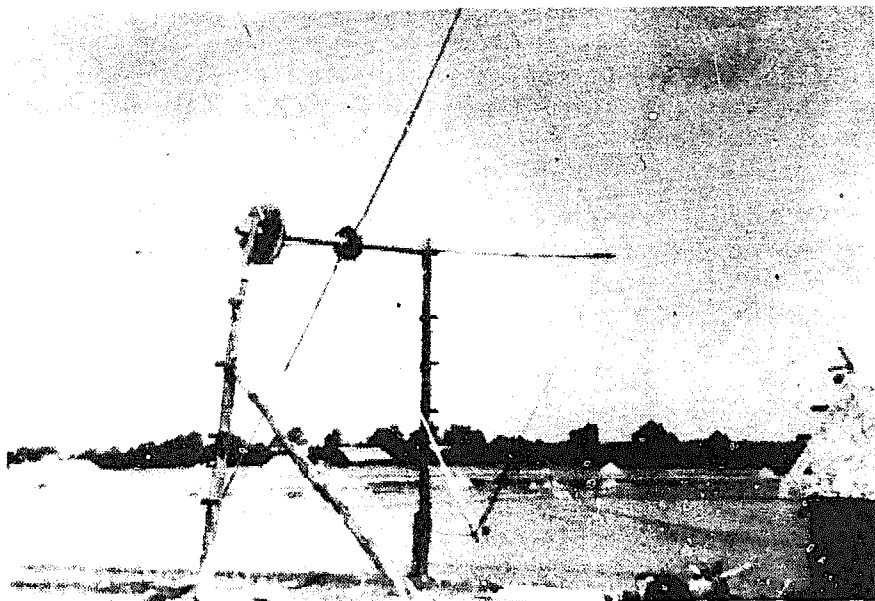

FIG. 1. A Six-Sail Thailand Windmill as Used in the Salt Works
(Bare Poles Condition)



FIG. 2. The Drive Shaft and Gear of a Thai Water Ladder in Use in the
Salt Works Near Samut Songkhram

The total system is grossly inefficient, admirably sized to the task it is to perform, and apparently something which the owner can afford. The chain drive provides considerable flexibility in location and orientation of the pump with respect to the fixed orientation wind wheel. Remarkable improvements could be made in this system simply by addition of frictionless plastic bearings on the wind wheel and the pump drive shaft, but then the water ladder would probably turn too fast. The job that is done by the machine system could, however, be done by a much smaller diameter fan mill driving a reciprocating pump, and total investment might be less. There seems to be no need to improve this gear, however. Even if more salt production were desired, the key would be more flat land for evaporative flats rather than improved pumps.

Windpower has also been used in the past to pump irrigation water in the Chao Phya Delta rice fields. Both two-bladed and four-bladed propeller type windscrews of about 6 meter diameter have been used. Figure (3) shows such a two bladed machine driving a water ladder in a rice field near the Don Muang Airport. In Figure (4) one can see the aloft mechanism of this type of pumper. A blade is whittled out of a plank about 6 m long x 30 cm wide by 5 cm thick. A rounded leading edge and a sharpened trailing edge is given to each half of the plank in such a way that some small twist and some semblance of foil shape is given to the blades. The plank is fastened at its center to an iron shaft of about 3 cm diameter by 60 cm length, on the blade end of which is an iron fitting much like an iron pipe foot flange through which four nuts and bolts hold the blade plank. This iron shaft rests in two wood bearings in the fore and aft upright members of the rotating pole-matcher. A pair of wood slats hold the top of this pole-matcher together whereas the



FIG. 3. A Two-Bladed Thai Windmill in Use For Water Pumping Near Don Muang

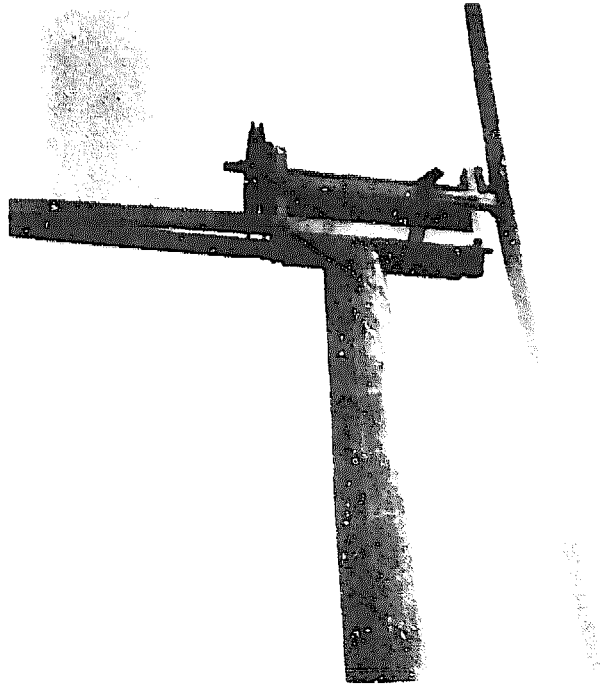

FIG. 4. Aloft Mechanism, Two-Bladed Thai Windmill

bottom is held together by a flat plank plus two long slats which extend on aft and which are used to train the windmill around in azimuth. The flat plank bottom of the pole-matcher has a hole cut in it which is a tight fit with a reduced diameter section of pole top. The pole matcher is not intended to move around in azimuth, easily: indeed this windmill is set by hand to the oncoming wind before it is started. The pole is about 25 cm in diameter, cut away at the top to carry the pole-matcher. The poles in use are about 5 meters tall above ground, are not treated with any preservative, and are set down into the earth. No stays or braces are provided. At the aft end of the iron shaft a combination wood and metal vee pulley of about 20 cm diameter is fitted, a vee pulley which drags an open link chain to transmit power to the pump below.

Figure (5) shows the owner of this wind pump, a man who identified himself as the local village chief. The wood and iron water ladder drive shaft fitted with a 120 cm diameter vee drive wheel and the eight tooth wooden paddle gear are also shown. The chain drive and a bamboo stick sprung chain tightener device are also evident. Figure (6) gives another view of the drive shaft, the chain, the chain tightener, the lower end of the pole, and of the water ladder set to lift water about one meter from a ditch up into an earth-walled plot of growing rice. The iron shaft ends of the drive shaft are carried in crotches cut from trees, each iron rod wearing its own bearing socket into the green wood crotch supporting it. The village chief started this machine by first pulling on the lanyard dropping down from the training slats to point the blade into the wind, then cranking it much like Wylie Post used to start his aeroplane engine by cranking the propeller. The propeller took off and revved up to a counted 150 revolutions per minute. It was

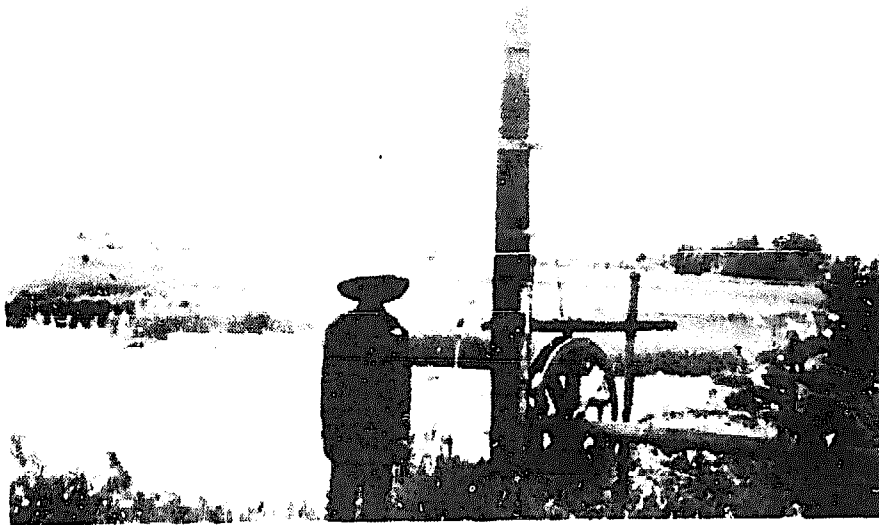

FIG. 5. Lower End of Chain Drive From Two-Bladed Thai Windmill,
and Windmill Owner

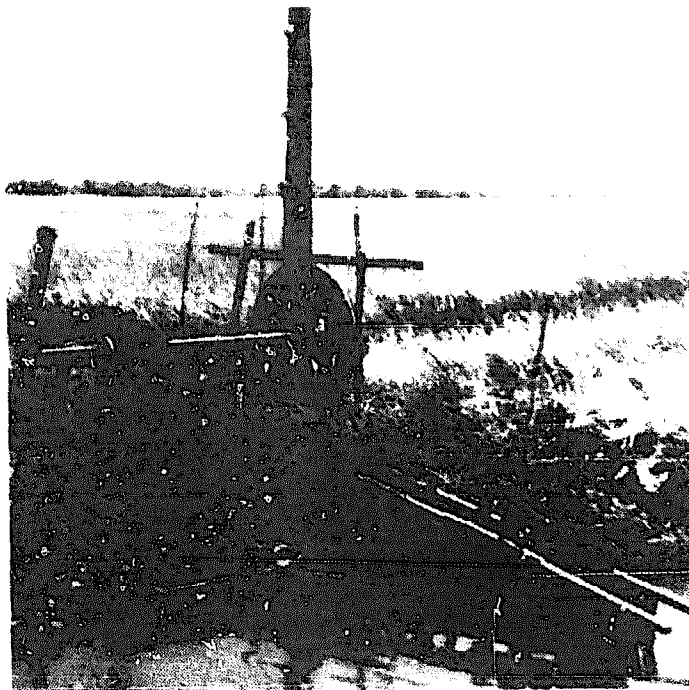

FIG. 6. Thai Water Ladder Driven by a Two-Bladed Windmill

estimated that an eight knot breeze was blowing at the time. In such a breeze this propeller was achieving a tip speed ratio of about eleven, which places it in the realm of a very high-speed propeller type windmill.

All of that windmill down to the pump drive shaft could be built by a man with reasonable wood working skills, a saw, a knife, a spoke shave or a plane, one or more chisels and one wood bit. But, the iron shaft would have to come from the blacksmith shop, the upper drive pulley and the fasteners probably come from a shop, the drive chain come from a hardware store and the water ladder and its drive shaft had to come from a wheelwright-blacksmith shop.

It is hard to conceive of a less expensive wind wheel. It could be improved by inserting friction-free plastic bearings in the upright wood parts that carry the iron shaft.

The great disadvantage to this wind machine is that it is not self-starting. If large-scale irrigation by windpower is desired, a self-starting (and probably self-training) wind machine is probably necessary. If water is to be lifted more than one meter, particularly if it is to be lifted out of a dug well, the water ladder will have to be replaced by a different pump, perhaps a piston pump.

There are nine other windmill water pumpers located and working in Thailand, 12 foot diameter AERMOTOR water pumpers on 42 foot tall steel towers (axis height). Figure (7) shows one of those pumpers located at a piggery in Petchaburi. That pumper has delivered an average of 86 cubic meters of water per month at a total head of 8 meters (water table about 2 m below ground, storage tank head = 6 m). Miss Maneewan Ama-amon of the Division of Agricultural Economics, Ministry of Agriculture and Cooperative, is in charge of this windmill evaluation experiment, and she provided the pro-

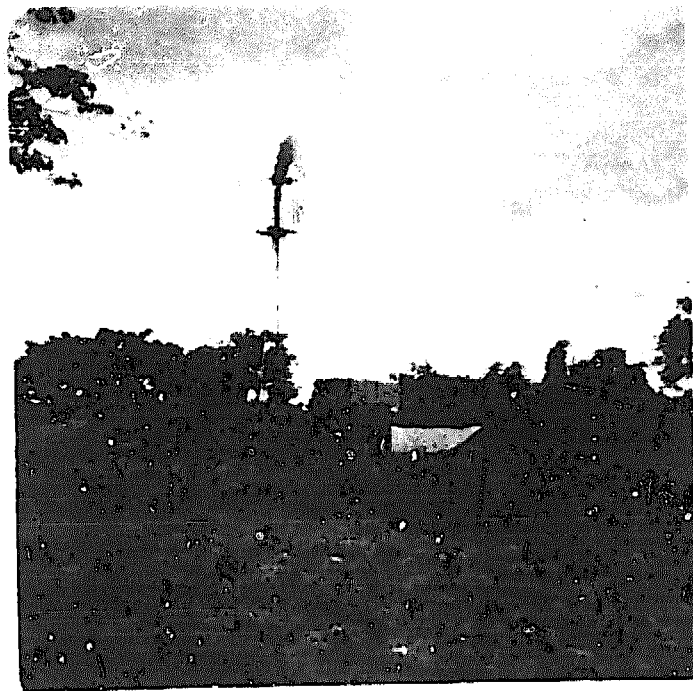

FIG. 7. An American Fan Mill, An Aermotor 12-Foot Diameter Wind Pumper Near Petchaburi

ductivity data given in Table 1.

Table 1: The 12-Foot Dia. Aermotor Wind-Pumping Experiment

Location and Number of Wind pumpers	Average Depth to Water	Height Above Ground of Delivery	Total Head	Average Monthly Production, Cubic Meters.
(a) Nong Kai (4)	4 m	6 m	14 m	33
(b) Petchaburi (1)	2 m	6 m	8 m	86
(c) Saraburi (2)	2 m	6 m	8 m	215
(d) Nakon Phanon (2)	8 m	6 m	14 m	150

The variability in productivity is large. It can be seen that these installations are all useful for the provision of clean water to animals (and humans). It is also easy to speculate that in the Saraburi region, which is on the western boundary of the Chao Phya Delta rice bowl, about 100 km, 015°T from Bangkok, one of these machines could dump water on the ground, working at a total head of only 2 meters, at a rate of about 860 cubic meters per month. That much water would irrigate rice production in about 14 rai (2.2 hectares) of land. The month-by-month productivity readings for these pumpers are to be provided by Miss Maneewan; then the rainy season/dry season possibilities for the machines can be assessed. Miss Maneewan said that an estimate was made of cost to reproduce this Aermotor windpumper in Thailand, and it was thought that each machine would cost 15,000 baht (\$750 U.S.), too much for most farmers to afford.

There is a windpower pumping experimental program underway at this time at the Department of Agriculture Technology, Ministry of Agriculture and

Cooperative, housed at Kasesat University, Bangkok. Mr. Methor Ratzatapiti, Mr. Charlermchui Suksri and Miss Sukumya Kotigal, of that Department, are experimenting with a number of windpowered water pumpers. Their attention is focused at this time on variants of the vertical axis machine hoping that they can contrive a sail system that will use renewable "native" materials such as woven rush mat and lumber.

In summary, there have been and are wind pumpers in Thailand ranging from a totally indigenous product of "high technology" concept, the propeller blade windmill, to the American fanmills of the 12 foot diameter Aermotor variety to recent experiments with hopefully low-cost vertical axis irrigation pumpers. Both Miss Maneewan and Miss Kotigal pointed out a dearth of good information on the water requirements of upland crops (indeed, any crop other than rice) for productive growth during the dry season. Professor Finkner at the N. E. Agricultural Center also pointed out a dry-season irrigator for upland crops might need provide only one inch (2.54 cm) of water per week to upland crops or to fruit trees fed by trickle irrigation. The existing Aermotor machines, modified into a machine made dominantly of wood, might be very close to a good answer to the next generation of wind pumpers.

5. The Winds and Related Resource Data for Thailand

(a) The Winds. Through the good services of LCDR Surin Sangsnit, Chief Hydrometeorologist of the Mekong Committee, an introduction was obtained to Captain Prosert Soontarotok, Deputy Director General of the Meteorological Department, and Commander Kasem Sukapinta, Chief, Climatology Division of the Meteorological Department. From those gentlemen copies of "Climatological Data of Thailand, 20 Year Period (1951-1970)," "Highest Wind Velocity in Thailand, Period 1937-1970, and "Mean Percentage Surface Winds Over Thailand, 20 Year Period (1951-1970)" were obtained. From those documents velocity-duration curves for a number of locations have been prepared and those in turn have been used for the estimation of capability of the several windpower systems described later on.

The wind pattern over Thailand is generally that of the monsoon, with warm, moist winds from the southwest quadrant during the rainy season, then a hauling of the winds clockwise to become the dry cooler winds from the northeast quadrant during the dry season. The construction of velocity duration curves showed that the wind is generally more energetic in the Central Plain and the Chao Phya Delta during the rainy season, whereas up in the northeast province near Mukdahan and Nakhon Phanom, there appears to be more energy in the winds in the dry season when they flow out of the north to east quadrant. There also appears to be a significant intensification of the southwest winds as they cross the Gulf of Thailand and reach Sattaip during the rainy season, but no where near as marked an intensification in the reverse flow across the Gulf toward Ko Samui during the dry season. The rainy season usually begins in May, rains reach their peak in September, and are gone by

November. The dry winds then usually blow from November until March.

As a generalization, the winds over Thailand are not strong. The most energetic winds are those over the Chao Phya Delta and Central Plain, which is also the most productive of the rice growing regions and the region best fitted with diversion irrigation systems and abundant stream water. All of those factors combined suggest that region as the place where double-cropping of rice using wind-pumped irrigation water might first be attempted.

(b) The Soil. A very large percentage of the soil of Thailand is the marine clay ideally suited to rice culture. When the rains fall this soil is ploughed, then puddled into a muddy soup into which the rice seedlings are set. Before it has been wetted, the soil can not be ploughed with the kind of implements currently available. The entire sequence starts with flooded land, and the ideal sequence has the water disappearing from that land just before the harvest is to begin. In much of Thailand this entire cycle is tied directly to natural rainfall. In other parts of Thailand the irrigation system is used to start the flooding of the land. In a few parts of the country water is removed from the fields into the irrigation system prior to the harvest. In the Northeastern region, at least, rice culture depends totally upon natural rain fall in over ninety percent of the tilled fields.

(c) Ground Water. In the Chao Phya Delta there are extensive rivers, canals and diversion ditches, and there is seldom a lack of water within a meter or so of the surface of a field. Irrigation systems have been building in Thailand for hundreds of years⁽¹⁾. The most recent projects aimed at providing dry season water by gravity from storage to irrigate an ultimate area of 1.375×10^6 Rai*, of which 5×10^5 Rai would be double-cropped with rice⁽²⁾. There is a major fault with this last project, however, in

*one Rai = 0.4 acres
= 0.154 hectares

that the large canals were designed to carry the flood waters of the wet season. During the dry season the flow level in them is so low that many farm ditch turn-outs have entrances well above the dry season canal water level. Pumping could readily overcome this deficiency in the gravity system, and such pumping should probably best be matched to the Irrigation Department's efforts rather than to the individual farmer.

There is also thought to exist a very large underground water supply about 100 feet beneath this Central Plain which could conceivably be pumped for irrigation purposes during the dry season, nature recharging it with the runoff water of the rainy season. Lifting large volumes of water 100 feet (31 meters) is not inexpensive, however.

In the Northeastern Region where new farm land has been created gradually from forested land over the past several decades, there is no bountiful supply of stream water. Nor is there an extensive gravity irrigation system as yet. An extensive exploratory well drilling project ⁽³⁾ showed that ground water could be found throughout the region but water from shallow wells could be very saline in about ten percent of the region. Hand dug wells at the Northeastern Agricultural Center have produced water at a level of only one or two meters below surface during the critical beginning and ending of the rainy season. Inadequate data were obtained from which an assessment of such wells, windpower pumped, as a type of irrigation can be made, but later paragraphs will assume that hand dug wells would sustain a sizeable withdrawal rate. The general topic of rice culture irrigation is covered well in Ref. (4).

(d). The Mekong River as an Irrigation Supply. Probably the most extensive water resource management project under consideration in the World today is the proposed Mekong Project, planned and studied under the sponsorship of the

Economic Commission for Asia and the Far East (ECAFE) of the United Nations through their Mekong Committee. The four riparian states are ultimately to have enough managed water to irrigate 5 million acres in Thailand and Laos plus supplemental water to help irrigate 7 million acres in the Mekong Delta, just from the first increment of this project, the PaMong Dam ⁽⁵⁾. The initial PaMong Service Area is shown to cover about one-third of the Northeastern Thailand Region and the ultimate Service Area will cover that entire Northeastern Region. Service is meant to include the above mentioned gravity irrigation of 7 million acres plus electricity at the home level for all hands. The initial capital cost estimated for the power plant portion to the end of the transmission lines was \$800 million in 1968; distribution of electricity and all distribution of irrigation water would require capital in addition to the \$800 million. In August 1974 there seemed to be more interest in Bangkok in obtaining financing for a nuclear power plant to provide additional electricity for Bangkok than in financing PaMong. The water is there in that river, all year long, despite the seasonal changes in river heights which see 15 meter excursions. Any system that could lift that water over the banks at a total head of one to 15 meters plus a steadily improved canal and distribution system would put that water to work. The expanding agricultural area in the Northeast is moving toward the river bank from its central starting position: canals 10 to 25 km long would be required in some instances to meet the existing fringe of rice land, and those canals would have to dodge the elevated ground in the Nakhon Phanom and Mukdahan region.

6. Irrigation in the Chao Phya Delta Using Windpower and Commercially

Available Windpumpers. It was decided to examine the energetics of the winds along a generally NNW to SSE line through the Chao Phya Delta, including the stations Nakhon Sawan, Don Muang and Sattaip, to see how much irrigation could be obtained therefrom. This line is shown on Figure (8).

Using the wind data in "Mean Percentage of Surface Winds Over Thailand, 20 Year Period, 1951-1970," monthly Velocity Duration Curves for each month at each station were drawn and the energy available in the wind, from 2 knots to maximum speed, was calculated for a swept area of 6 meter diameter at a 10 meter axis height. A typical set of curves and calculations are appended as Appendix 1.

Each velocity-duration curve was drawn through three data points -- all that were available:

- (a) the percentage of time wind speed was less than 17 knots.
- (b) the percentage of time wind speed was less than 4 knots, and
- (c) the percentage of time wind speed was less than 1 knot.

There is a possibility that these curves have incorrect shapes, and that the shape chosen, i.e., a simple hyperbola without an inflection point, may have lead to optimistic estimates of wind energy content. If this work is to be carried forward, effort must be expended to obtain other data points to insure that curve shape is appropriate. In Figure (9) and in greater detail in Appendix 2, "optimistic" and pessimistic" velocity duration curves through the same three points are shown. The "pessimistic" curves are indicative of considerably less energy content. There simply was not time enough available within the scope of this work to create a "minimum energy curve" at

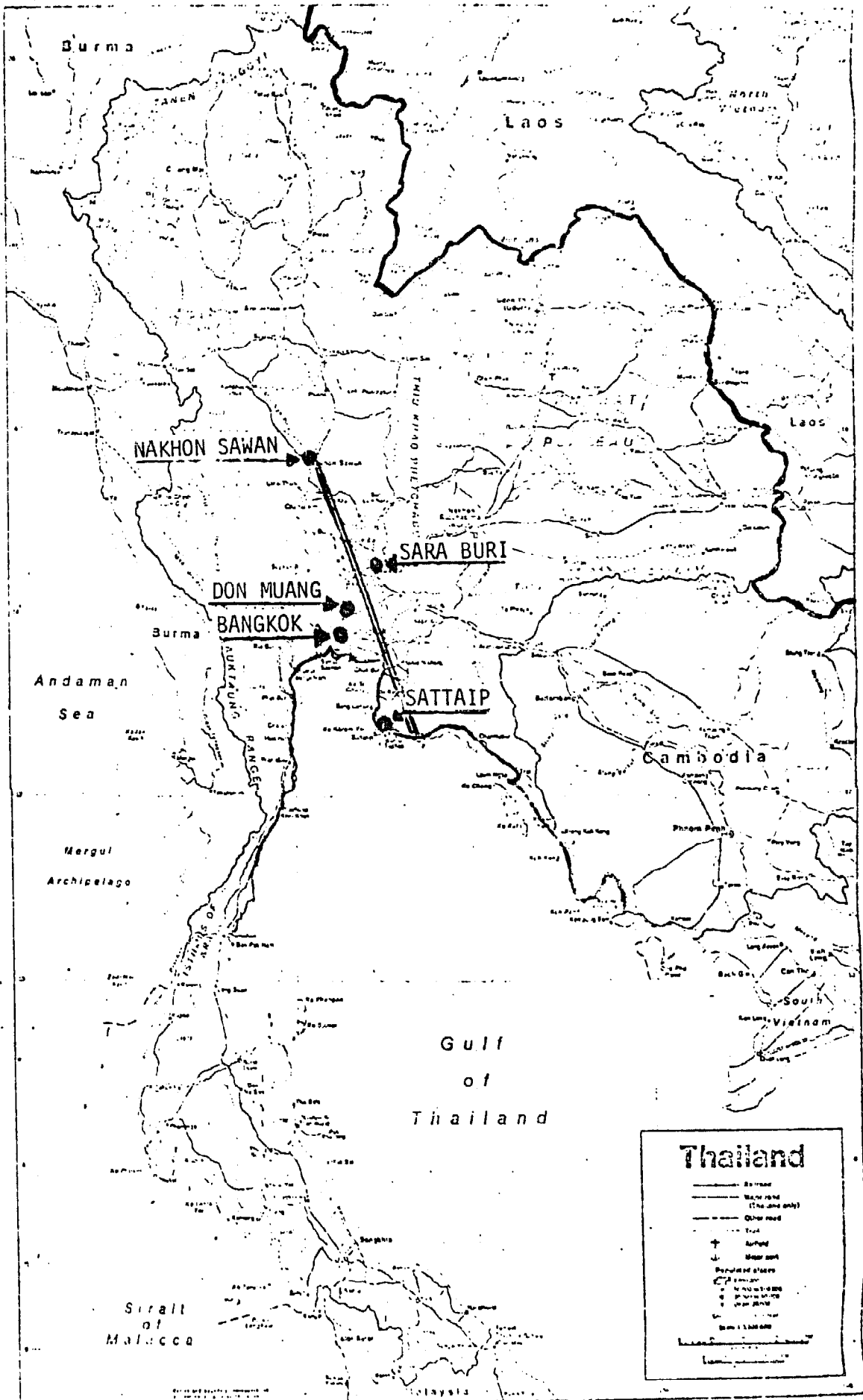

THE CHAO PHYA DELTA WIND LINE FIG. (8)

11-74 (1811)

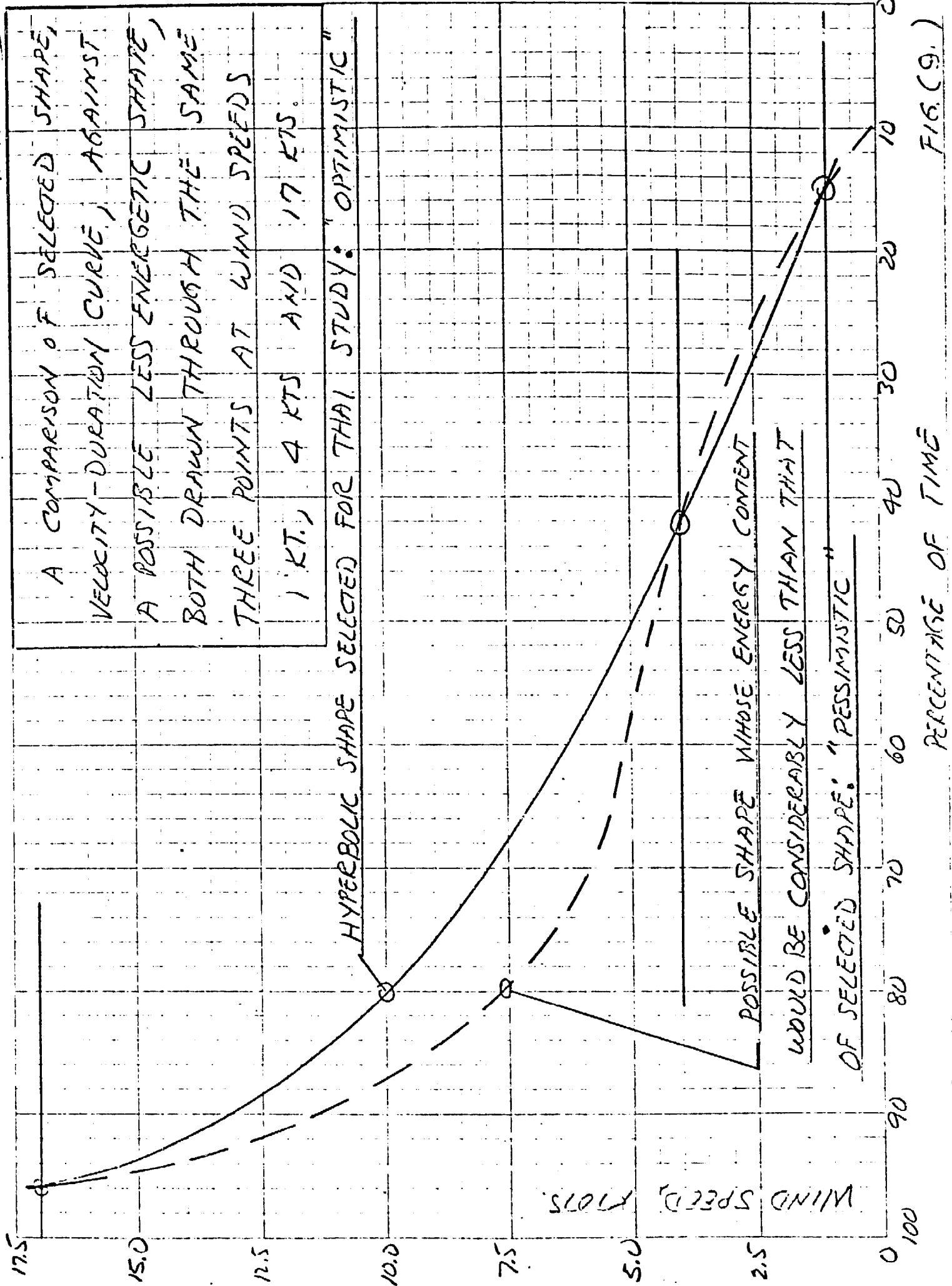

FIG. (9.)

each station, but such competitive curves were made for the central Chao Phya station, Don Muang, and for the Central Eastern Mekong Wind Line station, Mukdahan, and system productivities, pessimistic versus optimistic are compared.

To proceed with an analysis of wind pumped irrigation in the Chao Phya Central Plain, it was decided to first see what might be accomplished with a Wind Pumper similar to the 2-bladed machine observed at work near Don Muang. That pumper was not self-starting no matter how strong the wind at that station. Its axis was only 5 meters above ground. No data were obtainable as to how much water that kind of wind pumper could lift per day, week, month, season, on a continuing basis. And the data would not be too useful anyway because a person would have to stand watch around the clock to restart the mill each time the wind faded.

It was decided to estimate the performance of one or more existing, modern, windpumpers, including a propeller type, machines that are self starting. The first machine placed in the Don Muang wind regime at an axis height of 7.1 meters (and that height was chosen between 5 meters and the standard 10 meter height to which the velocity-duration curves were drawn simply because data were available therefore) was the German Lubing Model M022-3-6 Irrigation Pump. That machine has three blades, 2.215 meter diameter, and the blades self-start at a wind speed of about 5 kts. At a total delivery head of 3.85 meters, the productivity of that pumper was calculated as shown in Table 2.

During a "Dry Season" of 181 days, 1 November through 30 April, this pumper would deliver 7514 cubic meters. At a daily rate of 109 cubic meters per rai of land (2.5 rais = 1.0 acres), the one pumper could support rice culture on 2.47 rai. Since the typical Chao Phya Delta farm is still

LUBING WIND POWER PUMP M 022 - 3

Novel aero-

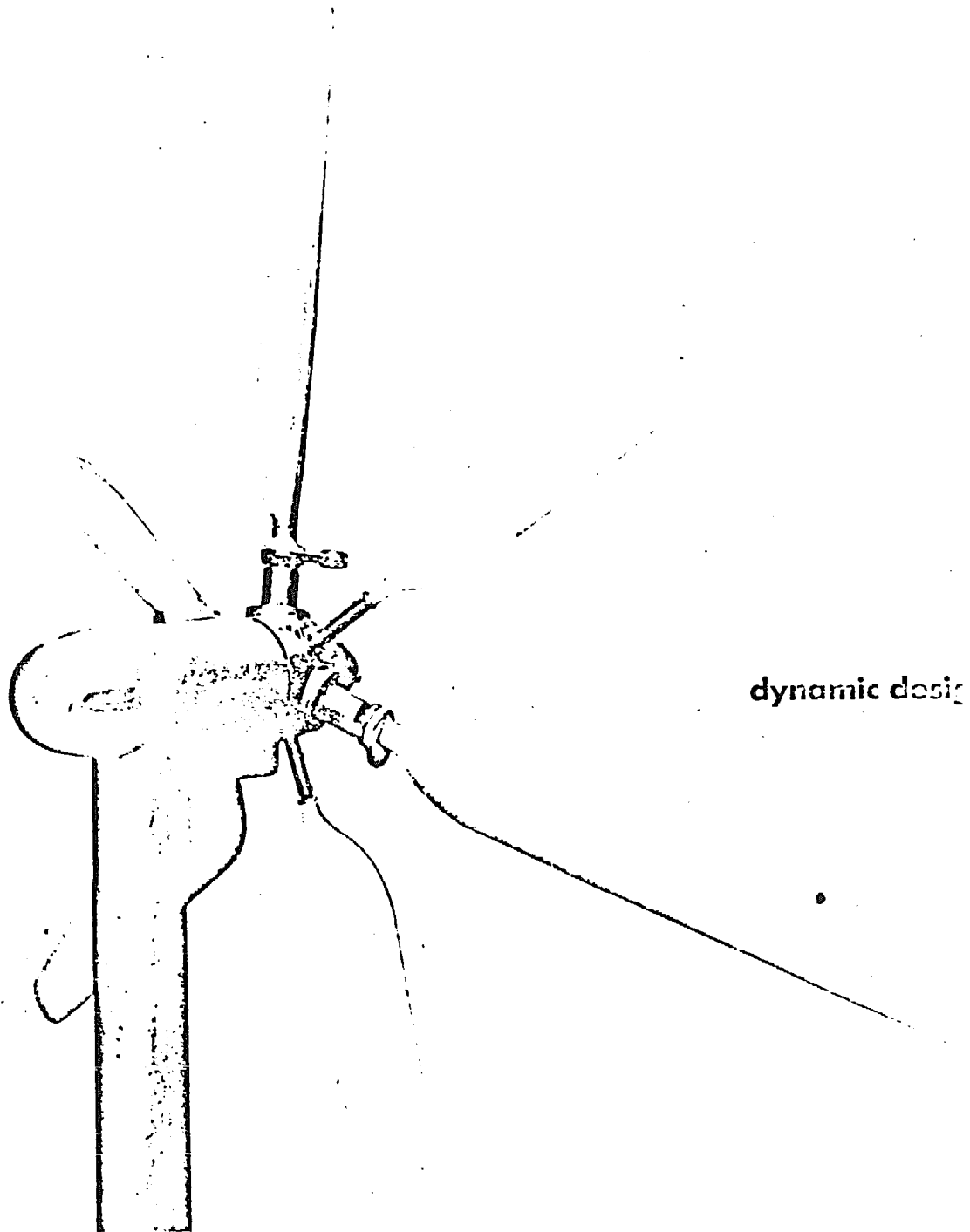

dynamic design

Wind-power pumping installation drive

type	A		B		C		Lifting capacity ~ lb.	Strokes per minute max. ~	Weight (nett) ~ lb.	Volume ~ cu. yd.
	Rotor sail diameter ft.	Hub height ~ ft.	Tower diameter in.	Stroke in.						
M 022-3-6	7.2	23	6.7	7.9	88	55	276	0.524		
M 022-3-9	7.2	33	6.7	7.9	88	55	309	0.785		
M 022-3-12	7.2	43	6.7	7.9	88	55	342	10.5		

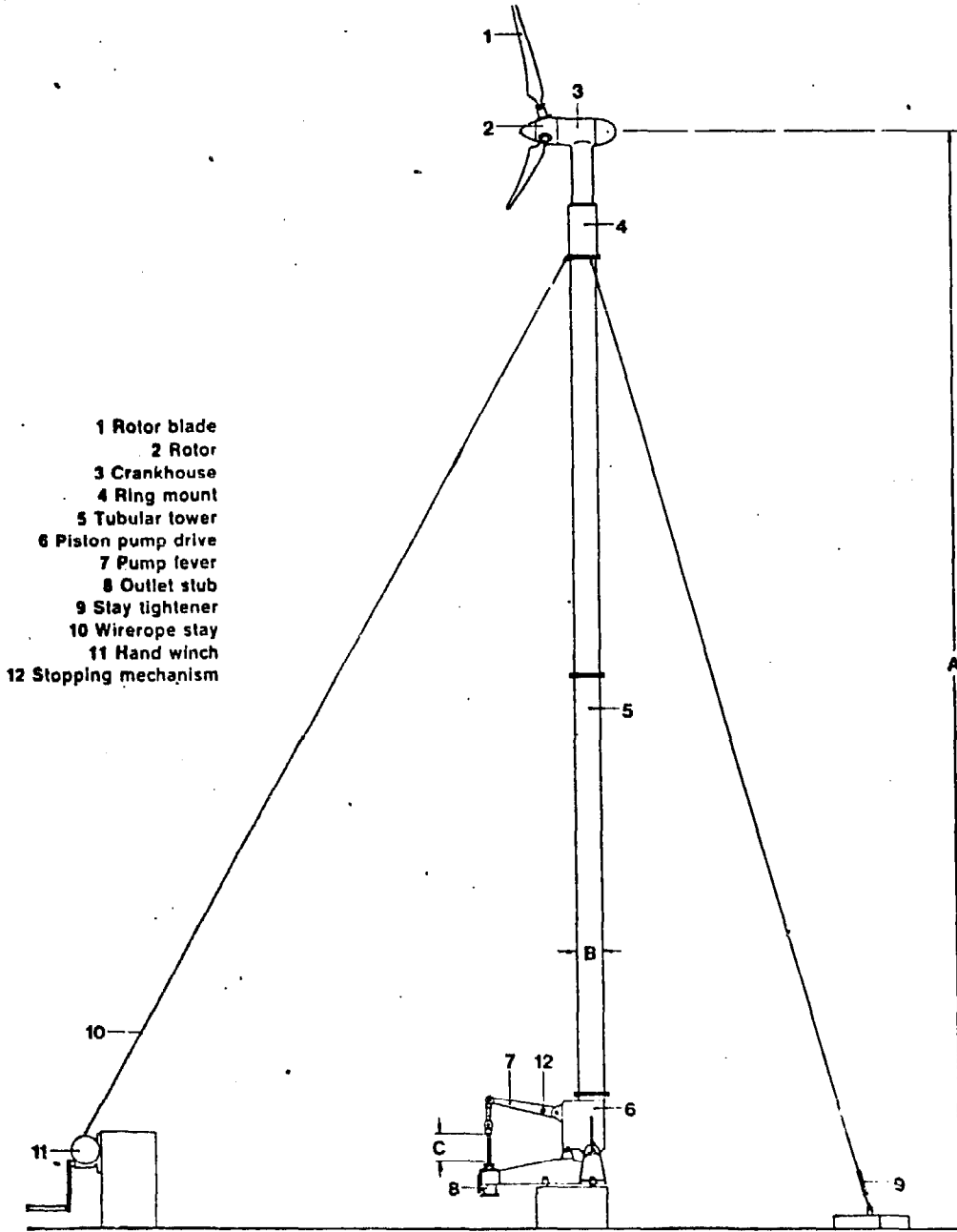

- 1 Rotor blade
- 2 Rotor
- 3 Crankhouse
- 4 Ring mount
- 5 Tubular tower
- 6 Piston pump drive
- 7 Pump lever
- 8 Outlet stub
- 9 Stay lightener
- 10 Wire rope stay
- 11 Hand winch
- 12 Stopping mechanism

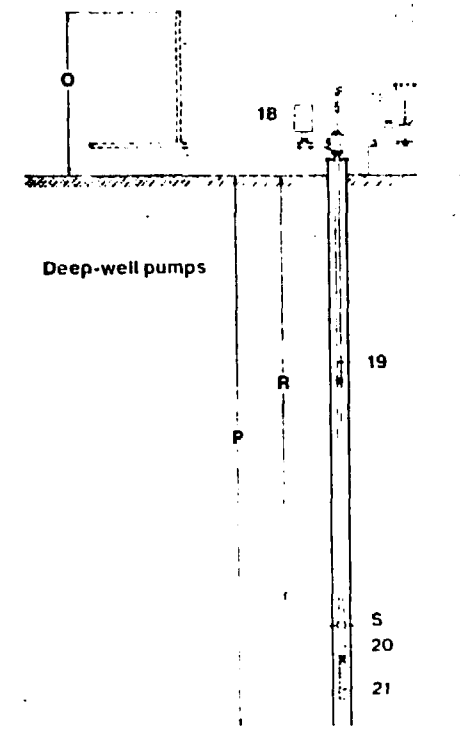
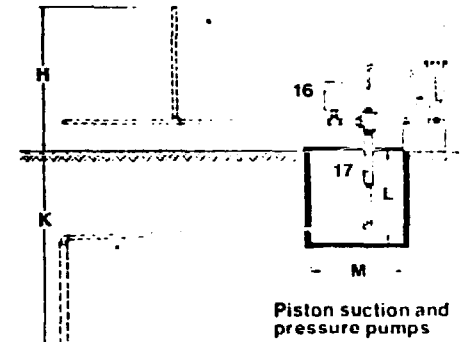
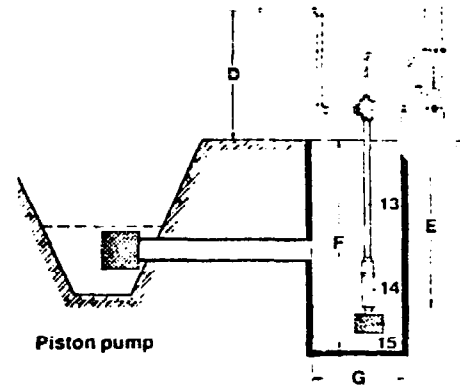

Piston pump for the M 022-3 windmill installation for draining and irrigating purposes

Type	Wind stat. m. p. h.	6.7	8.9	11.2	13.4	15.6	17.9	Delivery height ft.	E Water level ft.	F Well depth ft.	D Pressure head ft.	G Pressure line in.	Well dia in.	Weight ~ lb	Volume ~ cu yd
P 115-28	US gal h	360	527	824	1290	1490	1710	12.5	8.2	12.5	4.3	2	23	75	0.065
15-18	US gal h	360	527	824	1290	1490	1710	12.5	4.9	9.2	7.6	2	23	62	0.039
15-13	US gal h	360	527	824	1290	1490	1710	12.5	3.3	7	9.2	2	23	55	0.026

The pump unit consists of piston pump 14, filter 15 and delivery pipeline 13, high-grade steel piston rod.

Piston suction and pressure pumps for household water supply systems, pasture drinking units for cattle, irrigation, etc. for the M 022-3 windmill.

Type	Wind stat. m. p. h.	6.7	8.9	11.2	13.4	15.6	17.9	Delivery height ft.	K Suction height ft.	H Pressure head ft.	L Min. in.	M Max. in.	Suction pipeline in.	Pressure pipeline in.	Weight ~ lb
P 65 6	US gal/h	118	169	258	416	485	560	40	20	20	28	24	1 1/2	1 1/2	15.5
P 65 6	US gal/h	71	105	163	245	290	332	66	20	26	28	24	1 1/2	1	8.8
P 65 6	US gal/h	71	105	163	245	290	332	100	20	30	28	24	1	1	6.6

The pump unit consists of deep-well pump 20, filter 21, delivery pipeline with high-grade steel piston rod 19 and surge tank 18. The water level in the well and is particularly suitable in this form for low water levels.

Type	Wind stat. m. p. h.	6.7	8.9	11.2	13.4	15.6	17.9	Delivery height ft.	R Water level ft.	O Pressure head ft.	P Well depth ft.	S Max. dia in.	Delivery line in.	Pressure line in.	Weight ~ lb	Volume ~ cu yd
P 65 35								40	9	31	13	3.4	1 1/2	1 1/2	44	0.0196
P 65-65	US gal/h	118	169	258	416	485	560	40	19	21	23	3.4	1 1/2	1 1/2	73	0.039
P 65-95								40	28	12	33	3.4	1 1/2	1 1/2	101	0.059
P 65-125								40	38	2	43	3.4	1 1/2	1 1/2	130	0.078
P 50-35								66	9	57	13	3.1	1 1/2	1	130	0.098
P 50-65								66	19	47	23	3.1	1 1/2	1	155	0.118
P 50 95	US gal/h	71	105	163	245	290	332	66	28	38	33	3.1	1 1/2	1	180	0.137
P 50 125								66	38	28	43	3.1	1 1/2	1	203	0.157
P 50-155								66	48	18	53	3.1	1 1/2	1	227	0.176
P 50-185								66	58	8	63	3.1	1 1/2	1	250	0.196
P 40 35								100	9	91	13	3.1	1 1/2	1	274	0.215
P 40-65								100	19	81	23	3.1	1 1/2	1	298	0.236
J-95								100	28	72	33	3.1	1 1/2	1	322	0.295
J-125								100	38	62	43	3.1	1 1/2	1	346	0.262
P 40 155	US gal/h	45	68	105	158	184	211	100	48	52	53	3.1	1 1/2	1	370	0.281
P 40 185								100	58	42	63	3.1	1 1/2	1	395	0.3
P 40 215								100	68	32	73	3.1	1 1/2	1	420	0.32
P 40 245								100	78	22	83	3.1	1 1/2	1	440	0.34
P 40 275								100	87	13	93	3.1	1 1/2	1	470	0.36
P 40 305								100	97	3	103	3.1	1 1/2	1	490	0.38
P 35 35								130	9	121	13	2.5	1	1	420	0.4
P 35 65								130	19	111	23	2.5	1	1	440	0.418
P 35 95								130	28	102	33	2.5	1	1	460	0.438
P 35-125								130	38	92	43	2.5	1	1	480	0.458
P 35 155								130	48	82	53	2.5	1	1	500	0.477
P 35 185								130	58	72	63	2.5	1	1	518	0.496
P 35-215	US gal/h	37	53	79	121	140	161	130	68	62	73	2.5	1	1	540	0.516
P 35 245								130	78	52	83	2.5	1	1	560	0.536
P 35 275								130	87	43	93	2.5	1	1	580	0.555
P 35 305								130	97	33	103	2.5	1	1	600	0.575
P 35 335								130	107	23	113	2.5	1	1	617	0.595
P 35-365								130	117	13	123	2.5	1	1	637	0.615
P 35 395								130	127	3	133	2.5	1	1	656	0.635

The pump unit consists of deep-well pump 20, filter 21, delivery pipeline with high-grade steel piston rod 19 and surge tank 18

Wheel blades tested in wind tunnel

The LUBING Wind-power Pumping Installation, Type M 022-3, is a new addition to the LUBING Maschinenfabrik range of products. This installation is most suitable for powering deep-well pumps, supplying household water and draining and irrigating of small areas of land.

After many years of research and trials in our own wind-tunnel we have developed a modern windmill with aerodynamic profiled rotor blades in keeping with today's advance standards in performance and design.

The pump output increases to the square of the wind velocity up to wind speeds of 13.4 stat. miles per hour, then linear to 17.9 stat. miles per hour. From wind velocities of 17.9 stat. miles per hour up to gale force winds the output remains practically constant.

Construction and method of working

Three aerodynamic profiled blades made of a fibreglass compound are fitted on a ball-bearing mounted rotor shaft. The conventional rotor plane becomes a truncated cone due to the rotor blade angle. The rotor automatically turns in the direction of the wind through the velocity head of the wind leeward of the tower. The turning speed of the three rotor blades at wind velocities above 17.9 stat. miles per hour is limited to 500 r. p. m. by a centrifugal braking system. Consequently, the installation is absolutely stormproof. The wind-power is transferred to a crank through a two-stage transmission with hardened gear wheels running in an oil bath. The light metal crankcase is bolted to a tubular tower braced with $\frac{1}{4}$ in. dia. wire rope stays. The tower is made up of 9 ft. 8 in. pipelengths bolted together to form a 2, 3 or 4 section tower to which the light metal piston pump driving unit is fitted. The torque on the crank is transferred through a connecting rod running down the centre of the tower to a shift lever on the piston pump driving unit. All torque carrying parts in the piston pump driving unit are mounted in self-lubricating bearings and require no maintenance.

The pump is disengaged through a hand-lever. An overflow valve must be fitted in the reservoir or a pressure relief valve on the pressure water storage tank. The tower is lowered by means of a hand winch.

Piston pumps

Special pumps have been developed for the Type M 022-3 windmill according to height of delivery. They are simple suction and pressure pumps. Seamless steel pipes in lengths of 9 ft. 8 in. are bolted together to form the delivery pipeline when using the installation as a deep-well unit. The deep-well piston pumps are fitted with high-grade stainless steel piston rods mounted in plastic guides.

Erection and assembly

The windmill M 022-3 can be erected easily by one man. After the foundation has been completed the tower is assembled and the crank-house and piston pump driving unit fitted. The tower is then raised with a hand winch before being braced with three wire rope stays and set upright by adjusting the stay tighteners. The pumping unit - either a piston or deep-well pump - is then fitted to the delivery pipe and piston rod. Maintenance is restricted to a crank-house oil change every year. The tower is lowered by hand winch for this purpose so that there is no need to climb up the tower.

The installation as supplied consists of wind-power drive parts 1, 2, 3 and 4, tower 5, wire rope stays 10 with fittings and anchor bolts hand winch 11, piston pump drive units 6, 7 and 8 with stopping mechanism 12, foundation plan and erection instructions. Piston pump as to index.

Erection:

The sail unit should be higher than surrounding obstructions within a distance of, say, 200 yard. Suction and pressure pipelines and the piston pump driving unit must be protected from frost.

A complete wind power pump consists of:

1. the wind power pump drive and
2. depending on the intended use, the associated reciprocating pumps.

Ordering:

When ordering it is to be noted that the Type No. M 022-3-9 P 40-125 is a complete wind-power pump with a hub height of 33 ft. giving an output of 105 US gallons per hour at a wind velocity of 11.2 stat. miles per hour from a dept of 38 ft. Pumping height 60 ft. into a tank.



Table 2. Monthly Productivity of a Lubing Model M022-3-6 Irrigation Pump at Don Muang, 7.1 Meter Axis Height, 3.85 Meter Total Delivery Head.

Month	Cubic Meters	Month	Cubic Meters	Month	Cubic Meters
Jan	820	May	1533	Sept	1180
Feb	1240	Jun	1550	Oct	960
Mar	1751	Jul	1383	Nov	872
Apr	1929	Aug	1388	Dec	902

about 25 rai in size, ten such pumpers would be required. But, if the diameter of the pumper were increased to the same 6 meters as the Thai Two-Bladed Windpumper, and the total head reduced to the maximum 1.5 meters which the water ladder could handle, then productivity would be multiplied by a factor of about $(6 \div 2.215)^2 (3.85 \div 1.5) = (7.33) (2.56) \approx 18$. 18 times 2.47 = 44.5 rai. One modern pumper could then quite easily keep a family farm of 25 rai wet enough for rice culture during the second-crop "dry season." The productivity during the wet season would be somewhat better: the pumper could have inlet and discharge interchanged and could be used as a drainage device during the wet season as well. Both of the above statements assume that the existing canal and ditch systems would be able to provide water within 1.5 meters head of the rice fields during the dry season, and would serve as receptors for unwanted excess water during the wet season. Reference (2) suggests that the first assumption may be a good one, but there is no evidence available to add credence to the second assumption.

A second windpumper, a Dempster 14-foot diameter fan mill, was compared against the estimated performance of the Lubing at the Don Muang Site. At the upper end of the wind regime, at a wind speed of 15.6 kts, it was estimated

that that pumper would lift 650 cubic meters per day against the same 3.85 meter total head. If that type of machine were increased in size to 6 meters in diameter and total head were reduced to 1.5 meters, a daily productivity of $(6 \div 4.30)^2 \times (3.85 \div 1.5) = (1.94) (2.56) = (4.96) (650) = 3228$ cubic meters could be expected. 3228 cubic meters per day would sustain 29.6 rai of rice during a dry season.

Still another check can be made: the 12 foot (3.69 m) diameter Aermotor at Saraburi was earlier estimated to be able to sustain 14 rai of land in rice at a total head of 2 meters. Increasing that diameter to 6 meters and reducing that head to 1.5 meters suggest that that type of pumper could irrigate 49 rai of rice during a dry season.

It would therefore appear that a modern propeller type windmill or a modern fan mill type windmill of about 6 meters diameter with axis height of 10 meters, located at Don Muang, or between Don Muang and Sara Buri, could irrigate a family holding of at least 25 rai for rice culture during the dry season, provided it could take a suction from a ditch such that total head was of the order of 1.5 to 2.0 meters. It is possible that a dug well in that entire region might produce water fast enough to sustain that rate of withdrawal at that head. On the other hand, referring back to reference (2), it may be more appropriate to locate wind pumps along the main canals where they can draw from the "trickle" (but assured trickle of the dry season) in the canals and use their lift to fill the ditches whose turn-outs are high and dry above that trickle. The existing ditch system would then gravity-feed the fields.

The above estimates are for Don Muang (and, incidentally, the comparison against actual results with an Aermotor at Sara Buri suggests that the

assumed "optimistic" velocity-duration curves might not be too bad): what about the region to the north of Don Muang up to Nakhon Sawan, a distance of 215 km, and to the south of Don Muang down to Sattaip, a distance of 150 km? The productivity at the three sites can be estimated quantitatively by comparing the monthly energy in a 6 meter swept area at axis heights of 10 meters, Table 3.

Table 3. Estimated Energy Available in the Winds in a 6-Meter Swept Area at Axis Height of 10 Meters at Three Chao Phya Delta Stations.

Month	Nakhon Sawan	Don Muang	Sattaip
Jan	368 kWh	423 kWh	868 kWh
Feb	705	798	945
Mar	955	1234	1251
Apr	899	1460	1113
May	780	1074	1465
June	672	1080	2552
July	546	893	2446
Aug	480	889	2120
Sept	211	728	1471
Oct	150	550	809
Nov	236	461	1077
Dec	276	894	1030
Annual Total	6,278 kWh	10,484 kWh	17,147 kWh

Table 3 suggests that the wind pumpers to the south of Don Muang would be even more productive than at Don Muang whereas those to the north of Don Muang could be less productive. Nakhon Sawan is 250 km from the nearest coast and does lie only 100 km down wind of the highest portion of the Bilauktung Range.

More time could show exactly what the Lubing or the Aermotor might produce at Nakhon Sawan: it is suggested that it might still be quite adequate to serve a 25 rai farm with one 6 m diameter windpumper. So, it is concluded that there is an excellent possibility that windpower could be used to speed up the transition to double-cropping of rice in the extensive Chao Phya Delta. This might be accomplished by installing windpumpers at individual farms, as originally suggested by AID, each pump to take suction from a ditch or from a dug well. The water table is apparently almost at ground level throughout the entire region, but some experiments would certainly be appropriate before one could say that upwards of 2725 cubic meters of water could be withdrawn each day from beneath a 25 rai farm on a continuing basis. Or, perhaps windpumpers should be installed by the Royal Irrigation Department to overcome the apparent major problem of dry season canal water level being too low to feed laterals and farm ditches.

7. Proposed New Wind Pumpers for Dry Season Irrigation in Thailand.

7.1 An "Improved" Two-Bladed 6-Meter Wind Pumping System.

It appears somewhat doubtful that any windmill of 6 meter swept diameter could cost less or be more adaptable to home construction than the existing Thai Two-Bladed Windmill. The water ladder pump, on the other hand, could possibly be supplanted by a less expensive reciprocating pump if a jackshaft were added in the pole-matcher to reduce the rpm of a pump driving crank. One would also have to modify the pole-matcher so that it would yaw around a vertical axis lying in a vertically oscillating pump rod offset from the pole rather than around the vertical axis of the pole itself. And the performance of such a pumper would probably be improved if one or more of the following changes were made, each change to be evaluated for cost-benefit in model and full-size prototype tests before being adopted:

- (a) carve the blade from a plank to which several extra wood blocks were glued so that a larger angle of twist could be obtained near the hub, tapering to zero twist at the blade tips.
- (b) Those "extra wood blocks" glued to the plank could also be used to provide a tapered plan-form for the carved blade. It is thought that increased chord and plan-form near the hub could improve the self-start possibilities of this windmill, perhaps allowing it to self-start in 5 to 6 knot winds.
- (c) Provide a jackshaft within the pole-matcher structure aloft by which as much as a 6:1 speed reduction from windshaft to jackshaft might be achieved. Use simple grooved pulleys and flat leather belts. A belt tightening device could easily be incorporated by using weight-loaded eccentric bushings around the jackshaft.

- (d) Provide slippery teflon-filled bushings at all four bearings in the aloft gear (two for the windshaft, two for the jackshaft). These will have to be imported items, but they need not cost much and they should have very long life.
- (e) Provide a crank at the after end of the jackshaft. This crank will be used to impart the vertical oscillating motion to a reciprocating pump rod.
- (f) At eight knots of wind, the windshaft in improved low-friction bearings will probably turn at about 160 rpm. With a 6:1 reduction, the jackshaft will turn at 26.6 rpm, providing 53.3 strokes per minute.
- (g) The upper end of the pump rod will have to have a swivel joint worked into the piece that attaches to the pump rod so that the entire aloft mechanism can yaw (rotate) about the vertical axis of the pump rod. That kind of a swivel point could be made from close-grained wood. Some slippery plastic rubbing surfaces in it would help.
- (h) The "simple" model of this pumper would have a fixed crank arm distance, but the crank, primarily a wood disc keyed to the jackshaft, should be so constructed that the crank throw can be changed easily using simple hand tools.
- (i) The pole-matcher, or aloft structure, has now been complicated to the point where it must ride around in yaw on a pole-top platform which overhangs the pole so that the yaw axis can be slightly away from the pole itself. Sliding bearing shoes of slippery plastic or polished wooden roller bearings (conical-radially oriented) or wheels could be used between the pole-tip platform and the yawable (rotatable) aloft structure.

- (j) The reciprocating pump should be a double acting pump with suction and discharge valves of the leather hinged type. The pump, probably two barrels, complete with its valve enclosures, could be cast in concrete (ferro-cement) with adequate steel mesh reinforcement. To minimize piston packing wear, a glazed fired tile cylinder liner could be cast into the working part of the pump barrel. The Thais make excellent pottery, and glazed pottery should provide an essentially glass-smooth surface to the piston.
- (k) The piston can be made of wood, concrete or fired tile. The piston packing can be the old-fashioned type of leather piston packing, or, a modern slippery plastic piston ring could be retained in a two-part piston, thus increasing time-between-repairs and further reducing the friction of the system.
- (l) The piston rod should be of wood, and its length should be easily adjustable without throwing a wearing eccentric load on either the upper crank pin end or the lower piston end.
- (m) The entire "concrete pump" should be fastened by brackets to the bottom of the windmill pole, offset so that it can be located inside a well liner while the pole is located outside of the well liner. It should be possible to raise and lower the pump rather easily on installation and in service to match the level of water in the well from which it is pumping. And there should be a telescoping upper section to the pump barrel that can be slid up and down to let the lifted water spill out on the land without being raised an unnecessary cm.

(n) It is assumed that this pumper will take a suction from a dug well into which cast concrete well liner cylinders will be stacked.

Those liner cylinders could have an external ring cast on them, with adequate reinforcement, so located that the windmill pole would slide down into those rings.

Thus, the dug well, pole and surrounding earth all become a structural entity, and the pump as a structural entity in itself would be supported from the pole, hence located positively with respect to the well liner.

It has been estimated that this simple two-bladed windmill could achieve a coefficient of performance of 0.31, and that the pump could have an efficiency as high as 0.70. One great advantage of a reciprocating pump is that part-load efficiency is as good as full load efficiency.

A detailed analysis of this proposed pumper is given in Appendix 3, including an estimate of its performance at Don Muang.

Appendix 3 suggests that this type of pumper would do an excellent job of water lifting in the Chao Phya Delta Central Plain Region if it can be designed to self-start in a 5 knot breeze. The design analysis assumed that it would start, but proof of that major assumption will require a full-scale test of a prototype.

Appendix 3 also points out how a mechanism added to such a pumper that would adjust crank throw, proportional either to the first or second power of actual jackshaft (therefore windshaft) rpm could lead to enormous increases in pump delivery. If a complete history of windpump engineering were available one would probably find a quick lead to earlier attempts to fit such a "load-matcher" device to a windpumper. More will be said about this later.

It is thought that this entire windpumping system could be constructed of native materials in small shops except for slippery plastic bearings and piston rings which would have to be imported. The timber available in Thailand is of numerous varieties with an excellent range of properties as shown in reference (6).

In Table 4 a summary is given of estimated performance of both commercially available and "new" wind pumpers for the Don Muang region, working in both the optimistic and the pessimistic wind regimes. Appendices 3 and 4, as well as subsequent report section 7.3 add to the understanding and use of Table 4: it is entered at this point in the discussion because part of its results tend to summarize the above discussion in Section 7.1

Table 4. A Summary of Wind Pumped Irrigation Possibilities at Don Muang. Results
Given in Cubic Meters of Water Delivered in Six "Dry" Months at An Average
Head of 1.5 Meters. All Axis Heights = 10 Meters.

<u>Group A:</u>	<u>Using "Optimistic"</u> <u>Velocity-Duration</u> <u>Curves</u>	<u>Using "Pessimistic"</u> <u>Velocity-Duration</u> <u>Curves</u>
Existing Wind Pumps:		
(a) a Lubing 7.2 dia. irrigation pumper:	22,695 m ³	16,977 m ³
(b) an Aermotor 12'dia. pumper on 42' tower	(a) 6,880 m ³	(a) 6,880 m ³
<u>Group B: Existing Wind</u> <u>Pumps Extrapolated to</u> <u>6 Meter Diameter:</u>		
(c) a "6M. Lubing"	175,118 m ³	124,530 m ³
(d) a "6M. Aermotor"	18,167 m ³	18,167 m ³
<u>Group C: An Improved</u>		
(e) 6 Meter diameter Thai 2-bladed fixed throw reciprocator	69,442 m ³	55,891 m ³
<u>Group D: Proposed Variable</u> <u>Throw Reciprocators:</u>		
(f) the improved Thai 6 m 2-bladed, variable throw	-----	183,148 m ³
(g) the proposed 30-blade 6-m variable throw	-----	191,493 m ³

(a) Based on reported Productivity at Sara Buri.

7.2 A Proposed Small Diameter Fan Mill Wind Pumping System

In Section 7.1 it is assumed that an improved 6 m diameter simple two-bladed Thai windmill might self-start in a 5 kt breeze. This section examines a pumper that would certainly self-start in a 2 to 3 knot breeze.

It would appear that the problems of seed-bed drought at the beginning of the normal rice growing season and premature drying out of rice beds at the end of the normal rice season could be handled quite easily by relatively small, improved American type fan mill pumpers working piston pumps submerged in dug wells. The Royal Thai Government have already made an estimate of cost of a locally manufactured copy of the Aermotor 12-footer and have decided it would be too expensive. A different "12 footer" is therefore proposed. It would be a fan mill with 16 blades. The blades would be molded plywood, made between matched concrete molds in the existing Bangkok plywood factories, laminated from veneer cut from native timber, laminated with exterior grade glue. The molds would impart a carefully designed twist into the blades and they would be tapered outward in the exact shape which available theory and wind tunnel proofing dictate. Each laminated blade would be inserted into a wood spoke and the spokes in turn would be brought to an iron banded wood hub. The entire wheel would be a timber (plus glue) product, producible by native artisans possessing the same skills and tools required to build the water ladders.

The 12-foot diameter fan would be mounted on a three-inch diameter wood shaft. Two bronze bearing sleeves would be shrunk onto that wood shaft and they should preferably turn in bearings or bushings made of one of the slippery teflon-filled permanent no-wear plastic bearing materials. This

shaft would turn at no more than 60 rpm, so the bronze-on-plastic bearings should provide long life at low friction. Those plastic bushings would have to be imported: all else up to this point is indigenous material.

The fan and its shaft and bearings would be carried in a wood pole-matcher structure similar to that of the Thai Two-Bladed Windmill except that:

(a) Provision would be made for a jackshaft, wood pulleys and flat leather belts (indigenous), to reduce jackshaft rpm to about 20 rpm.

(b) The pole-matcher would ride on a pole-top platform in such a way that the mill could yaw around to match wind direction, yawing around a vertical reciprocating pump rod that would stay at the center of the yawing circle.

(c) The jackshaft would terminate in a crank, probably a metal crank pin fastened into a wood disc. The crank throw would be adjustable (i.e., the pump stroke would be adjustable). The crank would move a pump rod whose upper end would include a swivel joint. All of this could be wood, turned on the lathe as necessary, highly polished close-grain teak or mahogany. The pump rod would extend downward along the back of the pole.

A single pole set in earth, topped off by a wood pole-top platform would carry this machine at a 10 meter axis height. Guy ropes on the pole, set up tight with wood deadeyes, leading to substantial "deadmen" buried in the rice fields would steady the pole. The pole should be about 12 meters long and have a 20 to 30 cm small-end diameter.

The pump could be made from cast concrete with a small amount of reinforcing steel in it and a smooth plastic pipe "cylinder liner." That liner would

have to be imported. Or, it might be made of fired glazed pottery clay. It should be a double-acting pump and the valve chambers would be "cast" into the pump housing. The pump should be so configured that it is bracketed off the lower end of the pole, and its depth into the suction hole should be easily adjustable. Thus, the length of the pump rod must also be easily adjustable. The pump piston can be wood, fired clay, concrete or cast bronze. A leather packing of the old-fashioned variety could be used, but a square ring of "slippery plastic" (imported) would be better.

The pole would be set into the earth adjacent to the concrete or tile liners of the dug well from which a suction, adequate to this relatively small pump, could be taken. Indeed, the cast concrete well liners might have a strong socket for the bottom of the pole integrally cast onto them so that well and pole all go together as a unit.

This small "fan mill" type of wind pumper could achieve a coefficient of performance of 0.34, somewhat better than that of a low-twist two-bladed propeller type mill, and it would start by itself in 2 knot winds. Self-starting in low wind speeds appears to be a very desirable characteristic for any irrigation windpumper for Thailand service. The coefficient of performance for this kind of wind machine as a function of tip speed rate is given in Figure (4-1). That plot shows how this kind of windmill attached to a reciprocating pump can be matched to the torque requirements of the pump at relatively low wind speeds and still be able to not run away at higher wind speeds. As the wind speed increases, the reciprocating pump (whose stroke and diameter were matched to low wind speed capabilities) can not absorb the work which the wind wheel is producing. The partially loaded wind wheel, therefore, accelerates. The tangential speed of the accelerating wind wheel

moves the tip speed ratio up rapidly until the wheel has gone down the back slope of the C_p vs. tip speed ratio curve. As the C_p falls off, the work which the wind wheel can do again falls below that which the pump can absorb, and the system comes to equilibrium at a new rotational speed not very much greater than that corresponding to optimum C_p . The steepness of the fan mill characteristic curve is the secret of safe operation in variable winds of a rather simple work unit, the fixed-stroke fixed-displacement reciprocating pump. This same mechanism which saves the pump from running away is, however, that which grossly reduces the output of the pump from what it could be if there were a load matcher between the wind wheel shaft and the reciprocating pump.

7.3 A Proposed 6 Meter Diameter Fan Mill Pumper System for Irrigation Purposes.

For the larger irrigation task, that of providing enough water during the dry season to sustain a 25 rai second crop of rice, a "wood" fanmill of 6 meter diameter is proposed. This mill would have thirty laminated plywood blades, each carried in a wood spoke, all spokes brought together in a hub. The laminated blades would have twist and taper, tapering from 0.9 feet of chord at 0.3 radius outward to 3.0 feet of chord at the tip (1.0 radius). This fan mill will want to rotate at 8.3 rpm in a 5 kt wind and at 25 rpm in a 15 kt wind. The fanmill will drive a reciprocating pump. There is probably no requirement for a step-down in windwheel shaft speed here, so no jackshaft will be fitted.

This larger diameter pump could be fitted with a fixed throw crank much like the Aermotor, the two-bladed pumper, or the 12-foot wooden fan mill just described above. And the estimates made back in the previous section suggest that one such windpumper could irrigate a family farm of 25 rai for a dry-season rice crop in the richest part of the Thai Rice Bowl. Further analysis of the proposed 6-meter diameter fan mill windpumper during a reciprocating pump is given in Appendix 4.

7.4 A Gross Analysis of the Wind Irrigation Possibility in the Chao-Phya Central Plains Region

In Figure (8) one sees the proposed Chao Phya Delta Wind Line which extends from abreast Sattaip at the south up between Don Muang and Sara Buri into Nakhon Sawan. The energetics of the wind along thatline at an axis height of 10 meters above surface have been estimated by several means, the first of which has been a calculation of monthly energy in a specified swept area at each of three stations, Sattaip, Don Muang and Nakhon Phanom, using "Optimistic" velocity-duration curves. Those results were given earlier in Table 3, and are restated here for ease of reading: (see following page)

A first approximation of total productivity along this line can then be made by weighting:

(a) For the 115 km between Sattaip and Don Muang, average =

$$\left(\frac{1.63 + 1.00}{2}\right)(115) = 151.$$

(b) For the 110 km between Don Muang and Nakhon Phanom, average =

$$\left(\frac{1.00 + 0.60}{2}\right)(110) = 88$$

239

$$\frac{239}{225} = \underline{1.06} \times \text{Don Muang Productivity.}$$

Table 5. Monthly Total Energy in a 28.31 Square Meter Swept Area, Wind Speeds Between 2 kts and 17 kts, Kilowatt Hours.

10 m axis height

	Sattaip	Don Muang	Nakhon Sawan
Nov	1077 KWH	461 KWH	236 KWH
Dec	1030	895	276
Jan	868	423	368
Feb	945	798	705
Mar	1251	1234	955
Apr	1113	1460	899
"Dry Season" Subtotal	6284 KWH	5271 KWH	3439 KWH
May	1465	1073	780
June	2552	1080	672
July	2446	893	546
Aug	2120	889	480
Sept	1471	728	211
Oct	809	551	150
"Wet Season" Subtotal	10,863 KWH	5214 KWH	2839 KWH
Annual Total	17,147 KWH	10,485 KWH	6278 KWH
Annual Energy Normalized Against Don Muang	1.63	1.00	0.60

- (c) Assume 6 meter pumpers are placed as closely together as possible which is 8.5 meters center to center. Then in the 225 Km distance, total productivity along the line would be:

$$\frac{(225)(10^3)}{(8.5)} \text{ (Don Muang) } = \underline{26.47 \times 10^3 \text{ x Don Muang}}$$

- (d) Using Table 4, one obtains these estimates of total productivity along the line -- shift now to DON MUANG PESSIMISTIC WIND REGIME:
TOTAL DELIVERY HEAD = 1.5 METER.

(1) For 6 meter Lubings: $(26.47)(10^3)(1.245)(10^5)m^3 = 3.295 \times 10^9 m^3$, which during the 181 day dry season would sustain rice culture in $\underline{1.67 \times 10^5}$ hectares = $\underline{1.085 \times 10^6}$ rai
= $\underline{4.126 \times 10^5}$ acres

(2) For 6 meter improved Thai 2-bladed wind machines, capable of self-start in 5 knot wind, fixed-throw, reciprocating pump:
 $(26.47)(10^3)(5.589)(10^4) = \underline{1.479 \times 10^9 m^3}$, which during the 181 day dry season would sustain rice culture in 7.50×10^4 hectares
= 4.87×10^5 rai
= 1.85×10^5 acres

- (3) For 6 meter improved Thai 2-bladed wind machines, capable of self-start in 5 knot wind, and fitted with variable throw cranks and reciprocating pumps:

$$(26.47)(10^3)(1.831)(10^5)m^3 = 4.84 \times 10^9 m^3 \text{ which during the 181 day dry season would sustain rice culture in}$$

$$\begin{aligned} & 2.45 \times 10^5 \text{ hectares} \\ & = 1.59 \times 10^6 \text{ rai} \\ & = 6.06 \times 10^5 \text{ acres} \end{aligned}$$

- (4) For 6-meter proposed 30 blade variable throw fan mills
and reciprocating pump:

$$\begin{aligned} (26.47)(103)(1.915)(10^5)m^3 &= 5.055 \times 10^9 m^3 \text{ which during} \\ \text{the 181 day dry season would sustain rice culture in} \\ &2.56 \times 10^5 \text{ hectares} \\ &= 1.66 \times 10^6 \text{ rai} \\ &= 6.32 \times 10^5 \text{ acres} \end{aligned}$$

From the results shown above, it is suggested that the potential for windpumped irrigation in the most fertile rice region of Thailand during the "dry season" is huge and worthy of careful examination. The machines proposed are small, and the three new machines are thought to be amenable to low-cost in-country manufacture using native materials. The above results suggest that not only could the individual farmers use windpumpers to advantage, but integration of wind pumping into the Irrigation System could be very fruitful indeed.

7.5 Irrigation by Wind Pumper in the Khon Kaen Region

In Appendix 3 an estimate is made of the ability of an Improved Thai 2-Bladed 6 Meter, Fixed-Throw, Windpumper with reciprocating pump, to irrigate for rice culture during the dry season. The author was told at Khon Kaen that individual family land holdings up in that region were of the order of 5 rai rather than the 25 or more rai down in the Central Plains. The individual farmer could perhaps irrigate for a double crop up in that region using wind-power if the water table remains close enough to the surface during the dry season and if the land would drain into one dug well at a rate which would sustain the required withdrawal rate. As stated and referenced earlier, there has been proof of existence of substantial ground water in almost all of the

Northeastern Region, but wells must be bored quite deep in many places to avoid salting and they must also therefore be adequately cased. Such a bored well is probably quite expensive. So, the use of windpower in the Khon Kaen region must probably be coupled either to flowing streams or rivers or to dug wells. Coupling the windpumping concept to the work of the Royal Irrigation Department in that region might show the way to considerable dry season irrigation. Coupling windpumping to dug wells must have its feasibility demonstrated, and the demonstration is as much tied to productivity of dug wells as it is to the windpumper. It is concluded that considerable additional investigation is required, then considerable demonstration, before one could draw good conclusions as to the feasibility of windpumped irrigation in the Khon Kaen region.

7.6 Irrigation by Windpumping Along the Banks of the Mekong River

Appendix 5 examines the possibility that windpumping could be used to move irrigation water out of the Mekong River into the Northeastern Region either in advance of construction of the proposed hydro works on that river, or, for augmentation of the hydro project after it has been completed. It is concluded that rather extensive irrigation could be accomplished by windpumping of the Mekong if the required delivery and storage system for that water are built. With adequate storage to hold water lifted during the rainy season, when the river is high, plus water lifting during the dry season, when the winds are most energetic, one-third of a million acres might be made available for rice double-cropping by such a system. The machines to be used are described in most simple terms, but they are thought to be amenable to in-country manufacture using native materials to a large extent. Data for rise and fall of the river were taken from Reference (7).

8.0 On the Generation of Electricity by Windpower Over the Chao Phya Delta and Central Plain.

Referring back to Section 6 specifically to Figure (8) and to Table 3, one can make an approximation of the electricity generating capability along the proposed Chao Phya Delta Wind Line. Assume that a cable suspension system were built all along that line such that 20 meter diameter wind generators could be suspended along it at 30 meter center to center spacing, with average axis height at 40 meters. The total energy available in the wind to one such machine at Don Muang, per year, can be approximated at:

$$\left(\frac{20}{6}\right)^2 \left(\frac{40}{10}\right)^{0.48} (10,485 \text{ KWH}) = (11.11)(1.94)(10,485) = \underline{2.26 \times 10^5 \text{ KWH}}$$

Using the 1.06 weighting factor, and estimating that wind generators capable of extracting 25% of the total available energy would be installed, the annual productivity of such a system would be

$$\frac{(225)(10^3)}{30} (0.25)(2.26 \times 10^5) \text{ KWH} = \underline{4.22 \times 10^8 \text{ KWH}}$$

8,000 KWH with water and air will produce 2000 lbs of anhydrous ammonia (short tons). So, such a system could be used to produce 52,750 short tons of ammonia per year, which is 82% nitrogen content by weight. This would carry the nitrogen equivalent of 100,000 short tons of urea. A recent communication from Dr. Riggs at USOM, Bangkok, via Mr. Arnold of AID, reports that 395,029 tons of fertilizer were imported into Thailand last year, and 23,191 ton were manufactured in-country at Mae Mok. A three-tiered windfence raised along that 225 km Chao Phya Delta Wind Line would enable Thailand to become self-sufficient (1973 level) in nitrogenous fertilizer.

9.0 On the Generation of Electricity by Windpower Over the Gulf of Thailand

A first approximation has been made of the probable productivity of a windpower electricity generating system placed at sea in the Gulf of Thailand. The energetics of the wind in a 6 meter diameter swept area, axis height of 10 meters, were analyzed for Sattaip and for Ko Samui. The monthly energy available in the wind is plotted in Figure (10). There is clear evidence that the southwest monsoon intensifies as it blows across the open water toward Sattaip during the rainy season, and some evidence that the northeast monsoon also intensifies as it blows across the open fetch toward Ko Samui. From the data in Figure (10), an assumed "Monthly Energy Available in the Wind" value has been selected as tabulated below, for the proposed line of wind generators as shown in Figure (11).

Table 6. Assumed Energy Available in the Wind, in a Band 6 Meters High, Centered at 10 Meters above Surface, Along the Proposed Offshore Wind Line, Gulf of Thailand.

	<u>KWH @ 10 m Height</u>		<u>KWH @ 10 m Height</u>
Jan	1200	July	2400
Feb	1200	Aug	2200
Mar	1300	Sept	1500
Apr	1300	Oct	1300
May	1500	Nov	1200
June	2500	Dec	1100

Annual Total = 18,700 KWH

@ a.center height of 22m, Energy multiplier	=	1.45
34 m,	=	1.80
46 m,	=	2.08
58 m,	=	2.32
70 m,	=	2.54
	=	<u>10.19</u>

A COMPARISON OF ENERGY IN THE GULF AT TWO STATIONS ON OPPOSITE SIDES OF THE GULF OF THAILAND

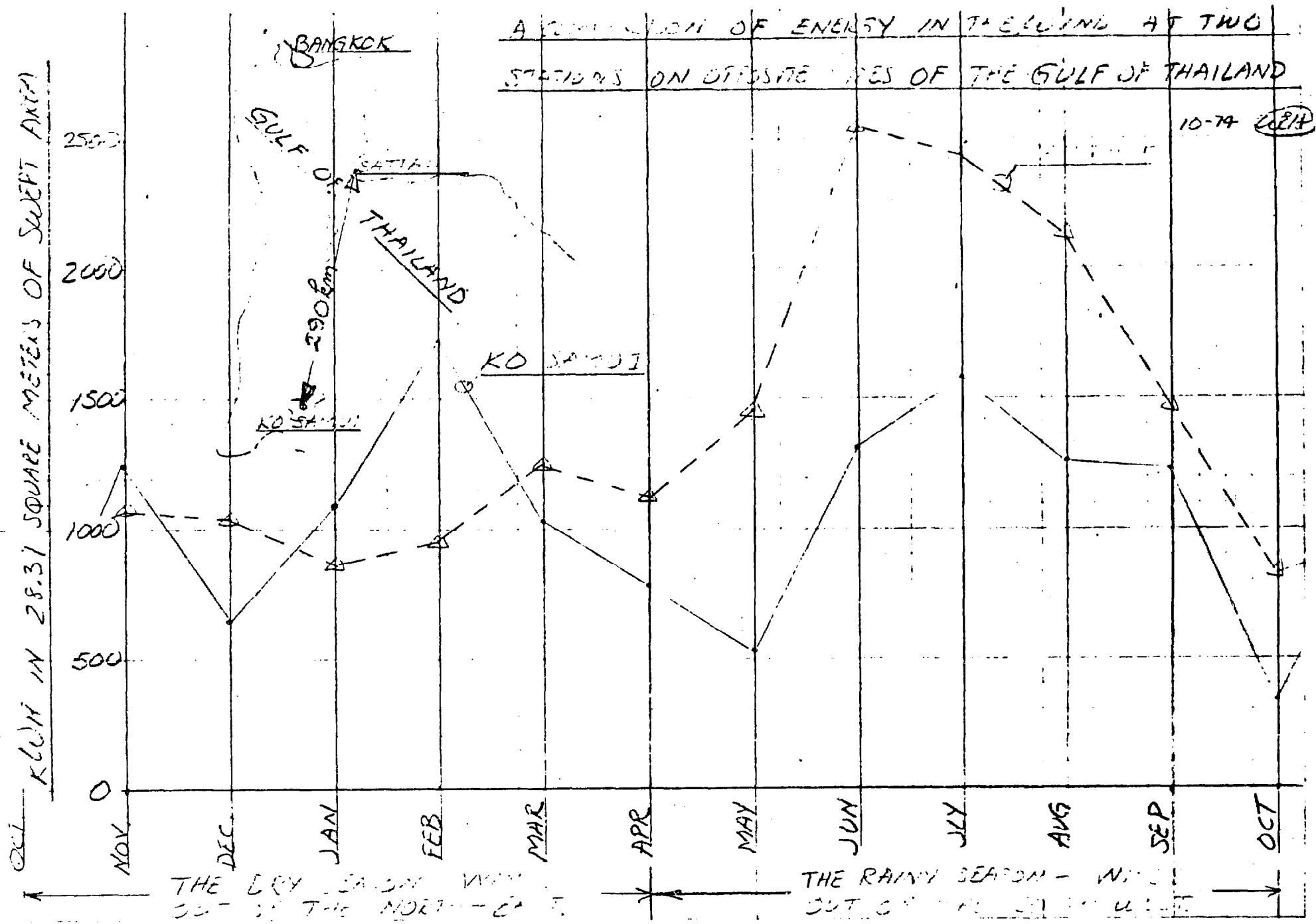

10-74 (221A)

FIG. (10)

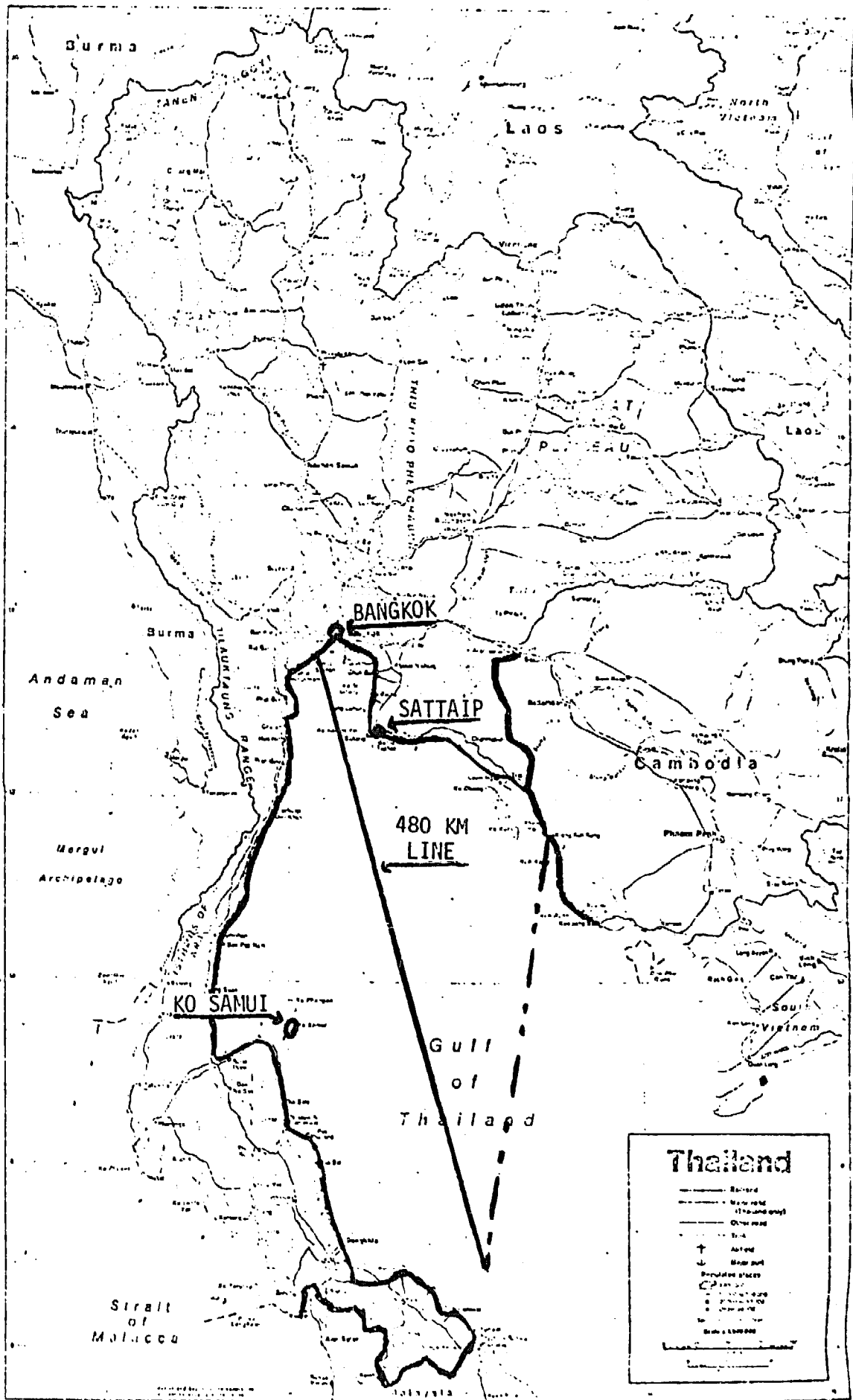

Central Intelligence Agency

A PROPOSED OFFSHORE WINDPOWER SYSTEM FOR THE GULF OF THAILAND. FIG. (11)

So, the energy in a band extending upward from 6m above surface to 76m above surface would amount to:

$$(18,700 \text{ KWH})(10.19)\left(\frac{4.0}{3.1416}\right) = \underline{2.426 \times 10^5 \text{ KWH}} \text{ for}$$

each 6 meters of length along that line.

Assume that wind generators could be placed in that band such that 25% of that available energy could be extracted. The annual yield would be:

$$\frac{(480)(10^3)}{6}(2.426)(10^5)(.25) = \underline{4.85 \times 10^9 \text{ KWH}}$$

It can be concluded that there is an excellent opportunity in the winds over the Gulf of Thailand to extract electricity of the order of the Kingdom's current total demand for electricity. ⁽⁸⁾ The topography of the Gulf of Thailand and the absence of hurricane or typhoon winds makes the region ideal even though the winds are not strong winds. By going to about 100 meters up in the air, a 50 percent increase in the amount estimated above is probable. Reference (9) discusses offshore windpower systems in some detail.

4.85×10^9 KWH of electricity plus water plus air fed into an electrolysis type of ammonia fertilizer plant would produce about 500,000 short tons of anhydrous ammonia fertilizer per year, the nitrogen equivalent of 947,867 tons of urea per year. The 1973 Thailand fertilizer consumption was 418,220 tons, of which 395,029 tons were imported, a major drain on the balance of payments. Reference (10) discusses in great detail the probable value of fertilization in future Asian agriculture.

10. Irrigation Via Windpower in the Philippines

Lack of time and lack of data have prevented a careful analysis of the windpower potential in the Philippines. A document similar to a "Mean Percentage of Surface Winds" was not available. In mid October the author did receive three sets of monthly frequency distribution charts for three different locations. With time, they can be reduced to velocity-duration curves. It can be said that "by inspection," the winds in the Philippines are in all places more energetic than those in Thailand. It would follow then that the same kinds of windpumpers as proposed for Thailand could probably be developed and placed in use in the Philippines. One major difference would probably be required: small wind pumpers located in the fields in the Philippines should be carried on poles hinged at the ground so that it would be a relatively simple task to disconnect a pump drive rod and lay down the wind pumper whenever high wind warnings were received from PAGASA. One must anticipate a number of such warnings each year.

There is already an extensive irrigation system in the Philippines, and it is being improved constantly. The desire for assured water during the dry season so that rice can be double-cropped is even more acute than that now felt in Thailand. Large numbers of petrol fueled and electric driven pumpers are at work in the Philippines: most or all of that fuel requirement could be removed by use of windpower. A number of large bore deep irrigation wells, pumped by large diesel pumpers, were observed in operation. Windpumpers of the 10 kW size could be designed for such large applications.

The author did receive at Los Banos a copy of Reference (11), in which a daily "average wind speed" and a "fastest mile" are recorded for each day of the year. With time a complete set of stylized velocity-duration curves could be

made from those data alone, but a number of "typical" curves based on hourly observations would be very helpful in deciding the proper shape for those curves. A complete set of 3-hourly wind velocity data taken at an instrument height of 5.67 meters at the U.P. College of Agriculture Weather Station are in hand, and they could be used to obtain excellent monthly velocity-duration curves for that site, or, they could be computer analyzed with time. Further work will require time beyond the scope of this present effort.

The maps of "Prevailing Surface Wind Streamliners and Isotachs" included in "Climatology and Wind Related Problems in the Philippines," Reference (12), suggest that windpower systems aligned along the NE to SW axis of the Sulu Sea might be very productive. A line bisecting the Tablas Strait, passing through the Cuyo Islands all the way down to Cagayan Sulu Island, might produce electricity delivered to Panay, Mindoro or Luzon at cost competitive with fossil generated electricity. If the Sulu Sea oil field becomes a reality, however, it may be difficult for any energy source to compete against petroleum based energy in the Philippines.

It can be concluded, generally, that windpower could be of great value to the Philippines if systems could be protected against tropical storms, and if wind pumping could be integrated into existing and planned irrigation projects, particularly those requiring drainage as well as supply of water.

11. The Ocean Thermal Differences Process, Thailand and Philippines: A Major Energy Possibility for the Future.

The past five years have seen a small but important renewal of interest in that solar energy process which is called the ocean thermal difference process, or, "ocean delta Tee." Much has been written resulting from that renewed research: several of the more general references will be given here (13), (14).

The Andaman Sea, sixty miles to the west of the Kra peninsula, out of the port of Kapoe, Thailand, provides a site in which a year-round temperature difference of 38° to 40°F could be found. Both the hot water and cold water resource in that area are huge, much larger than India plus Burma plus Thailand could ever begin to "use up," so the process would be absolutely renewable and its practice free from geopolitical problems. Power plants of the 100 megawatt electrical to 400 mWe size, could be operated out there, tied to the Thai mainland either by direct current cable or by gas or liquid pipeline. If electricity is the desired product, the energy umbilical would probably best be a d.c. cable. That cable would come out of the sea, go to Bangkok, a distance almost as long as the planned transmission line from PaMong to Bangkok. If fertilizer is the desired product, the umbilical would probably best be a pressure-balanced pipe-line (hose line) carrying ammonia liquor to Kapoe. At Kapoe the pipe line could be continued across the peninsula, then again in the sandy bottom of the Gulf of Thailand, on up the Chao Phya past Bangkok to one or more central fertilizer plants where, perhaps, the ammonia liquor would be converted to ammonium nitrate which can be bagged and distributed as a solid. Nothing other than electricity, water and air are required to feed this process: what is described here is a completely

natural fertilizer operation which expends no fossil resources and does not depend upon the willingness of anyone else to act or sell a product under his control.

Current estimates place the capital cost of ocean thermal differences power plants, for a regime where 38 to 40 F delta tee is available, near \$800 U.S. per installed kilowatt. The plants should easily achieve a plant factor of 93 percent. If capitalized by a sovereign state at six percent total fixed charges, a kilowatt hour of electricity from such a plant would cost at the plant 6 mills for production plus no more than 2 mills for operation and maintenance, a total of 8 mills (\$.008) per KWH. The fertilizer manufacturing machinery will probably cost another \$200 per kW capacity, which would add 1.5 mills for fixed charges plus 1 mill for operation and maintenance. One could thus have 8000 kWh of electricity fed into an ammonia production plant for a total cost of $(8,000)(\$0.0105) = \84.00 . For that \$84. U.S. one would receive 2000 lbs (0.906 metric tons) of a product which is 82% nitrogen. On the basis of nitrogen content, this would be the nitrogen equivalent of 1.79 metric tons of urea. Where today can one purchase a metric ton of urea for \$46.92 U.S., or, 4.7 cents per kilogram? When the author was at IRRI in August, 1974 a Mr. Benbo of the United Nations was there on a mission concerning the delivery of urea fertilizer. It is thought that Mr. Benbo said that urea, fob a U.S. port was up to \$380 U.S. per metric ton, with shipment to Manila or Bangkok adding \$120 U.S. or more per metric ton. He was talking about urea, delivered, at costs as high as \$500 to \$875 per metric ton in the near future. If the author heard those numbers correctly, there should certainly be considerable emphasis given to in-country manufacture of nitrogenous fertilizer by ocean thermal power plant energy. A more recent communication from Dr. Riggs at USOM Bangkok says that the current (November) 1974

price for urea is \$300. (U.S.) per metric ton and \$170. (U.S.) per metric ton for ammonium nitrate, in Bangkok.

The economics given here are brief and incomplete, but factually representative of what could be accomplished. The hardware required could not be fabricated in either Thailand or the Philippines, except perhaps for shipyard assembly. But, the plants could easily be operated and maintained by trained nationals of either country.

The ocean delta tee resource off the eastern coast of the Philippines, almost anywhere along her entire length, is huge. There is an obvious trade-off between proximity to the equator, closeness of deep cold water to the beach and proximity of market, in selecting optimum sites. The Philippines have a strong commitment to a national electricity system: ocean delta tee could provide all of the generation desired and in a nicely geographically distributed way. The Philippines have a strong commitment to accelerated use of fertilizer, HYV rice and double cropping: ocean delta tee could sustain that commitment.

Along with the nitrogenous fertilizer required by both countries there is a concurrent need for phosphates. The cold water brought up from near the sea bed to chill the condensers of the ocean thermal differences power plants is rich in dissolved phosphoric acid. It is possible that a degassing system applied to the spent cold circulating water might lead to the tapping of the world's largest phosphate bank, bottom sea water, for the benefit of humankind.

12. Vertical Axis Wind Machines

At the Plant and Service Section, Agricultural Engineering Division, Ministry of Agriculture and Cooperative, Thailand, Mr. Metha Ratjapiti, is working on several different vertical axis wind machines for water pumping. There is a very keen interest within the Royal Thai Government, that reaches to the King himself in putting the wind to work to help the peasant farmer. Ratjapiti's machines were being constructed from a combination of metal, wood and fibre mat. The great hope, of course, is that the fibre mat sails or rotor surfaces will be able to do for a vertical axis machine that which they do for the inexpensive but effective salt works wind pumpers. Several of the designs were using the flapping sails of the panemone, a very old concept indeed, one which has worked for centuries.

In the Philippines, at IRRI, I was also made aware of a keen interest in vertical axis machines. Figures (12) and (13) are two photographs of an oil-drum machine existing at IRRI. The machine was at that time unable to pump water because the canal water level was too low for its bucket-type pump to reach. That machine uses a home-made gear drive made by welding a star or spoked drive sprocket attached to the mill's vertical axis and a large diameter "gear" of horizontal axis built around the periphery of the bucket pump.

The strong interest in vertical axis machines was reemphasized by Dr. Marshal F. Merriam when I reached the East-West Center in Honolulu. Merriam feels that the vertical axis machine is probably the key to low-cost wind-pumpers. And back at home, one of my students, Edward Van Dusen, is firmly convinced that he can demonstrate how a vertical axis machine can achieve a coefficient of performance almost as high as that of a propeller type. I,

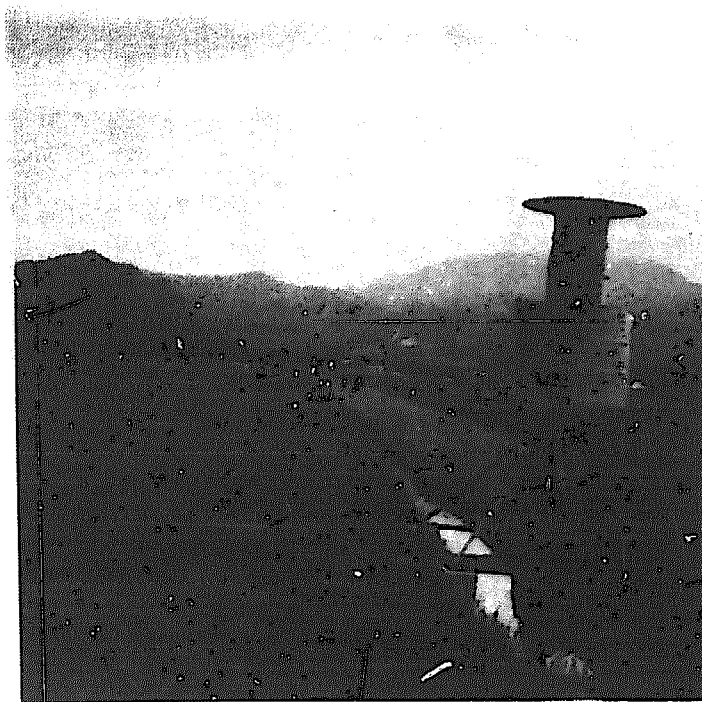

FIG. 12 A Two-Oil-Drum Vertical Axis Wind Pumper
at IRRI, Los Banos, Philippines

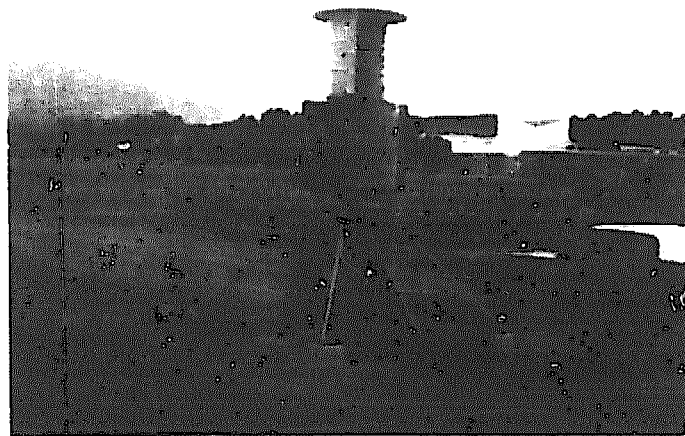

FIG. 13 Another View of the IRRI Two-Oil-
Drum Vertical Axis Wind Pumper

personally, have a great interest in a cross-flow type of wind generator, essentially a vertical axis machine, because I can see the limiting problem of the propeller type, the cantilever beam blade forced to live in a reversing stress field, disappearing with a properly designed cross-flow machine.

Still, the vertical axis machine has not been included in the proposed designs set forth in this report. One could say that they will come forward from others, anyhow. But, there is some genuine reservation as to the competitiveness of the smaller, close-to-ground rotor machine made from indigenous materials. The Thai farmers put their 2-bladed machine as high in the air as they could and still be able to reach the blade for starting purposes. There is a severe degradation in wind velocity as one approaches the ground, coming down in increments from 8 meters, for example, the greatest height reached by the typical Thai 2-bladed machine. (2 meters from ground to low tip, 5 meters from ground to machine axis, 8 meters from ground to highest tip). That 2-bladed propeller can be modified to achieve a C_p of 0.35. It is problematical that the kinds of vertical axis machines of the oil drum, etc., type ever achieve a C_p of 0.20. Indeed, there were reports by other investigators at Sherbrooke, Quebec, in May, 1974, in which vertical axis machines of the rotor type were delivering C_p 's of the 0.15 to 0.18 range.

Assuming that a vertical axis machine of the "cheap sail" type can achieve a C_p of 0.15, and that the lower edge can be 2m above ground, then the amount of swept area, to do the same work that can be done by the Thai 2-bladed of 28.31 square meter swept area and $C_p = 0.35$ will have to be 2.33 times as much = 66.06 square meters if it were in the same wind field as that which the 2-bladed sees sweeping between 2 and 8 meters above ground. If the axis

height is limited to the 2-bladed's 5 meters, so that pole and other structural features are comparable (and they really can't be, because the rotor machine is not usually built around a pole), the diameter of the rotor would be $66.06 \div 3 = 22$ meters. That is rather large, but not impossible. But, the aspect ratio of $22 \div 3 = 7.33$ is probably not the most favorable. If the height of the rotor machine is allowed to go above 5 meters, the diameter will reduce:

<u>rotor height</u>	<u>rotor diameter</u>
3 m	22 m
5	13 m
7	9.4 m
8	8.25 m

The last machine will see a wind field comparable to that felt by the propeller machine and the overturning moment on it is not much different from that on the 2-bladed machine under normal operations. There is, however, a real difference between a device which presents a 30 cm x 8 meter profile to the wind and another device which presents an 8.25 m x 8 meter profile to the wind, when the wind starts to blow. All in all, one must wonder if a straw-mat rotor much larger than one or two oil drums has much survival potential. And the smallest attractive wind pumper calculated herein is much larger than one or two oil drums.

13. Conclusions

I. Thailand

A. There are several situations in which windpumped water could improve the yield of agricultural operation in Thailand:

1. Small windpumpers pumping from dug wells could alleviate the start-of-season and the end-of-season random droughts which reduce rice yields in the traditional one-crop rice culture.
2. Larger windpumpers pumping from irrigation canals and ditches in the Central Plain could improve Dry Season irrigation such that rapid expansion of double-cropped rice culture could occur.

B. Both small and larger windpumpers can probably be constructed in-country essentially from indigenous materials. The small wind-pumper can probably be owned by individual farmers if such farmers have wells or other sources on or alongside their land adequate to feed the pumpers. The larger windpumpers should probably best be located by the Royal Irrigation Department in harmony with their improvements in systems for dry-season irrigation, and may therefore better be owned by collectives or governmental authority.

C. Larger windpumpers pumping from the Mekong River could accelerate the process of irrigation of the large portions of the Northeastern Region whose ultimate irrigation by water diverted by the PaMong project and subsequent works of the Mekong Project is now planned.

D. Small or large windpumpers pumping from dug wells or existing streams, or in some instances from deep bore holes, could accelerate the double-cropping of vegetables, upland crops and fruit in the central part of the North-East, radiating outward from Khan Kaen.

E. Electricity generated by windpower systems placed out in the Gulf of Thailand could economically increase the supply of electricity to the Bangkok metropolitan area.

F. Electricity generated by windpower systems placed out in the Gulf of Thailand could economically take over the supply of nitrogenous fertilizer.

G. Electricity generated by the ocean thermal differences process out in the Andaman Sea to the West of the Kra Peninsula, sending electricity ashore via on-sea-bed d.c. cable thence to Bangkok via overhead d.c. cable could deliver economic energy adequate to sustain all of the electricity demands of the Bangkok metropolitan area, electricity for canal and ditch irrigation pumping and the nitrogenous fertilizer manufacture that will be required to sustain maximum double cropping in Thailand in future.

H. The hardware required for any of the above suggested windpower systems needs to be developed, probably in a U.S. R & D laboratory setting first, then developed further in-country by perhaps a combination of AIT and the Division of Agricultural Engineering, Dept. of Agricultural Technology, Ministry of Agriculture and Cooperative, Royal Thai Government.

The hardware required for any of the windpower systems could be manufactured in Thailand.

I. The hardware required for the fertilizer plants or for the ocean thermal differences plants would be developed in the U.S. incident to the current national effort in that field. Most of that hardware would have to be manufactured in more industrialized countries, but there is some opportunity for Thai industry to expand adequately to

produce some of that hardware.

J. Whether or not the individual farmer would profit from, eat better or have an easier life if any of the suggested changes were implemented, is a question which can not be answered by a technologist. It is possible that adoption of any of the technology might simply lead to circumstances in which peasant farmers would produce more than they now produce, work harder all year 'round instead of relaxing during the dry season, but not really improve their individual material well-being at all. On the other hand, the nation as-a-whole and the hungry population of the World could hardly help but profit from any system which improved agricultural productivity in Thailand.

II. The Philippines

A. Analysis from which conclusions might be drawn relating to Windpower and the Philippines has been meager compared with that devoted to the Thailand situation. It is thought, however, that additional study will show the same kind of conclusions as those listed above for Thailand except that:

1. The windpower resource available in much of the Philippines is more energetic than that available in Thailand.
2. Most any Philippine wind system would have to be so configured that windwheels could be hinged or lowered down to the ground in advance of tropical windstorm arrival.
3. There is no interest in the Philippines in cottage-industry manufacture of windpumper systems: their manufacture in urban factory settings and distribution with government subsidy to

farmers would be favored.

4. There is a possible real need in the Philippines for large-scale drainage projects in which windpumping could be of value.

5. The distribution of electricity to villages and farms via central systems is much farther advanced in the Philippines than in Thailand, and the momentum in that direction might emphasize more incorporation of wind generated electricity plus electrical pumping than direct mechanical water pumping by windpower.

6. The ocean thermal differences resource available along the extensive east coast of the Philippines is enormous and very close to hand, and is probably the richest natural resource available to that country. Ocean thermal power plants could readily be integrated into the central electricity network thinking so strong in that country, and into their expanding fertilizer industry, lifting from their shoulders the yoke of dependence upon foreign petroleum resources.

14. Recommendations

I. Thailand

- A. Enlist the support of the Royal Thai Government in expansion of their current excellent system for wind measurements so that very accurate monthly velocity-duration curves can be prepared for areas of interest.
- B. Initiate the development of 4-meter diameter and 6-meter diameter wind machines of both the improved Thai 2-bladed type and of the proposed wooden fan mill type.
- C. Initiate the development of variable-throw crank mechanisms for windpumpers.
- D. Initiate development of reciprocating pumps constructed of indigenous materials.
- E. Initiate with the cooperation of the Mekong Committee a study of how windpumped Mekong water could accelerate and augment rather than duplicate the irrigation benefits now planned by that committee.
- F. Initiate with the Thai Royal Irrigation Department a study of how wind pumpers could best be incorporated into their current and long term plans to improve dry-season irrigation in the Central Plains.
- G. Initiate with the Electricity Generating Authority of Thailand, or with the Energy Authority of the Royal Thai Government, or both, a study of how Thailand could meet her future desired growth in electricity generation, particularly in the Bangkok region, by energy systems that consume no fuel.
- H. Organize with AIT and the Thai Ministry of Agriculture and Cooperative a windpower development program that would move prototypes

from a U. S. Laboratory to an AIT open-field test site, thence into the local manufacturing economy and into use in the fields, along the irrigation canals, along the Mekong River, and, perhaps, afloat out in the Gulf of Thailand.

II. The Philippines

- A. Enlist the support of PAGASA in the collection of additional wind data and their reduction into accurate velocity-duration curves for the various localities and wind regimes in which windpowered pumping or electricity generation could be of interest.
- B. Initiate the development of 4-meter diameter and 6-meter diameter wind machines of both the improved Thai 2-bladed type and of the proposed wooden fan mill type.
- C. Initiate the development of variable-throw crank mechanisms for wind-pumpers.
- D. Initiate development of reciprocating pumps constructed of indigenous materials.
- E. Initiate with the Philippines Irrigation Department a study of how windpumpers could best be incorporated into their current and long-term plans to improve two-season irrigation and drainage in the country.
- F. Initiate with the Central Electricity Generating Board of the Philippines a study of what role either wind generated electricity or ocean thermal differences generated electricity could play in the expansion of the supply of electricity to the Philippines.
- G. Initiate with the appropriate ministry of the Government of the Philippines a study of what role the ocean thermal differences process could play in the expansion of the supply of fertilizer to the Philippines and an accompanying reduction in petroleum consumption.
- H. Organize with SEARCA, the University of the Philippines and IRRI, a windpower development program that would move prototypes out of a U. S. laboratory to appropriate field tests in the Philippines and thence into quantity manufacture and installation.

15. References

- (1) "Royal Irrigation Department," September 28, 1970, a pamphlet of the R.I.D., Royal Thai Government, Bangkok, Thailand.
- (2) "FAO/UNDP Survey Mission for the Chao Phya Delta, Thailand," A Report to the United Nations Development Programme, Rome, 30 April 1968, WS/74283.
- (3) "Ground Water Resources Development of Northeastern Thailand," 1966, by Howard F. Haworth, Pongpan Na Chiangmai and Charoen Phianchaiwen. Ground Water Bulletin No. 2, Ground Water Division, Department of Mineral Resources, Ministry of National Development, Thailand.
- (4) "Lift Irrigation for Rice Production," by Jose Samual, Godofredo Salazar, Vergilio Cueno, internal publication of the Agricultural Engineering Department, The International Rice Research Institute, Los Banos, Laguna, Philippines.
- (5) "To Tame a River," 1968, U.S. Government Printing Office Publication 1968-0-296-181, Washington, D.C.
- (6) "A Short Introduction for Some Common Timbers of Thailand," by Narong Tonanon, Forest Products Research Division, Royal Forest Department, Ministry of Agriculture and Cooperative, Bangkok, 1974.
- (7) "Lower Mekong Hydrologic Yearbook," 1972, Volume 1, Office of the Executive Agent of the Committee for Coordination of Investigations of the Committee for Coordination of Investigations of the Lower Mekong Basin, c/o ECAFE, Sala Santitham, Bangkok 2, Thailand.
- (8) "Thailand Electric Power Study, December 1966," by Thailand Electric Power Study Teams, under Contract to AID-USOM.
- (9) "Pollution-Free Energy from Offshore Winds," by Wm. E. Heronemus, Preprints 8th Annual Conference and Exposition, Marine Technology Society, September 1972, Washington, D. C.
- (10) "Symposium on Fertilizer Economy-Proceedings and Report of the Survey," 1971 - Asian Productivity Organization APO Secretariat, AYOYAMA DAI ICHI MANSIONS, 4-4 Akasaka 8 - Chome Minato-Ku-Tokyo, 107 Japan.
- (11) "1971-2 Surface Meteorological Observations at the College Weather Station," Vol. XIII & XIV, Dept. of Agricultural Engineering, College of Agriculture, University of the Philippines.
- (12) "Climatology and Wind Related Problems in the Philippines" by Roman L. Kintanar, 1973, published at the International Workshop on Development of Design Criteria and Methodology for Low-Rise Low-Cost Buildings to Better Resist Extreme Winds, Nov. 1973, N.S.D.B., Herran, Manila, Philippines..

- (13) "Using Two Renewables," Wm. E. Heronemus, Oceanus, Vol. XVII, Summer 1974, Woods Hole Oceanographic Institution, Woods Hole, Massachusetts, pages 20-27.
- (14) "Ocean Thermal Difference Power Plant Design," by J. G. McGowan, W. E. Heronemus, J. W. Connell and P. D. Cloutier, June 1973, published as ASME conference paper.

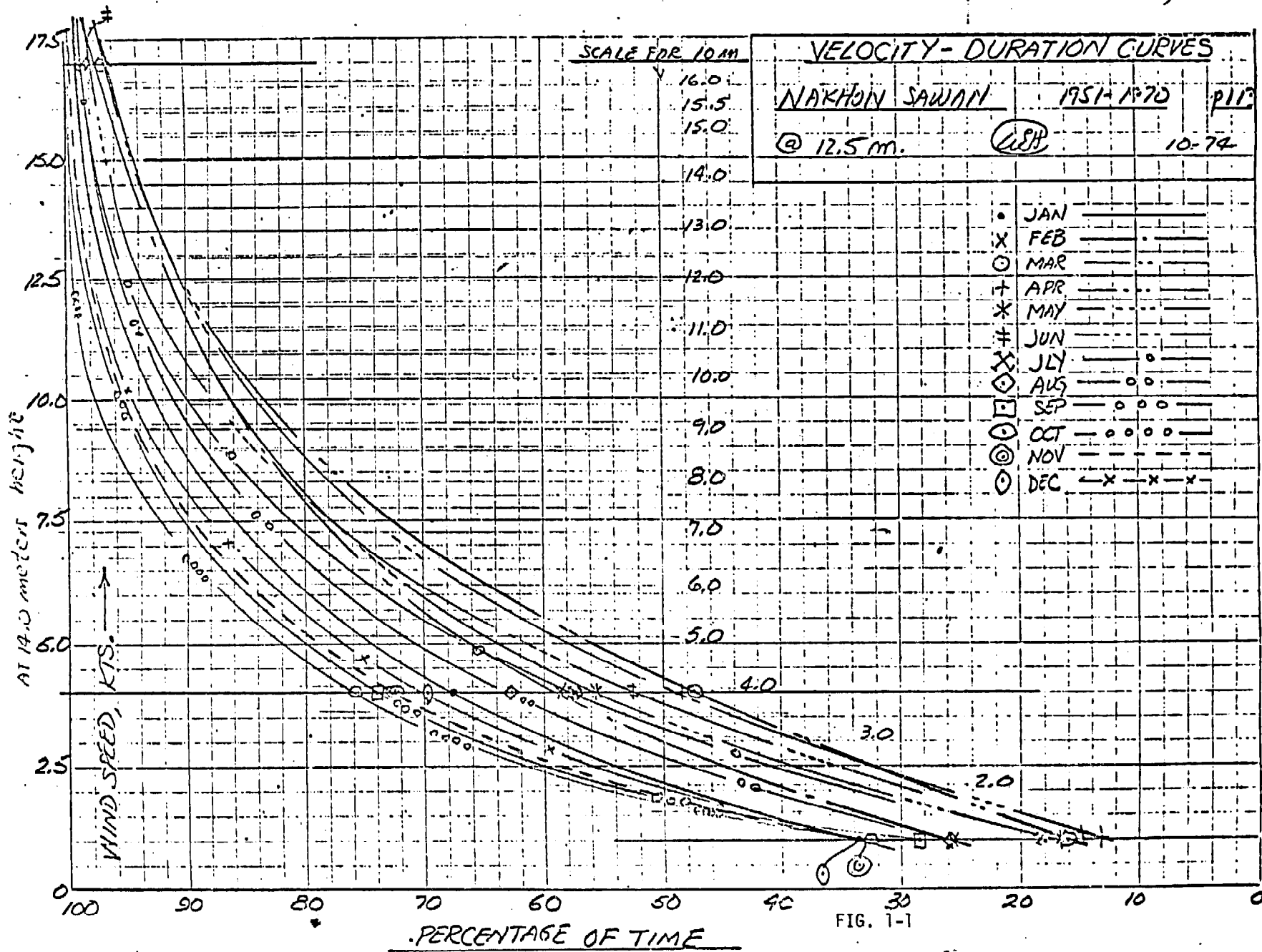

**Appendix 1: Monthly Velocity-Duration Curves, Nakhon Sawan, Plus Energy
Content Calculation Sheets, Showing Energy in a 6-Meter
Diameter Swept Area at 10 Meter Axis Height.**

MONTH FEB. SWEET AREA 28.31m² (6m D)
 PLACE NAKHON SAWAN HEIGHT 10m

WIND MACHINE
 PUMP

WIND

4% TIME INTERMENT (CENTERS) AT	HRS.	\bar{V} (KTS)	\bar{V}^3	A (m ²)	P KW	E KWH (IN WIND)	C _P	AVAILABLE SHAFT POWER
98%	26.58	16.8	4742	28.31	11.18	300.66		
94		13.5	2460		5.80	156.01		
90		11.3	1443		3.40	91.47		
86		9.5	857		2.02	54.36		
82		8.2	551		1.20	34.96		
78		7.0	343		0.81	21.75		
74		6.2	238		0.56	15.11		
70		5.4	157		0.37	9.98		
66		4.8	110		0.26	7.01		
62		4.3	79		0.19	5.04		
58		3.8	55		0.13	3.48		
54		3.3	36		0.08	2.28		
50		2.9	24		0.06	1.55		
46		2.5	16		0.04	0.97		
42		2.2	11		0.02	0.67		
38		1.7						
34								
30								
26								
22								
18								
14								
10								
6								
2								

$$P = (8.71 \times 10^{-5}) \times (A \text{ m}^2) \times (\bar{V} \text{ KTS})$$

2820

MONTH	PLACE	SWEET AREA	HEIGHT	WIND MACHINE PUMP			
4% TIME INCREMENT	HRS.	V (KTS)	V ³ (m ²)	P KW	E KW/H (IN WIND)	CP	AVAILABLE SWEET POWER
GENERATED AT	29.76	13.5	2460	5.70	172.72		
91%		10.3	1092	2.58	76.71		
94		8.4	592	1.40	41.61		
90		7.2	373	0.38	26.20		
86		6.3	250	0.59	17.55		
82		5.5	166	0.37	11.68		
79		4.8	110	0.21	7.76		
74		4.2	74	0.17	5.20		
70		3.7	51	0.12	3.56		
66		3.2	32	0.07	2.30		
62		2.8	22	0.05	1.54		
59		2.4	14	0.02	0.97		
54		2.0	8		0.56		
50							
46							
42							
38							
34							
30							
26							
22							
18							
14							
10							
6							
2							
Z							
P = (8.71 x 10 ⁻⁵)		X A m ² X V ³ (KTS)		368			

MONTH JANUARY SWEEP AREA 28.31 m² (6 m DIA)
 PLACE NAKHON SAWAN HEIGHT 10 m

WIND MACHINE
 PUMP

% TIME INCREMENT CENTERED AT	HRS.	\bar{V} (KTS)	\bar{V}^3	A (m ²)	P KW	E KWH (IN WIND)	C _p	AVAILABLE SWEEP POWER
98%	29.76	17.0	4913	28.31	11.55	349.91		
94		14.4	2986		7.04	209.62		
90		11.8	1643		3.87	115.34		
86		10.4	1125		2.65	78.96		
82		9.2	778		1.89	59.66		
78		8.3	572		1.35	43.14		
74		7.5	422		0.97	29.62		
70		6.7	300		0.71	21.11		
66		6.2	238		0.56	16.73		
62		5.6	175		0.41	12.33		
58		5.2	141		0.33	9.87		
54		4.6	97		0.23	6.83		
50		4.2	74		0.17	5.20		
46		3.8	55		0.13	3.85		
42		3.4	39		0.09	2.76		
38		3.0	27		0.06	1.87		
34		2.5	16		0.03	1.10		
30		2.2	11		0.01	0.31		
26		1.7						
22								
18								
14								
10								
6								
2								

Σ
 $P = (8.71 \times 10^{-5}) \times (A_{m^2}) \times (\bar{V}_{KTS})^3$ 955

6114

MONTH APRIL SWEET AREA 28.31 m² (6m DIA)
 PLACE NAKHON SAWAN HEIGHT 10 m

WIND MACHINE
 PUMP

4% TIME INCREMENT (CENTERED AT)	HRS.	V (KTS)	V ³	A (m ²)	P KW	E KWH (IN WIND)	C _p	AVAILABLE SHAFT POWER
98%	28.8	17.0	4913	28.31	11.59	333.78		
94		14.4	2986		7.04	202.86		
90		11.8	1643		3.87	111.63		
86		10.2	1061		2.50	72.10		
82		9.0	729		1.72	49.53		
78		8.0	512		1.20	34.78		
74		7.2	373		0.88	25.36		
70		6.5	275		0.65	18.66		
66		5.9	205		0.48	13.73		
62		5.4	157		0.37	10.70		
58		4.8	110		0.26	7.51		
54		4.4	85		0.20	5.78		
50		4.0	64		0.15	4.35		
46		3.6	47		0.11	3.17		
42		3.3	36		0.08	2.44		
38		2.8	22		0.05	1.45		
34		2.5	16		0.04	1.06		
30		2.2	11		0.02	0.72		
26		1.9						
22								
18								
14								
10								
6								
2								
Σ								

$$P = (8.71 \times 10^{-5}) \times (A \text{ m}^2) \times (V \text{ KTS})^3$$
 899

MONTH MAY SURVEY AREA 283/m² (6.0m Dia)
 RACE NATHAN SILDAN HEIGHT 10m

WIND MACHINE _____
 PUMP _____

WINDMILL HEIGHT AT	HPS.	V (KTS)	V ³	A (m ²)	P KW	E KWH (IN WIND)	CP	AVAILABLE START POWER
98%	29.76	16.5	4992	28.31	10.60	315.36		
94		13.6	2515		5.93	176.60		
90		11.4	1481		3.17	104.01		
86		9.5	857		2.02	60.19		
82		8.2	551		1.30	38.71		
78		7.2	373		0.85	26.20		
74		6.4	262		0.62	18.90		
70		5.8	195		0.96	13.70		
66		5.2	140		0.33	9.87		
62		4.6	97		0.23	6.43		
58		4.2	74		0.17	5.20		
54		3.7	51		0.11	3.55		
50		3.3	36		0.08	2.52		
46		3.0	27		0.06	1.89		
42		2.6	18		0.14	1.23		
38		2.3	12		0.03	0.85		
34		2.0	8		0.02	0.56		
30								
26								
22								
18								
14								
10								
6								
2								
Z								

P = (8.71 x 10⁻⁵) X A_m³ X V_{KTS}³)

780

MONTH JUNE SWEEP AREA 28.31 m² (6m Dia)
 PLACE NAKHON HEIGHT 10 m

WIND MACHINE
PUMP

4% TIME INCREMENT (CENTERED AT)	HRS.	\bar{V} (KTS)	\bar{V}^3	A (m ²)	P KW	E (IN WIND) KWH	C _p	AVAILABLE SHAFT POWER
98%	28.8	16.5	4442	28.31	10.59	305.19		
94		12.0	1728		4.07	117.39		
90		10.3	1073		2.58	74.24		
86		9.1	753		1.78	51.19		
82		8.1	531		1.25	36.10		
78		7.2	373		0.88	25.36		
74		6.4	262		0.62	17.80		
70		5.8	195		0.46	13.25		
66		5.2	141		0.33	9.55		
62		4.6	97		0.23	6.61		
58		4.2	74		0.17	5.03		
54		3.7	51		0.11	3.44		
50		3.4	39		0.07	2.67		
46		3.0	27		0.06	1.83		
42		2.6	18		0.04	1.19		
38		2.3	12		0.03	0.83		
34		2.0	8		0.01	0.59		
30								
26								
22								
18								
14								
10								
6								
2								

Σ
 $P = (8.71 \times 10^{-5} \times A_{m^2} \times \bar{V}_{KTS}^3)$ 672

MONTH Nov SWEPT AREA 28.31 m² (6 m DIA)
 PLACE NAKHON SAWAN HEIGHT 10 m

WIND MACHINE
PUMP

4% TIME INCREMENT (CENTERED AT)	HRS.	\bar{V} (KTS)	\bar{V}^3	A (m ²)	P KW	E KWH (IN WIND)	C _p	AVAILABLE SHAFT POWER
98%	29.76	14.8	3242	28.31	7.65	227.58		
94		11.0	1331		3.14	93.44		
90		9.1	753		1.78	52.90		
86		7.9	493		1.16	34.61		
82		6.8	314		0.79	22.07		
78		6.1	227		0.54	15.93		
74		5.3	149		0.35	10.45		
70		4.8	111		0.26	7.76		
66		4.2	74		0.17	5.26		
62		3.7	51		0.12	3.56		
58		3.3	36		0.08	2.52		
54		2.9	24		0.06	1.71		
50		2.6	18		0.04	1.23		
46		2.3	12		0.03	0.85		
42		1.9	7		0.01	0.48		
38								
34								
30								
26								
22								
18								
14								
10								
6								
2								

Σ
 $P = (8.71 \times 10^{-5} \times A_{m^2}) (\bar{V}_{KTS})^3$ 480.3

222

MONTH JULY SWEEP AREA 28.31 m² (6 m)
 PLACE NAKHON SAWAN HEIGHT 10 m

WIND MACHINE
 PUMP

TIME ELEMENT	HRS.	V (KTS)	V ³	A (m ²)	P (KW)	E (KWH IN WIND)	C _p	AVAILABLE SHAFT POWER
8%	29.76	15.0	3375	28.31	7.96	236.94		
34		11.5	1521		3.59	106.77		
40		9.6	885		2.08	62.11		
36		8.3	572		1.35	40.14		
32		7.4	405		0.96	28.44		
28		6.6	287		0.68	20.18		
24		5.9	205		0.48	14.42		
20		5.3	149		0.35	10.45		
16		4.8	110		0.26	7.76		
12		4.4	85		0.20	5.98		
8		4.0	64		0.15	4.49		
4		3.5	43		0.10	3.00		
0		3.2	33		0.08	2.30		
16		2.7	20		0.05	1.38		
12		2.4	14		0.03	0.97		
8		2.2	11		0.02	0.75		
4		1.9						
0								
16								
12								
8								
4								
0								
16								
12								
8								
4								
0								

$$= (8.71 \times 10^{-5}) \times A_{m^2} \times (V_{KTS})^3$$
546

28

MONTH SEPT. SWEEP AREA 28.31 m² (6 m dia)
 PLACE NAKHUW SAWA HEIGHT 10 m

WIND MACHINE
PUMP

4% TIME INCREMENT CENTERED AT	W.S.	V (KTS)	V ³	A (m ²)	P KW	E KWH (IN WIND)	C _p	AVAILABLE SHAF POWER
98%	28.8	11.5	1521	28.31	3.58	103.32		
94		8.5	614		1.45	41.72		
90		7.1	358		0.84	24.02		
86		6.1	227		0.52	15.42		
82		5.2	141		0.33	9.55		
78		4.5	91		0.21	6.19		
74		3.9	59		0.14	4.03		
70		3.4	39		0.09	2.67		
66		2.9	24		0.06	1.66		
62		2.6	18		0.04	1.19		
58		2.3	12		0.02	0.82		
54		2.0	8		0.01	0.54		
50								
46								
42								
38								
34								
30								
26								
22								
18								
14								
10								
6								
2								

Σ P = (8.71 × 10⁻⁵) × A m² × (V KTS)³ = 211.2

MONTH OCTOBER SWEET AREA 28.31 m² (6m Dia)
 PLACE N. H. J. SAWAN HEIGHT 10 m

WIND MACHINE
 PUMP

WIND SPEED INCREMENT CENTERED AT	HRS.	\bar{V} (KTS)	\bar{V}^3	A (m ²)	P KW	E KWH (IN WIND)	C _p	AVAILABLE SHAFT POWER
55%	29.70	9.7	913	28.31	2.15	64.87		
54		7.7	456		1.08	32.05		
50		6.5	275		0.65	19.28		
46		5.7	185		0.44	13.00		
42		4.8	111		0.26	7.76		
38		4.2	74		0.17	5.20		
34		3.6	47		0.11	3.28		
30		3.2	33		0.07	2.30		
26		2.8	22		0.05	1.54		
22		2.4	14		0.03	0.97		
18		2.1	9		0.02	0.65		
14		1.8	6		0.01	0.41		
10								
6								
2								

$$P = (8.71 \times 10^{-5}) (A \text{ m}^2) (\bar{V} \text{ KTS})^3$$

150.5

MONTH NOVEMBER SWEEP AREA 28.31 m² (6.01 D/A.)
 PLACE NAKHON SAWAN HEIGHT 10m

WIND MACHINE
 PUMP

% TIME INCREMENT (CENTERED AT)	HRS.	\bar{V} (KTS)	\bar{V}^3	A (m ²)	P KW	E KWH (IN WIND)	C _p	AVAILABLE SHAFT POWER
98%	28.8	12.0	1728	28.31	4.07	117.43		
94		8.7	658		1.55	44.74		
90		7.4	405		0.95	27.53		
86		6.2	238		0.56	16.19		
82		5.4	157		0.37	10.70		
78		4.7	104		0.24	7.05		
74		4.1	69		0.16	4.68		
70		3.6	47		0.11	3.17		
66		3.1	30		0.07	2.02		
62		2.7	20		0.05	1.34		
58		2.3	12		0.03	0.83		
54		1.9	7		0.01	0.46		
50								
46								
42								
38								
34								
30								
26								
22								
18								
14								
10								
6								
2								

Σ
 $P = (8.71 \times 10^{-5}) \times A_{m^2} \times (\bar{V}_{KTS})^3$ 236.1

CPH

MONTH DECEMBER SWEST AREA 28.31 m² (6m D/A.)
 PLACE NAKHON SAWAN HEIGHT 10m

WIND MACHINE
PUMP

4% TIME INCREMENT CENTERED AT	HRS.	\bar{V} (KTS)	\bar{V}^3	A (m ²)	P KW	E KWH (IN WIND)	C _p	AVAILABLE SHAFT POWER
98%	29.76	12.1	1771	28.31	4.18	129.37		
94		9.3	804		1.90	56.46		
90		7.7	456		1.08	32.05		
86		6.7	301		0.71	21.11		
82		5.8	195		0.46	13.69		
78		5.1	133		0.31	9.31		
74		4.9	118		0.28	8.26		
70		3.8	55		0.13	3.85		
66		3.7	39		0.09	2.76		
62		3.0	27		0.06	1.89		
58		2.6	18		0.04	1.23		
54		2.3	12		0.03	0.85		
50		2.0	8		0.01	0.56		
46								
42								
38								
34								
30								
26								
22								
18								
14								
10								
6								
2								

Σ
 $P = (8.71 \times 10^{-5}) \times A_{m^2} (\bar{V}_{KTS})^3$ 276.4

Appendix 2: Monthly Velocity-Duration Curves, Don Muang, Pessimistic Curve
Shape versus A Simplistic But Perhaps Optimistic Curve Shape.

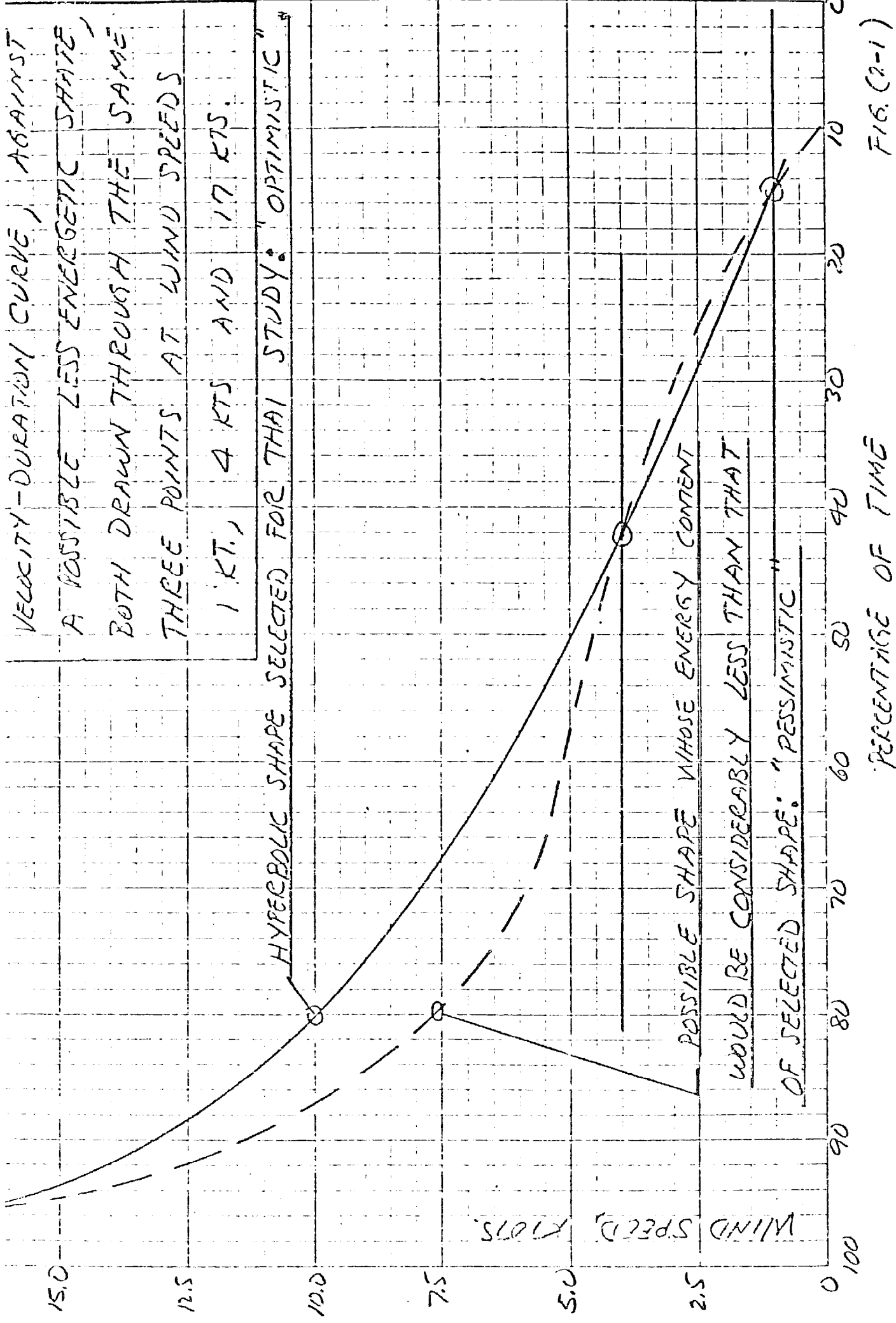

FIG. (2-1)

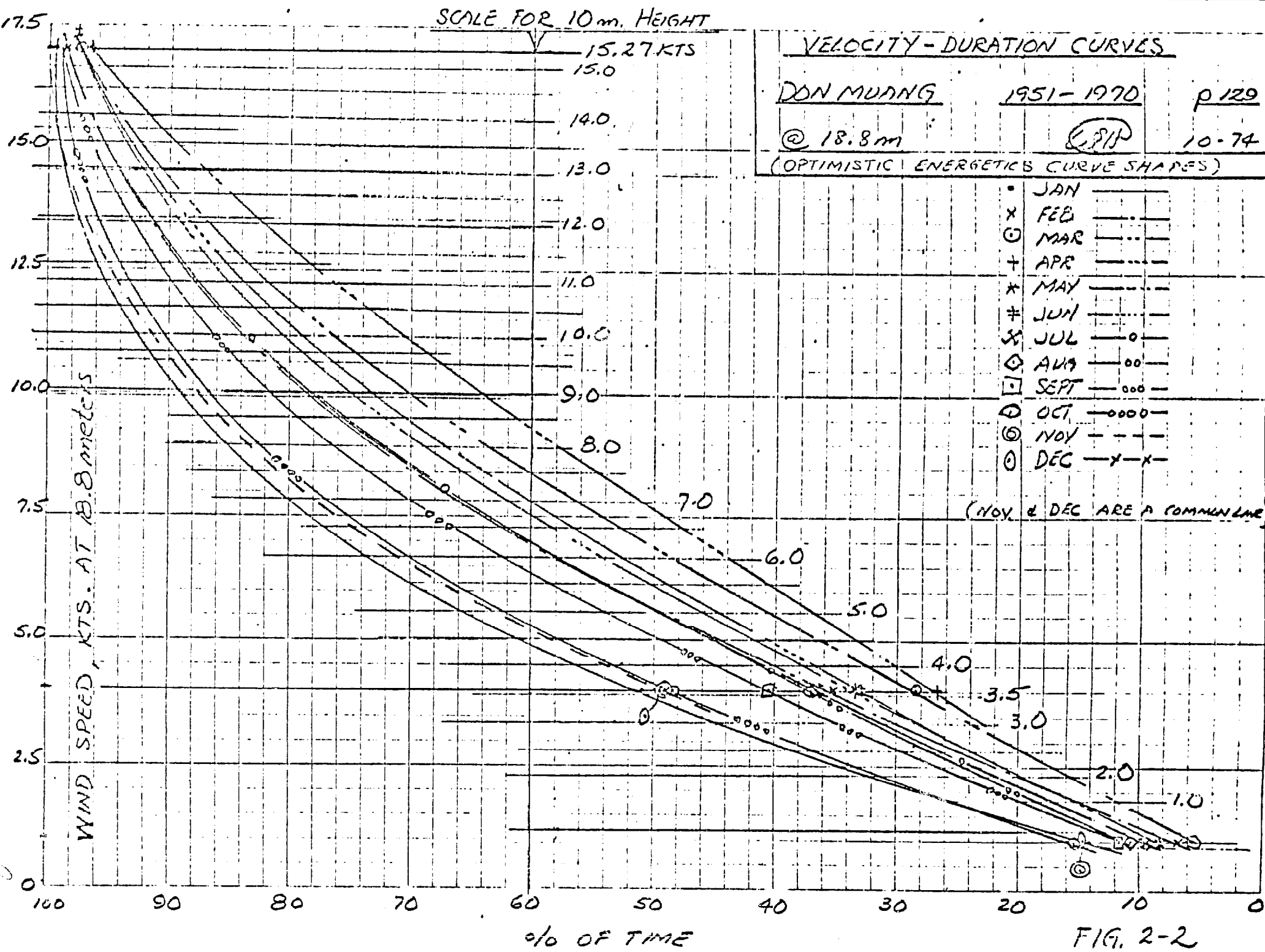

FIG. 2-2

11-74

VELOCITY-DURATION CURVES

1951-1970

DON MUANG

SCALE FOR 100 FT. GWT

175

150

125

100

75

50

25

0

10-74

@ 18.8 m.

15.0

14.0

13.0

12.0

11.0

10.0

9.0

8.0

7.0

6.0

5.0

4.0

3.5

3.0

2.0

1.0

0

(Pessimistic Energetics Curve Shapes)

JAN

FEB

MAR

APR

MAY

JUN

JUL

AUG

SEP

OCT

NOV

DEC

•

x

o

+

*

#

o

o

o

o

o

o

o

o

o

o

o

o

o

o

o

o

o

o

o

o

o

o

o

o

o

o

o

o

o

o

o

o

o

o

o

o

o

o

o

o

o

o

o

o

o

o

o

o

o

o

o

o

o

o

o

o

o

o

o

o

o

o

o

o

o

o

o

o

o

o

o

o

o

o

o

o

o

o

o

o

o

o

o

o

o

o

o

o

o

o

o

o

o

o

o

o

o

o

o

o

o

o

o

o

o

o

o

o

o

o

o

o

o

o

o

o

o

o

o

o

o

o

o

o

o

o

o

o

o

o

o

o

o

o

o

o

o

o

o

o

o

o

o

o

o

o

o

o

o

o

o

o

o

o

o

o

o

o

o

o

o

o

o

o

o

o

o

o

o

o

o

o

o

o

o

o

o

o

o

o

o

o

o

o

o

o

o

o

o

o

o

o

o

o

o

o

o

o

o

o

o

o

o

o

o

o

o

o

o

o

o

o

o

o

o

o

o

o

o

o

o

o

o

o

o

o

o

o

o

o

o

o

o

o

o

o

o

o

o

o

o

o

o

o

o

o

o

o

o

o

o

o

o

o

o

o

o

o

o

o

o

o

o

o

o

o

o

o

o

o

o

o

o

o

o

o

o

o

o

o

o

o

o

o

o

o

o

o

o

o

o

o

o

o

o

o

o

o

Appendix 3: Analysis of an Improved 6 Meter Diameter Two-Bladed Thai
Windmill Driving,

(A) A Variable-Throw Crank Thence a Reciprocating Pump of
Large Barrel Diameter

(B) A Fixed-Throw Crank Thence a Reciprocating Pump of
Moderate to Small Barrel Diameter

The 6m 2-Bladed "Thai" Windpumper

1. Look at the one-plank 2-bladed propeller driving a reciprocating pump.

$$C_p = 0.31, \frac{r}{v_0} = 6.0, \text{ and swept area} - 28.31 \text{ m}^2 = 304.5 \text{ ft}^2.$$

$$= \left(\frac{v_0}{3m}\right)(6.0)$$

(1)	(2)	(3)	(4)	(5)	(6)	(7)	(8)	(9)
v_0	v_0	v_0	Q	Q	rad/sec		Power	Permissible
kts	ms^{-1}	mph	$\frac{\text{ft lb}}{\text{ft}^2}$	ft lbs		$\frac{\text{rev}}{\text{sec}}$	$\frac{\text{ft lbs}}{\text{sec}}/\text{kW}$	Crank Arm Length
17	8.84	19.58	0.56	170.5	17.68	2.81	3014/4.10	0.372
15	7.80	17.25	0.41	124.8	15.60	2.48	1947/2.64	0.282
13	6.76	14.95	0.31	94.4	13.52	2.15	1276/1.73	0.200
11	5.72	12.65	0.22	67.0	11.44	1.82	766/1.04	0.163
9	4.68	10.35	0.18	54.8	9.36	1.49	513/0.70	0.091
7	3.64	8.05	0.10	30.4	7.28	1.16	221/0.30	0.045
5	2.60	5.75	0.05	15.2	5.20	0.83	79/0.11	0.018
3	1.56	3.45	0.02	6.1	3.12	0.50	19/0.03	
1	0.52	1.92			1.04	0.16		

2. Rate the total machine @ $V_0 = 15\text{kts}$:

$$\therefore \text{Max } Q = 124.8 \text{ lb ft}$$

$$P = 1947 \frac{\text{ft lbs}}{\text{sec}}$$

3. Assume pump works against a one meter head, $H = 3.28'$. Assume overall pump efficiency = 0.70

$$(0.70) \left(\frac{1947 \text{ ft lbs}}{\text{sec}} \right) = 3.28 \left[415 \frac{\text{lbs}}{\text{sec}} \right] = \text{water lifted per second} =$$

677 cubic meters per hour.

4. $\frac{415 \text{ lbs}}{\text{sec}}$ @ $\frac{2.48 \text{ rev}}{\text{sec}}$ means that the lbs lifted per stroke =

$$\frac{415 \text{ lbs}}{\text{sec}} \times \frac{\text{sec}}{1.24 \text{ stroke}} = \frac{335 \text{ lbs}}{\text{stroke}}$$

So, the maximum force downward on the pump will be 335 lbs. And the maximum Q available is 124.8 lb ft. \therefore The maximum crank arm may be $\frac{124.8}{335} = 0.372 \text{ feet} = \underline{4.47 \text{ inches}}$.

5. With a stroke = $(2)(0.372) = 0.744'$, and moving a volume of

$$\frac{335 \text{ lbs}}{62.4 \frac{\text{lbs}}{\text{ft}^3}} = 5.37 \text{ ft}^3 \text{ per stroke, I need a piston area} = \frac{5.37}{0.744} = 7.217 \text{ ft}^2$$

$r^2 = 2.2974$ $r = \underline{1.515 \text{ ft}}$ -- We need a pump barrel 1.6 feet radius = 3.2 feet diameter.

6. $\frac{415 \text{ lbs}}{\text{sec}} \times \frac{3600}{2.206} = \frac{677,243 \text{ kg}}{\text{hr}} = \frac{677 \text{ cubic meters}}{\text{hr}}$

7. When $v_0 = 15$ complete column (9):
permissible crank arm length = $\frac{\text{Available Q}}{335 \text{ lbs on piston}}$

8. So, if I build a 6 meter dia. "improved" 2-Blade Thai Windmill, fitted with a 3.2 foot dia. reciprocating pump, double acting, and can provide a variable crank throw mechanism that will adjust the crank to a function of wind speed, I can achieve the following pumping rates at 1.5 meter total head, and at pump efficiency = 0.70:

v_0 kts	Power Available From Wind Shaft	Pumping Power	Permissible Crank Arm Length	Water Delivery Cubic meters/hour 1.5 meter ^Ø head
5	79 ft lbs per sec	55 $\frac{\text{ft lbs}}{\text{sec}}$	0.045	18
7	221	155	0.091	51
9	513	372	0.163	123
11	766	536	0.200	177
13	1276	893	0.282	295
15	1947	1363	0.372	451

It will be shown that this pumping system is very productive in the Don Muang wind. It would appear that some backing away from the 2.3 foot diameter barrel, a somewhat longer stroke, and a lower axis height could be injected, and one would still have an adequately productive system at lower cost.

9. The Fixed Throw Reciprocating Pump

Now take a different approach. Assume the 6m 2-bladed has a $\beta_0 = 3^\circ$, and that it drives a crank of fixed length which oscillates a piston pump of fixed size. Select a design point at $v_0 = 7$ kts, for instance:

$$\text{@ } v_0 = 7 \text{ kts, } Q \text{ available} = \underline{30.4 \text{ ft lbs}}$$

$$= 7.28, \text{ Power} = 221 \frac{\text{lb ft}}{\text{sec}} = 0.30 \text{ kW}$$

$$\text{overall pump efficiency} = 0.70, H = 3.28.$$

$$(9.70)(221) = (3.28)[47 \frac{\text{lbs}}{\text{sec}}] = \frac{\text{water lifted}}{\text{sec}}$$

$$= \frac{1.16 \text{ rev}}{\text{sec}} = \frac{2.32 \text{ strokes}}{\text{sec}}$$

$$\therefore \text{ water lifted per stroke} = \frac{47 \text{ lbs}}{\text{sec}} \times \frac{\text{sec}}{2.32 \text{ strokes}} = 20.25 \frac{\text{lbs}}{\text{stroke}}$$

$$\frac{30.4 \text{ ft lbs}}{20.25 \text{ lbs}} \text{ would allow me to have a crank arm of 1.50 feet!}$$

With a crank arm of 1.50 feet, stroke = 3.00 ft

$$\frac{20.25 \text{ lbs}}{62.4 \text{ lbs/ft}^3} = 0.324 \text{ ft}^3 \quad \frac{0.325 \text{ ft}^3}{3.00 \text{ ft}} = 0.108 \text{ ft}^2$$

$$r^2 = 0.034 \quad r = 0.185 \text{ ft} = 2.22 \text{ inches} \quad \underline{\text{dia} = 4.44 \text{ inches!}}$$

$$\left(\frac{47 \text{ lbs}}{\text{sec}}\right) \left(\frac{3600}{2.206}\right) = 76,700 \frac{\text{kg}}{\text{hr}} = \frac{76.7 \text{ cubic meters}}{\text{hr}}$$

What will happen to this pump when V_0 increases beyond 7 kts? Q available will exceed that required and pump will speed up -- as it speeds up, tip speed ratio will go beyond 6, C_p will fall off, until speed is such that power available is again equal to power dissipated.

Assume V_0 moves to 9 kts. Ideal power would move to $513 \frac{\text{ft lbs}}{\text{sec}}$, and mill should come to steady state @ $1.49 \frac{\text{rev}}{\text{sec}}$. @ $\frac{1.49 \text{ rev}}{\text{sec}}$, = $2.98 \frac{\text{strokes}}{\text{sec}}$, pump

$$\text{will move } \left(\frac{20.25 \text{ lbs}}{\text{stroke}}\right) \left(\frac{2.98 \text{ strokes}}{\text{sec}}\right) = \frac{60.345 \text{ lbs}}{\text{sec}}$$

$$(60.345)(3.28) = 197.9 \text{ ft lbs/sec}$$

Pump will speed up attempting to make enough strokes per sec to about 513 ft lbs sec.

$$\frac{513}{3.28} = 156 = (20.25) \left(\frac{n \text{ strokes}}{\text{sec}}\right) \quad n = 7.72 \text{ strokes/sec}$$

$$\text{rps} = 15.44 \frac{\text{rev}}{\text{sec}} = \frac{97.07 \text{ rad}}{\text{sec}}$$

$$f = 291 \quad \frac{\Omega r}{9 \text{ kts}} = \frac{291}{4.68} = 62$$

$$\text{but } c_p \text{ will have reached } 0.05 @ \frac{\Omega r}{9} = 9.5$$

so n will certainly not go that high -- in fact the new c_p will be

$$\left(\frac{197.9}{513}\right)(0.31) = 0.12 \text{ which means } \frac{\Omega r}{V_0} \text{ will reach } 9.0$$

$$\therefore = \frac{(9)(4.68)}{3} = 14.04; \quad = 2.23 \text{ rps}$$

$$@ 2.23 \text{ rps, this pump will produce } \left(\frac{20.25 \text{ lbs}}{\text{stroke}}\right) \left(\frac{4.46 \text{ strokes}}{\text{sec}}\right) = \frac{90.3 \text{ lbs}}{\text{sec}}$$

Let $V_0 = 11 \text{ kts}$. New c_p will have to be $\left(\frac{197.9}{766}\right)(0.31) = 0.80$ -- new tip speed ratio will be 9.2 $= 2.29 \text{ rps}$.

and productivity would be $92.32 \frac{\text{lbs}}{\text{sec}}$

Let $V_0 = 15 \text{ kts}$: new $c_p = \left(\frac{197.9}{1947}\right)(0.31) = 0.03$ -- new $\frac{\Omega r}{V_0} = 9.6, \Rightarrow 2.39 \text{ rps}$

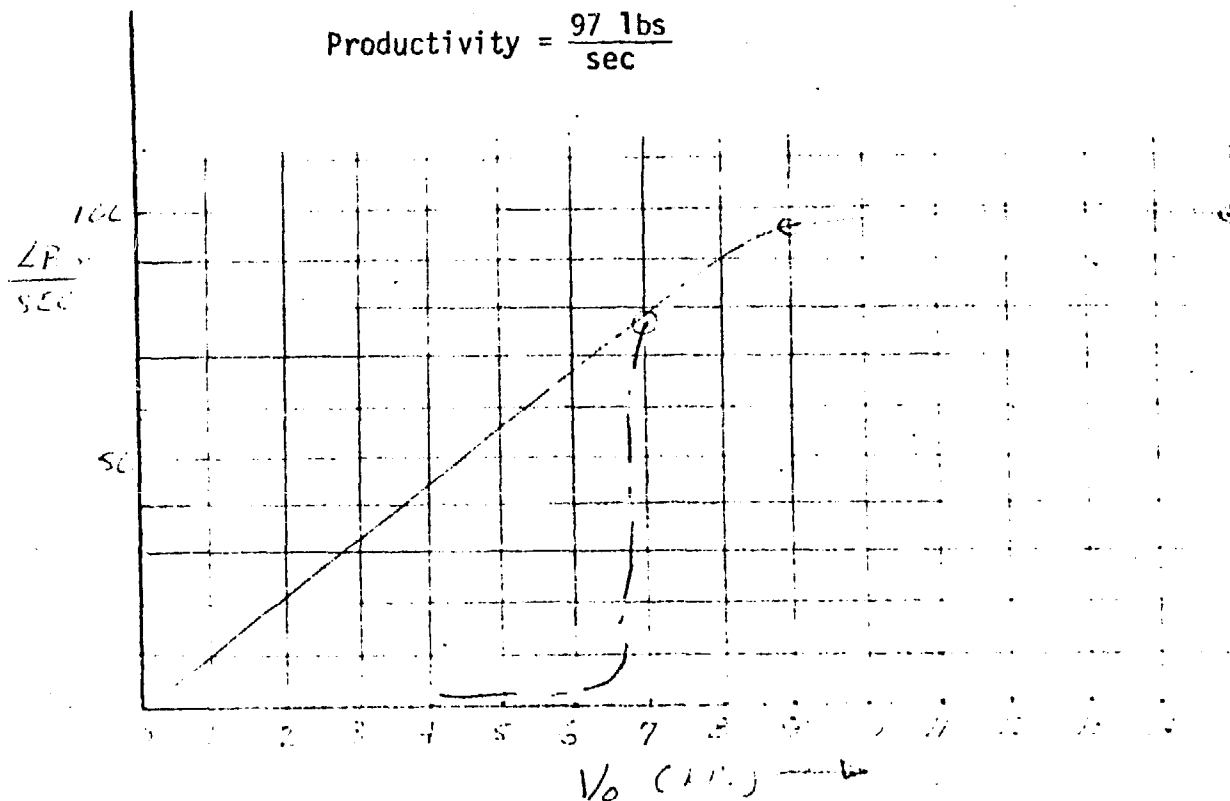

What happens at wind speeds less than 7 kts? Pump is stalled!

10. Bring this design way back -- to say, a pumper rated at $V_0 = \underline{3 \text{ kts}}$ -- assuming that blade will allow it to start in a 3 kt breeze --

$$Q = \underline{6.1 \text{ lb ft}} \quad \text{and power} = \frac{19 \text{ lb ft}}{\text{sec}} = 3.12 \frac{\text{rad}}{\text{sec}} \quad h = 3.28$$

$$\frac{(0.70)(19)}{3.28} = \frac{4.05 \text{ lbs}}{\text{sec}}$$

$$\text{@ } 0.50 \frac{\text{rev}}{\text{sec}} = \frac{1 \text{ stroke}}{\text{sec}}$$

$$\text{weight per stroke} = \underline{4.05 \text{ lbs}}$$

$$\frac{6.1 \text{ lb ft}}{4.05 \text{ lbs}} \text{ permits a crank arm of } \underline{1.506 \text{ feet}} = 3.00 \text{ ft stroke}$$

$$\frac{4.05 \text{ lbs}}{62.4 \text{ lb/ft}^3} = 0.0649 \text{ ft}^3 \quad A = 0.0216 \text{ ft}^2 = \pi r^2$$

$$r^2 = 0.00688 \quad r = 0.08'$$

For a machine rated at 3 kts

V_0	new C_p	new μ	new Ω	new ω	<u>strokes</u> sec	Productivity lbs/sec	m^3/hr	
3	0.31	6.0	3.12	0.50	1.0	4.05	6.6	
5	(19/79)	.074	9.1	7.89	1.26	2.52	10.2	16.6
7	(19/221)	.027	9.5	11.52	1.84	3.67	14.9	24.3
9	(19/513)	.011	9.6	14.98	2.38	4.77	19.3	31.5
11	(19/766)	.007	9.8	18.49	2.94	5.88	23.8	38.8
13	(19/1276)		9.8	22.08	3.51	7.02	28.4	46.3
15			9.9				33.1	54.0

But this pump will probably not cut-in until wind speed is 5 knots, even though it has been rated at 3 knot wind speed. With this kind of a pumper, I would like to assess the monthly yield at Khon Kaen, for example

10-9 KHON KAENG 3-9 SYSDY

10 months, over

No	2	incl.	HRS.	Form	100%	%	5	incl	Hrs	100%	100%
1	0.5	7.44	3.72	3.0	150	—	1	6.72	572	25.8	311
2	1.0	7.44	7.44	25.4	345	100	1	6.72	672	25.8	311
3	2.5	18.6	18.6	50.3	710	97	2	13.44	238	522	
4	5.0	37.2	37.2	100.3	1172	92	5	33.60	19.3	1238	
5	7.5	55.8	55.8	149.9	1221	85	7	47.04	14.9	1144	
6	12	89.3	89.3	230.2	1316	73	12	80.7	10.2	1343	
7	19	141	141	375	1452	54	19	121	10.2	1343	
8	—	7.44	—	—	—	100	—	7.20	—	—	
9	1	7.44	7.44	20.9	238	100	2	14.4	25.8	—	
10	3	22.3	22.3	63.8	816	98	2	14.4	25.8	—	
11	5	37.2	37.2	105	1172	90	6	43.2	10.3	1144	
12	5	37.2	37.2	105	1172	90	6	43.2	10.3	1144	
13	5	37.2	37.2	105	1172	90	6	43.2	10.3	1144	
14	5	37.2	37.2	105	1172	90	6	43.2	10.3	1144	
15	5	37.2	37.2	105	1172	90	6	43.2	10.3	1144	
16	5	37.2	37.2	105	1172	90	6	43.2	10.3	1144	
17	5	37.2	37.2	105	1172	90	6	43.2	10.3	1144	
18	5	37.2	37.2	105	1172	90	6	43.2	10.3	1144	
19	5	37.2	37.2	105	1172	90	6	43.2	10.3	1144	
20	5	37.2	37.2	105	1172	90	6	43.2	10.3	1144	
21	5	37.2	37.2	105	1172	90	6	43.2	10.3	1144	
22	5	37.2	37.2	105	1172	90	6	43.2	10.3	1144	
23	5	37.2	37.2	105	1172	90	6	43.2	10.3	1144	
24	5	37.2	37.2	105	1172	90	6	43.2	10.3	1144	
25	5	37.2	37.2	105	1172	90	6	43.2	10.3	1144	
26	5	37.2	37.2	105	1172	90	6	43.2	10.3	1144	
27	5	37.2	37.2	105	1172	90	6	43.2	10.3	1144	
28	5	37.2	37.2	105	1172	90	6	43.2	10.3	1144	
29	5	37.2	37.2	105	1172	90	6	43.2	10.3	1144	
30	5	37.2	37.2	105	1172	90	6	43.2	10.3	1144	
31	5	37.2	37.2	105	1172	90	6	43.2	10.3	1144	
32	5	37.2	37.2	105	1172	90	6	43.2	10.3	1144	
33	5	37.2	37.2	105	1172	90	6	43.2	10.3	1144	
34	5	37.2	37.2	105	1172	90	6	43.2	10.3	1144	
35	5	37.2	37.2	105	1172	90	6	43.2	10.3	1144	
36	5	37.2	37.2	105	1172	90	6	43.2	10.3	1144	
37	5	37.2	37.2	105	1172	90	6	43.2	10.3	1144	
38	5	37.2	37.2	105	1172	90	6	43.2	10.3	1144	
39	5	37.2	37.2	105	1172	90	6	43.2	10.3	1144	
40	5	37.2	37.2	105	1172	90	6	43.2	10.3	1144	
41	5	37.2	37.2	105	1172	90	6	43.2	10.3	1144	
42	5	37.2	37.2	105	1172	90	6	43.2	10.3	1144	
43	5	37.2	37.2	105	1172	90	6	43.2	10.3	1144	
44	5	37.2	37.2	105	1172	90	6	43.2	10.3	1144	
45	5	37.2	37.2	105	1172	90	6	43.2	10.3	1144	
46	5	37.2	37.2	105	1172	90	6	43.2	10.3	1144	
47	5	37.2	37.2	105	1172	90	6	43.2	10.3	1144	
48	5	37.2	37.2	105	1172	90	6	43.2	10.3	1144	
49	5	37.2	37.2	105	1172	90	6	43.2	10.3	1144	
50	5	37.2	37.2	105	1172	90	6	43.2	10.3	1144	
51	5	37.2	37.2	105	1172	90	6	43.2	10.3	1144	
52	5	37.2	37.2	105	1172	90	6	43.2	10.3	1144	
53	5	37.2	37.2	105	1172	90	6	43.2	10.3	1144	
54	5	37.2	37.2	105	1172	90	6	43.2	10.3	1144	
55	5	37.2	37.2	105	1172	90	6	43.2	10.3	1144	
56	5	37.2	37.2	105	1172	90	6	43.2	10.3	1144	
57	5	37.2	37.2	105	1172	90	6	43.2	10.3	1144	
58	5	37.2	37.2	105	1172	90	6	43.2	10.3	1144	
59	5	37.2	37.2	105	1172	90	6	43.2	10.3	1144	
60	5	37.2	37.2	105	1172	90	6	43.2	10.3	1144	
61	5	37.2	37.2	105	1172	90	6	43.2	10.3	1144	
62	5	37.2	37.2	105	1172	90	6	43.2	10.3	1144	
63	5	37.2	37.2	105	1172	90	6	43.2	10.3	1144	
64	5	37.2	37.2	105	1172	90	6	43.2	10.3	1144	
65	5	37.2	37.2	105	1172	90	6	43.2	10.3	1144	
66	5	37.2	37.2	105	1172	90	6	43.2	10.3	1144	
67	5	37.2	37.2	105	1172	90	6	43.2	10.3	1144	
68	5	37.2	37.2	105	1172	90	6	43.2	10.3	1144	
69	5	37.2	37.2	105	1172	90	6	43.2	10.3	1144	
70	5	37.2	37.2	105	1172	90	6	43.2	10.3	1144	
71	5	37.2	37.2	105	1172	90	6	43.2	10.3	1144	
72	5	37.2	37.2	105	1172	90	6	43.2	10.3	1144	
73	5	37.2	37.2	105	1172	90	6	43.2	10.3	1144	
74	5	37.2	37.2	105	1172	90	6	43.2	10.3	1144	
75	5	37.2	37.2	105	1172	90	6	43.2	10.3	1144	
76	5	37.2	37.2	105	1172	90	6	43.2	10.3	1144	
77	5	37.2	37.2	105	1172	90	6	43.2	10.3	1144	
78	5	37.2	37.2	105	1172	90	6	43.2	10.3	1144	
79	5	37.2	37.2	105	1172	90	6	43.2	10.3	1144	
80	5	37.2	37.2	105	1172	90	6	43.2	10.3	1144	
81	5	37.2	37.2	105	1172	90	6	43.2	10.3	1144	
82	5	37.2	37.2	105	1172	90	6	43.2	10.3	1144	
83	5	37.2	37.2	105	1172	90	6	43.2	10.3	1144	
84	5	37.2	37.2	105	1172	90	6	43.2	10.3	1144	
85	5	37.2	37.2	105	1172	90	6	43.2	10.3	1144	
86	5	37.2	37.2	105	1172	90	6	43.2	10.3	1144	
87	5	37.2	37.2	105	1172	90	6	43.2	10.3	1144	
88	5	37.2	37.2	105	1172	90	6	43.2	10.3	1144	
89	5	37.2	37.2	105	1172	90	6	43.2	10.3	1144	
90	5	37.2	37.2	105	1172	90	6	43.2	10.3	1144	
91	5	37.2	37.2	105	1172	90	6	43.2	10.3	1144	
92	5	37.2	37.2	105	1172	90	6	43.2	10.3	1144	
93	5	37.2	37.2	105	1172	90	6	43.2	10.3	1144	
94	5	37.2	37.2	105	1172	90	6	43.2	10.3	1144	
95	5	37.2	37.2	105	1172	90	6	43.2	10.3	1144	
96	5	37.2	37.2	105	1172	90	6	43.2	10.3	1144	
97	5	37.2	37.2	105	1172	90	6	43.2	10.3	1144	
98	5	37.2	37.2	105	1172	90	6	43.2	10.3	1144	
99	5	37.2	37.2	105	1172	90	6	43.2	10.3	1144	
100	5	37.2	37.2	105	1172	90	6	43.2	10.3	1144	

JAN

2000

1500

905

1221

57

22

372

802

1238

1238

1238

SITE KHON KHEN

SYSTEM 3-10 6m 20A 37.3 3KT. RECIP AXIS HEIGHT 10M
 HEAD 1m

MONTH	V ₀ (KTS)	% TIME	Z	INCR	HRS	RATE	Q ₃	Z	INCR	HRS	RATE	Q ₃	MONTH
MONTH JUNE	16	—		7.44				—	7.00				MONTH JUNE
	15	—											
	14	100											
	13		2		14.88	28.4	690	2		14.4	28.4	687	
	12	98											
	11		3		22.3	23.8	803	3		21.6	23.8	839	
	10	95											
	9		5		37	19.3	1165	7		50.4	19.3	1587	
	8	90											
	7		9		67	14.9	1629	9		72.2	14.9	1794	
	6	81											
	5		13		97	10.2	1615	14		101	10.2	1611	
	4	68											
2		20		149	4.05	915	23		166	4.05	1011		
	48			377		6930	44		427		7611		
MONTH JULY	16	100		7.44				—	7.00				MONTH JULY
	15		1		7.44	30	364				30		
	14	99											
	13		2		14.88	28.4	690	1		7.00	28.4	345	
	12	97											
	11		3		22.3	23.8	807	3		22	23.8	854	
	10	94											
	9		7		52	19.3	1622	6		43	19.3	1477	
	8	87											
	7		9		67	14.9	1671	11		52	14.9	1614	
	6	78											
	5		14		104	10.2	1731	12		57	10.2	1615	
	4	64											
3		23		171	4.05	1130	22		70	4.05	1014		
2	41			436		8471	46		477		7511		

SITE KHON KHEM

3-11 SYSTEM (2000000 30% 317. RECIP. AXIS HEIGHT 10000)
HEAD 1000

V ₀ (KIS)	% TIME	Z	INCR	HRS	RATE	Q ₃	% TIME	Z	INCR	HRS	RATE	Q ₃
16			7.20						7.44			
15							100					
14												
13								2		14.88	28.4	690
12	100						95					
11		1		7.2	23.8	280		2		10.55	33.8	572
10	99						96					
9		4		28.8	19.3	907		6		45	19.3	1406
8	95						90					
7		6		43.2	14.9	1050		9		67	14.9	1328
6	89						81					
5		11		79	10.2	1315		10		70	10.2	1218
4	73						71					
		18		130	4.05	859		21		156	4.05	1000
2	50			288		4411	50			342		6573
16			7.20						7.44			
15												
14	100						100					
13		3		22	28.4	1001		2		15	28.4	690
12	71						97					
11		3		22	23.8	839		3		22	23.8	577
10	94						95					
9		7		50	19.3	1557		6		45	19.3	1406
8	87						89					
7		9		45	14.9	1576		9		67	14.9	1328
6	78						80					
5		13		74	10.2	1551		11		82	10.2	1322
4	65						77					
3		19		137	4.05	900		12		134	4.05	1000
2	46			340		7700	51			342		6573

MONTH DC7

MONTH DC

Summary of predicted performance of the 6m, 2-blade, 3°₀, 5KT, Reciprocating Pump, 10m axis height @ Khon Kaen:

Water pumped against a Head of one meter:

Nov.	7465				
Dec.	6839	Usual			
Jan.	6196	181	=	38,404 cubic meters	
Feb.	5222	day			
Mar.	6209	"dry season"	$\frac{38,404}{(181)(109)}$	=	$\frac{1.95 \text{ hectares}}{12.65 \text{ rai}}$
Apr.	6473				
May	6950				
June	7662	usual			
July	8049	185			
Aug.	7309	"Rainy			
Sept.	4411	Season"			
Oct.	6573				

For this pumper during the dry season: If the water table were to vary from 1 meter to 3 meters, i.e., Head = 2 meter average, the pumper would be able to irrigate only 1/2 of the 12.65 rai = 6.325 rai. So, this pumper may be marginal -- but it is certainly the most simple and least expensive.

The predicted performance characteristics of this two-bladed machine were calculated by Forrest Stoddard, a doctoral candidate at U.Mass., using a strip theory developed and programmed by him for the UMass Computer System. Those characteristics are given in Figure 3.1 and 3.2. They show that this very simple windmill blade, carved from one rather thin plank, could be quite effective when running. Its major drawback is its inability to self-start. If that problem could be solved by using additional paddle blades, a la Lubing, and if the variable throw crank mechanism can be developed as a reasonably priced hardware item, the two-bladed mill driving a reciprocating pump would be a very cost effective irrigation device.

C_p vs.- tip speed ratio for various constant values
of root pitch
2-bladed design
 $V_0 = 10$ MPH
constant chord, untwisted blades
 $\beta_0 = 3^\circ, 5^\circ, 7^\circ, 9^\circ, 11^\circ, 13^\circ$

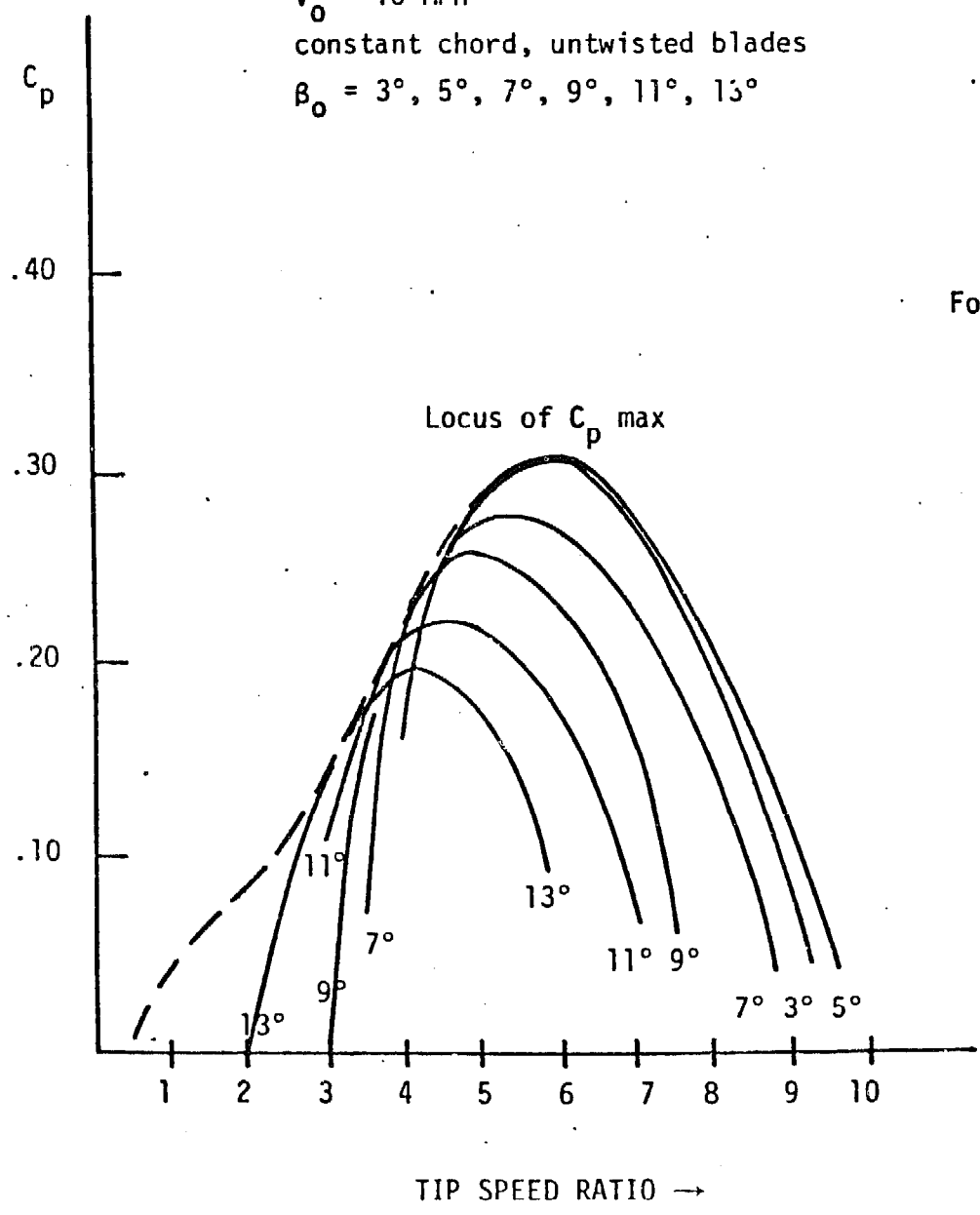

Forrest Stoddard
10-74

Fig. 3-1

Thrust and root bending moment vs. tip speed ratio for
windspeed = 10 MPH
2-bladed Thai windmill

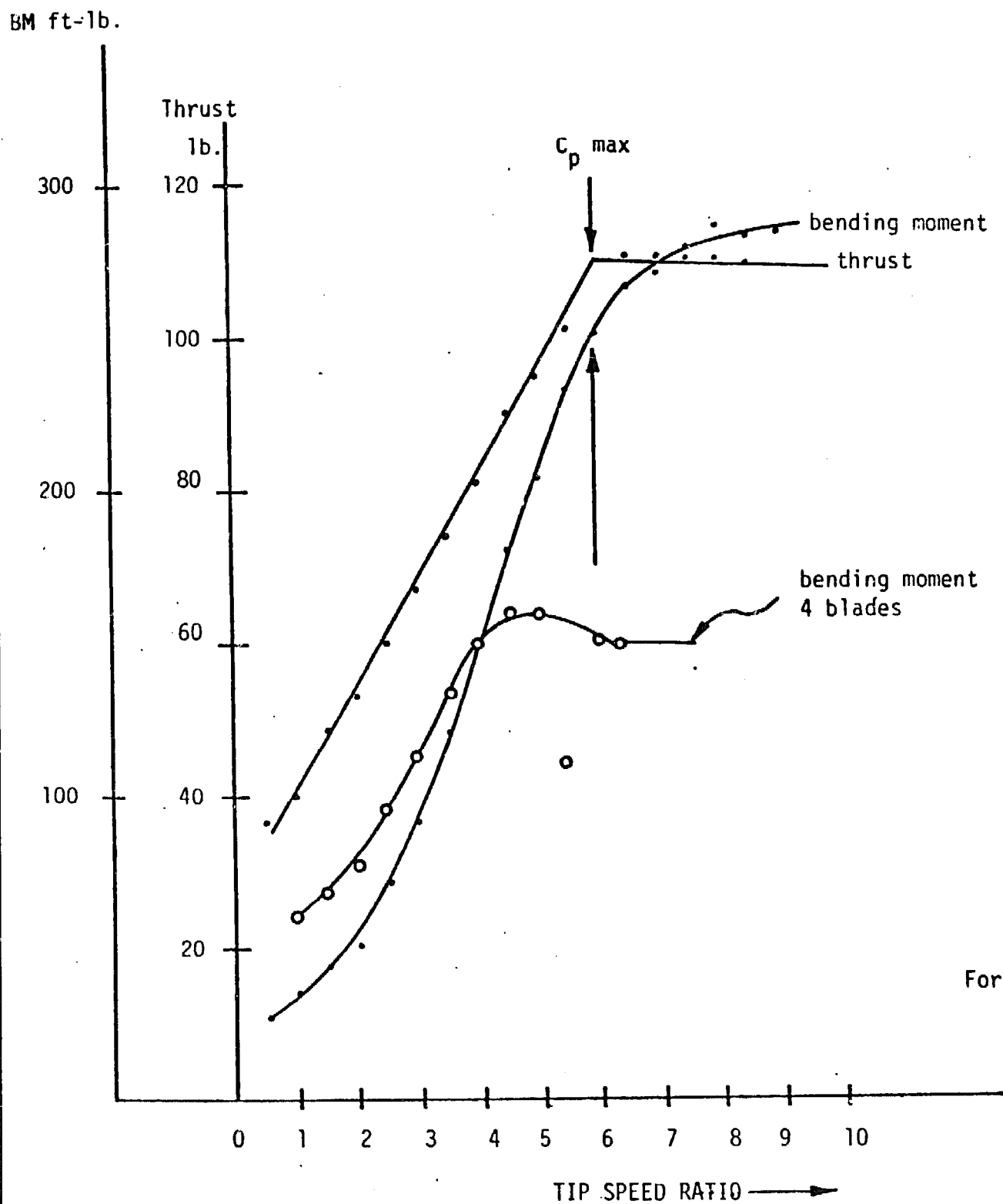

Forrest Stoddard
10-74

Fig. 3-2

Appendix 4: Analysis of Wood Construction Fan Mill Irrigation Pumps
Using Reciprocating Pumps

1. From the analyses of the winds in Thailand it appears that a carefully designed American Fan Mill type of windmill, one that would respond to winds of velocities as low as two or three knots, could be a good design. It will be difficult to compete against the very low cost of an improved Thai 2-bladed windpumper, but it is thought that an excellent fan mill could be built of wood. The fan mill certainly has a much better chance of being self-starting than does an improved 2-Bladed mill, so the competition when based on cost per unit of delivered water might go to a more expensive fan mill with greater productivity in low speed winds.
2. The analysis starts from the work of Forrest Stoddard who calculated the torque available in foot pounds per unit of swept area, the predicted speed of rotation and thus the expected wind shaft power, all as functions of wind speed, V_0 . Those data are given in the left portion of Table (4.1) which follows. The assumed design point and historical and calculated characteristics for fan mills are given in Fig. (4-1).
3. Rate the 6 meter variable throw fan mill pump at 15 knots.

The Maximum Torque available = $(2.65)(299) = \underline{792 \text{ lb ft}}$ with the pump working against a 1.5 meter head (4.875 feet), and at an assumed pump efficiency of 70%,

$$(0.70)(2060 \frac{\text{ft lbs}}{\text{sec}}) = (4.875 \text{ feet}) [296 \frac{\text{lbs}}{\text{sec}}]$$

So, 296 lbs of water will be lifted per second = 483 cubic meters of water per hour.

$$[\frac{296 \text{ lbs}}{\text{second}}] \cdot [\frac{\text{sec}}{0.828 \text{ stroke}}] = \frac{357 \text{ lbs}}{\text{stroke}}$$

The Q available at 15 kts = 792 lb ft. Therefore, a crank throw of $\frac{792}{357} =$

Table (4.1)

(1) V_o KTS	(2) V_o MS ⁻¹	(3) V_o mph	(4) Torque per unit area: ft lbs/ft ²	(5) Ω	(6) Rev per Sec.	(7) Wind Shaft Power ft lbs/KW sec	(8) Crank Throw for Maximum Productivity	(9) Delivery at $\eta=70\%$ m ³ /hr.	(10) Wind Shaft Power ft lbs/KW sec	(11) Crank Throw for Maximum Productivity	(12) Delivery at $\eta=70\%$ m ³ /hr.	(13) Ω /Rev per Sec	
1	0.52	1.92	0.05	0.17	.028	3/.003	0.04'=1.27cm	0.7	1.69/.002	1.06'=2cm	0.4	0.25/.042	
3	1.56	3.45	0.13	0.52	.083	20/.03	0.11'=3.31cm	4.7	13.45/.018	0.16 =5cm	3.1	0.78/0.12	
5	2.60	5.75	0.31	0.87	.138	81/.11	0.26'=7.91cm	19	54/.07	0.39=12cm	12.6	1.30/0.207	
7	3.64	8.05	0.60	1.21	.193	217/0.30	0.50'=15.32cm	51	144/.20	0.75=23cm	34	1.81/0.29	
9	4.68	10.35	0.95	1.56	.248	443/0.60	0.80'=24.25cm	104	295/0.40	1.19=36cm	69	2.34/0.37	
11	5.72	12.65	1.40	1.91	.303	799/1.02	1.17'=35.73cm	187	532/0.72	1.75=53cm	124	2.86/0.45	
13	6.76	14.95	2.00	2.25	.359	1345/1.83	1.68'=51.05cm	315	895/1.22	2.50=75cm	209	3.38/0.54	
15	7.80	17.25	2.65	2.60	.414	2060/2.80	2.21'=67.64cm	483	1371/1.86	3.32=101cm	321	3.90/0.62	
17	8.84	19.58	3.55	2.95	.469	3131/4.25	2.97'=90.62cm	734	2084/2.83	4.44=135cm	487	4.42/0.70	
				For a 6m Diameter: tip speed ratio=1.0		For a 6-meter Diameter Fan, 30 blades, variable throw, at 1.5 meter total head			For a 4-meter Diameter Fan, 16 blades, variable throw, at 1.5 meter total head, tip speed ratio = 1.0.				

2.21 feet could be used. And one pump stroke would be 4.42 feet long.
357 lbs per stroke = 5.72 cubic feet per stroke.

$$\frac{5.72 \text{ ft}^3}{4.42 \text{ ft}} = \underline{1.294} = \text{the required net cross sectional area of the}$$

piston. Assuming a circular piston, and allowing for the piston rod, a piston radius of 8.11 inches = 20.6 cm.

So, the pump can be described, first approximation, as a double acting reciprocating pump of 70 percent overall efficiency,

- a) effective stroke = 4.42 feet = 135 cm
- b) bore diameter = 42 cm
- c) weight of water over piston
at start of upward stroke = 162 kg

4. To keep this pump from stalling, as the wind speed reduces, the crank arm must be made smaller so that the available torque equals a full weight of water over piston at start of upward stroke times the crank throw. This is the essence of "the variable throw" or varying crank arm concept. Column (8) in Table (4.1) is now filled out from the expression:

$$\text{Column (8)} = \frac{(299)(\text{column (4)})}{357} = (0.8375)((4)).$$

5. The 30 blade 6 meter dia. fan mill as described above would be pumping water in a 3 knot breeze at the rate of 4.7 cubic meters per hour, which if sustained would provide for rice culture on 6.7 rai of land. When the much greater productivities at higher wind speeds are taken advantage of by increasing pump stroke as the wind freshens, the number of rai that could be irrigated rises dramatically. The key to that augmentation lies in the design of a control device that can be built in Thailand of indigenous materials and at a reasonable cost. It is thought that such a

device could be constructed following the general principles of the old Fitchburg Engine Governor, and other mechanisms which can be called "variable throw crank mechanisms."

6. A Smaller Diameter Fan Mill Driving a Variable Throw Reciprocating Pump.

Examine a 4-meter diameter pump of the fan mill type. At 15 knots windspeed, the fan mill should have a maximum torque available, $Q = 528 \text{ lb ft.}$ Rate this smaller pump at 15 kts. With the pump working against a 1.5 meter head (4.875 feet) and at an assumed overall pump efficiency of 70%,

$$(0.70)(1371 \frac{\text{ft lbs}}{\text{sec}}) = (4.875 \text{ feet})[197 \frac{\text{lb}}{\text{sec}}]$$

$$\frac{197 \text{ lbs}}{\text{sec}} = 321 \text{ cubic meters per hour delivery rate}$$

$$[\frac{197 \text{ lbs}}{\text{sec}}][\frac{\text{sec}}{1.24 \text{ stroke}}] = 159 \frac{\text{lbs}}{\text{stroke}}$$

The Q available at 15 kts = 528 lbs ft. Therefore, a crank throw of $\frac{528}{159} = 3.32$ feet could be used. One pump stroke would then be 6.64 feet. 159 lbs per stroke = 2.54 cubic feet per stroke.

$\frac{2.54}{6.64} = 0.383$, the required net piston area in square feet. Allowing for the piston rod, a circular piston of 4.42 inches is required = 11.2 cm radius.

So, this pump can be described, first approximation, as a double acting reciprocating pump of 70 percent overall efficiency,

- | | |
|---|-----------------|
| a) effective stroke = 6.64 feet = | <u>202 cm</u> |
| b) pump bore diameter = | <u>22.4 cm</u> |
| c) weight of water on top of piston at start of upward stroke = | <u>72.07 kg</u> |

7. To keep this pump from stalling as the wind speed reduces, the crank arm must be reduced so that a full weight of water on top of the piston at the start of an upward stroke times that crank arm will not exceed the torque available. Column (11) in Table (41) shows how the crank arm must be varied as a function of wind speed. $\text{Column (11)} = \frac{(199)(\text{Column (4)})}{159}$
8. The first approximations of two different variable throw reciprocating pump fan mill type wind pumps are given above. The desired design lies somewhere in between. It is probable that the better pump would be "rated" at a wind speed considerably lower than that of 16 knots, and that the variable throw crank would not be expected to cover the full range of wind speeds. In fact, providing for a crank of 4.44 foot throw astern of a 13 foot diameter fan is probably not practical. So, the design would probably be a hermaphrodite between the variable throw and the fixed throw concept, with variable throw available at the lower wind-speeds to keep the pump from stalling out because a piston and stroke matching higher wind speeds had been fitted. Then, above the middle range of wind speeds, the variable throw crank would reach the limit of its stroke (say, for example, a 1.5 foot stroke, maximum stroke), and from there on the pumper would respond to increased wind speeds by trying to run away. As it speeded up, however, under its inadequate load, it will soon reach a tip speed ratio where the coefficient of performance has fallen off so that the power ability of the mill equates to the power demand of the pump. Equilibrium is established. The shape of the Fan Mill characteristic, C_p vs $\frac{\Omega R}{V_0}$, Fig. (4-1) on page App. 4-7 shows how steep the backside of that curve is, and how quickly equilibrium will be found.

The next order of business is examination of such hermaphrodite pumps.

9. Three different views of a 6 m diameter 30 blade fan mill, wood construction, are given in the three figures which follow, Figures (4-2), (4-3) and (4-4). The fan mill is conceived as a wheel-wright's product, a wheel of 30 spokes, into each of which a molded plywood blade is inserted and pinned. The sketches show a 4-foot diameter cylindrical box on the aft end of the windshaft. Some preliminary sketching and calculating produced a good start on that "variable throw crank mechanism" within such a box. Time has not been adequate, however, to bring the design to presentable form.

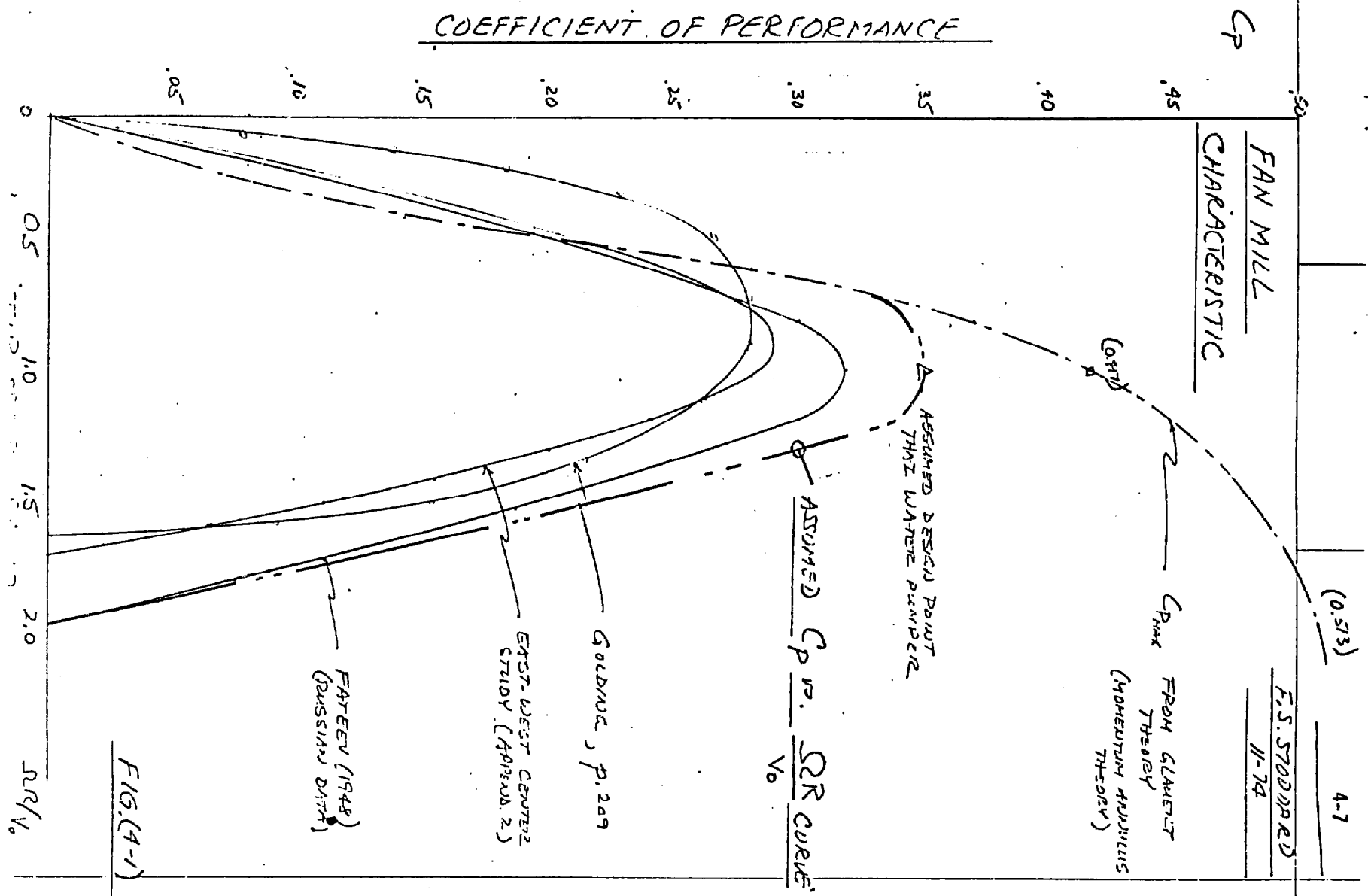

30 BLADE 6 METER DIA. FAN MILL
PROFILE

scale - 1/2" = 1 foot -- WEH -- 11/74

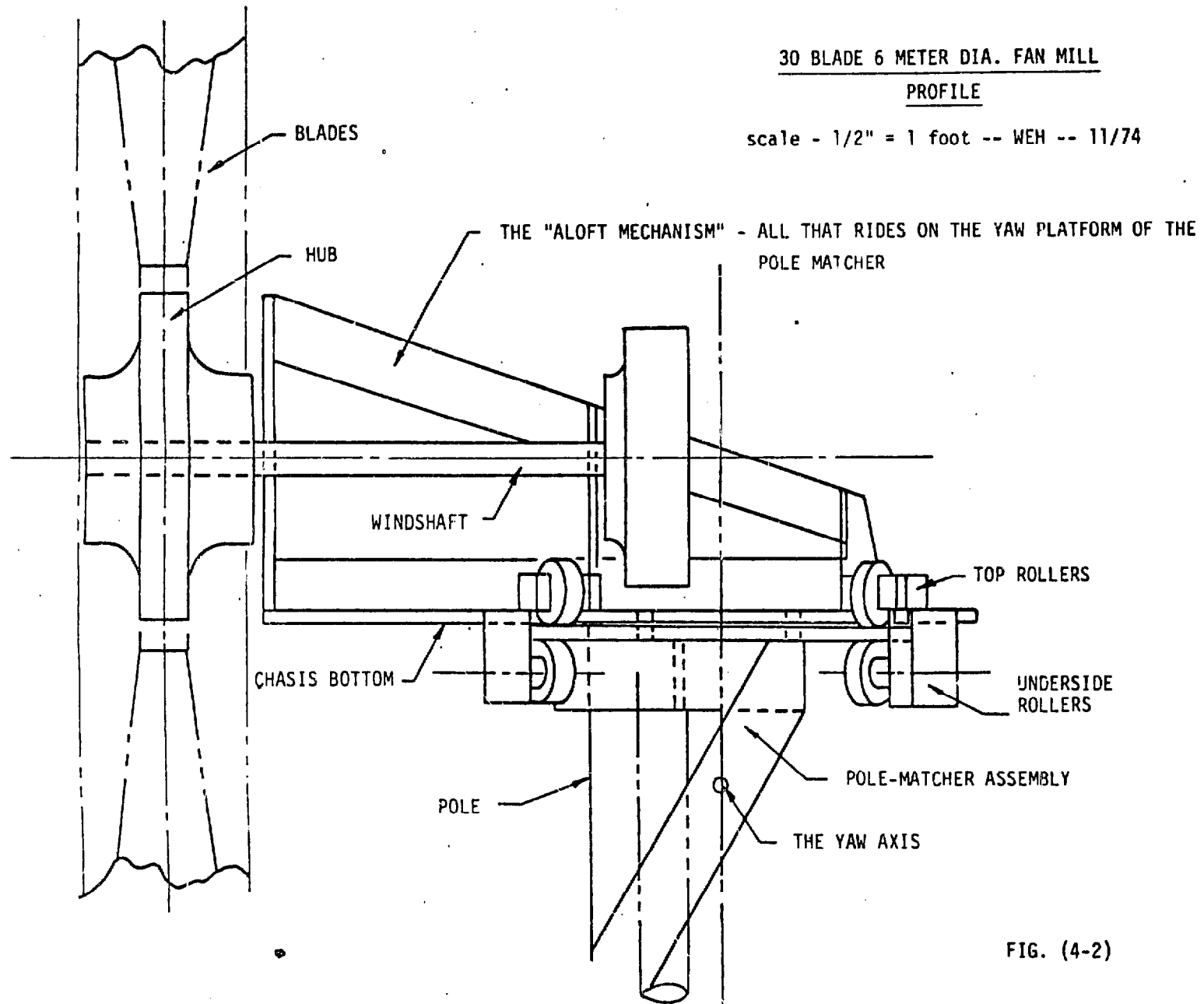
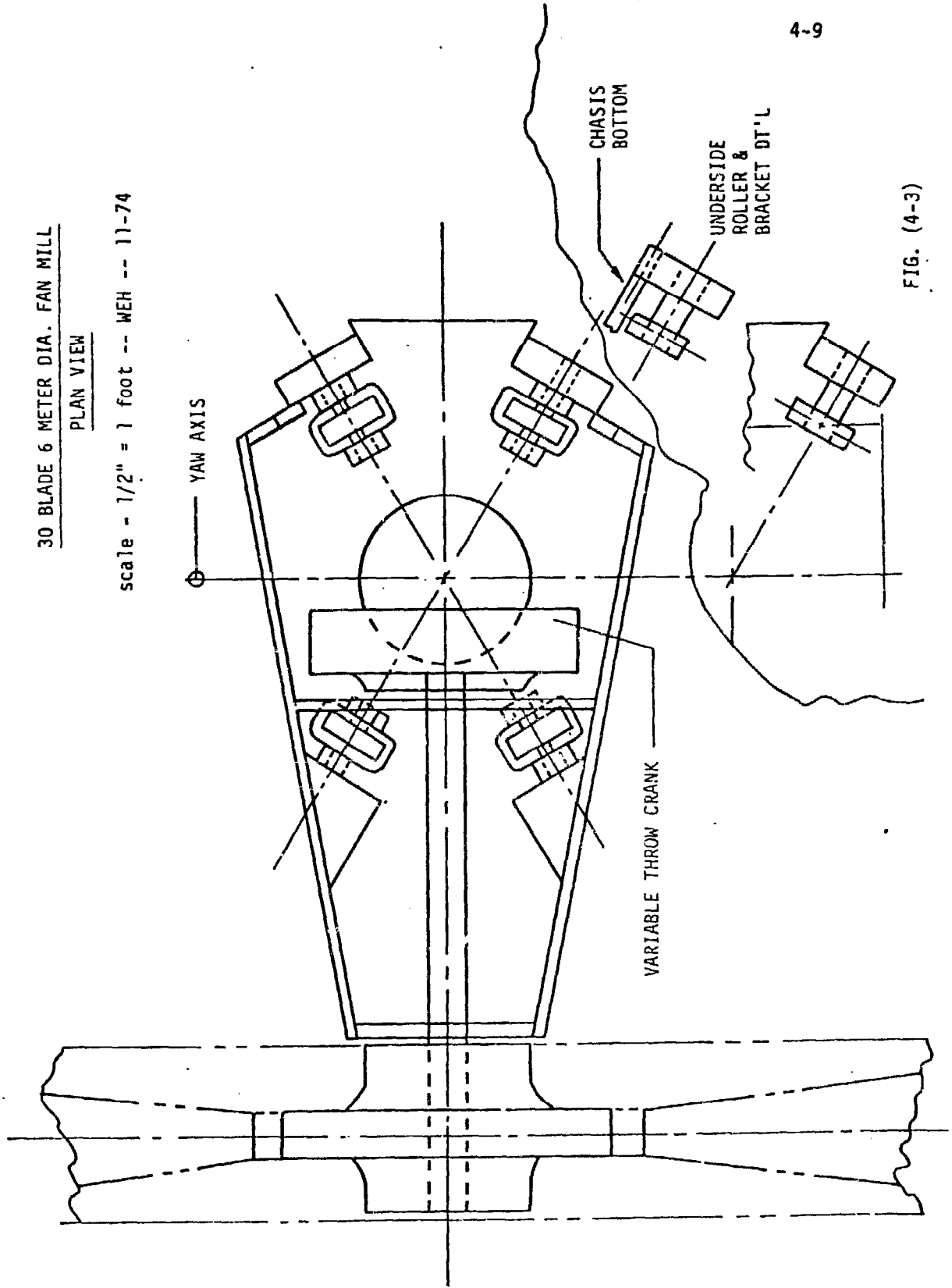

FIG. (4-2)

30 BLADE 6 METER DIA. FAN MILL

PLAN VIEW

scale - 1/2" = 1 foot -- WEH -- 11-74



4-9

FIG. (4-3)

30 BLADE 6 METER DIA. FAN MILL
POLE MATCHER

scale - 1/2" = 1 foot -- WEH -- 11/74

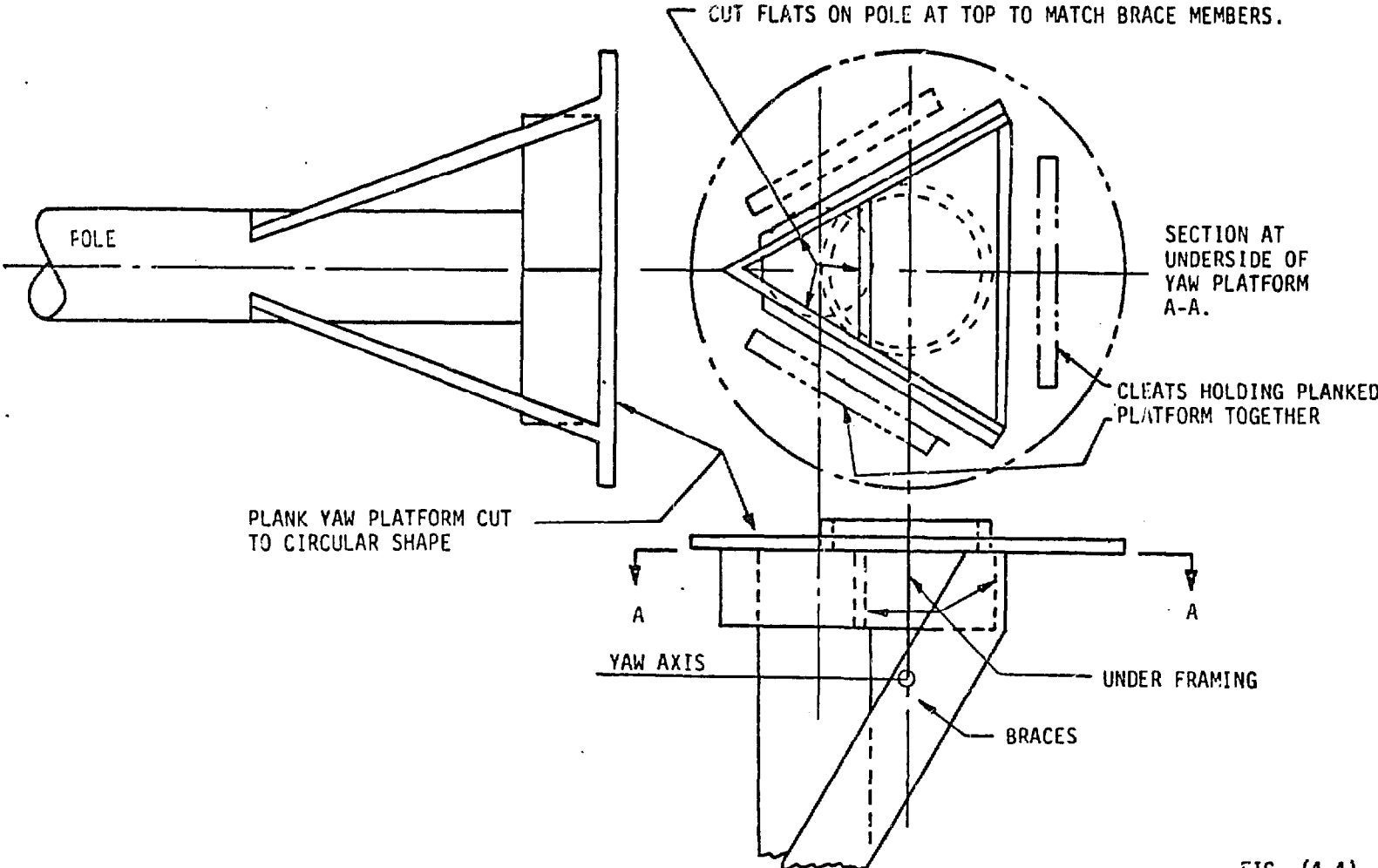

FIG. (4-4)

Appendix 5. A First Approximation of a Mekong Irrigation Pumper and
Eastern Mekong Wind Pumped Irrigation System.

1. It is postulated that wind driven pumpers of considerable size, but still no larger than can be constructed primarily from Thai materials, can be mounted on timber pole platforms at the edge of the Mekong River, fitted with hinged reciprocating pumps so arranged that a suction can be just beneath the surface of the river as it rises and falls, and the discharge just above the top of the river bank. Such pumpers, of the fan mill type, able to respond to winds of 3 knots velocity or greater, would then deliver irrigation water up out of the river, over the river bank, into diversion canals. The canals would lead the water to the west and south into the expanding agricultural region around and on the Khorat Plateau.

2. This System could be as large as a line of pumpers extending from Bung Kau in the northeast, along the river a total distance of 250 kilometers, to the confluence of the Mekong and the Mae Nam Mun rivers due east of Ubon Ratchatani. This line of wind machines is shown on Figure (5.1) as the Eastern Mekong Wind Line.

3. Productivity along this line has been estimated by evaluating the energetics of the wind at three stations, Nakhon Phanom, Mukdahan and Ubon Ratchatani. The three velocity duration curves are attached hereto, labeled Figure (5.2), (5.3), and (5.4) respectively. Those three curves must be recognized as "optimistic" curves drawn through the three available data points, and therefore the projected amount of pumping might well be optimistic. The first approximation was made of the total energy in the wind, from 2 knots to 17 knots,

at an axis height of 10 meters. A similar calculation was made for Khon Kaen, back at the "center" of the Northeastern Region, to gain some insight as to the variations in wind energy across that entire region. The results are given in Table 5.1. The results indicate a maximizing of energy at the Mukdahan location, a slight thinning out to the south, a significant thinning out to the north. They also indicate a significant change in energetics between Khon Kaen site and the Eastern Mekong Wind Line. At Khon Kaen the winds are strongest in the wet season monsoon, that is, they are still dominated by the onshore winds from the southwest. But by the time one has traveled about 100 kilometers northeast toward the Mekong, the winds are stronger in the dry season or northeast monsoon. That shift in energetics works in favor of an irrigation system attempting to provide for double-cropping.

4. A better approximation (or at least a more conservative one) of the feasibility of an extensive Mekong Windpumped Irrigation System has been made by preparing an alternate set of velocity duration curves for Mukdahan, labeled "Mukdahan (Pessimistic)", Figure (5.5). Then using those curves, estimates have been made of the amount of irrigation one might expect from several different irrigation pumps in that wind regime. The results are given in Table 5.2.

5. Now "design" a larger irrigation pumper that is of the fan mill type, still constructed of timber, 18 meters in diameter, with axis at 30 meters above surface. The tower for this machine would be made of poles with cross bracing and a timber platform at the top on which a turntable carrying the aloft mechanism of the big wheel would be located. There would be a variable throw crank installed, which would drive a double-acting reciprocating pump. The pump

Table 5.1. Energy in the Wind in a 6-Meter Diameter Swept Area,
Centered 10-Meters Above Surface, in the Northeastern Region
(kilowatt hours)

Month	-Khon Kaen	Nakhon Phanom	Mukdahan	Ubon Ratchatani
Nov.	363	313	1296	932
Dec	331	396	1225	916
Jan	276	547	930	625
Feb	197	402	515	381
Mar	267	261	498	323
Apr	265	140	359	280
"Dry Season" Subtotal	1699 KWH	2059 KWH	4823 KWH	3457 KWH
May	299	93	264	260
June	285	62	256	498
July	381	117	306	556
Aug	298	117	265	479
Sept	142	81	232	211
Oct	274	143	794	643
"Wet Season" Subtotal	1679 KWH	613 KWH	2117 KWH	2647 KWH
Annual Total	3378 KWH	2672 KWH	6940 KWH	6104 KWH
Relative Energy Normalized Against Mukdahan	0.49	0.38	1.00	0.88

Table 5.2. Estimated Capabilities of Several Irrigation Pumps at MUKDAHAN, Using "Pessimistic" Wind Velocity-Duration Curves, Pumping to a 1.5 Meter Head.

	Nov. Thru' Apr. Dry Season	May Thru' Oct. Wet Season
A. The 6 meter diameter 30 blade fan mill with variable throw crank, reciprocating pump	146,329 m ³ (48 rai)	112,952 m ³ (36 rai)
B. The Lubing M022-3-6, 7.2 foot diameter (2.215m) irrigation pumper	11,932 m ³ (4.05 rai)	9,013 m ³ (2.9 rai)
C. A 6 meter diameter Lubing (extrapolated)	87,919 m ³ (29.5 rai)	66,128 m ³ (21.3 rai)

would be hinged so that its suction end could ride up and down with the river surface in a "ditch" dug in the river bank adjacent to the tower. The head against which the pump would have to operate has been averaged month-by-month per the following Table (5.3) which is based on page 187 of "Lower Mekong Hydrologic Yearbook," 1972, Vol. 1, (6). It is assumed in the calculation that follows that pump delivery will:

- (a) vary inversely as the total head against which water must be lifted,
- (b) vary as the square of the swept area of the wind mill
- (c) vary as the 0.48 power of the ratio of axis height compared against the 10 meter standard axis height.

One can thus estimate the monthly productivity of the 18 meter diameter fan mill at 30 meter axis height by extrapolating from the calculated productivity of the 6 meter diameter fan mill at 10 meter axis height at a constant 1.5 meter head by

$$Q_{18} = (Q_6) \left[\left(\frac{18}{6} \right)^2 \left(\frac{30}{10} \right)^{0.48} \left(\frac{1.5}{\text{ave. head}} \right) \right]$$

$$Q_{18} = (Q_6)(15.24) \left(\frac{1.5}{\text{average head}} \right) = \frac{22.87 Q_6}{\text{average head}}$$

Table 5.3. Estimated Productivity of an 18m Mekong Pumper, Axis Height 30 m., at Mukdahan (pessimistic)

	Jan	Feb	Mar	Apr	May	June	July	Aug	Sept	Oct	Nov	Dec
Q_6 m ³ /mo.	22,827	18,356	21,099	18,429	17,831	16,426	18,737	16,973	15,365	27,620	35,466	30,122
Average Head m	10.93	11.47	11.57	11.62	11.44	9.72	6.61	1.68	5.12	7.25	9.18	9.53
Q_{18} m ³ /mo.	47,763	36,600	41,706	36,271	35,646	38,648	64,828	231,055	68,632	87,126	88,356	72,286

Dry Season, Nov. thru' April, this would irrigate 16.4 hectares for rice.

Wet Season, May thru' Oct., this would irrigate 26.1 hectares for rice.

When the monthly variation in river height is introduced into the wind-pumper productivity analyses, the "Wet Season," even with the less energetic winds, is found to be much more productive. This leads at once to speculation as to how this kind of a windpumped irrigation source can be tied into existing or planned diversion irrigation schemes which include significant storage. If, for example, four months' worth of the wet season's pumping (Jun, Jly, Aug., Sept) were stored, and only 20% of that were lost by evaporation, then the Dry Season irrigation possibility becomes 645,060 cubic meters better which would increase the 16.4 hectares to 49 hectares.

6. To approximate the maximum irrigation possible from a line of 18 meter pumpers spaced as closely together as possible (center to center distance = 25.5 meters) along the Eastern Mekong Wind Line, one can proceed as follows:

(a) Average productivity along the 100 km from Mukdahan toward Ubon Ratchatani = $\frac{1.0 + 0.88}{2} = 0.94$ x Mukdahan Productivity.

(b) Average productivity along the 50 km from Mukdahan to a point abreast of Nakhon Phanom = $\frac{1.00 + 0.38}{2} = 0.69$ x Mukdahan Productivity.

(c) Average productivity along the 100 km from abreast Nakhon Phanom all the way to Bung Kau will be the same as at Nakhon Phanom = 0.38 x Mukdahan Productivity.

(d) ∴ Weighted Productivity =

$$\begin{array}{rcl}
 (100)(0.94) & = & 94 \\
 + (50)(0.69) & = & 34.5 \\
 + (100)(0.38) & = & \underline{38} \\
 & & \frac{166.5}{250} = 0.666
 \end{array}$$

(e) Therefore, one line of Mekong Irrigation pumps might irrigate:

$$\left[\frac{(250)(10^3)}{(25.5)} \right] [0.666] [49 \text{ hectares}] = \underline{320,000 \text{ hectares}}$$

$$= \underline{800,000 \text{ acres}}$$

using 9,803 pumper stations,

which is about one-third of the estimated one million hectares that would be irrigated by the PaMong Dam and diversion irrigation system. Of course, this concept presented here does remove water from the river all year long and would reduce river flow. For example, at Ban Dan, the metering station due east of Ubon Ratchatani, during the lowest flow month, April, the average minimum discharge (1962-1972) was 1,410 m³/sec.

If the 9,803 pumping stations were each removing the average 0.666 x Mukdahan productivity during April, removal would be at the rate of

$$\frac{(9.803)(10^3)(0.666)(36.27)(10^3)}{(.720)(3.6)(10^6)(24)} \frac{\text{m}^3}{\text{sec}} = 13.70 \frac{\text{m}^3}{\text{sec}}$$

which would be about 1% of the average minimum discharge. Whether or not that would be acceptable is not known.

7. The 9,803 pumping stations could be doubled or trebled, partially along the Mekong River Bank but also along the banks of tributaries.

8. It is concluded that extensive dry-season irrigation of the Northeastern Region could be accomplished by wind pumping available river water, provided the necessary distribution and water storage scheme were available. It is thought that the capital investment required would be a very small fraction of that required for the comparable gravity diversion system, but, of course, the wind pumped scheme would not provide the electricity sought as the primary product of the proposed hydroelectric system. The original question asked,

however, was, "could wind pumped Mekong River water speed up irrigation of Thailand while capital for the Mekong Project is being accumulated?" -- and the answer appears to be "yes."

9. The same amount of wind pumping (or more) could be accomplished on the Laotian side of the river in that region. The author has been told that the winds on down the river in Cambodia and South Vietnam are even stronger than they are up on the proposed Eastern Mekong Wind Line, but no data have been collected or analyzed relating to that possibility.

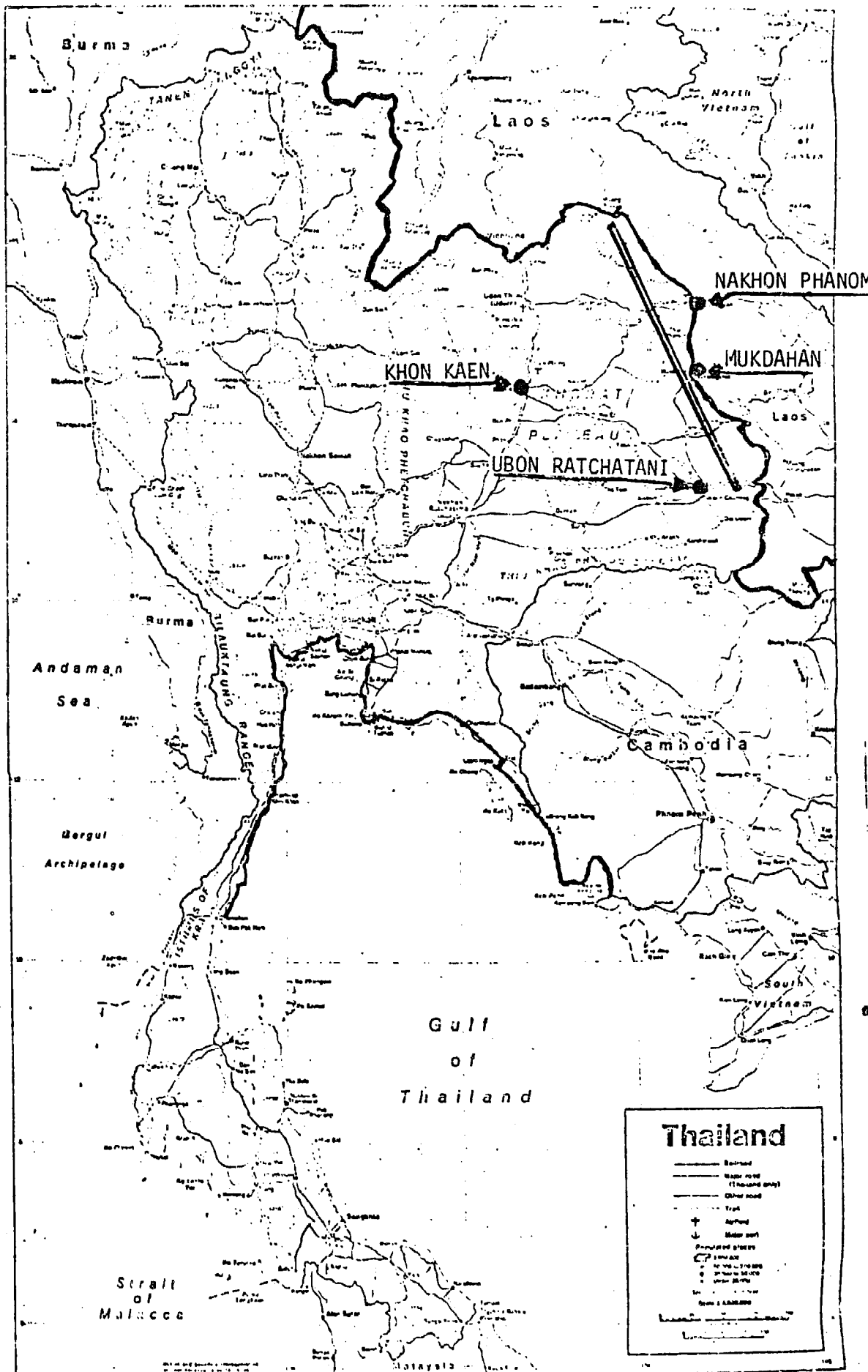

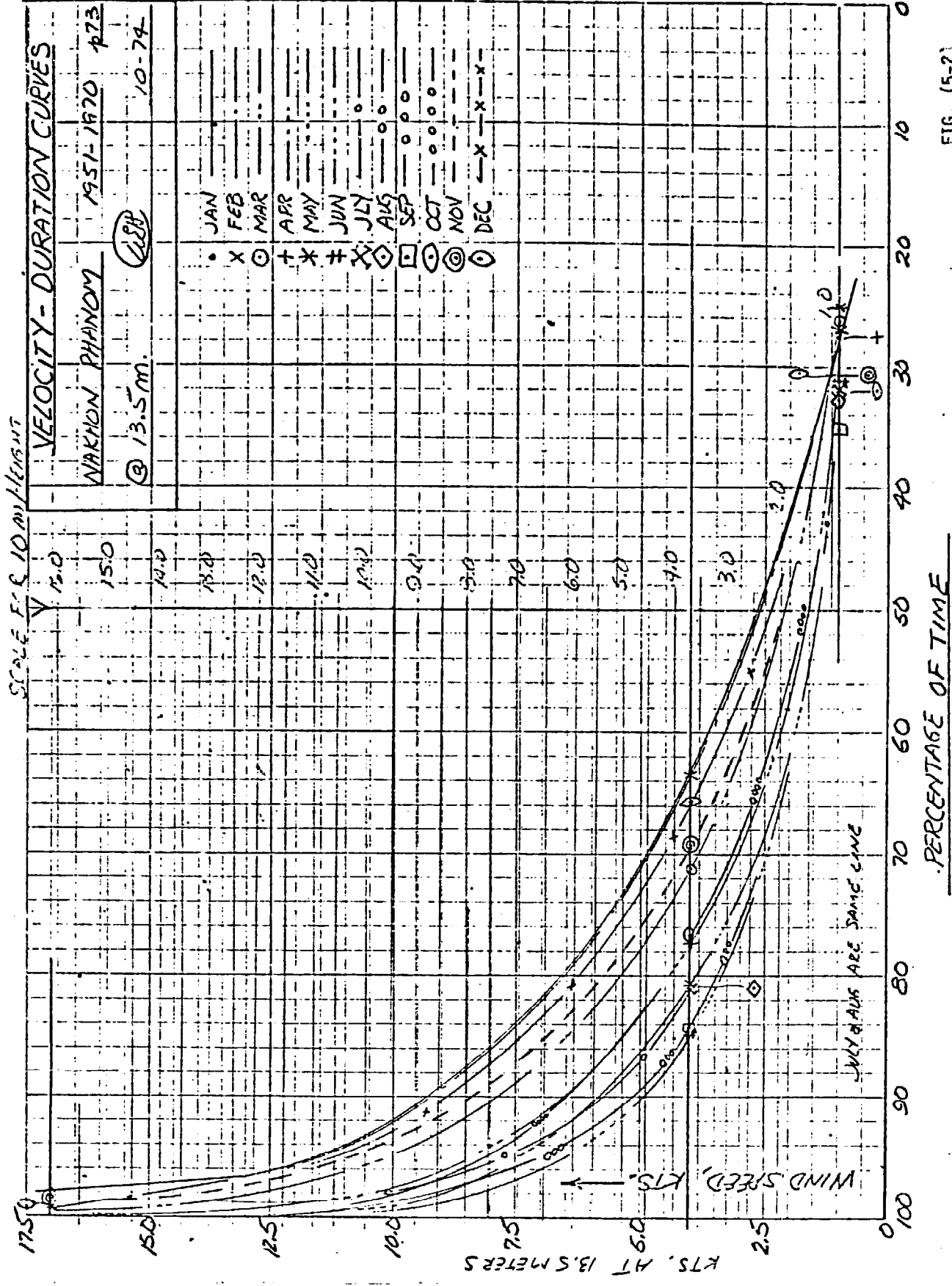

FIG. (5-2)

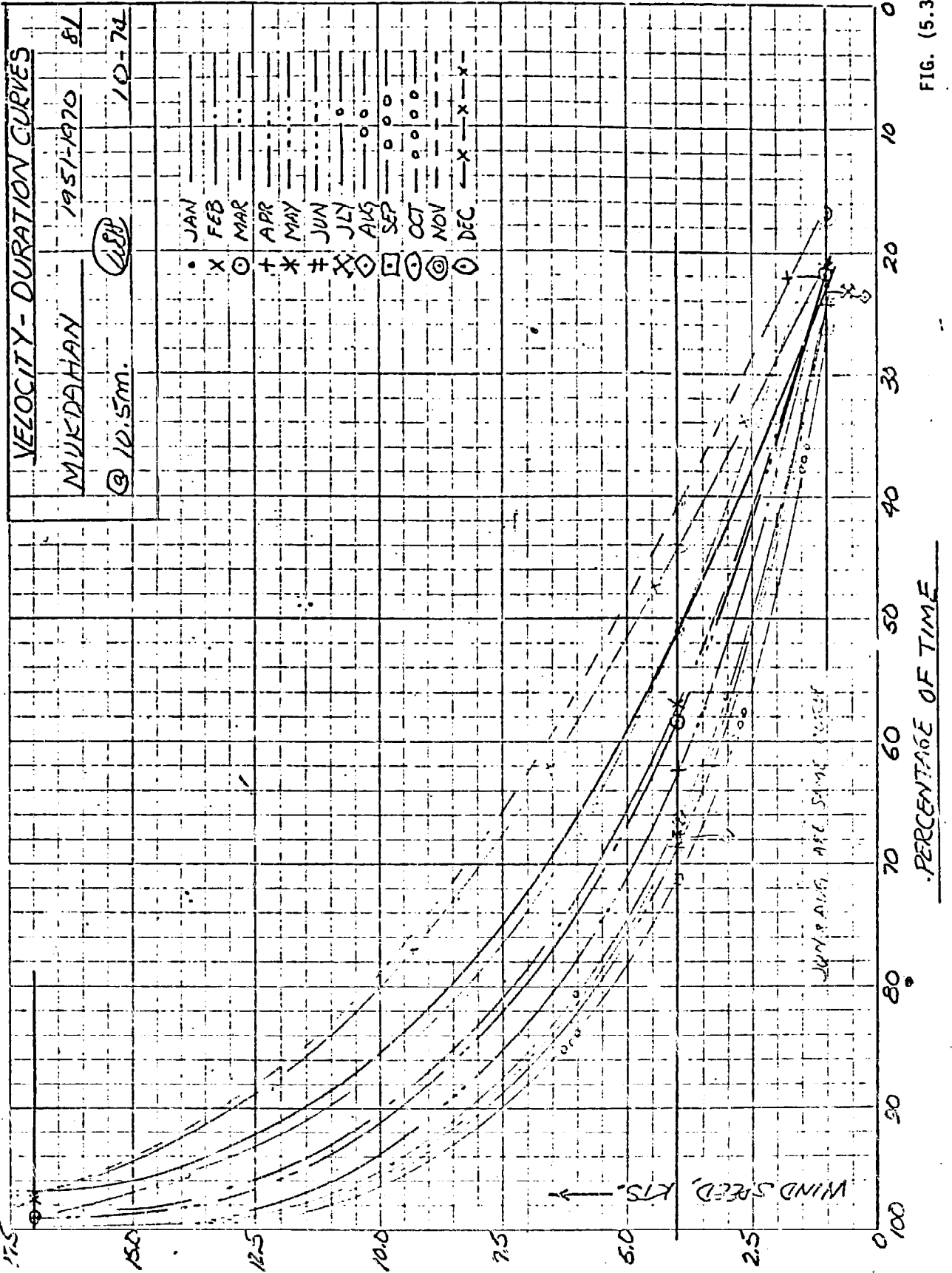

FIG. (5.3)

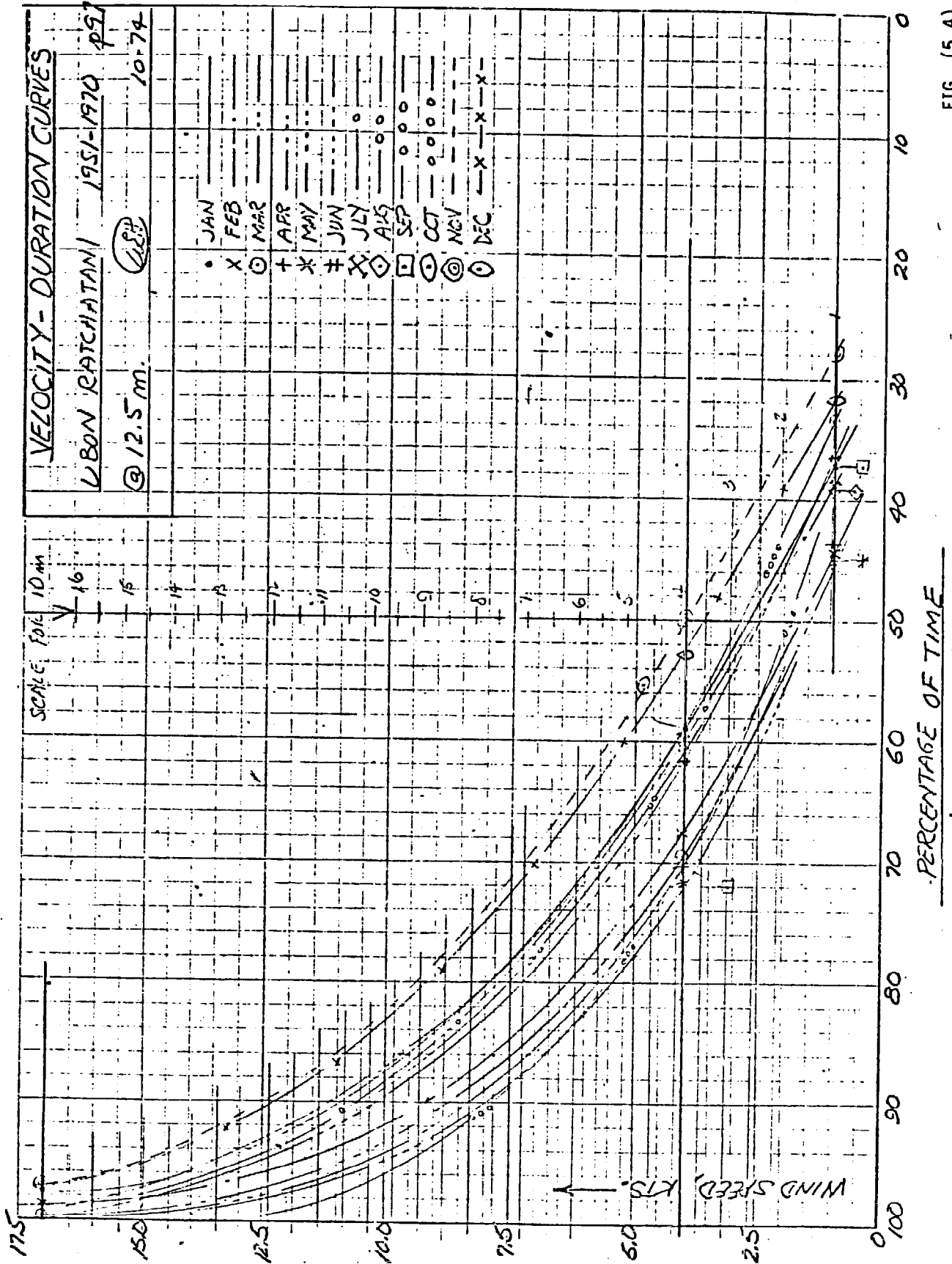

FIG. (5.4)

Appendix 6: A Proposed Program for Development of the Thai Windpower Resource
and Other Asian Energy Resources

6.1 Work should be started in a number of places if the ideas, conclusions, recommendations of this report are to be useful. Effort is required to:

- 1.(a) Select in priority order one or more "windpower systems" for development.
 - (b) Verify, with greater accuracy, the windpower resource at sites involved in selected windpower systems.
 - (c) Determine the availability of water from dug wells at involved sites.
 - (d) Start a program to measure the water requirements of crops other than rice whose culture is desired at involved sites.
 - (e) Determine the interaction with planned irrigation schemes at involved sites.
 - (f) Proceed with the invention, development and test and proof of key hardware components required for selected windpower systems.
 - (g) Create an in-country test and demonstration site, perhaps at AIT, for in-country proof of selected windpower systems.
 - (h) Arrange for manufacture of parts and components, to match in-country materials, skills, tools, labor, literally a transmutation from AIT demonstrated U.S. laboratory prototypes into Thai-built commercial or do-it-yourself products.
2. The flow of action could be:
- (a) From U.S. AID via R.E.D. and USOM, Bangkok, to the Royal Thai Government and back again, concerning policy and programs.
 - (b) From the University of Massachusetts (Amherst) with prototype components and systems, to AIT for demonstration and test.

(c) From AIT to the Ministry of Agriculture and Cooperative, both the Division of Agricultural Economics and the Division of Agricultural Engineering, for replication of components and systems.

3. The University of Massachusetts should start the invention, development, and test of:

- (a) improved 2-bladed Thai propeller windmachines, several sizes.
- (b) reciprocating pumps
- (c) the 30-blade 6-meter fan mill, including the laminated plywood blades for that fan mill.
- (d) the variable throw crank for the 2-bladed Thai propeller machines
- (e) the variable throw crank for the 30-blade 6-meter fan mill.
- (f) the smaller 4-meter fan mill

A test site on the Hadley plain adjacent to the Connecticut River, whose water could be moved back and forth for test, should be created at UMass for system tests.

- 4. AIT should start to build the in-country test site, on or adjacent to their grounds in the Central Plain, instrumented to that level necessary to measure water lifted and relative effectiveness of systems.
- 5. After review by the Mekong Committee and the Royal Irrigation Department, and if the concepts are found to be sound by those groups, UMass should start the design and development of large wooden irrigation windpumpers.
- 6. Somewhere within either the U.S. AID program or some United Nations program, resources should be found for a study of the ocean thermal differences process as provider of fertilizer and pollution-free fossil-fuel-free electricity for tropical peoples. Or perhaps that is a program that should be funded by the World Bank, the Rockefeller Foundation or

the Ford Foundation. It should be started, soon, and the UMass team should be at the center of it.

Appendix 7: Chronology of Visit, Places Visited and People Contacted

1. Chronology:

- a. Departed CONUS 10 August 1974
- b. Arrived Bangkok 12 August 1974
- c. 13 Aug. At the R.E.D. office, Bangkok - Mekong Committee Hdqtrs, Sala Santitham
- d. 14 Aug. R.E.D. Office
Meteorology Department, R.T.G.
- e. 15 Aug. To N.E. Agricultural Center, Tha Phra, on North to UDORN and near Loei
- f. 16 Aug. Return to Tha Phra
Khuan Ubon Ratane Dam
Seminar at Khon Kaen
- g. 17 Aug. Return to Bangkok
- h. 18 Aug. Sunday -- Tourist spots in Bangkok
- i. 19 Aug. R.E.D. office
Mekong Committee
- j. 20 Aug. Kasesat University
Agricultural Engineering Division, Windmills at Pathum Thani near Don Muang, Department of Forestry
- k. 21 Aug. Farm Management Section, Division of Agricultural Economics, Windmills at Petchaburi
Windmills in the Salt Flats
- l. 22 Aug. ECAFE, Natural Resources Division: Seminar at R.E.D. office
- m. 23 Aug. A.I.T. - Lecture
- n. 24 Aug. R.E.D. Office
- o. 25 Aug. Departed Bangkok, proceeded to Manila

- p. 26 Aug. SEARCA, Los Banos
IRRI
- q. 27 Aug. Department of Agricultural Engineering, University of
Philippines, Los Banos, PAGASA, Manila
- r. 28 Aug. Seminar at IRRI
SEARCA
Return to Makati
- s. 29 Aug. USAID, Manila
National Science Development Board, Manila
Departed Manila for Honolulu via Guam
- t. 29 Aug. University of Hawaii
- u. 30 Aug. East-West Center
Departed Honolulu for home
- v. 31 Aug. Back in Amherst, Mass.

2. Places Visited

- a. Regional Economic Development Office, Bangkok.
- b. U.S. Operations Mission, Bangkok
- c. Royal Thai Government, Ministry of Agriculture and Cooperative:
 - (1) The Northeast Regional Agricultural Center, Khon Kaen.
 - (2) The Agricultural Engineering Division at Kasesat University, Bangkok.
 - (3) The Royal Forest Department, Bangkok.
 - (4) Agriculture Work Unit, Nong Kai
 - (5) Agriculture Work Unit, Petchaburi
- d. The Mekong Committee, ECAFE, Bangkok
- e. Royal Thai Government, Ministry of Communications, Meteorological Dept.

- f. Natural Resources Division, ECAFE, Bangkok
- g. Asian Institute of Technology
- h. U.S. AID office, Manila
- i. Southeast Asia Graduate Research Center for the Study of Agriculture (SEARCA)
- j. International Rice Research Institute (IRRI)
- k. Department of Agriculture Engineering, University of Philippines, Los Banos.
- l. The Weather Bureau of the Philippines (PAGASA), Manila
- m. The East-West Center, Honolulu
- n. The School of Engineering, University of Hawaii, Honolulu

3. People Contacted

(a) at RED, Bangkok: Principal contacts:

- (1) K. Rabin, incoming Director
- (2) R. Halligan, Deputy Director
- (3) C. S. McClusky, Assistant Program Officer
- (4) J. Hanks, Liaison Officer, Mekong Capital Project
- (5) L. A. Cohen, Sr. Engineering Advisor
- (6) L. Lucian, Liaison Officer

(b) at U.S.O.M., Bangkok

- (1) Dr. Riggs
- (2) Chane Kalayanamitra

(c) at N. E. Agricultural Center

- (1) Khun Borisuthi, Director
- (2) Khun Santisuk, guide from DAE
- (3) Dr. Benjasil, Associate Director

- (4) Dr. Russell H. Brannon, Chief of U. Ky, Party
- (5) Verne Finkner, U. Ky Party
- (6) J. Thurston, U. Ky. Party
- (d) at RTG, Department of Agricultural Engineering
 - (1) Mr. Sumnao
 - (2) Mr. Metha Ratjatapiti
 - (3) Mr. Chalermchui Saksui
 - (4) Miss Sukunya Kotigal
- (e) at RTG, Department of Meteorology
 - (1) Captain Soontarotok, Deputy Director-General
 - (2) Commander Kasem Sunkapinta
 - (3) Lieut. Commander Surin Sangsnit
- (f) at RTG, The Royal Forest Department
 - (1) Mr. To Nanon
- (g) at RTG, Department of Agricultural Engineering (2nd day)
 - (1) Chacong Meekul, Chief of Agricultural Economics
 - (2) Miss Maneewan Ama-Amon
- (h) at A.I.T.
 - (1) Dr. Harold Hoelscher, Pres.
 - (2) Dr. Shlomo Angel
 - (3) Dr. Peter A. Cowell
 - (4) Dr. Norbert Ackermann
 - (5) Dr. Maung Nay Htun
- (i) at ECAFE, Natural Resources Division
 - (1) Philip Kyaw Myint
 - (2) J. A. Callow
 - (3) George Finlinson

- (4) M. S. Haeri
- (5) A. S. Manalac
- (j) at SEARCA, Los Banos, Philippines
 - (1) Dr. Sam-Arng Srinkta, Associate Director
 - (2) Dr. Drillon - Director
- (k) at U. P. Los Banos
 - (1) Cielo R. Sumayo
 - (2) Marietta S. Adriano
 - (3) Carlos R. del Rosario
 - (4) Harry Van Riuten
 - (5) Cayetano Intong
 - (6) Lamperto Palencia
- (l) at IRRI
 - (1) A. U. Khan
 - (2) Godofredo C. Salazar
 - (3) J. Metz
- (m) at PAGASA, Manila
 - (1) Mr. Minosa
 - (2) Mr. Bonhoe
 - (3) Mr. Lomotan
 - (4) Dr. Roman Kintanar
 - (5) Prof. Hugo de la Cruz
- (n) at National Science Development Board, Makati
 - (1) Dr. Florencio A. Medina
 - (2) Francesco A. San Juan
- (o) at U.S. AID, Manila
 - (1) R. J. Delaney

(2) R. H. Masters

(3) Mr. Johnson

(p) at East-West Center, Honolulu

(1) Dr. Manuel Alba

(2) Dr. John Goodman

(3) Dr. Marshall Merriam

(q) at University of Hawaii

(1) Dr. Paul Yuen

(2) Dr. John Shupe

(3) Dr. Edmund Cheng

(4) Prof. Don Avery