

AT MICROFICHE
REFERENCE
LIBRARY

A project of Volunteers in Asia

China: Recycling of Organic Wastes in Agriculture

by: Food and Agriculture Organization of the
United Nations

Published by:
Food and Agriculture Organization of the
United Nations
Via delle Terme di Caracalla
00100 Rome
Italy

Paper copies are \$ 5.00.

Available from:
UNIPUB
345 Park Avenue South
New York, NY 10021 USA

Reproduced by permission of the Food and
Agriculture Organization of the United Nations.

Reproduction of this microfiche document in any
form is subject to the same restrictions as those
of the original document.

**china:
in agriculture**

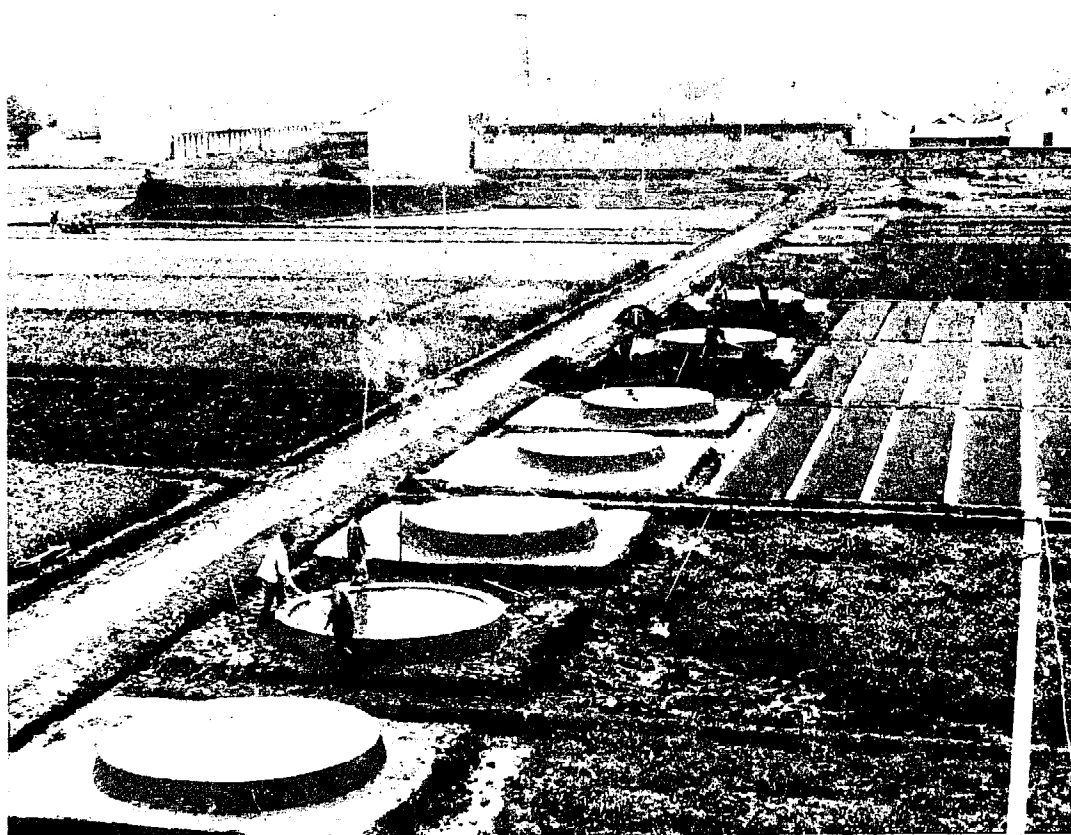

**FOOD AND AGRICULTURE ORGANIZATION
OF THE UNITED NATIONS** **ROME**

**china:
recycling of organic wastes
in agriculture**

**report on an FAO/UNDP study tour
to
the people's republic of china
28 april - 24 may 1977**

First printing 1978
Second printing 1978.

UNIPUB is the exclusive United States distributor of this publication.

Kindly indicate in any review or listing that the publication is available from:

unipub

345 Park Avenue South
New York, N.Y. 10010

Please send us two copies of your review or listing.

Price: \$5.00

unipub 345 Park Avenue South • New York, N.Y. 10010

M-09
ISBN 92-5-100524-9

The copyright in this book is vested in the Food and Agriculture Organization of the United Nations. The book may not be reproduced, in whole or in part, by any method or process, without written permission from the copyright holder. Applications for such permission, with a statement of the purpose and extent of the reproduction desired, should be addressed to the Director, Publications Division, Food and Agriculture Organization of the United Nations, Via delle Terme di Caracalla, 00100 Rome, Italy.

© FAO 1978

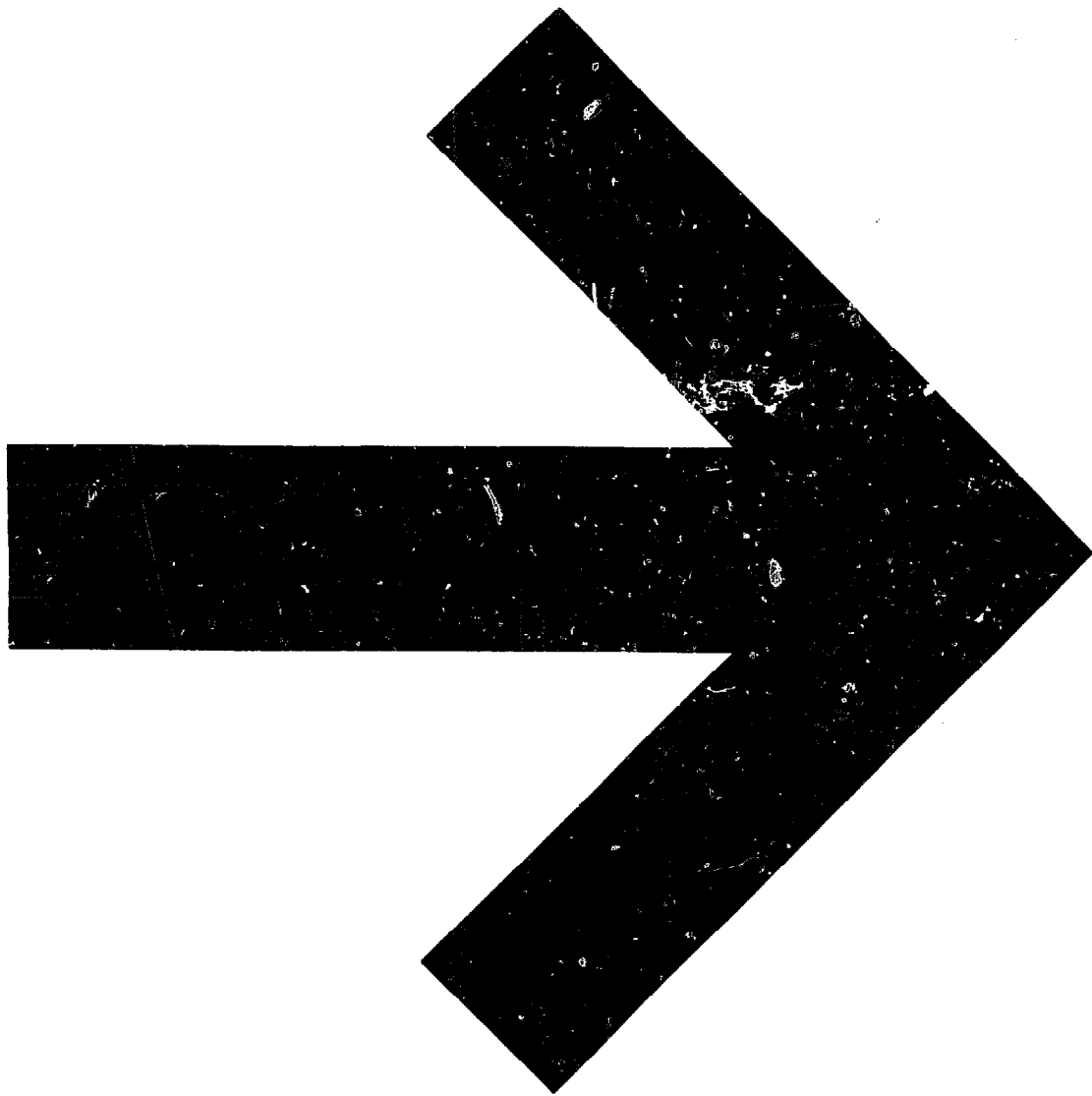

CONTENTS

	<u>Page</u>
INTRODUCTION	xi
ACKNOWLEDGEMENTS	xii
MAP OF CHINA	xiii
CHINESE UNITS OF MEASURE	xiv
BASIC FACTS	xv
CHAPTER 1 : RECYCLING OF ORGANIC MATERIALS	1
1.1 General	1
1.2 Important Manurial Resources	1
1.3 Extent and Manner of Use of Some of the Important Manurial Resources	2
1.3.1 Animal wastes	2
i Pig excreta	2
ii Cattle wastes	5
1.3.2 Human habitation wastes	5
1.3.3 Crop wastes	6
1.3.4 Green manures and aquatic plants	7
1.3.5 Bio-fertilizers	9
1.3.6 Silt	9
1.3.7 Other resources	11
i Fish wastes	11
ii Silk wastes	11
iii Animal bones	11
iv Oil cakes	11
v Ashes	12
vi Poultry droppings	12
vii Sheep and goat droppings	12
viii Industrial wastes	12

	<u>Page</u>
1.4 Techniques for Processing Composts and Stable Manure	12
1.4.1 General	12
1.4.2 Some typical techniques for making composts from various types of waste material	12
i Composting at field sites	12
ii Dry manure	15
iii Liquid manure	17
iv High temperature compost	17
v Earth compost (fertile earth)	17
vi Composting mixtures of city garbage and night soil	17
vii Organo-mineral manures	21
1.4.3 Methods and rates of application of compost and manures	21
1.4.4 Selected experimental work on home made manures	22
i Effect of compost on crops	22
ii Effect of compost on soils	24
iii Application of organic fertilizers	26
 CHAPTER 2 : BIO-FERTILIZERS	 29
2.1 General	29
2.1.1 Azolla	29
i Optimum conditions for growth of Azolla	31
ii Azolla production	31
iii Use of Azolla as green manure	34
iv Nitrogen fixation by Azolla	34
v Fertilization of Azolla	37
vi Disease and pests of Azolla	37
vii Advantages derived from growing Azolla	38
2.1.2 Blue-green algae	38
 CHAPTER 3 : GREEN MANURE CROPS AND AQUATIC PLANTS	 41
3.1 Green Manuring	41
3.1.1 Astragalus sinicus	42
3.1.2 Sesbania cannabina	42
3.1.3 Inoculation of legumes	42
3.2 Aquatic plants	44

	<u>Page</u>
CHAPTER 4 : BIO-GAS TECHNOLOGY AND UTILIZATION	47
4.1 General	47
4.2 Bio-gas Technology	48
4.3 Building a Bio-gas Plant	52
4.4 Use of Gas	53
4.5 Use of Sludge and Effluent	61
4.6 Some Useful Data	61
CHAPTER 5 : VISITS TO RESEARCH STATIONS, COMMUNES, PRODUCTION BRIGADES/TEAMS	64
5.1 Research Institute of Agricultural Sciences of Jiangsu Province, Nanjing	64
5.2 National Research Institute of Soil Science, Nanjing, Jiangsu Province	65
5.3 Cheng Hsiang Production Brigade, Peng Niu Commune, Wu Chin County, Jiangsu Province	67
5.4 Huashi Production Brigade, Kiang Yin County, Jiangsu Province	67
5.5 Yueh Chi People's Commune, Wu County, Jiangsu Province	68
5.6 Agricultural Research Station of Feng Chiao Commune, Jiangsu Province	68
5.7 Agricultural Research Institute of Wu Chin County, Jiangsu Province	69
5.8 Malu People's Commune, Shanghai	70
5.9 Shanghai City Waste Disposal	71
5.10 Chao Yang Sewage Treatment Plant, Shanghai	73
5.11 Fu Shan Municipality, Guangdong Province	73
5.12 Agricultural Research Station, Hsi Chiao Commune, Nanhai County, Guangdong Province	74
5.13 Hsin Hui County, Guangdong Province	74
5.14 Tachai, Hsi Yang County, Shanxi Province	75
5.15 Chun Sum Production Brigade, Hebei Province	76
5.16 Ta Heh Production Brigade, Hebei Province	76

	<u>Page</u>
CHAPTER 6 : EXTENSION OF EXPERIENCE GAINED IN CHINA IN ORGANIC RECYCLING	78
6.1 General	78
6.2 Recycling Programmes and Activities	78
6.2.1 Preliminary investigations	78
6.2.2 Socio-economic aspects of organic recycling	79
6.2.3 Elements of development programmes	80
i Bio-fertilizers	80
ii Green manuring	82
iii Garbage composting	83
iv Sewage utilization	84
v Night soil disposal and utilization	85
vi Bio-gas plants	85
vii Organo-mineral fertilizers	87
viii Aquatic plants	88
ix Tanks, pond and river silt	88
6.3 Research Needs	88
ANNEX 1 THE PEOPLE'S COMMUNE SYSTEM	90
2 AGRICULTURAL RESEARCH AND EXTENSION	92
3 MINERAL FERTILIZERS	94
4 VISITS AND EXPERIENCES OF GENERAL INTEREST	96
5 LITERATURE ON RECYCLING OF ORGANIC WASTES	97
6 PROGRAMME	98
7 PERSONS MET	101
8 LIST OF PARTICIPANTS	105

LIST OF FIGURES

<u>No.</u>		<u>Page</u>
1	Recycling of organic wastes in the People's Republic of China	3
2	Arch-shaped shelter for pigs with frontal pit. Ta Heh Production Brigade, Hebei Province	4
3	Foreground: Concrete tanks for night soil covered with plastic. Background: Transport of garbage from Shanghai. Malu People's Commune, Shanghai	6
4	Compost bins for fermentation of city garbage. Fu Shan, Guangdong Province	6
5	Three-tank fermentation system for treatment of night soil on the countryside. Malu People's Commune, Shanghai	7
6	Boat for sucking silt from the bottom of the canal. Foreground: Silt tanks. Malu People's Commune, Shanghai	10
7	City garbage in state of fermentation, covered by silt. Malu People's Commune, Shanghai	10
8	Silt-grass mixture or pit manure. Yueh Chi Commune, Wu County, Jiangsu Province	13
9	Turning over of the silt grass mixture. Agricultural Research Station, Feng Chiao People's Commune, Jiangsu Province	14
10	Silt-grass manure pits. Agricultural Research Station, Feng Chiao People's Commune, Jiangsu Province	14
11	High temperature compost heap (using bamboo for making holes for aeration). Chun Sun Production Brigade, Chao County, Hebei Province	16
12	High temperature compost heaps, sealed with plaster of mud. Chun Sun Production Brigade, Hebei Province	18
13	High temperature compost heaps, showing the preparation of the aeration system using bamboo. Chun Sun Production Brigade, Hebei Province	18
14	High temperature compost heap (using maize stalks for aeration). Tung Shao Ying Production Brigade, Ta Heh County, Hebei Province	19
15	High temperature compost heap sealed by mud and showing aeration system using maize stalks. Ta Heh Production Brigade, Hebei Province	20
16	Silt being dried before it is ground and mixed with animal and human waste for dry manure. Chang Nan Production Brigade, Hsin Hui County, Guangdong Province	20
17	Azolla pinnata growing on the water surface between rice seedlings. Huashi Production Brigade, Jiangsu Province.	29

<u>No.</u>		<u>Page</u>
18	The water fern <i>Azolla pinnata</i> , (a) the water fern (10 X); (b) leaf with the blue green algae in the cavities (100 X); (c) <i>Anabaena azolla</i>	30
19	Overwintering methods of <i>Azolla</i> : (a) in a pit; (b) in a heap. Changzhou, Jiangsu Province	32
20	Seeding rice field with <i>Azolla</i> . Huashi Production Brigade, Jiangsu Province	33
21	Fields prepared for rice cultivation and inoculated with <i>Azolla</i> . Huashi Production Brigade, Jiangsu Province	33
22	<i>Azolla</i> , 10 days after inoculation, ready for ploughing under. The mat in the canal prevents loss of <i>Azolla</i> . Agricultural Research Station, Feng Chiao People's Commune, Jiangsu Province	35
23	Ploughing under of <i>Azolla</i> layer before rice transplanting, using a 12 HP walking tractor. Huashi Production Brigade, Jiangsu Province	35
24	<i>Azolla</i> covering the water surface between rice seedlings and ready for burying in the soil. Huashi Production Brigade, Jiangsu Province	36
25	Burying of <i>Azolla</i> seedlings. Huashi Production Brigade, Jiangsu Province.	36
26	Inoculation of paddy with blue green algae. Nanjing, Jiangsu Province	39
27	Foreground: nursery for <i>Sesbania</i> . Background: rice field inter- planted with <i>Sesbania</i> (in rows). Hsi Chiao People's Commune, Guangdong Province	43
28	Transplanting of <i>Sesbania</i> in rice field. Hsi Chiao People's Commune, Guangdong Province	43
29	Water plants (<i>Alternanthera</i>) grown on Tai Lake, Yueh Chi People's Commune, Jiangsu Province	46
30	Localized cultivation of <i>Alternanthera</i> on Tai Lake. To control growth borders of plots are marked with poles and ropes Yueh Chi People's Commune, Jiangsu Province.	46
31	Bio-gas cycle in China	49
32	Construction of a bio-gas plant, inlet on the right; outlet on the left in background. Cheng Hsiang Production Brigade, Jiangsu Province	51
33	Building of piggery with inlet for animal wastes to bio-gas plant. Cheng Hsiang Production Brigade, Jiangsu Province	51
34	Some bio-gas digesters used for 40 000 units built in Huai Lu County, Hebei Province	54

<u>No.</u>		<u>Page</u>
35	Bio-gas unit No. 1 with small manometer	55
36	Bio-gas unit No. 2 shallow	55
37	Bio-gas unit No. 3 made with lime and earth	56
38	Bio-gas unit No. 4	57
39	Bio-gas unit No. 5	57
40	13 bio-gas units 14 m ³ each. Ta Heh Middle School, Huai Lu County, Hebei Province	58
41	43m ³ bio-gas unit for the Hospital of Ta Heh Commune, Hebei Province	58
42	Simple manometer indicating bio-gas pressure. Cheng Hsiang Production Brigade, Wu Chin County, Jiangsu Province	58
43	7-10 m ³ bio-gas units (household size)	59
44	50 m ³ bio-gas unit (piggery size)	59
45	Larger size bio-gas plant, gas used to fuel diesel engine. Foreground: outlet; centre: outlet for gas by plastic pipe; background: inlet. Chun Sun Production Brigade, Hebei Province	60
46	Outlet of large size bio-gas plant. Effluent pumped into irrigation drain. Cheng Hsiang Production Brigade, Jiangsu Province	60
47	General view of Tachai Production Brigade, Shanxi Province	77

LIST OF TABLES

<u>No.</u>		<u>Page</u>
1	Composition of pig manure	4
2	Composition of silt	11
3	Effects of compost on yield increase of important crops	23
4	Residual effect of compost on rice	23
5	Effect of compost on soil porosity	24
6	Effect of compost on bulk density and stickiness of soil	24
7	Effect of compost on water absorption ability of soil	25
8	Effect of compost on evaporation from soil	25
9	Effect of compost on enzyme activity	26
10	Estimated use of organic fertilizers in China	27
11	Yields from various methods of application of <i>Azolla pinnata</i> in China	37
12	Commonly grown aquatic plants and their composition	44
13	Yields of green matter, nitrogen and protein of various green manure crops and aquatic plants	45
14	Fertilizer trial on rice	69

INTRODUCTION

This is a report on the first of a series of Study Tours being organized under the FAO/UNDP Programme, in cooperation with the People's Republic of China (INT/76/015).

The Study Tour took place from 28 April to 24 May 1977 and its purpose was to acquaint senior staff from developing countries with practices in the recycling of organic wastes in agriculture and to exchange experience.

The Study Group consisted of 20 participants - 17 from countries in Asia, Africa and the Near East and three from FAO. In all, 17 nationalities were represented (see Annex 8 List of Participants).

After being introduced in Peking, the group travelled extensively in the Provinces of Jiangsu, Guangdong, Shanxi, Hebei and in the area of Shanghai (see Annex 6 Programme). Excellent relations were established with the Chinese hosts concerned with planning and carrying out the study programme.

The major part of the report is devoted to the main subject of the Study Tour - recycling of organic wastes in agriculture - and it emphasizes the practical aspects and applicability of the methods studied in China. The chapters on the various aspects of organic recycling are followed by notes on visits to agricultural institutes, production brigades, etc. which should help in understanding the whole operation of organic recycling practices. These are followed by a chapter containing suggestions for follow-up activities on the experiences gained in China in order to ensure that the knowledge acquired will be applied in the widest possible way in the participants' own countries.

For easier reading, hectare (ha) and kilogramme (kg) or ton (t) have been used as measuring units and US Dollars (\$) as a monetary unit but a table showing how these compare with the Chinese units is given on page xiv.

Each member of the group has contributed to the report but special credit goes to Dr. L.S. Yadava and Dr. M.H.A. Alaa El-Din for their efforts in its finalization.

Appreciation is also expressed to FAO colleagues for their contributions and helpful comments on this report.

F.W. HAUCK

TEAM LEADER

ACKNOWLEDGEMENTS

The members of the FAO/UNDP Study Tour to China on Recycling of Organic Wastes in Agriculture, which took place from 28 April to 24 May 1977, wish to express their appreciation to the Government of the People's Republic of China, to the Food and Agriculture Organization of the United Nations and to the United Nations Development Programme for the opportunity to participate in this Tour.

In China the group visited Peking, the Provinces of Jiangsu, Guangdong, Hebei, Shanxi and the municipality of Shanghai. The members of the group were deeply impressed by the agricultural, economic and cultural achievements of the People's Republic of China. They gained valuable experience, especially in the field of recycling of organic wastes in agriculture which will be most useful in the development of agriculture in their own countries.

The members of the group are very grateful to their Chinese hosts for the excellent organizational arrangements made during the Study Tour, the outstanding friendliness met everywhere in China and for the warm hospitality extended to them throughout the Tour.

The members of the group wish to express special thanks to their hosts at the Ministry of Agriculture and Forestry, i.e., Mr. Li Yung-kai, Director, Bureau of Foreign Affairs, Mr. Chang Shih-ohan, Head of the International Division and the staff of the International Division, who made travel arrangements within the country and acted as interpreters - Mr. Hsu Kuo-ohang, Mr. Tung Ching-sung, Mr. Wang Yu-chung and Miss Kung Chien-ying. The group also wishes to express its sincere appreciation to the staff at the Chinese Embassy in Rome for their kind assistance in the preparation of the Tour.

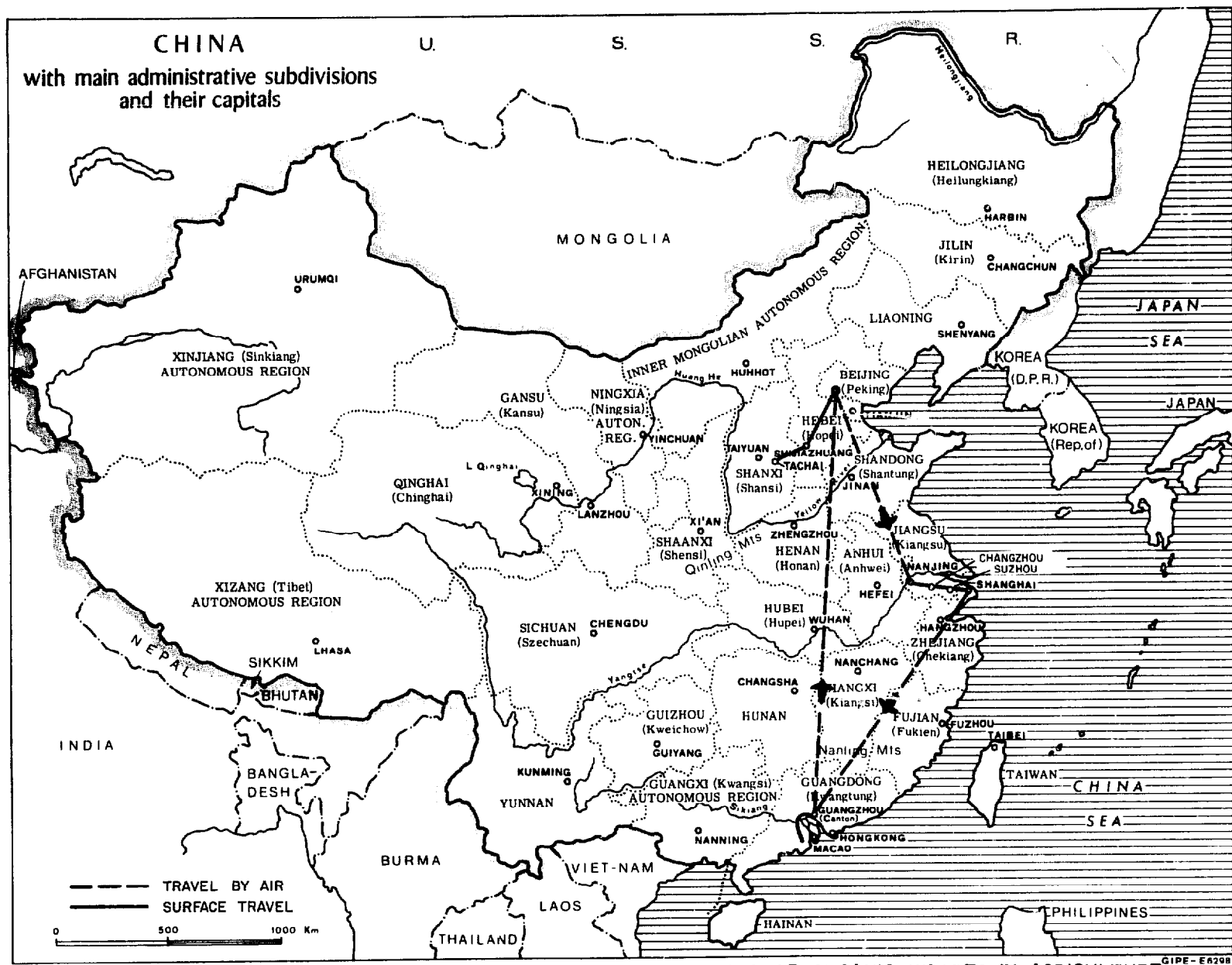

ITINERARY OF THE FAO STUDY TOUR TO CHINA ON RECYCLING OF ORGANIC WASTES IN AGRICULTURE
28 APRIL - 24 MAY 1977

CHINESE UNITS OF MEASURES

1 mu	-	0.066	ha
1 ha	-	15	mu
1 li	-	0.500	km
1 km	-	2.000	li = 1 gungli
1 jin	-	0.500	kg
1 kg	-	2.000	jin = 1 gungjin
1.00 yuan	-	0.54	US\$
1.00 US\$	-	1.85	yuan

The Chinese are phasing out the jin and the li units and are making gungli and gungjin (metric units) standard.

BASIC FACTS

The People's Republic of China has a total area of 9.6 million km². The distance from east to west measures over 5 000 km and from north to south over 5 500 km.

China's present population is about 850 million. The Han nationality is the most numerous, making up 94 percent of the total population. The rest consist of more than 50 nationalities, including Mongolian, Hui, Tibetan, Uighur, Miao, Yi, Chuang, Puyi, Korean, Manchu and Kaoshan, etc.

Out of the total population, 680 million or 80 percent live in rural areas. The main official language is standard Chinese based on the Peking dialect. Other principal dialects are Cantonese, Shanghai, Fukienese and Hakka.

Administratively, China now consists of three municipalities directly under the central authority (Peking, Shanghai and Tientsin), 22 provinces and five autonomous regions.

The topographical outline is a three-step west-east staircase. It begins with the Chinghai-Tibet Plateau 4 000 metres above sea. Crossing the Kunlun and Chilian ranges on the plateau's northern edge and the Hengtuan Mountains on its eastern edge, the land slopes away to highlands and basins mostly from 2 000 to 1 000 metres above sea; then it descends further eastward to hilly regions and plains below 1 000 metres.

The country's climate is controlled by monsoon winds. The complex terrain, the vastness of the country and the big difference in latitude (53°N to 4°N) give the country a great many types of climate, one of the factors favouring agricultural development. China can thus grow a very wide range of food crops (rice, wheat, maize, sorghum, millet, oil seed crops, groundnut, rape, sesame, etc.); industrial crops (sugarcane, sisal, cotton, coffee, cocoa, tea, tobacco) and fruits and vegetables.

The varied patterns of climate, topography, rocks and vegetation over China's vast territory and its long history of agricultural development, has given it many kinds of soils - red and yellow, meadow, brown, black, chestnut, desert and semi-desert soils.

China has at present about 130 million ha of land under arable and permanent crops, which is 13.4 percent of the total area of the country. Since 1961 the agricultural area has been increased by about 10 million ha. From the total agricultural area, 84.7 million ha or 66 percent are under irrigation. (Source: FAO Production Yearbook, Vol. 30, 1976).

CHAPTER 1

RECYCLING OF ORGANIC MATERIALS

1.1 General

China uses recycled organic wastes in agriculture on the largest scale. To the Chinese, there is nothing like waste; waste is only a misplaced resource which can become a valuable material for another product. This way of looking upon waste is one of the guiding principles of China's traditional concept of the multi-purpose use of resources and the recovery and re-use of waste materials. The insistence on the recovery and re-use of waste materials for agricultural purposes goes far beyond the traditional custom. Since Liberation (1 October 1949, when the People's Republic of China was proclaimed by Chairman Mao) the country has been aiming at transforming waste into wealth and the protection of the social and physical environment and thus of human health. It is also viewed as an essential for social development by changing the traditional division of labour and the specialisation of work.

Every manurial resource is carefully collected, conserved and used on the land, so eventually helping to maintain soil productivity in a system of intensive cultivation and acting as a 'buffer' against shortages of mineral fertilizer. At present, about two-thirds of the total nutrient intake is derived from natural manures and heavy reliance on these manures will continue because:

- the Chinese have developed a long standing experience in matching the various types of organic manures to their local soils and it will take some more time to acquire a thorough knowledge of crop behaviour, soil quality and the corresponding functions of particular types of mineral fertilizer;
- while mineral fertilizers are relatively costly, organic manures are constantly available locally at little or no cost except in manpower;
- the commune members prefer organic manure because it increases the organic matter in the soil and improves soil structure;
- experiments and soil analysis have indicated that Chinese soils are in general more responsive to nitrogen than phosphate and to phosphate than potash, and that most of these soils have no micro-nutrient deficiencies as a result of long term use of organic manures;
- construction of fertilizer factories makes great demands on funds, equipment and technical ability. The development of a fertilizer industry has to be gradual, depending upon internal resources rather than imports.

1.2 Important Manurial Resources

Important manurial resources available locally for conservation and use are:

- animal wastes: cattle dung, urine and pig excreta;
- human habitation wastes: night soil, urine, sewage/sludge, garbage;
- crop wastes: straw, husks, stalks and stubbles, weeds, grasses, leaves, sugarcane-trash, tea and cotton wastes;

- green manures and aquatic plants;
- bio-fertilizers;
- silt;
- other resources.

Figure 1 provides a simplified diagrammatic presentation of recycling of these waste materials in agriculture, as practised in China.

1.3 Extent and Manner of Use of some of the Important Manurial Resources

1.3.1 Animal wastes

i. Pig excreta

Pig excreta are the main source of home-made manures. The communes promote collective pig raising and also encourage individual members to raise their own. The number of pigs has more than quadrupled since liberation (57.8 million to 238 million head in 1976). A target of one pig per person or one pig per mu (15 pigs per hectare) has been set. Today, many prefectures, counties and communes have reached their targets; for instance, the Yueh Chi Commune (Wu County), which the group visited, now owns 1.6 pig/mu or 1.8 pig/person.

Pig excreta are rich in organic matter, nitrogen and phosphorus. The effects of applying it to the soil are long lasting. The Chinese people regard a pig as a "costless fertilizer factory moving on hooves". This is justified on the following grounds. Chinese agronomists assume that the application of one ton of nitrogenous fertilizer (ammonium sulphate) would raise the grain yield (rice) by three tons. According to estimates, the manure produced by a pig through the year serves to increase grain output by 100 to 150 kg. Thus, the manure produced by 20 to 30 pigs in a year could produce the same result as one ton of ammonium sulphate. As scavengers depending largely upon kitchen waste and wild grass for fodder, the sale price of meat, bones, bristles, etc. from a slaughtered pig would usually more than cover the costs of labour and feed and thus leave its annual yield of around 3 000 kg of manure as a free gift for the owner.

Since a production team comprises about 30-40 households, it is not unusual for such a unit to own 30-40 head of pigs all the year round. When applied to rice, this 'costless' manure gives about 3 t of additional grain which could be sold to the state without any deduction of fertilizer cost as in the case of using ammonium sulphate.

The Chinese Government has a pragmatic approach to its policy towards pig raising. The communes find it difficult to rear pigs in sufficient numbers and at costs as low as in the households, nor can they afford to grow enough fodder crops. It is for these reasons that the Government has allowed individual members to rear pigs both as a source of supply of pigs to the State and of manure to the production brigades/teams which are largely dependent on pig manure for plant nutrient supplies. The individual members also stand to gain some supplementary income from pig raising.

An owner generally keeps his pig in an arch-shaped shelter with a frontal deep pit (about 2 m deep, provided with stone steps) filled with crop wastes, straw and grass. The pig defecates in the pit. The material in the pit is raked over from time to time and more straw and grass added. The manure is finally sold for use on collective land.

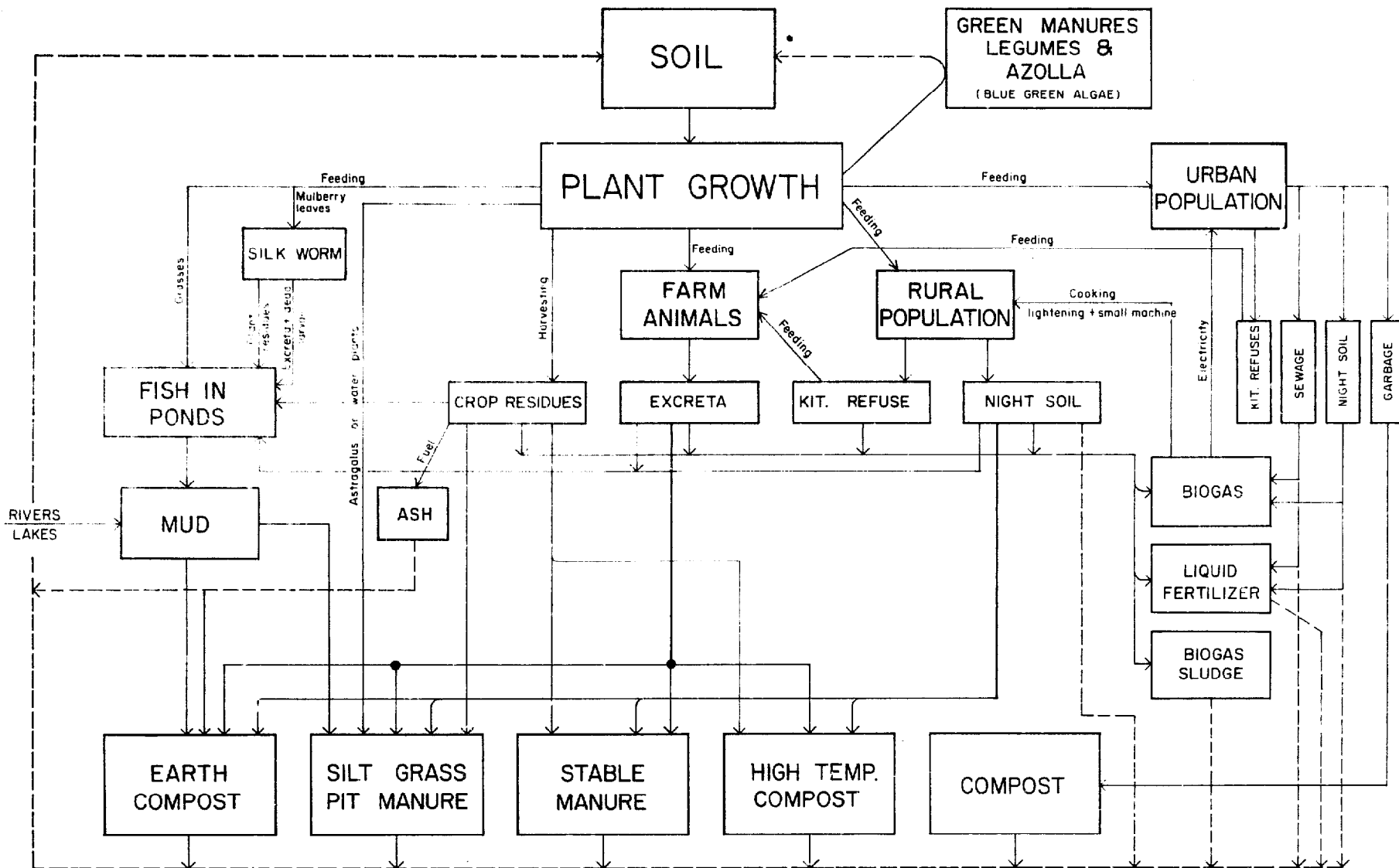

Fig. 1 RECYCLING OF ORGANIC WASTES IN THE PEOPLE'S REPUBLIC OF CHINA

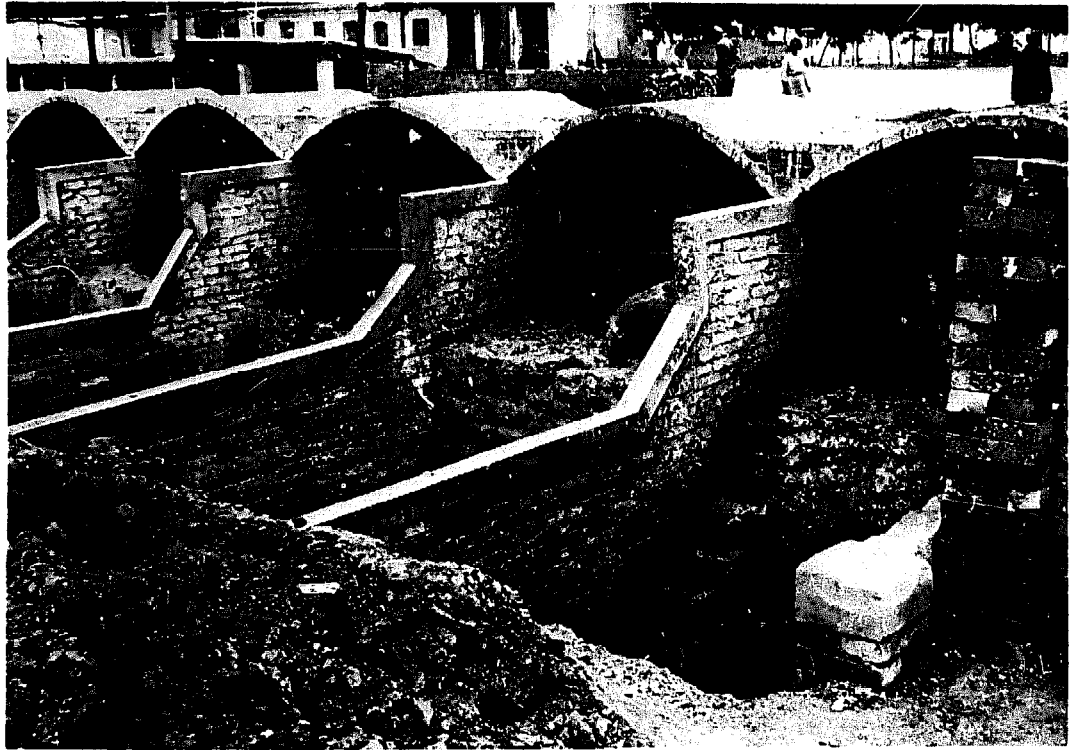

Fig. 2 Arch-shaped shelter for pigs with frontal pit. Ta Heh Production Brigade, Hebei Province.

Table 1

COMPOSITION OF PIG MANURE

Source	Composition %					
	Organic matter	N	P ₂ O ₅	P	K ₂ O	K
Pig manure (fresh)	15.0	0.60	0.40	0.18	0.44	0.37
Pig urine	2.0	0.30	0.12	0.05	1.00	0.83
Pig manure (air-dried)	34.32	2.12	0.98	0.43	2.45	2.03
Pig manure (litter)	34.00	0.48	0.24	0.11	0.63	0.52

Reported by Yueh Chi Peoples' Commune, Jiangsu Province

The raising of pigs collectively is, however, carried out in sties. Water from washing down the sties is stored in tanks and applied directly to crops as top dressings of liquid manure, when needed. The washings from pig sties situated on the banks of a watercourse are taken directly by boats to fields along the watercourse.

The solid manure is made by mixing the pig excreta with an equal quantity of dried fine mud and stored in manure sheds. It is used as and when required as a basal dressing at the rate of 80-100 t/ha. The mud helps in minimizing nitrogen losses as well as in reducing smells. The pig excreta are also used for preparation of compost together with grasses, silt and crop wastes, and for feeding bio-gas plants.

ii. Cattle wastes

Cattle play an important role in the Chinese economy as they provide an abundant source of manure and valuable items in the diet, as well as being a main source of motive power for agriculture. The livestock population (cattle, water buffaloes, donkeys, mules and camels) in China is reported to have increased from 59.8 million in 1949 to 98 million head in 1976.

A cow or buffalo produces from 6 to 9 t of manure per year. The dung is collected from the stalls and pathways and is composted with crop wastes, weeds, grass and silt. To a limited extent the dung is also used in bio-gas plants.

Droppings and urine from goats and sheep also provide rich sources of plant nutrients. The number of sheep and goats is reported to have increased from 42.4 million in 1949 to 135 million head in 1976. Poultry, duck and rabbit droppings constitute a minor source of plant nutrients.

The nutrient contents of different animal manures, as reported, are indicated below:

	N %	P ₂ O ₅ %	P %	K ₂ O %	K %
Buffalo	0.30	0.25	0.11	0.10	0.08
Sheep	0.70	0.60	0.26	0.30	0.25
Poultry	1.63	1.54	0.68	0.85	0.71
Rabbit	1.72	2.96	1.30	-	-

1.3.2 Human habitation wastes

Night soil has been collected and used for the fertilization of crops for centuries and is a rich source of plant nutrients. From the point of view of conservation and utilization of natural resources, the practice is commendable, although, for health reasons, strict controls have to be carried out. Since night soil is considered a valuable source of crop nutrients, its application to the fields could not be banned on the grounds of being a public health hazard lest ill health be replaced by famine. After liberation, practical modifications were made to existing practices. The principle of giving priority to prevention has been adopted and there have been health campaigns aimed at the extermination of pests and diseases. The commune members were exhorted to store night soil in properly designed closed storage chambers for a four week period to destroy hook worm and schistosoma ova prior to its application. The storage chambers are now widely used in rural areas. Another method gaining importance is to pass night soil through bio-gas plants where



Fig. 3 Foreground: Concrete tanks for night soil covered with plastic. Background: Transport of garbage from Shanghai. Malu People's Commune, Shanghai.



Fig. 4 Compost bins for fermentation of city garbage. Fu Shan, Guangdong Province.

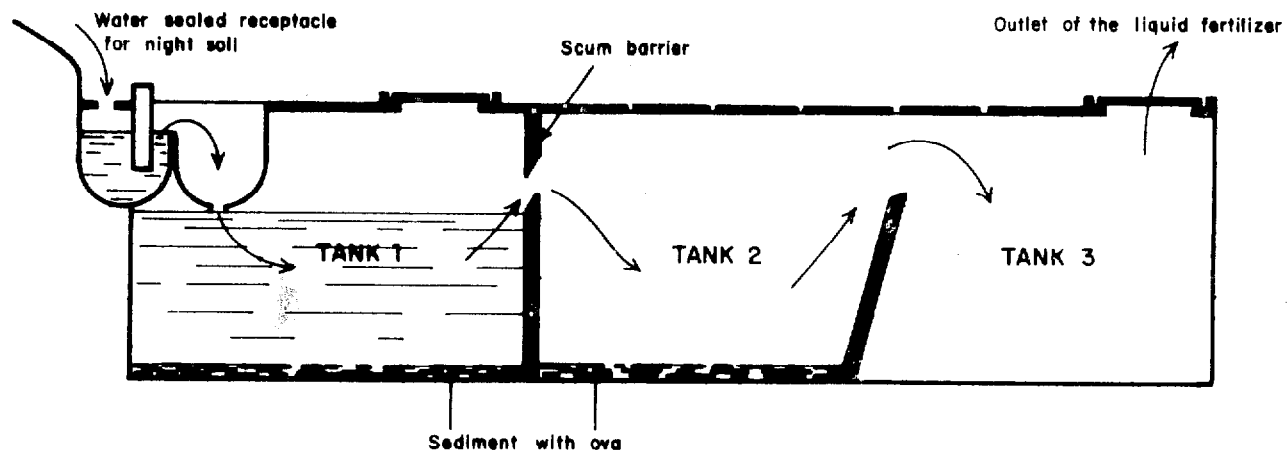

Fig. 5 THREE-TANK FERMENTATION SYSTEM FOR TREATMENT OF NIGHT SOIL ON THE COUNTRYSIDE. MALU Commune (SHANGHAI)

it is subjected to anaerobic digestion which effectively kills parasitic micro-organisms. Night soil is also used as a source of food for fish. Public latrines are built over the fish ponds.

In cities, night soil is efficiently collected and despatched to the rural areas in closed carts or by boat and is mixed with city or crop wastes for high temperature composting, or it is stored in covered pits for about 1-2 months before being distributed to production brigades/teams.

Sewage from sewered areas is taken through pipes to rural areas for irrigation. The sewage is supplied free to communes which have to lay pipes for taking the sewage. The communes receive a subsidy amounting to 20% of the capital cost. Sludge from the treatment plants is pumped to fields where it is kept in improvised tanks and, when dried, is used on land as such for a basal dressing.

City garbage is effectively reclaimed. It is transported daily out of the city areas into the countryside in the thousands of *congcong* boats that ply China's vast network of canals. It is unloaded at the water's edge on commune fields and mixed with night soil for high temperature compost making. Disposal of city garbage in this manner not only improves urban environmental hygiene but also provides large amounts of high quality organic fertilizer for agriculture. The city garbage is partly used for feeding pigs.

City garbage and night soil disposal systems of the type described are by far the most common. However, in certain municipal areas, the city garbage and night soil are processed into manure by the municipalities themselves and sold to production teams. The group came across such a system being used by the Fu Shan Municipality. The garbage is unloaded into compost bins for fermentation for a period of 25 days. The decomposed material is screened and supplied to production teams on payment. Likewise, night soil is subjected to anaerobic digestion. The bio-gas is used to generate electricity and the sludge is sold to commune members.

The disposal systems followed by the municipal bodies help to return to the surrounding agricultural areas much of the constituents of manurial value which originally came into the city/town from the countryside in the form of food and other agricultural products, thus establishing a cyclic change. Under this arrangement, the productive capacity of the lands should not show appreciable deterioration over a period of years.

1.3.3 Crop wastes

Crop wastes or residues like *gou* stalks, stubble, trash, husks, etc. also serve as fertilizer when incorporated into the soil. A mineral fertilizer in appropriate quantities is added to the soil to speed decomposition and make the nutrients available. However, the quantity of these wastes available for manurial purposes may be small because a large proportion is used as animal feed or fuel. Such surplus wastes as are available are used for compost making together with animal/pig/human excreta. Long fibrous materials like sorghum and maize stalks are first chopped mechanically and then composted with nitrogenous rich materials (human/pig excreta) in certain proportions to ensure an appropriate C:N ratio (25:1) for speedy and efficient decomposition.

Green vegetation from the mountains, weeds, leaves and turf (non-crop residues) are also applied to the fields after processing.

1.3.4 Green manures and aquatic plants

a. Green manures

Green manure which is regarded as a 'natural food' for the rice crop is widely used; the most common green manures are (1) milk vetch (*Astragalus sinicus*), (2) hairy vetch (*Vicia villosa*), (3) common vetch (*Vicia sativa*),

(4) sesbania (Sesbania cannabina), (5) sun hemp (Crotalaria juncea) and alfalfa (Medicago sativa).

The area under green manure crops is reported to have been increased from 1.3 million hectares after liberation to 6.6 million hectares in 1977.

b. Aquatic plants

In areas served with networks of waterways, water weeds are cultivated to provide fodder for livestock and manure for the fields. The weeds provide a major portion of fodder requirements and to that extent pressure on land for fodder raising is relieved. Fish culture is also stimulated under water weeds. The Chinese say "if you live near water, make the best use of water". The commune members living near waterways have demonstrated in full measure how it is done.

An account of the green manuring practices and cultivation of water plants for manure is given in Chapter 3.

1.3.5 Bio-fertilizers

Bio-fertilizer is one of the important inputs made possible by recent advances in modern agricultural technology. China has developed the use of bio-fertilizers (blue green algae and Azolla) which fix atmospheric nitrogen.

Azolla cultivation, particularly, has been developed on a large scale for fixing nitrogen for rice crops as well as for green manuring. Bio-fertilizers are a cheaper source of N than mineral fertilizers. Their development and the extent and mode of their field application are described in Chapter 2.

1.3.6 Silt

In areas such as the Yangtse and Pearl River deltas, which are densely supplied with waterways, silt is an important source of fertilizer. A large amount of plant, animal and microbial debris accumulates at the bottom of ponds reserved for fish culture which consequently makes the pond mud rich in humus and manurial constituents (N,P,K). The ponds are generally located between cropped areas. It is reported that 50 kg of fish produce enough pond mud to fertilize 0.6 ha of land. The pond mud is collected four to five times a year and applied to vegetables or spread on the sugarcane fields, mulberry beds and banana plantations. Removal of pond mud and associated organic matter also helps to increase the oxygen in the water which is so essential for fish.

The silt from the bottom of lakes and waterways is removed by silt pumps (silt suckers) installed on boats and is deposited in pits on the sides of the banks for use in composting with weeds, grasses, green manures and crop wastes, or when dried it is mixed with night soil or pig manure. Lumps of mud or silt are mechanically powdered for mixing with night soil or pig excreta for making dry manure on a large scale. Silt and mud are also used to cover manure heaps or sludge as a means of controlling flies.

Silt in large quantities is used not so much for its plant nutrients as for improving the physical condition of soils. The main beneficial effect of silt is attributed to its capacity to help retain soil moisture and improve soil structure.

Due to erosion, rivers in China tend to accumulate large amounts of silt and its removal not only helps to clear the waterways but recovers for agricultural use the fine soil originally lost by erosion.



Fig. 6 Boat for sucking silt from the bottom of the canal. Foreground: Silt tank. Malu People's Commune, Shanghai



Fig. 7 City garbage in state of fermentation, covered by silt. Malu People's Commune, Shanghai

Table 2

COMPOSITION OF SILT

	<u>River silt</u> Sichico (Guangdong) %	<u>Lake silt</u> Tai Lake (Wu County) %
Organic Matter	3.30	5.0-8.0
N	0.18	0.27
P ₂ O ₅ (P)	0.15 (0.06)	0.50 (0.22)
K ₂ O (K)	0.50-0.60 (0.40-0.50)	0.90 (0.75)

Ammoniacal nitrogen in silt is reported to be two or three times more abundant than in field soil. Silt is also considered to be useful as a culture of living micro-organisms, particularly those that fix N.

1.3.7 Other resources

The other manurial resources in use in China are (i) fish wastes, (ii) silk wastes, (iii) animal bones, (iv) oil cakes, (v) ashes, (vi) poultry droppings, (vii) goat and sheep droppings and (viii) industrial wastes.

When appropriately tested and processed these relatively minor sources provide concentrated organic fertilizers.

i. Fish wastes

Aquaculture in China is a part of the overall agricultural system and considerable quantities of fish waste become available for use as manure, apart from the waste products derived from fish that accumulate in ponds and/or lakes.

ii. Silk waste

Cocoon wastes are fed to fish which in turn supply waste/droppings for fertilization of cropland. It is basically a natural cyclical pattern and appears to be ecologically sound.

iii. Animal bones

China maintains well over 300 million larger animals. The bones from slaughtered and fallen animals are crushed for production of bone-meal which is a rich source of phosphatic fertilizer.

iv. Oil cakes

As by-products from crushing for oil, cakes and meals from soybean, groundnuts, rape seeds, sesame seeds, tea seeds and tung seeds make a substantial source of concentrated manure in China. These are used mostly for cash crops such as fruit and vegetables.

v. Ashes

Ashes from burnt straw, stalks, bushes, wood and coal are used as fertilizer, either alone or mixed with human excreta.

vi. Poultry droppings

The rapid expansion of poultry farming during recent years has considerably increased the availability of poultry droppings for application to the soil as manure. It is estimated that about 40 adult birds produce nearly one ton of manure per year.

vii. Sheep and goat droppings

The number of sheep and goats has been increasing in China. They produce substantial quantities of droppings rich in plant nutrients. Chinese farmers have long been familiar with the use of these droppings as fertilizer.

viii. Industrial waste

Industrial wastes are usually recovered in substantial quantities and are being re-used mainly in the form of effluents. The effluent, a source of plant nutrients is applied to the land by irrigation. Factories, enterprises, government officials, schools and the general population are involved either as a part of their daily routine or through participation in drives for collecting wastes for re-use in industry or agriculture.

1.4 Techniques for Processing Composts and Stable Manure

1.4.1 General

There are several techniques used in making home-made manures or composts depending upon the quantity and quality of materials available, circumstances and environment, in each locality. These techniques were developed over the ages on the basis of traditional practices and experience but have now been standardized and given a scientific basis.

Fermented manures of a type similar to traditional farmyard manure and compost are processed from mixed organic wastes of agriculture like straw, stalks, weeds, aquatic plants, animal dung, urine and habitation wastes like city refuse, night soil, sewage or sludge, etc. These materials undergo intensive decomposition in storage with adequate moisture and finally yield a dark brown humified manure.

The decomposition is carried out by a large variety of micro-organisms which essentially require the presence of adequate quantities of carbonaceous materials to serve as a source of energy and a corresponding proportion of nitrogenous materials for building their body-cell substance. With these basic requirements and with adequate moisture, mixed organic wastes become a suitable habitat for numerous micro-organisms which live and multiply, carrying on their activities of decomposition by breaking down complex materials into simple compounds. Finally, on their death, they become a part of the manure themselves. Processed manure will thus contain transformed compounds of a humic nature, some intermediate products of decomposition of the original materials, compounds synthesized by micro-organisms and the cell substance of living and dead microbes.

1.4.2 Some typical techniques for making composts from various types of waste material

i. Composting at field sites

Aquatic weeds or green manure crops, rice straw, animal dung or pig excreta and silt are used in making compost. These are put in alternate layers in a circular or rectangular pit dug in a corner of a field. The pit is filled layer by layer,

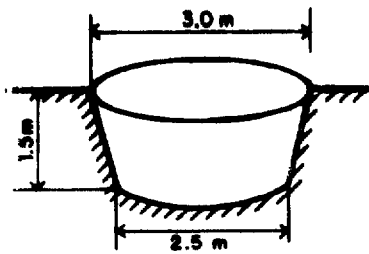

COMPOSITION / PIT

River silt or mud	7,500 kg
Rice straw	150 kg
Stable manure (pig)	1,000 kg
Green manure plants or water plants	750 kg
Superphosphate	20 kg

N content	0.3 %
P ₂ O ₅	0.2 %
K ₂ O	0.3 %
Organic carbon	4.5-6.0%
C/N-ratio	15-20:1
O.M.	7.8-10.3 %

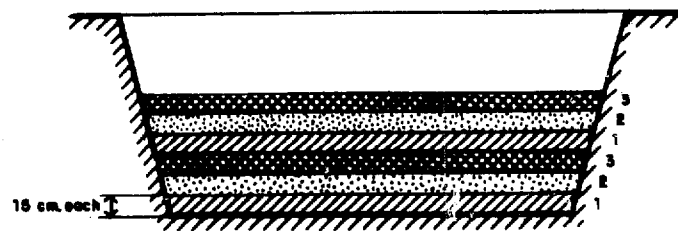
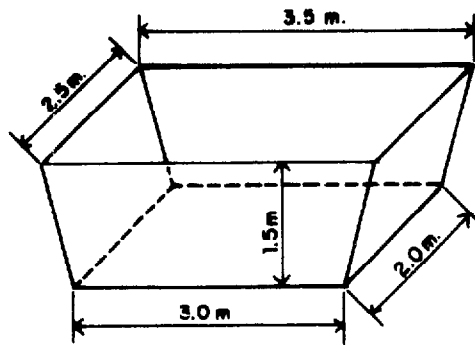

- 1 Green manure (legumes, e.g. Astragalus; or water plants, e.g. water hyacinth)
- 2 Silt straw mixture
- 3 Stable manure (pig manure)

Fig. 8 SILT-GRASS MIXTURE OR PIT MANURE. YUEH CHI Commune, WU County (JIANGSU Province)



Fig. 9

Turning over of the silt grass mixture. Agricultural Research Station, Feng Chiao People's Commune, Jiangsu Province



Fig. 10

Silt-grass manure pits. Agricultural Research Station, Feng Chiao People's Commune, Jiangsu Province.

each layer being 15 cm thick. The top layer is of mud and a water column 3-4 cm deep is kept at the hollowed surface to create anaerobic conditions. The anaerobic conditions help in reducing the nitrogen losses to a minimum. Figure 8 illustrates the design and dimensions of these pits and the position of layers of different wastes.

The approximate quantities of different wastes put in the pit are:

	<u>tons</u>
River silt	7.50
Rice straw	0.15
Pig excreta or animal dung	1.00
Aquatic plants or green manure crops	0.75
Superphosphate	0.020

The contents of the pit are turned over three times, the first turning being done a month after the pit is filled. During this turning superphosphate is added and thoroughly mixed with the composting material and water is added to the mass to provide optimum moisture. The second turning is done after another month and the third after about 2 weeks. The manure is ready for application in a total of three months time.

Each pit gives about 8 t of manure which is sufficient for 0.1 ha of crop land. The composition of such a manure as reported by the Yueh Chi People's Commune is given below:

C : N ratio	15-20: 1
Organic matter (%)	7.8 - 10.3
Nitrogen (%)	0.30
P ₂ O ₅ (%)	0.20
(P) (%)	(0.09)
K ₂ O (%)	0.30
(K) (%)	(0.25)

The group saw a series of such manure pits located all along the borders of fields at the Agricultural Research Station of the Fang Chiao Peoples' Commune. These pits were reported to have been filled during the slack season when materials for composting are collected.

ii. Dry manure

- a. Dried and ground mud (ground mechanically for mass production) is mixed with pig excreta in equal proportions and placed in a pile under cover in a manure shed until needed.
- b. Ash is mixed to 40% with night soil or pig excreta. This is then mixed with an equal quantity of mud and kept under cover for use when needed.

This type of manure is generally prepared in the shade in the warmer zones. The manure sheds constructed for the purpose are simple structures, oblong in shape with walls or pillars 1-1.5 m high, tiled or thatched roofs and with enough space for aeration.

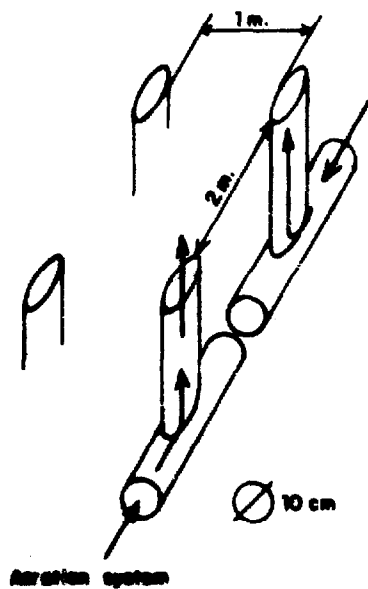

COMPONENTS

- 40 % Crop stalks
- 30 % Agricult. wastes and garbage
- 30 % Animal manures, excreta and night soil

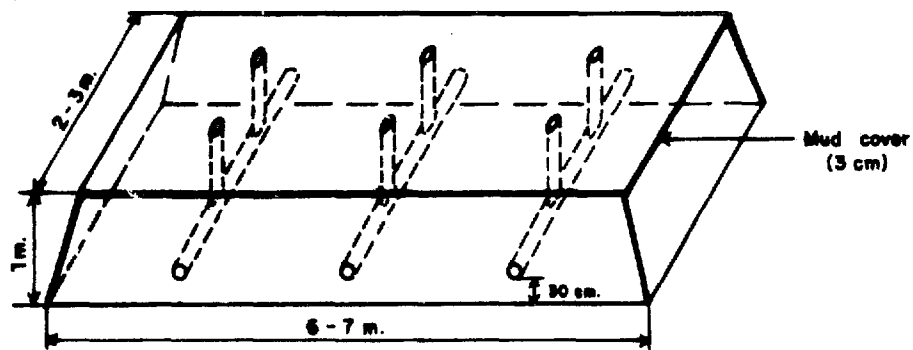

**Fig. 11 HIGH TEMPERATURE COMPOST HEAP (USING BAMBOO FOR MAKING HOLES FOR AERATION)
CHUN SUN PRODUCTION BRIGADE, CHAO County (HEBEI Province)**

The group saw how dry manure was being prepared by the members of the No. 1 production team of Chang Nan Production Brigade. The use of a machine to powder the mud was of particular interest as also were the manure sheds used.

iii. Liquid manure

- a. Pig droppings and washings from the sty are led into a cement pit about 3 m in diameter and 1.5 m deep. Weeds and aquatic plants are added and kept there for 10-15 days for fermentation. The liquid manure is applied as a top dressing.
- b. Night soil and urine are collected in special tanks which have small openings. The tank is sealed after filling and the contents are left to ferment for 2-3 weeks or so before being used for top dressing.

iv. High temperature compost

High temperature compost is chiefly a compost of human and animal excrement and chopped plant stalks. The ratio of excrement to crop waste is about 1:4. The materials are placed in a heap made up with alternate layers, starting with crop residues and followed by excrement. The optimum moisture content is attained by adding water.

While making the heap a number of bamboo poles are inserted to serve as vents or chimneys. After the heap is formed, it is sealed with a plaster of mud 3 cm thick. The bamboo poles remain in position for a day and are then withdrawn, leaving the holes. When the temperature rises to 60-70°C (which develops in about 4-5 days) the holes are sealed. The heap is usually turned after two weeks to ensure even decomposition. While turning, water, animal or human excreta are added to make up any moisture deficiency. The turned material is repled and sealed. The compost is ready in two months time. Compost of this type is considered to be of high quality and free from parasitic micro-organisms.

Figure 11 illustrates the size of such heaps and the arrangements made for aeration. A demonstration was arranged at the Chun Sun Production Brigade Chao County, Hebei, to show the group how high temperature compost was made. The group also saw a modification of this type of compost making at the Tung Shao Ying Production Brigade, Ta Heh County, Hebei, where a bundle of maize stalks instead of bamboo poles was used for aeration. The raw materials used were crop stalks 30%, night soil 30-40% and silt 30%. Superphosphate was also used at the rate of 20 kg/t of composting material.

v. Earth compost (fertile earth)

Earth compost is a variant of stable manure in that copious quantities of dry soil (2 or 3 times that of the livestock excrements) instead of litter are spread on the floor of the stable or stall. The soil, which is added to from time to time, absorbs the liquids and ensures that the stable or stall is dry and comfortable for the animals. After several months, the excrements and soil are well mixed and become a high quality manure.

vi. Composting mixtures of city garbage and night soil

- a. City garbage (70-80% by weight), free from resistant matter such as glass or metal, and night soil (20-30% by weight) are mixed thoroughly. The mixed material is then piled in a heap about 4 m wide at the base, 2 m wide at the top, 1-5 m high and about 4 m long. After heaping about 30 cm high, sets of bamboo poles are laid horizontally on the heap at every 1.5-2 m, each set connected at the centre with a bamboo pole



Fig. 12 High temperature compost heaps, sealed with plaster of mud. Chun Sun Production Brigade, Hebei Province.



Fig. 13 High temperature compost heaps, showing the preparation of the aeration system using bamboo. Chun Sun Production Brigade, Hebei Province.

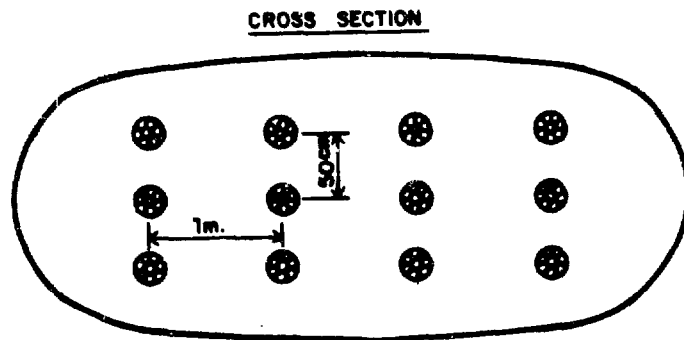
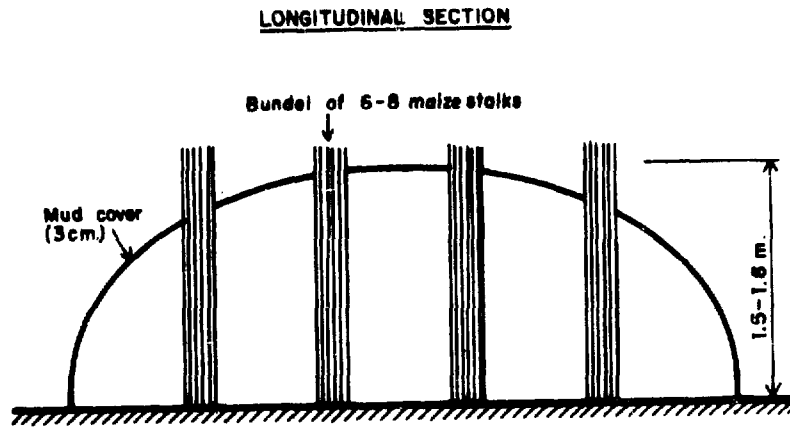

COMPONENTS

- 1/3 Earths
- 1/3 Crop stalks
- 1/3 Horse dung, night soil,
20 kg/ton superphosphate

Fig.14 HIGH TEMPERATURE COMPOST HEAP. (USING MAIZE STALKS FOR AERATION)
TUNG SHAO YING PRODUCTION BRIGADE, TA MEH County (HEBEI Province)



Fig. 15 High temperature compost heap sealed by mud and showing aeration system using maize stalks. Ta Heh Production Brigade, Hebei Province.

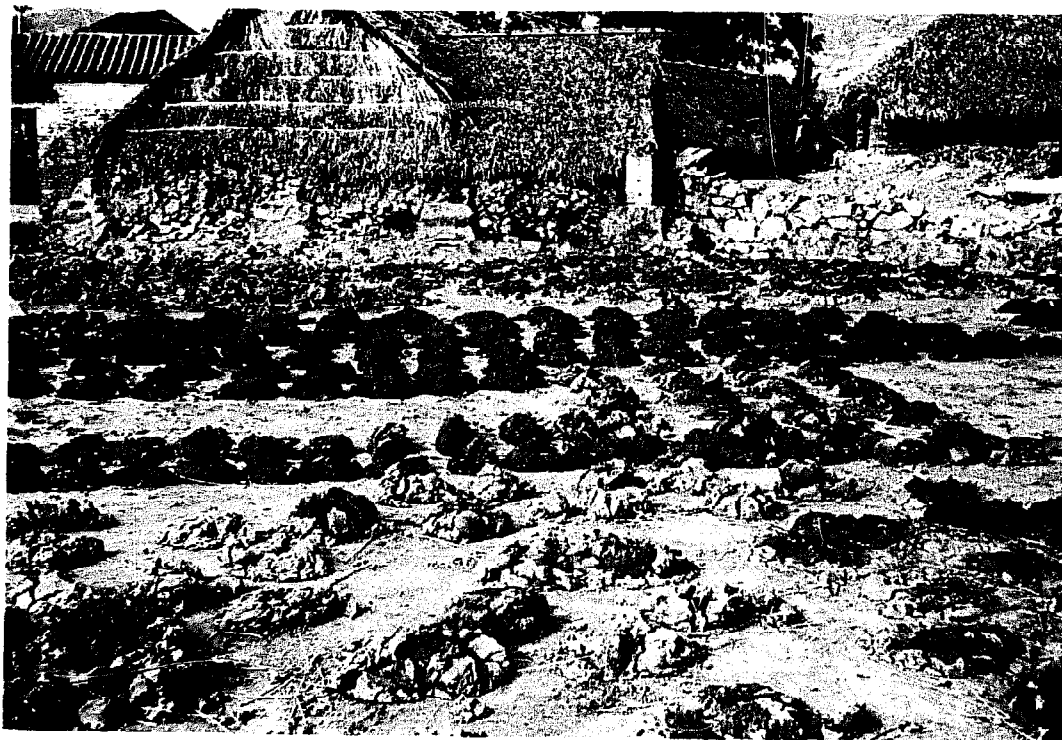

Fig. 16 Silt being dried before it is ground and mixed with animal and human waste for dry manure. Chang Nan Production Brigade, Hsin Hui County, Guangdong Province.

stood vertically. On completion, the heap is sealed with a 2-3 cm thick coat of 40% soil and 60% cinders mixed with water. The day after heaping, the bamboo poles are withdrawn so leaving airways for ventilation.

The temperature of the heap rises to over 50-55°C within 1-2 days and this temperature is maintained for more than 10 days, effectively destroying pathogenic micro-organisms and parasite eggs, and breaking down putrefying organic matter. The compost is ready in 3-4 months.

In summer, bamboo poles need not be used for ventilation. With a proper moisture content and loose stacking, a temperature of about 55°C is developed.

- b. In large scale composting, city refuse and night soil are placed in heaps 1 m high, 1 m wide and any convenient length with garbage and night soil laid in alternate layers in the ratio of 3:1 by volume (or in equal weights). The ventilation system is also applied in this case. This type of composting requires less work and space and maintains temperatures above 50°C.

Plastering the heaps with mud maintains moisture and temperature, avoids nutrient losses, prevents emergence of maggots from the pile to complete their life cycle and keeps out breeding flies.

vii. Organo-mineral manures

- a. Weathered coal, peat or lignite is broken up and mixed with ammonium, sodium nitrate and potassium to become a humic acid fertilizer easily absorbed by crops. It is also used to adjust the soil pH.
- b. Liquid ammonia is mixed with peat in the ratio of 1:6. Some mud is added and the material is then kept in a pit for about a week before use.
- c. Pig excreta are mixed with ashes, cinders and black soil, adding liquid ammonia. The material is kept in a heap for a week before use.

1.4.3 Methods and rates of application of compost and manures

The bulk of the compost or manure is usually applied during land preparation before planting. The manure is ploughed under or harrowed into the soil soon after it has been evenly spread over the land. An additional application is made at planting time when it is used in conjunction with mineral fertilizer in furrows, the top layer being of manure which may perhaps harbour some strains of nitrogen-fixing bacteria.

Liquid manure (moisture content exceeding 88%) is applied as a top dressing, and if the quantity is large, it is applied by irrigation systems. To achieve optimal effectiveness of liquid manures, different times of application are recommended for various types of soil. For light and medium soils, it is best to apply liquid manure in early spring. For medium-heavy soils, it is applied during summer and autumn. In dry regions and in the lowlands, it is applied in winter.

It is claimed that the type of manure used is matched to the soil and plant. For instance, ashes are used on sandy soils, sheep manure and animal manure on black soils and pig manure on brown soils.

Rates of application of organic manures vary according to the crop, soil, season and type of manure. These are determined by criteria such as: (a) the amount of nutrients, mainly

nitrogen, which can be effectively utilized by the crops grown; (b) the amount which would not reduce seed germination and seedling growth rate; (c) the amount which can be physically deposited or incorporated into the land.

Manure containing less than 50% moisture is applied at rates as high as 200-300 t/ha. With night soil slurry or liquid manure with 90% moisture content, application rates are limited to 20-30 t/ha for each application.

The following rates are generally used on selected crops:

	t/ha
Rice 1st crop	60-70
Rice 2nd crop	60-70
Wheat	75-100
Maize	75-90
Soybean	30-45
Cotton	70-75
Sugarcane 1st crop	75-135
Sugarcane (ratoon)	75-135 + mud at 65 t/ha

To meet the optimum requirement of organic manures, it is aimed to keep the number of livestock in balance with the area of cultivated land. Suitable storage facilities (manure shed, manure heaps, tanks) are maintained so as to apply manure during periods of the year when utilization is most effective and to avoid losses of nutrients in storage through run-off, leaching and volatilization.

1.4.4 Selected experimental work on home-made manures

A few of the important experimental results concerning the beneficial effects of home-made manures are briefly described below.

i. Effect of compost on crops

Field experiments carried out all over the country have given results indicating that an application of 500 kg of compost will give a 25-50 kg increase of rice grain. The increase in production of wheat, sorghum, grain millet, soybean, maize, potato and sugarbeet are listed in the following table.

Five years of continuous experiments on the application of compost to paddy soil in Nanjing and to dark brown soil in northwest China indicated that the effect of compost lasted through the crops of rice, wheat and others. On the double-cropping rice land, the subsequent effect of compost was more evident.

Table 3

EFFECTS OF COMPOST ON YIELD INCREASE OF IMPORTANT CROPS

Crop	Amount of compost applied (t/ha)	Yield (kg/ha)	Increase (kg/ha)
Maize	0	4 408	
	30.4	5 700	1 292
Potato	0	7 737	
	38.0	14 630	6 893
Sugarbeet	0	26 741	
	15.2	33 600	6 856
Wheat	0	2 336	
	38.0	3 230	904
Millet	0	2 257	
	38.0	3 341	1 087
Sorghum	0	1 664	
	38.0	3 078	1 414
Soybean	0	1 877	
	30.4	2 310	433

Table 4

RESIDUAL EFFECT OF COMPOST ON RICE

Amount of compost applied to early rice (kg/ha)	Yield of early rice (kg/ha)	Total increase in yield (kg/ha)
0	3 154	-
21 052	3 914	988
23 560	4 043	1 026

The application of compost has also been found to improve the quality of upland crops. Field experiments carried out on apples showed that the fruit from compost-treated trees contained 12.63% of sugar and 0.32% of acid, with an increase of 1.88% and 0.10% respectively in favour of the treated trees. Moreover, the compost-treated trees showed greater resistance to adverse conditions.

ii. Effect of compost on soils

The application of compost improves the physio-chemical and biological conditions of soils besides providing plant nutrients. The humus in compost is a colloidal material with negative electric charge and is coagulated with cations and soil particles to form granules. Soil with more granules is less sticky, higher in buffering capacity, has a better permeability and greater water holding capacity, and is capable of regulating the pH of the soil, thus creating a good environment for crop growth.

Table 5 EFFECT OF COMPOST ON SOIL POROSITY

Treatment		Depth (cm)		
		0-10	10-25	25-50
Total porosity (%)	No compost	51.6	49.4	43.7
	Compost ^{1/}	52.3	56.4	46.0
Permeability to air (%)	No compost	16.1	8.8	
	Compost ^{1/}	18.2	7.5	

^{1/}With compost at 38 t/ha

Table 6 EFFECT OF COMPOST ON BULK DENSITY AND STICKINESS OF SOIL

Application rate (t/ha)	Bulk density g/ml	Stickiness ability g/cm ²
0	1.35	1.90
38	1.25	1.31
76	1.25	1.23
152	1.23	0.90

The change in bulk density and porosity of soil directly influences the growth and respiration of the roots of crop plants. The variation of stickiness effects the workability of soil.

Application of compost has an effect on water holding capacity and on the evaporation of water from soil as shown below:

Table 7 EFFECT OF COMPOST ON WATER ABSORPTION ABILITY OF SOIL

Number of days elapsed	Amount of water absorbed in the soil with no compost applied (%)	Amount of water absorbed in the soil with 228 t/ha of compost applied (%)
1	24.2	25.5
2	25.4	27.5
3	26.2	28.6
4	26.3	29.0
5	26.3	29.5

Table 8 EFFECT OF COMPOST ON EVAPORATION FROM SOIL

Number of days elapsed	Light loam		Sandy loam	
	With compost (%)	Without compost (%)	With compost (%)	Without compost (%)
1	5.71	7.14	4.17	10.0
2	12.14	17.14	17.43	21.4
3	18.57	31.43	14.27	27.1
4	23.57	40.70	17.85	32.8
5	41.43	55.71	23.57	37.1

The application of compost affects enzyme activity, fibre decomposition and carbon dioxide generation in the soil. As compost is increasingly applied, the urease and proteinase become more active. This reflects not only a greater amount of nitrogenous materials contained in the soil but also the rate of mineralization of nitrogenous compounds and the increase of the nitrogen supply to the crop. The decomposition of organic matter in the soil has a close relationship with dehydrogenase and hydrogen - peroxidase which accelerate the liberation of CO₂ and the decomposition of fibrous material.

Results obtained from these studies are shown in the table below:

Table 9 EFFECT OF COMPOST ON ENZYME ACTIVITY

Rate (compost)	Yield (kg/ha)	C (%)	N (%)	P (%)	CO ₂ mg/g in soil	Fibre decomposition position 1/	Proteinase 2/	Urease 3/	Hydrogen peroxidase 4/	Dehydrogenase 5/
76 t/ha	3 040	2.56	0.0273	0.067	3.90	18.99	241	360	3.46	1.70
38 t/ha	2 606	1.88	0.0243	0.062	2.86	16.58	190	301	3.18	1.35
None	2 151	1.79	0.0200	0.062	2.56	10.56	156	209	2.74	0.80

- 1/ Fibre decomposition is expressed as CO₂ in mg/g soil.
- 2/ The activation of proteinase is expressed as NH₄-N mg/100 g in soil.
- 3/ The activation of urease is expressed as NH₄-N mg/100 g in soil.
- 4/ The activation of hydrogen peroxidase is expressed by the number of ml consumed by 0.1 N KMnO₄.
- 5/ The activation of dehydrogenase is the readings in colorimeter.

Source: Soil and Fertilizer Research Institute, Shandong Province.

Compost reduces soil erosion. Studies in Sichuan Province have indicated that on a sloping sandy soil the compost treated section had 16% less surface run-off and 41% less erosion than the control. Compost has proved most efficacious for improvement of saline and alkaline soils.

iii. Application of organic fertilizers

An attempt has been made to estimate the extent of the use of organic fertilizers in China. The estimates given in the table are based on the information gathered or assumed, and supported in some cases by published data; at best they are approximate only. The estimates are given in the table below:

Table 10

ESTIMATED USE OF ORGANIC FERTILIZERS IN CHINA^{1/}

	Quantity available in <u>million tons</u>	Nutrient content %					Plant nutrients in <u>thousand tons</u>				
		N	P ₂ O ₅	P	K ₂ O	K	N	P ₂ O ₅	P	K ₂ O	K
1. Night soil (at 60% available)	127	0.60	0.20	0.09	0.30	0.25	762	254	111	381	316
2. Cattle manure (at 70% available)	411	0.60	0.30	0.13	0.80	0.66	2 460	1 233	534	3 288	2 713
3. Pig manure (at 80% available)	571	0.50	0.40	0.18	0.50	0.42	2 855	2 284	1 004	2 855	2 370
4. Goat and sheep manure (at 60% available)	65	0.60	0.30	0.13	1.20	0.99	390	195	85	780	645
5. Poultry manure (at 70% available)	23	1.46	1.17	0.51	0.62	0.51	336	269	117	143	118
6. Plant residues and water plants (at 70% available)	273	0.30	0.20	0.09	0.60	0.50	819	546	240	1 638	1 359
7. Green manures (at 80% available)	48	0.40	0.10	0.04	0.40	0.33	192	48	21	192	159
8. Mud and silt (at 80% available)	144	0.25	0.13	0.06	0.15	0.12	360	187	82	216	179
9. City garbage (at 60% available)	13	0.60	0.40	0.18	1.00	0.83	78	52	23	130	108
10. Oil seed cakes (at 80% available)	4.0	7.00	1.00	0.44	2.00	1.66	28	4	2	8	7
11. Others	10.0	0.40	0.20	0.09	0.40	3.32	40	20	9	40	33
TOTAL	1 689						8 320	5 092	2 228	9 671	8 007

1/ See following explanatory notes

Explanatory notes for basis of calculation

- | | | |
|-----|---------------------------------|---|
| 1. | Night soil | 0.25 t per capita; population 850 million persons |
| 2. | Cattle manure | Animal population 98 million head, 6 t manure per animal/year |
| 3 | Pig manure | Pig population 238 million head, 3 t manure per pig/year |
| 4. | Goat and sheep manure | Animal population 135 million head, 0.8 t manure per animal/year |
| 5. | Poultry manure | Animal population 1.3 billion head, 1 t manure per 40 animals/year |
| 6. | Plant residues and water plants | at the rate of 3 t /ha agricultural land (130 million ha) |
| 7. | Green manure | 6 million ha, at 10 t/ha |
| 8. | Mud and silt | 180 million tons assumed on the basis that 10 million ha of land in delta areas receive 8 t/ha and 50 million ha in other areas at the rate of 2 t/ha |
| 9. | City garbage | Assuming an urban population of 150 million persons and city garbage per capita at 0.15 t/year |
| 10. | Oil seed cakes | 5 million tons a year |
| 11. | Others | These include such items as ashes, fish wastes, silk wastes, bones, goat and sheep droppings |

Taking 130 million ha as the area of cropped land in China, the average quantity of organic fertilizer available per hectare is about 13 t per year. In terms of plant nutrients, each hectare of cropped land thus receives about 64 kg of N, 39 kg of P₂O₅ (17 kg P) and 74 kg of K₂O (61 kg K) through organic fertilizers. However, as the supply of these manures is already approaching the maximum production limit, production of mineral fertilizers has of necessity to be stepped up to meet the growing demand for plant nutrients vitally important for increased crop production.

CHAPTER 2

BIO-FERTILIZERS

2.1 General

Biological processes for fixing atmospheric nitrogen through symbiosis and by free-living nitrogen fixing organisms offer good scope and should be exploited. In China, it is recognized that a natural biological agency can be employed whereby atmospheric nitrogen can be utilized for fertilizing vast areas of lowland rice. The two means used are: (a) *Azolla* and (b) blue-green algae. Techniques for their use in rice cultivation are described below.

2.1.1 Azolla

Azolla consists of a floating branched rhizome which small, alternate, overlapping bilobed leaves and simple roots which hang down into the water and it reproduces itself mostly vegetatively, although spores are also found. The nitrogen-fixing blue-green algae, *Anabaena azollae*, is always found in the cavities of leaves as a symbiont which fixes the atmospheric nitrogen necessary for the growth of the plant.



Fig. 17

Azolla pinnata growing on the water surface between rice seedlings. Huashi Production Brigade, Jiangsu Province.

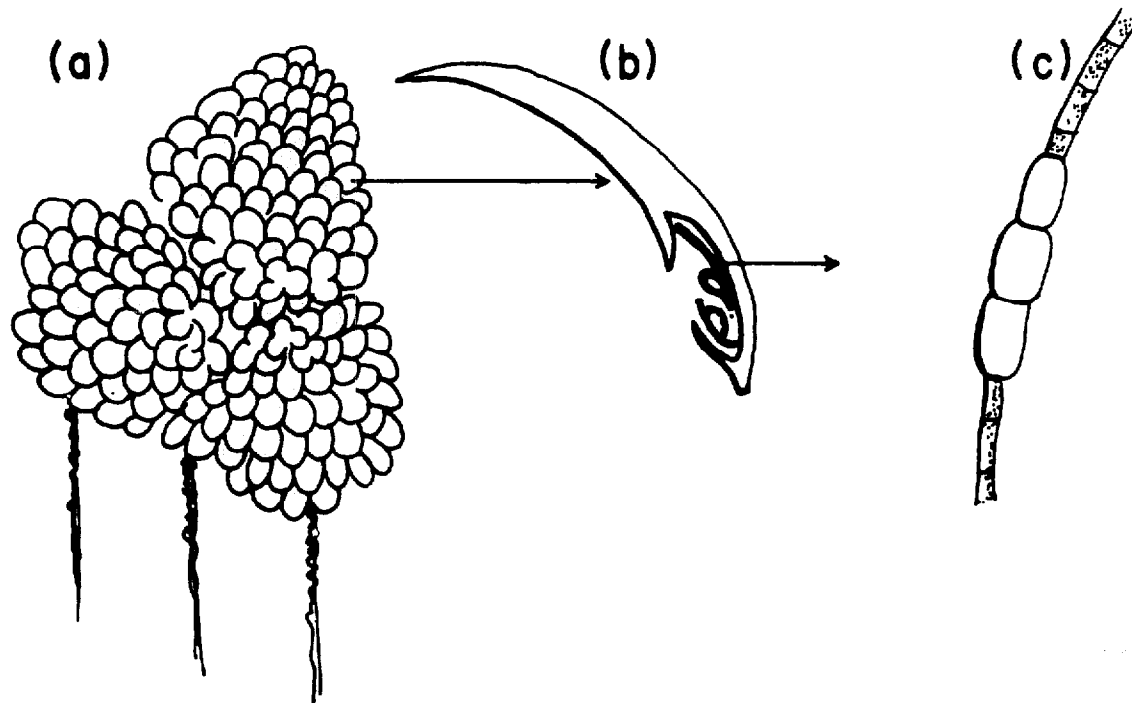

Fig. 18 THE WATER FERN *Azolla pinnata*, a) THE WATER FERN (10 X);
 b) LEAF WITH THE BLUE GREEN ALGA IN THE CAVITIES (100 X);
 c) *Anabaena azollae*, A FILAMENTOUS HETEROCYSTOUS BLUE GREEN
 ALGAE (1000 X).

The utility of Azolla as a fertilizer source was first demonstrated by Khien from North Vietnam, in 1957. Azolla is now known for its ability to fix large quantities of atmospheric nitrogen (312 kg/ha/year, Becking, 1976; 30-40 kg/ha/month, Matsuo 1976; 103-162 kg/ha/year, Stewart, 1977) as well as for its ability to supply to the ecosystem a substantial amount of green matter (157.5 t/ha/year in China; 200-300 t/ha/year in Vietnam, Boswinkle, 1976) which, moreover, facilitates the growth of heterotrophic nitrogen fixing micro-organisms.

The common Azolla in China is Azolla pinnata, a floating fern locally named 'luping' or 'hang ping'. It was introduced into China about 20 years ago.

i. Optimum conditions for growth of Azolla

- a. The optimum temperature for growth of Azolla in China is between 20-28°C. It was, however, reported that a tropical strain of Azolla grows at temperatures ranging from 30 to 35°C in the southernmost province of Hainan. Azolla does not survive temperatures lower than 0°C and higher than 35°C.
- b. Standing water a few centimetres deep and phosphorus are necessary for its growth.
- c. Soils of pH 6 to 7 support the best growth. Since Azolla tolerates a limited range of temperatures and it can only be propagated vegetatively, the Chinese take great care to protect it from frost in the northern provinces and high temperatures in the southern provinces.

Azolla is protected from extreme temperatures, using one of the following methods:

- after collecting the Azolla and draining off the adhering water, it is placed in a special pit lined and covered with straw matting;
- another method, which is more effective, is to keep the Azolla on a straw mat laid over intersecting drainage grooves. The grooves also provide aeration. The height of the heap is maintained at 50-60 cm. The heap is covered with straw mats, which are pegged down, to prevent damage from low temperatures and loss of moisture;
- to protect Azolla from high temperatures, it is kept in field basins or ponds with water circulation and/or is shaded by planting trees around the ponds/water basins.

ii. Azolla production

One-hundred kg of Azolla are put in a nursery bed (120 m²) divided into small basins (3 m x 4 m) of 8 cm depth. Standing water is maintained in the nursery to a depth of 3-5 cm. A planting density of 0.7 to 0.8 kg/m² is most favourable for rapid multiplication. At a lower density the plant takes longer to cover the nursery and also absorbs less solar energy.

After 4-6 weeks each 100 kg of Azolla grows in weight to about 500 kg which is sufficient for "seeding" 0.066 ha. The nursery is covered with plastic sheets if the temperature is low.

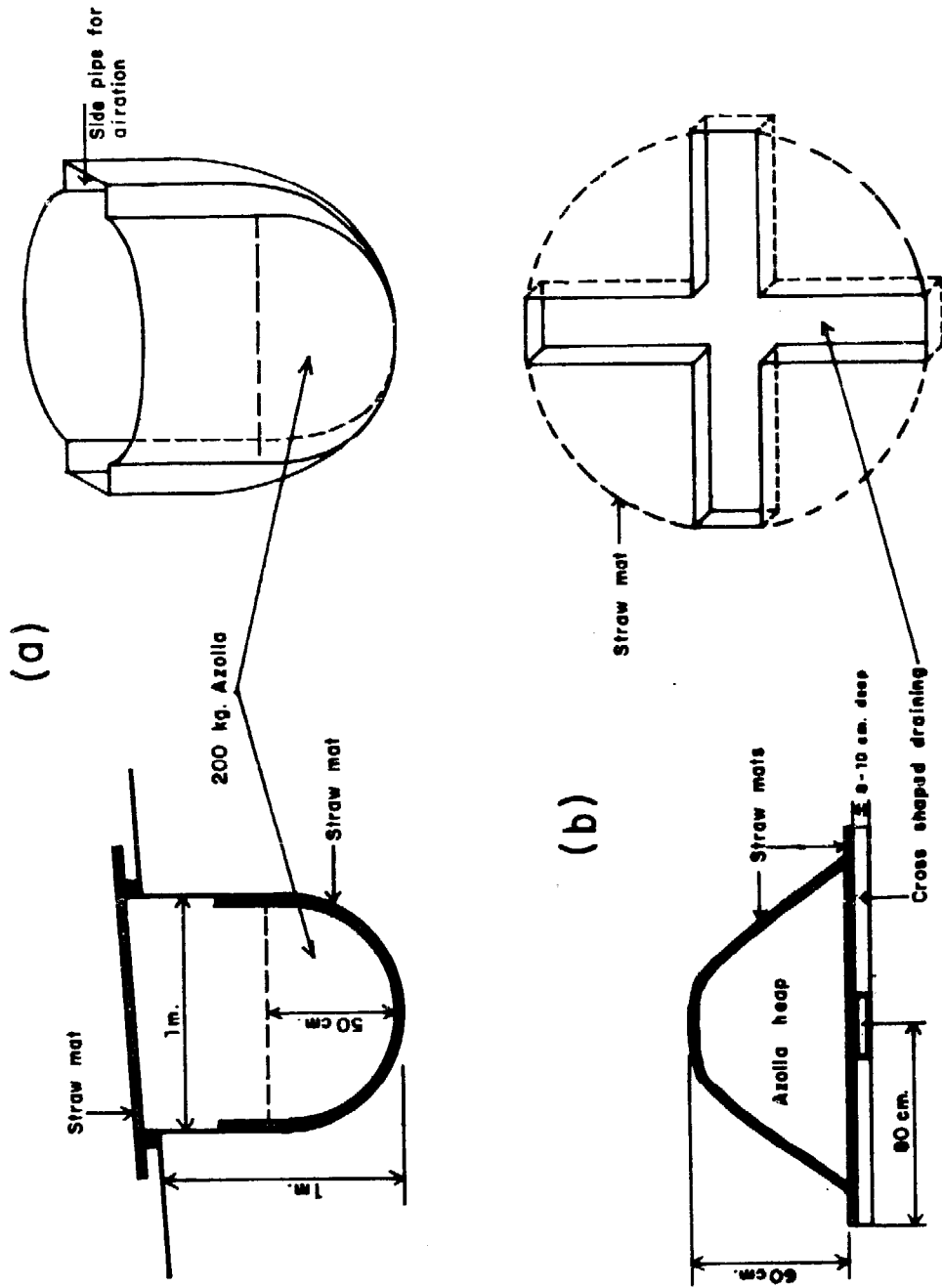

Fig. 19 OVERWINTERING METHODS OF AZOLLA : a) IN A PIT; b), IN A HEAP.
CHANGZHOU (JIANGSU Province)



Fig. 20 Seeding rice field with Azolla. Huashi Production Brigade, Jiangsu Province.



Fig. 21 Fields prepared for rice cultivation and inoculated with Azolla. Huashi Production Brigade, Jiangsu Province.

After seeding the field, the Azolla (500 kg) grows to double its weight every 5 days, i.e. 1 000 kg in 5 days, 2 000 kg in another 5 days.

The group was told in Hsin Hui (Guangdong) that at temperatures above 20°C Azolla would double its weight in 3 days. It was stated that the maturity and yield of the crop can be judged from the degree of covering of the water by the plant. When the margins of individual plants are in contact with one another, the yield amounts to 15 t/ha, but when the plants overlap one another the crop is mature and the yield would be 22.5 t/ha.

iii. Use of Azolla as green manure

The fields being prepared for rice cultivation are flooded and seeded with Azolla at the rate of 7.5 t/ha. After about 5-10 days, when the Azolla has reached a suitable density (22.5 t/ha) the water is drained off, and the Azolla is ploughed under using a 12 h.p. 'walking tractor'. Thereafter, the field may again be flooded for further growing and subsequent ploughing under of Azolla if it is intended to improve soil fertility further or rice seedlings are transplanted.

Azolla regenerates with the rice seedlings and obtains a density of 22.5 t/ha in 10-15 days. It is then buried in the soil by hand. This process is usually repeated two or three times, the last being at panicle differentiation of the rice plants. In any case, when the Azolla covers the entire water surface it must be buried to avoid starving the rice plants of oxygen. It decomposes 8-10 days after incorporation in the soil.

Whenever the interval between winter and early rice crops does not allow Azolla to be grown before transplanting, Azolla seed pieces prepared in a nursery are spread 5-10 days after transplanting the rice seedlings. The same rate of seeding and the same technique is used in this case.

iv. Nitrogen fixation by Azolla

Fields are seeded with Azolla at the same rate as for green manuring, and the crop is harvested up to 10 times in a period of 3-4 months. In one harvest, the yield of Azolla is about 15 t/ha. About 8t/ha of Azolla is left in the field to serve as "seed" for the following crop. The total yield of Azolla through its growth period of 3-4 months is about 160 t/ha. The harvested Azolla is used as planting material for other rice fields. As it is rich in protein and minerals, it is also used as a feed for pigs and ducks and for compost making with grass, silt, etc.

Azolla yields very large quantities of green matter (about 160 t/ha) in a period of 3-4 months, containing about 425 kg of nitrogen (more than 2 t in terms of ammonium sulphate or about 1 t of urea). The green matter and the rate of protein production contributed by Azolla is higher than that of Sesbania cannabina which has the highest nitrogen fixation ability of all the leguminous plants.

Higher nitrogen gains have been achieved through the association of Azolla and Anabaena in China than in Vietnam.



Fig. 22 Azolla, 10 days after inoculation, ready for ploughing under. The mat in the canal prevents loss of Azolla. Agricultural Research Station, Feng Chiao People's Commune, Jiangsu Province.



Fig. 23 Ploughing under of Azolla layer before rice transplanting, using a 12 HP walking tractor. Huashi Production Brigade, Jiangsu Province.

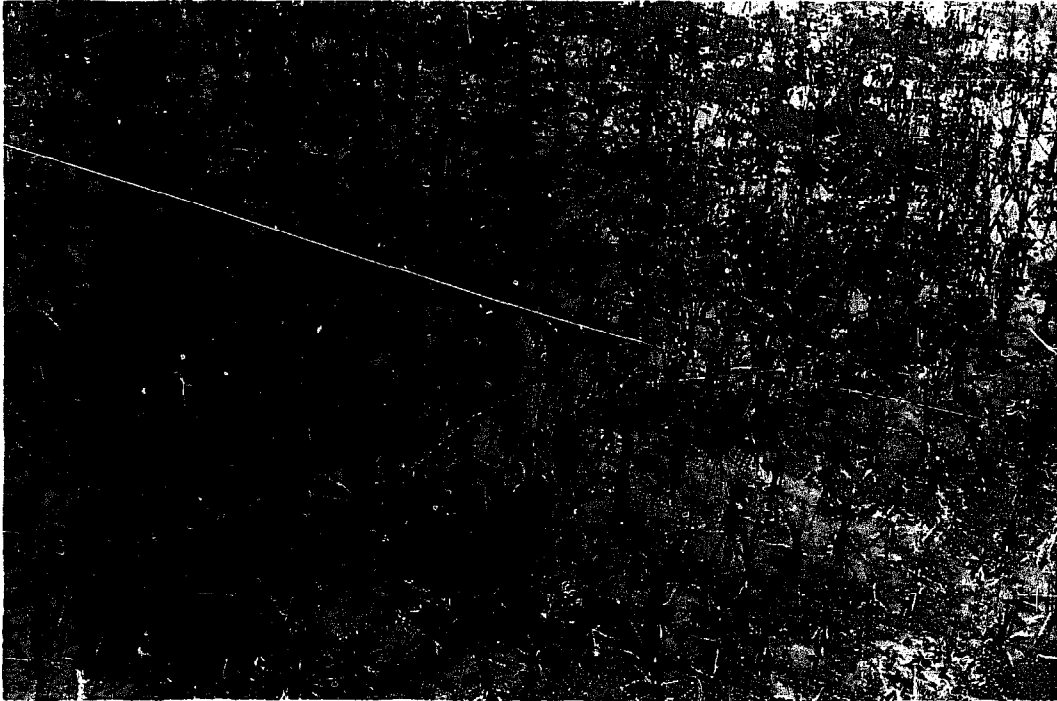

Fig. 24 Azolla covering the water surface between rice seedlings and ready for burying in the soil. Huashi Production Brigade, Jiangsu Province.



Fig. 25 Burying of Azolla seedlings. Huashi Production Brigade, Jiangsu Province.

Table 11 YIELDS FROM VARIOUS METHODS OF APPLICATION OF AZOLLA PINNATA IN CHINA

Application method	Green material t/ha	N kg/ha	In terms of	
			Ammonium sulphate kg/ha ^{1/}	Urea kg/ha ^{1/}
<u>As a green manure crop</u>				
Ploughing under only	22.5	61.2	306.0	133.0
Ploughing under and hand burying once	45.0	122.4	612.0	266.1
Ploughing under and hand burying twice	67.5	183.6	918.0	399.1
Ploughing under and hand burying three times	90.0	244.8	1 224.0	532.2
<u>As a nitrogen fixer</u>				
10 harvests in 100 days	157.5	428.4	2 142.0	931.3

^{1/} Calculated on the basis of information received.

v. Fertilization of Azolla

As nitrogen requirements are met from the air, phosphorus is the main fertilizer necessary; it is applied to the plots at a rate of 150-225 kg/ha as superphosphate (24-36 kg P₂O₅ or 11-16 kg P per hectare). Occasionally, ash from rice straw is also added as a source of potassium at the rate of 20.0 kg/ha K₂O (16.6 kg/ha K). The nitrogenous mineral fertilizer requirements of rice are reduced by half by using Azolla.

vi. Diseases and pests of Azolla

Azolla, like all crops, is attacked by various diseases and pests, chiefly the following:

a. Fungal diseases

- (1) Rhynchospora: causes grey spots on the surface of leaves. The disease is widespread at temperatures higher than the optimum. To control the disease, spraying with diluted Defusit (1 part Defusit to 250 parts of water) is recommended after every 7-10 days, using 1 125 litres of the diluted mixture per hectare. A mixture of equal proportions of Dipterex and Malathion (both at 0.1 to 0.2%) is also used to control the disease.

(2) Damping-off: this disease occurs at high temperatures and high plant densities and is controllable by thinning or ploughing under the crop.

b. Insect disease

Brown borer and grey borer: the plants are frequently attacked by the larvae of lepidopterous insects, which feed on the leaves. Spraying with Fenitrothion or with a mixture of Dipterex and Malathion controls the pests.

c. Snails

Snails eat the roots and leaves of Azolla. The above mentioned insecticides for control of borers are also used for control of snails.

vii. Advantages derived from growing Azolla

1. Gain of nitrogen through nitrogen fixation.
2. Increase in organic matter of the soil. (It was reported by the Huashi Production Brigade (Jiangsu) that the organic matter content of the soil increased from 1.3 to 2.8% and that of the nitrogen from 0.09 to 0.20% as a result of introducing Azolla cultivation.)
3. Saving of nitrogenous mineral fertilizer of up to 30-40 kg/ha. (Application of Azolla to the fields in addition to mineral fertilizer is reported to have given 10-15% higher yields of rice over the mineral fertilizer alone.)
4. Improved soil structure.
5. Provision of a nutritious feed for livestock at intervals of 7-10 days.
6. Acts as an indicator of nutrient deficiency.

The group had the opportunity to see large-scale Azolla cultivation in various production brigades (e.g. Huashi, Kiang Yin County, Jiangsu Province and Cha Kung, Hsin Hui County, Guangdong Province) where the techniques of raising Azolla were also demonstrated.

2.1.2 Blue-green algae

Blue-green algae, belonging to a group of heterogeneous cryptogamic plants containing chlorophyll are highly efficient utilizers of solar energy and have the ability to fix molecular nitrogen. Research and development on algae have been undertaken for some time. However, the potential for three-fold use of algae as a food, fertilizer and energy source has attracted renewed attention.

In China, both basic and applied research is being carried out. An inoculum of a mixture of Anabaena sp. and Nostoc sp. is prepared at the Agricultural Research Institute, Nanjing in flasks containing suitable media under sterile conditions. The algae so grown are then transferred to larger glass bowls to grow under non-sterile conditions.

A quantity of the fresh algae is then used to inoculate a nursery plot (5-7 m long, 1 m wide and 20 cm deep) at the rate of 150 g/m². The water in the nursery is 6-7 cm deep. After about 7 days the algae in the plot attain a density of 500-1 000 g/m². The nursery is covered with transparent plastic sheets to protect the plants from cold.

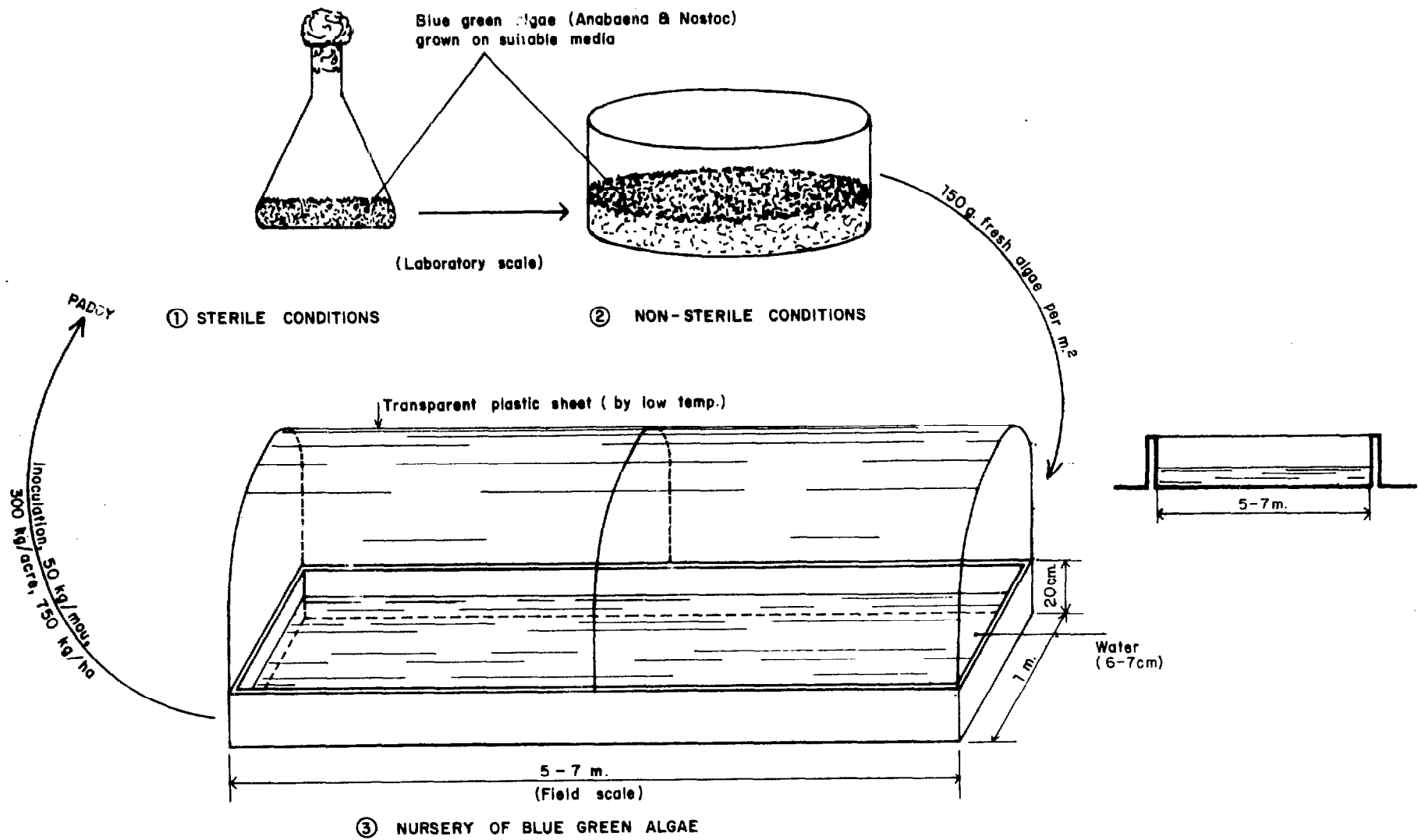

Fig. 26 INOCULATION OF PADDY WITH BLUE GREEN ALGAE, NANJING (JIANGSU Province)

After preparing the field for rice cultivation, it is flooded and algae at 750 kg/ha are spread as inoculum. The algae grow to reach 7.5 t/ha within 10-15 days and even to 15 t/ha at temperatures above 30°C.

It was reported that, under experimental conditions, the increase in yield was about 10%. Further research work was reported to be in progress to reach a stage at which algae could be beneficially used.

CHAPTER 3

GREEN MANURE CROPS AND AQUATIC PLANTS

3.1 Green Manuring

Green manures are crops which are not (or only partly) harvested for animal or human consumption but are ploughed under for adding organic matter, improving soil structure and preventing nutrient leaching, and also in the case of leguminous crops for adding fixed nitrogen to the soil. They are normally planted where cereal crop residues are used for domestic fuel or cattle feed, as in many developing countries, and in countries such as China the organic matter is the major source of plant nutrients.

The Chinese, who regard green manures as "natural food" for plants and soils, have been practising green manuring for a long time. Green manuring was given added impetus when the National People's Congress of the People's Republic of China, in its second session held in April 1960, decided that green manuring should form part of the National Programme for Agricultural Development (1956-1967). It was emphasized thus: "Increase energetically the output of farm manure and chemical fertilizer energetic efforts should also be put into growing green manure crops according to local conditions bacterial fertilizer should be increased to the fullest extent."

As a result, the area under green manure crops has increased from 1.3 million hectares after liberation to about 6.6 million hectares in 1976 (excluding area under aquatic plants which are also partly used for green manuring).

The leguminous crops usually used for green manuring in Chinese agriculture are:

1. Astragalus sinicus (milk vetch)
2. Vicia villosa (hairy vetch)
3. Vicia faba (broad bean)
4. Vicia sativa (common vetch)
5. Medicago sativa (alfalfa)
6. Pisum arvense (field peas)
7. Melilotus officinalis (sweet clover)
8. Crotalaria juncea (sun-hemp)
9. Phaseolus aureus (golden gram)
10. Sesbania cannabina (sesbania)

In south China, winter green manure crops such as milk vetch and sesbania are grown in winter; north China grows alfalfa and hairy vetch.

Four systems of green manuring are followed:

1. Green manure crop sown and ploughed under in the same field.
2. Green manure crop is harvested and buried in other fields of 3-4 times the size. Roots remaining from the harvested crop enrich the first field.
3. Green manure crop is cut, mixed with grasses and mud and put in pits located in corners of fields for compost making or is fed to biogas plants.
4. Interplanting green manure crops with summer rice crops.

The techniques of green manuring with the most common crops used are described below:

3.1.1 Astragalus sinicus is either grown in rotation with two rice crops or intercropped with taller cereal crops (e.g. maize). For example, in Yueh Chi People's Commune, Wu County, Suzhou Prefecture, Jiangsu Province, 267 ha out of 287 ha were put under Astragalus while the area under Vicia, Crotalaria and Sesbania was only 20 ha. In Wu County, as a whole, the area under green manure crops was reported to be about one-third of the rice area.

Astragalus is sown in September-October and is ploughed under or harvested in April-May. Its yield of fresh green matter is about 37-45 t/ha.

3.1.2 Sesbania cannabina grows under varied agro-climatic conditions: tropical, subtropical and semi-arid, and is resistant to drought, soil acidity, alkalinity and waterlogging.

A special technique has been developed for growing Sesbania in nurseries and transplanting the seedlings in the summer rice crop. The seed is sown in the nursery in late March or early April at the rate of 70-90 kg/ha. One hectare of nursery produces sufficient seedlings to green manure 50 ha of rice fields. Superphosphate at the rate of 225 kg/ha and night soil or compost at the rate of 7.5 t/ha is applied in the nursery plot. The seedlings attain a height of 15 cm 30 days after seeding. When the seedlings are 7-10 cm taller than the rice plants to be green manured they are transplanted in the paddy field in rows at a spacing of 2-3 m between rows and 30-35 cm within the row. The Sesbania plants are topped when they attain a height of 90-150 cm to stimulate branching and leaf production. A full grown plant attains a height of 3 m and weighs about 5 kg.

The first additional manuring of the paddy field is done with superphosphate (75 kg/ha) and compost (2.25 t/ha) 10 days before harvesting the rice (or 20 days after transplanting of Sesbania seedlings).

Fifteen days after harvesting the rice, a quick acting nitrogen fertilizer such as ammonium sulphate is applied at the rate of 50-60 kg/ha and Sesbania is ploughed under 3 days before the transplanting of late rice.

The yield of green manure ploughed under is about 15-22.5 t/ha containing 82.5 kg of nitrogen, 10.5-15.8 kg of P_2O_5 (4.6-7.0 P) and 22.5-33.75 kg of K_2O (18.7-28.0 K).

The advantage of this method of green manuring is that Sesbania plants do not occupy the cultivated area for more than a month and yet yield as well as when sown as a sole crop for green manuring. Another advantage of transplanting Sesbania seedlings is that it benefits even the first crop of rice.

Growing of green manure crops substantially reduces demand for mineral fertilizer. The group was told that the Ling Si production Brigade, which introduced green manuring with Sesbania in 1972, has been able to reduce nitrogenous fertilizer (ammonium sulphate) consumption from 75 to 45 kg/ha, so reducing fertilizer costs from US\$ 68.0 to 40.5 for each hectare of rice sown. It was claimed that green manuring in conjunction with mineral fertilizer raised the rice yield from 4 125 kg to 5 025 kg/ha, i.e. 21.8% increase.

3.1.3 Inoculation of legumes

Mycorrhizal cultures are generally used for legumes and these are applied every 4th or 5th year in the same field. They are reported to increase the yield of green matter by about 15 percent.

The cultures are prepared locally by the production team. Although elsewhere bacterial inoculum for legumes is normally prepared under sterile conditions in special laboratories, the Chinese have developed a method so simple that it can be followed by the commune members themselves.



Fig. 27 Foreground: nursery for Sesbania. Background: rice field interplanted with Sesbania (in rows). Hsi Chiao People's Commune, Guangdong Province.



Fig. 28 Transplanting of Sesbania in rice field. Hsi Chiao People's Commune, Guangdong Province.

Methodology

a. Collection and preservation of nodules

Plants of each species are carefully uprooted when they carry the largest number of active nodules. These plants are air-dried in the shade and the nodules are removed from them when an inoculum is to be prepared.

b. Preparation of the inoculum

The nodules are crushed and mixed with cool sterile water, adding 1% sugar, 1.0% starch and di-potassium hydrogen phosphate. The latter can be replaced with superphosphate, which is neutralized to pH 7.

c. Use of inoculum

The seeds which are to be inoculated are exposed to the sun for 3-4 hours and then soaked in water for 20 hours; they are then mixed with inoculum. As the partially germinated inoculated seeds tend to be sticky, they are mixed with rice husk to make broadcasting easier.

If seeds are not required for immediate sowing after inoculation, soaking in water is omitted and after exposure to the sun they are only mixed with the inoculum and air-dried.

3.2 Aquatic Plants

In areas with networks of waterways, aquatic plants are cultivated to provide fodder for livestock and manure for fields. Aquatic plants provide a major portion of fodder requirements and to that extent pressure on land is relieved. Fish culture is also stimulated under water weeds. The Chinese say: "If you live near water, make the best use of water". The commune members living near waterways have demonstrated in full measure how this is done.

The commonly grown aquatic plants and their composition are given in Table 12.

Table 12 COMMONLY GROWN AQUATIC PLANTS AND THEIR COMPOSITION

Aquatic plant	Content						
	Moisture %	N (% on dry basis)	Protein %	Fat %	Cellulose %	Sugar %	Ash %
1. <u>Alternanthera philoxeroides</u>	93.90	2.50	1.10	0.30	1.30	1.80	1.60
2. <u>Fistia striatotes</u>	96.16	1.94	1.07	0.26	0.58	1.63	1.30
3. <u>Eichhornia crassipes</u>	93.90	2.28	1.20	0.20	1.10	2.30	1.30

Alternanthera is the most widely cultivated aquatic plant in the northern provinces of China because of its tolerance to lower temperatures while *Eichhornia* and *Pistia*, which are sensitive to cold, are grown in the southern provinces. Special techniques have been developed by the Chinese for cultivating these plants to ensure their protection from cold and frost and their localized cultivation to avoid obstruction in navigation.

Areas of water adjacent to the banks of waterways are demarcated and localized for growing aquatic plants. The localization is effected by pitching bamboo sticks around the area and securing them with ropes or wire. Thirty to forty t/ha of plants are used to seed the water surface area so localized. The seeding is done in late April or early May. The *Alternanthera* plant grows profusely and within 2-3 months spreads over an area of 1 m² and to a depth of 1 m. The plants reach maturity in July and August. A long-handled rake is used to pull out the plants which are loaded into boats and ultimately taken to wherever needed. The second harvest is taken after 3 months (October-November). A harvest of 225-375 t/ha of open water per year has been reported.

Table 13 indicates composition, yield, etc. of various green manure crops and aquatic plants.

Table 13 YIELDS OF GREEN MATTER, NITROGEN AND PROTEIN OF VARIOUS GREEN MANURE CROPS AND AQUATIC PLANTS

Crop	Yield of		Growth period (days)	Rate of protein production (kg/ha/day)	
	Green material (t/ha)	Nitrogen (kg/ha)			Protein (kg/ha)
<u>Alternanthera</u> ^{1/}	225-375	344-572	2 147-3 572	365	5.88-9.79
<u>Eichhornia</u> (on land) ^{2/}	87.5	122	761		
(on sewage water) ^{3/}	250.0	348	2 174	365	5.96
<u>Sesbania</u> ^{1/} intercropped with early rice	15.0-22.5	38-124	519-775	30	17.3-25.8
<u>Asolla pinnata</u> (Jiangsu) ^{1/}	157.5	431	2 679	100	26.8
<u>Asolla</u> (in Vietnam) ^{4/}	200-300	547-821	3 419-5 131	365	9.37-14.06

Source:

- 1/ Calculated from information received in China
- 2/ Harley (1976)
- 3/ Abu El-Fadal (1960)
- 4/ Boswinkle (1976)



Fig. 29 Water plants (*Alternanthera*) grown on Tai Lake, Yueh Chi People's Commune, Jiangsu Province.

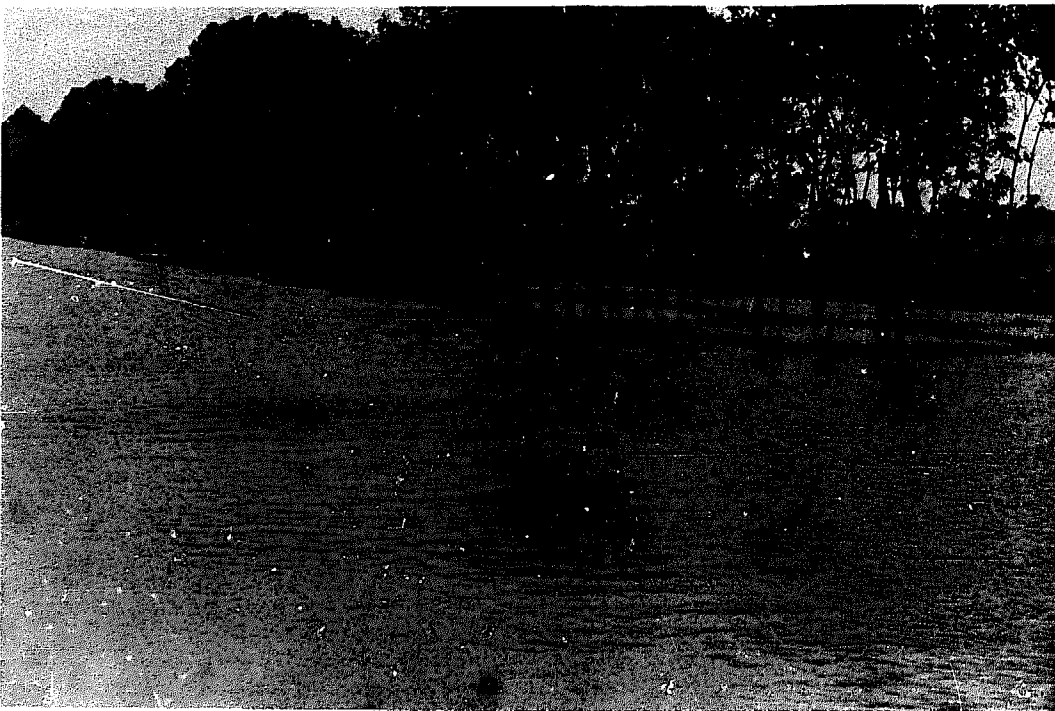

Fig. 30 Localized cultivation of *Alternanthera* on Tai Lake. To control growth borders of plots are marked with poles and ropes. Yueh Chi People's Commune, Jiangsu Province.

CHAPTER 4

BIO-GAS TECHNOLOGY AND UTILIZATION

4.1 General

The technology and utilization of bio-gas has recently attracted attention all over the world. The rationale behind it is seen in the ecological benefits of the utilization of animal and agricultural wastes, conservation of natural resources, pollution control, environmental sanitation and, above all, exploitation of new resources of energy. In the developing countries application of bio-gas technology acquires extra importance. The productivity of farmlands in these countries, which is low owing to insufficient use of locally available resources of ground water, fertilizers and fuels, can be improved with cheap energy provided by bio-gas technology. The local resources are largely unused; local fuels and organic manures in the form of animal and vegetable wastes are partly wasted and are partly burned in inefficient furnaces which capture little of the energy content and preserve almost none of the fertilizer value. Through bio-gas technology, these wastes alone can provide fuel for domestic use, energy for irrigation and other agricultural operations, organic manures for farms and light and electricity in remote villages.

Bio-gas technology is not new. The second world war saw its experimental development, and since then investigations on various aspects have been going on, though haltingly, in one country or another. However, the recent oil and fertilizer crisis has been instrumental in reviving interest in this technology. A number of countries, both developed and developing, have started further investigations aiming at analysis of the prospects, problems and tasks associated with bio-gas plants, developing suitable designs for family size as well as village size community bio-gas plants, the emphasis being on ease of assembly, use of cheaper and more stable materials and optimized dimensions and conditions of operation. These investigations also include the development of efficient bio-gas utilization devices such as bio-gas burners, spark ignition engines and further development of pumps for irrigation, as well as development of an integrated bio-system which assures the supply of fuel, fertilizer and food.

China has made remarkable progress in this field. The first Chinese attempts to convert organic wastes into bio-gas date from 1958, but a massive and apparently well organized campaign to popularize the technology started only some years ago. Since about 1972, the number of bio-gas plants in different parts of the country has been reported to be increasing rapidly. In a county visited in Hebei province, 40 000 out of 56 000 households have bio-gas plants. According to Chinese sources, there are nearly 1 000 000 bio-gas plants in use in China, although the great majority are located in only a few counties. The climatic requirements of bio-gas plants limit their efficient use to the southern part of the country, but they can also have a limited seasonal use in other areas.

Bio-gas plants have been recognized as a boon to the members of the production teams/brigades because of the several benefits accruing from them. Briefly these are:

- i. The manure obtained from bio-gas plants is richer in nitrogen content and more in quantity than that obtained by conventional composting. It is reported that fermentation increases the ammonia content by 120 percent and the amount of quick acting phosphorus by 150 percent. In a comparative trial conducted in Wu Chin County, the application of bio-gas manure gave a 17% increase in wheat yield over conventional compost. In fact, these plants are regarded as 'miniature manure factories'.

- ii. Bio-gas manure is free from the offensive odour normally associated with manure pits/heaps. The parasites normally present are also killed during the process of digestion and storing of slurry.
- iii. Bio-gas plants conserve local fuel, wood or imported coal and kerosene, and upgrade into an excellent organic fertilizer the vegetable refuse which would be otherwise burned inefficiently and animal and human wastes which might otherwise be a serious threat to health.
- iv. Bio-gas can be used to power internal combustion engines and to substitute for diesel oil in small electric generators. A saving of 70% of diesel oil in running internal combustion engines on bio-gas at the bio-gas research station in Wu Chin County was reported.
- v. The gas provides a clean and convenient fuel for household cooking and a good light for reading. The rice straw which is otherwise burnt as fuel is saved for use as fodder or for silage making.
- vi. Bio-gas saves time in cooking and thus reduces the housekeeping load for women.
- vii. Bio-gas plants are complementary to piggery development.

Bio-gas programmes are thus regarded as a part of the social reconstruction programme of China. The programme is supported through national conferences, the training of technicians, the manufacture of simple gas stoves and lamps, rubber or plastic pipes and pressure gauges and through the design of differently shaped fermentation pits.

4.2 Bio-gas Technology

The process of bio-gas generation, which is essentially the digestion under anaerobic conditions of organic wastes, produces a gas which is largely a mixture of methane and carbon dioxide. The methane is a combustible gas. The digestion is a two-part process and each part is performed by a specific group of organisms. The first part is the breakdown of complex organic matter into simple organic compounds by acid forming bacteria. Several species of acid forming bacteria grow and reproduce rapidly. These are not very sensitive to their environment. They break down complex organic substances and produce primarily acetic acid and propionic acid, together with ammonia and carbon dioxide. The second group of micro-organisms, the methane-formers, break down the acids into methane and carbon dioxide. This group is composed of a relatively few species of bacteria that grow and reproduce slowly and are quite sensitive to their environment.

In a properly functioning digester, the two groups of bacteria must be balanced so that the methane-formers just use the acids produced by the acid-formers. If the acid-formers get ahead of the methane-formers, acids begin to accumulate, the pH drops, the methane-formers are inhibited and ultimately digestion ceases. The main bio-chemical and other operational factors which are important in controlling the speed and quality of the digestion are as follows:

- a. **Temperature:** The micro-organisms which take part in methane production have optimum activity at 20-30°C. At lower temperatures, gas production is reduced. The relationship between gas production and temperatures observed in China is indicated below:

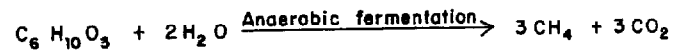
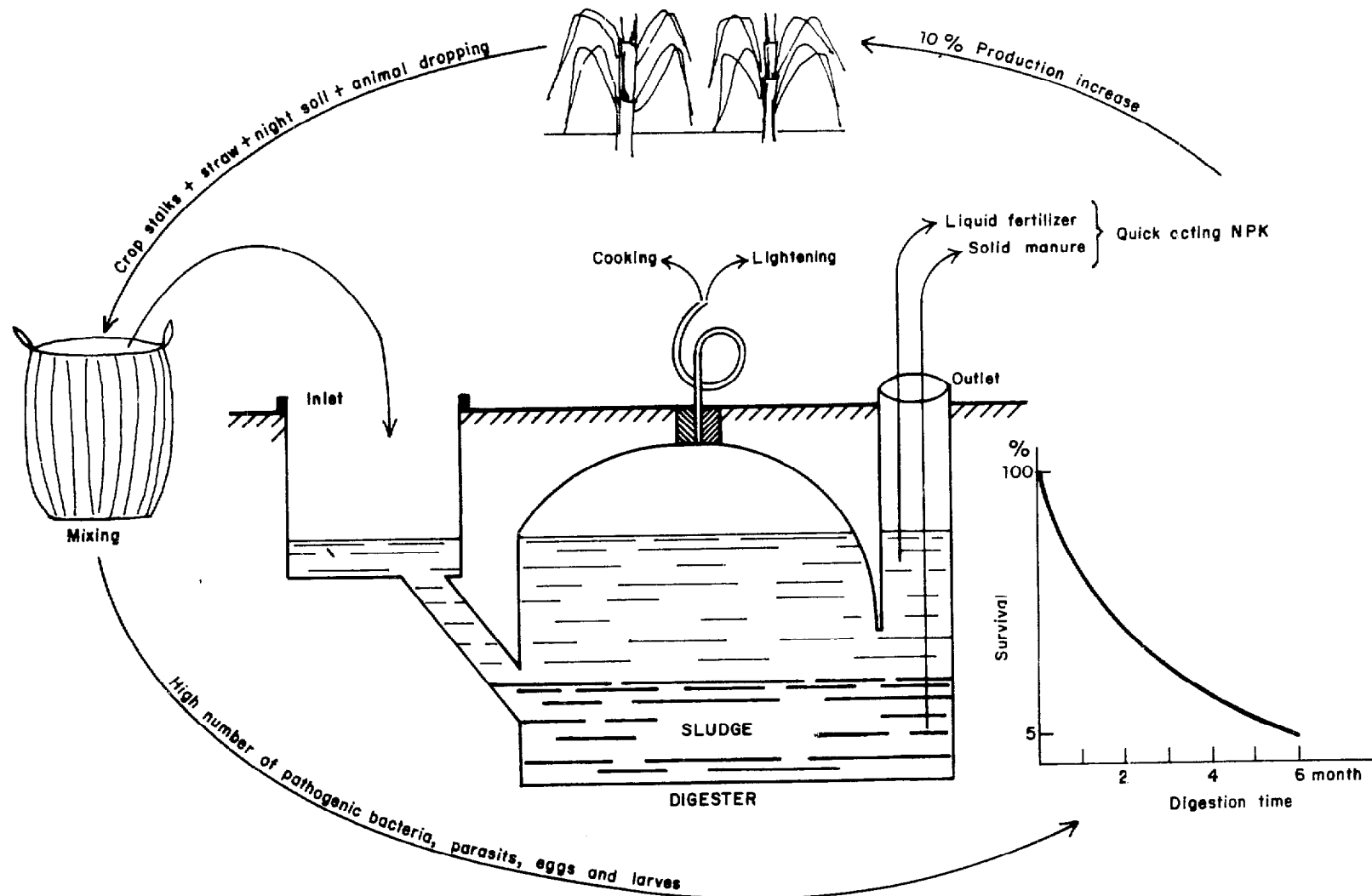

Fig. 31 BIOGAS CYCLE IN CHINA

<u>Material</u>	<u>Temperature</u> (°C)	<u>Gas production</u> (cm ³ /day)
Rice straw,	29.31	0.55
pig manure	24-26	0.21
and grasses	16-20	0.10
	12-15	0.07
	Below 8	Negligible

b. Hydrogen ion concentration

Methane forming bacteria are sensitive to pH. They work best in a range of pH 6.8 to 7.2 although they will tolerate a range of 6.5 to 8.0. If the pH grows too high the acidic carbon dioxide formed by the digestion process brings it down, but if it should be too low, the gas producing bacteria are unable to use up the acids quickly enough and the digestion stops. It will be a matter of some time before the balance is restored and digestion can resume. Introducing fresh raw material for digestion at a too high rate can cause the fermenting material to become acidic.

In China, addition of lime solution or grass ashes is recommended for maintaining the pH between 7 and 8.

c. Carbon: nitrogen ratio

The bacteria require both carbon and nitrogen in order to live, but they use up carbon about 30 to 35 times faster than they use nitrogen. When the ratio in the raw material is about 30 to 1, the digestion proceeds at an optimum rate, other conditions being favourable. When the ratio is lower there are losses of available nitrogen affecting the manurial value of the digested matter.

d. Dilution

The anaerobic fermentation of organic matter proceeds best if the feeding material contains 7 to 9% solid matter. The usual materials fermented in a bio-gas plant normally contain higher percentages of solids and they are therefore usually diluted with water. Insufficient dilution increases the viscosity to a point where bacterial growth is inhibited; or if excessive, stratification occurs that requires continuous stirring. The pH and ammonia toxicity also become more critical with insufficient dilution.

In China, common combinations of raw materials are reported to be: a mixture of urine (20%) and human excreta (30%) and water (50%); or 10% human excreta, 30% animal dung, 10% straw and grass and 50% water; or 20% human excreta, 30% pig manure and urine and 50% water; or 10% each of human and animal waste, 30% marsh grass and 50% water. Crop wastes, green grass and other vegetable materials are decomposed for more than 10 days prior to their being put into the digester.

e. Stirring

Stirring of the slurry inside the digester is desirable to stimulate bacterial action resulting in higher gas production, though it is not always essential. Continuous feeding of fresh waste into the digester always induces some movement in the mass of material in the digester, helping to expose fresh undigested material to the bacteria.

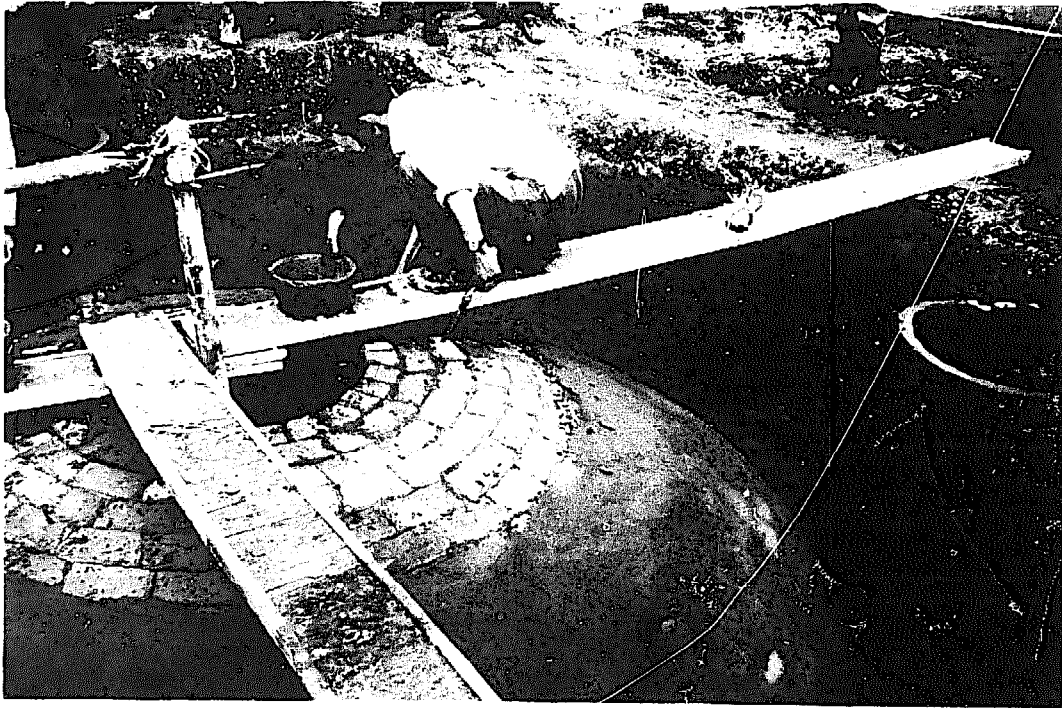

Fig. 32 Construction of a bio-gas plant, inlet on the right; outlet on the left in background. Cheng Hsiang Production Brigade, Jiangsu Province.



Fig. 33 Building of piggery with inlet for animal wastes to bio-gas plant. Cheng Hsiang Production Brigade, Jiangsu Province.

In the Chinese bio-gas models, there is no provision for agitation. It has, however, been reported that in digesters fed with night soil alone, stirring increased gas production by 80% in comparison with non-stirring.

f. Design of bio-gas plants

The basic design of bio-gas plants provides for an anaerobic tank (digester) and a gas chamber to collect the methane/carbon dioxide mixture. The performance, however, depends upon many factors.

Five designs of bio-gas plant are reported to have been evolved in China. The group was able to see a large number of working bio-gas plants at some of the places visited. A 10 m³ capacity design is taken as the standard design for a household. Some brigades have adopted a collective approach and built larger plants to supply gas for small internal combustion engines for pumps, generators and/or other purposes such as cooking food for pigs, distillation etc.

The unique feature of the bio-gas plants in use in China is that the gas holder and the digester are combined in one unit. The gas holder is the brick dome shaped cover of the digester itself. In the construction of these plants local materials are used. People along rivers use mainly pebbles, those in mountain areas use stones and the people in the plains use bricks. A mixture of lime and earth in the proportion 5% and 95% respectively is used in the construction. The walls of the bio-gas unit are thinly plastered with cement. For the standard capacity plant, the requirements of these materials are: bricks, 3 000; lime 1 000 kg, and cement 100 kg. The cost of construction is reported to be US\$ 25 excluding labour charges.

When gas is formed, it ascends towards the top of the dome and pushes the effluent down. The displaced level of the effluent provides the necessary pressure for the release of the gas from the plant. The pressure of the gas is kept constant through an automatic adjustment of water pressure. The pressure equalization is based on the principle that increased gas pressure pushes slurry up the feed inlet and the outlet chamber openings and decrease in pressure is balanced by return of slurry into the digester. The sizes of the inlet chamber and the outlet chamber are stated to be important features and their design has undergone some changes over the years. The digester is built below ground level. The removal of sludge and maintenance are carried out twice a year. One-third of the sludge is left in the digester to act as 'seeding' material.

4.3 Building a Bio-gas Plant

In constructing a plant, a round hole measuring 3 m in diameter and 3 m deep is first dug. The digester portion which extends from the base to a height of 2 m is well compacted using an earth-lime (95:5) mixture. The gas-holder portion, the brick dome-shaped cover of the digester, is then constructed leaving spaces for the inlet and outlet pipes which are 60 cm in diameter and are at the same level just above the ground. They are covered with concrete slats to avoid any mishap.

The gas outlet (55 cm upper diameter, 45 cm lower diameter) is situated at the top of the gas holder from which the gas flows through a polyethylene tube to the point of consumption.

Advantages of this type of bio-gas plant are:

- i. Lower construction costs since no mild steel is used. Steel is scarce and expensive, particularly in rural areas.
- ii. The plants can be easily constructed by production team members who know how to work with bricks and cement.
- iii. Since there are no moving parts, wear and tear and maintenance costs are almost negligible.
- iv. Maintenance of proper temperature is easier because of the whole structure being under ground.

Figures 34 to 46 explain the designs of bio-gas plants in use in China, suited to local requirements.

These gas plants are, however, not without problems. The most important limitation is the impossibility of using them efficiently in colder regions of China because of the thermal requirements of the fermentation process. Even in warmer climates, a considerable decrease in efficiency and cessation of bio-gas production can occur if the sludge lacks liquidity to balance the acid and methanogenic bacteria. Other problems are associated with sand accumulation, scum build-up and loading of human and animal wastes in proper dilution. The half-yearly opening of the digester for sludge removal and maintenance is a bothersome operation. The gas in the chamber is likely to be subjected to variable pressure because the difference between the levels of the slurry in the digester chamber and outlet chamber is likely to vary continuously. Such variable pressures are not conducive to efficient functioning of the gas appliances. Furthermore, high pressure may be exerted on the slurry which is likely to reduce the gas production.

The group was told that these problems were being further investigated besides the new ones such as how to store surplus gas for use in winter and how to remove sludge and effluents by machines.

4.4 Use of Gas

The gas which comes out of the bio-gas plants is quite similar to natural gas. It usually contains 60-70% methane, 30-35% carbon dioxide, some hydrogen, nitrogen and traces of hydrogen sulphide. The gas has a calorific value of about 5 000 Kcal/m³.

A ten cubic metre capacity plant generates around 5 m³ of gas per day. When properly managed, the plant is sufficient to supply a Chinese family with enough fuel for cooking and lighting. Bio-gas must be burned on an appropriate burner for maximum efficiency. Its flame speed factor, which is a measure of the speed at which a flame will travel along a column of the gas, is low compared to that of natural gas. This means that when the bio-gas is fed to a burner made for natural gas, the flame tends to rise above the burner. Bio-gas fed at a lower pressure would stay on the burner, but might not burn efficiently and less heat would be recovered from each cubic metre of gas. The low pressure of bio-gas and the low flame propagation speed of methane, which is further slowed down by carbon dioxide, call for a special design of bio-gas appliances.

The burners in China are designed for a bio-gas ratio of 1:10 and these are locally made from a mixture of soil and ash. The burners are placed in a deep hearth to provide maximum heat to the utensils. Other accessories such as stoves, pipes, lamps and pressure gauges are also locally made.

For lighting, bio-gas can be fed into any gas lamp with a mantle. In China small size silk mantles are used owing to low pressure of the gas. The brightness of a standing bio-gas lamp is reported to be greater than that of a hanging type because of the low density of the bio-gas coupled with the upward direction of the hot gases.

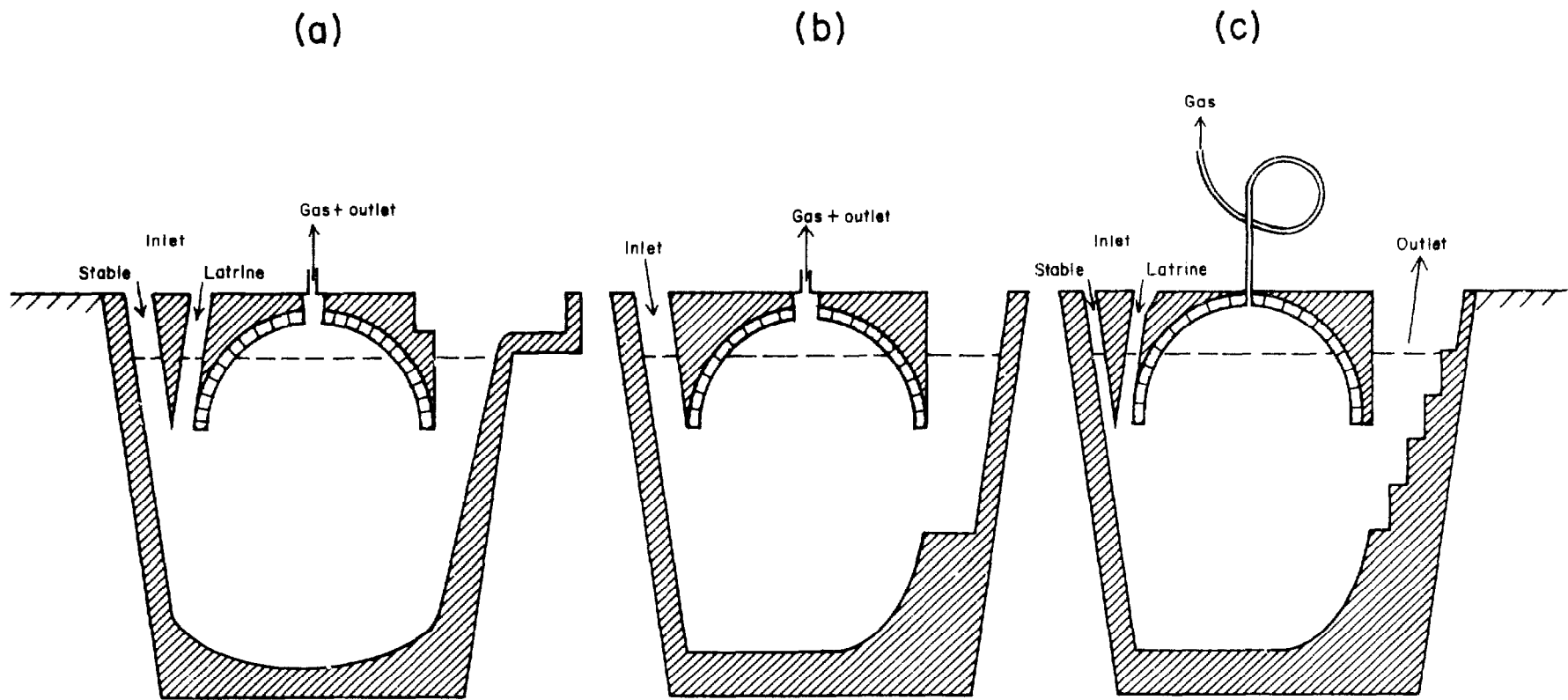
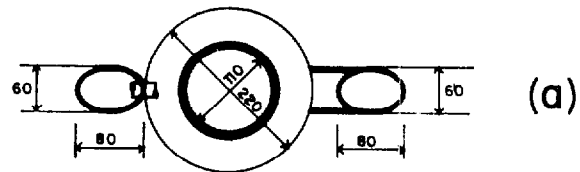
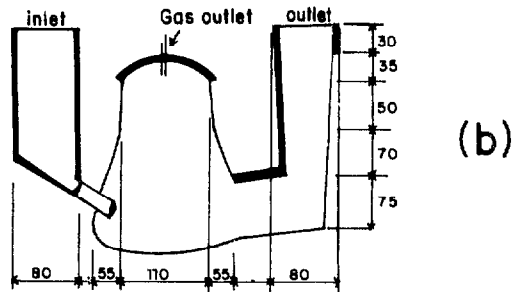

Fig.34 SOME BIOGAS DIGESTERS USED FOR 40.000 UNITS BUILT IN HUAI LU County (HEBEI Province)
 Presented at the exhibition of biogas at PAICHI KAN Production Brigade, LITSUN Commune, HUAI LU County (HEBEI Province)



(a)



(b)

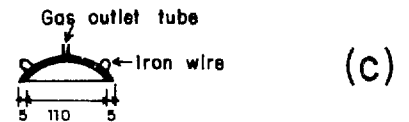

(c)

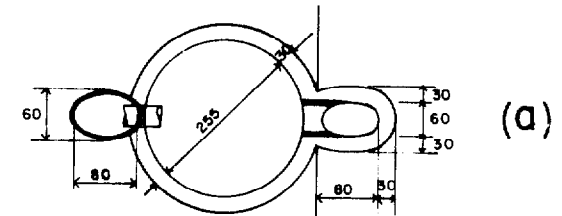

(a)

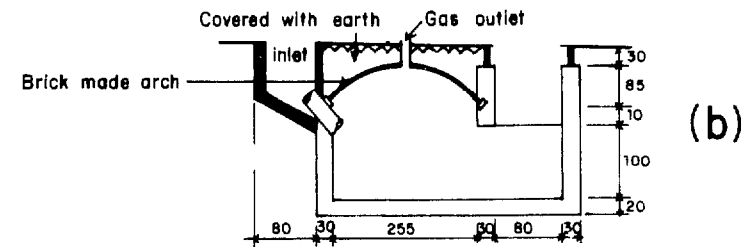

(b)

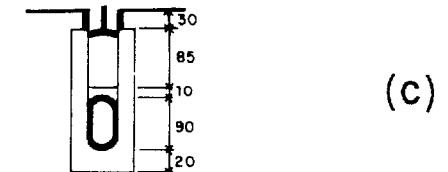

(c)

BIOGAS UNIT N° 1 WITH SMALL DIAMETER

Total volume: 4.72 m³, fermentation chamber: 4.63 m³, arch: 0.09 m³

- a) Front elevation drawing
- b) Longitudinal profile
- c) Precast cement cover

INGREDIENTS : Fresh pig dung: 1000 kg.
Inoculants: 500 kg.

Fig. 35

BIOGAS UNIT N° 2 SHALLOW

Total volume: 7.29 m³, fermentation chamber: 5.11 m³, arch: 2.18 m³

- a) Front elevation drawing
- b) Longitudinal profile
- c) Longitudinal profile

INGREDIENTS : fresh pig dung: 1000 kg.
inoculants: 500 kg.

Fig. 36

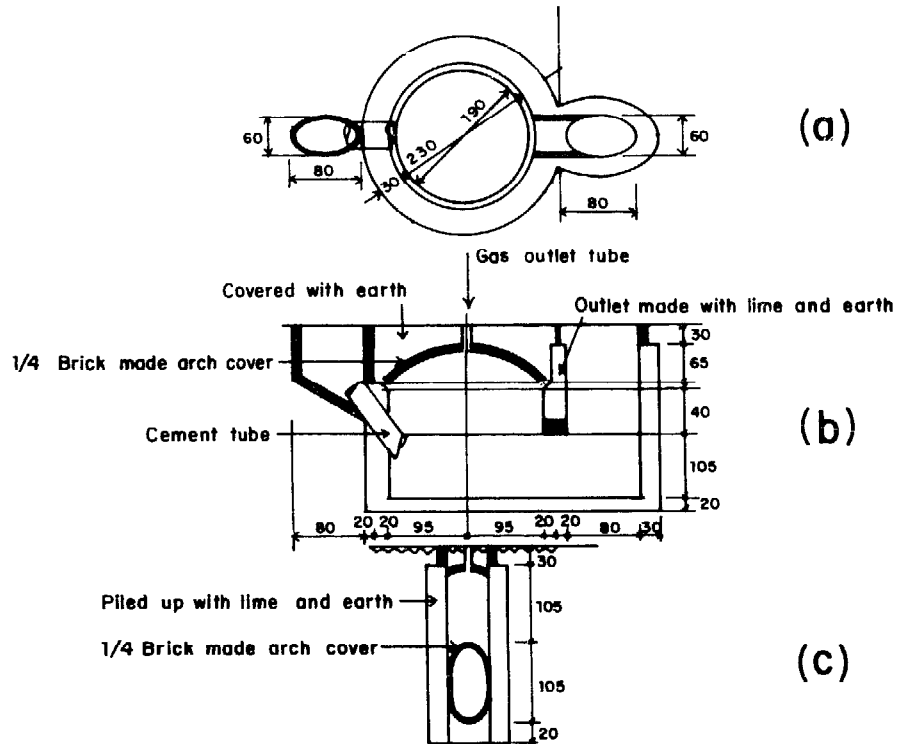

BIOGAS UNIT N° 3 made with lime and earth.

Total volume: 6.42 m³, fermentation chamber: 5.06 m³, arch: 1.36 m³

a) Front elevation drawing

b) Longitudinal profile

c) Longitudinal profile

Fig. 37

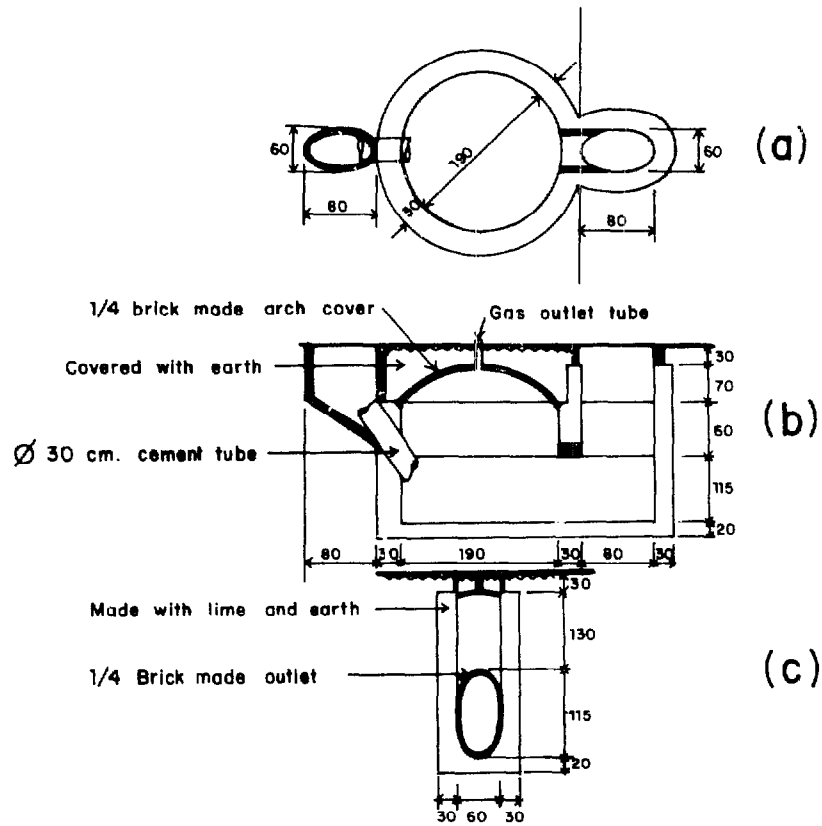

BIOGAS UNIT N° 4

Total volume: 6 m³, fermentation chamber: 5 m³, arch. 1 m³

- a) Front elevation drawing.
- b) Longitudinal profile.
- c) Longitudinal profile.

Fig. 38

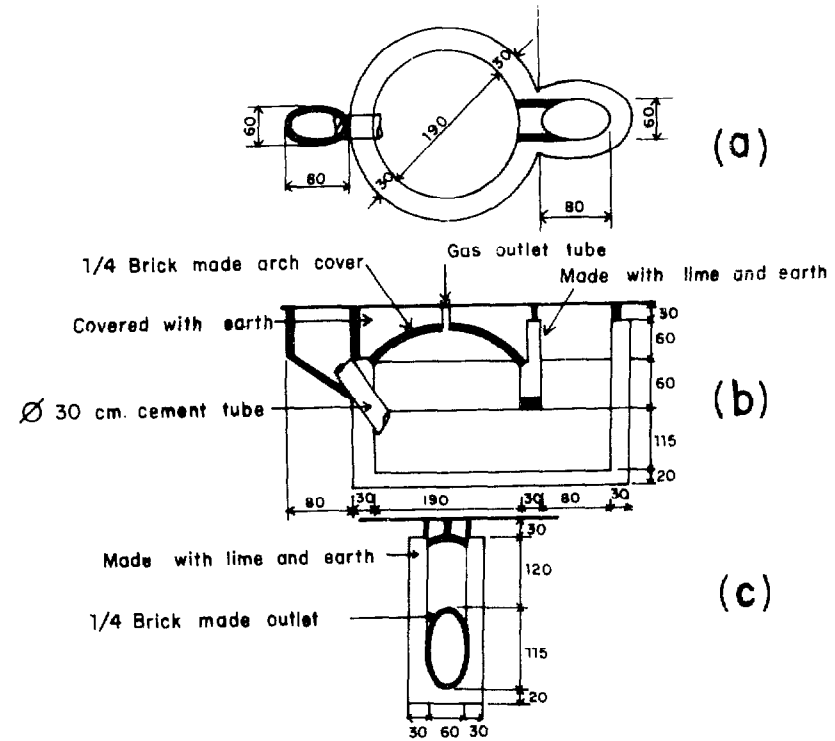

BIOGAS UNIT N° 5

Total volume: 5.85 m³, fermentation chamber: 5 m³, arch. 0.85 m³

- a) Front elevation drawing
- b) Longitudinal profile
- c) Longitudinal profile

Fig. 39

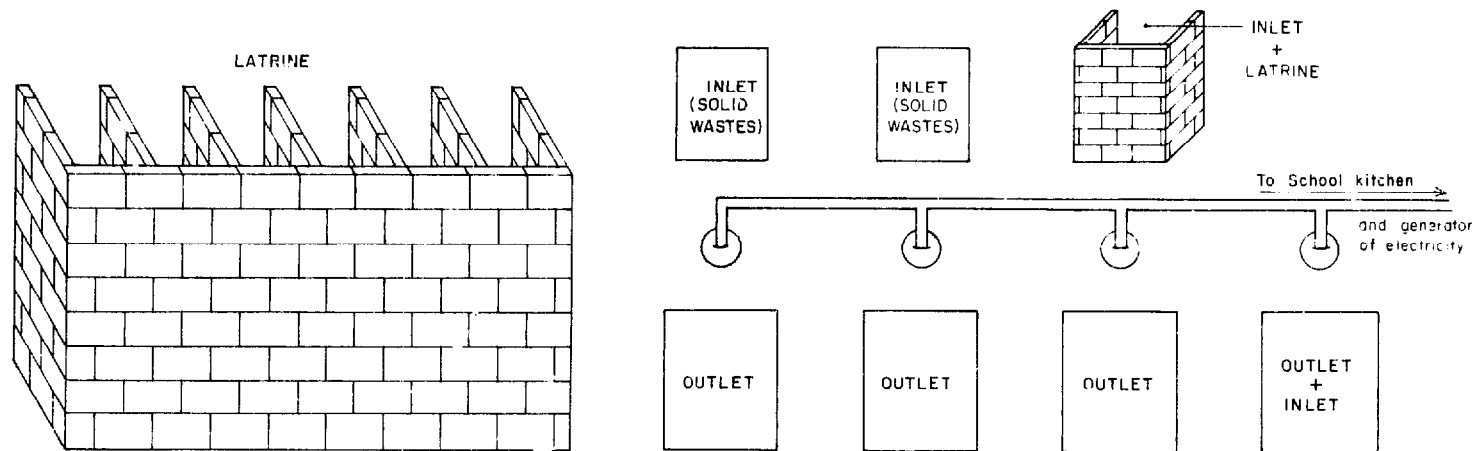

Fig. 40 13 BIOGAS UNITS 14 m³ EACH, TA HEH MIDDLE SCHOOL, HUAI LU County, (HEBEI Province)

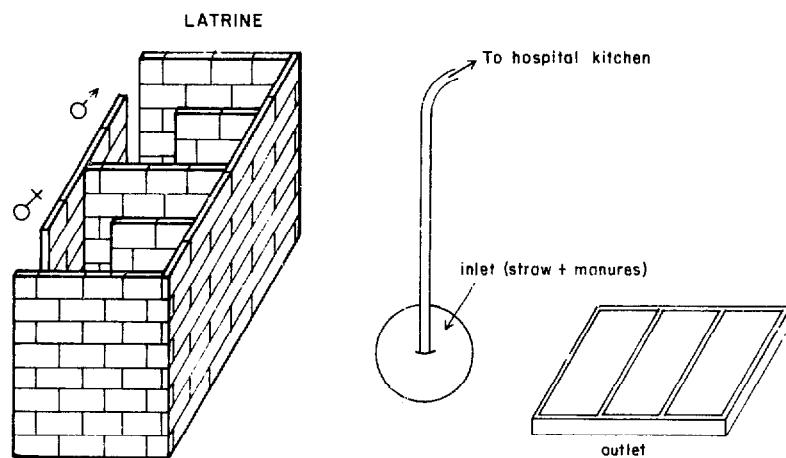

Fig. 41 43m³ BIOGAS UNIT FOR THE HOSPITAL OF TA HEH Commune (HEBEI Province)

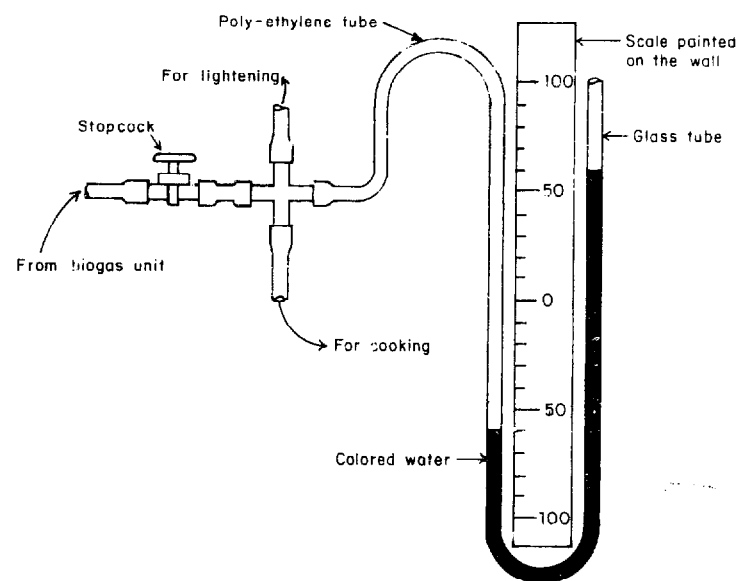
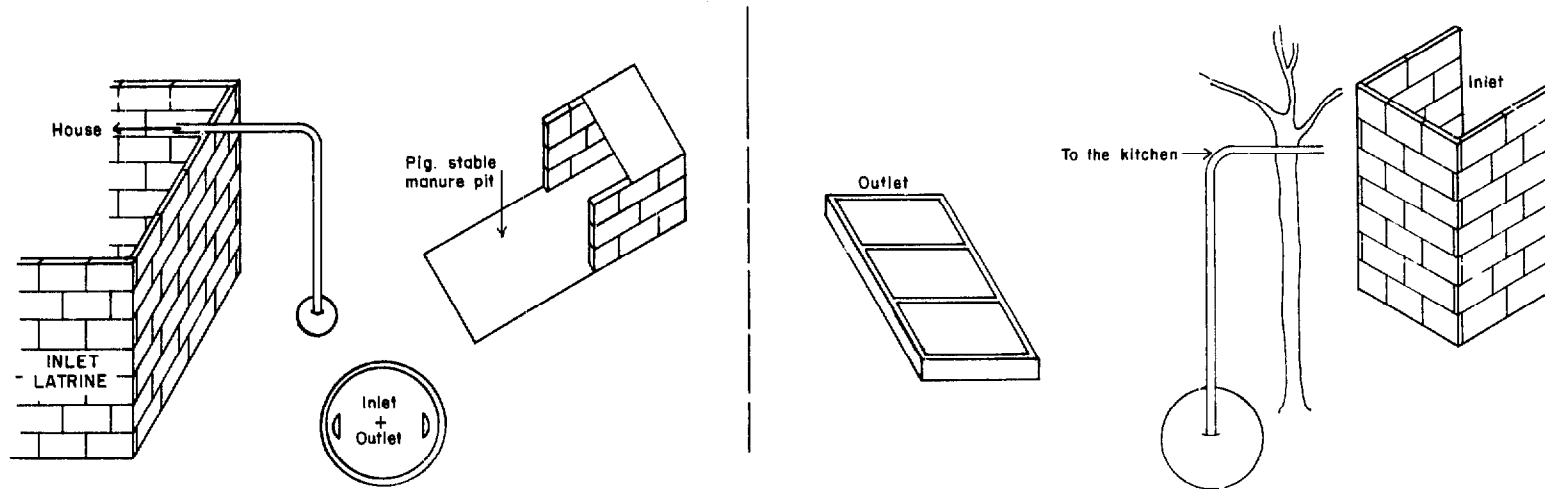

Fig. 42 SIMPLE MANOMETER INDICATING BIOGAS PRESSURE CHENG HSIANG Brigade, WU CHIN County (JIANGSU Province)



a) CHUN SUN Prod. Brigade, CHAO County, HEBEI Province

b) TA HEH People's Commune (HEBEI Province)

Fig. 43 7-10 m³ BIOGAS UNITS (household size)

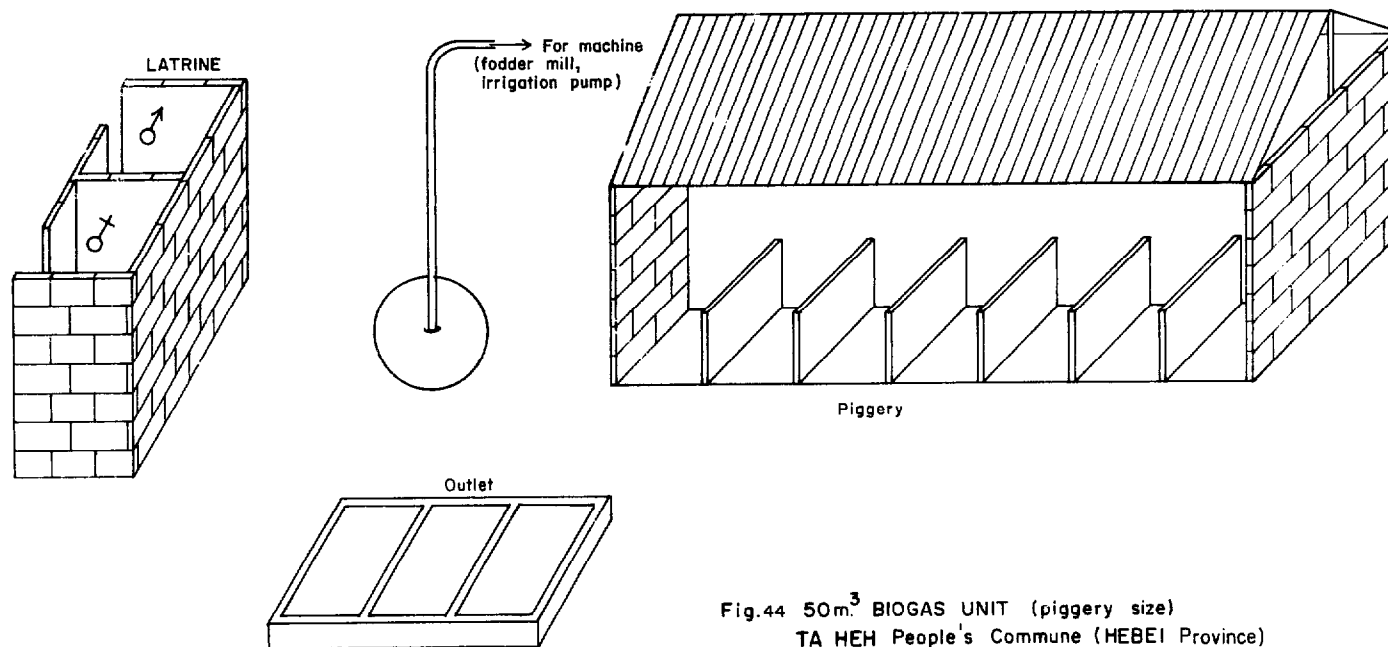

Fig. 44 50m³ BIOGAS UNIT (piggery size)
TA HEH People's Commune (HEBEI Province)

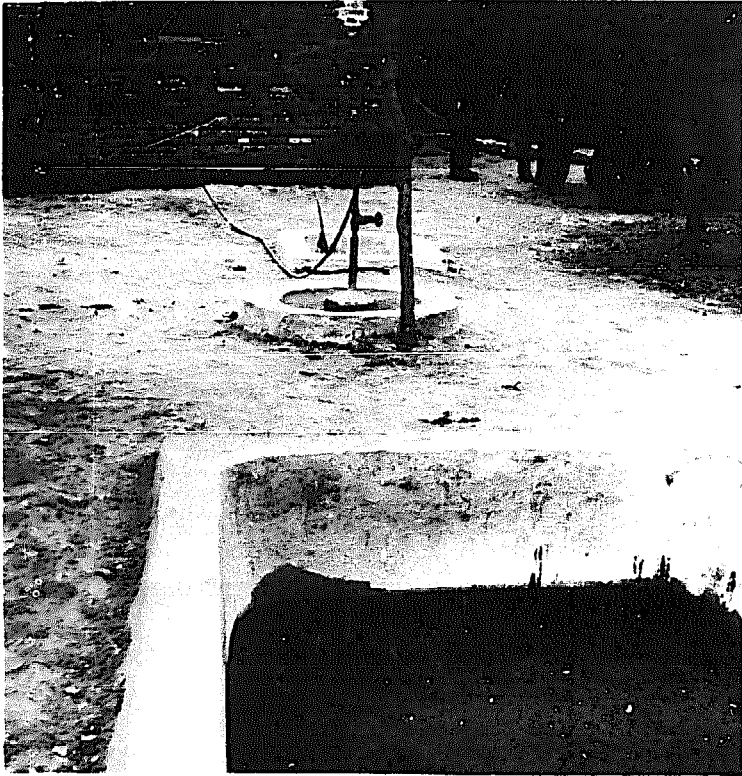

Fig. 45 Larger size bio-gas plant, gas used to fuel diesel engine. Foreground: outlet; centre: outlet for gas by plastic pipe; background: inlet. Chun Sun Production Brigade, Hebei Province.



Fig. 46 Outlet of large size bio-gas plant. Effluent pumped into irrigation drain. Cheng Hsiang Production Brigade, Jiangsu Province.

Any internal combustion engine can be adapted to use bio-gas. The group saw a diesel engine running on bio-gas. The engine was fuelled by connecting the gas to the air intake and closing the diesel oil feed. It was reported that one cubic metre of gas was enough to run an internal combustion engine (one h.p.) for 2 hours, a three ton truck for 2 km, to light a lamp (60-100 watts) for 6 hours and to generate one kilowatt of electricity.

4.5 Use of Sludge and Effluent

The output of sludge per year per plant (10 cubic metre capacity) is roughly 10 cubic metres. Sludge is used directly as manure for basal or top dressing. It is also used for making humic acid fertilizer. When not required, it is heaped, plastered and kept till needed. The output of effluent is about 14 cubic metres per year. It is either applied to the land with irrigation water or stored in a tank for application as a top dressing.

Composition of sludge/effluent reported by the Ta Heh Production Brigade was:

Composition of bio-gas sludge and effluent

	<u>Sludge</u>	<u>Effluent</u>	
* N	650.0 p.p.m	500.0 p.p.m	* available
* P	40.0 "	15.0 "	
K	9 400.0 "	2 000.0 "	
Org. matter %	35.0		

A field trial carried out by the production brigade showed that the application of effluent to wheat crops increased tillering rates and numbers of spikelets over those obtained from ammonium chloride.

4.6 Some Useful Data (Bio-gas Research Station, Cheng Hsiang)

a. Comparative efficiency of various types of wastes for gas production:

1.	Cow dung	100.0
2.	Water hyacinth	114.0
3.	Sorghum residue	130.0
4.	Water lettuce	145.0
5.	Pig manure	154.0
6.	Grasses	177.0
7.	Rice straw	187.0
8.	Night soil	221.0

b. Rate of gas production from different mixtures of wastes at 25-28°C

<u>Materials</u>	<u>Mixture proportion</u>	<u>Gas production after 70 days per gramme of material</u> (ml)	<u>Gas production after 400 days per gramme of material</u> (ml)
Grasses	} 3:1 1:1 1:2 1:5	178	-
+		152	-
rice straw		184	-
		134	-
Rice straw	-	120	240
Human excreta	} 1:4	-	384
+ rice straw			
Wheat straw	-	-	160
Human excreta and wheat straw	1:4	-	316

c. Effect of seeding or inoculation of fresh material with digested material

<u>Fresh material</u>	<u>Digested slurry</u> (g)	<u>Gas production</u> (ml/g of material)
250 g night soil	20	27
"	100	138
"	400	307

The above establishes the beneficial effect of 'seeding' the fresh material with digested slurry which acts as an inoculum.

d. Rates of kill of parasites in digested slurry

Investigations carried out in China indicate that the most resistant egg of all parasites is the round worm ovum and that the bio-gas plant has relatively little impact on its viability. Under simulated conditions, the viability rates of ascarid (round worm) eggs ranged from 63 to 93 percent after 10 to 90 days decreasing to 20% after 180 days. Para-typhoid B bacilli survived for a period of 44 days and schistosomes were observed to live up to 37 days.

Detailed investigations have shown that the reduction in the level of disease causing organisms in bio-gas digesters is due to both the physical separation of the organisms by their settling to the bottom of the digester and to their natural mortality under adverse conditions. The major contributing factor to their reduction in the case of the hardier parasite eggs is that of physical separation.

Effect of time of digestion on mortality of organisms

<u>Organism</u>	<u>Days of digestion</u>	<u>Percent mortality</u>	<u>Days of digestion</u>	<u>Percent mortality</u>
Snail	20	95.12	32	100.0
Hookworm	50	92.17	90	100.0

Sedimentation of parasite eggs in bio-gas plants
(in 500 ml of effluent)

	<u>Inlet</u>	<u>Outlet</u>	<u>Sedimentation (%)</u>
Upper stratum	14 039	578	95.96
Lower stratum	50 260	15 695	77.10

CHAPTER 5

VISITS TO RESEARCH STATIONS, COMMUNES, PRODUCTION BRIGADES OR TEAMS

5.1 Research Institute of Agricultural Sciences in Jiangsu Province, Nanjing
(3 May 1977)

The Research Institute of Agricultural Sciences in Jiangsu Province is the highest level Institute in the Province. It has a comprehensive research role to investigate scientific and technical problems in agricultural production throughout the province. In essence, the research work centres around implementing 'the eight point charter for agriculture'

The Institute has a total working staff of more than 700, of whom about 300 are research and technical personnel, and an experimental farm of about 80 ha. There are various specialized departments, such as: (1) the Department of Food Crops, doing research on the selection, cultivation and popularization of new strains of rice, wheat, maize and sweet potatoes, as well as on the corresponding high-yield cultivation techniques; (2) the Department of Industrial Crops: research on the selection, cultivation and popularization of cotton, rape seed and soybean as well as the appropriate techniques for obtaining high yields; (3) the Department of Plant Protection: research on the incidence of insect pests and plant diseases affecting the main crops and the damage they cause, as well as the techniques for their prevention and cure; (4) the Department of Soil Amelioration and Fertilizers: research on the improvement of saline and alkaline land, the selection and cultivation of new strains of leguminous crops and techniques for short-term inter-planting as well as techniques in the choice and application of new bacterial and mineral fertilizers; (5) the Department of Agro-Physics and Agro-Chemistry: research on techniques for treating crops both physically and chemically to create new strains, and on the isotope tracer technique and analysis of nutrient contents of crops and fertilizers; (6) the Department of Animal Husbandry and Veterinary Science: research on the prevention and cure of main diseases affecting draught animals and livestock and breeding new breeds of pigs; (7) the Department of Aquatic Products: research on the selection and breeding of new stocks of freshwater fish, the prevention and cure of the main fish diseases and the investigation of freshwater fish resources.

At present, research at the Institute is concentrated on the following four areas: (a) breeding improved varieties of food crops (rice, wheat, maize and sweet potatoes), oil crops (rape and soybean), industrial crops (cotton) and vegetables; (b) research on cropping systems, cropping patterns and practices to increase cropping intensity to attain high production per unit area per year, the objective being to develop three food crop systems (one wheat crop and two rice crops) with a total grain production target of 22.5 t/ha. This target has already been achieved in eight experimental locations in the province. The current programme is to investigate appropriate cropping patterns, crop varieties with suitable growth periods, effective fertilization practices and production of livestock feed and fodder in the cropping systems, measures for prevention and control of insect pests and diseases of main crops; (c) crop production research to find effective measures for prevention and control of insect pests and diseases of main crops; (d) fertilizers and fertility conservation involving studies on organic manures, green manures, mineral fertilizers, bacterial fertilizers and improvement of saline and alkaline soils.

The study team were given the opportunity to visit some of the Institute's laboratories, the fertilizer and entomology laboratories in particular. The chemistry laboratory is provided with modern standard analytical instruments to handle a large number of analyses. The entomology laboratory has a very good insect collection and, in addition to its own research, also mounts specimens of the major pests of economic crops

showing the life cycles of insects with their respective predators, for supplying to local research units for reference, as teaching aids and for use in extension work. It appeared that more emphasis was placed on preventive measures, crop surveillance and disease resistant varieties rather than on chemical control. DDT was recommended as a standard insecticide; other insecticides do not exceed the toxicity of DDT. Biological control was being investigated. For reclaiming saline soil, green manuring followed by rice cultivation was recommended.

On the use of nitrogen-fixing blue-green algae, particularly a mixed culture of Nostoc and Anabaena in rice fields, it was reported that a rice yield increase of about 10% was obtained under experimental conditions. However, some technical problems such as high pH, antagonistic micro-organisms in the soil and climatic factors still had to be resolved before the technique could be applied successfully at the farm level.

In compost making, it was recommended that 0.5 to 1% of superphosphate should be incorporated with the composting materials to help suppress the loss of nitrogen, thereby improving the fertilizing value of the compost. As much as 30% of the nitrogen could be lost from an open compost heap, but the addition of superphosphate would reduce the nitrogen losses to around 10%, and by sealing the compost heap nitrogen losses become negligible.

Green manure applied at 15 000 kg/ha would increase the rice yield by 750 kg/ha. A standard practice recommended was to grow green manure crops over 30% of the cropland in the first cropping season, with 60% under wheat and 10% under rape.

5.2 National Research Institute of Soil Science, Nanjing, Jiangsu Province
(3 May 1977)

The National Research Institute of Soil Science is a specialized Institute of the Academy of Agricultural Sciences and was established in 1953. At present, there is a total working staff of 400 of which about 300 are research scientists. The Institute has 9 Departments: Soil Geography, Agricultural Chemistry, Physical Chemistry, Bio-chemistry, Micro-biology, Soil Physics, Soil Reclamation, Paddy Soils, Soil Conservation and Pollution. Major research programmes of the Institute are:

- a. Soil survey and land resources evaluation
- b. Improvement of problem soils particularly saline and alkaline soils
- c. Soil improvement for high crop yield
- d. Proper utilization of fertilizers and manures
- e. Soil micro-biology
- f. Soil pollution problems

The study team visited several of the Institute's research laboratories and was quite impressed to see that they were well equipped, with modern, sophisticated instruments such as an atomic analyser, atomic absorber, spectrophotometer and an electron microscope. Many of these sophisticated instruments were made in China and the Institute has its own electronic workshop to make special parts as well as to repair scientific instruments. In the plant nutrition laboratory, quick test kits are prepared for distribution to commune experimental stations. In the soil pollution laboratory, studies are being conducted on the persistence of pesticides in soil, suitability of industrial waste water for use with soil, etc. In the soil micro-biology laboratory, some research was in progress on soil-borne plant pathogens as well as isolation and culture of Rhizobium strains. The Institute, however, did not conduct any research on composting, green manuring and other recycling practices as these applied research topics were meant to be carried out at the research institutes at lower levels.

The Institute has a soil museum which is stocked with about 100 soil profiles representing different soil types in the country. The main soil types are:

i. Red and yellow earths

These soils are characterized by a high percentage of sesquioxides which confers on them their characteristic red and yellowish red colouring. Red and yellow earths are very acid but can be made quite fertile by applying organic manures, growing green manure crops and application of lime and fertilizers. These soils cover the greater part of South China. They may be correlated with the Orthic and Ferric Acrisols of the classification.

ii. Meadow soils

These soils show signs of hydromorphy but are quite fertile and exist chiefly in the tropical and sub-tropical regions of the country where they are used as paddy lands. They correlate with Gleysols, Gleyic Luvisols and Gleyic Acrisols.

iii. Brown earths

These soils are more fertile than the red earths. As they drain well, they are suitable for growing both food crops and fruit. They correlate with Dystric and Eutric Cambisols.

iv. Black soils

These soils were formed under steppe vegetation of leguminous plants and gramineous herbage. Their dense rooting system, when decayed, turned into humus far down in the soil. They are very fertile soils, comparable to Chernozems and Phaeozems.

v. Chestnut soils

These soils are formed in short grass steppes. They contain less humus than the black soils but their fertility is still fairly high. They correlate with Kastanozems.

vi. Desert and semi-desert soils

These soils develop in the arid and semi-arid areas. They have a loose structure and low humus content but are rich in various mineral elements. They suffer from drought and sandstorms as well as salinization. They are Yermosols and Xerosols, and Solonchak and Solonetz soils occur frequently as inclusions. A significant contribution from the Institute is the preparation of a new soil map of China at scale 1:10,000,000 and an explanatory book on 'Soils of China', to be published in Chinese in 1978.

The library of the Institute has a very extensive collection of scientific books, works of reference and journals from all over the world. Current scientific periodicals were up to date. It appeared that scientists of the Institute had facilities to keep abreast with the latest scientific information from other parts of the world.

The Institute maintains close working relations in corresponding fields with staff of research institutes in the provinces by providing specialized training and consultations.

5.3 Cheng Hsiang Production Brigade, Peng Niu Commune, Wu Chin County
Jiangsu Province (5 May 1977)

Wu Chin County has a population of 1.2 million persons and a cultivated land area of 87 000 ha. Agriculture is highly intensive with a multiple cropping index of 2.1.

The county has earned a reputation in carrying out bio-gas programmes, and 60 000 bio-gas plants were reported to have been set up in it. The group was interested in the studies being carried out on bio-gas technology at the bio-gas research station. The studies relate to gas production using different types of wastes singly or in combination, relationship between gas production and temperature, pathogen destruction in slurry, seeding with fermented material, etc.

The study team saw two bio-gas plants under construction and also some plants working at the Cheng Hsiang Production Brigade. Last year, the production brigade conducted studies on the comparative value of bio-gas manure and ordinary compost. The bio-gas manure gave a 17% higher yield of wheat than an equivalent weight of an ordinary compost. Bio-gas manure was also compared with lake silt. A yield increase of 750 kg/ha of rice was obtained through application of bio-gas manure.

The production brigade has a population of 1 100 and a total cultivated area of 105 ha. It runs a feed processing unit for pigs, a distillery and a bio-gas plant. The methane from the bio-gas plant is used as fuel in the distillery. The agricultural research team of the brigade was established in 1974. The team has a membership of 39 workers and an area of 7.5 ha earmarked for seed multiplication. The production brigade supplied the following quantities of improved seeds to the nine production teams under it:

<u>Year</u>	<u>Seed supply</u>	<u>Purity</u>
1974	15 000 kg	98.0%
1975	25 000 kg	98.5%
1976	65 000 kg	99.0%

The study group also saw cultivation of Azolla practised extensively by the brigade and attended an educational performance emphasizing the various social benefits accruing from the use of bio-gas.

5.4 Huashi Production Brigade, Kiang Yin County, Jiangsu Province
(7 May 1977)

The production brigade has a population of 1 060 with a cultivated area of 57 ha. Before liberation, the houses were scattered, land was subject to frequent floods and crop yields were very low (1 515 -2 273 kg/ha). In 1952, land holdings were consolidated and placed in the charge of the production brigade. Work on the pattern of the Tachai movement was initiated in 1964. As a result, 57 hillocks were removed to reclaim land for cultivation, 4 000 m of subsoil drainage laid and sprinkler irrigation was installed to serve 7 ha. The grain yield reported to have been obtained was:

1970	12 100 kg/ha/yr
1972	15 150 "
1976	20 450 "

The mono-crop system has been replaced by double cropping. The farm operations are semi-mechanized. The brigade has food reserves of 130 t and a public reserve fund of \$294 000. The brigade provides numerous facilities to the members such as nursery school, medical care service, canteens, etc. The wage income has been increasing from year to year. It was \$38 per member per year in 1963 which increased to \$78 per member in 1976.

The brigade maintains poultry, pig, duck and rabbit farms. There is also a foundry workshop. Azolla is extensively grown by the production brigade with very beneficial effects on the soil fertility. For rice, in addition to Azolla, 375 kg/ha of ammonium bicarbonate are used in two applications, the first at the time of puddling the soil and the second seven days after transplanting. Superphosphate is also applied at 375 kg/ha.

Forty bio-gas plants were reported to have been set up by the production brigade. It has a research centre employing 12 research workers. These workers go out to study field conditions and to discuss problems with commune members and they also arrange training for the commune members at the brigade's research centre. This production brigade has no production team.

5.5 Yueh Chi People's Commune, Wu County, Jiangsu Province
(8 May 1977)

The commune consists of 9 production brigades, one fish production brigade and 89 production teams. The number of families in the commune is 2 925 with a total population of 13 100 persons. The area under cultivation is 952 ha in addition to 264 ha of forest area and 264 ha of open water. Agriculture as well as subsidiary occupations have been markedly developed. The total yield obtained in 1976 was reported to be 4.8 times that obtained before liberation. In 1976, the commune sold about 4 600 t of grain to the state and retained a good reserve of 145 t of grain. The important secondary occupations of the commune are: chicken, goose and duck raising, and sericulture. In the matter of pig raising, the commune has surpassed the target of 'one pig one mu' (about 15 head/ha); the average stocking rate reported was 24 pigs per ha. In 1976, 225 t of fish products and 24 t of silk cocoons were processed.

Ploughing, irrigation, crop protection and drainage operations have mostly been mechanized. The commune has invested \$420 000 in machinery. The distribution of machine power is equal to 3.75 horse power/ha of land. The living standard of the commune members has also been raised. In 1977, each commune member obtained \$59 and 300 kg of food grains. Additionally, educational and cultural improvements have also been attained.

The commune has a network of waterways where water weeds are cultivated for pig feed as well as for compost making. The three aquatic plants grown are: (1) Alternanthera philoxeroides (147 ha); (2) Eichhornia crassipes (53 ha) and (3) Pistia stratiotes (40 ha). A harvest of 55 000 t of these aquatic plants is obtained per year of which pig feed and compost making absorb 24 000 t each and the balance is used for seed supply.

The study group toured the water area in boats to see aquatic plant cultivation and harvesting methods. The group was impressed by the care with which these plants were cultivated, harvested and converted into fodder or compost. For compost making, weeds are mixed with silt and grasses. Green manuring is also popular in this commune. The green manure crops in use are (1) Astragalus, Sesbania, Crotalaria and Vicia. The total acreage under Astragalus is 267 ha whereas the total area for legumes is 20 ha. The total quantity obtained from all the green manure crops is of the order of 10 000 t/year.

5.6 Agricultural Research Station of Feng Chiao People's Commune, Jiangsu Province
(9 May 1977)

The Research Station was set up in 1971 with its research work mainly concentrated on selection of seeds, testing of seeds, weather forecasting and plant protection. The research station keeps in touch with local agricultural problems and undertakes experimental work to solve them.

The Feng Chiao Commune comprises 28 production brigades and 2 841 production teams and has a cultivated area of 2 667 ha. Agriculture is highly intensive, raising three crops in a year (wheat-rice-rice). Triple cropping has been possible by using early varieties of these three crops. The following yields are reported to have been achieved in the experimental plot of the research station:

1.	Wheat	6 105 kg/ha
2.	Early rice	9 075 "
3.	Late rice	7 410 "

The average yield of food grains obtained at the research station is 15 090 kg/ha. The average yield of food grain obtained in the commune in 1976 was 13 515 kg/ha. The Ma Pang Production Brigade obtained a record yield of 2.5 t/ha/year during 1976. It has been possible to achieve high yields through application of organic manure at high rates. Pig manure and aquatic weeds are the main sources of organic manure used in the commune. The application rate of organic manure is as high as 227 t/ha/yr. Green manuring is not possible in the triple cropping system.

The commune has an agricultural technical school attached to the research station and has 60 workers and technicians on its staff. It provides one year training courses in agriculture and in addition, short courses are also arranged for members of the commune. In the last two years, 84 students who graduated from this school are working as agro-technicians in the communes of the county. Research workers from the provincial research institute are invited annually to give lectures. Experienced members of the commune and local farm experts also teach regularly but on a part-time basis. The subjects taught by the full or part-time teachers are for the most part the same as those taught by the commune members but there is a difference. While the latter stress the local advanced techniques and experience of immediate practical value to the students the former give systematic instruction in the elements of agricultural science, supplementing it with practical lessons.

5.7 Agricultural Research Institute of Wu Chin County, Jiangsu Province
(10 May 1977)

The Institute was set up in September 1972 and has a staff of 102 workers and researchers. The research programme of the Institute is mainly confined to: (1) seed selection of main crops; (2) standardization of high yielding agricultural practices; (3) control of insects and pests; (4) economic use of fertilizer and manures and tapping of various manurial resources; (5) Pig raising and (6) sericulture. The results achieved at the Institute are demonstrated at the research stations and production units at lower levels. Results from a fertilizer trial on rice conducted at the Institute given in Table 14 are:

Table 14 FERTILIZER TRIAL ON RICE

Kind of manure	Application of manure/fertilizers kg/ha	Yield kg/ha	Index number
1. Ammonium Bicarbonate (17% N)	450	5 865	100
2. Grass + silt	75 000	6 015	102
3. Aquatic plants	105 000	6 150	105
4. Pig litter	30 000	6 255	106.7
5. Sheep litter	22 500	6 450	109
6. Ammonium Bicarbonate (17% N)	300	5 070	100
7. Sesbania	15 000	5 475	107
8. Alternanthera	45 000	5 385	106
9. Grass + silt	60 000	5 310	104
10. Rice straw	16 500	5 100	100.7

As the potassium content of the soil in the county is low or medium, different local resources of potassium fertilizers are being tapped and tested for wider application to the soils.

The study group visited the county office and learnt that: the county comprises 37 people's communes, 820 production brigades and 8 000 production teams; the population is 1.1 million of which 0.99 million are engaged in agriculture; the total cultivated area is 74 667 ha and there is a labour force of 0.51 million. Agriculture is highly intensive in this county (cropping intensity = 2.6).

Acresage under different crops

Early rice	58 667 ha
Late rice	70 000 "
Single rice crop	1 333 "
Wheat	40 000 "
Rape seed	8 000 "
Green manure crops	22 000 "

The county has progressively increased the yields of crops and total food production:

<u>Year</u>	<u>Average yield per ha</u>	<u>Total food production</u>
1949	2 250 kg	195 000 tons
1965	7 125 "	515 000 "
1976	9 450 "	685 000 "

The increase in yield has been achieved through self-reliance, land improvement and application of heavy dressings of manures supplemented by mineral fertilizers. Silt and aquatic plants are used extensively. The county has a fleet of 20 000 boats for carrying silt. It was reported that the following quantities of organic manures are applied per ha:

1.	Silt plus grass mixture	150 tons
2.	Animal manure, pig manure	30 "
3.	Green manure crops	37.5 "
	Total	217.5 "

Average consumption of fertilizers (ammonium bicarbonate) was reported to be 300 kg/ha/yr. Through the liberal use of organic manures, the organic content of soils has increased to more than 2%, as against 1.5%, in 1959.

5.8 Malu People's Commune, Shanghai
(12 May 1977)

The commune was formed in 1958. It has a population of 30 000 in 7 000 households. It has 14 production brigades, 144 production teams and a cultivated area of 2 261 ha. Percentage distribution of area under different crops is:

Foodgrains	50%
Cotton	35%
Oil crops, roots and vegetables	15%

Being in the vicinity of Shanghai city, the commune is also engaged in other gainful activities such as raising livestock including pigs, poultry, rabbits, dairy, freshwater fish production, mushroom cultivation, rice processing mills, manufacture of farm implements, and machinery to cater for the needs of the city dwellers. A number of sideline occupations such as handicrafts (bamboo weaving) sewing and pearl culture have gained importance.

Pig raising in the commune has also quickly developed:

<u>Year</u>	<u>No. of pigs</u>
1949	4 176
1957	6 780
1965	32 101
1976	47 100

The commune has made great progress in mechanization and it now has 200 tractors (almost one tractor for 10 ha) and 37 tube-wells. For compost making the commune receives 30 000 t of city garbage and 10 000 t of night soil per year from Shanghai Municipal Committee free of charge. It also makes compost from silt, pig manure and straw and it maintains 500 boats for carrying night soil and city garbage to production brigades/teams. The total amount of organic manure used in the commune annually was reported to be 300 000 t, equivalent to 133 t per hectare of cultivated land.

The heavy dressings of organic manure have been mainly responsible for the great increase in yield of grain crops, as shown below:

<u>Year</u>	<u>Average yield of grain</u> <u>(kg/ha)</u>
1949	3 360
1957	4 612
1965	11 407
1976	15 480

In the past, the commune was a grain-deficit unit obtaining grains from the national food reserve but now it is a grain surplus unit. Last year (1976), 3 000 t of grain were supplied to the state. Each crop in the rotation wheat-rice-rice receives a basal application of organic manure made from pig manure, silt and grass at 60 t/ha, followed by a second application of organic manure to the seedlings at 7.5 t/ha. If the crop shows a need for more nutrients, mineral fertilizers are added.

The study group saw wheat fields interplanted with cotton. Cotton plants are raised in a nursery and the seedlings are planted in holes dug by a small hand tool in the wheat fields in early May. Cotton seed is sown in a nursery for two reasons:

- i. As a protection from cold, a nursery can be covered with polyethylene sheets;
- ii. cotton seedlings so raised and later transplanted are not subjected to shade by the wheat plants.

It was reported that transplanted cotton gave a 10-15% higher yield than direct sown cotton. Cotton was also seen interplanted among onions.

5.9 Shanghai City Waste Disposal (12 May 1977)

The Shanghai metropolitan city has a population of 10.7 million persons (city area population 5.1 million and suburban area population 5.6 million) comprising 10 counties, 147 communes, 2 800 production brigades and 28 000 production teams. The Cleansing Department of Shanghai is responsible for the disposal of city waste. For that purpose, Shanghai city area has been divided into 10 districts and each district has its own cleansing department. A district is subdivided into sections and each section has a number of nightsoil collection tanks into which the households dump their night soil. The collection tanks are towed by trucks to wharves where the night soil is dumped into storage tanks. An insecticide (Dipterex) is applied to the contents of the tanks at

2 g/m³ of night soil to kill fly larvae. From the tanks the night soil is dumped into 50 t capacity boats after a week of storage and delivered at the storage tanks owned by communes and production brigades along the waterways. Night soil is kept in these tanks for about two weeks during which period all pathogenic micro-organisms are destroyed through anaerobic fermentation. The tanks are covered with plastic sheets. From these tanks, the night soil is pumped into the boats of production teams. It is collected by team members from boats by bucket and applied directly to the field. In this way, the entire quantity (10 000 t per day) of night soil collected in Shanghai city is delivered to different communes in rotation.

About 3 500 t of domestic garbage are available daily from Shanghai city. Each family deposits the domestic garbage at a fixed point from where it is carried in trucks which are emptied into 40-50 t capacity boats. The boats deliver the domestic garbage at community farms along the streams. The garbage is composted by members of the production brigade/teams. About 1 000 trucks and carts are used for carrying the city garbage to different delivery stations. Night soil and domestic refuse is supplied at the delivery sites free of cost. The communes have to arrange transport of these materials from the delivery sites to the fields.

Composition of city wastes

	<u>Night soil</u> (%)	<u>Domestic garbage</u> (%)
1. Moisture	80	-
2. Organic matter	5-10	15-20
3. N	0.5-0.8	0.37
4. P ₂ O ₅	0.2-0.4 (P, 0.1-0.2)	0.15 (P, 0.06)
5. K ₂ O	0.2-0.3 (K, 0.17-0.28)	0.37 (K, 0.31)

The study group watched compost being made from domestic garbage in Malu Commune. The garbage is stacked in heaps about 5 m in diameter and 2 m high and is usually covered with a thin layer of silt. It is turned twice during the three months it is on the ground, at the end of which it has become a brown friable material. To make it richer, garbage is generally mixed with pig manure/night soil and then piled to circular or rectangular heaps. To provide the necessary moisture, night soil or water is added to the garbage while making heaps or turning the material.

The group also saw a three-chamber septic tank designed for treating night soil. It was claimed that during the period of retention of night soil, pathogenic micro-organisms were killed. The night soil from the latrines passes into the storage chamber through an inlet. The effluent remains in the third chamber for about a week and thereafter is applied to fields. The sediment in the storage chamber is removed twice a year for use as manure.

During a visit to the commune hospital, the role of barefoot doctors in popularizing measures for the prevention and cure of diseases was explained.

A visit to the Chiao Ting Fertilizer Factory was also arranged. The factory, set up in 1959, produces 80 000 t of ammonium bicarbonate per year. The predicted production capacity of the factory was reported to have been exceeded by 20%. Eighty percent of the equipment and spare parts is manufactured in the factory itself. Methanol is synthesized from the waste gases.

5.10 Chao Yang Sewage Treatment Plant, Shanghai
(13 May 1977)

In the afternoon the group visited the Chao Yang Sewage Treatment Plant of Shanghai metropolitan city. The plant was set up in 1954 to serve the residential area of Chowan. It was designed to treat 5 700 m³ of sewage per day and to serve a population of 40 000 persons. The plant now treats about 8 000-10 000 m³ of sewage per day, serving a population of 70 000 persons.

Sewage is treated by an activated sludge process. No facilities have been provided for drying sludge because it is directly pumped to a sludge storage tank located in the farm area. The reported composition of the sludge was: N, 0.3%; P₂O₅, 0.15% (P, 0.07%) and K₂O, 0.02% (K, 0.17%). The compositions of raw and treated sewage were not available. Sludge and treated sewage are supplied free of charge to the commune. The underground pipes for transporting the sludge and treated sewage are laid by the commune. Twenty percent of the capital cost of laying the underground pipes is given as a grant by the state to the commune. There are 10 such sewage treatment plants set up by the Shanghai metropolitan city to serve the sewered areas.

The group also visited Chang Chin People's Commune to see sewage irrigation on an area of about 130 ha. Vegetables are mainly grown on this land. In areas receiving sewage irrigation no manure is added because the plant nutrients supplied through sewage can more than meet the requirements of the vegetables. It was reported that the sewage irrigation gave yields about 15% higher than those obtained through well irrigation. The yield of vegetables was reported to be about 100 t/ha. The sewage is applied intermittently, the time between applications being from one to three weeks depending on the condition of the soil. The vegetables are grown on ridges and the sewage is applied in furrows between the ridges.

The sludge from the sewage treatment plant is stored in a sludge tank for two or more weeks before used as a basal application or top dressing.

5.11 Fu Shan Municipality, Guangdong Province
(14 May 1977)

The group studied the urban waste disposal system adopted by the municipality. The city has a population of 140 000 persons.

The garbage (about 60 t/day) is brought to one of the three treatment sites where it is put into closed compost bins for fermentation; if necessary, the moisture content is adjusted by adding water. A series of 80 such bins, each of 11.25 m³ capacity, has been provided at the treatment site visited. The bin is covered and has a ventilation hole at its base. During the fermentation period (25 days) parasites are killed by the high temperatures (70°C) attained. Fully treated garbage is removed through the door in the front of the bin, screened, and taken by the commune members on payment of \$0.80/t.

Night soil (170 t/day) is put into tanks of 45 cubic metre capacity. Thirty-two such tanks have been provided at the treatment site and each tank is 10.5 m long, 2.4 m wide and 2.3 m deep. These tanks are constructed below ground in two rows of 16 each. They are inter-connected with pipe lines and have a common drain and are provided with gaslight covers fitted with water seals. The tanks are connected with the gas holder into which gas is pumped. The tanks are filled with night soil to a depth of 1.9 m. The night soil undergoes anaerobic digestion in the tank for 22 days, during which time methane is evolved. The gas is stored in a sausage shaped bag made of 0.22 mm thick Hypolon laminated with neoprene and reinforced with nylon and with a PVC inlet and outlet. The bag rests on a water surface as an aid for detection of leaks. About 230 m³ of gas are produced daily, but in the winter the output is reduced by 50%. The gas is used to generate electricity. The sludge from the tanks is sold to the commune members at \$2.10 per ton, while the effluent is led through a pipe to a boat for transport to the fields.

The garbage and night soil have the following composition:

	<u>N</u>	<u>P₂O₅</u>	<u>P</u>	<u>K₂O</u>	<u>K</u>
Garbage	0.2-0.23	0.5	0.22	0.33	0.27
Night soil	0.40	0.2	0.09	0.15	0.12

5.12 Agricultural Research Station, Hsi Chiao Commune, Nanhai County, Guangdong Province (15 May 1977)

The group visited the Research Farm of the Hsi Chiao Commune and saw sesbania cultivation for green manuring. Sesbania is a leguminous annual crop of which there are two varieties: one with green stems and the other with red. The latter is cultivated by the commune because it is resistant to drought, acidity, alkalinity and waterlogging; it also resists high temperature and humidity. It produces the first two leaves 8-10 days after seeding and attains a height of 15 cm in about 30 days. The plants start branching 35-80 days after seeding. Sesbania cannabina grows to a height of 3 m and each plant weighs about 5 kg.

The techniques of raising sesbania seedlings and their transplanting in rice fields were explained to the group. A practical demonstration of transplanting seedlings was arranged.

5.13 Hsin Hui County, Guangdong Province (15-16 May 1977)

The county comprises 22 people's communes with a total population of 820 000 persons. The cultivated area is 55 000 ha. The main crops of the county are rice, sugarcane and mulberry. The county is reported to have attained a high growth of agricultural production. The following rice yields were quoted:

1949	2 250 kg/ha/year
1958	6 000 "
1971	7 500 "

The increase in productivity was mainly attributed to water conservation measures coupled with heavy dressings of natural manures.

The group visited the No. 1 production team of Chang Nan Production Brigade to see how composting was done.

The production team consists of 51 farming families with a population of 244 persons. The cultivated area is 16 ha. The brigade owns 548 pigs. On the average, each family has 11 pigs, the manure from which meets 60-70% of requirements. The rice yield in 1976 was 8 258 kg/ha. The yield of wheat cultivated in 1976 over an area of 5.3 ha was 1 909 kg/ha. The production team keeps all the pigs in a pigsty which is situated on the bank of a stream. Washings from the pigsty are led directly into a boat which carries the liquid manure to the fields.

The group saw a few manure sheds constructed by the production team. In the manure shed, pig dung is mixed with powdered mud prepared by a machine designed for the purpose. The mixed material is stored in heaps for use when needed at 7 500 kg/ha/crop. Some mineral fertilizer is also applied as a supplement.

In the Cha Kung Production Brigade the group saw compost being made by the team members from different kinds of wastes.

Green manure crops, pig urine, human and animal excreta and garbage, are all put together in a pit and an equal volume of water is added. The pit is two-thirds covered and one-third is open. The manure is ready in one month's time and is applied in liquid form. The group also saw Azolla cultivation in the nursery and in rice fields.

One day (17 May) the group had discussions with Chinese experts on green manuring, cropping systems, research on organic manures, use of fertilizers, silt, use of inoculation, blue-green algae, etc.

5.14 Tachai, Hsi Yang County, Shanxi Province
(18 May 1977)

The study group visited Tachai which has earned a name in developing socialist agriculture through self-reliance and hard work. Tachai is a production brigade of Tachai People's Commune. It has 83 households with a population of 450 persons of whom 160 form its labour force; 57 hectares of cultivated land and 80 head of cattle, horses and mules.

The brigade's greatest achievements have been in the field of reclamation and development of land, installation of an irrigation system and construction of new houses for the members. 'Man-made land' has been carved out of gullies and ridges. A further improvement has been in the soil itself - the depth of the original topsoil has been increased from 16 cm to 1.20 m by bringing soil from sloping areas. Since 1970, 37 hill-tops have been levelled off and 24 gullies filled in, merging the brigade's 4 700 small plots into 1 500 man-made level fields which are convenient both for tractor ploughing and irrigation. A 7 km canal has been built along the mountain slope to bring water from Kuchuang reservoir to Tiger Head hill where five water storage tanks have been built and underground pipelines laid for irrigation.

In the past, a dry spell or a flood would cause disaster; today, both have been controlled through irrigation and flood control devices. Sprinkler irrigation has been introduced in high areas and 80% of the cultivated land has been brought under irrigation from various sources. Twenty-seven hectares of barren hills have been re-afforested with 120 000 trees of which 40 000 are fruit trees. Forest earnings contribute 11% of the brigade's total income. Agricultural mechanization has been going on steadily. The brigade has two bulldozers, six tractors and a number of agricultural machines. A ropeway has been laid to carry agricultural produce, manures and fertilizers. Threshing and processing of agricultural products are mostly mechanized. In agriculture, new techniques such as close planting in widely spaced rows and breeding new strains suited to the local climate are being adopted. These have helped to improve seed strains, to grow two crops instead of one and to grow fine grain in place of coarse grain.

Organic manure is constantly applied to newly reclaimed land at 150 t/ha. Manure is applied to other land at a rate of 75 t/ha per crop, plus 200 kg/ha of ammonium bicarbonate and 75 kg/ha of superphosphate.

Manure is made from crop stalks (maize, sorghum), cattle dung and human excreta.

The yield of grain has been increasing as indicated below:

<u>Year</u>	<u>Grain yield per hectare</u> (kg/ha)
1953	1.800
1974	7.600
1975	8.200

The grain output was reported to have exceeded the best pre-liberation figure by tenfold. The brigade's food grain contribution to the state has grown with the increase in production. In 1975, it sold the State a record of 150 t of grain, averaging 2 t per household per year. The collective economy has shown a corresponding growth, the total income from farming, forestry, animal husbandry and sideline occupations being 13 times that of the early cooperative years. The accumulated funds in 1977 were 60 times those of 1955; the accumulated fund in 1977 was 24.1% of the total income in that year. A larger accumulation fund has made available more funds for productive investment. In 1977, the amount so invested amounted to 31.5% of the accumulation fund. Agricultural taxes in 1977 amounted to 0.83% of the total income of the brigade in that year as against 8.5% in 1955.

With the expansion of production, the income of the brigade members also increased from \$28 in 1955 to \$74 per member in 1974. In addition, the members enjoy a number of facilities. High school education has been made available to all children in the brigade. Tuition fees from kindergarten to senior middle school are borne by the brigade. Cultural and recreational activities are funded from the common fund and all members receive cooperative medical care. All the brigade members live in new houses or new cave rooms paying an annual rent of \$1.30 per room or the equivalent of the value of two working days. Food grain is distributed on the principle of "to each one according to his need".

5.15 Chan Sun Production Brigade, Hebei Province
(19 May 1977)

The study group was shown how high temperature compost is made and a practical demonstration was given. In high temperature compost making, rice straw, garbage and night soil and animal excreta were used.

<u>Composition of high temperature compost</u>		
	(%)	
Nitrogen	0.5	
P ₂ O ₅	0.3	P 0.13
K ₂ O	0.6-0.7	K 0.5-0.6
Organic matter	20	

The manure is applied at 90 t/ha/hear. The members of the production brigade rear pigs individually. Each family keeps its pig in a small semi-circular sty to which is attached a small compost pit. The depth of the pit is about 2 m and it is almost filled with dry mud and straw. The pigs defaecate in the pit, the contents of which are periodically turned over. The manure is ready after 40 days in summer and 60-80 days in winter.

A visit was paid by the group to Paichi Ken Production Brigade (Litsun Commune, Huai Lu County). Huai Lu County has a population of 280 000 persons. The County is reported to have done well in water conservation and land improvement. Double cropping has been introduced. The grain yield has increased from 4 155 kg/ha in 1974 to 10 500 kg/ha in 1976. Bio-gas was introduced in 1973 since when 40 000 families in the county are reported to have set up bio-gas plants. The group saw the bio-gas exhibition arranged by the county. Among the exhibits was an internal combustion engine running on bio-gas.

5.16 Ta Heh Production Brigade, Hebei Province
(20 May 1977)

The production brigade consists of 100 families. The group visited a bio-gas plant under construction and a senior middle school run by the brigade. Thirteen bio-gas plants have been set up in this school to impart bio-gas technology to the students. The capacity of each plant is 14 m³. Crop wastes and night soil are used in these plants which supply in full all gas for cooking and all the electricity required by the school (340 students and 35 teachers and other staff.) The sludge from the plants is used on the farm run by the school.

The school also conducts two short-term courses on agricultural machinery and the use of electricity in agriculture. After graduating the students go to the countryside for two years to work on the farms. The Ta Heh Production Brigade is reported to have set up 642 bio-gas plants.

The group inspected the wheat experimental plot which was laid out to study the comparative value of mineral fertilizers and effluent from bio-gas plants. Ammonium chloride at 375 kg/ha was applied to half the plot and effluent from the bio-gas plant was applied at 150 t/ha to the other half. Both plots were given a basal dressing of 60 t/ha of bio-gas sludge. The following observations were quoted:

	<u>Plot receiving ammonium chloride</u>	<u>Plot receiving effluent</u>
1. No. of tillers	1.43 million	1.12 million
2. No. of spikelets	52 600	440 000

The group also visited Tung Shao Ying Production Brigade (Ku Cheng People's Commune) where the process of compost making was seen. Crop waste, silt and night soil/horse droppings were mixed thoroughly and while making the heap, a very large bundle of crop stalks was inserted to provide aeration.



Fig. 47 General view of Tachai Production Brigade, Shanxi Province

CHAPTER 6

EXTENSION OF EXPERIENCE GAINED IN CHINA ON ORGANIC RECYCLING

6.1 General

The wealth of experience amassed in the People's Republic of China during the past 28 years can, with suitable extension, be used to help other developing countries in their efforts to meet their ever-growing agricultural needs. In most developing countries, a large proportion of organic wastes remain as such, whereas their utilization for remedying shortages of agricultural inputs should be an important aspect of national economy.

The foregoing chapters present detailed information on the recycling of organic wastes in agriculture as practised in China and on the policies to step up such activities both from the point of increasing agricultural production and of environmental sanitation. In this chapter some suggestions are made how to take best advantage of the experience gained in China in order to benefit other countries.

6.2 Recycling Programmes and Activities

6.2.1 Preliminary investigations

Wastes may be broadly classified into three main groups:

- agricultural and animal wastes/by-products
- community wastes (rural and urban wastes)
- industrial wastes

It might be useful to conduct a comprehensive study in various countries on the present state of organic waste utilization and the potential scope of its exploitation. The study could be carried out from the following points of view:

resources (origin of wastes) such as: (i) crop wastes/by-products, (ii) forest wastes/by-products, (iii) fruit and vegetable processing wastes, (iv) animal wastes/by-products, (v) community wastes, (vi) fisheries and marine wastes and (vii) industrial wastes.

end-products such as: (i) animal and poultry feed, (ii) organic fertilizer, (iii) protein food, (iv) paper, pulp board making, (v) industrial chemicals (furfural, oxalic acid, activated carbon, silicon, etc.).

The study should envisage the following lines of action:

- i. Present state of utilization of wastes including:
 - a. identification of wastes,
 - b. present use of wastes in quantity and value, and
 - c. reasons why the results of investigations in the use of waste materials, which have proved to be technically feasible, have not been beneficially used, and remedial measures in this regard.

- ii. Assessment of possible utilization of wastes including:
 - a. identification of wastes,
 - b. availability, collection, storage in quantitative terms,
 - c. identification of research and development of projects,
 - d. areas for further work.
- iii. Prospects for utilization of wastes including:
 - a. invitation of project proposals indicating the scope of the study, time, frame, cost implication and who is to undertake the study in the utilization of wastes,
 - b. preliminary estimates of techno-economic feasibility,
 - c. identification of viable projects for improving agricultural productivity

The availability of wastes depends on natural resources; so their assessment in quantitative terms is not amenable to direct methods. An estimate of their availability is possible by indirect computation. Moreover, these wastes are bulky in nature, containing nutrients in organically bound form; therefore decomposition of these wastes for a certain period is necessary to reduce volume and convert the nutrients into easily available forms for use by the plant. The public health point of view must also be considered.

6.2.2 Socio-economic aspects of organic recycling

There is scope for utilization of organic materials as a major source of crop nutrients in developing countries because of the short supply of mineral fertilizers, easy availability of organic resources, the comparatively low production cost of organic fertilizers and the availability of labour.

The constraints to full exploitation of organic recycling potential available in these countries are:

- a. Lack of awareness of the possibilities and lack of interest on the part of the society towards the programme,
- b. inadequate infrastructure for collection of wastes in rural and urban areas,
- c. inadequate technological development,
- d. lack of skill,
- e. social prejudices,
- f. lack of definite policy and programmes on the part of national governments to support the use of organic fertilizers,
- g. financial difficulties concerning initial investment.

There is already sufficient working knowledge, experience and technical information available on city garbage composting, night soil treatment, utilization of sewage and animal wastes and fallen cattle, bio-gas, rural waste composting and green manuring. The Chinese have this experience and India has also made a remarkable contribution in the field of recycling organic wastes in agriculture. Those of the developing countries who do not have the requisite technical information and expertise available in this field would do well to ask for expert assistance from outside in the formulation and implementation of a nationwide programme for development of local manurial resources.

6.2.3 Elements for development programmes

i. Bio-fertilizers

Scientists have shown that biological fixation of nitrogen is a very promising and cheap supplementary source of nitrogen for crops. Many of the developed countries have already adopted this approach. The contribution of legumes to nitrogen fixation in the soil is highest in Australia and in the United States of America where legumes provide a large amount of nitrogen for primary production.

China has also made use of atmospheric nitrogen through extensive use of green manuring and Azolla culture. Other countries would do well to emulate these examples. These possibilities should be of particular interest to developing countries which still spend much of their foreign exchange on importing mineral fertilizers and continue to have problems in distributing them to farmers. For these, and technical reasons, it appears that many developing countries would benefit greatly by making extensive use of nitrogen fixation techniques and practices.

Hitherto leguminous plants have been used as green manure to enrich the soil by their nitrogen fixing ability, but another more beneficial way of harnessing nitrogen is by using blue-green algae which are known to fix nitrogen to the extent of 40-50 kg/ha.

Work on the economic use of algae has been going on in many countries and there has been considerable basic and applied work in this field (e.g. in Japan, China and India). In the context of this report algae are of particular interest as bio-fertilizer. In Japan and some other Asian countries, algae have long been used as manure. It has been demonstrated in some field trials in Japan that algal inoculation resulted in a yield increase of 2% in the first year, 8% in the second, 15% in the third and 20% in the fourth year. In China, algal inoculation has started; under experimental conditions, the rice yield was increased by 10%.

Useful work on the role of algae as a bio-fertilizer, especially in connection with rice crops, has also been done in India. Various blue-green algae, e.g. *Nostoc* and *Anabaena cylindrospermum*, can be used for nitrogen fixation. The higher yield of the crop is not only due to nitrogen fixation by the algae but also to the release of some vitamins and growth promoting substances. Methods have been developed for large scale production of algae. They can be either cultured in a tank or on moist volcanic gravel or by open air soil culture. Another method is cultivation in sewage water which is then used for irrigation purposes.

Some other major areas where algae can help substantially in promoting productivity are:

- a. as a source of food for man and domestic animals: the algae as foodstuffs have some unique advantages, for example the whole plant can be eaten with no waste. The protein content is very high. The algae crop in general is not affected by climatic fluctuations and can be grown throughout the year if adequate precautions are taken. Even the cultural techniques are very simple.
- b. as a source of energy: the recent energy crisis has attracted global attention to algae as a potential material for conversion of solar energy into transportable fuel. Algae can fix 2.5 to 3.5% of the solar radiation and like other organic material can be subjected to anaerobic fermentation and generate bio-gas (methane); the digested material could be used as manure.
- c. phosphobacteria: there are also bacteria (phosphobacteria) which excrete acids into the growth media and hence solubilize bound phosphates. These organisms can be useful in the utilization of rock phosphates with a low phosphorus content. Australia has forged ahead in the manufacture of 'Bio-super' by inoculation of a sulphur bacterium into a mixture of rock phosphate and sulphur.

Some suggestions for developing the use of bio-fertilizers

1. The techniques developed in China for Azolla culture could potentially be applied in developing countries. These countries may initially adopt the techniques to be applied to rice fields on a trial basis. Assistance might be arranged for the transfer of such practices.
2. On an immediate basis, countries which have developed algal bio-fertilizer could be requested to supply the cultures and give complete details of multiplication and application to other countries interested in initiating such a programme.
3. Since the agro-climatic and edaphic conditions may vary in different regions, it is also necessary to initiate programmes to isolate and identify the blue-green algae already present and native to their own respective environments.
4. Farmers in developing countries should be provided as quickly as possible with the best currently available technology to use algal inoculation: (a) through intensive agricultural education and extension to the farmers with demonstrations on the use of algae as green manure and in bio-gas plants to enhance bio-gas production and (b) through mass production packaging, storing and supply of algae for culture.

ii. Green manuring

Green manuring is practised in China but expansion of the multiple cropping system in that country would limit the scope of green manuring. Nevertheless, in other countries where inadequate quantities of materials, such as cattle dung and crop wastes, limit production of compost, green manures are the cheapest form of organic fertilizer. However, their place in the cropping pattern would need to be planned, as growing only for ploughing into the soil involves the loss of a crop.

Most members of the Leguminosae are widely distributed in the tropics and sub-tropics. The floral composition of the natural vegetation in any developing country will reveal a herb, shrub or tree belonging to the three sub-families Mimosoideae, Caesalpinnioideae and Papilionaceae. Raising perennial shrubs such as Glicicida maculata, on dry lands, on borders of fields, around manure pits, along irrigation channels etc. would largely make up the deficiency in raw materials for compost making.

Some of the practices that could be adopted for green manuring are:

- a. sowing a green manure crop, harvesting it and using it for compost making with other crop wastes instead of ploughing under the crop. In this manner, the field, which must be left unsown until decomposition of ploughed-in green manure, could be cultivated immediately for sowing;
- b. *Sesbania* seedlings may be transplanted on borders of paddy fields; out of every 4-5 plants being left for seed and the remaining plants ploughed under after the harvest of the first crop of paddy. The plants that are ploughed under serve as a green manure crop for the following crop of paddy;
- c. if a heavy yield of a green manure crop is obtained in one unit area, it can be ploughed under in 3-4 other units;
- d. leaves of green manure trees or forest leaves can be used as green manure, the leaves being applied to paddy fields at the time of puddling;
- e. pulses like cowpea, soybean, green gram, etc. may be included in the cropping pattern without loss of any commercial or cereal crop. In a period of 4-6 weeks the crops supply an adequate quantity of green matter for green manuring and perhaps 2 or 3 pickings of beans as vegetables;
- f. legumes could also be advantageously grown in orchards. Plantation crops also afford opportunities for the inclusion of legumes in multi-layer cropping.

Legume inoculants: Chinese farmers have developed a simple method for preparing legume inoculants for increasing the nitrogen fixating capacity of green manure crops. It could be scientifically tried in other countries. (see 3.1.3).

Much work on isolation and screening of Rhizobium for efficient strains suited to different legume crops has been done in various countries and a number of cultures are now available.

Interested countries should set up their own 'legume bank', which could include all the legumes grown with full agronomical, nutritional and management details. There is also a need for quality control standards for legume cultures now being prepared and marketed.

iii. Garbage composting

City garbage should be converted into compost as a means of garbage disposal.

In China, city garbage is diverted in raw form to surrounding commune areas where it is made into compost with night soil, animal wastes, etc. Transport of raw refuse to the countryside involves much haulage at considerable cost in labour and materials. It is also a health hazard. A better way would be for the municipal authorities themselves to compost the city garbage with night soil, in equal proportions by weight, and then supply it to People's Communes at cost price or even at a nominal profit. There should be arrangements for sieving compost by means of a hand rotary sieve or a mechanical sieve.

The municipal authorities may adopt one of the three composting methods best suited to their conditions:

- a. Conventional composting in trenches/heaps,
- b. compost bins,
- c. mechanical composting.

Method a. is most commonly adopted in China. In certain cities/towns compost bins are used for composting. The bins are simple structures with little aeration and in which it takes a relatively long time to ferment the garbage. A modified bin (method b.) consisting of a cell type structure with a porous base and space beneath for aeration and drainage could be used with advantage. The base could be made of bamboo mesh, and the top would serve as a loading hatch and there could be an unloading door at the front. The closed bin would help prevent the escape of odours associated with fermentation. The air would help thermophillic fermentation and with a suitable moisture content (50%) temperature would rise to 65 or 70°C within 3-5 days.

Mechanization in composting city garbage (method c.) has been introduced in several countries, both developed and developing.

A number of compost plants have been set up in the United States and Europe, but the problem of marketing compost has restricted the use of mechanized composting as a method of refuse disposal. However, this system has found favour in a number of other European countries.

In Asian countries, mechanical composting has had limited success and the following conclusions can be drawn:

1. Compost plants should not be operated with a profit motive. whereas it actually costs money to treat sewage or to reduce pollution, the aim that disposal of solid wastes should bring any financial income to the compost plant is not logical.
2. The advantages of mechanization should be made use of, but turn-key projects of patented processes developed for highly industrialized environments requiring high degrees of skills in operation and maintenance may not be suitable. A partially mechanized compost plant would be ideally suited for the developing countries.

3. A new concept in mechanical composting is called for. Besides the normal mechanical composting, it would be necessary to impregnate the compost during processing with cheap sources of nitrogen and phosphorus. The resulting product would be a much needed organo-mineral complex having an organic base which would release the nutrients required by the plants in balanced quantities. The enriched compost could be transported economically over greater distances for marketing and use.

iv. Sewage utilization

In arid regions, water shortage is a continuing problem, sometimes limiting agricultural and economic growth. In this context, subjecting municipal waste water (domestic sewage) to varying degrees of treatment and re-using the reclaimed water in agricultural production becomes increasingly attractive. Added to the resource value of waste water is the value of reclamation as a means of controlling pollution.

Waste water reclamation and re-use in agriculture is common in China, India and Israel and, to a limited extent, in Europe and the USA.

However, for health reasons, the sewage for re-use in agriculture needs some prior treatment. The two conventional methods of treating sewage, viz. trickle filtration and activated sludge processes or their modifications, are too costly and thus preclude their adoption in several countries.

The oxidation pond treatment, a recent innovation, has attracted great interest all over the world. It has great scope in developing countries because of its simplicity and low cost. Its efficiency is comparable or in some respects even superior to that of conventional treatment. Its capital cost plus capitalized running costs is estimated to be in the range of US\$ 1 to 3 per head as against US\$ 5 to 20 for the trickle filter process.

In the oxidation pond, decomposition of organic matter takes place contemporarily with algal photosynthesis. The decomposition makes available CO₂, NH₄ and other simple substances which the algae can utilize. For their part the algae produce oxygen which the aerobic bacteria require. The two kinds of micro-organisms are therefore of mutual assistance to one another. Given appropriate conditions for abundant algal activity, the net effect of an oxidation pond is to produce organic matter in algal cells.

Effluent from oxidation ponds is suitable for quick growing types of fish, and the final effluent from the fish pond can be gainfully utilized for irrigation purposes. Oxidation ponds have their highest potential in the tropics and subtropics to which areas inexpensive treatment of this kind is most suited.

Sewage farming is different from general farming. The quantity of sewage that is applied depends on the nature of the soil. Proper crop rotations and the simultaneous cultivation of green manure crops are pre-requisites of a successful sewage farm, as in this way the tilth of the soil will be maintained under intensive cropping.

Under continued sewage irrigation but with inadequate drainage, crop yields diminish steadily, indicating the gradual development of "sewage sickness" of the soil. Treatment of such soils with burnt lime followed by a fallow period is useful. In some soil types, subsurface drainage must be employed to ensure adequate aeration.

Concentrated sewage has to be suitably purified or diluted with water to make it fit for agricultural use. Sewage irrigation promotes considerable weed growth. The remedy lies in planting the crops at a wider spacing so as to facilitate weeding.

v. Night soil disposal and utilization

China has been making use of human excreta as manure for agricultural production for a long time and has developed sanitary methods for its treatment.

In most Asian countries there is strong prejudice and social inhibition against the handling and use of night soil. Consequently methods which do not involve direct handling of night soil should be considered for these countries.

In cities, night soil digestion offers the best solution. The process involves the same digestion process as with sewage - sludge in conventional sewage treatment plants. The digestion plants are usually designed so that they can become component parts of complete treatment plants when water-borne sewerage schemes become possible. The digestion plants have an additional advantage in that bio-gas is also obtained which could beneficially be utilized for heating, cooking and lighting or for generation of electricity.

A night soil digestion system has been widely adopted in Japan. The sludge obtained is dried/heated, bagged and supplied to farmers for use as manure.

In village homes, the simple technology adopted in Swedish rural areas may be tried. The technology is based on bacterial action inside closed containers known as "compost toilets". Human excreta, leaves and kitchen wastes are emptied into these toilets. After several months of decomposition, the process produces an odourless and innocuous humus which can advantageously be used as a fertilizer.

vi. Bio-gas plants

The recent energy crisis and the resultant widespread fertilizer shortages and their high prices, making their use un-economic for certain crops, have forced developing countries to re-examine the problem in order to make the fullest use of indigenous resources. In this context, the possibility of using the biological process of anaerobic fermentation to reconcile the conflicting needs of both fuel and manure from the same sources (cattle dung, crop wastes) has stimulated renewed worldwide interest in bio-gas plants. A bio-gas plant generates the combustible gas methane through the digestion of cellulosic organic waste and refuse materials without impairing their manurial value.

China has made a commendable contribution to bio-gas technology and utilization. A special feature of the bio-gas plants designed in China is that they are cheap, simple and can be made locally by using indigenous materials. The four million plants reported to have been set up in China are a visible symbol of the nation's self-reliance and determination to make the most of its assets, the biggest of which are its manpower, rural resources and ingenuity.

In most of the developing countries, local fuels and fertilizers available in the form of animal and vegetable residues are partially wasted and partially burned in inefficient furnaces which capture little of the energy content and preserve almost none of the fertilizer value. Anaerobic digestion of these wastes can provide fuel for domestic and commercial use, for irrigation and, as the economy expands, for cottage industries as well.

The energy values recovered from manure and other agricultural wastes may not seem impressive but at the unit level of farms and rural homes, each plant costing less than US\$ 50 can produce enough methane gas for cooking and nitrogen rich manure for crops for an average sized family. While fertilizers and electrification have benefitted those who have them, they are not widely available and the prospects that such centralized sector-wise development will reach even a bare majority of the people in the next generation are remote in most of the developing countries. It is in this background that bio-gas technology could be considered a means for solving the fertilizer and fuel needs of rural people.

The currently available technology on bio-gas in China, India and in some of the other developing countries is sufficient to expand this programme, but clearly there are some technical problems which remain to be solved to perfect the bio-gas plants for all conditions.

So far, the emphasis has been on individual plants. The introduction of community gas plants (fed on cattle dung, pig excreta, human excreta, water hyacinth, etc.) to developing countries is long overdue and would be of great service to the community, especially the weak sections.

In urban areas, community plants (fed with human excreta) should be installed, for instance in colleges, schools, etc. The gas can be used for cooking and heating purposes and the slurry (digested sludge) led through a pipe to fields and used with irrigation water. There are opportunities for the installation of bio-gas plants instead of costly underground drainage systems in government sponsored housing schemes.

At present the use of bio-gas is usually limited to fuel for cooking and production of manure. The farming community is equally interested in cheap and easily available fuel for diesel engines for lifting water for irrigation and for other agricultural operations. Diesel oil being expensive, bio-gas plants of larger capacities in rural areas will, therefore, prove more attractive, economic and a boon to farmers for watering their fields. Similarly, bio-gas plants can be used in cottage industries in rural areas.

The developing countries would be well advised to introduce bio-gas technology in the rural areas to provide fertilizer and energy from local sources in a manner consistent with full employment. These projects may be adopted in several contiguous villages as part of an integrated rural development programme.

Funding of such projects could be sought from national and international agencies. In view of the increasing interest in bio-gas, research on much needed development of bio-gas technology should be intensified. Investigations could include:

- a. further work on chemical, microbiological and engineering aspects;
- b. insulation studies for increasing gas generation;
- c. studies on conversion of internal combustion and compression ignition engines;
- d. growing of algae in the liquid fraction of the residual slurry;
- e. development of light machinery to run on bio-gas so as to widen the scope of use of gas for cottage industries;
- f. improvement in burner design;

- g. utilization of bio-gas for agricultural purposes such as driers and hatchery heaters;
- h. socio-economic aspects of bio-gas plants;
- i. investigations on hydro-electric generation programmes based on conventional water wheels driving small alternators;
- j. solar and wind energy collectors.

Training courses for technical personnel are needed urgently.

vii. Organo-mineral fertilizers

China has been producing organo-mineral fertilizers though perhaps on a limited scale. Superphosphate and ammonia are generally used together with organic materials in making these fertilizers.

Agronomically, the benefits from balanced use of organic manures and mineral fertilizers are well established. An organo-mineral fertilizer has the following advantages:

- a. it supplies all the nutrients in balanced quantities and therefore improves the percentage utilization of nutrients added in fertilizers as required by crops;
- b. it prevents losses of nutrients because of the high ion exchangeable capacity of organic matter;
- c. it supplies nutrients readily and steadily over the entire growing period of crops;
- d. it helps maintain the soil organic matter at a steady level, thereby ensuring good soil physical properties and fertility status;
- e. it has significant residual effects on succeeding crops and helps maintain productivity;
- f. it is more economic to transport the material over greater distances since it is enriched in N, P and K and contains more plant nutrients per unit volume, as compared to bulky organic manures.

Thus, such an organo-mineral complex would help in removing the shortcomings of organic manures on the one hand and mineral fertilizers on the other.

There is, therefore, a need to popularize production of organo-mineral fertilizers in developing countries.

There could be several approaches to production of enriched organic manures. It has been found that the rate and extent of liberation of nitrogen from applied organic manures is adequate for normal plant growth when their C:N ratio is less than 10:1 or the nitrogen content is more than 2.5%. In practice, the C:N ratio of organic wastes can be reduced by adding the requisite amount of nitrogen in the form of nitrogenous fertilizer. Thus a low quality manure containing 0.5% N with a C:N ratio of 20:1 can be treated with ammonium sulphate solution to add 20% more nitrogen. This would reduce the C:N ratio to 8:1 and the enriched manure can then be utilized effectively. This method is well suited to the direct utilization of large quantities of organic wastes of wide C:N ratios such as paddy and groundnut husks, wheat chaff, tobacco wastes and any material in a suitable physical condition to be easily incorporated in soil. This method enables the process of composting to be eliminated, thus saving time and labour.

There is a chemical process also for disintegrating bones, leather wastes and obtaining a sterilized bone-meal powder which can be used as manure or as a cattle feed. The dry bones are treated with diluted caustic soda (5.0%) until they disintegrate completely to form a paste (12-15 days). The disintegrated material is then washed with water and treated with 10% hydrochloric acid solution to neutralize it. The dried material yields bone-meal in powder form.

viii. Aquatic plants

Aquatic plants are considered as weeds in most countries and all possible means are taken to eliminate them, while in China these plants are cultured in a systematic way to provide material both for compost making and fodder for pigs. Feeding pigs with various aquatic plants such as water hyacinth, water lettuce or water chestnuts as a substitute for concentrate feed is a useful innovation. These plants could also serve as raw material for bio-gas plants, as in China.

Techniques for controlled cultivation of water plants adopted in China are worth emulating by other countries. A simple method is to drag out the plants from waterways and put them on the banks for semi-drying; they are then reaped in alternate layers with mud or silt in equal proportions. To hasten decomposition, the heap is turned two or three times and when turning, it must be ensured that the undecomposed plants are completely covered and not left exposed on the surface.

ix. Tank, pond and river silt

The beneficial effect of silt or mud on crop growth and soil improvement is well known to Chinese farmers. The extensive use of silt in agriculture in that country also helps in de-silting waterways, tanks and ponds. The mechanical device for sucking mud from the bottom of waterways could be adopted with ease in other countries.

6.3 Research Needs

Generally speaking, research - particularly applied research - on the use of organic materials as manure, has not been developed to the extent as on inorganic, mineral fertilizer use. There is, therefore, a need to initiate and expand research on all aspects of organic recycling.

Although China has a well-organized organic manure research programme, it is oriented towards the solving of specific district or commune problems. There is still a need for certain investigations which can be made at country or even regional level. For example, in bio-gas production improvement is needed in the separation of methane from carbon dioxide and to extend gas production into the colder months of the year; more information is required regarding the interaction between organic and mineral fertilizers; new or improved varieties of legumes are needed with high nitrogen-fixing capacity; methods of composting could be improved to give products with more favourable C:N ratios for fertilizer use; and so on.

ANNEXES

THE PEOPLE'S COMMUNES SYSTEM

The basic unit of rural production, administration, planning and a socialist community life is the People's Commune. It corresponds by and large to the old market district of pre-revolutionary times (Hsiang). There are at present about 55 000 people's communes in China. The original number of about 27 000 communes in 1958-59 was increased to 77 000 after the consolidation measures of 1961 in order to have smaller, administratively more wieldy units, and then gradually again reduced by mergers whenever local economic experience showed that two or more very small communes could be operated more rationally on a larger scale.

The People's Commune has a two-tier inner structure; it is subdivided into several Brigades which organizationally correspond to the Advanced Agricultural Producers' Cooperative of the pre-1958 stage. In most cases, the Brigade is co-extensive with a larger village or group of smaller hamlets. It is subdivided into several Production Teams which represent the historically grown hamlet, small village or part of a larger village. Teams consist of 6-50 households, i.e. those which normally do their field work together (and have done so in the past); a team's cultivated area may range from 1 to 15 ha. The Brigade groups several teams with about 50 to 400 households and 50-400 ha but there are a few brigades which are not further subdivided into teams; the model brigade of Tachai is one of those exceptions.

There is a relatively clear division of labour between the three tiers of the commune system: the Team manages crop work in the fields, small-scale animal husbandry (poultry and pigs), small-scale tree plantations and other operations closely connected with the farmers' daily routine. The Brigades usually manage local irrigation and land improvement works, seed multiplication and testing, larger-scale animal husbandry, run farm machines, repair and maintenance shops, small-scale and seasonal sideline activities and rural industrial enterprises, supply and retail stations (shops and warehouses), undertake fish farming and agricultural forestry work. The Communes are responsible for rural capital construction, labour deployment, full-time rural industries, large-scale land reclamation and pilot and infrastructural projects.

All three tiers are governed by the assembly of their members who elect their Revolutionary Committees, and on the Commune level the People's Council (40-200 representatives), who then elect the Commune's Revolutionary Committee. The Committees, in charge of management, are composed of 5-9 members who are not professional administrators but must exercise a productive profession which they continue to practice during their tenure, and must after a given time return to the rank and file in order to make room for new committee members, cultivators like them.

The functioning of the Commune Committees is supervised by the County (Hsien) authorities, whose Community Control Board controls the administrative practices, audits the financial management and functions as a court of appeal in conflicts between commune organs. In each case, the local party cells, party committees and party secretaries act as foremost animating and guiding elements under the principle of "unified leadership" (between communal, administrative and party structures) which ensures close control and pre-eminence of the Chinese Communist Party (CPC) in decision-making at the village level.

The Commune Committee controls the two most vital organs of the collective: the trade and supply cooperative and the finance and saving cooperative. Although both are called cooperatives they are in fact administrative organs entirely dependent upon the instructions from the Commune management. The first handles collection of the contractually due quantities of produce (quotas) for delivery to the Hsien authorities, of grain amounts to be delivered in lieu of taxes, and of purchasing any above-quota

quantities of produce that the collective or individual members want to commercialize. Inversely, it is also responsible for procuring the necessary production inputs for the brigades and teams, and of ordering and commercializing consumer goods from the state trading organization at the Hsien level, to the individual members of the collectives through the stores and distribution points at the brigade level.

The savings coops act as local branches of the People's Bank in collecting the credit assets of the collective and of individual members; the latter may have savings accounts. They accept payments and remittances from the Commune and its funds to the Hsien authorities and the People's Bank and inversely handle loans from the latter to the commune.

The Communes' and Brigades' accountants work closely with those two cooperatives. The accounting is carried out in two categories: in kind and in money. Commune revenue is accounted in these two terms. Remittances are being made from the gross revenue in the following order to the tax account, to the quota delivery account, to the three commune funds and to working accounts. These transfers must be accepted by the Commune members' assembly, usually twice a year. Once all production expenses are met and the necessary and statutory remittances are made, the assembly decides upon the distribution of the net proceeds: usually this is being done in two ways, in kind by giving each member first a basic amount of produce such as grain, sugar, cooking oil, cotton, etc. and distributing the remainder in proportion to the work points each member has earned during the period of account under study. In the same way, the cash net proceeds are distributed.

The three statutory funds to be supported by mandatory remittances from the collectives' gross revenue are: the welfare fund, from which the communes pay health, education and other social expenses; the reserve fund, which serves to defray unforeseen social costs, supports hardship cases, etc; and the accumulation fund. The latter is by far the most important as it is from it that the Commune pays for capital investments, be it in infrastructure, in agricultural capital equipment or in expansion of productive capacity into other fields, i.e. rural small-scale industries. The level of remittance is theoretically freely mixed by the assembly but the state, through its organs and the local GPC committee, sees to it that the rate of accumulation is not too low. In recent years, it was mentioned that in most well-run communes the rate of accumulation was 10-12% (of gross revenue), in exemplary ones like Tachai, it was said to exceed 20% and more.

AGRICULTURAL RESEARCH AND EXTENSION

Scientific research activity is mainly under the jurisdiction of the Chinese Academy of Agricultural Sciences, which is subordinate to the Ministry of Agriculture and Forestry. The Academy is responsible for long term agricultural research. Besides this, the Academy also operates a number of specialized research institutes and laboratories such as the National Institute of Forestry, National Institutes of Plant Protection, Horticulture, Sericulture and Soils. Each National Research Institute specializes in a major field of agriculture or a specific discipline of agricultural science and covers agricultural problems all over the country in its special field. The Chinese Academy of Sciences also does some research on agriculture but it is only confined to fundamental research whereas the Academy of Agricultural Sciences mainly devotes its time to applied research. The National Research Institutes solve basic scientific problems and thus provide scientific feedback for research institutes at lower levels. The provinces and autonomous regions have their own academies of agriculture; each province has its own agricultural research institute as do the municipalities of Shanghai and Peking. At the county level also, there are Agricultural Research Stations. Technical advances from these research stations have to reach the field production level and the field problems have to reach the research stations for solution. Communal research and technical service systems at the commune level have been introduced. Under these systems there are four levels of research for the masses, starting from the county to the production team. Thus there is one agricultural research station in each county, one experimental farm in each commune, one research team in each production brigade and one research group in each production team. Through this system research findings are transformed into field trials, demonstrations and extension with extension services as such. The organizational structure of the commune facilitates rapid demonstration of both information derived from its own research activities and the results conducted at the higher level institutions.

In Jiangsu Province alone, the number of workers engaged in agricultural activities out of the total population of 55 million, of which 40 million is farming community, was reported to be at 1.2 million. It is evident that China has developed a large network of agricultural experiment stations and demonstration farms. While at levels from the county upward research funding is contributed by the State, the communal levels support their own research in a spirit of self-reliance.

A provincial research institute maintains a close linkage with the technical practices and problems of the farming masses in different parts of the province in three ways:

1. Through the research institutes at prefectural level and further (4 level system of agricultural research for the masses - county, commune, brigade and production level).
2. Assigns one-third of its scientists to conduct agricultural research for and with the farming masses in the countryside for certain periods varying from one to three years depending upon the nature of the research problems. They also popularize results of scientific research and take part in scientific experimentation, thus learning some practical agriculture from small farmers and making on-the-spot improvements in practices.
3. Selects experienced workers from among the commune members to work at the institute and to receive in-service training in scientific agriculture relating to their local problems. About 120 individuals are so trained each year.

Research programmes of the institute are formulated by taking into consideration the requirements of the State, the needs of the farming community and the institute's own views. To be of practical benefit to the commune members, field research is generally conducted on the principle of a "three-in-one" combination involving research, demonstration and extension.

The research is oriented to increase agricultural production in the following manner:

1. Extensive investigation of the national resources in the country and their use and the study of efficient tapping of new resources.
2. Overall study of the better utilization of land and water areas and the extension of cultivated lands including reclamation of alkaline and other poor soils.
3. Application of Chinese traditional experience in intensive farming and of the latest science technology to raise the level of agricultural production.
4. Strengthening of research in economics.

The "Eight-point charter for agriculture" proclaimed by Chairman Mao serves as basic guidelines for carrying out the above research tasks. The charter calls for (1) soil improvement, (2) rational application of fertilizers, (3) water conservation, (4) breeding of high yielding varieties, (5) rational close planting, (6) plant protection, (7) field management and (8) introduction of improved farm implements.

MINERAL FERTILIZERS

In China, although the major portion of plant nutrients is supplied by organic recycling and only one-third by mineral fertilizers, the sustained higher yields needed to support the population make it necessary to enlarge the quantity of mineral fertilizers in the effort to increase agricultural production. In addition, the policy of raising yields through intensive cropping systems, i.e. double or triple cropping, places a still greater demand on mineral fertilizers. The Chinese Government has, therefore, taken measures to increase fertilizer production.

Initially, in China, the emphasis was on setting up small factories and about 2 000 county-sponsored small-scale factories were established, almost one for each county. The advantages of such small factories are: less capital investment, less mechanization, minimum storage and transport costs of the finished product, and time saving. These small factories were designed by Chinese experts and equipped with 'home-made' machinery. At present, about 60% of the fertilizer is produced by small and medium-sized factories with an average annual output of about 20 000 tons. The main produce is a nitrogen fertilizer, ammonium bicarbonate.

The study team visited two small-scale fertilizer factories producing ammonium bicarbonate; one was the Yishing County factory which produces 20 000 tons, and the other the Chiao Ting fertilizer factory producing 80 000 tons per year. The predicted production capacity of this factory was reported to have been exceeded by 20%, and 80% of the equipment and spare parts is produced by the factory itself.

Ammonium bicarbonate contains 17.5% nitrogen which makes it a relatively low analysis fertilizer. The production process is relatively simple and cheap and is made according to the following reaction:



The raw materials used for the process are coal, air and water and two steps are involved:

1. production of ammonium hydroxide by combining water and ammonia,
2. carbonation of the ammonium hydroxide with carbon dioxide.

The production cost was given as about US\$50 per ton and the selling price to the production brigades as about US\$73.

The packaging of ammonium bicarbonate in plastic bags considerably reduces the loss of ammonium.

In view of the increasing need for mineral fertilizers in China, the number of small-scale factories is still increasing, but for some time now more emphasis has been placed on larger-scale factories and to this end, 28 large-scale factories begun production during the Fourth Five-year Plan for 1971-75. Import contracts for 13 more large-scale factories, mostly urea plants, await implementation from 1976 onwards, which could supply Chinese agriculture with an additional 2.2 million tons of nitrogen per year, equal to about half of the current consumption.

The consumption of mineral fertilizers in China in 1975/76 was:

4.555 million tons	N	
1.253 " "	P ₂ O ₅	(0.552 million tons P)
0.401 " 5	K ₂ O	(0.333 million tons K)

From these quantities, the following amounts have been produced in China during the same period:

3.300 million tons	N	
1.246 " "	P ₂ O ₅	(0.548 million tons P)
0.300 " "	K ₂ O	(0.249 million tons K)

(Source: FAO, Monthly Bulletin of Agricultural Economics and Statistics, 3 Volume 26, March 1977).

VISITS AND EXPERIENCES OF GENERAL INTEREST

Despite the heavy working programme during the Study Tour, our Chinese hosts were still able to arrange visits of historical, political, technical, industrial, economic and cultural interest. These were to:

the Great Wall

the Ming Tombs

Tien An Men, Square of the Heavenly Peace

the Imperial Palace Museum

the 1st May Celebrations

the Agricultural Exhibition, Peking

the Glassware Factory, Peking

the Yangtse River Bridge, Nanjing

Dr. Sun Yat-sen's Mausoleum, Nanjing

the Walking Tractor Factory, Changzhou

the Construction Material Factory, Changzhou

the Exhibition Hall, Changzhou

the Pottery Factory, Tingsan Hang County

the Sanchun Cave

Gardens in Suzhou including Tiger Hill Garden and Mu Garden

the Suzhou Embroidery Research Institute

the Shanghai Industrial Exhibition

the Chinese Export Commodities Fair, Guangzhou

the Hsin Hui Fan Factory

the Memorial Garden to the Martyrs of the Guangzhou Commune Uprising

film shows: *The East is Red*

Tachai Production Brigade

several outstanding cultural performances, particularly by young people

the Pei Yuan Restaurant, Guangzhou; the Peking Kaoya Dien (Peking Roast Duck Restaurant) and many other places where we could appreciate the exquisite Chinese cuisine.

All these experiences served to supplement our impression of China as it is today.

SELECTED LITERATURE ON RECYCLING OF ORGANIC WASTES

The Soil and Fertilizer Research Institute, Shandong Province
Compost and its effects on soil and crops in China

K. William Kapp
Recycling in contemporary China.
In. World Development, Vol. 3, July-August 1975

Department of Environmental Health, Institute of Hygiene, Chinese Academy of
Medical Sciences, Peking.
Sanitary effects of urban garbage and night soil composting in China

US-CHINA RELATIONS PROGRAM
China's energy policies and resource development,
Report of a Seminar, Stanford University, 1976

Michael G. McGarry
The Taboo Resource - The use of human excreta in Chinese agriculture,
The Ecologist, 1976

FAO
Organic materials as fertilizers, Soils Bulletin 27, 1975

FAO
Organic materials and soil productivity, Soils Bulletin 35, 1977

FAO
Organic recycling in Asia and the Pacific, Soils Bulletin (in print)

G.E. Venkataraman
Algal bio-fertilizers for rice cultivation,
Indian Agricultural Research Institute, New Delhi, 1977

UN Economic and Social Commission for Asia and the Pacific
Biogas technology and utilization
Bangkok, 1975

P. Dart
Recent developments in the field of biological nitrogen fixation,
ICRISAT, Hyderabad, 1976

J. Goldstein
Sensible sludge - A new look at a wasted natural resource,
Rodale Press, Emmaus, PA, USA, 1977

National Academy of Sciences
Making aquatic weeds useful,
Washington, D.C., 1976

C.G. Golueke
Biological reclamation of solid wastes,
Rodale Press, Emmaus, PA, USA, 1977

E.P. Taiganides
Animal Wastes
Applied Science Publishers Ltd., London, 1977

PROGRAMME

1977

- 28 April Arrival of participants in Peking
Introduction and discussion of the programme with
Mr. Li Yung-kai, Director of the Bureau of Foreign Affairs
Ministry of Agriculture and Forestry.
Welcoming dinner by courtesy of Mr. Li Yung-kai
- 29 April Agricultural Exhibition
Introductory discussions
Imperial Palace Museum
- 1 May Participation at Labour Day celebrations - invitation by
Mr. Li Yung-kai
- 2 May Travel by air to NANJING, capital of Jiangsu Province
Presentation of the programme and introductory discussion
Visit to Yangtse River Bridge and to Dr. Sun Yat-sen's Mausoleum
- 3 May Research Institute of Agricultural Sciences, Jiangsu Province
Soil Research Institute of Academy of Sciences
- 4 May Travel by train to CHANGZHOU
Introductory discussion
Visit to Walking Tractor Factory, Construction Material Factory and
to the Industrial Exhibition Hall
- 5 May Wu Chin County : bio-gas and green manure
- 6 May Yishing County : fertilizer factory
- 7 May Kiang Yin County : green manures, Azolla
Travel by train to SUZHOU
- 8 May Yueh Chi People's Commune : green manure and aquatic plants
- 9 May Group discussion
Agricultural Research Station of Feng Chiao People's Commune
- 10 May Agricultural Research Institute of Wu Chin County : green manure a
organic manure
Discussion with the Chinese counterparts

1977

- 11 May Group discussion
 Travel to SHANGHAI
 Introductory discussion
- 12 May Malu People's Commune : night soil and garbage;
 treatment of night soil and garbage from Shanghai City
 Fertilizer factory of Chiao Ting County
- 13 May Shanghai Industrial Exhibition Hall
 Chao Yang sewage treatment plant
 Use of sewage by the Chang Chen People's Commune
 Travel to GUANGZHOU
- 14 May Fun Shan City : treatment of night soil and garbage
 Chinese Export Commodities Fair, Guangzhou
- 15 May Hsin Hui County : green manure, night soil and compost. Azolla
- 16 May Hsin Hui County (contd....)
 Travel to Guangzhou
 Group discussion
- 17 May Discussion with Chinese counterparts
 Travel by air/train to TACHAI (Shanxi Province) via PEKING
- 18 May Tachai Exhibition
 Tachai Production Brigade
 Film Show on Tachai
 Travel by train to SHIJIAZHUANG (capital of Hebei Province)
 Introductory discussion
- 19 May Chun Sun Production Brigade : high temperature compost and stable manure
 Paichi Kan Production Brigade (Huai Lu County): bio-gas
- 20 May Ta Heh People's Commune : bio-gas
 Tung Shao Ying Production Brigade : high temperature compost
 Discussions with Chinese counterparts
- 21 May Travel by train to PEKING

1977

21, 22, 23, 24 May

Concluding discussions

Preparation of report

Final discussions with Chinese counterparts

Farewell dinner by courtesy of the Team Leader

24 May (evening)

Departure of participants to their home countries

PERSONS MET

PEKING

Ministry of Agriculture and Forestry

Li Yung-kai, Director of Foreign Affairs,
Chin Feng-chu, Permanent Representative to FAO
Chang Shih-chan, Head of International Division
Hsu Kuo-chang, Staff member International Division
Tung Ching-sung, Staff member International Division
Wang Yu-chung, Staff member International Division
Kung Chien-ying, Staff member International Division

JIANGSU PROVINCE

Agricultural Department

Tang Lu-yu, Director of Agriculture Department
Li Kung-chen, Head of Livestock Division
Li Pa, Technician
Sui Huai-yu, Staff of Agriculture Department
Ma Yung-tang, Staff of Agriculture Department
Wang Kung-son, Staff of Agriculture Department

Research Institute of Agricultural Sciences of Jiangsu Province, Nanjing

Yang Yun-sheng, Head of the general office of the Revolutionary Committee of the
Institute
Sheng Hsin-pei, Deputy Director of the Department of Soil Science
Huang Yu-shin, Research Officer (Bacterial fertilizer)
Yen Yu-chou, Research Officer (Bacterial fertilizer)
Chu Pei-li, Research Officer (Green Manure)
Ting Chien-ying, Research Officer (Green Manure)
Kuo Shao-cheng, Research Officer (Wheat)
Lu Pei-wen, Research Officer (Plant Protection)
Fan Heng-piao, Responsible member of the Secretarial Unit, Office of the
Revolutionary Committee

National Research Institute of Soil Science, Nanjing

Hsung Yi, Vice Chairman of the Revolutionary Committee, Specialist in Soil Physics and Chemistry

Lu Ju-kun, Assistant Professor Department of Agro-Chemistry

Hsi Chen-fan, Professor, Department of Soil Geography

Liu Wen-cheng, Research Officer (Saline and Alkaline Soils)

Shih Shu-lian, Research Officer (Soil Bio-Chemistry)

Tu Li-mai, Research Officer (Soil Bio-Chemistry)

Wu Chin County

Chang Tz6-heh, Vice-Chairman of the Revolutionary Committee of Wu Chin County

Yu Hung-sheng, Chief of the Methane Gas Office of the Revolutionary Committee

Shen Chih-chang, Deputy Chief of the Methane Gas Office

Ni Fu-li, Staff member of the Methane Gas Office

Chang Pu-chin, Chairman of the Revolutionary Committee of Pen Niu Commune

Chou Shou-hai, Chairman of the Revolutionary Committee of Cheng Hsiang Production Brigade

Kiang Yin County

Chang Chen-hua, Deputy Officer-Director, Kiang Yin County

Wu Shi-tung, Vice-Chairman of the Revolutionary Committee of Huashi Production Brigade

Chau Hung-pi, Head of the Reception Group

Chang Jeng-chou, Staff member of the Reception Group

Wu Yu-chai, Staff member of the Reception Group

Suzhou

Hsiao Ting, Director of Agriculture Department Wu County

Ting Chi-wing, Technician of Agriculture Department of Wu County

Wang Ri-hua, Staff of Agriculture Department

Hu Chang-chin, Head of Reception Group of Foreign Affairs of Suzhou

Chuan Kuan-yian, Head of Foreign Affairs Division of Wu County

Yush Chi People's Commune

Ku Hsan-shan, Chairman of the Revolutionary Committee of the Commune

Pan Shuo-chin, Head of Agriculture Scientific Research Station

Mo Chao-yuan, Technician

Feng Chiao People's Commune

Chang Ming-chuang, Head of Agricultural Scientific Research Station

Yang Chin-chin, Vice Director of Agricultural Scientific Research Station

Hsiao Chin-hsung, Brigade Leader

Scientific Research Institute of Wu County

Shih Tai-fu, Vice Chairman of the Revolutionary Committee of the Research Institute
Tu Tan-chang, Technician
Ku Wei-chun, Technician

SHANGHAI

Yen Ming, Responsible member of Agricultural Department of Shanghai
Li-Hsuei Kiang, Responsible member, Agricultural Department
Chou Wei-chi, Vice Chief of the Production Division of Agricultural Department
Chin Cheng-shan, Responsible member of the Cleaning Administration of Shanghai
Yang Yu-chen, Staff member
Chang Kwang-tzu, Staff member
Li Cheng-hsun, Vice-Chairman of the Revolutionary Committee of Malu People's Commune
Peng Fang-hsu, Staff member of the Revolutionary Committee
Yao Chu-hua, Physician, Malu's Hospital
Tan Yun-lung, Responsible member of the Revolutionary Committee of Chao Yang Sewage Treatment Plant
Ma Ching-fang, Responsible member of the Revolutionary Committee of Chao Yang Sewage Treatment Plant
Wang Tsuei-eh, Technician of Sewage Plant
Shen Hung-chi, Responsible member of Chang Chen People's Commune
Hsu Lin-fa, Responsible member of Chao Yang Production Brigade

GUANGDONG PROVINCE

Guangzhou

Shei Yung-shing, Director Agricultural Department
Ling Chee, Agronomist
Chang Hua-chi, Head of Soil and Fertilizer Division of Agricultural Scientific Research Institute
Chang Chuang-ta, Technician
Lin Hsao-chin, Assistant Professor Agricultural Scientific Research Institute
Chu Hwei-huo, Assistant Professor Agricultural Scientific Research Institute
Lian Chao-huang, Lecturer of Agriculture and Forestry College
Liu Hsu-chi, Lecturer of Agriculture and Forestry College
Lui Teng-hui, Assistant of Agriculture and Forestry College
Hsie Li-chang, Assistant of Agriculture and Forestry College

Fu Shan

Chen Wei, Vice Director of the Department of Health
Ting Shu-hua, Responsible member of the Foreign Affairs Division of Fu Shan City
Hsu Chao-ming, Technician of the Agriculture Department Fu Shan
Chen Tsang, Chief of the Environment and Sanitation Administration of Fu Shan City

Hsin Hui County

Chen Yu, Vice-Chairman of the Revolutionary Committee of Hsin Hui County
Li Ping, Vice-Director of Agricultural Department of the County
Chang An-nan, Vice-Chairman of the Revolutionary Committee of Hueng Chen Commune
Hsu Wen-ching, Director of the Commune Office

TACHAI

Chia Lai-hen, Vice-Chairman of the Revolutionary Committee of Tachai Production Brigade

HEBEI PROVINCE

Hua Chi, Deputy Director of Agricultural and Forestry Department
Hse Yung-chang, Head of Agricultural Division
Ting Tin-tse, Staff member of Agricultural Division
Chang Tse-chi, Staff member of Bureau of Foreign Affairs

Chao County

Ma Chen-kuo, Vice-Chairman of the Revolutionary Committee of Chao County
Chou Huen-hou, Director of the Office of the Revolutionary Committee
Kao Chen-yung, Director of Agriculture
Ho Ping, Staff member, Office of Foreign Affairs
Yang Tung-ching, Chairman of the Revolutionary Committee, Hsao Chuang People's Commune
Chang Hsuang-hsui, Chairman of the Revolutionary Committee Chao Production Brigade
Tsui Lin-shan, Vice-Chairman of the Revolutionary Committee Chao Production Brigade

Huai Lu County

Yen Chang-hai, Vice-Chairman of the Revolutionary Committee
Wang Tse-chien, Director of the Agricultural Department
Chang Yueh-ming, Vice-Chairman of the Revolutionary Committee, Ta Heh People's Commune
Wang Kau-chun, Vice-Chairman of the Revolutionary Committee, Ta Heh Production Brigade
Chen Ta-chai, Vice-Chairman of the Revolutionary Committee, Ta Heh Production Brigade
Yang Yu-chun, Director of Ta Heh Middle School
Li Lin-chang, Teacher of Ta Heh Middle School
Tu Ying-chien, Vice-Chairman Revolutionary Committee
Chin Chang-lin, Vice-Chairman Revolutionary Committee, Li Lin People's Commune
Hsen Jueh-fa, Chairman Shihkan Production Brigade
Hu Hsen-yuan, Staff member Office of Foreign Affairs
Wang Tse-mei, Vice-Chairman Ku Chin People's Commune
Wang Sheng-chei, Chairman of Tung Shao Ying Production Brigade
Wang Chun-tang, Staff member, Office of Foreign Affairs Shijiazhuang
Wang Hsu-chin, Vice-Director of Agricultural Department
Chao Mou-yuan, Head of Bio-gas Office of the Prefecture

LIST OF PARTICIPANTS

AFGHANISTAN

Mohammad Aref NOORI
President of Research and Soil Studies
Ministry of Agriculture
Kabul

BANGLADESH

Mosharraf MUSSAIN
Agricultural Chemist
Bangladesh Agricultural Research Institute
Dacca

BURMA

U KHIN
Deputy Divisional Manager
Agricultural Corporation
Saggaing

CAMEROON

Adam David FONGYEN
Deputy Director Food Development Authority
P.O. Box 1682
Yaounde

EGYPT

Sami Mohammed SHEHATA
Head, Microbiology Research Department
Institute of Soils and Water Research
Giza

Mohamed Nabil Ahmed ALAA EL-DIN
Assistant Professor
Microbiology Research Department
Institute of Soils and Water Research
Agricultural Research Center
Giza

ETHIOPIA

Teferi MAKONNEN
Head, Agronomy Section EPID
P.O. Box 3824
Addis Ababa

GHANA

Emmanuel T. ABLAKWA
Chief of Agriculture
Development Service Institute
P.O. Box 3726
Accra

INDIA

Topal Saran VYDIARTHI
Commissioner, Fertilizer Promotion
Ministry of Agriculture and Irrigation
New Delhi

Lekahman Singh YADAVA
Deputy Commissioner, Manures
Ministry of Agriculture and Irrigation
New Delhi

NEPAL

Manik Lal PRADHAN
Chief, Soil Science and Agricultural Chemistry Division
Ministry of Food, Agriculture and Irrigation
Khumal Tar Lalitpur

NIGERIA

Oladosu AWOYEMI
Chief Agricultural Officer
Federal Ministry of Agriculture
PMB 12613 - 34/36 Ikoyi Road
Lagos

PAKISTAN

Nisar Hussain KHAN
Deputy Secretary, Livestock Division
Ministry of Agriculture
Islamabad

Mohamed ZAFFARULLAH
Assistant Animal Husbandry Commissioner
Livestock Division
Ministry of Agriculture
Islamabad

PHILIPPINES

Cirisco GIBRALTAR
Provincial Agricultural Extension Supervisor
Bureau of Agricultural Extension
Region No. VI
Iloka City

SRI LANKA

Ranjith SENEVIRATNE
Research Officer
Agricultural Research Institute
Mahailupalama

TANZANIA

David MASANJA
Director, Crop Development Division
Ministry of Agriculture
P.O. Box 9071
Dar-es-Salaam

F.W. Hauck (TEAM LEADER)
Chief
Soil Resources Development and Conservation Service
FAO Headquarters
Via delle Terme di Caracalla
Rome, Italy

Bhakdi Lusanandana
Regional Plant Production and Protection Officer
FAO Regional Office for Asia and the Far East
Bangkok, Thailand

Racim Sant'Anna
Regional Soil Resources Officer
FAO Regional Office for Africa
P.O. Box 1628
Accra, Ghana

THE FAO SOILS BULLETINS:

1. Soils of the arid zones of Chile, 1965 (E**)
2. A survey of soil laboratories in sixty-four FAO member countries, 1965 (E**)
3. Guide on general and specialized equipment for soil laboratories, 1966 (E**)
4. Guide to sixty soil and water conservation practices, 1966 (E**)
5. Selection of soil for cocoa, 1966 (E** F** S***)
6. Aerial photo interpretation in soil survey, 1967 (E* F* S**)
7. A practical manual of soil microbiology laboratory methods, 1967 (E**)
8. Soil survey interpretation and its use, 1967 (E*)
9. The preparation of soil survey reports, 1970 (E** F** S*)
10. Physical and chemical methods of soil and water analysis, 1970 (E* F* S*)
11. Soil fertility investigations on farmers' fields, 1970 (E* F* S*)
12. A study on the response of wheat to fertilizers, 1971 (E*)
13. Land degradation, 1971 (E* F*)
14. Improving soil fertility in Africa, 1971 (E* F*)
15. Legislative principles of soil conservation, 1971 (E*)
16. Effects of intensive fertilizer use on the human environment, 1972 (E*)
17. Trace elements in soils and agriculture, 1972 (E* F*** S*)
18. Guide to the calibration of soil tests for fertilizer recommendations, 1973 (E* F*** S***)
19. Soil survey interpretation for engineering purposes, 1973 (E* F* S*)
20. Fertilizer legislation, 1973 (E* F*** S*)
21. Calcareous soils, 1973 (E* F*)
22. Approaches to land classification, 1974 (E**)
23. Management properties of ferrasols, 1974 (E** F***)
24. Shifting cultivation and soil conservation in Africa, 1974 (E* F*** S*)
25. Sandy soils, 1975 (E*)
26. Planning and organization of fertilizer use development in Africa, 1975 (E*)
27. Organic materials as fertilizers, 1975 (E* F* S*)
28. S.I. units and nomenclature in soil science, 1975 (E*)
29. Land evaluation in Europe, 1976 (E*)
30. Soil conservation in developing countries, 1976 (E* F* S*)
31. Prognosis of salinity and alkalinity, 1976 (E*)
32. A framework for land evaluation, 1976 (E* F* S*)
33. Soil conservation and management in developing countries, 1977 (E*)
34. Assessing soil degradation, 1974 (E*)
35. Organic material and soil productivity, 1978 (E*)
36. Organic recycling in Asia (E*)
37. Improved use of plant nutrients (E***)
38. Soil and plant testing and analysis (E*** F*** S***)
39. Guidelines for prognosis and monitoring of salinity and sodicity, 1978 (E***)
40. China: recycling of organic wastes in agriculture, 1978 (E* F*** S***)
41. Organic recycling in Africa (E*** F***)

Availability: October 1978

E	English	*	Available
F	French	**	Out of print
S	Spanish	***	In preparation

FAO Soils Bulletins are available through the authorized FAO Sales Agents or directly from Distribution and Sales Section, FAO, Via delle Terme di Caracalla, 00100 Rome, Italy