

**AT** MICROFICHE  
REFERENCE  
LIBRARY

A project of Volunteers in Asia

Improving Building Skills

Published by:

Oficina de Investigacion y Normalizacion  
Ministerio de Vivienda y Construccion  
Lima  
Peru

Available from:

Oficina de Investigacion y Normalizacion  
Ministerio de Vivienda y Construccion  
Lima  
Peru

Reproduction of this microfiche document in any form is subject to the same restrictions as those of the original document.



# IMPROVING BUILDING SKILLS

## PERU



MINISTERIO DE VIVIENDA Y CONSTRUCCION  
OFICINA DE INVESTIGACION Y NORMALIZACION

Prepared by OIN and INTERTECT

Artists:

A. Andia, OIN

A. James Viets, INTERTECT

# How to Lay Out a House

---

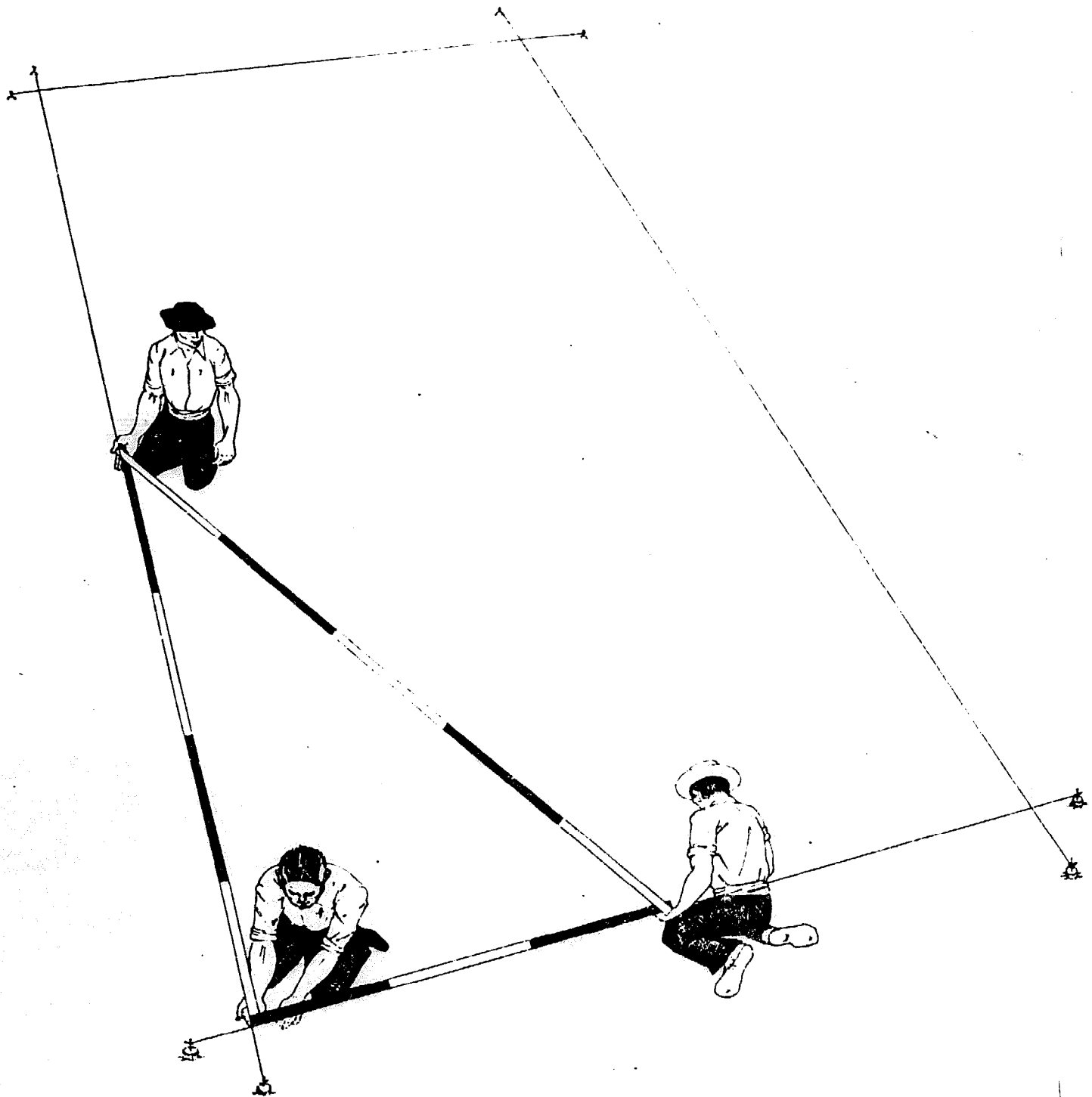

Using string, mark the outline of the house. Use the "3-4-5" method to make sure the string is square.

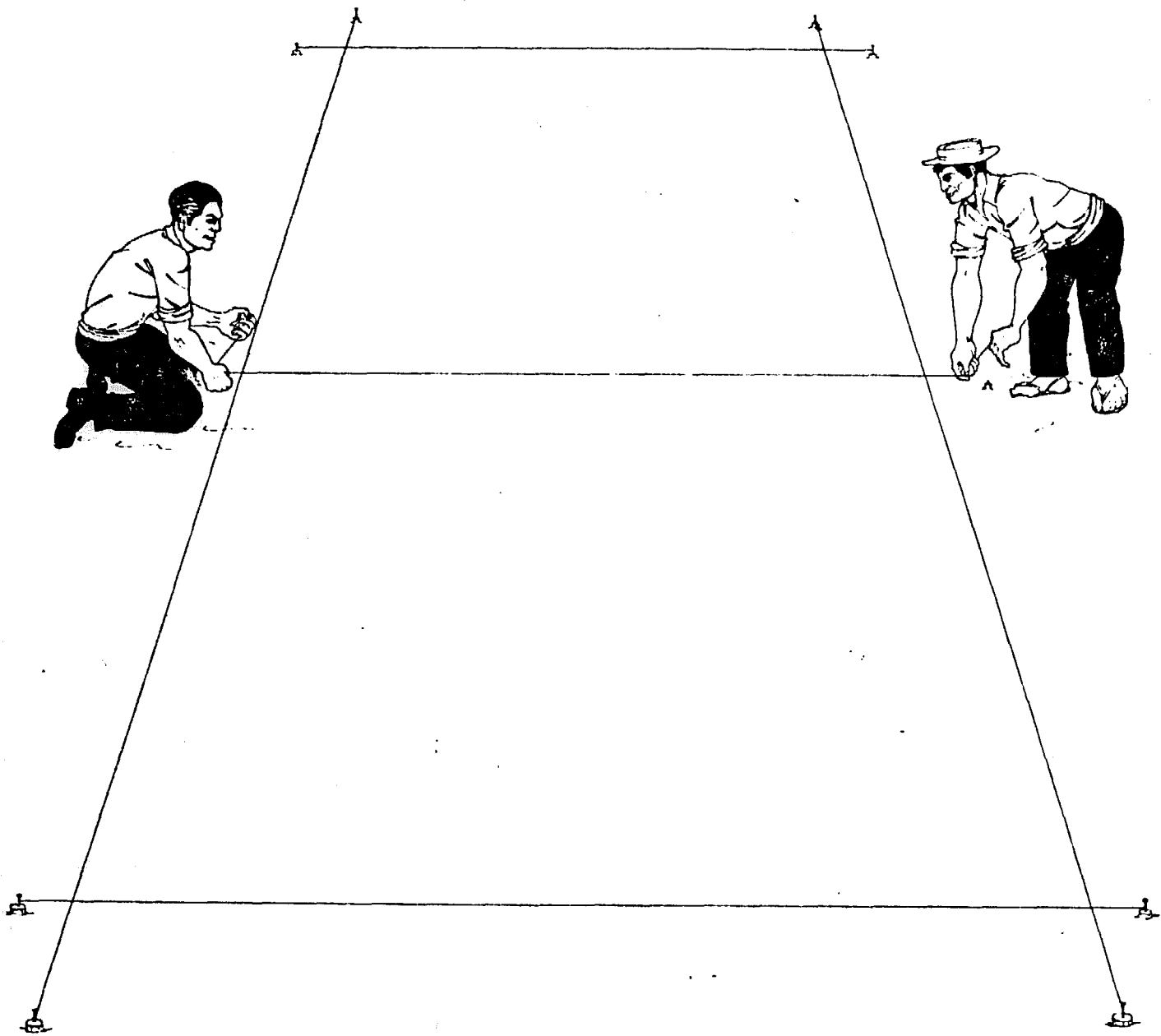

Tie a string to mark where the inside wall will go. Check to make sure it is perpendicular to the outside wall.

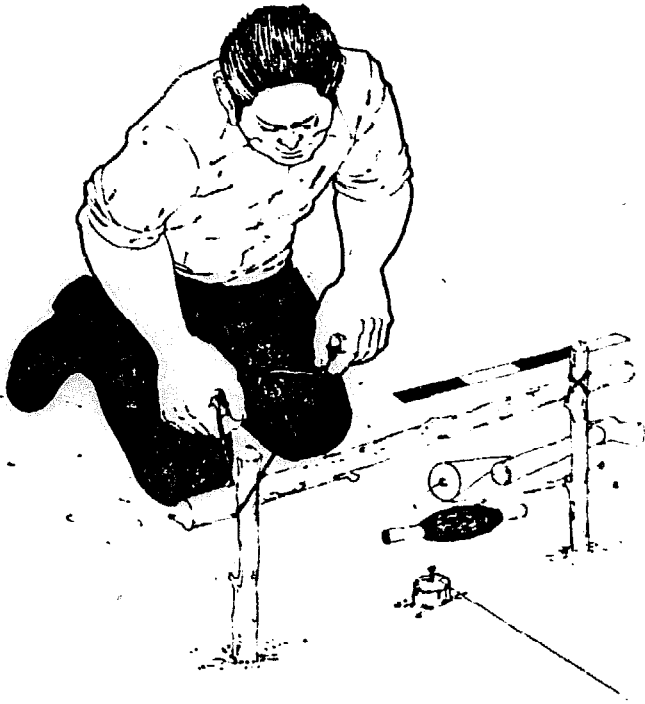

Build a batterboard over each stake.

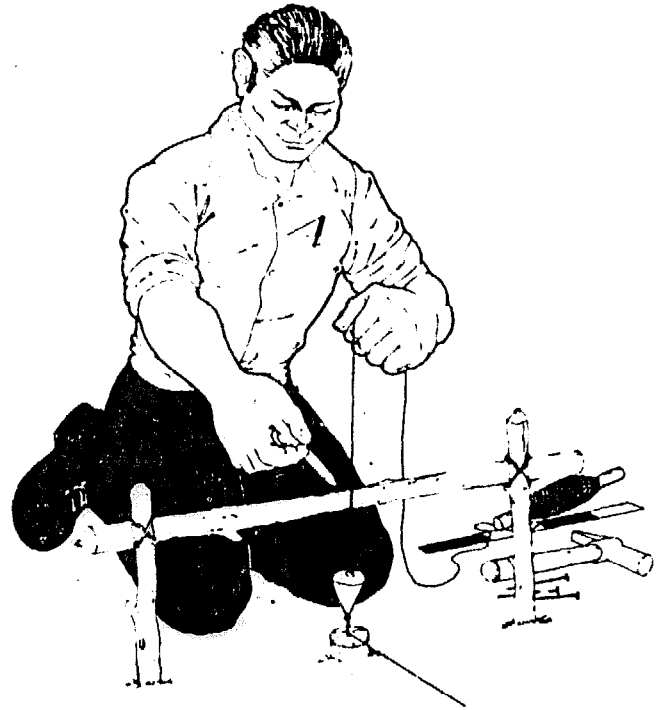

Using a plumb, mark the point on the batterboard exactly above the nail.



Put a nail in the batterboard at the mark.



Using the nail as the center point, mark the width of the foundation on the batterboard.

Tie string over the marks to outline the foundation.

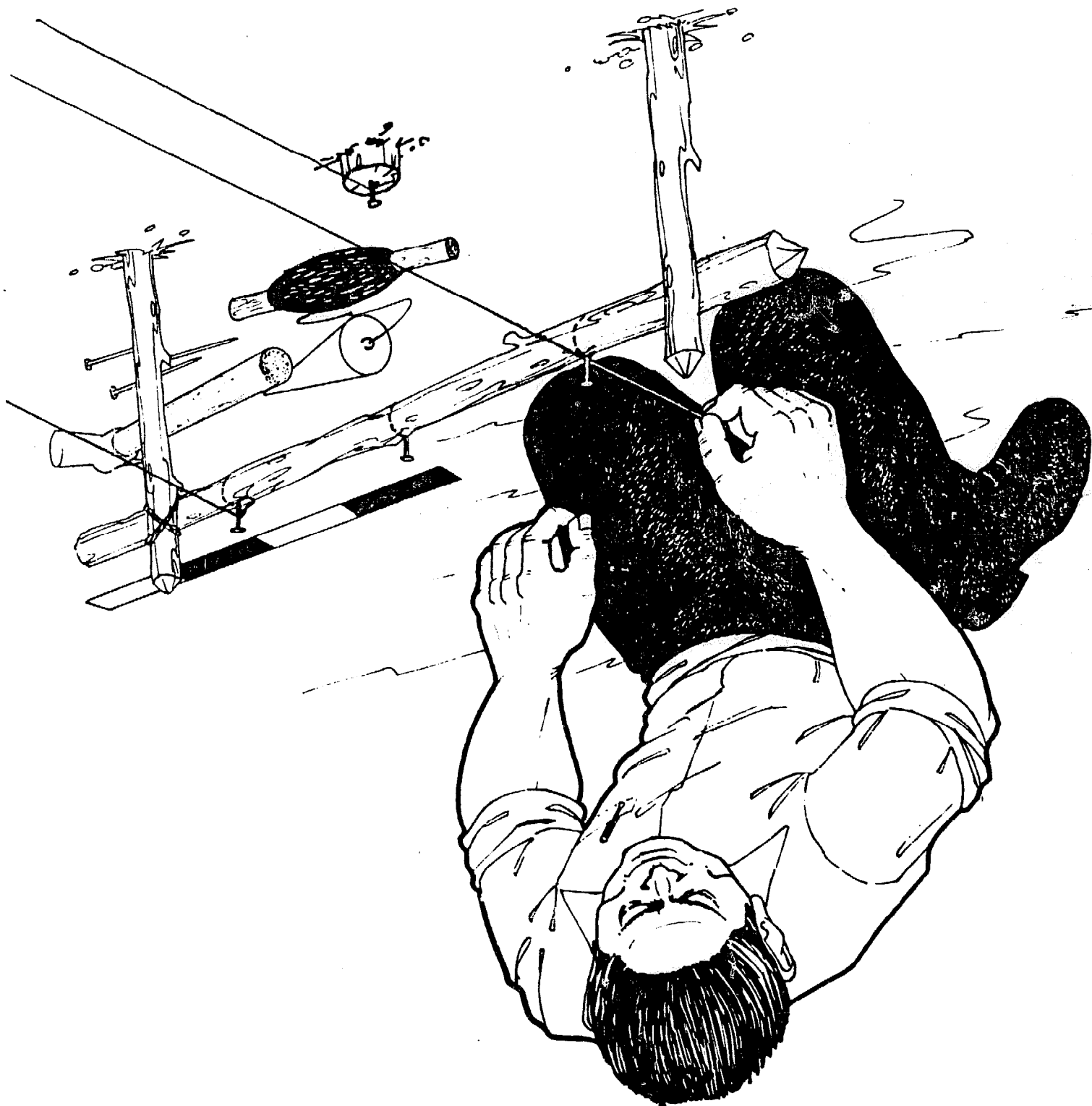



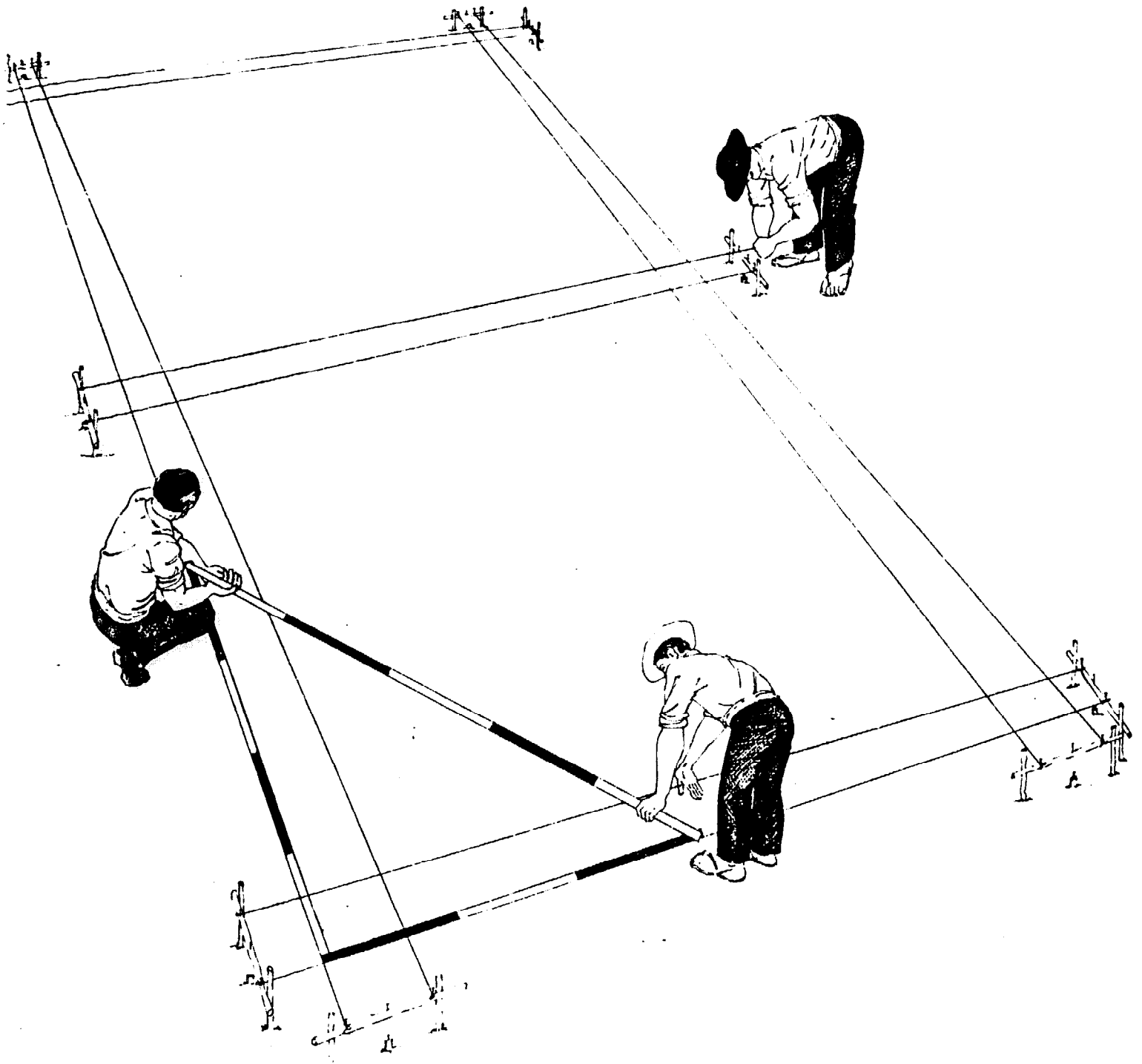

Use the "3-4-5" method to check that the new strings are square.

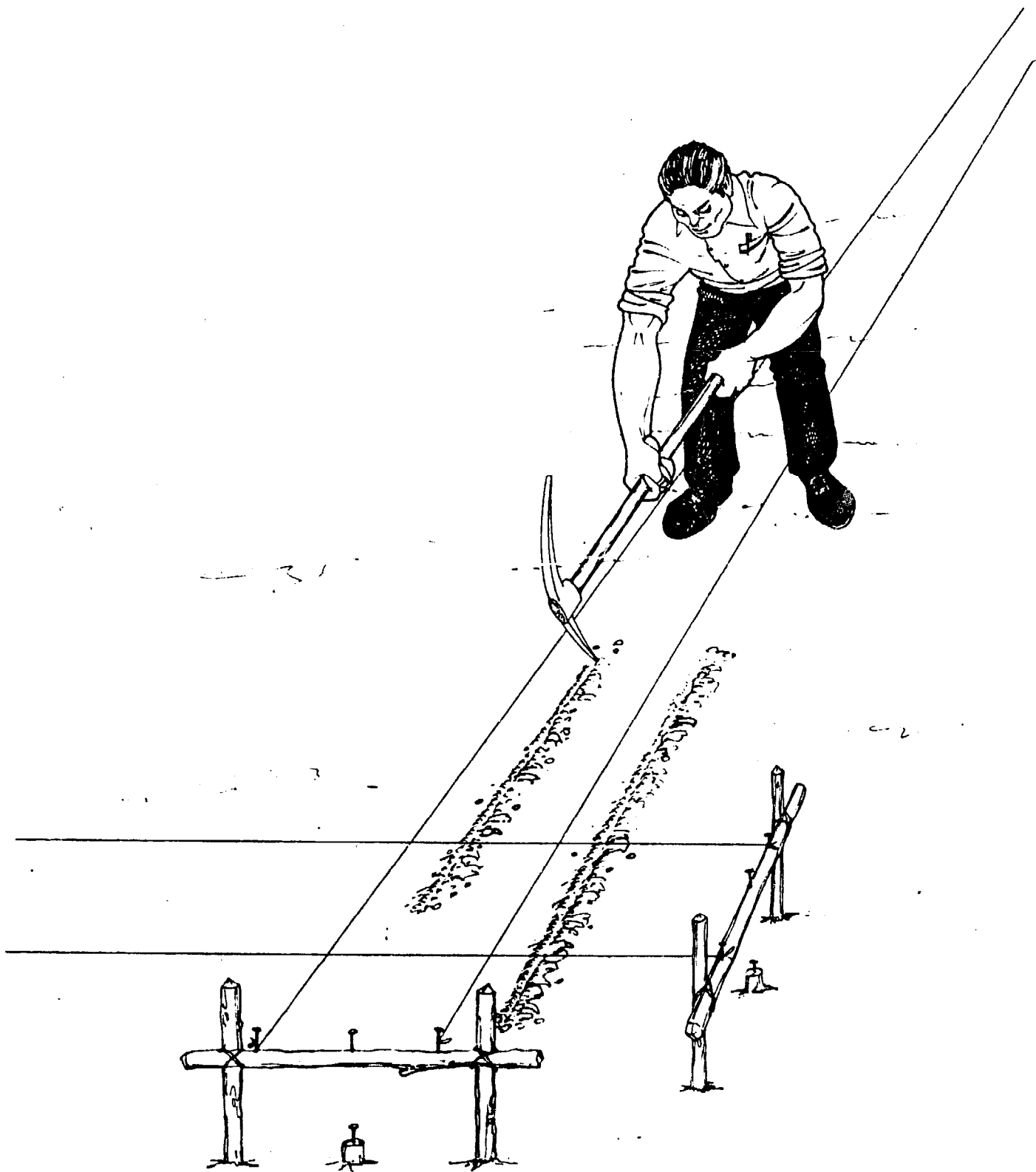

Using the string as a guide, mark the line of the trench for the foundation.

# **How to Use a Level and Plumb**

---

---

THE LEVEL

If the bubble in the level is not centered, the thing being checked is not level.

Not Level

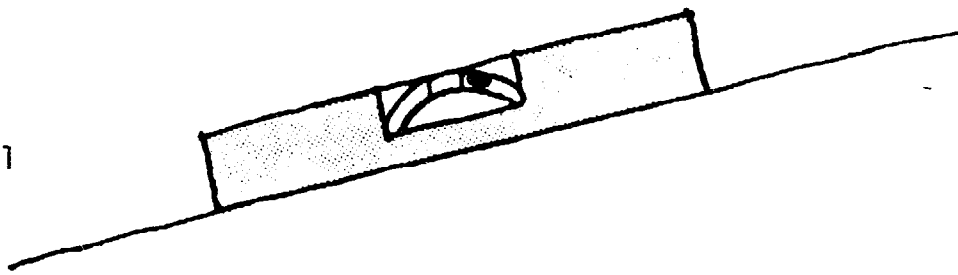

Level

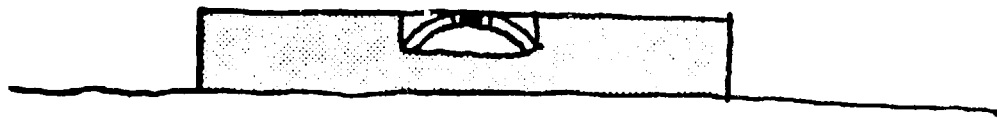

THE PLUMB

A plumb is used to determine if a wall is built correctly.

This wall is not straight and is dangerous.

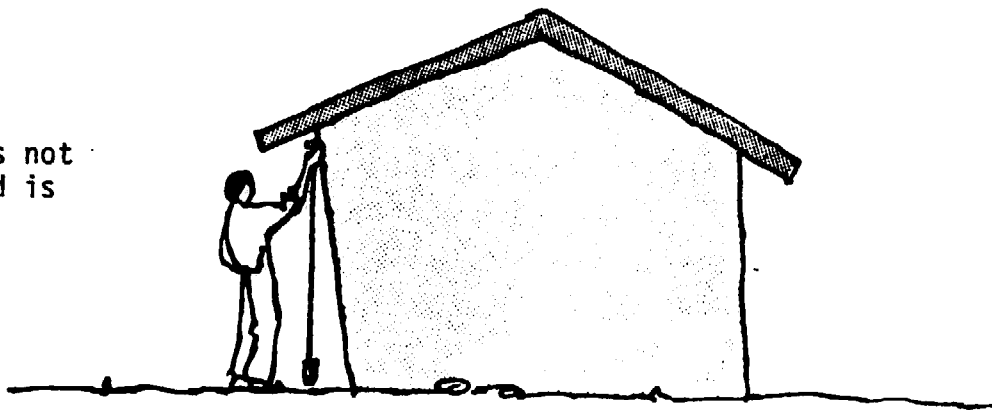

This wall is built correctly and is safe.

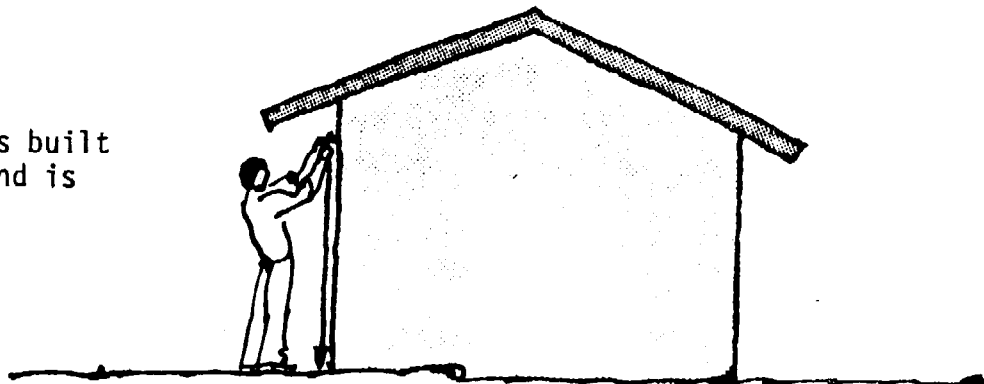

# **How to Build a Straight and Level Wall**

---

## HOW TO BUILD A LEVEL AND PLUMB WALL

Step 1

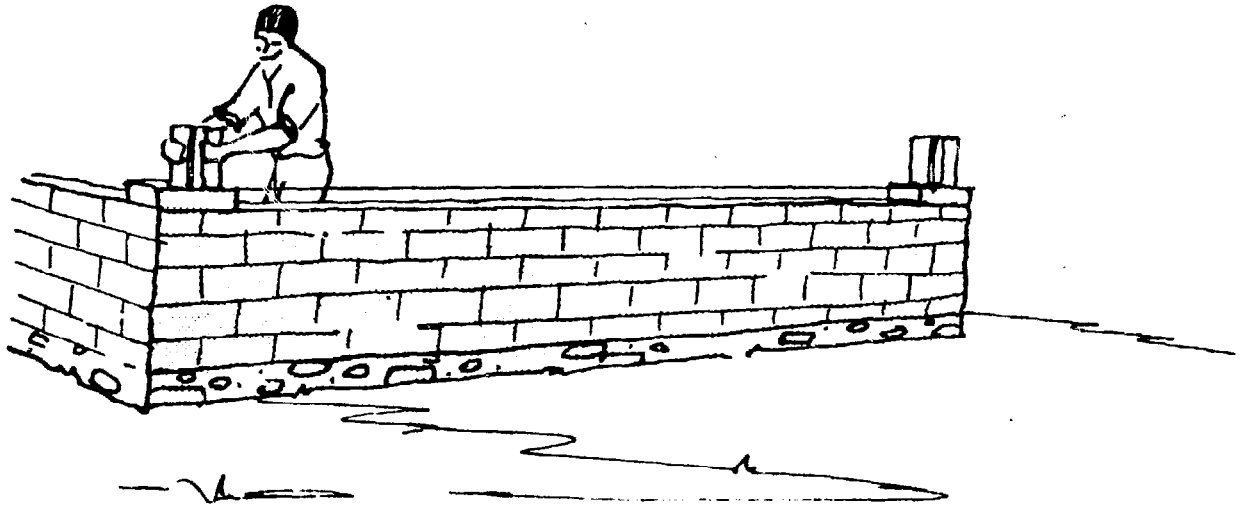

Tie a string from corner to corner to use as a guide to place the adobes in a straight line.

Step 2

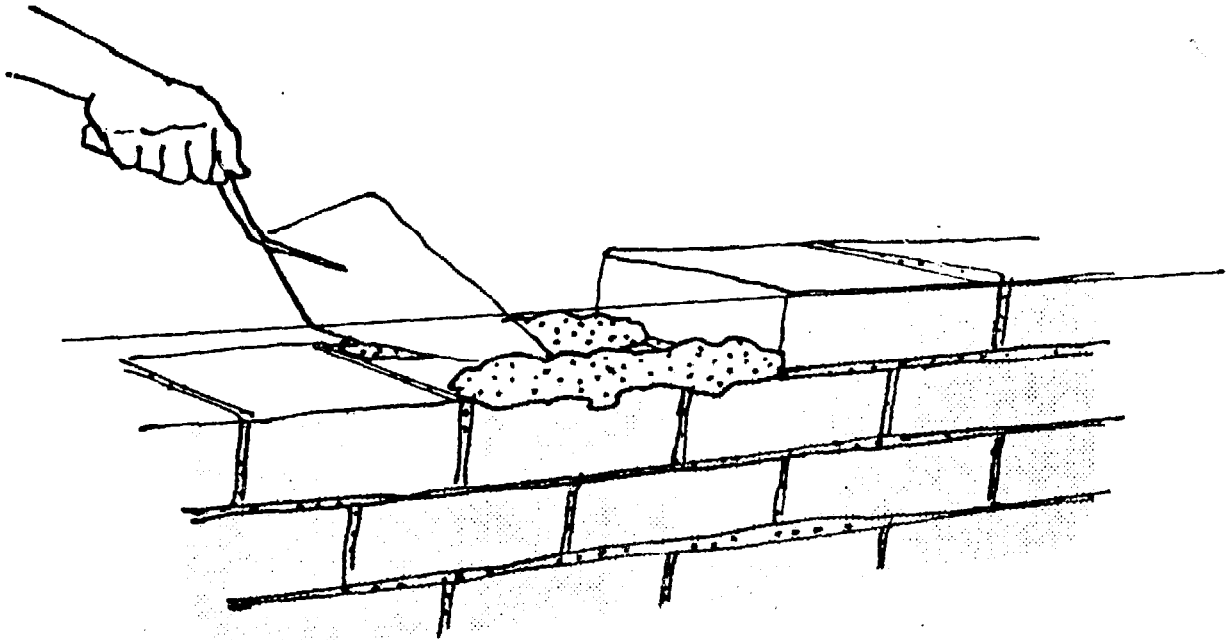

Put the mortar on the wall like this.

Step 3

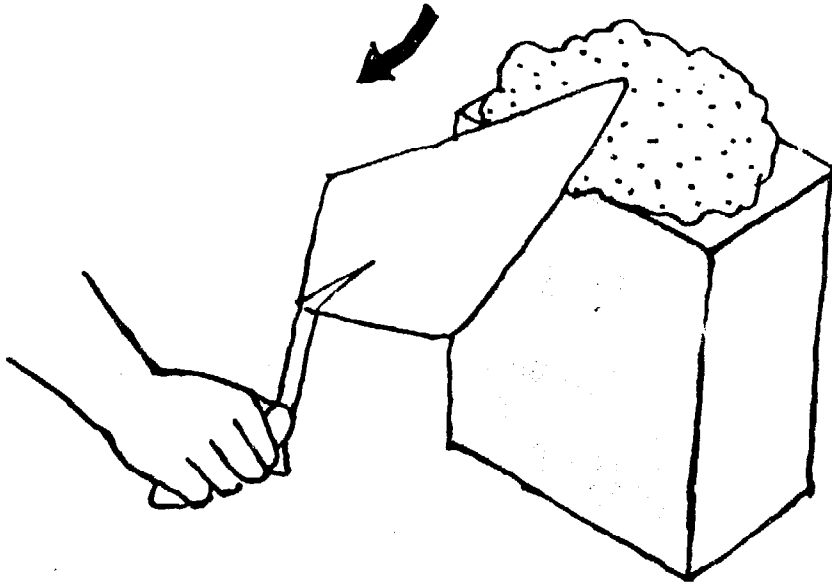

Put mortar on the end of an adobe.

Step 4

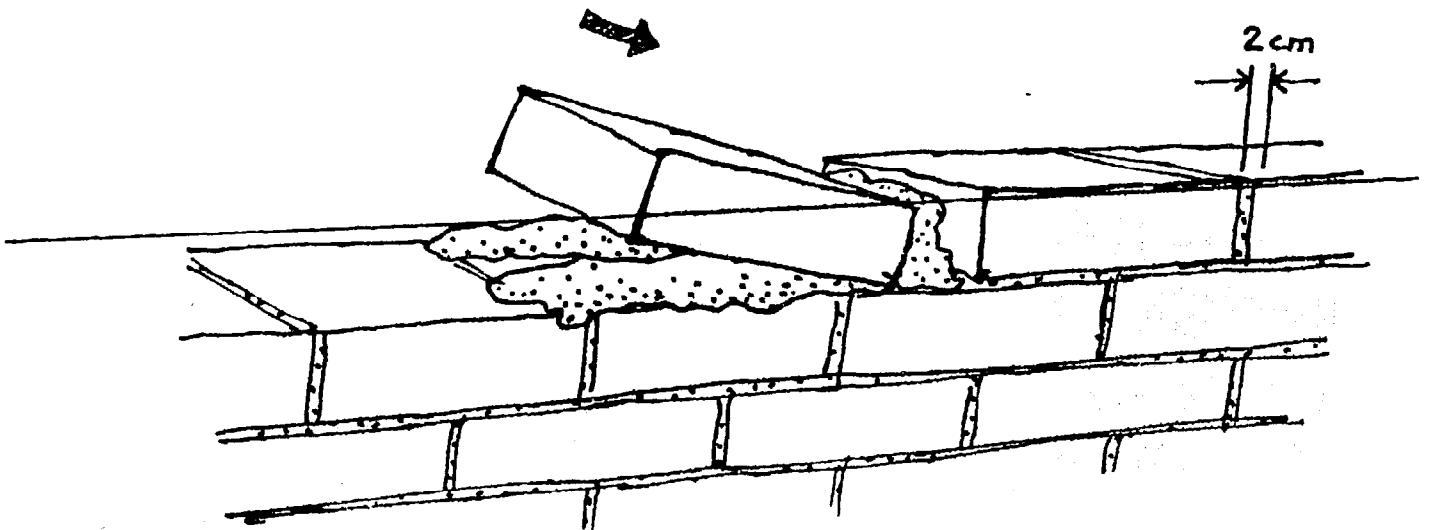

Put the adobe on the wall.

Step 5

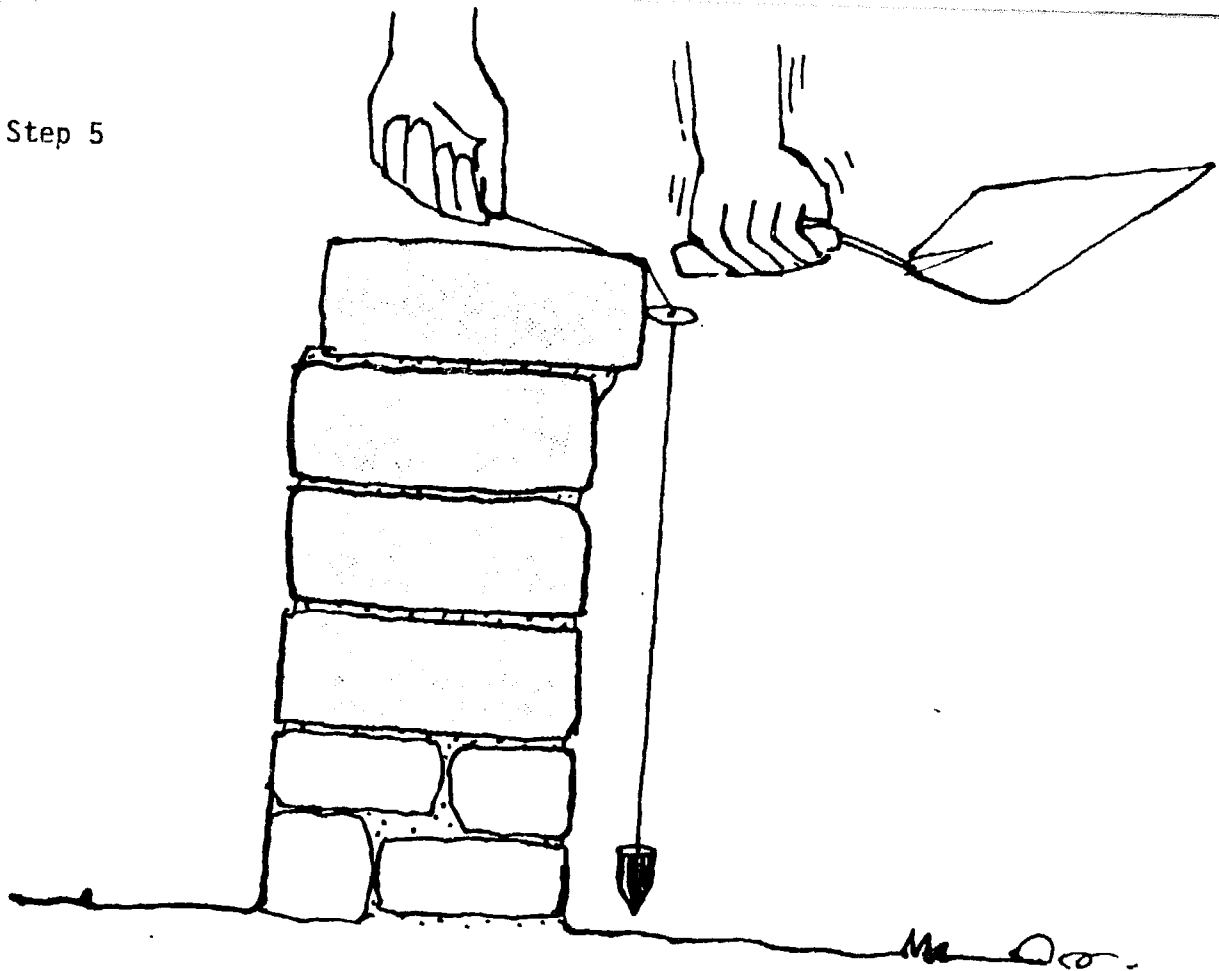

Using a plumb, tap the adobe into place until it is in line with the rest of the wall.

Step 6

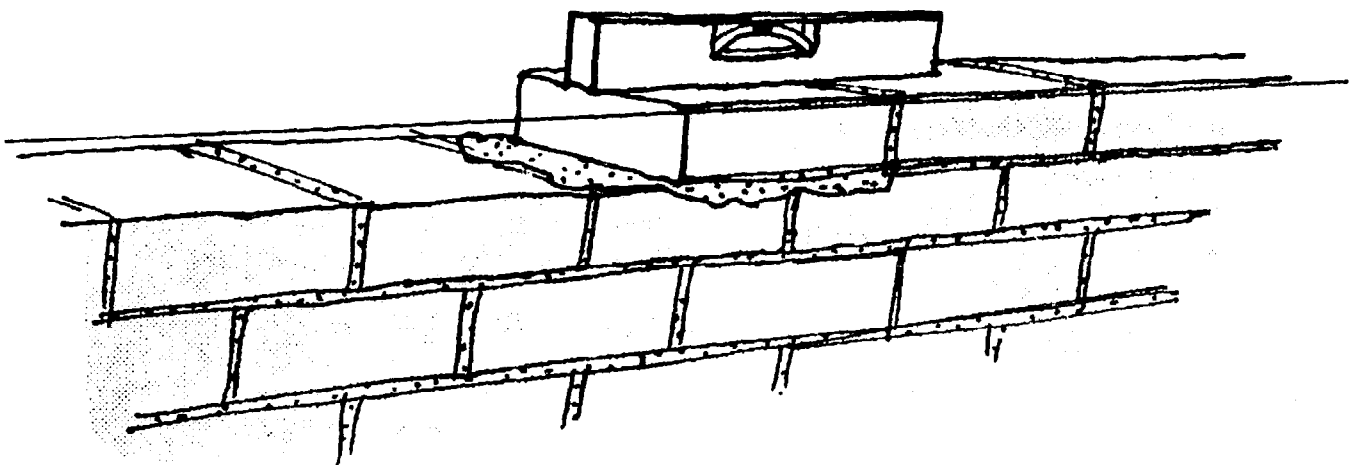

Use a level to make sure the adobe is flat.



# How to Place Roofing Sheets

---

# HOW TO BUILD A SHEET ROOF

Step 1

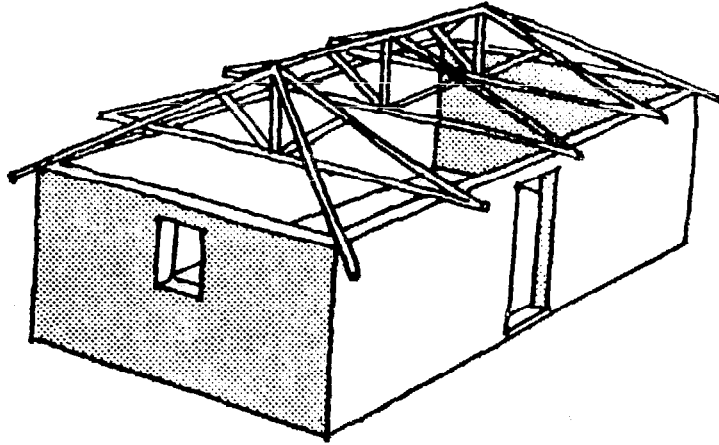

Step 2

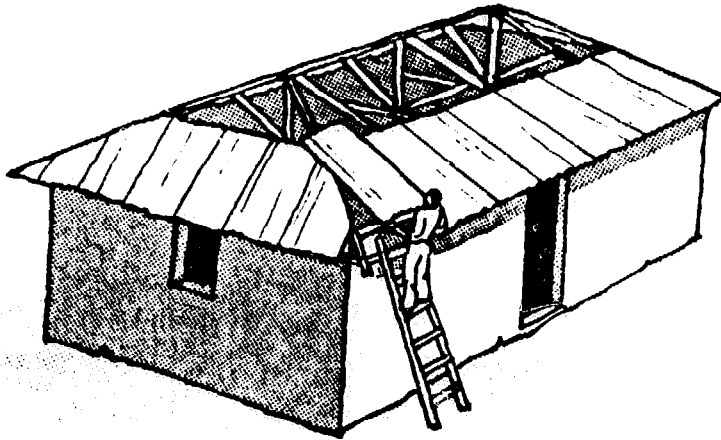

Overlap the sheets  
one and one-half canals.

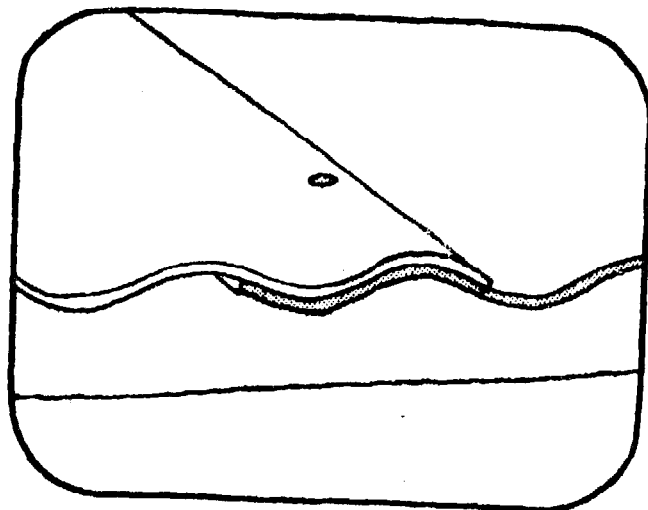

Step 3

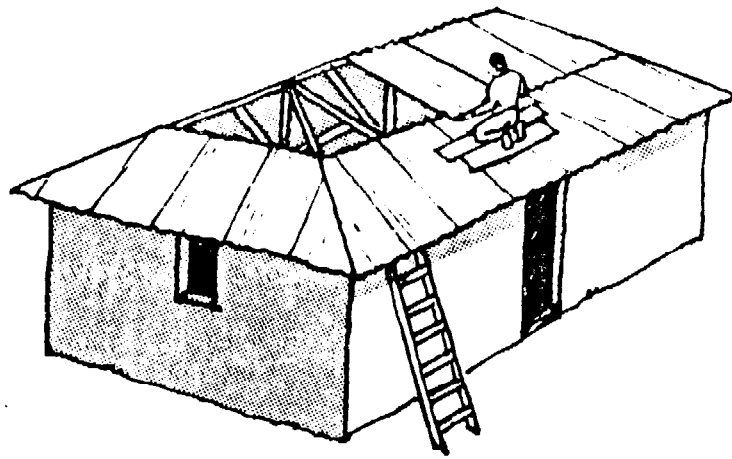

Overlap the second layer of sheets a minimum of 5 cms.

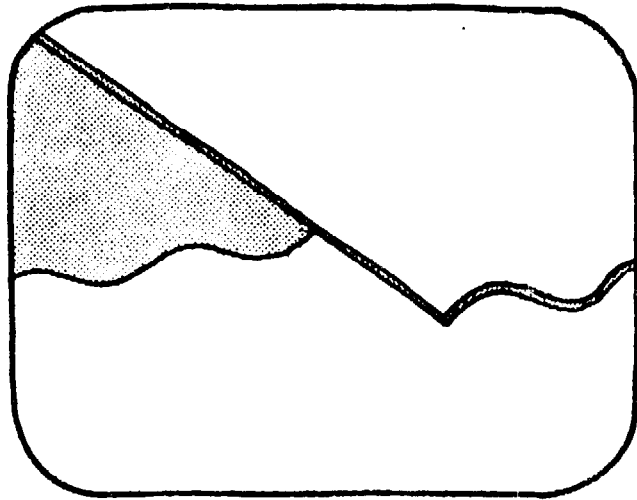

Step 4

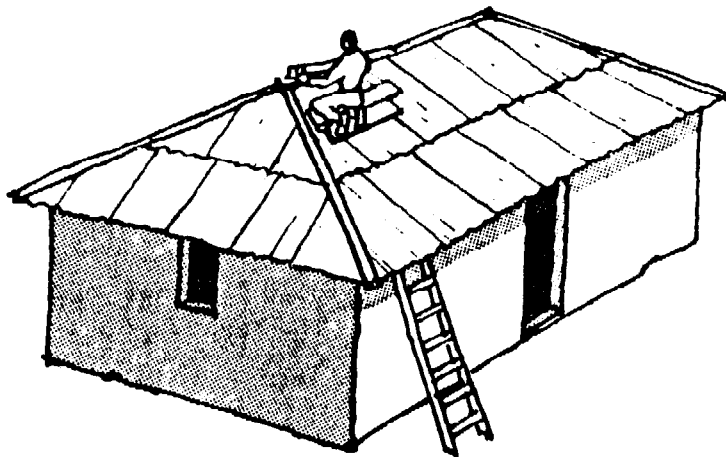

# **How to Build a Tile Roof**

---

---

HOW TO BUILD A TILE ROOF

Step 1

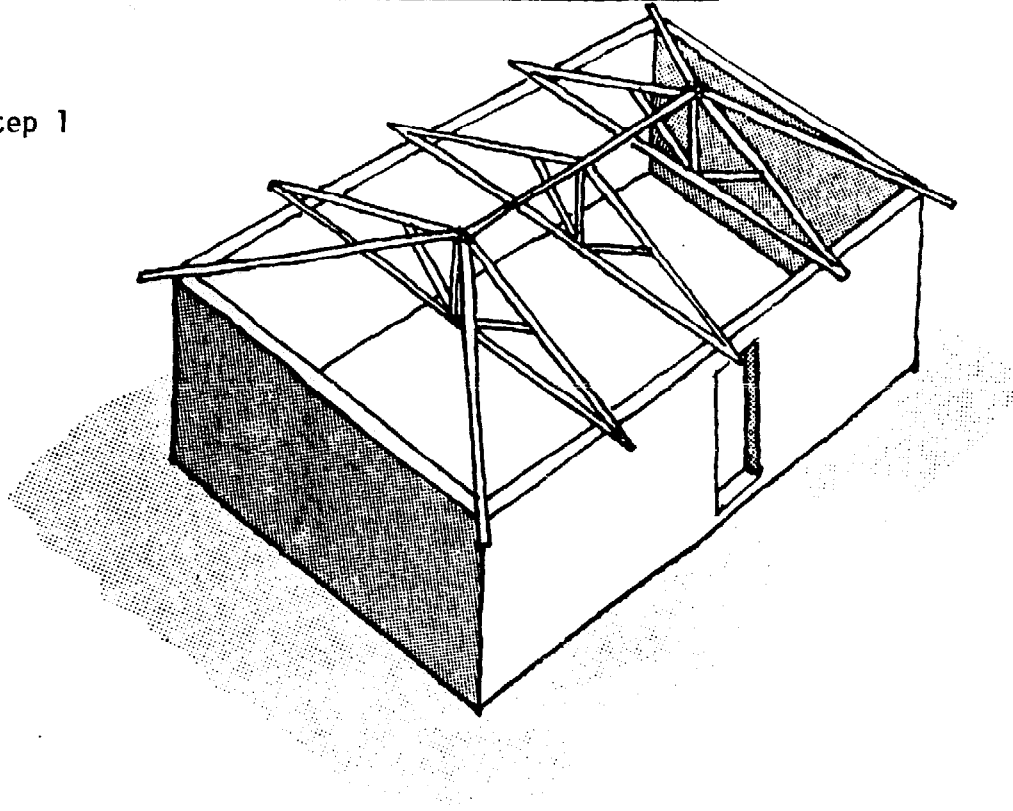

Step 2

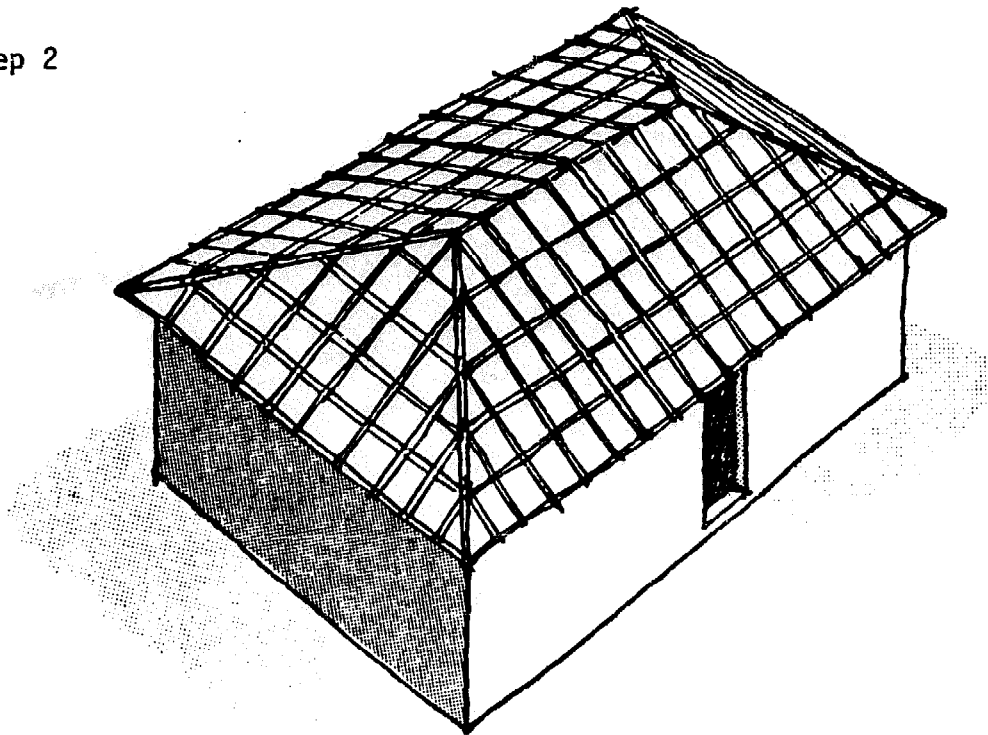

Step 3

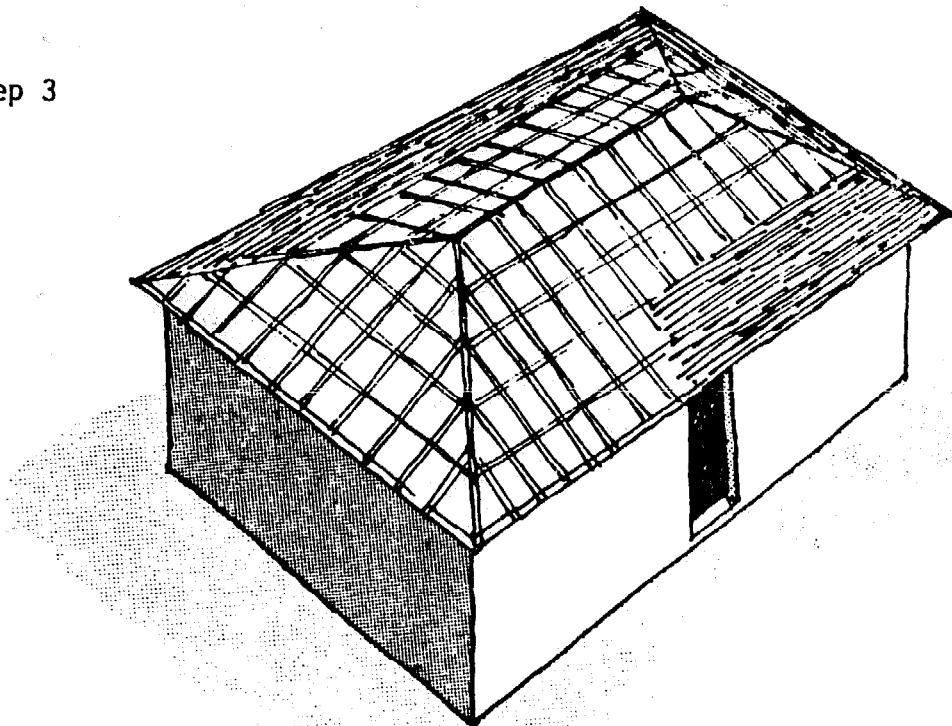

Step 4

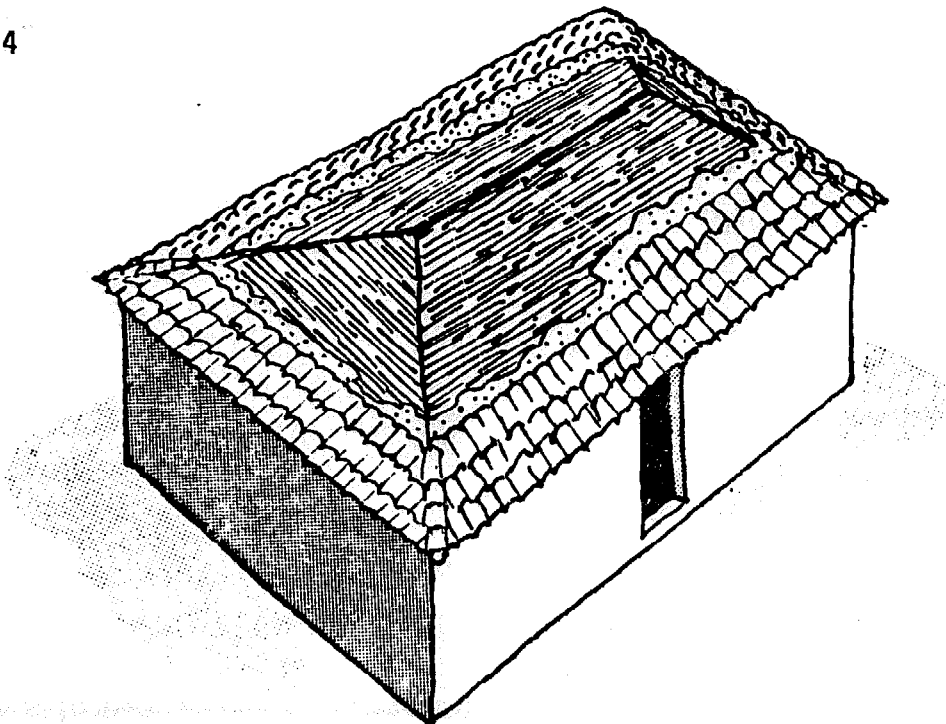

# **How to Build Safe Gables**

---

## HOW TO BUILD A LIGHTWEIGHT GABLE

### 1. Cane gable

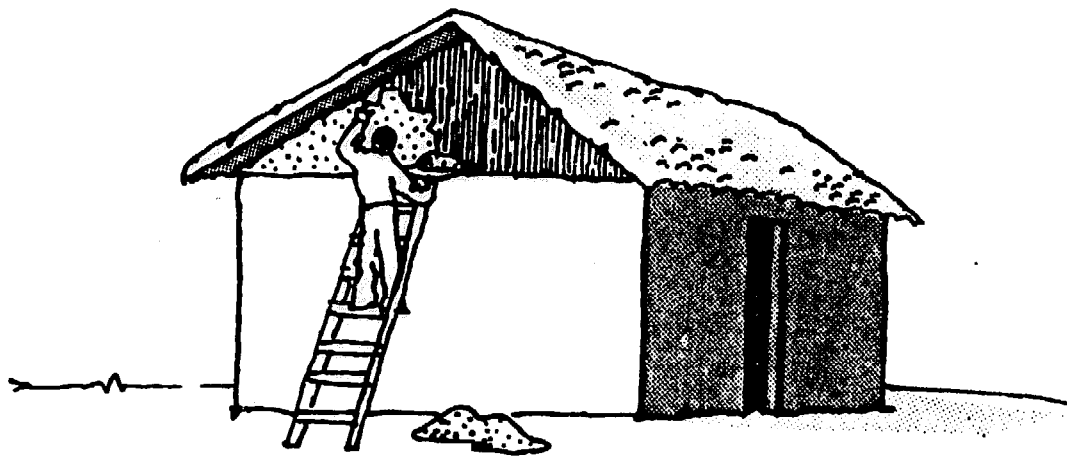

### 2. Wood gable

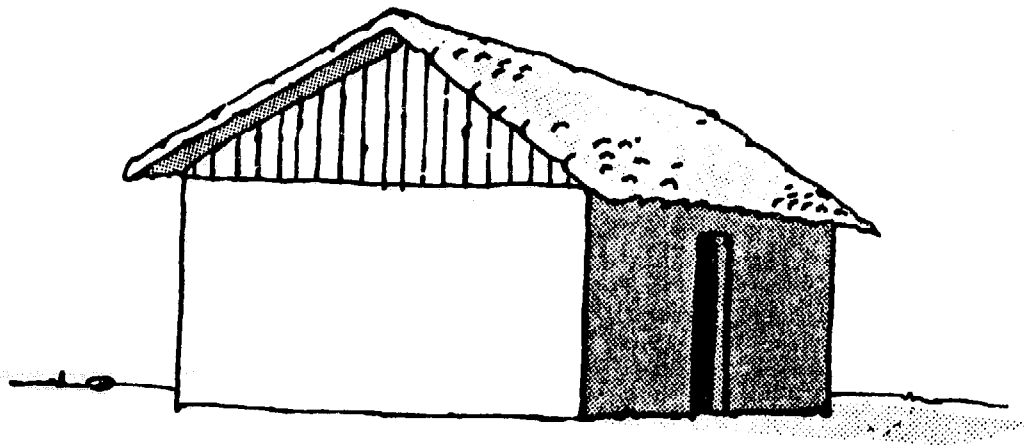



3. Metal screen gable

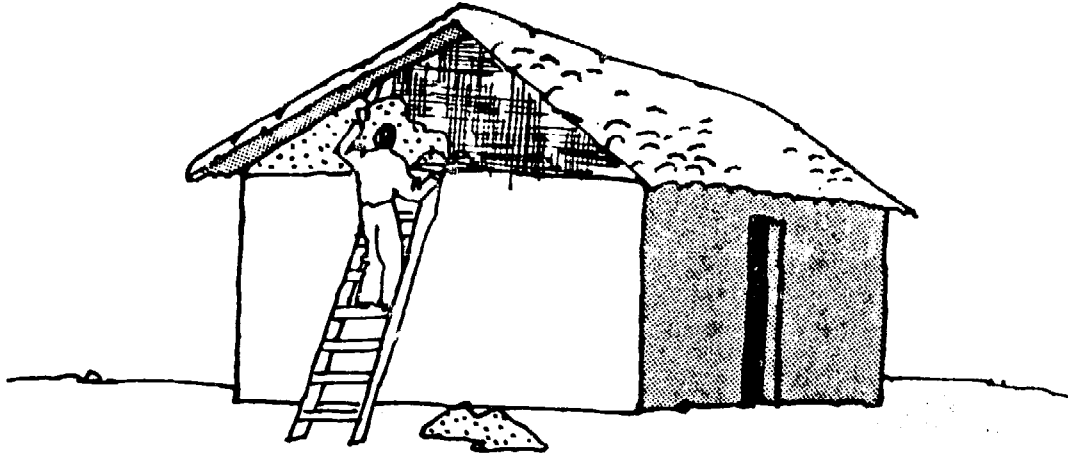

4. Adobe gable with wood inside

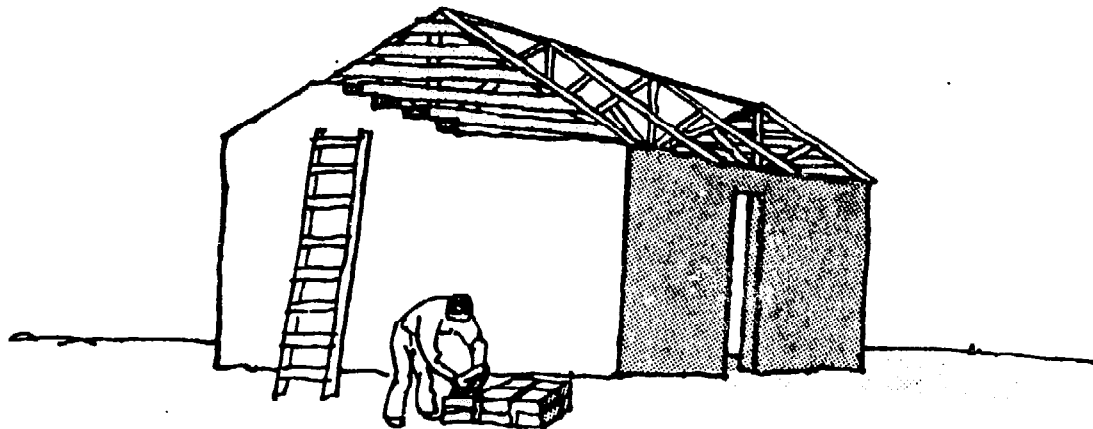

5. A better solution -- a house without gables

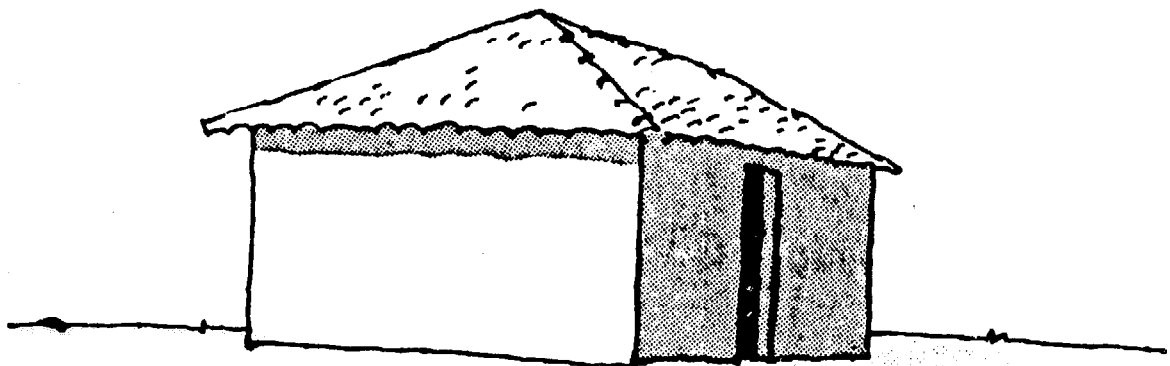

# Empalmes

---

JOINTS

These are the best joints:

1. The "Cadena"

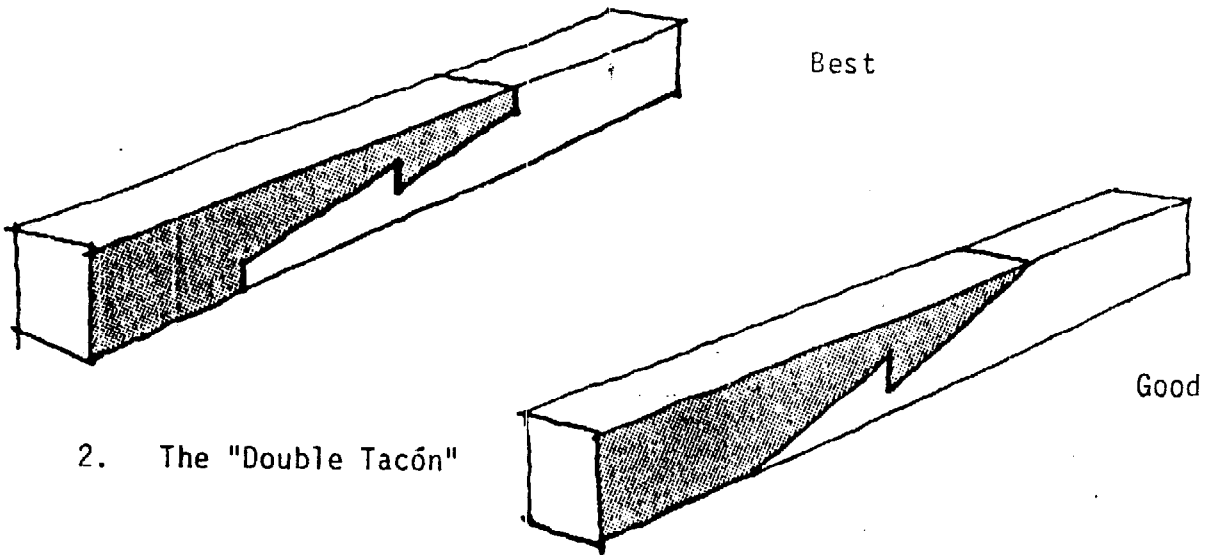

2. The "Double Tacón"

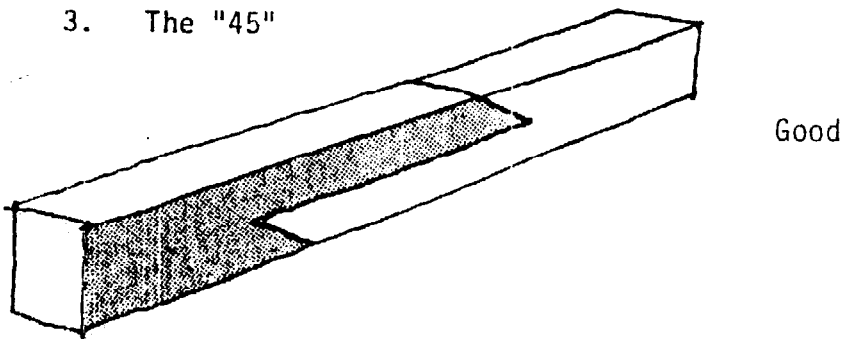

4. The "Escuadra"

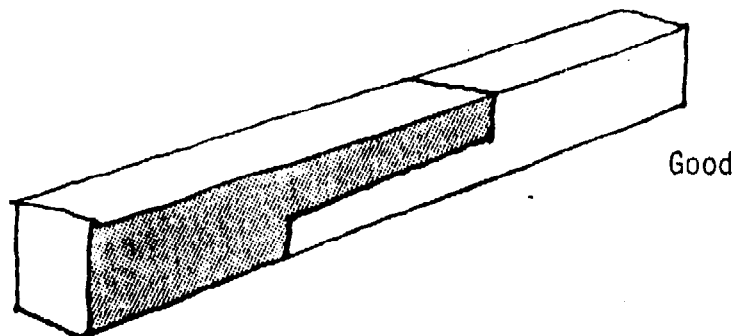

FALSE JOINTS

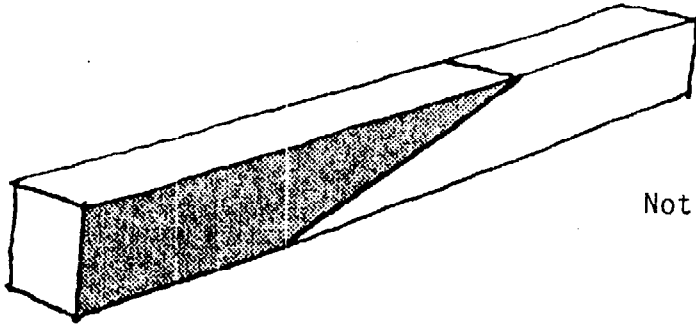

Not Recommended

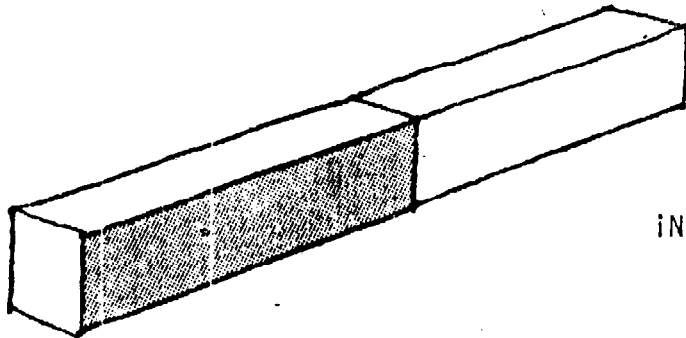

No!

HOW TO NAIL EACH TYPE OF JOINT

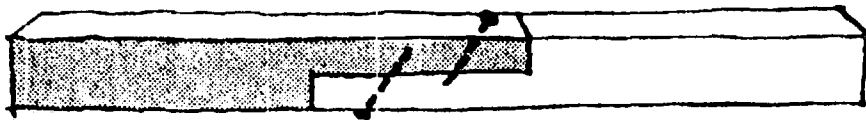
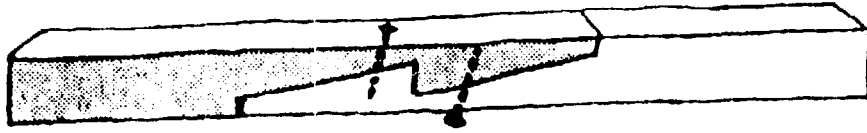

Nails should not pass from one side of the wood through the other -- it will split the wood. It is better to place the nail on an angle.

# HOW TO USE GUSSETS TO SUPPORT THE JOINT

1.

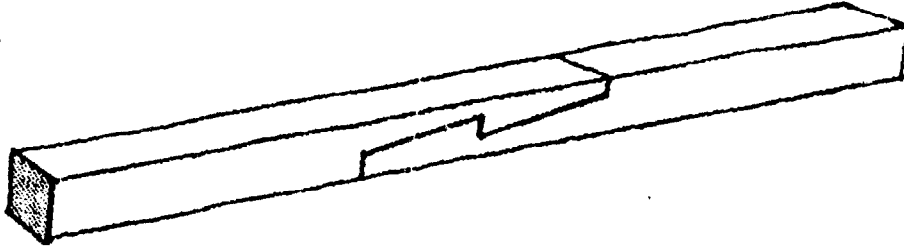

2.

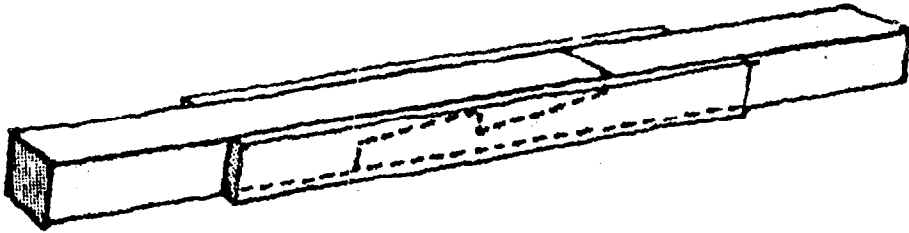

3.

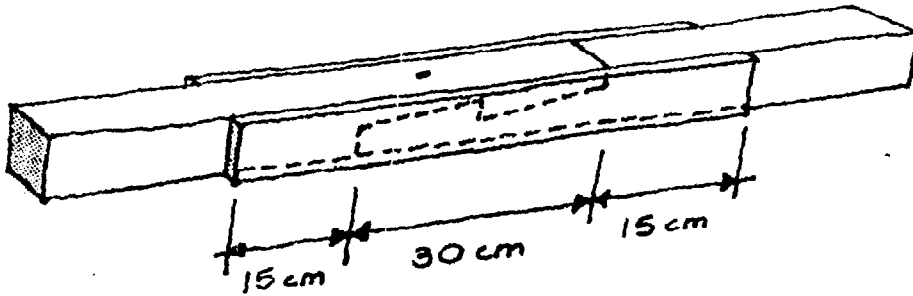

4.

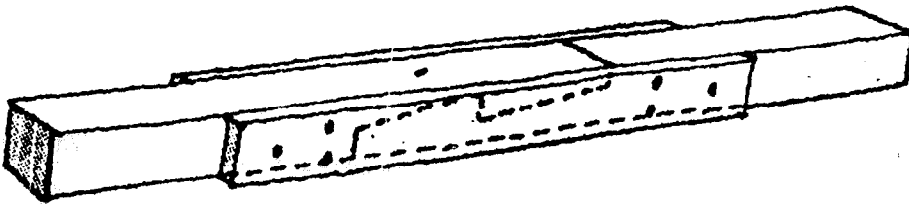

It is very important to reinforce the joint with gussets on both sides of the joint.

# HOW TO MAKE JOINTS USING ROUND POLES

1. Nail the joint

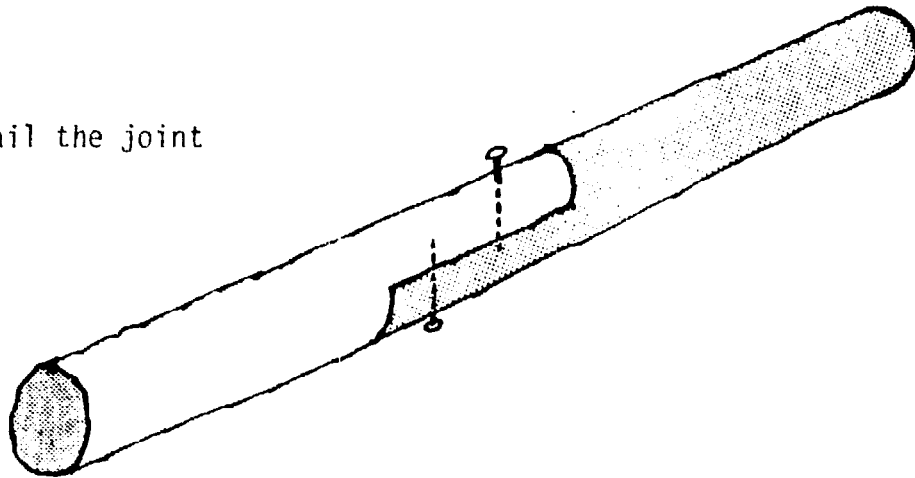

2. Plane the area where the gusset goes

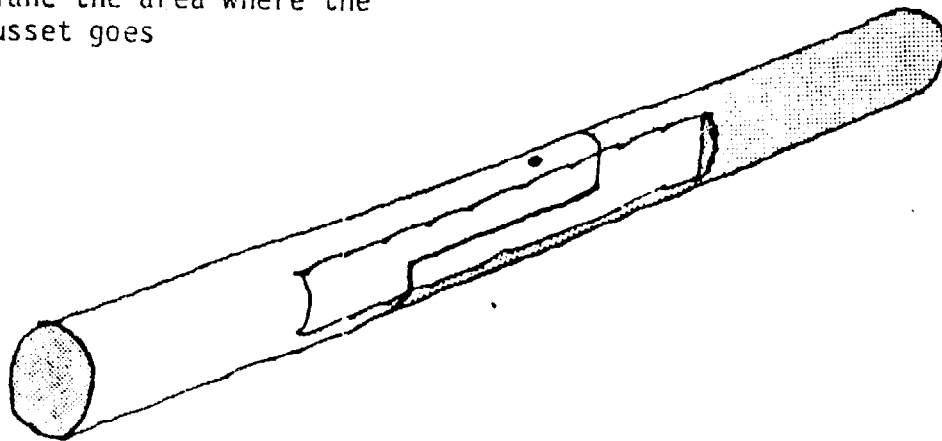

3. Attach the gusset

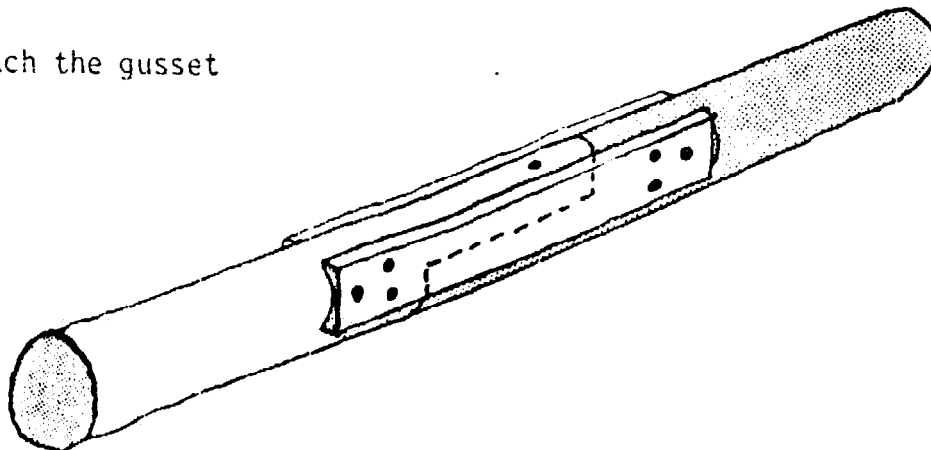

Use the "cadena" for the collar beam.

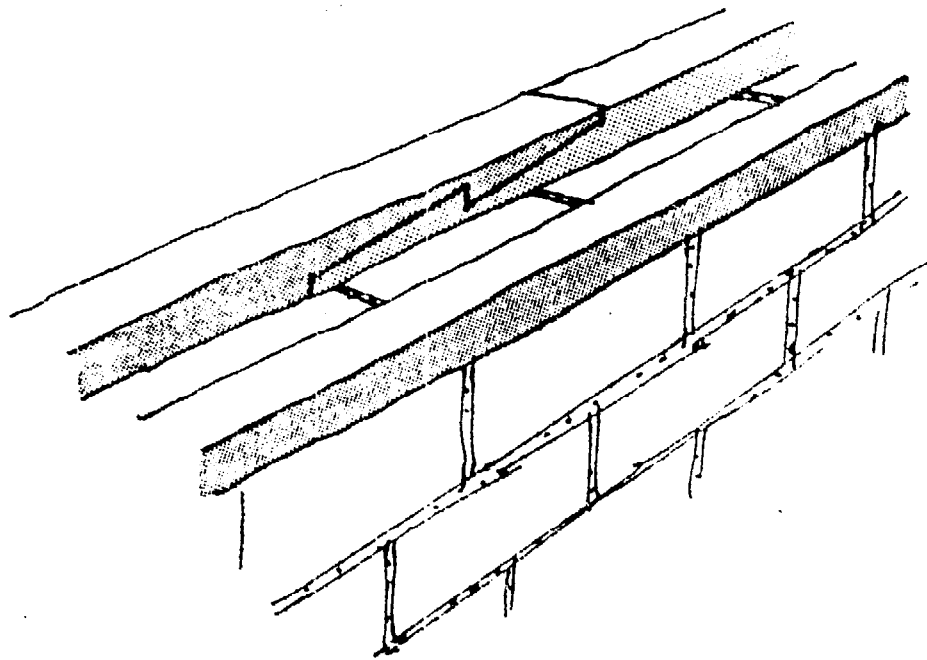

Do not put a joint over a door or window.

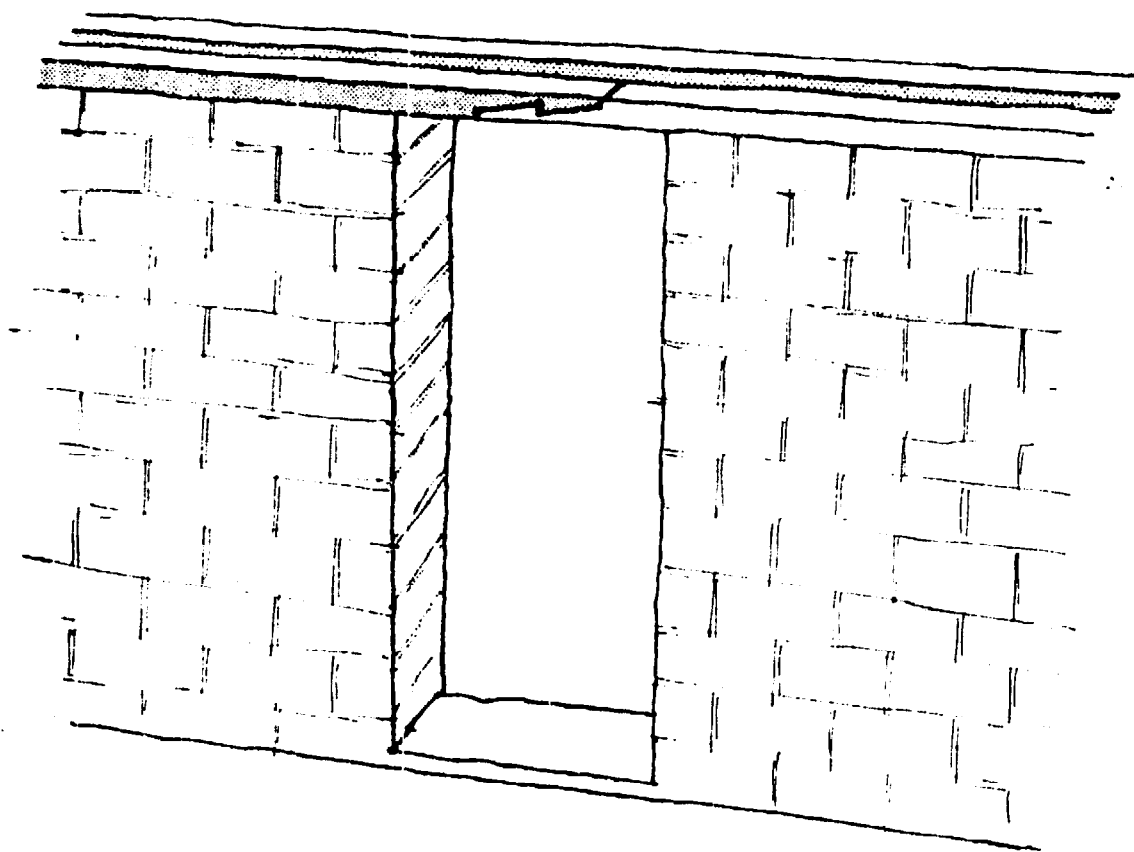



An "espiga" joint is best for the corners of the collar beam.

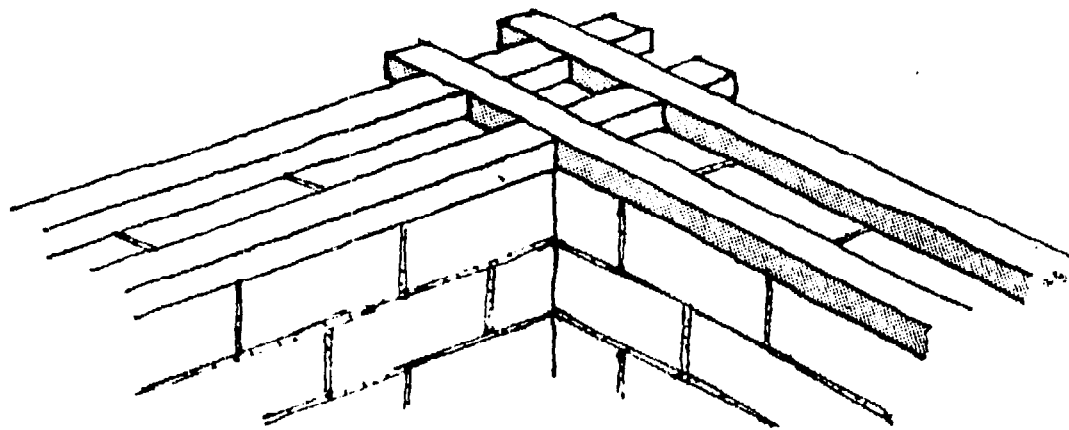
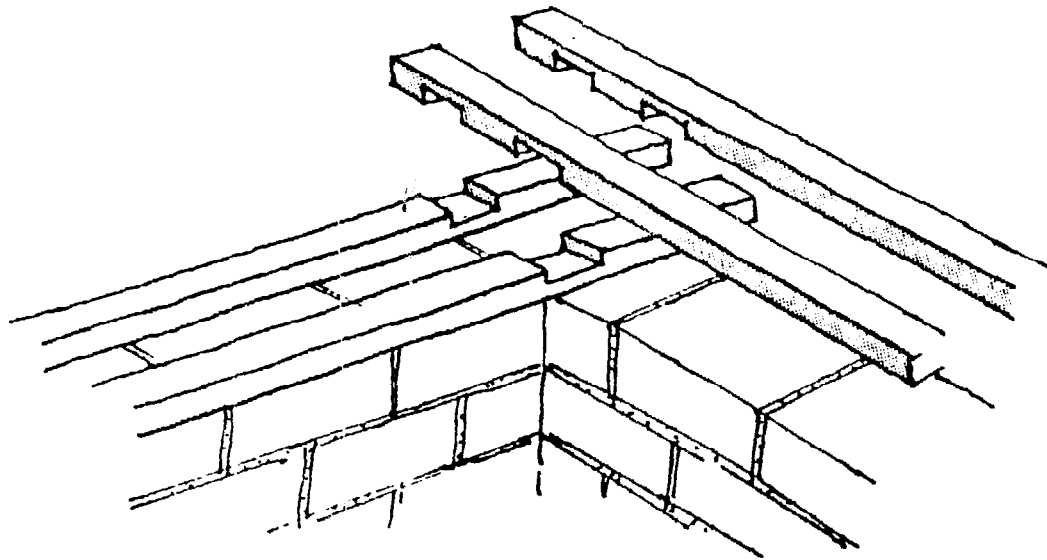

An "espiga" joint is best to unite the collar beam of an interior wall with the collar beam of an exterior wall.

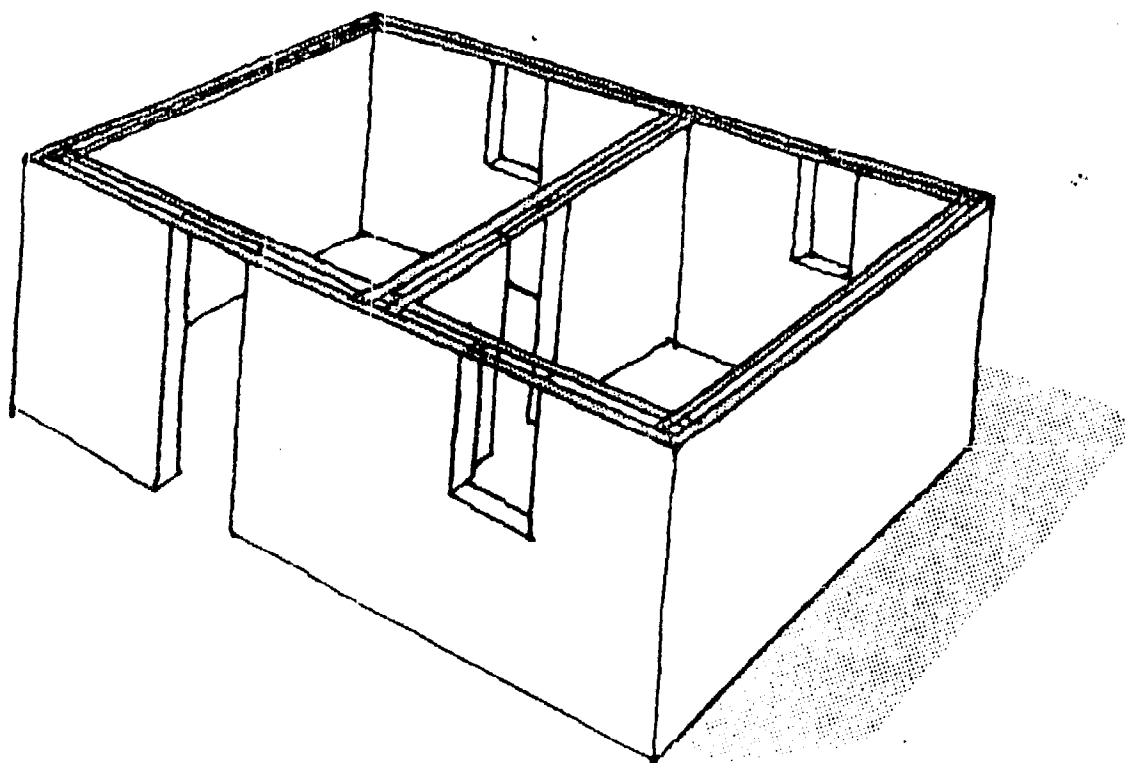
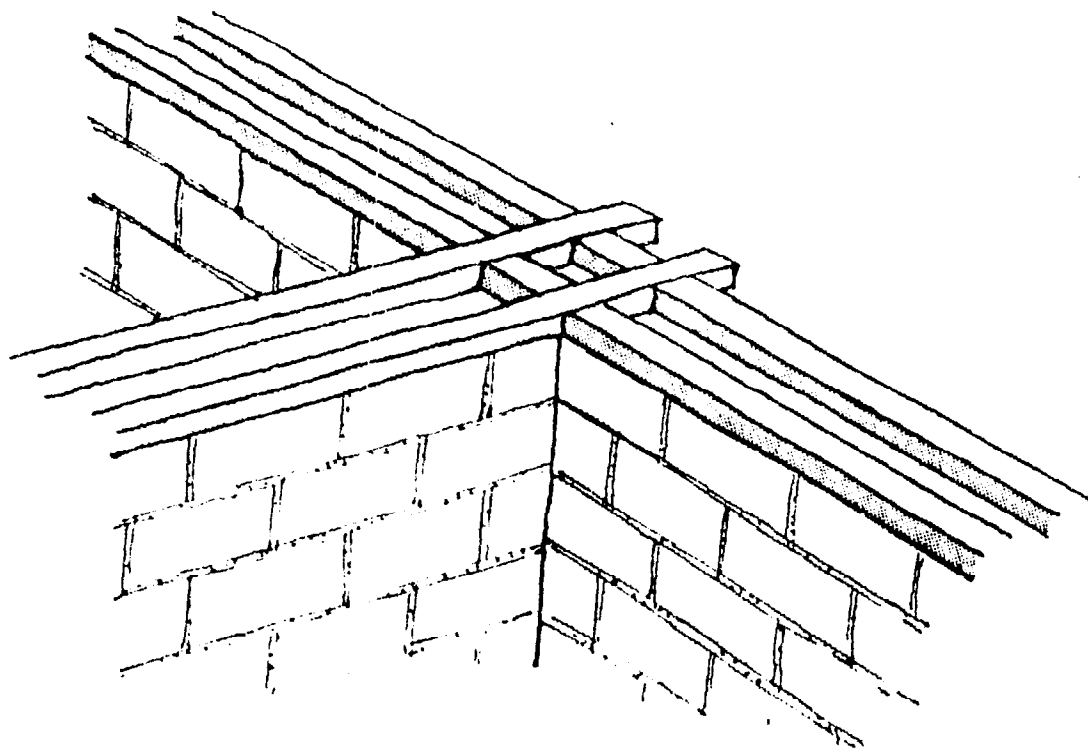

WHERE TO PLACE JOINTS IN THE ROOF TRUSS

YES

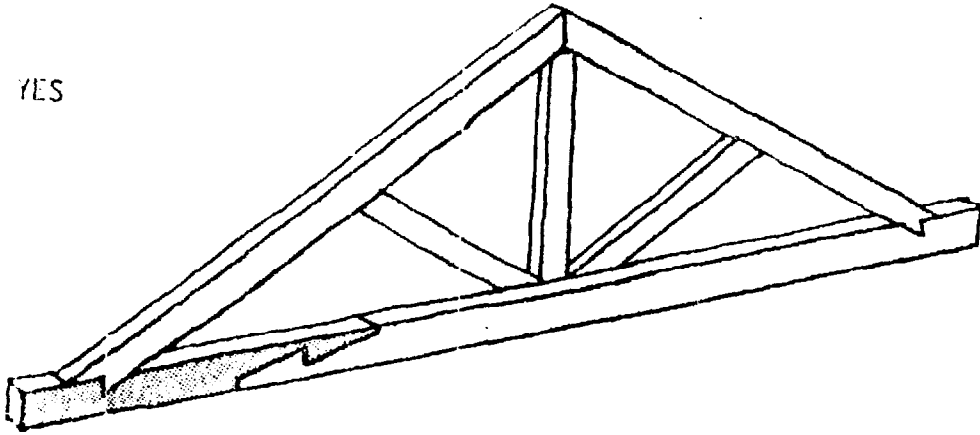

NO

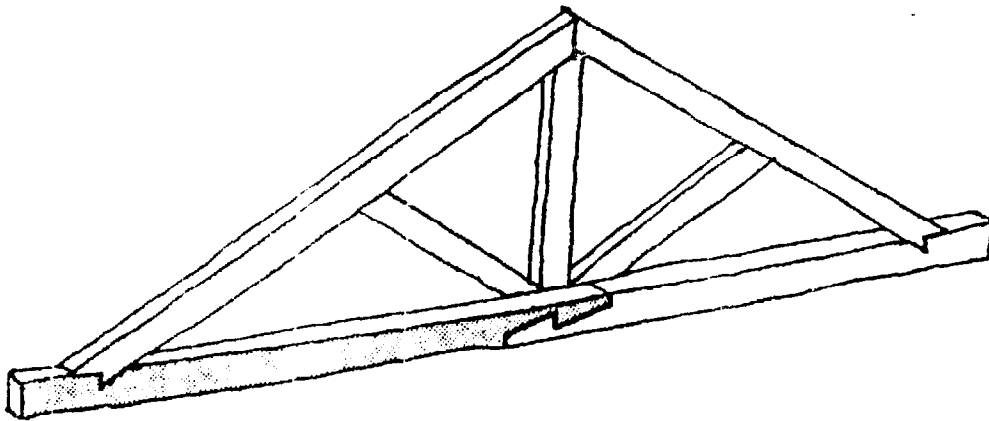

WHERE TO PLACE GUSSETS IN THE ROOF TRUSS

