

# **AT** MICROFICHE REFERENCE LIBRARY

A project of Volunteers in Asia

The Backyard Mechanic (Volume 1)

Published by:

Superintendent of Documents  
Consumer Information Center  
P.O. Box 100  
Pueblo, Colorado 81002  
USA

Available from:

same as above

Reproduced by permission.

Reproduction of this microfiche document in any form is subject to the same restrictions as those of the original document.



★ THE ★  
BACK-YARD  
MECHANIC

*Volume One*

Reprinted from

**DRIVER**

THE TRAFFIC SAFETY MAGAZINE for THE MILITARY DRIVER

# Table of Contents

|           |                                    |    |
|-----------|------------------------------------|----|
| Part I    | <i>Tools &amp; Work Area</i>       | 2  |
| Part II   | <i>Inspection</i>                  | 5  |
| Part III  | <i>Oil &amp; Lube</i>              | 10 |
| Part IV   | <i>Transmission</i>                | 15 |
| Part V    | <i>Disc Brakes</i>                 | 19 |
| Part VI   | <i>Radiators</i>                   | 23 |
| Part VII  | <i>Emission Control Devices I</i>  | 28 |
| Part VIII | <i>Emission Control Devices II</i> | 33 |
| Part IX   | <i>The Amazing Vacuum Gage</i>     | 38 |
| Part X    | <i>Dieseling</i>                   | 41 |
| Part XI   | <i>The Battery</i>                 | 46 |
| Part XII  | <i>The Automatic Choke</i>         | 53 |

**DRIVER**

THE  
TRAFFIC SAFETY MAGAZINE  
FOR THE  
MILITARY DRIVER



 n auto maintenance series designed to help the novice working at home, as well as to provide a few reminders for the experienced hobby-shop mechanic.

*Prepared and written by*

*the*

*Air Force's DRIVER Magazine Staff,  
AFISC/SEDD, Norton AFB, CA 92409*

# DRIVER

has always recommended using the base hobby shop for auto maintenance and repairs. We still do. But, we know that many people who live miles from their assigned bases find it inconvenient to drive to the hobby shop to do minor auto work.

A lot of "not-so-mechanical" people prefer working at home, so they can take their time with minor maintenance—and learn as they go. Others would simply rather spend their car-repair weekends at home, and don't mind investing in the tools and equipment required for back-yard auto work. These are the people this feature is directed to, although it is designed to aid the hobby-shop mechanic as well as the back-yard variety.

If you plan to be involved with major repairs, we urge you to use the hobby shop, where the proper tools and assistance are available. But, many regular maintenance and repair jobs such as oil change and lube, tuneup, brake adjustment, and shock absorber replacement can be done safely and efficiently at home.

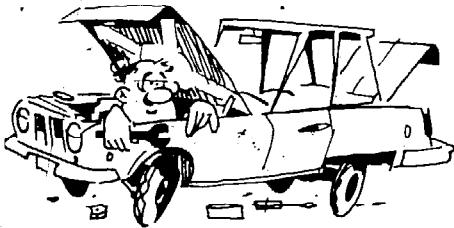

## GET INTO IT

If you're one of those "not-so-mechanical" people, this is the perfect time to get into doing your own auto work. Most car maintenance is not difficult, and requires only a little knowledge and a modest investment in the essential equipment. You can begin with small jobs in the convenience of your own driveway. You'll have the satisfaction of doing the work and saving a considerable amount of money. Before long, you'll probably be doing all your auto repairs.

The back-yard mechanic's most common mistake, however, is getting into a job without the necessary tools, parts, and know-how. We'll get into this more when we discuss specific jobs in future issues. For the time being, you should establish a suitable working area if you want to be a safe and efficient back-yard mechanic.

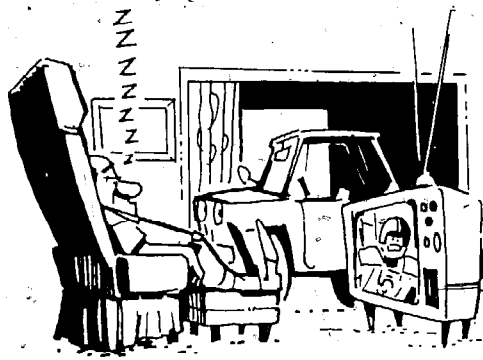

## THE HOME WORK AREA

A carport or enclosed garage is ideal, but even a paved drive provides a satisfactory place to work. Working on the bare ground is generally not desirable, but you can use cardboard sheets or a tarp as a clean working surface on level ground.

Adequate lighting and a workbench are two essentials of a proper work area. A UL-approved trouble light (available for under \$2), along with normal daylight or garage lights, usually provides sufficient lighting for most jobs. A clean table or workbench should be used for laying out service manuals and parts. A wide

to keep a couple of bricks or heavy wooden blocks handy to use as wheel chocks.

One final item you might add to your home workshop is a liedown-creeper. Creepers (a horizontal board on casters or swivel wheels) provide a comfortable and easy way to work under a car, and are available for less than \$8.

When you've established your working area, you'll need something to work with. Tools are a mechanic's best friends, and a basic set is all that's required for most back-yard work.

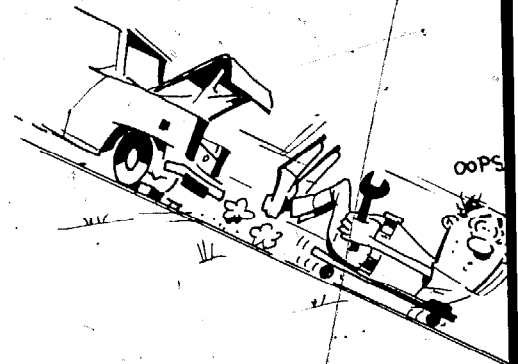

**THE DRIVER** kicks off an auto maintenance series designed to help the novice working at home, as well as to provide a few reminders for the experienced hobby-shop mechanic

# BACK-YARD

board placed on concrete blocks easily substitutes as a workbench.

## SAFETY STANDS ESSENTIAL

Of the utmost importance to your home work area is a set of good-quality safety stands or ramps. Top-quality jack stands are surprisingly inexpensive when purchased on sale from a discount or parts house, and will easily pay for themselves the first couple of times they are used. The ramps are a little safer and easier to use, but initially more expensive.

Either ramps or stands are absolutely mandatory whenever a car is raised off its wheels. You should never get under a car that is supported by a bumper jack alone. Jacks are strictly for emergency use, and cars frequently slip off a conventional jack. Many people are killed or injured each year because they failed to use safety stands. And don't forget

Safety stands are an essential feature of a well-equipped home work area. They are very reasonably priced, and will pay for themselves the first couple of times they are used. Stands are mandatory whenever a car is raised off its wheels. Many people have been killed or seriously injured while working under a car supported with only conventional jacks.





## BASIC TOOLS

Many of you may already have most of the tools you'll need for routine mechanical work. For those new to the self auto-repair business, an adequate tool kit should begin with a set of open-end or combination wrenches. Combination wrenches, those with an open-end fitting at one end and a box-end fitting at the other, are the most versatile.

A set of 1/2-inch-drive socket wrenches, and possibly some smaller sockets in the 1/4- or 3/8-inch drive size should suffice. To these basic wrenches, you can add a medium-sized crescent wrench. Assorted types and sizes of screwdrivers are essential, as are a pair of regular and

needle-nose pliers. Round off your tool kit with a pair of vise grips, a feeler gage, a spark plug wrench, a gapping tool, and a 12-volt test lamp (see picture below).

Many popular department and discount stores often feature complete tool kits in the \$25 to \$50 price bracket. These stores also have frequent sales on wrench sets and individual tools you may need. While you're shopping, you might pick up a grease-gun (available for less than \$5); then you can do a complete oil change and lube. This is the most common maintenance item, and probably one of the first things you'll want to do at home. For a complete run-down on basic hand tools, see Part 7, "You, the Mechanic!" (Sep '71 DRIVER).

A good working area and basic tool set will facilitate most regular car maintenance jobs, but some common jobs require special tools or equipment. We'll discuss these specific items in a future installment. Whether you want to borrow or purchase these items, or go to the hobby shop,

when performing these special jobs is up to you. Many of the important gages and test-equipment items required are available for only a few dollars; you may want to add these to your home workshop. By purchasing items as you need them, you can build a very complete car tune-up and repair center right at home.

When you've accumulated the basics we've mentioned—you'll be set



to start maintenance and repair jobs at home. We'll begin the series next month with some simpler jobs and progress into more complicated tasks. In the meantime, why not ease into the game by giving your car a thorough check-up?

The following suggestions should help every week-end mechanic save time, money, and frustration; whether he be a novice or master—no matter where he is working.

- One of the best means of saving money is purchasing commonly re-

*continued*

# MECHANIC

A basic set of tools is all that's required for most back-yard work.

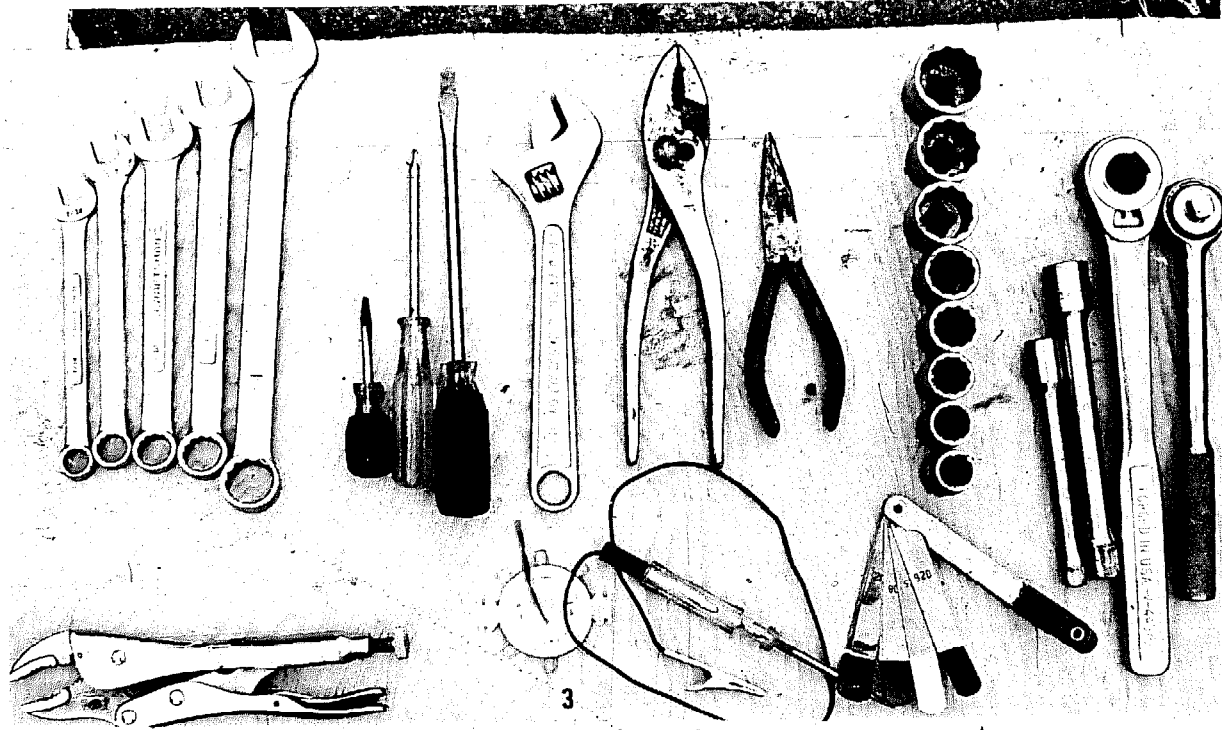

continued

## THE BACK-YARD MECHANIC

placed parts before you need them. This will allow you to get such items as tuneup kit, air filter, and fan belt when they are on special. This will save running around trying to get an essential item in an emergency. You also won't be faced with paying an inflated price at the first or only shop



that stocks a badly needed part.

- Get a shop manual—and use it. Shop manuals save time and prevent frustrating mistakes, give specifications, and tell what special tools or procedures are required for a certain job. A manual is absolutely essential for anything more than basic maintenance. Your car dealer or your hobby shop or parts house attendant should be able to tell you where to get a shop manual.

- When you start a job, keep a complete record of how everything comes apart. Sketches or polaroid shots

should be made of complicated disassemblies. Be especially cautious of small springs, screws, and adjustment bolts—mark on the sketch exactly how these integral parts fit.

- Keep a fully assembled model for reference if possible. For instance, if you're doing a brake job, do one wheel at a time; then you'll always have a model to check when reassembling.

- Keep removed parts organized. Parts which must be replaced in the same position from which they were removed should be tagged and placed on a rack or in a box. Nuts, bolts, and smaller parts can be organized in a TV-dinner tray, muffin pan, or other such containers. Every part, including nuts and bolts, should be marked to indicate its location. This will save a

lot of time by precluding the common problem of digging nuts and bolts out of a box and wondering which ones go where.

- Tag all electrical connections and wires to be removed. Also, when removing a linkage or adjusting rod nut, measure the length of exposed thread before removing the nut. When reassembling the piece, you'll know exactly how to adjust the nut.

- Allow yourself plenty of time when beginning a job. Have all the required parts and tools ready. If the job has an uncertain parts requirement, be sure you will have plenty of time to get the needed parts, and that a shop stocking what you need will be open.

- Unless you're an expert, don't try to rebuild important components. The cost of a professionally rebuilt part, or even a new one, is often not much more than the price of a rebuild kit.

- Most importantly, know what work to have done by an expert. Machine work, muffler replacement, tire repairs, and emission-control maintenance, among other specialized jobs can usually be done more efficiently by shop or mechanic with special equipment. The small amount of money you save on these jobs may not warrant your time or trouble. •

Organization of removed parts is the best way to save time and trouble. Large parts should be labeled, and sketches made of how and where they fit. Nuts, bolts, and small parts can be organized in a TV-dinner tray, muffin pan, or other compartmented container. Another good idea is keeping removed components in sequence of removal when disassembling a large part.

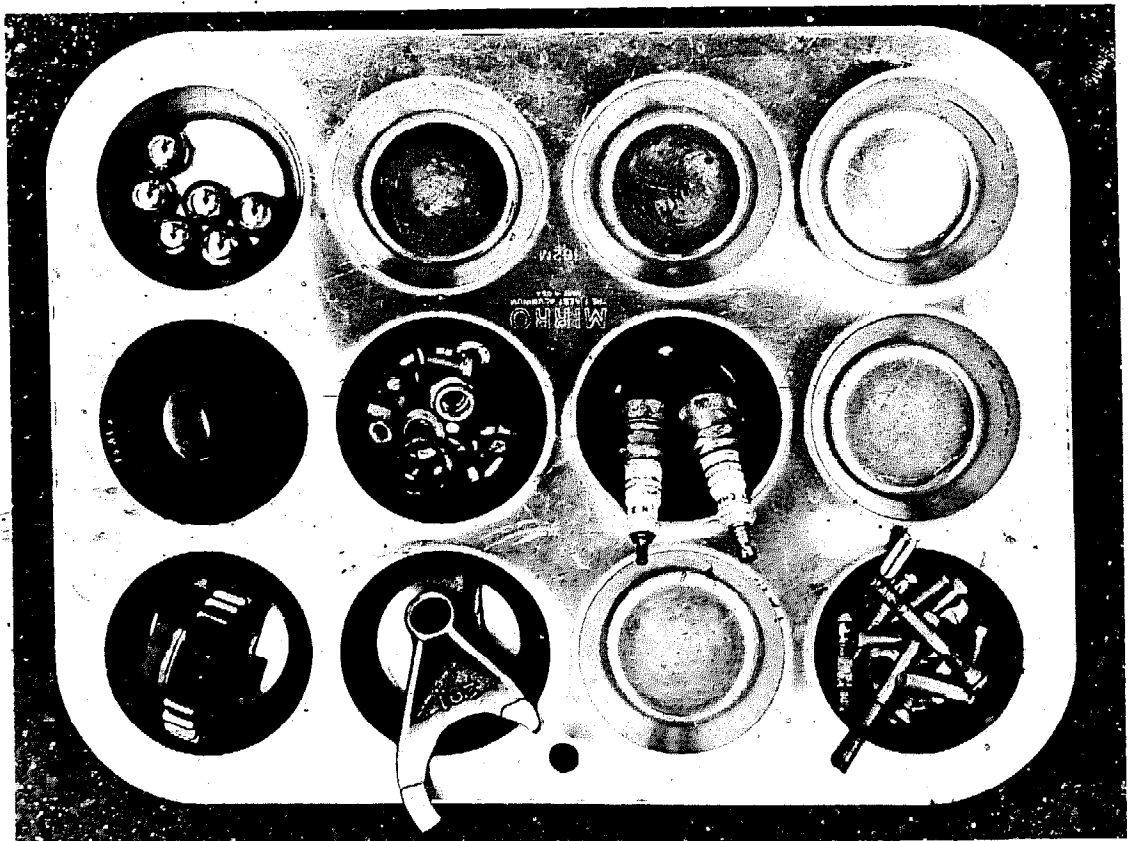



# the BACK-YARD MECHANIC PART II

A quick inspection at home saves time and money

In last month's issue we discussed setting up a home work area, and suggested you begin your "back-yard" auto work with a thorough "once-over" of your car. So, this month we'll get into the specifics of a safety and reliability inspection.

A fairly complete auto inspection at least every 6 months is essential for safe and economical driving. Frequent inspections can save money by exposing necessary minor repairs before they become serious problems—and can keep faulty equipment from causing accidents.

For those people, residing in states requiring safety inspections,\* performing your own check before the state inspection can save time waiting for a reinspection. It can also save a lot of money by allowing you to repair faulty items, or replace them when they are on sale.

In California for instance, a violation discovered during a random roadside inspection must be corrected within 14 days; however, the vehicle is not supposed to be driven until the necessary repairs are made. If this seems a bit unfair, just remember, in most states you can be issued a traffic citation for vehicular safety violations such as a burned-out headlight.

\* More than 30 states now require safety inspections at least annually. Other states operate random checks, and in some, city or county inspections are required.



## GET INTRODUCED

For you "not-so-mechanical" types, a complete auto inspection is a good way to acquaint you with your car, so you will be ready to move on to auto maintenance jobs to be discussed in future issues. You'll also be a better and safer driver by understanding how your vehicle works—and you'll have the satisfaction of knowing your car is in top shape.

A thorough inspection can be carried out at home in little more than an hour, using only the tools and equipment discussed last month



## LIGHTS

Get your owner's manual ready, and begin with a walk-around inspection—noting obvious problems such as a loose license plate or missing tire valve caps. Flip on the lights and check for burned-out headlights (both bright and

dim), parking lights, and taillights. Try the turn signals—if they don't blink and the bulbs are not burned-out, the flasher is probably faulty. The flasher unit on most cars is a small metal canister that plugs in under the dash. Your manual will show the location of this inexpensive unit if you have trouble finding it. Hit the brake-pedal a few times to be sure both brakelights operate. If a buddy is not available to help you, look for the reflection against a garage door to check the brakelights. Don't forget to put the car in reverse and check for burned-out back-up lights.

Replacement light bulbs and headlamps are available at most discount and auto stores. Burned-out bulbs can be replaced by removing the screws

Taillights and back-up lights are easily replaced by removing the outer lens—or, in some cases, they are removed through the trunk. Front parking lights and body side lights are sometimes reached from under the body.

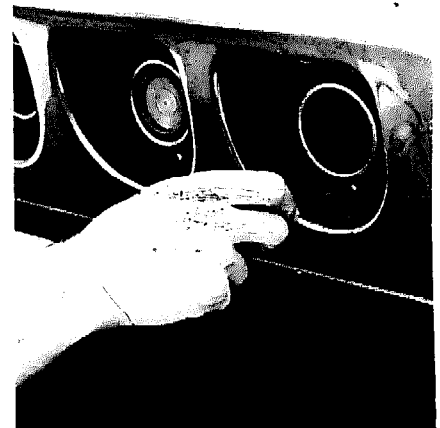



from the outer lens (see picture). Sometimes the bulb must be reached from under the body, as in the case of body side lights. Tail and back-up lights are usually accessible from the trunk.

Headlights are equally easy to replace; but be sure to get the proper lamp. On a dual system (four headlights) there is a separate lamp for dim and for bright—note which lamp you need. On a single unit system (two headlights), where both bright and dim beams are in a single lamp, it's not quite so confusing—but you still have to get the proper lamp for your car. If you're unsure, take the old lamp with you when you go for a new one.

A burned-out headlight is replaced by removing the outer trim and loosening the lamp retaining screws (located around the edge of the lamp). Pull the wire connector plug loose from the back of the lamp, and you're ready to install the new light.

### HEADLIGHT AIM

You'll probably need to align your headlights after replacing a lamp. Even if you don't replace any lights, headlight aim should be checked. Misalignment of the headlights is one of the most frequent causes of safety inspection failure.

Your owner's manual or service manual should give instructions and a headlight aiming pattern. If not, a blank wall and a roll of tape will suffice until you can get the lights adjusted at a service station. Drive the car up to a wall, then mark precisely where the lights (both bright and dim) shine. Back the car away 25 feet, and with someone in the driver's seat, adjust the lamps until they focus on the marked spots. The aiming adjusters on newer cars can be reached through the outer headlight trim (see picture). Older cars may require removal of the trim to adjust the lights.

Finish your exterior inspection by checking the wiper blades for wear. A

Headlight aiming adjusters can be reached through the headlight trim on newer cars—but most older cars require removal of the outside trim to adjust the headlights.

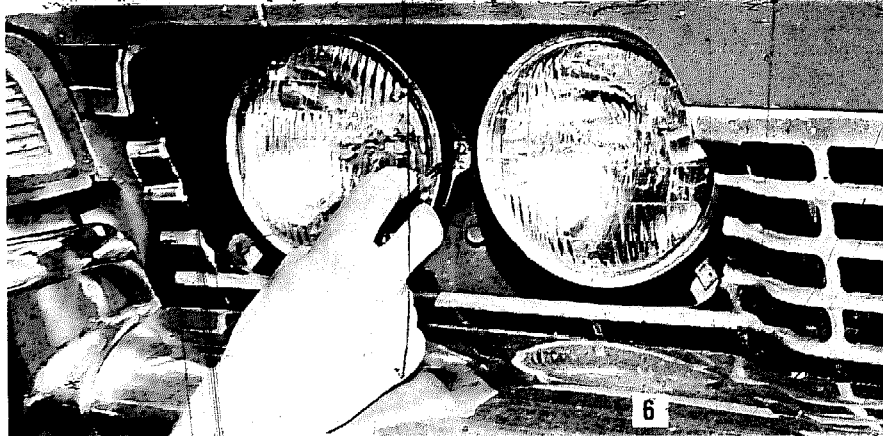

blade which leaves rubber sticking to the glass is ready for replacement. If the windshield washer seems to lack pressure, remove the reservoir and clean the strainer screen—dirt in the screen often impedes washer flow. Don't forget to check the aim of the washers and top-off the reservoir with the proper solvent mixture.



### INSIDE THE CAR

Be sure the heater and defroster work. If the fan fails to operate—look for a blown fuse at the terminal fuse box. Check steering wheel play by turning the wheel slowly until the front wheels move. There should not be more than 3 inches of free play—if there is, you're probably in need of new tie rods or other steering system repairs. These should be done by a qualified mechanic. Tighten the seat belt mountings, and be sure the seats are fastened securely to their tracks.

If the horn doesn't work, this is the time to fix it. Locate the wire connector at the horn—pull it loose and hook one lead of a test light to a ground. Probe the connector with the other light lead while someone pushes the horn button or ring. If the test light glows, the horn is shot. If the test light fails to glow, the problem is a faulty relay or switch. Pull the connector at the horn relay (usually located near the front wheel along the inside of the engine compartment) and probe it while someone operates the horn. If the light glows, the relay is bad. If it doesn't, the problem is at the horn switch.

### UNDER THE HOOD

Raise the hood and check the cooling system. Replace the radiator and heater hoses if they feel mushy, are cracked, or show signs of leaking. The clamps

should be tight, but not so tight they cut into the hoses.

Carefully release any pressure from the radiator, remove the cap and check the coolant level. If the liquid is rusty or discolored, you should flush and replenish the system with the proper antifreeze-coolant mixture, following the instructions in your manual. Brown sludge developed around the filler neck means you'll probably need to take your car in for a radiator back-flush.

Replace any drive belt which shows signs of wear. A belt having 1/2-inch or more of play halfway between the pulleys should be tightened by loosening the component, holding it, and exerting pressure to tension the belt. If a pry bar is needed to adjust the belt properly, be sure not to put the end of the bar under anything delicate—such as the outside frame of an alternator or the power steering fluid reservoir.

The battery is an item which should have constant inspection and care—and this is a good opportunity to make sure the battery case is clean, and the terminals are corrosion free, tight, and coated with petroleum jelly to inhibit recurring corrosion. Also, check the battery wafer level.



### BRAKE FLUID ESSENTIAL

Be extremely cautious of the brake fluid reservoir—low fluid could mean a leak in the brake system... and a leak could spell disaster in the form of a brake failure. The fluid reservoir is located, with the master cylinder, near the fire wall (see picture). If the fluid is not up to the recommended level, check for leaks around the master cylinder and at the brake line connections. Leaks anywhere in the brake system should be taken care of immediately. If you're unsure of where the leak is, or the proper repair procedure, it is best to leave this to a reputable brake shop or mechanic.

### EMISSION SYSTEM

Remove your carburetor air filter and look for black, oily deposits—these, as well as rough low-speed idle and operation indicate problems in your exhaust emission system. A malfunction in the emission system is usually caused by a plugged positive crankcase ventilation

*continued*



Hoses and belts are items which cause more car problems than any other parts. Replace hoses that feel mushy, are cracked, or show signs of leaking. Tighten belts that have more than 1/2-inch of play—if the belt is tight enough, but still squeals or slips, it is probably glazed on the inside—replace it.

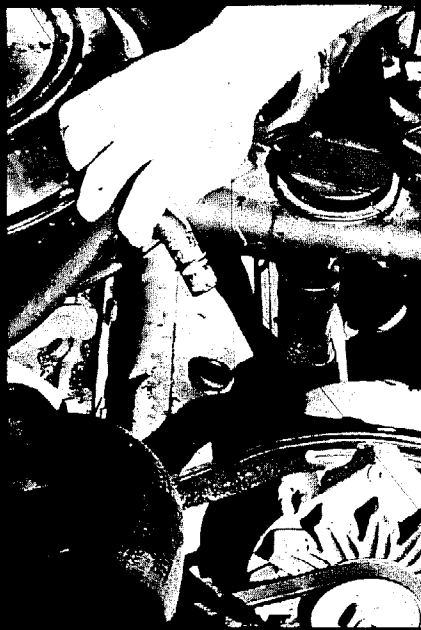

The PCV valve is the emission system part most likely to cause problems. Pull it loose from its mounting and shake it—if it doesn't click, replace it. Black oily deposits on the air filter, or rough low-speed operation indicate problems somewhere in the emission system that should be taken care of.



The automatic transmission dip stick (usually located near the fire wall) should be checked frequently. The fluid should be reddish in color—any other color, or fluid that smells like varnish, indicates transmission problems. Check your owner's manual for the correct procedure for checking the fluid level.

continued

## THE BACK-YARD MECHANIC

(PCV) valve or a damaged hose. Find the PCV valve, usually located in the rocker arm cover or intake manifold (see picture), and shake it—it should click. If not, replace it. Start the engine and hold your finger over the open end of the valve; you should feel a strong suction. If not, check the hose for cracks or kinks.

### TRANSMISSION

The automatic transmission is one final area of concern under the hood. Most people wait until shifting problems develop before they even think about the transmission... by then it is often too late to avoid expensive repairs. Locate the transmission dipstick, usually hidden behind the engine near the fire wall (see picture). Refer to your owner's manual for the proper procedure for checking the fluid level—this is usually done with the engine warm and idling, and the selector in "Park."

The fluid should have a reddish color; if it is orange or black, or smells like varnish, the shifting bands may be starting to fail. The problem can still be rectified with the proper maintenance. DRIVER will feature an entire



### CONSULT-MANUALS FOR PROPER PROCEDURES

article on automatic transmission maintenance in the near future. Meanwhile, have your car checked by an expert if you suspect such problems.

### SHOCKS

Now you're about to get under the car and into the final, but more complicated checks. But, before putting the car up on safety stands, check the shock absorbers. All shocks sweat, but excessive fluid on the outside of a shock means it is worn out. Also, if a hard push down on the front or rear of the car produces more than three bounces before the car stabilizes, better check into new shocks. See "You, the Mechanic!" Part 8, Nov '71 DRIVER.

### UNDER THE CAR

Carefully jack up the front-end and place it securely on safety stands—don't forget to chock the rear wheels. If you don't have a buddy helping you, it's a good idea to let someone know you'll be working under the car so they can check on you periodically... just in case.

The first thing you'll want to do is trace all the brake lines from the master cylinder to the wheels, looking for fluid leaks. Next, check the transmission, clutch, and differential fluid levels by opening the plugs located on the side of the housings. Your owner's manual will show their locations and give lubricant specifications.

Check the exhaust system for leaks by placing your hand around the joints, with the engine running (before it gets hot). A leak can be felt. Leaking joints can be sealed by tightening the clamps or by covering the joints with a special sealer. Tap the muffler and pipes with a wrench; a dull clank indicates metal ready to rust through and in need of replacement.

With the wheels off the ground, try to rock each wheel from top to bottom, and side to side. More than 1/4-inch of play indicates a loose or worn wheel bearing. Remove the wheel hub and tighten the lock nut to the correct speci-



The brake fluid reservoir is part of the master cylinder—located near the fire wall opposite the steering wheel. Check the fluid level after cleaning all dirt and gunk from the reservoir top. If the fluid is low, look immediately for leaks in the system—the fluid has to have gone somewhere.

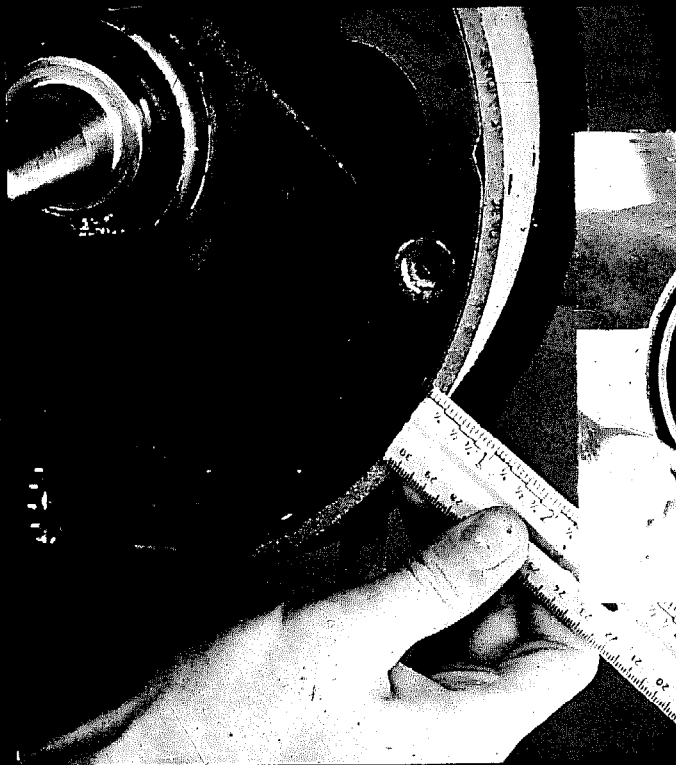

Brakes are one of the most critical areas for inspection. Brake shoes should have at least 1/32-inch of lining above the rivets, or above the shoes on bonded linings. Disc brakes should also be measured for pad thickness—your owner's manual will give the recommended thickness. Brake drums should be evenly worn and free of large scratches or grooves. Worn drums can be machined and reused, but excessively or unevenly worn drums should be replaced.

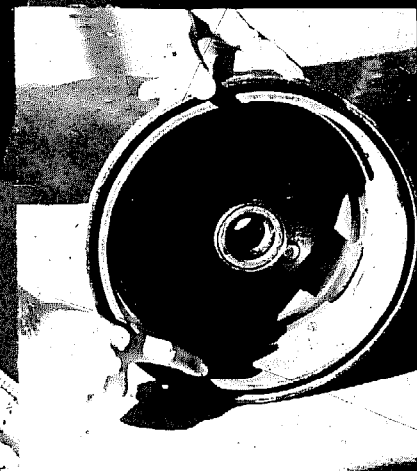

fications. If the wheel is still loose, the bearings probably need to be replaced. Excessive play in the wheels, when lifted up from the bottom with a bar or lever, indicates ball joint or king pin problems. If you suspect this, better have the car immediately checked out by a reputable front-end specialist. Check the steering system by shaking the idler and Pitman arms. Twist the tie rods. (Some are designed to turn—notice which kind you have.) (See picture). Any movement or looseness may be serious—see a specialist.

## BRAKES

The final and probably most important checks are the brakes and tires. With the front wheels removed, disc brakes can be measured for pad thickness. Your manual will give procedures for this, as well as the minimum thickness before the pads need to be replaced. On older cars with drum brakes, you will have to remove the drum to inspect the brake linings. Consult your manual for the proper removal procedure. The drum should be smooth with no large scratches. If the drums are excessively worn, you should take them to a shop for turning. There should be at least 1/32-inch of lining above the rivets on riveted shoes, or above the

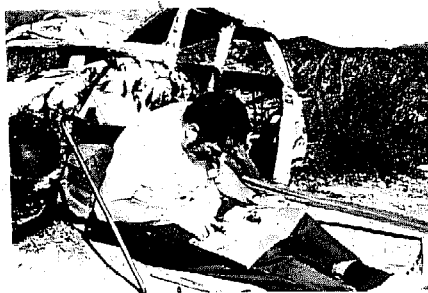

## PAST ISSUES OF DRIVER ARE USEFUL

shoe on bonded linings. If the linings are worn beyond this point, or worn unevenly, you'll need to replace the shoes. Lift up the edge of the rubber cup over the end of the wheel cylinder and check for fluid leakage. If leakage is occurring, you need to have the cylinders rebuilt. Anything appearing unusual during this inspection is reason for a thorough professional brake inspection.

The rear brakes should also be checked. However, rear drum removal often requires special wheel pullers. If you don't have the knowledge and equipment for the job, your mechanic can pull the rear drums and inspect the linings for you. Even though the front brakes usually wear first, many people replace only the front shoes when they do a brake job. So, your rear linings may be shot even when your front shoes



## CHECK FOR UNUSUAL WEAR PATTERNS

look new.

## TIRES

Tires are always critical—inspect them for tread depth and uneven wear patterns caused by out-of-balance wheels or a misaligned front-end. Unusual wear patterns are a good indication of the need for a trip to a balance and front-end shop. Tires should have at least 2/32-inch of tread at every groove. A good way to check this is inserting a Lincoln-head penny, head first, into the tread. If rubber doesn't at least come to Abe's head, you'd better look for a tire sale. Maintaining proper air pressure is the best way to stretch tire mileage. If you don't have a good tire gage, you should get one and use it often.

*continued*

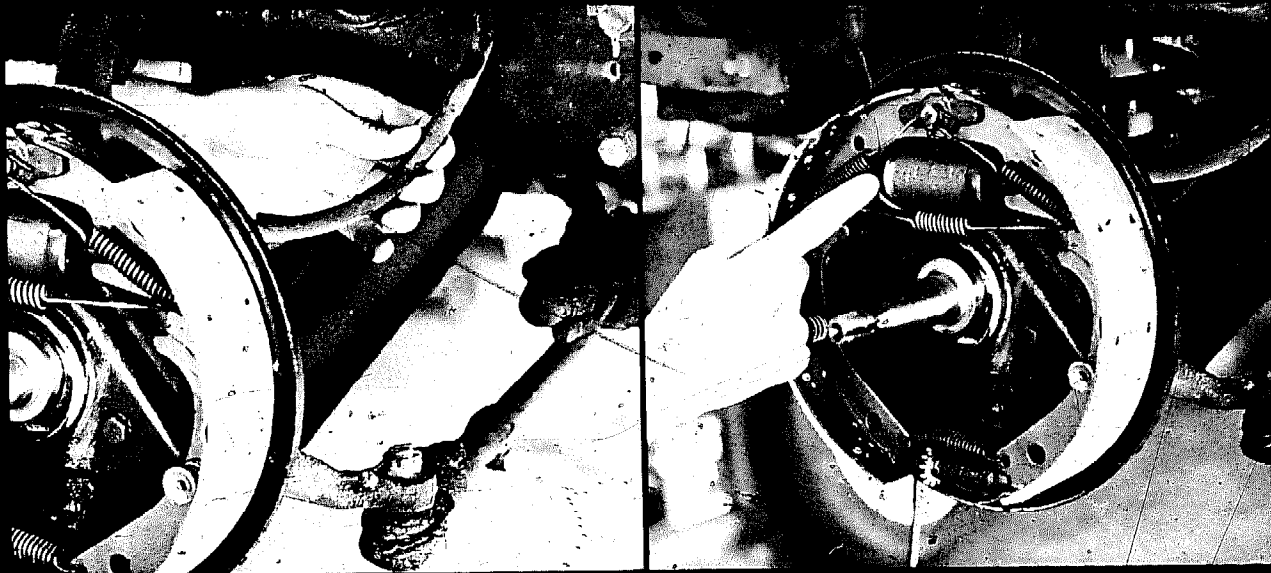

Brake lines are another important element of the brake system. Lines should be traced from the master cylinder to the wheels, checking for leaks. The wheel cylinders can be checked for leaks by pulling back on the rubber cups. A leaking wheel cylinder must be rebuilt or replaced.

continued

## THE BACK-YARD MECHANIC ROAD TEST

If everything has checked out so far, hit the road for a performance analysis and final brake check. Make several "panic stops" in a traffic-free area. Any excessive pulling, noise, or brake fade is reason for an expert brake



MAKE SEVERAL PANIC STOPS

inspection. You can check brake balance by locking your brakes at 5 mph on a dirt or gravel surface. All four skid marks will be about equal in length if your brakes are balanced.

If your engine's performance is a little down, you might try taking your car to an automotive diagnostic center. See "Give Your Car a Clean Bill-of-Health," Dec '72 DRIVER. A diagnostic test will give you a complete performance rundown, so you'll know exactly what engine parts need adjustment or replacement—and it will confirm the findings of your safety inspection. •

"Now if I just had a good detailed article on body and fender work!"



The steering system is an area of great concern. Shake the Pitman arm, idler arm, and twist the tie rods. Any movement could be serious—have the car checked out by a front-end specialist. Some tie rods are designed to move, however, so check the manual to be sure which type you have.

# THE BACKYARD MECHANIC PART III



**N**ow that you know your way around your home "auto shop" and your car—you may want to change the crankcase oil and lubricate your car. These are, without a doubt, among the most productive and easily accomplished auto maintenance jobs the back-yard mechanic can perform. You can do a complete oil change and lube at home for half the usual cost. The complete job should take less than an hour, and requires only a few items you may already have.

By doing the work yourself, you can also avoid the hassle of making an appointment, and waiting for your car at a service station. In addition, you'll feel good knowing the job is done thoroughly and correctly, and that you didn't pay an exorbitant rate for the filter, oil, and minimal labor involved.

## WHY CHANGE?

Modern engine oil is miraculous stuff; when used properly and changed regularly it can work wonders in your car's engine. What constitutes "regularly," however, is a somewhat debated subject. Most auto manufacturers recommend oil changes every 6,000 miles or every 3,000 miles during extreme use. DRIVER agrees with many experts, however, who feel this may be stretching or "thinning" the oil a bit.

The old saying used to be, "Oil doesn't wear out—it just gets dirty

and needs to be replaced." This is still true to a large degree, but today's low-pressure, low-emission engines operate at higher temperatures, and the abundance of air conditioning and other power options coupled with excessive high-speed and stop-and-go driving places the oil under additional stress. The oil can also be thinned by gasoline and water, and the protective additives can evaporate. The excessive heat, contamination, and evaporation make frequent oil changes more important than ever, especially on new cars.

The products illustrated in this story are not necessarily endorsed by DRIVER or the U.S. Air Force.

## HOW OFTEN?

You can't hurt your engine by changing the oil too often—this is certain. And there is a lot of evidence supplied by professional racers and mechanics, as well as happy car owners with long-lasting engines, which indicates frequent changes are the key to long and trouble-free engine life. DRIVER therefore recommends changing the oil *and filter* every 3,000 miles for maximum engine protection. Longer intervals or less frequent filter changes may be acceptable to maintain a new car warranty—but, since you will be buying your oil and filters at discount prices as well as saving the labor cost of an oil change, you can easily afford the increased engine protection.

## OIL AND FILTERS

If you've always had your oil changes done at the local service station, you may be a bit confused on the subject of oil and oil filters. The place to buy oil is the Base Exchange or other discount store. The top-quality oil which you may pay up to a dollar a quart for at a service station costs less than half that at a discount store. Many stores also sell oil by the case at even greater savings. The same is true of filters. Most discount stores regularly stock top-name filters at half or even a third of the price you would pay at a service station. Also, oil and filters are frequently placed on sale, so

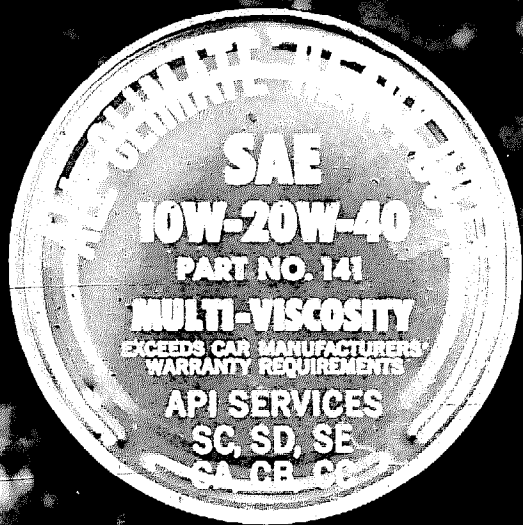

All motor oils are labeled to show their qualities or service recommendations. Pre-1971 cars should use oil certified at least SD (Service Deluxe). New cars require SE (Service Extreme) oil. Premium quality oils are certified both SD and SE, so they will provide the best service for all cars.

Few items are required for a complete oil change and lube. Besides oil and a new filter—you need only a small grease gun, an oil pour spout or can opener and small funnel, and a wrench to loosen the drain plug. Filters should be hand tightened, only—but they sometimes get too tight, and a filter wrench is helpful in loosening them.

watch the ads and stock up on these items when the price is right. Then you'll have everything you need when you're ready to change the oil, and you'll save a bundle over the long run.

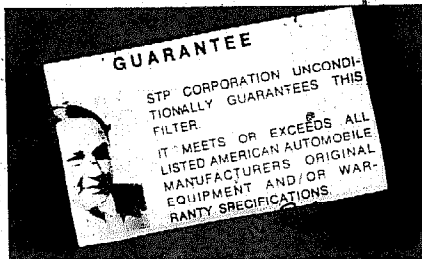

Use only filters certified to meet all manufacturers' warranty requirements—this assures you of the filter's quality. To protect a new-car warranty, clip the certificate from the filter box and keep it with a complete record of the oil changes.

**OIL QUALITY**

Quality is the most important consideration when choosing an engine oil. All oil cans are labeled with a code which indicates the oil's service recommendation. For pre-1971 cars you should use an oil certified at least SD (Service Deluxe). New cars require SE (Service Extreme)-certified oil. Most high-quality oils are certified both SD and SE, however, so this shouldn't present a problem. Any premium quality oil will provide the required engine protection, so what brand of oil you use is mainly personal preference. It is a good idea, however, to continue using the oil regularly used in your engine, since oil additives differ from brand to brand. But if you decide to switch brands for any reason, pick a widely available premium-quality SD or SE-certified oil and stick with it.

Flushing out a dirty engine before changing oil is great for keeping oil clean. The inexpensive canned flush is easy to use, and is recommended for engines which have accumulated sludge and gunk on the inside.



conditions. The multi-viscosity oils, 10W30, 10W40, and even 10W50 (the "W" designating oil for winter use) have become quite popular and are widely recommended for their protection over a broad temperature range. DRIVER feels a 10W40 variety is a good choice for year-around use under normal conditions. A lighter weight oil is often needed in extremely cold climates, or a heavy-weight, single-grade oil may be recommended in some circumstances. Your owner's

manual explains this, and gives temperature requirements for using single-grade oils.

**FILTERS**

All quality filters are essentially the same—but be sure the filter you buy is certified to meet all manufacturers' warranty requirements. Several companies have recently developed special, double-stage, heavy-duty filters. DRIVER has seen this type filter

*continued*

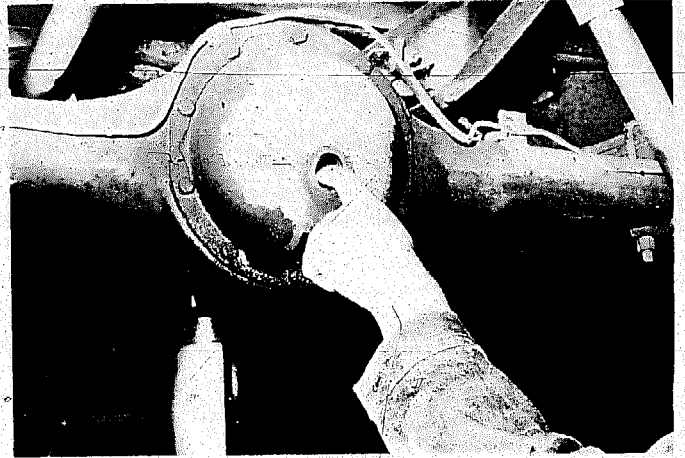

Check the standard transmission and differential fluid levels by removing the plugs located on the side or back of the housings. If the car is sitting level, the fluid should at least be even with the bottom of the hole. Your manual gives lubricant specifications.

continued

## THE BACK-YARD MECHANIC

in wide use on high-performance engines. And since these filters are generally not much more expensive than popular single-stage filters—they may be well worth the money.

### ADDITIVES

A subject that always comes up when discussing engine oils is the use of additives. Several of these "oil fortifiers" have been widely advertised. The true value of these products is not quite so well known, if at all. A recent study by a consumer-oriented research group, however, indicated these products do work as advertised—but the study concluded your engine doesn't really need them if you use a high-quality oil and change it regularly. There is also the possibility of a voided warranty if such a product is in use when a certain type of engine failure occurs.

### WARRANTY

One final question you may have before performing your own oil change is, "Will it void my new-car warranty?" The answer is definitely "No," provided you use oil and filters certified to meet warranty requirements, and follow the prescribed maintenance schedule. Keep a complete record of when you changed oil—what oil was used, and clip the warranty certificate from the filter

box. If this record is kept, there should be no question in event of a warranty claim.

### GET READY

In addition to a new filter and the proper quantity of oil (your owner's manual will give the quart capacity of your engine), you'll need only a few more items to perform an oil change. You may need a can of engine flush, if the oil on the dipstick is excessively dirty, and you'll need a container for the used oil. You can buy a drip pan for less than a dollar, but an old plastic bucket or other container will work just as well. The drip pan will slide under the car more easily, however, if you decide to change oil without putting the car up on stands or ramps.

You'll need a wrench to open the drain plug; on most cars an open-end or crescent wrench will do, but you may need a socket wrench for a car with a recessed drain plug. You may also need a filter wrench. The last item you'll need is a can opener and small funnel, or an oil pour spout that punctures the can. Spouts like those used at a service station are inexpensive and handy. Now you're all set for an oil change.

### CLEAN YOUR ENGINE

One final matter to consider before draining your oil is—how dirty does the oil get between changes? Some engines, especially on older cars, get cruddy on the inside—and when oil is added, it gets dirty immediately. The purpose of changing oil is to drain out dirt and contaminants, and add clean oil. If the new oil quickly picks up dirt, you're really not doing your engine much good. If you have a dirty engine, it's a good idea to use a can of engine flush, following the easy instructions on the can before draining the old oil.

### DOING THE JOB

Lay out everything you'll need, including your tools, and a couple of rags or some paper towels for wiping spilled oil and greasy hands. Run the engine until it reaches operating temperature—this allows the oil to circulate and pick up the contaminants you want to drain out.

Carefully jack up the car's front-

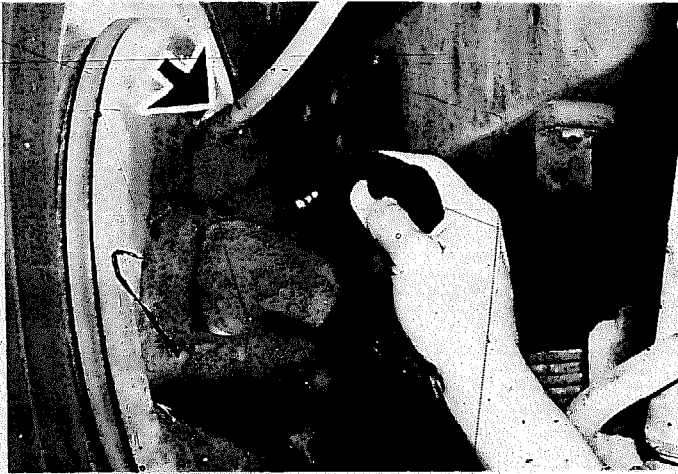

Lube old-style ball joints, after wiping the grease fitting clean, by pumping lube into the joint until clean grease oozes out. Wipe the excess from around the

joint. Sealed ball joints should be filled with lube until they just begin to expand. Overdoing it will ruin the seal, and the joint will run dry. The solid grease plugs

on sealed joints should be reinstalled immediately after lubing. Replacing these plugs with permanent grease fittings is not recommended.

end, and place it securely on jack stands. But, first set the parking brake and chock the rear wheels. Or drive it onto your ramps. If the car is on ramps, you should also chock the front wheels to prevent any movement. Lay a sheet of cardboard under the oil pan and position the drip pan under the drain plug. Loosen the drain plug with a wrench. Screw the plug out by hand until the last thread is about to let go. Then give it a quick final turn and pull it and your hand away from the hot oil which will flow out.

While the oil runs out, check underneath the car for some of the inspection items mentioned in last month's "Back-Yard Mechanic." Look for any fluid leakage around the bottom of the radiator and transmission oil pan, at the rear axle, and at the insides of all four wheels. Inspect the brake lines and suspension system carefully.

When most of the oil is drained out, remove the oil filter. The filter cartridge should be loose enough that you can remove it by hand. If not, use a filter wrench, or drive a punch or large nail through the filter and use it for leverage to break the cartridge loose. The oil filter will contain oil, so be sure there is a pan under it.

With the filter removed, the drain plug out and the ignition off, turn the crankshaft over a couple of times with the starter or an extension hand starter to work the last drops of oil out of the crankcase (the engine will

be ruined, if you operate it without oil). While the final bit of oil drips out, you can check the fluid levels.

#### FLUID LEVELS

The manual transmission and differential (rear axle) fluid levels can be checked by unscrewing the plugs located at the back or side of the housings. Some of these plugs are designed to be opened with a special wrench, but a 1/2-inch drive ratchet will do the trick on the square-hole plugs. Insert the drive into the plug and twist it loose. If the plug is so tight that it might damage the ratchet drive, get the proper wrench or have the levels checked at a service station. The fluid levels should be at least even with the bottom of the plug holes when the car is sitting level; if the front-end is blocked up, the lube should seep out when you loosen the plugs. Have the levels topped off at a service station if they are low. This operation requires a special lubricant syringe that facilitates getting the heavy lubricant into the casings.

#### CHASSIS LUBE

If you own one of the new lubricated-for-life cars, or a car with an extended lube period (30,000 to 40,000 miles), it probably wouldn't pay you to invest in lube equipment. However, if you own a pre-1970 car, or more than one vehicle, you can save a considerable sum by investing in a small grease gun (under \$6), and doing your own lubes. Check

your owner's manual for the required lubrication frequency and for a lube chart.

Most new cars utilize sealed ball joints which require a different lubing procedure than the old-style joints. These joints should be filled by removing the solid grease plug and using a grease gun with a special rubber tip. Fill the joint until you feel it expand—overdoing it will ruin the seal. If you don't have a rubber tip adapter for your grease gun, screw a regular grease fitting into the hole to add lube. Replace the solid plug immediately—a regular grease fitting may not retain the pressures developed in a sealed joint, and it may run dry. However, this job cannot be done on a ramp; the wheels should be hanging free when the joints are lubed.

Lubing an older car takes a little more time. Pre-1970 cars may have 10 or more grease fittings scattered throughout the front-end and drive train. Check a lube chart (if it's available) for all the required lube spots on your car. If you don't have a lube chart—you'll just have to look closely for all the fittings. Older cars should

*continued*





After all the oil is drained out, replace the drain plug, wipe the filter seat (shown) clean, and spin the new filter on. Fill the crankcase with the proper quantity of oil—idle the engine for a few seconds to allow the new filter to absorb oil, and check the dipstick to be sure the oil is up to the proper level. Operate the engine at fast idle for a few minutes, and check for leaks at

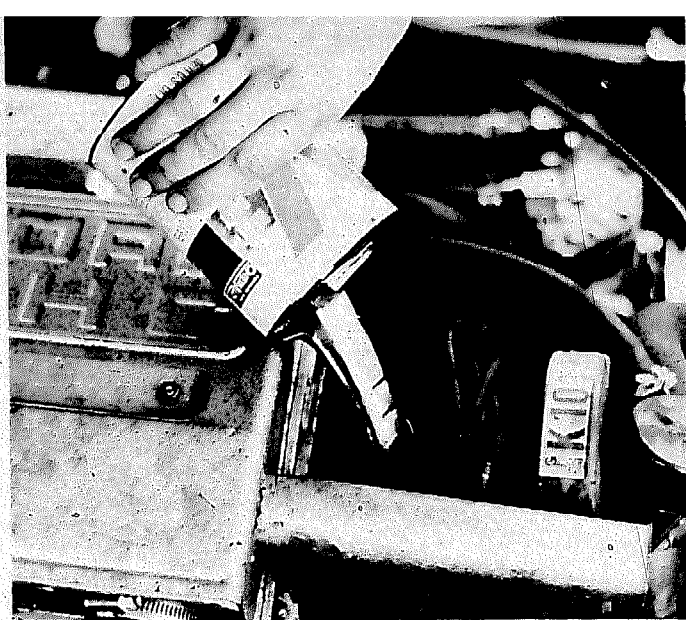

the filter—filter gaskets don't always seal correctly. Check the car over, and tighten nuts and bolts on the underside. Now you can further emulate a high-class service station job by lubing the distributor cam, putting a drop of light machine oil in the generator/alternator oil receptacle, vacuuming the inside of the car, and washing the windshield, windows, and light lenses.

continued

## THE BACK-YARD MECHANIC

be lubed, after wiping the fitting clean, by snapping the grease gun nozzle onto the fitting and pumping the lube into the joint until clean grease oozes out. To keep it from collecting dirt, be sure to wipe the excess grease from the outside of the fitting.

### FINISH THE JOB

After hitting all the lube spots, clean the oil pan drain plug threads, and gasket (if it has one), and install the plug. Tighten it snugly with a wrench. Apply a light film of engine oil to the filter gasket. Wipe the filter seat (at the engine) clean, and be sure the old gasket is not sticking to

the seat. Start the threads carefully, and spin the new filter on until the turning gets harder. Give the filter another half turn to seal the gasket. Don't wrench the filter on any tighter—this may distort the gasket and cause a leak.

Fill the crankcase with the proper amount of oil, and idle the engine for a few seconds to allow the new filter to absorb oil. Check the dipstick to make sure the oil is up to the proper level. Then fast-idle it for a few minutes—switch the engine off and check for leaks at the filter. The filter gasket doesn't always seal correctly.

### NOT QUITE YET

Before putting everything away, take a couple of extra minutes to put on some final touches that will really

outdo a service station job. Some cars call for lubrication of such parts as steering-arms stops, transmission linkage, distributor, latches and hinges, and parking brake cable. Check your manual for these items. This is also a good time to inspect some of the important items mentioned in last month's "Back-Yard Mechanic" article if you haven't already done so.

One final bit of preventive maintenance that's likely to save you some trouble is tightening nuts and bolts from one end of the car to the other. Give special attention to tightening the oil and automatic transmission pans—these bolts frequently work loose and account for most of the liquid splotches you find under your car.



## WHAT ABOUT THE MESS?

Now you've finally finished—except for one thing. You're left holding the bag, so to speak—well, really, the bucket . . . of dirty oil. There are several things you can do with this fluid mess, but we feel one of the best solutions is to pour the oil into a sealable container (such as a plastic bottle), cap it tightly and take it to a service station for disposal. •

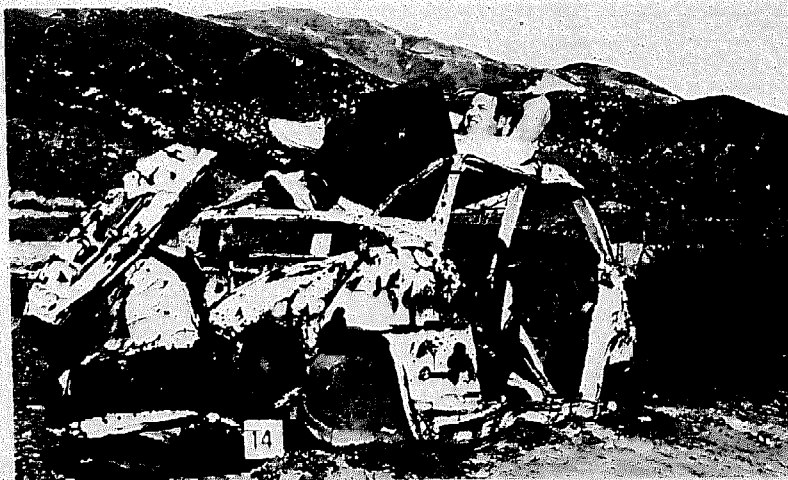

To most people, an automatic transmission is a mysterious device which takes the hassle (or the fun) out of driving. Few motorists dare even contemplate the inside works of their "magic" gear box. This is unfortunate, and one reason automatic transmission shops are so busy.

There's no doubt an automatic transmission is a complex and sophisticated bit of machinery—specialists spend years learning the specifics and idiosyncrasies of the many types and varieties used today. But neither the principles behind the automatic nor the routine maintenance required to keep it working correctly are that mysterious or intricate.

You can perform many common transmission maintenance tasks easily at home, and probably avoid an expensive transmission job. All you really need is a basic understanding of your automatic. If you have serious transmission problems, however, having it repaired at a reputable specialty shop or by a qualified mechanic is the *only* way to go.

### FLUID LINK

The transmission in any vehicle has a rather difficult job—providing a link between a constantly turning engine and the drive wheels which turn only part of the time. In the "old days" (as well as today on about 10 percent of all cars), this problem was resolved by use of a manually operated clutch, which physically disconnected the engine from the gears. The automatic transmission eliminates the clutch "nuisance" (or fun) by replacing the mechanical link with a fluid coupling that allows the engine to idle while the gear lever is in "Drive."

### HYDRAULIC COMPUTER

But, being more than just a link, the automatic transmission is a computer which matches your demand for acceleration with engine speed, wheel speed, and load conditions. It then chooses the proper gear ratio and initiates a gear change if necessary, and does it quite accurately if it is in good operating condition.

Various types and styles of automatic shifters have been tried since the first semi-automatic was introduced in the 1930s. Today, however, most automatics are basically the same, and consist of three hydro-mechanical devices: a torque converter to provide the fluid link, a set of valves operated by oil pressure to control transmission bands and initiate shifts, and two planetary gear assemblies to transmit the power (Fig. 1).

### POWER LINK

The torque converter provides the fluid coupling. It fits onto the front of the transmission housing, and bolts into

# THE BACK-YARD MECHANIC PART IV

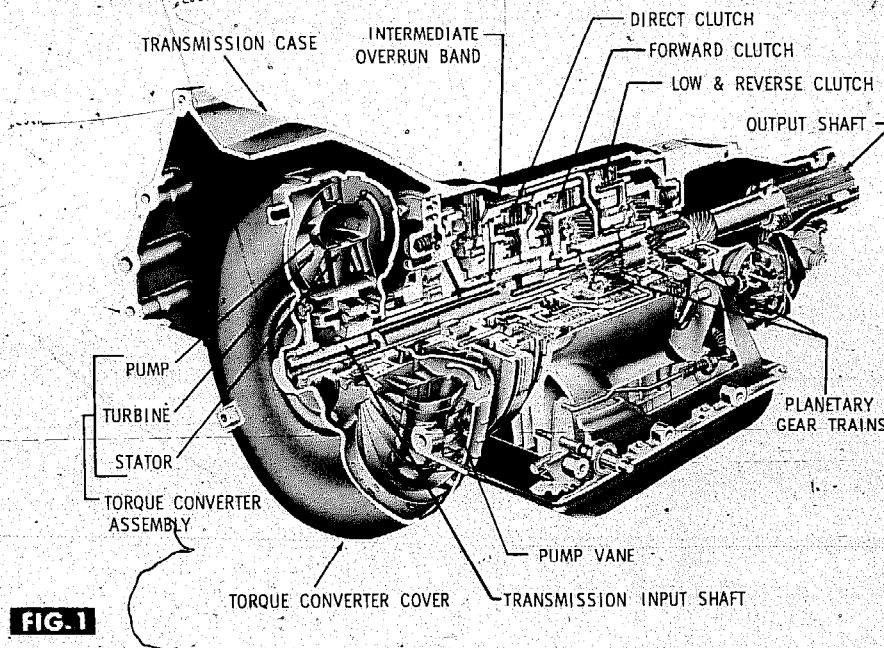

**FIG. 1**

the engine. Inside its housing are three sets of blades known as the pump, stator, and turbine, immersed in light oil (transmission fluid) (Fig. 1). Energy passes from the engine through the fluid and the blades, and is transmitted as mechanical torque to the drive wheels by the output shaft. All three blade sets rotate together at cruising speed, providing maximum output with little slippage. At idle, the torque converter allows maximum slippage and very little torque output.

### SERVOS

A small pump inside the gear box initiates the big job of changing gear ratios. This pump supplies fluid under pressure to various piston-in-cylinder servos (Fig. 2). These servo units perform the hydro-mechanical functions of operating the clutches and brakes (inside the transmission) which effect gear changes.

### BANDS

Actual gear changes are possible through two sets of planetary gears

(Figs. 1 & 2). These gears are so arranged that those not held by a brake (transmission band) will move. A transmission band is simply a circular strip of spring steel that fits around a drum or shaft which controls a planetary gear or one of its members. When the servo-unit piston closes the band properly around a drum or shaft to keep it from turning, a gear change occurs. (Fig. 3).

The transmission bands, however, sometimes loosen or get out of adjustment and can't clamp around the component tightly enough; then you may get "slipping" or erratic shifts and need a band adjustment. But, on most late-model cars, band adjustment is seldom necessary after the initial warranty work.

### FLUID

Since the entire transmission is bathed in fluid and operates on hydraulic pressure, the best way to prevent transmission problems is to check the transmission dipstick frequently. Your manual shows the proper procedure for this—usually done with the engine warmed to

Your automatic transmission is a complex bit of machinery—but you can keep it working right, and easily cure most of its minor ailments before they become serious.

**NOTE:** Because of the many different types and varieties of automatic transmissions in use, this article is designed to be only a general guide. It should help the back-yard mechanic understand his transmission, and to avoid expensive and unnecessary repairs. The procedures outlined are generally applicable to all transmissions, but a manual should be consulted before doing any transmission work.

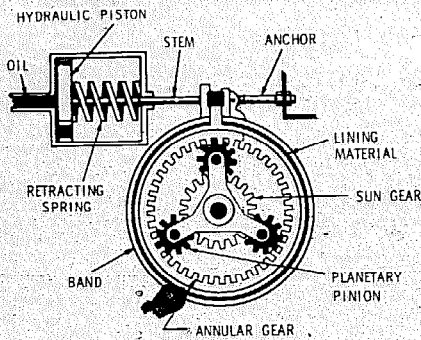

**FIG. 2**

operating temperature and idling in "PARK." But first work the selector lever through the gears a couple of times (with your foot on the brake) to allow all the valves and passages to fill before you check the fluid level.

#### COLOR IMPORTANT

The transmission dipstick is nearly always found near the fire wall on the side opposite the steering wheel. Read the dipstick in the same manner you would read the crankcase dipstick. Check for fluid color as well as level. The fluid should be sparkling red, with no contamination. Fluid which is orange or black, swells like varnish, or is contaminated, indicates a possible parts failure or other transmission damage.

#### ADD FLUID

Bring the fluid level up to specifications if it is low, using only fluid recommended by the manufacturer; there is no longer a universal-type transmission fluid.

Most transmissions are filled through

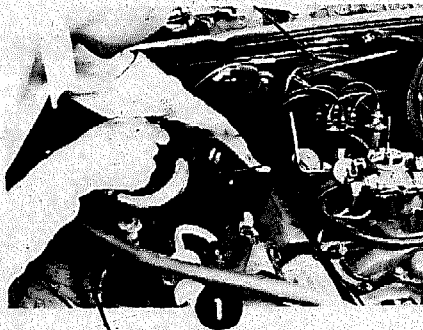

Checking the fluid regularly is the best way to prevent automatic transmission problems. The transmission dipstick is usually found at the rear of the engine compartment, near the fire wall.

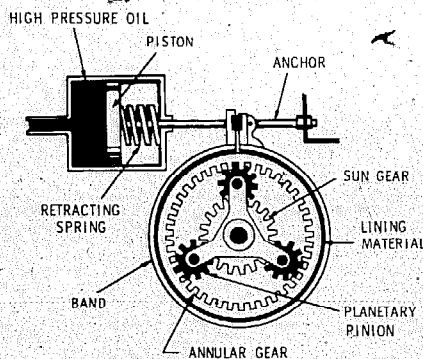

**FIG. 3**

Fluid is usually checked with the engine at operating temperature, and idling in "Park." Bring the fluid level up to specifications if it is low, using only fluid recommended by the car manufacturer.

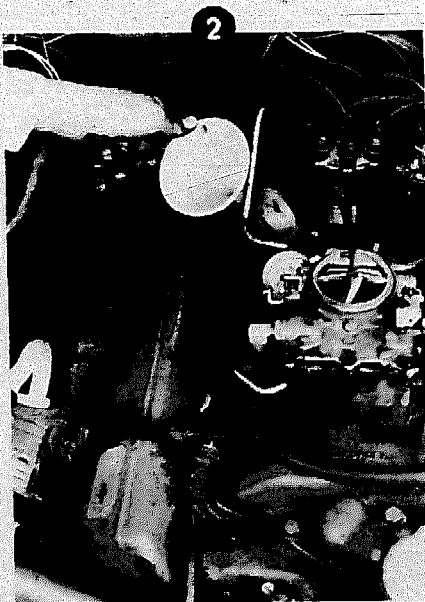

the tube that holds the dipstick. Do not overfill the transmission; while low fluid will cause harsh or erratic shifts and damage the internal parts, too much fluid will aerate and cause similar troubles. If the fluid level is above the "Full" mark on the dipstick, check it again after thoroughly heating the engine and running through the gear ranges. If it still indicates overfull, drain the excess.

Even if you keep the fluid level up to specs and otherwise treat your automatic properly, you may still encounter some transmission difficulties. Your transmission might also require a periodic fluid change or "tuneup." Most of these jobs can be done at home or in the hobby shop, with few if any special tools (depending upon the type and condition of the transmission).

#### MANUAL ESSENTIAL

Before getting into any transmission work, however, we must emphasize that a shop manual covering the transmission in your car is *absolutely* essential. While most new transmissions are essentially the same, there are still more than 20 different types and variations in common use; so DRIVER couldn't possibly cover even part of them in any detail.

The procedures to be discussed are generally applicable to most transmissions, but you should study your manual carefully for the specifics on yours. The manual should outline most of these jobs, step-by-step.

#### COMMON PROBLEM

Harsh, erratic, or "slipping" shifts are high on the list of automatic transmission ailments, and should be taken care of immediately to prevent serious damage. But, many unsuspecting automatic owners rush off to a transmission shop and rack up a big bill unnecessarily.

Bad shifts are more often the result of minor part failure or improper fluid level than anything more serious. Some less scrupulous shops have been known to replace only a minor part, and soak the customer for a lot of work not needed or completed. So, if your car develops shifting problems, it's well worth your time and money to look into it yourself.

*continued*

continued

## THE BACK-YARD MECHANIC

### TRACE DOWN A BAD SHIFT.

Check the fluid first. Be especially cautious of small carbon specks which result from overheating of the fluid—these can easily block the sensitive valves and passages in your transmission. If the level is AOK, and the fluid isn't discolored or contaminated, trace all fluid and vacuum lines from the transmission to their sources, looking for cracks or leaks.

### KICKERS?

If those items check out and you still have bad shifts, don't panic. Some transmissions have electric kickdown switches which can cause problems. These switches are often found on or near the carburetor—your service manual shows the location of this switch if your transmission uses one. Disconnect the switch and road-test the car. If shifting smooths out, replace the switch.

Many cars use a manual kicking valve similar to the kick-down switch. This valve is controlled by pressure linkage on the carburetor, and can be disconnected for a road test. If shifting improves, replace the valve.

### MODULATOR VALVE

This item causes more transmission

problems than any other part. The inexpensive little valve is used on nearly all transmissions, Chrysler products being one exception.

The modulator valve is screwed into the transmission housing, and is connected to the carburetor by a vacuum line. It is easily replaced by simply unscrewing the old valve and installing a new one. However, you'll probably need to raise the car to get to the valve easily.

Place the car's front-end carefully up on jack stands (or drive it onto ramps), set the parking brake, and chock the wheels. Be sure the pins on the safety stands are fully extended through the holes and secured—they can slip out if they're not.

Place a drip pan under the modulator valve, pull the vacuum line, and unscrew the valve. Most valves have an interior spring-and-pin assembly—remove the pin when removing the valve, and reinstall the new valve with the old pin. Fluid will leak from the hole, so install the new valve as quickly as possible. Have a pint or two of transmission oil handy, just in case you lose an excessive amount in the process.

### FLUID CHANGE

If the new modulator valve doesn't correct the poor shifting, and your car's

transmission is so equipped, drain the transmission reservoir and clean or replace the filter or screen. This will often alleviate shifting problems, especially those occurring in automatics which require periodic fluid changes and haven't had them.\*

### TUNEUP

Some automatics may need a complete transmission tuneup to correct shifting problems. This usually involves band adjustments in addition to draining the fluid, cleaning or replacing the filter, adjusting the linkage, and replacing the fluid. Band adjusting is fairly easy on some transmissions, while others require special tools and knowledge. Study your manual carefully to determine if a band adjustment is recommended, and then decide whether you're capable of doing it. Perhaps, with a little study and a torque wrench, you can do the entire job.

### DRAINING FLUID

With the required amount of fluid, a transmission pan gasket, and a new screen or filter (if required) on hand,

*\*On some transmissions periodic oil changes are recommended only during a tuneup or major maintenance, or when the fluid is contaminated. Check your manual for your transmission's requirements, and never exceed the specified change frequency.*

The transmission linkage and electric kick-down switch (kicking-valve) are easily adjusted or replaced. They frequently cause improper automatic shifts.

The modulator valve (arrow) is an inexpensive item which screws into the back of the transmission housing. It causes more transmission problems than any other part. Replacing this part may correct any minor transmission problems you have, including erratic shifts.

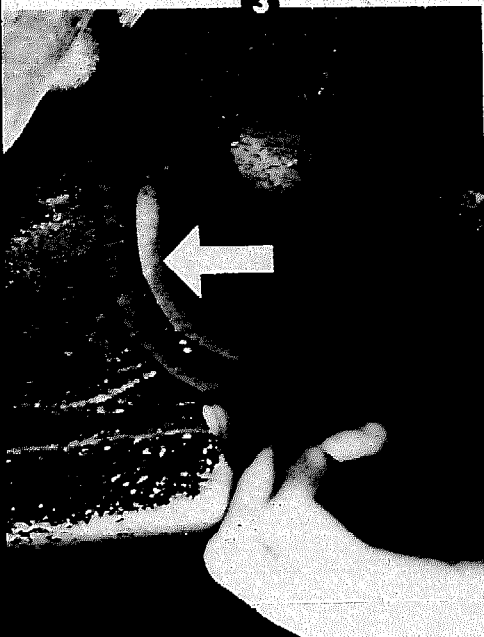

you're ready to drain the old fluid. Raise the car on stands or ramps and place a container under the transmission pan—some transmissions hold as much as 8 quarts of oil, so be sure the container is large enough to hold it all.

Some transmissions have drain plugs—most don't. If not, you'll have to remove the pan to drain the fluid. Loosen two opposing pan bolts, remove the others, and pop the pan loose with a screwdriver or putty knife. Allow time for the oil in the transmission to drain, then hold the pan steady while you remove the two loosened nuts—and be careful not to spill the fluid when you lower and empty the pan. The torque converter should also be drained. Most have one drain plug, and some have two—check your manual.

Inspect the drained fluid carefully for carbon specks or metal debris; if you find either, you may need a transmission overhaul. Clean the pan and parts such as the torque converter and filter or screen, as specified in the manual.

#### WATCH THOSE BOLTS

Replace removed drain plugs, fit the transmission pan with the new gasket, and replace the pan. Don't overdo it when tightening the pan bolts. Anything past "good-and-snug" may distort the gasket or the pan and produce a leak.

Refill the transmission with fluid, but

stop a little short of the recommended refill capacity. Start the car and let it warm to operating temperature. Work the selector lever through the gears to fill all the valves; then, with the selector in "Park," slowly add fluid up to the proper level.

#### OTHER PROBLEMS

A frequent problem which terrifies an unsuspecting automatic owner is a car that won't move when he operates the lever—or one that starts in any gear.

Both of these situations are frequently caused by a loose or damaged neutral safety switch. A properly functioning switch insures your car will start only in "Park" or "Neutral." Tightening or replacing the switch will usually solve both problems. The neutral switch is usually located on the steering column, or under the selector lever housing on a floor-mounted lever. Your manual shows the exact location and gives service tips.

#### LEAKS AND NOISES

Leaks and unusual noises are some of the most frequent complaints of automatic transmission owners. Leaks can be serious if not repaired; they might result in your driving when the fluid is low, which can damage your transmission. Make occasional checks for splotches of transmission oil beneath your car after it has been parked over-

night. Minor leaks from such areas as the modular valve, oil cooler fittings, and speedometer adapter O-ring can be easily traced and repaired.

Unfortunately, most major leaks are from the main seals, and require dropping the transmission for repair. A can of transmission sealer may help a small leak, but a major leak calls for seal replacement.

Some noise is normal in most automatics. A persistent knock or scrape, however, usually means a loose torque converter or a cracked drive plate which should be repaired immediately. Grinding, clunking, or excessive noise of any kind also indicates needed repair.

So, briefly, this is the automatic transmission story. If you take your car in for the initial (warranty) transmission adjustments, and check the fluid regularly, you shouldn't have these troubles.

But, if your transmission does get a little out of shape—keep your cool; study your manual and follow the steps outlined here, and you'll probably have it back in shape in no time. If it's too complicated for you to handle, get to a reputable shop immediately—driving with a poorly operating automatic can, and usually does, cause serious and very expensive damage. •

One of the most common transmission maintenance procedures is draining the fluid, cleaning or replacing parts, and adding new fluid. Some transmissions have drain plugs—most don't, and require dropping the pan (right).

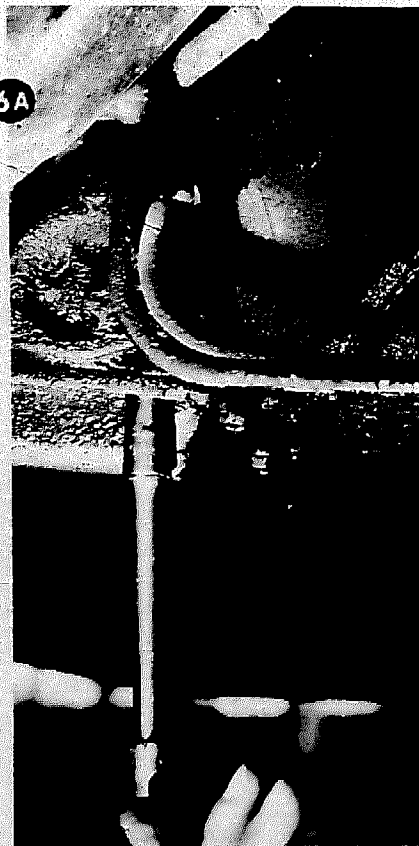
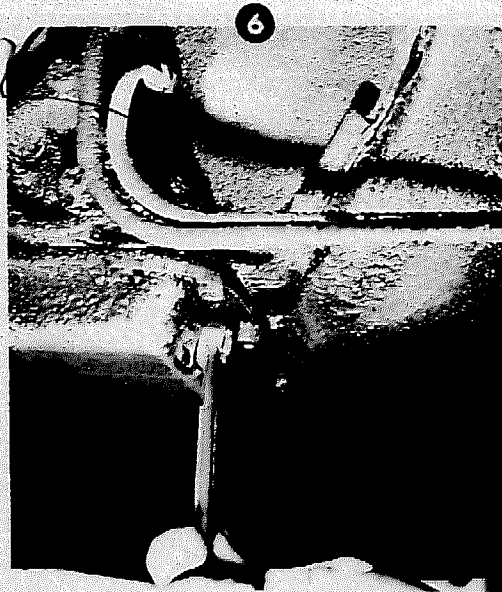

Some automatics require periodic band adjustments and fluid drains. Band adjusting, as well as most common transmission maintenance, can usually be performed by the back-yard mechanic who studies a manual. Studying a shop manual, or general manual which gives exact specifications and procedures, is essential before doing any transmission work.

**7** Install vacuum modulator with the vacuum modulator and the gasket.

14. Install oil pan, using a new gasket, then the main attaching bolts.

15. Install the converter and safety holding strap J-2949 or a suitable substitute.

**Low Band Adjustment**

Tighten the low servo adjusting screw to 40 inch pounds. The input

we full  
151. A. 5  
sure, in  
to 3 MP  
applied  
locking  
the screw  
while the  
Notes:  
adjustment  
screw to

#### TORQUE REFERENCES

Transmission Case to Engine  
25-30

# DISC BRAKES *screeeeeeeech*



**D**isc brakes are super-effective, but super-complicated; the average guy shouldn't mess with them . . . Right? Wrong! This is a popular, but erroneous, misconception among many back-yard mechanics.

Caliper disc brakes are, in fact, far less complicated and easier to work on than conventional drum brakes. You can replace worn friction pads, the equivalent of "relining" drum brakes, easily at home in less than an hour. This is the most common disc brake maintenance, and can usually be performed with only a few simple tools. And, doing it yourself can save as much as \$30.

Discs are now standard on at least the front wheels of many cars, and operate essentially in the same manner as conventional drum brakes. Fluid pressure created by depressing the brake pedal pushes out a set of pistons (either two or four in each caliper). These pistons force a set of brake pads against the wheel assembly rotor, or disc, creating friction to slow the turning wheel (Fig. 1). These friction pads wear, just as drum-brake linings wear, and need periodic replacement. Disc pads generally wear faster than drum linings.

(left) Pins or bolts, usually in combination with springs, spacers, and washers, hold the pads in the calipers on most disc brakes. Driving or pulling the pins out and removing other retainers frees the pads.

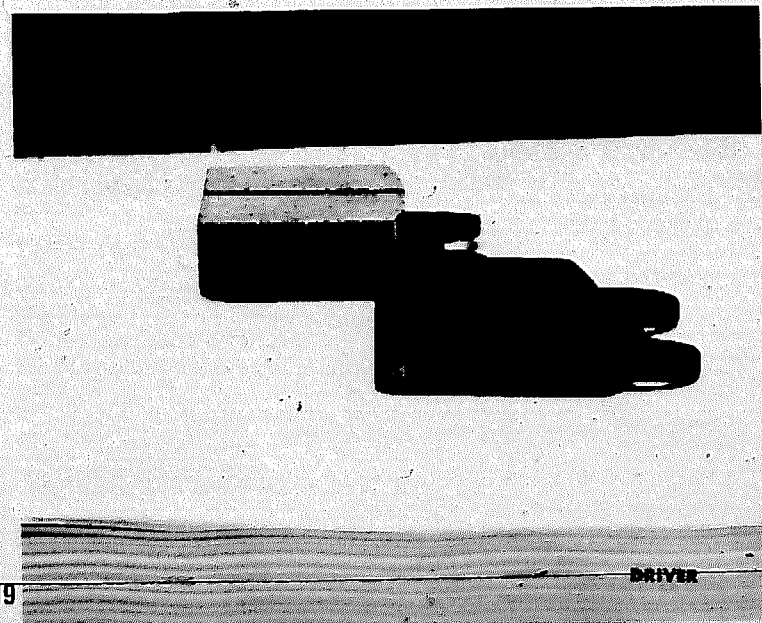
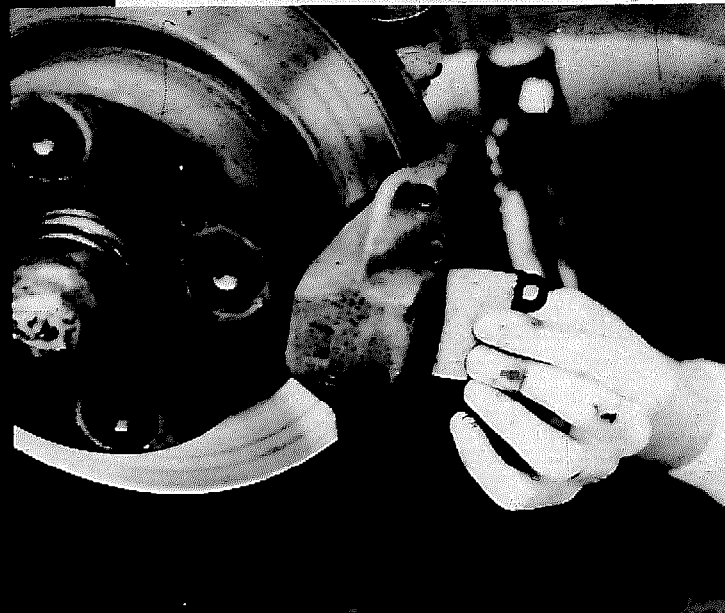
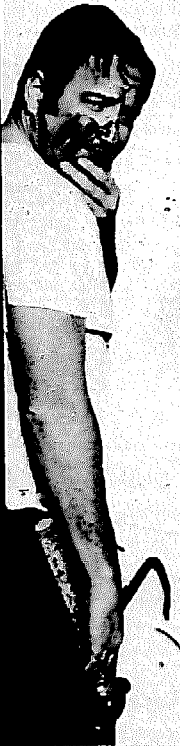

# Jeep



Disc brakes are far more effective than conventional drum brakes, yet less complicated. You can reline your disc brakes easily at home. It just takes a few minutes, and a few common tools. And, if you do it regularly, you'll probably never have to worry about doing any other disc brake maintenance.

and should be checked regularly for excessive decrease in pad thickness:

### WHEN TO REPLACE

Measure the pad thickness with a ruler or feeler gage after the first 12,000 miles, and each additional 6,000 miles after that. Some pads must be removed from the caliper to be measured, while others can be checked in place. Always have a new set of pads on hand if you have the type which must be removed for inspection—then you can immediately install the new pads if the old ones are too thin.

Replace the pads when they are worn to less than 1/8-inch thickness, or worn to the minimum thickness specified in your manual. If the pads are allowed to wear past 1/16-inch thickness, expensive caliper and/or disc damage will result. Replacing these inexpensive pads well before they reach their wear limits is strongly recommended by brake experts for obtaining maximum trouble-free brake life.

### LATERAL RUNOUT

While regular pad replacement may prevent the need for any major disc brake work, there are a couple of fairly common problems which can develop. Lateral runout is a condition affecting the disc. Runout is the movement of the disc from side to side (wobble) as it rotates. This condition is usually the reason for noise, chatter, or vibrations during braking. Brake disc replacement is required when there is excessive runout, so be sure to have the discs checked by a mechanic at the first sign of trouble.

### PARALLELISM

This situation is simply a variation in the thickness of the disc. It can also re-

(far left)  
Pads are easily pulled from the caliper after removal of the pins and retainers.

(near left)  
This pad (front) is not worn all the way to the replacement point, but is badly glazed. Frequent pad replacements are recommended to prevent disc damage from unevenly or excessively worn pads, and to insure maximum brake life and service.

sult in the need for disc replacement if left unattended. However, you can look for this condition when checking the pads, by measuring the disc thickness at four opposite places. Your manual shows how to control developing parallelism.

### STUDY MANUAL

Pad replacement consists basically of the five steps outlined below. Before beginning to work, however, study a manual carefully to familiarize yourself with the procedure given for your brakes. Also, check the manual for recommended installation of other new parts when friction pads are replaced. It's often recommended that parts such as pins, springs, and clips be discarded and new ones installed when changing pads. You should replace any of these parts if they are corroded, bent, or worn, even if replacement is not recommended in the manual.

### PAD REPLACEMENT EASY ON ALL BRAKES

There are three basic disc brake types manufactured by six main companies. Although disc brakes differ somewhat in design, pad replacement is nearly

*continued*

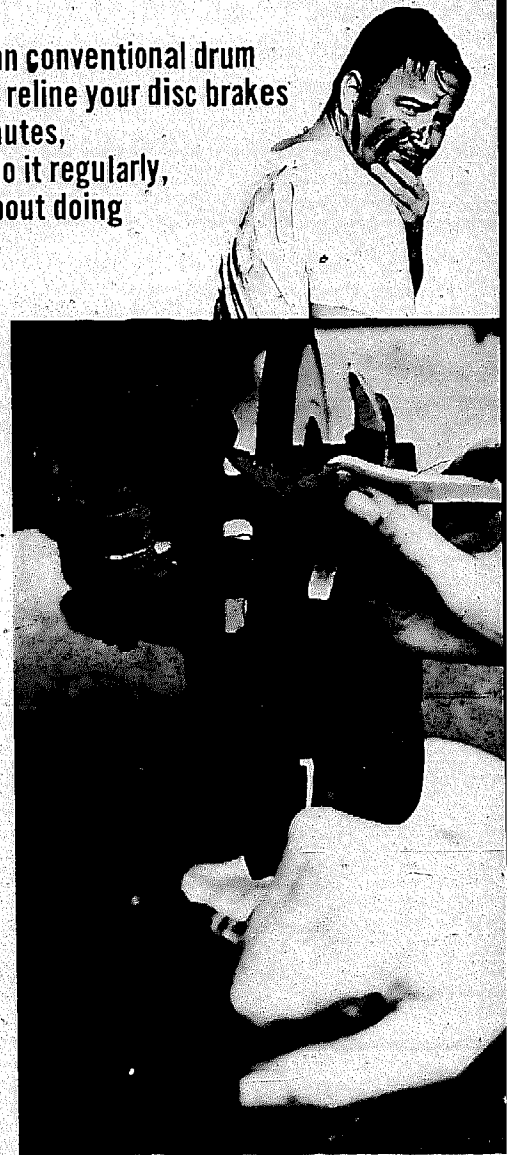

Bottoming the brake system pistons in their bores is necessary to make room to insert the new, thicker brake pads. A special tool is recommended for this job, but it can be done with common tools if you're careful not to damage the piston or disc.

Fig. 1

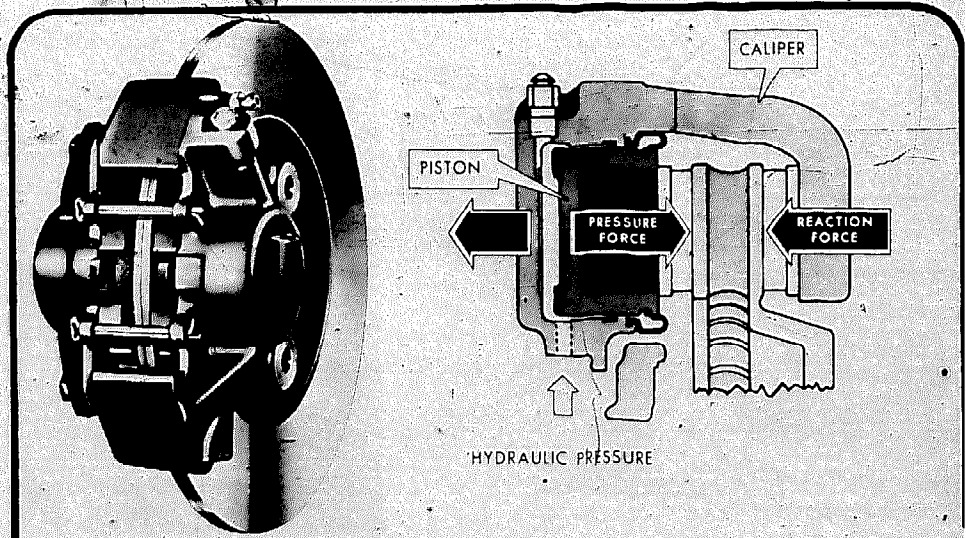

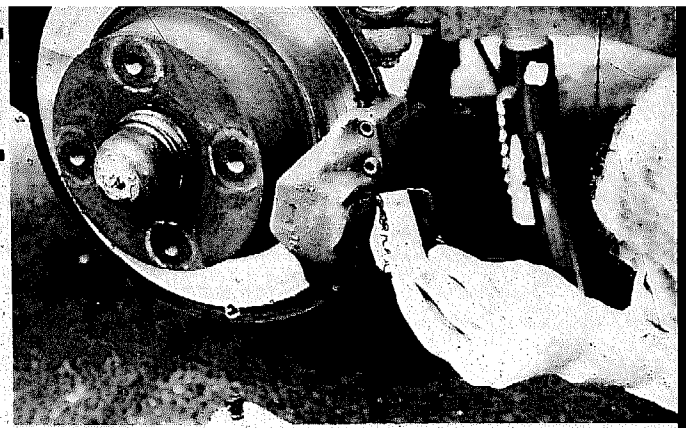
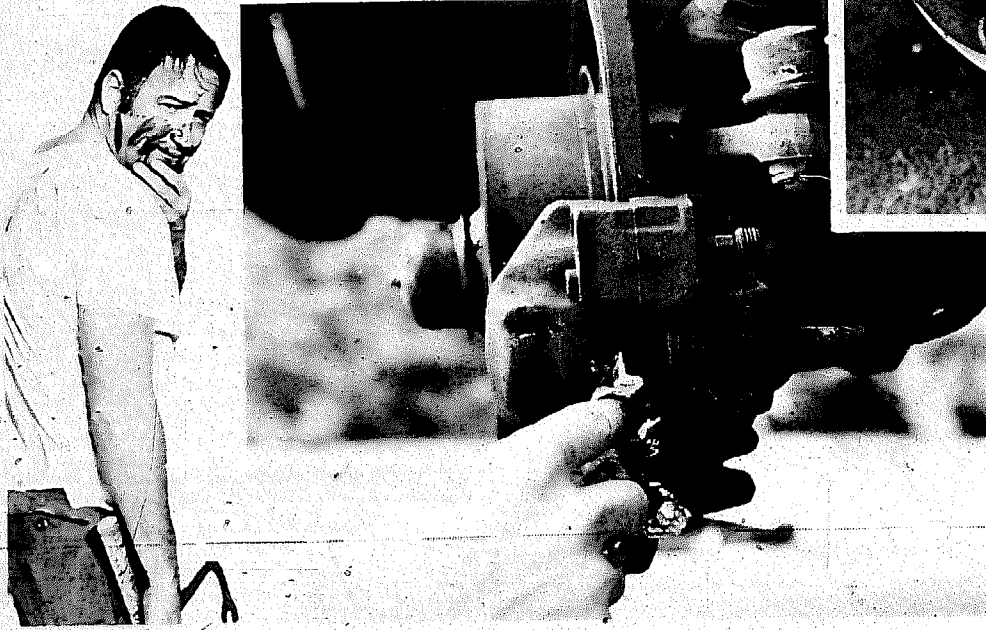

The caliper and disc should be cleaned with denatured alcohol (left) before inserting the new pads exactly as the old ones came out (above).

Retainers and all other parts can be carefully replaced after the pads are properly inserted into the caliper.

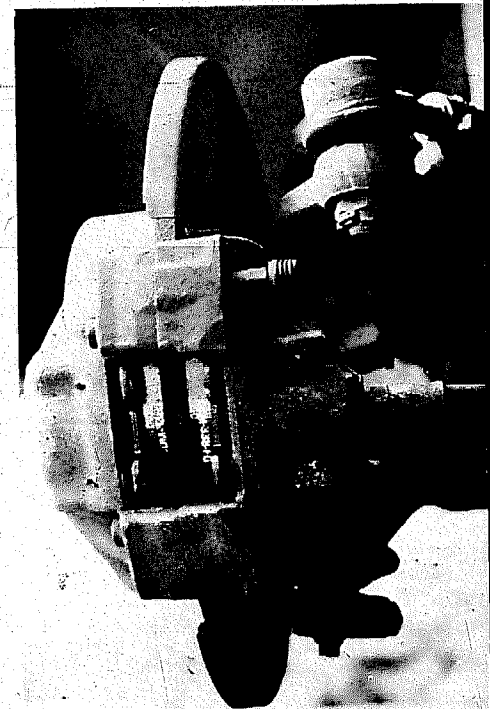

identical on all models. The main difference on some models is that the caliper must be lifted from the disc before the pads can be removed; on others, the pads can be pulled directly from the caliper.

Pads can be purchased from most parts houses, and range in price from \$10 to more than \$30 a set. However, you can often get good-quality pads for about half the usual cost from discount stores or auto parts mail-order houses. Just be sure these pads are certified to be original equipment quality, or meet SAE standards.

#### GET STARTED

First, procure new pads, other parts to be replaced (as specified in the manual), denatured alcohol (for cleaning brake parts), and a can of the proper brake fluid. Determine from the manual what tools you'll need, and have these handy. A special tool is generally recommended for compressing the pistons into their bores, but it's not necessary. This will be explained later.

Loosen the lug nuts on both front wheels before you raise the front-end. Then set the emergency brake and chock the rear wheels before raising the car's front-end just enough to get the tires off the ground, and support the car with safety stands. Don't forget to

*\*If you usually use ramps for working under your car, you'll have to borrow a set of jack stands... or head for the Base Auto Hobby Shop to do this job.*

check the stands' locking pins to be sure they are fully extended through the holes.

Remove both front wheels and compare the exploded brake diagram in the manual with the actual brake assembly on your car. Be sure to clearly identify the parts referred to in the pad-change instructions. *Work on only one wheel at a time, so you'll always have a properly assembled brake for reference.*

The next step is to determine if the caliper has to be lifted from the discs before the pads can be removed. If so, follow the removal instructions in your manual, and securely suspend the removed caliper from the car with a piece of safety wire to prevent damage to the unit and brake fluid line.

#### REMOVE PADS

The retainers that hold the pads in place can now be carefully removed. They may be cotter pins, bolts, clips, or springs. Most cars use a form of pin, often in combination with washers, clips, springs, or spacers. Drive or pull these pins (whichever is required) through the caliper, and remove any other retainers, noting how they fit. Organize the removed parts on a clean surface in the order in which they were removed.

Pull the pads directly out of the caliper. This can usually be done by hand, but a pair of pliers and a little force may be needed. If your particular brake uses two differently shaped pads in the

same caliper, note which side each pad came from. If the pads are of the same dimension, it's impossible to install the new ones incorrectly.

#### CLEANING

Clean the caliper, disc, and entire brake assembly with denatured alcohol, checking as you go for fluid leaks, wear, or other unusual signs. **DO NOT** use anything but alcohol for cleaning brake parts; if petroleum-base fluids get on the disc or friction pad, the brake won't work. Be sure all parts are dry before re-installing.

#### BOTTOMING THE PISTONS

Before inserting the new pads, the brake system pistons must be forced all the way back into their bores. All disc



brakes are self adjusting—as the friction pad wears thinner, the piston comes farther out of its bore to maintain a proper seat between the pad and the disc. Therefore, each piston must be pushed back into its bore to create room to slide the new, thicker pad into the caliper.

Most manufacturers recommend special tools to prevent damaging the brake assembly when bottoming the pistons. However, the pistons have only slight fluid-spring pressure on them, and can be easily forced into their bores with common tools if you're careful.

If the piston fails to move with pressure, however, the caliper must be rebuilt. Caliper rebuilding is generally best left to a good mechanic. Opening the bleed screw will have no effect on a stuck piston, so don't do it unless you want to bleed the system.

Your manual probably suggests simple tools which can be adapted for this job. If not, a large C-clamp positioned around the caliper can be tightened to force the piston into its bore. You should protect the part by placing a block of wood or piece of sponge between the piston and the clamp; or, a screwdriver can usually be used to depress the pistons if you're extra careful.

#### DRAIN SOME FLUID

Before the pistons can be forced into their bores, however, it is sometimes recommended that some brake fluid be drained from the system. This prevents possible overflow at the master cylinder.

Fluid is drained at the master cylinder, or bled out at the bleeder screw (at the brake assembly). Follow the draining instructions in your manual carefully; if you don't, you may let air into the system... and could be in for a real "non-braking" experience.

**DO NOT** pour the drained fluid back into the system. Refill the reservoir with new fluid of the proper type after you've finished working on both brakes—before driving the car.

#### INSTALL PADS

Insert the new pads into the caliper exactly as the old ones came out. On most brakes, both pads are identical and cannot be inserted improperly. But on some, especially the four-piston disc brakes used on many larger American cars, the two pads differ. Check the assembled brake against the manual to be sure you have the pads properly inserted.

Reinstall all pins, springs, spacers, and other removed parts, being sure to replace those that need it. Finish reassembling the brake according to specifications, and replace the caliper if it was removed. Double-check the manual and compare the re-assembled brake with the other, to be positive everything is back together correctly.

Tighten any loose bleed screws or brake-line connections, and follow the instructions in the manual for bleeding and closing the system, if required. Pump the brake pedal slowly to reseat the pistons against the pads. Before pumping the brake, however, be sure there is plenty of fluid in the master cylinder reservoir. Air can be pumped into the system if the fluid level has been bled low. Reinstall the wheel assembly and spin it while your wife or buddy operates the brake pedal to be sure the brake operates.

Repeat the pad replacement and check procedures on the other brake assembly. Tighten the lug nuts properly on both wheels when you get the car on the ground. Test-drive the car, being alert for unusual noises and braking patterns—if there are none, you're all set.

#### OTHER MAINTENANCE

A couple other things you may need to do at the same time you change pads include packing the wheel bearings with grease and inspecting the rear brakes. Packing the front bearings on a disc brake equipped car is fairly involved,

and usually requires removing the entire brake assembly. The job won't be covered here, but you can probably do it by following the instructions in your manual. Many people leave this job to experts, and get a complete brake system inspection at the same time.

#### REAR BRAKES

Most cars using front discs usually have standard drum brakes on the rear. These brakes do not wear as fast as the front brakes, but should also be inspected regularly. Since removing the rear drums may require special wheel pullers, it may be a good idea to have a mechanic check the rear brakes.

Disc brakes, as well as most late-model drum brakes, are self adjusting. However, some import cars, such as VW, have adjustable rear brakes. You can usually finish the job on these cars by pumping the brake pedal to centralize the brake shoes, and inserting a brake adjustment tool or screwdriver into the adjuster holes (generally found on the back sides of the wheels covered with rubber dust plugs). Turn the adjuster nut until the wheel drags slightly when spun by hand. Back off the nut until the wheel turns freely. If more than five adjustment teeth pass before the brake tightens, you're going the wrong way. Your brakes probably have two adjustment nuts per wheel. Adjust the second nut by turning it in the opposite direction. Reinsert the dust plugs. Check your manual for the specifics on your car. ●



(left) The locking pins are driven back into the caliper, and through the pad locks to finish the job.

A few cars still use adjustable rear brakes with front disc brakes. Adjust these brakes manually to specifications, after both front brakes have been relined, checked out, and road tested.

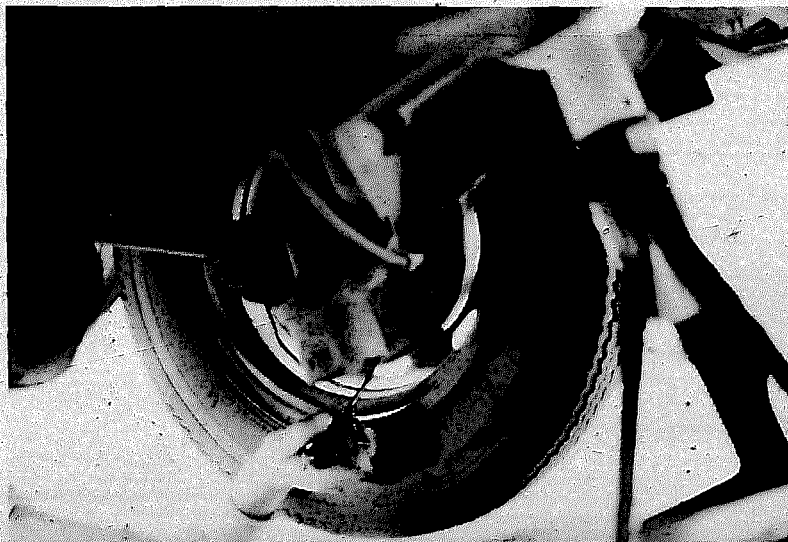

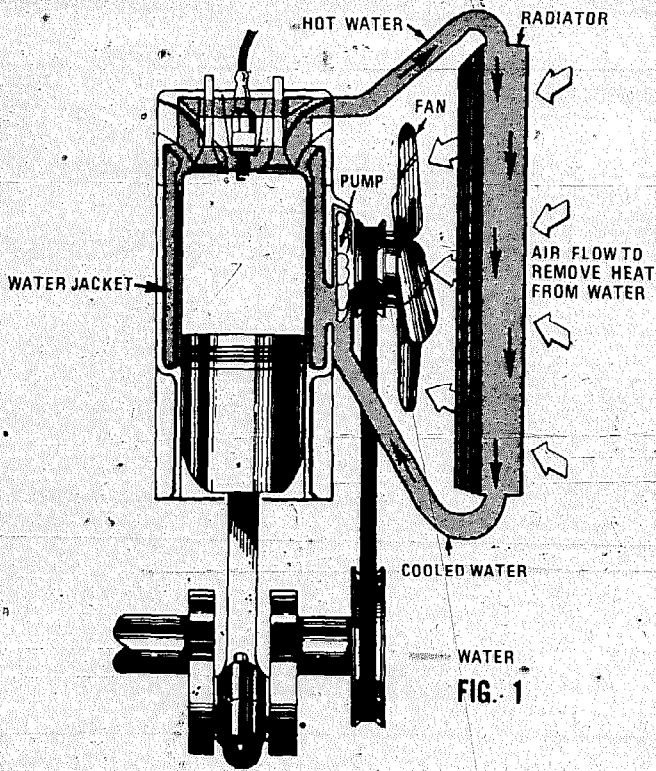

THE BACK-YARD MECHANIC PART VI

# DON'T BLOW YOUR COOLANT

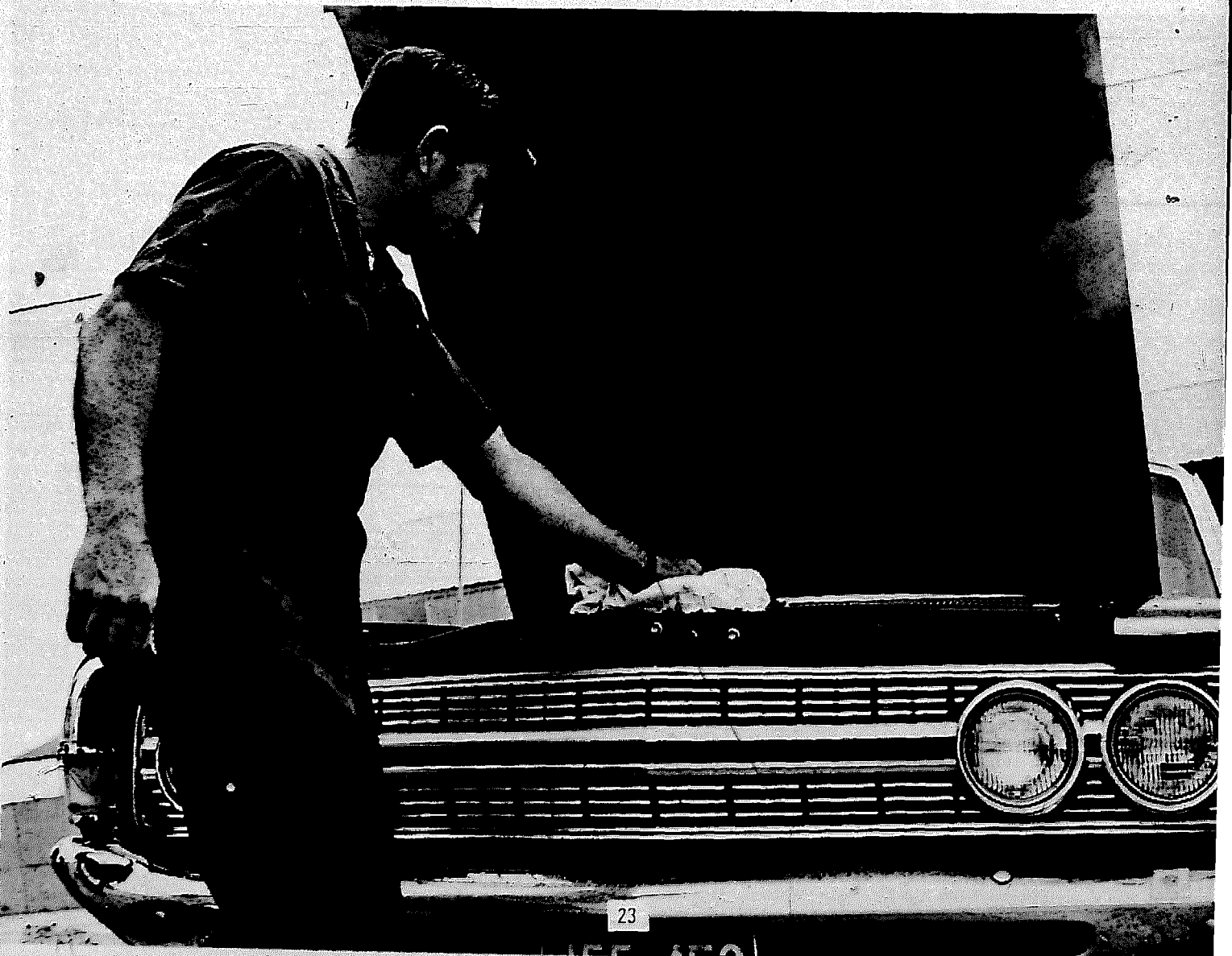

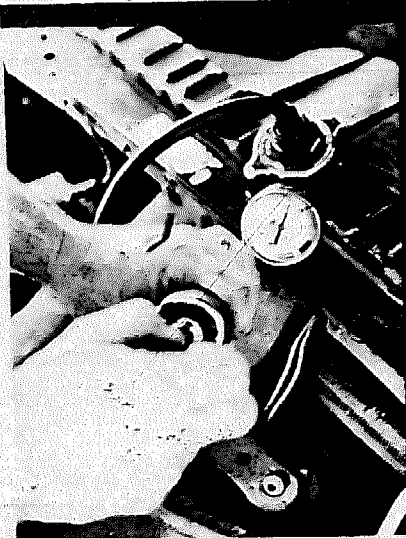

1 The most common type of pressure tester attaches to the radiator filler neck. Pump it until the dial indicates the pressure rating of the system. If the pressure reading drops, there is a leak in the system. Also use the tester to check the radiator cap for a leaking seal.



2 Radiator "Quick-Flush" products help to loosen accumulated rust and sludge before flushing the system.

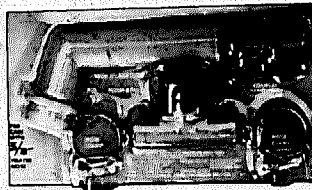

3\*

Using an inexpensive flushing kit is the safest, easiest, and most effective way to flush your cooling system at home.

4-4A

Installing a kit to flush the cooling system requires only cutting a heater hose and installing a T-fitting.



**A**lthough it's still early in the hot season, many of you have probably already had occasion to glance nervously at your temp gauge or "idiot light" as you passed a car with its hood up—radiator steaming.

If the sight of an overheated car bothered you a little bit, you had good reason to be concerned. More cars than ever are overheating. This is partly because today's low-compression, emission-controlled engines run much hotter. Newer cars also have hotter rated thermostats, but smaller radiators and a decreased ability to dissipate heat. However, if your car's cooling system is kept in good condition, it can easily handle the heat.

Most cars overheat because their owners don't take a few minutes to do the very simple and inexpensive periodic maintenance their cooling system needs.

It's easy to understand the need for a cooling system when you realize that combustion temperatures inside your engine reach 4,500° F. Temperatures of lubricated parts, such as pistons, exceed 400° F, and the engine would quickly destroy itself if some means were not employed to dissipate the heat.

Most cars circulate liquid (some engines are air cooled) around the cylinders and heads to conduct heat away from the engine. The hot coolant is pumped from the engine to the radiator and cooled by air from the fan. Then the cooled liquid is returned to the engine to repeat the job. (Fig. 1.)

#### PRESSURE ESSENTIAL

In addition to liquid coolant, proper pressure is essential in a modern cooling system. Cooling systems are pressurized to allow the engine to run hotter without boiling the vital coolant.

For instance, the boiling temperature of ethylene glycol antifreeze-coolant at sea level is around 220° F. Add 15 pounds of pressure, however, and the boiling level jumps to about 265° F.

Since the normal operating temperature of many engines is near 200° F, it is essential that your car's cooling system hold the proper pressure for the engine to keep its cool under strain.

This pressurization is why you should remove the radiator cap very carefully, only after bleeding off the pressure—especially when the engine is hot. What many of you may have painfully discovered is that when the engine is hot, the coolant may be hotter than its normal boiling temperature, but doesn't boil because it's under pressure. When the radiator cap is removed quickly, the pressure drops, and the boiling level falls well below the temperature of the coolant. The result: a dangerous geyser of super-hot liquid.

#### PRESSURE CHECK

Checking your car's cooling system for pressure leaks is an important part of maintaining the system. This should be done at least every 2 years, when the system is flushed and other maintenance performed.\* The pressure test can be performed before draining the coolant, to test the hose condition, since most leaks occur at hoses or con-

nections. If you're planning to replace any hoses, however, do a pressure check as a final step to be sure the system is holding pressure.

You can purchase a pressure tester for around \$20. But, no more frequently than you'll use it, you may want to head for the hobby shop or have a mechanic perform the pressure check.

There are two basic types of pressure testers, but the most common type simply attaches to the radiator filler neck after removing the cap. Pump pressure into the system until the dial on the tester indicates the pressure rating for your car (the service manual lists this, but generally a system which holds 15 psi is pressure tight). Wait about 10 minutes—if the pressure on the dial drops, you have a leak in the system.

#### CAP IMPORTANT

Clean any foreign material from beneath the rubber sealing washer on the underside of the radiator cap with a piece of stiff cardboard. Attach the cap to the tester and pump up the pressure until the dial indicates the pressure rating shown on the cap. If

*continued*

\* A recent survey indicated more than half the cars on the road have cooling systems which aren't holding their rated pressures. Since many cars overheat for this reason, it might be advisable to pressure-check the system more frequently, especially during extra hot weather, or when mountain driving is anticipated.

The products illustrated in this story are not necessarily endorsed by DRIVER or the U.S. Air Force.

continued

## DON'T BLOW YOUR COOLANT

pressure bleeds off after 5 minutes, you need a new cap. Leaking radiator caps are one of the main causes of overheating, so always replace a cap which leaks.

Your car's cooling system operates (although at a lessened capacity) even if it has a pressure leak. However, your car can't keep its cool without some type of liquid, or if rust and corrosion block the coolant passages and the radiator.

Hook a water hose (garden type) to the T-fitting. Water is back-flushed through the system—when it splashes out of the radiator, colorless, the system is clean.

### COOLANT WEARS OUT

Draining, flushing and replenishing the cooling system periodically is the most productive but most overlooked cooling system maintenance. These steps are important because all types of antifreeze-coolant lose their potency over a period of time. When the rust inhibitors in the solution are exhausted, corrosion and rust accumulate and clog the system. This clogging leads to overheating, and eventually will lead you to a shop for a radiator back-flush.

However, the fairly expensive back-flush can be easily avoided by frequently draining and flushing the system to eliminate contaminants. Most car manufacturers recommend this procedure

every 2 years or 24,000 miles. But, since antifreeze-coolant is inexpensive, it may be well worth your time and money to perform this service yearly—especially if you notice a buildup of rust or sludge in the radiator.

### FLUSHING KIT

Draining and flushing the cooling system can be done by either of two methods. The usual method requires opening all drain plugs on a hot engine (some of which may be hard to get to), and trying to flush out rust and sludge with a hose. The new "hassle-free" method requires purchasing a flushing kit for less than \$2, and spending 5 minutes to install the kit and completely flush the system.

DRIVER strongly recommends using the flushing kit, which is the fastest and most efficient method of flushing your car's cooling system at home. Using a kit is also a safer method, since it eliminates the need for opening the drain plugs, a possible source of a bad burn.

Because it is the most practical flushing method, we'll limit our discussion to the use of these widely available kits. If you prefer to drain and flush the cooling system manually, however, remember that you must open the engine drain plugs as well as the radiator drain cock to thoroughly purge the system. It's also a good idea to get a can of radiator "quick-flush" and follow

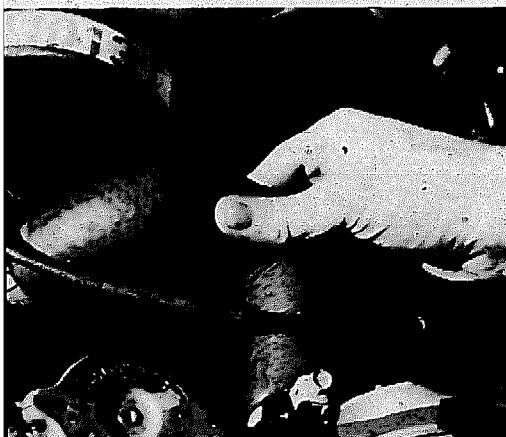
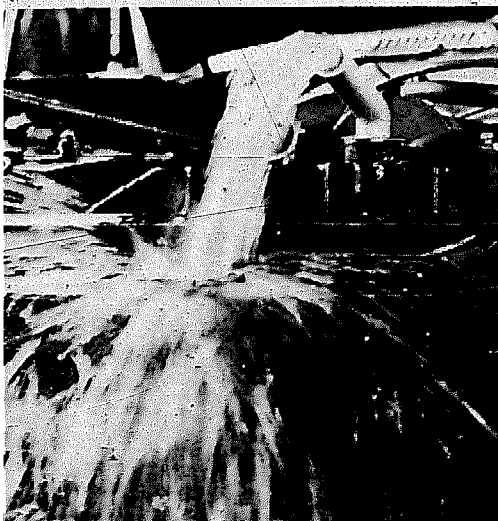
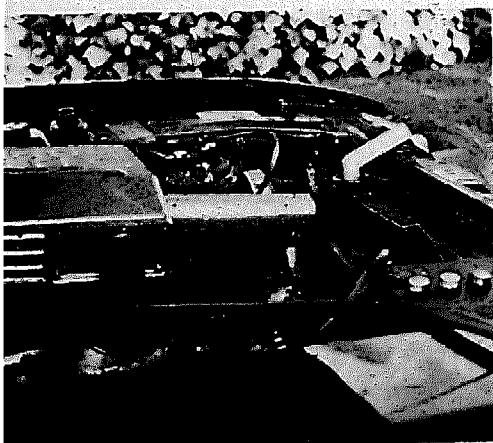

Inspect hoses, and replace as necessary. Hoses excessively mushy or brittle when squeezed are overdue for replacement. Lower radiator hose may look good, but, if the spring inside has lost tension, it will cause overheating problems.

Replace belts which are frayed, cracked, or glazed. Adjust the belts so they have less than 1/2-inch of free play between the pulleys. A special gage is recommended for exact tensioning.



Universal, or flexible replacement hoses are less expensive, more widely available, and work as well as hoses designed for your car. Worm-type hose clamps are best.



the instructions on the can before flushing the system by either method.

### USING FLUSHING KIT

Kits come with nearly everything needed to flush clean all but the most corroded systems, and include easy-to-follow instructions. To install the kit, first carefully release the pressure at the radiator cap. Locate the heater hose which runs from the firewall to the engine block. There are two heater hoses: one runs to the water pump, but the one which goes to the block is the one you want.

Cut the heater hose in two near the firewall. Insert the T-fitting, provided in the kit, into the hose. Tighten the two hose segments to the "T" with the clamps provided (see pictures). Remove the radiator cap and insert the splash pipe into the radiator neck. Install a hose (garden type) at the T-fitting, and turn the water on full blast.

The water flowing in from the hose forces the coolant in the engine back through the system passages and up through the radiator, back-flushing the system. Simply let the water run until it splashes out of the radiator, colorless—then the system is clean.

### HOSES

Check all radiator and heater hoses after flushing the system. Replace hoses every 2 to 3 years, or when they are worn, cracked, or even partially split.

Fill your cooling system with the proper mixture of antifreeze coolant after flushing the system and inspecting hoses and belts. Plain water is not recommended for cooling system use at any time.

9

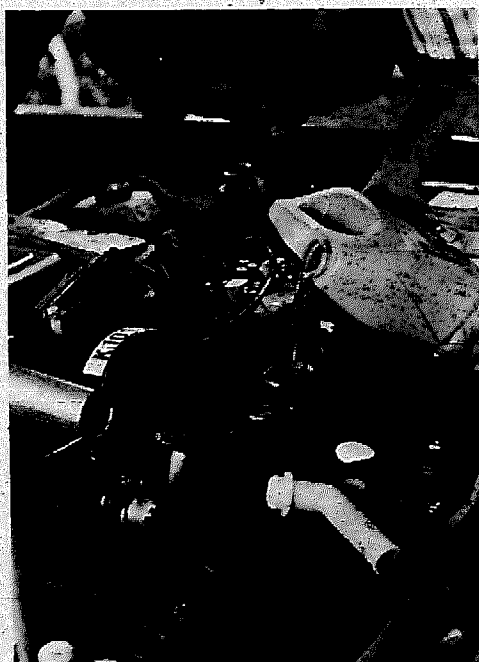

Also change any hose that feels mushy or extremely brittle when squeezed firmly. Be especially watchful for signs of splits when you squeeze the hoses; these splits have a habit of bursting wide open under pressure.

Don't overlook the small bypass hose on some models, located between the water pump and engine block. Also check the lower radiator hose very carefully. This hose contains a coiled-wire lining to keep it from collapsing during operation. If the wire loses tension, the hose can partially collapse at high speed and restrict coolant flow. This results in a very elusive overheating problem. For this reason, most mechanics replace this critical hose every 2 years, regardless of its apparent condition.

Replacement hoses designed for your car may be difficult to find, but the more popular universal or flexible type hoses will work just as well if they're of good quality. Be sure to remember that the lower radiator hose must be replaced with a hose containing a coiled support wire. Also keep in mind that installing one or two new hoses may increase pressure in the system, causing unreplaced hoses to leak unless they're in very good condition.

Before installing a new hose, clean off the connection with a wire brush and coat the surface with sealing compound. Place new clamps (don't reuse old spring-type clamps, even if they look good) on each end of the hose before positioning the hose, to make the clamping procedure easier. Slide the clamps to about 1/4-inch from the end of the hose when it is properly positioned on the fitting. Tighten the clamp just short of cutting into the hose.

### BELTS

Since drive belts are an essential part of your cooling system, you should replace those which show wear, are cracked, or are glazed on the inside surface. A loose or glazed fan belt is especially bad, since it may reduce airflow and keep the water pump from delivering the required amount of coolant. The belt can also slip on the generator/alternator pulley and allow the battery to run down. A fan belt is one of those very inexpensive items which can cause a very expensive headache if it fails on the road. Don't hesitate to replace a worn belt, and carry a spare.

Adjust all belts with a tension gage if you have one—exact tensioning is most important on a belt driving a lot of power equipment. If you don't have a

gage, adjust the belts until there is about 1/4- to 1/2-inch play when the belt is pressed between the pulleys. Overtightening belts causes serious damage in many cases, so be sure there is at least 1/4-inch of play.

### WATER NOT RECOMMENDED

With all the hoses securely clamped, and the belts properly tensioned, tighten the draincock and replace any removed drain plugs. You are ready to refill the system with the proper mixture of good-quality antifreeze-coolant.

Plain water is no longer recommended for cooling system use, even in summer. Glycol base coolant has many advantages over water: it dissipates heat more readily, has a higher boiling temperature, and has rust inhibitors as well as water-pump lubricants.

### FILLING THE SYSTEM

To fill a system which has been flushed with the flushing kit, disconnect the garden hose at the "T" and simply pour coolant into the radiator. The coolant will displace the water in the system, which will flow out at the "T." When you've added the correct amount of coolant (your manual gives the quart capacity of your cooling system, and the antifreeze container has a mixing chart on it), close the "T" with the cap provided. Since the "T" remains in place, all you have to do next time you want to flush your cooling system is to hook up a hose.

On a system which was drained through the drain openings, pour in the correct quantity of coolant (again, remember to close all drain openings) and fill the system the rest of the way with water. In either case, however, never exceed a 3/5 mixture of antifreeze to 1/5 water. While a 50-50 mixture is generally about normal, exceeding a 2 to 1 mixture solution actually decreases the heat dissipation and freeze-protection characteristics of the solution.

A final pressure check is a good idea, especially if you replaced any hoses. The check will assure you that all hoses are sealing correctly, and that the system is pressure-tight. If your car's cooling system fails to hold proper pressure after replacing hoses and tighten-

*continued*

continued

## DON'T BLOW YOUR COOLANT

ing clamps, however, check Chart A for other sources of pressure leakage. If your system maintains the correct pressure, but still overheats, check Chart B for common causes of overheating.

### JUST IN CASE

Timely maintenance should prevent the problem of a hot car, warped engine block, hot temper, and expensive towing bill. But, it's a good idea to have a few items in the trunk for emergencies.

You can never tell when a drive belt might snap, so don't take any chances

Installing an inexpensive coolant recovery system is one of the best ways to keep your car's cool. These devices are standard on some cars, and eliminate coolant loss as well as keep your car running cooler.

10



with the critical fan belt. Always carry a spare belt and the tools to install it. Spare radiator hoses shouldn't be necessary if you change the hoses regularly. But, a roll of tape and a few extra hose clamps can be useful for temporarily sealing small leaks or reinstalling a popped-off hose.

A gallon of water and a few rags to protect your hand when removing a steaming radiator cap are essential. The rags can also be stuffed into the filler neck to temporarily replace a blown radiator cap.

Finally, don't forget to check the coolant level frequently, and be sure to have the solution checked for freeze protection before the first north winds start blowing.

### CHART A

- Check the radiator's locking to be sure it isn't pulled up or distorted. The radiator cap should seal easily and tightly on the ring.
- Check for leaks at the thermostat housing gasket.
- Check for leaks at the water pump. The gasket or the pump itself could be leaking.
- Check for leaks at the radiator seams. If a can of radiator sealant doesn't stop the leak, you should take it to a reputable radiator shop for repair.
- A head gasket could be leaking. Drop some oil from the dipstick onto a hot engine part, such as the exhaust manifold; if it sizzles, water has leaked into the oil. Have the engine checked by a good mechanic.

### CHART B

- Check for obstructed airflow through the radiator. A high-pressure spray from a hose is usually sufficient to remove an accumulation of bugs or other obstructions from the radiator.
- Check the coolant level with the engine at operating temperature (be sure to release the pressure and protect your hand when removing the cap). Bring the level up to the bottom ring on the filler neck with the engine idling.
- Check the antifreeze mixture to be sure it is at the recommended strength. Try one of the radiator "Keep-Cool" additives.
- Check ignition timing and brakes. Retarded timing or dragging brakes cause an engine to run hot.
- Check the fan drive and its clutch. This is a special device designed to turn the fan at an increased speed when the engine gets hot. Your manual shows how to check this device if your car has one.
- Check the thermostat operation. A thermostat sticking shut will cause a car to overheat, since the coolant can't circulate to the radiator. Manuals show several methods for checking the thermostat. Be sure to install a new gasket if you remove the thermostat for inspection.

(This article compiled, in part, from information provided by Capt William M. Peoples, Hq Central Air Force Reserve Region (AFRES):)

Note: Department of Defense components have been charged with the responsibility of "leading the way" in USAF vehicle emission pollution abatement. Military units desiring specific information on emission control should contact Capt William M. Peoples, Chief, Transportation Div (TSLT), Directorate of Logistics, Hq Central Air Force Reserve Region (AFRES), Ellington AFB TX 77030.

# emission control devices.



Illustrated above is our artists' concept of the ultimate pollution control device, a knot tied in the tailpipe during a stage-one smog alert.

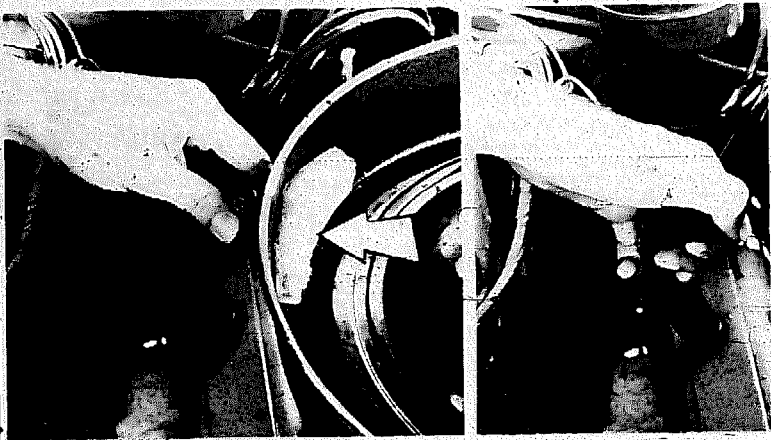

1-2

To check a closed PCV system, first pull the air supply hose loose at the air cleaner. Be careful not to damage the special filter (arrow) to which it usually attaches. With the engine idling, a slight pull or vacuum at the end of the hose means the system is operating properly. An absence of vacuum indicates a plugged system.

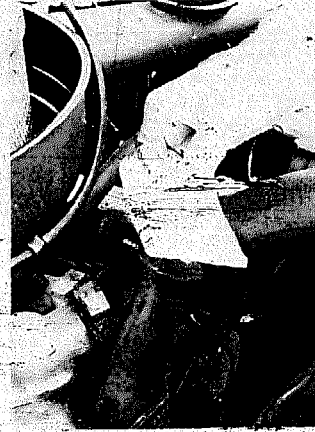

3-4

Place a piece of paper on the oil filler tube (with the cap removed). If the paper is sucked against the tube (with the engine idling), the air hose is plugged or leaking. Clean a plugged hose with PCV solvent and a straightened coat hanger. Replace a leaking hose. If the paper still is not sucked against the tube, the PCV valve is probably plugged.

**A**ir pollution has been around a long time—much longer than the automobile. But today, auto emissions are largely responsible for the polluted air in many cities. And, the internal combustion engine produces most of the hydrocarbons and nitrogen oxides which create the harmful photochemical\* “smog” peculiar to southern urban areas.

Large-scale efforts to control automotive emissions and the resulting smog began in the early '60s, with installation of the Positive Crankcase Ventilation (PCV) system on all new cars.

The now universal PCV system proved to be effective, reducing the average vehicle's daily hydrocarbon emissions from an estimated 1.25 pounds to about 1 pound. This reduction, however, had little effect on the smog problem because of the yearly increase in the number of motorized vehicles.

Several more control devices, designed to further reduce the emission levels of each car, have been added during the last 7 years. Engine design changes such as reshaped combustion chambers, as well as altered tune specs, have also been implemented to

\*Smog is formed when sunlight causes hydrocarbons and nitrogen oxides to combine in a photochemical reaction. “Smog” originally referred only to photochemical air pollution found in sunny southern cities. The term is now generally used to refer to air pollution in any urban area. This usage will apply in this article.

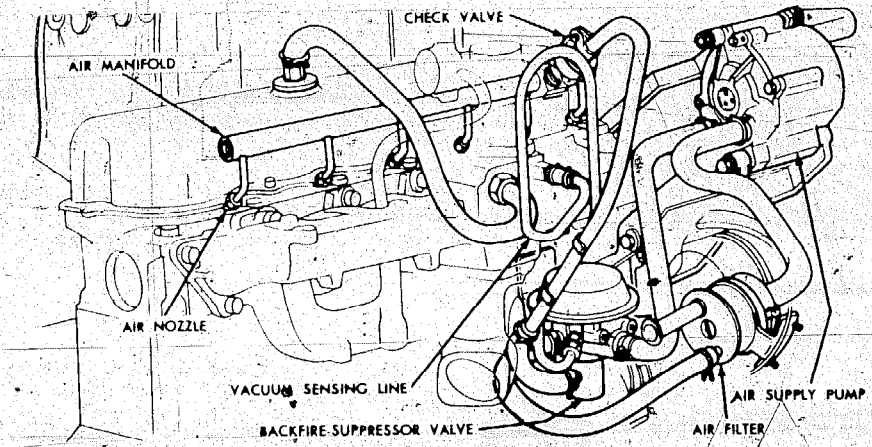

This diagram shows the various units of an AIR system on a six-cylinder engine, using a by-pass type backfire-suppressor valve.

Fig. 1

help control the auto's smog-producing byproducts. These devices and adjustments have reduced emissions considerably.

By 1968, automotive emission control devices were preventing 500,000 gallons of hydrocarbons and 2,400 tons of carbon monoxide from entering California's air each day. Along with reducing emissions, however, smog controls continue to sap engine performance and economy, making them very unpopular with many people.

**DO YOURSELF A FAVOR**

Despite your feelings about emission controls, however, they do work:

Permission to reprint Fig. 1 courtesy Cowles Education Corp. Copyright 1968 by Harold T. Glenn.

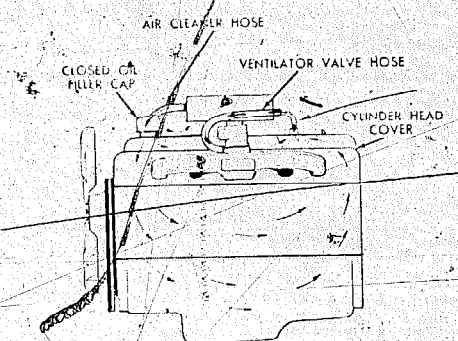

Fig. 2

they are necessary, and will be with us until there is a technological breakthrough. Your car is designed to operate with its pollution control systems working. So, you'll be doing yourself, your car's engine and your environ-

*continued*





**5** Pull the valve loose from its grommet and shake it. If it doesn't click freely, replace it. If the valve clicks, check for vacuum at the end of the valve (with the engine idling). If none, the hose between the valve and carburetor vacuum passage is probably plugged.

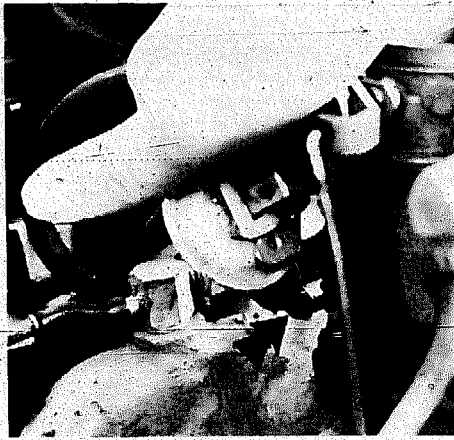

**6** Pull the hose loose from the base of the carburetor (arrow). With the engine idling, suction at the vacuum fitting means the hose is plugged and should be cleaned or replaced. The carburetor vacuum passage will have to be cleaned if there is no suction at the fitting.

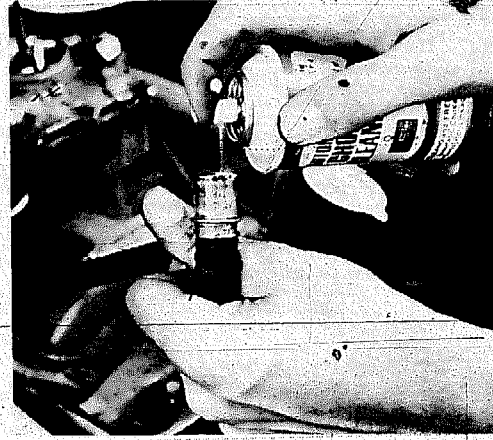

**7** Cleaning the PCV valve regularly and replacing it yearly are essential to keep the ventilation system operating at top efficiency.

continued

## THE BACK-YARD MECHANIC

ment a favor by keeping these systems properly maintained. And, driving with a disconnected or otherwise inoperable smog device is illegal, as well as harmful to your car's engine in most cases.

### SMOG DEVICES NOT REALLY THAT COMPLEX

You can perform general operational checks, and do most (if not all) of the regular emission system maintenance easily at home. All you'll really need, in addition to a couple of common tools and a few minutes, are a can of automatic choke cleaner and some PCV solvent (available for less than \$2 each). Even if you perform these services while your car's emission systems are under warranty, the car should be taken to a certified mechanic to keep the warranty in effect. However, performing the regular maintenance shown here and in your manual, before taking the car in, can reduce the cost of the required visits.

### SEVEN BASIC SYSTEMS

There are seven basic types of emission controls used on American cars today. The operation and maintenance procedures for all seven types will be generally discussed in two parts, in the order in which the systems were adopted by the auto industry. This will give you a general knowledge of the types your car uses, and what maintenance is required. Procedures differ between cars, however, and a service manual should be con-

sulted before performing any such maintenance.

### VENTILATION SYSTEM

Crankcase blowby\* gases were the first automotive emissions to be controlled, with the adoption of the aforementioned Positive Crankcase Ventilation system. The PCV system was introduced to take the place of the road draft tube which vented unburned gases from the crankcase, directly into the atmosphere.

The PCV system reduces hydrocarbon emissions by circulating fresh air down through the crankcase to pick up the blowby gases. These gases are then re-routed through the carburetor and into the combustion chamber and burned before being expelled into the atmosphere through the exhaust (Fig. 2).

### PCV VALVE IMPORTANT

The well-known PCV valve is the heart of crankcase ventilation. It is simply a spring-loaded device which regulates the flow of blowby gases according to engine speed and manifold vacuum. However, carbon and gunk deposited by the blowby gases will eventually clog the PCV valve and/or system hoses, and the gases cannot flow to the carburetor for burning. When this happens, your engine will run very poorly and spew out additional pollutants.

If the system becomes completely plugged, the blowby gases trapped in

\*Unburned gases forced past the piston rings and into the crankcase during combustion.

the crankcase will dilute the oil and cause excessive oil burning and engine wear. And, over a period of time, the pressure built up in the crankcase can be enough to blow engine seals and cause serious oil leaks.

Servicing your car's PCV system can be done quickly and easily, however, and prevents such problems. The entire operation takes only a few minutes, but it does require a little more than just shaking the PVC valve.

The best time to check out the PCV system, as well as doing most emission system work, is when you change the engine oil. Checking the systems this frequently will help ensure they are operating.

### TWO TYPES OF PCV SYSTEMS

There are two types of PCV systems in use today. The open system, which was used on most pre-1968 cars, draws its fresh air supply through a filter inside the oil filler cap. The more common closed system, installed on nearly all cars since 1968, draws its air supply from the air cleaner by way of a hose linking it and the oil filler cap (or sometimes the rocker arm cover). Other than routing of the clean air, the two systems are identical and the check procedures are basically the same.

### CHECKING CLOSED SYSTEM

On a closed system, the first step is to check for suction at the fresh-air hose, which runs from the air cleaner to the oil filler cap. Pull the hose loose at the air cleaner, after removing the air cleaner top to see if the hose is

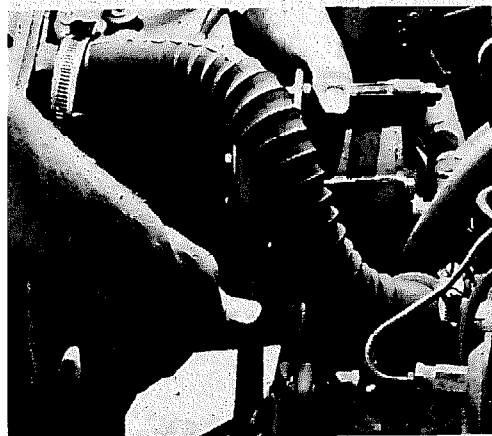

8

The air injection pump's drive belt must be in good condition and properly tensioned for the pump to deliver the required amount of air.

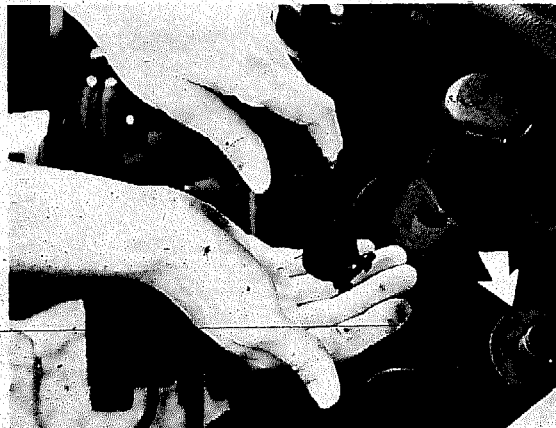

9-10

Remove the air delivery hose at the distribution manifold\* (on the exhaust manifold). With the engine idling, air should flow from the hose. If the flow increases when the engine is fast idled, the pump is working correctly. The check valve (arrow) should also be tested when the delivery hose is removed. Depress the valve plate (inside the valve), then release it. If it doesn't pop back to its original position, replace the valve. A V-8 engine has a valve at each manifold, and both should be checked.



attached to a filter.

If your car uses such a filter, be careful not to break the molded fitting when pulling the hose loose. Clean or replace the filter as required. The molded filter units are available for less than \$1 at most parts or discount houses.

With the engine idling, place your thumb over the end of the hose. You should feel a slight pull or vacuum, indicating air is being drawn all the way through the system. If so, the system is operating properly. Locate the PCV valve (usually in the rocker arm cover, or in the intake manifold) and clean it, following the procedure given later.

If there isn't any vacuum at the end of the hose, the system is plugged. Remove the oil filler cap and cover the filler tube with a piece of paper. If the paper is sucked against the tube with the engine idling, the hose between the air cleaner and filler cap is plugged. Clean the hose by running some solvent through it and pulling a clean cloth through the length of hose. A straightened clothes hanger will serve as a cleaning rod.

Although the air hose sometimes plugs on older cars, plugging of this hose is fairly rare. If there is an absence of vacuum at the air hose, there will usually be little or no vacuum at the filler tube, indicating that the PCV valve is probably plugged.

Locate the PCV valve, pull it carefully from its rubber grommet and shake it. If it doesn't click freely, install a new valve. If the valve clicks, it's OK. In that event, either the car-

buretor vacuum passage or the hose between it and the PCV valve is plugged.

Trace the hose from the PCV valve to the carburetor and pull it loose from its fitting. With the engine idling, place your finger over the fitting. If you feel vacuum, the hose is plugged and needs to be cleaned (using the procedure given previously) or replaced. If there is no vacuum at the fitting, the carburetor vacuum passage is plugged and must be cleaned out. This job usually requires removing the carburetor, and is best left to an expert.

#### CHECKING OPEN SYSTEM

Checking an open PCV system is basically the same, except that the first step is removing the oil filler cap and soaking it in solvent to clean the mesh filter inside. Then proceed to the paper-on-the-oil-filler-tube check. If there is vacuum at the filler tube, the system is open—just clean the PCV valve. If there is no vacuum at the filler tube, check the valve, hose, and carburetor vacuum passage as previously explained.

#### CLEANING VALVE

Cleaning the PCV valve should be done each time the system is checked, to keep it operating at top efficiency. However, the valve should be replaced at least once a year, regardless of its condition, or if it is plugged. Since a new valve costs less than \$2, it's not worth your trouble to try and clean a plugged valve.

While various solvents can be used to keep the valve clean, a can of PCV

solvent with a spout end, or an aerosol can of automatic choke cleaner, works best. Insert the spout end (or a small screwdriver if you're using an aerosol spray) into the end of the valve, and work the valve's spring plunger in and out, squirting in a few shots of solvent.

Start the engine and let it idle as you work more solvent into the valve. Reinstall the valve, and let the engine run a few minutes to evaporate the solvent.

#### AIR INJECTION SYSTEM

The exhaust emission problem was the second area to be attacked in the fight against smog. Air injection systems designed to further reduce hydrocarbon emission were introduced in California in 1966-67. These devices, which provide for more complete combustion of exhaust gases, were adopted nationwide the following year. Air injection systems have been eliminated on some newer models, but many cars have this system.

There are several types of air injection systems (known as the "A.I.R." system on General Motors cars, and as the "Thermactor System" on Ford products), but they all operate in essentially the same manner. A belt-driven pump supplies air to an injection, or air distribution manifold (mounted on the exhaust manifold), which has a nozzle positioned behind each exhaust valve. Oxygen-rich air is injected into the exhaust manifold to combust unburned hydrocarbons before they are expelled as exhaust.

*continued*

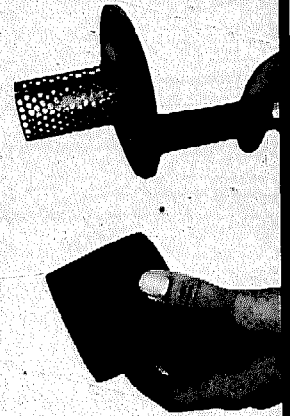
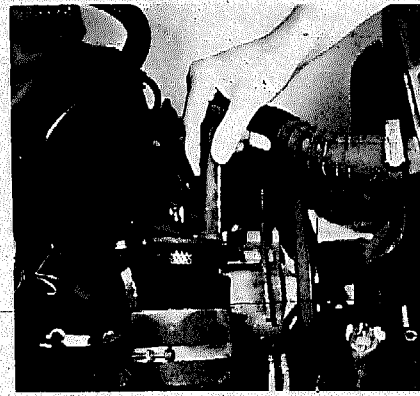
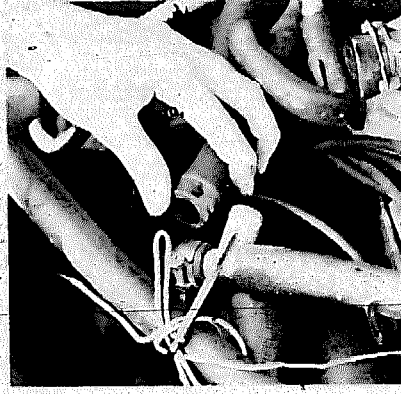
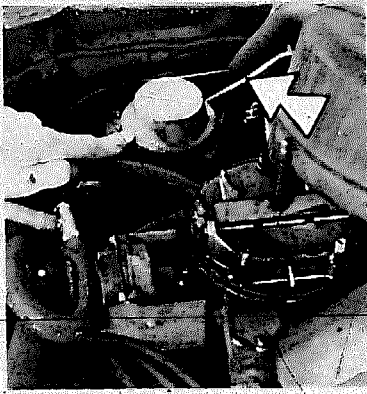

11-12 The anti-backfire, or bypass valve, is an important component of the air injection system. Locate the valve and the vacuum line which runs to it (arrow). Trace the air hose which runs from the check valve to the T-fitting near the valve. Pull the hose loose at the fitting. With the engine idling, air should flow from the fitting. Pinch off the vacuum line for about 5 seconds, then release it. If airflow from the hose doesn't diminish, replace the valve.

13-14 Replacing the air filter every 12,000 miles is the most common air injection system maintenance. Many systems, however, draw air from the carburetor air cleaner, and do not have a separate air cleaner.

continued

## THE BACK-YARD MECHANIC

In addition to the air pump, the essential parts of the injection system are an anti-backfire device and a check valve to prevent exhaust from backing up through the system (Fig. 1).

### FEW PROBLEMS

Properly installed and adjusted air injection systems are quite reliable, and seldom cause problems. However, a malfunctioning system can cause engine surge, backfiring, and overheated spark plugs, as well as increased hydrocarbon emissions. So, a quick check at the same time you inspect the PCV system is well worth the effort.

The air pump is the most critical part of the air injection system, and is the first item to check. The pump is usually located in front of the engine, and is driven off the pulley that drives the fan. Although the pump rarely malfunctions, its drive belt can slip or break. Replace the belt if it is cracked or frayed, and be sure it is properly tensioned—generally about 1/2 inch of play between the pulleys.

### AIRFLOW

Proper air delivery from the pump is essential to the injection system's operation. To check for airflow, trace the air hose from the pump to the air distribution manifold(s) (a 6-cylinder engine has only one, whereas a V-8 engine has one for each cylinder bank). Remove the hose at the manifold.

With the engine idling, there should

be a constant flow of air from the hose. If the airflow increases when you fast idle the engine, the pump is OK. If the airflow is insufficient, the pump's air filter may be clogged or the pump will probably have to be replaced.

### CHECK VALVE

To prevent exhaust gases from backing up through the system, special check valves are used. These valves are usually located at the air distributor manifolds, but may be installed in the air hose. Operation of these valves should be checked regularly, since they occasionally malfunction (some manufacturers recommend regular replacement of these valves—check your manual).

Disconnect the air supply hose at the valve. The valve plate should be positioned against the valve seat (in the up position in most cases) away from the air manifold. Depress the plate with a screwdriver and release it. If it doesn't pop back to its original position, replace it. It should also be replaced if exhaust escapes from the valve with the engine idling.

### ANTI-BACKFIRE VALVE

Another special device is used to prevent backfire during deceleration. There are two types of anti-backfire systems used, but the bypass, or anti-backfire valve, is used on most cars. The bypass valve is designed to divert airflow from the pump to another source when the engine is decelerated. This temporarily leans out the fuel mixture, providing better combustion and eliminating deceleration backfire.

To test the bypass valve, trace the

hose which runs from the air manifold check valve to the T-fitting near the bypass valve. With the hose removed at the T-fitting, and the engine idling, air should flow from the fitting. To simulate deceleration conditions, pinch off the vacuum line which runs to the anti-backfire valve (see picture).

Release the vacuum line after about 5 seconds. If airflow from the fitting does not diminish, replace the valve.

### AIR FILTER

Other than periodic inspection and/or replacement of the check valves, the only regular maintenance your car's injection system will probably need is replacement of the system's air filter. This should be done every 12,000 miles on systems fitted with external filters. Most of these units use replaceable filter elements which are replaced by removing the locking nut, installing the new filter, and re-installing the nut.

A few units use a rotating air filter inside the air pump. These filters are sometimes tricky to replace, so check your manual for the correct procedure. Most of the newer systems draw air from the carburetor air cleaner, however, and replacing this filter every 12,000 miles takes care of both jobs.

### NEXT MONTH

Hopefully, you're already convinced of the value of properly maintaining your car's emission systems. So, next month we'll jump right in with the thermostatic air cleaner system, and bring you up-to-date on all emission control systems installed through model year '73.

## THE BACK-YARD MECHANIC PART VIII

# EMISSION CONTROL DEVICES

Last month's "Back-Yard Mechanic" discussed maintenance of the common PCV and air injection systems. This month, we'll begin with the nearly universal manifold heat control valve/thermostatic air cleaner and cover the rest of the smog devices in use today.

*Note: As stated in the previous installment, if your car's emission systems are under warranty, the vehicle should be taken to a certified mechanic to keep the warranty in effect. Also, emission systems vary somewhat, and the procedures outlined here should be considered only as general guides. Consulting a service manual before doing any emission system work is essential.*

(Smog pictures courtesy Los Angeles Air Pollution Control District)



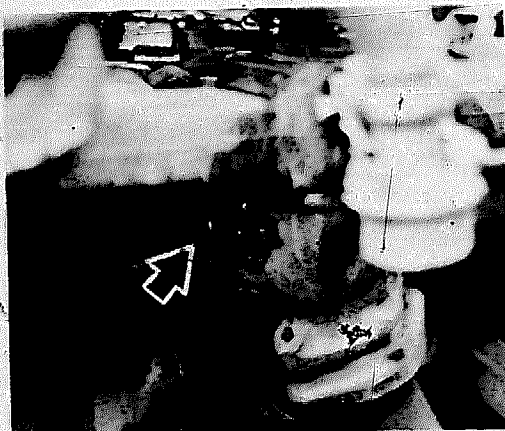

1 The heat riser valve (arrow), located on the exhaust manifold or exhaust crossover pipe, is critical to engine performance, gasoline economy, and emission control. Check it regularly for free operation.



2-2A Ford's thermo air cleaner system uses a thermostatic unit (arrow) to control the air snorkel and heated air duct. If the valve does not operate properly, the thermostatic unit should be replaced.



The battle against air pollution has resulted in the manufacture of some rather sophisticated automotive emission control devices during the past 4 years. However, maintaining these newer systems is nearly as easy as caring for the older, less complex devices. In most cases, all you need is a can of aerosol choke cleaner or similar solvent, a vacuum gage (available for less than \$5 at any auto supply store), and, of course, a trusty service manual.

Regular maintenance of all smog devices is essential for controlling harmful auto emissions which result in air pollution. But correct operation of some of the more recent devices is especially critical in a couple of other areas. A malfunction in any one of these devices can drop engine performance, cause dangerous engine stalls, and waste all kinds of gas. The latter is a big consideration, now that gas stations are getting to you at more than 40¢ a gallon in many areas.

#### HOT AIR

In 1968-69, the thermostatically controlled air cleaner system was in-

roduced to replace, or in some cases bolster, the air injection system. The thermo system ducts heated air into the air cleaner to raise the combustion temperature of a cold engine. This reduces hydrocarbon emissions by improving engine efficiency during warm-up—a period when efficiency is low and emission correspondingly high.

The thermostatic air cleaner system evolved from the simpler manifold heat control valve (heat riser), however, which was originally designed only to improve cold engine performance. Virtually every car which doesn't have a thermo system uses a heat riser, and some cars use both systems. Therefore, we'll discuss the heat riser before getting into the slightly more complex thermo systems.

#### HEAT RISER

The heat riser is basically just a valve on the exhaust manifold which opens and allows exhaust gases to flow into the intake manifold when the engine is started cold. The heated manifold improves combustion until the engine warms itself. As the engine warms, a thermostatic control spring

unwinds gradually to close off the exhaust manifold. When the engine reaches operating temperature, the valve should be closed to prevent overheating of the fuel mixture. However, corrosion frequently keeps the valve from operating freely, or even freezes it. If the valve sticks in the "no heat" position, the engine either stalls or runs poorly and wastes gas until it warms up. A valve sticking in the "heat" position causes the engine to run as if it is out of tune, so the heat riser should be checked regularly—at least at every tuneup.

Locate the valve on the exhaust manifold of in-line engines, or on the exhaust crossover of most "V" engines. With the engine cold, check to see that the thermostatic control spring is against its anchor pin. If not, or if the spring is broken, replace it.

Have a buddy start the cold engine and rev it quickly while you observe the valve's counterweight. If the valve moves about ½-inch and returns to its original position, then gradually closes as the engine warms, it's OK—spray the exposed ends of the valve shaft with solvent to keep the valve free.

If the valve doesn't move when the engine is revved, soak the valve shaft with solvent and work the counterweight until the valve flops back and forth freely. Light taps with a hammer may be required to free a tightly stuck valve but it's well worth the time and effort.

Fig. 1 Ford Thermo System—Cold

Ford thermostatic air cleaner with engine cold. Note that all air that goes through air cleaner is from the duct over the exhaust manifold.

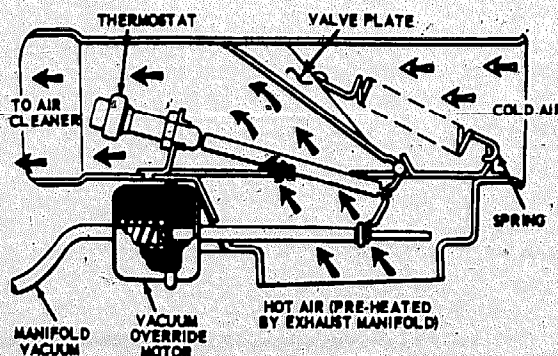

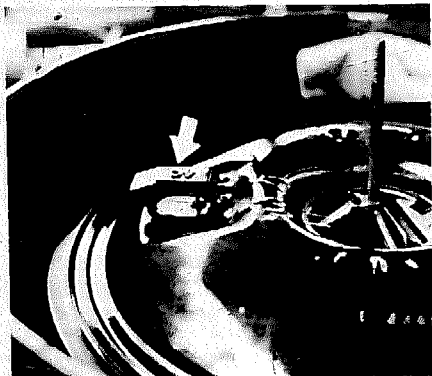

3 The GM thermo unit is a vacuum-controlled device regulated by a temperature sensor (arrow).

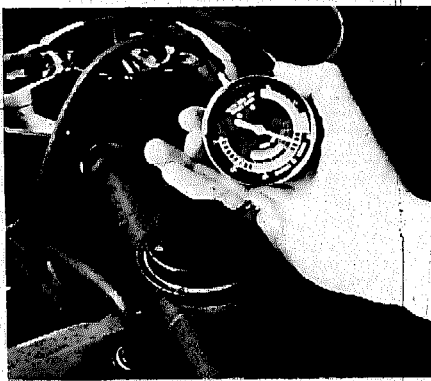

4 If the snorkel of a GM system fails to close when a cold engine is started, check for at least 8 psi of vacuum at the diaphragm unit. Low vacuum means a leaking hose or connection is causing the problem. If the vacuum is sufficient, replace the diaphragm.

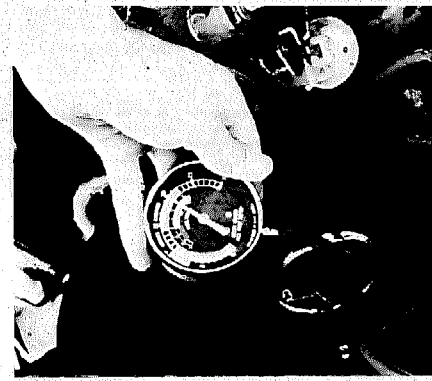

5 The temperature sensor is probably faulty if the snorkel valve doesn't open properly as the engine warms. Lift the air cleaner and check for vacuum at the line which runs from the engine to the sensor. If there is at least 8 psi, replace the sensor.

continued

## THE BACK-YARD MECHANIC

### THERMOSTATIC AIR CLEANER

The thermo air cleaner, which evolved from the heat riser, is basically a more precise device for controlling engine warmup and the amount of pollutants expelled during this period. There are two basic thermo systems, the Ford and the General Motors devices. Chrysler products use the GM system, and American Motors cars use a device very similar to Ford's. Although the mechanics of the two systems differ, their operation is nearly identical. When the engine is cold, the air cleaner intake snorkel closes off, and a valve opens allowing heated air from the exhaust manifold to enter the air cleaner as intake (Fig. 1).

While the engine warms, the air snorkel gradually opens and the heated air valve closes, allowing a mixture of heated air and outside air to enter the carburetor. When the engine reaches operating temperature, the air snorkel should be open and the heated air duct closed, since no more heated air is needed to keep the engine running efficiently (Fig. 2).

There are special thermometers and techniques to make sure that the thermo systems are right on. But the specifications are reasonably broad, and if your car runs satisfactorily during warmup and checks out according to these general procedures, it should be OK. However, if you determine the system is not operating correctly, it's best to have it accurately calibrated by a certified mechanic.

### FORD THERMO SYSTEM

The Ford device uses a thermostatic control spring connected to a single valve which controls both the air snorkel and heated air duct (Fig. 1). To check this system, first make sure the air cleaner is properly connected to the heated air pipe or hose. With the engine temperature below 85°F (a thermometer can be placed in the air cleaner to check this), the air snorkel should be closed off by the valve. If not, check for a broken thermo control spring or a binding valve. A binding valve can be freed with solvent. Replace the thermostatic unit if the spring is broken.

Start the engine and let it idle. As the engine warms, the valve should slowly open the air snorkel and close off the heated air duct. If this does not occur, replace the thermostatic unit. Before the engine reaches operating temperature, you should test the vacuum override.

With the engine idling, rev it quickly. The valve should pop open and give the engine a needed breath of air to keep it from stalling. If it doesn't,

pull the vacuum line which runs to the override unit, and check for at least 15 in. of vacuum with the gage. If the vacuum is low, there is probably a bad connection or leaking hose. If the vacuum is sufficient, but the override doesn't work, replace the vacuum device (called a motor by Ford).

### GM THERMO SYSTEM

The GM device uses a pivoting valve in the air cleaner neck similar to the Ford system, but differs in that it is vacuum controlled (Fig. 3). The GM device also has a vacuum override system which opens the air valve to prevent a cold engine from stalling when accelerated.

To check the GM system, begin with the engine cold and not running. The valve in the air snorkel should be open. The valve should close immediately when the engine is started. If it doesn't, the temperature sensor inside the air cleaner is probably faulty (Fig. 3). Lift the air cleaner body and install the vacuum gage to the line which runs from the engine to the bottom of the temp sensor. If

Fig. 2 Ford Thermo System—Hot

As engine warms up fully, all air comes from the air cleaner neck. The valve has been moved to block off the exhaust manifold duct.  
Below: Vacuum motor can be tested by removing from air cleaner and connecting it to a source of engine vacuum.

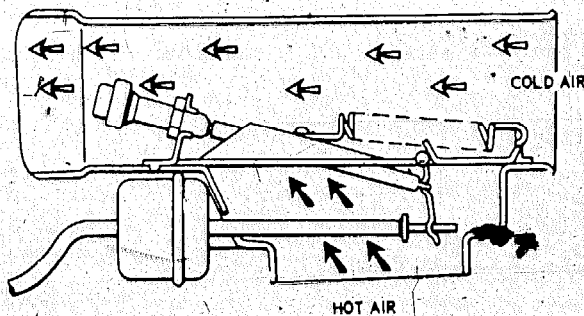

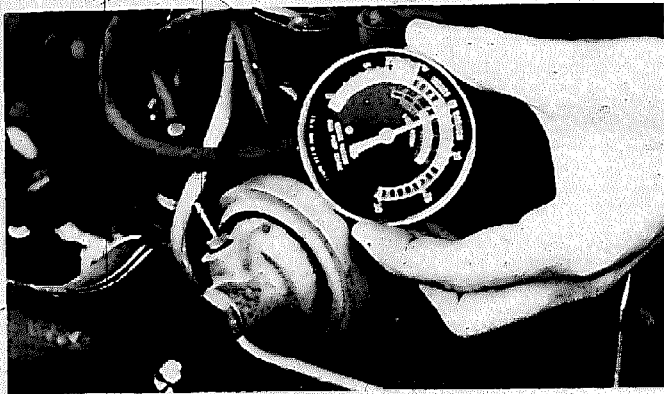

6 Readings at the vacuum advance unit are used to determine if the car's vacuum advance/retard controls are working correctly. Most cars use several of these devices, and a manual should be consulted for the specifics of the devices your car uses.



7 A special pressure vacuum filler cap must be used on all cars equipped with a fuel evaporative system.

there isn't 8 in. of vacuum at the sensor, look for leaks or bad connections. If the vacuum is adequate, replace the sensor.

### VACUUM CHOPPERS

Introduced with the thermostatic air cleaners as "clean air packages" on many 1969-70 cars were various types of carburetor and distributor controls. The most common of these controls, generally called vacuum choppers, are designed to eliminate spark advance below a certain speed, and during deceleration. These devices cut down on emissions, but can dangerously cut engine performance and kill your gas mileage if they're not doing their thing. They should be checked at every tuneup, or any time the car seems to be down on power and everything else checks out. Your manual tells exactly what advance/retard systems your car uses, and gives specific checkout procedures.

There are three types of vacuum

choppers, all of which can be easily checked for general operation. The Ford, General Motors, and American Motors systems are checked in essentially the same manner. The car's rear end must be supported off the ground to allow the wheels to be turned by the drive shaft. The safest way to do this is to drive the car against a solid wall (on a level surface) such as concrete block garage wall. Then, raise the car's rear end just enough to get the wheels off the ground and support the car with safety stands. Be extra sure the stand's locking pins are fully extended through the holes, and chock the front wheels.

### FORD

The Ford vacuum chopper uses a speed sensor device which doesn't allow vacuum advance below 18 mph on acceleration or below 23 mph on deceleration. If the operating temperature is below 58°F, however, a sensor overrides the vacuum chopper.

This allows spark advance at all speeds to prevent cold engine stalling.

To check the Ford system, pull the vacuum line which runs from the carburetor to the advance unit loose at the unit and attach the vacuum gage. With the car properly raised, supported, and at operating temperature, have a helper slowly accelerate (with the transmission in gear) until a vacuum reading is obtained—this should occur around 18 mph.

Nonexistent or incorrect vacuum readings can be caused by a broken speedometer cable, faulty speed sensor, or leaking vacuum line. Have the system inspected by a mechanic if the vacuum readings are incorrect and all connections check out.

The temperature sensor (usually located in the door—check your manual) may also cause incorrect vacuum advance. The temp sensor can be checked by cooling it with ice and checking the vacuum reading as before. If full vacuum advance isn't available with the sensor below 58°F, replace it.

### GENERAL MOTORS

The GM system is controlled by a transmission switch that allows vacuum advance when the car is shifted into high gear. The device can be generally checked; but, because of the complicated operation of the system, the car should be taken to a qualified mechanic if the chopper is malfunctioning.

With the car properly raised, and the vacuum gage attached, have your helper accelerate to about 25 mph with the transmission in high gear, or until an automatic transmission shifts

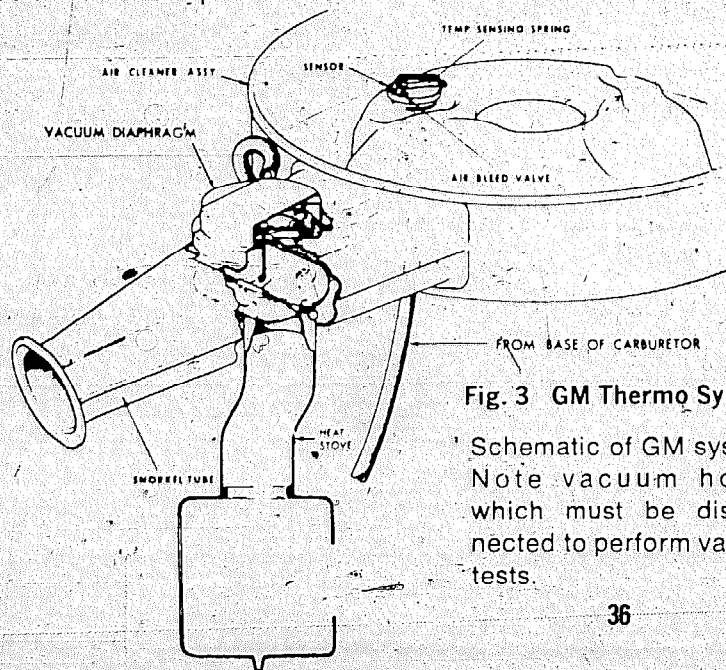

Fig. 3 GM Thermo System

Schematic of GM system. Note vacuum hoses which must be disconnected to perform various tests.

continued



continued

## THE BACK YARD MECHANIC

to high. The gage should show vacuum with the car operating in high gear. Vacuum should drop when the car is decelerated in a lower gear. If not, check for a leaking vacuum line—any other problems should be handled by a certified mechanic.

The GM system also uses a low-temperature override similar to Ford's. Locate the temp sensor (your manual gives its location) and check it as with the Ford system.

### AMERICAN MOTORS

American Motors cars also use a transmission controlled advance system—check your manual for the specifics.

### CHRYSLER

The Chrysler vacuum chopper is designed to retard the spark whenever the throttle closes. It can be easily checked with the car resting normally on the ground. Locate the ground wire which is connected to a switch at the carburetor throttle stop screw (Fig. 4). Run the engine at idle and disconnect the ground wire. If engine speed increases when the wire is disconnected, this means the vacuum advance is kicking in and the unit is operating properly.

### FUEL EVAPORATIVE SYSTEM

The two most recent emission control devices are the ones which account for most of the weird hoses running everywhere under the hood—the

(Figures 1, 2, 3, and 4 extracted from AUTO REPAIRS YOU CAN MAKE, ARCO Publishing Co., Inc.)

Fig. 4  
Chrysler distributor with solenoid control

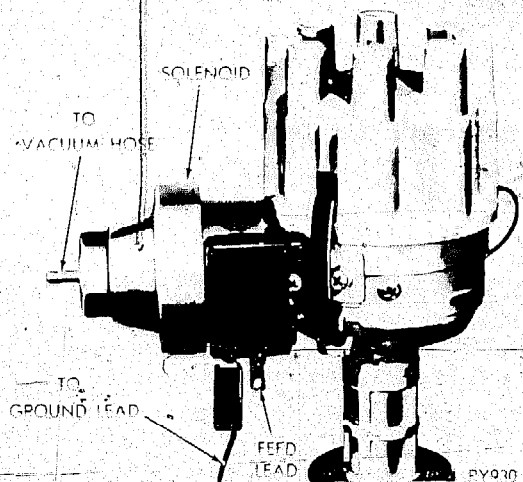

ones which scare off many a would-be back yard mechanic. Actually, neither of these systems require much maintenance, and shouldn't freak you out. The first device is the fuel evaporative system, adopted in 1971 to control hydrocarbon emissions from fuel vapor loss.

Basically, the evaporative system is just a closed fuel system which re-routes wasted liquid fuel back to the gas tank to be reused. It also stores fuel vapors instead of venting them to the atmosphere. The evaporative system doesn't generally require any maintenance except for a periodic replacement of the charcoal canister (used for storing fuel vapors) or its filter, if so equipped. Your manual outlines the required maintenance on this system. Problems can develop in the system, however, and if you smell excessive gas vapors, or if the engine starves from lack of fuel, have the system checked out by a mechanic.

A pressure vacuum gasoline filler cap must be used with the fuel evaporative system. A standard cap would render the emission system ineffective

and could cause the fuel tank to collapse.

### EGR

The most recent emission system is the Exhaust Gas Recirculation (EGR) system. The EGR is designed to reduce nitrogen oxide emissions by recirculating exhaust gases into the intake manifold to dilute the fuel charge which reduces peak flame temperature.

The EGR's operation is relatively simple, with its main component being a vacuum-operated valve. The different types and variations of EGR systems are too numerous to cover here, but easy procedures for maintaining the system used on your car can be found in any up-to-date manual.

So, this is generally the smog device story. You're stuck with 'em—like it or not. And, since these devices rob your horsepower and kill your gas mileage if they're not working right, you can do yourself and everyone else a favor by taking proper care of them.



# the amazing vacuum gage

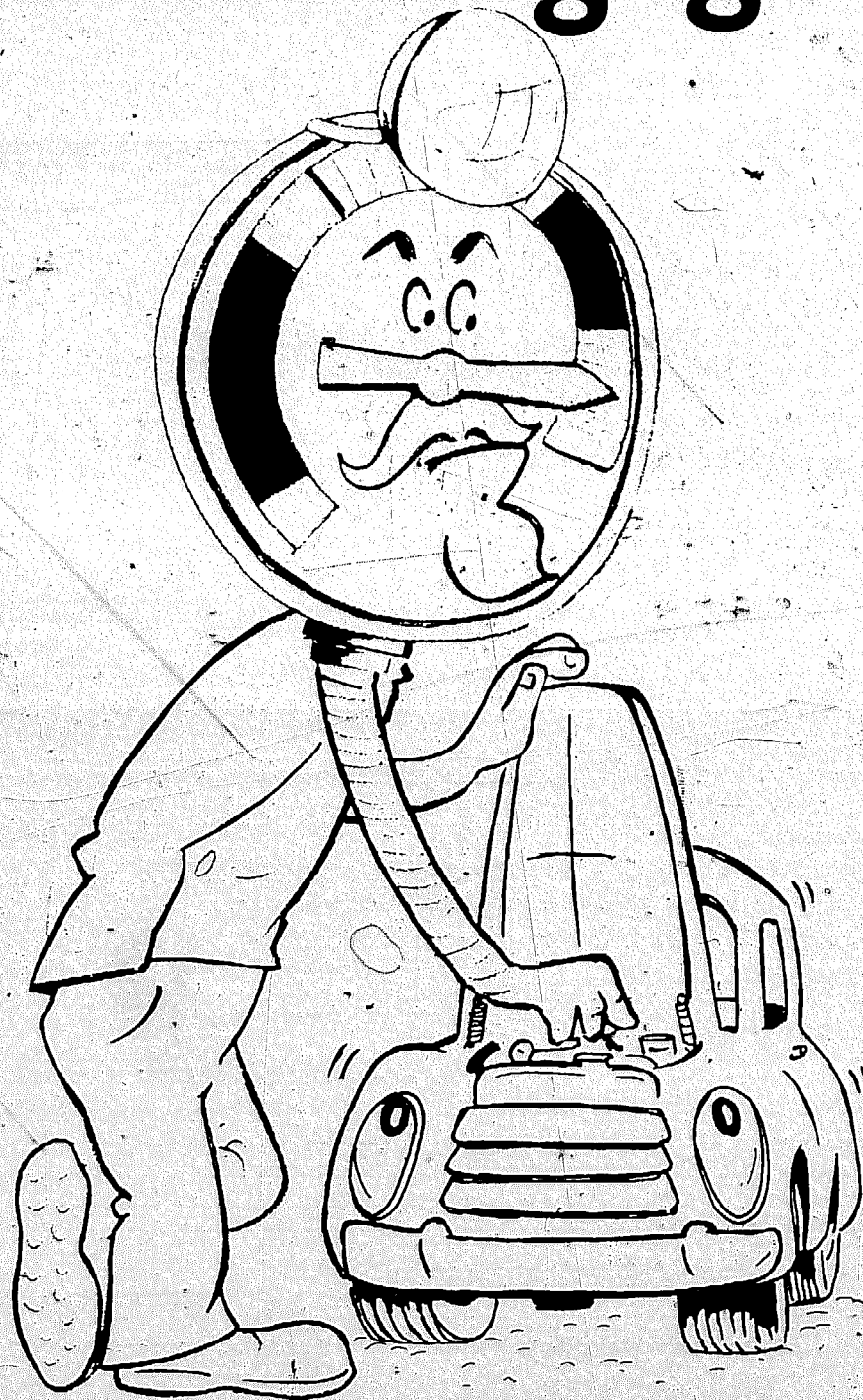

**H**ave you always threatened to—but never really gotten into back-yard mechanic-type work? If so, the reason may be that you think all kinds of expensive equipment is needed to work on your car. But, this just isn't true. Sure, scientific engine analyzers are great, and sometimes necessary; but in many cases, simple equipment will do the job. Take the \$5 vacuum gage for example.

The "engine doctor," as the vacuum gage is known, can quickly and accurately diagnose more than 30 engine ailments, including sticking valves, improperly adjusted carburetors, and even blown head gaskets. Sound like a lot to expect from such a simple, inexpensive device? Well, it's not when you consider how important vacuum is to your car.

## VACUUM ESSENTIAL

Your car's engine creates, and actually operates on vacuum. In addition, many engine parts and accessories are controlled by vacuum, including the automatic choke and power brakes.

Vacuum is created in each engine cylinder as the piston goes down on its intake stroke. When the intake valve opens, the fresh fuel charge is drawn from the intake manifold into the combustion chamber (Fig. 1). This creates vacuum at the intake manifold, which varies according to the engine's operating condition. Vacuum is highest when the engine is idling, since the carburetor throttle plate is closed. As the engine is accelerated, the plate opens and vacuum drops.

When an engine is operating properly, there is a steady, constant vacuum at idle, as each cylinder smoothly and efficiently draws in its fuel charge. But, any malfunction or misadjustment which affects engine efficiency also alters the vacuum. Since specific engine problems affect manifold vacuum in certain ways, a vacuum gage can accurately diagnose the condition of an engine by simply measuring the amount and condition of vacuum.

## INSTALL IT PROPERLY

Before the "doctor" can do its thing, however, it has to be installed properly. You can't just pull the vacuum advance line at the distributor

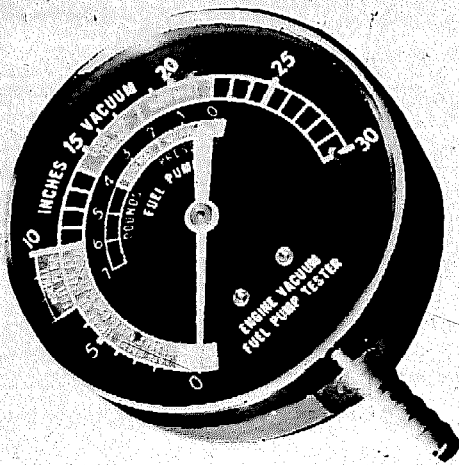

An inexpensive vacuum gage is the backyard mechanic's most useful diagnostic tool.

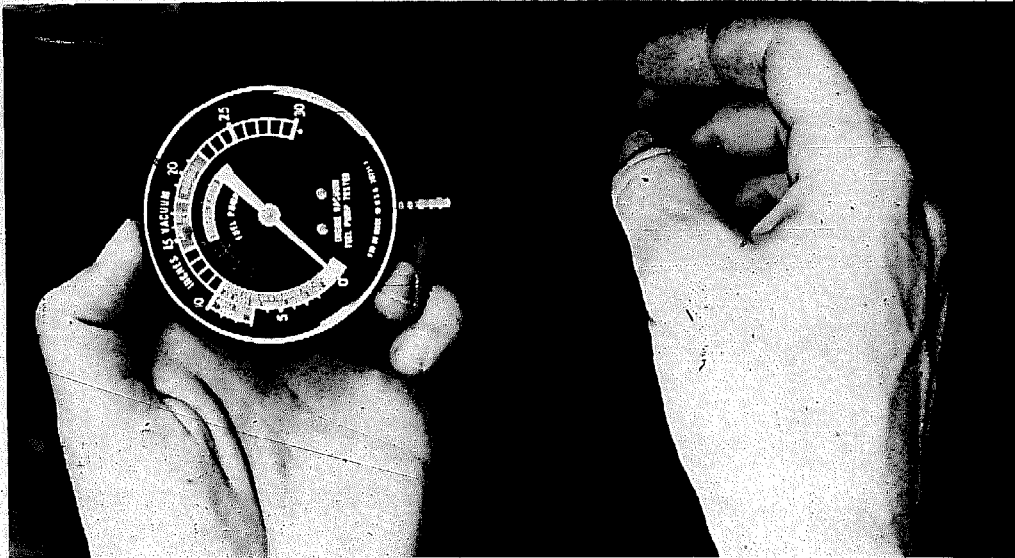

To get accurate vacuum readings, the gage must be attached to a primary source of manifold vacuum. The best installation procedure varies from engine to engine, but simply attaching the gage to the vacuum advance line at the distributor doesn't work.

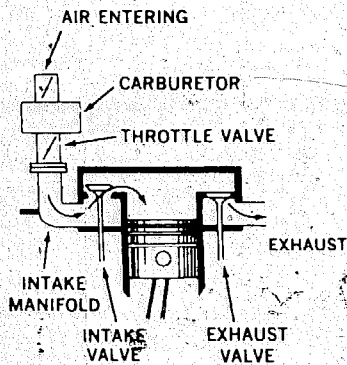

Fig. 1  
Idle: Throttle plate is closed—vacuum is high.  
Acceleration: Throttle plate opens (shown) allowing air to be drawn in—vacuum drops.

ing it shouldn't be a hassle. Adequate vacuum gages range in price from \$4 to \$12 at most auto and discount stores. The better models, however, have more complete instructions, as well as all necessary installation hardware.

#### SEVERAL METHODS

The 3 most common vacuum gage installation procedures are outlined below, but for best results, follow the procedure recommended by the gage's manufacturer. On older cars with vacuum-operated windshield wipers, installing a gage is super-easy. Simply remove the wiper system vacuum hose at the intake manifold, and attach the gage's hose. Few cars, however, have vacuum-operated wipers today, so you'll probably need to locate another vacuum source.

Many cars have a threaded plug in the manifold which can be removed, and a special fitting installed. This fitting is usually supplied with the vacuum gage. But if your's didn't come with one, or it is the wrong size, a parts house should be able to supply a fitting which will work.

If there isn't a plug in the manifold, simply obtain a T-fitting which can be installed in a vacuum line. The hose which attaches to the power brake unit or the vacuum assist on disc brake-equipped cars works best. Attach the gage as close to the vacuum source as possible.

#### GAS MILEAGE?

When you have the gage installed according to instructions, warm the engine to operating temperature and set the idle to specifications. The en-

*continued*

A dash-mountable vacuum gage, which is calibrated in fuel economy ranges, is a help in driving for maximum gas mileage. It also displays accurate engine diagnosis at a glance.

A steady vacuum reading in the acceptable range is an excellent indication that your car's engine is in good condition.

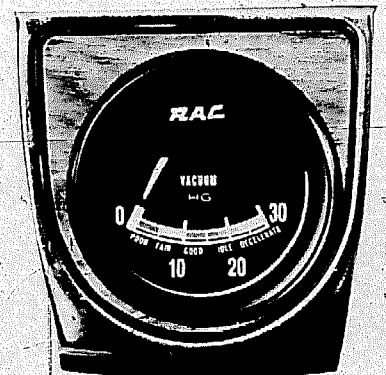

continued

## THE BACK-YARD MECHANIC

engine must be idling correctly to get an accurate vacuum reading, since vacuum drops as the throttle plate opens. Because high vacuum readings mean narrow throttle plate openings, they also mean high fuel economy. Many people install a dash-mountable vacuum gage and use it to help maximize their gas mileage by driving with high vacuum readings at all times.

### CORRECT READINGS

With the engine warm and idling properly, getting an instant engine diagnosis is easy. Simply watch the action of the gage's needle. A healthy engine will give a steady, constant vacuum reading between 17 and 22 inches.\* On some newer 4- and 6-cylinder engines, however, a reading of 15 inches is considered acceptable. With high-performance engines, a slight flicker of the needle can also be expected. You should discount for the fact that the gage reading will drop about 1 inch for each 1,000 feet above sea level.

If your car's engine gives a steady

\*A vacuum gage measures vacuum in inches of mercury.

vacuum reading in the acceptable range when idling, and the needle drops toward zero and jumps back past 20 when the throttle is opened and closed quickly; the engine is in good shape. Any other readings indicate a problem.

### INCORRECT READINGS

Probably the most common "not so good" reading is when the needle oscillates slowly. This means something is causing engine speed to fluctuate—probably faulty carburetion. If you get this type of reading, first check the condition of the gasket at the base of the carburetor, and tighten the nuts holding the carb to the manifold. Also, make sure the nuts holding the manifold to the engine are tight, and that the air filter is not plugged. If the needle still fluctuates, the idle mixture probably needs adjustment.

Locate, and turn the mixture adjustment screw(s) in until the gage reading drops 2 inches, or until you hit the stop on carburetors equipped with idle limiter caps. Then, turn the screw(s) out until the gage reaches the highest obtainable reading. If the needle still fluctuates after resetting the mixture, and the carb has gone

30,000 miles or so, better try a new or rebuilt carburetor.

### INSTRUCTIONS

Other possible vacuum readings and what they mean should be fully explained in the gage's instructions. The accompanying chart shows some of the most common readings and what engine malfunctions they indicate. Most service manuals and auto tuneup guides also outline the many uses of the vacuum gage.

### MOTOR MONITOR

The vacuum gage is an excellent diagnostic tool when you have engine problems. But, its real value occurs with more frequent use. By making regular vacuum checks, you can spot developing problems and correct them before they become serious.

The best way to keep constant tabs on your engine is to install a permanent dash-mountable vacuum gage. These "motor monitors" are available for less than \$6 at most auto supply and discount stores. Since they are calibrated in fuel economy ranges, they will help you maximize your gas mileage—as well as give you a complete engine analysis at a glance. ●

## HOW TO READ THE MANIFOLD VACUUM GAGE

LATE  
IGNITION TIMING

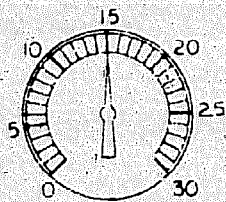

A low but steady reading generally indicates late ignition timing. If resetting the timing to specifications doesn't improve the reading, valve timing is incorrect.

MANIFOLD  
LEAK

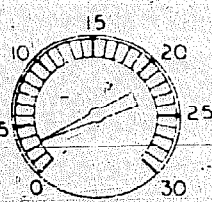

A very low reading indicates a vacuum leak—probably at the carburetor gasket or intake manifold gasket.

CARBURETOR  
ADJUSTMENT

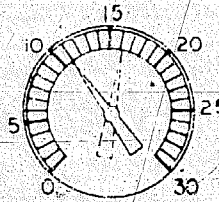

If the needle oscillates slowly between 11 and 16 inches, carburetor adjustments are needed (see text).

STICKING  
VALVES

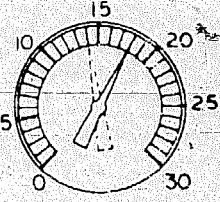

If the needle drops intermittently, valves are sticking.

BURNT OR LEAKING  
VALVES

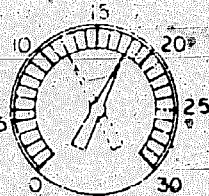

A burnt or leaking valve will cause a consistent drop of the needle each time the load valve comes into operation.

WEAR VALVE  
SPRINGS

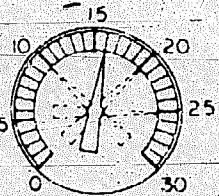

If the reading is normal at idle, but the needle vibrates as engine speed increases, weak valve springs are indicated.

LEAKING  
HEAD GASKET

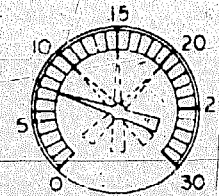

Excessive vibration of the needle at all speeds indicates a leaking head gasket.

CHOKED  
MUFFLER

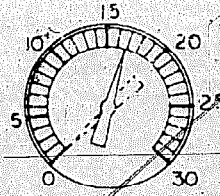

A stuck heat riser or restricted exhaust system will cause the needle to drop to zero as engine speed increases.

# Dieseling

How to keep your car from running away with itself

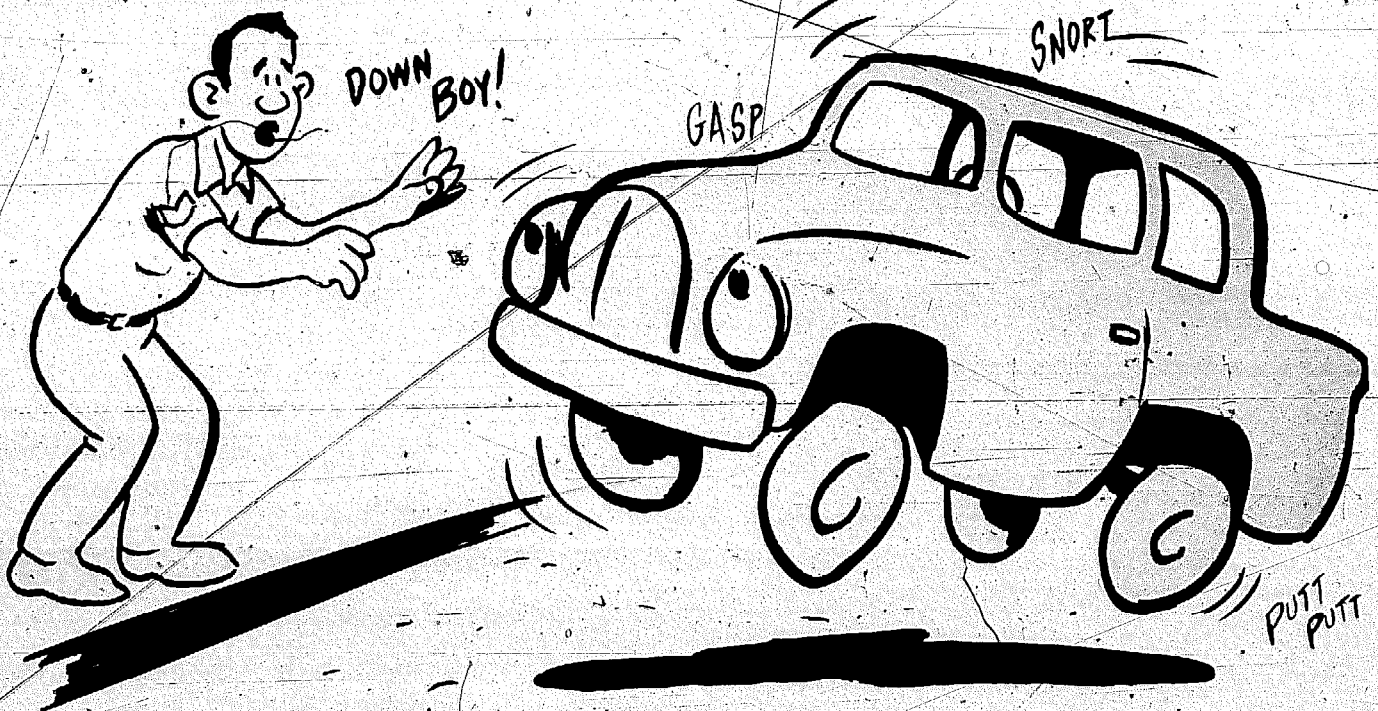

It's probably no surprise to most of you if your car runs for a few seconds after you switch off the ignition. "Dieseling," or "run-on" as this condition is called, is rather common—especially with 1968 and newer American cars.

Dieseling generally isn't harmful to the engine, but in most cases it is an indication that something isn't quite right. And, if you've ever pulled into a parking lot and had your car continue to run for endless seconds after

switch-off—gasp, clattering, and shaking itself violently to a stop, you know this can be frightening, as well as embarrassing. So, it's an all-round good idea to have a car that stops when you shut it off.

## THE CAUSES

Dieseling occurs when heat ignites unburned fuel in the engine's combustion chambers after the ignition is turned off. Most engines have some excess gas in the cylinder at switch-

off. However, since there isn't any ignition spark after the engine is switched off, dieseling doesn't occur unless there is sufficient heat to ignite the fuel. This is why your car is more likely to diesel on a hot day, or after it has been run extra hard.

The amount of fuel in the engine at switch-off also affects dieseling— with more fuel, there is a greater chance of ignition. Cars with automatic transmissions are prone to dieseling for this reason. Since an auto-

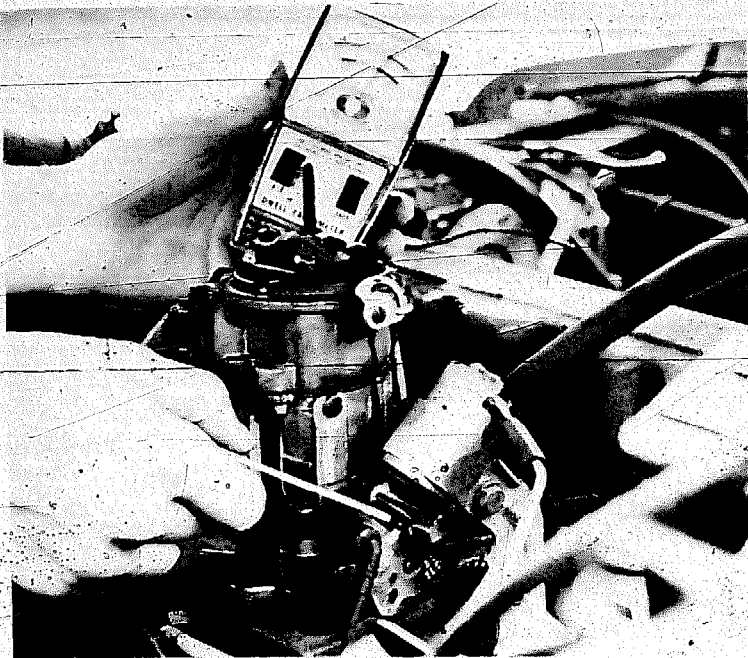

Correct idle speed is critical in controlling emissions and dieseling. Engine idle should be set precisely to the manufacturer's specifications using a tachometer and following recommended procedures. Hot idle is set at the anti-dieseling solenoid on engines so equipped—at the throttle linkage on most others.

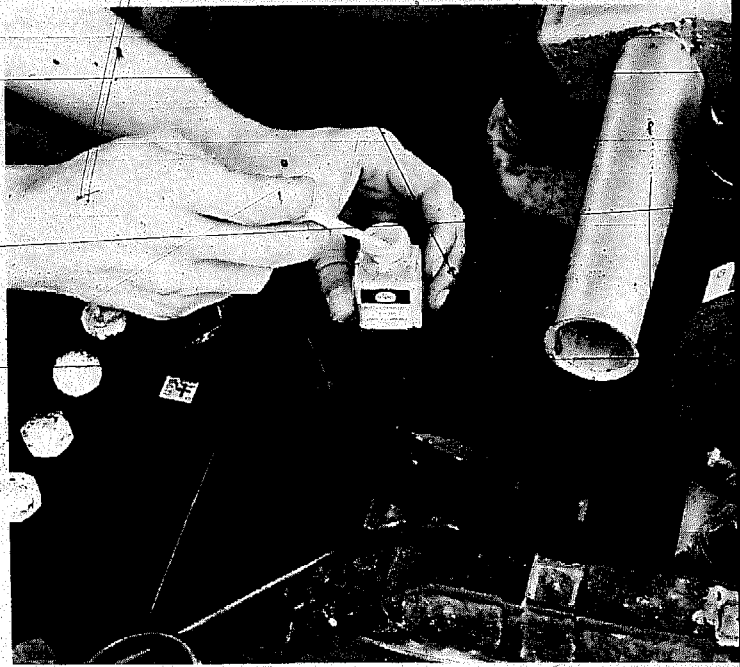

Ignition timing must be "right on" for today's emission-controlled engines to run properly, and not diesel. Marking the proper timing notches with fluorescent and/or white enamel paint makes them more visible. This will facilitate more accurate settings—especially when using a weak flashing neon bulb timing light.

matic is taken out of gear and placed in neutral or "Park" before the engine is turned off, the idle speed increases, allowing an extra amount of gas to enter the engine at switch-off.

#### NEW CARS

Post '68 model cars are more susceptible to dieseling than older cars because of higher idle speeds and engine operating temperatures used for controlling emissions.

Other emission control-related factors which contribute to dieseling in newer cars include the use of leaner, hotter-burning fuel mixtures, as well as later ignition timing settings. Retarding the timing on current engines is critical in reducing emissions. However, because the spark is occurring later in the combustion cycle, there is less time for heat escape—therefore, more combustion heat buildup. Retarded timing settings also allow the use of lower octane fuels which burn hotter and contribute to dieseling.

#### SOLUTIONS?

Because of these engine tune factors, the first thing many people do if their car starts dieseling is switch to a higher octane fuel and/or advance the timing. Higher octane fuel

A sticker inside the engine compartment of all 1968 and newer cars gives the vital timing and idle specifications.

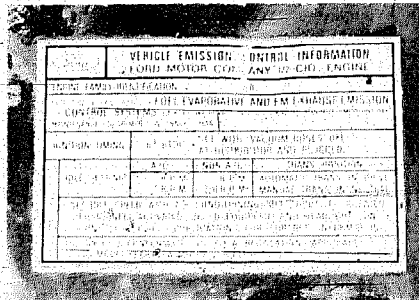

may eliminate dieseling since it burns cooler and reduces the engine's operating temperature slightly. However, this isn't the solution to the problem, and it may damage an engine designed to run on sub-regular fuel.

Advancing the timing, richening the fuel mixture, or decreasing the idle speed are other methods some people use in an attempt to control dieseling. But, doing any of these things merely defeats the necessary anti-pollution measures designed into your engine. And altering any of these adjustments from factory specifications is usually illegal!

#### SOLUTIONS!!!

So, what can you do if your car starts dieseling? Well, despite possible frequent evidence to the con-

Aim the light carefully at the timing pointer and sight directly down the middle of the light to avoid error when aligning the timing marks.



continued

## THE BACKYARD MECHANIC

trary, your car's engine is designed not to run on after you switch it off. If it does, it's probably because it needs a tuneup.

But, let's say you just put a good tune on the engine and it's still reluctant to quit when it should. Then, the first thing to do is make sure the idle speed and ignition timing are set exactly to the manufacturer's specs. Misadjustment of these critical settings is very frequently the cause of dieseling.

### ANTI-DIESELING DEVICES

If all essential adjustments check out, and the engine is still a bit over-anxious at switch-off, you'd better check into the car's anti-dieseling device.

In 1969, after engine tune modifications on the '68 models made dieseling common, the manufacturers be-

gan installing special anti-dieseling devices. One of these devices is used on most cars built after 1969—especially on models with larger engines and/or automatic transmissions. Your manual shows what type of device your car uses, if it is so equipped.

### SOLENOID

The most common of these devices is the anti-dieseling solenoid, called a throttle modulator on Ford products. The solenoid is a mechanical device that mounts on the carburetor and controls dieseling by allowing the throttle plate to close completely when the ignition is turned off. This prevents combustible air and fuel from entering the cylinders after switch-off.

The solenoid's main component is a special plunger. When the engine is warm and off the fast-idle cam, the plunger extends against the throttle linkage or throttle-stop screw and holds the throttle plate open to maintain engine idle. When the ignition is

switched off, the plunger retracts allowing the throttle plate to close off the air to the cylinders.

### OPERATION

The solenoid can be quickly and easily checked for proper operation. Remove the air cleaner assembly and locate the solenoid at the carburetor. With the engine warmed to operating temperature and the idle properly set, have a friend hold down the accelerator (with the engine off) so the throttle linkage is retracted from the solenoid.

Then, simply watch the action of the solenoid's plunger as your friend switches the ignition on—then off. If the plunger extends with the ignition on—then retracts when the ignition is switched off, it's operating correctly.

If the plunger fails to move, disconnect the wire running to it (see picture). With the ignition on, but the engine not running, touch the wire to a metal "ground." If the wire sparks, the solenoid is faulty. Check

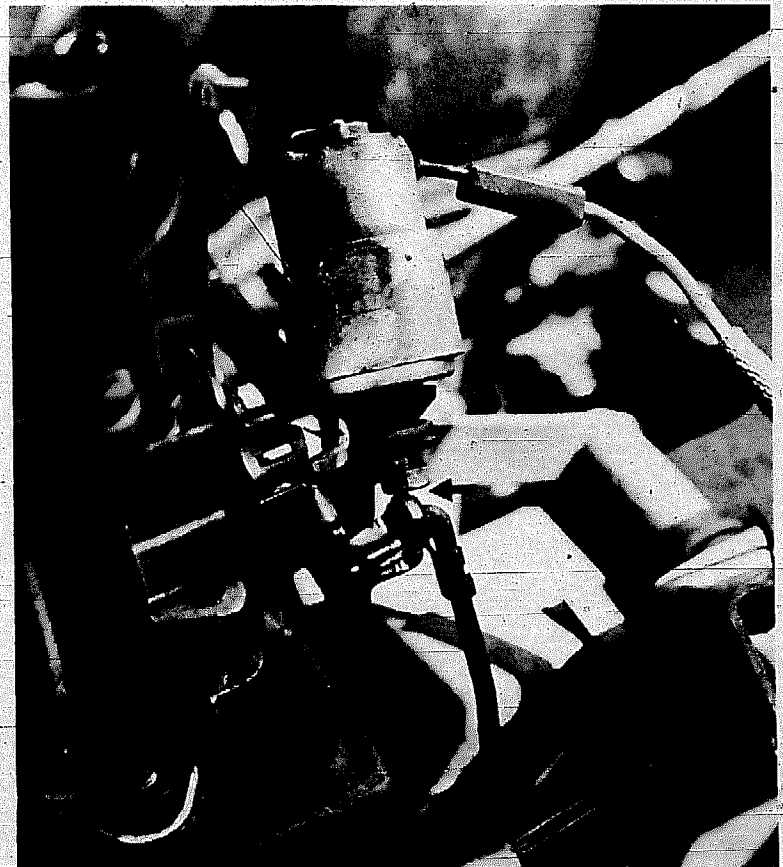
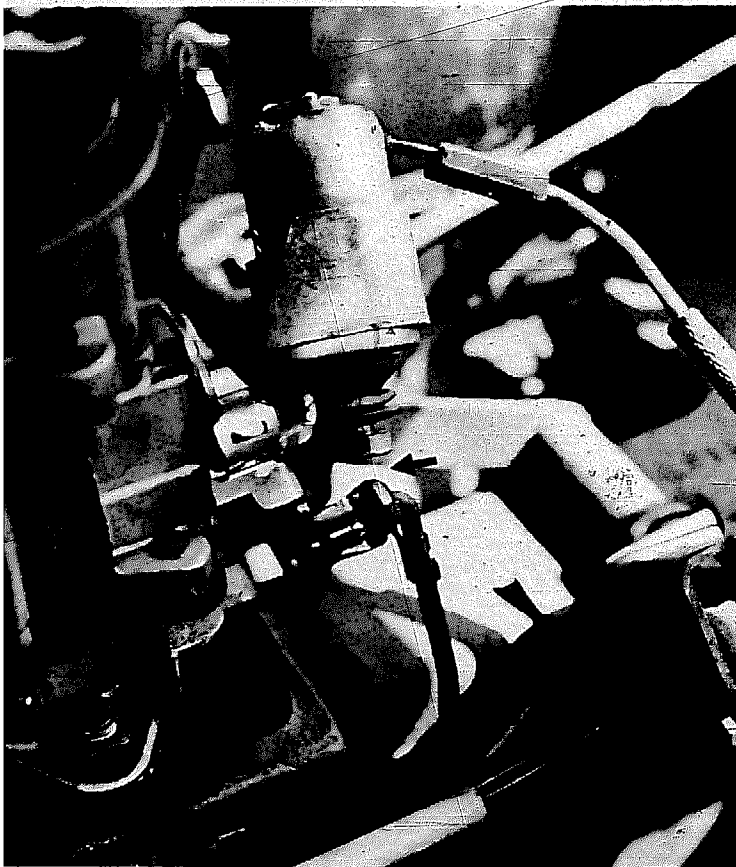

Many 1969 and newer cars use special anti-dieseling devices. The most common is the anti-dieseling solenoid. Solenoids on all cars are essentially the same. With the engine at operating temperature, the solenoid plunger extends against the throttle linkage or throttle-stop screw to maintain engine idle. The plunger should retract when the ignition is shut off. If it doesn't, and the wire to the solenoid is electrically hot, the solenoid must be replaced.

your manual for proper solenoid replacement and adjustment procedures on your car. If the wire doesn't spark, it is probably disconnected at the wiring harness on the firewall, or at the ignition switch. The wire could also be shorted out. Trace the wire back from the solenoid until you locate the problem.

#### ADJUSTMENT

With the engine idling normally, simply pull the wire loose at the solenoid to check the solenoid's adjustment. Idle speed should drop, and preferably the engine should stall or die. If it does, the solenoid is adjusted reasonably close to specs.

If engine speed doesn't drop off considerably when the wire is removed, the solenoid needs adjustment. Adjusting the solenoid on most cars requires simply turning the plunger adjustment nut and the throttle-stop screw until the engine idles properly, and stalls when the plunger retracts. Check your manual for the correct adjustment procedure

on your car.

#### AC SYSTEM

On many newer cars with factory-installed air conditioning, the anti-dieseling solenoid has been replaced by a simple relay system that engages the air conditioner compressor when the ignition is switched off. This puts the engine under extra load, causing it to burn all of the fuel in the combustion chambers as the engine is turned off—helping to eliminate dieseling.

This type of anti-dieseling system can be very easily checked for proper operation. With the engine running and all air conditioner controls in the "off" position, observe the air conditioner compressor's clutch as a friend switches off the engine. The clutch should engage for several seconds, slowing the engine.

If the clutch doesn't engage when the ignition is switched off, look for a loose connection at the compressor or anti-dieseling relay. The relay is usually located under the dash—but

check your manual to be sure. If all connections are tight, if the relay is properly grounded, and if the air conditioner operates normally, the relay is faulty.

#### OTHER CAUSES

Dieseling is nearly always the result of an untuned engine and/or inoperable or improperly adjusted anti-dieseling device.\* However, there are a few items which may go unchecked in a regular tuneup that can contribute to or cause dieseling. The manifold heat control valve (heat riser) and the throttle linkage are two of these items.

If the heat riser valve sticks in the "heat" position, the fuel mixture will be overheated, resulting in dieseling and other performance problems. The valve should be checked for proper

\* On some 1970-71 Ford models, dieseling may occur because of feedback through the alternator warning light circuit. A diode kit is available from Ford to cure this problem. A failure of this diode may also cause dieseling.

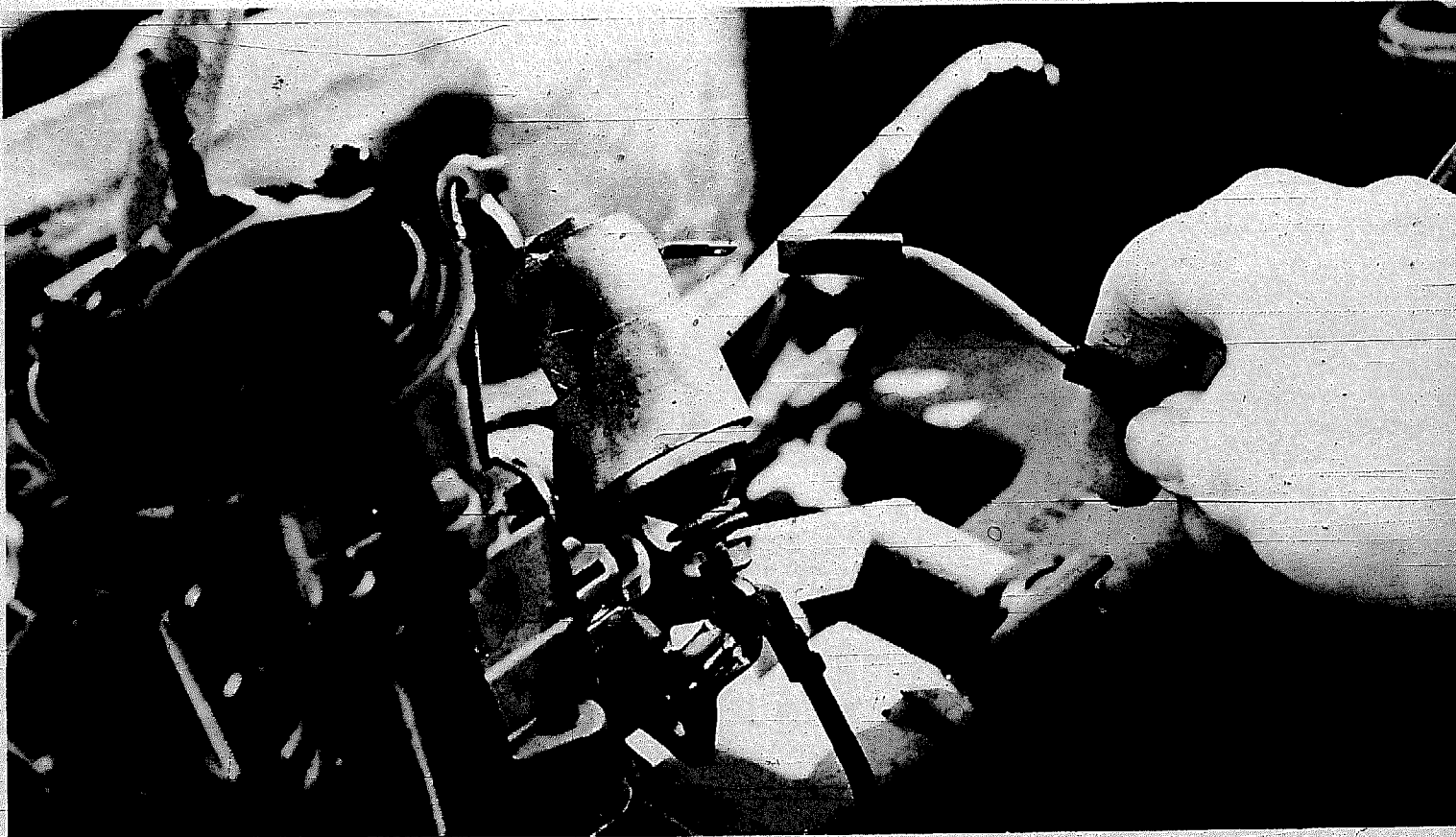

Pulling the wire loose with the engine warm and idling will drop the idle speed considerably, and even stall the engine if the solenoid is properly adjusted. If pulling the wire doesn't affect idle speed, the solenoid needs adjustment.

continued

## THE BACKYARD MECHANIC

operation and doused regularly with solvent to keep it operating freely. (See "The Back-Yard Mechanic," Aug '73 DRIVER).

A dirty throttle linkage can also contribute to dieseling by holding the throttle plate open slightly when the engine is shut off. The linkage should be kept clean and checked periodically for free operation.

Even if you have everything ad-

justed "right on," however, occasional dieseling is considered normal on today's emission-controlled engines—especially when they have been run hard on a hot day. But there are a couple of final things you can do to give your engine a break—especially when it's slightly overheated and you think it might want to keep running after you tell it to stop.

First, always let the engine idle normally for a few seconds before shutting it off. Revving the engine just as you switch it off not only

contributes to dieseling, but is also harmful to the engine. The excess fuel which enters the engine dilutes the oil in the cylinders, causing inferior lubrication when the engine is restarted.

With an automatic transmission, it's also sometimes desirable to leave the selector in "Drive" and your foot on the brake when you shut off the engine. This keeps the engine under load, and the idle speed from increasing and sending excess gas to the cylinders at switch-off. ●

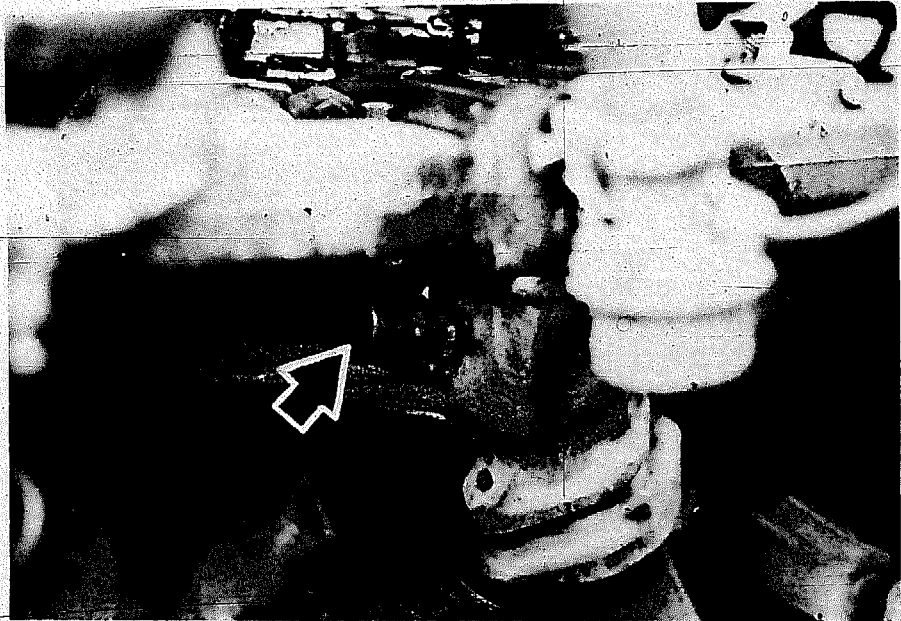

A stuck heat riser or throttle linkage can cause or contribute to dieseling. Check both mechanisms regularly for proper operation. Frequent dousing with solvent will help keep them working freely.

It was once thought carbon buildup in the engine was the main cause of dieseling. With today's engines this generally isn't the cause. However, regular cleaning of the carburetor and combustion chambers with aerosol cleaner-decarbonizer will help keep your engine running right, as well as deter dieseling.

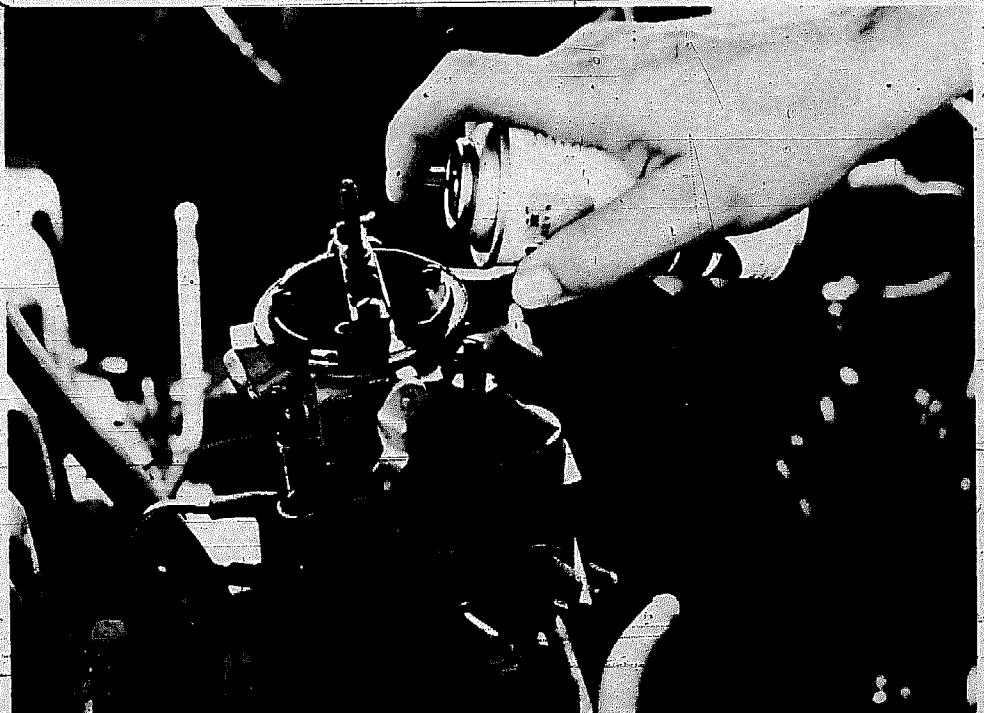



THE BACK-YARD MECHANIC - - PART XI

# THE BATTERY

Don't let your battery let you down!



**Y**ou probably take your car's battery pretty much for granted. In fact, you've probably been ignoring if not totally abusing your battery all summer and getting away with it. But unless you want to be walking that first morning winter hits hard, you'd better reestablish a proper relationship with your battery.

Many batteries make it through summer without a hint of trouble, but expire the first time the mercury drops. This is because cold absolutely zunks a battery. A fully charged battery loses nearly 65 percent of its available power when the temperature drops from 80° to 0° F. But... your car's engine requires 2½ times the cranking power to fire up at 0°, as it does at 80° F. So, you can see why it's essential to get your battery ready for the cold season *before* the bottom drops out of the thermometer.

Also, by getting your car's battery in shape now and keeping it that way, you'll save a lot of money. You shouldn't have to worry about tow charges or jump starts. Plus, with proper battery maintenance and care, you can easily double the guaranteed life of a battery.

#### WINTERIZING

If you have a new car, you might have a sealed, maintenance-free battery—this is the new trend in battery construction. But chances are you have the old-style battery that's going to require a bit of preparation to get you through the cold season.

The first step in winterizing a battery is a cell test. The corner service station can check out your battery, or you can invest in a handy battery hydrometer and do the job yourself. An adequate hydrometer can be purchased for less than \$2 at any auto or discount store. It gives an accurate indication of a battery's condition by measuring the specific gravity\* of the electrolyte. Here's why and how.

*\*Simply stated, specific gravity is the weight or density of a substance compared to the weight or density of an equal volume of water.*

An inexpensive battery hydrometer provides a quick and accurate battery strength test. It is also handy for adding water to the battery.

#### SPECIFIC GRAVITY

A standard storage battery produces current on demand through a chemical reaction between the battery plate material and the sulfuric acid in the electrolyte liquid. When a battery is fully charged there is a high percentage of acid in the electrolyte to react with the plates. Since acid is heavier than water, the specific gravity is high if a battery is in good condition.

When a battery discharges, the acid in the electrolyte combines with the material in the plates and changes to a solid substance (lead sulfate). This is what is known as battery sulfation, or sulfating. When this happens the specific gravity drops because a high percentage of the heavier acid has gone out of solution. So, low specific gravity indicates a weak or discharged battery.

#### STRENGTH TEST

To check out a battery with a hydrometer, simply draw a sample of electrolyte from each battery cell—jotting down the specific gravity reading\* and returning the electrolyte to the cell it was taken from before testing the next cell. A good cell will have a specific gravity of at least 1.260 or higher. A discharged cell will read 1.160 or lower. These figures are based on an electrolyte temperature of 80° F. So, if you want exact readings, check the temperature of the electrolyte and deduct

*continued*

*\*Some inexpensive hydrometers are calibrated in only "Good," "Fair," and "Poor" ranges. Because of the limited accuracy of these hydrometers, the battery should be checked at a service center if a reading other than "Good" is obtained.*

## BATTERY TESTER

TESTED TWICE  
FOR GREATER  
ACCURACY

NO. RX 537-VP

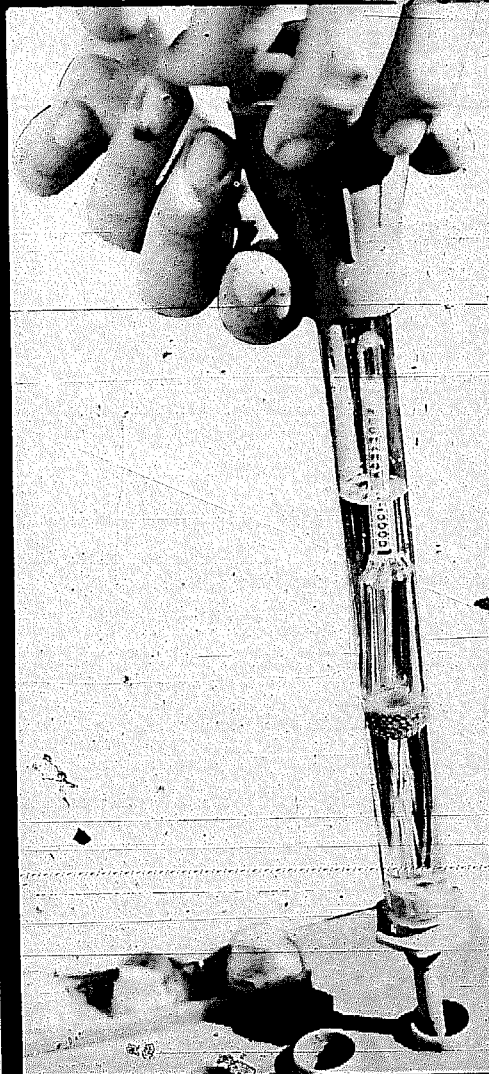
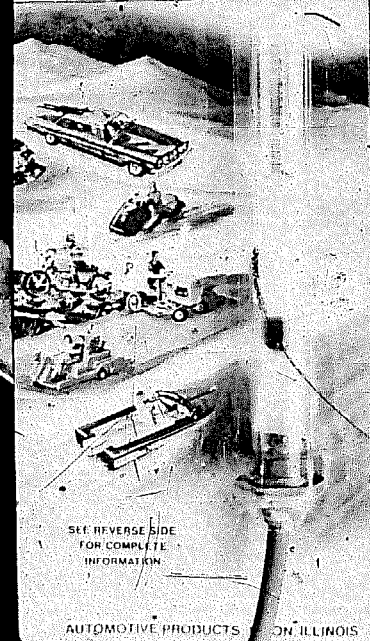

continued

## THE BACK-YARD MECHANIC

.004 from the gravity reading for each 10 degrees below 80° F, or add .004 for each 10 degrees above 80° F.

### CHARGE?

Variation between the cells exceeding .050 indicates bad cells—the battery should be replaced. If the battery is slightly discharged in all cells, it can probably be brought to full charge with a small home-type trickle charger.

If the battery is badly run-down or fails to charge to at least 1.225 in every cell, it should be checked out by a reputable shop. The battery may be able to be revitalized by a slow charge with a heavy-duty commercial charger. A shop can also check your battery with a variable load tester if you are uncertain of the battery's condition.

### OTHER MAINTENANCE

If your battery passes a specific gravity test and/or is brought to full charge it should get you through the cold season with no sweat—provided you take several more precautions. Dirt and corrosion on the battery case and terminals trap moisture and promote slow discharge. To prevent this, you should periodically remove the battery from the car and thoroughly clean it. Many GM cars, however, have sealed side terminals which require only occasional wire brushing of the terminals.

### PRECAUTIONS

Before handling a battery, however, be sure to remove all rings and jewelry. Also, remember that battery electrolyte is an acid solution. If you get any on your skin or clothing rinse it

off immediately; and, wash your hands and arms with soap and water when you're through working with the battery. Finally, never smoke when working around a battery. Batteries normally give off explosive hydrogen gas—especially when being charged.

When you're ready to remove the battery for cleaning, locate the ground cable—this is the cable connecting to the engine or car frame. Nearly all American cars are negative ground, but check to be sure. The negative cable should be black and the word "Neg" or a minus sign should be molded on the battery case or terminal.

With the ignition switch off, loosen the clamp bolt and remove the negative cable. A special terminal puller (see picture) is recommended for removing the clamps, but a screwdriver

When removing a battery, the ground cable (usually the negative cable) which attaches to the engine or car frame should always be removed first. Replace it last when reinstalling a battery.

A special cable terminal puller is best for removing battery cables.

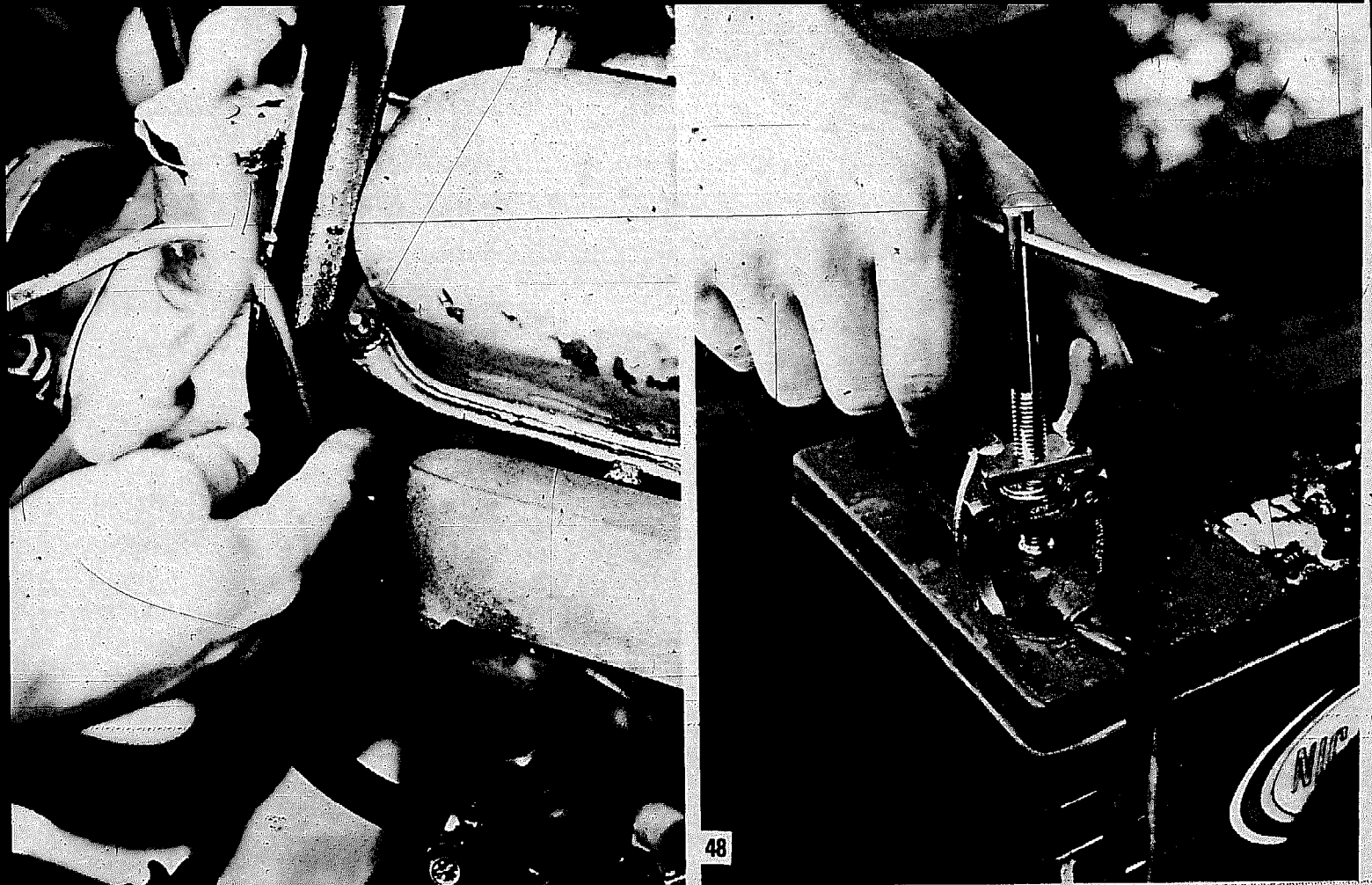

and pliers will do the job if you're careful. You may have to spread the clamp to get it off the terminal without a puller. Pull the negative cable away from the battery and remove the positive cable.

#### CLEANING

With both cables removed; loosen or remove the battery hold-down bracket and lift the battery from its carrier and place it on the ground. Using steel wool or a special cleaning tool (see picture) clean all dirt and corrosion from the battery posts and cable clamps. Replace the cables if the insulation is cracked, wires are frayed, or the cables are otherwise damaged.

After cleaning the terminals and clamps, scrub the battery case with a baking soda solution. Rinse the

*continued*

**Accumulated corrosion** like this can easily short-out a fully charged battery. The battery terminals and cable clamps should regularly be cleaned with steel wool or an inexpensive battery cleaning tool (pictured).

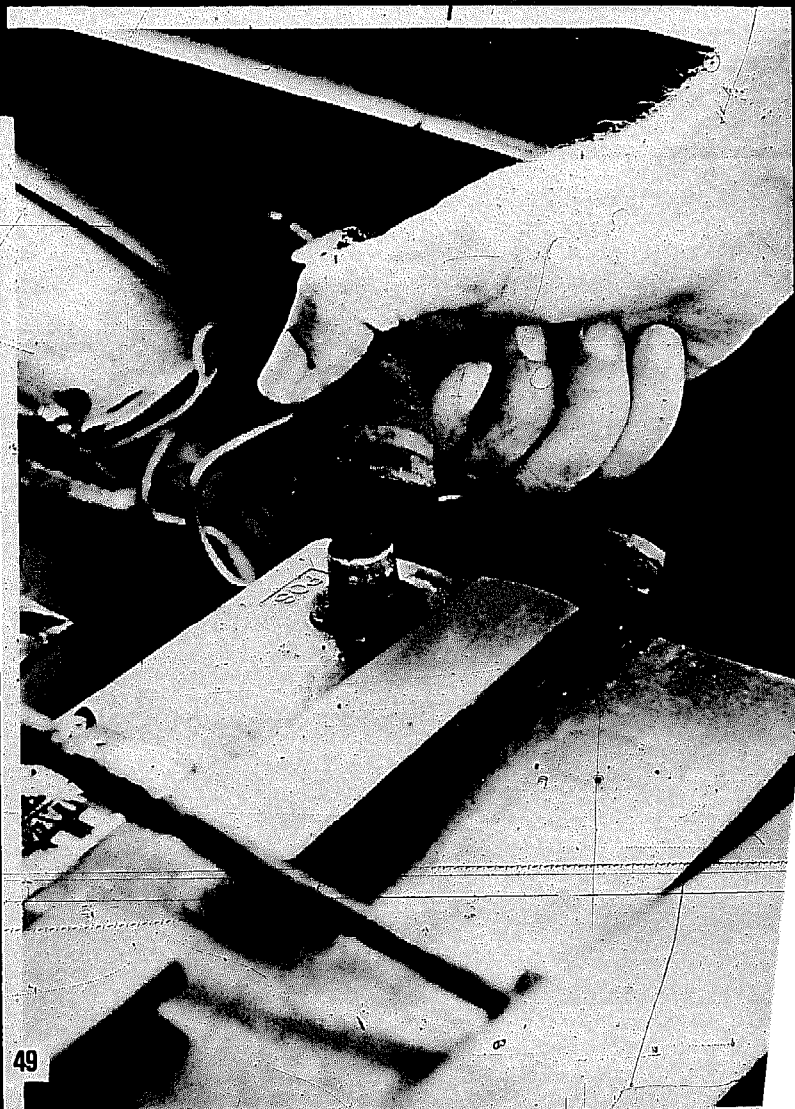
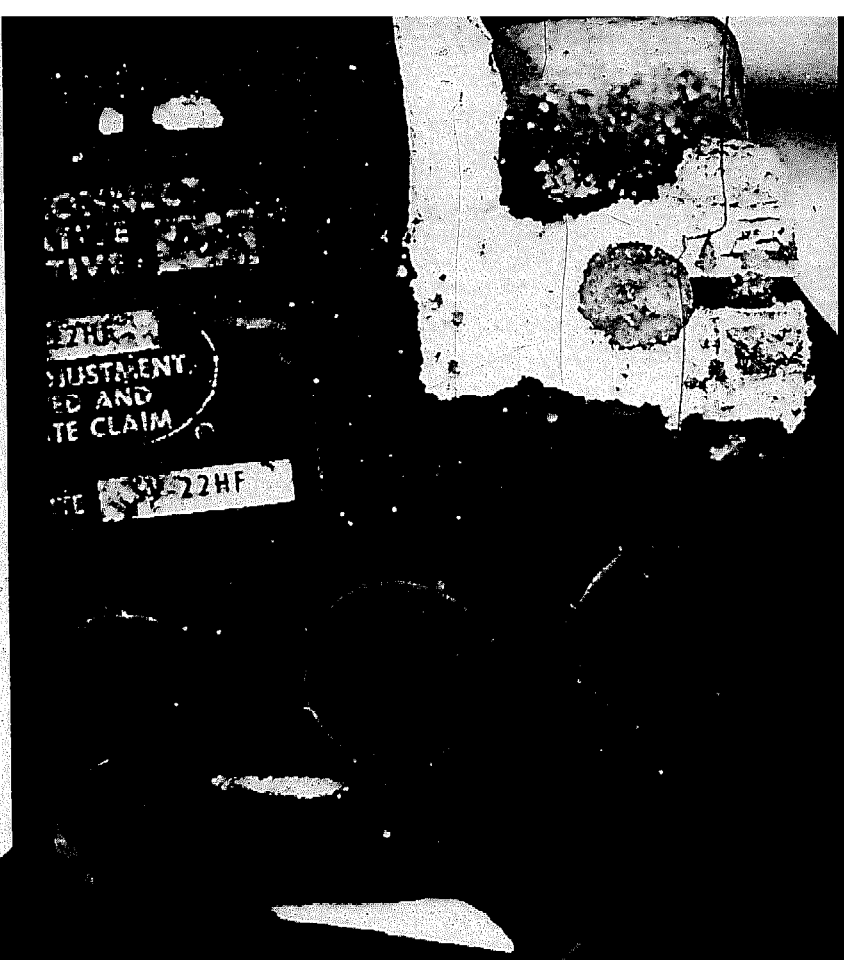

continued

## THE BACK-YARD MECHANIC

battery thoroughly with clean water, and let it dry. Before reinstalling the battery, check for cracks in the case—small ones can be repaired with a special battery sealer, but large ones call for a new battery.

Replace the battery so the appropriate terminals and cables correspond, and install the hold-down bracket. Don't overtighten the bracket—this can crack the battery case. After tightening the cable clamps,

cover the tops of the terminals and clamps with a light coating of petroleum jelly to prevent corrosion build-up.

### BUYING A BATTERY

We've talked about revitalizing a battery—but what if your old battery is shot? Well, if you're into saving money you should slide down to the local discount or department store—pick up a battery and install it yourself. Department stores offer a variety of power range batteries for about  $\frac{1}{3}$  to  $\frac{1}{2}$  the price of an equivalent battery at a service station.

The only trick to buying a battery at a discount store is to check the application chart that shows what battery you need. Be sure and get one with at least the power rating of the battery you car presently has. Generally, your best bet is to get a slightly heavier-duty battery than the chart recommends. A less powerful battery has to work harder and, therefore, is not going to last as long. A battery more powerful than required is also less likely to fail, since it has power to spare for most conditions.

A new battery can be installed following the hookup instructions given



Periodic removal and washing of the entire battery with baking soda solution will prevent dirt from discharging the battery. The case should be thoroughly rinsed and dried before reinstallation.

previously. Just be doubly sure you have the cables connected to their proper terminals. This shouldn't be a problem since the terminals are clearly labeled on the battery. You can doublecheck the hookup by turning the lights on with the ignition key in the "On" position. If the cables are properly installed, the amp gage will show a discharge or the alternator warning light will glow. If not, reverse the cables.

#### WATER LEVEL

Proper maintenance is essential for prolonging battery life whether you

have a new power plant or you're still making it with the old one. Keeping the electrolyte up to its proper level is the most important battery maintenance. Check the water level at least every two weeks—especially in summer when the water evaporates.

The required water level should be marked on the battery case. If it's not, maintain the level at about  $\frac{1}{8}$ - to  $\frac{1}{4}$ -inch above the plates. Distilled water, if available, should be used to bring low cells up to the proper level. However, tap water is better than no water if the battery is low. But be sure not to overfill the battery—or

spill water on the case. Over-filling the battery causes it to discharge and possibly even freeze in cold weather. Also, if you add water in winter, be sure to do it right before you are going to drive the car to prevent the battery from freezing. And don't perform a hydrometer check until about three days after adding water.

#### WINTER CHECKS

Along with checking the electrolyte level regularly, an occasional hydrometer check is a good idea in

*continued*



After washing, the battery should be kept clean and dry. After reinstalling the cables, lightly coat the tops of the terminals with petroleum jelly to prevent corrosion build-up.

continued

## THE BACK-YARD MECHANIC

winter. A perfectly healthy battery can discharge in winter due to heavy use of accessories such as the heater and defroster. This is where an inexpensive home-type trickle charger can come in handy. A slow overnight charge can get a battery up to full strength and make sure it fires up the engine in the morning. Also, a fully charged battery is less likely to freeze than one that is run-down. However, to prevent battery damage be sure to follow the charger's instructions carefully. Never try to charge or jump a frozen battery.

Even if you keep your battery properly charged, the water level correctly maintained, and regularly clean off the dirt and corrosion, you still might come out some morning, turn the ignition key, and be greeted by only a low groan from under the hood. When this happens you'll probably need a jump start. Assuming you have a set of heavy-duty jumper cables, the job

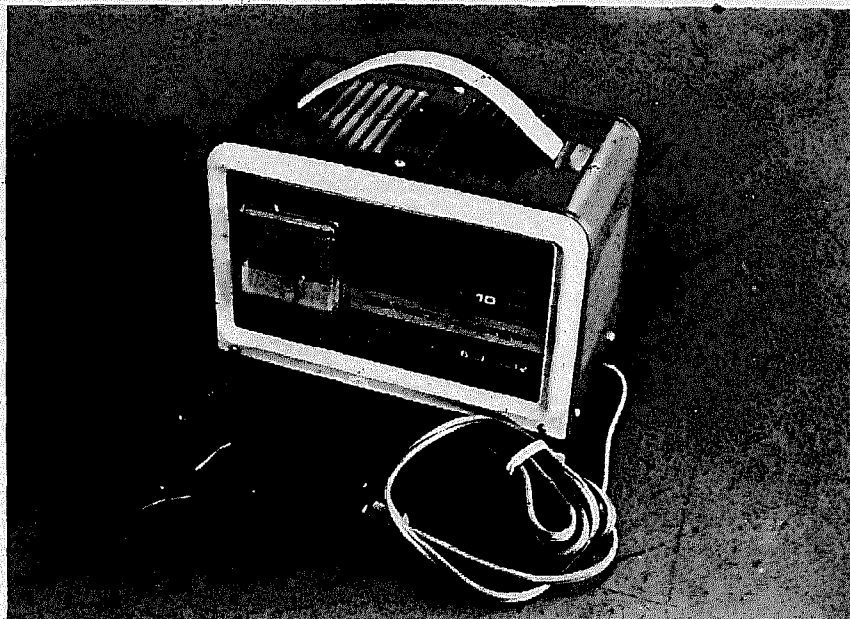

An inexpensive home charger is great for keeping a battery at full charge in winter. All battery chargers should be used carefully according to the manufacturer's instructions.

will be simple and safe if you check out "Jump Starts," September '73 DRIVER for the correct jump start procedures.

The following list of battery tips can also help make sure your battery survives this winter—maybe even a couple more. ☺

## BATTERY TIPS

- Along with keeping the water level properly maintained, keeping the battery clean and dry is essential for maximizing battery life. Check the terminals periodically for corrosion build-up. Corrosion frequently shorts-out a full charged battery—corroded terminals is the first problem to check for if the starter fails to work and the headlights won't come on.

- If you have to add water regularly to one or two cells, the battery may have a cracked case. But if all or most of the cells require water more than every 1000 miles or so, the battery is probably overcharging. Have the voltage regulator

checked out to prevent severe battery damage.

- Check the generator/alternator belt regularly for proper tension. A loose or glazed belt can run down a battery quickly.

- Keep the engine properly tuned to reduce the starting load on the battery.

- Get in the habit of turning off all accessories every time you start the car.

- When starting a cold car, place the transmission in neutral and disengage the clutch to reduce the starting drag.

- Avoid slow speed and short distance driving that doesn't give the battery time to charge back up after a start—especially in winter when the battery has to work harder to start the engine.

- Try and limit the use of accessories when driving in stop-and-go traffic.

- If you don't plan to use your car for a week or so in cold weather, remove the battery and store it in a warm place to prevent it from discharging and possibly freezing. Wrap the battery in old rags to prevent acid damage to the area in which it's stored.

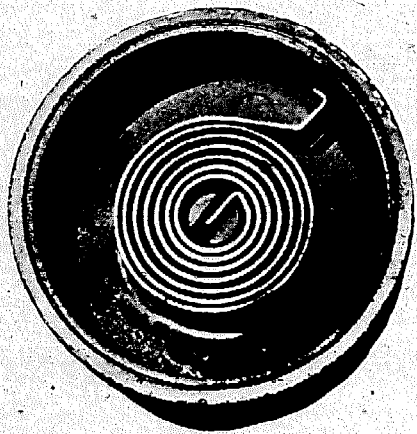

## The **AUTOMATIC CHOKES**

Keep it automatic to save gas and cut emissions

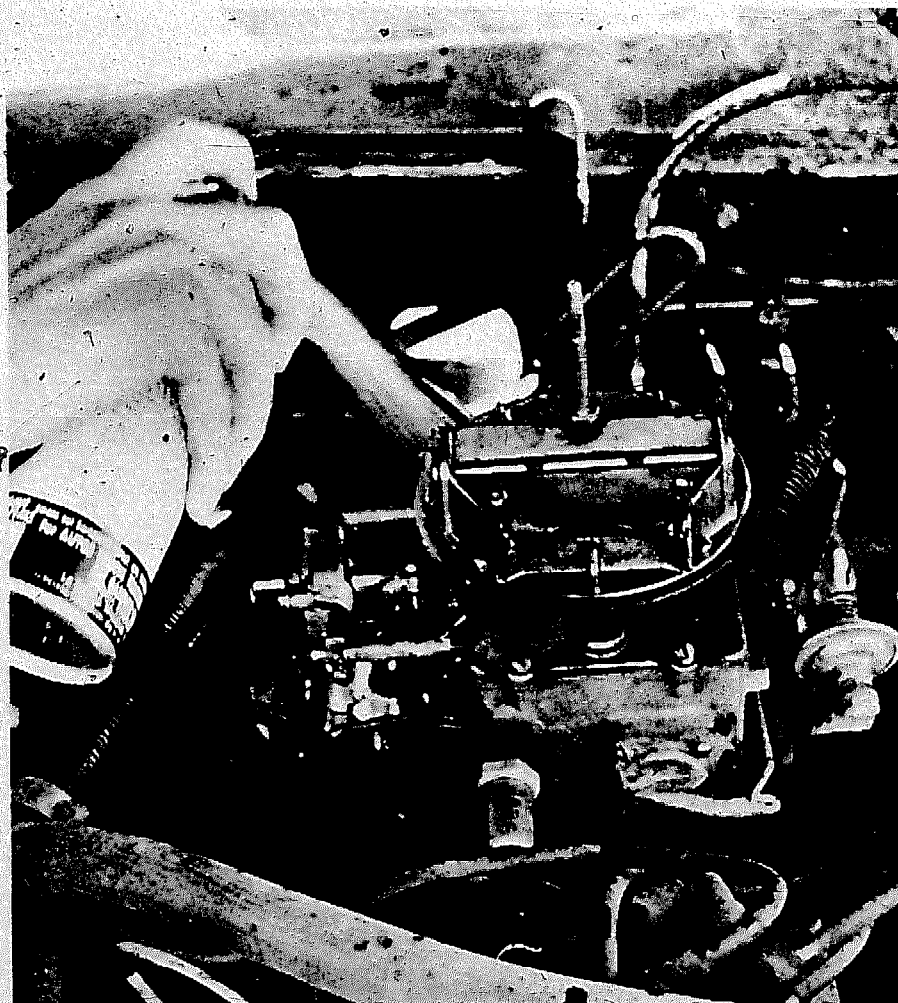

Regular dousings with aerosol choke cleaner will help prevent the most common choke problem—sticking linkages.

**N**ow that the cold season has really arrived, you may have discovered that your car doesn't start so well. If so, it's probably because it's not getting choked. Even if your car is super-tuned it's going to have starting problems if the choke isn't doing its thing.

Today's automatic chokes, while generally more reliable than the manual type, are not perfect. Ailments such as incorrect adjustment, a sticking linkage, or a faulty thermostatic coil can cause starting as well as performance problems for your engine. But most choke problems are the result of a simple lack of maintenance and can be remedied with a can of aerosol choke solvent and a screwdriver.

### WHY A CHOKES?

Most engines are designed to run on an air/fuel mixture of about 14 to 1, or 14 parts of air to every part of fuel. But there's one problem. When an engine is cold and inefficient it can't ignite this lean a fuel mixture. To start a cold engine, more fuel and less air must be supplied to the combustion chambers.

A choke takes care of this problem by simply closing off the carburetor throat, allowing less air to enter the carb. With less air in the carb, the percentage of fuel going to the com-



A sticking choke plate linkage is common—check the plate regularly for free operation.

As the engine warms, combustion in the combustion chambers increases and combustion occurs more readily. As the engine warms, the choke plate gradually opens, allowing more and more air to enter the carb until the engine is fully warmed and burning the normal fuel mixture.

#### CHOKE TYPES

There are three basic types of automatic chokes used today. But the well-type and in-carb chokes are by far the most common. These chokes use a temperature-sensitive metal coil and a special vacuum control unit to regulate the operation of the choke plate.

The well choke is used on most Chrysler products and has the thermo coil located in a special well on the intake manifold. This type choke is easily identified by a connecting rod running from the coil to the choke linkage at the carb. It also uses an external vacuum control diaphragm.

In-carb chokes are the most popular type and are used on most Ford and GM products. The thermo coil and vacuum control are actually part

of the carburetor with this choke. The in-carb choke is characterized by the round thermostatic coil cover on the back or side of the carb.

The third type of choke is the water-heated system used on some late model Ford products. This system operates in essentially the same manner as mechanical chokes, except that it is controlled by the cooling system water temperature. Because these systems are rare, as well as prac-

*continued*

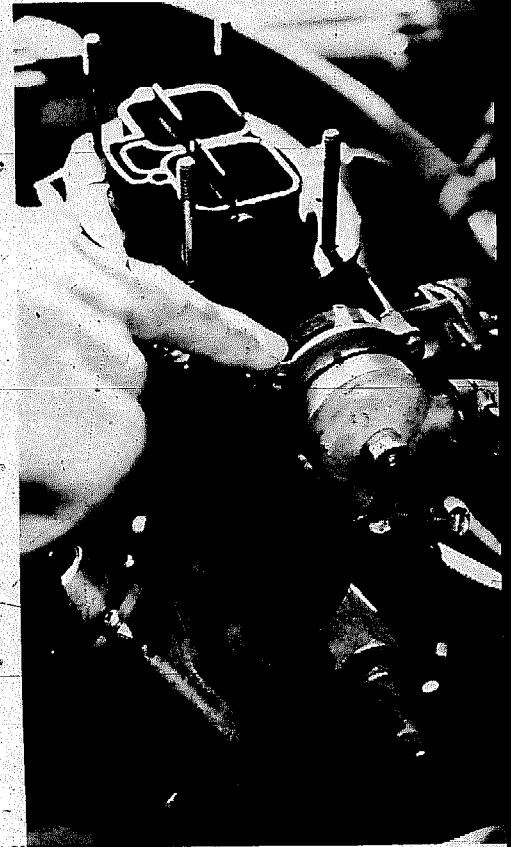
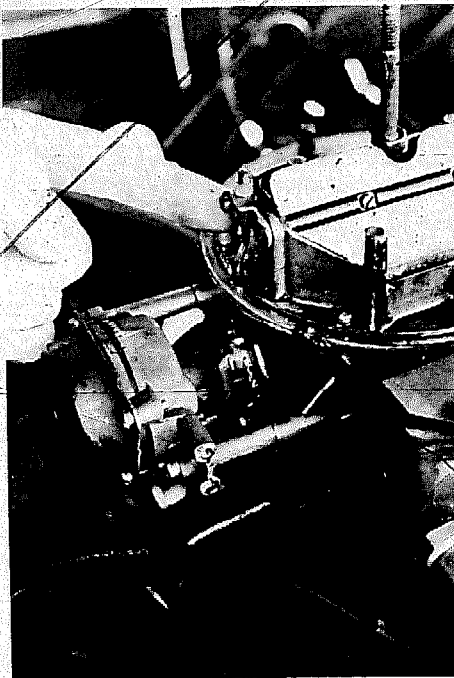

The water-heated choke, used on some late model Ford products, is a very reliable and maintenance-free choke system. Adjustments are made by turning the cover to realign the calibration lines.

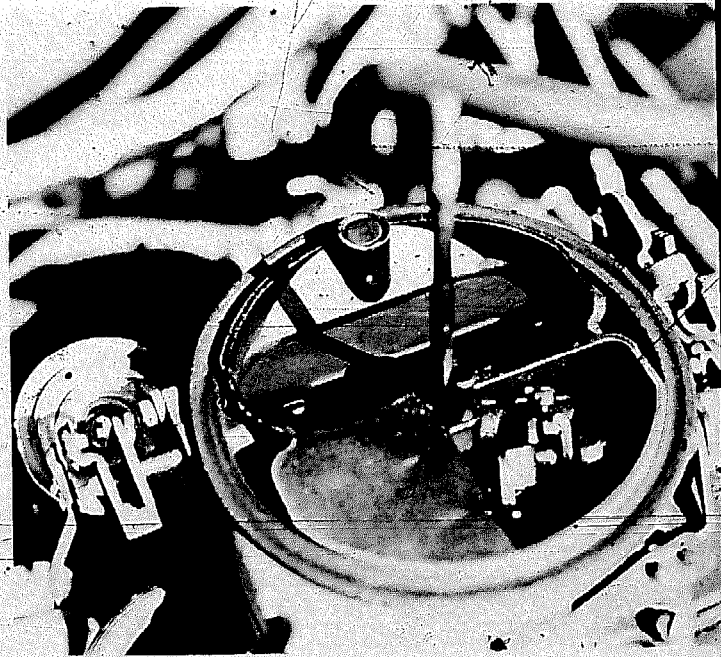
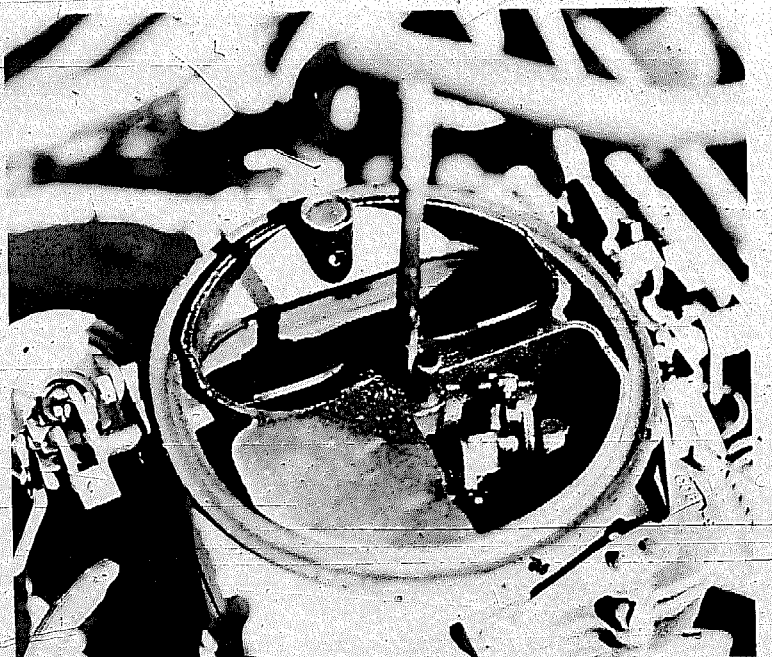

With a cold engine the choke plate should close fully. The plate should pop open slightly when the engine starts. If not, the choke's vacuum control needs adjustment or replacement.

continued

## THE BACK-YARD MECHANIC

ically maintenance-free, they won't be discussed. However, a service manual gives complete information if your car uses this type choke.

### OPERATION

The common well and in-carb chokes, while slightly different in design, operate in essentially the same manner. When an engine is started cold, the thermostatic coil tension is very high and holds the choke plate closed—even though the vacuum unit, which is attached to the choke plate linkage, is pulling on the plate trying to open it. But as the engine warms, the coil tension decreases and the vacuum unit is able slowly to overcome the coil tension and open the choke plate. With the engine at operating temperature, the vacuum pull easily overcomes the weak coil tension and the plate stays open.

### CONDITION

When a choke isn't doing its thing it's usually pretty obvious, since the car won't start or keep running after it starts. But frequently, a sticking or improperly adjusted choke goes unnoticed. Since either of these conditions cause excess fuel consumption and exhaust emissions, the choke should be checked out regularly—even if the engine starts easily.

But before checking the choke's operation, make sure the choke plate operates freely. It's a good idea to thoroughly clean the entire choke assembly with solvent *before* checking the choke operation. Dirty or sticking linkages are by far the most frequent causes of choke problems.

### CHECK OUT

To check the choke, remove the air cleaner top so you can observe the choke plate. With the engine cold and not running, the choke plate should be closed. If it's not closed (a non-closing plate is rare), the choke coil probably needs adjustment or replacement—this will be covered later.

Start the engine. If the closed plate cracks open slightly, then gradually opens as the engine warms, the choke is operating correctly. However, it may still need adjustment.

### ADJUSTMENTS

Other than sticking linkages, a choke that opens too quickly or too slowly is the most common choke problem. If the plate opens too fast (lean setting) the engine will stall and waste gasoline until it can warm itself. More often the choke plate opens too slowly (rich setting), or overchokes. In addition to wasting gas, overchoking causes excess engine wear by allowing excess raw gas to go into the engine and dilute the oil. Dark exhaust smoke during warmup means you are wasting gas and polluting the air unnecessarily and that you need a leaner choke setting.

Adjusting an in-carb choke is especially easy. Remove the air cleaner assembly and locate the plastic coil cover on the back or side of the carburetor (see photo). The cover is calibrated with lines showing richer and leaner settings. There is also an arrow indicating the leaner settings. Moving the cover to the left (in the direction of the arrow) leans the choke setting by reducing tension on the coil and allowing the choke to open sooner. Turning the cover to the right richens the setting by holding the choke closed longer.

If an adjustment is needed, simply loosen the three screws holding the cover and move the cover one line in the appropriate direction. Tighten the

screws and test the new setting with a cold start. *The leanest setting that will start the engine and keep it running properly is best.* A service manual gives the normal recommended setting for your car, usually one line rich—but this may be a bit rich for many climates. You can experiment with the setting to find the best one for your engine and climate.

### WELL CHOKES

Most well chokes are not adjustable, so if you experience choke problems with this type, you'll probably have to replace the entire coil assembly. However, a few Chrysler products do have adjustable well chokes (check your manual). After removing the coil from the well, the locknut holding the calibration plates can be loosened and the lines realigned for a richer or leaner setting—whichever is required. The standard setting on these chokes is one line rich.

### COIL

If the choke plate fails to close with the engine cold, or fails to open correctly after adjustment, the thermostatic coil should be replaced. On an in-carb choke this is accomplished by removing the three screws holding the plastic cover. The coil fits inside the cover (see photo) and can be easily

*continued*

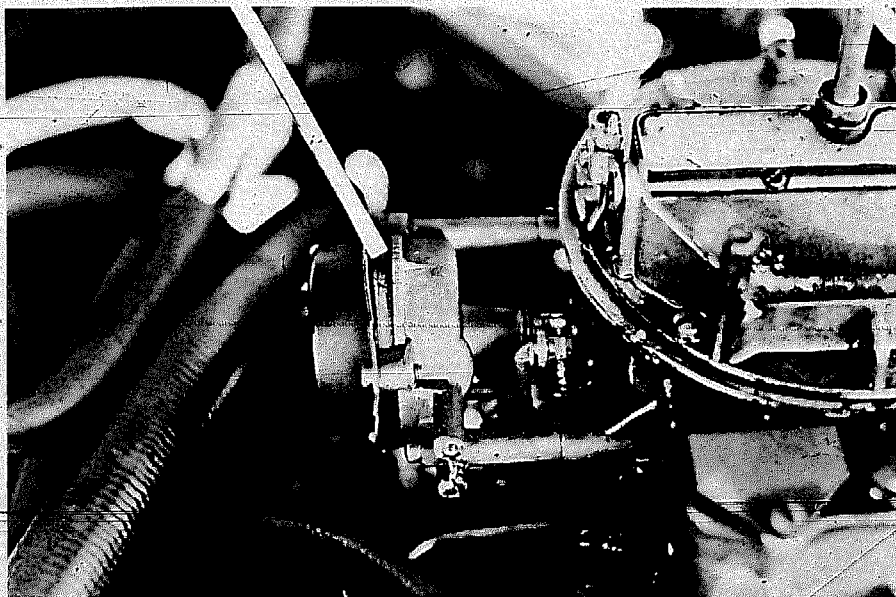

Automatic chokes occasionally need to be readjusted to a leaner or richer setting. Adjust an in-carb choke by turning the thermostatic coil cover. Lines on the cover indicate the degree of setting—either richer or leaner.

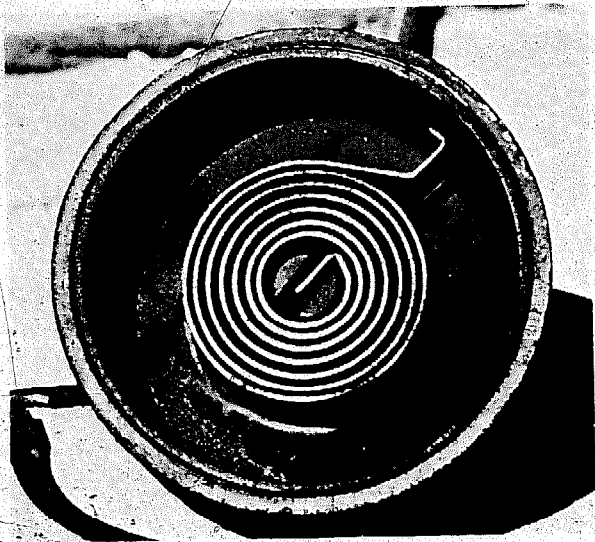

The thermostatic coil is located in the plastic cover on in-carb chokes. The coil is easily replaced if weak or seized.



The well choke has its thermostatic coil in a special well on the intake manifold. To remove the coil, loosen the well cover, disconnect the rod at the choke linkage and lift out the coil assembly.

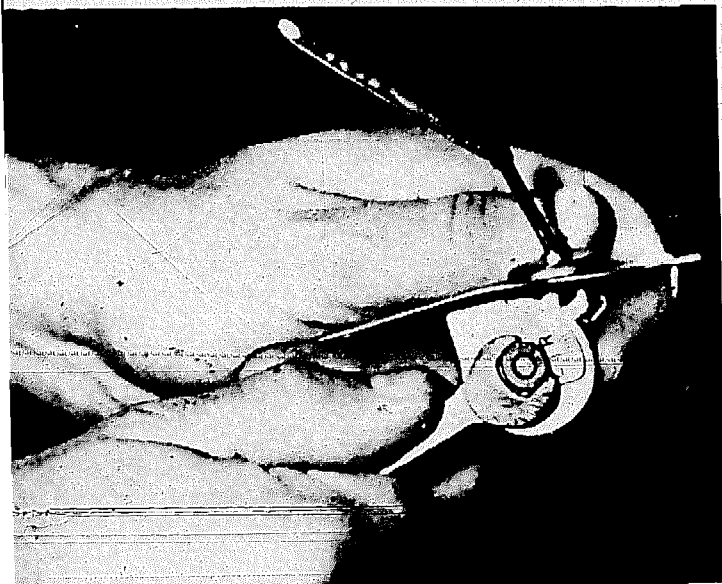

Most well chokes aren't adjustable. But a few Chrysler products do have adjustable well chokes. To make an adjustment, loosen the locknut and realign the plates to increase or decrease coil tension, which richens or leans the setting.

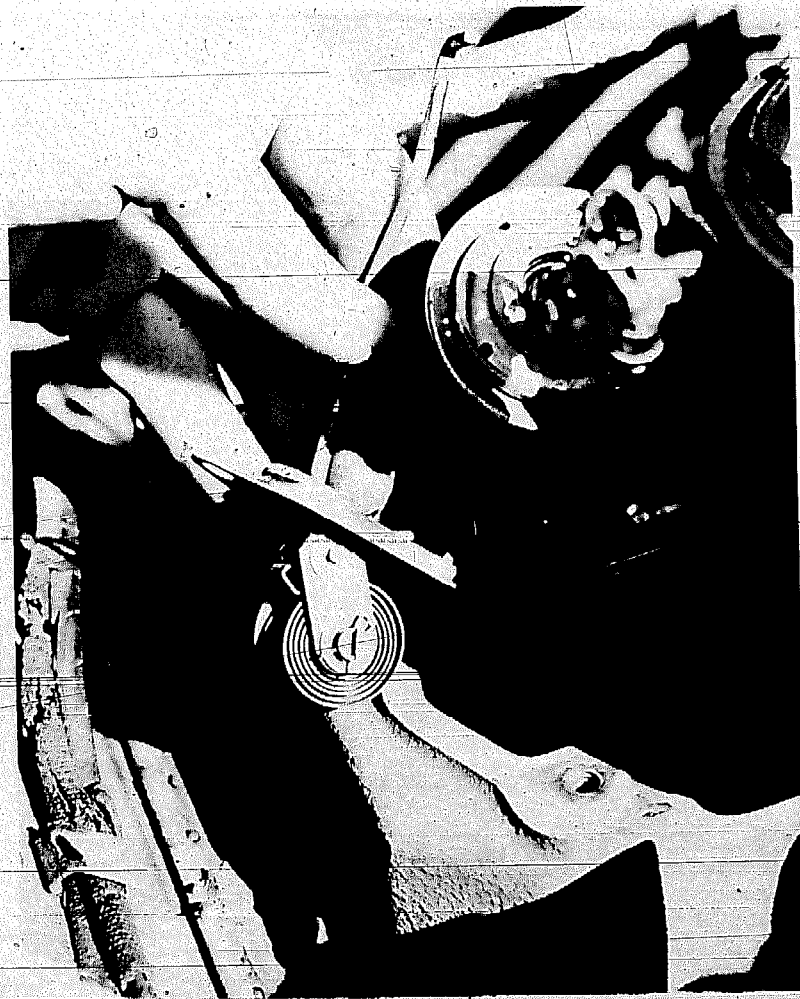

continued

## THE BACK-YARD MECHANIC

pulled loose and the new coil installed.

Replace the cover, making sure any spacers or washers are correctly installed and that the coil attaches to the choke plate linkage as did the original coil. Set the choke to factory specs and try a cold start.

To replace the coil on a well choke, loosen the nuts on the well cover and remove the cover. Then disconnect the connecting rod at the choke linkage and lift the coil assembly from the well. Install a new coil on the end of the rod and place the entire assembly back into the well. Don't forget to reattach the connecting rod at the carb.

### VACUUM UNIT

The vacuum control unit on a well choke occasionally goes bad. If the choke plate does not pop open when the engine is started cold, or opens extremely slowly after replacing and/or adjusting the thermo coil, you may have a bad vacuum unit.

To quickly check the vacuum control, with the engine warm and idling, close the choke plate and release it. If the plate doesn't open immediately, the vacuum unit is probably faulty.

In this situation, the next step is to pull the vacuum line loose from the control unit and check for vacuum (with the engine running). If there isn't vacuum, check for a leak or plugged line. If there's sufficient vacuum at the line, the unit is faulty. Replace it by removing the screws holding the unit to the carb and install a new one.

The vacuum control on an in-carb choke very rarely malfunctions. However, if it does, it's probably because the vacuum piston is sticking in its bore (see photo). Remove the coil cover and check to see that the piston moves freely. A few shots of solvent can usually free a stuck piston. If the piston is free and the vacuum control fails to operate, the entire choke assembly will have to be replaced.

### VACUUM KICK

One other choke adjustment which can give you problems is what's known as vacuum "kick." This refers to the amount the choke plate

opens when the engine is started cold. The plate must open for the engine to get enough air to continue running after it starts. But if the plate opens too far, the engine will stall because of the lean mixture. If you continue to have choke problems after checking the other adjustments, a vacuum kick adjustment may be needed. A service manual gives specs and procedures for this job.

### CLEANING

As previously mentioned, the most important choke maintenance is a regular dousing of the entire choke assembly with solvent. On in-carb

chokes, the internal surfaces—especially the vacuum piston and bore—should also be sprayed. But be sure to use only choke solvent or carb cleaner since oil causes linkage sticking dirt to collect.

If you keep your choke clean and doing its thing, you shouldn't have to hassle with no-starts and cold engine stalls. But even more important, an engine that starts and warms up properly uses less fuel and expels fewer emissions. So by keeping your choke and emission control systems "right on" you can do your thing for your budget, as well as our scarce fuel and air. ☺

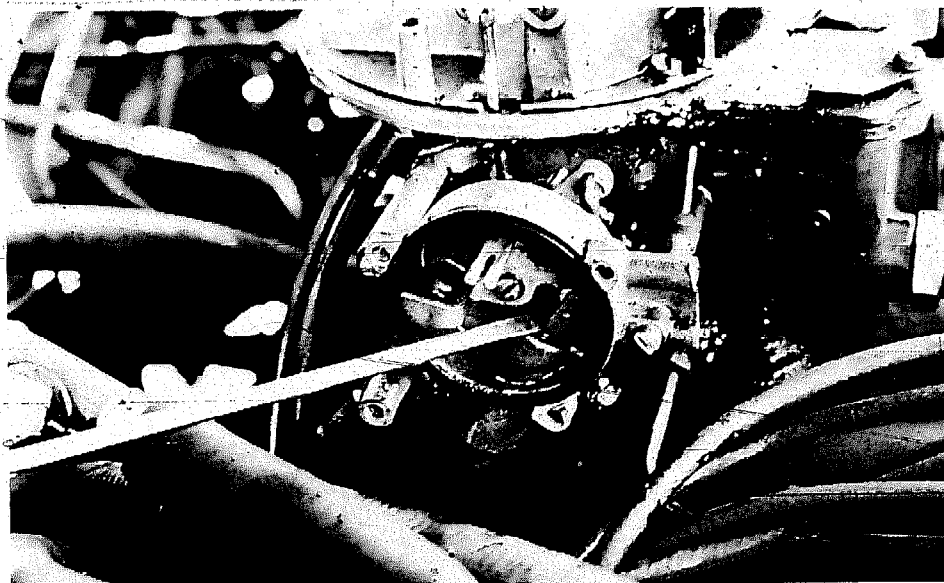

The vacuum control on an in-carb choke is a special piston inside the carb. An occasional shot of solvent in the piston bore keeps the vacuum control functioning.

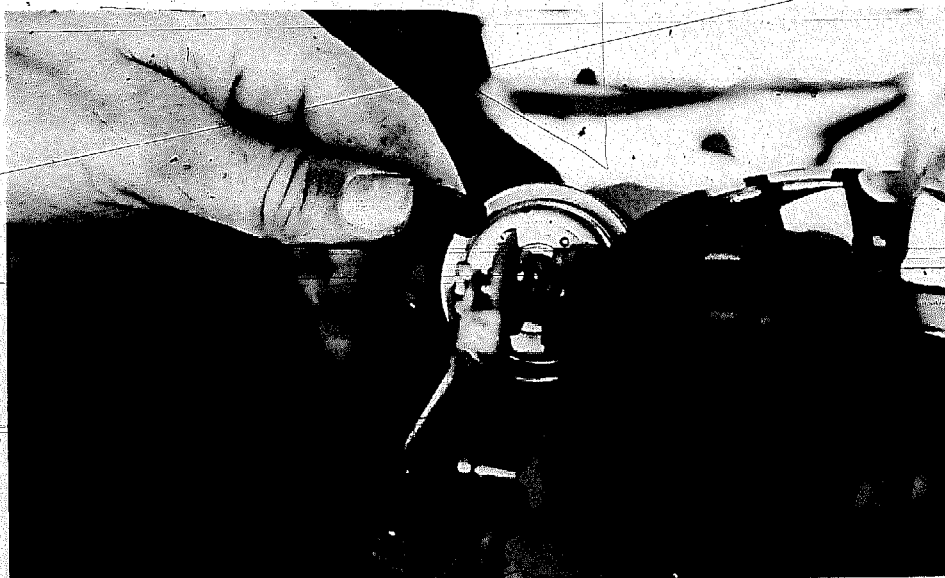

A faulty external vacuum control on a well choke can cause delayed plate openings. If a vacuum control problem is indicated, first check the vacuum hose. If there is vacuum at the hose the unit is faulty and should be replaced.