

# **AT** MICROFICHE REFERENCE LIBRARY

A project of Volunteers in Asia

Boats from Ferro-Cement

Utilization of Shipbuilding and Repair Facilities  
Series No. 1

Published by:

United Nations Industrial Development  
Organization  
P.O. Box 300  
A-1400 Vienna  
Austria

Paper copies are \$2.50; ask for publication  
number E.72.II.B.23 when ordering.

Available from:

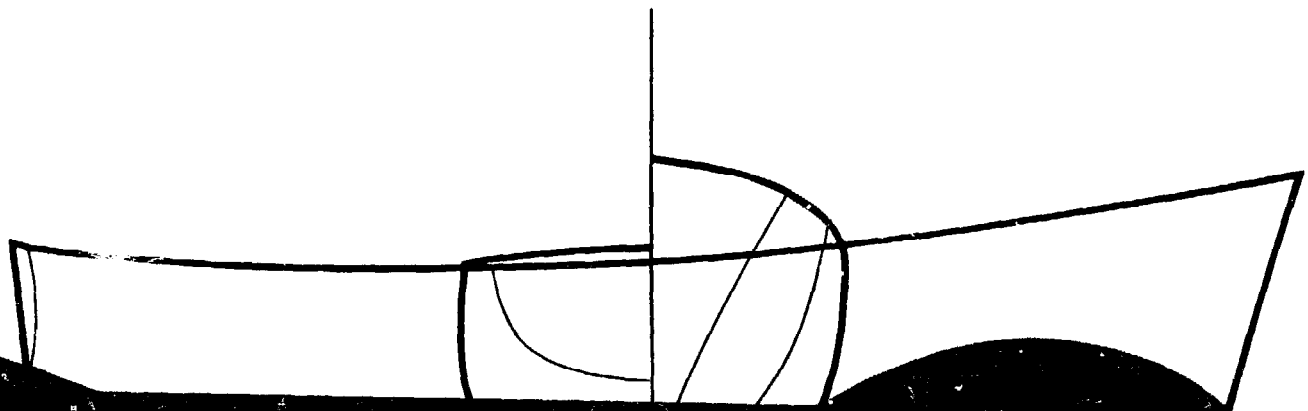
Publications Sales  
Room A-3315  
United Nations  
New York, NY 10017 USA

Reproduced by permission of the Department of  
Public Information, United Nations.

Reproduction of this microfiche document in any  
form is subject to the same restrictions as those  
of the original document.

UTILIZATION OF SHIPBUILDING AND REPAIR FACILITIES SERIES No.1

# BOATS FROM FERRO-CEMENT



UNITED NATIONS

UNITED NATIONS INDUSTRIAL DEVELOPMENT ORGANIZATION  
VIENNA

UTILIZATION OF SHIPBUILDING AND REPAIR FACILITIES  
SERIES No. 1

# BOATS FROM FERRO-CEMENT



UNITED NATIONS  
New York, 1972

Material in this publication may be freely quoted or reprinted, but acknowledgement is requested, together with a copy of the publication containing the publication or reprint.

ID/85

UNITED NATIONS PUBLICATION  
Sales No.: E. 72. II. B. 23  
Price: \$U.S. 2.00 (or equivalent in other currencies)

## FOREWORD

The technical assistance activities of the United Nations Industrial Development Organization (UNIDO) in the field of shipbuilding and repair have grown tremendously since the inception of the organization in 1966. These activities include advising Governments on development programmes for their shipbuilding industry; establishing pilot repair facilities; undertaking feasibility studies on reactivation of shipyards; and giving technical and managerial advice to shipyards—including those engaged in ferro-cement boatbuilding. This assistance is extended to developing countries all over the world.

UNIDO's interest in the field is understandable in the light of the increasing importance of shipbuilding and repair in developing countries. In fact, a gradual transfer of this industry from developed to developing countries would appear to be under way. This is already evident in Greece, India, Mauritius, Pakistan, Peru, Portugal and many other countries whose shipbuilding industries are suddenly booming. Two of the main reasons for this transfer are the increasing labour costs and difficulty in labour relations in many developed countries.

This is the first in a series of studies under the general title "Utilization of shipbuilding and repair facilities", designed to serve as a guide to technical assistance by UNIDO in this field and to support its activities.

There is no doubt about the urgent need in most developing countries for fishing boats that will help in solving their acute food problems and for boats that will facilitate transportation in areas where rivers and channels are the most commonly used communication routes. Construction of orthodox wood hulls is not always feasible: these require an abundance of well-qualified labour; suitable types of wood which are becoming scarce; and protection from woodworms and other parasites, necessitating careening up to four times a year in order to avoid extensive and irreparable hull damage. Nor are steel hulls always advisable for small craft; and in any case they require expensive metalworking machinery as well as highly skilled labour.

Ferro-cement boatbuilding is perfect for developing countries. It requires the minimum of qualified personnel, imported raw materials and capital equipment and the boats produced compare favourably with those made from other materials in terms of price, performance, maintenance costs and life span.

It is unlikely that there will be any major advances in the use of ferro-cement in fields other than the construction of vessels of the normal displacement type. However, as experience is gained, larger and better boats will be built with this material.

The use of sub-surface vessels and storage units will no doubt increase and it is probable that ferro-cement or some other form of reinforced concrete will be developed as the principal medium of construction for these vessels, particularly those of a spherical shape.

This study, which is intended to serve as a guide to the practical utilization of ferro-cement in the building of small boats, has been prepared for UNIDO by W. M. Sutherland, Managing Director, Ferro-Cement Limited, Auckland, New Zealand. The views and opinions expressed in this publication are those of the author and do not necessarily reflect the views of the secretariat of UNIDO. The author acknowledges the contributions made to this study by Mr. A. Sannergren, UNIDO Expert on Shipbuilding and Repair, Suva, Fiji.

## CONTENTS

<i>Chapter</i>		<i>Page</i>
I.	HISTORY OF FERRO-CEMENT .....	1
II.	PROPERTIES AND ADVANTAGES OF FERRO-CEMENT .....	5
III.	DESIGN CRITERIA .....	11
IV.	MATERIALS USED IN THE MANUFACTURE OF FERRO-CEMENT ..	15
V.	METHODS OF CONSTRUCTION .....	25
VI.	HULLS SUITABLE FOR FERRO-CEMENT CONSTRUCTION .....	33
	Selected Bibliography .....	43

### *Annex*

1.	Guidelines for the construction of ferro-cement vessels (American Bureau of Shipping) .....	47
2.	Specification for the design and construction of ferro-cement hulls (Ferro-Cement Ltd., New Zealand) .....	55
3.	Drop and fire tests on a 27-foot launch hull (Ferro-Cement Ltd., New Zealand) .....	73
4.	Construction details for a typical ferro-cement boat (Ferro-Cement Ltd., New Zealand) .....	81

LIST OF FIGURES

	<i>Page</i>
<i>Frontispiece.</i> Ferro-cement fishing boat built by students in Fiji . . . . .	xii
1. The world's first patent for reinforced concrete . . . . .	3
2. Chipping out and repairing damage to fishing boat after grounding . . . . .	7
3. Result of punching test carried out on top surface of panel, using 1½-in. diameter punch . . . . .	13
4. Result of punching test carried out on bottom surface of panel (woven mesh), using 1½-in. diameter punch . . . . .	14
5. Result of punching test carried out on bottom surface of panel (hexagonal mesh), using 1½-in. diameter punch . . . . .	14
6. Lamination in the skin of the hull caused by air trapped during the plastering process . . . . .	21
7. Pipe-frame method of boat construction . . . . .	26
8. Welded frames and engine beds . . . . .	26
9. Wooden frame-and-batten method of boat construction . . . . .	28
10. Male moulding . . . . .	29
11. Female moulding . . . . .	30
12. Fibreglass and concrete construction . . . . .	32
13. Three basic types of hull . . . . .	35
14. A 55-ft schooner . . . . .	37
15. A 55-ft cutter "Innisfree" . . . . .	37
16. The "Awahnee", a 53-ft cutter . . . . .	38
17. A 48-ft game fishing launch . . . . .	38
18. A 27-ft fishing boat . . . . .	39
19. A 38-ft fishing boat . . . . .	39
20. A 48-ft combination trawler . . . . .	40
21. A 48-ft combination trawler at work . . . . .	40
22. A 54-ft 6-in. fishing boat . . . . .	41
23. A 38-ft tug . . . . .	41
24. A 100-ft barge . . . . .	42

*Annex 2*

2-1. Suggested minimum punching strengths for ferro-cement panels . . . . .	66
---	----

*Annex 3*

3-1. Fire test on a 27-ft launch hull . . . . .	76
---	----

*Annex 4*

4-1. Pipe frames being bent over full-size lofted lines, using ratchet pipe bender . . . . .	103
4-2. Ratchet pipe bender . . . . .	103



LIST OF FIGURES (*cont'd*)

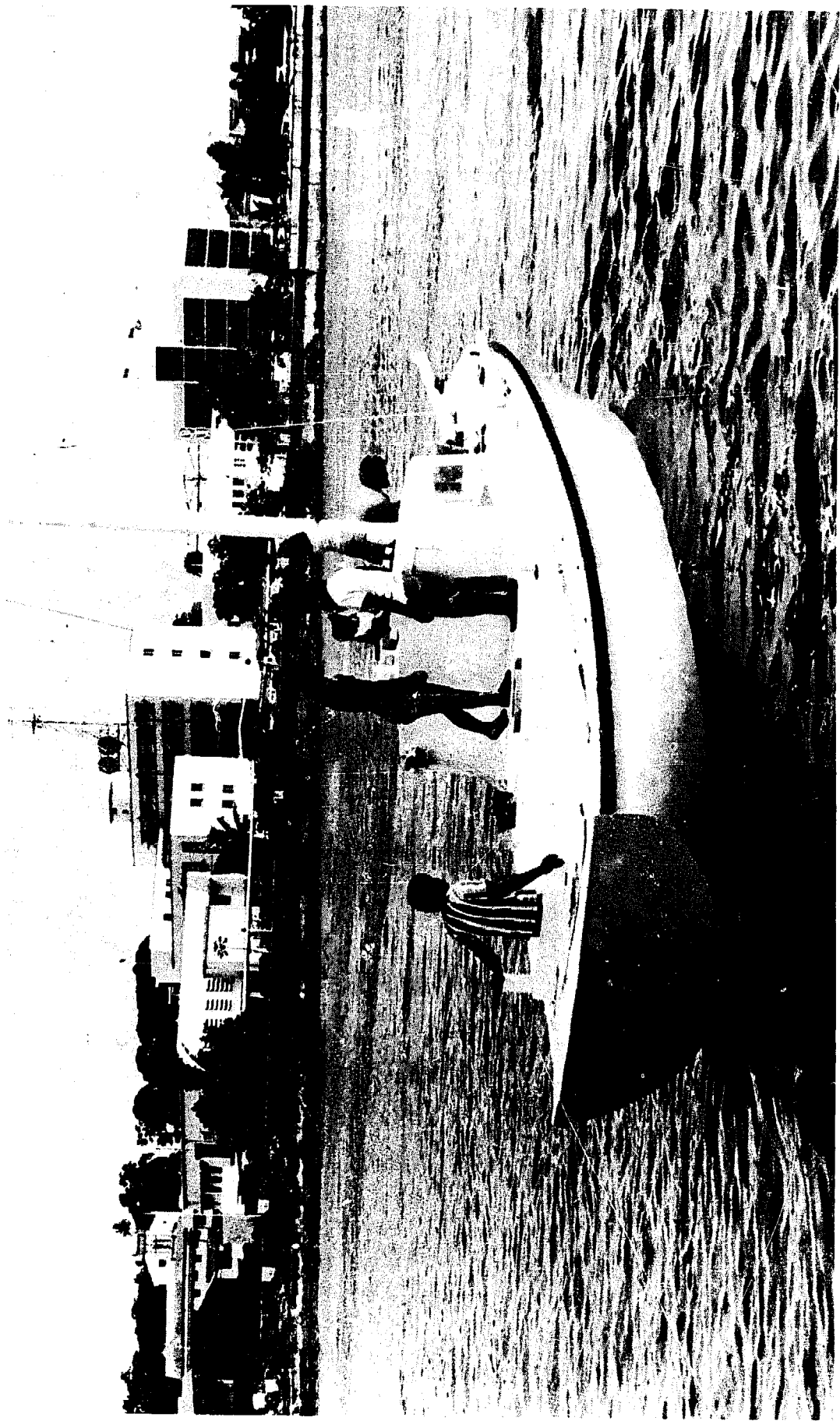
	<i>Page</i>
4- 3. Typical pipe frame being welded on top of full-size lofted lines .	104
4- 4. Curved jig for making radiused transom .....	104
4- 5. First stage of setting up frame .....	105
4- 6. View from aft showing first layer of mesh in position .....	105
4- 7. Second layer of inner mesh being laid .....	106
4- 8. View of inside stem showing breast hooks and rods used to form profile of radiused stem .....	106
4- 9. Fore and aft rods in position .....	107
4-10. Fore and aft rods completed and first pairs of transverse rods in position .....	107
4-11. Transverse rods loosely in position .....	108
4-12. View of transverse rods being tied .....	108
4-13. First layers of square welded outer mesh hung in position from shear .....	109
4-14. First stage in framing deck. View looking aft .....	109
4-15. View looking forward at same stage as figure 4-14 .....	110
4-16. Same view as figure 4-15, with deck steel and mesh completed ..	110
4-17. Same stage as figure 4-16, looking aft .....	111
4-18. Steel and ballast keel being poured .....	111
4-19. Fabricated frames used in construction of 41-ft FAO fishing boat in Uganda .....	112
4-20. Mortar slump test .....	112
4-21. Mortar mixer (paddle) .....	113
4-22. Fairing the hull .....	114
4-23. Standard detail (keel—cross section) .....	115
4-24. Standard detail (stern) .....	116
4-25. Standard detail (frame assembly) .....	117
4-26. Standard detail (bulkhead ground) .....	118
4-27. Setting up the frame .....	119
4-28. Typical pipe frame, showing layout of main members and diagonal bracing .....	120
4-29. Twister .....	121
4-30. Stitching tool .....	121
4-31. Tensioning of the longitudinal rods .....	122
4-32. Typical composite frame .....	123

## EXPLANATORY NOTES

The following abbreviations are used in this publication:

ACI	=	American Concrete Institute
ASTM	=	American Society for Testing Materials
BS	=	British Standards
BSI	=	British Standards Institution
FAO	=	Food and Agriculture Organization of the United Nations
HT	=	High tensile
ID	=	Inside diameter
LWL	=	Low-water line
MS	=	Mild steel
NZS	=	New Zealand Standards
RHS	=	Regular hollow section

*The 10-metre-long boat shown overleaf has a ferro-cement hull made by forcing a Portland cement/sand mixture into a chicken-mesh wire framework. It was built by students of the Derrick Technical Institute, Fiji. Designed by Arne Sannergren, of Sweden, a UNIDO expert assigned at Government request to advise on building and repair of ships, it is a prototype that has proved the feasibility of building boats in this way. It offers advantages, such as durability, resistance to shock and fire, ease of repair, and low cost. Following encouraging results in trials a series of such fishing boats is being built.*



## I. HISTORY OF FERRO-CEMENT

The history of ferro-cement is an interesting story that goes back to the year 1850, when reinforced concrete was used for the first time, in France. Since that time, remarkable advances have been made in the utilization of reinforced concrete, and this most versatile and economical form of plastic material has now become the accepted medium for the construction of major bridges, multi-storey earthquake-resisting buildings, nuclear power reactors, reservoirs, roads, and even underwater structures. The integrity of reinforced concrete and its capacity to be moulded into forms that are quite impossible to achieve with any other known material are well established. Why, then, has concrete not been fully developed in the field of boat construction?

In 1845, Jean-Louis Lambot, a French landowner, constructed several rowing boats, plant pots, seats and other items from a material that he called "Feriment" in a patent which he took out in 1852 (see figure 1). The patent reads, in part, as follows:

"My invention is a new product that can replace timber (in wood flooring, water containers, plant pots etc.) that is exposed to damage by water or dampness. The base for the new substance is a metal net of wire, or rods interconnected to form a flexible woven mat.

"I fashion this net into a form that is similar to the article I want to create, then I use hydraulic cement or a bitumen tar or mix to fill up the joints."

This information was published in the patent magazines of the day, but for several reasons the invention was not immediately accepted:

- (a) Communication facilities throughout the world at that time certainly could not be compared with those of the present day, and as few people outside of France were even aware of such a patent, it remained buried deep in the archives of the patent office.
- (b) The shipbuilding industries were firmly established in most countries of the world, as shipping was the dominant form of transportation. Many of these industries were centuries-old and their craftsmen were fully experienced in the use of timber. There were adequate supplies of timber and thus no necessity to search for new construction materials.
- (c) The introduction of steel to shipbuilding, together with the advent of the reciprocating engine, opened the way for new techniques. Steel became, and still is, the ideal medium for building ships.

While steel was being developed for industry, concrete was being developed for the building of houses, roads and bridges. It was only during the First and Second World Wars that serious attention was given to the use of concrete in shipbuilding, and this only because supplies of the materials normally used were depleted. During the Second World War, especially, a large number of reinforced concrete ships were constructed. However, although these ships represented remarkable feats of engineering, the shipbuilders reverted to the use of steel as soon as the war was over and regular supplies of the conventional materials were once again available.

Shortly after the Second World War, an Italian architect and engineer, Pier Luigi Nervi, began experiments in the construction of small to medium-sized sailing vessels, using the existing but deserted shipyards and working with concrete and wire. Nervi's method differed from the many other approaches to concrete shipbuilding over the previous fifty years in that, for the first time, the thickness of the hull sections was considerably reduced, and what appeared to be a new material was created. Nervi carried out many tests on this material and called it "Ferro-Cemento".

The strength and durability of ferro-cement are pointed up by the fact that nearly all the ships constructed by the firm of Nervi and Bartoli at the time are still in existence, and in very good condition. Even more remarkable is the fact that the two dinghies built by Jean-Louis Lambot, in 1850, the first attempt at the utilization of reinforced concrete as we know it today, are still in existence. There are, of course, many other examples of thin-shelled ferro-cement boats constructed during the past 120 years, but it would be beyond the scope of this report to describe them all.

Ferro-cement has attracted a notable degree of attention within the past ten years. Concrete has been used to maximum advantage in housing and other forms of construction in the Union of Soviet Socialist Republics, and extensive research into its use for these purposes has yielded information that engineers can apply to shipbuilding. In New Zealand, North

---

*Figure 1. The world's first patent for reinforced concrete. Jean-Louis Lambot, who took it out in 1852, called his product "Ferciment". The upper part of the illustration shows metal reinforcing designed for use in either a water container or a plant tub. The key to lettering in the upper part is:*

- A—Durable net
- B—Cement covering
- C—Metal stability bar
- D—Metal rods

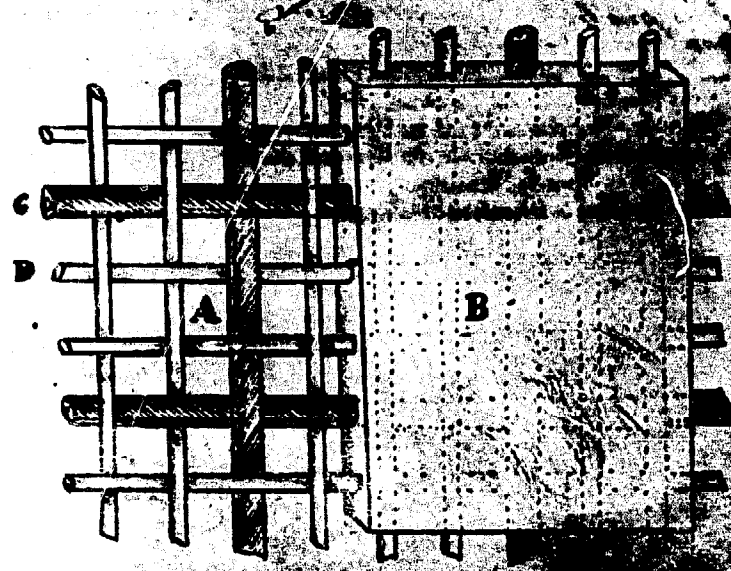
*The lower portion shows the interior build-up of reinforcing designed to be used in place of a wooden floor covering or beam. The key to this part is:*

- A—Plate on which metal rods are fastened
- B—Frame for bedding the rods
- C—Cement covering
- D—Metal rods
- E—Rivets

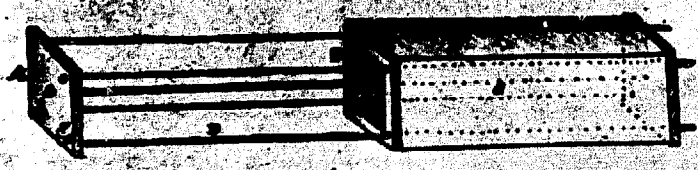
*(Reproduced from Vom Caementum zum Spannbeton, Vol. I, by permission of the publishers, Bauverlag GmbH, Wiesbaden, Federal Republic of Germany.)*

America, and the United Kingdom, ferro-cement firms have been established and are slowly building up experience. During the past two years, several countries in South-East Asia, including the Philippines and the Republic of Viet-Nam, have been attempting to develop ferro-cement as a ship-building material. The mass production of ferro-cement sampans in

*Projet pour l'édification de navires  
de Monsieur Lamotte*



*Plan métallique ou en bois d'un bateau.  
Dans lequel on voit une coupe.*



*Coupe intérieure d'un modèle  
ou d'une partie.*

- Figure 1* *Figure 2*
- A. partie métallique* *A. plaque pour faire les bords extérieurs*
  - B. partie bois* *B. cadre en bois pour servir de support*
  - C. côté en bois* *C. partie intérieure ou en bois*
  - D. fil de fer* *D. fil de fer*
  - E. coupe en bois*

*6*

*Lamotte*

### RESISTANCE TO FIRE AND ROT

Although ferro-cement as a material is naturally resistant to rot and corrosion, the degree of resistance depends on the quality of the mortar used and the proximity of the mesh to the surface. In many cases, unsatisfactory plastering has been the cause of shrinking and other defects. However, there is more than enough evidence to show that well-prepared ferro-cement is a highly rot-resistant material.

Ferro-cement is also fire-resistant and, under normal circumstances, will withstand even a major fire without suffering serious damage. A boat hull made of this material will resist fire much better than one constructed of either timber or fibreglass.

### SIMPLICITY OF APPLICATION

It will be seen in the chapters that follow that hull construction using ferro-cement is relatively simple and that, although skilled personnel are required for both training and supervision, most of the work can be carried out by unskilled workers.

### LOW MAINTENANCE REQUIREMENTS

Provided the design requirements are complied with, virtually no maintenance will be needed for ferro-cement, and painting will be for decorative purposes only. Insufficient coverage of the steel will result in surface blemishes. However, these can be chipped out and filled with suitable plastic materials. Electrolysis may also occur when the mesh cover is insufficient or the mortar is porous.

### EASE OF REPAIR

Every boat suffers damage to the hull, sooner or later, and therefore simplicity of repair or modification is of great importance. It is particularly important in areas where fishing boats and other commercial craft operate and where trained boatbuilders or craftsmen capable of undertaking repair work are not available. Many ferro-cement boats damaged in the Pacific have been repaired sufficiently well by their crews to enable them to become fully operational again within a few hours. In many cases, these temporary repairs have been so successfully carried out as to be permanent.





*Figure 2. Chipping out and repairing damage to fishing boat after grounding*

### IMPACT STRENGTH

Many claims have been made regarding the impact strength of ferro-cement, and it is important that this property of the material be fully understood. However, a distinction must be made between "impact" and "punching" as its poor resistance to the latter is one of the disadvantages of ferro-cement.

There does not appear to be any precise or definable method of examining the impact strength of material used in the shipbuilding industry. There are, of course, several well-established technical definitions of impact, but these usually relate to the surface hardness of steel and when they are applied to other materials, such as timber, fibreglass and ferro-cement, the results may be completely misleading. The problem of impact, its definition, measurement and methods of design to overcome it are therefore extremely complex, even today.

Several types of impact may be experienced by a ship or boat and these are dealt with, separately, in the paragraphs that follow.

#### *Wave impact*

Wave impact means the sudden overloading of localized areas of the hull when a ship drops off a wave in very heavy seas, or when the seas crash against a particular section of the hull. Ferro-cement has very high

resistance to this type of impact as long as the hull has adequate curvature to permit shell action. The material has a very low bending tolerance when used as a flat section and hulls that have flat areas of ferro-cement are unsuited to operation in heavy seas. However, it has been proven beyond all doubt that relatively thin ferro-cement hulls, with well-curved sections, can resist the most violent storms and buffeting. This is one of the most significant characteristics of ferro-cement.

### *Localized impact or "punching"*

Another type of impact that a hull may suffer is buffeting on a beach. If there are no rocks and if the hull has adequate curvature, the resistance of the section is very high, and as long as the points of contact with the beach are distributed over sufficiently large areas of the hull, which is inevitable when a boat is in contact with sand, there is little chance of serious damage. The hull can carry great loads when the bilges are adequately curved, thanks to the shell effect. Ferro-cement also exhibits very good qualities when fenders are used and collision impact is evenly distributed.

The greatest damage to ferro-cement can be caused by collision with the fluke of an anchor, the stem head of a colliding vessel, bolts protruding from a wharf pile or fending system, or any really hard protruding object. A steel fuel drum, dropped on to a deck and striking on its edge, is likely to cause damage.

Caution should be exercised in interpreting the results of impact testing, detailed in annex 2 (para. 3.4.3.4) of this publication, as these tests have been carried out on flat sections that did not have the benefit of arching, as would be the case in an actual hull. The basic characteristic of concrete is that, under tension, it will carry a known load without any apparent deformation until suddenly, without warning, it cracks, showing no obvious area of yielding. Because of this characteristic, it must be expected that when it is subjected to the type of loading specified in the tests, there will be no warning of when the cracking is going to occur.

There are many examples of this type of structural damage to ferro-cement vessels, but one of the interesting aspects of it is that even when the first punching has taken place, the mesh and broken concrete usually remain intact, thus preventing sudden and unrestricted flooding. Naturally, there are many degrees of damage and no specific rule can be applied to all cases.

### *Hull stiffness*

Hull stiffness is another factor of impact strength that is worth considering. The stiffness or resilience of any object resisting force is of great importance. When a large ship is berthing alongside a wharf, it projects an enormous amount of energy, and unless this can be dissipated through an efficient fendering system, damage must result, either to the ship or to the wharf. The shape of the hull and the material used for its construction

play an important part in the design of a boat. Very thin ferro-cement sections can be flexible as long as the load is applied evenly over the surface as would be the case if the boat were in heavy seas or being pounded on a sandy beach. When a very localized force of, say, one-inch diameter, is applied to a thin and flexible ferro-cement panel, it is highly probable that punching will take place. However, this would be less likely to occur in the middle of a flexible section than it would in an area adjacent to a very stiff bulkhead.

Resistance to punching or impact is a major consideration when designing ferro-cement hulls of any type. The real difficulty, in this regard, is not in determining the strength of the hull, but rather in deciding what loads it will have to bear. It is an easy matter for an engineer to calculate the stresses necessary for a section once the actual loads can be determined. Unfortunately, because of the great number of variables involved, such as the weight of the ship and the resisting force, the speed of impact, the hardness of the impacting areas and the stiffness of the hull, precise design criteria cannot be specified. However, experience has shown that, for a given set of conditions, for example, a fishing boat working in heavy seas, a certain thickness of ferro-cement hull can be determined that will be sufficient to resist the knocks and blows that may be sustained.

Unfortunately, such experience can only be gained through trial and error and frequently even minor failures bring unwarranted criticism or rejection of a particular material. Timber, steel, aluminium, fibreglass and ferro-cement all have their various weaknesses, and it is the responsibility of the designer of the boat to determine which material is the most suitable for the conditions for which the boat is intended. It is not possible, in this study, to go further into this aspect of designing, but it can safely be said that well-designed and constructed ferro-cement hulls will perform extremely well within their designed capacity.

#### WEIGHT

One cubic foot of ferro-cement weighs approximately 165—170 lb. The average weight for a one-inch-thick slab is 14 lb/ft<sup>2</sup>. Variations in this weight will be minimal, depending on the quality and quantity of sand, cement and steel used.

Timber is one quarter of the weight of ferro-cement, and steel is three times the weight. The important consideration, however, is the equivalent weight per square foot of materials required for several different boat hulls.

It will be seen from table 1 that boats constructed of ferro-cement are considerably heavier than those made of timber and weigh nearly the same as the smaller, lighter type of steel vessels. However, while ferro-cement has a weight disadvantage where small craft are concerned, in many other classes of vessel its weight works to its advantage (see chapter VI, "Hulls suitable for ferro-cement construction").

Table 1

WEIGHTS AND THICKNESSES OF SELECTED MATERIALS USED IN THE CONSTRUCTION OF LIGHT- TO MEDIUM-DUTY CRAFT

	Length: 30 ft		Length: 50 ft		Length: 80 ft	
	Thickness <sup>a</sup> (in.)	Weight <sup>b</sup> (lb/ft <sup>2</sup> )	Thickness <sup>a</sup> (in.)	Weight <sup>b</sup> (lb/ft <sup>2</sup> )	Thickness <sup>a</sup> (in.)	Weight <sup>b</sup> (lb/ft <sup>2</sup> )
Timber .....	3/4	5	1 3/8	9	2	15
Steel .....	1/8	7	3/16—1/4	13	Variable	23
Aluminium .....	3/16	3 3/4	1/4—5/16	7	Variable	12
Fibreglass .....	Variable	4 3/4	Variable	9	Variable	15
Ferro-cement .....	5/8	10	1	17	1 3/8	24

<sup>a</sup> Thickness is shell, planking or plating thickness only.

<sup>b</sup> Weight is an over-all figure that includes shell, frames, keel, stiffeners etc.

On account of the limitations imposed by its weight, the use of ferro-cement for decks and superstructures should be carefully considered. Its relatively low strength when used in flat sections, such as decks, calls for increased thickness, and this, in turn, increases the weight. Heavy weights at deck level invariably have an adverse effect on the stability of the hull.

#### EASE OF ATTACHMENT

The joining of dissimilar materials always presents problems and in the shipbuilding industry the simplest solution is to use steel sections that can be welded together without difficulty. In timber craft, parts can usually be screwed and glued together, though difficulty is sometimes encountered in making sure that the connexion will be solid and equal to the attaching material. The problem with fibreglass is usually one of local stiffness. Owing to the flexibility of thin sections of fibreglass, it is essential that special reinforcing be given to connexions made with this material.

With ferro-cement, several solutions are possible, such as gluing and screwing, as in the case of timber, or a combination of the methods used for fibreglass. Timber grounds can be screwed and glued to the hull and then reinforced or sealed off by using fibreglass between the concrete hull and the timber. For interior construction, timber, fibreglass or steel can be bolted on. Where fastenings for fittings such as cleats and winches are to be attached, the standard practice is to drill holes through the concrete, or mount the fitting on a base of plastic or similar hard material and then use a backing plate to distribute the load as required.

### III. DESIGN CRITERIA

The designs of the early builders of ferro-cement or reinforced concrete boats were based mainly on established codes of practice, and intuition. However, though these codes of practice enable engineers and designers to calculate accurately the loads that can be applied to flat, simple sections and, conversely, the type and amount of reinforcing necessary to resist a given load, they are useful only in the construction industry and cannot truly be applied to the building of small sailing vessels with thin sections.

The pioneers in ferro-cement, such as Lambot and, more recently, Nervi, discovered that very thin sections of concrete, when heavily reinforced with wire mesh, exhibited what could almost be termed "flexible" characteristics. The success of ferro-cement in constructions with complicated shapes and curves and, indeed, the example of the early ferro-cement boats gave many non-technical persons the impression that this "flexibility" was a special characteristic of the cement itself, whereas much of the success was attributable directly to the forms and designs to which the cement was applied.

The International Association for Shell Structures, which was founded in Spain in the early 1960s with the purpose of studying and regulating the use of reinforced concrete in the field of civil engineering, has now become a well-established organization concerned with the design and construction of the most complicated structural forms. Ferro-cement is used extensively in the construction of these forms, but much of the actual design is still based on intuition. Nowadays, however, the initial intuition or theory can be checked by mathematical procedures that have been developed for the purpose.

Whereas many of the early ferro-cement hulls were constructed virtually on a trial-and-error basis, research in recent years has shown very clearly that the behaviour of the material can be accurately calculated by using the standard procedures laid down for reinforced concrete. However, many properties of the material that are particularly relevant to boat construction are not covered in the codes. Among these properties are:

Resilience that contributes to hull stiffness and deflection characteristics of the various sections;

Impact resistance;

Resistance to cracking caused by shrinkage;

Resistance to temperature stresses;  
Acceptable cracking under local flexing; and  
Resistance to water penetration.

Many other properties are still under examination.

A practical upper limit to the amount of steel that can be packed into a given skin thickness, while still leaving room for plaster, has been established at approximately 24 to 30 lb of steel per cubic foot of cement. This figure has been arrived at through practical experience and mathematical calculations. The steel should be distributed so that as much of it as possible is placed close to the two surfaces of the hull and divided approximately equally between the two surfaces of the skin. However, this is only a general rule and a close study of the design recommendations given in annex 2 is advised.

#### COVERING THE STEEL

Experience has shown that the minimum practical cement cover that can be applied to the steel and still give protection against corrosion is approximately 2 mm, or  $\frac{1}{12}$  in.

#### THICKNESS OF THE STEEL

To permit the minimum coverage defined above, and to control both surface crazing and cracking caused by the various flexural stresses that may be set up in the concrete, the maximum thickness of the steel should be no greater than about 17 gauge.

#### ULTIMATE BENDING FAILURE

As the ferro-cement hull may have to withstand loads for which no computations have been made, the skin construction should be stiffer than that of normal reinforced concrete so that at the point of failure it will remain reasonably strong and watertight. To meet this requirement a minimum of 24 to 30 lb of steel per cubic foot is recommended.

#### IMPACT RESISTANCE

Punching tests are carried out to obtain semi-quantitative comparisons between various forms of panels. These tests are made by punching the surface of a test panel with a metal punch  $1\frac{1}{2}$  in. in diameter. The span, which is four times the panel thickness, plus two inches, should be in one

direction only (see annex 2, para. 3.4.3.4). It has been found that resistance to impact increases with (a) the thickness of the panel; (b) the amount and type of reinforcing; and (c) the distance between the loaded surface and the reinforcing steel.

Results also indicate that it is reasonable to expect minimum punching strengths of approximately:

1,200 lb for 1-in. thickness

3,000 lb for 1-in. thickness

7,500 lb for 2-in. thickness

Figures 3, 4 and 5 show the effects of punch-testing on the top and bottom surfaces of panels, and it can be seen that all held together to give some resistance to water penetration.

Current design recommendations that will serve as a guide to designers are given in annex 2.

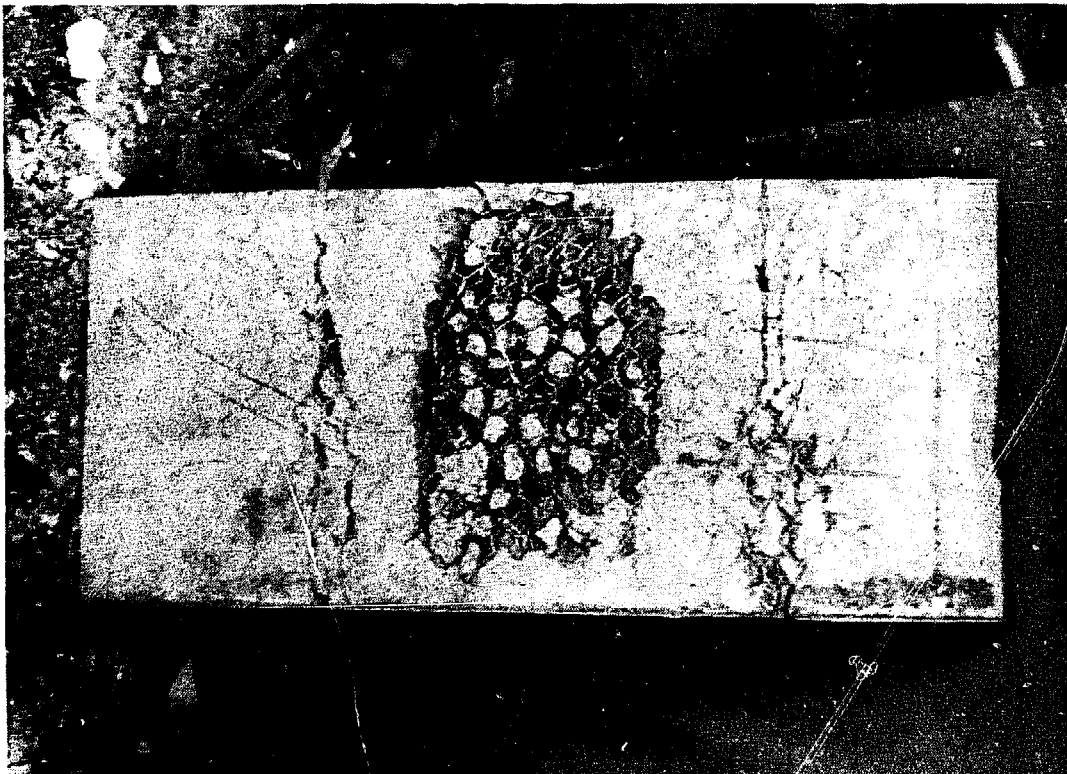
*Figure 3. Result of punching test carried out on top surface of panel, using 1 1/2-in. diameter punch*





*Figure 4. Result of punching test carried out on bottom surface of panel (woven mesh), using 1½-in. diameter punch*

*Figure 5. Result of punching test carried out on bottom surface of panel (hexagonal mesh), using 1½-in. diameter punch*





#### IV. MATERIALS USED IN THE MANUFACTURE OF FERRO-CEMENT

The materials used in the manufacture of ferro-cement are steel wire or mesh, and cement mortar. The proportions and combinations used depend upon the availability of materials.

##### WIRE MESH

The basic material is a suitable wire mesh. A careful analysis of the many technical reports dealing with the properties of ferro-cement will show that the actual strength of a ferro-cement panel depends on the tensile strength of the mesh and its proximity to the outer surface of the sections.

The most popular type of mesh in use today is manufactured from 19-gauge wires spaced approximately half an inch apart. When endeavouring to build up the quantity of steel in a section, there is a tendency to use wire of a higher gauge, with various combinations of spacings, but considerable caution should be exercised when moving away from established practice, as problems such as shrinking, cracking, and inadequate covering of the steel arise and, in many cases, become critical. (The physical properties of ferro-cement are described in detail in annex 2.)

The principal types of mesh in current use are described in the paragraphs that follow.

##### *Welded mesh*

Nineteen-gauge wires, spaced half an inch apart, are normally used in this mesh. These wires must be of a low to medium tensile strength in order that electrical welding can be carried out efficiently during the manufacturing process. Unfortunately, welded mesh has a number of disadvantages, which include the possibility of weak spots at intersections, and insufficient mouldability.

##### *Weak spots at intersections*

These result from inadequate welding during the manufacture of the mesh. This deficiency can impose serious limitations even when a higher tensile steel wire is used to give an improved mesh. Tests have shown that, in many cases, mesh made from this higher-quality wire has a greater tendency to fail than other types of mesh when the intersections are subjected to loading.

*Insufficient mouldability*

A wire mesh that is being placed on the surface of a hull should be capable of being bent to the contours of the hull without buckling or breaking. Unfortunately, welded mesh lacks this mouldability with the result that the wastage factor is very high when it is used.

*Hexagonal netting*

Perhaps the most common type of mesh being used today, in both amateur and professional ferro-cement boatbuilding, is the commercially available hexagonal netting, which has a twisted joint between the individual wires. This netting is usually made from a low-strength wire (to facilitate manufacture) and, in theory, has less effective strength than welded mesh. The quantity of steel per square foot is also slightly greater.

*Flexibility*

One of the virtues of hexagonal netting is that it can be easily bent, and in some types of moulding lends itself well to stretching over a mould. One of its greatest advantages is that it can be stitched to adjacent layers of netting. The outside edge of each width of mesh has a longitudinal twisted wire which helps to eliminate loose ends and facilitates the simple stitching of the edges to prevent flotation or displacement during the plastering operation. This mesh is probably the most easily available on the market today.

*Woven mesh*

The simple woven mesh that is used for screens, and comes in many patterns, was at first considered unsuitable for ferro-cement construction because its wires were not straight. However, tests indicate that this mesh performs as well as, if not better than, either welded or hexagonal netting. One of the difficulties encountered in using it is that it is very elastic and is difficult to hold in position, though it does, when stretched, readily conform to compound curves.

*Watson mesh*

Extensive research into the performance of ferro-cement panels reinforced with different types of mesh indicates that the use of higher-yield steel mesh can mean a considerable improvement. A new type of woven mesh, known as the Watson mesh, has been developed and is being manufactured by Ferro Cement Ltd. in New Zealand. It consists of parallel strands of wire, of any thickness, type or quality, assembled by a special process. This mesh would appear to be perfect for ferro-cement constructions as it can be (a) bent or moulded to compound curves; (b) butt-jointed rather than lapped; and (c) manufactured from any combination of high tensile wires, stainless steel or otherwise. Prototype craft have already been constructed, using this mesh, and it is expected that regular production will begin in the near future.

### *Mesh from expanded metal*

Diamond-patterned mesh is cut from sheets of expanded metal. This mesh is ideal for many kinds of plaster work and was designed specially for the construction industry. Therefore, designers should make sure that the particular mesh to be used will satisfy their own structural requirements, and in particular they should remember that under certain conditions splitting can occur, if the wrong type of mesh is used.

### *Galvanized wire*

It is common practice today to use galvanized mesh, although testing has shown that there is little difference, if any, between the galvanized and the ungalvanized varieties. It is important to bear in mind, however, that hexagonal mesh that has been galvanized before weaving should not be used. In some cases where this netting has been used, electrolysis, due to faulty construction, has removed the galvanizing from the wire, thus reducing the effectiveness of the weaving.

## VOLUME OF MESH OR STEEL REQUIRED

A proportion of 25 lb of steel per cubic foot of mortar provides a ferro-cement section with the characteristics suitable for boat construction. This steel should be placed as near as possible to either surface of the section; it should also be equally distributed between the surfaces and in a longitudinal and transverse direction. Many amateur designers have used large, mild steel rods, closely spaced in a longitudinal direction, with several layers of very light 22-gauge netting on either side. However, while the total volume of steel per cubic foot is satisfactory, its disposition within the section is completely inadequate. When using galvanized mesh, it is important that all the mesh be suitably oxidized before it is plastered. This can be accomplished by spraying the mesh before it is used.

## PROTECTION OF THE STEEL

As long as the recommended sizes and spacing of wires are adhered to, a cement covering of about 2 mm, or  $\frac{1}{12}$  in., will provide adequate protection against corrosion.

## MORTAR

Much has been written over the years on the subject of concrete and cement in its various forms and it is not the purpose of this study to duplicate, or add to, what has already been written. The selected

bibliography that follows chapter VI will be of assistance to the reader who is interested in studying the subject further. Suffice it to say here that, in principle, the mortar required for ferro-cement boat construction should have the highest possible compressive strength, impermeability, hardness, resistance to chemical attack and, perhaps the most important factor of all, the consistency to remain thoroughly compacted, without voids, behind concentrations of reinforcement or wire mesh. However, whereas the strength of mortar is in proportion to its water/cement ratio, its workability is also directly proportional to the amount of water used. A suitable compromise must therefore be arrived at in order to get a satisfactory end product. As the various properties of mortar are, in general, related to its compressive strength, it can be seen that the use of excessive water in the mixing, to allow ease of placing the mortar, unfortunately adversely affects nearly all the other properties. The specification for a suitable mortar is a compressive strength of no less than 6,000 lb per square inch at 28 days on 2 in. × 2 in. cubes. If this strength can be achieved, it is likely that the remaining properties will be satisfactory.

#### CEMENT

Cement is the most important material in a suitable mortar for ferro-cement. However, although many different types of cement are available, it will be found that the ordinary Portland cement that is used in the building industry is adequate for most mortar mixes.

The following are examples of the specifications required for cements suitable for ferro-cement constructions:

##### *US Specifications, ASTM, Type 1*

This is a general, all-purpose cement that can be used where cement is not subjected to high sulphate action from salt soils or sea-water, or subject to excessive rises in temperature due to hydration.

*British equivalent:* Ordinary Portland cement, to British Standard 12.

##### *US Specifications, ASTM, Type 2*

This cement was developed specifically to resist sulphate attack and is ideal for ferro-cement hulls and other marine-type structures. It is also suitable for use in hot climates.

*British equivalent:* No direct equivalent, but the following cements can comply:

Low-heat Portland cement to BS 1370.

Portland blast-furnace cement to BS 146. (It should be noted that mainly ordinary Portland and sulphate-resisting Portland cements and perhaps Portland blast-furnace cement, would be used in parts of Scotland.)

Sulphate-resisting Portland cement to BS 4027.

*US Specifications, ASTM, Type 3*

High early-strength cement. This is simply a fast-setting cement that is suitable for use in cold climates but which must be used with caution in warm areas.

*British equivalent:* Rapid-hardening Portland cement to BS 12.

*US Specification, ASTM, Type 5*

This sulphate-resisting cement is the most ideal cement for use in ferro-cement hulls.

*British equivalent:* Sulphate-resisting Portland cement to BS 4027.

In addition to those listed above, special high-aluminous cements are available that should be used only under the direction of skilled personnel.

## SHRINKAGE-RESISTANT CEMENT

In recent years, considerable research and development has been applied to the production of cements that will resist shrinkage during the curing process. A good deal of progress has been made, and limited quantities of these cements are available in certain areas. The potential for shrinkage-resistant cements in ferro-cement construction is very high, as they overcome some of the most serious problems encountered with normal cements. However, the advice of experienced and qualified technicians should be sought before using these cements.

## AGGREGATES

The quality of the sand used for ferro-cement is naturally of prime importance, as it affects the quality of the mortar. Sand can be produced from many types of material such as silica, basalt rock, limestone, or even soft coral. An adequately strong mixture based on certain types of coral sand can be obtained by using additional quantities of cement. However, great caution should be exercised in the selection of such sands, as very soft sands can be seriously affected by abrasion and chemical reaction. Porous material will allow moisture to penetrate very thin sections with subsequent failure of the reinforcing. Sands and cements should be selected by persons technically competent to evaluate all the factors involved. The grading of the sand particles is important and should, if possible, comply with the specifications detailed in annex 2 to this study. Sands containing hard, sharp silica or rock particles are excellent for the purpose. All sands should be free from dirt and clay, as these will have a detrimental effect on the mixture.

## MIXING

One of the greatest problems in mixing mortar is ensuring that the cement is thoroughly wet, and this can be satisfactorily achieved only by using the paddle-type mixer designed especially for mortar (see figure 4-21 in annex IV.). It can be shown that the workability of mortar for a given water/cement ratio varies considerably with different methods of mixing, such as mixing by hand, ordinary concrete bowl mixing, and mixing in regular mortar mixers. Perhaps the most important aspect of the mixing of cement is the possibility of shrinkage if it is not done properly. When the mortar is mixed thoroughly, in the type of mixer recommended for the purpose, the shrinkage is considerably less than when it is done by hand, or in a conventional mixer. When mortar is mixed by hand, the proportion of water to cement should be higher in order to obtain the degree of workability that is produced in a paddle-type mixer.

## ADDITIVES

Various types of additives are claimed to improve properties such as the impermeability and workability of the mix. In principle, additives are used in the basic mix to lend cohesion, and their use can certainly help in overcoming the various deficiencies caused by improper mixing and the use of substandard cements and sands.

### *Accelerators and retarders*

Sometimes climatic conditions make it necessary to use additives that will either accelerate or slow down the setting of the mortar. In such cases, various mixes should be tested, using different additives, before any attempt is made to plaster the hull. The manufacturer's recommendations with regard to the use of these additives should be strictly adhered to.

### *Pozzolan*

Pozzolan materials such as "fly ash", ground blast-furnace slag, or other materials of this nature, may be added to the mix as a replacement for about 10 per cent of the cement. The purpose of these materials is to increase the resistance of the mix to sulphate attack, to improve its workability, and, perhaps, to strengthen it. However, extreme caution should be exercised in adding such materials, as the type and quantity of pozzolan material required will depend on the type and quantity of cement being used. As cements vary considerably throughout the world, technical advice should be obtained before using pozzolan materials. In most cases, however, mortar consisting of ordinary cement, sand and water, as detailed in annex 2, will be sufficient to provide a first-class product.

## APPLICATION OF THE MORTAR

Before beginning to plaster a hull, it should be ascertained that all the equipment necessary to allow the work to proceed without interruption is on hand. Application of the mortar to the hull is one of the greatest problems encountered in ferro-cement boatbuilding. Plastering by hand has, until now, proved to be the most satisfactory method. However, if the mortar is of the correct water/cement consistency, it is extremely difficult to get it to penetrate the layers of wire and mesh. The tendency, therefore, is to use a wetter mix with greater workability, but this results in increased shrinkage and a reduction in the compressive strength of the mortar.

A recommended technique is to force the mortar from the outside to the inside of the hull where it can be finished off to a smooth surface. Unfortunately, this technique is difficult and requires considerable skill in getting the mortar to penetrate thoroughly the layers of wire and mesh. Under no circumstances should the inside mortar be applied until that from the outside has fully penetrated, and plastering from both sides at once should never be done, as this invariably results in air becoming trapped between the layers, causing lamination in the skin of the hull. (See figure 6.)

A two-stage technique has been developed in which the mortar is forced from the outside of the hull to the inside as thoroughly as possible.

*Figure 6. Lamination in the skin of the hull caused by air trapped during the plastering process*



No attempt is made to complete the interior until the outside layer has been allowed to harden for several days. The internal skin is then applied, using special vibrating floats that ensure complete penetration of the mortar, thus minimizing the possibility of air becoming trapped. Experience has shown that if this interior layer, or finishing coat, is applied without the use of such vibrators, air is certain to get trapped between the layers.

When using the one-off technique, perhaps the most desirable method is to place the mortar from the inside of the hull, using vibrators, with sheets of plywood or similar material on the outside as temporary framework against which the vibrators can work. This method ensures complete and positive plastering.

### VIBRATORS

After considerable experimentation, it has been found that the conventional orbital sanders that are used in the woodworking industry are probably the most successful vibrators for hull plastering. A simple wooden plate bolted to the face of the sander produces an excellent vibrating tool. However, the use of vibrators should be carefully supervised to ensure that mortar already placed is not subsequently disturbed.

Boats 40 ft to 50 ft in length can be plastered in one operation by a team of plasterers. The number of plasterers required will depend on their ability and training, but it has been found that a team of from ten to twenty is capable of handling most jobs of this size.

### SPRAYING

The spraying on of mortar is a process that requires considerable skill and should be undertaken only by experienced and trained persons. The great disadvantage of spraying is the build-up of rebound material behind the mesh. When mortar is sprayed against the mesh, by air or any other technique, particles of sand bounce off the backup boards and even the reinforcing, and unless this rebound material can escape, it becomes trapped by the steel, creating cavities and weak spots.

### CONSTRUCTION JOINTS

The plastering operation should be completed in one day to avoid making joints that can become a source of trouble later on.

If the plastering cannot be completed in a day, it is still possible to obtain satisfactory joints, provided the correct techniques are used. The mortar, when it dries or hardens, develops a film, known as laitence, on its exposed surface. This laitence has little strength and new mortar should never be placed against it. It is therefore essential that the laitence be



removed before the mortar has finally set. This can be accomplished quite easily by spraying the exposed edge of the mortar with a fine jet of water or air, once it has hardened sufficiently (six to ten hours after placing, depending on temperatures). This will provide a relatively rough surface of exposed sand grains. Before placing fresh mortar against this surface, a bonding agent should be applied. The most suitable is ordinary Portland cement grout, mixed to a creamy consistency. This should be brushed well into the previously dampened surface and the new mortar placed against it as soon as possible. Alternatively, special epoxy resin glues can be applied to the joints to ensure perfect jointing.

### SURFACE FINISHING

Large battens should be used at all times during the plastering process to ensure that the hull is fair and to avoid bumps and hollows between the frames (see figure 4-22 in annex 4). On completion of the plastering, the surface of the hull should be worked with wooden floats. The use of steel trowels should be restricted to giving a smooth surface in the finishing process. If a rough surface that will provide a good bonding surface for subsequent painting is required, a sponge should be used.

### CURING

Just as a well designed and mixed mortar can be spoilt by lack of compaction, so a well designed mix, properly placed and compacted, can be spoilt by lack of curing. The hydration process by which cement gel is formed from ground cement clinker and water is relatively slow and though some 60 per cent of it is complete within seven days, and most of it in 28 days, complete hydration does not take place for many years. However, hydration cannot take place without water and if the mixing water is allowed to dry out of the hull, hydration and, consequently, the strength and durability development of the hull, will be retarded. This is especially important if pozzolanic materials are used in the mix. The process of retaining water in the mix during this early period is called "curing".

Curing can be accomplished by covering the hull immediately after plastering is completed and keeping it covered for at least seven days. To counteract the air that is bound to seep underneath the covering, causing dehydration of the concrete, it is sometimes necessary to provide additional humidity, either by installing water sprays or by placing trays of water around the hull. A particularly useful method of moist curing is to cover the hull with hessian and keep it constantly wet, using water sprays. Intermittent spraying is of little value. If a black plastic cover is placed over the hull, and trays of water placed around and inside the hull, good, moist curing conditions will be achieved, and in direct sunlight the

temperature under the plastic sheeting will rise considerably, thus accelerating strength development of the concrete. Proprietary forms of curing membrane, usually waxy materials for painting on the surface of the concrete, are available. However, while these materials prevent some of the moisture from evaporating, they also diminish the adhesiveness of the surface for subsequent coatings of materials such as paints. They should, therefore, be used with caution. Even materials of this type that are claimed to be volatile, and that should, ordinarily, be dissolved in time by the heat and friction of the air, do not always entirely evaporate and sometimes leave waxy areas, with poor bond properties, on the hull. The amount of water provided initially in the mix to give the desired water/cement ratio will be sufficient only for full hydration of the cement if evaporation and drying out are prevented.

Curing should be continued for at least seven days. If it is interrupted, care should be taken to see that the hull does not dry out, otherwise shrinkage cracking may occur.

#### *Steam curing*

When it is possible to construct the hull in a single plastering operation, the use of steam for curing is both desirable and advantageous. When using this process, however, it is advisable to wait some 4 to 5 hours after plastering has been completed before applying the steam in order to allow the final mortar to set. The steam can be provided from any source of low pressure and should be what is commonly known as "wet" steam. The normal steam generators that are used for cleaning purposes are quite suitable and are available in most areas. During the curing process, the hull should be covered with suitable plastic sheets and the joints sealed to prevent the loss of steam. The steam should be applied along the bottom of the enclosure and in such a manner that it will not be in direct contact with the hull at any point. It should take about two hours for the steam to raise the temperature within the plastic envelope to approximately 160° F. This temperature should then be maintained for a period of six hours, after which it can be allowed to cool over a further period of no less than four hours. It is preferable, whenever possible, to extend the cooling process over a longer period, but under no circumstances should sudden cooling of the hull be allowed, as this will have a detrimental effect on the curing. Further work on the hull can be carried out immediately after the steam curing. Steam curing causes pronounced laitence on mortar surfaces, and when it is used particular care must be taken of the joints.

## V. METHODS OF CONSTRUCTION

There are many different ways of constructing ferro-cement boats, but whichever method is chosen, the important considerations are:

- (a) Accuracy of shape;
- (b) Uniformity of the reinforcing mesh;
- (c) Thorough and complete penetration of the mortar; and
- (d) Proper curing of the mortar.

The design specifications shown in the annexes set out, very carefully, the requirements which, if followed, will ensure a good quality product.

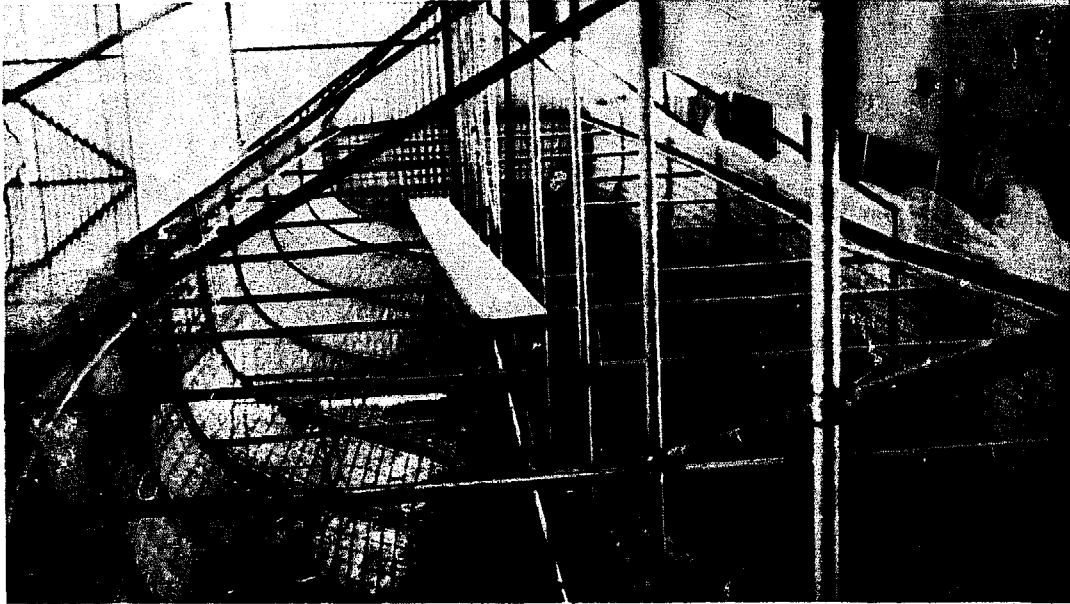
### FRAME METHOD

Several methods of constructing one-off units of ferro-cement boats have been developed in the last few years. Each of these methods has both advantages and disadvantages.

The first method developed in New Zealand was the pipe-frame construction, a complete explanation of which is given in annex 4. Most of the details of this construction can be applied to other forms. Rather than repeat the description for each process, this chapter will discuss only the salient points.

#### *Pipe-frame method*

The major advantage of the pipe-frame method (see figure 7) is that the frame around which the hull is constructed can be bent with simple equipment and joined together, either by welding or bolting, with little difficulty. The shapes of the frames are taken from the lofted sections, and when the frames are placed and hung in position they are strong enough to support the wire and mesh without distortion. In addition, the use of circular pipes means that, when the longitudinal wire rods are fastened to the frames, they are true and fair to shape. When wooden frames are used, as in conventional boat construction, it is necessary to shape the outside edge of the wooden frames and this requires some skill with woodworking tools. The use of square, or flat, sections for the frames presents the same difficulty and should be avoided. When pipe frames are used, the longitudinal rods are tied to the pipes, and when the hull is completed, the frames can

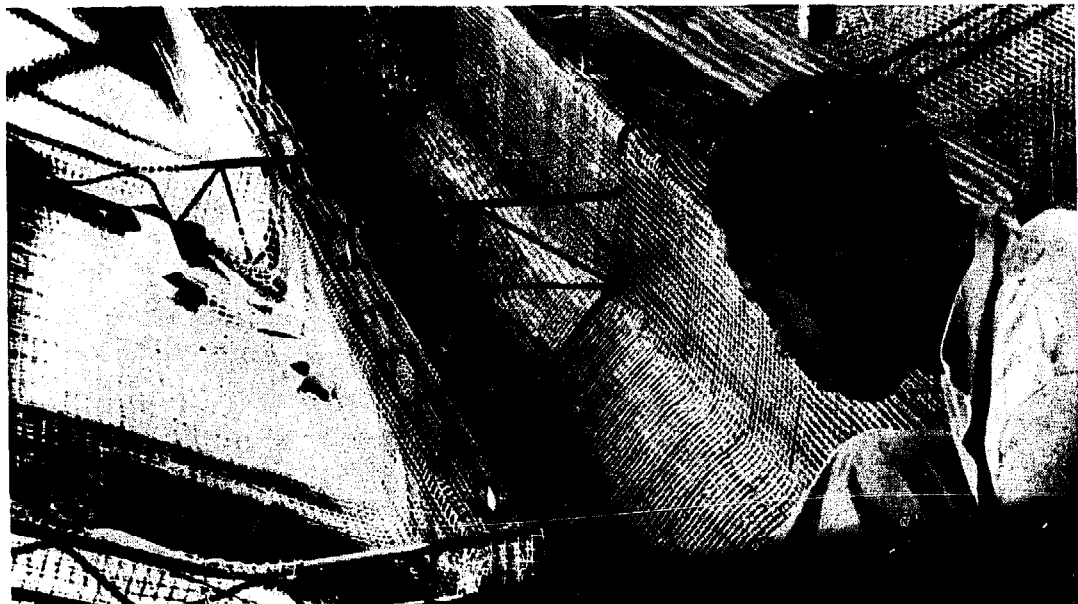


*Figure 7. Pipe-frame method of boat construction*

be removed simply by cutting the ties. The advantage of this operation is that if more than one hull is required, the frames can be standardized and used over and over again, thus cutting down on tooling costs.

If the pipe frames are to be left in the hull, penetration of the mortar must be complete around the frames. There have been many examples of bad mortar penetration when frames were left in the hull. Leaving the frame in the hull has the effect of strengthening it, but it also adds weight, for which due allowance must be made.

*Figure 8. Welded frames and engine beds*



### *Welded frame method*

Welded frames (see figure 8) come in prefabricated kits and are probably the most suitable frames for amateur boatbuilders. They are factory-produced to fine tolerances, incorporate high-quality welding, and are supplied ready to assemble. However, this form of construction requires more skill and man-hours than others.

Though it is possible to remove the frames, they are usually left in the hull. The advantage of the permanent welded frame is that there is less difficulty in obtaining mortar penetration and the ribs provide excellent means for attaching bulkheads to the hull. However, these ribs can, in some cases, reduce the effective area within the hull.

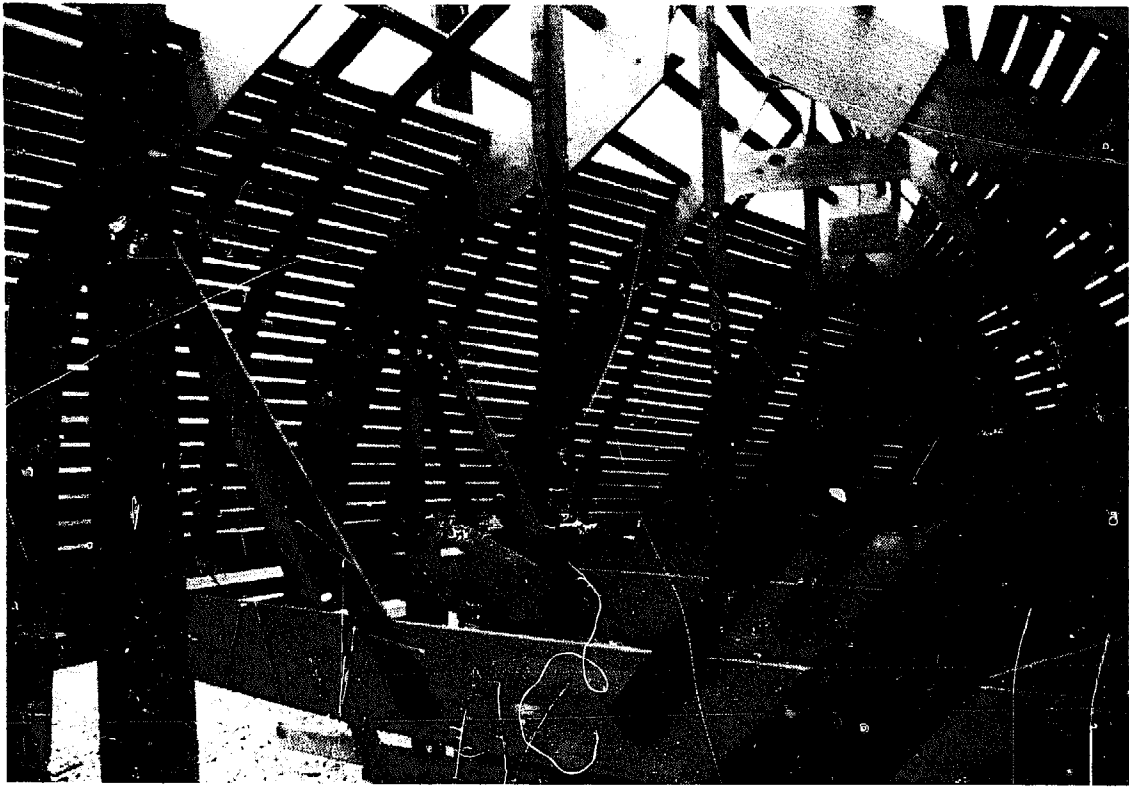
### *Wooden frame method*

Wooden frames can be made from any quality timber that will not twist during the construction process. The frames, which can be manufactured in the same manner as the forms for a timber boat, must be faired around to allow the correct placement of the longitudinal steel rods. Attaching these rods to the wooden frames often presents difficulties and in many cases staples are used. Considerable care must be exercised in removing the frames from the hull, if damage is to be avoided. This problem may be alleviated by incorporating in the frame permanent wooden grounds that may be left in the hull.

### *Frame-and-batten method*

The frame-and-batten method of construction (see figure 9) consists of setting up pipe, welded or wooden frames to which longitudinal battens are attached, either by wire ties or nails, at 2- to 3-in. intervals. This forms a sort of male mould around which the boat can be built. The battens should be free of kinks and should be of a soft wood to which wire mesh can be fastened directly. The longitudinal and transverse rods can be eliminated, if necessary, provided sufficient mesh is substituted to ensure that the necessary steel content is maintained. If a hull requires greater thickness in order to withstand heavy impact loads, it may be necessary to add spacing steel rather than build up with mesh alone. When the plastering of this hull is completed, the timber battens may be either removed or left inside to form grounds for a wooden lining, or, in some cases, to enable a skin of ferro-cement to be fastened on the inside with insulating material in the gaps between the timber battens. This form of construction is very strong and relatively simple, but it has disadvantages, among which are difficulty in ensuring that the mortar has penetrated behind the wooden battens and, if the battens are to be removed, the likelihood of damage to the hull during their removal.

The foregoing are the main methods of frame construction, but, of course, there are many variations on these techniques.



*Figure 9. Wooden frame-and-batten method of boat construction*

### MOULDING METHOD

There are the three basic moulding techniques:

Male moulding;  
Female moulding; and  
Injection moulding.

As it is beyond the scope of this report to deal with all three processes in detail, only general principles will be discussed.

#### *Male moulding*

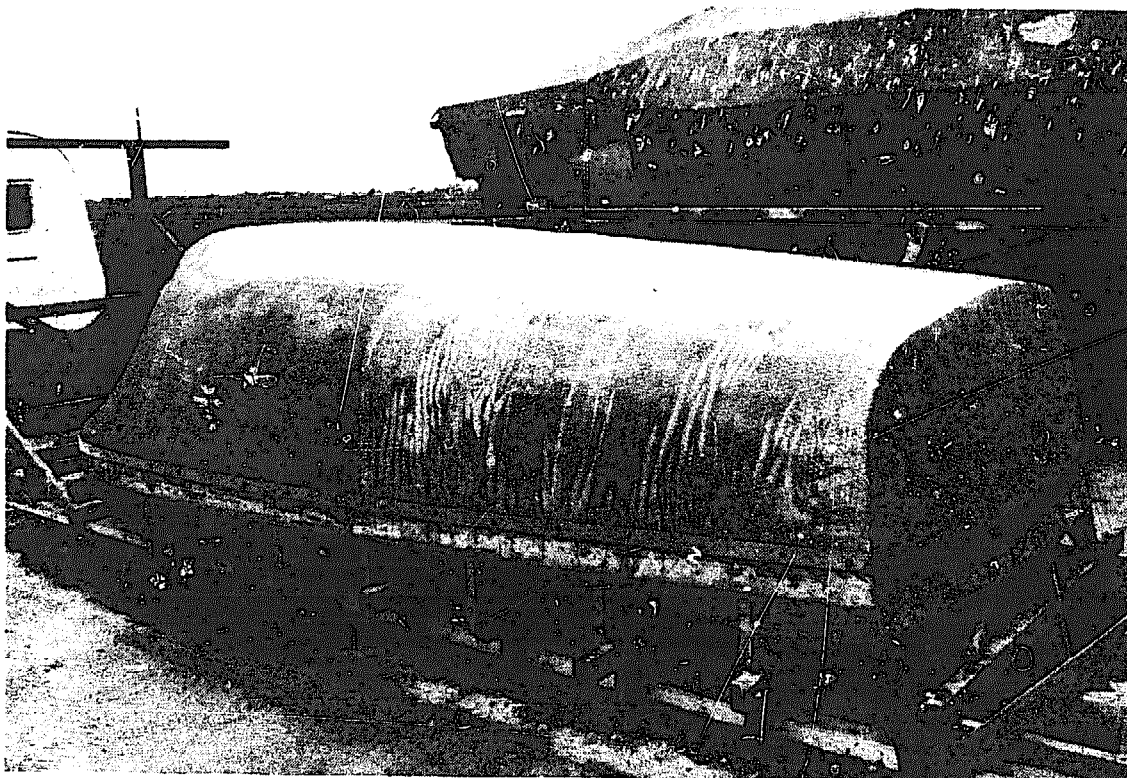
The male moulding system (see figure 10) makes it possible to construct a complete mould that can be either polished or covered with a membrane to keep it separated from the mortar. The framework may be any type of construction that can be removed, either in sections or in a single piece, after the hull has been cast. The shape of the mould is very important in this form of construction—only simple designs being suitable. The process also presents many problems such as:

- (a) Placing the steel in such a manner that it will remain firmly in position adjacent to the mould, but without touching it.

- (b) Obtaining thorough penetration of the mortar.
- (c) Avoiding mortar shrinkage. When using male moulding techniques, it is essential that allowance be made for shrinkage of the mortar. If a solid mould is used, severe cracking of the cast hull may occur. Considerable difficulty may be experienced in removing the mould from the hull. As there is no simple solution to this problem, this form of construction should be tackled only by people experienced in the field.
- (d) Attaching bulkheads. After demoulding, the internal surface of the hull is usually very smooth and it is difficult to fasten bulkheads to it securely without drilling through the hull at frequent intervals. The use of fibreglass as a means of fixing bulkheads to the concrete hull has many inherent dangers and should not be adopted to the exclusion of other means.
- (e) The outer surface of the hull must be finished by hand and the quality of the finish therefore depends on the plaster used and the skill of the plasterer.

For hulls of the appropriate shape, and designed to accommodate the type of mesh that is appropriate to the shape, this form of construction can be very fast and needs a minimum of labour.

*Figure 10. Male moulding. This form of construction is limited to very simple designs but is very fast and needs minimal labour input*



### *Female moulding*

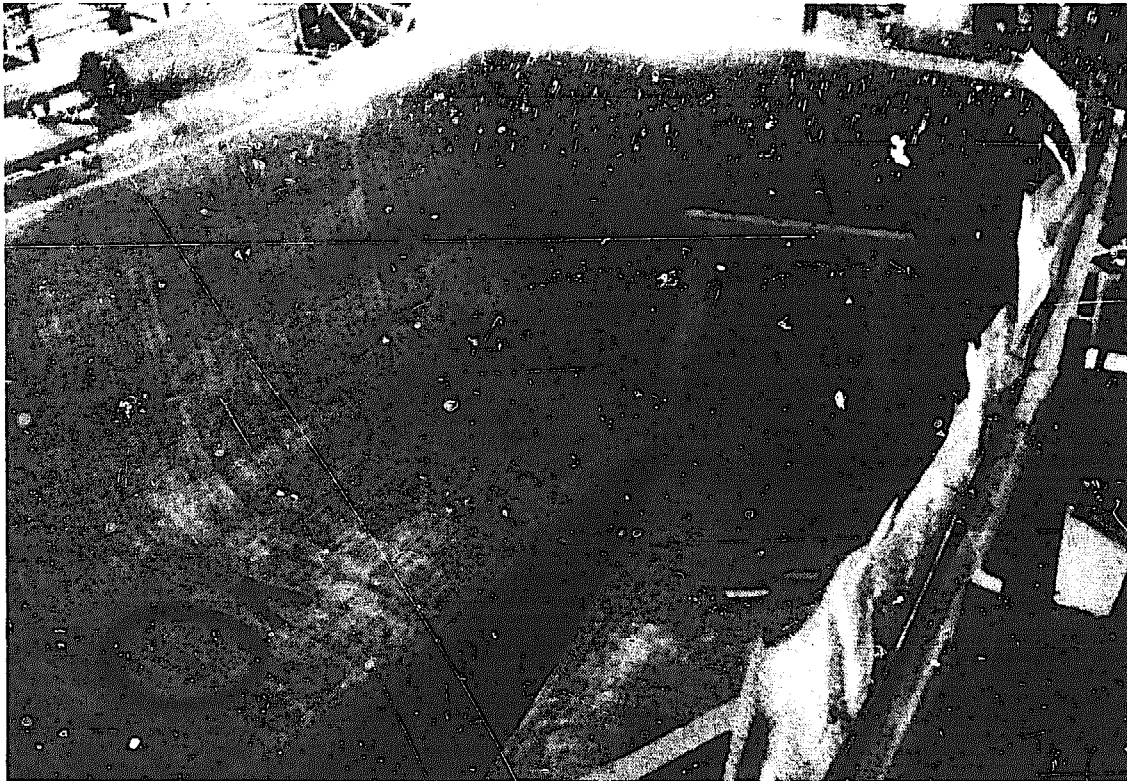
Female moulding (see figure 11) offers the greatest potential for ferro-cement boatbuilding; it also presents many problems. A female mould can be produced in ferro-cement simply by setting up a framework to the inside of which plaster is applied. The main problem with this type of construction, however, is the extreme difficulty in plastering the hull to obtain fair shape with the concave sections.

The most common method is to construct a plug, as with fibreglass, from which a female mould can be manufactured. The placing of the mesh within a female mould presents a problem, as it is difficult to keep the mesh to the correct shape. However, an advantage is that the internal bulkheads, stiffeners, frames and any other fastenings or attachments can be placed and secured to the mesh before the plastering is undertaken. This also saves a lot of time.

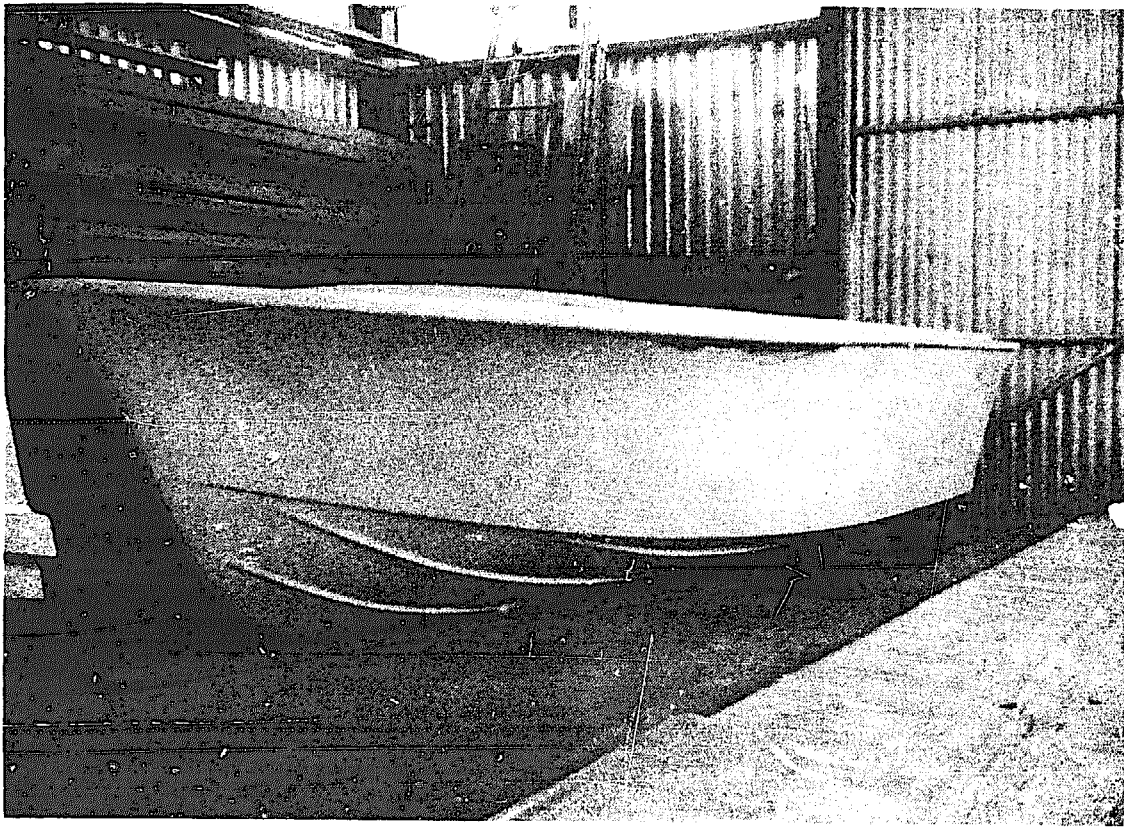
Perhaps the greatest advantage in female moulding is that the external finish does not depend entirely on the ability of the plasterer but solely on the quality of the finish provided on the mould.

The one big problem with the system is that of providing adequate cover or protection to the mesh on the outer surface of the hull: as the mesh normally touches the female mould and the cover is minimal, some form of outer cover must be provided afterwards.

*Figure 11. Female moulding. In spite of difficulties of application, this form of construction offers the greatest potential for ferro-cement boatbuilding*







*Figure 12. Fibreglass and concrete. Development work is still being carried out on this combination of materials. Fibreglass provides a better finish and additional protection for the ferro-cement hull*

## VI. HULLS SUITABLE FOR FERRO-CEMENT CONSTRUCTION

The basic qualities that make ferro-cement ideal for boat construction are the ease with which it can be moulded to any shape, and the unit weight per square foot. Though a minimum practical thickness of  $\frac{5}{8}$  in., which equals  $8\frac{1}{2}$  lb/ft<sup>2</sup>, is permissible, the standard thickness used in small boats (e.g. 45-footers) is one inch, or 14 lb/ft<sup>2</sup>. In practice, however, the unit weight per square foot is increased to allow for additional thickening around the keel and corners, and this must be taken into consideration when determining the actual weight of a boat.

Of the three basic types of hull—light displacement (or planing), semi-displacement, and displacement—only the last two are suitable for ferro-cement construction. (See figure 13.)

### LIGHT DISPLACEMENT HULLS

A light displacement craft is one that can be driven across the surface of the water at high speed. The speed at which it travels is proportional to the load applied per square foot of water surface area and to the horsepower provided. Ferro-cement is completely unsuitable for this type of craft, as the weight of the hull is too great. Matching the performance of a light-weight craft of the same type would call for excessive horsepower and fuel consumption.

### SEMI-DISPLACEMENT HULLS

The hull of a semi-displacement craft is a compromise between a planing hull and an ordinary displacement hull. It travels reasonably well at normal displacing speeds and can be used economically at slow speeds. It is also possible, by reducing weight and boosting horsepower, to increase the speed. For example, a 40-ft hull would have a normal displacement speed of approximately eight knots and would be able to carry heavy loads without difficulty. A semi-displacement hull can, in fact, be driven at a speed of ten or eleven knots and still remain within a realistic power-weight range, provided loads are limited.

## DISPLACEMENT HULLS

Displacement hulls are designed to travel with the minimum power at the maximum water-line speed. Any attempt to drive them faster than this is extremely difficult and uneconomical. However, they can carry heavy payloads and maintain the same maximum speed without very much increase in power, whereas both the planing and semi-displacement hulls require considerable power to exceed their displacement speed, and their performance in this range is proportional to the weight carried. Ferro-cement is ideal for this type of hull.

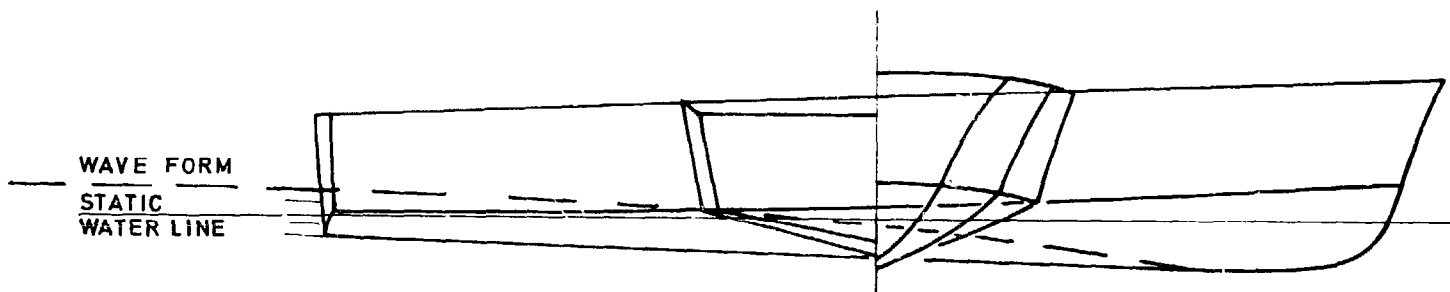
## HULL SHAPES

In any design for a planing or semi-displacement hull, it is probable that the bottom surfaces will be quite flat or, even if they are slightly curved transversely across the hull, they will be flat, fore and aft, in the after half of the vessel. The topsides are frequently also flat but these can be curved if the designer so requires. The semi-planing hull normally has a hard chine, but this can also be curved if necessary.

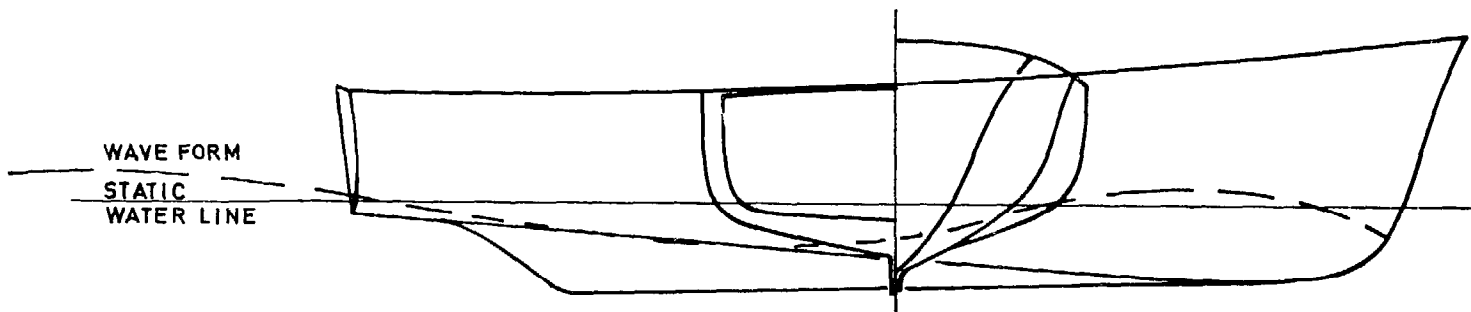
Curvature of the hull is still the subject of much discussion among designers of high-speed boats. Ferro-cement is not suitable for flat sections and if it is to be used in the construction of semi-displacement hulls, great care must be taken that sufficient transverse curvature is provided to guarantee the strength of the hull.

Designers of displacement hulls make every effort to use easily curved sections that allow the water to flow easily and with a minimum of resistance around the shape. Experience has shown that the ideal shape for a boat is one that is smoothly curved in both directions and this shape is excellently suited to ferro-cement construction. As the weight of such a hull is not critical, it is a relatively simple matter to design one that can accommodate the extra weight of the ferro-cement without prejudicing the power/displacement ratio. Many types of conventional displacement hulls in use today lend themselves to ferro-cement construction; these include tugs, fishing boats, house boats, work boats, or any ocean-going displacement craft.

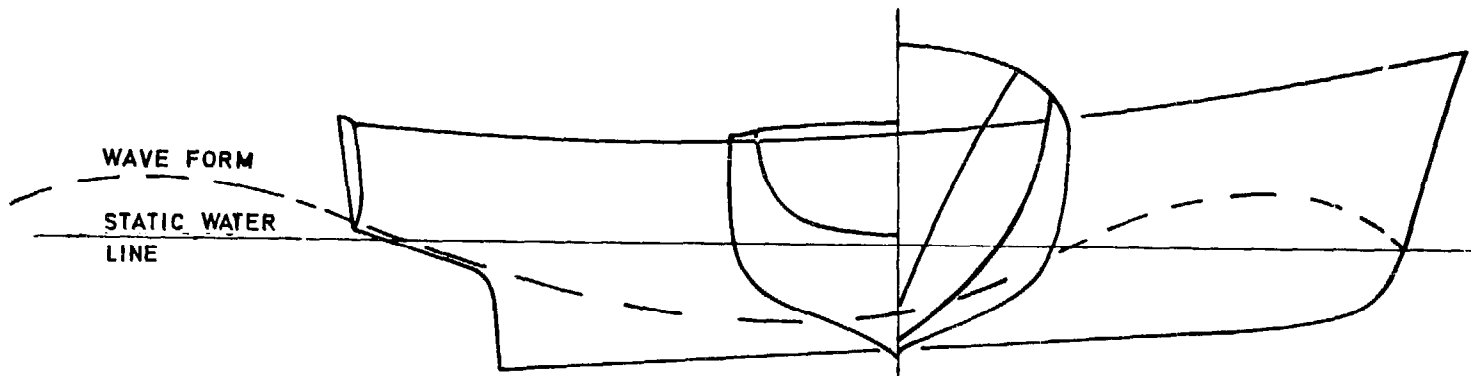
Many examples of local variations on the basic hull form can be seen around the world (see figures 14—24 inclusive). The canoe, originally carved out of a tree trunk, has a very long and narrow form and can be driven through the water at high speeds with a minimum of effort. Although this shape is not favoured by the present-day commercial boating community because of its inadequate carrying capacity and stability, there are many cases where it is still applicable. Modern, heavy displacement naval craft continue to be built along the sleek lines of the canoe. This form of hull can be constructed very successfully in ferro-cement, but it should be realized clearly that it will probably weigh much heavier than its timber or fibreglass counterpart. Its greater weight will certainly cause it to draw more water, but this may not be a serious problem.



*Light displacement (planing) hull*



*Semi-displacement hull*



*Displacement hull*

*Figure 13. Three basic types of hull*

## BUOYANCY

Buoyancy is a very important factor in boat construction. Ferro-cement is approximately two and a half times heavier than water, and both steel and aluminium are heavier still. Timber is approximately half the weight of water.

Timber hulls, if they are not carrying heavy ballast or heavy engines, often continue to float when damaged and filled with water, and in many parts of the world today, fishermen, sportsmen and travellers owe their lives to this excellent property.

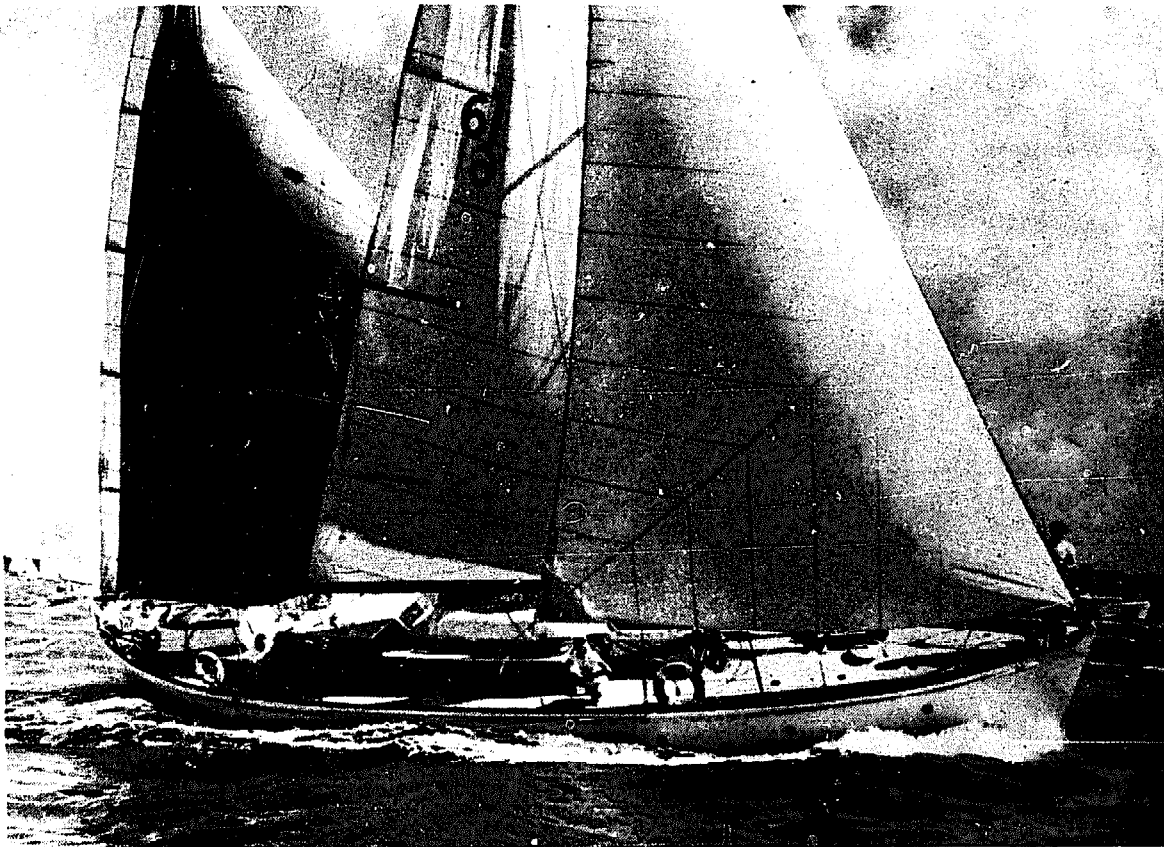
However, buoyancy can be provided in any type of hull by building in watertight or airtight compartments and by incorporating adequate buoyancy material in the construction. A hull that is constructed in such a manner that it provides its own natural buoyancy has distinct advantages. Ferro-cement is a material which, by use of sandwich construction consisting of thin skins of ferro-cement and a material such as polystyrene and polyurethane, has much to offer in this respect.

## DECKS AND BULKHEADS

In most boats the decks and bulkheads are relatively flat sections for which ferro-cement on its own is not ordinarily a desirable construction material. However, the addition of suitable stiffening such as rolled steel joists, angle irons, channel sections, timber beams, or even ferro-cement ribs, can provide the strengthening required. Sandwich construction may be the ideal solution to the problem of decks and bulkheads, as this form provides considerably increased strength and stiffness over a similar weight of plain ferro-cement section.

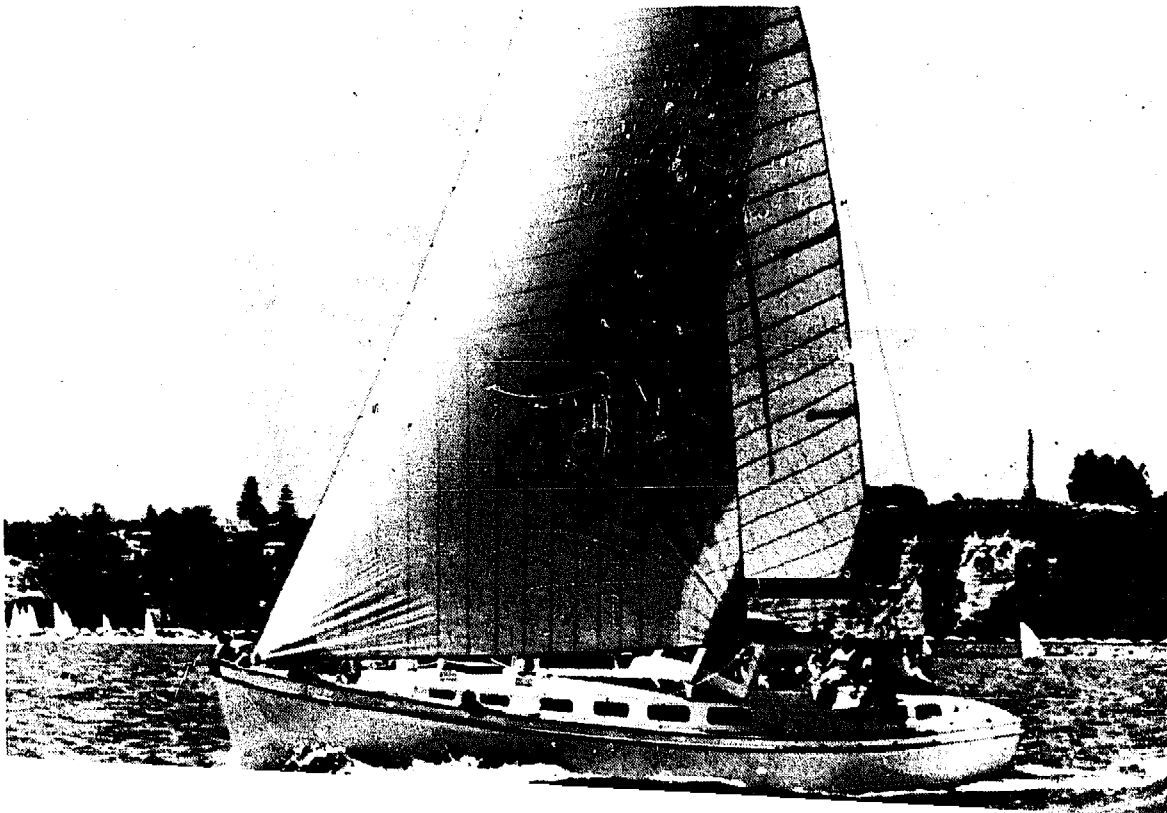
## INSULATION

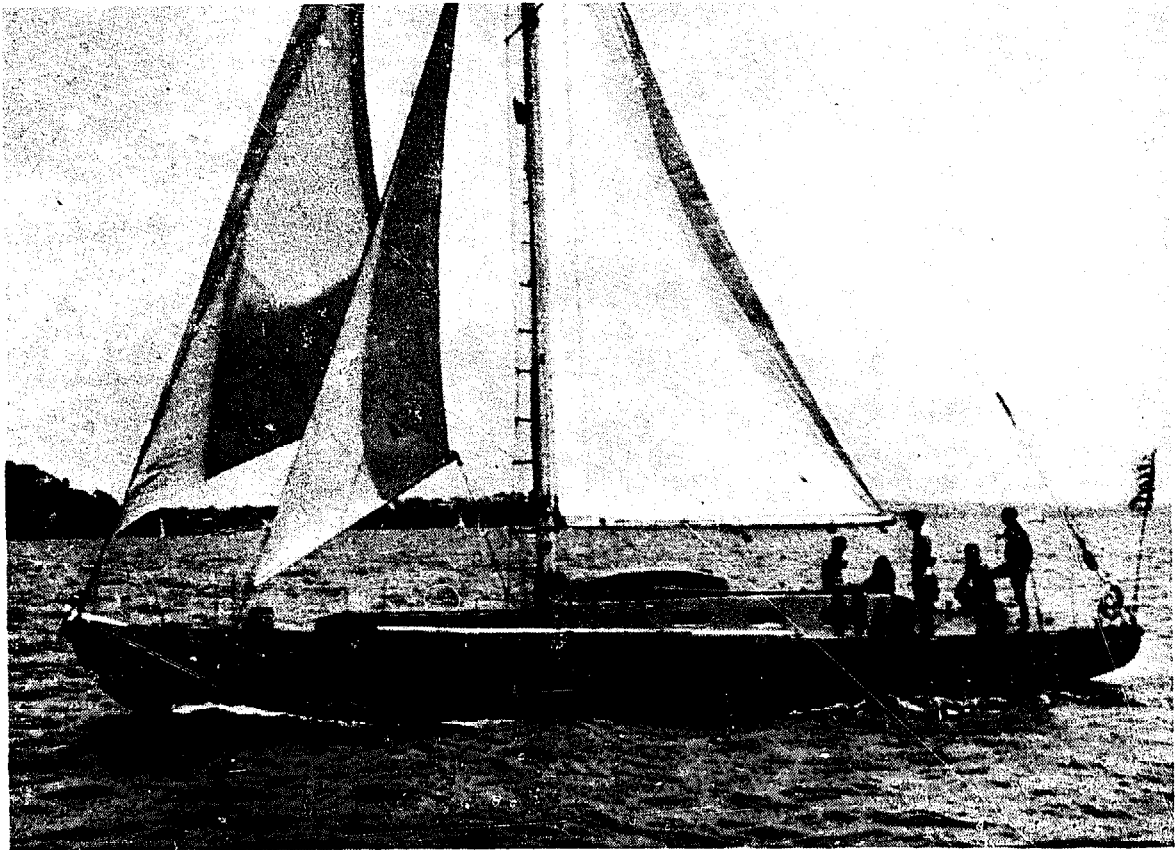
Ferro-cement as a material ranks between timber and metal with respect to transmission of high or low temperatures. In commercial application, or in areas of high or low temperatures, attention must be paid to this factor, as serious problems of flexure and stress can result from excessive variations of temperature. The decks of a vessel, when exposed to the tropical sun, will almost certainly expand and unless adequate provision is made for the resulting stresses, the hull may crack. The same applies to areas around engine rooms and freezing compartments. The use of light-colour or sunlight-reflecting paints is a help in offsetting this problem. Sandwich-type construction is highly desirable for these areas and although more expensive than a single skin, it may well prove to be less costly than a single construction with insulation added.



*Figure 14. A 55-ft schooner. Photograph by courtesy of New Zealand Herald*

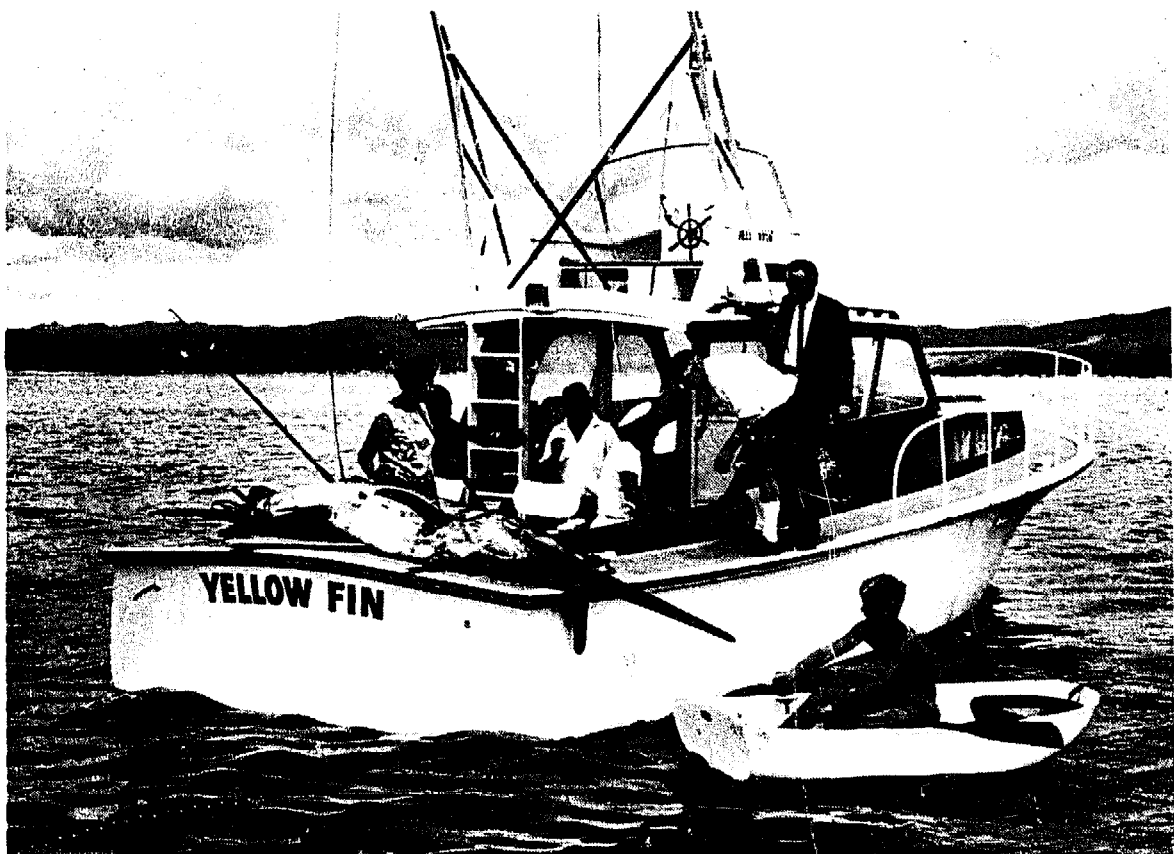
*Figure 15. A 55-ft cutter "Innisfree"  
Photograph by courtesy of New Zealand Boating World*

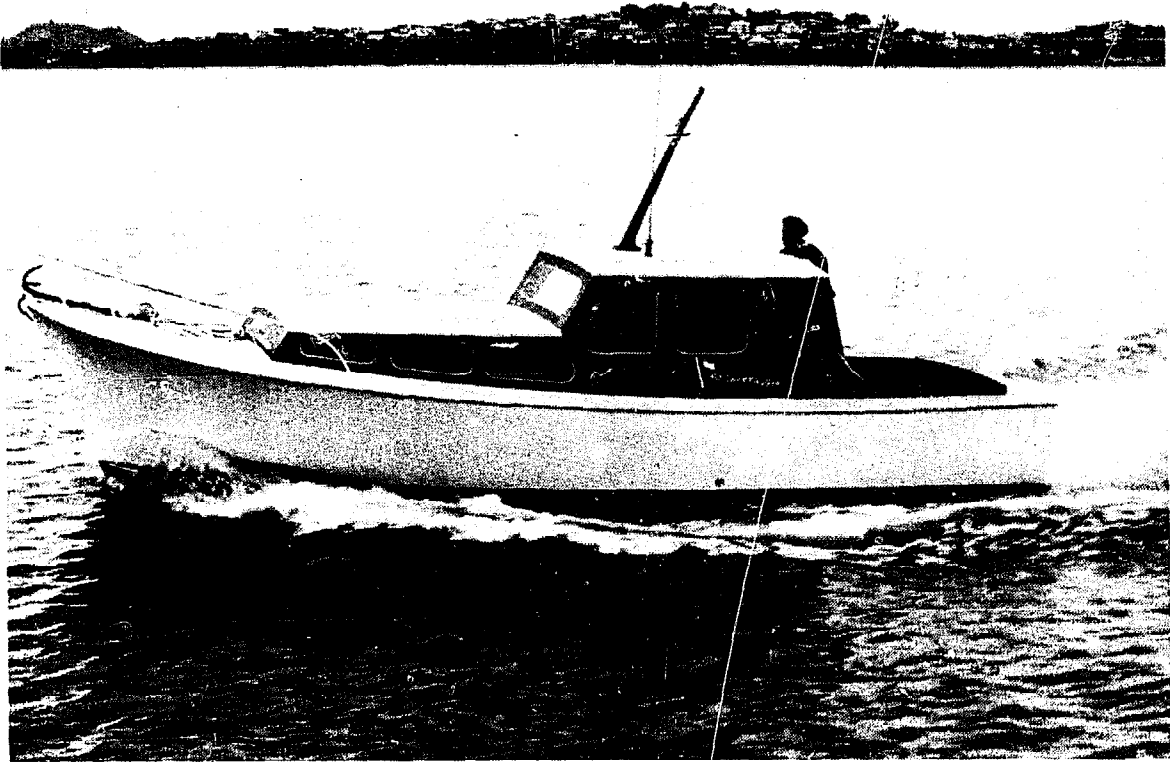




*Figure 16. The "Awabnee", a 53-ft ferro-cement cutter built in New Zealand in 1963 by California veterinarian, B. Griffiths, to his own design and modifications. In 1967, Mr. Griffiths, who is one of today's foremost authorities on ferro-cement construction, successfully sailed the "Awabnee" around the world*

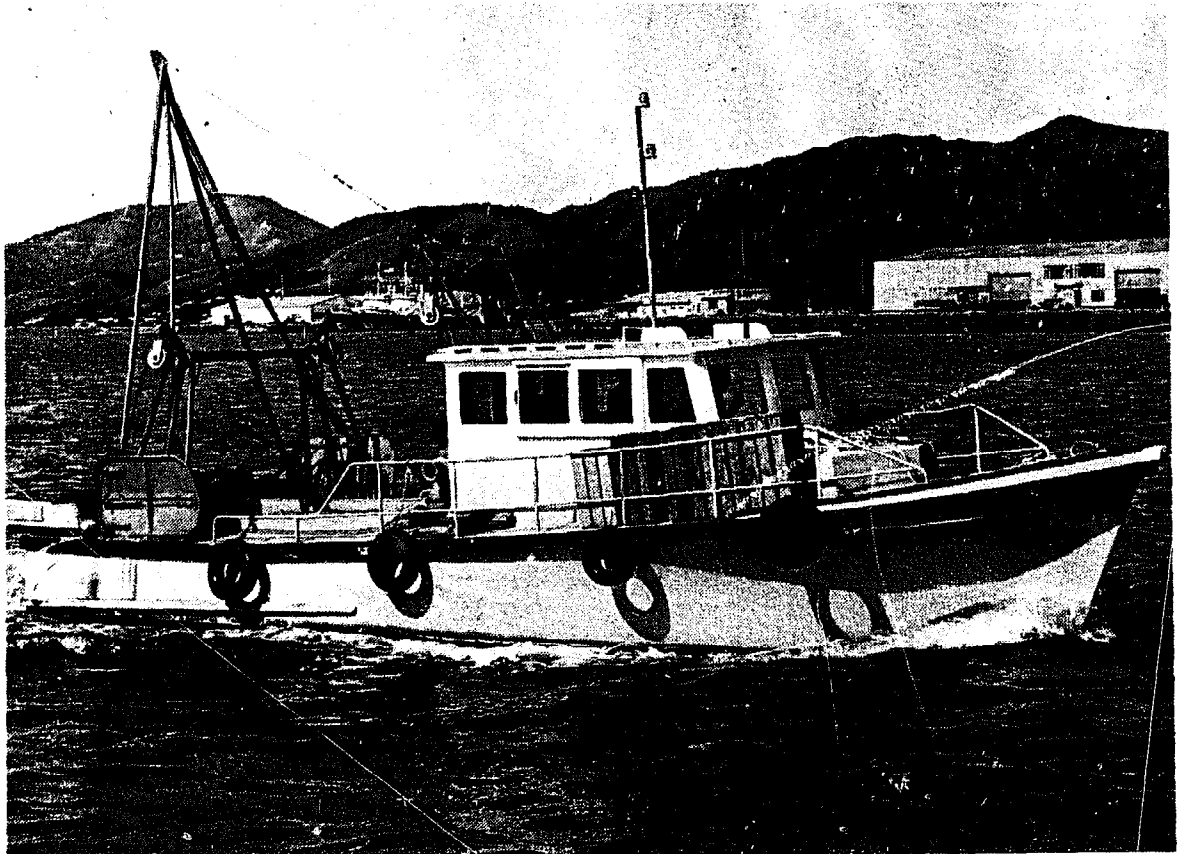
*Figure 17. A 48-ft game fishing launch*



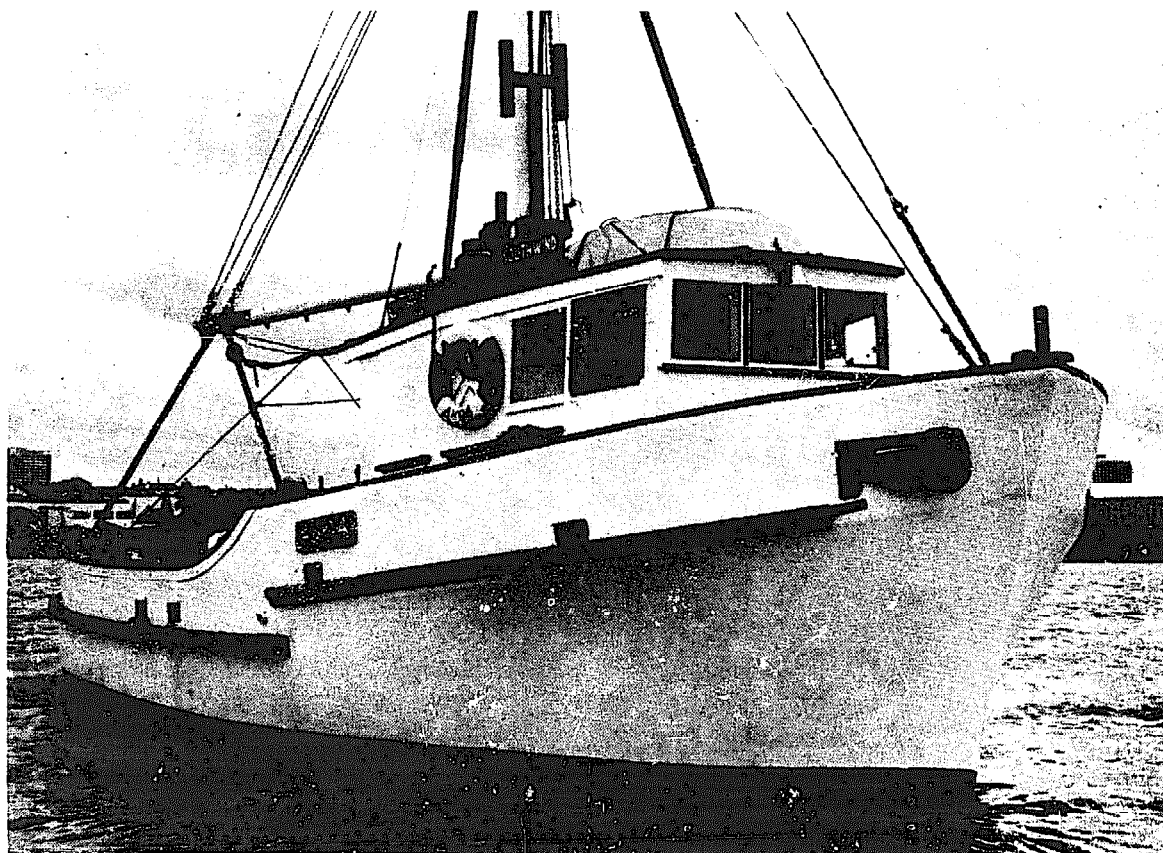


*Figure 18. A 27-ft fishing boat*

*Figure 19. A 38-ft fishing boat*

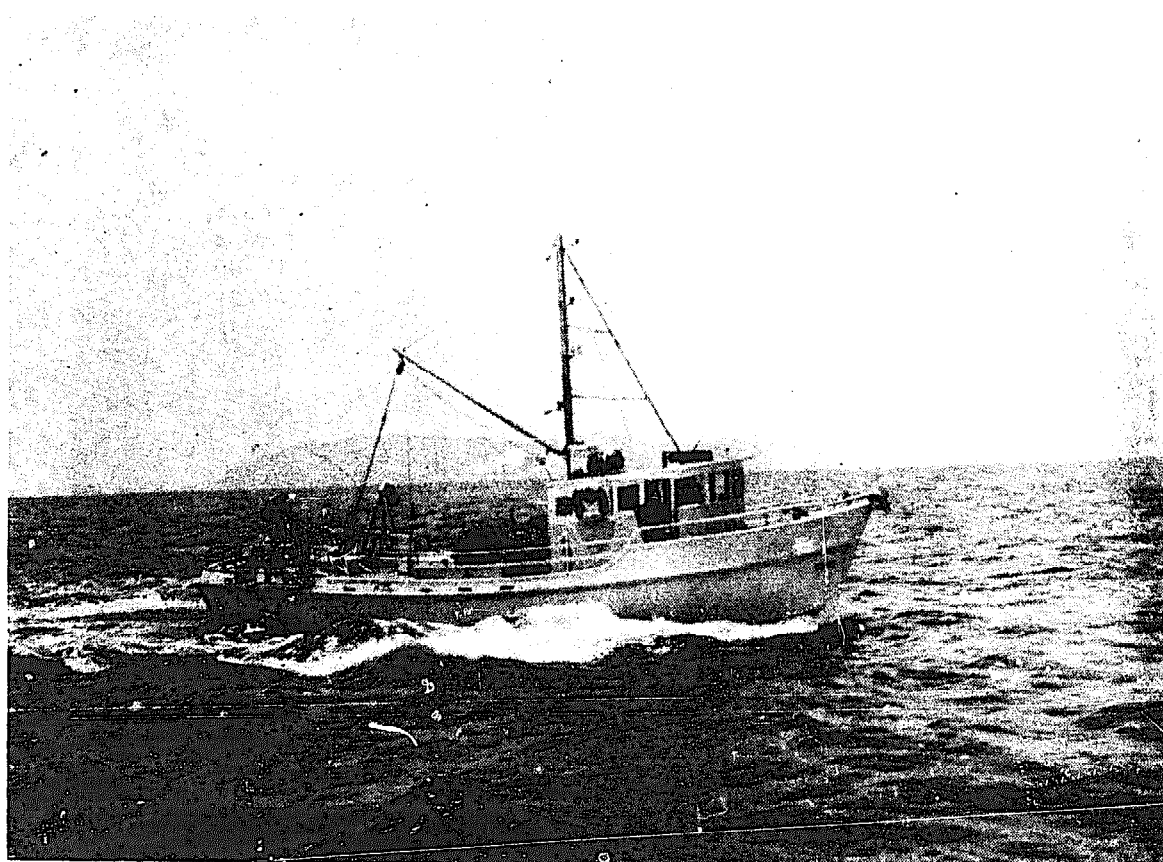


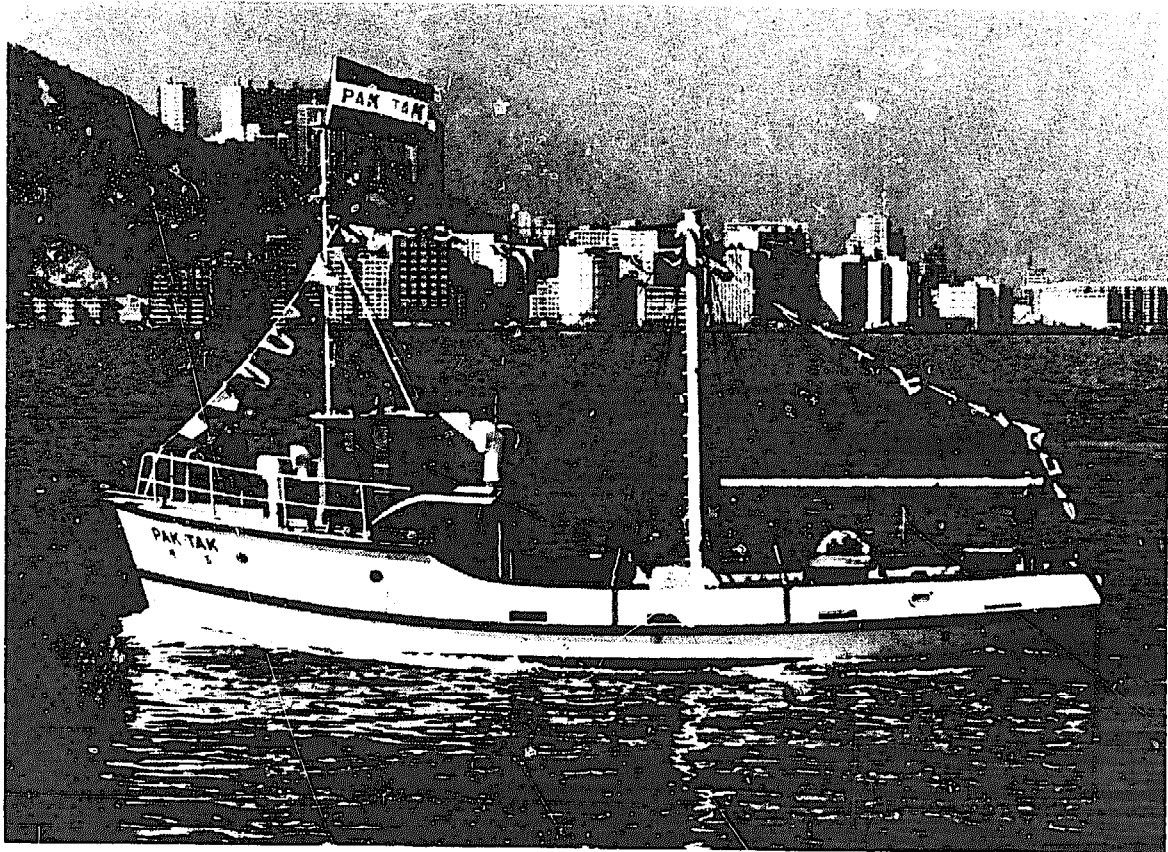




*Figure 20. A 48-ft combination trawler*

*Figure 21. A 48-ft combination trawler at work*

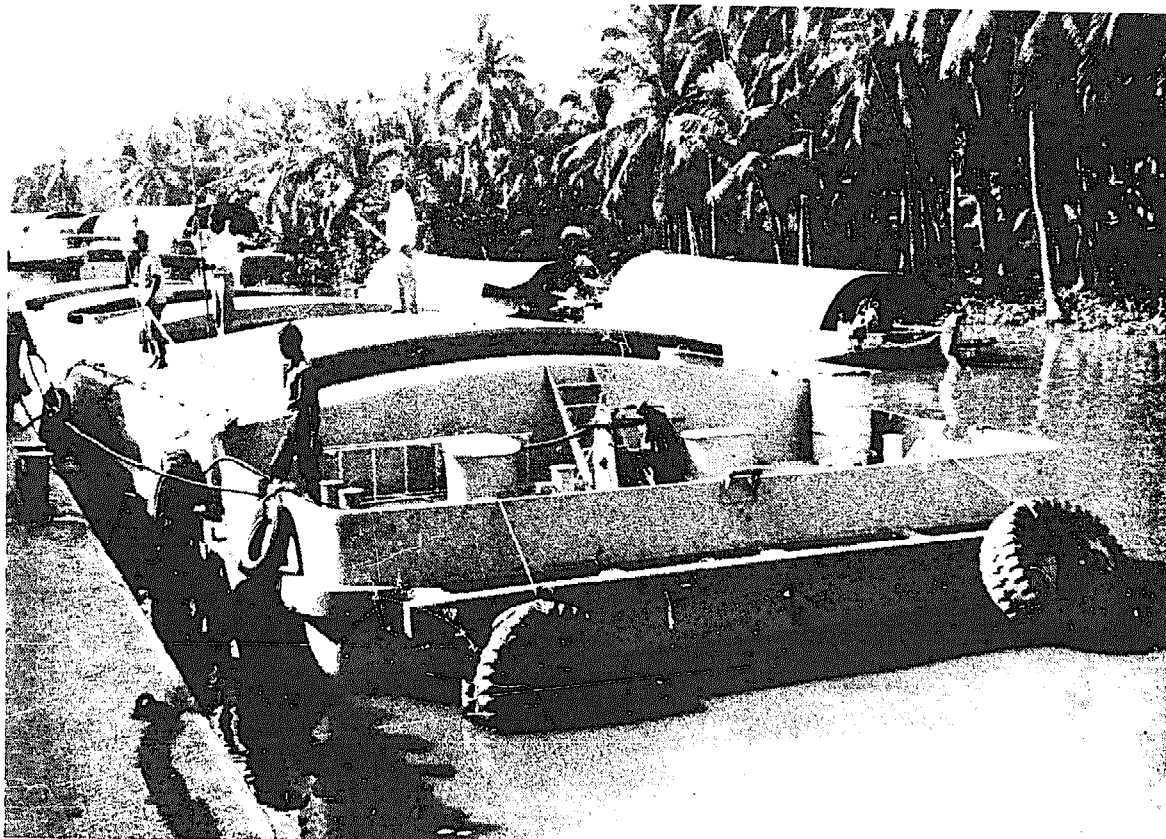




*Figure 22. A 54-ft 6-in. fishing boat. Photograph by courtesy of Concrete Products magazine, U.S.A*

*Figure 23. A 38-ft tug*





*Figure 24. A 100-ft barge*

## SELECTED BIBLIOGRAPHY

ANON. (1967) "Tentative Requirements for the Construction of Yachts and Small Craft in Ferro-Cement", *Lloyd's Register of Shipping*, January issue (Tech. Note: FC/REQ/1).

ANON. (1970) "Expansive Cement Concretes—Present State of Knowledge", *ACI Journal*, August issue (Title No. 67—35).

ANON. [date unknown] "A Rice Silo that can Save a Nation Millions", *SEATO Review*.

AMERICAN BUREAU OF SHIPPING (1969) *Guidelines for the Construction of Ferro-Cement Vessels*, New York.

AMERICAN CONCRETE INSTITUTE (1963) *ACI Standard Building Code Requirements for Reinforced Concrete* (ACI 318—63), Detroit, Mich.

AMERICAN CONCRETE INSTITUTE (1970) "Building Code Requirements for Reinforced Concrete (proposed revision of ACI 318—63)", *ACI Journal*, February issue.

AMERICAN CONCRETE INSTITUTE (1968) *Epoxies with Concrete* (No. SP-21), Detroit, Mich.

AMERICAN CONCRETE INSTITUTE (1969) "Recommended Practice for Atmospheric Pressure Steam Curing of Concrete (proposed ACI standard)", *ACI Journal*, November issue (Title No. 66—50).

BENFORD, J. R. and H. HUSEN [date unknown] *Practical Ferro-Cement Boatbuilding*, Jay R. Benford, Box 456, Friday Harbour, Washington, USA.

BERMEJO, R. T. (1970) "How Ferro-Cement Boat Building Started in Cavite", *Philippines Herald*, Navy Day Supplement, 9 February.

BEZUKLADOV, V. F. *et al.* (1968) "Ship Hulls Made of Reinforced Concrete (Design, Strength and Construction Technology)", *Navships Translation No. 1148* [from Russian], November issue, Naval Ships Systems Command, Washington, D. C.

CANBY, C. D. (1969) *Ferro-Cement with Particular Reference to Marine Applications*, Department of Naval Architecture and Marine Engineering, University of Michigan, Ann Arbor, Mich.

DEPARTMENT OF FISHERIES OF CANADA (1969) *Proceedings Conference on Fishing Vessel Construction Materials* (Canadian Fisheries Report No. 12; Cat. No. Fs4-24/12), Queen's Printer for Canada, Ottawa.

FERRO-CEMENT LTD. (May 1970) "Review of Existing Experimental Work", Auckland, New Zealand (unpublished).

FERRO-CEMENT LTD. (May 1969) "Specification for the Design and Construction of Ferro-Cement Hulls", Auckland, New Zealand (unpublished).

FERRO-CEMENT LTD. (May 1969) "Typical Ferro-Cement Boat Building Construction Details", Auckland, New Zealand (unpublished).

FYSON, J. F. (1969) *Ferro-Cement Construction for Fishing Vessels, Fisheries Technical Paper No. 76*, FAO, Rome.

GARDNER, J. (1971) "Regular Reviews of Information and Progress regarding Ferro-Cement", *National Fisherman*, June issue.

HARTLEY'S BOAT PLANS LTD., *Boat Building with Hartley*, 6th ed., Box 30094, Takapuna North, Auckland, New Zealand.

HOFISOY, A. and I. GUKILD (1969) "Bond Studies on Hot Dip Galvanized Reinforcement in Concrete", *ACI Journal*, March issue (Title No. 66—17).

HURD, M. K. (1969) "Ferrocement boats", *ACI Journal*, March issue.

ISHAI, O. and N. BAVLI (1966) "Shrinkage and Cracking of Cement Mortars Used for Exterior Coating", *ACI Journal*, November issue (Title No. 63—57).

JACKSON, G. W. and W. M. SUTHERLAND (1969) "Concrete Boat Building, its Techniques and its Future", Allen & Unwin, London.

KEY, W. H., Jr. (May 1970) *Impact Resistance of Ferro-Cement Plates*, Naval Architecture and Marine Engineering, M.I.T., Cambridge, Mass. (Thesis).

LACHANCE, L. and P. FUGERE (1970) "Construction of a Ferro-Shotcrete Motor-Sailer Hull", *L'Ingénieur*, March issue.

LORMAN, W. R. (1968) *Engineering Properties of Shotcrete* (No. SP—14A), American Concrete Institute, Detroit, Mich.

MAHAFFEY, P. I. (May 1970) *Ferrocement—Technical Memorandum*, Cement and Concrete Association of Australia.

MINERALS AND METALS GROUP, TECHNOLOGICAL RESEARCH INSTITUTE (1969) *Ferro-Cement for Construction of Fishing Vessels* (Co-operative Research Programme No. 21—Report No. 1), ASRCT, Bangkok.

MORGAN, R. G. (June 1968) "Concrete as Shipbuilding Material", in *Proceedings of the International and Shipping Conference*, Institution of Marine Engineers, London.

NAAMAN, A. E. (September 1970) *Reinforcing Mechanisms in Ferro-Cement*, Dept. of Civil Engineering Materials, M.I.T., Cambridge, Mass. (Thesis).

NERVI, P. (1951) "Ferro-Cement: Its Characteristics and Potentialities", *Ingegnerie* (C.A.C.A. London Library, Translation 60) 1965.

NEW ZEALAND MARINE DEPARTMENT (1969) *Provisional Requirements for the Construction of Ferro-Cement Boats*, Wellington, New Zealand.

SAMSON, J. and G. WELLENS (1968) *How to Build a Ferro-Cement Boat*, Samson Marine Design Enterprises Ltd., P.O. Box 98, Ladner, B.C., Canada.

SANNERGREN, A. (January 1971) "Report on 30' O" Ferro-Cement Boat—Fiji", UNIDO, Vienna (unpublished).

SCRIVENER, J. C. and A. J. CARR, "An Analysis of Ferro-cement Hulls", paper presented to the Pacific Symposium on Hydro Mechanically Loaded Shells, held in Honolulu, Hawaii, under the auspices of the International Association of Shell Structures, 15 October 1971.

SMITH, F. W. A. (1969) "Tests for Fire Endurance Limit and Structural Strength of Ferro-Cement Test Panels", prepared for Ferro-Cement Ltd. (unpublished).

*Vom Caementum zum Spannbeton; Beiträge zur Geschichte des Betons*, Bauverlag, Wiesbaden and Berlin, 1964.

WALKUS, R. (1967) *Ferrocement Extensibility Investigations*, Scientific Papers of Łódź Technical University No. 2 (in Polish).

WALKUS, R. (1970) *Ferrocement in Bending, Fissurisation, Deformation and Working Stages*, Scientific Papers of Łódź Technical University No. 5 (in Polish).

WALKUS, R. and T. G. KOWALSKI (1971) "Ferrocement: A Survey", *Concrete*, February issue.

WHITENER, J. R. (1971) *Ferro-Cement Boat Construction*, Cornell Maritime Press, Cambridge, Md.

**Annex 1**

**GUIDELINES FOR THE CONSTRUCTION  
OF  
FERRO-CEMENT VESSELS**

American Bureau of Shipping, 19 August 1969

## 1. GENERAL CONDITIONS

### *1.1 Classification*

Vessels which have been wholly or primarily built of ferro-cement, and which have been built under the special supervision of the Surveyors to the Bureau, in accordance with these Guidelines, or their equivalent, and other relevant sections of the Rules, will be considered for classification, and where approved by the Committee, distinguished in the Record by the symbols + A1 "Annual Survey". The type of construction, "Ferro-Cement", will be noted in the Record.

### *1.2 Workmanship*

The Surveyor is to satisfy himself that all operators employed in the construction of vessels to be considered for classification are properly qualified in the type of work proposed, and that equipment and other facilities are such that acceptable standards can be obtained for the construction of the hull, superstructures and appendages thereto, and for the installation of equipment, machinery, piping and the electrical system.

### *1.3 Construction surveys*

The builder is to maintain a schedule of systematic inspections at regular intervals during the construction of the vessel, and records thereof, made by qualified personnel of the yard, are to be made available for inspection by the Surveyor. The Surveyor is to be present at the completion of all the major stages of construction. Additional visits will depend on the size of the vessel, and requests of the owner or builder.

### *1.4 Surveys after construction*

The hull is to be subject to an Annual Survey on drydock, equivalent to a Special Survey. The hull is to be examined internally and externally, and all framing, appendages, deck houses, bulkheads, etc. are to be examined. These Annual Surveys are to continue until sufficient experience has been acquired to determine that surveys at longer intervals are reasonable and proper.



### *1.5 Submission of plans*

Plans showing the particulars, arrangements and details of the principal parts of the hull structure of each vessel, to be built under Special Survey, are to be submitted and approved before the work of construction is commenced. These plans are to indicate clearly the particulars, as well as the details and arrangements of the reinforcements of the hull. A construction schedule, giving details of materials, mixes, reinforcements, mortar application and curing procedures, is also to be submitted. Generally, plans should be submitted in triplicate.

### *1.6 Calculations*

The designer is to prepare strength calculations to justify the strength of the hull and its components. These calculations are to be based on the values obtained from the testing procedure, as prescribed in Section 4, and are to be submitted with the plans, as required by 1.5.

## 2. PARTICULARS AND CONSTRUCTION

### *2.1 Definitions*

The definition of a hull or structure built in ferro-cement is as follows:

A thin, highly reinforced shell of concrete in which the steel reinforcement is distributed widely throughout the concrete, so that the material, under stress, acts approximately as homogeneous material. The strength properties of the material are to be determined by testing a significant number of samples of representative panels, according to Section 4. If a similar approval is obtained from a recognized authority, the Bureau may waive these requirements, upon review of the previous tests and such check tests as may be deemed necessary.

### *2.2 Reinforcements*

The steel content of the ferro-cement should be as high as practicable, and arranged in such a manner as to allow adequate penetration of the mortar, and thereby result in a void-free material. The reinforcing rods, pipes and wire mesh are to be evenly distributed and shaped to form. Transverse frames or bulkheads are to be fitted, to provide adequate transverse strength. The reinforcement network should be securely welded or otherwise fastened together, so that it remains in its original position during the application of the mortar.

Structural steel sections may be incorporated into the ferro-cement structures as longitudinal strength members, floors, etc., but care must be taken to ensure penetration of the mortar, and a proper bonding between the framework and the mesh.

The reinforcements may be tapered towards the ends of the structure, where the hull form becomes "finer", but care is to be taken to avoid

discontinuities in the strength of the reinforcements, and ends of members are to be faired into the adjoining structure. The overlaps of the mesh layers at the keel, transom edges, etc. are to be staggered to allow even distribution of reinforcement in those areas, and to ensure satisfactory penetration of the mortar. Butts in reinforcement are to be suitably staggered, to avoid discontinuities.

### *2.3 Formwork*

In methods of construction where internal or external forms are employed, satisfactory penetration of the mortar must be ensured, and the reinforcements are to be secured, so that distortion is minimized on the application of mortar. The formwork is to have a smooth surface, and is to be thoroughly cleaned before applying the mortar.

### *2.4 Concrete*

The methods employed for the mixing, handling, compacting and curing of the concrete are to be consistent and should result in high-quality material. The mortar should be applied as soon as possible after mixing, and constant agitation of the mix is to be provided during the waiting period. If any separation of water from the mix is observed during the waiting period, the mortar is to be remixed before application. Containers used to transport the mortar are to be clean. Care must be taken during the application of the mortar, so that no void spaces remain adjacent to the reinforcements or in corners. Vibrators, and/or hand rodding, are to be used to compact the mortar at thicker sections. A complete coverage of the reinforcement is to be ensured, although the thickness of coating should be kept at a minimum, and an excessive build-up of cement is to be avoided. Ferro-cement structures are to be cured in a satisfactory manner. Various methods of curing are acceptable, depending on ambient conditions but, in general, the curing should be done by water spraying, by steam curing under a hood, or by membrane curing. Normally, curing should not commence until about three to four hours after the mortar application, or when the mortar has taken its first set. This period may be longer in association with low atmospheric temperatures. The temperature during the curing period is to be kept approximately constant. Where a form is employed, it shall be kept in position for as long as practicable during curing.

## 3. MATERIALS

### *3.1 Cement*

The cement shall be ordinary Portland cement, in accordance with a suitable approved specification, such as ASTM C 535-67T. Other cements will also be considered providing they offer adequate watertightness and

uniform consistency. Cement should be stored under dry conditions, and if the application of the mortar is done in stages, a suitable turnover of cement stock is to be arranged to ensure consistent freshness. Any presence of lumps in the cement renders it questionable for use, and it is to be sieved before mixing.

### *3.2 Aggregate*

Aggregates are to have suitable strength and durability, and are to be free of foreign materials, including chemical salts. The aggregate is to include clean, washed sand of a silicious nature and should comply with a suitable specification, such as ASTM C 330-68T.

### *3.3 Water*

Water is to be free from foreign materials that may impair the strength and resistance of the mortar. It is to be free of salts.

### *3.4 Mixing*

Mixing is to be done in such proportions as to give consistently the required strength, as determined by Section 4. The proportions of the mix are to be by weight. The water/cement ratio is to be controlled as low as possible to give the material a consistent quality and workability. Initially this is to be judged by a slump test and practicable workability under the existing conditions. Once this criterion is established, the mortar is to be held to a consistent slump-test standard.

### *3.5 Reinforcements*

Reinforcements (rods, pipes, expanded metal, and wire mesh) are to have sufficient tensile and yield strength and ductility, and other properties essential for good construction. The reinforcements are to comply with a suitable specification, such as ASTM A 615-68, 185-64 and A 390-66. The reinforcements are to be free from millscale, grease and any other contamination. Light corrosion is not objectionable, but should be brushed to remove free oxide. Black or galvanized reinforcements are acceptable.

## 4. TESTING

### *4.1 Mechanical properties testing*

The mechanical properties tests, as listed below, are to be performed on representative samples. Prior to commencement of construction, preliminary tests are to be carried out on standard test pieces, as described below, in order to determine that the proportions of the mortar mixes and properties and arrangements of the reinforcements will satisfy the design

strength requirements of the vessel. The preliminary test pieces are to be in accordance with a suitable specification such as ASTM C 192-68, although curing may be done at an accelerated rate. Preliminary tests are to be carried out satisfactorily before construction is begun. During construction, test pieces, as described below, are to be made from the same mortar batches that are used in the actual hull construction, and the following tests are to be carried out.

For each 50 cubic feet, or fraction thereof, a minimum of one each of the following tests, compressive, direct tensile, flexural, and impact, are to be made. At least three of each of these tests are to be made for each hull or structure. Where larger unit hulls or structures are being built and large identical mixes of mortar are used, one set of tests per batch of 10 cubic yards (7.65 m<sup>3</sup>), or fraction thereof, shall be carried out. A minimum of six sets of tests are to be made for each unit of construction. These tests are to be carried out in a manner that will yield reliable values of the tensile and compressive strength at both cracking and failure, as well as the modulus of rupture and elasticity and impact strength of the reinforced samples. In the construction tests, the curing is to be in accordance with a suitable specification such as ASTM C 31-66.

*(a) Compressive test*

The compressive test is to be carried out on unreinforced samples, which are to measure 4 in. in diameter and 8 in. in length. The compressive test is to conform to a suitable specification, such as ASTM C 39-66, and the test report is to conform thereto.

*(b) Direct tensile test*

The tensile strength is to be determined by the "split-cylinder" test, using similar testing apparatus as is used for the compressive test. Specification ASTM C 496-66 describes the procedure for this test, and offers the formula to determine the "splitting tensile strength". The test pieces are to be unreinforced and of the same size as those used in the compressive test. However, it should be noted that the true tensile strength of the specimen lies between 50 and 70 per cent of the "splitting tensile strength".

*(c) Flexural test*

The flexural tests are to be carried out on slabs of concrete approximately 4 ft long and 12 in. wide and of the same thickness as the hull. The test pieces are to be reinforced and should have the same pattern of reinforcement as the actual hull. The flexural test is to conform to a suitable specification, such as ASTM C 293-68 and ASTM C 78-64, but care must be taken to ensure that the load application and support blocks provide a uniform load across the test piece. Furthermore, readings are to be taken at both cracking and failure.

*(d) Impact test*

An impact test is to be performed on representative reinforced panels. The thicknesses and reinforcement of the test panels are to follow the same patterns as those of the actual hull. The panel, which is to be flat, should measure about 2 ft  $\times$  2 ft, and is to have two mutually perpendicular vee notches  $\frac{1}{25}$  in. (1 mm) wide and  $\frac{1}{12}$  in. (2 mm) deep across the centroid of test panel. The notches are to be at right angles to the edges. A drop-weight-type test is to be employed. Failure occurs when the test panel develops a leak, and this is to be determined by a water-hose test, or the equivalent. The test report is to include the following data:

1. Identification number.
2. All dimensions of the specimen.
3. Applied load that causes failure.
4. Curing history, and moisture condition of specimen at testing.
5. Defects of specimen and age.
6. Ambient conditions.

**Annex 2**

SPECIFICATION  
FOR THE  
DESIGN AND CONSTRUCTION  
OF  
FERRO-CEMENT HULLS

## INTRODUCTION

The use of ferro-cement for the construction of small boat hulls has become widely accepted and the techniques of construction are well known.

Its use has now been extended to the construction of larger vessels, including work boats, for commercial use. To satisfy the requirements of classification authorities, this specification has been drawn up as a basis for design, acceptance, construction, inspection and information.

Ferro-Cement Limited has several years of experience in the successful use of the material. Research is being undertaken at present by the Company and by other investigators and this specification is based on the experience and knowledge that is currently available. Although there are aspects of the behaviour and characteristics of ferro-cement that have not been fully investigated, sufficient is known to present this specification as a working basis for its design and construction. As more information becomes available through research, experience, etc. the appropriate amendments will be made.

### PART 1. GENERAL REQUIREMENTS

#### *1.1 Classification*

All vessels requiring classification by an authority, viz. Lloyds, New Zealand, Marine Department, shall be built to the requirements of this specification.

#### *1.2 Works*

Ferro-cement vessels shall be built in properly equipped works that comply with the following minimum requirements:

- 1.2.1 Buildings shall be sufficient in size to ensure that the complete construction of the ferro-cement sections of the vessel can be carried out within the buildings.
- 1.2.2 Provision shall be made for the storage of all cement and aggregates in dry conditions. Aggregate bins will be such that surplus water in freshly delivered material may freely drain away.
- 1.2.3 Provision shall be made for mixing all mortar under cover.
- 1.2.4 Provision shall be made for adequate steam curing of all ferro-cement work.

### 1.3 Laboratory

Provision shall be made for a separate testing laboratory in which simple tests such as slump determinations and set-off times can be made and where effective preparation and recording of other control tests can be carried out.

The laboratory shall be equipped with the following:

- 1.3.1 Set of accurate pan scales weighing 20 lb, by ounces.
- 1.3.2 Standard compression test moulds 6 in.—8-in. and 4-in. diameters.
- 1.3.3 Set of plank moulds for flexure tests.
- 1.3.4 Slump testing equipment—12-in., 8-in., and 4-in. diameters.
- 1.3.5 Test bench with hardened knife edge stools for load testing of panels.
- 1.3.6 Set of accurate certified weights— $\frac{1}{4}$  oz to 20 lb.
- 1.3.7 Records filing cabinet.
- 1.3.8 Bench and furnishings.
- 1.3.9 Thermometer and humidity gauge.
- 1.3.10 Set of BS sieves,  $\frac{3}{8}$  in.,  $\frac{3}{16}$  in., No. 7, No. 14, No. 25, No. 52 and No. 100.

### 1.4 Inspection

The Works shall institute a system of rigid inspection of vessels being constructed. These shall be held at regular stages of the vessels' construction and shall be carried out by the Design Engineer or his nominee, who may or may not be directly employed by the construction company.

Minimum required inspection stages shall be:

1. The time of lofting (check skin thickness allowances).
2. When steel reinforcement and mesh placement are half completed.
3. When steel reinforcement and mesh placement are completed.
4. Immediately prior to plastering.
5. During application and compaction of mortar.
6. At stripping of major formwork or frames.
7. At end of curing period.
8. At the completion of all remedial work required as a result of previous inspections.

A signed record of these inspections shall be kept for scrutiny by any supervisory authority or surveyor.

#### 1.4.1 Information to be recorded

The following information shall be recorded for each vessel constructed and retained on the construction company's files for future reference by surveyors or other authorities as required:



- (a) Dimensions and type of vessel.
- (b) Type and number of layers of mesh used.
- (c) Type of main reinforcing rod used and the mean of 50 random measurements of spacing observed to be reported in the longitudinal direction for the transverse steel and the verticle direction for the longitudinal steel.
- (d) Spacing, gauge and type of wire ties used.
- (e) General observations of environment, temperature and draught conditions to be made prior to commencement of plastering.
- (f) Material record.
  - (i) Origin and type of sand used in mortar.
  - (ii) Grading curve for sand used.
  - (iii) Mix design of mortar giving proportions by weight of sand, cement and water.
  - (iv) Details and quantity of any additive used.
  - (v) Assessment of water content of sand and any subsequent adjustment to mortar mix to compensate for water content of sand.
  - (vi) Source, type and delivery date of cement used.
  - (vii) Results of slump tests carried out on plaster.
  - (viii) The number and identification of test samples.
  - (ix) Date of plastering and making of test samples.
  - (x) Date of testing samples and results.
- (g) Plastering record.
  - (i) Method of plastering used and name of person responsible for the application of the plaster and for final finishing.
  - (ii) Continuity of plastering:
    - a. Time of commencement.
    - b. Time of completion.
    - c. Record of any delays in application in excess of 30 minutes.
  - (iii) Method of compaction used.
  - (iv) Average thickness of mortar, noting maximum and minimum and location thereof.
- (b) Record time of initial set of final batch of mortar applied.
- (i) Curing.
  - (i) Method of curing:
    - a. Hull
    - b. Decks
    - c. Bulkheads
  - (ii) Time of commencement of curing:
    - a. Hull
    - b. Decks
    - c. Bulkheads,

- (iii) If steam cured:
  - Record time to reach curing temperature, time at curing temperature and time of cooling for each section.
  - a. Hull
  - b. Decks
  - c. Bulkheads
- (iv) Observations after completion of curing giving details of surface quality achieved and amount of steel mesh protruding.
- (v) Details of remedial work specified.

## PART 2. MATERIALS

### *2.1 Cement*

- 2.1.1 Cement shall be ordinary Portland cement to NZS 1844 (1964), BS 12 or other equivalent specification.
- 2.1.2 Cement shall be freshly delivered for each plastering operation. Any cement showing signs of caking shall be rejected (see test requirement in Clause 2.1.4).
- 2.1.3 Cement delivered for a specific plastering operation shall not be retained for future such operations.
- 2.1.4 Should lumps be present in the cement, samples shall be tested by sieving with a No. 25 BS mesh sieve, or equivalent, and should any lumps be retained the cement shall be rejected.
- 2.1.5 Cement shall be stored in a dry position suitably removed from the site of the mixing operations to ensure that the bags remain dry.

### *2.2 Sand aggregates*

- 2.2.1 The sand aggregate used shall be clean, sharp, washed material preferably with a high silica content, and shall be free from deleterious matter including chemical salts.
- 2.2.2 The sand aggregate shall have a high abrasive resistance and shall be suitably graded to ensure uniform dense plaster.
- 2.2.3 The sand aggregate shall be substantially free from pumice or diatomaceous material.
- 2.2.4 Suitable hard abrasive sands derived from volcanic rock (e. g. quarry dust) may be used subject to the design engineer's approval and subject to the grading being satisfactory.

2.2.5 The sand aggregate shall be graded so as to fall within the following limits which correspond to grading zone 2 for fine aggregates according to BSs 882, 1964. For normal ferro-cement, use Grading B below.

<i>Sieve size</i>	<i>Percentage passing BS sieve by weight</i>
A {	3/8 in. . . . . 100
	3/16 in. . . . . 90—100
B {	No. 7 . . . . . 75—100
	No. 14 . . . . . 55— 90
	No. 25 . . . . . 35— 59
	No. 52 . . . . . 10— 30
	No. 100 . . . . . 0— 10

### 2.3 Water

2.3.1 Water shall be fresh and free from deleterious matter. Normal local authority mains drinking water supply shall be considered suitable. Water from any other source shall require the Design Engineer's approval before use.

### 2.4 Mortar

#### 2.4.1 *For hand plastering*

All mortar shall be mixed in a suitable motorized pan or paddle-type mortar mixer. Conventional rotating drum concrete mixers shall not be used.

#### 2.4.2 *For spray plastering*

All mortar shall be mixed in a pan or paddle-type mixer prior to spraying. This mixer can be either separate or attached to the spraying machine.

2.4.3 The mortar shall be thoroughly mixed in the following proportions, by weight, assuming dry sand:

Cement . . . . .	93 lb
Sand . . . . .	186 lb
Water . . . . .	42 lb
Water/cement ratio . . . . .	0.45

Cecon water-reducing additive, 7 fl. oz per 93 lb bag of cement.

2.4.4 Adjustment to the above mix shall be made to allow for the water content of the sand.

A sample of sand shall be taken prior to mixing, to assess the water content, and suitable adjustment to the mix shall be made.

The water content shall be assessed by using the siphon-can method, as suggested by the Cement and Concrete Association of New Zealand.

2.4.5 Notwithstanding the provisions of Clause 2.4.3, the water/cement ratio shall be controlled to be as low as possible to give a mortar mix consistent in quality and workability. This consistency will be checked by regular slump tests combined with practical workability as required by the plastering tradesmen.

## PART 3. DESIGN

### *3.1 Definition of ferro-cement*

Ferro-cement is a form of reinforced concrete that contains a large proportion of steel widely dispersed in a matrix of dense mortar made of sand and cement. The high steel content renders the ferro-cement flexible and the mesh reinforcement controls cracking in the mortar.

### *3.2 Structural analysis*

#### *3.2.1 Method*

Accepted methods of structural analysis in naval architecture and marine design shall be applied to the hull to determine the internal forces and moments acting in it under the worse conditions of loading.

#### *3.2.2 Testing*

Alternatively, the hull's strength may be determined by testing.

### *3.3 Design loading*

#### *Beam action due to design wave*

3.3.1 In considering the moment of resistance of the hull when acting as a beam under design wave conditions, the whole monolithic concrete section of the hull shall be taken into account when computing position of the neutral axis and the induced stresses.

3.3.2 In order to establish conformity in calculations made to assess the hull strength, the following assumed loadings should be considered for vessels less than 80 ft in length. Calculations for vessels of greater length will be specially considered.

1. Considering the hull as a beam subject to hogging and sagging bending moments. A bending moment of  $\frac{\Delta L}{20}$  lb ft is to be used, where  $\Delta$  is the extreme displacement in pounds and  $L$  the over-all length in feet.
2. Calculations made for the full shell and transverse framing subject to water pressure are to assume a static water and dynamic wave load.
3. In calculating the scantlings for deck structure, a uniform loading equivalent to a 3-ft head of sea-water is to be assumed.
4. Structural bulkheads are to withstand a sea-water pressure equivalent to the head obtained when a compartment on one side of the bulkhead is flooded.
5. Where high local loadings occur, calculations for local strength shall be based on the total pull or thrust applied at that point and allowable stresses shall be in accordance with section 3.4 of this specification.
6. The effect of shrinkage stresses should be assessed to ensure that the minimum quantity of reinforcing is sufficient to distribute the stresses adequately.

3.3.3 Design criteria for beam action under design wave are as follows:

1. The maximum tensile stress in the structure shall be no greater than 50 per cent of the tensile stress causing cracking of the ferro-cement section.
2. As the mortar should not be considered to have any tensile strength, the maximum tensile stress in the mild steel should not exceed 18,000 p.s.i. and the compressive stress in the concrete should not exceed 1,000 p.s.i.

### *3.4 Design loads*

#### *Other load conditions and secondary effects*

- 3.4.1 For loading conditions other than those caused by wave action, e. g. berthing load, loads from equipment such as winches, gallows or other mechanical gear and for secondary stresses set up in the hull by water pressure such as bending moments between bulkheads, etc., where applicable the hull shall be designed according to the following requirements or, alternatively, the required strength can be determined by test.

3.4.2 The following factors of safety shall be the minimum acceptable where ultimate strength design methods are used in relation to a ferro-cement section:

(i) Flexure

$$F_{Fu} = \frac{M_{ult.}}{M_{max.}} = 3.0$$

Where  $F_{Fu}$  is the ultimate factor of safety in flexure,  $M_{ult.}$  is the ultimate bending moment of the ferro-cement section determined from test, or from analysis (see 3.4.3.1), and  $M_{max.}$  is the maximum working moment of the ferro-cement section.

(ii) Direct tension

$$F_{Tu} = \frac{T_{ult.}}{T_{max.}} = 2.0$$

Where  $F_{Tu}$  is the ultimate factor of safety in tension,  $T_{ult.}$  is the ultimate tensile strength of the ferro-cement section (3.4.3.2).  $T_{max.}$  is the maximum working tension in the ferro-cement section.

### 3.4.3 *Structural characteristics of ferro-cement*

#### 3.4.3.1 Flexure

Where required, the working capacity of a ferro-cement section in flexure shall be assessed according to the current ACI Building Code Requirements for Reinforced Concrete (i. e. the ACI Standard 318-63 or its later amendment or revision).

The working stress design method may be used to give directly the permissible working moment in the section.

The ultimate strength design method may also be used. If so, the yield strength,  $f_y$ , of the high tensile steel shall be assumed to be 75,000 p.s.i. The coefficient  $\phi$  shall be 1.0 and the factor of safety shall be as defined in 3.4.2.1 of this specification.

Alternatively, tests may be conducted to determine the ultimate flexural strength of the ferro-cement section to the satisfaction of the designer.

#### 3.4.3.2 *Direct tension*

The ultimate strength of ferro-cement in direct tension shall be taken to be aggregate tensile strength of the steel alone. (It should be noted that if galvanized wire is used, the steel alone shall be taken to act and that the galvanizing shall not be considered as contributing to the strength of the wire.)

If acceptable tests have been carried out on the particular construction in question and have demonstrated without doubt that its tensile strength is greater than that of the steel alone (even with the presence of shrinkage cracks in the mortar), then the strength evaluated from such tests may be accepted as a basis for design.

The allowable direct tension in the ferro-cement shall be such as to satisfy 3.4.2.2 of this specification but not sufficient as to be detrimental to the watertightness of the hull.

#### 3.4.3.3 *Direct compression*

In general, compressive forces do not govern a design, but rather flexure, tension or impact. However, the permissible direct compressive stress in ferro-cement shall be taken as  $0.4x$  (the cylinder strength of the mortar), where the cylinder strength of the mortar is defined according to the ACI Building Code Requirements for Reinforced Concrete (i.e. the ACI Standard 318-63 or its later amendment or revision).

#### 3.4.3.4 *Impact*

To date, the method used to obtain a semi-quantitative comparison between various forms of reinforced panels has been the punching test. This consists of a metal punch (1½-in. diameter) being pressed against the surface of a test panel spanning in one direction only, the span being four times the panel thickness plus two inches. Loads obtained have ranged from about 1,000 lb for some ½-in.-thick panels up to 8,000 lb for 2-in.-thick panels.

It has been found that the punching strength increases with (a) panel thickness; (b) the amount of reinforcing; and (c) the distance from the loaded surface to the reinforcing steel.

Some panels (for example ¾-in. panels with four layers of chicken mesh in the top and bottom faces and no longitudinal steel) failed in bending before punching occurred, indicating that this form of construction is seriously under-reinforced in this direction. Otherwise failure occurred by a sudden clean penetration of the loaded surface by about 1/8 in. by the punch, with a widespread cracking showing on the under surface. Apart from variations in the strength, the degree of damage in similarly constructed panels of different meshes appeared to be the same.

All held together fairly well to provide good resistance to water penetration and it is evident that any further comparison of reinforcing combinations should include this aspect as part of the test. Results indicate that it would be reasonable to expect a minimum strength of approximately 1,200 lb for ½-in.-thick skins; 2,500 lb for ¾-in.-thick skins; 3,000 lb for 1-in.-thick skins, and 7,500 lb for 2-in.-thick skins. (These are plotted in figure 2-1.) It is probable that the minimum values can be increased considerably in the 1-in.

and thicker range as existing tests were obtained using panels which were made from low-strength mortars.

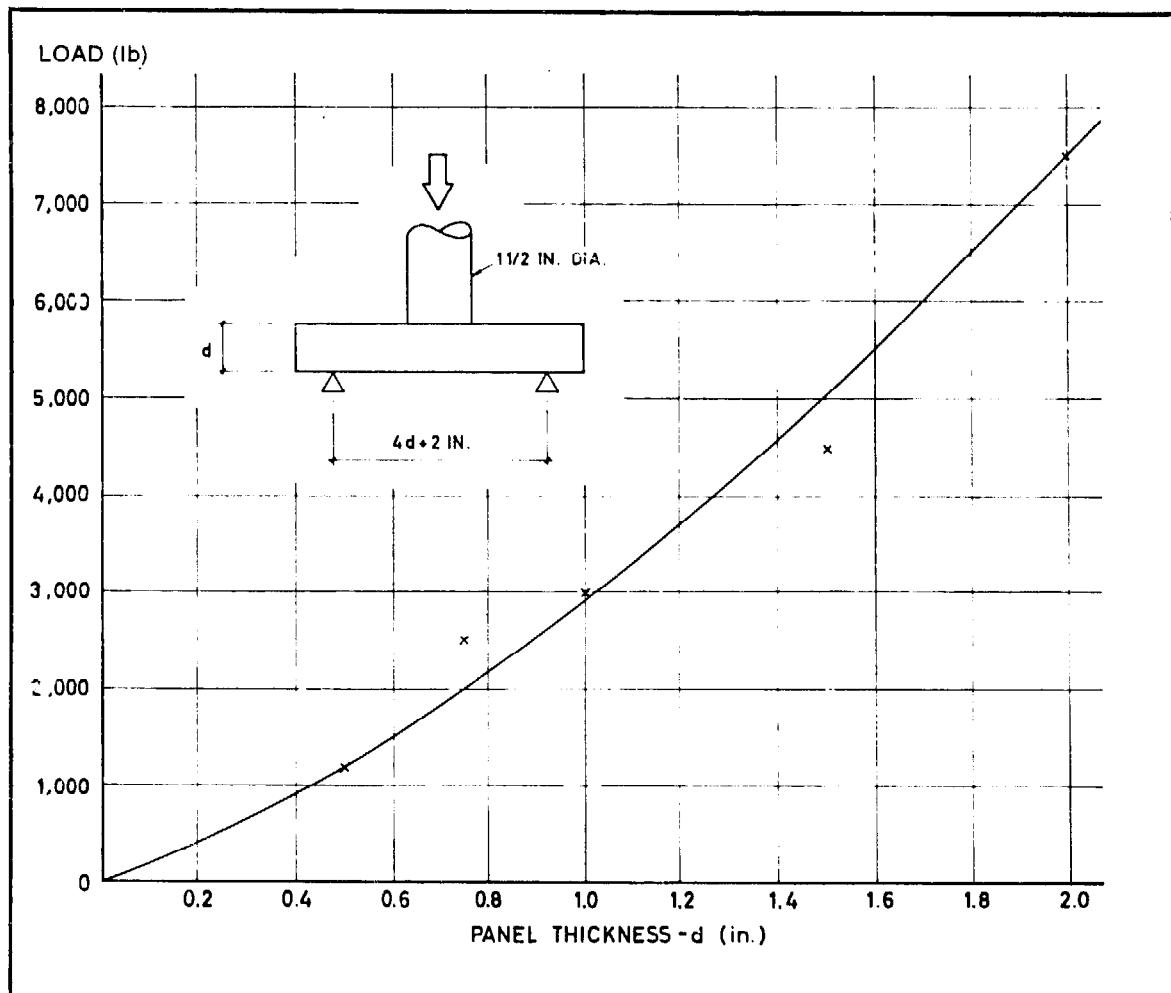
### 3.4.3.5 Homogeneous flexural action

It is true that ferro-cement behaves like a homogeneous material. However, its flexural strength is dependent on the steel content and disposition and therefore a working stress for the homogeneous material cannot be specified. Such a working stress could vary over a wide range and its use shall be permitted only where it is based on test results or analysis according to Clause 3.4.3.1.

### 3.4.3.6 Modulus of elasticity

As with reinforced concrete, the modulus of elasticity of ferro-cement varies over a considerable range depending on mortar strength, steel content, disposition and quality, rate and intensity of loading, age, etc. For the purpose of estimating deflections, the modulus of elasticity of a solid ferro-cement section shall be assumed to be  $0.5 \times 10^6$  p.s.i. for long-term loading and  $1.0 \times 10^6$  p.s.i. for short-term loading.

Figure 2-1. Suggested minimum punching strengths for ferro-cement panels





## PART 4. CONSTRUCTION

### 4.1

The Design Engineer shall prepare drawings, specifications and calculations for the particular vessel to be constructed and all construction will be carried out with his knowledge and under the supervision of personnel appointed by him.

### 4.2

Minimum drawings for any vessel shall consist of not less than the following:

- (a) A vessel profile;
- (b) A lines plan;
- (c) Sufficient cross sections to show the required layout of steel reinforcing and mesh; and
- (d) Additional details as required to show reinforcement around openings and load points such as in the area of the propulsion unit or winches, gallows, mast, etc.

### 4.3

Reference should be made to all drawings and specifications which give details of the work to be carried out by other trades in the construction of the vessel so that provision can be made for any openings or fixings that may be required.

### 4.4

All plans, specifications and other data required by the approving authority shall be submitted to that authority in accordance with their accepted procedure prior to commencement of construction.

### 4.5

During construction of the vessel all record sheets required in Part 1 of this specification shall be faithfully completed by the person immediately in charge of construction who will also ensure that the inspecting authority is kept fully informed on the progress of the construction of the vessel.

### 4.6

Construction shall be by either the suspended hull method, i.e. the erection of reinforcement on vertical pipe or other framing or by the use of a male mould with the hull being constructed in the inverted position.

#### *4.7 Reinforcement*

Steel rods and mesh are to be disposed and shaped to the boat's form such that the production of void-free material may be obtained. Sufficient transverse reinforcement is to be placed in addition to the mesh to allow for shear forces experienced as the result of bending and torsional movement of the hull at sea. Adequate reinforcement is to be placed locally where high loads are experienced. Any discontinuities in the strength of the reinforcement are to be avoided and an adequate overlap is to be provided where reinforcing rods are joined.

A minimum steel content equivalent to 25 lb of steel per cubic foot of concrete should be provided in each of two directions, at right angles. This steel will consist of both centrally placed rods with outer layers of mesh on both sides in accordance with the engineer's design requirements.

Hull and deck reinforcement must be arranged to give an integral structure. Reinforcement and mesh are to be securely wired to avoid movement during the placing of the mortar.

#### *4.8 Concrete*

Mixing, handling and compaction of the concrete should be consistent and closely supervised to ensure high quality material. The builder should be guided by established codes of practice such as NZS 1900, Chapter 9, 1964, or a similar approved standard.

Application of the mortar to the reinforcement can be carried out by one of two methods:

- (a) Where the concentration of reinforcement is not excessive, the hull may be plastered from one side only on the condition that the mortar can be forced from one side through to the inside and complete penetration can be assured. In order to do this it is essential that the water/cement ratio of the mortar is not increased to give added workability, otherwise the total strength of the mortar will be reduced. Under no circumstance should the inside of the plaster be smoothed or touched until complete penetration has been assured.
- (b) The hull may be plastered from the outside in one operation, allowing the mortar to penetrate as far as it will. In areas of concentrated reinforcement this will probably not exceed half way and in other areas it may come through to the interior. Where this occurs, the excess mortar on the inside should be scraped back to ensure very rough finish back to the inside layer of mesh. No attempt should be made to smooth the inside of the hull. After complete water curing for a period of not less than four days, the interior of the hull may be plastered in sections or in areas that can be handled adequately by a plastering team. Prior to the application of the interior layer of mortar, a cement and water grout of thick consistency should be painted over the mesh so that it penetrates to the surface of the

plastered layer. Then mortar may be applied and thoroughly vibrated to ensure its penetration through the mesh and, in particular, to prevent air being trapped. Under no circumstances should poker or any other heavy vibrators be used, as these will cause damage to the external layer. Suitable vibration can be provided by the use of orbital sanders fastened to a wooden plate which will serve as a float. These vibrators provide very-high-frequency low-amplitude vibration, which ensures thorough penetration of the mortar without affecting the previously cast plaster.

The hull may be plastered in sections using either of the above techniques, provided care is taken to ensure a clean joint between the hull and the decks, or between any sections which are plastered. Mortar should be placed within a reasonably short period of adding the mixing water and agitation continued during the waiting period. During handling and placing of the mortar, care is to be taken to avoid segregation of the mix. Decks may be plastered in separate operations, as with the hull, and using either of the above techniques, but at all times clean joints between sections must be assured.

Bulkheads shall be made integral with the hull, except where bulkhead grounds are provided, which should also be integral with the hull.

The use of bonding agents where concrete joints are made will be given special consideration. Under no circumstance is any bonding agent which is unstable in water to be used.

Apertures for fittings may be formed prior to placing mortar or may be cut after completion and curing of the hull. All apertures should have the bare concrete surface adequately sealed before fixing the skin fittings.

#### *4.9 Curing*

The hull and other concrete structures are to be properly cured once the mortar has taken its first set. The set concrete is to be kept wet for a period depending on the type of cement used and the ambient conditions.

Any approved method of curing which will prevent evaporation of the residual water will be considered.

Where any formwork is used, e.g. at the keel, it should be kept in position for as long as practical during the curing period.

#### *4.10 Other structural materials*

Where deckhouses or other structures are of wood or steel they should comply with the "Requirements for the Construction of Wooden Fishing Boats, their Machinery and Equipment" 1968, or "Requirements for the Hull Construction, Machinery and Equipment of Steel Fishing Boats" 1969, respectively, or other rules approved by the Marine Department.

Engine shafting, steering gear and piping arrangements should also comply with the above rules. Where approval is requested for concrete fuel tanks cast integral with the hull structure, a suitable approved lining material is to be placed once the concrete has dried out.

## PART 5. TESTING

### *5.1 General requirements*

The following tests or approved equivalent tests agreed with the Surveyor are to be carried out on the mortar, sample panels and placed concrete structure. Any other tests requested by the surveyor should also be carried out. The cost of all tests is to be borne by the builder.

### *5.2 Slump testing of the concrete mix*

The concrete mix should be subject to sufficient slump tests which are to be generally in accordance with Part II of NZS 192, 1952, or similar approved standard, and should not exceed 2 in.

The slump of the concrete should be the lowest possible that will permit thorough compaction.

### *5.3 Compression tests*

During manufacture and placing of concrete random samples of the mix are to be selected in the presence of the surveyor and standard test cylinders moulded from each sample and suitably identified. These should be cured under standard conditions and tested at 28 days in accordance with the requirements of NZS 192, 1952, or a similar approved standard. The tests should be witnessed by the surveyor, unless carried out by a testing laboratory, when the certified results are to be submitted to the surveyor.

### *5.4 Sample representative panels*

Where necessary, sample panels are to be prepared in order to check vertical, sloping, and horizontal mortar application, from the same materials and mix and reinforced with the same numbers of layers of wire mesh as are proposed for the hull. These are to be prepared prior to application of the mortar to the vessel's reinforcement and inspected by the surveyor. Test panels to the same thickness as the hull should be cured during the curing period of the vessel and by the same means. The surveyor will then subject a number of the panels to whatever destructive or other tests he considers necessary in order to assess the quality of the ferro-cement.

Sufficient test panels should be made available to a recognized testing laboratory where flexural and impact tests should be carried out and a certified report on the results of these tests forwarded to the surveyor. Flexural tests on panels about 4 ft long by 12 in. wide should conform to a suitable approved standard but care must be taken to ensure that the load application and support blocks provide a uniform load across the test piece.

Readings are to be taken at both cracking and failure of the panel during the flexure test.

Refer back to paragraph 3.4.3.4.

### *5.5 Watertightness of the structure*

The hull and other surfaces which are intended to be watertight, are to be closely inspected for surface faults after curing, and when any formwork is removed. A smooth, sound-appearing surface will normally be presumed watertight until tested. On completion, the forepeak should be tested by flooding (this may be done afloat). Other watertight bulkheads may be hose tested.

## PART 6. CLEANING DOWN AND PAINTING

### *6.1 Cleaning down*

Cleaning down should not be undertaken until a reasonable period of curing has elapsed. All loose ends of wire should be cut back and care taken to fill all pin holes with epoxy filler cement or similar approved filler.

### *6.2 Painting*

A paint system should be applied which complies with an approved paint specification for concrete supplied by the paint manufacturer.

**Annex 3**

**DROP AND FIRE TESTS ON A 27-FOOT LAUNCH HULL**

## INTRODUCTION

A prototype 27-ft launch hull was drop-tested by dropping it from various heights onto the water. Subsequent to this test, several gallons of petrol were poured into the bilges and set alight.

The purposes of these tests were to:

1. Evaluate a new form of construction which consists of a female moulding process using mesh only without any other form of steel.
2. Determine the fire resistance of a normal ferro-cement hull.
3. Evaluate the potential of a woven mesh as compared to welded or a netting-type mesh.

## DESCRIPTION OF THE TEST HULL

The hull used was a prototype produced in a female mould using three layers of woven mesh. The weight of the mesh was 1.3 lb per square foot, which gives a density of 25 lb per cubic foot. The total hull was approximately 5/8 in. thick. During the construction process, the transverse diaphragms around the engine beds and forward bulkheads were precast and placed in position before casting of the actual hull. This allowed a very good connexion between the hull and the diaphragms.

The plastering of the hull was carried out from the inside using vibrators of the Nucon type. These vibrators were not completely successful and complete penetration of the mortar through the hull was not achieved in all places. About ten per cent of the outer surface of the hull had to be filled in with mortar after demoulding.

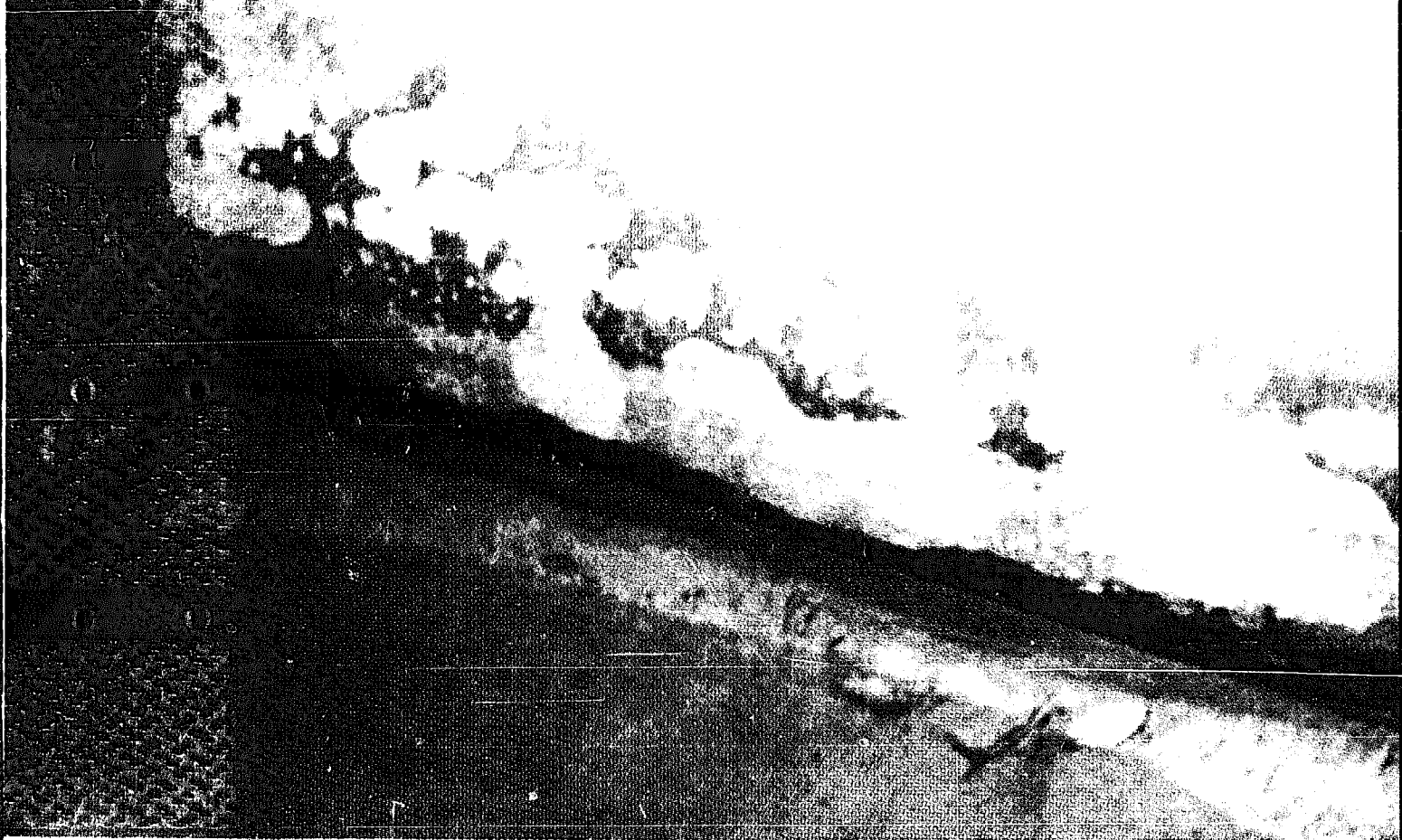
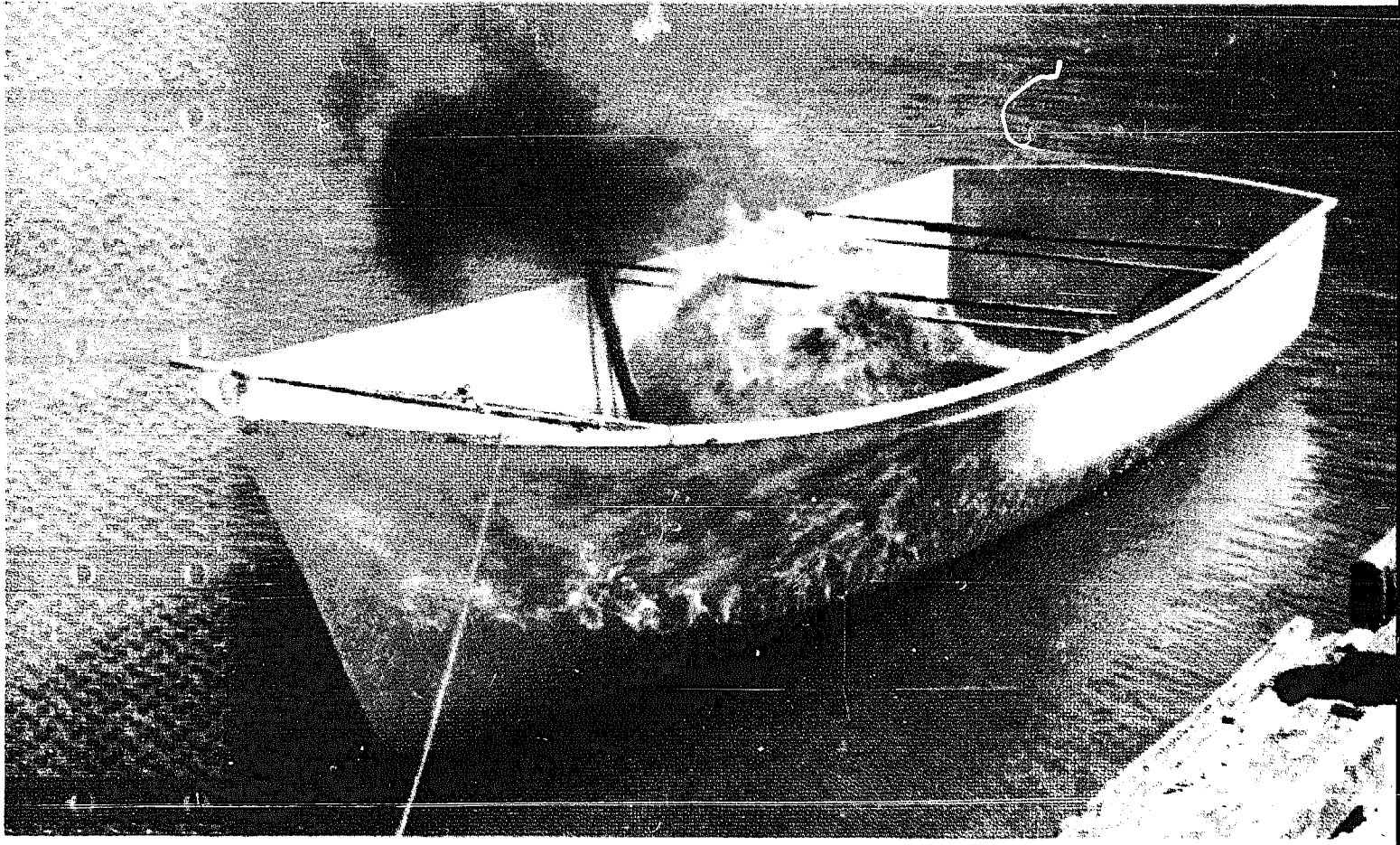
No difficulty was experienced with the demoulding, and the hull lifted out from the female concrete mould remarkably easily. The hull was given two coats of Micanox and then, before launching, a coat of white primer. The hull was twelve weeks old at the time of testing.

Before dropping, the transverse ties were placed between the gunwales at two points in order prevent the unnecessary flexing which would have been caused during the drop tests, due to the absence of decks.



*Figure 3-1  
Fire test on  
a 27-ft launch  
hull*





### *Test I. DROPPING*

The hull was lined up underneath the mobile crane and slings were attached to eye bolts set in the keel. Wire strops were passed through eyes attached to the cross bracing at the centre point to keep the hull in an upright position during lifting. A mobile crane standing on the wharf then raised the hull some two feet out of the water. However, the slings were of incorrect length and the hull hung in a stern-down position with the result that when it dropped with a free fall the stern section fell at least two feet into the water. This particular test imposed excessive load on the very flat sections in the after area of the hull, as the whole load of the hull was placed on the flat section adjacent to the tuck. The bracing of the transverse ties holding the slings in place and keeping the gunwales from flexing, was insufficient due to the angle of the slings, and the bending of the brace caused the failure of the gunwale which was slightly cracked during the first lift and prior to the drop.

Further drops were then made using slightly modified slinging to correct the previous misalignment. Four drops of three feet were made, followed by two at five feet. The final drop, with the hull in a completely level position, was made from a height of eight feet.

### RESULTS

There was no damage to the hull resulting from the drop tests, apart from a very minor sprawling of the concrete at the rear end of the keel at the junction between the hull and the top of the keel. At this point, the change in direction is ninety degrees around a very small radius and would be the area subjected to the full impact force of the first drop test on the very flat section aft. The sprawling of the concrete occurred during the first drop test and did not become progressively worse, even with the final drop from eight feet.

### *Test II. FIRE TEST*

At the conclusion of the drop tests two gallons of petrol were poured into the sump and bilges of the boat and fired. The fire initially burned very strongly in the engine sump and between two bulkheads containing approximately one and a half gallons of petrol. The flames were considerable and during the fire, which lasted for about eight minutes, a popping sound could be heard which was later identified as the spalling off of small pieces of surface mortar. (See figure 3-1).

At the conclusion of the test it was found that, although slightly blackened, the main hull itself was in good condition, though there was a slight surface sprawling of the mortar in the areas immediately adjacent

to the confined petrol. No serious damage of any sort was suffered and repairs to rectify the sprawling were relatively simple. No damage to the paintwork on the outside of the hull could be observed and there was no sign of damage to any of the areas on the outside of the hull which had been filled with plaster owing to the inadequate penetration of the first application of the mortar.

### CONCLUSION

This hull, which was a semi-displacement hull with flat sections aft, although unsuitable for this type of test, performed exceptionally well and substantiates the integrity of ferro-cement for boat construction.

## **Annex 4**

# CONSTRUCTION DETAILS FOR A TYPICAL FERRO-CEMENT BOAT

*Prepared by Ferro-Cement Limited, Auckland, New Zealand, May 1969*

Textual references to figures in this annex do not follow a numerical order because many of the photographs submitted to illustrate this part of the publication form in themselves a pictorial essay showing a natural sequence of steps in the building of a ferro-cement boat. The corresponding references in the text have therefore been left in the original order and the figures placed at the end of the annex.

## PART 1. PIPE FRAMES

### *1.1 Bending the frames*

The pipe frames are bent after the construction sections have all been drawn full size on the floor. Pipe frames are constructed of  $\frac{3}{4}$ -in.-inside-diameter pipe. "B" grade pipe is preferred as it is less likely to kink when bent. Deck frames or beams and the water-line beams are made of square pipe 1-in.  $\times$  1-in.  $\times$  10-gauge hollow section.

The girth of each frame, from the topmost point to the keel, is first measured around and an additional 6 to 9 in. allowed on the length of the pipe cut. The pipe is then bent approximately to shape by bending slowly through a hole in a block of wood. This bending jig consists simply of a piece of 4-in.  $\times$  3-in. timber, approximately 2 ft long, clamped or bolted onto a bench or some other solid member that will provide a rigid base. A hole,  $1\frac{1}{4}$  in. diameter, is drilled through this. The pipe frame is put through the hole and then, every 3 or 4 in., a downward pressure is exerted on the pipe, bending it slightly into shape. It is important not to let the pipe twist during the preliminary bending, as this causes distortion. When the frame is required to be bent into a reverse curve, the pipe must be turned over completely and the performance repeated. After the two halves of the pipe have been bent approximately to shape they are set down on the floor for bending to the exact final shape, using a mechanical bender (see figures 4-1 and 4-2). In this final bending, work must start from one end of the pipe. As the pipe is bent to the correct shape against the lines on the floor, a small hole is drilled in it at each water-line and a nail is driven right through the pipe, holding it to the floor at that position. When the pipe is being bent into a reverse curve it is important that the pipe bender be moved completely from one side of the frame to the other and not just turned end for end.

### *1.2 Frame assembly*

When both pieces of pipe have been bent true they are set up on each side of the centre line in their correct positions. The water-line holes that have been drilled in the pipe are used to position it on the correct water-lines. Check measurements should be made from the sheer back to the centre line and from the load water-line back to the centre line to ensure that both sides are exactly the same. The 1-in.  $\times$  1-in.  $\times$  10-gauge square section pipe at the deck, which is a cambered pipe, and the pipe at the load water-line, which is a straight pipe, are now welded into position.

The load water-line pipe is straight and at each frame its top edge is positioned at the load water-line. It is advisable to have permanent chocks nailed to the floor at the load water-line position so that each load water-line is positioned in exactly the same place. The cambered deck pipe, which has been bent previously to the required deck camber from the lofted lines, is set in between the side pipes, approximately 3 to 5 in. below the true deck line. This amount of offset will depend on the depth of the gunwale section which is being built into the boat, plus the boxing used, plus an additional  $\frac{1}{2}$ -in. clearance that is usually allowed for packing between the deck pipe and the boxing. This  $\frac{1}{2}$  in. is for removable packing, which is incorporated to allow the frames to be removed more easily after the plastering has been completed. (For details of this set-up see figure 4-25.) At the bottom of the keel the two sides are joined by a short horizontal pipe. This pipe is kept up from the keel by sufficient distance to allow the keel pipe or profile pipe to be fitted fore and aft in its correct position. Side packers will also be fitted at each side of the profile pipe at a later stage and the bottom ends of the frames will be cut back at approximately  $45^\circ$  to avoid any hard corners along the keel which are likely to chip. (For an illustration see figure 4-23.)

### *1.3 Welding of frames*

The welding of the frame assembled on the floor needs considerable care. All joints should be first tack-welded only. The sequence of work should be from deck beam to LWL, to keel, followed by pipe-hanging and diagonal bracing. Under no circumstances should any joint be completely welded, as this will cause considerable distortion. It is far better to rotate around the frame and bracing four or five times and have a frame which is true.

Where possible, work should be carried out in a triangular pattern. The same sequence must be applied when the frame is lifted off the floor and turned over to weld the other side. If pipe frames are to be built in, joints should be welded at one side only. This allows deck beam, LWL and braces to be removed more readily by twisting with a wrench.

A centre-line pipe, or hanging pipe, is next welded into place. It is helpful to have permanent chocks nailed to the floor so that one side of this pipe is located exactly on the centre line. The pipe should extend above the frames to a common level or the height of the hanging girder in the shed. Across the top of this hanging pipe a plate, 2 in. x  $\frac{1}{4}$  in., and about 4 in. long, is welded. This extends to one side only and should be positioned by placing against a block permanently nailed to the floor, so that all these plates will lie at exactly the same height. When welding this plate to the top of the hanging bar, care must be taken that the weld extends on only three sides of the hanging pipe, and that the angle formed by the centre line and the underside of the hanging plate is completely free of weld. The length of the hanging pipe varies with each boat, depending on the draught and the clearance required at ground level in the shed. Diagonal braces

are now added, from the centre line down to a point approximately 6 in. from the frame at water-line level. These diagonal braces must be kept sufficiently down from the top of the centre pipe to allow clearance on the main fore and aft hanging beam and are welded to the deck pipe and the water-line pipe. For larger craft a second pair of diagonal braces, lower down, is recommended. If a sheer ferro-cement rail is to be built onto the boat, the tops of the shell pipes should be cut off at the top of the deck beams and then tack-welded back into position. These can be easily removed after the hull has been formed and before the decks are boxed up. (See figures 4-3 and 4-17.)

#### *1.4 Keel pipe or profile*

A complete profile of the boat or keel pipe is made up on the lofted lines from the same material as the frames, that is to say,  $\frac{3}{4}$ -in.-internal-diameter pipe. Where a very fine end is required, such as the after end of the keel, smaller diameter pipe or rod can be used. The same procedure for bending is followed, but in this case the holes are drilled at the water-lines and at station points. These holes should be marked clearly, as sometimes water-lines and station points are very close together and are easily confused. Where there are sharp angles in the keel or profile pipe, bracing should be fitted in such a way as to be clear of the pipe frames.

#### *1.5 Fabricated frames*

An alternative method of framing the shape of the vessel is to use fabricated frames. Fabricated frames are normally left in the finished hull and can be of advantage if located so as to form bulkhead grounds, structural floors or tanks.

Fabricated frames are made on top of the full-size lofted lines in the same manner as pipe frames. It is necessary to draw additional stations where frames are required in a position not corresponding to the lofting stations.

The outer rod of the fabricated frame is best made of  $\frac{3}{8}$ -in.-diameter rod and the inner rods may be made of  $\frac{1}{4}$ -in.-diameter rod. To make the frame, bend the outer rod in place on the lofted lines and bend the inner rod parallel to the outer rod, but 3 in. inside. Short pre-bent rods are then welded between the main rods to form a truss. Alternatively, a continuous length of rod may be bent and welded between the two parallel rods to form a truss.

The welding requires considerable care to ensure that the finished frame does not get distorted and it is recommended that the services of an experienced welder be used for this operation.

The fabricated frames are made in two halves, as for a pipe frame, and then carefully positioned and welded together. Additional rods are welded in both directions across the lower area to tie the two halves together and form a floor. Figure 4-19 shows fabricated frames used in the construction

of a 40-ft trawler in Uganda, where this method was found to be more convenient than the pipe-frame method.

If the lower or floor area of the frame is large, such as in a tank division or bulkhead, heavy welded mesh can be cut to pattern and then welded into place, instead of welding in individual rods.

In some instances the frames can be covered with mesh and precast on the floor before setting up. The mortar is kept back from the perimeter of the frame, leaving several inches of the mesh exposed. Then this mesh can be lapped and tied to the inside hull mesh before plastering.

In some applications it can be advantageous to use composite frames. In this case the lower section of the frame is made by the fabricated method and left in the boat, and the upper section is a temporary pipe frame that is removed after plastering. (Figure 4-32 illustrates such a composite frame.)

## PART 2. SETTING UP THE FRAME

### *2.1 Hanging frames*

In principle, the frames are hung along an overhead channel bar. This bar is usually a permanent fixture in the building shed. Ideally, the channel bars should be approximately 6 in. deep by 3 in. wide. They must be straight and level, and the vertical side must be plumb. This channel forms the datum line from which all measurements of the boat are taken. The first step is to mark on the channel beam the position of each station and also of the stem and the transom. Next, the frames are hung by hooking the 2-in.  $\times$   $\frac{1}{4}$ -in. support plates over the channel bar, clamping them temporarily square and then tack-welding on one side only. Welding on one side only allows the frames to be moved slightly when the final, accurate squaring is done. When all the frames have been hung, the forward frame is plumbed in a fore and aft direction. A diagonal brace of  $\frac{3}{4}$ -in. water pipe is welded to one side of the centre pipe, near the bottom of the frame, and then run aft and upwards, covering about four or five frame spaces, and welded to the channel bar holding the forward frame in a truly plumb position. On the side of the centre-line pipe opposite to the diagonal brace, an angle bar, 2 in.  $\times$  2 in.  $\times$   $\frac{1}{4}$  in., is run through the frames, with one flange resting on the load water-line beams and the other butted against the centre-line pipes.

This angle bar is checked for fairness and should be tied in position at this time. If it is necessary to use more than one length of bar, they should be butted together and a short length of angle bar used as a butt strap. Since angle bar has a sharp corner on the outside and is rounded on the inside corner, spacers—nails are ideal—should be put in before welding. The rest of the frames are now plumbed in a fore and aft direction. As each frame is made plumb the diagonal brace is welded to the centre-line bar. When all the frames have been plumbed in a fore and aft direction and



welded to the diagonal braces, the 2-in.  $\times$  2-in.  $\times$   $\frac{1}{4}$ -in. channel bar is welded to the opposite side of the centre-line pipe and to the load water-line pipes. The keel, or profile pipe, is next welded into place. The frames are lined up with the holes in the keel pipe, which have been drilled to represent station points. It is essential to remember to mark the centre line on the short pipes across the bottom of the frames so that the keel pipe is positioned exactly on the centre line. (See figure 4-27.)

### *2.2 Square frames*

The frames must now be squared accurately across the centre line of the boat. This is done by fastening two measuring tapes to the back of the stem pipe on the centre line at approximately deck level. One tape is taken aft on the starboard side and the other on the port side. The frame is then moved fore and aft until the measurements on both tapes are equal. After the deck beam has been checked for straightness, a brace is welded from the stem to the frame to hold it square. These braces are pipes bent approximately to the deck profile and welded to the underside of the deck beam, approximately 6 to 9 in. in from the outside of the frame. This squaring procedure should be repeated with every frame throughout the entire length of the boat at deck level and again at load water-line level. A second set of braces should now be welded to the underside of the load water-line pipes. Random-length pipes may be used for these braces. (See figure 4-27.)

### *2.3 Levelling the frames*

The frame of the vessel is now plumb in a fore and aft direction, the frames are square across the boat and the profile is correctly positioned. The whole frame structure can now be levelled in a thwart-ships direction. As each frame is levelled, vertical braces are welded from the deck pipe to convenient strong points in the framework of the shed. Care should be taken to keep these vertical braces clear of areas that will be included in the framing at a later stage, such as deck areas. These vertical braces will be approximately on every third or fourth frame. Intermediate frames may be braced back diagonally to the centre channel. (See figures 4-17 and 4-28.) The side packers referred to in paragraph 1.2 can now be fitted alongside the profile pipe at the bottom of the keel and the frame corners cut back at a  $45^\circ$  angle. (See figure 4-23.)

The whole frame of the boat has now been set up accurately and rigidly and, except for any special details, is ready for the inner layers of mesh to be hung.

### *2.4 Special details*

#### *Radised stem or "soft nose"*

Where the stem and fore-foot are to be on a changing radius (soft nose), small breasthooks are cut out of  $\frac{1}{8}$ -in. —  $\frac{3}{16}$ -in. plate on each water-line. The shapes are lifted from the full-size lofted lines, due allowance being made for the skin thickness. The outside edge of these is cut  $\frac{1}{4}$  in.

smaller than the inside of the skin, allowing  $\frac{1}{4}$ -in. mild steel rods to be laid vertically from top of stem down to the keel.

To position these breasthooks, stretch a 16-gauge wire from the stem to the first frame through the corresponding water-line holes. Sit the breasthooks on these wires. Plumb down from the centre line to centre of the aft end of the breasthook and tack-weld in place. Next tie  $\frac{1}{4}$ -in. rods to the breasthooks, welding at the top only. If these rods cross a pipe frame, they must be cut in flush. (See figures 4-8, 4-23 and 4-24.)

#### *Propeller tube and rudder stock*

At the positions of the stern tube and rudder, a piece of pipe,  $\frac{1}{4}$  in. greater in diameter than the fittings to be used, is cut around the centre pipe and welded in place. The centre pipe will be cut out after the hull is plastered. (See figures 4-6 and 4-12.)

### PART 3. HANGING THE MESHES AND REINFORCING RODS

#### *3.1 The lay-up* (See tables, pages 100—102)

A typical mesh lay-up would be as follows:

Three layers of  $\frac{1}{2}$ -in. hexagonal 19-gauge galvanized mesh on the inside.  
Longitudinal steel, 0.200-in.-diameter high tensile at 3-in. centres maximum.

Transverse steel, 8-gauge galvanized hard drawn wire at 3-in. centres maximum.

Three layers of  $\frac{1}{2}$ -in.  $\times$   $\frac{1}{2}$ -in. 19-gauge galvanized welded mesh.

Mesh ties are 19-gauge stainless-steel wire.

Steel ties are 16-gauge black iron wire.

This lay-up would result in a hull  $1\frac{1}{16}$  in. to  $\frac{1}{8}$  in. thick, such as would be used for a work boat approximately 40 ft in length.

The thickness is estimated as follows:

Inner mesh	3 layers $\frac{1}{2}$ -in. 19-gauge hexagonal mesh, galvanized 6 at 0.04 in. . . . .	0.24
Longitudinal steel	0.200-in. high tensile rod at 3-in. maximum centres (not galvanized) . . . . .	0.20
Transverse steel	8-gauge wire (mild steel) at 3-in. maximum centres (not galvanized) . . . . .	0.16
Outer mesh	3 layers $\frac{1}{2}$ in. $\times$ $\frac{1}{2}$ in. 19-gauge square welded mesh, galvanized, 6 at 0.04 in. . . . .	0.24
Cement cover	2 at 0.1 in. (minimum) . . . . .	0.20
		<hr/> 1.04

It is of the utmost importance to allow the mesh to take its own lay as far as possible, even if this means very large overlaps in some parts. If the overlaps are likely to cause difficulties in working, then the surplus mesh may be cut away. The coinciding of overlaps of different layers should be avoided as much as possible. Inner layers of mesh should not be pulled too tight as the slack will be taken up when final tying right through the steel is done.

It is often found, particularly in concave curves such as those in the area where the hull bottom curves into the keel, that the edges of the mesh become taut and will not conform with the general line. This can be overcome without cutting the mesh merely by snipping the edge in one or more (usually more) places.

### *3.2 Inside mesh*

The first layer of mesh is hung longitudinally and is tied into the pipe frame at 6-in. to 9-in. intervals with 18-gauge galvanized wire. An overlap of about 12 to 18 in. is allowed at the top if required to be used as starter mesh for the deck. This layer of mesh should not be pulled taut and should be allowed to take its own lay as far as possible. Sufficient overlaps should be allowed to run wild at the after end to cover the transom. An effort should be made to stagger overlaps where different lays or strakes of mesh meet.

Mesh should overlap to one side of, and just abaft, the stem. It is a good idea to overlap one strake on the port side and the next one down on the starboard side. Work should be done from top to bottom.

Although the strakes of wire are all tied to the pipe frames, the individual strakes are joined at the overlaps by means of stitching, i. e. twisting the strands together. (See figure 4-30 for illustration of stitching.) This method of joining can only be used with hexagonal chicken mesh as the square welded mesh is too rigid and must be tied.

After the first layer of mesh has been hung longitudinally, the second layer should be hung diagonally. Hang the first diagonal strake amidships on one side and work forward and aft from it. On small boats it is possible to carry a strake from one side, round the keel, and up the other side. On bigger boats, however, the mesh should be cut to overlap on each side of the keel. If the first layer of diagonals overlaps on the port side, then the second should overlap on the starboard side, and vice versa.

Again, the mesh must be allowed to take its own lay as far as possible. No ties are used in this layer, at this stage, and it is merely stitched to the previous layer. It may be necessary to stitch or tie the layers together between frames at a later stage if they tend to bulge in different directions, i. e. the inner layer bulging inwards and the outer layer outwards, with a large gap between them.

The best way of laying the diagonal mesh is for several persons to hold the strake approximately in its position, allowing a good overlap

to run wild at the top. A good strong stitch is then taken in the centre of the strake (or a tie if preferred) at the top, so that if necessary the mesh can swivel when pulled into final position. The strake is held in its proper position and is stitched to the previous layers in the area between the keel and the bilge. The first stitches are taken working upwards and downwards until the mesh is lying as flat as possible against the previous layer(s).

The procedure for hanging the second diagonal layer is the same, but the strakes of mesh should be laid as nearly as possible at  $90^\circ$  to the previous layer. It will be found that the diagonals are easier to hang and lie much better than the longitudinals. However, it is preferable to hang a longitudinal layer first, on which to attach the diagonals. By hanging each layer in a different direction, coincidence of overlaps is avoided as far as possible. (See figures 4-6 and 4-7.)

### *3.3 Longitudinal rods*

High tensile steel is used for the longitudinals. Rods are cut two or three feet over length. One end is bent approximately to fit across the transom, allowing sufficient for a good overlap with longitudinal rods from the opposite side of the vessel. The after end is secured first, the rod being held roughly in position along the hull and then placed under tension and positioned exactly before tying. A simple tensioning device that utilizes two steel hooks and a length of old inner tube can be of great help in this operation. (For details of this device see figure 4-31.)

Where the design or specification calls for a certain spacing between rods, it should be noted that this is the maximum spacing allowed. In order to achieve this, the spacing of the ends of the rods will have to be narrowed down considerably. In extreme cases it may be necessary to cut some of the rods short and tie the ends in alongside full-length rods.

Reasonable tension must be kept on the rods to ensure that there is no bulging between ties (the rods are tied at each frame), but at the same time too much tension must be avoided to prevent flattening between frames. While the rods are being hung, it will probably be found that the mesh between frames will bulge out and push the rod out of fair. This must be prevented, and the mesh must be hammered or tied back out of the way. In the event that there is a lot of bulge, some of the slack can be pulled out of the mesh by using a simple tool known as a "twister" (see figure 4-29). The method used is to insert the steel spikes into the mesh and twist. If any tension comes on the mesh, this method will break the wires, so it should be used only to take out slack.

The upper few rods, down to the deck level or the lower edge of the rubbing band, follow the line of the sheer. Below this level the rods must follow the curve of the hull. This requires constant checking, and the line of each rod should be checked and adjusted if necessary before proceeding to the next rod. One method of speeding up this procedure for beginners is to lay down a rod of about 12 in., correct its lay and tie, and then fill in

the space between. It will be found that this spacing in between can be gauged accurately by eye. Rods are laid horizontally across transom until the lower edge is reached, when it becomes necessary to turn them up vertically.

At the bow, rods are allowed to run wild past the stem. When all tying has been completed, the rods are cut back to just abaft the stem. Small pieces of mild steel bar are bent to fit the shape of the stem and tied onto the longitudinals.

The reason for this is that high tensile rod is very difficult to bend sharply and is liable to break. Overlaps should be 60 diameters. Laps should either be under or over the longitudinals, not outside, to maintain skin thickness. (See figure 4-9.) As mentioned previously, the rods must be curved to fit the hull. Design spacing is the maximum space between rods. In the main part of the hull it will be found that maximum spacing will be obtained amidships, and the end spacing of the rods will have to be narrowed down to keep the rods seating or laying fairly. However, when the garboard area is reached, it is necessary to adjust the laying of the rods so that when reaching the vertical side of the keel the rods are lying truly horizontal. In this case it may be found necessary to keep maximum spacing at the ends, and narrow the spacing amidships. In either case, overcrowding of the rods should be avoided, as it hampers proper penetration of the mortar. It is quite permissible to cut out rods or to insert short lengths. Wild ends should be avoided and should be tied to neighbouring rods.

Longitudinal rods under the flat part of the keel are carried well forward until they overlap the inner rods at the stem by several feet.

When reaching the narrow part of the forefoot they can be reduced in number in exactly the same way as the inner stem rods.

On each side of the transom there will be an area with only transverse rods. This space must be filled up with short lengths of vertical rod, bent at the lower end to tie into the longitudinal rods on the quarters.

### *3.4 Transverse rods*

The operation is commenced by hanging and tying a transverse rod half a space to each side of each pipe frame (this gives a full space between the actual rods). These rods are tied to every second fore and aft rod only. Where possible, on easy curves such as under the quarter or the lower part of the forefoot, the transverse rods should be continued, from side to side. Where the bend is too sharp, such as the right-angled corners of the keel, the cut should be made just short of the bend or corner and small lengths of mild steel, bent to shape and overlapped for the usual 60 diameters, used. (See figure 4-10.)

When using springy high tensile wire, make a small bend in the top of each transverse. Hook this through the loose mesh at the top to prevent the end whipping or twisting during tying.

When this operation has been completed the remaining transverses are hung at the correct spaces and tied loosely. Three or four 18 to 20-ft

longitudinal battens of 2-in. × 1-in. timber are then hung, faired and wired to the pipe frames at vertical intervals of about 12 to 15 in.

The transverses are then properly positioned, checked for fairness and then wired to the longitudinals. (See figures 4-11 and 4-12.)

Note after the battens have been properly tied, the hooked part at the top of the transverse may be cut off. This will allow the rod to lie better. One full frame space at each end of the batten is left untied to ensure fairness with the next section as the batten is moved along the hull. On no account may heat be used to facilitate bending of high-tensile or cold-drawn steel. Neither should welding be used on the rods in the course of their length. Where bends are too sharp, use mild steel inserts bent to shape and tied to the high tensile with proper overlap.

### *3.5 Bulkheads, bulkhead grounds and floors*

If any or all the above members are to be incorporated in the ferro-cement structure of the hull, their steel reinforcing must be lapped and tied into the main rod structure of the hull. Connexion to the hull will be by means of starter rods and these must be incorporated at this stage, before the outer mesh layers are hung. Figure 4-26 illustrates the layout of starter rods and meshes for a bulkhead ground and exactly the same method is used for a full ferro-cement bulkhead and for installing floors.

To determine the position of the bulkhead ground starters it is necessary, first, to determine the position of the bulkhead on the boat. This is accomplished by working its position relative to one of the station frames. Next, the amount of offset of the ground from the actual bulkhead face can be determined, and from this, the position of the inside positioning rod. It should be noted that, for ease in fitting and installing the bulkhead to the ground, grounds are usually placed on the narrowing side of the bulkhead, that is to say, forward of the bulkhead in the forebody of the vessel, and aft of the bulkhead in the afterbody.

Move the straight edge to the position of the vertical rod and with the straight-edge square across the boat, plumb down and tie the inside positioning rod to the longitudinal steel. Right-angled starter rods of the same diameter as the transverse rods are then pushed through the mesh from the outside, at each longitudinal, and tied to the vertical positioning rod and to the longitudinals. The outside leg of the starter rod should be long enough to pick up, and be tied to, two longitudinal rods.

When the starters are being used for grounds only, the starter rods are bent again at right angles at the designed moulded depth of the ground and spot-welded to a  $\frac{1}{4}$ -in. mild steel rod, forming the inside face of the ground. Three layers of mesh of the same size as the inside hull mesh are then wrapped over the rod framework and securely tied through the ground framework.

This mesh turns at right angles and is lapped and tied to the inside hull mesh as well. Note that the laps with the hull mesh are staggered and the outside lap should be at least 3 in.

Prior to plastering, a shaped piece of timber shuttering must be cut and aligned square and plumb across the hull to form the face to which a wooden bulkhead can be bolted later. Care should be taken with the fitting of this shuttering, because if it is not squarely aligned it will tend to buckle any bulkhead that is bolted to it. (See figures 4-16 and 4-18.)

### *3.6 Bulkheads*

Where a full bulkhead is to be made in ferro-cement, horizontal and vertical rods are lapped and tied to the starter rods and the necessary number of layers of mesh hung and tied on both sides of the rods. The mesh is lapped and tied to the inside hull mesh, just as in the case of grounds. Ferro-cement bulkheads of large area will have stiffening ribs formed by tying in stirrup rods and placing extra layers of mesh over them.

### *3.7 Floors*

Ferro-cement floors are constructed in the same manner as bulkheads. Limber holes must be left in the floors to allow free passage of bilge water. These holes can be lined with polythene tube.

### *3.8 Outer layers of mesh*

The first two centre layers of mesh should be hung diagonally, at approximately 90° to each other. Individual strakes of mesh must overlap by approximately 3 in.

If hexagonal mesh is used it can be stitched to the inside mesh, but if square welded mesh is used it must be carefully tied to avoid bulging and unfairness. The outside layer is laid fore and aft.

When all the outer layers of mesh are in place, they must be tied right through the inside mesh. Twenty-gauge stainless-steel wire is used for this operation, which is carried out from the outside of the hull. The wire is bent into a long "U" shape and pushed through the meshes from the outside so as to hook the inside layers of mesh. The legs are then pulled taut on the outside, twisted together and the surplus ends cut off. The ties are positioned as necessary to ensure a uniform thickness to the mesh and rod structure. If possible, ties should include at least one rod. Ties should be made near to the intersections of longitudinal and transverse rods to avoid pulling the inner and outer layers of mesh too closely together, thereby giving the hull an unfair, dimpled surface. This tying operation is very tedious but it is of the utmost importance in ensuring a fair mesh framework of uniform thickness for the plasterer, one that will not require any unnecessary mortar build-ups.

## PART 4. PLASTERING OF THE HULL

### 4.1

When the netting and steel work of the hull have been completed and the shape fully faired so that there are no lumps or hollows in the boat, all the mesh should be watered down sufficiently to ensure that the galvanized netting is properly oxidized. New galvanized netting that has a shiny finish should not be plastered until the outer surface has been dulled by oxidization. This work can be done by spraying the hull with water for several days prior to commencement of the plastering operation.

### 4.2 *Preparation for plastering*

The total weight of the hull without the concrete is not very great and usually it can be suspended freely from the supporting structure. At this point a suitable tray should be placed beneath the hull. This is used during the curing cycle to catch any water which may be used to recirculate in the curing process. Following this, keel blocks are laid underneath the keel and suitable timber placed on top of these to act as shuttering for the mortar in the keel section.

Attention should be paid to supporting the hull fully so that during the concreting operation, when many extra tons of mortar are applied, the whole hull shape will not deform or deflect out of position. It is usual to plaster the bottom section of the keel first, using vibrators to ensure proper penetration of the mortar from the inside. In many cases, ballast can be placed during this operation and the keel section allowed to cure overnight before commencing the hull itself. This method establishes a solid base that will support the weight of the completed hull. In some cases it is desirable to plaster the keel and the hull in one operation, leaving the interior of the keel hollow to be filled with ballast and concrete as desired later on. When plastering the keel, usually the day before the hull is started, the mortar should be kept back behind the outer layers of mesh so that in the actual plastering of the hull it can completely base the keel without the need for external joints. Where joints are necessary, the edge should be kept clean and this may be treated with either a cement grout or one of the recognized wet-to-dry epoxy resins that are specially designed for the jointing of such construction joints.

### 4.3 *Plaster mix and mixing*

The specification for the plaster is as set down (in annex 2 of this publication) or it will be specified by a responsible person after consideration of the materials available at the site. In general, the plaster should be weight-batched to provide correct proportions of sand and cement and, where necessary, Pozzolan or other additives. It is most desirable that



the mixer should be of the special paddle type (see figure 4-21). Conventional tilting concrete mixers are not really suitable for mortar, and if these are used it will be found that the concrete strength may be little more than half the strength of that obtained by using the correct mixer. If it is necessary to use such a mixer, the mortar should be thoroughly mixed by hand after discharge from the mixer. In most cases the specification for the mortar will be clearly defined and the simplest method of measuring its workability will be by the use of the standard slump cone. (See figure 4-20.) The instructions for using this slump cone are defined in the standard specifications of all countries, but personnel trained in their use should carry out the tests. Excessive water will result in a mix which is much too wet and the strength will be correspondingly reduced.

#### *4.4 Plastering the hull*

There are several schools of thought on the plastering of hulls and it would be unreasonable to be dogmatic about which method produces the best results. In the early days of ferro-cement boats, the plastering was carried out from one side until the mortar was forced through to the opposite side, where it was then cleaned off and smoothed to provide a cover of approximately  $\frac{1}{10}$  in. Unfortunately, in many cases the concentration of reinforcing and wire mesh were such that when the mortar was of the correct consistency in terms of strength, it was impossible to get it to penetrate the full distance. When that happened, mortar was forced back from the opposite side and incomplete penetration resulted. It is possible, by using a more workable mix, to ensure that the mortar will penetrate the mesh, but the danger of this is that the shrinkage and strength of the mortar will be seriously affected and the ultimate performance of the boat likewise. When plastering is carried out over a male mould, or in a female mould, it is also difficult to ensure that penetration of the mortar has taken place.

When plastering hulls in a single-stage operation, it is vitally necessary that adequate supervision is available to guarantee thorough penetration of the mortar to the opposite side before attempting the finishing. Single-stage plastering is preferable to any other method currently available, provided that the design of the boat, the composition of the reinforcing and other circumstances permit it. Research into plastering has shown that where mortar is applied in layers, there is constant danger of failure at the interface, between the layers, particularly if the hull sustains damage.

When using moulds, vibrators are ideal for ensuring penetration of the mortar and overcoming many of the serious difficulties that have been experienced in the past.

When applying the mortar it is important also to ensure that the final skin, or finishing coat, which fair the hull, is applied well before the initial set of the main plaster has taken place.

#### *4.5 Two-stage plastering*

As a result of the many difficulties experienced in single-stage plastering, a technique has been developed whereby the mortar is applied from the outside of the hull to the point where it has penetrated virtually to the inside layers of mesh and the inside is left untouched until the outer layer has hardened and cured. One of the main reasons for adopting this technique is that, wherever plasterers or finishing hands are allowed to complete the inside of the hull, the tendency is to skin over areas that may not have been fully penetrated.

With the two-stage method it is then possible, after removal of frames or installation of bulkhead grounds, etc., to apply the mortar from the inside as a finishing skin only. This can be applied using vibrators. When the two-stage technique is being used, it is of the greatest importance that the internal skin be vibrated into place. Failure to do this will result in trapped air and voids between the two layers. The use of the vibrators removes this air and ensures a thorough compaction. Before applying the interior layer of mortar, it is essential to place a cement grout, consisting of water and cement mixed to a thick consistency, which can be painted onto the surface prior to the application of the mortar. This technique helps to give a more highly finished job, but doubts are still expressed in engineering circles regarding the absolute quality of the joint between the two layers. It should be understood that when the two-stage plastering system is used, differential shrinkages must occur and varying degrees of cracking will result. However, it is also fair to point out that in all fields of endeavour, compromises are essential in obtaining a satisfactory solution.

#### *4.6 Sectional plastering*

When undertaking the plastering of a large vessel, it may well be preferable to plaster it in sections, using the single-stage process. In this case it is desirable to keep the construction joints as tidy as possible and, if practicable, surplus mortar on the edges should be blown away with compressed air before the setting takes place. During the plastering operation, the joints should be coated with grout or, if preferred, a wet-to-dry epoxy resin which will ensure a more perfect joint. In many cases, this sectional plastering has proved extremely satisfactory. The disadvantage of the method is the difficulty in obtaining a fair and smooth joint between the sections and this, once again, is due to the differential shrinkage of the layers of mortar which are, of course, at different ages.

#### *4.7 Plaster finishing*

In the course of a normal plastering operation a team of plasterers apply the mortar, and when sufficient has been placed the finishing hands take over and fair the hull. This work requires the services of highly skilled plasterers and should not be attempted by amateurs unless they have had considerable experience. The mortar can be placed on the hull

most effectively with ordinary steel floats but all finishing should be done with wooden floats. Long wooden battens (see figure 4-22) should be used regularly to fair the hull, to show the plasterers where additional mortar is required to fill hollows, or where excess mortar should be removed. There are two possible ways of finishing the hull:

4.7.1 On completion of wood floating, the hull is smoothed over with a damp sponge. This operation requires experience, as it must be done with the right type of sponge, at the right time, and with the right touch. The resulting surface is slightly roughened and, after curing, the free sand particles can be rubbed off leaving a final surface that provides an excellent bond if the hull is to be fibreglassed or coated with several layers of paint or filling compound.

4.7.2 On completion of wood floating, the hull is steel-trowelled to a very smooth finish. This technique produces an extremely hard outer skin but requires the services of master tradesmen to prevent numerous ridges and hollows from being formed.

When the plastering is completed and the initial set has taken place, it is most important to follow around and to clean off very carefully any small droppings of mortar, stain or other slight imperfections as, once the plaster has set, their removal requires very heavy grinding, which is undesirable.

#### *4.8 Surfacing of the hull*

Experience has shown that it is better to avoid grinding the finished surface of the ferro-cement other than very lightly to remove sand particles that may have accumulated. Any excessive grinding invariably exposes odd ends of mesh, removing the galvanizing and leaving potential areas for corrosion should the paint finishing be unsatisfactory. When using moulding techniques, this situation is less likely to occur. A recommended specification suggests that, as long as the cover to the steel or wire mesh is a minimum of two millimeters, or approximately  $\frac{1}{12}$  in. thick, there is little danger of corrosion.

The plastering of a hull is a very final operation and as soon as the mortar has set there is very little that can be done to make changes or rectify mistakes. The final quality of the hull depends on the competence of the plastering operation. With this in mind, the greatest caution should be exercised when undertaking the work and it should be done by the most skilled personnel obtainable.

#### *4.9 Curing*

The curing of a concrete hull is of the utmost importance and has been dealt with in a separate section. With single-stage plastering, steam curing, which has many advantages, can be used. However, it is not recommended for two-stage or sectional plastering. Steam curing of mortar should never be undertaken without skilled supervision. (See chapter IV of this publication.)

## REINFORCING ROD WEIGHTS FOR VARYING DIAMETERS AND SPACINGS

Size	Rod diameter (in.)	Weight (lb/lin. ft)	Weight (lb/ft <sup>2</sup> at centres)				
			(1½ in.)	(2 in.)	(2½ in.)	(3 in.)	(4 in.)
12 gauge .....	0.104	0.029	0.228	0.171	0.137	0.114	0.086
10 gauge .....	0.128	0.043	0.340	0.255	0.204	0.170	0.138
8 gauge .....	0.160	0.068	0.544	0.408	0.326	0.272	0.204
<sup>3</sup> / <sub>16</sub> in. ....	0.187	0.094	0.752	0.564	0.451	0.376	0.282
0.200 in. ....	0.200	0.107	0.856	0.642	0.514	0.428	0.321
<sup>1</sup> / <sub>4</sub> in. ....	0.250	0.167	1.336	1.002	0.802	0.668	0.501
0.276 in. ....	0.276	0.203	1.624	1.218	0.974	0.812	0.609
<sup>5</sup> / <sub>16</sub> in. ....	0.312	0.261	2.088	1.566	1.253	1.044	0.783
<sup>3</sup> / <sub>8</sub> in. ....	0.375	0.376	3.008	2.256	1.805	1.504	1.128
<sup>7</sup> / <sub>16</sub> in. ....	0.437	0.511	4.088	3.066	2.453	2.044	1.533
<sup>1</sup> / <sub>2</sub> in. ....	0.500	0.668	5.344	4.008	3.206	2.672	2.004

## WEIGHTS PER SQUARE FOOT OF STANDARD MESHES IN COMMON USE

Mesh	in. × in. × gauge	Pounds
Chicken mesh .....	<sup>1</sup> / <sub>2</sub> × <sup>1</sup> / <sub>2</sub> × 22	0.114
Chicken mesh .....	<sup>1</sup> / <sub>2</sub> × <sup>1</sup> / <sub>2</sub> × 21	0.133
Chicken mesh .....	<sup>1</sup> / <sub>2</sub> × <sup>1</sup> / <sub>2</sub> × 20	0.185
Chicken mesh .....	<sup>1</sup> / <sub>2</sub> × <sup>1</sup> / <sub>2</sub> × 19	0.240
Square welded mesh .....	<sup>1</sup> / <sub>2</sub> × <sup>1</sup> / <sub>2</sub> × 19	0.192
Square welded mesh .....	<sup>1</sup> / <sub>2</sub> × <sup>1</sup> / <sub>2</sub> × 18	0.288
Galvanized chicken mesh .....	<sup>1</sup> / <sub>2</sub> × <sup>1</sup> / <sub>2</sub> × 17	0.344
Galvanized square welded .....	<sup>1</sup> / <sub>2</sub> × <sup>1</sup> / <sub>2</sub> × 16	0.460
Galvanized square welded .....	1 × 1 × 18	0.144
Galvanized square welded .....	1 × 1 × 17	0.192
Watson mesh .....		0.676

SUGGESTED STEEL LAY-UP FOR A  $\frac{5}{8}$ -IN.-THICK HULL<sup>a</sup>  
 (Minimum steel required: 1.25 lb/ft<sup>2</sup>)

<i>Member</i>	<i>Steel weight per ft<sup>2</sup> (lb)</i>	<i>Thickness (in.)</i>
<i>Mesh</i>		
6 layers $\frac{1}{2}$ in. $\times$ $\frac{1}{2}$ in. $\times$ 19-gauge hexagonal . . . .	1.440	0.480
Cement cover:		
2 at 0.1 in. . . . .		0.200
	1.440	0.680
<i>Alternatively:</i>		
3 layers of $\frac{1}{2}$ -in. $\times$ $\frac{1}{2}$ -in. $\times$ 19-gauge hexagonal . . . . .	0.720	0.240
3 layers of $\frac{1}{2}$ -in. $\times$ $\frac{1}{2}$ -in. $\times$ 19-gauge square welded .	0.576	0.240
Cement cover:		
2 at 0.1 in. . . . .		0.200
	1.296	0.680
<i>Or:</i>		
2 layers of Watson mesh . . . . .	1.352	0.420
Cement cover:		
2 at 0.1 in. . . . .		0.200
	1.352	0.420

<sup>a</sup> It is recommended that the best lay-up for a section of this thickness is an all-mesh lay-up form on a mould

SUGGESTED STEEL LAY-UP FOR A  $\frac{7}{8}$ -in.-THICK HULL  
(Minimum steel required: 1.75 lb(ft<sup>2</sup>))

<i>Member</i>	<i>Steel weight per ft<sup>2</sup> (lb)</i>	<i>Thickness (in.)</i>
Alternative lay-ups:		
1. <i>All mesh</i>		
5 layers $\frac{1}{2}$ -in. $\times$ $\frac{1}{2}$ -in. $\times$ 19-gauge hexagonal . . . .	1.200	0.400
3 layers $\frac{1}{2}$ -in. $\times$ $\frac{1}{2}$ -in. $\times$ 19-gauge square welded. . . . .	0.576	0.240
Cement cover:		
2 at 0.12 in. . . . .		0.240
	1.776	0.880
2. <i>Rods and mesh</i>		
Fore and aft rods:		
$\frac{3}{16}$ -in.-high tensile at 3-in. centres . . . . .	0.376	0.187
Transverse rods:		
8-gauge hard drawn at 2-in. centres . . . . .	0.408	0.160
Inner and outer mesh:		
Each: 2 layers (total 4 layers) $\frac{1}{2}$ -in. $\times$ $\frac{1}{2}$ -in. $\times$ 19- gauge hexagonal . . . . .	0.960	0.320
Cement cover:		
2 at 0.1 in. . . . .		0.200
	1.744	0.867

SUGGESTED STEEL LAY-UP FOR A  $1\frac{1}{8}$ -IN.-THICK HULL  
(Minimum steel required: 2.25 lb/ft<sup>2</sup>)

<i>Member</i>	<i>Steel weight per ft<sup>2</sup> (lb)</i>	<i>Thickness (in.)</i>
Fore and aft rods: 0.25 high tensile at 4-in. centres .....	0.501	0.250
Transverse rods: 0.20 hard drawn at 2½-in. centres .....	0.513	0.200
Inner mesh: 3 layers ½-in. × ½-in. × 19-gauge hexagonal ....	0.720	0.240
Outer mesh: 3 layers ½-in. × ½-in. × 19-gauge square welded .	0.576	0.240
Cement cover: 2 at 0.1 in. ....		0.200
	<u>2.310</u>	<u>1.130</u>

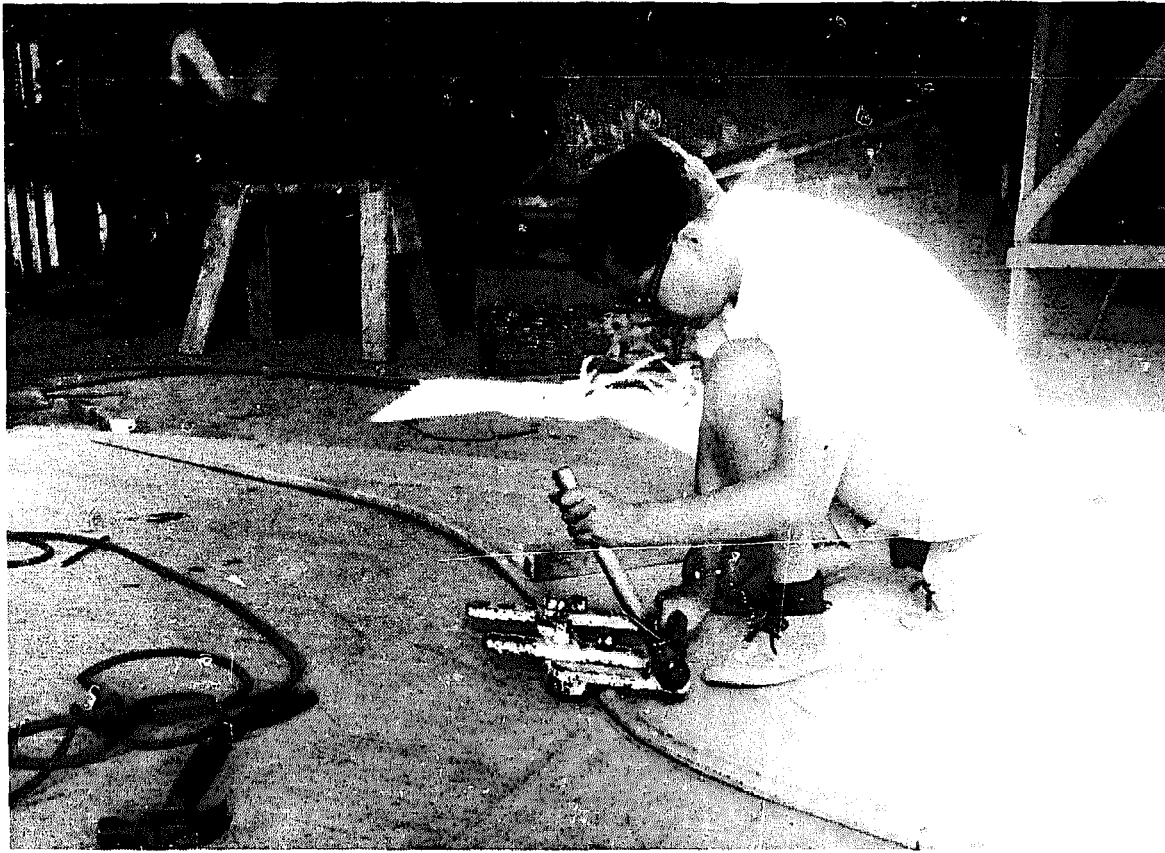
SUGGESTED STEEL LAY-UP FOR A  $1\frac{3}{8}$ -IN.-THICK HULL  
(Minimum steel required: 2.75 lb/ft<sup>2</sup>)

<i>Member</i>	<i>Steel weight per ft<sup>2</sup> (lb)</i>	<i>Thickness (in.)</i>
Fore and aft rods: 0.25 high tensile at 4-in. centres .....	0.501	0.250
Transverse rods: Either: 0.25 hard drawn at 4-in. centres .....	0.501	0.250
Or: 0.200 hard drawn at 4-in. centres .....	0.513	0.200
Inner mesh: 4 layers ½-in. × ½-in. × 19-gauge hexagonal ...	0.960	0.320
Outer mesh: 4 layers ½-in. × ½-in. × 19-gauge square welded	0.768	0.320
Cement cover: 2 at 1/8 in. ....		0.250
	<u>2.730</u>	<u>1.390</u>
	<u>2.850</u>	<u>1.340</u>

SUGGESTED STEEL LAY-UP FOR A 1-<sup>5</sup>/<sub>8</sub>-in.-THICK HULL  
 (Minimum steel required: 3.25 lb/ft<sup>2</sup>)

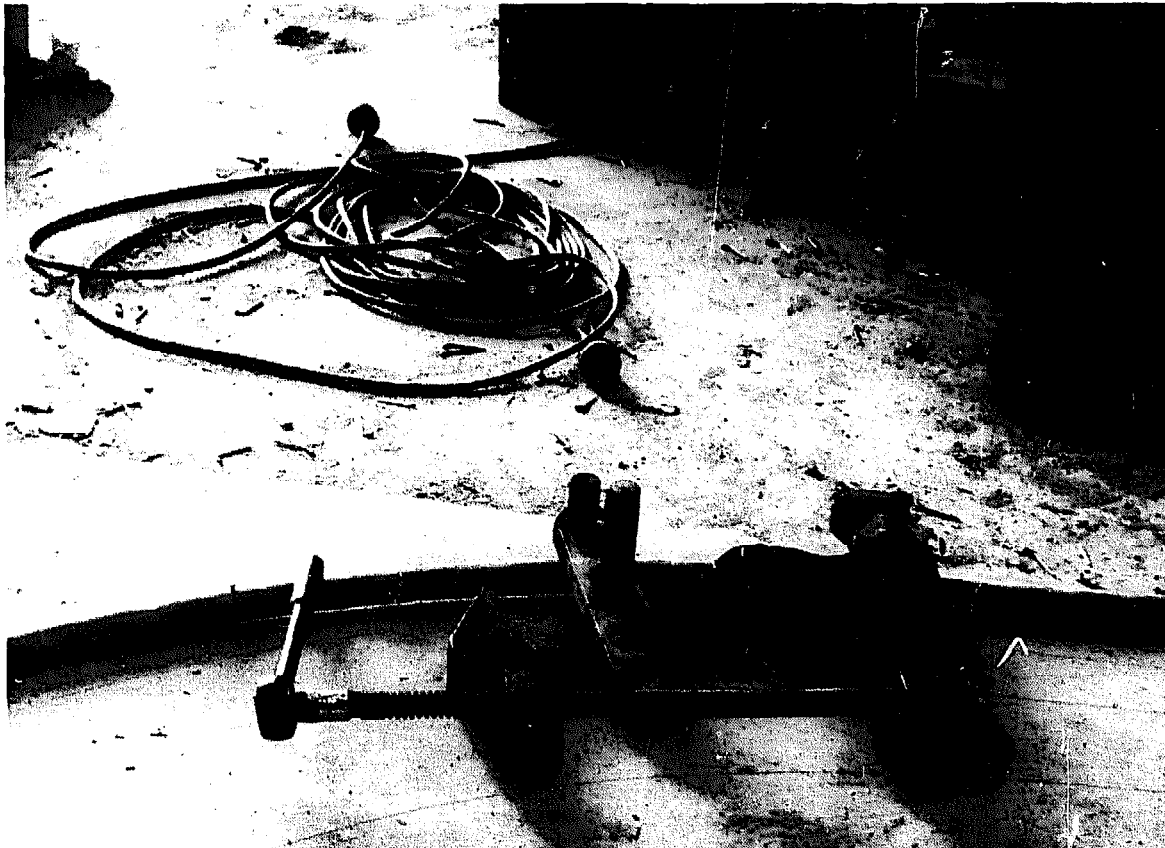
<i>Member</i>	<i>Steel weight per ft<sup>2</sup> (lb)</i>	<i>Thickness (in.)</i>
Fore and aft rods: 0.276 high tensile at 3-in. centres .....	0.812	0.276
Transverse rods: 0.276 high tensile at 3-in. centres .....	0.812	0.276
Inner mesh: 4 layers 1/2-in. × 1/2-in. × 19-gauge hexagonal ....	0.960	0.320
Outer mesh: 4 layers 1/2-in. × 1/2-in. × 19-gauge square welded .	0.768	0.320
Cement cover: 2 at 1/8 in. ....		0.250
	<u>3.352</u>	<u>1.442</u>

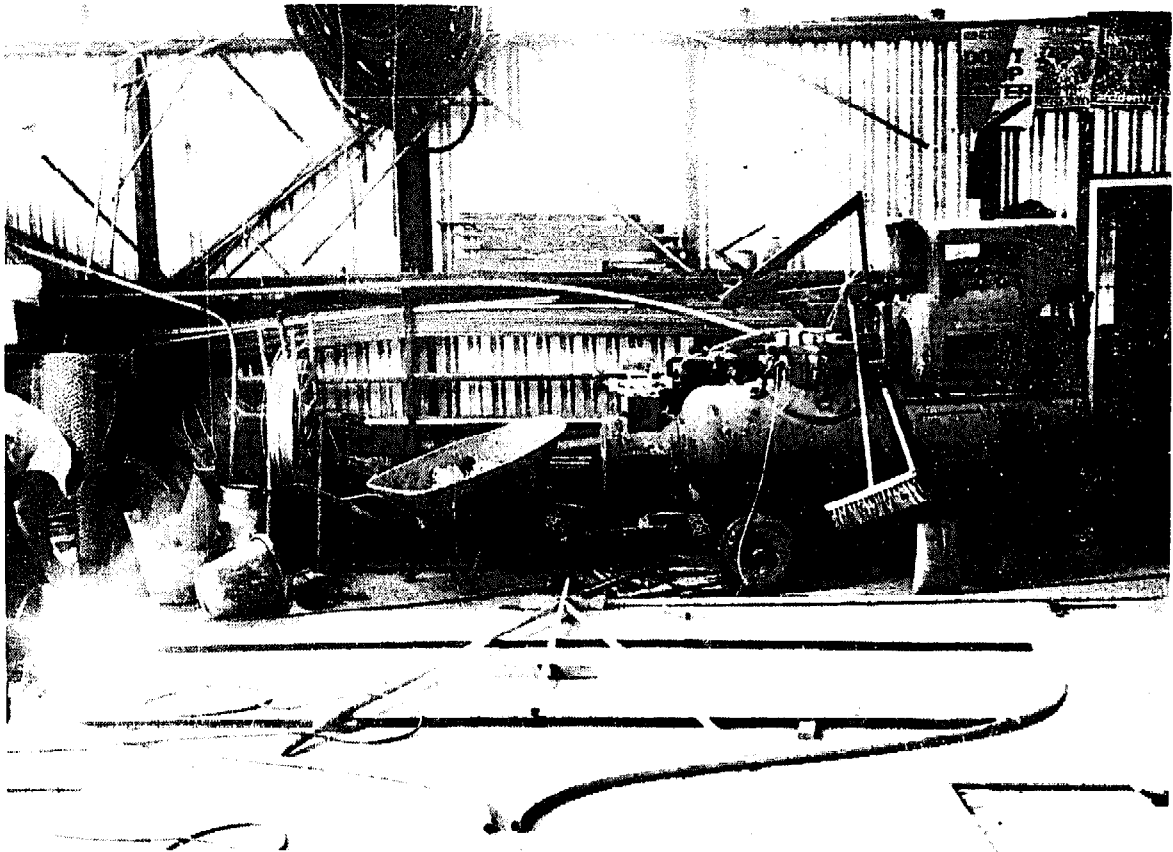




*Figure 4-1. Pipe frames being bent over full-size lofted lines, using ratchet pipe bender*

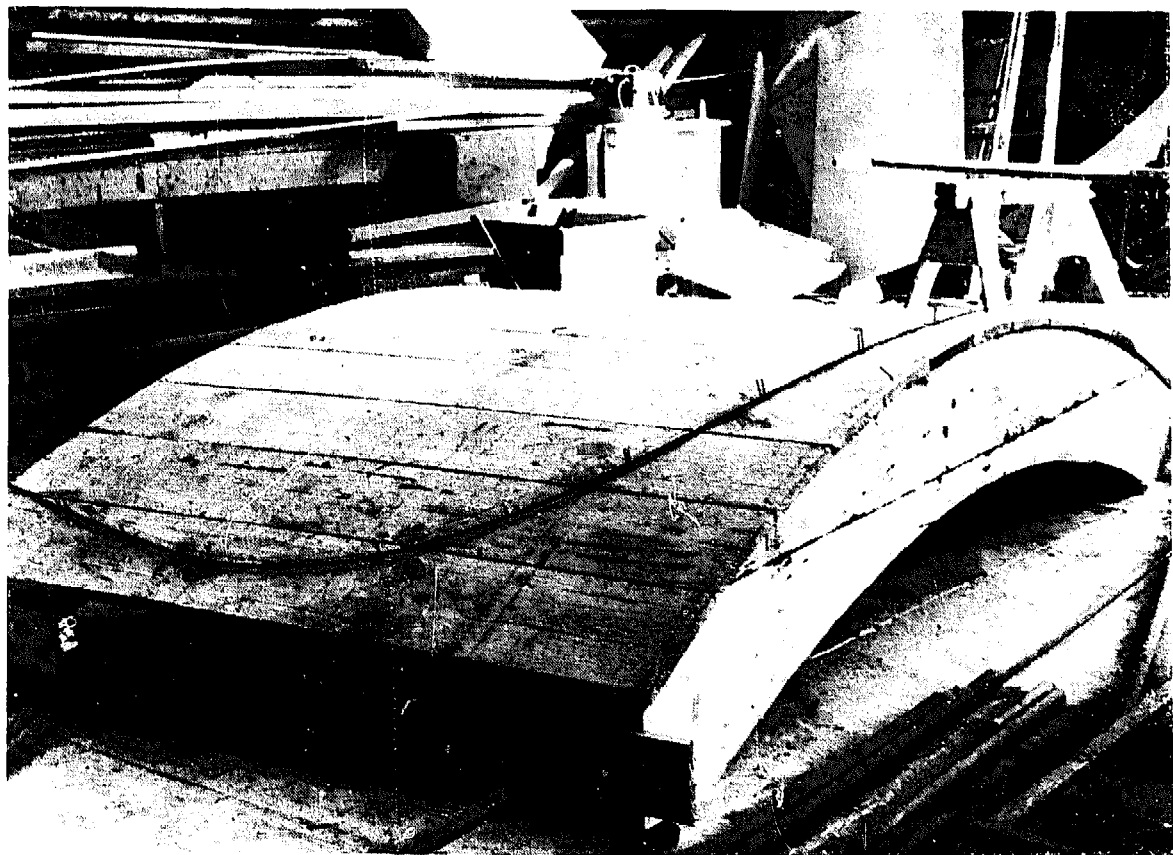
*Figure 4-2. Ratchet pipe bender*

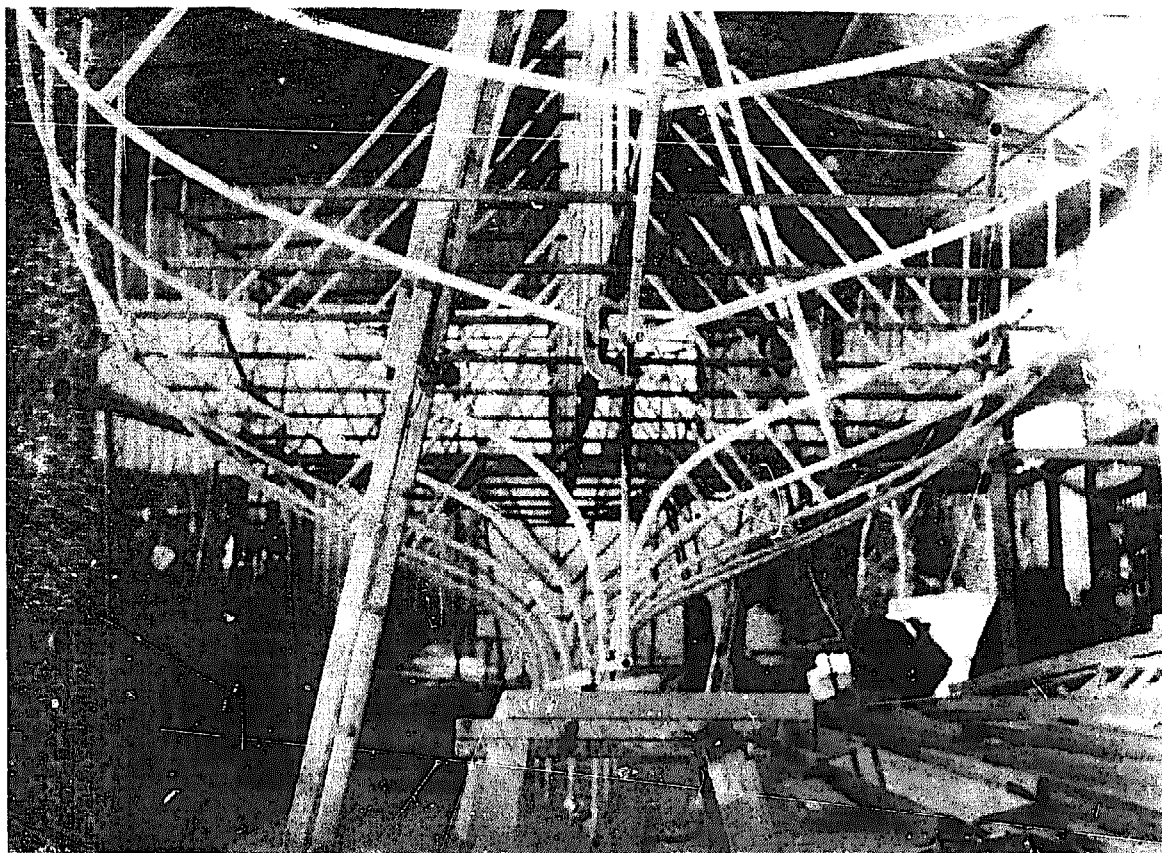




*Figure 4-3. Typical pipe frame being welded on top of well-size lotted lines. Note permanent chocks nailed to floor at water-line level and centre line to ensure that these pipes are in precisely the same position at every frame*

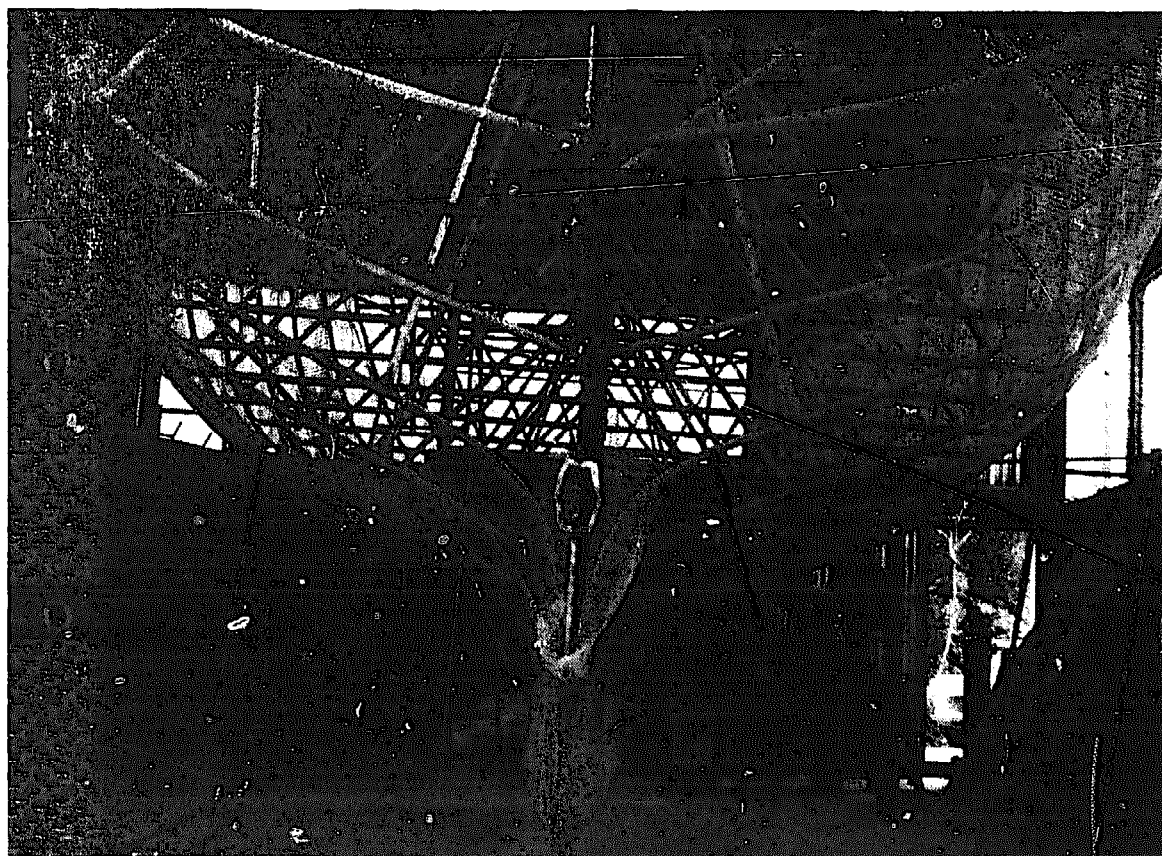
*Figure 4-4. Curved jig for making radiused transom. Note that hull lines have been developed full size on the jig*





*Figure 4-5. First stage of setting up frame. Pipe frames have been hung, profile pipe is in position but the frame wood has not yet been squared, plumbed or levelled*

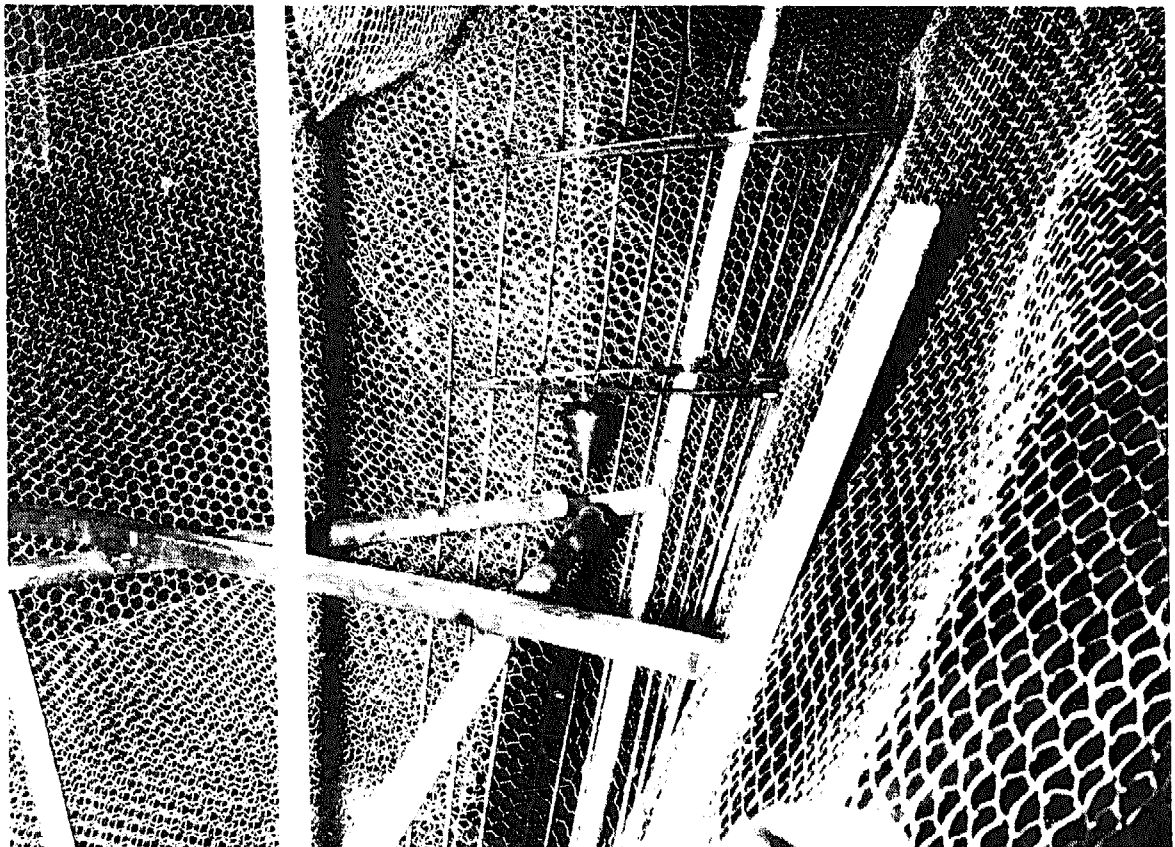
*Figure 4-6. View from aft showing first layer of mesh in position. This initial layer is laid fore and aft. Note also template on stern pipe for propeller shaft boss*

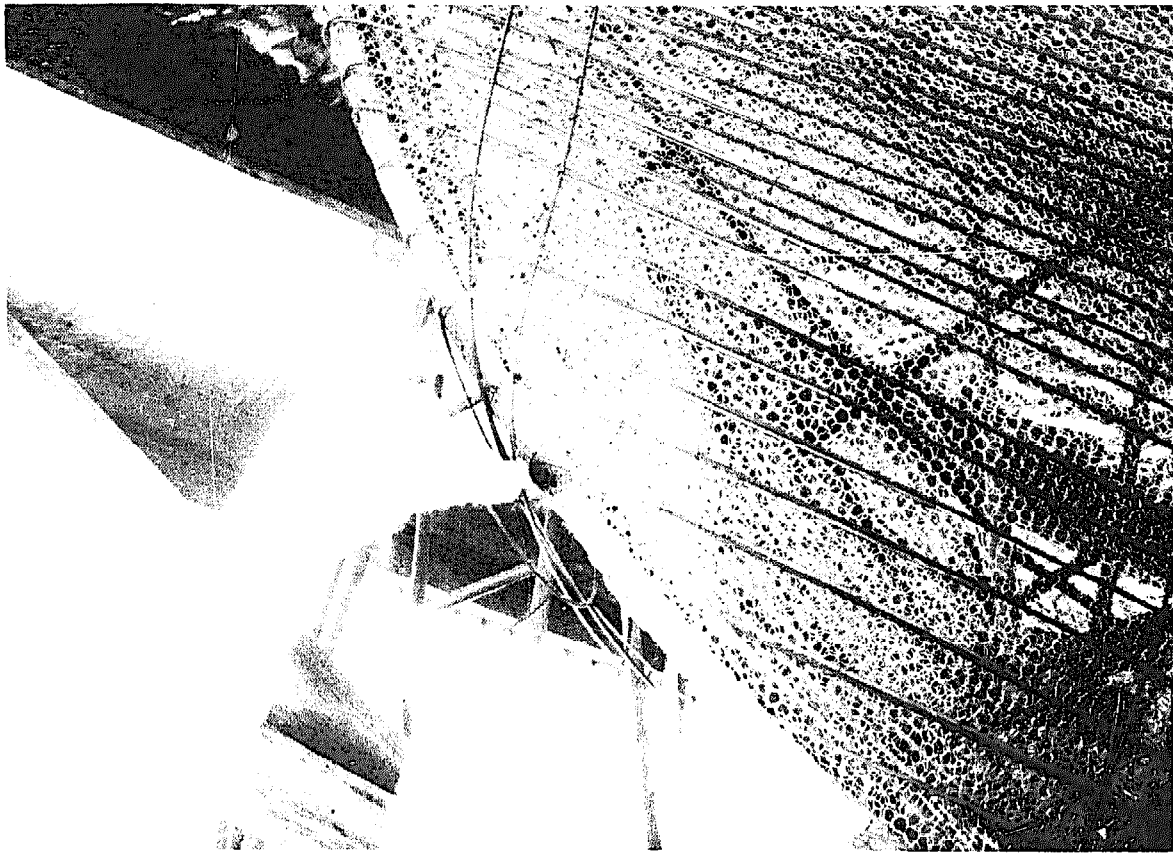




*Figure 4-7. Second layer of inner mesh being laid. Note first layer laid fore and aft and the amount of overlap to each strake of mesh*

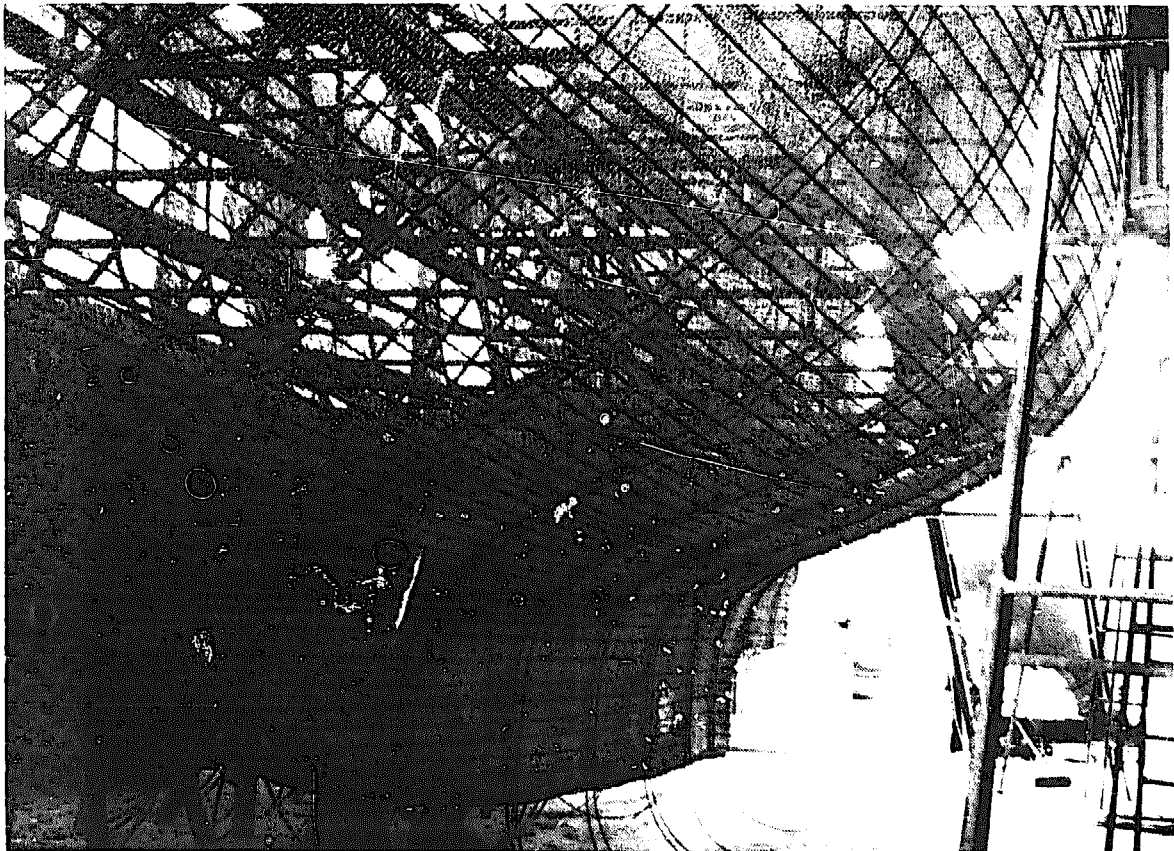
*Figure 4-8. A view of inside stem showing breast books and rods used to form profile of radiused stem. Also shown are squaring braces at deck level*

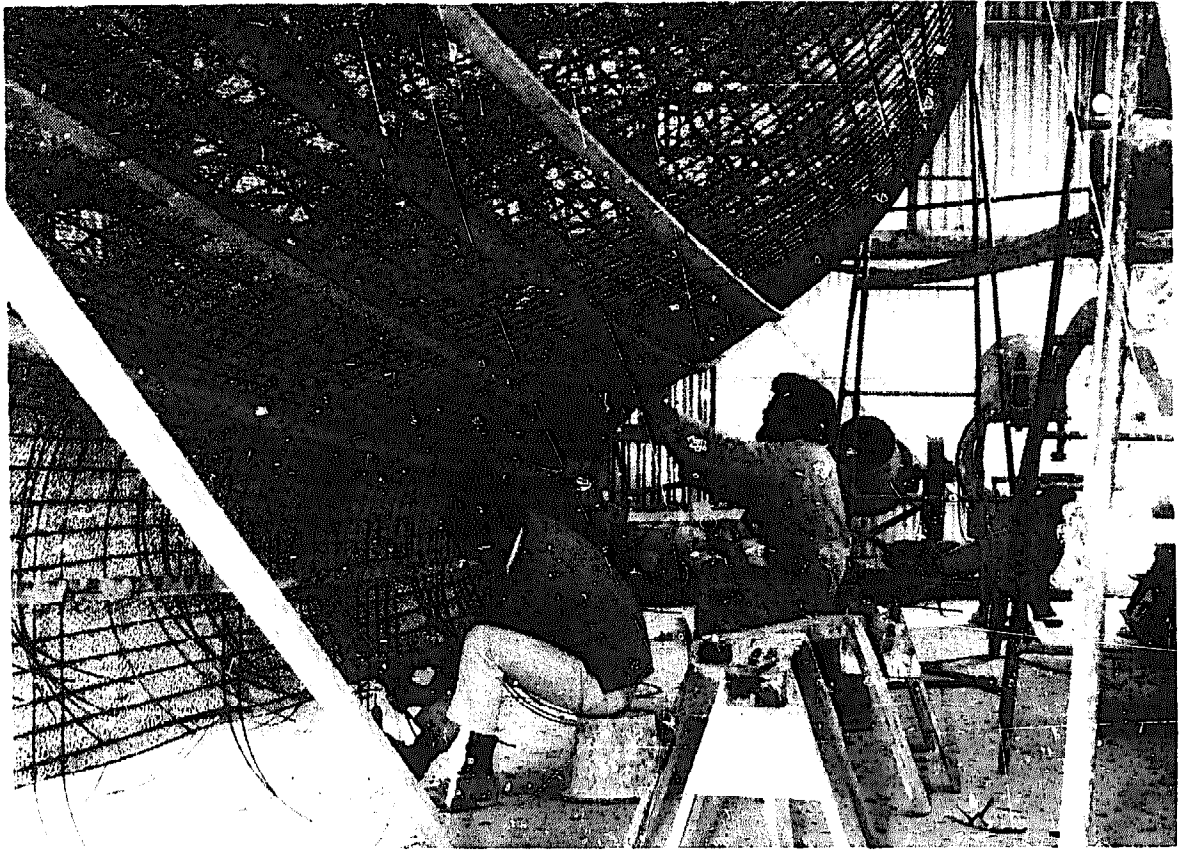




*Figure 4-9. Fore and aft rods in position. Note that high tensile rods are cut off short of stem and mild steel rods bent around the stem. Note also that the mild steel and high tensile rods are lapped and tied for at least 60 diameters*

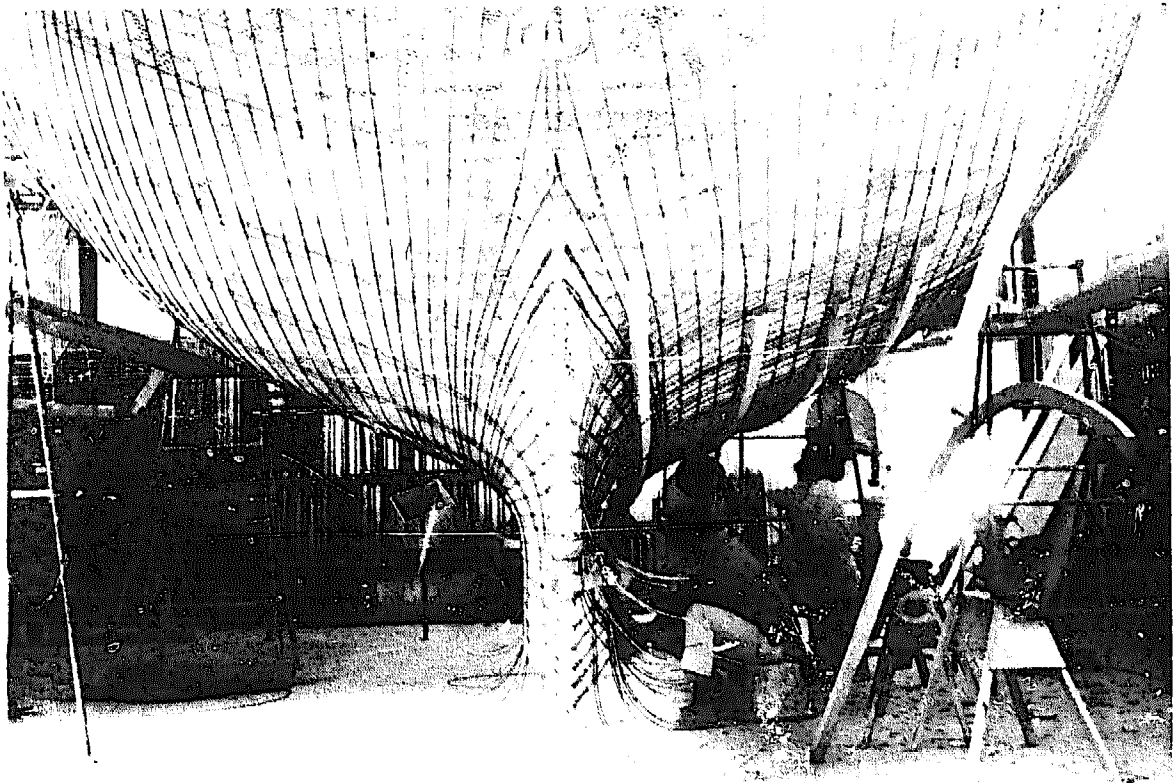
*Figure 4-10. Fore and aft rods completed and first pairs of transverse rods in position one-half space each side of pipe frame*





*Figure 4-11. All transverse rods loosely in position and long wooden battens being used to hold them fair to pipe frames while they are tied to the longitudinals*

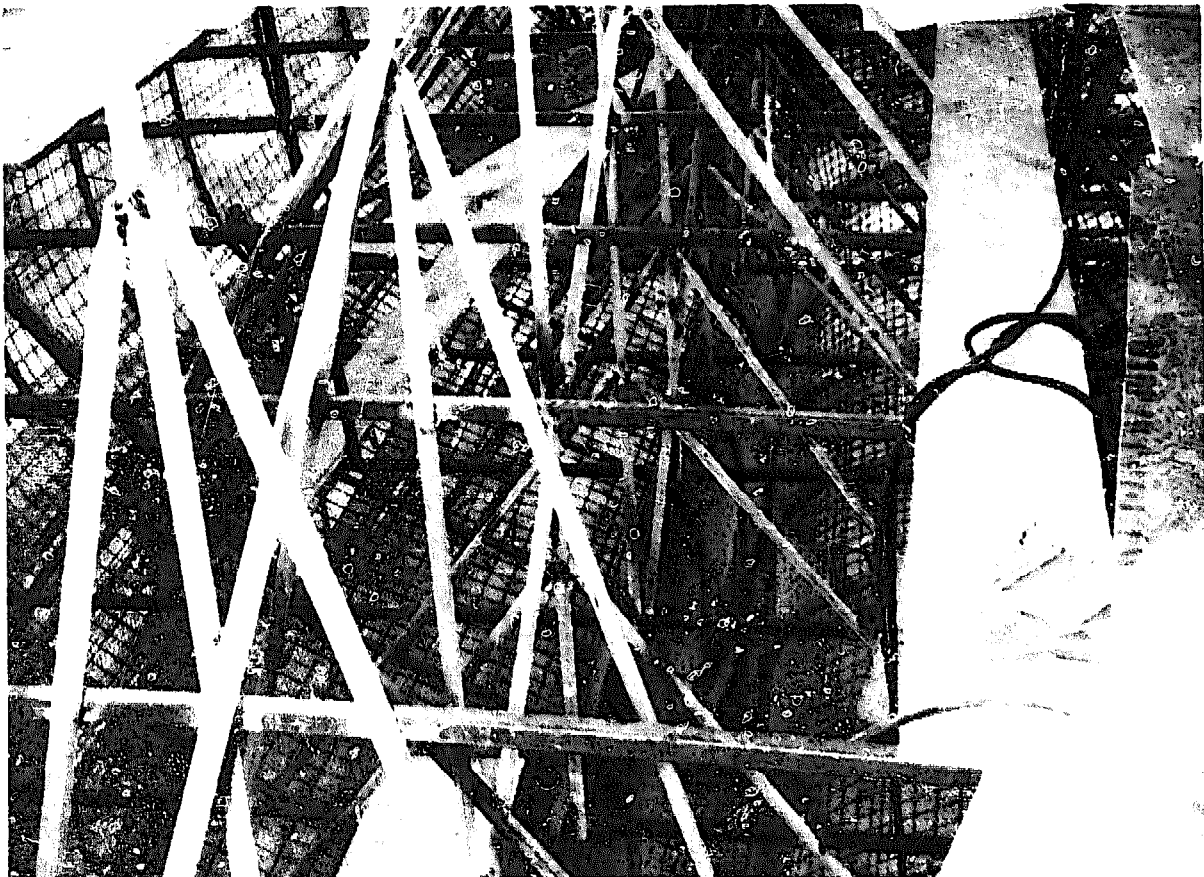
*Figure 4-12. Further view of transverse rods being tied. Note how longitudinal rods are lapped around aft end of keel similar to stem. Note also template for propeller boss (lower) and rudder stock (upper)*

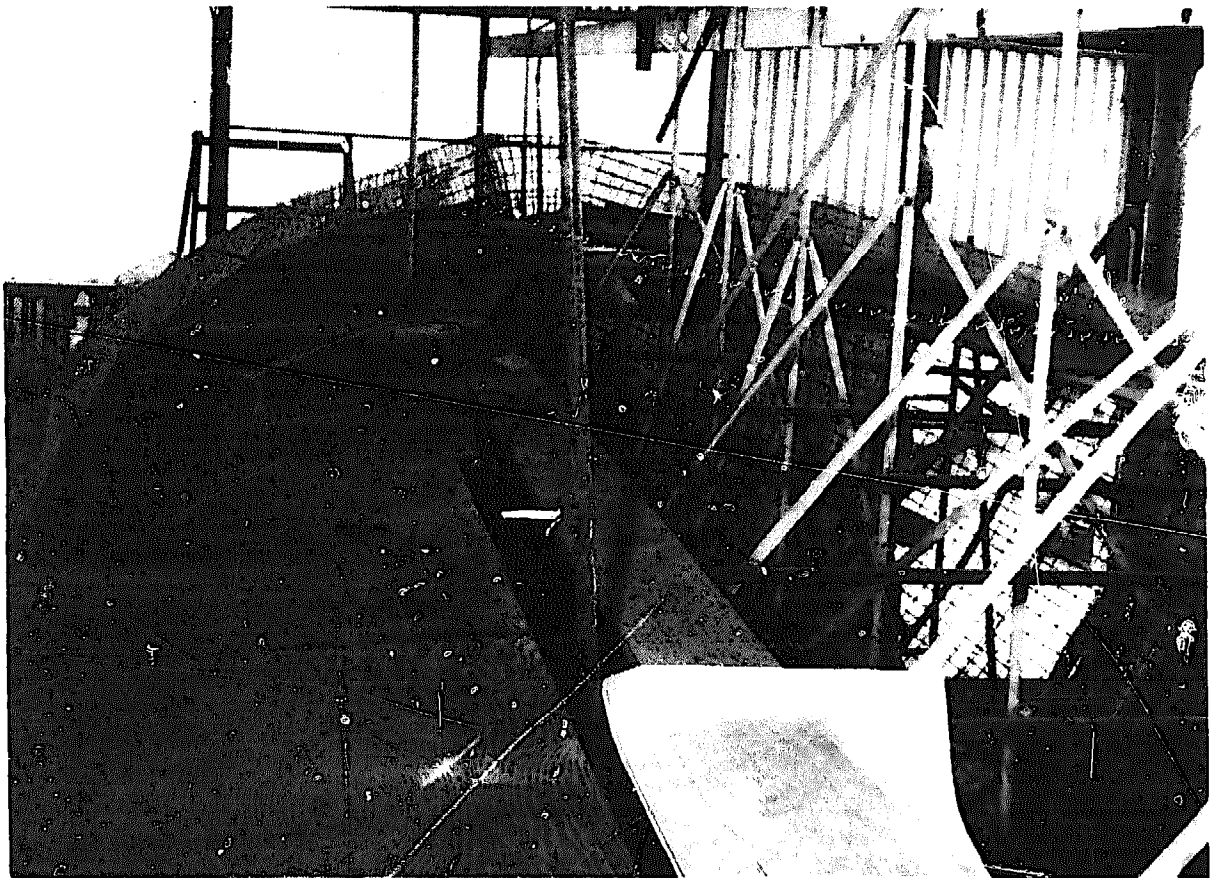




*Figure 4-13. First layers of square welded outer mesh hung in position from sheer. Tying commences at top of sheer and works progressively down the hull to underside of keel*

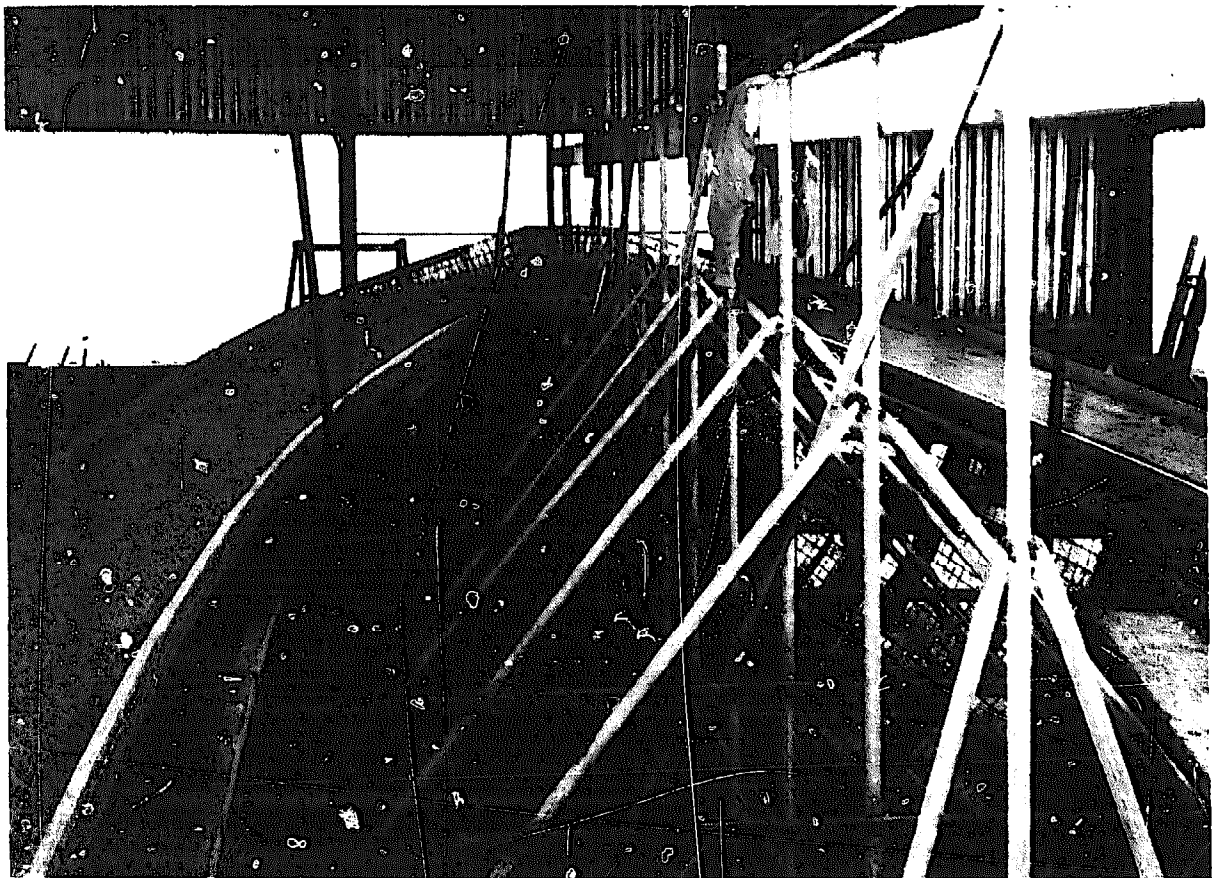
*Figure 4-14. First stage in framing deck. View looking aft. Note 2-in. x 2-in. wooden stringers laid on top of cambered deck pipe and plywood boxing on top of stringers*



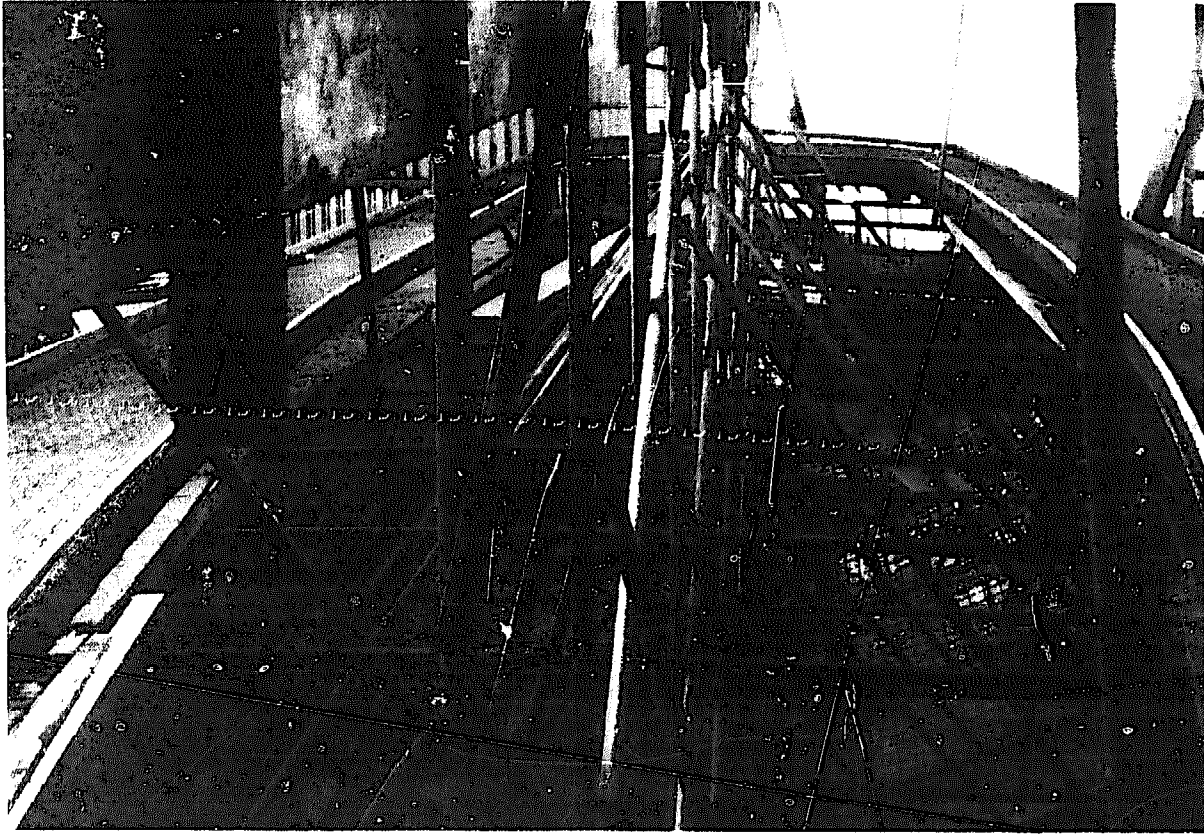


*Figure 4-15. View looking forward at same stage as figure 4-14. Note on left how excess of inner mesh has been left upstanding. This will be folded over and lapped onto deck*

*Figure 4-16. Same view as figure 4-15, with deck steel and mesh completed. Note wooden upstand around carlin line and wooden batten at top of sheer used for fairing and also as screed for plastering*



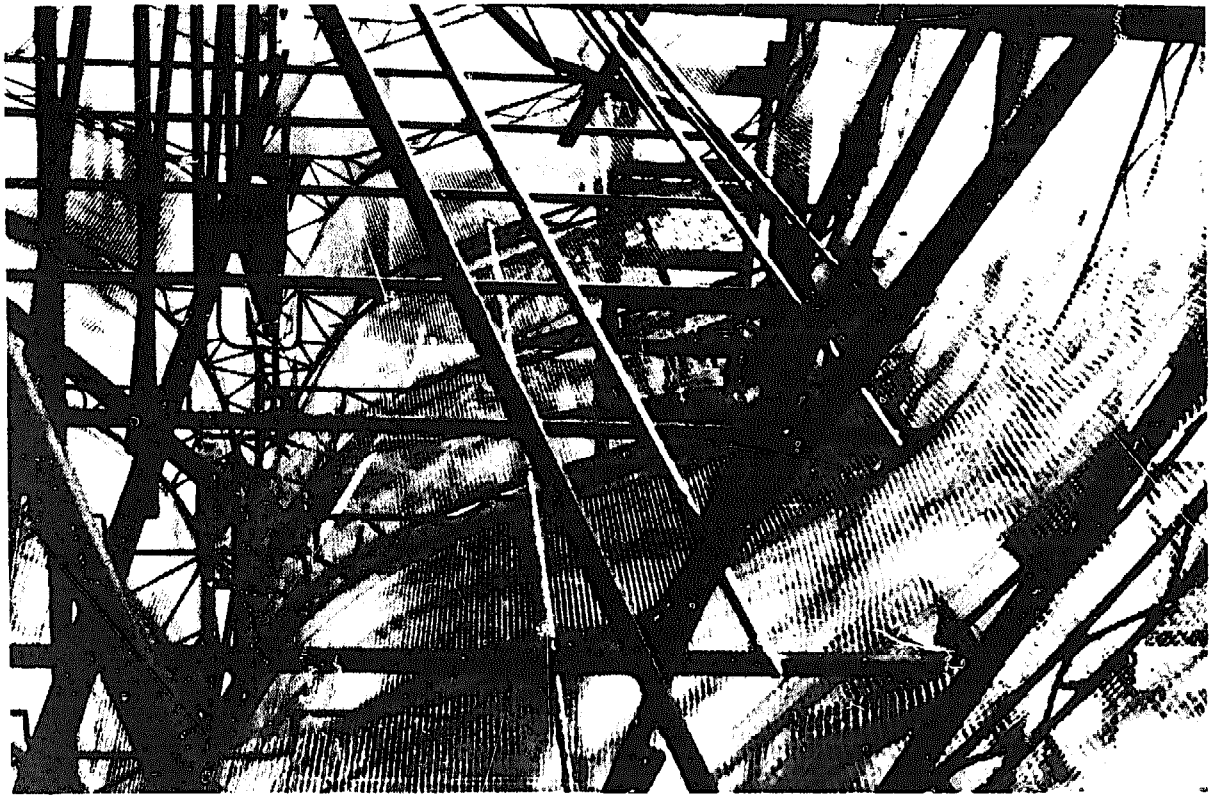




*Figure 4-17. Same stage as figure 4-16, looking aft. This photograph illustrates well the bracing of the hull, 6-in.  $\times$  3-in. hanging bar permanently fastened into the shed roof trusses and the method of hanging the centre pipe over the bar with a 4-in.  $\times$  2-in. offset plate*

*Figure 4-18. Steel and ballast keel being poured. Note scrap steel embedded in mortar mix, and vibrator being used. Wooden shapes are shutters for bulkhead grounds which can be seen meshed up in upper part of the photograph. Folded panels of mesh each side of keel are lapped across centre line after ballast is poured, tied together and finally plastered over*

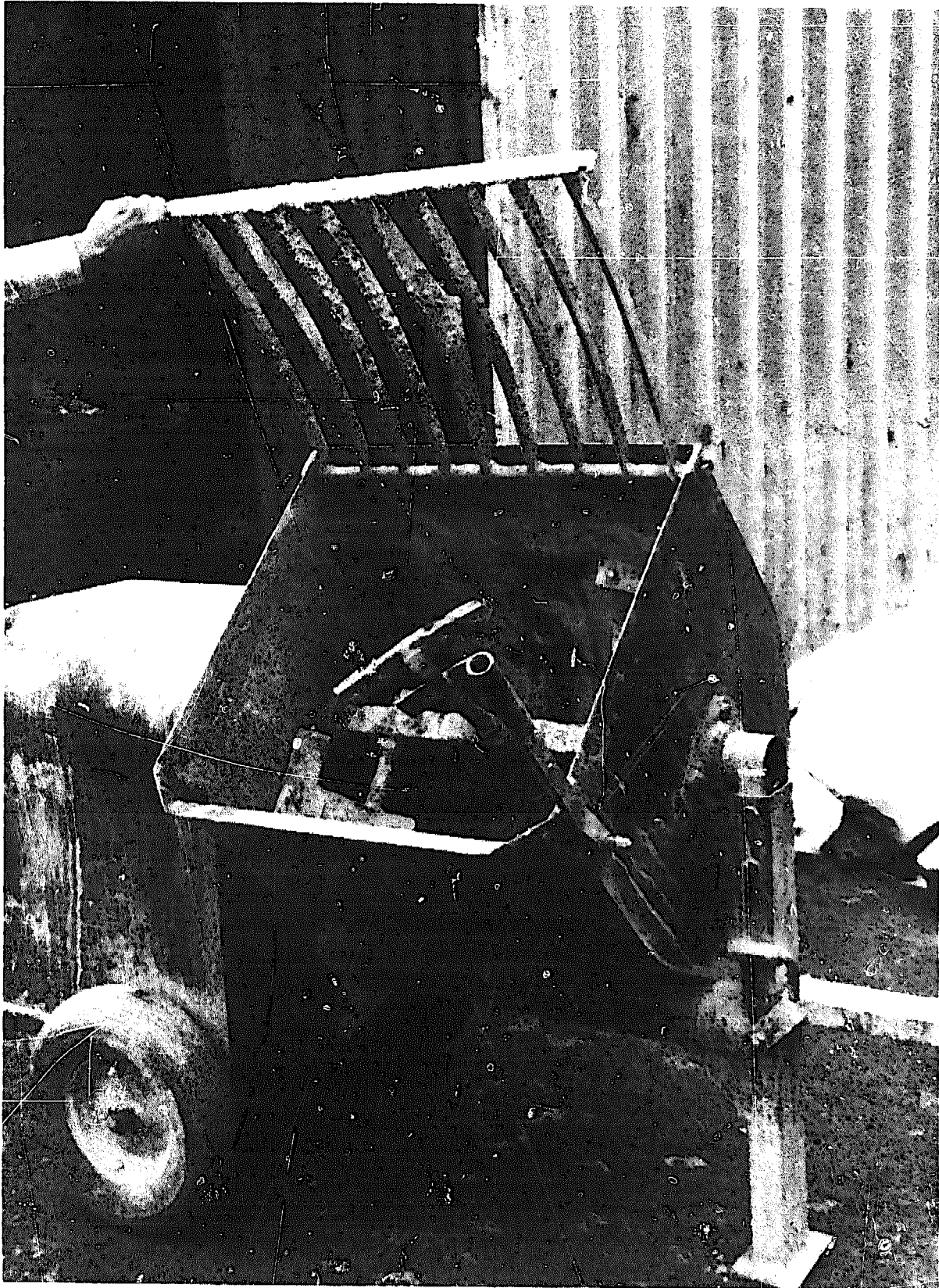




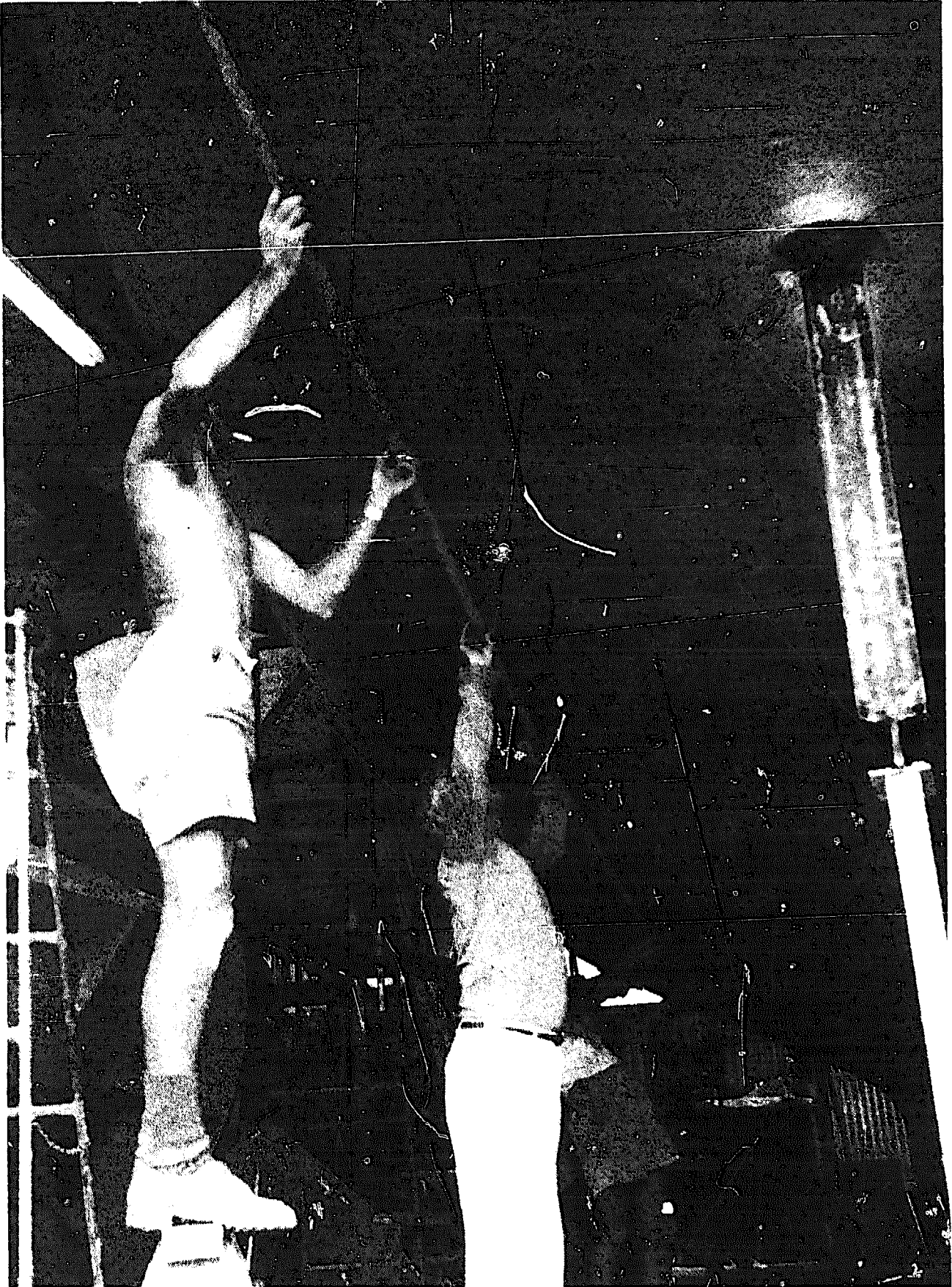
*Figure 4-19. Fabricated frames used in construction of 41-ft F.AO fishing boat in Uganda*



*Figure 4-20. Mortar slump test*



*Figure 4-21. Mortar mixer (paddle)*



*Figure 4-22. Fairing the hull*

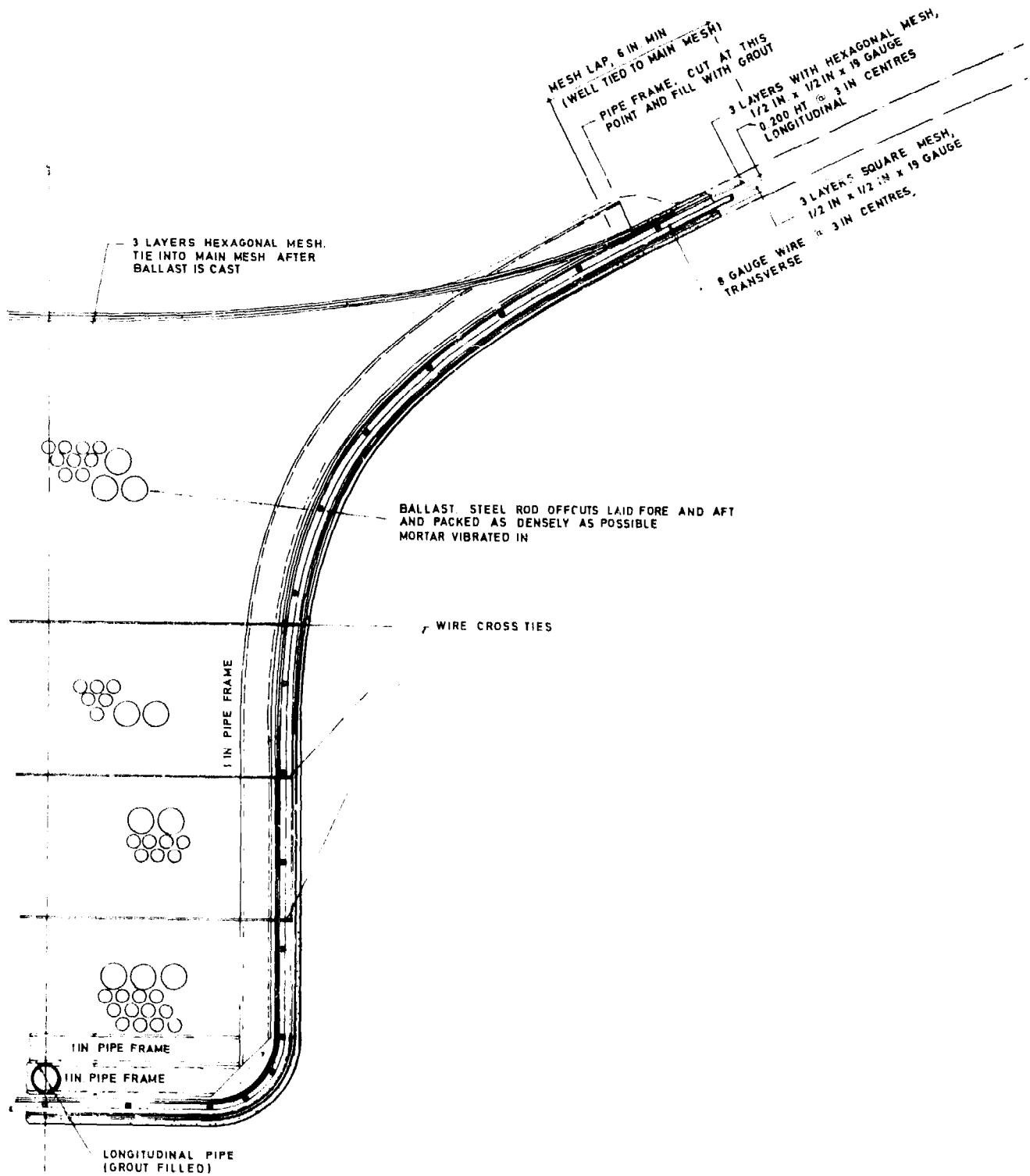


Figure 4-23. Standard detail (keel cross section)

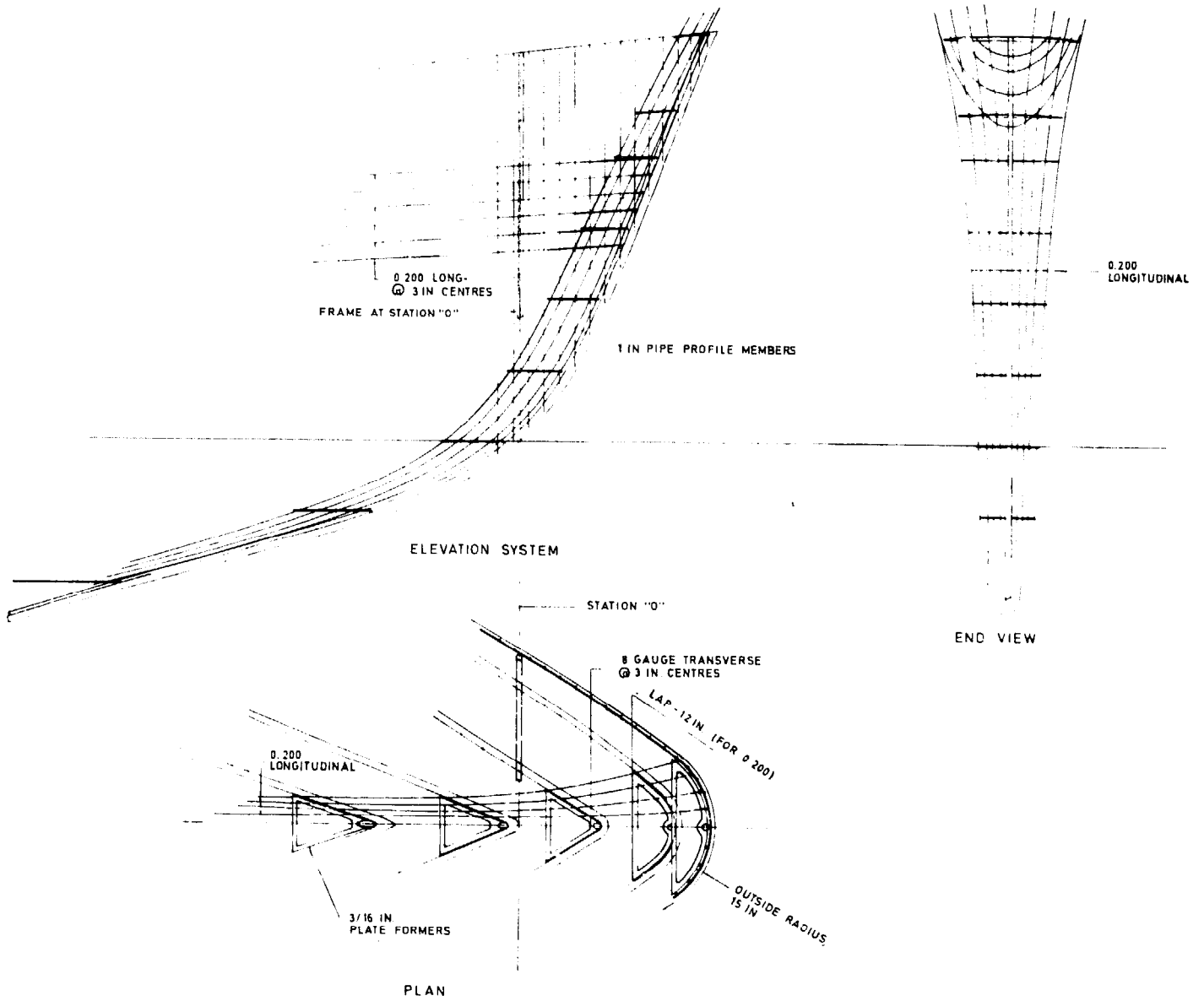


Figure 4-24. Standard detail (stern)

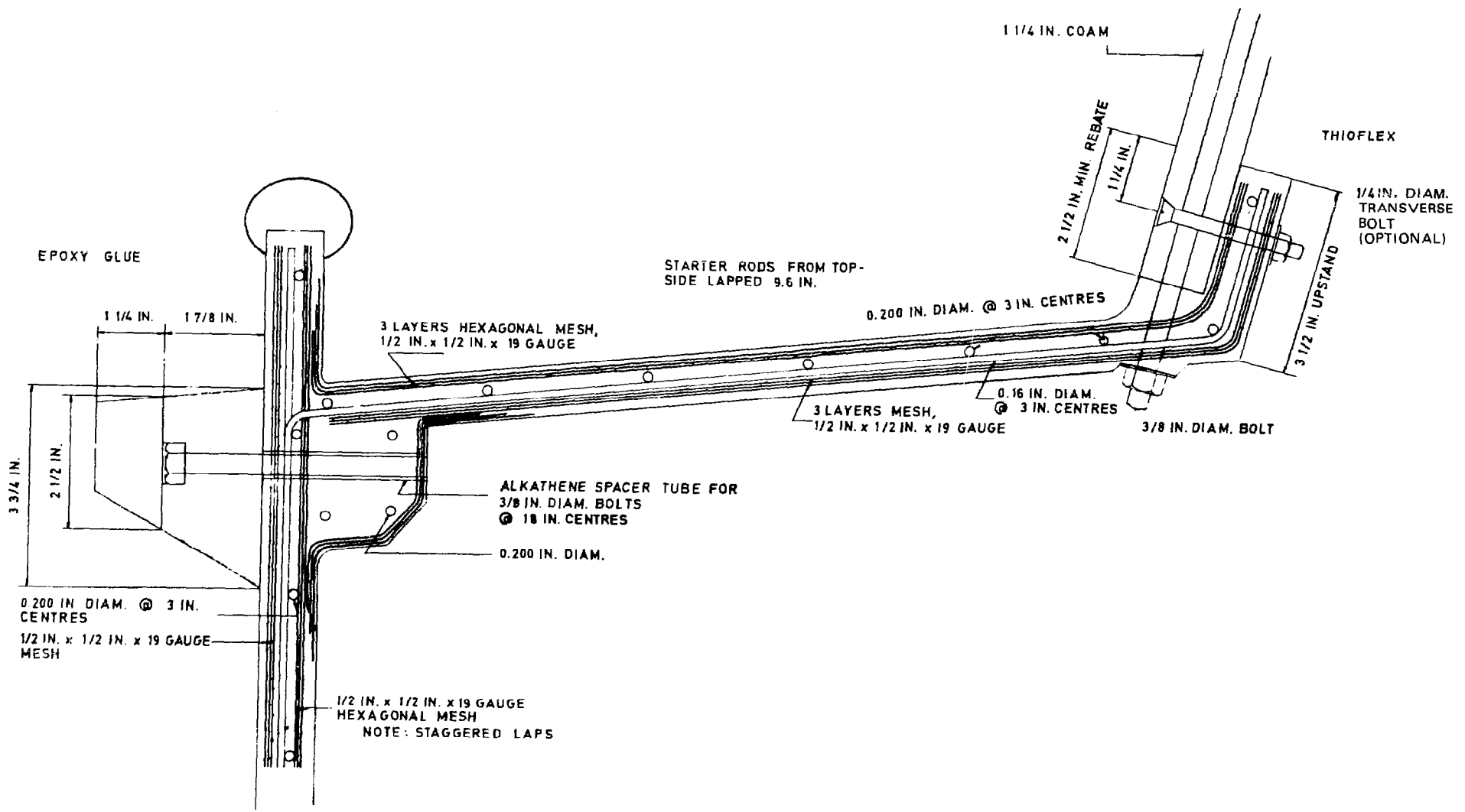


Figure 4-25. Standard detail (frame assembly)

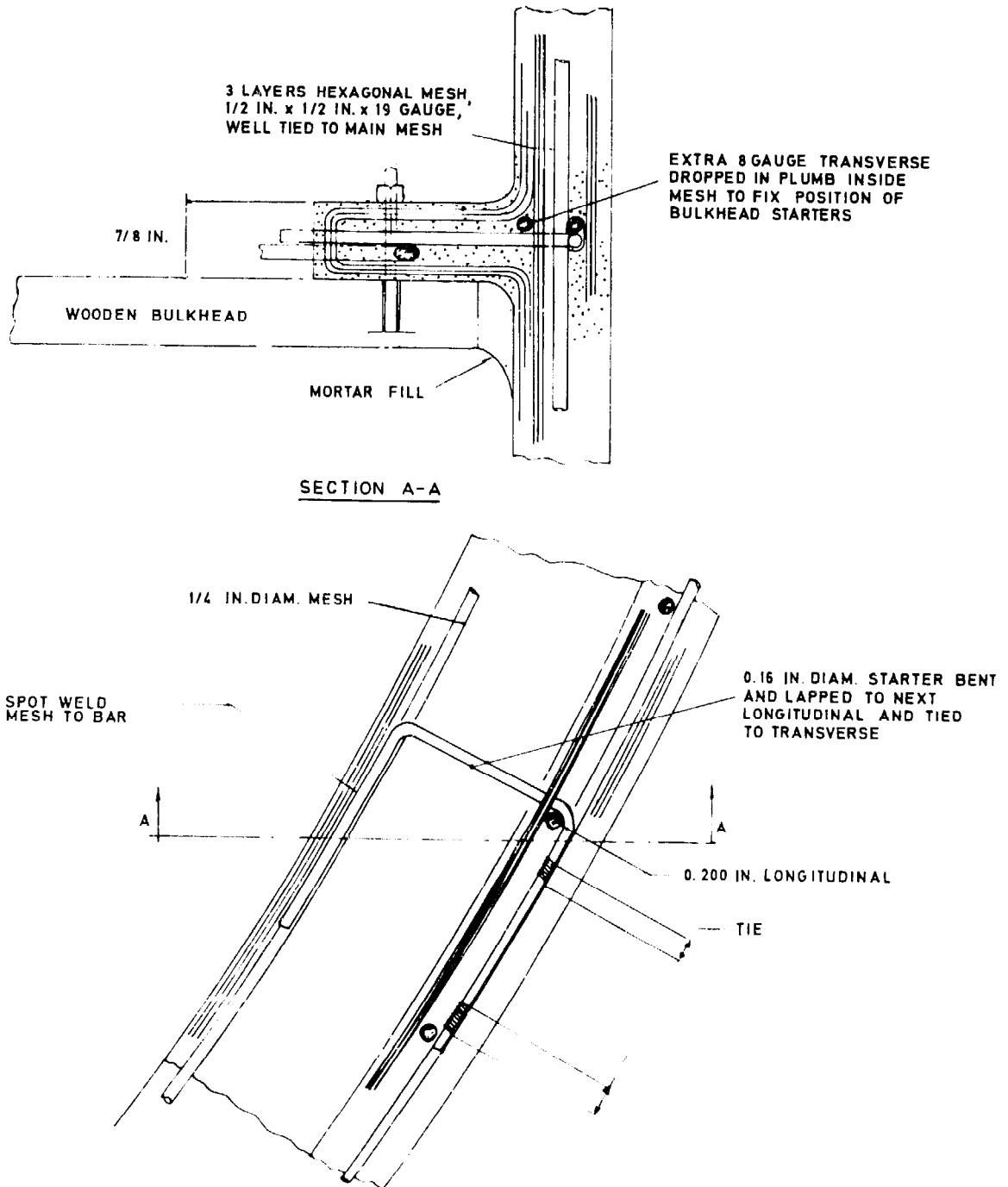


Figure 4-26. Standard detail (bulkhead ground)



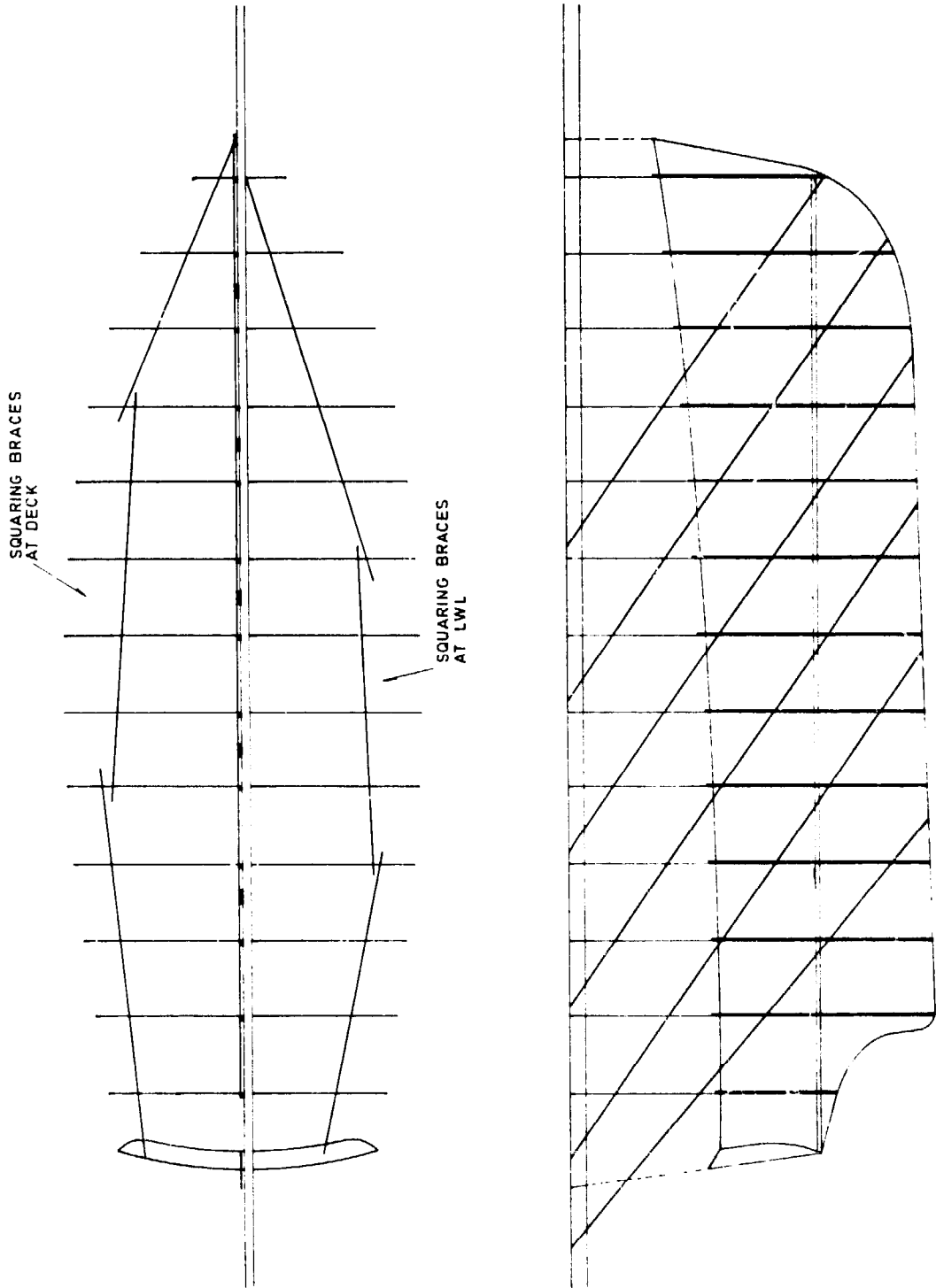
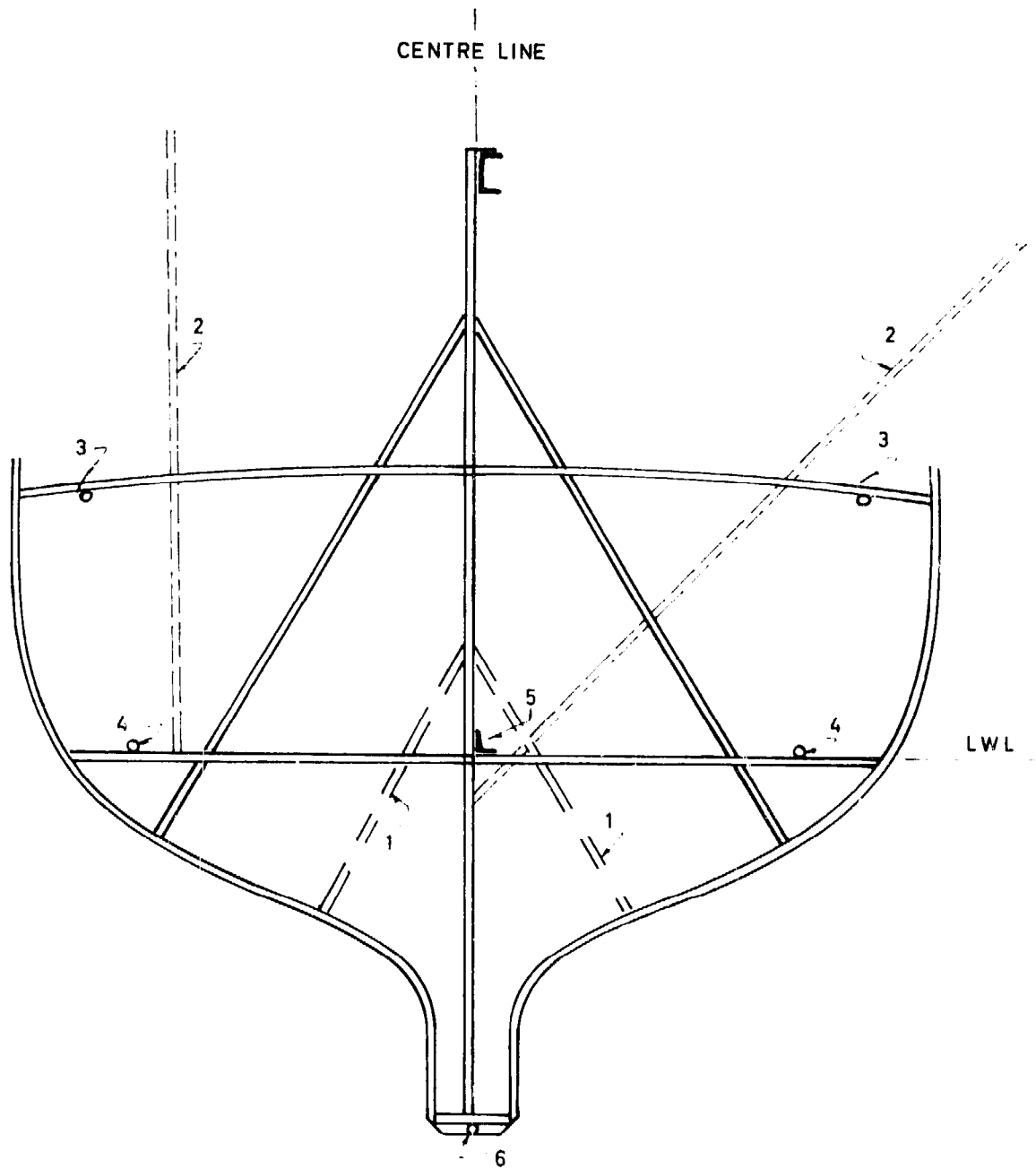


Figure 4-27. Setting up the frame



1. ADDITIONAL DIAGONAL BRACES == == IF REQUIRED.
2. BRACES TO STRONG POINTS IN SHED TO HOLD FRAMEWORK PLUMB ATHWARTSHIPS.
3. SQUARING BRACES AT DECK.
4. SQUARING BRACES AT LWL.
5. ANGLE BAR (L) RUNNING FORE AND AFT AT JUNCTION OF LWL AND CENTRE LINE.
6. PROFILE PIPE IN POSITION AND PACKERS ALONGSIDE

Figure 4-28. Typical pipe frame, showing layout of main members and diagonal bracing

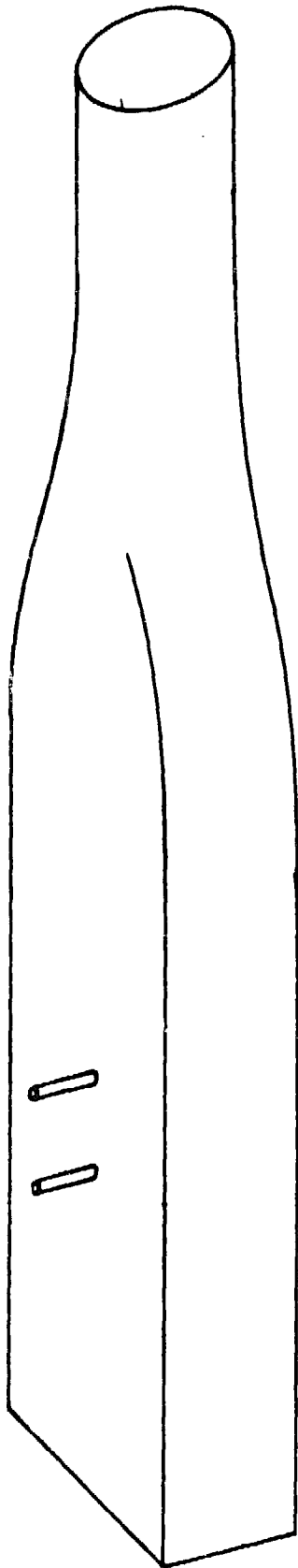


Figure 4-29. Twister

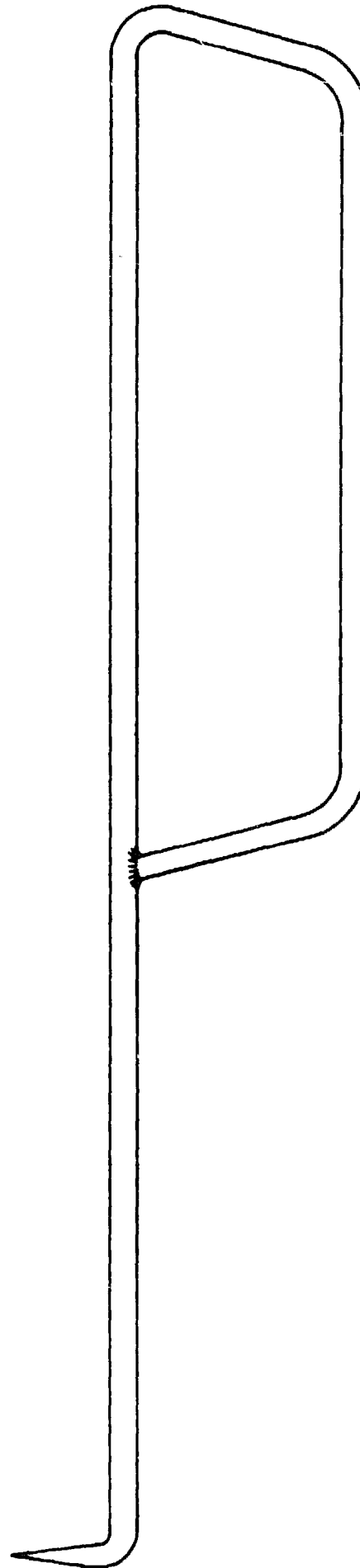
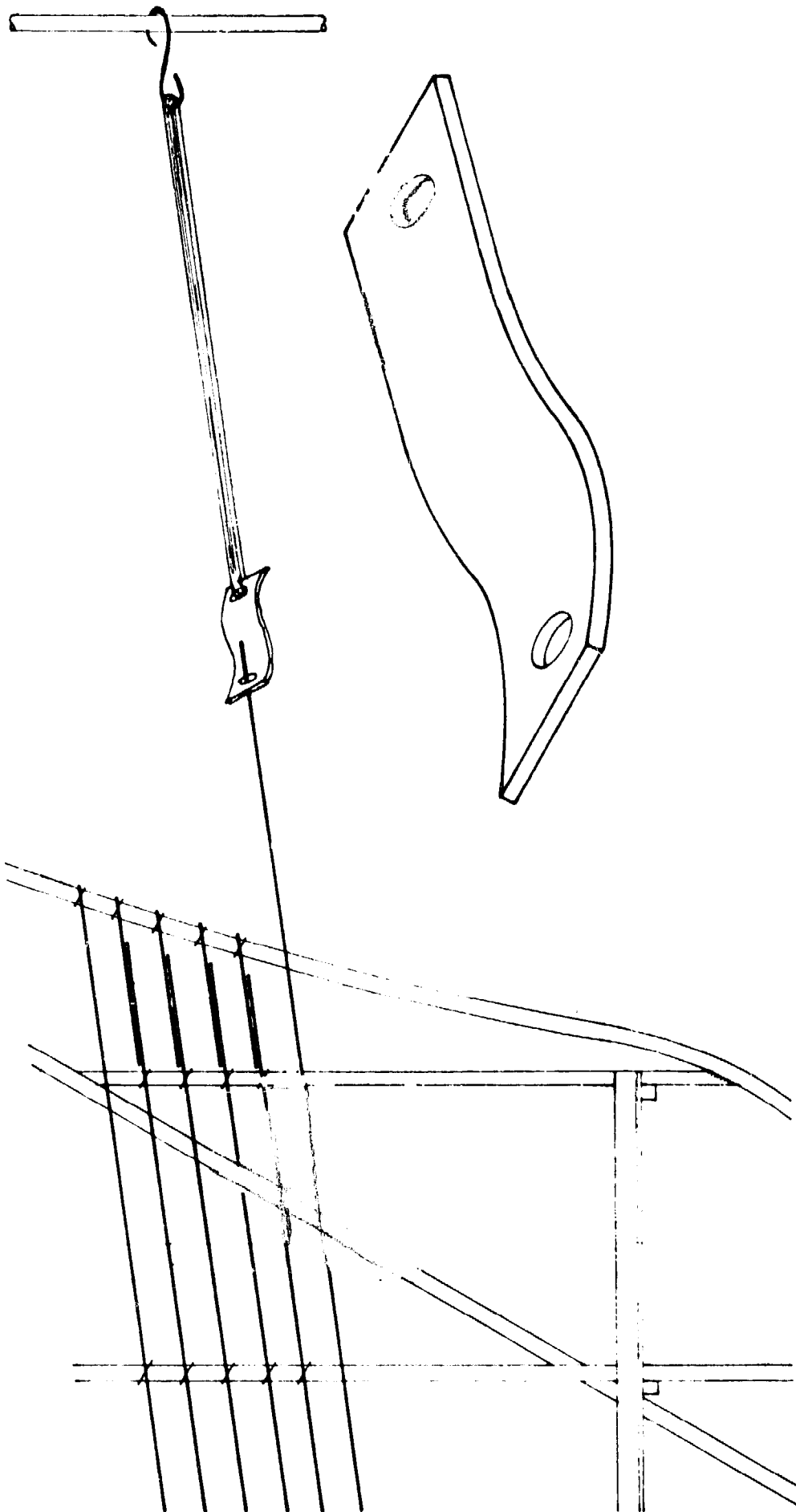


Figure 4-30. Stitching tool



*Figure 4-31. Tensioning of the longitudinal rods*

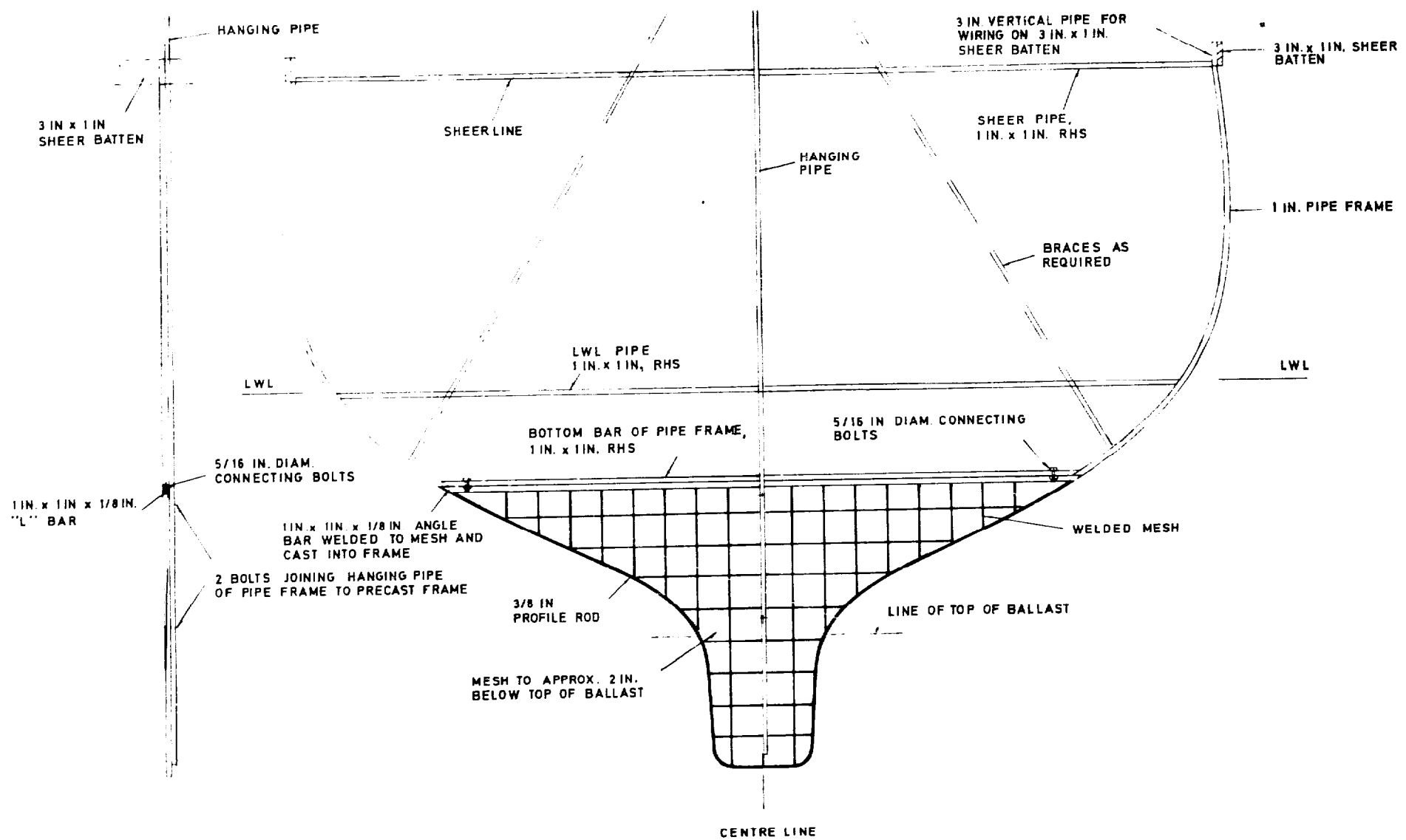


Figure 4-32. Typical composite frame

### HOW TO OBTAIN UNITED NATIONS PUBLICATIONS

United Nations publications may be obtained from bookstores and distributors throughout the world. Consult your bookstore or write to: United Nations, Sales Section, New York or Geneva.

### COMMENT SE PROCURER LES PUBLICATIONS DES NATIONS UNIES

Les publications des Nations Unies sont en vente dans les librairies et les agences dépositaires du monde entier. Informez-vous auprès de votre librairie ou adressez-vous à: Nations Unies, Section des ventes, New York ou Genève.

### КАК ПОЛУЧИТЬ ИЗДАНИЯ ОРГАНИЗАЦИИ ОБЪЕДИНЕННЫХ НАЦИЙ

Издания Организации Объединенных Наций можно купить в книжных магазинах и агентствах во всех районах мира. Наводите справки об изданиях в вашем книжном магазине или пишите по адресу: Организация Объединенных Наций, Секция по продаже изданий, Нью-Йорк или Женева.

### COMO CONSEGUIR PUBLICACIONES DE LAS NACIONES UNIDAS

Las publicaciones de las Naciones Unidas están en venta en librerías y casas distribuidoras en todas partes del mundo. Consulte a su librero o diríjase a: Naciones Unidas, Sección de Ventas, Nueva York o Ginebra.

Printed in Austria

Price: \$U. S. 2.00  
(or equivalent in other currencies)

United Nations publication

71-5731 — October 1972 — 4,400

Sales No.: E. 72. II. B. 23

*English only*

1D/85