

Building With Earth: A Handbook

By: John Norton

Published by: Intermediate Technology Development Group Limited
Myson House
Railway Terrace
Rugby CV21 3HT
U.K.

Available from: Intermediate Technology Publications
103/105 Southampton Row
London WC1B 4HH
U.K.

Reproduced with permission.

Reproduction of this microfiche document in any form is subject to the same restrictions as those of the original document.

BUILDING WITH EARTH

A Handbook

John Norton

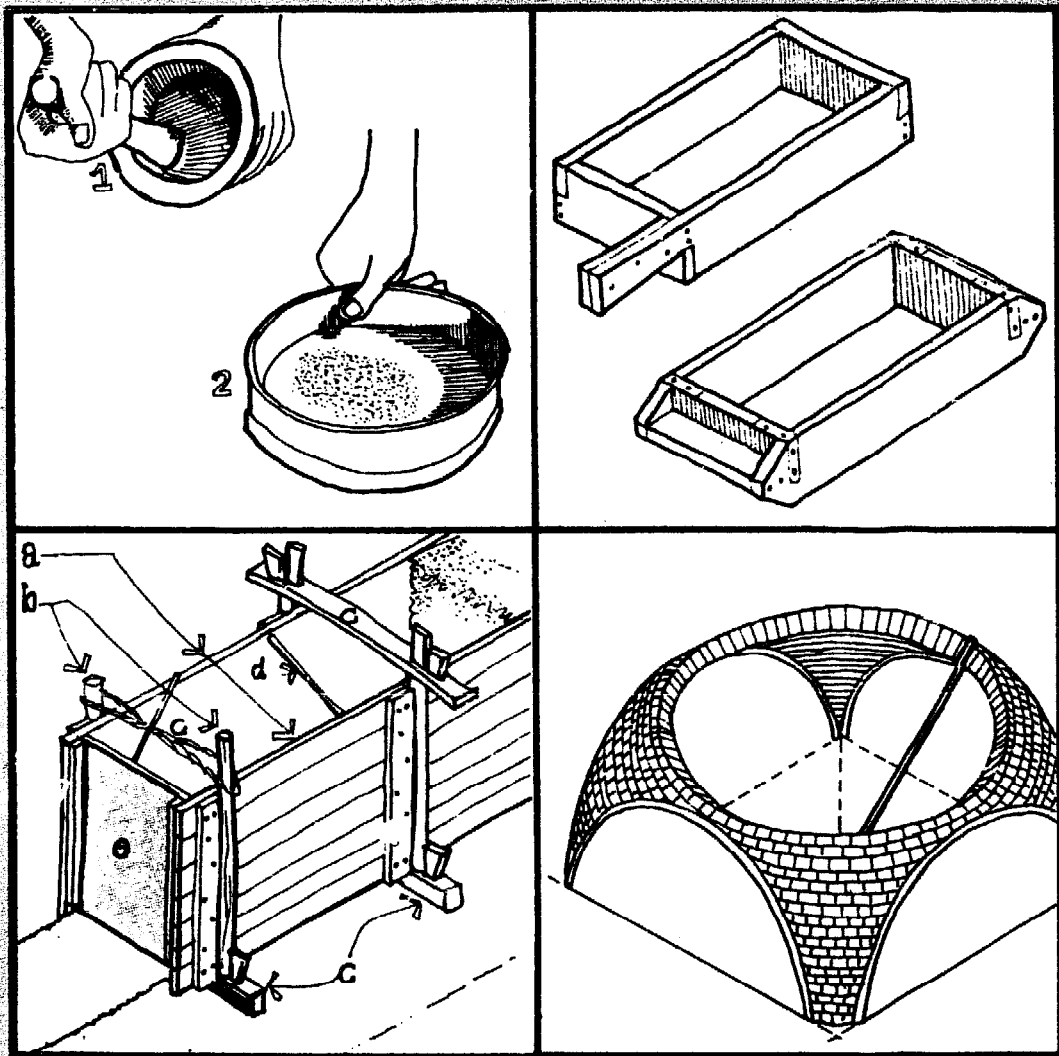

BUILDING WITH EARTH

A Handbook

John Norton

IT Publications 1986

Intermediate Technology Development Group Limited
Myson House
Railway Terrace
Rugby CV21 3HT, U.K.

© John Norton, 1986
Development Workshop

All rights reserved. No part of this document may be reproduced or transmitted in any form or by any means, electronic or mechanical, including photocopy, recording or any storage or retrieval system, without the prior permission in writing from the copyright owner.

ISBN 0 946688 33 8

Printed by Salvo Print, Leamington Spa, Warwickshire, U.K.

PREFACE

Building with earth is both a science and an accumulation of expertise. In recent years, some of the expertise which was passed down over centuries has been lost, as the circumstances that people live in change and as they turn to new materials which seemingly meet their contemporary building needs. Meanwhile, a science of building with earth has developed in order to evaluate the old techniques, improve the use of earth and overcome its limitations, and to make it possible to compare the performance of earth with other materials which are, perhaps, better known. In the course of this development, building with earth has become a technology. For many people, however, it has remained the most straightforward, cheap and readily available method of meeting their building needs.

The purpose of this handbook is to bridge the gap between the science and the tradition of building with earth. It aims to give a clear understanding of the techniques of building with earth and to provide straightforward methods for analysing earth, testing its performance, and deciding if and how to improve and use it. In doing so, it provides a basis for comparing earth as a building material with other materials in common use.

The author, John Norton, co-founder and co-director of Development Workshop, has been working for some 15 years to improve and develop the local and national ability of people in Third World countries to meet their building and planning needs. In the course of his work in numerous countries, he has had extensive experience of building with earth and developing its use. This includes work with Hassan Fathy, author of *Architecture For The Poor*.

Michael Parkes
Manager
Mineral Industries Programme
Intermediate Technology Development Group

June 1986

CONTENTS

	Page
1. INTRODUCTION.....	1
2. GENERAL CHARACTERISTICS.....	3
Structure	4
Climatic Performance	4
Earthquake Resistance	5
3. SOIL TYPES.....	6
What Soil Is	7
Soil Composition	7
- Particle Gradation	7
- Particle Characteristics	8
Laterites	8
4. SOIL ANALYSIS.....	9
Before You Start	10
- Preliminary Analysis	10
- The Sample	10
Types of Test	11
- Soil Composition Tests	11
- Plasticity Tests	14
- Tests for the Optimum Water Content	18
5. PERFORMANCE AND PERFORMANCE TESTING.....	20
Visual Assessment	21
Compressive Strength	21
Resistance to Water Erosion	22
Bending Strength or 'Modulus of Rupture'	22
Moisture Absorption	23
6. WALL CONSTRUCTION.....	24
Combination Walls	25
- Wattle and Daub	25
- Double Layer Framework and Mud Infill	27
Load-Bearing Walls	28
- Direct Moulding	28
- Mud Bricks	30
- Rammed Earth	35
- Compressed Blocks	41
7. ROOFS, FOUNDATIONS AND FLOORS.....	45
Roofs	46
- Vaults and Domes	46
- Flat and Pitched Roof	48
- Reinforced Earth Roof	49
Foundations	49
Floors	49
8. STABILIZATION.....	51
How to Choose a Stabilizer	52
Use of Stabilizers	53
- Cement	53
- Lime	55
- Pozzolanas	55
- Bitumen	56
- Straw	57
- Others	57
9. RENDERS.....	58
Types of Render	59
- Mud Plaster	59
- Cement/Sand	59
- Cement/Lime/Sand	59
- Cement/Soil & Lime/Soil	59
- Cement and Lime Slurries	60
- Lime/Pozzolana with Sand or Soil	60
- Gypsum/Lime & Gypsum/Lime/Sand	60
- Bitumen/Soil	60
- Soil/Cow Dung	60
- Matting & Thatch	60
- Brick or Tile Facing	61
- 'Local' Renders	61
Use of Renders	61
10. OTHER CONSIDERATIONS.....	63
SELECT BIBLIOGRAPHY.....	66

1. INTRODUCTION

The intention of this handbook is to be of practical help both in choosing whether and how to build with earth, and in working with it, from the selection of a soil through to construction and maintenance.

It is, however, important to recognize that the technology of earth building is extremely varied, not only in a technical sense - the soils available, the way they can be used, and the functions to which they are applied, but also in a social sense - from the user's viewpoint there is a great variation in what is regarded as an acceptable standard.

Earth is a building material capable of very high quality and great durability, in wet as well as in dry climates. But it is also, because of its widespread and often free availability, the material most frequently used by people with no other resources for meeting their building needs. As such, its association with poverty has distorted its image, so that it is not always thought of as either a quality or a durable material.

Making the best use of the material can help to redress the balance. In this handbook, techniques and equipment for soil analysis and performance testing have been chosen so that a high standard can be achieved without having recourse to either an established materials testing laboratory or expensive equipment. When carefully followed, the results of these tests are sufficiently reliable to enable both a good understanding of the materials available, and an accurate evaluation against the standards and the performance of other comparable materials.

The performances suggested give an indication of what should be expected. In this, as in all sections, the handbook should be used to complement practical experience, and never to replace it.

Terminology

Within the handbook the terms 'earth' and 'soil' have been used variously to mean the same thing. 'Mud' is also referred to, and is used to describe earth that is or has been in a wet soft state.

'Kg/cm²' have been used to express pressure, because kg are likely to be the most commonly available measure of weight. To make the comparison with the various SI Units in use by different authors:

$$\begin{aligned} 1\text{kg/cm}^2 &= 0.0981 \text{ N/mm}^2 \\ &= 0.0981 \text{ MN/m}^2 \\ &= 0.0981 \text{ MPa} \end{aligned}$$

References

References are given at the end of each section, and there is a short bibliography at the end of the handbook which may serve for further reading.

2. GENERAL CHARACTERISTICS

2.1 STRUCTURE

Earth used in building can be characterized as having moderate strength in compression, but very little strength in tension or bending. The lack of tensile strength means that, when earth is used as a load-bearing material, all compression forces must pass down within the thickness of the structure to the ground. For example, thin earth structures such as vaults and domes must be built with care to follow the line of compressive forces.

Both the lack of tensile strength and the moderate compressive strength of unstabilized and uncompacted earth (by comparison with higher strengths of fired bricks or concrete) mean that load-bearing earth walls are generally massive. The compressive strength of earth can be increased by compaction, and by stabilization with cement or lime, and by doing so it is possible to build thinner structures, with consequent potential savings in the amount of material required.

Unstabilized earth loses much of its compressive strength when damp, and therefore a basic rule of building with earth is to protect it from contact with moisture. This can be done by placing the earth wall on top of a water resistant footing (e.g. stone or fired brick, and with possible use of a damp proof course), and thus out of reach of ground water; and by protecting the walls from rain with a covering, either in the form of a waterproof and overhanging roof, or with a protective render. Stabilization can be used to reduce the weakening effect of moisture on a soil.

2.2 CLIMATIC PERFORMANCE

Partly because of the thickness of most earth construction, and because of earth's low thermal conductivity value, rooms built with earth are usually well insulated.

Earth has a thermal conductivity value in the order of 0.50 W/m degC for mud-brick, compared with 1.21 W/m degC for fired brick, 1.44 W/m degC for concrete, and 1.53 W/m degC for limestone (*1). The conductivity varies particularly according to the amount of air (which has a low conductivity value of 0.026 W/m degC) contained in the soil. Compacted soils and soils where the voids have been filled by a stabilizer will usually have a higher conductivity value (0.60 - 0.65 W/m degC).

The combined factors of low conductivity and thickness mean that it takes a long time for - for example - a peak outside temperature to be transmitted to the interior. Typical time lags are +/- 6 hours for a 0.3m thick compressed block wall, and +/- 9 hours for a 0.5m thick mud-brick wall. The insulation value of this long time-lag is particularly valuable in places where there is a large diurnal range of temperature, which is common in hot dry climates. The effect is to balance the extremes of night-time cool and day-time heat, resulting in a constant interior air temperature. Fig 2.1 shows this effect and its relationship to the temperature comfort zone for a mud-brick house in Cairo (*2). Fig 2.2 shows comparative data for an

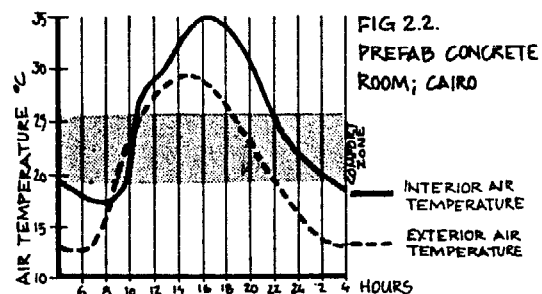
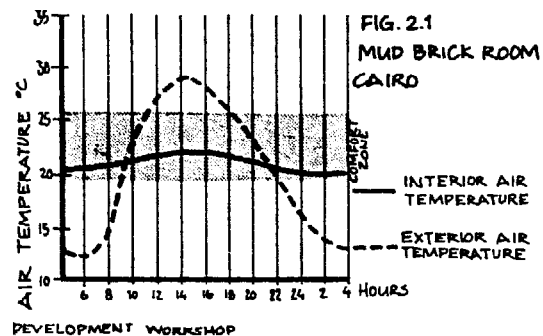

identical house built with thin prefabricated concrete walls and a corrugated iron roof: the interior air temperature is higher than the outside air temperature because of high external surface temperatures due to solar radiation (*2). The benefit of the long time-lag is reduced in areas where there is a low diurnal temperature range (e.g. typical of hot humid conditions) and it is no coincidence that thin walls built with mud plaster or packing on a framework (see Section 6.1.1 & 6.1.2) are common under these conditions.

2.3 EARTHQUAKE RESISTANCE

Earth buildings have the reputation of being prone to damage and collapse in an earthquake. The lack of tensile strength contributes to this risk. However, more than a shortcoming of the material itself, poor technique and workmanship, poor building layout, and lack of reinforcement often contribute to the poor earthquake resistance of earth buildings. When building with earth in earthquake risk areas the following are precautions that should be taken (*3):

The building should be tied together horizontally, by the foundations, by a ring beam at the top of the walls, and by intermediate horizontal rings such as at lintel level. This reinforcement can be achieved with timber, laid in the wall, or by reinforced concrete ring beams. Reinforcement can be of metal rods, or bamboo. Chicken wire laid between courses of blockwork can also be used to provide horizontal continuity. Ring beams are particularly important when the building has a heavy roof, and in the case of vault building, additional ties should be used spanning across the width of the vault.

The building should be tied together vertically, with posts or reinforcing bars placed within the walls, particularly at all corners and wall junctions, and on both sides of openings.

The horizontal and vertical framing or reinforcement should be tied together. Vertical and horizontal framing can be built into the wall, or can be placed on both sides of the wall like a sandwich.

Block and brick-work should be well bonded, both in the thickness and the length of the wall. Blocks and bricks should be dampened before laying, to improve their adhesion with the mortar.

Openings should never be placed close to corners and wall junctions. The plan of the building should be simple and symmetrical, and by preference of rectangular or circular form. The length of the building should be no more than three times the width. Buildings of more than a single storey should be avoided.

*1 Cain A., Afshar F., and Norton J. OMAN: The problems and potentials of the indigenous built environment in a developing country, Development Workshop, London, 1975.

*2 Development Workshop. 'Climatic studies of traditional building at the Cairo Building Research Centre,' unpublished material, 1973.

*3 Development Workshop. A strategy for developing indigenous building in earthquake regions, C.E.D.S., Tehran, 1978.

3. SOIL TYPES

3.1 WHAT SOIL IS

Soil is produced by a combination of actions: the wearing or breaking down of rocks by weathering; the interaction of dissolved silicates, present in the parent rock, with various soluble salts to form the clay minerals; and the decomposition of vegetable and plant matter. Physically, soil is a compound matter made up of solids, water and air.

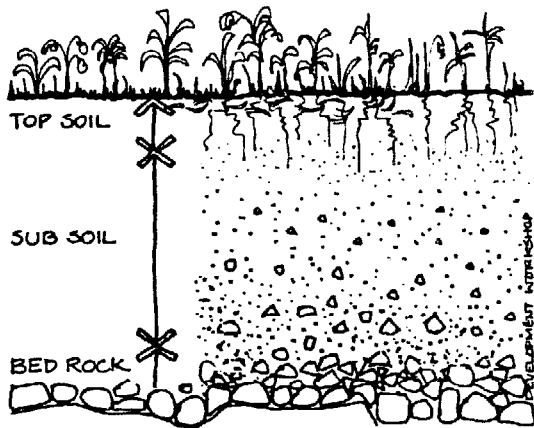

Although the depth of soil varies, in general if a vertical cut is made in the soil it will show that the soil is made up of layers, varying in texture, colour and depth. There may be many different layers, but a typical profile of a soil can be divided into three parts: topsoil, containing large quantities of organic matter; subsoil, containing little or no organic matter; and bed-rock, which may or may not be broken down into lumps.

Earth suitable for construction comes from the subsoil layers. The topsoil layer, because it contains organic matter which will continue to decompose and change, and which sometimes has a negative effect on certain stabilizers, is not normally used for construction. (There have been exceptions to this, such as sod walls once used in Scotland.) The topsoil, which should therefore always be removed, can often be identified by its dark colour, and by its musty smell, accentuated when the soil is damp or warm.

3.2 SOIL COMPOSITION

3.2.1 PARTICLE GRADATION

Soils are composed, in varying proportions depending on the soil type, of four grades of particle size: gravel, sand, silt, and clay. Not all soils contain some of each grade. The generally accepted decimal grading is:

Gravel	60.00 mm	to	2.00 mm	
Sand	2.00 mm	to	0.06 mm	
Silt	0.06 mm	to	0.002mm	
Clay	less than 0.002mm			(British Standard Grading)

(The American Society for Testing Materials, ASTM, use a different grading:

Gravel	100.00 mm	to	5.00 mm
Sand	5.00 mm	to	0.08 mm
Silt	0.08 mm	to	0.002mm
Clay	less than 0.002mm		

Note that the upper limits of silt, sand and gravel are all higher than for the BS/Decimal gradation, causing different interpretation when soil combinations are presented in proportional percentages.)

In this handbook all proportions relate to the British Standard decimal gradation.

3.2.2 PARTICLE CHARACTERISTICS

Gravel, sand and silt are made of different size particles of rock, and they form the stable body of a soil. They share the characteristic that they retain the same size when wet or dry. (A slight exception should be made in the case of silt, which does sometimes swell a little when wet, and will hold together when wet and compact.) To be of use in building each of these needs to be mixed with additional material acting as a binder.

Clay is quite different from the other particle sizes. It acts as the binder in most soils, and is characterised by its stickiness when damp, by its hardness when dry. It is also, unlike the other grain sizes, generally unstable, and swells when wet and shrinks when dry, which often results in cracking.

Clay is made up of minute particles, visible only with a microscope. Each particle is coated by a film of water, held by surface tension, and it is this water which binds each particle to its neighbours. Even when the clay is extremely dry, the particles are still strongly bound together by tiny points of water, and it is the tension in the water which gives the dry material its strength. As clay is dried out, the particles are drawn more tightly together, the overall volume of the soil shrinks, and cracking between 'lumps' of clay occurs. When wetted, the layer of water coating each particle increases, and the clay appears to swell.

Balancing the characteristics of clay with those of the gravels, sands and silts, is essential for building successfully with earth. To do this it is necessary to analyse the soils that you have available.

3.3 LATERITES

Lateritic soils require a separate mention. They are highly weathered tropical soils containing varying proportions of iron and aluminium oxides which are present in the soil as clay minerals. A lateritic soil tends to be more resistant to weathering than a comparative (in particle size) soil which is not lateritic. In some cases laterite which is soft in the ground will harden on exposure to air, and in general lateritic soils produce hard building blocks. Some studies have indicated that laterites have a pozzolanic reaction when mixed with lime, and are thus well-suited to stabilization. (See 8.2.3: Stabilization - Pozzolanas.) Lateritic soil colours range from ochres through red, brown or violet to black, and can usually be identified by the relative darkness of their colour. They occur in tropical countries and areas which were tropical and have now become arid.

4. SOIL ANALYSIS

4.1 BEFORE YOU START

One should not underestimate how important soil analysis is, and it is worth devoting the effort needed to get an accurate result. Methods for soil analysis can be divided, in descending order of accuracy and increasing simplicity, into detailed laboratory tests; field laboratory tests, which can be done with a limited amount of specialized equipment; and field tests, which can be done with no equipment or one or two simple items which are easily and commonly obtained or made. Clearly, one should always undertake the most accurate tests at one's disposal.

Explanations of detailed laboratory tests are not given here but can be obtained from the reference at the end of this section, (*1), or from the author.

4.1.1 PRELIMINARY ANALYSIS

The following are simple tests which help to identify soil types, and which may save one from testing soils which are unsuitable for building.

Observation

Cracking in dry soil suggests a high clay content, while a dry soil which is loose and grainy suggests sand. Take a damp lump of soil and cut it in half with a blade: the cut surface of a plastic clay soil will be smooth and bright, whilst a silty or sandy clay will have an opaque surface, possibly crumbly when there are large amounts of sand in the soil.

Touch

Rub the soil between the fingers, or better still, grind it between your teeth, (soils are usually quite clean!) and you will be able to tell if the particle size is coarse or fine. Clay soils feel smooth, and when damp, sticky; when dry, powdery. They will feel smooth between your teeth. Silt will feel slightly gritty in the mouth, but quite smooth in the hand. Sand is gritty in both hand and mouth.

Smell

This can identify the presence of organic matter, which has a musty smell, accentuated when the soil is damp and warm.

4.1.2 THE SAMPLE

Taking samples

Samples for analysis should be taken from the subsoil and never from the topsoil. Soils vary over short distances, and therefore several samples should be taken from the area where you expect to get soil for building. Because each soil profile may contain several soil types, note and test each layer. (Fig 4.1.) Each sample for testing should weigh about 20kgs, and more for detailed laboratory tests.

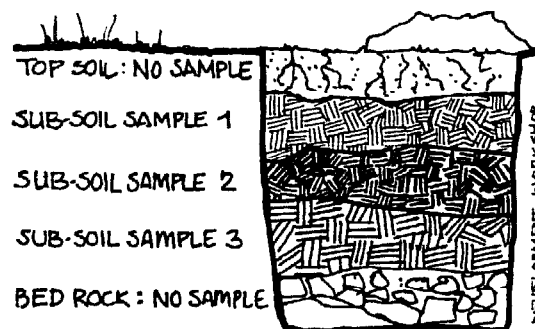

FIG. 4.1. SAMPLES FROM A TRIAL HOLE

Preparing the sample

Before doing any tests, break up any lumps in the soil in a wooden or rubber pestle and mortar. Soils for construction should contain few particles larger than 6.0mm, and these need to be removed by passing the soil through a 6.3mm mesh sieve.

A large soil sample can be divided into smaller samples by quartering, as follows:- divide a circular heap by two diameters, one at right angles to the other, so that there are four equal parts; remove two opposite quarters, and mix the other two together so that they contain a representative half of the original pile; repeat the process as many times as necessary to get smaller samples.

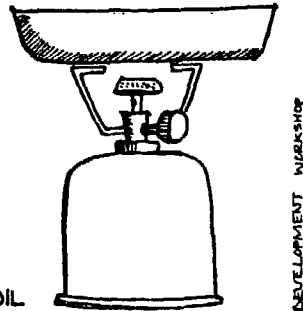

FIG 4.2. DRYING SOIL

Some of the tests which follow require the soil to be dried before or after testing. This can be done in an oven, at a constant temperature of 105 - 110°C, over a period of 8 hours or more, or in a pan over a gas or paraffin pressure-stove. Stir the soil around whilst it is drying, which takes an hour or more depending on its dampness.

4.2 TYPES OF TEST

There are three basic types of test that need to be done.

To determine the COMPOSITION of a soil, which will establish its basic characteristics and give an indication of its probable potential use.

To establish the PLASTICITY of the soil, which is particularly important when considering soil stabilization.

To establish the OPTIMUM WATER CONTENT of the soil, the level at which, when compacted, a maximum density is achieved, and therefore greatest strength.

4.2.1 SOIL COMPOSITION TESTS

- (i) PARTICLE SIZE ANALYSIS BY SEDIMENTATION/SIEVING:
with special equipment - medium to high accuracy.

A practical method for doing particle size analysis is by sedimentation and syphoning, to separate clays from gravel, sand and silt; and by sieving to separate the gravel, sand and silt from each other. Clays are too fine to be separated by sieving.

Equipment required:-

- graded soil-testing sieves;
- a balance accurate to at least 0.1 gms (preferably to 0.01 gms);
- soil drying equipment (see 4.1.2);
- one or more stainless heat-resistant drying dishes to hold the sample;
- a water supply (for wet sieving);
- a 1-litre graduated glass measuring cylinder, with an inside diameter of about 65mm;
- a circular metal disk on a stem which can be lowered down inside the cylinder;
- a rubber tube for syphoning material from the cylinder;
- a watch and a pinch of salt.

The Sedimentation Test: separation of clay by syphoning.

Method:-

Carefully weigh out a dry sample of 100gms, and put it in the cylinder. Add a pinch of salt to it, which helps disperse the clay grains. Add water up to 200mm mark. Close the top of the cylinder, with the palm of the hand or a cork, and shake the contents vigorously, end over end, until a uniform suspension of the grains is achieved. Put the cylinder down and time from this moment.

After 20 minutes lower the metal disk gently down to cover the material that has settled at the bottom of the cylinder, making sure not to disturb it. This in effect isolates the heavier and larger grained material - fine gravel, sand and silt - which has fallen to the bottom faster, from the fine grained material - clay - which is still in suspension. Now syphon off all the water and suspended material, dry it out and weigh it. Record the weight result as a percentage of the total weight of the sample to get the proportion of clay in the soil.

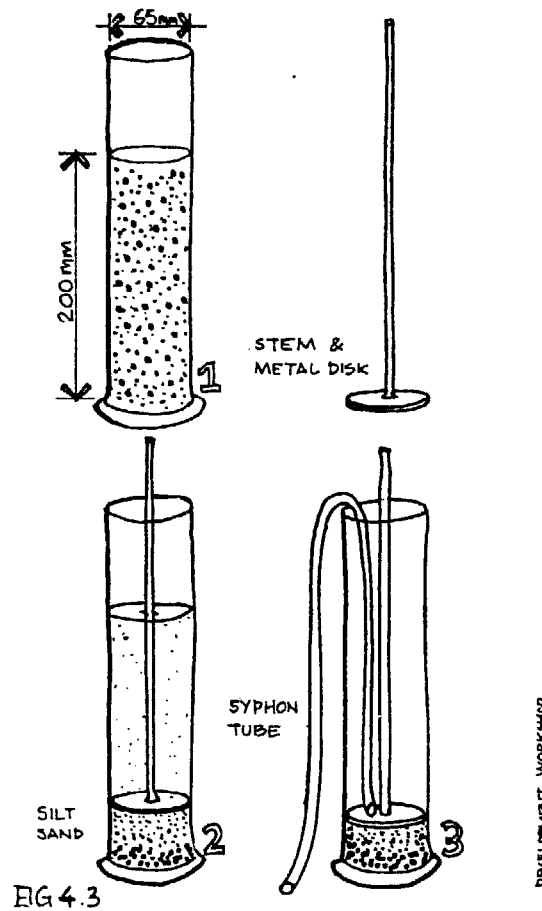

Dry Sieving: separation of gravel, sand and silt.

Method:-

Dry the portion of the sample which had settled to the bottom of the cylinder, and then sieve it to separate the gravel, sand and silt as follows. One needs at least two sieves: a 2mm mesh for separating sand from fine gravel, and a 0.063mm mesh for separating the silt from the sand. (Additional sieves can be used to sub-divide the sand into coarse sand - larger than 0.6mm mesh; medium sand - larger than 0.2mm mesh; and fine sand.) The sample is shaken in each sieve, and the portion which will not pass through the mesh is weighed.

It is permissible to try and break up lumps of finer grain material in order that they should pass, but nothing should be forced through the mesh. The proportion remaining in each sieve should be calculated as a percentage of the total sample and recorded on a chart. Material remaining in the 2.0mm sieve is gravel; in the 0.063mm sieve, sand; and material passing through the 0.063mm sieve, silt.

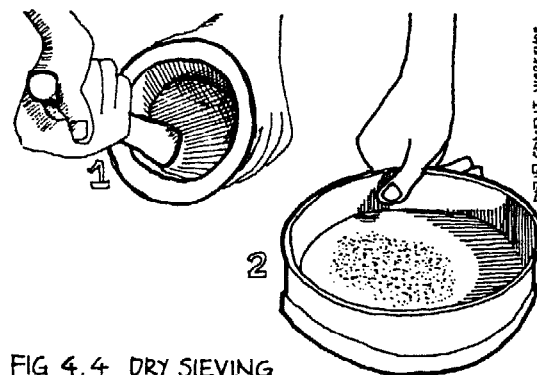

From these two tests - sedimentation and dry sieving - one has established the proportions of each particle group. A typical soil suitable for use in mud bricks could have the following proportions: sand 40-75%; silt 10-30%; clay 15-30%.

Wet Sieving: separation of gravel and sand from silt/clay.

Wet sieving gives a more accurate separation of gravel and sand from the silt and clay combined, because it uses larger samples, (1kg fine soil, 2kg coarse soil,) but it takes longer to do. It should be used for analysing lateritic soils in order to ensure that clay particles trapped in fissures on larger particles are washed out. Wet sieving is then followed by the sedimentation test to determine the silt and clay proportions alone.

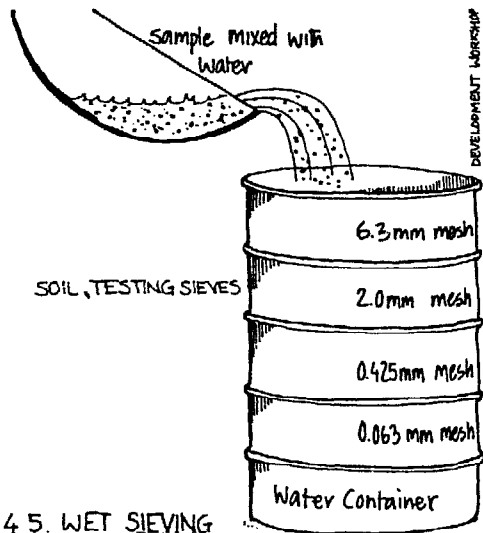

FIG 4 5. WET SIEVING

Method:-

Use the same sieves as for dry sieving. Place the sieves one on top of the other in descending order, with the finest mesh at the bottom. Place them over a container to catch the water and the material passing through the finest sieve. Mix the soil sample with water, and wash it through the sieves. Dry and weigh the portions of gravel and sand remaining in each sieve. Dry the silt and clay which have passed through the 0.063mm sieve into the container, and separate them from each other with the sedimentation/syphon test as above.

(ii) SIMPLE PARTICLE SEPARATION BY SEDIMENTATION:

minimum equipment - low accuracy.

A simple method for getting an indication of the particle distribution of a soil with no specialist equipment is the "jar" test.

Equipment required:-

- a straight-sided, flat-bottomed glass jar, the narrower and taller the better;
- measuring tape or scale;
- a watch and a pinch of salt.

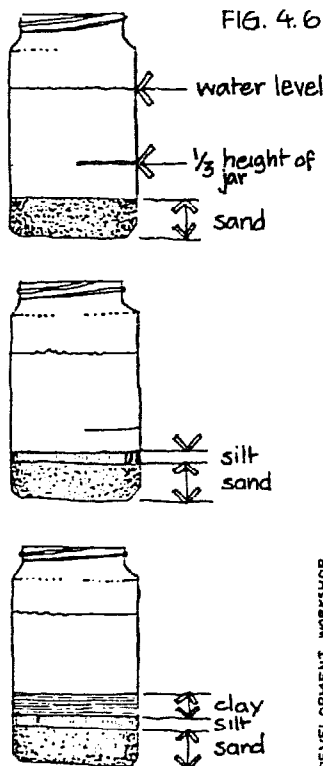

FIG. 4.6

Method:-

Mark off on the side of the jar one third of its height and record the height, (H). Fill the jar with dry soil up to just above the $\frac{1}{3}$ mark. Compact the soil slightly and remove any soil above the $\frac{1}{3}$ mark. Add water till the jar is about $\frac{3}{4}$ full: more and one later risks spilling it. Add a pinch of salt, and mix the soil, salt and water together. Then with the top sealed, shake the jar vigorously until the soil particles are in suspension and let it sit for an hour. Then shake the jar vigorously again, put it down, and time one minute. When 1 minute is up, mark on the side of the jar, without moving it, how much soil has settled to the bottom. This amount (T1) is fine gravel and sand. Keep timing. After 30 minutes, mark again how much soil has settled to the bottom. The new total (T2) is fine gravel, sand and silt together. After 24 hours, mark again how much soil has settled to the bottom. This new total (T3) includes fine gravel, sand, silt and clay.

The depth of clay = T3 - T2;

The depth of silt = T2 - T1.

Divide each depth by the total (H) and multiply the result by 100 to get the percentage proportion of each particle size. Record the result. Repeat the test with another sample and compare the result.

This same test is often explained without timing, and the results obtained by visually identifying the different layers and measuring them. If the layers are visible, compare the result with the timed results, but timing is important because in many soils, particularly dark ones, the critical separation between silt and clay will not be visible.

The results of the "jar" test should always be complemented by the other simple tests given below: 4.2.2 (ii) Dry Strength Test; 4.2.2 (iii) Ribbon Test; and 4.2.3 (ii) Drop Test.

4.2.2 PLASTICITY TESTS

The particle size analysis on its own will not indicate how a soil will behave. The consistency of clay in the soil relative to its moisture content varies according to its mineral and chemical composition. To work with a soil one needs to find out its 'liquid limit' and its 'plastic limit', and consequently its 'plasticity index'.

- The LIQUID LIMIT is the moisture content at which a soil passes from a plastic state (soft solid) to a liquid state (when it begins to flow).

- The PLASTIC LIMIT is the moisture content at which a soil becomes too dry to be in a plastic state.

- From these two states one can calculate the PLASTICITY INDEX of a soil.

(i) THE 'ATTERBURG' TESTS:

special equipment required - medium to high accuracy.

Equipment required:

- the laboratory apparatus used to work out the liquid limit, (the Casagrande apparatus,) can be approximated in a field laboratory with a curved dish and grooving tool (or knife) as shown in Fig 4.7;
- a soil testing sieve with a mesh of 0.425mm;
- a balance, accurate to at least 0.1 gms, preferably to 0.01 gms;
- two water proof, air-tight containers: one large enough to hold 200 - 250gms of soil, the other at least half the size;
- soil drying equipment, (4.1.2);
- a rod, diameter 3mm and length 100mm (useful, not essential);
- a blade, preferably bendy;
- a smooth, flat surface, such as glass, about 200 x 200mm;
- clean water.

FIG 4.7

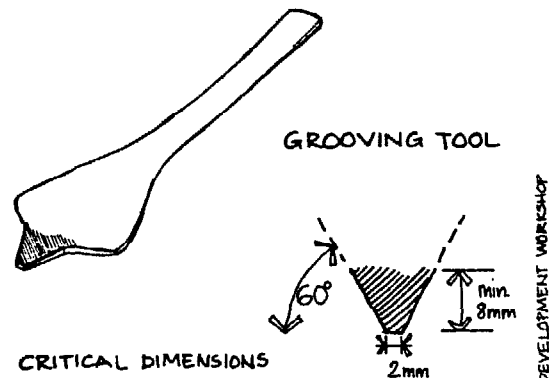
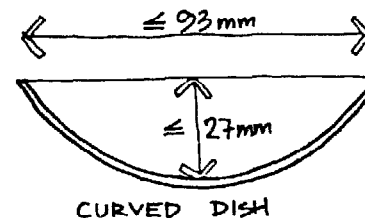

Use a sample weighing 200gms which has passed through the 0.425mm sieve for these tests.

To establish the Liquid Limit

FIG 4.8



FIG 4.9

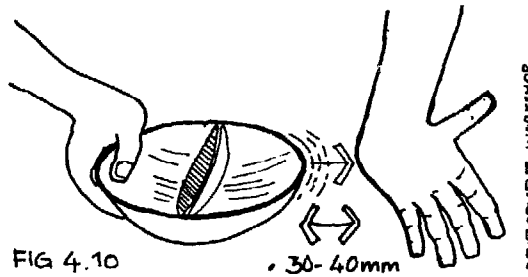
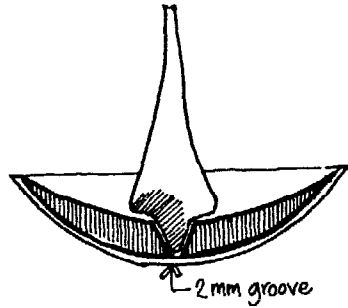

FIG 4.10

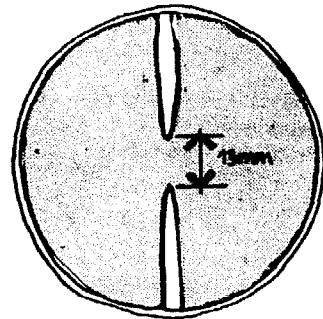

FIG. 4.11

Method:-

Mix 70gms of the sample with drinkable water to the consistency of a thick paste. Smooth the sample into the curved dish to a maximum depth of 10mm. (Fig 4.8.) Separate the mixture into two equal portions by drawing the grooving tool across the diameter of the dish. This should leave a V-shaped groove, with a gap at the bottom 2mm wide, and slopes to the groove at an angle of 60° from horizontal. (Fig 4.9.) If you don't have a suitable grooving tool, carefully use a knife blade to make as accurate a groove as possible.

Hold the dish firmly in one hand with the groove in the soil pointing away from you. Then tap the dish slightly with a horizontal motion against the heel of the other hand 10 times. The dish should be moved a distance of about 30 - 40mm to strike against the other hand, which should remain still. (Fig 4.10.) If it takes more than 10 taps to make the groove flow together, the soil is too dry: add a little water. If it flows together with less than 10 taps, it is too wet: add more dry soil. When the moisture content of the soil has been adjusted so that the two portions of soil come into contact at the bottom of the groove along a continuous distance of 13mm after 10 taps, (Fig 4.11) the soil is at the liquid limit (*2).

Put the sample into a sealed container, weigh it, subtract the weight of the container, and record the result. Now dry the sample thoroughly and record the dry weight. The liquid limit is calculated by dividing the water content (i.e. the weight difference between wet and dry samples) by the dry sample weight, and multiplying the result by 100 to get the percentage.

To establish the Plastic Limit

Method:-

Take about 5gms of the sample. Mix it with water into a thick paste, moist enough to be malleable but not sticky. Mould it into a ball and then roll it between the palms of the hands until it begins to dry and crack. Now divide the sample into two equal parts and do the following test for each part.

Mould the sample into a roll, about 6mm in diameter, and about 50mm long, and roll it between the fingertips and the smooth surface, with enough pressure to reduce the diameter to 3mm, keeping the pressure constant.

Use the rod to check the diameter. The sample is too wet if it can be rolled to 3mm or less without breaking, and too dry if it breaks when it is still thicker than 3mm. Wet (by adding water) or dry (by rubbing between the palms) the sample accordingly. The plastic limit has been reached when the sample breaks into pieces just over 10mm long at a diameter of 3mm.

FIG 4.12
THREAD TEST

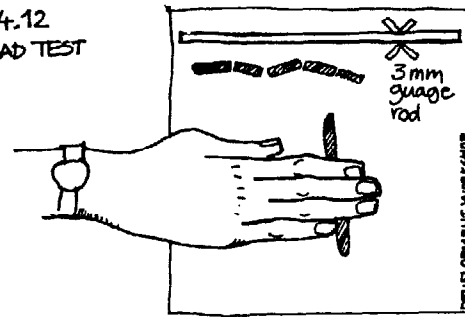

Quickly take the sample, put it in an airtight container and weigh it. Subtract the weight of the container and record the result. Dry the sample and weigh it again. The plastic limit is the weight of the water (the difference between the wet and dry weight) divided by the dry sample weight, and the result multiplied by 100 to get a percentage. If the results from each half sample differ by more than 5%, do the test again.

A quick indication of a soil's characteristics can be made as follows: Proceed with the above test to establish the plastic limit of the soil, until the thread breaks at 3mm diameter. Now quickly take the broken thread and remould the material into a ball in your hand. If the resulting ball crumbles easily or cracks when squeezed it is normally suitable for use in building. If the ball is hard or difficult to crush, there is too much clay and the soil will require modification. These results can be compared with the results of the Dry Strength Test 4.2.2 (ii).

To calculate the Plasticity Index

Subtract the plastic limit from the liquid limit:

$$PI = LL - PL.$$

The plasticity index is useful for determining the type and amount of stabilization a soil will need. This is affected by the amount and type of clay there is in the soil. The liquid limit, plastic limit and plasticity index for each soil tested can be marked on the Atterberg Limits Chart (Fig 4.13). See 8: Stabilization, for the application of this information.

SOIL EXAMPLE
LIQUID LIMIT = 32
PLASTIC LIMIT = 21
PLASTICITY INDEX = 11

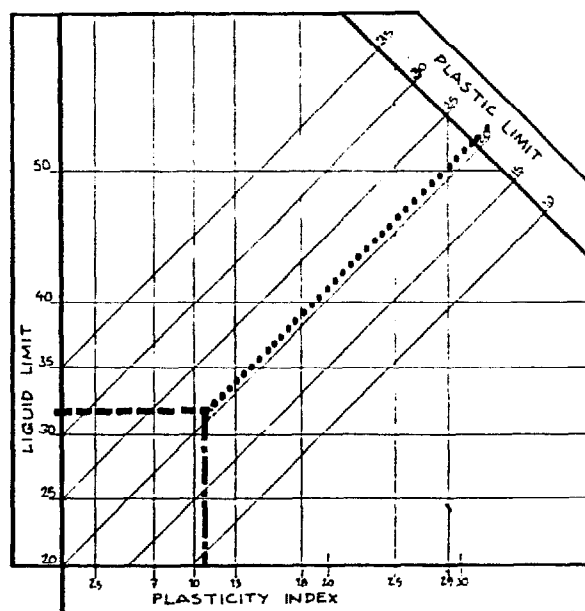

FIG 4.13. PLOTTING A SOIL ON THE ATTERBERG LIMITS CHART

(ii) DRY STRENGTH TEST:

minimum equipment - low accuracy.

This can be used to check the plasticity of a soil, with no equipment other than a 0.425mm mesh sieve, and is a crude guide to the appropriate type of stabilization to use (see 8: Stabilization).

Method:-

Take a soil sample where grains larger than 0.4mm have been sieved out, moisten it, and form it into a ball about 20mm in diameter. Dry the ball out in the sun (or in some other form of radiant heat). Try to break and crumble the dry lump with your fingers, and observe the result:

- if the lump crumbles easily, this indicates low strength and low clay content / high fine sand and silts content: cement and bitumen could be suitable stabilizers; the soil is generally suited to compaction;
- if the lump is crumbled with difficulty, this indicates medium strength and clay content, with silty or sandy clay: stabilize to reduce movement; the soil is suited to mud brick and, if crumbled without too much difficulty, good for compaction;
- if the lump cannot be crumbled, this indicates high strength when dry, due to a high clay content, but the soil is likely to swell when wet: it will be difficult to use, requiring considerable additives (lime, sand, straw) and/or compaction for use.

(iii) RIBBON TEST:

no equipment - low accuracy.

FIG 4.14

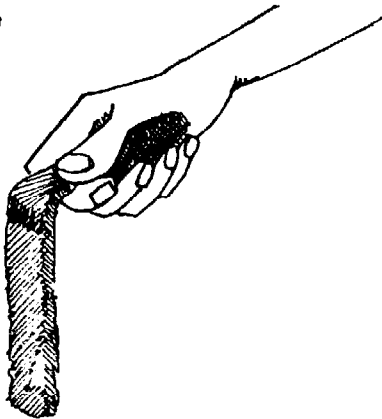

This is a simple way of testing the soil on site.

Method:-

Take enough soil to form a roll about the size of your thumb but about 2 or 3 times longer. Wet it slightly until it is still firm but damp. Put the roll in your hand and flatten it between thumb and forefinger to form a ribbon of 3 - 6mm thickness. Push the ribbon that results out in front of your thumb and forefinger.

See how long the ribbon gets before it breaks:

- a long ribbon, 25 - 30cms, indicates a lot of clay, and a soil generally unsuitable for load-bearing construction. The soil is likely to crack when drying, and to be susceptible to moisture: a stabilizer will be needed;
- a short ribbon, 5 - 10 cms, suggests soil normally suitable for building; within this range, the longer ribbon would be better suited to mud bricks, the shorter ribbon better suited to compaction;
- no ribbon at all means there is not enough clay and the soil is unsuitable for load-bearing construction. It requires modification (by adding sand, stabilizing, high compaction etc.) to be acceptable for use.

4.2.3 TESTS TO ESTABLISH THE OPTIMUM WATER CONTENT

The amount of water in the soil at the time of moulding is important, and has a direct bearing on the strength of the finished wall. The compressive strength of a wall or block improves with an increase in the dry density of the soil (the weight of solid material in a given volume). At a given amount of compaction, there is an optimum water content at which the maximum dry density of soil is obtained. With too much or too little water efficient compaction will not be achieved.

There are two straightforward methods for establishing the optimum water content.

(i) COMPACTION TEST:

equipment required - good accuracy.

Using a mould of a given volume and a constant amount of compaction, soil samples can be tested by varying the water content until the maximum density is obtained.

Equipment required:-

- a balance accurate to at least 0.1 gms (an accuracy of 0.01 gms is better);
- a straight-edge;
- a mould of the basic dimensions shown in Fig 4.15, (which gives a volume of $1000\text{cm}^3 = 1 \text{ litre}$), and with a removable upper extension to contain the loose earth whilst tamping;
- a tamp with a 50mm diameter base and weighing 2.5kgs;
- soil drying equipment (see 4.1.2) and a metal drying tray big enough to hold the sample.

Method:-

Weigh the empty mould and base (weight = W1).

Arrange the tamp so that it falls from a controlled height of 300mm above the sample. This can be done with the guiding tube, up which the weighted tamp face is pulled to the required height. The tube rests on the soil, and can be moved around.

Start either with a very dry mix or with a wet mix, and carry out tests increasing or decreasing the moisture content accordingly. Mix each sample dry, adding any stabilizer, and then sprinkle water to get an even mix. Fill the mould about 70mm deep and compact. The mould should be eventually filled with three compacted layers each about 38mm deep, so experience will indicate how much soil to start with for each layer. Compaction is done by letting the tamp fall freely from 300mm onto the soil, a total of 25 times over the whole sample area. Repeat until the mould is full. The extension on top of the mould is used to contain loose soil during compaction. When compaction is complete, remove the extension and remove any excess soil above the top of the mould. Quickly weigh the sample and the mould (W2). Subtract the weight of the mould to get the wet block weight (W3):

$$W3 = W2 - W1$$

FIG. 4.15 OPTIMUM WATER CONTENT TEST

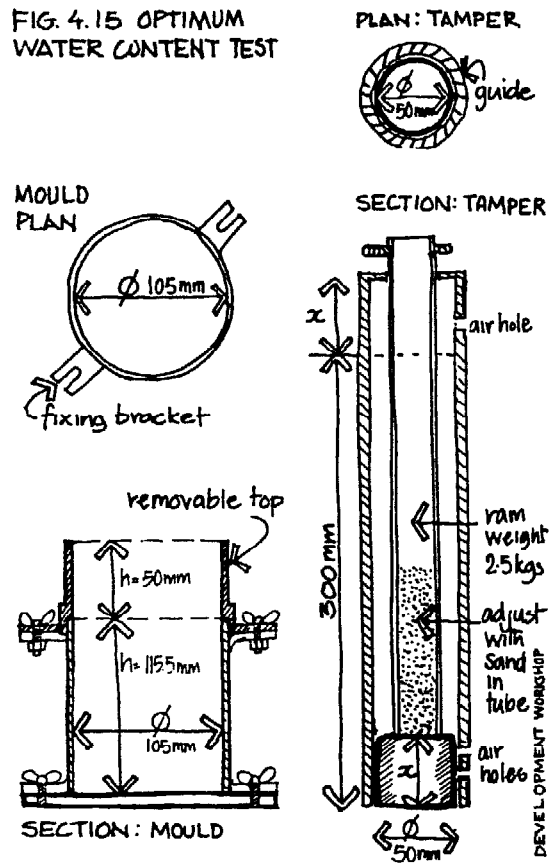

Place the soil sample on the drying dish taking great care that no material is lost. Dry until no further weight change occurs and weigh the sample. This is the dry weight (W4). The moisture content (M) is calculated as follows:

$$M = (W3 - W4) \div W4.$$

Multiply the result by 100 to show as a percentage. Because the sample volume was 1 litre, the proportional water content can be shown as a liquid volume which facilitates applying the results on site if soil measuring boxes are used.

Keep repeating the tests until a maximum dry weight value (W4) is achieved: this will indicate the optimum water content.

(ii) DROP TEST:

no equipment required - medium accuracy.

Method:-

Take soil that has had some water added to it. Squeeze the damp soil into a ball in your hand. Then with your arm straight out at shoulder level, drop the soil ball onto a smooth clean surface at ground level and observe the result:-

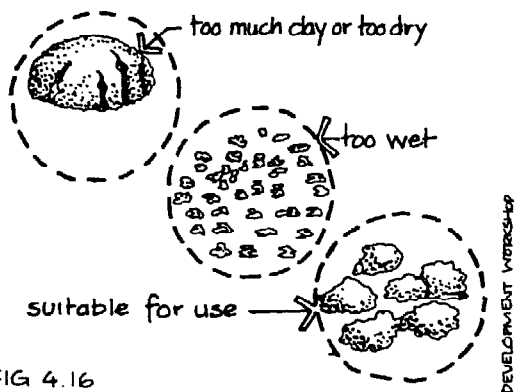

FIG 4.16

- if the soil stays in one piece it is too dry: add water and try again;
- if the soil is still in one piece the clay content is too high;
- if the soil breaks into many pieces, it is too wet: leave it to dry a while and try again;
- when the dropped ball breaks into only a few pieces it is close to the optimum water content, and suitable for use.

Continue to use the drop test to check the water content of the soil as it is being used.

*1 British Standards Institution. BS 1377: Methods of test for Soils for Civil Engineering Purposes, London, 1975.

*2 Stulz R. Appropriate Building Materials, Intermediate Technology Publications Ltd. / SKAT, 1983.

5. PERFORMANCE & PERFORMANCE TESTING

There are at present no internationally accepted norms for building with earth. It is arguable to what extent they would be useful, given the variations in conditions of use and requirements. The figures given below, however, indicate what performance can be reasonably expected with stabilized and unstabilized soils. In many cases, to meet national standards for material performances or the specific needs of a building, higher strengths may be required and can be achieved, although not always economically. The tests given here can all be set up without complex equipment and are therefore suitable for monitoring materials performance on site without dependence on a laboratory.

5.1 VISUAL ASSESSMENT

Bricks and blocks should be of uniform size. Mud bricks should be strong enough to stack, transport, and handle without undue care on site. The edges should not break off easily. For both mud bricks and rammed earth there should be no signs of slump or expansion, which are the result of moulding too wet or of the wall being built up too fast. Some cracking is likely in mud bricks: one guideline (*1) suggests a maximum of 3 cracks per brick, no more than 3mm wide and 76mm long. One can add that any bricks with cracks more than half their width should be rejected or broken and used as half bricks.

5.2 COMPRESSIVE STRENGTH

Suggested dry compressive strength values for unstabilized mud brick are at least 15kgs/cm², and ideally 20kgs/cm² or more, after 1 month curing (*2). Compressive strength values for stabilized soils are given as wet strengths, since this is the critical strength condition. These values should be at least half the dry strength value. A suggested minimum for cement stabilized blocks is 14kgs/cm² wet compressive strength after 1 month (*3). Much higher strengths can be achieved and may be necessary. Lime achieves its strength more slowly than cement: double the time before testing.

Method:-

For stabilized earth the sample should be immersed for 16 hours in cool water and then allowed to drain for 30 minutes before testing. Unstabilized earth should be tested dry.

If using laboratory compression testing equipment, the sample should be placed between two plywood sheets 2.4 - 4.8mm thick, which just overlap the edges of the sample, and then positioned in the equipment.

When the very large weights required to do compression tests on full size blocks are not available, it is common to make small test samples, 50mm in diameter or square, and 50mm high. If these cannot be made on site, use a saw or mason's axe to cut a larger sample or block into roughly the right size and measure its surface area.

Practical equipment for compression testing using a lever system is shown in Fig 5.1. Cover the sample with plywood or a board 20mm thick (more for larger samples). Place weights on the end of the lever arm, or suspend them from it.

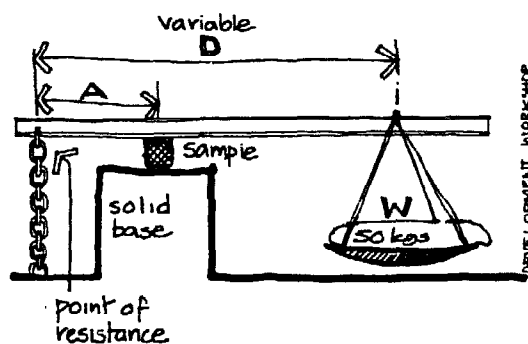

FIG 5.1. APPARATUS FOR COMPRESSION

Calculate the compression (C) as follows:

$$C = W \times (D \div A)$$

where -

W = weight;

D = distance from weight to point of resistance (variable);

A = distance from point of resistance to centre of the sample (300mm).

Compression is increased by increasing either W, or D, or both, until the sample fails. Divide the compression by the surface area of the sample for the result. Test five samples for an average compressive strength.

A simple quick field test for wet stabilized bricks is to try and scratch the brick surface with one's thumbnail. Normally no mark should appear on a brick intended for one or two-storey construction. However, an exception should be made in very dry regions, where a scratch on the surface might not suggest an unacceptable brick.

5.3 RESISTANCE TO WATER EROSION

The spray test is a practical way of determining resistance to water erosion.

Method:-

Set up a 100mm diameter shower head at a distance of 180mm from the surface of the test sample, and spray the whole surface at a pressure of 1.4kg/cm² for two hours. After two hours examine the block. For unstabilized surfaces the results can be interpreted as follows.

- Pitting 6 - 12mm deep is acceptable for use in areas with less than 500mm rainfall p.a.
- Pitting 0 - 5mm is acceptable for use in areas with 500 to 1250mm rainfall p.a.
- In areas with rainfall higher than 1250mm p.a. there should be no pitting.

For a more rigorous test on stabilized surfaces, do the same test but keep spraying for 6 hours, and then interpret the results as above.

Do these tests on at least five identical samples to establish an average.

Materials which fail will need rendering, and renders which fail will require regular maintenance and alternatives should be sought.

5.4 BENDING STRENGTH OR 'MODULUS OF RUPTURE'

There are straightforward tests to establish how much central pressure a brick or block supported at its two ends can take before it breaks. The resulting 'modulus of rupture' value for mud brick should be at least 2kg/cm², and preferably between 3 and 3.5kg/cm².

Method:-

Place a brick or block across the gap between two parallel bars 250mm apart, (less with smaller bricks). With a third bar, apply pressure, using weights or compression equipment, evenly across the middle of the brick (Fig 5.2). Record the pressure (or weight) at which the brick breaks. Calculate the modulus with the formula (*4):

$$M = 1.5 \times 250\text{mm} \times \frac{\text{pressure}}{\text{width} \times \text{depth}^2}$$

(Note: 250mm is a variable.)

FIG 5.2

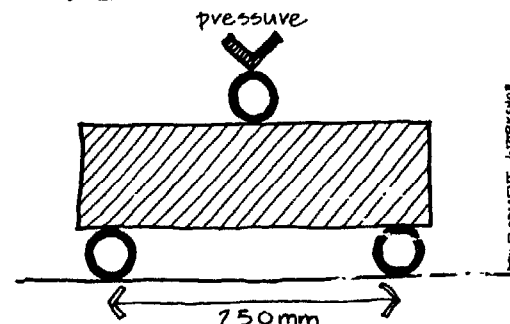
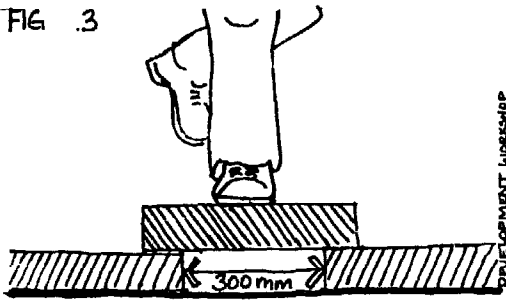

FIG 3



Test three or more samples for an average.

A practical alternative for large blocks is to set the block up in the same way on two supports, and stand on it to apply pressure. (Fig 5.3.) With large blocks space the supports 300mm apart to compensate for the foot's extra width. Don't use a person who is very light!

5.5 MOISTURE ABSORPTION

Stabilized earth should have a low moisture absorption rate: between 2 and 3% is good, and 4% is the limit in wet regions. Absorption can be measured by weight.

Method:-

Take five samples, either whole blocks or, preferably, smaller samples as they can be dried out more quickly. (This applies to rammed earth as well.) Weigh each sample and then dry it out until no further weight reduction is recorded. Then expose the samples to constant saturation or immersion for 7 days, and weigh them again. The absorption is the increase in weight of the wet sample as a percentage of the dry weight. Average the results from the five samples.

In the absence of accurate weighing equipment, absorption can be assessed by the dimensional difference between a dry and a wet sample. Prepare the samples in the same way as above, and accurately measure the dry and wet dimensions. Expansion when wet should be at most 0.2% for stabilized compressed blocks, and 0.1% for in-situ rammed earth (*3).

*1 USAID Department of Housing and Urban Development.

*2 Development Workshop. "Mud brick vault and dome construction," unpublished material, Architectural Association, London, 1973.

*3 Fitzmaurice R.F. Manual for Stabilized Soil Construction for Housing, UN Technical Assistance Programme, New York, 1958.

*4 Doat P. et al, CRATerre. Construire en Terre, Paris, 1979.

6. WALL CONSTRUCTION

Wall construction is the most common use of earth. Walls can be divided into two groups:-

- combination walls, where the earth is used in combination with a supporting organic framework, usually resulting in a thin wall;
- and load-bearing walls, usually relatively massive and thick.

In addition to the methods shown below, there are various other techniques which have at one time been common in a particular area, but which are not currently in widespread use, and therefore not dealt with in detail here. These include, for example, wall building with turf or 'sods', and trogloditic construction where the building is actually excavated.

6.1 COMBINATION WALLS

6.1.1 WATTLE AND DAUB

This is one of the simplest and cheapest forms of wall construction. For many people in Africa and Asia it is the only way they can afford to build, and therefore for this reason alone should not be ignored. It is a technique which is increasingly associated with poverty, although this need not be the case: many examples are of durable and good quality. There are numerous regional variations.

FIG. 6.1. WATTLE AND DAUB

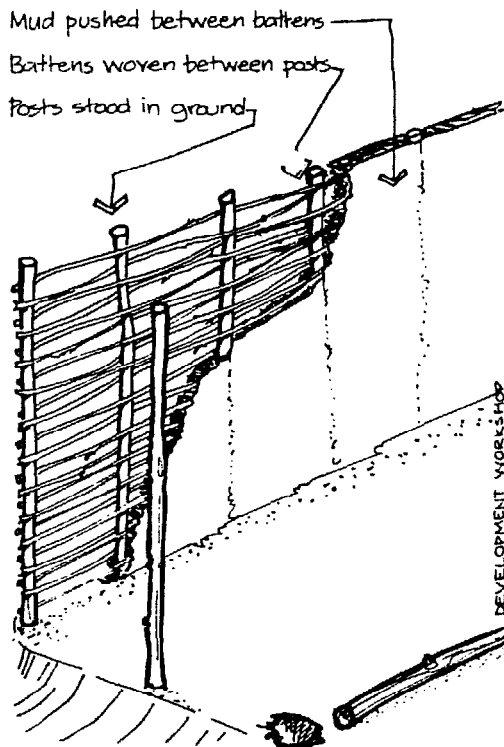

The structure of the wall is provided by a framework of vertical posts set into the ground. Branches, reeds or bamboo, (depending on what is available), are woven horizontally between the posts to form a lattice. Mud is applied to the framework on both the inside and the outside, at a sufficiently wet consistency for the mud to be squeezed between the branches. (Fig. 6.1.) Walls are usually thin, 100 - 150mm. Soils similar to those used for mud bricks are suitable (see 6.2.2), of which soils with a higher clay content can be used, because the framework largely negates the effect of shrinkage in the soil. Mud is applied in layers, and cracks which occur in earlier layers can subsequently be filled in. Vegetable fibres, straw or animal hair are often mixed in with the mud to help it bind. The wall is finished off with a plaster, usually mud-based, and when possible using a sandier soil than used in the bulk of the wall.

Buildings with this wall system have lightweight roofs, usually thatch or corrugated sheeting. The thinness of the walls means that they do not have the same thermal mass normally associated with earth wall construction, but this is not necessarily a disadvantage, especially where there is no great daily range in temperature.

The main advantages of this wall system are that it is a simple and cheap way to build walls.

- Little skill is required and work can be done single-handed.
- Relatively small amounts of earth are needed, which is important where earth is not available on site.
- Framework can be made of slight and irregular pieces of wood, thus potentially obtained direct from the countryside or by scavenging.
- The framework provides resistance to collapse in an earthquake, although not when the wood has been eaten by termites.

There are several disadvantages associated with this type of construction.

- Because the wooden framework is in direct contact with the ground, deterioration is often caused by termites and by fungal decay. Although wattle and daub walls can last for 30 years or more, damage to the framework can reduce this to as little as 2 or 3 years.
- The framework often lacks rigidity, or is too insubstantial to support the weight of mud. In either case distortion of the frame causes the mud to fall off.
- Maintenance and replastering annually is normally necessary because of movement in the structure.

Fire is often cited as a problem, but the mud plaster actually protects the framework, and considerably delays combustion. Tests on date palm panels, for example, have shown destruction by fire at just over 1 minute for unprotected material, and limited damage by fire after 18 minutes for a panel plastered with mud (*1).

Several precautions should be taken, when means permit, to improve the durability of the framework and thus extend the life of the wall. Diagonal bracing should be used to avoid distortion of the framework. Substantial horizontal framing at 1m intervals creates smaller panels to be filled in with branches and mud. This reduces both the vertical weight of the material on weak wattle and the risk of frame distortion, both of which cause the mud to fall off.

The durability of timber varies from place to place, and local knowledge may be the best guide of what to use. Fungal decay cannot occur where the moisture content is less than 20%, so make sure that the base of any building is well drained. Ideal protection against subterranean termites is to create a barrier between the ground and the timber. In all cases remove the bark of wood. Preservatives, which may be difficult to obtain, can be used to protect timber. The most common are: tar-oil (creosote) used diluted 1 part to 3 parts gasoil or 2 parts petrol or kerosene; and poisons, of which the best known are Dieldrin and Aldrin, either of which can be diluted in a ratio of about 1:40 with water. These are all best applied under pressure, but can be painted on. They work most effectively on dry woods. The same mixtures can be mixed into the ground at the base, but will slowly be washed out by rain.

In some traditional construction infill panels for wattle and daub have been made with bundles of straw, plastered over with mud. A similar and more recent development has been to make small prefabricated panels using large amounts of straw bound by a high clay soil in a ratio (by weight) of 1 part straw : 8.5 parts soil, mixed in in liquid state (*2).

6.1.2 DOUBLE-LAYER FRAMEWORK WITH MUD INFILL

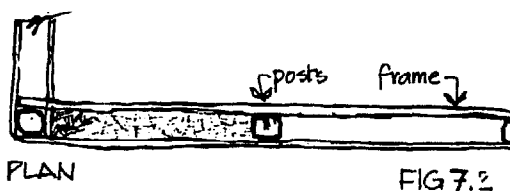
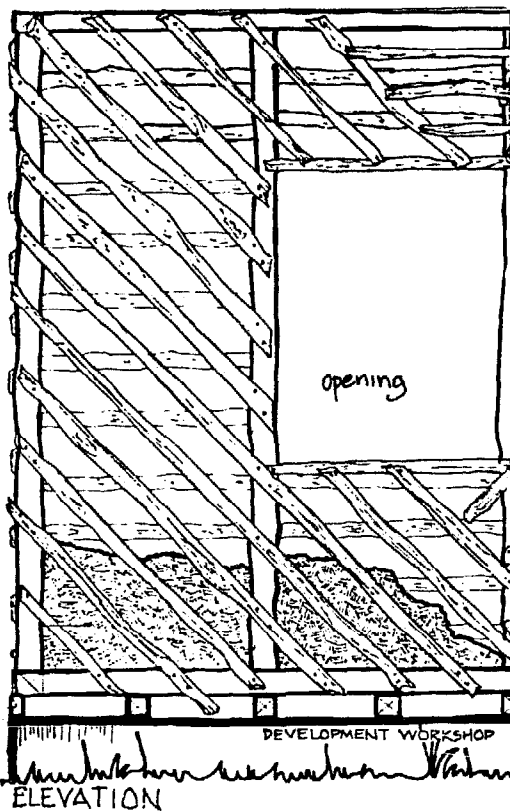

FIG 7.2

This is a system where mud is packed into the space between two retaining faces of framework. A load-bearing structure is built with timber (or bamboo) posts, and beams (Fig 6.2), preferably erected on a solid plinth of stone or brick. In poorer versions of this technique the posts are placed directly in the ground. Horizontal and diagonal slats of wood or bamboo are nailed at close intervals on either side of the posts. The spacing of the vertical posts depends upon the width of the slats: 40mm wide bamboo slats need posts at about 0.3m centres, with gaps between the slats of about 60 - 100mm, whilst more substantial wooden slats (80 - 100mm) can have posts as far apart as 0.8 - 0.9m. The interior of the framework is then filled with mud, by hand in lumps, or, on wider walls, with a spade, and packed down tightly so that the mud pushes out between the slats. The walls are usually about 150 - 200mm thick. The earth used should have at least enough clay to bind it and can be similar to that used for wattle and daub. Straw, vegetable fibres or animal hair is sometimes added. It is not uncommon to see stones and fired bricks included as well. The surface of the wall may or may not be plastered. The strips not only support the mud, but also protect it from impact damage and to some extent from water erosion. The roof is supported on the framework, not the mud infill, and should be lightweight: thatch, tile or metal sheeting are common.

In comparison to wattle and daub, this wall method tends to require larger amounts of earth, and a more substantial framework. It is not uncommon to see wattle and daub used for outhouses and the double framework used on houses. Because the mud is contained by the framework rather than sticking to it, this system is in general stronger than the wattle and daub, and less susceptible to movement. The framework provides good resistance to the effects of an earthquake.

There are the same problems of termites and fungal decay, and the same precautions should be taken. However, because the slats are visible, they can be replaced when damaged without dismantling the wall. The use of a plinth reduces the detrition rate of the organic material.

6.2 LOAD-BEARING WALLS

6.2.1 DIRECT MOULDING

This is a wall building system where earth in a plastic state is piled up, shaped and compacted by hand without the use of any confining framework. The resulting earth wall is load-bearing and carries the weight of the roof. There are two basic versions of this method of building with earth: one used for thin walls, and the other for thick walls.

Thin moulded walls

These are widespread in sub-Saharan and central Africa, but now tend to be used more for building granaries than houses.

Round buildings are constructed in a way similar to coil pottery. The walls are built up in successive rings, 0.4 - 0.5m high, made up of individual rolls or lumps of earth, pressed into place by hand, and then smoothed to the desired finish either by hand or with a stone or piece of wood. The base of the wall, either of stone or mud, is between 0.15 and 0.40m thick, tapering to 0.05 - 0.20m thick at the top. The walls usually taper inwards. In some cases the sides of the wall are smooth, in others the exterior face of each successive layer slightly overlaps the layer below. Soils used should contain 50-75% sand and silt, and lateritic soils are favoured because of their quality of hardening when exposed to air. Straw is usually added, especially to the higher clay content soils, and traditionally a variety of other substances have been added to the soil (see 9: Renders.) Enough water - approximately 20%, is added to achieve a plastic mouldable consistency, and the mixture is puddled with the feet and left to soak for at least 24 hours, before being used. Two assistants work on preparing the soil and moulding it into lumps which are thrown to the builder who places the lump on the wall and pushes it into the desired shape.

Each layer is left a day or two to dry before the next layer is added. The finished wall is plastered (see 9: Renders). In the past this technique was used to build complete domed structures, but thatched roofs are now more common. This technique makes economical use of soil and uses little or no organic material. Very little special equipment is needed, but skill is required. In areas where wood and branches are scarce, it remains a common way of building stores. It is not suitable for the construction of straight walls.

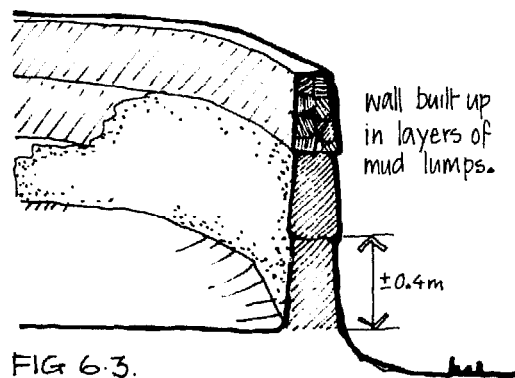
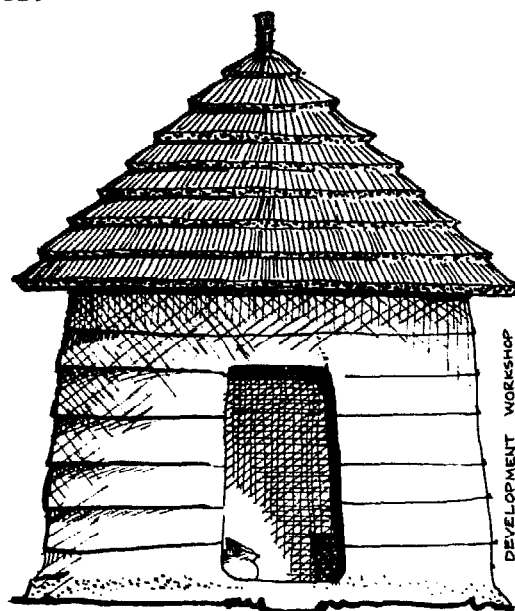

FIG 6.3.

Thick moulded walls

Substantial load-bearing earth walls can be built without the use of any formwork. In Iran, walls 8 or more metres high have been built with this system to shelter ice-making ponds, and it remains a common domestic wall-building method. In the Yemen, an almost identical system, characterised by stepped up corners, is used to build houses several storeys high. In Southwest England, a similar method - Cob - was once common for house-building.

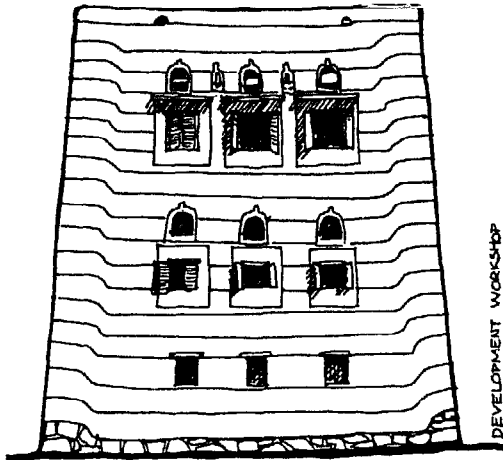
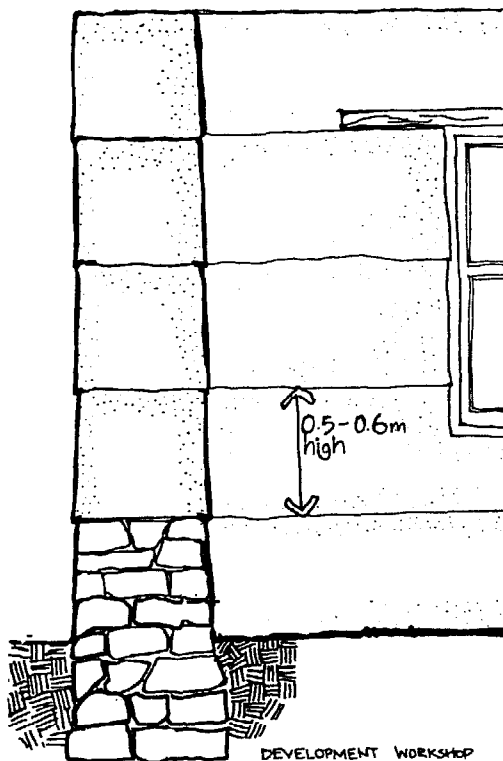

FIG 6.4. HOUSE IN NORTH YEMEN

FIG 6.5. DIRECT MOULDING. CASPIAN IRAN



The walls are built up on a stone or fired brick foundation, rising 0.3 - 0.4m above ground level. (In the Yemen (Fig 6.4), the corners have stone built up an additional 0.6m, which raises each successive layer of mud at the corners as well, and in other areas it is common to see a similar, although less accentuated, corner upstand. It has been suggested (*3) that this technique provides additional strength at the corners, and resistance to earthquake movement.) The top of the foundation should be no wider than the wall above it. The wall is often tapered. In Iran, for example, a 3-metre high wall could be as much as 0.75m wide at the base and only 0.3m at the top. With skill and care parallel walls can be built. Soil for this type of construction should contain about 20-25% clay, the rest fine and coarse sand and up to 20% gravel. Large stones should be removed. Straw or chaff is normally added: about 5kgs per lm^3 damp soil when the clay content is low, and up to 15kgs per lm^3 when the clay content is high. Water is added to achieve a stiff mouldable consistency (use the Drop Test, 4.2.3). The water/soil/straw mixture is left to soak in a pit at least overnight, and preferably for up to two days, which allows the fibre to soften and combine with the soil. Before use the soil should be kneaded into a plastic mass (with feet, or by an animal walking in it.) A large hand-compacted lump of mud is then handed, or thrown, to the mason, who in turn places it with force onto the wall, and pummels it into place so that there are no voids. A series of lumps make up the width and height of the layer. The sides are shaped by hand to the desired degree of smoothness. Each layer is about 0.6m high. (Fig 6.5.)

The completed layer is then left to dry, in warm weather for two days, before starting the next layer. In damp conditions it helps to make each layer thinner, which reduces the drying time, otherwise the drying time for each layer before work can continue becomes prolonged and makes this type of construction extremely slow. The sides of the completed layers are smoothed off by hand, or with a stick, knife or stone. In England a sharp pointed spade used to be used to trim off excess material on cob walls.

It is common for each layer to begin with a 50mm overhang on both sides of the layer below, so that the wall is built up in a series of tapered layers, without greatly reducing the overall width of the wall as it goes up. In some cases the layers are separated by a clearly incised band. Between the layers, timber poles can be placed to provide reinforcement, and in a similar way layers of split bamboo are also used to help tie the wall together. Any organic material should, ideally, be treated with some form of preservative, and at the very least used when properly dried.

Openings for doors and windows can either be allowed for as work progresses, or can have an enclosure framed by stone, brick or timber.

The finished wall must always be rendered, (see 9: Renders).

This is a building technique which, when done with care, can produce a strong and inexpensive wall. No special equipment is needed. Productivity depends upon the amount of time it takes to prepare the mud, but actual wall-building can go quite fast. Four men mixing and moulding can do about 3m³ in a day, provided the raw materials are at hand. Mud-mixing is often a family activity, which helps productivity. The main delays occur because of the drying time needed between building each layer.

Despite the simplicity of this technique, its major disadvantage is that, lacking compaction and consequently strength, these walls use a lot of both earth and water. If these are not available directly on the site, they require considerable transportation. When earth is excavated beside the building site, this leaves deep pits which can become rubbish tips and insanitary ponds.

6.2.2 MUD BRICKS

Mud bricks and blocks are the best known and one of the most versatile ways of using earth for construction. They have, over centuries, been used to build almost every type of domestic and public building. Perhaps significantly, these include fortresses, palaces, tombs and temples, some of which, already several thousand years old, are a testament to how excellent, in varied climates, this material can be.

In production, an advantage of mud bricks or blocks is that they can be made, if need be, at the source of the raw materials, and then moved to the building site more economically than moving loose earth and water. Other advantages are that a minimum of equipment is required to produce a good building material; one can test and select acceptable bricks before they are used in building; and the use of a small building element - the brick or block - permits great flexibility in the size and shape of the walls.

Mud bricks or blocks are made from wet earth, which is pushed or thrown into a mould, the mould removed and the brick left to dry. After several days, the bricks can then be stacked for immediate use or stored for use later.

Brick size and shape

The size should be chosen to suit the way the brick will be used. Whilst in some cases blocks are made to measure the full width of a wall, this is not so suitable where the structure demands a variety of wall widths, nor for tall building. Large blocks can be laid quickly on walls close to the ground, but a mason can often work faster high up with small bricks that can be thrown to him and laid with one hand. It is not uncommon to use two sizes of brick, for example, one for walls, another for roofing. In areas where there is a mud brick or block tradition a standard (or nearly standard) size brick may already be in use. Make sure that bricks or blocks are produced in moulds with consistent dimensions, since this is often not the case.

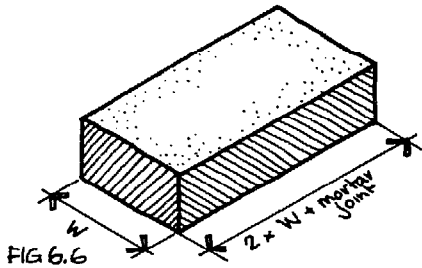

DEVELOPMENT WORKSHOP

Bricks or blocks can be square or rectangular. When square they should ideally be the same width as the wall, to simplify bonding without requiring much cutting of bricks. Small square bricks can be used in combination with rectangular bricks of half the width, although one then needs careful calculation for the number of each type.

Rectangular blocks, unless they are the same dimension as the width of the wall, should be made in the following proportion:

length = (2 x width) + mortar joint of 20mm. (Fig 6.6)

The dimensions of the brick or block can also be dictated by weight and strength, since large blocks which are too thin will handle badly: the depth should be 20 - 30% the length, and no less than 50mm on small bricks. Blocks weighing much more than 22kgs will tire out a man working with them all day. (A block measuring 400 x 190 x 100mm weighs about 13kgs.) However, the weight can be considerably reduced and the tensile strength of the block increased by adding straw, (see 8: Stabilization.)

The mould

FIG 6.7

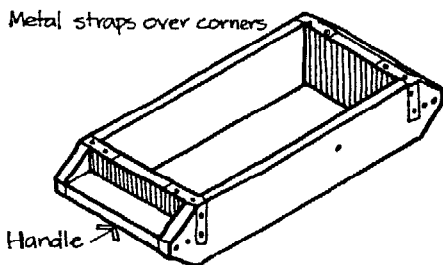
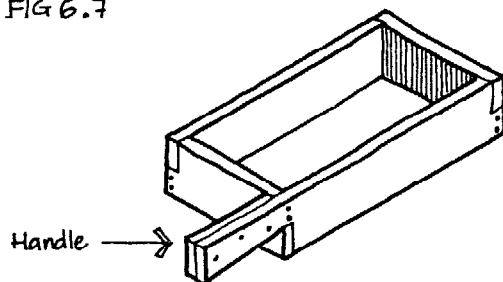

DEVELOPMENT WORKSHOP

The most commonly used type of mould has sides but no base, so that both the mould and the mud inside it rest on the same base, the ground or a table. The mould can be made of wood or metal. (Fig 6.7 shows typical examples in wood.) It must be solid enough to retain its shape, and to stand continuous use day after day. Wooden moulds can be reinforced with metal strips at the joints. The handles can also help provide rigidity. There are examples of multiple moulds for making many bricks or blocks at a time, but in practice it is easier to work with moulds making 1 to 2, or 1 to 4 blocks, as there is less probability of spoiling the moulded bricks as the form is removed.

For precise measurement, the mould should be dimensioned to allow for shrinkage. This can be determined from the Shrink Box Test, (see 8.2.1,) but in general 10mm on the width and length should be sufficient.

Moulds with a bottom are commonly used in forming bricks for firing, because the result is more precise, but they tend not to be used for unfired brick-making, in part because the production rate is slower, but also because, unlike in the case of a fired brick, it is easy to trim off any imperfections that result from using a bottomless mould.

Before using a wooden mould soak it in oil for 2 or 3 days.

The material

Use the soil tests to select a suitable soil. Top soil should not be used, and grains larger than 10mm should be removed by sieving. Suitable particle distributions are:

sand 40 - 75%
silt 10 - 30%
clay 15 - 30%

In soil used for brick-making, a higher sand content lowers moisture absorption and improves resistance to abrasion, whilst a high clay content provides cohesive strength. Sandy soils do not have sufficient cohesive strength to avoid crumbling, whilst clayey soils are susceptible to water and swell when wet, or shrink and crack when dry. Fig 6.8 shows how strength and water resistance change with different proportions of sand and clay. Ideally, one should try to choose a soil which combines these two characteristics in the way which best suits the intended use of the brick.

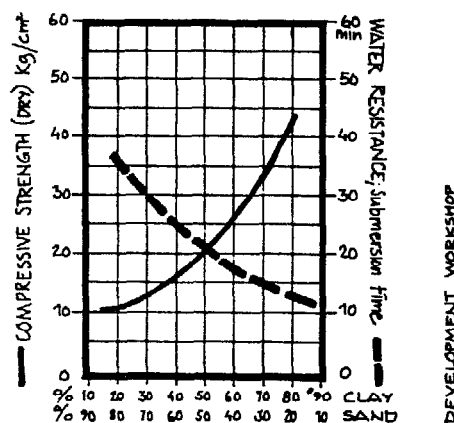

FIG 8 DIAGRAM OF MUD BRICK STRENGTH AND WATER RESISTANCE.

With a high clay content soil, one can add sand, if this is conveniently available. Straw can be added to reduce the risk of cracking when drying, to improve the tensile strength, and to lower the weight of the block. As a guide, allow 5kgs straw per $1m^3$ soil when the sand content is less than 50%, and as much as 15kgs per $1m^3$ if the sand content is as low as 30%.

The suitable moisture content for moulding can be established by the Drop Test (see 4.2.3.) The optimum water content will vary from soil to soil, but will be between 15 - 30%. One should allow at least $\frac{1}{3}$ the volume of the soil: for $1m^3$ blocks, allow 333 litres water. The block-making site should be as close as possible to a water supply, in order to avoid the cost and difficulty of water transport.

Production

The earth should be excavated and all organic matter and stones removed, if necessary by sieving, in which case the earth must be dry. It should be mixed in a large pit, about 2.5 - 3m in diameter, and 0.4m deep, which allows plenty of mud for a good day's production by one moulding team. Mix near to the source of the soil, and on the same spot if possible.

Add water, and straw if necessary, to the earth, and mix well together, either by puddling it with feet or with the help of a cow or oxen, well-suited to tramping through mud. Make sure any lumps are broken down. Leave the mixture at least overnight and preferably 24 hours or more, to soak. Mix again thoroughly, checking that the moisture content is right. At this

stage, mix in any stabilizer, but only to that amount of mud which is going to be used straight away. Take the mixed mud to the moulding site.

The moulding site must be clean and flat. Before moulding, the moulder wipes an area clear of any debris. Using a bowl or bucket of water placed beside him, he wets the inside of the mould, by splashing or immersion, and places it on the smooth ground. The mould is then filled with mud, either by filling it up by hand or with a spade, and then pushing the mud down so

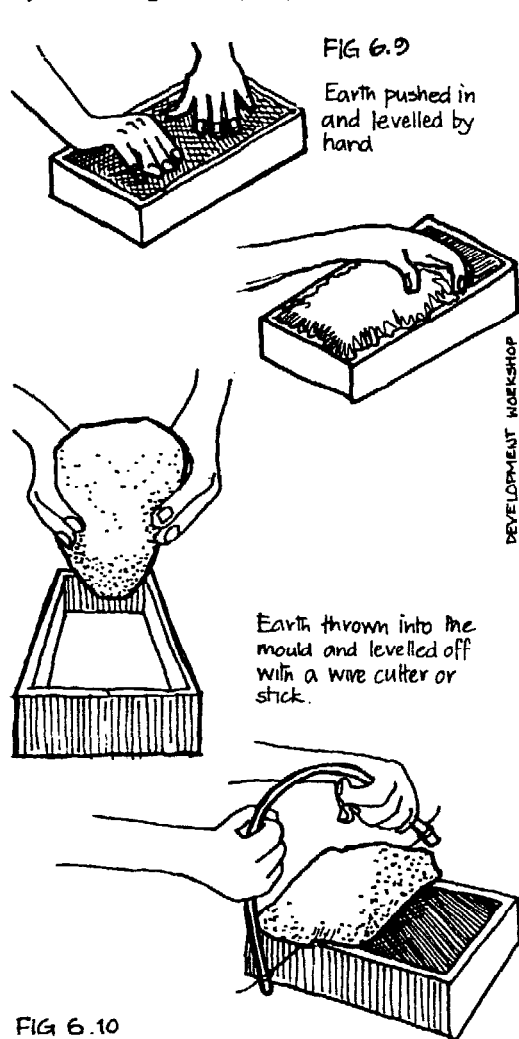

that there are no voids (Fig 6.9); or preferably, by taking a lump of mud, sufficient to fill the mould, forming it into a slightly wedge-shaped ball, and then throwing it with force into the bottom of the mould, in such a way that the ball flattens out with the impact, and spreads out to fill the whole mould. The latter method is faster, and gives good results when working with small moulds, but is less practical when the mould and the amount of mud required are large. There is often a tendency for mud to be used too wet, as this facilitates both filling and removing the mould, but the high water content increases the risk of shrinkage and cracking.

An alternative method for making small bricks is to work with a dry mould: roll the ball of mud in sand, powdery earth or, (as is sometimes used,) chaff or chopped straw, so that its outer surface is coated; then throw the lump into the mould. The mud spreads out to fill it. The coating comes into contact with the sides of the mould and acts as the releasing agent, allowing the mould to be easily slid off. This method produces drier and therefore more precise bricks with less likelihood of shrinking.

With either wet or dry moulding, the excess mud is scraped or cut off, level with the top of the mould. Wet mud can be smoothed off by hand, but a rounded stick is sometimes used, and in the case of dry moulding, a wire stretched between two ends of a bent piece of wood. (Fig 6.10.) The mould is then removed, and the brick remains on the ground to dry.

Production rates

Productivity depends upon the size of the brick and the skill of the moulders. Moulding is usually done by teams, with, for example, 2 labourers mixing and supplying mud to 2 moulders. A skilled moulder should be able to produce 1500 small bricks a day or more. Rates of 250 an hour in areas with a good brick tradition are not uncommon. However, with larger blocks, such as are common in Africa, productivity is lower. Much depends on the incentive to work and the organisation of material supply. Productivity should, however, be at least 2 - 3 times higher than the productivity for compressed blocks of a comparable size.

Curing

Although often called 'sun-dried bricks', it is actually better to protect the freshly-moulded brick from direct sunshine, so that the water it contains does not evaporate too quickly and cause it to crack. Providing shade for the moulding area is usually too expensive, but it is not uncommon to cover the freshly made brick with loose earth, straw or grass. The bricks are left to dry for one or two days, depending on the weather, until they are dry enough to be lifted and stood on edge. Remove any bricks that have large or deep cracks in them, and melt them down for remoulding. If more than 10% of the bricks are rejected, check the following:

- is the soil mix wrong?
- are the bricks being moulded too wet?
- is the initial drying too fast?

Any of these can cause cracking.

Acceptable bricks are then be left in the sun to dry, for another 2 to 3 weeks. They can be loosely stacked, allowing air to pass between them, after 1 or 2 weeks. One should never use mud bricks before they have been properly dried, and one can check this by breaking a brick in half and noting the moistness of the inside. Fully dried bricks can be stacked for later use, or transported to the building site.

Laying.

Mud bricks or blocks should be laid with a mortar using mud similar to the mud used in making the bricks. When the original soil has a high clay content, a slightly higher sand content in the mortar can help reduce shrinkage between bricks. Never use a sand cement mortar, as this does not adhere to mud.

Before each brick is laid, wet the surface, by dipping it in water. This softens the surface and helps it to merge with the mud mortar to become a solid mass, and it also reduces the risk that the wet mortar, on contact with the dry surface of the brick, will shrink away as it dries and leave a weak gap.

Make sure that the vertical joints between bricks are about 20mm thick - not much more or less - and that they are filled with mortar at the time of laying. It is common for this to be neglected and this is a cause of weakness in mud masonry walls.

The bricks or blocks should be laid with a good bonding pattern. The key points are:

- there must be no vertical joint in one brick (or block) course directly in line with the vertical joint in the course below;
- walls only one brick thick need only be bonded along the length of the wall, but with thicker walls one should lay bricks both along the length of the wall, and alternately from the front to the back of the wall (Fig 6.11). This helps to ensure that the individual bricks or blocks are bonded together in both directions, to form a solid mass.

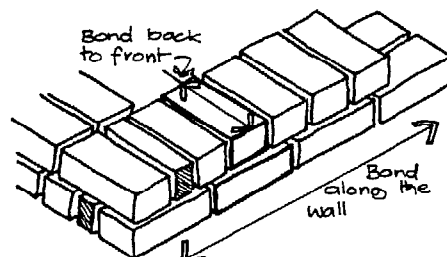
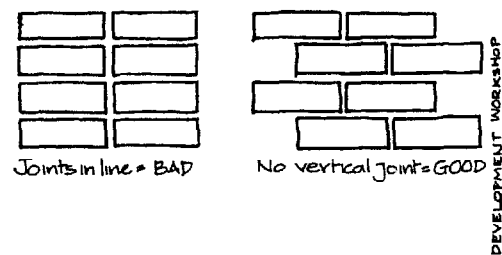
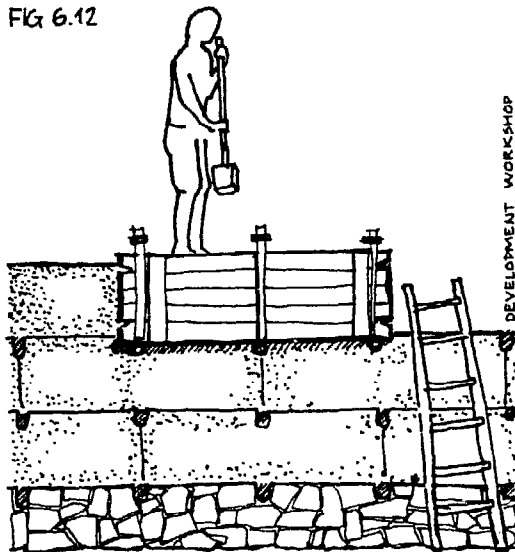

FIG 6.11 BONDING

6.2.3 RAMMED EARTH

Rammed earth, also commonly known by its French name *Pisé*, is a technique which has been used for centuries. It requires more equipment and skill than mud brick, but it nevertheless has widespread use. Morocco, where rammed earth has been used for palaces, fortifications, as well as for whole towns, and where it is in strong contemporary use, has some of the finest examples.

FIG 6.12



A rammed earth wall is built up in layers of earth compacted with a manual or pneumatic tamp between two wooden or metal forms, each 1.5m - 3.0m long and between 0.5m and 1.0m high. The complete formwork, incorporating the two forms and other items required to keep them rigid at the right distance apart, are set up firmly over a previously completed layer (or the base of the wall). Each time the space between the forms is filled up with earth and compacted, the formwork is dismantled and moved along to allow the next section of wall to be built. As the process is repeated, the building goes up in layers.

Unlike mud brick, which relies for its strength solely on the binding effect of clay, rammed earth is stronger because it has been compacted, increasing the density of the earth and therefore its strength. The increased density also reduces the amount of water that can be absorbed, and therefore makes rammed earth less susceptible to movement and softening caused by water. On the other hand, because the soil is compacted, for a given volume, rammed earth uses more soil than mud bricks.

FIG 6.13

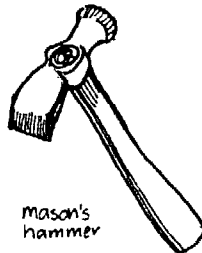

Equipment and tools

The essential equipment is the formwork and the tamp. You will also need a sack, basket, bucket or bowl for carrying the earth; a water container; a mason's hammer or small pick; a shovel; and a ladder. It helps to have a sieve for removing stones from the soil, although one can manage without, (chicken wire, for example, can be used for this).

The formwork

In the past 50 or so years, much effort has gone into developing different types of formwork, of various sizes, mobility, weight, and complexity. When making the choice, one should keep in mind the following criteria.

- The formwork must be rigid, able to withstand the outward pressure of the compacted earth. By comparison, shuttering for concrete is not subjected, over a similar surface area, to as much pressure.
- The formwork must not be too heavy, making assembly cumbersome and time-consuming, especially when working on the upper layers of the building.
- On the other hand, the formwork must not be so small that, being quickly filled, it requires frequent dismantling and repositioning, which can be very time-consuming.

(contd. overleaf)

- The formwork should permit the width of the wall to be varied to meet structural requirements.
- The formwork should be simple both to erect, and to maintain.

Fig 6.14 shows the basic elements of the formwork: (a) the two sides of the form; (b) the vertical posts used to brace the form, which can be either fixed or movable; (c) the transverse-ties, of wood, tubing, threaded rod, or - common at the top of the shuttering - of rope; (d) spacing sticks, to hold the forms at the right distance apart; and (e) the end-boards, which close off the open ends of the formwork, so that normally only one is in use, the other end being closed by the preceding section of wall.

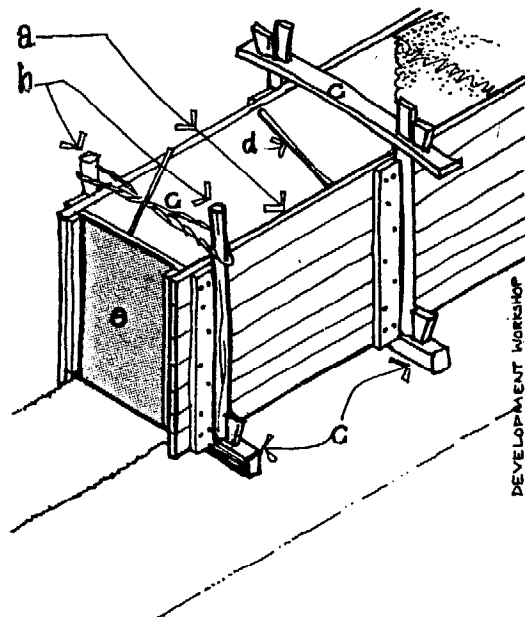

FIG 6.14 BASIC ELEMENTS OF FORMWORK

The sides of the form can be made with timber planks, 30 - 50mm thick, or with thinner but stronger material, such as plywood, 20mm thick. Planks are preferable because they can be individually replaced when damaged. With thin material, more bracing is required to stop any distortion of the boards between the vertical bracing posts. When planks are used, the inner surface is planed, and the planks held together by battens screwed or nailed to the outer face of the form (Fig 6.15). The inside face of the form should be oiled for protection and to facilitate removal. When threaded rod is used for the transverse-ties, it is common for the vertical posts (b) to be fixed to the planking and to double as battens holding the planks together.

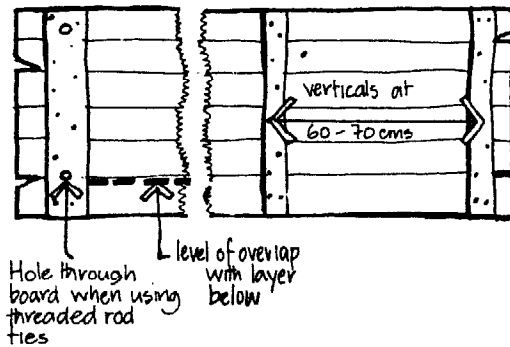

FIG 6.15 FORM

The ties, of whichever type, connect with the vertical posts. The spacing of ties and vertical posts along the length of the form depends upon the thickness of the form. Using planks 30 - 35mm thick, the posts can be spaced at 0.65 - 0.70m centres, further apart with thicker planks, and closer together with thinner. Plywood may need additional horizontal bracing.

Fig 6.16 shows one of the simplest versions of transverse tie and posts. The ties can be made of wood, or a short length of scaffolding pole (or similar). They are placed in grooves cut in the previous layer of wall, at the spacing suited to the forms being used. If the tie is tapered it can be more easily removed from the groove after the formwork has been filled. The forms rest on these transverse ties. The ties must be far enough below the top of the wall for the forms to overlap the previous layer by 100mm or more, in order to stop them moving.

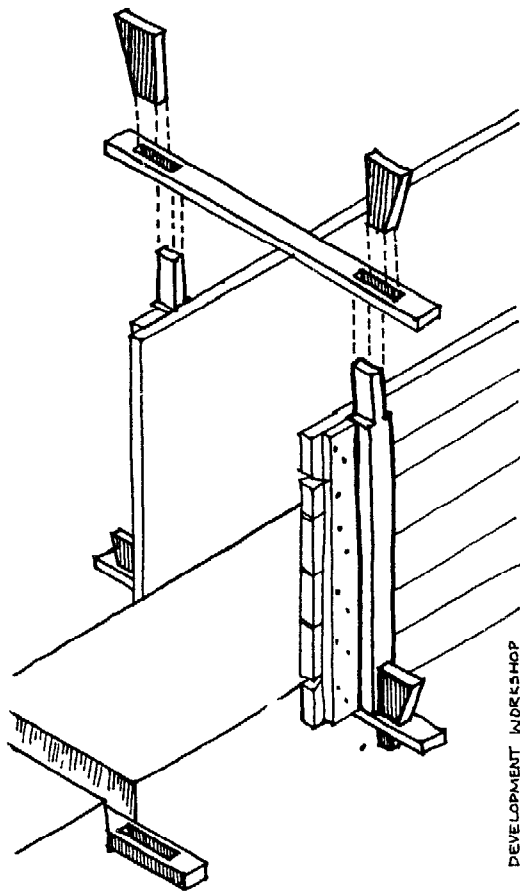

FIG 6.16 WEDGED TIES

At either end of the transverse tie is a slot. The bottom of the vertical post fits into this slot, and is pushed up tight against the form, and the side of the wall it overlaps, by the use of a wedge. Adjustment to the wall width is made by altering the depth at which the wedge is pushed in. At the top of the form, the posts on each side are held together across the width of the wall, either by using the same system of transverse bar, with slots at either end and wedges (Fig 6.16), or by tying the two posts together with a rope (Fig 6.14), which is simple and efficient. The distance between the two forms, determined at the bottom by the width of wall, is fixed with a spacing-stick (d), pushing the two forms apart at the top, and with the end-board (e), which also closes off the open end of the formwork. The end-board is held in place by two battens (Fig 6.14), or wedged against the transverse bars (Fig 6.17). Different width walls use different end-boards, although in some cases the width is changed by nailing on more boards. The formwork should overlap the previous section of wall by 150 - 200mm.

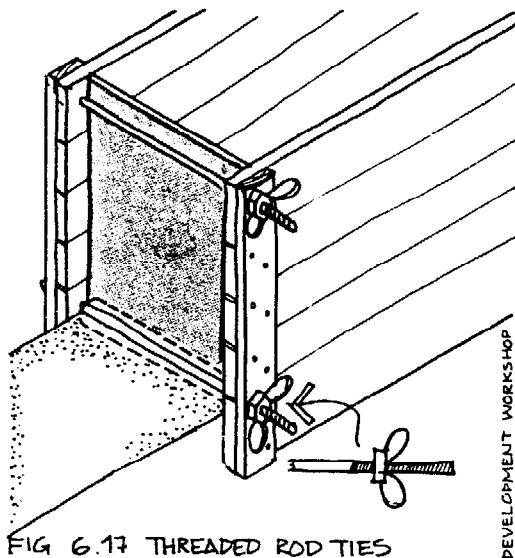

FIG 6.17 THREADED ROD TIES

An alternative is the use of threaded rods with nuts. (Fig 6.17.) In this case the rod rests on top of the layer below, not in a groove. It is passed through a hole in the form, corresponding to the position of a vertical post nailed to the form, and held tightly in place with a washer and wing nut. Adjustments to the width of the wall are made by tightening or unscrewing the nut, and changing the length of the spacing stick. The form projects down approximately 150mm below the top of the previous layer. (Fig 6.17). Another threaded nut and bolt set is used at the top of the form. The end-board is placed against these two rods. To avoid the thread being damaged, a metal tube can be used as a sleeve on the wall, through which the rod slides. The tube is removed afterwards. This method is slightly more laborious to erect, because the forms have to be supported until the rods have been pushed through the

holes in the form, and can take the weight. Also there is no flexibility in the placing of the transverse ties, which is sometimes inconvenient at corners and when working with irregular lengths of wall.

There are some examples of formworks which move on rollers, requiring little dismantling and re-assembly time. The rollers rest on previously completed sections of wall. The roller passes over the freshly completed section of wall as the formwork is moved to the new position. An inverted U-shaped bracket is used as a clamp over the whole formwork to hold the two sides tightly against the wall below. With this system there is a risk of damaging the newly completed wall as the rollers move over it, and changes to wall widths are difficult.

Formwork dimensions

The dimensions of the formwork are influenced by the thickness and weight of the wood being used, the dexterity of the work team in assembling the formwork, and in some cases, the availability of machinery for lifting and holding heavy forms in place. Aim for the largest form that can reasonably be handled, since this will require fewer moves. However, anyone using this technique for the first time might do well to work with a smaller, more easily handled, form.

The height of the form should be between 0.6 and 0.9m, including the depth of the layer of compacted earth (between 0.5 and 0.7m) and the amount the form overlaps the layer below (100 - 200mm depending on the type of transverse ties being used). The length can be between 1.50 and 3m, with 2m a good working length. Allow for the overlap with the preceding section of wall.

Width of wall

The width of the wall will vary, according to the intended height of the wall, the quality of the soil, and whether the soil is stabilized or not. Stabilized rammed earth walls can be as thin as 0.3m. Because compaction normally takes place with a man standing between the two sides of the formwork, a minimum of 0.4m is more convenient. As a guide, for unstabilized soil, the width to height ratio should be between 1:8 and 1:12, the latter economising on soil but requiring good quality control. It is quite common, when building several storeys for the walls to have a batter, of between 50 and 100mm per metre rise.

The tamp

Tamps (or rammers) can be manually operated or pneumatic.

Manual tamps

The tamp has a handle and a head. The handle is usually 1.5 - 1.8m long, to suit the average height of the users, and of a diameter which is comfortable to hold. It can be made of wood, or metal. A metal pipe can be used, and has the advantage that it can be filled with sand to vary the weight according to the strength of the tamper. The tamp head can be made of wood or metal. Wooden heads should be 'shod' with a sheet of

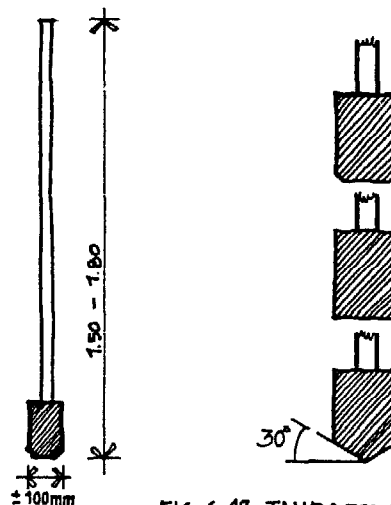

FIG 6.18. TAMP & TAMP HEADS

metal or with nails densely hammered into its base. The weight of the tamp, and the size and shape of the head, and the force with which it hits the soil are important in getting the optimum compaction. An optimum weight is between 7 - 10kgs, and any heavier than this will tire out the operator (*4). Tests have indicated that the tamp should be dropped 150 - 300mm with moderate force (*5). The tamp head should be small (80 - 100mm²), with either a flat face with chamfered edges, or a gentle wedged profile, angled at 30° to the horizontal (*4/*5). (Fig 6.18.) Although larger tamp faces are used, they should not exceed 225mm², and are better in an oblong, rectangular form.

Pneumatic tamps

There are several makes of impact tamper, driven by compressed air, which greatly reduce the time and labour involved in tamping. Vibrating tampers are in general unsuitable. The tamp face should be small (70 - 100mm²). Practical experience will show the best way of using a pneumatic tamper, but the soil should be compacted in thin layers 100mm thick.

The material

Soil for rammed earth wall-building should have a high sand content, with just enough clay in it to act as a binder.

Suitable particle distributions are:

Sand / fine gravel	45 - 75%
Silt	15 - 30%
Clay	10 - 25%

The soil should be used quite dry, with a moisture content close to the plastic limit. Carry out tests to determine the optimum water content (see 4.2.3.)

Construction

Excavate earth and remove any lumps and stones, by sieving, or by a simple method of shovelling earth to the top of a pile so that the larger lumps roll to the bottom where they can be removed by hand. There should be no organic matter. As the earth needs to be used quite dry, cover it if there is a risk of rain.

The wall must be built up on a stone or brick footing, on top of a suitable foundation. The footing should come up at least 0.2m and ideally more than 0.5m above ground level, to avoid any contact with ground water. The footing should never project out beyond the external face of the wall and the top must be level (stepped if the site slopes). If the threaded rod system is used for the transverse ties, the formwork can now be placed directly on the footing, with the two forms projecting down below its surface on either side. If transverse bars are being used, mark their position at the correct distance apart. Then, leaving a gap where the bars will be placed, build the footing up the same depth as the transverse bar plus another 100mm (equal to the overlap of the form): see Fig 6.19.

Starting at a corner of the building, erect the formwork. To assist their removal later, place some sand in the grooves under the transverse bars. Make sure that the whole formwork is level and plumb, and with the end-boards and spacing-stick in place, tighten the whole formwork with the wedges, rope or wing nuts (depending on the system you are using). The end-boards will help in getting the formwork in plumb. Next, if available, put a thin layer of cement mortar at the edge of the wall, filling any gap between the form and the base. This stops the earth falling through small gaps and helps in achieving a neat finish, but is not essential.

During the following process, check from time to time that the formwork is in plumb. The person with the tamp stands inside the formwork on the wall. Damp earth is poured in and spread out evenly (by foot) to a depth of 100mm. The earth is then tamped, starting at the corners, working along the edges, and then in the middle, repeatedly until the tamp no longer leaves an impression in the earth, and the sound of the tamp changes from a muffled sound to a solid clear sound. The 100mm of earth should compact to about 50 - 70mm. Repeat the process with more 100mm layers, until the whole formwork is full. Dismantle the formwork and move it along to do the next section of wall. The completed section will resemble a very large block of compact earth. (A variant of the system used in France, allowing one to dispense with the end-board, is to tamp the end of the section into a slope of 45°. Because the next section of wall overlaps this sloping end, in theory this gives a stronger bond, but tamping the slope is more difficult, and the volume of the formwork is inefficiently used.) Grooves should be cut in the top of the completed layer, with a small pick or mason's hammer, to allow the transverse bars to be placed for the next layer, using the same dimensions as at the base (Fig 6.19.) Make sure that, just as in masonry, one section of wall overlaps the joint between two sections in the layer below. Similar overlapping of sections should be done at corners as well. Because the corners are weak, precautions can be taken to strengthen or protect them, such as by putting in a triangular fillet to produce a chamfered corner (Fig 6.19); or by building up the corner with concrete wedges, stone or brick work. Special formworks have been devised for going round corners, but in practice simple straight formwork can be used with little difficulty, provided the design is also simple. Openings can be made by moving the position of the end-board to close off a part of the wall, or by pre-forming a 'reservation' with wood, or with a brick or stone enclosure to the window. Slopes to accommodate roof pitches can be achieved by drawing the angle of the slope on the inside of the formwork, and tamping the soil to this slope. Reinforcement can be introduced in-between the layers when there is a risk of movement. If timber is used it should be treated with preservative beforehand.

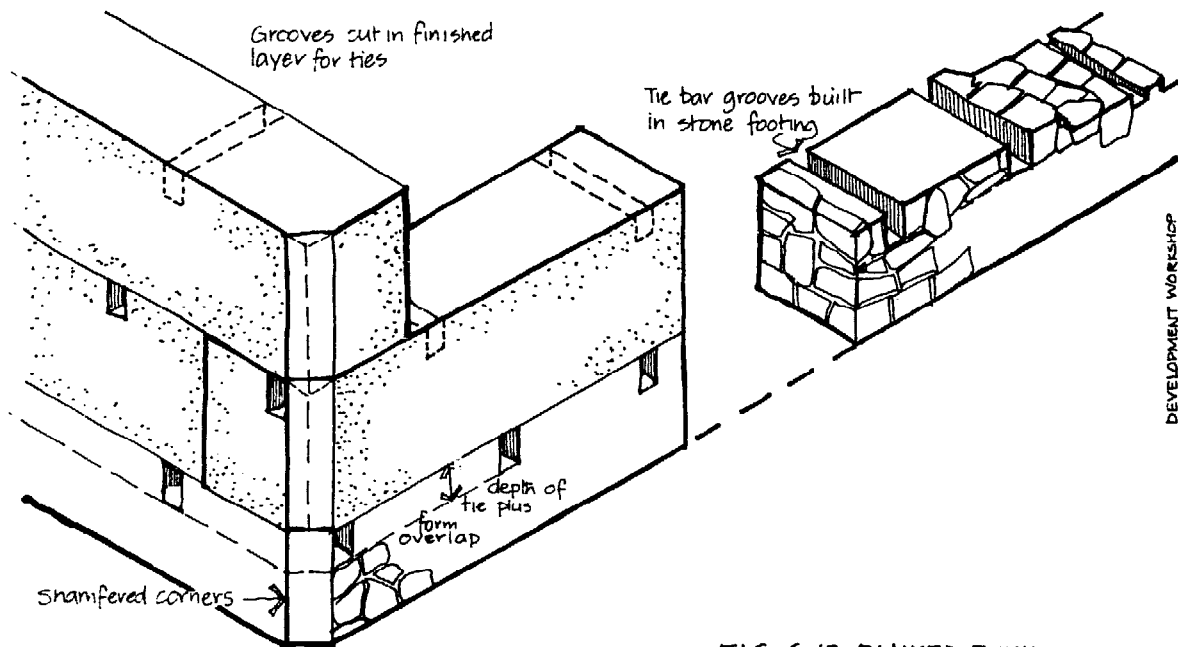

FIG. 6.19. RAMMED EARTH WALLING

The speed at which rammed earth walls can be built depends upon the drying time needed between successive layers, which depends upon the weather. In some cases the practice is to allow two weeks' drying after every two layers, and in others three or four days between each layer. With a large building, a single layer could take this long and work could progress continuously, but basically time must be allowed for a section of wall to cure before it can be built on. In general one should allow for slower progress in damp cool weather. Daily progress depends upon the size of the formwork, and how high off the ground the work is. An average for small formwork with a volume of 0.5m^3 is about 40 minutes for filling and 20 for assembling the formwork when near the ground, but this can slow to almost twice these times high up. A team consists of four men or more: two mixing, one carrying earth, and one tamping.

The earth should not be allowed to dry out too quickly, to avoid cracking, and this is especially the case when stabilizers are used. A common practice is to cover the top of the walls with grass or dry earth to provide shade.

6.2.4 COMPRESSED BLOCKS

The production of compressed soil blocks has undergone considerable development this century, and is a young technology by comparison with any of the others. Compacting the soil in a small form produces a block which is, by virtue of the increased density, both stronger and more water resistant than an ordinary mud brick, and which can be used to build walls with a higher height to width ratio. Compressed blocks have the advantage over rammed earth, which is also compacted, that the blocks can be produced at the source of raw material, stocked, and transported to the building site when needed.

Compressed blocks, usually combined with a stabilizer, have often been used to promote a new contemporary image for building with earth. The disadvantage of compressed blocks by comparison with mud bricks or rammed earth, is that they are more laborious to produce.

Production

Soil compaction is done either in a small mould, using a tamp, (although this is not very common,) or with a press, which can be manually operated or motorised. The procedure for using a mould is similar, on a small scale, to that used for rammed earth walls (6.2.3). When using a press, soil similar to that used in rammed earth is loaded into the press and compacted. Unlike in the case of mud bricks, where the brick has to be left to dry where it is moulded, the compacted block is removed from the press and taken to a curing area to dry.

Equipment and tools

The essential equipment is the press, together with oil for lubricating it, and any recommended spare parts. Also required are pick-axes for excavating the soil; a large screen sieve ($1.5\text{m} \times 1.0\text{m}$), with a 5 - 6mm mesh; a shovel; and a can for sprinkling water, (a large tin with holes punched in the bottom will do), or a watering can with a rose. Containers for moving soil can also double as a measure for the amount being used (e.g. 'x' wheelbarrows or buckets full). A large shaded area is needed for curing the blocks.

The press

There is a large variety of presses. The majority work on the basis of applying static pressure which slowly compresses the soil. The motorised presses are capable of daily production rates often well in excess of 2000 blocks, while the manual presses should produce between 300 and 1000 blocks a day, depending very much on the organisation of the site and the willingness of the operators.

The choice of press will be influenced by the quality of the block it produces, the ease of operation, and the cost of the machine. One should consider - bearing in mind the type of building work being done and local conditions - the following:-

- whether the press allows the operator consistently to produce the amount of compaction required in order to achieve blocks of sufficient density to meet the standard specified for the building;
- whether the press can be operated quickly enough and with a small enough team for block production to be cost effective;
- the ease with which the press can be moved from one site to another, a factor of both weight and size; many of the small manual presses, with acceptable quality and output, can be transported by small vehicle;
- the durability of the press, and the ease with which it can be locally maintained and repaired;
- the possibility of changing the mould size to suit the needs of a specific building;
- if motor-powered, will the fuel be readily available?

Specifications

There are two factors which determine the basic efficiency of a press. The first is the difference between the depth of the compressed block and the depth of uncompacted earth. CRATerre (*6) suggest that the ratio should be at least 1:1.65, (Fig 6.20,) and in practice presses with a ratio slightly less than this need to have the soil pushed down by hand in the mould, and the level topped up, in order to make sure that enough material is being compacted. This takes time. Presses with a ratio higher than 1:1.65 will not need precompaction and can consequently be filled more rapidly (and even automatically by hopper). However, as the ratio increases, so too must the compaction pressure, in order to force a larger amount of soil into a given compact volume.

The second factor is the compaction pressure. Although there are other variables as well (optimum water content, soil composition...), increasing the compaction pressure on a soil increases the resulting dry density (with resulting higher compressive strength and lower moisture absorption.) The smaller

FIG 6.20 COMPRESSION RATIO

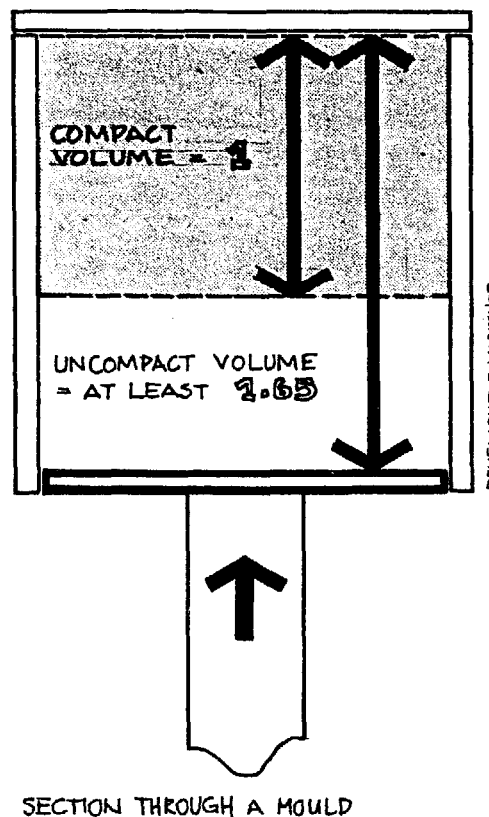

manual presses (*7), work on a fulcrum principle, transferring to a piston the force generated by one or two people pushing down or pulling on a lever arm. Compaction pressures in the order of 10 - 40kg/cm² can be achieved. 10kg/cm² is barely acceptable and the effort of compaction may not be justified by the result. 20kg/cm² and more is good: higher compaction pressures are usually achieved at the cost of lower production efficiency. The compaction pressure depends upon the compression ratio; the amount of energy that can be applied without exhausting the operator(s); and the efficiency of the mechanism in transforming that energy into compaction thrust rather than, for example, breaking the lever arm.

The Material

Soil for compressed block production should have a high sand content, with just enough clay to act as a binder. Any material coarser than 5-6mm should be sieved out. The soil needs to be mixed dry, especially if stabilizers are being added. Suitable particle distributions are:

Sand/fine gravel	45 - 75%
Silt	15 - 30%
Clay	10 - 25%

Mixing should take place beside the press. Before starting to mix, establish the optimum water content (see 4.2.3 for methods). The soil will be used quite dry, close to the plastic limit. Using the optimum water content percentage (usually between 8 and 16%), work out the proportions in terms of the measure to be used on site: number of cans of water per wheelbarrow load of soil; number of shovels of soil per can of water, etc. Before adding any water, mix in any stabilizer being used. Unlike mixing cement, the water must not be poured onto the soil, but sprinkled, so that no part gets saturated, and with the small amount of water being used, all parts become moist. Check the moisture content by the Drop Test (4.2.3).

Block production

Before starting production, check that the press is, if need be, properly bolted to a stable base, and that moving parts are clean and oiled.

Fill the mould of the press, precompacting with one's hands if the press has a low compression ratio, and especially in the corners which can be weak. Compact the block. Freshly made blocks can be removed from the base/push plate carefully by hand, although it may help avoid damage if the block is picked up between two boards. The block is then taken to the shaded curing area, and placed on a clean flat surface. The following day the blocks can be stacked to make room for the next day's production, but not very tightly together. If no stabilizer, or a bitumen stabilizer, has been used, drying can take place in four or five days. When stabilizing with cement one should allow a week or more, and twice as long again if stabilizing with lime. With both lime and cement stabilization blocks should be kept moist for the first four or five days, by daily sprinkling.

Output

Daily output depends upon the type of the machine being used and how well the process is organised. Block output using a manual press is often given at between 350 and 500 blocks with a team of four people working an 8-hour day. The team includes one person filling the form with soil, two working the press, and one removing the block to the curing area. When calculating the cost effectiveness of working with a press, one must add to this basic team the people excavating, sieving and mixing the soil, and the people working in the curing shed stacking the previous day's production and

keeping it moist. A more efficient team operating a manual press is likely to be as many as 7 to 9 people.

Block dimensions

The depth of blocks produced by different presses varies, but for each press is usually unchangeable. The width and length of blocks also vary from one press to another, although approximate dimensions of 290 x 140mm are common. Quite a number of machines can be ordered with different mould sizes, and a few with interchangeable moulds (*7), which can be very useful. Tiles and different blocks can also be made by the insertion of wooden blocks to reduce the volume and change the profile.

Construction

Wall building should follow the basic principles for masonry, with attention paid to bonding. Walls with unstabilized compressed blocks should not be less than one block-length thick on load-bearing walls, and more if the structure requires it. Good quality stabilized compressed blocks can be used like concrete blocks. Unstabilized soil blocks should be laid with a mud mortar, whilst cement or lime stabilized blocks can be laid with soil:cement in a ratio of 8:1, or soil:cement:lime in a ratio of 9:1:2. Lime improves the plasticity of the mortar, and reduces the likelihood of it cracking, because it dries more slowly. Blocks should be dampened before laying. Mortar joints should be about 10mm thick.

Renders

Unstabilized block walls will need rendering. In theory stabilized blocks should not require rendering if well made, but in practice most stabilized walls are covered with a thin coating applied at a fairly liquid consistency. See 9: Renders, for more detail.

- *1 Cain A., Afshar F., and Norton J. Oman: The Problems and Potentials of the Indigenous Built Environment in a Developing Country, Development Workshop, London, 1975.
- *2 Houben H. and Guillaud H. Primer on Earth Construction, CRATerre/UNCHS/PGC/AGCD/CRA, Brussels, 1985.
- *3 Lewcock R., from Architecture of the Islamic World, ed. Michell G., London, 1978.
- *4 Kern K. The Owner-Built Home, New York, 1972.
- *5 DeLong H.H. Rammed Earth Walls, South Dakota State College, USA, 1959.
- *6 Doat P. et al., CRATerre, Construire en Terre, Paris, 1979.
- *7 Manual presses include CINVA Ram; Development Workshop Ram (with interchangeable moulds); Tersteram (reputation for consistent performance); Ellson Blokmaster. In addition, some presses have better regional availability than others.

7 ROOFS, FOUNDATIONS AND FLOORS

7.1 ROOFS

Roofing with earth can be divided into load-bearing vaults and domes, flat or pitched roofs where earth is used as a covering, and, less common, reinforced earth roofs.

7.1.1 VAULTS AND DOMES

Vaults and domes can be built entirely of earth without the need for any supporting structure, either during or after construction. They are, therefore, one of the most interesting applications of earth roofing, especially in areas where timber, the principle alternative structural material in roofing, is in short supply. Vaults and domes using earth are normally built with mud brick or compressed and stabilized bricks, (there have been some examples of rammed earth vaults built with shuttering). Although there are many subtle variations in form and technique, the basic principle of vault or dome building makes use of the compressive strength of earth, and takes into account its lack of tensile strength. All forces must be passed down within the thickness of the structure to the ground. Although vault and dome roofing is a very large subject, a brief summary is given here.

Vaults

In vault building, the clearest explanation of the principle can be seen by taking the example of a chain (strong in tension, weak in compression), which, when suspended from its two ends, will hang in a pure tensile form - a catenary. This same form, inverted, should be followed in earth vault building. (Fig 7.1.) In Nubian vault building (one of the most straightforward and well-known methods) this catenary form is used in combination with a rise to span ratio of 0.55m per 1.0m span. Lower rise to span ratios, (typical in Iran,) require greater accuracy in brick laying and good compressive strength in the bricks. Most important, lower profile vaults exert greater outward thrust on the supporting walls, which consequently have to be thicker, tied or buttressed. Wall widths, in the absence of a counter-thrust or tie, can be broadly calculated by projecting the catenary curve on down from the spring point of the vault to the ground (Fig 7.2). Figs 7.3-5 show the principles of Nubian vault building (*1), without shuttering. Note that the brick courses are built up leaning against a back wall. The top of this wall can be shaped to follow the form of the vault.

FIG 7.1. VAULT FORM

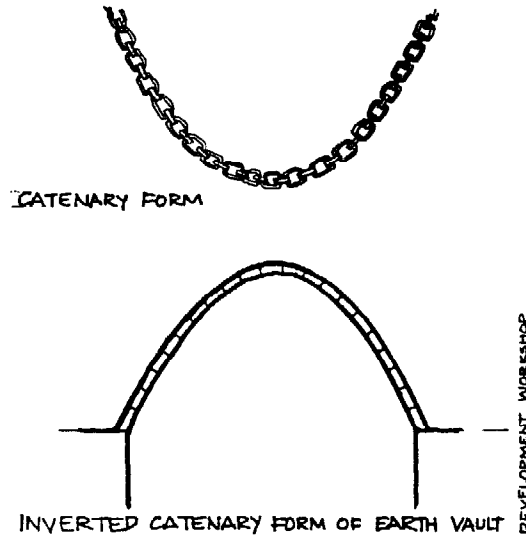
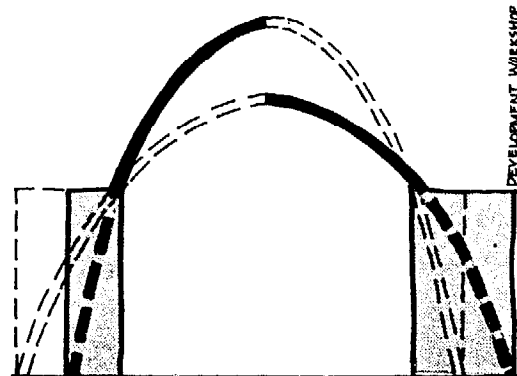

FIG. 7.2 VAULT RISE AND WALL THICKNESS



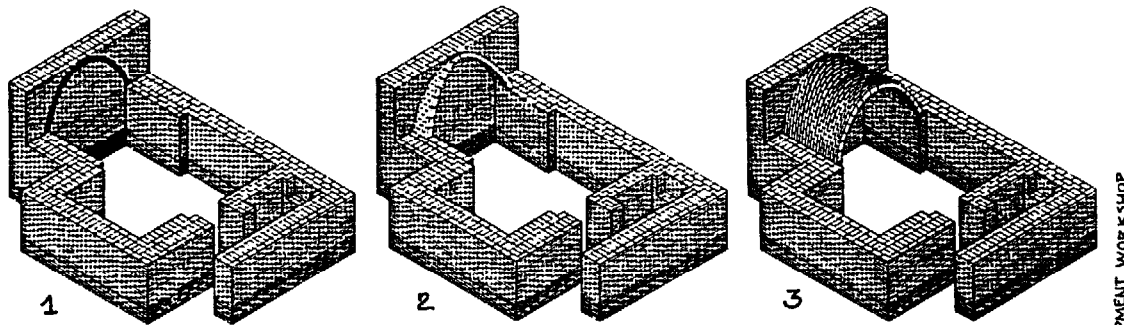

FIG 7.3-7.4-7.5. NUBIAN VAULT BUILDING: DRAWINGS OF A HOUSE IN GOURNA, UPPER EGYPT BUILT MEMBERS OF D.W. DEVELOPMENT WORKSHOP

Mud bricks used for vault building are made in the same way as those used for wall building, but are commonly wider (giving greater depth to the vault) and thinner, which reduces the weight of each brick. Extra straw is also sometimes added to reduce the weight. Typical vault brick dimensions are: 240 x 140 x 50mm (Upper Egypt); 200 x 200 x 50mm (parts of Iran). Working with mud mortars, for both mud bricks and stabilized bricks, is easier because they adhere quickly to the bricks. With cement mortars more care has to be taken to hold the bricks in place until the course has been completed, and an alternative to use on cement or lime stabilized bricks is a gypsum and soil mortar which is very adhesive.

FIG 7.6. DOME BASE WITH RADIAL ARM

Domes

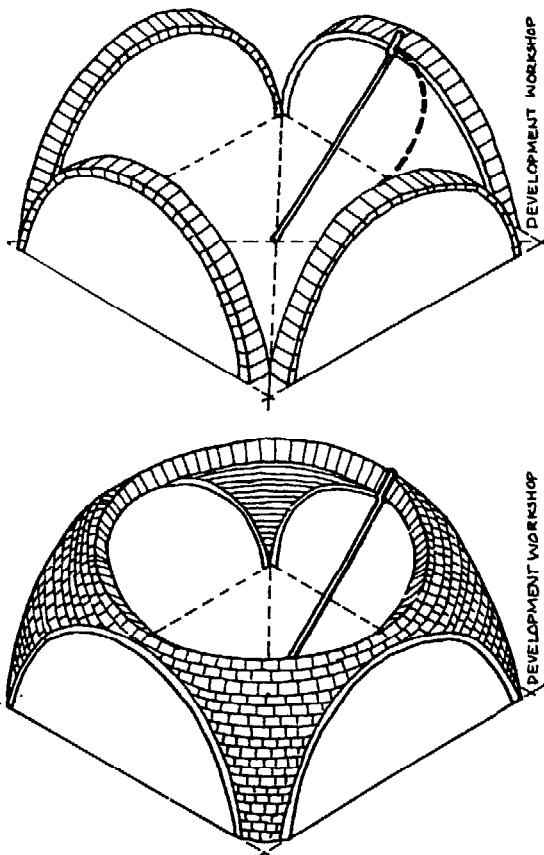

FIG 7.7. DOME WITH PENDENTIVES

In domes the same principle of compression applies, but in addition to the curved profile, transferring weight to the ground, its circular form also gives strength. Some domes are built with a catenary profile, which makes efficient use of the material, but which requires good skill to build. Domes in the form of a segmented sphere are more common because they are easier to build. The central point of the sphere is fixed, by positioning a post with its top at the right height. A radial arm, of string or wood, and measuring the exact radius of the sphere, is fixed to the top of the post so that it can be rotated and moved up and down. This 'arm' indicates the exact distance and angle of elevation of every brick in the dome in relation to the centre. (Fig 7.6.) The bricks are built up in concentric circles, each circle forming a compressive ring. The angle of the bricks gets steeper with each successive ring. The most common, but by no means sole, application of a dome is to cover a circle or a square. The transition from a square base to a segment of a sphere is done either by using pendentives, (Fig 7.7), or by

using squinches, (Fig 7.8). The forces in a spherical dome pass from compression to tension at an angle close to 51° from the vertical, and counter-pressure must be provided at this angle to stop the dome bulging outwards.

Domes can be built with mud bricks or stabilized compressed bricks, either the same size as used for vaults, or thicker, and not necessarily as wide. The bricks can be laid with the same types of mortar used for vaults: always mud with mud bricks.

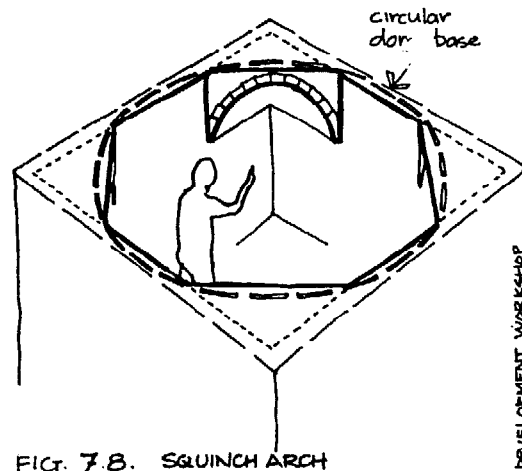

FIG. 7.8. SQUINCH ARCH

The vault or dome structure is usually quite thin (average 250mm), but this can be increased by putting on another layer of bricks, laid flat, to provide extra insulation and strength. Vault or dome roofs require good protection from rain damage, firstly by making sure that rainwater can drain off the roof immediately, and secondly by putting on a good render, (see 9: Renders.)

7.1.2 FLAT AND PITCHED ROOFS

Flat roofs are often used as a living area, for sleeping, and for drying grain etc, and are thus an important part of the house. In most cases these roofs are almost flat, although in areas of very high rainfall it is possible to find up to a 25° slope. The earth is used as a covering over a framework. The roof either overhangs the perimeter walls of the building (Fig 7.9), or is bounded by a small upstand or parapet, depending largely on regional style. In the former case the roof usually slopes gently (1 in 10) in one direction to allow rainwater run-off, whilst in the latter case the roof has to be laid to ensure that rainwater drains to valleys and water spouts passing through the parapet (Fig 7.10.)

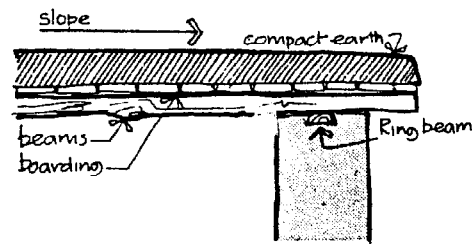

FIG 7.9. FLAT ROOF WITH OVERHANG

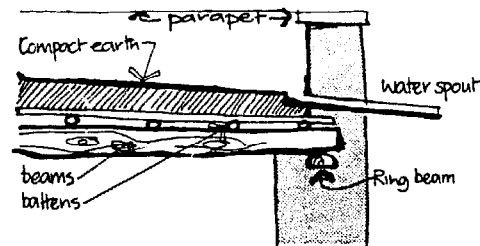

FIG 7.10 FLAT ROOF WITH PARAPET

Fig 7.11 shows a typical mud roof. Spans depend upon the timber used, but are typically 3 - 4m. The roof is built up in layers: beams covered by branches or boards; a layer of matting or cardboard as a base for the earth, and then one or two layers of earth. Soils for roof covering should be similar to those used for Rammed Earth: for example, a good soil profile is 45 - 50% sand, 25% clay, and the remainder silt and fine gravel. The earth is compacted to a depth of 150 - 200mms. Traditionally earth roofs in areas with high

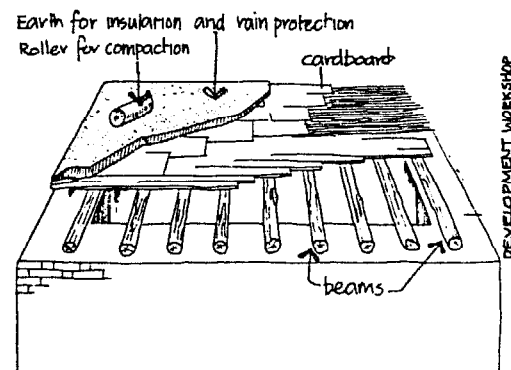

FIG 7.11. TRADITIONAL FLAT ROOF. IRAN

rainfall are compacted after each heavy downpour, and sometimes stone rollers are kept on the roof for this purpose. Snow should be removed as soon as possible. Good drainage is essential. If maintained regularly, these roofs can be watertight and provide good insulation.

The earth covering of these roofs can be improved by cement or lime stabilization, as appropriate, (see 8: Stabilization). One should bear in mind that the timber framework is liable to flex when additional loads are on it, (snow, people walking..), which can cause cracking in cement or lime stabilized roofs. The alternative is to introduce a separate waterproof layer, with the earth used only to provide insulation. Common waterproofing methods are:

- covering the earth with a layer of bitumen and hessian, usually on a thin layer of sand (and sometimes cement) immediately over the earth;
- covering the earth with a layer of cement, often on a chicken wire base: a system better suited to sloping roofs, and liable to cracking, especially if walked on; it requires expansion joints over large surfaces;
- the use of corrugated roof sheeting, or sometimes plastic, underneath the earth: a method which has the drawback that moisture can get trapped in between the sheeting and the earth, and cause deterioration.

In general, waterproofing should be in the earth or above it, and not underneath it.

7.1.3 REINFORCED EARTH ROOFS

There are two main uses of reinforced earth in roofing, neither currently very common. The first method is to make up an earth rib, where branches (palm fronds, bamboo, thin sticks) are used as reinforcing bars and enveloped with a high clay content mud. The ribs, usually curved for rigidity, replace the beams used in flat and pitched roofs (described above). Branches span between ribs, and over these there is a covering of earth. Examples of this use of reinforced earth can be seen in Hausa buildings, and similar applications have been made in Iran. The second technique uses large amounts of straw bound by clay and formed into small precast panels, which can then be placed between supporting beams. This system has been referred to in connection with wattle and daub walls (6.1.1) and has interesting possibilities for developing lightweight roofing.

7.2 FOUNDATIONS

In general earth is not a good material for foundations, because of its susceptibility to water and its low load bearing capacity. A basic principle of building with earth is to keep it out of contact with the ground. However, earth can be used in building foundations by mixing it with slaked lime in proportions of between 3 and 6%, depending on the soil, and using it with stones, or on its own, when compaction is necessary. Because lime dries slowly, as much time as possible should be allowed between completing the foundation and beginning the walls.

7.3 FLOORS

Earth floors are common. Top soil should be removed, and the subsoil compacted if it is sandy, left uncompactd if it contains much clay. Build

up the base of the floor with some form of hard-core, (such as gravel, broken bricks, rocks or laterite lumps,) and compact this. If no hard-core is available, use earth. This sub layer should be level and above ground level. The top layer of the floor should be about 100mm thick for unstabilized earth, and at least 50mm thick for cement or lime/pozzolana stabilized earth. Mixes should be richer than used for stabilizing walls: 1 part cement to 6 - 8 parts sandy soil, and the floor must be kept damp whilst curing. Large areas of floor should be divided by shrinkage joints to avoid cracking. Earth can also be successfully mixed with ash, or with cow-dung and compacted. Lateritic soils tend to make good floors.

*1 Original drawings by Development Workshop, based on a house built by members of the group in New Gourna, Upper Egypt, 1973.

8. STABILIZATION

The purpose of stabilization is permanently to improve a soil, by increasing its strength; or by reducing the variations in cohesion and size caused by changes in moisture content; or by reducing the erosive effect of water on the surface; or by combinations of these.

Before embarking on any stabilization, one should examine the following:

- Whether the available earth used without any stabilizer will provide sufficient strength, and resistance to the effect of water, to meet the requirements of the building. In many cases it will.
- Whether any shortcomings in the soil's performance can be overcome by design instead of stabilization. For example, walls likely to be damaged by rain may be more practically protected by a large roof overhang or a protective rendering than by the use of a stabilizer, and to do so may be more in keeping with the resources available.
- Whether stabilization to increase water resistance can usefully be limited to external surfaces only.

The effect of stabilization must be permanent. Compaction, for example, increases the strength of a soil, but its effect can be reversed by water, and therefore a stabilizer may need to be added if exposure to water is likely. Conversely, some of the best results of stabilization are achieved when it is combined with compaction, and therefore the two are often treated together. Stabilization can, however, be used on uncompacted soils as well.

8.1 HOW TO CHOOSE A STABILIZER

The main materials used in stabilization are cement, lime, pozzolanas, and bitumen. Some of these are used in combination. In addition there are other stabilizers, some of which are traditional or unique to a particular area, and not always well understood.

When choosing a stabilizer, make sure that it will work at a low dosage, that it is available in sufficient quantities for the job (often not the case with traditional stabilizers), and that it is easy to use. Most of all make sure that it is cost effective relative to the benefits it brings: stabilization can improve the quality of a soil, but many excellent earth buildings have been built without it.

Which stabilizer to use can be indicated by the plasticity index and the liquid and plastic limits of the soil (See 4.2.2 for tests to work these out). These have been combined into what are known as the Atterberg Limits, which are used as a classification of soil, and to which various authors have attributed suitable types of stabilizer. Fig 8.1 gives an interpretation of these, but one should note that lateritic soils found in the tropics will not necessarily conform. There is in fact no substitute for practical experimentation, but the classification does give an indication of which stabilizers to experiment with.

The plasticity index can be altered, and consequently which stabilizer to use changed, by altering the particle size distribution of the soil. The plasticity index will be lowered by adding sand, and raised by adding clay, and just as this will alter the balance between cohesive strength and susceptibility to water, so too will it alter which stabilizer to use. It is quite common to find within a small area soils with different particle

size distributions, and this often occurs as one digs deeper. It may be practical to mix a sandier soil with a high clay content soil to produce an improved soil.

FIG 8.1. INTERPRETATION OF ATTERBERG LIMITS

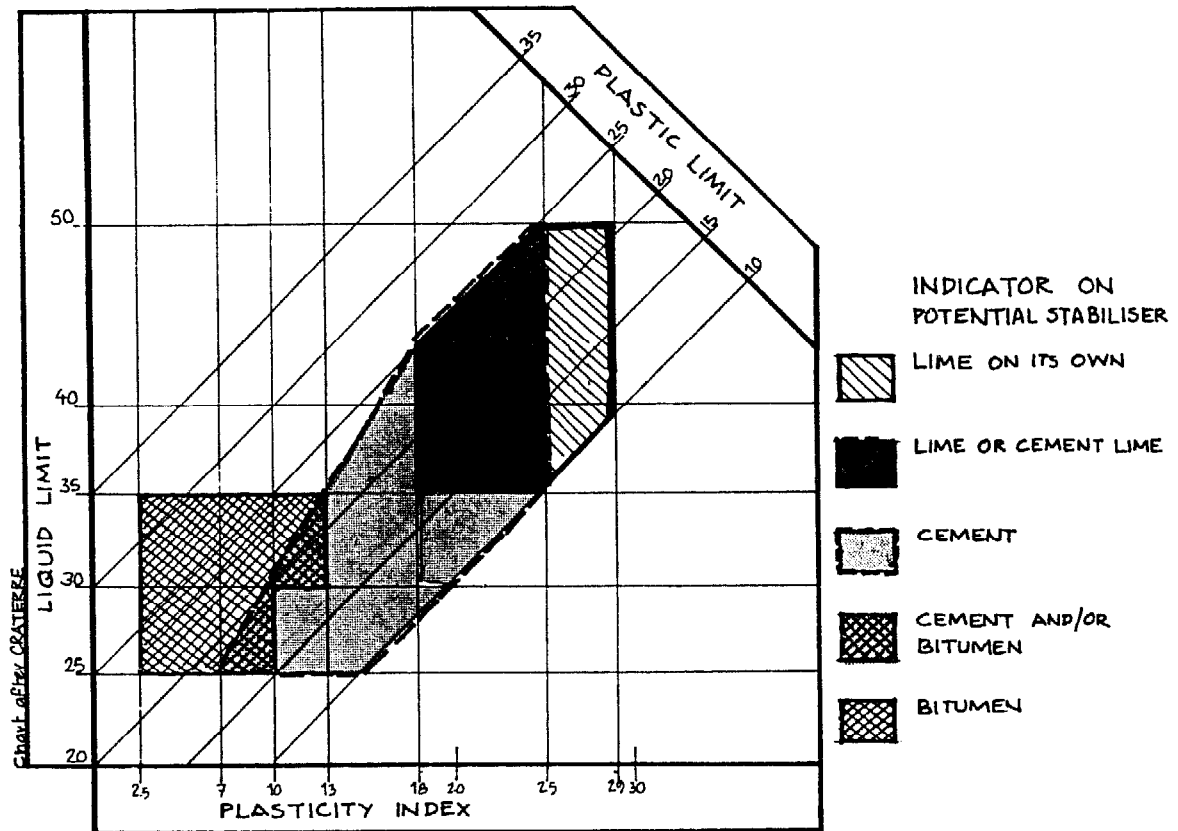

8.2 USE OF STABILIZERS

8.2.1 CEMENT

Ordinary Portland cement should be used. Cement acts as a binder and reduces the porosity of a soil. When mixed with water, the action of cement is to fill the voids in a soil and form a continuous coating round each particle, binding everything together. It works better on the coarse sandy particles of the soil, which alone are not cohesive, and inefficiently on high clay content soils, in part because the tiny clay particles behave in a manner similar to the cement, acting as a binder, and it is therefore difficult for the cement to bind them.

Cement increases the compressive strength of a soil, but for a fixed quantity of cement and compaction, the compressive strength drops as the clay content increases. A soil with a 10% clay content (an effective minimum for the soil to be cohesive) may require only 5% cement, but this will increase to nearer 10%, and more, when the clay content is 30%. More than 10% cement is normally uneconomic. When the clay content is high, it helps to use a mixture of lime with cement, (see 8.2.2: Lime).

Cement, by filling the voids in a soil, also reduces the swelling and shrinking effect of water. This is achieved by adding 5% cement, and no advantage is gained by adding more to soils for which a higher compressive strength is not required.

To work out how much cement to use with a soil, make test blocks with identical compaction and water content, but varying the cement content between 5 and 10%. Test them for compressive strength, moisture absorption, and resistance to water erosion, (see 5: Performance Testing), and use the lowest cement dosage with which acceptable results are obtained. In any major construction these tests are essential, and remember that blocks produced in laboratory conditions are likely to be stronger than the same mix on site, because of better quantity control, mixing and curing. A good preliminary guide to how much cement to use can, however, be obtained from the 'shrink box test'.

Shrink box test

Method:-

Make a box out of wood with internal dimensions of 600 x 40 x 40mm. The box should have a bottom but no top (Fig 8.2). Oil the inside surfaces. Take a sample of soil intended for stabilization and moisten it to its optimum water content (check this with the Drop Test, 4.3.2). Tamp the soil firmly into the box with a stick and then smooth off the surface. Dry the contents for three days in the sun, a week in dry shade or in a warm room. When the sample is completely dry, measure how much it has shrunk. Push all the soil, including separated lumps, tightly up to one end of the box. Measure the gap created by the shrinkage in the soil. The results can be interpreted (*1) as follows:

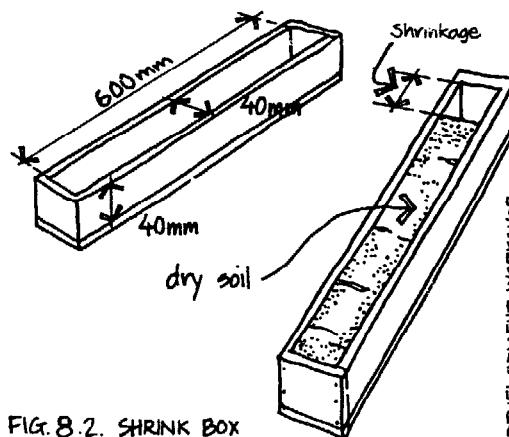
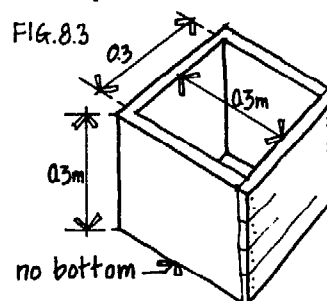

FIG. 8.2. SHRINK BOX

Shrinkage	Cement : Soil
Less than 12mm	1 : 18
12mm - 24mm	1 : 16
25mm - 39mm	1 : 14
40mm - 50mm	1 : 12

Cement does not mix easily with soil, and therefore this should be done when the soil is dry in order to facilitate a good mix. Poor mixing results in weak stabilization. Make sure that any clay lumps are broken down as small as possible. Cement stabilization works best with soils which have an even spread of particle sizes, so that there are no large voids, and similarly compaction improves the efficiency of the cement. Compaction, which is usual with cement stabilization, should be done quickly after mixing, and with the water content close to the optimum. The optimum water content should be worked out for the soil with the cement added, and not for the soil alone, since the cement changes the particle size profile, and raises the optimum water content. Soil-cement should be cured slowly, in shade, protected from drying winds and kept damp for a week, and then stored for another week or more before use. Strength improves with slow curing.

As a guide for mixing, a 50kg sack of cement fills a box with internal measurements of 0.3 x 0.3 x 0.3m = 0.027m³. This allows the proportion of soil:cement to be calculated by volume instead of weight. Use an appropriately dimensioned measuring box for the soil once the suitable cement percentage has been determined.



8.2.2 LIME

Unlike cement which works with the coarse particles of a soil, lime works with the clay minerals in the soil. On its own lime does not have a cementitious effect, but it reacts with some of the clay minerals and water to produce a cementing effect, increasing the soil's strength and reducing susceptibility to water. This is known as a pozzolanic reaction. Lime therefore works most effectively as a stabilizer with a high clay content soil, which is not normally suitable for stabilization with cement, nor easily compacted.

The reaction of lime with the clay minerals is slow. This could make it difficult to use as a stabilizer on its own. However, one of the beneficial effects of lime on a soil is to lower its plasticity and liquid limit, (see Fig 8.1 Atterberg Limits Chart), by reducing the amount of water the soil can absorb. This has two results: the soil is easier to compact; and cement can be used more efficiently than is normally the case with a high clay content soil. This latter result means that it could be useful to use a small amount of cement to give quick stability, supplemented by the slower strengthening reaction of lime.

Either quick-lime or hydrated lime can be used for stabilization. Quick lime has a drying out effect, which can be useful with very high clay soils, but one must be sure that there are no unslaked lumps in it before it is used.

The amount of lime to use has to be established by producing blocks with consistent compaction and water content, and testing them (see 5: Performance Testing). Select the lowest dosage giving acceptable results. Some tests (*2) have indicated that there is an optimum lime dosage for a soil beyond which compressive strength decreases. Likely dosages are between 3 - 10% lime by dry weight, and will increase as the clay content increases.

Mix lime with soil in the same way as cement, with a water content at or just above the optimum. When compacting high clay soils, mix the lime in and allow the soil to stand for a day or two, during which the lime will react with the clay, helping to break it down, and making it easier to compact. If adding cement as well, do so just before compaction. Lime stabilized soils should be kept wet for at least two weeks after mixing, and longer if possible. Blocks should be kept at least two months before being used.

8.2.3 POZZOLANAS

Pozzolanas are materials which will set hard when mixed with lime and water or cement and water, of which the former is the more common use. The advantage of using a pozzolana are threefold: when mixed with lime it speeds hardening, increases strength and moisture resistance (thus a similar effect to adding cement to lime); its use decreases the amount of cement or lime required (up to 25% of the cement volume); pozzolanas tend to occur naturally or to be waste products. The most common pozzolanas are fly ash; burnt clay powder (crushed waste from brick or tile kilns) known also as 'surkhi' (its Indian name); rice husk ash, made from burning chaff; and volcanic ash. They vary in the degree to which they have a pozzolanic effect, and are the subject of much research. Dosage with lime should be between 1:1 and 3:1 part lime, and must be determined by testing. Laterites sometimes have a pozzolanic effect with lime.

8.2.4 BITUMEN

Note: bitumen is not the same material as asphalt, but in the USA, confusingly, bitumen is called asphalt.

The main purpose of using bitumen is to reduce the effect of water on a soil. It works on the finest particles of the soil. Bitumen must be diluted before it can be mixed with soil. When the dilutant has evaporated, the bitumen is left as a thin coating over the clay particles. This stops the soil from absorbing or losing moisture, and makes it stable. The bitumen is therefore a water repellent, and it improves the wet strength of a soil.

Bitumen also has a cohesive effect when used in small amounts, which can add some dry strength to soils that are otherwise uncohesive, such as sands. Conversely, larger dosages weaken the dry strength of a soil.

Because bitumen works on the fine particles in the soil, only small amounts are needed on low clay/high sand content soils to give them better wet strength and some cohesion. The low clay/high sand soils also compact well, which improves the dry compressive strength, and the best results are therefore achieved by combining bitumen stabilization with compaction. When making compressed blocks the bitumen acts as a lubricant, helping the ejection of the block from the mould.

Soils suitable for mud brick making, with a higher clay content, can also be stabilized with bitumen. A higher clay content requires a proportionately higher bitumen dosage in order to greatly reduce the swelling and shrinking effect of water on soil, but this high dosage risks reducing the dry compressive strength and increases the cost. However, an improvement in the stability of mud bricks when exposed to moisture can be achieved, since a reduction in water absorption is possible at quite low bitumen dosages, and does not in fact increase significantly with large dosages.

To be used with a soil bitumen must be either dissolved with solvents, when it is known as 'cut-back'; or mixed with water with the help of an emulsifier.

The main agents for making a cut-back are gasoline, kerosene (also known as paraffin oil), or naphtha, which is the most volatile. Add enough solvent to the bitumen to achieve semi-liquid mixture. Mixing with 30 - 40% gasoline gives the slowest drying rate, and therefore the best mixing. Kerosene (or paraffin oil) dries faster, but can be mixed in proportions between 25 - 30%. Naphtha dries quickly, and is therefore more difficult to use, even though good results can be achieved. One should note that with increased amounts of solvent the inflammability increases.

With emulsions, bitumen is mixed with about 35 - 40% water with the aid of small amounts of emulsifier (1 - 2%). There are various proprietary emulsifiers, but one can also use soap effectively. The bitumen can be heated in order to help start off mixing with emulsions.

The amount of bitumen to add to a soil must be determined by testing, (see 5: Performance Testing), but one source (*3) suggests testing with 2 - 3% cut-back, or 3 - 6% emulsion. The diluted bitumen will be measured in litres, related to the volume of dry earth. The earth should be well mixed with water before bitumen is added. When making mud bricks, work with water content higher than the optimum, as this makes it easier to mix. Straw (which absorbs bitumen) should only be added just before moulding, otherwise larger amounts of bitumen will be needed. For compaction, make sure that the combined bitumen and water content of the soil is close to the optimum water content.

8.2.5 STRAW

The function of straw is to reduce cracking during the curing process, and to reduce weight. It reduces the swelling and shrinking effect of water, but should not be relied upon as a method of water protection. It is also used to increase tensile strength. Small prefabricated panels can be made, where it is more a case of the earth being used as a binder for the straw, than the straw being used as a stabilizer for the earth, (see 6.1.1 Wattle and daub, and 8.1.3 Reinforced earth roofs.)

8.2.6 OTHERS

In addition to these stabilizers there are various other products, traditional and modern, such as gypsum, used for stabilization. As these are most commonly used as renders, however, they are dealt with in the following section.

*1 Enteiche A. Soil Cement, its use in building, United Nations, 1964.

*2 Chantry G. La Chaux: sa production et son utilisation dans l'habitat, G.R.E.T., Paris, 1981.

*3 The International Institute of Housing Technology in California, University of Fresno, USA.

9. RENDERS

Most earth walls, even when stabilized, benefit from being rendered. The purpose of renders and surface finishes may be any or all of the following:

- waterproofing;
- resistance to wear, by rain washing or abrasion;
- reduced maintenance;
- reduction in heat gain by reflection;
- ease of surface cleaning;
- improved appearance.

The choice of render depends upon the type of wall as well as the materials available and the sort of protection desired. A difficulty with many renders is that they will not adhere well to earth walls, and this is particularly the case with unstabilized earth walls. The need to improve renders is increasing as the ability and willingness to carry out regular maintenance diminishes. On the other hand, it would be a mistake to think that a render can replace regular inspection and repair, if required.

9.1 TYPES OF RENDER

The following are some of the renders which can be used, providing varying amounts of protection.

9.1.1 MUD PLASTER

Mud plaster is suitable for use on unstabilized walls. It is applied wet, 15 - 25mm thick. Mix sandy soil with straw, chopped into short lengths. The mixture is left to soak a minimum of 24hrs, and much longer if possible. Soils which have a high clay content should, if practical, have sand added to them to increase water resistance and reduce cracking. 25:75 clay:sand is a good ratio. Most mud plasters have to be repaired annually when used externally, but adhere well to earth walls, and are thus the most common general protection. Repair does not necessarily mean total replacement, and cracks and holes can be filled up. Excellent internal finishes can be achieved with mud plasters.

9.1.2 CEMENT/SAND

Cement/sand renders are not well suited to unstabilized earth, and if used with it should be applied as a weak mix in 2 or 3 thin layers, 4 - 6mm per layer. The first coating should have a low cement content (1:15), increasing with each layer up to 1:8. Never make the mix too rich, as it will not adhere to the earth. For soil-cement walls, use a cement sand mix between 1:6 and 1:9. Keep the layers thin and apply them wet.

9.1.3 CEMENT/LIME/SOIL

This has the same problems of adhesion as cement/sand, but better workability and slower drying. It can be used on cement or lime stabilized surfaces, in proportions of 1:2:9 or 1:3:12 cement:lime:sand.

9.1.4 CEMENT/SOIL & LIME/SOIL

Cement/soil renders can be used on walls stabilized with cement, with proportions between 1:10 and 1:8 cement:soil. Soil should be sandy. Lime/soil renders can also be used on lime or cement stabilized earth, in proportions between 1:5 and 1:10 and are improved by adding a quarter

amount of cement, and/or 1 part brick dust. Soil-based renders have a better adhesion than sand-based renders.

9.1.5 CEMENT AND LIME SLURRIES

Mixed with water in a ratio of 6:1:1 (water:cement:lime) these produce a good water-proof coating, which is brushed onto walls like paint. Adding clean fine sand helps to give a gritty texture which improves resistance to water. They can last 5 - 10 years. Lime mixed with boiling water in a ratio of 3:7, with 1 part melted tallow produces whitewash, also applied with a brush. Slurries and whitewash will tend to flake off.

9.1.6 LIME/POZZOLANA WITH SAND OR SOIL

The best known of these plasters uses powdered burnt clay with lime, and is known as 'surkhi.' Other pozzolanas include fly ash, burnt rice husks, and volcanic ash. The ratio of pozzolana to lime depends upon the amount of silica in the pozzolana and the speed with which strength is required. High pozzolana dosages (4:1 pozzolana:lime) work faster, but 2:1 is common, as is 3:1 in the weaker pozzolanas. A suitable render is 1:2:9 lime:pozzolana:sand for use with stabilized earth, and a weaker mix on unstabilized earth.

9.1.7 GYPSUM/LIME & GYPSUM/LIME/SAND

External renders using gypsum:sand:lime in a ratio of 5:4:1 and small amounts of water can be used, with a final coat leaving out the sand. Internal renders can be done without the lime. (Lime improves the water resistance.) Very good results are achieved if the plaster can be applied to a surface with projecting fibres, which provide a good key.

9.1.8 BITUMEN/SOIL

Using either cut-back or emulsified bitumen, (see 8.2.5), mixed with soil, good renders can be achieved. Dosages should be between 5 and 10% with mud mortar as in 9.1.1 above. High clay content soils require more bitumen than sandy soils. The latter are preferable. The render should be applied in two thin coats, to a total thickness of 10 - 20mm. This is a more efficient use of bitumen for water-proofing than stabilizing the mass of the wall. Bitumen plaster can last up to 10 years. A variant of the bitumen plaster is to spray or paint the wall with bitumen emulsion: this then requires a coating of sand to seal it, and whilst giving good water-proofing, provides little protection against impact.

9.1.9 SOIL/COW DUNG

Mixed in proportions of 1:5 dung:soil, the dung acts as a binder. This gives a good finish coating to mud plasters when applied as a paste. It can be improved with a weak dosage of bitumen, but requires regular maintenance.

9.1.10 MATTING & THATCH

Matting is sometimes hung over earth walls to protect them from rain and impact damage. The mats can be made out of palm fronds, leaves or grasses, and are either hung over the wall in the form of a suspended mat, or hung from battens in a manner similar to thatching. This is a technique which provides good protection to the wall from both rain and impact damage, but it harbours insects and is sometimes eaten by animals. The matting or thatch has to be replaced after 1 or 2 years.

9.1.11 BRICK OR TILE FACING

There are two basic versions of this form of protection. The first is to build a mud brick wall with an external face of fired bricks. Care must be taken that the two materials are bonded together, and since there is no chemical bond, this must be done by interlocking the fired bricks into the mud brick wall. Tests (*1) have identified two acceptable bonding patterns (Fig 9.1). The second version is to mould bricks with a small fired tile facing (Fig 9.2) inserted in the mould before the mud is added (*2).

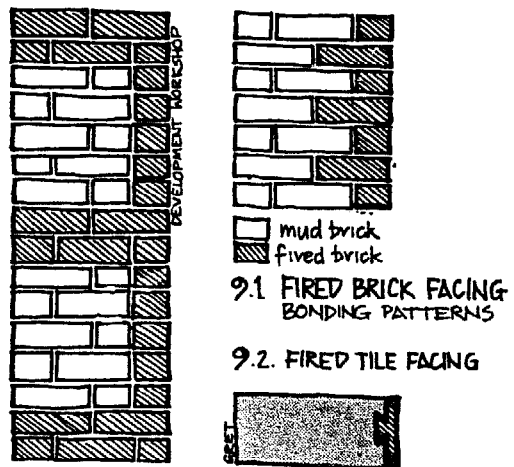

9.1.12 'LOCAL' RENDERS

There are numerous 'local' renders, based on vegetable products, soils or wastes. Some of these work well, and are worth testing. For example, Development Workshop has tested renders made from diluted powdered acacia pods, which contain tannic acid, and found a durability improvement of 3.5 over the ordinary mud renders described in 9.1.1 above (*3).

9.2 USE OF RENDERS

Good rendering depends much on preparing the wall properly so that the render will adhere. Renders which are 'strong' are particularly prone to separation from the wall they are protecting: this is often the case with cement-based renders. When lamination occurs, water penetrating through cracks into the gap between the render and the wall can do great damage. One of the most popular techniques of rendering with cement is to fix chicken wire to the earth wall, and use this as a key for a cement/sand render, so that little attention is paid to adherence with the wall or roof being rendered. When using this system in areas of prolonged rainfall one should be aware that structural damage by water can occur without being visible on the surface of the render.

There are various ways of preparing a good key for the render, including the chicken wire mentioned above. Chicken wire (or similar) should be fixed at regular intervals to the wall, with spikes or pegs. Spikes and nails can be used alone to provide a key, placed in a dense but irregular pattern, and hammered well into the wall. Another method is to face the wall with bits of broken pottery, tiles etc., which project out from the surface, and are either put in at the time of building, or pushed into the mortar whilst it is still damp (Fig 9.3). A similar effect is achieved by placing fibres in the wall while it is being built so that

FIG 9.3.

Broken tiles pushed into damp mortar;

Wooden pegs;

Nails and spikes;

Holes; and grooving;

Fibres projecting from the wall.

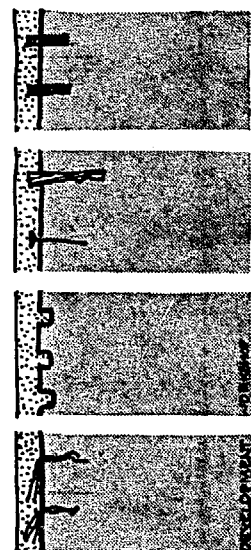

they project beyond the surface. When working with bricks or blocks the joints should be cleaned out to a depth of 15mm or more. The rougher the surface the better the key, and this can be achieved by making grooves or holes in the surface.

Surfaces should be brushed down in all cases to remove loose matter and dust, and then dampened before the render is applied. Renders are best applied in several thin layers, of increasing strength. Renders adhere better if applied with force: thrown on with a trowel or in balls. Renders smoothed on firmly by hand adhere well to rough surfaces, and this is often the traditional way of working.

- *1 Development Workshop. A strategy for developing indigenous building in earthquake regions, C.E.D.S., Tehran, 1978.
- *2 Gué J. Innovations in Mud Walls, C.S.V./G.R.E.T, Paris, 1985.
- *3 Development Workshop. "Builders' Training Workshop & Literacy Centre Construction Project: Chikal, Niger," unpublished material, 1982.

10. OTHER CONSIDERATIONS

The decision whether to build with earth, and if so, how, is not purely a matter of technical choice, but depends as much - and in some cases more - on a number of other factors, not all of which are easily determined. Amongst these, one should bear in mind the following.

The economics of building and maintenance

These should be considered from the 'client's' point of view:

- how much will the building cost to build?
- how long will it last?
- how much maintenance will it require, and what will this cost?

One should consider that public facilities, or those not owned by a community, are less likely to be maintained than privately owned buildings, and therefore their maintenance requirements should probably be low.

In low income situations, techniques and materials requiring lower capital outlay and higher annual expenditure or effort on maintenance, may be an attractive proposition.

Economics can also be considered from a national or collective viewpoint, in terms of reduction in energy and import costs, although this is seldom a persuasive argument for the individual builder.

Resources

One should consider both the availability of skills for building with earth, which may influence the choice of technique, and the long and short term availability of any equipment needed for processing the materials, as well as the potential for local repair, if relevant.

These concerns are particularly valid when planning work with contractors, whose operation may be set up to work efficiently and profitably with other techniques or materials.

Material availability

Building with earth involves, in most cases, large amounts of both earth and water. If these are available directly on site, one should consider the holes that may be left after excavating enough earth for the building - they often get filled with rubbish and standing water.

If earth and water are not available on site, transport will be a major factor: loose earth occupies between 1.5 (for mud brick) and 2 (for compressed earth) times the volume of the finished wall. Water quantities will vary between 25 and 35% of the volume of earth (including water for damping bricks, mortars, etc.) and will need transporting in barrels or a tanker. Processing materials close by their source is normally cheaper.

Environment

This includes the need to choose a building system which suits the local micro-climate (see 2.2), but also consideration of the earthquake and flood risk, changing ecological conditions, (particularly timber shortages,) and the effect of increased building density, (see above on material availability.)

Psychology and socio-cultural acceptability

Despite strong economic, technical, and climatic evidence in earth's favour, and numerous examples - both old and new - of high quality building, for many people earth has an image or association of poverty, and in some cases under-development. Notions of prestige or public image will often negatively influence the acceptability of an otherwise logical use of earth for building. This is as much a factor in the choice of which way to use earth, as it is in whether to use earth at all.

Legislation and institutional acceptability

Often a reflection of the psychological factor above, performance standards and zoning regulations may preclude, either directly or indirectly, the use of earth for building. Similarly, both loans and insurance are often difficult to obtain, because of a belief in the poor durability of earth. In addition to visual evidence that earth is a durable building material, carrying out performance tests helps to give earth a more specific basis for comparison with other building materials. Such testing also serves as a basis for establishing contracts with organisations unfamiliar with earth construction. Improving the credentials of earth and assuring a high quality in its use can reduce some of the reticence with which building with earth is sometimes regarded, and encourage its recognition as an excellent building material.

SELECT BIBLIOGRAPHY

- Agarwal A. Mud, mud. The Potential of Earth-based Materials for Third World Housing, London, 1981.
- Barrot P. Retour a la terre au Perou, 'Réseaux' No.32, GRET, Paris, 1985.
- British Standards Institution. BS 1377: Methods of test for soils for Civil Engineering Purposes, London, 1975.
- Cain A., Afshar F., and Norton J. Oman: The Problems and Potentials of the Indigenous Built Environment in a Developing Country, Development Workshop, London, 1975.
- Chantry G. La Chaux: sa production et son utilisation dans l'habitat, GRET, Paris, 1981.
- CONESCAL. Tecnologia de Construccion en Tierra sin Cocer, Mexico, 1983.
- CONESCAL. Tecnologia de Tierra y su Aplicacion en la Construccion de Espacios Educativos, Mexico, 1982.
- Dancy H.K. A Manual of Building Construction, Intermediate Technology Publications Ltd., London, 1975, (revised edition.)
- DeLong H.H. Rammed Earth Walls, South Dakota, 1959.
- Denyer S. African Traditional Architecture, London, 1978.
- Dethier J. Des Architectures de Terre, Paris, 1982.
- Development Workshop. A Strategy for Developing Indigenous Building in Earthquake Regions, C.E.D.S., Teheran, 1978.
- Doat P. et al., CRATerre. Construire en Terre, Paris, 1979.
- Enteiche A. Soil Cement: its use in building, United Nations, 1964.
- Fathy H. Gourna: A Tale of Two Villages, Cairo, 1969.
- Fenton A. The Island Blackhouse, Edinburgh, 1978.
- Fitzmaurice R.F. Manual for Stabilized Soil Construction for Housing, UN Technical Assistance Programme, New York, 1958.
- Fréal J. L'architecture paysanne en France: la maison, Paris, 1979.
- Gardi R. Indigenous African Architecture, Bern, 1973.
- Gué J. Innovations in Mud Walls, GRET/CSV, Paris, 1985.
- Houben H. and Guillaud H. Primer on Earth Construction, Brussels, 1985.
- Jeannet J. et al. Le Pisé: Patrimoine, Restauration, Technique d'avenir, Puy-de-Dôme, 1986.
- Kern K. The Owner-Built Home, New York, 1972.
- Lunt M.G. Stabilised Soil Blocks for Building, Overseas Building Notes, Building Research Establishment, 1980.
Also Colonial/Overseas Building Notes Nos. 8, 14, 54, 71, 81, 106, 121.

- Middleton G.F. Earth wall construction, Canberra, 1952.
- Michell G. (editor) Architecture of the Islamic World, London, 1978.
- Norton J. Manual for Constructing a Community Building, Development Workshop, Toronto, 1986.
- Norton J. Manuel de Construction Parasismique, Development Workshop, Toronto, 1986.
- Patty R.L. Paints and Plasters for Rammed Earth Walls, South Dakota, 1940 (?)
- Ross Noble R. Turf-Walled Houses of the Central Highlands: An Experiment in Reconstruction, Folk Life, Vol. 22, 1983-4.
- Smith R.G. Building with Soil-Cement Bricks, Building Research and Practice, March/April, 1974.
- Smith R.G. Improving Moulding Devices for Hand-made Bricks, Appropriate Technology, Vol.7, No.4, 1981.
- Spence R.J.S. and Cook D.J. Building Materials in Developing Countries, London, 1983.
- Spence R.J.S. (editor) Lime and Alternative Cements, Intermediate Technology Publications Ltd., London, 1974.
- Stulz R. Appropriate Building Materials, Intermediate Technology Publications Ltd. / SKAT, 1983.
- VITA Making Building Blocks with the CINVA-Ram Block Press, Maryland, 1966.
- Webb D.J.T. Stabilised Soil Construction in Kenya, from proceedings of MTEC '83, Paris, 1983.