

AT MICROFICHE REFERENCE LIBRARY

A project of Volunteers in Asia

Soil-Cement: Its Use in Building

Published by:
United Nations
New York, NY 10017 USA

Paper copies are \$7.00; available in English,
Spanish, and French editions. Ask for publication
E.64.IV.6 when ordering.

Available from:
Publications Sales
Room A-3315
United Nations
New York, NY 10017 USA

Reproduced by permission of the Department of
Public Information, United Nations.

Reproduction of this microfiche document in any
form is subject to the same restrictions as those
of the original document.

soil - cement

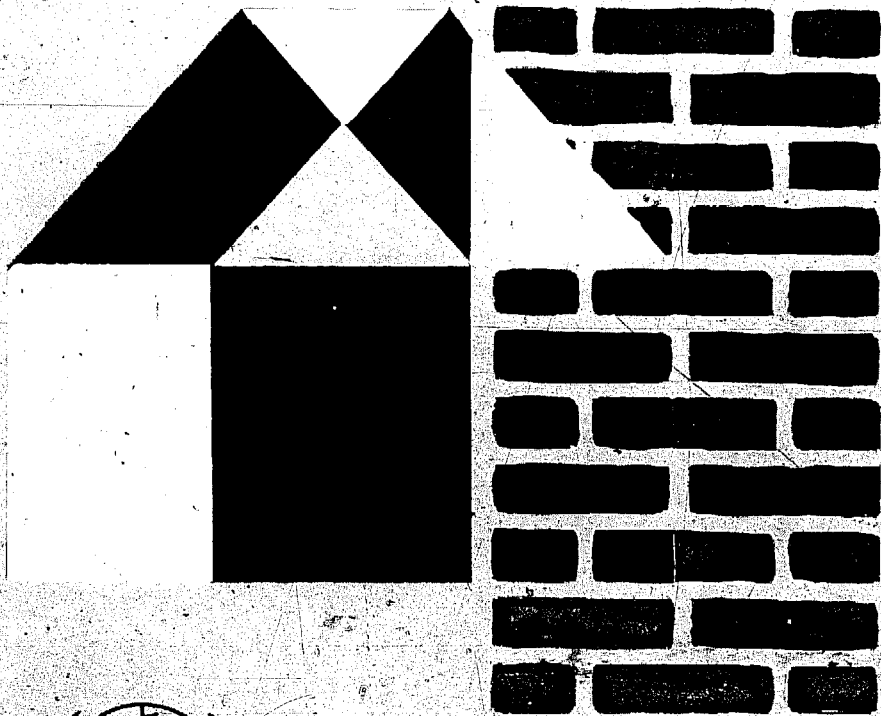

UNITED NATIONS

THE INTER-AMERICAN HOUSING AND PLANNING CENTRE

THE INTER-AMERICAN HOUSING AND PLANNING CENTRE (CINVA) was established by the General Secretariat of the OAS in 1951 within the precincts of the National University of Colombia at Bogotá, as part of the Programme of Technical Co-operation of the Organization of American States and in accordance with a decision by the Inter-American Economic and Social Council. The Centre was permanently incorporated into the General Secretariat of the OAS on 1 January 1959 and has become one of the field activities of the Department of Social Affairs. Its functions include educational activities in the fields of housing, community planning and building, research work, and the publication of information on housing and related fields.

Yale University provides advisory and technical administrative services for the Centre's policies and programmes, in accordance with an agreement signed between Yale and the General Secretariat of the Organization of American States on 10 March 1961.

The Government of Colombia also collaborates in the operations of the Centre through the Land Credit Institute and the National University of Colombia.

Department of Economic and Social Affairs

soil-cement its use in building



UNITED NATIONS
New York, 1964

The reader is referred to the end section of this publication for figures Nos. 1-93 in illustration of the text.

ST/SOA/54

This publication was prepared and first issued in Spanish by the Inter-American Housing and Planning Center, Pan-American Union, Department of Social Affairs. The French and English versions have been prepared by the United Nations.

UNITED NATIONS PUBLICATION

Sales No.: E. 64. IV. 6

Price: \$U.S. 6.00
(or equivalent in other currencies)

TABLE OF CONTENTS

FOREWORD

INTRODUCTION

CHAPTER I. SOILS

	<u>Page</u>
Origin	1
Elementary properties and basic components	1
Elementary properties.	1
Internal friction.	1
Cohesion	2
Compressibility.	2
Elasticity	2
Capillarity.	2
Texture.	2
Chemical composition and colour.	2
Basic components	3
Coarse particles	3
Fine particles	3
Identification and classification	4
Survey	4
Taking a sample.	4
Laboratory tests	4
Granulometric analysis	5
Testing procedure	5
States of consistency	5
Testing procedure	6
Liquid limit	6
Plastic limit.	6
Shrinkage limit.	6
Porosity, unit weight and specific gravity	6
Compaction	7
Field tests.	7
General tests	8
Granular composition	8
Visual examination	8
Testing by touch.	8
Sand, silt and clay, silt, clay	8
Sedimentation test	8
Tests of fine fraction	9
Separation (shaking) test	9
Table 1. Surface water reactions in fine soils	11
Dry strength test	11
Table 2. Dry strength test	12
Brightness test	12
Supplementary field method for identification of soil texture	12
Table 3. Field method for identification of soil texture.	13
Workability of soils used as construction material	14
Table 4. Table of "workability of soils" used as construction materials	14

TABLE OF CONTENTS (continued)

CHAPTER II. SOIL AS A CONSTRUCTION MATERIAL

	<u>Page</u>
Background	15
Forms in which soil is used.	15
Stabilized soil.	15
Methods of stabilization	16
Consolidation.	16
Waterproofing.	17
Chemical treatment	17
Addition of a binding agent.	17

CHAPTER III. PREPARATION OF SOIL-CEMENT

Introduction	18
General.	18
Influence of the soil components	18
The ideal soil	18
Clay	18
Advantages of soil-cement.	19
Preparation.	19
Components	19
The soil	19
Taking and classifying samples.	19
Selection.	19
Recommendation	20
Preparation.	20
The cement	21
The water.	22
Mixing the components.	23
Preparation area	23
Dry mixing	23
Adding the water, and wet mixing	23
Amount of water needed	23
Compacting the mixture.	24
Shuttering method.	24
Moulding method.	25
Simple moulds or forms	25
Mechanical moulders.	25
The CINVA-RAM moulder.	26
Drying and curing.	26
Monolithic walling	27
Blocks	27
Some comments on certain soil cement laboratory tests.	27
Compressive strength test.	28
Moisture-density relations test of soil-cement mixtures.	28
Durability tests	28
Wetting and drying test.	29
Freezing-and-thawing test.	29
Water absorption test.	29
Shrinkage test	29
Unit weight test	30
Erosion test	30

TABLE OF CONTENTS (continued)

CHAPTER IV. USE OF SOIL-CEMENT IN HOUSING CONSTRUCTION	Page
Introduction	31
Foundations.	31
General.	31
Lower foundations.	32
Cyclopean concrete	32
Rammed soil-cement	33
Soil-cement blocks	33
Upper foundations.	33
General.	33
Methods for upper foundations.	34
Cement concrete.	34
Rammed soil-cement	34
Soil-cement blocks	34
Walling.	34
General.	34
Horizontal waterproofing	35
Waterproof cement mortar	35
Bitumen.	35
Bituminous felt.	35
Wall-building.	36
General.	36
Soil-cement blocks.	36
Bonding.	36
Wall junctions	36
Mortar	37
General.	37
Types of mortar.	37
Reinforcing.	38
General.	38
Pillars.	38
Vertical reinforcement	38
Wall plates.	39
Horizontal reinforcements.	39
Lintels.	39
Monolithic walling of soil-cement.	40
Apertures.	41
Fixing of frames	41
Roofs.	42
Roofing.	42
Soil-cement roofing.	42
The roof support	42
Flooring	43
Soil-cement made <u>in situ</u>	43
Thin soil-cement pieces.	44
Soil-cement blocks	45
Wall finishes.	45
Paint.	46
Cement-based paint	46
Lime-based paint	46
Plaster.	46
Plaster of soil-cement mortar.	47
Plaster of cement mortar	47
Plaster of lime mortar	47

TABLE OF CONTENTS (continued)

CHAPTER V. ACCOMPLISHMENTS IN SOIL-CEMENT

	<u>Page</u>
The purpose of this chapter	48
Houses	48
Rural dwelling of soil-cement	48
Sample house of soil-cement	49
Rural dwelling, San Jerónimo	50
House of soil-cement blocks	50
Soil-cement house	51
Soil-cement house in the United States of America	53
Soil-cement houses in Colombia	55
Soil-cement house in Venezuela	55
Soil-cement house in Brazil	56
Soil-cement house in Bolivia	57
Soil-cement house in Chile	58
Schools	59
Saucio rural school	60
Rural school of soil-cement in Colombia	60
Catenarian arch	61
Soil-cement cisterns and silos	62
Cistern for the experimental dwelling in Chambimbal Village, Colombia	62
Cistern for the soil-cement house built at the CINVA "experimental building station"	62
Soil-cement silos	63
Kitchen ranges	63
Range for the experiment dwelling at Chambimbal Village, Colombia	63
Household range for the San Jerónimo Rural Project, Colombia	64
Range for the soil-cement cottage, Colombia	64
Range for the Tabio experimental country school, Colombia	65
Ovens	65
Soil-cement oven for the cottage built at the CINVA "experimental building station"	65
Soil-cement oven for the experimental dwelling at Chambimbal Village, Colombia	66
Other uses	66
Thermal insulation with soil-cement	66
Special soil-cement blocks for ventilation	67
References	67

TABLE OF CONTENTS (continued)

CHAPTER VI. ANNEXES

	<u>Page</u>
Annex I. Test for loss of length by shrinkage of soil	69
Annex II. Soil-cement floor tiles	70
Annex III. The siphoning method.	71
Scope	72
Apparatus	72
Table I	73
Table II.	73
Reagents.	74
Sampling.	74
Procedure	74
Report.	75
Granulometric curve	76
Examples.	76
Colloidal material.	77
Comparison between the standard method and the siphoning method.	78
Comparative table	78
Bibliography.	79

FOREWORD

The use and improvement of traditional low-cost building materials has occupied an important place in the research programme of CINVA. As a part of these activities, considerable research has been done with stabilized soil to improve the use of a material which has been extensively used since colonial days in rammed-earth or similar buildings.

One result of these researches was the development of the CINVA-RAM machine, which combines the features of being simple to operate, efficient, and easy to transport to places lacking motor roads. This machine is designed primarily to stabilize earth with cement, but it has been used in many countries to produce building materials utilizing other stabilizing agents. However, the machine is still most commonly and widely used to stabilize soil with cement in order to obtain strong and durable building materials. It is employed in many rural and urban areas, especially for self-help and mutual aid housing programmes.

Although the technique of stabilizing soil with cement is a simple one, it nevertheless requires some degree of competence if the building material obtained is to have the qualities needed for optimum use. In connexion with the CINVA-RAM machine, CINVA prepared an elementary publication on soil-cement, which is not intended to solve the many problems that might arise but gives basic instructions for making soil-cement blocks. The United Nations later published a Manual on Stabilized Soil Construction for Housing,* based on experience in various parts of the world and intended for the use of engineers and builders. Practical experience has shown that there is a need for instructional material at a level intermediary between these two publications - the elementary and the advanced - to meet the requirements of qualified contractors and similar personnel who are not normally faced with difficult technical problems but who carry out a good deal of stabilized soil construction. This publication, Soil-Cement: Its Use in Building, has been prepared to meet this need. The order of presentation, the terminology used, and the large number of illustrations, are designed to make the instructions more readily understandable with a view to the greatest possible circulation and impact. A further objective is to promote the wider use of soil-cement, which can lead to a reduction in construction costs, wherever favourable conditions exist, because of the inexpensiveness of the material itself and also because it can be made by the families themselves to build their own homes. Its use may also provide an adequate solution in rural areas where the production or transportation of other building materials is difficult and costly.

CINVA takes this opportunity to thank all those who have given encouragement to or shown interest in the use of soil-cement, in conjunction with the CINVA-RAM machine, not only in Latin America but in other continents. Sincere gratitude is also expressed for the collaboration received from many professional men, scientific institutions and housing organizations in the task of research.

Rafael Mora-Rubio
Field Director of the
Inter-American Housing and Planning Centre

* Sale No. 58:II,H.4.

This study was prepared by Engineer Augusto A. Enteiche G., staff member of the former Interamerican Housing and Planning Centre (CINVA).

INTRODUCTION

The use of simple compacted soil (natural earth) as a building material dates from time immemorial, and it can be said that ever since, and down to the present day, the method of building houses with earth has been used, because of its constructive qualities. Yet, despite its good insulating and resistant properties, there are limitations to the use of earth owing to its lack of strength and its vulnerability to moisture and the erosive effects of external agents.

Provided that natural soil possesses a combination of certain characteristics, however, it can be subjected to the process known as "stabilization". The effect of adding a stabilizing agent like Portland cement, for instance, is not only to enhance its best qualities but to impart to it other properties which soil alone does not possess.

The stabilization process consists of taking soil from the earth, pulverizing it, adding to it a certain small amount of cement, adding water until the optimum moisture content of the mixture is reached, and subjecting it to moderate pressure, thus producing a mass which, when set, possesses great strength. The result is a material able to bear a much higher work-load than could be carried by soil without cement, and durable enough to withstand the continuous effects of atmospheric agents.

The compound of soil, cement and water, mixed in the proper proportions and compacted to the proper degree, constitutes "soil-cement".

Soil-cement has acquired a good name as a building material, and it can compete in technical quality with materials commonly used in low-cost construction. Its use is steadily and gradually increasing in all countries, particularly in rural and suburban areas. The simplicity of the technique involved means that peasants and workers, without special training, can build their own homes inexpensively and without the use of complicated and time-consuming skills.

This paper shows how soil-cement may be used at various stages in the construction of a house, together with a number of examples which may be helpful to anyone wishing to use this material for building purposes.

Soil-cement: its use in building is divided into chapters, dealing with basic facts and practical application, on: knowing soils; soil as a construction material; the preparation of soil-cement; the use of soil-cement for housing; and accomplishments in soil-cement.

The author takes pleasure in thanking the staff of the Inter-American Housing and Planning Centre for their co-operation, and in particular Mr. Alberto González Gandolfi and Mr. Raúl Ramírez R., the former CINVA expert, for their valuable help.

The author also thanks Mr. Alejandro Sandino P., Director of the Materials Testing Laboratory of the School of Engineering of the National University of Colombia, and Mr. Gustavo Maldonado L., Engineer in Charge of the Soils Section of the Materials Testing Laboratory of the School of Engineering of the National University of Colombia, for their excellent collaboration.

Bogotá, August 1963

I. SOILS

ORIGIN

The earth's crust is the outer envelope of the solid part of the globe. The upper or surface part consists of a layer of loose fragmentary material of varying depth. The top part of this layer, which varies in coarseness, is called soil. It comes from the decomposition of rock and of the remains of living creatures which are found in it (fig. 1) 1/

The living rock is turned to soil material after undergoing changes resulting from mechanical processes (disintegration), chemical processes (decomposition), and mechanical-biological processes.

If a vertical cut is made in the soil, it will be seen that the latter is composed of layers which are sometimes quite distinct in colour and depth. This cut is called a cross-section, and each layer is called a level (fig. 2).

Soil may be considered as a compound of solid matter, liquid matter (water) and gaseous matter (air). The solid matter in the soil is formed of mineral fragments in various stages of disintegration and decomposition. The solid components with the greatest degree of disintegration include sands, silts and clays. Mixed with these is a varying amount of organic matter.

The top layer of soil, which is called the "topsoil", usually contains a considerable proportion of organic matter as a result of the accumulation of mineral and vegetable remains. This layer containing organic matter is subject in turn to the effects of moisture and dryness, and to the soaking of water through it. Beneath the topsoil lies the subsoil, containing little or no organic matter.

ELEMENTARY PROPERTIES AND BASIC COMPONENTS

Elementary properties

If soils are to be used as a building material, it is most important to know in advance how they may behave under the various conditions to which they will be subjected in practice. It is possible to predict the behaviour of the material by studying some of its properties, as follows:

Internal friction

This is the force which resists the sliding of one particle over another.

Internal frictions are produced in a clayey mass or a mass of sand, according to the moisture content; in clays, because of their consistency, 2/ the force of friction is much less than in sands.

1/ The reader is referred to the end section of this publication for figures Nos. 1-93 in illustration of the text.

2/ See "States of consistency" in this chapter.

Cohesion

True cohesion, or adhesion, is caused by the forces of molecular attraction, which bind together the contact surfaces of the particles of clay.

Apparent cohesion, or moisture cohesion, is the cohesion of soils when they are moistened with a certain amount of water; this property is of fundamental importance in the stabilization of soils, since their cohesion can be changed and improved by appropriate processes.

Clay is cohesive only up to a certain moisture content, because if the small particles of water covering the grains of the material become too large through the addition of more water, the grains separate and lose their cohesion.

Compressibility

Compressibility is the name given to the property, which some soils possess, of diminishing in volume when a given pressure is exerted upon them. Such pressure has the effect of reducing the porosity of the soil by diminishing the number of voids.

Elasticity

A soil which diminishes in volume when pressure is applied and returns to its former volume, or almost so, when the pressure is removed is said to be elastic.

Capillarity

This is the property, which soils possess, of absorbing moisture from all sides.

The amount of capillary water^{3/} retained by each category of soil will depend on the number and size of the voids it contains. The finer the soil, the greater is its capillary capacity. This is because it has more small ducts containing particles of water.

Texture

Soils are composed of particles which vary in size and shape. Texture refers to the sizes and proportions of the particles contained in the soil. It is determined by granulometric analysis.

Chemical composition, and colour

As a rule, chemical composition is closely related to the colour of the soil.

It is possible in many cases, simply by visual examination, to identify the approximate chemical composition of soils by their colours.

3/ Water attracted by the narrow tubes or ducts between the particles of soil, owing to a physical phenomenon known as capillarity.

Among other colouring agents found in soils, the following effects, produced by certain components of iron and by organic matter, may be mentioned:

Components of iron give the soil a red, yellow or grey colour.

Large amounts of organic matter in soils make them dark or coffee-coloured; dark blue, dark grey, or dark green; broadly speaking, it can be said that, the darker a soil is, the greater is the proportion of organic matter it contains.

Basic components

A soil is composed of the following basic elements, in varying proportions: very coarse sand, coarse, medium and fine sand, silt and clay. The usual method of determining the proportions is to classify the particles of soil by size, through granulometric analysis.

In the present paper, soils have been classified conventionally, on the basis of their granulometric analysis and according to the name of the predominant basic component; as sandy, silty or clayey soils.

In order to facilitate classification, however, the basic soil components have been grouped according to particle size, as follows:

- (a) Coarse particles, or sands, from 4.76 mm to 0.074 mm in size;
- (b) Fine particles (silt and clay), less than 0.074 mm in size (ASTM^{4/} No. 200 sieve).

Description of the basic components

Coarse particles

Sand. This can be regarded as the structural and inert element in soil. It is stable when moist, but unstable when dry.

Sand has a high internal friction. It has no cohesion and no plasticity. It does not contract when dried. It is pervious, and is compressed almost instantaneously when pressure is applied to its surface.

Fine particles

* Silt. The size of the particles cannot be seen with the naked eye, but they feel gritty between the teeth. Silt has little cohesion or internal friction. It may change in volume when worked. It is difficult to compact.

Clay. This is the active fraction of the soil, to which it imparts important properties, both physically and chemically. Because of its high plasticity, clay readily takes the desired shape. It is a material smooth to the touch and sticky when wet.

^{4/} American Society for Testing Materials.

Dry clay absorbs a considerable proportion of water with a notable increase in volume; when it dries, it returns to its original volume, but the shrinkage of the mass produces cracking. It is virtually impervious, and is compressed very slowly when pressure is applied to its surface.

IDENTIFICATION AND CLASSIFICATION

Before soil is used as a building material, a survey of the site from which it is to be taken must first be made, after which samples of the soil must be obtained for physical and mechanical tests to provide a detailed knowledge of its properties.

Survey

The purpose of a survey is to describe and classify the properties of soils at their place of origin.

In order to make a survey, a cross-section is cut through the soil to a depth of approximately two metres below the topsoil. The depth of the topsoil and the composition of the layers of subsoil - i.e., the depth of those layers and the materials of which they are composed - will then be noted.

Taking a sample

The sample of soil is taken from the same cut used for the survey; it should be representative of the materials at the site and must not include the topsoil, which contains organic matter. Such topsoil, where it exists, is identified by its pronounced dark colour and its characteristic odour of decomposed organic matter, which becomes more pronounced if it is heated (figs. 3 and 3 (a)).

The sample taken should be used to study the soil by granulometric analysis and other tests. These tests will indicate the elementary physical properties and behaviour of the soil which is to be used.

The tests can be carried out either in the laboratory or in the field. The use of any given method of testing will depend on the facilities available in the area. It is desirable, however, to make use of a materials-testing laboratory whenever the magnitude of the work so requires.

An account of the laboratory procedures is given below.

Laboratory tests

This account of the laboratory tests is given in very summary form and purely by way of illustration, since this paper is intended to be of practical use to construction technicians.

When the sample reaches the laboratory, any material consisting of very coarse particles (fig. 4) larger than 4.76 mm (ASTM No. 200 sieve) is removed. The remaining matter is subjected to the following tests, details of which are given below:

(a) granulometric analysis; (b) states of consistency; (c) porosity, unit weight and specific gravity; (d) compaction.

Granulometric analysis

The basic soil components are determined by granulometric analysis, which measures the size of the particles within a given range. This is expressed as a percentage of the total weight of the matter being tested.

The soil components are separated according to size with the use of sieves. The sieves usually bear a range of numbers, which relate to established conventional scales.

It is difficult to make a granulometric analysis of the fine soil particles by using sieves. For this reason, the fine material is usually tested in the laboratory by "siphoning", and in the field by "sedimentation".

Testing procedure

The portion of soil to be tested, which has passed the 4.76 mm sieve and may contain silt and/or clay, is placed in the No. 200 sieve and washed. Two groups of material are thus obtained. The portion retained in the No. 200 sieve is again sieved through a set of meshes calibrated from 4.76 mm to 0.074 mm, and the size of the particles is thus determined (figs. 5 and 5 (a)).

The portion which has passed the No. 200 sieve consists of silt and/or clay, and it is subjected to a test known as the "siphoning method", 5/ which consists of determining the proportions of silt and/or clay respectively (figs. 6 and 6 (a)).

States of consistency

When dealing with a soil, it is very important to know not only its granular composition but also certain physical properties of the material, made up of fine particles. Tests have therefore been devised which make it possible to determine these properties, in an approximate way, by studying the "states of consistency" of soils.

Soils may assume various states, between the extremes of solidity and liquidity, according to changes in their moisture content which can be effected at will in the laboratory.

Consistency is the degree of apparent cohesion or moisture content of the particles in a soil and their resistance to external forces which tend to distort or destroy their structure. Consistency depends on the moisture content of the soil.

When a cohesive soil - for instance, clay - is very wet, it becomes a viscous liquid (first state of consistency). As the water in the soil evaporates, it

5/ Method suggested by Mr. Raúl Valle Rodas, explained in detail in annex 3.

becomes a soft solid; until a point is reached where very little force is needed to mould it into any form; it is now a plastic solid (second state). If the water continues to evaporate, the soil next becomes a true solid, but it is still soft (third state). It can no longer be moulded, because it breaks before changing shape; but two or more pieces will unite if pressed together. Finally, if the process of evaporation continues, the soil acquires greater solidity and displays the general characteristics of a hard solid (fourth state).

The Swedish scientist Atterberg established "limits" between these four states of soil consistency. He gave the name "liquid limit" to that separating the liquid and plastic states, "plastic limit" to that between the plastic and soft solid; and "shrinkage limit" to that separating the soft solid state from the hard state.

Testing procedure

Liquid limit. This is the moisture content at which a soil begins to flow when shaken lightly in a suitable apparatus. It is expressed as a percentage of the dry weight of the soil.

It has been established that this is the moisture content at which a mass of soil divided into two portions can be reunited in a suitable apparatus by shaking a given number of times (figs. 7 and 7 (a)).

Plastic limit. This is the moisture content at which a soil passes from the plastic to the soft solid state.

It has been established conventionally that this is the moisture content at which a soil can be rolled with the hand into threads approximately three millimetres in diameter, whereupon the thread breaks (fig. 8).

Shrinkage limit. This is represented by a moisture content such that, even if the evaporation of water continues, the volume of the soil mass remains constant, or in other words, it ceases to shrink.

It has been established that, for testing purposes, a mass must be prepared, consisting of a small amount of soil with a proportion of water corresponding approximately to the liquid limit, as defined above. This paste is crammed into a mould of known volume, which is placed in an oven until the soil is completely dried, forming a cake. The weight and volume of the dry cake is then determined. The figures obtained are used to calculate the shrinkage limit by a certain formula.

Porosity, unit weight and specific gravity

The porosity of a soil is the relation between the volume of voids and the total volume, and this name is given to the percentage of the volume of the soil occupied by the pores.

Unit weight is the weight of dry soil contained in a given volume (the weight per litre in kilogrammes).

The unit weight of a soil is in inverse relation to its porosity and increases as it is compressed, since the same volume then contains a larger quantity of soil owing to the reduction of the voids.

Specific gravity is the weight of dry, solid soil contained in a given volume, without reference to the voids.

Specific gravity is always greater than unit weight. When a soil is compacted, its unit weight increases owing to the reduction of the space occupied by the pores. If a soil could be compacted until it became a completely solid mass, its unit weight would equal its specific gravity.

Compaction

If we compress a mass of soil mechanically, we increase its unit weight; this process is called compaction.

When a relatively dry soil is compacted, the particles cannot move within the mass because of friction between them, which is caused by the lack of a lubricating agent - in this case, water. This results in a high percentage of voids and a low unit weight. When a soil is lubricated with more water and then compacted, the particles move easily, the percentage of voids is reduced, and the unit weight increases until a certain limit is reached. This limit to the increase in the unit weight is achieved when sufficient water has been added to produce the "optimum moisture content" of that soil; there is then sufficient lubrication to give, on compaction, the best possible unit weight, i.e., the "maximum unit weight".

When a soil with a certain percentage of moisture is compacted, a given unit weight is obtained. If the percentages of moisture are varied before compaction, the resulting unit weights will also vary. If these percentages of moisture are related to the corresponding unit weights, certain values are obtained which can be represented graphically in the form of a curve, known as a "compaction curve". If we take the point of maximum unit weight in this curve, we shall find the corresponding optimum moisture content (fig. 9).

A soil compacted to optimum moisture content and maximum unit weight possesses considerable stability, even if it is later saturated with water.

Field tests

Soil tests in the field ^{6/} consist of practical methods giving results which, although approximate, are acceptable enough as a basis for deciding how the soil should be used as a building material.

These field tests indicate the percentages of the basic components in the soil sample taken at the site, and consequently the type of soil tested.

Field tests may be divided into:

- (i) General soil tests;
- (ii) Tests of the fine fraction.

^{6/} See "Identification and classification", p. 4.

The general tests comprise the following:

- (a) Visual examination;
- (b) Testing by touch;
- (c) Sedimentation.

Tests of the fine fraction comprise the following:

- (a) Shaking test;
- (b) Dry strength test;
- (c) Brightness test.

General tests

Granular composition

Visual examination. This gives an idea of the proportion and size of the coarse granular components (very coarse, coarse, medium and fine sands) and, by inference, of the fine particles (silt and clay), since the smallest particles visible to the naked eye are those of 0.074 mm, i.e., fine sands.

Testing by touch. The feel of a soil to the touch indicates its basic component with sufficient accuracy in the field.

The following procedure is used for this purpose:

- (a) A representative sample of the soil is taken, the very coarse particles, larger than 4.76 mm (gravel), being removed.
- (b) The sample is rubbed between the fingers, or between the fingers and the palm of the hand, to estimate the size of its components.

Sand. Generally speaking, coarse particles, or sands, when dry, have a characteristic rough feeling to the touch and lack cohesion. The size of the grains ranges approximately between 4.76 mm and the smallest particle visible to the naked eye (0.074 mm),

Silt and clay. Both silt and clay should be tested by touch in both the dry and moist states, as follows:

Silt. Dry silt has a rough feel similar to that of fine sand, but less pronounced; moist silt is of medium plasticity.

Clay. Dry clay is usually in the form of coarse clods or grains, and resists pulverization; moist clay is very adhesive and plastic (figs. 10 and 10 (a)).

Sedimentation test. This test supplements the preceding ones and indicates the proportions of the basic soil components with greater accuracy.

We take a transparent glass bottle, with a mouth sufficiently wide to be covered with the hand, cylindrical or prismatic in shape, with a flat bottom, and

with a capacity of not less than one half-litre. Soil is placed in the bottle up to one quarter of its depth. Clear water is added up to three quarters of its depth, and the bottle is left undisturbed until the soil is saturated with water.

The mouth of the bottle is then covered with the hand, and the bottle is shaken vigorously and left to settle on a horizontal surface. After one hour, the same process of shaking and allowing to settle is repeated. After forty-five minutes it will be noted, without moving the bottle from its place, that a layer of sand has settled at the bottom, and above it, in most cases, a second layer of silt will have formed. Above this second layer there will be water containing clay in suspension, which will gradually settle at the rate of 12 mm per hour (figs. 11 and 11 (a)).

After eight hours, the different basic components are measured.

The total depth (100%) of the sediment in the bottle is measured, disregarding the water above the sediment. Each layer must be measured separately and related to the total depth, and the result of this calculation will give the percentages of the components in the soil which is being tested.

Tests of the fine fraction

These tests of the fine fraction are used to detect the silts and clays contained in a soil, and they may reveal the presence of very fine sands which were not detected by means of the tests described above.

Soils containing large amounts of silt and clay show marked changes in their physical properties when their moisture content is changed. Many fine soils shrink when dried and expand when moistened. This is an unfavourable factor when they are used in construction work.

Silts are different from clays in many important respects, but because of their apparent similarity they are often confused. Silt and clay, pulverized or dry, are identical in appearance, but they can be easily identified by their behaviour in the presence of water.

Silts are fine grains, essentially unstable in the presence of water. When dry, silt can be pulverized easily under the pressure of the fingers.

Clays have a low resistance to deformation in the moist state, but they dry out into very cohesive masses. Violent shrinkage or expansion with changes in moisture content are characteristic of clays. They are difficult to compact when moist.

Separation (shaking) test

This test, which is also called the "surface water test", is used to distinguish fine sand from silt or clay.

For this test, we use all the fine particles taken from the soil sample, which are separated in the following manner:

This test begins in the manner indicated for the "sedimentation test". The soil sample is then shaken vigorously in the bottle and left to settle for thirty seconds. With the use of a siphon consisting of rubber tubing, the water, together with the material in suspension contained in it, is then immediately drawn off into a shallow receptacle. This type of receptacle is used to allow this material also to settle, after which the water, now without any material in suspension, can be poured off, while the portion of soil wanted for testing remains at the bottom. Any excess water it may contain is eliminated by evaporation. A portion of this material is then taken and rolled in the palm of the hand until it forms a ball approximately 2.0 cm in diameter, which must be brought to a soft, but on no account viscous, consistency by adding the necessary water. The ball is placed in the palm of one hand and struck vigorously against the other hand several times, so that the ball is shaken horizontally (figs. 12 and 12 (a)).

After the ball has been shaken, either of the following reactions may be observed:

- (a) A film of water appears on its surface, giving it a smooth, glossy and "livery" appearance; or
- (b) There is no change in the appearance of the water on its surface.

Next, the ball is squeezed with the fingers of the other hand (fig. 13), and either of the following reactions may occur:

- (a) The water disappears from the surface, the small mass hardening and eventually cracking or crumbling;
- (b) The appearance of the water may not change, the ball being simply deformed into a dripping plastic mass.

In order to observe the reactions that occur at both stages of the test - shaking and squeezing the ball - it is desirable to repeat these actions several times.

The reaction is called rapid, if the water appears and disappears quickly; it is called slow if the water appears and disappears gradually; and it is called nil if the condition of the water does not appear to change.

These three reactions provide guidance for the identification of the fine components of the soil, as indicated in table 1.

TABLE 1

Surface water reactions in fine soils

Type of reaction	Effect on the ball	Significance
Rapid reaction	Water appears and disappears rapidly.	Denotes a lack of plasticity and indicates a very fine sand or an inorganic silt.
Slow reaction	Water appears and disappears slowly.	Indicates a slightly plastic silt or a silty clay.
Nil reaction	The condition of the water does not appear to change.	Pressure of the fingers produces a dripping plastic mass, but no film of water appears and there is no hardening of the ball. Indicates a clay or an organic material of considerable plasticity

Recommendation:

In order to facilitate siphoning, the following recommendations are made:

- (a) The rubber tubing to be used as a siphon should be completely filled with water and one end closed with the fingers.
- (b) The open end should be inserted in the bottle to a depth slightly above the sediment.
- (c) The closed end of the siphon should be at a lower level than the bottom of the bottle.

Dry strength test

This test is used to measure the plasticity of the soil. For this purpose, the soil is separated in the same way as for the preceding test and formed into a ball moistened to the consistency of dough, with a diameter of approximately 2.0 cm. The ball must be dried completely in a dry atmosphere, in the sun, or with direct heat. Its resistance to crumbling or pulverization is tested between the fingers (fig. 14), and may vary in degree according to the fine components predominant in the soil, as shown in table 2.

TABLE 2

Dry strength test of the elasticity of fine soils

Dry strength	Effect on the dry ball	Significance
Low strength	The ball can be easily pulverized.	Denotes a lack of cohesion and indicates inorganic silts, very fine sands, or a soil combination containing a small amount of clay.
Medium strength	Considerable pressure of the fingers needed to pulverize the ball.	Indicates an organic clay, silty clay, or a rather sandy clay.
High strength	The ball cannot be pulverized.	Indicates inorganic and highly plastic clay.

Brightness test

This is a quick test for detecting the presence of clay.

The best way of making the test is to cut a mass of rather moist soil with a knife. If the cut surface is seen to be bright, this indicates highly plastic clay, while an opaque surface indicates silt or sandy clay (fig. 15).

Supplementary field method for identification of soil texture

Table 3 7/ is included as a supplementary guide to identification, in addition to the field tests.

7/ Taken from Manual on Stabilized Soil Construction for Housing, United Nations publication, Sales No.: 58.II.H.4.

TABLE 3

Field Method for Identification of Soil Texture

Soil Texture	Visual Detection of Particle Size and General Appearance of the Soil	Squeezed in Hand and Pressure Released		Soil Ribboned Between Thumb and Finger when Moist
		When Air Dry	When Moist	
Sand	Soil has a granular appearance in which the individual grain sizes can be detected. It is free-flowing when in a dry condition.	Will not form a cast and will fall apart when pressure is released.	Forms a cast which will crumble when lightly touched.	Cannot be ribboned.
Sandy Loam	Essentially a granular with sufficient silt and clay to make it somewhat coherent. Sand characteristics predominate.	Forms a cast which readily falls apart when lightly touched.	Forms a cast which will bear careful handling without breaking	Cannot be ribboned.
Loam	A uniform mixture of sand, silt and clay. Grading of sand fraction quite uniform from coarse to fine. It is mellow, has somewhat gritty feel, yet is fairly smooth and slightly plastic.	Forms a cast which will bear careful handling without breaking.	Forms a cast which can be handled freely without breaking.	Cannot be ribboned.
Silt Loam	Contains a moderate amount of the finer grades of sand and only a small amount of clay - over half of the particles are silt. When dry it may appear quite cloddy; can readily be broken and pulverized to a powder.	Forms a cast which can be freely handled. Pulverized it has a soft flour-like feel.	Forms a cast which can be freely handled. When wet, soil runs together and puddles.	Will not ribbon but has a broken appearance, feels smooth, and may be slightly plastic.
Silt	Contains over 80 per cent of silt particles with very little fine sand and clay. When dry, it may be cloddy; readily pulverizes to powder with a soft flour-like feel.	Forms a cast which can be handled without breaking.	Forms a cast which can be handled. When wet, it readily puddles.	It has a tendency to ribbon with a broken appearance, feels smooth.
Clay Loam	Fine textured soil breaks into hard lumps when dry. Contains more clay than silt loam. Resembles clay in a dry condition. Identification is made on physical behaviour of moist-soil.	Forms a cast which can be handled without breaking.	Forms a cast which can be handled freely without breaking. It can be worked into a dense mass.	Forms a thin which readily breaks, barely sustaining its own weight.
Clay	Fine textured soil breaks into very hard lumps when dry. Difficult to pulverize into a soft flour-like powder when dry. Identification based on cohesive properties of the moist soil.	Forms a cast which can be handled freely without breaking.	Forms a cast which can be handled freely without breaking	Forms long thin flexible ribbons. Can be worked into a dense compact mass. Considerable plasticity.
Organic Soils	Identification based on the high organic content. Muck consists of thoroughly decomposed organic material with considerable amount of mineral soil finely divided with some fibrous remains. When considerable fibrous material is present, it may be classified as peat. The plant remains or sometimes the woody structure can easily be recognized. Soil colour ranges from brown to black. They occur in lowlands in swamps or swale. They have high shrinkage upon drying.			

WORKABILITY OF SOILS USED AS CONSTRUCTION MATERIALS

The purpose of table 4 is to give an approximate idea of the possibility of using different soils as construction materials by indicating the degree of workability, which will be considered when we deal with the stabilization of soils.

TABLE 4^{a/}

Table of "Workability of Soils" used as construction materials

NAME OF SOIL	PROPERTIES OF SOIL	
	Permeability when compacted	Workability ^{b/} as a construction material
Sands	Pervious	Excellent to fair
Silty sands	Semipervious to impervious	Fair
Clayey sands	Impervious	Good
Organic silt and very fine sands. Silty or clayey fine sands with slight plasticity.	Semipervious to impervious	Fair
Inorganic clays of low to medium plasticity. Sandy clays. Silty clays.	Impervious	Good to fair
Organic silts. Organic clays of low plasticity.	Semipervious to impervious	Fair
Inorganic silts. Elastic silts.	Semipervious to impervious	Poor
Inorganic clays of high plasticity.	Impervious	Poor
Organic clays of medium to high plasticity	Impervious	Poor

a/ Extracted from the table given by the Bureau of Reclamation, in Unified Soil Classification System.

b/ Workability of a soil is the ease with which a given material can be handled or worked in a normal mixture, dry or moist, and ease of compaction.

II. SOIL AS A CONSTRUCTION MATERIAL

BACKGROUND

Historically, the first reference to the use of soil as a construction material dates from the time of Hannibal, during the Second Punic War, when it was used to build watch-towers for look-outs. These towers were seen intact by Pliny, a Roman officer sent to Spain in the year 67, 300 years after they had been erected. Observers in recent years have vouched for the existence of these soil structures, twenty centuries old.

In the Americas, soil in its natural form has been widely used in buildings. Noteworthy examples are: the pre-Spanish structures raised by the ancient Indians in Peru, using bricks and blocks of crude clay simply dried in the sun, the ruins of which can be observed to this day. The bricks were of small dimensions, measuring up to 0.40 m in length by 0.20-0.25 m in width and 0.10 m in depth; the blocks were of enormous dimensions, being up to 1.50 m in length and 1.00 m in depth. These can be seen at the fortress of Paramonga and the ruins of Chanchán.

The famous Church of Santa Cruz in South Carolina, in the United States, withstood the violent Charleston earthquake with only slight cracking.

The Convent of San Francisco in the Argentine city of Santa Fé, whose soil walls were completed in 1695, is further evidence of the durability of this construction material.

Forms in which soil is used

Soil is used in construction in the following forms:

- (a) In the form of rubble, cut from the surface of the earth, in pieces or blocks of soil.
- (b) As bricks, made in wooden forms or moulds with soil moistened to the required degree.
- (c) Moistened soil compacted in situ in suitable rigid frames to form monolithic walling (rammed earth).
- (d) As stabilized soil, by combining it with an agent in order to improve its constructive properties.

STABILIZED SOIL

Despite its good insulating and resistant qualities, the use of simple compacted soil (natural soil) is vulnerable to moisture and to the erosive effects of external agents.

Soil stabilization is the name given to certain processes to which natural soils are subjected in order to make them more suitable for use as a construction material.

The addition of stabilizing agents not only enhances the best qualities of soils, but imparts to them other properties which they alone do not possess. For instance, stabilized soil is of much better technical quality and more durable than its predecessors, adobe and simple rammed soil, which have definitely proved their utility in construction work through the years.

The usual stabilizing procedure consists of taking soil from the earth, pulverizing it, adding some stabilizing agent, moistening it to achieve the "optimum moisture content" and therefore the "maximum unit weight", and finally subjecting it, manually or mechanically, to heavy pressure (compaction) in order to restore its original cohesion.

Methods of stabilization.

Methods of stabilization must meet the following criteria:

- (a) The basic material used must be soil.
- (b) The resulting material must be able to withstand the effects of climatic agents, in order to retain its properties.
- (c) The process must be such as to give the material sufficient internal friction and cohesion to meet in a satisfactory manner the demands placed upon it.

The basic methods of stabilizing soil are as follows:

- (a) Consolidation;
- (b) Waterproofing;
- (c) Chemical treatment;
- (d) Addition of a binding agent.

This list does not include all possible methods, since there are some hybrid methods which combine two or more of the above.

Only the general aspects of the first three stabilization methods are dealt with here, but the fourth, being the subject of this paper, is discussed in greater detail.

Consolidation

When soils are consolidated, their particles are drawn closer together and their internal friction is thus increased. As they become more compact, the number of voids is reduced, and this prevents the penetration of water, which might affect the internal friction and cohesion of the soils and cause changes of volume.

Some natural soils require the addition of one or other of the basic soil components before they can be consolidated.

This method of stabilization is performed in accordance with the usual procedure mentioned above (see "Stabilized soil").

Waterproofing

Waterproofing consists of adding to the soil bituminous materials (asphalt or pitch), which combine with the soil to form mixtures that are stable and highly resistant to the penetration of water. Thus, the moisture content of the mixture remains more or less constant, and the result is a material possessing invariable properties.

The low cohesion of some natural soils is greatly improved by the addition of bituminous materials which are themselves sticky and cohesive, and this is another of the peculiar advantages of this method.

One of the most important requirements of this stabilization method is that the soil and the bituminous material must be uniformly mixed. In order to obtain an acceptable mixture, therefore, the soil must be pulverized, so that the bituminous material can be distributed uniformly.

This stabilization method gives very effective results in the case of cohesive soils made up of fine particles (clayey soils) which do not pulverize or mix easily, provided that a suitable mechanical mixer is used.

The drawback to this stabilization method in some cases is that the bituminous materials are vulnerable to the effects of soil bacteria, with the result that the absorption of water is increased and the material becomes unstable.

Chemical treatment

Chemical stabilization involves the use of procedures designed to improve the physical properties of soils through the addition of such chemical substances as lime or sodium silicate and calcium chloride.

Chemical treatment not only improves the physical properties of soils but also, in some cases, changes their chemical composition for the better. In order to treat soils with chemicals, therefore, it is necessary to know their chemical composition.

Stabilization with lime not only produces chemical changes in soils, thus modifying their elementary properties, but also has a binding effect and increases their strength.

Addition of a binding agent

This method consists of mixing a soil with some agent so that its particles bind together and remain firmly united and unaffected by moisture variations, thus producing a strong and very durable material. The binding agent generally used is Portland cement.

For this type of stabilization, pulverized soil is thoroughly mixed with the proper amount of the binding agent, and sufficient water is added to hydrate the cement, eventually causing the soil to consolidate. The cement combines with the water, sets, and forms a material of great strength.

III. PREPARATION OF SOIL-CEMENT

INTRODUCTION

General

The use of natural soil in the traditional form of adobe or "rammed earth" is limited because of its low strength, which means that it can only be used in walls of great thickness, and its vulnerability to atmospheric agents, and especially to the effects of erosion.

If this natural soil possesses certain technical characteristics, it is possible, by adding to it a small given proportion of cement, mixing it with water until the optimum moisture content is achieved, and compacting it to a certain degree, to produce a mass possessing great strength when set. When this is done, the material can bear much greater work-loads than could be carried by the soil without cement, and it also possesses maximum durability in the presence of the continuous action of atmospheric agents. The effect of the cement on the soil is to change the behaviour of its particles and to improve its stability, converting the resulting mass into a structure unlikely to deteriorate and of greater strength.

This compound of soil, cement and water, mixed in the proper proportions and properly compacted, constitutes soil-cement.

Influence of the soil components

The ideal soil

The proper soil for stabilization with cement is one which gives high strength and does not shrink appreciably when dried. An ideal soil must be very compactable and must consist of a mixture of sand, silt and clay, the latter two in such a proportion as to give the mixture sufficient cohesion and a good granular composition, without harmful shrinkage (fig. 16).

Clay

Clay imparts elasticity and strength to soils. However, soils which contain a percentage of clay higher than a certain limit (25%) have a strong tendency to crack and shrink with variations of moisture, when they become dry.

Stabilization of clayey soils by this method is costly, for the following reasons:

- (a) A greater amount of cement is needed;
- (b) Pulverization of the clay is a very slow process;
- (c) It is difficult to moisten the mixture of clay and cement, owing to the formation of clods.

One way of offsetting these disadvantages is to add a carefully measured amount of sand to the over-clayey soil. When this is done, the soil meets the criteria for an ideal soil.

Advantages of soil-cement

The addition of cement to soil produces a material which possesses all the following advantages:

- (a) There is little change of volume through absorption or loss of moisture.
- (b) It does not deteriorate when submerged in water.
- (c) It has a compressive strength similar to, or even greater than, an ordinary brick of fired clay.

PREPARATION

The preparation of soil-cement should be restricted to the following stages:

- (a) Components;
- (b) Mixing of the components;
- (c) Compaction of the mixture;
- (d) Drying and curing.

Components

The soil

Taking and classifying samples

In order to prepare soil-cement, and bearing in mind that not all soils are suitable for this purpose, a survey is made of the area adjacent to the work site and a note is made of the various soils available. After a preliminary visual selection, samples are taken and those considered unsuitable are discarded. The procedure to be adopted in taking samples is indicated under "Identification and classification".

The samples obtained are tested, either in the laboratory or in the field, in order to classify the soil, or in other words, to determine its properties and the proportions of the basic components it contains. Both tests are described clearly and in detail under "Identification and classification".

Selection

On the basis of the tests, the soil most suitable for use in the preparation of soil-cement is selected.

Sandy soils are chosen, when available, because they produce the best results when stabilized. The optimum proportion is 75 per cent sand and 25 per cent silt and clay; the content of clay included in the latter percentage should be not less than 10 per cent. The sand in a soil constitutes its skeleton, but a certain amount of clay is needed to bind the mass together.

Broadly speaking, the soils considered suitable for soil-cement construction work are those containing a minimum of 45 per cent sand with 55 per cent silt and clay, and a maximum of 80 per cent sand with 20 per cent silt and clay.

Soils containing organic matter, which is found mainly in the topsoil, produce unsatisfactory results when stabilized.

The recommended percentages are only approximate, since soils may be found containing different proportions of the basic components from those indicated and producing favourable results. In the case of fine soils, this is due fundamentally to the chemical composition of the soils, which it is difficult to determine by field tests.

Recommendation: The final choice of the proper soil should be made on the basis of a preliminary selection according to the proportions indicated above, and in the light of the behavior of the soil when subjected to field tests (as indicated under "The cement", which allow the reaction of the soil under consideration in the presence of cement and water to be observed.

Once the soil sample has been found to be of acceptable quality and the site from which the material will be taken has thus been decided, the preparation of the soil begins in earnest.

Preparation

In its natural state, soil may possess a certain degree of moisture, which must be reduced by exposure to the air; for this purpose, the soil is spread in shallow layers on a smooth surface and protected against rain.

The reason for reducing the moistness of the soil is to make it easier to sieve and later to mix, dry, with the cement.

The soil has the proper moisture content when a handful can be taken and squeezed and no water appears on the surface, and when the ball thus formed, upon being released, disintegrates without the appearance of lumps.

When the natural moisture content of the soil has been reduced, any clods which it may contain are broken up and pulverized by striking them with a shovel (fig. 17), after which the soil is sieved through a screen held horizontally at a height of approximately 0.80 m above the ground. This screen should consist of a 4.76 mm wire mesh in a wooden frame with two "shafts" at one end to allow the screen to be shaken while the soil is being sieved, and with the other end attached to a flexible fitting from which it is suspended (fig. 18).

The material which has passed the screen can be used for making soil-cement.

This material must be stored in a damp-proof place, near the area where the soil-cement will be prepared.

Soil-cement, when prepared, is a compound of soil, cement and water. The high quality of the resulting construction material depends on the use of the correct proportions of both the solid materials - soil and cement - and the liquid component, water.

The cement

The cement generally used is Portland cement, the technical qualities of which are widely known and are guaranteed by the manufacturers. However, cement must be stored indoors in a place with waterproof walls and ceiling, and the floor, which must also be waterproof, should be raised above ground level.

It should be noted that prolonged storage of cement causes a gradual reduction of its strength. Lumps also form and this is a sign that the cement is old or is being affected by moisture.

In the field, the percentage of cement to be used in soil-cement mixtures is determined experimentally, varying the proportion of cement by volume between 4.75 per cent and 12.5 per cent and using the same type of soil.

The percentages mentioned must be adjusted according to the type of soil used, in accordance with the following table:

TYPE OF SOIL ^{a/}	NORMAL PERCENTAGE OF CEMENT
Sandy ^{b/}	4.75-9.10
Silty	8.35-12.5
Clayey	12.5-15.4 (not recommended for use)

^{a/} See "Basic components" and "Identification and classification".

^{b/} In some cases, the use of sandy soil requires an increase in the percentage of cement. Four different percentages should be tried with the soil to be used - two equivalent to the extremes indicated in the table for the type of soil in question, and two intermediary ones.

For each percentage, three blocks are made in, say, the following dimensions: 29 cm in length, 14 cm in breadth, and 9 cm in depth.

The mixture is prepared as indicated above under "Mixing the components", and the same moisture content and compaction must be ensured in each case.

The drying and curing of the blocks must be done in the manner indicated under "Drying and curing".

Fifteen days after they are made, the blocks are subjected to the following tests:

(a) Tensile strength (fig. 20). The tensile strength is tested in the following manner: The soil-cement block is placed on two supports measuring 2.5 x 2.5 x 15 cm, which are 20 cm apart. In the centre, and on top of the block, is placed a third support of the same measurements as the others, and from it is suspended, by means of a flexible fitting, a receptacle into which weights are placed.

The strength of the block can be measured by the weight that is added to the receptacle before the block breaks. The highest breaking point will indicate the best-quality block.

(b) Unit weight. This is tested by weighing in a balance each of the blocks that have been made. The "maximum unit weight" will indicate the best block (strength and durability are directly proportional to the "unit weight" of the material).

(c) Sound test. Upon being struck lightly with a hammer, the block should produce a metallic sound (fig. 21).

(d) Hardness test. If a 10 cm nail, for instance, is taken in the hand and the block is struck obliquely, no cavities deeper than 5 mm should be produced (fig. 22).

(e) The block should have sharp, firm edges (fig. 23).

(f) The block should not show any marked changes in its original dimensions.

(g) When submerged in a container of water for eight hours, the block should not show signs of disintegration (figs. 24 and 24 (a)).

The water

The amount of water to be used is a fundamental factor because, if the mixture is either too dry or excessively moist, this will affect the workability of the material and its subsequent strength and durability.

The amount of water is that needed to hydrate the cement, to give the mixture the optimum moisture content (this state is explained below) and to facilitate the maximum compaction of the soil.

Each type of soil requires a specific degree of moistness if it is to be compacted correctly. Broadly speaking, the total amount of water should vary between 8 per cent and 16 per cent (in volume?).

Too little or too much water means more work in compaction, because it is difficult for the components of the mixture to cohere.

The water used should be clean, and should not contain any matter in suspension which might affect the quality of the soil-cement.

Mixing the components

Preparation area

Economy is a basic factor in the preparation of soil-cement mixtures. Rational planning of the "preparation area" is therefore essential (fig. 25).

It is desirable that the components of the soil-cement should be conveniently at hand, and a "mixing base" should therefore be prepared, consisting of a level, hard and non-absorbent floor, so that the components will not be subjected to variations of moisture through contact with the floor, and matter other than the components of the mixture will not be picked up in the mixing.

Dry mixing

Before the components are mixed, they must be measured out in the specified proportions. For the purpose of measuring, it is desirable to use a receptacle of known volume and easy to handle.

When the soil has been measured out, it is deposited on the "mixing base" and spread out in a layer not deeper than 10 cm. The cement is added by sprinkling it uniformly over the layer of soil.

It is essential for the cement to be distributed as uniformly as possible through the soil. The mixture is considered to be ready when all the material has taken on a uniform colour (figs. 26 and 26 (a)). This operation can be done by hand or with a mechanical mixer (fig. 26 (b)). Hand mixing means that the components must be turned over with a shovel on the "mixing base".

Adding the water, and wet mixing

When the dry soil and cement are thoroughly mixed, the mixture is spread in a shallow layer on the "mixing base", and water is sprinkled on it from a watering-can until the moisture is distributed uniformly throughout the mixture (fig. 27).

The amount of water added must be that needed to give the maximum unit weight.

The optimum moisture content of the mixture can be determined by a simple field test, which is explained below.

Amount of water needed

The test consists of taking a handful of moistened mixture and squeezing it in the hand. When the hand is opened, any of the following results may be seen.

(a) The mixture retains the shape of the hand (fig. 28) without soiling it; it can be pulled apart without disintegrating (fig. 29); in addition, if it is dropped from a height of 1.10 m to a hard surface, it will disintegrate into a loose material similar to the original mixture (figs. 29 (a) and 29 (b)). This means that the mixture has the right amount of water.

(b). The mixture retains the shape of the hand, but sticks to it and soils it; when it is dropped in the same way as before, it will not disintegrate but will flatten (fig. 30). This means that the mixture has too much water.

(c). The mixture crumbles and does not retain the shape of the hand (fig. 31). This mixture has not enough water.

Compacting the mixture

If we have a mixture of soil-cement, moistened with a proper amount of water, and we want it to assume a specific shape when the drying process is completed, the mixture is placed into a mould or form and is compacted. This moulding is called "compaction", and it must be carried out within two hours after the water is added to the mixture.

In this operation, the loose mixture is compressed up to a certain limit and its total volume is thus reduced. When the process is completed, we shall have obtained a "maximum unit weight" and shall have a harder, more compact mass with a minimum of voids.

Two methods may be employed for compacting soil-cement used in construction, as follows:

(a) One method uses shuttering^{8/} which may be of large size, making it possible to construct one section after another of walling rammed in place, known as "monolithic walling".

(b) The other system uses moulds to prefabricate small-sized parts, which are joined together during the construction work.

The suitability of one system or the other will be determined, in individual cases, according to local conditions and the building methods employed.

Shuttering method

For this method, the shuttering must meet the following requirements:

(a) It must be rigid, in order to avoid distortion (it is generally made of wood or iron, suitably reinforced) (figs. 70 and 70.(a)).

(b) The length and depth of the shuttering will depend primarily on the dimensions of the walling and the facilities for handling it.

(c) The clamps of the shuttering should be such as to allow rapid assembly and dismantling.

Under this method the mixture, with its correct moisture content, is transported to the place where the walling is being erected and is placed in the shuttering until it forms a loose, uniform layer not more than 15 cm in depth.

8/ Also called "forms" or "moulds".

Compaction is effected with a metal or wooden rammer, the lower end of which is shaped like an arch (or wedge), or which terminates in a square base approximately 7.5 cm. square. The lower edges or corners should be slightly rounded to prevent damage to the shuttering during ramming. The shaft of either type of rammer should be round and should be 1.5 m long (fig. 32). The rammer is used by driving it against the mixture with both hands.

Maximum compaction has been achieved when the strokes of the rammer produce a clear and metallic sound, in contrast to the dull, muffled sound of the mixture when it is being rammed.

A new section can be constructed, on the third day, on top of one already finished.

Immediately the last layer of the section or piece of walling under construction is completed, the shuttering is removed and the material is covered with moist sacking, which should be kept moist for three days.

This method allows very rapid work. The resulting construction is very solid and has a smooth finished surface. Being monolithic, it possesses great stability. The technique is simple and easy for anyone to learn.

Moulding method

The method of compacting in moulds consists of making blocks by the following procedures:

- (a) In simple moulds;
- (b) By mechanical moulder.

Simple moulds or forms

The making of blocks by this method requires the use of a rigid mould, which may be made of detachable pieces, hinged, or in one piece, and is usually of wood, together with a rammer of the same material (figs. 33, 33 (a) and 33 (b)).

The block is made in the following manner: The mould is placed on a flat, non-absorbent surface, and the loose, moist mixture is placed in it in successive shallow layers, which are individually rammed until the maximum compaction is achieved. As soon as the block is finished and its upper surface has been smoothed off, the mould is removed (fig. 34).

There is one type of mould which requires the use of a special implement for removing the mould from the block. This instrument, which is known as a "pusher", allows the surrounding mould to be slid upwards, leaving the block in its place (figs. 35 and 35 (a)).

Mechanical moulders

Either hand-operated or motor-driven moulders may be used for making blocks by this method.

Among the mechanical moulders in use, the following may be mentioned: the Landcrete, the Winget, the Ellson and the CINVA-RAM.

The CINVA-RAM moulder

This moulder (figs. 36 and 36 (a)) is operated as follows:

(a) The CINVA-RAM moulder should be set up in a level place inside the "block preparation area" and near the "mixing base".

(b) The box of the moulder (a metal mould) should be coated on the inside with a protective film (oil or grease) to prevent the soil-cement mixture from sticking to its walls. Figure 37 shows the moulder in its "rest position" and ready for the box to be filled.

(c) The block-making process begins with the insertion into the moulder box of some loose, moist mixture, the total volume of which depends on the peculiarities of the soil used. The volume required is determined in each case by trial and error, after a number of test blocks have been made.

The cover is then closed (fig. 37 (a)), the lever is swung into its vertical position, and the catch is raised to enable compaction to begin (fig. 37 (b)).

(d) As the level of the moulder is lowered, the piston slides part of the way up, producing its maximum pressure when the lever is in a horizontal position (fig. 37 (c)).

(e) When the block has been made, it is removed from the mould by turning the lever in the opposite direction until it is again horizontal, but on the other side. In this position, the piston has reached its maximum height, pushing the block upwards and releasing it on top of the moulder box (fig. 37 (d)).

(f) The block is carefully removed from the moulder and taken to the drying area (fig. 37 (e)).

Where blocks are to be made with very sandy soils, a plate must be placed in the bottom of the box before the loose mixture is put in, in order to facilitate removal from the mould (figs. 38 and 38 (a)).

Drying and curing

The drying time of the cement is very important in soil-cement; for this reason, the mixing and compacting operations must be performed and completed before that process sets in, or in other words, within a period of two hours.

The drying and the subsequent setting of the cement produce a decisive physical effect, forming a new skeleton in the soil.

The drying and curing methods to be used for monolithic walling and for blocks are radically different, and they are therefore treated separately.

Monolithic walling

For drying and curing, monolithic walling needs a moist covering (wet sacking) for the first three days after it is made; thereafter, it is sprinkled with a fine spray of water until the end of a period of eight days.

Blocks

To ensure proper drying, the blocks must be stored with adequate protection against sun and rain.

The blocks are kept away from the earth on a dry level surface (fig. 39).

The blocks must be allowed to dry slowly and without violent changes of temperature. Loss of moisture must therefore be strictly controlled during the first twenty-four hours after they are made, in order to prevent them from drying out completely all at once, since this may affect the quality of the material.

After the first twenty-four hours, the blocks are watered regularly with a sprinkler (watering can) in a fine spray under low pressure (fig. 40).

On the third day after they are made, the blocks are stacked or piled, and spraying is continued until the end of eight days (fig. 39 (a)).

The blocks may be used for construction twenty-one days after they are made. At the end of that time, they have attained very nearly their maximum strength, and the major physical changes (e.g., shrinkage) have also taken place.

SOME COMMENTS ON CERTAIN SOIL CEMENT LABORATORY TESTS

Reference has been made in the preceding chapters to field tests for obtaining the proper proportions and quality of the components of soil-cement in order to have a good end-product. A better material will be obtained if these proportions and qualities can be adjusted on the basis of the results of laboratory tests.

These tests will not provide worth-while results unless they can be compared with other tests carried out with similar components and in accordance with fixed criteria (international technical standards). Comparison will make it possible to determine the best qualities to which the material being tested must conform as closely as possible.

The technical standards mentioned above are established by institutions with specialized experience of construction material standardization. ^{9/} Information on the subject should be obtained from them.

^{9/} 1. American Society for Testing Materials (ASTM). 2. British Standards Institution. 3. Other national construction-material standards institutions. 4. Association Française de Normalisation.

There follow some brief comments on some of the tests used to determine that technical standards are met:

Compressive strength test

This test is used to determine the strength of the material (figs. 41 and 41 (a)). If it does not meet the required standard, it should be borne in mind that:

(a) There is a clear relationship between the compression test, the type of soil, the proportion of cement, and the optimum moisture content.

(b) Compressive strength increases with age. If it does not, the soil definitely contains some substance which attacks the cement.

(c) Compressive strength tends to become greater as unit weight increases. Above the degree of optimum moisture content; strength will tend to decrease as the moisture content increases. 10/

(d) Each soil-cement mix requires a certain cement content to give good results; above this amount, increases in cement do not give a corresponding increase in strength. 11/

Moisture-density relations test of soil-cement mixtures 12/

This test is used to determine the relationship between the moisture content of a soil-cement mixture and its dry unit weight. It is performed by varying the moisture content of a soil-cement compacted in the laboratory, before the cement hydration and under certain special conditions.

The moisture content and the corresponding compacted dry unit weight are plotted in a "Moisture-Unit Weight" graph of the soil-cement. This graph includes a point indicating the "optimum moisture content", to which the "maximum unit weight" corresponds.

Durability tests 13/

Durability tests give the best indication of the behaviour of soil-cement as a construction material.

These tests consist of laboratory procedures, and are known as the "wetting-and-drying" and "freezing-and-thawing" tests. Their results indicate the most suitable cement content.

10/ This idea is taken from Empleo de Bloques de Suelo-cemento en la construcción de habitaciones económicas, by César Arriagada, Chile, 1955.

11/ Manual on Stabilized Soil Construction for Housing, United Nations, publication, Sales No.: 58.IT.H.4, p. 30.

12/ American Society for Testing Materials, Designations D558-44, D559-44 and D560-44.

13/ American Society for Testing Materials Designations D559-44 and D560-44.

Wetting and drying test

This test is intended for determining the soil-cement losses, moisture changes, and volume changes (swell and shrinkage) produced by repeated wetting and drying of compacted soil-cement specimens. ^{14/} The material is subjected to twelve successive cycles of wetting and drying; after each cycle it is brushed, and the loss in weight of the dry material, the moisture content (absorption) in relation to the moisture content at the time of moulding, and the difference in volume in relation to the volume at the time of moulding, are determined (figs. 42 and 42 (a)).

Freezing and thawing test

In this test, the soil-cement is subjected to the effects of intense internal tensions, and this discloses the soil-cement losses, moisture changes, and volume changes (swell and shrinkage) produced in compacted specimens of soil-cement mixtures by successive freezing and thawing. The material is subjected to twelve successive cycles of freezing and thawing; after each cycle it is brushed, and the loss in weight of the dry material, the moisture content in relation to the moisture content at the time of moulding, and the difference in volume in relation to the volume at the time of moulding, are determined (figs. 43 and 43 (a)).

Water absorption test

This test indicates whether an increase in the proportion of cement in a soil-cement mixture produces a standard reduction in the absorption of water.

There is another test which concerns the absorption of water in relation to the compaction of the mixture; low absorption indicates high compaction.

Where the results of the test deviate from the standards, changes can be made in the preparation of the material, by varying the compaction and/or the proportion of cement in order to obtain better results.

Shrinkage test

This test is based on the shrinkage which takes place when a soil-cement mixture dries. The material which shrinks the least is the best in this respect.

There is another test, devised by Mr. A.E.S. Alcock of the United Nations, which makes it possible to determine the proportion of cement on the basis of the loss in length by shrinkage of the soil to be used. This method is explained in annex I (fig. 44).

^{14/} A representative sample of the soil-cement being tested.

Unit weight test^{15/}

The unit weight of soil-cement varies according to the type of soil and the degree of compaction. It ranges from 1,500 to 2,000 kg/m³.

A unit weight much below 1,500 kg/m³ indicates that the quality of the soil and/or the degree of compaction must be improved.

Erosion test

This test indicates the resistance of the soil-cement to the direct effects of a fine spray of water under a certain pressure (figs. 45 and 45 (a)). It can be used to determine the behaviour of the material, especially against the combined effects of rain and wind.

Since there are no refined standards for this test, samples containing different proportions must be tested in order to determine the most suitable product.

^{15/} See the explanation of this notion under "Unit weight".

IV. USE OF SOIL-CEMENT IN HOUSING CONSTRUCTION

INTRODUCTION

The preceding chapters have dealt with the fundamentals of soil science and the use of soil as a construction material with the addition of cement.

The purpose of this chapter is to show the possibilities offered by soil-cement, as applied to the various stages of construction of a house.

The methods described are those normally used for a simple building, in their fundamental aspects, and employing the most commonly known craft techniques. In every operation where it is possible and economical to use soil-cement, this has been included; in other cases, some techniques and materials which may serve as satisfactory adjuncts are recommended.

FOUNDATIONS

General

The site selected for the foundations must be capable of bearing the loads transmitted by the building.

Foundations consist of two fundamental parts: the lower foundations, in contact with the bottom of the excavation, which are the foundations proper, and the upper foundations, which rise from the lower and are generally less thick.

The strength required of the foundations varies greatly, according to the type of house and the nature of the building site. It is desirable, therefore, before deciding upon the kind of foundations to be used for a particular house to carry out a soil survey from the standpoint of safety and economy factors. If there is any doubt about the quality of the foundation site, expert advice should be obtained.

The lower the strength of the foundation soil, the broader the foundation or "seating base" needed for the house.

The foundations of a house should preferably be continuous; consequently, no gaps should be left in places where there will be door and window openings, unless proper precautions are taken (Fig. 46).

Foundations should always rest on firm soil. On a firm but sloping site it is usual, for reasons of economy and safety, to follow the gradient; the foundations are then laid in slips of varying length according to the gradient (Fig. 47).

Soils firm enough for foundations are those composed of stones, gravel; consolidated dry sand, and consolidated wet sand and compacted clays not subject to appreciable moisture changes.

Soils unsuitable for foundations are those composed of vegetable matter, dune sands, dumped earth or fills, and weak clays.

When the site for the house has been staked out, the excavations within which the foundations will be laid are dug. The depth of excavation will depend on the quality of the foundation soil, which will determine its ability to bear the weight imposed on the foundations without settling or sinking of the soil.

If the site for the foundations is of inferior quality, it is desirable to excavate deeper and to improve the horizontal base by laying down materials which can stand heavy compaction with a rammer (small stones).

At muddy or filled sites, it is recommended that strong hardwood piles, of suitable diameter and length should be driven into the bottom of the excavation at intervals depending on the estimated load (fig. 48).

Even where the foundation soil is of good quality, it is recommended that the minimum depth of wall foundations should be 0.40 m in the case of walls bearing the weight of the roof.

In order that the weight of the house may be distributed over a greater area, the lower foundations should be at least 10 cm wider than the upper foundations (fig. 49).

In laying the foundations of a house with walls of soil-cement, an important factor to consider is that the foundations must be able to withstand destructive agents, and particularly moisture. Moisture must not be allowed to rise to the base of the walls.

The strength of the foundations must be at least equal to that of the soil-cement walls, whether the latter are of prefabricated blocks or monolithic.

The methods for foundations recommended below are economical, simple and technically sound. The choice of method will depend on the materials available.

Lower foundations

Cyclopean concrete^{16/}

For this type of foundation, the bottom of the excavation is covered with a bed of concrete (approximate depth: 10 cm) containing 175 kg of cement per cubic metre of concrete (1:3.75.6 by volume, approximately) on which is placed a layer of washed stones of 7 to 40 cm, so arranged that spaces are left between them and that they are thoroughly embedded in the concrete. A second layer of the same type of concrete is then added, so that the first layer of stone is completely immersed and covered to a depth of at least 3 cm. This process is repeated until the required depth of foundation is achieved (fig. 49).

The lower foundations are topped off with a rough, level layer of concrete.

^{16/} Concrete to which are added large stones or boulders, in proportions varying from 25 to 40 per cent. As this method for foundations does not use soil-cement, it is considered to be of general application.

Rammed soil-cement

For this type of foundation a mixture of cement and soil is first prepared in proportions of approximately 1:10 by volume, with an appropriate amount of water. ^{17/}

A shallow layer of small stones, thoroughly compacted and suitably watered, should be placed at the bottom of the excavation; the soil-cement mixture is added in successive loose layers 10 cm deep and compacted by ramming until the maximum unit weight is achieved. ^{18/} The material must be rammed uniformly throughout the foundations until the required depth is attained. The top of the foundation should be level and distinctly rough (fig. 50).

Consideration may be given to the possibility of introducing into this type of foundation a certain percentage of small washed stone, which should not be larger than 5 cm.

Rammed soil-cement foundations must be laid at a well-drained site, since the compressive strength of soil-cement is appreciably reduced when it is saturated with water.

Soil-cement blocks

This type of foundation is constructed with prefabricated blocks made from cement and soil mixed in proportions of approximately 1:10 by volume. ^{19/} The bottom of the excavation is levelled off and a layer of concrete, mixed in proportions of 1:3.75:6 by volume, is spread over it to a depth of 10 cm and finished with a rough surface. The first course of blocks is laid on top of this, in a bed of mortar containing cement in the proportion of 1:6 by volume. The foundation is built up to the required height with successive courses of blocks (fig. 51).

Upper foundations

General

The top of the upper foundation must be approximately 15 cm above ground level; in other words, the total height of the upper foundation will be approximately 15 cm.

When the lower foundation reaches ground level, the work of constructing the upper foundation goes on with the use of shuttering, which is made of wooden boards adequately supported.

The foundation shuttering, must be so made that the bounds are perfectly aligned, propped up, braced and secured against movement of any kind (fig. 52).

^{17/} See "Preparation".

^{18/} See "Porosity, unit weight and specific gravity".

^{19/} See "Preparation".

An upper foundation is generally used for walls made of prefabricated blocks, since monolithic or rammed soil-cement walling is built directly on the lower foundations.

Methods for upper foundations

Cement concrete

This type of upper foundation is made of concrete containing 175 kg of cement per cubic metre of concrete, with stone not larger than 7 cm.

Rammed soil-cement

For this type of upper foundation a mixture of cement and (sandy) soil is first prepared in proportions of approximately 1:8 by volume, with an appropriate amount of water. When the shuttering has been properly erected, the soil-cement mixture is placed in the mould in two equal and successive layers. Each layer is separately compacted by ramming until the maximum unit weight is obtained. 20/

It is essential that the top of the upper foundation should be absolutely level and have a grooved surface to facilitate adhesion of the mortar for the first course of blocks forming the wall (fig. 53).

The upper foundation shuttering is removed after five days.

The upper foundation surrounding the house must be adequately waterproofed on the outside (with plastering or cement-based paint).

Soil-cement blocks

This type of upper foundation is made from prefabricated solid blocks of cement mixed with (sandy) soil in proportions of approximately 1:8 by volume. 21/ When the line of the wall has been marked out, three courses of blocks made to the specified proportions are laid on top of the foundation and joined together with a mortar containing waterproof cement in the proportion of 1:2 or 1:3 by volume. The vertical and horizontal joints in the three courses should be not wider than 1 cm, and the mortar should be pressed firmly inwards, with a suitable implement, into a V-shape (fig. 51).

WALLING

General

A wall is any component structure standing vertically and consisting of parts which are held together with a moist mixture called mortar. Walling can also be constructed monolithically in situ.

20/ See "Porosity, unit weight and specific gravity".

21/ See "Preparation (The cement)".

The structural function of a wall is to transmit the loads imposed on it to the foundations, without effect to the wall itself. Another function of a wall is to serve as a protection against the weather.

The thickness of a wall is determined by the function which it is to perform in the house and the materials of which it is to be constructed.

Horizontal waterproofing

When the foundations have been built up to the required level, the division between foundations and wall is marked by a damp course of horizontal insulating or waterproofing material.

The purpose of the damp course is to protect the wall from moisture which may rise from the earth by capillary action.

The horizontal waterproofing of a soil-cement wall may be effected in various ways, including the following:

Waterproof cement mortar

This type of damp course is made with a mixture of Portland cement and sand in proportions of 1:2 or 1:3 by volume; it is advisable to add to this mixture a further waterproofing agent, preferably a chemical one, in the amounts recommended by the manufacturer.

The damp course should be given an absolutely horizontal finish and should be not more than about 15 mm in depth (fig. 51).

The mortar is spread over the surface of the foundation, forming a horizontal layer which will be smoothed off with a trowel (fig. 54).

Bitumen

This type of damp course is formed by applying two coats of hot bitumen to the surface of the foundation with a brush.

The foundation surface must be clean and dry to ensure perfect adhesion of the bitumen.

Bituminous felt

This type of damp course is laid in the following manner: hot bitumen is applied with a brush to the surface of the foundation, which must be clean and dry, and a strip of bituminous felt is bonded to it (fig. 55). Where two strips of felt are required, the strips must overlap and be bonded together with the same hot asphalt in order to obtain an absolutely unbroken waterproof layer.

Wall-building

General

Before work on building a soil-cement wall begins, all its horizontal and vertical lines must be marked out.

When a wall is being built, each course must be strictly horizontal and the wall must be absolutely vertical; to achieve this, a carpenter's level, plumb-line and a string are used. These tools must be handled correctly (fig. 56).

The gauge is a very useful instrument in building a wall of soil-cement blocks, since, properly used, it enables perfectly uniform courses to be laid. It consists of a piece of wood marked in lengths corresponding to the depth of the block plus the mortar.

When work begins on a length of walling, a plumb and level gauge is placed at each end (fig. 57) with the help of the "string", attached to each gauge and tightly drawn, the courses of blocks can be kept perfectly horizontal and vertical.

Soil-cement blocks

Building a wall of soil-cement blocks calls for the correct use of tools.

To facilitate and simplify the placing of blocks in the wall, the use of a "block fitter" offers a simple, sure and speedy solution (fig. 58).

Bonding

The way in which blocks are arranged in a wall is called bonding.

An essential requirement of correct bonding is that all the joints should be carefully arranged to ensure the proper transmission of vertical loads. In other words, alternate courses are so laid that the vertical joints or seams in one course do not coincide with those in the course below it.

Bonding, or the proper distribution of joints, requires that the seams of a course of blocks should coincide with the centre points of the block-faces in the course above.

Figures 59 and 59 (a) illustrate the bonding of soil-cement blocks in wall construction.

Wall junctions

The junctions of walls built with soil-cement blocks must be bonded wherever possible. Figures 60 and 60 (a) illustrate two methods of joining walls of different thicknesses.

When a wall of lesser thickness is joined to a wall of greater thickness, it is desirable to insert between them an artificial joining device, using metal hooks, plates or mesh, as illustrated in figure 60 (b).

Figure 61 shows how cavity blocks are used in joining two walls. 22/

Mortar

General. Mortar is a compound of certain solid materials and water which, when mixed in the proper proportions, form a mass that sets after a certain time and binds the blocks firmly together.

The specific setting time of mortar varies according to the binding agent used (cement, lime, etc.).

The strength of a wall depends on the combined strength of the blocks and the mortar.

If blocks and mortar are of equal strength in a wall subjected to vertical loads, both will bear the pressure equally; but if there is any weakness in the mortar, the blocks will be subjected to shearing stress resulting inevitably in cracks and fissures.

It is a mistake to use high-strength soil-cement blocks with weak mortars or low-strength blocks with good-quality mortars, since in the latter case, conversely to what occurs in the former, the failure will be in the blocks.

Absorption of water by the blocks from the fresh mortar is a factor to be reckoned with in soil-cement wall construction. In order to ensure a sufficient amount of water for proper setting of the mortar, it is advisable to moisten the surface of the blocks in contact with the mortar.

The mortar used between courses and in the vertical joints should not be more than 1 cm in depth; it should also contain the amount of water required for correct setting.

A very desirable feature of wall finishing is the "marked seam", which is obtained by trimming the seams of fresh mortar between the blocks with a suitable tool, so that the faces of the blocks protrude (fig. 62).

Types of mortar. The following mortars can be used with soil-cement blocks:
(a) cement mortars; (b) cement and lime mortars; (c) soil-cement mortars;
(d) mortars of soil-cement mixed with lime.

The addition of a given percentage of hydrated lime to a soil-cement mortar can yield very favourable results. This depends on the type of soil used.

The most highly recommended mortars are those made of: (a) cement and (sandy) soil in the proportions of 1:7 to 1:10 by volume; 23/ (b) cement with lime and soil in the proportions of 1/2 to 1 of cement, 1 to 1/4 of lime and 8 to 12 of soil by volume.

22/ For cavity blocks, see "vertical reinforcement".

23/ See "The cement".

When lime mortar is used, it solidifies as water is lost through evaporation or absorption by the blocks, and setting takes place slowly.

Reinforcing

General. Soil-cement is, in general, capable of withstanding certain shocks or stresses caused by seismic disturbances. 24/

In regions subject to very intense seismic disturbances, tensile stresses which cannot be absorbed by the soil-cement material may occur; it is therefore desirable to install pillars and wall plates, properly reinforced, to absorb stresses of this kind. Adequately reinforced pillars are placed at wall junctions, and reinforced wall plates at the top of the walls.

In regions where statistics show that earth tremors are not too intense, the pillars can be dispensed with, provided that there is an adequate distribution of interior anchor walls in relation to the external walls. Nevertheless, it is always advisable to add a wall plate, or beam which serves to anchor the whole structure and the roof.

Pillars. Reinforcing pillars for soil-cement walls are placed inside the walls themselves or at wall junctions; consequently, their dimensions will depend on the thickness of the walls. The smallest dimension of pillars will be 15 cm through the thickness of the wall; and the pillars are reinforced with four iron rods 10 mm in diameter, with iron braces 6 mm in diameter every 25 cm. The pillars should be properly anchored to the foundation. The concrete used in the pillars should contain 240 kg of cement per cubic metre of concrete (1:2 1/2:4 1/2 approximately by volume). The coarse aggregate used should be not larger than 5 cm (small stone).

Vertical reinforcement. A type of cavity block which makes it possible to install vertical reinforcements inside the wall, in order to make soil-cement walls more secure in regions subject to earthquakes is shown in figure 63. These vertical reinforcements, spaced at suitable intervals, increase the stability of the house.

Cavity blocks are made of cement and (sandy) soil in the proportions of approximately 1:9 by volume. 25/

This type of reinforcement consists of iron rods 6 or 7.5 mm in diameter, anchored to the foundation. The concrete fill for this type of reinforcement should contain 210 kg of cement per cubic metre of concrete (1:2.75:5 approximately by volume). The coarse aggregate used should be not larger than 2 cm (very small stone).

Figure 64 illustrates vertical reinforcement using cavity blocks.

24/ Report of the National Bureau of Standards. Soil-cement is also capable of withstanding shocks or stresses caused by high winds.

25/ See "Préparation (The cement)".

Another use of cavity blocks is in artificial T-joints, as illustrated in figure 61.

Wall plates. In seismic regions, it is of the greatest importance to install at the top of the wall a continuous beam which provides rigidity and contributes to the stability of the house. ^{26/}

Experience in areas exposed to earthquakes has shown that a wall beam at the top of walls is very necessary, because it serves to anchor the walls and to take the iron ties holding the roof. The best material for beams is undoubtedly reinforced concrete; however, timber has been widely used for this purpose with acceptable results.

It is recommended that reinforced concrete beams should have a depth of 10 cm and a width equal to the thickness of the wall, and should be reinforced with four longitudinal iron rods 10 mm in diameter, with iron braces 6 mm in diameter placed every 25 cm. The concrete to be used in beams should contain 240 kg of cement per cubic metre of concrete (1:2 1/2:4 1/2 approximately by volume). The coarse aggregate used should be not larger than 4 cm (small stone).

Figure 65 shows a special type of U-shaped soil-cement block which can be used to make crown beams without need of shuttering. This method has the advantages of simplicity and economy.

U-blocks of cement and (sandy) soil are made in the proportions of approximately 1:8 by volume. ^{27/} The preparation and use of such blocks is similar to that of ordinary blocks for walling.

U-shaped soil-cement blocks are reinforced with two iron rods 6-10 mm in diameter, with braces of No. 10 wire (3.429 mm in diameter) ^{28/} every 30 cm. Figure 65 (a) shows how U-blocks are placed for reinforcement. The concrete to be used should contain 240 kg of cement per cubic metre of concrete (1:2 1/2:4 1/2 approximately by volume). The coarse aggregate to be used should be not larger than 2 cm (very small stone).

Horizontal reinforcements. In active seismic regions, it is desirable, in addition to pillars, vertical reinforcements and wall beam, to insert iron rods 6 mm in diameter lengthwise in the body of the wall, in the mortar, every three or four courses. This horizontal reinforcement gives considerable protection against wall collapse (fig. 66).

Lintels. The doors, windows and other openings in any building made of soil-cement blocks must have a structural component placed above the opening. This component is known as a "lintel".

^{26/} A beam is to be recommended in every case and in every building, including those erected in non-seismic regions.

^{27/} See "Preparation (The cement)".

^{28/} American Steel and Wire Company (ASWC).

The main function of a lintel is to support the loads bearing down on it.

Lintels can be made of various materials, e.g., wood, iron bars, and reinforced concrete (fig. 67).

A rational way of utilizing soil-cement to make lintels is to use U-blocks, applying the same techniques and criteria as were specified for wall beam, as regards reinforcement and type of concrete.

After being prefabricated in U-blocks, the lintel is turned out on the floor; when the time needed for the drying and curing of the concrete fill is completed, it is transferred to its appointed place (fig. 68).

The overlap of the lintel ends embedded in the wall should be not less than three times the depth of the lintel (fig. 69).

Monolithic walling of soil-cement

Soil-cement walling of great stability can be built monolithically. Construction work begins at the damp course. For this purpose shuttering, which must be perfectly plumb and level and in contact with the foundation of the house under construction, is set up. Loose soil-cement is placed in the shuttering in uniform successive layers, which are compacted with a rammer. ^{29/} When the shuttering has been filled it is immediately removed to the next length or section to be built, so that it abuts upon the end of the finished section and the foundation. The same process is repeated for the second section.

The seams between sections are bonded and are tongued and grooved (fig. 69 (a)).

For the form or shuttering, the recommended dimensions are: height 0.80 m and length 2.00 m. The shuttering may be made of wood or metal.

Types of shuttering are very varied. Figures 70 and 70 (a) show some of those used in construction of monolithic soil-cement walls. ^{30/}

The construction of forms requires great care, for on their perfection depends the perfection of the wall. There has to be a plan in their design which will render a maximum of rigidity with a minimum of weight.

"The maximum depth of the forms should be proportionate to the height of the wall. It is not desirable to produce a given number of complete courses (horizontal sections) and then to find that the shuttering must be set up again in order to ram a final section of a few centimetres."

T-shaped junctions and angles of monolithic soil-cement walls may be effected as shown in figure 71. ^{30/}

^{29/} See "Compacting the mixture".

^{30/} Casas de tierra apisonada y suelo-cemento. Anthony F. Merrill.

It is possible in monolithic wall construction to fix bolts in the top of the wall for the purpose of securing wooden wall plates (fig. 72). Alternatively, concrete wall beams can be constructed directly onto the wall (fig. 73).

In this method of construction, it is desirable to make the lintels in the manner indicated under the heading "Apertures".

Apertures

Apertures are the openings which are left in walls, primarily for doors and windows.

The major constructional problem with respect to these openings relates to the supporting piece which is placed immediately over the door and/or window, i.e., the lintel. 31/

It is customary and traditional to continue using the same type of material for that part of the wall lying above the door and window lintels (fig. 74).

Very noticeable constructional defects in soil-cement walls generally occur above the door and window lintels. To remedy this fault, successful experiments have been made in the use of light materials (fig. 75). 32/

When the roof timbers rest directly on the lintel, the difficulty noted above does not arise (fig. 76).

Fixing of frames

Wooden door and window frames are fixed to the walls by means of pieces of wood called dowels embedded in the walls.

One of the most essential properties of dowels is that they should have maximum adhesion to the walls and enable the frames to be properly secured.

Dowels must be protected against damp; the usual practice is to waterproof them with a bituminous paint.

Figure 77 shows a special type of cavity block designed to facilitate the insertion of dowels in walls made of soil-cement blocks. 33/

Figure 78 shows some of the types of dowel most commonly used in building: (a) notched dowels; (b) dowels sheathed in metal mesh; (c) dowels studded with nails; (d) dowels forced into position. The first three types are held in place with mortar.

31/ See "Lintels".

32/ This solution is the most desirable in the case of monolithic walling.

33/ This cavity can also be used to house the lugs which are usually found on metal frames.

ROOFS

A roof consists essentially of (a) the roofing; and (b) the roof supports.

Roofing

The purpose of the roofing is to protect the house against the effects of the weather.

Roofing materials should be light and amenable to use with the least pitch compatible with local weather conditions.

Soil-cement roofing

If it is desired to use soil-cement as roofing for a house, the following methods may be used: (a) laths or reeds are laid on the roof truss or joists and nailed down; a plastic mortar of cement and (sandy) soil in the proportions of 1:7 by volume, with vegetable fibres 3 cm in length added as a reinforcement in the proportion of one part to four parts of mortar, is spread over the laths or reeds. The layer of mortar should be 3 cm deep, duly compacted, and its surface should be smoothed with a trowel (fig. 79). After the material has had time to dry and harden, two or three coats of bituminous material are brushed over the surface in order to make the roofing waterproof. ^{34/}

A uniform sprinkling of small gravel (maximum diameter 5 mm; minimum diameter 1 mm) over the last coat of bituminous material is recommended (fig. 79 (a)).

Another method, similar to the above, is the following: (b) laths or reeds are laid on the roof, truss or joists and nailed down; a plastic mortar of cement and (sandy) soil in the proportions of 1:7 by volume is spread over the laths or reeds to a depth of approximately 1 cm and compacted. Rust-free barbed-wire is laid at intervals of 0.30 m lengthwise and crosswise, over the fresh mortar. This wire mesh is covered with a further layer of mortar of the same kind to a depth not exceeding 2 cm. This is compacted and its surface is smoothed with a trowel (fig. 80).

After the mortar has had time to dry and harden, its surface is finished as explained under (a) above.

The roof support

The roof support should be simple and designed to bear the roofing and any fortuitous loads with comparative ease.

^{34/} Another method of waterproofing roofing is to apply two coats of lime wash (see "Paint").

The roof support may be of wood (known as the "roof timbers"), of metal or of reinforced concrete.

Figure 81 shows a wooden roof truss made of boards, which is very suitable for a ridged roof without centre support.

This truss is recommended for its lightness, ease of construction, high strength and low cost.

Soil-cement walls have little low resistance to tensile forces consequently, the roof should transmit to the walls only vertical thrusts, eliminating all lateral thrusts.

Where roof timbers are concerned, one of the most important problems is how they are to rest on the walls, and a correct method of securing or anchoring them to the soil-cement wall must be found (figs. 82, 82 (a), 82 (b) and 82 (c)). The timber can also be secured to the walls by means of a special wooden post called the "pole-plate"; which rests upon the wall beam and is attached to it with metal bolts or hooks through the pole beam or with metal clamps around it (fig. 83).

In certain regions not subject to earthquakes, it is feasible to place the pole plate directly on the soil-cement wall, so that it serves as a wall plate. When this is done, it is essential to include below the beam, and directly on top of the wall, a thin layer of mortar (a mixture of cement and (sandy) soil in the proportions of 1:8 by volume) ^{35/} to correct any unevenness in the seating of the beam on the wall. In addition, in order to ensure better adhesion between the soil-cement mortar and the beam, the portion of the latter which will be in contact with the mortar should be covered with a metal mesh.

Where a house is built with soil-cement walls, the roof truss can be made of metal parts, and can be anchored to the walls along the general lines indicated above.

FLOORING

Flooring must act as an insulator and must be hard-wearing and attractive in appearance.

If soil-cement is to be used in the construction of house floors, it is recommended that one of the following methods be adopted:

Soil-cement made in situ

The ground on which the flooring is to be laid must first be levelled to the required height or "trace level", which is usually marked on the wall; next, it is smoothed off and compacted. Compaction consists of ramming the soil, adequately moistened and with small stone or gravel added.

^{35/} See "The cement".

When the floor base 36/ is finished, specific points, generally on one level, are noted for reference purposes.

Soil-cement mortar for the flooring should be made up in the proportions of one part of cement to six or eight parts of sandy soil, with the requisite amount of water. 37/

The soil-cement should be laid to a depth of 5 cm in the following manner: a layer of soil-cement, as specified, is laid between the reference points to form "guide strips" or "master strips" approximately 7.5 cm wide which must be well compacted.

All the sections of floor remaining between "guide strips" is filled with the soil-cement mixture, which must be rammed firmly and uniformly until maximum compaction is obtained.

Each section of floor under construction is finally levelled by sliding a "scraper" 38/ between the "master strips", thus removing all excess material. The surface is then finished off with a plastering trowel 39/ (fig. 84 and 84 (a)).

When the soil-cement mortar has set sufficiently, the flooring surface is smoothed over with a finishing trowel.

Another method of finishing is to sprinkle water from a watering-can over the floor (when the soil-cement mortar has set sufficiently), to dust it with dry cement, and finally to smooth it with a trowel.

To obtain a coloured finish, the dry cement must be mixed with the pigment in advance and the compound dusted over the layer of soil-cement mortar when it is half set. The surface is then smoothed with the trowel.

To avoid cracks and fissures in the flooring, it is recommended that shrinkage joints should be left at intervals of 1.5 m. These joints should be deep and well defined (3 cm deep and 1/2 cm wide, approximately).

Thin soil-cement pieces

These thin soil-cement pieces, which are also known as floor tiles, 40/ can be made with the CINVA-RAM moulder. 40/

To lay these tiles, the earth must be levelled and compacted as indicated above for soil-cement made in situ.

36/ Levelled and compacted earth.

37/ See "Preparation (The cement)".

38/ This is a straight piece of wood with rectangular faces, measuring 2.5 x 7.5 cm and varying in length from 1.50 m to 4.00 m.

39/ Fratás. A wooden tool known in some Spanish-speaking countries as a platacho or fratacho.

40/ See annex II: "Soil-cement floor tiles".

When the base is finished, a quantity of mortar sufficiently moist to be spread easily in a layer 2 cm thick is laid on top of it. The mortar is composed of one part of cement to six parts of sandy soil (fig. 85).

When laying flooring tiles, it is essential first to appoint some of them as reference points to serve as guides for laying the remainder (fig. 86).

Wherever possible, soil-cement tile is laid with overlapping seams, and it is gently tapped into the mortar to ensure perfect adhesion. The remainder of the tiles are laid in a similar manner.

Gaps between tiles should be reduced to a minimum, so that their edges touch.

Three days after the floor tiles are laid, the joints should be fronted with a cement slurry 41/ made with pure cement or cement and pigment, according to the type of tile used in the flooring. The slurry is poured on the floor and spread evenly with a broom so that the joints are completely filled (fig. 87).

After a few hours, the floor surface should be cleaned so as to remove the surplus cement left on the tiles.

The finished floor should be closed to traffic for seven days.

Soil-cement blocks

To lay soil-cement blocks, the earth must be levelled and compacted as indicated above for soil-cement tiles.

Blocks to be used for flooring must be made with a wearing surface possessing the same functional qualities as that of soil-cement tiles. 42/ The body of the block should be made from a mixture of one part of cement and six or eight parts of sandy soil. 43/

When laying floors of soil-cement blocks, the instructions given for making floors of soil-cement tiles should be followed exactly.

WALL FINISHES

In order to improve upon the natural wall surface, it is usual to apply a coating, which may be any one of the following:

- (a) A paint - cement-based paint or lime-based paint;
- (b) A plaster - soil-cement mortar or cement mortar.

41/ A compound of water and cement in a liquid state.

42/ See annex II: "Soil-cement floor tiles".

43/ See "Preparation (The cement)".

Paint

Paint is "a homogeneous mixture of one or more pigments in a medium, which is used to cover and/or protect objects with a film of colour".

"Satisfactory results with paints can be obtained only when the following factors are present: (a) the product is of good quality; (b) the surface has been satisfactorily prepared; and (c) the paint is correctly applied". 44/

Before painting, it is necessary to cleanse the walls of mixture and dirt, removing all loose material and filling any cavities.

Cement-based paint

Cement-based paints possess excellent properties, especially as waterproofers, and they are very economical. Their essential ingredients are cement and water, and pigment may be added.

Before the painting of a wall of soil-cement or similar material begins, it should be sprayed with water in order to prevent the wall from absorbing water from the paint and thus hindering its curing (Fig. 88).

The paint should be applied with a brush in two coats and cured for three days by spraying.

Lime-based paint

This is one of the oldest and most economical paints used as a wall finish. It is essentially a lime wash (lime and water), to which pigment may be added.

Lime wash is applied to the wall in two or three coats with a brush (fig. 89). It can also be used in a thicker form and spread with a trowel; in the latter case, it is applied in one or two coats of greater thickness.

To ensure greater adhesion of the paint to the wall, a quantity of glue or other binder is added to the wash (lime and water).

Plaster

Plaster is a wall covering, made with mortar, which gives a smooth and waterproof finish.

Before applying plaster, it is desirable to prepare walls by removing from their surfaces any excess mortar protruding from joints or other extraneous matter left adhering to them during construction.

44/ Argentine Materials Standardization Institute.

Plaster of soil-cement mortar

The best mixtures for this type of plaster are: (a) one part of cement to five or eight parts of sandy soil by volume; ^{45/} (b) the same mixture, plus a proportion of lime not exceeding 50 per cent of the amount of cement used.

Before plastering, reference points are noted on the surface of the wall at intervals of 1.5 m; thus, the thickness of the coating and, consequently, its "rightness" can be determined (fig. 90).

"Guide strips" or "master strips" 7.5 cm wide are applied between the points of reference and left to dry for two days. Mortar is then applied between two adjoining vertical strips and smoothed off, the surplus being removed with a scraper. This is done by resting the scraper on the "master strips" and sliding it over them (fig. 91). This procedure is continued until the whole surface of the wall has been rendered. A tool known as a plastering trowel is used to finish off the plaster surface.

Soil-cement plaster should be cured for three days by continuous spraying.

Plaster of cement mortar

The correct proportions for the mortar are one part of cement to between six and nine parts of sand by volume.

To apply this type of plaster, the instructions given above for plasters of soil-cement mortar should be strictly followed.

Plaster of lime mortar

In regions where good quality limes are available, it may be economical to use a certain proportion of lime in the mixture.

In Argentina, for example, it is usual to follow this procedure: (a) a first coating of thick plaster, consisting of one-fourth part of cement, one part of paste lime, three parts of coarse or medium sand and one part of brick dust (or an equal quantity by volume of fine sand), is applied to the wall, prepared as indicated above under "Plaster of soil-cement mortar"; (b) this coarse plaster is given a fine finish by covering it with a mixture consisting of two parts of paste lime to five parts of fine sand by volume.

^{45/} See "The cement".

V. ACCOMPLISHMENTS IN SOIL-CEMENT

THE PURPOSE OF THIS CHAPTER

Soil-cement has acquired a reputation as an excellent construction material. It is being used more and more in all countries, especially in rural and suburban areas.

This chapter presents a number of examples which may be helpful to anyone wishing to try using this material for construction purposes. The examples also attest to the good qualities of soil-cement when it is properly employed.

The instructions given in this paper are sufficiently complete to enable anyone who follows them to obtain results as good as, or better than, those illustrated here.

HOUSES

Rural dwelling of soil-cement (1)^{46/}

An experimental dwelling, basically of soil-cement, in the village of Chambinbal, Municipality of Buga, Department of Valle del Cauca, Colombia. This building was the outcome of a detailed study, in which several teachers and fellows from the 1957 CINVA regular course took part. It was designed to suit the characteristics and level of living of the inhabitants of the region, and a more rational and advanced method of using local materials and techniques was applied in its construction.



^{46/} For numerical references, see the end of the chapter.

Sample house of soil-cement (2)

Under an agreement between the Land Credit Institute (Instituto de Crédito Territorial) of Colombia and CINVA, it was decided to construct a soil-cement cottage. The object was to demonstrate the correct way of using soil-cement blocks produced with the CINVA-RAM moulder. The project showed what economies could be effected through the use of this machine in self-help and mutual aid programmes of rural housing.

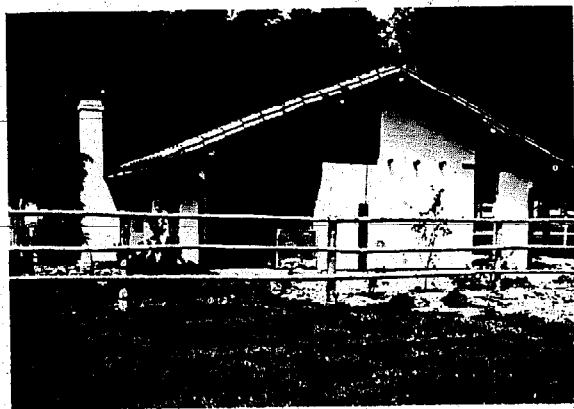

Rural dwelling, San Jerónimo (3)

In 1956, CINVA agreed with the Director of Rural Education of the Colombian Ministry of Education to carry out a project of some magnitude in a rural environment. Thus began the San Jerónimo (Antioquia) Pilot Project, which offered a means of conducting a practical experiment, adapting working methods, training technical personnel with a practical outlook, and framing a possible solution to the rural housing problem with the use of educational resources.



House of soil-cement blocks (4)

The dwelling shown in the photographs was built in Argentina, in the San José area of the Sierras de Córdoba.

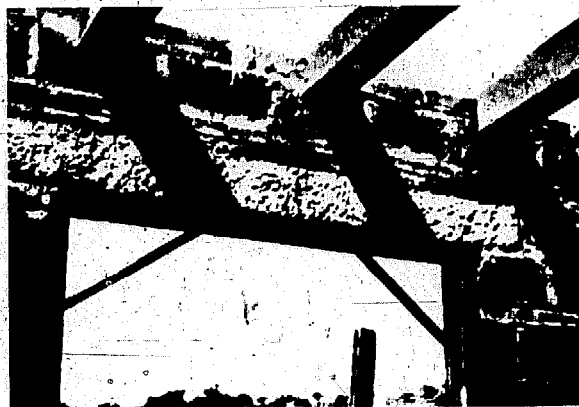



Soil-cement house (5)

The Water Authority of the Province of Buenos Aires decided to provide adequate housing for its overseers along the canals which traverse much of the territory. It elected to try using soil-cement for buildings in the No. 16 canal zone, in the Saladillo district.

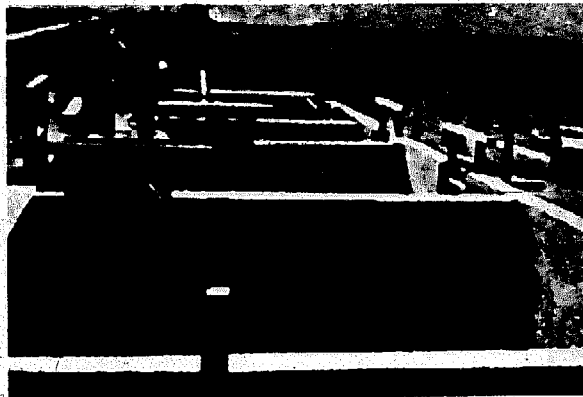

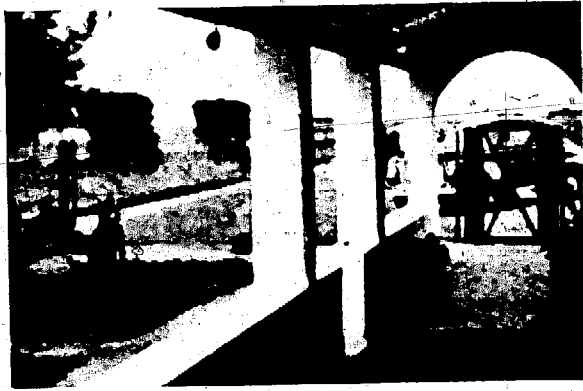



Soil-cement house in the United States of America (6)

In this design the door and window openings run from the floor to the roof, so that it was unnecessary to work with the soil-cement on small sections or to make the lintels excessively strong. A wood filling was used below the windows.



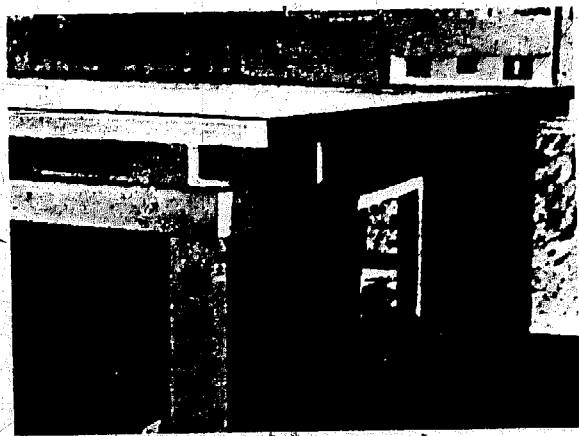
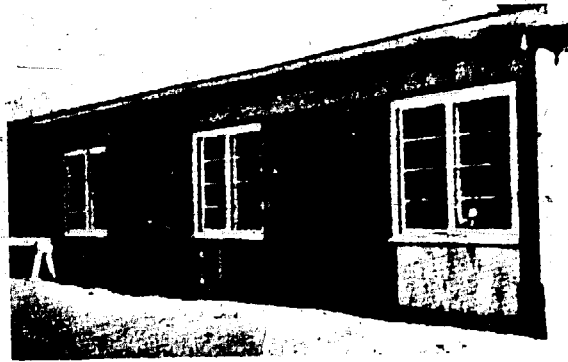

Soil-cement houses in Colombia

Houses built at Caicedonia (Valle) with soil-cement blocks made with the CINVA-PAM moulder. They are outstanding for the excellence of the masonwork.

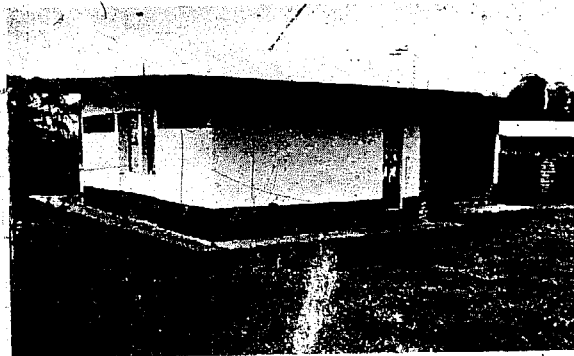

Soil-cement house in Venezuela

Soil-cement dwellings built under contract in the city of Caracas. They show the excellent masonwork possible with prefabricated soil-cement components. The roof is of asbestos cement.



Soil-cement house in Venezuela (7)

Soil-cement dwelling built for demonstration and practice in the grounds of the Practical School of Agriculture (M.A.C.) at Providencia. Recommended for warm climates by the Malariology Division of the Public Health Department of the Venezuelan Ministry of Health and Welfare.

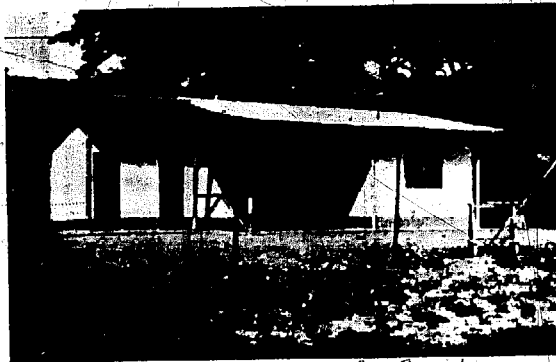

Soil-cement house in Brazil (8)

Villa constructed at Valle Florida, Municipality of Petropolis, State of Rio de Janeiro.

In Brazil a number of projects using soil-cement walling have been carried out, primarily through the efforts of the Brazilian Portland Cement Association.





Soil-cement house in Bolivia (9)

Soil-cement dwelling constructed by Bolivian State Oilfields for the Director of Operations at his Sanandita headquarters.



Soil-cement house in Chile (10)

Experimental soil-cement structures erected by the Scientific Housing Centre,
University of Chile.

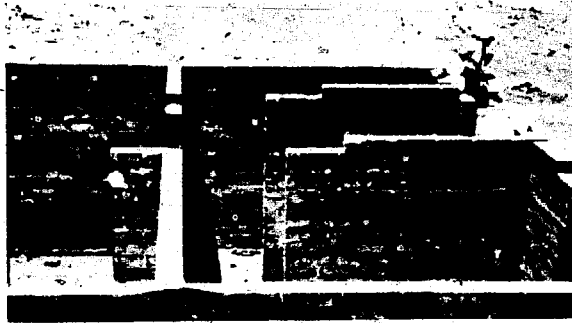

Soil-cement house in Chile (11)

The National Institute for Technological Research and Standardization (Inditecnor), with the collaboration of the Department of Scientific and Technological Research of the Catholic University of Chile, constructed this experimental soil-cement house.



SCHOOLS

Tabio experimental country school (12)

Built experimentally at El Salitre Village, Municipality of Tabio, Department of Cundinamarca, Colombia.

This experiment had its origin in the programme and study devised by CINVA to "demonstrate a methodology for the construction of rural schools", employing the efforts of the rural community concerned, local materials and, for making soil-cement blocks, the CINVA-RAM moulder.

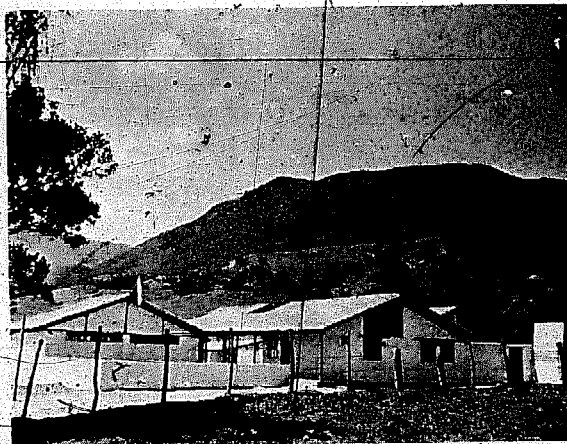

Saucio rural school (13)

This project, carried out at Saucio Village, Municipality of Chocontá, Colombia, also had its origin in the programme and study mentioned in the preceding paragraph.

The erection of this school provided a practical exercise as part of a process of "community development", which may be defined as "the development of the potentialities of a community or social group towards a common end or collective benefit".



Rural school of soil-cement in Colombia

The Cundinamarca Board of Education built at La Calera, near Bogotá, a rural school with a metal frame and walls of prefabricated soil-cement blocks.



CATENARIAN ARCH

With a view to finding new applications for soil-cement blocks, the Technological Section of CINVA proceeded in 1958 to design and build at its "experimental building station" an arch of soil-cement blocks made with the CINVA-RAM moulder.

The form selected was the catenary, as being most suitable from the standpoint of thickness and constant weight throughout the arch.

The arch's dimensions are:

Clear span	6.5 metres
Clear height	3.0 metres
Thickness	9 centimetres

The basic material used was blocks of cement and (sandy) soil, in the proportion of 1:10 by volume. The mortar used between the blocks was 1:3 (cement-sand) by volume.

The structural behaviour of the arch has been satisfactory. At the time of writing (1963) no cracking whatever has occurred, and although not subjected to load-bearing tests it has fortuitously supported the weight of several persons.

This kind of structure may obviously have important uses in rural areas, particularly as a cover for areas intended for storing goods and machinery.

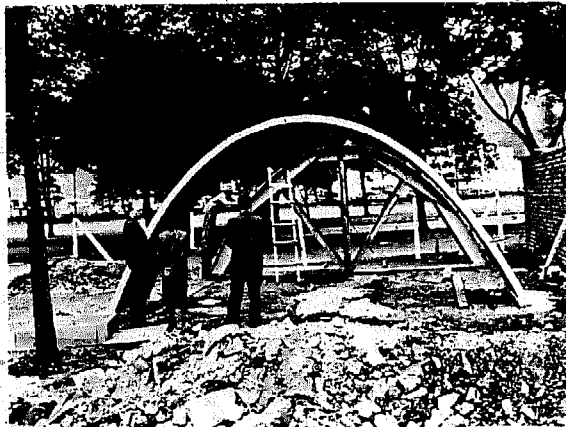

SOIL-CEMENT CISTERNS AND SILOS

Domestic water supply in rural dwellings presents a problem which is usually resolved by complex and costly methods.

The cistern constructed of prefabricated soil-cement components is a solution now being applied with good results.

The illustrations below show some experimental designs:

Cistern for the experimental dwelling in Chambimbal Village, Colombia (14)

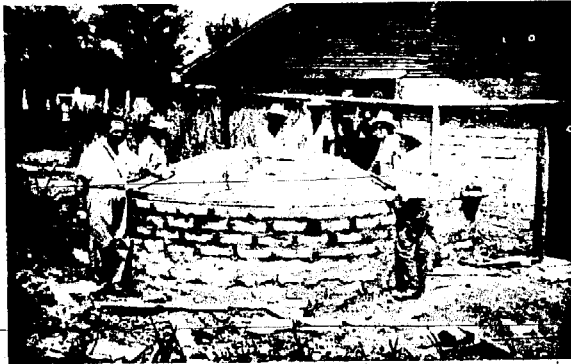

Cistern for the soil-cement house built at the CINVA "experimental building station" (15)

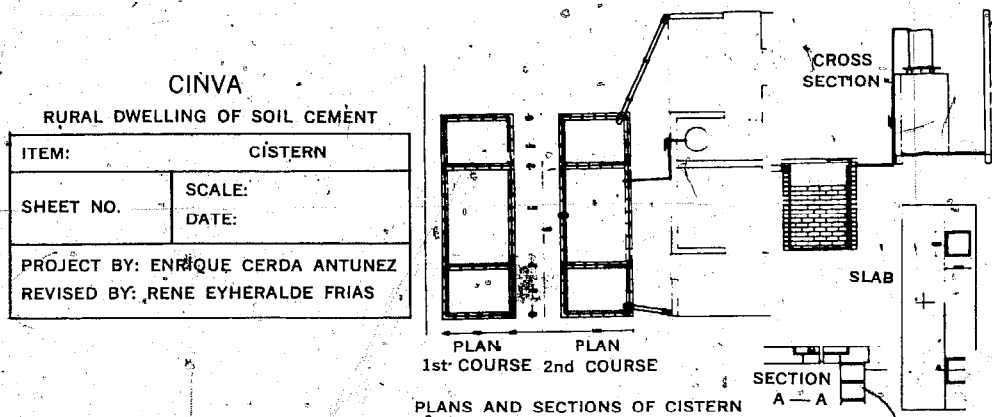

Soil-cement silos (16)

Soil-cement has been used in the construction of silos with very satisfactory results.



KITCHEN RANGES

The installation of a kitchen in rural dwellings requires the construction of a range, together with a stove-pipe to prevent fire hazards, which will generate sufficient heat and can be produced cheaply by the use of simple and effective craft techniques.

Range for the experiment dwelling at Chambimbál Village, Colombia (17)



Household range for the San Jerónimo Rural Project, Colombia (13)

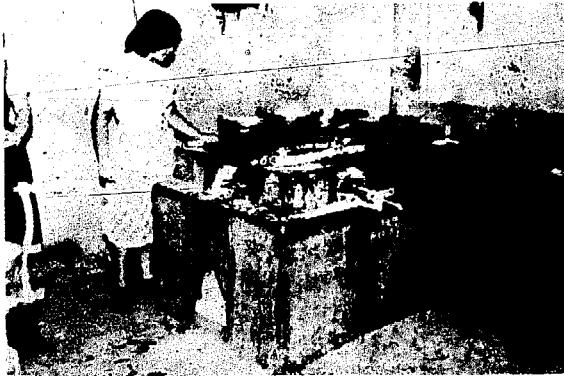

Range for the soil-cement cottage, Colombia (19)

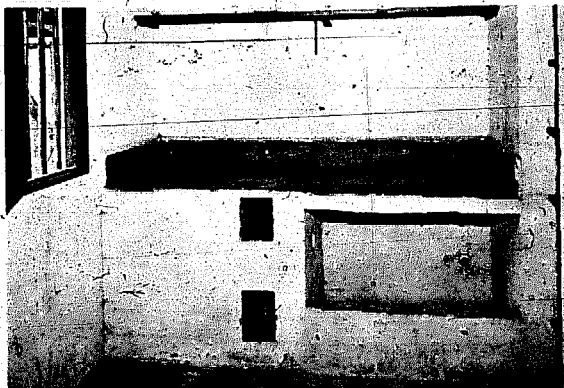

Range for the Tabio experimental country school, Colombia (20)

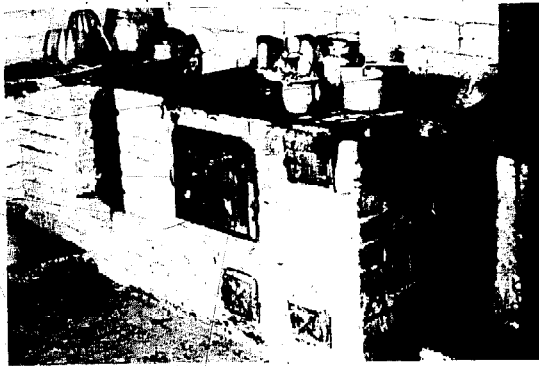

OVENS

The oven is an indispensable adjunct to the rural dwelling in many country communities.

Soil-cement oven for the cottage, built at the CINVA "experimental building station" (21)

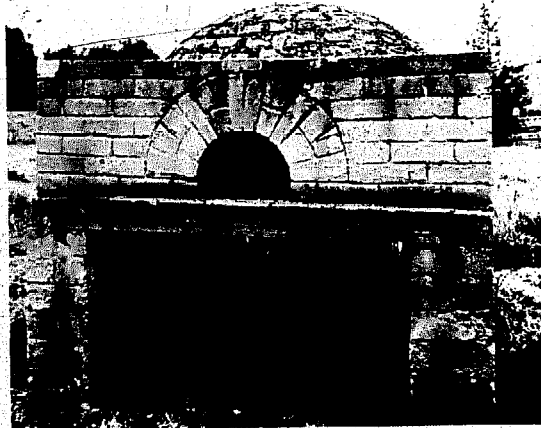

Soil-cement oven for the experimental dwelling at Chambimal Village, Colombia (22)

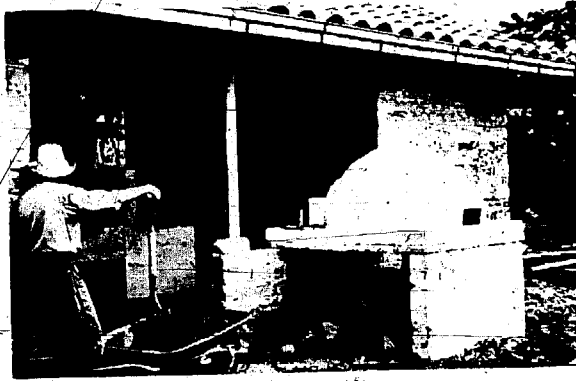

OTHER USES

Thermal insulation with soil-cement (23)

In seventy-four buildings erected for the water authority (ANDA) at La Rioja and Catamarca (Argentina), the roofs were made of precast concrete beams and slabs. Thermal insulation was provided by a packing of soil-cement.

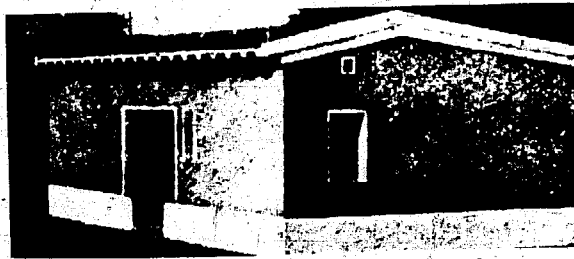

Special soil-cement blocks for ventilation

Specially designed soil-cement blocks may be used to provide openings for ventilation in the walls of a dwelling, as was done in the CINVA "building shops" shown here.

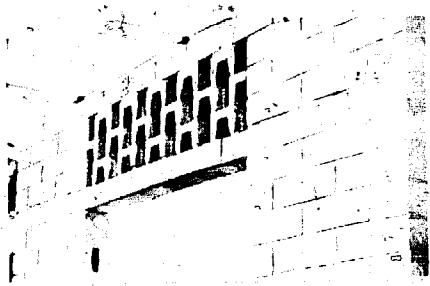

REFERENCES

- (1) La Vereda de Chambimbal [Chambimbal Village], study and action in rural housing, CINVA publication, 1958.
- (2) Casa campesina de suelo-cemento [Soil-cement cottage], building plans, CINVA publication, 1957.
- (3) Proyecto Rural de San Jerónimo [San Jerónimo Rural Project], CINVA publication, 1956.
- (4) Cemento Portland, journal of the Argentine Portland Cement Institute, No. 12, May 1947.
- (5) Cemento Portland, journal of the Argentine Portland Cement Institute, No. 6, July-August 1945.
- (6) Cemento Portland, journal of the Argentine Portland Cement Institute, No. 7, December 1945.
- (7) Vivienda Sana [Healthful Housing], Malariology Division, Department of Public Health, Ministry of Health and Welfare, Venezuela, 1957.
- (8) Casas de Tierra Apisonada y Suelo-Cemento [Houses of Rammed Earth and Soil-Cement], by Anthony F. Merrill.
- (9) Casas de Tierra Apisonada y Suelo-Cemento [Houses of Rammed Earth and Soil-Cement], by Anthony F. Merrill.
- (10) La Vivienda, official organ of the Scientific Housing Centre, No. 4, November-December 1954, Santiago, Chile.

- (11) Casa experimental de suelo-cemento [Experimental soil-cement house], Department of Scientific and Technological Research of the Catholic University of Chile, by Rolando Maturana and Hernán Ayarza.
- (12) Technical information about this rural school project may be obtained from CINVA.
- (13) Technical information about this rural school project may be obtained from CINVA.
- (14) La Vereda de Chambimbal [Chambimbal Village], study and action in rural housing, CINVA publication, 1958.
- (15) Casa campesina de suelo-cemento [Soil-cement rural house], building plans, CINVA publication, 1957.
- (16) Cemento Portland, journal of the Argentine Portland Cement Institute, No. 17, November 1948; No. 5, April-May 1945; No. 6, July-August 1945.
- (17) La Vereda de Chambimbal [Chambimbal Village], study and action in rural housing, CINVA publication, 1958.
- (18) Proyecto Rural de San Jerónimo [San Jerónimo Rural Project], CINVA publication, 1956.
- (19) Casa campesina de suelo-cemento [Soil-cement rural house], building plans, CINVA publication, 1957.
- (20) Technical information about this project may be obtained from CINVA.
- (21) Casa campesina de suelo-cemento [Soil-cement cottage], building plans, CINVA publication, 1957.
- (22) La Vereda de Chambimbal [Chambimbal Village], study and action in rural housing, CINVA publication, 1958.
- (23) Cemento Portland, journal of the Argentine Portland Cement Institute, No. 5, April-May 1945.

VI. ANNEXES

ANNEX I.

Test for loss of length by shrinkage of soil^{a/}

"Make a box without a lid exactly 60 cm long inside by 4 cm wide and 4 cm deep inside. Oil or grease the inside surfaces of the box thoroughly. Put in wet soil without cement. The soil should have the optimum wetness. b/ Ram the soil into all corners of the box with a small stick, and finally use the stick to smooth off the surface. Place the box in the sun for at least three days or in the shade for at least seven days. Do not let rain fall on it.

"At the end of this time measure by how much the soil has become shorter in length by shrinking. You may have to add up the loss in length by shrinkage at each end of the box, or you may be able to push the soil, which should be dry and hard, to one end, and measure all the shrinkage at the other end of the box.

"If the soil has shrunk not more than 12 mm use one part of cement to eighteen parts of soil. If it has shrunk more than 12 mm but less than 25 mm, use one part of cement to sixteen parts of soil. If it has lost more than 25 mm, but less than 38 mm, use one part of cement to fourteen parts of soil, while if it has lost more than 38, but less than 50 mm, use one part of cement to twelve parts of soil.

"If the soil has cracked very badly at several places, not just one or two cracks, or if it has arched up out of the box, or has shrunk more than 50 mm, do not use it for building."

a/ Method suggested by A.E.S. Alcock.

b/ See "Compaction" and "Adding the water, and wet mixing".

ANNEX II

Soil-cement floor tiles

Soil-cement tiles for flooring can be made with the CINVA-RAM moulder along the same general lines as are indicated for block-making. c/

The soil-cement tile consists of two parts: the upper part, or wearing surface, from 1 to 4 mm thick, and the lower part, or "body" of the tile, from 3.1 to 3.4 cm thick (fig. 85).

The mixture for the "body" of the tile should contain one part of cement to between six and eight parts of sandy soil by volume, with the requisite amount of water. d/ The instructions given for block-making apply to the choice and preparation of the soil, and to the mixing and compacting. e/

The wearing surface of the tile may consist of pure cement, a mortar of very fine sand in the proportion of two or three parts to one part of cement, or a mixture of cement, pigment and fine sand in proportions determined experimentally according to the pigment used.

The CINVA-RAM moulder is used to make soil-cement tile in the following manner:

(a) The special metal-covered wooden plate or platform (fig. 92)^{f/} supplied with the machine is placed at the bottom of the metal box.

(b) The material for the bearing surface of the tile is placed in the mould first, and the material for the body is then added. The whole is moulded so as to obtain maximum compaction.

(c) The tile is removed as shown in figure 93.

(d) The tile is dried and cured in the manner indicated for blocks.^{g/}

c/ See "Preparation" and "Thin soil-cement pieces".

d/ See "The cement".

e/ See "Preparation".

f/ The plate is six centimetres thick.

g/ See "Blocks".

ANNEX III

The siphoning method^{h/}

Like the standard method, this new method is based on the principle of sedimentation. The latter is expressed by Stoke's law, which gives the rate of fall of a small sphere in a viscous fluid as:

$$V = \frac{gd^2(Y_1 - Y_2)}{18n}$$

where:

V = velocity in centimetres per second,

g = acceleration in centimetres per second per second,

d = diameter of the sphere in centimetres,

n = viscosity in dyne-seconds per square centimetre or poises (changes with temperature),

Y₁ = specific gravity of the sphere in grammes per cubic centimetre,

Y₂ = specific gravity of the medium in grammes per cubic centimetre.

If the velocity is measured in centimetres per minute, and d in millimetres:

$$V = \frac{gd^2(Y_1 - Y_2)}{30n}$$

In applying Stoke's law to the determination of the sizes of particles in a soil, the following limitations should be taken into consideration:

(a) Soil particles are not spherical. Some are angular, round, disk-shaped, and so forth. Thus, according to E. and W. Squires of the Massachusetts Institute of Technology, the relationship between the diameters of spherical and disk-shaped particles is:

$$D = 0.752 D' \sqrt{a}$$

^{h/} This method has been revised. It was originally submitted by its author to the American Society for Testing Materials (ASTM) in 1945 and published in the ASTM Bulletin, No. 137, in August 1945. The method was tested by Mr. C.M. Johnston, of the United States Public Roads Administration (see the ASTM Bulletin, No. 144, of January 1947). The slight changes which have been introduced make the method easier to use. Reprinted from Método del Sifoneado para el Análisis Mecánico de Suelos, by Raúl Valle Rodas. Caracas, 1955.

where:

- D = diameter of sphere,
- D' = diameter of disk,
- a = D/H,
- H = height of disk.

(b) Stoke's law relates to the motion of one sphere only and does not therefore take into account the reciprocal influence or interference among particles which certainly occurs in a mass of soil in a fluid medium.

The above-mentioned limitations, among others, show us that the granulometric analysis of a soil based on the principle of sedimentation or on Stoke's law is approximate.

In the proposed method, the mean settling period of silt particles was taken as 1 centimetre per minute. This value, as can be seen from table I, provides a safety factor, because at the end of one minute all the silt particles will have settled to a distance of one centimetre. Settling velocities were determined for fluid temperatures of 10° to 30°C and for soil specific gravities of 2.25 to 2.95. These are the conditions normally found.

Similarly, the mean velocity of fall for clay particles was taken as 0.020 centimetres per minute. Table II gives the velocity of fall for clay particles at different temperatures and specific gravities.

1. Scope

This method indicates the procedure for determining the percentages of stone, gravel, sand, silt and clay contained in a soil.

2. Apparatus

- (a) Balance. A balance sensitive to 0.1 g.
- (b) Stirring device. An electric stirring apparatus with removable stirring paddle. It is desirable that the dispersion cup should have baffle rods.
- (c) Drying device. An electrical or kerosene oven which can maintain a temperature of about 110°C.
- (d) Graduated vessels. Glass containers with an inside diameter of not less than 6.4 centimetres and a height of not less than 25 centimetres. The graduates of 1,000-millilitre capacity commonly used in laboratories are suitable.
- (e) Metal disk. A non-corrosive metal disk attached to a rod (see figure A), to separate the settled material from that remaining in suspension.
- (f) Siphon. A rubber tube to siphon off the material remaining in suspension.
- (g) "Pyrex" glass beakers. Beakers of about 600-ml capacity.

TABLE I

Temperature		Specific gravity g/cm ³	Velocity corresponding to a diameter d = 0.05 mm, cm/min	Velocity corresponding to a diameter d = 0.005 mm, cm/min	Mean velocity for silt particles, cm/min*
°F	°C				
50	10	2.95	12.18	0.122	1.22
		2.65	10.30	0.103	1.03
		2.25	7.81	0.078	0.78
68	20	2.95	15.85	0.158	1.58
		2.65	13.41	0.134	1.34
		2.25	10.16	0.102	1.02
86	30	2.95	19.89	0.199	1.97
		2.65	16.82	0.168	1.68
		2.25	12.75	0.127	1.27

* The mean velocity was taken as the square root of the product of the velocities corresponding to the largest and the smallest size of silt particles. The mean velocity for clay particles was computed in the same way.

TABLE II

Temperature		Specific gravity, g/cm ³	Velocity corresponding to a diameter d = 0.005 mm, cm/min	Velocity corresponding to a diameter d = 0.001 mm, cm/min	Mean velocity for clay particles, cm/min
°F	°C				
50	10	2.95	0.122	0.0049	0.024
		2.65	0.103	0.0041	0.020
		2.25	0.078	0.0031	0.016
68	20	2.95	0.158	0.0063	0.032
		2.65	0.134	0.0054	0.027
		2.25	0.102	0.0041	0.020
86	30	2.95	0.199	0.0080	0.039
		2.65	0.168	0.0067	0.033
		2.25	0.127	0.0051	0.026

(h) Sieves. A series of sieves of square-mesh woven wire cloth. The sieves required for the test are as follows:

Sieve Designation	Sieve Opening
3/4"	19.100 mm
No. 10	2.000 mm
No. 60	0.250 mm
No. 200	0.074 mm

If more plotting points are wanted for the granulometric curve, a greater number of sieves may be used.

3. Reagents

(a) Dispersing agents. Any of the following agents may be used: hydrogen peroxide, sodium hydroxide, sodium carbonate, sodium oxalate, or ammonia.

(b) Deflocculating agents. Sodium silicate or gum arabic solution.

4. Sampling

A representative sample of about five kilogrammes is taken. The material is thoroughly mixed so as to break up the lumps, but care must be taken not to fracture the particles.

5. Procedure

(a) Use 50 to 100 grammes of the oven-dried material passing the No. 10-sieve.

(b) Place the soil in a beaker and add about 300 ml of water, stirring constantly until the soil is completely wetted.

In the case of clayey soils, it is advisable also to add about 100 ml of hydrogen peroxide (6 per cent) or of sodium hydroxide (3 per cent). Stir the mixture constantly while adding the dispersing agent.

(c) Leave the sample to soak for at least one hour.

(d) If it is noted that the soil tends to flocculate (coagulate), add, shortly before it is placed in the electric stirring device, about 20 ml of sodium silicate (30 Baumé) or 50 ml of a solution of gum arabic (45.2 grammes of gum arabic in one litre of water).

The amount and concentration of the reagents may be varied according to the characteristics of the soil.

(e) The mixture is poured carefully into the dispersion cup and is then beaten in the electric stirring device for one minute.

(f) After the material has been dispersed, transfer it into a graduated glass vessel and fill the vessel with water to a height of at least twenty centimetres. Shake the contents thoroughly, turning the cylinder upside down

and back several times with the palm of one hand placed over the mouth of the vessel and the other hand holding the base (see figure A).

(g) After the shaking operation is completed, place the vessel on a table and let the soil in suspension settle for twenty minutes.

If the contents of the vessel occupy a height of over 20 centimetres, add one minute for each centimetre to the aforesaid settling period of twenty minutes. h/

(h) After twenty minutes carefully introduce the metal disk until it touches the material settled at the bottom. The purpose of this is to separate the settled material from that still in suspension.

(i) Using a rubber tube, carefully siphon off the material still in suspension.

(j) Transfer the material settled at the bottom of the vessel into a beaker. It is recommended that a wash bottle should be used in removing the sample. Try not to use too much water, so that the container with the sample may be put into the oven at once.

(k) Place the container with the soil sample in the oven until the sample is completely dried, and weight the dry material.

(l) Sieve the dry material on the Nos. 60 and 200 sieves, and record the weight of the material that passes each sieve.

6. Report

The percentage of material retained on the 3/4" sieve is reported as stone.

The percentage of material retained on the No. 10 sieve is reported as gravel.

The percentage of material retained on the No. 60 sieve is reported as coarse sand.

The percentage of material retained on the No. 200 sieve is reported as fine sand.

The percentage of material which passes the No. 200 sieve and which previously settled is reported as silt.

The percentage of material which passes the No. 200 sieve and which was previously siphoned off is reported as clay.

Note: In practice, the material which passes the No. 200 sieve (0.074 mm) can be classified as silt. However, if it is thought desirable to report only particles smaller than 0.050 mm as silt, the No. 270 sieve (0.050 mm) can be used, or the percentage corresponding to 0.05 mm on the granulometric curve can be taken.

h/ The settling period for silt particles was calculated at one centimetre per minute.

Granulometric curve

Where the aperture size in millimetres of the different sieves used is known, it is a simple matter to plot a granulometric curve, as shown in figure B. The use of semilogarithmic paper is recommended in plotting this curve.

Examples

Example No. 1. (All the material passes the No. 10 sieve.)

Weight of oven-dried material	100	grammes		
Weight of settled material remaining after siphoning	55	"		
Difference (clay)	45	grammes		
Results of sifting the material remaining after siphoning	{	Weight of material retained on the No. 60 sieve (coarse sand)	20	grammes
		Weight of material retained on the No. 200 sieve (fine sand)	16	"
		Weight of material passing the No. 200 sieve (silt)	19	"
		55	grammes	

Thus we have:

Gravel (material retained on the No. 10 sieve)	0.0	grammes	0.0	per cent
Coarse sand (material retained on the No. 60 sieve)	20.0	"	20.0	"
Fine sand (material retained on the No. 200 sieve)	16.0	"	16.0	"
Silt (material passing the No. 200 sieve)	19.0	"	19.0	"
Clay (material siphoned off)	45.0	"	45.0	"
			100.0	per cent

Example No. 2. (Only a part of the material passes the No. 10 sieve.)

Material retained on the 3/4" sieve	10	per cent	(stone)
Material retained on the No. 10 sieve	15	"	(gravel)
Material passing the No. 10 sieve,	75	"	(sand, silt and clay)

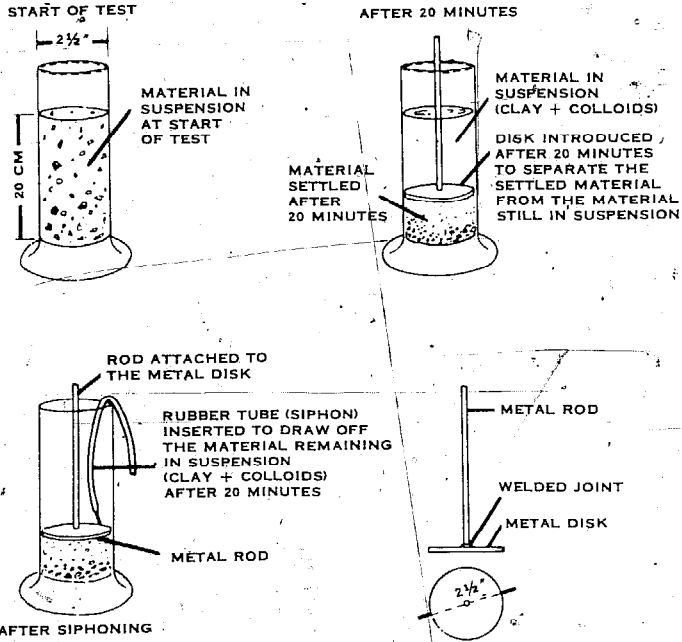

Fig. A

MECHANICAL ANALYSIS
GRANULOMETRIC CURVE

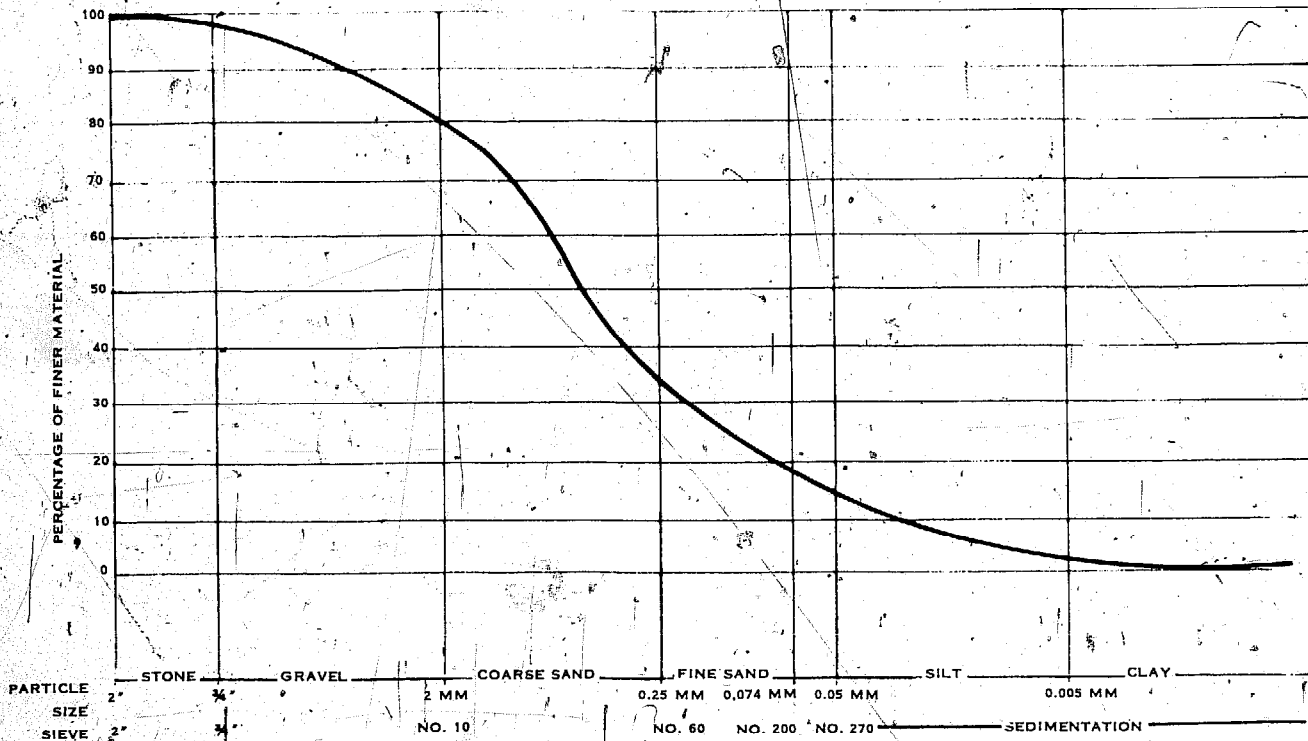

Fig. B

Results of the test conducted with the material passing the No. 10 sieve:

Weight of the oven-dried material	100 grammes	
Weight of the settled material	68 grammes	(Retained on No. 60 12 grammes Retained on No. 200 20 grammes Passing No. 200 36 grammes)
<u>Difference (clay)</u>	<u>32 grammes</u>	<u>68 grammes</u>

Final results:

Stone	10.0 per cent
Gravel	15.0 "
Coarse sand . . 12 g x 0.75	9.0 "
Fine sand . . . 20 g * 0.75	15.0 "
Silt 36 g x 0.75	27.0 "
Clay 32 g x 0.75	24.0 "
	<u>100.0 per cent.</u>

Colloidal material

The classification given above is the one normally used in practice.

However, it is desired to ascertain the percentage of colloidal matter (particles smaller than 0.001 millimetres) included in the "clay fraction", the following procedure should be used:

- (a) Transfer the material siphoned according to section 5 above to another graduated vessel.
- (b) Fill the vessel containing the siphoned material with water to a height of 20 centimetres, mix thoroughly and stand on a table for seventeen hours.

The velocity of fall for clay particles was calculated at 0.020 centimetres per minute.

- (c) After seventeen hours, introduce the metal disk and siphon off the material remaining in suspension. This material in suspension is classified as colloidal matter.

Example: Suppose that the 45 per cent of clay (clay + colloids) obtained in example No. 1 is transferred to a graduated vessel and subjected to a second siphoning after seventeen hours:

Weight of the material siphoned off in the first operation	45 grammes	
Weight of the material retained after the second siphoning	34 "	34 per cent
Difference (colloidal material)	<u>11 grammes</u>	<u>11 per cent</u>

Thus we find that the 45 per cent "clay fraction" is composed of:

Clay	34 per cent
Colloidal material	11 per cent

COMPARISON BETWEEN THE STANDARD METHOD AND THE SIPHONING METHOD

The results obtained by this method^{1/} are practically identical with those obtained by the Standard Method, but the test is quicker and simpler to perform. The comparative table below shows some of the advantages of using the siphoning method.

	Standard Method	Siphoning Method
Specific gravity determination	Necessary	Not necessary
Use of hydrometer	Necessary	Not necessary
Temperature correction	Necessary	Not necessary
Specific gravity correction	Necessary	Not necessary
Hydrometer correction	Necessary	Not necessary
Soaking period	18 hours	1 hour
Sedimentation period	60 minutes	20 minutes
Computations	Laborious: charts and slide rule needed	Very simple: neither charts nor slide rule needed
Total testing time per sample (exclusive of drying and sieving)	19 hours	1 1/3 hours
Number of samples that can be tested per eight-hour working day	10	50

Siphoning.

BIBLIOGRAPHY

1. Alcock, Alhead Edward. Mejores construcciones con tierra en los trópicos, mis experiencias en la Costa de Oro [Better building with earth in the tropics; my experiences in the Gold Coast], translated by Antonio J. Sucre. No imprint. 10 sheets, 28 cm.
2. Alcock, Alhead Edward. 'Swishcrete': Notes on stablized cementearth in the Gold Coast. In Colonial Building Notes, 17, set. 53.
3. Alliende, A. Carlos. Mecánica de los suelos [Soil mechanics]. Santiago, Ed. Universitaria, 1958. 2 v. illus., tables, diagrams, 21 cm.
4. American Road Builders' Association. Soil stabilization; an exhibit displayed by the Bureau of Public Roads of the United States Department of Agriculture. San Francisco, 1939. 21 p. illus., 23 cm.
5. American Society for Testing Materials. Cement, concrete, ceramics, thermal insulation, road materials, waterproofing, soils. Philadelphia, ASTM, 1954. (Supplement to Book of ASTM Standards, including Tentatives).
6. American Society for Testing Materials. Report of Committee D-18 on soils for engineering purposes. Philadelphia, 1958. 12 p. illus., 23 cm. (ASTM preprint 15).
7. Arriagada Amengual, César. Construcción con ladrillo de suelo cemento en la estación experimental del Centro Científico de la vivienda de la Univ. de Chile [Building with soil-cement brick at the experimental station of the Scientific Housing Centre of the University of Chile]. In Vivienda (Santiago, Chile), year 1, 4, pp. 16-19, Nov.-Dec. 1954.
8. Arriagada Amengual, César. Empleo de bloques de suelo-cemento en la construcción de habitaciones económicas; memoria para optar el título de Ingeniero Civil [Use of soil-cement blocks in building low-cost dwellings; thesis for the degree of civil engineer]. Santiago, University of Chile, School of Engineering, 1955. 162 p. illus., 28 cm.
9. Ayarza E., Hernán. Casa experimental de suelo-cemento [Experimental soil-cement house], by Hernán Ayarza E. and Rolando Maturana C. Santiago, Catholic University of Chile, Department of Scientific and Technological Research, 1954, 11 p. illus., 27 cm. (Experimental Housing Station, publication No. 2).
10. Ayarza E., Hernán. Casa experimental no. 2 de tierra apisonada [Experimental rammed-earth house No. 2], by Hernán Ayarza E. and Rolando Maturana C. Santiago, El Imparcial, 1956. 14 p. illus., 27 cm. (Catholic University of Chile. Department of Scientific and Technological Research. Experimental Housing Station; publication No. 5).

11. Ayarza E., Hernán. Muros monolíticos de suelo-cemento [Monolithic soil-cement walling]. Santiago, Catholic University of Chile, Department of Scientific and Technological Research, 1954. 28 p. illus., 27 cm. (Experimental Housing Station, publication No. 4).
12. Barbará Z., Fernando. Materiales y procedimientos de construcción [Building materials and methods]. Mexico City, Society of Mexican Architects, National College of Architects, 1955. 596 p. illus., plans, 31 cm.
13. Barber, Edward S. Examples of highway soil engineering. Philadelphia, American Society for Testing Materials, 1958. 23 p. illus., 22 cm. (ASTM preprint 101b).
14. Bertram, Major George E. Soil tests for military construction. Washington, American Road Builders' Association, 1956. 95 p. illus., 22 cm. (Technical Bulletin No. 107).
15. Betts, M.C. Rammed earth walls for buildings, by M.C. Betts and T.A.H. Miller. Washington, D.C., U.S. Govt. Printing Office, 1947. 23 p. illus., 23 cm. (U.S. Dept. of Agriculture, Farmers Bulletin No. 1500).
16. Bogotá. Division of National Highways, Design Dept. Construcción suelo-cemento y sus usos, procedimientos de construcción para superficies de suelo-cemento [Soil-cement building and its uses, building methods for soil-cement surfaces]. (Bulletin No. 64).
17. Brazil. Ministry of Health. Casa de terra; as técnicas de estabilização do solo a serviço do homem do campo [Earth house; methods of soil stabilization for the rural population]. Brazil, Special Public Health Service, 1958. 122 p. illus., 23 cm.
18. Brookings (South Dakota). Department of Agricultural Engineering. The relations of colloids in soil to its favourable use in pisé or rammed earth walls. No imprint. 23 p. illus., 22 cm. (Bulletin No. 298).
19. Burkhart, Edsel J. Investigation of soils and building techniques for rammed earth construction. Texas, Engineering Experiment Station, 1949. 23 p. illus., 28 cm. (Texas Engineering Experiment Station, Research Report No. 6).
20. Carri, Victor. La construcción de casas económicas con suelo-cemento [Building low-cost houses with soil-cement]. Argentina, Ministry of Public Works. No date. 17 p. illus., 27 cm.
21. Una casa de bloques de suelo-cemento [A house of soil-cement blocks]. In Cemento Portland (Buenos Aires) No. 12, p. 20, May 1947.
22. Una casa que marca un jalón en el uso del suelo-cemento [A house that marks a milestone in the use of soil-cement]. In Cemento Portland (Buenos Aires) No. 5, pp. 4-5, April-May 1945.

23. Casas de suelo-cemento en Estados Unidos de America. [Soil-cement houses in the United States of America]. In Cemento Portland (Buenos Aires) No. 7, pp. 11-13, Dec. 1945.
24. Centro Interamericano de Vivienda y Planeamiento. - CINVA-RAM, máquina portátil para hacer bloques de tierra estabilizada [CINVA-RAM, a portable machine for making stabilized-soil blocks]. Bogotá, 1957. 14 p. illus., 23 cm. (CINVA publications, series: Circulation No. 4).
25. Centro Interamericano de Vivienda y Planeamiento. Proyecto de San Jerónimo (Antioquia) Colombia; una experiencia de educación en vivienda rural [Project of San Jeronimo (Antioquia) Colombia; an experiment in education in rural housing]. Bogotá, 1958. 31, 58 p. illus., 28 cm. (CINVA publications, series: Technical No. 4).
26. Cerda Antunez, Enrique. Casa campesina de suelo-cemento, juego de planos de construcción [Soil-cement cottage, building plans]. Bogotá, CINVA, 1957. 26 sheets, illus., 28 cm. (CINVA publications, series: Building Plans No. 1).
27. Ceylon. Department of Town and Country Planning. Ramméd earth houses. Colombo, Ceylon Govt. Press, 1954. 16 p. illus., 24 cm.
28. Chalon, Pablo F. El arte de construir de los antiguos peruanos [The building art of the ancient Peruvians]. In El arquitecto peruano, (Lima), twentieth year, No. 226-227, May-June 1956.
29. Charry Lara, Guillermo. Características esenciales de los suelos [Basic characteristics of soils]. Colombia, Ministry of Public Works, Dept. of National Roads, 1955. 21 p. 28 cm. (Publication No. 3-SD-04).
30. Chile. - General Administration of Public Works, Dept. of Roads. Normas para el ensayo y clasificación de materiales de la Sección Laboratorio e Investigaciones [Standards for materials testing and classification of the Laboratory and Research Section]. Santiago, 1950. 119 p. 25 cm.
31. Chile. Ministry of Public Works and Communications, Dept. of Irrigation. Procedimientos de laboratorio para ensayar materiales de tierra, con fines de fundación y construcción [Laboratory procedures for testing earth materials for foundations and construction building]. Santiago, 1949. 145 p. illus., 32 cm.
32. Clare, K.E. Laboratory experiments in the stabilization of clays with hydrated lime, by K.E. Clare and A.E. Cruchley. London, The Institute of Civil Engineers, 1957. 16 p. illus., 28 cm.
33. Colombia. Inter-American Co-operative Service of Public Health. Ensayos de laboratorio sobre tierra-cemento [Laboratory testing of earth-cement]. Bogotá, 1955. 42 p. illus., 22 cm.

34. Conference on soils for engineering purposes. Mexico City, 1957. Conference Papers (with supplementary discussion) ... Sponsor: Committee D-18 on soils for engineering purposes, American Society for Testing Materials, Mexican Society of Soil Mechanics, A.G. Philadelphia. No date. 501 p. illus., 28 cm. (ASTM Special Technical Publication STP No. 232).
35. Cytrin, S. Soil construction; its principles and application for housing, includes a report on experiments in stabilized soil and light reinforced concrete roof construction carried out during 1953-55. Jerusalem, The Weizmann Science Press of Israel, 1957. 183 p. illus., 24 cm.
36. Dreyfus, J. Manuel de la construction en terre stabilisée en Afrique occidentale française [Manual of stabilized-soil construction in French West Africa]. Provisional edition. Dakar. Information Service of the Office of the High Commissioner for French West Africa. No date. 84 p. illus., 29 cm. (Study No. 1).
37. Earth for homes. In Ideas and Methods Exchange (Washington), No. 22, March 1955.
38. Ellson Equipments. Building in stabilized soil. Westgate, Johannesburg, Abrahams, 1956, 20 sheets, illus., 25 cm.
39. Ellson Equipments (Pty) Ltd. Johannesburg. Ellson high compression four-mould brick press; operating instructions and service manual, section A-B. Johannesburg, No date. 2 f., 23 cm.
40. Enteiche G., Augusto A. Aplicación de la tierra estabilizada en la construcción de viviendas [Use of stabilized soil in house building]. Bogotá, CINVA, 1957. 93 p. illus., 28 cm.
41. Enteiche G., Augusto A. Suelos estabilizados con cal y materiales bituminosos [Soils stabilized with lime and bituminous materials]. Bogotá, 1960. 107 p. illus., 28 cm.
42. Essai d'exposition aux intemperies de constructions en terre stabilisée [Weathering test of stabilized earth structures]. In Habitat, technical report, Dakar, No. 2, Feb. 1958.
43. Estabilización de suelos [Soil stabilization]. In Caminos y construcción pesada [Roads and heavy construction] (Chicago), Vol. xiv, Nos. 1-2, Jan.-Feb. 1955.
44. Eyheralde F., René. La tierra estabilizada como material de construcción [Stabilized soil as a construction material]. In Vivienda (Bogotá), first year, No. 2, pp. 8-11, June 1955; and In Nuestra Arquitectura (Buenos Aires), twenty-sixth year, No. 312, pp. 217-220, July 1955.

45. Fitzmaurice, Robert. Manual on stabilized soil construction for housing. New York, United Nations, 1958. 125 p. illus., 28 cm.
46. France. Central Research Office for Overseas equipment, Housing Service. La construcción en béton de terre [Building in soil-concrete]. Paris, Imp. spéciale du B.C.E.O.M. 1952, 66 p. illus., 21 cm.
47. Frick, Otto. Construcción de edificios [Construction of buildings], by Otto Frick with the collaboration of Mr. Knoll, translation of the fifteenth German edition. Buenos Aires, Labor. No date. 2 v. illus., 23 cm. (Biblioteca de Construcción Labor) Vol. I: Building in stone and brick; Vol. II: Building in wood.
48. García A., Javier. Estudio de suelos estabilizados [Study of stabilized soils]. Bogotá, CINVA, 1958. 22 sheets, illus., 28 cm.
49. Grimer, F.J. The effect of pulverization on the quality of clay-cement. London, 1957. 5 sheets, illus., 28 cm.
50. Hess, Friederich. Construcción y forma [Building and form]. Translation of the third German edition by Antonio Munné. Buenos Aires, G. Gili, 1954. 436 p. illus., 31 cm.
51. Instituto del Cemento Portland Argentino. Buenos Aires. Construcción de pavimentos de suelo-cemento manual [Manual construction of soil-cement pavements]. Buenos Aires, 1958. 125 p. illus., 22 cm.
52. Instituto del Cemento Portland Argentino. Buenos Aires. Memoria del simposio "el suelo cemento en la construcción de calzadas" [Records of the symposium on "Soil-cement in road building"]. Buenos Aires, 1956. 156 p. illus., 28 cm. (Its publication No. 39-M4).
53. Instituto del Cemento Portland Argentino. Buenos Aires. Suelo-Cemento, Bibliografía [Soil-cement, bibliography]. Buenos Aires. No date. 27 cm.
54. Instituto del Cemento Portland Argentino. Buenos Aires. El suelo-Cemento en la construcción de calzadas; comportamiento estructural del pavimento de suelo-cemento [Soil-cement in road building; structural behaviour of soil-cement pavement]. Bogotá, General Administration of National Highways, 1958. 80 sheets, tables, 32 cm.
55. Jiménez Salas, José. Mecánica del suelo y sus aplicaciones a la ingeniería [Soil mechanics and its applications in engineering]. Madrid, Barcelona Ed. Dossat, 1954. 533 p. illus., 25 cm.
56. Johnson, A.L. Tecnología de la arcilla y su aplicación a la estabilización de los suelos [Clay technology and its application to soil stabilization], by A.L. Johnson and D.T. Davidson. Bogotá, General Administration of National Highways, 1958. 46 sheets, illus., 33 cm.

57. Johnson, A.W. The use of compaction to stabilize soils. In The Bulletin of Engineering and Architecture. Lawrence, Kansas, No. 36, pp. 23-32, 1955.
58. Kirkham, John Edward. How to build your own home of earth. No imprint. 37 p. illus., 22 cm.
59. Lambe, T.W. Improvement of soil-cement with alkali metal compounds, by T.W. Lambe, A.S. Michaels and Z.C. Moh. Cambridge, Mass., Massachusetts Institute of Technology, 1949. 29 p. illus., 28 cm.
60. Legget, Robert F. Geología para ingenieros; relaciones entre los estudios geológicos y la ingeniería [Geology for engineers; relationships between geological studies and engineering]. Barcelona, G. Gili, 1950. 608 p. illus., 25 cm.
61. Lyon, T. Lyttleton. Edafología, naturaleza y propiedad del suelo [Edaphology, the nature and properties of soil] by T. Lyttleton Lyon and Harry O. Buckman. Mexico City, Continental, 1956. 479 p. illus., 22 cm.
62. Maclean, D.J. Estabilización con cemento de suelo con alto contenido de arcilla [Cement stabilization of soil with a high clay content], by D.J. Maclean, P.J. Robinson and S.B. Webb. In Informes de la construcción (Madrid), fifth year, No. 48, pp. 514-520, Feb. 1963.
63. Markus, Thomas A. Design techniques for earth housing. Cambridge, Mass., Massachusetts Institute of Technology, 1955. 136 sheets, illus., 29 cm. M.I.T. thesis for the degree of Master in Architecture.
64. Massachusetts Institute of Technology. Proceedings of the conference on soil stabilization, 18-20 June, 1952.
65. Massachusetts Institute of Technology. Soil stabilization research. Sponsored by industrial funds. Boston, 1955. 4 f. illus., 28 cm.
66. McNeal, Donald D. Baldosas de suelo-cemento para pisos [Soil-cement floor tiles] prepared by Donald H. Michael and Rudard A. Jones. 2nd ed. Bogotá, CINVA, 1959. 22 p. illus., 24 cm. (CINVA publications, series: Circulation No. 4).
67. Mela Mela, Pedro. Tratado de edafología y sus distintas aplicaciones [Treatise on edaphology and its various applications]. Madrid, Dossat, 1954. 582 p. illus., 26 cm.
68. Merrill, Anthony F. Casas de tierra apisonada y suelo-cemento [Rammed earth and soil-cement houses], by Anthony F. Merrill. Buenos Aires, Windsor, 1949. 242 p. illus., 23 cm.
69. Middleton, G.F. Earth-wall construction, pisé or rammed earth or puddled earth adobe or puddled earth-stabilized earth. Sydney, Department of Works and Housing, Commonwealth Experimental Building Station, 1952. 46 p. illus., 24 cm. (Commonwealth Experimental Building Station, Bulletin No. 5).

70. Miller, T.A.H. Adobe or sun-dried brick for farm buildings. Washington, D.C., Govt. Printing Office, 1949. 17 p. illus., 23 cm. (U.S. Department of Agriculture, Farmers Bulletin No. 1720).
71. Patty, Ralph L. Points and plasters for rammed earth walls. Brookings, S.D., Agricultural Experiment Station, 1940. 39 p. illus., 22 cm. (Agricultural Experiment Station, South Dakota State College, Bulletin 336, May 1940).
72. Portland Cement Association. Chicago. Short-cut soil-cement testing procedures for sandy soils. No imprint. 11 p. illus., 28 cm.
73. Portland Cement Association. Chicago. Short-cut test methods for determining cement factors for sandy soils in mild climatic areas of the south-west. No imprint. 17 p. illus., 28 cm.
74. Portland Cement Association. Chicago. Soil-cement laboratory handbook. Chicago, 1956. 63 p. illus., 27 cm.
75. Portland Cement Association. Chicago. Soil-cement pavement. No imprint. 11 p. illus., 23 cm.
76. Portland Cement Association. Chicago. Suelo-cemento, manual de laboratorio /Soil-cement, laboratory handbook/. Bogotá, General Administration of National Highways, Design Dept., 1957. 96 p. tables, 33 cm.
77. Prilliano, Juan. Curso práctico de edificación /Practical course in building/. 2nd ed., Buenos Aires, Construcciones Sudamericanas, 1951. 281 p. illus., 27 cm.
78. Results of experiments on stabilizing soil that is to be used as a building material in Iran. In Ideas and Methods Exchange (Washington), No. 51, Sept. 1958.
79. Sao, Paulo. Estabilização de solos /Soil stabilization/. Rio de Janeiro, Instituto Nacional de Tecnologia, 1940. 50 p. illus., 23 cm.
80. Un siló subterráneo gigante /A huge underground silo/. In Cemento Portland (Buenos Aires), No. 6, p. 4, July-August 1945.
81. Silos subterráneos, revestidos con suelo-cemento /Underground silos lined with soil-cement/. In Cemento Portland (Buenos Aires), fourth year, No. 17, pp. 11-14, Nov. 1948.
82. Soil and soil-aggregate stabilization; a symposium presented at the thirty-fourth annual meeting. 11-14 January, 1955. Washington, 1955. 175 p. illus., 25 cm.
83. Soiltest Incorporated. Chicago. Apparatus for engineering tests of soils, concrete, asphalt, materials. 5th ed. No imprint. 128 p. illus., 27 cm. (Catalog. 56).

84. Solís Vindas, Hugo. Aplicaciones del suelo-cemento en la construcción de la vivienda rural. [Uses of soil-cement in building rural housing]. Bogotá, CINVA, 1957. 41 sheets, illus., 28 cm.
85. Suggested specifications for soil-cement construction. Chicago, Portland Cement Association. No date. 3 p. 27 cm. (Portland Cement Publications, No. SCB 12).
86. Terzaghi, Karl. Mecánica de suelos en la ingeniería práctica [Soil mechanics in practical engineering], by Karl Terzaghi and Ralph B. Peck. Buenos Aires, El Ateneo, 1955. 680 p. illus., 23 cm.
87. Terzaghi, Karl. Mecánica teórica de los suelos [Theoretical soil mechanics], by Karl Terzaghi. Buenos Aires, Acme, 1945. 512 p. illus., 23 cm.
88. Tschandlbrueff, Gregory P. Mecánica del suelo; cimientos y estructuras de tierra [Soil mechanics; earth foundations and structures]. Madrid, Aguilar, 1958. 624 p. illus., 22 cm.
89. United States. Department of the Interior, Bureau of Reclamation. Earth manual on the use of earth materials for foundation and construction purposes. Denver, Colorado, 1958. 398 p. illus., 26 cm.
90. United States. Department of the Interior, Bureau of Reclamation. Unified soil classification system; a supplement to the earth manual. Denver, Colorado, 1943. 27 p. illus., 27 cm.
91. Valiosa experiencia en suelo-cemento; la dirección de hidráulica de la provincia de Buenos Aires obtuvo notables resultados en dos casas construidas sobre el canal no. 16 [Valuable experience with soil-cement; the Water Authority of the Province of Buenos Aires obtained noteworthy results with two houses built on the No. 16 canal]. In Cemento Portland (Buenos Aires), No. 6, pp. 5-7, July-August 1945.
92. Valle, Juan Agustín. Suelo-cemento; necesidad de aprovechar la clasificación edofológica de los suelos y de hacer una revisión de los ensayos de identificación y de calidad [Soil-cement; the need to use soil classification and to revise the identification and quality tests]. Buenos Aires, Instituto del Cemento Portland Argentino, 1950. 18 p. illus.
93. Valle Rodas, Raúl. Carreteras, calles y aeropistas; principios generales de la mecánica de suelos aplicados a la pavimentación y métodos para el cálculo de pavimentos flexibles [Highways, streets and air strips; general principles of soil mechanics applied to paving, and planning methods for flexible pavements]. Buenos Aires, El Ateneo, 1958. 396 p. illus., 23 cm.

94. Valle Redas, Raúl. Método del sifoneado para el análisis mecánico de suelos [Siphoning method for the mechanical analysis of soils]. Caracas, Imp. López, 1955. 24 p. illus., 23 cm.
95. Vautier, Ernesto. ~~Chambimbal; estudio y acción en vivienda rural~~ [Chambimbal Village and action in rural housing], edited by Ernesto E. Vautier and Orlando Fals Borda. Bogotá, CINVA, Department of Scientific Exchange and Documentation, 1958. 93 p. illus., 28 cm. (CINVA publications, series: Technical, No. 6).
96. Venezuela. Malariaology Division. Vivienda sana [Healthful housing], Maracay, Division of Health Education, 1957. 119 p. illus., 24 cm.
97. Vivienda de suelo-cemento [Soil-cement dwelling]. In Cemento Portland (Buenos Aires), No. 35, May-June 1955.
98. Warland, E.G. Construcción moderna [Modern building], translation from the English by M. Company. Barcelona, G. Gill, 1947. 192 p. illus., 27 cm.
99. Webb, T.L. The properties of compacted soil and soil-cement mixtures, for use in building, by T.L. Webb, T.F. Cilliers and N. Stutterheim. Pretoria, National Building Research Institute, 1950. 62 p. illus., 24 cm.
100. West, Graham. A laboratory investigation into the effect of elapsed time after mixing on the compaction and strength of soil-cement. London, The Institute of Civil Engineering, 1959. 7 p. illus., 25 cm.

FIGURES - Nos. 1-93

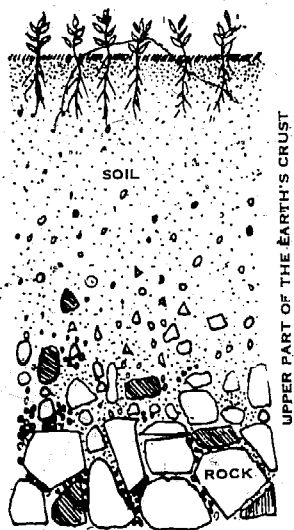

Fig. 1 Location of the soil in the earth's crust.

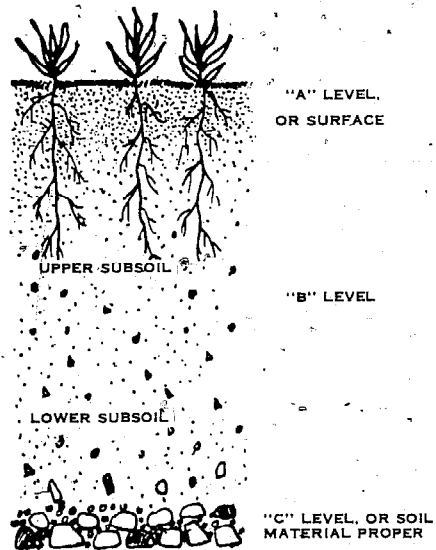

Fig. 2 Layers of which the soil is composed.



Fig. 3 Determining the presence of organic matter by smell.



Fig. 3 (a) Determining the presence of organic matter by smell.



Fig. 4
Very coarse
particles of soil.

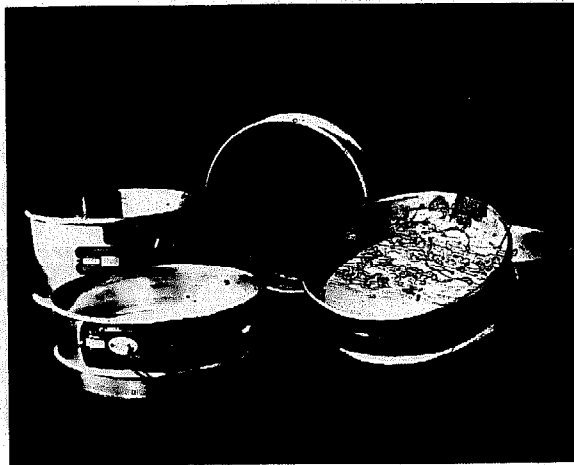

Fig. 5 Set of sieves for granular analysis.

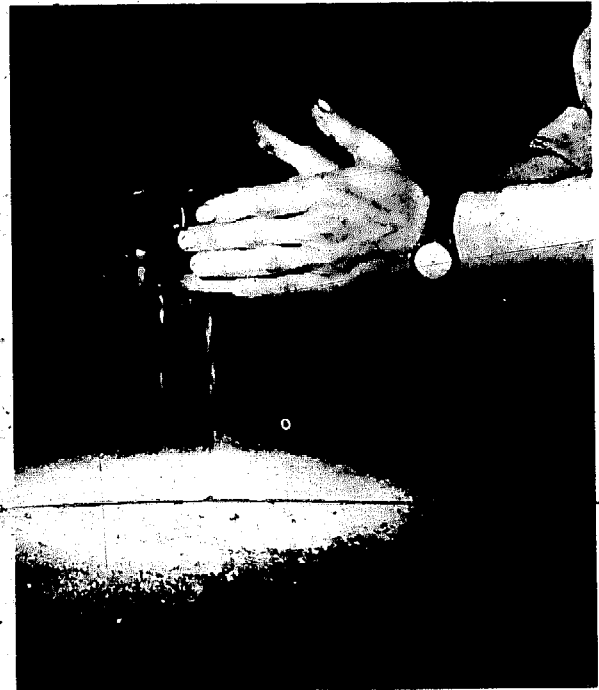

Fig. 5 (a) Sieving soil.



Fig. 6 Siphoning test.

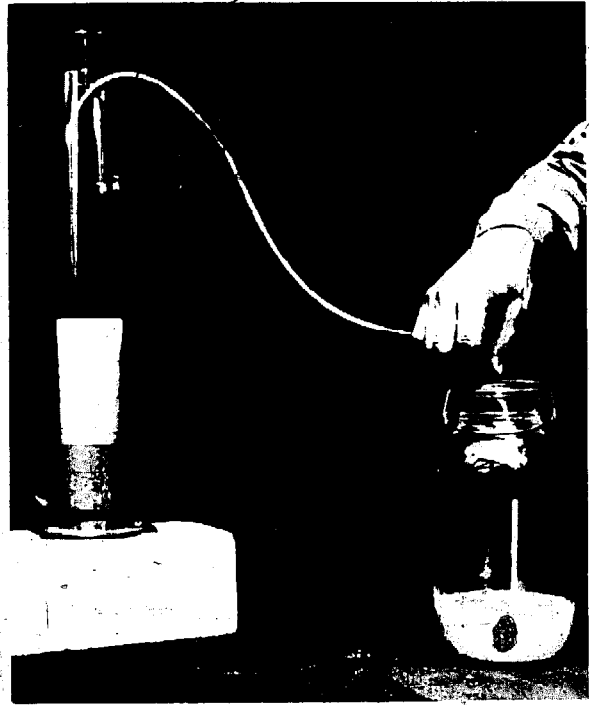

Fig. 6 (a) Siphoning test.

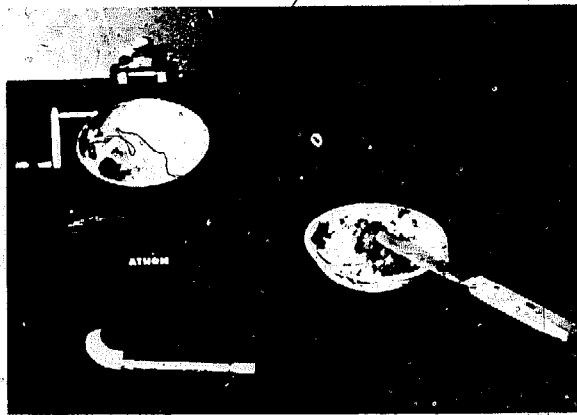

Fig. 7 Testing the liquid limit.

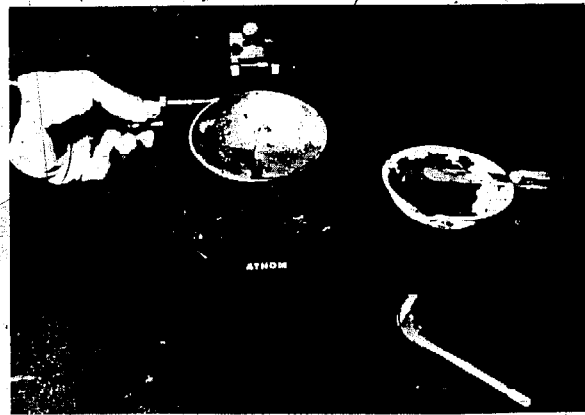

Fig. 7 (a) Testing the liquid limit.

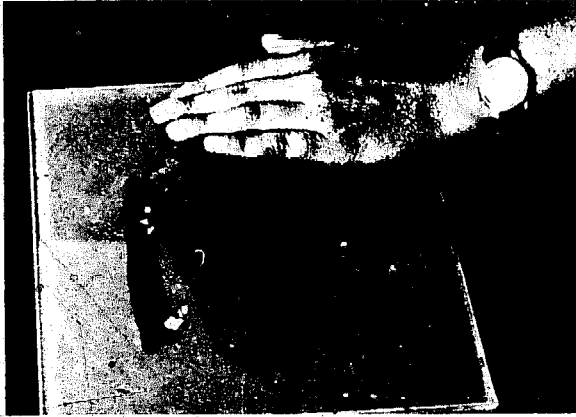

Fig. 8 Testing the plastic limit.

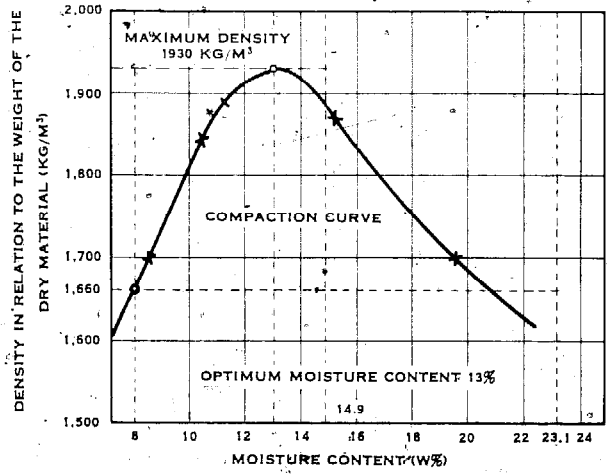

Fig. 9 Compaction curve



Fig. 10 Testing the plasticity of a clay by touch.



Fig. 10 (a) Testing the plasticity of a clay by touch.



Fig. 11 Sedimentation test: shake the bottle vigorously.



Fig. 11 (a) Sedimentation test: the material is left to settle.

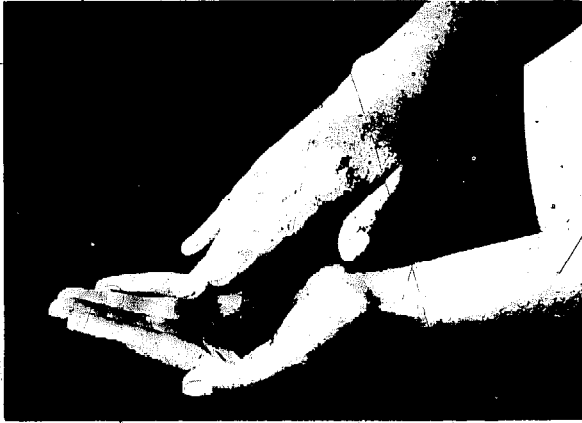

Fig. 12 Forming a ball of soil for the separation (shaking) test.

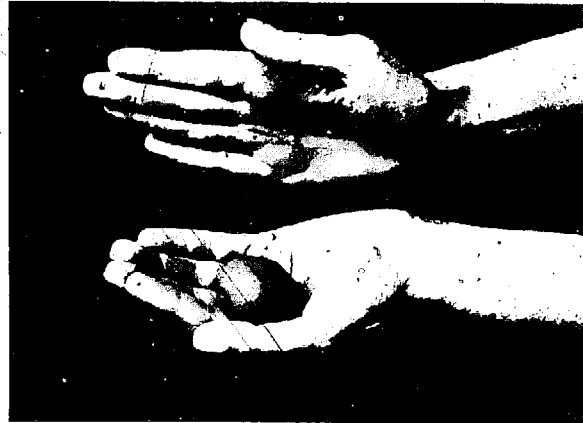

Fig. 12 (a) Shaking the ball of soil horizontally.

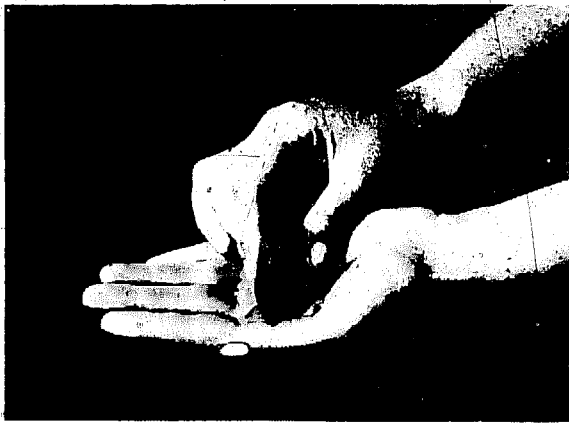

Fig. 13 Separation (shaking) test: squeezing the ball of soil with the fingers.

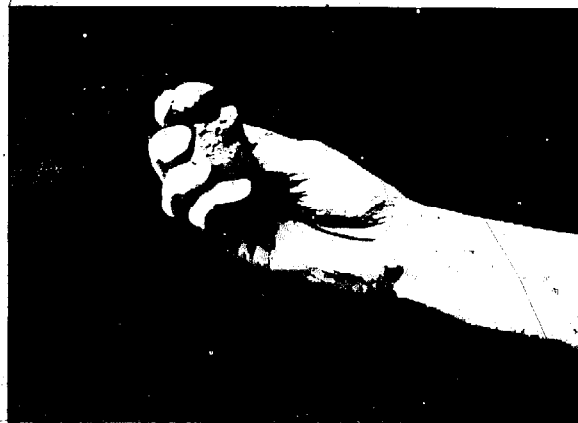

Fig. 14 Dry strength test: pulverizing the ball of soil between the fingers.



Fig. 15 Brightness test.



Fig. 16 Basic components of the ideal soil:
sand, silt and clay.



Fig. 17 The clods of soil are pulverized
with blows from a shovel.



Fig. 18 Sieving soil through a screen.

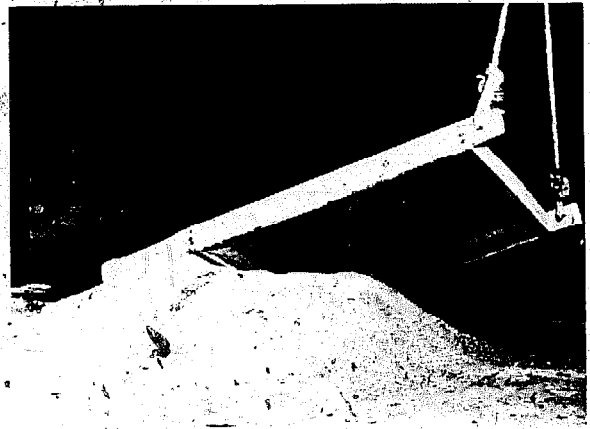

Fig. 19 Storing the soil in a proper place.



Fig. 20 Testing the tensile strength of a soil-cement block.

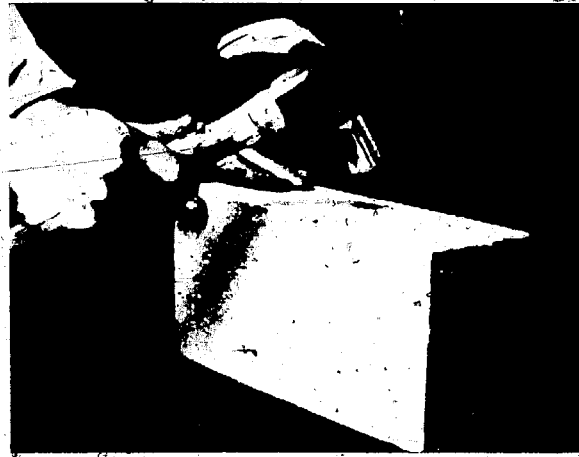

Fig. 21 Sound test.

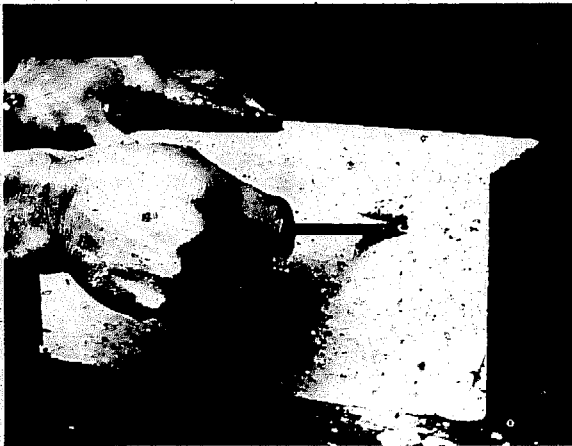

Fig. 22 Hardness test.

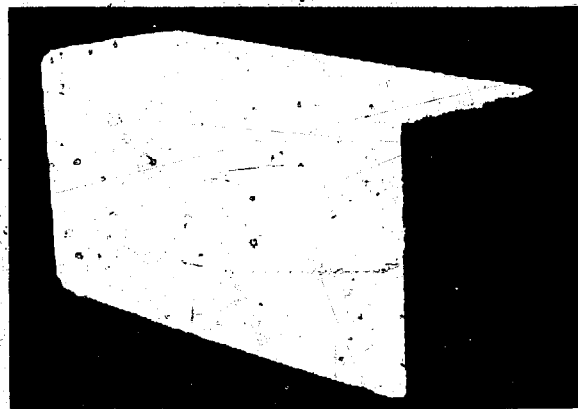

Fig. 23 The block should have sharp, firm edges.



Fig. 24 Undisintegrated block.

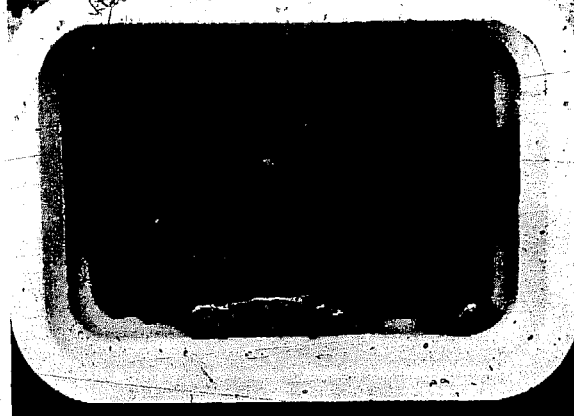

Fig. 24 (a) Disintegrated block.



Fig. 25 Preparation area.



Fig. 26 Adding cement to the soil.



Fig. 26 (a) Mixing soil and cement.

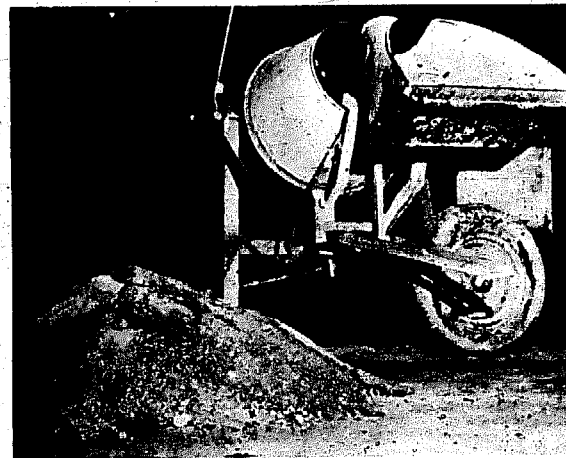

Fig. 26 (b) Mechanical soil-cement mixer.



Fig. 27 Adding water.



Fig. 28 The right amount of water: the mixture retains the shape of the hand.

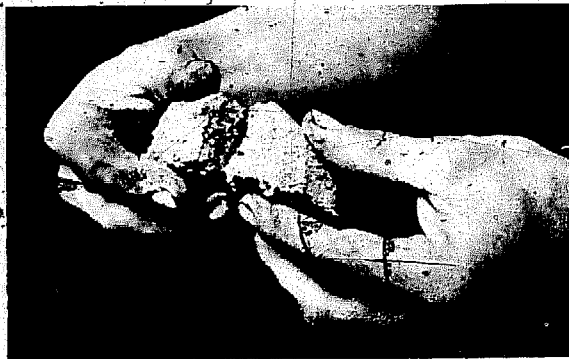

Fig. 29 The right amount of water: the mixture can be pulled apart without disintegrating.



Fig. 29 (a) The right amount of water: dropping test.

Fig. 29 (b)
The right amount of water:
material disintegrated
after being dropped.

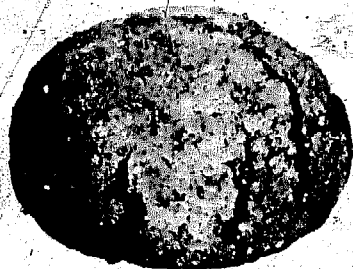

Fig. 30
Too much water:
material flattened
after being dropped

Fig. 31
Not enough water.



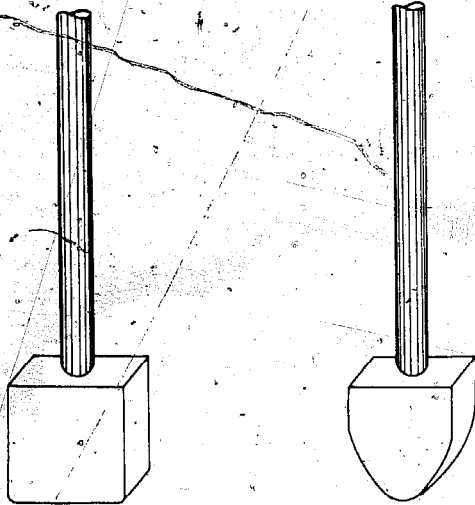

Fig. 32 Rammers for compacting monolithic walling.

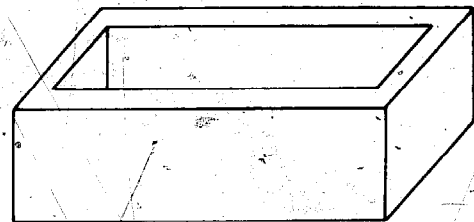

Fig. 33 One-piece mould.

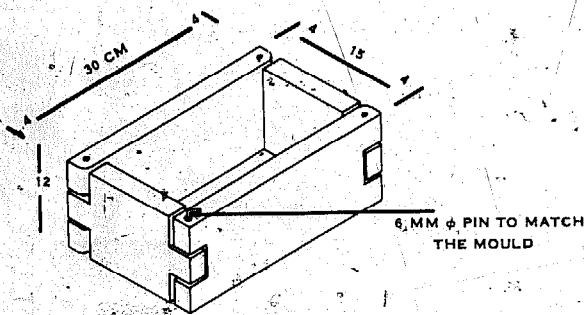

Fig. 33 (a) Hinged mould.

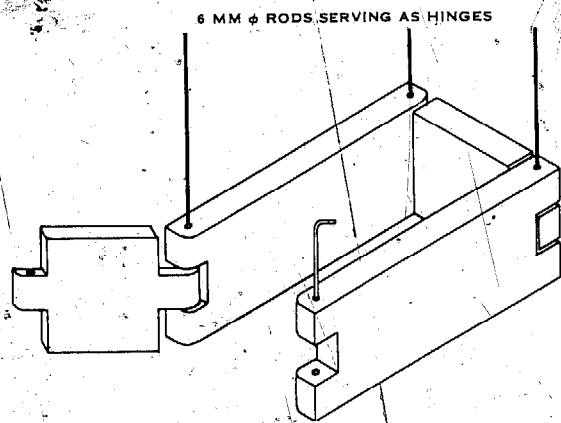

Fig. 33 (b) Mould made of detachable parts and hinged.



Fig. 34 Making blocks with a mould made of detachable parts and hinged.



Fig. 35 "Pusher".



Fig. 35 (a) Block-making mould, showing the "pusher" in use.

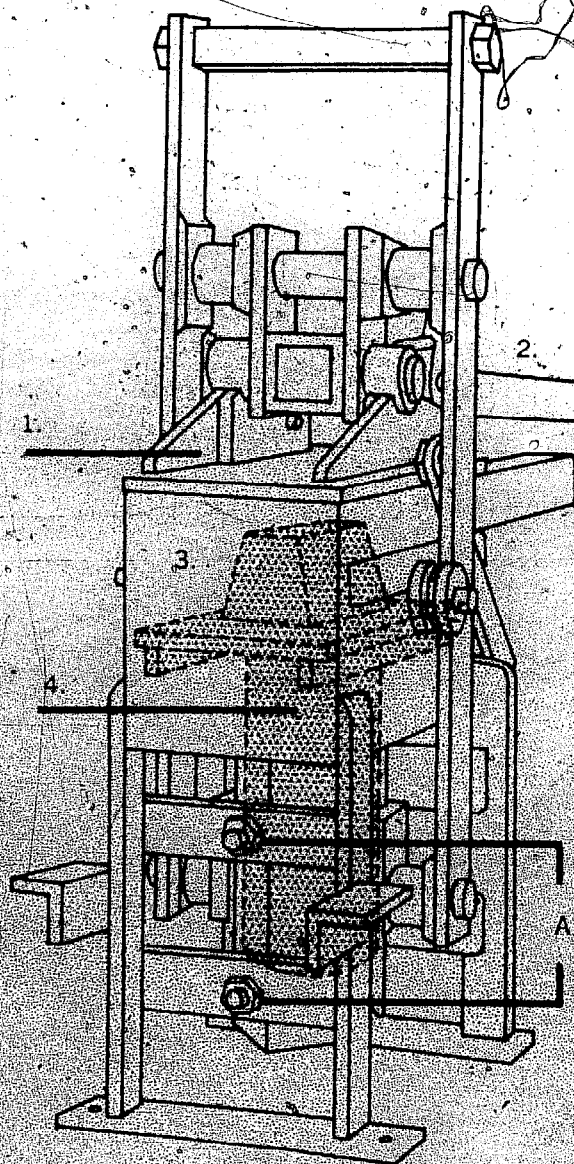

1. The COVER. A rectangle of metal, joined to the box by two movable rods at the side to allow it to slide open and to close. Above it are two brackets to house one of the upper shafts of the lever's connecting rods.

2. The LEVER. Consists of a set of connecting rods, operated by hand, which set the piston in motion.

3. The BOX. A metal mould supported by four angular iron legs, constituting the frame of the whole mechanism.

4. The PISTON. Consists of a cylinder, guided between two adjustable angles and ending in a rectangular plate which serves as a compression plunger. To this plate is screwed a piece of wood, the function of which is to stamp the blocks. If solid blocks are wanted, the wooden piece can be taken off by removing the screws and filling the holes left in the plate with small screws.

A. SCREWS FOR LOOSENING THE PISTON GUIDES. Are used to loosen the piston if it fits too tightly between the guides, or vice versa.

Fig. 36 - CINVA-RAM moulder for the production of soil-cement blocks: explanatory sketch.



Fig. 36 (a) CINVA-RAM moulder for making soil-cement blocks: photograph.

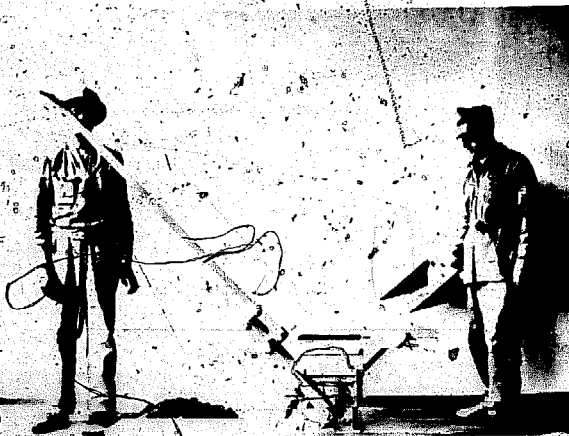

Fig. 37 Moulder ready for filling.



Fig. 37 (a) Closing the box.



Fig. 37 (b) Starting compaction.



Fig. 37 (c) Maximum compaction of the block.



Fig. 37 (d) Removing the block from the mould.

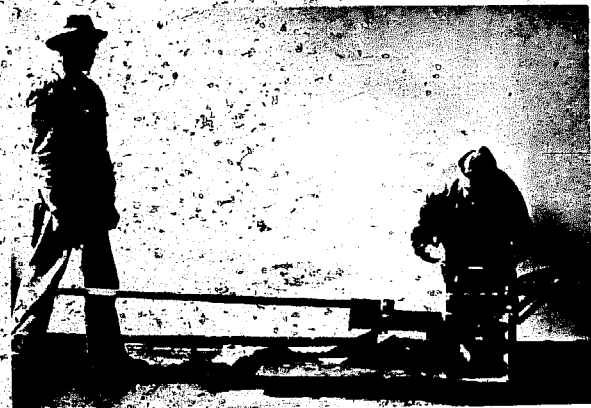

Fig. 37 (e) The block is carefully removed.



Fig. 38 Placing a plate in the moulder.



Fig. 38 (a) Removing the block, together with the plate.

Fig. 40 Watering the blocks.

Figs. 39 and 39 (a) Drying and curing the blocks. Newly-made blocks are kept under cover. Stacked blocks.

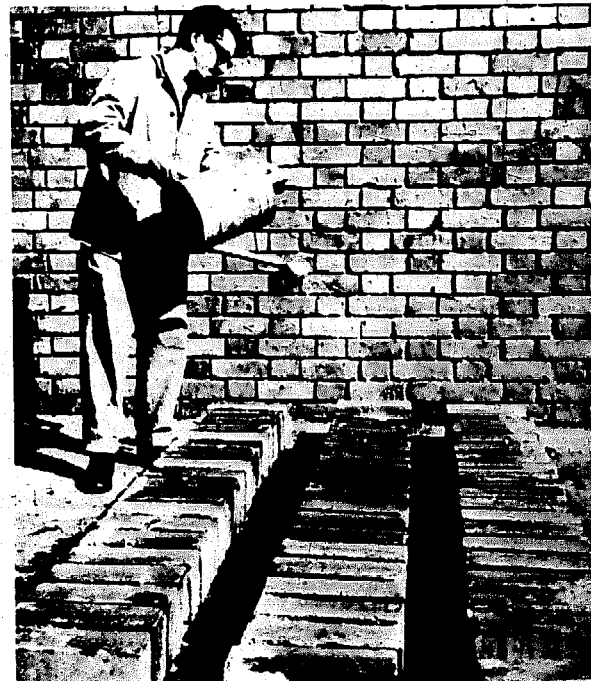

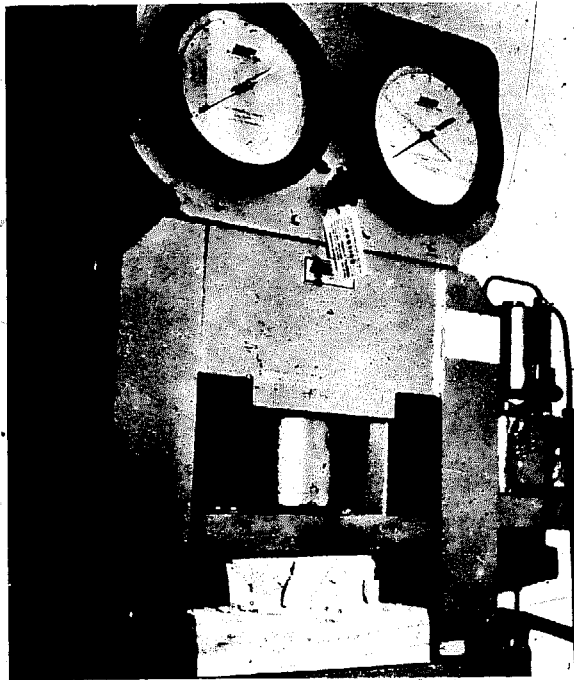

Fig. 41 Compression test for blocks.

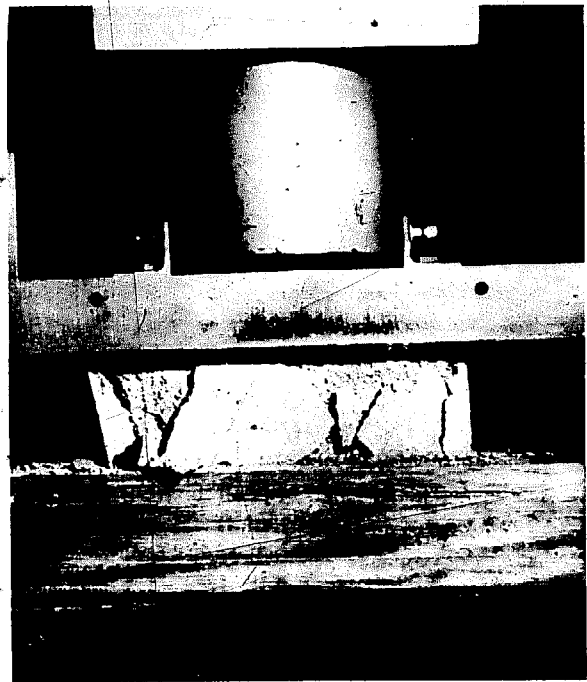

Fig. 41 (a) Compression test for blocks.

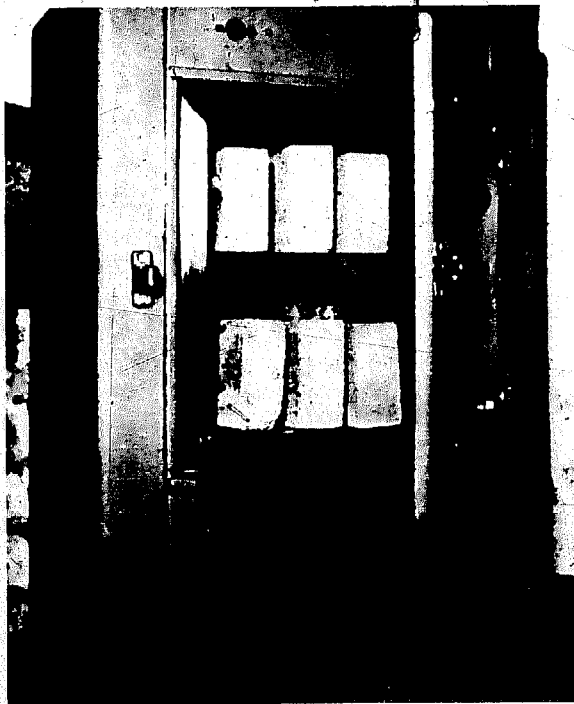

Fig. 42
Wetting-and-drying test: blocks being dried.



Fig. 42 (a)
Wetting-and-drying test: blocks being brushed.

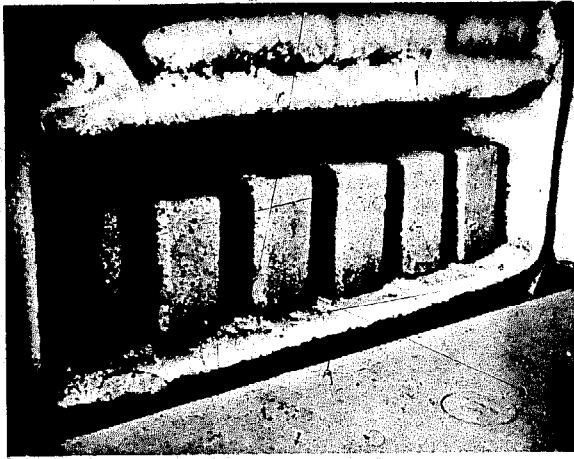

Fig. 43 Freezing and thawing test: freezing.

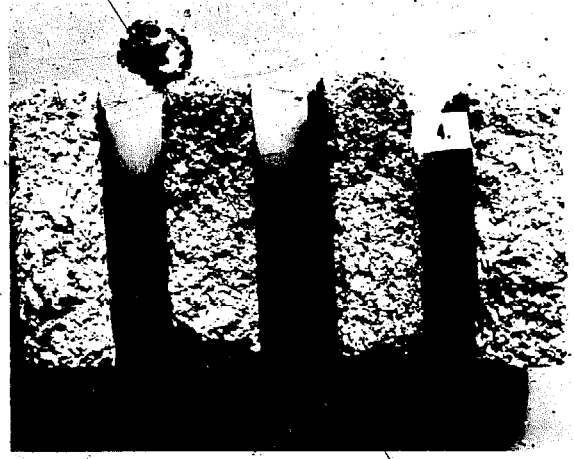

Fig. 43 (a) Results of the freezing and thawing test.



Fig. 44 Shrinkage test.

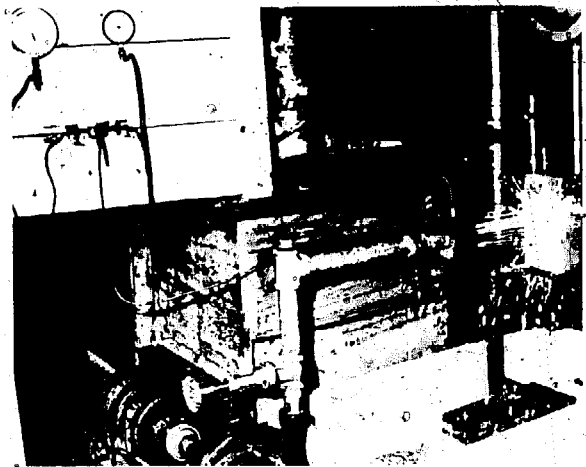
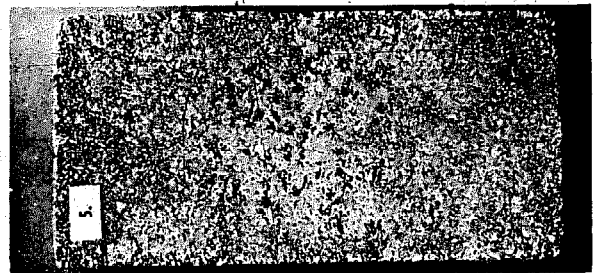

Fig. 45 Equipment for the erosion test.

Fig. 45 (a)
Effect of the
erosion test
on blocks.



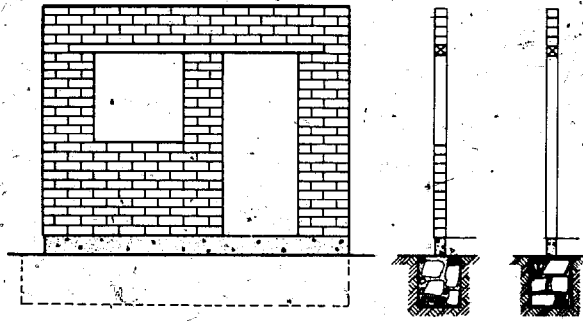

Fig. 46 Continuity of foundations and lintels:

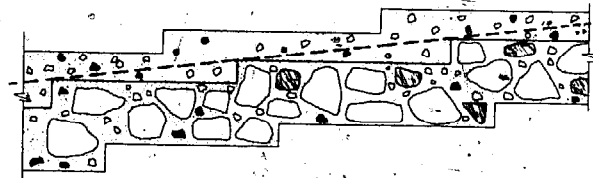

Fig. 47 Stepped foundations.

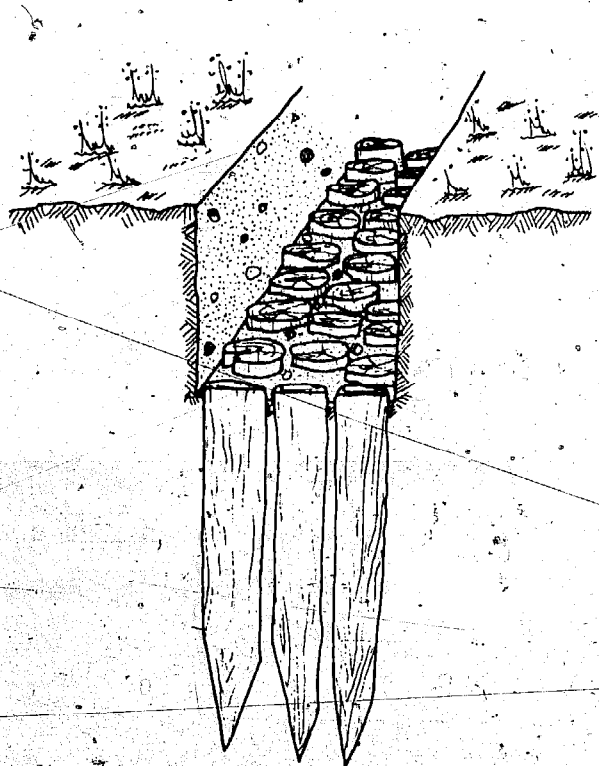

Fig. 48 Hardwood piles for foundations at muddy or filled sites.

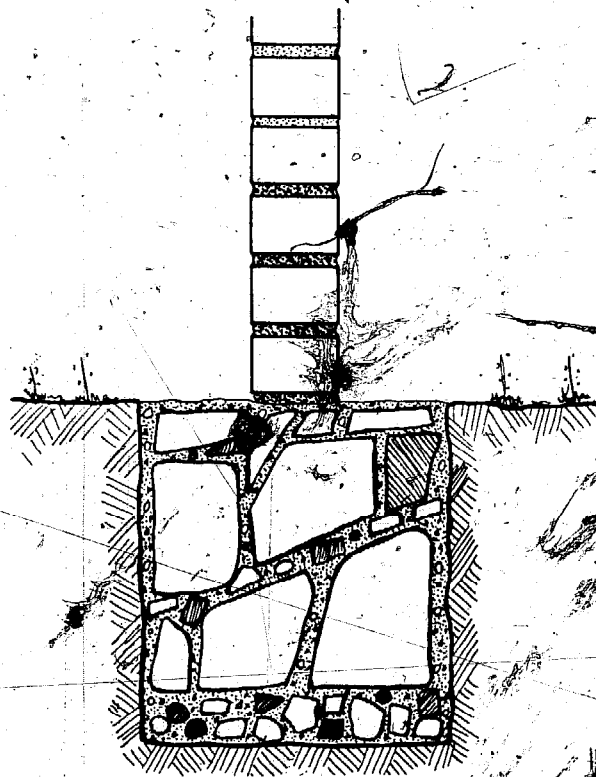

Fig. 49 or filled sites.



Fig. 50 Rammed soil-cement foundations.

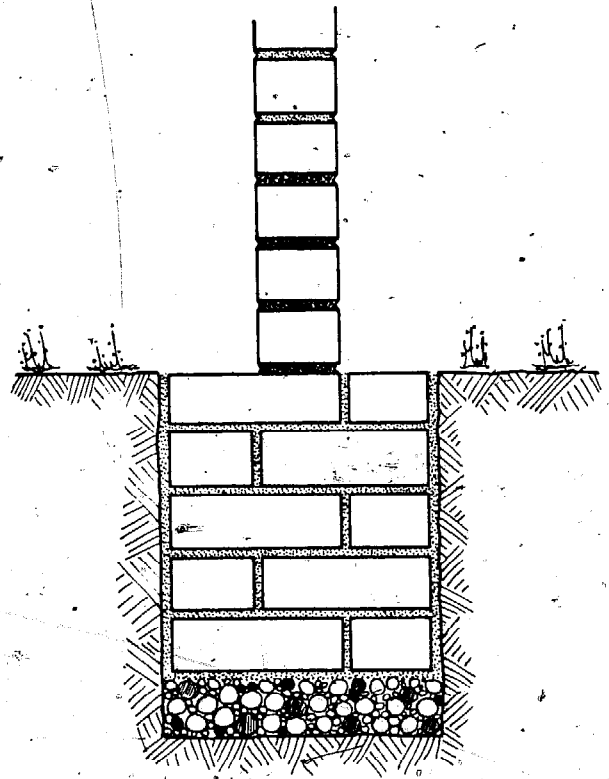

Fig. 51

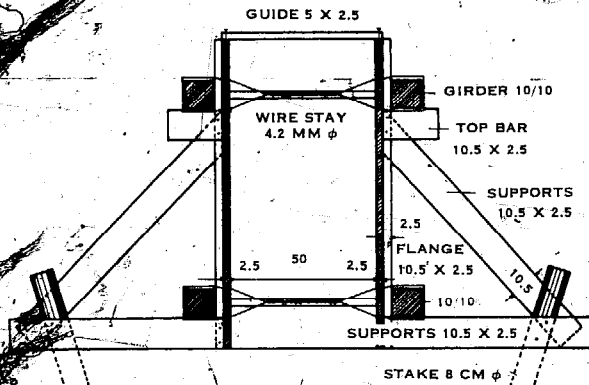

Fig. 52 Shuttering for upper foundations.



Fig. 53
Upper foundation of
rammed soil-cement.

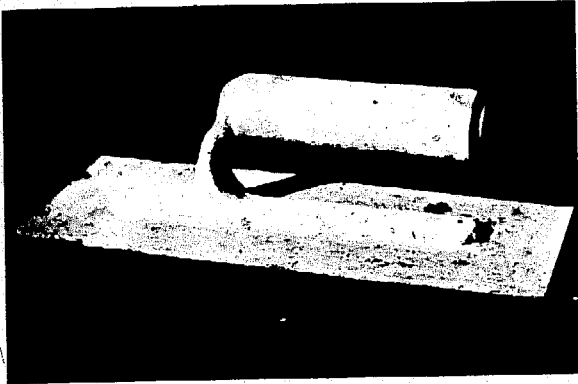

Fig. 54 Trowel.



Fig. 55 Damp course of bituminous felt.



Fig. 56 Building a wall of soil-cement blocks.



Fig. 57
Wall construction using soil-cement
blocks with the aid of a gauge.



Fig. 58 Laying soil-cement blocks with a "block fitter".

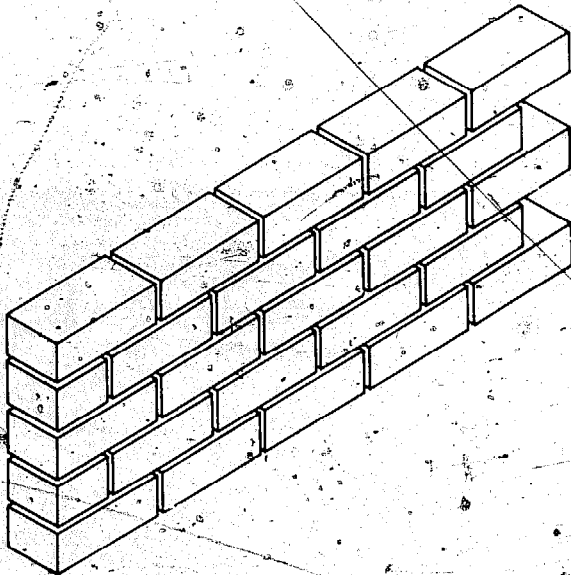

Fig. 59 Bonding of walls of soil-cement blocks laid as stretchers.

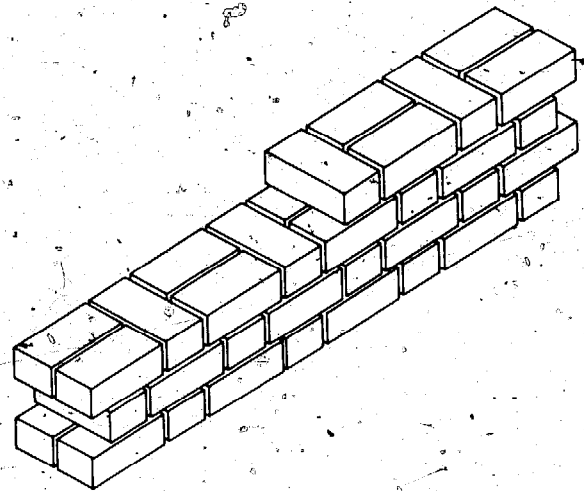

Fig. 59 (a) Bonding of walls of soil-cement blocks laid in courses of headers and double stretchers.

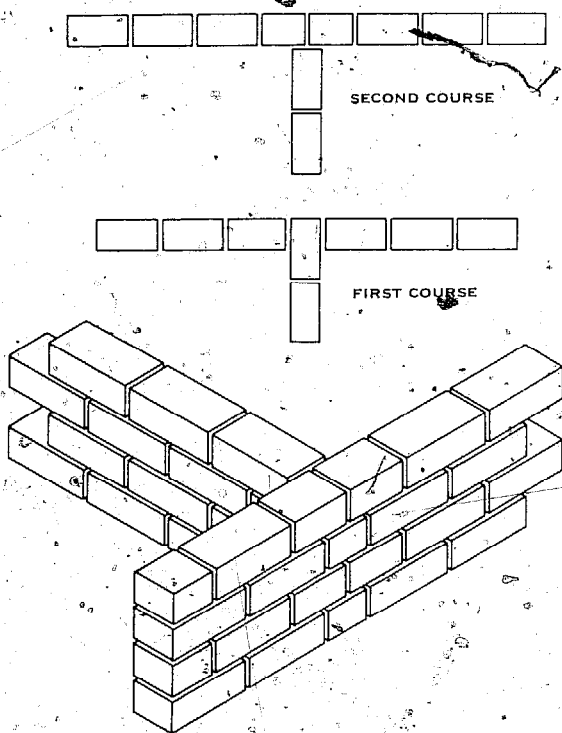

Fig. 60 T-junction: blocks laid as stretchers.

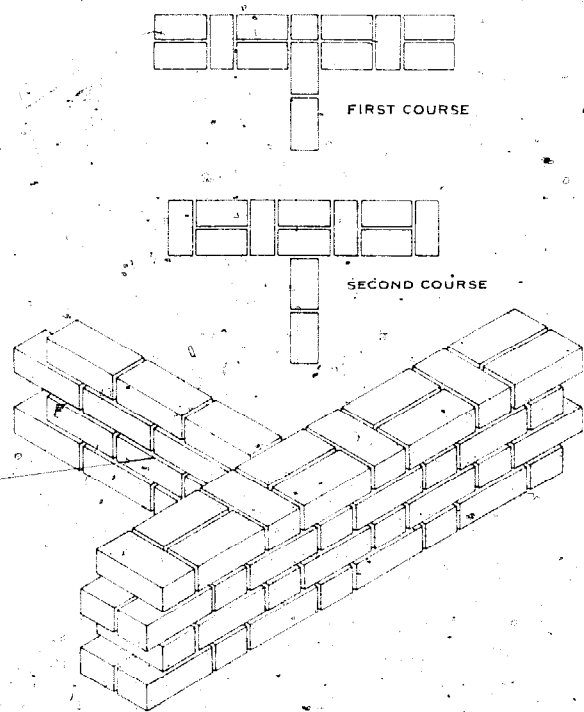

Fig. 60 (a) Junction of two walls of different thicknesses.

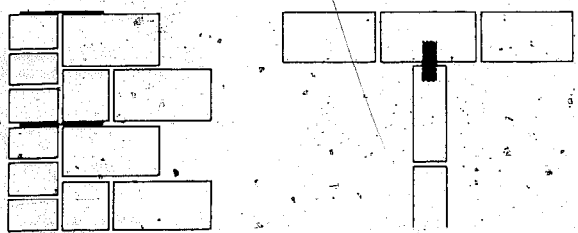

Fig. 60 (b) Artificial joining (with metal mesh) of two walls of different thicknesses.

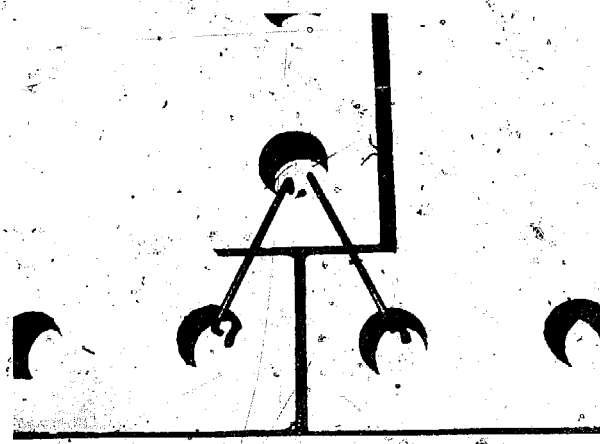

Fig. 61 Special T-joint using cavity blocks.



Fig. 62 Finishing an outer wall surface and trimming the seams.

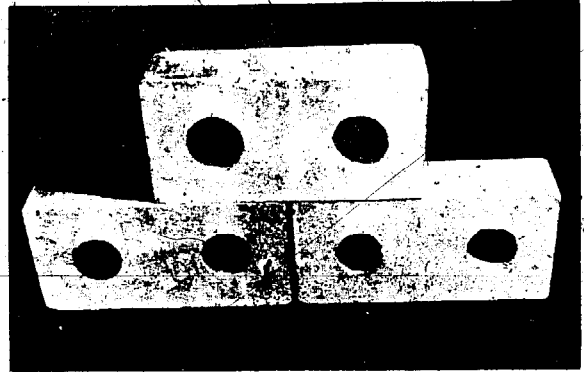

Fig. 63 Cavity blocks of soil-cement.

Fig. 64
Vertical reinforcement
using cavity blocks.

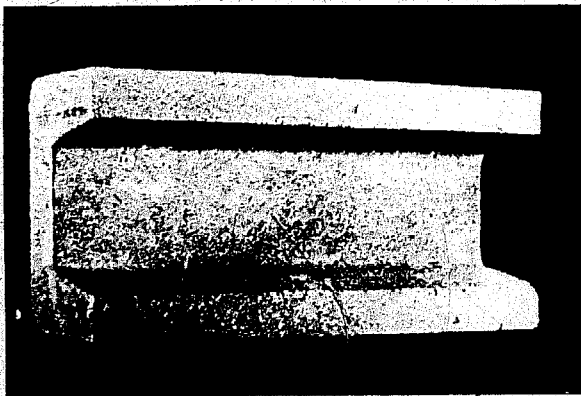
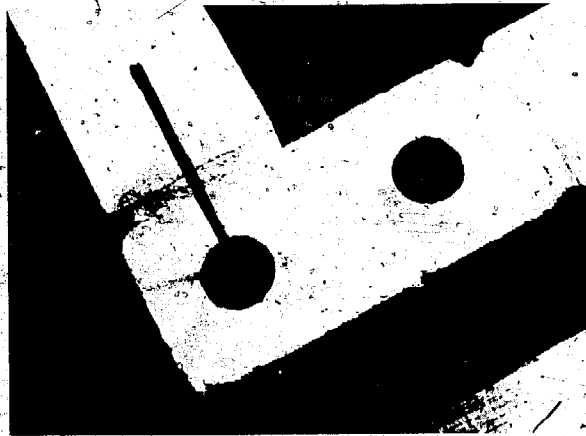

Fig. 65 U-shaped soil-cement block.

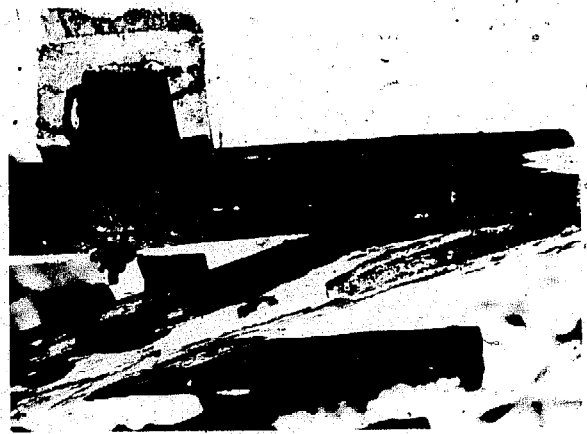

Fig. 65 (a) U-blocks used for a beam.

S



Fig. 66
Extra metal reinforcements for walls of soil-cement blocks are highly desirable in active seismic regions.



Fig. 67 Wooden lintel.



Fig. 68 Lintel prefabricated in U-blocks.

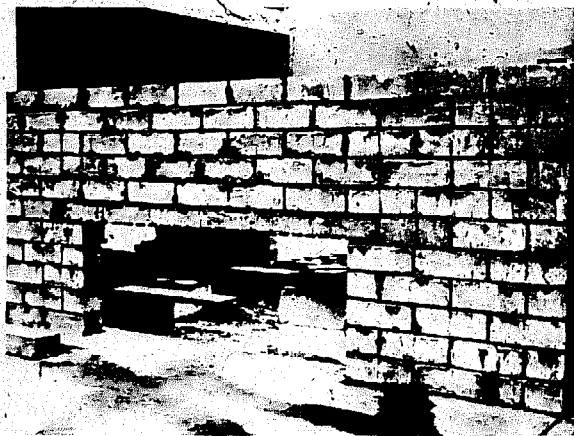

Fig. 69 Prefabricated lintel set in a wall.

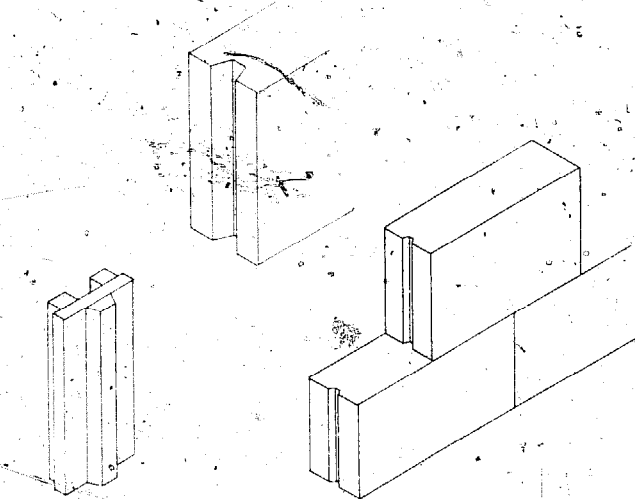

Fig. 69 (a) Seams of monolithic walling are bonded and are tongued and grooved.

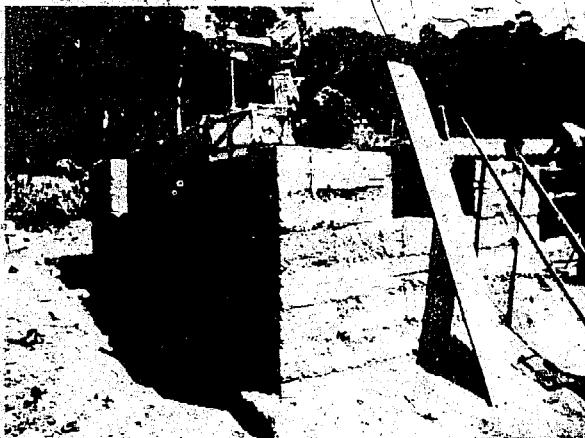
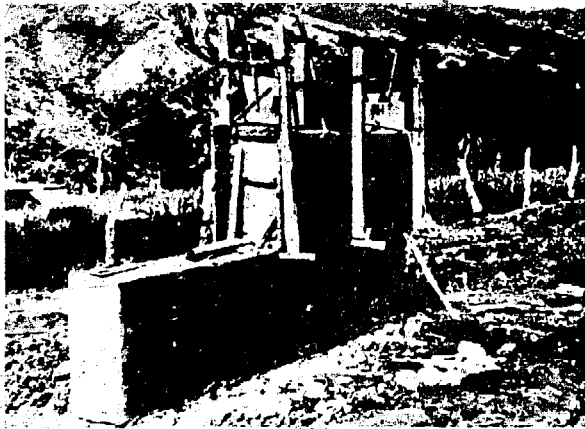

Fig. 70 Three types of shuttering for monolithic walling.

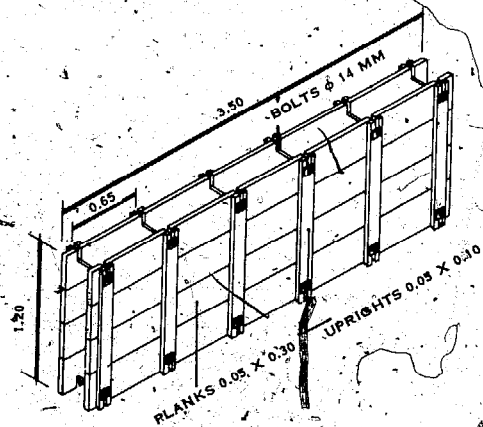
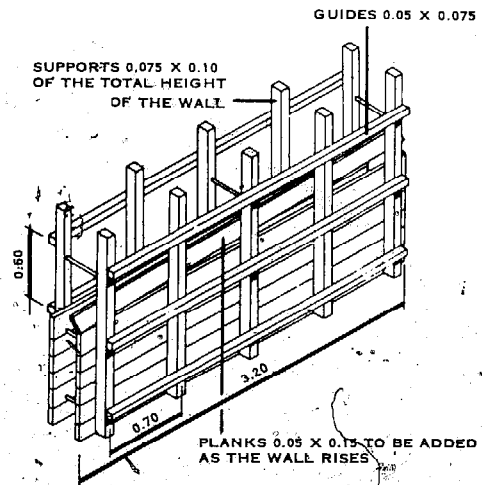
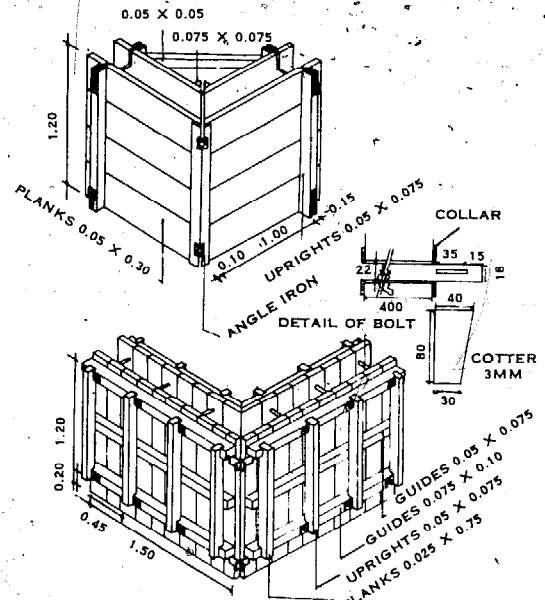

Fig. 70 (a) Shuttering for monolithic walling (Argentine Portland Cement Institute).

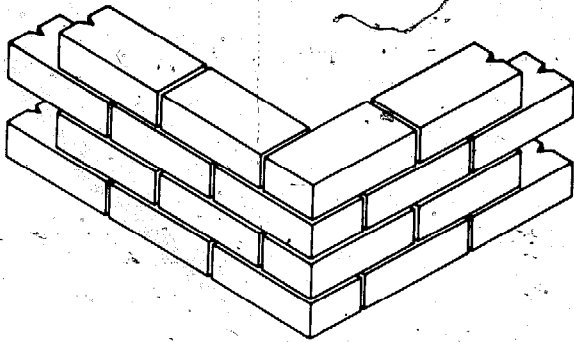

Fig. 71 Wall junction, using special blocks.

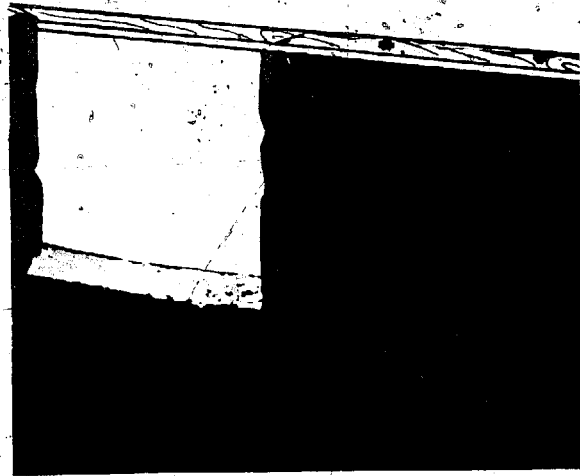

Fig. 72 Bolts fixed in monolithic walling.

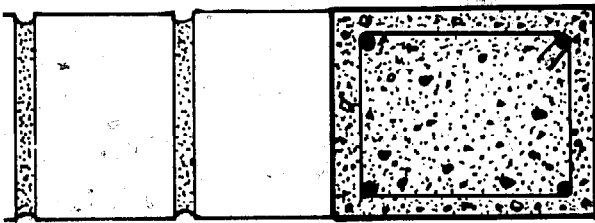

Fig. 73 Wall beam constructed directly onto the wall.

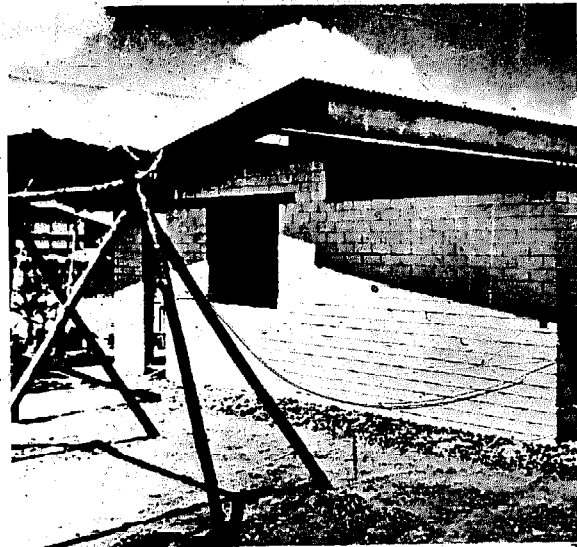

Fig. 74 Wall construction above the lintel.



Fig. 75 Light material (bamboo cane) filling above a lintel.



Fig. 76 Roof timbers resting on lintel.



Fig. 77 Cavity block to house a dowel.

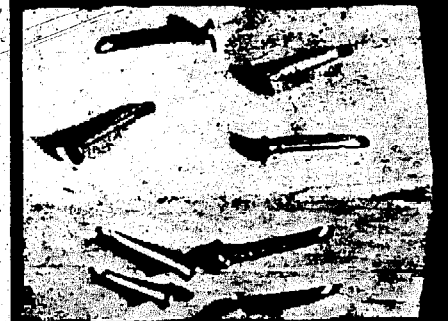

Fig. 78
Various types of dowels.



Fig. 79 Compacting the layer of soil-cement.

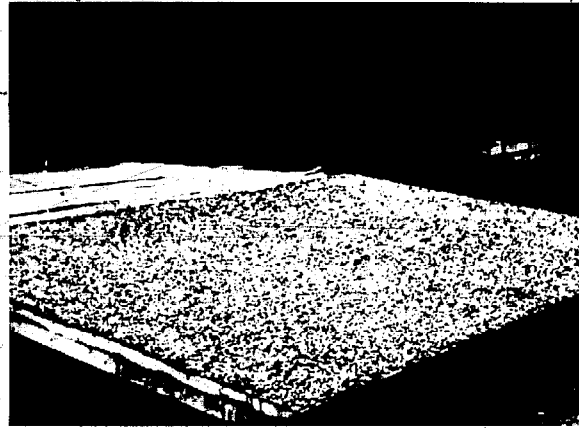

Fig. 79 (a) Soil-cement roofing with covering of bituminous paint and small gravel.

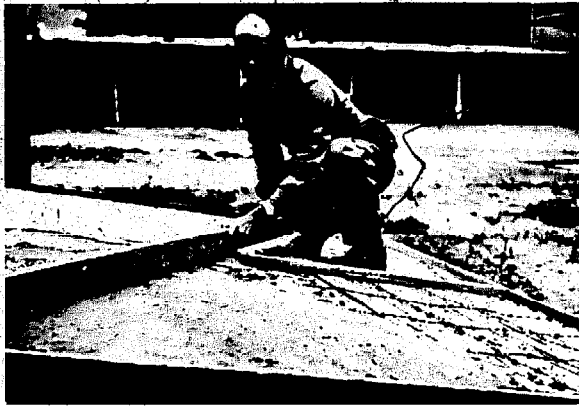

Fig. 80
Soil-cement roofing reinforced with barbed wire.

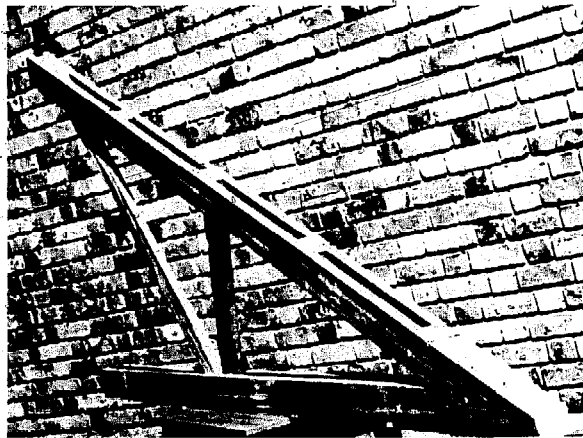

Fig. 81
Truss made of planked boards.



Fig. 82 Method of securing the roof truss to a soil-cement wall.

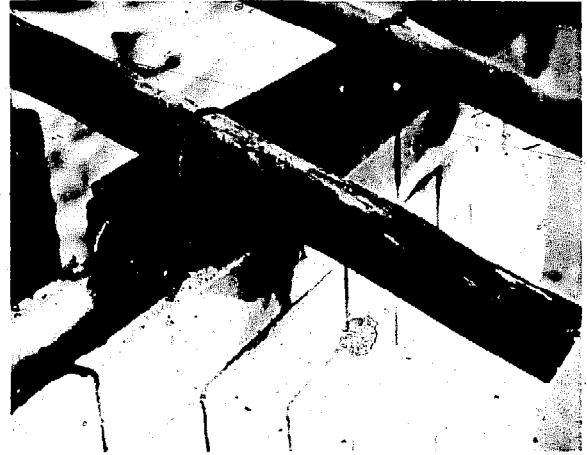

Fig. 82 (a) Method of securing the roof truss to a soil-cement wall.



Fig. 82 (b) Method of securing the roof truss to a soil-cement wall.



Fig. 82 (c) Method of securing the roof truss to a soil-cement wall.

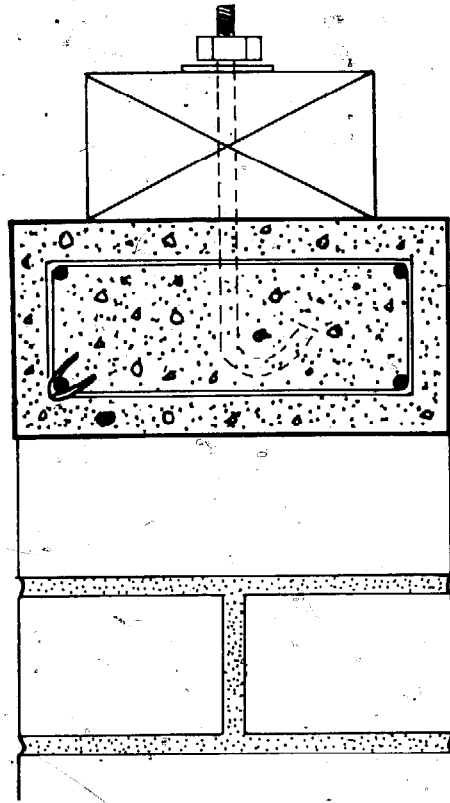

Fig. 83 Plate bolted to the wall beam.



Fig. 84 Using the "scraper" to make a soil-cement floor.



Fig. 84 (a) Smoothing the surface of a soil-cement floor with a trowel.

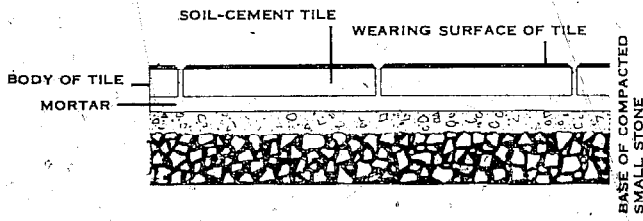

Fig. 85 Cross-section of a floor made with soil-cement tiles.



Fig. 86 Laying floor tiles.

Fig. 87 Applying cement slurry to the tile floor.



Fig. 88 Spraying a wall with water before painting.



Fig. 89 Painting a wall.



Fig. 90 Point of reference and "guide strip" for plastering a wall.



Fig. 91 Using the scraper in plastering a wall.

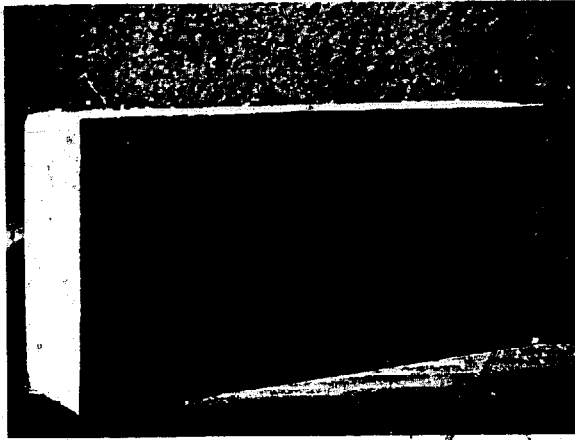

Fig. 92
Wooden plate used
in the CINVA-RAM
moulder for tile-making.



Fig. 93
Removing the tile

THE ORGANIZATION OF AMERICAN STATES

THE ORGANIZATION OF AMERICAN STATES (OAS) unites the twenty-one republics of the Western Hemisphere for the common purpose of maintaining the peace, ensuring freedom and security, and promoting the welfare of all Americans. The member states are Argentina, Bolivia, Brazil, Chile, Colombia, Costa Rica, Cuba, the Dominican Republic, Ecuador, El Salvador, Guatemala, Haiti, Honduras, Mexico, Nicaragua, Panama, Paraguay, Peru, the United States, Uruguay, and Venezuela.

The OAS is an outgrowth of the International Union of American Republics, created in 1890 during the First International Conference of American States, held in Washington, D.C. Today, it operates through a large number of different agencies and institutions throughout the Hemisphere, all contributing to the objective of preserving the peace and security of the member states and promoting, by co-operation action, their economic, social, and cultural development. The Pan American Union, the central and permanent organ and General Secretariat of the OAS, has its headquarters in Washington, D.C.

كيفية الحصول على منشورات الأمم المتحدة
يمكن الحصول على منشورات الأمم المتحدة من المكتبات ودور التوزيع في جميع أنحاء العالم. استعلم عنها من المكتبة التي تتعامل معها
أو اكتب إلى: الأمم المتحدة، قسم البيع في نيويورك أو في جنيف.

如何购取联合国出版物

联合国出版物在全世界各地的书店和经售处均有发售。请向书店询问或写信到纽约或日内瓦的联合国销售组。

HOW TO OBTAIN UNITED NATIONS PUBLICATIONS

United Nations publications may be obtained from bookstores and distributors throughout the world. Consult your bookstore, or write to: United Nations, Sales Section, New York or Geneva.

COMMENT SE PROCURER LES PUBLICATIONS DES NATIONS UNIES

Les publications des Nations Unies sont en vente dans les librairies et les agences dépositaires du monde entier. Informez-vous auprès de votre libraire ou adressez-vous à : Nations Unies, Section des ventes, New York ou Genève.

КАК ПОЛУЧИТЬ ИЗДАНИЯ ОРГАНИЗАЦИИ ОБЪЕДИНЕННЫХ НАЦИЙ

Издания Организации Объединенных Наций можно купить в книжных магазинах и агентствах во всех районах мира. Находите справки об изданиях в вашем книжном магазине или пишете по адресу: Организация Объединенных Наций, Секция по продаже изданий, Нью-Йорк или Женева.

COMO CONSEGUIR PUBLICACIONES DE LAS NACIONES UNIDAS

Las publicaciones de las Naciones Unidas están en venta en librerías y casas distribuidoras en todas partes del mundo. Consulte a su librero o diríjase a: Naciones Unidas, Sección de Ventas, Nueva York o Ginebra.

Litho in United Nations, New York
12895—January 1968—4,000
Reprinted in U.N., N.Y.
07918—April 1974—1,050

Price: \$U.S. 6.00
(or equivalent in other currencies)

United Nations publication
Sales No. E.64.IV.6
ST/SOA/54