

# **AT** MICROFICHE REFERENCE LIBRARY

A project of Volunteers in Asia

Biogas and Waste Recycling: The Philippine  
Experience

by **Julio D. Maramba, Sr.**

Published by:

Liberty Flour Mills, Inc.  
Maya Farms Division  
Liberty Building, Pasay Rd.  
Legaspi Village, Makati  
Metro Manila, The Philippines

Available from:

Liberty Flour Mills, Inc.  
Maya Farms Division  
Liberty Building, Pasay Rd.  
Legaspi Village, Makati  
Metro Manila, The Philippines

Reproduced by permission of Liberty Flour  
Mills, Inc.

Reproduction of this microfiche document in any  
form is subject to the same restrictions as those  
of the original document.

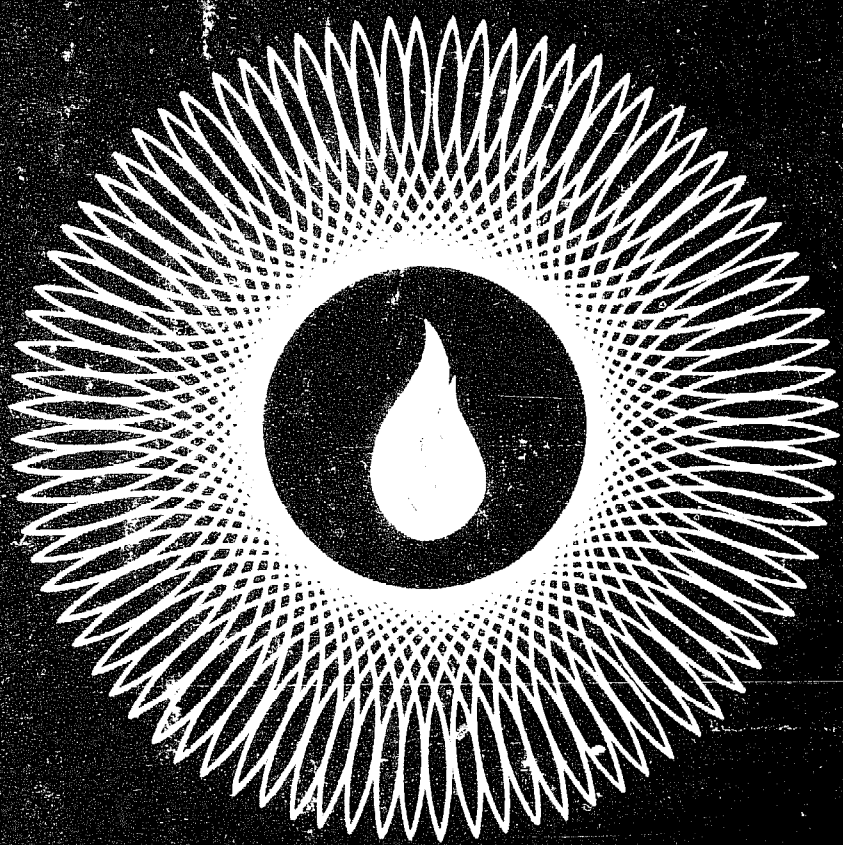
**BIOGAS**

**and**

**WASTE**

**RECYCLING**

**THE PHILIPPINE EXPERIENCE**



**FELIX D. MARAMBA, Sr.**

## ABOUT THE AUTHOR

Felix D. Maramba, Sr., B.S., University of Illinois; M.S., Iowa State University; D.Sc., Gregorio Araneta University Foundation (*honoris causa*); Registered Professional Mechanical Engineer; Registered Professional Agricultural Engineer. Served the government as Chief of the Industrial Engineering Division of the Bureau of Science; Director of the Bureau of Plant Industry; and Manager of Land Settlement and Development Corporation. In the educational field, he was Assistant Professor of Agricultural Engineering, U.P. College of Agriculture; Professor of Mechanical Engineering, Far Eastern University; and Dean of Engineering and of Graduate Studies, Gregorio Araneta University Foundation. At present he is President and Director of Liberty Flour Mills, Inc., Consultant to the Ministry of Energy on Nonconventional Sources of Energy and member-at-large of the Executive Board of the National Research Council of the Philippines.

Maramba pioneered in the search for indigenous sources of energy: rice hull to replace coal for firing boilers and rice dryers in the 20's; alcohol to replace petroleum oil to run tractors and trucks in the 30's; charcoal producer gas to run trucks and cars during the Japanese occupation; and more recently, biogas as a substitute for LPG and gasoline. He also pioneered in farm mechanization and processing of agricultural products.

## ABOUT THE CONTRIBUTING AUTHORS

Enrico D. Obias, Registered Chemical Engineer, B.S. Ch.E., University of the Philippines, 1958, *cum laude*. He received practical training in Europe, studying quality control and research in several manufacturing plants. He is at present Operations Vice President of Maya Farms, the Agro Industrial Division of Liberty Flour Mills, Inc.

Julian Banzon, B.S. Chem., University of the Philippines; Ph.D., Iowa State University; Professor of Agricultural Chemistry (retired); *Professor Emeritus* of Food Science and Technology, U.P. at Los Banos; first Director of the Atomic Energy Commission; Fellow, Crop Science Society of the Philippines; Fellow, American Association for the Advancement of Science. He is at present Chemistry Consultant for several corporations.

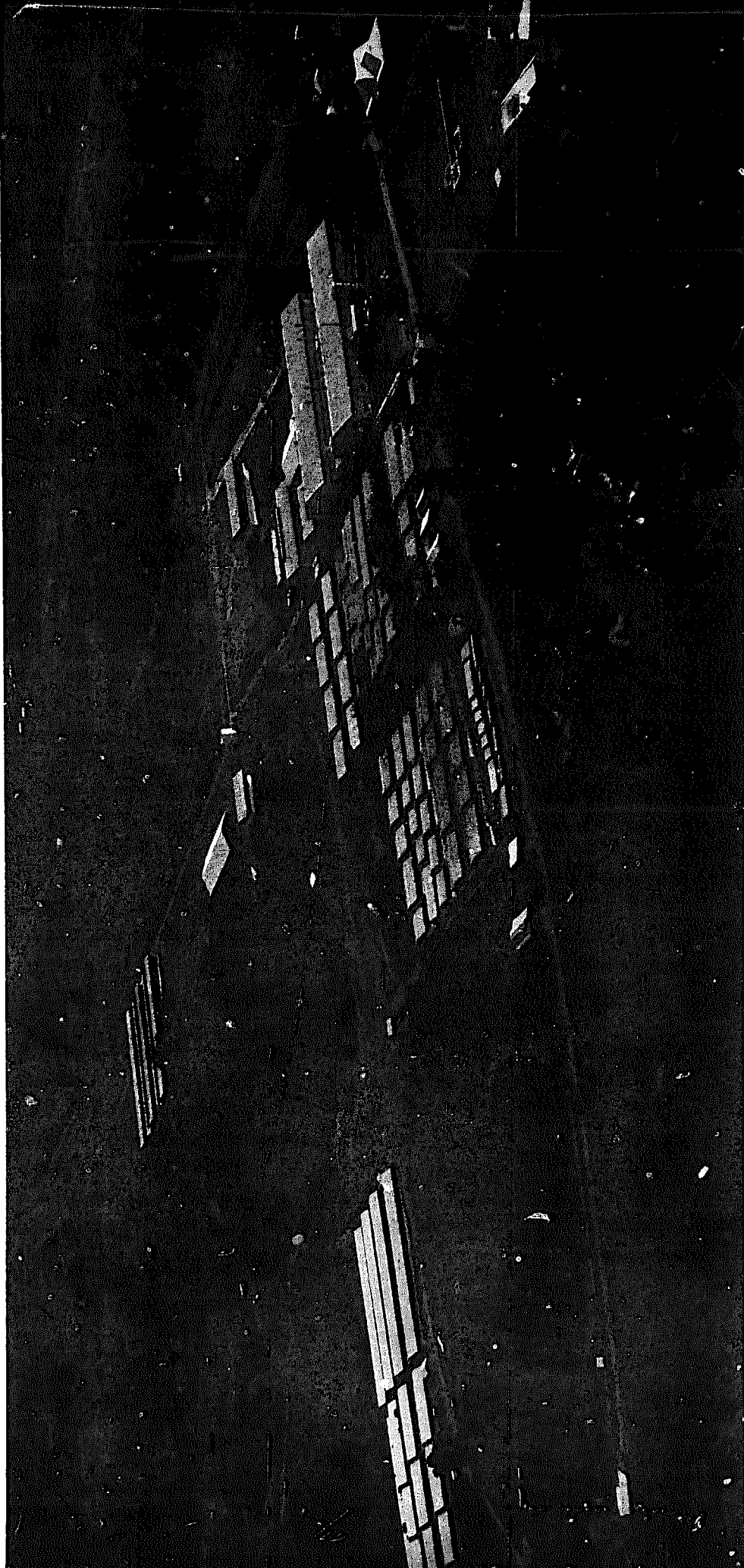
Celso Taganas, Registered Civil Engineer; B.S.C.E., National University, 1950; Assistant Vice President, in charge of Biogas Works construction and operation at the Maya Farms.

Ruth Alumbro, B.S., M.S., University of the Philippines; Head, Microbiology Department of the Quality Control, Research and Development Division, Liberty Flour Mills, Inc.

Alexandro A. Judan, Jr., C.P.A., B.B.A., *cum laude*, University of the East, Operations Vice President, Accounting and Finance Division, Liberty Flour Mills, Inc.

**BIOGAS**  
 **AND**  
 **WASTE RECYCLING**  
 **THE PHILIPPINE EXPERIENCE**





**Aerial View of Maya Farms**

# **BIOGAS AND WASTE RECYCLING**

## **THE PHILIPPINE EXPERIENCE**

**Felix D. Maramba, Sr.**  
**B.S., M.S., D.Sc. (*honoris causa*)**

### **Contributing Authors**

**Enrico D. Obias, B.S. Ch.E.**  
**Julian Banzon, B.S. Chem., Ph.D.**  
**Calixto Taganas, B.S.C.E.**  
**Ruth D. Alumbro, B.S., M.S.**  
**Alejandro A. Judan, Jr., B.S.B.A., C.P.A.**

**Maya Farms Division**  
**Liberty Flour Mills, Inc.**  
**Metro Manila, Philippines**

Copyright 1978  
by  
Felix D. Maramba, Sr.

All rights reserved. No part of  
this publication may be reproduced  
or transmitted in any form or by  
any means, electronic or mechanical,  
including photocopy, recording or  
any information storage and  
retrieval system, without the  
written permission of the senior  
author.

Printed by  REGAL PRINTING COMPANY

**In memory of two Filipino scientist-technologists**

**Manuel L. Roxas  
and  
Bienvenido Ma. Gonzales**

**Who laid the foundation for Philippine agro-industrial development**

## PREFACE

When Liberty Flour Mills, Inc., decided to establish Maya Farms, an integrated livestock farm, meat processing and canning operation in the Antipolo Hills of Rizal province, Philippines, pollution control was an integral part of the planning. After the various alternative methods were studied, anaerobic fermentation was chosen and adopted. The choice was made on the basis of what I had previously seen of the biogas plants in India and Taiwan. The biogas practitioners in India were enthusiastic about the biogas fuel for cooking and lighting, and in Taiwan, about the savings in their fertilizer bills. However, what particularly impressed me was the absence of foul odor and flies. It was evident that the solution of the problem involved expertise in chemistry, microbiology, engineering, etc. It was therefore decided that a group of specialists would work together in a crash development program.

We read whatever literature we could gather on biogas and started our experiments. Later, I made another trip, this time to Europe, the United States, Australia and India, to learn more, principally on the various designs and methods of operation. Chapter VII shows the most common designs. We tried a number of biogas plants which we thought would be applicable, properly modified to fit local conditions, because we found no single design that would meet varied requirements. Chapter VI is devoted to the discussion of suitable designs for different conditions.

The biogas plants which we established, successfully controlled the air pollution from the tons of manure produced daily by 10,000 pigs. But though the biogas plants greatly reduced the pollutional characteristics of the manure, the voluminous sludge still posed the problem of water pollution. Because it contained traces of toxic substances, it could not be applied as fertilizer in large doses. Intensive and expensive efforts of Maya Farms to solve the problem resulted in the development of the sludge-conditioning plant discussed in Chapter VIII.

Sludge conditioning not only eliminated the toxicity to fish and crops but it also improved the fertilizer performance far beyond what the chemical analysis would indicate. An unexpected bonus of great significance was our discovery that the solids recovered from the sludge could be processed into an excellent animal feed material. We found later that the dried sludge was rich in vitamin B<sub>12</sub>, a growth-promoting factor in animal feeds. Results of feeding trials would also indicate the presence of other unidentified growth factors (UGF).

Sludge conditioning may well be Maya Farms' most significant contribution to biogas technology. The value of the recoverable feed materials alone, without considering the biogas, biofertilizer, and pollution control, makes the whole system a profitable venture. The utilization of the sludge as fertilizer and as a source of feed materials is discussed in Chapters XIII and XIV. Chapter XV covers the function of the biogas works for pollution control.



Maya Farms has adopted the term "biogas works" to distinguish a biogas operation with sludge conditioning from a biogas plant operation. The biogas works, or operating combination of the biogas plant and sludge-conditioning plant, is discussed in Chapter IX.

After the oil embargo in 1973, we started experimenting on the industrial uses of biogas. First it was used as a substitute for LPG (liquefied petroleum gas). We found that the biogas may be used in any appliances intended for LPG, with minor adjustments. The Engineering Division of Liberty Flour Mills, Inc. started manufacturing appliances specifically intended to use biogas: gas stoves, refrigerators, lechon oven, etc. It made adjustments on mantle lamps and water heaters to use biogas. It converted charcoal flat irons to use biogas. Biogas was used successfully to run internal combustion engines to pump water from deep wells, to operate the feed-mixing plant, and to operate an electric generator that runs the freezers at night. We also used the biogas to fire a boiler, but we did not have enough gas to do all these at the same time.

After finding so many uses of biogas, our next aim was to find ways to increase the daily production and to reduce the costs of construction and operation. The hundreds of trials on laboratory scale and pilot scale biogas plants paid off handsomely. We were able to increase the production capacity of the biogas plant by 70-80% with more efficient stirrers, and by reducing the retention time of the waste slurry inside the digester from 50-60 days to 23-30 days. By improving the quality of our starter, we were also able to produce flammable biogas the day after charging the digesters, where it used to take 4 to 6 days before good gas was obtained.

Reduction of the retention time to one-half increased the biogas production and at the same time doubled the manure-processing capacity of the biogas plants. In other words, the capital outlay required to construct biogas plants to dispose of the same amount of manure was reduced to one-half. To find other ways of cost reduction, we tried various designs of the biogas plant. We built modified versions of the India single-walled vertical digester with floating gasholder, the Taiwan double-walled horizontal digester with floating gasholder, the China cylindrical digester with fixed-dome gasholder. We built continuous-fed and batch-fed, integrated type and split type biogas plants. We built digesters with single chamber and double chamber, in double rows, in triple rows and in clusters. We built them above ground and underground. We ended up with our own designs of both batch-fed and continuous-fed digesters.

Because of the great potential of biogas operations in waste recycling, our research and development work spilled over into a recycling system. We not only recycled the manure, but also converted the bones, blood and meat scrap in the meat processing plant into feed materials. Then we tried mixing the corn stover and rice straw with the manure slurry. Gas production was improved but the stover and straw required drying, crushing and chopping which consumed too much energy. Instead of giving them up entirely, we looked for a better way of using them. We fed them to ruminants and got the manure of the ruminants for the biogas plant. Thus the stovers and straws together with the weeds still helped produce meat before reaching the biogas plant. The inedible portion of the crop residues were composted to serve as soil conditioner.

To find other ways of recycling our excess liquid sludge, we also experimented on producing chlorella as a protein source for the hog feeds, but the high costs of harvesting

and drying chlorella made its production cost much higher than the cost of other available protein sources like soybean oil meal and fishmeal. Instead, we decided to grow the algae in fishponds so that the fish can feed on them directly.

Seeing all the benefits we were getting out of the recycling operations, it did not take long to realize the socio-economic impact if such recycling systems could be practiced throughout the country. Part IV discusses this matter and presents possible applications of a recycling system of farming, introduces the varied roles that biogas can play in rural development and shows the beginning of biogas practice in the Philippines.

This book is a summary of our experiences – of our attempts to solve one problem, that of pollution, and of how the solution evolved into a sort of wonder pill for the modern world's major headaches: pollution, the energy crisis, food shortage and under-employment of the farmers. Aside from solving our pollution problem, the biogas works turned out to be a rich source of a fuel gas, organic fertilizer and feed materials. The solution did not come easily. There were failures and near misses, financial gambles taken and sometimes lost, but in the process, we have learned a lot, and are still learning. We feel we should share this stock of knowledge with others.

Late in 1976, President Ferdinand E. Marcos directed the Energy Development Board (now Ministry of Energy) to embark on a crash program to use biogas as a substitute fuel. In this connection, he instructed the Director of Animal Industry to establish model biogas works in their stock farms; at least one in every region within six months, one in each province within one year, then in every town where it has a breeding station. The Maya Farms was charged with the task of training government technicians who would take care of constructing and operating biogas works and propagating their use. We are happy for having been given this opportunity.

**Felix D. Maramba, Sr.**

## ACKNOWLEDGMENT

The help of the following technical men, who are all involved in the research and development work on biogas at Maya Farms, is gratefully acknowledged:

Domingo Bautista, B.S.M.E.	Registered Mechanical Engineer
Dr. Patrocinio Santos, Ph.D.	Formerly Microbiologist of the National Institute of Science & Technology
Dr. Leopoldo Castillo, Ph.D.	Animal Nutritionist of the U.P. College of Agriculture
Dr. Mario Tongson, D.V.M.	Chief Parasitologist of the U. P. College of Veterinary Medicine
Fidel Junatas, B.S.S.E.	Registered Sanitary Engineer
Pacifico Pangilinan, B.S.E.E.	Registered Electrical Engineer
Hector Gatchalian, B.S.Chem.	Registered Chemist
Romeo A. Icasas, B.S.A.	Animal Husbandman
Dr. Leopoldo Capistrano, D.V.M.	Veterinarian
Alfredo Hernaez, B.S.A.	Formerly Agronomist of the Bureau of Plant Industry
Felipe Agdeppa, B.S.H.	Soil Technologist of the Bureau of Soils
Agustin Mangila, B.S.A., LLB.	Agricultural Economist
Ramon Dizon, B.S.M.E.	Registered Mechanical Engineer Home Appliances Manufacturer
Estrellita S. Tala, B.S. Ch. E.	Chemical Engineer
Meynardo Maghirang, B.S. Ch. E.	Chemical Engineer
Rosita Immaculata, B.S. Chem.	Chemist
Zenaida S. Hernandez, B.S. Med. Tech.	Laboratory Technician

More thanks are due : to the different embassies in the Philippines for their help in gathering information on the research and application of biogas in their respective countries;

: to the Philippine embassies abroad for furnishing us with biogas literature;

: to the Ministry of Energy and the National Science Development Board for their encouragement;

: to the National Pollution Control Commission for their valuable suggestions;

: to the National Research Council of the Philippines for making possible the publication of this book.

# CONTENTS

<b>Preface</b>			vii
<b>Acknowledgment</b>			x
<b>Part I – Scientific Aspects</b>			3
<b>Chapter</b>	<b>I</b>	<b>Nature and History of Biogas</b>	<b>5</b>
	<b>II</b>	<b>Biochemistry and Microbiology</b>	<b>11</b>
	<b>III</b>	<b>Laboratory and Pilot Plant Experiments</b>	<b>21</b>
	<b>IV</b>	<b>Raw Materials for Biogas Production</b>	<b>39</b>
	<b>V</b>	<b>The Sludge</b>	<b>47</b>
<b>Part II – Biogas Technology</b>			61
<b>Chapter</b>	<b>VI</b>	<b>Fundamentals of Biogas Plant Design</b>	<b>63</b>
	<b>VII</b>	<b>Biogas Plant Designs Around the World</b>	<b>73</b>
	<b>VIII</b>	<b>Sludge-Conditioning Plant Designs</b>	<b>87</b>
	<b>IX</b>	<b>Biogas Works Designs</b>	<b>101</b>
	<b>X</b>	<b>Planning and Establishing the Biogas Works</b>	<b>115</b>
	<b>XI</b>	<b>Operating Biogas Works</b>	<b>131</b>
<b>Part III – Utilization and Economics</b>			143
<b>Chapter</b>	<b>XII</b>	<b>Biogas as Fuel</b>	<b>145</b>
	<b>XIII</b>	<b>Sludge as Fertilizer</b>	<b>153</b>
	<b>XIV</b>	<b>Sludge for Feed and Other Uses</b>	<b>159</b>
	<b>XV</b>	<b>Biogas Works for Pollution Control</b>	<b>165</b>
	<b>XVI</b>	<b>The Economics of Biogas Works</b>	<b>171</b>
<b>Part IV – Waste Recycling Through the Biogas Works</b>			181
<b>Chapter</b>	<b>XVII</b>	<b>Recycling System of Farming</b>	<b>185</b>
	<b>XVIII</b>	<b>Rural Development through Waste Recycling</b>	<b>193</b>
	<b>XIX</b>	<b>Biogas Works in Practice</b>	<b>201</b>
	<b>XX</b>	<b>Socio-Economic Impact of Biogas Works</b>	<b>213</b>
<b>Glossary of Terms</b>			218
<b>Bibliography</b>			223
<b>Index</b>			227

## LIST OF TABLES

	Page
3-1 Relative volume of digester space to contain one kilogram of hog manure in various manure-water ratios	31
3-2 Weight of components in experimental slurries of various manure-water ratios and starter percentages	35
3-3 Rate of biogas production	36
4-1 Elemental composition of some proteins	39
4-2 C/N ratio, total solids and volatile solids of some biogas-producing materials	43
4-3 Carbon content of selected materials related to biogas production	44
4-4 Relative weights of components of hog manure	44
4-5 Characteristics of hog manure	45
5-1 Composition of sludge in relation to days of fermentation	48
5-2 Mineral composition of a sample of total sludge	48
5-3 Mineral composition of the solid and the liquid portions of a sample of sludge	48
5-4 Percentages of constituents remaining in sludge and percentage converted to biogas	54
5-5 Theoretical maximum volume of biogas producible from one kilogram of material	55
5-6 Conversion percentage of hog manure to biogas	57
10-1 Approximate daily manure available from different animals and the daily biogas production	116
10-2 Biogas consumption	117
10-3 Kind of manure requirement, gas production and cost of biogas plant	118
12-1 Composition of biogas and the common fuel gases	146



<b>12-2 Heating value of biogas and the common fuel gases</b>	<b>146</b>
<b>12-3 Heating value of other energy sources</b>	<b>147</b>
<b>13-1 Plot fertilizer experiment on rice</b>	<b>155</b>
<b>15-1 Quality standards for different classifications of water</b>	<b>169</b>
<b>15-2 Characteristics of wastewater from different sampling stations at Maya Farms</b>	<b>169</b>
<b>15-3 Qualitative description of odors</b>	<b>170</b>
<b>15-4 Threshold odor numbers of wastewater at different sampling stations at Maya Farms</b>	<b>170</b>
<b>16-1 Comparative costs of construction of small biogas plants</b>	<b>173</b>

## **LIST OF FIGURES**

	<b>Page</b>
3-1 Laboratory set-up for study of biological production of methane	22
3-2 Typical biogas production curve	24
3-3 Gas production curves for various manure-water ratios	26
3-4 Gas production curves on equal slurry volume and equal manure weight basis	27
3-5 Gas production curves for stored pig manure	29
3-6 Gas production curves for varying starter percentage	29
3-7 Relation of percentage of starter and number of days to produce 50 liters of biogas	29
3-8 Effect of age of starter on gas production	29
3-9 Ratio of volume of gas per day to volume of digester slurry	32
3-10 Rates of biogas production during active growth and senescence in relation to dung concentration	32
3-11 Gas production curves from chicken manure slurries	32
3-12 Gas production curves for corn stalk and rice straw	32
5-1 Changes in percentage composition of sludge during methane fermentation of hog dung	53
5-2 Changes in weight of components of sludge during methane fermentation of hog dung	53
5-3 Percent reduction in weight of protein, fat, total carbohydrates, volatile solids and total weight	56
5-4 Percent distribution of total weight loss	56
6-1 Integrated biogas plant flowsheet	70
6-2 Split continuous-fed biogas plant	70

<b>6-3 Batch-fed biogas plant</b>	<b>71</b>
<b>6-4 Night soil biogas plant</b>	<b>71</b>
<b>7-1 Gobar gas plant, with overflow outlet (Patel)</b>	<b>78</b>
<b>7-2 Gobar gas plant, with pipe outlet</b>	<b>78</b>
<b>7-3 Manure gas plant with latrine (Gotaas)</b>	<b>78</b>
<b>7-4 Belur Math gobar gas plant</b>	<b>78</b>
<b>7-5 Taiwan single stage biogas plant</b>	<b>79</b>
<b>7-6 Taiwan 2-stage methane generator</b>	<b>79</b>
<b>7-7 China biogas plant</b>	<b>79</b>
<b>7-8 Anaerobic digestion of pig waste</b>	<b>79</b>
<b>7-9 Darmstadt system</b>	<b>80</b>
<b>7-10 Schmidt-Eggersgluss system</b>	<b>80</b>
<b>7-11 Weber system, cow dung type</b>	<b>80</b>
<b>7-12 Bihugas-Anlage (Poetsch)</b>	<b>80</b>
<b>7-13 Ducellier-Isman system</b>	<b>81</b>
<b>7-14 Gartner-Ikonoff system</b>	<b>81</b>
<b>7-15 Drum digester for fibrous materials (Buswell-Boruff)</b>	<b>81</b>
<b>7-16 Gas generating plant for vegetable wastes (Burke-Jacobs)</b>	<b>81</b>
<b>7-17 Organic digester (Fry)</b>	<b>82</b>
<b>7-18 Methane recovery digester (Chan)</b>	<b>82</b>
<b>7-19 Sanamatic tank (Coulthard)</b>	<b>82</b>
<b>7-20 Kenya batch digester</b>	<b>82</b>
<b>7-21 Continuous organic waste digester (Araneta)</b>	<b>83</b>
<b>7-22 Garbage fermentation tank (Valderia)</b>	<b>83</b>

<b>7-23 Methane gas producing device (Cadiz-Velasquez)</b>	<b>83</b>
<b>7-24 Night soil digester (Maya Farms - Bautista)</b>	<b>83</b>
<b>7-25 Horizontal continuous-fed biogas plant (Maya Farms-Obias)</b>	<b>84</b>
<b>7-26 Continuous-fed digester for livestock farms (Maya Farms-Taganas)</b>	<b>84</b>
<b>7-27 Batch-fed digesters for agro-industrial operations (Maya Farms-Maramba)</b>	<b>84</b>
<b>7-28 Floating dome gasholder for split type biogas plants</b>	<b>84</b>
<b>7-29 Continuous-fed digester for slaughterhouses (Maramba-Taganas)</b>	<b>85</b>
<b>7-30 Vertical continuous-fed biogas plant (Maya Farms-India)</b>	<b>85</b>
<b>7-31 Fixed dome continuous-fed biogas plant (Maya Farms-China)</b>	<b>85</b>
<b>7-32 Double-walled continuous-fed biogas plant (Maya Farms-Taiwan)</b>	<b>85</b>
<b>8-1 Single pond sludge-conditioning plant</b>	<b>98</b>
<b>8-2 Double lagoon sludge-conditioning plant</b>	<b>99</b>
<b>8-3 Multi-lagoon sludge-conditioning plant</b>	<b>100</b>
<b>9-1 Family farm biogas works flowsheet</b>	<b>106</b>
<b>9-2 Crop-livestock biogas works flowsheet</b>	<b>107</b>
<b>9-3 Agro-pulp biogas works flowsheet</b>	<b>108</b>
<b>9-4 Livestock biogas works flowsheet</b>	<b>109</b>
<b>9-5 Feedlot biogas works flowsheet</b>	<b>110</b>
<b>9-6 Integrated meat-processing biogas works flowsheet</b>	<b>111</b>
<b>9-7 Agro-industrial biogas works flowsheet</b>	<b>112</b>
<b>9-8 Slaughterhouse biogas works flowsheet</b>	<b>113</b>
<b>9-9 Cooperative biogas works flowsheet</b>	<b>114</b>
<b>9-10 Night soil biogas works flowsheet</b>	<b>114</b>
<b>11-1 Floor plan for compost bunk</b>	<b>139</b>

**17-1 Recycling chart, Maya Farms**

**183**

**19-1 Sta. Barbara biogas plant**

**206**

**19-2 BAI biogas plant**

**206**

**19-3 PAC biogas plant**

**206**

**19-4 UPCA biogas plant**

**206**



## LIST OF ILLUSTRATIONS

1-1	Microbiology laboratory at Maya Farms	2
1-2	Microbiological assay of vitamin B <sub>12</sub>	19
1-3	Pollution control laboratory	19
1-4	Experimental laboratory digesters at Maya Farms	22
1-5	Pilot plant batch-fed digesters	37
1-6	Pilot plant continuous-fed digesters	37
1-7	First experimental biogas plant	38
1-8	Laboratories and one of the pilot plants for biogas research at Maya Farms	38
1-9	Animal manure and crop residues are the biggest potential sources of biogas	46
2-1	Biogas works at Maya Farms	60
2-2	Industrial scale biogas plant	72
2-3	Gasholders for the fourth biogas plant unit under construction at Maya Farms	86
2-4	Settling basins	95
2-5	Sludge-conditioning canals with overflow dams	95
2-6	Waterwheel aerator	95
2-7	Solid sludge drier	96
2-8	Detoxifier	96
2-9	Incinerator	97
2-10	Compost bunk	97
2-11	Biogas plant	105
2-12	Sludge-conditioning plant	105
2-13	Biogas works with a windmill	140

<b>3-1</b>	<b>Biogas-powered deepwell pump</b>	<b>142</b>
<b>3-2</b>	<b>Biogas-powered feedmill</b>	<b>150</b>
<b>3-3</b>	<b>Biogas-heated drying room</b>	<b>151</b>
<b>3-4</b>	<b>Pig brooder and poultry brooder converted to use biogas</b>	<b>151</b>
<b>3-5</b>	<b>Cooking with biogas at Maya Farms canteen</b>	<b>152</b>
<b>3-6</b>	<b>Lechon roasters</b>	<b>153</b>
<b>3-7</b>	<b>Crop drier</b>	<b>154</b>
<b>3-8</b>	<b>Fertilizer test plots</b>	<b>158</b>
<b>3-9</b>	<b>Crop field and fishponds</b>	<b>158</b>
<b>4-1</b>	<b>Waste recycling at Maya Farms</b>	<b>180</b>
<b>4-2</b>	<b>Biofertilized vegetables on trellis</b>	<b>191</b>
<b>4-3</b>	<b>Harvesting tilapia at Maya Farms</b>	<b>191</b>
<b>4-4</b>	<b>Fishponds and crop fields</b>	<b>192</b>
<b>4-5</b>	<b>Biogas-powered 60 kva electric generator at Maya Farms</b>	<b>198</b>
<b>4-6</b>	<b>IPOPI charcoal-fed trucks</b>	<b>199</b>
<b>4-7</b>	<b>Windmill</b>	<b>199</b>
<b>4-8</b>	<b>Solar heater</b>	<b>199</b>
<b>4-9</b>	<b>Rice hull firing chamber</b>	<b>200</b>
<b>4-10</b>	<b>Biogas plant in Calasiao, Pangasinan</b>	<b>209</b>
<b>4-11</b>	<b>Sta. Barbara biogas works</b>	<b>210</b>
<b>4-12</b>	<b>Biogas plant at BAI breeding station</b>	<b>210</b>
<b>4-13</b>	<b>Night soil biogas plant at Liberty Foundation Dormitory</b>	<b>211</b>
<b>4-14</b>	<b>India model</b>	<b>211</b>
<b>4-15</b>	<b>China model</b>	<b>212</b>

<b>4-16 Taiwan model</b>	<b>212</b>
<b>4-17 Maya Farmhouse model</b>	<b>212</b>
<b>4-18 Biogas for household appliances</b>	<b>217</b>
<b>4-19 Ducks feasting on scum</b>	<b>217</b>

## **PART I**

### **SCIENTIFIC ASPECTS**

- Chapter I Nature and History of Biogas**
- II Biochemistry and Microbiology**
- III Laboratory and Pilot Plant Experiments**
- IV Raw Materials**
- V Sludge**



**Illustration 1-1: Microbiology laboratory.**



## PART I

### SCIENTIFIC ASPECTS

The initial difficulty to be contended with when a piggery was set up at Maya Farms in 1972 was ecological in nature. The hog farm polluted the drainage creek and diffused odors. A good number of possible solutions were considered. One was to dry the pig manure and sell it as fertilizer. However, there would be high energy requirements during the long rainy months, to say nothing of the unpleasant steaming odors arising from the forced drying. Another method proposed was standard sewage treatment, but calculations showed that the cost would be high. Still another method considered was anaerobic fermentation, but there was no available recorded experience to go by. The potential to produce methane gas was present and this at a time when the supply of energy was becoming even more critical than that of food.

Literature on methane was ample but not on methane fermentation. Huge quantities of methane had by now been already mined in many regions of the world. This natural gas occurs in nature, and is often associated with petroleum oil. In contrast to these huge natural deposits, decaying straw, leaves and other organic matter buried in muddy stagnant waters, produce the same methane gas by action of microorganisms; hence the names swamp gas, marsh gas, muck gas. In some swamps, the gas ignites, very likely due to another naturally produced gas, phosphine, which is self-igniting when it comes in contact with air. (Such pergolic substances keep modern jet engines always aflame.) These eerie bluish dancing flames shimmering in swamps were called *ignis fatuus* by the Romans, the deceiving light, for a person who is fascinated by the flame is lured farther and gets lost in the trackless swamps. Even today, in English dictionaries and encyclopedias, the word or term "will-o-wisp" remains. In still another form, methane appears as the eternal flame burning in shrines of diverse cults and beliefs. Methane gas is not the only legacy handed down to us by nature through eons of time during which organic matter was converted to products we are now dependent on for energy. The present reserves of coal, petroleum oil and natural gas may be traced back to the plants and animals that existed in ages past. The remains of these prehistoric living organisms were converted by high temperature, high pressure and microorganisms over the long geological periods to our present-day sources of energy.

It is now almost certain that the methane in natural gas was formed through the bacterial decomposition of organic matter, vegetation and other organisms that lived eons ago. At the present time this decomposing process is still going on. A few years ago, a garbage dump near the Rizal Coliseum in the City of Manila emitted an inflammable gas during attempts to sink a well for water.

In the Philippines, there has been as in many countries, sporadic interest in biogas. In 1965 M. Felizardo went to Europe on an official mission for the Philippine Coconut Administration; he returned with an unusually enthusiastic report on the experience of Germany on biogas. Work on biogas started soon after: Eusebio, Alicbusan, the groups at

**Pampanga Agricultural School, the Bureau of Animal Industry, the Economic Development Foundation, and Maya Farms. Patents began to appear: Valderia, Cadiz, Velasquez, Araneta, etc.**

**It is to be noted that during the oil embargo in 1973, interest shifted to energy production, and the pollution control aspect was kept in the background. But eventually the animal raisers, especially of hogs and poultry, found themselves staring into the realities of the pollution evil, and anaerobic fermentation again regained attention as a means of control.**

## Nature and History of Biogas

Methane is the simplest member of a large family of chemical compounds called hydrocarbons. They contain only the elements carbon and hydrogen. The first six members of this family are:

Methane	$\text{CH}_4$	Butane	$\text{C}_4\text{H}_{10}$
Ethane	$\text{C}_2\text{H}_6$	Pentane	$\text{C}_5\text{H}_{12}$
Propane	$\text{C}_3\text{H}_8$	Hexane	$\text{C}_6\text{H}_{14}$

Methane is a gas at our ambient temperature and pressure. It is a colorless, odorless gas about half as heavy as air. It is characterized by a critical temperature of  $-82^\circ\text{C}$  and a critical pressure of 45.8 atmospheres. In other words, methane liquefies only if the temperature is at or lower than  $-82^\circ\text{C}$  and requires at least a compression pressure of 45.8 atmospheres. By contrast, butane (lighter fluid) can be obtained as a liquid at ambient temperatures and at pressures slightly higher than atmospheric. Liquefied petroleum gas or LPG is butane or propane or a mixture of both. Butane and propane have critical temperatures high enough so they can exist as liquid at ambient temperatures. The next higher hydrocarbon is pentane; it is a liquid and a component of gasoline – from methane to ethane to propane to butane and to pentane, the critical temperatures increase and the gases become easier to liquefy.

It can be seen now why compression alone will not liquefy methane. However, methane can be compressed to a gas volume so small as to be comparable to a liquefied gas as far as volume reduction is concerned, but certain problems arise: 1) the tank container must be extra strong, thick, heavy and of special construction; 2) a costly high compressor system is necessary; 3) expensive gas pressure reduction devices are needed for every tank when the compressed gas is used.

There are many advantages to be gained in transporting methane as a liquid even with the severe requirement of maintaining a temperature of at most  $-82^\circ\text{C}$  and a pressure of at least 45.8 atmospheres throughout the time of transport and storage. The volume of the liquid, however, is approximately only 1/600th that of the gas at  $25^\circ\text{C}$  and this is an advantage in storage. The problems met in handling gases at such cryogenic temperatures have been quite satisfactorily solved in the development of space rockets. But would it be economical to apply this knowledge to methane? Let us quote from a well-known magazine:

This scheme was the subject of successful experiments in 1959 when the converted *Methane Pioneer* made seven trips from Louisiana to England. Each cargo of 2000 cold tons warmed up into 100 million cubic feet for London's gas system. France and England are now building methane tankers.

Methane burns in air with a pale, faintly luminous, very hot flame. The heat of combustion is 978 BTU per cu. ft. Its auto ignition temperature is  $650^\circ\text{C}$ . The explosive

mixtures with air are those over 5.53% methane and those lower than 14%. Methane, unlike carbon dioxide, is very sparingly soluble in water. Hydrogen constitutes 25% of methane in contrast to 16.7% in pentane or 11.11% in water; even ammonia contains only 17.6% hydrogen. By making methane react with steam of high temperatures, the hydrogen output is doubled:  $\text{CH}_4 + 2\text{H}_2\text{O} \rightarrow \text{CO}_2 + 4\text{H}_2$ . Carbon black, fluffy material of colloidal fineness and used to make rubber tough and resistant to wear, is obtained by cracking methane. Other industrially important products synthesized from methane are methyl chloride, chloroform, carbon tetrachloride, methyl alcohol, formaldehyde, nitromethane and others. As mentioned earlier, one large use of methane is to supply hydrogen for fertilizer (ammonia) manufacture.

Methane is nowadays industrially produced by destructive distillation of bituminous coal (coal gas production) and by coal carbonization.

From records that are at present available, it is apparent that this gas now called biogas has been observed and studied since ancient times. After the time of the Romans, the Greeks and the Chinese, and much later with the ushering in of the scientific era, there appears to have been a continuing interest on the subject leading to the present degree of utilization of this gas.

### **History of Biogas**

One of the earliest to mention biogas was Van Helmont in 1630, in a communication about an inflammable gas emanating from decaying organic matter. Van Helmont was one of the early observers and interpreters of natural phenomena who nowadays would be called "scientists". In 1667 a man by the name of Shirley described this gas more precisely; he is now generally considered as its discoverer (Sathianathan, 1975). An Italian, Alessandro Volta, (from whom the electrical unit, volt, was derived) wrote a letter on November 14, 1776, about a combustible gas evolved when the bottom sediments of ponds near the town of Como, northern Italy, and in Lake Verbano, were stirred. He found that the gas exploded when mixed with air and ignited; he even determined the proportions of gas to air that gave the loudest explosion.

In 1870 Joseph Priestley, a name well-known in the history of chemistry, reported an "air" (that is, a gas) that was produced by the decay of substances when submerged in water.

The first allusion to animal manure comes from Humphrey Davy, who reported early in the nineteenth century the presence of this combustible gas in fermenting farmyard manure. Davy is known for the invention of the miner's safety lamp. Even today the principle involved in that lamp may be used as the simple method to avoid explosions in circumstances where a gas (like biogas) is likely to be ignited.

It was in 1804 when John Dalton established the chemical constitution of methane. Dalton is considered the father of modern atomic theory. It is to be noted that this gas methane attracted the attention of the famous scientists of that day. Not only chemists like John Dalton, Humphrey Davy, and Joseph Priestley, but also those whom we now classify as physicists like Alessandro Volta, and William Henry became interested in the muck gas. It was William Henry who deduced the probable identity of the then synthetic illuminating gas as methane. This was in 1806.

It appears that by that time, the physical scientists (physicists and chemists) had advanced knowledge about biogas, as far as their disciplines allowed, and from there the microbiologists took over. Louis Pasteur himself devoted some time to look into the process but it was one of his students by the name of Bechamp who in 1868, tried to show that microorganisms were involved in the production of methane from organic matter. It appears that Bechamp was not able to give a very convincing proof for it and credit is usually given to Tappeiner who worked during the years 1882 to 1884. Another student of Pasteur, Gayon, produced so much gas that Pasteur entertained the idea of using the gas for illumination and heating.

With the chemical constitution fixed by John Dalton, the microbiological nature of the process demonstrated by Bechamp and Tappeiner, and the starting source material shown to be organic matter by a number of observers it would do well to consider at this point the more applied development.

It is reported in literature that as early as 1896, gas from sewage was already used for lighting a street in Exeter, England. That a combustible and potentially useful gas could be obtained from human feces, must have been amply demonstrated in India, for in 1900 a methane (biogas) generating plant from human wastes was constructed in a leper asylum in Matunga, India (Sathianathan, 1975). This was the Homeless Lepers' Asylum, now known as the Acworth Leprosy Hospital in Wadals, India. This is also mentioned by Boruff and Bushwell in 1930. It is likely that the asylum was pestered by the obnoxious odor of their wastes, resulting in the confinement of this pollutant and later the discovery of a practical way to use the evolved gas.

The production of biogas in quantity from cellulosic materials came even later than that from human wastes. It appears that in 1914 the Dutch tried to produce biogas from the waste of straw board manufacture. This was in Indonesia when it was still the Dutch East Indies.

After World War I, in 1918, the British became interested in the production of methane from farm wastes. This seems not to have prospered for a number of reasons that will be discussed later.

In 1930 Boruff and Bushwell from Illinois in the United States published articles about the production of methane from farm residues like cornstalk. Up to 1952 Bushwell was still publishing articles on the subject. Jacobs and also Levine (well-known for his bacteriological *endo agar* medium) both from Iowa State, also in the United States, were much concerned about the generation of this gaseous fuel in relation to the enormous amounts of available farm cellulosic wastes.

In the years around 1940, many municipal sewage treatment plants in the United States and elsewhere were already employing anaerobic "digestion" as part of the treatment of municipal waste, and thereby generating methane which was used to generate electricity for the plant. This indicated that for pollution control, the anaerobic digestion process is proven effective, with additional benefits in the form of a supply of a useful gas.

The French in North Africa, between the years 1940-51, are reported to have made extensive efforts to develop so-called methane digesters. There is ample literature on their work in French journals. The designs and prototypes were developed by G. Ducellier and M. Isman in the then French North Africa as early as 1937.

Work on biogas development in Germany is well summarized by Tietjen (1975) from about 1951. There were three groups that developed procedures: a) Strell, Goetz and Liebmann at Munich, b) Reinhold and Noack at Darmstadt, c) Schmidt and Eggersgluss at Allerhop. Later, other procedures were worked out: the Honhenheim, the System Berlin and the Poetsch. There was parallel work in East Germany. In general, the conclusion was: "the aspect of energy balance was judged as unfavorable because of climatic conditions..." Gas from sewage was another matter since proper sewage treatment and disposal could not be evaded. Tietjen reports that in 1951, 48 sewage treatment plants in West Germany provided more than 16 million cu. m. of sewage gas, 3.4% of which was utilized for power production, 16.7% for digester heating, 28.5% was delivered to the city gas supply system and 51.4% was used as motor fuel for vehicles.

At the latter part of World War II; Germany and the Nazi-occupied areas found themselves in a deep crisis with respect to fuel for vehicles. Not only the engines for transport of people, food and merchandise but also the farm machinery, like tractors, were sorely in need. Methane (actually biogas) was generated from manure using several hurriedly developed digesters. The gas, which could not be liquefied under practical conditions, was compressed at 3,000 psi and charged into pressure steel "bottles". Such bottles were filled with gas the equivalent of 10 gallons of gasoline and thus served as fuel during the crisis. This experience of Germany shows that it is possible to run the farms through the energy coming from farm waste. It may be cheaper to use petroleum fuel nowadays but not for long because of the present worsening of the energy crisis. A handicap of the colder climates is the requirement of relatively high temperature, certainly higher than 26°C and preferably 30°C to 35°C for the biogas production.

After World War II, there was extensive development on biogas generation in many countries: South Africa, Rhodesia, Kenya, Uganda, Russia, Australia, Italy, Korea, Taiwan, Japan, Israel, United States, India, and the Philippines.

In 1965 Chung Po of Taiwan published a pamphlet on two designs of family-size digesters and the use of the sludge for fertilizer and chlorella culture. (The so-called Taiwan design appears in another chapter.)

A great deal of significant work on biogas has been done in India, but this work reached the outside world only in more recent times when almost every country became interested in the subject. An authoritative review of developments in India is given by Bashbai Patel in a paper presented in the ESCAP-NIST Biogas Utilization Workshop in 1975. Research on Biogas (Gobar gas) was undertaken in India since 1939 but it was not until 1951 that there was a real start in its use. Developments however were slow and disappointing until 1961 when the Indian Khadi and Village Industries Commission took over. By 1973-74, some 7000 biogas plants had already been installed, and the number more than doubled by 1974-75. One reason for this expansion of biogas plants was the improvement in the design, construction and operation of practical digesters. Furthermore, sufficient knowledge was obtained for the utilization of the gas not only for cooking but also for lighting and running engines. Success may also be attributed to the very competent scientists involved, such as J. Patel and Ram Bux Singh, among others. The extensive work on biogas in India may be divided into three phases: experimentation, 1937-1950; pilot studies, 1950-1963; and full operational stage, from 1964.

**In the raising of animals in confinement, made necessary by an ever-increasing meat-eating population, the disposal of animal wastes presents a pressing pollution problem. Hence large numbers of studies on the subject were reported each year in the countries affected, mostly in the United States. The solution to problems of animal waste treatment or disposal or utilization became the object of studies in academic and research institutions. It became the subject of theses research for the master's and even for the doctoral degree. Seminars, regional and international conferences, and symposia have been organized on a subject which has, within a brief period, been found to be of double value: a solution to this particular kind of pollution and at the same time a good energy source with the extra benefits of organic fertilizer as a by-product. Nor is this the end of the benefits, as will be shown in a separate chapter.**

## Chapter II

### Biochemistry and Microbiology

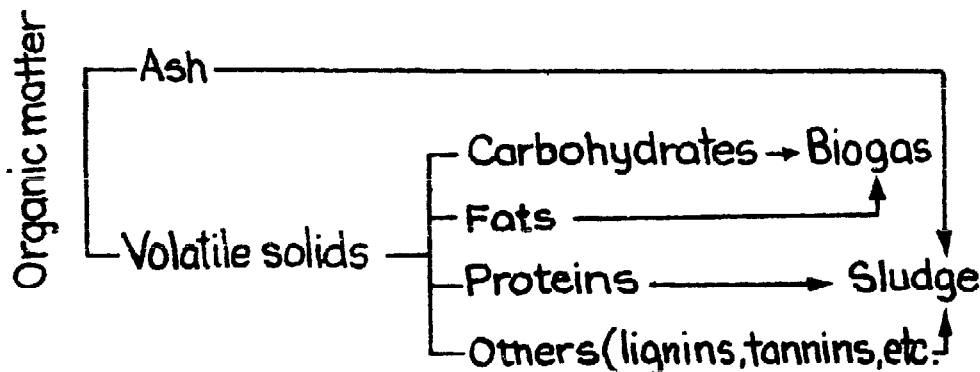
At present there is no longer any doubt about the microbiological origin of biogas. The gas is obtained from decaying leaves, straw, grass, etc. that are submerged in stagnant water or from a slurry of animal manure, either alone or with straw (farmyard manure). It is also formed in quantity in the rumen or stomach of so-called ruminant animals. In each case bacteria have been shown to be associated with biogas formation.

#### Organic Matter

Organic matter is the material of which living organisms are composed. In this category are, therefore, the materials that constitute plants and animals. The chemical element which is found in all organic matter is carbon; however, not all materials containing carbon are organic matter, as for example limestone ( $\text{CaCO}_3$ ) and calcium carbide ( $\text{CaC}_2$ ).

The principal components of organic matter are carbohydrates, fats and proteins, and a rather heterogeneous group we will designate here as phenolics since they are in some way related to phenol. Among the phenolics are lignin and tannin. These together with other minor groups like chitin and resins are found to be more resistant to microbiological action than the first three groups. The biggest group are the carbohydrates which comprise the celluloses, hemicelluloses, starches, and sugars. It must be remembered that organic matter is a very complex material and there are not only difficulties in classification but also inadequate information.

A simplified scheme of the composition and fate of organic matter in methane fermentation is shown in the following diagram:



Biogas is observed to arise from the bacterial decomposition of organic matter. The more knowledge gained about a process, the more likely the process can be improved or manipulated to the advantage of mankind. For this reason there have been attempts to gain as much information as possible about how organic matter is changed to biogas. Since the process is microbiological, it is natural that one of the first studies made was to isolate and identify the specific kind of bacteria and the particular material or chemical compound

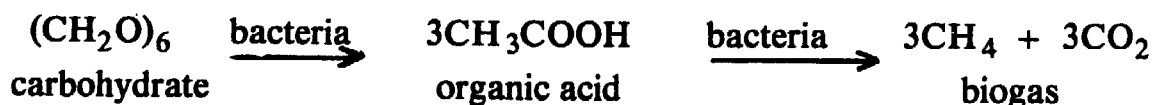


acted upon; this latter is called the substrate. Thus in the fermentation of sugar, the microorganism is yeast, the substrate is sugar and the products are ethyl alcohol and carbon dioxide. This alcoholic fermentation has been studied very well; it is known, for example, that the sugar is converted to alcohol not in one biochemical step, but through a succession of changes brought about by enzymes present in yeast. The overall process can be summarized thus: Sugar  $\longrightarrow$  alcohol + carbon dioxide. This can be written as a chemical reaction, and by employing the methods of chemistry we may say that 100 grams sugar (glucose) give 51.1 grams alcohol and 48.9 grams carbon dioxide. The conversion of glucose to alcohol is then 51.1 %. This is a theoretical maximum, hence a valuable piece of information to have. Additionally, because of our precise knowledge of alcoholic fermentation, and of a succession of biochemical steps that finally lead to the production of alcohol, it is possible (and this has been done on an industrial scale) to detour the process such that glycerol and not alcohol is the final main product.

Such basic knowledge is lacking in the biogas conversion process. The search for such knowledge is made very difficult because it turns out that several microorganisms, and not only one, are involved in methane production. To compound the difficulty, it has been found that many chemical compounds in the "parent" organic matter (not sugars alone as in alcoholic fermentation) can serve as substrate for biogas production. We have therefore a rather complex case of many kinds of microorganisms, acting upon many kinds of chemical compounds in the production of methane gas.

The substrate or raw materials known to be acted upon by the methane bacteria are very simple compounds. They fall into three groups: (1) fatty acids containing 1 to 6 carbon atoms; (2) alcohols containing 1 to 5 carbon atoms (both straight and branched-chain); and (3) the gases carbon dioxide, hydrogen and carbon monoxide. Additional compounds which are believed to be also probably acted upon by the methane bacteria are the long chain fatty acids, some dicarboxylic acids, acetone, 2, 3-butylene glycol and even some aromatic compounds like benzoic acid.

Since organic matter is largely composed of cellulose, starches, gums, pectins, etc. and these are rather complex compounds the question arises as to how these are converted to biogas. The inference therefore is that the complex compounds are changed to the simple compounds which in turn give rise to biogas. According to H. A. Barker (1956), the conversion of these complex compounds to methane is a multi-stage process in which bacteria that cannot form methane most likely convert these substrates to simple compounds which are then transformed by the methane bacteria to biogas. Symbolically, the series of changes, may be written thus:



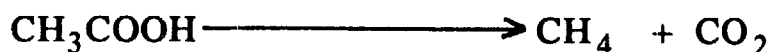
Since the process of biogas production involves at least two distinct kinds of bacteria, it appears that the use of a single pure culture of a bacterium, as practised in most fermentative processes, is not called for. As far as present knowledge goes, a mixed culture is necessary. To complicate matters, even the production of methane from an already simple compound has been found to require different species of methanogenic bacteria, depending on the kind of this simple compound. Barker found that even for the complete

fermentation of so simple a compound as valeric acid ( $C_4H_9COOH$ ), as many as three species of methane bacteria may be required.

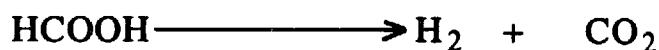
This rather severe selectivity of substrate by each species of methane-producing bacteria has given rise to the descriptive term "extreme substrate specificity".

### Theories Regarding the Origin of Methane

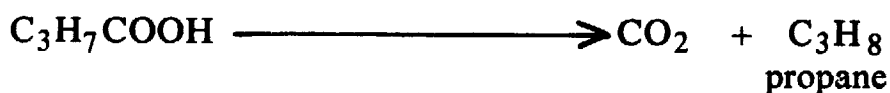
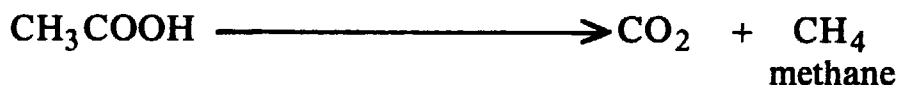
A chemical explanation of methane formation may be shown in the formation of methane from acetic acid as a case of decarboxylation:



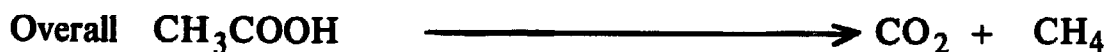
From formic acid, decarboxylation gives  $CO_2$  + hydrogen which are gases also found in biogas:



If this bioconversion, as methane formation is often called, is always a process of decarboxylation, then gases other than methane will be formed from organic acids as indicated in the following chemical equations:



Actual observation indicates that only methane is formed, irrespective of the kind of acid. It is therefore likely that even these simple acids are further converted, first to one kind of compound which then becomes the immediate precursor of methane. This explanation, the Van Niel carbon dioxide reduction theory, postulates that  $CO_2$  and  $H_2$  are the immediate precursors of methane and that the carbon dioxide is reduced by the hydrogen in the process. In the bioconversion to methane, the first step then is production of  $CO_2$  and  $H_2$  from the acid; the second step is the chemical reduction of the  $CO_2$  by the  $H_2$  to form methane as illustrated below:

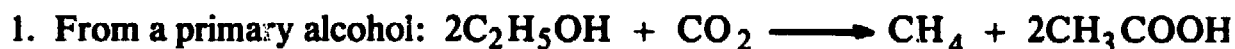


That this chemical explanation may be true is indicated by studies which have shown that as much as 70% of biogas comes from the acetic acid present in the substrate. Bacteria which are normally found in the intestinal tract may also be found free-living in the soil and these form large amounts of acetic acid.

The stepwise formation of  $\text{CH}_4$  from formic acid may be as follows:



From other simple compounds, the formation of  $\text{CH}_4$  may be given as follows:



2. From a secondary alcohol:



3. From a higher fatty acid:

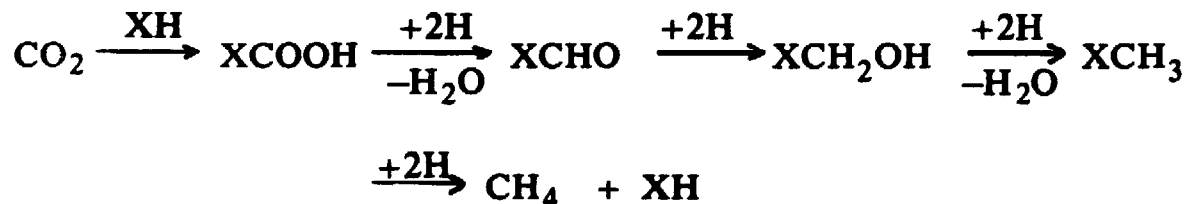


4. From methanol:  $4\text{CH}_3\text{OH} \longrightarrow 3\text{CH}_4 + \text{CO}_2 + 2\text{H}_2\text{O}$

It will be noted that  $\text{CO}_2$  is a reactant in the first three reactions given above, but not in the last reaction. It has been postulated that the origin of methane is  $\text{CO}_2$  and the process involves steps that are well known in chemistry.

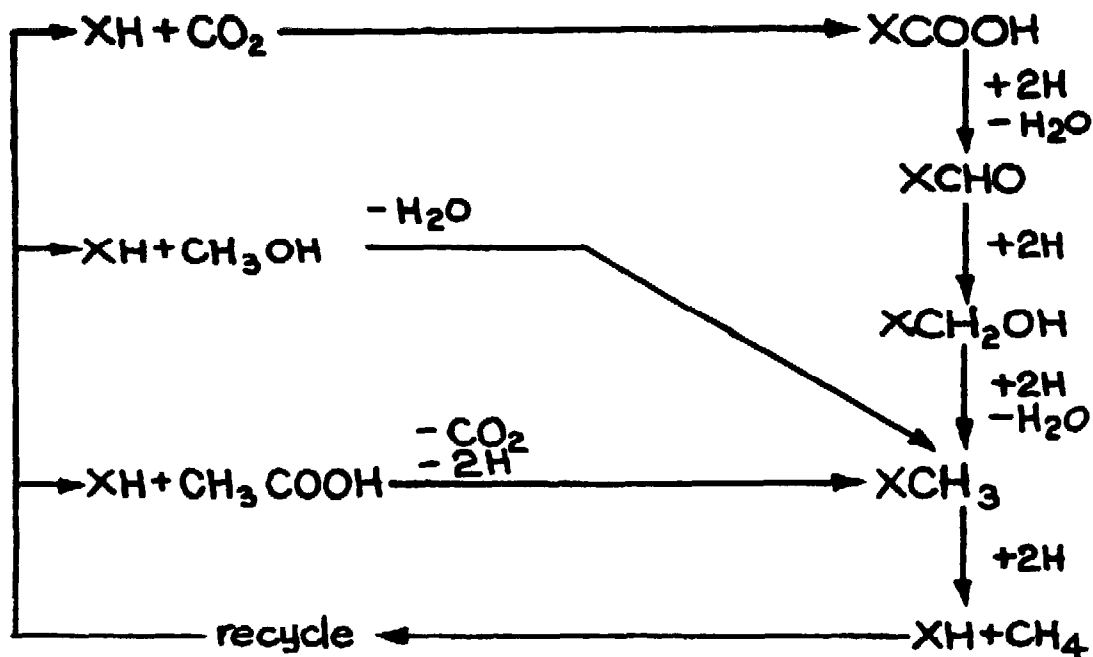


The process starts with the reduction of  $\text{CO}_2$  by hydrogen to produce formic acid, then to formaldehyde to methanol and finally to methane. Actual experiments, however, have failed to show that this sequence of events actually takes place. Barker therefore suggests that the initial reductive step is not by hydrogen but by a hydrogen carrier probably in combined form represented by  $\text{XH}$ . The reductive steps, comparable to the  $\text{CO}_2$  reduction process earlier given, are then:



The hydrogen carrier is regenerated and recycled as illustrated above.

The formation of  $\text{CH}_4$  from methanol and from acetic acid may also be shown to involve the carrier  $\text{XH}$  and thus make possible a unified theory as to the mechanism of formation of  $\text{CH}_4$ , but in these two latter cases the oxidant is not  $\text{CO}_2$  although the reductant is the same,  $\text{XH}$ . The complete scheme of Barker is as follows:



The theory then is that complex chemical compounds are biodegraded to simpler compounds and ultimately to  $\text{CO}_2$ ,  $\text{CH}_3\text{OH}$  or  $\text{CH}_3\text{COOH}$ ; these latter compounds, through the action of methanogenic bacteria, yield methane through an initial reaction with a hypothetical compound  $\text{XH}$ . Obviously the compound  $\text{XH}$  must be found or demonstrated to exist. It appears that the burden of proof was assigned as a thesis for a Ph. D. degree. The student, Thressa Stadtman, successfully unearthed sufficient evidence to show that  $\text{XH}$  is a cobalt-containing compound that exhibits vitamin  $\text{B}_{12}$  activity. Adding support to the possible involvement of vitamin  $\text{B}_{12}$  in methane fermentation is the finding that sludges from methane fermenters are quite rich in this vitamin, thus opening a new potential of usefulness of the bioconversion process.

The present overall picture of the process of biogas (or methane) formation from organic matter is then as follows:

1. The agent of change (from organic matter to biogas) consists of two groups of bacteria: the methane-forming and the nonmethane-forming bacteria. These latter act on the complex organic compounds in the substrate (raw material), such as cellulose, starch, proteins, fats, etc., converting them to more soluble compounds largely by hydrolysis: the carbohydrates to simple sugars, the fats to fatty acids and glycerol, the proteins to proteoses, peptones, etc.
2. This initial change is followed by a conversion of these compounds largely to acids of one to six carbon atoms, to alcohols of one to five carbons and to other similarly simple compounds. Free oxygen is not needed in the process and is even harmful.
3. The methanogenic bacteria act on these acids, alcohols, etc.; the final metabolic products are  $\text{CH}_4$  and  $\text{CO}_2$  (biogas). These bacteria demand strict anaerobic conditions; even mild oxidizing substances like nitrates must be absent.

4. The mechanism of formation of biogas from simple compounds is not yet very clear but there is evidence that a vitamin B<sub>12</sub> compound is involved, hence the apparent enrichment of this vitamin in the sludge.
5. A decrease in pH as a result of acid formation inhibits the growth of the methane-forming bacteria, therefore acid formation must proceed slowly and in step with the methane-forming process. The maintenance of a proper range of pH is of course attained through the presence of buffers which are generated in the fermenting medium.
6. It is apparent that the rate of acid formation will depend on the rate of the conversion to biogas; that is, acid is allowed to form only about as fast as it is converted to CH<sub>4</sub> and CO<sub>2</sub>.

### **The Bacteria in Biogas Production**

Pig manure, by itself, generates biogas spontaneously, although it takes quite some time for this to happen. Hobson and Shaw (1967), using a 15-liter digester initially filled with water, added pig manure gradually so that the water was replaced in about 4 weeks' time. By then the total solids was 2%. Operating as a continuous-fed system, pig manure was added daily at the rate of 0.03 lb. per cu. ft. per day. At regular time intervals they determined the kind and number of bacteria. Their results were as follows:

First week: Total count was  $5 \times 10^6$  to  $5 \times 10^7$  /ml.

The number of amylolytic bacteria (starch decomposers) was greater than  $4 \times 10^4$  /ml.

Third week: By this time the methanogenic bacteria (methane producers) began to appear, numbering about  $10^3$  /ml. and they increased in number with increasing time.

Fourth to fifth weeks: The cellulolytic bacteria (cellulose decomposing), numbered  $10^4$  to  $10^5$  /ml. The proteolytic bacteria (protein-decomposing) also appeared at about this time at greater than  $4 \times 10^4$  /ml.

Ninth week: The methanogenic bacteria reached  $10^6$  /ml.

In another study of the bacteria in pig dung the following results were obtained by Hobson and Shaw (1967) in a slurry of 4% "settable solids":

Total count at start:

Anaerobic,  $6.4 \times 10^8$  /ml.

Aerobic, about  $2.4 \times 10^8$  /ml.

The nonmethanogenic bacteria were found to be principally the noncellulolytic and the cellulolytic bacteria.

#### **I. Noncellulolytic bacteria.**

1. Streptococci, facultatively anaerobic, constituting 43 to 47% of all isolates. Non-proteolytic and nonamylolytic, probably play a role in maintaining the anaerobic condition in digesters.

2. **Bacteroids**, constituting 20 to 80% of the anaerobic bacteria. Gram-negative pleomorphic rods, short to medium length; some are coccobacilli, mostly amyolytic. Ferment mono- and disaccharides as well as glycerol producing propionic, acetic and butyric acids.

3. **Clostridia**. The most active proteolytic bacteria found belong to three groups:

- A. Amyolytic; very similar to *Clostridium butyricum*; fermentation products are acetic and butyric acids.
- B. Proteolytic; ferment sugars forming acetic and isovaleric acids.
- C. Proteolytic but do not ferment sugar.

II. Cellulolytic bacteria, a heterogenous group present in  $10^4$  to  $10^5$  /ml. were isolated. One isolate was a Gram-positive rod, generally curved, often in short chains. From cellulose, it produced mainly propionic acid, occasionally acetic as well as traces of formic and succinic. Other isolates were Gram-negative coccobacilli or rods of various morphologies. They form volatile acids from cellulose.

III. Other bacteria isolated in small quantities were lactobacilli, staphylococci, glycerol-fermenters and lipolytic bacteria.

The methanogenic bacteria began to appear on the third week and by the 9th week they reached a count of  $10^6$  /ml. Of acids tested as substrates, only formic and butyric acids were converted to methane. The organism was classified as *Methanobacterium formicicum*, a Gram-negative rod of variable length. It produces methane from a mixture of CO and hydrogen gases or from formate, but not from acetate, propionate, isobutyrate, valerate, isovalerate, succinate, pyruvate, glucose, ethanol, propanol, butanol or isobutanol.

The methanogenic bacteria possess the following general characteristics (Barker, 1956):

1. Strictly anaerobic; not only molecular oxygen but also compounds that easily give oxygen like the nitrates must be absent. In Barker's studies (1956), pure cultures of these bacteria were obtained successfully for the first time only by using sodium sulfide to remove the last traces of oxygen.
2. Require a pH range for growth of 6.4 to 7.2 (other authors put the optimum pH at 7.2 to 8.2). However, one species grows at pH 8-9, and in peat bogs where the pH is about 4, some methane is also formed.
3. Utilize ammonium salts as nitrogen source.
4. No known need for nutritional factors (probably amply supplied by commonly used substrates). This is in contrast to other organisms like yeast.
5. Produce methane as a major metabolite.
6. Exhibit extreme substrate specificity; these bacteria are able to utilize only a few very simple compounds.

In accordance with known microbiological techniques, attempts have been made to grow in strict isolation, each species of bacterium that produces methane. This has proven to be very difficult; hence there are only very few that are definitely confirmed to be methane producers.

Barker (1956) classified the methanogenic bacteria as follows:

**Family: Methanobacteriaceae**

**A. Rod-shaped cells**

**I. Nonsporulating: *Methanobacterium***

1. *Mbact. formicicum* ----- CO, H<sub>2</sub>, formate<sup>1/</sup>
2. *Mbact. propionicum* ----- propionate
3. *Mbact. sohngeni* ----- acetate, butyrate
4. *Mbact. ruminantium*<sup>2/</sup> ----- CO<sub>2</sub>, H<sub>2</sub>

**II. Sporulating: *Methanobacillus***

1. *Mbac. omelianskii* ----- H<sub>2</sub>, primary and secondary alcohols

**B. Spherical cells**

**I. Cells not in sarcina arrangement: *Methanococcus***

1. *Mc. mazei* ----- acetate, butyrate
2. *Mc. vannieli* ----- formate, H<sub>2</sub>

**II. Cells in sarcina arrangement: *Methanosarcina***

1. *Ms. barkerii* ----- CH<sub>3</sub>OH, acetate, CO, H<sub>2</sub>
2. *Ms. methanica* ----- acetate, butyrate

**Methane Production in the Rumen** – Pertinent to this discussion on methane producers are the results of studies on the microflora of the rumen. Hungate and co-workers (through Thimann, 1963) have shown that the rumen contains many organisms closely related physiologically, mostly short rod, oval or coccus, which actively ferment cellulose to organic acids like acetic and propionic. Methane results from the secondary fermentation of these acids by methanogenic bacteria which have been found present up to  $2 \times 10^8$  /ml. in rumen fluid. A cow reportedly gives as much as 700 liters of gas in a day.

**Need for a Massive Amount of Starter**

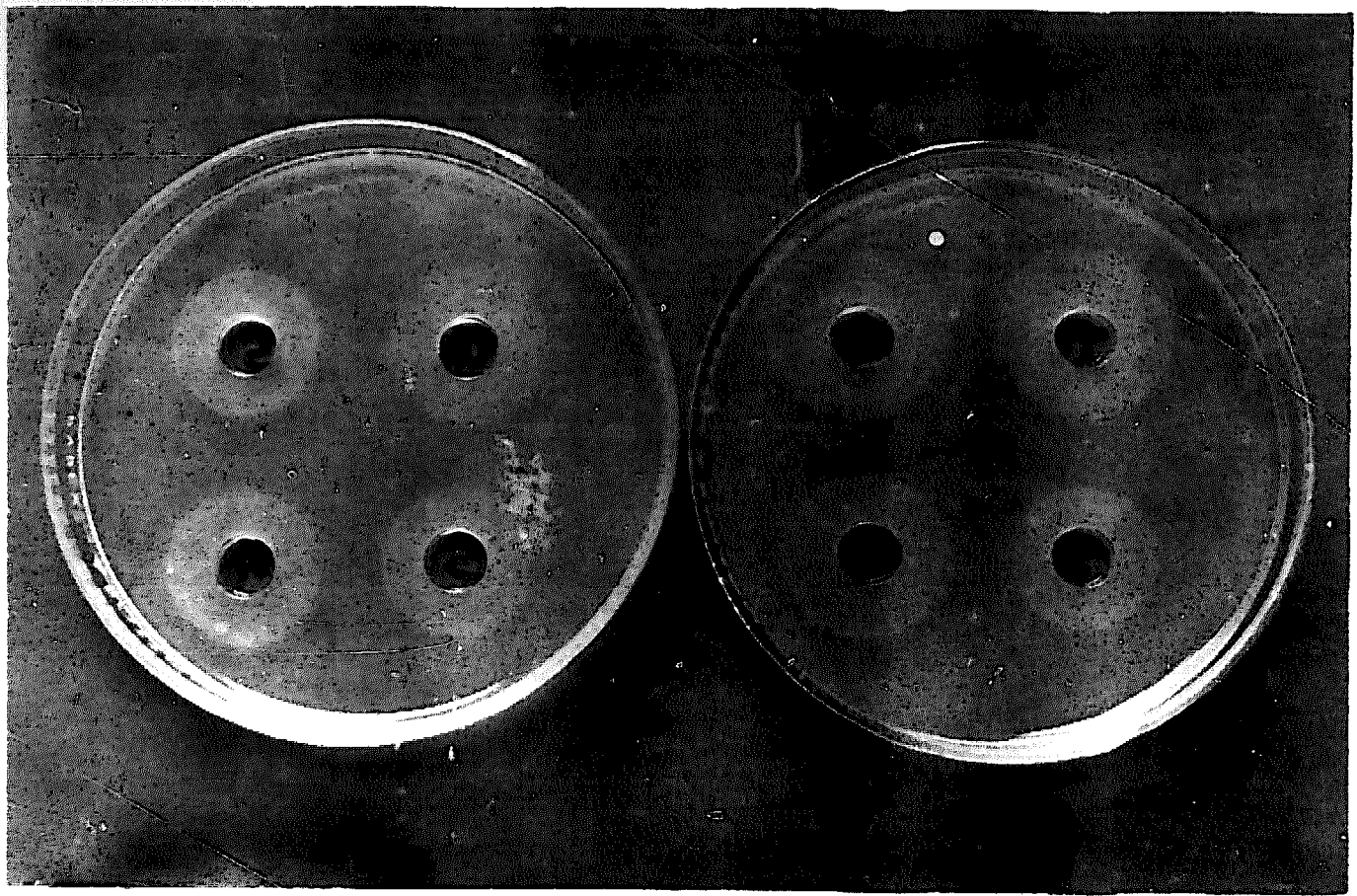
Since both methanogenic and nonmethanogenic populations are needed for biogas production, it is therefore evident that not only should these two kinds of bacteria be present, but they should also be in the optimum proportion. This proportion is no doubt present in an actively fermenting digester, no more than 20 days old, and constitutes the best seed or starter. Additionally such a starter has already developed sufficient buffers to maintain the pH at the desired value. An actively fermenting material also generates hydrogen sulfide (and probably other soluble sulfides) which brings about the highly anaerobic condition demanded by the methane-producing bacteria. It is now understandable why a massive amount of inoculant or starter, no less than 20% of total starting slurry, is insurance against digester failure.

---

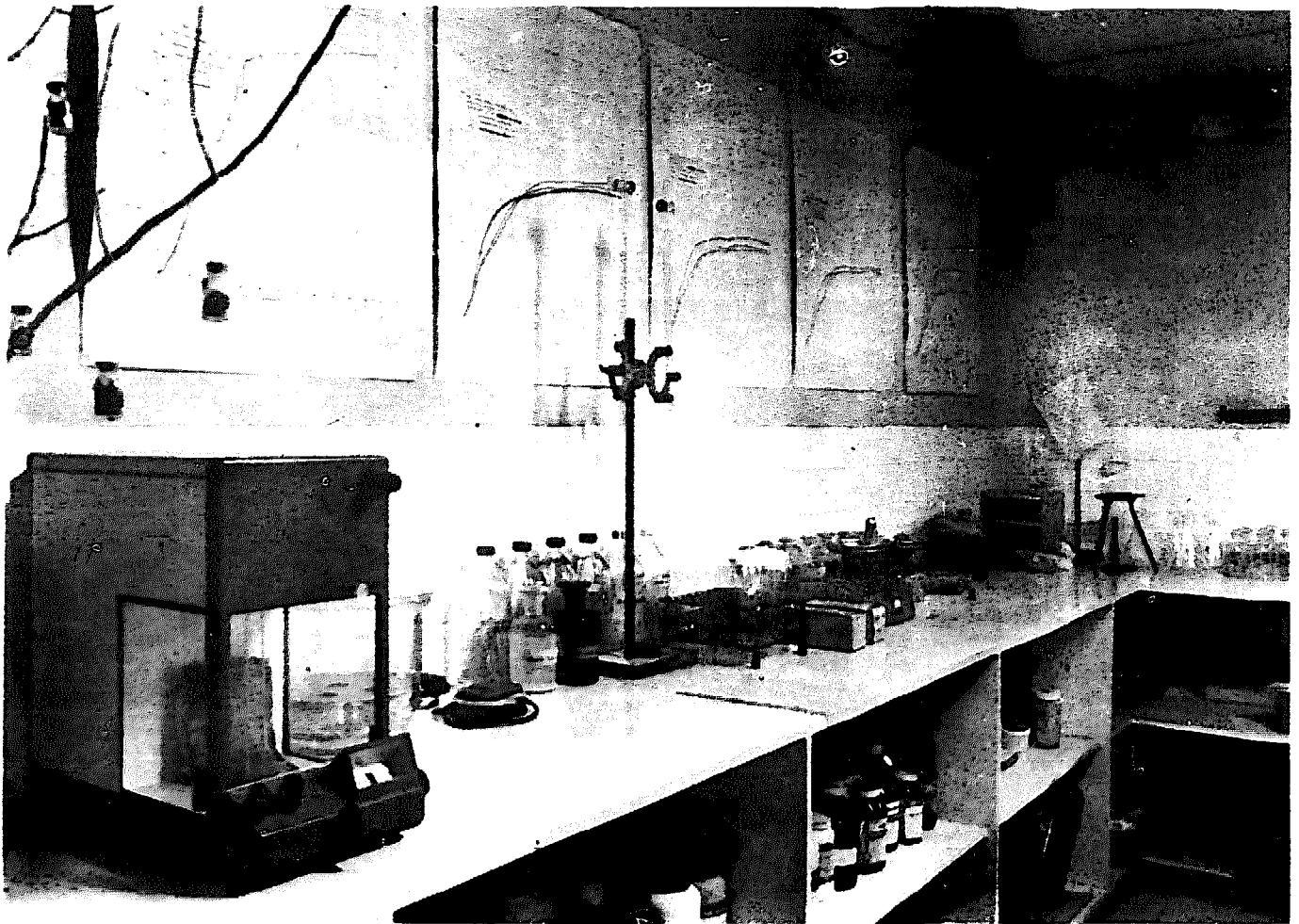
<sup>1/</sup> Known substrates.

<sup>2/</sup> Added to Barker's list.





**Illustration 1-2: Microbiological assay of vitamin B<sub>12</sub>**



**Illustration 1-3: Pollution control laboratory**



## Chapter III

### Laboratory and Pilot Plant Experiments

(All the experiments described in this chapter were conducted in the laboratory at Maya Farms.)

It is highly desirable to get the highest possible conversion of hog manure to biogas and the minimum amount of the sludge by-product. Since eventually the sludge will have to be disposed of, large quantities may present a problem. The fermenting mixture of manure and water should be as concentrated as possible. From the beginning, it was clear that the specific operating conditions would have to be worked out and this would be better done in a laboratory where conditions of operation are smaller and easier to control than in large installations.

For use as a "digester", (as the fermentation tank is called in literature on biogas), the ordinary gallon bottle proved to be suitable. It is easily available, being of local manufacture and often used as container for many liquid food commodities. It is inexpensive, and since cost is a matter of concern when up to a hundred such bottles may be needed at one time, it is therefore adequate for the task on hand. A charge of 2.7 liters of digester slurry into the 3.8-liter (one gallon) bottle leaves a safe headspace of about 1.0 liter. The height of the slurry in the bottle in relation to the diameter gives a 1:1 ratio, a very desirable attribute for anaerobic fermentation. The charge of 2.7 liters of slurry is large enough for good reproducibility among the five replicates that are always run. The usual, although minor, difficulty in inserting several pieces of glass tubing into a rubber stopper is not met since the gallon bottle accepts a large stopper and can easily accommodate 3 to 4 pieces of glass tubing.

#### Laboratory Set-up for Methane Fermentation

The set-up is shown in Fig. 3-1. There are three one-gallon bottles. Bottle A serves as the digester; bottle B is the gas holder and bottle C is the water-overflow collector, empty at the start. The digester (A) is charged with 2.7 liters of the prepared experimental digester slurry, a mixture of hog manure, water and starter. Bottle B is filled completely with water. The rubber stoppers fitted with the interconnecting glass tubing are inserted into the bottles, preferably wired in place since gas pressure is developed. In operation, gas generated in A pushes out an equal volume of water from B to C. The volume of gas can be determined from the volume reading in C which has been previously calibrated. Bottle C may be omitted if a drain can be provided for tube d in which case Bottle B will have to be marked in liters. The digester slurry charged in Bottle A does not usually generate more than 3 liters of gas in 24 hours; hence the water in bottles B and C need not be attended to more than once a day. The gas collected is allowed to escape into the air after due measurement of its volume or after samples are taken for analysis; B is refilled with water collected in C because this water is already saturated with the gas. Solubility correction for gas volume is thus diminished. Bottle A is briefly shaken once a day to loosen up gas



Illustration 1-4: Experimental laboratory digesters at Maya Farms

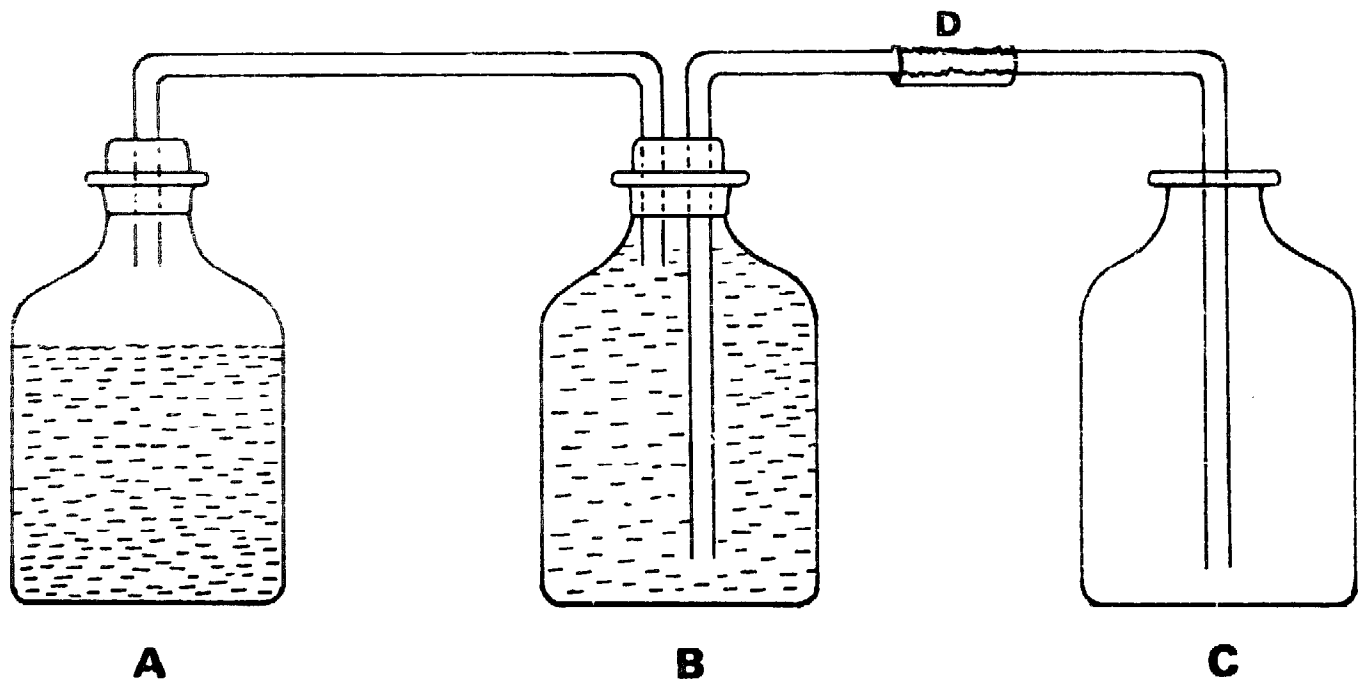


Fig. 3-1: Laboratory set-up for study of biological production of methane

bubbles in the slurry. Gas bubbles are entrapped in the slurry especially in thick slurries. The fermentation room has shelves to accommodate a hundred three-bottle set-ups and adjoins a heated drying room; the temperature in the fermentation room is thus kept at  $31^{\circ} \pm 3^{\circ}\text{C}$  throughout the year. The fermentation room is preferably well-enclosed with a controlled air exit, a small ventilating fan fixed on a convenient wall.

To set up a fermentation run, a digester slurry is made by dispersing fresh hog manure in water, placing the mixture into bottle A and adding the starter. If the desired ratio of hog manure to water is 1:1 and the starter is 25%, then the weight of the starter is  $0.25 \times 2.7$  kg. or 0.675 kg. since the digester slurry totals 2.7 kg. The weight of the manure and the water is  $2.7 \text{ kg.} - 0.675 \text{ kg.}$  or 2.025 kg. and hence, manure weight is 1.0125 kg. In general the relationship is: digester slurry = manure + water + starter. The water for making the slurry is unchlorinated; the starter comes from an actively-fermenting hog manure slurry in its 20th to 25th day of fermentation. The volume of gas evolved is measured every day.

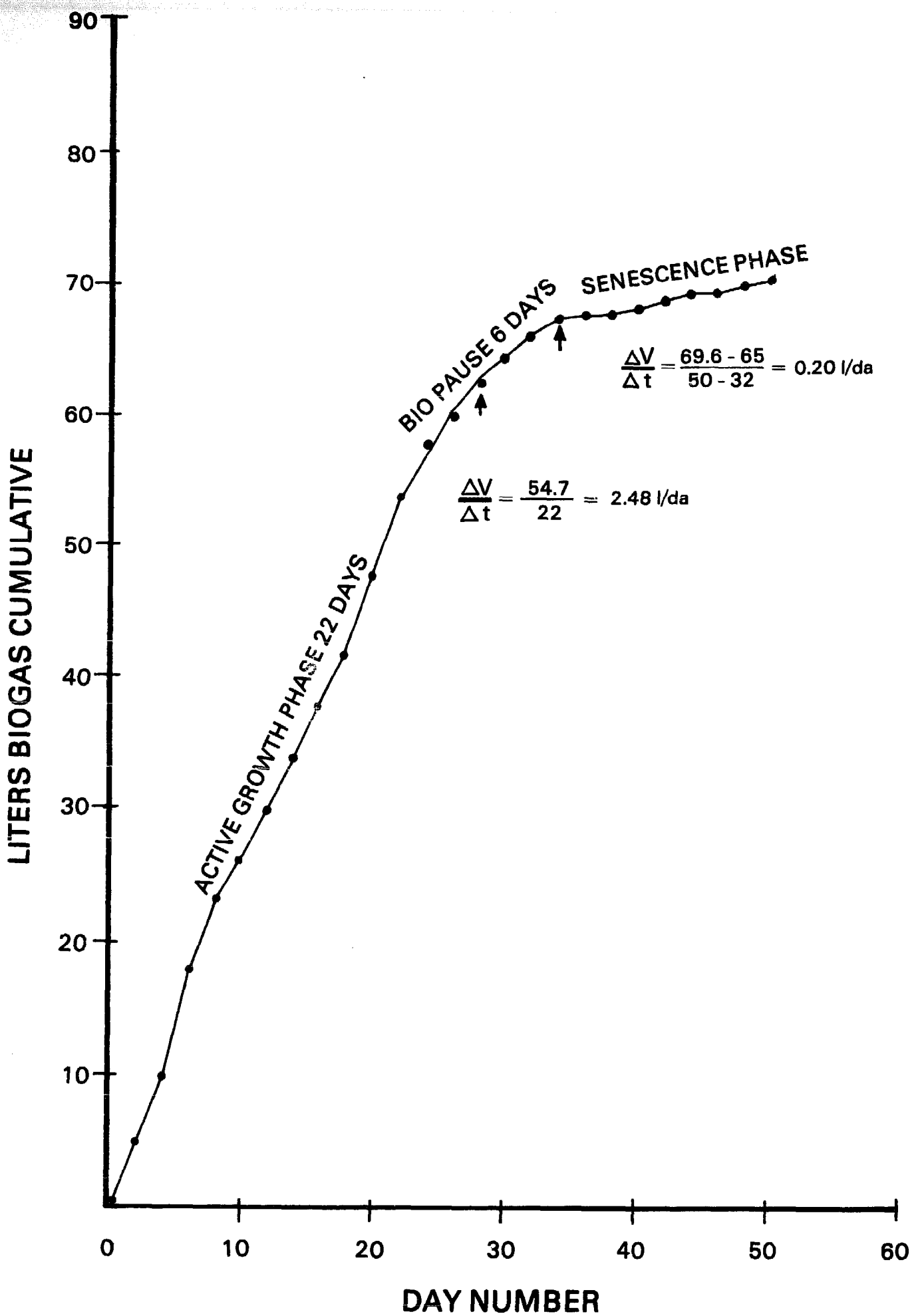
### The Gas Production Curve

The plot of the cumulative gas volume against time (day number) is the gas production curve, Fig. 3-2. Its appearance is similar to the well-known growth curve of bacteria. However, the initial lag phase is not in evidence probably because of the massive amount of inoculant (starter). Gas is measurable within 24 hours and continues to increase; this portion of the curve is the logarithmic phase. In due time the increase in gas volume slackens. The curve makes a bend and continues to increase but at a much reduced rate. This part of the curve is the "senescence phase"; the "biopause" phase is the sector where the logarithmic phase changes over to senescence. In Fig. 3-2 the logarithmic or active growth phase lasts 22 days, followed by the biopause of about 6 days, after which senescence takes over. This is the general shape of a typical gas production curve for methane fermentation.

It will be noticed in Fig. 3-2 that the rate of gas production in the growth phase is much higher than that in the senescence phase. The change-over takes place during biopause. There is reason to operate a fermenter (digester) only up to biopause because of the decline in gas production thereafter. The retention time is the number of days that the fermenting slurry is retained in the digester. Since in the present example the biopause lasts six days, the operator of the fermenter may select his retention time within this period. It is to be noted that retention time may also be selected or adopted. The operator may wish, with reason, to adopt a retention time earlier than biopause although he will be losing gas. He may also prefer a retention time after biopause in which case he will be wasting digester space because his digester produces gas inefficiently after biopause. The time when biopause occurs is therefore important.

The active growth phase and also the senescence phase are very close to being linear. Assuming this to be the case, it is possible to calculate the rate of gas production in each phase. For the growth phase of 22 days, the rate is:

$$\frac{54.7 \text{ liters}}{22 \text{ days}} = 2.5 \text{ liters per day}$$



**FIG. 3-2 TYPICAL BIOGAS PRODUCTION CURVE**

For the senescence phase, taking the gas volume between the 32nd and 60th days, the rate is:

$$\frac{(68.6 - 65.0)}{(50 - 32)} = 0.20 \text{ liter per day.}$$

The rate of gas production during the growth phase is more than ten times the rate during senescence.

The rate of gas production during the growth phase is a good index for the study of conditions for methane fermentation. It is to be noted however that besides the rate in liters of gas per day, another informative ratio is the number of liters of gas per kg. of manure. The various methods that may be used in reporting gas production are shown below:

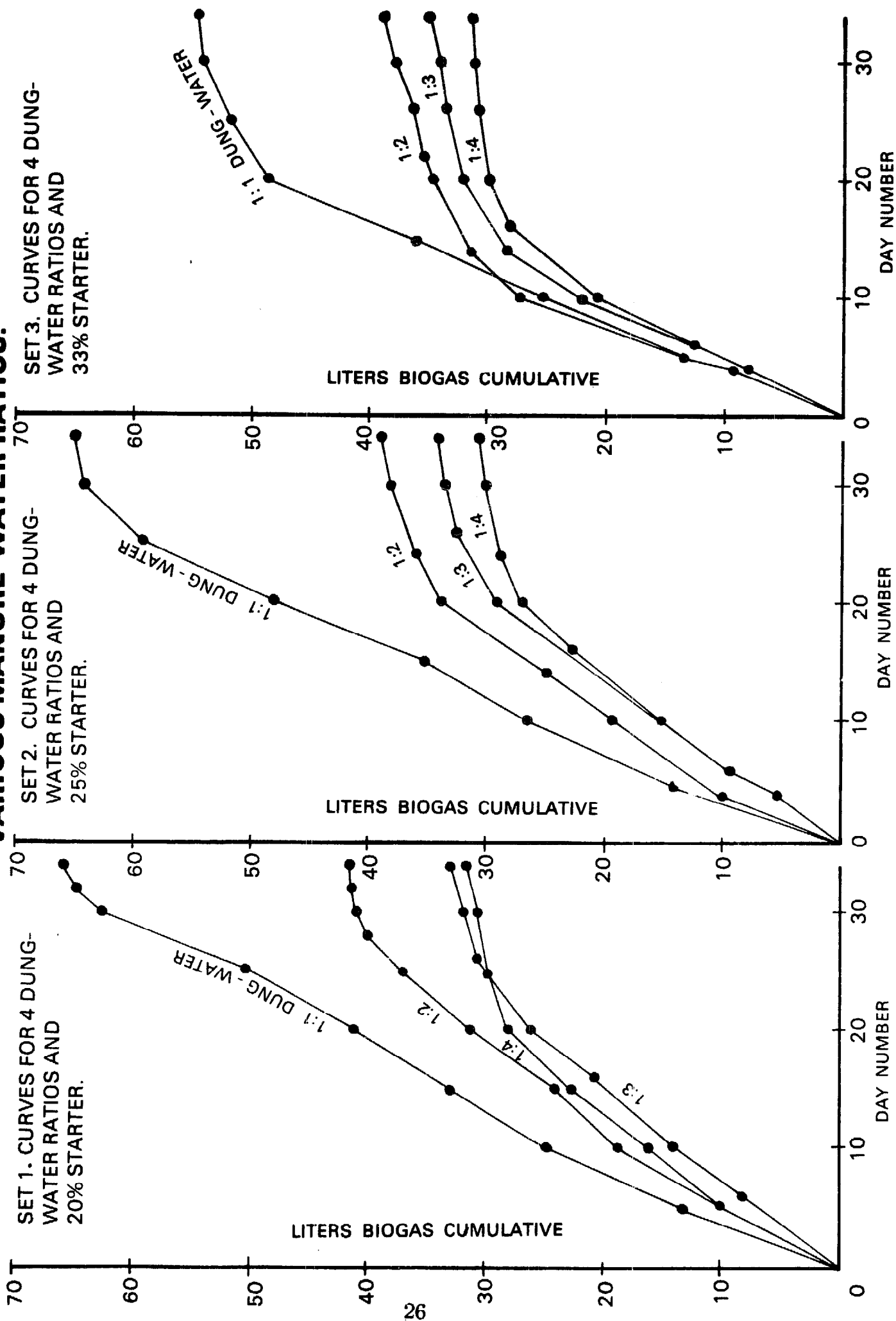
	Time Period in Days		
	0-20	0-30	0-60
Gas volume, liters	48.0	64.5	71.4
Gas per day, liters	2.40	2.15	1.19
Gas per kg. manure	47.4	63.7	70.5
Gas per kg. per day	3.37	2.12	1.12

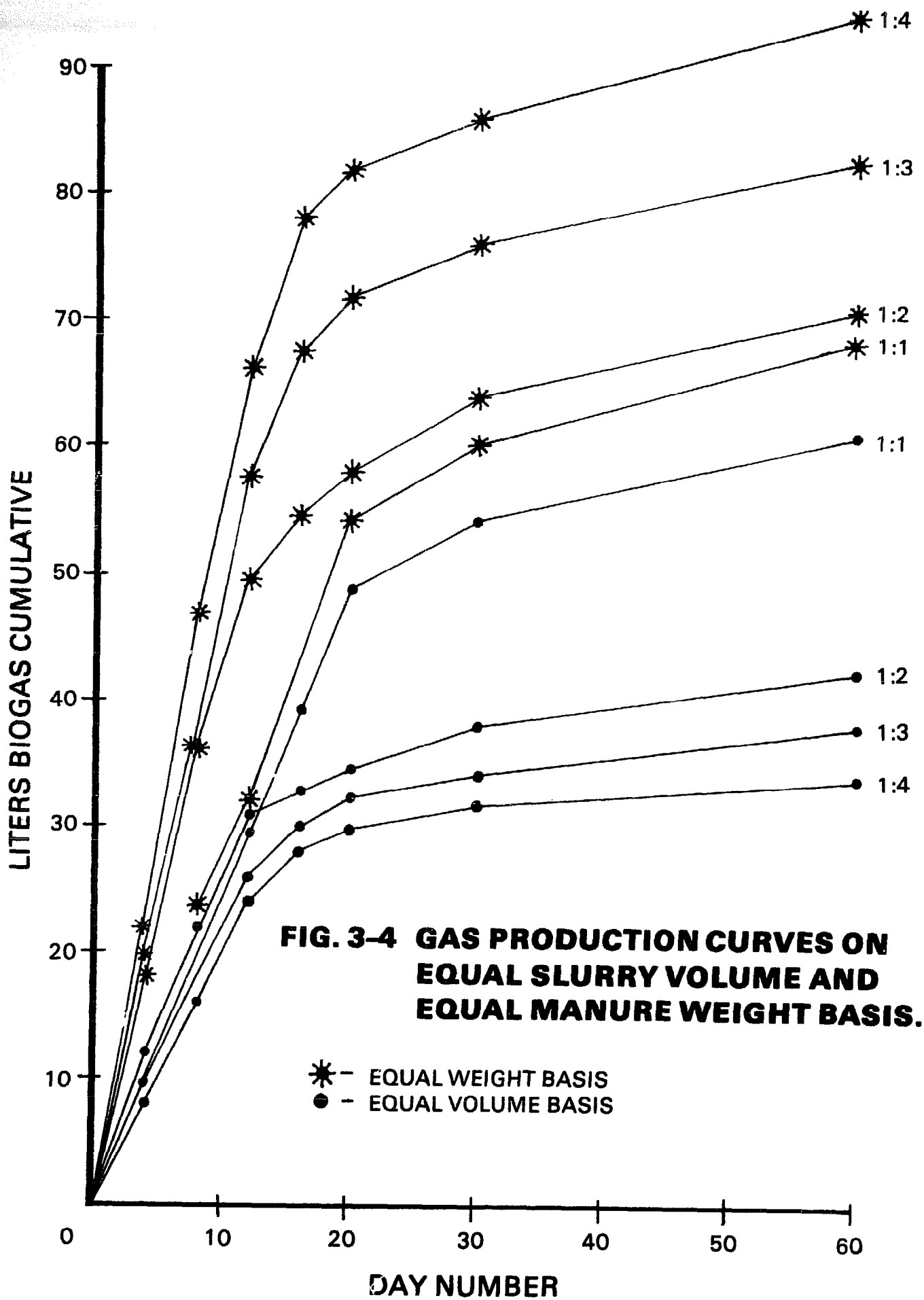
### The Proportion of Manure to Water

The raw material for fermentation in the experiments is hog manure. For biogas production, the questions that arise at the start are: (1) how much dilution with water is needed and (2) how much starter is used. To provide answers to these questions, the following manure-water mixtures or slurries were prepared: 1:1, 1:1.5, 1:2, 1:3 and 1:4 using fresh manure, i.e. collected within 24 hours, and untreated deep-well water. The total volume of the slurry was kept at 2.7 liters (approx. 2.7 kg.) in order not to overload the gallon jar digester. Each bottle was seeded with a vigorously fermenting starter, the amount of which was adjusted so as to furnish starter equivalent to 20%, 25% and 33% (1/5, 1/4 and 1/3) of the 2.7 liters of slurry. The amount of starter is calculated first: 20% x 2.7 kg.; 25% x 2.7, and 33% x 2.7 kg. In a 1:2 manure/water slurry, the weight of manure is  $\frac{2.16}{(1 + 2)}$  or 0.72 kg. and that of water is 0.72 x 2 or 1.44 kg. The weights of starter, manure, and water for the experiments are calculated in the same manner and are tabulated in Table 3-2.

All the experimental "digesters" gave measurable volumes of gas within 24 hours. The amount of gas was measured every day. The plot of gas volumes in liters against time in days are given in Fig. 3-3. In all cases the characteristic gas production curve was obtained, each having a well-defined active growth phase, a biopause and a senescence phase. The lowest percentage of starter employed, namely 20%, appeared to be adequate. The rates of gas production of slurries of equal volume (but different manure-water ratios) are different from the rates calculated at equal manure weights for the same manure-water ratios. When computed on equal weight basis, i. e. per kg. of manure, the curves appear in the reverse order as in the experimental results which are on equal slurry volume of 2.7 liters (Fig. 3-4). It can be seen from the graph that the volume of gas per kg. of manure is larger, the more dilute the slurry. However, the 1:1 slurry gives more gas per day for the same digester space than a more dilute slurry because of the larger weight of raw material (manure) in the 1:1 slurry but less gas on equal weight of manure basis.

**FIG. 3-3 GAS PRODUCTION CURVES FOR VARIOUS MANURE-WATER RATIOS.**





**FIG. 3-4 GAS PRODUCTION CURVES ON EQUAL SLURRY VOLUME AND EQUAL MANURE WEIGHT BASIS.**

\* - EQUAL WEIGHT BASIS  
 ● - EQUAL VOLUME BASIS

### Effect of Stored Manure

There is a belief that storage of pig manure for a few days would enhance its biogas-producing capability. The experimental trials of manure stored at 0, 1 day and 3 days are shown in Fig. 3-5 and indicate that fresh or one day old manure is best for biogas production.

### Amount of Starter

Since the production of methane is a fermentation process, the amount of the inoculant or starter is of prime importance. Literature on the subject is meager. It is practical to use as starter, a portion of a successful methane fermentation from the activated sludge in sewage treatment works. In some procedures, the manure slurry is allowed to ferment without benefit of an added starter. To determine the amount of starter, the apparatus consisted of the previously-described 3-bottle set-up; the digester slurry was fixed at 2.7 kg. manure-water ratio at 1:1 and the starter amount varied to correspond to 0, 5, 10, 15, 20, 25 and 33% of 2.7 kg. The weights involved in kg. were as follows:

	digester slurry = manure + water + starter			
for 0% starter:	2.7	=	1.35 + 1.35	+ zero
for 5% starter:	2.7	=	1.28 + 1.28	+ 0.135
for 10% starter:	2.7	=	1.21 + 1.21	+ 0.270
for 15% starter:	2.7	=	1.15 + 1.15	+ 0.405
for 20% starter:	2.7	=	1.08 + 1.08	+ 0.540
for 25% starter:	2.7	=	1.01 + 1.01	+ 0.675
for 33% starter:	2.7	=	0.90 + 0.90	+ 0.90

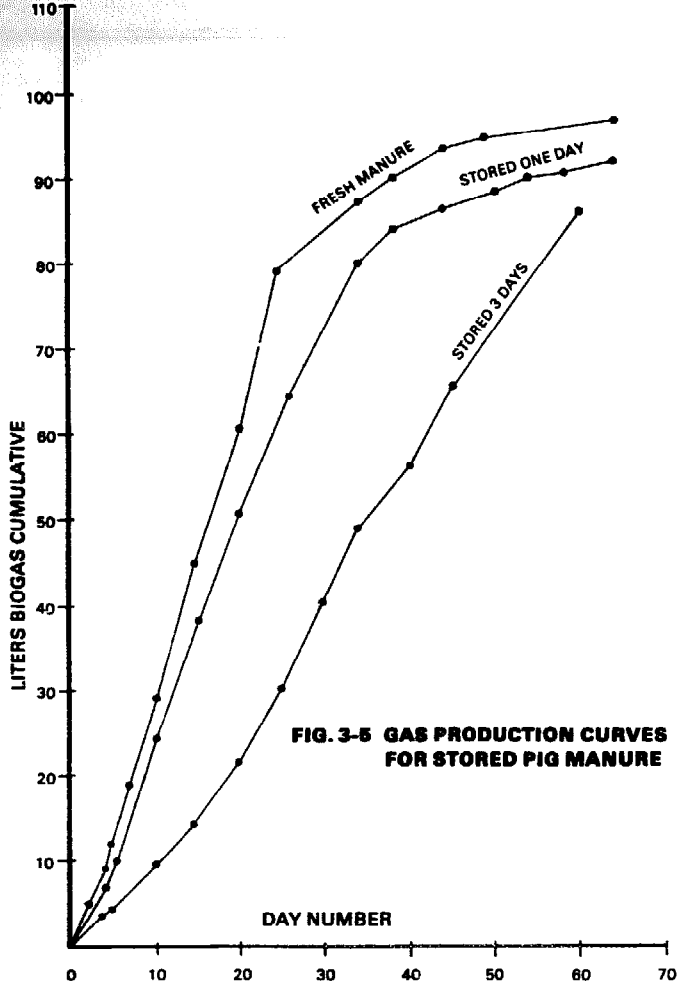
The figures were arrived at by calculating as follows: Weight of starter: 5% of 2.7 kg. = 0.135 kg. Weight of manure and water: 2.7 kg. - 0.135 kg. = 2.565 kg. Weight of manure or weight of water for a 1:1 (w/w) ratio is one half of 2.565 kg. or 1.28 kg.

The results of this experiment are given in the form of gas production curves in Fig. 3-6. It is easily seen that a slurry without added starter is a very poor performer. An inoculant is essential to good gas production. Increasing the amount of added inoculant improves performance up to 20% after which the gas production curves appear normal with well-defined growth phase, biopause, and senescence phase. From this experiment, it seems that the starter must be at least 20% of the weight of the digester slurry. A digester containing 1000 liters of slurry inoculated with 1.0 liter of starter is not likely to perform well. It should be noted that the substrate material, hog manure, is not given a pre-sterilizing treatment; hence it is teeming with many kinds of organisms that can easily overwhelm the bacteria in the starter if these bacteria constitute only a very small proportion.

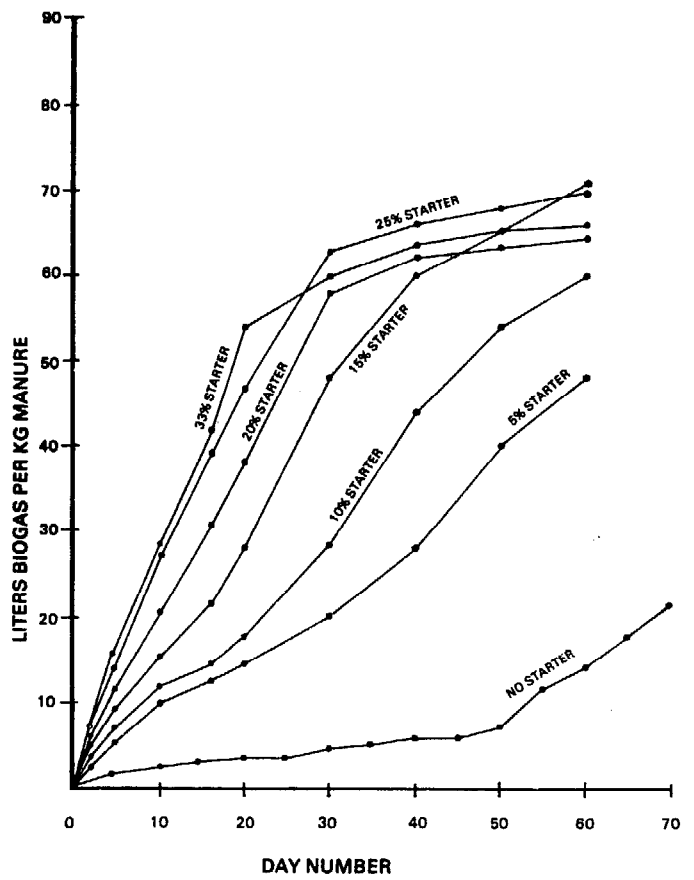
The better performance of fermentation employing larger amounts of starter is further shown in the following tabulation.

Starter, % (A)	5	10	15	20	25	33
Liters gas produced, 20 days (B)	15	18	28	38	47	54
Days to produce 50 liters gas (C)	60	45	31	25	21	19

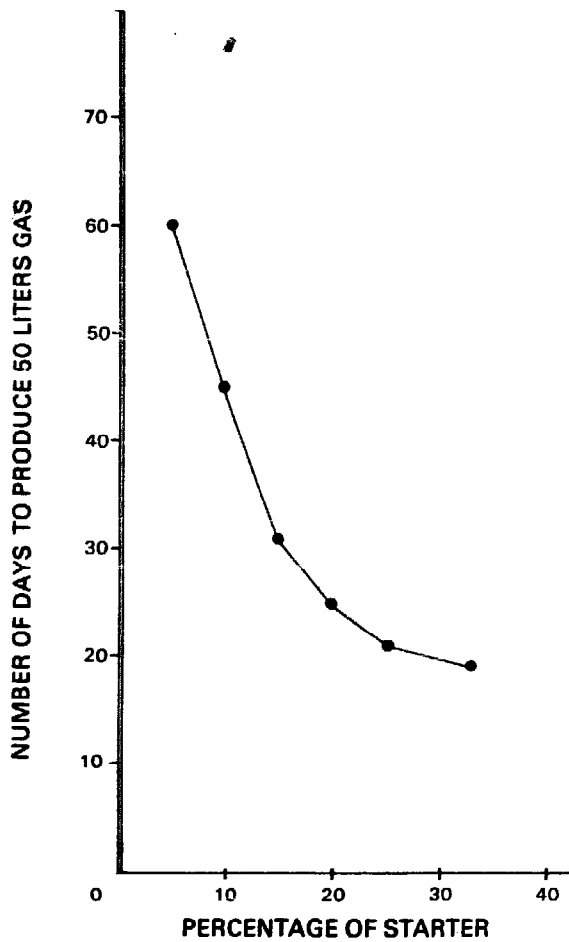




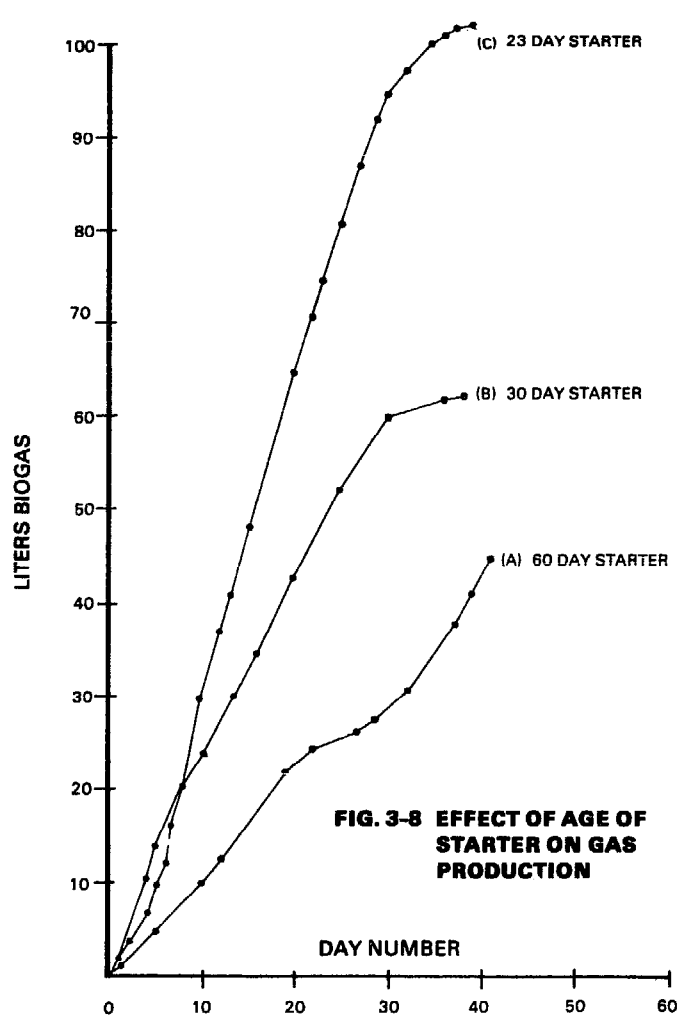
**FIG. 3-5 GAS PRODUCTION CURVES FOR STORED PIG MANURE**



**FIG. 3-6 GAS PRODUCTION CURVES FOR VARYING STARTER PERCENTAGE**



**FIG. 3-7 RELATION OF PERCENTAGE OF STARTER AND NUMBER OF DAYS TO PRODUCE 50 LITERS BIOGAS.**



**FIG. 3-8 EFFECT OF AGE OF STARTER ON GAS PRODUCTION**

With 20 days fermentation time, the 20% starter gave twice as much gas as the 10% starter. This 2:1 relation is also apparent in the 33% and 15% starter. The value B/A is fairly constant; so is the value of A x C. The plot of starter percent (A) against the 20-day gas (B) is shown in Fig. 3-7. It is seen that the higher the percentage of starter, the better is gas production. The extreme case will be the situation where all fermenting slurry is used as starter. It is hardly conceivable that this arrangement can be made practical, but it is what actually happens in a continuous-fed digester which will be discussed later.

### **Age of Starter**

The starter or inoculum should come from a vigorously fermenting slurry; the slurry should be at the active growth phase. In one set of the laboratory experiments, starters coming from slurries that had undergone fermentation for 23 days, 30 days and 60 days were used as starters (five replicates each). The results, as shown in Fig. 3-8, indicate the greater gas production rate as well as relatively larger volume of biogas (30-day period) produced by the 23-day old starter.

### **Gas Production at a Constant Volume of Digester Slurry and at a Constant Weight of Manure**

In the laboratory experiments on the effect of dilution of the manure on gas production, the weights of hog manure had to be varied, since the volume of the digester space is necessarily constant at 2.7 liters. Gas production for this kind of situation is given in the set of curves in Fig. 3-4. The impression is that the more dilute slurries, like 1:4 manure-water mixtures, give a poor performance. When gas production figures are calculated on the per kilogram of manure basis, there is a very striking change in the order of performance. The starred lines of Fig. 3-4 show this. On a constant weight basis, that is, on the per kg. basis, the most dilute slurry gives the larger volume of gas. For comparing efficiencies of gas production from a given material, a comparison based on the yield of one kg. of the material under varying conditions appears logical. For comparison of actual digester performance we cannot neglect the imposed condition of a constant volume of digester slurry.

This discussion brings relative advantages and disadvantages in employing dilute slurries. With the option of operating a digester on thin slurry such as 1:4, one can expect to get a high conversion of manure to gas on the per kg. basis. The retention time is short; experiments indicate a period as short as 15 days or even less, and thus the slurry will go through the digester rather quickly in continuous-fed digesters. Pumps may be used to move the slurry, which is a great convenience. However, there will be a voluminous amount of sludge to dispose of. Since this sludge is quite well "digested", it will be expected to require less conditioning to get it ready for further utilization.

The other option is to use as thick a slurry as possible, 1:1 or even thicker. The material will be difficult to move with pumps. The volume of gas produced per day will be high although the conversion efficiency per kg. manure will be rather low and the post-digestion time will be longer. The digester space per unit weight of manure will be small and retention times will be longer, about 30-40 days. The relative volumes of digester needed when employing various dilutions are shown in Table 3-1. A 1:4 slurry occupies 2.5 times the volume of a 1:1 slurry, although both slurries contain the same initial weight of manure.

TABLE 3-1  
**Relative Volume of Digester Space to Contain  
 One Kilogram of Hog Manure in Varying Manure-  
 Water Ratios. (Starter 20%, Digester Slurry 2.7  
 Liters)**

Manure-water ratio (dilution)	1:1	1:2	1:3	1:4
Weight of manure, kg.	1.08	0.72	0.54	0.432
Digester space (slurry) liters	2.7	2.7	2.7	2.7
Relative digester space	1.0	1.5	2.0	2.5

### **Ratio of Volume of Gas/Day to Volume of Digester Slurry**

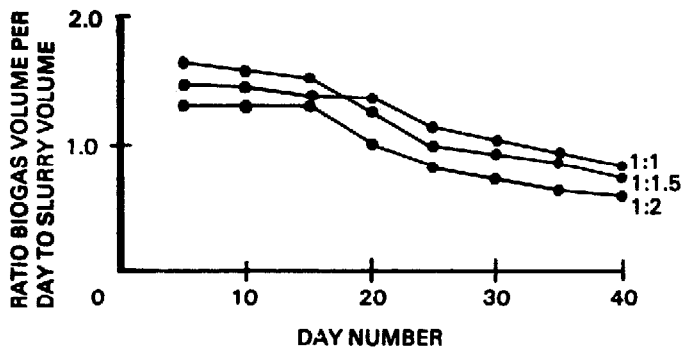
A useful and simple rule of thumb used to check on performance of working digesters is that the value of the ratio of gas volume per day to digester slurry volume, is about 1. Fig. 3-9 gives plots of these ratios in relation to day number of digester operation. From the 5th to the 15th day of operation, the ratio gas volume per day to slurry volume is about 1.5. After 20 days the ratio decreases to less than 1. This is to be ascribed to senescence. Of the three dilutions studied, 1:1, 1:1.5 and 1:2, the last gave the smallest values. A good working digester therefore has a volume ratio of gas to slurry of at least 1:2 (for slurries of 1:1 to 1:2).

### **Rates of Biogas Production**

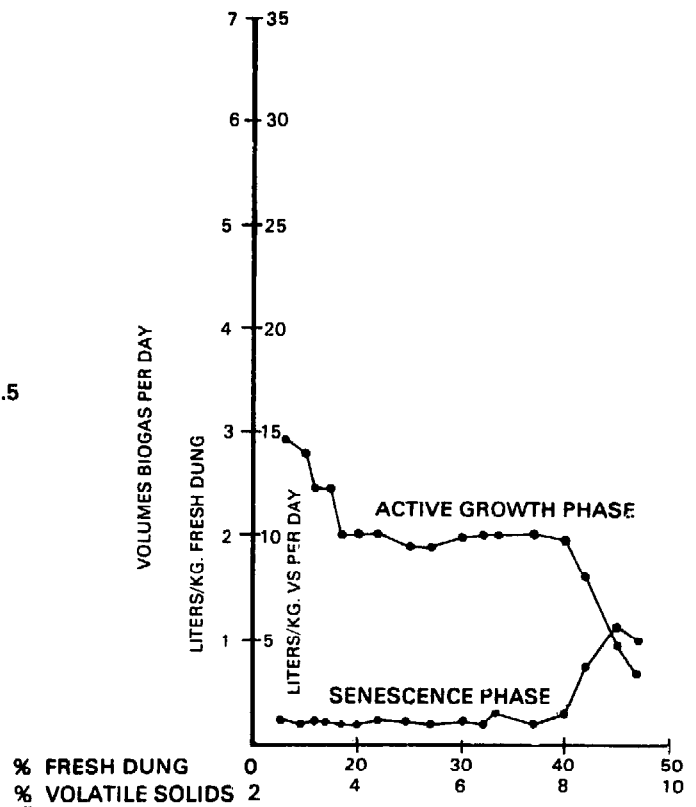
While the total volume of biogas evolved during the active growth phase is useful information, the rate at which the gas is produced is equally of value. The rate may be calculated in liters of gas per day per kg. of starting material. The weight of volatile solids (V.S.) or the non-ash dry matter, is often used by scientific workers instead of the dry matter content. Table 3-3 gives these rates averaged for each of the following time periods: 0-20, 0-30, 0-60 days, and for three starter percentages. The 20-day period comes nearest to the period of active growth, that is, from the start to biopause. The rates are highest in the 0-20 day period and progressively decrease in the longer periods. The decrease is due to the onset of the senescence phase (low rate period). The general average rate of biogas formation for the 0-20 day period is 13.6 liters of gas per day per kg. volatile solids; the value for the 0-30 day period is 10.5 liters/day per kg. V. S. The plot of the rate (liters per day per kg.) against V. S. is shown in Fig. 3-10. At the active growth phase the value of this rate is quite constant over the range of about 4 to 8% V. S. The highest rates are those for more dilute slurries and for shorter fermentation periods, although the limits have not been determined. In so-called continuous-fed operation, the observed high rate of gas production is probably due to the effect of shorter retention time often adopted.

### **Rate of Gas Production During Senescence**

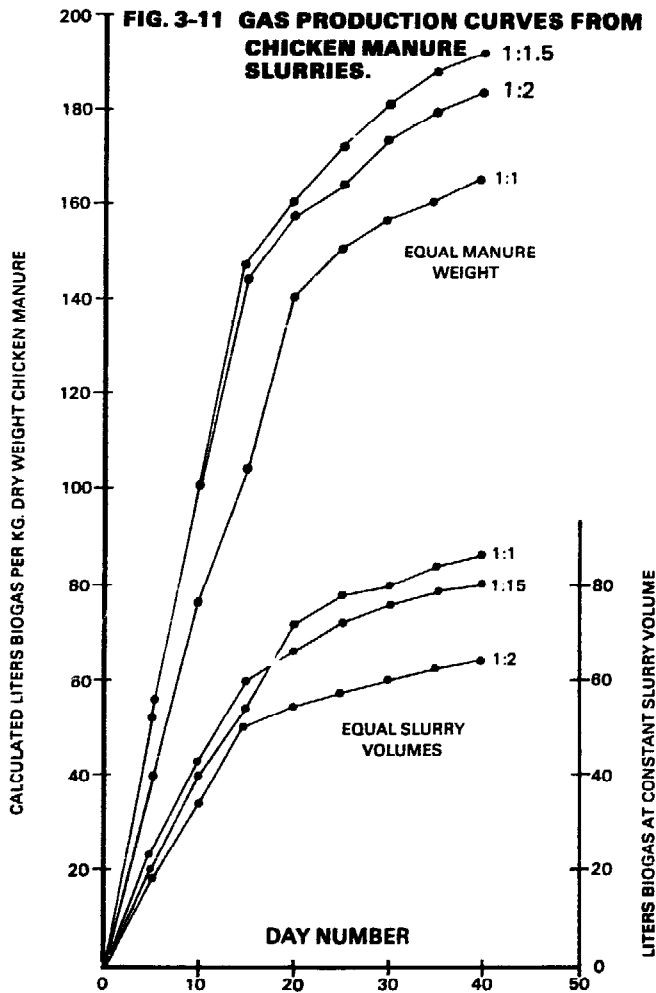
Fig. 3-10 also gives the rates of biogas production during the senescence phase. The calculated values are close to 0.2 liters per day per kg. starting material over the range of 3% to 8% V. S. The senescence rate is about one-tenth the active growth rate. It is to be noted here that these results show that the correction of the observed gas volumes from the volume of gas coming from the starter is small when the starter employed is already at or near senescence.



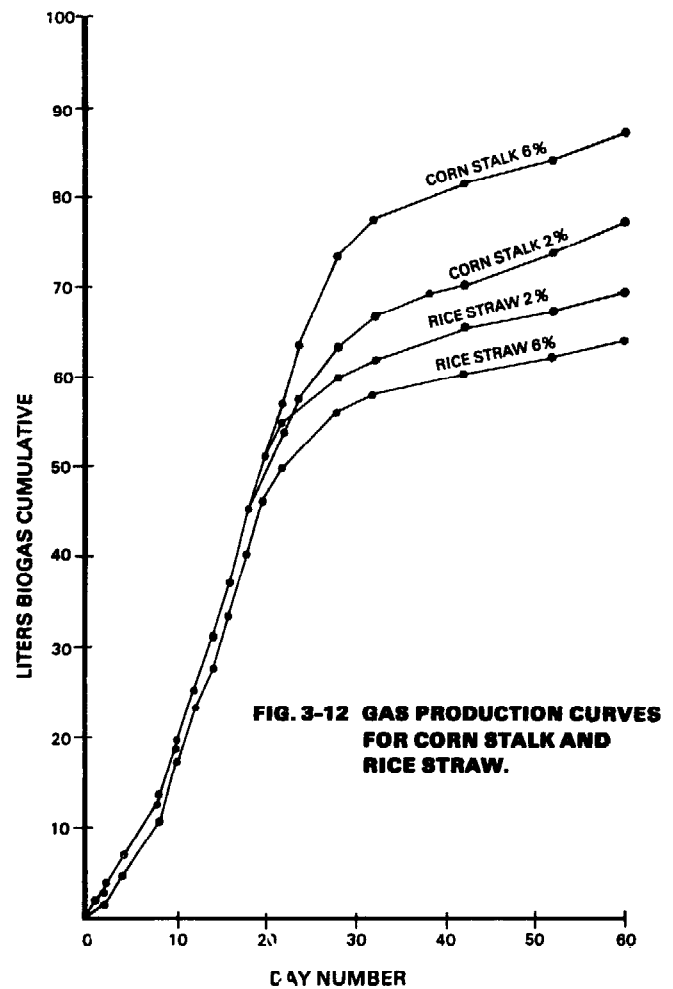
**FIG. 3-9 RATIO OF VOLUME OF GAS PER DAY TO VOLUME OF DIGESTER SLURRY.**



**FIG. 3-10 RATES OF BIOGAS PRODUCTION DURING ACTIVE GROWTH AND SENESCENCE IN RELATION TO DUNG CONCENTRATION.**



**FIG. 3-11 GAS PRODUCTION CURVES FROM CHICKEN MANURE SLURRIES.**



**FIG. 3-12 GAS PRODUCTION CURVES FOR CORN STALK AND RICE STRAW.**

## **Gas Production from Other Substrates**

Fig. 3-11 gives the gas production curves for poultry manure. The volume of biogas per kg. of dry manure is plotted here against number of days of fermentation. The curves show a well-defined active growth phase but the biopause is rather indistinct and merges with the senescence phase. Retention time is therefore not easily determined from the graph. The shape of the senescence curve appears to indicate that the chicken dung was undergoing a relatively strong fermentation beyond the active phase. This may be due to inadequate fine grinding of the manure. Further trials should be made also on greater dilutions, with more stirring and probably the addition of a carbon source since the C/N value for chicken manure is lower than for pig manure. (See Chapter 4).

Fig. 3-12 gives the gas production curves for ground corn stalks and chopped rice straw, both in admixture with hog manure. The gas curves have well-defined phases. The active growth phases have identical slopes for all these substrate materials with a value of 2.87 liters per day, which is higher than in most of the pig manure experiments. Biopause was reached latest with 8% ground corn stalks (26 days) followed by 2% ground corn stalks (22 days); chopped rice straw reached biopause earlier (about 18 days). The senescence phase still produced gas at a fairly high rate, due probably to a secondary fermentation. It is evident that the process of fermentation consisted of a primary process whereby the more easily fermented compounds underwent decomposition at a high rate; this was followed by the decomposition of the more difficultly fermentable materials during senescence, either because of their nature (cellulose, lignin) or because of larger particle size due to inadequate grinding.

### **Desirable Characteristics of a Gas Production Curve of a Batch-fed Digester**

The various forms of gas production curves are shown in Fig. 3-6. There are advantages in having a methane fermentation that proceeds in such a manner that the gas production curve (gas volume plotted against day number) has the following characteristics:

1. Three definite, well-defined phases may be distinguished: active gas production, biopause and senescence. When this is the case, the optimum retention time becomes also definite, so that the number of days of retention in the digester is well-defined.
2. The slope of the senescent phase should preferably be as small as possible, which indicates that the discharged sludge will be evolving very little gas and in consequence have less odor and require less sludge conditioning.
3. The slope of the active gas production phase should be as large as possible and of a constant value; a wavering value indicates that there are factors (change in temperature, lack of stirring, overloading, lack of starter, etc.) that are appreciably affecting the normal operation of the digester.

### **Corrections on the Measured Gas Volumes**

Since the experimental studies involved measurement of gas volumes, the following corrections are applicable:

1. Gas coming from the added inoculum or starter which tends to increase the observed gas volume. According to Fig. 3-10, the rate of gas formation averages 2 liters per kg. per day. The volume of gas from a 20% starter is expected to be  $0.36 \times 0.2 \times 2.0$  or 0.144 liters/

day but only 40% of the manure actually ferments (see Chapter 5), hence  $0.4 \times 0.144$  or 0.057 liter/day; for a fermentation lasting 20 days, the volume of gas coming from the starter is 1.15 liters.

2. Solubility of  $\text{CO}_2$  in water. Such solubility is 0.034 molar or 0.85 liter gas per liter of water at  $25^\circ\text{C}$ , or 1.8 liters gas in 3 liters of water are lost through solubility effect. Part of the  $\text{CO}_2$  continuously diffuses out of the solution into the air; hence the amount of  $\text{CO}_2$  lost is greater than can be accounted for by a mere solubility data. Because of such loss of  $\text{CO}_2$ , the experimentally measured volume of biogas is smaller by at least 1.8 liters than is actually produced in the experiment.

3. Aqueous tension or vapor pressure exerted by water on the gas volume. This value increases with temperature and is about 32 mm. at room temperature. Atmospheric pressure is generally around 750 mm, hence the partial pressure is about 718 mm. The measured gas volumes are therefore to be multiplied by the factor 0.97 to correct the volumes for water vapor.

In summary, the observed biogas volume is larger by 1.15 liters which is the estimated volume of gas given off by the starter in 20 days. It is smaller by at least 1.8 liters due to loss of  $\text{CO}_2$  through its solubility in water at ambient temperature and pressure. The observed gas volume tends to be larger because of the vapor pressure of water; correcting for this factor, the biogas volume is 0.97 times that of the observed volume. All in all, the corrections are small and more or less cancel each other; hence all gas volumes reported are actual measured volumes.

### **Application of Batch Operation Data to Continuous-fed Operation**

The data so far obtained came from experiments where the digester (fermenter) is given one charge of slurry for the duration of the fermentation. The active growth, biopause and senescence phases are all obtained from such batch operations. It is said that the biogas installations developed in the then French Algeria by Isman and Ducellier were of this kind.

Later developments in many parts of the world have favored a system where the digester is given fresh material, usually every day, with automatic displacement of an equal amount of sludge so that this mode of operation has been called continuous-fed operation. In such a case, gas is evolved in more or less constant volume; the slurry is always at active growth phase except at or near the end of the digester where the sludge about to be discharged should be at biopause or early senescence phase. The slurry therefore is fed at one end of the digester, goes slowly through the length of the digester, so that by the time this slurry reaches the exit end, it is already at biopause or senescence phase. The retention time is the interval between the feed-in and the discharge. This is the general idea regarding the continuous-fed mode of operation. Any digester may be operated either batch or continuous-fed, although there are additional requirements for the latter. For example, there must be provision so that the slurry fed in one day does not pass out as sludge the following day.

Obviously it is an advantage to have a sufficiently long digester. The problem of length can be tackled in two ways. First, avoid the question and take any digester (which should have a length). Since most any digester cannot be stretched or contracted to the correct length stipulated by theory, the adjustment comes in the form of the daily feed, also called

load. A retention time which is based on batch experiments has to be adopted. Let us say the time adopted is 25 days. Therefore, for a 1000-liter digester slurry, the daily load of slurry would be 1000 liters/25 days or 40 liters/day. By putting in 40 liters of slurry every day, it will take 25 days for that slurry to reach the exit end.

Second, this time the question is approached head on. Consider again a 1000-liter digester slurry. A retention time based on batch experiments must be adopted, say 20 days this time. Consider the entire digester as consisting of 20 batches, one for each day. We can conceive each daily batch to be in a container holding 1000/20 or 50 liters. Each container must have practical dimensions, say 50 cm. deep, 50 cm. wide and 20 cm. "long". Obviously the length of the desired digester would be 20 times the length, or 400 cm. The complete dimensions of the digester would then be 50 cm. deep, 50 cm. wide and 400 cm. long. The depth and width may be changed to more convenient dimensions but the length should remain the same for 1000 liters slurry and 20 days retention time.

In the preceding discussion it is evident that the value of the retention time is crucial. The retention time normally is selected from any day number within the biopause. There is no way to determine biopause in a continuous-fed digester. The value has to be obtained from a batch operation.

It is noticed that the rate of gas production in a continuous-fed digester is generally larger than in batch. The rate of gas production is somewhat higher at the earlier stages of fermentation at less dilution and with greater proportion of starter. In a continuous-fed operation, the fermenting slurry itself acts as starter; hence, not only is the relative amount of starter very large, but this kind of starter is also at its most active growth phase.

Consider the case when the fermented or fermenting slurry is used as the diluting material for preparing slurries. Since this acts also as starter, the advantage is obvious. This is the situation when there is thorough stirring and it happens in small digesters of cubical or near cubical shape. In digesters that are long with small cross section, the daily load mixes only with the previous day's load or the last two days' load.

**TABLE 3-2**  
**Weights of Components in Experimental Slurries of Various**  
**Manure-Water Ratios and Starter Percentages. (All Weights in Kg.)**

Manure/ H <sub>2</sub> O	20% starter starter soln = 0.54		25% starter starter soln = 0.675		33% starter starter soln = 0.90	
	manure + H <sub>2</sub> O = 2.16		manure + H <sub>2</sub> O = 2.025		manure + H <sub>2</sub> O = 1.8	
	Manure	Water	Manure	Water	Manure	Water
1:1	1.08	1.08	1.013	1.013	0.90	.90
1:1.5	0.864	1.296	0.81	1.215	0.72	1.08
1:2	0.72	1.44	0.675	1.35	0.60	1.20
1:3	0.54	1.62	0.506	1.52	0.45	1.35
1:4	0.432	1.728	0.405	1.62	0.36	1.44

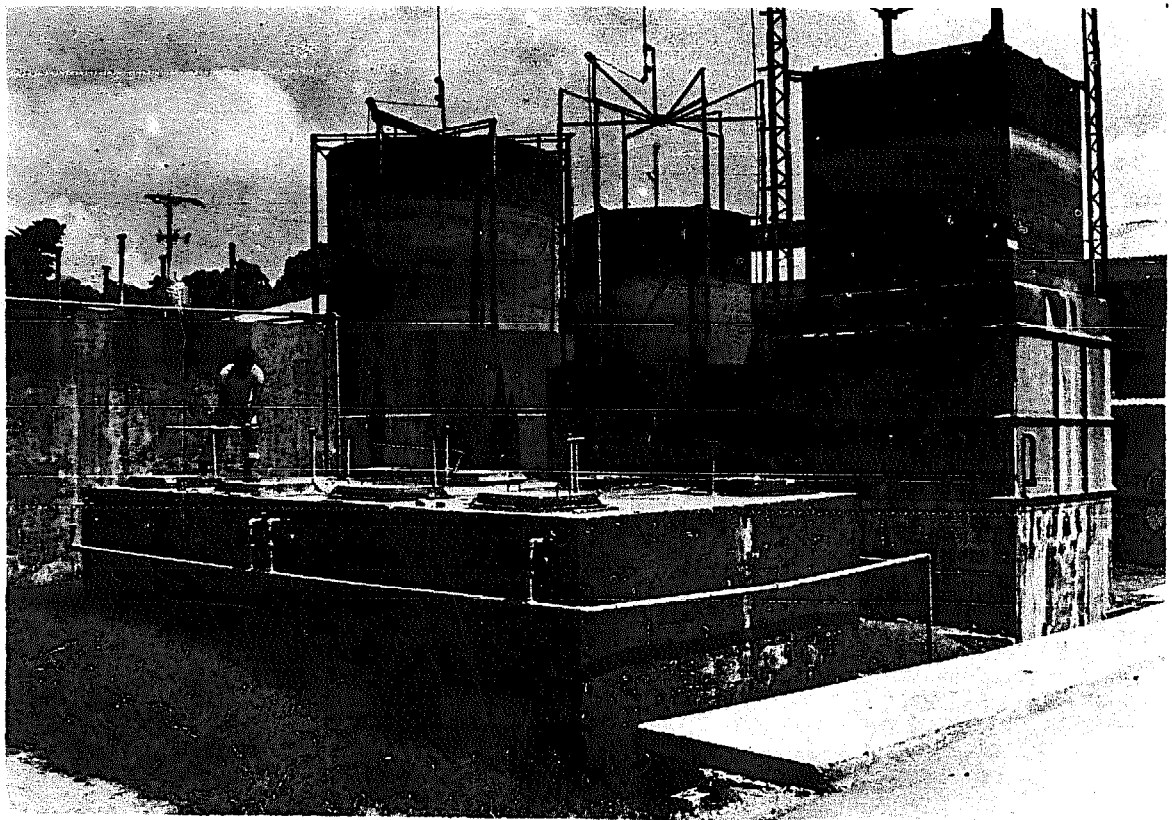
In batch operation, the starter is the smaller component and is added to the slurry which is a much larger amount. Thus, when the starter is 20%, the main body of slurry is 80%. In a continuous-fed operation, the situation is the reverse; the slurry amounts to only the daily load or only 1/30th of the entire digester contents (when retention time is 30 days) but the digester contents act as the starter. It is more realistic to consider, however, that the day's slurry input mixes with the previous two days' slurry in the digester, in which case the effective percentage of starter is about 33%. Such large proportion of starter promotes high rates of biogas production, as has been discussed earlier.

TABLE 3-3

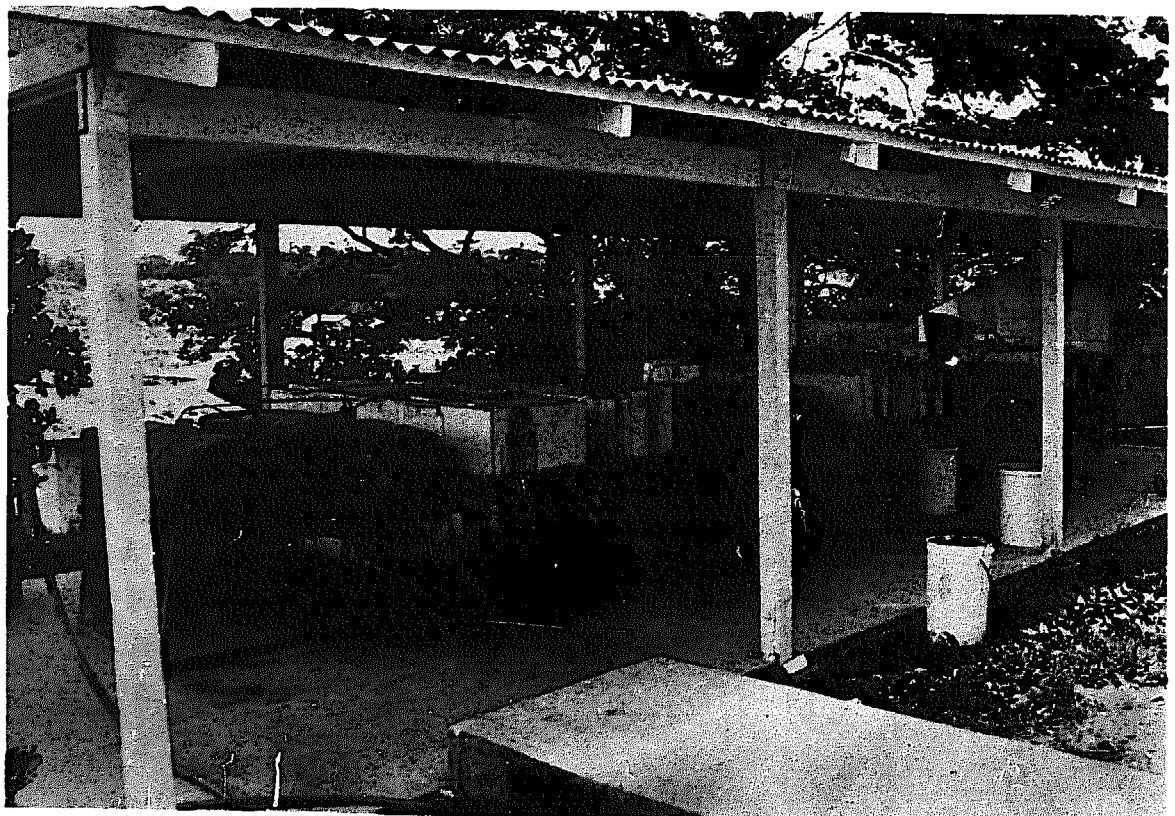
Rate of Biogas Production for Three Time Periods and Three Percentages of Starter.  
(Rates in Liters Gas Per Day Per Kg. Volatile Solids.)

Starter	Manure Water	Time period, days		
		0-20	0-30	0-60
20%	1:1	9.4	9.6	5.5
	1:1.5	10.6	9.9	5.5
	1:2	10.9	7.8	4.3
	1:3	12.8	9.4	5.3
	1:4	15.5	12.2	6.8
	Average	11.8	9.8	5.5
25%	1:1	11.7	10.4	5.8
	1:1.5	13.2	10.2	5.7
	1:2	12.5	9.3	5.4
	1:3	13.2	9.8	5.4
	1:4	17.7	13.8	7.3
	Average	13.6	10.7	5.9
33%	1:1	13.5	9.9	5.6
	1:1.5	13.1	9.4	5.2
	1:2	14.5	10.4	5.8
	1:3	17.6	12.4	6.7
	1:4	19.1	13.5	7.5
	Average	15.5	11.1	6.2
General average		13.6	10.5	5.8

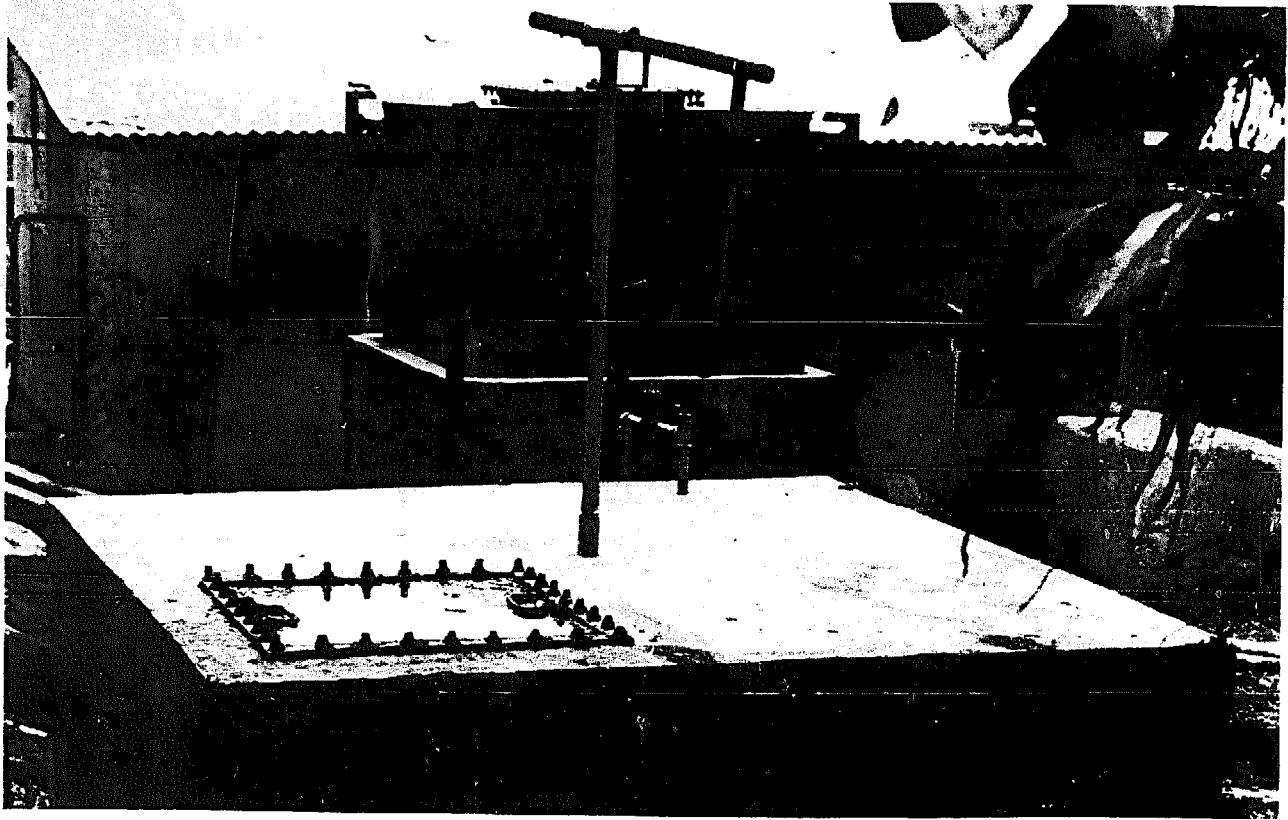




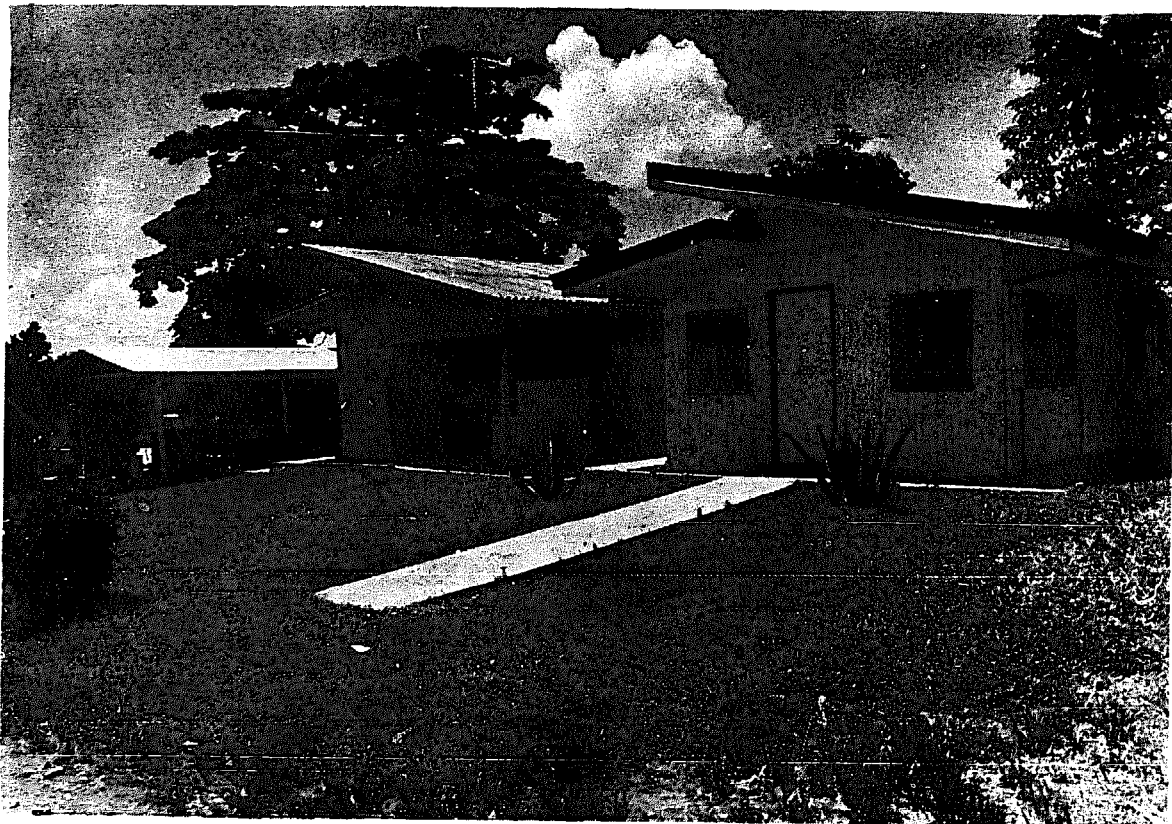
**Illustration 1-5: Pilot plant batch-fed digesters**



**Illustration 1-6: Pilot plant continuous-fed digesters**



**Illustration 1-7: First experimental biogas plant at Maya Farms**



**Illustration 1-8: Laboratories and one of the pilot plants for biogas research at Maya Farms**

## Chapter IV

### Raw Materials for Biogas Production

The raw material for biogas production is organic matter. Marsh gas originates from the decomposition of manure, leaves and similar material through the action of bacteria. All organic matter contains carbon; methane and carbon dioxide are carbon compounds. Thus the first requirement of a raw material for biogas production is that it must contain carbon organically bound. This means that such materials as limestone, an inorganic compound which contains about 12% carbon, will not do.

The conversion of organic matter to biogas is accomplished through the activities of various kinds of bacteria as discussed in an earlier chapter. The element nitrogen, in combined form, is needed by bacteria for their life processes and hence must also be supplied. A deficiency of nitrogen tends to limit the growth and activities of the bacteria. A large oversupply, however, has been found to be detrimental, causing the liberation of ammonia. Cases of ammonia toxicity have been mentioned in literature. What is important is the quantity of nitrogen in relation to that of carbon. It is the consensus that to be adequate, the nitrogen should be about equal to 1/30th the weight of the carbon, that is  $C/N = 30$  at most. Among biogas raw materials, the source of nitrogen is the protein present; proteins in general contain 16% nitrogen. Table 4-1 gives the nitrogen content of some known proteins and the C/N values. When the C/N ratios are large, there is too much carbon. The last column of Table 4-1 gives the value of  $N \times 30$  or the weight of C needed to increase the C/N ratio to 30.

TABLE 4-1

Elemental Composition of Some Proteins

Protein	C (%)	H (%)	N (%)	S (%)	O (%)	C/N	Weight of C to make C/N = 30 grams
Gelatin	49.4	6.8	18.0	0.70	25.1	2.74	540
Fibrin	52.7	6.8	17.0	1.10	22.5	3.10	510
Hemoglobin	52.7	7.3	17.7	0.45	19.5	3.00	531
Casein	53.0	7.0	15.7	0.80	22.7	3.38	471
Gliadin	52.7	6.9	17.7	1.03	21.7	3.00	531
Elastin	51.4	7.0	18.6	0.88	22.1	2.76	558

An idea of the nitrogen content of animal manures, straw, and other possible biogas producers is furnished by Table 4-2. The approximate values of C/N are also given.

The main source of carbon is organic matter, and the carbon compounds in organic matter are carbohydrates, fats and proteins. In Table 4-3 are given the carbon content of

various materials including that of methane, carbon dioxide and butane for comparison. The carbohydrates have a carbon content close to 44%.

Lignin, which is mostly found in wood, has a higher C content but it has been found that it is not easily acted on by bacteria. The fats are very rich in carbon but have not been well studied as biogas material. The compounds that have received much study and have shown to produce biogas are acetic acid, glycerol, ethyl alcohol, methyl alcohol and other relatively simple carbon compounds.

Returning to the C/N requirement, Table 4-1 shows that for the protein known as gelatin,  $N \times 30 = 540$ ; this means that a hundred grams of gelatin containing 18 grams N (18% N) can be mixed with a carbohydrate like cellulose (44.4%) to obtain a C/N value of 30. The weight of the cellulose is calculated as follows:

Weight of C from 100 grams of gelatin: 49.4 grams

Weight of C from the cellulose material: 540 grams - 49.4 grams = 490.6 grams

Weight of cellulose (44.4% C) containing 490.6 grams of C:  $\frac{490.6}{0.444} = 1104$  grams

Hence a mixture of 100 grams gelatin and 1104 grams cellulose has a C/N value of 30.

The situation is reversed in the case of rice straw; the C/N value is 51 and the percentage of carbon and nitrogen are 35.7 and 0.7%, respectively. More N should be available to reduce the C/N to 30. Since the required C/N ratio is 30 and for straw,  $C/N = 51$ ;

$$\frac{(C/N) \text{ straw}}{(C/N) \text{ required}} = \frac{51}{30} \text{ or } 1.7$$

The nitrogen content of the straw must be increased by a factor of 1.7:  $1.7 \times 0.7$  or 1.19 grams. The C/N value is now 30. If ammonium sulfate, 20.2% N, is to be used as N source, then

Weight of ammonium sulfate containing 1.19 grams N =  $\frac{1.19}{0.202}$  or 5.95 grams

To calculate how much N is needed by cellulose so that  $C/N = 30$ , Table 4-3 provides data. Since cellulose contains 44.4% C, 100 grams cellulose need 1.48 grams nitrogen. This may be supplied by urea which contains 46.6% N, 20% C.

$$C/N = \frac{\text{Weight C}}{\text{Weight N}} = \frac{44.4 + 0.2 W}{0.466 W} = 30, \text{ where } W \text{ is weight of urea}$$

$$W = 3.22 \text{ grams}$$

Urine may be used as the source of urea. It contains (on the average) 2% urea (w/v) or 0.02 grams/ml., hence the volume needed to supply 3.22 grams of urea is:

$$\frac{3.22 \text{ grams}}{0.02 \text{ grams}} = 161 \text{ ml.}$$

Other natural sources of N may be used. For example, hog dung which contains 2.8% N:

$$\frac{1.50 \text{ grams}}{0.028 \text{ grams}} = 53.6 \text{ grams hog dung}$$

to supply 1.50 grams N which are needed by the cellulose in the preceding case.

The large amounts of cellulosic materials left over as residues by crop plants have been the center of interest in the past, regarding potential for biogas production. The situation has changed and at present, interest and concern have moved to animal manure because of a relatively new problem – pollution. Increased population together with migration to the cities has resulted in the commercial-scale raising of food animals. Large numbers are reared and fed in confinement; this has led to accumulation of manure which has become a major pollutant. Fresh manure is difficult to dispose of; it is not easy to incinerate, not only because of the amount of water it contains, but also because of the foul odor during burning. Disposal by spreading requires large areas of land. Lately there have been several symposia in the United States and elsewhere on the subject of animal waste disposal. It is now becoming more and more apparent that one of the successful and practical methods is methane fermentation. There have been found several concomitant benefits besides pollution control which are dealt with in the succeeding chapter on sludge.

### **Hog Manure**

Of the animal manures, hog dung probably presents a representative problem. Since it is a singularly good material for biogas production, it will be discussed lengthily. Tabulated in concise form (Table 4-5) are its characteristics. Part I of this table, which gives the amount of dung in relation to hog weight is useful in making estimates of dung production. Although the data are from American observations, nevertheless they can be taken as a general guide.

Part II, nutrient composition, shows results obtained from the Maya Farms laboratory analysis of hog dung. Part III gives calculated values of certain data of importance in biogas production. As has been pointed out earlier, carbon is the key element in biogas formation. This carbon is a part of the volatile solids which is the non-ash constituent of the dry matter of the dung. In current publications the yield of biogas is often quoted on the basis of dry matter; more often, on the basis of volatile solids. We prefer to use the carbon content as basis since biogas originates from the carbon in the raw material.

In Part III of Table 4-5 are given the calculated values of the expected volume of biogas from hog dung based on carbon content. These are 200 liters/ kg. fresh dung, 798 liters/kg. dry matter, and 988.5 liters/kg. volatile solids. These volumes are at the temperature range of 30°-34°C and at atmospheric pressure. These values set the upper limit of biogas production from hog dung.

### **Human Excreta as Biogas Raw Material**

The question has often been asked as to the possibility of using human excreta for biogas production. This matter is of interest to the person who wants to dabble in biogas

but has neither animal dung nor crop residues; the only materials readily and constantly available are feces and urine. The question was answered in the affirmative long ago. Sewage treatment plants have incorporated the anaerobic digestion step, thereby producing biogas. The gas is used in the treatment plant for generating electricity.

### **Other Animal Manures**

The main raw materials for biogas production nowadays are the various animal manures, also called animal wastes or dung. There appears to be very little study on their nature and composition, yet they present a pollution problem that can be expected to continue to increase with the expanding population. One would expect animal manure to be a valuable material, considering that reportedly only 16% of the feed given to chicken is recovered as poultry meat and about 20% of the feed given to pigs is recovered as pork. A lot of original animal feed is therefore present in the manure, and its utilization is of importance. The nutrient composition of several animal manures is given in Table 4-2. There is little information on what compounds are actually present. From available data (Concepcion, 1936; Hobson and Shaw, 1967; and others), the main components are the following:

1. Feed residues, undigested or only partly so, but not absorbed in the digestive tract of the animal
2. Intestinal bacterial cells which may constitute as much as 40 percent of the total solids of the manure
3. Intestinal secretions
4. Residues of bacterial action.

Since manure is composed partly of feed that has undergone digestive processes in the animal, it is a unique material that has already undergone partial proteolytic and amylolytic action (in the case of ruminants, also cellulolytic). The bacteria not only cause further chemical changes but also add their cell constituents. The amount of these bacterial cells is considerable, being reported as 20 to 40% of the dry matter of manure. As is to be expected, the composition of manure varies with the kind of animal, age, composition of feed, etc. As far as methane production is concerned, the information needed is what components are sources of gas. According to Maya Farms studies, which are discussed in Chapter 5, the main sources are the carbohydrates. The relative weights of components of hog manure are shown in Table 4-4.

Regarding the production of biogas from organic matter, it is to be noted that the gas production curves exhibit a characteristic of not dying off abruptly. Gas is produced at a steady rate from the start, up to a falling rate (about 1/10th of previous rate) but not to zero rate. This may be interpreted as continuing gas production from more resistant substrates, probably cellulose and lignin. The less resistant substrates are likely the starches, sugars and similar compounds. So far our substrate materials have not included the fats and oils, hence no statement can be made about them. Peanut (or ground nut) oil meal was reported as an excellent methane-producing material in India.

It appears that in biogas formation from most organic matter like pig manure, the process consists of two parts: the rapid conversion to gas of the more vulnerable components, chiefly the carbohydrates, followed by a comparatively slower gas

production from the less fermentable materials at about one-tenth the former rate. The rapid rate lasts anywhere between 15 to 25 days, depending on several factors; the slower rate persists for some time, extending even beyond 60 days. An estimate on the relative amounts of organic matter conversion to biogas will be shown in Chapter V.

TABLE 4-2

The Carbon/Nitrogen Ratio, Total Solids and Volatile Solids of Some Biogas-Producing Materials

Biogas-producing materials	Total solids (%)	Volatile solids (% of total) % of T.S.	C (%)	N (%)	C/N
<b>A. Animal Dung</b>					
1. Hog	25	80.7	38.3	2.8	13.7
2. Carabao	15	80.5	37.0	1.6	23.1
3. Cow	16	77	35.8	1.8	19.9
4. Chicken	48	77.4	35.7	3.7	9.65
5. Duck	53	23.6	21.9	0.8	27.4
6. Pugo	30	81.8	33.7	5.0	6.74
<b>Household Wastes</b>					
1. Night soil	15	90	47.7	7.1	6.72
2. Kitchen waste	31	92	54.3	1.9	28.60
<b>C. Crop Residues (air-dry)</b>					
1. Corn stalk	86	92	43.9	1.2	56.6
2. Rice straw	89	79	35.7	0.7	51.0
3. Corn cobs	82	96	49.9	1.0	49.9
4. Peanut hulls	90	95.5	52.7	1.7	31.0
5. Cogon	—	92.8	—	1.07	—
6. Bagasse	—	95.5	—	0.40	—
<b>D. Others</b>					
1. Kangkong	4	84	33.5	4.3	7.8
2. Water lily	5	77	33.0	2.9	11.4
3. Grass trimming	15	87	39.2	2.5	15.7

**TABLE 4-3**  
**Carbon Content of Selected Materials**  
**Related to Biogas Production**

Material	C (%)	H (%)	O (%)	Weight of N to make C/N = 30 (grams)
Glucose	40	6.7	53.3	1.33 <sup>1/</sup>
Sucrose	42.1	6.4	51.5	1.40
Starch	44.4	6.2	49.4	1.48
Cellulose	44.4	6.2	49.4	1.48
Hemicellulose	45.4	6.1	48.5	1.51
Lignin	62.69	5-6.5	26-33.5	2.07-2.3
Fats	76.79	11-13	10-12	1.53-2.63
Coconut oil	73.3	11.6	15.0	2.44
Acetic acid	40.0	6.7	53.3	1.33
Methane	75.0	25.0	0.0	-
Carbon dioxide	27.3	0.0	72.7	-
Glycerol	39.1	8.7	52.2	1.30
Ethyl alcohol	52.2	13.0	34.8	1.74
Methyl alcohol	37.5	12.5	50.0	1.25
Butane (LPG)	82.8	17.2	0.0	-
Propane (LPG)	81.8	18.2	0.0	-

<sup>1/</sup> 100 grams glucose contain 40 grams C and need 1.33 grams N so as to have a C/N value of 30.

**TABLE 4-4**  
**Relative Weights (Grams) of Components of Hog Manure**

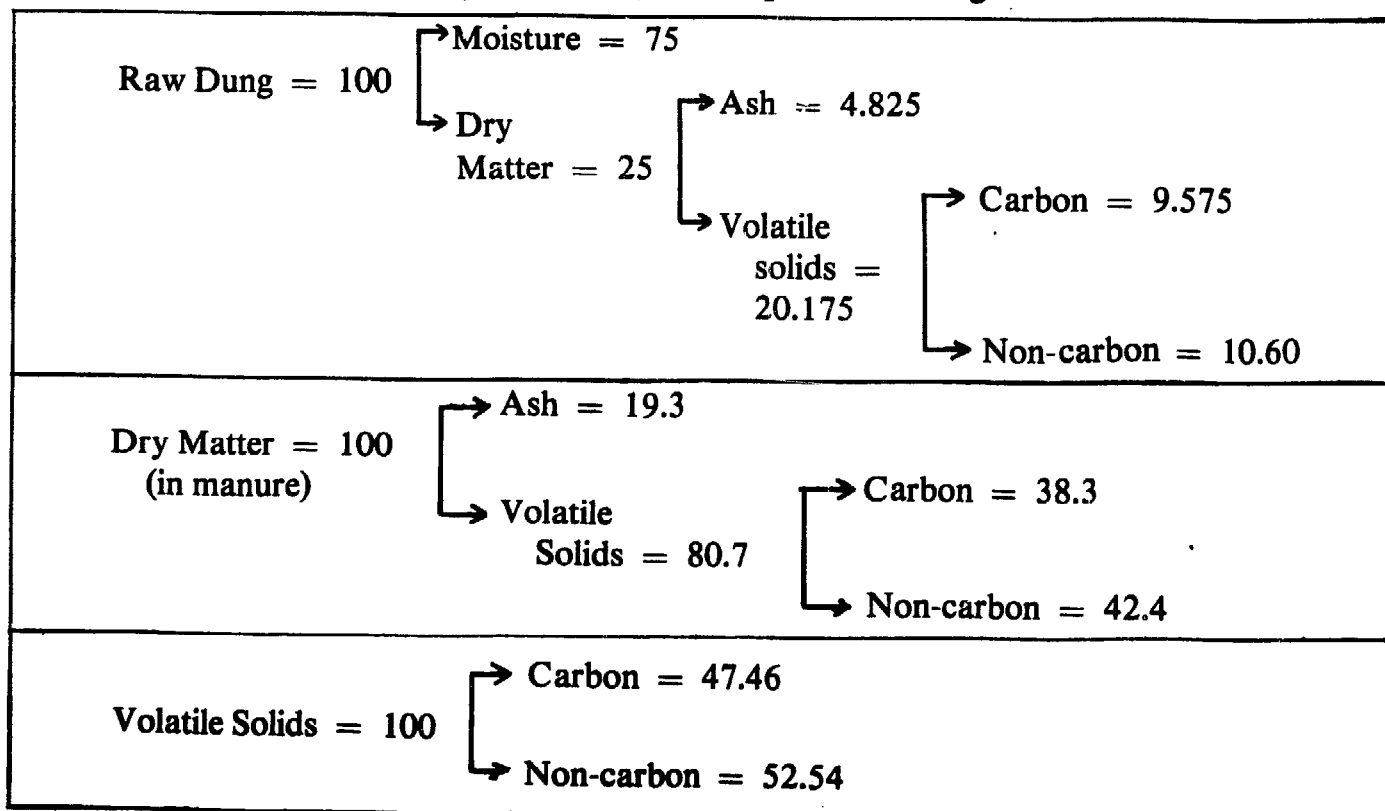




TABLE 4-5

Characteristics of Hog Manure

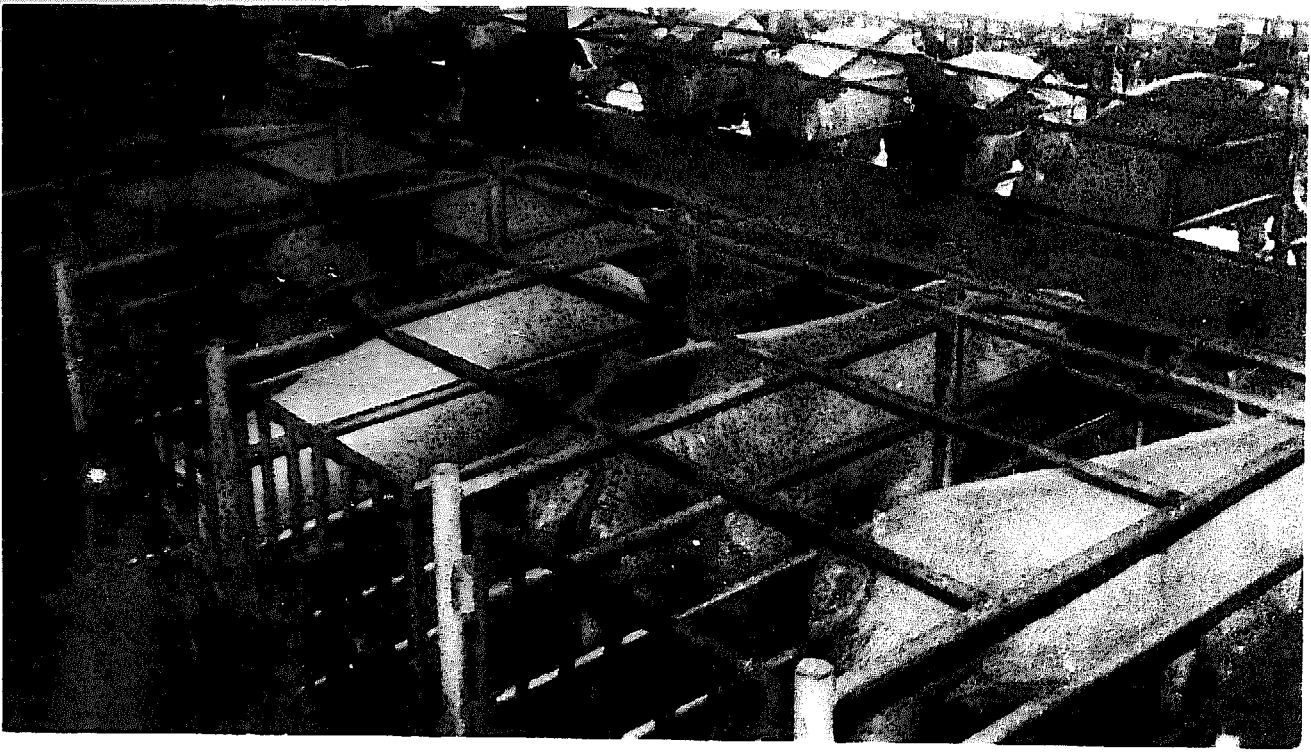
<b>I. Amount of Manure in Relation to Hog Weight (Fry)</b>			
<b>Hog Weight (kg.)</b>	<b>Manure (kg./day)</b>	<b>Feces (kg./day)</b>	<b>Urine (kg./day)</b>
18-36	2.55	1.23	1.32
36-55	5.22	2.45	2.77
55-73	6.67	2.95	3.68
73-91	8.00	3.86	4.14

<b>II. Composition (Maya Research Lab, 1975)</b>	
Moisture	75.0% fresh weight
Ash	19.3% dry weight
Protein	17.5% dry weight
Fat	3.3% dry weight
Fiber	16.1% dry weight
NFE	43.8% dry weight

<b>III. Biogas Production Characteristics for Hog Manure (Maya Research Lab., 1976)</b>			
	<b>Fresh basis</b>	<b>Dry basis</b>	<b>V. S. basis</b>
Total solids, %	25	100	—
Volatile solids (V.S.), %	20	80.7	100
C, organic, %	9.57	38.3	47.5
N, %	0.7	2.8	3.47
C/N ratio	13.7	13.7	13.7
Gas, liters/kg. material (Theoretical)	200	798	988



**Illustration 1-9: Animal manure and crop residues are the biggest potential sources of biogas.**

## Chapter V

### The Sludge

The by-product of the biogas plant is the sludge, an aqueous suspension of solids in a liquid. It has the appearance of dark mud, and on closer look, fine fibers become evident. When newly discharged, it still lets off biogas slowly (senescence phase). The original offensive odor of hog manure is replaced by an entirely different odor, that of hydrogen sulfide. The volume of the sludge is large, for there is very little volume decrease brought about by methane fermentation. The disposal of the sludge thus presents a formidable problem for the large biogas plant. The gravity of this problem had not previously been realized because biogas plants have generally been small family-size affairs producing sludges that could easily be shovelled and spread in orchards or vacant lots. Since the Maya Farms had to cope with the manure of 10,000 hogs, the area needed for this amount of sludge to be disposed of became colossal. (For 30,000 cu. ft. per day of biogas produced, there are 37 tons per day of sludge). Unless useful outlets can be devised for the utilization of this sludge, it can be concluded that the methane fermentation process is not a solution to the pollution problem posed by animal wastes.

#### Characteristics of the Sludge

The characteristics of the sludge vary with the retention time adopted. Strictly speaking, retention time should be a time beyond the active growth phase. This is not easy to determine in continuous-fed closed digesters. It is only in batch laboratory fermentations, where a daily record of gas output is kept, that the end of the growth phase can be ascertained. In continuous-fed digesters, the retention time is selected or adopted, there being no quick practical method. The sludge we will discuss is that obtained at senescence or at late biopause. This corresponds to a retention time of 25 to 30 days for 1:1 to 1:2 manure-water slurries.

Newly-discharged sludge bubbles out biogas slowly, for fermentations do not die out abruptly. Air tends to quench the process of fermentation because the methane bacteria, being anaerobic organisms, cannot continue their activity under aerobic conditions. The bubbling in the sludge eventually stops and a dark solid portion settles down leaving a turbid upper layer. These two kinds of sludges will be discussed separately because there is a difference in their utilization.

The chemical nature of the whole sludge is largely unknown. The utilization of sludge will depend upon familiarity with the properties and characteristics. As will be noted later, the finding that the sludge contains appreciable amounts of vitamin B<sub>12</sub> immediately opened up a new area of utilization.

Analysis of the nutrient composition of a material is usually undertaken to determine its suitability as feed. The whole sludge, solid and liquid were evaporated down and analyzed. To determine any change in composition, sampling was done at 10, 20, 30 and 50 days

fermentation. The results are given in Table 5-1 and indicate the great variability with age of some constituents.

The mineral composition is analyzed to determine the value of a material for fertilizer use. Table 5-2 gives the data obtained.

**TABLE 5-1**  
**Composition of Sludge in Relation to Days of**  
**Fermentation**  
**(Dry Basis)**

Day	Ash (%)	Protein (%)	Fat (%)	Fiber (%)	NFE (%)
0	16.57	15.75	4.95	15.22	47.50
20	21.55	20.10	5.60	11.10	41.65
30	24.32	20.50	4.95	9.37	40.70
50	26.67	22.00	4.37	7.52	39.40

**TABLE 5-2**  
**Mineral Composition of a Sample of Total Sludge**

N, total, %	0.26	Fe, ppm	30.5
P <sub>2</sub> O <sub>5</sub> , total, %	0.52	Cu, ppm	1.2
P <sub>2</sub> O <sub>5</sub> , available, %	0.23	Zn, ppm	9.2
K <sub>2</sub> O, total, %	0.05	Mn, ppm	10.0
Ca, %	0.37		

**TABLE 5-3**  
**Mineral Composition of the Solid and the Liquid Portions**  
**of a Sample of Sludge**

	Solid Sludge	Liquid Sludge
N, total, %	2.07	0.08
P <sub>2</sub> O <sub>5</sub> , total, %	7.31	0.15
P <sub>2</sub> O <sub>5</sub> , available, %	4.97	0.15
K <sub>2</sub> O, total, %	0.75	0.03
Ca, %	4.9	trace
Mg, %	0.64	—
Fe, ppm	0.77	0.66
Cu, ppm	0.01	0.18
Zn, ppm	145	0.28
Mn, ppm	0.96	0.47
Organic matter, %	49.6	—

The solid sludge has a fertilizing value for crops, as can be seen in Table 5-3. A rather unexpected windfall came when the dried solid sludge was tried as feed component for the hogs. Not only did this sludge satisfactorily perform as feed but it also materially hastened weight increase. It is of course quite well known that the residues of several commercial fermentations, streptomycin, butanol-acetone, etc., contain vitamin B<sub>12</sub> elaborated by the ferment organisms. A characteristic of the methane-producing bacteria is also the production of compounds having vitamin B<sub>12</sub> activity (Barker, 1956). Actual tests have confirmed this in the Maya Farms laboratory. This vitamin is a normal additive in pig rations. There may be other vitamins and even so-called UGF (unidentified growth factors) in the solid sludge. While we can attribute the favorable effect on pig growth to the presence of amino acids and trace elements in the sludge, it is more probable that the large effect on pig growth by so small an amount of component (10% of feed) is due to vitamins, B<sub>12</sub> in particular, and UGF.

When a fibrous crop residue like rice straw is the main portion of the substrate material in methane fermentation, the solid sludge consists largely of undigested fibers. Samples were sent to a pulping research agency, and results show that pulp from such solid sludge produces paper which can be used at least for wrapping. These results confirm the findings of other groups but the economics have yet to be worked out.

As to the basic principle involved, it is evident that the bacteria in methane fermentation first act on the more easily decomposable constituents of the substrate which are the sugars, starches, gums and simpler polysaccharides, leaving the more resistant fibers. This process of bacterial pulping, as it may be called, is not as complete as the commercial chemical pulping. It is to be recalled, however, that the Chinese and Japanese make beautiful rice paper from the straw by preliminary soaking, followed by beating to free the fibers. The prolonged soaking is conducive to bacterial action. This process of separating fibers from straw is closely related to another fiber-separating method, namely retting.

It should not be forgotten also that while attention is centered on the residues produced by bacterial action, there is also a mass of bacterial cells in the sludge. This is the "biomass". Feces in general are reported to consist of as much as 40% bacterial cells. The sludge and feces are virtual cemeteries of microorganisms.

### **The Liquid Sludge**

The liquid sludge comprises about 90% of the total sludge from the biogas plant. The large volume poses a big disposal problem. Of the solid sludge it can be said that the problem has been satisfactorily solved through its utilization as a hog feed ingredient. The solid sludge is small in quantity and can be dried and stored. By contrast, the liquid sludge is voluminous and is a very dilute solution. Example of the composition is given in Table 5-3 obtained by atomic absorption techniques. Sludge collected in lagoons revealed no indication or tendency for eutrication nor undue ill effects in plants due to salinity. However, since the sludge is the end product of a strictly anaerobic process, it takes weeks to get atmospheric oxygen to dissolve in the liquid. The big problem is the practical utilization of such a big volume of liquid. Several prospects present themselves:

1. The liquid sludge may be used as irrigation water and also as fertilizer. As will be described in later chapters, this method of usage of the liquid sludge has been very successful. Blue-green algae grow in profusion in the rice fields irrigated with this sludge,

and no doubt they increase the fertilizing value by fixing atmospheric nitrogen. It is likely also that this sludge contains plant hormones (indoleacetic acid was first discovered in urine) and plant UGF because the dark green leaves and general robust appearance of the plants cannot be explained by the chemical composition alone of the sludge, which is particularly low in nitrogen.

2. The liquid sludge may prove to be a good culture medium for growing chlorella and other similar algae. There is a world-wide interest in commercial production of these algae although we find this activity less promising for the present.
3. The liquid sludge may be employed for hydroponics, but this still requires further study and development.
4. The liquid sludge may be valuable in aquaculture. This sludge exposed to the brilliant tropical sunlight supports a profuse growth of plankton. Fish, particularly tilapia, feed on this plankton. The rice fields at Maya Farms are now being replaced by tilapia ponds. The advantages of aquaculture are: (a) simplicity of operations in comparison with culturing chlorella, which involves additional harvesting, drying, and bagging; (b) no destructive effects of typhoons as in rice cropping; (c) no loss of grain due to birds.

### **Toxicity of the Sludge**

Literature on biogas is generally silent about the toxic effects of the sludge. The sludge is hailed as an excellent crop fertilizer and as an excellent medium for growing chlorella. That all is not well, however, is hinted at in the statement that the sludge should be allowed to "ripen" before use. Indeed we find the freshly discharged sludge to be very toxic to fish and to plants even when greatly diluted with water. *Tilapia*, a fish noted for its ability to survive in a very hostile environment dies in the fresh liquid sludge. A hardy water-loving plant, kangkong, fails to develop and even grass withers when watered with fresh liquid sludge.

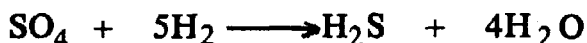
The cause of this toxicity could be ascribed to osmotic effects due to high content of salts or to the actual presence of toxic substances. The identification of the toxic substances would be a long hunt and would likely require some equipment beyond the available budget. Recent work on rice cropping in India and at the International Rice Research Institute in the Philippines point to hydrogen sulfide as a material toxic to rice. The  $H_2S$  is formed from the anaerobic decomposition of organic matter in submerged soil. In an article on anaerobic dairy wastes by White, Taiganides and Cole (1971), the odor of the wastes was found to come from alkyl sulfides like methyl sulfide and ethyl sulfide. Part of the foul odor came from methanethiol and from hydrogen sulfide. When the sludge at Maya Farms was tested for the presence of  $H_2S$  (and soluble sulfides) using the usual lead acetate method, a positive indication was readily obtained. Regarding the toxicity of hydrogen sulfide, Merck Index (1956) states:

Extremely hazardous. Collapse, coma and death from respiratory failure may come within a few seconds after one or two inspirations. Insidious poison as sense of smell may be fatigued and fail to give warning of high concentration. Low concentration may produce irritation of conjunctiva and mucous membranes. Headache, dizziness, nausea and lassitude may appear after exposure.

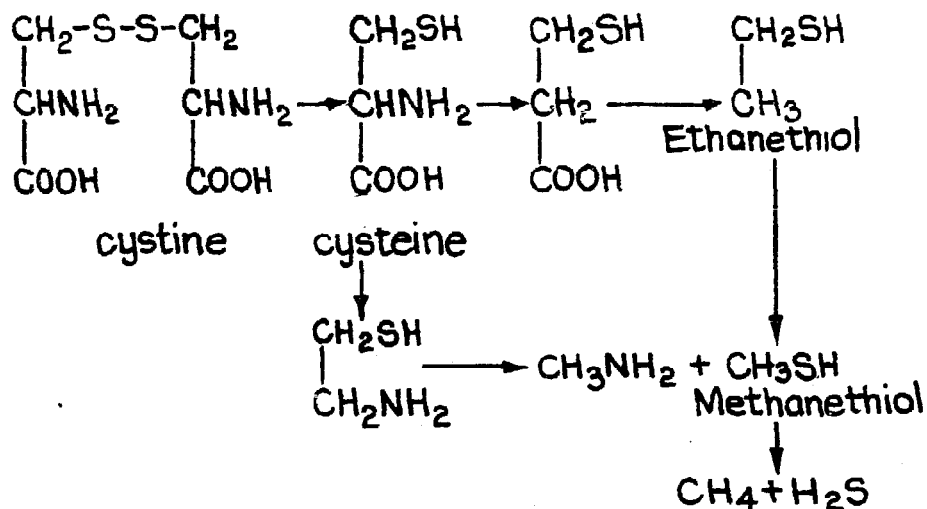
The toxicity described above refers to inhalation of the gas by human beings. It is well known that  $\text{Na}_2\text{S}$  and  $\text{CaS}$  are depilatory and are so used in industry and in cosmetics. Not only do these dissolve hair but they also exert the same action on feathers, nails (of the finger and toes), and skin. The high pH (7 to 8) of the sludge tends to promote this action. These soluble alkali sulfides could then be the source of toxicity by contact. The Merck quotation above also states that, they "produce irritation of conjunctiva and mucous membranes".

The possible sources of  $\text{H}_2\text{S}$  and the sulfides are the following:

1. Human urine contains sulfates. Under the conditions of anaerobic fermentation the sulfates are reduced to sulfides:

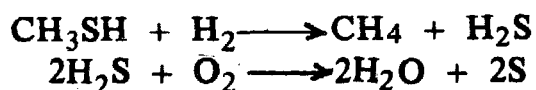


2. The sulfur-containing amino acids like methionine and cystine can give rise to the alkyl hydrosulfides and  $\text{H}_2\text{S}$ . The decomposition scheme is given by Harrow and Mazur:



### Detoxification of the Sludge

If the cause of toxicity of the sludge is  $\text{H}_2\text{S}$ , then detoxification can be achieved by oxidizing the  $\text{H}_2\text{S}$ . The other sulfides decompose, giving off hydrogen sulfide which in turn is oxidized to water and sulfur.



Well-aerated sludge is free from the sulfide odor and is no longer toxic to fish or plants. The solid sludge when exposed to the air to dry soon attracts ants and insects, sure signs of detoxification. It is also a sign that it may have feed value.

When dissolved in water, the  $\text{H}_2\text{S}$  is readily decomposed by the oxygen also dissolved therein, hence the need to create conditions for effective aeration such as bubbling air, exposure of large surfaces to the atmosphere, etc.

### Nondevelopment of *Ascaris* Eggs in Methane Fermenting Slurry

A professional parasitologist placed eggs of *Ascaris suum* in laboratory methane fermenters and in water controls. After 20, 25, 30 and 40 days of such treatment, the eggs

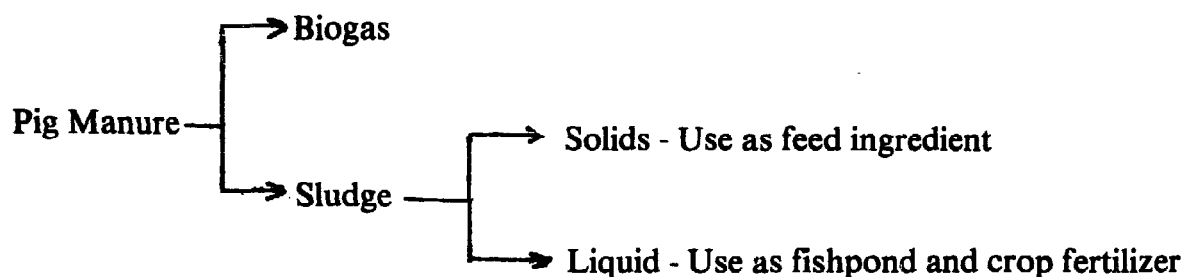
were recovered and transferred to petri dishes and examined for development. There were no signs of development even after 40 days, in the eggs exposed to methane fermentation. The eggs in the control started to develop on the 25th day and became embryonated by the 30th day. Ascaris eggs are known to be very resistant to adverse environmental conditions. The results of the experiment speak well of the efficacy of the methane fermentation in controlling the spread of intestinal parasites. It is to be recalled that the main objection to the use of night soil in truck gardening is the ever present menace of these intestinal parasites.

### **Presence of Salmonella in the Sludge**

Preliminary tests have shown the absence of these organisms. Controlled experiments are needed for verification; this is of utmost importance.

### **Outline of System for Sludge Disposal**

Methane fermentation was considered as a solution to animal waste disposal. As it turned out, this fermentation produces another waste product, the sludge, which is also a water pollutant. However, an adequate solution for its disposal has been found and discussed in the preceding sections. To summarize, the scheme is as follows:



Other means of disposal of liquid sludge:

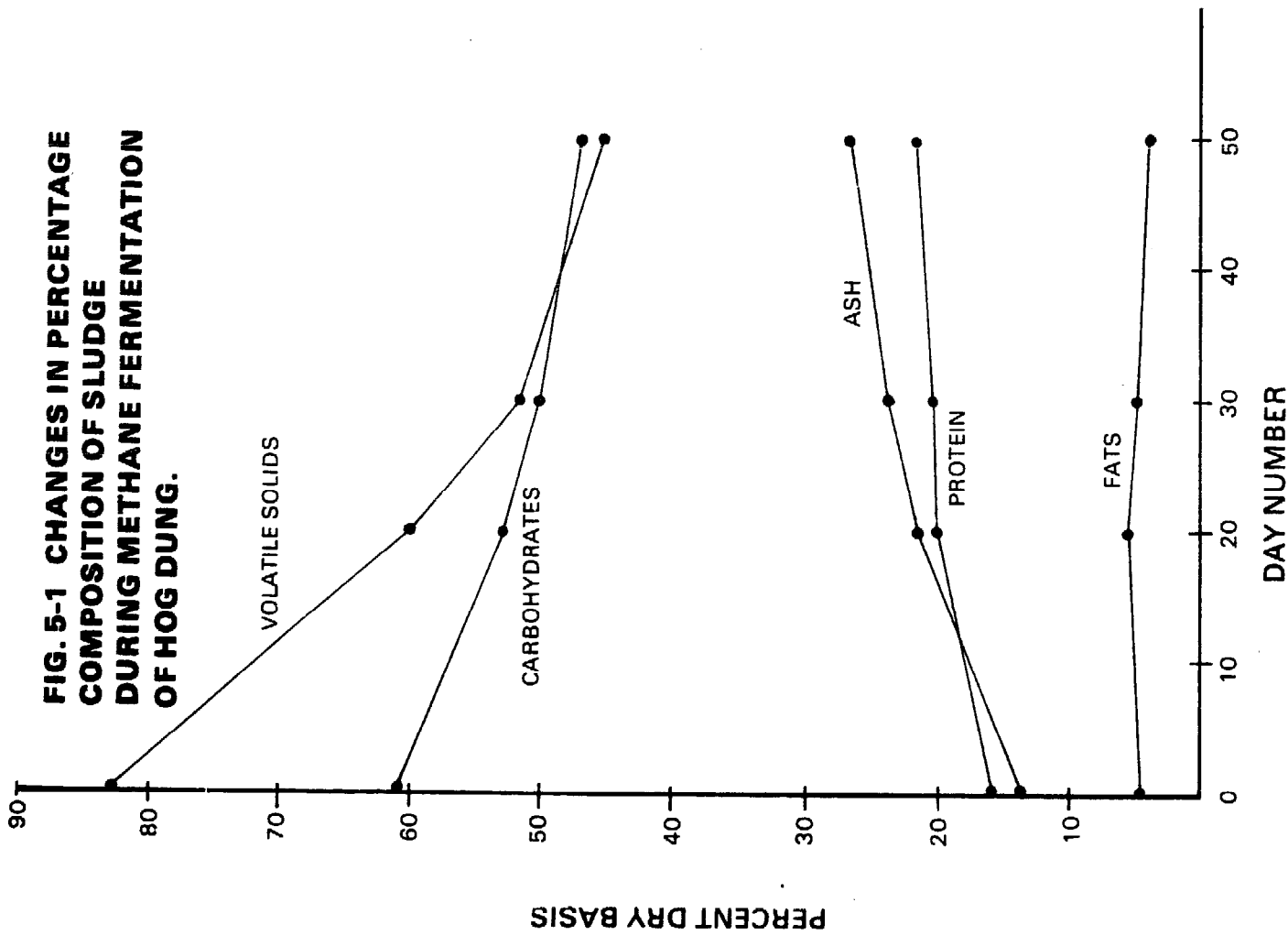
1. Natural seepage in fishponds
2. Natural dilution by rain and spill-over to streams
3. Natural evaporation in irrigated crop fields
4. As composting liquid

### **Change in Composition during Sludge Formation**

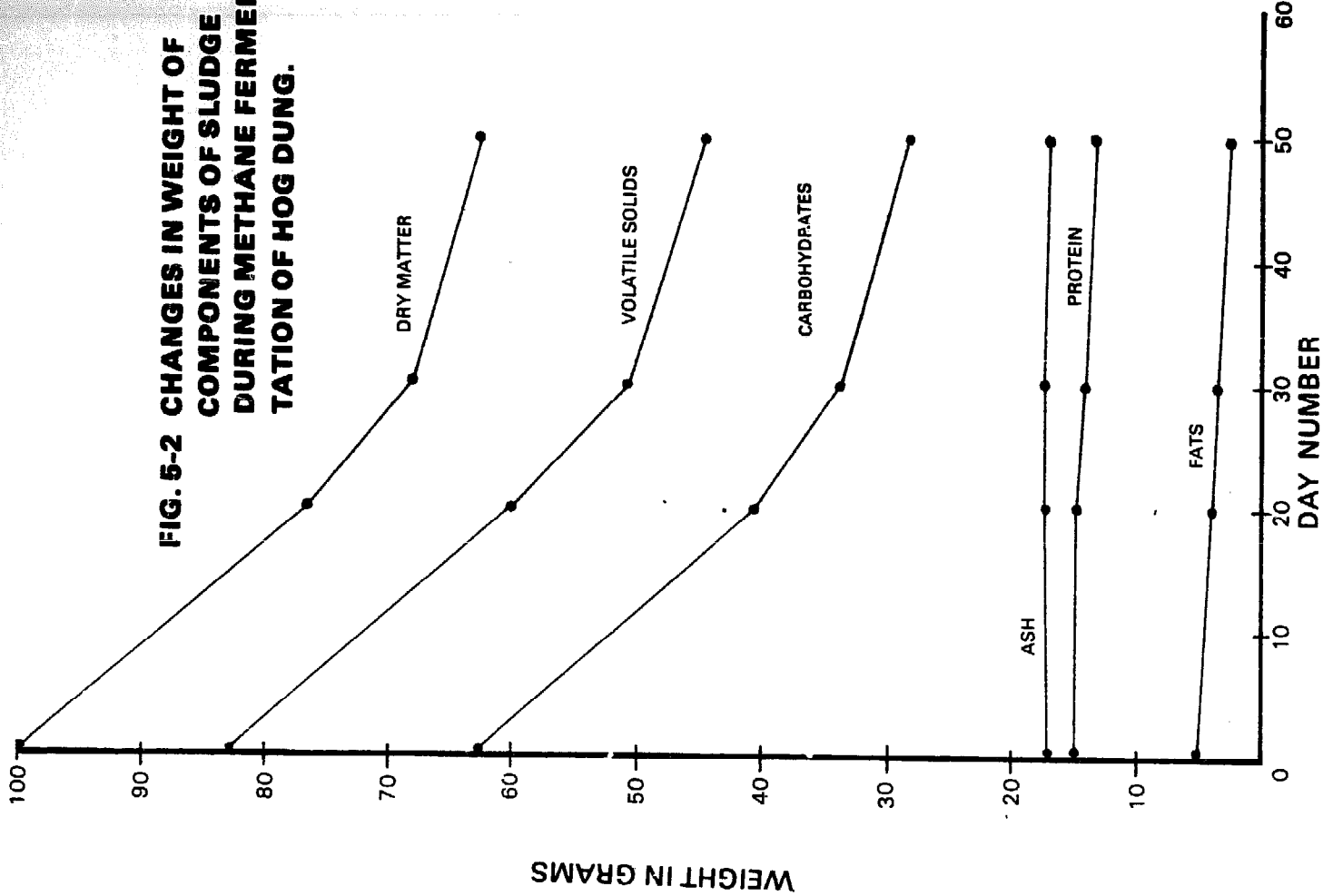
If the manure slurry (digester slurry) is analyzed for protein, fats, carbohydrates, and ash at different times during the methane fermentation, we will have information as to which of these compounds undergo the most change, and whichever underwent the greatest change must be the chief contributor to biogas formation. Those that changed the least will be expected to remain and form the sludge. Hence, in actively fermenting slurries, samples were taken at the start, then after 20 days, 30 days, and 50 days. The entire mass of solid plus liquid was quickly evaporated to dryness and chemically analyzed. The results are shown in Fig. 5-1. The largest decrease is in the percentage of volatile solids (non-ash portion). The total carbohydrates also registered a decrease. The fats decreased only a little, but the protein and the ash actually increased percentage-wise. All these figures are given as percentages of the dry sludges, namely those taken after 50 days, 30 days, 20 days and at the start.



**FIG. 5-1 CHANGES IN PERCENTAGE COMPOSITION OF SLUDGE DURING METHANE FERMENTATION OF HOG DUNG.**



**FIG. 5-2 CHANGES IN WEIGHT OF COMPONENTS OF SLUDGE DURING METHANE FERMENTATION OF HOG DUNG.**



These results support the often-stated claim that methane fermentation does not lose the nitrogen (proteins) and the sludge has therefore a higher percentage of N than the original manure. This occurrence makes the sludge superior to compost, for composting is known to lose a large part of the nitrogen.

### Changes in Weight during Sludge Formation

Percentages are deceiving when both numerator and denominator change at the same time. The percentage may come out very large even when the numbers involved in the division are very small. Hence, instead of percentage, the weights are better considered. Since the ash is nonvolatile and inorganic, it should not change in weight at any time during sludge formation. It serves as an internal standard. The sludge weights at 0, 20, 30 and 50 days were calculated to constant ash weight. The changes in weights are shown in Fig. 5-2. The dry matter (total solids), the volatile solids and the total carbohydrates all exhibit large decreases in weight. Even the protein actually decreased in weight, although it increased in percentage. Since the weight of protein at day zero was 15.75 grams and only 13.67 grams at day 50, the percentage loss in weight is 13.2%. Likewise the percentage reductions in weight of fats, carbohydrates, volatile solids and dry matter, within 50 days fermentation are shown in Fig. 5-3. The carbohydrates lost the most, 53.5% of the original weight, and the fats lost 45%; hence it may be deduced that biogas is produced mainly by the anaerobic decomposition of carbohydrates and fats. The sludge contains the major part of the proteins, the remnants of the carbohydrates and fats and all the ash (minerals).

TABLE 5-4  
Percentage of Constituents Remaining in Sludge  
and Percentage Converted to Biogas

	Dry matter	Ash	Protein	Fat	CHO <sup>1/</sup>	V.S. <sup>2/</sup>
Converted to gas	37.87	0	13.2	45	53.5	45.4
In sludge	62.13	100	86.8	55	46.5	54.6

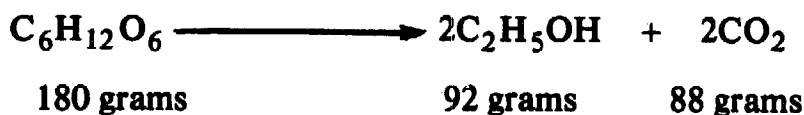
<sup>1/</sup> carbohydrates      <sup>2/</sup> Volatile solids

According to Table 5-4, this particular sample of sludge comprises 62% of the original dry matter in the hog manure, 100% of the ash, 86.8% of the protein, 55% of the fats, 46.5% of the carbohydrates and 54.6% of the volatile solids. These figures are to be taken only as one example. The performance of digesters depends on many conditions, hence results are quite variable. Sludge composition will surely change with the retention time adopted. Indications are that the very dilute slurries give higher biogas volumes per kg. manure, hence less sludge. The percentage distribution of total weight of hog manure lost, from 0-50 days is shown in Fig. 5-4.

### Theoretical Maximum Yield of Biogas

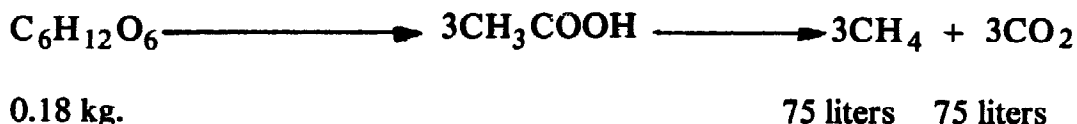
It is highly desirable that the upper limit of biogas volume be known. If biogas production reaches this limit, then there is no more need to exert added efforts to improve on it. The limit is a gauge for determining conversion efficiencies of substrates to biogas.

In alcoholic fermentation, there is a known theoretical equation which serves as basis for calculation.



The maximum weight of alcohol is 92 grams from 180 grams of glucose or 51.1% of the weight of glucose.

In methane fermentation, no definite chemical equation is known, nor has it been sought so far. For the sake of exploring possibilities, an equation is offered using also glucose as substrate:



The maximum biogas volume amounts to 150 liters at 30°C and 1 atm. pressure from fermentation of 0.18 kg. glucose.

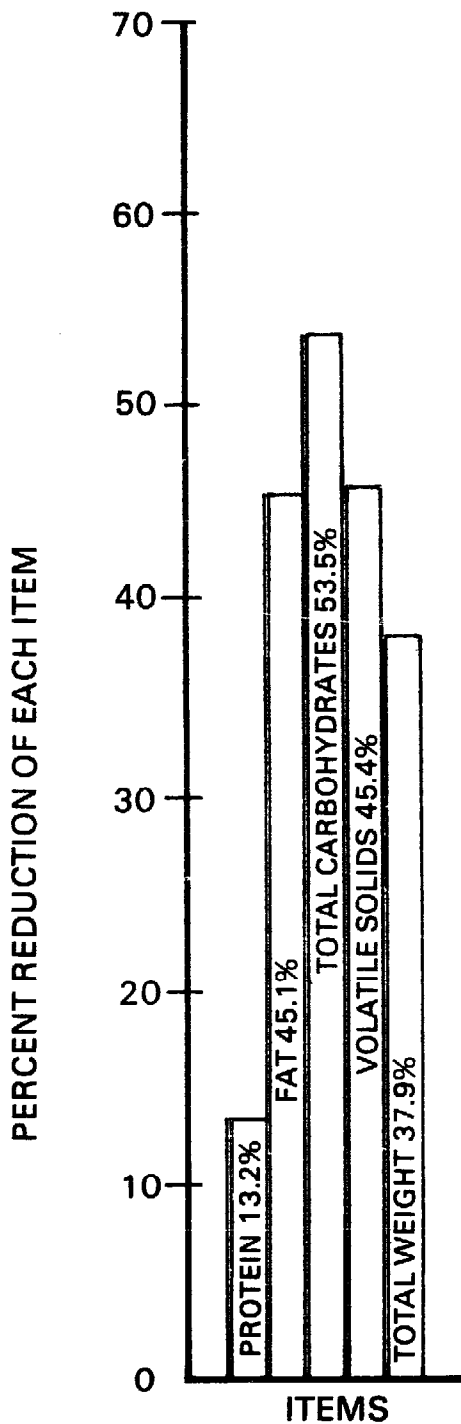
It will be seen that calculations become simplified when CH<sub>4</sub> and CO<sub>2</sub> are taken together and this calculation is based on the generalization in chemistry that one mole of a gas occupies a volume of 22.4 liters at 0°C and 1 atm. pressure. At ambient tropical temperatures of 30° to 34°C this molar volume is 25 liters. Hence, if all the 6 moles of carbon in glucose are converted to biogas, the carbon will produce 6 moles x 25 liters/mole or 150 liters biogas; in terms of per kg. glucose the volume is 833 liters (30°, 1 atm.). We can therefore construct a table showing the theoretical maximum volume of biogas producible from 1.0 kg. of a carbon-containing material, Table 5-5.

TABLE 5-5

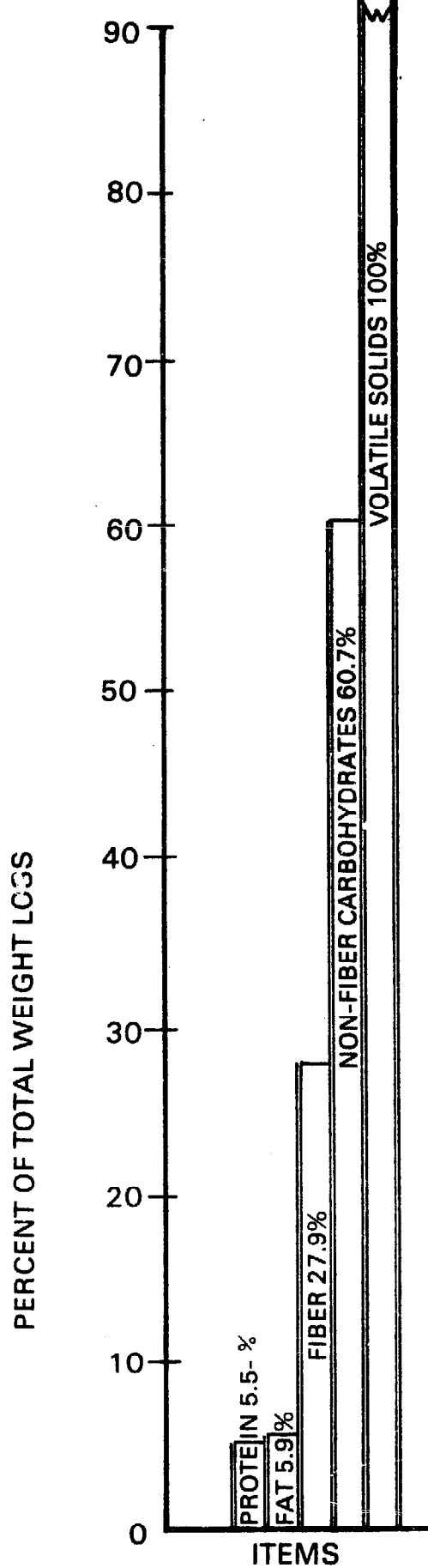
Theoretical Maximum Volume of Biogas (30°C) Producibile from one Kilogram of Material.

Material	Chemical formula	C content (%)	Max biogas (liters/kg.)
Carbon	C	100	2083
Cellulose	(C <sub>6</sub> H <sub>10</sub> O <sub>5</sub> ) <sub>n</sub>	44.4	926
Starch	(C <sub>6</sub> H <sub>10</sub> O <sub>5</sub> ) <sub>n</sub>	44.4	926
Surcrose	C <sub>12</sub> H <sub>22</sub> O <sub>11</sub>	42.1	877
Glucose	C <sub>6</sub> H <sub>12</sub> O <sub>6</sub>	40.0	833
Acetic acid	C <sub>2</sub> H <sub>4</sub> O <sub>2</sub>	40.0	833
Hog manure, fresh	—	9.6	198
dry	—	38.3	798

It is now necessary to know only the carbon content of an organic substrate to predict the maximum volume of biogas that the substrate can produce. The chemical determination of organic carbon (not the inorganic carbon which may not be fermentable) therefore becomes necessary. The carbon content of hog manure, we find, is well



**FIG. 5-3 PERCENT REDUCTION IN WEIGHT OF EACH ITEM 0 TO 50 DAYS**



**FIG. 5-4 PERCENT DISTRIBUTION OF TOTAL WEIGHT LOSS 0 TO 50 DAYS**

represented by the value of 38% dry basis. We are now in a position to calculate the percentage conversion of the material in hog manure to biogas. When subjected to methane fermentation, 0.90 kg. of hog manure (25% of dry matter and analyzing 38% carbon, dry basis) gave the measured volumes of biogas (30°C, 1 atm.), column B, in Table 5-6:

**TABLE 5-6**  
**Conversion Percentage of Hog Manure to Biogas**

A	B	C
Time (days)	Biogas (liters)	Conversion (%)
0	0	0
20	64.9	36.5
30	94.8	53.3
35	100.5	56.5
39	102.5	57.6
Infinite	178.1	100

Calculation of the conversion percentage:

The weight of carbon in the hog manure is  $0.90 \text{ kg.} \times 0.25 \times 0.38 = 0.0855 \text{ kg.}$

The number of moles of carbon =  $0.0855 \text{ kg.} / 0.012 \text{ kg. per mole}$   
= 7.125 moles

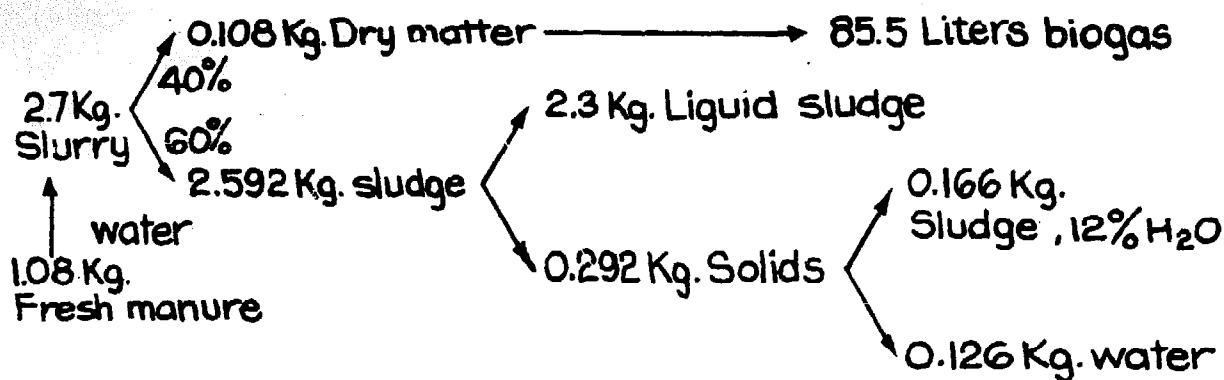
Each mole of C is equivalent to 25 liters (30°C, 1 atm.) of biogas. Hence the maximum biogas volume will be 7.125 moles x 25 liters/mole or 178.1 liters (30°C, 1 atm.) During the 20-day period, the biogas conversion is  $\frac{64.9}{178.1} \times 100$  or 36.5%. After 35 days, the value is 56.5%.

The conversion efficiency may also be taken as the percentage change in volatile solids (non-ash solids). Thus in one experiment, the amount of solids was reduced from an initial 33.43 grams to 45.56 grams in 50 days or a percentage reduction of 45.4%. Since biogas is produced at the expense of volatile solids, the figure 45.4% represents also the conversion percentage of V. S. to biogas.

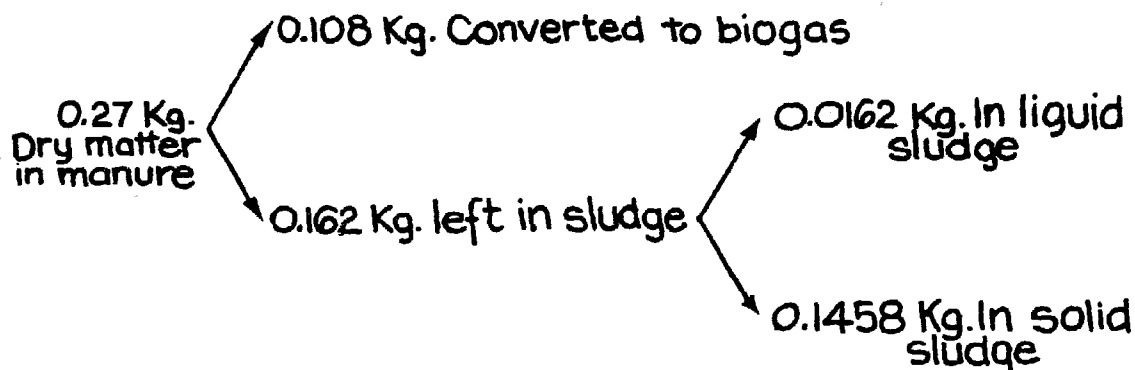
This discussion on conversion yields of biogas may seem out of context in a discussion on sludge. However, the accounting for the amount of sludge is dependent on the quantity of biogas produced as will be shown in the next section.

### **Yield of Sludge**

Because of the finding that the sludge, particularly the solid portion, is commercially useful, the need arises for more information regarding yield. In 2.7 liters of manure-water slurry (10% solids), the hog manure weighed 1.08 kg., fresh or 0.27 kg., dry. Of this weight 40% was converted to gas, and 60% remained as sludge. The final amounts of the products of the fermentation are better shown in the following diagram:



1.08 kg. fresh hog manure in a 2.7 kg. manure-water slurry, upon fermentation, produces 2.592 kg. of spent slurry which constitutes the sludge. Of this sludge 0.292 kg. separates as solids (50% H<sub>2</sub>O) from 2.30 kg. of liquid sludge (a ratio of 7.88:1). The solid is sun-dried to 12% H<sub>2</sub>O, yielding 0.166 kg. It is to be noted that the liquid: solid ratio of 7.88:1 holds only for 2.7 kg. digester slurry containing 1.08 kg. manure (8.1% volatile solids). Increasing the proportion of manure will of course tend to increase the resulting solid sludge. Per 1,000 liters of biogas, the amount of wet sludge is 3.4 kg. containing 1.7 kg. dry matter. The dry matter balance is:



The information here given will probably be more useful when recalculated per 1,000 kg. manure; the values are:

- 1,000 kg. fresh manure in a 2,500 kg. digester slurry leads to:
- 79,000 liters of biogas (30°C, 1 atm. pressure)
- 2,400 kg. total sludge, which consists of 2,130 kg. liquid and 270 kg. of semisolid sludge, which when dried gives
- 154 kg. of solids, 12% moisture content, upon evaporation of
- 116 kg. of water.

If the 1,000 kg. of fresh manure were dried to 12% moisture content, the amount of water to be evaporated is 716 kg. which is considerably larger than the 116 kg. of water given above. This comparison is being made because the direct drying of hog manure is one of the methods suggested for getting rid of it by conversion into a dry form for fertilizer use. Forced drying of fresh manure is likely to cause odor pollution.

**Part II**  
 **BIOGAS TECHNOLOGY**

**Chapter VI Fundamentals of Biogas Plant Design**

**VII Biogas Plant Designs around the World**

**VIII Sludge-Conditioning Plant Designs**

**IX Biogas Works Designs**

**X Planning and Establishing the Biogas Works**

**XI Operating Biogas Works**

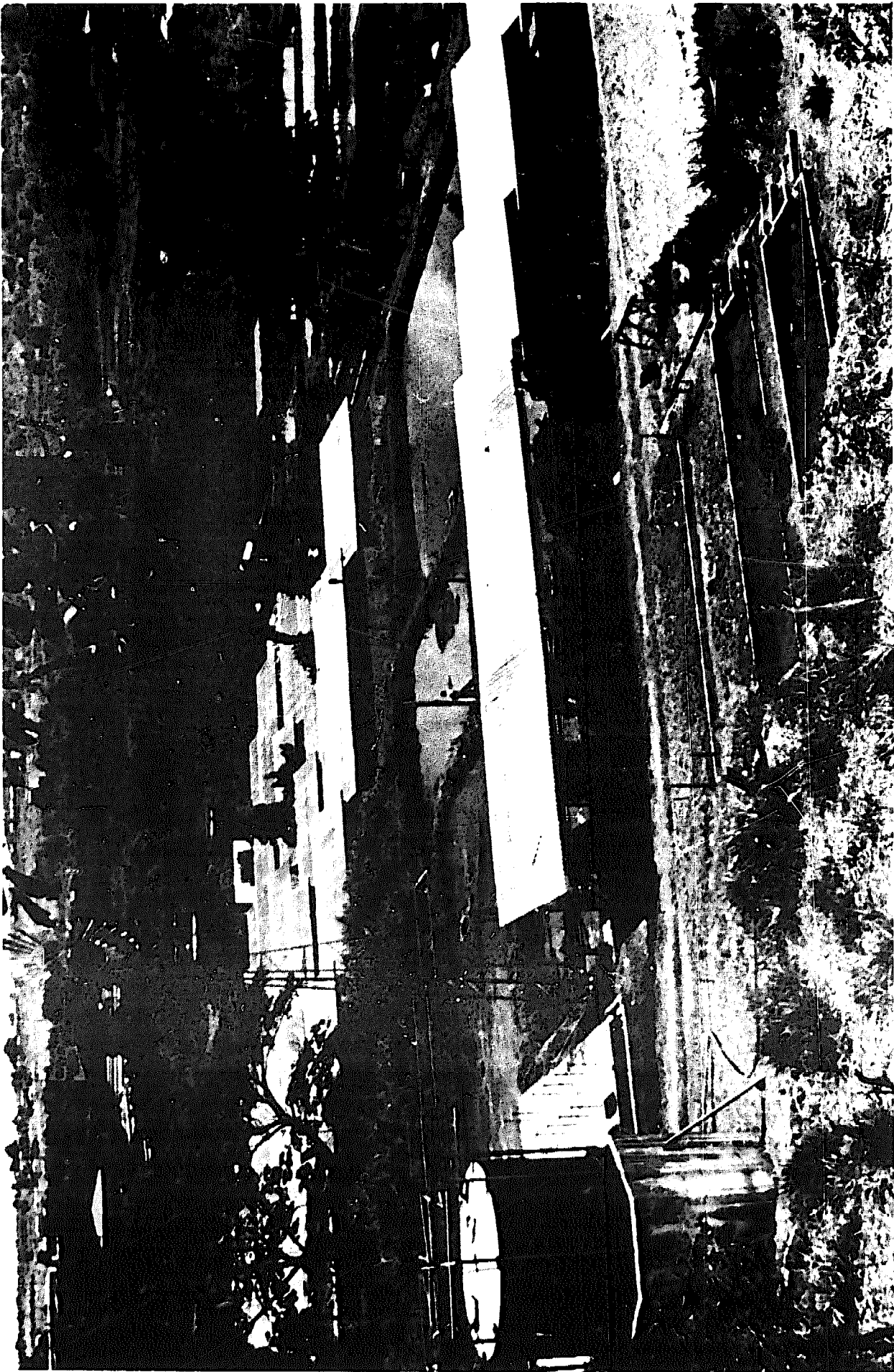


Illustration 2-1: Biogas works at Maya Farms



## PART II

### BIOGAS TECHNOLOGY

When organic matter is decomposed, it undergoes biological and chemical changes. In the process it yields distinctly new products. What these products are depends on the conditions under which the digestion takes place. If the digestion takes place in the open (aerobic decomposition) ammonia, carbon dioxide, and a great deal of heat are produced. All these products are lost into the atmosphere and what remains (a solid) is known as compost. Its main value is as a soil conditioner. If the digestion takes place in the exclusion of air (anaerobic decomposition) it produces biogas and sludge. These are trapped inside the digester.

The gas evolved in the anaerobic decomposition of organic matter in nature gained world attention because of its methane content which was found to be a valuable fuel. For this reason when this gas began to be produced artificially, the equipment used to produce the gas was called "methane generator". When the nature of the anaerobic decomposition of organic matter was studied, it was found that the gas evolved was not pure methane but a composite of methane ( $\text{CH}_4$ ), carbon dioxide ( $\text{CO}_2$ ), some hydrogen and minute amounts of hydrogen sulfide ( $\text{H}_2\text{S}$ ) and other gases. For this reason the gas began to be called "biogas" and the equipment that produced the gas, the "biogas plant". When later it was found that the sludge produced was a valuable fertilizer, some biogas practitioners in Germany called the equipment the "Bihugas Plant" (hu for humus).

The term "biogas plant" in this book refers to the unit which produces the biogas and sludge, including any accessory equipment for improving the fuel value of biogas. The biogas plant controls the air pollution that would be caused by the organic waste; but even though the BOD (biochemical oxygen demand) in the waste slurry is greatly reduced, the sludge still poses a problem as a water pollutant. Subsequent work on the sludge at Maya Farms led to the development of the sludge-conditioning plant. This term refers to the unit which controls the water pollution from sludge by recovering and processing the sludge solids into biofeed or sometimes paper pulp materials and utilizing the treated liquid sludge as a biofertilizer and in this way water pollution is controlled. The combination of the biogas plant and the sludge-conditioning plant is referred to as the "biogas works".

Part II, "Biogas Technology", will discuss the subject in six chapters:

Chapter VI Fundamentals of Biogas Plant Design

VII Biogas Plant Designs around the World

VIII Sludge-Conditioning Plant Designs

IX Biogas Works Designs

X Planning and Establishing the Biogas Works

XI Operating Biogas Works

There are two government entities that are engaged in Biogas Works Research in the Philippines: the National Science Development Board and the University of the Philippines at Los Banos. Among private entities engaged in biogas works are the Economic Development Foundation and Maya Farms, the Agro-Industrial Division of the Liberty Flour Mills, Inc. The National Research Council of the Philippines encourages research by giving financial aid to research projects. Biogas practice is encouraged by the Philippine Government which gives certain tax credits for those who build biogas works. There is also an Association of Biogas Practitioners. The purpose of the Association is to compare notes among the members on the operation of biogas works and to propagate the practice.

## Chapter VI

### Fundamentals of Biogas Plant Design

Agricultural industries have so developed that materials that cause pollution are produced in large quantities. In particular the modern method of raising animals in large numbers and in confinement has resulted in daily production of large quantities of manure which, aggravated by the high ambient tropical temperatures, have polluted the atmosphere with nauseating odor. It has also served as the breeding place for flies that not only bother both man and beast but also spread diseases. Crop residues have a tendency to accumulate in unwieldy amounts, and occupy areas that can better be utilized for crops.

Animal manures are the principal polluting materials. They come from the raising of hogs, poultry, cattle, ducks, and also from humans. Manures are the residuals of animal digestion. They are composed of materials that have not been digested, or digested but not absorbed in the intestinal tract. Other components come from the breakdown of the food or feed through the action of microorganisms which grow naturally in the gastrointestinal tract under the ideal conditions of body temperature and abundance of nutrients. Thus not only are normal products of digestion present, but also products of bacterial action and the bacterial cells themselves. The offensive odor of the feces of livestock and of humans are attributed to products of bacterial decomposition of nitrogenous substances. The decomposition of carbohydrates and fats gives rise to methane and carbon dioxide together with small quantities of hydrogen, hydrogen sulfide and carbon monoxide. The mixture of these gases is called biogas.

#### Conditions for Biogas Production

The greater the production of biogas, the more complete is the anaerobic digestion and hence the more effective is air pollution control. The optimum conditions for successful digestion are therefore of prime importance. These are:

1. Presence of the right kind of bacteria which should be in the active growing stage, and in sufficient numbers;
2. Presence of the raw materials, well dispersed in water;
3. Adequate amounts of nutrients for the growth of the bacteria, particularly a carbon-to-nitrogen ratio of 30 to 1 or thereabouts;
4. Absence of air and of oxygen sources which means strict anaerobic conditions;
5. pH of about 7 to 8 and a temperature range of 25°C to 37°C for mesophilic digestion; the ideal is 30 to 35°C. For thermophilic digestion the ideal temperature is 55 to 65°C;
6. Retention time sufficient to produce the maximum amount of biogas economically;
7. As the digester slurry decomposes, a mixture of coarse fibrous materials is released and accumulates at the surface, forming what is known as scum. If the scum is not broken it will prevent the biogas from surfacing.

## **The Products of Methane Fermentation**

The products resulting from methane fermentation are a gas and a residual liquid-solid sludge. The gas is actually a mixture composed of:

1. Methane, a gas of simple composition and chemical structure, ( $\text{CH}_4$ ) and related to the better known LPG components, propane ( $\text{C}_3\text{H}_8$ ) and butane ( $\text{C}_4\text{H}_{10}$ ). Methane has a high heating value, but unlike LPG, cannot be easily stored in liquefied form. It is colorless, odorless, half as heavy as air, burns with a faint blue flame.
2. Carbon dioxide ( $\text{CO}_2$ ), a well-known gas, is the component of carbonated soft drinks which make them effervesce. It can be stored in the liquid state and can be supplied even in solid form, called "dry ice". Carbon dioxide has no fuel value and hence its presence in biogas only serves to lower its heating value.
3. Hydrogen, carbon monoxide and hydrogen sulfide gases are present in only small amounts in biogas. Hydrogen is the lightest of all gases, and is used in filling toy balloons. It is highly inflammable and even forms explosive mixtures with air. Carbon monoxide can serve also as a fuel. Hydrogen sulfide has the peculiar odor of rotten eggs. It burns in air and is quite soluble in water. It has no fuel value. It corrodes metals.

The biogas plant is designed to process the animal manures and other organic wastes to produce biogas and sludge and to control air pollution. It consists of two main parts: a digester or a set of them, where the organic materials are digested; and the gasholder, or a set of them, where the biogas is collected and stored, pending use.

### **The Digester**

The digester is a tank of many forms of construction. It should be airtight not only to prevent the escape of the biogas it produces but also to prevent the entrance of air since the methane-producing bacteria thrive only in the absence of oxygen. Furthermore, if the pressure inside the digester happens to go below the atmospheric pressure, air may enter the digester and may form an explosive mixture with the biogas. The digester should also be waterproof; otherwise part of the slurry water may leak out and the slurry concentration would be too thick for proper digestion. It may also interfere with the smooth flow of the slurry. There should be sufficient headspace over the digester slurry so that the scum that forms on the surface of the slurry will not clog the gas outlet at the top of the digester. Digesters are provided with stirrers to break the scum that forms on top of the slurry and to mix the supernatant liquor with the fresh slurry.

The digester may be classified according to the method of charging it with slurry: the batch-fed digesters and the continuous-fed digesters.

The batch-fed digester is charged with fresh slurry to full capacity and sealed and the slurry is allowed to decompose for the duration of the retention time adopted, after which it is opened, the sludge discharged and the digester refilled.

The batch-fed digester has one chamber and may be built overground or underground. It is charged through a manhole on top and the sludge is discharged by gravity through an outlet pipe on the side. If the fibrous portion of the sludge is recovered for use as pulp, it is provided with a side manhole to take the pulp material out. There is provided at the top of the digester a pipe with a cap for replenishing any water evaporation. There is an outlet for

the biogas to pass to the gasholder. Each digester is provided with stirrer to break the scum. In some designs, the stirrers are constructed to stir the digester slurry as well.

The batch-fed biogas plant has one sump to serve all the digesters in the plant, since only one digester is charged at one time. This sump serves to accumulate the raw materials with the right amount of water to constitute the fresh slurry to be charged to the digester. The capacity of the sump is equal to the fresh slurry capacity of one digester. For overground digester, a pump is provided to transfer the fresh slurry from the sump to the digester. The sludge flows out by gravity. For an underground digester a pump is provided to discharge the sludge. The fresh slurry flows to the digester by gravity. The required volume of a batch-fed digester depends on the amount of raw materials available, the concentration of the fresh slurry, the amount of starter and the retention time. The capacity is equal to the digester slurry capacity of the digester.

A continuous-fed digester is charged fully at the start of operation and a small amount of fresh slurry is added daily. The newly-charged fresh slurry automatically expels approximately an equal volume of sludge. The daily production of biogas and sludge is fairly uniform until the digester is opened for cleaning. If a continuous-fed biogas plant has only one digester, the supply of biogas and sludge stops completely during cleaning and a few more days until the newly-charged digester starts producing biogas. If there are two digesters which are cleaned by turns, the biogas supply will be cut by one half during cleaning. If there are three, the supply is reduced to two-thirds, etc.

The continuous-fed digester may have one, two or three chambers. In some designs of the two-chamber digester the partition may be part way and in others it is complete. In the three chambers, partitions are complete. In some designs of the two-chamber type, the primary chamber is bigger than the second chamber; in others it is the other way around; and still others have the two chambers equal in size. In the three-chamber design, the first two are equal in size while the third is twice as big.

In a one-chamber digester, there is an inlet pipe at one end and an outlet pipe at the opposite end. A baffle present between the two pipes reduces the possibility of fresh charge entering the discharge pipe. In a two-chamber digester, the inlet pipe enters the primary chamber and the outlet leads out of the second chamber. The inlet pipe enters the first chamber just above the bottom level of the supernatant liquor. The connecting pipe between the primary and secondary chambers originates just above the floor and empties the slurry at the top level of the slurry in the secondary chamber. In the three-chamber design, the inlet pipe discharges the fresh slurry close to the bottom of the first chamber. The connecting pipes between the primary and the secondary chamber and secondary to the leaching chamber originates from close to the floor and empties its contents at the slurry level of the next chamber. The outlet pipe originates from close to the floor of the last chamber and empties its contents into the decantation tank at the level of the digester slurry.

In a continuous-fed biogas plant, there is one sump or mixing tank for each digester. The capacity of the sump or the mixing tank is equal to the daily charge of the digester it serves. The volume of a continuous-fed digester depends on the available raw materials, the concentration of the fresh slurry, the retention time and the number of digesters in the biogas plant.

The digesters are provided with means to break the scum that forms during digestion as well as mix freshly-charged slurry with the old slurry.

**In the temperate regions, the digesters are heated, particularly during the cool weather. The heater may consist of hot water or hot air passing through pipes in the digester. In others, the digester slurry is recirculated through a heat exchanger.**

### **Gasholder**

**There are two types of gasholders: the fixed dome and the floating dome. In the fixed dome type the biogas accumulates in the dome over the digester slurry. The digester slurry serves as the reversible displacement medium. The biogas accumulating in the dome pushes out a portion of the slurry into a higher level auxiliary compartment. The digester slurry flows back by gravity as the biogas is consumed. Needless to say the dome must be airtight, otherwise the biogas will leak out.**

**The floating dome type consists of two parts: an open receptacle filled with liquid and an upside-down tank floating on the liquid. In a split biogas plant the gasholder dome floats over a separate receptacle. In an integrated type biogas plant the digester serves as the receptacle. In one type of gasholder, the digester slurry serves as the liquid. In another type the digester has double walls, water is placed between the walls, and the gasholder dome floats on this water. In the two-chamber digester in some designs the gasholder floats over the first chamber and in others it floats on the second chamber.**

**In an integrated biogas plant where the gasholder is directly over the digester slurry, the biogas automatically accumulates in the gasholder dome. If the digester has two chambers, the dome sits over one chamber. The biogas evolved in the other chamber goes through a flexible pipe to the gasholder dome over the other chamber. In the split type the biogas flows through a connecting pipe between the digesters and the gasholder.**

**The floating gasholder has variable capacity to compensate for differences between the rate of biogas production and consumption while keeping the pressure inside the gasholder constant. To accomplish this, the gasholder shall consist of a watertight open receptacle full of liquid and an airtight open tank (dome) placed upside down over the liquid content of the receptacle. The dimensions of the gasholder dome shall be such that when it is floating, no part shall be less than 5 to 6 inches between the side of the dome and inner side of the water receptacle. Guides shall be provided so the dome may move up and down without tilting or getting too close to one side. The guide posts can be connected in the periphery of the water receptacle. To prevent the gasholder dome from moving up too high and allowing the gas to escape, cross bars should be located at a height such that when the dome is full of gas the rim remains still immersed in the liquid seal. The depth of immersion depends on the maximum gas pressure allowable inside the gasholder. For example: if the allowable pressure is twelve inches column of water, the dome should rise only up to such a height that its rim shall be 12 inches below the surface of the liquid seal. In this way when the pressure of the gasholder exceeds 12 inches column of water, the gas will bubble out of the water seal.**

**The gas pressure in the gasholder is dependent on the weight of the gasholder dome. If it is too light for the required pressure, weights may be distributed uniformly on top of the dome. If the dome is too heavy counterweights may be provided.**

**The capacity of the gasholder depends on the relationship between gas production and consumption. If the production and consumption are more or less the same at all times the**

capacity of the gasholder will be minimal; but if the use of the gas is concentrated within a short period each day the gasholder should be large enough to contain 24 hours production. For example, if the gas is used during an 8-hour period, the capacity of the gasholder shall be a little over two-thirds of the daily gas production. If it is used continuously for 16 hours, the capacity should be a little over one-third the daily biogas production.

The gas pressure required at the point of use depends on the appliances used. In India, the appliances require 3-4 inches column of water. In the Philippines, 4-6 inches are required. The gas pressure inside the gasholder should be higher than that required by the appliances to make up for the loss due to friction in the distribution pipe where the gas flows.

### **The Piping System**

The piping system in a split type biogas plant consists of two parts: the gas pipe connecting the digesters and the gasholder and the distribution system. Pipes originating flush with the lower side of the top of each digester in the biogas plant pass through the CO<sub>2</sub> scrubber and enter the gasholder at floor level of the receptacle and rise up to 10 inches above the water level inside the receptacle. The distribution system leaves the gasholder from 10 inches above the water level of the receptacle to a minimum of one foot above the floor level. In an integrated type biogas plant the biogas automatically collects in the gasholder dome over the digester slurry. U-traps are used to remove the water condensation all along the lines. A U-trap should be provided at every low portion along the gas line where an accumulation of condensed water might clog the gas flow.

### **Carbon Dioxide Scrubber**

About 30 to 40% of the biogas consists of carbon dioxide. If this is removed, it would mean cutting this much in the size of the gasholder. Even if only one-half of the CO<sub>2</sub> is removed it would still be a big saving in the gasholder construction cost. Furthermore, the elimination of part of the CO<sub>2</sub> will raise the BTU value of the resulting gas which will mean a higher power obtained from the engine.

The CO<sub>2</sub> may be scrubbed off the biogas by the use of a carbon dioxide scrubber. It consists of a tank with stirrers to mix the lime or ashes in the water inside the tank. When the biogas from the digester bubbles through the limewater or lye, the CO<sub>2</sub> component is absorbed. The residue is removed from the bottom and used as potash fertilizer or soil conditioner.

### **Hydrogen Sulfide Scrubber**

Hydrogen sulfide is very corrosive and may even cause the embrittlement of metal; hence it is essential that it be removed from the biogas used for running internal combustion engines. A practical way to remove the H<sub>2</sub>S is by passing the biogas through two layers of iron filings in an enclosed container.

### **Biogas Plant Types**

Biogas plants may be classified into four types:

1. Integrated, continuous-fed;

2. Split, horizontal, continuous-fed;
3. Three-stage, continuous-fed; and
4. Batch-fed.

**Integrated, Continuous-Fed Biogas Plant** – The integrated, continuous-fed biogas plants are used for small plants with capacities up to about 500 cu. ft. digester slurry volume. They have only one digester. The gasholder dome is directly over the digester slurry. The main purpose is to produce biogas for lighting, ironing clothes and cooking family needs, and biofertilizer for the croplands and fishponds. The plant is provided with a mixing tank where the fresh slurry is prepared and charged into the digester. The sludge empties into a decantation tank. For simplicity, small biogas plants which do not use the gas in internal combustion engines have no provisions for scrubbing the biogas of  $\text{CO}_2$  or  $\text{H}_2\text{S}$ . Fig. 6-1 shows a flow sheet for the integrated biogas plant.

There are four models of integrated, continuous-fed biogas plants:

1. Vertical digester with floating gasholder dome, such as the India (Patel) model;
2. Horizontal digester with floating gasholder dome, such as the Maya Farms (Obias) model;
3. Double-wall digester with floating gasholder dome, such as the Taiwan model;
4. Fixed-gasholder dome, such as the China model.

An integrated, continuous-fed biogas plant may be used for large biogas operations if the biogas is used more or less continuously such that the required biogas storage capacity is less than one-third of the volume of biogas produced daily. The horizontal digester should have two chambers, with the first chamber two or three times longer than the second chamber. The dividing wall should be open about three feet from the bottom to allow easy passage of the slurry from the first to the second chamber while retaining the scum in the first chamber. The first chamber is provided with stirrers and a fixed cover. The gasholder floats over the slurry in the open-topped second chamber. This design costs much less to construct than the split type.

**Split, Continuous-Fed Biogas Plant** – The split, continuous-fed biogas plants have horizontal continuous-fed digesters. Each digester has an inlet and outlet pipe. Several rows of digesters may be constructed with common sides, but each digester should have its own sump. A medium-size split, continuous-fed plant has one floating dome gasholder but a large plant has two or more. The gasholder forms a separate unit; the carbon dioxide ( $\text{CO}_2$ ) scrubber forms another unit. Biogas for use in internal combustion engines shall be passed through a hydrogen sulfide ( $\text{H}_2\text{S}$ ) scrubber. Fig. 6-2 shows a flow sheet for the split continuous-fed biogas plant.

The three-stage continuous-fed plant has three chambers and is used, if so desired, to produce some biogas from night soil. The night soil flows to the primary chamber while the wash water from the kitchen, bathroom and laundry flows to the third chamber. The biogas is recovered from both the primary and secondary chambers, though the latter produces much less gas. To start with, manure slurry should be placed in the digester in order to get gas quickly. The night soil maintains the gas production if there are at least sixty persons using the toilet. If fewer people use it, there will be a need to add manure



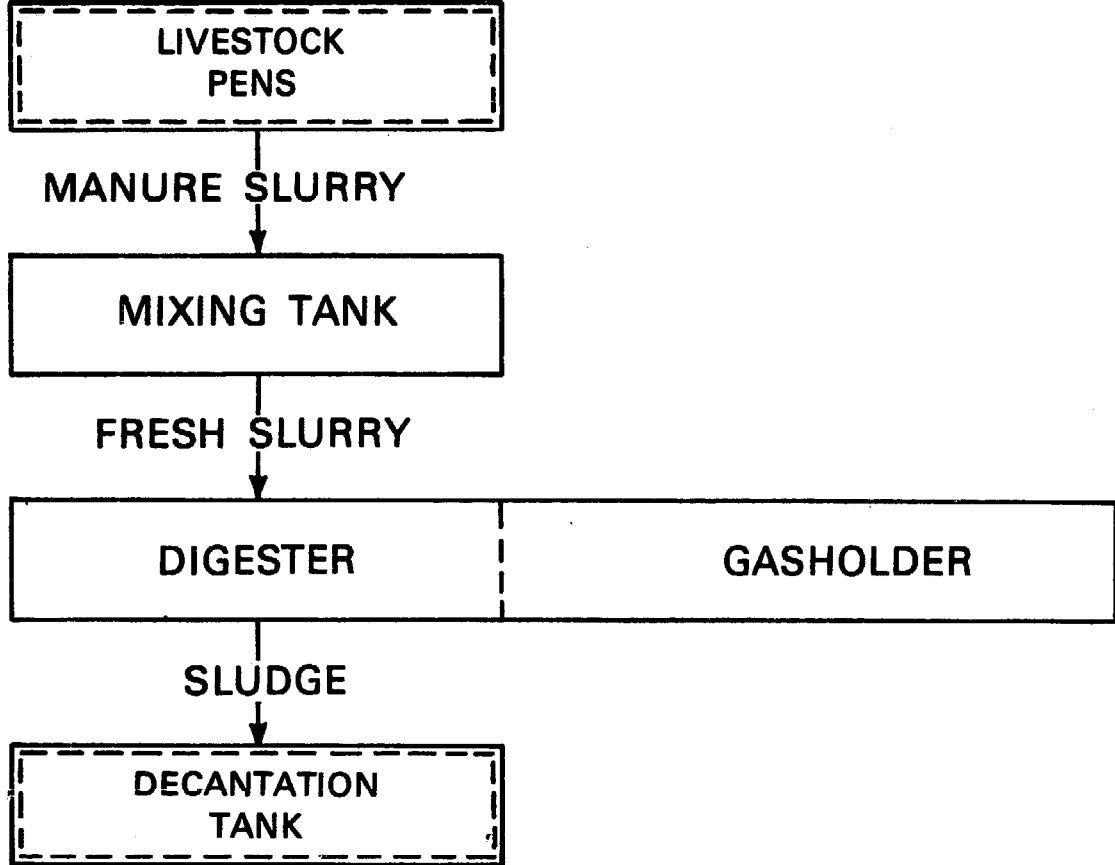
from time to time. The most convenient manures to use are those that are dry like that of poultry.

The sludge moves from the primary chamber to the secondary chamber then to the third chamber. Fig. 6-4 shows a flow sheet for the three-stage biogas plant.

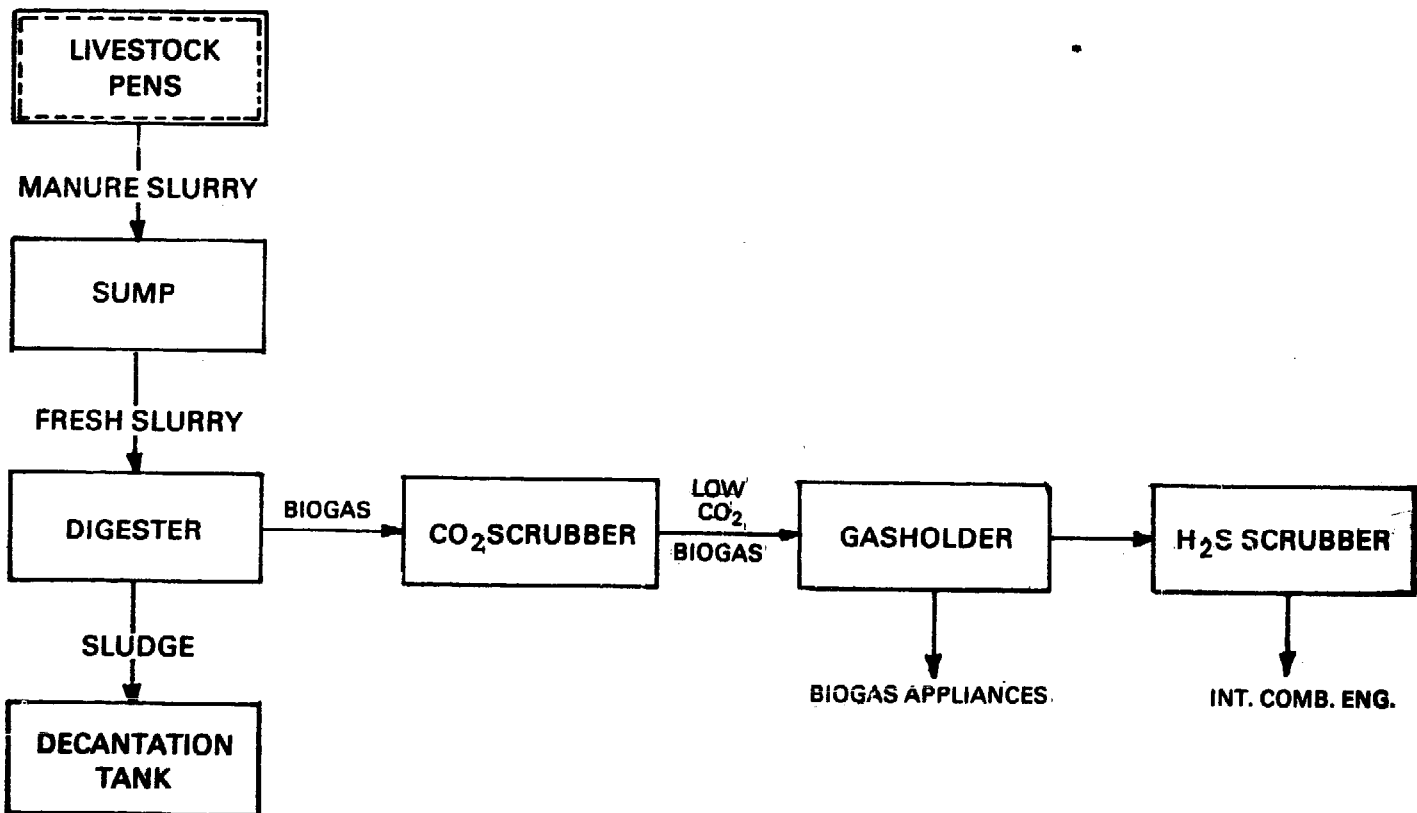
**Batch-Fed Biogas Plant** – A batch-fed biogas plant shall have as many digesters as the number of days of retention time plus one so that one digester is discharged and charged with slurry every day. In case of extreme necessity, there shall be at least one-half as many digesters as the number of days of retention time plus one thus discharging and charging one digester every two days. Manure more than two days old is a poor producer of biogas. Keeping the manure too long before use would also cause pollution.

The batch-fed digester is used when crop residues are mixed with manure particularly when it is desired to recover paper pulp materials.

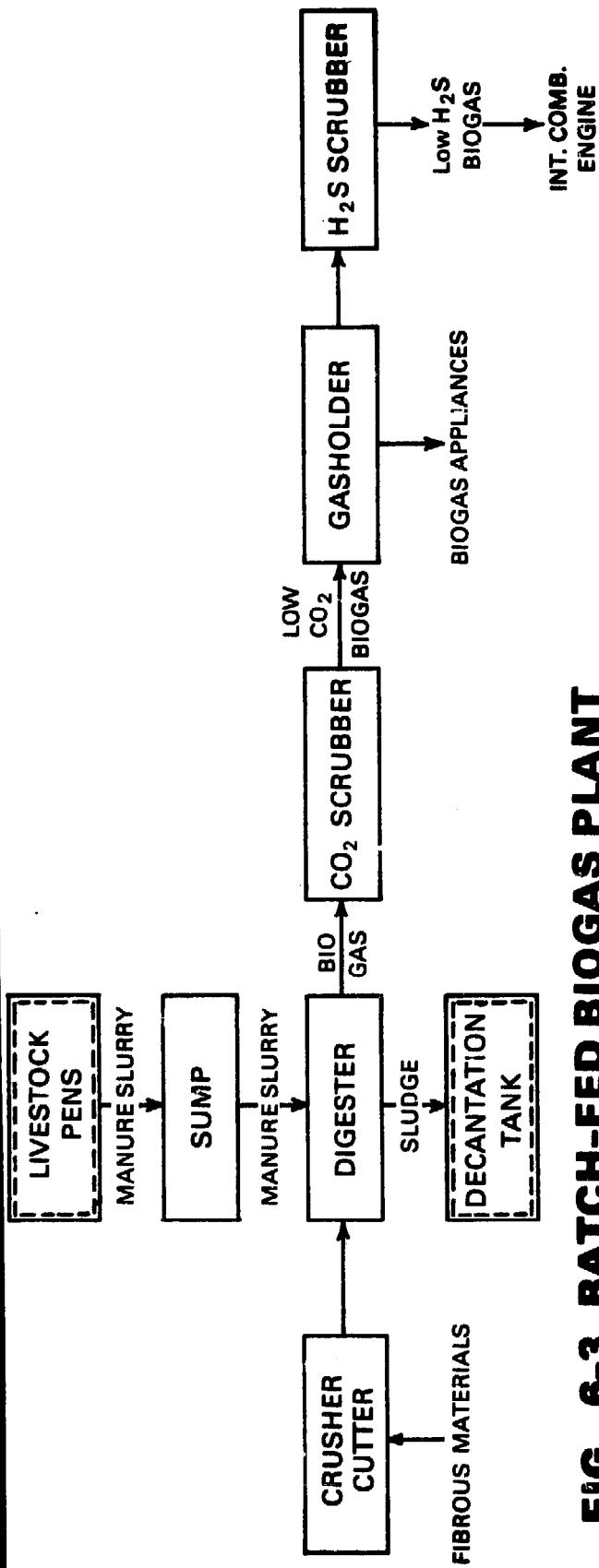
The batch-fed biogas plant consists of two lines of single chamber digesters placed side by side and back-to-back so that three sides of each digester are common (except the four corners of the block) in order to save on construction materials and reduce the walls exposed to the ambient temperature. A medium-size plant would have one common gasholder while large ones have two or more gasholders. The gasholders are of the split floating type. Fig. 6-3 shows the flow sheet for a batch-fed biogas plant.



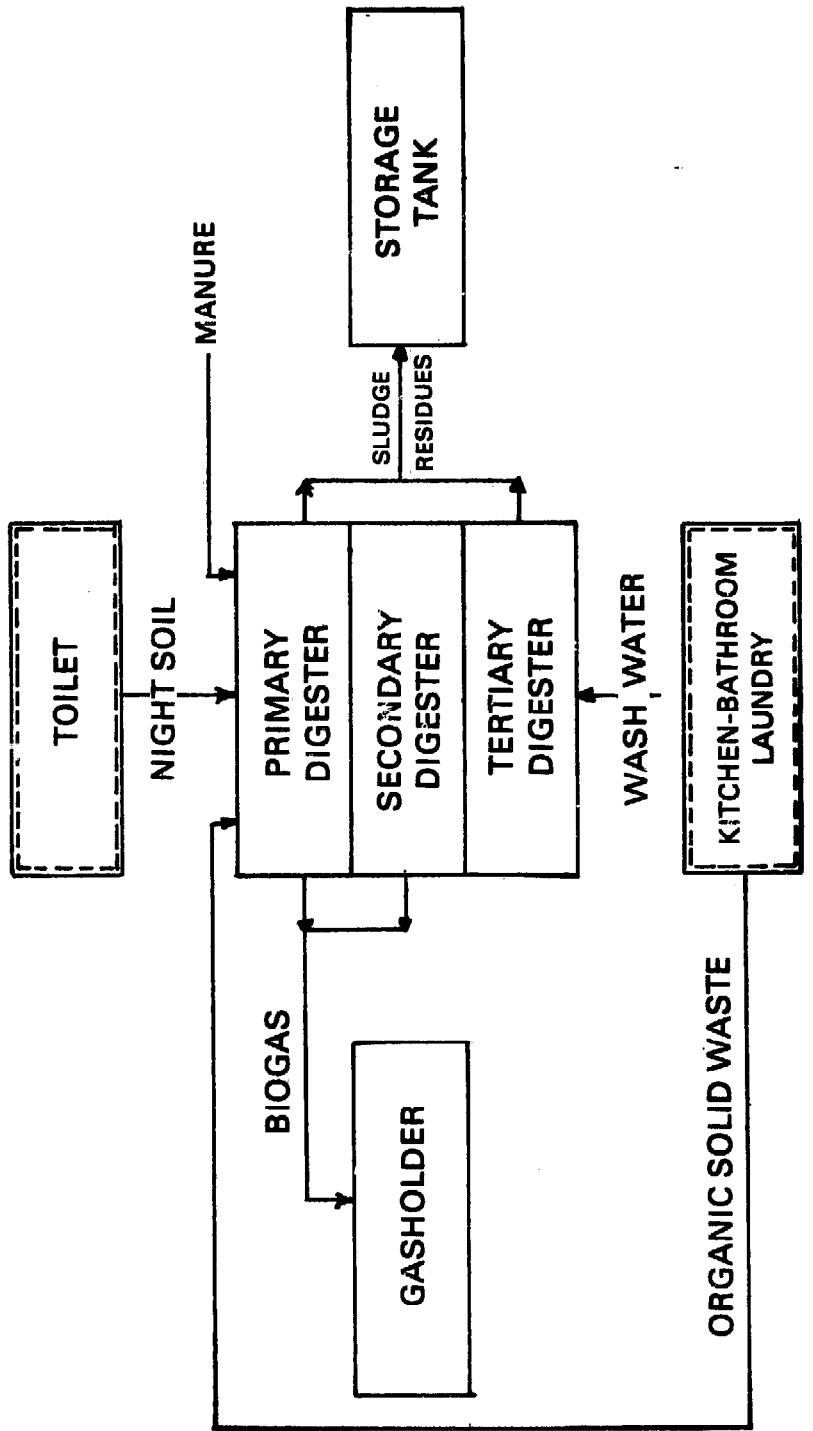
**FIG. 6-1 INTEGRATED BIOGAS PLANT FLOWSHEET**



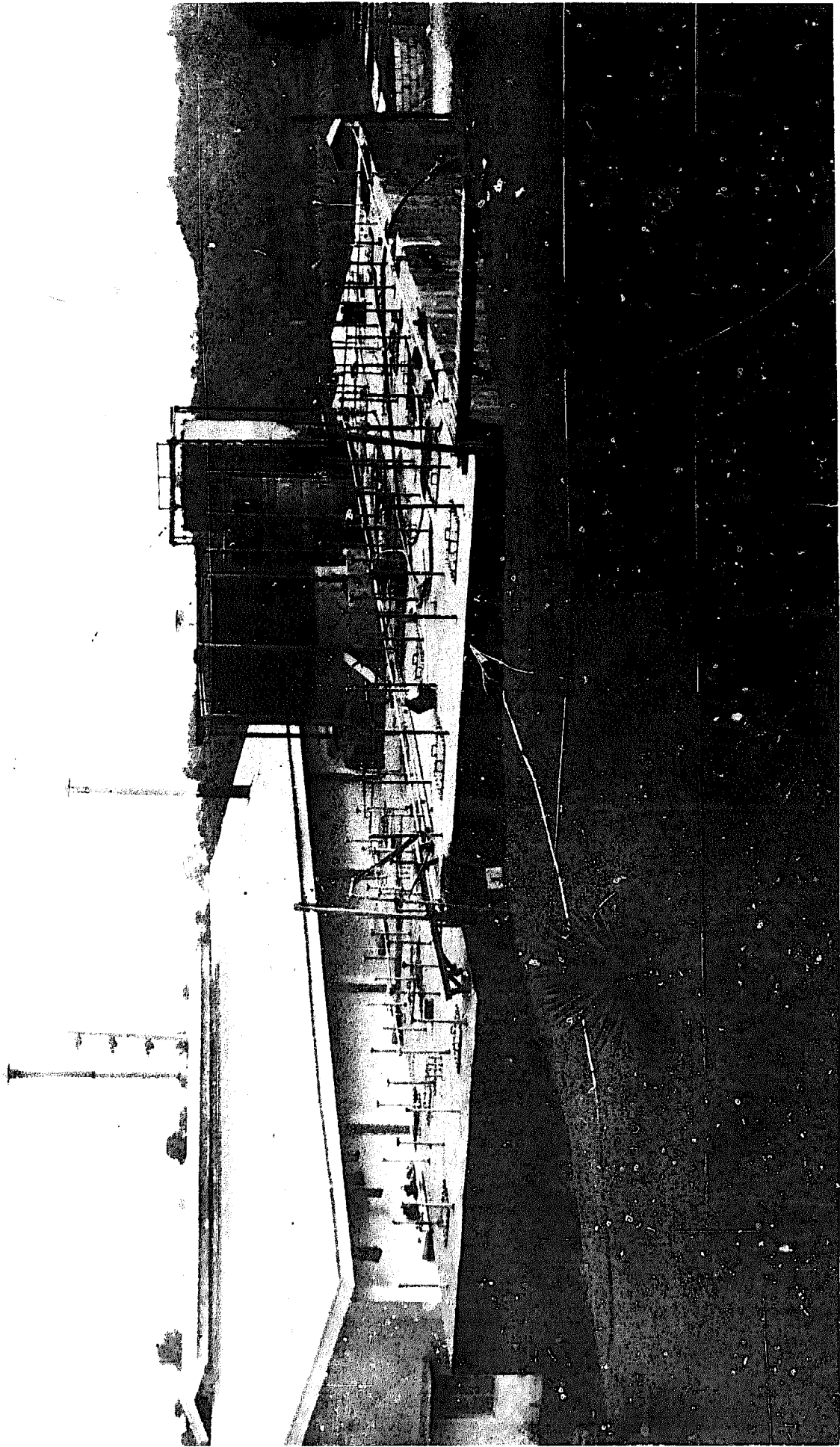
**FIG. 6-2 SPLIT CONTINUOUS-FED BIOGAS PLANT**



**FIG. 6-3 BATCH-FED BIOGAS PLANT**



**FIG. 6-4 NIGHT SOIL BIOGAS PLANT FLOWSHEET**



**Illustration 2-2: Industrial-scale biogas plant**

## Chapter VII

### Biogas Plant Designs Around the World

During the last thirty-five years, there have been developed numerous designs of biogas plants around the world. Variations in the different designs are found in all aspects of the biogas plant construction and operation. Many digesters are designed for continuous-fed operation but there are few for the batch-fed. Some of the biogas plants have the gasholder integrated with the digester while others have the digester and the gasholder as separate units. Commonly used materials of construction are bricks, concrete or concrete hollow blocks for the digester and gasholder water tank, and steel, plastic materials or rubber for the gasholder dome. Many variations are found in the system of stirring the sludge and breaking the scum. In the temperate regions the digesters are insulated and are provided with heaters. Manure is the most common raw material. Some designs incorporate special features for handling specific materials such as crop residues and night soil. Some are provided with means to scrub off the carbon dioxide ( $\text{CO}_2$ ) and hydrogen sulfide ( $\text{H}_2\text{S}$ ) from the biogas to raise its heating value and prevent corrosion, respectively. The biogas is used as fuel and the sludge is used as fertilizer. Solid sludge is processed and used as feed materials at Maya Farms.

The schematic representations of some of the known designs are shown on Fig. 7-1 to Fig. 7-32.

#### Salient Features in Different Designs

The various designs all over the world incorporate distinctive features either in the digester or in the gasholder. The Gobar biogas plant designs (Fig. 7-1, 2) are Indian. One type has a pipe outlet for withdrawing sludge from the bottom of the digester. Since the inlet pipe introduces the fresh slurry also at the bottom portion of the digester, a baffle bisecting the lower half of the digester is used to prevent any fresh slurry from going directly from the inlet pipe to the outlet pipe. The other type designed by Patel has an overflow outlet, skimming off the sludge from the surface of the slurry. Both types have deep cylindrical brick-walled digesters integrated with the gasholder. The gasholder is an inverted cylindrical steel tank floating on the slurry. It floats up when filled with biogas and sinks in the slurry when the gas is used. A fixed stirring device is incorporated in the gasholder and stirring is accomplished by turning the gasholder back and forth around its center pivot. Gobar biogas plants are popularly used in rural farmhouses in India. The raw material utilized is "gobar" or cow dung. The operation is continuous-fed.

Another design is Gotaas' manure gas plant with latrines (Fig. 7-3). The gasholder is also integrated with the digester but the digester is bigger and rectangular in shape. It is built right alongside the latrine for direct feeding. A separate mixer and feed inlet is provided for the addition of cow dung slurry.

The Belur Math Gobar gas plant (Fig. 7-4) is used in Calcutta. The digester is built above ground and it has brick walls and a fixed steel dome. The gasholder forms a separate unit and consists of an inverted steel tank floating over an open concrete tank of water.

**This gasholder design is commonly used whenever the gasholder is not integrated with the digester. Most of the variations in biogas plants may be found in the digester design.**

Taiwan has two types of biogas plants. One type has a single-compartment double-walled digester (Fig. 7-5). The gasholder is integrated with the digester, but unlike the Indian design, the gasholder does not dip in the digester slurry. The sides of the gasholder dip in the water seal between the two walls. A fixed stirring crossbar is attached inside the gasholder. It serves mainly to break the scum formation on the surface of the digester slurry. The only stirring action is upwards and downwards as the gasholder rises and falls over the slurry.

The other Taiwan design (Fig. 7-6) has a two-compartment digester. The first compartment is similar to the first type, square in cross section, double-walled and integrated with a floating gasholder. The second compartment is rectangular, with about twice the length of the first compartment and it has a fixed sheet-iron cover. The two compartments have one common side and a pipe brings the overflow from the first to the second. Stirring is done by pulling and releasing a string attached to a floating wooden crossbar inside the digester. The biogas produced in the second compartment goes to the floating gasholder through a flexible hose. The double-walling gives a cleaner, less messy operation since no slurry is exposed. However, the construction cost is much higher, and the repair and maintenance in case of leakage is more difficult than with a single-walled digester.

The China biogas plant (Fig. 7-7) has a dome-topped chamber which utilizes the lower portion as the digester and the fixed dome as the gasholder. The pressure of the gas collected in the dome pushes part of the digester slurry into an adjacent auxiliary chamber which has a higher surface level. When the gas is used, the slurry in the auxiliary chamber flows back into the digester. This design provides better insulation from climatic changes; but the gas pressure is variable.

The anaerobic digester used in Japan (Fig. 7-8) is a steel tank with an agitator and a water coil for heating the slurry. It is used for waste treatment in piggeries and in distilleries. Germany's Darmstadt system (Fig. 7-9) designed by Reinheld has a mechanically-rotated paddle wheel stirrer and a steam heating coil for winter operation. The Schmidt-Eggersgluss system (Fig. 7-10) can handle chopped straw with cow dung. Thin slurry from the bottom of the digester tank is sucked by a pump and forced through a rotating flush nozzle to break the straw layer which forms on the surface of the digester slurry. The straw is thoroughly dispersed before discharging any slurry. The Weber system (Fig. 7-11) also uses chopped straw mixed with cow dung. Inside the digester, mixing is effected only by the tangentially entering fresh slurry. The accumulated layer of the straw on the surface of the digester slurry is manually removed once a year. Conical wooden beams in the digester serve to break the straw layer to allow the passage of gas through the surface. The Bihugas-Anlage system (Fig. 7-12) designed by W. Poetsch uses a centrifugal pump to recirculate the dilute digester slurry, passing through a heat exchanger for heating.

France's Duccellier-Isman system (Fig. 7-13) has two digesters in parallel, with a pump recirculating the slurry through a heat exchanger. The Gartner-Ikonoff system (Fig. 7-14) operates on the same principle as the China design. Instead of having an auxiliary chamber, the Gartner-Ikonoff system has one tank partitioned in such a way that gas

collects in the midsection and pushes part of the digester slurry through a central pipe to the upper section. As the gas is used, the slurry flows back to the lower digester section.

The drum digester for fibrous materials (Fig. 7-15) designed by A.M. Buswell and C. S. Boruff of the University of Illinois, is characterized by a submerged rotating cylindrical wire-covered drum inside a cylindrical digester. In this way, the fibrous materials remain in the drum where they can be removed while the digested materials flow to a sludge compartment. In the Maya Farms-Maramba design (Fig. 7-27) for fibrous materials, the sludge flows by gravity to the settling tank after opening the discharge valve while the fibrous materials remain in the digester from where they are later removed through a side manhole.

The Burke-Jacobs gas generator for vegetable wastes (Fig. 7-16) has a concrete-walled digester with a liquid sealed steel cover. The recirculating pump has a screened suction inlet to keep pieces of vegetable wastes from clogging the pump. The Fry biogas plant (Fig. 7-17) has a horizontal cylindrical digester tank with a water heating coil. The scum which builds up over the digester slurry is periodically skimmed off through the manhole at the end of the tank.

The methane recovery digester of G. Chan (Fig. 7-18) has the underground portion single-walled while the portion above ground is double-walled with an oil seal for the integrated gasholder. The inlet and outlet pipes are located near the slurry surface.

The Sanamatic tank (Fig. 7-19) designed by Coulthard of Australia, is a rubber bag digester. It is insulated and supported by a steel structure. A gas-heated coil at the bottom of the tank is used for heating the digester slurry. The feed slurry is pumped in from a mixing tank.

The Kenya biogas plant (Fig. 7-20) has a circular double-walled digester built above ground. The gasholder is integrated over the digester with a water-oil seal. It operates on the batch process.

There are a number of biogas plant designs used in the Philippines. Some are simple modifications of designs from Taiwan, India and other countries while others have been developed through work experiences with biogas operations. A few inventors have patented designs with the Philippine Patent Office.

### **Biogas Plant Patents**

The Vicente Araneta-patented design (Fig. 7-21) incorporates a gas-water scrubber unit to reduce carbon dioxide, odorous gases and any entrained froth from the gas evolved. A pipe laid at the bottom of the chamber and another pipe with two openings just below the slurry surface are connected to a reversible pump to function both for charging and discharging the digester. The Garbage Fermentation tank (Fig. 7-22) of Roberto Valderia is designed for sanitary disposal of organic kitchen scraps. The inlet has a manually operated screw conveyor. The integrated floating gasholder has an oil seal. The design of Teodoro Cadiz and Reynaldo Velasquez (Fig. 7-23) is for kitchen garbage and animal wastes. It has two chambers: a digester chamber with a concrete bottom and a leaching chamber with soil bottom. The digester chamber is partitioned by baffle walls to create a snake path from the inlet end to the outlet end of the digester. The first partition has a

concave bottom and a clean-out pipe for removing heavy foreign materials which settle at the bottom.

### **Maya Farms Biogas Plant Designs**

Maya Farms has various kinds of biogas plants. The big units are part of the waste recycling system for the Farms' integrated hog farm, meat processing, and canning operations. Sludge-conditioning units are provided to supplement the pollution control aspect and complete the waste recycling by recovering the solids as feed materials and improving the quality of the liquid for use as fertilizer. The small units have been set up mainly for testing and demonstration purposes.

The night soil digester designed by D. Bautista, (Fig. 7-24) is used for the Farm employees' dormitory. The night soil is flushed directly into the first chamber of the digester. The slurry flows from the first to the second, then to the third chamber. However, biogas is collected only from the first and second chambers. The third chamber, which also receives the other household wastewater, has pebbles at the bottom to allow leaching.

The horizontal continuous-fed biogas plant (Fig. 7-25) has been designed by E. Obias as a low-cost model for places where the vertical type is not practicable, such as in places where the water table is high or where adobe or rock formations are found near the ground surface. Some operational advantages are obtained by placing the floating gasholder over the second chamber of the digester. In this way, the effect of ambient temperature fluctuations is minimized because the first chamber where much of the biogas is produced, is well insulated by masonry. Moreover, since the slurry in the second chamber has been partially digested in the first chamber, the exposed portion is not untidy and has practically no offensive odor.

The split type, horizontal, continuous-fed biogas plant (Fig. 7-26) has been designed by C. Taganas for livestock farms. The first chamber of the digester is double the size of the second chamber, making the operation less prone to clogging. Stirrers are provided only in the first chamber. The second chamber has a thin slurry with minimal scum formation. The separate gasholder has roller guides for the floating tank.

The batch-fed digester (Fig. 7-27) designed by F.D. Maramba, Sr. for agro-industrial operations calls for as many individual digesters as the number of days retention time plus one. The capacity of each digester is equal to the daily available fresh slurry plus the necessary starter so that the digesters can be discharged and recharged one a day, one after another. This assures a continuous supply of biogas. To minimize construction cost, the digesters are cubical and built in clusters, with the side walls shared by adjacent digesters. The digesters are built above ground to facilitate unloading, especially when crop wastes are used as raw materials together with the manure. Side outlet pipes are provided for draining out the liquid sludge. The remaining fibrous materials can be removed through the side manholes. The gasholder design is shown in Fig. 7-28.

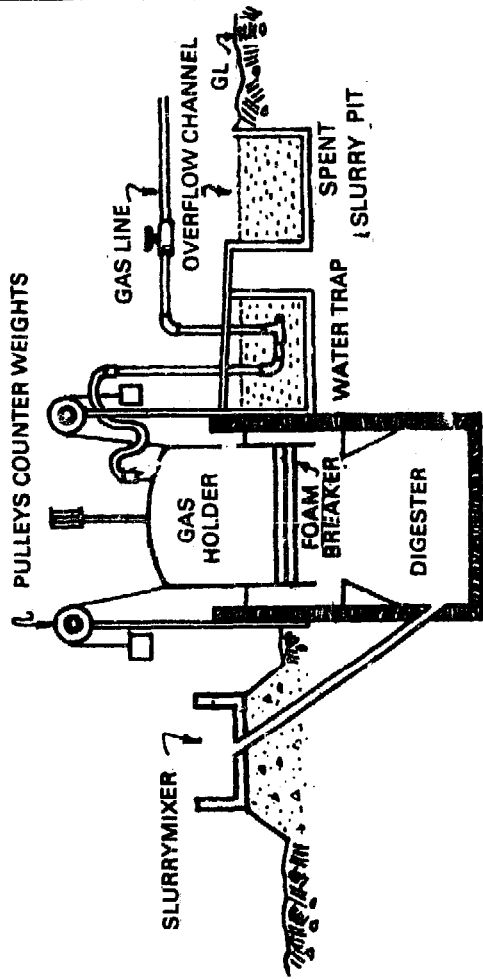
Fig. 7-29 shows the Taganas-Maramba design for slaughterhouses. The digester is similar to the Maya Farms-Taganas design but Maramba has incorporated with it a sludge tank with a pebbled flooring to allow leaching. Excess liquid goes to the sewer or through loosely linked pipes to complete the leaching.



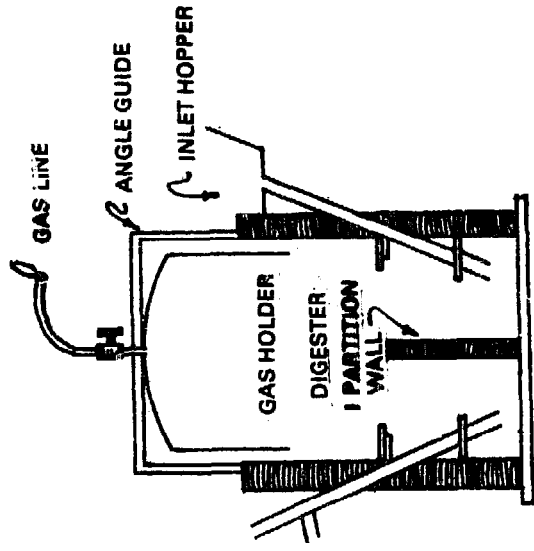
The vertical continuous-fed biogas plant (Fig. 7-30) is an adaptation of the India (Patel) design. The digester cross section is octagonal instead of circular for easier construction. The guide rail for the floating gasholder is simplified by the use of a pipe fixed in the center of the steel tank. The pipe slides up and down over a smaller-diameter inner pipe which is firmly anchored at the center of the digester. This design is the simplest and cheapest to construct for small operations where digging deep is no problem. The operation is a bit messy because the gasholder dips in the fairly fresh slurry. A portion of the scum is exposed around the sides of the floating tank.

The fixed domed continuous-fed biogas plant (Fig. 7-31) is similar to the China design. Instead of bricks, Maya Farms used hollow concrete blocks, and concrete pipes for the inlet and outlet. Temperature insulation is good. Some disadvantages are the limited gasholding capacity and variable gas pressure.

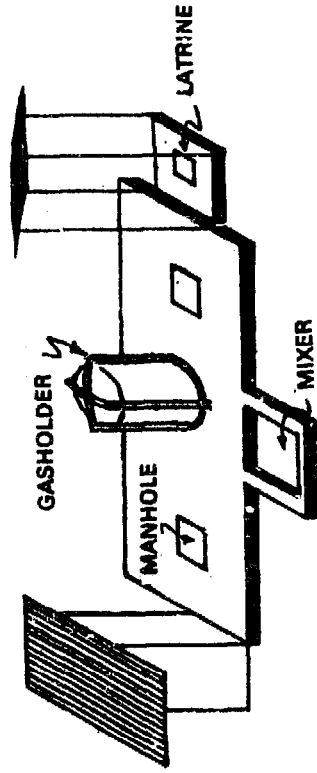
Fig. 7-32 is a modified version of the Taiwan two-chamber, double-walled design. A more efficient stirrer is used in place of the fixed bamboo stirrer. The first chamber is bigger than the second. This results in a thinner slurry which minimizes the chances of clogging in the digester. Since the gasholder dips in a water seal, the operation is neater and cleaner.



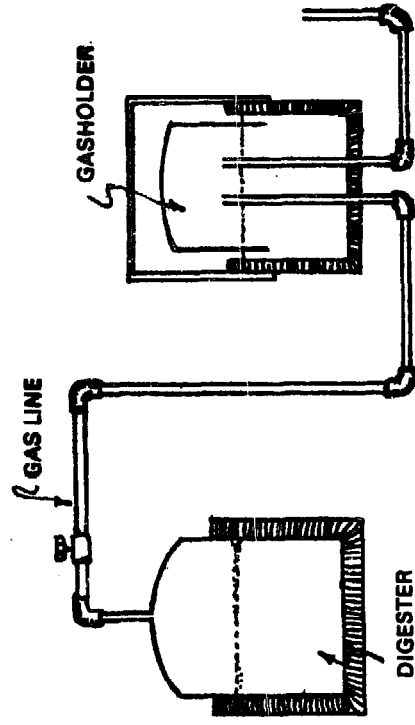
**FIG. 7-1**  
**GOBAR GAS PLANT\* with overflow outlet**  
 (PATEL; INDIA)  
 \*INDIAN AGRICULTURAL RESEARCH INSTITUTE



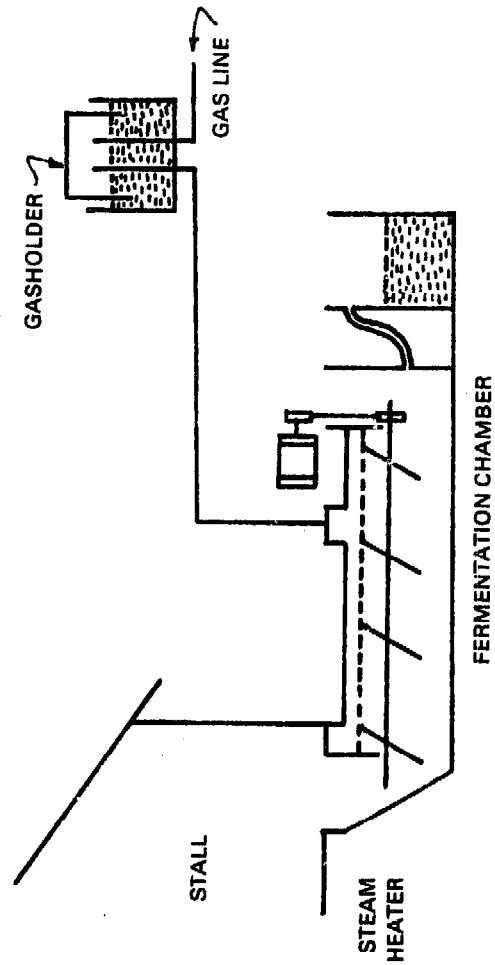
**FIG. 7-2**  
**GOBAR GAS PLANT\* WITH PIPE OUTLET (INDIA)**  
 \*CENTRAL PUBLIC HEALTH ENGINEERING  
 RESEARCH INSTITUTE



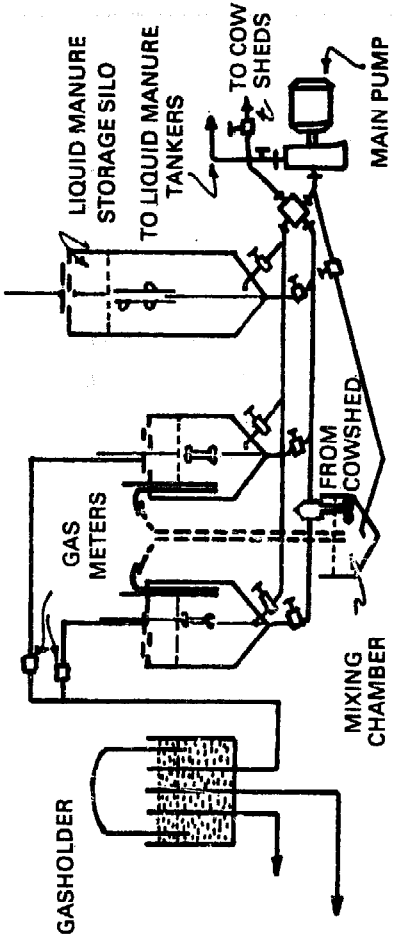
**FIG. 7-3**  
**MANURE GAS PLANT WITH LATRINES**  
 (GOTAAAS)



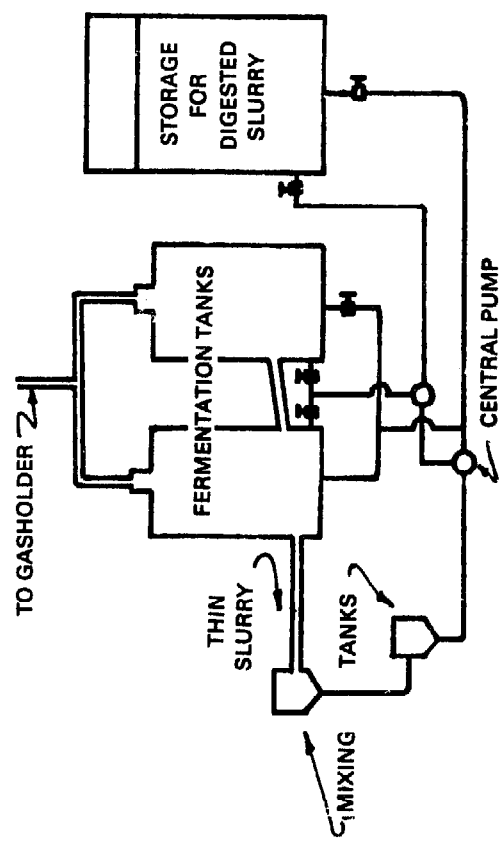
**FIG. 7-4**  
**BELUR MATH GOBAR GAS PLANT**  
 (CALCUTTA)



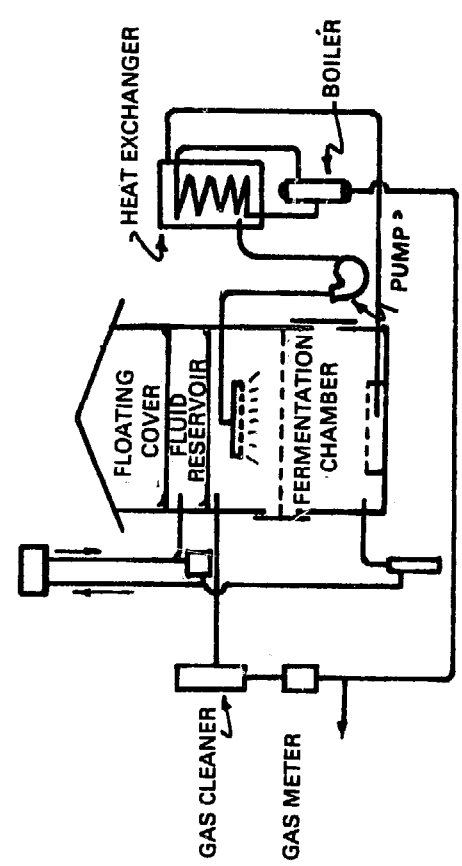
**FIG. 7-9**  
**DARMSTADT SYSTEM**  
 (REINHOLD, GERMANY)



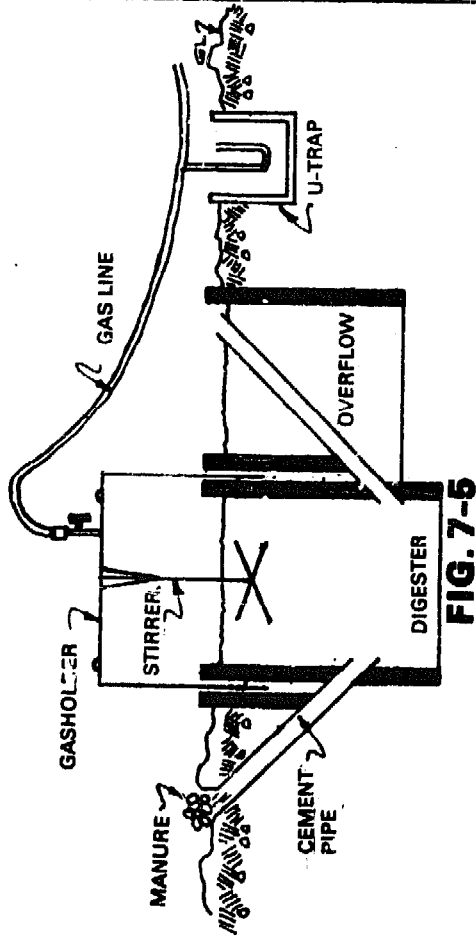
**FIG. 7-10**  
**SCHMIDT - EGGERS GLUSS SYSTEM**  
 (GERMANY)



**FIG. 7-11**  
**WEBER SYSTEM COW DUNG TYPE**  
 (GERMANY)

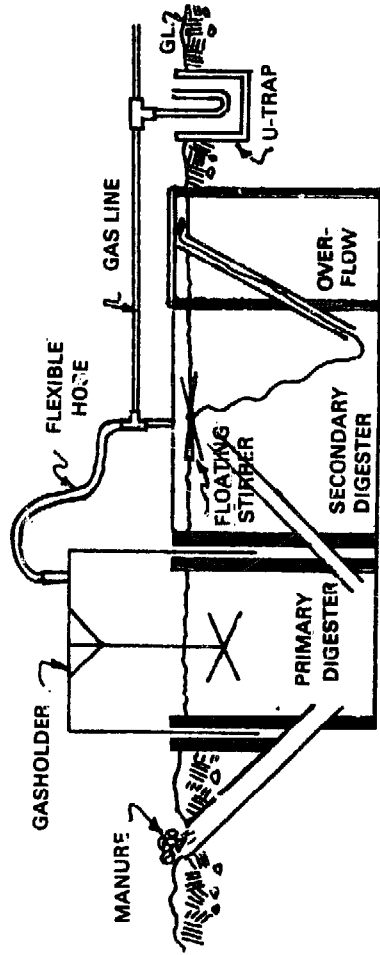


**FIG. 7-12**  
**BIUGAS ANLAGE**  
 (W. POETSCH, GERMANY)



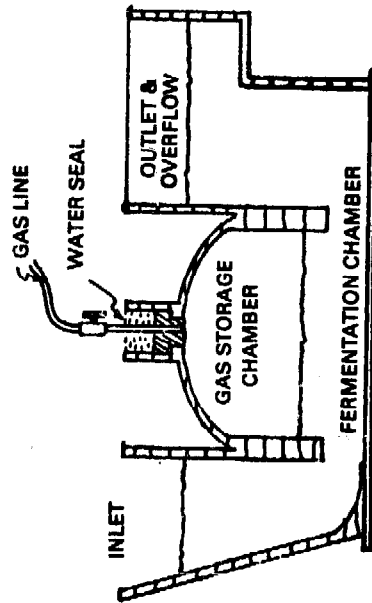
**FIG. 7-5**

**TAIWAN SINGLE STAGE BIOGAS PLANT**



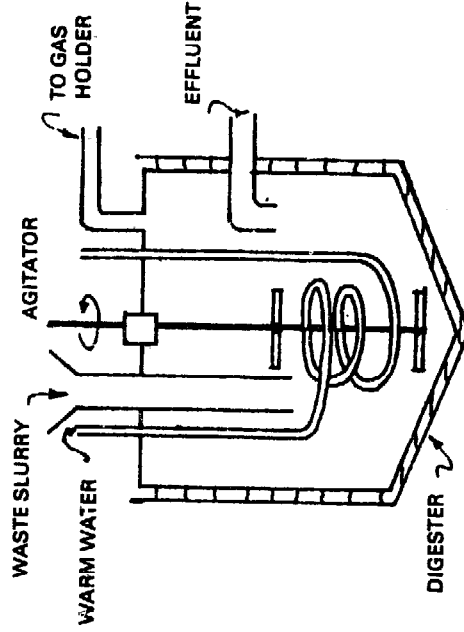
**FIG. 7-6**

**TAIWAN 2-STAGE METHANE GENERATOR**



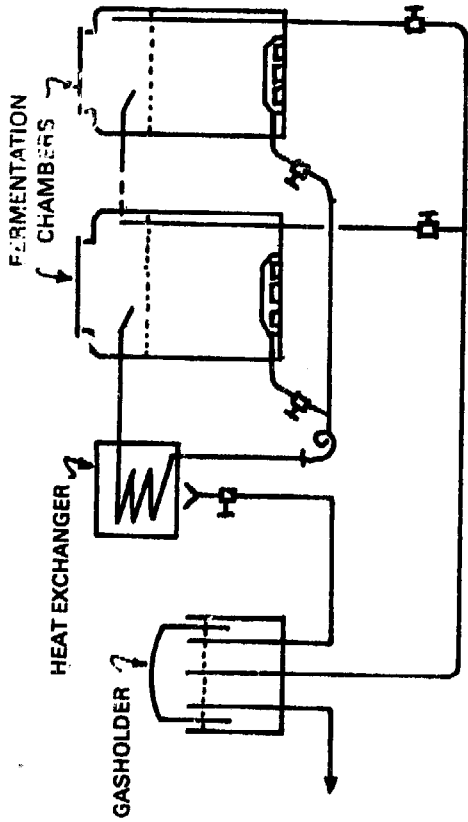
**FIG. 7-7**

**CHINA BIOGAS PLANT**

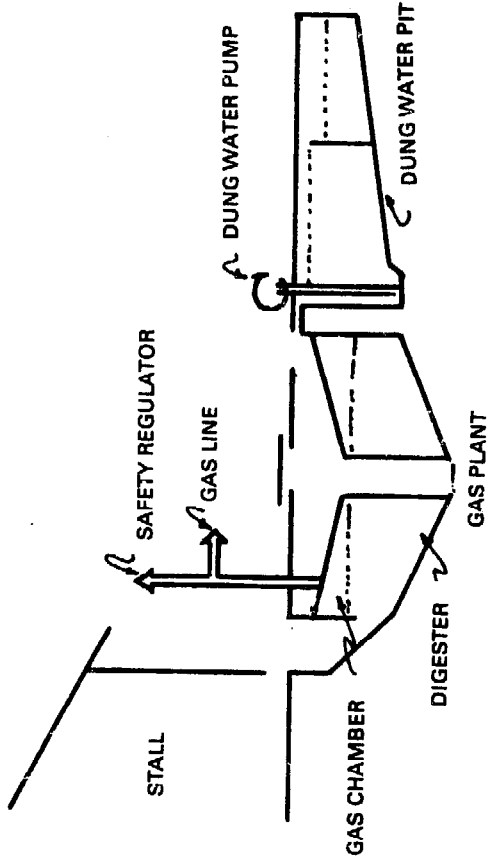


**FIG. 7-8**

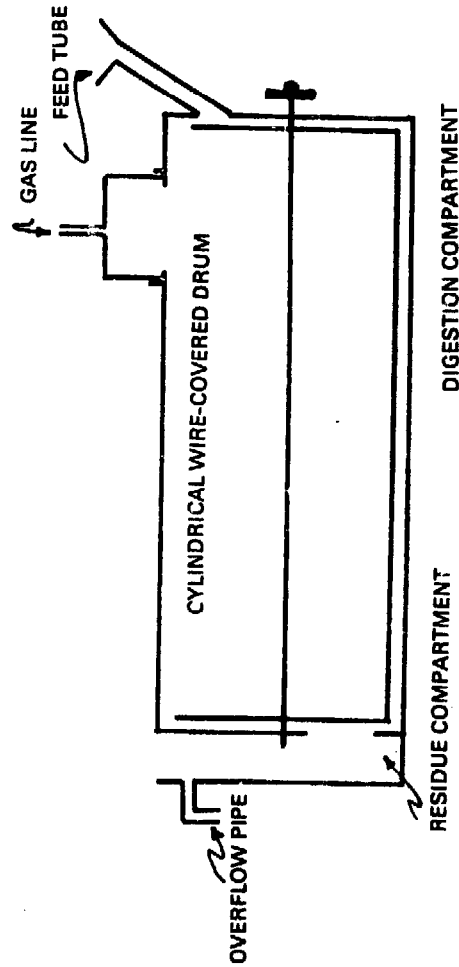
**ANAEROBIC DIGESTION OF PIG WASTE  
(JAPAN)**



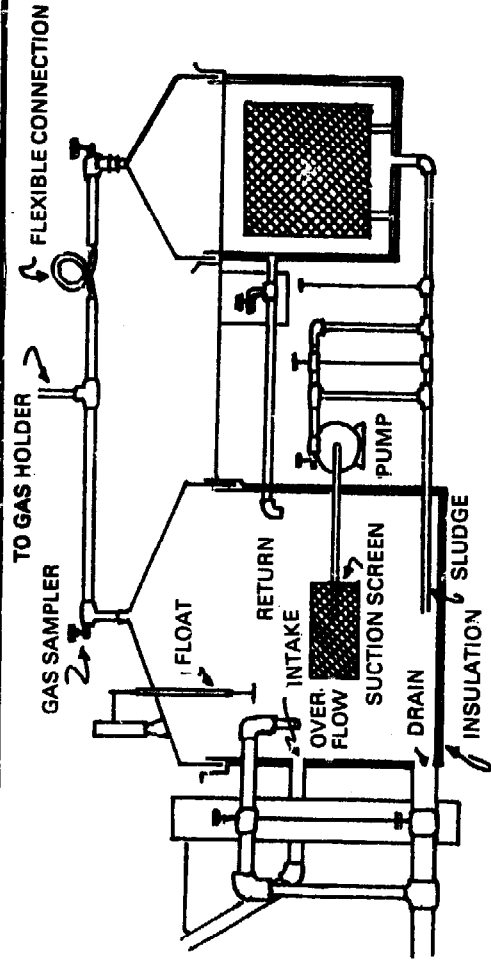
**FIG. 7-13**  
**DUCCELLIER - ISMAN SYSTEM**  
 (FRANCE)



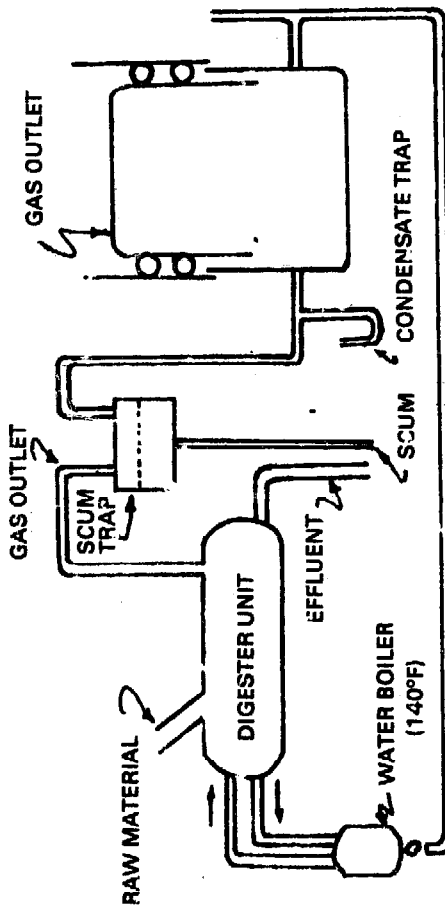
**FIG. 7-14**  
**GARTNER-IKONOFF SYSTEM**



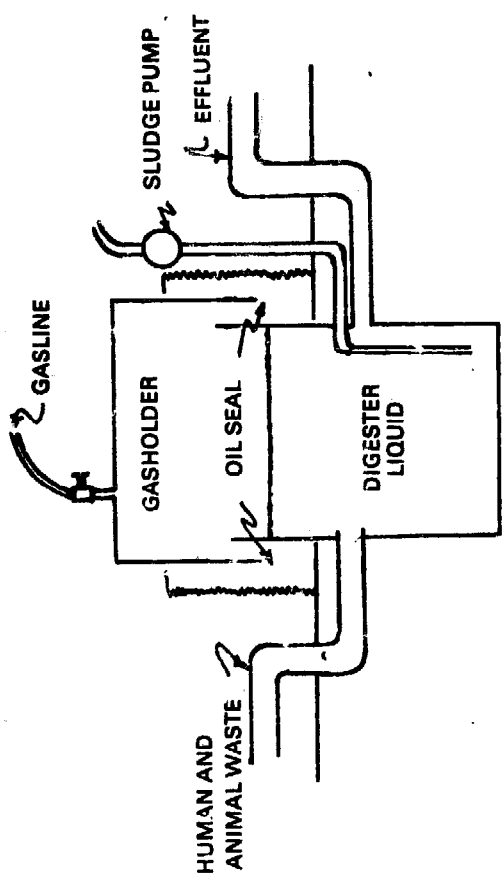
**FIG. 7-15**  
**DRUM DIGESTER FOR FIBROUS MATERIALS**  
 (BUSWELL-BORUFF; UNIVERSITY OF ILLINOIS)



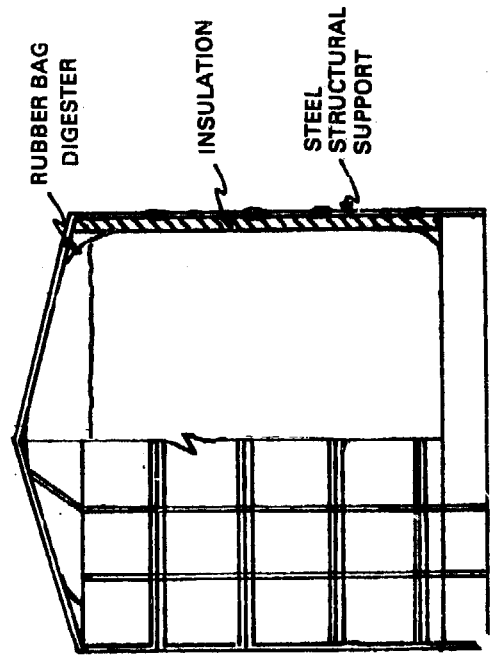
**FIG. 7-16**  
**GAS GENERATING PLANT FOR VEG. WASTES**  
 (BURKE-JACOBS; AMES, IOWA)



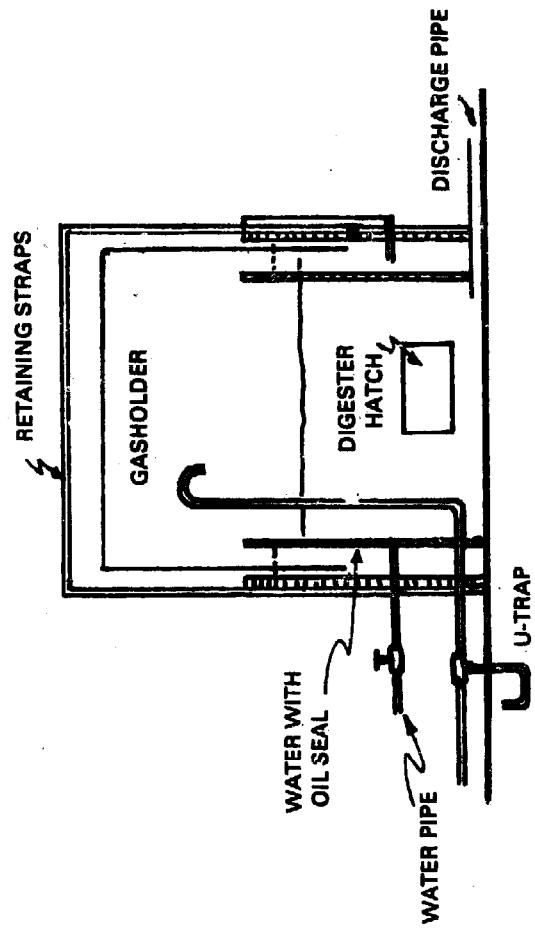
**FIG. 7-17**  
**ORGANIC DIGESTER**  
 (L. FRY, USA)



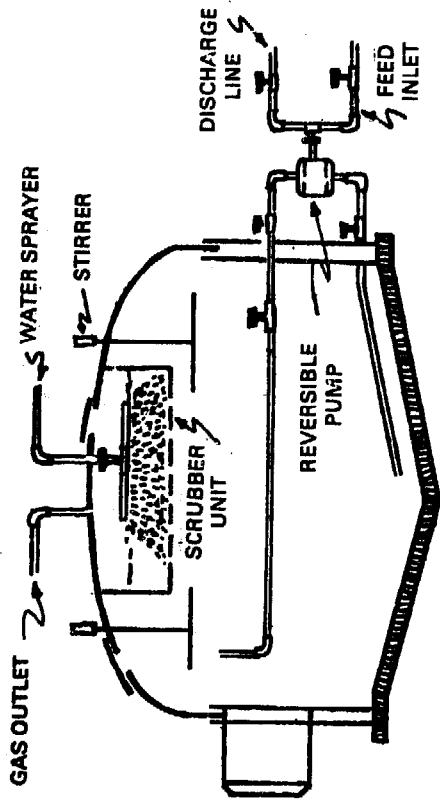
**FIG. 7-18**  
**METHANE RECOVERY DIGESTER**  
 (G. CHAN, TAIWAN)



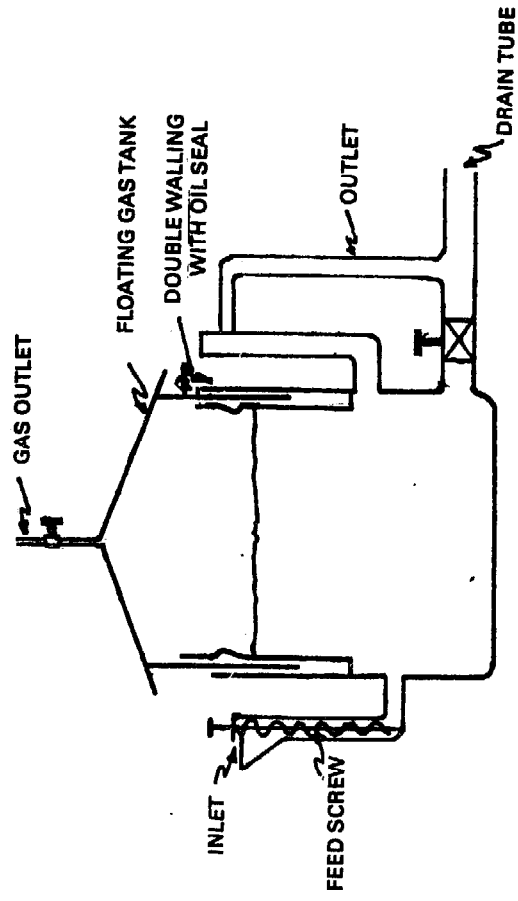
**FIG. 7-19**  
**SANAMATIC TANK**  
 (COULTHARD, AUSTRALIA)



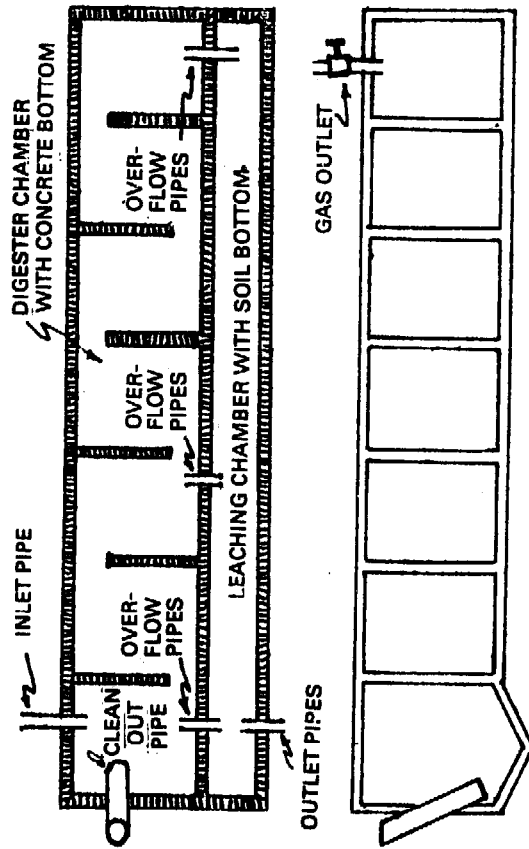
**FIG. 7-20**  
**KENYA BATCH DIGESTER**



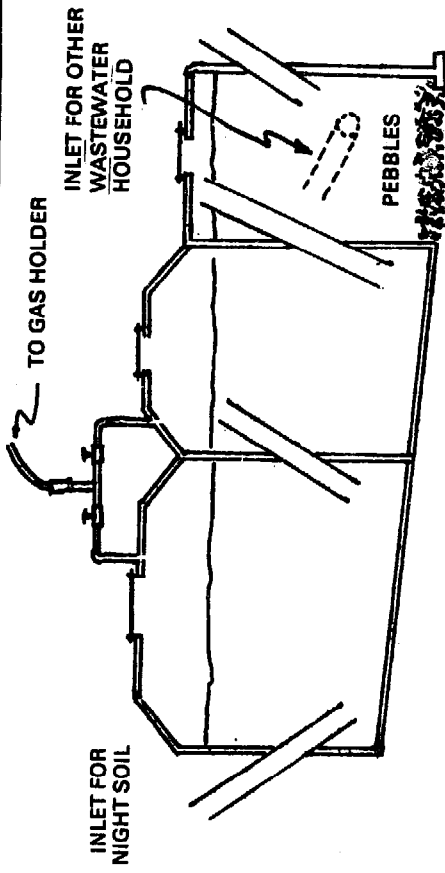
**FIG. 7-21**  
**CONTINUOUS ORGANIC WASTE DIGESTER AND METHANE GAS GENERATOR**  
 (V. A. ARANETA; PHIL.)



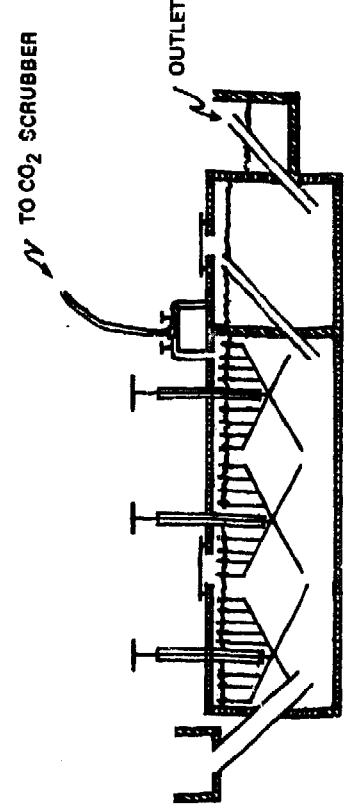
**FIG. 7-22**  
**GARBAGE FERMENTATION TANK**  
 (R. V. VALDERIA; PHIL.)



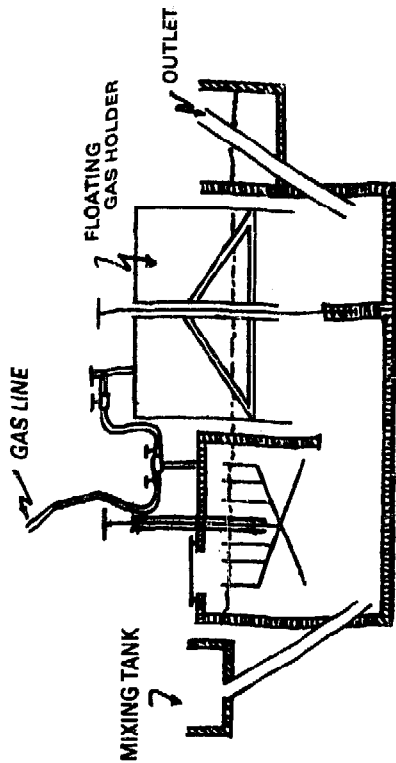
**FIG. 7-23**  
**METHANE GAS PRODUCING DEVICE**  
 (T. CADIZ & R. VELASQUEZ; PHIL.)



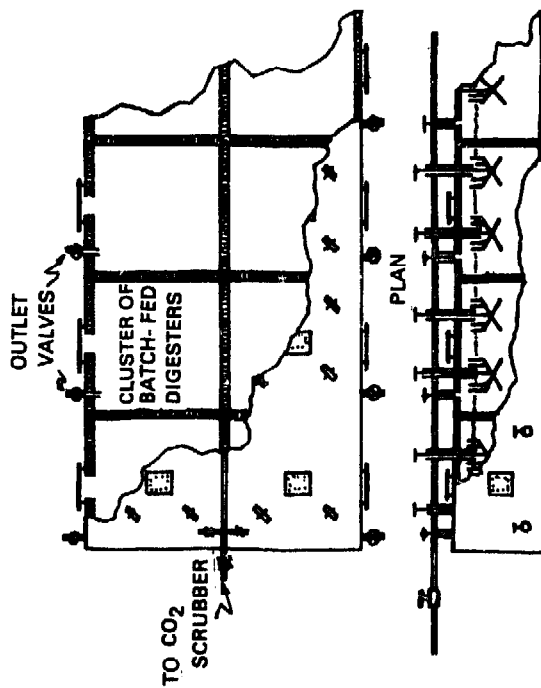
**FIG. 7-24**  
**NIGHT SOIL DIGESTER**  
 (MAYA FARMS - BAUTISTA)



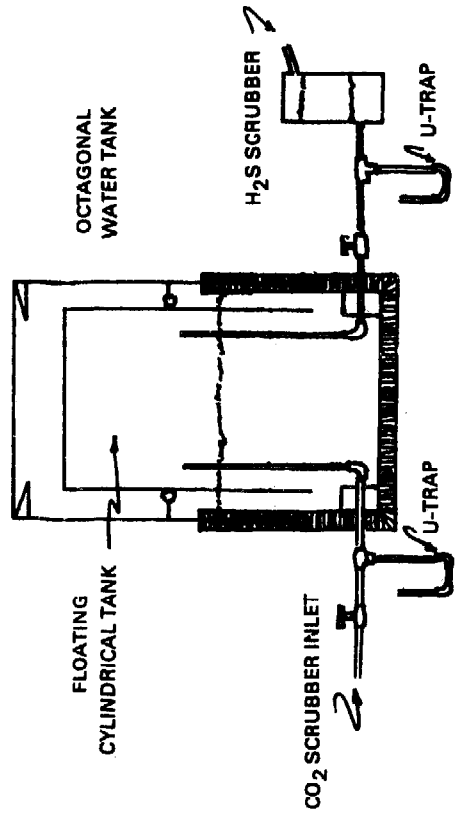
**FIG. 7-26**  
**CONTINUOUS-FED DIGESTER**  
**FOR LIVESTOCK FARMS**  
**(MAYA FARMS - TAGANAS)**



**FIG. 7-25**  
**HORIZONTAL CONTINUOUS-FED BIOGAS PLANT**  
**(MAYA FARMS - OBIAS)**

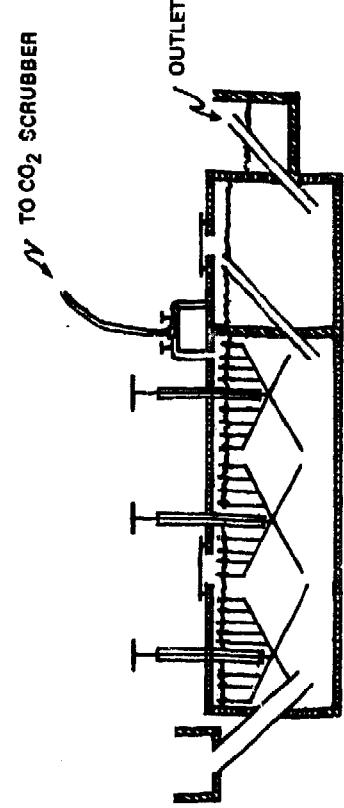


**FIG. 7-27**  
**BATCH-FED DIGESTERS FOR AGRO-INDUSTRIAL**  
**OPERATIONS**  
**(MAYA FARMS-MARAMBA)**

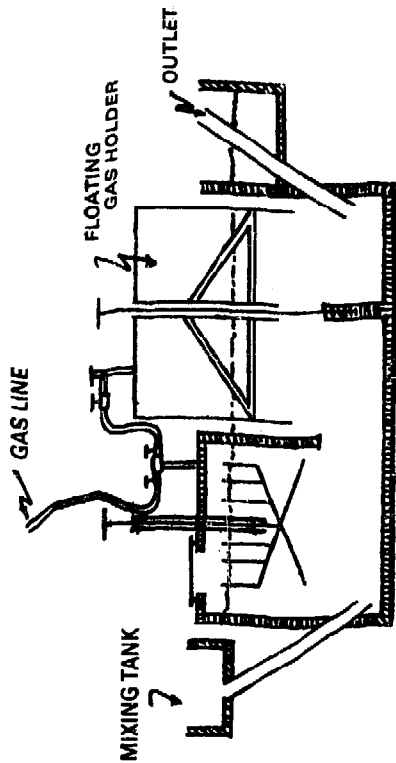


**FIG. 7-28**  
**FLOATING DOME GASHOLDER**  
**FOR SPLIT-TYPE BIOGAS PLANT**

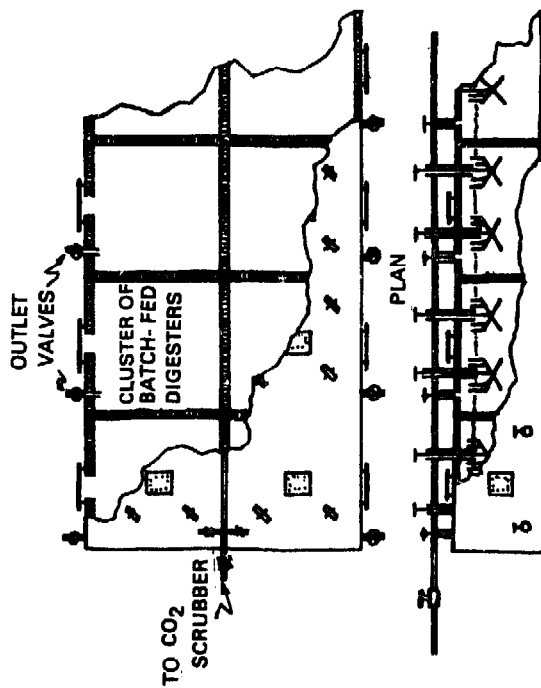




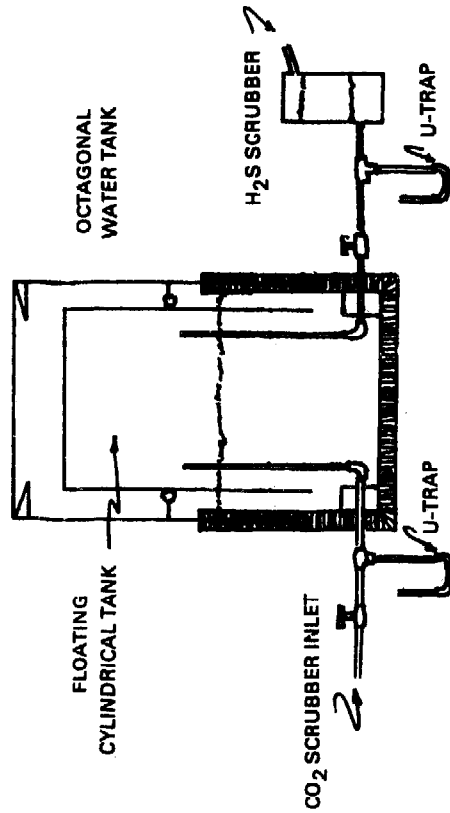
**FIG. 7-26**  
**CONTINUOUS-FED DIGESTER**  
**FOR LIVESTOCK FARMS**  
**(MAYA FARMS - TAGANAS)**



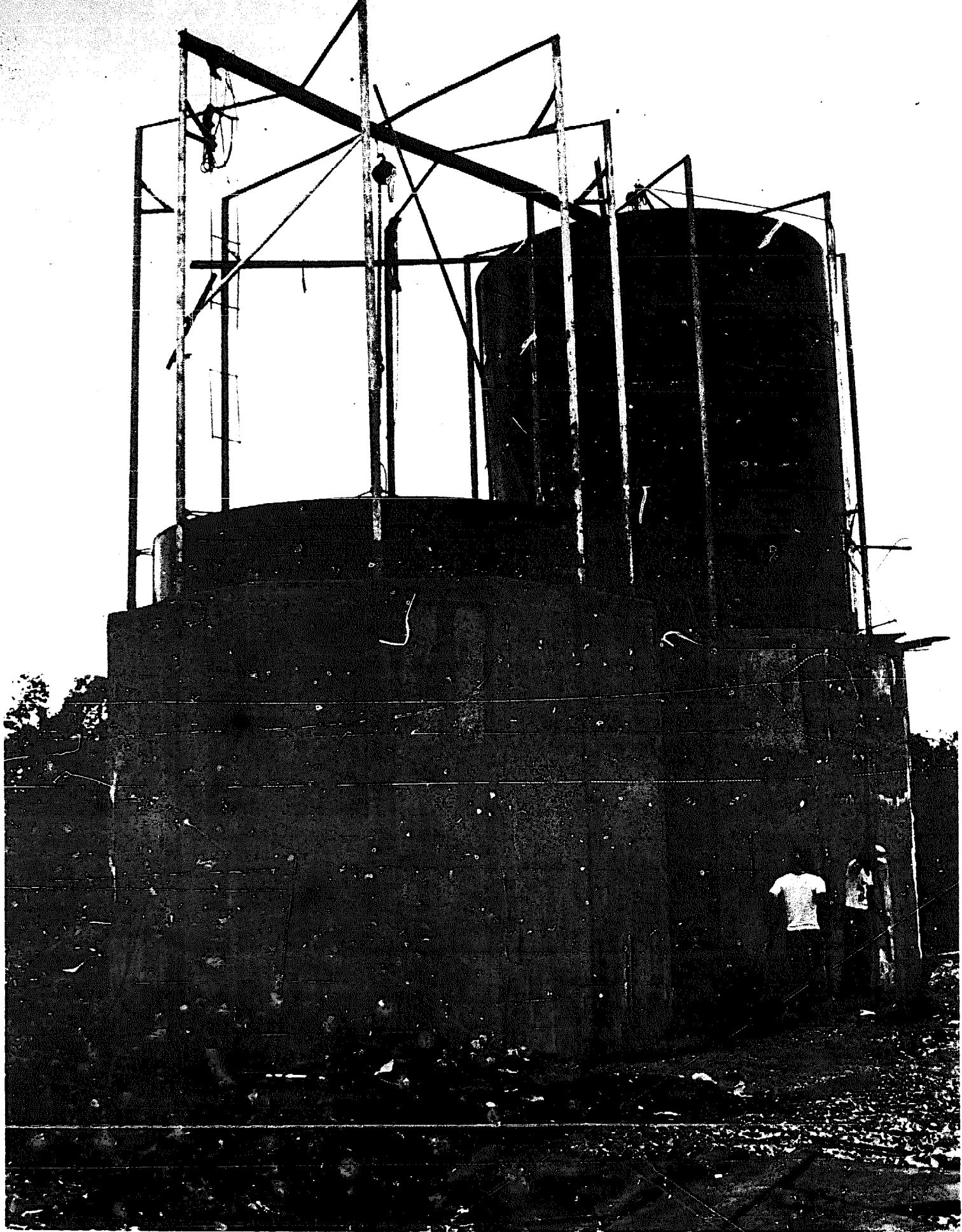
**FIG. 7-25**  
**HORIZONTAL CONTINUOUS-FED BIOGAS PLANT**  
**(MAYA FARMS - OBIAS)**



**FIG. 7-27**  
**BATCH-FED DIGESTERS FOR AGRO-INDUSTRIAL**  
**OPERATIONS**  
**(MAYA FARMS-MARAMBA)**



**FIG. 7-28**  
**FLOATING DOME GASHOLDER**  
**FOR SPLIT-TYPE BIOGAS PLANT**



**Illustration 2-3: Gasholders for the fourth biogas plant under construction at Maya Farms**

## Chapter VIII

### Sludge-Conditioning Plant Designs

The process of methane fermentation produces biogas which is evolved from a residual material left in the digester. This is called the sludge. Though the biogas process greatly reduces the BOD and COD of the waste slurry, the BOD and COD of the sludge is still far in excess of the level tolerated by the National Pollution Control Commission for discharging into public waters.

Literature on biogas suggests its use as fertilizer. But it can only be applied in small quantities; otherwise, it would be toxic to plants and fish. Literature on biogas indicates that the sludge is a good fertilizer because it contains all the plant nutrients originally present in the manure, since digestion takes place in sealed containers and only carbon and hydrogen are used to produce the biogas. Indian literature suggests that the sludge shall not be used until at least after two weeks of exposure to air. Even with this precaution it was observed that the use of the sludge in large doses and continuously has an adverse effect on plants. The experience at the Maya Farms is in agreement with the Indian observation. The Sewage Plant in London observes that the sludge is not a good fertilizer.

Under these circumstances the sludge in big biogas operations present a problem of disposal because it is voluminous. This is made more serious by the disposal of the wash water from livestock stables as in the case of large stock farms. To facilitate the cleaning of large livestock pens, a lot of pressurized water is used to wash off the manure. A processing plant increases the amount of this undesirable water. If all this water is charged with the manure into the digesters, bigger and/or more digesters will be required. This is costly. If the excess water is drained directly to the fields, it will damage the crops. If it is let loose, it will cause water pollution.

Aside from its toxicity the fresh sludge comes out of the biogas plant with still some slightly objectionable odor unless the operation allows sufficient retention time. A biogas plant will bring down air pollution to a satisfactory level if the waste slurry is retained in the digester not less than 60 days. However, this is not always the most expedient retention time. A shorter period would have a number of advantages. It is evident that the shorter the retention time, the less is the digester volume required to process the same amount of waste, and hence the lower is the construction cost of the digesters. Moreover, experiments at Maya Farms show that with sufficient and good quality starter, 80 to 90% of the biogas can be obtained within the first 30 days. Thus with the same slurry capacity of the digester, much more biogas is obtained daily when a shorter retention time is used in the biogas operation. Another advantage, in the case of continuous-fed digesters, is that the digester slurry is more homogeneous and flows more easily. With 60 days retention, the solids tend to settle at the bottom. Solids remaining in the digester reduce its capacity and eventually clog the transfer pipes. This would necessitate cleaning of the digester more often with consequent service interruption.

To solve the problem of water pollution, Maya Farms developed the sludge-conditioning plant. It consists of treating the sludge and the surplus water so that much of it may be used as feed and fertilizer right on the farm and whatever is the excess could be safely discharged to public water. This chapter presents a number of sludge-conditioning plant designs to suit variations in the biogas works operation.

### **Nature of the Sludge**

The knowledge about the nature of the sludge is of prime importance in determining the solution to the disposal problem. The sludge is the visible end product of the anaerobic fermentation process and consists mainly of unfermented or unfermentable materials. As far as it is known, it contains cellulosic fibers, lignins, tannins and other similar chemical entities. Anaerobic fermentation is relatively little studied, hence the breakdown products are largely unknown. There is some similarity with the processes taking place in the rumen of ruminants and in fact methane is one of the gases passed out by these animals. Much of the information deals with the cellulosic part of the feed. The degradation of the proteins in animal digestion is relatively well studied, but information as to what happens to the proteins in the methane fermentation is again largely lacking. There is evidence (see Part I of this book) that a big fraction of the proteins remains in the sludge and is therefore not converted to volatile products like ammonia. It is likely that the protein nitrogen of the original substrate material has become assimilated into the newly developed cells of the methane bacteria. In a way the bacterial cells have become the storage compartments of protein. The occurrence of course is not unusual; it is the basis of "single cell protein" production.

The activity of the bacteria in methane fermentation has also resulted in the formation of chemical compounds which have detrimental effect on plants and fish. It appears that this toxicity is largely due to a water-soluble gas, hydrogen sulfide ( $H_2S$ ), because this gas is known for its high toxicity. Chemical tests confirm its presence in the sludge as well as in the biogas. As to its origin, there have been studies which show that  $H_2S$  is a decomposition product of sulfur-containing amino acids; it is also formed from the chemical reduction of sulfates which are normally present in urine.

To avoid the formation of hydrogen sulfide, one may try to remove the sulfates and the sulfur amino acid. This step, however, is practically impossible to undertake not only because of cost but also because the methane bacteria themselves appear to require  $H_2S$  for their growth. The sulfur amino acids are among the "essential" amino acids for man and may be so also for these bacteria.

The other recourse is to remove the hydrogen sulfide. In biogas, the  $H_2S$  is removed by chemical action of iron filings. This method may be applied also to the sludge with proper adaptations. Another approach makes use of the destruction of hydrogen sulfide by oxidation, using air to accomplish the process. This is the basis of the method being used in the sludge-conditioning plants at Maya Farms.

The findings on toxicity, retention time and surplus wash water led to the design of what is now called the sludge-conditioning plant to accompany biogas plants. The two plants together are known as the Biogas Works. At the Maya Farms the biogas plant has the functions of producing biogas and sludge and of controlling most of the air pollution. The functions of the sludge-conditioning plant are:

1. To supplement the air pollution control function of the biogas plant;

2. To recover the coarse portion of the sludge as pulp material;
3. To recover the fine solids from the sludge and process the same into feed materials;
4. To condition the liquid and initiate the growth of algae to enhance its fertilizer value;
5. To control water pollution by utilizing the sludge or disposing it in a sanitary way.

The sludge-conditioning plant consists of:

1. Solid sludge recovery and biofeed processing system; and
2. Liquid sludge treatment system.

The solid sludge recovery and processing system consists of the decantation tanks, dryers, detoxifier and beaters. The liquid sludge treatment system consists of lagoons, crop fields, fishponds, and irrigation and drainage canals. Attached to the sludge-conditioning plant are the compost stacks or bunks and incinerator to dispose of wastes not used in the biogas plant.

The sludge flows from the digesters to the decantation tanks. Each of the tanks, made of masonry, has a capacity equal to the daily sludge output. The settled solids are recovered and dried in the sun or by an artificial drying system. When drying, the temperature should be low to avoid destroying the vitamins in the sludge, but high enough to insure that any parasite eggs that find their way there are destroyed.

The liquid sludge from the decantation tanks flows into the treatment lagoons. The purpose of the lagoons is to aerate the liquid sludge in order to eliminate any remaining foul odor and oxidize the toxic substances such as hydrogen sulfide. It also initiates the growth of nitrogen-fixing algae so that algae would grow profusely wherever the liquid fertilizer is applied, thereby supplying the plants with an abundance of nitrogen.

There are four types of sludge-conditioning plants:

1. Single pond, Fig. 8-1
2. Double lagoons, Fig. 8-2
3. Multi-stage lagoons, Fig. 8-3
4. Settling lagoons.

### **The Single Pond Sludge-Conditioning Plant**

The single pond type of sludge-conditioning plant is designed to accompany small biogas plants for an operation where there is no wash water in excess of what is needed in the fresh slurry, and where the sludge-conditioning plant is close to the farmhouse. The retention time shall be 50 days in the digester in order to have better control of air pollution in the digester before emptying the sludge into the decantation tank. The retention time in the sludge-conditioning plant shall be 24 days: 10 days for digestion and 14 days for aging.

The single pond type of sludge-conditioning plant consists of:

1. Decantation tanks
2. Feed material processing unit
3. Algae pond
4. Storm drain

5. Compost stack
6. Fishpond
7. Crop fields
8. Irrigation and drainage canals
9. Incinerator.

The purpose of the decantation tank is to receive the sludge from the digesters and separate the solid from the liquid portions. After one day in the decantation tank, the liquid portion is allowed to flow to the algae pond through a filter consisting of grass cuttings. The solids that have settled are dried and detoxified. These are used as feed materials for the animals that excreted the manure.

The purpose of the algae lagoon is to initiate the growth of algae and age the liquid sludge. The rain water from the storm drain will dilute the liquid sludge to promote the growth of algae. During prolonged drought, fresh water is added instead. After 24 days or more in the algae lagoon the liquid sludge makes a good biofertilizer-irrigation water for the crop fields and fishponds. The canals are intercepted by overflow dams so that the liquid absorbs more air. During the flow through the canals to the field more algae multiply. In flooded fields algae also multiply, thus increasing the nitrogen value of the biofertilizer.

A portion of the liquid is used to fertilize the fishponds. The fishponds are included for two reasons: to raise fish and to grow more algae for fertilizer. The feed sweepings from the piggery and/or poultry houses are used as supplementary feed for the fish. The fishpond shall not be less than one meter to 1.5 meters deep. No water-loving plants should be allowed to grow in the fishpond because they would compete with fish for oxygen during the night. The fishpond water should be constantly flowing to increase the oxygen content in the water.

The overflow from the flooded fields and fishponds pours out to the drainage canals. The canals are intercepted with overflow dams in order to improve aeration. This drainage water is used to irrigate the upland crops and moisten the compost. In this way water pollution that would otherwise be caused by the sludge will be controlled. The crop field would raise feed for the livestock and poultry and for food.

The compost raw materials consist of the crop residues not consumed by the livestock, the grass filter material, the scum from the algae pond and the sludge residues recovered from the digester and algae pond.

All the wastes unfit for use as raw materials in the biogas plant and for the compost are burnt in the incinerator. The ash is used in the CO<sub>2</sub> scrubber and the residue is used as potash fertilizer.

### **Double Lagoon Sludge-Conditioning Plant**

The double lagoon sludge-conditioning plant is used in operations with no significant cropping and where the wash water is more than that what is required in the fresh slurry. It consists of:

1. Digestion lagoon
2. Decantation tank

3. Feed material processing unit
4. Storm drain
5. Algae lagoon
6. Fishpond
7. Irrigation and drainage canals
8. Incinerator.

The excess water from the manure slurry goes to the digestion lagoon to undergo fermentation for the same number of days of retention as that of the digesters. After fermentation it flows to the algae lagoon.

The sludge flows to the decantation tank which is the same as that in the single lagoon except that the bottom of the tank is lined with a layer one foot thick of sand and gravel with uncemented layer of cement blocks or bricks. This will allow seepage of part of the liquid sludge so that when collecting the solid sludge no inorganic material would be carried along.

The feed material treatment system shall be the same as in the single pond type of sludge-conditioning plant. The liquid sludge from the decantation tank flows to the algae lagoon. The algae lagoon is the same as that in the single lagoon type of sludge-conditioning plant except that it is bigger.

The fishpond is the same as in the single lagoon type of sludge-conditioning plant except that it is also bigger. The liquid sludge to fertilize the fishpond shall come from the algae lagoon. The overflow from the fishpond is used to fertilize the gardens.

The overflow from the algae lagoon and the fishpond go to a canal that would be used by neighboring farms. If none would use it, it would be necessary to build a large aeration canal intercepted by overflow dams. This liquid sludge is diluted further by funnelling the relatively clean water that flows from the pens after completing the washing of the manure.

### **Multi-stage Lagoon Sludge-Conditioning Plant**

The multi-stage type of sludge-conditioning plant is used in large farms engaged in cropping and raising of livestock. It consists of:

1. Digestion lagoon
2. Decantation tanks
3. Feed materials processing unit
4. Storm drain
5. Aeration lagoon
6. Dilution lagoon
7. Aging-Storage lagoon
8. Irrigation canal
9. Fishpond
10. Incinerator
11. Compost bunk
12. Crop field
13. Drainage canals.

In addition, there are two optional units which may or may not be included, depending on circumstances:

14. Paper pulp separation unit

15. Catch basin.

The digestion lagoon, the decantation tanks and feed material processing system are the same as those in the double lagoon sludge-conditioning plant.

If it is desired to recover the fibrous materials in the sludge for use as paper pulp raw material, this is placed in a drum lined with perforated screen and washed with clean water. The washing flows to the decantation tanks.

The catch basin receives the wash water from the processing plant. It separates the solids from the water. The solids are used as raw material for composting. The liquid flows to the dilution lagoon to dilute the contents.

The digestion lagoon is similar to that in the double lagoon type of sludge-conditioning plant except that the contents after digestion flow to the aeration lagoon. The retention time in the digestion lagoon is 30 days, hence it should have a capacity equal to 30 times the input.

The purpose of the aeration lagoon is to allow the oxidation of toxic substances and increase the dissolved oxygen in the liquid sludge. Artificial aerators may be used to accelerate the process. At Maya Farms a windmill is used to drive waterwheels with perforated buckets to increase the exposure of the liquid sludge to the air. For better aeration, the lagoon should not be deeper than one meter and the retention time should be 15 days. The inlet and outlet canals are packed with grass cuttings which serve as filters. Filtration helps to reduce the solid deposits in the lagoons and thus reduces the frequency of cleaning.

The aerated liquid sludge overflows to the dilution lagoon. The purpose of the dilution lagoon is to maintain the concentration of the liquid sludge at a level conducive to the growth of the nitrogen-fixing algae. The dilution water comes from the storm drains and the waste water from the processing plant, if there is any. During the dry season, it may be necessary to add fresh water. The retention time is 15 days, hence the capacity shall be equal to 15 times the inflow.

The overflow from the dilution lagoon goes to the aging-storage lagoon. The purpose of the aging-storage is to continue the growth of the algae and to age the liquid fertilizer for about two weeks before using. The profuse growth of nitrogen-fixing algae wherever it is applied provides the plants with ample supply of nitrogen. The capacity of the aging-storage lagoon will depend on how regularly the liquid fertilizer is used.

The fishpond is fertilized with liquid sludge. The fish feed on the algae that grow and on the feed sweepings from the pigpens. The overflow from the fishpond is used as fertilizer-irrigation water for the crop fields and to moisten the compost.

### **Compost Bunks**

Farming requires compost to keep the carbon-nitrogen ratio in the soil as close to 13:1 as possible. Most agricultural lands particularly those that are continuously cropped



become deficient in organic matter. Compost is a good soil conditioner. The ready raw materials for compost are crop residues and weeds not consumed by the ruminants, the filter materials from the aeration lagoon and the sludge residues from the digester and the lagoons.

Composting requires the combined action of both aerobic and anaerobic bacteria. Aerobic fermentation is aided by providing ventilation tubes and periodic turning of the stack. Anaerobic fermentation can be accelerated by using the sludge residues to serve as starter. The walls are made of cement or concrete hollow blocks. The partitions may be made of wood. A roof is constructed to avoid excessive drying of the compost under the sun or its getting too wet when it rains.

### **Incinerator**

The incinerator is the same as that in the double lagoon sludge-conditioning plant.

### **Crop Fields**

The purpose of the crop field is to make use of the liquid sludge as fertilizer and the compost as soil conditioner, and to control pollution at the same time. It is clear that there should be enough croplands and fishponds to utilize all the liquid sludge, otherwise the excess can still cause water pollution.

### **Irrigation Canal**

The biofertilizer-irrigation water passes from the aging-storage lagoon to the fishpond and lowland fields by way of the irrigation canal. This canal also serves to aerate the liquid and grow more algae.

### **Drainage Canals**

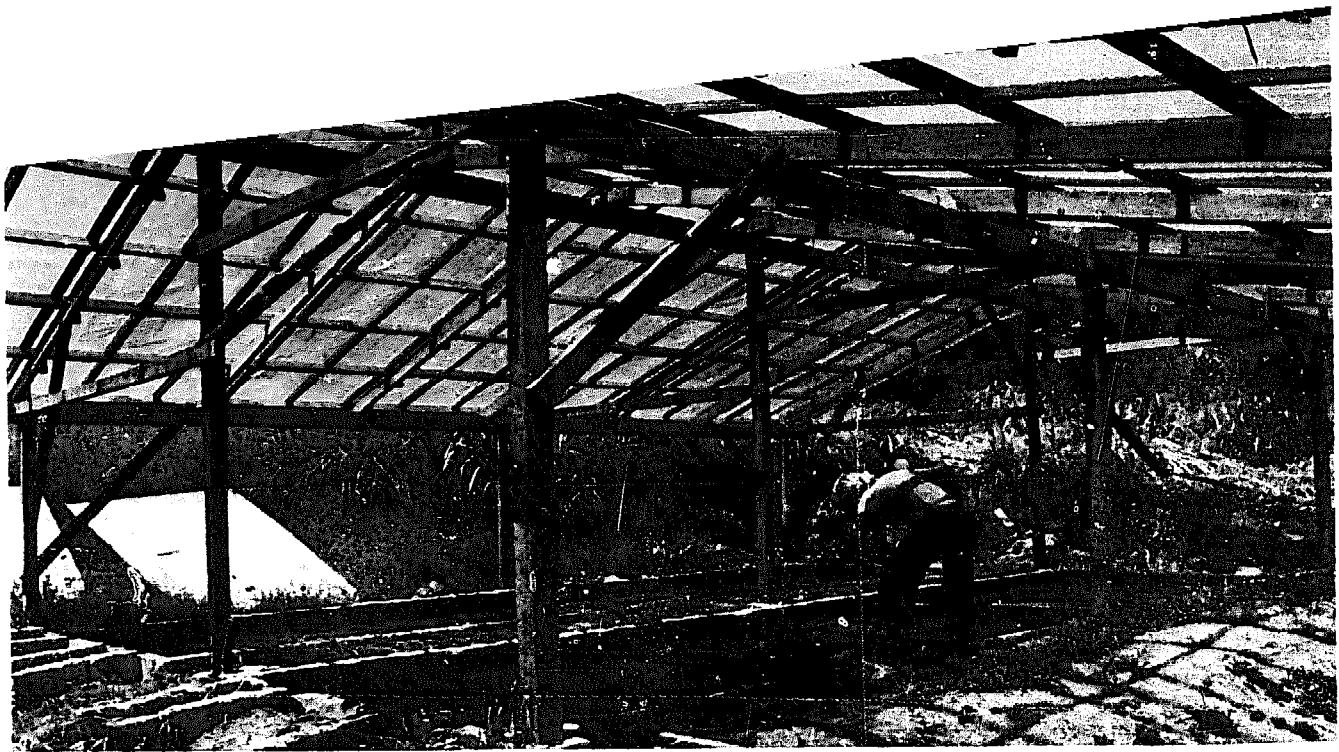
The overflow from the fishpond and lowland fields go to the drainage canals where it is further aerated. This is enhanced by constructing overflow dams along the way. There should be as many of them as possible depending on the contour of the land and the length of the canal. The water from the drainage canal is also used to moisten the compost and to irrigate upland crops by pumping. All the excess water shall be drained to a waterway after the water is within the BOD and COD requirements of the Pollution Control Commission. A quick method is developed for the purpose. Fish in a cage are lowered to the end of the drainage canal. If the fish will not come up above the water with open mouth after one hour, it means that there is sufficient oxygen in the water and therefore it is safe to drain it to a waterway.

### **Sanitary Excavators**

Whenever night soil is used as raw material in the digester, the sludge is used only as filling material in many places because of unpleasant connotations. From time to time the digesters are opened, water is added, and the dilute sludge is pumped into trailer tanks and disposed of.

## **Settling Lagoon**

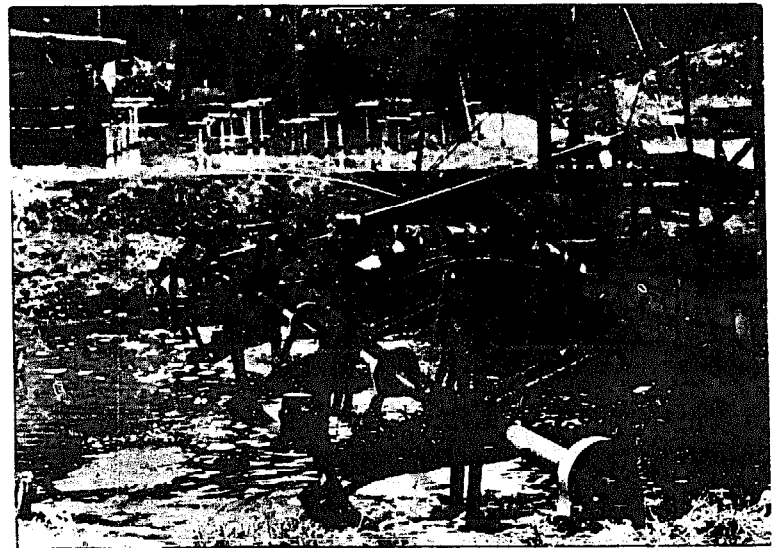
If the main reason for the biogas is to control pollution, as in a city sewage system, all the wastewater should go with the slurry through the digesters even though this would require large digester capacities. The sludge flows into settling lagoons. Part of the liquid sludge is recycled through the digester as starter to speed up the decomposition of organic wastes. The retention time is 23-25 days. The liquid sludge flows to a series of lagoons where it is aerated until the BOD and COD are reduced to acceptable levels.



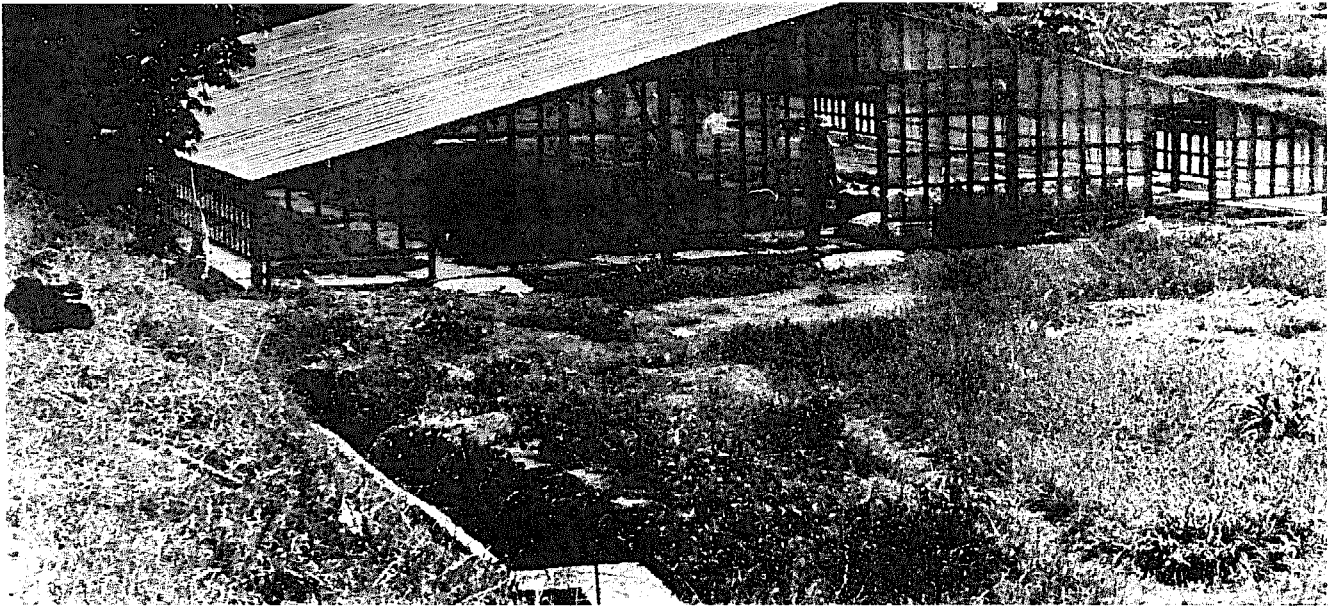
**Illustration 2-4: Settling basins.**



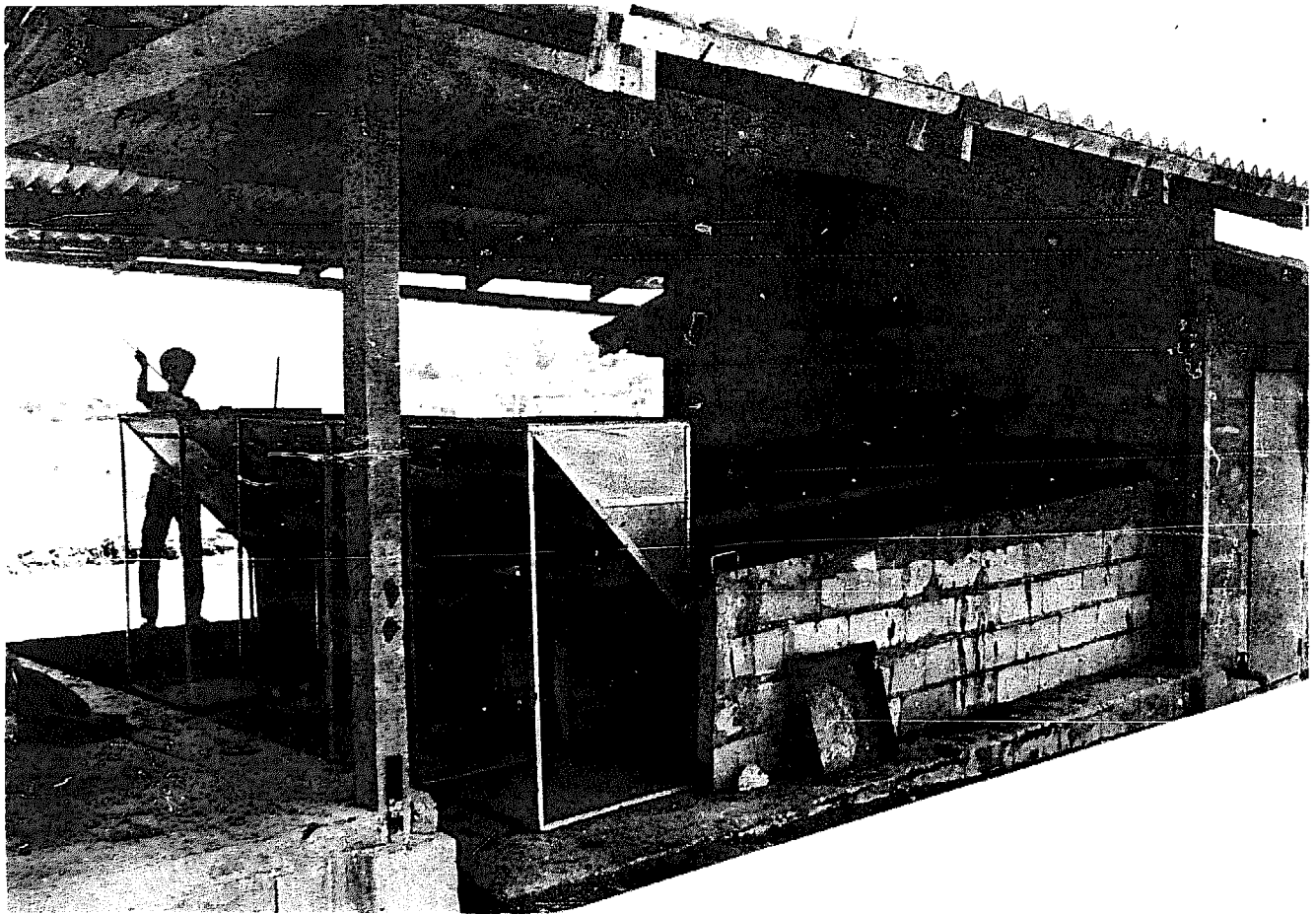
**Illustration 2-5: Sludge conditioning canals with overflow dams.**

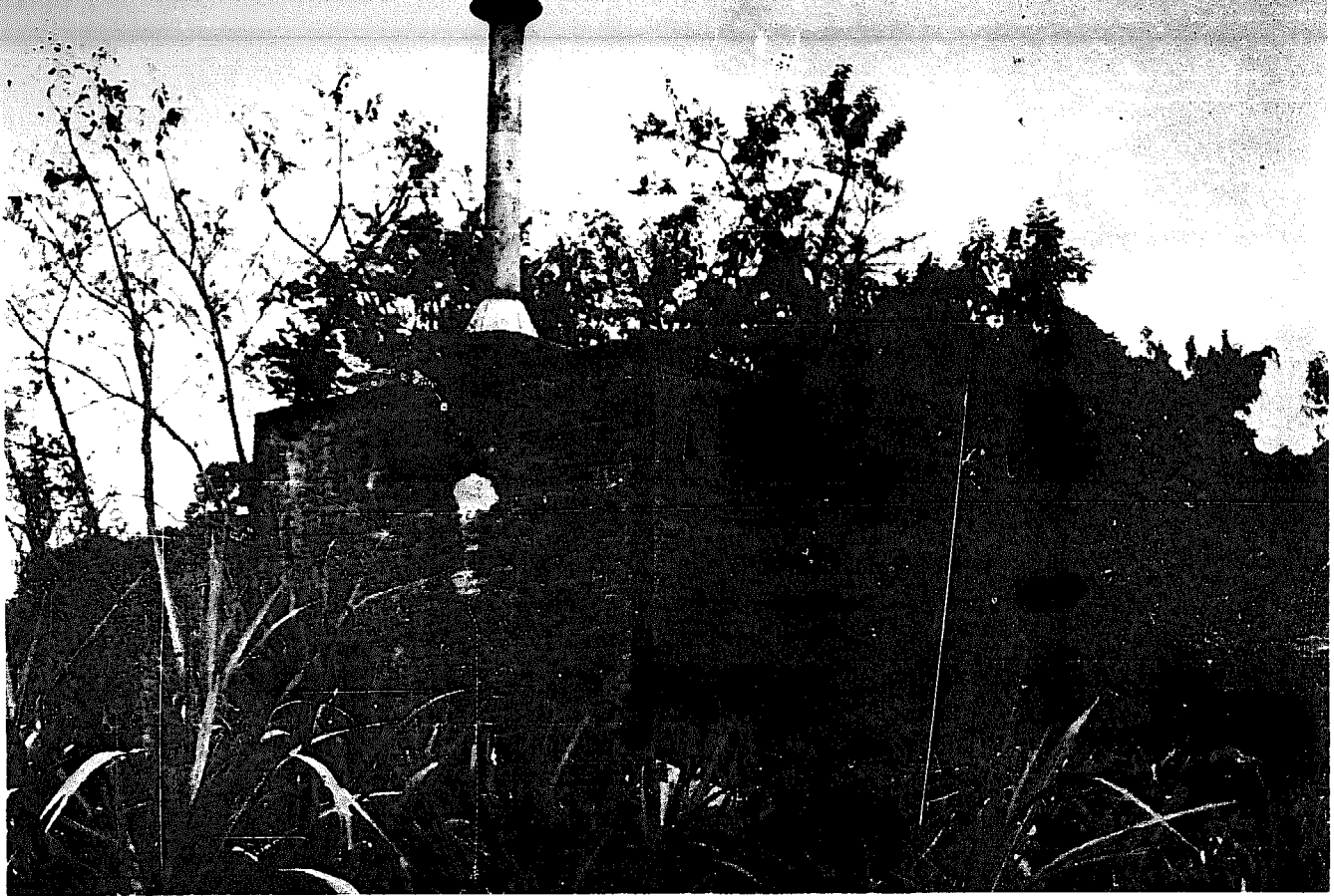


**Illustration 2-6: Water-wheel aerator**

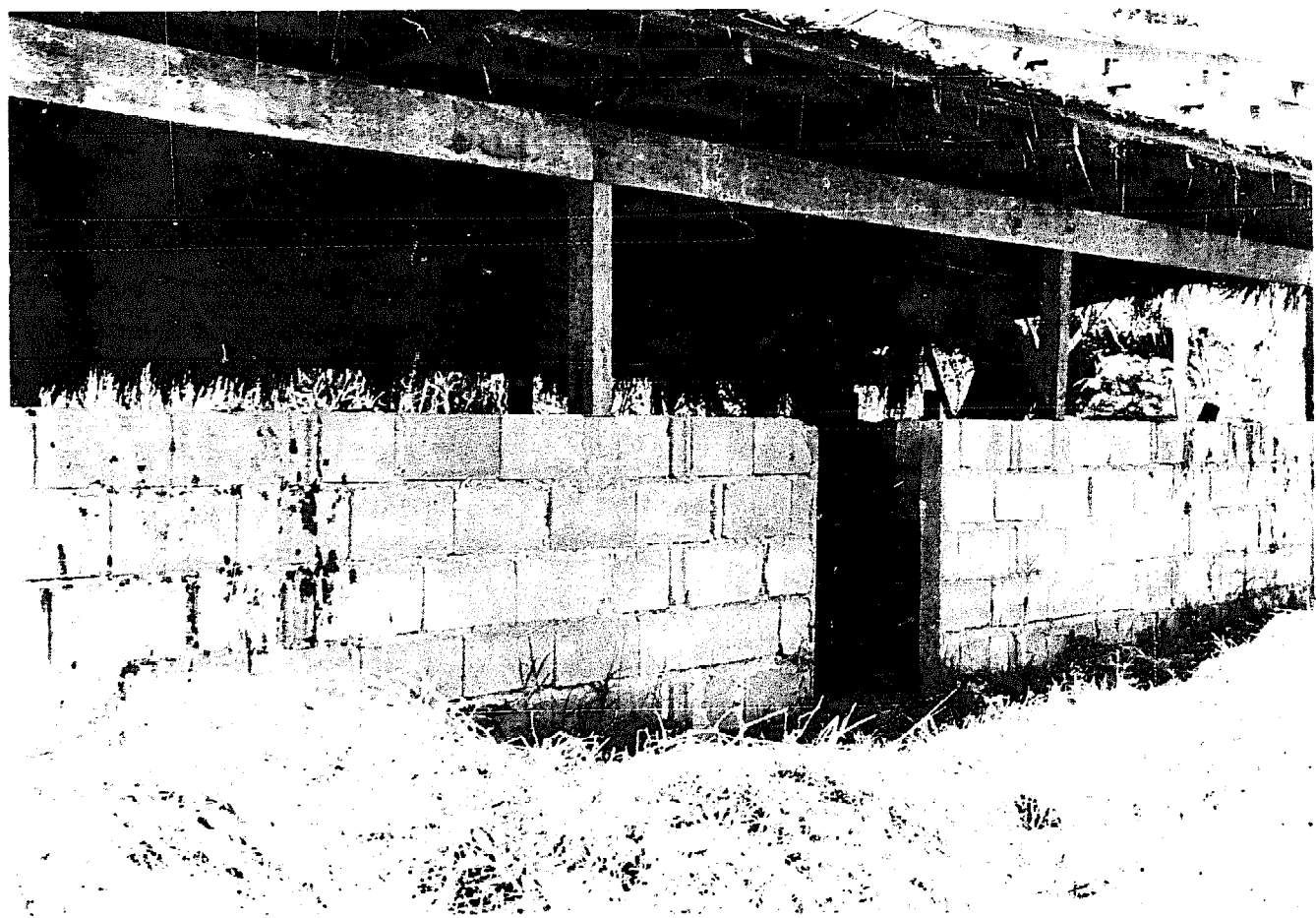


**Illustration 2-7: Solid Sludge Dryer**

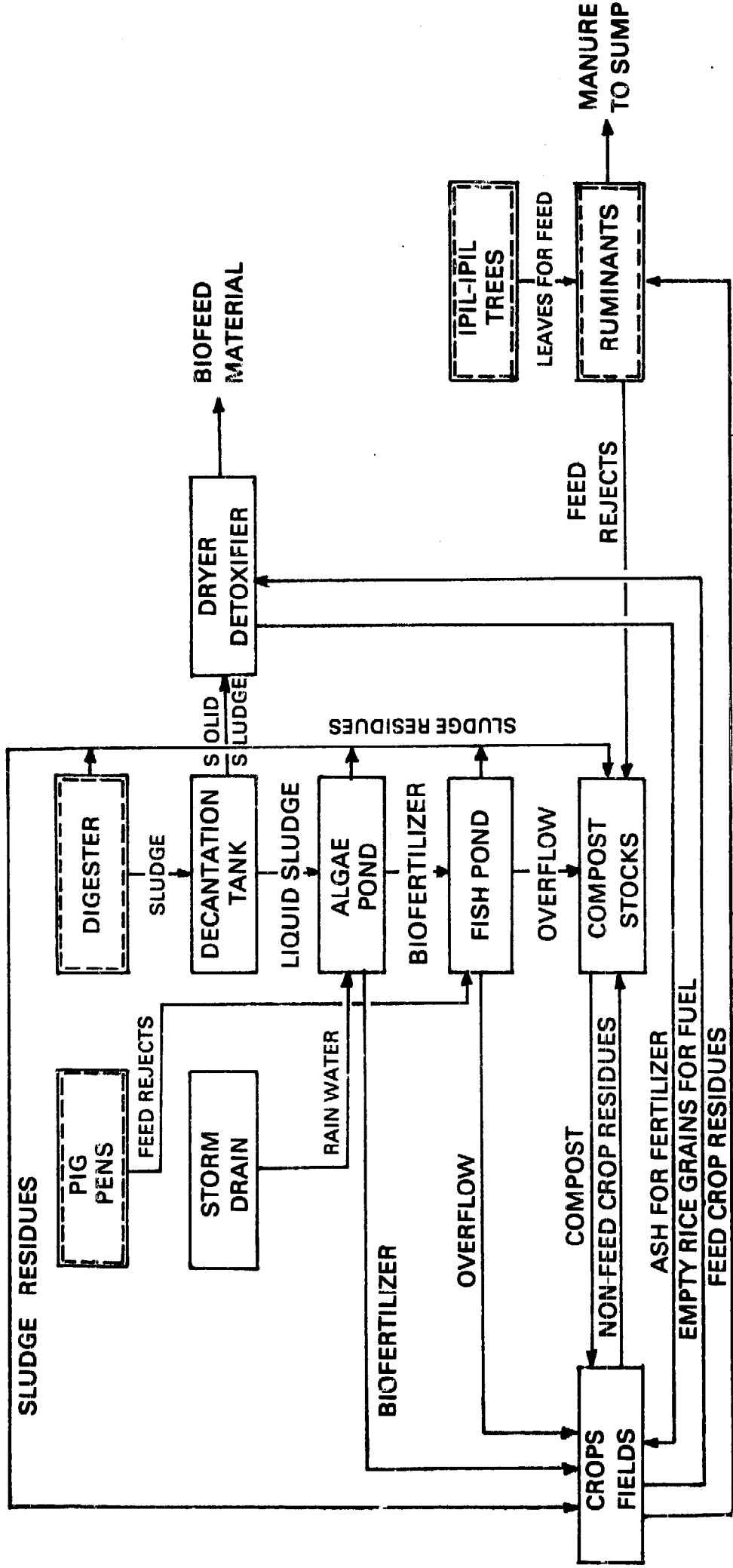




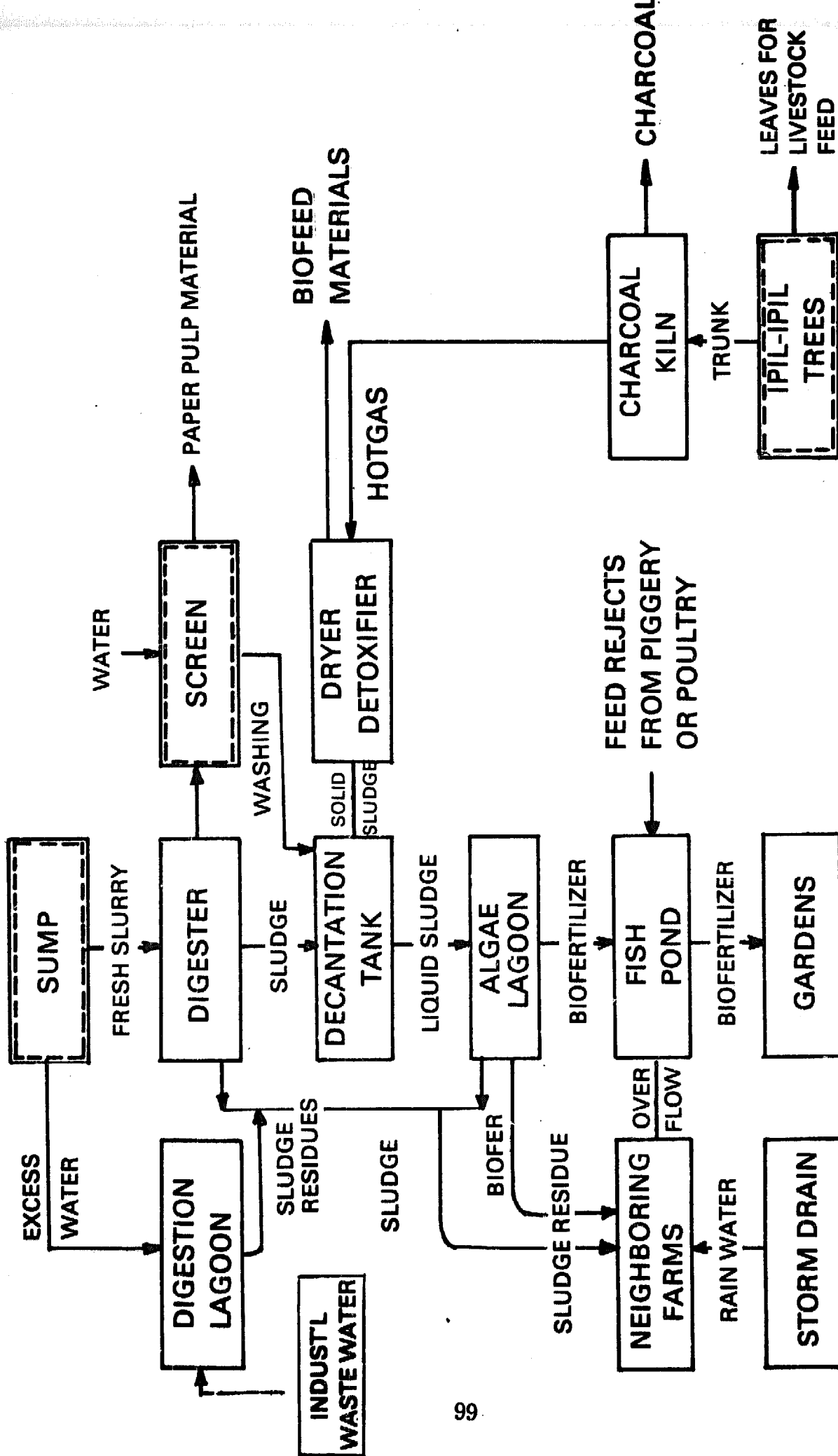
**Illustration 2-9: Incinerator**



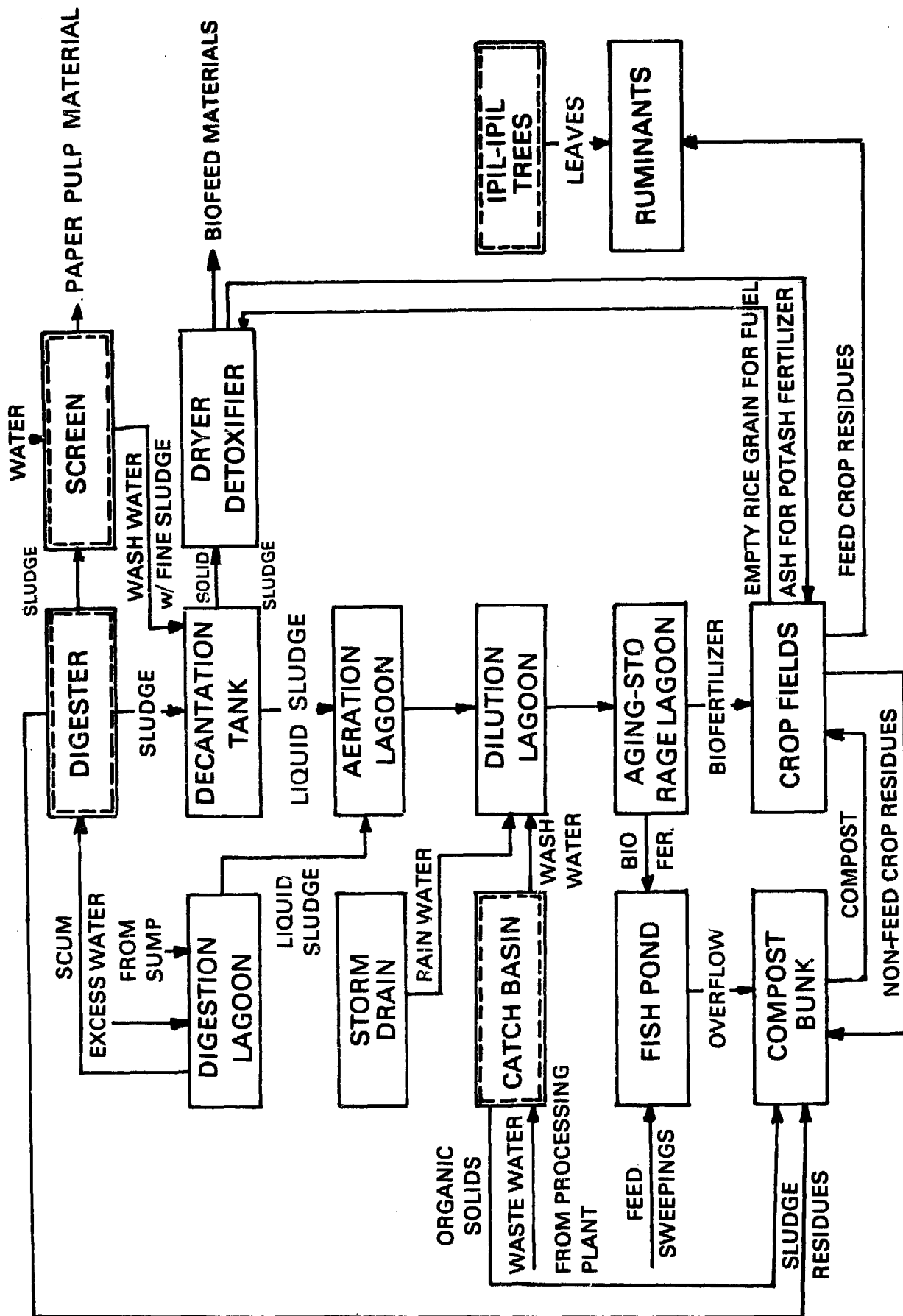
**Illustration 2-10: Compost Bunk**



**FIG. 8-1 SINGLE POND SLUDGE-CONDITIONING PLANT**



**FIG. 8-2 DOUBLE LAGOON SLUDGE-CONDITIONING PLANT**



**FIG. 8-3 MULTI-LAGOON (WITH CATCH BASIN) SLUDGE-CONDITIONING PLANT**



## Chapter IX

### Biogas Works Designs

Biogas Works consists of two parts: the biogas plant and the sludge-conditioning plant. There are four types of biogas plants and four types of sludge-conditioning plants as described in Chapters VI and VIII. Various combinations of these plants make up the biogas works. The choice of which types to combine depends on the particular situation and purposes of the biogas works. Typical examples may be found in the following:

1. Family farm biogas works
2. Crop-livestock farm biogas works
3. Agro-pulp farm biogas works
4. Feedlot and dairy farms biogas works
5. Agro-industrial farm biogas works
6. Stock farms biogas works
7. Livestock-industrial farm biogas works
8. Slaughterhouse biogas works
9. Cooperative electric plant biogas works
10. Night soil biogas works
11. Sewerage biogas works.

#### Family Farm Biogas Works

In a family farm the biogas works may serve the following purposes:

1. To produce enough biogas to light the home, cook the family meals, iron the clothes and perhaps to operate a refrigerator, to pump a limited amount of water for the home, the livestock and the biogas works;
2. To process the solid sludge into biofeed material; and
3. To treat the liquid sludge to improve its quality as fertilizer.

These may be accomplished as cheaply and as simply as possible by putting up an integrated, continuous-fed type of biogas plant accompanied by a single pond sludge-conditioning plant.

Fig. 9-1 shows the family farm biogas works flow sheet.

#### Crop-Livestock Biogas Works

The crop-livestock biogas works has the same purposes as the family farm, but the operation is bigger. Since there will be more manure, the larger horizontal, continuous-fed biogas plant should be used. An auxiliary CO<sub>2</sub> scrubber may also be utilized to improve the quality of the fuel and reduce the construction cost of the gasholder. Because of the large volume of sludge produced, it would pay to construct the more efficient multi-stage lagoon sludge-conditioning plant.

Fig. 9-2 shows a crop-livestock biogas works flow sheet.

### **Agro-Pulp Biogas Works**

Where two or three crops of rice are planted per year, there will be plenty of rice straw which is a good pulp material. For such fibrous materials, a batch-fed biogas plant is the most suitable. To improve the biogas production, chicken manure is preferably used to combine with the straw. The high nitrogen content of chicken manure provides the necessary nourishment for the methanogenic bacteria. Chicken manure is also easier to handle because it is air dry.

The multi-stage lagoon type of sludge-conditioning plant including a pulp recovery equipment is used.

Fig. 9-3 shows an agro-pulp biogas works flow sheet.

### **Piggery and/or Poultry Biogas Works**

A piggery and/or poultry farm has no cropping to speak of. The main purpose of the biogas works is to produce a large amount of biogas to pump the water for the animals, to grind and mix the feed, and to process the solid sludge into biofeed. For this reason, the efficient split, horizontal, continuous-fed biogas works is called for. Because the farm does not engage in cropping to any extent, there is little use of fertilizer in the farm and no compost is made. Therefore, the double lagoon type of sludge-conditioning plant is used.

Fig. 9-4 shows a piggery and/or poultry biogas works flow sheet.

### **Feedlot and/or Dairy Farms Biogas Works**

In feedlots and dairy farms, there will be a large amount of fibrous materials in the form of feed rejects and beddings. Since cropping is not a part of the farm, there will be no need of composting the fibrous materials. They may as well be used as raw materials for the biogas plant. For this purpose, a batch-fed biogas plant is best. Because a large amount of biogas is needed for pumping and electric generation, it is worthwhile to scrub off the carbon dioxide and hydrogen sulfide to improve the quality of the biogas.

The sludge-conditioning plant should include a pulp recovery equipment to recover the pulp. The fine solid sludge is processed into biofeeds. Since there is no extensive cropping, the liquid sludge does not have to be efficiently recovered. For this reason, the double lagoon sludge-conditioning plant is all that is required.

Fig. 9-5 shows a feedlot/dairy farms biogas works flow sheet.

### **Livestock-Industrial Biogas Works**

In a livestock-industrial enterprise there is need of a large amount of biogas for power to pump water, generate electricity and to grind and mix feeds; therefore the split, horizontal, continuous-fed biogas plant is used. The carbon dioxide and hydrogen sulfide should be scrubbed off and because there is no pressing need for fertilizer, the double lagoon sludge-conditioning plant would do for the purpose.

Fig. 9-6 shows the livestock-industrial biogas works flow sheet.

### **Agro-Industrial Biogas Works**

As in the livestock-industrial enterprise, a great deal of biogas is required for power, hence the necessity of using a split, horizontal, continuous-fed biogas plant. As much as

possible, biofeed should also be recovered. Since there is also a need for a great deal of the fertilizer for the crops, the use of a multi-stage sludge-conditioning plant is recommended.

Fig. 9-7 shows an agro-industrial biogas plant flow sheet.

### **Slaughterhouse Biogas Works**

The slaughterhouse is usually built at the edge of a town next to the public market and close to a river or creek. Such a place is crowded, so there is not much space. The objectionable practice of dumping the wash water with manure to the river may be obviated by the installation of a biogas works.

The biogas plant in this case should consist of a split two-chamber, continuous-fed type. The biogas may be used to run an internal combustion engine to run a pump during off hours and an electric generator to produce electricity when the slaughterhouse is in operation. It is also used to heat the scalding vat. This biogas requirement needs a split, horizontal, continuous-fed biogas plant. In order to avoid air pollution in a crowded place, the retention time should be 50 days.

The sludge may be given free to neighboring farmers who may recover the solid sludge and process it as feed material and use the liquid as fertilizer.

Fig. 9-8 shows the flow sheet of such biogas works.

### **Night Soil Biogas Works**

In communities where there is no sewerage system, septic tanks are used for sanitary disposal of the night soil. In such a case the sanitary excavator removes the sludge residues from the septic tank often, the frequency depending on the size of the septic tank. He disposes of the sludge residues by burying it in distant places where it will not cause pollution. By using a night soil biogas works for a dormitory or midden shed, biogas may be produced from the night soil. The biogas plant of this type consists of a split three-chamber digester type. To start with, the digester is charged with manure. If there are at least 60 users, there will be sufficient biogas produced to supply the occupants for lighting, cooking, and ironing their clothes.

Fig. 9-10 shows a night soil biogas works flow sheet.

### **Cooperative Electric Plant Biogas Works**

It is possible for a rural community to have an electric plant run on a cooperative basis with biogas if a large number of residents are engaged in broiler raising. The poultry manure can be collected daily and used as raw material for the biogas plant. To minimize air pollution, the biogas plant should have a horizontal continuous-fed digester with a separate gasholder and the retention time should not be less than 50 days. The sludge should flow into a storage tank from which the farmers can haul the sludge to their farms.

Fig. 9-9 shows the flow sheet of a cooperative electric plant biogas works.

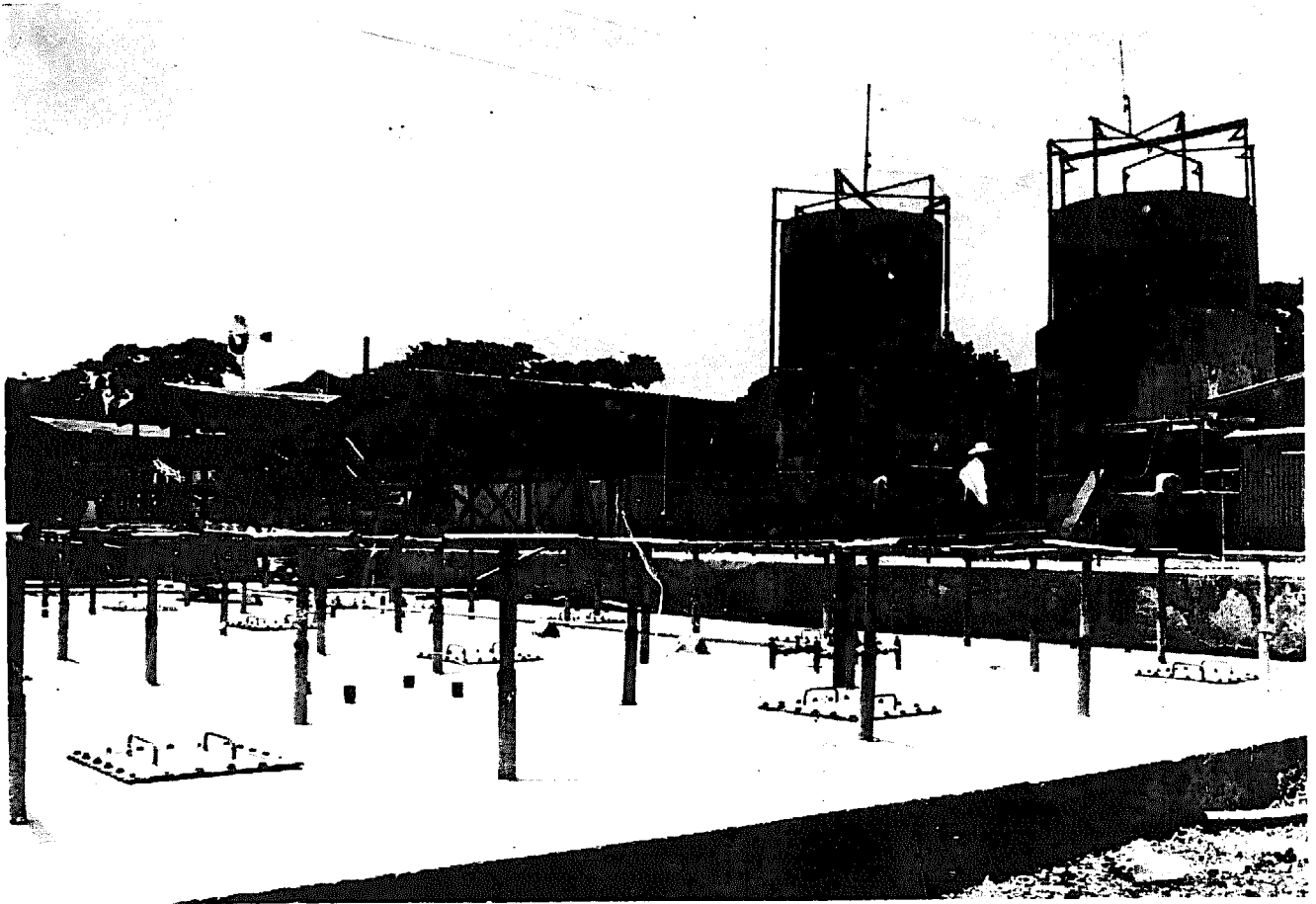
### **Sewerage Biogas Works**

Biogas digesters may be incorporated in sewage works treating domestic and industrial wastes. The main objective is to achieve maximum BOD and COD reduction, though the biogas is often utilized in heating or generating power for the sewage works

operations. The waste heat from the engines is used to preheat the incoming slurry, to maintain the digester temperature, and for other heating purposes.

The sewage works normally has a number of digesters to take care of load fluctuations and allow maintenance without disrupting the operation. The digesters are huge tanks with flat or conical bottoms often with diameters up to 100 feet and depths of 20-40 feet. The floating gasholder domes may be integrated over the digester tanks or they may form separate water-sealed units.

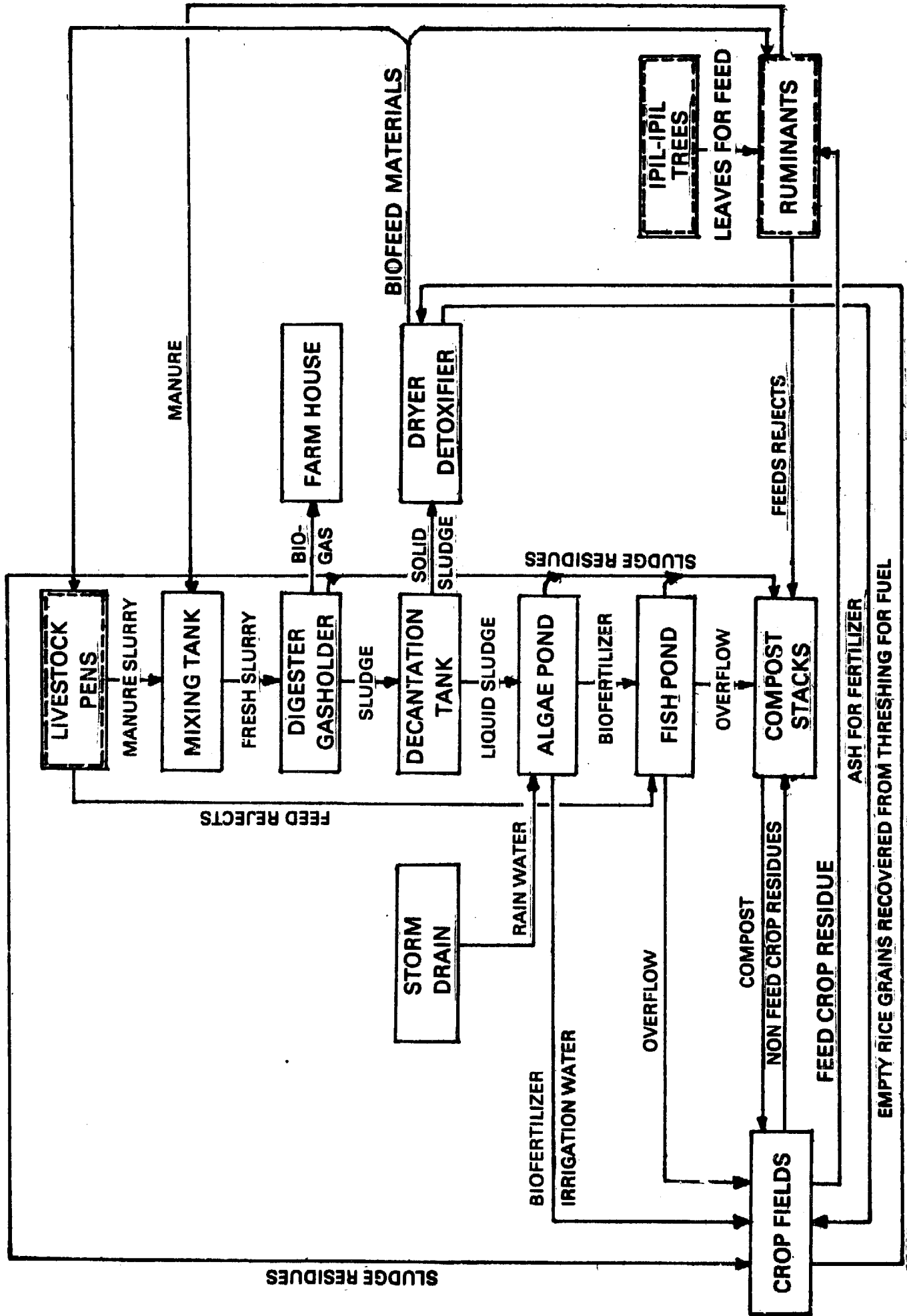
The operation is continuous, with charging done once or twice a day. The feed slurry contains 5 to 6% solids. Retention time is 20 to 30 days and the temperature of the digester slurry is maintained around 30-35°C. The digested sludge flows to settling lagoons. The solids content of the sludge is reduced by about 50%, so it is stable and no longer carries any obnoxious odor.



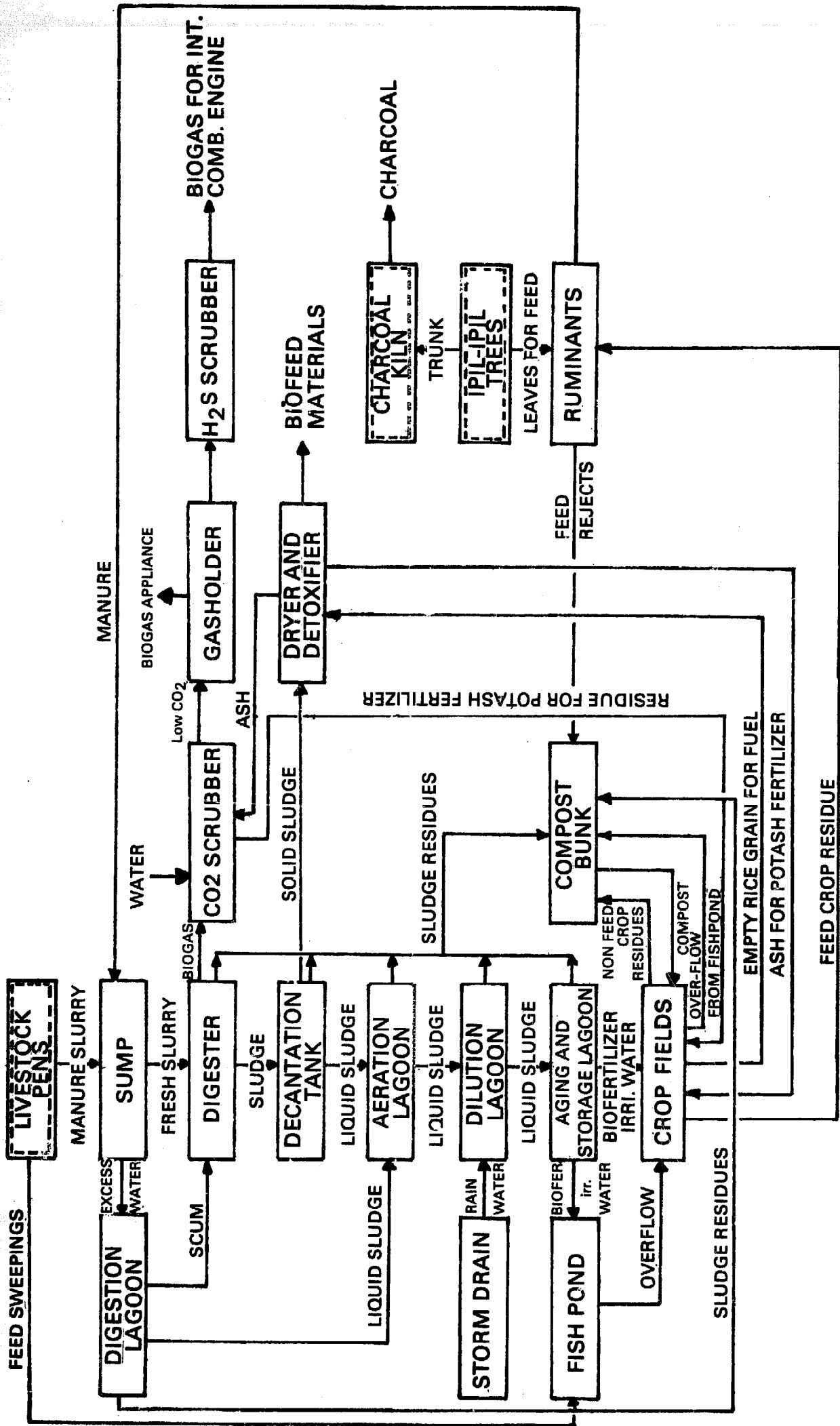
**Illustration 2-11: Biogas Plant**



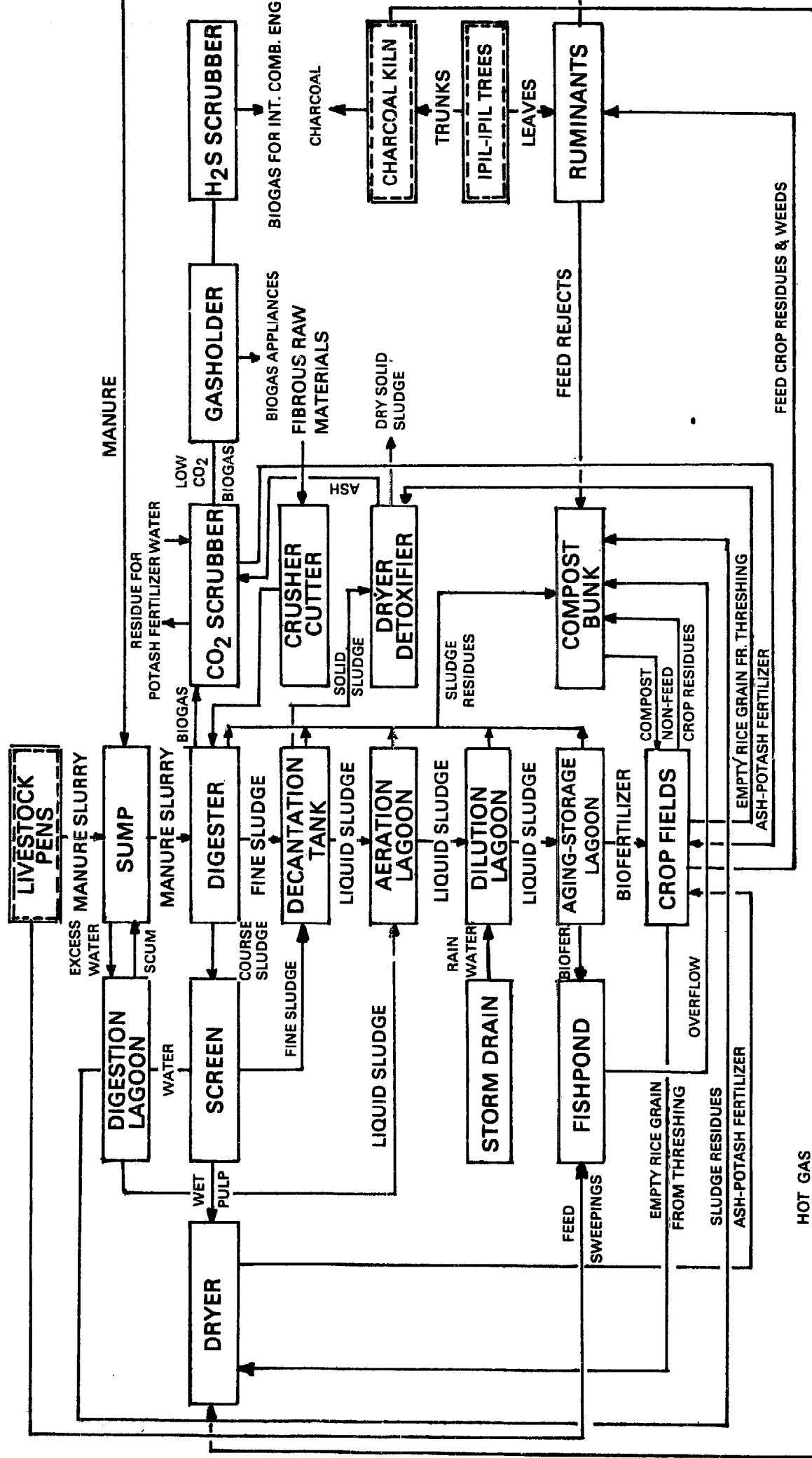
**Illustration 2-12: Sludge-Conditioning Plant**



**FIG. 9-1 FAMILY FARM BIOGAS WORKS FLOWSHEET**

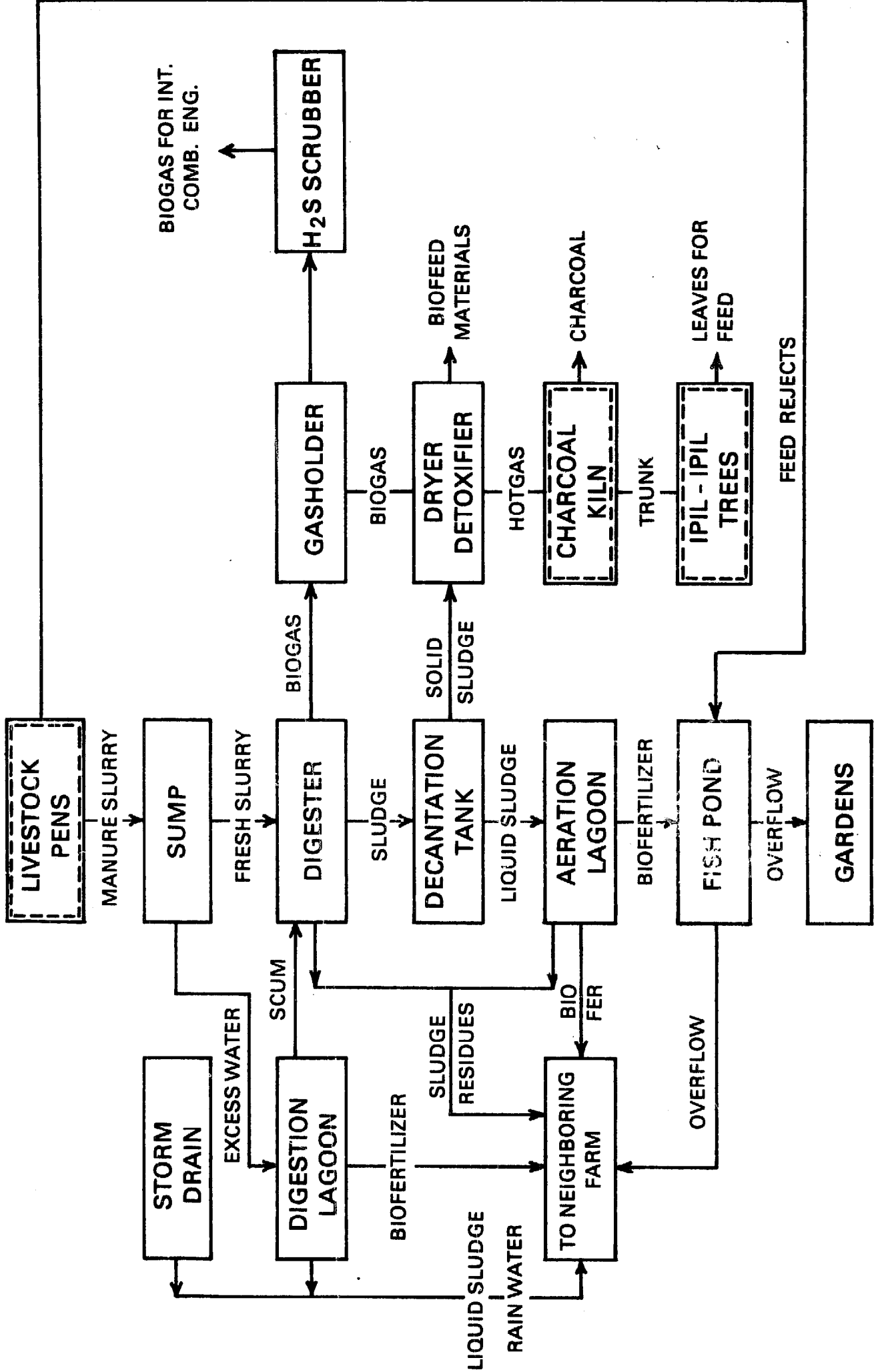


**FIG. 9-2 CROP-LIVESTOCKS BIOGAS WORKS FLOWSHEET**

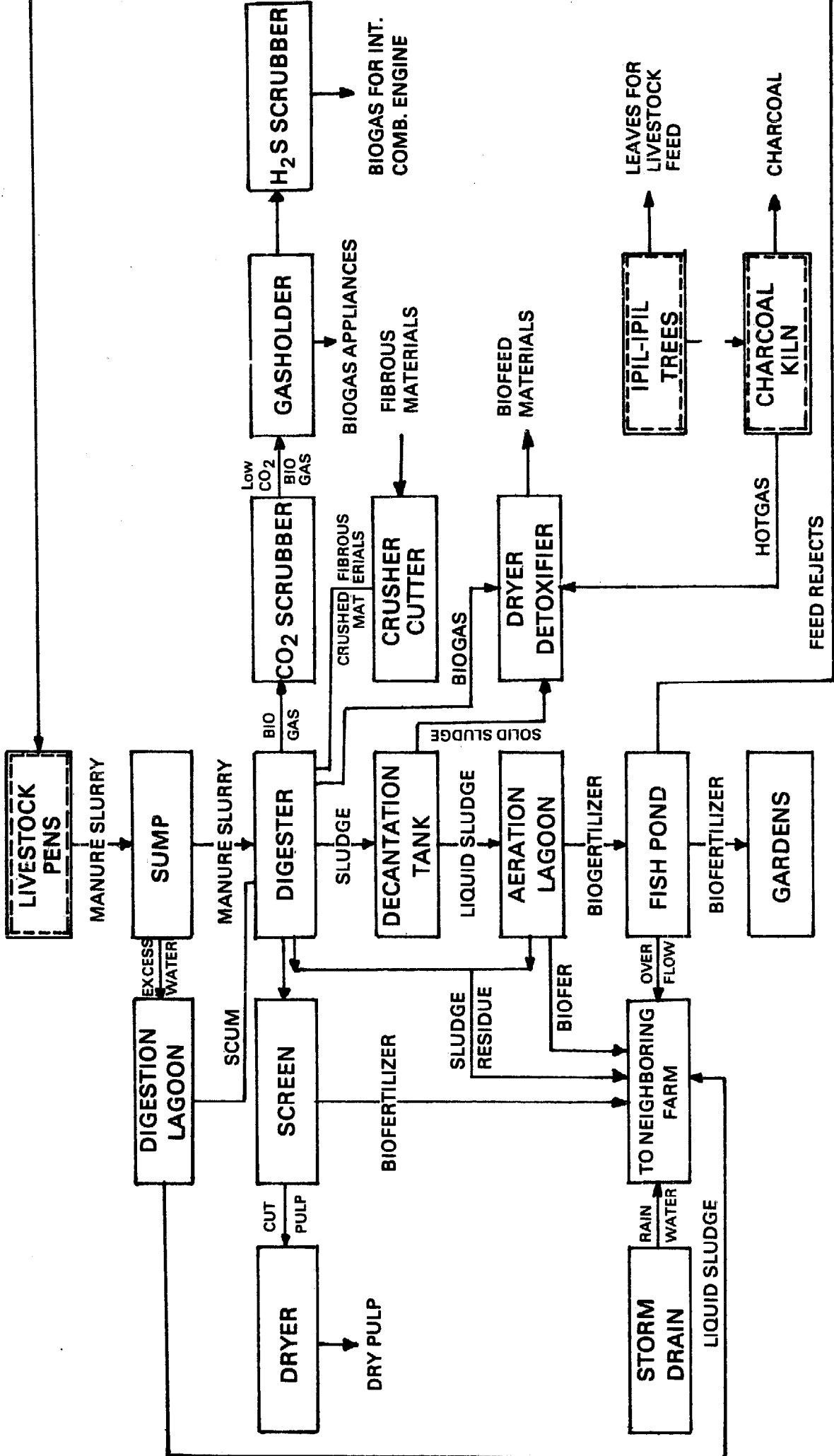


**FIG. 9-3 AGRO-PULP BIOGAS WORKS FLOWSHEET**

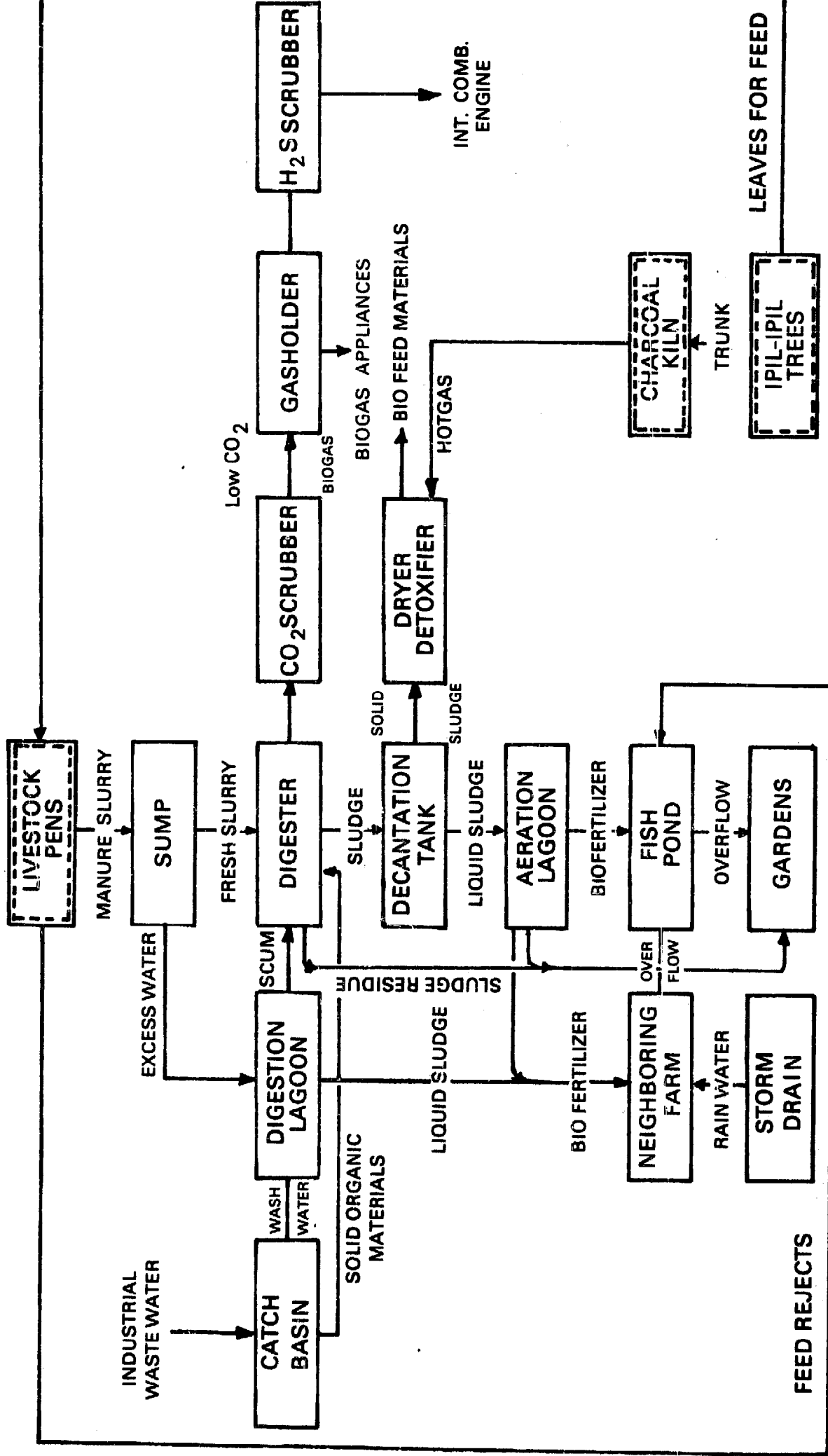




**FIG. 9-4 LIVESTOCK BIOGAS WORKS FLOWSHEET**



**FIG. 9-5 FEEDLOT BIOGAS WORKS FLOWSHEET**



**FIG. 9-6 INTEGRATED MEAT PROCESSING BIOGAS WORKS FLOWSHEET**

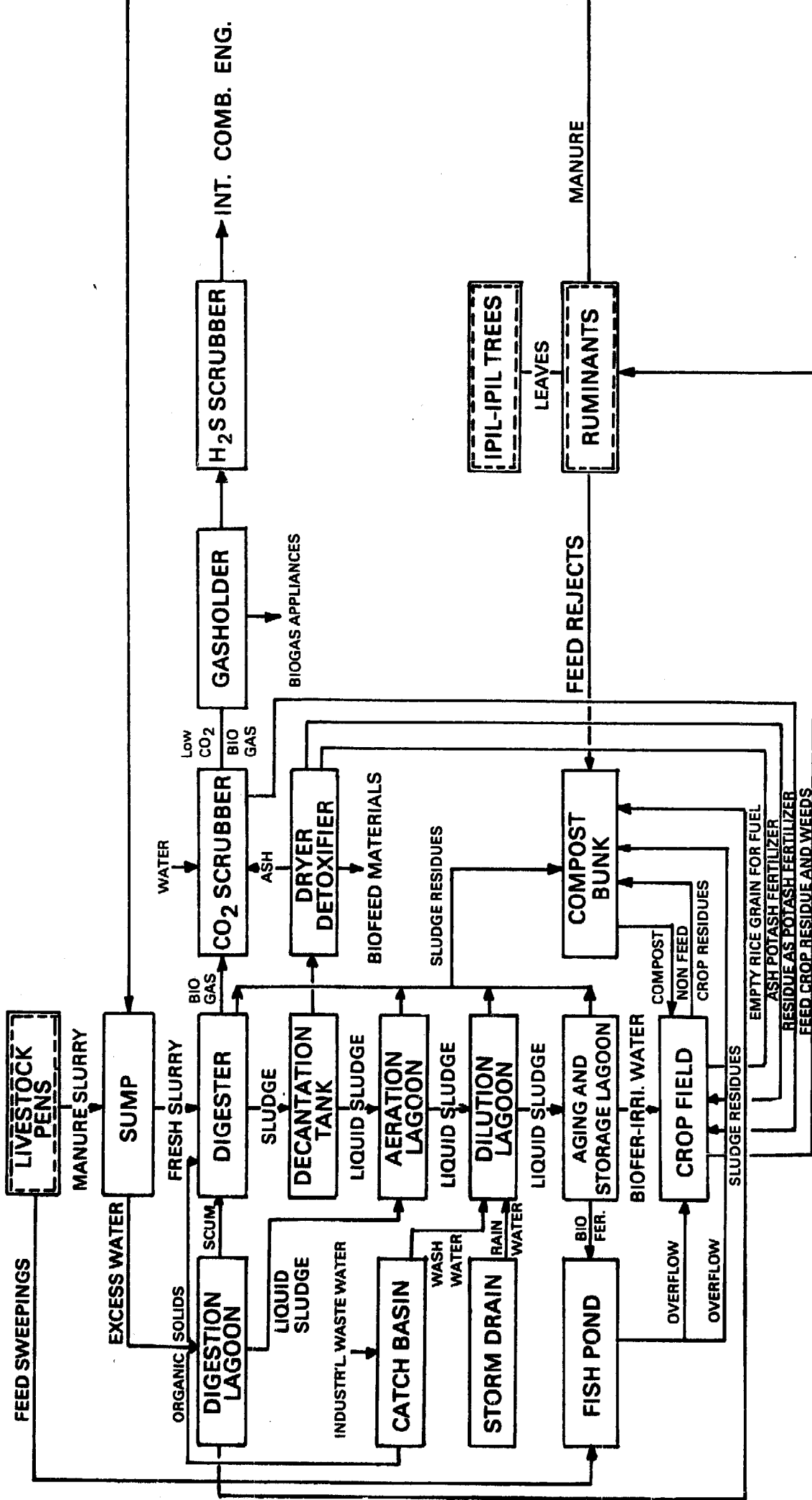
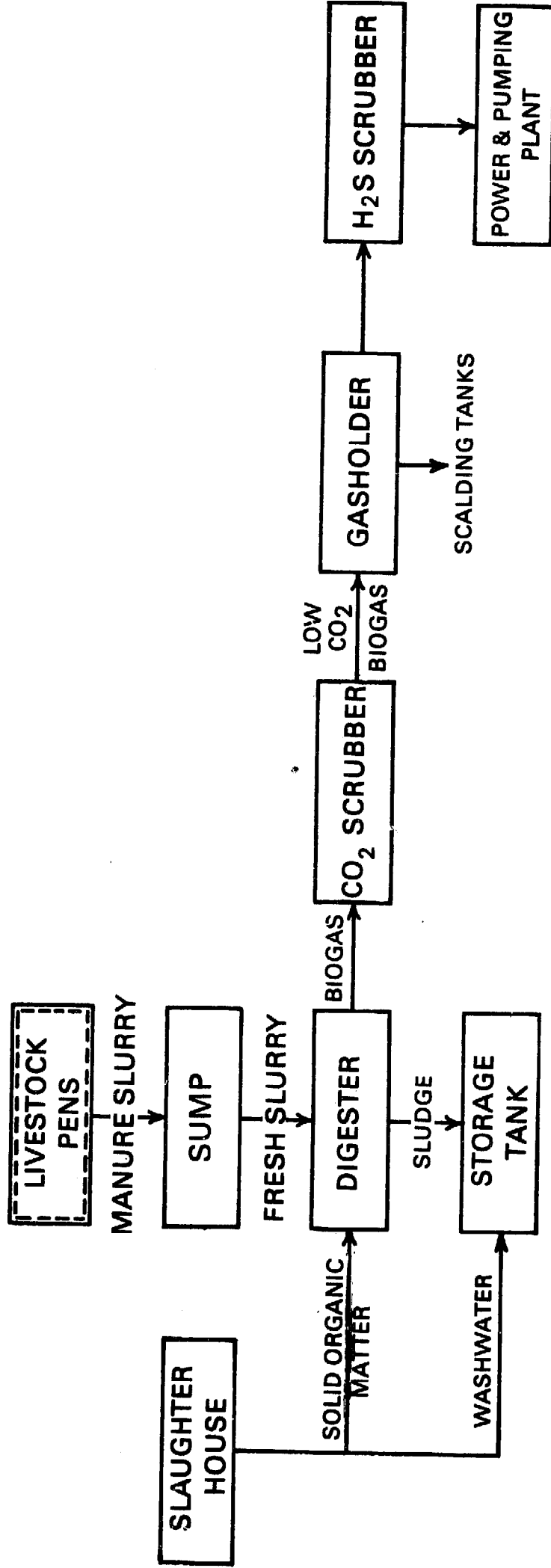
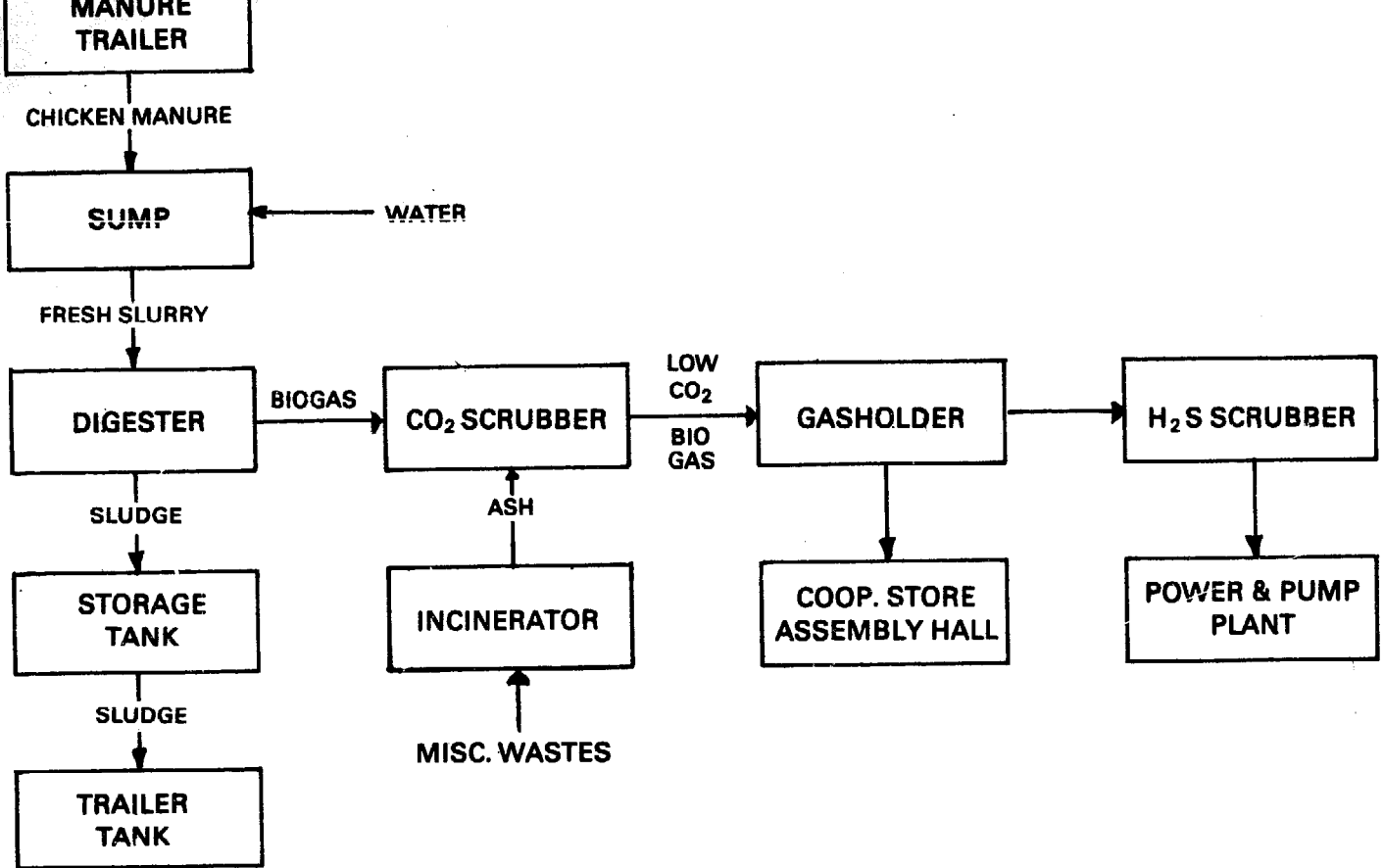


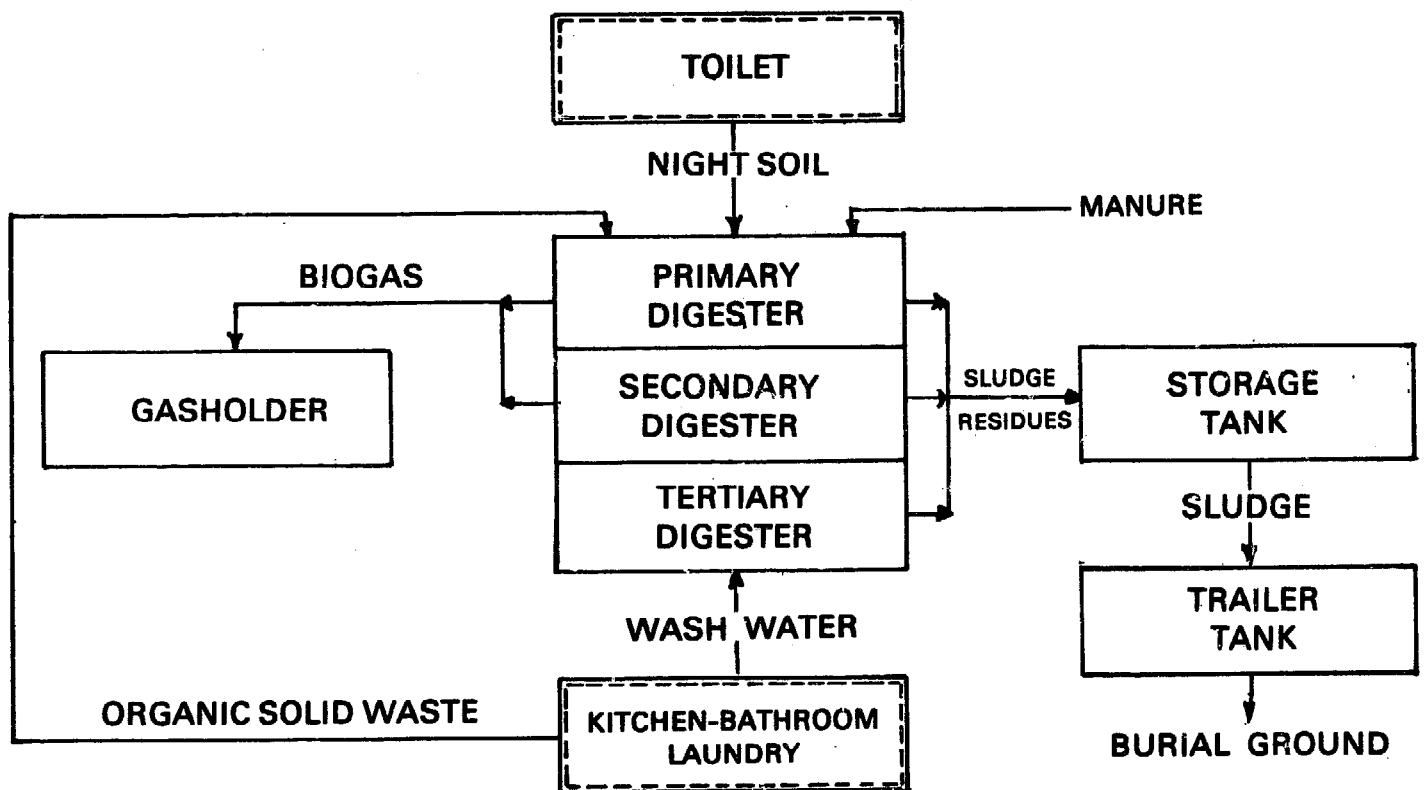
FIG. 9-7 AGRO-INDUSTRIAL BIOGAS WORKS FLOWSHEET



**FIG. 9-8 SLAUGHTERHOUSE BIOGAS WORKS FLOWSHEET**



**FIG. 9-9 COOPERATIVE BIOGAS WORKS FLOWSHEET**



**FIG. 9-10 NIGHT SOIL BIOGAS WORKS FLOWSHEET**

## Chapter X

### Planning and Establishing the Biogas Works

The biogas works consists of a biogas plant and a sludge-conditioning plant. The biogas plant produces biogas and sludge and controls most, if not all, air pollution. The sludge-conditioning plant improves the feed and fertilizer value of the sludge produced by the biogas plant, completes the control of whatever air pollution is left in the sludge, controls water pollution and promotes sanitary conditions.

#### Should One Build Biogas Works?

One might think of establishing biogas works because he and/or his neighbors are bothered by the foul odor brought about by manure; or he is hard hit by the cost of power and/or fertilizer and/or feed. Before he makes up his mind he should look carefully into six important points, with the aid of a competent biogas practitioner:

1. What kind of and how much manure is the source of pollution? How much will it cost to dispose of the manure in other ways?
2. How much gas can the available organic wastes produce? Is it enough for one's requirements? How much would be saved by using biogas?
3. How much feed can be derived out of the sludge? How much savings will be made?
4. How much fertilizer can the biogas works produce? How much is the present fertilizer bill? How much will be saved?
5. How much will it cost to build and operate the biogas works? What is the total savings?
6. How much would it cost to hire personnel to build and operate the biogas works?

#### Pollution Control Savings

If the foul odor is caused by chicken manure it may be better to sell the manure to fishpond owners unless there is enough justification to set up biogas works to produce fuel, feed and fertilizer. A small amount of pig or cattle manure may be composted if there is enough crop field, or buried if there is enough space for it. If these are not available and the foul odor is a very serious one, he will have to move out to where there will be no neighbors to complain and suffer the foul odor; or one may put up biogas works because chemical or bacteriological control measures are more expensive to maintain. One can figure out how much the control of pollution would cost.

#### Fuel Savings

Table 10-1 gives the approximate daily excretion of manure by different kinds of livestock and the amount of biogas they can produce when used as raw material in a biogas plant. Table 10-2 gives the consumption of biogas by different machinery,

equipment, appliances and by a family of 5 to 7 members. From this data one may determine how much would be saved by setting up biogas works.

### Feed Savings

Livestock digest only about 50% of the animal nutrients in the feed consumed. The dry solid sludge recovered from the biogas works is about 10% of the weight of the fresh manure. The feed materials recovery is about 10% of the amount of feed consumed by the animals.

### Fertilizer Savings

The liquid sludge recovered from biogas works using manure of 4 sow units (4 sows and all offspring up to 8 months old, totalling 40 heads) has been found at Maya Farms to be sufficient to fertilize one hectare of land planted to two crops of corn and one crop of rice per year. The only element lacking as compared with recommended chemical fertilizers is potash. This is supplied by the ash recovered after burning the empty grains recovered during the threshing of palay. To this may be added what is required to fertilize 200 sq. m. of fish (tilapia) ponds. At the Maya Farms such a pond produces about 3 kilos of tilapia every week.

TABLE 10-1. Approximate Daily Manure Available from Different Animals and the Daily Biogas Production.

Animals	Fresh manure		Biogas cu.ft.	Sludge	
	kg.	cu.ft.		Liquid liters	Solid (dry) kg.
<b>Poultry in confinement</b>					
1) 1 Layer unit	7.5	0.28	15-18	8.0	0.75
2) 1 Broiler unit	20.0	0.74	40-50	22.0	2.00
<b>Piggery</b>					
3) 1 Sow unit	15.0	0.55	30-37	16.0	1.50
4) 1 Porker unit	11.0	0.40	22-28	12.0	1.10
<b>Cattle &amp; Carabao</b>					
5) Work animal unit	8.0	0.30	8-10	8.7	0.80
6) Breeder unit	14.0	0.52	14-17	15.0	1.40
7) 1 Feed lot unit	15.0	0.55	15-17	16.0	1.50

Basis: Manure water ratio (v:v) 1:1

- 1) 1 Layer unit = 100 hens
- 2) 1 Broiler unit = 100 day old - 1 wk; 100 of 1 wk-2; 100 of 2 wk-3 wk;  
100 of 3 wk-4 wk; 100 of 4 wk-5; 100 of 5 wk-6 wk;  
100 of 6 wk-7 wk; 100 of 7 wk-8 wk = 800



- 3) 1 Sow unit = 1 sow and all offsprings up to 8 mo. old
- 4) 1 Porker unit = 1 of 3-4 mo. old; 1 of 4-5 mo. old; 1 of 5-6 mo. old;  
1 of 6-7 mo. old; 1 of 7-8 mo. old
- 5) 1 Work animal = 1 bullock or carabao fit to work (only about half of the manure is collected).
- 6) 1 Breeding animal = 1 cow or carabao
- 7) 1 Feed lot cattle = 2½-3 year old to be fed for 3-6 months

TABLE 10-2. Biogas Consumption

Cooking	
small burner	8 cu.ft./hr.
medium burner	10 cu.ft./hr.
large burner	15 cu. ft./hr.
Lighting, mantle lamp	2-3 cu.ft./hr.
Gas refrigerator, 8 cu.ft.	2.5-3.0 cu.ft./hr.
Gasoline engine	15 cu.ft./hr./hp output
Family of 5-7	
Cooking, 3 meals	40-50 cu.ft./day
Cooking and lighting (w/ 2 mantle lamps)	60-70 cu.ft./day
Cooking, lighting and ironing clothes	70-80 cu.ft./day
Cooking, lighting, ironing clothes, gas ref.	145-160 cu.ft./day
Cooking, lighting, ironing clothes, gas ref. 3 hr. pumping water (1 hp)	250-280 cu. ft./day

Small biogas works would require about 2 hours attention of the owner every day. One with 10,000 cu.ft. continuous-fed digester would require 3 men to operate. One with 20,000 cu.ft. batch-fed digester would require 5 men to operate.

Table 10-3 gives the approximate (1977 prices) cost of building different kinds of biogas plants for small sizes (up to 15 cu. ft. manure capacity).

### Personnel to Build and Operate Biogas Works

Biogas works are built to fit a certain set of farm conditions to the last detail. Building biogas works patterned after a successful one is not advisable. One's farm may differ in one small detail and for that reason would require a different design. Large-size biogas works requires many labor-saving and efficiency gadgets that make a difference in operational cost, quality of the products, the quality and amount of the biogas and sludge as well as the cost of construction and operation. In India there are several government offices, foundations and associations to help small farmers build their small biogas plants. In the Philippines, the Bureaus of Animal Industry, Agricultural Extension and Plant Industry as well as some foundations are engaged in helping small farmers to establish their biogas works. There are also some corporations offering service to large concerns.

An average farmer can learn to run the farmhouse biogas works in two weeks by working on (not just visiting) a successful operation. Livestock biogas works would need a trained technical man; but agro-industrial biogas works require the full-time job of an engineer.

TABLE 10-3. Kind of Manure Requirement, Gas Production and Cost of Biogas Plant

Kind of manure and purpose	Fresh manure		Cost of infrastructure (Phil. Peso)*				Biogas		Sludge	
	kg.	Daily requirement cu.ft.	Vertical digester		Horizontal digester		in cu. ft.	Liquid liters	Solid kg. (dry)	
			Floating gasholder temp above 28°C	Fixed gasholder temp below 28°C	Integral type temp above 28°C	Split type temp below 28°C				
Chicken Manure Cooking, lighting & ironing Cooking, lighting, ironing & gas refrigerator Cooking, lighting, ironing gas refrigerator & water pumping (3 hrs.)	30	1.1	P1600-1800	P2000-2200	P1900-2100	P3700-4000	60-70	45	3.0	
	72	2.67	2900-3200	5800-6100	3600-3900	6100-6400	145-160	112	7.2	
	125	4.62	3700-4100	6400-6700	6500-7000	8000-8400	250-280	197	12.5	
Pig Manure Cooking, lighting & ironing Cooking, lighting, ironing & gas refrigerator Cooking, lighting, ironing gas refrigerator & water pumping (3 hrs.)	30	1.1	1600-1800	2000-2200	1900-2100	3700-4000	60-70	45	3.0	
	72	2.67	2900-3300	5800-6100	3600-3900	6100-6400	145-160	112	7.2	
	125	4.6	3700-4100	6400-6700	6500-7000	8000-8400	250-280	197	12.5	
Carabao or Cow Manure Cooking, lighting, & ironing Cooking, lighting, ironing & gas refrigerator Cooking, lighting, ironing gas ref. & water pumping (3 hrs.)	60	2.4	2600-2800	5100-5400	3200-3500	5600-5900	60-70	100.8	6	
	145	5.37	4700-5200	7500-8100	7700-8500	10500-11000	145-160	225.4	14.5	
	250	9.26	6800-7300	9300-9700	9500-10500	12100-13200	250-280	388.9	25	

\* US\$1.00 = P7.50

The designing of biogas works should be entrusted to one who has actually designed an efficiently operating biogas works of the size one intends to put up. To attempt to construct one after examining an operating biogas works is dangerous because a small difference in the conditions will be sufficient to make the biogas works more costly to build and operate, and less efficient, or it may even fail completely.

There are two Philippine government entities actively propagating the establishment of biogas works: the Bureau of Animal Industry and the National Science Development Board. The former is building biogas works in all its stock farms and breeding stations scattered all over the country to demonstrate the value of biogas works. The Bureau and the NSDB help interested parties in the design of their biogas works.

To avoid unnecessary expense the designer should ask the prospective client to give the former as much information as possible on the prevailing conditions in the place where the biogas works would be established. (Pages 128-130 show the questionnaire used by Maya Farms). After studying the information, the designer would visit the site to verify the report and decide on whether or not the construction of biogas works is feasible. Going back to his office he makes an estimate of the construction and operation costs. The estimate is submitted to the owner for decision on whether he would want to continue the project or not. If he decides to continue, the plans are then made.

### **Biogas Plant Types to Use**

For small biogas plants up to 500 cu. ft. of digester slurry capacity, the integrated type is preferred to reduce cost of the infrastructure. Because the sludge-conditioning plant necessarily has to be close to the homes in small farms, the retention time shall be 50 days in order to digest its manure as much as possible, to avoid foul odor diffusing to the house.

Large biogas plants use the split type to avoid cooling the digester slurry through the gasholder. Because in large farms the sludge-conditioning unit may be located away from the house, the retention time may be reduced to 30 days to reduce the volume of the digesters, and consequently reduce the cost of infrastructure.

If only manure is used as raw material, continuous-fed digesters are suggested, to reduce operational labor costs. If crop residues are used as raw materials in combination with manure, the batch-fed digesters are best. This is done where there is not enough manure to produce the required biogas and/or if there is an abundance of fibrous materials, like beddings in feed lots and dairies, that have to be disposed of and/or when it is desired to recover paper pulp materials.

### **Raw Materials Combination**

Chicken and pig manure produce the most biogas and the highest value of sludge followed by carabao and cattle manure, crop residues and garbage. Though chicken and pig manure produce almost two times as much biogas as that of the carabaos and cattle, a combination of the first and the second will produce more than the two digested separately. If the crop residues are fed to the carabaos and/or cattle, the resulting manure when used as raw material in a biogas plant will produce more biogas and better quality sludge for

feed and fertilizer than when the crop residues are used alone as raw materials. This method of using the crop residues will also avoid the cost of cutting and crushing the crop residues if it is used directly as raw material for the biogas plant.

Garbage is more valuable as feed for the pigs than as raw materials for the biogas plant. The use of night soil in a biogas plant is mainly for pollution control and secondly for the biogas. In the Philippines no one will touch the sludge derived from night soil.

Fresh slurry concentrations used vary from 1.0:1.0 up to 1.0:2.0 by volume. The amount of starter to use varies from 15 to 25% of fresh slurry for batch-operations. The retention time varies from 20 to 50 days. The more concentrated the slurry is, the longer is the retention time. The longer the retention time is, the less amount of starter used. The concentration, retention time and starter to be used will depend on the requirements of the biogas works at hand.

### **Mesophilic vs. Thermophilic Digestion**

Digestion of the organic matter at temperatures ranging from 30 to 37°C is known as mesophilic. If the digestion is at temperatures ranging from 55 to 65°C, it is known as thermophilic. Thermophilic digestion has the advantage of shorter retention time, hence requires lower digester volume. However, it requires the installation of heaters, and more energy is used to heat the digester. When fuel was cheap and the purpose of the digestion of organic matter was to control pollution, thermophilic digestion was justified, but with the increasing cost of fuel, the mesophilic digestion is preferable. In the tropics where the ambient temperature is favorable for mesophilic digestion, there is little justification for thermophilic operation.

### **Heating and Insulating the Digester**

In the temperate countries even the mesophilic digesters have to be insulated and heated to maintain the digester slurry temperature at a level favorable for bacterial action. In mountainous regions in the tropics it will be sufficient to just insulate the digesters and charge them during the hottest part of the day. When using the integrated type of biogas plant, the gasholder dome must be made of masonry or the split type biogas plant should be used to avoid cooling the slurry through the steel gasholder dome. One design provides heating by surrounding the digester with manure and allowing the manure to decompose aerobically, thus emitting heat. A French practitioner charges the digester with manure and allows it to partly decompose, then after 20 to 24 hours pours the slurry water and closes the digester. If the digester is large and the walls are insulated, it can keep the heat until the end of the retention time.

### **Batch-fed or Continuous-fed Digesters**

Digesters may be classified, according to the manner of charging with slurry, as batch-fed and continuous-fed. Batch-fed digesters are charged with slurry to capacity and sealed, and the slurry is allowed to decompose until the end of the retention time when the digester is opened, discharged and recharged. If the biogas plant has as many digesters as the number of days in the retention time plus one, say 30 + 1, one digester will be discharged and charged every day. On any day, 29 digesters are producing gas at different stages of development, one is just getting started and one is being discharged and charged. Hence there will be a uniform amount of biogas and sludge produced every day.

On the other hand, a continuous-fed digester is charged daily with small amounts of slurry. After the digester has been filled with the right amount of slurry, the daily production of biogas and sludge will be more or less uniform until the time of cleaning when production of biogas and sludge stops. If there is one continuous-fed digester in the biogas plant, production completely stops while the digester is being cleaned. There will be very little production until the digester has been filled with the right amount of manure. If there are two digesters, the production is reduced to one-half. If there are three, production is reduced to two-thirds, etc. .

Since the charging of fresh slurry into the continuous-fed digesters is simultaneous with the discharging of the sludge, it is likely that some of the incompletely digested or even fresh slurry may find its way to the exit pipe and come out of the digester with the sludge. Hence, pollution control is not as efficient in the continuous system as in the batch system where nothing comes out of the digester until the end of the retention period.

If there is not enough manure to produce the required amount of biogas, crop residues may be used in combination with manure in a batch-fed digester. It is not advisable to use crop residues in the normal continuous-fed digester as they cause clogging and this necessitates more frequent cleaning of the digester.

In the continuous-fed biogas plant, the starter is added only at the initial stage of the operation. The following daily charge does not require any more starter. In a batch-fed biogas plant every charge requires an addition of starter. This means bigger volume of digesters for the same amount of biogas production.

The operation of a batch-fed biogas plant requires approximately twice as much man-hours as that of a continuous-fed biogas plant. This is because each batch-fed digester has to be discharged at the end of the retention time while in the continuous-fed biogas plants, the fresh slurry charged into the digester automatically dislodges an equivalent amount of spent slurry.

Judging from the above, batch-fed digesters should be used only when it is necessary to use fibrous materials as raw materials. This may be the case for a biogas plant in a processing plant or when the solid sludge is to be used as paper pulp.

### **Single Chamber vs. Double Chamber**

The slurry solids become heavier as they decompose; thus the fully-digested slurry solids settle at the bottom of the digester. These will continually accumulate and clog the lower end of the inlet pipe in a single-chamber digester. The situation can be remedied by reducing the retention time and allowing the lighter, incompletely digested sludge to come out of the digester and providing a lagoon for the sludge, to remove any residual foul odor. This is possible in wide open spaces but not in a crowded place. In such a case, the remedy is to use a double-chamber digester. The sludge in the first chamber will move to the second chamber where digestion continues until the residual odor becomes minimal. However, double-chamber digesters are more expensive to build than single chambers.

There are more chances in a single-chamber digester for part of the slurry to find its way to the outlet before it is adequately digested than in a double chamber where there is a partition wall and the only way is through a steeply inclined pipe. This is particularly true in vertical digesters because the distance between the inlet and outlet is shorter than in a

horizontal digester. For this reason, in vertical digesters, there is a baffle board between the inlet and outlet pipes.

### **Vertical vs. Horizontal Digesters; Underground vs. Overground Digesters**

Digester walls underground do not have to be as strong as that above the ground because the secondary soil helps oppose the pressure of the digester slurry. Since stronger walls require more expensive materials, the underground walls would be cheaper to build.

Most of the vertical digester walls are underground. Most of the horizontal walls are above ground. For this reason, the vertical digesters would require less expensive materials than the horizontal digesters.

On the other hand if the ground is hard to dig, the cost of digging may be more than what one saves in the material costs. Another factor is the water table and flood level. If the water table reaches the digester, it would cool the digester slurry, hence would retard digestion. The flood water should not be allowed to enter the digester, otherwise it would dilute the digester slurry.

Therefore, if the ground is easy to dig and the water table and flood level are low, either a vertical or a horizontal digester may be used; but the vertical is cheaper to construct. If the ground is hard to dig, and/or the water table and/or the flood level are high, the practical thing to do is build a horizontal digester. If a vertical digester is built, the digester will be extended high over the ground level and would be hard to charge with slurry.

### **Cylindrical vs. Rectangular Digesters**

The cylindrical digester requires less materials than the rectangular, but making a cylindrical digester requires forms and a more experienced mason. The compromise structure may be octagonal in shape. If multi-digesters are required in a biogas plant, a rectangular shape would use less materials because the digesters can be built side by side and back to back with common walls. In addition, the digesters are less exposed to the ambient temperature.

### **Large Single vs. Multiple Small Digesters**

As a general principle a large container costs less to build than several smaller ones with a total capacity equal to the large one; however, there is a limit to the size at which it can be built economically. Large structures require more reinforcement and thicker walls to support its weight. There is also a limit at which a digester may be built. What is necessary here is to determine the cost of building.

### **Single Wall vs. Double Wall**

In order to avoid the exposure of the slurry in an integrated biogas plant, the digester can have double walling filled with water where the gasholder floats instead of on the slurry. However, this is an expensive construction. Furthermore, in case of leaks it will be very difficult to locate and to repair. It is found more convenient to use a split-type biogas plant if a neat-looking biogas plant is needed.

### **Joint or Separate Digesters**

Separate digesters have the advantage in that all parts except the bottom side are readily accessible. Furthermore, when built above ground, the outside can be painted black to

catch the radiant heat of the sun, a free source of heating energy. They are more expensive to construct, but when they are built back to back and side to side, they can be built at much reduced cost.

### **Integrated vs. Split-Type Biogas Plants**

A biogas plant with only one digester may be built using the digester slurry as the liquid seal receptacle for the gasholder dome, thus saving on materials and labor needed to build a separate water receptacle and having to put a cover over the digester. However, for a multi-digester biogas plant the split type is more economical because instead of having one gasholder for each digester, one can serve several digesters. For very large plants, two gasholders may be built for 31 or even 61 digesters. The main reason for this is to insure continuous operation in case one gasholder needs repair.

### **Masonry vs. Steel vs. Rubber or Plastic Digesters**

Masonry (bricks, concrete blocks or cement) is the most common building material for digesters and gasholder dipping tanks because it is readily available and does not require highly-skilled men to build them. In the Philippines, masons make their own concrete hollow blocks during the dry season. They bring a rented mold and a few bags of cement to the river banks where sand is free and make the concrete hollow blocks they need for their construction work. Concrete is made of sand, gravel, cement and reinforcing bars which are all available in small towns. In India, brick factories are found even in the remotest areas. Masonry may be used to build digesters of any size.

### **Floating Dome vs. Fixed Dome Gasholder**

The floating dome gasholder has a more constant biogas pressure than the fixed dome gasholder. It is also less expensive to construct but would not last as long as the fixed gasholder domes. Because the floating gasholder dome is made of steel which is a good conductor of heat, it cools the digester slurry during the night in an integrated type of biogas plant. If the ambient temperature is below 25°C this may cause a low biogas production. On the other hand, the fixed dome gasholder, because it is made of masonry which is a better insulator, causes less cooling of the digester slurry. The biggest disadvantage of the fixed dome gasholder is the variable biogas pressure. A fixed dome gasholder is used for small plants only.

### **Digester Size**

Once the type of biogas works is selected, the next step is to determine the size of the digesters, sumps and decantation tanks. The digesters in a plant should be adequate to handle all the available raw materials, otherwise pollution control will be inadequate. If the digester or digesters are too small or too few, the retention time of the slurry in the digester will be too short. This results in improper digestion producing excess carbon dioxide and less methane, and the sludge will emit a foul odor. If the digesters are too large, construction cost will be high. There are lower and upper limits of the economic size of digesters.

The volume of the digester must be equal to the volume of the digester slurry plus one foot head space above it. The volume of the digester slurry is equal to the volume of the

fresh slurry plus the starter. The volume of the fresh slurry depends on the volume of the daily available raw materials, the moisture content of the materials and the concentration of the fresh slurry.

In a small integrated continuous-fed biogas plant if there are 5 cu. ft. of fresh manure and the concentration is 1.0 manure to 1.0 part water, the fresh slurry would be 5 + 5 cu. ft. or 10 cu. ft. The digester volume should be 10 x 50 or 500 cu. ft. plus 1 foot head space.

In a batch-fed digester, if there are 100 cu. ft. of fresh manure and the concentration is 1 manure to 1.5 part water, the fresh slurry shall be 100 + 150 or 250 cu. ft. If the starter used is 20% of the fresh slurry, the volume of the digester slurry would then be 250 + 50 or 300 cu. ft. Hence, the volume of the batch-fed digester should be 300 cu. ft. plus one foot head space.

Under the same conditions, the slurry capacity of a continuous-fed digester would be 250 x 30 or 7500 cu. ft. Since the maximum size of an economic unit of a continuous-fed digester is about 2500 cu. ft., there should be 4 digesters with a slurry capacity of 1875 cu. ft., plus one foot head space.

### **Mixing Tank and Sump**

Small biogas plants use tanks where the manure and water are mixed. The manure is brought there in baskets. The pens are washed with the amount of water needed in the slurry. The wash water flows to the mixing tank. The manure and water are thoroughly mixed before charging to the digester.

When pens are washed with pressurized water, the mixing of the manure and water is accomplished during washing. The dilute manure slurry flows to the sump. The sump serving a continuous-fed or batch-fed digester using manure only as raw material should have a capacity equal to the daily fresh slurry charge of one digester. In a batch-fed digester using both manure and crop residues, the sump has a capacity equal to the manure plus the water required for the manure and the crop residues. The crop residues are charged directly to the digester. In a continuous-fed type there shall be one sump for each digester since all the digesters in the biogas plant are charged daily. In a batch-fed type there is only one sump for the biogas plant since only one digester is charged every day.

### **Size of Gasholder, Gas Pressure and Distribution Pipes**

The gasholder capacity is dependent on the volume of the biogas produced and the distribution of the use of the biogas. In a household, the use for cooking and ironing is somewhat evenly distributed throughout the day. The lighting load is in the evening while the water pumping is done early in the morning. Hence the capacity of the gasholder should be equal to the production during the night from about 10:00 p. m. to 5:00 a. m.

If the biogas is used in a factory, the heavy load is for 8 hours during the day. The biogas is used for generating electricity during the off-hours. With proper timing operations, a smaller gasholder would be adequate.

In a livestock farm, the maximum load is during the pumping of water while the pens are being cleaned. A large gasholder will be needed.

The size of the distribution pipes is dependent on the distance and volume of biogas that will pass through per unit of time.



## **Materials of Construction**

Masonry is the most popular building material for the walls of the digester and the water seal tank. It can be either brick or hollow blocks, whichever is cheaper. Where labor is expensive and for a large overground digester, reinforced concrete is used. The floor and the cover are also made of concrete.

The floating gasholder is made of steel sheet.

Polyethylene pipes are found the best for distribution pipes. They do not rust under the ground and they can be laid with slight bends so allowance may be made to absorb the expansion and contractions due to changes in temperature.

## **Sludge-Conditioning Plants**

The type of sludge-conditioning plant depends on the purpose of biogas works and the type of biogas plant to use. (See Chapters VIII and IX).

If there is a large space available for the lagoons, they should be as shallow as possible in order that the liquid sludge will be better aerated. The minimum economic depth of contents should be about three feet, and the maximum economic depth is about seven feet. If the ground is underlain with shallow adobe, the surface can be scraped and the soil used to construct the dikes. If this is not sufficient, soil may be brought from other places or the adobe may be dug or even adobe walls may be built. The bottom of the lagoon should be level. If the ground is too steep, the upper portion may be scraped and used to fill the lower portion. In this case a stronger dike will be needed on the filled side.

The level of the contents of the lagoon shall be from one to one-half feet below the level of the dike. This is necessary to avoid the flow of the contents over the dike in case of rain storms; hence what this allowance shall be will depend on the amount of storm drain that enters the lagoons. To take care of the extra flow, emergency outlets shall be built. The floor of the exit is flush to the normal level of the content of the lagoon. The emergency exits should be capable of draining the storm drains in case of a rain storm.

If the contour of the land will permit, the difference in surface level of the contents of one lagoon and that of the next lagoon where it flows to should not exceed one foot nor less than six inches. This is necessary to save on cost of constructing and maintaining the dikes. The normal connections between the lagoons should be large enough so that the transfer of incoming charge shall take place within six hours. The connections should contain filter materials like grass packed sufficiently to trap the suspended solids in the liquid that flows through it. The bottom of this connection should be at an elevation corresponding to the regular surface of the content of the lagoon that holds the contents. It is as high as the maximum level at charging time.

## **Layout**

The layout of the buildings and the different parts of the biogas works shall follow the contour of the land so that there is a continuous flow of the materials by gravity. These include processing plants, livestock pens, sumps or mixing tanks, digester, catch basin, digestion lagoon, decantation tanks, aeration lagoons, dilution lagoon, aging-storage lagoon, irrigation canals, fishponds, crop fields, drainage canals. Whenever the contour of the land will not permit the flow by gravity, pumping will have to be resorted to. The farmhouse, office and factory should be located at a sufficient distance from the livestock

stable to avoid the foul odor; the biogas works should be close to and lower than the livestock corral so as to receive the manure by gravity. The gasholder shall be located close to where biogas will be used to reduce pumping cost.

The foundation ground of the digester as well as the gasholder should be well compacted, then the coarse material over it is placed and then compacted again before the structure is built on.

### **Leak Test of Digester and Gasholder**

After the digester is completed, examine the bottom, wall and cover part by part with a stick. The spots with hollow sound should be pared off and repasted. After the masonry has cured, wash the digester clean, and fill it up with clean water. Mark the spots that get wet from outside. If there are leaks, empty the digester and repair the leaks. Repeat the test until all leaks are plugged. When no leaks remain, fill the digester to an additional one foot deep. Repeat the same tests and plug the leaks. Repeat the procedure until the top is reached. Plug the leaks in the water container in the digester.

There are two steps to be taken to detect leaks in the gasholder dome: 1) Inspect the welding faults by positioning the gasholder dome against the sun. Weld the holes. 2) Then immerse the gasholder dome upside down in the water to its highest position. Cover the surface of the dome with soap suds. Lower the gasholder gradually and observe the leaks as shown by the bubbling soap suds. Plug the holes. After all the leaks have been closed, apply protective paint.

### **Digester Capacity**

The digester should match the amount of available raw materials. If it is too small, pollution will not be adequately controlled, and the biogas, feed materials and fertilizer production will be low. If too large, the cost of the infrastructure will be higher than required, with consequent higher cost of production.

### **Gasholder Capacity**

The gasholder should be of sufficient size to hold the biogas produced during the period when the biogas is not being used. If too small, part of the biogas produced during the off-use period will be lost and there will not be enough biogas during the peak load. If too large, the infrastructure cost will rise with consequent higher cost of production.

If part of the biogas is used farther away from the digester as is the case if the excess gas in a livestock farm is used in a nearby barrio, a separate gasholder should be built in the barrio. The barrio digester should have a capacity equal to the gas allotted to the barrio. By this way the biogas will flow even during the time the barrio is not using the biogas. If no separate gasholder is provided, the gas will flow to the barrio only when people use the biogas. This will mean either a very large pipe line which is very expensive, or the barrio will not get sufficient gas.

In large biogas plants two or three gasholders may be necessary to insure availability of gas even when one gasholder is being repaired or serviced. There is also a maximum economic size of gasholder.

### **Gas Pressure and Gas Lines**

Biogas machines, equipment and appliances operate efficiently at a certain gas pressure. In India, this is three to four inches column of water. In the Philippines this is from

four to six inches. These are the pressures at the point of use. As the gas flows through a pipe the pressure is reduced due to friction; hence the pressure at the gasholder should be higher. Pressure lost in small pipes is greater than in the large ones and the longer is the pipe line, the more pressure is lost. Therefore the size of the pipe lines shall depend on the length of the pipe. They should be calculated carefully to insure that the right gas pressure is obtained at the point of use and at the least cost of the pipes.

As the gas flows through the pipe, some of the moisture content of the biogas condenses. This condensate should be systematically removed, otherwise it may clog the pipe. Furthermore, very moist gas gives lower heat flame. This may be detected by a reddish flame when it burns. To avoid this the pipeline should be provided with a U-trap at every depression. This is opened from time to time to remove the water condensation along the line.

Plastic pipes are preferable for use when the pipe is buried underground, firstly because they do not rust and secondly because they may be laid with slight bends. These bends will take care of contraction and expansion due to changes in temperature.

### **Leakage Test of Piping and Removal of Air**

A careful examination of the digester should be made before it is charged in order to avoid having to discharge and charge again. The inlet transfer and outlet pipes should be inspected for leaks before they are installed. Wash the pipe well. Close one end tightly. Stand the pipe with the closed end at the bottom. Fill it up with clean water. Water will appear wherever there is a leak. Empty the pipe and plug these parts. Repeat the process until the pipe sides keep dry after filling it with water. After the pipes are leak-proof then they may be installed.

Before using the biogas, make sure that the pipes have been exhausted of air. Release the biogas from the gasholder to the pipe line. After a lapse of time, (the larger is the pipe line, the longer is the time), test the flammability of the gas by attaching a small gas pipe. Feel the flow of the gas. If you can detect the odor of rotten eggs (this shows the presence of  $H_2S$  which is the sign of the biogas) light the gas. If the flame is blue, this means that biogas has started to flow. Close the pipe.

### **Drainage Canals**

If there is more liquid sludge than what can be used in the farm, the drainage canals should be as long as possible so that there will be time enough to aerate the sludge before it is allowed to flow to a public stream. The canal should have a slope of about  $2^\circ$ . There shall be built one overflow dam about one foot wide at the top and about every 25 ft. apart with a fall of about 6 inches each. The canal should be about two to three feet deep. The width will be such as to accommodate the water that would flow through it.

**LIBERTY FLOUR MILLS, INC.**  
**Research & Development Division**  
**Maya Farms**

**QUESTIONNAIRE ON BIOGAS WORKS PROJECT**

1. Name and address of person or entity wanting/intending to build biogas works

Name: \_\_\_\_\_

Address: \_\_\_\_\_

Please check:

- Owner
- Consultant
- Contractor
- Others - Please state \_\_\_\_\_

2. Location of farm where the biogas works shall be built

Name of farm \_\_\_\_\_

Elevation above sea level \_\_\_\_\_

Barrio \_\_\_\_\_ distance from town or city \_\_\_\_\_

Province \_\_\_\_\_ distance from Manila \_\_\_\_\_

3. Check the purpose of the biogas works (1. for main purpose, 2. for second, 3. for last).

- pollution control (how far is the nearest home from the proposed site of the biogas works?) \_\_\_\_\_
- to produce biogas for fuel (Please state what you would wish to use the biogas for.) \_\_\_\_\_
- to produce total sludge for fertilizer
- to produce liquid sludge as fertilizer-irrigation water.
- to produce solid sludge as feed materials

4. Number of animals raised -

Animals Raised	Degree of Confinement		
	Total Confinement	Loose with Night Corral	Loose without Night Corral
	No. of Heads	No. of Heads	No. of Heads
Cattle ranch			
Dairy			
Swine breeding			
Swine fattening			
Poultry-layers			
Poultry-broilers			
Work animals			
Others: Please specify			

5. What crops do you grow?

Rice	_____	hectares
Water chestnut	_____	hectares
Corn	_____	hectares
Miscellaneous flooded crops	_____	hectares
Miscellaneous dryland crops	_____	hectares
Orchard	_____	hectares
Fish pond	_____	hectares

6. Please submit a map of the farm indicating the terrain and soil conditions.

- a) Please attach a contour map if available. If not, described the terrain as fully as you can.
- b) Subsoil condition. How deep do you have to dig before reaching adobe or rock formation where the proposed biogas plant is expected to be built?
- c) Water table. At what depth do you have to dig before ground water appears where the proposed biogas works is expected to be built?
- d) Does the farm get flooded occasionally? If so, how deep over the ground where the proposed biogas works is expected to be built?
- e) How deep is the surface well in the farm?
- f) How deep is the deep-well in the farm or nearby?  
Capacity in gallons per minute?

7. What are the prevailing wages in the community?

- a) Laborers \_\_\_\_\_ per day
- b) Carpenters \_\_\_\_\_ per day
- c) Masons \_\_\_\_\_ per day
- d) Welders, tinsmith, plumber \_\_\_\_\_ per day

8. What are the prevailing costs of construction materials in the community?

- a) Cement \_\_\_\_\_
- b) Sand \_\_\_\_\_
- c) Gravel \_\_\_\_\_
- d) Concrete hollow blocks  
1 - 6" x 8" x 16" \_\_\_\_\_  
2 - 4" x 8" x 16" \_\_\_\_\_
- e) Reinforcing bars  
1 - 1/2" dia. x 20' \_\_\_\_\_  
2 - 3/8" dia. x 20' \_\_\_\_\_  
3 - 5/8" dia. x 20' \_\_\_\_\_
- f) MS Plate  
1. 1/8" x 4' x 8' \_\_\_\_\_  
2. 5/32" x 4' x 8' \_\_\_\_\_  
3. 3/16" x 4' x 8' \_\_\_\_\_

- g) G. I. pipes & fittings
1.  $\frac{1}{2}$ " dia.  $\times$  20', sch. 40
  2. 1" dia.  $\times$  20', sch. 40
  3.  $1\frac{1}{2}$ " dia.  $\times$  20', sch. 40
  4. 2" dia.  $\times$  20', sch. 40

- h) P.E. pipes
- $\frac{1}{2}$ " dia., per ft.
  - 1" dia., -do-
  - $1\frac{1}{2}$ " dia., -do-
  - 2" dia., -do-

---

---

---

---

---

---

---

---

---

---

## Chapter XI

### Operating Biogas Works

The operation of small biogas works is simple but it requires attention to details. An irresponsible operator who would try and make shortcuts will materially reduce the efficiency of the works. Two weeks to one month training of an ordinary laborer would enable him to operate a small plant. Large plants would require a well-trained foreman to oversee the operation. For large biogas works using mechanical equipment, an engineer would be required.

#### Biogas Plant

##### Raw Materials and Collection

Any organic waste, principally manure, may be used as raw material. Kitchen garbage will do but it is more valuable as feed for pigs. Crop residues are good raw materials but are expensive to prepare. If they are fed to ruminants this extra cost of preparation is avoided, and the manure is a better material than the original crop residues. Unless paper pulp materials shall be recovered, do not use crop residues. Remove the coarse long fibers from horse manure.

The collection of the manure of loose animals is difficult and the amount collected varies greatly depending on the diligence of the collector. When the animals are loose during the day and confined in corrals at night, about one half of the manure may be recovered. If the animals are kept in confinement, the total manure and most of the urine may be collected.

Dry manure, like that of poultry and goats in confinement, are swept, placed in baskets and brought to the mixing tank. Wet manure, like that of pigs and cattle if kept in confinement, may be collected in leak-proof containers if the quantity is small. The floor is then washed with a controlled amount of water. In large piggeries, dairies and cattle feedlots, pressurized water is used to wash the manure to canals leading to the sumps. This results in more water than needed in the slurry. The excess water will have to be treated, otherwise it will cause pollution. In the case of feedlot and dairy farms, the beddings are first raked up and placed in piles before the manure is washed off.

The manure and garbage should be used as fresh as possible. On the third day, their methane-producing capacity starts to deteriorate. In the meantime it emits foul odor. Crop residues are better when air-dry. They should be free from molds. All fibrous materials should be thoroughly crushed and cut to at least one-half inch long.

In the dairies and feedlots, the animals are fed partly with hay. Hay is also used as bedding and these get mixed with the manure. The feed rejects and bedding should be separated from the manure. In crop-livestock farms, the bedding and feed rejects are used for composting, and the manure, for the biogas digester. In the agro-industrial biogas works, when there is a large requirement of biogas and not much use for compost, the fibrous materials may be used as raw materials for the biogas works. If there is enough of these materials, the fibrous part of the sludge may be used as paper pulp material. There are advantages in using a combination of raw materials. The pig manure and chicken

droppings have higher nitrogen than required while the cow and carabao manures are lower than required. When they are used in combination, the nitrogen ratio is closer to the requirement, hence more gas is produced when combined than the total when used separately. The same is true with the combination of manure with crop residues.

### **Starter and Seed Starter**

To insure fast and efficient methane production, the fresh slurry should be inoculated with methane-producing bacteria of known ability, age from 20-30 days. This is known as starter. It comes from the turbid liquid sludge of a digester that has been producing biogas efficiently. In case the new biogas works is too far away from a working one and hence it is impractical to get the necessary amount, one may prepare his own starter by obtaining a gallon for use as seed starter. This may be multiplied in 55-gallon drums. Clean the drum very well. Place a petcock on the cover of the drum. Prepare a slurry, in the proportion of 1 pig or chicken manure to 1.5 water by volume. Place the slurry together with the seed starter filling the drum up to 4 inches below the top cover. Close the plug tightly. Connect the plastic tubing to the petcock extending to the bottom of a pail of water. Open the petcock so all the gas can come out but air will not enter the barrel.

After 25 days the starter is ready. If your digester is so big that you need more than one barrel, you can multiply your starter by splitting the first product among the number of barrels you need. Follow the same procedure as above; after another 25 days you have all the starter you need.

### **Fresh Slurry Concentration, Starter, Retention Time**

As a general rule, the less concentrated the slurry, the shorter is the retention time. The longer the retention time is, the less starter is required. The usual fresh slurry concentration for a batch-fed digester is 1 manure to 2 of water by volume and 23 days retention time or 1:1 concentration for a 30 days retention time; for small, continuous-fed, 1:1 fresh slurry concentration on 50 days retention time; for large continuous-fed, 1.5 fresh slurry concentration and 30 days retention time; for sewage digesters with very dilute fresh slurry, 20 days retention time. The starter is usually 20 to 25% of the fresh slurry. In the batch-fed, starter is added to every charge. In the continuous-fed, the starter is added only to the original charge.

In small plants the wash water used is exactly what is needed for the fresh slurry concentration. But in large plants where pressurized water is used, the manure slurry coming from the pen to the sump contains more water than required for the fresh slurry. When the sump gets filled, the solid portion sinks while the excess water flows to the digestion lagoon. When the operator feels the slurry concentration is correct, he shifts the flow to the next sump. He stirs the filled sump and checks on the concentration. An experienced operator can tell if the concentration is correct by pushing a piece of stick while stirring the contents. If not correct, he reshifts the manure slurry flow to the first tank. He repeats the process until he gets the right concentration. He shifts the flow to the second sump and allows the contents of the first sump to the digester, if the sump is of higher elevation than the digester. If lower, he transfers the fresh slurry to the digesters by buckets or by pumping.



## **Charging and Discharging Digesters**

In the batch-fed biogas works, the digesters are scheduled for discharging and charging one at a time to cover a cycle equivalent to the retention time. At the end of the retention time the sludge is discharged, leaving enough sludge to serve as starter. Then the fresh slurry is charged at the hottest time of the day so that the slurry charged will be at the highest temperature possible. In charging make sure that the digester slurry leaves a space of about one foot. This is necessary to insure that the scum that forms on the surface of the sludge during digestion does not clog the gas outlet.

The overground batch-fed digesters are charged with fresh slurry by pumping and discharged of the sludge by gravity. It will be difficult to pump slurry with higher concentration than 1 solid to 2 water. It would then be necessary to use this fresh slurry concentration and use a shorter retention time, unless it would be feasible to add into the digester more manure to make up for the extra water. This will be rather difficult when using wet manure like that of pigs. Dry manure like that of chickens will be easier. When using crop residues, this will be easy. The sludge is discharged by gravity. The fibrous sludge that would not pass through the discharge pipes are removed from the digester through a side manhole. If a large amount of fibrous materials is used, it may pay to recover the fibrous materials from the sludge and use it as paper pulp material. This is done by placing the fibrous portion of the sludge in a perforated drum and washing it well with clean water.

The underground batch-fed digester is charged with fresh slurry by gravity and discharged by pumping. Because fibrous materials would not pass through the discharge pipes and the underground batch-fed digesters do not have side manholes, fibrous materials like crop residues cannot be used. The sludge is also too thick to be pumped, hence it would be necessary to dilute the sludge before pumping.

While constructing a continuous-fed biogas plant, start collecting as much manure as possible about two weeks before the expected completion of the digesters. Cover the collected manure so it will not attract and breed flies. Plug the outlet of the mixing tank. Deposit manure required for one day charge to the mixing tank or sump. Add the required amount of water for the right concentration of the fresh slurry. Stir well to insure that all the manure is broken into small pieces and well mixed with the water. If garbage is used, crush it well before adding the right amount of garbage to one day charge. Remove all undigestible materials. Unplug the outlet. Stir the mixture well while charging the fresh slurry into the digesters. Repeat the procedure until all the manure has been used up. Figure the amount of starter and charge this to the digester. Suppose the fresh slurry charge is equivalent to 14 days and the retention time is 28 days, therefore the digesters are half full. Fill the digester up to its full capacity with water (do not forget that the full charge will still leave 1 ft. open space above the digester slurry). The daily charge after this starting charge shall be double the concentration of slurry required. Suppose the concentration is 1 solid material to 2 water, then this initial fresh slurry charge is 1 to 1. This is necessary to bring up the dilute original charge to the required concentration. After 14 days, the concentration of the fresh slurry shall be 1 to 2. Preparation of the fresh slurry and charging into the digester shall be during the hottest part of the day. The floor of the mixing tank is slanting away from the outlet, so that the heavy material will be left there. Plug the outlet and remove the materials left.

If there are more than one digester in a biogas plant, one digester shall be given the original charge at a time. The first digester will get its daily charge only after all the other digesters in the plant shall have had their original charge. All the digesters in a continuous-fed are charged daily, one after another.

The top of the effluent pipe of the continuous-fed digester extends to the level of the digester slurry. Immediately before charging the digester of the split-type biogas plant, the gas line to the gasholder is closed and the gas outlet is opened to allow the gas pressure in the digester to go back to atmospheric. The effluent pipe extension or plug is removed, then charging of fresh slurry starts. In this way the digester slurry will return to the normal level. After completing the charging, the effluent pipe extension or the plug is returned, the gas outlet is closed and the gas connection to the gasholder is opened.

### **Stirring the Digester Slurry**

The digester slurry should be stirred every day for at least one minute to break the scum formation as well as to break pocket formations in the supernatant liquor. In the continuous-fed digester, the stirring takes place while the digester is being charged with fresh slurry.

If stirring becomes very heavy, it shows that there has accumulated an undue amount of sludge residue at the bottom or the scum at the surface. This may happen if the daily stirring has been neglected or the continuous-fed digester is due for regular cleaning. The only remedy is to open the digester and remove the residues. Clean the digester well, scraping all residues sticking to floor and sides. Residues in the digester reduce the capacity of the digester.

### **Digester Efficiency**

The day after filling and sealing a batch digester, a flammability test of the biogas should be undertaken before the gas is allowed to flow to the gasholder. This is done by connecting a gas burner to the petcock and lighting it. If the flame is bluish then it is allowed to flow to the gasholder. If the flame is reddish it should be released to the atmosphere. If the test is negative the test is repeated the following day and daily thereafter until a bluish flame is obtained.

A week before a batch-fed digester is scheduled for discharging, the biogas production capability of the digester slurry must be checked. This is done by closing the valve and connecting a manometer to the petcock. If after 10 minutes the pressure of the gas does not increase by at least 1 inch column of water this means that gas production is low and therefore the digester needs recharging before the end of the retention time. One year after the original charge and every year thereafter, a continuous-fed digester should be checked for gas production in the same way as in the batch-fed digester. If gas production is below normal, an inspection is made and if the digester is found defective, it should be discharged and recharged. The usual reason is, a large amount of residues is deposited at the bottom of the digester. If this is the case the digester should be cleaned of the residues. Clean the digester thoroughly. This is also an opportunity to inspect for digester defects and make necessary repairs.

If the fresh slurry would not get into the continuous-fed digester, it is a sign that the inlet pipe and/or transfer pipe and/or outlet pipe are clogged. This is a sign, too, that the sludge residues are so high that they have reached the inlet end of the pipes, or the slurry is too thick, or the digester has been over-charged. Thick slurry is usually due to the use of fibrous raw materials or a leak in the digester. The only remedy is to open the digesters. Clean it up well and check for leaks.

When the transfer pipes get clogged or when stirring becomes difficult, the digester should be opened and checked. If a thick sludge residue has accumulated at the bottom of the digester, it is time to clean out the digester. If fibrous materials are used as raw materials in a continuous-fed digester, cleaning will be done more often.

If the effluent emits foul odor, the likely cause is overcharging the digester. Check and make the correction.

If the biogas production is lower than expected, it may be due to several causes:

1. There is not enough manure in the digester.
2. The slurry temperature is low.
3. The starter is of a poor quality.
4. The gas pipes may be leaking.
5. The pH of the slurry is low. If it drops to less than 7.5, add some effluent in the charge daily until it goes back to normal.

If it is hard to stir, it may be due to the following causes:

1. The fresh slurry charge is too thick.
2. An undue amount of fibrous material was used.
3. The fresh slurry was not sufficiently mixed.
4. Stirring was left untended for some time.
5. Leakage in the digester caused the liquid to seep out.

## **Gas Holders and Distribution System**

### **Floating Gasholder**

Remove as much of the air in the gasholder dome as you can by opening the gas outlet and then lowering the dome as low as you can before feeding the biogas in.

The water in the gasholder tank evaporates. The evaporation is reduced if oil is added to the exposed surface. Some spill out when there is excess gas. This should be replenished to maintain the proper water level; otherwise a lot of gas will bubble out when the floating tank reaches the top. Remove the scum between the wall and the gasholder dome. Paint as often as you discover any rust forming.

### **Biogas Pressure**

The biogas pressure depends on the weight of the floating gas tank. If a higher pressure is necessary, sandbags or other weights may be placed on top of the gasholder. If the pressure is too high, counterweights should be installed. In the case of the fixed dome gasholder, the pressure is maintained by the difference in the levels of the slurry in the digester and in the auxiliary compartment.

## **H<sub>2</sub>S Scrubber**

If the biogas is used in an internal combustion engine, it would be necessary to remove as much of the H<sub>2</sub>S as possible, otherwise the engine cylinder and piston would be corroded. This is done by passing the biogas through the iron filings. At the Maya Farms the H<sub>2</sub>S scrubber consists of a hermetically-sealed 55-gallon oil barrel with two layers (1 ft. deep) of iron filings. The biogas enters at the bottom and exits at the top. The H<sub>2</sub>S scrubber used with a 25 H.P. engine running about 12 hours a day is changed every 6 months. The old scrubber is then opened and the iron filings are changed.

## **CO<sub>2</sub> Scrubber**

If it is desired to reduce the carbon dioxide component in biogas, the gas from the digester may be bubbled through a CO<sub>2</sub> scrubber. A mixture of water and ash or lime can be used in the scrubber to absorb the carbon dioxide. The mixture should be changed at regular intervals to maintain a high absorbing capacity.

## **Gas Distribution System**

The size of the distribution line depends on the volume of the gas that would flow through it and the distance from the source to where the gas shall be used.

Depressions should be avoided in the distribution system, but if this cannot be avoided, provide a U-trap for every depression along the line. After the new gas line has been installed, allow the gas to flow through it until all the air it contains is driven out. This is done by opening the valve connecting the pipe line to the gasholder until all the air is driven out. This is checked by connecting a gas burner to the line and lighting it. A bluish flame means that the biogas has started to come, which indicates that the air has been driven out. If the test is negative, keep it open until you get the bluish flame. This accomplished, connect the different machines, equipment and appliances. There should be one control valve for each of them.

## **Safety Precaution**

Certain precautions should be observed in the operation of the biogas plant. Biogas can be explosive when mixed with air in the proportion of 1 part biogas to 8-20 parts air in an enclosed space. This situation may occur when the digester is opened for cleaning, when the gas is released to repair the gasholder, or when there is a gas leakage in a poorly ventilated room. In such cases, avoid smoking, sparks and open flames. Do not go inside a digester unless there is someone who can get you out in case you need help. Although biogas is not poisonous, it can cause suffocation for lack of oxygen. Never allow negative pressure in the digester, gasholder or in the pipings because air will enter and the mixture of biogas may become explosive.

A small gas flow can be lit at the open end of a gas appliance provided the gas flow is held low. If the flow is too strong, the flame will burn inches away from the open end. The best way to light is to place the flame at the opening before opening the biogas valve. Then you can regulate your opening to suit the amount required.

## **Sludge-Conditioning Plant**

### **Single-Pond Type**

The sludge empties to the decantation tank and the following day the liquid sludge is allowed to flow out of the decantation tank. The solid portion of the sludge is recovered

from the decantation tank and mixed with the slop at the time of cooking. In small piggeries they do not use the standard mixed feeds. The kitchen slop, banana stalk, rice bran and miscellaneous other available pig feeds are used.

The liquid sludge is drained into the pond where it is retained for about 24 days before it is applied as fertilizer to the crops and fishponds. The liquid sludge fertilizer application for crops shall be about 4,000 liters per crop per hectare. In the fishpond the application is about 0.5 liter per sq. m. per week. The plankton that grows serves as feed for the fish supplemented by the feed sweepings from the pigs or chicken pens. Keep the fishpond free of water-loving plants. Replenish water that has evaporated or leached out with fresh water.

The pond should be cleared of scum every week and of the sludge residues every year. The scum should be cleared to avoid foul odor and to allow better aeration. The sludge residue is removed from the pond, otherwise the deposits will reduce the capacity of the pond.

The crop residues, weeds and ipil-ipil leaves are used to feed ruminants.

The compost stack raw materials are the ruminant feed rejects, the scum and the sludge residues from the pond. The compost stack is kept moist with the water from the fishpond.

All the unsanitary wastes are incinerated. The ashes are used as potash fertilizer.

### **Double-Lagoon Type**

The sludge from the digesters is treated in the same manner as in the single-lagoon type. The liquid sludge drains to the algae lagoon. The excess water from the fresh slurry sump flows to the digestion lagoon. The contents of the dilution lagoon drain to the algae lagoon after twelve days. From the algae lagoon the liquid flows to the irrigation canal to fertilize the crop after another 12 days. Part of this is used to fertilize the fishpond as in the single-lagoon type. The lagoons are cleaned in the same manner as in the single-lagoon type.

The solid sludge is dried in the sun for 2 to 3 days during the sunny days; but during the rainy days, the solid sludge is dried in drying sheds roofed with plastic sheets. Drying will take 4 to 5 days.

The wash water of the pens that goes to the digestion lagoon has a great deal of dissolved manure. It is contaminated with bacteria and other micro-organisms. The bacteria break down the manure into nutrients which algae use along with carbon dioxide. The algae in turn produce oxygen for the bacteria.

The scum should be removed at least once a week. The scum consists of the entrained solids which are caught up by gas bubbles rising to the water surface. Removal of the scum improves the surface exposure to air and sunlight, thus improving detoxification.

### **Multi-Stage Lagoon Type**

The sludge coming from the digesters is treated in the same manner as in the double-lagoon type except that the fuel used in heating the artificial drier comes from the heat emitted by the charcoal-making and by the burning of ipil-ipil twigs and of crop residues not used in the digester.

The water in excess of what is needed in the fresh slurry drains to the digestion lagoon. After 30 days of retention time it flows to the aeration lagoon through a filter of grass

cuttings. The liquid sludge from the decantation tank drains also to the aeration lagoon through another grass filter. The aeration system consists of water wheels rotated by the power of a windmill. After 15 days retention the contents drain to the dilution lagoon through a grass filter.

The washing from the processing plants drains to the catch basin. The organic solids are removed and sent to the compost bunk while the water drains to the dilution lagoon.

The scum in the digestion lagoon shall be treated in the same manner as in the double-lagoon type of sludge-conditioning plant.

After 15 days retention in the dilution lagoon, the contents drain to the aging-storage lagoon. After at least 14 days of retention the contents of the aging-storage lagoon flow to the field through the irrigation canal.

The treated liquid sludge is used in the same manner as in the single pond type of sludge-conditioning plant. The processed solid sludge is used in the same manner as in the double-lagoon type of sludge-conditioning plant. The clearing of the lagoons is done in the same manner as in the single-pond and double-lagoon types of sludge-conditioning plant.

The crop residues, the weeds and ipil-ipil leaves are used in the same manner as in the single-lagoon type of sludge-conditioning plant.

The filter materials shall be changed twice a week. The filter material is used as raw material for compost.

### **City Sewage System**

If the main reason for the biogas plant is to control pollution as in the city sewage systems, all the water should be included in the fresh slurry charge to the digesters. For this reason a large volume of digesters is required.

The sludge empties into settling basins. A large portion of the liquid sludge (same volume as the fresh slurry) is returned to the digester to serve as the starter to speed up decomposition of the incoming slurry. The retention period is reduced to 20-23 days.

The liquid sludge not returned to the digesters flows to a series of lagoons where it is aerated until the BOD and COD is reduced to acceptable levels.

### **Operating the Compost Bunk**

Fig. 11-1 shows the floor plan of a compost bunk. The raw materials are stacked into bunks A and B simultaneously. The first materials to be placed are the coarser materials, such as corn stalks, in a 6-inch thick layer. Over this is a layer of grass filter materials from the aeration lagoon, and feed rejects from the carabaos and cows. The third layer is 4 to 6 inches of the scum from the digestion lagoons and sludge residues from the digester and lagoons. The stack is compacted lightly, then the alternate layers are repeated until the bunker is full. The top is covered with earth, thick enough to prevent excessive evaporation. It should be kept moist by sprinkling with water from the drainage canal from time to time. The size of the bunkers should be such that it will take from 2 to 3 weeks to change and they are about 4 to 5 feet high. The compost pile should be well aerated by sticking through the center a piece of bamboo with its nodes removed and with holes along its length.

After filling bunkers A and B, D and E should also be filled in the same manner. After completing D and E, A and B are ready for turning. The contents of bunker A and B are transferred to C simultaneously and mixed by shoveling.

Bunkers A and B are again refilled. By the time this is emptied, bunkers D and E are ready to be mixed in bunker F in the same manner as in C. After mixing in F, refill D and E: After about 4-5 weeks, the contents of bunkers C and F are mixed together in G. After another 6 to 7 weeks, the compost is ready for use. Enough compost will be produced to be applied to the fields in an amount of at least four tons per year per hectare.

### Operating the Incinerator

All waste materials unfit for feed or as raw materials for the biogas plant or as composting materials shall be burnt in the incinerator. The ashes are used in the CO<sub>2</sub> scrubber or as potash fertilizer.

### Irrigation Canals

The treated liquid sludge flows to the lowland fields through the irrigation canal. When used in the rice field, it should not exceed 4,000 liters per crop per hectare. This is based on the concentration of the liquid sludge coming straight from the digester using a fresh slurry concentration of 1:1. The actual volume allowed in the field should be adjusted, depending on the concentration of the fresh slurry used and the dilution of the liquid sludge at the time of application. If the rice fields need more irrigation water, fresh water supplement should be applied.

### Drainage Canals

The upland fields are irrigated and fertilized from the drainage canals by pumping if necessary. Part of this water is used to moisten the compost. The excess shall be treated further to insure that the BOD and COD are within the requirements of the National Pollution Control Commission. This is checked by covering cages containing the fish. If the fish does not come up to the surface of the water with open mouth within one hour, it is a good indication that the water is within the requirements of the National Pollution Control Commission.

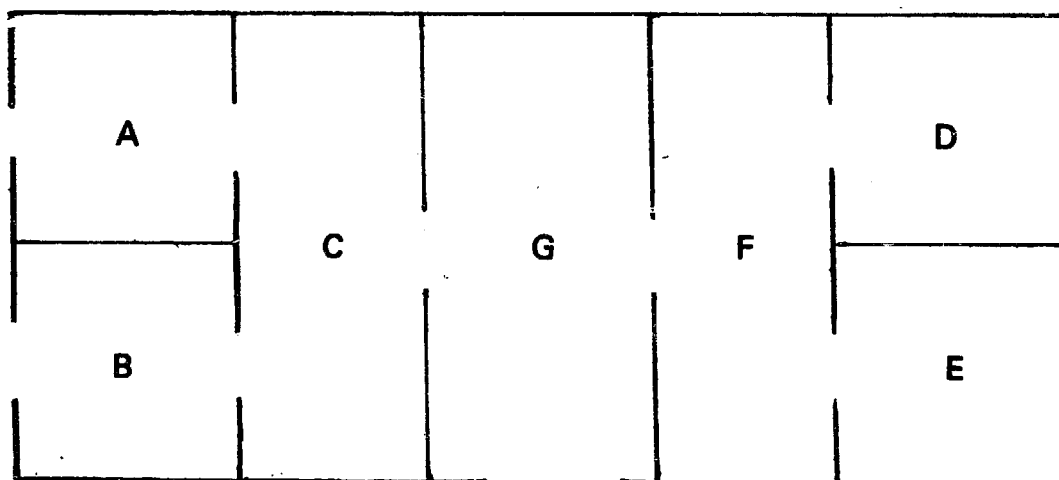
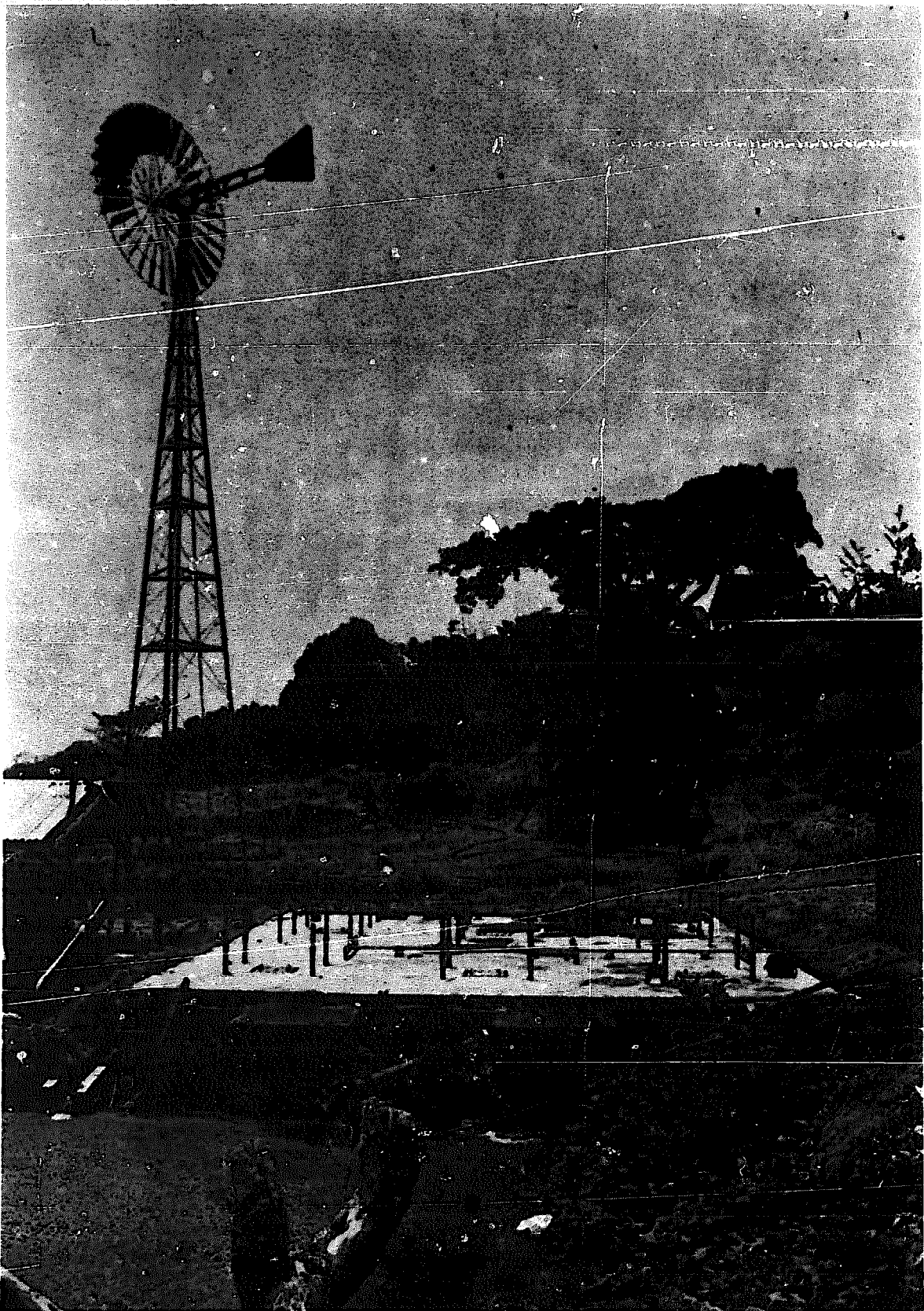


Fig. 11-1: Floor plan of compost bank



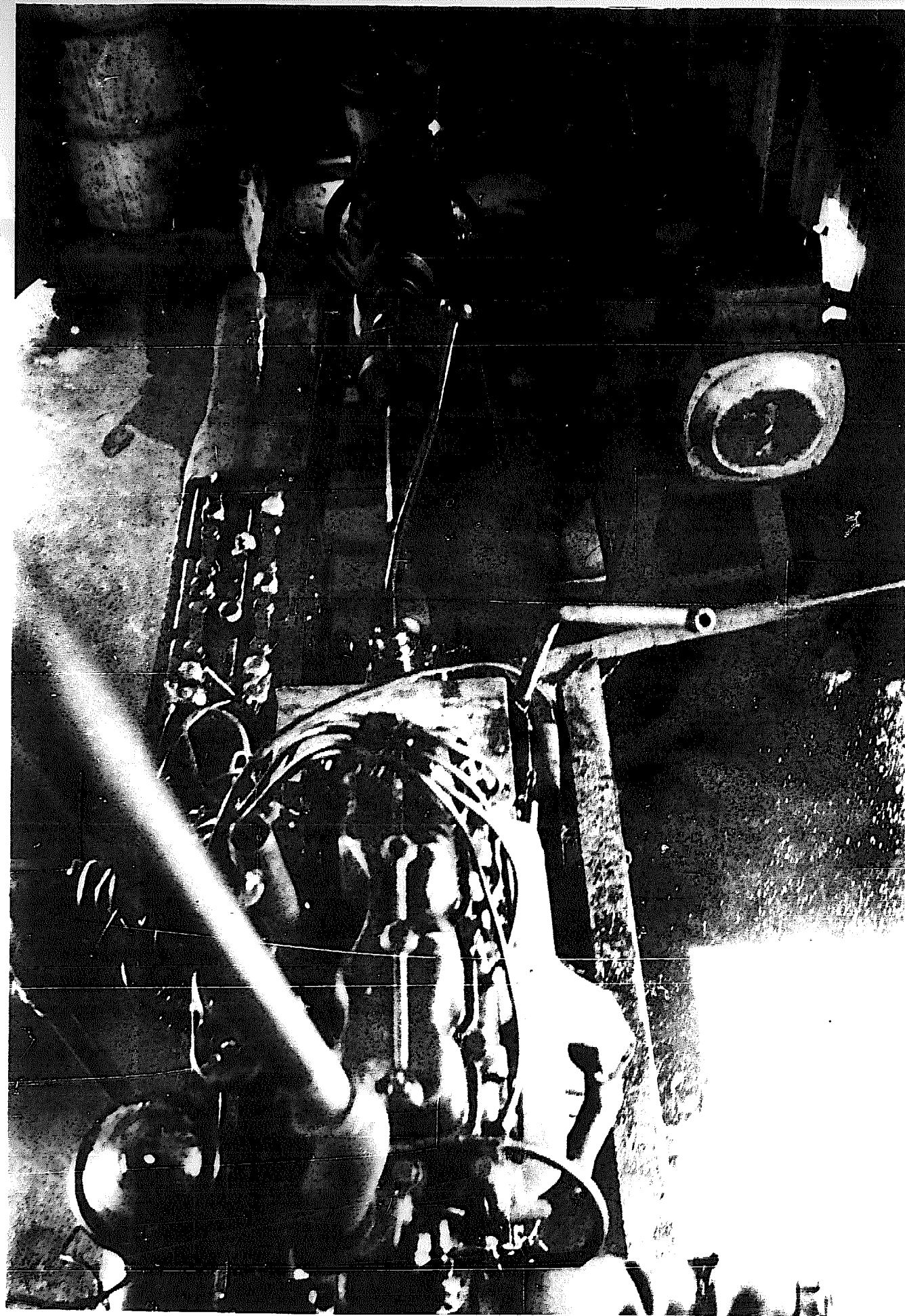


**Illustration 2-13: Biogas works with a windmill to help in aerating the sludge.**



**PART III**  
**UTILIZATION AND ECONOMICS**

<b>Chapter</b>	<b>XII</b>	<b>Biogas as Fuel</b>
	<b>XIII</b>	<b>Sludge as Fertilizer</b>
	<b>XIV</b>	<b>Sludge for Feed and Other Uses</b>
	<b>XV</b>	<b>Biogas Works for Pollution Control</b>
	<b>XVI</b>	<b>Economics of Biogas Works</b>



**Illustration 3-1: Biogas-powered deepwell pump, 240 gpm, 400 ft. deep at Maya Farms.**

## **PART III**

### **UTILIZATION AND ECONOMICS**

Because of the energy crisis, the present emphasis is on biogas as a source of energy. Biogas is a versatile fuel which can be used for direct heating as well as for running internal combustion engines. The gas engines in turn provide power to operate equipment, machinery and motor vehicles either directly or indirectly through electric generation.

With the problems of rising cost, unreliable supply and water pollution plaguing the manufacture and use of chemical fertilizers, the use of the sludge as an organic fertilizer should gain more popularity. Sludge is a source not only of nitrogen, phosphorus and potassium but also of the trace minerals essential to proper plant growth. It is also a good soil conditioner.

The recycling of the solids recovered from sludge is a later development at Maya Farms. The solids are processed into feed materials rich in vitamin B<sub>12</sub> and other unidentified growth factors (UGF). The feed materials supply around 10% of the total feeds requirement of the hog farm which produces the manure used in the biogas plant. The savings in feed costs have turned the biogas works into a profitable operation.

The pollution control aspect will assume greater importance as the world population grows denser. When people start crowding into the open country, the present systems of disposing of animal wastes will no longer suffice. Livestock raisers will have to set up biogas works to control both air and water pollution.

The economic potentials of the biogas works can be assessed in terms of (a) pollution control for ecology balance, (b) biogas as a source of energy, and (c) biofeed and biofertilizer for food production.

Since biogas operations have not reached general commercial application, the evaluation of economic worth is based on the method of value assignment, dependent on what product or system is replaced by its particular use.

Part III discusses the utilization and economics of biogas works in the following chapters:

- |                     |   |
|---------------------|---|
| <b>Chapter XII</b>  | <b>Biogas as Fuel</b>                     |
| <b>Chapter XIII</b> | <b>Sludge as Fertilizer</b>               |
| <b>Chapter XIV</b>  | <b>Sludge for Feed and Other Uses</b>     |
| <b>Chapter XV</b>   | <b>Biogas Works for Pollution Control</b> |
| <b>Chapter XVI</b>  | <b>The Economics of Biogas Works</b>      |

## CHAPTER XII

### Biogas as Fuel

This is not the first time that humanity is faced with an energy crisis. Nations have suffered from lack of fuel at some time or other. In times of war, a nation's normal sources of energy may be cut off for an extended period. At other times the shortage may just be due to a temporary dislocation of supply, but the ingenuity of man has always come up with some solution.

In the early part of this century, motive power in the Philippines was steam produced by firewood. When the nearby forests were exhausted, the rice mills converted their boilers to use rice hull.

Prior to World War II, Professor Anastacio Teodoro, together with Alejandro Catambay, Jesus Mamisao and Julian Banzon of the University of the Philippines, College of Agriculture, conducted research and actually used mixtures of gasoline and alcohol from molasses, and later on alcohol alone, to run automobiles and trucks. Dr. Gregorio Y. Zara used alcohol to fly his airplane. Felix D. Maramba, assisted by Bernabe Dacanay, both of the Philippine Bureau of Science, experimented with coconut oil as a substitute fuel for diesel engines. They also conducted research and used coconut shell in gas producers to run motor vehicles. These researches were put to good use when the Japanese took over the supply of petroleum and alcohol during the Japanese occupation of the Philippines from 1941 to 1945.

In 1911, the Birmingham Sewage Works in England established anaerobic digesters and later utilized biogas to run a gas engine generator. When Germany ran short of petroleum during the second world war, the Germans set up biogas plants, bottled the biogas in high pressure tanks and ran their cars and tractors on biogas.

A shortage of liquefied petroleum gas (LPG) in the Philippines in 1975 initiated the first large-scale industrial application of biogas as fuel. Maya Farms, a private enterprise which had established its biogas works to control the pollution from its integrated hog farm, meat processing and canning operations, started harnessing biogas as a fuel substitute. Biogas first replaced LPG as fuel for cooking and other heating operations in the canning plant. Within the following year, biogas replaced steam for heating the scalding tank in the slaughterhouse and the cooking tanks in the meat processing plant; it replaced the electric heaters in the drying rooms; it ran converted gas engines to replace the electric motors for the deepwell pumps; and it ran the gas refrigerators and electric generators. In 1977, Maya Farms put up its biogas-powered feed mixing plant.

#### Fuel Value

As may be seen in Table 12-1, biogas consists of methane ( $\text{CH}_4$ ) and carbon dioxide ( $\text{CO}_2$ ), with some hydrogen, nitrogen, carbon monoxide, oxygen and traces of hydrogen sulfide and other gases. Its fuel value comes mainly from methane which has a heating value of 994 BTU/cu. ft. The other combustible gas components are hydrogen and carbon

monoxide. Carbon dioxide and nitrogen are inert; they do not contribute to the fuel value of biogas. The percentage composition of the various gases in biogas varies with the raw materials used in producing the biogas as well as with the temperature, pH and other conditions at which the biogas process takes place.

The percentage of the combustible components in biogas can be increased, thereby improving its fuel value, by removing the inert carbon dioxide. This may be done either by bubbling the biogas through lime water to absorb some of the carbon dioxide or by compressing the biogas and drawing off the liquefied carbon dioxide. However, both methods entail extra costs and labor. Since carbon dioxide does not interfere in the normal uses of biogas, its removal is not imperative. Biogas is used as is in most instances.

Biogas is flammable at around 8 to 20% mixture in air. It compares favorably in heating value with other fuel gases. Table 12-2 shows that it has a higher heating value than producer gas, water gas (blue gas) and coal gas (town gas).

**TABLE 12-1**

**Composition of Biogas and the Common Fuel Gases.**

	<b>Biogas</b>	<b>Natural gas</b>	<b>Coal gas</b>	<b>Water gas</b>	<b>Producer gas</b>
<b>Methane, %</b>	54-70	96.1-98.1	31.6	0.7	1.5
<b>Carbon dioxide, %</b>	27-43	0.8	1.8	3.5	3.5
<b>Carbon monoxide, %</b>	0.1	—	6.3	43.5	30.0
<b>Hydrogen, %</b>	1-10	—	53.0	47.3	10.0
<b>Nitrogen, %</b>	1-5	1.1-3.2	3.4	4.4	54.5
<b>Oxygen, %</b>	0.5-1	—	0.2	0.6	0.5
<b>Others, %</b>	trace	—	3.7	—	—

**TABLE 12-2**

**Heating Value in BTU per cu. ft. of Biogas and the Common Fuel Gases.**

<b>Biogas</b>	<b>540 - 700</b>
<b>Natural gas</b>	<b>967</b>
<b>Coal gas (Town gas)</b>	<b>586</b>
<b>Water gas (Blue gas)</b>	<b>302</b>
<b>Producer gas</b>	<b>135</b>

**TABLE 12-3****Heating Value in BTU per pound of Other Energy Sources.**

LPG (liquefied petroleum gas)	22,300
Crude oil	18,300-19,500
Gasoline	20,500
Fuel oil	18,300
Kerosene	19,800
Ethanol	11,600
Coal (bituminous)	10,200-14,600
Charcoal	12,500-14,000
Firewood	7,000-8,500
Electricity (BTU/KWH)	3,417

**Direct Heating Applications**

The most efficient use of biogas is in cooking, drying and other direct heating purposes. With a properly designed burner, as much as 60% of its fuel value is utilized in heating. A good burner provides for premixing of air with the gas prior to combustion. With the correct air-biogas mixture, the flame temperature can be as high as 800°C. Premixing with air can be achieved by providing the burner with an injector orifice, air opening, and mixing chamber to the burner ports. The size of the orifice and the ports would depend on the desired heating capacity of the burner, the gas pressure, and the flame speed (the speed at which a flame travels along a column of the gas). If the gas velocity at the burner port is much higher than the flame speed, the flame will have the tendency to lift off and be extinguished. The gas velocity may be reduced by either reducing the gas flow or enlarging the burner ports. If the port is too big, backfiring may occur. Patel and Patankar (1951) claim that the ratio of the total area of the burner ports to the area of the injector orifice should be 222.7 for Gobar Gas (biogas from cow dung). The Watson House Laboratory recommends a ratio of about 300 to 1.

Biogas can also be used with simple burners. The efficiency is lower, but simple burners are cheap, easy to fabricate, and they serve the purpose, especially for people in the rural areas. The simplest burner consists of an ordinary iron pipe, closed at one end and perforated along its length with one or two rows of holes 1/8 inch to 3/16 inch in diameter and 1/2 inch to 3/4 inch apart.

Appliances designed for other fuel gases can be converted to use biogas. Because of differences in heating value, in gas pressure, in flame speed and in the proper air-gas mixture ratio, it may be necessary to alter the sizes of the injector orifice, the air opening and/or the flame ports. Fortunately, biogas normally has lower available pressure and lower flame speed in comparison with the common fuel gases, so that adjustments can usually be made by simply enlarging the injector orifice and/or the flame ports.

At the Maya Farms, LPG appliances such as gas ranges, water heaters and gas mantle lamps were readily converted to biogas by enlarging the injector orifice to 1/8 inch

diameter. Gas refrigerators with LPG burner assembly were also converted to run on biogas. At 5 inches water, the biogas pressure could not activate the burner regulator. This was by-passed and a 1/4 inch diameter orifice was used. The biogas consumption of various heaters and appliances at Maya Farms in cu. ft. per hr. are as follows:

Slaughterhouse scalding tank	245
Cooking tank	85
Rendering plant drying room	325
Gas range	
small burner	8
medium burner	10
large burner	15
Water heater	30
Gas refrigerator, 8 cu. ft.	2.5-3
Gas lamp	2-3

### **Internal Combustion Engines**

Internal combustion engines can be converted to use biogas as fuel. For this purpose, the trace of hydrogen sulfide in the gas should be removed. Otherwise it can cause corrosion. The biogas may be passed through ferric oxide or iron filings to scrub off the hydrogen sulfide. The ferric oxide can be regenerated by heating in the presence of air.

For diesel engines, fuel cannot be totally replaced with biogas. Some amount of diesel fuel is required for ignition. The diesel engine is converted to a dual-fuel engine by attaching a biogas carburetor to the air intake manifold. With biogas, diesel-injection may be reduced to 15-25%. The bigger engines require even less diesel fuel. C. J. Mardon reports (1975) that as little as 2% diesel fuel is used in large stationary engines 500 H. P. and above. At the Becton Plant in London, 5% diesel fuel is used. At the Maya Farms, a two cylinder, 31 H. P., diesel engine which was converted to a dual-fuel engine developed 80% of the rated power. The rpm dropped from 1800 to 1150 when biogas was used with 25% diesel fuel injection. The biogas consumption was about 12 cu. ft. per H. P. per hour.

For gasoline engines, biogas can completely replace gasoline. Gasoline engines can be converted to use biogas by changing the carburetors. A simple biogas carburetor can be fabricated from a one-inch diameter copper tube fitted with a 3/8-inch copper tubing inlet for biogas at the midsection and a butterfly valve at one end of the tube to control the biogas-air mixture. At Maya Farms, converted 4-cylinder engines have replaced the electric motors running the two deepwell pumps. A 4-cylinder engine runs a generator to light the farm at night. Another 4-cylinder engine runs a feed mixing plant. A 6-cylinder engine is coupled to a 60-KVA generator for the refrigeration machinery of four walk-in freezers. Since the engines are stationary, the radiators have been replaced with water cooling towers.

A small gasoline engine can also be converted to run on biogas as long as it has an oil crankcase to provide lubrication. The power developed by the engine with biogas as fuel is about 60% that with gasoline, but the rpm is the same. The biogas consumption is 14-16 cu. ft. per H. P. output per hr.

The horsepower output from a converted engine can be increased if necessary. One way is by scrubbing off the carbon dioxide from biogas. With the resulting higher heating value of the gas, more power will be obtained. Another way is by increasing the compression ratio of the engine. Methane does not pre-ignite even at high compression ratios. The octane rating of methane (128) is much higher than that of gasoline.

Using biogas with stationary engines presents no problem. The gas can be piped direct from the gasholder to the engine. However, the available biogas may be much more than what can be utilized in this manner. For example, in the case of poultry and livestock farms, the biogas potential from the animal manures is much more than what is normally needed for pumping water, electric generation, feeds mixing and direct heating uses in the farm. The biogas can be utilized fully if it can be used in mobile engines, in running the farm vehicles.

For mobile engines, a sufficient amount of gas should be carried around to allow the vehicles to negotiate reasonable distances. This requires bottling the gas in high pressure tanks. A cylinder made out of light aluminum alloy and reinforced by a three-layer winding of high tensile wire is reportedly being used in France as a high pressure natural gas container for automobiles. An 8-inch diameter, 3 ft. long cylinder can hold at 3,000 psi enough gas equivalent to about five gallons of gasoline. A vehicle with 2 of these cylinders would have a fuel supply equivalent to 10 gallons of gasoline. Trucks can have bigger cylinders to carry more fuel.

It is imperative to use such a special type tank because the gas has to be compressed under 2800-3000 psi in order to carry sufficient quantities in reasonably sized containers. With this high pressure, an ordinary unreinforced tank could explode with disastrous results in case of a vehicular accident.

Unlike LPG, biogas can not easily be liquefied. Methane, its main fuel component, has a critical pressure of 45.8 atm. and critical temperature of  $-82.46^{\circ}\text{C}$ . Perhaps the necessity for such high pressure storage of biogas can be avoided if a medium can be found to absorb the methane and release it under controlled conditions.

In compressing the biogas, it may be possible to remove the carbon dioxide component. If the gas is sufficiently cooled at some intermediate stage of the gas compression, the carbon dioxide can be liquefied and drained off through some form of a liquid trap. This will improve the fuel value of the gas and the effective fuel capacity of the high pressure container.

### **Advantages of Biogas**

Biogas serves practically all kinds of fuel requirements for domestic and industrial purposes. In the home, it can be used for cooking, for lighting, for ironing clothes, for water heaters and other heating uses, for running gas refrigerators, water pumps and electric generators. In the farm it can be used for crop drying and pumping water. In industrial operations, biogas can be used in most of the direct heating applications, as in cooking vessels, scalding tanks, drying rooms, and to run internal combustion engines for various power needs.

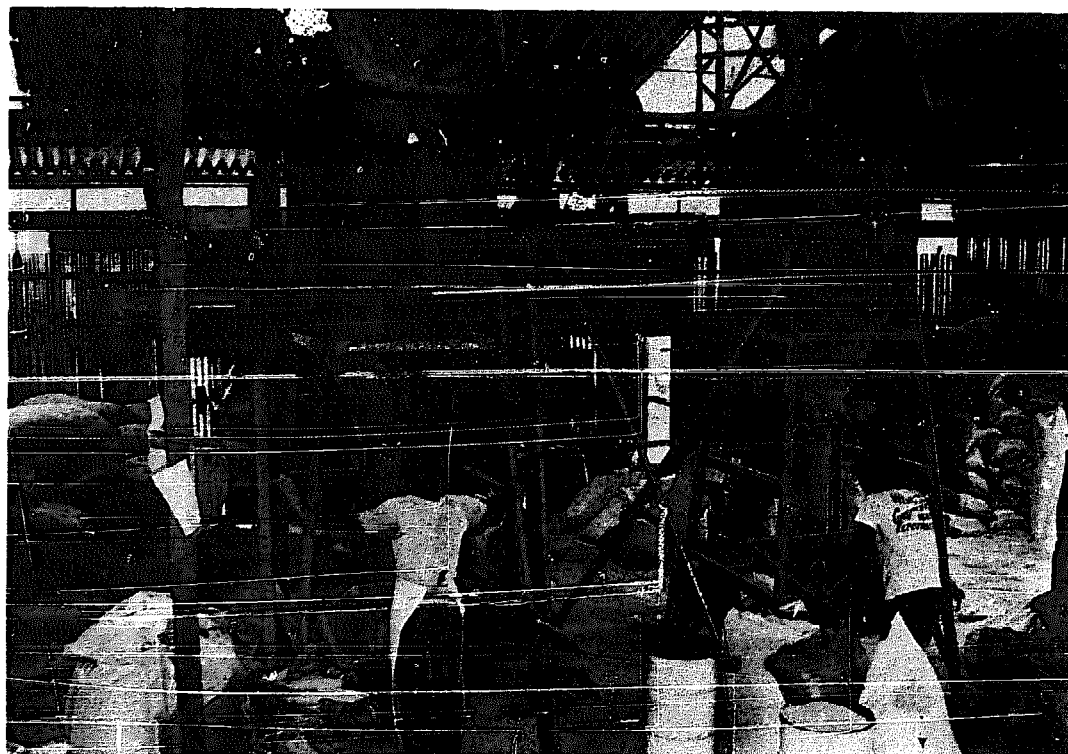
Other advantages in using biogas are:

1. It has a higher heating value than producer gas, coal gas and water gas.



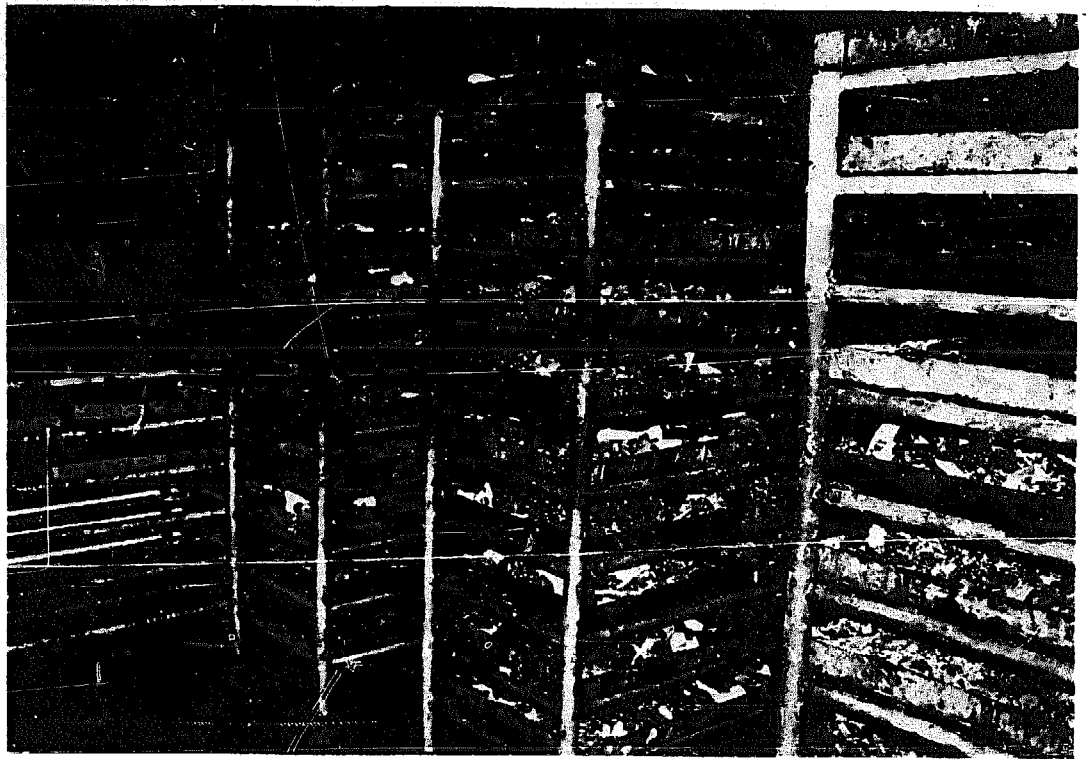
2. It is non-poisonous, unlike producer gas and coal gas which contain high levels of the highly toxic carbon monoxide.
3. It burns with a clean, bluish, sootless flame.
4. It has no offensive smell.
5. It has a very high octane rating. It can be used with high compression ratio engines.
6. It is easy to produce. The biogas plant is simple and easy to construct from readily available materials. No complicated imported equipment is necessary. Operation of the plant does not require special skills. People anywhere, especially those living in areas hardly reached by commercial fuels, can easily put up biogas plants to produce their own fuel requirements.
7. The raw materials, organic wastes such as animal manures and crop residues, have no economic value and are abundant particularly in the rural areas. The supply is non-depletable.
8. Moreover, biogas production promotes sanitation and helps control environmental pollution by converting organic wastes into useful organic fertilizer and feed materials while producing a valuable fuel in the process.

Biogas production is certainly not going to solve the present energy crisis but biogas can help solve the energy problems of those who are the first to run out of supply in the event of any fuel shortage – the farms, the cottage industries and people in the rural areas. It is they who can benefit most from biogas and fortunately, they are also in the best position to establish and operate the biogas works. These people compose 50 to 80% of the inhabitants of any country.

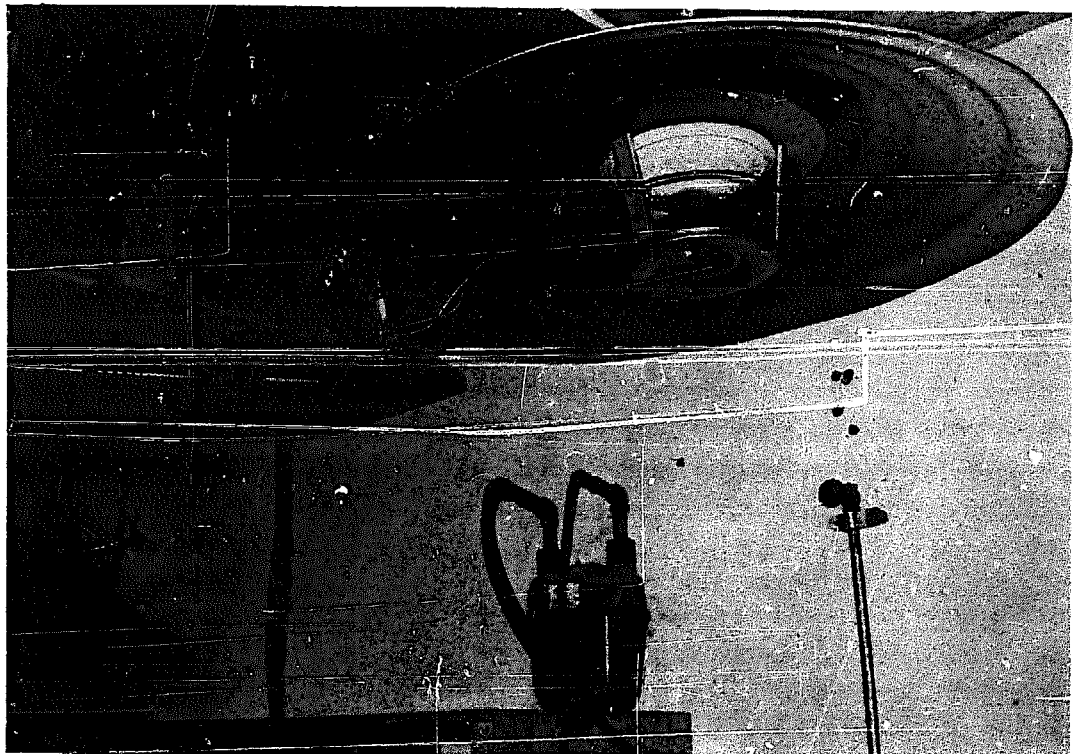


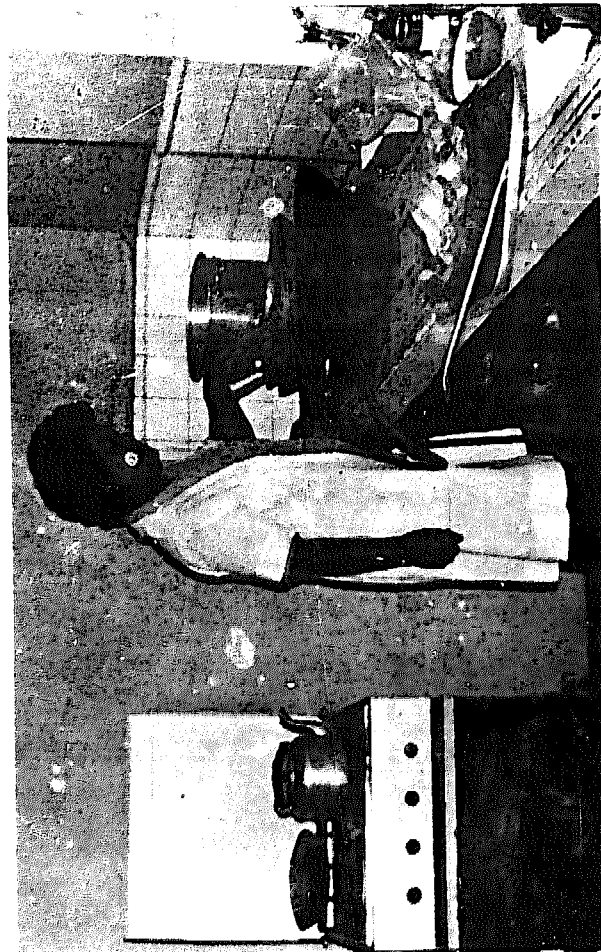
**Illustration 3-2**  
**Biogas-powered**  
**feed mill.**

**Illustration 3-3:  
Biogas-heated  
drying room in  
rendering plant.**

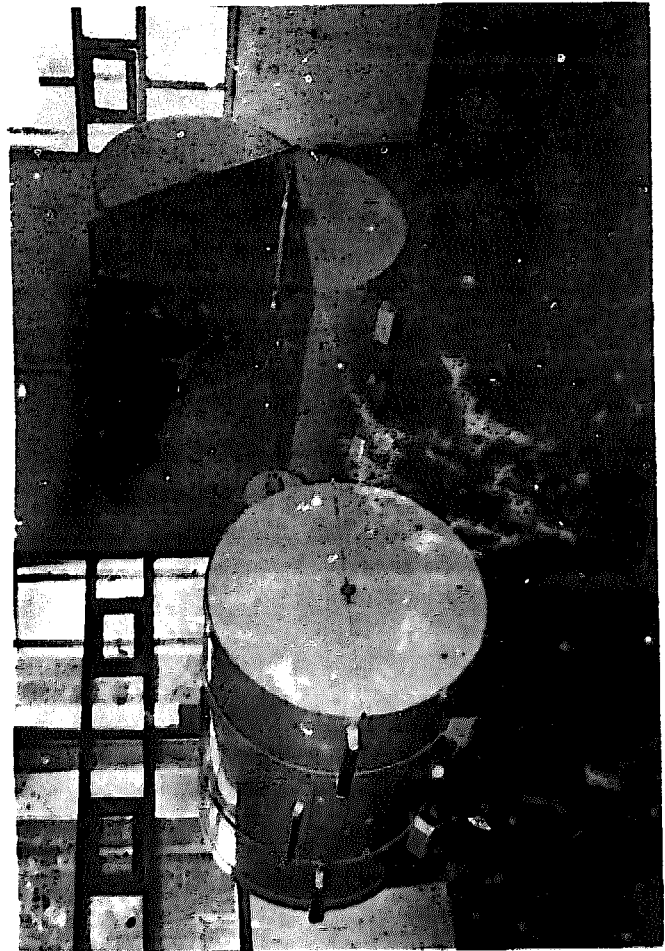


**Illustration 3-4:  
Pig brooder and  
poultry brooder  
converted to use  
biogas.**





**Illustration 3-5: Cooking with biogas at Maya Farms canteen.**



**Illustration 3-6: Lechon roasters**



**Illustration 3-7: Crop drier**

## Chapter XIII

### Sludge as Fertilizer

Growing plants need certain nutritional elements. Carbon, hydrogen and oxygen are obtained by the plant from the surrounding air and from water. The other essential elements are supplied through the soil. The elements in the soil may be depleted after several croppings and through leaching; that is, the elements may be washed away by water seeping through the soil. Unless these nutrients are replaced in the soil, subsequent crops may give poor yields.

Nature's way of keeping the soil fertile is by recycling the organic wastes, by returning all the plant wastes to the soil. This worked well when the goods were consumed where they were produced. When the population shifted to the cities, the food grown in the farm was sent to the population centers, and the wastes were not returned. The old farmers had to make do by returning to the soil whatever crop wastes were left on the farm and by using animal manure as supplement.

The early agricultural researchers introduced the practice of composting the wastes before applying them to the soil. This was a big improvement. They explained that the plants could make use of the nutrients only after the waste decomposed. If the wastes are applied raw, a large amount of nutrients is lost through leaching and vaporization of the ammonia produced by aerobic fermentation process. Furthermore, since nitrogen is needed in the fermentation process, the microorganisms compete with the crops for the available nitrogen during the period of decomposition. The heat generated in the process also adversely affects the plant growth.

Composting however proved to be laborious and required a long time. The pressure to increase food production for the expanding population brought about the introduction of chemical fertilizers. They became popular because they were inexpensive, readily available and easy to handle.

#### Chemical Fertilizers

Chemical fertilizers are commercially manufactured products containing one or a combination of the principal nutrient elements nitrogen, phosphorus, and potassium. Nitrogen is in the form of nitrates, ammonium compounds or organic compounds of nitrogen; phosphorus is usually used in the form of phosphates, and the supply of potassium normally comes from natural deposits of potassium salts. Mixed fertilizers are sold on the basis of their content of nitrogen, phosphorus and potassium, stated as percent N,  $P_2O_5$ , and  $K_2O$  in that order. Thus an 8-10-12 fertilizer contains 8% nitrogen, 10% phosphorus calculated as  $P_2O_5$ , and 12% potassium calculated as  $K_2O$ . Small amounts of other essential elements are sometimes included in the mixture.

Although mixed fertilizers are also called complete fertilizers, they are really incomplete in the sense that they may lack some of the other elements necessary for plant growth. Aside from carbon, hydrogen, oxygen, nitrogen, phosphorus and potassium, plants need

some amount of calcium, magnesium, sulfur, iron and very small amounts of copper, manganese, zinc, boron and molybdenum. A number of plants also require aluminum, sodium, chlorine and silicon.

Continuous use of chemical fertilizers can deplete the soil of some other nutrients. Another disadvantage in using chemical fertilizers is the water pollution caused when excess chemicals find their way into bodies of water. Nonetheless, farmers have persisted in the exclusive use of chemical fertilizers in spite of the warnings that complete abandonment of organic fertilizers would cause the deterioration of the fertility of the soil, and in spite of the pollution caused by the chemical fertilizers and the unused farm wastes. The disadvantages are overshadowed by the convenience of use and the immediate response of the yields.

### **Natural Fertilizers**

The natural fertilizers, compost and manures, have not been totally abandoned, at least not by the agricultural scientists. New ways are being evolved to shorten composting time and to improve the quality of the compost. Better ways of utilizing manures are being found. These developments, together with the presently escalating price, unreliable supply and pollution problems of chemical fertilizers have started a move to return to the traditional organic fertilizers.

The biogas process presents an improved treatment for both crop wastes and animal manures. In the aerobic decomposition of organic matter, ammonia and carbon dioxide are lost in the air. There is also considerable leaching of soluble nutrients. Thus the resulting compost has less nutritive elements than are originally present in the raw material. In the biogas way, when organic materials are decomposed in the waterproof, air-tight chambers, only carbon, hydrogen and oxygen in the form of methane ( $\text{CH}_4$ ) and carbon dioxide ( $\text{CO}_2$ ) are lost. Practically all the other essential elements are retained in the sludge.

In small biogas operations, the sludge can be used as fertilizer after a few weeks' exposure in shallow ponds. For bigger operations, a convenient way of utilizing the sludge as fertilizer is to separate the solid portion from the liquid portion. The liquid biofertilizer should be aged in shallow lagoons for 15 to 30 days to allow some aeration and escape of hydrogen sulfide and other gases that may be harmful to plants. From the lagoons, the liquid can flow by gravity to where it is needed, and it can be pumped up to higher grounds. The solid biofertilizer is dried and applied to more distant parts which cannot be reached by irrigation. If there is excess fertilizer, some of the solid biofertilizer can be sold. Depending on the soil analysis and the crop grown, it may be necessary to supplement the biofertilizer with some other source of nutrient elements to meet the requirements of normal plant growth.

The nutrient content of the biofertilizers varies with the raw material used in the biogas plant. Where animal manure is used, the phosphorus content is usually lower than the nitrogen and potassium contents. However, the biofertilizer at Maya Farms has more phosphorus than either nitrogen or potassium. This may possibly be due to the Farms' special feed formulations which incorporate high percentages of wheat pollard. Wheat pollard has a high phosphorus content as compared with other feed materials. A sample analysis of the biofertilizer from Maya Farms is shown in Table 5-2.

TABLE 13-1

**Plot Fertilizer Experiment on Rice-Maya Farms**  
**Treatment-Control, no Fertilizer**

Plot 1 sq. m.	Total No. of Tillers per plot	No. of Tillers per plot		Total Height of Plant at Maturity per plot	Total Weight of Straw per plot	Total Weight of Grains per plot
		Bearing	Non-Bearing			
1	483	343	140	961	888.2	529
2	394	289	105	857	728.5	436
3	428	306	122	972	888.0	326
4	487	347	140	963	835.3	625.8
<b>TOTAL</b>	<b>1792</b>	<b>1285</b>	<b>507</b>	<b>3753 cms.</b>	<b>3340 gms.</b>	<b>1916.8 gms.</b>
<b>MEAN</b>	<b>448</b>	<b>321.25</b>	<b>126.75</b>	<b>938.25</b>	<b>835 gms.</b>	<b>479.2 gms.</b>

**Treatment-Effluent-5714 ml.**

5	507	402	105	1025	959.3	550.0
6	462	332	130	983	798.9	394.8
7	460	351	109	997	702.4	570.6
8	523	396	127	949	794.2	512.6
<b>TOTAL</b>	<b>1952</b>	<b>1481</b>	<b>471</b>	<b>3954 cms.</b>	<b>325.48 gms.</b>	<b>2028.0 gms.</b>
<b>MEAN</b>	<b>488</b>	<b>370.25</b>	<b>117.75</b>	<b>988.5 cms.</b>	<b>813.7 gms.</b>	<b>507.0 gms.</b>

**Treatment-Effluent-388 ml.**

21	530	400	130	983	792.7	663.9
22	425	309	116	961	842.0	441.3
23	497	330	167	958	967.5	507.6
24	509	401	108	1026	903.2	611.9
<b>TOTAL</b>	<b>1961</b>	<b>1440</b>	<b>521</b>	<b>3928 cms.</b>	<b>3505.4 gms.</b>	<b>2224.7 gms.</b>
<b>MEAN</b>	<b>490.25</b>	<b>360</b>	<b>130.25</b>	<b>982</b>	<b>876.35</b>	<b>556.17 gms.</b>

**Treatment-Ammonium sulfate + disodium phosphate + potassium sulfate (8 gm. - 8 gm. - 3 gm.)**

29	532	433	99	957	904.4	563.4
30	504	394	110	947	835.2	483.1
31	556	394	162	1000	844.8	680.4
32	487	381	106	978	1290	444
<b>TOTAL</b>	<b>2079</b>	<b>1602</b>	<b>477</b>	<b>3882 cms.</b>	<b>3874.4 gms.</b>	<b>2170.9 gms.</b>
<b>MEAN</b>	<b>519.75</b>	<b>400.5</b>	<b>119.25</b>	<b>970.5 cms.</b>	<b>968.6 gms.</b>	<b>542.72 gms.</b>

### **The Solid Biofertilizer**

The solid biofertilizer is composed mainly of humus or organic matter and the plant nutrients. It has a carbon to nitrogen ratio of around 13:1 which is desirable because of its closeness to the C/N constancy that exists in many arable soils. This means that the sludge can be used directly for fertilization of crops without the adverse effect of serious competition by decomposition organisms in the soil and the plant for its nitrogen supply. As an organic fertilizer it plays an important role in plant nutrition as well as in soil conservation. It is not only a carrier and source of nutrients, but it also serves as an excellent soil conditioner. It improves the physical condition of the soil by improving texture, moisture-holding capacity, and aeration. It increases the buffering capacity of the soil. It combines with inorganic soil constituents to prevent their loss by leaching but



releases them for the use of the plants. It stimulates the growth microorganisms. It retards the irreversible fixation of nutrients, prevents soil erosion and smooths out temperature fluctuations.

Aside from the major plant nutrients---nitrogen, phosphorus and potassium, the solid biofertilizer contains calcium, sulfur, magnesium and the essential trace elements copper, zinc, manganese and others.

### **Liquid Biofertilizer**

The liquid biofertilizer contains only small amounts of nitrogen, phosphorus and potassium, but considering the fact that a large amount of water is needed for irrigation, these nutrients can build up to excessive quantities. Moreover, the liquid biofertilizer promotes a profuse growth of nitrogen-fixing algae wherever it is applied. Since algae have a short life cycle, the decaying algae supplement the available nitrogen.

Used at Maya Farms as irrigation water for flooded rice (IR-26), the available phosphorus content of the irrigated soil increased by 80 to 500 ppm while available potassium increased by as much as 300 ppm. Besides phosphorus and potassium, a sufficient nitrogen supply was apparent from the appearance of the crop.

The alarming increase of plant nutrients in the soil due to continuous irrigation with liquid biofertilizer should be guarded against. Its use for irrigation should be regulated in order not to subject the soil to excessive amounts of these elements. Besides using it in irrigation, it may be applied as a foliar spray or ground spray. It may also be beneficial for gardens and plants in pots. Without regulating its use the excess nutrient elements in unbalanced proportions may result in abnormal plant growth or yield. For example, an excessive amount of phosphorus represses the availability of trace elements like iron and zinc, which are essential to plant growth. Unregulated use of the water for irrigation also has the tendency of making the pH of the soil slightly alkaline, although alternate flooding and draining tend to bring the pH somewhat lower.

Like the solid biofertilizer, the liquid sludge also carries trace elements like zinc, iron, manganese, copper and others. The rice field at Maya Farms originally had low levels of these elements. After one cropping, with continuous use of the liquid biofertilizer for irrigation, the trace elements increased to high levels in the soil.

Biofertilizer is not only a good fertilizer for land crops but also a good growth promoter for algae in ponds. The algae can be grown directly in fishponds to serve as food for the fish, or a high protein alga, chlorella, can be raised in shallow ponds, harvested and fed to poultry or livestock. Chlorella is a potential source of a high protein supplement for animal feeds. (Further discussion on fishponds and chlorella culture may be found in the next chapter, "Sludge for Feed and Other Uses.")

The following precautions should be observed to obtain the optimum benefit from the application of biofertilizers:

1. Fresh sludge from the biogas digester contains some compounds like hydrogen sulfide which can be toxic to plants. Symptoms of this have been observed at Maya Farms when the fresh sludge was applied in the ricefield. Aging and aeration of the sludge in a shallow

releases them for the use of the plants. It stimulates the growth microorganisms. It retards the irreversible fixation of nutrients, prevents soil erosion and smooths out temperature fluctuations.

Aside from the major plant nutrients---nitrogen, phosphorus and potassium, the solid biofertilizer contains calcium, sulfur, magnesium and the essential trace elements copper, zinc, manganese and others.

### **Liquid Biofertilizer**

The liquid biofertilizer contains only small amounts of nitrogen, phosphorus and potassium, but considering the fact that a large amount of water is needed for irrigation, these nutrients can build up to excessive quantities. Moreover, the liquid biofertilizer promotes a profuse growth of nitrogen-fixing algae wherever it is applied. Since algae have a short life cycle, the decaying algae supplement the available nitrogen.

Used at Maya Farms as irrigation water for flooded rice (IR-26), the available phosphorus content of the irrigated soil increased by 80 to 500 ppm while available potassium increased by as much as 300 ppm. Besides phosphorus and potassium, a sufficient nitrogen supply was apparent from the appearance of the crop.

The alarming increase of plant nutrients in the soil due to continuous irrigation with liquid biofertilizer should be guarded against. Its use for irrigation should be regulated in order not to subject the soil to excessive amounts of these elements. Besides using it in irrigation, it may be applied as a foliar spray or ground spray. It may also be beneficial for gardens and plants in pots. Without regulating its use the excess nutrient elements in unbalanced proportions may result in abnormal plant growth or yield. For example, an excessive amount of phosphorus represses the availability of trace elements like iron and zinc, which are essential to plant growth. Unregulated use of the water for irrigation also has the tendency of making the pH of the soil slightly alkaline, although alternate flooding and draining tend to bring the pH somewhat lower.

Like the solid biofertilizer, the liquid sludge also carries trace elements like zinc, iron, manganese, copper and others. The rice field at Maya Farms originally had low levels of these elements. After one cropping, with continuous use of the liquid biofertilizer for irrigation, the trace elements increased to high levels in the soil.

Biofertilizer is not only a good fertilizer for land crops but also a good growth promoter for algae in ponds. The algae can be grown directly in fishponds to serve as food for the fish, or a high protein alga, chlorella, can be raised in shallow ponds, harvested and fed to poultry or livestock. Chlorella is a potential source of a high protein supplement for animal feeds. (Further discussion on fishponds and chlorella culture may be found in the next chapter, "Sludge for Feed and Other Uses.")

The following precautions should be observed to obtain the optimum benefit from the application of biofertilizers:

1. Fresh sludge from the biogas digester contains some compounds like hydrogen sulfide which can be toxic to plants. Symptoms of this have been observed at Maya Farms when the fresh sludge was applied in the ricefield. Aging and aeration of the sludge in a shallow



pond for about two weeks brings down the concentration of these toxic compounds within safe levels.

2. Continuous use of biofertilizer may result in too much growth of nitrogen-fixing algae. The excessive nitrogen may result in weak roots and stems. This is particularly deleterious at the heading stage of rice.
3. Continuous application of the biofertilizer in clay soil may cause problems around the root areas of the crops.
4. Too much biofertilizer in fishponds can cause excessive growth of algae. Since algae have a short life cycle, the decaying algae can deplete the oxygen in the water and cause asphyxiation of the fish.

### **Hydroponics**

Considering the rich content of nutritive elements in the liquid biofertilizer, it may be possible to utilize it to reduce the fertilizer cost in hydroponics. Hydroponics is the cultivation of plants in a chemical solution specially prepared to contain all the essential nutrients necessary for plant growth. This method can be used to raise practically all kinds of plants. However, since it requires skilled labor as well as expensive equipment and materials, it is mainly practiced in arid areas or used to grow out-of-season vegetables and flowers in well-populated areas.

The plants may be cultured over water or sand or gravel. In the water culture method, the roots of the plants are immersed in the nutrient solution. The plant itself is set on a porous material such as moss or wood shavings in a wire netting suspended about an inch above the solution. In the sand or gravel culture method, the plant is grown on coarse sand or fine gravel. At various intervals, the nutrient solution is poured over the sand or gravel, is allowed to seep through and drained off into a reservoir. The nutrient solution is prepared by adding to the water all the elements essential to plant growth, except carbon, oxygen and hydrogen which are obtained by the plant from the air and water.

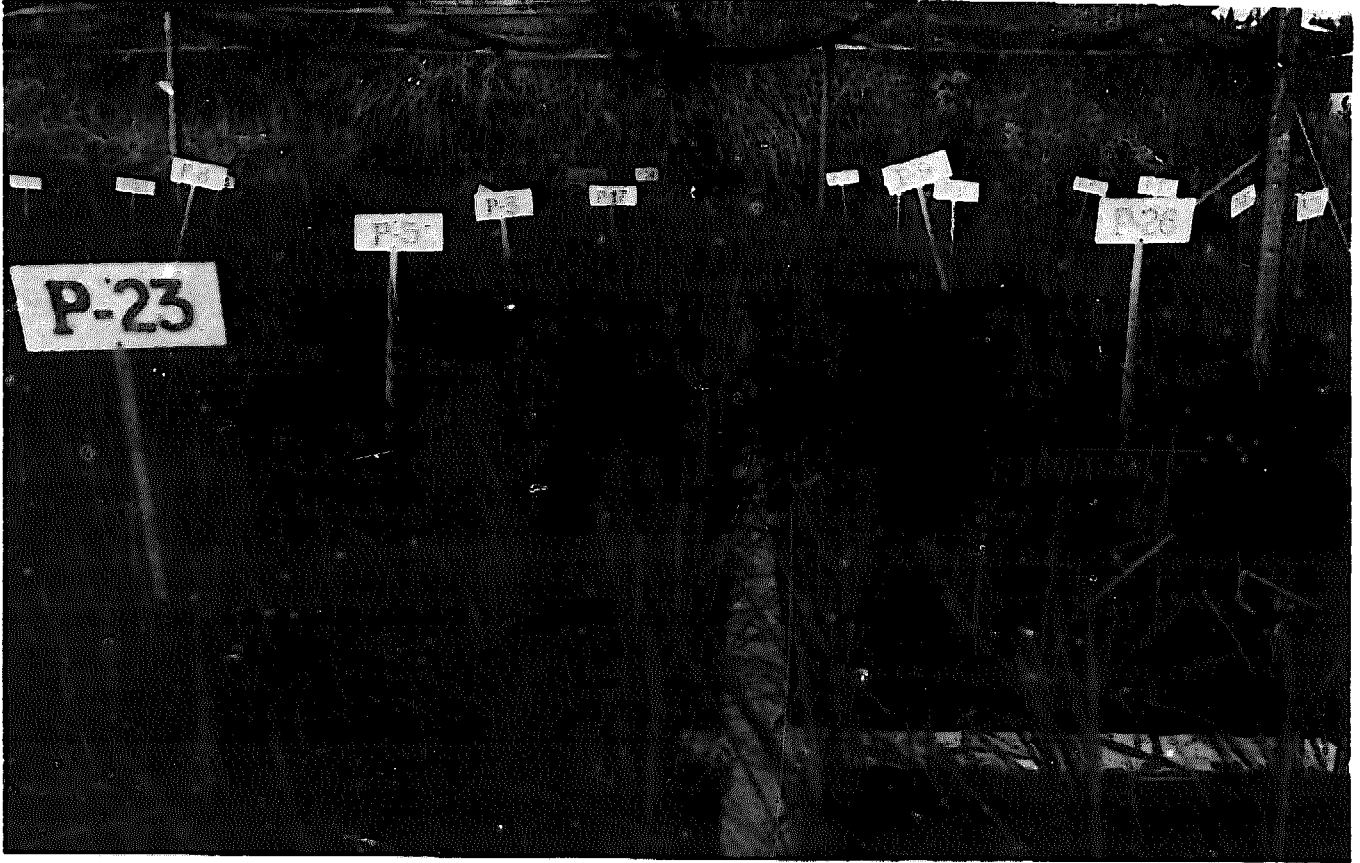
### **Sludge in Composting**

Not all organic wastes on the farm are fit for use as raw material for the biogas plant. Plant wastes high in lignin and hemicellulose should not be used. These wastes are better composted. The composting can be accelerated by using fresh sludge.

To obtain complete and rapid decomposition of organic wastes, both aerobic and anaerobic bacteria must be present in large numbers. Anaerobic bacteria decompose cellulose, the main constituent of plants. Hemicellulose and lignin, the other constituents, yield more readily to aerobic bacteria. The combined action of aerobic and anaerobic microorganisms is obtained when fresh sludge which is still full of anaerobic bacteria from the biogas digester is used in composting. The crop wastes and the fresh sludge are piled alternately. The pile is kept moist with the sludge and allowed to decompose for about 60 days. The trace elements such as Cu, Mn, Fe, Zn, etc. present in the sludge also make for a superior compost.

## **Importance Of Organic Fertilizer**

In the Philippines and other countries with a hot and humid climate, the decomposition of organic matter in the soil is much faster than in temperature countries. In the tropics therefore, the soil is generally low in organic matter content. This makes the soil easily deteriorate in plant nutrients or soil fertility. The surface soil also becomes easily eroded due to lack of organic matter. The use of organic fertilizers is thus of vital importance particularly in tropical countries.



**Illustration 3-8: Fertilizer test plots**



**Illustration 3-9: Crop field and fishponds—Maya Farms**

## Chapter XIV

### Sludge for Feed and Other Uses

The sludge from a biogas plant is a good source of animal feed materials. Some of these feed materials can readily be availed of to reduce feed costs and improve the quality of the feeds. Others, such as chlorella, may still be too costly to produce as compared with alternative feed materials, but the potential is there to supply important feed nutrients whenever the need arises.

The solids can be recovered from the sludge and processed into a valuable feed ingredient. The biogas process synthesizes B complex vitamins, particularly vitamin B<sub>12</sub> which is an important growth promoting factor in animal feed. From feed experiments, it also appears to have other unidentified growth factors. The economic value when the solids are recycled as feed material is very much higher than when used as a fertilizer-soil conditioner.

The remaining liquid can be used to grow chlorella. This high protein alga can replace soybean meal as a protein supplement for feed. At the current costs of soybean meal and other protein sources, commercial production of chlorella is not yet economically feasible. There is no doubt, however, that with increasing prices and rising demand, chlorella will be among the important feed materials in the future. The liquid sludge with or without the solids can be used to grow plankton in fishponds. Plankton is an excellent feed for fish.

Sludge can also serve as a possible material in pulp-making when crop wastes are digested in a biogas plant. Rice straws and corn stalks are potential sources of paper pulp. However, because they are bulky and hard to digest, the high costs of handling and chemical treatment do not make them economically attractive. In the biogas process, the strength of the fibers is hardly affected but the bulk of the crop wastes is greatly reduced. Predigestion of the sludge takes a shorter time and consumes less chemicals in the pulp treatment than when the materials are used fresh.

#### **Solid Sludge as Feed Material**

Animals utilize only about half the nutrients in the feed that they consume. The animal manure still contains a considerable amount of undigested organic matter. This undigested material can be used again as feed. In fact, poultry and pig manure have been used as feed for pigs and cattle.

However, the use of fresh manure directly as feed is not commonly practiced. Many poultry and livestock raisers are understandably reluctant to feed it to their animals. Either they are afraid of spreading diseases among their herd, or they may find the manure too messy to handle, or the idea of feeding it to their animals may grate against their sensibilities.

The objectionable characteristics of manure can be eliminated by processing it in a biogas plant. The aerobic pathogens or disease-carrying germs are killed in the anaerobic process. The sludge is not messy. Dry sludge looks and handles like humus. It no longer has the offensive smell of manure, and unlike manure, it does not attract flies. Moreover, the biogas process not only retains the nutrients but it also enriches the sludge with B-complex vitamins, particularly vitamin B<sub>12</sub>, which are synthesized during the biogas digestion.

The solids are recovered from the sludge by allowing them to settle out in settling tanks and by draining the liquid. They are then dried, preferably under the sun. During rainy days, artificial drying may be resorted to, but care should be taken not to subject the solids to very high temperatures which can destroy the vitamin content. The dried lumpy solids are then ground and detoxified before mixing with the other feed materials. In small operations where wet feeding is practiced, the settled sludge may be fed with the slops without drying.

Maya Farms ran experiments incorporating 5% and 10% dried sludge in the growing and fattening pig rations. The dried sludge was used to substitute part of the wheat pollard in the feed formulations. A total of 300 pigs were used in the experiment. Each trial had 5 replicates of 20 pigs each. Feeding was *ad libitum*. The results were as follows:

#### Grower Hog Mash

	Control	w/ 5% Sludge	w/ 10% Sludge
Average initial weight, kg.	20.0	19.9	19.9
Average final weight, kg.	42.0	42.9	43.7
Average weight gain, kg.	22	23	23.8

#### Fattener Hog Mash

	Control	w/ 5% Sludge	w/ 10% Sludge
Average initial weight, kg.	42.0	42.9	43.7
Average final weight, kg.	76.8	76.4	79.0
Average weight gain, kg.	34.8	33.5	35.3

The initial experiments were carried only up to 10% dried sludge because the recovery of dry sludge from the pig manure is approximately 10% of the feed consumption of the pigs. It was deemed sufficient if the sludge could serve as a filler material to reduce feed costs. However, with the unexpectedly encouraging results in the feeding trials, further experiments were worked out to try to get the most benefit from the dried sludge.

The improved performance of the feed mixed with dried sludge specially in the case of the grower hog mash, may be largely due to the vitamin B<sub>12</sub> and possibly some other unidentified growth factors in the sludge. Thus a feeding trial with 15% sludge replacing part of the pollard ingredient in the grower feed formulation is under way. If the result of this experiment warrants the use of 15% sludge in the grower mash, this can be maintained by reducing the sludge mixture in the breeder mash. The feeding trial on the fattener mash retained the sludge at 10% but this was used to replace all the fishmeal and part of the pollard in the fattener feed.

The use of dried sludge as pollard replacement in hog feeds brings about a lot of savings in feed costs. If it serves to eliminate the need for the expensive fishmeal or meat meal, even if only in the fattener ration, much more savings can be realized. Another advantage is that the pigs reach the slaughter weight a little earlier.

## **Vitamin B<sub>12</sub>**

When poultry or swine not on pasture are raised on rations with no protein supplement of animal origin, nutritive deficiencies develop, particularly in the case of chicks and young pigs. Experiments have shown that the beneficial effect of feed materials of animal origin is mainly due to the fact that they contain vitamin B<sub>12</sub>, which feeds from plant sources do not have. Vitamin B<sub>12</sub> is effective in curing anemia and the neurological symptoms of pernicious anemia. It is essential for the hatchability of eggs and for the growth of chicks and young pigs. High mortality in young chicks may result when hens are fed rations deficient in Vitamin B<sub>12</sub>.

A member of the B-complex group of vitamins, B<sub>12</sub> is among the most expensive commercially-prepared organic products. Fortunately, it has high physiological activity and only minute amounts are required for treatment. It is synthesized by several kinds of microorganisms including the methane-producing bacteria and those that produce antibiotics. The present commercial production of vitamin B<sub>12</sub> is from the mother liquor left in the preparation of antibiotics. However, the vitamin B<sub>12</sub> synthesized by the methane bacteria in the biogas process is such that some scientists consider sludge as a potential source of the vitamin.

Preliminary results of research being conducted at Maya Farms indicate concentrations over 3000 mcg. of vitamin B<sub>12</sub> per kg. of dry sludge. In comparison, fishmeal has only around 200 mcg. per kg., meat and bonemeal has just over a hundred mcg. per kilo. Fishmeal and meat and bone meal are the main sources of vitamin B<sub>12</sub> in animal feeds.

## **Parasites and Pathogens**

One problem with using sludge for feeds is the possibility of transmitting diseases through sludge from the manure of sick animals. Maya Farms passes the dried sludge through a sterilizing process to make sure that it is safe for use as a feed material. Meanwhile, experiments are being conducted to find out whether the biogas process renders the sludge completely free from parasites and pathogens or disease-carrying germs. Preliminary results are encouraging but more exhaustive work is necessary to establish a definite conclusion.

So far the microbiological laboratory of Maya Farms has tested the viability of ova of seven types of pathogens in sludge. Results have all been negative even though the original hog manure gave positive results on some of the pathogens like *E. coli*.

Experiments done by Dr. M. Tongson, professor of parasitology of the College of Veterinary Medicine, University of the Philippines, showed that *Ascaris suum* ova placed in biogas modules failed to develop after 20, 25, 30 and 40 days exposure to the fermenting hog manure. The same eggs also failed to embryonate when subsequently transferred to room temperature.

In testing the viability of parasites in the biogas process, the ascaris egg was chosen because among ova it is one of the most resistant to adverse environmental conditions. It is also resistant to disinfectants that ordinarily kill all other helminth ova. The *ascaris ovum* has a thick outer coating which protects the developing embryo from desiccation and extremes of temperature. Thus the possibility that eggs of other helminths of swine could survive and remain viable in the sludge is quite remote since their egg coats are thinner than those of *ascaris*.

## **Chlorella**

After the solids are recovered from the sludge, the remaining liquid with its content of nutrients and trace minerals make a very good growth promoter of algae. Algae are primitive plants, including the seaweeds and the green scum, in fresh water ponds. Most algae contain chlorophyll, the green coloring matter which enables green plants to make their own food. There are more than 20,000 known species of algae.

Chlorella is a single-celled high protein alga. With a protein content of 36 to 40%, it makes a good protein supplement for animal feeds. The liquid portion of the sludge can be used to promote the growth of the chlorella in shallow ponds. The pond should be lined with concrete, metal or plastic material to avoid contamination and make harvesting easier. Chlorella is harvested early in the morning before sunrise, while it is at the bottom of the pond. The water can be drained out and the chlorella is then scraped off. It is harvested 6 to 7 days after the inoculation with a chlorella seed stock. The yield is directly influenced by solar radiation. Dr. J. A. Eusebio, et. al., of the University of the Philippines report production outputs varying from 1750 kg. per hectare to 8750 kg. per hectare per month, depending on the amount of the solar radiation.

Chlorella can be used in amounts up to about 10% of animal feeds to replace soybean oil meal for protein supplementation. However, at the present cost of soybean oil meal, large-scale commercial production of chlorella is not yet economically viable. The harvesting and drying requires a lot of labor. Nonetheless, with rapidly increasing requirements for animal feeds, it is only a matter of time when the supply of protein supplements will fall short of the demand. The chlorella will then take its place among the important protein sources for animal feeds.

## **Fishponds**

The basic source of feed for fish is the plankton, the huge number of small plants and animals found near the surface of bodies of water. The plant population of plankton consists mainly of algae. The animal population consists of many kinds of single-celled organisms, crustaceans and the larvae form of other animals.

Poultry and livestock manures are used directly in fishponds to grow plankton but the odor has a tendency to have an adverse effect on the palatability of the fish. This is particularly evident in the case of *bangus* (milk fish). A better way is to pass the manure through a biogas plant and use the resulting sludge in the fishpond. Several advantages are gained in this manner:

1. The sludge is not odorous and will not adversely affect the palatability of the fish.
2. The sludge promotes the growth of the plankton better than fresh manure does.

3. The sludge has a lower BOD than the fresh manure slurry, thus leaving more oxygen available for the fish in the fishpond.
4. Biogas and biofeed are produced.

Maya Farms uses only the liquid portion of the sludge for its fishponds because the solids are recovered as feed material. The amount added to the fishponds is controlled to avoid excessive growth of algae. With a short life cycle, the decomposing algae can deplete the oxygen in the water, sometimes causing the asphyxiation of the fish. The farm raises *tilapia*, a hardy fish which thrives in fresh water and brackish water conditions. *Tilapia* feeds primarily on plankton but also consumes some amount of other organic matter. With nothing but the plankton and hog feed sweepings as fish food, the fishponds yield about 2 tons of *tilapia* per hectare every three months.

The culture of *tilapia* can be a lucrative operation. Once started, the maintenance cost is minimal. The sludge from a biogas plant is sufficient to support the growth of plankton in the fishpond and the undigested solid nutrients can serve as direct feed supplement for the fish. There is no problem with cost or supply of fingerlings because *tilapia* is very prolific. It attains sexual maturity in about three months and breeds as often as once a month. In fact, there is need to control the *tilapia* population in the fishpond, otherwise overcrowding will cause stunted growth and poor harvest of large fish.

Overcrowding can be controlled by maintaining separate ponds for breeding, and stocking the other ponds only with manually-selected male fingerlings. The male *tilapia* is differentiated by examining the urogenital papillas, a finger-like structure behind the anus at the belly part of the fish. The male has one opening at the tip of the papilla while the female has two openings, one for the exit of the egg and the other for urine. Another distinguishing factor is that the papilla of the male is tapering while that of the female is somewhat brown and rounded.

Other ways of controlling *tilapia* population are:

1. Use of predators, like *dalag*, which feed on the *tilapia* fry,
2. Early harvesting before the fish spawns, and
3. Artificial sex reversal, by feeding the *tilapia* fry with a synthetic male sex hormone such as methyltestosterone.

For raising *tilapia* on plankton, the optimum depth of the pond water is 75 to 100 cm. The recommended stocking rate is about one to two fish per square meter of water surface.

### **Filling Material**

When the solid sludge is objectionable for use in anything that has to do with food production, such as when night soil is used as raw material, it is used instead as filling materials. The solid materials recovered in the sewage plants are used as such.

### **A Profit Making Venture**

The biogas works at Maya Farms was established primarily to control the pollution emanating from the tons of manure produced daily by more than ten thousand pigs. The cost involved in constructing and maintaining the biogas plants and sludge-conditioning plant was substantial, but the air pollution, water pollution, as well as the problem with

flies were effectively controlled. Some cost savings were attained later on when the biogas was utilized as fuel and the sludge, as fertilizer, in the agro-industrial operations. With the use of the sludge solids for feed materials, the biogas works has turned into a profitable venture.

This latest development on the utilization of sludge for feeds should be an irresistible inducement, particularly for poultry and livestock raisers, to establish biogas works. A considerable amount of investment is required, but once they realize the feed value of the vitamin B<sub>12</sub> -enriched sludge and its cost savings potential, it will not take long before the biogas operation becomes a popular adjunct to animal farms all over the world.



## Chapter XV

### Biogas Works For Pollution Control

The large volume of animal manure, sewage and other organic wastes that are being produced daily all over the world makes pollution control a matter of great urgency. Improper disposal of these wastes pollutes the air with offensive-smelling gases and poses a hazard to health. In water, the biodegradation of these organic wastes depletes the dissolved oxygen, sometimes rendering the water unfit for fish and other aquatic life.

A number of ways have been devised to control such environmental pollution. The early approach consisted simply in treating the pollutants to remove the undesirable characteristics. Various systems with varying degrees of success in containing pollution have been generally used. Recent developments have come up with a better approach to pollution control. Pollution is now avoided by making use of the waste, and by turning the waste materials into something useful through waste recycling.

#### Pollution Control Systems

For wastewater with fairly low concentrations of organic matter, the common methods of treatment are as follows:

**SEPTIC TANK** – This is basically a settling tank that retains the solids portion of sewage long enough to permit adequate decomposition of sludge. The end products are still unstable, requiring sub-surface distribution of the effluent.

**IMHOFF TANK** – This is similar to the septic tank, with two compartments where sedimentation occurs in the upper level and digestion in the lower level. It permits the development of a better effluent.

**CHEMICAL PRECIPITATION** – Alum, lime and ferrous sulfate are added to produce flocs and make sedimentation more efficient. Under ideal conditions about 90% of sewage solids are removed and BOD is reduced by 85%.

**INTERMITTENT SAND FILTRATION** – This is used for treatment of liquid sewage. The sand filter consists of a bed of sand equipped with underdrains. The liquid sewage is applied intermittently over the entire bed. As the sewage filters through, the microorganism coating sand particles oxidize the organic materials in the sewage. The resulting effluent is clear and has a low BOD.

**TRICKLING FILTER** – This is also the treatment of liquid sewage. It consists of a bed of crushed stone, gravel, etc., with drains at the bottom of the tank. The liquid is sprayed over the bed surface. The filtering medium becomes coated with microorganisms that metabolize organic materials to stable end products.

**ACTIVATED SLUDGE** – The process accelerates the aerobic fermentation of organic waste by seeding with “activated sludge” and mixing vigorously with air or oxygen. It

makes use of a closed tank divided into two or more compartments. The seeding and vigorous aeration are done in the first compartment where the wastewater enters. Aeration continues in the intermediate compartments. The flocculated solids are allowed to settle out in the last compartment before the treated water is released. The "activated sludge" is taken from the settled solids which are full of aerobic bacteria. The whole treatment takes only 4 to 6 hours.

Other systems are used in the treatment of more concentrated organic waste slurries. Animal manure and thickened sewage are usually treated in either open lagoons or oxidation lagoons. The lagoon system consists in simply holding the organic waste in an open lagoon. This keeps fresh waste from contaminating bodies of water but it often pollutes the air with malodorous gases. The oxidation lagoon provides a mechanical device to achieve better exposure of the waste to air to retard anaerobic fermentation which generates the foul-smelling gases.

An incinerator is sometimes used to burn dry wastes but this contributes to air pollution.

The biogas plant has been used for pollution control in a number of countries. Large sewage treatment works in England, the United States, Australia and Singapore have biogas plants to treat the organic materials in the sewage. The biogas is used as fuel to generate light and power for running the equipment and machinery in the works. Some breweries and distilleries in Japan are reportedly running biogas plants to treat the industrial wastes. In Australia, biogas plants are also used to take care of the waste in some large dairy farms and in the wool industry.

In the rural areas of India, Taiwan and some other Asian countries, small domestic-type biogas plants are used to obtain biogas and biofertilizer from manure. Although pollution control is not the primary objective in such cases, the benefits to local sanitation and hygiene cannot be discounted.

However, the biogas plant controls only air pollution. The BOD and solids contained in the effluent, although greatly reduced by the anaerobic digestion, are still high enough to make the sludge a potential water pollutant.

### **The Biogas Works**

At Maya Farms, the control of both air pollution and water pollution is achieved through the biogas works, which consists of the biogas plant and sludge-conditioning plant. The sludge-conditioning plant solves the water pollution problem by recovering and processing the sludge solids into animal feed materials while aerating and aging the remaining liquid in lagoons for use as fertilizer-irrigation water.

Pollution control tests are regularly conducted to check the effectivity of the biogas works. Samples are obtained and characterized at different points in the process, starting from the untreated waste to the point where it is discharged. The effluents are analyzed by using the standard methods recommended by the American Public Health Association (1971). The following pollution indices are performed: biochemical oxygen demand (BOD), chemical oxygen demand (COD), pH, dissolved oxygen, total solids, dissolved solids, suspended solids and the threshold odor number. Sampling is performed according to the APHA recommendations.

## **Water Pollution Control**

The efficiency of the combined biological processes used in the Maya Farms biogas system has been evaluated in terms of (1) the reduction of COD, BOD, total solids, suspended solids, dissolved solids, and threshold odor number; (2) maintenance of pH at 6.5 - 8.5; and (3) optimizing the dissolved oxygen content. The values obtained at the discharge end are compared with Philippine legal requirements for agricultural and Class C river waters (Table 15-1).

### **Biochemical Oxygen Demand**

The BOD of the undigested hog manure slurry is about 3000 mg/liter. After digestion and subsequent sludge treatment the BOD value is 200 mg/liter, a reduction of about 93%. A high percentage of the oxygen demand is removed by the treatments; of the various treatments the biggest reduction occurs during biodigestion. The BOD at the discharge point after the sludge treatment lagoons is still relatively high. However, it does not pose a problem for Maya Farms because during the dry season, the discharged effluent is absorbed by the crops, and during the rainy season the wastewater is highly diluted. The amount of effluent used in the fishponds is controlled to maintain a low BOD.

In farm operations where continuous cropping is not feasible and where there are no agricultural areas around to absorb the water discharge, it may be necessary to put up an activated sludge treatment tank after the lagoons in order to control water pollution completely. The activated sludge process makes use of a closed tank which is divided into two or more compartments. The wastewater enters the first compartment where it is seeded with activated sludge taken from the last compartment and mixed vigorously with air or oxygen. The vigorous aeration is continued in the intermediate compartments where the organic materials ferment and flocculate. The flocculated solids settle out in the last compartment before the water is discharged. The activated sludge actually consists of these settled solids which are full of aerobic bacteria. It greatly accelerates the aerobic fermentation of organic matters so that the necessary wastewater retention time in the activated-sludge tank is only 4 to 6 hours to eliminate the water pollutants.

### **Chemical Oxygen Demand**

The COD values follow the trend of the BOD values. Before digestion, COD values range from 2100 to 4400 ppm; after digestion, COD values range from 80 to 190 ppm. This is a COD reduction of 91 to 98%.

### **Solids (Total, Dissolved and Suspended)**

The total solids before digestion range from 3700 to 7400 ppm; after biodigestion and the subsequent treatment, the total solids decrease by 81 to 94%, to values of 400 to 1400. These values are within the total solids content specified for Class C river water (fishing) and Class D waters (agricultural). The dissolved and suspended solids follow the trend for total solids.

### **pH**

The pH values from the sampling stations are slightly acid to slightly basic (6.5 to 7.5). These values are within the required pH of 6.5 to 8.5 for fishing and agricultural waters.

## **Dissolved Oxygen**

The dissolved oxygen starts increasing in the conditioning lagoons. It goes up to 2.2 in the aging lagoon, 2.4 ppm in the rice field and 6.1 ppm in the fishponds. This again meets the requirements for fishing waters (5 ppm min.) and agricultural waters (3 ppm).

The value obtained on the waste slurry were initially highly polluttional. After biodigestion, there was a 81% to 98% removal of the polluttional properties. The subsequent lagoon treatments and dilutions were very efficient in increasing the dissolved oxygen and decreasing COD and BOD.

## **The Odor Problem**

Loehr (1975) stated that in livestock waste management, the use of anaerobic methods with methane production in the control of odor has not been recommended since the technological aspect for this process is not fully developed and cannot be applied. At Maya Farms, the odor problem was solved by the biogas works. As in water pollution, the efficiency of the system as a means of controlling odor was tested by using the APHA methods for the qualitative and the quantitative determination of odors.

Samples were taken from the various sampling stations and subjected to qualitative descriptions with the aid of Table 15-3. The threshold odor numbers (TON), the quantitative approach, were determined by using the judgment of eight trained panelists. Table 15-4 shows the TON and the descriptions of the odors taken from seven sampling stations. Before digestion, the odor was disagreeable and very pronounced, with a TON of 8000. After digestion, the odor was described as chemical (Hydrogen sulfide) and the TON was 300 and 120 as the effluent passed through the aeration lagoon and aging lagoon respectively. After the ricefields, the TON was 22 and the odor was that of damp earth. At the fishponds, the TON was 1.5 and the odor was described as earthy.

TABLE 15-1. Quality Standards for Different Classifications of Water:\*

Characteristics	Class AA (Waterbed)	Class A (With treatment) Source of domestic water supply	Class B Bathing	Class C Fishing	Class D Agricultural and industrial	Class E Navigation and Water disposal	Class SA Shellfishing	Class SC Fishing
Coliform-MPM/100 ml, max	50-100	50-5000	50-240	1000	100-1000	-	70	1000
Turbidity-units, max	0-10	10-250	15-20	5-10	-	-	5-50	5-20
Color	0-20	20-150	10-30	5-10	-	20-100	10-50	5-20
Odor-threshold odor No. max	0-50	3-8	0-5	10-50	50-80	80	10-50	50-80
Temperature, °F max.	86	86	86	93	-	-	86	93
Total solids, ppm, max.	500-5000	500-5000	-	3000	500-2000	-	-	-
pH range	6.5-7.5	6.5-8.5	6.5-8.5	6.5-8.5	6.9	5	-	6.5-8.5
B. O. D.	0.7-1.5	1.5-2.5	2.5-10	10-30	-	-	-	6.5-8.5
D. O. - mg/liter	6.5	5.0	5	5	3	1	-	5

\* Official Gazette 63 (28): 5999-6018 (1977).

TABLE 15-2. Characteristics of Wastewater from Different Sampling Stations at Maya Farms:

Sampling Stations	Threshold Odor No.	pH	Dissolved Oxygen mg/l	BOD mg/l	COD mg/l	Total Solids mg/l	Suspended Solids mg/l	Dissolved Solids mg/l
Manure Slurry Sump	8000	7.0	0	3,505	2,300	5,394	2,508	2,886
Aeration Lagoon	300	6.5	0	373	190	1,400	400	1,000
Aging Lagoon	120	7.5	2.2	200	106	1,100	300	800
Rice Fields	22	7.0	2.4	500	100	1,000	300	700
Fishpond	1.5	7.0	6.1	100	40	400	100	300

## Chapter XVI

### The Economics of Biogas Works

The problem of wastes in a livestock farm, such as from cattle, hogs and fowl is a recurring situation that always confounds the raiser. It pollutes the air and makes it obnoxious and unbearable to breathe. It can pollute the waterways, and destroy flora and fauna. It can attract flies and pests and provide breeding places for them and other pathogenic organisms.

With these real and potential dangers, a careful study for a good management of the wastes is a necessary alternative for the livestock raiser. To him waste has no value but still needs to be disposed of properly. For small farms, waste collection and disposition can be manageable at small expense but as the farm population increases in number, the magnitude of the problems of waste management becomes a bigger poser.

It seems only logical that the initial sphere of attack to the problem is only for control of pollution. Methods used range from the collect-and-bury scheme to water dilution methods and also the use of aeration and settling lagoons or ponds. It could include capital-intensive units with a high degree of labor costs used in its operations. The owner is not given many options for the problem at hand. He cannot avoid it; hence, he has to face it head on whatever the cost unless he is willing to suffer the ill-effects of waste pollution.

Such were the initial problems faced by Maya Farms – the dangers posed by pollution. Gradually the biogas works were developed and soon enough an integrated livestock raising-cropping system evolved, with the biogas plant providing the linkages. The recycling operation soon included the wastes from the canning plant, meat processing plant, the slaughterhouses and field crops.

#### Economic Potentials

Aside from solving the pollution problem, the biogas works produce an energy source, feed materials and organic fertilizer. Hence, the economic potentials of the system can be generally grouped into three categories: (a) pollution control for ecology balance, (b) biogas for energy source, (c) biofeed and biofertilizer for food production.

**Pollution Control for Ecology Balance** – The control of pollution in livestock farms can be costly especially if the pollution control device is installed exclusively to abate pollution. The investment becomes a sunk cost. The corresponding amount is allocated, by way of depreciation charges, against operating income over the number of years of its expected usefulness. It therefore becomes an extra burden on operations.

If the biogas works are used for a similar situation, it will still cost money to set up and operate, but it does not necessarily become a sunk cost because other benefits, such as biogas, feeds and fertilizer, are derived from the system. The amount of money expended in putting up the biogas works will gradually, over the years, be repaid or compensated back by the value of the biogas, feeds and fertilizers it will produce. No part of that cost is

imputed on pollution control. The pollution control aspect of the system gets a free ride in so far as sharing in the cost of the biogas works is concerned.

As to the owner or practitioner, he benefits from the savings that he enjoys in not having to spend for a pollution control unit that functions exclusively for abatement but does not produce any other positive benefit or product.

To illustrate, if a purely pollution control unit would cost ten thousand pesos (P10,000.00) to install and operate, the owner will save this same amount of money if he installs biogas works to solve his pollution problem, even granting that the latter would cost more, say, fifteen thousand pesos (P15,000.00). This is so because the P15,000 invested in biogas works, aside from controlling pollution, can produce tangible products such as biogas, biofeed and biofertilizers. (\$1.00 = P7.50)

**Biogas as an Energy Source** – The biogas produced by the system serves as fuel for heating and for generating power. The assignment of value for the benefits derived from the use of biogas depends on what particular petroleum product is substituted by biogas for each type of appliance or engine used.

If biogas is used as a substitute for LPG, the value of the biogas consumed is the equivalent value of LPG that would be necessary to attain the same degree of heating. Thus, if one cu. m. of biogas can produce the same heat as one pound of LPG, which costs one peso per pound, therefore the same one cu. m. of biogas carries a value of one peso. In situations where biogas is used to substitute for kerosene, like in a gas mantle lamp or in an absorption-type refrigerator, then the value assignable to biogas would be that value of kerosene equivalent to produce the same amount of heat. In like manner, where biogas is used as fuel to run an internal combustion engine that used to be gasoline-fed, then the value assignable to biogas thus used is the value of gasoline that has been substituted in running the engine to produce an equivalent power. The power may be used for pumping or to generate electricity. If used for the latter purpose, then, a different value is assignable to biogas because it would now be equated with the amount of money normally paid for electric power. For example, if electric generators are used, one cu. m. of biogas is sufficient to generate 1.5 kwh. Therefore, in places where the cost of electricity is, say, twenty centavos per kwh. the cost of 1.5 kwh is thirty centavos which then would be the equivalent value of one cu. m. of biogas used to generate that much electricity. The same cu. m. of biogas would differ in value if used also to generate electricity in places where the average rate paid for electricity is, say, fifty centavos in which case, the cost value of 1.5 kwh would be seventy-five centavos.

This method of value assignment to biogas on the basis of value substituted appears to be the only logical method inasmuch as biogas has not yet attained its own market price identity. Considering that biogas may best be used within the same vicinity where it is produced, restricted mainly by the difficulty of containerization, the economic benefits derived from its use is identifiable with the specific costs of the particular petroleum product in the same locality. The higher these costs are in a locality where the biogas plant is, the higher would be the economic value of the benefits derived therefrom.

To recapitulate, hereunder are equivalent fuels substituted by one cu. m. of biogas, viz:

- = one lb. of LPG
- = 0.52 liters of diesel oil
- = 0.54 liters of gasoline

Also, one cubic meter of biogas when used as fuel for a gasoline engine can generate 2.2 hp which can be harnessed to generate 1.5 kwh. These are based on the experience of Maya Farms.

**Biofeeds and Biofertilizers in Food Production** – The sludge that comes out from the digesters may be used in its component forms, which are the liquid and the solid. The liquid sludge can be used as fertilizer for food crops like rice, corn and vegetables, and to support plankton growth in fishponds. The solid sludge is processed into feed materials. The utilization of the sludge as feed is a great help toward self-reliance in food production.

In order to determine the economic value of the sludge, the method of value assignment again is used. The economic value of the liquid sludge, when used as fertilizer, would be equated to the value of that commercial fertilizer necessary to attain the same level of fertilization. Thus, in the experimental plots used for rice it was found that in order to attain the ideal 80 kg. of nitrogen per hectare, it would be necessary to apply about 3.56 bags of urea fertilizer (commercial type, 45% N) or, apply about 57 cu. m. of liquid effluents from the digesters. Thus, an equivalent value of about P5.14 of commercial fertilizers value per cu. m. of the liquid biofertilizer is obtained.

In the case of the solid portion of the sludge, at Maya Farms it is used to replace part of the pollard in the mixed feed formulation. Although the feed performance is better when sludge is used, we can use the cost of pollard as the base value of the solid sludge.

### The Biogas Works

A utility model of a biogas works could range in size depending on available wastes to feed the system, from one cu. ft. capacity to a high of about 4,800 cu. ft. single digester capacity. Of course, requirements for bigger capacities could be met with a series of digesters. Aside from the size, the type of digester also influences the cost of construction.

Table 16-1 shows construction costs of small biogas plants with digesters that can take a daily input of one to four cu. ft. of manure, under various designs belonging to the continuous-fed type. Construction cost using the vertical design could range from P1,900 to P4,000, depending on the capacity to handle manure volume. The horizontal, two-

TABLE 16-1

#### Comparative Costs of Construction of Small Biogas Plants

(Using Different Models of the Continuous-fed Type at 1977 Costs)

Volume of manure input/day 75% MC	A Vertical design	B Horizontal two-chamber	C Fixed dome
1 cu. ft.	P1,900 - 2,100	P2,300 - 2,500	P2,400 - 2,600
2 cu. ft.	2,400 - 2,600	3,200 - 3,400	3,400 - 3,600
3 cu. ft.	3,200 - 3,500	4,500 - 4,800	4,700 - 5,000
4 cu. ft.	3,700 - 4,000	6,100 - 6,500	5,900 - 6,300

**Note:** The proportion of solids to liquids in the slurry for continuous-fed vertical design and for the fixed dome is 1:1.5 and that for the continuous-fed horizontal two-chamber type is 1:2. Retention for all the three types is 50 days.



**chamber design has a range of from P2,300 for the one cu. ft. to P6,500 for the four cu. ft. input capacity. The fixed dome design starts at P2,400 to a high of P6,300.**

**Some idea of the construction costs may be derived from two of the bigger units now in operation at the Maya Farms. A 24-digester batch system which measures 10 ft. square on the sides and 8 ft. deep inside dimensions for each digester costs P150,000 including the gasholder. A centrifugal pump costing P15,000 goes with this model. It produces 305 cu. m. of biogas daily and each digester has a slurry volume of 700 cu. ft.**

**Another unit of the continuous-fed design with 4 rows of 2-chamber digesters each measuring 10' x 55' x 9" inside costs P155,000 to construct, including its gasholder. It produces about 425 cu. m. of biogas daily and has a total digester slurry volume of 17,600 cu. ft.**

### **Operating Expenses**

**For the small biogas works, operating expenses can be kept to the minimum because the owner or members of his household can operate it. The big units require full-time laborers to attend to the operations. These laborers can also be assigned to do odd jobs from time to time when their attention is not needed at the biogas plant. For the batch system and the continuous-fed system mentioned in the preceding section, three laborers and one laborer, respectively, are required. The simplicity of operation of the continuous type becomes easily apparent here.**

**Cost of money used in the construction is imputed at 17% per annum. If the owner supplies the funding, then he does not have to pay for interest. If financing is needed, the interest expense is reduced as payments against the principal are made. This is a vanishing item of expense, depending on the ability of the borrower to amortize the loan.**

**Depreciation is another item of expense. It represents an allocation of the total cost previously spent for fixed assets like a biogas plant and its attendant equipment. It means the periodic decline in value of a property used due to wear and tear, the passage of time, the action of the elements, or obsolescence. Although this is classified as an expense there is no corresponding amount of money paid out with it. For the illustrations used in this chapter, the cost of the biogas plant is depreciated over a period of ten years useful life, or 10% per annum.**

**Some administrative expenses may be charged against the operations of the plant. This may involve the sharing of salaries of certain executives or foremen whose time is partly spent with the project aside from their regular jobs.**

### **Income and Savings**

**Normally, a business transaction involves an exchange of values, such as, if a merchandise is given out for cash received, or vice versa, or when a laborer is paid for services rendered. The amount received in payment for a product or service is income to the receiver. Thus, the sale of livestock or other farm products becomes a source of income and funds which can then be used to buy commercial fertilizers for the farm. These are examples of funding income cycles which can be repeated many times over or may take other forms. Take the case now of a farmer who produces fertilizers which he can use or**

sell to others. He can use the proceeds to buy other goods or services, including probably another type of fertilizer. If he does not sell the fertilizer that he produces and uses it up in his farm such that he will not have to buy any additional fertilizers, the value of his original fertilizer production must be equated to the value of the additional fertilizer that he then does not need to purchase.

Emphasis is given on this method of income recognition from value substitution bordering on barter concepts because it does not involve the receipt or payment of money. This is the pattern used in the evaluation of the income potential of the biogas operation. Income levels are identified with the value of products being substituted. We have discussed this at length and together with the computations presented in the table, some degree of agreement is hopefully established.

The idea of savings means that a product or service that must be paid for is actually paid for with a smaller amount in kind or none at all. The amount saved is the difference between the intended payment and the actual payment given to meet the obligation fully. This is the essence of the savings that the biogas works generates in the area of pollution control. By controlling pollution it forgoes with the expenditures for a separate pollution control effort. The savings in this respect belong to the biogas works.

### **Financial Analysis of Operations**

In order to answer any doubts raised on the financial viability of the system, we shall look closely at the data on the large biogas works based on the Maya Farms experience.

Various income identities are evaluated and these are connected with the class of products substituted for by biogas, biofeed or biofertilizer. It must be stressed that these income figures are based on the assumption that all the biogas, biofeed and biofertilizers would be fully utilized. The figures presented along each product follows the assumption of full substitution. Actual utilization which will involve any combination of these substitutions would necessitate some exercise in extrapolation.

The value/benefit analysis uses the current costs of petroleum products and electricity obtaining in the locality. We must hasten to stress that these unit values could vary from one community to another especially in the provincial areas, and from one year to another. In the Philippine context, for electricity costs, it is accepted that Meralco rates at 35 centavos per kwh are the lowest as compared with those in the rural areas where it may run to as high as P1.00 per kwh. In the biogas evaluation that follows, two unit costs, one for suburban and the other for rural operation (P0.50/kwh ave.), are separately considered for comparison.

The presentation herein of the economic value of the biogas system is made on the assumption that there is total utilization of the biogas and sludge produced by the system. In actual practice, however, utilization may take any combination of the substitution. It may be used also simultaneously as substitute for petroleum products or to generate electricity, or any combination thereof. In such instances, the economic impact can be measured according to the degree of this combination and the extent of utilization.

The extent of utilization of biogas and sludge may vary between urban and rural areas. In urban areas there could be full utilization of the biogas but partial or little use only for the sludge. In the rural areas, maximum utilization could tilt in favor of the sludge which is used as feed and fertilizer and with only partial use of the biogas produced. At Maya Farms all the biogas produced is utilized in simultaneous combinations.

## Study on a Biogas Works for a 5000-Pig Farm

### I Basic Data Based on the Maya Farms Experience

Type of digesters	continuous-fed, 4 rows
Total digester capacity	17,600 cu.ft. of digester slurry
Total gasholder capacity	5,000 cu. ft.
Retention time	25 days
Manure: water ratio	1:1½ by volume
Manure input	7,500 kg/day
Products output –	
Biogas	15,000 cu. ft./day 155,000 cu. m./yr.
Dry sludge	750 kg/day; 274 tons/yr.
Liquid sludge (25% loss from leaching and evaporation)	520 cu. ft/day 5,370 cu. m./yr.

### II Cost Evaluation

#### A. Biogas

biogas produced per annum	155,000 cu. m.
values substituted by biogas (1 cu. m. biogas =)	
1. LPG (=1 lb. @ P1.00/lb.)	P155,000
2. Gasoline (= 0.54 liter @ P1.50/l)	125,550
3. Diesel fuel (= 0.52 liter @ P1.20/l)	96,720
4. Electricity	
a) in suburban areas (= 1.5 kwh @ P0.35/kwh)	81,375
b) in rural areas (= 1.5 kwh @ P0.50/kwh)	116,250

#### B. Dry sludge

1. as feed material, 274 tons × P600	P164,400
2. as fertilizer-soil conditioner, 274 × P100	27,400

#### C. Liquid sludge, as fertilizer

5,370 cu.m. × P5.14/cu.m.	P27,600
---------------------------	---------

### III Financial Analysis

#### A. Capital investment

1. for pollution control only or for pollution control and biogas	
a) biogas plant	P155,000
b) sludge treatment unit	55,000
total	P210,000

2. for pollution control, biogas and fertilizer	
a) biogas plant	P155,000
b) sludge-conditioning unit	<u>65,000</u>
• Total	P220,000
3. for pollution control, biogas, fertilizer and feeds	
a) biogas plant	P155,000
b) sludge-conditioning unit	65,000
c) feed processing unit	<u>35,000</u>
	P255,000
<b>B. Operating expenses</b>	
1. for pollution control only, or pollution control and biogas labor	P9,400
interest, 17%	35,700
depreciation, 10%	21,000
repair and maintenance	3,000
administrative	<u>12,000</u>
	P81,100
2. for pollution control, biogas and fertilizer labor	P14,100
interest, 17%	37,400
depreciation, 10%	22,000
repair and maintenance	4,000
administrative	<u>12,000</u>
	P89,500
3. for pollution control, biogas, fertilizer and feeds labor	P23,500
interest, 17%	43,350
depreciation, 10%	25,500
repair and maintenance	8,000
administrative	<u>12,000</u>
	P112,350

**C. Net operating savings and return on investment**

1. biogas works for pollution control and biogas utilization

	<b>net operating savings</b>	<b>investment recovery period</b>
a) LPG substitution	P73,900	2.8 yr.
b) gasoline	44,450	4.7
c) diesel oil	15,620	13.4
d) electricity		
a) suburban, P0.35/kwh	275	
b) rural, P0.50/kwh	35,150	6.0

2. biogas works for pollution control, biogas and fertilizer utilization

	<b>net operating savings</b>	<b>investment recovery period</b>
a) LPG substitution	P120,500	1.8 yr

b) gasoline	91,050	2.4
c) diesel oil	62,220	3.5
d) electricity		
a) suburban, P0.35/kwh	46,875	4.7
b) rural, P0.50/kwh	81,750	2.7

3. biogas works for pollution control, biogas, fertilizer and feeds utilization

	<b>net operating savings</b>	<b>investment recovery period</b>
a) LPG substitution	P234,650	1.1 yr.
b) gasoline	205,200	1.2
c) diesel oil	176,370	1.4
d) electricity		
a) suburban, P0.35/kwh	161,025	1.6
b) rural, P0.50/kwh	195,900	1.3

## **PART IV**

### **WASTE RECYCLING THROUGH THE BIOGAS WORKS**

- |                |              |  |
|----------------|--------------|--|
| <b>Chapter</b> | <b>XVII</b>  | <b>Recycling System of Farming</b>               |
|                | <b>XVIII</b> | <b>Rural Development through Waste Recycling</b> |
|                | <b>XIX</b>   | <b>Biogas Works in Practice</b>                  |
|                | <b>XX</b>    | <b>Socio-Economic Impact</b>                     |

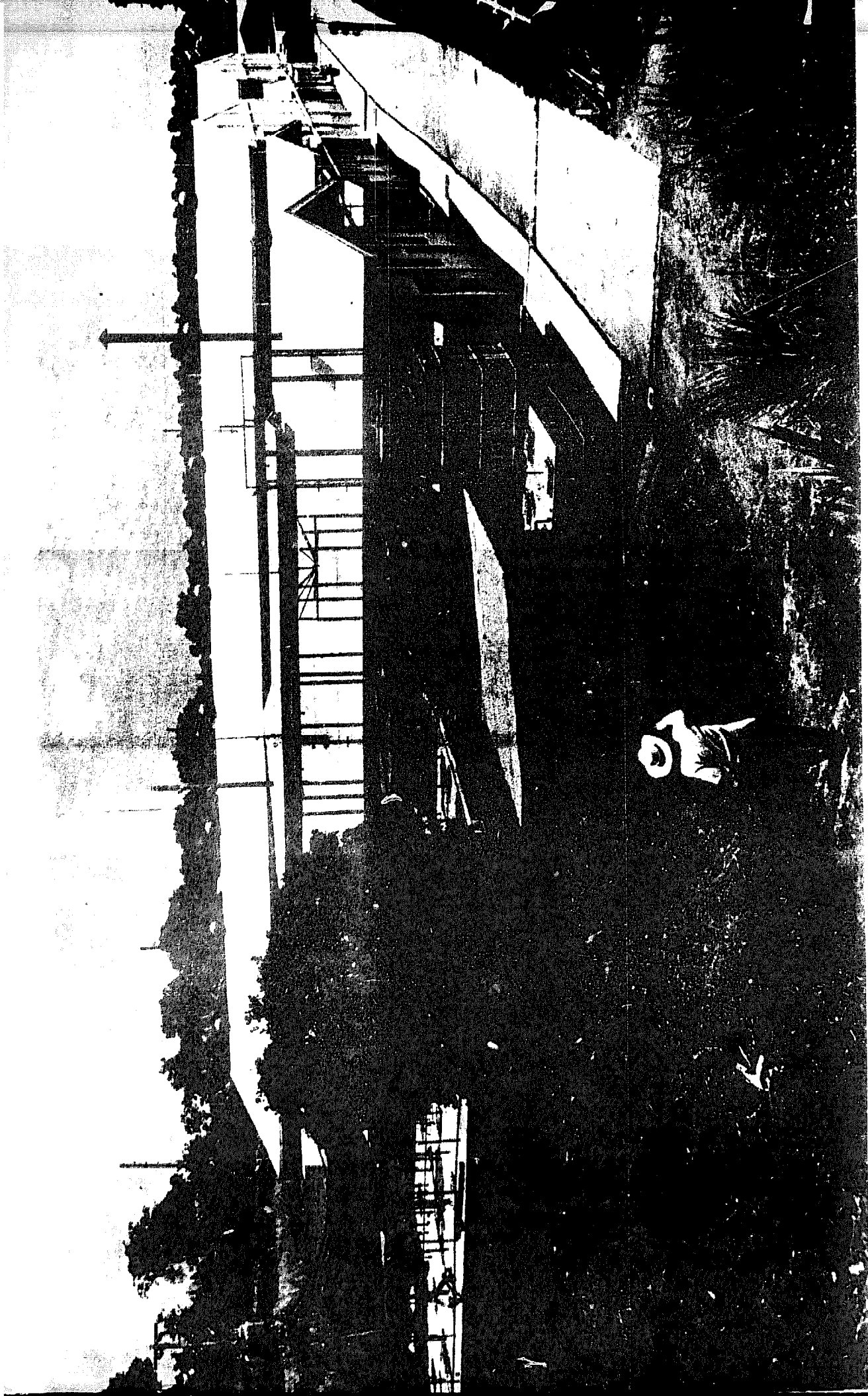


Illustration 4.1: Waste recycling with biogas works and rendering plant in an integrated hog farm, meat processing and canning enterprise

## **PART IV**

### **WASTE RECYCLING THROUGH THE BIOGAS WORKS**

The widening gap between man's needs and the availability of resources is mainly due to the thoughtless use of the latter. The petroleum oil shortage has made us realize the necessity of taking better care not only of our energy reserves but of all our dwindling resources. There is now a growing awareness of the need to conform to the predesigned cycles of nature to guide us in solving this problem.

Nature shows us many examples of conservation through recycling. There is the simple recycling of water which evaporates, rises, forms clouds, and comes back to earth as rain. Living organisms take in oxygen from the air and give off carbon dioxide. Plants utilize the carbon dioxide, reduce the carbon to produce food for man and feed for animals and other living organisms and release the oxygen back into the air. The wastes (night soil, manure and crop residues) are returned to the soil to become plant nutrients.

Civilized man, unfortunately, has interfered with nature. He mindlessly neglects to return the waste to perform their destined biological function. This has resulted in the depletion of food nutrients in the croplands. He overcut the forests and allowed soil erosion from the hillsides, causing floods and droughts. Man's realization of his folly may bring about a "Recycling Revolution".

The introduction of the biogas process will be the first concrete step towards the Recycling Revolution. By using the organic wastes as raw materials, the biogas process not only solves the problem of waste disposal and eliminates potential sources of pollution but also converts these materials of no economic value into materials which are essential to human survival -- fuel for man's energy needs, and feed and fertilizer to meet man's requirements for food production. By providing the people in rural areas with a fuel gas, the biogas works helps prevent the denudation of forests since the cutting down of trees for use as firewood becomes unnecessary. It reduces household needs for coal, petroleum oil and other energy sources for cooking, and by providing an inexpensive and abundant supply of organic fertilizer, it diminishes if not eliminates the farmer's dependence on the chemical fertilizers which are often in short supply and are getting more and more expensive, and which oftentimes end up as water pollutants. By converting the solid sludge into vitamin-rich feed materials, the biogas works assures the poultry and livestock raisers a substantial supply of inexpensive feed extenders which are good sources of vitamin B<sub>12</sub> and other unidentified growth factors for their animal feeds.

Waste recycling through the biogas works results in a more economical and more effective utilization of the land. It creates a healthier and more aesthetic environment. It leads towards a life of self-sufficiency and self-reliance. It provides full employment to the farm family and assures the practitioner of an income sufficient to maintain a decent standard of living.

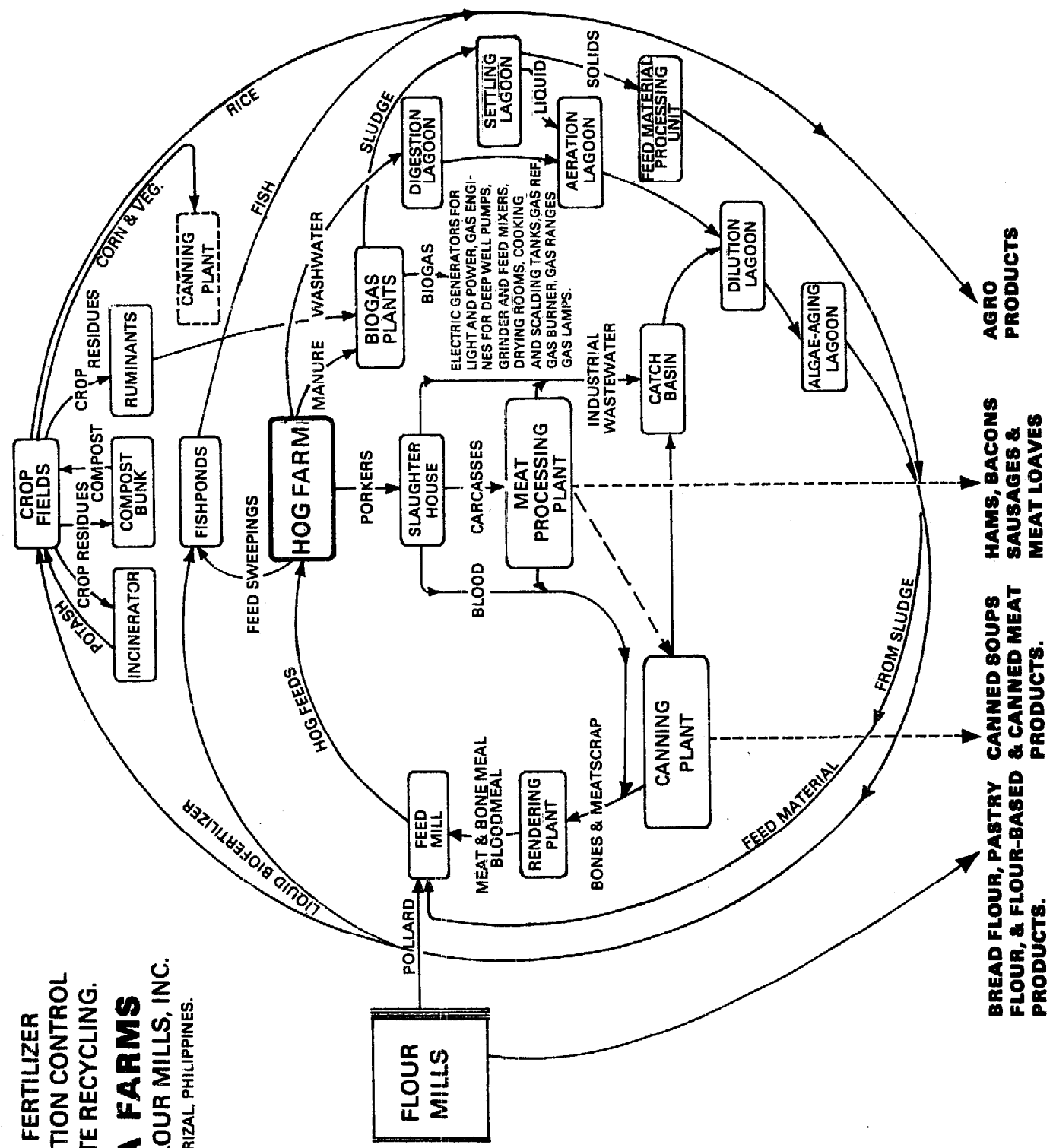


**Part IV discusses various recycling systems integrated with the biogas works, and their socio-economic impact, in the following chapters:**

<b>Chapter XVII</b>	<b>Recycling System of Farming</b>
<b>XVIII</b>	<b>Rural Development through Waste Recycling</b>
<b>XIX</b>	<b>Biogas Works in Practice</b>
<b>XX</b>	<b>Socio-Economic Impact of Biogas Works</b>

**FUEL, FEED, FERTILIZER  
AND POLLUTION CONTROL  
THRU WASTE RECYCLING.**

**MAYA FARMS**  
LIBERTY FLOUR MILLS, INC.  
ANGONO, RIZAL, PHILIPPINES.



## CHAPTER XVII

### Recycling System of Farming\*

Among the most pressing problems of the world today is the production of sufficient food for the growing population. It cannot be solved by opening up more land for cultivation and pastures. We have already overcut our forest, causing droughts, floods and environmental imbalance. The best solution is to reorganize our farming system to make the present agricultural lands produce more food. We need to have cheaper and more reliable sources of fertilizer, feeds and energy. We have to make full use of the labor potential in the farms.

The recycling system of farming being advocated by Maya Farms seeks to maximize the food productivity of the land through an integrated recycling operation. It consists of:

1. An integrated system of farming, combining crops and livestock in a more or less symbiotic relationship;
2. Programming farm work in such a manner that would keep the farm family occupied all day long and all year round;
3. Utilizing the biogas works to recycle the farm wastes in order to control pollution and at the same time minimize dependence on external sources for farming requirements of fertilizer, feed and fuel; and
4. Improving the earning power and raising the standard of living of the farm family.

Traditionally, the crop farmers grow food crops and supply the feeds needed by the livestock farmers while the livestock farmers just raise the animals. Cropping is seasonal and does not require a full day's work; hence the crop farmer does not fully utilize his time. The livestock farmer, too, does not need the whole day to feed and care for his animals. In both cases, the farm families have time to spare. They are under-employed and many of them remain poor.

In an integrated system of farming, the livestock raised are those that feed on the crops (and crop residues) that grow well on the farm. This eliminates the additional costs of transportation and services of middlemen. The farm family would be operating two farms at the same time. This also saves on pasture land because the farmer would be using crop residues instead of pasture grass to feed the ruminants.

The manure would be used as raw material for the biogas works, producing fuel, feed and fertilizer, thus saving on three items which most farmers in the traditional system of farming can barely afford to buy and often have difficulty in acquiring. The biogas works would also solve the problem of disposing of the manure and would make the environment more pleasant to live in.

\*Before the completion of the recycling experiments the term biogas was used instead of recycling.

## **The Working Basis**

The recycling system of farming was developed at Maya Farms on the basis of their scientists' own studies, experiments and experiences on the operation of the biogas works. The system works as follows:

If the cropland is unirrigated, it is planted to rice at the height of the rainy season. Right after the rice harvest, a ninety-day corn variety is planted. This is followed by another corn crop which is harvested at the time of planting the next rice crop. Weeding is done by manually pulling the weeds three weeks after planting the crops. The practice will not affect the yield while the weeds will serve as feed in addition to the crop residues (rice straw and corn stovers) for ruminants like carabaos and cows.

The ruminants, however, will need some protein supplements and green feed. These can be provided by ipil-ipil leaves. When the ipil-ipil tree is three years old, it may be cut about 1 to 1½ meters above the ground every three months. About 10 tons (dry weight) of leaves may be recovered per hectare per year. The crop residues and weeds from three crops planted in one hectare and the leaves from giant ipil-ipil planted on 1000 sq.m. will be sufficient for feeding three heads of carabaos or cows all year round.

Aside from the ruminants, pigs and some chickens are raised. They feed on the corn, rice bran and ipil-ipil leaves. The animal manure is collected and used as raw material for the biogas plant. The manure from four sow units and three cows and/or carabaos will produce enough biogas to cook the family meals, iron their clothes, light their home and run a gas refrigerator. With more animals, large biogas plants can be used and the biogas can run an internal combustion engine to operate an electric generator that can supply electric power for pumps, lights, radios, television sets and other appliances.

The liquid sludge, after treatment in the sludge-conditioning plant, will be used to fertilize the rice and corn field and to grow plankton to feed the fish in a fishpond. The feed sweepings in the pig pens can serve as supplementary feed for the fish. With four sow units, sufficient liquid sludge can be produced to fertilize one hectare planted to three crops per year. In areas deficient in potassium, this element may be supplied from ashes of burnt empty rice grains and other farm wastes not fit for the ruminants nor the biogas plant nor for composting.

The solid sludge may be recovered and processed into feed materials rich in vitamin B<sub>12</sub> and possibly other unidentified growth factors. It will constitute about 10% of the feed requirement of the animals that excreted the manure used in the biogas plant.

Three modules on the recycling system of farming have been worked out as illustrative examples: Module I, called a "Family Farm", shows how a 1.2 hectare subsistence farm may be developed to become a prosperous farm; Module II, called a "Clan Farm", shows how a 3.5 hectare farm can be developed to accommodate the expanding family of a farmer and the families of his two sons; and Module III, called a "Retiree Farm", shows how a 7.0 hectare farm can be developed by a retiree to keep him gainfully occupied while providing comfort in his retirement.

## **The Family Farm**

Most of the farms distributed by Land Reform are about 1.2 hectares of unirrigated land with about 1.0 hectare planted with crops. The farmer grows a crop of rice followed by a

**crop of corn. Because of lack of fertilizer, his yield is only 30 cavans of palay and 2 tons of corn. He has a work carabao. He raises a sow fed mainly with rice bran, banana stumps, and kitchen wastes. The piglets are sold when they are three months old. He also raises about 5 or more hens on the loose for home consumption. With this type of operation, the family income would not be sufficient for a decent standard of living.**

**This small farm may be organized in line with the recycling system of farming to increase productivity and improve the family standard of living. The 1.2 hectare may be reapportioned as follows:**

**0.03 hectare for home lot**

**1.00 hectare for one crop of rice and two crops of corn per year**

**0.02 hectare for livestock corral and biogas works**

**0.02 hectare for fishpond**

**0.10 hectare for ipil-ipil in wastelands and boundary**

**0.03 hectare for canals and paths**

**The vegetables are planted on the rice paddies and fishpond dikes. The fruit trees are planted around the buildings. The climbing vines -- squash, patola, ampalaya and the like -- are grown on trellises over the roads and paths.**

**From the offspring of his one sow, the farmer can retain three breeding gilts so that eventually he will have 4 sows. He will keep their offspring up to 7-8 months old, selling them then as gilts and porkers. They will be fed with standard feeds using the corn harvest, the rice bran and biofeed materials he can recover from the biogas works. He will buy the rest of the feed ingredients. Used as raw material in a biogas plant, the manure will produce an average of 150 cu. ft. of biogas, 7 to 8 kg. of feed materials, and about 100 liters of biofertilizer per day.**

**The biofertilizer will be sufficient for the fishpond, one crop of rice and two crops of corn. With the fertilizer, the farmer can easily get 60 cavans of rice per crop and six tons of grain for the two crops of corn.**

**By the time the reorganization is in full operation:**

- 1. the fertilizer requirement for the three crops per year can be supplied by the treated liquid sludge from the sludge-conditioning plant and the ash after burning empty rice grains;**
- 2. the corn crops, rice and ipil-ipil will be sufficient to supply the corn grain, rice bran and ipil-ipil leaf meal needed for the hog feeds; the processed vitamin-rich feed material recovered from the sludge-conditioning plant will constitute about 10% of the feeds;**
- 3. the rice straw, corn stover, weeds and ipil-ipil leaves will be sufficient to feed three carabaos;**
- 4. the crop residues not consumed by the carabaos and the sludge residues from the conditioning lagoons will be composted, and the compost will be used to maintain the nitrogen-carbon ratio of the soil as close to 1:13 as possible;**

5. the fishpond will be fertilized with the liquid sludge to grow the plankton to feed the fish, supplemented by the feed sweepings from the pig pens;

6. the biogas produced will be sufficient to

- a. cook the meals of the farm family
- b. light the home and piggery
- c. iron the clothes
- d. run a gas refrigerator;

7. the farmer will be able to sell the extra rice, porkers, gilts, culls and fish.

If the 1.2 hectares are irrigated, two crops of rice and one crop of corn will be grown. In this case there will not be enough corn feed materials. The farmer can buy the corn deficiency, raise the four sow units and keep the offspring up to seven months old. This will still be more profitable because the extra rice will bring in more income than the corn to be bought. The other alternative is to raise only two sow units, in which case he will have to forego the gas refrigerator.

Another alternative is to raise six units and rear the offspring up to three months old as most backyard pig raisers do. This will also be profitable in places where there is a big demand for piglets to fatten. In this case, however, there will be less biogas produced; so he will then have to give up his refrigerator.

With such an operation, the farm family will be fully occupied every day all year round operating two farms in one; but with the increased income and reduced cost of inputs the family would be able to live more comfortably.

### **The Clan Farm**

A farmer with his wife and four children (two boys and two girls) can be fairly comfortable with a 3.5-hectare farm. He can grow one crop of corn during the dry season and one crop of rice during the rainy season. He can hire four laborers to help during the peak seasons. It will be possible to raise two work carabaos and one caracow for his farm power and a sow which he will feed mainly from rice bran, banana trunks and kitchen wastes.

Eventually, the farmer sees his children growing and realizes that later their farm will be inadequate to support them in their accustomed standard of living. As the Filipino custom goes, when a girl gets married she is given whatever the parents can afford. When a boy gets married he is given a part of the farm to operate or he works with his parents. The farm will be divided into three, one third for each boy and the third plus all personal properties of the parents, when they pass away, go to the two girls.

The alternative is to organize the farm as a partnership of the parents and the two boys and operate in line with the recycling system of farming. This is more advantageous than three separate farms. The farm shall be apportioned as follows:

3.00 hectares planted to two crops of corn and one crop of rice

0.09 hectare for home lots

**0.06 hectare for livestock corrals and biogas works**

**0.06 hectare for fishpond**

**0.29 hectare for canals, roads and wastelands which will be planted to giant ipil-ipil.**

**As in the family farm, the vegetables will be planted on the paddies and fishpond dikes and the fruit trees, between the buildings. Trellises will also be used for the climbing vines.**

**They will plant two crops of corn and one crop of rice. They will gradually increase the carabao population to nine heads of carabaos, chicken to thirty heads and pigs to twelve sow units. They will raise the offspring to seven or eight months old, selling the gilts and the porkers. The farm operations would be much the same as that in the family farm.**

**The manure will produce three times as much sludge to fertilize his treble crops grown and to feed his treble population of livestock. The biogas produced will be sufficient to cook their meals, iron their clothes and operate an electric plant that would supply power for lighting, radio, TV set and pumping water. The 3.5 hectares that gave a fair standard of living for one family can give a still higher standard of living for three families after it is organized in the recycling system of farming.**

### **The Retiree Farm**

**Many Filipinos, while gainfully employed, invest their savings in the acquisition of farms where they expect to retire. With the Land Reform, however, the major portion of these farms are distributed to the tenants and only seven hectares are left with the owner. The recycling system of farming makes the operation of seven hectares challenging enough to make life interesting without overworking the retiree.**

**He can grow irrigated rice continuously throughout the year on 5.5 hectares and one crop of corn and two crops of rice on one-half hectare. He can plant ipil-ipil along the boundaries and on the wasteland, and build a 200 sq. m. fishpond. He can raise 18 heads of cattle and one sow unit. He can establish biogas works using the animal manure.**

**The farm area may be allocated as follows:**

- 0.17 hectare for home lot of retiree and his farm helpers**
- 5.50 hectare for rice fields (continuous cropping)**
- 0.50 hectare for one crop corn and two crops rice**
- 0.04 hectare for livestock shed and the biogas works**
- 0.02 hectare for fishponds**
- 0.60 hectare for ipil-ipil grown along boundaries and wasteland**
- 0.17 hectare for roads and canals**

**With a good irrigation system, the 5.5 hectares can be planted to nonseasonal varieties of rice to get three crops per year. One-half hectare will be planted to one crop corn and two crops of rice. The yield should be around 100 cavans per hectare or 85.7 tons of palay for the six hectares, and 1.5 tons of corn. The fertilizer will come from the biogas works, compost and ash from empty rice grains.**

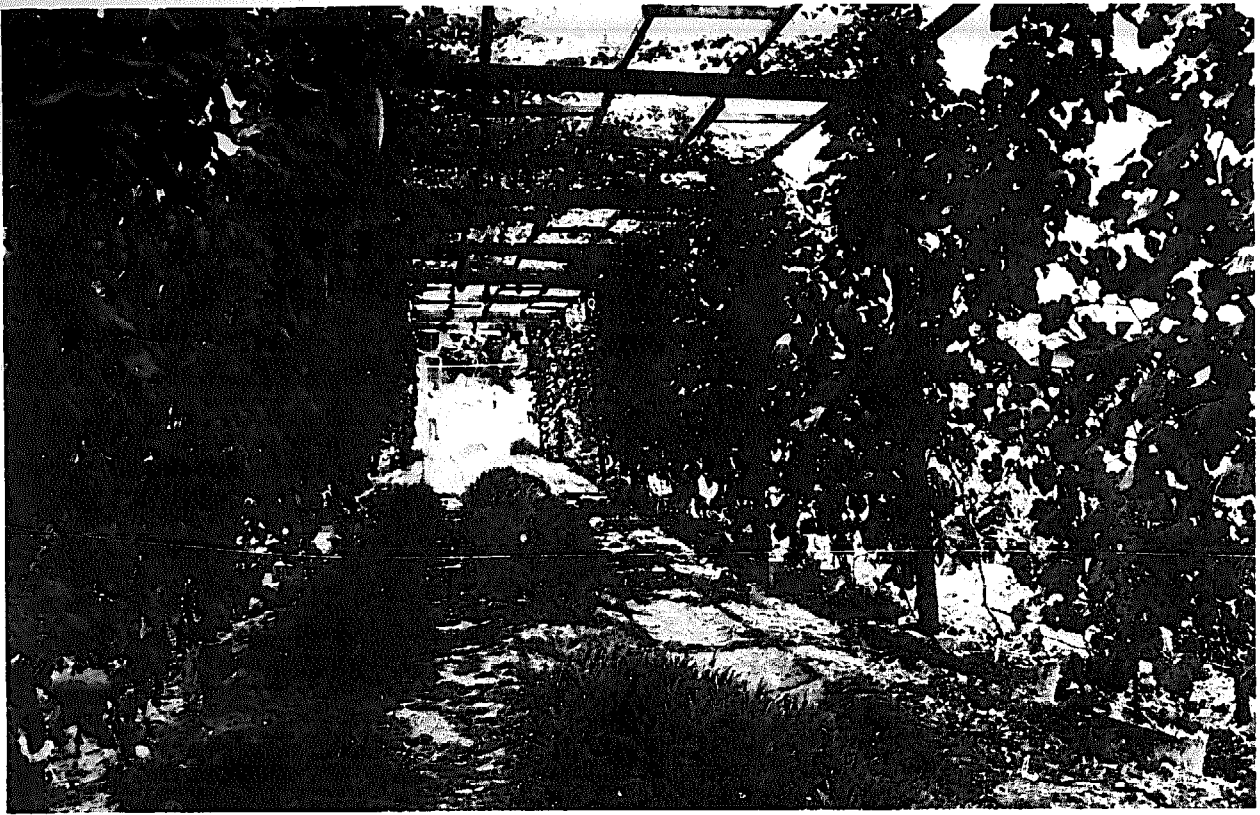
**The eighteen heads of cattle (one bull and 17 cows) will feed on the crop residues, weeds and ipil-ipil leaves. The finishing steers can be given feed concentrates consisting of sludge, rice bran and salt. The pigs will be fed with kitchen slops, corn, rice bran, sludge and ipil-ipil leaves.**

**Part of the biofertilizer from the biogas works will be used in the fishpond to grow plankton to feed the fish. The 200 sq.m. fishpond should be 1.5 m. deep.**

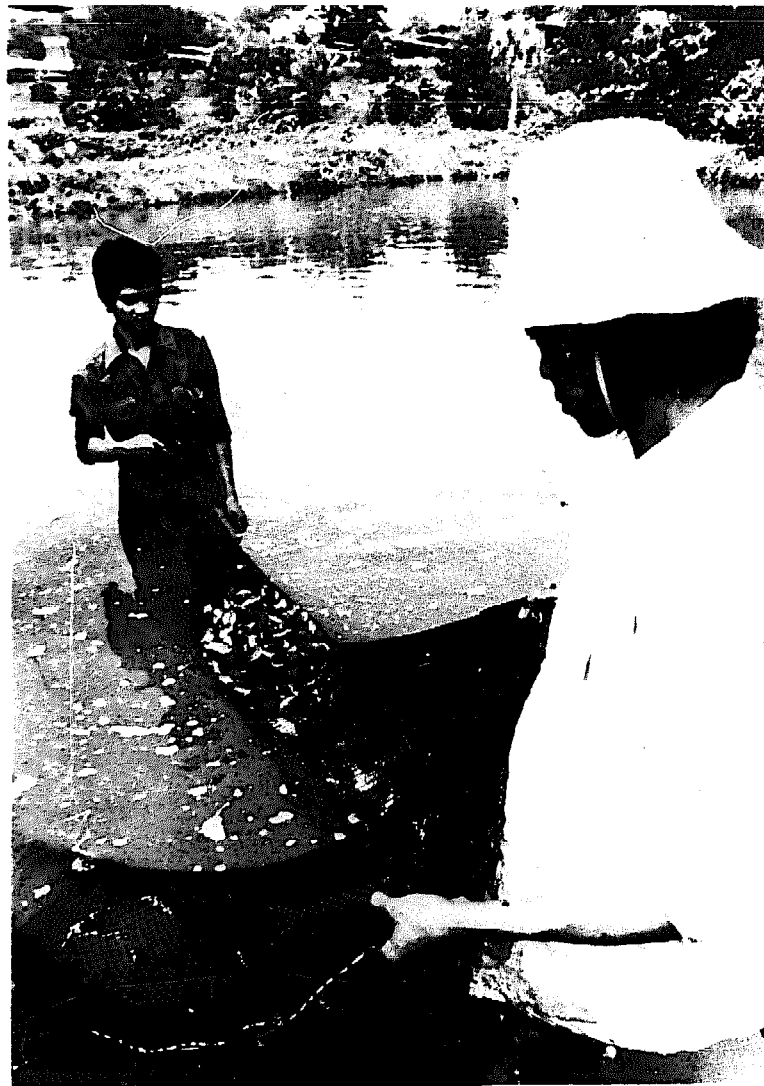
**The cattle and pigs will produce about 285 kg. of manure each day. When used in the biogas works, the manure should produce 300 to 350 cu.ft. of biogas, 25 to 30 kg. of dry sludge for feeds and around 20 cu. ft. of biofertilizer per day. The biogas works will cost around P8000. The biogas will be sufficient for cooking the meals, ironing clothes, running a refrigerator and running a 1.5 kva electric generator 5 hours a day for pumping water, for lighting, radio and television.**

**His income from the sales of the rice will more than cover the operating expenses of the farm and the cost of all the comforts in life he has been accustomed to as a well-paid executive.**





**Illustration 4-2: Biofertilized vegetables on trellis at Maya Farms.**



**Illustration 4-3: Harvesting tilapia at Maya Farms.**



**Illustration 4-4: Flaponds and crop fields utilize the liquid sludge as fertilizer-irrigation water.**

### Rural Development Through Waste Recycling

Life in the rural areas does not have much attraction particularly for the more talented and ambitious youth because of lack of opportunities for advancement as well as facilities for the amenities of life. A young man goes to the city in search of a better paying job. If he succeeds, he stays in the city for good. If he fails, he stays anyway because he will not admit failure and lose face among his old friends. Thus city slums get more and more crowded while the countryside loses its more enterprising members. This is unfortunate. Since most of the food is produced in the countryside, it would mean that food production would be in the hands of the less progressive.

Realizing this, many countries have started programs of rural development to induce the people to remain in the farms by dispersal of industries, but to do this there must be available cheap power. Rural electrification has been started but has suffered setbacks because such progress depends mainly on petroleum oil which is now in short supply and has gone up in price. Rural areas, being farthest from the source of supply with poor transportation facilities and least able to afford it, will also be the most hard hit whenever shortages occur or prices rise. Alternatives are the hydro power and geothermal power. These will take long to develop and would require a big outlay of capital mostly in terms of foreign exchange which we are short of. Besides, the rural areas will still have to compete with the urban areas for the energy supply, and as has been experienced, the urbanites have a louder voice and would get the limited supply.

Rural development should be reoriented toward energy that may be derived from within the rural areas. It should require a small outlay of capital and be managed and operated by the people in the area. The ready answer is the farm wastes. The biogas supplemented by rice hull, energy plantation, wind power, waterfall and water flow and solar heat would be the best sources of power in the rural areas. The raw materials are in abundance and are nondepletable. Biogas plants can be built to suit practically any desired situation and capacity. The installation and operation require only intermediate technology using locally available materials. With the electricity generated locally, there will be no need of high-tension wires and step-down transformers. It can be managed and operated easily by the people in the locality.

#### Biogas Works

The livestock farms need only 40% of the biogas that can be produced from their manure. There are many such farms in the rural areas and many more are being established every year because of the increasing demand for meat due to the increasing population and the nutrition-consciousness of the people. The excess biogas from such farms can be tapped for use in the rural areas.

**The Midden Shed** - A biogas plant can be integrated with a midden shed for a community schoolhouse. A midden shed accommodating around 400 persons a day can provide

sufficient material to produce 400 cu. ft. of biogas per day. The gas can be used for cooking in the home economics class as well as for pumping the water requirements of the school and the midden shed.

For sanitation purposes, the horizontal, three-chamber biogas plant should be used. The first two chambers where biogas is collected are leak proof and airtight while the third serves as the leaching chamber. The remaining solids can be removed by sanitary excavators when the leaching chamber gets full after some years of service.

**A Cooperative System** - Some communities have quite a number of big and small poultry raisers in fairly close proximity to one another. These poultry raisers can establish cooperative biogas works to process the poultry manure which can be collected daily as raw material for the biogas plant. The biogas produced should be sufficient to provide their energy requirements for lighting, poultry brooding and water pumping. The sludge can be sold to fishpond owners as fertilizers or it can be processed to recover the solids for feed material.

The following study shows how the biogas from the manure of around 168,000 birds can supply the energy needs of 50 families together with their poultry operations.

**Bird-raising capabilities according to social standing of 50 families –**

Above average:	5 families × 12,800 birds =	64,000 birds
Average:	20 families × 3,200 birds =	64,000 birds
Below average:	25 families × 1,600 birds =	40,000 birds
		168,000 birds

**Biogas potential from manure of 168,000 birds = 9,000 cu. ft./day.**

**Electrical Requirements –**

	<b>Residence</b>	<b>Poultry</b>	<b>Total</b>
5 families:	300 watts × 5 +	1,280 watts × 5 =	7,900 watts
20 families:	150 watts × 20 +	320 watts × 20 =	9,400 watts
25 families:	80 watts × 25 +	160 watts × 25 =	6,000 watts
			23,300 watts

**Biogas Consumption –**

30 kva Electric generator running  
 12 hrs./day =  $40 \times 15 \times 12 =$  7,200 cu. ft./day

Water pump for community  
 =  $20 \times 15 \times 6 =$  1,800 cu. ft./day  
 9,000 cu. ft./day

**Rural Electrification** - The biogas potential from the manure in livestock farms is far in excess of the energy requirements for the operation of the farm. It will not be difficult to make arrangements with a livestock farm to establish a biogas plant so that the biogas can be used to run an electric generator to supply the power requirements of the farm and a nearby community. The farm can put up a sludge-conditioning plant to process the solids into feed materials.

**The following study shows how the electrical requirements of a 200-family barrio can be generated from a piggery with 500 sow units or approximately 5,000 pigs:**

**Piggery with 500 sow units produces around 7.5 tons manure/day.  
Potential biogas production = 15,000 cu. ft./day.**

**Piggery Biogas Requirement –**

Deepwell pump 20 HP × 15 × 6 hrs. =	1,800 cu. ft./day
Generator for light and pig brooders	
10 × 15 × 12 hrs. =	1,800 cu. ft./day
Feed mill, 20 HP × 15 × 9 hrs. =	<u>2,700 cu. ft./day</u>
	<b>6,300 cu. ft./day</b>

**Barrio with 200 families –**

**Electrical requirements according to social standing –**

Above average:	20 families × 300 watts =	6,000 watts
Average:	80 families × 150 watts =	12,000 watts
Below average:	100 families × 80 watts =	<u>8,000 watts</u>
		<b>26,000 watts</b>

**Biogas consumption of a 35 kva electric generator**

running 12 hrs./day =  $45 \times 15 \times 12 =$  **8,100 cu. ft.**

An equitable sharing of costs by the farmer and the electric plant operator is suggested. The cost of building the electric plant shall be shouldered by the electric plant operator while the farmer shall pay for the cost of constructing the sludge-conditioning plant. The cost of the biogas plant shall be shared 40% by the farmer and 60% by the operator. The digesters and a gasholder shall be located in the farmer's premises and another gasholder shall be located in the electric plant premises. The operation of all the equipment shall be undertaken by the respective owner of the premises where they are located. The farmer shall keep 40% of the biogas produced and all the sludge. The electric plant operator shall be entitled to 60% of the biogas.

**The Municipal Slaughterhouse -** The slaughterhouse in a provincial town usually constitutes a source of unsanitary conditions and pollution. It is normally located within the poblacion, and disposal of the manure and slaughterhouse wastes is always a problem. The biogas works can easily solve this problem and at the same time produce enough fuel for lighting and for heating the scalding vats in the slaughterhouse.

For instance, a small slaughterhouse may butcher 10 pigs and 2 large animals daily. The animals are brought in the afternoon for slaughtering early in the following morning. The manure collected in the stockyard and the contents of the stomach and entrails would be around 200 kg. daily. These would be sufficient to produce about 400 cu. ft. of biogas and 20 cu. ft. of sludge per day.

**The biogas can be used as follows:**

Lighting 3 gas mantle lamps	4 hrs./day	30 cu. ft.
Heating of scalding vat	4 hrs./day	220 cu. ft.
Pumping water	3 hrs./day	150 cu. ft.

The sludge which is a good organic fertilizer and soil conditioner can be given to interested farmers in the community. The sludge is sufficient to fertilize 20 hectares planted to two crops per year.

**Dispersal of Agro-industrial Operation** - At present, livestock is raised in the farm. The live animals are then shipped to the cities for processing. According to experience these transported animals lose about 5% of their live weight during travel per 100 kilometers. Added to this loss is the cost of transportation and the profit of the middlemen. Then the processed meat is transported to the provincial towns, very often in refrigerated trucks. This raises the price of the processed meat beyond the paying ability of a large segment of the population. By processing the meat near the consumers, the price would be reduced to meet the purchasing power of more people.

The following study shows the biogas works and recycling in an integrated piggery and meat processing operation with a capacity of 10 porkers per day:

**Piggery** - with 250 sow units or approximately 2,500 pigs, produces 3.5 to 4 tons of fresh manure per day

**Biogas works** - disposes of the manure as raw material to produce 7,500 cu. ft. of biogas per day, 400 kg. feed materials per day and 11,000 liters of liquid biofertilizer

**Slaughterhouse** - slaughters 10 porkers from the piggery every day

**Rendering plant** - converts the meat scraps, bones and blood from the slaughterhouse and meat processing plant into meat and bone meal and blood meal

**Feed mixing plant** - mixes the meat and bone meal, blood meal and the feed material from the biogas works together with corn and other ingredients to meet the feed requirement of the piggery

**Meat processing plant** - produces ham, bacon, meat loaves and sausages

**Biogas utilization per day –**

Electric generator, 10 × 15 × 6	= 900 cu. ft. for lighting and heating the pig brooders
Deep well pump, 10 × 15 × 8	= 1200 cu. ft. for the water requirements of the integrated operation
Slaughterhouse	= 200 cu. ft. for heating water in the scalding tank
Rendering plant	= 1000 cu. ft. for cooking the blood and drying the cooked blood, bones and meat scraps
Feed mixing plant, 20 × 15 × 9	= 2700 cu. ft. to run the corn grinder and feed mixers
Meat processing plant	= 1500 cu. ft. to heat the cooking tanks

## **Supplementary Sources of Energy**

There are wastes that cannot be used as feeds nor as raw materials for the biogas plant. These could substantially supplement the biogas to make the rural areas self-sufficient in energy. There is more than enough sunshine needed to grow and dry the crops. The wind is strong enough to run windmills in most areas. There are lands too steep to grow crops but where ipil-ipil may be planted. There is an abundance of rice hull in rice farms which is only a nuisance and is costly to dispose of. Very often there are waterfalls that may be harnessed. All these may be used as supplementary sources of energy.

**Rice Hull** - Rice hull is best-suited for the rice farm. It can be used to fire steam boilers and palay driers. The steam would run a steam engine that would turn a line shaft that will run the different equipment for threshing and milling as well as a small electric plant to light the rice mill. The drying and milling will be in operation for 24 hours. Threshing will be done only during the day while at night the electric generator would be in operation. It was found at the Bigol Farm in Pangasinan that if a rice mill operates 24 hours per day and stops only on weekends, the empty grains recovered during threshing of palay and the rice hull recovered from the milling of the same palay will be sufficient to thresh, dry and mill the same palay.

The ashes from the burnt rice hull are used as potash fertilizer, as soil conditioner and as filling material.

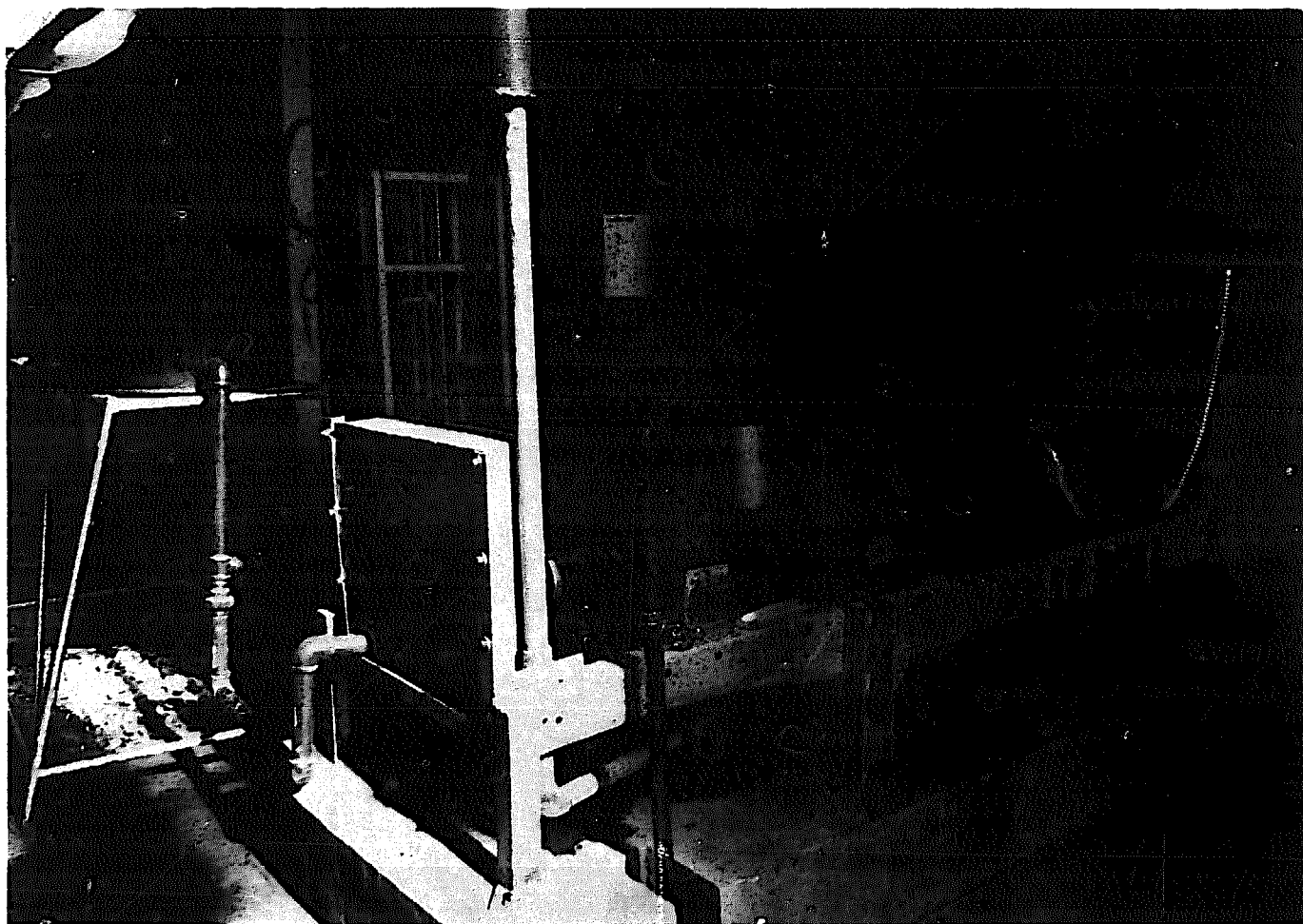
**Energy Plantation** - By energy plantation is meant the growth of trees for use as fuel. There are many steep hillsides in the rural areas which are unfit for cropping. These areas are well suited to grow ipil-ipil which grows fast and is easy to propagate. Three years after planting, the trunks may be made into charcoal to be used as raw materials to produce producer gas which may be used to run gas engine to pump irrigation water, and/or electric plants. It was found during the Japanese occupation that one liter of gasoline is equal to 1.5 kg. of coconut shell charcoal or 1.65 kg. of ipil-ipil charcoal. Charcoal can also run tractors, trucks, and cars. Ipil-ipil leaves are good feed material high in protein and rich in vitamin A. They are also used as nitrogen fertilizer. In making charcoal, the waste heat can be used for any drying operation.

**Wind Power** - The movement of the air caused mainly by unequal temperature in different areas often carries sufficient force which can be converted to mechanical power through the use of a windmill. Wherever the wind blows over 10 km./hr., it is worth installing a windmill. Any place except those by the side of a hill can have this much velocity. The windmill is most efficient when used as mechanical power as in pumping water for home consumption and replenishing water in the fishponds. Because of the intermittent blowing of the wind, large storage tanks would be required. Another proven service of the windmill is to run a small electric plant. Due to the intermittent breeze, however, it would be necessary to store the electric energy in storage batteries.

**Solar Power** - Most often, crops and feed material are spread under the sun to dry but during the rainy season, a shed with plastic roofing would be required. There are now in the market various equipment utilizing solar energy for heating water for home use. Solar energy can also be used for generating electricity as well as for refrigeration but the equipment needed for this purpose is too costly for use in rural areas.

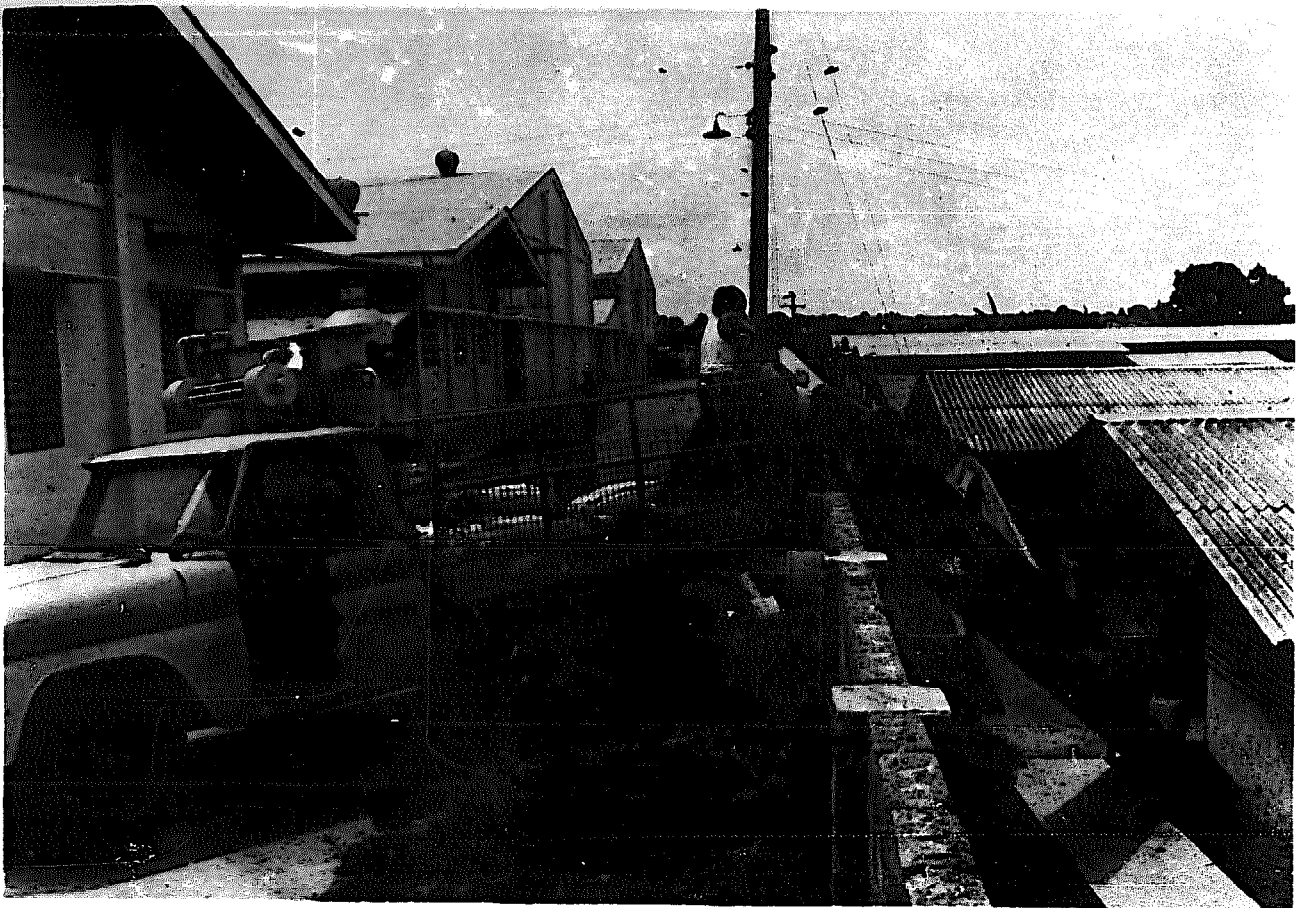
**Water Power** - The many waterfalls are another source of power. Waterwheels are very popular in Pangasinan for irrigating dry land crops such as vegetables, betel leaf and the like. During the dry season, a makeshift low dam is used to concentrate the water into a narrow channel. A waterwheel is made of bamboo and is built with a diameter such that the upper rim is slightly higher than the land to be irrigated. The flow of the water turns the waterwheel and, at the same time, the bamboo buckets scoop water. As the waterwheel turns, it lifts the water buckets, spilling their contents to a bamboo funnel with a thin iron sheet extension. The slanting funnel will allow the water to flow to the fields to be irrigated. During the rainy season, the waterwheel is dismantled and stored to be set up again when the dry season starts.

If there is a spring on a hillside or a river and the water may be made to flow in slopes of at least 30° below the horizontal, a hydraulic ram is a good means to get water supply. A hydraulic ram is a simple device which uses the power from falling water to force a small portion of the water to a height greater than the source. Any working fall from 2 to 100 ft. can be used. Commercial hydraulic rams are available, but they can also be made according to specification in any machine shop.

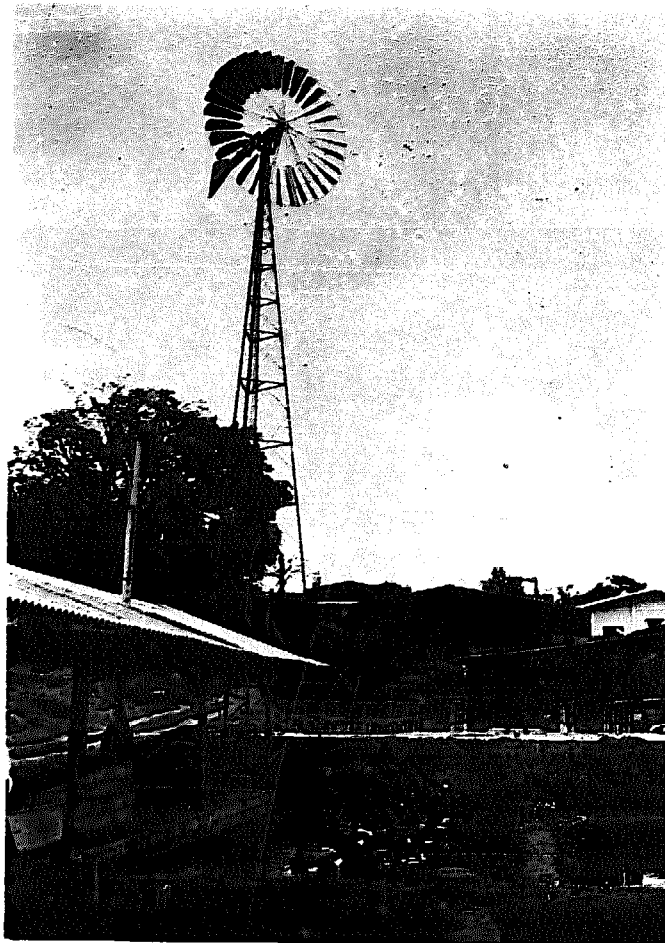


**Illustration 4-5: Biogas-powered 60 kva electric generator, Maya Farms**

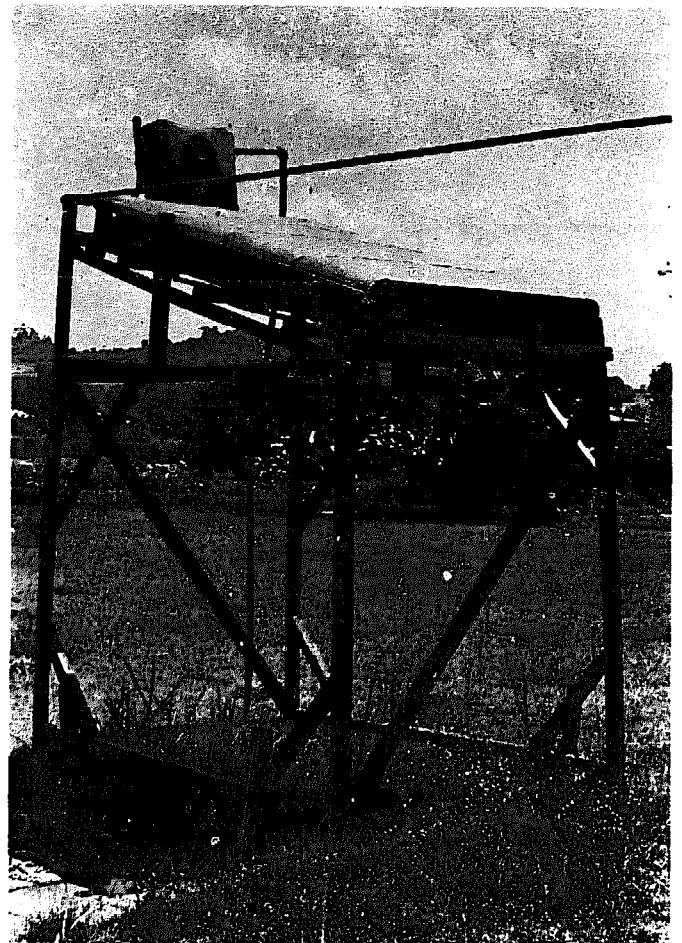




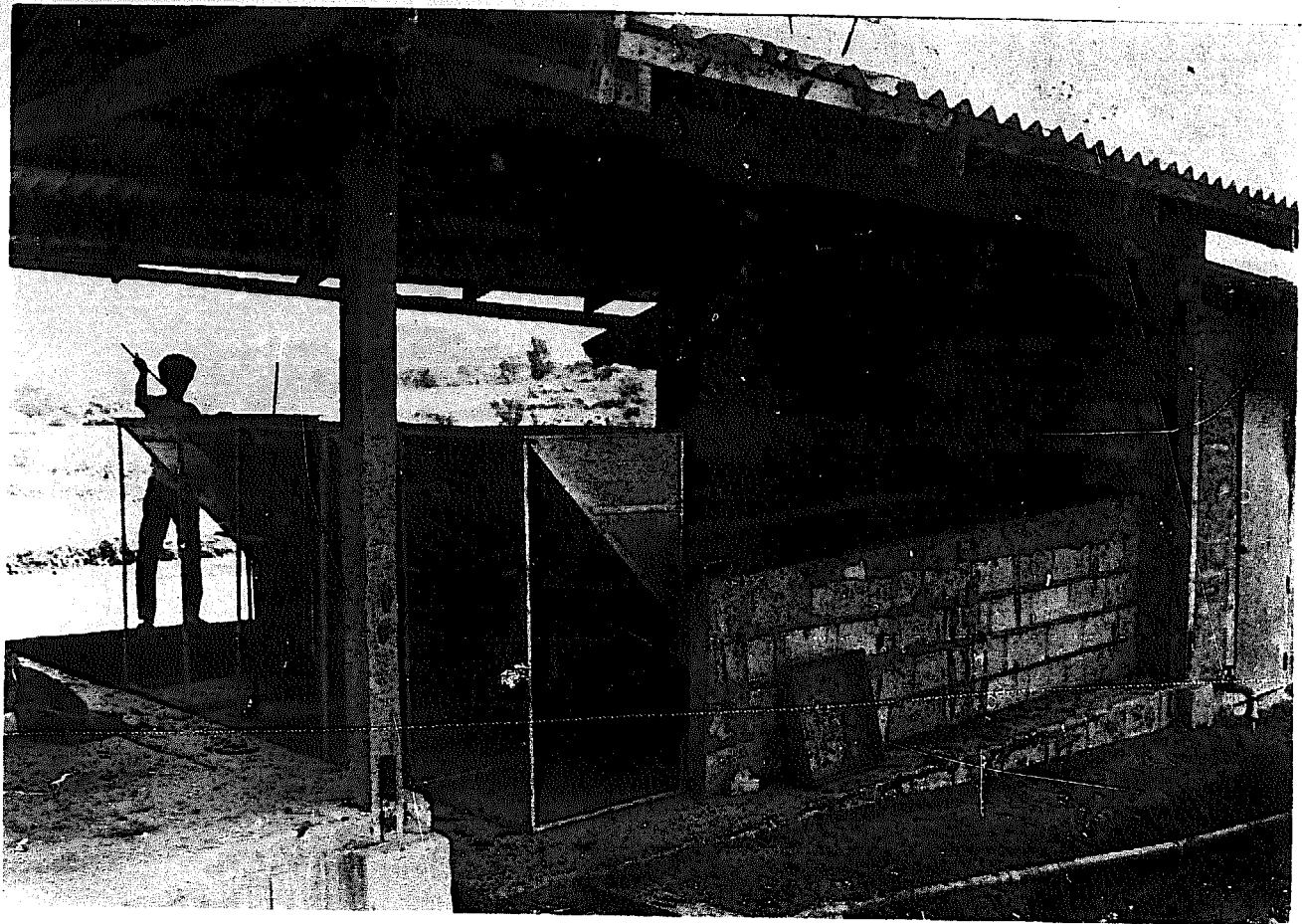
**Illustration 4-6: IPOPI charcoal-fed truck, Maya Farms**



**Illustration 4-7: Windmill**



**Illustration 4-8: Solar heater**



**Illustration 4-9: Rice hull firing chamber**

## Chapter XIX

### Biogas Works In Practice

The first known application of biogas (then known as methane gas) was in Exeter, England, when in response to the predictions of Pasteur that horse manure may be used to light the streets of Paris, a mantle lamp was lighted in a street. There was no attempt to prove economic feasibility, only to prove it could be done.

Europeans were the first to use anaerobic digestion in the control of pollution caused by sewage.

The Indians were the first to produce biogas (which they called gobar gas) as fuel to cook their meals. Their biogas plant consisted of a deep cylindrical open tank where a mixture of cow dung and water was placed, with a smaller steel tank placed upside down floating over the manure and water mixture. As a bonus, the residue (sludge) was used as fertilizer.

The Germans and French found biogas an effective measure in an emergency. In the latter part of World War II and immediately after, when oil was extremely scarce in Germany and France, biogas was used as fuel for their tractors and trucks in the farms. The sludge was used as fertilizer. The fact that they produced enough to eat proved the efficiency of biogas. However, as soon as they could get the oil, they abandoned biogas since oil as fuel is cheaper than biogas from waste. The main reason for the high cost of producing biogas in the temperate countries is the low temperature. The digesters have to be heated and this requires a sizable amount of energy.

The Chinese farmer is very fertilizer-conscious. He meticulously collects his manure and other crop residues which he composts to fertilize his crops. After learning that anaerobic digestion would avoid the losses of plant nutrients, which happens in aerobic digestion in composting, he adopted the biogas system. The mainland Chinese built biogas plants entirely of masonry because of the scarcity of steel; hence the fixed dome biogas plants. In Taiwan, the horizontal type digesters were developed to make bigger digesters without the necessity of digging very deep. Because they had access to steel, they used the floating gasholder dome.

Though to the Chinese the principal reason for the biogas plant is for fertilizer, they have found it profitable to use whatever gas they produce for cooking their meals and for lighting. No effort has been made to produce gas at a lower cost.

In Africa, biogas development was undertaken by the large livestock farmers to dispose of their large amounts of manure. With the biogas plant, they saved on labor in the loading and spreading of the manure in the fields. The biogas, a by-product, is used for fuel to run engines. The engine cooling water and the exhaust gas were used to heat the digester slurry.

The first large-scale industrial application of biogas started in the Philippines when the Maya Farms established biogas plants primarily to control the pollution from its integrated

hog farm, meat processing and canning operations. It was not until after the oil embargo in 1973 that experiments were conducted on the industrial use of biogas. Now biogas has replaced LPG for cooking and other direct heating requirements and it is used as fuel for internal combustion engines that run the deepwell pumps, feed-mixing machinery and electric generators.

To avoid water pollution from the large amounts of sludge issuing from the biogas plants, Maya Farms has developed a sludge-conditioning system wherein the solids are recovered from the sludge and processed into feed materials while the remaining liquid is aerated and aged in a series of lagoons to improve its fertilizer value.

Individual biogas practitioners are found all over the world today -- in Europe, Russia, U. S. A., Australia, Africa, but it is in the Asian countries that the urgency of developing biogas plants is most greatly appreciated. Both the government and private sectors in most Asian countries are involved in research, development and promotion of biogas plants.

**India** - India has the most extensive program for biogas development. As of the first quarter of 1978, over 50,000 biogas plants have been established to produce biogas as fuel for domestic cooking and lighting. Some of the larger biogas operations use biogas to run diesel engines at a biogas-to-diesel fuel ratio of 85:15. The use of the sludge as fertilizer is increasing.

The Khadi and Village Industries Commission plays a key role in the promotion of biogas in India. The KVIC provides trained functionaries, detailed drawings, manuals and promotional materials. The KVIC design incorporates with the floating gasholder a device to stir the digester slurry and to break the scum. The design capacity is from 1.5 to 85 cu. m. biogas output per day. The retention time is 50 to 60 days, with cow dung (gobar) as main raw material.

The building of biogas plants is financed through loans from nationalized banks. The Ministry of Agriculture subsidizes 20 to 25% of the cost of construction. KVIC staff attend to services after erection and continually evaluate working plants.

**Korea** - In spite of its cold winters, Korea is reported to have around 27,000 small biogas plants (1976). The digester consists of a rectangular concrete tank built underground. The gasholder is made of PVC. Cattle or pig dung is used, with 20 days retention time.

Most digesters are not operated between December and March when the temperature goes as low as 17°C. The biogas serves only as a supplementary fuel for cooking and home heating since not enough gas is produced. The sludge is mixed with compost and used as a soil conditioner.

**China** - The reported number of biogas plants in the province of Szechuan alone as of 1975 was 200,000 family-size units. The charge consists of a mixture of urine, night soil and water. Decomposed vegetable matter is also added. Lime or grass ash is used to maintain the pH of the slurry at around 7.8.

The sludge is taken off from the middle of the digester to allow pathogens to settle and remain at the bottom. The fixed-dome biogas plant is cleaned out once a year. Although the main interest is in the sludge as fertilizer, the biogas is also used in cooking and lighting.

**Taiwan** - Taiwan farmers use the double-walled digester with the integrated floating gasholder dipping in the water seal. The commonly used raw material is hog manure. As in China, the sludge is used as fertilizer and the biogas comes as a bonus fuel for cooking and lighting.

**Japan** - Anaerobic digesters were used to treat distillery wastes but this has been discontinued because the treatment was not effective in removing the brown color pollutant in the wastes. Research is now directed at pollution control of livestock and urban wastes. Experiments include mesophilic and thermophilic processes, with 25 days retention for the mesophilic and 7 days retention time for thermophilic digestion.

**Pakistan** - In Pakistan, the Chinese design with a fixed-dome gasholder is preferred because of low winter temperatures and high steel costs. The government attempt of subsidizing the construction of biogas plants has reportedly not come up to expectations, but those built by private practitioners without subsidy are generally well maintained.

**Thailand** - The emphasis on biogas operations in Thailand is on sanitation. The Health Department is responsible for its promotion in coordination with the Rural Development Department to control disease carriers such as fruit flies and house flies. Because of the high costs of construction, the present biogas practitioners in Thailand are the relatively rich farmers.

**Nepal** - In order to overcome the high water table in the Nepal plains the vertical type biogas plant is used with a taper modification. Instead of digging deep, the lower portion of the digester is made with a bigger diameter than the upper portion.

The main raw material is cattle dung. However, a plan to put up a cheese plant includes a biogas plant using pig manure to produce fuel for the cheese-making operation. The waste products from the cheese plant will be utilized as feed for the pigs.

**Indonesia, Bangladesh, Sri Lanka** - Biogas is still in the early development stage in Indonesia, Bangladesh, and Sri Lanka. In Indonesia, biogas cannot compete as fuel with the highly subsidized kerosene. The main interest is in hygiene and sanitation. Bangladesh and Sri Lanka are interested in biogas as an alternative source of energy but are still working on the economic feasibility of the biogas operation.

**Singapore** - Biogas is produced by anaerobic digestion of the sludge in both of Singapore's main sewage treatment works. The 8,000 cu. m. of biogas produced per day is used in dual fuel engines to generate electricity for the plant operation and lighting. The water used to cool the engines is circulated through heat exchangers in the digesters.

**Philippines** - The government entities promoting biogas development in the Philippines are the National Institute of Science and Technology and the Bureau of Animal Industry. The NIST does research, prepares bacteria cultures to serve as starters and provides technical assistance. The Bureau of Animal Industry was instructed by President Marcos in 1976 to install demonstration plants in its breeding stations all over the country -- one biogas plant in each of the 12 regions within 6 months; one in every province within one year; and then one in every locality where it has a breeding station. The BAI has performed well ahead of schedule.

The Philippines has not adopted a standard design for biogas plants. However, most digesters are shallow, either single chamber with square cross section or double chamber with rectangular cross section. The floating gasholders integrated over the digester have a square cross section. The larger biogas plants have the gasholders floating over water tanks separate from the digester. The commonly used raw material is pig manure.

The uses of the biogas plants in the Philippines are as varied as the designs. The following are a sampling of biogas operations, including biogas works in a dormitory, a backyard piggery, an orchard, a slaughterhouse, poultry and livestock farms, demonstration projects and in a private agro-industrial enterprise.

**The Liberty Foundation Dormitory** - The dormitory built by the Liberty Foundation for the workers at Maya Farms has night soil biogas works instead of a septic tank to dispose of the sewage. The 80-100 residents use the biogas for cooking their meals and ironing their clothes. Not enough biogas is produced for lighting. For this purpose, biogas from another installation is utilized to run an electric generator in the evening.

The biogas plant has three chambers. The night soil and flush water drain into the first chamber. Hog manure was used to help start the biogas works and from time to time hog manure is added to supplement the biogas production. The slurry flows from the first chamber to the second, then to the third chamber. The biogas generated in the first and second chambers goes to a separate water-sealed floating gasholder. The domestic wash water joins the slurry in the third chamber which has a porous bottom to allow leaching. Excess water from the leaching chamber goes to the leaching pipes. The accumulated sludge in this chamber is periodically removed by a sanitary excavator in the same way as in a septic tank.

**The Backyard Piggery in Muñoz** - Mr. Alejandro Judan, Sr., a farmer-businessman in Muñoz, Nueva Ecija, raises pigs in his backyard. Bothered by the smell and the flies attracted by the pig manure, he decided to put up biogas works. It consists of an integrated vertical continuous-fed biogas plant and a single sludge-conditioning pond. The biogas is used for cooking meals and ironing clothes. The sludge is used to fertilize his rice fields and fishponds.

Mr. Judan solved the pollution problem in his backyard, but since his next-door neighbor also raises pigs, his plans include letting his neighbor direct the pen washings to his biogas works which can still accommodate them, with a shorter retention time. With the extra biogas, he would be able to install an electric generator to run a water pump and to light both his home and his neighbor's.

**An Orchard in Sta. Barbara** - Ms. Manuela Maramba is a retired professional nutritionist of the U. N. Food and Agriculture Organization. An enthusiast for self-sufficiency and self-reliance, she has a fruit orchard, a vegetable garden, a nursery, a piggery and poultry in a small farm of about 1.6 hectares in Sta. Barbara, Pangasinan. Before she established her biogas works, she was already practising waste recycling. The manure from the poultry and piggery was used to fertilize the orchard and vegetable garden. The chickens were dressed in the farm, and the entrails together with chopped banana stalks and vegetable scraps were cooked and fed to the pigs.



When Ms. Maramba learned about biogas, she decided to establish biogas works to improve on her recycling scheme. All the manure now passes through the biogas works. The biogas is used for cooking the feed for the pigs, for cooking meals, ironing clothes, lighting and running a gas refrigerator and a water heater. The sludge was found to be a better fertilizer than the fresh manure for her orchard and vegetable garden.

Because the farm has a high water level, the biogas plant, Fig. 19-1, has been constructed partly above ground. It is an integrated, vertical, continuous-fed type designed to process the daily manure from 8 sows and 800 broilers at a retention time of 50 days. When the animal population was later increased to 16 sows and 1,600 broilers, the retention time was reduced to 25 days so that the same digester could handle all the manure. An auxiliary floating gasholder was constructed as a separate water-sealed unit to take care of the additional gas production. A fishpond was also built to be fertilized by some of the liquid sludge.

**Piggery in Calasiao** - Mr. Jose Parayno is a retired engineer and his wife is a retired school teacher. They operate a general store and a medium-sized piggery of about 300 pigs behind the store in the town of Calasiao, Pangasinan. Although the pig manure was hauled every day to their rice field some five kilometers away, their neighbors still complained of the foul odor from the piggery. Hearing about how biogas works controls pollution and improves sanitation, he visited Maya Farms and decided then and there to have one built in his piggery.

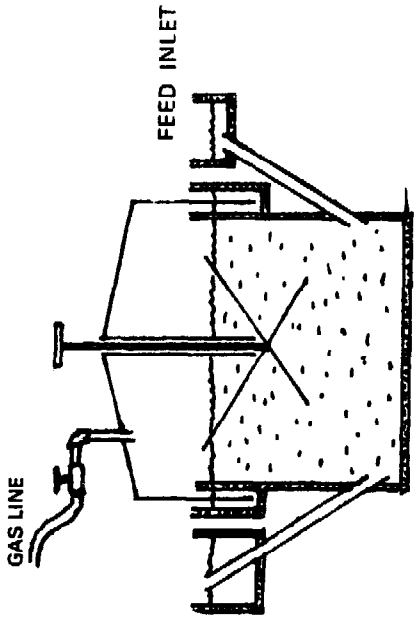
With the help of Maya Farms, he built an integrated, continuous-fed biogas plant. His digester is 8 feet deep with a 12-ft. square cross section. For sludge conditioning, he built a 5 ft. by 13 ft. by 3 ft.-deep decantation tank and sent the overflow to a nipa grove behind the piggery.

After the biogas plant went into operation, his neighbors stopped complaining. Now it is Mr. Parayno who complains because of too many visitors who come to see his biogas works every day. The biogas is used for cooking, ironing clothes and lighting the piggery.

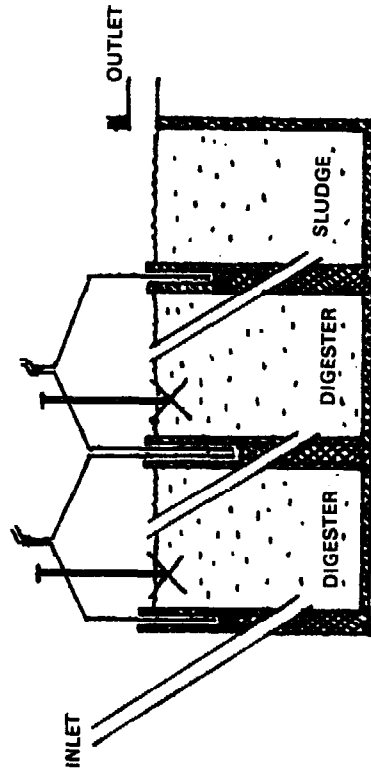
Mr. Parayno enjoys recounting what happened during the long dry summer in 1977 when the hydro-electric plant in Central Luzon could not generate enough power. He extended his biogas line to his general store and transferred some of the mantle lamps from his piggery. During the frequent brown-outs, he had the only brightly-lit store open in the area. This brought in a lot of customers.

He contemplates to install a 2.5 kva electric generator run by biogas. He still has enough biogas to run the generator 3 hours for pumping water and 12 hours for lighting his piggery, his home and his store.

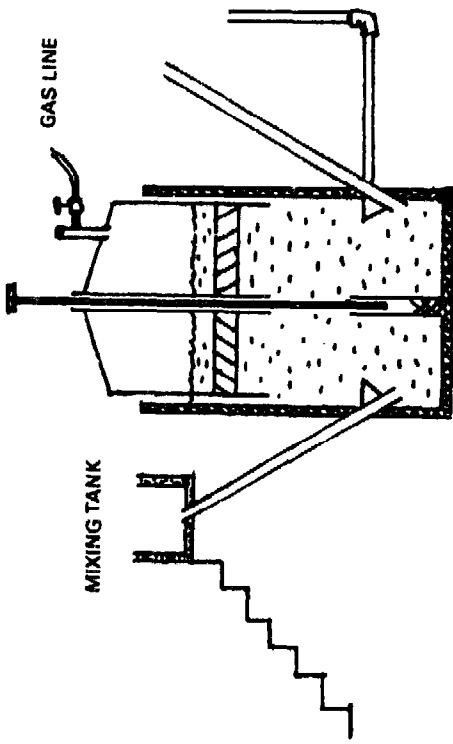
**The Slaughterhouse in San Juan** - The San Juan slaughterhouse in Metro Manila is beside a creek, near a residential area. It has holding pens for the pigs and large animals which are brought in the afternoon for slaughtering early the following day. The average number of animals butchered daily is 200 porkers and 30 large animals. The amount of manure from the holding pens plus the contents of the stomach and intestines would be approximately 3.5 tons per day. These manure can be used together with the wash water as raw materials in the biogas plant to produce around 7,000 cu. ft. of biogas per day.



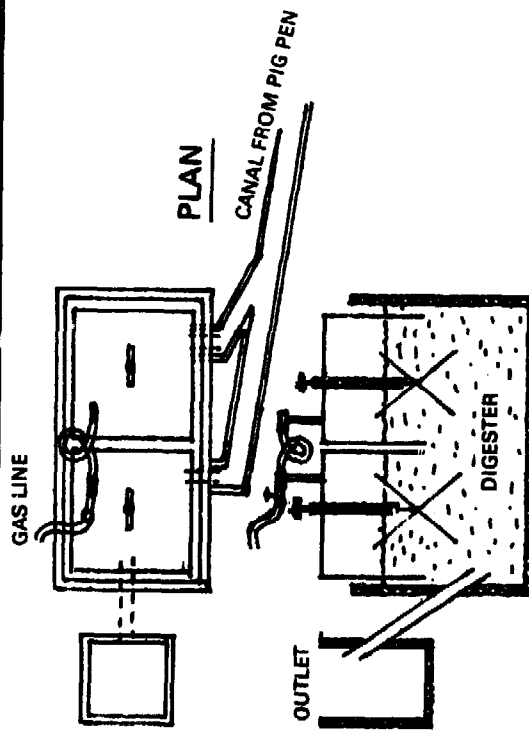
**FIG. 19-2**  
**BAI° BIOGAS PLANT**  
 \*BUREAU OF ANIMAL INDUSTRY



**FIG. 19-4**  
**UPCA° GAS DIGESTER**  
 \*UNIVERSITY OF THE PHILIPPINES,  
 COLLEGE OF AGRICULTURE



**FIG. 19-1**  
**STA. BARBARA BIOGAS PLANT**  
 (MAYA FARMS-INDIA)



**FIG. 19-3**  
**PAC° BIOGAS PLANT**  
 \*PAMPANGA AGRICULTURAL COLLEGE



**BAI Stock Farm in Tarlac** - The biogas works in the breeding station of the Bureau of Animal Industry in Tarlac was established for demonstration purposes. The biogas plant (Fig. 19-2) is double-walled, single chamber, integrated and continuous-fed. The manure and urine in the pig pens are washed directly into the digester. The effluent sludge goes to an algae pond. Part of the liquid from the pond is used to fertilize a fishpond and the rest is used to fertilize a field planted to Napier grass for feeding the large animals in the stock farm.

The biogas produced, estimated at around 200 cu. ft. a day, is used in the office and in four family cottages for heating water and cooking.

**The Pampanga Agricultural College** - The biogas works at the Pampanga Agricultural College consists of a continuous-fed biogas plant and a sludge pond. The digester is single-walled, horizontal, with a rectangular plan (Fig. 19-3). There are two integrated gasholders floating side by side over the digester slurry. The manure and wash water from the pig pens flow through an open canal to the digester. Ten students quartered in two cottages near by use the biogas for cooking their meals. The students take turns in attending to the biogas plant operation. The sludge is used to fertilize the vegetable farm of the students.

**The UP College of Agriculture** - Dr. J. A. Eusebio runs a model recycling project at the University of the Philippines College of Agriculture at Los Baños, Laguna. The operation includes a piggery, a biogas plant, a fishpond and a chlorella pond. The manure and washwater from the pig pens go to the biogas digester. The effluent is used to fertilize the growth of algae in the fishpond. Chlorella, a high protein alga, is raised in a pond on top of the pig pens. The chlorella is used as a protein supplement replacing soybean meal in the pig rations.

The continuous-fed biogas digester (Fig. 19-4) has two chambers in series. Each chamber is integrated with a floating gasholder. The sides of the gasholders dip in the water seal between the double walling of the digester chamber.

**The Golden Farm in Sta. Maria** - The Golden Farm in Sta. Maria, Bulacan, has a piggery, poultry and a feedlot for fattening cattle. The manure from 360 pigs and the pen washings go to the biogas plant. The biogas is used as fuel for drying the collected chicken droppings which are then fed to the cattle. The solid sludge is recovered as feed material for the pigs. The remaining liquid is used as fertilizer for squash, ampalaya and calamansi plants.

The biogas plant has a Maya Farms-Taganas design digester, Fig. 7-26, and a separate floating dome gasholder, Fig. 7-28.

**The Poultry and Livestock Farm in San Pedro** - The expansion of the poultry and livestock farm of the Aries Agro-Development Corporation in San Pedro, Laguna, incorporated biogas works to control pollution and produce biogas as fuel for the energy requirements of the farm. The biogas plant has parallel continuous-fed digesters to handle 5 to 6 tons of chicken, pig and horse manure per day. The daily production capacity is 10,000 to 12,000 cu. ft. of biogas. The gas collected in a separate floating gasholder unit is for running a deepwell pump and an electric generator and for heating water in the chicken dressing plant.

**Integrated Meat Processing-Canning Enterprise in Angono, Rizal** - The operation of Maya Farms, the agro-industrial division of Liberty Flour Mills, Inc. is an offshoot of the

main by-product in flour milling. Since wheat pollard is a good feed material especially for pigs, Liberty Flour Mills went into feed mixing. Feed mixing led to hog raising which in turn led to slaughtering, meat processing and canning. Thus Maya Farms was born. The integrated hog farm-meat processing-canning operation is spread over 24 hectares on a gentle slope of the Antipolo Hills in the outskirts of Metro Manila.

The porkers raised in the farm are butchered in the slaughterhouse. The carcasses are cut up in the meat processing plant and the prime cuts are made into ham, bacon and other specialty products. The pork trimmings are used in hotdogs, meat loaves, canned sausages and canned viands. The canning plant also utilizes the ham bones in preparing the broth for the canned soup products. A substantial part of the vegetables needed in the canned soup production is likewise raised in the farm.

These operations produce a considerable amount of wastes. The 10,000 pigs in the hog farm produce about 15 tons of manure per day. Bones, meat scrap and blood come from the slaughterhouse and the meat processing plant. The canning plant garbage includes bones, meat scraps and vegetable wastes. Added to these are the daily pen washings from the hog farm and the industrial waste water from the processing plants. In order to control pollution and at the same time recover some value out of all these wastes, Maya Farms has adopted a total waste recycling program. The recycling operation includes the following:

1. rendering plant
2. biogas works
3. feed mixing plant.

In the rendering plant, the meat scraps, bones and blood are cooked or steamed under pressure, then dried and ground into meat meal, bone meal and blood meal. Tallow is recovered from the liquid residue in steaming. Meat meal and blood meal are good sources of protein for animal feeds while bone meal is a source of calcium and phosphorus. Tallow is high in energy value.

These feed ingredients are used in the feed mixing plant in preparing the hog feeds. Other by-products and recycled materials used in the feed mixing are the pollard from the flour mill and the dried sludge recovered in the biogas works. The feed mixing plant runs entirely on biogas from the biogas plants.

The biogas works, consisting of the biogas plant and sludge-conditioning plant, is the heart of the recycling system at Maya Farms. Before the biogas works was established, the people in the neighboring areas often complained about the smell and the pollution of the nearby creek. Now the biogas operation has eliminated the odor problem. And the neighbors, observing the fertile growth of the crops in the agro unit, come around to ask for some of the nutrient-rich water to be thrown their way.

Maya Farms has both the continuous-fed and batch-fed digesters, with a total capacity of 50,000 cu. ft. The water-sealed floating gasholders form separate units, with a combined storage capacity of 6,200 cu. ft. All the gasholders are interconnected by gas lines. The biogas production is about 30,000 cu. ft. per day. Under construction are additional continuous-fed digesters with a combined volume of 24,000 cu. ft. and gasholders with a total capacity of 8,000 cu. ft. to accommodate the expansion of the hog farm from 10,000

to 15,000 pigs. In the drawing board is another set of biogas works which will be established when the hog population is expected to reach 20,000 heads.

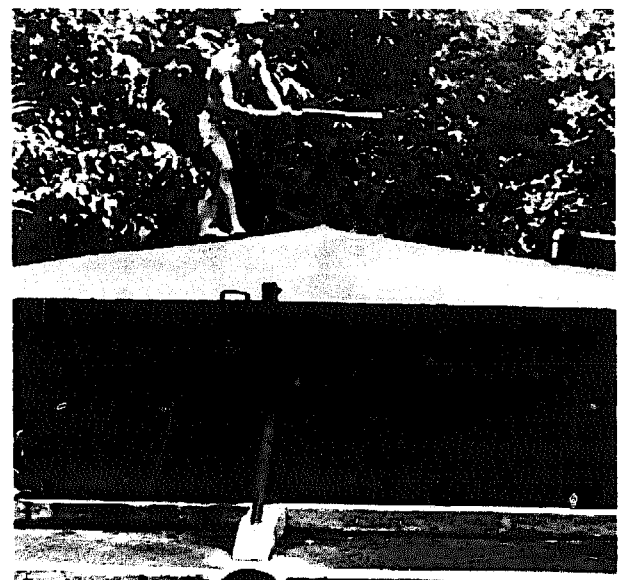
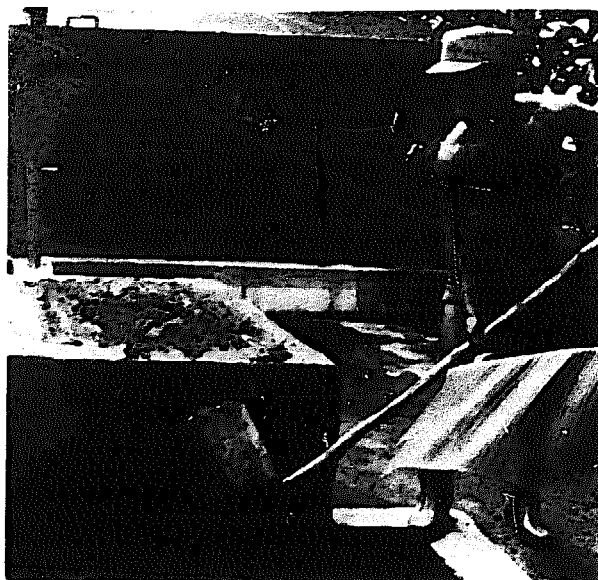
Biogas replaced LPG (liquefied petroleum gas) for all cooking operations in the rendering plant and canning plant. It has replaced steam for heating the scalding tank in the slaughterhouse and the cooking vats in the meat processing plant. It replaced the electric heaters in the drying rooms. Biogas runs the gas refrigerators and water heaters. It runs old converted gasoline engines to replace the electric motors running the two deepwell pumps in the farm. It runs other old gas engines to pump the manure slurry, and to provide power for the feed mills and corn grinder in the feed mixing plant. Biogas is used to generate electricity in the evenings to make use of the gas produced at night.

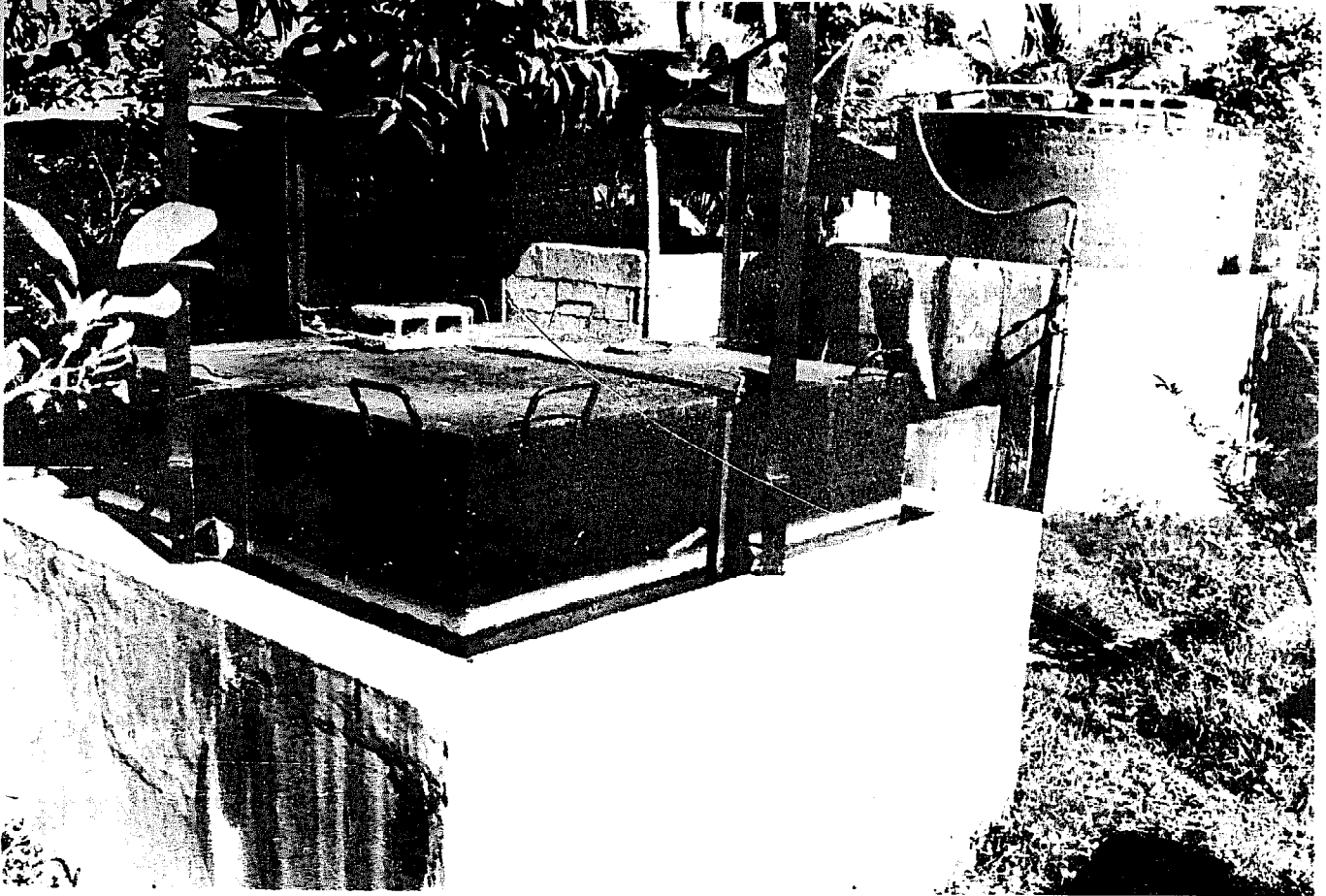
The manure slurry is retained in the biogas digesters for 30 days. After this period, the resulting sludge no longer attracts flies and any slight residual smell readily dissipates after exposure to air. This sludge undergoes conditioning by passing through settling basins and lagoons. The settled solids are recovered, dried and processed into feed materials. The liquid portion of the sludge is retained in a series of lagoons where it is mixed with some amount of washwater and the excess washings from the hog pens. A windmill is used to drive a waterwheel to help in aerating the liquid sludge. Aeration removes some toxic substances like hydrogen sulfide to improve the fertilizer value.

The agro unit was set up to utilize the nutrient-laden irrigation water issuing from the lagoons. Sweet corn and vegetables are grown to supply the requirements of the canning plant. During the rainy season, rice is planted in place of the corn and vegetables. The low areas have been converted to fishponds. The tilapia fish feed on the plankton growth promoted by the liquid fertilizer, supplemented by feed sweepings from the pig pens. The fishponds yield about 2 tons of *tilapia* per hectare per harvest (every three months).

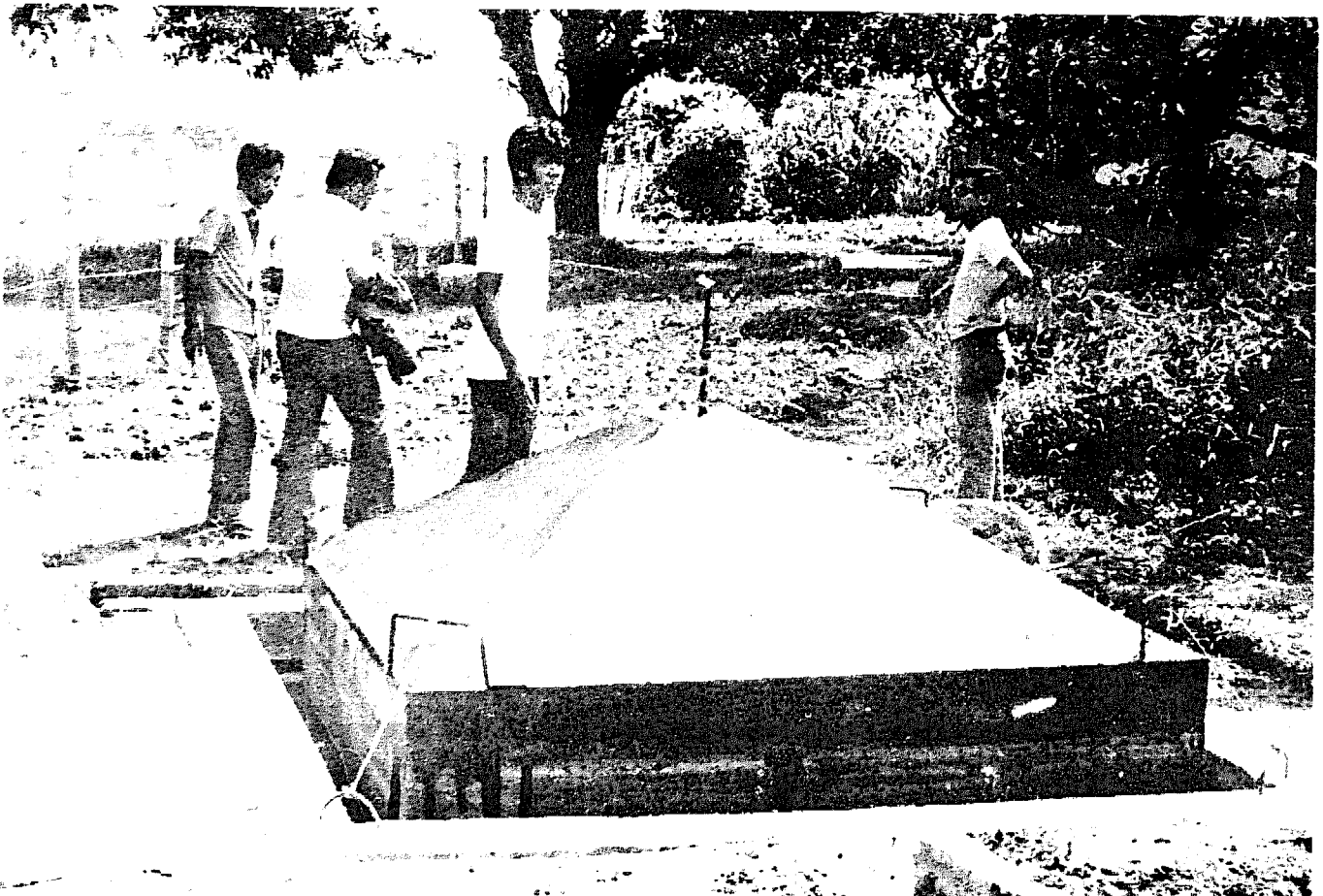
Maya Farms initiated its waste recycling program mainly for pollution control. Over seven hundred fifty thousand pesos have been spent in setting up the system. The material benefits and savings derived from waste recycling have now turned the operation into a profit booster. The savings in energy cost due to the use of biogas is about P10,000 per month. The value of the feed materials recovered from the sludge is more than P25,000 per month. In addition, there are the savings and extra income from the rendering plant and the agro unit.

**Illustration 4-10:** Biogas plant in Calasiao, Pangasinan





**Illustration 4-11: Sta. Barbara biogas works**



**Illustration 4-12: Biogas Plant at BAI breeding station**

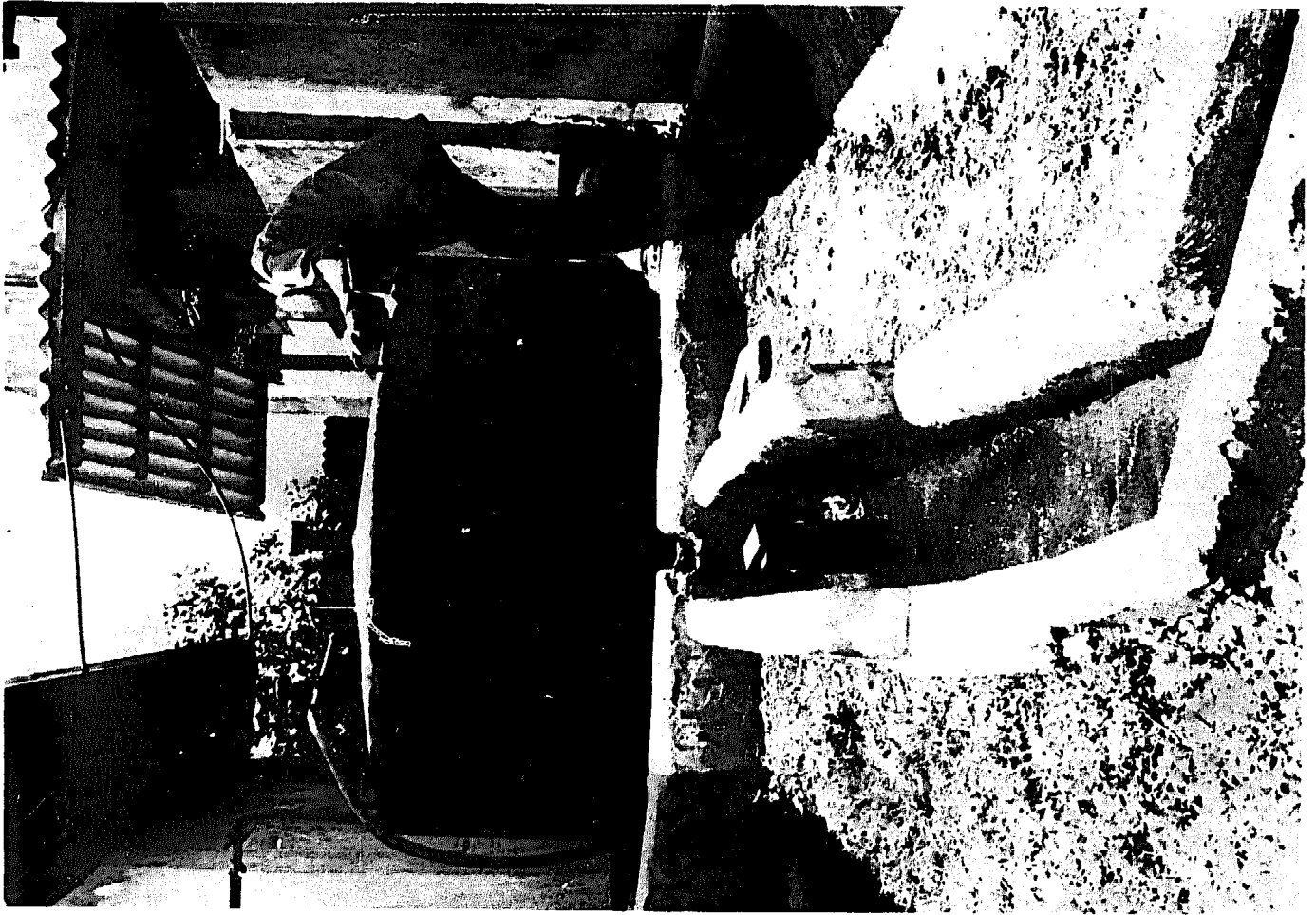


Illustration 4-14: India model

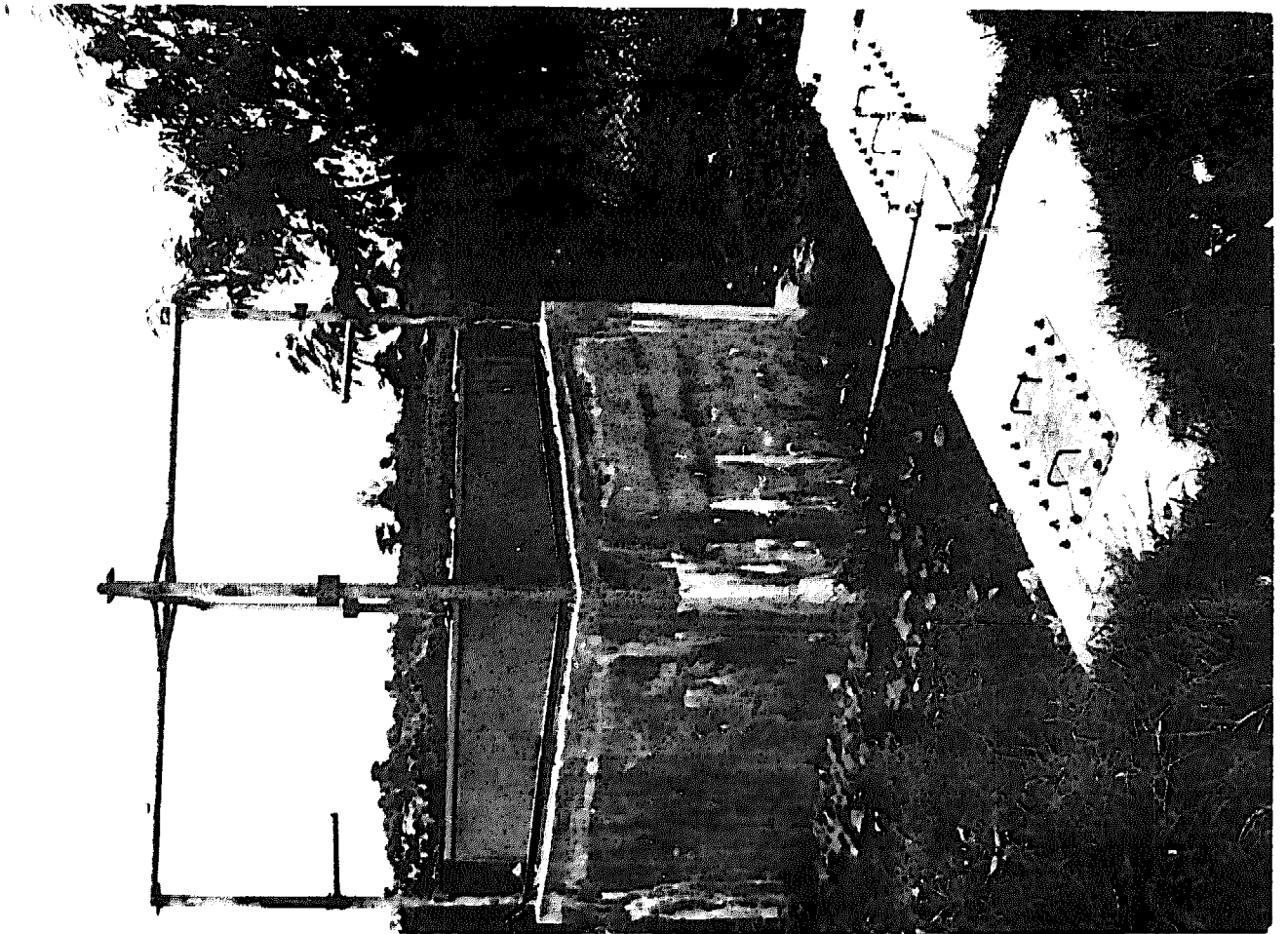
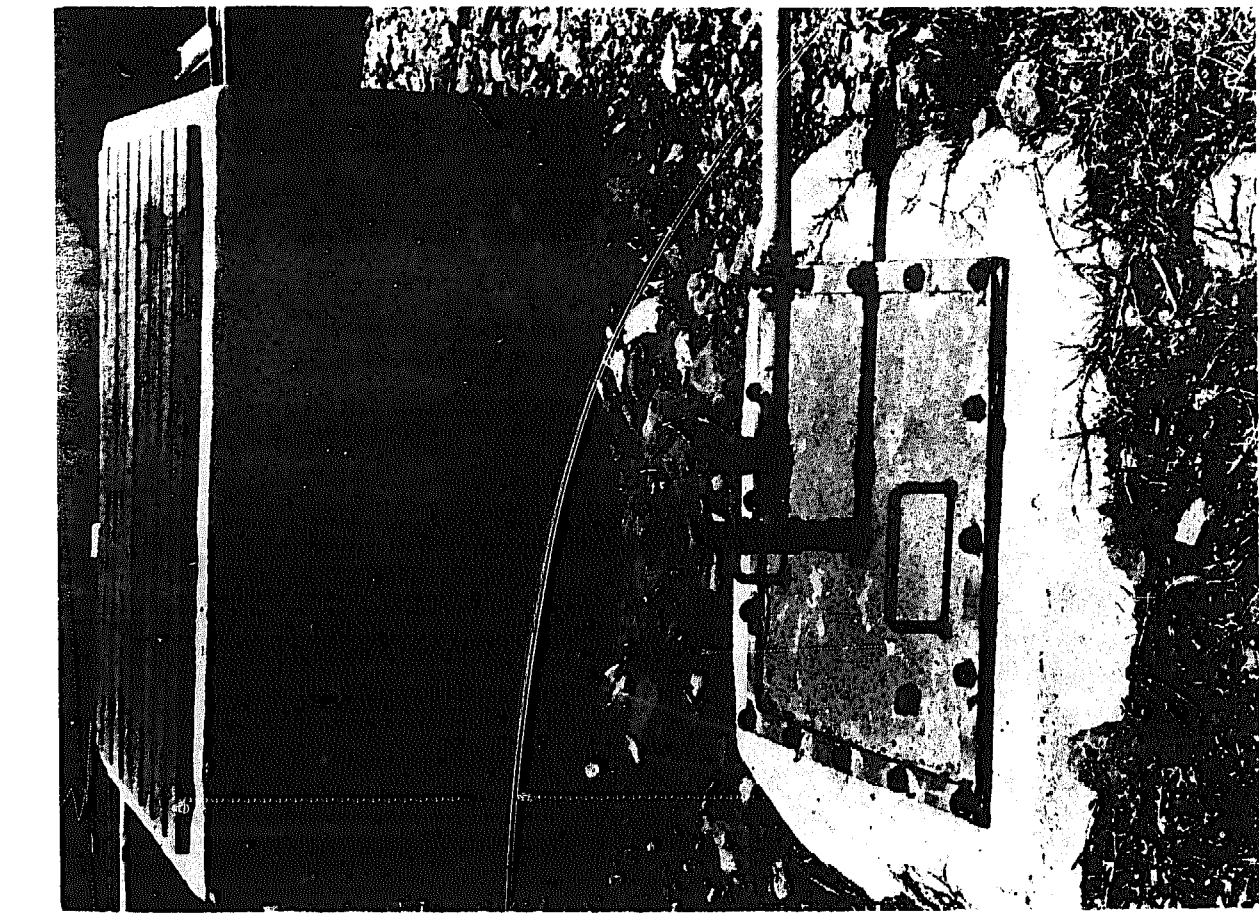
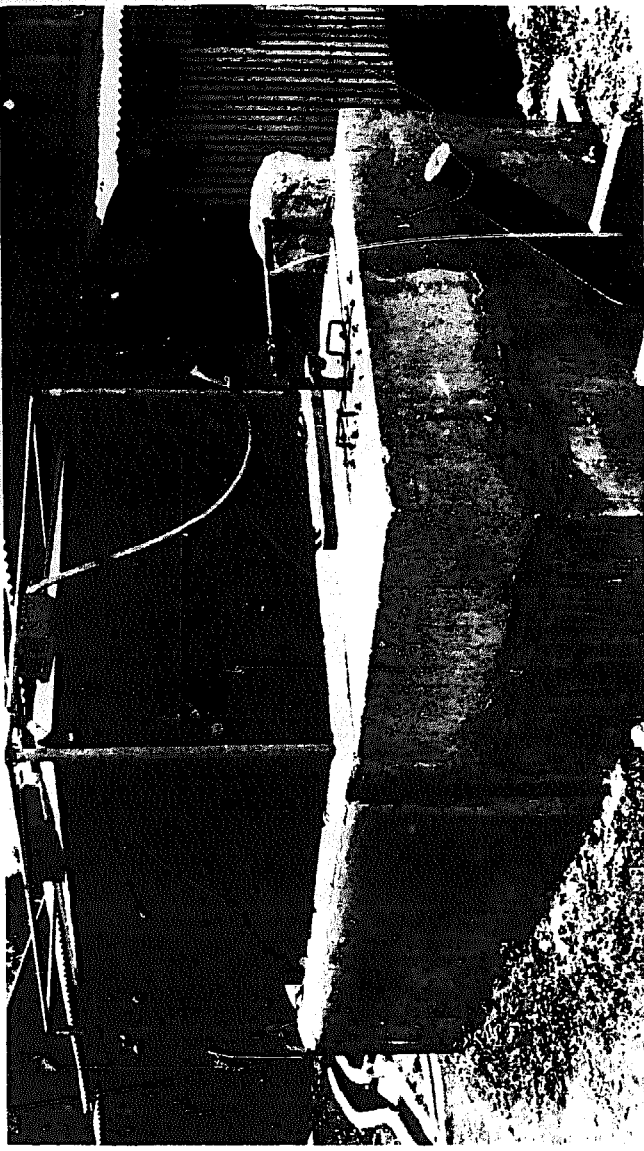


Illustration 4-13: Night Soil biogas plant at Liberty Foundation Dormitory

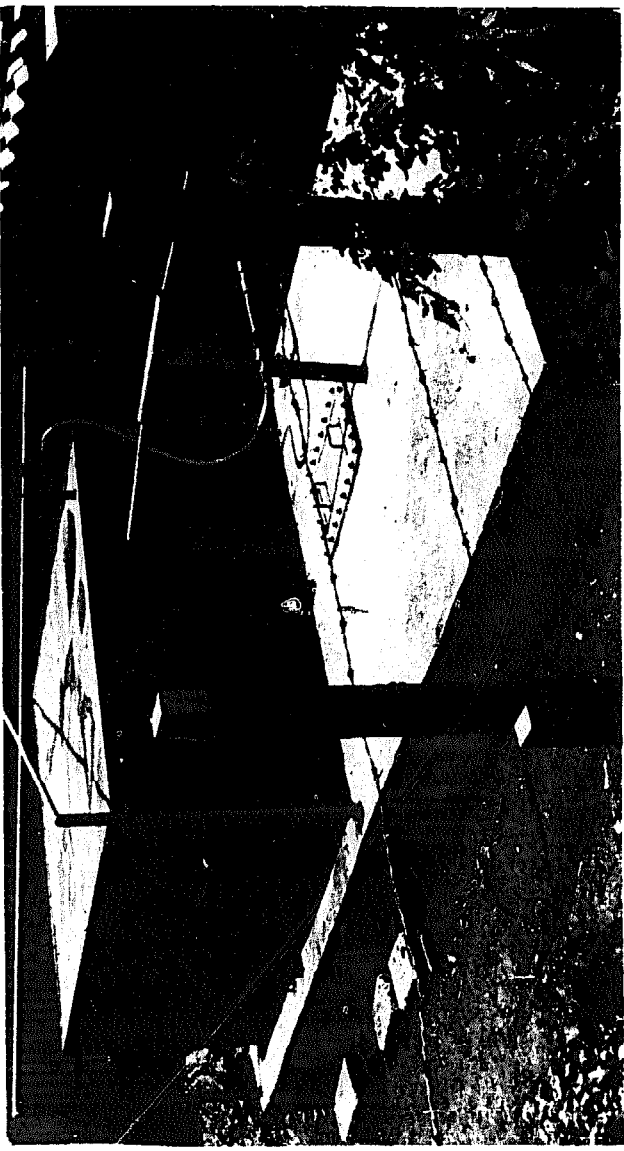




**Illustration 4-15: China model**



**Illustration 4-16: Taiwan model**



**Illustration 4-17: Maya Farmhouse model**

## Chapter XX

### **Socio-Economic Impact of Biogas Works**

Man's first concern has always been adequate food supply. Ancient man was a nomad. For his nourishment, he depended on what he could gather from the forests, in much the same way as the animals that inhabited his surroundings. From past experiences, he learned to plant food crops and domesticate livestock; thus he was assured of a relatively steady food supply. When inhabitants grew in numbers, he opened forests. As man became more civilized, he met his food production problem by selecting higher-yielding crops and more productive livestock. He learned to use animal power in his farming operations. As science developed, he learned to improve his farming techniques. He developed high-yielding varieties of crops and more prolific livestock with higher feed conversion efficiency. He learned to till the soil more effectively and to irrigate and fertilize his crops with chemicals. As medical science significantly reduced infant mortality and extended life expectancy, population increased faster than ever.

Civilized life does not depend on food alone. It also requires conveniences for more comfortable living: homes, home appliances, schools, factories, offices, theaters, etc. All these require more resources. Man met these needs through the industrial revolution. He became so confident of his power that he went out to conquer nature instead of aiding it to produce his needs. He was warned by his fellowmen of foresight of the impending exhaustion of resources if he persisted in his wasteful ways, but he called them doomsters. He went merrily on. It took the oil embargo to make him realize his improvidence in the use not only of oil but also all of nature's bounty.

During the last quarter of the twentieth century, man has to face the situation of dwindling resources, particularly of land and energy, and the problem of pollution as well. He has to make the limited land produce more. Energy in the form of petroleum oil which he has become accustomed to is not always available in sufficient quantities and is now being priced almost beyond his means. As man increases his consumption, he creates more wastes that pollute the environment. There is no doubt about the capability of man to solve these problems. Various methods have been devised by people all over the world which will contribute in varying degrees to an over-all solution.

In the Philippines the Green Revolution has started auspiciously, but it has suffered setbacks due to lack of energy and fertilizers. The Masagana 99 program of rice production of the Department of Agriculture has succeeded in turning the Philippines from a rice importing country to a rice exporter. But how long will Masagana 99 be able to sustain its momentum of progress? How will it fare in the face of the increasing cost and short supply of land, energy and fertilizers?

The oil embargo prompted many nations to take immediate action, both on a short-and on a long-term basis. The public and private sectors were asked to conserve energy. Investment restrictions were relaxed to encourage oil exploration. Scientists redoubled their

efforts to find substitutes for oil. Studies and efforts to tap alternative sources of energy, both conventional and non-conventional, started in earnest. Among the non-conventional sources is biogas. With it is the recycling of farm wastes to help produce food.

Based on experiences and observations of the biogas works at Maya Farms which were developed after intensive study, the following conclusions were drawn: Biogas works is made-to-order for the tropics. Ordinarily, the most expensive part of the operation of biogas works would be to maintain the temperature of the digester slurry at around 30-37°C. The ambient temperature in the tropics seldom goes much below this temperature, hence there is no need for heating the digesters. During winter, in the temperate countries, anaerobic digestion requires as much as 90% of the biogas produced to heat the digesters. At Maya Farms there is no need for this.

Biogas works is made-to-order for the Third World. Although perfecting the system requires much research, no expensive and complicated equipment are needed to establish and operate it. They can be manufactured in non-industrialized countries and the necessary technology is available there.

Biogas works is made-to-order for the farm. The raw materials are continuously produced there, hence there is a reliable and inexhaustible supply. Biogas is well suited for the farmer's power requirements. The solid sludge is fed to the livestock right where it is produced; the liquid sludge just flows to the fields. Transportation of inputs to the farm which is expensive and uncertain is avoided. With biogas works the farmer gets most of his feed and fertilizer requirements when he needs them, costing him next to nothing.

On the national level biogas as fuel can materially reduce the importation of petroleum oil and hence reduce foreign exchange requirements. The Bureau of Animal Industry statistics for 1976 shows a total animal waste production of 18,514 MT/day carabao manure, 7,292 MT/day cattle manure, 7,776 MT/day hog manure and 1,143 MT/day chicken manure. If only half of this manure production had been processed through biogas plants, the biogas produced would have exceeded 8 billion cubic feet in one year, with the energy value equivalent to 900,000 barrels of petroleum oil per year. At \$13 per barrel, the savings in foreign exchange would have been over eleven million dollars.

A large portion of the biogas would be used as fuel for cooking. This will mean less pressure for cutting trees for firewood, a practice which has caused deforestation, resulting in drought, floods and the extension of deserts in the thickly populated countries.

The use of biogas as fuel to cook the meals of the farm family promotes neatness in the kitchen and makes cooking more comfortable. Since biogas burns without producing any soot, cooking utensils are easily cleaned. Pollution of the air is also avoided. For this reason the Indian farm housewife can brag that she can still be attractive even after preparing the family meals.

The sludge from anaerobic digestion retains all the nutrients contained in the manure. The diluted liquid, when exposed to sunlight, supports the growth of algae rich in nitrogen, the biggest source of fertilizers. At Maya Farms it was found that the manure of four sow units subjected to anaerobic digestion will produce sufficient fertilizer for one hectare cropland planted to three crops per year and 200 sq. m. of fishpond. The only element



lacking is potash which is supplied by the ashes of diseased crop residues burned because they are not useful as raw materials for the biogas plant nor for compost. These organic fertilizers will displace chemical fertilizers which cause water pollution. It means big savings in the cost of producing food.

Part of the liquid sludge may be used to fertilize fishponds to grow algae and zoo plankton that feed the fish. Thus a general biogas practice can make inland areas self-sufficient in fish. The solid sludge may be processed into feed materials which are rich in growth-promoting factors and which can constitute 10%-15% of the feed requirements of the pigs that excreted the manure. The readily available feed materials will contribute greatly in increased production, hence lower the cost of meat which the underprivileged can barely afford to buy.

In the Philippines, the traditional method of farming leaves the farmer with some free time. The crop farmer is occupied only early in the morning and late in the afternoon. He is free also between planting and harvesting time and between harvesting and planting time. On the other hand, the livestock farmer needs only a few hours to care for his animals. These "idle" periods in the farms in the old system need to be productively utilized. Would an integration of cropping and livestock farming work towards this goal? The farmer's use of irregular time patterns of work is dictated more by the type of cropping operations than by a lack of interest, willingness or industry.

The recycling system of farming envisions the full employment of the labor resources available in the farm. The farmer feeds and takes care of his animals and attends to his biogas works in between his field cropping work. He spends his time between harvesting and planting and between planting and harvesting to weed his cropland. Instead of destroying weeds he allows them to grow up to three weeks old so they may serve as feed for his carabaos and/or cows. He will use this slack time for the maintenance of the stables and other structures. He plants ipil-ipil, harvests the leaves for feed and makes charcoal out of ipil-ipil trunks. Needless to say, a man fully employed earns more than one who is partly employed. The utilization of slack time would spell the difference between a subsistence farm and a farm with income sufficient for a decent standard of living. The recycling system of farming will not only increase productivity per unit area and per farm family, but would also make the farm almost self-sufficient.

We are running short of land to produce food. The recycling system of farming makes full use of the crop residues by feeding them to ruminants and the manure is used as raw material for the biogas works. With the present practice, one head of cow will require one hectare of pasture; but one hectare of cropland plus 1,000 sq. m. of ipil-ipil planted on broken land will feed three heads of cattle. If these ruminants now using pastureland are raised in farms at the rate of three cows and/or carabaos per hectare of cropland, a large portion of the present pastures may be converted into croplands, thus increasing land available for cropping.

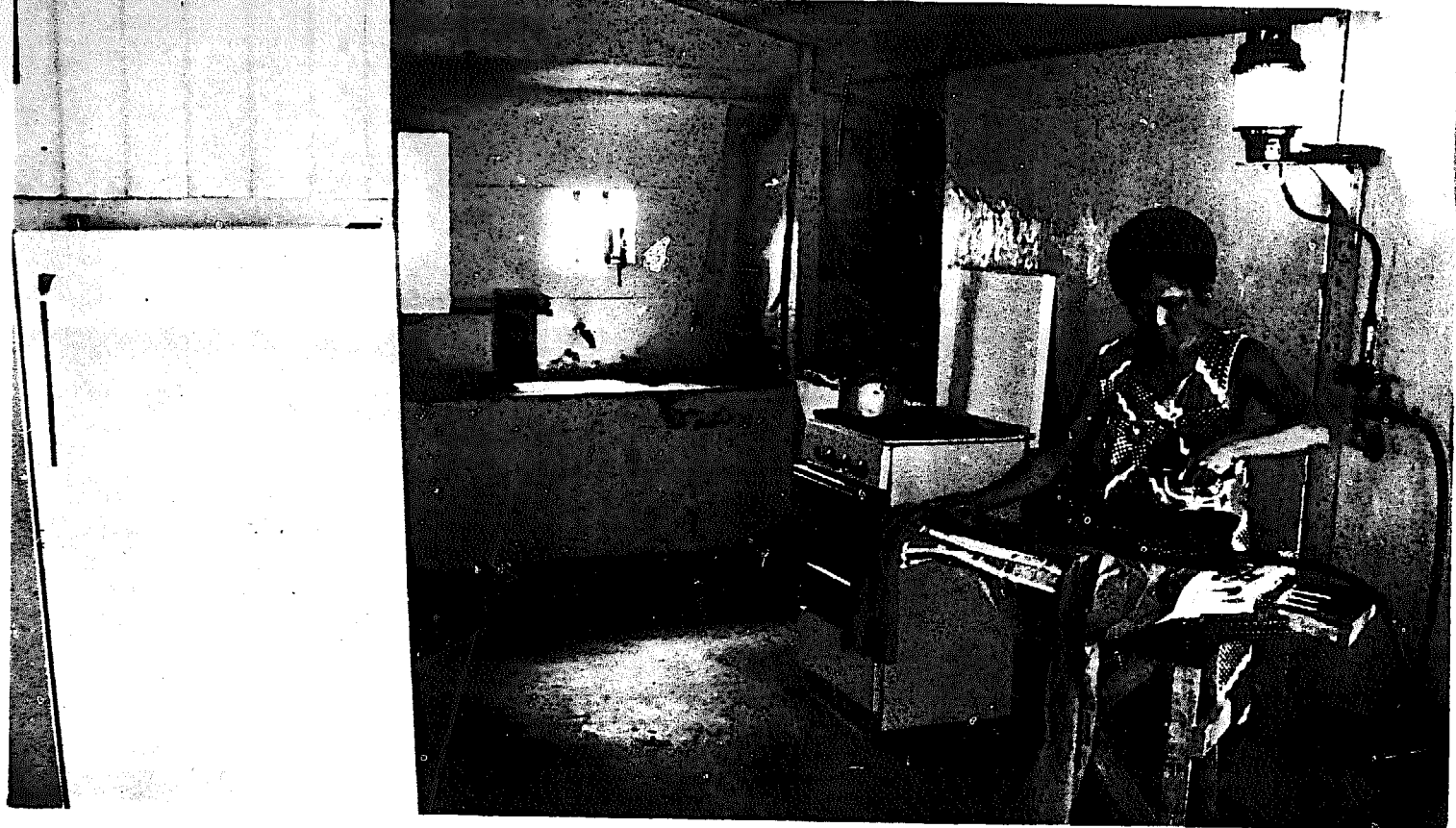
A large livestock farm will need only about 40% of the biogas it can produce from the manure. If such a farm would use windmills, waterfalls, solar heat and the like, it can spare more. This extra biogas may be used as fuel for power plants to generate electricity which may be used to give light to the neighborhood and also to start small-scale industries in the countryside.

The poor facilities for life's conveniences (particularly electric power) in the rural areas are mainly responsible for the increasing migration of young people from the rural to the urban areas. Aside from congesting the cities, this migration leaves the farms short-handed for the task of food production. Food shortage especially in developing countries can be minimized if the more capable people would stay in the farm to tend to the production of food.

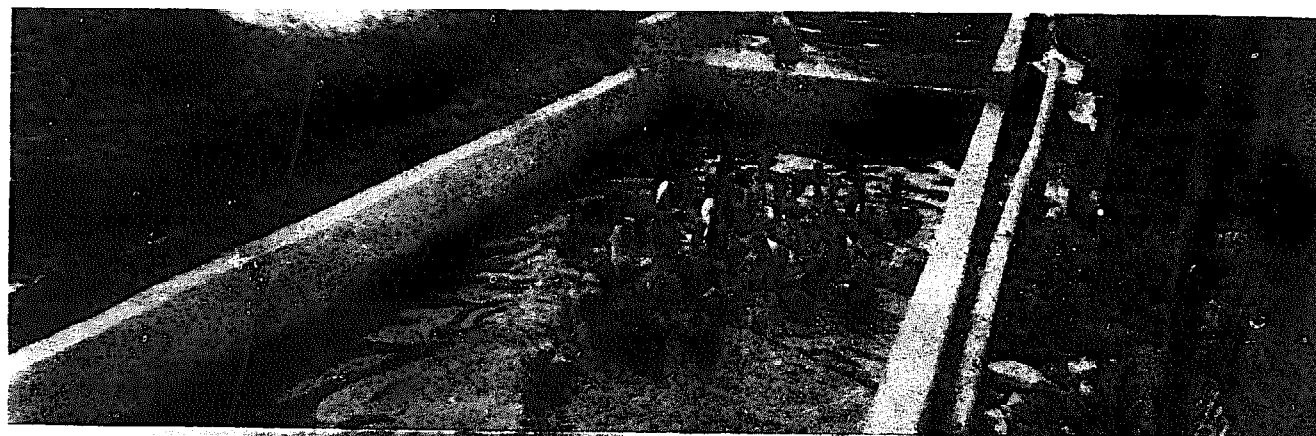
The proliferation of the biogas works will redound to the upliftment of the social and economic life in the rural areas. It will improve the living conditions by controlling the pollution of the air and the waters and by promoting sanitation. Through electrification, it will widen the social consciousness of the people by placing within their reach the various media of communication and hence improve education; it will raise the standard of living by providing the means for economic advancement. By utilizing wastes and indigenous materials to serve the farming needs and by making the land more productive through the recycling system of farming, it will create a pattern of rural living that can lead towards self-reliance.

Last but not least is the control of pollution caused by the manure and other farm wastes. Sanitary conditions are promoted by eliminating the manure which breeds flies. It is known that the use of chemical fertilizers has contributed greatly in the pollution of streams. This pollution can be minimized if organic fertilizer from sludge is used instead.

However, the biogas works is a new concept and as is the fate of new ideas it will encounter initial resistance. For one, it costs money to put it up and maintain it. It requires new techniques in operation. How well will it control pollution and promote sanitary conditions? How good is the fertilizer and feed value of the sludge? How good is the biogas fuel? Is the biogas works economically feasible and socially acceptable? A deeper understanding of these questions shall go a long way toward general acceptance of the biogas works. It is our hope that this book will help contribute towards such understanding and better appreciation of the biogas works and waste recycling.



**Illustration 4-18: Household appliances - gas range, gas water heater, gas refrigerator and gas flatiron**



**Illustration 4-19: Ducks feasting on scum**

## GLOSSARY OF TERMS

- ACTIVE GROWTH PHASE** - the first phase in the biogas process characterized by rapid production of biogas; it is represented by a steep line in the biogas production curve.
- AERATION LAGOON** - a shallow lagoon used to remove toxic substances like hydrogen sulfide from the liquid sludge and to expose it to oxidation in order to enhance its fertilizer value.
- AGING-STORAGE LAGOON** - a lagoon where the liquid sludge from the dilution lagoon goes and is stored, pending use.
- ALGAE** - primitive plants including seaweeds and the green scum in fresh water ponds.
- ALGAE POND** - a pond used to retain the liquid portion of the sludge from the decantation tank to age it and initiate the growth of algae in a single pond type of sludge conditioning.
- BATCH-FED DIGESTER** - a digester which retains all the slurry charged without further addition until discharged at the end of the retention time.
- BIOFEED** - the solids recovered from the sludge and processed into feed material; it is rich in vitamins, particularly vitamin B<sub>12</sub>.
- BIOGAS** - the gas produced when organic wastes ferment in the absence of air in a biogas digester; it is composed of methane, carbon dioxide, some hydrogen and traces of carbon monoxide, nitrogen, hydrogen sulfide, water vapor, etc.
- BIOGAS PLANT** - the device used to process organic wastes to produce biogas and sludge and/or simply to serve a useful purpose such as control of pollution; it consists mainly of the digester and gasholder.
- BIOGAS PRODUCTION CURVE** - the graph of the cumulative volume of biogas produced daily from a batch process biogas generating apparatus.
- BIOGAS SYSTEM OF FARMING** - a farming system where crops and livestock are in symbiosis and the wastes are fully utilized through the biogas works.

## **BIOGAS WORKS**

- the combined operation of a biogas plant and sludge-conditioning plant.

## **BIOPAUSE**

- the transition period in the biogas process represented by the time span between the active growth phase and the senescence phase in the biogas production curve.

## **CARBON DIOXIDE (CO<sub>2</sub>) SCRUBBER**

- equipment used to reduce the carbon dioxide component in the biogas in order to improve the heating value of the gas and reduce the gas storage requirement.

## **CHLORELLA**

- a single-celled, high protein alga.

## **C:N RATIO**

- the ratio of the carbon and the nitrogen content in organic material; to improve biogas production efficiency, materials with high C:N ratios should be combined with materials of low C:N ratios to get a ratio around 30:1.

## **CONTINUOUS-FED DIGESTER**

- a digester which is regularly charged with small amounts of fresh slurry at short intervals; the freshly charged slurry automatically dislodges an approximately equal volume of effluent or sludge so that the process continues without interruption unless the digester gets clogged, in which case it will have to be cleaned out and started all over again.

## **DECANTATION TANK**

- an open chamber which receives the effluent directly from the continuous-fed digester; the solids settle out and are recovered from this tank while the liquid drains into the aeration lagoon.

## **DIGESTER**

- the part of a biogas plant wherein the slurry of organic wastes is retained to ferment in the absence of air; fermenter is a more appropriate term, but digester is more commonly used.

## **DIGESTER SLURRY**

- mixture of fermenting organic wastes and water inside the digester.

## **DIGESTER SLURRY CAPACITY**

- the proper volume of slurry inside the digester; it is equal to the volume of the digester minus an allowance of one foot headspace above the slurry surface.

## DIGESTION

- the common term used to refer to the fermentation of organic wastes in the absence of air in a biogas plant.

## DIGESTION LAGOON

- a lagoon used to retain the excess wash-water from the livestock pens for some time to allow a combination of aerobic and anaerobic fermentation of entrained organic materials.

## DILUTION LAGOON

- a lagoon where the liquid sludge from the aeration lagoon goes and industrial wastewater, storm drains and sometimes freshwater are added.

## EFFLUENT

- the sludge or spent slurry from a continuous-fed digester.

## ENERGY PLANTATION

- trees planted for firewood and other energy uses.

## FIXED DOME GASHOLDER

- in a totally closed, integrated biogas plant, the upper section where the biogas collects and is retained until it is used; the gas displaces part of the digester slurry into an auxiliary chamber.

## FLOATING GASHOLDER

- a biogas container made out of an inverted tank floating over a pool of liquid which serves as the gas seal; the tank floats up when it fills with biogas and sinks as the gas is depleted.

## FRESH SLURRY

- the mixture of organic wastes and water to be charged into a digester.

## FRESH SLURRY CONCENTRATION

- the proportion of solids to water; 1:1 means one part solids to one part liquid by volume; 1:2 means 1 part solids to 2 parts liquid; solids refer to the fresh manure (75% moisture) or other organic matter.

## GASHOLDER

- the part of the biogas plant where biogas is collected and stored.

## HYDROGEN SULFIDE (H<sub>2</sub>S) SCRUBBER

- an equipment used to reduce the corrosive hydrogen sulfide content in biogas; it can be made out of a drum filled with iron filings or iron oxide.

## INOCULANT, INOCULUM

- a substrate which has a high concentration of methane-producing bacteria and

## INTEGRATED BIOGAS PLANT

## LIQUID BIOFERTILIZER

## LIQUID SLUDGE

## MANURE

## MANURE SLURRY

## MANURE:WATER RATIO

## METHANE (CH<sub>4</sub>)

## METHANOGENIC BACTERIA

## MIXING TANK

## ORGANIC WASTES

## PLANKTON

## RETENTION TIME

## SENESCENCE

which is usually prepared in a laboratory to be used to start a biogas generating unit.

- a biogas plant with the digester and gas-holder combined in a single unit.

- the liquid portion of the sludge which has passed through sludge-conditioning to reduce toxic substances and enhance its fertilizer value.

- the liquid portion of the sludge.

- the excreta of animals.

- the mixture of manure and water coming from the livestock pens.

- the ratio of the volume of fresh manure to volume of water in a manure slurry; the ratio such as 1:1 or 1:2 indicates the slurry concentration used in particular biogas operations.

- a compound of carbon and hydrogen; it is a colorless, odorless, flammable gas; it is the main constituent of natural gas, coal gas and biogas.

- anaerobic bacteria which feed on organic materials, producing methane in the process.

- an auxiliary device where the organic waste is mixed with water to make the fresh slurry.

- useless materials originating from plants, animals and other living matter.

- the huge number of small plants and animals found near the water surface; the plants consist mainly of algae and the animals consist of many single-celled organisms.

- the number of days the organic waste slurry is supposed to remain inside the digester, that is, from the day the slurry is charged to the day it comes out of the digester.

- the last phase in the biogas process characterized by a much slower biogas pro-

## SLUDGE

duction than that in the active growth phase.

- the residue left after the production of biogas; it is the mixture of anaerobically fermented organic wastes and water discharged from a digester; it is also called *effluent* when discharged from a continuous-fed digester.

## SLUDGE CONDITIONING

- treatment of the sludge to obtain fertilizer and feed materials and to control water pollution.

## SLUDGE-CONDITIONING PLANT

- the combination of devices in which the sludge is treated to obtain biofertilizer and biofeed and to control water pollution; it may include lagoons, solids recovery and processing unit, compost bunks, fish ponds and crop fields.

## SLUDGE RESIDUE

- the sludge recovered during the cleaning of the digesters.

## SOLID BIOFERTILIZER

- the solids recovered from the sludge and dried to serve as an organic fertilizer-soil conditioner.

## SOLID SLUDGE

- the solid portion of the sludge.

## SPLIT TYPE BIOGAS PLANT

- a biogas plant with the gasholder forming a separate unit from the digester.

## STARTER

- a substrate with a high concentration of active methane-producing bacteria used to hasten the anaerobic fermentation of organic wastes; it is usually taken from the digester slurry of an active biogas plant.

## U-TRAP

- a U-shaped pipe attached to low points along the biogas line in order to catch and remove water condensates which may otherwise clog the gas line.



## BIBLIOGRAPHY

Acharya, C.N. 1935. Studies on the anaerobic decomposition of plant materials. *Biochem. J*29:525-541

Alicbusan, R.V. 1975. Microbiology of fermenting organic wastes in biogas production. ESCAP Workshop on Bio-Gas Technology and Utilization, Manila, Oct. 13-18.

Alicbusan, R.V. et al. 1974. Fuel gas production from agricultural wastes and garbages. Terminal Report, National Institute of Science and Technology, Manila

American Public Health Association. 1971. Standard Methods for the Analysis of Water and Wastewater. 13th edition. New York; A P H A

ASAE. 1971. Livestock Waste Management and Pollution Abatement. Proceedings International Symposium on Livestock Waste, April 19-20.

Barker, H.A. 1956. Bacterial Fermentations - the Biological Formation of Methane, pp. 1-27. New York: John Wiley & Sons.

Berry, E.C. 1966. Requirements for microbial reduction of farm animal wastes. Management of Farm Animal Wastes. Michigan: ASAE

Boruff, C.S. and A.M. Buswell. 1930. Fermentation products from corn stalks. *Ind. Eng. Chem.* 22:931-933

Boshoff, W. H. 1963. Methane production by batch and continuous fermentation methods. *Prop. Sci.* 5 (3): 155-165

Bousfield, S. et al. 1973. Where there's muck there's gas. *Pig Farming* p. 79 Nov.

Buswell, A.M. and C. S. Boruff. 1933. Mechanical equipment for continuous fermentation of fibrous materials. *Ind. Eng. Chem.* 25:147

Cooney, Charles, L. 1975. Thermophilic anaerobic digestion of solid waste for fuel gas production. *Biotechnology and Bioengineering*, XVII:1119-1135.

De Leon, Honorata, 1974. Indicators of water pollution. In:Proc. of the Chemical Society of the Philippines Convention, Manila. March 29, 1974. In Press.

Economic and Social Commission for Asia and the Pacific. Bio Gas Technology and Utilization. Reports on Preparatory Mission and Workshops in New Delhi (1975) and Manila (1976)

Economic Development Foundation. 1976. Fuel Gas from Organic Waste. Manila, Philippines.

ESCAP Newsletter. 1976. Examples of plant designs. *Biogas*. (2)

Eusebio, J.A. 1975. Chlorella-manure and gas-fish pond recycling system in integrated farming. ESCAP Workshop on Bio-Gas Technology and Utilization, Manila, Oct. 13-18.

Eusebio, J.A., B.I. Rabino and E. C. Eusebio, 1976. Recycling System in Integrated Plants and Animal Farming. Technical Bulletin vol. 1 no. 1 Los Baños University of the Philippines

Fry, J. 1961. Farmer turns pig manure into horse power. *Farmers Weekly*. Feb. 22, South Africa.

Fry, L. J. 1973. Methane Digesters for Fuel Gas and Fertilizer. Massachusetts. The New Alchemy Institute.

Ghosh, S. N. 1975. Significance of organic manure for tropical countries. *Oil Commentary*. 12 (July): 1-3.

Greely, S. and C. R. Belzy. 1936. Operation of sludge gas engines. *Sewage Works J.* (1):57-62.

Hanuman, H.S. 1977. Biogas technology. ESCAP Roving Seminar on Rural Energy Development.

Harrison, Eleanor, K. A. Lees and F. A. Wood. 1951. The assay of vitamin B<sub>12</sub>. Part VL. Microbiological estimation with a mutant of *Escherichia Coli* by the plate method. *The Analyst* 76(898): 696-705.

Hobson, P.N. and B.C. Shaw. 1971. The role of strict *anaerobes* in the digestion of organic material. In: G. Sykes and F. Skinner (eds.) *Microbial Aspects of Pollution*. London: Academic Press. pp. 103-121.

Hobson, P.N. et al. 1974. Anaerobic digestion of organic matter, *Critical Review in Environmental Control* 4(2): 131-191.

Hockenhull, Ed. 1960. The microbiological production of vitamin B<sub>12</sub> and sulphide from sewage. *Progress in Industrial Microbiology*. London: Heywood and Co. Ltd. pp. 29-45

Huang, Chia. 1977. Hog-crop-fish integration offers many advantages, *Med. Agric. Ind.* 5(May): 18-19.

Hutchinson, T. H. 1972. Methane farming in Kenya. *Compost Sci.* 13(6): 30-21 *Nov/Dec*.

Imhoff, K. and G. Fair. 1956. *Treatment of Sewage Wastes*. New York: John Wiley & Sons, Inc.

Imhoff, K. and C. Keefer. 1952. Sludge gas as fuel for motor vehicles. *Wat Sewage Works J.* 99-284.

Jacobs, P.B. 1934. Heat and light on the farm - the utilization of farm wastes. *Architect. Rec.* 7:358.

Jewell, W. J. et al. 1976. *Bioconversion of Agricultural Wastes for Pollution Control and Energy Conservation*. New York. New York State College of Agriculture and Life Sciences.

Le Turk, E. 1935. Adaptability of sewage sludge as a fertilizer. *Sewage Works J.* 7(4): 597-610

Mann, I. 1962. *Processing and Utilization of Animal By-Products*, FAO Agricultural Development Paper No. 75. Rome: FAO

Mardon, C.J. 1975. *The Production of Methane from Organic Wastes in Australia*. CSIRO

McGarry, M.G. 1971. *Unicellular Protein Production Using Domestic Wastewater*. Bangkok: ASRCT

Molarney, W. 1971. An introduction to aquaculture on the organic farm and homestead. *Organic Gardening and Farming Magazine*, pp. 71-76, August.

Mylois, R.L. and R. E. Hungate. 1954. Experiments on methane bacteria of sludge. *Canadian J. Bacterial* 1:55-64.

National Water and Air Pollution Control Commission. 1967. Rules and Regulations. *The Official Gazette*, 63(28): 5999-6013.

Parikh J.K. and K.S. Parikh. 1977. Mobilization and impacts of biogas technologies. *Energy* 2:441-455.

Patel, J. J. and G. L. Patanker. 1951. Burner design for gobar gas plants. *Khadi Gram Udyog March*.

Po, Chung, 1973. Production of methane gas from manure. In: *Proc. International Biomass Energy Conference* May 13-15.

Popel, F. and CH. Ohnmacht. 1972. Thermophilic bacterial oxidation of highly concentrated substrates. *Water Research* 6:807-815

Ram Bux Singh. 1974. *Biogas Plant*. Gobar Gas Research Station, Ajitmal, Etawah, Uttar Pradesh: India.

- Rodulfo, H.R., R. V. Alicbusan, N. B. Hernandez, J. R. Sagun and R. C. Velez. 1976. Preparation and utilization of methane bacteria as starter in biogas production. NSDB-NIST Project 7316 Evaluation Seminar, Nov. 4, 1976, National Institute of Science and Technology, Manila
- Santos, P. S., E. J. Abad, A. G. Paguia, and B. S. Lat. 1965. Vitamin B<sub>12</sub> and antibiotic activity of actinomycetes isolated by a selective method. *Philippine J. Sci.* 103(4): 207-220.
- Sathianathan, M. A. 1975. Bio-gas Achievements and Challenges. Association of Voluntary Agencies for Rural Development, New Delhi.
- Sittig, Marshall. 1973. Pollutant Removal Handbook. New York: Noyes Data Corporation.
- Smith, P. H. and R. E. Hungate. 1958. Isolation and characterization of *Methanobacterium ruminantium* n. sp. *J. Bacteriol.* 75:713-718.
- Soddell, J. 1975. Treatment, recycling and disposal of wastes. Third National Conference Chemical Engineering, Victoria, Australia.
- Soddell J. et al. Farm scale digestion of pig waste for methane production. Report to CSIRO, Victoria, Australia.
- Stadtman, Thressa C. 1967. Methane fermentation, *Ann. Rev. Microbiol.* 121-142.
- Stoner, Carol H. 1976. Producing Your Own Power. Rodale Press, Inc.
- Taiganides, E. P. et al. 1963. Anaerobic digestion of hog wastes. Journal Paper No. J-4604, Iowa Agric. & Home Economics Experimental Station, Ames, Iowa.
- Thimann, Kenneth V. 1966. The Life of Bacteria, Their Growth, Metabolism and Relationships. New York: The Macmillan Company.
- Tietjen, C. 1975. From biodung to bio-gas-historical review of European experience. Paper presented at the 7th National Agricultural Waste Management Conference, Syracuse, New York, April 16-18.
- Uriarte, Filemon. 1976. Important parameters of wastewater treatment and pollution abatement and their significance. In Proc. NPCC-NSDB Pollution Control Training Course, Manila June 9-30.
- Valderia, R. V. 1974. Garbage fermentation tank, Philippine Patent No. UM - 1371.
- Viray, Pedro P. 1976. Water quality criteria and standards. In Proc. NPCC-NSDB Pollution Control Training Course Manila, June 9-30.

# INDEX

- activated sludge, 165
- aeration lagoon, 92
- aging-storage lagoon, 92
- agro-industrial operation, dispersal of, 196
- alcohol, 145
- algae, 156, 159, 162
- algae lagoon, algae pond, 90
- Animal Industry, Bureau of, 119, 203, 207
- Araneta, 75
- Aries Agro-Development, 207
  
- Banzon, 145
- Barker, 12, 15, 17
- Bautista, 76
- Bechamp, 7
- Belur Math, 73
- Bigol Farm, 197
- Bihugas-Anlage, 74
- biochemical oxygen demand, BOD, 167
- biofeed, See feed materials
- biofertilizer, 153
  - economic benefits, 173
  - experiment on rice, 155
  - precautions, 156
- biogas, 145
  - advantages, 149
  - bacteria in the formation, 16
  - bottling, 149
  - composition, 146
  - consumption rate, 148
  - direct heating, 147
  - formation involving 2 kinds of bacteria, 18
  - industrial use, 145
    - as motor fuel, 145, 148
    - nature and history, 5
    - production during senescence, 31
    - rates of production, 31
    - raw materials for production, 39
    - safety precaution, 136
  - substrates, 33
  - theoretical maximum yield, 54
- biogas operation in –
  - agricultural college, 207
  - dormitory, 204
  - integrated meat processing, 207
  - orchard farm, 204
  - piggery, 204
  - poultry and livestock farm, 207
  - slaughterhouse, 205
  - stock farm, 207
- biogas plant, 119, 131
  - batch-fed, 69, 120
  - continuous-fed, 68, 120
  - cost and operating data, 118, 173
  - raw materials, 119, 131
  - split type, 123
  - types of, 67
- biogas plant designs, 73
- biogas practice, 201
  - Africa, 201
  - Bangladesee, 203
  - China, 202
  - Europe, 201
  - India, 202
  - Indonesia, 203
  - Japan, 203
  - Korea, 202
  - Nepal, 203
  - Pakistan, 203
  - Philippines, 203
  - Singapore, 203
  - Sri Lanka, 203
  - Taiwan, 203
  - Thailand, 203
- biogas works, 101
  - cost analysis, 175
  - economics of, 171, 213
  - establishing, 115
  - layout, 125
  - Maya Farms, 208

- operation of, 131
- pollution control, 165
- socio-economic impact, 213
- biogas works designs, 101
  - agro-industrial, 102
  - agro-pulp farm, 102
  - cooperative electric plant, 103
  - crop livestock farm, 101
  - family farm, 101
  - feedlot/dairy farm, 102
  - livestock-industrial, 102
  - night soil, 103
  - piggery/poultry farm, 102
  - sewerage, 103
  - slaughterhouse, 103
- biopause, 23, 33
- Birmingham Sewage Works, 145
- Burke-Jacobs, 75
- burner design, 147
- Buswell and Boruff, 75
  
- Cadiz-Velasquez, 75
- carbon dioxide, 64, 149
- carbon dioxide scrubber, 67, 136
- carbon to nitrogen ratio, 43, 155
- Catambay, 145
- Chan, 75
- chemical fertilizer, 153
- chemical oxygen demand, COD, 167
- chlorella, 159, 162, 207
- Chung Po, 8
- clan farm, 188
- coconut oil, 145
- compost, 90, 153, 157
- compost bunk, 92, 138
- conditioning lagoons, 89, 125
- cooperative biogas system, 194
- corn stalk, 33
- Coulthard, 75
- crop field, 93
- crop residues, 120
  
- Dacanay, 145
- Dalton, 6, 7
- Darmstadt system, 74
- Davy, 6
- decantation tank, 89
- deforestation, 214
- diesel engine, 148
- digester, 64, 123
  - above ground vs underground, 122
  - batch-fed, 64, 120
  - construction materials, 123, 125
  - continuous-fed, 65, 120, 122
  - economic size, 123
  - experimental, 21
  - floating dome vs fixed dome, 123
  - heating vs insulation, 120
  - relative sizes for varying manure:
    - water ratio, 31
  - single large vs multiple small, 122
  - single chamber vs double chamber, 121
  - single wall vs double wall, 122
  - vertical vs horizontal, 122
- digestion lagoon, 91
- dilution lagoon, 92
- dissolved oxygen, 168
- double lagoon sludge conditioning plant, 90, 137
- drum digester, 75
- dual fuel engine, 148
- Duccellier-Isman system, 74
  
- economics, 171
- energy plantation, 197
- Eusebio, 162, 207
- excreta as biogas material, 41
  
- family farm, 186
- feed materials, 159
  - economic benefits, 173
  - experiment on pigs, 160
- fertilizer, 116, 153-(see biofertilizer)
- fishpond, 90, 162
- flame temperature, 147
- Fry, 75
- fuel gases, 145
- fuel value, 145
  
- Gartner-Ikonoff system, 74
- gas producer, 145
- gas production curve, 23
  - desirable characteristics, 33
- gasholder, 66, 124, 126, 135
- gasoline engine, 148

Gayon, 7  
Gobar biogas plant, 73  
Golden Farm, 207  
Gotaas, 73  
Green Revolution, 213  
  
heating value, 146, 147  
Henry, 6  
hog manure, yield of biogas, 57  
    characteristics of, 44, 45  
    conversion percentage to biogas, 57  
    dry matter balance in fermentation, 58  
hydraulic ram, 198  
hydrogen sulfide, 64, 148  
hydrogen sulfide scrubber, 67, 136  
hydroponics, 157  
  
Imhoff tank, 165  
incinerator, 139  
integrated farming system, 185  
internal combustion engine, 148  
ipil-ipil, 186, 197  
  
Judan, 204  
  
Khadi and Village Industries Commission, 8, 202  
  
Liberty Foundation Dormitory, 204  
Liquid sludge treatment system, 89  
  
**Mamisao**, 145  
manure, 116, 131, 214  
Maramba F. D., 75, 76, 145  
Maramba, M., 204  
Masagana 99, 213  
Maya Farms, 145, 166, 201, 207  
mesophilic digestion, 120  
methane, 64, 149  
    Barker's scheme of formation, 15  
    fermentation, 13  
    liquefied, 5  
    properties of, 5  
    theories of formation in nature, 13  
    van Niel theory, 13  
methanogenic bacteria, 17  
midden shed, 193  
mixing tank, 124  
multi-stage lagoon sludge conditioning, 91, 137

National Institute of Science and Technology, 203  
National Science Development Board, 119  
night soil biogas works, 204  
Obias, 68, 76  
organic fertilizer, 154, 158  
organic matter, 11  
    changes during methane fermentation, 58  
    composition and nature of, 11  
Pampanga Agricultural College, 207  
paper pulp, 159  
parasites, 161  
Parayno, 205  
Pasteur, 7  
Patel, 8, 73  
pathogens, 161  
pH, 16, 167  
    range of methane bacteria, 17  
piping system, 67, 124, 136  
plankton, 162  
plant nutrients, 153  
Poetsch system, 74  
pollution control, 115, 165-, 171  
pressure, 67, 124, 126, 135  
Priestley, 6  
  
Ram Bux Singh, 8  
recycling, 185  
    see also waste recycling  
refrigerator, 148  
Reinheld, 74  
retention time, 23, 120, 132  
retiree farm, 189  
rice hull, 197  
rice straw, 33  
ruminants, 186  
rural development, 193-  
rural electrification, 194  
  
sanamatic tank, 75  
Schmidt-Eggersgluss system, 74  
scum, 137  
senescence  
    gas production during, 31  
    phase, 23  
septic tank, 165  
settling lagoon, 94  
sewage, 94, 138, 166  
Shirley, 6

single pond sludge conditioning, 89, 136  
slaughterhouse, municipal, 195, 205  
sludge, 47, 88, 153  
    changes in composition and weight, 54  
    characteristics of, 47  
    detoxification of, 51  
    disposal, scheme for, 52  
    see also biofertilizer, feed materials  
sludge conditioning, 87, 125, 136  
slurry  
    preparation of in experimental trials, 28  
    relation to daily gas output, 31  
slurry concentration, 120, 132  
soil conditioner, 155  
solar energy, 197  
solid sludge recovery system, 89  
Stadtman, 15  
starter, 120, 132  
    effect of age, 30  
    effect of percentage on gas formation, 28, 35  
    need of massive amount, 18  
stock farm, 207  
sump, 124  
Taganas, 76  
Tappeiner, 7  
Teodoro, 145  
thermophilic digestion, 120  
Tietjen, 8  
tilapia, 163, 209  
Tongson, 161  
U-trap, 136, 222  
Valderia, 75  
Van Helmont, 6  
vitamin B<sub>12</sub>, 161  
    in sludge, 15, 49  
    in methane fermentation, 15  
Volta, 6  
waste recycling, 181, 193, 208  
wastewater, characteristics of, 169, 170  
waterwheel, 197  
Weber system, 74  
windmill, 197  
Zara, 145