

AT MICROFICHE
REFERENCE
LIBRARY

A project of Volunteers in Asia

Design of Small Water Storage and Erosion
Control Dams

by: A.D. Wood and E.V. Richardson

Published by:

United States Agency for International
Development
Washington, DC USA

This publication out of print in 1983.

Reproduction of this microfiche document in any
form is subject to the same restrictions as those
of the original document.

AGENCY FOR INTERNATIONAL DEVELOPMENT WASHINGTON, D. C. 20523 BIBLIOGRAPHIC INPUT SHEET	FOR AID USE ONLY
---	-------------------------

1. SUBJECT CLASSIFICATION	A. PRIMARY Agriculture
	B. SECONDARY Watershed Management

2. TITLE AND SUBTITLE
Design of Small Water Storage and Erosion Control Dams

3. AUTHOR(S)
Wood, A.D. and Richardson, E.V.

4. DOCUMENT DATE June 1975	5. NUMBER OF PAGES 88p.	6. ARC NUMBER ARC 627.8-W873
--------------------------------------	-----------------------------------	--

7. REFERENCE ORGANIZATION NAME AND ADDRESS
**Colorado State University
 Dept. of Civil Engineering
 Fort Collins, Colorado 80521**

8. SUPPLEMENTARY NOTES (*Sponsoring Organization, Publishers, Availability*)

9. ABSTRACT
 The design criteria and construction methods for small earth and rock-filled dams are presented. The materials and methods to be used are considered for both mechanical and manual labor.

Several types of ponds, foundation conditions, and water uses are discussed as design considerations. Special attention is given to the selection of appropriate outlet works and spillways. The construction of earth embankments is quite dependent on available materials, however, placement of water barriers and drains allows some flexibility in the cross section design. An appendix is included to address the problem of seepage and its influence on design.

10. CONTROL NUMBER PN-AAB-118	11. PRICE OF DOCUMENT
12. DESCRIPTORS Earth filled dams, Water storage, Erosion control, Seepage	13. PROJECT NUMBER 931-11-120-115
	14. CONTRACT NUMBER AID/CSD-2460
	15. TYPE OF DOCUMENT Research Study

**DESIGN OF SMALL WATER STORAGE
AND EROSION CONTROL DAMS**

by

**A. D. Wood
Graduate Research Assistant**

**E. V. Richardson
Professor, Civil Engineering**

**Paper developed under support from U.S. Agency for International
Development under contract AID/csd-2460. All reported opinions,
conclusions or recommendations are those of the authors and not
those of the funding agency or the United States Government.**

**Department of Civil Engineering
Colorado State University
Fort Collins, Colorado**

June, 1975

211(d)

DESIGN OF SMALL WATER STORAGE AND EROSION CONTROL DAMS

by

A. D. Wood and E. V. Richardson

ABSTRACT

The design criteria and construction methods for small earth and rock-filled dams are presented. The materials and methods to be used are considered for both mechanical and manual labor.

Several types of ponds, foundation conditions, and water uses are discussed as design considerations. Special attention is given to the selection of appropriate outlet works and spillways. The construction of earth embankments is quite dependent on available materials, however placement of water barriers and drains allows some flexibility in the cross section design. An appendix is included to address the problem of seepage and its influence on design.

KEY WORDS: Earth-filled dams, water storage, erosion control, seepage

TABLE OF CONTENTS

<u>Section</u>	<u>Page</u>
ABSTRACT	ii
LIST OF FIGURES	iv
ENGLISH TO SI (METRIC) CONVERSION FACTORS	vi
GLOSSARY	vii
FORWARD	viii
I Introduction	1
A. Uses	1
B. Types	1
II Factors Governing Selection of Site, Type, and Capacity	6
A. Purpose	6
B. Topography	8
C. Subsurface investigation	8
D. Climate	12
E. Equipment and labor	13
F. Statutory restrictions, costs, and time	14
III Design	15
A. Dugout ponds	15
B. Embankments and foundations.	17
C. Outlet works	26
D. Spillways	37
IV Construction	42
A. Site preparation	42
B. Excavation	44
C. Embankment	46
V Inspection, Maintenance, and Operation	47
REFERENCES	49
Appendix A - SEEPAGE THROUGH EMBANKMENTS	50
Appendix B - SOIL MECHANICS OF EMBANKMENTS	60

LIST OF FIGURES

<u>Figure</u>		<u>Page</u>
1	Pond Uses	2
2	Pit Pond	4
3	Types of Embankments	5
4	Hillside Pond	7
5	Borings at Proposed Site	10
6	Methods of Waste Material Disposal for Pit Ponds .	16
7	Estimating Storage Volume	18
8	Design Factors of Freeboard	20
9	Suggested Flood Storage Depth	21
10	Methods of Embankment Drainage	23
11	Treatment of Pervious Foundations	25
12	Shute Spillway	27
13	Outlet with Multi-Stage Inlet	27
14	Reinforced Concrete Inlet and Pipe	29
15	Concrete Block Inlet with CMP Barrel	29
16	Hooded CMP Inlet	30
17	Monolithic Outlet Works	30
18	CMP Outlet Works	31
19	CMP Outlet with Stop Logs	31
20	Typical Pipe Spillway Design Chart	32
21	Typical Pipe Design Table	33
22	Stilling Basins	35
23	Manifold Basin	36
24	Debris Traps for CMP Risers	38
25	Typical Earth Spillway	39

<u>Figure</u>		<u>Page</u>
26	Typical Earth Spillway	41
27	Staking Layout	43
28	Timber Diversion Flume	45
A1	Particle Size Distribution for Typical Soil Types	51
A2	Seepage Lines Through Homogeneous Embankments . . .	52
A3	Seepage Lines Through Zoned Embankments	53
A4	Approximate Method of Seepage Determination	56
A5	Typical Values of Permeability Coefficients	57
B1	Unified Classification and Properties of Soils. . .	61
B2	Soil Volume and Weight Relationships.	66
B3	Embankment Settlement Example	69
B4	Calculations of Example Settlement Problem.	70
B5	Typical Proctor Test Curves	72
B6	Shear Strength Relations.	75
B7	Embankment Slope Stability.	78

ENGLISH TO SI (METRIC) CONVERSION FACTORS

<u>To convert</u>	<u>To</u>	<u>Multiply by</u>
inches (in)	millimeters (mm)	25.40
inches (in)	centimeters (cm)	2.540
inches (in)	meters (m)	0.0254
feet (ft)	meters (m)	0.305
miles (miles)	kilometers (km)	1.61
yards (yd)	meters (m)	0.91
square feet (sq ft)	square meters (m ²)	0.093
square yards (sq yd)	square meters (m ²)	0.836
acres (acre)	square meters (m ²)	4047.
square miles (sq miles)	square kilometers (km ²)	2.59
cubic feet (cu ft)	cubic meters (m ³)	0.028
pounds (lb)	kilograms (kg)	0.453
tons (ton)	kilograms (kg)	907.2
pounds per square foot (psf)	newtons per square meter (N/m ²)	47.9
pounds per square inch (psi)	kilonewtons per square meter (kN/m ²)	6.9
gallons (gal)	liter (dm ³)	3.8
acre-feet (acre-ft)	cubic meters (m ³)	1233.
gallons per minute (gpm)	cubic meters/minute (m ³ /min)	0.0038

GLOSSARY

CRITICAL FLOW--occurs at the unique depth where the specific energy of a given discharge is a minimum. For any other flow, two velocities are possible. Due to this unique velocity, depth, and slope which can occur for a given discharge and channel shape, critical flow is important in the design of hydraulic structures.

DRAWDOWN--the vertical distance a free water surface is lowered. In a reservoir, drawdown is usually measured from the designed normal water elevation.

FETCH--the length of open exposure across a water surface.

HYDROSTATIC PRESSURE--the pressure in a liquid under static conditions.

It is the product of the liquids specific weight and the vertical distance between a given point and the free water surface.

OPTIMUM MOISTURE CONTENT--the water content (expressed as a percent of dry soil weight) at which a soil can be compacted to a maximum dry unit weight by a given compaction effort.

PIPING--the movement of soil particles by seeping water. Massive piping usually results in sloughing where seepage exits from the soil profile.

PROCTOR DENSITY (compaction curve)--the relationship between the dry unit weight and the water content of a soil for a given compaction method. The curve which illustrates this relationship indicates the maximum density that can be produced for a given soil and at what water content.

FOREWORD

Earth dams, if designed and constructed properly, can be extremely safe. Large earth dams have been subjected to earthquakes and overtopping by waves without failure. However, many small earth dams, the size of the subject of this manual, have failed. The failures usually resulting from improper construction rather than poor design. The basic reason that construction and design were faulty, causing failure, is the low cost of small dams. Because they are inexpensive, sloppy control of construction and poor designs are made. However, it is not the cost of the dam that must be considered in assessing the consequence of a dam failure, but the potential damage and loss of life that may result from the rupture of the dam and potential economic loss resulting from not having the water the dam was built to impound. In the design and construction of small dams, careful assessment must be made of all potential damages that can result from failure, the total potential damages determine the amount of care that must be taken in the design and construction, not just the cost of the dam.

In the design and construction, there are five critical areas that need careful consideration. These are:

1. Potential seepage along any outlet pipes and along the embankment contacts with the foundation including the sides where piping can occur.
2. Potential leaks in the outlet pipes. Any leak in the pipes can remove embankment material either in the pipe or along the outside of the pipe by piping.
3. Size, location and maintenance of the flood spillway which is constructed to protect the dam.

4. Control of the type of material, its placement and compaction in the embankment.

5. Control of seepage through the dam so that its egress on the downstream face can be controlled to prevent erosion.

There are many areas of concern in the design, construction and maintenance of a small dam. The above list identifies major causes of small dam failures.

In general, this manual gives sufficient information for the design, construction and maintenance of small dams for erosion control and small scale water supply where failure of the dam would only have the economic consequence of the cost of the dam. Where loss of life or larger economic loss could occur, a competent engineer should design and inspect the structure.

I. Introduction

Although we hear most often about the large dams and reservoirs on major tributaries, farm ponds can be one of the most effective and useful structures in soil and water conservation.

A. Uses

Whether constructed on a hillside as a by-pass pond, or across a gully, an earth embankment can serve as an erosion control by decreasing flow velocities through a watershed and thus decrease sediment movement. A large portion of any sediment load that does occur, can be trapped by the pond and prevented from causing damage downstream. Similarly, an embankment, when designed with some storage capacity, can retard flooding downstream during peak flows.

As a result of this conservation of water, a properly designed embankment can provide a usable supply of water. With appropriate outlet works or water lifting devices, water can be utilized for irrigation, stock watering, and fire protection (Fig. 1). However, especially when used for irrigation, the storage capacity should be carefully planned and regulated to prevent severe drawdowns.

An additional benefit of creating a pond is the recreational possibilities; from swimming to fishing. If fish production is to be considered, the pond should be designed no smaller than one-fourth acre surface area with a six foot average depth

B. Types

Although pond designs vary with location and purpose, each is basically one of three types. The *pit* or *dugout* pond is developed by enlarging an already existing depression or simply by excavating a

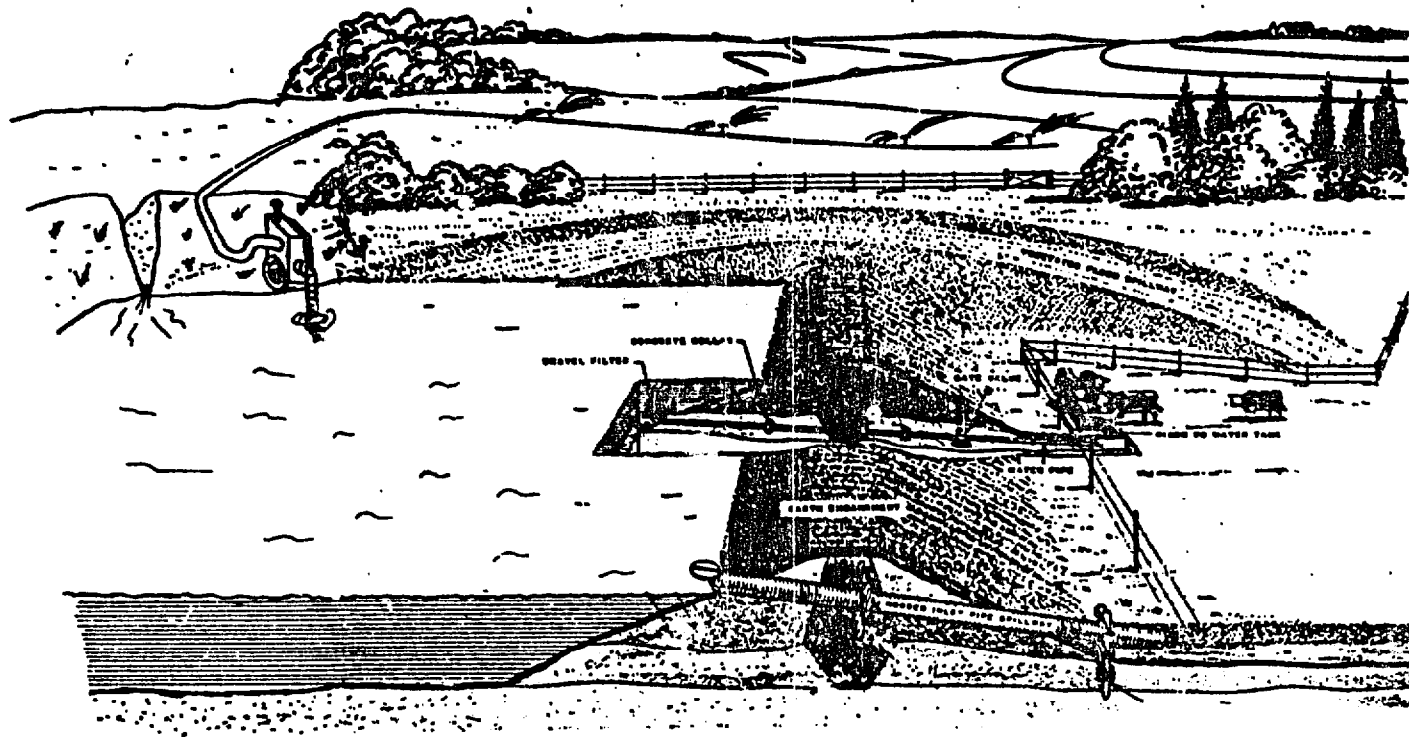

FIGURE 1 - POND USES
(U.S. Soil Conservation Service, 1969)

pit in flat land areas (Fig. 2). The sources of water can be springs, underground seepage, or tile lines. Runoff should only be expected to contribute a small amount of the total supply. If existing depressions are normally wet, such as swamps, an impervious subsoil can be expected which will provide good water retention. However, if the depression appears well drained, another site should be selected, unless a lining (such as asphalt or clay layer) is to be considered.

The second and most widely used type is the *embankment* pond. Concrete, timber, and steel dams are forms of embankment, but are rarely considered for ponds due to high costs. An earth and/or rock filled embankment is generally the easiest and least expensive ponding method for the amount of water stored and materials moved. Where the foundation soil and the embankment material are sufficiently impervious to provide an adequate water barrier, (as with silts and clays) the embankment is constructed entirely of this one material. This is a *homogeneous* type of embankment (Fig. 3a). To provide sliding resistance along the foundation and prevent piping, the homogeneous fill is keyed into the foundation stratum by means of a key trench excavated the length of the embankment. If available fill material is not sufficiently impervious to retard seepage, a *zoned* embankment must be designed. In this type, the major portion of the embankment is pervious material and a water barrier is constructed. This barrier can be in the form of an internal core (Fig. 3b) or diaphragm (Fig. 3d), or as an impervious blanket on the upstream slope (Fig. 3c). The commonly referred to *rock fill dam* is nothing more than a zoned embankment with very large, pervious material. The details and variations of these embankments will be discussed later.

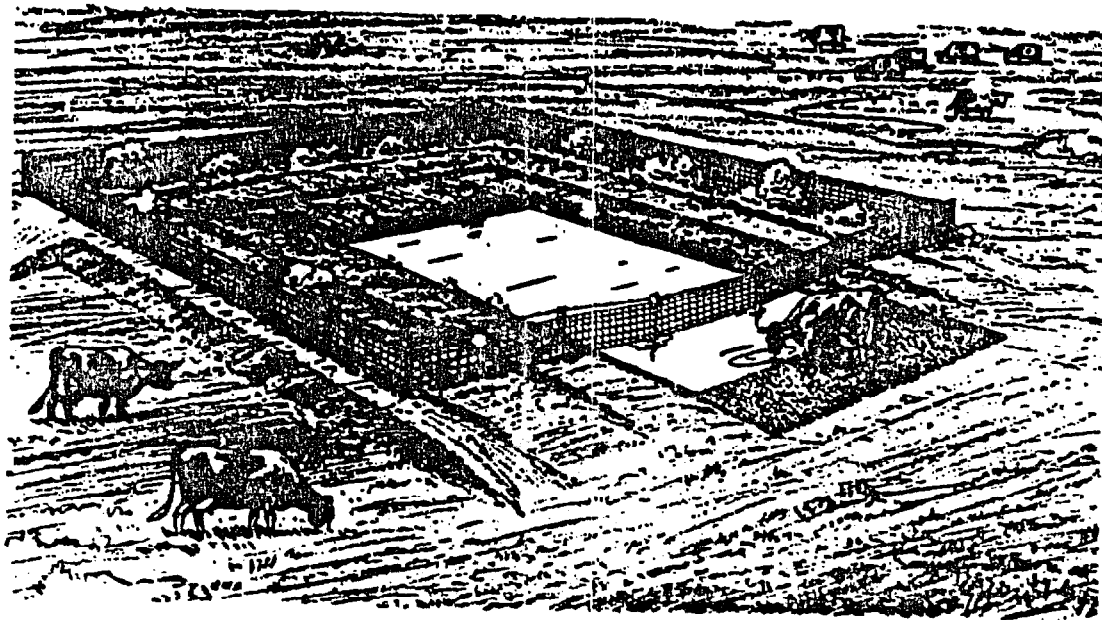

FIGURE 2 - PIT POND
(U.S. Soil Conservation Service, 1969)

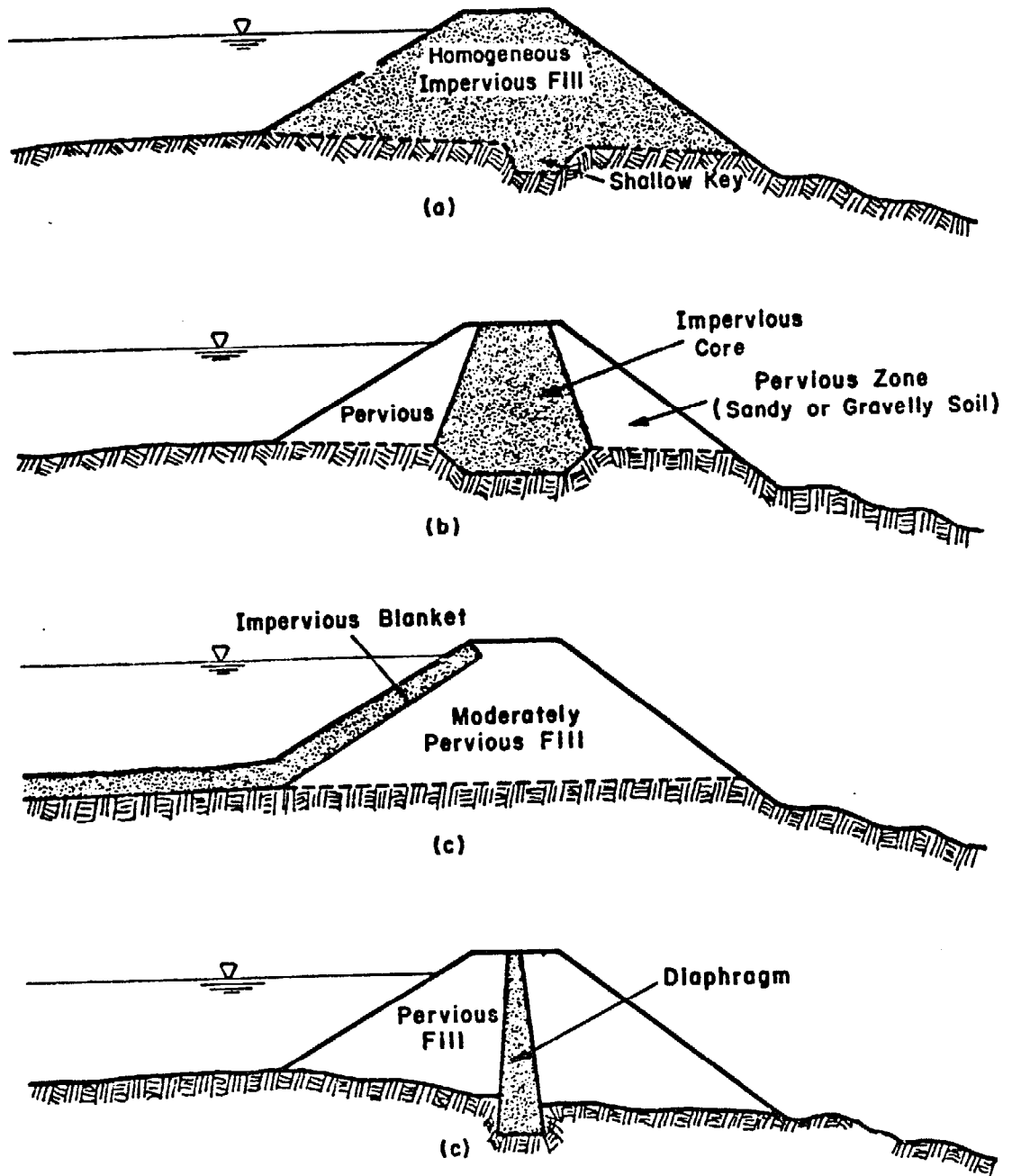

FIGURE 3 - TYPES OF EMBANKMENTS

The third kind of pond is actually a combination of the dugout and embankment ponds. It is often called a *hillside* or *by-pass* pond. It is designed when the dam cannot be placed across a gully or stream, due possibly to property lines or water rights. It is constructed on sloping land by excavating the uphill pond area and placing the cut material on the downhill side to form the embankment. As shown in Fig. 4, discharge into the pond can be regulated by means of an upstream diversion. This method of water storage is also used frequently to retain farmlot wastes and function as a sewage lagoon. With good planning and proper design, these basic water storage structures can be adapted to most locations.

II. Factors Governing Selection of Site, Type, and Capacity

A. Purpose

As with most engineering structures, several designs may be possible for a particular site. However, when the intended use of the pond is considered along with the site characteristics, an optimum design can be developed. For example, if the pond is to be used for irrigation, it should be located as centrally as possible to all fields to prevent excessively long reaches of pipes or canals. The location should also afford adequate storage capacity and low seepage losses. However, if the structure is primarily for flood and erosion control, the site should allow maximum runoff interception and the embankment material can be more pervious. When rapid drawdown is expected due to irrigation or stock watering, a zoned embankment with good upstream slope protection would be preferable to a homogeneous dam with only vegetation cover.

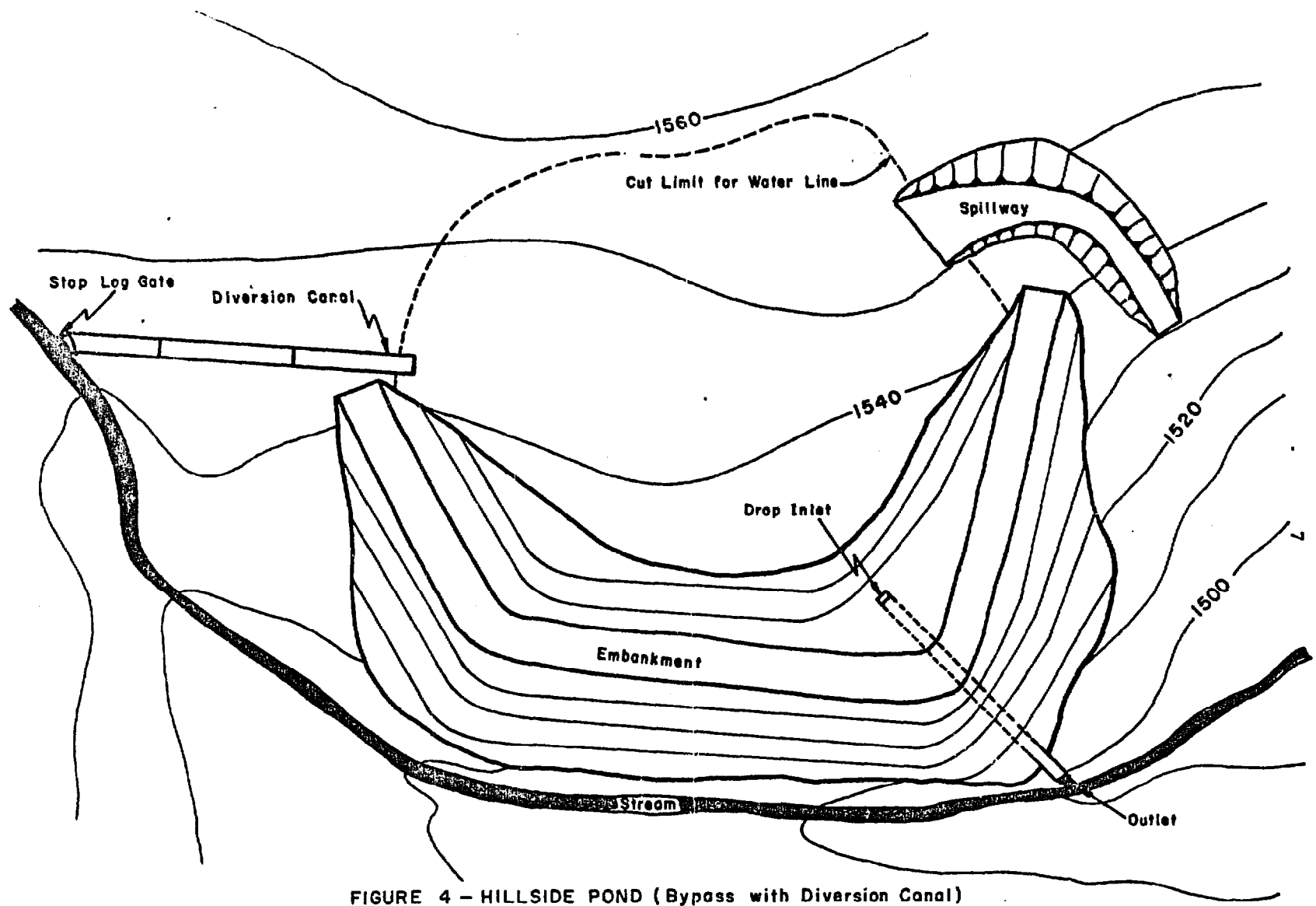

FIGURE 4 - HILLSIDE POND (Bypass with Diversion Canal)

B. Topography

Topography, to a large degree, influences the site, type, and capacity of pond. For an embankment type pond, some desirable site characteristics are:

1. Narrow valley at damsite to reduce fill and provide deep water storage which reduce evaporation losses.
2. Wide abutments for an emergency spillway with minimum excavation.
3. An alternate water course to allow diversion during construction.
4. A flat valley slope upstream to minimize deep cuts in the pond area.

Where the topography is nearly level, a dugout pond is more suitable. However, the site should have a high water table to prevent seepage loss and an adequate drainage area or aquifer supply to keep the pond full.

To insure that the water storage capacity at a selected site will be adequate for the intended use, an estimate of capacity should be made. For an embankment pond, a reasonable estimate can be made by multiplying the proposed surface area by 0.4 times the maximum water depth at the dam. For a dugout pond, the capacity will simply be the volume of proposed excavation.

Topographical maps, visual inspections, and preliminary surveys are valuable guides to site selections.

C. Subsurface investigation

After a pond site has been located which is suitable for the topography and intended use, the local subsurface should be investigated to determine the quality of the foundation strata and the classification of available borrow soil for the embankment fill. To obtain this

information, boring and/or test pits should be extended to stable and relatively impervious material. Figures A1 and A5 in the appendix give a classification and values of permeability as a function of particle size. As a rule, if such material is very deep, investigation to a depth equal the dam height is sufficient. Mobile drills or back hoes are best suited for such exploration, but for small ponds, hand augers or posthole diggers are adequate. Areas to be investigated, as shown in Fig. 5, are:

1. Along the embankment centerline, continuing up abutments.
2. Various points in the pond and borrow areas.
3. Along the centerline of the emergency spillway.
4. Any points where footings will be constructed, e.g., at drop inlet.

Soils in the ponded area should contain layers of materials that are relatively impervious and thick enough to prevent high seepage losses. Natural layers of clays and silts are good materials, while sands and gravels should be avoided. However, ponding can be accomplished on sands or silty sands if the water table is high enough or if sealing or lining can be afforded. Sites where faults or limestone sinks and caverns are present should also be avoided without extensive investigations and laboratory tests. Sites in earthquake areas deserve special design considerations and will be discussed later.

The soil profile beneath the embankment and at footings must provide stable support for all conditions of saturation and loading in addition to being relatively impervious. Foundation soil of low shear strength will require a flatter sloped and broader dam. A more liberal allowance for embankment settlement must be allowed for soft foundation material. If the foundation material is pervious, a seepage cutoff

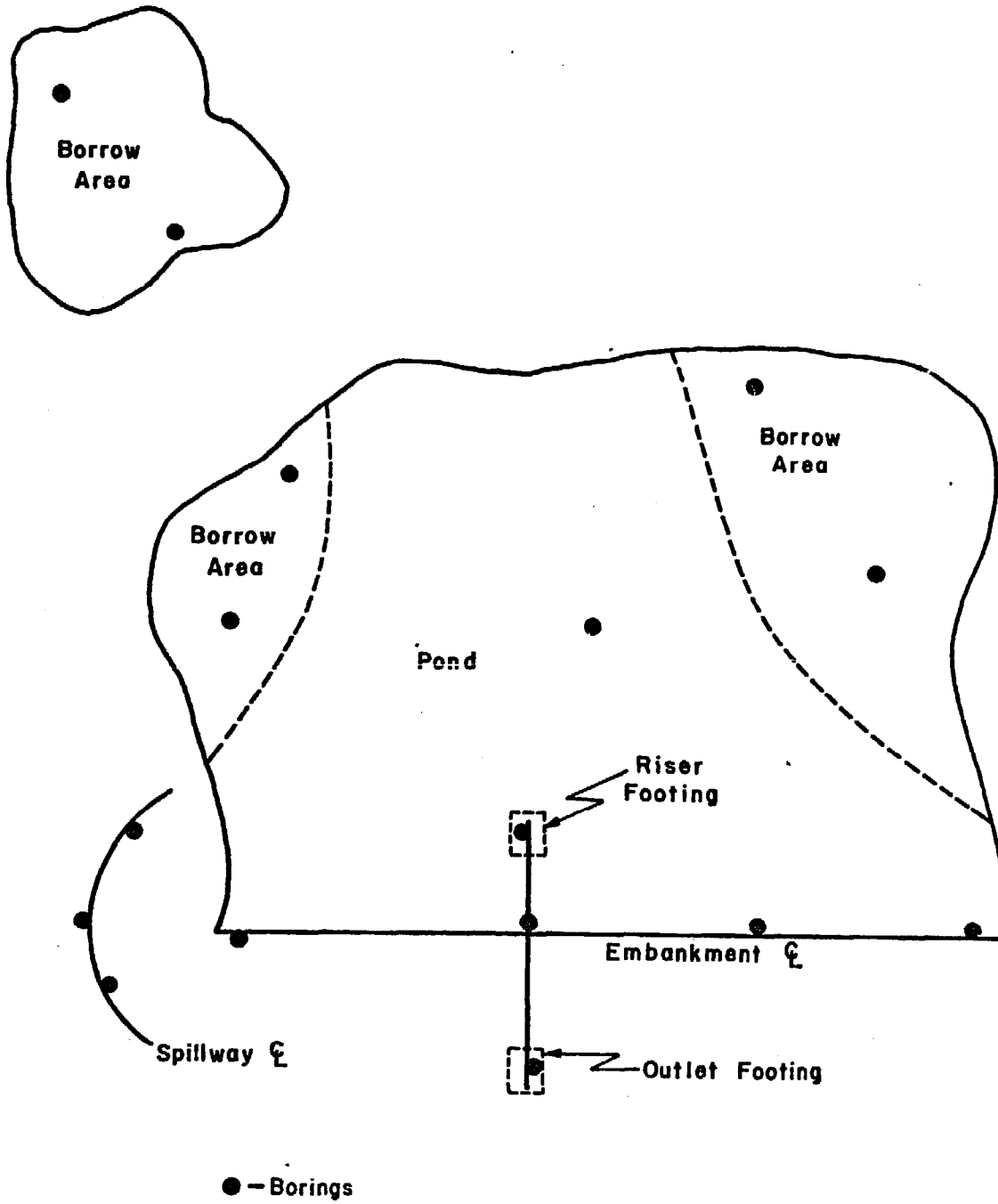

FIGURE 5 - BORINGS AT PROPOSED SITE

trench or impervious blanket will be needed. Rock foundations are excellent for bearing strength, but often require grouting to seal fractures to control seepage. Springs in or near the embankment can cause serious piping and should be avoided.

Borings in the emergency spillway site should be made to a depth at least one foot below the spillway's finished grade. The soil should be classified and the compaction and plastic qualities determined in order to design for maximum velocities in the spillway.

The type of material which will be available from excavations and borrow areas must be evaluated for bearing strength and permeability to determine if the embankment will need an impervious core or blanket, optimum moisture, and the degree of compaction that can be achieved. If borrow material is not available at a reasonable distance from the project, it should be determined if enough cut material can be obtained from the pond and spillway areas to construct the embankment.

Sites proposed for dugout ponds also require a thorough subsurface investigation to insure that the soil layer at the designed depth is relatively impervious. If the pit pond is to store water from an aquifer, test holes should be made to determine the level to which the water will rise. When this level is more than six feet below existing ground level, the site will not be economical to construct unless another water source can be utilized.

Methods of subsurface testing and the evaluation of collected samples and data can be obtained from most soil manuals, soil text books, or field handbooks from such organizations as the U.S. Soil Conservation Service, or the Mexican Secretary of Hydraulic Resources (Secretaria de Recursos Hidraulicos).

D. Climate

Climate is an important consideration at a proposed pond site. Not only must it be considered for hydrological design data, but is of critical concern during construction. The estimated mean and peak runoff discharges, as discussed in previous presentations, are the primary input for spillway capacities. Evaporation, which is a function of climatic conditions, must be considered along with seepage in determining the net loss of storage. Wind and temperature are factors that will be important in embankment freeboard design.

During construction, little work should be done on embankments of fine-grained soils in wet or freezing weather. Movement on wet or frozen silts and clays will destroy any compaction effort. However, placement of pervious soil or rock can be done during such wet or freezing periods. In rainy areas, to facilitate construction and provide drainage during operation, embankments would best be designed of pervious materials with an internal impervious zone. In arid areas, the lack of water may be a problem in maintaining optimum moisture for compaction. An adequate water supply should be available, either from the stream or some outside source and a continuous check made on the moisture content of fill material. When necessary, water must be sprayed on each fill layer before compaction, being careful not to puddle or over water.

In dry climates, it should be determined if vegetation can be maintained as slope protection or if an alternate cover will be necessary. This is a very important consideration, since a hard rain can easily destroy a bare earth structure.

E. Equipment and labor

The availability and use of construction equipment, either mechanical or manual, is a limiting factor in pond location and design. The basic operations which are needed for pond construction are *excavation, hauling, spreading, and compaction*. For small ponds, either dugout or embankment types, manual and animal labor can be especially well used. Steep, narrow valley sites also make machinery movement difficult and are better suited for manual labor. In such cases, the excavation can simply be done by pick and shovel, but an allowance for increased manpower will be necessary in hard clay and rocky soils.

Wheelbarrows can be used for hauling short distances, however for leads of more than 180 meters the efficiency decreases and animal-drawn carts or scrapers should be used. Spreading the material can be done by shovel or an animal-drawn scraper or blade. Good compaction is difficult to achieve with manual labor, and thus the design should allow for more seepage and greater settlement. Spreading thin layers of fill (i.e., 3-4 in.), hand tamping, utilizing maximum cart traffic, and possibly even herding livestock across the embankment will aid in compaction. Special care in tamping must be used around spillways, outlets, and abutments to insure good compaction.

If the soil to be excavated is not excessively hard or rocky, one or two farm tractors and a few accessories can be sufficient to build a pond. With a plow to loosen soil and a front-end loader or drawn scraper to excavate, a pond can be constructed quite inexpensively. If an embankment pond is to be built, a wagon for hauling and a water-filled roller for compaction may also be needed.

If heavy equipment is available or the pond is quite large, several combinations of machinery can be used and will produce a strong structure in a relatively short time. A single bulldozer can normally excavate and spread the cut material for a fair size dugout pond (approximately 1/2 acre) in a single day. Most small embankment ponds can be built with a bulldozer and a sheepsfoot or rubber-tire roller. If the pond area is large or fill must come from a borrow area, a towed or self-propelled pan, or a truck should assist in hauling. As embankment size increases, more equipment may be necessary to improve construction economy.

No matter which level of equipment is used, some means of applying water to aid compaction should be available, and hand or pneumatic tamping should be done at spillways, outlets and abutments.

F. Statutory restrictions, costs, and time

Before spending any time or money on site investigations or designs, any legal regulations governing water rights and ponding structures should be considered. Restrictions are often made on the distance from impounded water to roadways or buildings and on factors of safety in design specifications. Property lines and water rights may limit the pond location and amount of water storage.

Because of widely fluctuating economic and labor conditions in different localities, it is not possible to consider costs in this presentation. However, the amount of time and money spent in pond construction should always be weighed against the value of the pond's uses.

III. Design

A. Dugout ponds

Dugout ponds are the simplest type to construct and thus require only a few design considerations. The shape can be made to fit any location, however a rectangular shape is the most convenient to excavate if machinery is used. For a pond fed by aquifers, the design area will depend on the capacity desired and the depth of the aquifers. However, since aquifer inflow may be altered by the construction, additional area should be available for pond enlargement if the original design proves inadequate. For a dugout pond fed by runoff or diverted streamflow, any combination of area and depth can be designed which yields the desired storage volume. For example, if approximately 0.25 acre-feet (or 82,000 gallons) of water are needed for stock watering and a permanent storage of 0.75 acre-feet allowed for fire protection, any dimensions which provide one acre-foot of volume will be adequate. However, it should be remembered that the greater the surface area, the greater the evaporation and seepage. Thus, a 0.25 acre area with a four foot depth would be a reasonable design. The side slopes should not be steeper than the natural angle of repose of the soil or 1:1. If livestock will be allowed to water directly from the pond, at least one side should have a slope of 4:1 or flatter and be protected with a paved, rock, or timber surface as in Fig. 2.

The placement of excavated material must be included in the design. It can be *stacked* or *spread* at the pond site, or *removed* altogether. If stacked (Fig. 6a), the embankment should have flat enough sides to prevent soil erosion back into the pond. A berm, the width of the

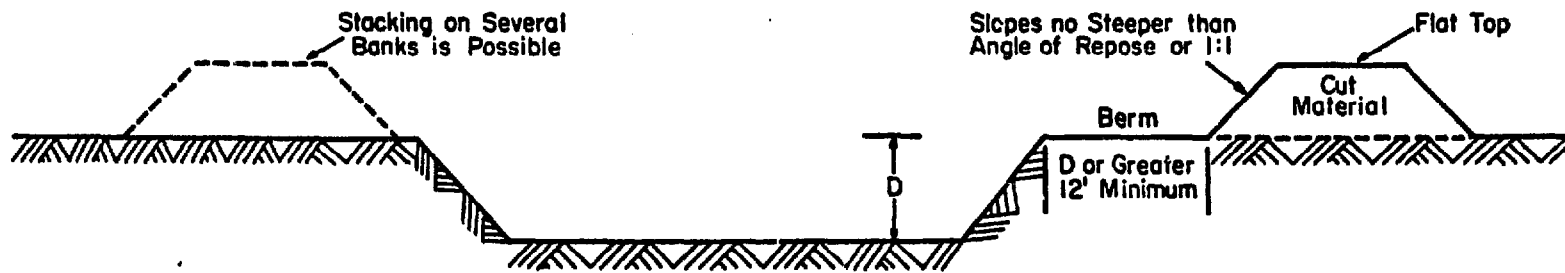

(a) WASTE MATERIAL STACKED

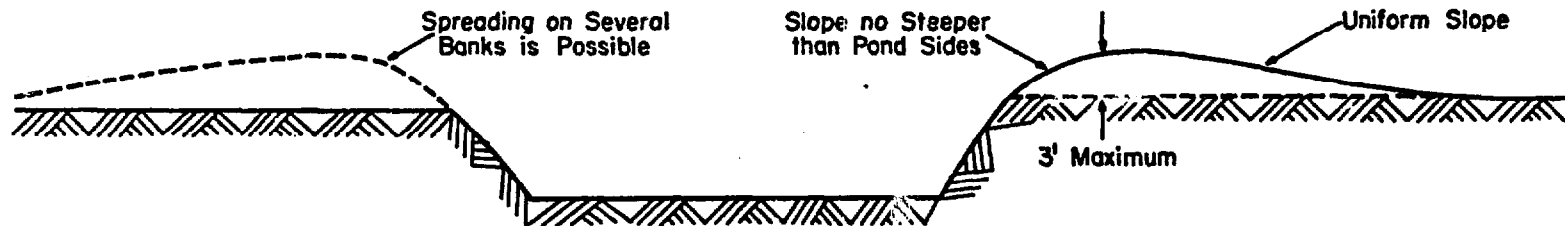

(b) WASTE MATERIAL SPREAD



(c) WASTE MATERIAL REMOVED

FIGURE 6 - METHODS OF WASTE MATERIAL DISPOSAL FOR PIT PONDS

pond's depth, or at least 12 feet, should also be allowed to insure stability of the pond's sides. Embankments placed on the windward side of the pond can reduce evaporation. Spreading the cut material along one or more sides has several advantages; decreased pressure on pond sides, protection against overflow, and ease of establishing vegetation cover. The height of spread material should not exceed three feet and the slopes graded quite flat (Fig. 6b).

B. Embankments and foundations

The major design consideration for embankment type ponds is the dam cross section, while the pond area is almost pre-designed.

The pond area is determined by trial and error. The desired storage volume will be produced by a best-fitting dam height and corresponding area within the waterline elevation contour. As previously mentioned, a good estimate of storage volume is 0.4 times the dam height, times the pond area. Thus, as illustrated in Fig. 7, set a trial dam elevation and see if the area circumscribed by the contour at that elevation will fit this estimate. If the estimate is reasonable, determine the amount of cut necessary to provide the desired minimum pond depth. Then compute the actual volume that will result. If this trial does not give a tolerable result, adjust the dam elevation accordingly. Also, determine if the useable cut material is sufficient to construct the embankment. If more fill is needed, it can be obtained by deepening the pond or obtaining a borrow area. Deepening the pond should be considered first to hold down costs. The additional volume will also increase the sediment trap efficiency.

In the process of determining the needed pond area, the required dam height has also been obtained. However, to provide a factor of

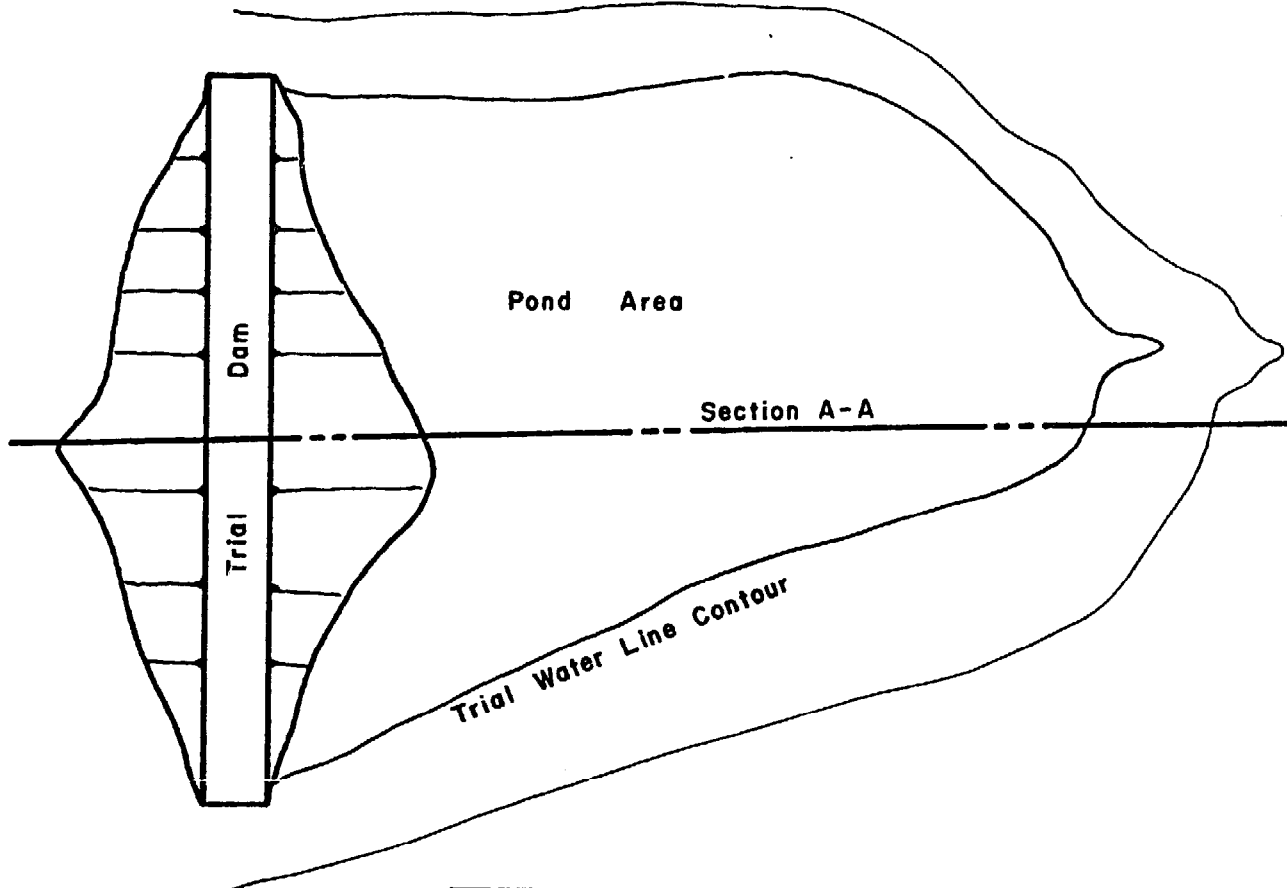

$\text{Storage Volume} \approx 0.4 \times \text{Area} \times \text{Dam Height}$

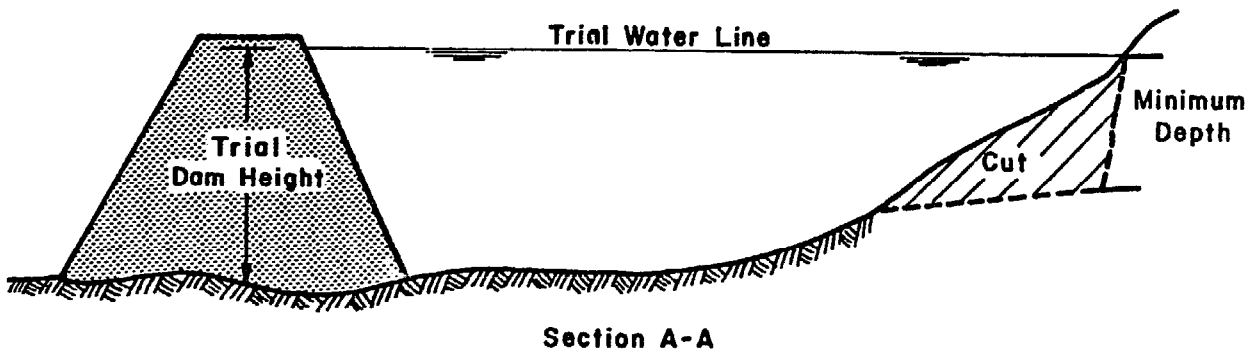

FIGURE 7 - ESTIMATING STORAGE VOLUME

safety against overtopping, a *freeboard* must be added to the normal waterline elevation (Fig. 8). Of primary importance is the flood storage free board. This is the elevation difference between the outlet works crest and the emergency spillway control section. To avoid calculating flood routing data for the watershed of a small pond, graphical guides, such as Fig. 9, can be used to estimate the flood storage based on peak runoff and pond area. The depth of flood flow in the emergency spillway must also be added to the freeboard. (This design depth will be determined later.) An allowance should also be made for wave action and frost penetration. For ponds, wave height can be estimated by Hawksley's formula: $h = 0.025 (f)^{\frac{1}{2}}$, where h is the wave height and f the fetch in feet. The amount of freeboard to allow for loosening of soil by freezing and thawing can be obtained from local frost penetration records. Additional freeboard should be added for safety if valuable property would be damaged by an embankment failure.

Another addition to the constructed dam height must be an allowance for settlement. This can accurately be determined by considering void ratios for the fill material. However, a good rule for small ponds is to increase the dam height by 10 percent at each point since small dams do not usually receive adequate compaction.

Once the dam height has been determined, the top width and side slopes can be designed. On embankments less than 50 feet high (which usually includes farm ponds), slopes should not be steeper than 3:1 on upstream faces and 2:1 on downstream faces for most materials. Well-graded soils, if well compacted, can tolerate 2:1 slopes on both faces, while coarse materials may require 4:1 sides. If machinery is used in

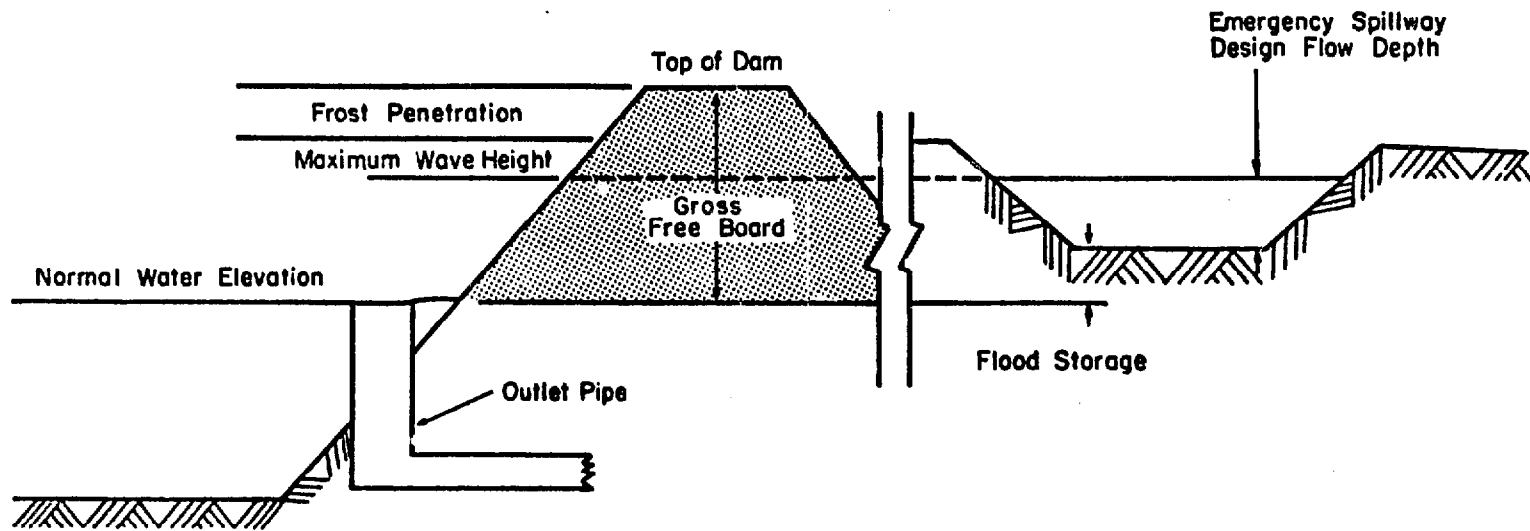

FIGURE 8 - DESIGN FACTORS OF FREEBOARD

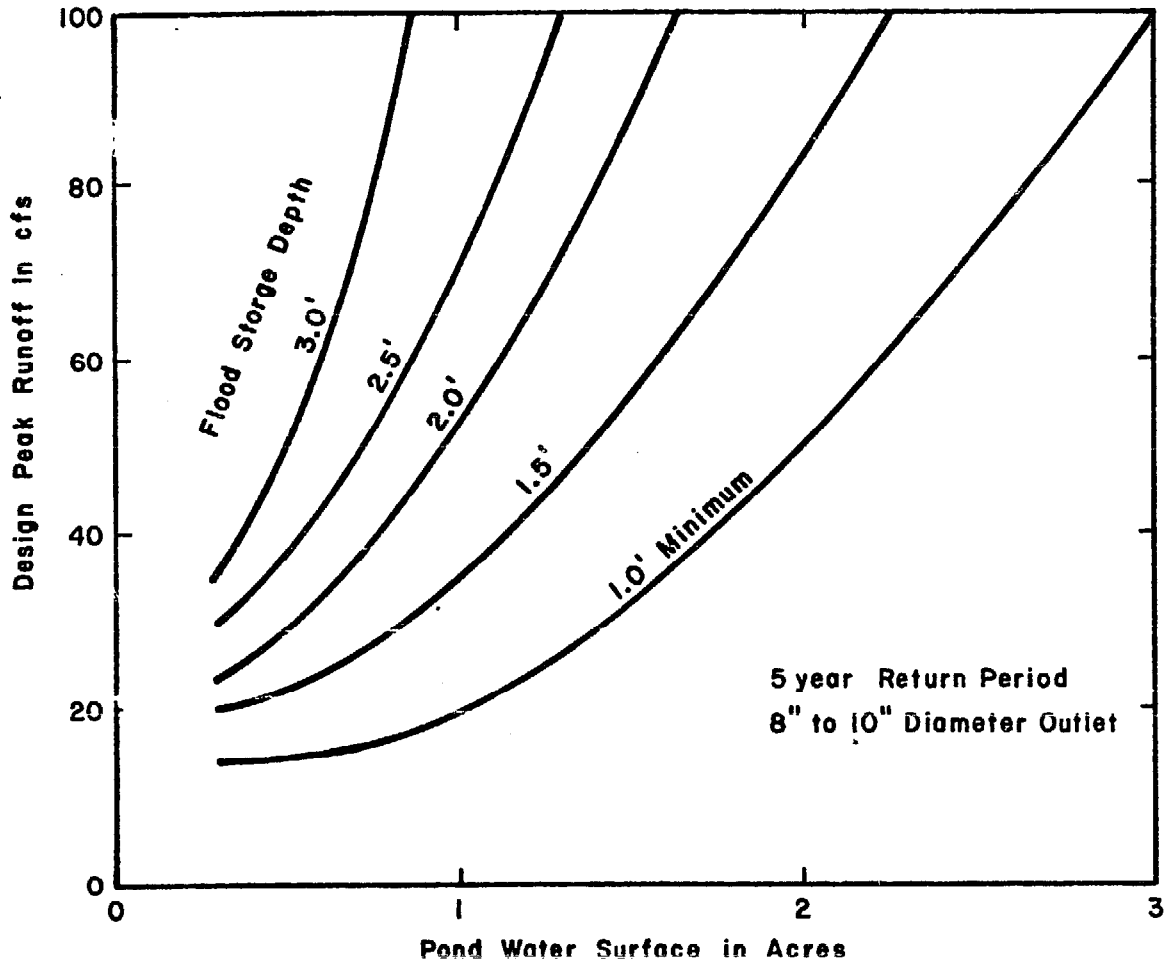

FIGURE 9 - SUGGESTED FLOOD STORAGE DEPTH
 (Schwab, G.O., et al. Soil and Water Conservation Engineering)

construction, the minimum top width must be the width of the placing and compacting equipment. However, an embankment less than 15 feet high should have at least a seven foot top width. Higher embankments should use the guideline that the crest width should equal one-fifth the maximum dam height plus 10 feet.

It should be noted that if the pond site is in an area of frequent earthquake activity, flatter side slopes near the dam crest and a small additional freeboard should be designed to improve stability and increase the factor of safety.

With the information obtained from the subsurface investigations and having determined the dam height, a design can be developed for the dam cross section. As previously discussed, fine-grained materials allow for a homogeneous cross section. However, a *rock toe drain* (Fig. 10a) or *pervious drainage blanket* (Fig. 10b) should be included at the downstream toe to prevent piping. This is done by placing rock and/or a sand and gravel filter along the toe for the first several layers of fill. If rock or gravel is not readily available or more drainage is thought necessary, tile drain pipe may be installed within a sand filter in the lower downstream third of the embankment (Fig. 10c).

If the embankment material is quite permeable, several combinations of *impervious cores, diaphragms, and blankets* can be designed to reduce seepage through the dam. However, for small ponds, an internal core of well compacted clay is usually the easiest and most economical to construct (Fig. 3b). At the foundation elevation, the core should account for the inside one-third of the dam thickness along the entire dam length. The core should have side slopes of 1:1 or steeper, but at least sufficient to extend the core to the embankment crest. If

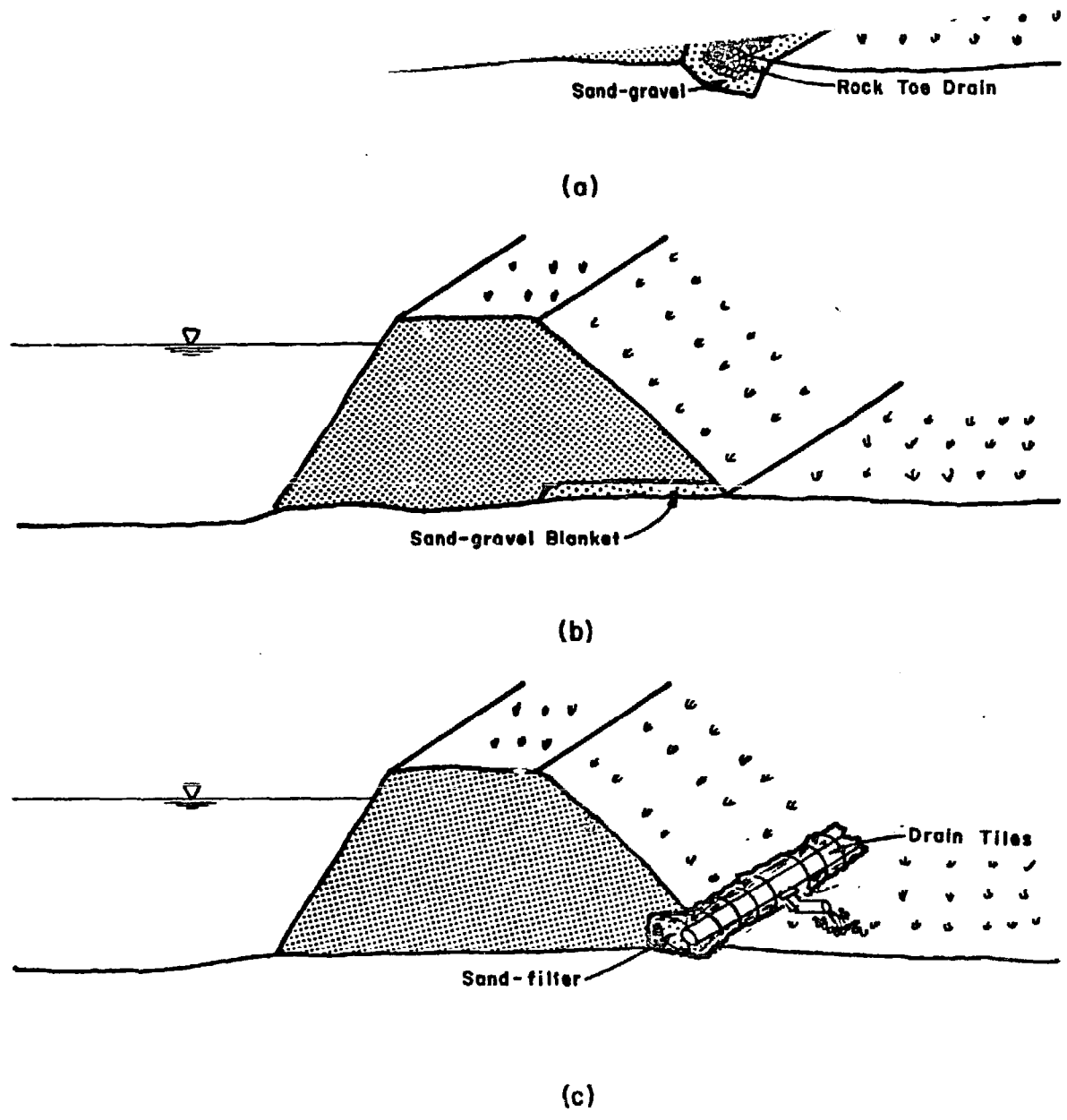

FIGURE 10 - METHODS OF EMBANKMENT DRAINAGE

clay type material is not available, an internal diaphragm (Fig. 3d) or upstream blanket (Fig. 3c) of concrete or bituminous concrete can provide an adequate water barrier. However, diaphragms are susceptible to cracking from settlement and blankets are often undermined. They should be avoided when possible for small dams and carefully designed and constructed when necessary. A toe drain should also be included in the design of a zoned embankment.

The most satisfactory foundation for a dam is a thick layer of impervious material at or near the surface. To prevent slippage and seepage between such a foundation and the embankment fill, a shallow *key* trench should be designed (Fig. 3a). It should be at least two or three feet deep and about 10 feet wide. For a zoned embankment with an impervious core, the key trench becomes a downward extension of the core (Fig. 3b). If the foundation consists of permeable soil, with a rock or impervious stratum at a reasonable depth, the trench should be excavated down to that layer, as in Fig. 11a. Such a *cutoff* trench is filled with impervious soil the entire embankment length and up the abutments. The cutoff should have a bottom width of at least four feet and with about 1:1 side slopes. If the impervious substratum is too deep to be reasonably reached, a blanket design might be utilized. For the previously mentioned reasons an overlying blanket, as in Fig. 3c, should be used with caution. However, a blanket extension of an internal core is a good design for deep, pervious foundations. This impervious blanket should be extended well upstream to prevent undermining (Fig. 11b).

During the design stage of any earth embankment, the seepage under and through the dam should be estimated to check the size and location of water barriers and drains. A discussion of embankment seepage is given in Appendix A.

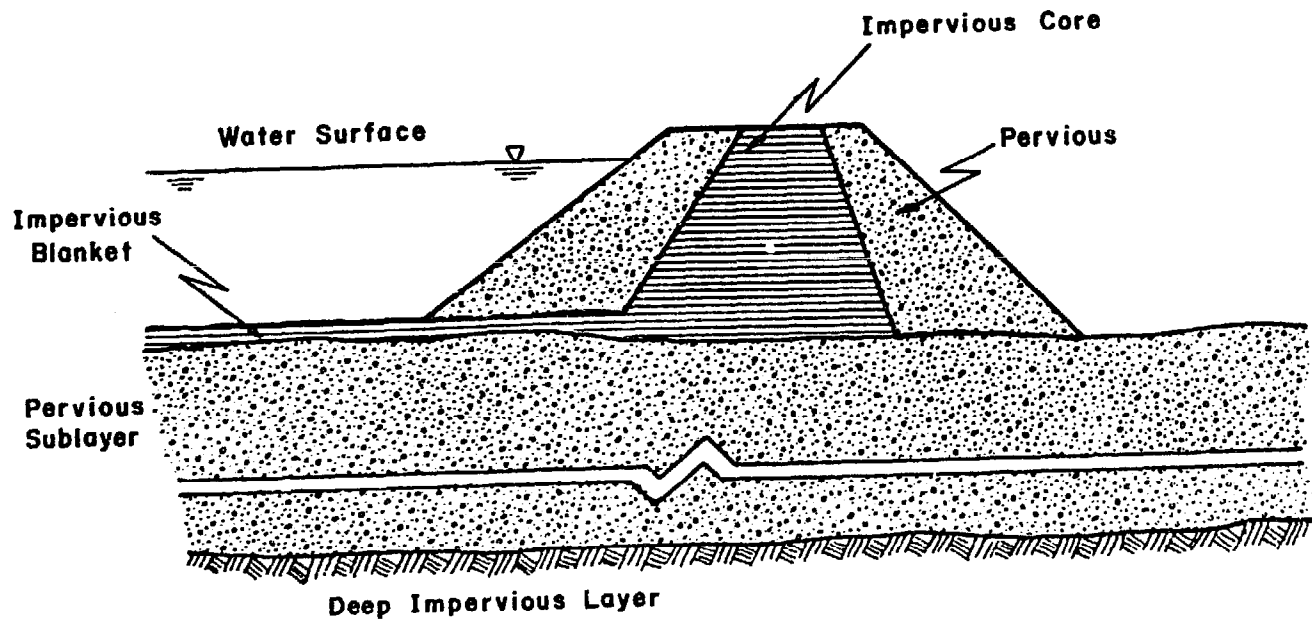
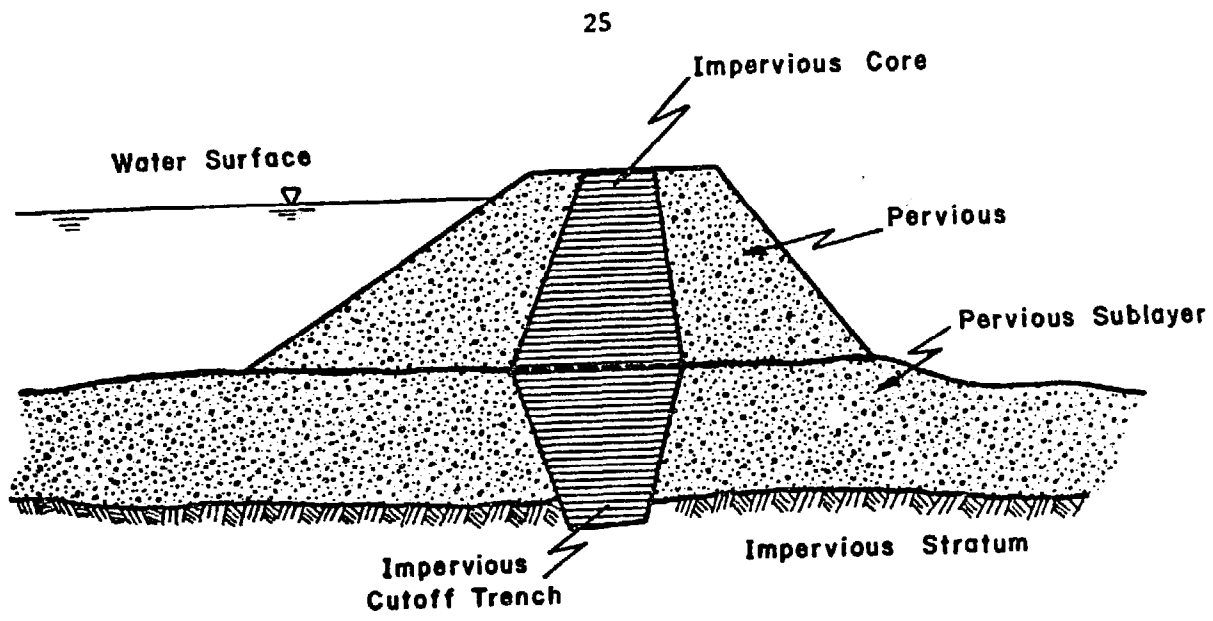

FIGURE II - TREATMENT OF PERVIOUS FOUNDATIONS

Some form of slope protection must be designed for the embankment to prevent erosion. For small ponds, the best cover is a good thick sod on the up and downstream faces and crest. If the top of the dam is to be used as a roadway or livestock crossing, the edges of the crest should be protected by fencing or rock to prevent damage. Where arid conditions prevent good vegetation or if severe drawdown is expected, a riprap cover can be used. A sand and gravel filter, one to two feet thick, should be provided beneath the riprap to keep the fine embankment material from washing out.

C. Outlet works

Most small ponds are protected from overtopping by a vegetated emergency spillway. However, to allow drawdown by gravity and to prevent the earth spillway from being continually wet, an *outlet structure* is usually provided. However in arid regions, outlet structures are often not needed and the flood spillway or spreading ditches are used as outlets. The outlet structure is usually designed to carry the mean flow. However, if steep or soft abutments prohibit the safe use of an earth spillway to carry peak flows, the outlet works must be designed to carry both mean and flood flows. This can be done with a *chute spillway* or *multi-stage* inlet. A chute spillway (Fig. 12) should only be constructed on an embankment of well compacted soil with a high bearing strength. However, a multi-stage inlet, such as Fig. 13, can be designed for any outlet works and provides for a flood storage capacity.

Outlet works must be constructed of durable material that will resist damage due to settling or moving loads. Several basic combinations of outlet structures are usable for pond dams; a *concrete block*

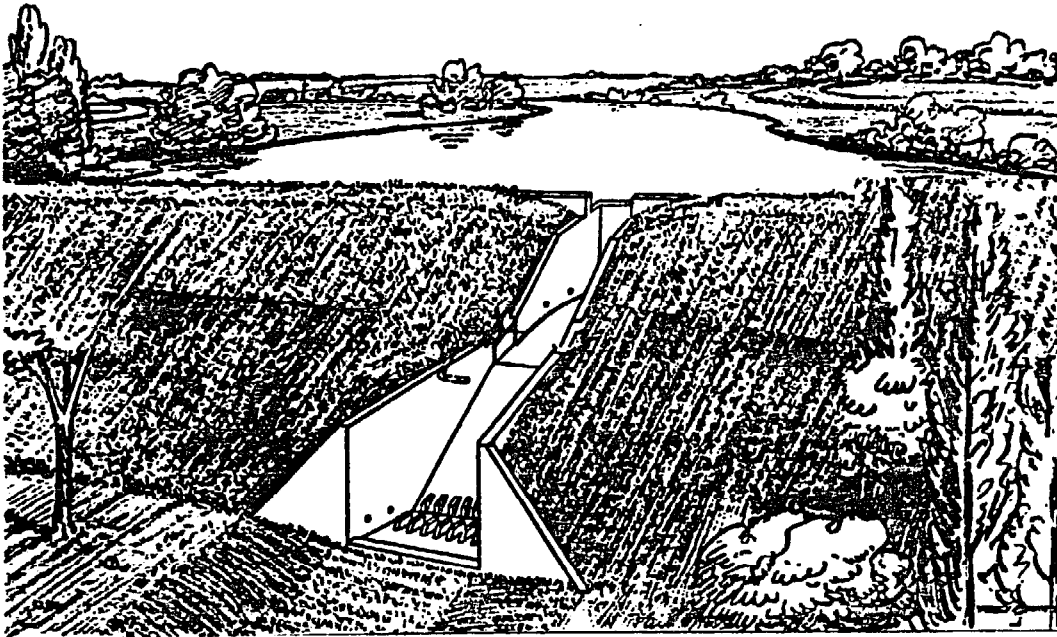

FIGURE 12 - SHUTE SPILLWAY
(U.S. Soil Conservation Service , 1969)

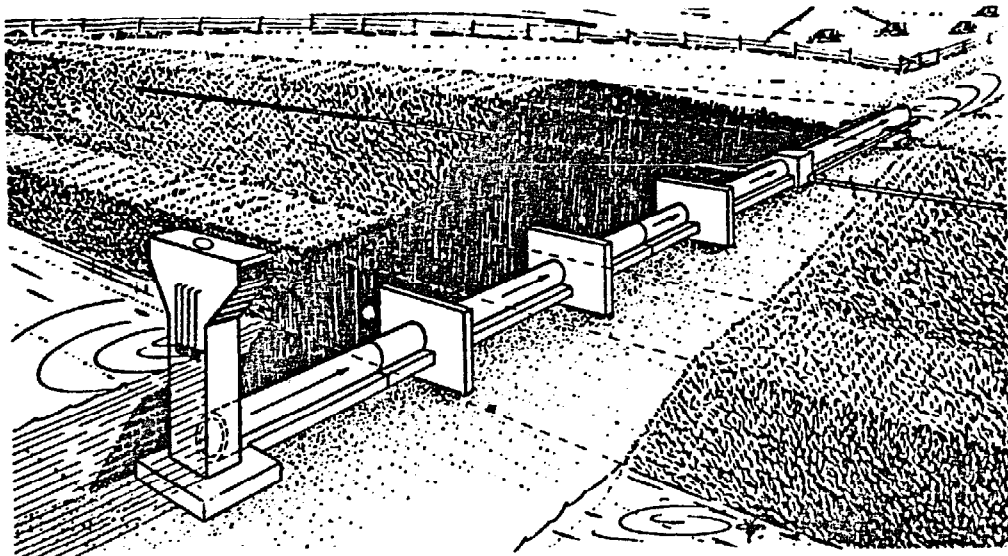

FIGURE 13 - OUTLET WITH MULTI-STAGE INLET
(U.S. Soil Conservation Service , 1969)

or *reinforced concrete* inlet with a *corrugated metal pipe* or *concrete pipe* conduit (Figs. 14 and 15), a *hooded CMP* conduit with no riser (Fig. 16), or for larger ponds, a *monolithic structure* combining riser and barrel (Fig. 17). However, the most popular outlet structure for small ponds is a *CMP conduit* passing through the embankment with a drop inlet of the same material (Fig. 18). Such a structure is more durable than concrete, can be assembled off the project site and set in place in one operation at the proper fill elevation. For the construction of several small ponds, the design of these outlets can be standardized and mass assembled, saving time and money. As shown in Figs. 18 and 19 this type outlet can easily be used with a valve or gate to allow drawdown for irrigation or other water uses. The inlet pipe to this valve or gate can also be used to divert runoff through the dam during construction.

To determine the size outlet works necessary to carry the design flow, it is best to consult design tables or graphs (Figs. 20 and 21) which provide discharge capacities for various combinations of risers and barrels. Entering such figures with only the design flow, several usable pipe sizes and design heads will be suggested. This design head is the elevation difference between the inlet and the emergency spillway, as mentioned in the freeboard discussion. If such guidelines are not available, Bernoulli's principle and Manning's equation of flow may be utilized.

All conduits passing through the dam should be fitted with *antiseep collars* to prevent erosion of soil along the outside surface of the conduit. These collars can be metal, welded to the pipe, or concrete, poured in forms around the conduit after it is in place in the embankment. Two 2' x 2' collars are usually sufficient for small

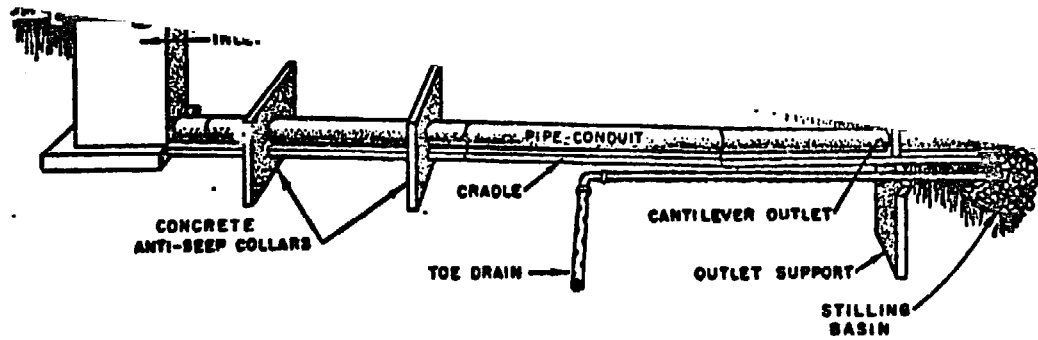

FIGURE 14 - REINFORCED CONCRETE INLET AND PIPE
(U. S. Soil Conservation Service, 1969)

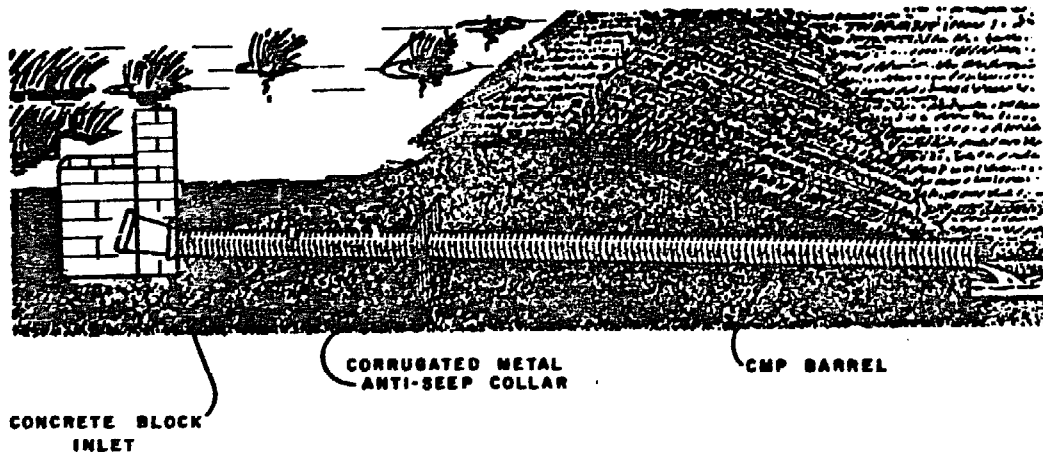

FIGURE 15 - CONCRETE BLOCK INLET WITH CMP BARREL



FIGURE 16- HOOD CMP OUTLET
(U.S. Soil Conservation Service, 1969)

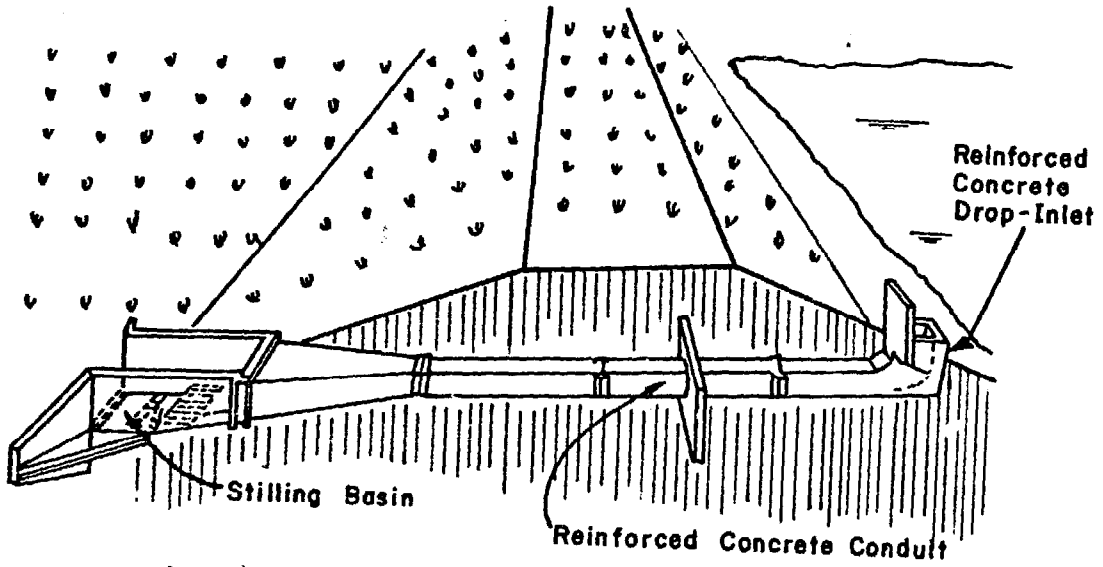

FIGURE 17 - MONOLITHIC OUTLET WORKS

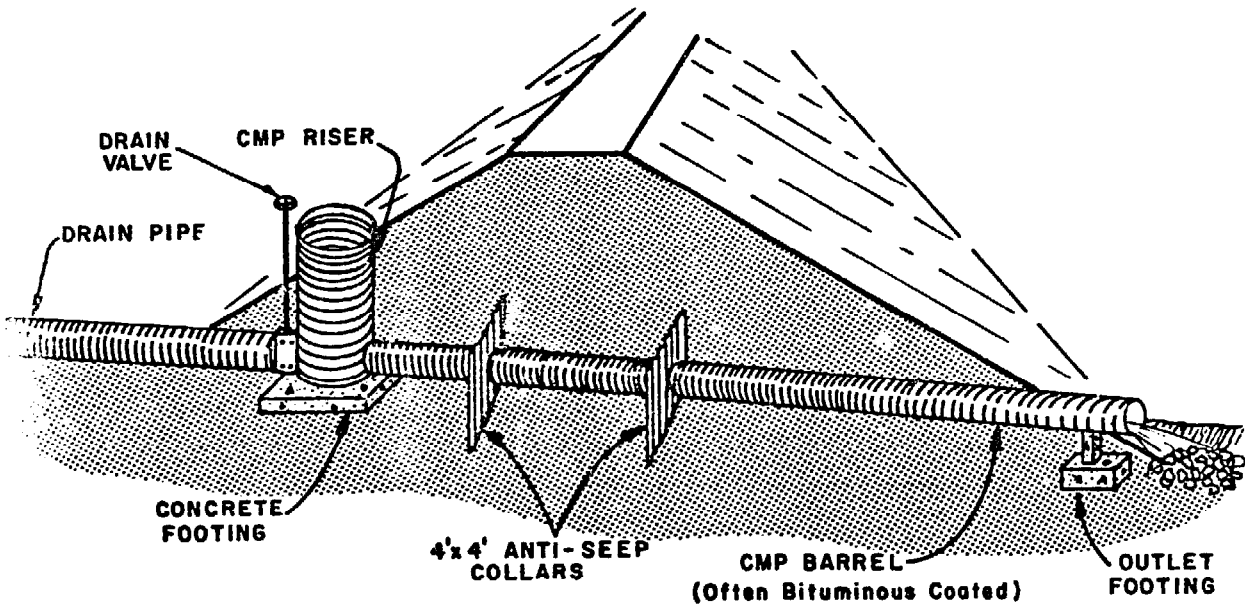

FIGURE 18 - CORRUGATED METAL PIPE OUTLET WORKS

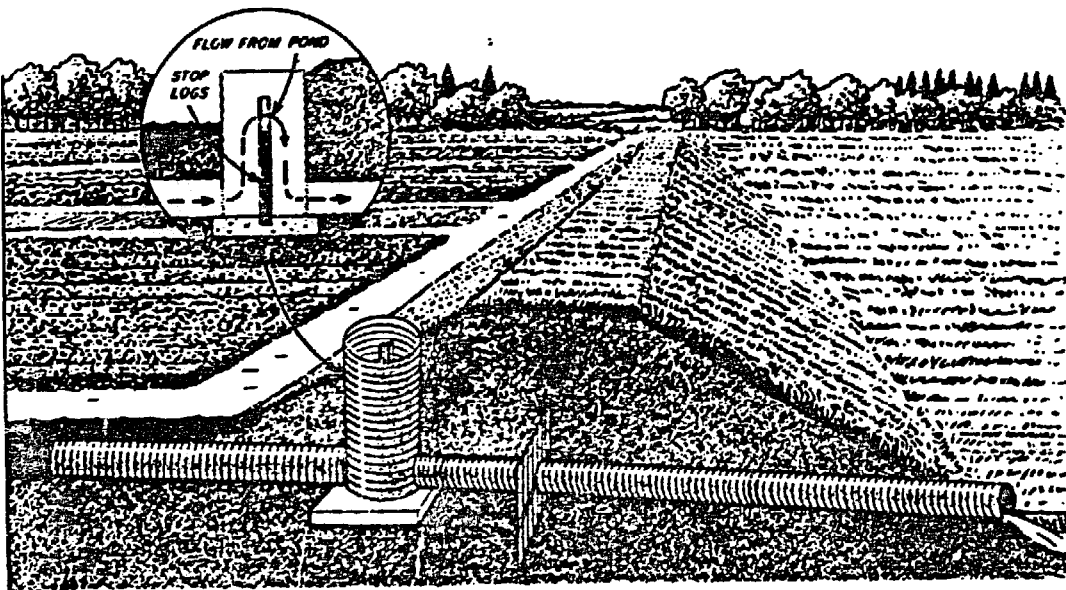

FIGURE 19 - CMP OUTLET WITH STOP LOGS
(U.S. Soil Conservation Service, 1969)

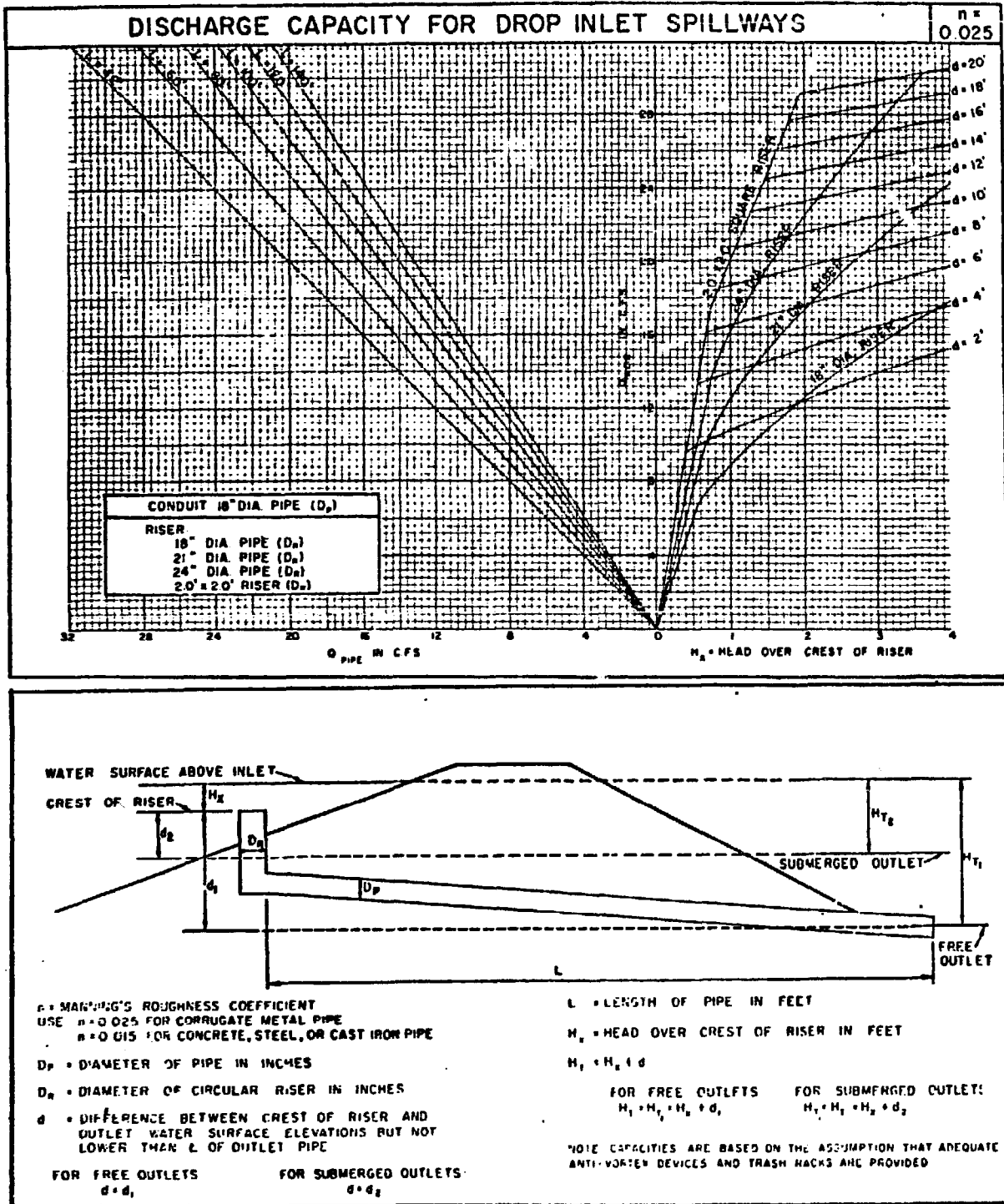

FIGURE 20 - TYPICAL PIPE SPILLWAY DESIGN CHART
 (U.S. Soil Conservation Service, 1969)

CAPACITY OF CORRUGATED METAL PIPE CULVERTS
OUTLET CONTROL - FULL FLOW - WITHOUT HEADWALLS

CIRCULAR

DIAMETER INCHES	Length	CUBIC FEET PER SECOND																
		Head on Pipe - Feet																
		0.1	0.2	0.3	0.4	0.5	0.6	0.8	1.0	1.2	1.4	1.6	1.8	2.0	2.5	3.0	3.5	4.0
20 Feet	12	1.0	1.4	1.7	2.0	2.2	2.4	2.8	3.1	3.4	3.7	4.0	4.2	4.4	5.0	5.4	5.8	6.2
	15	1.7	2.4	2.9	3.4	3.8	4.1	4.8	5.3	5.8	6.3	6.8	7.1	7.5	8.4	9.2	9.9	11
	18	2.6	3.6	4.4	5.2	5.7	6.2	7.2	8.0	8.8	9.5	10	11	11	13	14	15	16
	21	3.6	5.1	6.2	7.2	8.0	8.8	10	11	12	13	14	15	16	18	19	21	22
	24	4.9	6.8	8.4	9.6	11	12	14	15	17	18	19	20	21	24	26	28	30
	27	6.2	8.8	11	12	14	15	18	20	21	23	25	26	28	31	34	36	39
	30	7.8	11	14	16	17	19	22	25	27	29	32	33	35	39	42	46	49
	36	12	16	20	23	26	28	33	37	40	43	46	49	52	57	63	68	72
	42	16	23	28	32	36	39	45	51	55	60	64	68	71	79	86	93	100
	48	22	30	37	43	48	52	60	68	74	80	85	90	94	106	117	125	134
54	28	39	48	55	61	67	78	87	94	102	109	116	121	136	149	160	171	
60	34	48	59	68	76	83	96	107	118	126	134	142	150	167	182	197	210	
	velocity					4		5	6			7		8	9	10		
40 Feet	12	0.8	1.1	1.4	1.6	1.8	2.0	2.3	2.5	2.8	3.0	3.2	3.4	3.6	4.0	4.4	4.8	5.1
	15	1.4	1.9	2.4	2.7	3.1	3.4	3.9	4.3	4.8	5.2	5.5	5.9	6.2	6.9	7.6	8.2	8.8
	18	2.1	3.0	3.7	4.3	4.8	5.2	6.0	6.8	7.4	8.0	8.6	9.0	9.6	11	12	13	14
	21	3.0	4.3	5.3	6.1	6.8	7.4	8.6	9.6	11	12	12	13	14	15	17	18	19
	24	4.2	5.9	7.2	8.4	9.4	10	12	13	15	16	17	18	19	21	23	25	27
	27	5.5	7.8	9.6	11	12	14	16	17	19	21	22	23	25	28	30	33	35
	30	7.0	9.8	12	14	16	17	20	22	24	26	28	30	31	35	38	42	44
	36	10	14	18	21	24	26	30	33	36	39	42	45	47	53	58	62	66
	42	15	21	26	30	33	36	42	47	51	55	59	62	66	74	80	88	93
	48	20	28	35	40	45	49	56	63	69	74	80	84	89	99	109	118	127
54	26	36	45	51	57	63	72	81	89	96	103	109	115	128	140	152	163	
60	32	45	55	64	72	78	90	100	110	120	128	136	143	160	175	190	202	
	velocity					4		5	6			7	8		9	10		
60 Feet	12	0.7	1.0	1.2	1.4	1.6	1.7	2.0	2.2	2.4	2.6	2.8	2.9	3.1	3.5	3.8	4.1	4.4
	15	1.2	1.7	2.1	2.4	2.7	3.0	3.4	3.8	4.2	4.5	4.8	5.1	5.4	6.0	6.6	7.1	7.6
	18	1.9	2.7	3.3	3.8	4.2	4.6	5.3	5.9	6.5	7.0	7.5	8.0	8.4	9.3	10	11	12
	21	2.7	3.9	4.8	5.5	6.1	6.6	7.7	8.7	9.5	10	11	12	12	14	15	16	17
	24	3.8	5.4	6.6	7.6	8.4	9.2	11	12	13	14	15	16	17	19	21	22	24
	27	5.0	7.1	8.7	10	11	12	14	16	17	19	20	21	22	25	27	29	31
	30	6.4	9.0	11	13	14	16	18	20	22	24	25	27	28	32	35	37	40
	36	9.7	14	17	19	22	24	27	31	33	36	38	41	43	48	52	56	60
	42	14	19	24	28	31	34	39	44	48	51	55	58	61	68	74	80	86
	48	19	27	32	38	42	46	53	59	64	69	74	78	82	92	100	108	116
54	24	34	42	48	54	59	68	77	83	90	96	102	108	120	131	142	152	
60	31	43	53	61	68	74	86	97	105	113	120	128	135	150	166	178	190	
						4		5	6			7	8		9			

FIGURE 21 - TYPICAL PIPE DESIGN TABLE
(U.S. Soil Conservation Service, 1969)

water pipes and two 4' x 4' collars will protect most outlet works (Fig. 18). For large embankments, the number and size of collars should be large enough to increase the creep length along the conduit by 10 to 15 percent. These collars should be equally spaced along the middle two-fourths of the pipe.

To prevent damage to the outlet works by settling, *footings* should be designed at inlet and outlet structures. A simple timber support (Fig. 16), consisting of two posts with cross members is usually adequate for the outlet pipe. Placing conduits through the dam on a *camber* will also allow for settling. A camber at the centerline of the dam equal to about two percent of the fill height should be sufficient.

To prevent erosion of the downstream toe, a *stilling basin* of some form is needed at the barrel outlet. For a chute or monolithic structure, a diverging channel with baffle blocks, such as Fig. 22t, is a well-suited energy dissipator. For simple pipe outlets, a basin or riprap (Fig. 22a) is usually sufficient. The minimum size for such a basin should be 15' x 5' with a thickness of 18". If high velocities are expected through the outlet, the riprap basin can be combined with a *manifold basin* to effectively reduce velocity head (Fig. 23). This type outlet, developed at Colorado State University by Fiala and Albertson (1960), is easily constructed by laying the last section of outlet pipe on an adverse slope and partially obstructing the orifice with a slatted cover. This is a good method to dissipate energy, but adequate support of the outlet works should be insured in the design to prevent movement due to dynamic forces. Any type stilling basin used should be designed well downstream of the dam toe to prevent scouring.

Several design considerations should also be made to prevent the conduit from becoming clogged. Six inches should be the minimum

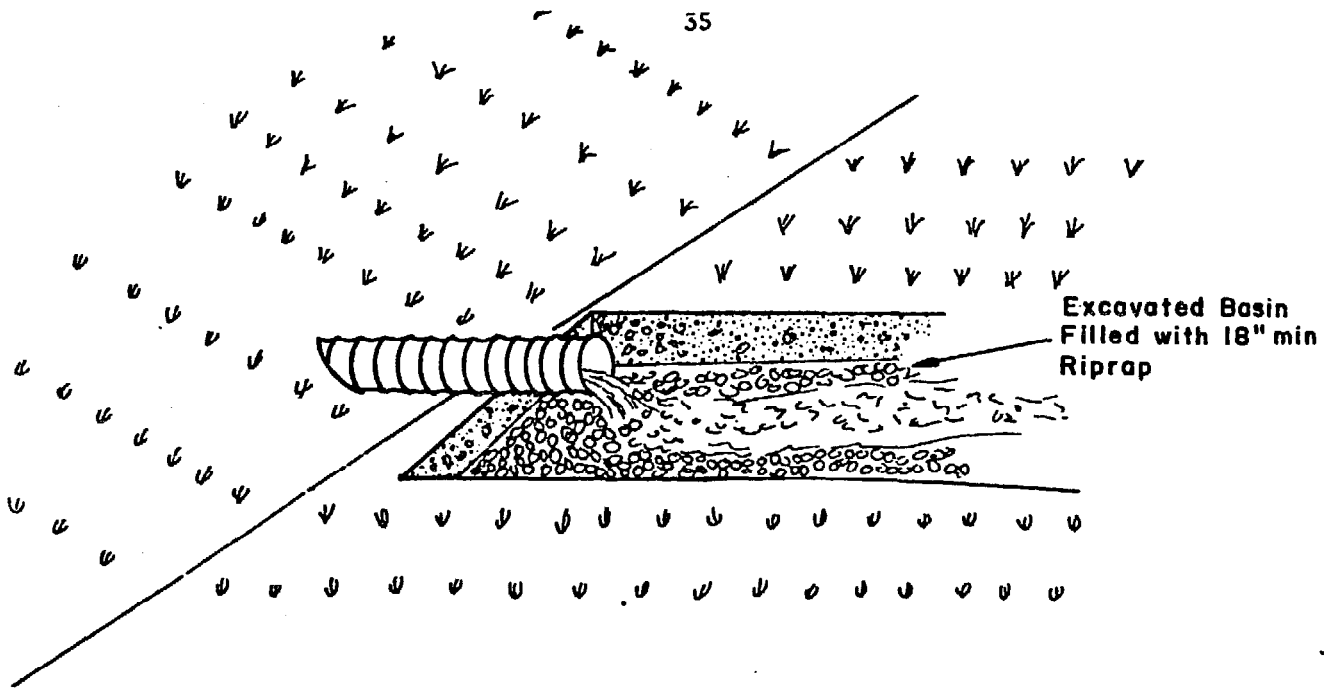

(a) Riprap Basin

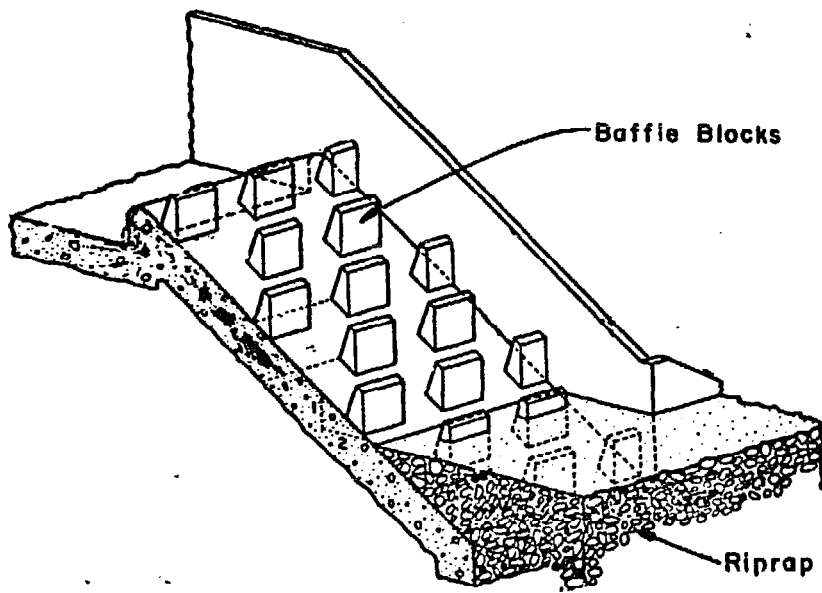

(b) Reinforced Concrete Basin

FIGURE 22 - STILLING BASINS

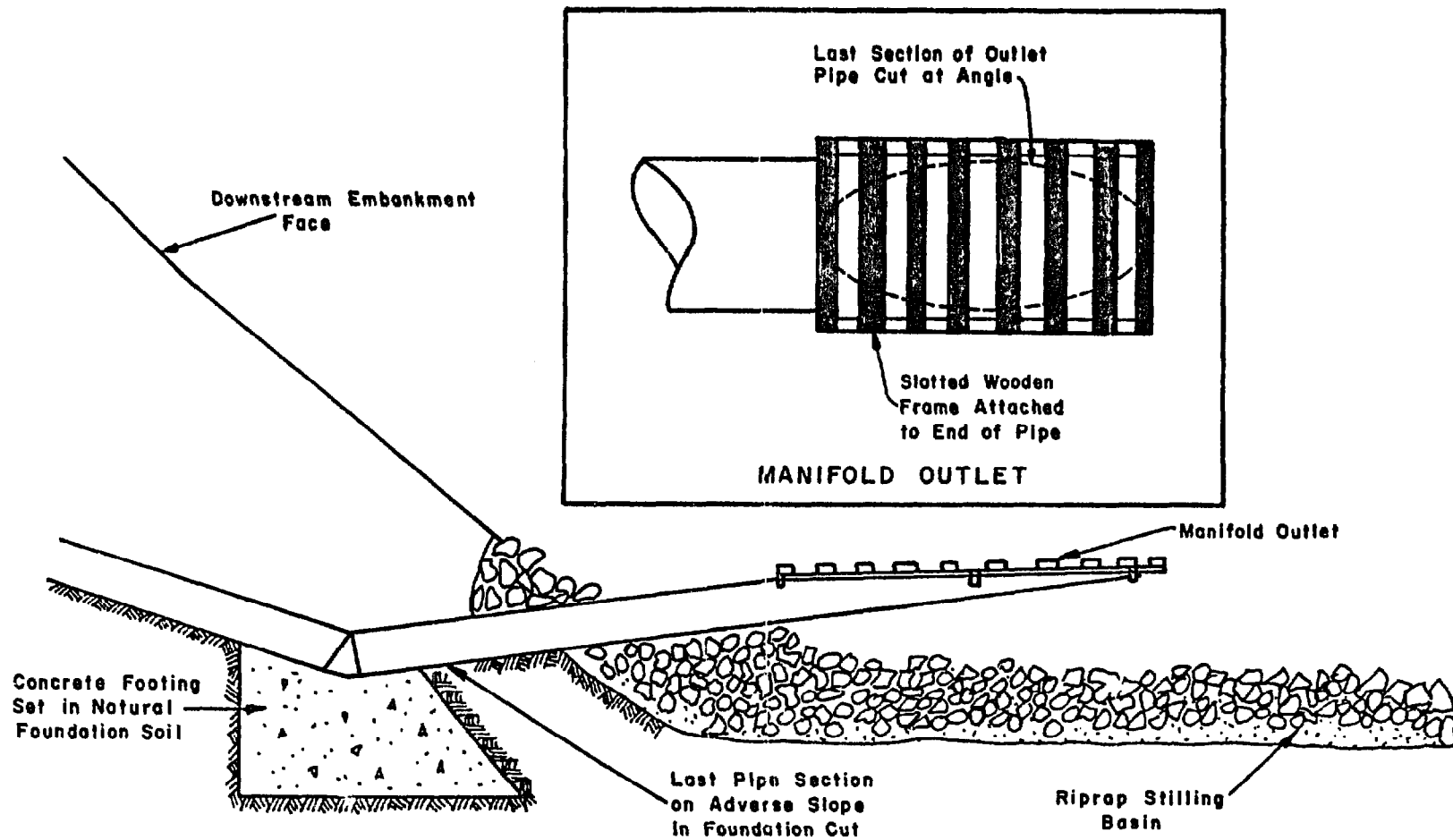

FIGURE 23 - MANIFOLD BASIN

diameter for outlet works. Some type of *debris trap* should be affixed to any inlet structure. For a metal pipe riser, this can simply be a rack of several reinforcing bars welded over the inlet, as in Fig. 24. For concrete inlets (Fig. 14), bars can be laid across the orifice. Such a trap should allow passage of small objects to avoid clogging the trap itself and thus increasing the riser crest elevation. For vertical pipe risers, an *anti-vortex baffle* should be included in the debris trap (Fig. 24a) to prevent harmful vortex turbulence. The outlet opening at the toe should be covered with a hinged door or bars to prevent animals from entering and clogging the conduit with debris.

D. Spillways

To safely by-pass flood runoffs that exceed the storage capacity of the pond, an emergency or flood spillway must be provided. If a natural saddle in the topography exists at some point on the pond's edge, this could prove adequate if large enough. If no such depression exists, a channel must be designed through at least one of the dam's abutments. Such an earth spillway should never be constructed on or near fill material.

An emergency spillway consists of three sections, as shown in Fig. 25; and *approach section*, a *control level*, and an *exit channel*. Flow enters through the approach section and becomes critical flow at the control crest of the level section (Fig. 25b). The flow is then discharged at the designed conditions, through the exit section if the exit slope is equal to or greater than critical slope. The approach channel should have a slope of not less than three percent to insure drainage, and an entrance width at least 50 percent greater than the control section. The control crest should be located near the extended

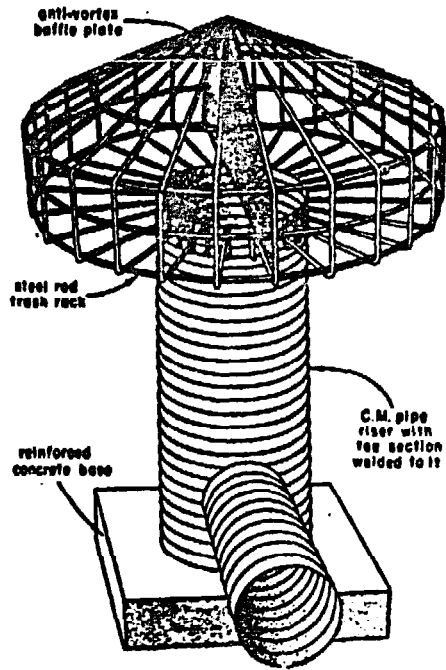

(a) CORRUGATED METAL PIPE RISER WITH CONICAL TRASH RACK AND BAFFLE

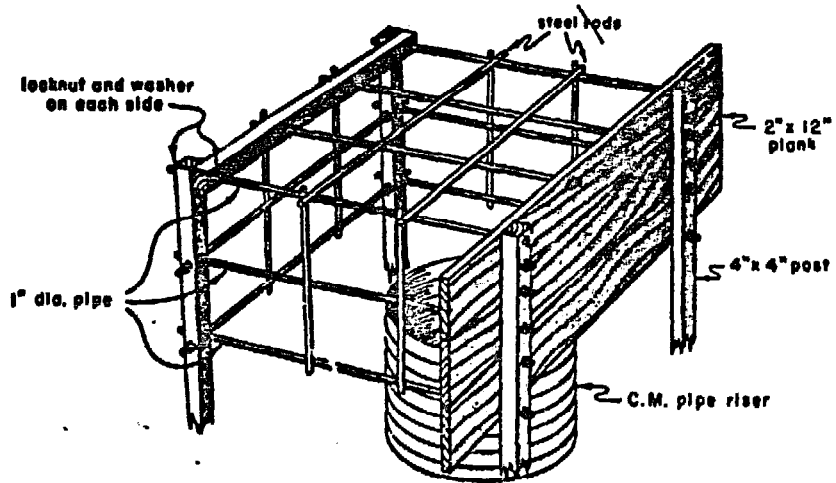

(b) TIMBER HEADWALL AND TRASH RACK

FIGURE 24 - DEBRIS TRAPS FOR CMP RISERS
(U.S. Soil Conservation Service, 1969)

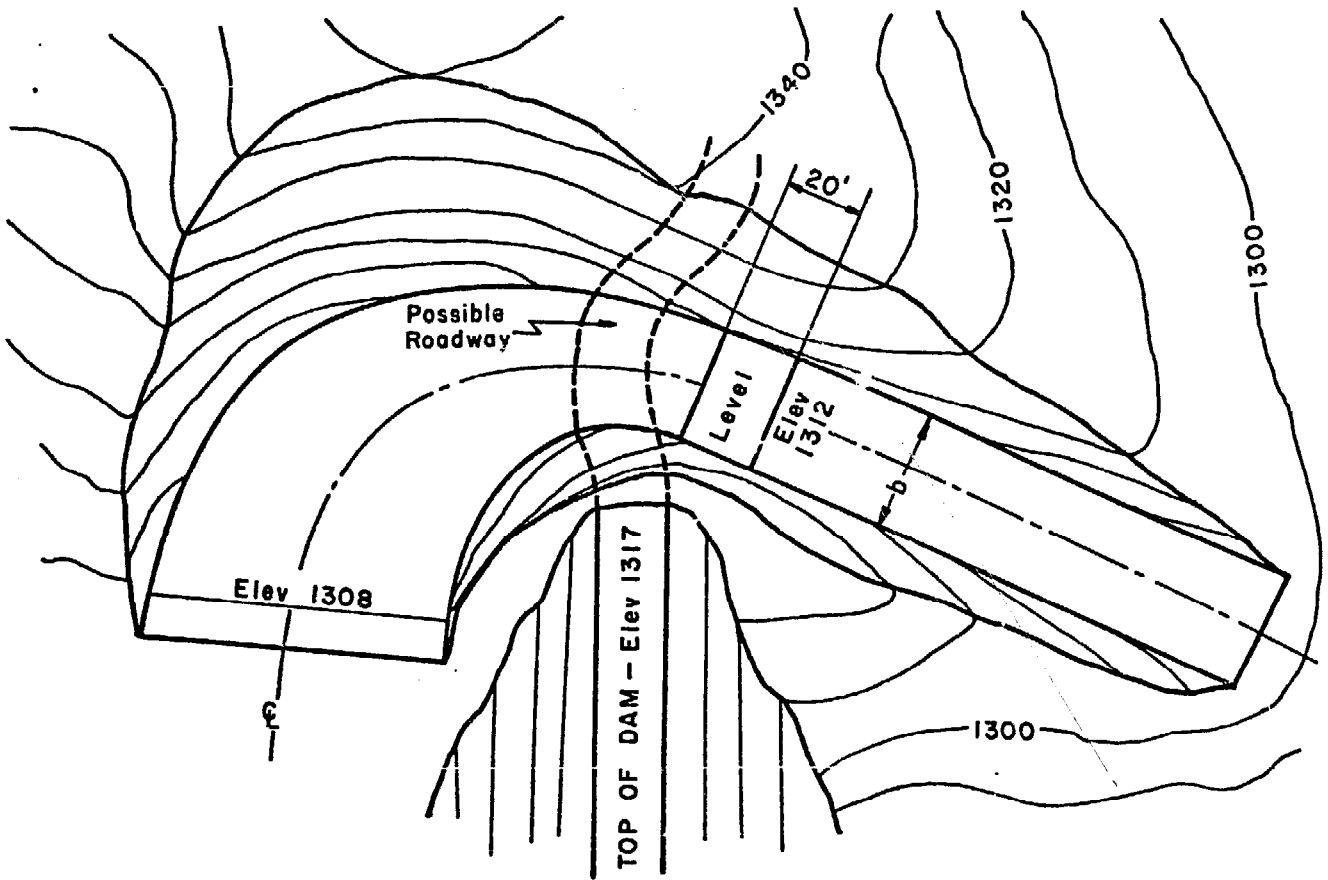

(a) Layout and Grading

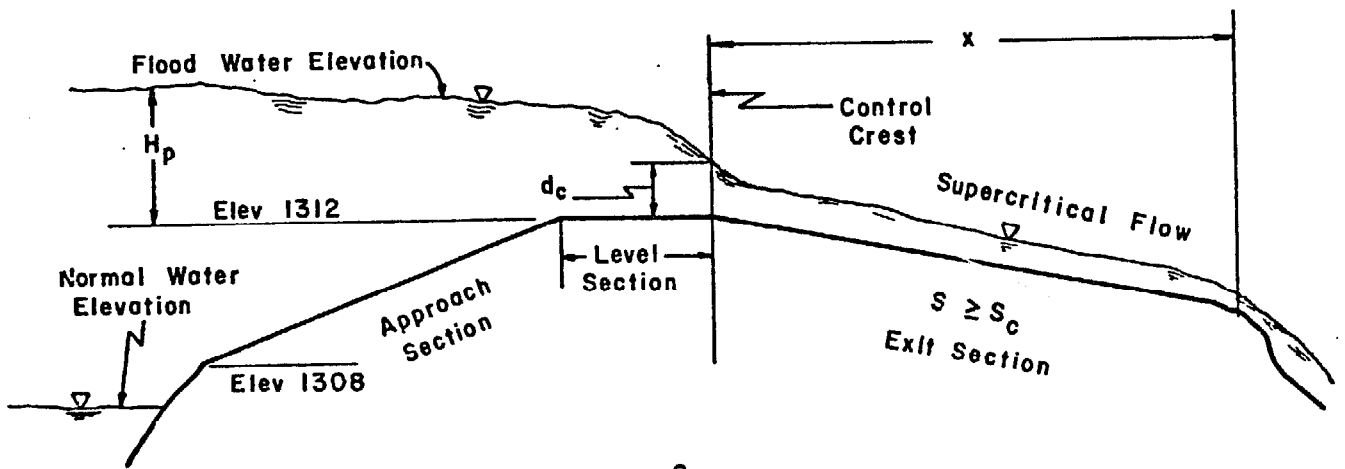

(b) Profile Along E of Spillway

FIGURE 25- TYPICAL EARTH SPILLWAY

centerline of the dam, with the level section upstream of the control crest. The level section should be at least 20 feet long to be stable. The exit section should be as straight as possible and confine the outflow until it is a safe distance from the embankment fill. There the water can be released into ditches for spreading or returned to the natural waterway. Although the exit slope must be critical or greater, it should not produce velocities which will cause erosion of the spillway cover. Thus, maximum velocities usually should not exceed 6 fps. If higher velocities would occur because of an inability to construct a flatter slope, riprap or a drop structure should be considered.

As with the outlet works, the design specifications for earth spillways are most easily obtained from design tables such as Fig. 26. Such tables will suggest several combinations of spillway widths, lengths, and slopes which will accommodate the design peak flow. Any combination chosen should produce a velocity in the exit section below the maximum permissible. If such tables are not available, application of the broad-crested weir formula and waterway design procedures can be utilized to determine the cross-section area of the control section and the exit slope required. The side slopes of the spillway channel should not exceed 2:1 and the bottom width should not exceed 35 times the design depth of flow in the control section. If this width would be exceeded, consideration must be given to the use of a spillway at each abutment.

The spillway bottom must be level and should be protected with a good sod growth. If climate or soil prohibit such growth, bare original earth will suffice, but the permissible velocity must be decreased. Riprap should be placed wherever outflow may damage fill

STAGE (In) FEET		SPILLWAY VARIABLES	BOTTOM WIDTH (b) IN FEET															
			8	10	12	14	16	18	20	22	24	26	28	30	32	34	36	38
0.6	O	7	8	9	10	12	14	14	16	17	18	20	21	22	24	25	27	28
	V	2.7	2.7	2.7	2.7	2.7	2.7	2.7	2.7	2.7	2.7	2.7	2.7	2.7	2.7	2.7	2.7	2.7
	S	3.9	3.9	3.9	3.9	3.9	3.9	3.9	3.9	3.8	3.8	3.8	3.8	3.8	3.8	3.8	3.8	3.8
	X	3.2	3.3	3.3	3.3	3.3	3.3	3.3	3.3	3.3	3.3	3.3	3.3	3.3	3.3	3.3	3.3	3.3
0.7	O	8	11	12	14	16	19	20	22	24	26	27	29	30	33	35	36	38
	V	2.9	2.9	3.0	3.0	3.0	3.0	3.0	3.0	3.0	3.0	3.0	3.0	3.0	3.0	3.0	3.0	3.0
	S	3.7	3.7	3.7	3.7	3.7	3.7	3.7	3.7	3.7	3.6	3.6	3.6	3.6	3.6	3.6	3.6	3.6
	X	3.6	3.6	3.6	3.6	3.6	3.7	3.7	3.7	3.7	3.7	3.7	3.7	3.7	3.7	3.7	3.7	3.7
0.8	O	11	14	16	19	21	24	26	29	31	33	36	38	41	43	45	48	51
	V	3.2	3.2	3.2	3.2	3.2	3.2	3.2	3.2	3.3	3.3	3.3	3.3	3.3	3.3	3.3	3.3	3.3
	S	3.9	3.9	3.9	3.9	3.9	3.9	3.9	3.9	3.9	3.9	3.9	3.9	3.9	3.9	3.9	3.9	3.9
	X	4.0	4.0	4.0	4.0	4.1	4.1	4.1	4.1	4.1	4.1	4.1	4.1	4.1	4.1	4.1	4.1	4.1
0.9	O	14	17	20	23	26	30	32	35	38	42	45	47	50	52	55	58	60
	V	3.3	3.3	3.3	3.6	3.6	3.6	3.6	3.6	3.6	3.6	3.6	3.6	3.6	3.6	3.6	3.6	3.6
	S	3.3	3.3	3.3	3.2	3.2	3.2	3.2	3.2	3.2	3.2	3.2	3.2	3.2	3.2	3.2	3.2	3.2
	X	4.4	4.4	4.4	4.4	4.5	4.5	4.5	4.5	4.5	4.5	4.5	4.5	4.5	4.5	4.5	4.5	4.5
1.0	O	19	22	25	28	32	36	40	43	47	51	55	59	63	66	68	73	76
	V	3.7	3.7	3.8	3.8	3.8	3.8	3.8	3.8	3.8	3.8	3.8	3.8	3.8	3.8	3.8	3.8	3.8
	S	3.1	3.1	3.1	3.1	3.1	3.1	3.1	3.1	3.1	3.1	3.1	3.1	3.1	3.1	3.1	3.1	3.1
	X	4.8	4.8	4.8	4.8	4.8	4.8	4.8	4.8	4.8	4.8	4.8	4.8	4.8	4.8	4.8	4.8	4.8
1.1	O	20	27	30	35	38	43	48	52	56	61	64	69	74	79	82	86	90
	V	3.9	4.0	4.0	4.0	4.0	4.0	4.0	4.0	4.0	4.0	4.0	4.0	4.0	4.0	4.0	4.0	4.0
	S	3.0	3.0	3.0	3.0	3.0	3.0	3.0	3.0	3.0	3.0	3.0	3.0	3.0	3.0	3.0	3.0	3.0
	X	5.2	5.2	5.2	5.2	5.2	5.2	5.2	5.2	5.2	5.2	5.2	5.2	5.2	5.2	5.2	5.2	5.2
1.2	O	25	31	34	40	45	49	54	60	65	70	74	79	84	90	95	100	105
	V	4.1	4.1	4.2	4.2	4.2	4.2	4.2	4.2	4.2	4.2	4.2	4.2	4.3	4.3	4.3	4.3	4.3
	S	2.9	2.9	2.9	2.9	2.9	2.9	2.9	2.9	2.9	2.9	2.9	2.9	2.9	2.9	2.9	2.9	2.9
	X	5.5	5.5	5.6	5.6	5.6	5.6	5.6	5.6	5.6	5.6	5.6	5.6	5.6	5.6	5.6	5.6	5.6
1.3	O	30	37	42	47	52	59	65	71	76	81	88	92	99	105	110	116	122
	V	4.3	4.3	4.4	4.4	4.4	4.4	4.4	4.4	4.4	4.4	4.4	4.5	4.5	4.5	4.5	4.5	4.5
	S	2.9	2.9	2.8	2.8	2.8	2.8	2.8	2.8	2.8	2.8	2.8	2.8	2.8	2.8	2.8	2.8	2.8
	X	5.9	5.9	6.0	6.0	6.0	6.0	6.0	6.0	6.0	6.0	6.0	6.0	6.0	6.0	6.0	6.0	6.0
1.4	O	35	42	48	55	62	68	75	82	89	95	101	109	116	122	127	134	140
	V	4.5	4.5	4.6	4.6	4.6	4.6	4.6	4.6	4.6	4.6	4.6	4.6	4.7	4.7	4.7	4.7	4.7
	S	2.8	2.8	2.8	2.7	2.7	2.7	2.7	2.7	2.7	2.7	2.7	2.7	2.7	2.7	2.7	2.7	2.7
	X	6.3	6.3	6.4	6.4	6.4	6.4	6.4	6.4	6.4	6.4	6.4	6.4	6.4	6.4	6.4	6.4	6.4
1.5	O	40	48	56	64	70	78	86	93	100	108	114	121	130	138	146	152	159
	V	4.7	4.7	4.7	4.8	4.8	4.8	4.8	4.8	4.8	4.8	4.8	4.8	4.8	4.9	4.9	4.9	4.9
	S	2.7	2.7	2.7	2.7	2.7	2.7	2.7	2.6	2.6	2.6	2.6	2.6	2.6	2.6	2.6	2.6	2.6
	X	6.7	6.7	6.7	6.8	6.8	6.8	6.8	6.8	6.8	6.8	6.8	6.8	6.8	6.8	6.8	6.8	6.8
1.6	O	46	54	63	71	82	88	96	106	113	121	129	136	144	154	164	173	182
	V	4.8	4.9	4.9	4.9	4.9	4.9	5.0	5.0	5.0	5.0	5.0	5.0	5.0	5.0	5.0	5.0	5.1
	S	2.7	2.7	2.6	2.6	2.6	2.6	2.6	2.6	2.6	2.6	2.6	2.6	2.6	2.6	2.6	2.5	2.5
	X	7.2	7.2	7.2	7.2	7.2	7.2	7.2	7.2	7.2	7.2	7.2	7.2	7.2	7.2	7.2	7.2	7.2
1.7	O	52	60	70	81	90	100	110	118	129	137	145	155	162	172	182	192	201
	V	4.9	5.0	5.1	5.1	5.1	5.1	5.1	5.1	5.1	5.1	5.1	5.2	5.2	5.2	5.2	5.2	5.2
	S	2.6	2.6	2.6	2.6	2.6	2.5	2.5	2.5	2.5	2.5	2.5	2.5	2.5	2.5	2.5	2.5	2.5
	X	7.6	7.6	7.6	7.6	7.6	7.6	7.6	7.6	7.6	7.6	7.6	7.6	7.6	7.6	7.6	7.6	7.6
1.8	O	58	68	78	90	100	110	121	132	141	149	160	168	179	190	201	212	222
	V	5.0	5.2	5.2	5.3	5.3	5.3	5.3	5.3	5.3	5.3	5.3	5.3	5.3	5.4	5.4	5.4	5.4
	S	2.5	2.5	2.5	2.5	2.5	2.5	2.5	2.5	2.5	2.5	2.5	2.5	2.5	2.5	2.5	2.5	2.5
	X	8.0	8.0	8.0	8.0	8.0	8.0	8.0	8.0	8.0	8.0	8.0	8.0	8.0	8.0	8.0	8.1	8.1
1.9	O	65	76	88	100	110	122	133	145	155	166	175	188	196	208	220	232	243
	V	5.2	5.3	5.4	5.4	5.4	5.4	5.4	5.5	5.5	5.5	5.5	5.5	5.5	5.5	5.5	5.5	5.5
	S	2.5	2.5	2.5	2.5	2.5	2.5	2.5	2.5	2.4	2.4	2.4	2.4	2.4	2.4	2.4	2.4	2.4
	X	8.3	8.4	8.4	8.4	8.4	8.4	8.4	8.4	8.4	8.4	8.4	8.4	8.4	8.4	8.4	8.4	8.5
2.0	O	72	84	98	110	124	134	148	160	172	182	192	204	218	232	240	253	266
	V	5.4	5.4	5.5	5.6	5.6	5.6	5.6	5.6	5.6	5.6	5.6	5.6	5.7	5.7	5.7	5.7	5.7
	S	2.3	2.3	2.3	2.4	2.4	2.4	2.4	2.4	2.4	2.4	2.4	2.4	2.4	2.4	2.4	2.4	2.4
	X	8.6	8.7	8.8	8.8	8.8	8.8	8.8	8.8	8.8	8.8	8.8	8.8	8.8	8.9	8.9	8.9	8.9
2.2	O	79	94	107	120	133	148	160	172	185	197	212	223	236	252	265	276	288
	V	5.5	5.6	5.6	5.7	5.7	5.7	5.7	5.8	5.8	5.8	5.8	5.8	5.8	5.8	5.8	5.8	5.8
	S	2.3	2.4	2.4	2.4	2.4	2.4	2.4	2.4	2.3	2.3	2.3	2.3	2.3	2.3	2.3	2.3	2.3
	X	9.0	9.2	9.2	9.2	9.2	9.2	9.2	9.2	9.2	9.2	9.2	9.2	9.2	9.3	9.3	9.3	9.3
2.4	O	95	112	129	143	158	176	192	204	220	234	246	263	280	297	313	333	340
	V	5.7	5.8	5.9	5.9	6.0	6.0	6.0	6.0	6.1	6.1	6.1	6.1	6.1	6.1	6.1	6.1	6.1
	S	2.4	2.4	2.4	2.3	2.3	2.3	2.3	2.3	2.3	2.3	2.3	2.3	2.3	2.3	2.3	2.3	2.3
	X	9.9	9.9	9.9	10.0	10.0	10.1	10.1	10.1	10.1	10.1	10.1	10.1	10.1	10.2	10.2	10.2	10.2

Note: Dimensions Shown on Figure 25

FIGURE 26- TYPICAL EMERGENCY SPILLWAY DESIGN TABLE
(Prepared by U.S. Soil Conservation Service)

material. If the dam crest is to serve as a roadway, the road should cross the spillway upstream of the level section (Fig. 25a). This will maintain good cover and dimensions in the control and exit sections.

IV. Construction

A. Site preparation

After an appropriate design has been developed, all cuts, fills, and structures should be located at the site by staking, as shown in Fig. 27.

Stakes, offset one foot, should be placed along the top width of the cutoff or key trench, and the desired cut noted. The embankment is best located by stakes at 50 feet or less intervals along the upstream and downstream toes. The proper slope and top width will be denoted by these stakes on the abutments. The earth spillway is located by cut stakes along the lines of intersection of the side slopes and the original surface. Similar cut stakes should also mark the normal water elevation along the natural contour. After the proper level of fill has been reached, stakes indicating the position of inlets, seepage collars, conduits, and outlet works should be set in place.

Once the limits of the pond have been staked out, the site can be cleared and the embankment foundation prepared. All growth within the pond, spillway, and dam areas should be removed. Any large growth, which might later cause bank erosion, should also be removed from the pond's perimeter. Stripping of any unsuitable soil from the dam foundation is also necessary. Scarifying to a depth of six inches should be done to improve the bond between embankment and foundation materials.

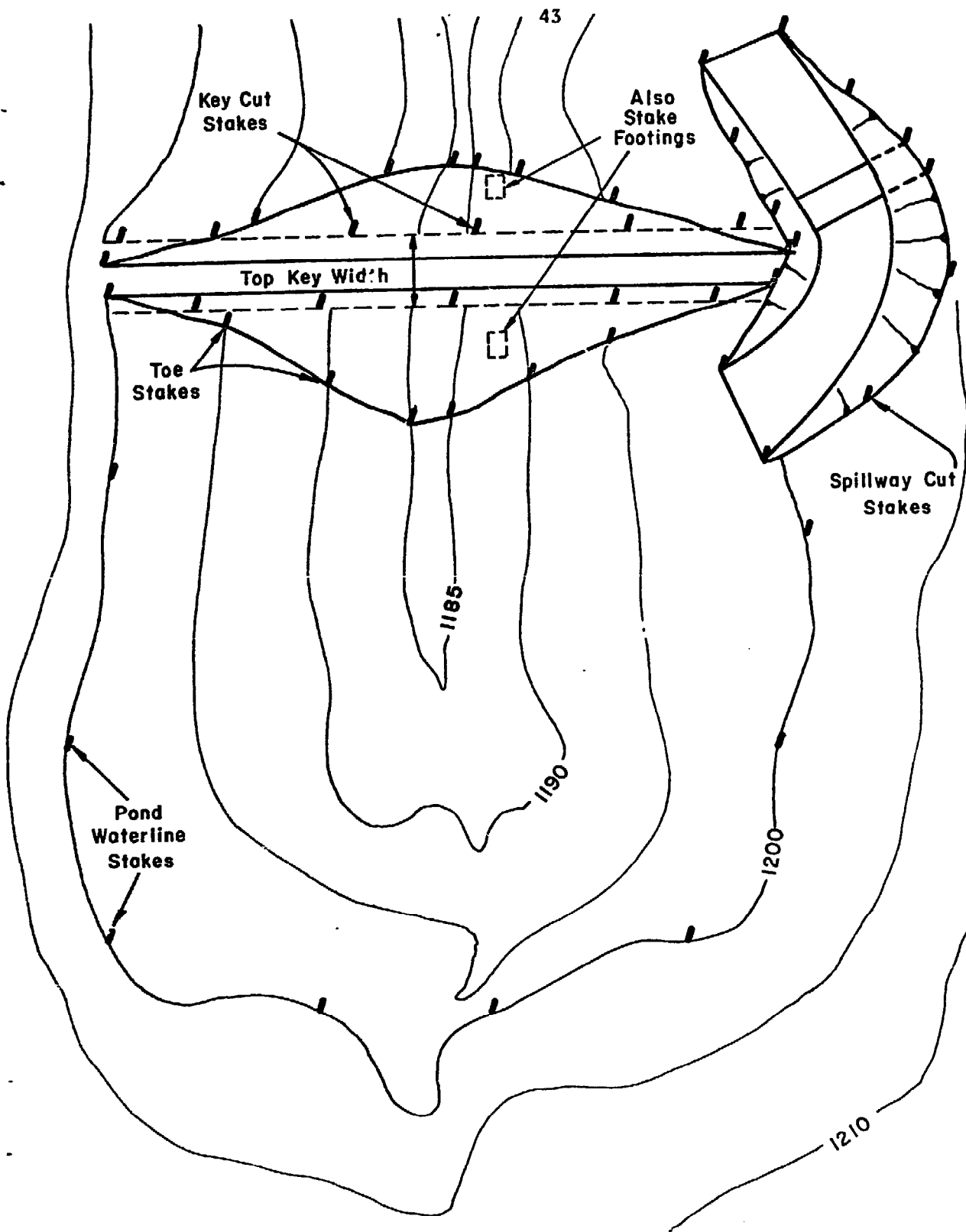

FIGURE 27 - STAKING LAYOUT

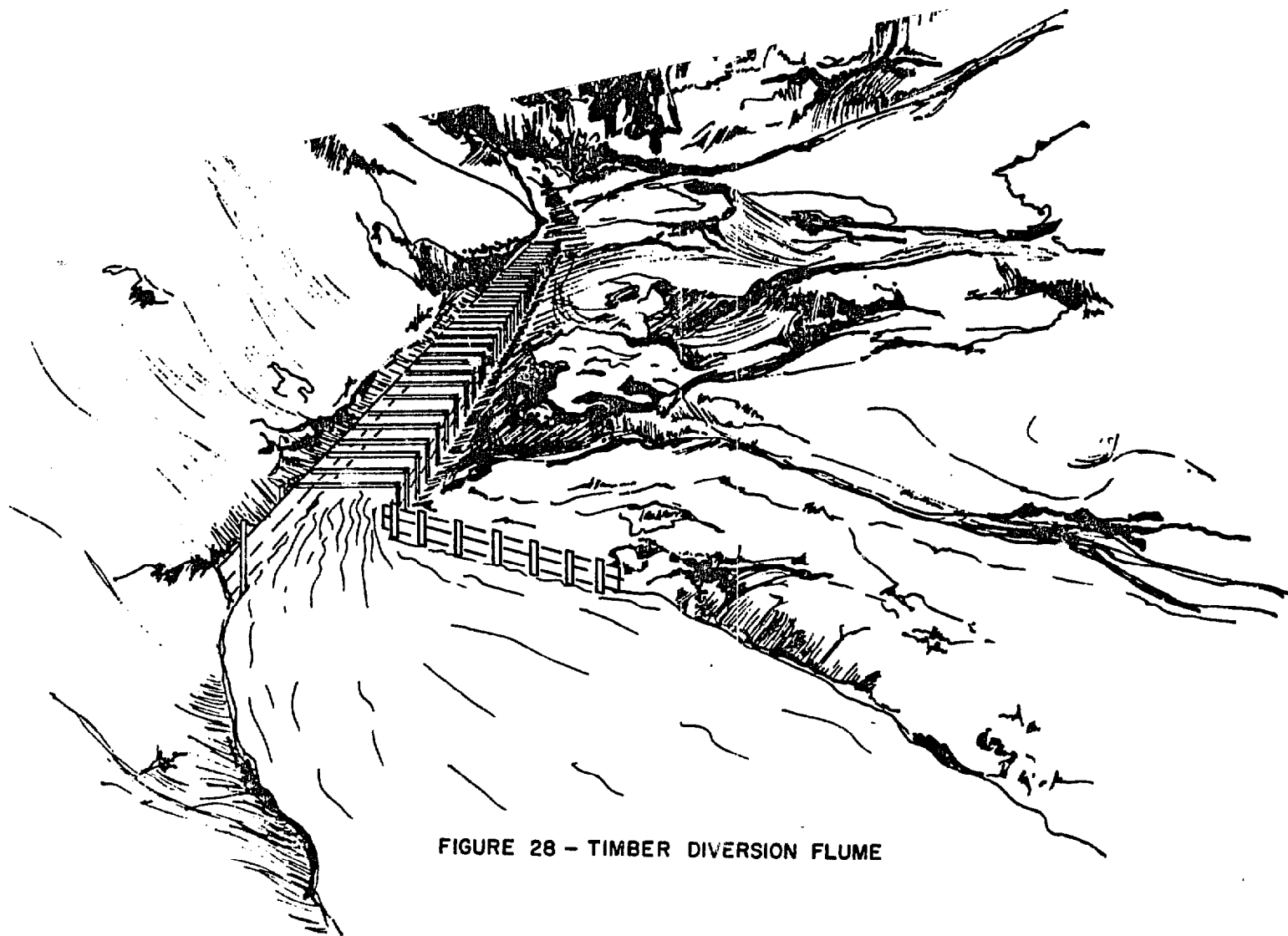

FIGURE 28 - TIMBER DIVERSION FLUME

C. Embankment

The proper *placement and compaction* of fill material should be the major concerns of earth dam construction. The fill material should be spread in thin layers along the entire length of the dam. For machinery compaction, these layers should be eight to ten inches thick for pervious soils and four to six inches for cohesive soils. Wherever hand tamping is done, these layers should not exceed four inches. The height of fill should progress evenly across the entire dam length except where diversion is necessary. Continuous checks should be made during compaction to see that optimum moisture and a good density are maintained. For earth dams, compaction should be 85 to 100 percent of the maximum Proctor density. If soil is too dry, sprinkling after placement or irrigation of the borrow area should be done. Disking to give exposure can be done to dry soil that is too wet. For embankments designed with an impervious core, care should be taken not to intermix pervious materials. However, all zones should fill evenly to insure compaction. As the proper elevations are reached, any structures should be placed, and special care taken to insure compaction of fill around them. This is best accomplished with hand or pneumatic tampers. Four feet of hand tamped fill should be put over conduits before allowing heavy machinery to move over it. Fill and compaction operations should cease during rain or freezing weather which would hamper compaction. As previously mentioned, vibrating, sheep's foot rollers provide good compaction, but for small dams, routing available equipment across the embankment should suffice.

Forms used to build concrete outlet works should be removed before backfilling and all pipe and collar connections should be checked for water tightness.

Upon completion of fill operations, all slopes should be trimmed to remove excess soil which may cause small slides and erosion. Wherever vegetation is to protect the slopes, a good layer of top soil should be provided. Riprap should be carefully placed to prevent segregation of sizes.

V. Inspection, maintenance, and operation

Inspection of the pond during construction is important to insure conformity with design. This basically involves checking elevations, testing moisture and compaction, and inspecting placement of outlet works. Once completed and a good sod cover has developed, a farm pond requires a minimum of maintenance. Fencing should be placed where necessary to prevent livestock from destroying banks, especially on spillways and the dam.

Regular inspections of the pond should be made to spot needed repairs. Rills or washes on the dam and spillway should be filled, compacted, and resodded. Vegetation on the dam should be mowed and fertilized to promote good root growth. Under no conditions should woody growth be permitted on or near the embankment. Disturbance of riprap by wave action should be corrected.

Inspections during rapid changes in the water level due to flooding or drawdown should be made to check for sloughing or cracking.

Phreatophyte and algae growth in the pond should be prevented, however some small dense vegetation on the bank may be useful to catch sediment runoff.

To prevent health hazards around the pond, water containing waste materials should be diverted from ponds, and rodents and insects should be controlled.

With careful planning and construction, a pond can effectively conserve soil and water resources with a minimal amount of maintenance.

REFERENCES

- Albertson, M. L. and G. R. Fiala, "The Manifold Stilling Basin," Civil Engineering Department, Colorado State University, Fort Collins, Colorado, 1960.
- Casagrande, A., "Seepage Through Dams," J. New Eng. Water Works Assoc., 1937.
- Cedergren, H. R., "Seepage, Drainage, and Flow Nets," Wiley and Sons, Inc., 1967.
- Davis, C. V., "Handbook of Applied Hydraulics," McGraw-Hill, 1942.
- Dreiblatt, D., "The Economics of Heavy Earthmoving," Praeger Publishers, 1972.
- Justin, J. D., W. P. Creager and J. Hinds, "Engineering for Dams," Wiley and Sons, Inc., 1955.
- Hough, B. K., "Basic Soils Engineering," Ronald Press Co., 1969.
- National Resources Committee, "Low Dams; A Manual of Design for Small Water Storage Projects," U.S. Government Printing Office, Washington, D.C., 1939.
- Schwab, G. O., "Soil and Water Conservation Engineering," Wiley and Sons, Inc., 1966.
- Sherard, J. L. et al., "Earth and Earth-Rock Dams," Wiley and Sons, Inc., 1963.
- Simons, D. B., M. A. Stevens and F. J. Watts, "Flood Protection at Culvert Outlets," Prepared for Wyoming State Highway Department, 1970.
- United Nations, ECAFE, Proceedings of the Third Regional Technical Conference on Water Resources Development, Flood Control Series No. 13, Bangkok, 1958.
- United Nations, ECAFE, "Earthmoving by Manual Labour and Machines," Flood Control Series No. 17, Bangkok, 1961.
- United Nations, ECAFE, Proceedings of the Regional Symposium on Dams and Reservoirs, Flood Control Series No. 21, New York, 1962.
- U.S. Bureau of Reclamation, "Treatise on Dams," Denver, Colorado, 1948.
- U.S. Bureau of Reclamation, "Design of Small Dams," Second Edition, U.S. Government Printing Office, Washington, D.C., 1973.
- U.S. Soil Conservation Service, Engineering Field Manual, 1969.

Appendix A

SEEPAGE THROUGH EMBANKMENTS

Since the cross section design of earth embankments should be a function of the available construction materials, a guide to soil permeability and location of seepage is needed to properly position water barriers and drains.

Figure A1 suggests a classification by particle size distribution to better recognize the permeability of soils. With this guide, the subsurface investigations of dam sites can be analyzed to determine if borrow material must be located for an impervious core or blanket. Furthermore, the embankment foundation can be evaluated for its ability to retard water seepage under the dam. Of course, seepage takes place through any dam material, even concrete. However, by locating this seepage and designing for it, damage by piping can be avoided.

Figure A2 illustrates positions of the seepage line through embankments of homogeneous material. This seepage or saturation line is the gradient above which there is no hydrostatic pressure. As seen in Fig. A2a and A2b, seepage will occur on the downstream face of an embankment of impervious material without drainage whether the foundation is pervious or not. For an impervious foundation, the seepage can egress through a filter blanket (Fig. A2c). If a shallow pervious foundation is present, a cutoff and/or rock toe drain should safely drawdown the saturation line (Fig. A2d). The cutoff allows the downstream pervious foundation to act as a drainage blanket. If available materials warrant the use of an impervious core, the seepage line should be drawn as in Fig. A3a for an impervious foundation. In this case, the downstream pervious embankment material serves as a drain. Where the foundation is about as permeable as the core, the seepage through

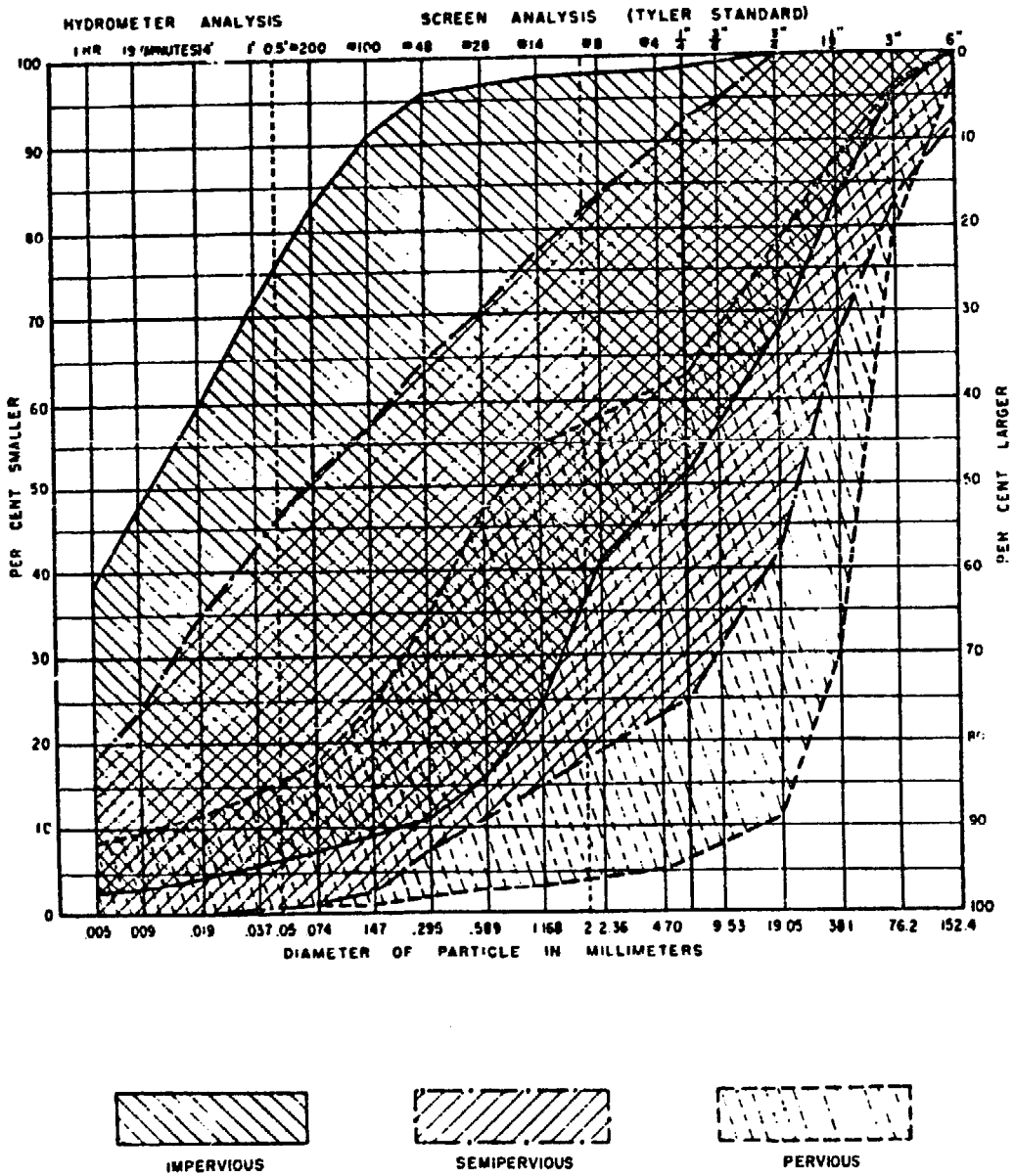
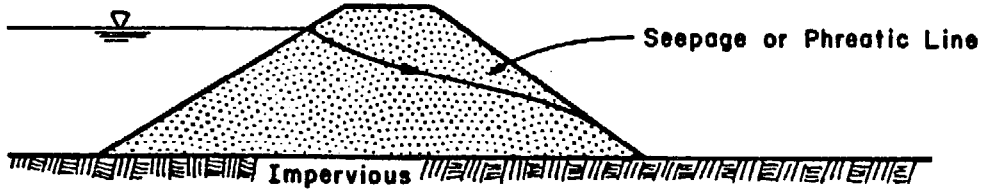
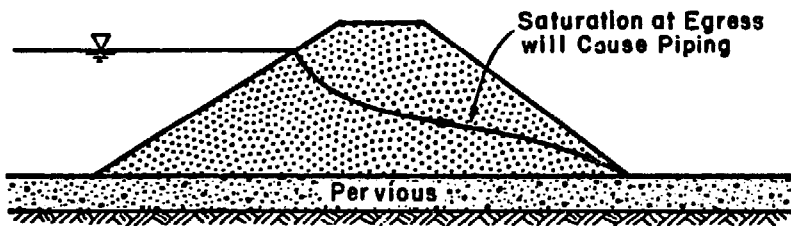

FIGURE A1 - PARTICLE SIZE DISTRIBUTION FOR TYPICAL SOIL TYPES
 (Bureau of Reclamation, 1948)



(a) Impervious Foundation without Drainage



(b) Pervious Foundation without Drainage

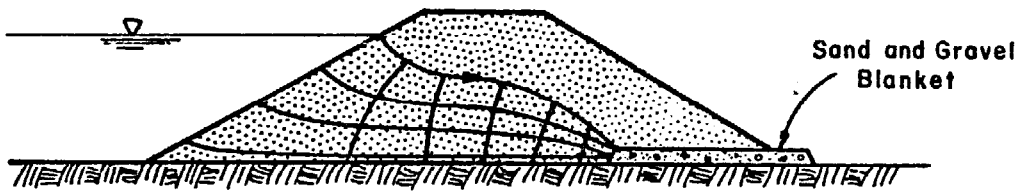

(c) Impervious with Filter

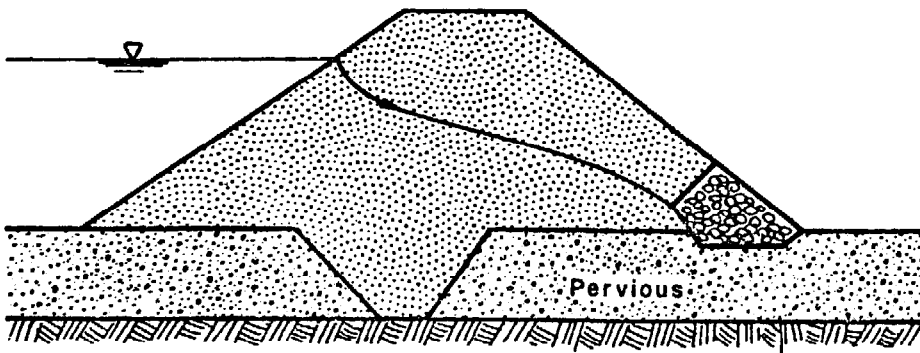

(d) Pervious with Cutoff and Drain

FIGURE A2 - SEEPAGE LINES THRU HOMOGENEOUS EMBANKMENTS

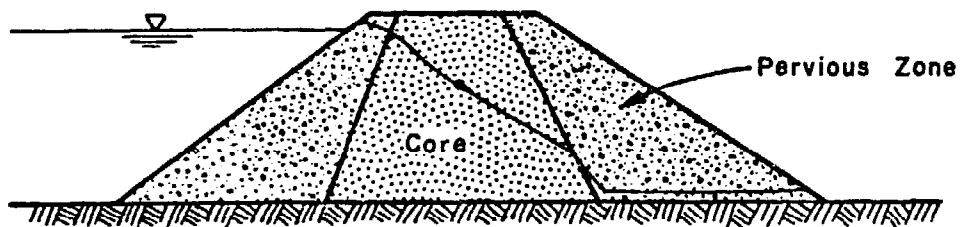

(a) Impervious Foundation

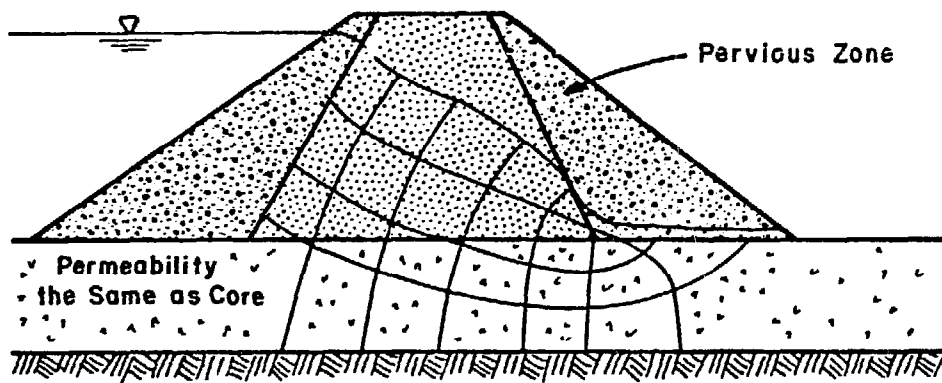

(b) Relatively Impervious Substrata

FIGURE A3 - SEEPAGE LINE THRU ZONED EMBANKMENTS

it will appear as Fig. A3b. If the foundation is any more permeable, a cutoff trench should again be utilized. However, in any zoned embankment, some protection should be provided at the downstream toe to insure against piping; either a drain or riprap cover with a gravel filter.

As demonstrated in Figs. A2c and A3b, the seepage line is actually a boundary for drawing the entire *flow net* through a dam. This flow net consists of two sets of lines; *flow lines*, which approximate the actual path of water moving through the soil, and *equipotential lines* which indicate gradients of equal hydrostatic pressure. The intersections of these lines occur at right angles, which aids in the drawing of the flow net. As in Fig. A3b, the lower boundary of the flow net is any impervious layer, and the resulting diagram should appear as a series of homologous rectangles. Some excellent guides to constructing flow nets are given by Arthur Casagrande, "Seepage Through Dams."

While construction of flow nets gives a good picture of the entire seepage pattern, the main concern is knowing where the saturation line will egress on the downstream slope and what quantity of seepage can be expected. Although complex approaches to these problems can quite accurately predict results, an approximate method has been developed by Creager, et al. (1945), which yields adequate results for small earth dams. This method can be used for homogeneous or zoned cross sections. In a zoned embankment, the pervious zones are considered to be much more permeable than any impervious core and thus have practically no influence on the position of the seepage line. As seen in Fig. A3b, the seepage line through a pervious zone can be drawn almost horizontal, and then the impervious core is handled the same as a homogeneous cross section.

Referring to Fig. A4, this method begins with the assumption that:

$$e = \frac{h}{3} \quad (1)$$

where

e = the vertical distance from the impervious foundation to the egress of the seepage line, and

h = the vertical distance from the impervious foundation to the water level in the pond.

By applying Darcy's law for moisture movement through soil, the seepage discharge through the dam is:

$$q = \frac{k(h-e)}{L} \frac{(h+e)}{2} = \frac{k}{2} \frac{(h^2 - e^2)}{L} \quad (2)$$

where

q = discharge in any units of volume per time,

k = hydraulic conductivity of the soil (a sample of k values is given in Fig. A5), and

L = mean length of seepage path.

As shown in Fig. A4, this length L is found by the expression

$$L = (1.3 h + 2 z - \frac{e}{2}) \cot \alpha + W \quad (3)$$

where

z = vertical distance from headwater to top of dam,

W = top width of dam, and

α = angle formed by the downstream slope and the foundation surface.

Using Eqs. (2) and (3), the value of e for which q is a maximum can be found by trial and error or by differentiation, but for side slopes flatter than 1:1, the approximation e equal to $h/3$ is sufficient. Thus, Eq. (2) becomes

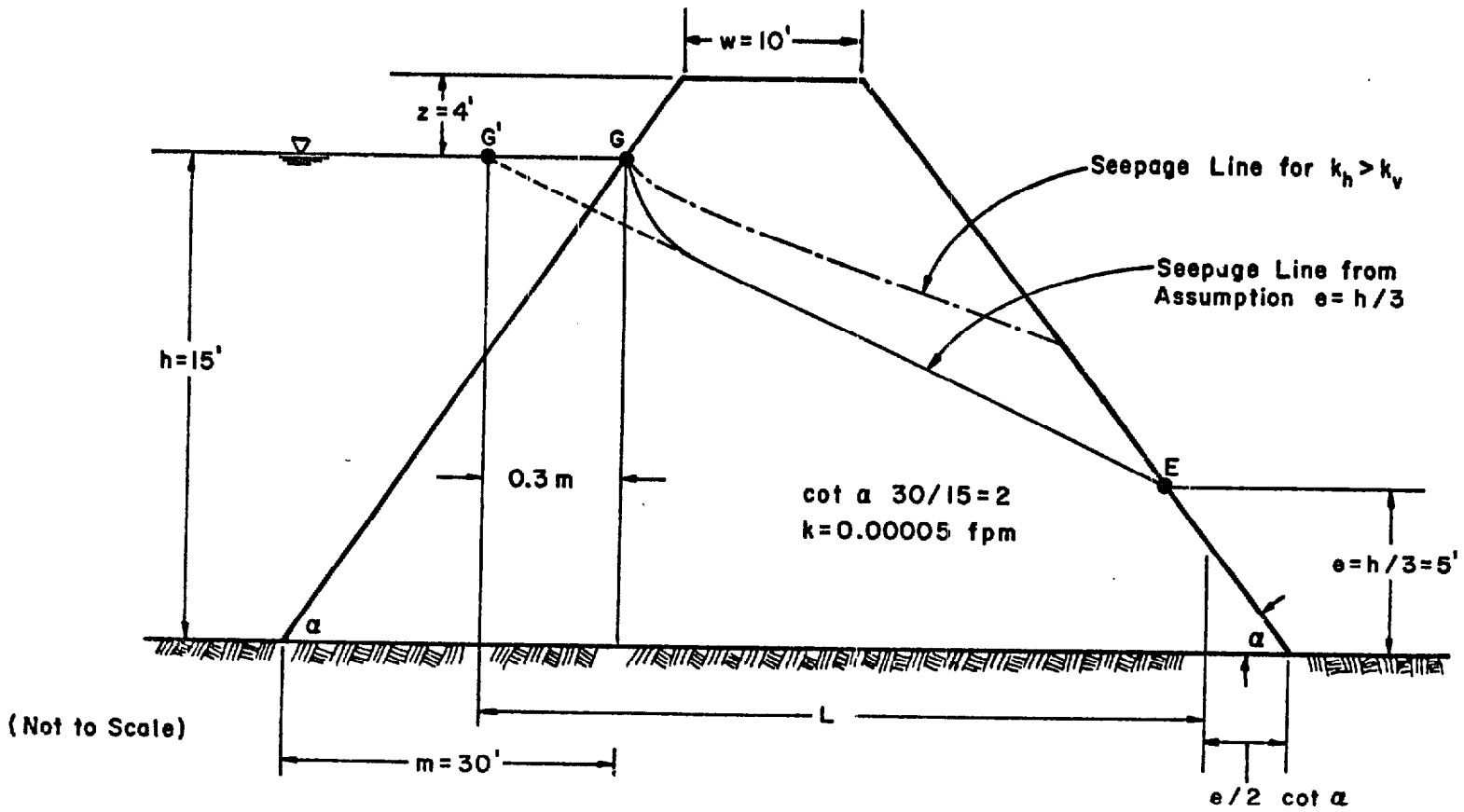

FIGURE A4 - APPROXIMATE METHOD OF SEEPAGE DETERMINATION

	PARTICLE SIZE RANGE				"EFFECTIVE" SIZE		PERMEABILITY COEFFICIENT - k		
	Inches		Millimeters						
	D _{max}	D _{min}	D _{max}	D _{min}	D ₂₀ in.	D ₁₀ mm	Ft/yr	Ft/mo	Cm/sec
Derrick STONE	120	36	--	--	48	--	100x10 ⁶	100x10 ⁵	100
One-man STONE	12	4	--	--	6	--	30x10 ⁶	30x10 ⁵	30
Clean, fine to coarse GRAVEL	3	1/4	80	10	1/2	--	10x10 ⁶	10x10 ⁵	10
Uniform GRAVEL	3/8	1/16	8	1.5	1/8	--	5x10 ⁶	5x10 ⁵	5
Very coarse, clean, uniform SAND	1/8	1/32	3	0.8	1/16	--	3x10 ⁶	3x10 ⁵	3
Uniform, coarse SAND	1/8	1/64	2	0.5	--	0.6	0.4x10 ⁶	0.4x10 ⁵	0.4
Uniform, medium SAND	--	--	0.5	0.25	--	0.3	0.1x10 ⁶	0.1x10 ⁵	0.1
Clean, well-graded SAND & GRAVEL	--	--	10	0.05	--	0.1	0.01x10 ⁶	0.01x10 ⁵	0.01
Uniform, fine SAND	--	--	0.25	0.05	--	0.06	4000	400	40x10 ⁻⁴
Well-graded, silty SAND & GRAVEL	--	--	5	0.01	--	0.02	400	40	4x10 ⁻⁴
Silty SAND	--	--	2	0.005	--	0.01	100	10	10 ⁻⁴
Uniform SILT	--	--	0.05	0.005	--	0.006	50	5	0.5x10 ⁻⁴
Sandy CLAY	--	--	1.0	0.001	--	0.002	5	0.5	0.05x10 ⁻⁴
Silty CLAY	--	--	0.05	0.001	--	0.0015	1	0.1	0.01x10 ⁻⁴
CLAY (30 to 50% clay sizes)	--	--	0.05	0.0005	--	0.0008	0.1	0.01	0.001x10 ⁻⁴
Colloidal CLAY (-2 μ > 50%)	--	--	0.01	10 ^Å	--	40 ^Å	0.001	10 ⁻⁴	10 ⁻⁹

FIGURE A5 - TYPICAL VALUES OF PERMEABILITY COEFFICIENTS
(From Hough, B.K., Basic Soils Engineering)

$$q = k \frac{\left(h - \frac{h^2}{9}\right)}{2L} = \frac{4 kh^2}{9L} \quad (4)$$

For the example shown in Fig. A4, $e = 15/3 = 5$ ft. The egress point E can then be located. Point G' is located a distance 0.3 m from G on the water surface, where m is the horizontal projection of the upstream slope from G to the toe. As shown, the seepage line can then be drawn from G to E. Therefore, $G' = 0.3 \times 30 = 9$ ft from G. Then, from Eq. (3),

$$L = (1.3 \times 15 + 2 \times 4 - 5/2) \times 2 + 10 = 60 \text{ ft.}$$

Finally, from Eq. (2),

$$q = \frac{4 \times 0.00005 \times 15^2}{9 \times 60} = 0.017 \text{ cfm per lineal foot of dam.}$$

This discharge can be converted to any units desired as illustrated in Fig. 5A.

Usually, soils show a difference between their vertical and horizontal permeability. This should be checked during analysis of materials from subsurface investigations. If such a difference exists, a simple technique is used to locate the seepage line. Multiply all the actual horizontal dam dimensions by $\sqrt{k_v/k_h}$, where k_v and k_h are the permeability coefficients in the vertical and horizontal, respectively. Then compute the location of G' and the discharge as before. The results can be rescaled to normal proportions and may look something like the seepage line for $k_h > k_v$ in Fig. A4.

Once the seepage egress and discharge have been found, a rock toe drain, drainage blanket, or drainage tile can be located at this point to prevent sloughing (Fig. 10). Here can be seen an advantage to zoned embankments. The downstream pervious zone can intercept the seepage

from any point of egress along the impervious zone. If the pervious material is much larger than the impervious core, it is well to construct a sand and gravel filter between the two zones to prevent internal piping.

Filters, toe drains, and drainage blankets should be designed with the following recommended (USBR) criteria to prevent smaller grained soils from clogging the pores of the larger filter material:

$$(1) \quad 5 < \frac{D_{15} \text{ of filter}}{D_{15} \text{ of base}} < 40,$$

$$(2) \quad \frac{D_{15} \text{ of filter}}{D_{85} \text{ of base}} \leq 5$$

(3) the size distribution curve of the filter should be nearly parallel to the curve of the base material, and

(4) the maximum size particle in filter material should be 3 inches.

For this criteria, the *base* is the soil being protected from piping. Thus, in a multilayer sand-gravel filter, the sand is the base to the gravel filter, and the embankment soil is the base to the sand filter. Furthermore, if drain tile is used:

$$2 \leq \frac{D_{85} \text{ of filter}}{\text{max. opening in tile}} .$$

All filter and drain material should be compacted to the same density required in the other pervious zones of the embankment.

This approximate method for locating and computing seepage through an earth embankment has proven quite sufficient for the design of small dams. For a more thorough discussion of seepage, a text of soil mechanics should be consulted.

Appendix B

SOIL MECHANICS OF EMBANKMENTS

To better understand the importance of a good design and the proper placement and compaction of a water storage embankment, some of the basic soil mechanics should be studied. This appendix presents some soil mechanics that can serve as a design guide for small embankments and the basis for preliminary studies on large dams.

I. Classification

Several methods of classifying soils are in use today. However, the *Unified Soil Classification System* is particularly applicable to the design and construction of embankments. As shown in Fig. B1, the Unified System accounts for several engineering properties and is adaptable to both laboratory and field use. By either visual or manual examination, soils are grouped according to particle size, gradation, and fine grain characteristics. A soils manual should be consulted for the exact procedures of laboratory or field tests. The gradation of a soil class is of particular importance for water storage and retention structures. *Well-graded* soils have uniform amounts of each particle size (within its range of sizes). Thus, the smaller grains fill in between larger grains and when compacted are optimum for use as impervious layers. *Skip-graded* soils usually have large and small grains, but lack middle sizes. These soils are susceptible to piping and/or shifting under pressure and should be avoided in dam construction. *Poorly-graded* soils have only a narrow range of grain sizes. Gravels and sands of this type are used for filter or drainage layers in embankments since such a gradation has no fine grains to block the passage

TYPICAL NAMES	IMPORTANT PROPERTIES						UNIFIED SOIL CLASSES
	SHEAR STRENGTH	COMPRESSIBILITY	WORKABILITY AS CONSTRUCTION MATERIAL	PERMEABILITY			
				WHEN CONTACTED	K CM. PER SEC.	K FT. PER DAY	
Well graded gravels, gravel-sand mixtures, little or no fines.	Excellent	Negligible	Excellent	Pervious	$K > 10^{-2}$	$K > 10$	GW
Poorly graded gravels, gravel-sand mixtures, little or no fines.	Good	Negligible	Good	Very Pervious	$K > 10^{-2}$	$K > 10$	GP
Silty gravels, gravel-sand-silt mixtures.	Good to Fair	Negligible	Good	Semi-Pervious to Impervious	$K = 10^{-3}$ to 10^{-6}	$K = 1$ to 1×10^{-3}	GM
Clayey gravels, gravel-sand-clay mixtures.	Good	Very Low	Good	Impervious	$K = 10^{-6}$ to 10^{-8}	$K = 1 \times 10^{-3}$ to 1×10^{-5}	GC
Well graded sands, gravelly sands, little or no fines.	Excellent	Negligible	Excellent	Pervious	$K > 10^{-3}$	$K > 1$	SW
Poorly graded sands, gravelly sands, little or no fines.	Good	Very Low	Fair	Pervious	$K > 10^{-3}$	$K > 1$	SP
Silty sands, sand-silt mixtures	Good to Fair	Low	Fair	Semi-Pervious to Impervious	$K = 10^{-3}$ to 10^{-6}	$K = 1$ to 1×10^{-3}	SM
Clayey sands, sand-clay mixtures.	Good to Fair	Low	Good	Impervious	$K = 10^{-6}$ to 10^{-8}	$K = 1 \times 10^{-3}$ to 1×10^{-5}	SC
Inorganic silts and very fine sands, rock flour, silty or clayey fine sands or clayey silts with slight plasticity.	Fair	Medium to High	Fair	Semi-Pervious to Impervious	$K = 10^{-3}$ to 10^{-6}	$K = 1$ to 1×10^{-3}	ML
Inorganic clays of low to medium plasticity, gravelly clays, sandy clays, silty clays, lean clays.	Fair	Medium	Good to Fair	Impervious	$K = 10^{-6}$ to 10^{-8}	$K = 1 \times 10^{-3}$ to 1×10^{-5}	CL
Organic silts and organic silty clays of low plasticity.	Poor	Medium	Fair	Semi-Pervious to Impervious	$K = 10^{-6}$ to 10^{-8}	$K = 1 \times 10^{-3}$ to 1×10^{-5}	OL
Inorganic silts, micaceous or diatomaceous fine sandy or silty soils, elastic silts.	Fair to Poor	High	Poor	Semi-Pervious to Impervious	$K = 10^{-6}$ to 10^{-8}	$K = 1 \times 10^{-3}$ to 1×10^{-5}	MH
Inorganic clays of high plasticity, fat clays.	Poor	High to Very High	Poor	Impervious	$K = 10^{-6}$ to 10^{-8}	$K = 1 \times 10^{-3}$ to 1×10^{-5}	CH
Organic clays of medium to high plasticity, organic silts.	Poor	High	Poor	Impervious	$K = 10^{-6}$ to 10^{-8}	$K = 1 \times 10^{-3}$ to 1×10^{-5}	OH
Peat and other highly organic soils.	NOT SUITABLE FOR CONSTRUCTION						Pt

SHEET 1 OF 4

FIGURE B1— UNIFIED CLASSIFICATION AND PROPERTIES OF SOILS
(U.S. Soil Conservation Service, 1969)

EMBANKMENTS								UNIFIED SOIL CLASSES
COMPACTION CHARACTERISTICS	STANDARD PROCTER UNIT DENSITY LBS. PER CU. FT.	TYPE OF ROLLER DESIRABLE	RELATIVE CHARACTERISTICS		RESISTANCE TO PIPING	ABILITY TO TAKE PLASTIC DEFORMATION UNDER LOAD WITHOUT SHEARING	GENERAL DESCRIPTION & USE	
			PERMEABILITY	COMPRESSIBILITY				
Good	125-135	crawler tractor or steel wheeled & vibratory	High	Very Slight	Good	None	Very stable, pervious shells of dikes and dams.	GW
Good	115-125	crawler tractor or steel wheeled & vibratory	High	Very Slight	Good	None	Reasonably stable, pervious shells of dikes and dams.	GP
Good with close control	120-135	rubber-tired or sheepfoot	Medium	Slight	Poor	Poor	Reasonably stable, not well suited to shells but may be used for impervious cores or blankets.	GM
Good	115-130	sheepfoot or rubber-tired	Low	Slight	Good	Fair	Fairly stable, may be used for impervious core.	GC
Good	110-120	crawler tractor & vibratory or steel wheeled	High	Very Slight	Fair	None	Very stable, pervious sections, slope protection required.	SW
Good	100-120	crawler tractor & vibratory or steel wheeled	High	Very Slight	Fair to Poor	None	Reasonably stable, may be used in dike with flat slopes.	SP
Good with close control	110-125	rubber-tired or sheepfoot	Medium	Slight	Poor to Very Poor	Poor	Fairly stable, not well suited to shells, but may be used for impervious cores or dikes.	SM
Good	105-125	sheepfoot or rubber-tired	Low	Slight	Good	Fair	Fairly stable, use for impervious core for flood control structures.	SC
Good to Poor Close control essential	95-120	sheepfoot	Medium	Medium	Poor to Very Poor	Very Poor	Poor stability, may be used for embankments with proper control. *Varies with water content.	ML
Fair to Good	95-120	sheepfoot	Low	Medium	Good to Fair	Good to Poor	Stable, impervious cores and blankets.	CL
Fair to Poor	80-100	sheepfoot	Medium to Low	Medium to High	Good to Poor	Fair	Not suitable for embankments.	OL
Poor to Very Poor	70-95	sheepfoot	Medium to Low	Very High	Good to Poor	Good	Poor stability, core of hydraulic fill dam, not desirable in rolled fill construction.	MH
Fair to Poor	75-105	sheepfoot	Low	High	Excellent	Excellent	Fair stability with flat slopes, thin cores, blanket & dike sections.	CH
Poor to Very Poor	65-100	sheepfoot	Medium to Low	Very High	Good to Poor	Good	Not suitable for embankments.	OH
DO NOT USE FOR EMBANKMENT CONSTRUCTION								Pt

SHEET 2 OF 4

FIGURE B1 - UNIFIED CLASSIFICATION AND PROPERTIES OF SOILS
(U.S. Soil Conservation Service, 1969)

CHANNELS		FOUNDATION					UNIFIED SOIL CLASSES
LONG DURATION TO CONSTANT FLOWS		FOUNDATION SOILS, BEING UNDISTURBED, ARE INFLUENCED TO A GREAT DEGREE BY THEIR GEOLOGIC ORIGIN. JUDGEMENT AND TESTING MUST BE USED IN ADDITION TO THESE GENERALIZATIONS.					
RELATIVE DESIRABILITY		BEARING VALUE	RELATIVE DESIRABILITY		REQUIREMENTS FOR SEEPAGE CONTROL		
EROSION RESISTANCE	COMPACTED EARTH LINING		SEEPAGE IMPORTANT	SEEPAGE NOT IMPORTANT	PERMANENT RESERVOIR	FLOODWATER RETAINING	
1	-	Good	-	1	Positive cutoff or blanket	Control only within volume acceptable plus pressure relief if required.	GW
2	-	Good	-	3	Positive cutoff or blanket	Control only within volume acceptable plus pressure relief if required.	GP
4	4	Good	2	4	Core trench to none	None	GM
3	1	Good	1	6	None	None	GC
6	-	Good	-	2	Positive cutoff or upstream blanket & toe drains or wells.	Control only within volume acceptable plus pressure relief if required.	SW
7 if gravelly	-	Good to Poor depending upon density	-	5	Positive cutoff or upstream blanket & toe drains or wells.	Control only within volume acceptable plus pressure relief if required.	SP
8 if gravelly	5 erosion critical	Good to Poor depending upon density	4	7	Upstream blanket & toe drains or wells	Sufficient control to prevent dangerous seepage piping.	SM
5	2	Good to Poor	3	8	None	None	SC
-	6 erosion critical	Very Poor, susceptible to liquefaction	6, if saturated or pre-wetted	9	Positive cutoff or upstream blanket & toe drains or wells.	Sufficient control to prevent dangerous seepage piping.	ML
9	3	Good to Poor	5	10	None	None	CL
-	7 erosion critical	Fair to Poor, may have excessive settlement	7	11	None	None	OL
-	-	Poor	8	12	None	None	MH
10	8 volume change critical	Fair to Poor	9	13	None	None	CH
-	-	Very Poor	10	14	None	None	OH
-	-	REMOVE FROM FOUNDATION					Pt

No. 1 is best numerical rating.

SHEET 5 OF 4

FIGURE B1 - UNIFIED CLASSIFICATION AND PROPERTIES OF SOILS
(U.S. Soil Conservation Service, 1969)

LABORATORY CRITERIA					UNIFIED SOIL CLASSES
COARSE-GRAINED SOILS Less than half of material passes the No. 200 sieve size.	GRAVELS Less than half of the coarse fraction passes the No. 4 sieve size.	<u>CLEAN GRAVELS</u> Less than 5% passing the No. 200 sieve size.	<u>WELL GRADED</u> Meets gradation requirements	GRADATION REQUIREMENTS ARE: $C_u = \frac{D_{60}}{D_{10}} > 6$ and $C_c = \frac{(D_{30})^2}{D_{10} \times D_{60}}$ between 1 & 1	GW
		<u>GRAVELS WITH FINES</u> More than 12% passing the No. 200 sieve size.	<u>POORLY GRADED</u> Does not meet gradation requirements		GP
		Borderline cases require the use of dual symbols.	Plasticity limits of material passing No. 40 sieve size plots below "A" line or P.I. less than 4.		Plasticity limits of material passing No. 40 sieve size plots above "A" line with P.I. more than 7.
	GC				
	SANDS More than half of the coarse fraction passes the No. 4 sieve size.	<u>CLEAN SANDS</u> Less than 5% passing the No. 200 sieve size.	<u>WELL GRADED</u> Meets gradation requirements	GRADATION REQUIREMENTS ARE: $C_u = \frac{D_{60}}{D_{10}} > 6$ and $C_c = \frac{(D_{30})^2}{D_{10} \times D_{60}}$ between 1 & 1	SW
		<u>SANDS WITH FINES</u> More than 12% passing the No. 200 sieve size.	<u>POORLY GRADED</u> Does not meet gradation requirements		SP
Borderline cases require the use of dual symbols.		Plasticity limits of material passing No. 40 sieve size plots below "A" line or P.I. less than 4.	Plasticity limits of material passing No. 40 sieve size plots above "A" line with P.I. more than 7.		SM
	SC				
FINE-GRAINED SOILS More than half of material passes the No. 200 sieve size.	SILTS AND CLAYS Liquid limit less than 50	Below "A" line or P.I. less than 4	Above "A" line with P.I. between 4 and 7 are border-line cases requiring use of dual symbols	ML	
		Above "A" line with P.I. more than 7		CL	
	SILTS AND CLAYS Liquid limit greater than 50	Below "A" line or P.I. less than 4 and L.L. (oven dry soil) < 0.7 L.L. (air dry soil)		<p style="text-align: center;">PLASTICITY CHART</p>	OL
		Below "A" line			MH
		Above "A" line			CH
		Below "A" line and L.L. (oven dry soil) < 0.7 L.L. (air dry soil)			OH
HIGHLY ORGANIC SOILS			L.L. (oven dry soil) < 0.7 L.L. (air dry soil)	Pt	

FIGURE B1—UNIFIED CLASSIFICATION AND PROPERTIES OF SOILS
(U.S. Soil Conservation Service, 1969)

of water between the larger grains. (See Appendix A for a discussion of soil permeability.)

II. Volume and Weight

No matter what class a soil is, a unit mass of soil consists of solid particles and pore fluids. These fluids occupy the voids between the solid particles and are usually air and/or water. Figure B2a represents a soil mass and Figs. B2b and B2c show the volume proportions of solids, water, and air present in that mass. The sum of the air and water volumes equals the void volumes, i.e.,

$$V_v = V_w + V_a$$

while the volumes of voids and solids must equal the total volume, i.e.,

$$V = V_v + V_s.$$

From these basic relations come the following parameters which will be used in later discussions:

$$\text{Void Ratio, } e = \frac{V_v}{V_s}$$

$$\text{Porosity, } n = \frac{V_v}{V}$$

$$\text{Percent Saturation, } s = \frac{V_w}{V_v} \cdot 100.$$

As with volume, the total soil mass weight is the sum of the solid, water, and air weights. However, air weight is usually considered to equal zero, and thus the weight relation becomes:

$$W = W_s + W_w.$$

From this relation comes the important soil parameter, *percent moisture*, which is the ratio of water weight to solid weight times 100, i.e.,

$$w = \frac{W_w}{W_s} \cdot 100.$$

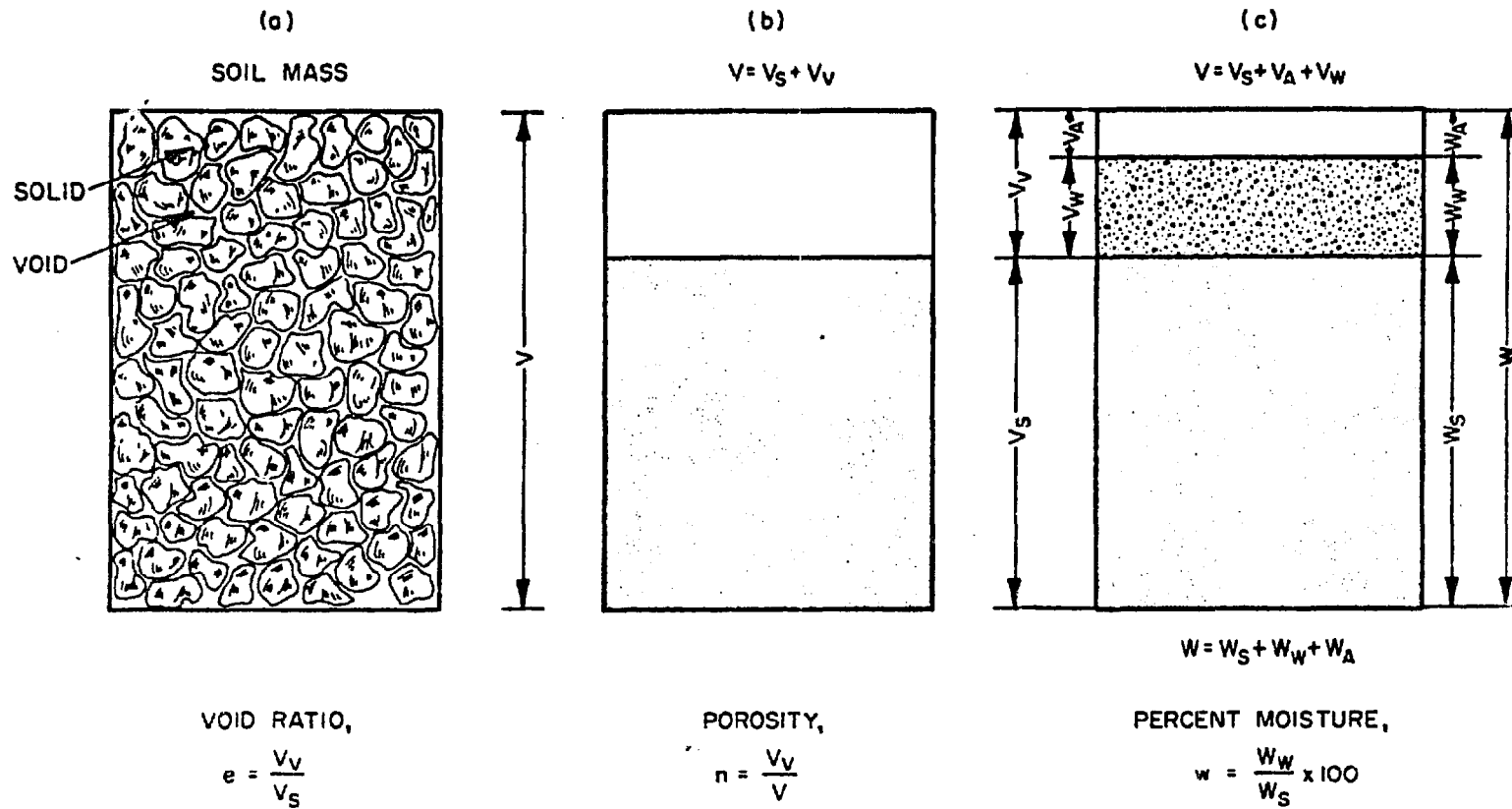

FIGURE B2 - SOIL VOLUME AND WEIGHT RELATIONSHIPS

Of course, the combination of volume and weight yields the unit weight,

$$\gamma = \frac{W}{V},$$

which in soil engineering is used interchangeably with the term *density*. The density referred to in compaction tests is specifically the unit dry weight,

$$\gamma_{\text{dry}} = \frac{W_s}{V}.$$

III. Compressibility, Compaction, and Settlement

The term *compressibility* refers to the amount of volume decrease brought about by a load (usually static), while *compaction* refers specifically to the volume decrease caused by tamping or rolling. Compressibility depends on the void volume and decreases with increasing density. The amount of settlement that an embankment will incur depends on the soil's compressibility and the amount of loading it is subject to. Obviously then, we can see that the more compaction an embankment receives during construction, the less will be the amount of natural settlement. Due to interparticle contact, larger grain soils are relatively incompressible under static loads, while fine grained soils are susceptible to natural settlement. The expression used most often in embankment design to describe compressibility is the *compression index*, C_c , which is determined by laboratory testing. This index is a ratio of the change in void ratio to the difference in pressure which caused the decrease in void volume, i.e.,

$$C_c = \frac{e_1 - e_2}{\log p_2 - \log p_1}.$$

Values for C_c can be found for most common soil types in soil manuals.

Because the embankment fill receives a compaction effort during construction, the major settlement problem is that of the foundation. The following example illustrates how the parameters developed can be used to calculate the amount of foundation settlement that can be expected, and thus allowed for in freeboard design. (From Basic Soils Engineering, Hough.)

Example 1 - For the preliminary dam design and subsurface conditions shown in Fig. B3a, estimate the amount of settlement at the centerline of the embankment.

By using the equation

$$\Delta H = H \frac{C_c}{1+e} \log \left(1 + \frac{\Delta p}{p_i} \right),$$

the foundation can be divided into layers of thickness H , and each layer's settlement, ΔH , calculated. These layers can be imaginary for a homogeneous foundation or actual, as in the case of distinct soil stratification. The total settlement will be estimated by the sum of ΔH . The calculations have been presented in Fig. B4. To serve as a guide to this table, the methods of calculations for the layer between 15 and 25 feet are as follows.

Initial body stress, p_i , due to overlying layers,

$$P_i = \gamma_1 D_1 + \gamma_2 D_2 + \dots \text{ (for each different } \gamma \text{)}$$

thus, $P_i = (5 \cdot 120) + (15 \cdot 42) = 1230$ psf.

Boundary loading at embankment centerline, $p = \gamma_{emb} H_{emb}$

thus, $p = 130 \cdot 50 = 6500$ psf.

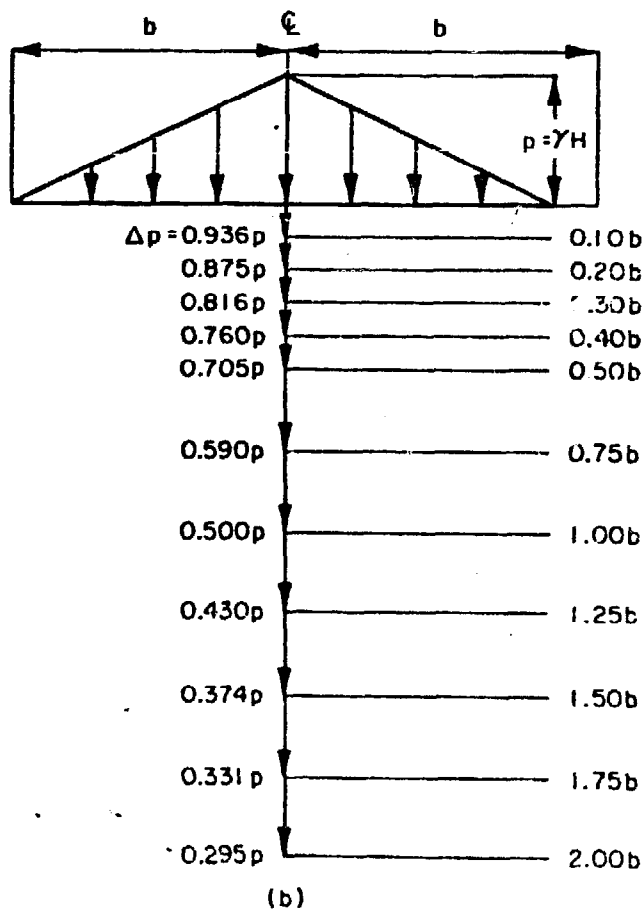
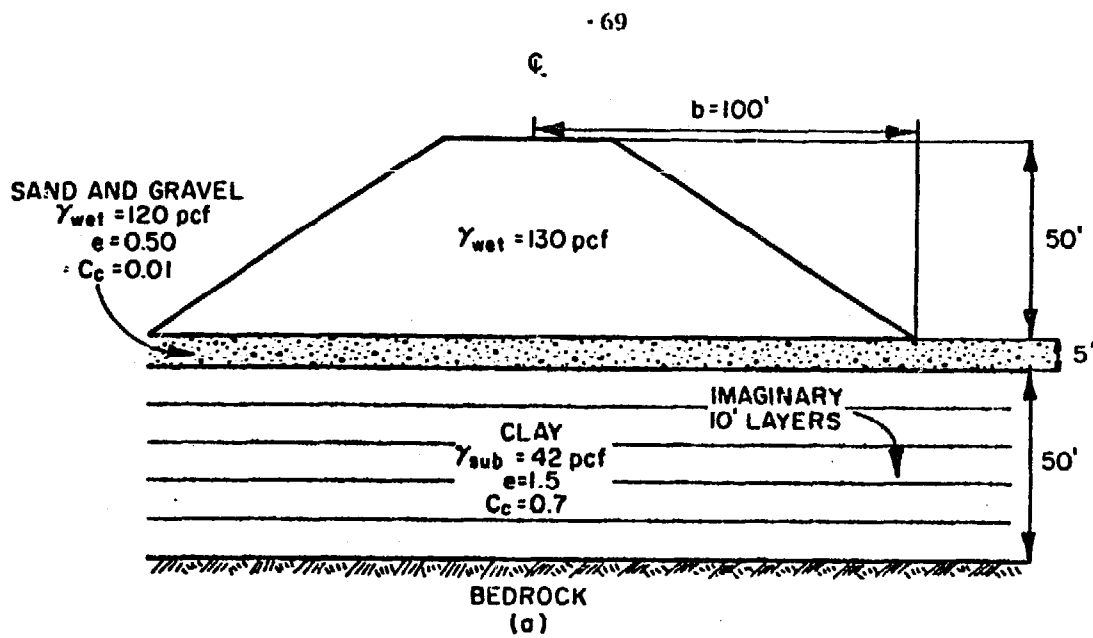

FIGURE B3 - EMBANKMENT SETTLEMENT EXAMPLE

$$\Delta H = H \frac{C_c}{1+e} \log\left(1 + \frac{\Delta p}{P_i}\right)$$

Depth, ft.	P_i	Δp		\log		H	ΔH	
Limits	Midpoint	psf	psf	$\left(1 + \frac{\Delta p}{P_i}\right)$	$\left(1 + \frac{\Delta p}{P_i}\right)$	$\frac{C_c}{1+e}$	ft	ft
0								
	2.5	300	6400	22.3	1.348	0.0067	5	0.05
5								
	10	810	6080	8.51	0.930	0.080	10	0.74
15								
	20	1230	5690	5.62	0.750	0.080	10	0.60
25								
	30	1650	5310	4.22	0.625	0.080	10	0.50
35								
	40	2070	4940	3.38	0.529	0.080	10	0.42
45								
	50	2490	4580	2.84	0.453	0.080	10	0.36
55								
							Total Settlement = 2.67	

Figure B4 - Calculations of Example Settlement Problem

As shown in Fig. B3b, express the depth at the center of this layer (20 ft) as $0.20 h$. Then, at depth $0.20 h$,

$$\Delta p = 0.875p = 5690 \text{ psf.}$$

From empirical values, the *compression ratio* is,

$$\frac{C_c}{1+e} = \frac{0.20}{2.5} = 0.08.$$

Then, from our initial equation,

$$\Delta H = 10 \cdot 0.08 \cdot 0.750 = 0.60 \text{ ft.}$$

For this example, the calculations only had to be made for the soil above the bedrock. Should such an impervious, incompressible substratum be very deep, the calculations need only be done to a depth where ΔH becomes negligible.

Several standards of *compaction* are available, however the Proctor Test was one of the first and is usually used for small dam construction. The exact procedures of this test are in most soil manuals. Example results of Proctor Tests for several soils are shown in Fig. B5. As can be seen, the maximum unit dry weight occurs at varying moisture contents for different soils. This optimum moisture content should be the percentage of water maintained in the soil during tamping and rolling to obtain good compaction. By field testing the soil after compaction, the density produced in the embankment layers should be 90 to 100 percent of the maximum density obtainable on the Proctor lab test curve. Good compaction, at optimum moisture content, will reduce settlement, permeability, and pore pressures and achieve a higher shear strength in the embankment soil.

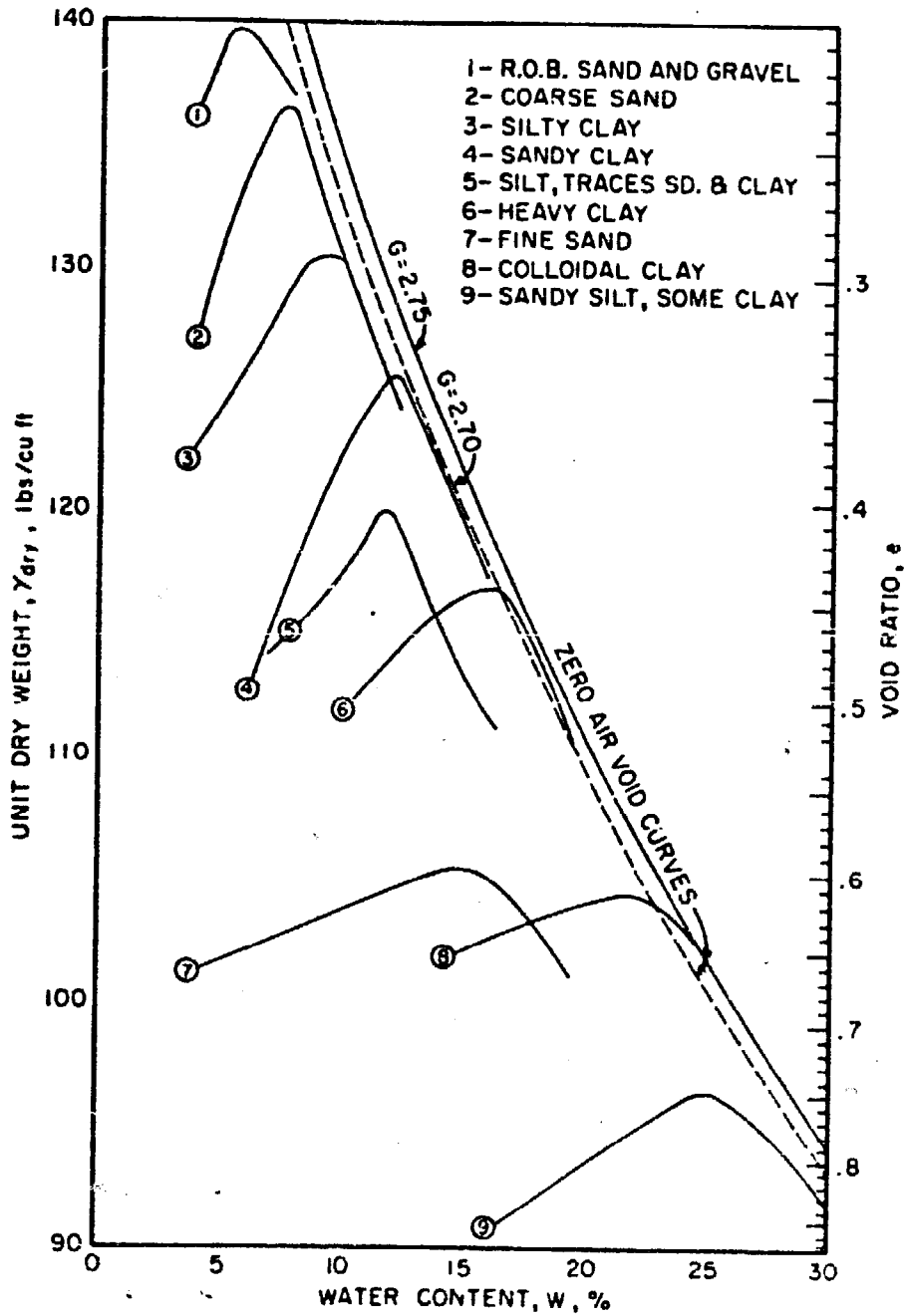

FIGURE B5 - TYPICAL PROCTOR TEST CURVES (B.K. Hough, 1969)

IV. Stress Analysis and Slope Stability

Unlike other construction materials such as concrete and steel, soil is weak in both compression and shear. Furthermore, the shearing strength and compressive stress vary for different soils, and for the same soil vary with seasonal changes, moisture, depth, and disturbances. Thus, a stress analysis of an earth embankment under all its possible conditions (i.e., during construction, during normal and high water levels, and during drawdown) is important to insure stability. Several aspects of soil mechanics, encompassing many methods of testing and design, must be considered in a complete stress analysis. The intent of this appendix is to describe some of the more appropriate aspects as they relate to small dam design and construction. The exact procedures of testing methods are enumerated in soil manuals and texts.

In Example 1, the pressure which produced the calculated settlement is termed the *effective stress* of the soil. It is the normal stress transmitted from particle to particle through the soil mass by direct grain contact, and is a function of the soil unit weight and depth. Normal stresses, produced by compacting equipment, result in the maximum soil density prescribed for good slope stability. However, this stability is actually dependent on the soil's shear strength. Shear strength is the amount of resistance a soil mass has against a shearing force. This resistance is the result of friction between the soil grains and when applicable, *cohesion*. Cohesionless soils depend entirely on grain friction for shear strength, and will be discussed first.

Cohesionless soils are usually those of coarser particles, i.e., silts, sands, and gravels. As shown in Fig. B6a, such soils develop a

higher shear strength with increased effective normal pressure. That is, for a soil mass of loose grains, a shearing force would be resisted primarily by the surface friction of the grains; as with any two sliding surfaces. However, as the soil mass is compacted, the grains interlock and a larger shearing force is required to produce displacement. Figure B6b shows the initial upward movement that is required to dislodge the upper soil mass grains from between the lower grains. This additional strength due to compaction is reflected in plots of shearing stress versus displacement for loose and dense soils (Fig. B6c). The surface of failure will obviously occur where the resistance is least. Thus it can be seen that uniform compaction of well-graded soils is important to improve shear resistance. The angle ϕ , which relates shear strength, s , to normal pressure, p , is called the *angle of internal friction* and $\tan \phi$ is the *coefficient of friction*.

When soils with low permeability coefficients (Appendix A) are compacted, water trapped in the voids develops pore pressure. Especially during construction, this pore pressure prevents maximum compaction (and interlocking) of the soil mass and can drastically reduce the shear strength. However, with time and subsequent settlement and seepage, this pore pressure will reside. Also, as most cohesionless soils are fairly pervious, pore pressures are not significant in pervious zones of small dams. To account for the loss of shear strength due to pore pressures, the equation relating shear strength to normal pressure becomes;

$$s = (p-u) \tan \phi \quad (1)$$

where u is the pore pressure. Several tests can be performed on soil

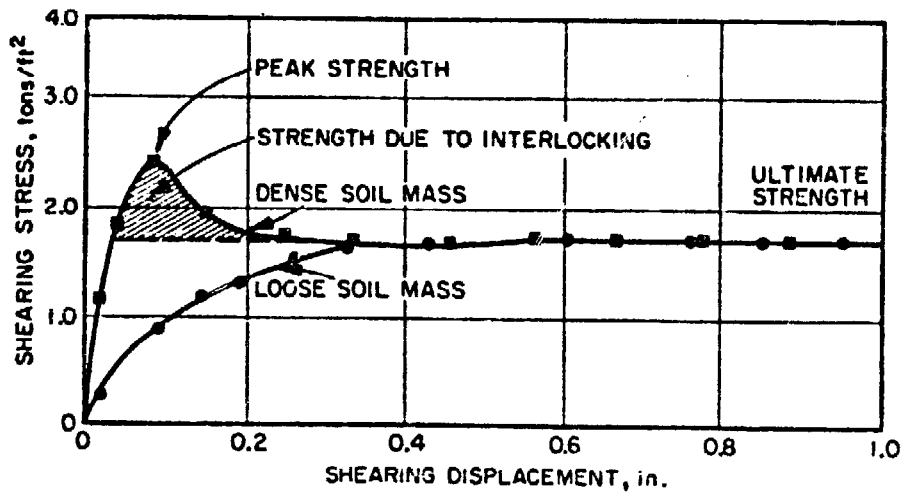
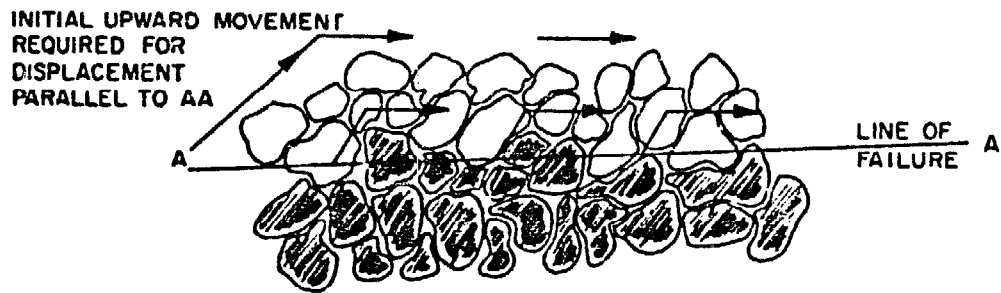
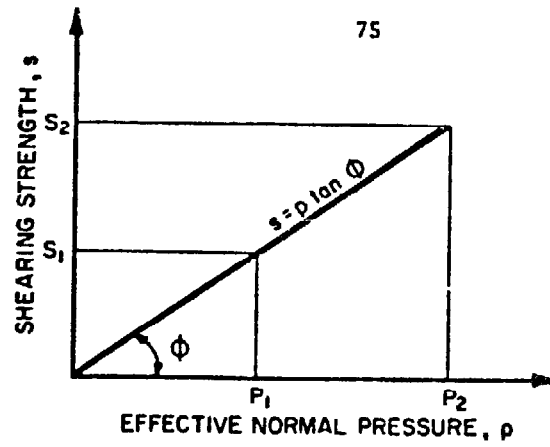

FIGURE B6 - SHEAR STRENGTH RELATIONS

samples to determine these parameters. They are generally referred to as direct shear tests and are conducted under *drained*, *undrained*, and *consolidated-undrained* conditions to simulate different normal and pore pressures.

Soils of only fine particles (i.e., clays) exhibit another form of soil behavior, namely *cohesion*. The strength of clays varies greatly with consistency (i.e., water content). Although it is difficult to measure cohesion alone, any shear strength which is not due to friction is considered cohesion. However, for pure clays, cohesion is the dominate parameter. The stickiness of very damp clay gives some idea of the property of cohesion. This parameter, when added to equation (1), yields;

$$s = c + (p-u) \tan \phi,$$

where c is cohesion. For these more impermeable particles, pore pressures are more significant. The U.S. Bureau of Reclamation has been measuring pore pressures in dams with piezometers, and has determined that pore pressures can be kept negligible by compacting at slightly less than optimum moisture content (approximately 0.7% less). Water acts as a lubricant during compaction and develops good cohesion, but too much can produce excessive pore pressures and cause slip or failure surfaces. Furthermore, when excess water evaporates from clays, cracking of the soil mass may occur.

Quite expectedly then, a well-graded soil with both coarser cohesionless grains and clay fines can combine the strengths of friction and cohesion. Soils of different gradations serve better in different areas of dam construction, as outlined in Fig. B1.

The common measure of embankment stability is the *factor of safety* of its slopes. This factor is defined as the ratio of resisting forces to the forces tending to cause soil movement. Thus, a safety factor (S.F.) of 1.0 denotes a slope on the verge of failure or at least partial movement. Again due to the many variables in soil, an S.F. of 1.5 to 2.0 is usually acceptable, whereas concrete and steel construction often only require 1.3. However, due to consolidation with the passage of time, an original S.F. of 1.5 may increase to 2.0.

Shear failures of embankments take the form of either rotational slides or translatory slides; the majority being the former. As shown in Fig. B7a, a rotational slide fails along an arc surface. If the shear resistance along a particular arc length does not equal or exceed the moment of the weight of soil above that arc, failure should be expected. Several methods are available to locate and analyze the weakest arc length in an embankment (the Swedish Circle Method being one of the most often used). Regardless of the method of analysis used, embankment stability should be studied for the different conditions under which the dam must exist.

During construction, pore pressures will probably be the greatest. The soil weight should be calculated on the basis of its moisture content and shear should be determined by undrained laboratory shear tests. When the reservoir behind the dam is at a normal operating stage, rotational failure is most likely to occur on the downstream face, often due to differential seepage. To check the S.F. for this condition, the soil may be saturated, or even submerged, and its weight must be determined accordingly. Values for shear resistance under this condition should be arrived at by consolidated-undrained shear tests. After

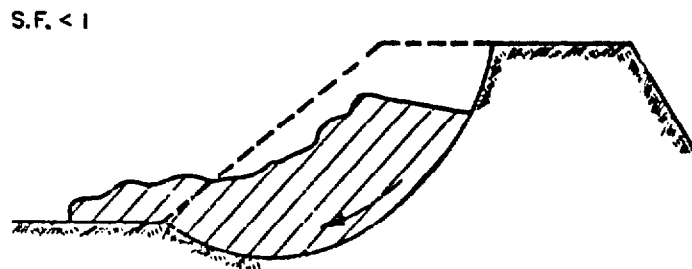
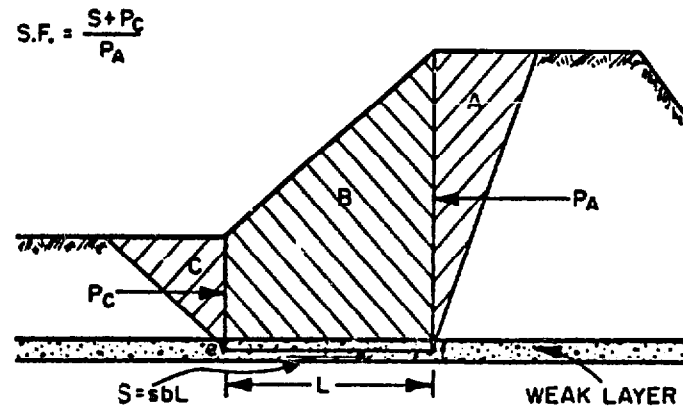
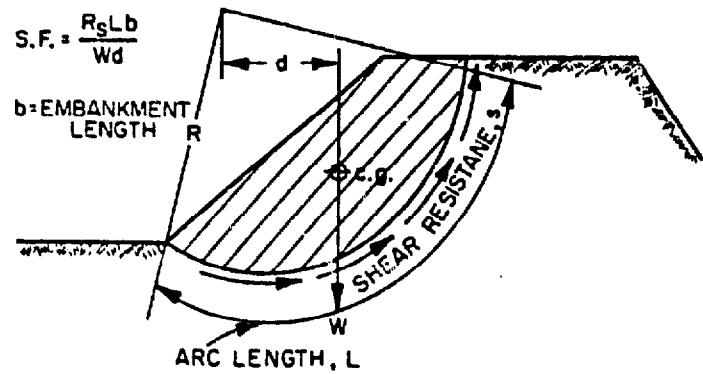

(a) ROTATIONAL SLIDE

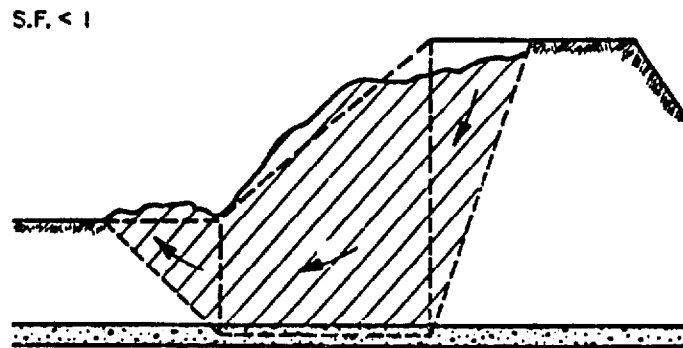

(b) TRANSLATORY SLIDE

FIGURE B7 - EMBANKMENT SLOPE STABILITY

rapid drawdown, the exposed upstream slope is saturated soil with a high unit weight, opposing the buoyed submerged soil in the lower portion of the failure arc. The stability of the upstream slope should thus be analyzed for various levels of drawdown, using the consolidated-undrained shear tests again for evaluating shear resistance. Here lies an advantage of zoned embankments. The outer pervious zones can drain more quickly than an impervious homogeneous cross section, and therefore reduce the period of low stability due to drawdown.

When a surface of weakness exists near the base of a slope or in the foundation, a shear failure may take the form of a translatory slide. As illustrated by Fig. B7b, the soil mass in wedge A exerts an active pressure (P_A) on block B, which is resisted by the shear resistance, s , along surface ef and the weight and shear strength of wedge C (in the form of passive pressure, P_C). As with the rotational slide, the ratio of the resisting forces to the active pressure determine the S.F., which if less than 1.0 should cause failure.

For any of the above conditions, if the factor of safety is less than desired, flattening of the side slopes, use of more shear resistant soils, and greater care in placing and compacting the embankment fill should be considered as methods of increasing the S.F. For small water storage and erosion control dam projects, the expense and time needed for stress analysis can usually be deleted if good design and construction guidelines are followed. However, the dam designer should be aware of the soil mechanics involved which determine embankment stability.