

AT MICROFICHE
REFERENCE
LIBRARY

A project of Volunteers in Asia

A Siting Handbook for Small Wind Energy Conversion
Systems

by: Harry L. Wegley, Montie M. Orgill and Ron L.
Drake

Published by:
United States Department of Energy
Washington, DC USA

Paper copies are \$ 9.00; quote accession number
PNL 2521 when ordering.

Available from:
National Technical Information Service
U.S. Department of Commerce
Springfield, VA 22161 USA

Reproduction of this microfiche document in any
form is subject to the same restrictions as those
of the original document.

U.S. DEPARTMENT OF COMMERCE
National Technical Information Service

PNL-2521

**A SITING HANDBOOK FOR SMALL WIND ENERGY
CONVERSION SYSTEMS**

HARRY L. WEGLEY, ET AL

**BATTELLE PACIFIC NORTHWEST LABORATORIES
RICHLAND, WASHINGTON**

MAY 1978

A Siting Handbook for Small Wind Energy Conversion Systems

by
**Harry L. Wegley
Montie M. Orgill
Ron L. Drake**

May 1978

Pacific Northwest Laboratory
Richland, Washington 99352
Operated for the
U.S. Department of Energy
by



PNL-2521

REPRODUCED BY
**NATIONAL TECHNICAL
INFORMATION SERVICE**
U. S. DEPARTMENT OF COMMERCE
SPRINGFIELD, VA. 22161

NOTICE

This report was prepared as an account of work sponsored by the United States Government. Neither the United States nor the Department of Energy, nor any of their employees, nor any of their contractors, subcontractors, or their employees, makes any warranty, express or implied, or assumes any legal liability or responsibility for the accuracy, completeness or usefulness of any information, apparatus, product or process disclosed, or represents that its use would not infringe privately owned rights.

The views, opinions and conclusions contained in this report are those of the contractor and do not necessarily represent those of the United States Government or the United States Department of Energy.

PACIFIC NORTHWEST LABORATORY

operated by

BATTELLE

for the

UNITED STATES DEPARTMENT OF ENERGY

Under Contract EY-76-C-06-1830

Printed in the United States of America

Available from

National Technical Information Service

United States Department of Commerce

5285 Port Royal Road

Springfield, Virginia 22151

NOTICE

THIS DOCUMENT HAS BEEN REPRODUCED FROM THE BEST COPY FURNISHED US BY THE SPONSORING AGENCY. ALTHOUGH IT IS RECOGNIZED THAT CERTAIN PORTIONS ARE ILLEGIBLE, IT IS BEING RELEASED IN THE INTEREST OF MAKING AVAILABLE AS MUCH INFORMATION AS POSSIBLE.

A SITING HANDBOOK FOR SMALL WIND
ENERGY CONVERSION SYSTEMS

by
Harry L. Wegley
Montie M. Orgill
Ron L. Drake

May 1978

BATTELLE
Pacific Northwest Laboratories
Richland, Washington 99352

Prepared for the U.S. Department of Energy,
formerly the Energy Research and Development
Administration, under Contract EY-76-C-06-1830.

FOREWORD

The primary purpose of this handbook is to provide siting guidelines for laymen who are considering the use of small wind energy conversion systems. With this purpose in mind, the handbook is being published in its current form to provide basic strategies to users as early as possible. The handbook will soon require updating due to rapidly changing technology and the evolving needs of users. Consequently, the authors also intend for this edition to serve as a review copy prior to wider distribution.

The authors wish to thank Dr. William Pennell for the technical guidance he provided, Dr. Carl Aspliden and Dr. Craig Hansen for their review, Jeanne McPherson and Chris Gilchrist for their help in editing, and Rosemary Ellis for her helpful suggestions and the many hours of typing she contributed. The writing of this handbook and the associated research were sponsored by the Department of Energy, Wind Systems Branch.

CONTENTS

FOREWORD	iii
1.0 INTRODUCTION	1.1
TASK A--Preliminary Feasibility Study	1.2
TASK B--Site and System Selection	1.3
2.0 GENERAL DESCRIPTION OF THE WIND	2.1
2.1 GENERATION OF THE WIND	2.1
2.2 INFLUENCES ON AIRFLOW	2.1
2.3 EFFECTS OF SURFACE ROUGHNESS	2.1
2.4 AVAILABLE POWER IN THE WIND	2.2
3.0 ENVIRONMENTAL HAZARDS TO WECS OPERATIONS	3.1
3.1 TURBULENCE	3.1
3.2 STRONG WIND SHEAR	3.2
3.3 EXTREME WINDS	3.3
3.4 THUNDERSTORMS	3.3
3.5 ICING	3.7
3.6 HEAVY SNOW	3.10
3.7 FLOODS AND SLIDES	3.10
3.8 EXTREME TEMPERATURES	3.10
3.9 SALT SPRAY AND BLOWING DUST	3.12
4.0 SITING IN FLAT TERRAIN	4.1
4.1 UNIFORM ROUGHNESS	4.2
4.2 CHANGES IN ROUGHNESS	4.7
4.3 BARRIERS IN FLAT TERRAIN	4.11
4.3.1 Buildings	4.11
4.3.2 Shelterbelts	4.15
4.3.3 Individual Trees	4.20
4.3.4 Scattered Barriers	4.21
5.0 SITING IN NON-FLAT TERRAIN	5.1
5.1 RIDGES	5.1
5.2 ISOLATED HILLS AND MOUNTAINS	5.9
5.3 PASSES AND SADDLES	5.11
5.4 CANYONS AND GORGES	5.12

Preceding page blank

5.5	VALLEYS AND CANYONS	5.14
5.6	BASINS	5.20
5.7	CLIFFS	5.21
5.8	MESAS AND BUTTES	5.26
5.9	ECOLOGICAL INDICATORS OF SITE SUITABILITY	5.28
6.0	METHODS OF SITE ANALYSIS	6.1
7.0	REFERENCES	7.1
	APPENDIX A - SOURCES AND USES OF WIND CLIMATOLOGY	A.1
	APPENDIX B - INITIAL ESTIMATE OF WIND ENERGY POTENTIAL	B.1
	APPENDIX C - ESTIMATING POWER OUTPUT FROM ANNUAL AVERAGE WIND SPEEDS AND WECS CHARACTERISTICS	C.1
	APPENDIX D - COMPUTATION OF OUTPUT POWER FROM WIND SUMMARIES	D.1
	APPENDIX E - UNITS CONVERSION	E.1

LIST OF FIGURES

2.1	Effect of Surface Friction on Low-Level Wind	2.3
2.2	Definition of the Rotor Disc	2.4
3.1	Simple Method of Detecting Turbulence	3.2
3.2	The Maximum Expected Winds for a 50-yr Mean Recurrence Interval	3.4
3.3	The Mean Annual Number of Days with Thunderstorms	3.5
3.4	Total Hail Reports 3/4 in. and Greater, 1955-1967	3.6
3.5	Tornado Strike Probability Within 5-Degree Squares in the Continental United States	3.8
3.6	Number of Times Ice 0.25 in. or More Thick Was Observed During the 9-yr Period of the Association of American Railroads Study	3.9
3.7	Extreme Storm Maximum Snow Fall	3.11
3.8	Annual Percent Frequency of Dusty Hours	3.13
4.1	Determination of Flat Terrain	4.2
4.2	Formation of a New Wind Profile Above Ground Level	4.7
4.3	Wind Speed Profiles Near a Change in Terrain	4.8
4.4	Transition Height in Wind Speed Profile Due to a Change Roughness	4.9
4.5	Example of a Transition Height Diagram Depicting One Change in Roughness	4.10
4.6	Airflow Around a Block Building	4.12
4.7	Zone of Disturbed Flow over a Small Building	4.13
4.8	The Effects of an Undisturbed Airflow Encountering an Obstruction	4.13
4.9	Airflow Near a Shelterbelt	4.16
4.10	Percent Wind Speed at Different Levels Above the Surface Behind a Row of Trees of Height, H	4.17
4.11	The Zone of Turbulence Behind a Shelterbelt	4.18
5.1	Definition of a Ridge	5.2
5.2	Acceleration of Wind over a Ridge	5.3
5.3	The Effects of Ridge Orientation and Shape Upon WECS Site Suitability	5.4
5.4	Ranking of Ridge Shape by Amount of Wind Acceleration	5.5

5.5	Percentage Variation on Wind Speed over an Idealized Ridge	5.6
5.6	Hazardous Wind Shear over a Flat-Topped Ridge	5.7
5.7	Effect of Surface Roughness on Wind Flow over a Low Sharp-Crested Ridge	5.8
5.8	Airflow Around an Isolated Hill (Top View)	5.10
5.9	A Schematic of the Wind Pattern and Velocity Profile Through a Mountain Pass	5.13
5.10	A Schematic Illustration of Flow Patterns that May Be Observed Through Gaps and Gorges	5.14
5.11	The Daily Sequence of Mountain and Valley Winds	5.16
5.12	Vertical Profile of the Mountain Wind	5.17
5.13	Possible WECS Sites in Sloping Valleys and Canyons	5.18
5.14	Possible WECS Sites Where Prevailing Winds are Channeled by Valleys	5.19
5.15	Airflow over Cliffs Having Differently-Sloped Faces	5.22
5.16	Top View of Airflow over Concave and Convex Portions of a Cliff Face	5.23
5.17	Vertical Profiles of Air Flowing over a Cliff	5.24
5.18	The Effects of Upwind Roughness on the Location of the Best WECS Site Downwind from a Cliff	5.25
5.19	Flow Around and over Buttes and Mesas	5.27
5.20	Wind Speed Rating Scale Based on the Shape of the Crown and Degree Twigs, Branches, and Trunk are Bent (Griggs-Putnam Index)	5.29
5.21	Deformation Ratio Computed as a Measure of the Degree of Flagging	5.30
A.1	Sample Wind Rose	A.3
A.2	Nuclear Power Plant Sites	A.4
A.3	Sample Wind Energy Rose	A.5
B.1	Available Wind Power--Annual Average	B.2
B.2	Annual-Average Wind Power at 50 m Above Higher Elevations, in Watts/m ²	B.3
C.1	Estimate of Expected Average Power Output for Wind Turbines	C.2
C.2	Percent Down Time	C.3
C.3	Percent Time Running at Rated	C.3
D.1	Hypothetical Output Power Curve	D.3

LIST OF TABLES

2.1	Percentage Change in Available Power with Changes in Wind Speed	2.5
4.1	Extrapolation of the Wind Speed from 30 ft to Other Heights Over Flat Terrain of Uniform Roughness	4.4
4.2	Power Change Due to Extrapolation to a New Height	4.6
4.3	Wake Behavior of Various Shaped Buildings	4.14
4.4	Available Power Loss and Turbulence Increase Downwind from Shelterbelts of Various Porosities	4.19
4.5	Speed and Power Loss in Tree Wakes	4.20
5.1	WECS Site Suitability Based Upon Slope of the Ridge	5.6
5.2	WECS Site Suitability on Isolated Hills	5.10
5.3	Mean Annual Wind Speed Versus the Griggs-Puttnam Index	5.31
5.4	Mean Annual Wind Speed Versus the Deformation Ratio	5.31
5.5	Griggs-Putnam Index Versus Annual Average Wind Speed for Conifers in the Northeastern United States	5.32
6.1	Various Approaches to Site Analysis	6.2
A.1	Sample Wind Summary	A.2
D.1	New Wind Summary	D.1
D.2	Hypothetical Wind Summary	D.4
D.3	Hypothetical Output Power by Speed Class	D.4
D.4	Conversion of % Frequencies to Hours	D.4

1.0 INTRODUCTION

This handbook was written to serve as a siting guide for individuals wishing to install small wind energy conversion systems (WECS). Small WECS are defined here as systems consisting of one or two machines, each having a rated capacity of less than 100 kilowatts. To understand and apply the siting principles discussed, the user needs no technical background in meteorology or engineering; he needs only a knowledge of basic arithmetic and the ability to understand simple graphs and tables.

According to manufacturers of small WECS, the greatest cause of dissatisfaction among owners has been improper siting.⁽¹⁾ A potential owner of a small WECS should realize that a relatively small investment to locate the best available site can easily yield savings of several thousand dollars over the lifetime of the system.

This handbook incorporates half a century of siting experience gained by WECS owners and manufacturers, as well as recently developed siting techniques. Through proper use of the siting techniques, an owner can select a site that will yield the most power at the least installation cost, the least maintenance cost, and the least risk of damage or accidental injury.

The siting of small WECS, through the use of this handbook, should be viewed as an integral part of an overall plan for potential WECS users. A suggested plan is presented in the following outline:

A. Preliminary Feasibility Study

1. Initial wind resource assessment

- a. Survey available WECS
- *b. Estimate power output
- c. Estimate power needs

* Since this handbook deals primarily with site selection, only asterisked topics are covered in detail; however, references are provided for all other topics.

2. Economic analysis
 - a. Analyze cost of WECS
 - b. Consider legal (and other) factors
 - c. Formulate working budget

B. Site and System Selection

1. Final wind resource assessment
 - *a. Select candidate site
 - *b. Determine available power at candidate site
2. Selection of WECS
 - a. Estimate power needs quantitatively
 - *b. Estimate power output quantitatively
 - c. Choose WECS and storage/backup system

The following step-by-step procedure is suggested as a method of integrating the siting handbook and other references to accomplish the tasks in the planning outline:

TASK A--Preliminary Feasibility Study

To make the initial wind resource assessment, take the following steps:

1. Obtain information on costs and operating characteristics of available WECS. The American Wind Energy Association can provide lists of manufacturers and distributors from whom this information can be obtained. The address is:

American Wind Energy Association
54468 CR 31
Bristol, IN 46507
2. Use the information in Appendix B of this handbook to make a rough estimate of wind power potential. If there is little potential, wind energy will probably not be competitive with other energy sources.
3. Consult a copy of Wind Power for Farms, Home, and Small Businesses by J. Park and D. Schwind, available on written request (see Reference 2). This booklet contains much practical information which complements the siting handbook.

4. Roughly estimate energy needs (both average load and peak load). Consult a WECS dealer and/or Chapter 4 of Reference 2 for assistance.
 5. Using Appendix C of this handbook, estimate power output for several available WECS. Will any of them produce sufficient power? If not, can energy conservation make up the energy deficit?
- o analyze the economics of the WECS, take the following steps:
1. If a WECS appears to meet power requirements, compare estimated WECS costs (over the life expectancy of the WECS) to the projected costs of conventional power for the same period. Chapter 6 of Reference 2 gives instructions for a thorough economic analysis.
 2. Consider the impact of all economic restraints, such as available funds, legal, environmental, and other concerns (see Chapter 7 of Reference 2).
 3. Formulate a working budget from this information if wind energy appears feasible.

TASK B--Site and System Selection

To make the final wind resource assessment, take the following steps:

1. Read Sections 2 and 3 of the siting handbook for essential information on the nature of wind, wind power, and WECS hazards.
2. Read the introduction to Section 4; classify terrain as flat or non-flat.
 - a. If Terrain is non-flat:
 - (1) Read Sections 4.1 and 4.2 for background.
 - (2) Read the portions of Sections 4.3 and 5 that deal with barriers or terrain features in or near the siting area.

(3) Follow siting guidelines given to select the best candidate site(s).

b. If terrain is flat:

(1) Read Sections 4.1 and 4.2 for background.

(2) If the surface roughness(a) is uniform, select candidate sites by reading applicable portions of Section 4.3.

(3) If there are changes in roughness, consider those effects in conjunction with the applicable portions of Section 4.3 to select candidate site(s).

3. Read Section 6 of this handbook and select a method of site evaluation; begin data collection (or arrange to have it done).

To select a WECS, take the following steps:

1. When all site evaluation data have been collected, use guidelines in Section 6 of this handbook to make final estimates of output power for various WECS.

2. Make a detailed estimate of energy needs if this was not done in the feasibility study (a WECS dealer and/or Chapter 4 of Reference 2 can provide guidance).

3. Select the WECS that meets energy requirements at the lowest cost.

(a) Surface roughness is explained in Section 2.3.

2.0 GENERAL DESCRIPTION OF THE WIND

2.1 GENERATION OF THE WIND

The ultimate energy source which drives the wind is the sun. Incoming solar energy, which generally decreases from the equator to the poles, is absorbed and reflected differently by various parts of the atmosphere and by the various types of surfaces (i.e., oceans, snow, and ice, sandy deserts, forests, etc.). The redistribution of incoming solar energy tends to produce low and high pressure areas.

Pressure differences in the atmosphere force the air to move toward lower pressure. Once the air begins to move, other factors modify both its speed and direction.

2.2 INFLUENCES ON AIRFLOW

Pressure systems (frequently 500 to 1000 miles or more in diameter), which are associated with large-scale wind patterns, tend to migrate from west to east across North America. As the air in the large-scale wind pattern moves through local areas, its speed and direction may be changed by the local topography and by local heating or cooling. At a particular WECS site, trees, buildings or other small-scale influences may further disturb the wind flow. The combined effects of these three scales of influence produce highly variable winds.

2.3 EFFECTS OF SURFACE ROUGHNESS

The surface over which the wind flows affects wind speed near that surface. A rough surface (such as trees and buildings) will produce more friction than a smooth surface (such as a lake). The greater the friction the more the wind speed is reduced near the surface.

Figure 2.1 illustrates how surface roughness affects wind speed by means of a vertical wind speed profile--simply a picture of the change in wind speed with height. Within 10 ft of the surface, wind speed is greatly reduced by friction. Wind speed increases, however, between the surface and 1000 ft as the effects of surface roughness are overcome. Knowing how the surface roughness affects the vertical wind speed profile is extremely valuable when determining the most beneficial WECS tower height.

2.4 AVAILABLE POWER IN THE WIND

To find a site with the most available wind power, it is essential to have a clear understanding of the variation of power with wind speed. The following equation defines this relationship:

$$\text{Available Power} = 0.5 \times D \times A \times S^3$$

where

D = air density

A = area of the rotor disc

S = the wind speed ($S^3 = S \times S \times S$, cube of wind speed).

Rotor discs (mentioned in the above equation) are illustrated in Figure 2.2 for three different types of WECS. Since air density (D) at a site normally varies only 10% or less during the year, the amount of power available depends primarily on the area (A) of the rotor disc and the wind speed (S). Increasing the diameter of the rotor disc (by increasing the blade length) will allow the WECS to intercept more of the wind, and thereby harness more power. (a) Since the available power varies with the cube of the wind speed, choosing a site where wind speed is greatest is desirable. Table 2.1 demonstrates how even a small change in wind speed results in a large change in available power. Suppose that

(a) The choice of WECS size should not be made solely on this basis, but in conjunction with the WECS dealer and/or Section 6 of this handbook.

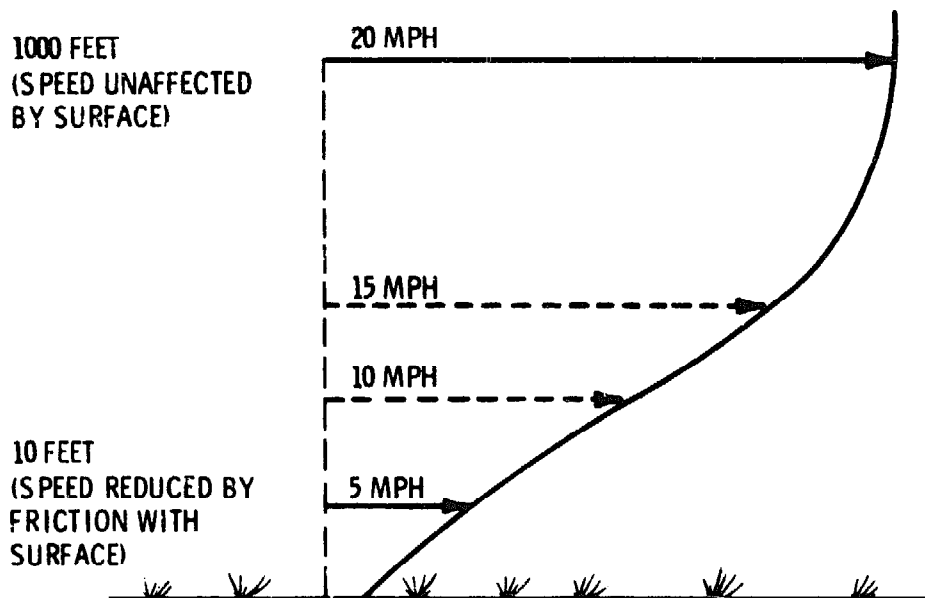

FIGURE 2.1. Effect of Surface Friction on Low-Level Wind

one computation of available power at a site had been based on a wind speed estimate of 10 mph when the actual speed was 9 mph. The actual available power would be almost 30% less than the estimated power due solely to a one mph error in the estimated wind speed.

To estimate the available power in the entire year it is necessary to estimate how frequently each wind speed occurs. The value that the user places on accurate estimations of available power will ultimately determine the time and money he is willing to spend to measure the annual frequencies of wind speeds at his site. Various approaches to wind data collection are discussed in Section 6.

Before a site is chosen, the user should know how available power and wind direction vary in the area. A convenient way of expressing this relationship is through the use of a wind energy rose, a graphic representation of the amount of wind energy associated with each wind direction. If a potential WECS user has lived at a location for a long period of time, he may intuitively

(HORIZONTAL AXIS ROTOR)

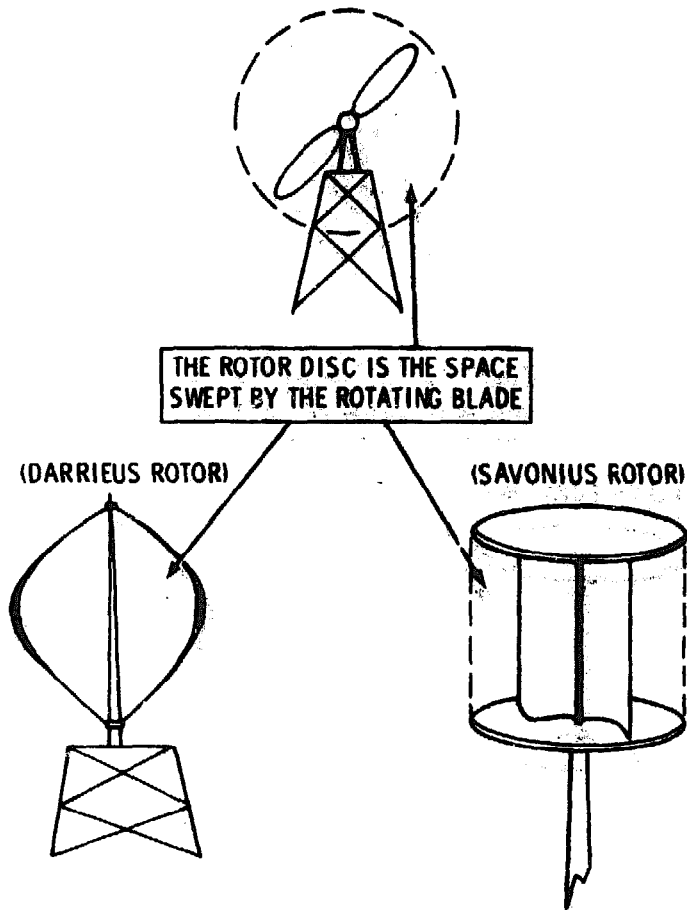

FIGURE 2.2. Definition of the Rotor Disc

know the principal power direction (i.e., the wind direction which will contain most of the available power). However, if data from a nearby observing station are available, a wind energy rose should be constructed from the summarized data (see Appendix A for definition, methods of construction, and use of wind energy roses).

TABLE 2.1. Percentage Change in Available Power
with Changes in Wind Speeds

<u>Speed mph</u>	<u>Percent Power Change From Power at Base Speed of 10 mph</u>
5	-88
6	-78
7	-66
8	-41
9	-27
10	0
11	+33
12	+73
13	+120
14	+174
15	+238

3.0 ENVIRONMENTAL HAZARDS TO WECS OPERATIONS

Environmental hazards may influence the economic feasibility of a WECS or the selection of a particular machine. For example, if salt spray at a coastal site reduces the expected lifetime of a WECS by one-half, the cost of wind energy to the user sharply increases. Good siting strategy, therefore, will not only maximize the wind speed, but also reduce hazards.

Many WECS hazards cannot be avoided. In such cases, the user must either purchase a WECS designed to survive in the local environment or in some way protect the WECS from the hazard. The potential economic impact of either approach must be evaluated.

3.1 TURBULENCE

Air turbulence consists of rapid changes in speed and/or direction of the wind. The turbulence most harmful to WECS is the small-scale, rapid fluctuation often caused by the wind flowing over a rough surface or a barrier. Turbulence has two adverse effects: 1) a decrease in harnessable power and 2) vibrations and unequal loading on the WECS that may eventually weaken and damage it.

To characterize the turbulence at a site, the user should determine the prevailing wind power direction (see Use of Wind Summaries in Appendix A).^(a) When the prevailing wind is blowing, the predominant areas of turbulence at a proposed WECS site can be detected by one or more 4-ft lengths of ribbon tied to a long pole, kite string, or string of a large helium-filled balloon. How much the ribbons flap indicates the amount of turbulence. A second string can be used to pull a balloon or kite into position over the WECS site (see Figure 3.1) to determine the height to which

(a) If more than one wind direction frequently occurs, the user should investigate each to understand the turbulence hazard to the WECS fully.

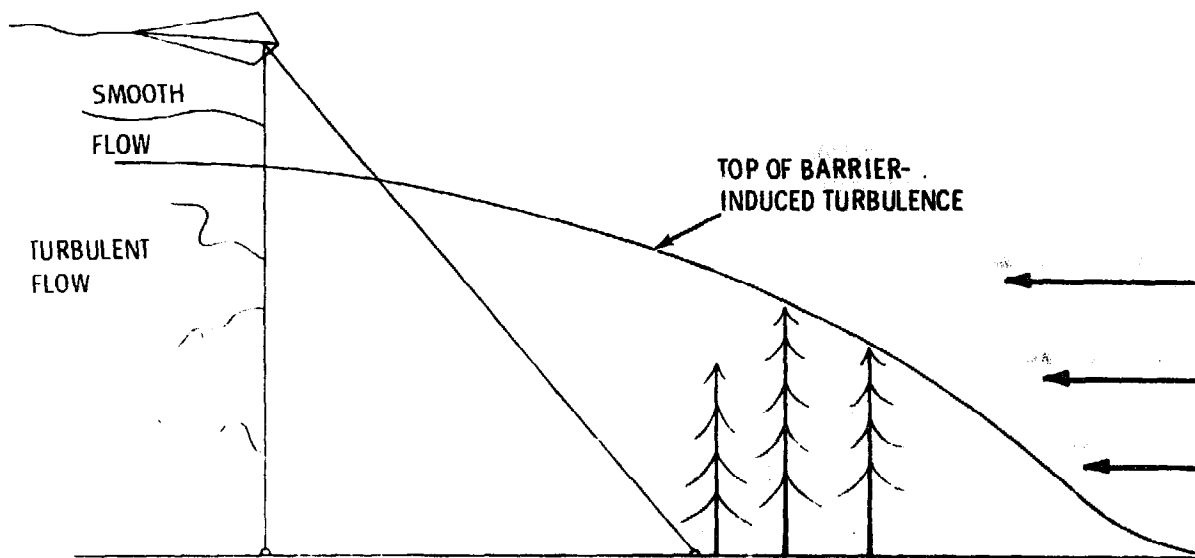

FIGURE 3.1. Simple Method of Detecting Turbulence

turbulence extends. The expected location and intensity of turbulence produced by barriers and landforms are described (at least qualitatively) in Sections 4 and 5.

3.2 STRONG WIND SHEAR

Strong wind shear may pose a hazard to small WECS in some locations. Wind shear is simply a large change in speed or direction over a small distance. If a large change occurs over a distance less than or equal to the diameter of the rotor disc (see Figure 2.2 for definition of rotor disc), then unequal forces will be acting on the blades. Over a period of time these forces could damage the WECS.

Generally the longer the blades, the more susceptible the WECS is to shear hazards. However, shear can be a hazard to any WECS whose rotor disc is too near the ground, a canyon wall, a steep mountain side, or the top of a flat-topped ridge (see Figure 5.0).

3.3 EXTREME WINDS

WECS blades and the supporting towers are both susceptible to damage from high winds. The blades become vulnerable if the protection systems designed into many WECS fail in extreme winds. Towers must be capable of supporting the WECS in all wind speeds which normally occur in the local area.

Figure 3.2 shows maximum wind speeds which might occur in a 50-yr period. However, since this is a national map, some local areas of very high winds (mostly in the Rocky Mountains) have been omitted. Users in or near mountains should obtain extreme wind speeds from nearby weather stations when planning a WECS (see Appendix A for sources of wind data).

The WECS dealer may assist in selecting the best tower, but before it is purchased, the user should contact local building inspectors to insure compliance with existing codes.

3.4 THUNDERSTORMS

Thunderstorms produce several hazards, such as severe winds, heavy rains, lightning, hail, and possibly tornadoes. Figure 3.3 shows that thunderstorms occur on over 40 days per year in most parts of the United States. The largest number and most intense thunderstorms occur in Florida and the Great Plains states of Kansas and Oklahoma.

Though the frequency of lightning is not available, it can be partially inferred from the thunderstorm occurrences shown in Figure 3.3. Considering its cost, a WECS should be protected from lightning strikes wherever it is located.

Hail often causes heavy damage to buildings; it may also cause damage to a wind machine and its support structure. Large hail is most frequently observed in Texas, Oklahoma, Kansas and Nebraska (Figure 3.4).

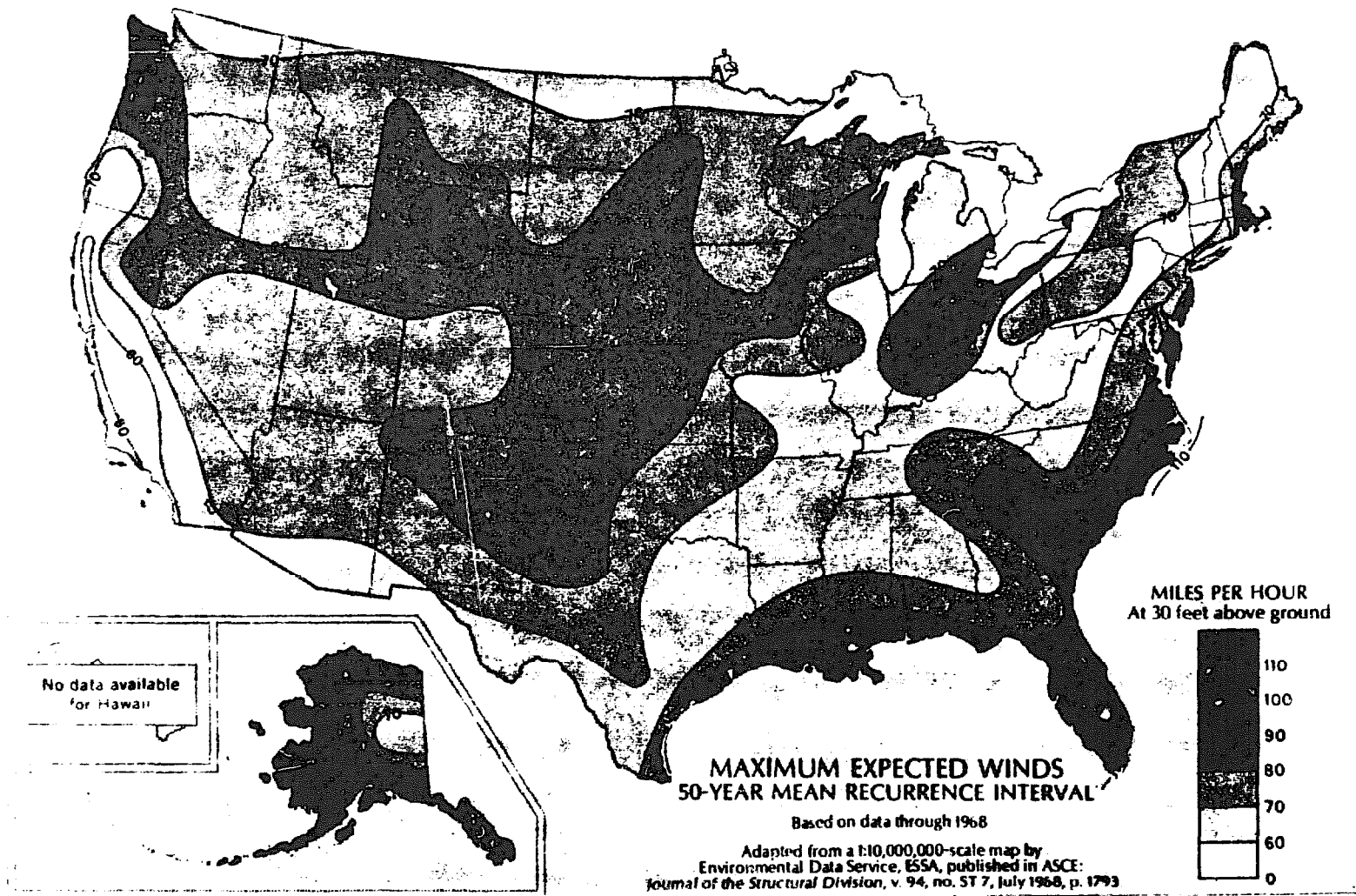

FIGURE 3.2. The Maximum Expected Winds for a 50-yr Mean Recurrence Interval⁽³⁾

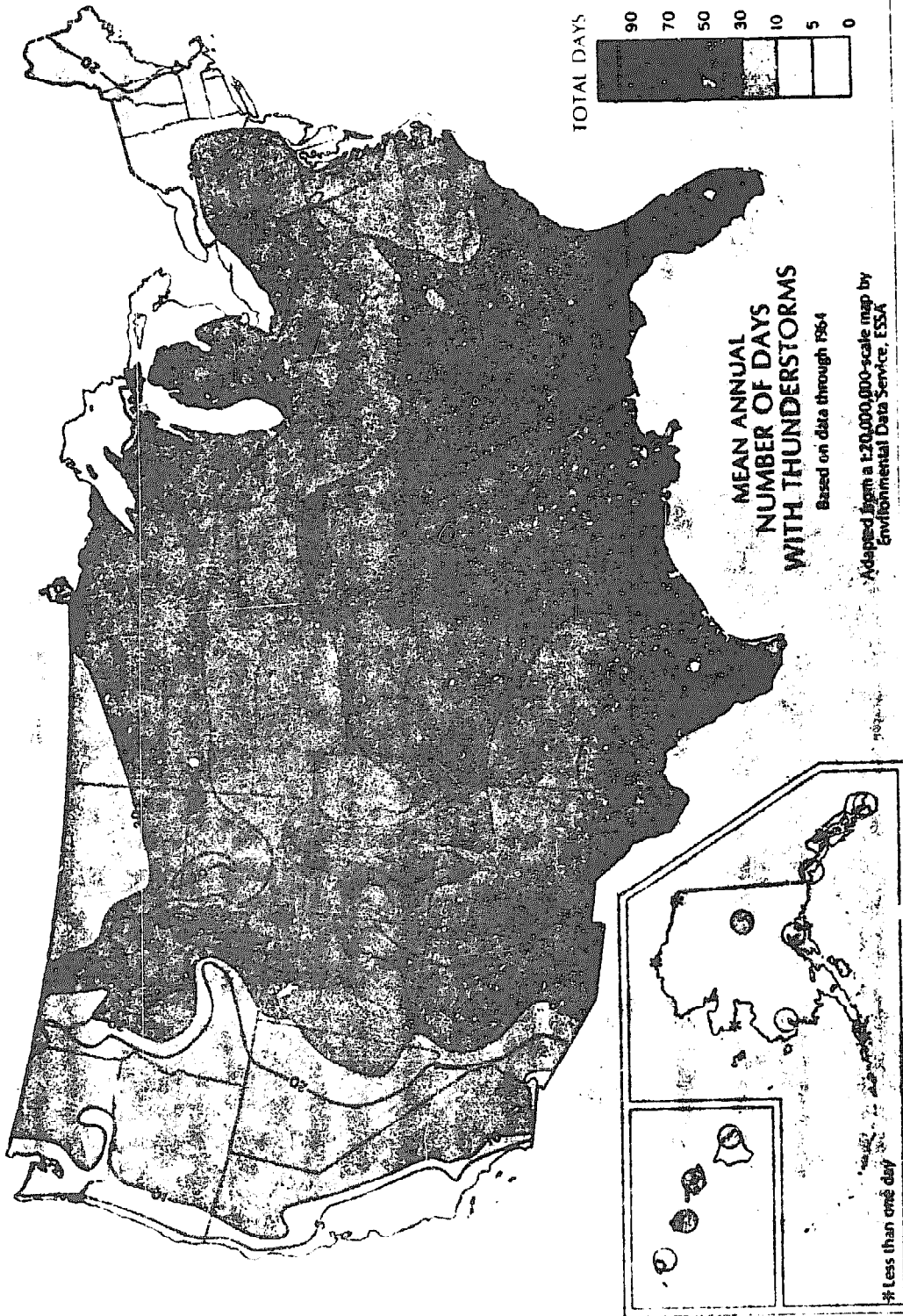

FIGURE 3.3. The Mean Annual Number of Days with Thunderstorms (4)

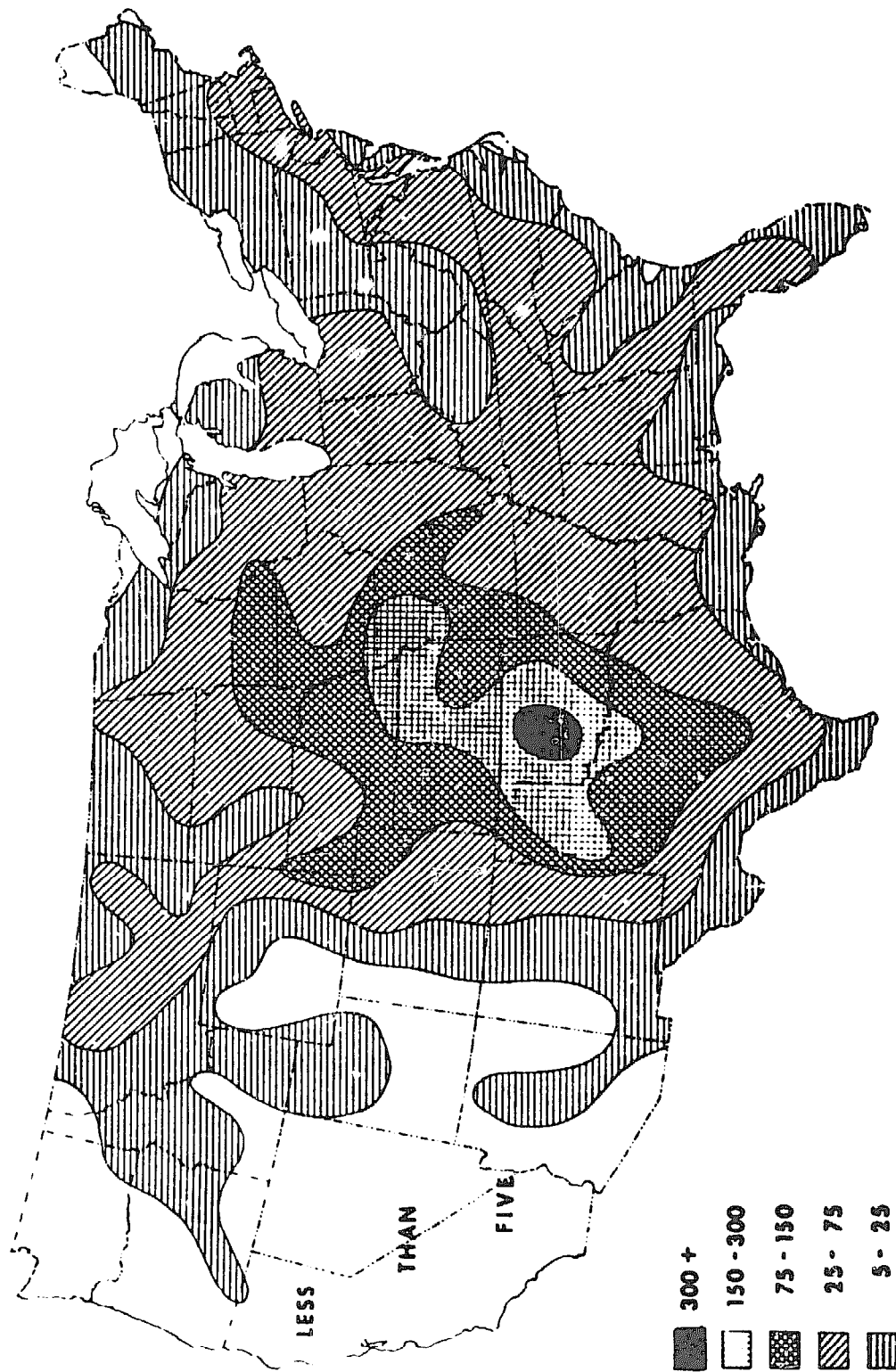

FIGURE 3.4. Total Hail Reports 3/4 in. and Greater, 1955-1967 (5)

Tornadoes occur most often in the central part of the United States in an area called "tornado alley," extending from southwestern Texas to northern Illinois. Figure 3.5 shows the approximate risk of a tornado strike for different areas of the continental United States. Since WECS, like houses, are not designed to withstand tornadoes, the prospective buyer must assess the risk of tornado damage.

3.5 ICING

Ice accumulated on blades, towers, and transmission lines can cause hazards or reduce the efficiency of wind machines. There are two types of icing: rime ice and glaze ice.

Rime ice differs from glaze principally because of its source. It forms from frost or freezing fog rather than rain. Rime icing occurs mainly at high elevations. It is drier, less dense, and therefore less hazardous than glaze; however, it can, over a period of time, build up large accumulations.

Glaze icing, formed from freezing rain, occurs most frequently in valleys, basins, and other low elevations. When rain falls through a subfreezing layer of air at the ground, the drops freeze on contact with the surface. Under favorable conditions, freezing precipitation can rapidly accumulate on a cold surface to thicknesses of more than two inches. Data gathered by the Association of American Railroads, Edison Electric Institute, American Telephone and Telegraph, and other organizations on ice accumulation on transmission lines in the United States have been analyzed for the period 1911-1938; the number of times icing greater than 0.25 in. occurred is shown in Figure 3.6.

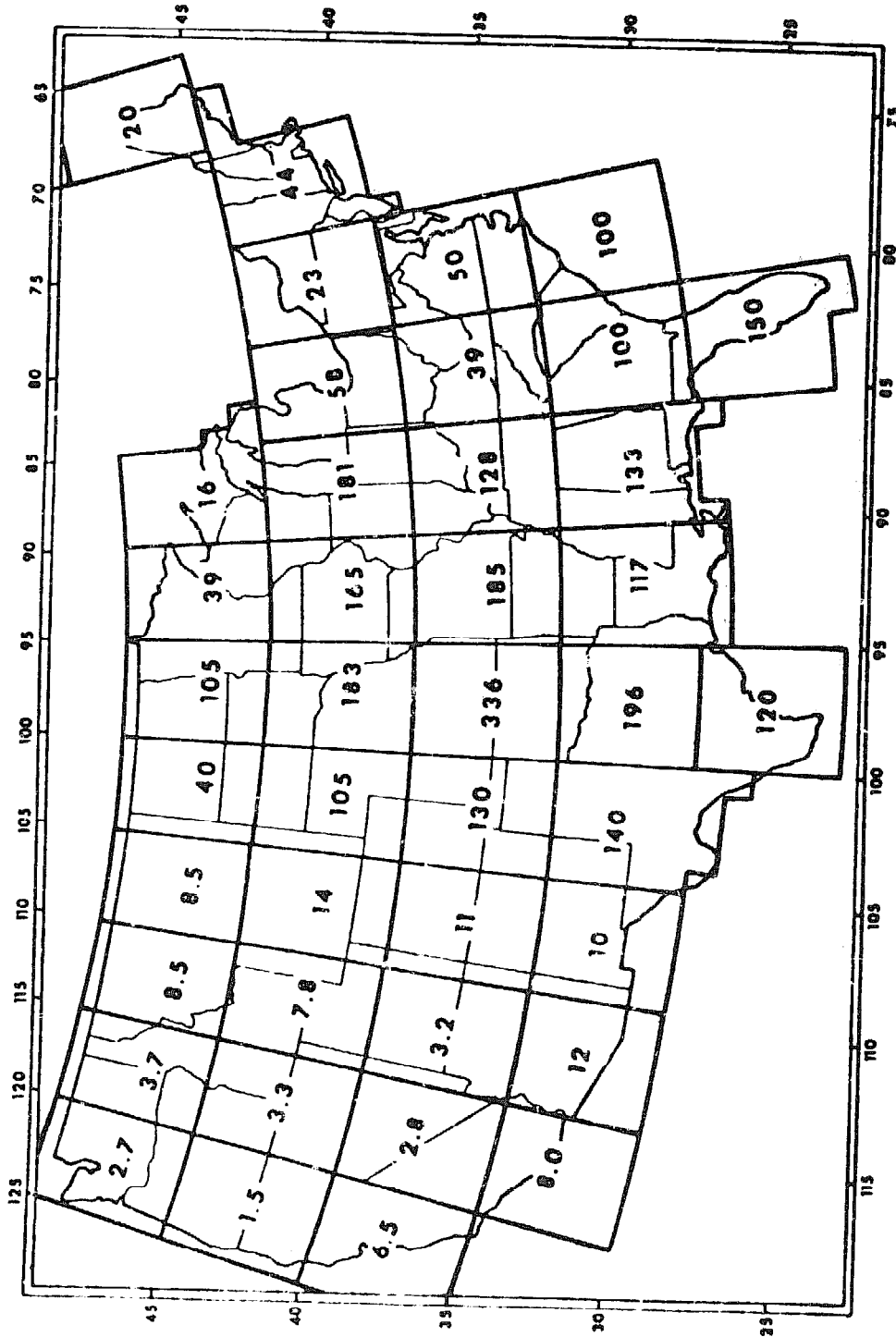

FIGURE 3.5. Tornado Strike Probability Within 5-Degree Squares in the Continental United States. The numbers represent chances in 100,000 of a tornado strike during a one-year period. (6)

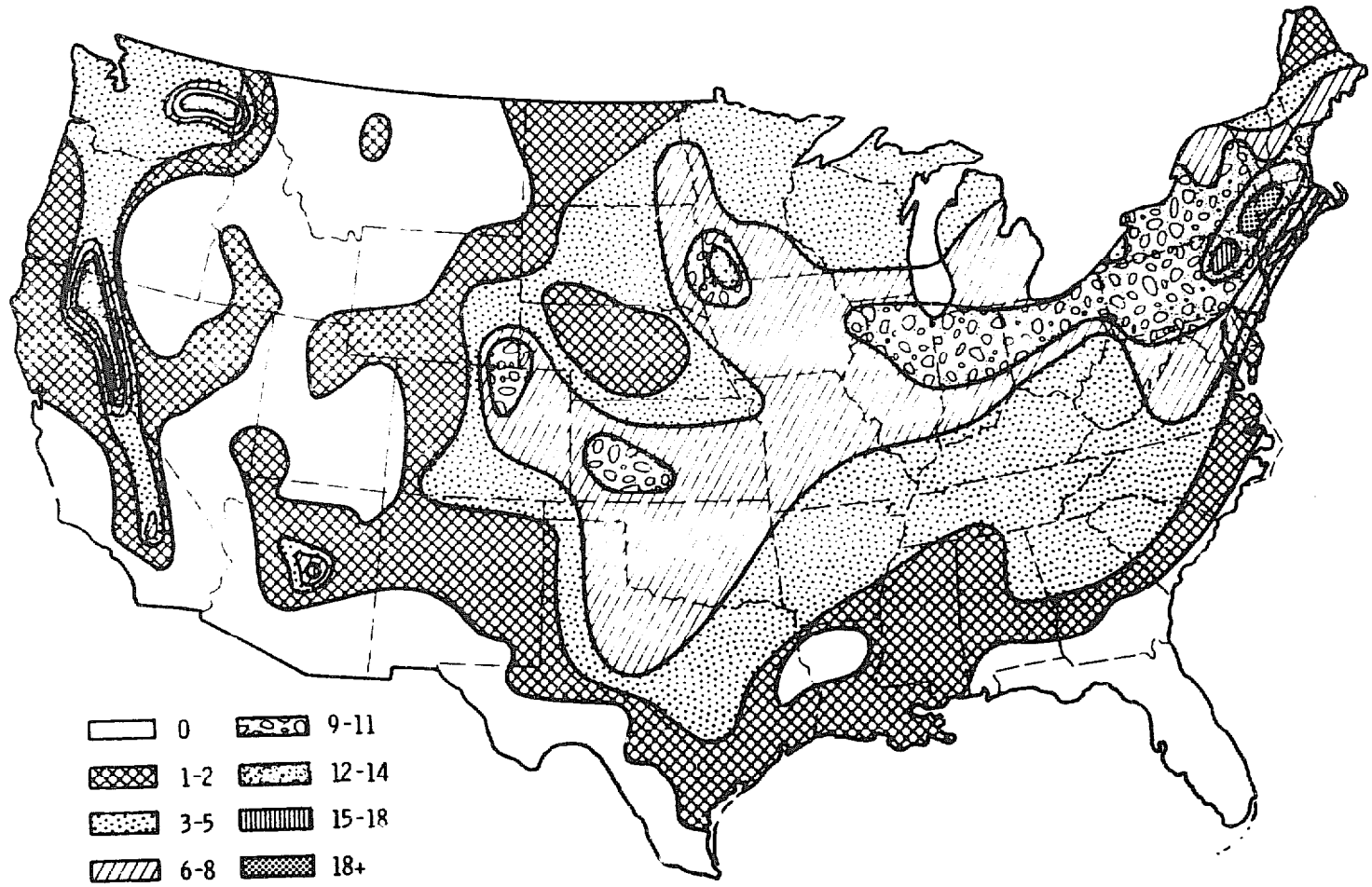

FIGURE 3.6. Number of Times Ice 0.25 in. or More Thick Was Observed During the 9-yr Period of the Association of American Railroads Study(7)

3.6 HEAVY SNOW

Snow causes three principal hazards to a WECS: 1) service and maintenance can be made difficult by excessive snow depths; 2) excessively heavy snowfall may damage parts of the turbine; and 3) blowing snow may infiltrate the machine parts and cause breakage from freezing and thawing.

Figure 3.7, which shows the maximum snow depth for a storm period, is provided as a guide for estimating snowfall. However, in some mountain regions much more snowfall has been recorded than is shown on the map. How long a typical storm lasts and how long snow remains on the ground are also important considerations.

As the figure illustrates, the high wind areas on the eastern sides of Lake Superior and Lake Michigan receive more snow (as much as 60 in. or more per year) than the area beyond these snowbelts. A potential user considering a site on the eastern sides of the Great Lakes should therefore consider the damaging effects of heavy snowfalls and blowing snow.

3.7 FLOODS AND SLIDES

Floods and slides are local problems which users of WECS will be aware of. In general, all structures should be kept out of floodplains. If an ideal wind site is located in a river valley, the user should build a structure to withstand flood conditions. He should also investigate the potential for earth slides and the stability of the soil foundation at any potential wind site.

3.8 EXTREME TEMPERATURES

Extremely high or low temperatures will adversely affect most WECS. Lubricants frequently freeze in very cold temperatures, causing rapid wear on moving parts. Many paints, lubricants, and

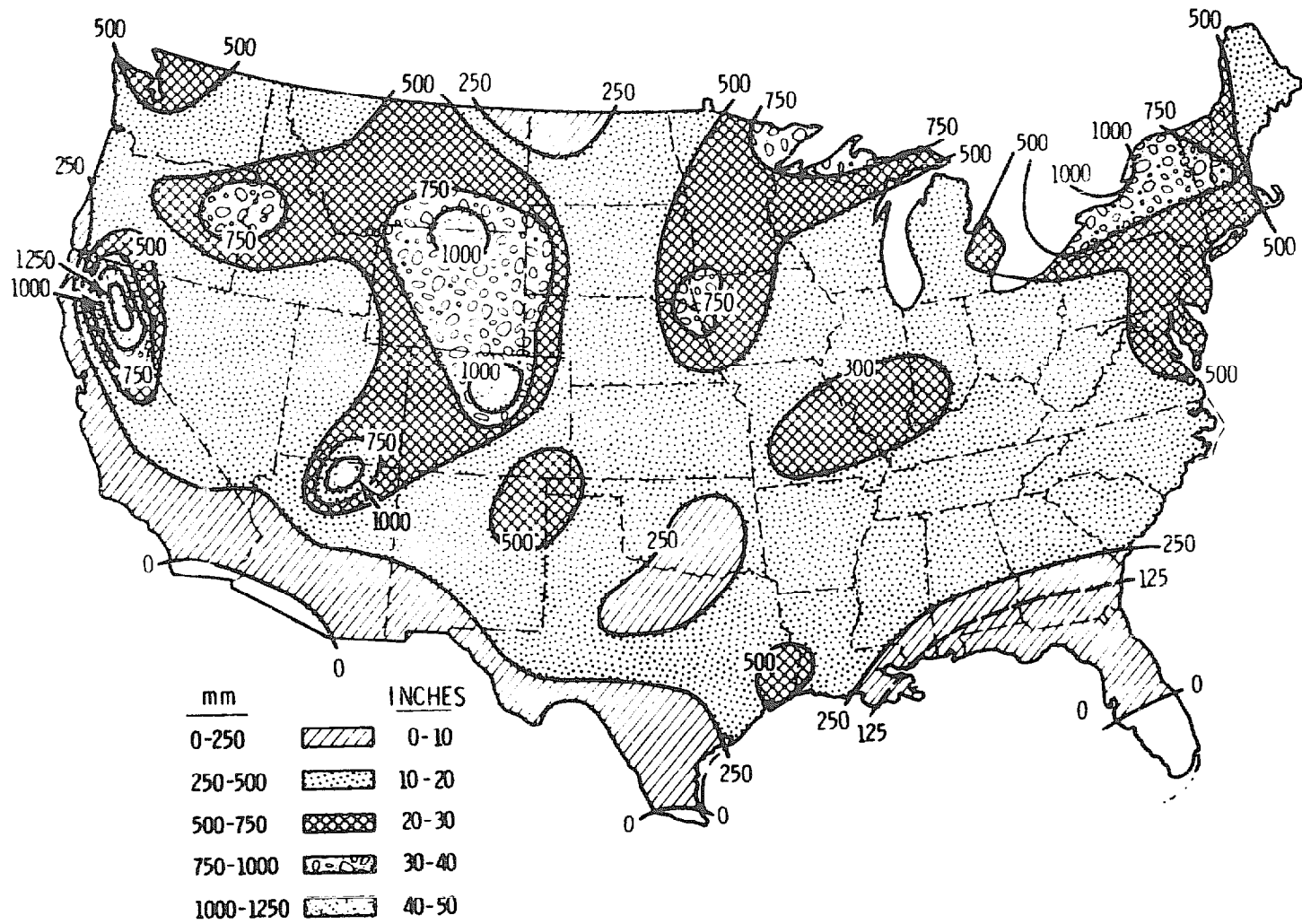

FIGURE 3.7. Extreme Storm Maximum Snow Fall (8)

other protective materials deteriorate in high temperatures. The user should review the local climatology and then consider the possible added expense of protecting the WECS against extreme temperatures.

3.9 SALT SPRAY AND BLOWING DUST

Salt spray and dust may damage a WECS unless the machines are properly constructed and maintained. The corrosive properties of salt spray should be taken into account for any site within 10 miles of the sea.

Blowing dust may damage the system if it penetrates the moving parts, such as the gears and turning shafts. Many diverse regions of the country (urban, agricultural, desert, valley and plain areas) are subject to suspended dust. However, mountainous, forested and coastal regions have few major dust storms. The highest frequency of dust occurs in the southern Great Plains, but blowing dust also occurs often in portions of the western states, northern Great Plains, southern Pacific Coast and the southeast (see Figure 3.8).

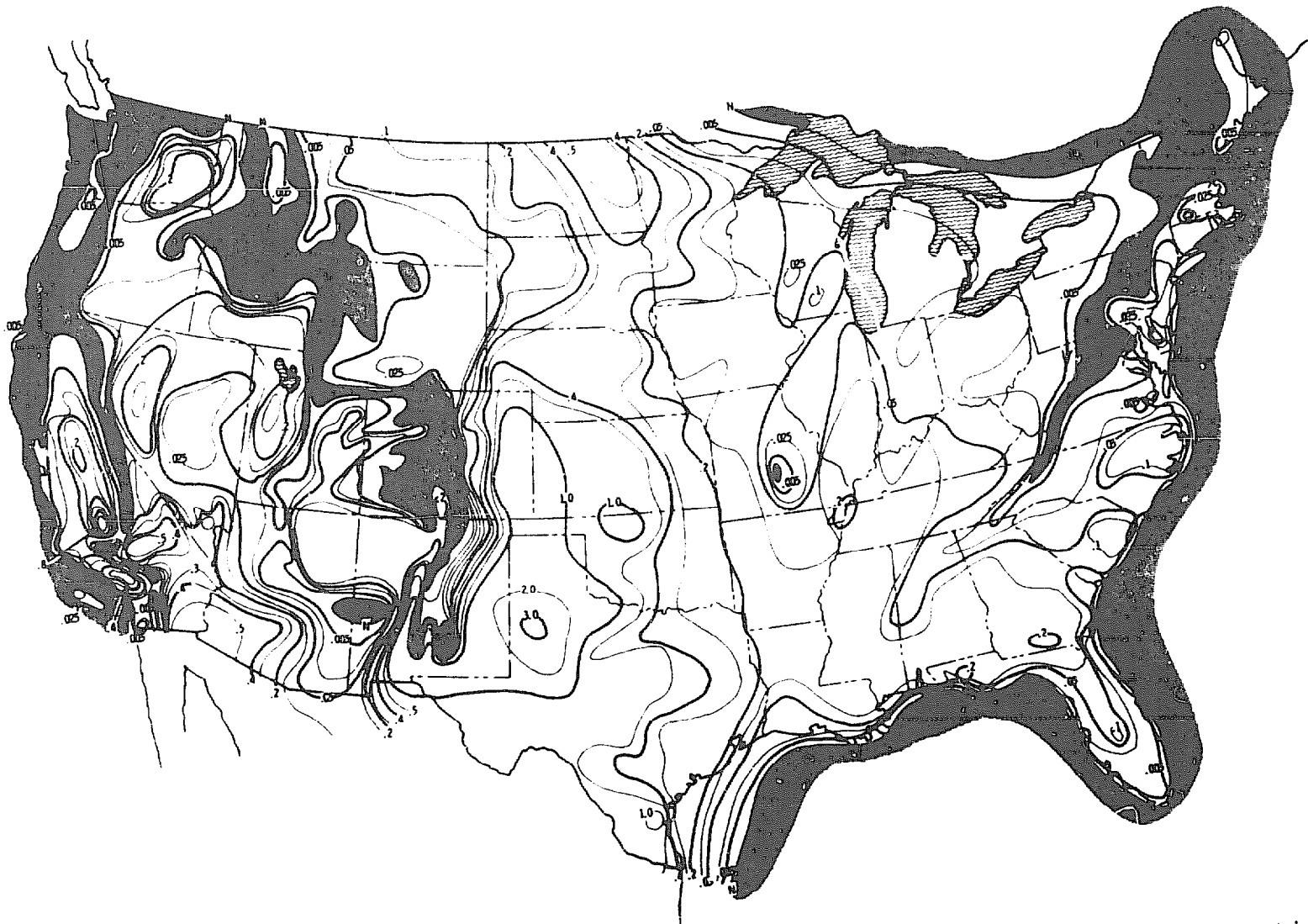

Figure 3.8. Annual Percent Frequency of Dusty Hours. (Based on hourly observations from 343 weather observation stations that recorded dust, blowing dust and sand when prevailing visibility was less than 7 mi (11 km). Shaded areas (N) represent no observations of dust. Period of record is from 1940 to 1970.) (9)

4.0 SITING IN FLAT TERRAIN

Choosing a site in flat terrain is not as complicated as choosing a site in hilly or mountainous areas. Only two primary questions need be considered:

- What surface roughnesses affect the wind profile in the area?
- What barriers might affect the free flow of the wind?

Terrain can be considered flat if it meets the following three conditions (Figure 4.1):⁽¹⁰⁾

- 1) the elevation difference between the site and the surrounding terrain is less than 200 ft for 3 to 4 miles in any direction;
- 2) the ratio of $h : \lambda$ in Figure 4.1 is less than 0.03; and
- 3) the entire rotor disc (see Figure 2.2) is at a height equal to or greater than 3 times the largest difference of terrain for 2 to 3 miles in any direction.

The potential user can determine if his site meets these conditions either by inspecting it or by consulting topographical maps. If the first two criteria are met, the third can sometimes be met by increasing the tower height. However, the user should determine if such an increase would be cost effective before making a final decision.

The conditions given for determining flat terrain are very conservative. If there are no large hills, mountains, cliffs, etc. within a mile or so of the proposed WECS site, Section 4 can be used for siting. However, if nearby terrain features might influence his choice of a site, the user should read the portion(s) of Section 5 dealing with these features to better understand the local airflow.

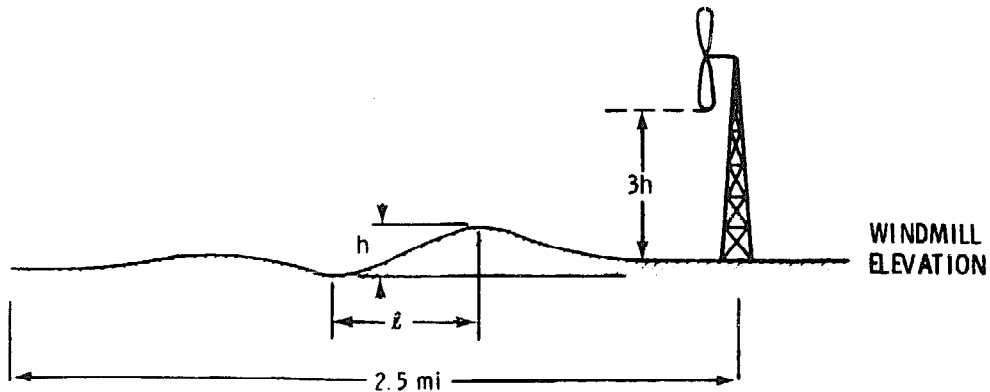

h - LARGEST DIFFERENCE OF TERRAIN

L - LENGTH OVER WHICH LARGEST DIFFERENCE OF TERRAIN OCCURS

FIGURE 4.1. Determination of Flat Terrain⁽¹⁰⁾

Wind rose information (see Appendix A) can also guide the user in determining the influence of nearby terrain. For example, suppose a 400-ft-high hill lies 1/2 mile northeast of the proposed site (this classifies the terrain as non-flat); also assume the wind rose indicates that winds blow from the northeast quadrant only 5% of the time with an average speed of 5 mph. Obviously, so little power is associated with winds blowing from the hill to the site that the hill can be disregarded. If there are no terrain features upwind of the site along the principal wind power direction(s), the terrain can be considered flat.

4.1 UNIFORM ROUGHNESS

Surface roughness describes the texture of the terrain. The rougher the surface, the more the wind flowing over it is impeded. Flat terrain with uniform surface roughness is the simplest type of terrain for a WECS site. A large area of flat, open grassland is a good example of uniform terrain. Providing there are no obstacles (i.e., buildings, trees, or hills), the wind speed at a given height is nearly the same over the entire area.

The only way to increase the available power in uniform terrain is to raise the machine higher above the ground. A measurement or estimate of the average wind speed at one level can be used to estimate wind speed (thus the available power) at other levels. Table 4.1 provides estimates of wind speed changes for several surface roughnesses at various tower heights. The numbers in the table are based on wind speeds measured at 30 ft because National Weather Service wind data is usually measured at that height. To estimate the wind speed at another level, multiply the 30-ft speed by the factor for the appropriate surface roughness and height. For example, if the average wind speed at 30 ft over an area of low grass cover is 10 mph, to determine wind speed at 80 ft, use the multiplication factor from Table 4.1 (which in this case is 1.17). Multiply the 10 mph speed by this factor to estimate the average wind speed at 80 ft: $1.17 \times 10 \text{ mph} = 11.7 \text{ mph}$.

If the height of the known wind speed is not 30 ft, wind speed can be estimated using the following equation:

$$\text{Estimated wind speed} = \frac{E}{K} \times S$$

where

E = the table value for the height of the estimated wind

K = the table value for the height of the known wind

S = the known wind speed.

Suppose the 10 mph in the previous example had been measured at 20 ft instead of 30 ft. To estimate the speed at 80 ft, divide the factor for 80 ft (1.17) by the factor for 20 ft (0.94) to obtain the corrected factor (1.24); then multiply this corrected factor by the known wind speed (10 mph) to estimate the 80-ft wind speed (12.4 mph). This calculation is shown in equation form below (using the equation above):

$$\frac{E}{K} \times S = \frac{1.17}{0.94} \times 10 \text{ mph} = 1.24 \times 10 \text{ mph} = 12.4 \text{ mph}$$

TABLE 4.1. Extrapolation of the Wind Speed from 30 ft to Other Heights over Flat Terrain of Uniform Roughness(a)

Roughness Characteristic	20	40	60	80	100	120	140	160 ^(b)	180 ^(b)	200 ^(b)
Smooth surface ocean, sand	0.94	1.04	1.10	1.15	1.18	1.21	1.24	1.26	1.29	1.30
Low grass or fallow ground	0.94	1.05	1.12	1.17	1.21	1.25	1.28	1.31	1.33	1.35
High grass or low row crops	0.93	1.05	1.13	1.19	1.24	1.28	1.32	1.35	1.38	1.41
Tall row crops or low woods	0.92	1.06	1.16	1.23	1.29	1.34	1.38	1.42	1.46	1.49
High woods with many trees	0.89	1.08	1.21	1.32	1.40	1.47	1.54	1.60	1.65	1.70
Suburbs, small towns	0.82	1.15	1.39	1.60	1.78	1.95	2.09	2.23	2.36	2.49

4.4

(a) The table was developed using power law indices obtained from C. Huang, Pacific Northwest Laboratory, Richland, WA 99352.

(b) These three columns should be used with caution because extrapolation to levels more than 100 ft above or below the base height may not be completely reliable.

Table 4.2 gives available wind power changes between levels. (a) If the height of the known wind is 30 ft, the percentage change of available power between this level and another can be read directly from the table. If the known height is other than 30 ft, this equation can be used to compute the available power change:

$$\text{Fractional Power Change} = \frac{E - K}{100 + K}$$

where

E = the table value for the estimated wind height

K = the table value for the known wind height.

Computing the available power change for the previous example (i.e., extrapolating from 20 ft up to 80 ft over low grass), K is -17, E is 60. The fractional power change is:

$$\frac{E - K}{100 + K} = \frac{60 - (-17)}{100 + (-17)} = \frac{60 + 17}{100 - 17} = \frac{77}{83} = 0.93$$

To express the available power change as a percent, simply multiply by 100 (0.93 x 100 = 93% increase in available power by raising the WECS from 20 ft to 80 ft above a low grass surface).

The heights in Tables 4.1 and 4.2 should not always be thought of as heights above ground. Over areas of dense vegetation (such as an orchard or forest) a new "effective ground level" is established at approximately the height where branches of adjacent trees touch. Below this level there is little wind; consequently, it is called the level of zero wind. In a dense corn field the level of zero wind would be the average corn height; in a wheat field, the average height of the wheat, etc. The height at which this level occurs is called the "zero displacement height," and is labeled "d" in Figure 4.2. If "d" is less than 10 ft, it can usually be

(a) Available wind power should be used only to compare sites, not to estimate output power because no WECS can harness all available power.

TABLE 4.2. Power Change Due to Extrapolation to
a New Height^(a) (Base Height = 30 ft)

<u>Characteristic Roughness</u>	<u>20</u>	<u>40</u>	<u>60</u>	<u>80</u>	<u>100</u>	<u>120</u>	<u>140</u>	<u>160^(b)</u>	<u>180^(b)</u>	<u>200^(b)</u>
Smooth surface	-17	12	33	52	64	77	91	100	115	120
Low grass	-17	16	40	60	77	95	110	125	135	146
High grass	-20	16	44	69	91	110	130	146	163	180
Tall row crops	-22	19	56	86	115	141	163	186	211	231
High woods	-30	26	77	130	174	218	265	310	349	391
Suburbs	-45	52	169	310	464	641	813	1009	1214	1444

- (a) The user is likely to be using National Weather Service (NWS) wind data. Since most NWS wind data is measured at about 30 ft, that level was chosen as the base height for this table. The table was developed using power law indices obtained from C. Huang, Pacific Northwest Laboratory, Richland, WA 99352.
- (b) These three columns should be used with caution because extrapolation to levels more than 100 ft above or below the base height may not be completely reliable.

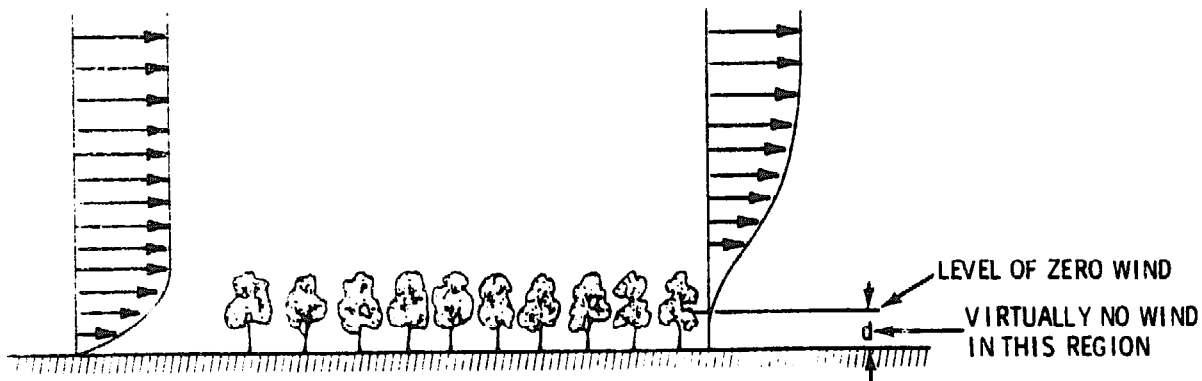

FIGURE 4.2. Formation of a New Wind Profile Above Ground Level

disregarded in estimating speed and power changes. However, if ground level is used when "d" is actually 10 ft or more, changes in speed and power from one level to another will be underestimated. Tables 4.1 and 4.2 express all heights above the "d" height, rather than above ground.

4.2 CHANGES IN ROUGHNESS

Often roughness varies upwind of the WECS. Figure 4.3 shows how a sharp change in roughness affects the wind profile. If a WECS were sited at the first level in Part A of this figure, the user would be greatly underutilizing wind energy, since roughness changes cause a sharp increase in wind speed slightly above the first level. Part B of the figure shows that in smooth terrain little, if anything, would be gained by increasing tower height from the first level to even as high as the third. One principle stands out: The user will gain more in terms of available power by increasing the height of a WECS tower located in rough terrain than he will by increasing the height in smoother terrain.

When siting in areas of varying roughness, determining the winds at one height from those measured at another presents a new problem: Which upwind surface roughness is influencing the wind

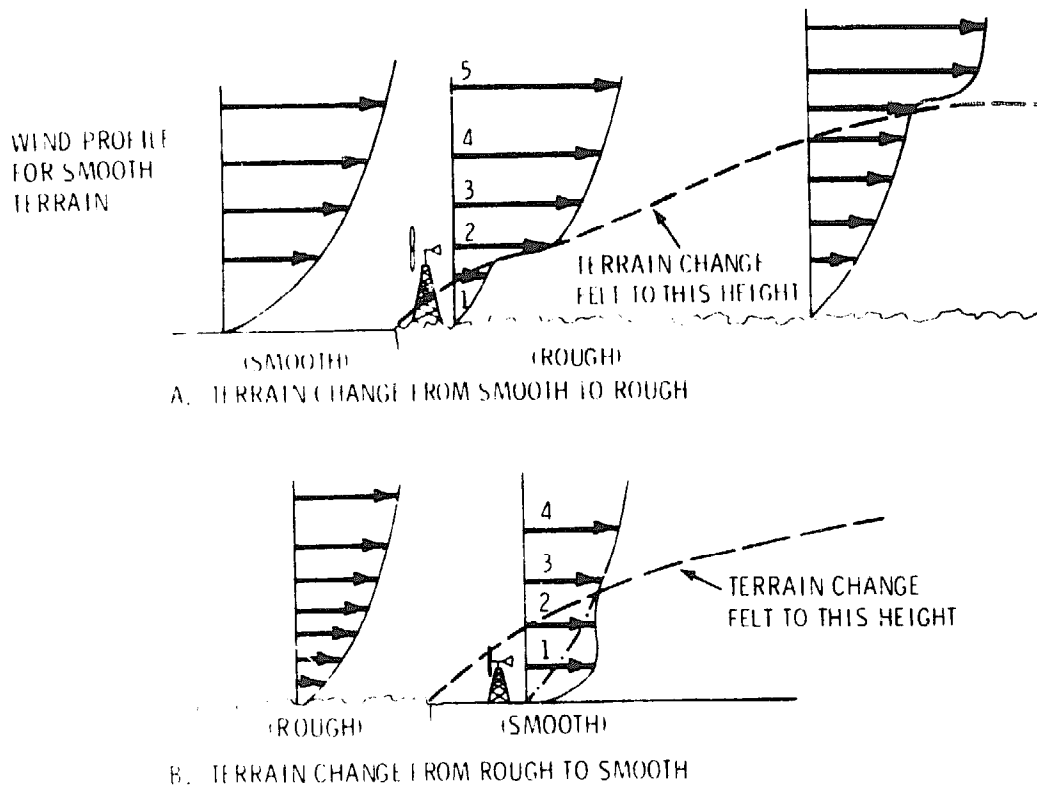

FIGURE 4.3. Wind Speed Profiles Near a Change in Terrain(2)

profile at the height of the WECS? As the figure demonstrates, the answer to this question can tell the user if he can significantly increase available power by increasing the tower height. In addressing this question it is crucial to know which wind directions are associated with the most power. Roughness changes along the most powerful wind directions will have the greatest effect on power availability at the site.

To estimate the level at which a dramatic change in wind speed might be expected, the user must estimate the height to which upwind surface roughnesses affect the wind profile. Figure 4.4 provides this estimate called the transition height.

		TO: (DOWNWIND)					
		a	b	c	d	e	f
FROM (UPWIND)	a	-	①	1	2	3	4
	b	5	-	2	3	3	4
	c	5	2	-	3	4	4
	d	5	2	3	-	4	5
	e	5	3	3	3	-	5
	f	5	4	4	4	5	-

*a - SMOOTH SURFACE
 b - LOW GRASS
 c - HIGH GRASS
 d - TALL ROW CROPS
 e - HIGH WOODS
 f - SUBURBS

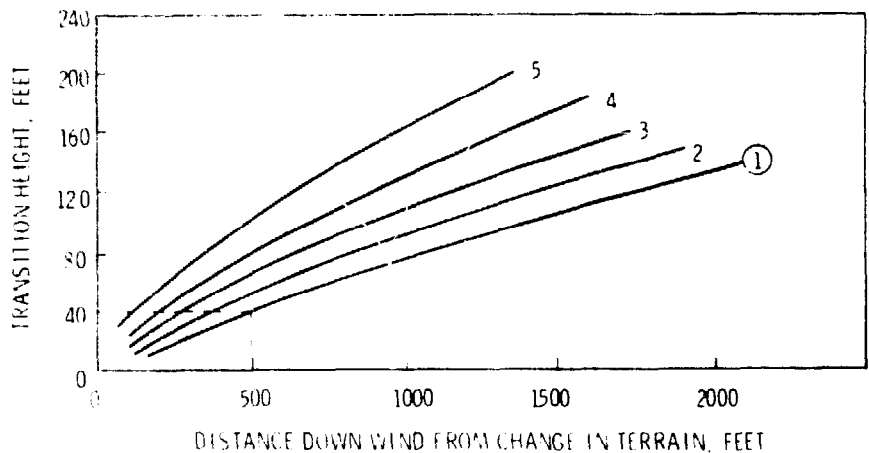

TO READ THIS GRAPH:

1. SELECT UPWIND AND DOWNWIND TERRAINS
2. ENTER TABLE ABOVE WITH APPROPRIATE LETTERS. SELECT NUMBER
3. USE CURVE WITH THAT NUMBER

*IF THESE TERRAIN CLASSIFICATIONS DO NOT APPLY EXACTLY, SELECT THE ONE NEAREST TO THE ROUGHNESS HEIGHT OF THE ACTUAL TERRAIN

FIGURE 4.4. Transition Height in Wind Speed Profile Due to a Change in Roughness (2)

The diagram in Figure 4.5 shows how data from Figure 4.4 can be used to take advantage of transition height. Since the terrain changes from an upwind "a" (water) to a downwind "b" (low grass) roughness, the upper portion of Figure 4.4 shows that curve 1 should be used. Curve 1 in the graph indicates that the transition height at 500 ft downwind of the shoreline is about 40 ft above the ground. Since the smoother surface (water) is upwind,

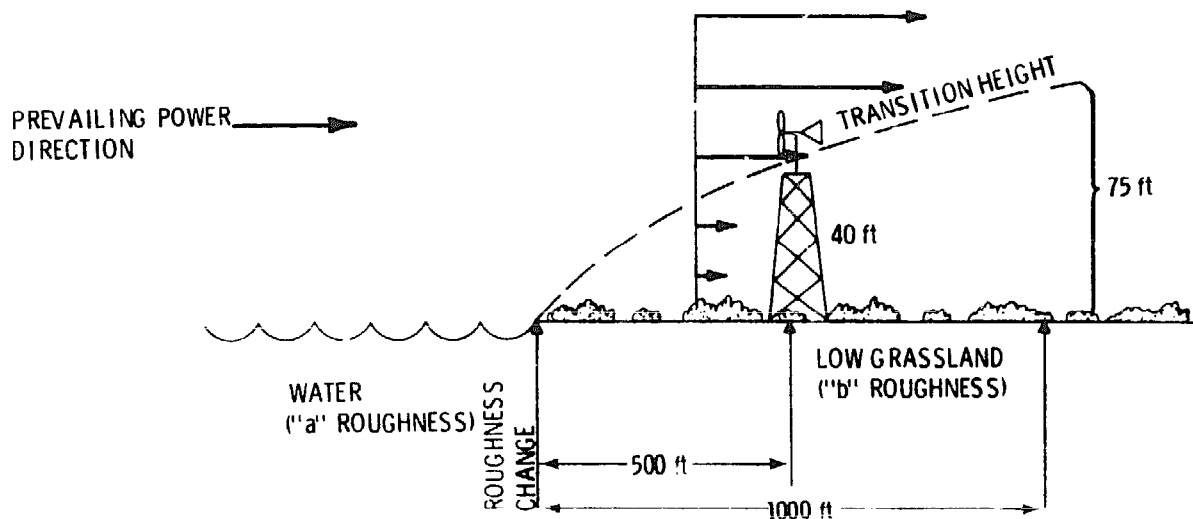

FIGURE 4.5. Example of a Transition Height Diagram Depicting One Change in Roughness

wind speed should increase sharply around the 40-ft level, 500 ft downwind from the roughness change. In this example, the WECS should be located above the transition height because that location has more available power. Had the rougher surface been upwind, there would be less to gain by locating the WECS above the transition height.

The transition height curves in Figure 4.4 are simplified approximations of a very complex phenomenon. Gradual rather than sharp roughness changes may cause the transition to occur in a layer of 10 to 20 ft or more rather than at a distinct level. Consequently, the information in this section should be used only to make estimates of the wind profile, which then can be used to select possible WECS sites and tower heights. The best way to verify the wind profile near a change in terrain roughness is to make a few wind measurements at various heights during prevailing wind conditions. The information in this section will help determine where to take these measurements to gain the most useful information about the wind.

4.3 BARRIERS IN FLAT TERRAIN

barriers produce disturbed areas of airflow downwind, called wakes, in which wind speed is reduced and turbulence increased. Because most wind generators have relatively thin blades which rotate at high speeds, barrier wakes should be avoided whenever possible, not only to maximize power, but to minimize turbulence. Exposure to turbulence may greatly shorten the lifespan of small WECS. (See Section 3.1 for a discussion of turbulence as a hazard.)

In the following sections several figures and tables are presented which describe wind power and turbulence variations in barrier wakes. To make this information useful, all lengths are expressed as the number of heights or widths of a particular barrier. By knowing the dimensions of a barrier, the user can apply the siting guidelines to his particular problem.

4.3.1 Buildings

Since it is likely that buildings will be located near a WECS candidate site, it is important to know how they affect airflow and available power. Figure 4.6 illustrates how buildings affect airflow.

As with roughness changes, building wakes increase in height immediately downstream. As the figure illustrates, the wind flows around the building forming a horseshoe-shaped wake, beginning just upstream of the building and extending some distance downstream.

A general rule of thumb for avoiding most of the adverse effects of building wakes is to site a WECS:

- upwind^(a) a distance of more than two times the height of the building;

(a) Upwind and downwind indicate directions along the principal power direction.

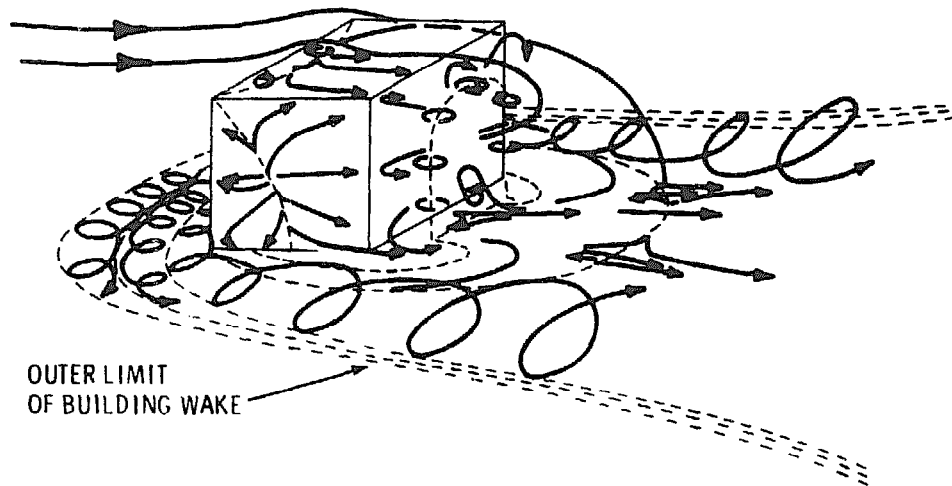

FIGURE 4.6. Airflow Around a Block Building⁽¹¹⁾

- downwind^(a) a minimum distance of ten times the building height; or
- at least twice the building height above ground if the WECS is to be mounted on the building.

Figure 4.7 illustrates this rule with a cross-sectional view of the flow wake of a small building.

The above rule of thumb is not foolproof, because the size of the wake also depends upon the building's shape and orientation to the wind. Figure 4.8 estimates available power and turbulence in the wake of a sloped-roof building. All of these estimates apply at a level equal to one building height above the ground. Downwind from the building, available power losses nearly vanish at a distance equal to 15 building heights.

Table 4.3 summarizes the effects of building shape on wind speed, available power, and turbulence for buildings oriented perpendicular to the wind flow. Building shape is given by the ratio "width divided by height." As might be expected, power reduction

(a) Upwind and downwind indicate directions along the principal power direction.

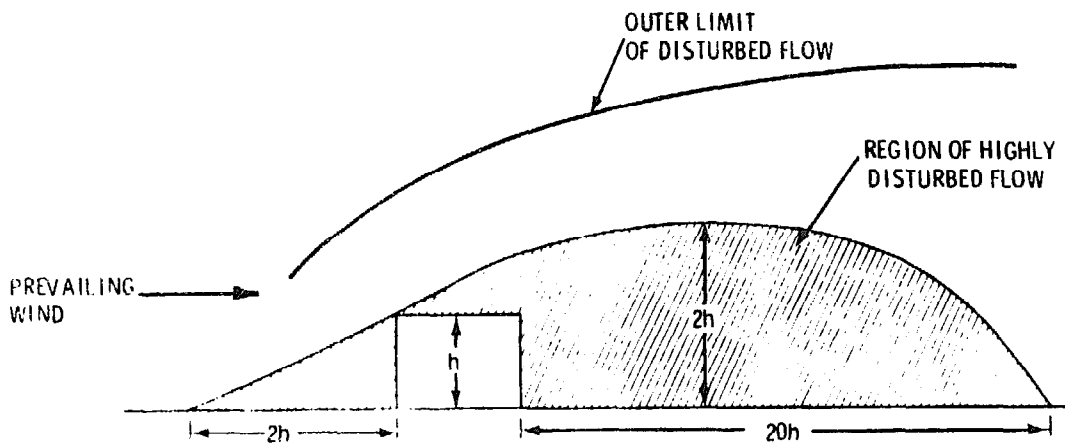
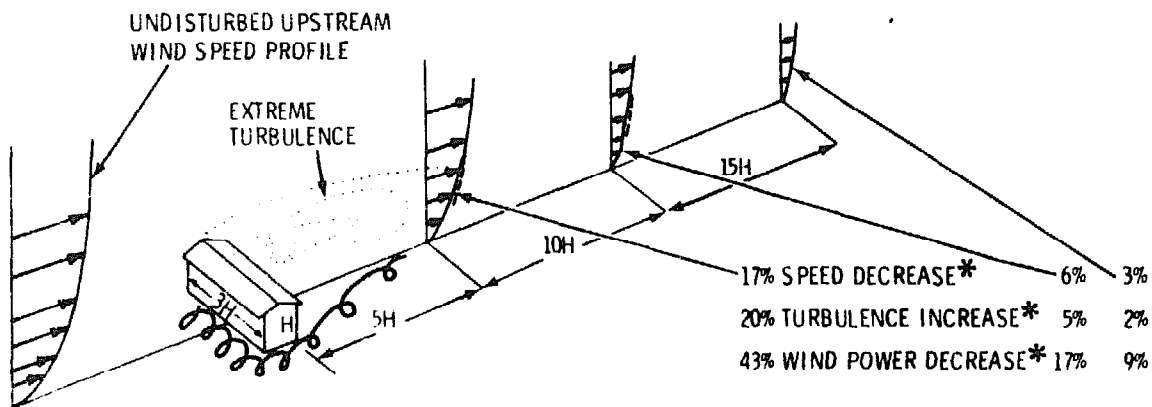

FIGURE 4.7. Zone of Disturbed Flow over a Small Building (10,12)



* APPROXIMATE MAXIMUM VALUES DEPEND UPON BUILDING SHAPE, TERRAIN, OTHER NEARBY OBSTACLES

FIGURE 4.8. The Effects of an Undisturbed Airflow Encountering an Obstruction (13)

is felt farther downstream for wider buildings; at twenty times the height downwind, only very wide buildings (those in which width : height = 3 or more) produce more than a 10% power reduction. The speed, power, and turbulence changes reflected in Table 4.3 occur only when the WECS lies in the building wake. Wind rose information (see Appendix A) will indicate how often

TABLE 4.3. Wake Behavior of Various Shaped Buildings (13)

Building Shape Width . Height	Downwind Distances (In Terms of Building Heights)									
	5H			10H			20H			
	Percent Speed Decrease	Percent Power Decrease	Percent Turbulence Increase	Percent Speed Decrease	Percent Power Decrease	Percent Turbulence Increase	Percent Speed Decrease	Percent Power Decrease	Percent Turbulence Increase	
4	36	74	25	14	36	7	5	14	1	
3	24	56	15	11	29	5	4	12	0.5	
1	11	29	4	5	14	1	2	6	--	
0.33	2.5	7.3	2.5	1.3	4	0.75	--	--	--	
0.25	2	6	2.5	1	3	0.50	--	--	--	
Height of the wake flow region (in building heights)		1.5			2.0			3.0		

4.14

this actually occurs. Annual percentage time of occurrence multiplied by the percentage power decrease in the table will give the net power loss. An example of such a calculation is given in Section 4.3.3.

If a tower is located on the roof of a building, the turbulence near the roof should be considered. A slanted roof produces less turbulence than a flat roof and may actually increase the wind speed over the building. The zone of speed increase may extend up to twice the building height if the building is wider than it is tall and is oriented perpendicular to the prevailing wind. However, since wide buildings are generally not very high, the roof is only exposed to the lower wind speeds near the ground. Rather than attempting to use the power in the wind accelerated over such a building, it is generally wiser to raise the WECS as high as is economically practical, taking advantage of the fact that winds usually increase and turbulence decreases with height.

4.3.2 Shelterbelts

Shelterbelts are windbreaks usually consisting of a row of trees. When selecting a site near a shelterbelt, the user should either

- choose a site far enough upwind/downwind to avoid the disturbed flow;
- use a tower of sufficient height to avoid the disturbed flow;
- or
- if the disturbed flow at the shelterbelt cannot be entirely avoided, minimize power loss and turbulence by examining the nature of the windflow near the shelterbelt and choose a site accordingly.

The degree to which the wind flow is disturbed depends on the height, length, and porosity of the shelterbelt. Porosity is the ratio of the open area in a windbreak to the total area (expressed here as the percentage of open area).

Figure 4.9 locates the region of greatest turbulence and wind speed reduction near a thick windbreak. How far upwind and downwind this area of disturbed flow extends varies with the height of the windbreak. Generally, the taller the windbreak is, the farther the region upwind and downwind that will experience a disturbed airflow.

Figure 4.10 illustrates the effect of a row of trees on the wind speed at various heights and distances from the windbreak. The wind speeds are expressed as percentages of undisturbed upwind flow at several selected heights. All heights and distances are expressed in terms of the height of the shelterbelt to make application to a particular siting problem easier.

When examining this figure, the reader should note that loose foliage actually reduces winds behind the windbreak more than dense foliage. Furthermore, medium-density foliage reduces wind speeds farther downwind than either loose or dense foliage.

For levels $1-1/2 H$ or less, the wind speed begins to decrease at 5 or 6 H upstream of the shelterbelt. Therefore, if the shelterbelt is 30 ft high and the WECS tower is only 45 ft high, the site should be at least 150 ft (5 H) upstream of the windbreak to entirely avoid the speed decrease and turbulence on the windward side.

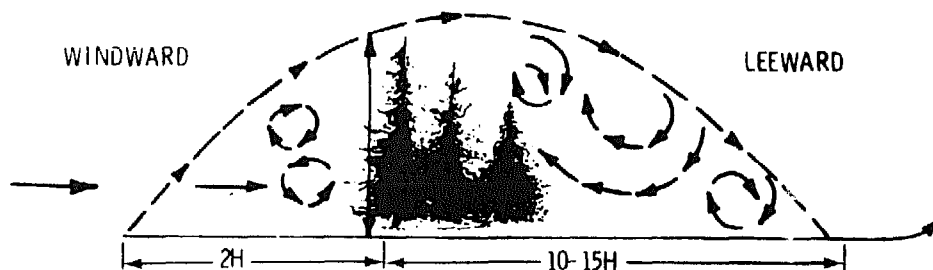
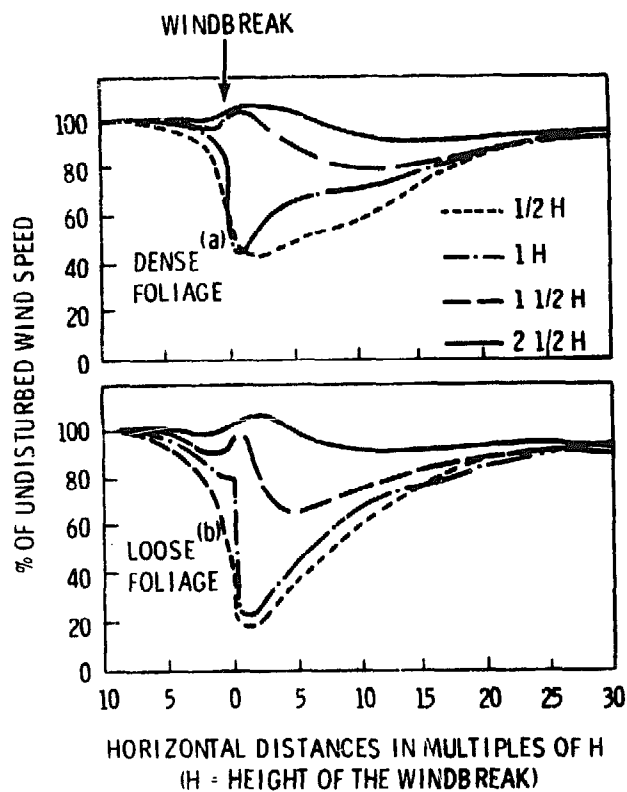

FIGURE 4.9. Airflow Near a Shelterbelt⁽¹²⁾



(a) COLORADO SPRUCE-TYPE TREE
(b) PINE TYPE TREE

FIGURE 4.10. Percent Wind Speed at Different Levels Above the Surface Behind a Row of Trees of Height, H (12)

At a distance of $2\frac{1}{2} H$ downwind, the wind speed at the $2\frac{1}{2} H$ level (for both dense and loose foliage) increases approximately 5%. At first glance this appears to be a good WECS site. However, there is a turbulent zone downwind from the shelterbelt that may make this site undesirable, particularly if the tower is too short. Figure 4.11 shows this zone of turbulence.

To capitalize on the acceleration of the wind over a shelterbelt, the entire rotor disc must be located above the turbulent zone. To determine where this turbulent zone is located, the user should study turbulence patterns during prevailing wind conditions.

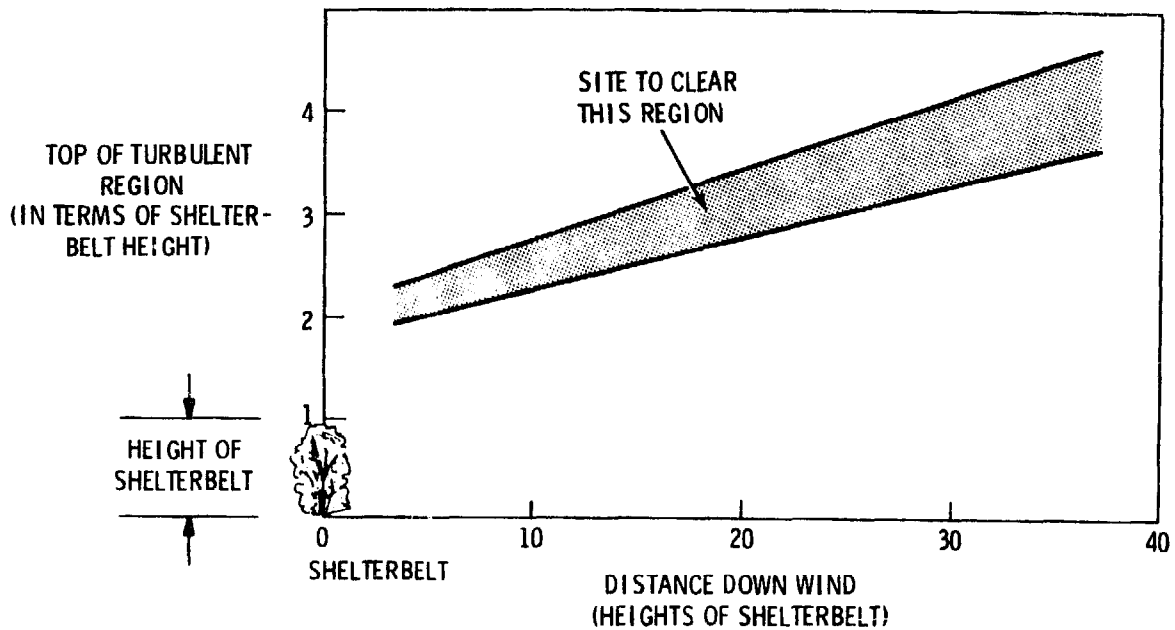

FIGURE 4.11. The Zone of Turbulence Behind a Shelterbelt

(Section 3.1 presents simple methods of turbulence detection.) He should also study other frequently occurring wind directions. If significant turbulence or power loss is possible when the wind blows from the most powerful directions, another site should be selected.

Table 4.4 provides information on the wind speed/available power reductions and turbulence increases for sites in the lee of the shelterbelt. Speed, power, and turbulence changes are expressed as upwind percentages. The porosity of the windbreak can be estimated visually, then Table 4.4 can be used to determine how far downwind the site should be located to minimize power loss and turbulence. Speed, power, and turbulence changes expressed in the table occur only when the WECS lies in the shelterbelt wake. Wind rose information (see Appendix A) will indicate how often this actually occurs. Annual percentage time of occurrence multiplied by the table percentage will give the net change. An example of this type of calculation is given in the following section.

TABLE 4.4. Available Power Loss and Turbulence Increase Downwind from Shelterbelts of Various Porosities (13)

Porosity (a) (Open Area : Total Area)	Downwind Distances (In Terms of Shelterbelt Heights)								
	5H			10H			20H		
	Percent Speed Decrease	Percent Power Decrease	Percent Turbulence Increase	Percent Speed Decrease	Percent Power Decrease	Percent Turbulence Increase	Percent Speed Decrease	Percent Power Decrease	Percent Turbulence Increase
0% (no space between trees)	40	78	18	15	39	18	3	9	15
20% (with loose foliage such as pine or broadleaf trees)	80	99	9	40	78	--	12	32	--
40% (with dense foliage such as Colorado Spruce)	70	97	34	55	90	--	20	49	--
Top of Turbulent Zone (in terms of shelterbelt height)	2.5			3.0			3.5		

(a) Determine the porosity category of the shelterbelt by estimating the percentage of open area and by associating the foliage with the example tree type.

4.3.3 Individual Trees

The trees near a prospective WECS site may not be organized into a shelterbelt. In such cases the effect of an individual tree or of several trees scattered over the surrounding area may be a problem.

The wake of disturbed airflow behind individual trees grows larger (but weaker) with distance, much like a building wake. However, the highly disturbed portion of a tree wake extends farther downstream than does that of a solid object. Table 4.5 may be used to estimate available power loss downstream. For example, consider a 30-ft wide tree having fairly dense foliage. At 30 tree widths (or 900 ft) downstream, the table indicates a 9% loss of available power whenever the WECS is in the tree wake. The numbers in the bottom two rows of the table provide estimates of the width and height of the tree wake. The velocity and power losses expressed in the table occur only when the WECS lies in the tree wake.

TABLE 4.5. Speed and Power Loss in Tree Wakes⁽¹³⁾

Distance Downwind (In Tree Widths)		5	10	15	20	30
Dense-foliage tree (such as a Colorado spruce)	Maximum percent loss of velocity	20	9	6	4	3
	Maximum percent loss of power	49	25	17	13	9
Thin-foliage tree (such as a pine)	Maximum percent loss of velocity	16	7	4	3	2
	Maximum percent loss of power	41	18	12	8	6
Height of the turbulent flow region (in tree heights)		1.5	2.0	2.5	3.0	3.5
Width of turbulent flow region (in tree widths)		1.5	2.0	2.5	3.0	3.5

If available, wind rose information (Appendix A) can be used to estimate the percentage of time a site will be in the tree wake, and thereby the total power loss due to the tree. For instance, suppose that 50% of the time the wind direction places the site in the tree wake. In the example above, the tree produced a 9% loss of available power. If the loss occurred 50% of the time, 4.5% (50% x 9%) of the available power would be lost annually.

4.3.4 Scattered Barriers

The advantages of increasing tower height are evident from this example, especially if scattered trees or buildings are in the vicinity. Since choosing a site not located in any barrier wake will probably be impossible in these areas, the WECS should be raised above the most highly disturbed airflow. To avoid most of the undesirable effects of trees and other barriers, the rotor disc should be situated on the tower at a minimum height of three times that of the tallest barrier in the vicinity. If this rule is impractical (for economic or other reasons), the user can

- 1) find the minimum height required to clear the region of highest turbulence by using the turbulence detection techniques outlined in Section 3.1, or
- 2) choose the site so that the WECS will clear the highest obstruction within a 500-ft radius by at least 25 ft.⁽¹⁾

5.0 SITING IN NON-FLAT TERRAIN

Any terrain that does not meet the criteria listed in Figure 4.1 is considered to be non-flat or complex. To select candidate sites in such terrain, the potential user should identify the terrain features (i.e., hills, ridges, cliffs, valleys) located in or near the siting area and then read the applicable portions of Section 5.

In complex terrain, landforms affect the airflow to some height above the ground in many of the same ways as surface roughness does. However, topographical features affect airflow on a much larger scale, overshadowing the effects of roughness. When weighing various siting factors by their effects on wind power, topographical features should be considered first, barriers second, and roughness third. For example, if a particular section of a ridge is selected as a good candidate site, the location of barriers and surface roughness should only be considered to pinpoint the best site on that section of the ridge.

5.1 RIDGES

Ridges are defined as elongated hills rising from about 500 to 2000 ft above surrounding terrain and having little or no flat area on the summit (see Figure 5.1). There are three advantages to locating a WECS on a ridge: 1) the ridge acts as a huge tower; 2) the undesirable effects of cooling near the ground are avoided; and 3) the ridge may accelerate the airflow over it, thereby increasing the available power.

The first two advantages are not unique to ridges, but apply to all topographical features having high relief (hills, mountains, etc.). As Section 2.2 points out, winds generally increase with height. A ridge, then, like a tower, raises a WECS into a region of higher winds. In addition, daily temperature changes affect

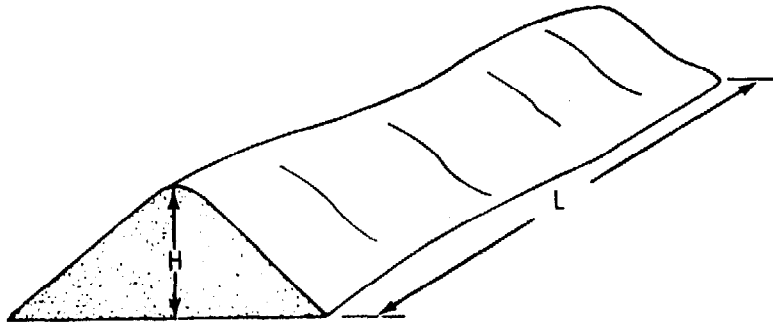

1. $H = 500$ TO 2000 ft
2. $L =$ AT LEAST $10 \times H^{(10)}$
3. ROUNDED OR PEAKED TOP (NOT FLAT)

FIGURE 5.1. Definition of a Ridge

the wind profile. At night as the earth's surface cools, the air near the surface cools. This cool, heavy air drains from the hillsides into the valleys and may accumulate into a layer several hundred feet deep by early morning. This cool dome of air disengages from the general wind flow above it to produce the cool, calm mornings that lowlands often experience. Because of this phenomenon, a WECS located on a hill or ridge may produce power all night, but one located at a lower elevation may not.

A similar, but more persistent, situation may occur in the winter when cold air moves into an area. Much like flowing water, cold air tends to fill all the low spots. This may cause extended periods of calm in the lowlands while the surrounding hills experience winds capable of driving a WECS.

By siting at higher elevations, such as on a ridge, the user can take advantage of more persistent winds. And, since a WECS located on a ridge produces more energy, it can reduce the amount of energy storage capacity needed (such as batteries) and provide a more dependable and economical source of power.

The third advantage is that the acceleration of the wind flowing over the ridge can greatly increase available power. Figure 5.2 shows how air approaching the ridge is squeezed into a thinner layer which causes it to speed up as it crosses the summit.

The orientation of a ridge relative to the prevailing wind direction is an important factor in determining the amount of wind acceleration over the ridge. Figure 5.3 depicts various ridge orientations and ranks their suitability as WECS sites. However, when comparing ridges, it is important to remember that a ridge several hundred feet or more higher than another should have significantly stronger winds simply because the wind increases with height. This is true even if the higher ridge is slightly less perpendicular to the prevailing wind than the lower ridge.

Part A of Figure 5.3 shows the ideal orientation of a ridge to the prevailing wind. The maximum acceleration at the ridge summit occurs when the prevailing wind blows perpendicular to the ridge line. The acceleration lessens if the ridge line is not perpendicular, as in Part B of the figure. When the ridgeline is parallel to the prevailing wind, as in Part C, there is little acceleration over the ridge top; however, the ridge may still be a fair to good wind site because it acts like an isolated hill or peak (see Section 5.2 for siting on hills or peaks).

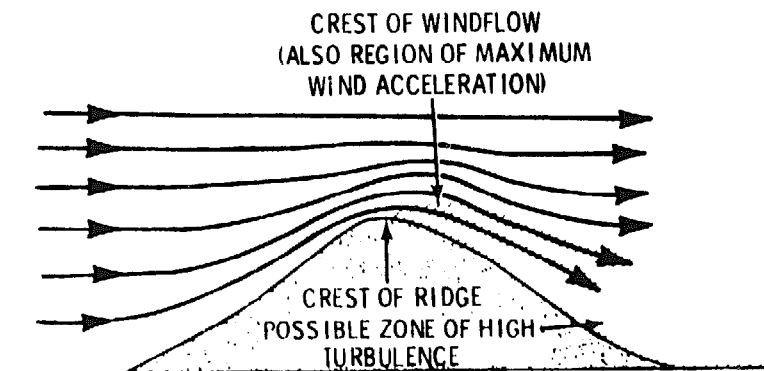

FIGURE 5.2. Acceleration of Wind over a Ridge (14)

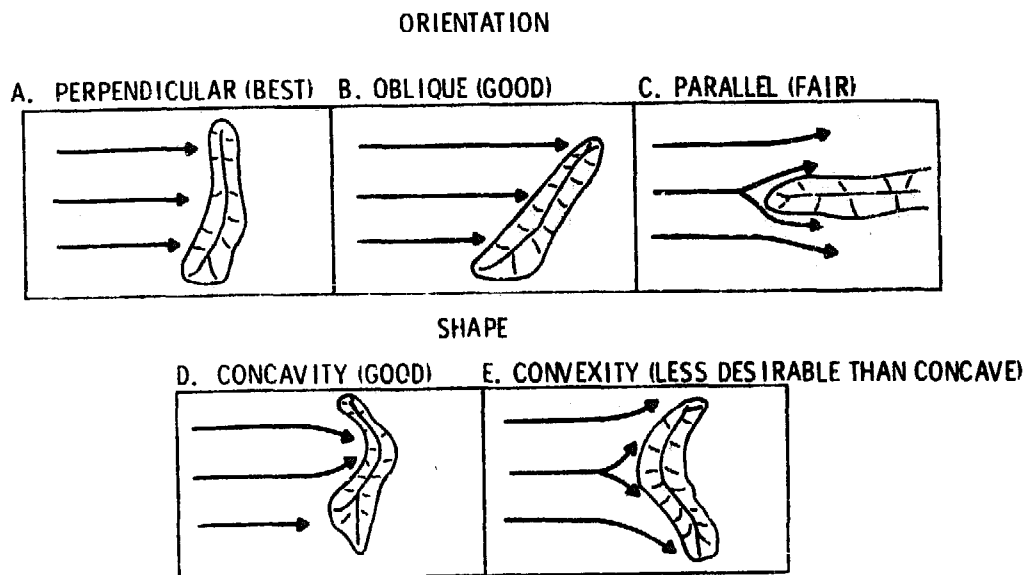

FIGURE 5.3. The Effects of Ridge Orientation and Shape Upon WECS Site Suitability

The orientation of concave or convex ridges (or such portions of a ridge) can further modify the wind flow. Part D of Figure 5.3 shows how concavity on the windward side may enhance acceleration over the ridge by funneling the wind. On the other hand, convexity on the windward side (Part E) reduces acceleration by deflecting the wind flow around the ridge.

Figure 5.4 shows the cross-sectional shapes of several ridges and ranks them by the amount of acceleration they produce. Notice that a triangular-shaped ridge causes the greatest acceleration, and that the rounded ridge is a close second. The data used in ranking these shapes were collected in laboratory experiments using wind tunnels to simulate real ridges. Though few wind experiments have been conducted over actual ridges, the results are similar to tunnel simulations. Both indicate that certain slopes, primarily in the nearest few hundred yards to the summit,^(a) increase the

(a) This portion of the ridge has the greatest influence on the wind profile immediately above the summit.

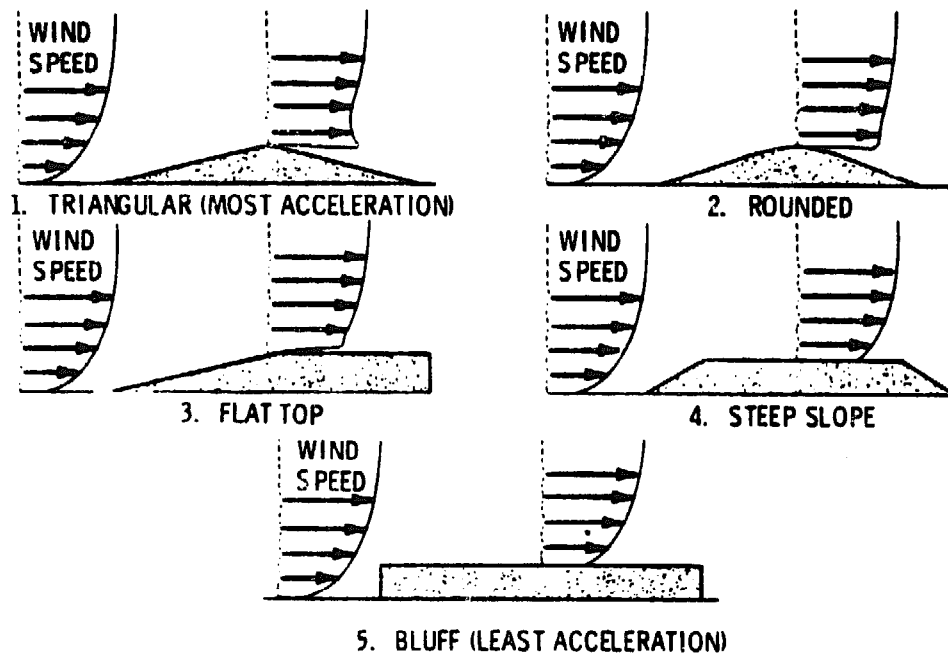

FIGURE 5.4. Ranking of Ridge Shape by Amount of Wind Acceleration(11)

wind more effectively than others. Table 5.1 classifies smooth, regular ridge slopes according to their value as wind power sites.

Figure 5.5 gives percentage variations in wind speed for an ideally-shaped ridge. Since these numbers are taken from wind tunnel experiments, they should not be taken too literally; nevertheless, the user should expect similar windspeed patterns along the path of flow. Generally, wind speed decreases significantly at the foot of the ridge, then accelerates to a maximum at the ridge crest. It only exceeds the upwind speed on the upper half of the ridge.

Another consideration in choosing a site on a ridge is the turbulent zone which often forms in the lee of ridges (Figure 5.2). The steeper the ridge slope and the stronger the wind flow, the more likely turbulence will form in the lee of the ridge. Thus, it is safest to site at the summit of the ridge, both to maximize power and to avoid lee turbulence.

TABLE 5.1. WECS Site Suitability Based Upon Slope of the Ridge(15)

<u>WECS Site Suitability</u>	<u>Slope of the Hill Near the Summit</u>	
	<u>Percent Grade(a)</u>	<u>Slope Angle</u>
Ideal	29	16°
Very good	17	10°
Good	10	6°
Fair	5	3°
Avoid	less than 5 greater than 50	less than 3° greater than 27°

(a) Percent grade as used above is the number of feet of rise per 100 ft horizontal distance.

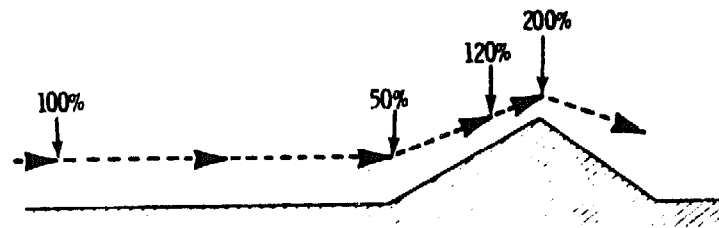

FIGURE 5.5. Percentage Variation in Wind Speed over an Idealized Ridge (2)

Shoulders (ends) of ridges are often good WECS sites. Even for a very long ridge, as much as one-third of the air approaching at low levels may flow around, rather than over, the ridge. (2) To move such a volume of air around the ridge, the wind must accelerate as it flows around the ends. No quantitative estimates of this acceleration are available at this time, but it appears that from the standpoint of available wind power the ends of ridges may rank second behind the ridge crest as the best potential WECS sites.

Flat-topped ridges present special problems because they can actually create hazardous wind shear at low levels, as Figure 5.6 illustrates. Consequently, the slope classifications used in Table 5.1 do not apply to these ridges. The hatched area at the top of the flat ridge indicates a region of reduced wind speed due to the "separation" of the flow from the surface. Immediately above the separation zone is a zone of high wind shear. This shear zone is located just at the top of the shaded area in the figure. Siting a WECS in this region will cause unequal loads on the blade as it rotates through areas of different wind speeds and could decrease performance and the life of the blade. The wind shear problem can be avoided by increasing tower height to allow the blade to clear the shear zone or by moving the WECS toward the windward slope.

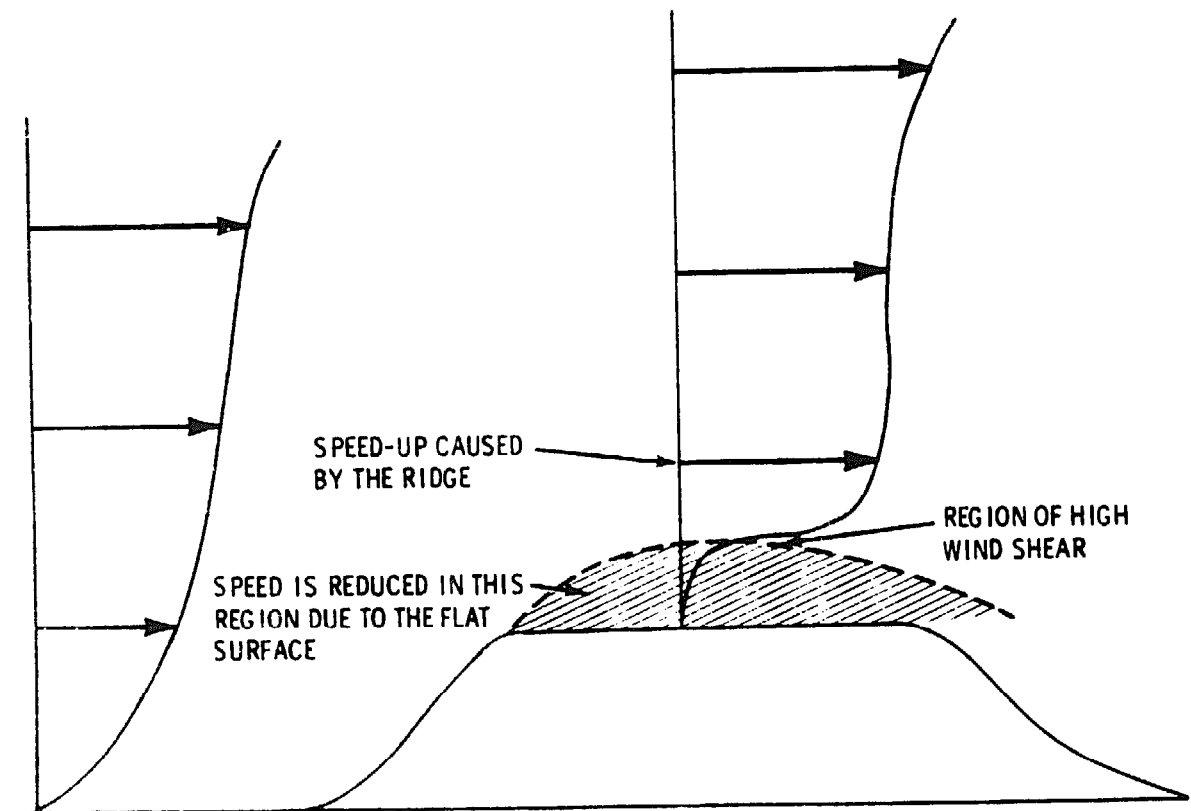

FIGURE 5.6. Hazardous Wind Shear over a Flat-Topped Ridge

As in the case of flat terrain, the effects of barriers and roughness should not be overlooked. Figure 5.7 shows how a rough surface upwind of a ridge can greatly decrease the wind speed. After selecting the best section of a ridge based upon its geometry, the potential user should consider the barriers, then the upwind surface roughness.

The most important considerations in siting WECS on or near ridges are summarized below:

- 1) The best ridges or sections of a single ridge are those most nearly perpendicular to the prevailing wind. (However, a ridge several hundred feet higher than another and only slightly less perpendicular to the wind is preferable.)
- 2) Ridges or sections of a single ridge having the most ideal slopes within several hundred yards of the crest should be selected (use Table 5.1). Ridge sites meriting special consideration are those with features such as gaps, passes, or saddles (Sections 5.3 and 5.4).

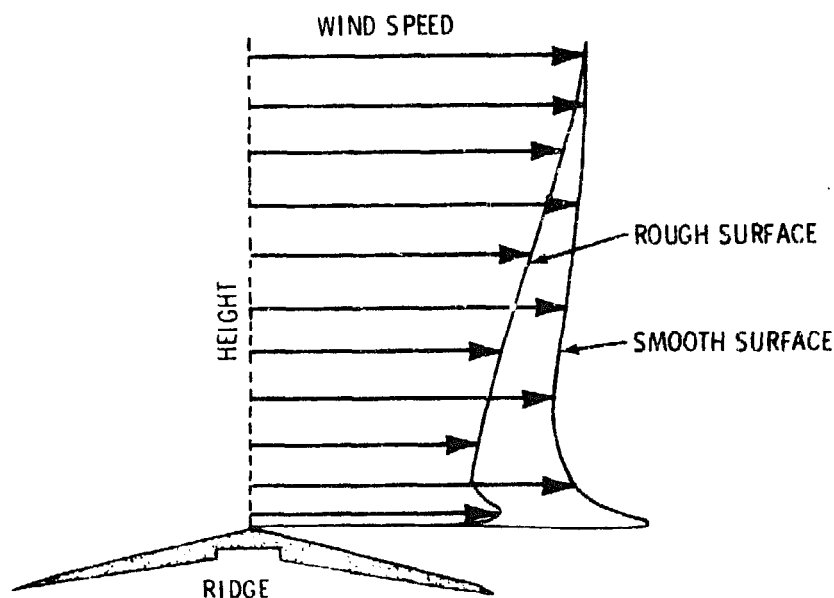

FIGURE 5.7. Effect of Surface Roughness on Wind Flow over a Low Sharp-Crested Ridge (11)

- 3) Sites where turbulence or excessive wind shear cannot be avoided should not be considered.
- 4) Roughness and barriers must be considered.
- 5) If siting on the ridge crest is not possible, the site should be either on the ends or as high as possible on the windward slope of the ridge. The foot of the ridge should be avoided.
- 6) Vegetation may indicate the ridge section having the strongest winds (Section 5.9).

5.2 ISOLATED HILLS AND MOUNTAINS

An isolated hill is 500 to 2000 ft high, is detached from any ridges, and has a length of less than 10 times its height. Hills greater than 2000 ft high will be referred to as mountains.

Hills, like ridges, may accelerate the wind flowing over them but not as much as ridges, since air tends to flow around the hill (Figure 5.8). Not enough information is currently available to make quantitative estimates of wind accelerations either over or around isolated hills. However, Table 5.1 can be used to rank hills according to their slope.

Two benefits are gained by siting on hills: 1) airflow can be accelerated, and 2) the hill acts as a huge tower, raising the WECS into a stronger airflow aloft and above part of the nocturnal cooling and resulting calm periods.

The best WECS sites on an isolated hill may be along the sides of the hill tangent to the prevailing wind (shown as hatched areas in Figure 5.8).⁽¹¹⁾ However, further research is required to verify this supposition. Currently, simultaneous wind recordings are the surest method of comparing hillside and hilltop sites.

Table 5.2 ranks the suitability of WECS sites on hills. However, the effects of surface roughness and barriers should also be weighed before a WECS site is selected.

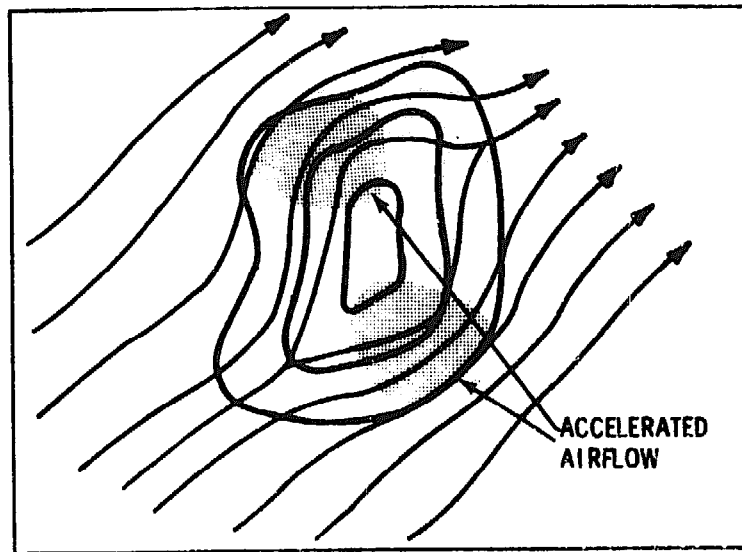

FIGURE 5.8. Airflow Around an Isolated Hill (Top View)

TABLE 5.2. WECS Site Suitability on Isolated Hills

<u>Suitability</u>	<u>Location</u>	<u>Flow Characteristics</u>
Best	Upper half of hills where prevailing wind is tangent	The point of maximum acceleration around the hill
Good	Top of hills	The point of maximum acceleration over the hill
Fair	Upper half of the windward face of the hill	A slight acceleration of flow up the hill
Avoid	Entire leeward half of hills(a)	Reduced windspeeds and high turbulence
	The foot and lower portions of hills	Reduced windspeeds

(a) Under certain conditions the strongest winds may occur on the leeward slopes of larger hills and mountains (such as on the east slopes of the Rocky Mountains). However, these winds are usually gusty, localized, and generally represent more of a hazard than a wind resource.

When choosing a site on isolated mountains, the potential user should consider all the factors discussed for hills. However, because of the greater size, greater relief, and more complex terrain configurations of mountains, other factors must be considered. Inaccessibility may create logistical problems, and thunderstorms, hail, snow, and icing hazards will occur more frequently than at lower elevations.

In spite of the drawbacks, an isolated mountain may still be the most promising WECS site in an area. To select the best site(s) in the favorable areas of the mountain, use the criteria for hills in Table 5.2. For mountains, these favorable areas may be very large, containing many different terrain features, barriers, and surface roughnesses. To pinpoint the best site(s), consider the largest terrain features first; then evaluate the barriers and surface roughness.

5.3 PASSES AND SADDLES

Passes and saddles are low spots or notches in mountain barriers. Such sites offer three advantages to WECS operations. First, since they are often the lowest spots in a mountain chain, they are more accessible than other mountain locations. Second, because they are flanked by much higher terrain, the air is funneled as it is forced through the passes. Third, depending upon the steepness of the slope near the summit, wind may accelerate over the crest as it does over a ridge.

Factors affecting airflow through passes are orientation to the prevailing wind, width and length of the pass, elevation differences between the pass and adjacent mountains, the slope of the pass near the crest, and the surface roughness. At this time, there has not been sufficient research to allow classification of WECS site suitability in terms of these factors. However, some desirable characteristics of passes are listed below:

- 1) the pass should be open to the prevailing wind (preferably parallel to the prevailing wind);
- 2) the pass should have high hills or mountains on both sides (the higher the better);
- 3) the slope (grade) of the pass near the summit should be sufficient to further accelerate the wind like a ridge (see Table 5.1 for slope suitability); and
- 4) the surface should be smooth (the smoother the better). (If the pass is very narrow, the user should consider the roughness of the sides of the pass.)

Figure 5.9 shows two views of the wind profiles in a pass. Part A is a view through the pass. A core of maximum wind (denoted by the innermost circle) is located in the center of the pass, well above the surface. Part B is looking across the pass. In this view, a strong increase in wind from the ground up to the wind maximum is clearly shown. The WECS should be sited near the center of the pass at a level as near the core of maximum winds as possible. Below this level there may be very strong vertical wind shear and much turbulence. Since the location of the core will vary from pass to pass, wind measurements are recommended before a final decision on WECS placement is made.

Passes to avoid are those not open to the prevailing wind (because there will be much less flow through them) and passes, or portions of passes, which are extremely narrow and canyon-like (because these may have turbulence and strong horizontal wind shear).

5.4 GAPS AND GORGES

In some areas rivers and streams have eroded deep gaps or gorges through mountain chains and ridges. The Columbia River Gorge in Oregon and Washington is an example. Since these gaps are frequently the only low-level paths through mountain barriers, much air is forced through them (Figure 5.10).

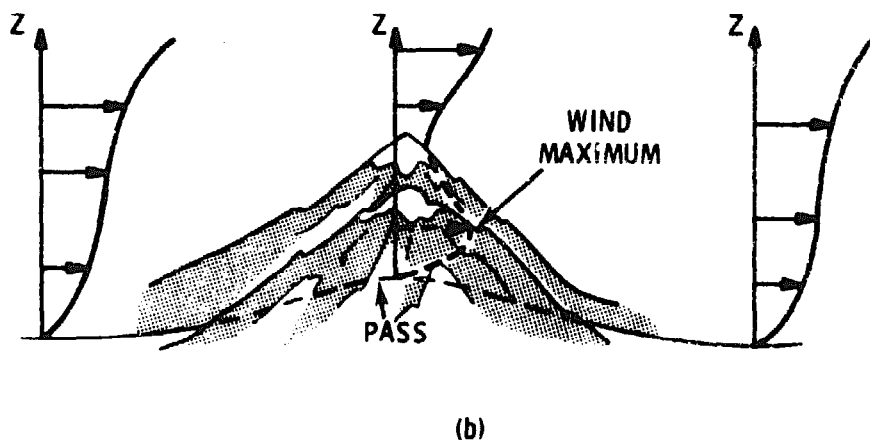
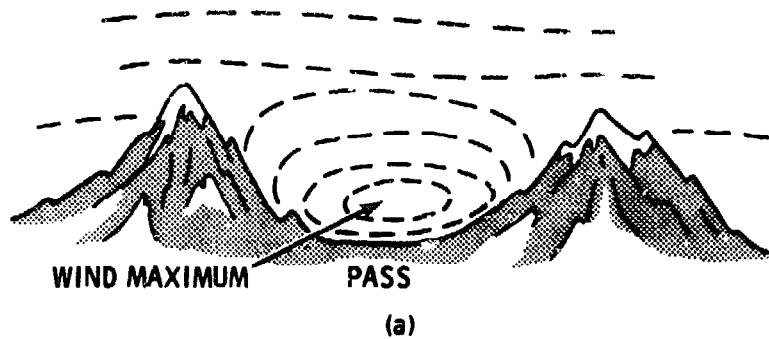

FIGURE 5.9. A Schematic of the Wind Pattern and Velocity Profile Through a Mountain Pass

The problem of siting WECS in gaps and gorges is much like that of siting in passes and saddles. However, there are a few important differences. On the positive side, gaps and gorges are generally deeper than passes and can significantly enhance even relatively light winds. A river gorge can augment mountain-valley or land-sea breezes providing a reliable source of power. Gaps and gorges are also usually more accessible than mountain passes. The chief drawback to sites in gaps and gorges is that, because they are narrow, there is often much turbulence and wind shear. In addition, since streams usually flow through them, there may be no land near the center on which to locate a WECS.

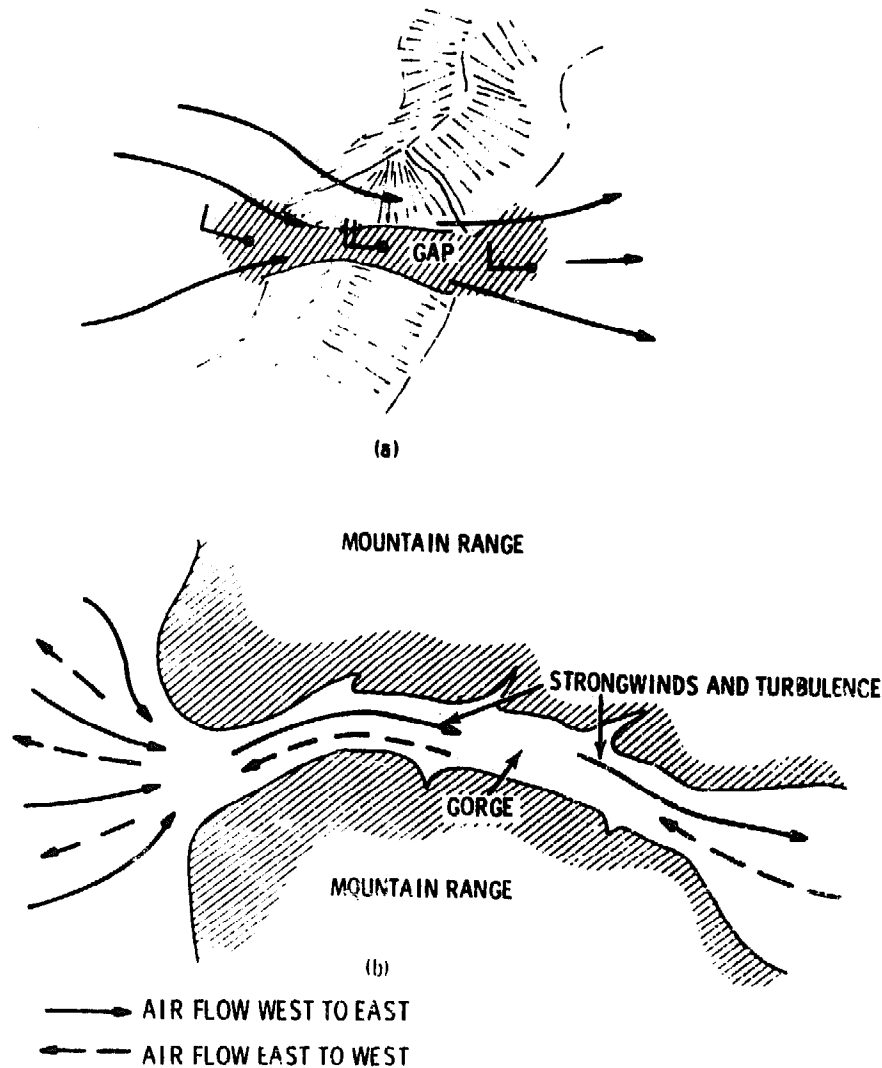

FIGURE 5.10. A Schematic Illustration of Flow Patterns that May Be Observed Through Gaps and Gorges

5.5 VALLEYS AND CANYONS

The airflow pattern in a particular valley or canyon depends on such factors as the orientation of the valley to the prevailing wind; slope of the valley floor; height, length, and width of the surrounding ridges; irregularities in the width; and surface roughness of the valley.

Valleys and canyons which do not slope downward from mountains are usually not good sites. Perhaps the only benefit to siting in non-sloping valleys is the possible funneling effect when the large-scale prevailing wind blows parallel to the valley. Funneling occurs only if the valley or canyon is constricted at some point. Unless the valley is constricted, the surrounding ridges will provide better WECS sites than the valley floor.

Three types of flow patterns occur in valley-mountain systems. The first, known as valley (mountain)-slope winds, occurs when the large-scale wind over the area is weak, and the daily heating and cooling cycle dominates. This happens most often during the warmer months (May to September).

The daily sequence of valley (mountain)-slope winds is shown in Figure 5.11. Shortly after sunrise when the valley is cold and the plains are warm, upslope winds (white arrows) and the continuation of the mountain winds (black arrows) combine (Part A). At forenoon when the plains and the valley floor are the same temperature, the slope winds are strong and there is a transition from mountain to valley winds (Part B). At noon and during early afternoon, the slope winds diminish. The valley wind is fully developed and the valley is warmer than the plains (Part C). In late afternoon, the slope winds cease and the valley winds continue. The valley is still warmer than the plains (Part D). Shortly after sunset when the valley is only slightly warmer than the plains, downslope winds begin and the valley winds weaken (Part E). In early night downslope winds are well developed. The valleys and plains are at the same temperature. This overall condition is characteristic of the transition period between valley and mountain winds (Part F). In the middle of the night, the valley is colder than the plains. Hence, the downslope winds continue and the mountain wind is fully developed (Part G). From late night to morning when the valley is colder than the plains, downslope winds cease and the mountain wind fills the valley (Figure H).

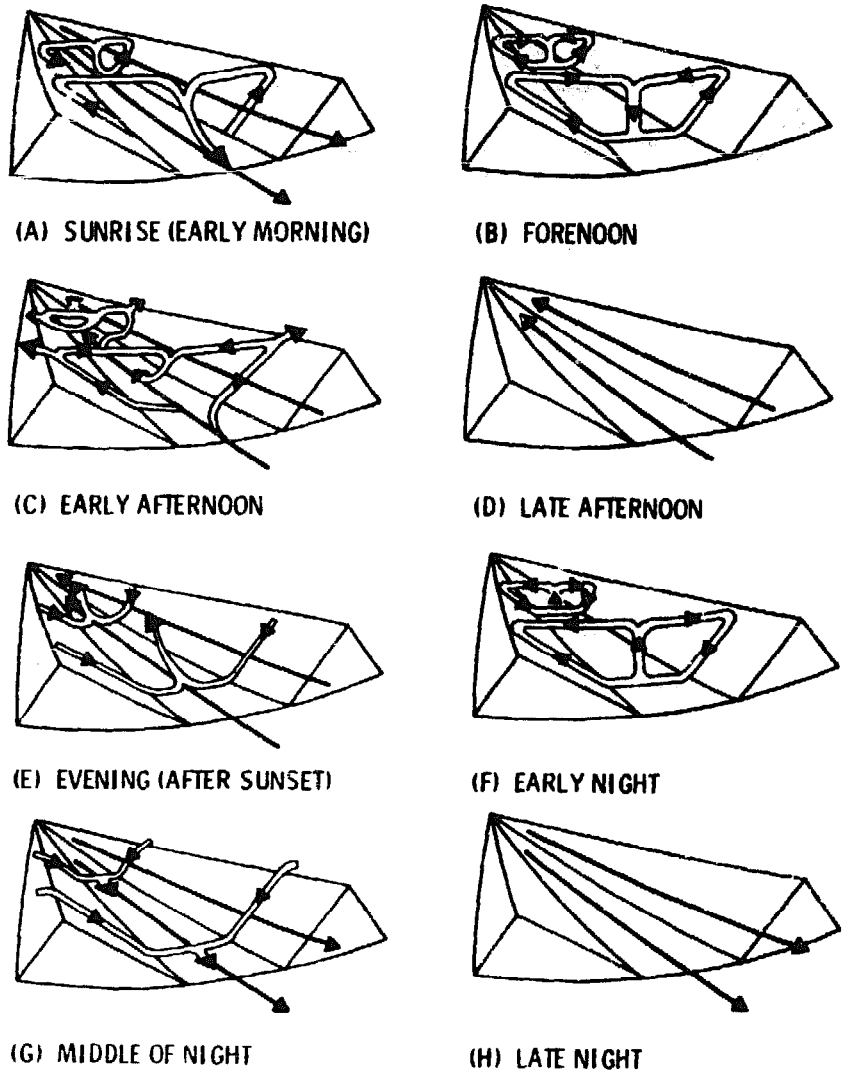
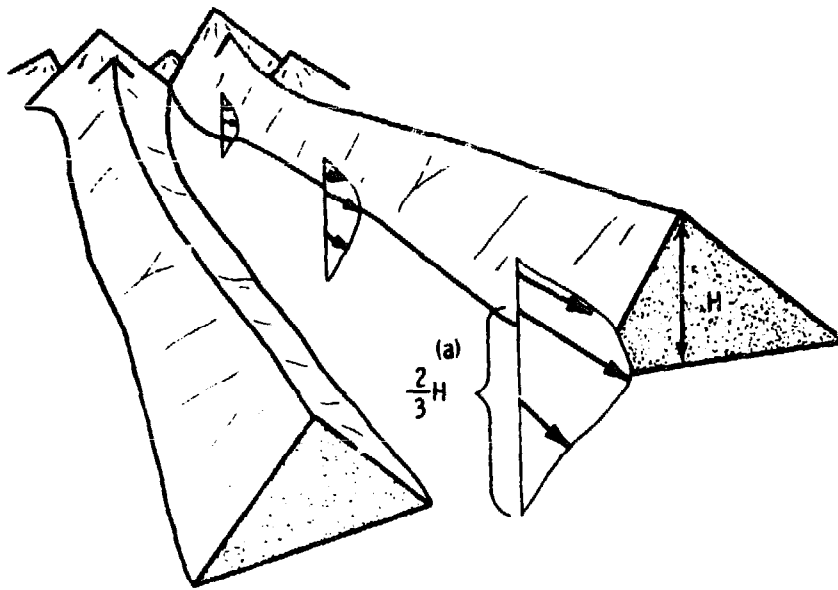

FIGURE 5.11. The Daily Sequence of Mountain and Valley Winds
 (Source: Reference 16, reprinted by permission
 of the American Meteorological Society)

The winds of greatest interest for small WECS users are the mountain wind at night (Parts A, G and H of Figure 5.11) and the valley wind during the afternoon (Parts C, D and E). Figure 5.12 illustrates a wind profile observed for mountain winds in Vermont. The wind accelerates down the valley, with the strongest mountain



(a) THIS PROFILE IS BASED UPON A LIMITED NUMBER OF OBSERVATIONS
IN A SINGLE AREA OF THE UNITED STATES

FIGURE 5.12. Vertical Profile of the Mountain Wind⁽²⁾

winds occurring at the mouth (lower end) of the valley, and the lightest winds at the head (upper end). In the vertical direction, the wind speed increases upward from the valley floor and has reached a maximum in the center of the valley at about two-thirds the height of the surrounding ridges. At the point of maximum wind, the speed may reach as high as 25 mph. The mountain wind is generally well developed for valleys between high ridges and/or rather steeply sloping valley floors. The upper half of the wind profile is very smooth while the lower half occasionally becomes gusty and turbulent.

The daytime wind blowing up the valley tends to be more sensitive to factors such as heating by the sun (the driving force for this wind) and the winds blowing high overhead. As a result,

the valley winds are more variable, and often weaker, than mountain winds. Unlike the mountain wind, which is strongest near the center of the valley, valley winds are normally greatest along the side slope most directly facing the sun. Figure 5.13 shows how to take advantage of mountain and valley winds.

The second type of flow pattern in mountain-valley systems occurs when moderate to strong prevailing winds are parallel to (or within about 35° of) the valley. In this case, broad valleys surrounded by mountains can effectively channel and accelerate the large-scale wind.

Figure 5.14 shows possible wind sites where valley channeling enhances the wind flow. Part A presents a funnel-shaped valley on the windward side of a mountain range. The constriction (or narrowing) near the mouth produces a zone of accelerated flow.

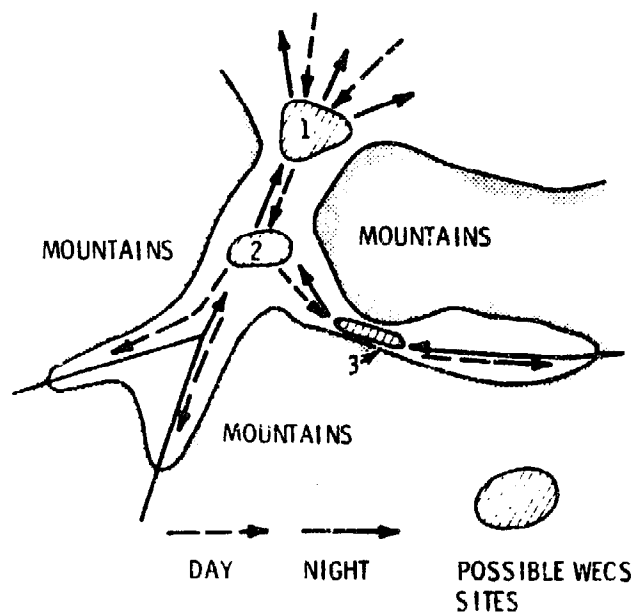

1. MOUTH OF THE VALLEY
2. JUNCTION OF TWO VALLEYS
3. CONSTRICTION IN THE VALLEY

FIGURE 5.13. Possible WECS Sites in Sloping Valleys and Canyons

PREVAILING WIND

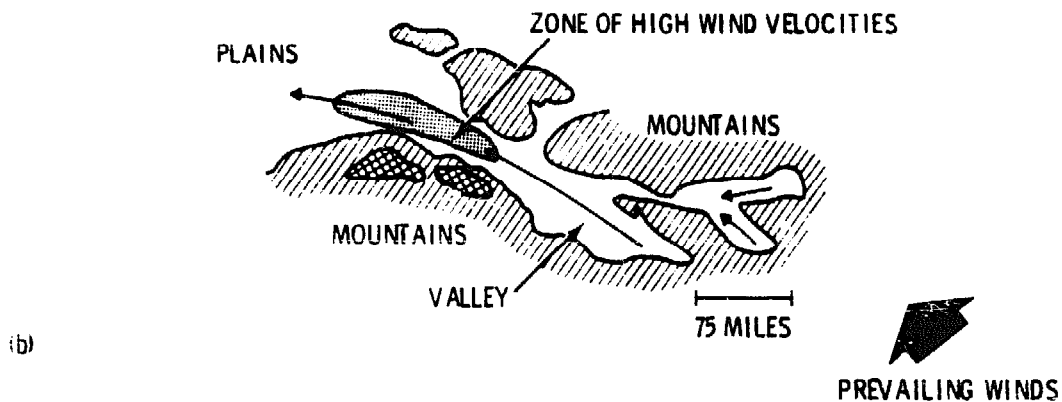
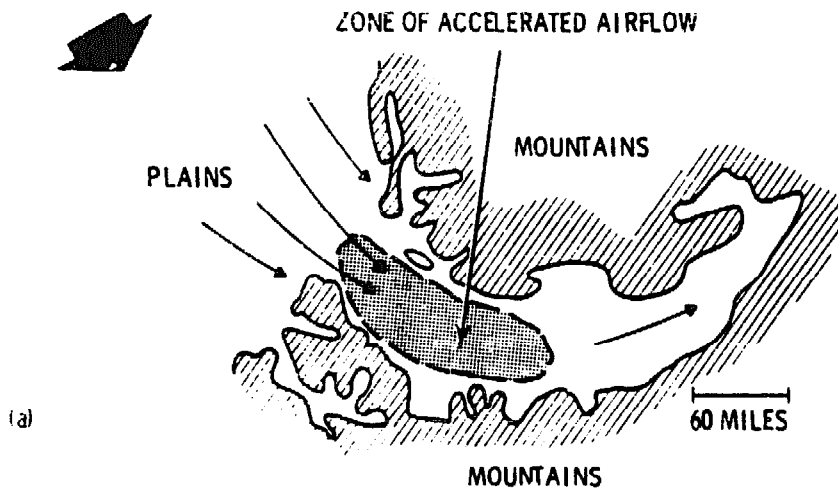

FIGURE 5.14. Possible WECS Sites Where Prevailing Winds are Channeled by Valleys

In this example, the valley is large (approximately 60 miles wide) and open to the prevailing wind. Part B shows a narrow valley in the lee of a mountain range. It is parallel to the prevailing wind and constricted slightly near its mouth.

A valley which is both parallel to the prevailing wind and experiences mountain-valley winds will provide sites which are dependable sources of power. Moderate to strong prevailing winds in winter and spring will drive the WECS. During the warmer months, mountain-valley winds can be utilized.

The third type of valley flow occurs when the prevailing wind is perpendicular to the valley (or crosses it at an angle greater than 35°). A valley eddy may be set up by a combination of solar heating and cross-valley winds. Though there may be times when this eddy could be exploited by a WECS located on either side slope of the valley, it is not a dependable power source because it only occurs on sunny days and is very turbulent.

To site WECS in valleys and canyons, the potential user should

- 1) select wide valleys parallel to the prevailing wind or long valleys extending down from mountain ranges;
- 2) choose sites in possible constrictions in the valley or canyon where the wind flow might be enhanced;
- 3) avoid extremely short and/or narrow valleys and canyons, as well as those perpendicular to the prevailing winds;
- 4) choose sites near the mouth of valley where mountain-valley winds occur;
- 5) insure that the tower is high enough to place the WECS as near to the level of maximum wind as is practical;
- 6) use vegetation to indicate high wind areas (see Section 5.9); and
- 7) consider nearby topographical features, barriers, and surface roughness (after favorable areas in the valley or canyon are located).

5.6 BASINS

Basins are depressions surrounded by higher terrain. Large, shallow inland basins (such as the Columbia Basin in southeast Washington) may have daily wind cycles during the warmer months of the year which can be used to drive small WECS. The flow into and out of a basin is similar to the mountain-valley cycle in Figure 5.11. In fact, valleys sloping down into basins may provide sufficient channeling to warrant consideration as WECS sites.

The flow of cool air from surrounding mountains and hills into the basin during the night is usually stronger than the flow out of the basin caused by daytime heating. Well-developed nighttime flow into a basin may average from 10-20 mph for several hours during the night, and occasionally more than 25 mph for periods of one or two hours. Afternoon flow out of the basin is generally lighter, averaging 5-15 mph.

Winter and spring storms combined with the summer wind cycles may provide sufficient wind power in basins for most of the year. However, in the fall and portions of the winter, basins frequently fill with cold air. During these periods the air in the basin may be stagnant for days or even weeks. Consequently, WECS in basins may require larger energy storage systems or possibly backup power for the calm periods.

The following guidelines are helpful when siting WECS in basins:

- 1) consider only large, shallow inland basins;
- 2) use vegetation indicators of wind (see Section 5.9) to locate areas of enhanced winds in basins; and
- 3) consider all topographical features, barriers, and surface roughness effects.

5.7 CLIFFS

A cliff, as discussed in this report, is a topographical feature of sufficient length (10 or more times the height) to force the airflow over rather than around its face. For such long cliffs the factors affecting the airflow are the slope (both on the windward and lee sides), the height of the cliff, the curvature along the face, and the surface roughness upwind.

Figure 5.15 shows how the air flows over cliffs of different slopes. The swirls in the flow near the base and downwind from the cliff edge are turbulent regions which must be avoided.

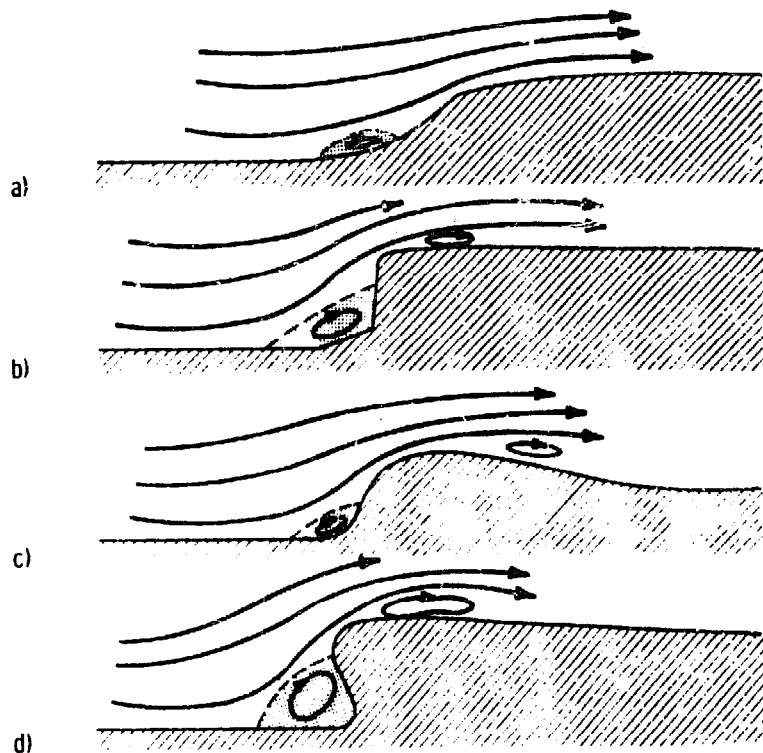

FIGURE 5.15. Airflow over Cliffs Having Differently-Sloped Faces

Turbulent swirls (which we will call areas of flow separation) become larger as the face of the cliff leans more into the wind. When the cliff slopes downward on the lee side, as in Part C of the figure, the zone of turbulence moves more downwind from the face. Part of the turbulence can be avoided by siting a WECS very close to the face of such hill-shaped cliffs. Selecting a section of the cliff having a more gradual slope (as in Part A) is sometimes advantageous because the tower height required to clear the turbulent zone is reduced.

Any curvature along the face of a cliff should also be considered. Figure 5.16 illustrates a top view of a curved cliff section. The curvature of the face channels the winds into the concave portions. Although no estimates are available of how much

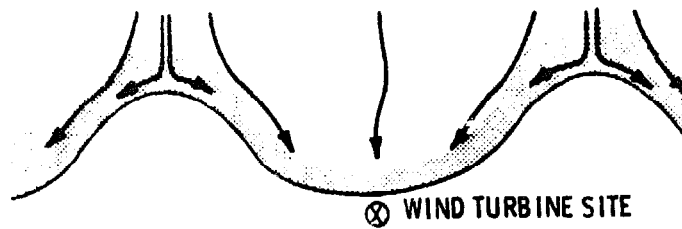

FIGURE 5.16. Top View of Airflow over Concave and Convex Portions of a Cliff Face

wind speed is enhanced in these concave areas, they are probably better WECS sites than convex areas because more air may be forced through them.

Laboratory and field experiments both indicate that cliffs do enhance the wind speed (much like ridges discussed in Section 5.1). Figure 5.17 shows the vertical wind profile of air flowing over a cliff. The longer arrows in Profile 3 compared to those in Profile 1 illustrate how wind speed is enhanced. The dotted regions show turbulent areas of flow separation. Wind speed rapidly increases near the top of the flow separation. This region of shear should be avoided, either by choosing a new site or by raising the WECS so that the rotor disc is above the shear zone.

Since this turbulent zone continually changes size and shape, it is wise to choose as high a tower as is practical (this will also increase available power). To estimate the size of the zone, follow the procedures for turbulence detection discussed in Section 3.1. Measurements should be made on several different days when the prevailing wind is blowing. In general, sunny days will produce larger turbulent zones. If the turbulence extends too high, consider sites very near the cliff edge.

Other factors to consider when siting on cliffs are the surface roughness upstream and the prevailing wind direction. For maximum enhancement of the wind speed, the prevailing wind direction should be perpendicular to the cliff section on which the WECS will be located.

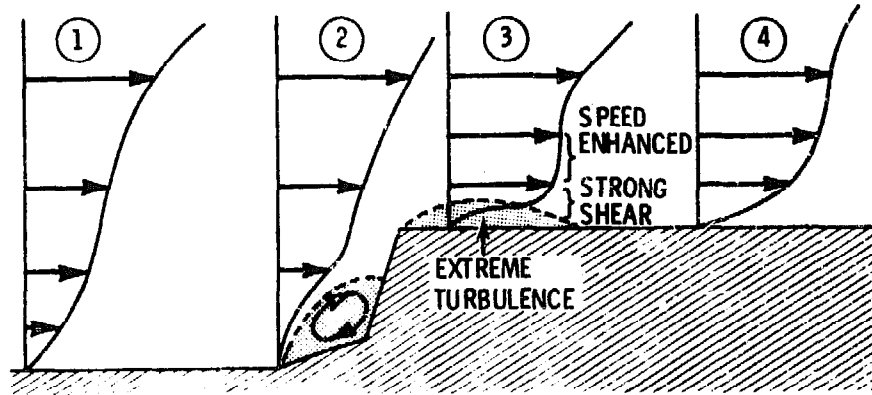

FIGURE 5.17. Vertical Profiles of Air Flowing over a Cliff

Studies of airflow over cliffs made in wind tunnels and with theoretical models show that the location of the zone of strongest winds depends on the height of the cliff. Provided the user can site above the separation zone, the best location on a cliff appears to lie between 0.25 and 2.5 times the cliff height downwind. For example, on a 100-ft cliff the best site would lie somewhere between 25 ft and 250 ft downwind from the cliff edge. For very rough surfaces upwind of the cliff (see Part A of Figure 5.18), the best site would be at about 0.25 times the cliff height downwind from the edge (or 25 ft in this example). Considering progressively smoother surfaces upwind, the ideal site would be farther downwind from the cliff. For very smooth upwind surfaces (Part B of Figure 5.18), the best site would be 2.5 times the cliff height downwind (or 250 ft in this example).

Since the location of the best site may depend on a complex combination of local influences, the best strategy is to make wind measurements to locate the best site. When in doubt, however, the safest policy is to select a site as near to the cliff edge as possible.

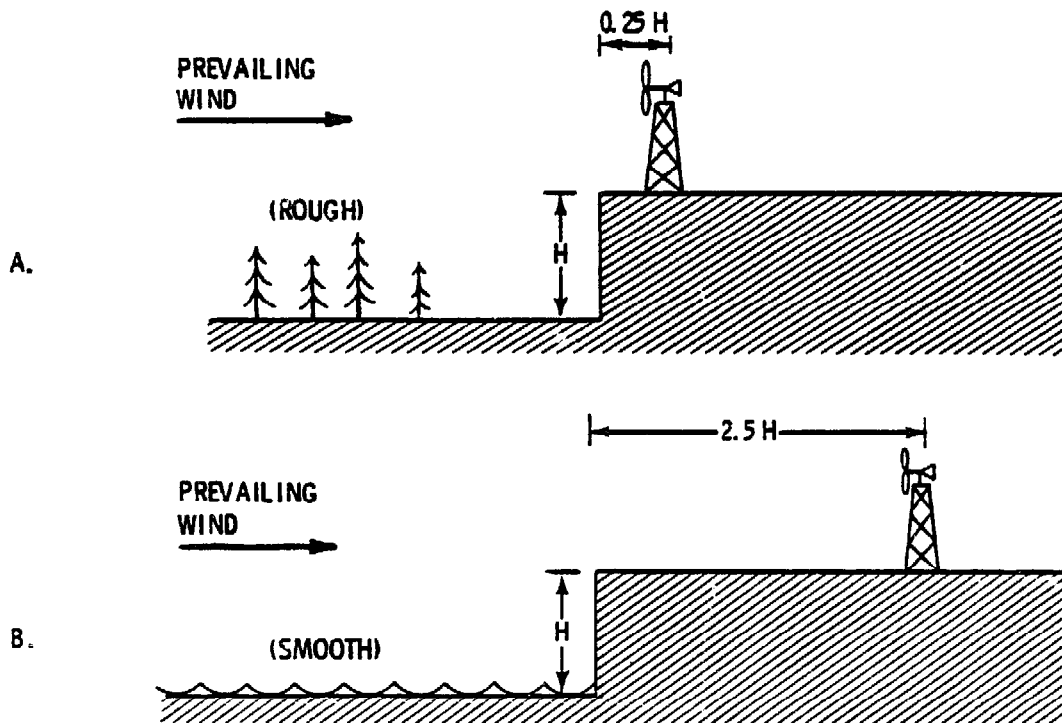

FIGURE 5.18. The Effects of Upwind Roughness on the Location of the Best WECS Site Downwind from a Cliff (10)

The following summarizes major points to consider when choosing a site on a cliff:

- 1) the best cliffs (or portions of a single cliff) are well exposed to the wind (i.e., they are not sheltered by tall trees);
- 2) the best cliffs (or portions of a single cliff) are oriented perpendicular to the prevailing winds;
- 3) if the face of the cliff is curved, a concave portion is the best location (Figure 5.16);
- 4) the shape and slope of the cliff (or section of a cliff) which cause the least turbulence should be selected (Figure 5.15);

- 5) general wind patterns near cliffs may be revealed by the deformation of trees and vegetation (Section 5.9);
- 6) the best sites will be between 0.25 and 2.5 times the cliff height downwind from the cliff;
- 7) a conservative strategy is to site as close to the cliff edge as possible; and
- 8) the entire rotor disc should clear the zone of separation.

5.8 MESAS AND BUTTES

Mesas and buttes are flat-topped mountains or hills bounded on all sides by cliffs. In the United States they are found almost exclusively in the western half of the country, primarily in the Southwest. Although they are generally high enough to intercept the stronger winds aloft, they are often found in regions of relatively light winds and frequently are inaccessible due to their steep sides.

Smaller buttes (those less than 2000 ft in height, and less than about five times as long as they are high) can be considered flat-topped hills. Consequently, they may have considerable turbulence and wind shear at low levels (Figure 5.6). The best WECS sites on such buttes appear to be along the windward edge.

Figure 5.19 shows some flow patterns over and around mesas and buttes. In Part A of the figure, the wind accelerates over the top, although not as much as over triangular or rounded hills. When a mesa or butte is located in an area where the winds are already enhanced by valley funneling or other effects, additional power benefits may be gained.

If the mesa or butte is more than 10 times longer than it is high, there should be enough flow over it (rather than around it)

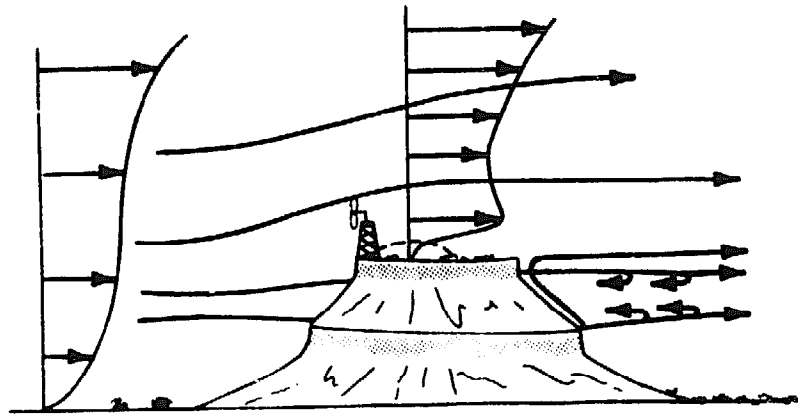

(a) SIDE VIEW

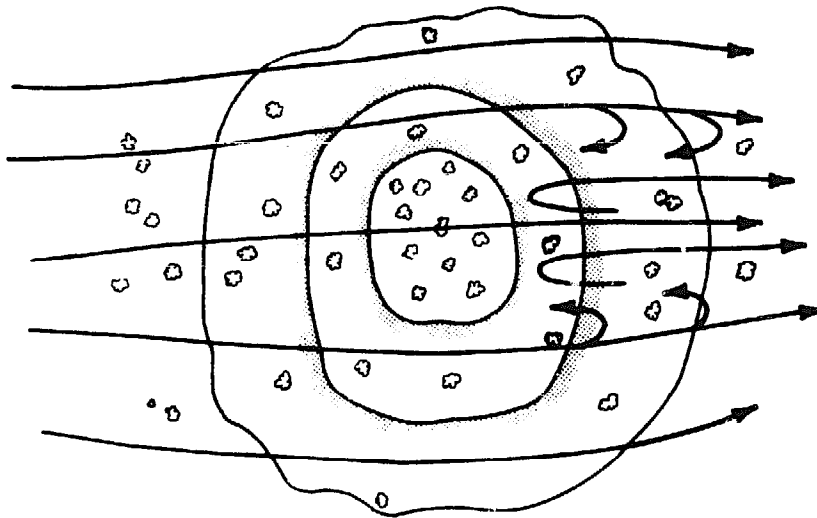

(b) TOP VIEW

FIGURE 5.19. Flow Around and over Buttes and Mesas

to be treated as a cliff (Section 5.7). Very large mesas (those more than 2000 ft high and more than 6 or 7 miles long) may also produce mountain-type effects (Section 5.2).

A WECS on a butte or mesa should be located on a tall tower on the windward edge. If there is no prominent prevailing wind direction, a very tall tower will provide some protection against turbulence and wind shear while the WECS is in the lee.

5.9 ECOLOGICAL INDICATORS OF SITE SUITABILITY

Vegetation deformed by high average winds can be used both to estimate the average speed (thus power) and to compare candidate sites. This technique works best in three regions: 1) along coasts, 2) in river valleys and gorges exhibiting strong channeling of the wind, and 3) in mountainous terrain. Ecological indicators are especially useful in remote mountainous terrain not only because there are little wind data, but because the winds are often highly variable over small areas and difficult to characterize. The most easily observed deformities of trees (illustrated in Figure 5.20) are listed and defined below:

- Brushing--Branches and twigs bend downwind like the hair of a pelt which has been brushed in one direction only. This deformity can be observed in deciduous trees after their leaves have fallen. It is the most sensitive indicator of light winds.
- Flagging--Branches stream downwind, and the upwind branches are short or have been stripped away.
- Throwing--A tree is windthrown when the main trunk and the branches lean away from the prevailing wind.
- Clipping--Because strong winds prevent the leader branches from extending up to their normal height, the tree tops are held to an abnormally low level.
- Carpeting--This deformity occurs because the winds are so strong that every twig reaching more than several inches above the ground is killed, allowing the carpet to extend far downwind.

Figure 5.20 is one of the best guides to ranking tree deformities by wind speed. Both a top view and a side view of the tree are shown to demonstrate the brushing of individual twigs and

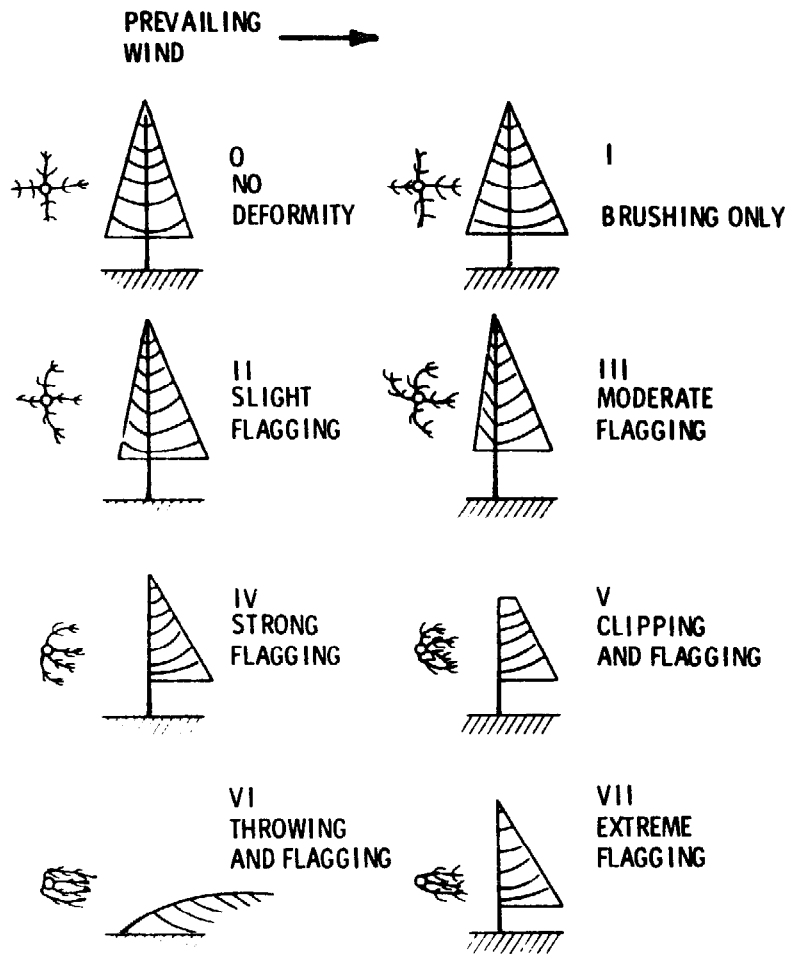

FIGURE 5.20. Wind Speed Rating Scale Based on the Shape of the Crown and Degree Twigs, Branches, and Trunk are Bent (Griggs-Putnam Index) (17)

branches and the shape of the tree trunk and crown. The figure uses the Griggs-Putnam classification of tree deformities described by indices from 0 to VII. When WECS sites are ranked by this scheme, only like species of trees should be compared, because different types of trees may not be deformed to the same degree.

Another good indicator of relative wind speeds is the deformation ratio. (17) It also measures how much the tree crown has been flagged. Figure 5.21 shows the two angles, a and b, that

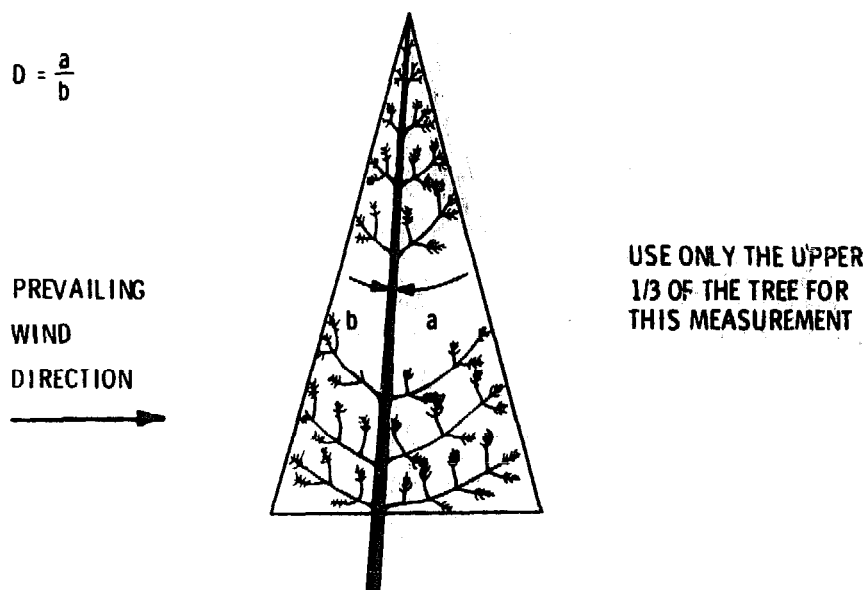

FIGURE 5.21. Deformation Ratio Computed as a Measure of the Degree of Flagging (17)

must be measured to compute the deformation ratio "D". To measure these angles, the trees can either be photographed or sketched to scale. (The user might sketch the tree on clear acetate while he looks at it through the acetate.) He should draw or take the tree pictures while viewing the tree perpendicular to the prevailing wind direction so that he can see the full effects of flagging.

To compute D, the two angles shown in the figure (a on the downwind side and b on the upwind side) should be measured in degrees using a protractor and then divided ($D = a \div b$). The larger the value of D, the stronger the average wind speed.

Mean annual wind speed is correlated with the Griggs-Putnam Index (Figure 5.20) in Table 5.3, and with the Deformation Ratio (Figure 5.21) in Table 5.4. These reflect only preliminary research results based on studies of two species of conifers, the Douglas Fir and the Ponderosa Pine. Further studies are examining these and other tree species to improve predictions of mean annual winds with ecological indicators.

TABLE 5.3. Mean Annual Wind Speed Versus the Griggs-Puttnam Index^(a)

Griggs-Putnam Index (as in Figure 5.20)	<u>I</u>	<u>II</u>	<u>III</u>	<u>IV</u>	<u>V</u>
Probable Mean Annual Wind Speed Range (mph)	6-10	8-12	11-15	12-19	13-22

(a) These data were prepared by E. W. Hewson, J. E. Wade, and R. W. Baker of Oregon State University.

TABLE 5.4. Mean Annual Wind Speed Versus the Deformation Ratio^(a)

Deformation Ratio (as in Figure 5.21)	<u>I</u>	<u>II</u>	<u>III</u>	<u>IV</u>	<u>V</u>	<u>VI</u>	<u>VII</u>
Probable Mean Annual Wind Speed Range (mph)	4-8	7-10	10-12	12-15	14-18	15-21	16-24

(a) These data were prepared by E. W. Hewson, J. E. Wade, and R. W. Baker of Oregon State University.

Because they are based upon limited data, Tables 5.3 and 5.4 should only be used to locate possible areas of high wind energy and to select candidate sites within such areas. The user should not select a particular WECS based on ecological indicators alone. A wind measurement program is recommended before the type of WECS and final site are selected.

Table 5.5 gives the results of some early attempts (about 1948) to estimate average annual wind speeds based on the Griggs-Putnam Index for certain evergreens in the Northeast. Though different species are often deformed to different extents by the same winds, very strong winds (those capable of causing strong flagging, clipping, or carpeting) affect different species the same. Comparison of the data presented in Table 5.3 (based on Douglas Fir and Ponderosa Pine) and Table 5.5 (based primarily on Balsam) bears out this fact.

TABLE 5.5. Griggs-Putnam Index Versus Average Annual Wind Speed for Conifers in the Northeastern United States
 (Adapted from Reference 18, Power from the Wind by Palmer Cosslett Putnam, ©1975 by Allis Chalmers Corporation. Reprinted by permission of Van Nostrand Reinhold Company, a Division of Litton Educational Publishing, Inc.)

Types of Deformation (Griggs-Putnam Index)	Description	Tree Height (Feet)	Velocity at Tree Height (mph)
Carpeting (VIII)	Balsam, spruce and fir held to 1 ft	1	27.0
Clipping (V)	Balsam, spruce and fir held to 4 ft	4	21.5
Throwing (VI)	Balsam thrown	25	19.2
Flagging (IV)	Balsam strongly flagged	30	18.6
Flagging (III)	Balsam moder- ately flagged	30	17.9
Flagging (II)	Balsam mini- mally flagged	40	17.3
Brushing (I)	Balsam not flagged	40	15.5
Flagging (II)	Hemlock and white pine show minimal flagging	40	10.6

Though the presence of one type of deformity (or a combination) may indicate an area of high average winds, and the degree of deformity may give estimates of the relative strengths of the winds, there are still pitfalls to rating sites according to tree deformity. Because past or present growing conditions can greatly affect the size and shape of trees, only isolated trees appearing to have grown under similar conditions should be compared. For example, a tree in or near a dense stand of timber should not be compared to an isolated tree. Another fact to be aware of is that limbs are stripped from trees not only by strong flagging. They can be damaged by man, disease, other trees that once grew nearby,

or possibly ice storms. Misinterpreting such signs could lead to the wrong assumptions about the prevailing wind direction and the average speed. Common sense, however, should reveal whether or not all the deformities observed in an area fit together into a consistent pattern.

The following guidelines summarize this section and suggest how to use ecological indicators effectively:

- 1) detect ecological indicators of strong wind;
- 2) compare isolated trees within the strong wind areas to select candidate sites;
- 3) consider flow patterns over barriers, terrain features, and surface roughness in the final selection;
- 4) measure the wind to insure that the best site in complex terrain is selected; and
- 5) base selection of a particular WECS and estimation of its power output on wind measurements, not on ecological indicators alone.

6.0 METHODS OF SITE ANALYSIS

Winds at a particular site may be recorded and analyzed by any one of three methods described in Table 6.1. Once the winds are recorded, the expected power output of a WECS may be computed.

The first method is the same one suggested in the preliminary feasibility study (page 1.2). It requires only a knowledge of the average annual wind speed, which can be obtained for nearby stations. Appendix A lists sources of wind climatology.

With this method, how frequently wind speeds occur is assumed to depend only on the mean wind speed. This allows computation of the output power from the mean annual wind speed and the WECS's operating characteristics (i.e., cut-in, rated, and cut-out wind speeds). However, care must be exercised in assuming that the mean wind at the site is about the same as that at a nearby weather station. That assumption may be true if both locations are within a few miles of each other and if both are in the same large area of flat terrain (e.g., the Great Plains, a large plateau, or a large basin).

The second method is more accurate than the first. An odometer-type wind recorder, which measures the miles of wind passing by the site (the wind run), should be used for a minimum of three months to collect onsite data, preferably during the three most windy months. A simple method of correlating wind and computing output power is presented in Appendix D.

The third method is the only reliable one for estimating power output in complex terrain. Mountains, valleys, and other topographical features cause the wind to vary from one location to another, and past attempts to correlate such winds have not been successful. An entire year of data should be collected at candidate sites in complex terrain.

TABLE 6.1. Various Approaches to Site Analysis

<u>Method</u>	<u>Approach</u>	<u>Advantages</u>	<u>Disadvantages</u>
1	Use only mean annual speed from a nearby station; determine annual power output (using Appendix C).	Little time or expense required for collecting and analyzing data. If used properly, can be highly accurate.	Only works well in large area of flat terrain where average annual wind speeds are 10 mph or greater.
2	Make limited onsite wind measurements, establish rough correlation with nearby station, then compute power output (using Appendix D).	More accurate than first method. Works well in all but very hilly or mountainous terrain.	Requires time to collect data. Data period must represent typical wind conditions. Added cost of wind recorders. Works poorly in mountains.
3	Collect wind data for the site and analyze it to obtain annual power output (using methods in Appendix D).	Most accurate method. Works in all types of terrain.	Requires a year of data collection. Added costs of wind recorders. Data period must represent typical wind conditions.

Simple odometer-type devices can be purchased for about \$100 or can possibly be rented from WECS dealers. By recording the miles of wind monthly and dividing miles by the number of hours in the month, the monthly average wind speeds (and in the same manner the annual average wind speed) can be computed. With that data and Appendix C, average output power can be estimated.

The wind recording equipment used will dictate how the data is analyzed. An odometer-type recorder is the least expensive, but provides no wind direction information. More sophisticated recording equipment is available which can gather the type of data contained in the wind summaries described in Appendix D, as well as other useful wind information. Some of this sophisticated equipment costs under \$1000, but can possibly be rented from WECS distributors. Since this equipment will sort winds by both direction and speed, it will provide a more accurate estimate of output power, it will better enable the user to select the most suitable WECS, and it may also enable him to select a site less affected by barriers (see example in Section 4.3.3 and use of wind summaries in Appendix A).

Those wishing to perform their own analysis may contact the American Wind Energy Association (AWEA) for lists of manufacturers who produce various types of wind-measuring devices and accessories (see Section 1 for the address). If such equipment is bought or rented, it should be located according to the same guidelines suggested in this handbook for an actual WECS.

The reader might also consult the following reference on wind measurement:

Enertech Corporation
Planning a Wind-Powered Generating System
Box 420
Norwich, Vermont 05055.

Another method of collecting onsite data might be considered. Some WECS dealers have equipment which can be programmed to simulate the power output of a particular WECS. This method permits direct readout of power output for one type of WECS, but decreases the ability to select the best WECS for the site.

If the user prefers, WECS dealers and meteorological consultants can be employed to analyze a site. The AWEA can furnish the names of some firms which provide such a service.

When the site analysis is completed and the final choice of a WECS is made, the user should remember that the operating characteristics of the most suitable WECS for a particular site will depend on his power needs and the wind characteristics at the site. The need for a backup or energy storage system will depend on the maximum expected return time of the wind (MERT). MERT is the longest interval in which the wind might remain below the WECS cut-in speed (i.e., the longest period in which no power will be generated).

Data on MERT is available for some weather stations, but, if it is not available for a nearby station, it can be estimated during the data collection process. If sophisticated wind recorders

are used, they can probably be programmed to determine return times automatically. If simple wind odometers are used, they must be read at least once or twice daily during low wind periods to estimate the MERT. Though maximum return times often occur in autumn, it is best to examine an entire year of data to estimate the return time.

7.0 REFERENCES

1. Survey of Historical and Current Site Selection Techniques for the Placement of Small Wind Energy Conversion Systems. Report to Battelle, Pacific Northwest Laboratories by American Wind Energy Association, Bristol, IN 46507, February 1977.
2. J. Park and D. Schwind, Wind Power for Farms, Homes, and Small Industry. Prepared for the Energy Research and Development Administration by Nielsen Engineering and Research, Inc., Mountain View, CA 94043 (in press, scheduled for publication in June 1978).
3. H. C. S. Thom, "New Distributions of Extreme Winds in the United States." Journal of the Structural Division, Proceedings of the Amer. Soc. of Civil Eng. 94(ST7):1787-1801, July 1978.
4. The National Atlas of the United States of America. Compiled by the U.S. Dept. of Interior, Geological Survey, Washington, DC, 1970.
5. M. E. Pautz, Severe Local Storm Occurrences, 1955-1967. ESSA Technical Memorandum, WBTM FCST 12, reprinted by and available from NOAA, Silver Spring, MD 20910, May 1974.
6. John D. Stevenson, "Application of Tornado Technology to Nuclear Industry." Proceedings of the Symposium on Tornadoes, Assessment of Knowledge and Implications for Man, June 22-24, 1976, Institute for Disaster Research, Texas Tech University, P.O. Box 4089, Lubbock, TX 79409.
7. Iven Bennet, Glaze: Its Meteorology and Climatology, Geographical Distribution, and Economic Effect. Technical Report EP-105, Quartermaster, Research and Engineering Center, Natick, MA, March 1959.
8. G. E. Daniels, ed., Terrestrial Environment (Climatic) Criteria Guidelines for Use in Space Vehicle Development. NASA-TM-X-64589, Marshall Space Flight Center, AL, 1971 (revised).
9. M. N. Orqill and G. A. Schmel, "Frequency and Diurnal Variation of Dust Storms in the Contiguous U.S.A." Atmos. Environ. 10(10):813-825, 1976.
10. W. Frost and D. Nowak, Handbook of Wind Turbine Generator Siting Techniques Relative to Two-Dimensional Terrain Features. Prepared for Battelle, Pacific Northwest Laboratories by FWG Associates, Inc., Tullahoma, TN 37388, November 1977.

11. V. A. Sandborn, Placement of Wind-Power Systems. EY-76-S-06-2438, Colorado State University, Fort Collins, CO, 1977.
12. J. Van Eimern, R. Karschon, L. A. Razumova, and G. W. Robertson, Windbreaks and Shelterbelts. Technical Note 59, World Meteorological Organization, Geneva, Switzerland, 1964.
13. R. N. Meroney, "Wind in the Perturbed Environment: Its Influence on WECS." Presented at American Wind Energy Association Conference, Boulder, Co, May 11-14, 1977, Colorado State Univ., Fort Collins, CO, 1977.
14. F. R. Eldridge, Wind Machines. NSF-RA-N-75-051, National Science Foundation Report prepared by Mitre Corp., available from U.S. Government Printing Office, Washington, DC 20402, 1975.
15. J. Frenkeil, "Wind Profiles over Hills (in Relation to Wind-Power Utilization)." Quarterly Journal of the Royal Meteorological Society 88(376):156-169, April 1962.
16. F. Defant, "Local Winds," Compendium of Meteorology. T. F. Malone, ed., American Meteorology Society, Boston, MA, pp. 655-672, 1951.
17. E. W. Hewson, J. F. Wade, and R. W. Baker, Vegetation as an Indicator of High Wind Velocity. Prepared for the Energy Research and Development Administration by Oregon State University, Corvallis, OR 97331, June 1977.
18. P. C. Putnam, Power from the Wind. Van Nostrand Reinhold Co., New York, NY, 1948, p. 84.
19. M. C. Verholek, Summary of Wind Data from Nuclear Power Plant Sites. BNWL-2220 WIND-4, Battelle, Pacific Northwest Laboratories, Richland, WA 99352, 1977.
20. J. Reed, "Wind Power Climatology." Weatherwise 27(6):237-242, December 1974.
21. D. L. Elliott, Synthesis of National Wind Energy Assessments. BNWL-2220 WIND-5, Battelle, Pacific Northwest Laboratories, Richland, WA 99352, 1977.
22. W. C. Cliff, The Effect of Generalized Wind Characteristics on Annual Power Estimates from Wind Turbine Generators. PNL-2436, Battelle, Pacific Northwest Laboratories, Richland, WA 99352, October 1977.

APPENDIX A

SOURCES AND USES OF WIND CLIMATOLOGY

SOURCES OF WIND CLIMATOLOGY

The National Climatic Center (NCC) at Asheville, North Carolina is usually the best source of wind data. NCC will, for the cost of reproduction (usually a few cents per copy), provide available summaries for sites in or near a locality. These data may be obtained by writing to:

Director
National Climatic Center
Federal Building
Asheville, North Carolina 28801

The wind summaries are generally similar to Table A.1. Frequently wind roses have been constructed for stations. Figure A.1 illustrates a typical wind rose.

An index has been developed which lists all sites for which wind summaries are available. These sites include past and present National Weather Service Stations, Federal Aviation Administration and Civil Aeronautics Administration sites, and military installations. The index entitled Index--Summarized Wind Data, by M. J. Changery, W. T. Hodge, and J. V. Ramsdell, (BNWL-2220 WIND-11), September 1977, can be obtained from:

National Technical Information Service
U.S. Department of Commerce
5285 Port Royal Road
Springfield, Virginia 22151.

Wind climatology may also be obtained from utilities operating nuclear power plants. Reference 19 may also be helpful because it contains summarized wind data from over 100 nuclear sites at the locations shown in Figure A.2. The summaries include wind speed frequencies by direction, graphs of wind speed versus duration of speed, height and location of the wind sensor, the average wind speed, the available wind power, and descriptions of the site and the surrounding terrain.

TABLE A.1. Sample Wind Summary--Percentage Frequencies of Wind Direction and Speed: Windspeed Intervals (Miles per Hour)

<u>Direction</u>	<u>0-3</u>	<u>4-7</u>	<u>8-12</u>	<u>13-18</u>	<u>19-24</u>	<u>25-31</u>	<u>32-38</u>	<u>Total</u>	<u>Average Speed</u>
N	1	1						2	5.5
NNE	1	2	1					4	5.8
NE	3	8	3					14	5.9
ENE	1	5	2					8	6.3
E	1	2						3	5.5
ESE	1	2						3	5.7
SE	1	3	2					6	7.1
SSE		3	2	1				6	7.8
S	1	3	3	1				8	8.3
SSW	1	3	5	5	1			15	11.5
SW	1	4	5	5	2			17	11.7
WSW	2	2	1					5	10.4
W	1	1						2	7.7
WNW	1	1						2	7.5
NW		1						1	5.9
NNW	1							1	6.1
Calm	3							3	
Total	20	41	24	12	3	0	0	100	8.1

Other possible sources of wind data are: the United States Soil Conservation Service, the Agricultural Extension Service, United States and State Forest Services, some public utilities, airlines, industrial plants, and agricultural and meteorological departments at local colleges and universities.

USES OF WIND SUMMARIES

Wind summaries for a potential WECS site are extremely useful. In complex terrain, such as hilly or mountainous areas, they are particularly valuable for developing good siting strategy and

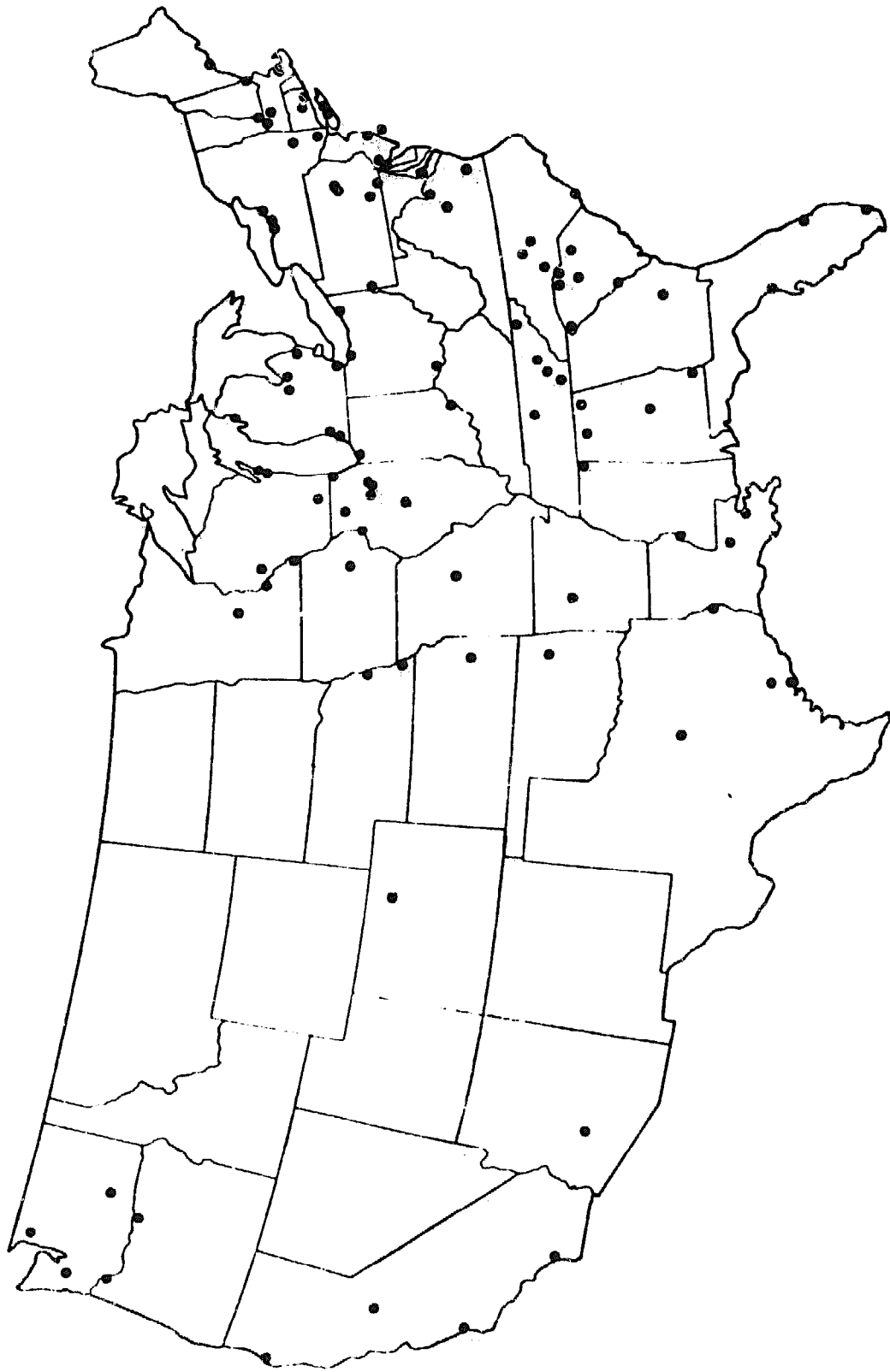

FIGURE A.2. Nuclear Power Plant Sites (19)

SAMPLE CALCULATION: IN TABLE A.1 WIND FROM THE NORTH BLOWS 2% (0.02) OF THE TIME AND AVERAGES 5.5 MPH.

$5.5 \times 5.5 \times 5.5 \times 0.02 = 3.3$
 (WHICH IS PLOTTED AT THE HEAD OF THE ARROW
 SHAFT COMING FROM A NORTHERLY DIRECTION)

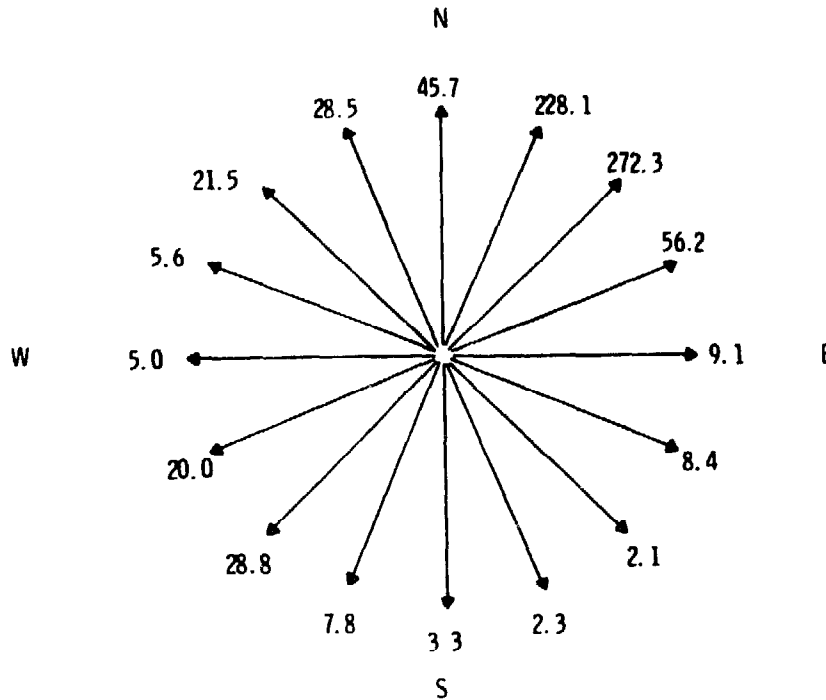

FIGURE A.3. Sample Wind Energy Rose (constructed from Table A.1)

In Figure A.3 most of the wind power is associated with winds blowing from the southwest, the prevailing power direction. The user should determine the prevailing power direction for his siting area and any other directions with which significant wind power is associated. To minimize the adverse effects of barriers, he should locate the WECS so that there are no barriers upwind, along any of these directions.

APPENDIX B

INITIAL ESTIMATE OF WIND ENERGY POTENTIAL

INITIAL ESTIMATE OF WIND ENERGY POTENTIAL

The best indicator of the practicality of WECS is the local history of WECS use. If WECS have been or are being used in the vicinity, users can supply useful information about the type, size, and application of their WECS; adequacy of the power output; siting procedures used; and accuracy of the estimated power output.

If there is no local history of WECS use, Figure B.1 provides a rough estimation of the wind power potential over the continental United States. In general, areas where available wind power is above 100 watts per square meter (wpsm) merit further investigation. Good WECS sites do exist in regions where available power is less than 100 wpsm, but are generally limited to small areas of locally enhanced winds, such as hills, mountains, ridges or sea-coasts. Figure B.2 illustrates this by presenting available power for only the higher elevations. The figure indicates that considerable wind energy is available even in the Southeast and the Southwest, which are shown as low power regions in Figure B.1.

Before deciding against using wind energy, the reader should examine the parts of Section 5 that discuss local landforms. But if the annual average wind speeds at nearby weather stations are less than 8 mph, and if there are no local terrain features to enhance the wind, small WECS are probably not practical.

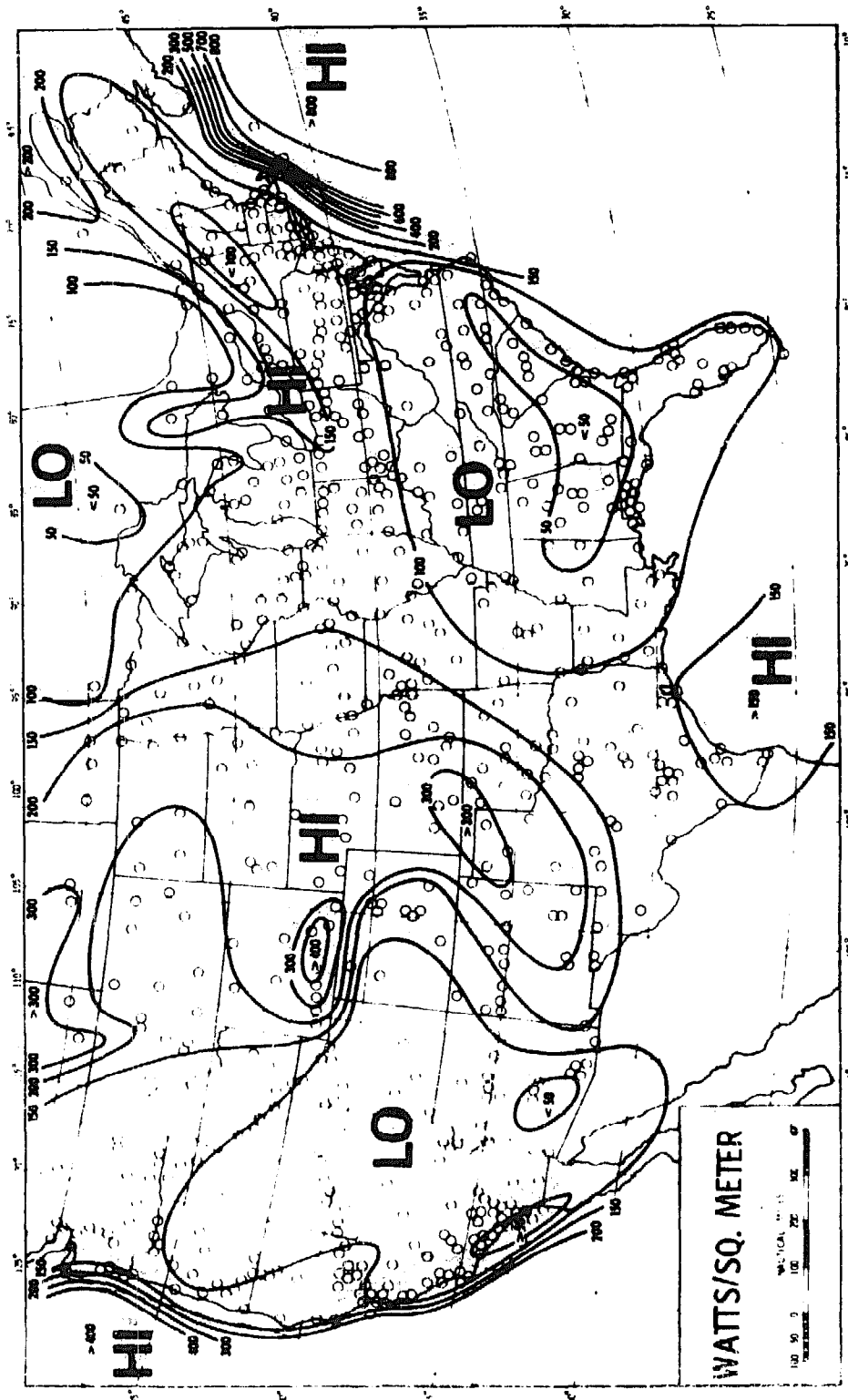

FIGURE B.1. Available Wind Power--Annual Average (20)

APPENDIX C

ESTIMATING POWER OUTPUT FROM ANNUAL AVERAGE
WIND SPEEDS AND WECS CHARACTERISTICS

ESTIMATING POWER OUTPUT FROM ANNUAL AVERAGE
WIND SPEEDS AND WECS CHARACTERISTICS

WECS CHARACTERISTICS NEEDED

- CI = Cut-In Speed = Wind speed below which the generator produces no electricity.
- RS = Rated Speed = The lowest speed at which the generator produces power at its rated capacity.
- CO = Cut-Out Speed = The speed above which the generator does not operate (due to hazardous winds).
If the machine does not cut-out, use a high speed (such as 50 mph).

PROCEDURE TO ESTIMATE AVERAGE ANNUAL POWER OUTPUT

AA = Annual Average Wind Speed

1. The following relationships give the two required ratios:

$$\frac{CO}{RS} \quad , \quad \frac{AA}{RS}$$

2. These two ratios are used in Figure C.1 to determine

$$\frac{\text{average power output}}{\text{rated power}}$$

3. This value multiplied by the rated power of the WECS gives the average power output (this will probably be in kilowatts).
4. Finally, the average power output in (in kW) multiplied by the number of hours per year (24 x 365 = 8760) gives the average annual power output (kW hours per year).

OTHER USEFUL ESTIMATES

To estimate down time and running time:

1. Compute these two ratios:

$$\frac{CO}{AA} \quad , \quad \frac{CI}{AA}$$

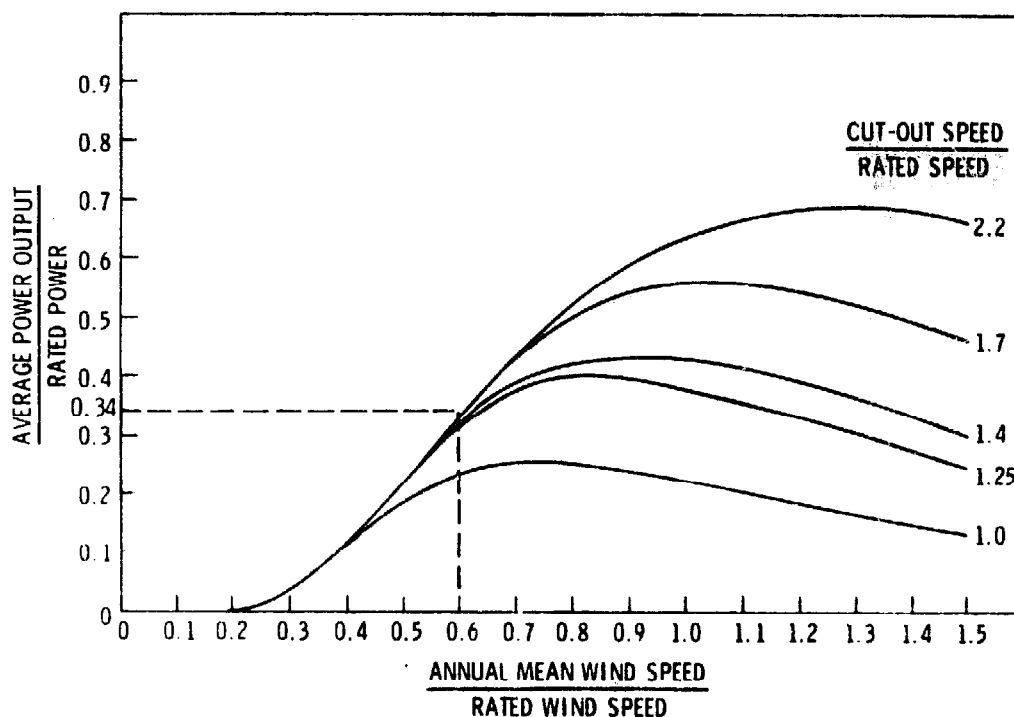

FIGURE C.1. Estimate of Expected Average Power Output for Wind Turbines. (22) (The dotted lines refer to the example given on Page C.4.)

2. These ratios were used in Figure C.2 to estimate the percentage of the time the WECS will not be generating (100 - % down time = % running time).

To estimate the percent of the time the WECS will be running at rated capacity:

1. Compute these ratios:

$$\frac{CO}{AA} , \frac{RS}{AA} .$$

2. Estimate how much of the time the WECS will run at rated capacity from these ratios and the information in Figure C.3.

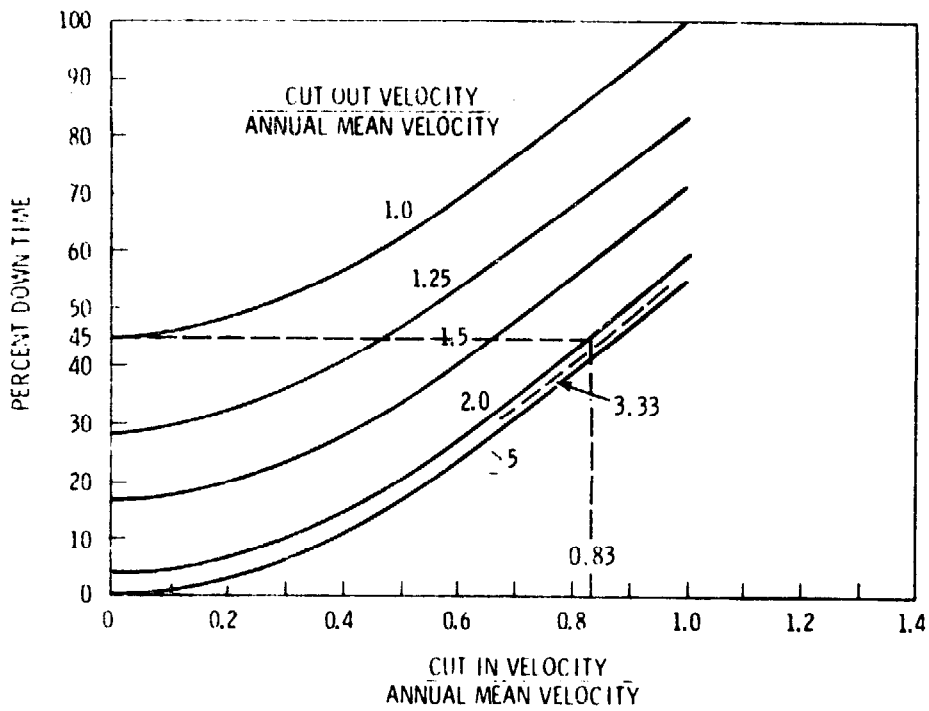

FIGURE C.2. Percent Down Time. (22) (The dotted lines refer to the example given on Page C.4.)

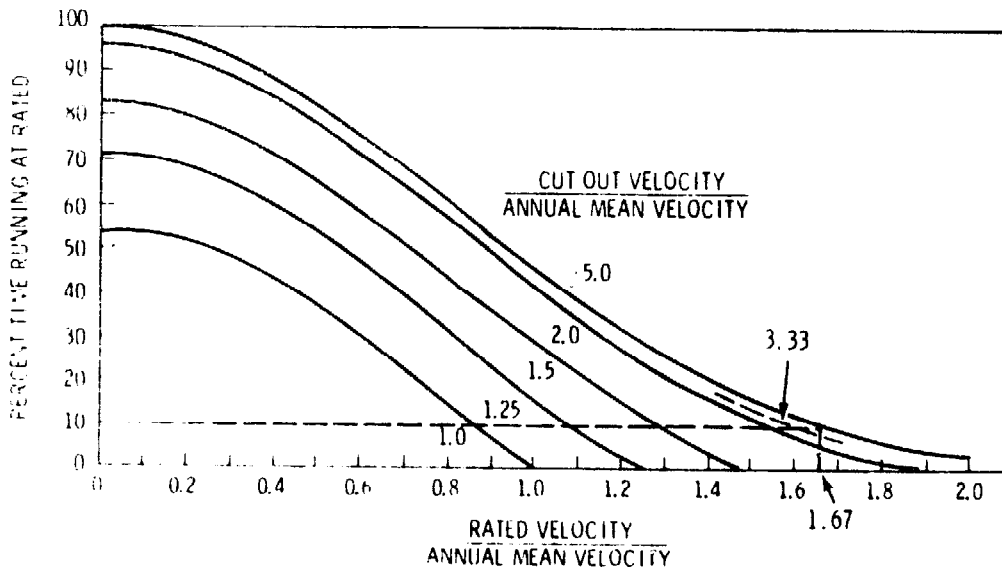

FIGURE C.3. Percent Time Running at Rated. (22) (The dotted lines refer to the example given on Page C.4.)

EXAMPLE PROBLEM

Given: CI = 10 mph Rated Power = 5 kW
 RS = 20 mph
 CO = 40 mph
 AA = 12 mph

Estimate: 1. Average annual power output
 2. Percent running time
 3. Percent time running at rated

1. $\frac{CO}{RS} = \frac{40}{20} = 2.0$ $\frac{AA}{RS} = \frac{12}{20} = 0.60$

Average power =

$$\frac{\text{average power}}{\text{rated power}} \times \text{rated power} = 0.34 \times 5 \text{ kW} = \underline{1.7 \text{ kW}}$$

Annual power =

$$\text{Average power} \times \frac{\text{hours}}{\text{year}} = 1.7 \text{ kW} \times \frac{8760 \text{ hours}}{\text{year}} =$$

$$\underline{\underline{14892 \frac{\text{kW hours}}{\text{year}}}}$$

2. $\frac{CO}{AA} = \frac{40}{12} = 3.33$ $\frac{CI}{AA} = \frac{10}{12} = 0.83$

% down time = 45%, running time = 100% - 45% = 55%

3. $\frac{CO}{AA} = \frac{40}{12} = 3.33$ $\frac{RS}{AA} = \frac{20}{12} = 1.67$

% running at rated = 10%

APPENDIX D

COMPUTATION OF OUTPUT POWER FROM WIND SUMMARIES

D-1

COMPUTATION OF OUTPUT POWER FROM WIND SUMMARIES

Two simple methods can be used to compute the output power from a WECS using a wind summary:

- 1) correlation of onsite data with nearby weather stations (see Method 2 presented in Section 6), and
- 2) computation of output power from a wind summary.

CORRELATION OF WINDS WITH A NEARBY WEATHER STATION

Select a nearby weather station located in the same type of terrain as the WECS site. (This technique does not work well in mountainous terrain.) Collect wind speed data for at least three windy months of the year (late winter and spring are suggested) and use them to compute the average wind speed at the site for the period. Obtain the average wind speed at the weather station for this time period, as well as the long-term wind summary; then divide the three-month average at the site by the three-month average at the station to get the correction factor. Using the long-term wind summary for the weather station, select the midpoint of each speed class and multiply it by the correction factor. In this manner a new wind summary can be constructed for the site which uses the corrected midpoints of each speed class and the original wind speed frequencies from the weather station summary. Use the new wind summary to compute power output.

EXAMPLE CORRELATION PROBLEM

- Given:
- 1) a three-month site average speed of 12.2 mph
 - 2) a three-month weather station average speed of 10.1 mph
 - 3) the long-term wind summary from the weather station (use Table A.1 in Appendix A).

Construct a new wind summary (shown in Table D.1 for the WECS candidate site).

Midpoints of speed classes

0 - 3 = 1.5	13 - 18 = 15.5
4 - 7 = 5.5	19 - 24 = 21.5
8 - 12 = 10.0	25 - 31 = 27.5

Correction factor

$$\frac{\text{Site 3-month average}}{\text{Station 3-month average}} = \frac{12.2}{10.1} = 1.2$$

TABLE D.1. New Wind Summary

New Midpoints (old midpoints x 1.2)	=	1.8	6.6	12.0	18.6	25.8	33.0
Old Frequencies of Wind Speeds (Table A.1)	=	20	41	24	12	3	0

The next step would be to use the newly computed wind summary to compute output power according to guidelines in the following section of Appendix D.

COMPUTATION OF OUTPUT POWER FROM A WIND SUMMARY

The data needed are the output power graphs or tables for the WECS being considered (see Figure D.1) and a wind summary (provided in Table D.2). First, determine the midpoints of each speed class in the wind summary. (Speed classes entirely below the cut-in speed of the WECS need not be considered.) If the wind summary from a nearby weather station is used to compute output power directly (i.e., with no correlation), the midpoints of each speed class may need to be multiplied by a height correction factor. If the height of the wind sensor at the weather station is known, it can be used as the base height. The correction factor can then be determined using the proposed WECS height, Table 4.1, and the instructions in Section 4.1. (The user need not make the height

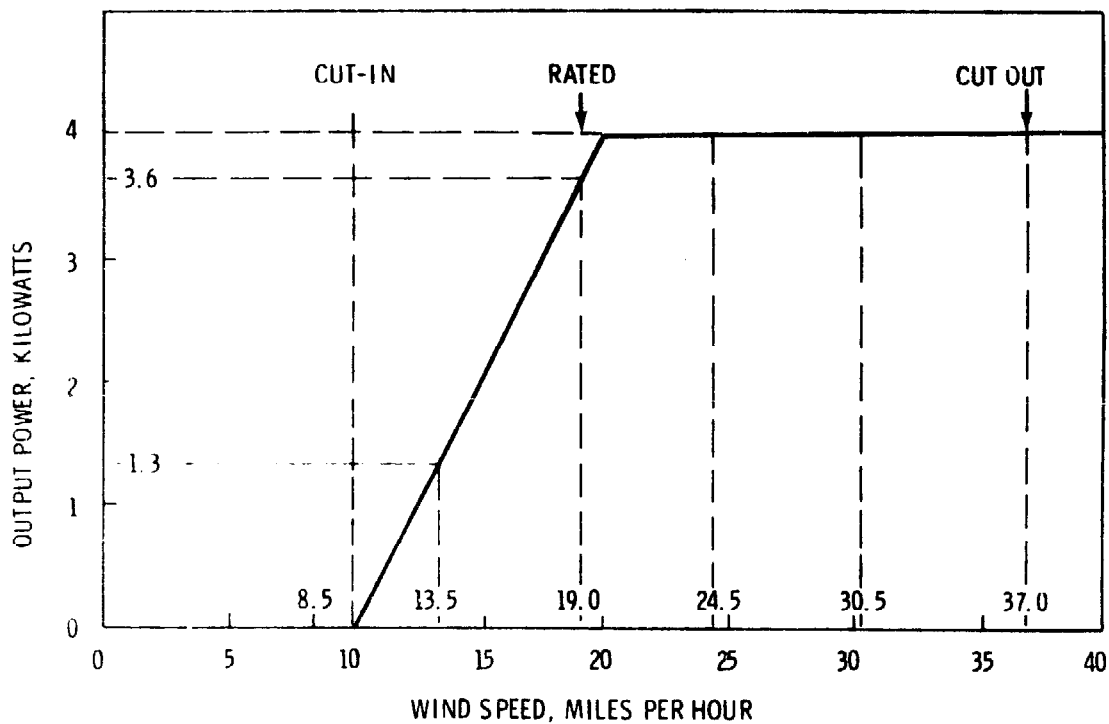

FIGURE D.1. Hypothetical Output Power Curve

correction if the height of the wind sensor and the WECS height are within 10 ft of one another.) Using the power output graph or table for a particular WECS (such as Figure D.1), determine the output power for the midpoint of each speed class (Table D.3). Be certain to convert all wind speeds to the same units before reading the output power. The final step is to multiply the output power for each speed class by the hours that the speed occurred (Table D.4); then add these products to obtain the total power expected per year.

Example of an Output Power Calculation from a Wind Summary

- Given: 1) the hypothetical power curve for a WECS in Figure D.1
 2) the hypothetical percentage frequency of wind speed and direction summary in Table D.2.

Compute the annual power output of the WECS.

**TABLE D.2. Hypothetical Wind Summary
(% Frequency of Occurrence)**

Direction	Speed (mph)								Percent	Mean Wind Speed
	1-3	4-6	7-10	11-16	17-21	22-27	28-33	34-40		
N	0.7	2.0	2.3	1.7	0.6	0.2	0.0		7.5	9.3
NNE	0.4	1.2	1.4	1.3	0.4	0.1	0.0		4.7	9.8
NE	0.4	1.3	1.4	0.6	0.2	0.0	0.0		3.9	8.1
ENE	0.3	0.7	0.4	0.3	0.0	0.0			1.7	6.8
E	0.4	0.7	0.3	0.1	0.1	0.0	0.0		1.7	6.5
ESE	0.4	0.8	0.3	0.1	0.0				1.7	5.6
SE	0.7	1.5	1.2	0.4	0.1	0.0			3.9	6.7
SSE	0.6	1.7	1.2	0.4	0.1				4.0	6.8
S	0.9	2.1	2.0	0.7	0.2	0.0			5.9	7.3
SSW	0.4	1.6	2.4	1.6	0.2	0.0			6.3	8.9
SW	0.5	1.5	2.3	3.0	1.0	0.2			8.3	11.0
WSW	0.3	0.9	1.1	1.0	0.3	0.0			3.6	9.6
W	0.6	1.6	1.4	1.2	0.4	0.1	0.0	0.0	5.3	9.0
WNW	0.6	1.7	1.8	1.9	1.1	0.5	0.1	0.0	7.6	11.3
NW	0.8	2.5	3.0	3.6	2.2	1.4	0.4	0.1	14.0	12.8
NNW	0.6	2.2	2.8	2.5	1.3	0.5	0.1	0.0	10.0	11.0
CALM									9.8	
% of Time Wind in Speed Range	8.6	24.1	25.3	20.4	8.1	3.0	0.6	0.1	100.0	8.8

TABLE D.3. Hypothetical Output Power by Speed Class

Midpoints of Speed Classes (mph) (Table D.2)	13.5	19.0	24.5	30.5	37.0
Power at Midpoints (kW) from Figure D.1	1.3	3.6	4.0	4.0	4.0

**TABLE D.4. Conversion of % Frequencies to Hours
(hr/yr = 365 x 24 = 8760)**

Speed Class	13.5	19.0	24.5	30.5	37.0
Percent Frequency	20.4	8.1	3.0	0.6	0.1
Hr of Occurrence/Yr (% x 8760 : 100)	1787	709	263	52	9

Power at midpoint (kW) x hr of occurrence/yr = kW hr/yr.

1.3 x	1787	=	2323.1
3.6 x	709	=	2552.4
4.0 x	263	=	1052.0
4.0 x	52	=	208.0
4.0 x	9	=	<u>36.0</u>

Total kW hr/yr 6171.5

If the user has collected and summarized a year of onsite winds, he should determine if the collected data is typical for the area. To do that wind statistics for the current year at a nearby station (i.e., the year in which onsite data were collected) can be compared with the long-term average at the station. All wind speed observations can be corrected for an abnormal year by multiplying them by this ratio: D/L , where "D" is the weather station annual average speed for the year of data, and "L" is the long-term average speed. For example, suppose the year examined was unusually windy. Assume that "L" for the nearest weather station was 10 mph, and "D" was 13 mph. To make the correction the midpoint of each speed class in Table D.3 should be multiplied by D/L , which equals $10/13$ or 0.77. In this example multiplying by the ratio will reduce the power at the midpoints obtained from Figure D.1. Completing the annual output power calculations will yield a lower, but more typical, annual power.

The output power computed above is the power flowing directly from the generator before any losses from resistance in the wiring or from an inefficient storage system. Such losses of power depend upon the system's design, and should be discussed with the dealer before a particular machine and storage/backup system is selected.

APPENDIX E

UNITS CONVERSION

UNITS CONVERSION

Length

$$\text{Feet} = \text{Meters} \times 3.28$$

$$\text{Meters} = \text{Feet} \times 0.305$$

$$\text{Miles} = \text{Kilometers} \times 0.621$$

$$\text{Kilometers} = \text{Miles} \times 1.609$$

$$\text{Miles} = \text{Nautical miles} \times 1.15$$

$$\text{Nautical Miles} = \text{Miles} \times 0.869$$

$$\text{Kilometers} = \text{Nautical miles} \times 1.852$$

Speed

$$\text{Miles per hour (mph)} = \text{Meters per second} \times 2.24$$

$$\text{Meters per second} = \text{mph} \times 0.447$$

$$\text{mph} = \text{Knots} \times 1.15$$

$$\text{Knots} = \text{mph} \times 0.869$$

$$\text{Knots} = \text{Meters per second} \times 1.94$$

$$\text{Meters per second} = \text{Knots} \times 0.514$$

$$\text{Kilometers per hour} = \text{Meters per second} \times 3.6$$

Area

$$\text{Square feet} = \text{Square meters} \times 10.76$$

$$\text{Square meters} = \text{Square feet} \times 0.093$$

Power

$$\text{Horsepower} = \text{Watts} \times 0.00134$$

$$\text{Watts} = \text{Horsepower} \times 746$$

$$\text{Horsepower} = \text{Kilowatts} \times 1.34$$

$$\text{Kilowatts} = \text{Horsepower} \times 0.746$$

$$\text{Kilowatts} = \text{Watts} \times 1000$$