

AT MICROFICHE REFERENCE LIBRARY

A project of Volunteers in Asia

Selecting Water-Pumping Windmills

Published by:

New Mexico Energy Institute
New Mexico State University
Box 3EI
Las Cruces, NM 88003 USA

Available from:

New Mexico Energy Institute
New Mexico State University
Box 3EI
Las Cruces, NM 88003 USA

Reproduced by permission of the New Mexico Energy Institute, New Mexico State University.

Reproduction of this microfiche document in any form is subject to the same restrictions as those of the original document.

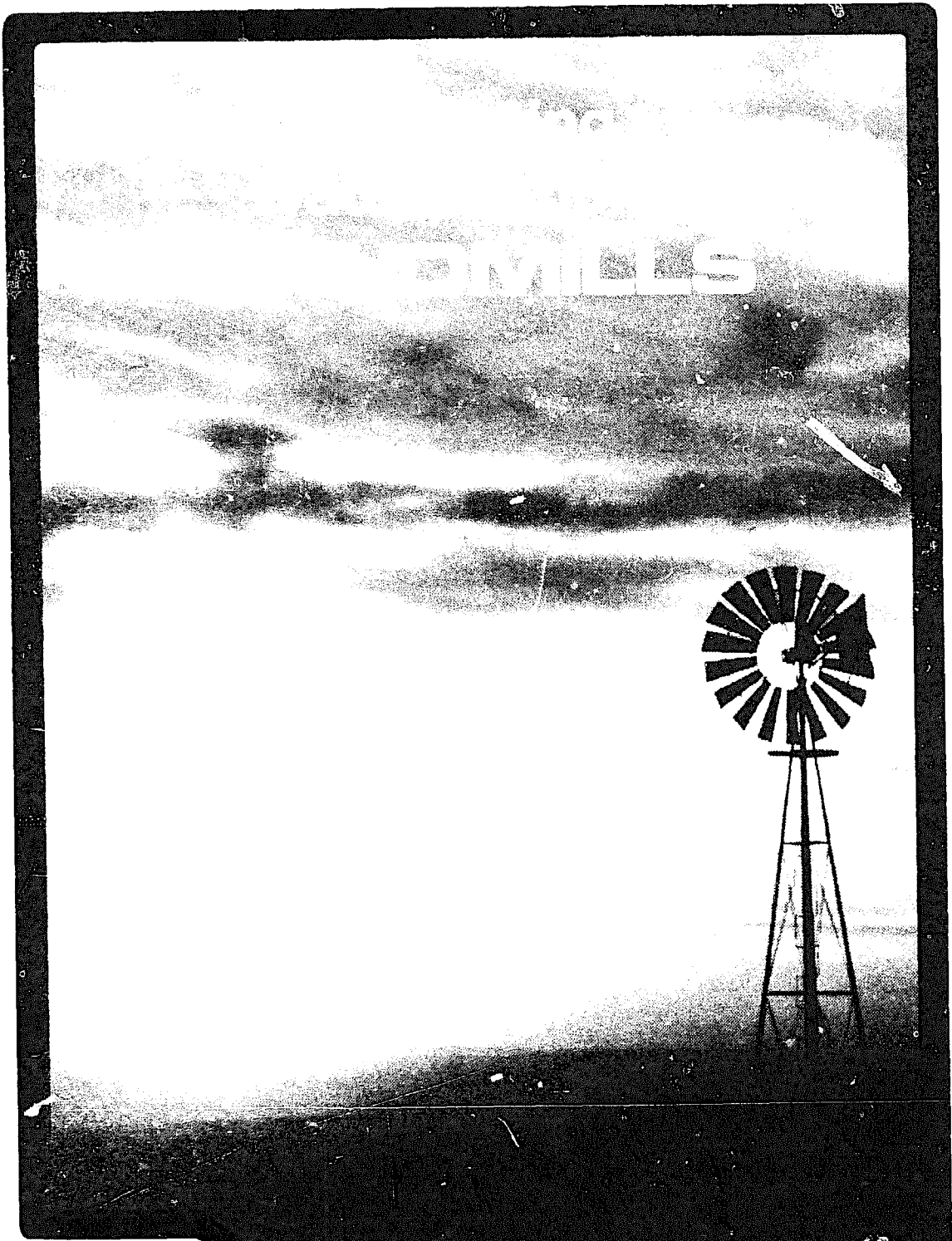

WINDMILLS

**NEW
MEXICO
ENERGY
INSTITUTE**

NMFI 11-0.6M

Selecting Water-Pumping **WINDMILLS**

Published by

**NEW
MEXICO
ENERGY
INSTITUTE**

P.O. Box 3E1 Las Cruces, New Mexico 88003
505 646-1745 NMEI 11-0-6M Jan 78

Cover Photo—Tom Hayward (Fhotec)

TABLE OF CONTENTS

Introduction	page 1
PART ONE: The Windmill, What It Does and How It Works	pages 2-6
I. Parts and Top Assembly • II. The Tower • III. The Well Seal and Pump Rod Assembly • IV. The Packerhead • V. The Drop Pipe • VI. The Cylinder and Screen	
PART TWO: Lift, Transport and Storage	pages 8-10
I. The Elevated Discharge Pipe • II. The Booster Mill • III. Tanks	
PART THREE: Siting and Sizing	pages 11-12
I. Traditional Approaches • II. Where to Put a Windmill • III. Choosing the Right Size	

The staff of the New Mexico Energy Institute at New Mexico State University is pleased to acknowledge the advice and support it received from several sources in preparing this handbook. Mr. Howard Dufford of Dempster Industries and Mr. Max Kelley of the Heller-Aller Company shared their time and knowledge with utmost generosity. Thanks are also due to the windmill resource people at the College of Agriculture and the Physical Science Laboratory at New Mexico State University. Without them this project would not have been possible.

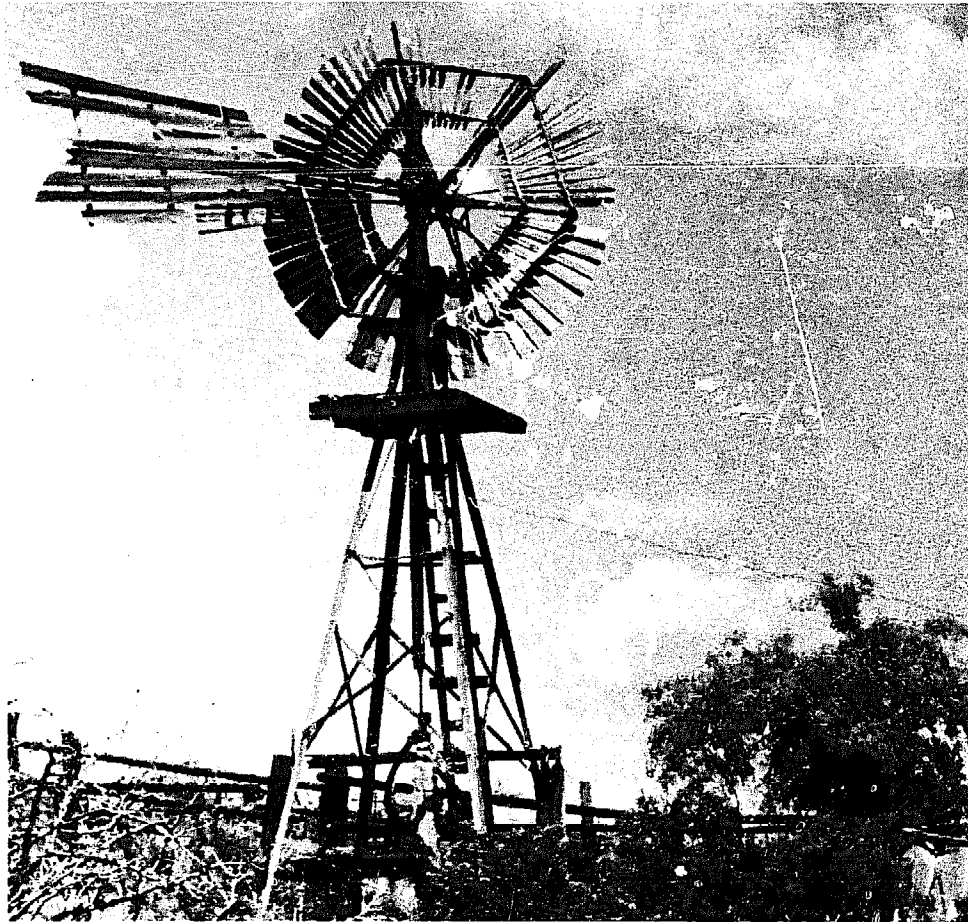

Fig. 1

INTRODUCTION

In 1854 Daniel Halladay invented a device for pumping well water with wind power. This simple machine, called a windmill, underwent a few improvements over the years, but the basic design remained unchanged. For many decades windmills were among the most familiar sights on the American prairie. Then, with the coming of rural electrification in the 1930's, they began falling into disuse.

Today windmills are staging a comeback thanks to rising conventional energy prices and the threat of power shortages. A piece of equipment which requires only wind to operate and, properly installed and maintained, can give over 40 years reliable service is a very attractive investment indeed.

Figure 1 shows a windmill built in 1888 by the A.J. Corcoran Company of New York. It is still in use on the J.M. Smith ranch in southwestern New Mexico, thus testifying to the durability of Daniel Halladay's wind-driven water pump.

PART ONE: The Windmill, What It Does and How It Works

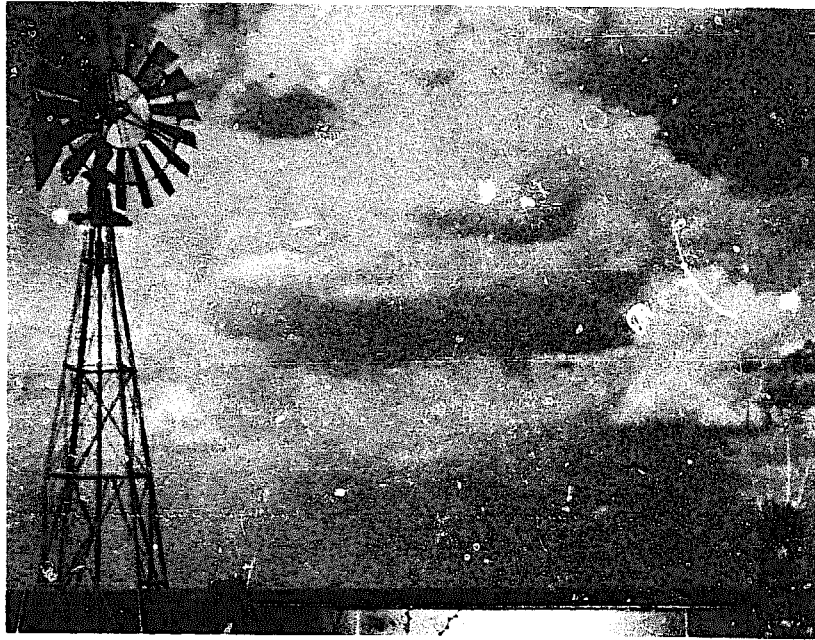

Fig. 2

I. Parts and Top Assembly

Figure 2 is a photograph of a typical windmill which supplies water for livestock. The tank next to it was deliberately made too high for animals to drink from since its purpose is to store water for distribution to troughs in several pastures. Figure 3 diagrams the basic parts of such a rig which are:

- the wheel, gear box and tail (top assembly)
- the tower
- the drive shaft
- the swivel
- the red rod, polished rod and sucker rod
(pump rod assembly)
- the packerhead
- the discharge pipe
- the well seal
- the drop pipe
- the cylinder and screen

The diameter of the wheel is a major factor in determining windmill size and is discussed in detail in Section 2 of Part Three. The diameters of commercially produced wheels range from 6 to 16 feet in 2-foot increments. Wheels 20 feet across are available on special order.

The wheel connects to a gear box which converts its rotary motion into vertical motion for pumping. The gear box contains a spring mechanism which allows the tail to fold parallel to the wheel in a high wind. This effectively shuts down the mill and prevents its self-destruction. When the gale subsides, the tail is released so it may turn the wheel back into the wind.

II. The Tower

The most important consideration in choosing a tower is the need to get the wheel above wind obstructions. The tower should be at least 10 feet higher than any tree, hill or building within a hundred yards of the mill site. Commercially produced towers come in 6-foot increments from 21 to 47 feet high.

It is also crucial for a tower to be strong enough to support the wheel mounted on top of it. Manufacturers' recommendations on matching towers with wheels are invariably detailed and precise, and they should be followed to the letter. The instruction sheets for tower assembly are similarly exact and deserve the same close attention.

Keeping the entire mill as easy to service as possible is a further concern in tower selection. Do remember that hoisting the underground pump mechanism for repair and maintenance is much easier if the tower height is a few feet more than the longest section of drop pipe or sucker rod.

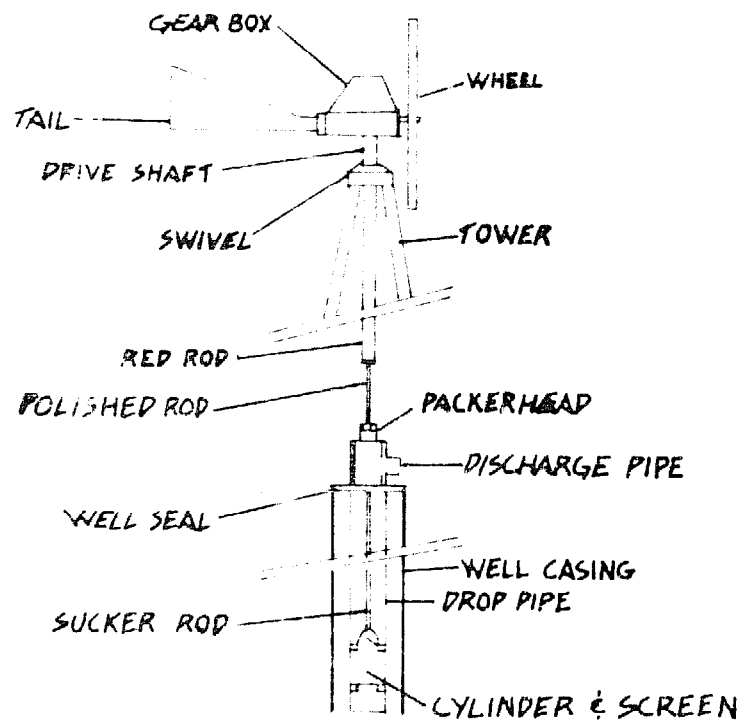

Fig. 3

III. The Well Seal and Pump Rod Assembly

Figure 4 details the pump rod assembly and a well seal with a packerhead. The well seal serves a double purpose. It keeps dirt, insects, thirsty rodents, lizards and other small animals from falling into the well and causing contamination. Also, it acts as a base for holding the drop pipe firmly in place.

The uppermost part of the pump rod assembly is the red rod. It is designed to be the weakest link in the pump train and, as such, should consist of a wooden spar no thicker than 2 inches. If anything goes wrong above or below it, the red rod is supposed to break in order to minimize damage to other more expensive or hard to reach parts.

Extending downwards from the red rod through the packerhead and well seal is the polished rod. It is usually made of brass to reduce friction. Also, brass resists corrosion, and this is important for a part that works in both air and water.

At its bottom end a coupling fastens the polished rod to the sucker rod. In general, mills which pump water no more than a hundred feet above well level have solid steel sucker rods. Those which raise water 100 to 250 feet use hollow steel. Deep well rigs take advantage of the lightness and buoyancy of wooden sucker rods to provide lift capacities of more than 250 feet.

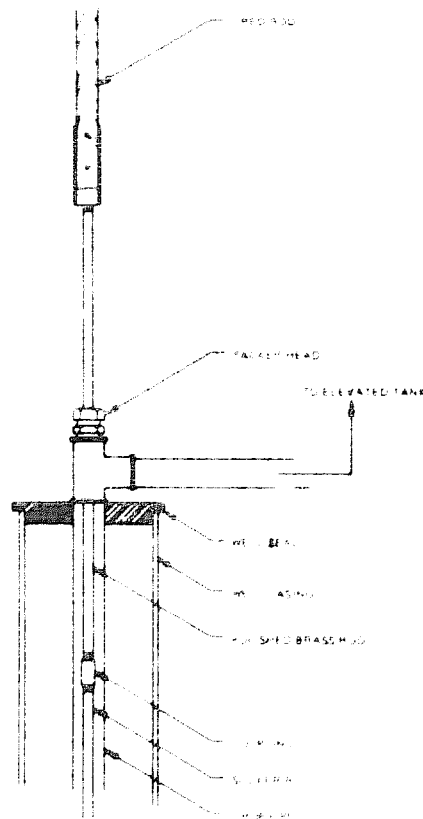

Fig. 4

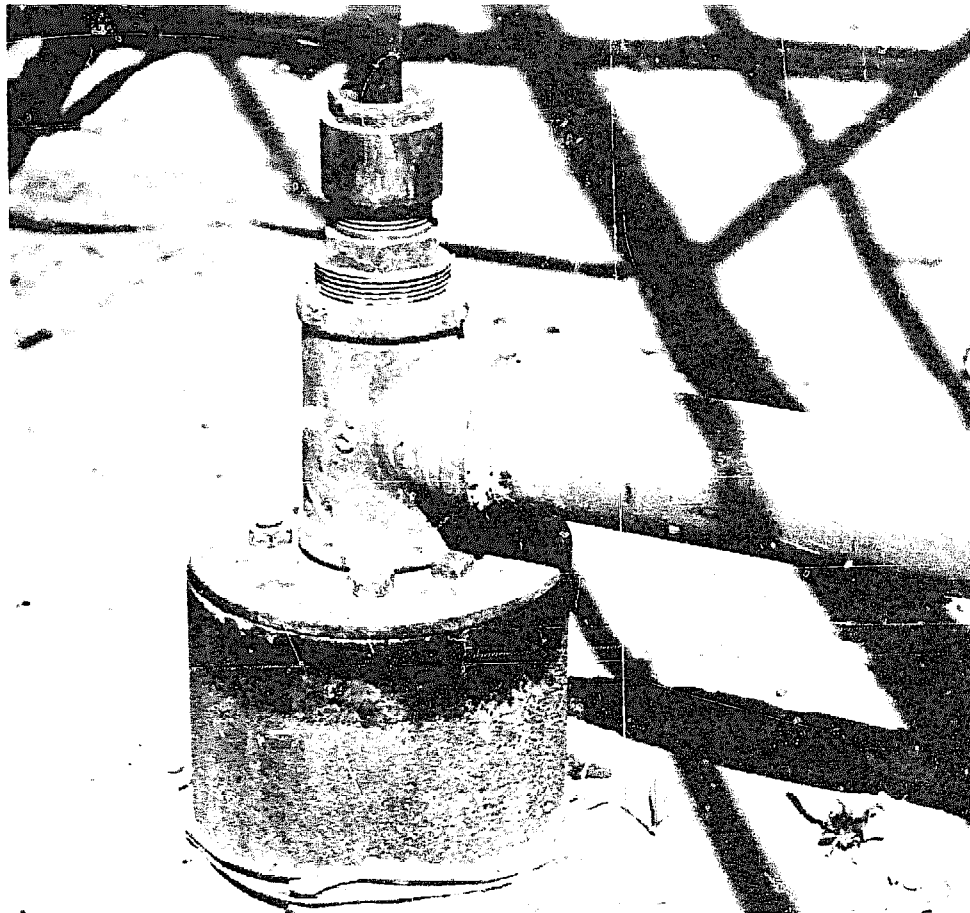

Fig. 5

IV. The Packerhead

A packerhead is a fitting usually made of brass which goes over the top of the drop pipe to prevent overflow. Figure 4 locates the part in diagram, and Figure 5 shows it photographically. A packerhead is necessary to pump water any higher than the inlet to the discharge pipe. A check valve at the same point may also be useful to keep water flowing to an elevated tank instead of spilling back into the well.

If there is any danger of freezing, however, it is best either to eliminate this check or install it along with the packerhead in a protected underground housing. A key factor in designing any windmill system is making sure that water will not remain too long in exposed uninsulated lines where it might freeze.

To pump water to a nearby tank below the level of the discharge pipe no packerhead is necessary. Still, it is often worth the trouble to install one. The fitting is not expensive, and it helps avoid well contamination.

V. The Drop Pipe

The well driller usually cases the well, and the windmill owner may then lower the drop pipe into place as part of the set-up procedure. A good grade of galvanized pipe in any standard size may serve as a drop pipe. Though other diameters of pipe may be preferable for some purposes, 2 inches is common for supplying domestic water.

It is important in choosing a drop pipe to make sure that it is smooth on the inside. Otherwise, replacement leathers are likely to be damaged when the plunger is lowered back into the cylinder. In extremely deep wells paying an extra 10 to 15 percent for the added smoothness of reamed and drifted pipe can be a wise investment. For lesser depths, however, good quality galvanized pipe usually proves satisfactory.

VI. The Cylinder and Screen

Figure 6 shows a cylinder. Its diameter and the length of the plunger stroke inside it are major factors in determining the windmill's pumping capacity. Standard cylinders range from 1 7/8 to 4 inches in diameter in increments of a quarter inch. Other sizes are available on special order.

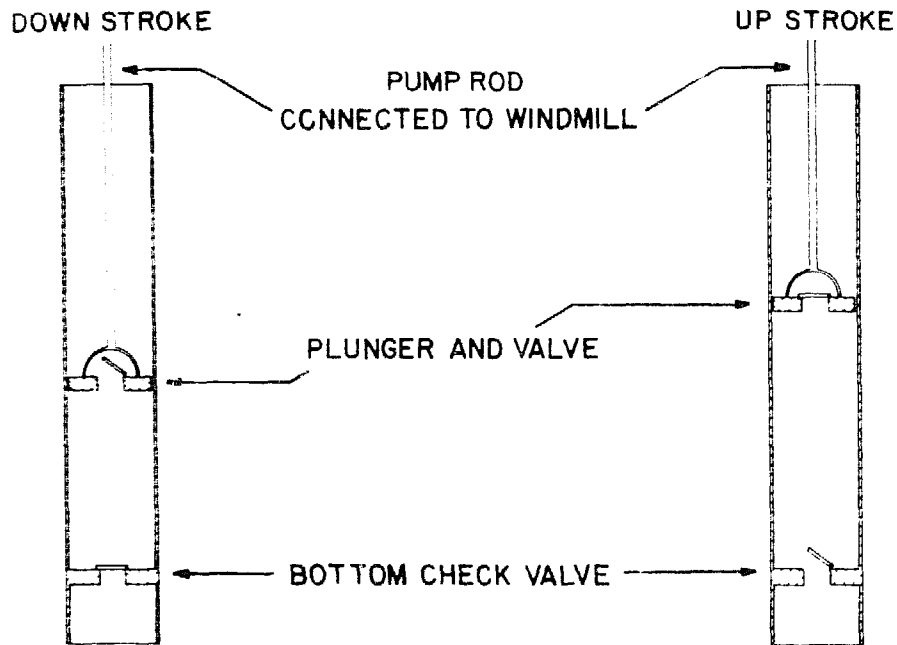

Fig. 6

The stroke of a windmill is the distance which the plunger moves up and down. A short stroke enables the mill to begin pumping in a light breeze, but in stronger breezes a long stroke causes more water to be pumped. Many gearboxes are designed to permit stroke adjustment, thus assuring optimum performance for a given windmill model under a variety of conditions.

In essence, the cylinder is the bottom of the drop pipe. It usually screws into the latter and is about 1/8 inch smaller in diameter. The size difference is a maintenance feature designed to assure the plunger enough leeway to move freely through the larger drop pipe. This facilitates changing the leathers which fit around the plunger and serve to assure a tight fit between it and the cylinder.

The smaller cylinder also provides a way to pull the bottom check valve if necessary. A set of threads in plunger and check valve makes it possible to connect the two and raise them as a single unit.

It usually is wise to put a screen just below the cylinder to prevent sand and other sediment from getting into the pump system and shortening its useful life.

PART TWO: Lift, Transport and Storage

I. The Elevated Discharge Pipe

The best way to build up water pressure is to raise the storage tank. If there is a hill nearby, this may be done in the manner illustrated by Figure 7. Otherwise, a tower is necessary. Each foot of elevation produces an additional .433 pounds of pressure per square inch (psi) in the line from tank bottom to outlet. Since a domestic faucet must have a pressure of at least 10 psi to work properly, it requires a minimum water elevation, or "head," of 23.1 feet. Dishwashers and washing machines demand 18 psi or 41.48 feet of head.

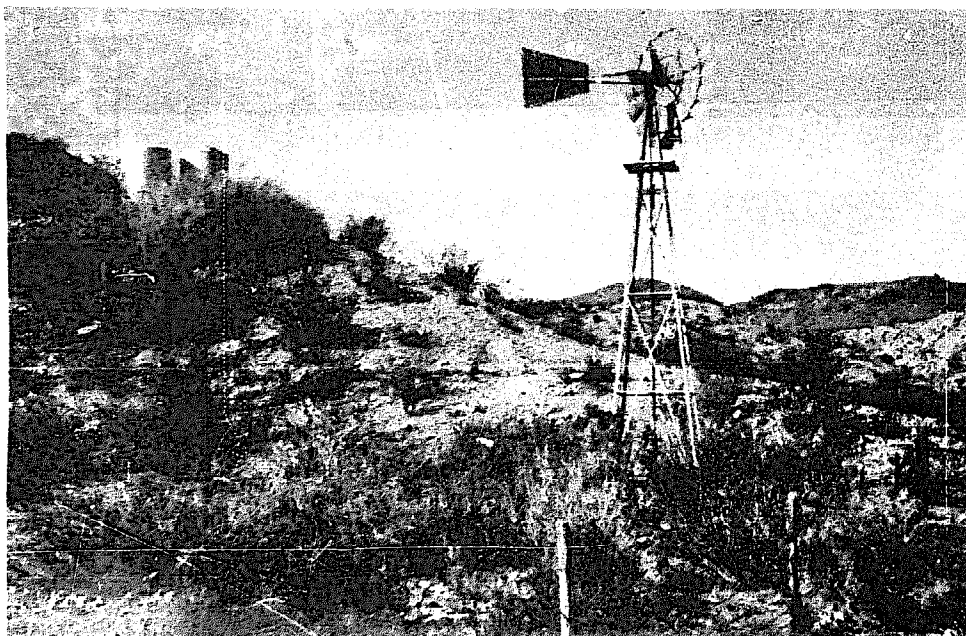

Fig. 7 The storage tanks at the upper left hold 1,700 gallons each. They stand 47 feet above ground-level at the site of the windmill which has been pumping water up the hill since 1928.

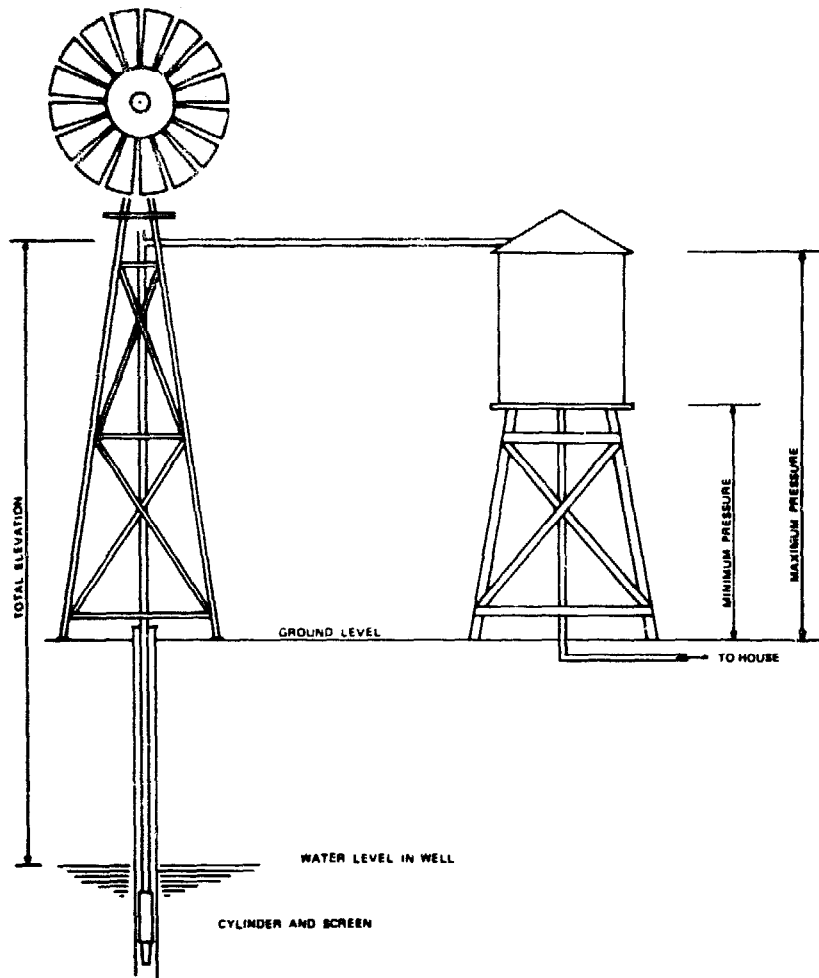

Fig. 8

The easiest way to pump water into a raised tank with a windmill is to extend the drop pipe as far as it can go without interfering with the swivel. As shown in Figure 8, this makes it possible to elevate the outlet to the discharge pipe virtually to the top of the tower.

An assembly of this type has the advantages of minimizing the length of the discharge line and lifting water as high as the windmill can pump it without a packerhead. The main disadvantages are elimination of the red rod as a safety feature and the system's inability to pump water any higher than the tower.

II. The Booster Mill

Booster mills can provide added capacity for transporting water some distance uphill or overland. While the main mill draws water from a well, the booster straddles a holding tank. It is thus in a position to reinforce the pumping process and maintain flow in a long line.

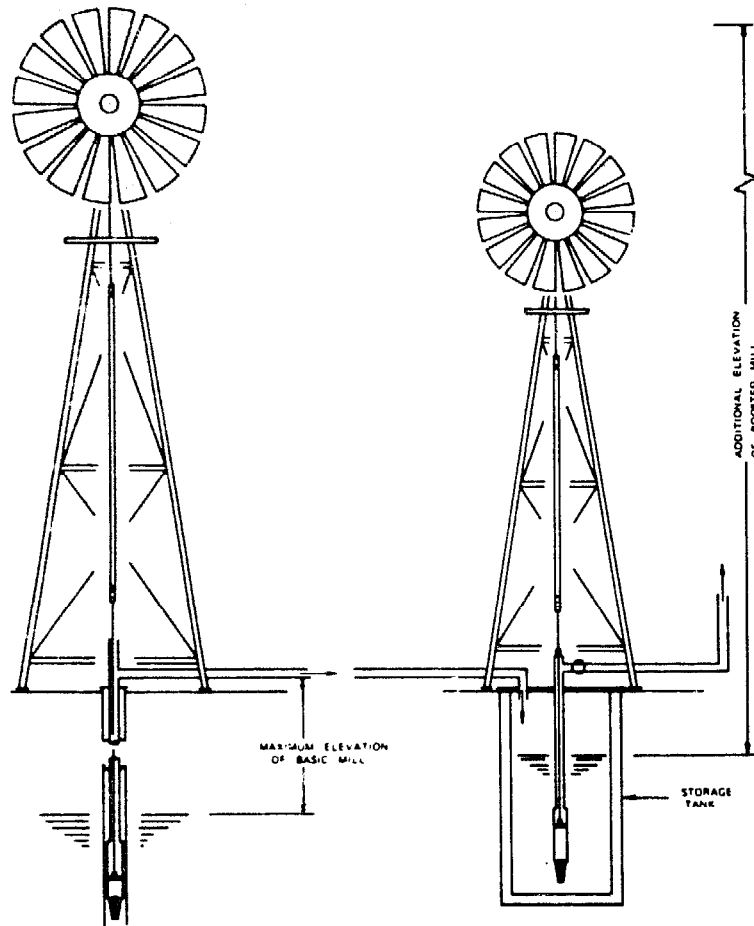

Fig. 9

Figure 9 shows schematically the relation between two windmills operating in tandem. Ordinarily, the booster mill has a lower tower in order to avoid wind interference between the two rigs. Though the distance between the two mills may vary considerably, they are unlikely to work well if placed closer than 50 feet apart.

III. Tanks

Tanks come in a variety of shapes, sizes and types, and windmills may be used to supply them all. The ordinary stock tank is low and open across the top so that animals can drink from it. The key consideration in choosing one is that the holding capacity be sufficient to water the herd which uses it.

Tanks storing water for human consumption involve a number of factors. Not only must they be well covered to prevent contamination from bird droppings and airborne debris, but they must, as noted in the discussion of lift, be high enough to assure good water pressure.

To determine the size tank needed for a domestic water supply, it is first necessary to estimate the number of gallons a household uses on an average day. Windmill salesmen customarily assume a daily per capita consumption of 50 gallons, and studies by academic experts on rural life also indicate that this figure is reasonably accurate. It remains then to decide how much reserve water a family ought to keep on hand.

A tank able to store up to a ten-day water supply offers some important advantages. The main one, of course, is that it greatly reduces the likelihood that the system will ever run dry. At the same time, it provides a substantial reserve for fire fighting should the need ever arise and offers a surplus for such purposes as keeping a small garden.

On the other extreme, minimum tank capacity to insure against periods of windlessness varies greatly from place to place. In the Southwest studies indicate that in low wind areas a reserve water supply equal to as many as seven days' average household use may be most desirable. In high wind areas it may be possible to get by with as little as three days' supply.

As in all matters concerning windmills, the best source of advice is usually a nearby owner or someone who remembers a time when windmills were in use in a particular locale. County agents are another possible information source. As a further aid in tank selection, the table in Figure 10 shows the content of cylindrical tanks for each foot in depth.

Inside Diameter		Gallons One Foot In Depth	Inside Diameter		Gallons One Foot In Depth
Ft.	In.		Ft.	In.	
1	0	5.87	5	9	194.19
1	3	9.17	6	0	211.44
1	6	13.21	6	3	229.43
1	9	17.98	6	6	248.15
2	0	23.49	6	9	267.61
2	3	29.73	7	0	287.80
2	6	36.70	7	3	308.72
2	9	44.41	7	6	330.38
3	0	52.86	7	9	352.76
3	3	62.03	8	0	375.90
3	6	73.15	8	3	399.76
3	9	82.59	8	6	424.36
4	0	93.97	8	9	449.21
4	3	103.03	9	0	475.80
4	6	118.93	9	3	502.65
4	9	132.52	9	6	530.18
5	0	146.83	9	9	558.45
5	3	161.88	10	0	587.47
5	6	177.67	10	3	617.17

Fig. 10

Inside Diameter		Gallons One Foot In Depth	Inside Diameter		Gallons One Foot In Depth
Ft.	In.		Ft.	In.	
10	6	653.69	15	3	1365.96
10	9	679.88	15	6	1407.51
11	0	706.07	15	9	1457.00
11	3	743.36	16	0	1503.62
11	6	776.77	16	3	1550.97
11	9	810.91	16	6	1599.06
12	0	848.18	16	9	1647.89
12	3	881.39	17	0	1697.45
12	6	917.73	17	3	1747.74
12	9	954.81	17	6	1798.76
13	0	992.62	17	9	1850.53
13	3	1031.17	18	0	1903.02
13	6	1070.45	18	3	1956.25
13	9	1108.06	18	6	2010.21
14	0	1151.21	18	9	2064.91
14	3	1192.69	19	0	2121.58
14	6	1234.91	19	3	2176.68
14	9	1277.86	19	6	2233.52
15	0	1321.54	20	0	2349.46

PART THREE: Siting and Sizing

I. Traditional Approaches

In the late nineteenth and early twentieth centuries windmill sales boomed, and windmill lore was widespread. Many well drillers in rural areas also sold and installed windmills. The purchase prices they quoted normally included set-up costs. Telling a buyer what size mill to buy and where to put it was a matter of drawing on rule of thumb knowledge plus a considerable store of vernacular wisdom about local water availability and wind conditions.

Unfortunately, little was ever written about traditional siting and sizing methods. This presents modern buyers, who often prefer to set up their own rigs, with something of an information gap. Engineers seeking to fill it combine what knowledge they can recover with the empirical findings of their own observations and research.

II. Where to Put a Windmill

It obviously makes no sense to put a windmill where there is no water, but where there is a choice of sites for drilling wells, factors concerning the windmill may be worth thinking about.

Deciding whether there is enough wind in an area to meet a specific water need with a windmill is largely a matter of particulars. Statements

about site selection are usually generalizations, and they are no substitute for familiarity with local conditions.

The rule of thumb in New Mexico is that most windmills will pump the equivalent of 8 hours a day at the rate produced by a 15-mile-an-hour wind. However, April tends to have the strongest winds and August the lightest. Maximum storage capacity serves under these circumstances as an important safeguard against periods of light breezes.

In open areas the choice of a specific windmill site is usually fairly simple. The main consideration is, as already noted, to get the wheel at least 10 feet above and 300 feet away from all wind obstructions. Even where there are no obstructions, though, tower height is worth thinking about since the wheel is likely to catch more wind at greater elevations. Wind availability at 50 feet, for example, may be 7 or 8 percent greater than at 30 feet.

Uneven terrain alters the process of site selection. Narrow valleys produce a funnelling effect which results in higher winds at lower elevations. Wide valleys tend to have light winds. In any case, longtime residents of an area are often the best source of wind information, and this is doubly true if they have experience with or memories of windmills in a given locale. Additional advice may be obtainable through the nearest weather station, a county agent, an airport or a university. The New Mexico Energy Institute at New Mexico State University has data on wind availability for many areas of the state.

III. Choosing the Right Size Windmill

Given adequate wind, the key to windmill selection is determining the amount of water which must be pumped and the height to which it must be lifted. The distance water must travel from the bottom of the pump cylinder to the top of the tank is the total elevation. Thus, picking a windmill is a matter of deciding what size system will pump the desired average number of gallons per hour to a particular total elevation.

Figure 11 shows the pumping capacities in a 15-mile-an-hour wind of several sizes of windmills at minimum stroke settings. Lengthening the stroke on mills designed for such adjustment results in more gallons of pumping per hour, but it decreases the total elevation to which water may be raised. Increasing the diameter of the wheel results in pumping to greater total elevation.

It is usually best to choose the largest wheel and the smallest cylinder consistent with need. This not only starts pumping in lighter winds, but it also minimizes mechanical strain on the system as a whole.

**TOTAL ELEVATIONS IN FEET
AND CAPACITIES IN GALLONS PER HOUR**

SIZE OF WINDMILL

CYLINDER SIZE	6 FT.		8 FT.		10 FT.		12 FT.		14 FT.		16 FT.		20 FT.	
	ELEV.	G.P.H.	ELEV.	G.P.H.	ELEV.	G.P.H.	ELEV.	G.P.H.	ELEV.	G.P.H.	ELEV.	G.P.H.	ELEV.	G.P.H.
1-7/8	120	115	175	119	260	103	390	121	570	103	920	138	1200	162
2	95	122	140	135	215	117	320	137	456	118	750	157	1026	184
2-1/4	77	165	112	170	170	148	250	174	360	149	590	199	903	232
2-1/2	65	204	94	210	140	182	210	214	300	184	490	245	896	287
2-3/4	56	247	80	255	120	221	175	259	260	222	425	296	692	347
3	47	294	68	303	100	263	149	308	220	264	360	353	603	413
3-1/4	39	345	55	356	87	308	128	362	186	311	305	414	496	485
3-1/2	34	400	49	412	75	357	111	420	161	360	265	480	390	562
3-3/4	29	459	42	474	65	411	96	482	141	413	230	551	310	646
4	27	522	38	539	57	467	85	548	124	470	200	627	252	734

**NOTE: TABLE IS BASED ON A 15 M.P.H. WIND
WITH MINIMUM CYLINDER STROKE SETTINGS.
FOR 10 M.P.H. WIND REDUCE CAPACITIES BY 38%.
18 FT. WINDMILL IS NOT AVAILABLE.
CYLINDER SIZE IS DIAMETER IN INCHES.
SIZE OF WINDMILL IS DIAMETER OF WHEEL IN FEET.**

Fig. 11

For Further Information

If you wish to consider a windmill for a water use of your own, you may want to talk with a distributor. The New Mexico Energy Institute at New Mexico State University has a directory of sales and services outlets, and you are welcome to write for a copy. It also has state-specific materials on wind availability which you may request. You may also write any of the three windmill manufacturers in the United States at the addresses given below. Or you may check libraries and bookstores for further information.

Addresses of Domestic Windmill Manufacturers:

Aermotor—P.O. Box 1364, Conway, Arkansas 72032

Dempster—P.O. Box 848, Beatrice, Nebraska 68310

Baker—The Heller-Aller Co., Corner Perry & Oakwood, Napoleon, Ohio 43545

The New Mexico State University Windmill Course

To further interest in windmills, New Mexico State University offers a course in windmill technology on a bi-annual basis. Its objective is to offer training in windmill uses. The course covers installation, overhaul and repair of existing mills as well as water production and distribution. Figure 12 shows a student in action in the outdoor classroom where new and old windmills are assembled and installed and all aspects of well equipment and actual water pumping are examined. For further information, write Department of Agricultural and Extension Education, Box 3501, New Mexico State University, Las Cruces, New Mexico 88003.

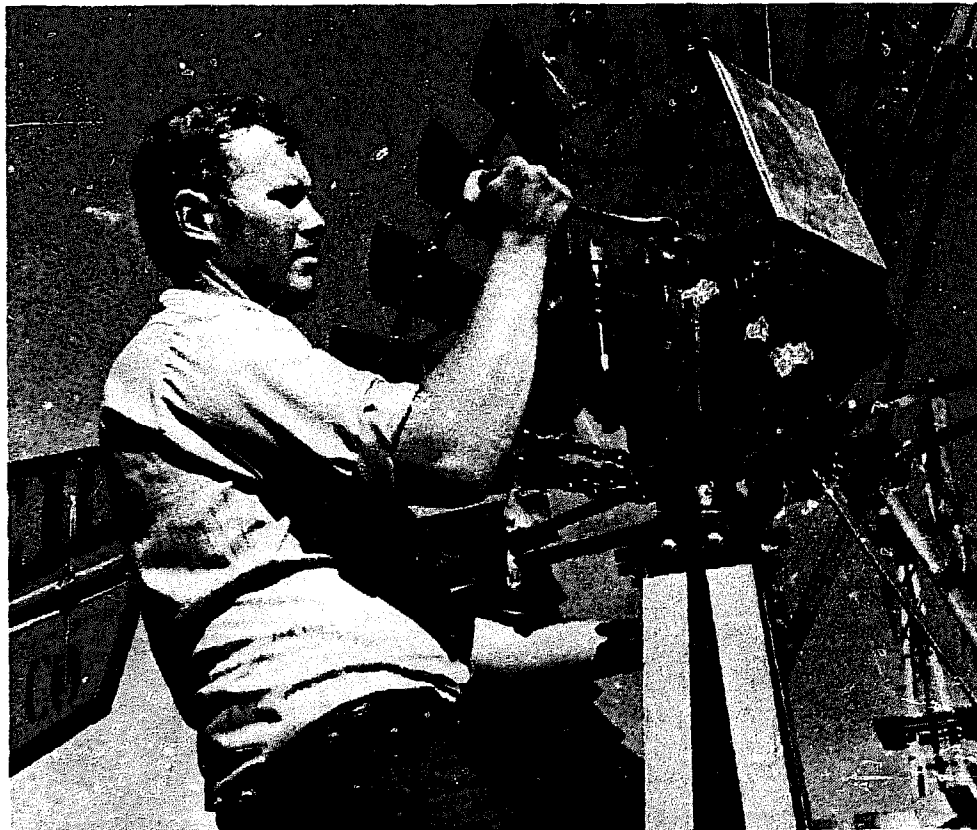

Fig. 12