

AT MICROFICHE
REFERENCE
LIBRARY

A project of Volunteers in Asia

Matching of Wind Motors to Low Power Electrical
Generators

by: H.J. Hengeveld, E.H. Lysen, and L.M.M.
Paulissen

Published by:
Steering Committee for Wind Energy in
Developing Countries
P.O. Box 85
3800 AB Amersfoort
The Netherlands

Paper copies are \$ 7.00; free copies are
available to research institutes in developing
countries.

Available from:
Steering Committee for Wind Energy in
Developing Countries
P.O. Box 85
3800 AB Amersfoort
The Netherlands

Reproduced by permission of the Steering
Committee for Wind Energy in Developing Countries.

Reproduction of this microfiche document in any
form is subject to the same restrictions as those
of the original document.

Matching of wind rotors to low power electrical generators

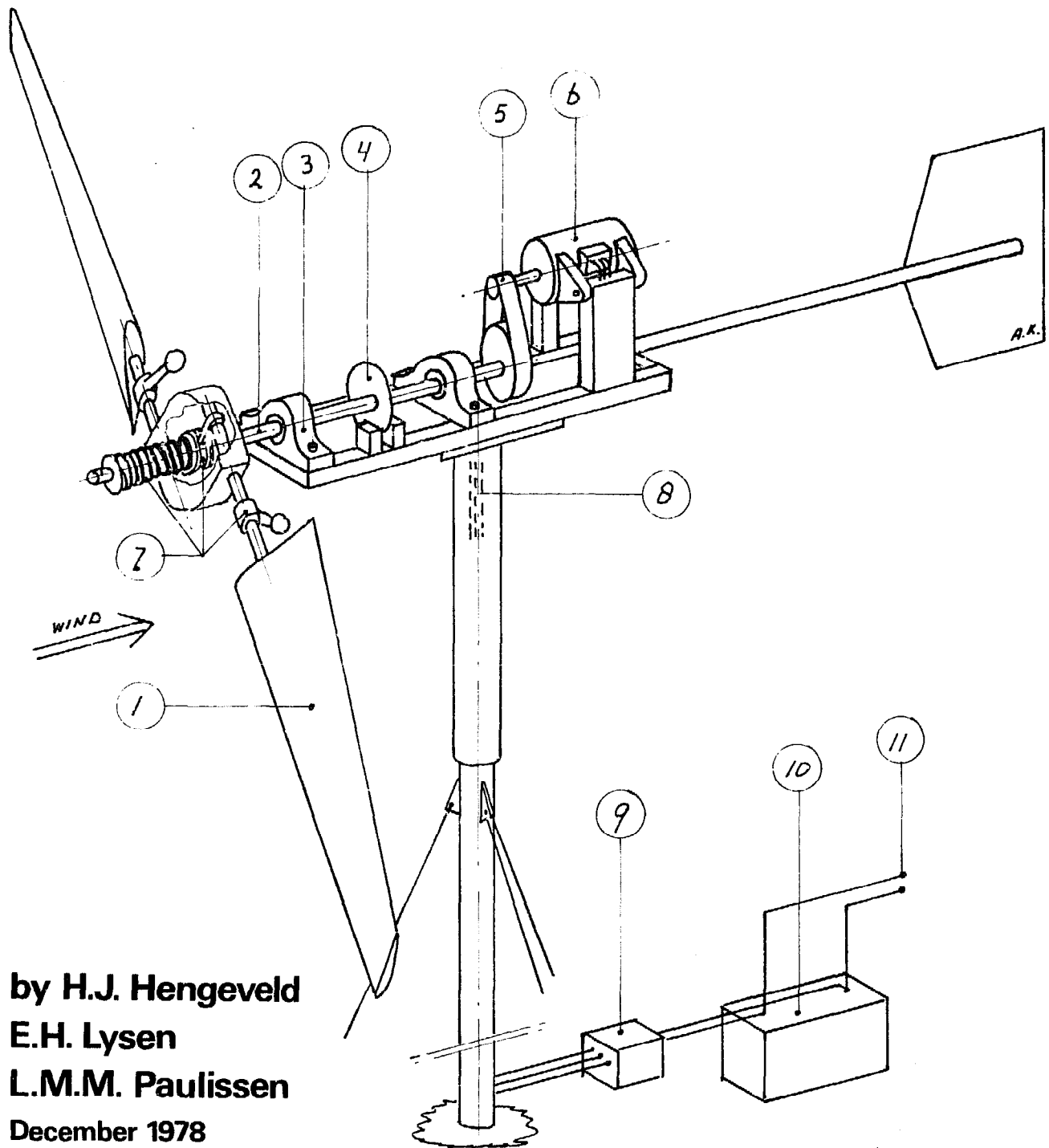

by H.J. Hengeveld
E.H. Lysen
L.M.M. Paulissen
December 1978



STEERING COMMITTEE ON WIND-ENERGY FOR
DEVELOPING COUNTRIES

(Stuurgroep Wind-energie Ontwikkelingslanden)

P.O. BOX 85 / AMERSFOORT / THE NETHERLANDS

MATCHING OF WIND ROTORS TO LOW POWER ELECTRICAL GENERATORS
FOR A GIVEN WIND REGIME

BY:

H.J. Hengeveld

E.H. Lysen

L.M.M. Paulissen

December 1978

SWD Steering Committee for Wind Energy in Developing Countries
(Stuurgroep Wind Energie Ontwikkelingslanden)
P.O. Box 85 / Amersfoort / The Netherlands

PUBLICATION SWD 78 – 3

This publication was realized under the auspices of the Steering Committee on Wind-energy for Developing Countries S.W.D., by a team of the Eindhoven University of Technology. The S.W.D. is financed by the Netherlands Ministry for Development Cooperation and is staffed by:

**the Eindhoven University of Technology,
the Twente University of Technology,
the Netherlands Organization for Applied Scientific Research, and
DHV, Consulting Engineers, Amersfoort**

and collaborates with other interested parties.

The S.W.D. tries to help governments, institutes and private parties in the Third World, with their efforts to use wind-energy and in general to promote the interest for wind-energy in Third World Countries.

<u>TABLE OF CONTENTS</u>	Page
1. INTRODUCTION	1
2. THE COMPONENTS OF A WIND-ELECTRICITY CONVERSION SYSTEM	3
3. WIND ENERGY SUPPLY AND ELECTRIC ENERGY DEMAND	4
3.1. Wind regime	4
3.2. Energy and power demand	16
3.3. Calculating rotor area and generator power	19
4. THE CONVERSION OF WIND POWER INTO ELECTRIC POWER	31
4.1. Windrotor characteristics	31
4.2. Generator characteristics	36
4.2.1. The synchronous machine (SM)	36
4.2.2. The asynchronous machine (AM)	38
4.2.3. Comparison of SM and AM	39
4.2.4. The commutator machine (CM)	41
4.2.5. Automobile generators	43
4.3. Matching windrotor and generator	51
4.3.1. The required data	51
4.3.2. The matching procedure	53
4.3.3. Practical hints to obtain the generator parameters	58
4.3.4. Example of the matching procedure	59
5. STORAGE OF ELECTRICITY	63
6. REFERENCES	67
APPENDICES	68
A. UNITS AND CONVERSION FACTORS	68
1. Prefixes	68
2. Units of energy	69
3. Units of power	69
4. Other conversion factors	70
B. WHAT HAPPENS IN A GENERATOR?	72
C. LIST OF COMMERCIAL WIND GENERATORS	81

SYMBOLS

A	swept area of windrotor	$[m^2]$
C_Q	torque coefficient	[-]
C_{Qstart}	starting torque coefficient	[-]
C_P	power coefficient	[m]
E_d	energy demand	[Wh]
E_a	estimated available energy	[Wh]
f	frequency	$[s^{-1}]$
i	transmission ratio	[-]
I	current	[A]
I_F	excitation current (field current)	[A]
I_G	output current of generator	[A]
k	Weibull exponent	[-]
n_r	r.p.m. of wind rotor shaft	$[(60.s)^{-1}]$
n_G	r.p.m. of generator shaft	$[(60.s)^{-1}]$
P_a	estimated available power	[W]
P_d	power demand	[W]
P_G	power input of generator	[W]
P_{kin}	kinetic power	[W]
P_{rated}	rated power	[W]
P_{shaft}	power at the shaft of the windrotor	[W]
P_{el}	electrical power output	[W]
p	number of pairs of poles	[-]
Q	torque	[Nm]
Q_{shaft}	torque at the shaft of the windrotor	[Nm]
Q_G	torque at the shaft of the generator	[Nm]
R	radius of the windrotor	[m]
U	terminal voltage	[V]
U_G	terminal voltage of the generator	[V]
V	wind speed	$[m s^{-1}]$
\bar{V}	mean wind speed	$[m s^{-1}]$
η_G	efficiency of the generator	[-]
η'_G	efficiency of the excitation of the generator	[-]
η_{Tr}	efficiency of the transmission	[-]
η_B	efficiency of battery and cables	[-]
λ	tip speed ratio	[-]
ρ	density of the air	$[kg m^{-3}]$
ω	angular speed	$[s^{-1}]$

Errata:

page

ii Remove: η_G^i efficiency of the excitation of the generator

49 Add: the indexes of the contacts: (a) upper contact,
(b) middle contact, (c) lower contact

54 Change the formulas 4.8 and 4.9 into:

$$\frac{1}{2} \rho C_{Pmax} \eta_{Tr} A V_{cut-in}^3 > \frac{I_F \cdot U_G}{\eta_G} \quad [W] \quad (4.8)$$

$$\frac{1}{2} \rho C_{Pmax} \eta_{Tr} A V_{cut-in}^3 > Q_{cut-in} G \cdot n_{cut-in} \frac{2\pi}{60} \quad [W] \quad (4.9)$$

60 line 10: change n_G^1 into η_G

line 20: change formula (4.8) according erratum page 54

line 21: change into: $\frac{1}{2} \times 1.2 \times 0.4 \times 0.8 \times 4.9 \times V_{cut-in}^3$ 45

1. INTRODUCTION

The aim of this publication is to give the reader guidelines to design a small-scale wind electricity conversion system. The emphasis lies on the electrical part of the system and its optimum matching to the rotor. The theory and the design of the windrotor itself can be found in other publications [1,2].

In chapter two the basic components of a wind-electricity conversion system are summarized. Then the matching of wind energy supply and electric energy demand is treated. The main chapter (4) on the conversion to electric power starts with a short summary of the characteristics of a windrotor and subsequently treats the different existing electrical machines. This chapter concludes with the analysis of the matching of rotor and generator. As the S.W.D. programme focuses on rural applications in developing countries, the given examples relate to small-scale wind systems, generating DC power and equipped with some battery storage. The last chapter is devoted to the storage of electricity.

It is assumed that the reader has some knowledge of basic technical physics. As the understanding of electrical machines is essential for this publication the authors have devoted one appendix (B) to "What happens in a generator?"

In other appendices definitions and conversion factors can be found and a list of commercial manufacturers of windgenerators.

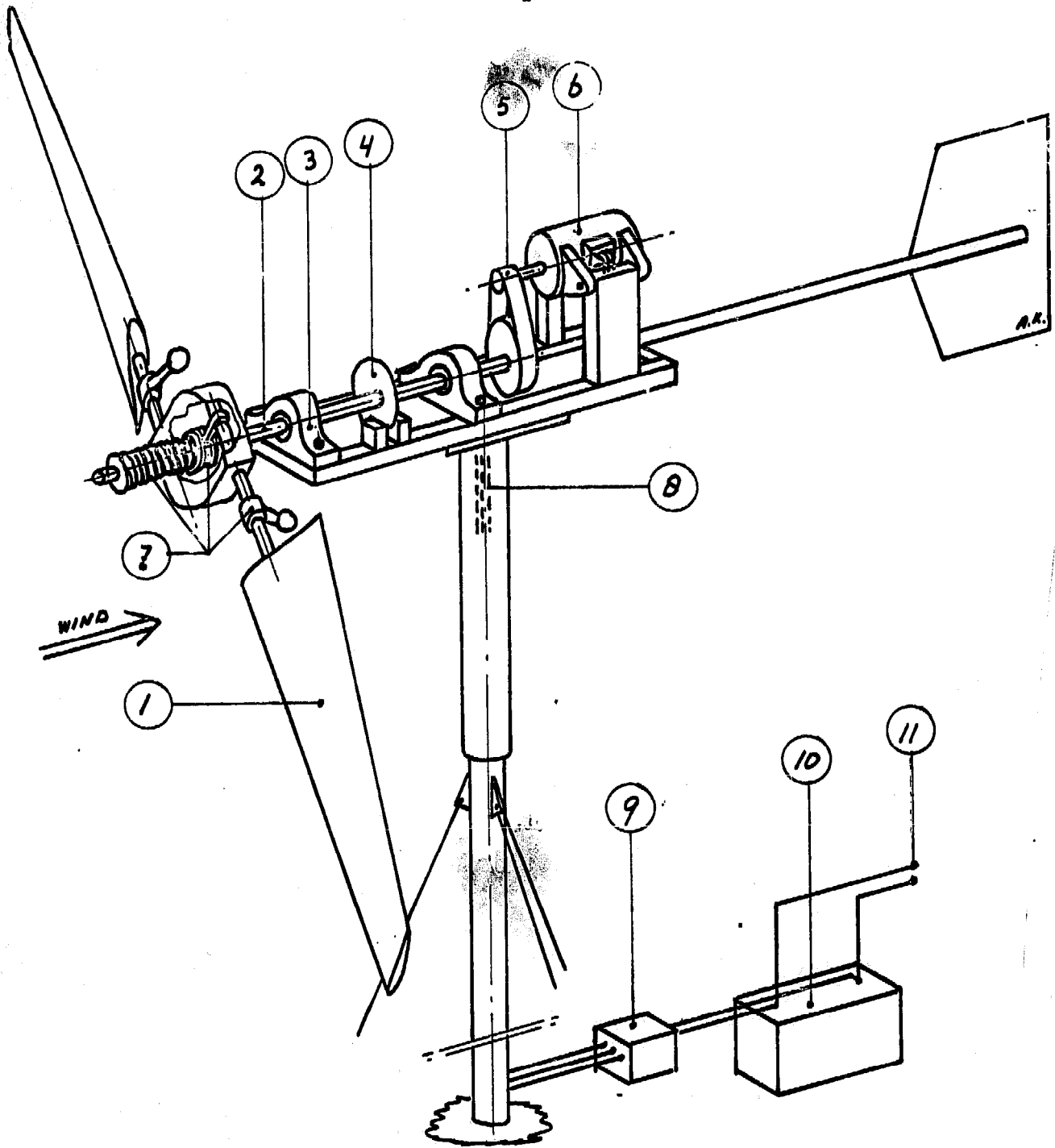

Fig. 2.1. The components of a typical wind-electricity conversion system:

1. windrotor
2. rotor shaft
3. shaft bearings
4. brake
5. transmission
6. generator
7. protective device against high wind speeds and over speed of the rotor
8. wiring (eventually sliprings) to conduct the generated electricity to the foot of the tower
9. generator control device (field current, voltage control)
10. storage battery (in case of DC systems)
11. load connection

2. THE COMPONENTS OF A WIND ELECTRICITY CONVERSION SYSTEM

The basic components of a wind electricity conversion system are shown in fig. 2.1. The practical realisation of each component may differ from design to design according to local conditions, available materials or creativity of the designer, but the components themselves can be found on any windgenerator.

Possibly the only exception is the storage device which is not present if the generator is directly coupled to a public grid.

The protective device against strong winds or overspeed of the rotor is a good example to show the wide variety of possible solutions in practice. Changing the pitch of the blades by means of centrifugal weights, as shown here, is a very common method for not too large windgenerators. Another possibility is the use of so-called "spoilers". These are flaps operated by centrifugal force which "spoil" the air-flow around the blades above a certain speed. In other cases the whole rotor head is forced sideways or upwards against a spring force, in order to catch less wind above a certain wind speed.

In fig. 2.1. a horizontal axis rotor is drawn, but obviously the same components can be found on a vertical axis rotor. Only the yawing mechanism can be omitted on most vertical axis rotors.

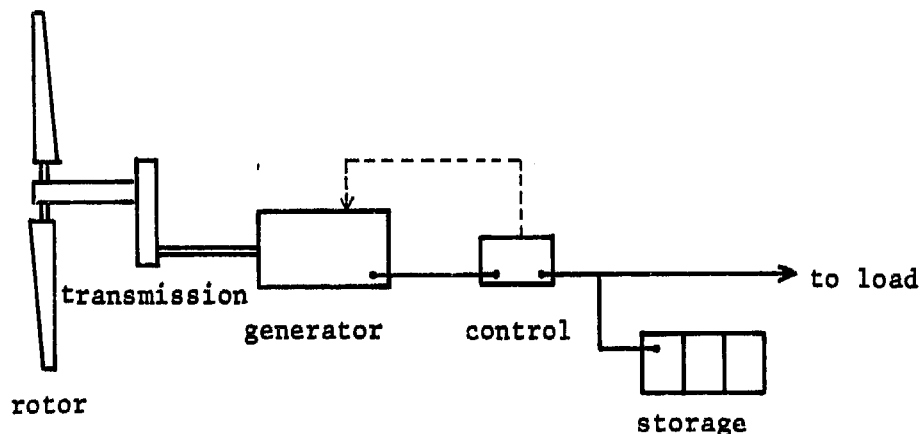

Fig. 2.2. Schematic representation of the energy flow through a wind electricity conversion system

The components involved in the energy flow through a wind electric conversion system are shown in fig. 2.2. The subsequent chapters concern the characteristics of these components and the way they can be coupled.

3. WIND ENERGY SUPPLY AND ELECTRIC ENERGY DEMAND

A wind electricity conversion system has the task to convert the available wind energy as efficiently as possible into electric energy. Efficiently, in this case, does not mean extracting the maximum available energy. The next examples may clarify this point of view.

If one wishes to utilize all the available energy, even that in very high wind speeds which occur only a few hours per year, this will result in constructing a rather heavy wind system and consequently in relatively high costs per kilowatt hour. It is more economical to build a lighter system that is protected against high wind speeds.

Another fact is that, particularly in developing countries, the availability of modest amounts of energy during most of the year is more worthwhile than a much larger yearly amount of energy concentrated within a few months with higher wind speeds. In the latter case huge storage batteries are necessary to ensure a more or less continuous supply during the year.

In the first part of this chapter the different ways to describe a wind regime are given. Then the energy demand is indicated and finally the matching of wind regime and energy demand is treated.

3.1. Wind regime

The hourly averages of the wind speed taken during one year (or month) form the basis of all following curves to describe a wind regime. The process of measuring the wind speed, taking these averages and computing the curves is treated in [3]. Here only the results will be given, preceded by the well-known formula to calculate the available power from the wind.

3.1.1. Power from the wind

Air mass flowing with a velocity V [m/s] through an area A [m²] represents a mass flow rate \dot{m} [kg/s] of:

$$\dot{m} = \rho \cdot A \cdot V \quad [\text{kg/s}]$$

and thus a flow of kinetic energy per second or kinetic power P_{kin} [W] of:

$$P_{\text{kin}} = \frac{1}{2} (\rho \cdot A \cdot V) V^2 = \frac{1}{2} \rho \cdot A \cdot V^3 \quad [\text{W}] \quad (3.1)$$

where

ρ = air density [kg/m^3] (1.225 kg/m^3 for 15°C (at sea level))

A = area swept by the rotor blades [m^2]
(for a propellor type rotor with radius R , $A = \pi R^2$)

V = undisturbed wind velocity [m/s]

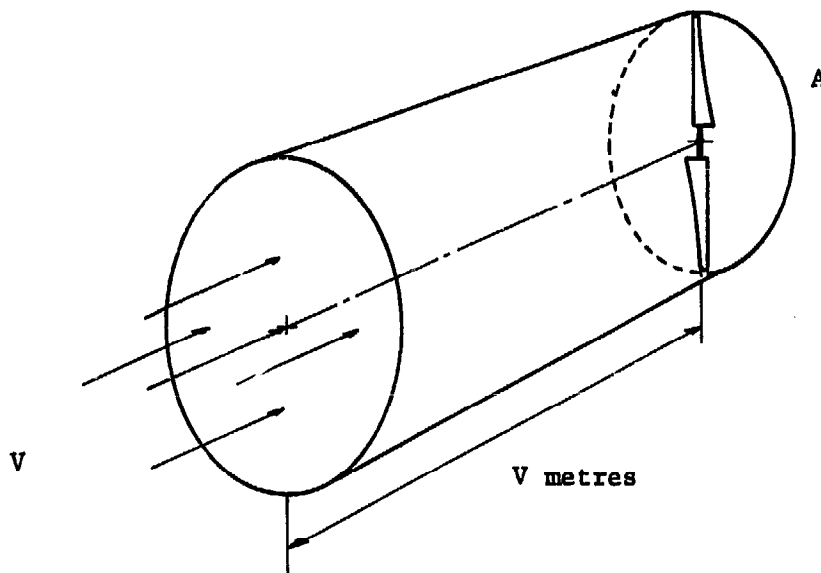

Fig. 3.1. Every second a volume $V.A.$ of air is flowing through an area A .

As a result the mass flow is $\rho.A.V.$ kg/s

In words this relation expresses the fact that the wind power is proportional to:

- the density of air
- the area swept by the rotor blades
- the cube of the undisturbed wind velocity

The function of a windrotor is to slow down (disturb) the wind velocity, thus transforming part of the kinetic power to mechanical power at the rotor shaft. The theoretically maximum available mechanical power at the shaft is, as derived by Betz [2], equal to:

$$P_{\text{shaft}} = \frac{16}{27} \times P_{\text{kin}} \quad [\text{W}]$$

Accounting for aerodynamic, mechanical and electrical losses with the estimates given in section 4.1, this results in the following rule of thumb for the available electrical power output P_a for the load:

$$P_a = 0.1 A V^3 \quad [\text{W}] \quad (3.2)$$

Table 3.1 and fig. 3.2 below are based on this formula and show the strong dependency of the power on the wind velocity.

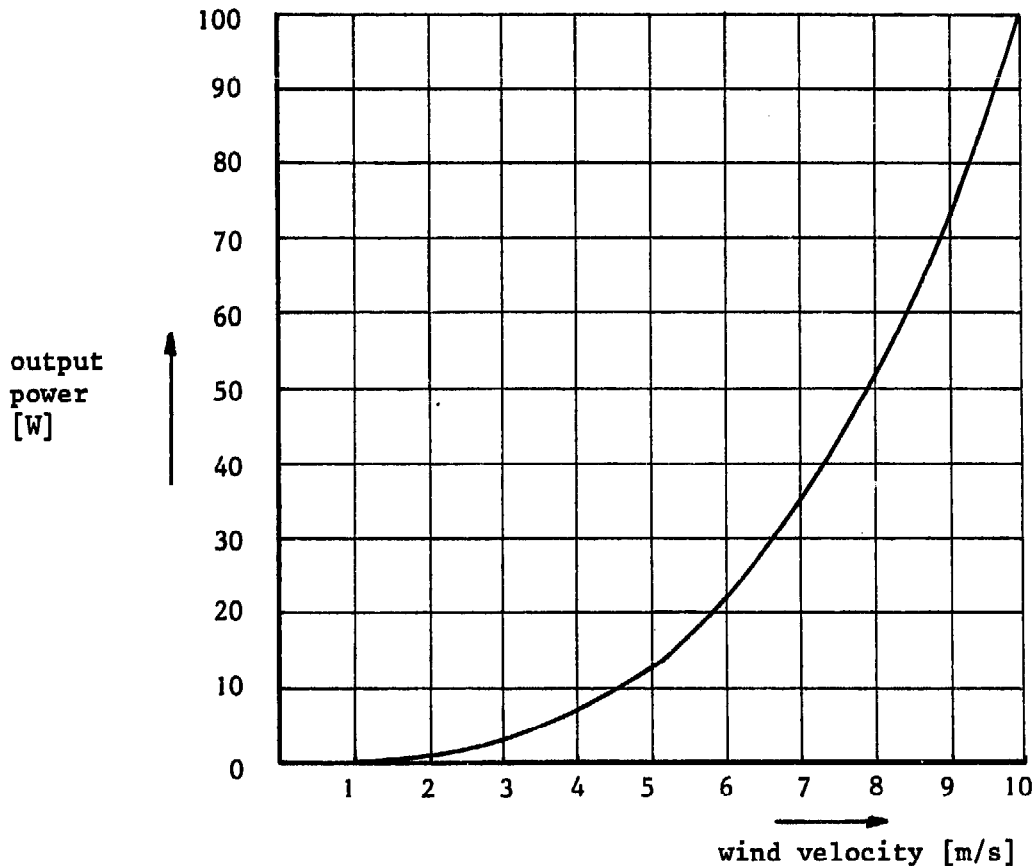

Fig. 3.2. A conservative estimate of the power output from each square metre of area swept by a windrotor: $P = 0.1 \times V^3$ [W/m²]

3.1.2. Wind distribution curves

In most cases only mean monthly or annual wind speeds at meteorological stations are known. They are presented in tables, such as table 3.1 or in geographical maps, see fig. 3.3. In the latter, places with the same annual mean wind speed are connected by lines, called "isovents".

Month	1967	1968	1969	1970	1971	1972	1973	1974	1975	1976
January	9.7	7.2	5.6	5.1	6.1	4.5	4.8	9.3	6.0	6.3
February	6.0	6.5	4.7	6.3	5.8	6.4	3.5	8.5	7.9	6.9
March	7.1	7.6	4.3	6.2	4.8	6.3	6.4	6.5	6.3	-
April	5.4	5.6	6.1	5.0	6.1	4.9	7.3	6.1	3.6	-
May	4.5	3.4	4.6	4.0	4.5	4.5	4.0	4.4	4.0	3.6
June	3.7	4.5	4.2	3.7	5.5	4.6	4.9	5.5	4.7	3.4
July	4.1	6.6	4.5	3.8	4.4	4.7	5.2	5.3	4.3	4.4
August	4.7	4.4	4.9	5.0	5.5	3.7	4.5	3.9	4.9	3.2
September	2.8	2.4	2.8	3.2	4.2	3.6	4.6	3.7	4.0	2.9
October	3.2	3.9	3.0	3.1	4.2	4.5	6.1	4.0	2.6	2.6
November	3.9	5.1	5.0	5.1	3.9	6.7	7.3	4.8	4.2	2.8
December	4.5	4.7	3.9	5.8	5.7	6.1	7.8	6.2	4.6	2.8
January	N	N	N	N	N	N	N	N	N	N
February	N	N	N	N	N	N	N	N	N	N
March	N	N	N	N	N	N	N	N	N	N
April	N	N	N	N	N	N	N	N	N	N
May	N	NW	N	NN	N	N	N	N	N	N
June	W	SW	SW	N	SW	SW	N	SW	SW	SW
July	SW	SW	SW	SW	SW	SW	SW	SW	SW	SW
August	SW	SW	SW	SW	SW	SW	N	SW	SW	SW
September	N	N&SW	SW	N	SW	SE&SW	SW	SW	SW	SW
October	N	N	N	N	N	N	NE	N	N	NE
November	N	N	N	N	N	N	N	N	N	N
December	N	N	N	N	N	N	N	N	N	N

Table 3.1. The mean monthly wind speed and wind direction during the years 1967-1976 at Atbara in Sudan [4]
The wind speed is given in knots (1 knot = 0.514 m/s)

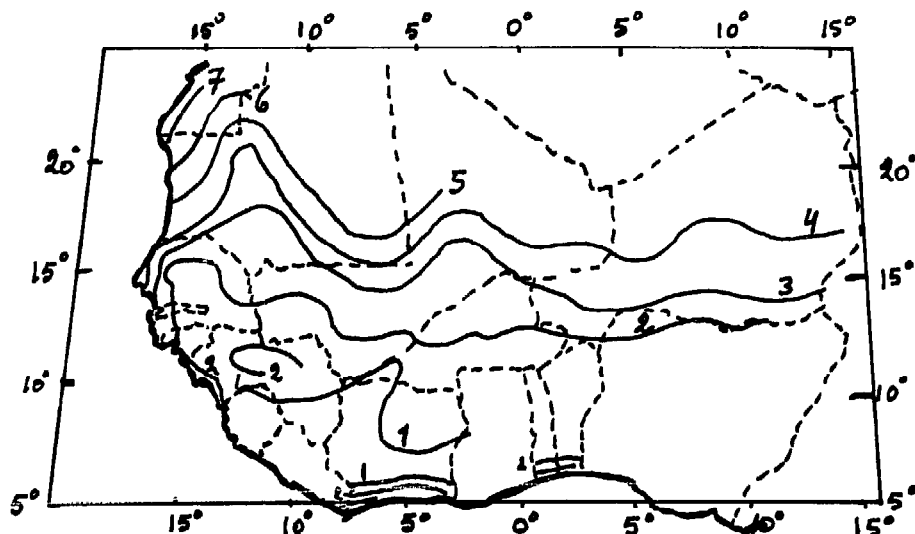

Fig. 3.3. Isovents in the Sahel area, connecting places with the same annual mean wind speed, given in m/s. The wind speeds are measured at 06, 12, 18 hours during the years 1951 to 1955 [4]

This gives a rough indication of the available wind energy, but for a more detailed analysis additional information is necessary. This implies measuring hourly averages at the meteorological stations preferably for a number of years, supplemented by short-time measurements at the location where a new windmill is planned.

The hourly wind speed can be determined in several ways:

- the average of the wind speed during the full hour
- the average of the wind speed during the last ten minutes of each hour (W.M.O. standard)
- the average of several "snapshot" measurements within an hour
- one snapshot measurement per hour (not so reliable)

All hourly wind speeds during a given period can be presented in the form of a table, but for wind energy utilization a presentation in wind distribution curves is preferred.

a. Time distribution curves

Time distribution curves of the wind speed (or the corresponding available power) indicate how the wind speed (or the corresponding power) changes from period to period during a day, a week, a month and a year. They show day-night fluctuations or seasonal variations and give an indication of the critical periods when little power is available. In fig. 3.4 an example is given of the distribution of the mean hourly wind speed at Gaya (India) during January and February 1961 and during the whole year 1961. Significant are the relatively high wind speeds in the afternoon. The distribution pattern of the available power is even more pronounced (fig. 3.5).

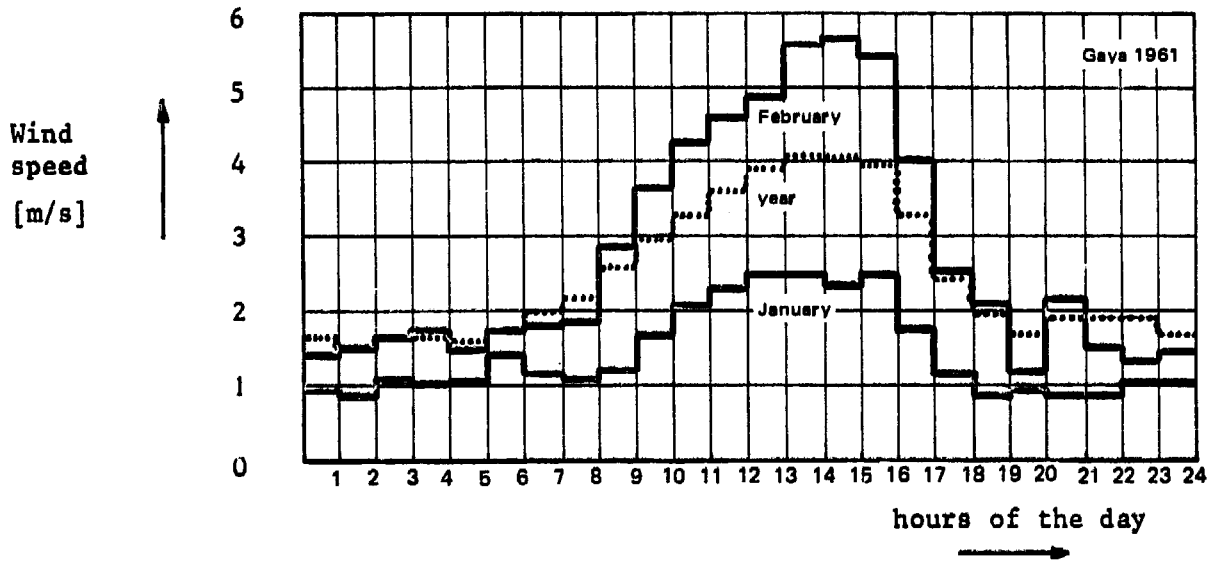

Fig. 3.4. The monthly and annual mean hourly wind speeds during the day at Gaya (India) in 1961. The mean monthly wind speed in January is 1.4 m/s, in February 2.7 m/s, while the mean annual speed is 2.4 m/s.

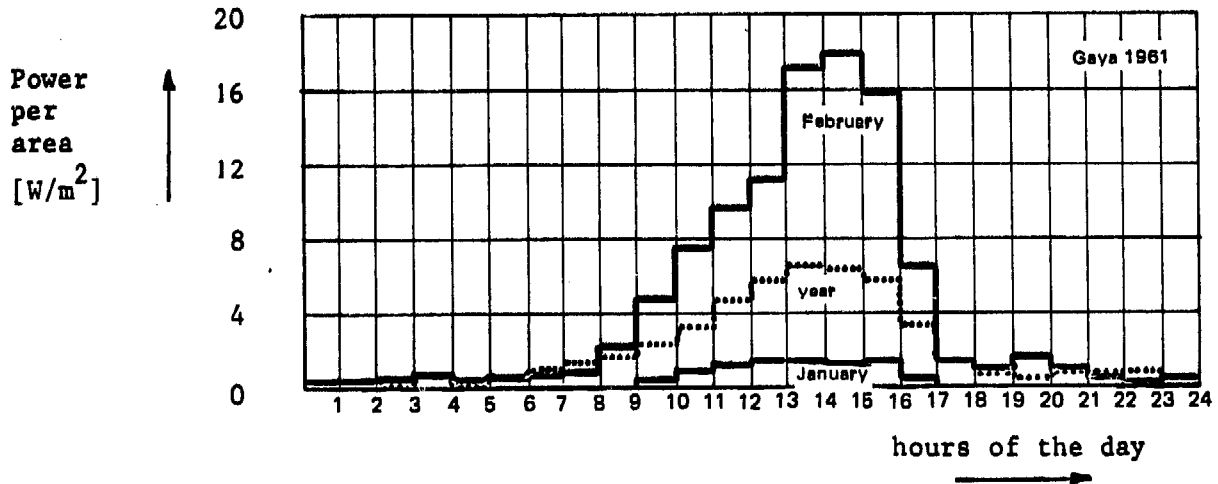

Fig. 3.5. The power distribution curve, derived from fig. 3.4, with $P = 0.1 V^3$ [W/m²]

b. Frequency distribution curves

If the number of hours per period that a given wind speed occurs is plotted against the wind speed, a velocity frequency curve is obtained (fig. 3.6).

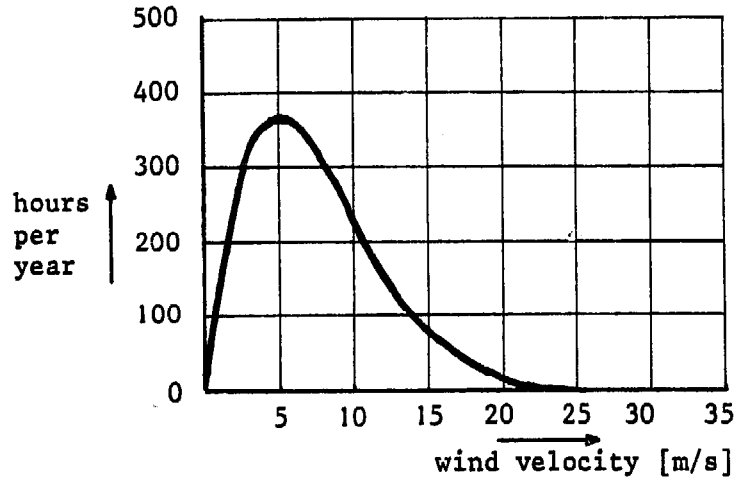

Fig. 3.6. The velocity frequency curve of St. Ann's Head (U.K.) with an annual mean wind speed of 7.2 m/s [5]

The top of this curve, the most frequent wind speed, is generally not the average wind speed. In trade wind areas with quite steady winds this might be true, but in other climates the average wind speed is higher than the most frequent wind speed.

The average wind speed \bar{V} is calculated as follows:

$$\bar{V} = \frac{t_1 V_1 + t_2 V_2 + \dots + t_i V_i + \dots + t_n V_n}{t_{\text{total}}} \quad [\text{m/s}]$$

where:

t_i = the number of hours that the wind speed V_i occurred

t_{total} = the total number of hours per period (8760 hours per year for example)

V_i = the wind speed

\bar{V} = the average wind speed

In practice, the number of hours t_i is given for intervals of the wind speed and then the frequency curve takes the form of a histogram (see fig. 3.16). For example: during 600 hours the wind speed was between 4 and 5 m/s. In this case the middle of the interval, here 4.5 m/s, is chosen as V_i and multiplied with 600 hours.

With formula (3.2) the available power per square meter of swept area can be estimated for each wind speed interval. Multiplying with the number of hours gives the available energy for each wind speed interval. If these energies are plotted against the wind speed, an energy frequency curve results (fig. 3.7).

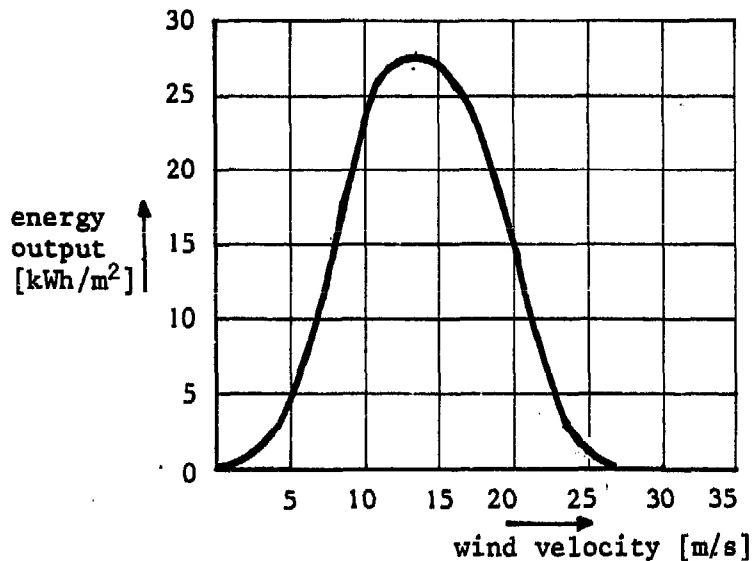

Fig. 3.7. The energy frequency curve of St. Ann's Head (U.K.), derived from fig. 3.6. with $P = 0.1 V^3$ [W/m²]

With practical data this curve takes the form of an energy histogram (fig. 3.18).

It is noticeable that the speed at which the maximum energy can be obtained is higher than the mean wind speed. For temperate maritime climates this speed is roughly 1.5 times the mean wind speed.

c. Duration curves

In some cases it is useful to know the number of hours per period that the wind speed was higher than a given wind speed. If, for example, this given wind speed is the speed at which the windmill starts producing net power (V_{cutin} , see 3.3), then this number of hours indicates the time that the windmill will operate.

The curve representing $t(V>V)$ is called a velocity duration curve and is found by integrating the velocity frequency curve.

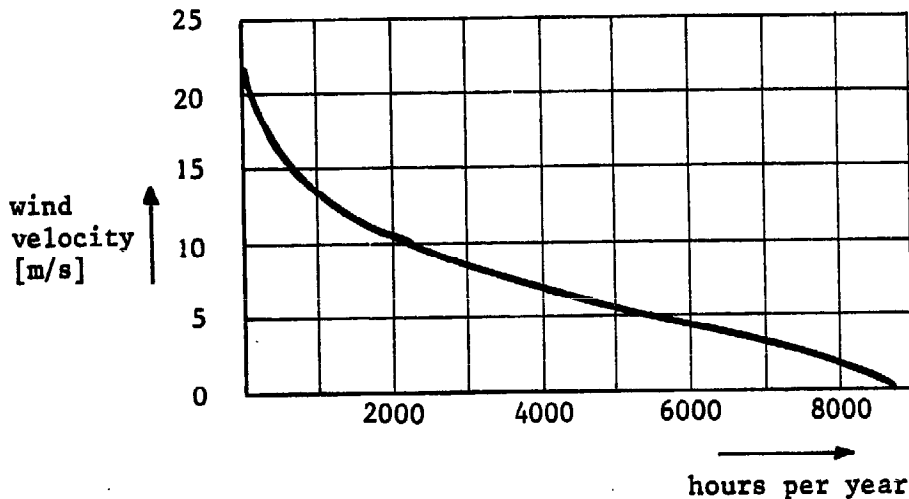

Fig. 3.8. The velocity duration curve of St. Ann's Head (U.K.), derived from fig. 3.6.

The intersection with the horizontal axis indicates the chosen period, i.e. the time that $V>0$ [m/s]. For trade wind climates with rather constant wind speeds for long periods, the velocity duration curve is fairly horizontal. In polar wind regimes with irregular wind speeds, the curve is much steeper.

If velocity duration curves for different areas with more or less the same climate are compared, they turn out to be surprisingly similar in shape. The comparison is done by dividing the curves by their mean velocity. It is obvious then to try to approximate these curves mathematically. Well known, and in this respect useful functions are the so-called Weibull functions. They are dealt with in a separate publication [7]. In fig. 3.9 the functions are shown for different types of climates, each with its characteristic Weibull-exponent.

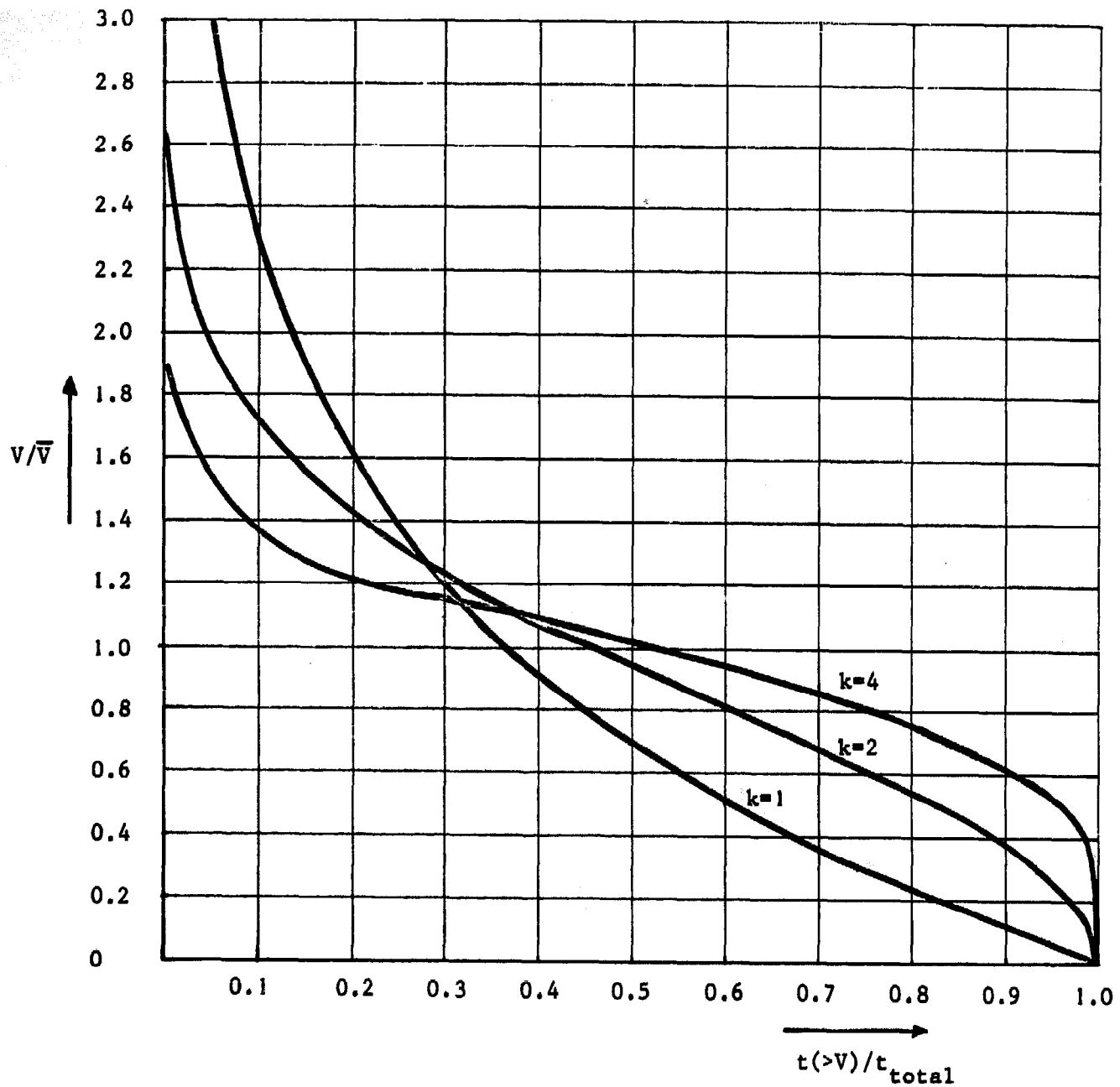

Fig. 3.9. Weibull functions, approximating (dimensionless) velocity duration curves for different wind regimes:

- $k = 1$: polar
- $k = 2$: temperate maritime
- $k = 4$: trade wind

The wind velocity is made dimensionless by dividing by average wind velocity \bar{V} . The time t_{total} represents the total period considered, i.e. 8760 hours for a year.

With formula (3.2) the velocity duration curve can be transformed into a power duration curve, indicating the number of hours per period that the power is higher than a given power (fig. 3.10).

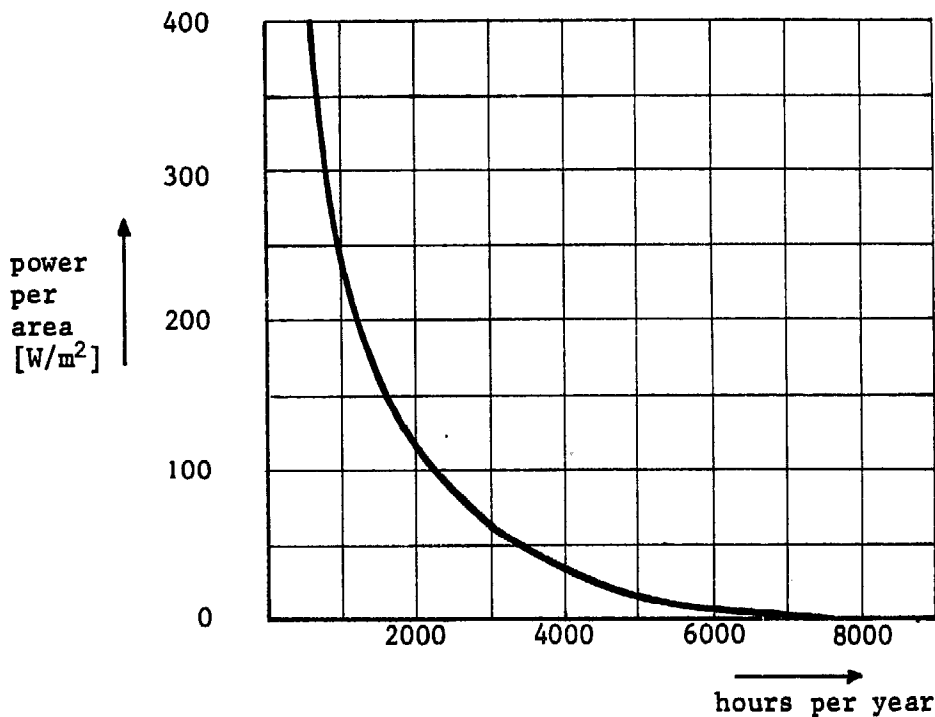

Fig. 3.10. The power duration curve of St. Ann's Head (U.K.), derived from fig. 3.8. with $P = 0.1 V^3$ [W/m²]

The area under this curve, or rather the integral of the curve, indicates the maximum amount of energy that can be extracted from the wind in the given period. Thus it is a useful curve to estimate the effect of not using some lower or higher wind speeds for power production as will be explained in 3.3.

d. The frequency of intervals with low wind speeds

The reliability of a wind regime can be expressed in terms of the number and length of the periods that the wind speed is lower than a given wind speed; number and length of such periods can be determined from the hourly data or from a continuous recording as shown in figure 3.11.

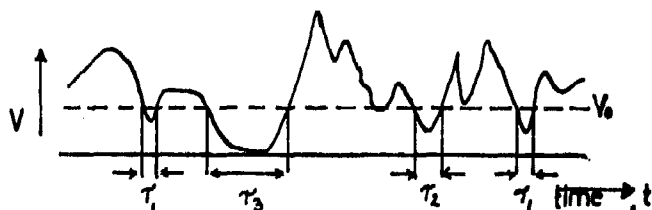

Fig. 3.11. The wind speed as a function of time.
The interval τ indicates the time that $V < V_0$.

This calculation is done for Bamako (Mali) and fig. 3.12 shows the result. It reveals that during a year on the average 46 periods of one day occur during which the wind speed is lower than 2 m/s.

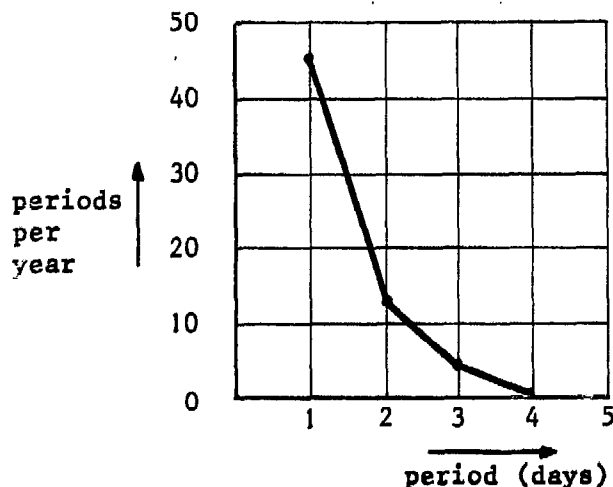

Fig. 3.12. The number of periods per year during which the wind speed was lower than 2 m/s.
The data were taken in Bamako, Mali [4].

This information is vital to determine the necessary storage capacity if a continuous supply of energy is envisaged.

e. Maximum wind speed

Very high wind speeds, which only occur during short periods, are not important for the energy production. It is necessary, however, to know their velocity to calculate the strength of the tower and the blades and to design safety mechanisms and/or brakes.

This information is also economically important.

A windgenerator designed to withstand 50 m/sec could have been built lighter and cheaper for a region where the wind speed for example once in fifty years reaches only 20 m/s.

3.2. Energy and power demand

In the case of rural applications most windgenerators will be used to charge batteries for lighting purposes and to feed radio or t.v. equipment. Therefore we will limit ourselves here to DC loads, to avoid the complications of computing reactive loads.

A first estimate of the energy demand then consists of multiplying the number of hours per day (year) that each apparatus is supposed to operate with its respective power demand.

For example:

3 lightbulbs of 60 watt during 4 hours per day result in 0.7 kWh per day or 260 kWh per year. Assuming for a moment that this is the only demand, then the windgenerator has to deliver more energy to also cover the losses, particularly of the storage battery. Part of the yearly energy will be stored in the battery with an overall efficiency of about 70%. Assuming that roughly $\frac{20}{24} = 83\%$ has to be stored (i.e. 220 kWh) the total energy rises to 350 kWh.

A minor, but not negligible extra demand is caused by the resistance losses in the cables. For example, a current of 10 Ampère in a (run) cable of 10 m length with a cross section of 2.5 mm² gives a voltage drop of 1.4 Volt. In a 12 Volt system this means a power loss of more than 10%. Larger cross sections give lower losses but are more expensive. Table 3.2 gives an indication of the voltage drop in copper cables.

cross section [mm ²]	diameter [mm]	Voltage drop I = 10 A (DC) [V/m]
0.75	0.98	0.47
1	1.13	0.35
1.5	1.38	0.23
2.5	1.78	0.14
4	2,26	0.087
6	2.76	0.058
10	3.57	0.035

Table 3.2 The voltage drop per meter (double-run) copper cable for a 10 A current (DC).

Because of the strong fluctuations in the current it is difficult to calculate the yearly cable losses. A rough estimate of 10% gives in our example an extra loss of 35 kWh per year. This brings the yearly demand to 385 kWh, i.e. about 50% higher than the first estimate of the demand without losses.

To determine the storage capacity, it is necessary to decide whether part of the demand has to be supplied at any desired moment or that the energy is utilized when it happens to be available. In the latter case a one day storage might be sufficient. One should realize that in this case the number of days that power will not be available (depending on the choice of V_{cutin} , see 3.3) is not to be ignored. In the former case a rough estimate can be made by multiplying the longest period of expected calm spells (with $V < V_{cutin}$, see 3.3) with the average required power P_{dnom} and with a factor of, say, 1.5 to cover the losses.

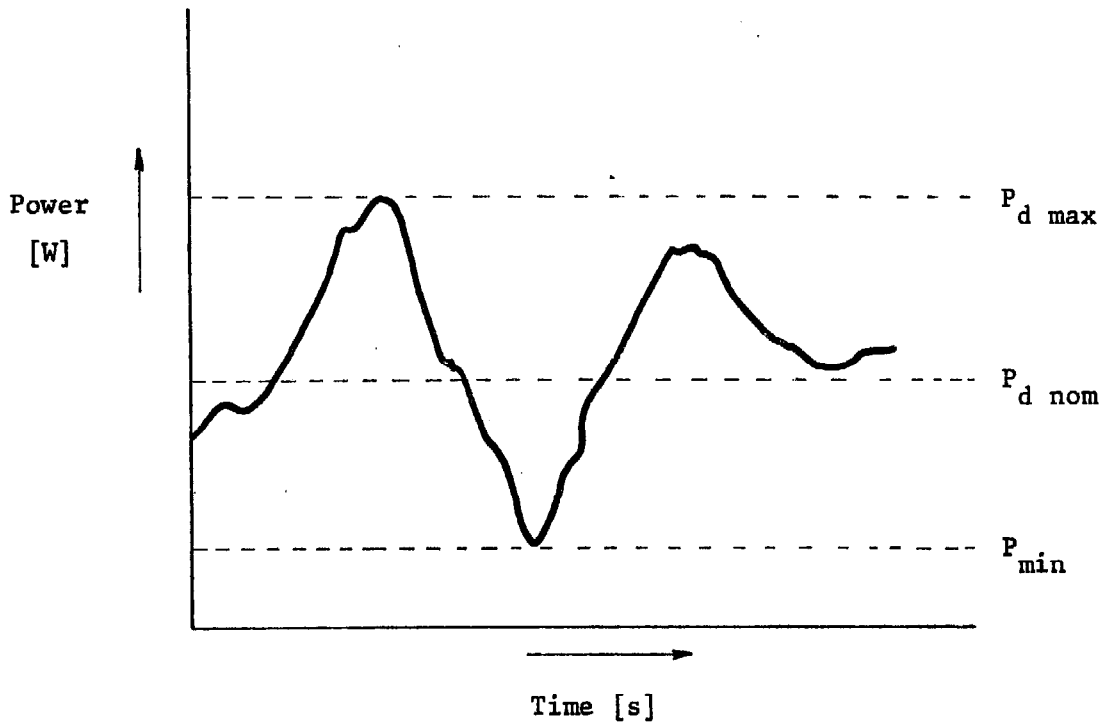

Fig. 3.13. The power demand as a function of time

Note: Small-scale isolated electric installations need not necessarily be in accordance with all standards used by the electric utilities for a large grid. Low voltage systems are inherently safe (below 40 V) for human beings for example. But a short circuit protection by means of fuses is indispensable to prevent fire outbreak and also to protect the generator against overload. A simple lightning protection on the tower of the windmill will also prove to be no luxury.

3.3. Calculating rotor area and generator power

In this paragraph we will show how to determine the necessary area of the rotor and the rated power of the generator, based upon the local wind regime and the energy demand.

A central problem is the choice of the three "design speeds" of the windgenerator. They are indicated in the velocity duration curve (fig. 3.14) and are defined as follows:

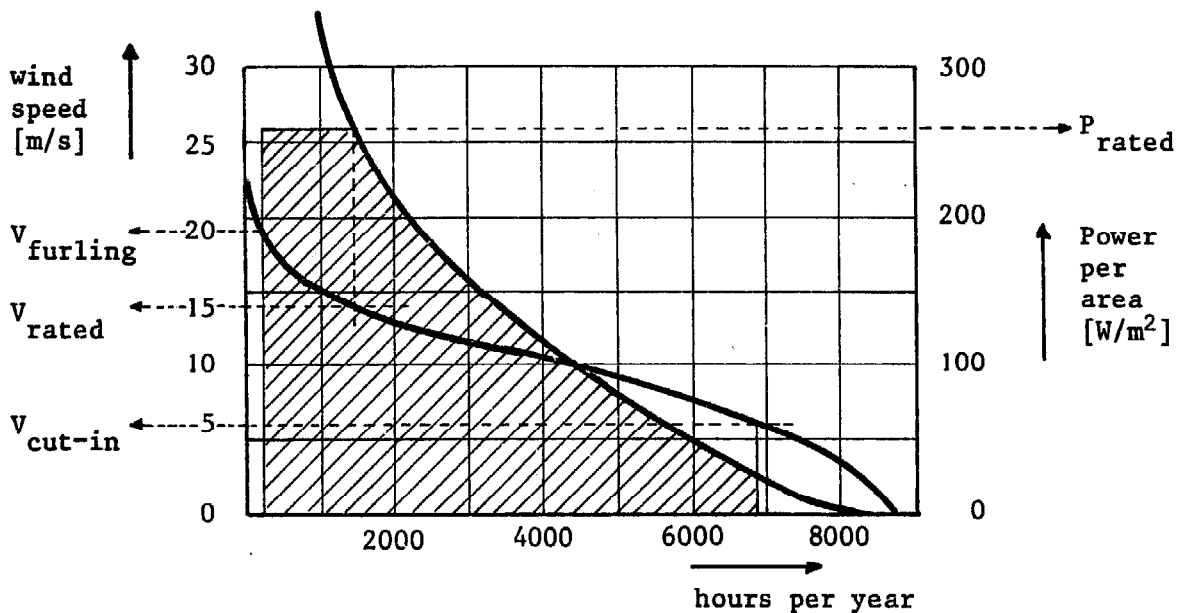

Fig. 3.14. Velocity and power duration curve at Mount Vermont (U.S.A.) with a mean annual wind speed of 9.4 m/s [5]

- V_{cut-in} = wind velocity at which the windgenerator starts producing net electricity
- V_{rated} = wind velocity at which the windgenerator reaches its maximum power output
- V_{furling} = wind velocity above which the windgenerator has to be stopped to prevent damage.

In the definition of V_{cutin} the word "net" electricity means that the energy for the excitation field is subtracted. The rotor starts turning at V_{start} , lower than V_{cutin} , but between V_{start} and V_{cutin} only produces some field energy. Obviously this does not apply to generators that do not need energy for excitation, such as permanent magnet generators.

For wind speeds higher than V_{rated} the power output of the wind generator remains constant due to some control device, for example by changing the pitch of the blades.

In fig. 3.14 the effect of the choice of the three design speeds on the total yearly output can be seen. The line F'C represents the power output of a windgenerator, approximated by the expression $P_a = 0.1 V^3 [W/m^2]$ for $V < V_{rated}$. The actual form of this curve is determined by the way in which the rotor is matched to the generator, as explained in 4.3.

The shaded area BCF'FG represents the energy which can be extracted annually per square meter of area swept by the rotor. One immediately concludes that more energy can be extracted by increasing V_{rated} and $V_{furling}$ and decreasing V_{cutin} . This simple choice, however, will lead to impractical solutions as we will see.

First some remarks about $V_{furling}$. In most climates the energy contribution of wind speeds higher than $V = 3 \bar{V}$ is negligible. If an automatic furling mechanism must be designed this choice for $V_{furling}$ is appropriate. For manual furling the practice will be that the windmill is stopped when storm is expected soon, i.e. $V_{furling}$ is more or less guessed. A third possibility is to make the construction strong enough to withstand the maximum speed to be expected in a period of, say, 30 years. Then the windmill need never be stopped and $V_{furling}$ does not exist.

The choice of V_{cutin} and V_{rated} is less straightforward and choosing one speed more or less fixes the other speed. This stems from the cubic relationship between power and wind speed and from the power speed relation of generators. Power outputs less than a few percent of the rated output are generally not very interesting. When V_{rated} is three times higher than V_{cutin} their corresponding powers differ by a factor 27, i.e. P_{cutin} is less than 4% of P_{rated} . For a ratio of four this percentage becomes 1.5%. On the other hand, if a generator delivers its rated power at a certain speed, say 1500 r.p.m. it usually does not produce any power below one third of this speed. We conclude that in general the ratio V_{rated}/V_{cutin} should not be higher than three.

The choice of V_{cutin} will be different if an isolated battery charging system is considered or a grid connected system. For battery charging a small amount of energy on as many days as possible is preferred to a high annual output that is produced in a few months with higher wind speeds. This means: choosing a low V_{cutin} . For temperate maritime and continental climates (Weibull exponent of two, see ref [7]) the wind speed is higher than $V = 0.7 \bar{V}$ during 70% of the year (6100 hours). If one wishes more operating hours: the wind speed is higher than $V = 0.5 \bar{V}$ for 80% of the year (7000 hours). One should realize however, that the amount of energy gained from wind speeds $0.5 \bar{V} < V < 0.7 \bar{V}$ is less than 1% of the yearly output.

The choice of V_{rated} determines the specific output of the wind-generator, i.e. the number of kWh per year per kW of installed power. The higher the ratio V_{rated}/\bar{V} the lower the specific output and vice versa.

Plotting the experimental data of five different windgenerators in this manner gave remarkable coherent results [13]. They are given in table 3.3.

V_{rated}/\bar{V}	kWh/kW year
1	5200
1.2	4300
1.4	3400
1.6	2700
1.8	2100
2.0	1700

Table 3.3 The influence of the ratio V_{rated}/\bar{V} on the specific output of windgenerators as found empirically by Harder [13] and Golding [5].

With these data the V_{rated}/\bar{V} ratio which gives the highest output per year can be determined. If for example a 1kW is chosen for $V_{rated}/\bar{V} = 1$ it produces 5200 kWh/year. The ratio V_{rated}/\bar{V} can be increased to 1.2 by increasing the installed power to $(1.2)^3 = 1.73$ kW, producing $1.73 \times 4300 = 7440$ kWh/year. The maximum is reached for $V_{rated}/\bar{V} = 3.2$ with $P = 32.8$ kW and a yearly output of 16400 kWh. This result is not as useful as it seems however. First, in [13] it is stated that all data for $V_{rated}/\bar{V} > 2$ are rather scattered and

less reliable. Secondly, the power of the generator rises more rapidly than its annual output. This implies that the kWh-costs at this "optimum" are higher than necessary.

Using the approximation that the generator forms 25% of the cost of the wind generator for $V_{\text{rated}}/\bar{V} = 1.6$ with 2700 kWh/kW and that the generator costs rise with the power 0.6 of its rated power [13] then minimum costs are obtained for $V_{\text{rated}}/\bar{V} = 2$. This is the optimum choice, however, for wind generators that can deliver all energy to a grid or a very large battery. For wind generators with a relatively small battery storage it is more important that the rated power (although lower) is available during a longer period. For $V_{\text{rated}}/\bar{V} = 2$ this period is only 4.3% of the year (380 hours), but for $V_{\text{rated}}/\bar{V} = 1.5$ it increases to 17% (1410 hours); all for a Weibull coefficient $k = 2$.

We may conclude that a reasonable choice for the three design speeds is:

$$\begin{aligned} V_{\text{cut-in}} &= 0.7 \bar{V} \\ V_{\text{rated}} &= 1.5 - 2.0 \bar{V} \\ V_{\text{furling}} &= 3 \bar{V} \text{ or higher} \end{aligned}$$

Once these choices are made the calculations are straightforward.

The swept area A of the rotor is found by dividing the yearly (or monthly) available energy per m^2 of swept area (the shaded part of fig. 3.14) by the yearly (or monthly) energy need.

$$A = \frac{\text{available yearly (monthly) energy per m}^2}{\text{yearly (monthly) energy need}} \quad [\text{m}^2]$$

If twelve monthly averages are available, then 12 areas will result of which it is advisable to choose the largest.

In case of a horizontal axis rotor the rotor diameter becomes:

$$D = \sqrt{\frac{4}{\pi} \cdot A} \quad [\text{m}]$$

The rated power P_{rated} is found with relation (3.2):

$$P_{\text{rated}} = 0.1 \cdot A \cdot v_{\text{rated}}^3 \quad [\text{W}]$$

In the following example this procedure will be shown and the effect of, for example, changing $V_{\text{cut-in}}$ is calculated.

Example

In this example we will discuss the choice of the design parameters based on a given demand and supply of energy. Actually, to be able to a reliable choice of the parameters, data during longer periods and over many years have to be obtained. The wind data to be analysed in this example are presented in table 3.4 and are transformed into the next curves:

- the velocity frequency curve, figure 3.16,
- the velocity- and power duration curve, figure 3.17,
- the energy frequency curve, figure 3.18,
- the mean velocity- and mean power distribution during a day, figure 3.19,
- the mean velocity- and mean energy distribution during the month, figure 3.20,
- the frequency curve of intervals with low wind speeds, table 3.5.

Then demanded power is given in figure 3.21: the nominal power, P_{dnom} , is 916 Watt, the minimum required power, P_{dmin} , is 800 Watt and the maximum power, P_{dmax} , 1500 Watt. Now we have to translate these figures into the characteristics of a generator in such a way that the energy supply covers the demand. The output characteristic of the wind power plant is generally given by the curve as shown in figure 3.15.

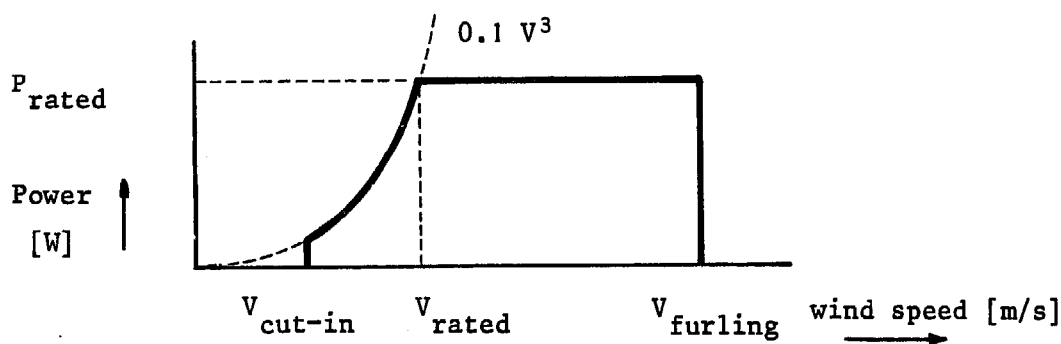

Fig. 3.15. The idealized power output curve of a wind generator

The power output is mathematically formulated by:

$$\begin{aligned}
 V < V_{\text{cut-in}} & \quad P_{el} = 0 \\
 V_{\text{cut-in}} < V < V_{\text{rated}} & \quad P_{el} = 0.1 V^3 \text{ [W/m}^2\text{]} \\
 V > V_{\text{rated}} & \quad P_{el} = 0.1 V_{\text{rated}}^3 \text{ [W/m}^2\text{]}
 \end{aligned}
 \tag{3.3}$$

Several cases follow in which the approximate output is calculated, using the analysed wind data presented in the figures 3.16 to 3.20 and table 3.4 and the power output performance 3.15.

- case a)

From the energy frequency curve, figure 3.18 we can conclude that the maximum available energy at a certain speed can be obtained at about 10 m/s. Now we will choose arbitrarily $V_{\text{rated}} = 10$ m/s;

$V_{\text{cut-in}} = 5$ m/s; $V_{\text{furling}} = 12$ m/s.

When these figures are substituted in the duration curve, figure 3.22, the shaded area shows the monthly available energy per square metre rotor surface, namely 30.7 kW/m². The monthly energy need is 660 kW (30 x E_d during a day, see figure 3.21). Therefore a minimum rotor surface is required of $660/30.7 = 21.5$ m². This means a wind rotor diameter of 5.2 metre. Using relation (3.2) the rated power can be calculated: $P_{\text{rated}} = 2124$ Watt.

In table 3.6 the mean diurnal power supply is calculated.

From the figures we can conclude that a reserve capacity of about 6.0 kWh is required from 19.00 till 07.00 hours for a continuous energy supply. But the above calculations are based on a period of a day. When table 3.5 is studied one can conclude that during the month of June 1975 one period of 133 hours occurs in which the mean hourly wind velocity was lower than 9 m/s. This means that a minimum reserve capacity of about 100 kWh is necessary for full electricity supply from the wind.

Several ways of reducing this required reserve capacity are:

- reducing the $V_{\text{cut-in}}$ value,
- enlarging the rotor diameter, which will result in a larger P_{rated} .

- case b)

As we saw in case a) the choice of a high V_{rated} , compared to the mean wind speed, $\bar{V} = 7,3$ m/s, results in a small diameter but demands the necessity of a large reserve capacity (because sufficient wind speed values are lacking during long periods, table 3.5). Now we will choose a larger diameter for the windrotor, a smaller V_{rated} -value and, accordingly, also a smaller $V_{\text{cut-in}}$ is taken.

We choose:

$$V_{\text{rated}} = 8 \text{ m/s}; \quad V_{\text{cut-in}} = 4 \text{ m/s}; \quad V_{\text{furling}} = 12 \text{ m/s}.$$

The graphical method, see figure 3.23, results in an energy supply of 21.6 kWh per square metre. The diameter has to be 6,24 m to cover the energy need. P_{rated} amounts to 1565 Watt. Table 3.6, case b), gives a summary of the average diurnal electricity production.

Table 3.5 shows that the period in which the wind speed is lower than 8 m/s can be 61 hours. Calculating the energy supply during this continuous period (indicated with a continuous line in table 3.4) with the aid of the power output characteristic relation (3.3) it means that a reserve capacity of 27.7 kWh is needed to warrant the electricity supply. The period indicated with the dotted line in table 3.4 yields a reserve capacity of 20.4 kWh. Together this means 48 kWh! The reserve capacity which must be installed in this case will be much smaller than in case a).

- case c)

The nominal diurnal power demand amounts to 916 Watt, if during 60% of the total time this nominal power is to be produced; from the duration curve figure 3.17 the nominal speed can be read, i.e. is known, $V_{nom} = 6$ m/s. The diameter of the wind rotor is

$$D = 2 \sqrt{916/0.1 \times \frac{V_{nom}^3}{\pi}}$$

$$= 7.35 \text{ m.}$$

When also the V_{rated} of 8 m/s is chosen and $V_{cut-in} = 4$ m/s the P_{rated} is $0.1 V_{rated}^3 \pi (3.67)^2 = 2166$ Watt.

Table 3.6 case c) presents the mean diurnal electricity production. In this case about 40% less reserve capacity has to be installed than in case b).

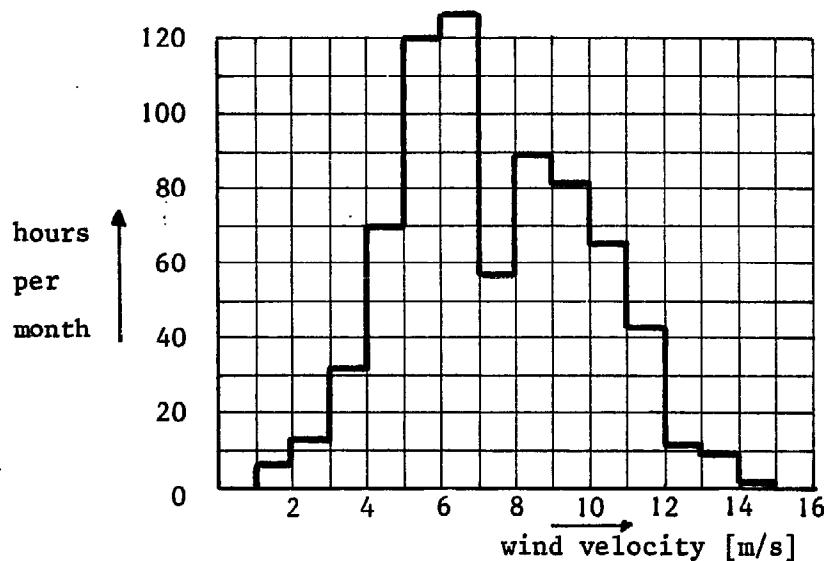

Fig. 3.16. The velocity frequency histogram for Praia (June 1975) derived from the data in table 3.4.

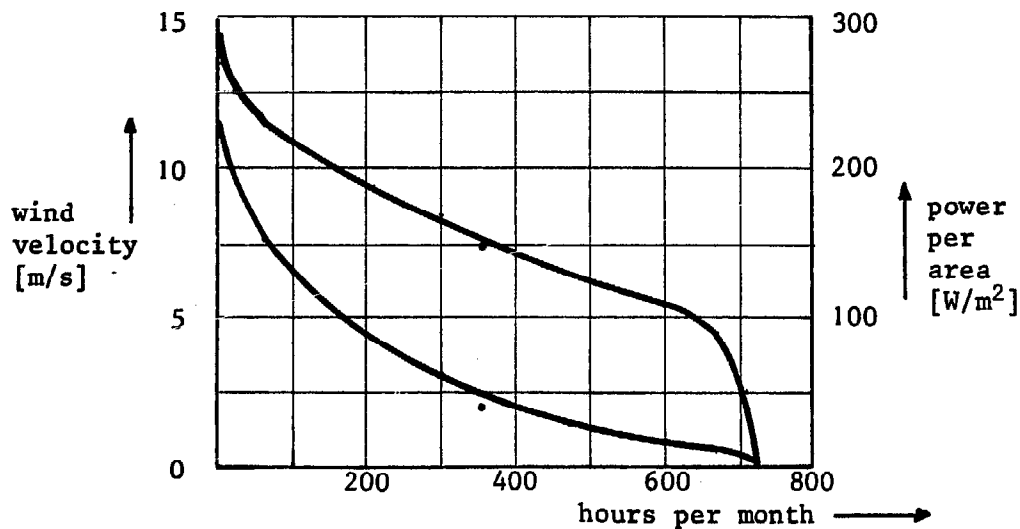

Fig. 3.17. The velocity duration curve (upper) and power duration curve (lower) for Praia (June 1975). The abnormal dip at 7.5 m/s in fig. 3.16. is smoothed out in these curves.

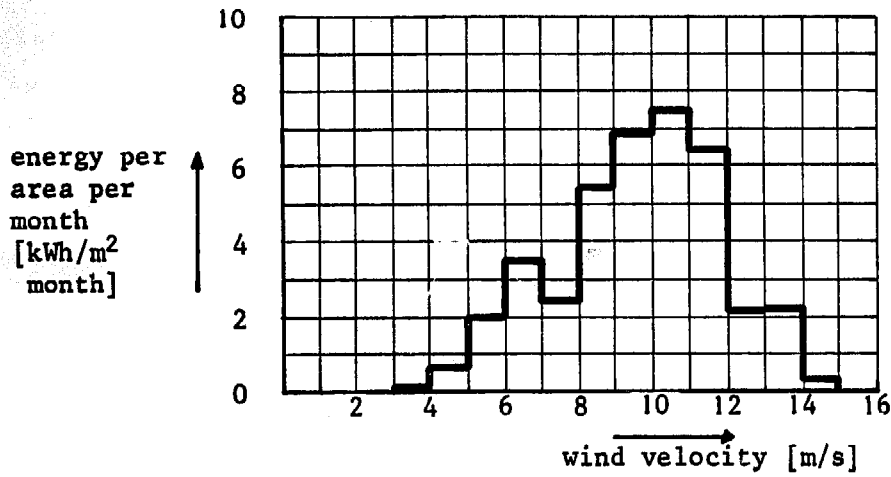

Fig. 3.18. The energy frequency histogram for Praia (June 1975) derived from fig. 3.16.

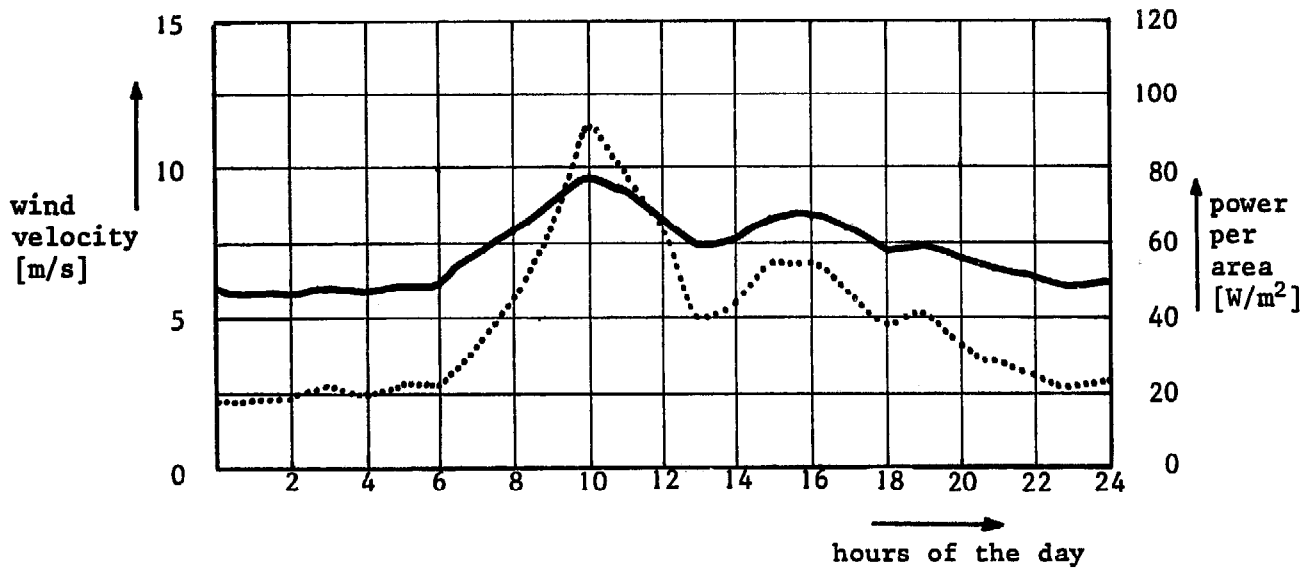

Fig. 3.19. The mean hourly wind speed in Praia (June 1975) during the day. The dotted line indicates the average available power.

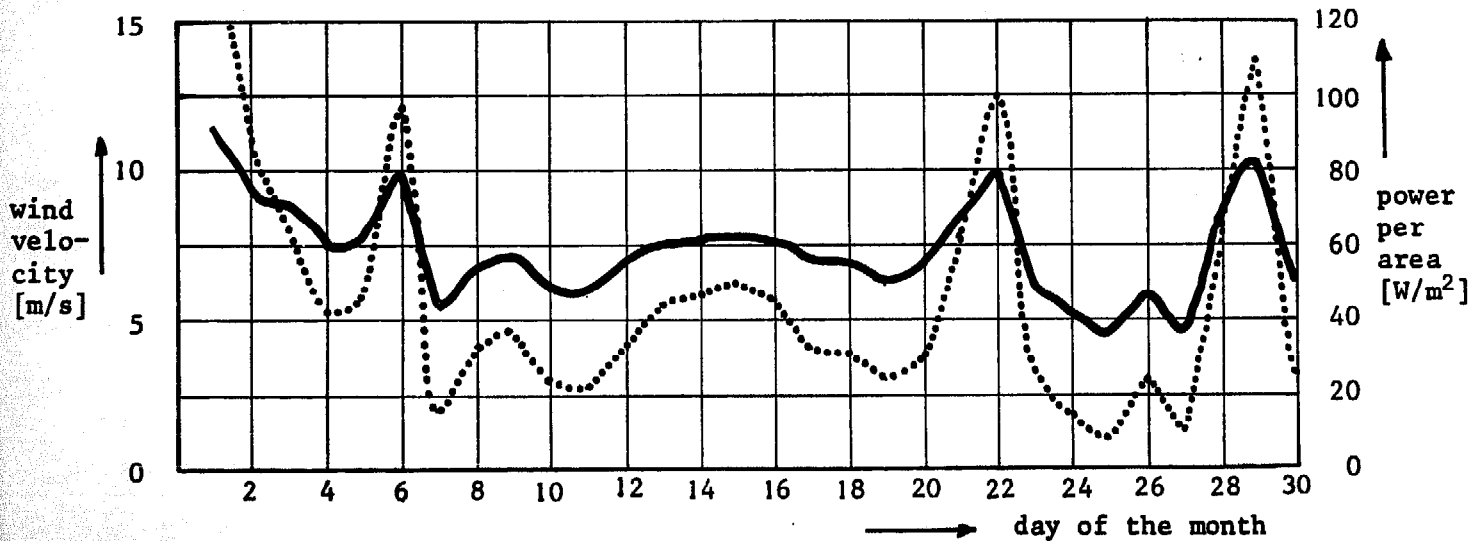

Fig. 3.20. The mean diurnal wind speed in Praia (June 1975). The dotted line indicates the average available power.

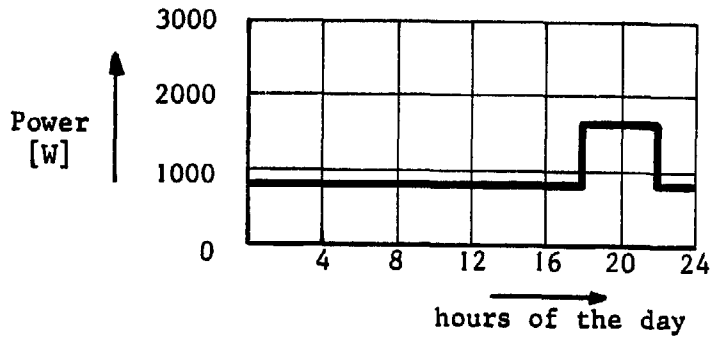

Fig. 3.21. The idealized mean power demand during a day

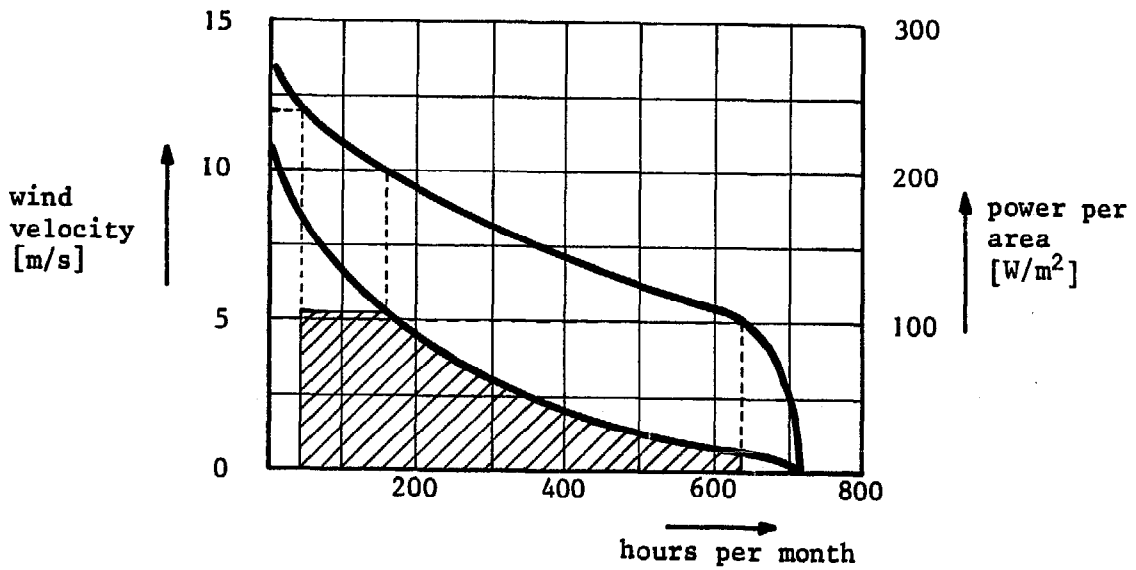

Fig. 3.22. The velocity and power duration curve of Praia (June 1975) with the three design speeds given in case a

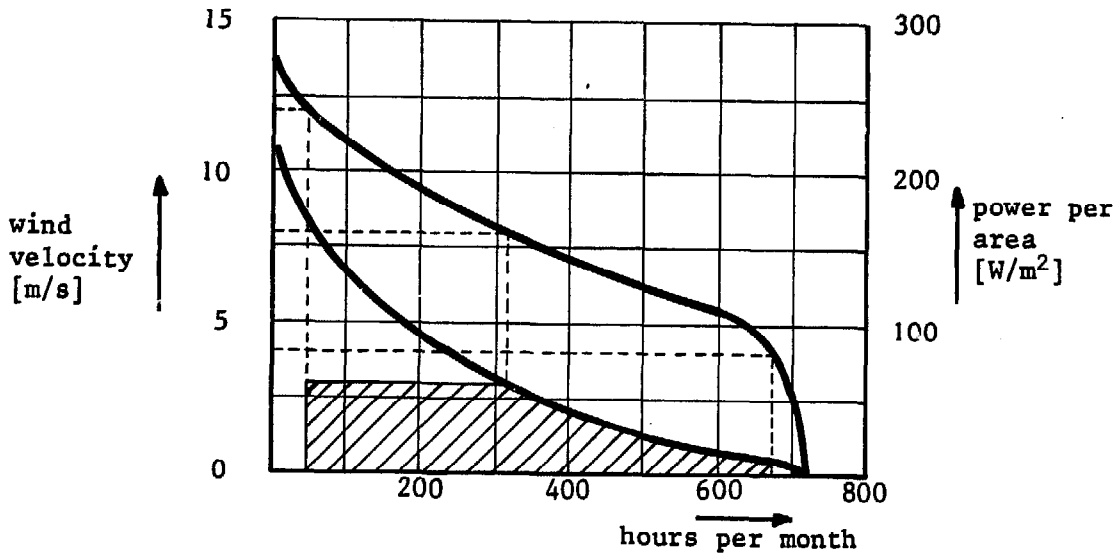

Fig. 3.23. The velocity and power duration curve of Praia (June 1975) with the three design speeds given in case b

hour day	1h	2h	3h	4h	5h	6h	7h	8h	9h	10h	11h	12h	13h	14h	15h	16h	17h	18h	19h	20h	21h	22h	23h	24h	diurnal speed
1	9,4	10,0	8,0	9,4	9,7	10,0	10,9	11,4	11,9	13,9	13,9	14,2	13,9	13,3	13,6	13,6	13,1	11,1	11,1	10,6	10,6	10,9	10,9	9,7	11,6
2	9,4	8,3	8,6	9,2	9,2	8,9	10,3	10,6	11,1	12,2	11,1	11,4	11,1	9,7	9,4	9,1	8,6	8,6	9,1	8,6	8,6	8,3	8,1	7,5	9,5
3	6,7	7,5	8,3	6,9	6,1	7,9	9,7	10,9	10,8	10,8	10,0	10,3	10,3	10,3	10,3	10,3	9,2	9,2	9,6	8,6	8,3	6,4	5,8	5,0	8,7
4	4,4	4,4	4,4	4,2	4,4	5,6	6,9	9,2	9,8	11,1	10,8	11,1	9,6	9,8	9,7	9,2	9,2	9,2	7,2	7,5	6,1	5,3	4,4	4,2	7,5
5	3,9	3,9	4,4	3,9	4,2	4,7	5,3	6,7	8,3	10,3	9,7	10,0	10,8	11,6	12,5	12,2	10,8	8,3	6,1	6,4	7,2	6,7	6,9	8,6	7,7
6	8,1	6,9	7,2	7,9	8,9	8,1	8,6	9,4	10,8	11,7	11,9	12,5	12,2	12,5	11,1	10,8	10,0	9,7	10,0	10,3	10,0	9,2	9,5	9,7	9,9
7	7,2	6,1	6,1	4,2	3,1	3,3	5,3	8,1	10,0	10,0	11,9	9,7	7,5	6,7	4,2	3,3	3,0	1,4	1,7	2,5	2,2	4,7	5,3	4,2	5,5
8	3,3	5,0	4,4	2,5	4,2	3,3	4,4	6,4	6,9	8,6	8,9	8,9	9,2	9,7	8,6	10,3	10,0	8,6	7,8	8,9	5,8	5,8	5,0	6,7	6,9
9	3,6	4,4	6,4	6,1	6,4	7,5	7,9	8,9	10,0	9,4	8,3	8,6	10,0	10,6	9,2	10,0	7,5	6,9	5,8	6,4	5,0	4,4	4,7	4,4	7,2
10	4,4	5,0	5,0	4,4	5,0	4,4	4,7	5,6	6,9	8,6	8,9	8,6	8,6	7,2	7,8	7,8	7,2	6,4	5,8	6,1	4,7	5,0	5,3	5,0	6,2
11	5,3	5,3	4,2	4,7	5,9	3,9	5,6	5,9	6,9	7,2	7,5	6,4	4,7	6,1	7,8	8,3	8,3	6,9	6,1	5,3	5,3	5,0	5,3	5,0	6,0
12	5,3	4,7	4,7	4,7	4,2	4,2	5,9	6,9	8,3	9,2	8,6	9,2	8,9	8,1	8,1	9,4	8,9	7,5	7,2	6,7	5,8	6,9	6,9	6,1	7,0
13	4,7	5,3	5,0	5,6	5,3	5,3	7,5	7,2	9,4	9,7	10,0	9,7	9,4	9,7	9,7	9,4	9,4	8,9	7,5	6,4	6,9	5,8	6,4	6,4	7,6
14	5,3	6,7	8,3	8,1	7,9	7,5	8,3	9,7	9,4	11,1	9,7	9,7	8,9	8,6	7,8	8,1	8,1	7,8	7,5	7,2	6,1	5,0	5,0	4,4	7,8
15	4,7	6,1	7,5	8,3	7,6	6,8	7,2	7,5	8,3	10,3	10,0	8,6	9,4	9,4	10,0	10,0	9,6	8,3	6,7	6,4	6,7	6,1	6,4	6,7	7,9
16	6,9	6,9	6,4	5,9	6,4	7,5	7,5	8,6	9,2	9,7	9,7	8,9	9,4	9,1	9,7	9,7	9,2	8,6	8,1	6,4	4,7	4,7	4,4	4,7	7,7
17	4,4	5,3	5,3	5,0	5,3	5,6	6,3	6,9	8,6	10,0	10,3	10,3	10,3	10,3	10,6	9,7	6,4	5,8	5,6	5,8	6,1	4,2	2,5	3,1	6,9
18	4,4	5,0	6,1	5,9	6,1	6,9	6,1	6,4	5,8	8,9	9,2	9,7	9,2	8,1	5,6	5,9	6,1	8,9	7,8	5,6	5,9	6,7	6,4	6,4	6,8
19	5,6	5,6	5,3	4,4	7,5	8,1	7,8	6,7	8,3	9,4	8,1	6,4	6,7	5,6	4,7	3,4	3,1	6,7	6,1	6,7	5,9	5,6	5,9	5,6	6,2
20	6,1	5,3	3,1	3,3	4,2	5,0	5,9	6,1	6,7	6,4	8,1	8,1	8,1	8,9	8,9	5,6	6,4	7,8	8,1	9,2	8,6	8,4	7,8	7,2	6,8
21	6,9	6,4	7,9	8,3	8,9	7,5	6,4	7,5	7,2	8,9	8,3	7,2	5,9	5,9	5,8	9,7	9,2	8,9	11,1	11,1	10,9	11,4	11,1	11,1	8,5
22	10,0	9,7	10,0	10,3	10,0	10,8	10,8	11,4	11,7	11,1	12,2	11,1	10,3	8,9	9,2	9,7	9,4	9,4	9,1	9,7	9,1	9,1	8,3	7,5	10,0
23	6,4	6,1	6,7	6,9	7,2	5,9	6,7	6,9	6,9	8,9	6,4	5,0	5,3	6,1	6,7	5,3	4,4	6,2	7,5	8,1	8,3	6,9	5,3	5,0	6,6
24	5,8	5,3	6,1	6,1	5,8	6,2	7,8	7,8	6,9	6,4	5,8	5,9	5,9	3,3	2,8	4,2	3,9	2,5	5,9	6,9	6,4	5,3	2,2	1,9	5,3
25	1,4	1,4	2,2	3,1	3,4	4,2	3,9	6,1	6,7	5,8	4,7	5,6	3,6	4,2	4,4	3,1	1,9	2,2	3,1	5,0	5,0	6,7	6,9	7,2	4,3
26	5,6	4,4	5,0	5,3	4,4	2,8	2,8	5,8	6,7	7,2	9,2	9,2	8,1	6,7	6,7	4,2	6,4	8,1	6,9	5,7	6,1	5,9	5,3	4,4	6,1
27	4,2	3,9	3,1	3,1	2,2	3,3	4,7	3,1	4,4	6,9	6,1	5,6	5,6	4,7	4,2	4,4	3,8	4,4	5,6	5,6	5,3	5,9	4,7	5,0	4,6
28	5,0	5,3	3,6	4,2	4,2	2,8	5,0	4,7	4,2	6,1	8,3	11,1	11,1	13,6	13,1	12,5	12,5	11,9	11,4	11,4	10,6	10,6	11,1	11,1	8,6
29	10,6	11,1	11,4	11,1	10,8	10,3	11,4	12,2	12,2	11,7	11,9	11,6	11,1	10,0	11,1	11,1	10,0	9,4	9,4	10,0	8,6	6,9	6,1	5,6	10,3
30	5,6	5,3	5,8	5,6	5,9	6,2	6,7	6,9	6,9	6,9	8,1	8,6	6,9	5,3	3,9	6,9	6,9	6,9	5,6	5,9	6,4	5,6	5,9	4,7	6,3
mean monthly at x hour	5,8	5,8	6,05	5,9	6,07	6,07	6,94	7,7	8,61	9,7	9,25	8,24	7,4	7,6	8,2	8,2	7,8	7,3	7,4	6,9	6,6	6,3	6,0	6,1	7,4 mean monthly

Table 3.4. The mean hourly wind speed in June 1975 at Praia (Meteorological Service Centre, Rep. Cape Verdian Islands). The velocities are indicated in meters per second

$\Delta\tau$ hours	V_m < 2 m/s	V_m < 3 m/s	V_m < 4 m/s	V_m < 5 m/s	V_m < 6 m/s	V_m < 7 m/s	V_m < 8 m/s	V_m < 9 m/s
1	/						/	
2	/							
3	/							/
4		/	/					/
5		/	/					
6				/				
7				/		/	/	
8						/		/
9					/			
10				/		/		/
11				/				
12							/	/
13								/
14							/	
15						/		
16								/
17					/	/		
18								
19								/
20						/		/
21							/	/
22					/			
23							/	
24						/		/
25								
26							/	
35								/
39						/		
40						/	/	
61							/	
65								/
133								/

Table 3.5. Frequency distribution of uninterrupted periods during which the wind speed is smaller than a given value V_m .
(Data for the example of section 3.3.)

hour	P_d Watt	Case a		Case b		Case c	
		P_{el} Watt	$E_{el} - E_d$ Wh	P_{el} Watt	$E_{el} - E_d$ Wh	P_{el} Watt	$E_{el} - E_d$ Wh
1	800	419	-381	596	-204	825	25
2	800	419	-381	596	-204	825	25
3	800	476	-324	690	-110	937	137
4	800	441	-359	628	-172	870	70
5	800	480	-320	683	-117	948	148
6	800	480	-320	683	-117	948	149
7	800	718	- 82	1022	222	1414	546
8	800	982	+182	1396	596	1932	1132
9	800	1373	+573	1565	765	2166	1366
10	800	1962	+1162	1565	765	2166	1366
11	800	1702	+902	1565	765	2166	1366
12	800	1202	97	1565	765	2166	1366
13	800	871	+ 71	1239	439	1714	914
14	800	944	1144	1324	524	1857	1057
15	800	1184	384	1565	765	2166	1366
16	800	1184	384	1565	765	2166	1366
17	800	1020	+220	1451	651	2008	1208
18	800	836	36	1184	389	1646	846
19	1500	871	-629	1239	439	1714	214
20	1500	706	-794	1004	204	1390	-110
21	1500	618	-872	879	79	1216	-284
22	1500	537	-963	764	-36	1058	-442
23	800	464	-336	660	-140	916	116
24	800	488	312	694	-106	962	162
		$V_{cut-in} = 5 \text{ m/s}$	$V_{cut-in} = 4 \text{ m/s}$	$V_{nom} = 6 \text{ m/s}$			
		$V_{rated} = 10 \text{ m/s}$	$V_{rated} = 8 \text{ m/s}$	$V_{cut-in} = 4 \text{ m/s}$			
		$V_{furl} = 12 \text{ m/s}$	$V_{furl} = 12 \text{ m/s}$	$V_{rated} = 8 \text{ m/s}$			
		$R = 2,60 \text{ m}$	$R = 3,12 \text{ m}$	$V_{furl} = 12 \text{ m/s}$			
		$P_{rated} = 2124 \text{ W}$	$P_{rated} = 1565 \text{ W}$	$R = 3,67 \text{ m}$			
				$P_{rated} = 2166 \text{ W}$			

Used symbols:

P_d = power demand, see figure 3.19.

P_{el} = power output, calculated with relation (3.3.).

$E_{el} - E_d$ = resulting energy production during one hour.

Table 3.6. The mean diurnal energy production of the wind generator, calculated in the example of section 3.3.

4. THE CONVERSION OF WIND POWER INTO ELECTRIC POWER

In this chapter the characteristics of windrotors and electric generators are described. With the knowledge of these two essential components their coupling can be undertaken to design an optimal wind electric conversion system.

In section 4.1 a comprehensive, although inevitable condensed, description of the characteristics of windrotors is given. The different types of electric machines are described in section 4.2. There are three main types: the synchronous, the asynchronous and the commutator machine. Two small-scale generators used in automobile electric systems, the alternator and the dynamo, receive more attention because of their wide availability.

Finally, in section 4.3, recommendations are given how rotor and generator can be matched. Optimal matching turns out to be a proper choice of transmission ratio and tip speed ratio of the rotor. An example is given to illustrate the matching procedure.

4.1. Windrotor characteristics

As any other torque generating machine a windrotor can be characterized by a torque-speed curve or the corresponding power-speed curve. One difference is that each rotor has a large number of torque-speed curves, one for each wind speed namely. Examples are given in fig. 4.1 and 4.2 for a four-bladed rotor with a diameter of 2.4 metre.

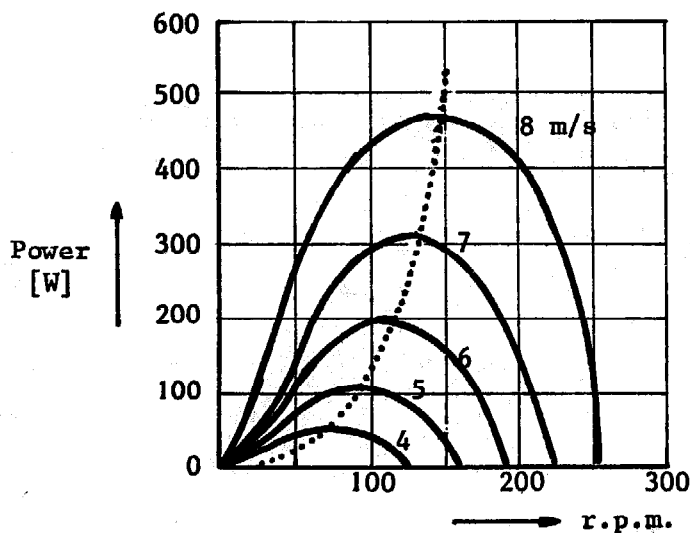

Fig. 4.1. The mechanical power output of a windrotor with four curved metal blades and a diameter of 2.4 m ($A= 4.5m^2$) as a function of speed for different wind speeds

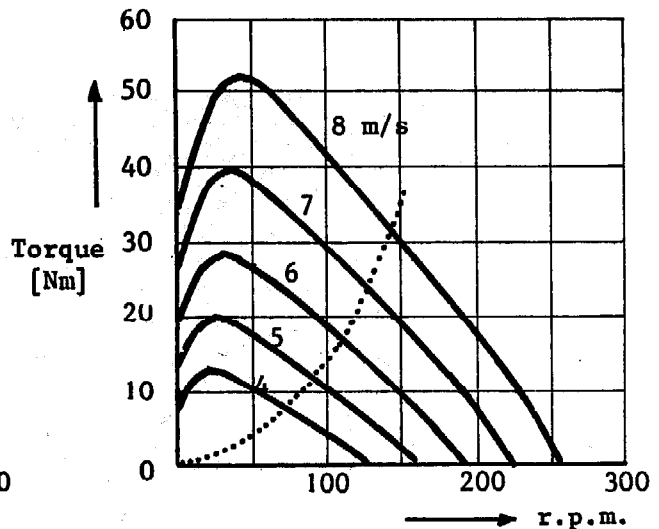

Fig. 4.2. The corresponding torque-speed curves of the rotor in fig. 4.1. for the given wind speeds

In both figures the dotted line connects all points where the windrotor produces its maximum power for a given wind speed. In the power-speed plot this "maximum power" line is a cubic, whereas in the torque-speed plot the optimum torque line varies with the square of the speed. One immediately concludes that the best load for a windrotor is a generator (or pump or other device) with a quadratic torque-speed curve. The matching process, described in 4.3, consists in coinciding the torque speed curves of rotor and generator as good as possible.

To compare different windrotors with each other, also at different wind speeds, the above curves are commonly made dimensionless by introducing the following coefficients:

$$\text{tip speed ratio} \quad \lambda = \frac{\omega R}{V} = \frac{2\pi n R}{60 V} \quad (4.1)$$

$$\text{power coefficient} \quad C_P = \frac{P_{\text{rotor}}}{\frac{1}{2}\rho V^3 A} \quad (4.2)$$

$$\text{torque coefficient} \quad C_Q = \frac{Q_{\text{rotor}}}{\frac{1}{2}\rho V^2 A R} \quad (4.3)$$

They are related as follows:

$$C_P = C_Q \cdot \lambda \quad (4.4)$$

The multitude of curves in fig. 4.1 and 4.2 can now be transformed into the single curves in fig. 4.3 and 4.4.

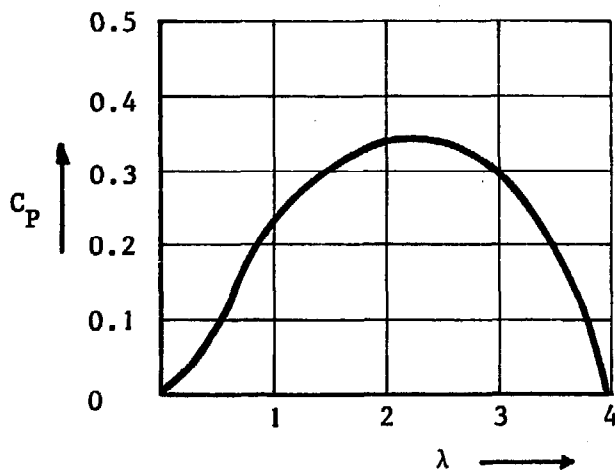

Fig. 4.3. The power coefficient C_P of the rotor in fig. 4.1. as a function of tip speed ratio λ

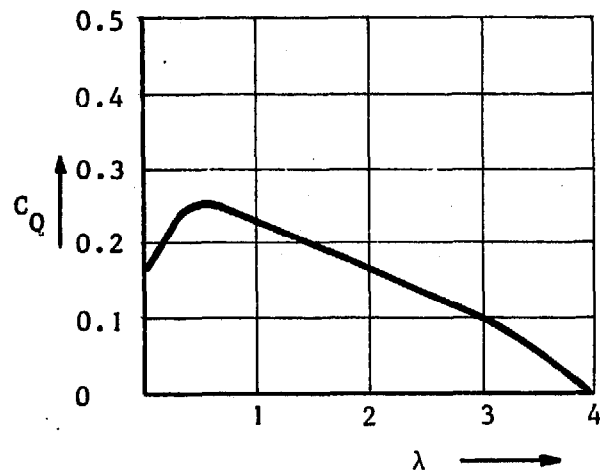

Fig. 4.4. The torque coefficient C_Q of the rotor in fig. 4.1. as a function of tip speed ratio λ

Fig. 4.3 shows that this rotor has its maximum power coefficient at $\lambda = 2.2$. The tip-speed ratio at which the power coefficient reaches its maximum value will be given the index zero, λ_0 .

The characteristics of different types of windrotors can be outlined in one figure. This is done in fig. 4.5 and 4.6 which give the power and torque coefficients of several types of rotors as a function of the tip-speed ratio.

Introducing an overall efficiency η_0 of the transmission and the generator the next general expression for the available (electrical) power can be given:

$$P_a = C_p \cdot \eta_0 \cdot \frac{1}{2} \rho V^3 A \quad [W] \quad (4.5)$$

Supposing a moderate power coefficient of $C_p = 0.3$ and a reasonable overall efficiency of $\eta_0 = 0.6$ we find the rule of thumb mentioned in 3.1.1. (with air density $\rho = 1.2 \text{ kg/m}^3$):

$$P_a = 0.1 V^3 A \quad [W] \quad (3.2)$$

With the aid of fig. 4.5 and 4.6 the next insights (developed for example in ref. [1]) can be understood.

- For each rotor design a maximum C_p value and a corresponding tip-speed ratio, λ_0 , can be given.
- The maximum obtainable power coefficient is about 0.45. Normally a C_p value of 0.3 - 0.35 can be relatively easy reached, for instance by means of curved metal blades.
- Rotors designed to operate at high tip-speeds ($\lambda > 5$) need blades with a good aerodynamic shape.
- High tip-speed rotors are favourable for the generation of electricity. This is because electric generators operate at high rotational speeds, thus the higher the tip-speed ratio of the rotor, the lower the gearing ratio of the transmission and the lower its losses and costs.
- The higher the tip-speed ratio λ_0 of a rotor, the lower the starting torque. As a rough rule of thumb the starting torque is given by:

$$C_{Q_{\text{start}}} \approx \frac{0.6}{\lambda_0^2} \quad (4.6)$$

N.B. Rotors with a linearized blade profile give considerable lower starting torques, while rotors with pitch angle control can give much higher starting torques.

The practical aspects of different rotors, as there are required fabrication technology, initial cost, maintenance, etc, are summarized in table 4.1 [9].

Theoretical maximum (Betz)

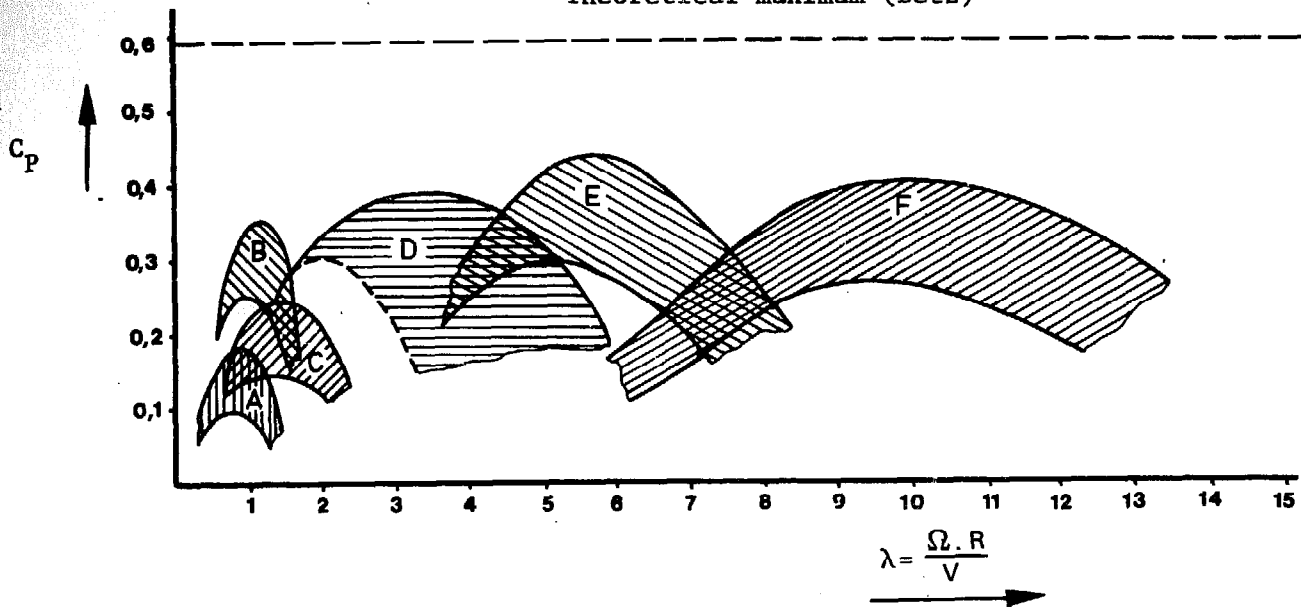

Fig. 4.5. The power coefficient of different types of windrotors as a function of tip speed ratio [8]

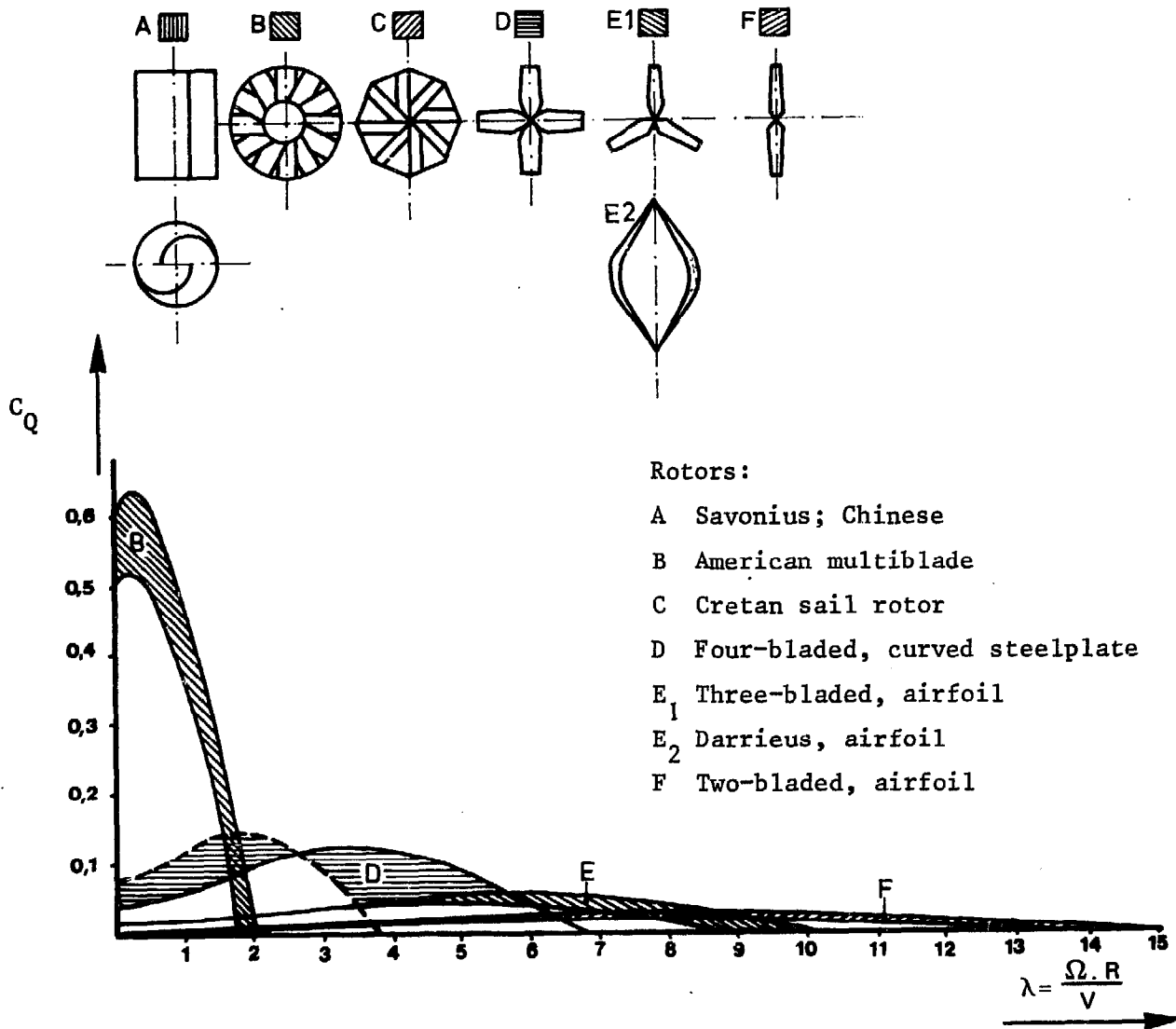

Fig. 4.6. The corresponding torque coefficients of the rotors in fig. 4.5.

Table 4.1. The practical aspects of some windrotors (taken from tables of M. Sherman in [8])

type	fabric- ation technology	initial cost	Main- tenance	control	Life	typical applica- tion	rated wind speed	dia- meter
1. Slow-speed rotors								
1a. Greek sail rotor	local wood metal sail	low	regular local	manual	medium	water pumping	low, medium	up to 10 m
1b. Multi-vane rotor	workshop metal	medium	low local	automatic semi automatic	long medium	water pumping	low, medium	up to 8 m 6 m
1c. Savonius rotor	local metal oil drum	low	local	nil	medium	water pumping	medium, high	up to 3 m
1d. Chinese vertical-axis rotor	wood local	low	regular local	manual	medium	water pumping	low, medium	up to 10 m
2. Medium-speed rotor								
2a. 4-blade cambered metal plate rotor	workshop metal medium technology or local	medium	low, trained personnel	automatic or semi-automatic	long medium	water pumping	medium	up to 6 m
2b. Princeton sailing rotor	workshop local, medium or high	low, medium	regular, trained personnel	automatic	medium	water pumping electricity	medium high	up to 8 m
2c. vertical-axis rotor with sails	metal sails	low	low	manual	medium	water pumping electricity	medium	up to 4 m
3. High-speed rotors								
3a. 3-blade rotor	workshop wood or metal	low	regular low	automatic	medium	electricity water pumping	medium high	up to 5 m
	workshop fibreglass reinforced plastic	medium	low, trained personnel	automatic	long	electricity	medium high	up to 10 m
3b. Darrieus rotor	extruded aluminum or fibre-glass reinforced plastic	medium	low, trained personnel	automatic	long	electricity	high	up to 24 m
4. Very-high-speed rotors								
4a. 2-blade rotor	aluminum or fibre-glass reinforced plastic	medium high	low, trained personnel	automatic	long	electricity	high	greater than 10 m
4b. 1-blade rotor	aluminum or fibre-glass reinforced plastic	high	low, personnel trained	automatic	long	electricity	high	greater than 10 m

4.2. Generator characteristics

An extensive description of the working principles of a generator is given in literature [11, 12]. In appendix B a short recapitulation of these principles is given.

For this text a short survey of different types of electric machines* is sufficient.

There are three main types:

- 1) The synchronous machine. A generator of this type is usually called: alternator.
- 2) The asynchronous machine. An induction squirrel-cage motor is of this class.
- 3) The commutator machine. For example a DC-motor or a dynamo.

We will give a short description of these three types and will discuss their characteristics with special reference to their aptitude of being driven by a windrotor.

4.2.1. The synchronous machine (SM)

This type is usually constructed in the following way:

- The rotor consists of a number of poles, around which coils are wound. When a DC current (the field current or excitation current) is flowing through the coils magnetic poles are created. The number of poles is even (each pair consists of a South and a North pole) and will usually have a value between 2 and 24. When the number of pairs of poles is p and the rotor rotates with n_G r.p.m., then a fixed point on the stator will see a magnetic field periodically

changing with a frequency of $\frac{p \cdot n_G}{60}$.

- On the stator, normally three coils are wound in such a way that, when a three phase current system flows through these coils (with a certain frequency f) a rotating magnetic field is generated. When the rotor- and stator-field rotate at the same frequency, but only then, a non-pulsating torque is exerted by the one field on the other.

In that case applies $f = \frac{p \cdot n_G}{60}$.

When the stator of the SM is connected to a voltage system with fixed frequency, f , the shaft (after synchronisation) will rotate at a fixed speed of $60 \cdot f / p$ revolutions per minute. Vice versa applies that, when the rotor is rotated at a fixed speed, the SM supplies a voltage of a fixed frequency. As a result, a windrotor coupled to a synchronous machine has to rotate at a constant speed (the synchronous speed) if the machine is directly connected to the public grid. If the machine operates independently, then speed variation

*We use the general term "electric machine" instead of "generator", because all electric machines can basically operate as a motor as well as a generator.

is possible, but the output voltage will have a variable frequency. For electric heating this will present no difficulties, for other applications rectification and subsequent DC/AC conversion might be necessary.

- In general the rotor of the SM has two sliprings to which the field current (DC) can be fed. The generated voltage and current is taken from a number of stator coils (depending on the number of phases). In fig. 4.7 this is drawn schematically.

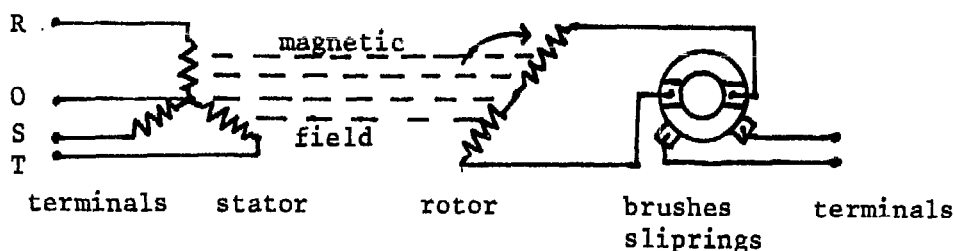

Fig. 4.7. Schematic representation of a three-phase synchronous machine

- There also exist slipringless (or brushless) types of synchronous generators. In one type a small extra generator is mounted on the extended shaft of the synchronous generator. This generator has field coils in the stator and the current is generated in the rotor. The generated current is rectified by diodes (mounted on the shaft) and fed to the field coils on the rotor of the original synchronous generator.

Another brushless type of synchronous generator is the generator with a permanent magnet rotor.

- Advantages:
- No losses caused by excitation currents.
 - No brushes, therefore lower friction losses.

- Disadvantages:
- A permanent field is not as strong as an excited field.
 - The possibility of controlling the generator output by controlling the field current is eliminated.

4.2.2. The asynchronous machine (AM)

- Basically, the stator of the AM is the same as that of the SM. The stator coils are normally connected to an AC-voltage system, e.g. grid. These coils, 1 for a single-phase AM and three for the three-phase AM, will supply the rotating magnetic field.
- The rotor windings are generally not connected to a power source but are short-circuited. Either a squirrel-cage rotor is used or the rotor windings are short-circuited outside the machine. The terminals are led outwards by means of sliprings. The latter construction gives the possibility to control the machine.
- The rotating stator field induces currents in the rotor. These currents are only limited by the impedance of the rotor winding. The magnetic field in the stator exerts a torque on the current conducting windings of the rotor and the rotor will have to rotate, forced by this torque. When the rotor rotates at the same speed as the rotating stator field (this speed is called the synchronous speed), no current is induced in the rotor and no torque is exerted on the rotor by the stator field. This means that, if the stator has to exert a force on the rotor, the rotor speed has to be unequal to the speed of the stator field. Stator field and rotor have asynchronous speeds.
- When an AM, rotating at synchronous speed, is connected to a load requiring a torque, the rotor speed will decelerate to a value where the difference in the speed of rotor field and stator field causes enough rotor current to produce the required torque. Now the machine acts as a motor.
- When, on the contrary, the AM is driven by a prime mover at a speed higher than the synchronous speed, currents will be generated in the rotor. (Stator is connected to our existing fixed frequency supply.) These currents excite a magnetic field which generates tension and subsequently current in the stator windings. Then the machine acts as a generator: electric power is leaving the stator connections. The function of the stator windings is:
 - 1) to produce a rotating magnetic field,
 - 2) to conduct the generated power.

When no three-phase voltage system is available, the machine will not easily operate as a generator.

In fig. 4.8 a possible configuration is drawn of an AM working as a generator without a connection to a public grid.

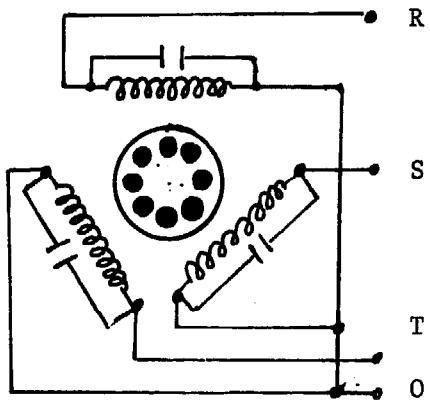

Fig. 4.8. Schematic representation of an asynchronous machine (AM), equipped with capacitors to provide self excitation

The stator windings form oscillating circuits together with the extra capacitors. These circuits are tuned to the desired frequency (50 Hz for instance). When synchronous speed is reached the remanent magnetism of the rotor is sufficient to generate current in the stator, (in the same way it happens in a SM normally), which is sufficient to start oscillating currents in the LC-circuits. These currents will produce a rotating magnetic field and the normal AM generating principle can maintain the rotor currents and thus generate stator currents.

4.2.3. Comparison of the SM and AM

A rough comparison of the SM and AM can be made by their torque-speed curves as they occur in connection with a strong public grid with fixed frequency (see fig. 4.9 and 4.10).

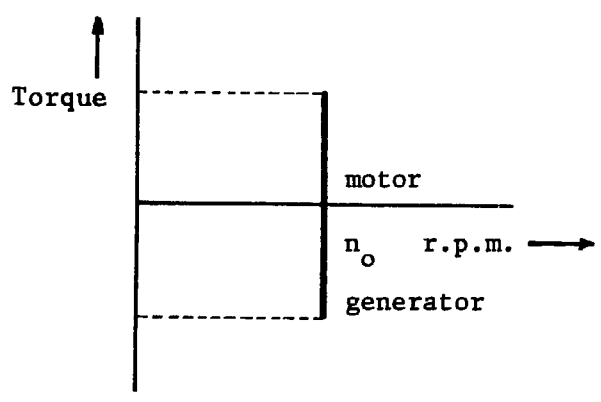

Fig. 4.9. The torque speed curve of a synchronous machine coupled to a strong grid

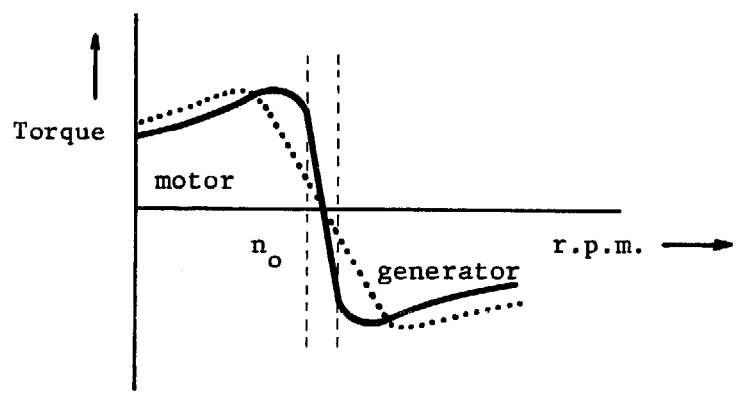

Fig. 4.10. The torque speed curve of an asynchronous machine coupled to a strong grid. Its operating range lies between $n_0 + 4\%$ and $n_0 - 4\%$. The dotted curve indicates a machine with a resistance in the rotor circuit.

- The synchronous machine can operate only at synchronous speed (fig. 4.9). At this speed all torques-values between Q_{\max} and Q_{\min} can be demanded from or applied to the shaft. If the torque is larger than Q_{\max} (or smaller than Q_{\min}), the machine will no longer keep pace with the network frequency. Large pulsating torques and currents are brought about in that case, which may possibly damage the machine.
A fixed-frequency network thus seriously limits the generator speed to one value. As a result, starting of the machine needs a special procedure. Disconnected from the grid, the machine has to be speeded up to synchronous speed by means of an auxiliary motor. When the right polarity, voltage phase sequence and the frequency are checked with special equipment, the connection with the network can be made. When no strong grid is available and the SM has to operate as a generator, then the rotational speed must be controlled mechanically (for instance: the speed of the diesel engine, the steam supply, the transmission ratio). Of course this is only necessary when a more or less fixed frequency is desired.

- The asynchronous machine can operate at a certain range of speed values around the synchronous speed n_0 . As we have seen, the origin of the transfer of energy between electrical and mechanical power is a certain difference (slip) between the rotational and the synchronous speed. At synchronous speed (slip is zero) no torque is exchanged between the machine and the load. On the other hand, when the slip is too large, the maximum or minimum value of the torque is exceeded and in the motor mode the machine will decelerate to zero, and in the generator mode the machine will run free and speed up, limited only by the mechanical friction.
A fixed-frequency network thus makes possible a small range of stable values of n . The AM can be started as a motor by simply connecting the stator to the network. Sometimes special arrangements have to be made to prevent high currents during starting. The range with stable n -values can be enlarged by several methods. One method is using sliprings on the rotor by means of which the rotor windings can be short-circuited through a variable resistance. The higher this resistance, the flatter the torque speed curve. An example is given in figure 4.10 by the dotted line. From this it is clear that the band with stable n -values is enlarged.
When no strong network is available, the AM can be used with the arrangements presented in figure 4.8. In this case the rotational speed should be kept in the range indicated in fig. 4.10 to obtain a fixed output frequency.

4.2.4. The commutator machine (CM)

Generally this type is constructed in the following way:

- On the stator a non-rotating magnetic field with one or more pairs of poles can be found. This field can be obtained by a permanent or electric magnet.
- On the rotor, a number of conductors is distributed in slots. The conductors are connected to the commutator and in series with each other. (See annex B.) As a result, a DC voltage appears on the brushes when the rotor rotates.

The CM is one of the oldest types of electric machines and a lot of improvements have been made on this type. This has resulted in a number of special arrangements. The torque speed curves of the CM are very strongly dependent on the way in which the electrical or mechanical load is coupled to the machine and on the way in which the magnetic field is excited. We give a survey of the different field-exciting methods in table 4.2 and show the torque-speed curve of the shunt wound machine (fig. 4.11).

The CM is often thought to be suitable only for DC-current. This is not the case. When an AC voltage is applied to a CM, the same performance is in most cases obtained as with DC. So, if a CM is connected to a strong network with fixed frequency and driven above speed n_0 (see figure 4.11) the CM will work as a generator and quite within a broad range of n values.

We need to mention here that for generating purposes the CM has been superseded by the synchronous machine and for driving purposes the asynchronous machine is used extensively nowadays. Only in special applications where variable rotational speed is required (i.e. electric train drive, rolling mills, cranes) the CM is often used as a motor. However, the dominating role of the CM is more and more taken over by the AM.

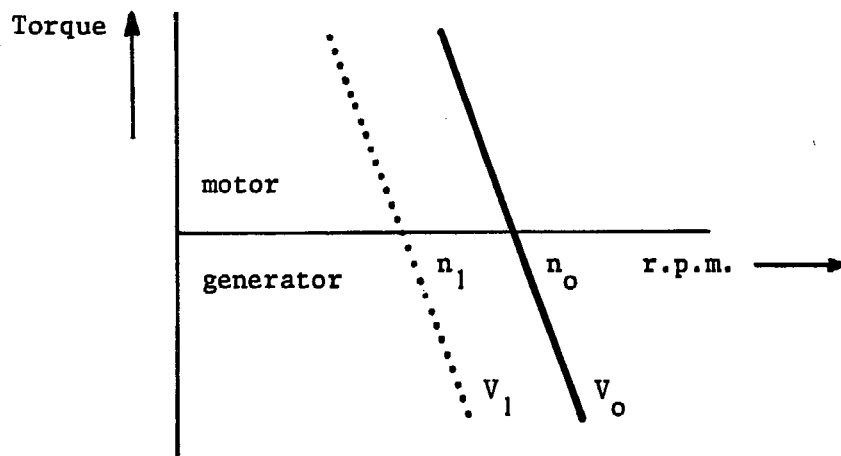
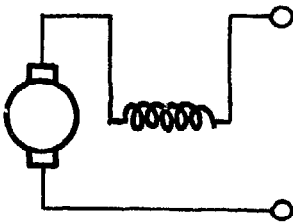
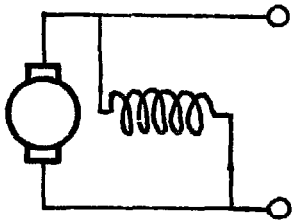
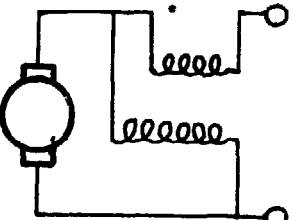
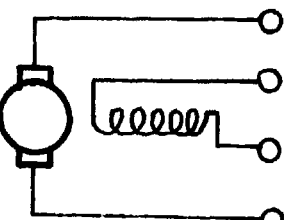

Fig. 4.11. The torque speed curve of a (shunt-wound) commutator machine at two voltages

Table 4.2. Basic circuits for commutator machines (CM)

Application	as generator	as motor
<p>Series wound</p> 	<p>not often used</p>	<ul style="list-style-type: none"> - when high starting torque is required: cranes, trains - when motor is permanently coupled to load - not when low or no torque may occur
<p>Shunt wound</p> 	<p>most frequently employed</p>	<ul style="list-style-type: none"> - when constant speed is required
<p>Compound wound</p> 	<p>special applications</p>	<ul style="list-style-type: none"> - when high starting torque is required and low torque may occur - when load fluctuates - when supply voltage fluctuates - electrical braking
	<p>only employed when a wide output range is required</p>	<p>used in a Ward Leonard speed control set</p>

4.2.5. Automobile electrical systems

Automobile generators, being widely used and therefore cheap and easily available, will be given a more extensive description in view of the possibilities they offer in wind electric plants. In all automobiles, a small electric generator is installed to supply energy for the ignition, lights and to charge the battery which is used in every car to provide energy at standstill and for starting the car.

A number of components of the electrical system of a car can be used in a small wind electric plant.

We must admit that these components are not the most suitable ones for our purpose, but since they are low priced and readily available they cannot be neglected.

The generator

In general two types dominate in automobiles:

- the dynamo, or DC-commutator generator. Mostly shunt wound; rarely fitted with a permanent magnet
- the alternator; an AC "synchronous" generator.
A rectifier (generally built in the generator) converts the AC voltage in to DC. The stator windings can be single, two or three phase.

Due to a simpler construction and better performance, the alternator is used more frequently nowadays than the dynamo.

The following description will serve as starting point for the discussion of using an automobile generator in a wind-driven electrical plant. First we will give a comparison between the characteristics of an alternator and a dynamo.

In figures 4.12, 4.13, 4.14 and 4.15 the generalized characteristics of these two types are given, when connected to a source or load with a fixed DC voltage.

The following definitions are used:

$n_{\text{cut-in}}$: the rotational speed at which the generator starts producing net electric power, i.e. it produces already its own field current.

n_{rated} : the rotational speed at which the rated current (or power) is produced. Here we choose:

$$I_{\text{rated}} = \frac{2}{3} I_{\text{max}}$$

The current in an alternator is limited at an acceptable value by the characteristic properties of the alternator.

It is possible that the current in a dynamo will increase to values which may damage the dynamo. A current limiting device is therefore necessary. We will discuss this later on.

Commonly the alternator starts generating current at a lower speed than the dynamo does: at $n_{\text{cut-in } 1}$ (alternator) and at $n_{\text{cut-in } 2}$ (the dynamo).

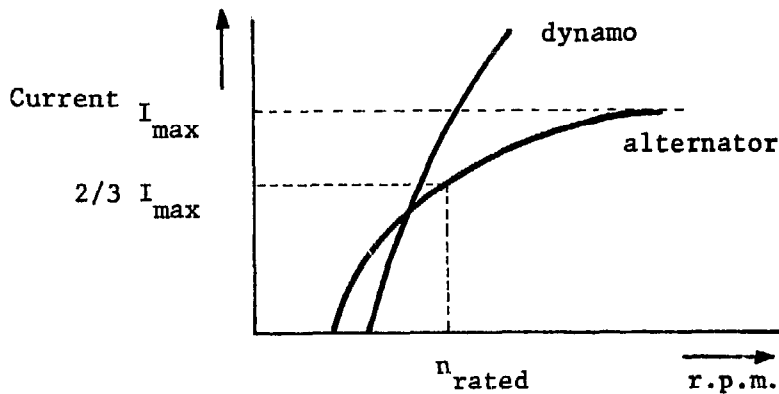

Fig. 4.12. The output current I as a function of the rotational speed of a dynamo and an alternator

The dynamo needs a higher starting torque than the alternator due to the brushes and commutator of the dynamo.

The electric power output of both devices will be proportional to the output current as long as the voltage of the battery is constant.

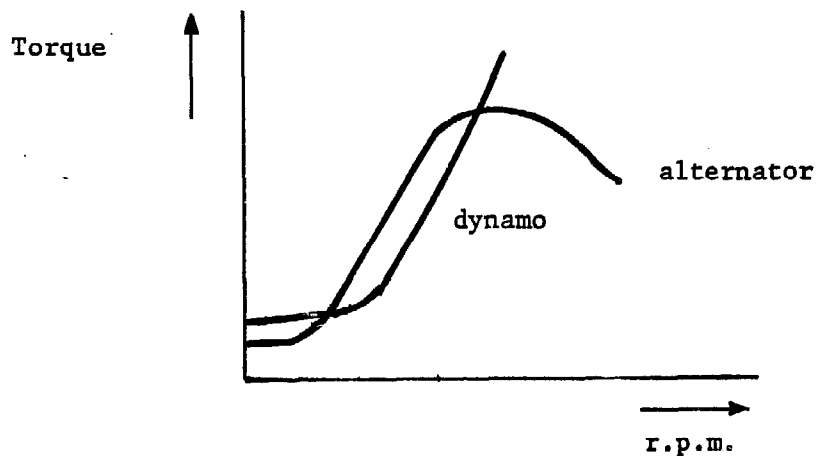

Fig. 4.13. The torque speed curve of a dynamo and an alternator

The mechanical power input of the alternator still increases for values of n when the electric output is already constant. Therefore, the efficiency of the alternator will decrease at high n -values.

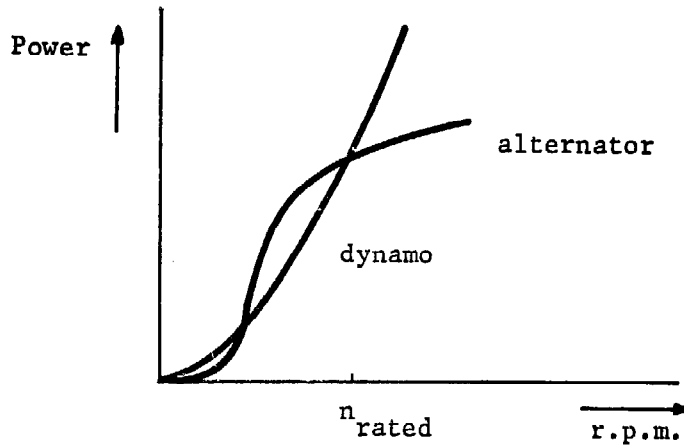

Fig. 4.14. The power output curves of a dynamo and an alternator

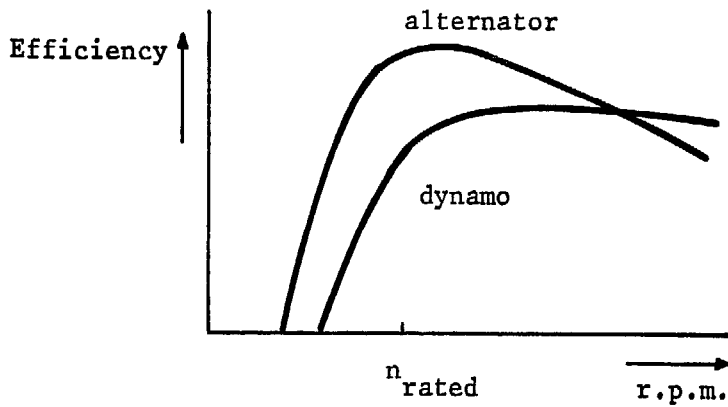

Fig. 4.15. The efficiency speed curve of a dynamo and an alternator

When the dynamo is equipped with a current limiter, the idealized I - n curve that is valid for both types of generator is given in fig. 4.16.

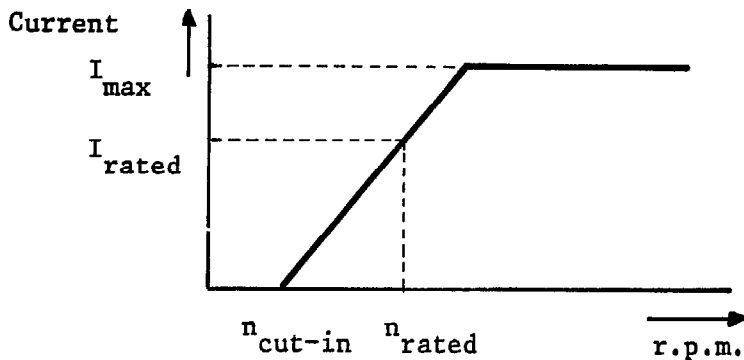

Fig. 4.16. The idealized current speed curve of a generator equipped with a current limiting device

The torque-speed curve can also be generalized. See fig. 4.17.

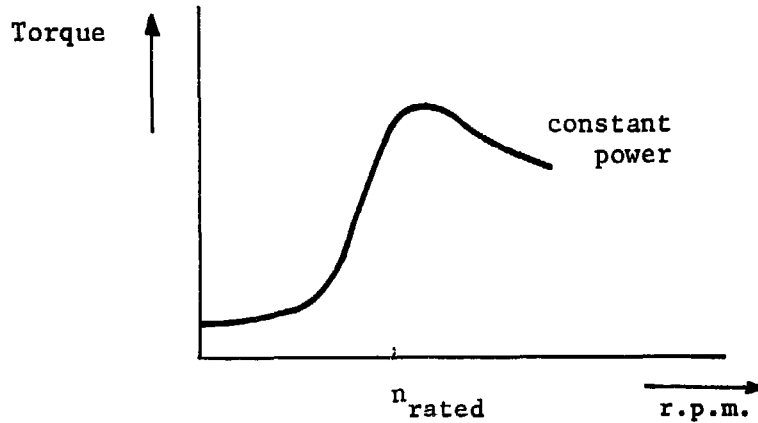

Fig. 4.17. The idealized torque speed curve of a generator

We can change the torque speed curve of a generator by changing the field current or by changing the voltage of the battery or load to which the generator is connected.

The relation between the field current I_F and the generator current I_G is given in figure 4.18.

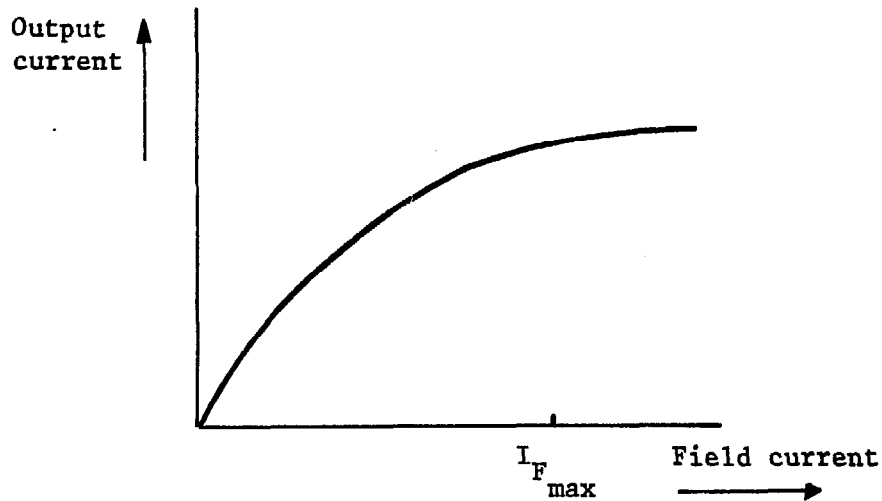

Fig. 4.18. The output current of a generator at fixed speed as a function of field current

Due to saturation of the magnetic circuit in the generator there is a limit in the increase of the output resulting from increases in I_F . Furthermore if I_F is greater than I_{Fmax} , the field windings may be damaged. In figure 4.19 torque speed curves for different field currents are given for an alternator.

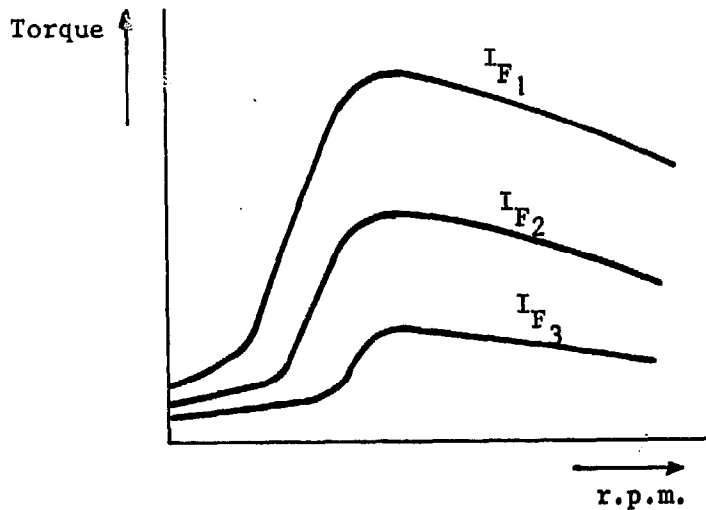

Fig. 4.19. The torque speed curves of an alternator for different values of the field current ($I_{F1} > I_{F2} > I_{F3}$)

It must be noted that the starting torque necessary for the generator has a minimum value if I_F is as small as possible. Via a so-called warning light, see fig. 4.23 a control possibility of the excitation current is obtained. The effect will be a lower field current during the starting period.

Field control and generator output control

As we have seen, the dynamo's output current has to be limited in order to prevent damage to the dynamo windings. This is done in most cases by diminishing the field current by means of an electromagnetic relay controlled by the generator current. Another reason for limiting the generator output (the dynamo as well as the alternator) is to prevent the battery voltage from rising too much. For example, a battery with six cells has a voltage of about 12 to 13 Volts. Charging the battery will increase the voltage, depending on the charge condition and the charge current. See section 5. When the load current is too high, the battery may also be damaged. In fig. 4.20a and 4.20b the general principles of these protecting devices are given. Generally, over-currents or over-voltages are detected by a relay, causing a diminishing of the field current.

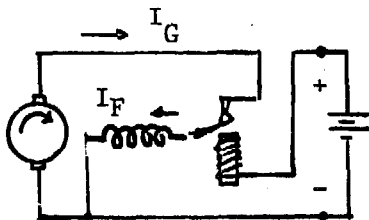

Fig. 4.20(a)
Voltage control system
with current relay (CCR)

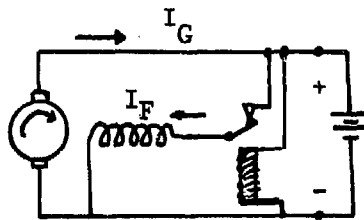

Fig. 4.20(b)
Voltage control system
with voltage relay (VCR)

For a dynamo a third control relay is necessary. This has the task to prevent the current from flowing from the battery to the dynamo when the dynamo's speed is too low to load the battery. In such a case, the battery will discharge in a short time. Such a relay is presented in fig. 4.20 c.

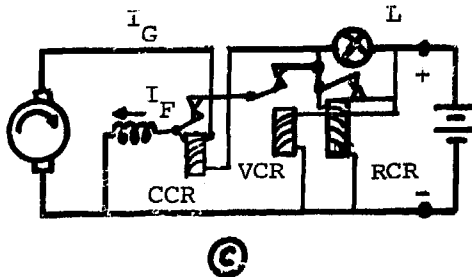

Fig. 4.20(c) Voltage control system with reverse current relay (RCR)

When there is no load current the Reverse Current Relay, RCR, contacts are open.

When the voltage generated by the dynamo (Field current is given by the battery through the warning lamp L) is as high as the battery voltage, the RCR contacts close and the generator starts loading the battery. The warning lamp L goes out.

- Generally, the field control relays are more complicated see fig. 4.21.

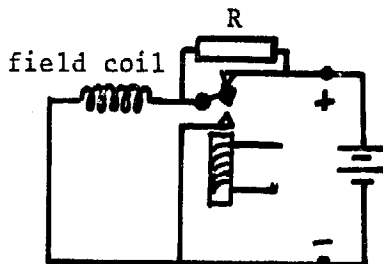

Fig. 4.21. A field current relay with 3 contacts. When the generator voltage is only slightly too high contact a-b will open and the (diminished) field current flows through the resistor R. When the voltage rises still further, contact b-c closes and the field coil is short-circuited.

For an alternator with rectifiers, no reverse current relay (RCR) or current limiting relay is necessary. The rectifiers will block reverse currents, and the current is limited by the characteristic properties of the alternator. In this case only a voltage control relay is necessary. In figure 4.22 this is drawn for a three-phase alternator.

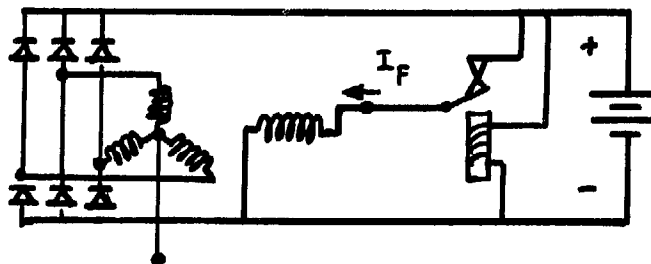

Fig. 4.22. A voltage control relay for a three-phase alternator with rectifiers

In some cases a method is used to prevent the field current from flowing when the rotational speed of the alternator is too low to charge the battery. See fig. 4.23.

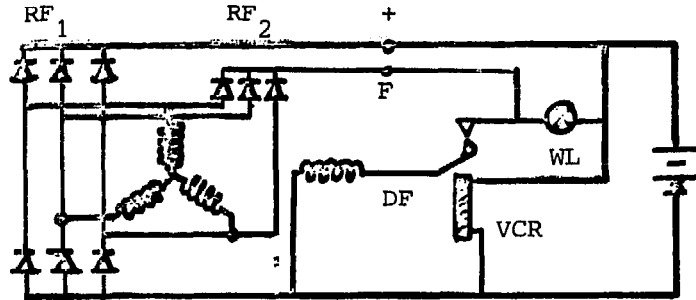

Fig. 4.23. A control system to prevent reverse current at low r.p.m. for an alternator

An extra set of diodes is used to feed the field coil. When no voltage is generated, a small field current flows through the warning lamp WL. When, by means of this field current, a voltage is generated, rectifier RF2 will start producing field current. When the voltage at F is as high as the battery voltage, the light WL goes out and the alternator starts loading the battery.

Load control

When using the current limiting and voltage control limiting relays in a wind power plant, we have to be aware of the fact that they serve as safeguarding and limiting devices to prevent damage to the battery or the generator.

They are not designed to improve the operation of the wind rotor generator set.

The voltage control relay (VCR) has a limiting effect on the power output of the wind generator because it diminishes the field current. The latter happens at higher wind speeds when the r.p.m. of the generator rises (and also the current) which causes an increase of the voltage, resulting in intervention by the VCR.

To avoid this effect, more load has to be connected to the generator, e.g. battery, light, heating device. By this the voltage will decrease and the generator will be able to supply maximum output. For reasons of safety it is better not to disconnect the voltage relay.

The best solution is to automatically switch a greater load to the generator when the rotational speed (or wind speed) increases. When such a control mechanism acts faster than the voltage relays, the latter will not bother us but only act in case of an emergency.

4.3. Matching windrotor and generator

4.3.1. The required data

In section 3.3 we chose values for $V_{\text{cut-in}}$, V_{rated} and V_{furling} and subsequently calculated the swept area A of the windrotor and the necessary rated power P_{rated} of the generator. We thereby used the assumption:

$$P_a = \frac{1}{2} \rho C_p \eta_{Tr} \eta_G \eta_B A V^3 = 0.1 A V^3 \text{ [W]} \quad 4.7$$

We shall now consider the real efficiencies to demonstrate the validity of this assumption. The various losses in the conversion process are clearly indicated in a so-called Sankey diagram of the energy flow as shown in fig. 4.24.

In this section we will finalize the matching procedure by calculating two essential parameters: the optimum gearing ratio i of the transmission and the tip-speed ratio λ_0 of the rotor. Also the wind speed V_{start} at which the rotor starts turning and the rated speed of the generator will be found.

To do so, we need some basic data, particularly from the generator. For convenience of the reader we shall first give a survey of all parameters that play a role in both matching procedures.

	from matching wind regime and load	from matching rotor and generator	basic data
design wind speeds	$V_{\text{cut-in}}$ V_{rated} V_{furling}	V_{start}	hourly wind speeds
rotor	A	λ_0	$C_p(\lambda)$
transmission	-	i	η_{Tr}
generator	P_{rated}	n_{rated}	$U_G, I_F, I_{G\text{max}},$ $n_{\text{cut-in}}, Q_{\text{start}}$ ($I_F = 0$ and max), P_G at n_{rated}
load	-	-	load pattern

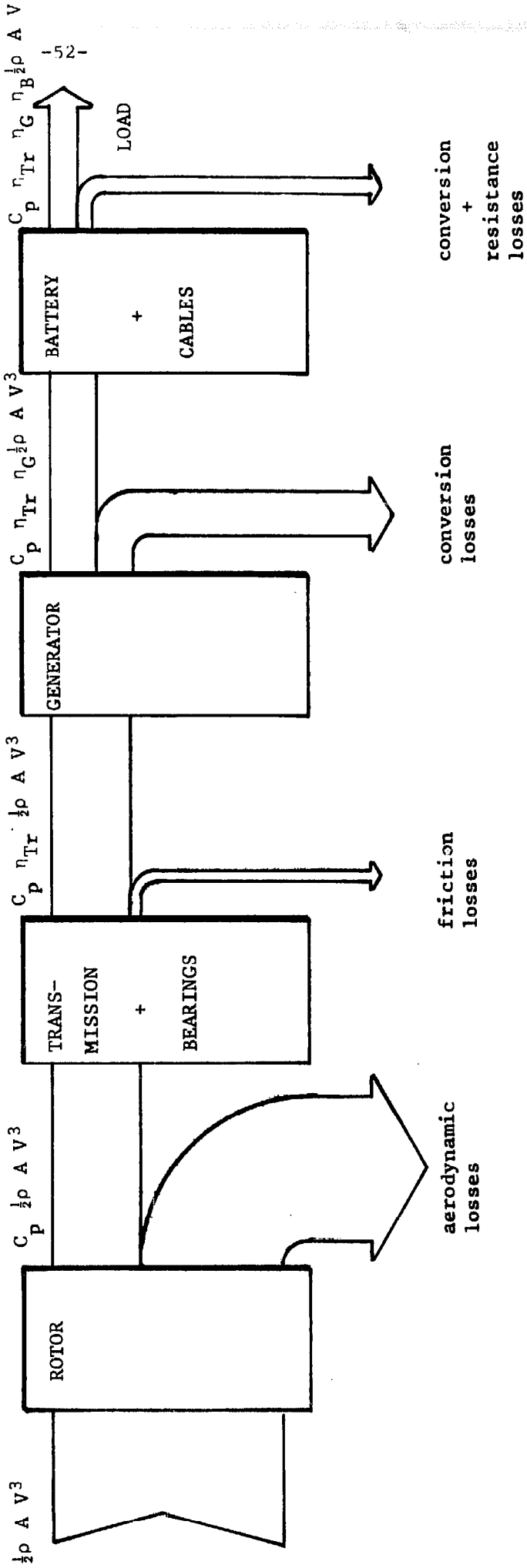
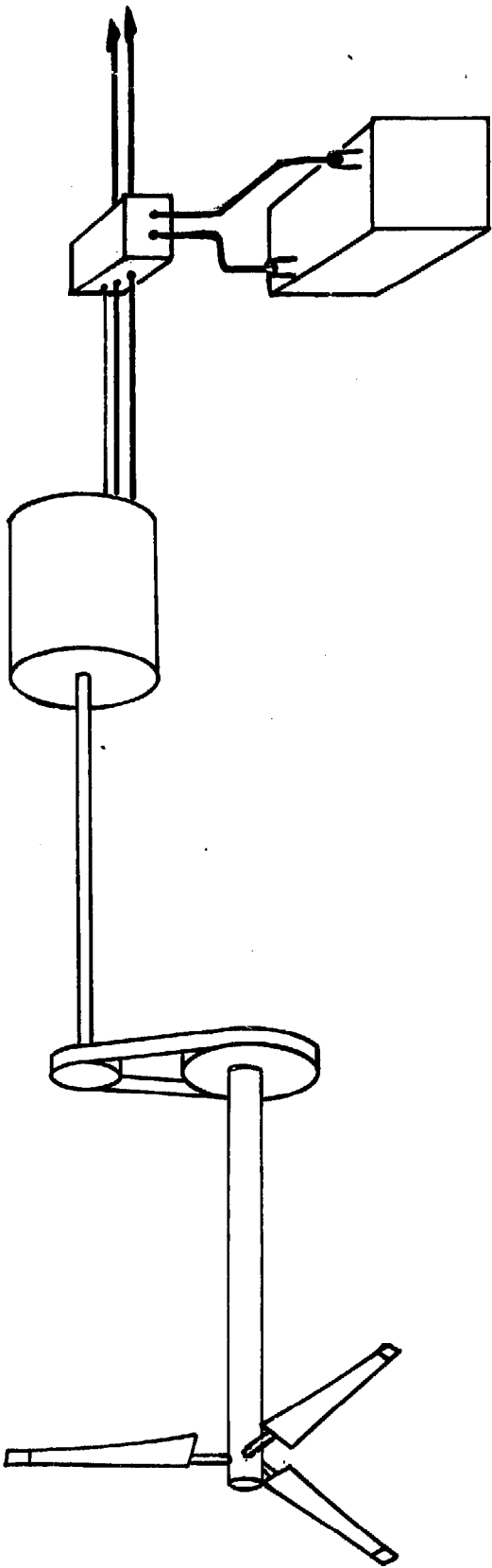

We see that, particularly from the generator, many data are needed which are normally not available. In 4.3.3. some practical hints are given in this respect.

It is important to realize the rather low efficiency of commercial automobile generators. The efficiency also strongly varies with speed.

Typical values are:

AC automobile generators $0.3 < \eta < 0.6$

DC automobile generators $0.2 < \eta < 0.4$

For comparison: generators with rated powers higher than a few kW have efficiencies above 80%, while generators in the MW range reach 95% or more.

The efficiency of the transmission may be considered high and almost independent of speed. In table 4.5 some information about different types of transmissions is given.

	cost	efficiency	maintenance	maximum transmission ratio of one stage
gear box (oiled)	6(high)	1 ($\approx 95\%$)	1 (low)	1 : 10
timing belt	5	2	2	1 : 6
chain wheel (greased)	4	3	5	1 : 4
V-belt	3	5	4	1 : 6
flat driving belt	2	4	3	1 : 10
friction gear	1(low)	6 ($\approx 70\%$)	6 (high)	1 : 10

Table 4.5 Properties of transmission devices.

4.3.2. The matching procedure

The procedure of matching the rotor to the generator implies that three demands are to be met:

- 1 The field energy (or cut-in energy) is produced at $V = V_{\text{cut-in}}$.
- 2 The tip-speed ratio remains close to λ_0 for $V_{\text{cut-in}} < V < V_{\text{rated}}$.
- 3 The rotor starts turning at $V_{\text{start}} < V_{\text{cut-in}}$.

These three conditions can be evaluated as follows.

1. The field energy (or cut-in energy) is produced at $V = V_{\text{cut-in}}$

In the case of a generator with field excitation:

$$\frac{1}{2} \rho C_{P_{\max}} \eta_{Tr} \eta_G A V_{\text{cut-in}}^3 > \frac{I_F \cdot U_G}{\eta_G} \text{ [W]} \quad (4.8)$$

For permanent magnet generators and other generators without external field excitation:

$$\frac{1}{2} \rho C_{P_{\max}} \eta_{Tr} \eta_G A V_{\text{cut-in}}^3 > Q_{\text{cut-in}} G \cdot n_{\text{cut-in}} \frac{2\pi}{60} \text{ [W]} \quad (4.9)$$

When the required data of the generator and the transmission are known and also the max. power coefficient of the rotor (the matching procedure ensures that at $V = V_{\text{cut-in}}$ the rotor operates at $C_{P_{\max}}$) this expression gives a value for $V_{\text{cut-in}}$. If this value turns out to be higher than the value chosen in the calculations in 3.3, the generator choice was wrong. With a given generator and a rotor still to be chosen, the simplest solution is to increase the area A of the rotor, bearing in mind that P_{rated} , now also increased, should not exceed the maximum power of the generator. If increasing A is impossible, the higher value for $V_{\text{cut-in}}$ has to be accepted, implying a smaller number of operating hours per year.

2. The tip speed ratio remains close to λ_0 for $V_{\text{cut-in}} < V < V_{\text{rated}}$

The simplest approximation for this condition is to fix λ at λ_0 for $n_G = n_{\text{cut-in}}$:

$$\lambda_{0,i} = \frac{2\pi n_{\text{cut-in}} R}{V_{\text{cut-in}}} \quad (4.10)$$

This formula should lead to the result that the torque speed curve of the generator more or less follows the quadratic $\lambda = \lambda_0$ curve in the torque speed curves of the wind rotor (fig. 4.25). This supposes the following relationship:

$$\frac{n_{\text{rated}}}{n_{\text{cut-in}}} \approx \frac{V_{\text{rated}}}{V_{\text{cut-in}}} \quad (4.11)$$

which is true for some generators, but definitely not always.

Following our guidelines: $V_{\text{rated}}/V_{\text{cut-in}} = 1.5/0.7 = 2.1$.

For synchronous and asynchronous generators, coupled to a grid, the ratio $n_{\text{rated}}/n_{\text{cut-in}}$ is around unity. In other words, they possess a very steep torque speed curve. Formula 4.10 will lead to a wrong result and a lower transmission ratio will result in a better approximation by keeping λ at λ_0 for a velocity half way between $V_{\text{cut-in}}$ and V_{rated} .

Limiting ourselves in this report to small scale DC generating machines, for which the $n_{\text{rated}}/n_{\text{cut-in}}$ ratio generally is of the order of 2, the given approach is satisfactory.

If, together with condition 3 hereafter, values for λ_0 and i are calculated, the resultant position of the generator curve versus the ideal $\lambda = \lambda_0$ curve must be judged. This can be done by drawing generator curves for different transmission ratios and choosing the curve closest to $\lambda = \lambda_0$ (fig. 4.25b). When a lower value for i is chosen care must be taken that $V_{\text{cut-in}}$ and V_{start} will not become too high.

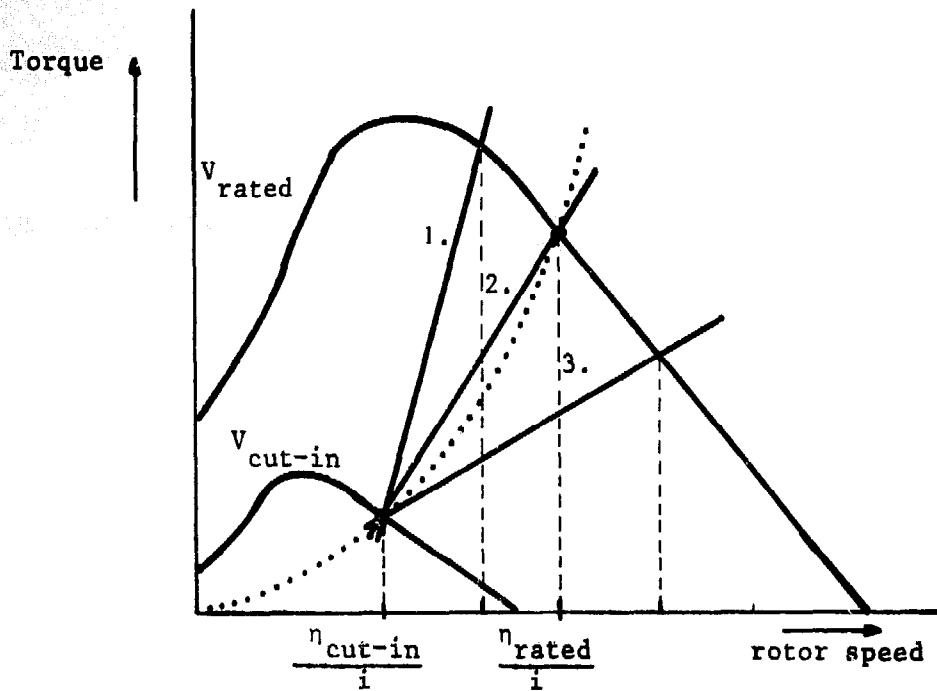

Fig. 4.25(a) The torque speed curves of three different generators are "matched" to a rotor by fixing $\lambda = \lambda_0$ at $V = V_{\text{cut-in}}$ (see formula 4.10). The generators nr. 1 and nr. 3 do not give the desired result because their speed at $V = V_{\text{rated}}$ is too low, respectively too high. Generator 2 gives a correct matching and will maintain the tip speed ratio approximately at λ_0 .

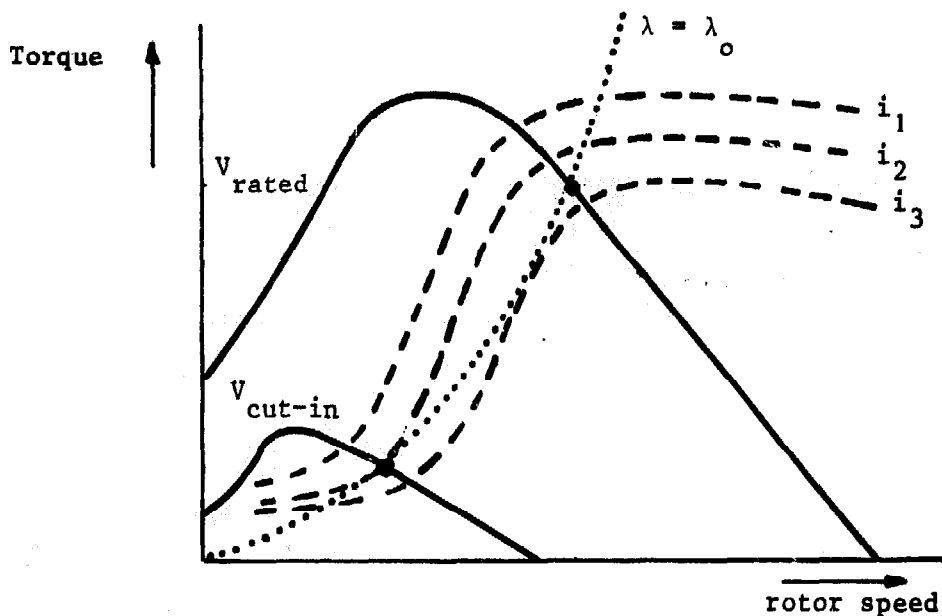

Fig. 4.25(b) The torque speed curve of a generator coupled to a rotor with three different transmission ratios. The calculated transmission ratio i_2 , which is the best choice at $V = V_{\text{cut-in}}$, turns out to be less good at wind speeds around V_{rated} . In this case i_3 is a better choice.

3. The rotor starts turning at $V_{start} < V_{cut-in}$

This condition implies that the starting torque of the rotor at V_{start} is larger than the starting torque of generator plus transmission:

$$C_{Q_{start}} \cdot \frac{1}{2} \rho V_{start}^2 A.R > Q_{start Tr} + i.Q_{start G} \text{ [Nm]} \quad (4.12)$$

As mentioned in section 4.1 the starting torque of many rotors can be approximated by:

$$C_{Q_{start}} = \frac{0.6}{\lambda_o} \quad (4.6)$$

The mentioned restrictions of this formula must be taken into account. The starting torque of a generator strongly depends on the field current. If a field current limiting device is used the next approximation applies:

$$Q_{start G} (I_F = 0) \approx 0.5 \times Q_{start G} (I_F = \max) \quad (4.13)$$

Expression 4.12 can be simplified by realizing that $Q_{start Tr}$ is much lower in general than $i.Q_{start G}$ and so becomes:

$$\frac{0.6}{\lambda_o} \cdot \frac{1}{2} \rho V_{start}^2 A R > i Q_{start G}$$

With the choices for λ_o and i from condition 2, different starting velocities can be determined. The final choice for λ_o and i must result in $V_{start} < V_{cut-in}$.

4.3.3. Practical hints to obtain the generator parameters

If an automobile generator is available, in most cases only the voltage U_G , the cut-in speed $n_{\text{cut-in}}$ and the maximum generator current $I_{G\text{max}}$ are given. How to obtain the other data?

P_G at n_{rated}

The torque-speed curve of most AC generators is a more or less straight line between $n_{\text{cut-in}}$ and the speed for which $I_G = 2/3 I_{G\text{max}}$ (this speed is often indicated in the type number, see the example below).

Therefore we may assume $P_{\text{rated}} \approx 2/3 I_{G\text{max}} \cdot U_G$.

Q_{start}

The starting torque of the generator depends on the pressure of the brushes on the commutator (or on the sliprings) and on the value of the field current. A common value for automobile generators is about 0.1 Nm. It can easily be measured by means of a spring balance and a rope wound around the shaft of the generator (fig. 4.26).

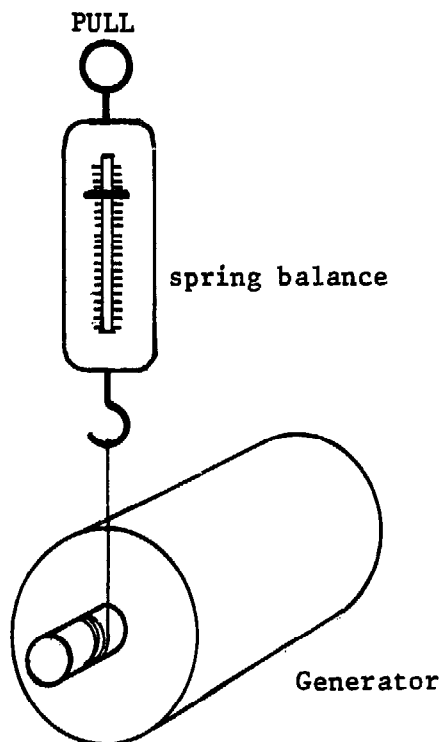

Fig. 4.26. A simple method to measure the starting torque of a generator: by gently pulling the spring balance. A force F kg can be read.

By pulling the rope slowly while reading the scale (of the order of 1 kg) the torque can be found:

$$Q_{\text{start } G} = F \times \frac{D}{2} \times 9.8 \quad [\text{Nm}] \quad (4.15)$$

where F = force read on spring balance in kg

D = diameter of generator shaft in m.

This measurement can be done for $I_F = 0$ and $I_F = \text{max}$.

I_F

The field current I_F is determined by measuring the current through the field coil only if connected to a battery of voltage U_G .

Example:

A generator 14 V 35 A 20 has $n_{\text{cut-in}} = 800$ r.p.m. and will be connected to a 12 V battery.

The code indicates: $U_G = 14$ V

$$I_{\text{max}} = 35 \text{ A}$$

$$n_G \text{ at } \frac{2}{3} I_{G\text{max}} = 20 \times 100 = 2000 \text{ r.p.m.}$$

We calculate: $P_G \text{ at } n_{\text{rated}} = \frac{2}{3} \times 35 \times 14 = 327 \text{ watt}$

Measuring Q_{start} and I_F gives:

$$Q_{\text{start}} = 0.05 \text{ Nm } (I_F = 0\text{A})$$

$$= 0.1 \text{ Nm } (I_F = 2\text{A})$$

$$I_F = 2\text{A}$$

4.3.4. Example of the matching procedure

Finally we shall give an example of the calculation of the tip-speed ratio λ , and the transmission ratio i using the parameters known from an analysis of wind regime and energy demand as given in 3.3.

Suppose we found:

$$V_{\text{cut-in}} < 4 \text{ m/s}$$

$$V_{\text{rated}} = 8 \text{ m/s}$$

$$P_{\text{rated}} = 250 \text{ W}$$

$$A = 4.9 \text{ m}^2 \quad (R = 1.25 \text{ m})$$

Suppose also that we have the following generator at our disposal: a Delco Remy BC 14-12 V NEO, 1100 62P-37A. Calculations and measurements give the following results:

$$\begin{array}{l} U_G = 12 \text{ V} \quad) \\ \quad \quad \quad \quad \quad) \text{ with } n'_G = 0.4 \quad P_G (n_{\text{cut-in}}) = 45 \text{ watt} \\ I_F = 1.5 \text{ A} \quad) \end{array}$$

$$n_{\text{cut-in}} = 900 \text{ r.p.m.}$$

$$I_{G\text{max}} = 30 \text{ A}$$

$$2/3 I_{G\text{max}} = 20 \text{ A, reached at } n_G = 2000 \text{ r.p.m.}$$

$$P_{\text{el}} = 260 \text{ W (2000 r.p.m.)}$$

$$Q_{G\text{start}} = 0.1 \text{ Nm}$$

We choose a transmission with an efficiency of 80% and a rotor with $C_{P\text{max}} = 0.4$.

The first condition results in:

$$\frac{1}{2} \rho C_{P\text{max}} \eta_{\text{Tr}} \eta_G A V_{\text{cut-in}}^3 > \frac{I_F \cdot U_G}{G} \quad (4.8)$$

$$\frac{1}{2} \times 1.2 \times 0.4 \times 0.8 \times 0.4 \times 4.9 V_{\text{cut-in}}^3 > 45$$

$$V_{\text{cut-in}} > 3.6 \text{ m/s}$$

We choose $V_{\text{cut-in}} = 3.6 \text{ m/s}$.

The second condition:

$$\lambda_o i = \frac{2\pi n_{\text{cut-in}} R}{V_{\text{cut-in}}} \quad (4.10)$$

$$\lambda_o i = \frac{2\pi}{60} \times 900 \times 1.25}{3.6} = 32.7$$

Also:

$$n_{\text{rated}} = \frac{V_{\text{rated}}}{V_{\text{cut-in}}} = n_{\text{cut-in}} \quad (4.11)$$

$$n_{\text{rated}} = \frac{8}{3.6} \cdot 900 = 2000 \text{ r.p.m.}$$

At this speed the generator produces 260 watt, enough for our purpose.

The third condition:

$$\frac{0.6}{\lambda_o^2} \cdot \frac{1}{2} \rho V_{\text{start}}^2 A R > i Q_{G_{\text{start}}} \quad (4.14)$$

$$\frac{0.6}{\lambda_o^2} \times \frac{1}{2} \times 1.2 \times V_{\text{start}}^2 \times 4.9 \times 1.25 > i \times 0.1$$

$$\frac{V_{\text{start}}^2}{\lambda_o^2 \cdot i} > 0.045$$

Combining the results of the second and the third condition gives:

$$V_{\text{start}}^2 > 1.5 \times \lambda_o$$

For different tip-speed ratios this becomes:

λ_o	4	5	6	7	8	9	10	-
V_{start}	2.4	2.7	3.0	3.2	3.4	3.6	3.8	m/s

We conclude that $\lambda_o < 9$ because $V_{start} < V_{cut-in}$

In this case $\lambda_o = 4$ was chosen because a transmission 1 : 8 was the nearest value available. (Remember: $\lambda_o i = 32.7$)

Fig. 4.27 shows how the generator characteristics match with the windrotor characteristics.

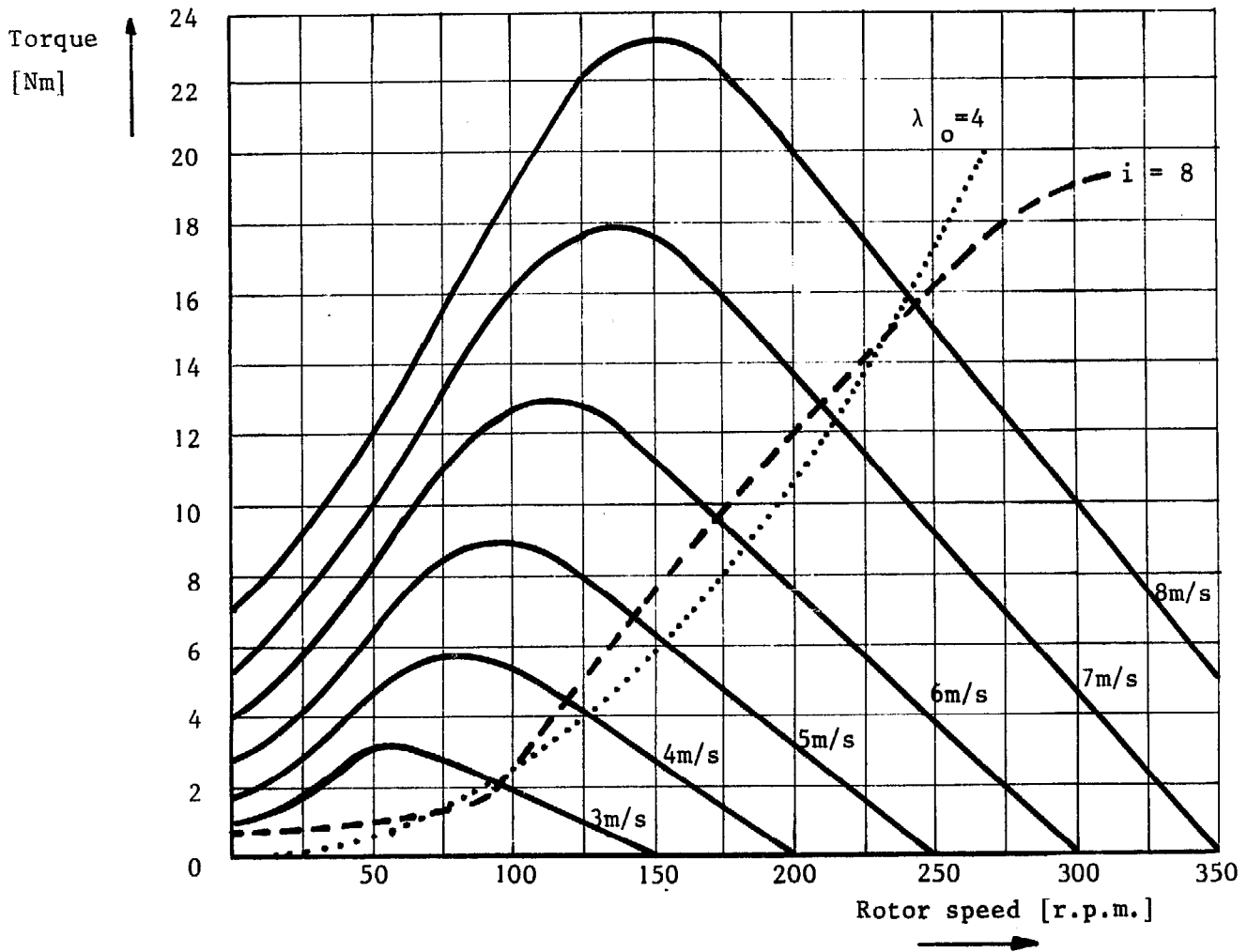

Fig. 4.27. The final torque speed curves of the wind rotor matched with a generator at transmission ratio 1 : 8, as calculated in example 4.3.4.

5. STORAGE OF ELECTRICITY

The most common method of storing the energy from small scale wind generators is to store the energy in the form of electricity. Other storage methods, such as: pumping water into large reservoirs, compressing air or accelerating flywheels are generally not yet available for this purpose.

Storage batteries are widely used to store moderate amounts of electrical energy. We shall give a short survey of some important characteristics of storage batteries.

Type

The material used for the plates of the battery and the kind of electrolyte indicate the type of the battery. Well-known is the lead-acid battery. Other types are: Ni-Cd and Fe-Zn, both alkaline batteries.

Voltage per cell

A battery consists of a number of cells, connected in series. Each battery type has its own typical voltage per cell, which also depends on the discharge situation of the battery (fig. 5.1).

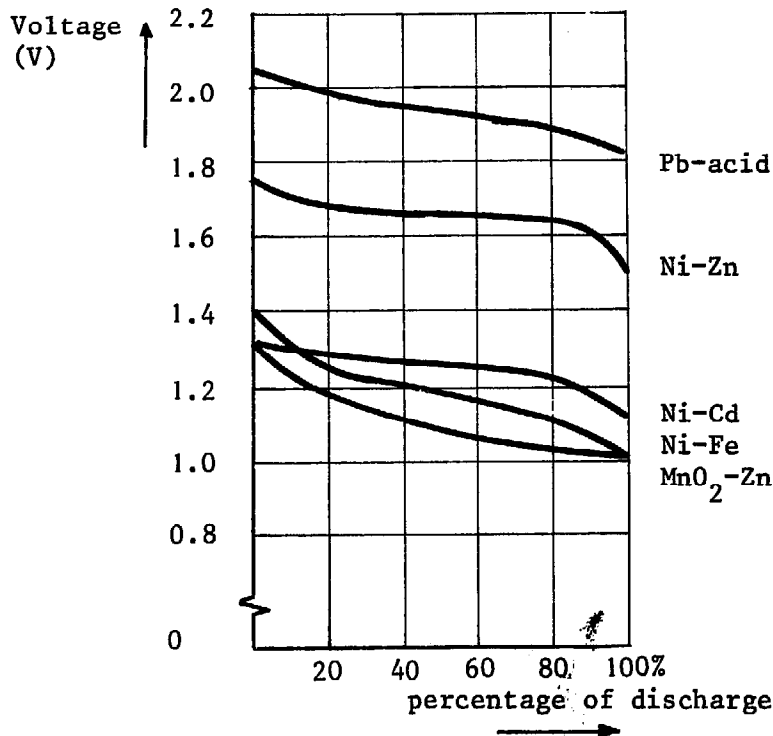

Fig. 5.1. The voltage of electrolytic cells as a function of the percentage of discharge during 5 hours discharging.

Capacity

The maximum amount of electrical energy that can be stored in a battery is called the capacity. The capacity is given in Ampère-hours [Ah]. It is important to realize that this capacity is not a fixed quantity, but depends on:

- the discharge current
- the density and temperature of the electrolyte
- the discharge pattern in time (interrupted discharge is better than continuous discharge)
- the age of the battery (the older the battery the more mass is lost from the plates)

In general the indicated capacity is given for a 20 hour discharge time and an electrolyte temperature of 27° C.

Example: a 12 V 40 Ah battery can deliver 2 A during 20 hours, but 4 A during less than 20 hours. This 2 A current is called the nominal discharge current. The influence of currents higher than this discharge current on the capacity is given in fig. 5.2.

A remark: the capacity of this battery can also be given in kWh: $12 \times 40 = 480 \text{ Wh} = 0.48 \text{ kWh}$.

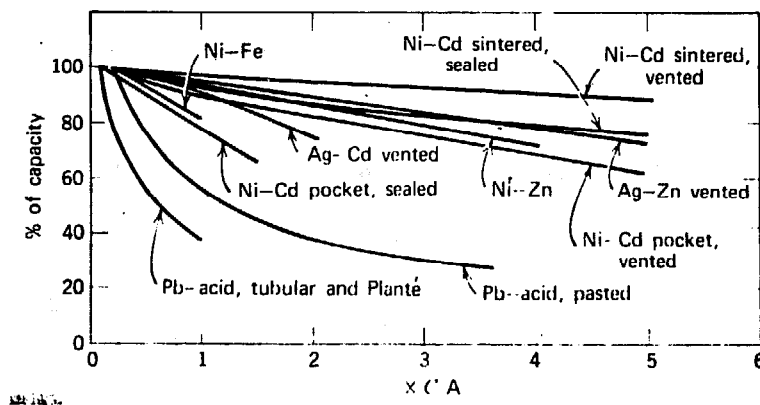

Fig. 5.2. The capacity of different electrolytic cells as a function of multiples of the nominal discharge current.

Service life

The service life of a battery depends on its type, the number and depth of discharge cycles, construction and operating conditions. In table 5.1 some indications are given.

System	Number of deep discharge cycles, >70%	Total life-time years
Ni-Fe	2000-4000	7-25
Ni-Cd pocket, vented	500->2000	8-25
Ni-Cd sintered, vented	300->2000	3-10
Ni-Cd sintered, sealed	200-2000	2-10
Ni-Cd pocket, sealed	100-250	~ 5
Ag-Cd sealed	~700	2
Ag-Cd vented	300-500	3
Ni-Zn	100-200	No data available
Ag-Zn sealed	~80	2
Ag-Zn vented	10-150	0.5-1.5
MnO ₂ -Zn	~50	No data available
Pb-acid, tubular	1400	4-10
Pb-acid, Planté	1000	10-15
Pb-acid, pasted	200-700	3-6

Table 5.1. The life-times of different types of batteries.

Efficiency

The energy efficiency of a battery indicates the ratio of the energy delivered by the battery and the energy fed to the battery. A common value for lead-acid batteries at nominal conditions (20 h discharge and 27°C) is 75%. In section 3.2 we used the value 70%.

Charging

When charging is performed with equipment connected to a grid or diesel powered generator two methods exist. The simplest is to charge at constant voltage, i.e. the charge current drops during charging. The average current in A is roughly 10% of the value of the capacity. This means that the battery is fully charged in about 10 hours.

A more complicated control system is needed for the second system: charging at constant current (five times higher than the average current of the first method), but until the cell voltage reaches its nominal voltage. Then this voltage is kept constant and the current, drops considerably. This method charges a battery in a much shorter period.

For wind generators equipped with an automobile generator, the corresponding voltage controller can be used.

Self discharge

Even if a battery is not discharged externally, the capacity will drop due to self-discharge. For lead-acid batteries this self discharge amounts to 0.2% to 1% of the capacity per day, depending on the quality of the battery.

6. REFERENCES

- [1] Jansen W.A.M., Smulders P.T.,
Rotor design for horizontal axis windmills.
S.W.D., c/o D.H.V. Amersfoort, the Netherlands, March 1977.
- [2] Wilson R.E., Lissaman P.B.S., Walker S.N.,
Aerodynamic Performance of Wind Turbines.
Oregon State University, Corvallis, June 1976.
N.T.I.S., U.S. Department of Commerce.
- [3] Paulissen L.M.M.,
Wind measurements and evaluation of winddata for the
utilization of wind energy.
S.W.D., c/o D.H.V. Amersfoort, the Netherlands, (to be published end 1978)
- [4] Cheret I.,
Etude du régime des vents en Afrique occidentale.
Possibilité d'utilisation des eoliennes pour l'exhaure de l'eau.
Service de l'Hydraulique de l'A.O.F., 1962.
- [5] Golding E.W.,
The generation of electricity by wind power.
Spon Ltd., London, 1955.
- [6] Hütter U.,
Considerations on the optimum design of wind energy systems (in German)
Kernforschungsanlage, Jülich, September 1974.
- [7] Meel J. van,
Weibull distributions in Wind Energy Statistics.
University of Technology Eindhoven, Report R-295-D, July 1977.
- [8] Proceedings of the Expert Working Group on Solar and Wind Energy.
U.N. ESCAP, Bangkok, 1976.
- [9] Proceedings of the Roving Seminar on Rural Energy Development.
U.N. ESCAP, Bangkok, 1978.
- [10] Stevenson W.D.,
Elements of power system analysis.
Mc Graw Hill, London, 1975.
- [11] Edwards J.D.,
Electrical machines; an introduction to principles and characteristics.
Textbook Company, Ltd, Aylesbury, U.K., 1973.
- [12] Hindmarsh J.,
Electrical Machines and their applications.
Pergamon Press, 1977.
- [13] Harder E.L.,
Specific Output of Windmills - A Discovery.
Proceedings of the IEEE, Vol. 65, no. 11, November 1977.

APPENDICES

A. UNITS AND CONVERSION FACTORS

A.1. Prefixes

Decade multiples and decimal sub-multiples of units have the following prefixes:

Prefix	Abbreviation	Numerical value
Tera-	T	10^{12}
Giga-	G	10^9
Mega-	M	10^6
Kilo-	k	10^3
hekto-	h	10^2
deca-	da	10
deci-	d	10^{-1}
centi-	c	10^{-2}
milli-	m	10^{-3}
micro-	μ	10^{-6}
nano-	n	10^{-9}
pico-	p	10^{-12}
femto-	f	10^{-15}
atto-	a	10^{-18}

A.2. Units of energy

In the S.I. (Système Internationale) system the unit of energy is the joule [J]. Equivalent units are:

$$1 \text{ J} = 1 \text{ kg.m}^2/\text{s}^2 = 1 \text{ N.m} = 1 \text{ W.s}$$

A joule is a relatively small amount of energy; in most cases one uses the mega joule (MJ).

Conversion factors to other energy units are:

	MJ	kWh	kcal	Btu
mega joule : 1 MJ =	1	0.278	238.8	947.9
kilo watthour : 1 kWh =	3.600	1	859.8	3412
kilo calorie : 1 kcal =	4.187×10^{-3}	1.163×10^{-3}	1	3.968
British Thermal Unit : 1 Btu =	1.055×10^{-3}	0.293×10^{-3}	0.252	1

A.3. Units of power

The S.I. unit for power is the watt (W). Equivalent units are:

$$1 \text{ W} = 1 \text{ kg.m}^2/\text{s}^3 = 1 \text{ N.m/s} = 1 \text{ J/s}$$

Electrical power P is the product of voltage U and current I:

$$P = U \times I \quad [\text{V.A} = \text{W}]$$

(Note: in the AC case the phase relationship between U and I has to be taken into account: $P = U \times I \times \cos(\phi)$)

Mechanical power can be represented by a force F moving an object with a velocity v:

$$P = F \times v \quad [\text{N.m/s} = \text{W}]$$

Mechanical power can also be represented by a torque Q rotating a shaft with angular speed ω :

$$P = Q \times \omega \text{ [Nm/s = W]}$$

The number of revolutions per minute can be found from:

$$n = \frac{60}{2\pi} \times \omega \text{ [r.p.m.]}$$

Other units of power are:	1 hp	=	745.7 W
	1 kcal/h	=	1.163 W
	1 Btu/h	=	0.2931 W

A.4. Other conversion factors

Length

1 inch	=	25.4	$\times 10^{-3}$	m
1 foot	=	0.3048		m
1 yard	=	0.9144		m
1 statute mile	=	1609		m
1 nautical mile	=	1853		m

Area

1 square inch	=	0.6452	$\times 10^{-3}$	m^2
1 square foot	=	0.0929		m^2
1 square yard	=	0.8361		m^2
1 acre	=	4047		m^2
1 square statute mile	=	2.589	$\times 10^6$	m^2
1 are	=	100		m^2
1 hectare	=	10,000		m^2

Volume

1 cubic inch	=	16.387	$\times 10^{-6}$	m^3
1 cubic foot	=	28.317	$\times 10^{-3}$	m^3
1 cubic yard	=	0.7646		m^3
1 U.S. gallon	=	3.785	$\times 10^{-3}$	m^3
1 imperial gallon	=	4.546	$\times 10^{-3}$	m^3
1 barrel	=	0.159		m^3

Velocity

1 M.P.H.	=	0.447	m/s
1 knot	=	0.514	m/s
1 km/h	=	0.2778	m/s

Temperature

$$T_{\text{Kelvin}} = T_{\text{Celsius}} + 273.15 \text{ K}$$

$$T_{\text{Celsius}} = \frac{5}{9} (T_{\text{Fahrenheit}} - 32^{\circ}\text{C})$$

$$T_{\text{Fahrenheit}} = \frac{9}{5} \cdot T_{\text{Celsius}} + 32^{\circ}\text{F.}$$

APPENDIX B

What happens in a generator?

A generator converts mechanical energy into electrical energy and heat. We are interested in those types in which the mechanical energy is supplied by means of a rotating shaft on which a torque can be exerted and from which electrical energy is released by means of a current and a voltage, in a DC or AC system.

In figure B.1 the quantities (in a DC-system) which describe the power flow through a generator are defined.

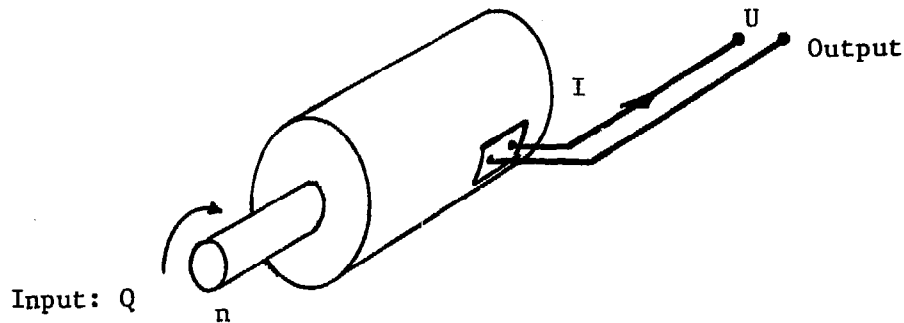

$$P_{\text{mech}} = \frac{Q2\pi n}{60} \text{ [W]}$$

$$P_{\text{el}} = UI \text{ [W]}$$

Fig. B.1. Input-output of generator.

What is the working principle of a generator?

In an electrical machine we always find the following components (see also figure B.2):

- 1) If an electrical conductor (with length ℓ [m]) is moving with a given velocity (with value v [m/s]) through a magnetic field (with flux density B [Tesla]) a voltage is generated with the value

$$e = B \cdot v \cdot \ell \text{ [Volt]} \tag{1}$$

B and v should be perpendicular to each other.

In any generator this basic principle can be found in some form, or other

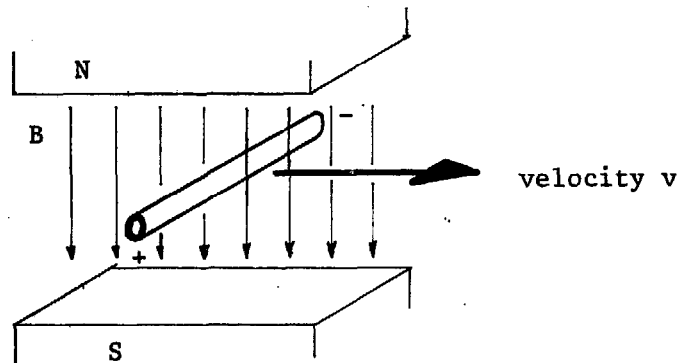

Figure B.2. A moving conductor placed in a magnetic field.

When the direction of B or v changes, the polarity of e will change also.

- 2) When an electric load is connected with the conductor, a current with value I [A] will flow, and a force is needed with value F [N] to move the conductor. This force is expressed by:

$$F = B \cdot I \cdot l \quad [N] \quad (2)$$

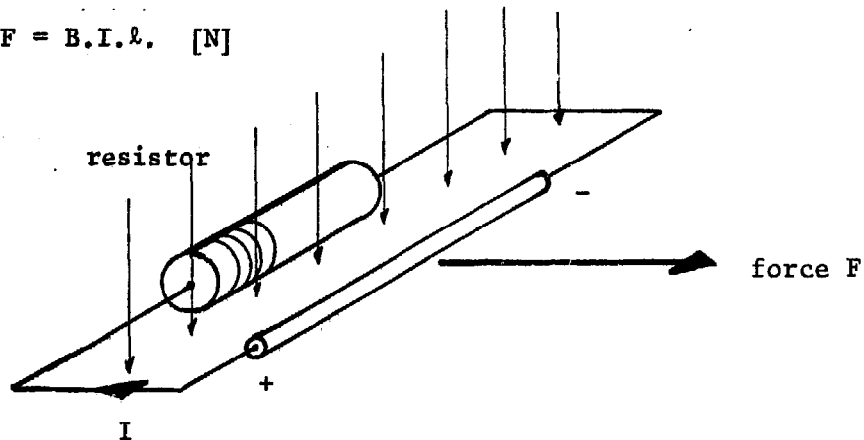

Fig. B.3. A current-carrying conductor in a magnetic field.

We see that a mechanical power source is needed to move the conductor when a current flows.

The mechanical power needed is:

$$P_{\text{mech}} = F \cdot v \quad [W].$$

The electrical power delivered is:

$$P_{\text{el}} = I \cdot e \quad [W].$$

When no losses occur, we see that:

$$P_{\text{mech}} = F \cdot v = B \cdot I \cdot l \cdot v = B \cdot v \cdot l \cdot I = e \cdot I = P_{\text{el}}.$$

This means: mechanical power is converted into electrical power

The principle can also act in the reverse direction: electrical power can be converted into mechanical power; this is what happens in an electric machine.

How is the basic principle realized in a generator?

We need a device in which the following is present in some way:

- a set of wires that can be moved at right angles to a magnetic field
- a possibility to exert a force on the moving wires
- a possibility to lead the generated current out of the generator.

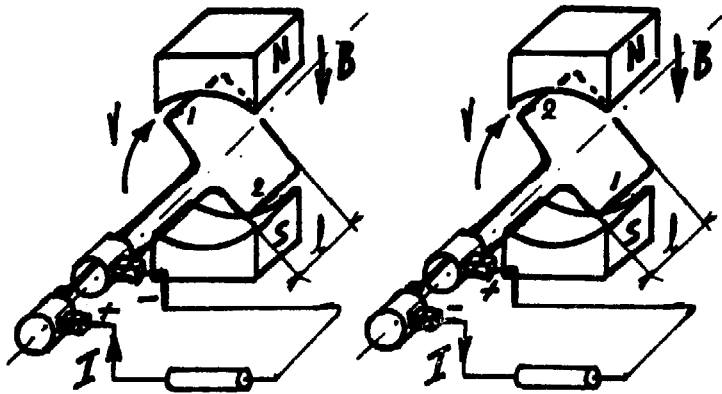

Fig. B.4. Electric machine with sliprings.

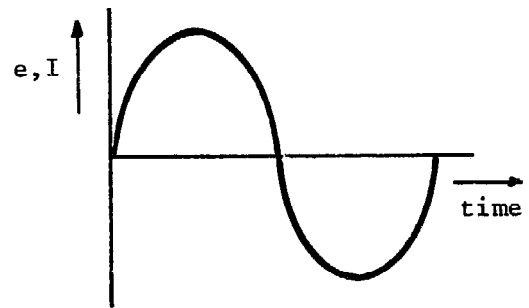

Fig. B.5. Alternating current.

In figure B.4. a generator is drawn on which all the necessary parts are present.

The two wires a and b can rotate and move periodically through the magnetic field that comes from a permanent magnet. A torque can be exerted on the shaft on which the wires are mounted and the generated current is "taken off" through slip-rings. The current will change its direction at each revolution, for each wire under the N-pole moves in just the opposite direction as under the S-pole. The resulting current is therefore called Alternating Current (AC).

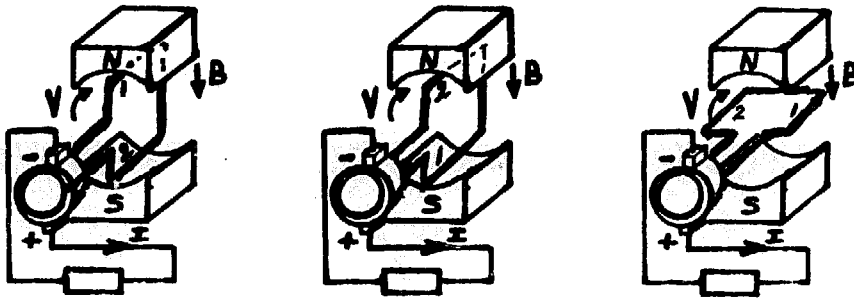

Fig. B.6. Electric machine with commutator

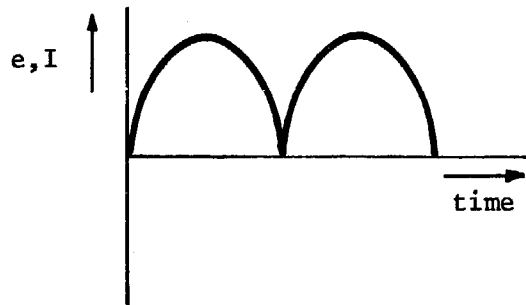

Fig. B.7. Pulsating direct current

In figure B.6. a generator is drawn that produces current flowing permanently in the same direction. This current is called Direct Current (DC). Because a commutator is used instead of sliprings, the connection of the coils in the generator is reversed two times during each revolution. The current then flowing is drawn in figure B.7. and from this we see that always the same direction is maintained. If we want to write formulas (1) and (2) for rotational motion instead of linear motion we may do so by replacing F by Q/r and v by ω/r (see also appendix A).

r is the radius of the circle described by the wires

ω is the angular speed of the wires

Q is the torque exerted on the wires

Now we can write:

$$e = B.l.r.\omega \tag{B.3}$$

$$Q = B.l.r.I \tag{B.4}$$

This is true for one wire and we have to be aware of the fact that the value of B seen by the wire is a periodical function of time and also e , I and Q .

From these relations (B.3) and (B.4) we see that the magnetic field B and the geometric dimensions l and r are common between the mechanical quantities Q and ω on one side and the electrical quantities e and I on the other. In this theoretical case we see that $e \cdot I = Q \cdot \omega$, this means that all mechanical energy is converted into electrical and vice versa.

Let us now have a look at the practical cases.

From the foregoing we know that in a generator we always have:

- 1) An electric circuit in which a voltage is generated and from which the generated current can flow to the "outside world". This circuit forms a set of wires which we call the armature winding in most cases,
- 2) a magnetic circuit that produces a magnetic field where the armature winding moves. This circuit consists of a magnetic source and of magnetic conductors. The source can be a permanent magnet or an electromagnetic coil excited by a field current. The magnetic conductors are formed by the material of which the generator is constructed, in most cases this is laminated iron.

1) and 2) are often also indicated as "the copper" and "the iron" respectively. From now on, we will only consider those types of electro-mechanical energy converters which have a moving part called the rotor that moves in a stationary part called the stator and which have (if necessary) a possibility to transport energy to or from the rotor. For that purpose a collector or a commutator can be mounted on the rotor. A collector consists of two or more sliprings and as many brushes, a commutator has a number of copper segments and normally two brushes. The armature winding can be mounted on the rotor and the "field source" (permanent or with coils) can be mounted on the stator or just the other way round.

In figure B.4 and B.6 we considered such a generator, having only two wires round the rotor surface area. Of course it is possible to use this area more effectively.

Figure B.8 gives a schematic survey of the possibilities to do this.

In figure B.8a the resulting voltage output from the one coil case is drawn once more. In figure B.8b we have augmented the number of coil sides to 8 and also the voltage output is 4 times larger. Too many conductors in one winding will not increase the voltage output any more if they don't move altogether through the same B -value at the same moment. For better utilisation of the iron and copper we create more magnetic sources as is shown in figure B.8c. By this the voltage output rises another two times. The amount of magnetic poles cannot be enlarged too much, because when they are placed too close to each other, the magnetic field-lines will leak directly from one pole to the other without crossing a moving wire on the rotor. Therefore, to use all the available space along the rotor, we have to use separate windings.

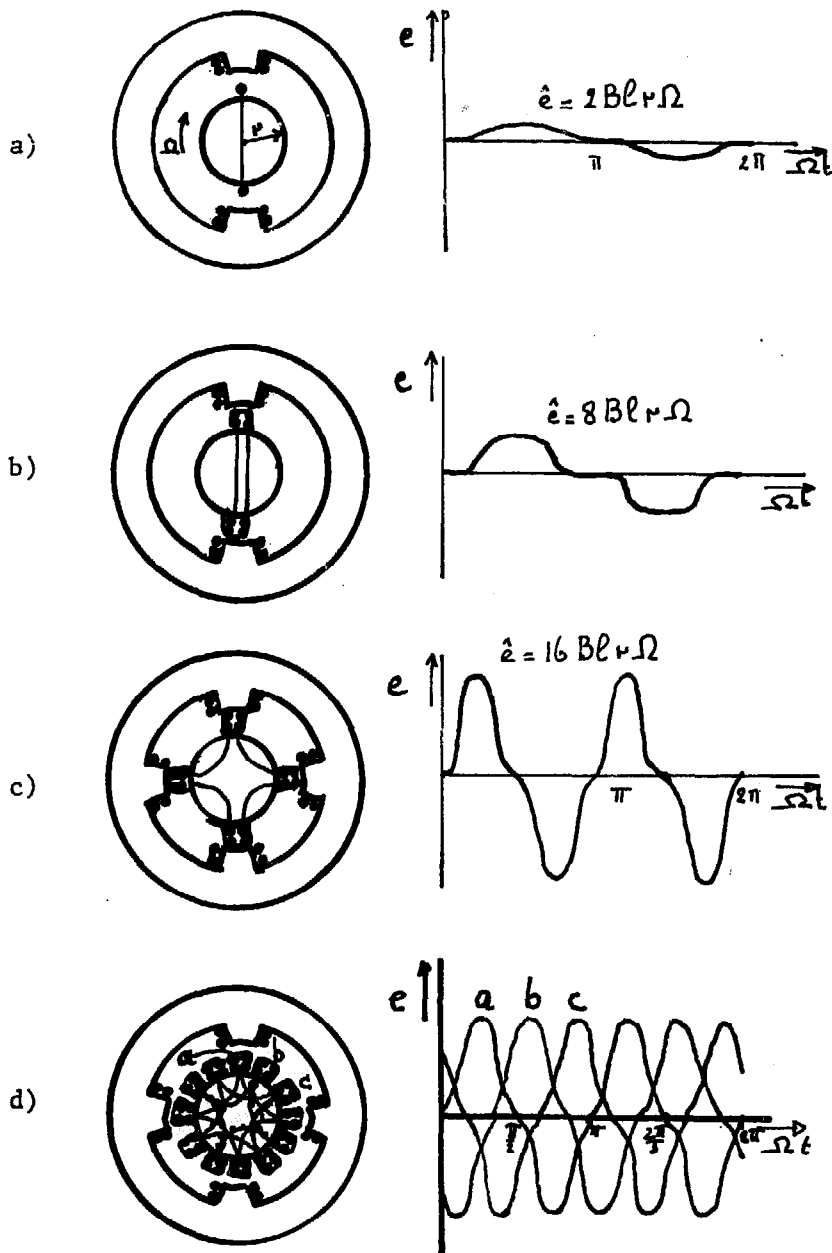

Fig. B.8 Examples to demonstrate how to use the magnetic field in a generator more effectively

- a) 2 poles, 2 windings
- b) 2 poles, 8 windings
- c) 4 poles, 16 windings
- d) 4 poles, 16 windings per phase
3 phases

In figure B.8d this is shown; three separate windings are mounted. Here we talk of a three-phase winding-system.

The three-phase voltage system is so often used because of another important advantage for the generator: the torque to be exerted on the rotating shaft is not a periodical function of time, but is constant, in contrast to the previous winding methods, which exert a pulsating torque.

In most cases, the armature winding is mounted on the stator so that the generated power is not carried through sliprings and brushes. In that case, the field current has to be supplied to the rotor through sliprings.

Losses in a generator

We can classify the losses in a generator as follows:

1) mechanical losses

- friction caused by the commutator or slipring on the brushes, and by the bearings. The friction torque is more or less independent of the speed and therefore, the power dissipated by this is roughly proportional to the speed,
- winding losses: the power absorbed in setting up circulating currents of air is usually very small, unless the machine is fitted with a cooling fan. These losses are proportional to the cube of the speed.

2) electrical losses

- I^2R loss in the armature winding and the field winding,
- iron loss in the rotor and stator-core, due to eddy currents and hysteresis. Eddy currents are generated in the iron in the same way as they are in the windings. They can be limited by constructing the iron from thin laminations, insulated from each other. Hysteresis losses are caused by the process of cyclic magnetization of the iron cores. These hysteresis losses are proportional to the frequency of the field current and approximately proportional to the square of the current.
- stray-load loss: magnetic flux which is not used in the process of electromechanical energy conversion causes additional iron losses. This is not so important.

All these losses together, which result in production of heat, determine the efficiency of the generator. The losses will, in general, increase with rotational speed.

Be aware of the voltage drop in the connection lines. Particularly with low voltage systems as commonly used in automotive car-electrical systems.

Some limiting factors

There is a lot to say about constructional details and special arrangements which are developed for electrical machines to improve their operation. However, it is not necessary to write extensively on these subjects here. Several good text books are available. To give an impression of the trends and limitations in enlarging the generator's performances we give in short the following points.

Looking at $e = N.p.l.r.\Omega.B$ $N =$ number of windings per pair of poles
and $Q = N.p.l.r.I.B$ $p =$ number of pairs of poles

one may be inclined to improve the machine's operation simply by enlarging one of the quantities in these formulas. This is possible with the following limitations:

- The magnetic field B .
In figure B.9 the relation is given between B and the field current I_F .

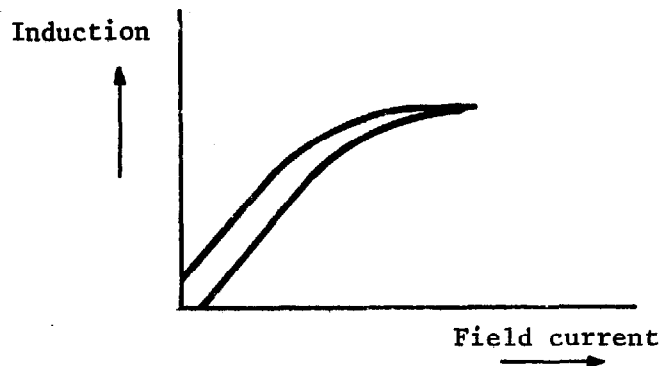

Fig. B.9. Magnetic induction as a function of the field current. The saturation value will be of the order of 1 - 1.5 Tesla.

The iron will saturate at a certain value of I_F ; enlarging the field current will have no further effect.

- The geometric dimensions l and r .
 - . enlarging r will have the positive effect of getting a greater speed v at the same rotational speed (for $v = \omega.r$), but will have the negative effect of needing more ineffective wiring (not intersecting the magnetic field). Such wiring is not usable for generating electricity but only causes I^2r loss and higher copper-costs.
 - . enlarging l will have the positive effect of using more copper in the right direction (perpendicular to the magnetic field) and thus enlarging the generated voltage.
 - . When r is relatively large we have to be aware of the possibility of large centrifugal forces and when l is relatively large we have to be careful not to bend the shaft by the rotor weight.

- The limit of e is determined by the insulation of the windings and the commutator.
- The limit of Q and ω is determined by the mechanical construction and the permissible values of the mechanical tensions and forces.
- The number of poles and conductors is limited by the available space in the machine and is determined by the required voltage, (high voltage implies many conductors and many poles) and by the required current (large current implies thick conductors requiring more space).
- The limit of I is determined by the I^2R losses in the armature winding and by the thermal behaviour of the machine.

We also have to mention the

- Armature reaction: The generated current I produces also a magnetic field, this will diminish the original magnetic field and thus will deteriorate the operation of the machine. This effect is proportional to I and is called armature reaction. Various methods have been developed to diminish this effect, for example, a compensating winding fitted in slots in the pole-shoes and connected in series with the armature winding.
- Commutation. In commutator machines the current is short-circuited for a short time during commutation. When the current is relatively large, this will affect the strength of the magnetic field. To compensate for this, use is sometimes made of so-called commutator poles or com-poles, wound with a winding in series with the armature winding.

APPENDIX C - List of commercial and experimental wind driven generator smaller than 100 kW

mill-type	wind-speed [m/s]	rotor ∅ [m]	no. of blades	aero dynamics transmission safety control	generating circuit	load and storage	price	reference
KSV300 KSV500 KSV800		2,3 2,5 3	2 2 2		300W dc 12/24/36V 500W dc 24....60V 800W dc 24....60V dc generator	battery		Elektro GmbH
WV15G	$V_r = 10,3$	3	2		1200W ac 12...110V	battery	\$ 1670 ('76)	
WV25G	$= 10,7$	3,5	2		1800W ac 24...110V		\$ 2100	
WV35G	$= 10,7$	4,4	3		4000W ac 48...110V		\$ 2900	
WVG50G	$= 13,4$	5	3		6000W ac		\$ 3320	
WVG120G		6	3		8000W		\$ 5120	
WV15W	$V_r = 10,3$	3	2		1,2kW ac 110V	grid 30-70Hz 1 phase	\$ 2100	
WV25D	$V_r = 11,2$	3,5	2		2 kW ac 110V	35-65Hz 3 phase	\$ 2900	
WV35D	$V_r = 10,3$	4,4	3		3,5kW ac 110/220/380V	40-60Hz 3 phase	\$ 3320	
WVG50D	$V_r = 10,3$	5	3		5 kW ac 110/220/380V	50-70Hz 3 phase	\$ 5120	
Neyrpic	$V_r = 10$	6,1 multivane		gearbox	8 kW 110V dc Shuntgenerator	battery	\$38000	Ateliers et chantiers Navals de Chalon-sur- Saone. Boite postale no. 103.71103 Chalon- sur-Saone

mill-type	wind-speed [m/s]	rotor Ø [m]	no. of blades	aero dynamics transmission safety control	generating circuit	load and storage	price	reference
Wincharger 1222H	$V_r = 10, V_{cutin} = 3$	1,83	2	direct drive airbrake speed control	200W 12V dc 4 pole dc generator	battery	\$ 395 incl. tower	Dyna Technology I Ecological Science Com. Sioux City, Iowa 51102 PO Box 3263 USA
Kedco 1200	$V_r = 9,4$ $V_{cutin} = 3,1$	3,67	3	centrifugal overspeed control by blade feathering	1,2 kW 14,4V 85A		\$ 1695('76)	Kedco inc.(213) 776- 6636 9016 Aviation Boulevard Inglewood, Calif. 90301
Model 30		2			250W 12/24/48V dc	battery	\$ 940	Walter
Model 50		2,55			500W		\$ 1300	Neustad Ostsee
Model 10		3,6			1000W dc		\$ 1800	
Model 20		5,1			2000W 48 dc			
12 Footer		3,6	3	Honey comb. blades	1000W 12 V dc	battery	plans \$ 15	Windworks, Box 329, Route 3, Mukwonoga Wisconsin 53149 USA
Noah type 15-45 kW		12	3		15-45 kW			Noah Energic Systeme Thüringerstr. 6 D 53 Bonn, W.Germany
30-90 kW	$V_r = 10$	12	6		30-90 kW, 380V ac 28 pole perm. magn. ac gen. variable freq.			
45-130kW Sailwing	$V_r = 8,9$	16 3,8	3 3	Sailwing rotor	45-130kW 1 kW automobile alter- nator			Grumman Aerospace Corp. Bethpage, N.Y. 11714 USA
Enag SA			2		400 W 24/30V 1,2 kW 24/30V 2,5 kW 110V			Enag S.A., Rue de Pont l'Abbe Quimper, Finisterre, France

mill-type	wind-speed [m/s]	rotor Ø [m]	no. of blades	aero dynamics transmission safety control	generating circuit	load and storage	price	reference
Adrianov/ Bystritskü		18	3	centrifugal re- gulator acting on Var-pitch propeller	40 kW, synchr. gen. 380 V	grid		Era trans. 1B-1161 + 1B-1249
24FP 5G	$v_r = 7 v_{cutin} = 2$	1.2	2	variable pitch propeller	30W 12/24V dc	battery	\$ 1250 ('77)	Aerowatt, Chancy 65, Paris.
100FP 5G	5 2	3.2	2		100W 12/48V dc	battery	\$ 2650	
150FP 7G	7 2	2	2		150W 12...48V dc	battery	\$ 2175	
300FP 7G	7 2	3.2	2		300W 12...48V dc	battery	\$ 3334	
1100FP 5G	5 2	9.2	2		1125VA 220/380V ac 3 phase, 50 Hz	grid	\$ 14480	
1100FP 7G	7 2	5	2		idem	grid	\$ 7040	
4100FP 7G	7 2	9.2	2		4500VA, 220/380V 3 phase, 50 Hz	grid	\$ 15300	
BW 11		1.4	2		100W 12/24V dc		\$ 704 ('76)	Hermann Brümmer Stromerzeugungs Anlagen, 3525 Helmarshausen Mühlenstr. 8
BW 21		2.4	6		400W 12...110V dc		\$ 920	
BW 41		4	3		800W		\$ 1450	
BW 51		5			1.5kW 380V ac		\$ 1920	
BW 61		6			2.5kW 380V ac		\$ 2390	
BW 81		8			5kW 380V ac		\$ 3000	
BW 120		12			7.5kW 380V ac		\$ 6800	

mill-type	wind-speed [m/s]	rotor Ø [m]	no. of blades	aero dynamics transmission safety control	generating circuit	load and storage	price	reference
Lübing M022-3	$V_r = 10$ $V_{cutin} = 3,5$	2,2	3+3	3 additional smaller blades to lower V_{cutin}	400W 24V ac perm. magn. rotor ac gen.	battery		Ludwig Bening 2847 Barnstorf PO Box 171, Germany
Testmodel Nat. Swedish W.E.P.	$V_{rated} = 10$ $V_{cutin} = 5$	18	2		63000W 400V ac	grid		Vindenergi i Sverige Resultatrapport juni 1977, Nämnden för Energi Produktion Forskning
	$V_r = 11$	30	3	variable pitch blades	100kW asynchr. gen 220V, 3ph. ac	grid		W.R. Sectorov NASA Technical Translation NASA TTF14:933 + NASA TTF15:307
	V_{cutin} (3kW)=5 switch to 10kW $V=8,5$	8	2	brake flaps on the end of the wings	3kW (6 pole ac gen.) 10kW (4 pole ac gen.)	grid		J. Juul
Allgaier	$V_r = 9$ $V_{cutin} = 3,4$	10	3	Variable pitch centrifugal governor double reduction gear prevents ex- ceeding 86 rpm	6kW cross compounded shunt gen. 220/310V dc	battery		Era trans. 1B-1760

mill-type	wind-speed [m/s]	rotor Ø [m]	no. of blades	aero dynamics transmission safety control	generating circuit	load and storage	price	reference
VAWT 18-15	$V_r = 10,4$ $V_{cutin} = 3,3$	4,6x5,5	2	vertical axis rotor	3,2kW 24-110V dc	battery	\$ 4100	DAF Ltd. 3570 Hawkestone Road Mississauga, Ontario L5C 2V8
VAWT 30-20	$V_r = 10,4$ $V_{cutin} = 3,3$	6x9,1	2		6kW 110V dc motor/generator		\$ 6100	
Quirk model L model M		3,66	3		1kW 32V 2kW 24...115V			Quirk's Victori Light Co Fairweather, Bellevue Hill New South Wales, Australia
Dunlite model L model M		3,25	3	variable pitch	1kW 12-50V	battery		Davey Dunlite Co, 21 Frome St. Adelaine 5000 Australia
	$V_r = 11$ $V_{cutin} = 3,6$	3,96	3		3kW 12-110V dc brushless			
10 hp	$V_r = 6,7$	9,8	3	fibre glass blades	7kW plans from BRACE			BRACE Research Institute

SWD PUBLICATIONS

Serial number		Price (incl. mail)	
		US \$	Dfl
SWD 76-1 (out of print)	Wind-energy utilization in Sri Lanka; potentialities and constraints. By A. Dennis Fernando and P.T. Smulders, 18 p., May 1976		
SWD 76-2	Literature survey; horizontal axis fast running wind-turbines for developing countries. By W.A.M. Jansen, 43 p., March 1976	3,-	7,50
SWD 76-3	Horizontal axis fast running wind-turbines for developing countries. By W.A.M. Jansen, 91 p., June 1976	7,-	17,50
SWD 77-1	Rotor design for horizontal axis windmills. By W.A.M. Jansen and P.T. Smulders, 52 p., May 1977	4,-	10,-
SWD 77-2	Cost comparison of windmill and engine pumps. By L. Marchesini and S.F. Postma, 49 p., December 1978	4,-	10,-
SWD 77-3	Static and dynamic loadings on the tower of a windmill. By E.C. Klaver, 39 p., August 1977	4,-	10,-
SWD 77-4	Construction manual for a cretan windmill. By N. van de Ven, 59 p., October 1977	5,-	12,50
SWD 77-5	Performance characteristics of some sail- and steel-bladed windrotors. By Th. A.H. Dekker, 60 p., December 1977	5,-	12,50
SWD 78-1	Feasibility-study of windmills for Water Supply in Mara Region, Tanzania. By H.J.M. Beurskens, 89 p., March 1978	7,-	17,50
SWD 78-2	Savoniusrotors for waterpumping. By E.H. Lysen, H.G. Bos and E.H. Cordes, 42 p., June 1978	4,-	10,-
SWD 78-3	Matching of wind rotors to low power electrical generators. By H.J. Hengeveld, E.H. Lysen and L.M.M. Paulissen, 85 p., December 1978	7,-	17,50

Research institutes in third world countries may ask for one copy free of charge, writing directly to:

SWD,
c/o DHV Consulting Engineers,
P.O. Box 85,
3800 AB Amersfoort, The Netherlands.

SWD publications can only be ordered by sending money to:

Bank Mees en Hope, acc. 25.00.72.009
P.O. Box 293,
Amsterdam, The Netherlands

and stating:

- a) serial number of publication wanted,
- b) on money transfer: file 3.04.20.29.05
- c) self addressed address in printing letters.