

AT MICROFICHE
REFERENCE
LIBRARY

A project of Volunteers in Asia

Community Water Supply and Sanitation in Nepal:
Sanitation Handbook

by Martin Strauss

Published by:

Community Water Supply and Sanitation Program
(SATA)

Available from:

Swiss Center for Appropriate Technology (SKAT)
Varnbuelstrasse 14
CH-9000 St. Gall
SWITZERLAND

Reproduced by permission.

Reproduction of this microfiche document in any form is subject to the same restrictions as those of the original document.

COMMUNITY WATER SUPPLY & SANITATION, NEPAL

SANITATION HANDBOOK

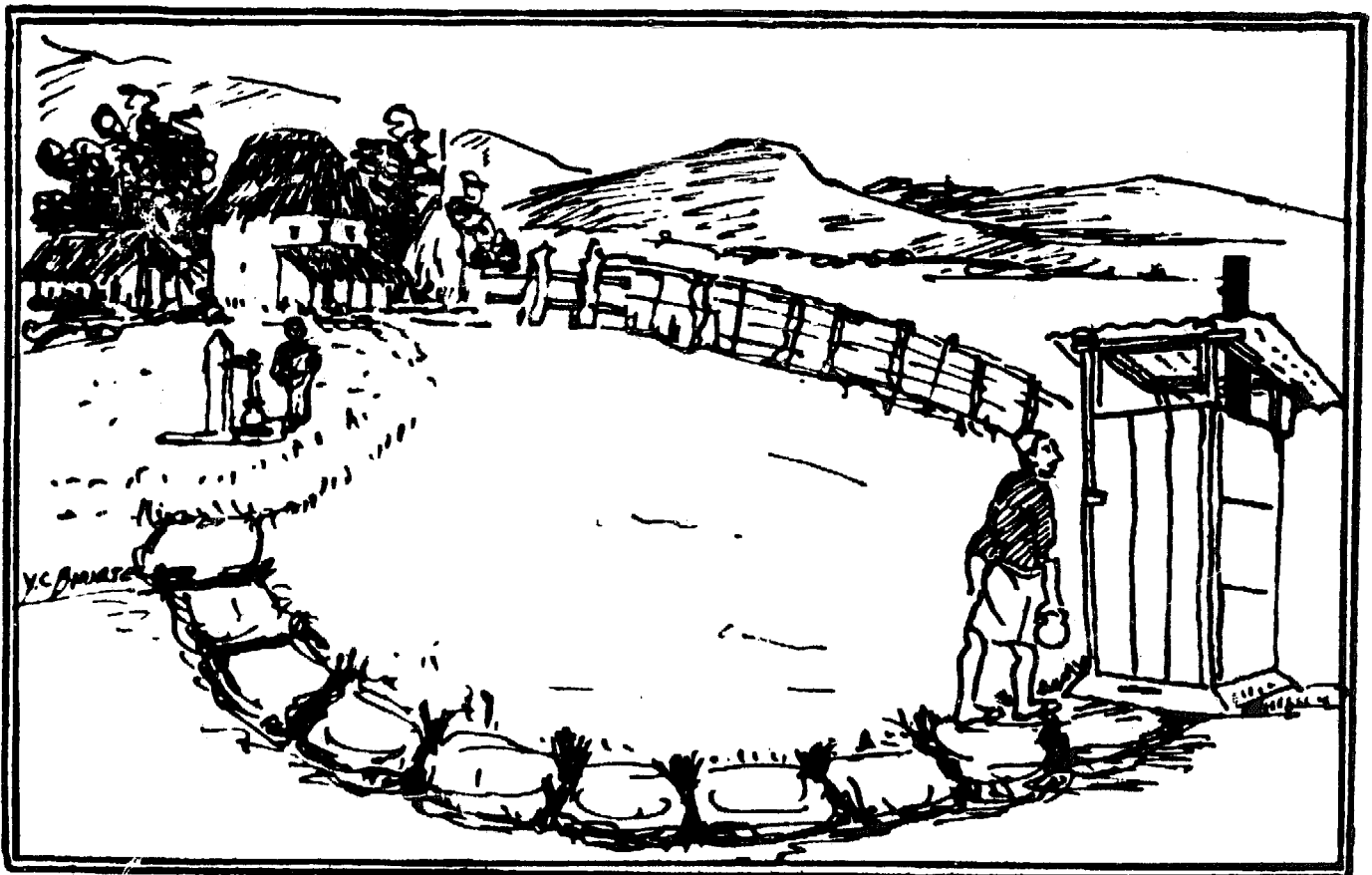

**COMMUNITY WATER SUPPLY
&
SANITATION, NEPAL**

SANITATION HANDBOOK

by
Martin Strauss

at
HMG, Panchayat and Local Development Ministry
Regional Directorate Pokhara

2nd Edition

June 1982 / Assaar 2039

- Review by R. P. Gautam, Health Educator, zonal Public Health Office, Pokhara
- Latrine drawings by W. Ruettimann
- Designs of school and health - post / teacher pit latrines developed in cooperation with UNICEF (Nepal) staff
- Editing by Babar Singh Gurung
- Printed at **Pokhara Centre Press**, Pokhara
- Book Composer : Sagar Deep Bajracharya
- Printing financed by SATA, Swiss Association for Technical Assistance

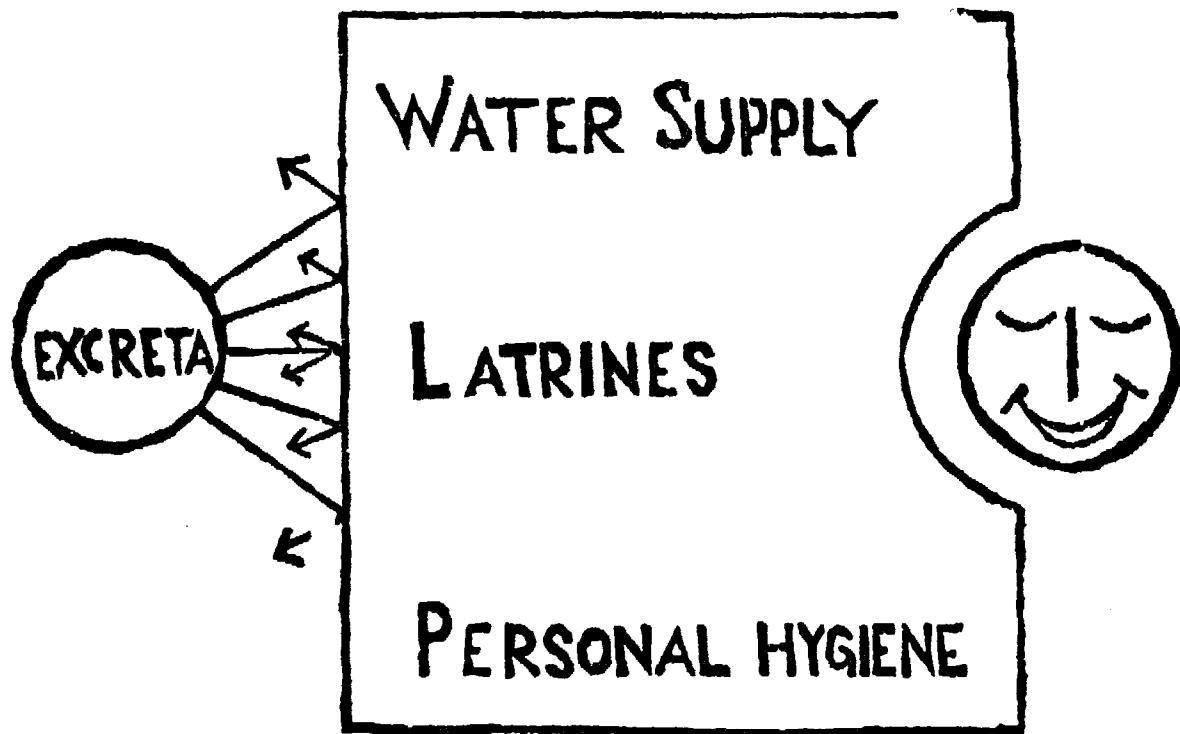
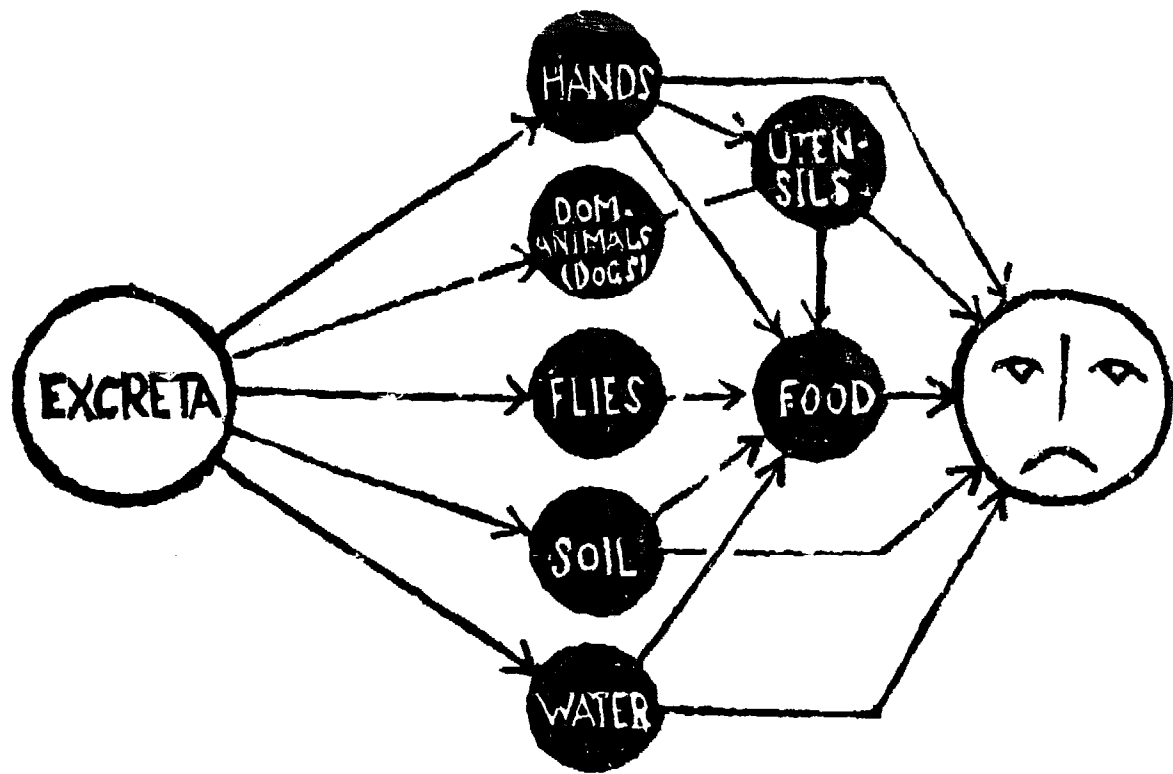

TABLE OF CONTENTS

	<u>page no.</u>
1. ABOUT EXCRETA- AND WATER-RELATED DISEASES, THEIR TRANSMISSION AND CONTROL	1
1.1 Introduction	1
1.2 Diseases and their transmission	1
1.3 Transmission of diseases through excreta: some typical examples	8
1.4 How the WATER FROM THE TAP helps to prevent diseases	18
1.5 How the proper construction and use of LATRINES helps to prevent diseases	25
1.6 Why and how to reduce the breeding and spread of flies and mosquitoes	27
2. DESIGN, CONSTRUCTION AND USE OF FAMILY PIT LATRINES	29
2.1 Basic features	29
2.2 Details and modifications	33
2.2.1 Pit construction in unstable soil	33
2.2.2 Pit construction in rocky underground	34
2.2.3 Squatting slab and lid	35
2.2.4 Latrine building	39
2.2.5 Vent pipe	42
2.3 Bill of quantities for a ventilated family pit latrine	44

	<u>page no.</u>
2.4 Placing of latrines	45
2.5 Promotion and users' involvement	46
2.6 The proper use and maintenance of family pit latrines	47
3. PIT LATRINES FOR SCHOOLS AND HEALTH POSTS	49
3.1 Introduction	49
3.2 Design basis	49
3.3 Upon filling of the pit	51
3.4 Sanitation education	52
- Drawings:	
. School pit latrine	53
. Teacher and health post pit latrine	54
4. SANITATION QUIZ	55
Drawing 1	57
Drawing 2	58
Drawing 3	59

1. ABOUT EXCRETA-AND WATER-RELATED DISEASES, THEIR TRANSMISSION AND CONTROL

1.1 Introduction

This book explains :

- How major diseases common in Nepal are transmitted (DISEASE TRANSMISSION ROUTES),
- that EXCRETA are a major source of such common diseases which frequently cause death and disablement, particularly among children,
- that and how WATER FROM THE TAP and LATRINES can, if properly used, serve to prevent these common diseases, and lastly,
- how to CONSTRUCT PIT LATRINES for the safe disposal of excreta.

The SANITATION QUIZ (Chap. 4, p. 55) might be a tool for self-testing in a simple way the understanding of the basic relationship between excreta, diseases, disease transmission, and the role of CWSS project work in preventing diseases, as outlined in Chap. 1. In trying to solve the quiz, the Table on p. 5 has to be used, mainly.

1.2 Diseases and their transmission

A great number of diseases are caused by micro-organisms (" kitanu, " extremely small organisms not visible to our eyes) which live in the human body and are transmitted from one person to another in several possible ways.

Water supply and sanitation can be the main tool to get rid of such "kitanu", i. e. to stop their transmission, thereby helping to improve the health of children, mothers and fathers.

- **Many disease-causing organisms (pathogens) leave the body of infected persons in the excreta of such persons and eventually reach others [see the Table on p. 5, transmission routes (1), (2), (3), (4), (8), (9), (10)]. Typical diseases of that kind are worm infections ("juka pareko"), amoebic dysentery ("ragat masi, aun") typhoid fever ("myadi jaro") and cholera ("haija"). The causative organisms (pathogens) of these diseases are transmitted from feces of infected persons to the mouth of other persons by direct or indirect routes, i. e. hands, food soil, and water. Infection might also occur by transmission of pathogens from feces of infected persons through the skin of other persons (hookworm disease).**
- **Excreta relate to human diseases also in that improperly disposed of excreta and excreta polluted water will be a source for feeding and breeding by insects such as flies, cockroaches and mosquitoes. Flies and cockroaches may mechanically transmit excreted pathogens ("kitanu") either on their feet or in their intestinal tract ('andra') (see transmission route no. (10) in the Table on p. 5). Skin and eye diseases, too, though not originating from excreta, are often transmitted by flies (route (6) in the Table). Mosquitoes by sucking peoples' blood may transmit diseases such as malaria, filariasis and many kinds of fevers, the pathogens of which circulate in the blood.**
- **Beside excreta-related diseases, eye and skin infections are another group of diseases common in Nepal. Like the excreta-based diseases, many of them are associated with a low standard of sanitation and personal hygiene, and are therefore also strongly related to CWSS project work (see. routes (5), (6) and (7) in the Table on p. 5).**

- Each disease is caused by a different type of pathogen.
- The pathogens of excreta-related infections common in Nepal belong to one of the following groups of organisms (listed in order of increasing size) :-

<u>Organism</u>	<u>Disease example</u>	<u>Remarks</u>
(1) Viruses	Hepatitis, polio)
(2) Bacteria	Bacillary dysentery, typhoid & paratyphoid fevers, cholera) extremely small) in size, not visible) to the naked eye
(3) Protozoa	Amoebic dysentery, giardia))
(4) Worms	Hookworm, ascaris, pinworm, tapeworm) generally visible) to the naked eye

- 1 gram (g) of feces from a disease carrying person contains from 1,000 (worm eggs) to 10,000,000 (viruses, bacteria) of such organisms.
- The time interval between transmission of pathogens to the mouth, skin, or eyes of a healthy person, and that person showing a sign of or starting to suffer from the particular disease (incubation period), may vary from a very few days (e. g. cholera) to a few weeks (e. g. amoebic dysentery) or a few months e. g. roundworm).
- Usually, infection by one type of these pathogens causes illness of variable duration and severeness; for certain diseases, especially when paired with other diseases or malnutrition in children, infection might even lead to disability or death.

- However, pathogens might also live in the human body and even be contained in a person's excreta **without** that person feeling sick. Such a person, too, will nevertheless be a source of infection for other persons.
- The **Table** on p. 5 shows in summarized form transmission routes of such diseases common in Nepal which CWSS field staff, by its work for water projects and community health promotion, can help to prevent. Excreta (feces mainly) are the starting point for the majority of these transmission paths.

Transmission routes and diseases listed in the Table are grouped such as to indicate which particular shortcomings with respect to water supply, excreta disposal and personal hygiene are the main common **causes** of transmission, namely:

CAUSES OF TRANSMISSION

- (1) • Lack of sufficient water and / or insufficient use of available water for washing and cleaning, i. e. for personal and domestic hygiene, or;
 - Consumption of feces-contaminated water.
- (2) • Excreta disposed of on open ground and in uncontrolled manner

The Table also indicates the major source of these common diseases, namely:

SOURCES OF TRANSMISSION

- (A) - Excreta
- (B) - Infected skin and eyes

- The **SANITATION QUIZ** on p. 55 deals with the transmission routes in illustrated form.

DISEASES COMMON IN NEPAL, CAUSED BY LOW STANDARDS OF WATER SUPPLY, EXCRETA DISPOSAL AND HYGIENE	SOURCE of disease		TRANSMISSION CAUSE (1) LACK OF SUFFICIENT WATER OR INSUFFICIENT USE OF WATER FOR WASHING AND CLEANING; OR: CONSUMPTION OF CONTAMINATED WATER										TRANSMISSION CAUSE (2) UNCONTROLLED EXCRETA DISPOSAL		REMARKS
	ENGLISH	NEPALI	(1)	(2)	(3)	(4)	(5)	(6)	(7)	(8)	(9)	(10)			
a. Amoebic dysentery	Ragat masi, aun	x	Excreta -> hand contact -> mouth	Excreta -> (hands) water -> mouth	Excreta -> hands -> food or utensils -> mouth	Excreta -> domestic animal (dog) -> utensils -> food -> mouth	Infected skin -> unwashed (bed-) clothes -> skin	Infected eyes -> flies or fingers -> eyes	Infected skin -> contact -> skin	Excreta -> soil -> skin	Excreta -> pig -> meat	Excreta -> soil, flies -> food -> mouth	D		
b. Bacillary dysentery	" " "	x											D		
c. Giardiasis	Giardia	x											D		
d. Pinworm	Churna	x											D		
e. Hepatitis A	Kamalpitta	x											D		
f. Cholera	Haita	(x)											D		
g. Typhoid fever	Myadi (typhoid) jaro	x											D		
h. Paratyphoid fever	Paratyphoid	x											D		
i. Polio	Bala pakshaghat	(x)													
j. Hookworm	Ankuse juka														
k. Roundworm (Ascariasis)	Juka														
l. Whipworm (Trichuriasis)	Korre juka												D		
m. Tapeworm	Phitte juka														
n. Conjunctivitis	Akha paknu, "rato bayo"	(x)													
o. Trachoma	Purano akhako rog, Akha phulo	(x)													
p. Scabies	Luto	x													

x - Disease transmitted mainly by this (these) route(s)
(x) - Disease sometimes also transmitted by this (these) route(s)
D - Diarrhoea ("chheme", "pakhala") is a common symptom of these diseases

- . Now, after carefully studying the Table, why not make a first trial to solve the SANITATION QUIZ (p. 55) ?
- . The diseases listed in the above Table which originate from excreta or from infected skin are widespread in Nepal. **Diarrhoea** ("pakhala", "chherne"), being associated with rapid loss of liquid from the body (dehydration), is an alarming symptom of such common diseases as dysentery, giardia, paratyphoid fever, cholera.
- . **Children** are the main sufferers from excreta-based diseases. Excreta-related infections are the major cause of death among children in Nepal, many of whom don't reach the age of 5, as is reflected in the figures below:
 - Out of 1,000 new-born children, 160 die before the age of 1 !
 - 50 % of all deaths occur among children of less than 5 years of age.
- . Most of the patients attending health posts and hospitals are sufferers of excreta-based "stomach problems".

Why ?

... because excreta are not properly disposed of in latrines, allowing diseases such as worm infections to further spread through direct contact, flies, contaminated soil or dust, and because the supply of good quality water in sufficient quantity and within short walking distance of people's homes is lacking. Also, due attention is not given to personal and domestic hygiene, such as the washing of hands, body, clothes and utensils. This leads to the spread of diseases like dysentery, giardia, paratyphoid and hepatitis through feces-contaminated hands, food, clothes, utensils and water.

In summary:

EXCRETA, particularly feces, are one of the major sources of **DISEASE** and **DEATH** in Nepal. Children are the main sufferers. Lack of sufficient water or neglecting the washing and cleaning of the body, clothes and utensils (i. e. poor personal and domestic hygiene), uncontrolled disposal of excreta and consumption of excreta-contaminated water cause the transmission of excreta-related diseases and of infections of the skin and eyes.

How, by our work as water supply & sanitation **ENGINEERS, OVERSEERS AND TECHNICIANS** can we help in the prevention of such diseases ? How will the **WATER FROM TAPSTANDS** and how will **LATRINES** help to cut down on spreading of diseases which are related to excreta and poor hygiene ?

The following chapters explain.

1.3 Transmission of diseases through excreta :
some typical examples

Person-to-person contact (route (1) in the Table on p. 5)

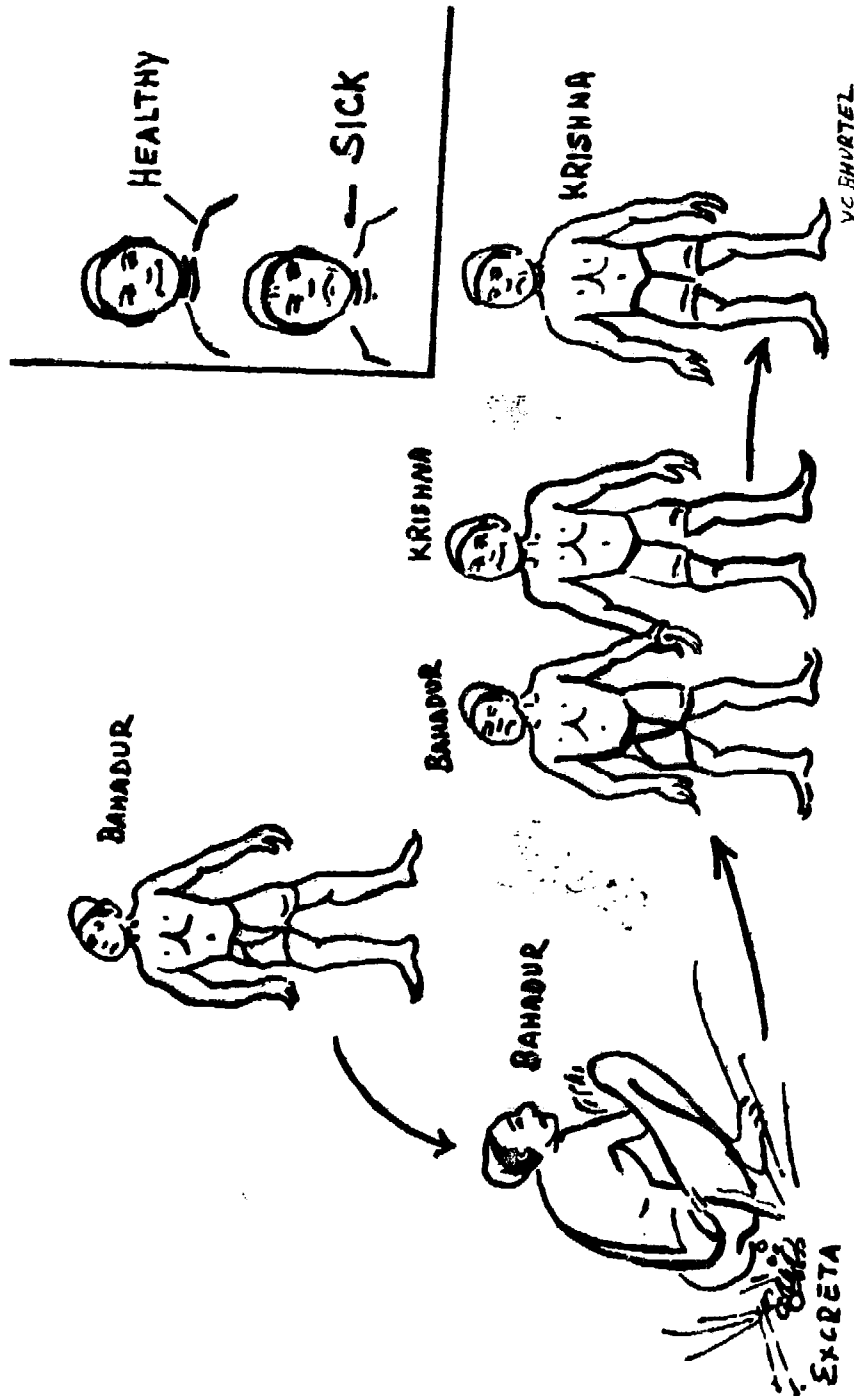

Bahadur is sick. He is suffering from "stomach problems", say amoebic dysentery ("ragat masi"). After defecating and anal cleansing he carries small amounts of excreta on his hands. These excreta contain the pathogens which cause amoebic dysentery. He might not have enough water or no water at all to wash his hands thoroughly; or, he might not know how important it is to wash one's hands thoroughly after defecation in order to avoid transmission of excreta-based diseases.

When Bahadur meets Krishna the pathogens on his hands will be transferred to Krishna by person-to-person (hand) contact. Krishna's hands are now contaminated by the dysentery-causing pathogens from Bahadur's excreta. When he then takes the hands to his mouth, say while eating or otherwise, he will then, like Bahadur, fall sick from amoebic dysentery.

Note: Food also might get contaminated by the excreta on Bahadur's hands. This is dangerous for other people, because they, too, might then become sick when eating that food (route (3) in the Table on p. 5).

Insects transmitting pathogens from feces to food
(route (10) in the Table on p. 5)

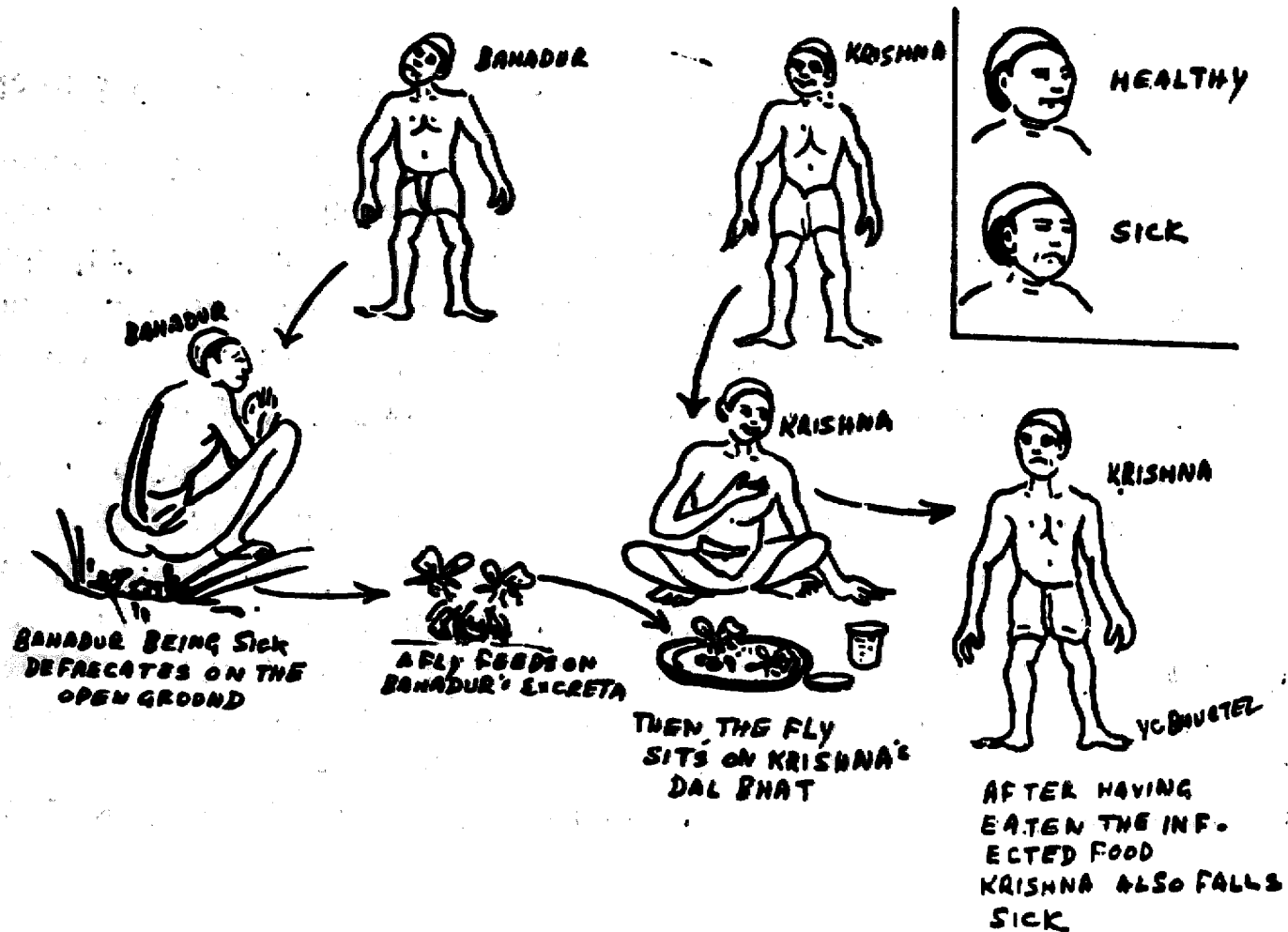

Bahadur is suffering from diarrhoea (“pakhala”, “chherne”) because he fell sick from a disease such as dysentery (“ragat masi”, “aun”), giardia or paratyphoid fever. Instead of using a latrine for excreta disposal he defecates on the open ground. Flies, therefore, can feed on Bahadur’s feces. Small amounts of feces containing the disease-causing organisms (“kitanu”) will become attached to the flies’ feet. When the flies next feed on Krishna’s “dal bhat” or other food, some of Bahadur’s feces will be transmitted from the flies’ feet to the food. Without noticing Krishna will ingest these very small amounts of Bahadur’s feces which contain large numbers of pathogens. The pathogens will cause Krishna to fall sick from the same disease Bahadur is suffering from, and to also be troubled by diarrhoea.

Note: Instead of by flies, food might also get contaminated by infected persons who carry small amounts of feces not visible to the eye on their hands (route (3) in the Table), by domestic animals such as dogs (route (4)), or by excreta-contaminated water (route (2)).

Some pathogens originating from excreta **multiply** on food, making food a very important part of disease transmission routes.

Consuming water which has been contaminated by excreta
(route (2) in the Table on p. 5)

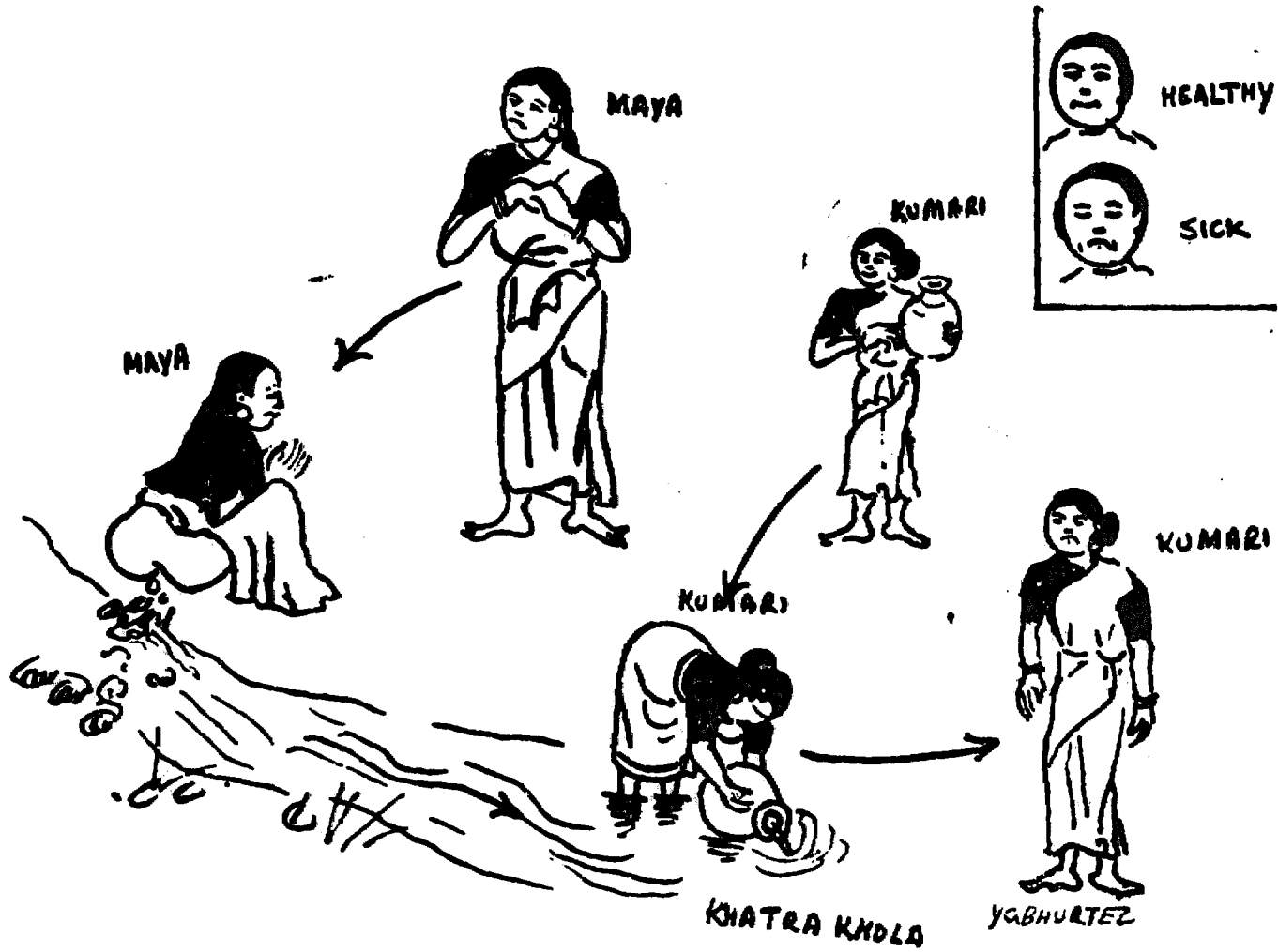

Maya who is suffering from heavy "stomach problems" such as hepatitis ("kamal pitta") or cholera ("haija"), goes to the little stream nearby her home in the early morning. She defecates into Khatra Khola. A little later Kumari fetches water from Khatra Khola. Meanwhile, Maya's excreta have been carried downstream and small amounts of them, unnoticed and invisible by Kumari, get into Kumari's "gagri". After drinking from the water which she had been fetching at Khatra Khola, Kumari will fall sick from hepatitis or cholera as before her friend Maya living at the village upstream.

Note: Like at "Khatra Khola", diseases will also be transmitted in small water holes ("kuwa", "pandero"), where people come to fetch water or to wash. Such water holes might be very prominent places of disease transmission, because the water of "kuwas" and "panderos", often being stagnant due to small yield particularly towards the end of the dry season, will get contaminated by fecal pathogens from the hands or utensils of infected persons.

Transmission of worm infections on excreta-contaminated soil (route (8) in the Table on p. 5)

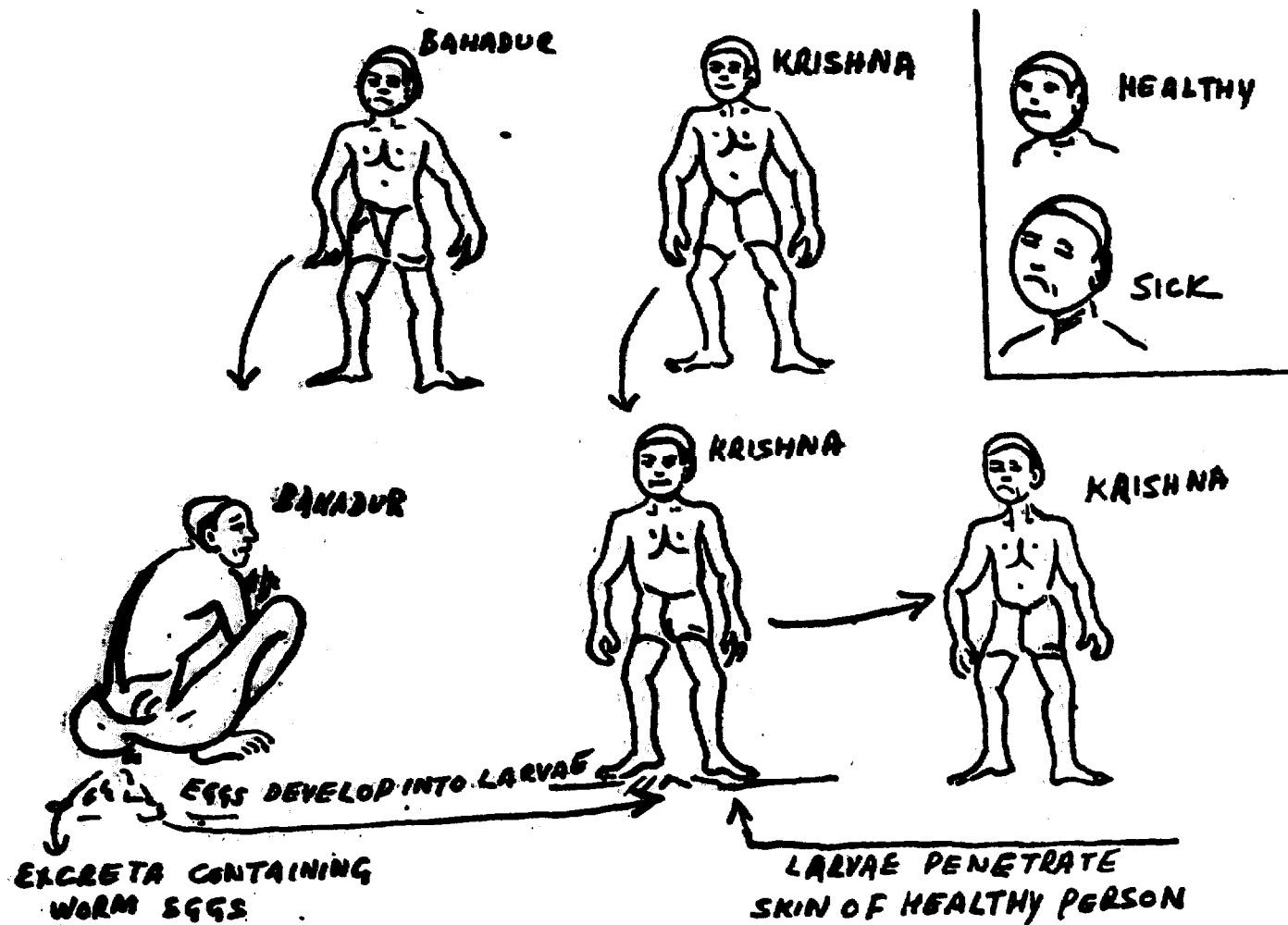

Bahadur has fallen sick from hookworm disease (“ankuse juka”). He lacks a latrine and therefore defecates on a footpath leading through the village. His feces contain eggs of the hookworm. Within 7 - 10 days these eggs will develop into larvae which then penetrate the bare skin of Krishna’s foot when he walks by and happens to step into Bahadur’s feces. The larvae, after passing through the lungs into Krishna’s intestinal tract (“andra”), will develop into worms which then cause disturbances in Krishna’s intestines and render him sick, as Bahadur.

Transmission of disease through an intermediate host
(route (9) in the Table on p. 5)

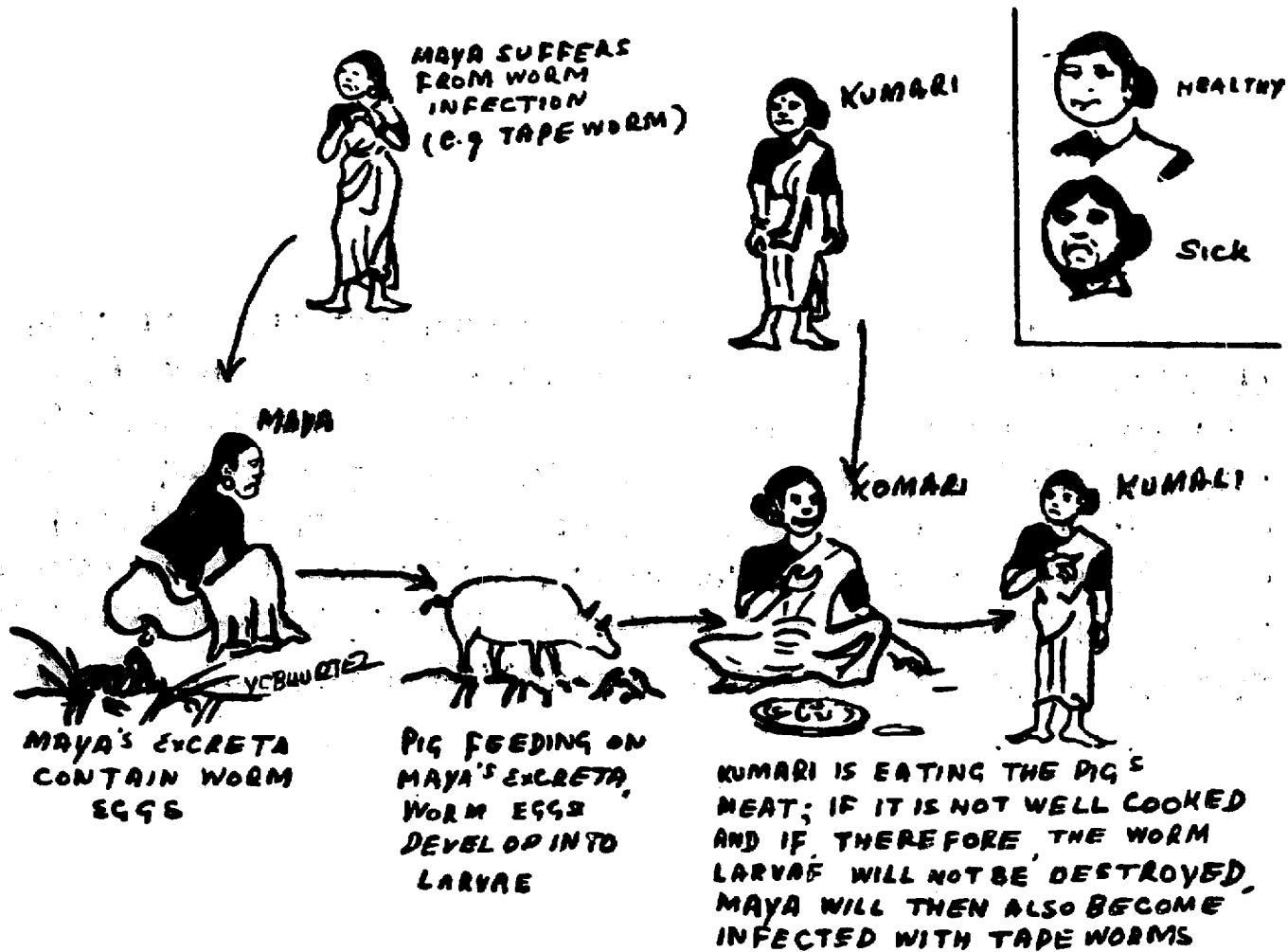

Maya is suffering from tapeworm infection. She defecates near her house on open ground, because she is lacking a latrine. One of the pigs which are kept in the village is attracted by the smell of excreta and eats Maya's feces which contain eggs of the tapeworms living in Maya's intestinal tract ("andra"). Inside the pig the eggs develop into larvae. Later on, the pig is slaughtered and the meat distributed to the villagers. Kumari, too, is eating some pork meat. If, however, the meat is not well cooked and therefore the tapeworm larvae are not destroyed, Kumari will become infected. The tapeworm larvae cause serious disturbances in Kumari's body,

The following chapters 1.4 and 1.5 explain how TAP WATER and LATRINES made available through water supply and sanitation projects can help to PREVENT THE TRANSMISSION OF DISEASES as is illustrated on the preceding pages and listed in the Table on p. 5.

1.4 How the WATER FROM THE TAP helps to prevent diseases

- The purpose of building water supplies is not only to provide drinking water of good quality; equally, if not more important for most hill areas in Nepal is to **increase the quantity of supplied water** and reduce water fetching time.
- Through construction of a piped water supply project (composed of properly built catchment, reservoir, break pressure tanks and tapstands), villagers can in fact benefit by having water close to their homes year-round, by being able to use more water than before, and by being provided water of safe and reliable quality.

Thus, there are two aspects associated with each water supply project:

A - water QUANTITY
("pani ko matra")

B - water QUALITY
("pani ko gun")

A — The water QUANTITY aspect

- By being supplied water in sufficient quantity throughout the year and within short walking distance to their homes, villagers can wash their hands, body, clothes and utensils more regularly and frequently than before when their water source was far away.
- How, exactly, does washing help to prevent disease transmission, to improve health and to avoid death of children and adults ?

Washing of hands :

- The thorough and frequent washing of hands with more water than people are traditionally used to, helps to remove the very small and invisible amounts of feces which are attached to people's hands after defecation. This reduces the risk of other persons (see example on p. 8), food or eating utensils becoming contaminated by excreta-based pathogens, which otherwise are transmitted from insufficiently washed hands.

Which transmission routes will be affected ? What kinds of diseases will be prevented ?

Transmission routes affected (see the Table on p. 5)	Prevention of diseases such as
(1): Excreta - hand) contact - mouth)	• Dysentery ("ragat masi") • Giardia
)	• Pinworm ("churna")
(2): Excreta - hand-) food - (or utens-) nils) - mouth)	• Hepatitis ("kamal-pitta") • Cholera ("haija") • Typhoid ("myadi jaro") • Paratyphoid

- Of course, besides washing hands, utensils (particularly eating utensils), too, must be washed regularly and thoroughly with a lot of water, and excreta must be disposed of in latrines, because the diseases listed here are not transmittable by hands, only, but may as well be transmitted by contaminated utensils or by flies feeding on excreta which are disposed of on open ground (see routes (4) and (10) in the Table).
- Thus, frequent and thorough washing of hands helps the prevention of diseases which otherwise can heavily disturb the stomach ("pet"), the liver ("kalejo") and intestinal tract ("andra") ! Thereby, diarrhoea ("pakhala", "chherne") will also be greatly reduced !

Washing of body and clothes:

- By having regular and sufficient supply of water at tapstands nearby their homes, children and adults can frequently and thoroughly wash their body, clothes, and bed clothes. This greatly helps to prevent eye and skin diseases which are transmitted by body contact, fingers, flies and contaminated clothes.
- The following transmission routes and diseases will be affected (see the Table on p. 5) :

<u>Transmission routes affected</u>	<u>Prevention of</u>
(5): Infected skin - unwashed (bed-) clothes - skin	. Conjunctivitis ("ankha paknu")
(6): Infected eyes - flies or fingers - eyes	. Trachoma ("purano ankha ko rog")
(7): Infected skin - contact - skin	. Scabies ("luto")

Washing of utensils:

- Eating utensils such as plates, cups and glasses may frequently get contaminated by very small and invisible quantities of feces attached to people's improperly washed hands.
- Dogs which are commonly allowed to eat food left-overs from people's dishes can also be frequent transmitters of pathogens from human excreta to eating utensils, as they prefer to eat and lick human feces disposed of on open ground.
- By thorough washing and rinsing with plenty of water, dishes can be rendered free of pathogens which otherwise may cause serious disturbances in the stomach and intestinal tract.
- The following transmission routes and diseases will be affected (see also the Table on p. 5):

Transmission routes affected	Prevention of diseases such as
(3): Excreta - hands -) utensils - mouth)	• Dysentery ("ragat masi") • Giardia
)	• Pinworm ("churna")
)	• Hepatitis ("kamal-pitta")
(4): Excreta - domestic) animal (dog) -) utensils - food -) mouth)	• Polio (" bala pakshaghat")

Thus, washing of hands, body, clothes and utensils means a great step forward for the prevention of diseases and improvement of health. Many communicable diseases are transmitted because of lack of insufficient use of water for washing, not necessarily or not only because of consuming water which might be contaminated ! This is usually not being recognized.

Therefore, one of the prime tasks of CWSS field personnel in promoting sanitation is to create awareness among villagers for how, by using tap water for washing, disease transmission may be prevented by washing-off pathogens from hands, body, clothes and utensils. Villagers' health will not improve if they drink good quality water from improved supplies unless they conceive and use the tap water as WASHING water as much as they consider and use it as drinking water !!

WATER SUPPLY means supply of

- water for WASHING ("DHUNE PANI")
- water for BATHING ("NUHAUNE PANI")

as much as it means supply of

- water for drinking ("khane pani")

How can CWSS technicians, overseers and engineers and how can villagers secure year-round and sufficient supply of water such that thorough and frequent washing of hands, body, clothes and utensils will be possible and become a habit ? The following measures help in achieving this:

- careful selection and construction of catchments
- proper design of pipelines and reservoirs
- careful siting of tapstands
- proper operation of the system (particularly closing the taps after use in order to save water)
- preventive maintenance and repairing.

B - The water QUALITY aspect

- Upon completion of a piped water supply scheme villagers will be supplied with tap water which is essentially free of disease - causing organisms and safe for drinking.
- If, in piped water supplies, catchments are properly constructed and protected, pipelines properly laid, reservoir and break pressure tanks closed off against any contamination and water containers ("gagri", "gagro") kept clean by the members of the family, transmission of diseases by water, such as in the example on p. 12, will essentially be stopped.

Transmission route affected (see Table on p. 5)	Prevention of diseases such as (see Table on p. 5)
(2): Excreta - (hands) - water - mouth	· Hepatitis ("kamal - pitta") · Cholera ("haija") · Typhoid ("myadi jaro") · Paratyphoid · Dysentery ("ragat masi") · Giardia

- What are the tasks of CWSS technicians, overseers and engineers and of villagers when aiming at supplying pathogen - free tap water ?
 - For catchments :
 - if possible, selection of sites such that upstream contamination of the source is excluded
 - fencing
 - protection of infiltration / drainage area by conserving forest or by re - afforestation
 - plenty and well compacted refill over spring catchment channels

- proper drainage of excess surface water
- protection against landslides
- For collection chambers, reservoirs, and break pressure tanks :
 - provision of covers to all manholes
- For pipelines :
 - proper trenching (depth), jointing and well compacted refilling
 - measures against plastic pipes being exposed on the ground
- Preventive maintenance and repairs !

In summary :

Many diseases, particularly those affecting the liver, the stomach and the intestinal tract, can be transmitted not only in water, but also due to insufficient use or non-availability of water for washing, as is shown in the Table on p. 5.

Therefore, to drink water of improved quality from the tap will in itself not help much in stopping disease transmission, if personal hygiene is not improved simultaneously. It is, in particular, the **thorough and frequent WASHING** of hands, body, clothes and dishes which will help to stop transmission of excreta-related diseases and infections of the skin and eyes !

If beneficiaries of improved water supplies are made aware of the way diseases are transmitted and of the role excreta play in this, they may also understand the **dual purpose of water supply** which is :

- to be provided with and use water for **WASHING** (“dhune ra nuhaune pani”) and
- to be provided with and use water which is essentially free of pathogens and safe for **DRINKING** (“khane pani”).

Chap. 1.5 explains how, beside water, the use of **latrines** is essential for stopping the transmission of excreta - based diseases.

1.5 How the proper construction and use of LATRINES helps to prevent diseases

- Excreta are the major source of communicable diseases.
- Chap. 1.4 explained how the very small and invisible amounts of fecal matter (which, however, may contain millions of pathogens) can be washed off from hands, the body, dishes and clothes by using plenty of water. This is an important means of stopping the transmission of numerous excreta-related diseases.
- **HOWEVER**, transmission of certain excreta - related infections, such as dysentery, giardia, pinworm, typhoid, roundworm e. g., might also take place irrespective of improved washing habits or consumption of safe drinking water : **FLIES** can carry small amounts of feces on their feet from feces disposed of on open ground to food (see the example on p. 10).

- **HOOKWORM** (“ankuse juka”) and **TAPEWORM** (“phitte juka”) diseases are transmitted exclusively due to **UNCONTROLLED DISPOSAL OF EXCRETA ON OPEN GROUND** (see the examples on pp. 14 and 16).
- Disposal of excreta in latrines will prevent the contamination of open water sources. From this, people who do not have access to a piped water supply, will greatly benefit (see also the example on p. 12).

Thus, the **USE OF LATRINES** for the disposal of excreta in a contained place and for the prevention of excreta-based diseases is as important as is the use of water for washing off fecal contamination !

- As is indicated below, the use of properly built latrines will much help to stop disease transmission by flies and to prevent transmission of most of the worm infections (see also the Table on p. 5):

Transmission routes affected	Prevention of diseases such as
(8): Excreta - soil - skin	• Hookworm (“ankuse juka”)
(9): Excreta - pig - meat	• Tapeworm (“phitte juka”)
(10): Excreta - soil - flies - food - mouth) • Roundworm (“juka”)) • Whipworm (“korre juka”)) • Dysentery (“ragat masi”)) • Giardia) • Pinworm (“churna”)) • Typhoid (“myadi jaro”)) • Paratyphoid

- Latrines must be constructed and maintained such that flies and mosquitoes will not be attracted by the wet excreta in the pit, and that, therefore, growth and multiplication of flies and excreta in the latrine's pit can not take place. Chapters 2. 1, 2. 2 and 2. 6 (design and construction of pit latrines) explain how to achieve this.
- Once a latrine has been built, all members of a family, **including children**, should use the latrine. Children when suffering from diarrheal diseases excrete very high loads of pathogenic organisms. By that, children's excreta, in particular, pose a great risk to public health; their controlled disposal is therefore of prime importance.

1.6 Why and how to reduce the breeding and occurrence of flies and mosquitoes

- **Flies** play a very important role for the transmission of excreta - related diseases (transmission of pathogens from excreta to food) as well as for the transmission of skin and eye diseases (see also Chap. 1.2).
- **Mosquitoes**, by sucking people's blood may transmit pathogens (e. g. those causing malaria) from sick to healthy persons, thereby spreading disease and posing a particular risk to health.

- Flies and mosquitoes preferably breed in wet excreta and in stagnant pools of water. The number of disease-transmitting flies and mosquitoes and the negative impact of these insects on people's health can best be reduced by removing potential breeding sites or, where this is not possible, by preventing access to potential breeding sites.

- How can CWSS field staff contribute towards this?
Mainly, by taking care that :
 - Excess water from tapstands is properly drained away by drain pipes and / or drain channels, and

 - Latrines be constructed in a way that flies and mosquitoes will not be attracted to wet excreta in the latrine pit (construction of proper latrine building including, if possible, a vent pipe; keeping the latrine door closed all the time in order to provide darkness around the squatting area and in the pit; see also Chap. 2, design and construction of pit latrines).

2. **DESIGN, CONSTRUCTION AND USE OF FAMILY PIT LATRINES**

2.1 **Basic features** ¹⁾

Pit :

- . size depends upon the number of users and number of years allowed for the pit to be filled
- . size of pit :
 - 90 110 cm (square)
 - 100 120 cm (circular)
- . depth :
 - 200 300 cm
- . a pit of 100 x 100 x 250 cm will have a lifetime of 4-6 years for a 7-member family (3 adults + 4 children, say)
- . necessity of pit lining depends upon soil stability
- . see also Chap. 2.2.1 and 2.2.2

Base :

- . serves as support for squatting slab and latrine building
- . to be raised above ground level
- . helps to prevent surface water, insects and small animals from entering the pit, and hookworm larvae from emerging from the pit

1) see also drawing of Health Post / Teacher Pit Latrine (Chap. 3, p. 54) for basic features

- material: stones or bricks with sand / cement or soil / cement mortar
- width: 25 35 cm

Mound:

- . heaped up earth around the part of the pit which is raised above ground (including base)
- . required to keep rain and surface water away from the pit
- . to be prepared from well compacted soil

Squatting slab:

- . can be constructed from :
 - single large stone plate; or
 - flat stone floor with mud mortar bedding and pointing, resting on bamboo or timber poles supporting structure; or
 - ferrocement (sand / cement mortar reinforced with wiremesh and a few iron bars; cast on site); or
 - planks (4 . . . 5 cm thick) from hard and insect resistant timber (e. g. "sal")

Note : full flooring with clay ("mato") not suitable, as floor may become a place for growth and transmission of hookworm larvae if soiled by excreta

- . choice of construction method depends upon:
 - availability of suitable local material such as sufficiently large stone plates, flat stones, bamboo and timber

- the season of the year for cutting bamboo, which should best be cut in dry season
- users' motivation to re-build bamboo or timber slab if and when necessary (expected life of such slabs will be shorter than of ferrocement slabs)
- . slab must have smoothest possible surface which, moreover, must be sloping towards the squatting hole; this allows for easy cleaning of the slab if soiled by excreta
- . squatting hole to be of suitable size and shape for both children and adults
- . foot rests to be provided
- . for details see Chap. 2.2.3

Lid for squatting hole :

- . necessary in latrines where venting is purely through openings between walls and roof of the latrine building and not by means of a vent pipe
- . placing a lid in a latrine which is vented by a vent pipe, will have the disadvantage of hindering the draft from the squatting area into the pit and up the vent pipe
- . see also Chap. 2.2.3

Latrine building :

- . Why is a proper building needed at all ? Wouldn't, as is sometimes seen, a mat ("chittra") or a few jute bags (for giving some privacy) be sufficient ?
- . In fact, a proper building fitted with a door (which may be of simple construction, though) is required :

- to keep the pit with the excreta and the squatting area as dark as possible; this helps to prevent flies and mosquitoes from entering the pit because they tend to stay away from dark places.

Note : Pits containing wet excreta which are just protected by simple matting or jute bags and therefore lighted by day light will be a major point of attraction for large number of flies and mosquitoes. They will feed and breed in the wet excreta, emerge again from the pit in even larger numbers and pose a great health risk as transmitters of diseases !

- to provide complete privacy to the user during defecation
- . a door must be fitted to the latrine building in order to provide darkness and privacy (exception: see Chap 2.2.4)

Note : the door must always stay closed in order to keep the interior of the latrine dark !

- . construction material: any suitable, locally available material such as:
 - bamboo or timber poles
 - bamboo matting ("chittra"), branch work ("hanga"), stones or bricks for walls
 - thatching ("khar"), bamboo matting, slates or corrugated GI-sheets for roofing
- . venting :
 - through openings between walls and roof; or:

- more effective: through a vent pipe extending from underneath the squatting slab to above the roof (see Chap. 2.2.5)

. see also Chap. 2.2.4

2.2 Details and modifications

2.2.1 Pit construction in unstable soil

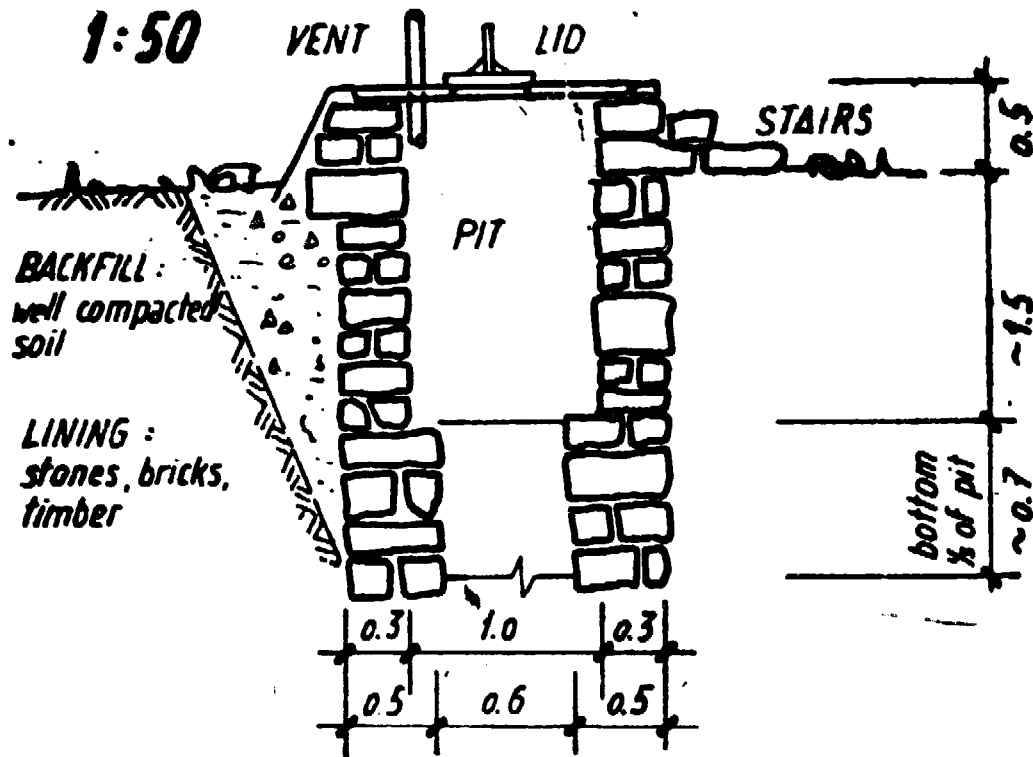

- . pit lining required to prevent collapsing of pit
- . if topsoil only is weak, lining is needed in the upper half or third of the pit only
- . material for pit lining :

- dry stone or brick masonry in lower 2/3 of pit.
mud masonry in upper 1/3 of pit
- matting ("chittra") supported by bamboo poles
- . pits of depth greater than 200 cm: increase wall thickness in bottom 1/3 of pit

2.2.2 Pit construction in rocky underground

- . Where the underground is rocky or contains large boulders and, therefore, pit digging to a min. depth of 200 cm is not possible, the pit lining might have to be raised well above the ground to allow for an adequate size with a min. pit life-time of 3-4 years.
- . A well compacted mound of clay soil has to be provided.

2.2.3 Squatting slab and lid

- a) . Slab from bamboo or timber support,
stone flooring and mortar

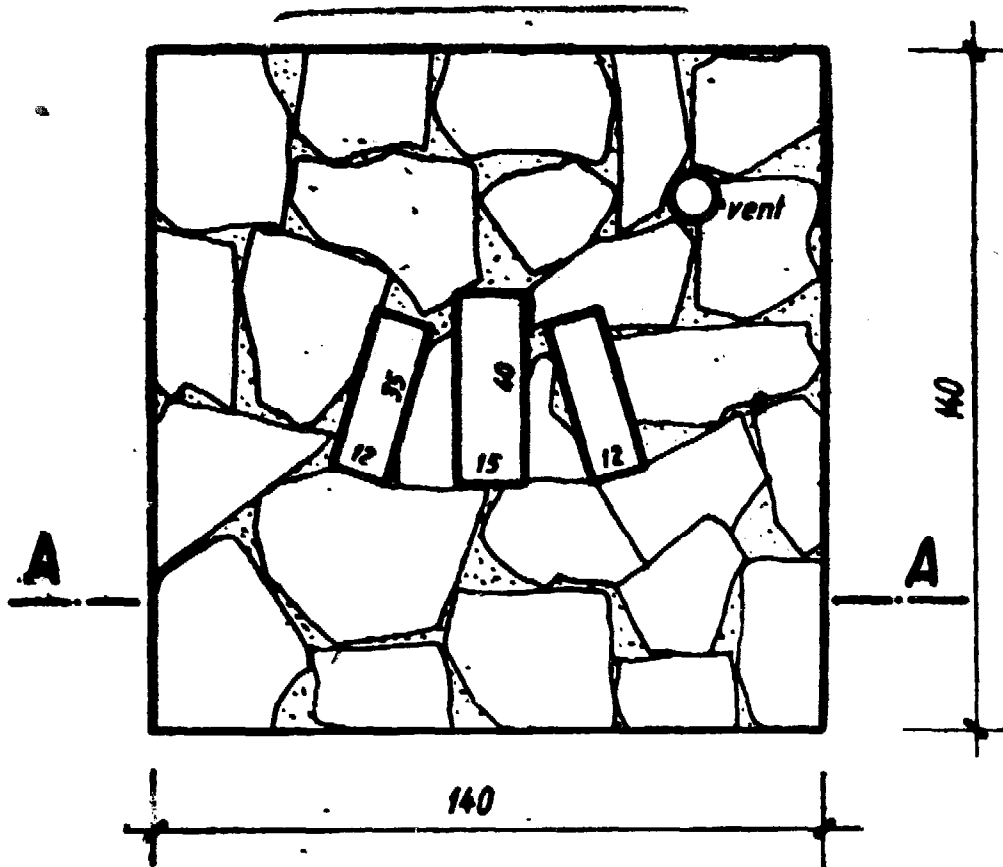

SECTION A-A, 1:20

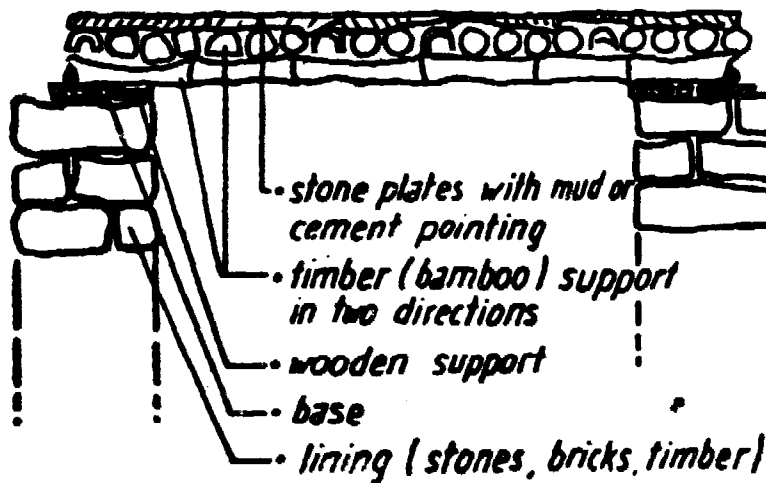

Construction guideline :

- . provide 2-directional supporting structure from bamboo or timber poles resting on latrine base, allowing for 15 x 40 cm squatting hole
- . place mud mortar on top of supporting structure to provide an even base for the stones
- . place properly cut smooth surfaced flat stones (mud pointing) on top of the mud mortar bedding; stone floor to extend well around the squatting hole, if possible from wall to wall of the latrine building
- . 2 stones to be provided as foot rests

b) . Ferrocement slab

FERROCEMENT - SQUATTING SLAB 1:20

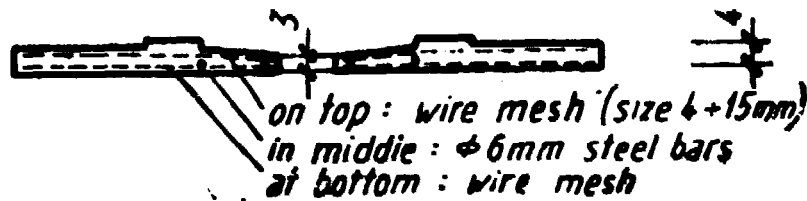
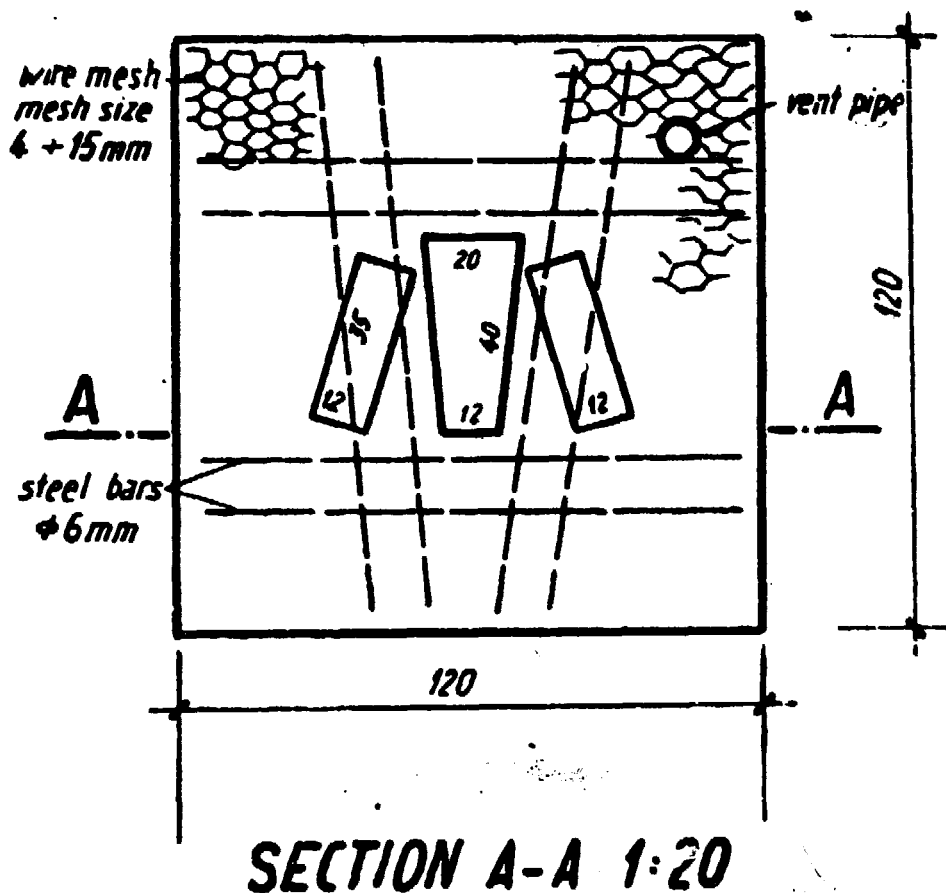

Construction guideline:

- prepare a level ground surface of min. 150 x 150 cm, if possible in a shady place
- cover the ground with a plastic sheet or with a thick layer of green leaves which cover the ground fully

- . place formwork (brick or timber) to allow for the desired slab size and thickness
- . place in this sequence: a first layer of wire mesh (mesh size 4 . . . 15 mm), 4 pc. of ϕ 6 mm steel bars parallel to the edges of the squatting hole, and a second layer of wire mesh, all cut to required size; place small stones or wood between the wire mesh and the reinforcing bars to keep them properly apart during casting of the slab
- . prepare a cement mortar mixture of 1:2:0.5 (cement: sand: water)
- . place the mortar in thin layers; squeeze and tap it well underneath and inbetween the wire mesh and steel bar reinforcement
- . while placing the final layers of cement mortar, make sure that the slab surface will be sloping towards the squatting hole
- . smoothen the slab surface
- . the final slab thickness shall be 3.5 4 cm, approximately

c). Lid

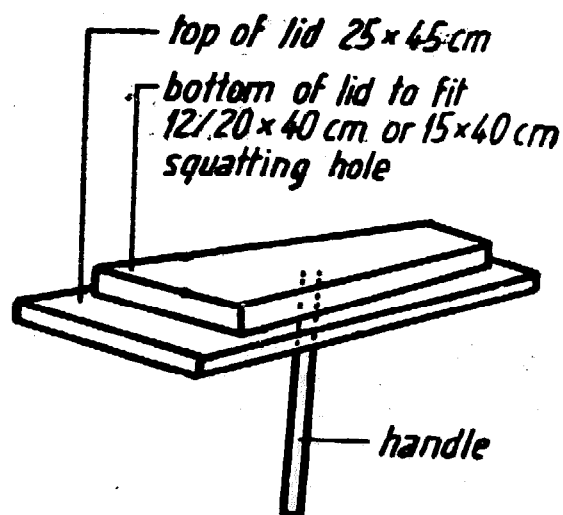

- . particularly important in latrine where venting is purely through opening between walls and roof of the latrine (no vent pipe)
- . put in place, it keeps the pit dark and thereby helps to prevent flies and mosquitoes from entering the pit, and feeding and breeding in wet excreta
- . to be placed on the squatting hole whenever latrine is not occupied
- . from timber; bottom of lid to fit inside squatting hole

2.2.4 Latrine building

- . quadratic or spiral shape
- . advantage of spirally shaped building: no need for door because squatting area and pit will be quite dark (and therefore unattractive to flies and mosquitoes) even without the building being fitted with a door; privacy is also provided
- . doors of quadratically shaped latrine buildings must always stay closed in order to keep the interior of the latrine dark and thereby keeping flies and mosquitoes away from the pit

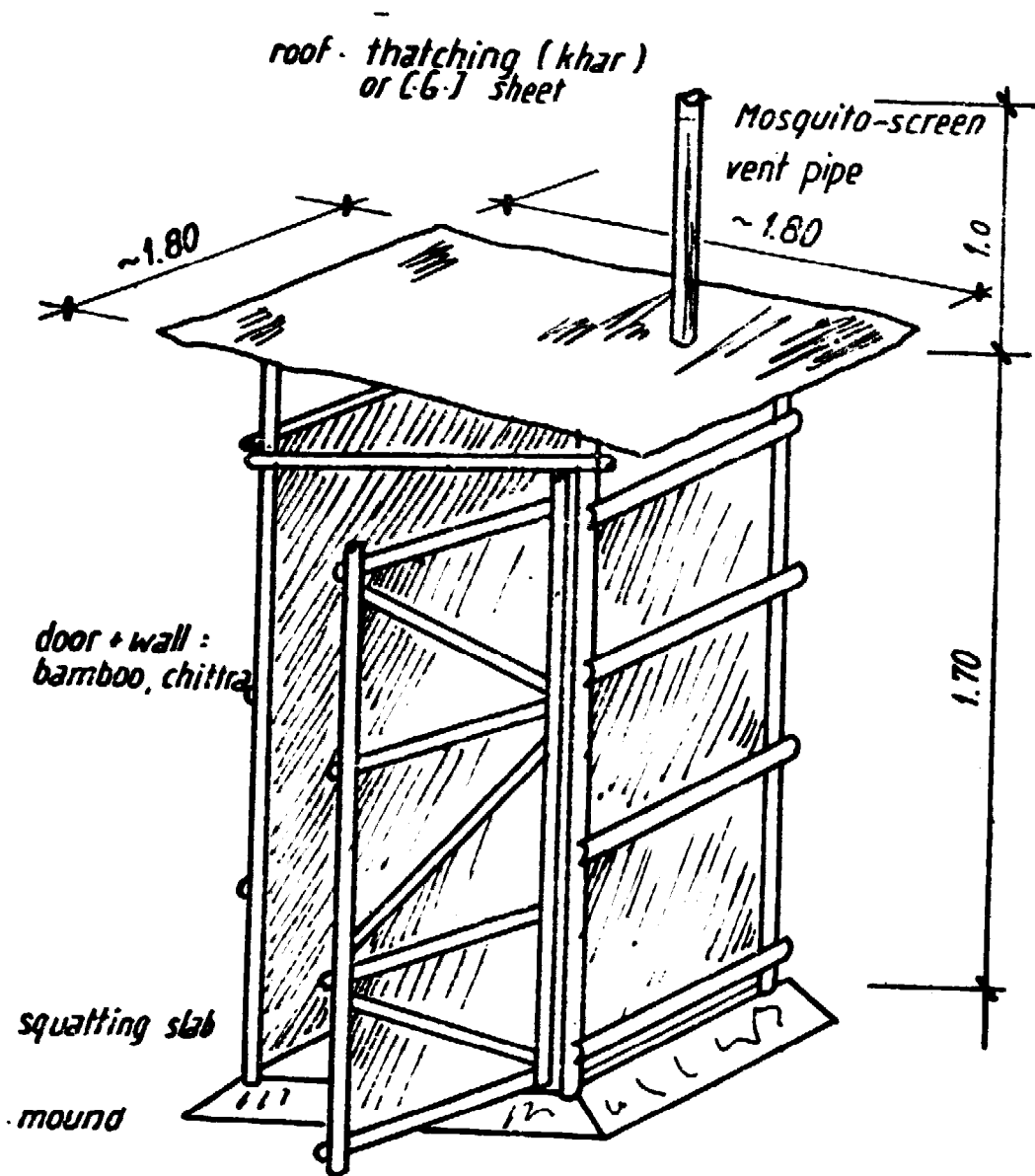

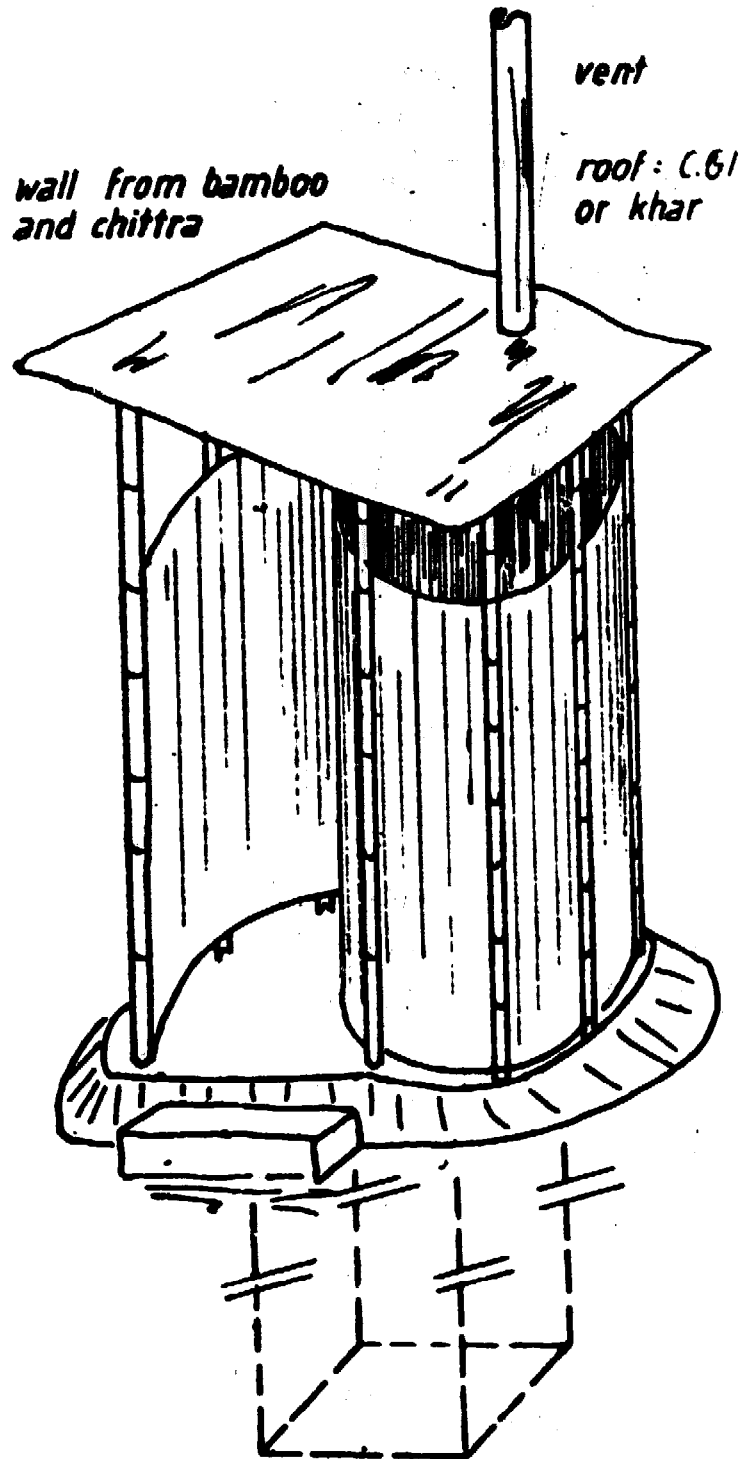

2.2.5 Vent pipe

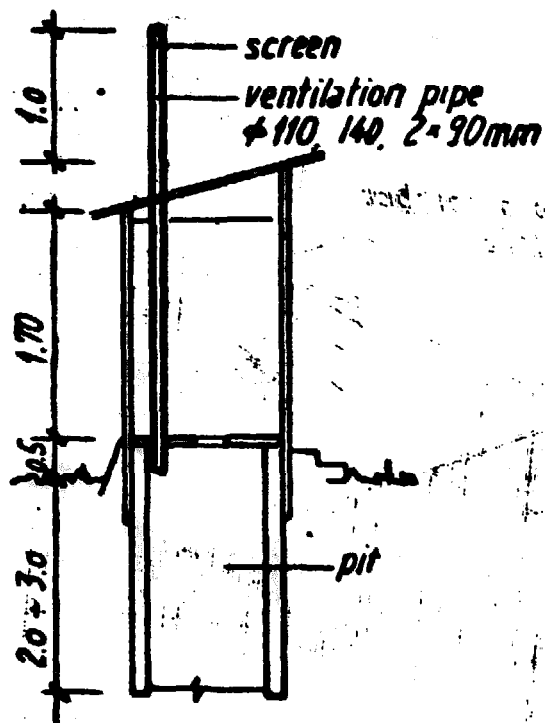

- . a straight pipe fitted into the squatting slab and extending from underneath the squatting slab to at least 1m above the roof
- . pipe to be fitted with a mosquito screen in order to prevent insects from escaping the pit or entering the pit through the vent pipe
- . satisfies two objectives:

A - Removal of unpleasant smells :

The vent pipe produces a draft from the squatting area into the pit and up the pipe; thereby, the interior of the latrine building will remain free of unpleasant smells, making the latrine attractive to the users.

B - Control of insect breeding :

Flies and mosquitoes which might enter the pit through the squatting hole will be attracted by the daylight at the upper end of the vent pipe; when moving towards the lighted end of the pipe they will be stopped by the mosquito screen fitted to the pipe and eventually die without being able to escape the pit; this prevents the latrine from becoming a source from which otherwise increased numbers of flies and mosquitoes may escape and pose a particular health risk as disease transmitters.

- pipe to extend well over the roof (min. 1m) in order to make top end well exposed to winds which, in turn, will create the up-draft in the pipe
- pipe material :
 - bamboo poles (tool needed to pierce and remove the membranes); or:
 - HDP pipe (supplied in straight, not coiled, form)
- diameter :
 - greater than 100 mm, if available
 - if pipes of less than 100 mm are available, only, two pipes should be fitted

2.3 Bill of quantities for a ventilated family pit latrine constructed from local material

Bill of quantities ¹⁾

Item	Use	Quantity
. Stones	. pit lining . squatting slab flooring	3 - 4 m ³ 0.5 m ³
. Bamboo (full size, inner diam. 90-100 mm)	. vent pipe	3 m
. Bamboo (full size, ø 8-10 cm)	. supporting poles and beams for latrine building	4 x 2.5 m + 4 x 1.5 m
. Bamboo (half size, ø 8-10 cm)	. squatting slab support (two-directional)	2 x 20 x 1.5 m
. Bamboo (one third size, ø 5-8 cm)	. for door, for reinforcement of walls of latrine building, and for roof thatching support	25 x 1.2 m
. Bamboo matting	. walls + door	10 m ²
. Thatching	. roof	2 layers of 1.5 m x 1.5 m
. Mosquito screen	. vent pipe	25 cm x 25 cm

¹⁾ for assumed method of construction see p. 45

Construction method assumed :

- . pit lining (to full depth, say) - stones
- . squatting slab - bamboo supporting structure + stone flooring
- . vent pipe bamboo + screen
- . latrine building - bamboo supporting structure + bamboo matting (walls) + thatching (roof)

2.4 Placing of latrines

- . distance to dwellings: 10 20 m (min. distance determined by potential or suspected fly and odor problems; these should, however, be minimal or nil in a properly built latrine which is fitted with a vent pipe and properly used and maintained ! max. distance limited by user's reluctance to walk far for defecation and user's interest to keep the latrine within the area of privacy around the home)
- . The door of the latrine building should face away from the direction of main rains.
- . Care is to be taken that the latrine will be safe against flooding by surface water as well as against damage by landsliding.

- . Beside considering technical aspects, full attention should be given to the user's preference for a suitable latrine location. Consciously or subconsciously, users might have cultural, religious and other reasons for wanting to place the latrine at a given distance and location relative to their or their neighbour's house.

2.5 Promotion and users' involvement

- . Assistance for the construction of a latrine should be provided only if there is interest and some basic awareness about the purpose and benefit of using a latrine among men and women in the particular family.
- . In order to promote awareness and interest, CWSS field personnel should discuss with potential users the role of excreta as a source of disease-causing organisms, the way diseases are transmitted from excreta, and how disposal of excreta in properly built latrines will help to improve people's health.
- . Furthermore, CWSS field personnel, when promoting and assisting the construction of latrines shall explain in detail the special features of a latrine, as well as the function and benefit of the various parts of a latrine (e. g. of the building incl. door, of the vent pipe incl. mosquito screen) to the future users.

- . Where villagers have previously constructed and used latrines (though, may be of simple standard), their views on, and experience with latrines should be discussed and given due consideration by CWSS field staff when promoting the construction of improved latrines.

2.6 The proper use and maintenance of family pit latrines

- . Family pit latrines should be built for the use by **one family only** (no communal latrines), as this will help to guarantee users' interest in construction, and proper use and maintenance of latrines.
- . It is very important that once the latrine is built, all the members of the family, **including the children**, will use the latrine each time they need to defecate.
- . The **door** of the latrine must always stay closed in order to keep the interior of the building dark. This helps to prevent flies and mosquitoes from being attracted to the wet excreta inside the pit.
- . **Regular cleaning** of the squatting slab is required to keep it free from spilled excreta which otherwise might attract flies and promote transmission of worm infections.
- . The use of water should be limited to anal cleansing and squatting slab cleaning. The latrine shall not be used for body and cloth washing, because, with excessive amount of water in the pit, the decomposition of excreta would be slowed down and the life-time of the latrine reduced.

- . When $\frac{2}{3}$ $\frac{3}{4}$ full, the remaining portion of the pit should be filled with humus. A new pit will have to be dug and a new latrine building be constructed by making use of any re-usable material from the previously built latrine (slab, vent pipe, etc.).

The content of the initially used pit shall be left to decompose and untouched for a period of **one year**, after which essentially all disease-causing organisms will have died off or become inactive. It may then be dug out and used as compost ("mal") on small vegetable fields.

3. PIT LATRINES FOR SCHOOLS AND HEALTH POSTS

3.1 Introduction

- . Schools and health posts, like people's homes, should be equipped with latrines of simple design and construction. To fulfill this purpose schools and health posts can choose the pit latrine. The latrines as shown in the attached drawings are of the pit latrine type; though of simple design they are easily maintainable, free of unpleasant smells and safe against collapse. Also, insect breeding can be avoided to a large extent.
- . The chosen design and method of construction should enable communities to install latrines at schools and health posts with mostly local material and with a minimum of outside technical assistance.

3.2 Design basis

$$V = 1.33 \times C \times P \times N,$$

where :

V = volume of pit after lining, [m³]

C = excreta accumulation

[0.2 . . . 0.6 m³ / person, year]

P = number of users

N = pit design life time, [years]

1.33 is used since the pit will have finished its useful life when 2 / 3 full, and a new pit will have to be constructed

. For schools:
.....

- It is assumed that in most places where latrines will be constructed, pit depth will be 2 m, approximately; digging might become difficult as pit depth increases much beyond 2m.
- Ferrocement is recommended for the construction of squatting slabs as such slabs will be easy to clean and durable.
- The use of ferrocement slab dictates a max. pit width of 1.0 ... 1.2 m.
- A useful min. pit life time of 2 ... 3 years is desired; within this period pupils' and teachers' preference for the improved disposal of excreta may develop to the extent that they will be sufficiently interested and motivated to not spare the effort of constructing new latrines when the initially built latrines become filled up.
- Thus, taking

C = approx. 0.02 m³ / pupil, year

P = 70 100 pupils

N = 2 ... 3 years

will give a pit volume

V = approx. 6 m³

(depth : 2 m
width : 1 m
length : 3 m)

. For health posts and teachers :
.....

- The equivalent of five full time users is assumed as a design basis (more than five persons would visit the health post in a day, however, or more than five teachers might be teaching at a school).
- Excreta accumulation is assumed to be 0.06 m³/person, year, approximately.
- If the pit is, say, 2m deep and 1m wide (V=2m³), it will have a life span of approximately 5 years.
- Thus :

$$\begin{array}{l} C = 0.06 \text{ m}^3/\text{p., yr} \\ P = 5 \\ N = 5 \text{ years} \end{array} \quad) \quad \underline{V = 2\text{m}^3}$$

3.3 Upon filling of the pit

- . As with family pit latrines, the pits of school, health post and teacher latrines will have to be abandoned when full. The superstructure consisting of ferrocement slab, latrine building and vent pipe may be re-used fully or in parts at the new latrine site.
- . The contents of filled pits have to be left untouched for a minimum of 12 months in order to allow pathogens to die off or become inactive, and the excreta to decompose. After this period the compost-like content of the pit may be dug out and applied to vegetable fields as a soil conditioner ("mal"). Empty pits can then be used again for new latrines.

3.4 Sanitation education

- . In addition to the construction of latrines, the basic principles of sanitation and personal hygiene, and the role which piped water and the use of latrines play herein (refer to Chap. 1) shall be communicated to and discussed with the water and sanitation committee members, village leaders and villagers by CWSS field staff.
- . CWSS field staff shall guide **TEACHERS** in teaching the aspects of disease transmission, and the benefits which can be derived from improved water supply and latrines in trying to stop the transmission of diseases ("sanitation kit").
- . Similarly, CWSS staff can join efforts with **HEALTH POST PERSONNEL**.

SCHOOL PIT LATRINE FOR 70-100 STUDENTS

PLAN 1:50

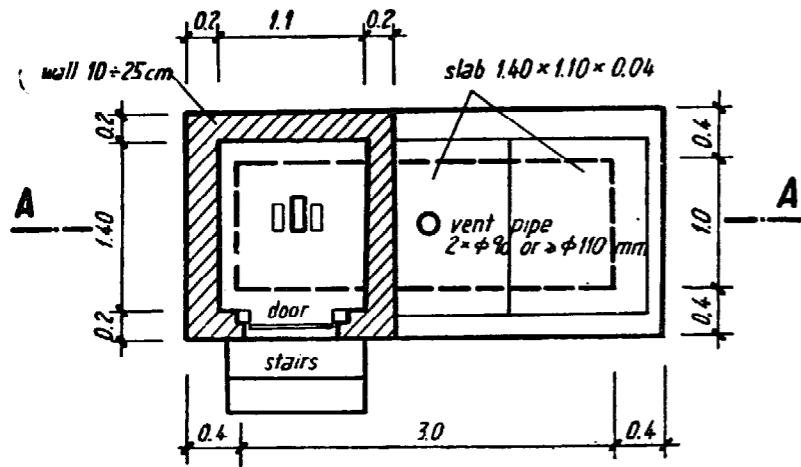

SECTION A-A 1:50

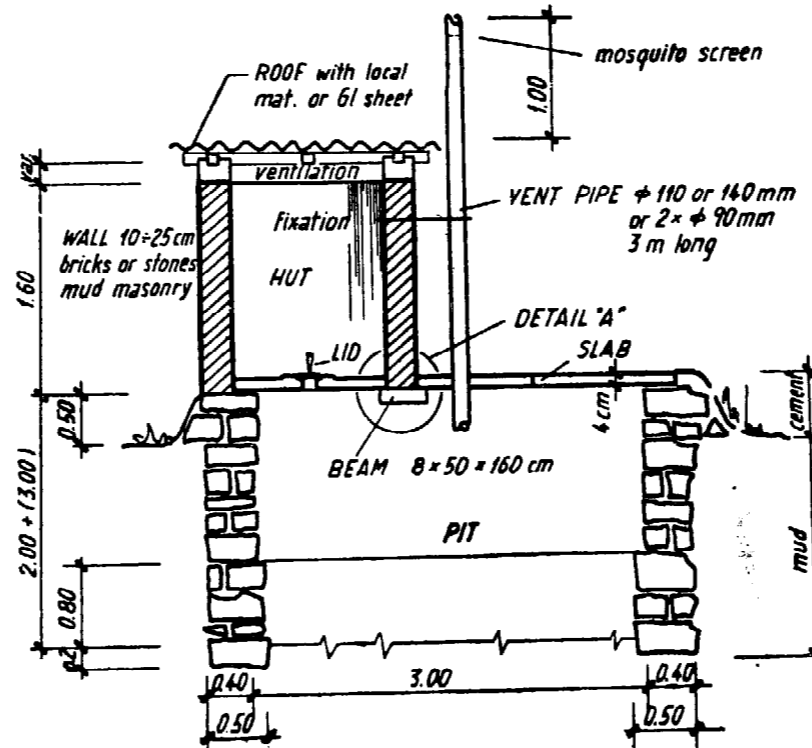

SQUATTING PLATE 1:50

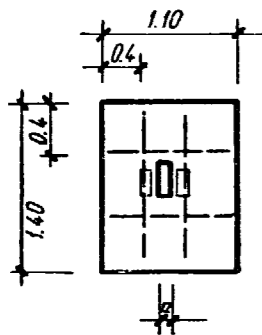

SLAB: 4 cm thick, reinforced with 4 bars φ 6 mm 1.05 / 1.35 m, and 3 layers wire mesh, size 4 x 15 mm

MIXTURE: cement : sand : water = 1 : 2 : 0.5

DETAIL "A" 1:20

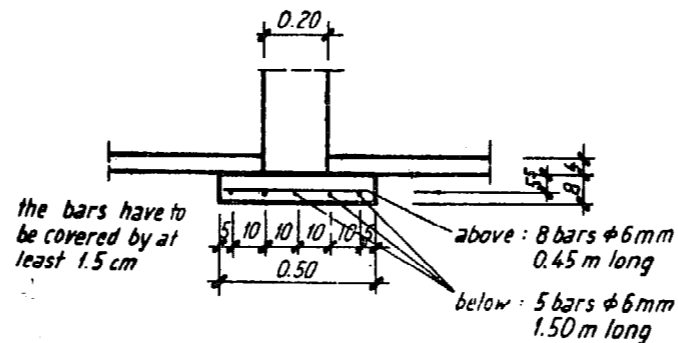

ESTIMATE

Contrib	description	unit	quant.	rate	amount
UNICEF-HMG	materials				
	cement	bag	5		
	wire mesh	m ²	13		
	reinforcement φ 6 mm	m ¹	26		
	plastic sheet	m ²	5		
	HDP-pipe φ 110 mm	m ¹	3		
	CGI sheet	m ²	3.5		
	wood	m ³	0.06		
	tools	-	-		
	nails, wire etc.	-	-		
transport	-	-			
labour	labour				
	WSST	month	1		
	mason	md	12		
	stone cutter	md	13		
	s. skilled labourer	md	20		
carpenter	md	2			
materials	stones	m ³	11		
	sand	m ³	1		
	gravel	m ³	1.25		
	bamboo φ 5 cm	m	15		
labour	labourer	md	16		

TEACHER AND HEALTH POST PIT LATRINE

PLAN 1:50

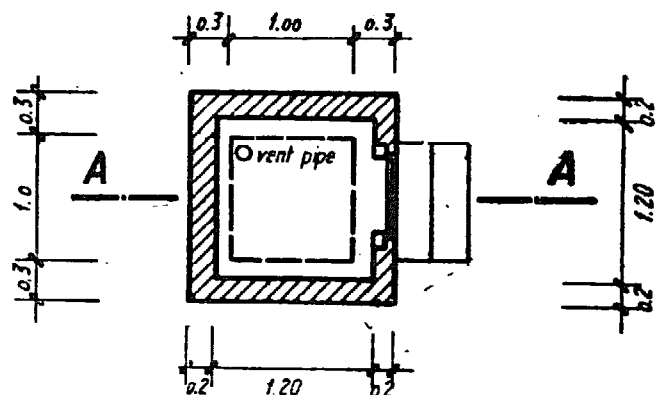

SQUATTING PLATE 1:50
DETAILS ALSO UNDER "FAMILY PIT LATRINE"

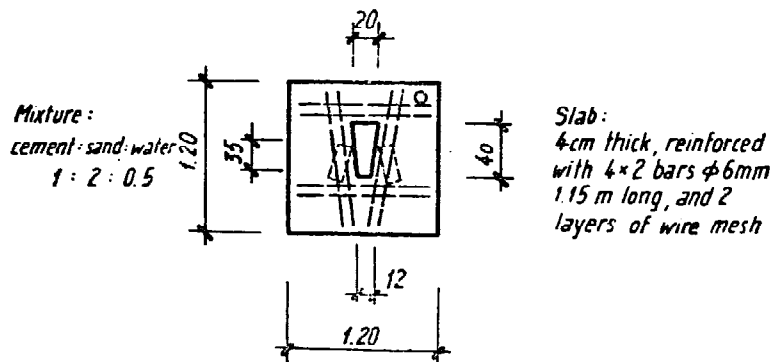

SECTION A-A 1:50

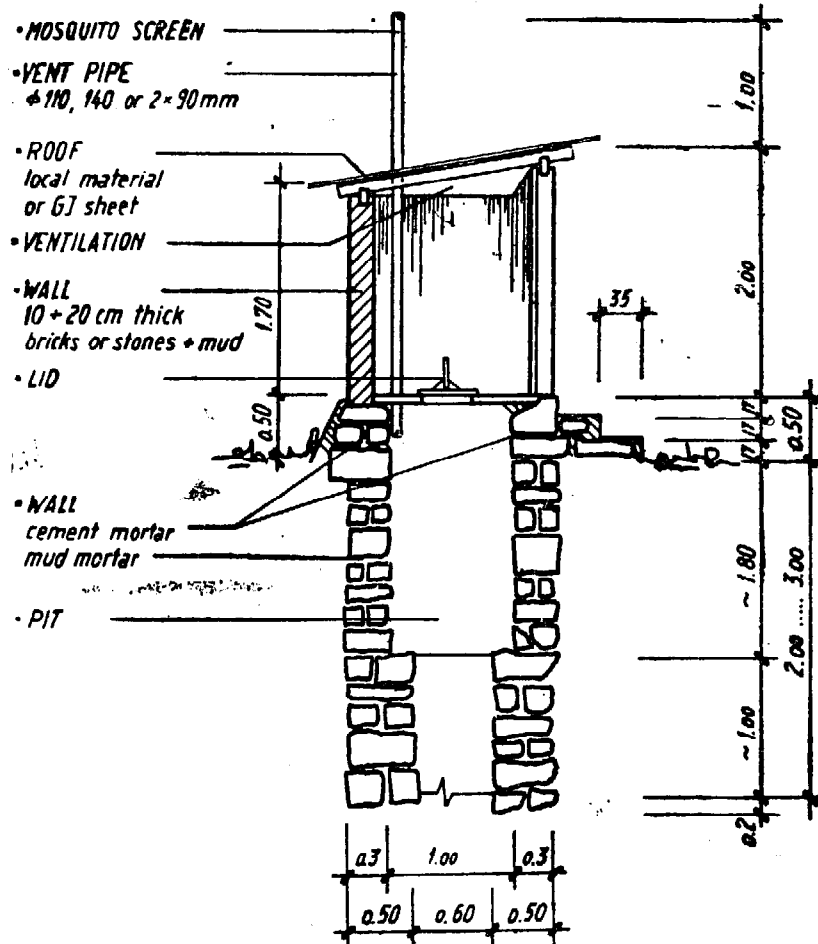

ESTIMATE

Contrib	description	unit	quant.	rate	amount
UNICEF-HMG	materials	cement	bag	2	
		wire mesh	m ²	3	
		reinforcement φ 6 mm	m ¹	9	
		plastic sheet	m ²	3	
		HDP-pipe φ 110 mm	m ¹	3	
		CGI sheet	m ²	3.5	
		wood	m ³	0.06	
		tools	-	-	
		nails, wire etc.	-	-	
		transport	-	-	
UNICEF-HMG	labour	WSST	month	1	
		mason	md	8	
		stone cutter	md	10	
		s. skilled labourer	md	15	
		carpenter	md	2	
Village	materials	stones	m ³	7	
		sand	m ³	0.5	
		gravel	m ³	0.25	
		bamboo φ 5 cm	m	15	
Village	labour	labourer	md	8	

4.

SANITATION QUIZ

Drawings no. 1, 2 and 3 on the following pages illustrate the ten transmission routes for excreta-, and skin- and eye-related diseases as are listed and explained in the Table on p. 5.

Arrangement of the drawings is made such as to present a short quiz by which the understanding of disease transmission and of the role of CWSS work for disease prevention may be selftested.

After having carefully studied the Table and Chpts. 1.2 - 1.5, any attempt to solve the quiz will certainly be successful !

The task consists of filling in on each drawing:

- a - The **number of the transmission routes** as listed in the Table on p. 5; (for this, brackets are provided on the arrow of each of the illustrated routes)
- b - A **proper title** for the particular drawing; the title shall refer to the **cause(s)** of transmission for the routes shown on the drawing, i. e. it shall mention which particular shortcomings with respect to water supply, water use and excreta disposal are the main common cause(s) of transmission
- c - **Examples of important diseases** which are transmitted by the transmission routes on the particular drawing
- d - The **proper and most effective measure(s)** which may be provided **from the CWSS "tool box"** to help stopping the particular disease transmission routes.

Note : In each drawing, "Bahadur" (the person shown in white pants and without shirt) represents the sick person, who first carries the disease-causing organisms; "Krishna" (the person shown in shaded pants and shirt) represents the person who first is healthy and then falls sick due to transmission of disease from "Bahadur".

SANITATION QUIZ
Drawing 1

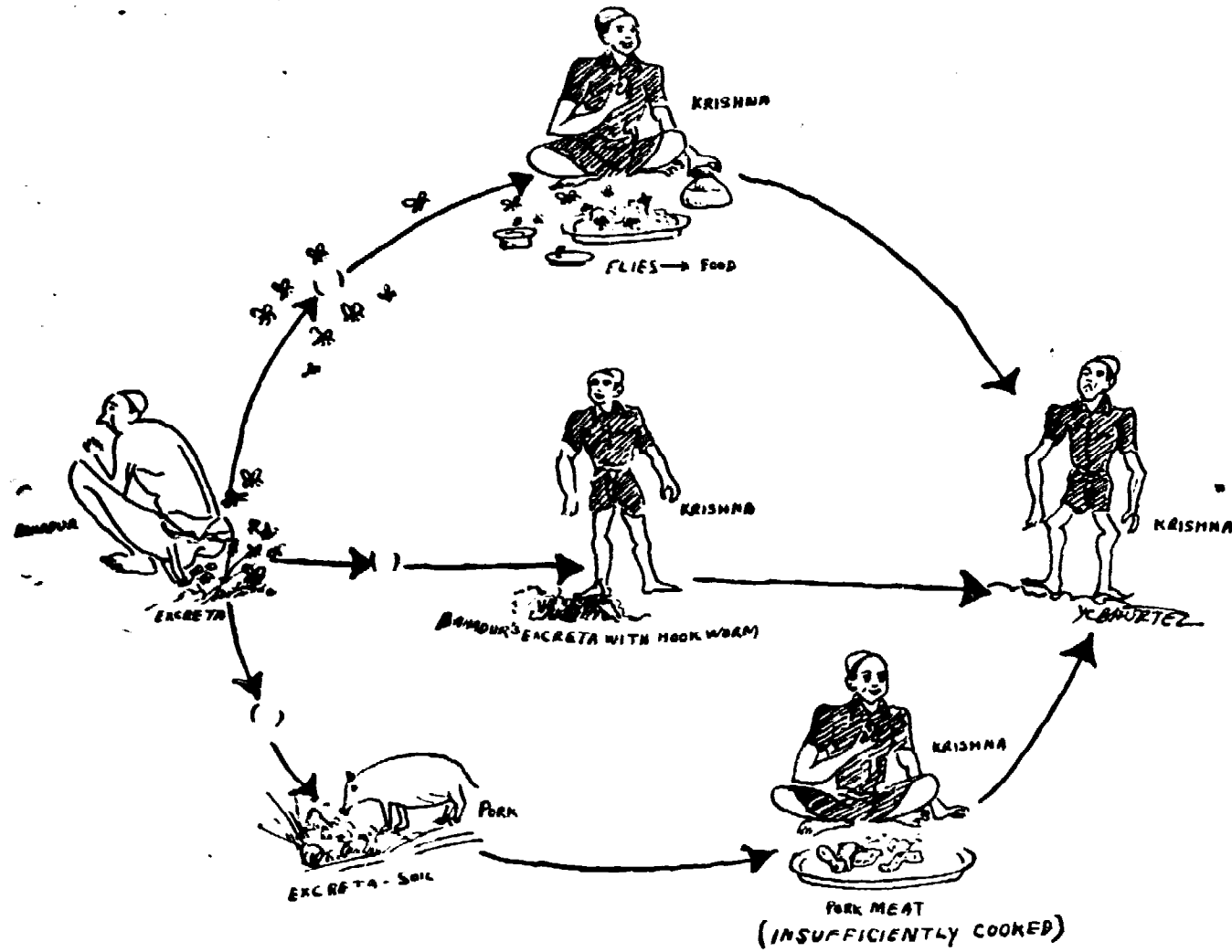

a - Number the transmission routes in the brackets provided

b - Title:

c - Examples of diseases transmitted :
.....

d - Preventive measure(s) from CWSS "tool box" :
.....

SANITATION QUIZ
Drawing 2

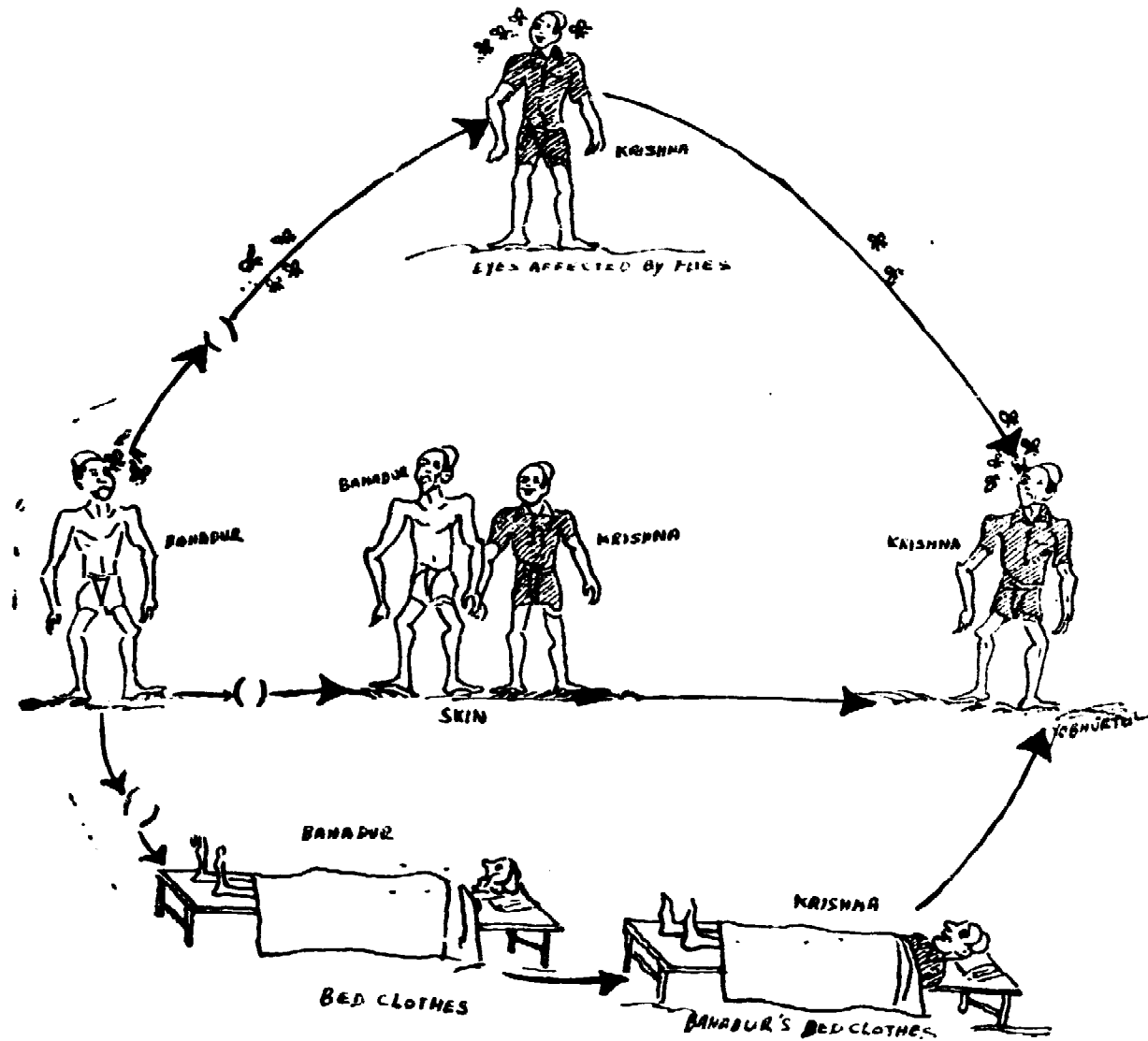

a - Number the transmission routes in the brackets provided

b - Title:

c - Examples of diseases transmitted :
.....

d - Preventive measure(s) from CWSS "tool box" :
.....

SANITATION QUIZ
Drawing 3

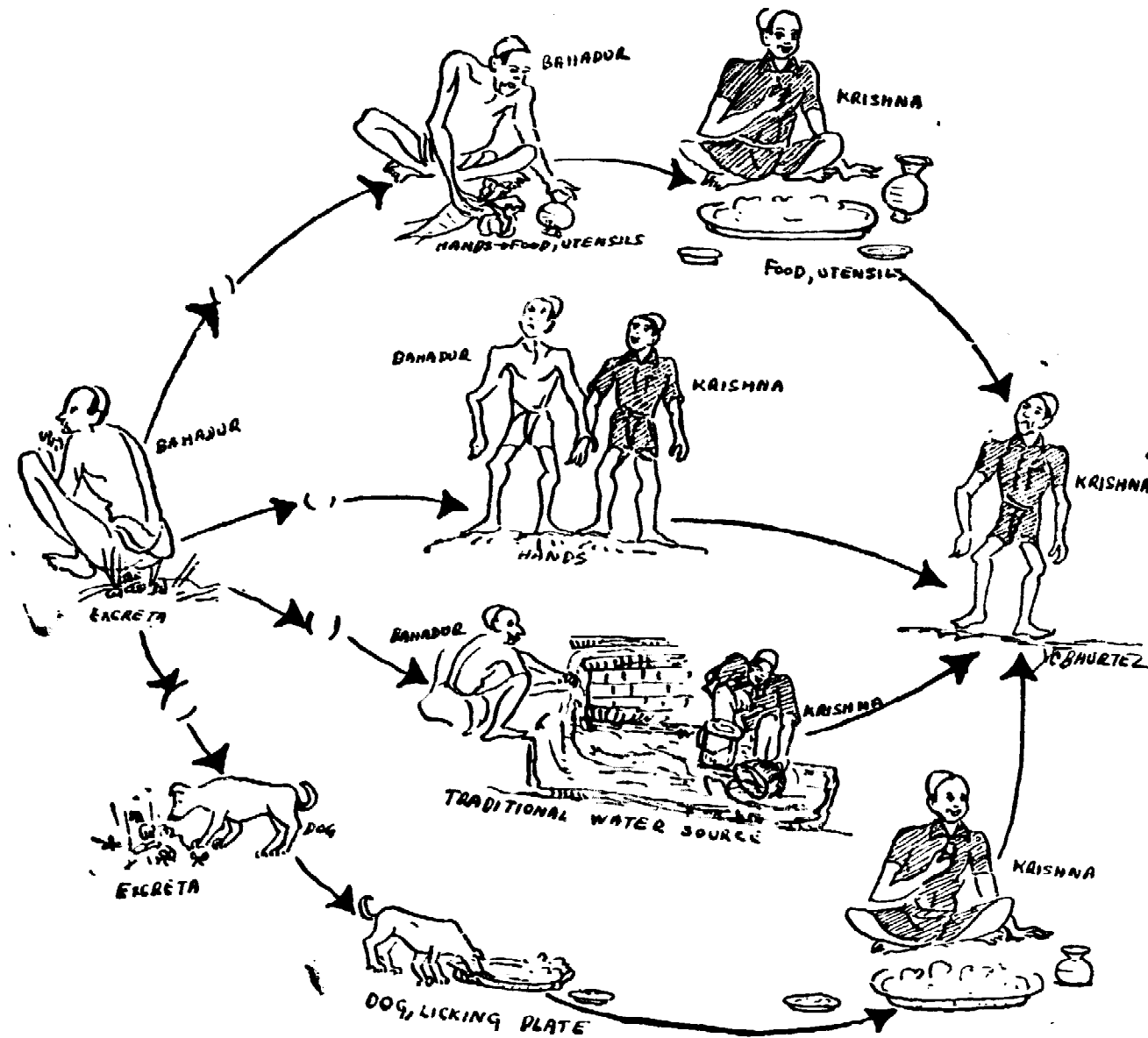

a - Number the transmission routes in the brackets provided

b - Title:

.....

.....

.....

c - Examples of diseases transmitted :

.....

.....

.....

.....

d - Preventive measure(s) from CWSS "tool box" :

.....

.....

.....

.....