

Women and the Transport of Water

By: Val Curtis

Published by: Intermediate Technology Publications
103/105 Southampton Row
London WC1B 4HH
U.K.

Available from: Intermediate Technology Publications
103/105 Southampton Row
London WC1B 4HH
U.K.

Reproduced with permission.

Reproduction of this microfiche document in any form is subject to the same restrictions as those of the original document.

WOMEN AND THE TRANSPORT OF WATER

Val Curtis

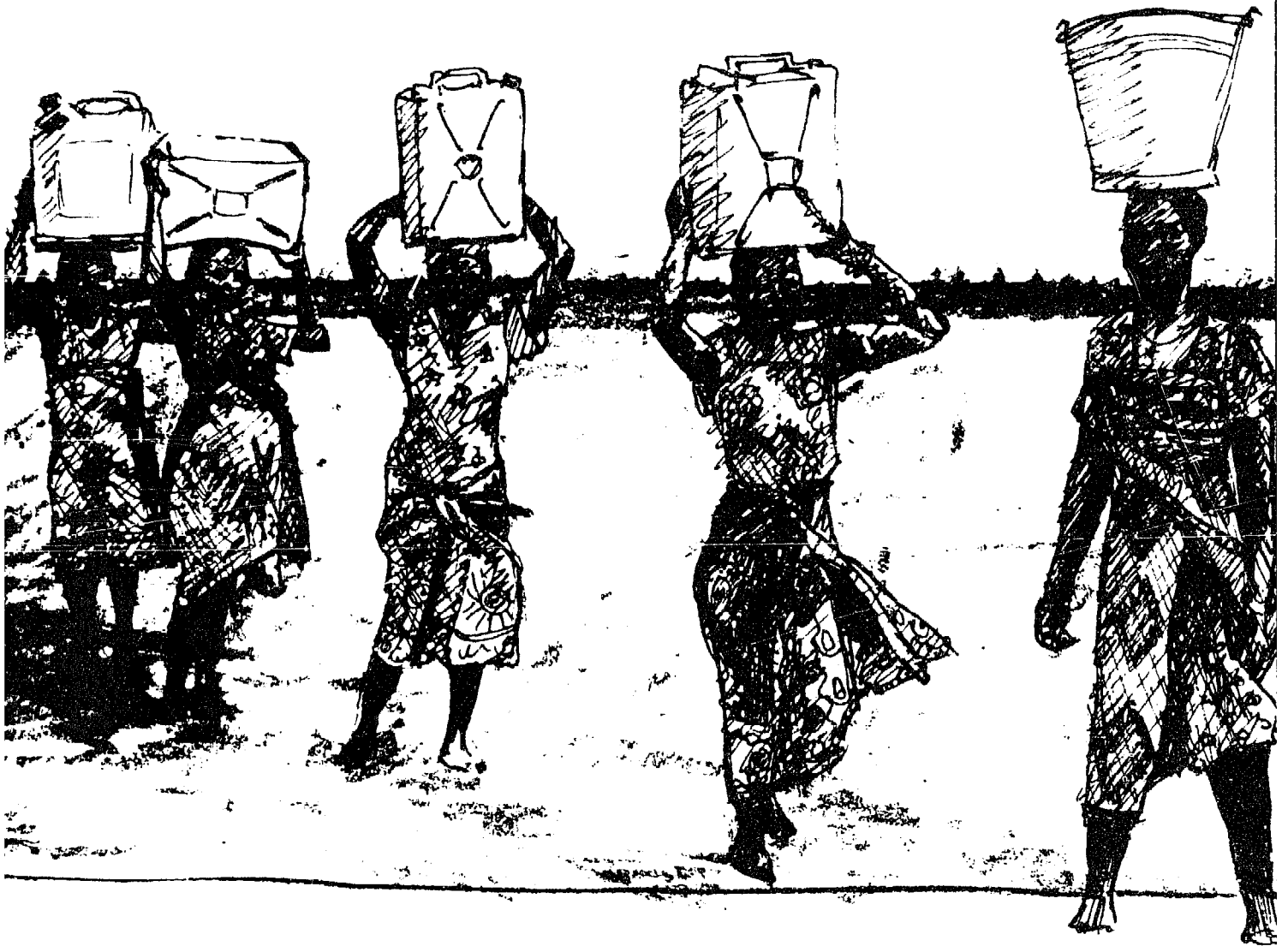

WOMEN AND THE TRANSPORT OF WATER

Val Curtis

**Intermediate Technology Publications,
9 King Street, London WC2E 8HW, U.K.**

© Intermediate Technology Publications 1986

ISBN 0 946688 42 7

The Intermediate Technology Development Group was founded in 1965 by the late Dr E.F. Schumacher. The Group, an independent charity, helps to introduce technologies suitable for rural communities in developing countries.

CONTENTS

	Page
List of Acronyms	iv
Preface	v
I WOMEN AND THE TRANSPORT OF WATER	
A Background	1
B Why Improve Water Supplies?	3
C Transport and Development	5
D The Division of Labour	6
E The Consequences of Having to Carry Water	9
1 Health effects	9
2 Economic effects	10
3 Social effects	12
F Alternative Technologies	13
1 Carrying aids	14
2 Wheelbarrows and handcarts	17
3 Animal transport	18
4 Others	19
5 Introducing new technologies	21
II KENYA: THE PROBLEMS AND SOME SOLUTIONS	
A Water Supply in Kenya	23
B The Workload	25
C Carrying Methods	28
D Case Studies in Kenya	32
1 Kamujene Farmers' Centre	32
2 Action Aid - Kibwezi Region	34
3 Utooni Development Project	36
4 Discussion	39
E Donkeys in Development	42
III CONCLUSIONS	
A General Conclusions	44
B Conclusions on Kenya	44
References	47

LIST OF ACRONYMS

AMRFF	African Medical and Research Foundation
ATAC	Appropriate Technology Advisory Committee
CARE-Kenya	Kenyan N.G.O.
CIDA	Canadian International Development Agency
DANIDA	Danish International Development Agency
FAO	U.N. Food and Agriculture Organisation
ICA	International Christian Aid
IDRB	World Bank
KEFINCO	Keyna - Finland Cooperation
KENAFYA	Kenya - Finland Health Project
KWAHO	Kenya - Water And Health Organisation
LWF	Lutheran World Federation
MCC	Mennonite Central Committee
NGO	Non Government Organisation
ODA	U.K. Overseas Development Agency
PFP	Partnership for Productivity
SIDA	Swedish International Development Agency
UNDP	United Nations Development Programme
UNICEF	United Nations Children's Fund
USAID	U.S. Agency for International Development
VSO	Voluntary Service Overseas (U.K.)
WeCo	Western College of Arts and Applied Sciences
WHO	World Health Organisation

* Note: 19 Kenyan Shillings = £1.00 as at April 1985.

PREFACE

Women in rural areas of developing countries have a heavy workload to sustain them, and their families' existence. One of their most arduous and time-consuming daily tasks is the haulage of water from often distant sources. Ideally each household would have a modern source in or near the home but this is a long way from being achieved. In fact, in many Third World countries improvements in water supply are not keeping pace with population growth, so more rather than fewer women are having to carry water. This paper looks at some of the problems women have with this work and investigates whether improved means of transport could help relieve their burden.

It is hoped that the publication of this paper will stimulate further discussion of the rarely considered area of labour-saving technology for rural women and that agencies may be encouraged to take up some of its recommendations for further work in the field.

The paper is divided into two parts. Part One looks at the scale of the problem and introduces some alternative transport ideas that could be of help. Part Two is based on field research in Kenya. It explores the state of water supply and suggests some ways in which improved transport could help in three selected communities.

Many organisations and individuals helped and guided me in this study. I would particularly like to thank the staff of Action Aid Kenya for their help and Andrena Faulkner for her generous hospitality. The assistance of Julie Adkins and Patrick Mutea, Joshua and Rhoda Mukusiya, David Horn, David Grey and Jan and Roger is gratefully acknowledged. The discussions with women in Kenya took up many hours of their precious time, I hope that further work from this study may one day repay the debt.

Val Curtis
I.T.D.G. London
1985.

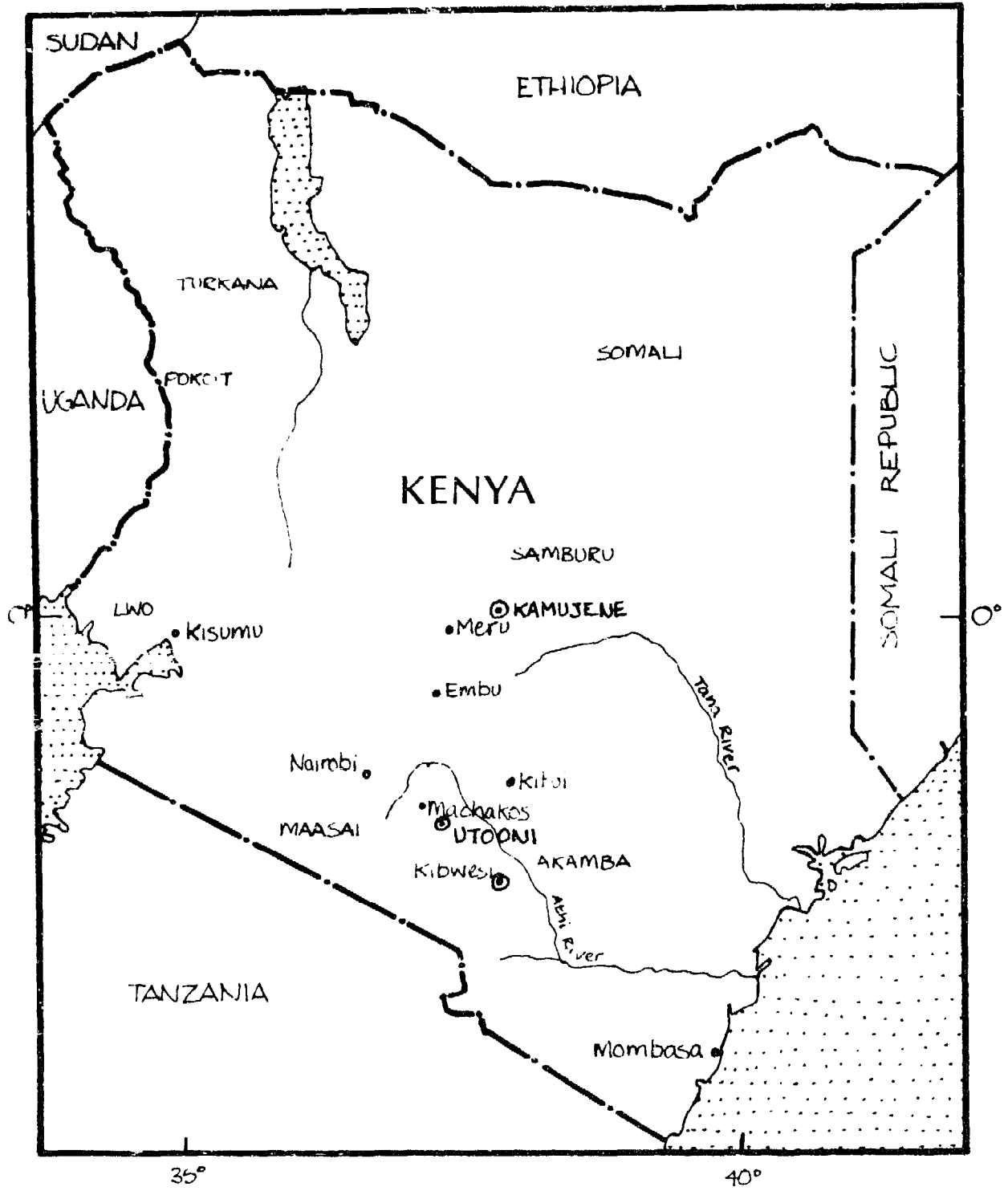

Fig 1. Map of Kenya.

I WOMEN AND THE TRANSPORT OF WATER.

A. Background

Whilst the vast majority of rural peoples in developing countries do not have water on tap, human portorage is still the most common means of transporting it. Water carrying, a task which falls mainly to rural women and their children is arduous, time-consuming and can be injurious to health. One of the purposes of improved rural water supply has been to reduce this burden, yet it is apparent that convenient, clean water within the reach of all by the year 2000 will remain a pipe dream.

In this, the U.N. Decade for Water and Sanitation, the problems of rural Africa have hardly begun to be addressed; water recedes as drought advances, so time and scarce energy expended in collecting water increase. Many women spend perhaps five hours out of a sixteen hour working day collecting a single load, even sleeping out at night to wait their turn to carry up to 30kg of water back to their homes. The work is arduous, leads to injury and deformity, and evidence shows that the work of rural women is getting harder.

Much time and effort has been spent in installing systems which bring water nearer the home but this has proved a difficult, slow task and the break-down rate for new installation is high. So most African women are condemned to continue to carry water in the traditional way. Yet this need not be the only way of reducing the problems women have with water supply. Throughout the world there is a great diversity of methods of portorage. In Asia the shoulder pole and the yoke are used extensively, in China they use carts and in the Andes, llamas. In flat terrain barrels may be harnessed to roll along or bicycles with trailers used to carry goods. Developing countries could learn from each other's practises and possibly also from the developed world where low-cost devices have been especially devised to make load carrying easier.

African women who so badly need them have not had access to these technologies, but if they did would they be able to afford any of them? Would the savings in labour be sufficient to persuade women or men that to find the money would be worthwhile even if the device showed no direct financial benefit?

If a market exists for improved water-carrying devices then it might be possible to set up a small industry which would provide employment and therefore income in rural areas to manufacture them.

This paper relates the findings of an investigation into the potential for rural people to help themselves by using and possibly manufacturing devices which could reduce the workload of water carrying. Eventually it would be hoped that any developments could be self-supporting and replicable to other areas. The work was based on desk research in the U.K., and a field trip to Kenya undertaken in the first quarter of 1985.

Kenya was chosen as a focus for this study because of the interest of various agencies in the field in improving the transport means available to rural women and because it is one of the countries where the Intermediate Technology Development Group focuses its attention.

This topic is not one that has been covered in any depth in the existing literature. Generally information came from informal contact both with representatives of organisations and individuals. Instead of attempting a statistical survey of rural women's water related behaviour and feelings it seemed far more appropriate to go with an open mind and spend as much time as possible listening to their own views. Discussions were thus highly informal and varied from location to location.

B. Why Improve Water Supplies?

At least two thirds of mankind draw their water from sources outside the household and carry it in containers to their homes. In East Africa the proportion is nearer nine out of ten (1). Even in this, the U.N. International Water Decade, advances in rural water supply are slow; high population growth means that more, rather than fewer people are having to carry water, often for longer distances. It has been estimated that today (1985) one hundred million more people than in 1975 have no improved water supply (2).

The minimum human requirement for water for survival ranges from about 1.8 to 3 litres per capita per day (pcd) depending on temperature, the amount of work the person is doing and the type of food consumed (1). Over and above that, water must be obtained for cooking, washing, for livestock and for irregular activities like brick making, beer brewing or construction. Consumption rates vary widely; whilst a refugee may be able to survive on a ration of 2 litres pcd, an urban inhabitant with flush toilet and bath uses 120 litres pcd.

This consumption rate is one of the variables that determine the time and energy that has to be spent on water collection. Others include:

- a) distance to source
- b) terrain to be traversed
- c) method of transport
- d) queueing time at source
- e) number of consumers in household
- f) number of people available to carry water.

There are many reasons for improving water supply, in both quality and in quantity. Life is impossible where there is no water, so all permanent settlement has some sort of source however far or poor in quality it may be. Where quantity is limited, increasing the supply can provide insurance against drought, allow for more hygienic behaviour which benefits health, and improve food production if water is used to irrigate crops and provide for livestock. Improving the quality of water also benefits health and provides an amenity which improves the quality of life.

Improving water supplies allows more water to be consumed: this can have a greater impact on health status than improving the quality. This is demonstrated in a study from Southern India (3) where quantity, rather than quality of water was found to be the main determinant for good health for children over three years of age. Most infection comes, not from drinking contaminated water, but by other routes, such as dirty hands or utensils. (Children under three are more vulnerable to water-carried infection because they have not yet acquired immunity to many enteric bacteria.)

Improving the accessibility of water by installing more water points or by making transport easier reduces the labour involved in hauling water. The advantages of this include:

a) releasing more time for:

- cultivation,
- education,
- income generation,
- leisure,
- child care.

b) improving health by:

- increased use of water,
- less injury from carrying,
- reduced energy requirements.

c) reducing population growth: the desire to have children for their labour capacity encourages large families.

d) enabling more children (especially girls) to attend school because their labour is required less at home.

e) stemming the drift to urban areas by improving rural amenities.

Technological development for reducing the labour of household chores gives women freedom of choice to decide how they will spend their time. From the options available to them they may prefer to increase the time they spend in household chores, thus improving the quality of life for their household. For example it is accepted that the introduction of the washing machine in the West has not saved much in total labour since clothes are now washed more frequently (4).

C. Transport and Development

The carrying of water is one aspect of the general problems that rural people have with transportation. For many isolated rural people modern means of transport are inappropriate. In India, for example, 70% of villages do not have an all-weather road connection and 55% have none at all (5); even if cars or pick-ups were affordable they would have no use.

Lack of means of transportation is both a cause and an effect of rural deprivation: deprivation prevents access to those resources that could help the poor to lift themselves from their poverty. People who live in isolated areas tend to be the most deprived: distant from extension and health services, they hear of new development ideas last. Distant from markets, they are limited in what they can sell by what they can carry and they have to buy essentials at higher prices. Time and energy that has to be spent transporting goods might have been better spent in improving the conditions of life by increasing cultivation or child care. Distance from services such as water or famine relief make the isolated most vulnerable to disaster. Distance from education and from neighbours means that isolated people rarely find a political voice to further their own interests.

Transportation problems are worst for those whom population pressures have forced into poorer agricultural land where there is less rain. Since the land is newly settled, infrastructure is poor and the area is, by definition, drier. This means that in order to provide for daily water needs, the fraction of the day that is spent carrying water is greater in drier zones.

Improvement in rural transport in general and in water carrying in particular can offer some means of helping poor rural people improve their circumstances.

D. The Division of Labour

Women in much of the Third World have a disproportionate share of the work that has to be done in rural areas. This is a fact that is often overlooked partly because of disagreements on the definition of 'work' and partly because few countries have tried to measure women's work, [only 6 out of 70 developing countries define water hauling as part of goods and services in the G.N.P (6)].

The total workload of women in rural areas is very high; a study in Burkina Faso found that on average women had 1.3 hours of free time in the first fifteen hours of waking. In my investigations in rural Kenya I asked women to describe a typical man's day and men to describe a typical woman's day. Answers showed that women got up an hour earlier than men, went to bed an hour later and had only a few hours rest during the day (when they would play with the children). It was considered that times were hard if men had to work for the whole morning.

Table 1 shows the division of labour for some selected activities from the Integrated Rural Survey of Kenya, this makes it appear that men do very little except grazing animals and buying food, but it must be noted that the questions do not discuss wage labour which some men are involved in.

Table 1. Percentage Distribution of Task by Sex and Activity for over 15's in Kenya. (Others do not engage in the activity or are not recorded.)

	Male	Female
Poultry care	3	9
Stall feed	8	12
Grazing cattle	25	24
Milking cattle	12	37
Grazing goats or sheep	21	27
Food preparation and cooking	5	90
House cleaning	5	90
Child care	1	63
Buying food	23	71
Fetching water	5	89
Fetching firewood	5	89

(Ref 11)



Fig. 2. Water Gourd with Shoulder Strap, Turkana.

Children in developing countries are observed to have a very high workload; a study from Burkina Faso showed that between the ages of 11 and 17 girls worked on average 5 to 8 hours per day, including 2 to 3 hours hauling water and grinding grain. Meanwhile boys worked at most 3 to 5 hours (8). In Sierra Leone a typical nine-year-old Mende girl spent more than 13 of her 16-hour day helping with household and income-generating tasks and half the time was spent on water-related activity (9).

Water collection is an activity particularly reserved for women and children; in many countries for a man even to be seen collecting water would bring shame. Men do though collect it for their own businesses and to sell. However, men will sometimes collect water for domestic use if some form of transport other than backloading or headloading is used.

In western Kenya the Lake Basin Development Authority found that 89% of water collectors were women and girls (10).

Women in rural areas have always been responsible for the house and children, for fetching firewood and water and in much of Africa they are responsible for food cultivation. This role has changed little, whilst the traditional male role has almost vanished. Men were responsible for defence and war making, for livestock husbandry and for religious observance. Society supports these functions to a much lessened degree but has not offered in exchange a place for all in the wage sector. Some men find employment locally in petty trade or cash farming, many others migrate from the rural areas leaving behind a female headed household where all tasks are carried out by women and children, unless remittances pay for some hired labour. The Integrated Rural Survey of Kenya (11) defines 30% of households as female headed. Some suggest that the figure may now be as high as 40%.

E. The Consequences of Having to Carry Water

The effects of having to carry water can be divided into three categories: health, economic and social.

1. Health effects

Carrying loads for long distances requires a substantial amount of energy which has to come from metabolized food. The rural poor often experience shortfalls in available food. Their best response to this event should be to do nothing that requires energy. Of course, for the rural woman who has to provide water for her family this is not a possible option and so she therefore risks malnutrition which makes her far more susceptible to disease. UNICEF's 1984 report 'The State of the World's Children' (12) discusses the plight of women:

'As important as a mother's time is her energy. And again the unequal standing of women... means that the mother is frequently ill and tired, devoid of the capacity for extra effort that the child's well being may demand. Of the 464 million women in the Third World no less than 230 million are estimated to be anaemic. In Africa 63% of pregnant women and 40% of non pregnant women are anaemic.' (WHO standards).

Energy-sapping anaemia is thus most severe during pregnancy, when, combined with continued heavy work such as water carrying, growth of the foetus can be impaired. The quantity and quality of breast milk is also adversely affected. This is a common problem in Kenya where women rarely get more than a few weeks respite from load carrying. Compounding the energy problem there is also a seasonal dimension; at the end of the dry season food is scarcest, work planting in the fields is at its hardest and the distance to water is at its greatest. Studies underway on the seasonality of malnutrition confirm that health is worst during the wet seasons, partly as a result of the workload during the previous dry season (13).

Methods of water carrying can result in injury and deformity. People who carry water on their backs with a head strap have a marked cranial depression. Maasai, Kamba and Kikuyu women in Kenya exhibit this and claim it as the cause of their frequent headaches. The African Medical Research Foundation (AMREF) reported that 10% of attendances by women at rural health centres were for

head pains. Backaches are more common; AMREF has said that 100% of Maasai women probably suffer and many are crippled by the age of 35. Load carrying also causes deformation of the spine which can result in obstruction of the birth canal, risking both mother's and child's life.

At Kenyatta Hospital in Nairobi doctors treat Kikuyu bursa, an osteo-arthritis of the soft tissue of the knee, which is found mostly in women and is caused by load carrying. They have also had to develop a special method of operating on the thyroid gland in Kenyan women because the neck muscles become so enlarged from load carrying.

Accidents which are a result of load carrying are frequent in poorer countries; slipped discs, paralysis, injury to carried children, broken backs and even strangulation by the head strap all occur. One study in Bangladesh revealed that 50% of broken neck cases in a rehabilitation clinic were the result of falls whilst carrying heavy loads (14).

However there are possible benefits in this heavy work load, (at least when compared with urban Westerners); fitness may allow work to be done more easily and the posture of an African woman skilled in headloading looks healthy, and must, to some extent, protect against injury.

Women are also exposed to health risks by venturing into the environments where water is collected. A traditional source may be a swamp or stream where mosquitoes breed exposing the woman or child to Malaria and Filariasis. Hookworm and jigger parasites also spread in damp environments where people congregate.

2. Economic effects

The workload associated with water carrying clearly has an opportunity cost, but to describe this more fully one has to decide what that opportunity is. At present there is a dearth of studies which give a clear picture of the economy of rural communities in transition from barter and livestock exchange to the cash economy. We know that precise conclusions are hard to draw when economic behaviour is dependant on many variables. Thus it is difficult to assign figures to this opportunity cost, as they could only be relevant to one specific complex situation.

White, Burton and White, in their classic study 'The Drawers of Water' (1) assign a cost to the journey for water in terms of the cost of the food energy used. In Feachem et al (16) an hourly value for the collector's time was imputed from what it would cost to save that time by improving the water supply. This was found to be a fraction of the hourly wage a woman could command were she able to find paid work.

Whatever its real value, reducing the burden of water carrying can allow women more freedom to decide how to spend their time. Given the opportunity, many women wish to engage in profit-making activity. For example, an Overseas Development Administration (O.D.A.) evaluation of a water project in Swaziland (14) found that the production of handicrafts doubled when women were saved the trouble of carrying water. (It did not mention whether twice the amount of handicrafts could be sold which is one way of costing the time.)

As with any domestic work time could also be valued by what a woman would charge were she to be paid by another to do it.

Many children, especially girls, are kept away from school when there is work to be done at home. This lack of education is a major factor in perpetuating women's low socio-economic status. The time spent carrying water might also be spent better, economically speaking, in cultivating larger areas of land to produce a surplus for cash (where more land is available). The lack of energy and poor health caused by the heavy workload must also reduce the efficiency of any paid work that is undertaken, thus reducing women's earning power.

A view expressed by many development workers is that one should not train women in income generating projects and skills because their domestic workload is too high to allow them time to participate. In this case the work of hauling water has a high economic penalty.

3. Social effects

The opinion is often expressed that fetching water fulfils an important social function; allowing women to keep in touch as they chat by the well. However this must be the result of observations from richer and/or urban areas; in poor rural areas women rarely stay longer than is necessary. A recent study in Kitui district found that in no case did the journey for water have a social or companionship function (17).

The time taken collecting water detracts from time that could otherwise be spent profitably socially; women could be organising self-help enterprises together and gaining a political voice to press for improved services.

F. Alternative Technologies

The technology of water carrying has been evolving ever since (wo)men learned to make vessels. Clay pots and animal skins, still in use in rural areas, have now been superseded by modern, river basin management with hot and cold water on tap in rich countries.

Since it is becoming clear that the amenity of piped water to all in the near future is unlikely to be achieved we need to consider the alternative offered by the improvement of transport technology. We will look at four groups of aids that seem to hold the most promise for the rural poor; most



Fig. 3. Shoulder pole used to carry water in Burma.

are traditional but some have been designed specifically for use in rural areas. The aids that are considered are all likely to be cheap enough to be within reach of the poor, be simple and durable, and able to work where there are no roads and can be manufactured locally. The aids fall into four categories: carrying aids; wheelbarrows and handcarts; animal transport; and others.

1. Carrying aids

The simplest carrying aid is the ring of banana leaves woven by an African woman to place beneath the water pot on her head. Slightly more complex is the leather or sisal strap, tied in a number of ways, attaching the vessel to the back or forehead (Fig. 2).

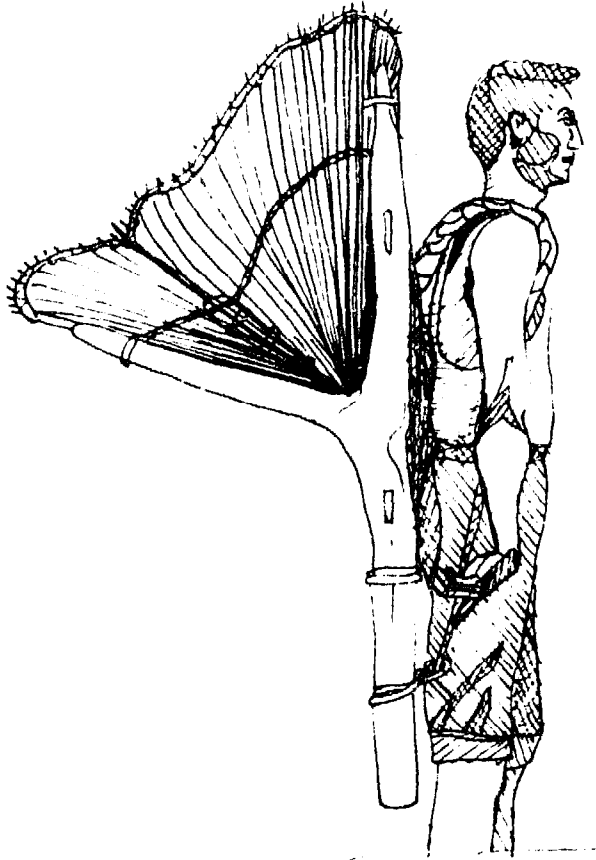
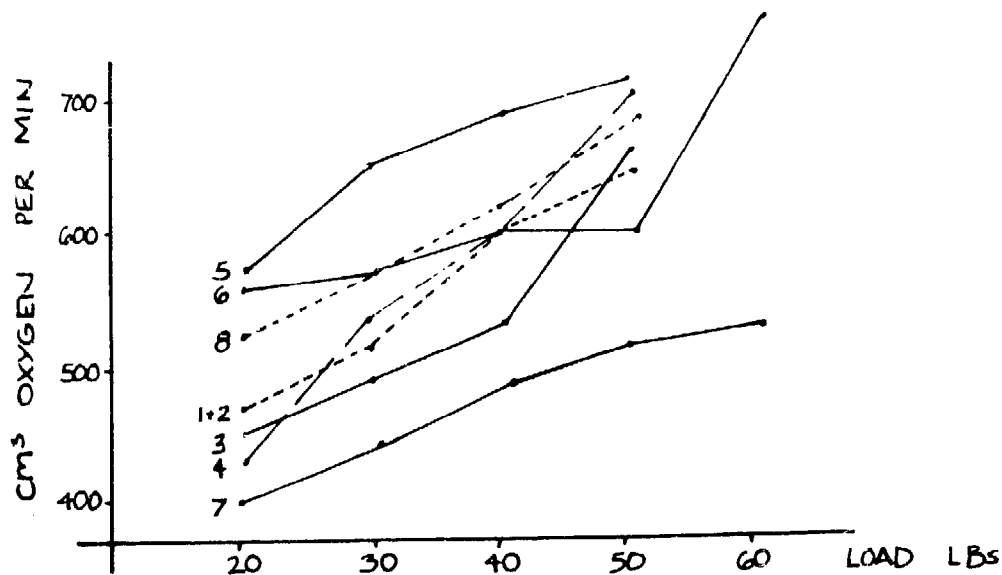

Fig. 4. The Chee-geh in Korea.

In Asia the flexible shoulder pole allows heavier loads to be carried, but some skill is needed to master the technique (Fig. 3). Variations on this theme include the rigid yoke which is made to fit the individual, the pole carried between two people and the pole which is strapped to the back. In Korea many farmers own a type of wood-framed rucksack called the chee-geh, which is efficient for carrying up to about 50kg but it is relatively complex to make (Fig. 4).

Research carried out by the Medical Research Council of the U.K. compares the efficiency of various methods of load carrying, the graph (graph 1) shows the oxygen requirements for different loadings for the different carrying methods shown in Fig. 5 (17).



Graph 1. Comparative Costs Of Eight Modes Of Transport. Oxygen Consumption Per Minute For Different Loads.



1. TRAY



2. TRAY WITH STRAP

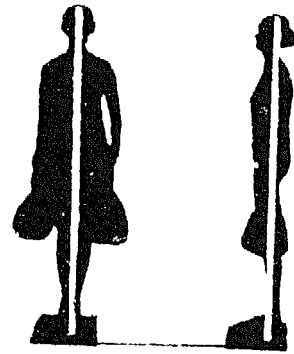

3. BUNDLES



4. HIP

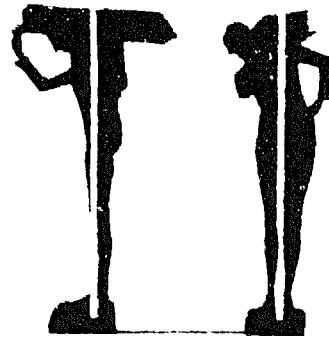

5. SHOULDER



6. BACK

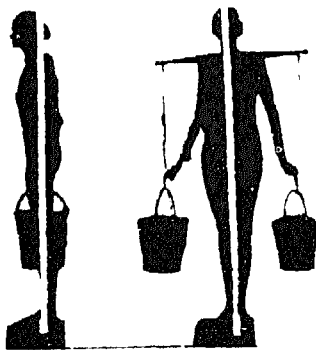

7. YOKE



8. HEAD



9. NORMAL POSTURE

Fig. 5. Load carrying positions for Graph 1.

The graph shows that the yoke requires the least energy expenditure but back and head loading are apparently not so efficient (15). In principle, for efficient carrying, the load should be as low down as possible to make balancing it easier and the load should move the centre of gravity of the body as little as possible from its normal moving position to avoid incurring additional horizontal reaction forces. Clearly, of the methods compared the yoke best fulfils these conditions.

2. Wheelbarrows and Handcarts

Wheeled devices have the major advantage that much of the load is carried directly by the wheel, so larger, awkward loads can be pushed or pulled longer distances. In the West the wheelbarrow is a common example, but the modern version is not particularly efficient or durable. In Africa small boys make a sort of trolley on which to place jerry cans of water. These are usually flimsy, with wheels that are too small to negotiate rough ground. I.T. Transport Ltd have developed a small farm transport vehicle (SFTV) which

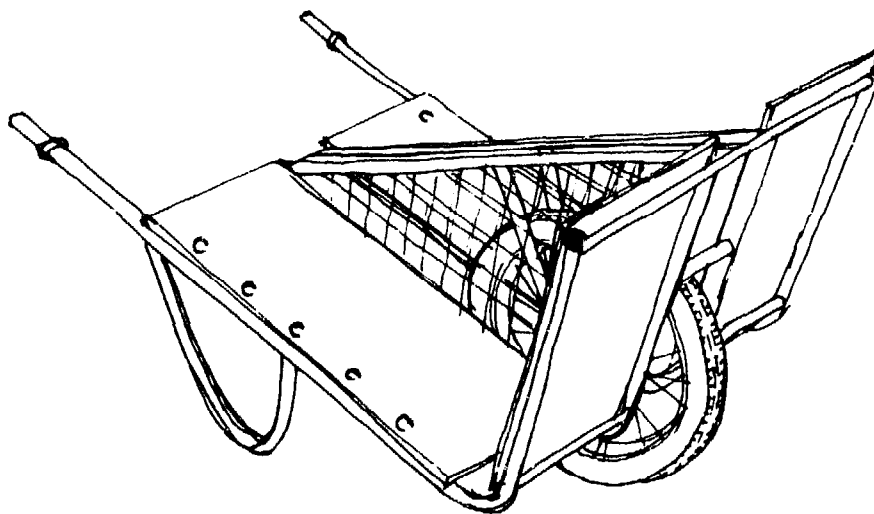

Fig. 6. I.T. Transport's Small Farm Transport Vehicle. (Prototype)

is a more efficient form of wheelbarrow. The majority of the load is carried by the wheel which is large enough to negotiate rough ground. Made from locally available materials it is a relatively cheap method of carrying up to about 200kg (Fig 6).

In China two-wheeled handcarts are used everywhere for transporting loads and many designs exist. The technology is well developed but the use of two wheels does restrict use to wider paths.

Wheeled devices are of limited use in sandy or muddy conditions since they sink and stick.

3. Animal Transport

Domesticated animals are used throughout the world as transport aids; the horse, buffalo, ox, elephant, camel and the donkey, the yak in the Himalayas and the llama in the Andes. Loads carried on the back of an animal require some form of saddle or pannier,

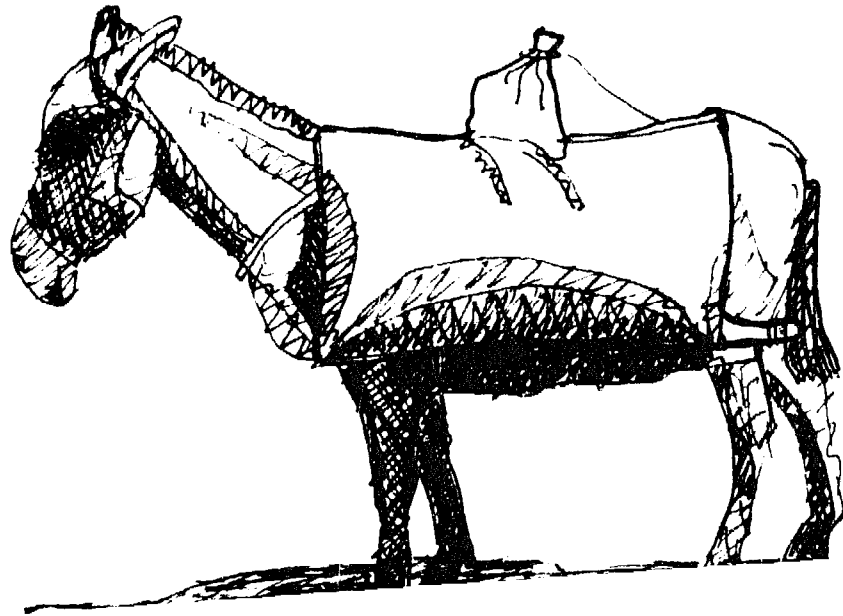

and many types exist, which vary in the stress that they put on the animal. In Ethiopia a simple, efficient water-carrying device is used. Made from heavy canvas in the form of a square bag, it is slung over the back of a donkey and distributes the weight comfortably (Fig 7). Again, the load can be shared with the ground by using an animal-drawn cart or a sled. In some parts of the world, for example in India, the cart has proved its worth to the small farmer, but in countries where carts are not already part of the traditional way of life problems with design, cost and quality of manufacture have prevented their adoption on a wide scale.

4. Others

Other ways of carrying water include rolling a barrel along the ground (Fig. 8) or fixing wheels to a drum as the child from Burkina Faso has done in Fig. 9. The main problem with drums is durability, they are only manufactured with the idea of using them once to sell petrol or diesel. Bicycles are seen in most third world countries and are often loaded with jerry cans. Even taxis or buses are used for water fetching but these methods are out of reach of the small farmer for a regular supply and are not considered further.

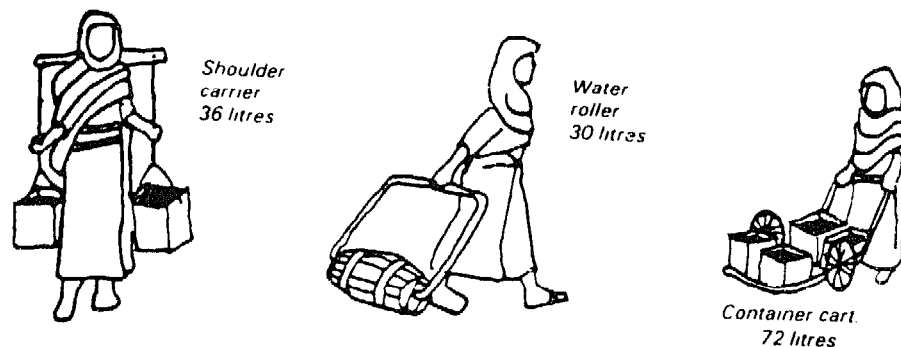

Fig. 8. Carrying capacity of various devices.
(The jerry can carried on head or back only allows 20 litres to be carried).



FIG. 9. Wheeled water drum in Burkina Faso.

A new book by Gordon Hathway, "Low-Cost Vehicles, Options for Moving People and Goods" (18) describes and illustrates a further range of means of transporting goods in general.

All these methods have potential for use in rural areas but as with the introduction of any new technologies there are many problems to confront.

5. Introducing New Technologies

The process of introducing new technologies to the rural poor has not been straightforward; many initiatives that once seemed a good idea have been abandoned and others have not been given enough time to develop. But experience suggests that there are some fundamental conditions which should be fulfilled:

The new technology must for example:

- a) be genuinely needed and wanted
- b) be time or effort saving
- c) not represent too great a leap from existing practice
- d) be well made and easy to maintain
- e) be low priced
- f) reach the intended beneficiary.

Initiatives are also highly unlikely to be successful if the intended beneficiaries have not been closely involved in the development of the product. The most common reason for failure, shown over and over in Marilyn Carr's book 'Blacksmith, Baker, Roofing-Sheet Maker' (19), which discusses case histories of attempts at the introduction of new technologies, is the lack of understanding between the outsider wishing to introduce new ideas, and the intended beneficiaries.

The following steps would seem to be essential in the introduction of new ideas:

1. Identification of needs and market
2. Search for technical solutions
3. Adaptation of prototypes to local circumstances
4. Extensive field testing to prove technical and economic viability
5. On-going technical assistance and after-sales service.

It is also vital to be very clear how any external funding will be used, since for a project to be called a success it must be able to survive and replicate unassisted. There is a case for externally funded support during the introductory phase to avoid those who cannot afford it having to take risks. But an initial subsidy can create false expectations and has to be very carefully balanced.

The focus of rural development work is beginning to shift from large-scale projects from which benefits are supposed to trickle down to the rural poor to projects aimed directly at the rural poor. But the poorest groups are the hardest to help, so it must be decided where the most effective place to concentrate is.

This study therefore offers some alternative ideas for different circumstances in Kenya. It has not, for example, looked at the possibility of working with nomadic pastoralists since far more time and resources would have to be invested than would be needed to work with settled agriculturalists.



Women transporting water in a village in Rajasthan, India. (WHO/A.S. Kochar)



Women will often have to carry children at the same time as water. (WHO/W. Brieger)



Girl using a plastic container for water, Ethiopia. (WHO/M. Devreede)



Children will often assist their mothers with daily water carrying. (WHO/J. Bland)



A home-made wheelbarrow in Kenya.

A predominantly Asian water carrying device, especially useful for watering crops. (UVA)





A water-carrying aid used in Nepal.
(WHO N. Willard)



Water may have to be carried over difficult terrain.
(WHO/D. Deriaz)



A girl brings home water in well-sealed bamboo tubes, Sarawak. (WHO)



A little girl in Guatemala starts on the long road home from the well. (WHO P. Almasy)



A home-made wheelbarrow in Kenya.

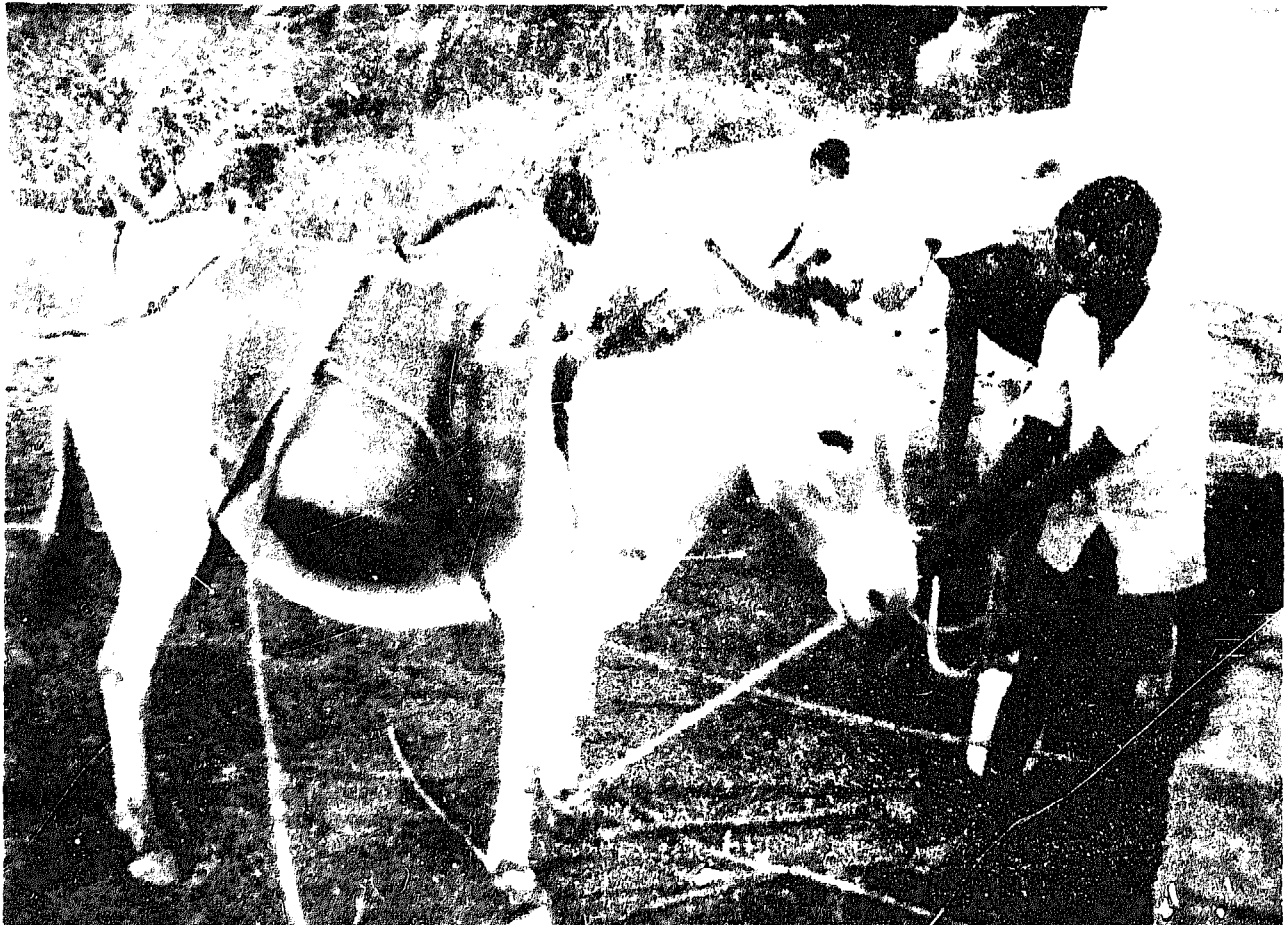

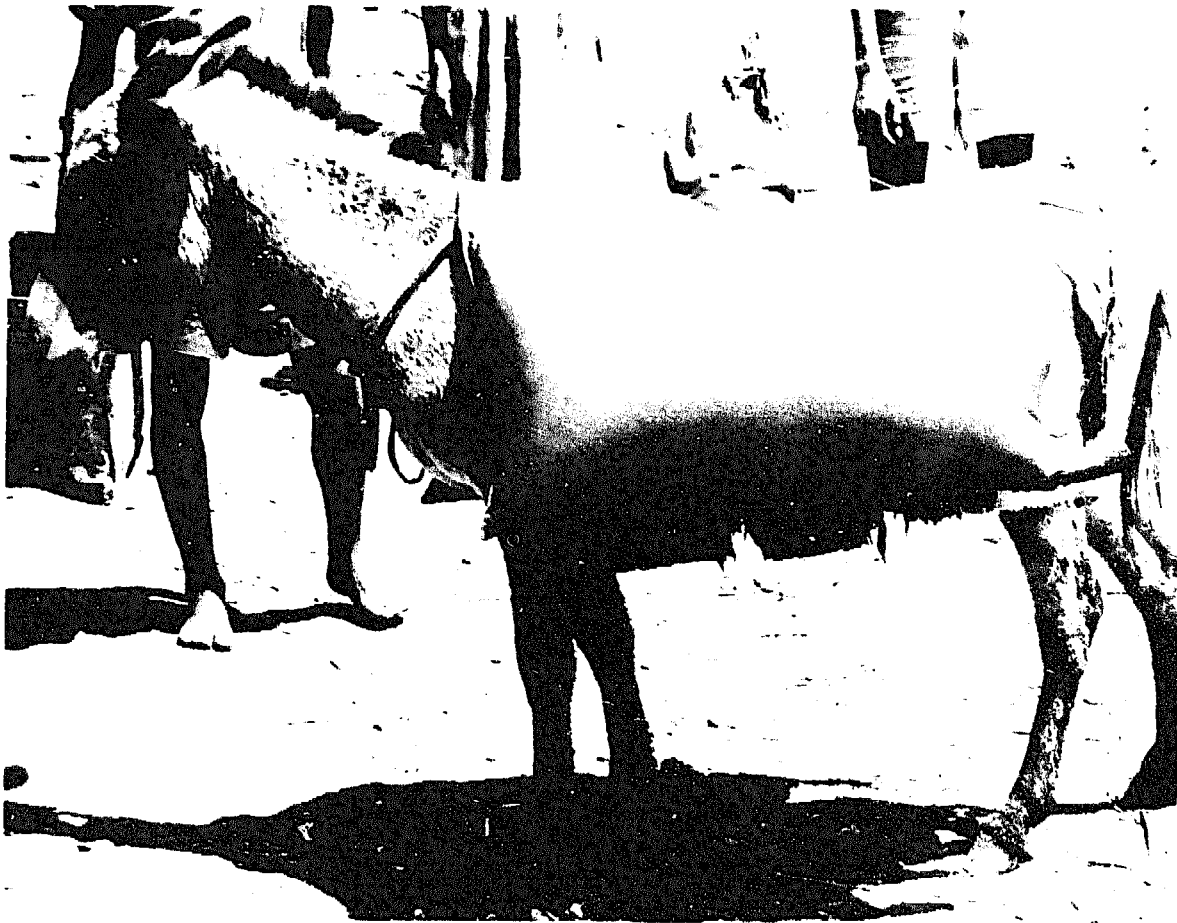

Sack panniers on a donkey, Ethiopia.

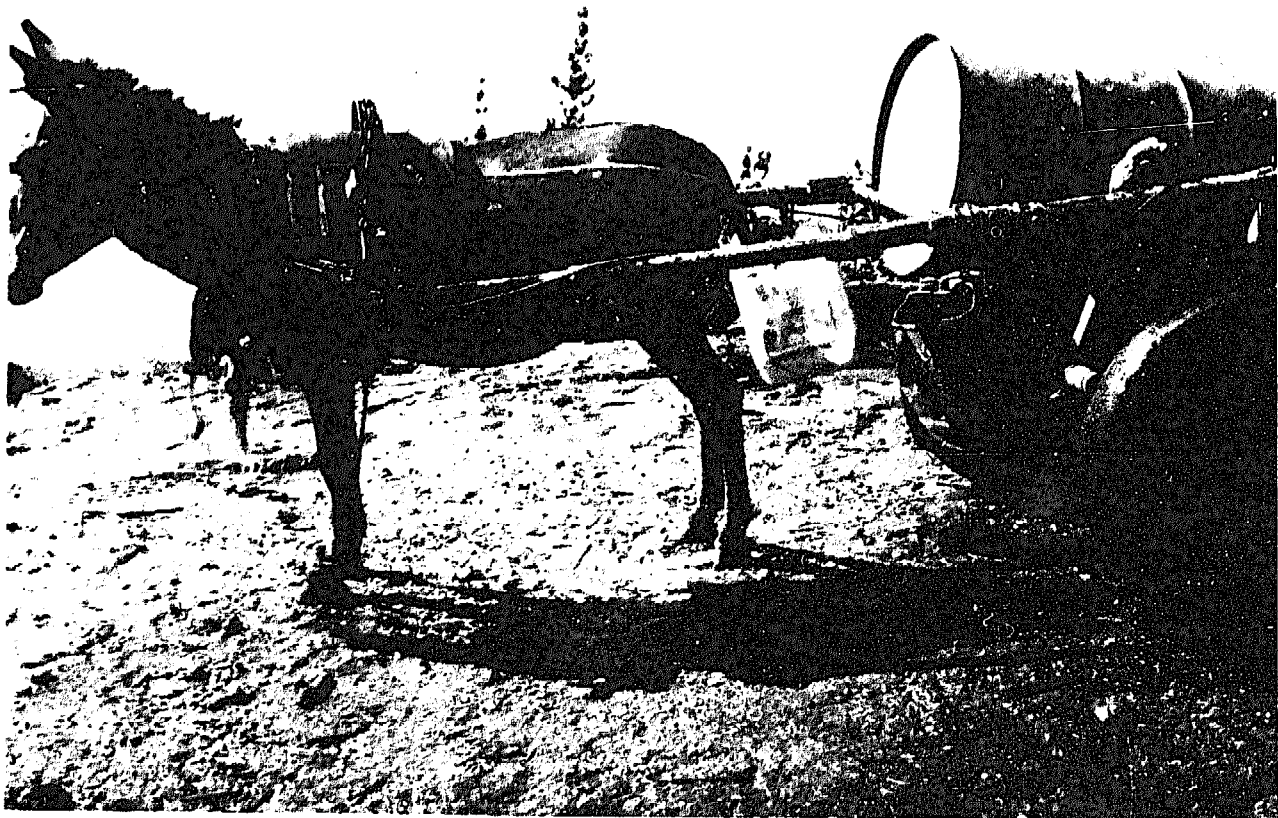

Simple donkey-cart with car-axle for carrying water.



The ox-trike designed by I.T. transport.

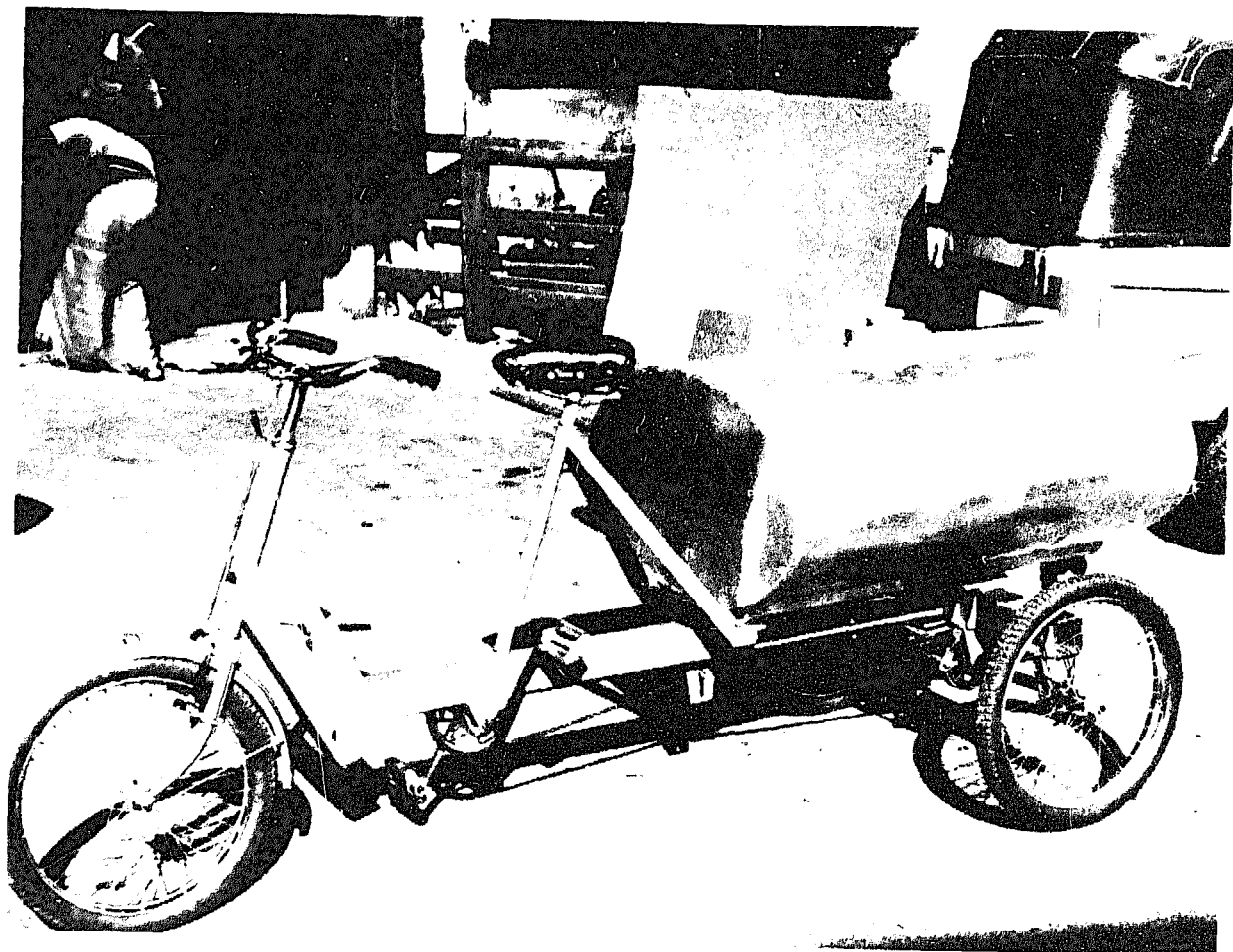

The ox-trike can be modified to carry water.

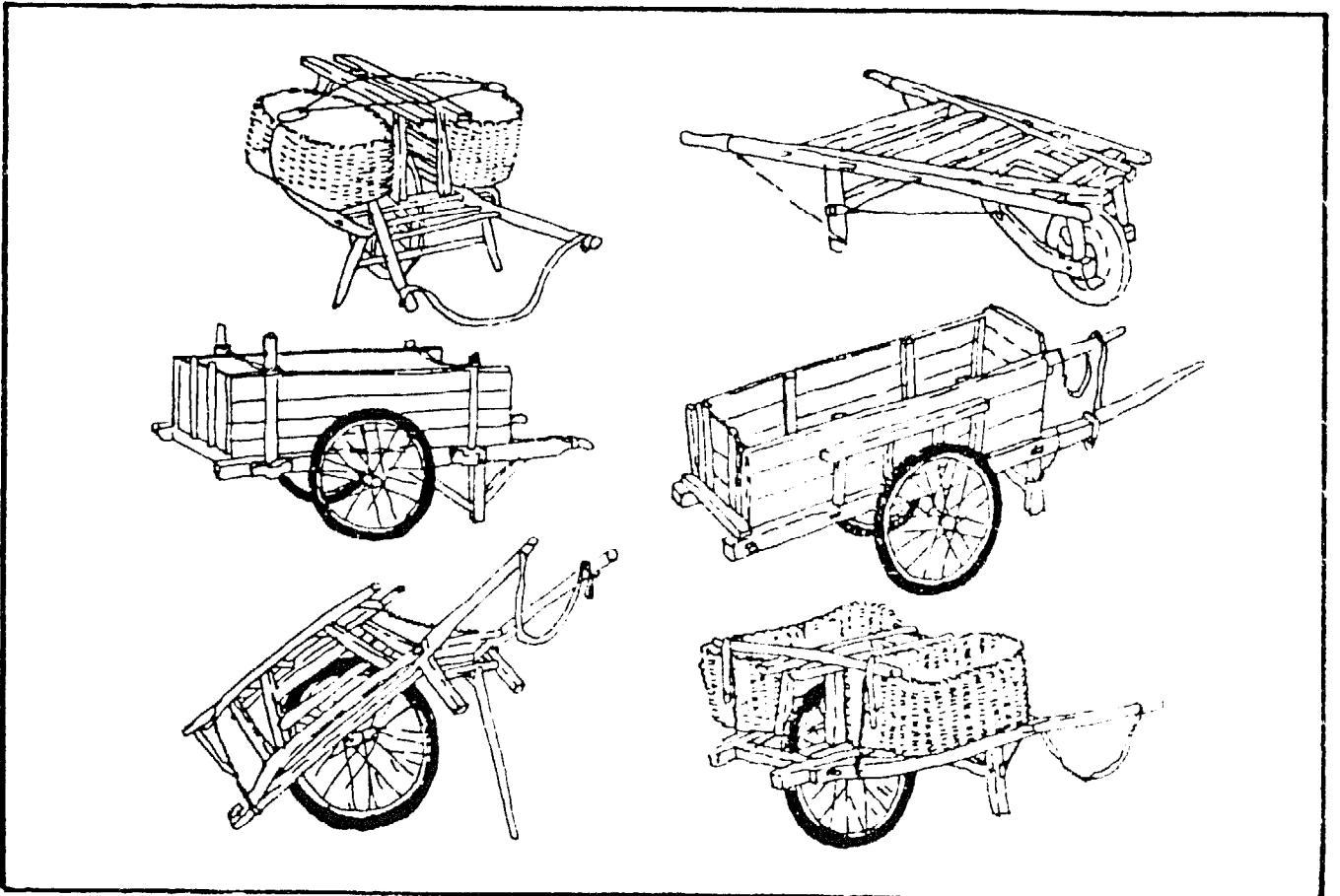
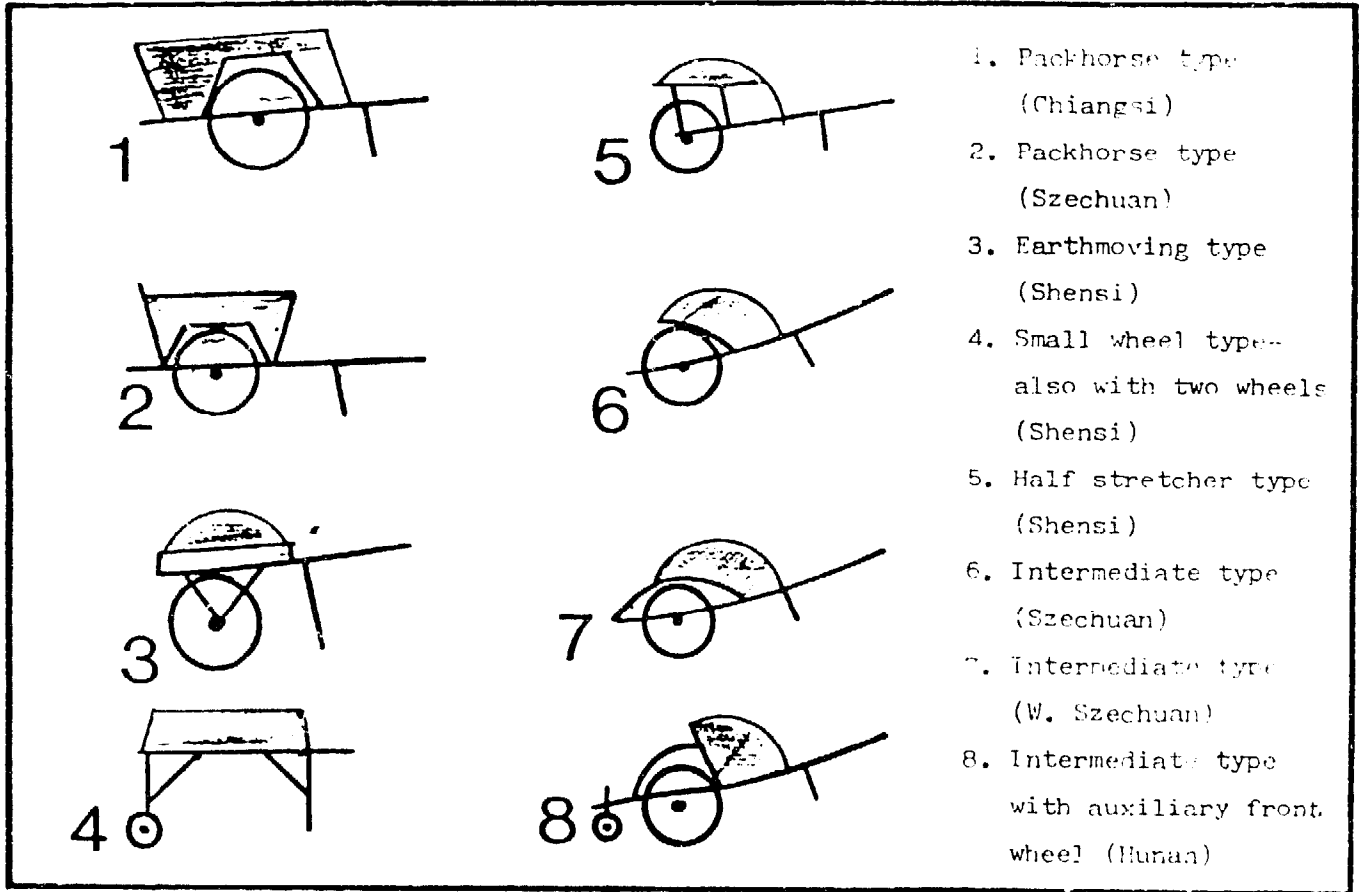

Types of Chinese wheelbarrows and carts.

II KENYA: THE PROBLEM AND SOME SOLUTIONS.

A. Water Supply in Kenya

The U.N Water Decade has focused attention on the state of water supply in rural areas and encouraged increased investment by governments and donor bodies in water projects. Kenya has taken the aims of the Decade on board but provides a good illustration of how difficult water development can be. Kenya is one of the more developed countries which also receives almost the highest amount of foreign aid in Africa. If water improvements are not making substantial progress in Kenya then it is clear that a search for alternatives could have valuable results for all of Africa.

The targets of the Government of Kenya for the water decade are to provide 'reasonable' access to water to all by the year 2000 (21). By this it means having an improved source within 1km in land of high and medium agricultural potential and within 5km in low potential areas. Many now accept that this is an impossible target. Setting it has probably done more harm than good, as will be shown.

The Ministry of Water Development is now responsible for rural water supply, though until 1975 responsibility was divided between six ministries. In the ten years since the Ministry's formation it has grown eight-fold and now absorbs 10% of the Government's development expenditure. As Carruthers discusses (21) this rapid growth has led to severe organisational problems compounded by a shortage of skilled Kenyans. This is one of the reasons why budgets for rural supply are often underspent.

Rural areas take 35% of the water development budget whilst 86% of the population live there. Governments the world over have to spend a disproportionate sum in the cities because the potential for political and health disaster is much greater. The Ministry has realised that the sum available cannot match the rural need for publically provided sources of water and is beginning to look at other alternatives such as self-help schemes, where a part of the cost and the labour is contributed by the beneficiaries. Unfortunately, now the population regard themselves as having been promised clean water for free, they do not see why they should work for it. Operating self-help schemes is extremely difficult: Ministry employees confirm that it will be exceedingly difficult for an arm of Government to adopt the flexibility required to work in this way.

Bilateral aid donors provide a large fraction of Kenya's water development budget. They tend to finance large initiatives over which they retain control in nominal partnership with the Ministry. For example, Finland has spent 8.5 million dollars to date on improving water provision in Western Province. Whilst these projects can cover large areas they have always in the past been unsustainable; once the personnel of the bilateral aid agency leave, breakdown rates soar and the populace return to traditional sources. Part of the solution is to have simple installations which are manufactured in the country (though O.D.A., for example, state that much of their aid is conditional on the purchase of British goods, such as hand pumps) but more important is the degree to which outsiders understand and act on beneficiaries' real needs. This requires that local people, especially women, have to be regarded as more than just consumers and a degree of control has to be surrendered to them.

One agency sees the importance of training local people for maintenance of water installations. When asked if women were trained for this job they enthusiastically said yes of course they were, because water is, after all, a woman's problem. There was, however, one qualification; that the trainees had to be able to read English, and as none of the women could, there were no women trainees.

Too often targets in this sort of project are set too high too fast so in the race for achievement flexibility is forgotten for the sake of standardisation, and long-term solutions are sacrificed for short term objectives. The broken down diesel or hand pump that one sees all over East Africa is a constant reminder that water projects have not had the success that was planned.

B. The workload

Kenya is a country about which it is hard to make generalisations because of the great variety of terrain, climate and socio-economic conditions. Visits to rural areas confirm that the majority of women appear to have a heavy daily workload in hauling water but available statistical evidence gives an incoherent picture, as one might expect from the spread of variables. Nevertheless we here present some of the figures from such surveys as illustration of the magnitude of the workload. Table 2 gives some figures from the Integrated Rural Survey of Kenya (11).

Table 2. Percentage Distribution of Rural Households by Distance to Water and by Season (1978).

	Wet Season	Dry Season
<1km	51.2	43.9
1-2	34.6	33.3
2-3	8.7	13.5
3-5	4.1	6.3
>5km	1.4	3.0

The survey states that it has not covered the remotest areas of Kenya so these figures have most relevance to the most accessible and generally wettest regions.

Some figures quoted are misleading; the Government of Kenya's 1984-89 Development Plan (21) states that no household is more than 1.8km from water but then later remarks that 5km should be a minimum design distance for future installation.

White, Burton, White (1) do not claim their figures are anything but illustrative of a few less remote areas. They record an average of 54 minutes spent per day in water carrying for each household but the spread of values is from 3 to 264 minutes. They consider maximum possible distances to walk to water in terms of calories of food energy consumed in a day to be 18km on the flat, and 5km for a 12 degree slope. (The maximum distances quoted to the author were 22km on a slope in Kibizi District and 25km on the flat in Kwale District.)

Tables 3 to 5 are from a study by Angela Sinclair of water use in a remote area of North Kitui (17). Her sample was selected to be as representative as possible. The average values are 6.1 km to water in the dry season and 1.5km in the wet. The tables show that dry season distances can be long and that the majority spend over three hours on their round trip. Many people (number not recorded) have donkeys to help them which explain why so few trips per day are recorded in Table 5. Without donkeys people would have to make the same journey with water on their back several times in a day.

Another study for the Government of Kenya in Kitui District (25) gives an average of 22 hours per week per household spent collecting water and 48% of the sample had a round trip of more than 8km.

Table 3. Distance Water Carried from Home to Source in a Sample of 22 people in North Kitui

	Dry Season	Wet Season
<1km	2	9
1-3	7	10
4-6	8	2
7-9	0	0
>10km	5	0

Table 4. Time Taken for Each Round Trip for Above Sample

	Dry Season	Wet Season
<1 hour	2	11
1-2	1	8
2-3	7	2
3-4	3	0
4-5	3	0
5-6	0	0
>6 hours	6	0

Table 5. Number of Trips per Day for Above Sample

	Dry Season	Wet Season
<1	1	0
1	14	3
2	4	8
3	3	4
>3	0	6

(Source, Ref 16)

It must be noted that few of these studies make the point that distance to water is dynamic, changing constantly from pools that form nearby after rain, to such great distances in years of drought that people without a reliable supply may be forced to move.

Field investigations confirmed that there is a wide variety in the distances and terrains that women have to travel to get water. Nevertheless it was clear that those in the poorer drier areas had the furthest to go. Many complained of the heavy workload, especially when their children were at school and unable to share the labour. In these visits, which were weighted towards the poorer areas, probably one quarter of the women contacted were within 500m of a reliable source in dry seasons, one quarter between 0.5 and 2km and the rest with distances up to 15km. Their position improved after rain so that one third would be within 500m, one third between 0.5 and 2km and one third with distances of up to 10km. Women and children make anything from one to nine trips for water for each household per day, and in most cases each load is a 20 litre vessel plus a 5 litre vessel. The total weight is thus in the order of 25kg.

In some pockets in rural areas of Kenya the workload of water collection was much reduced by the use of the donkey. Thus loads did not have to be carried and trips to the water source had to be made less often. In parts of Mwingi and Kitui and around Ikanga up to 50% of the families consulted owned donkeys.

These illustrations show that many women do indeed spend a large fraction of their time collecting water in rural areas of Kenya. The areas where the problems are worst are the most remote and driest, but these are the very areas in which it is hardest to find solutions. Women themselves identify water carrying as one of their greatest burdens which they wish they had the resources to solve.

C. Carrying methods in Kenya

The vast majority of rural women still physically carry water in Kenya. Methods tend to divide along tribal lines, thus Kikuyu, Akamba and Maasai use a head strap to secure a vessel carried on the back (see Fig 2). Meru and Embu tie a strap around the shoulders in one of two ways, either as a single loop or a double loop crossing at the front. The Bantu Lwo and Luhya peoples in the flat lands around Lake Victoria carry vessels on their heads (Fig 10), the Pokot, Samburu and Turkana in the north and the coastal tribes do likewise.

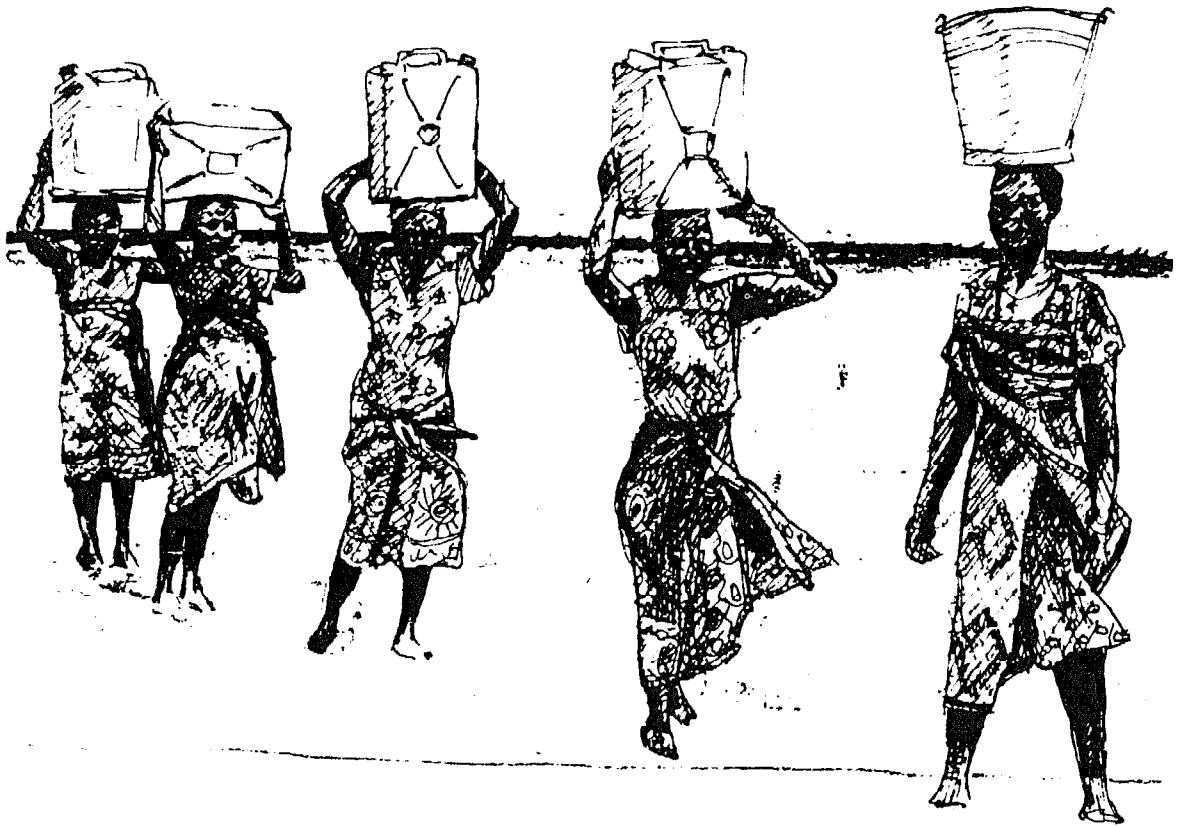

Fig. 10. Lwo women at Lake Victoria.

In the more developed south the traditional clay pot for carrying water has been replaced by either the plastic 20 litre jerry can, the plastic or galvanised sheet bucket or the 20 litre square, tin 'debe'. Hundred and two hundred litre drums intended for diesel are also used where they can be transported. In less developed areas the cheaper clay pot is carried but this has a high weight penalty; of perhaps 2kg for a 10 litre vessel. Animal skins are sometimes still used in Turkana.

Transport aids do exist in some of the poorer areas in the form of the donkey; the Integrated Rural Survey (11) gives some figures for ownership by province.

Table 6. Percentage of Holdings with Donkeys by Province and Year

Date	1976
Coast	3.7
Eastern	5.4
Central	0.7
Rift Valley	7.4
Nyanza	3.7
Western	0.0
Total	3.1

Jerry cans are tied to the donkey's back with a rope which passes, uncomfortably, around the windpipe. More satisfactory are the sack panniers that carry one can on each side. In Turkana and Maasai land the pack saddle is still in use for both goods and water pots. One is illustrated in Fig 11. A good strong male donkey carries four jerry cans, (80kg) whilst a female will not carry more than two because of the risk that she is in foal and if so, might abort.

Amongst better off families metal wheelbarrows are used by men and boys to carry jerry cans of water, often in surprisingly steep terrain. The major limitation to their use is that the wheels sink in sandy or loose soil. Small boys often make a sort of rough trolley wheelbarrow which is of some use but is fragile and has only whatever wheels are available from discarded machinery, which are often too small to be efficient.

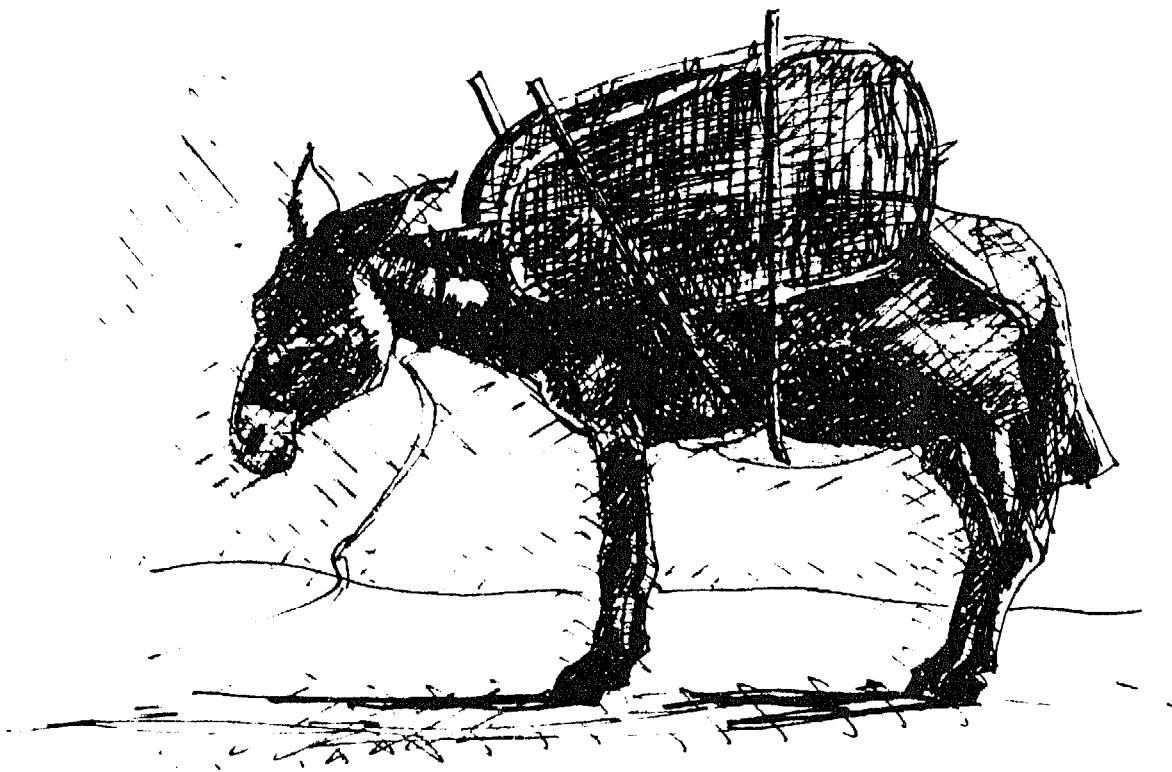

Fig 11. The Maasai pack saddle.

When water is sold commercially by men there is usually a transport aid involved. In the poorest areas donkeys or bicycles which carry 40 litres of water can negotiate rough, narrow paths. Elsewhere wheelbarrows, handcarts, animal carts and in some cases, pick-up trucks help with transport (Fig 12). In one case in the coastal hinterland water shortages were such that women commissioned a bus to fetch water returning with a layer of jerry cans covering the entire floor.

But in Kenya by far the most usual method of transport is on the back or head of a woman or child.

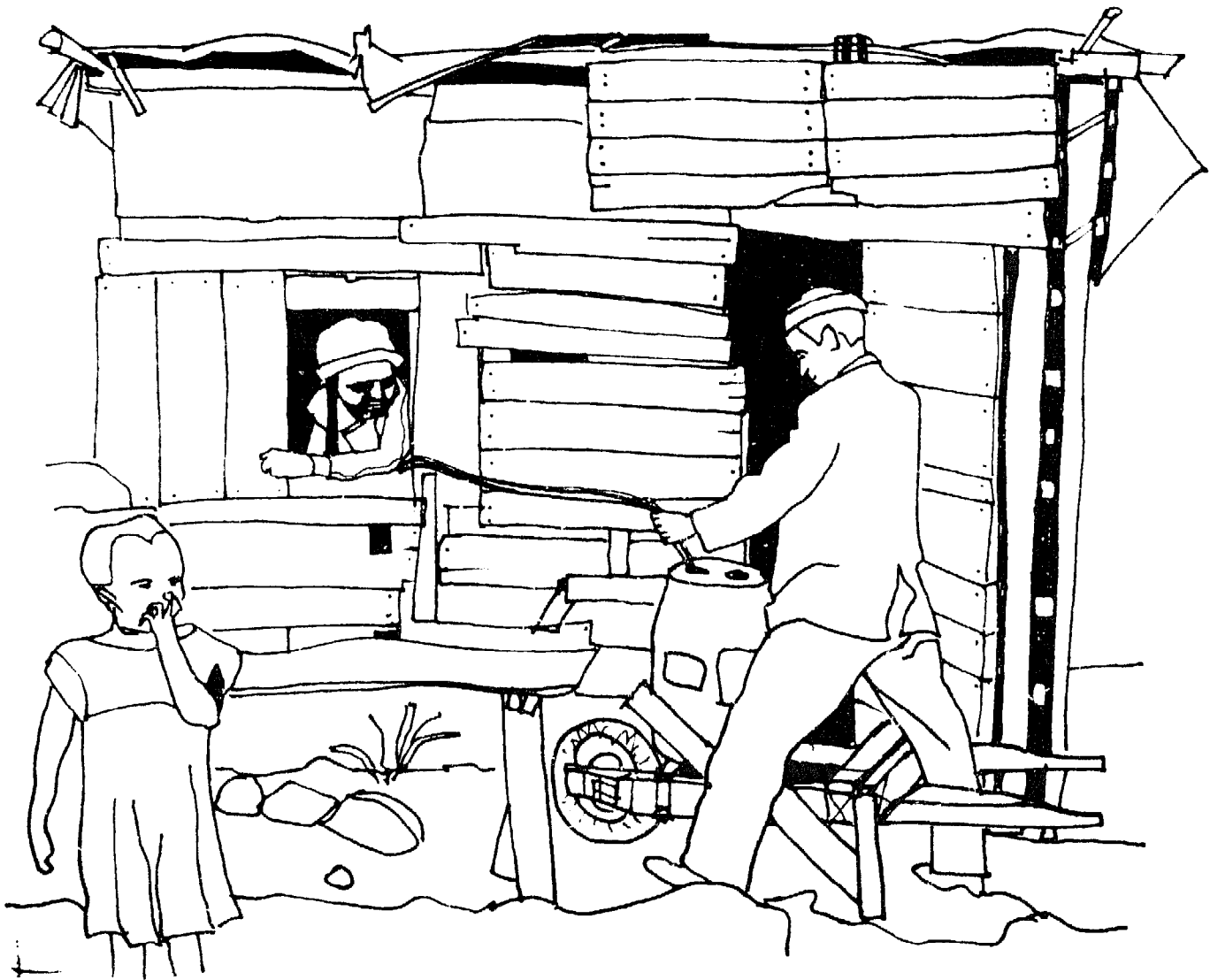

Fig. 12. Man with wheelbarrow at a water Kiosk in Kabere, a Nairobi slum.

D. Case Studies in Kenya

Of the places and projects visited in Kenya three were chosen as suitable places where work on improving water transport could be progressed in the future. Locations are marked on the map in Fig 1.

The selection of the three possible sites for further work was a result of many factors. Most rural communities in Kenya could benefit in some way from improved transport. For example, over a thousand women's groups have applied to the umbrella organisation, Mandaeleo ya Wanawake for help with their water supply. But the choice was unfortunately limited, in practice, by logistical constraint to those places with some form of development work already underway. Of these Kamujene, Action Aid in Kibwezi and the Utooni Project were alike in that the organisers were all interested in the problem of water transport; Women's groups were also apparently keen to get involved in some future work on the subject; and parts of or all of each project area had real problems with getting access to water.

1. Kamujene Farmers' Centre, Diocese of Meru

Kamujene is a small farm training and demonstration centre that aids small farmers and women's groups. It is located at the foot of the Nyambene Hills about 40km from Meru and covers a growing area around the centre. Rainfall here is extremely erratic and in the lowland parts averages less than 500mm per year which means it has low agricultural potential. Deforestation is severe in the region (to a large extent because the operations of British American Tobacco require that farmers dry their tobacco using wood fires) and erosion is taking much of what good soil there is. Kamujene is working to encourage soil conservation, tree planting and improved agriculture. It recently decided to start working through the existing women's groups and has widened its area of interest into domestic development. The centre now has a British volunteer and a Kenyan farm manager who are in regular contact with about thirty women's groups of which about half are in the very dry lowland areas.

In the upland areas cash crops such as coffee, tea and tobacco are grown. The extra cash this brings in reflects in the level of development of the people: they have been able to begin collections with the aim of getting piped water installed under gravity flow from the nearby mountain springs. By contrast cash crops are hardly grown in the lower areas and the distances (20km or so) from the mountain springs make the cost of pipes prohibitive.

So in the lowland areas women walk to river beds to dig waterholes, covering in dry seasons anything up to 10km. Even after rain, average distances are still about 3km one way along narrow, sandy paths.

Transport is one of the problems that groups identify: a group that is 8km from the nearest track and 35km from the nearest market told how, because of the previous bad years, there was a general shortage of cash, so no public vehicle found it worthwhile to maintain services. This made it hard for people to travel to buy supplies or to have access to the famine relief food that was available. Prices for basic needs such as salt and clothes are about 10% higher in a local shop than they would be in Meru. They felt improved transport would enable them to get more surplus to market, bringing back these essentials purchased at the lower, town prices. Some women related paying between 1 and 6 shillings to a water seller for a jerry can of water when they were unable through ill-health to go for themselves. The sum paid depended on the distance the water had to be transported, the need, the ability to pay and the relationship to the water seller.

Many possible ways of improving transport were discussed; one woman had a wheelbarrow which was rarely used because the sandy patches in the paths were too hard to push or pull a wheel through. Others liked the idea of bicycles but would have needed solid tyres which cannot be spoilt by thorns or sunlight. There was universal agreement that donkeys are a good idea, they can be grazed with other animals, they survive well in drought, they are a familiar and desired item and they can carry four times what a person can manage.

So why are donkeys not used in the Meru area if they are such a good idea? They are a common sight just across the Tana River in Kitui District so why have they not spread? Unless donkey husbandry is impossible in Meru because of some presently unknown factor such as East Coast Fever, the only explanation for the different ownership patterns must be cultural. Women told how they had little control over what their husbands spent money on and that men regarded a woman's hauling role as natural (confirmed by the reaction of most men faced with this issue) so did not see the need for transport aids. One explanation is that across the river, water is often so distant that men have to help with the work. They have thus appreciated the value of a donkey.

Groups in this poorer area came together in the first place with the aim of helping with the heavy work on each other's shambas (smallholdings) but they are keen to try anything new, especially if it could earn them money. They thought they could make money from a limited number of donkeys by carrying water. The theoretical maximum income, assuming a market, would be 600 shillings per month generated by being able to sell a load of four cans six times a day at one shilling per can. A donkey can also be loaned out for 10 shillings a day when someone has building work to do. One of the projects that groups are working on with Kamujene's assistance is the growing of vegetables which are currently sold at high prices in the markets. Donkeys could carry water for irrigating plots, provide a means of getting produce to market and could thus be a source of income.

Women in the upland areas should eventually solve their water problems, whilst in the lowland the problem is worse and the solution more difficult. Yet the lowland groups are the keenest and most enthusiastic for development and present an opportunity to initiate some work amongst one of the most deprived settled groups in Kenya.

2. Action Aid Kenya, Kibwezi Region.

Action Aid is an international charity with a large operational set-up in Kenya. Funding is based on child sponsorship but their work is diversifying from school support to embrace young farmers' groups, the disabled and, more recently, rural women's groups. The latter programme is called the Community Support Programme (CSP) and is administered by Kenyan field workers who are trained in the fields of basic agriculture, livestock raising and health care.

The regional centre, based in Kibwezi, covers an area of mostly marginal land, some of which has only been settled for the last 15 years. The area suffered badly in the past three years of drought and many lost all their livestock.

Here, where the main sources are the Athi River and its tributaries and a pipe line following the railway, even in good seasons getting water is a severe problem. Many live between 3 and 8km from a source and those living on the plateaux on either side of the valley live a steep 20km walk away. There are a number of projects underway to attempt to ameliorate these conditions; AMREF have built seven protected wells, CARE-Kenya nine small dams and the Ministry are working on the rehabilitation of several small town piped water schemes. These efforts however, do not match the growth in population and inflow to the region.

Women here always put water first when they listed their problems. Fresh in their minds was the experience of being unable to carry enough water to keep their cattle alive when sources retreated in the drought years.

The history of a project that the Aka na Eitu women's group set up shows what such groups can do but also illustrates the vulnerability of existence in marginal areas. The group is now in contact with Action Aid's CSP field worker but was initially formed to work on each others shambas. They then decided what they really needed was to get hold of oxen for ploughing. First they took 3 shillings from each member to rent a shamba on which they grew maize which they then exchanged with members for eight goats. After a year the goats had bred to twenty of which sixteen were sold to buy two oxen and a plough for communal work on each others fields, the person with the burden of caring for them having first use. But after only a year the drought came and the oxen died.

The idea of donkeys appealed to women in the area mainly because of their resistance to drought. The women were interested in them both as a means for carrying water and as a draught animal for ploughing. Of agriculturalists and locals consulted none could give reasons for the scarcity of donkeys in the region except to say that because they are rare they are expensive. Present cost is around 1200 shillings for a male and 1800 shillings for a female which is about one and a half times what they cost in areas where donkeys are common. Though it is difficult to tell from discussions with the women, there is a suspicion that donkeys are regarded with some disdain as being old fashioned and not progressive.

Action Aid have some experience with the introduction of donkeys as carrying aids in the area. Initially supported schools were provided with donkeys to fetch water but the practice has been discontinued as too many died. There has been no formal evaluation of this failure but it seems that the problem was the handout mentality; "this was a gift so it doesn't matter if it dies, we will be given a new one", rather than the unsustainability of donkeys. It seems that responsibility for care should have been much more closely defined if there was to be any success with this give-away approach.

Action Aid also encouraged the manufacture of ox-carts at the Kyoni Kya Athi Young Farmers Centre near Kibwezi. This project was also abandoned because the design was not technically suitable, the heavy steel wheels stuck in the sandy soil, and because the quality of fabrication was not high enough from an institute that was primarily for skills training.

In this region wheelbarrows would not work well because of the sandy routes. A degree of interest was shown in the use of the yoke for carrying water which could have great advantages when compared to traditional back loading for carrying water and might be pursued further.

3. Utooni Development Project, Kola Market, Machakos

The Utooni Project covers 60sq km of high to medium potential land which ranges from steep mountain sides to flat valley. It was conceived by Joshua Mukusya who had experience of development projects elsewhere and wanted to see what he could do for his own community. A lot has been achieved in the 6 years since the start of work; better livestock introduced, terracing for soil conservation adopted, water tanks built and people are more informed about health.

Those groups attached to the project form their own priorities and number one on these lists is the need for improved water supply. The chosen solution at Utooni has been to harvest rainwater from their roofs; but this requires substantial investment. A corrugated galvanised sheet roof for a small house with guttering costs 3500 shillings and the materials for a 'ghala' tank (cement plastered over a woven basket) about 1200 shillings. This provides about 4 cubic metres of storage which with careful consumption can last the average family about two months. For rainwater storage to last through periods of drought at least two small buildings would need to be roofed and at least 4 tanks constructed. (Building one large tank would be cheaper.) Hence a typical investment to achieve this would have to be in the order of 11000 shillings (£570). The project leader has constructed about 80 cubic metres of storage in his compound which is enough to last him through drought.

The introduction of grade cattle has led to a greater demand for water; kept in a zero-grazing stall, water has to be brought at a rate of about 80 litre per cow per day. Improvements in transport could help with more than just water, fodder has to be brought from and manure returned to the fields.

Some women in the project area have long walks for water; as usual, the poorer women on poorer agricultural land have to go furthest. Some have a 2km climb up to mountain springs whilst others walk 5-10km to the river at the valley bottom.

There was enthusiasm for donkeys as a cheaper alternative to water tanks. People felt that their running costs would not be high as many are now planting fodder crops and donkeys could be fed with the other cattle. Nobody had tried using wheelbarrows in the area but some people felt that their journeys to water were over suitable terrain and so were their journeys to market.

The women offered various ways that transport aids could be used:

- a) To collect water for
 - domestic use
 - cattle
 - brickmaking
 - house mudding
 - vegetable plots
 - beer brewing
- b) To carry building materials for communal projects or for profit.
- c) To transport fodder for cattle and return manure to the fields.
- d) To take goods to market and back.
- e) To carry maize to the mill.

Some of these activities are possible income earners, carrying building materials or water and fodder for other people's cattle for example. (Some women already carry water on their backs for cattle at 1 shilling per 20 litre load.) Women felt sure they could earn the cost of a donkey in a few months.

To gain some idea of the patterns of load carrying in the project area the author asked women on their way to the weekly market if they would mind having their loads weighed. The results of this rough survey are presented in Table 8.

Table 8. Some samples of the loads, and the distances they are carried to market in Kola, Machakos

Person	Load	Weight (kg)	Total (kg)	Distance (km)	Walking Time (hrs)
Girl	maize*	20			
	fruit	2.5	22.5	5	2
Girl	maize	20			
	veg	3	23	8	3
Old woman	clay pots	12.5			
	veg	4	16.5	6	2.5
Woman	maize	19			
	veg	3	22	7	3
Young woman	clay pots	18			
	veg	1	19	8	2.5
Woman	sisal	8			
	veg	1	9	5	1
Young woman	maize	9			
	sisal	6	15	3	0.75
Woman	maize	23			
	veg	1	24	7	3
Boy	maize	12.5	12.5	7	3
Woman	cabbages	26	26	7	2.5
Old woman	tomatoes	3			
	maize	23	26	8	3

Notes: Loads were weighed on uncalibrated scales and distances and times were what was reported by the interviewee.

* Maize is the staple food. The dry grain has to be ground to make flour for a sort of porridge called posho. A family of, say eight members, will need about 4kg per day so the woman will have to go to the mill at least once a week with a 20kg load. For many of these women the trip, including waiting time, would clearly take all day.

The survey was biased in that only people carrying loads were selected but the sexual representation is accurate, i.e. no men were carrying loads.

Thus the adoption of transport aids would be useful to women in a number of ways. However, women expressed the opinion that for a new transport idea to catch on it would either have to be supported by individual men who have the money or through the women's groups which have considerable power.

Utooni is a place where people have been shown what good some of the new development ideas can do, and are now all clamouring to join the project. Thus people have become very 'development minded' and are very receptive to new ideas. For example, when visiting one group's water source, which was up an extremely steep loose path, the author suggested that perhaps some of the regular communal work days could be used to make the path easier to negotiate. The suggestion was apparently taken up with great enthusiasm by the women who began to plan when they would start work.

4. Discussion

The visits to Kamujene, Utooni and Kitwezi and a variety of other places with less severe water problems suggested some general patterns and solutions.

The visits allowed the author to talk in an informal fashion with individual members, and with the group en masse in an attempt to get a picture of the women's problems and of their preferred way of solving them. Photographs and drawings of alternative transport aids were discussed and it is largely from these reactions that conclusions were drawn.

Working with women's groups is common practice for development projects in Kenya. This has the advantage that a group is a forum where women can make decisions and have them respected when often they do not have this power in their homes. It also allows them control of money in a fashion that is, on the whole, socially acceptable. Men do sometimes join groups but in a subsidiary role.

The areas of Kenya with the most severe water problems are those in the drier marginal areas. It is for this reason that the study concentrated on drier areas. In other places that were visited a large proportion of the members of each group had distances of less than 500m to go. It was felt that to suggest

improved water transport as a project would be unpopular for group activity when the problem only affected perhaps 60% of the members. The conclusions drawn from this work are thus applicable only to these poorer areas. Had other projects not working through groups in more developed areas been studied then different forms of transport might have been found to be more suitable.

The groups all put a high priority on the solution of their water problems and saw improved transport as one answer. By far the most interest was generated in the use of the donkey, partly because of its familiarity but also because the disadvantages of other aids were apparent to the women. They all felt that donkeys were easy to care for, disease and drought resistant, fecund and long-lived. [By comparison with native cattle donkeys live on average two years longer and produce an average of 3 offspring compared to the cow's 2.1 (24).] Donkeys are half the price of oxen and are therefore less of a gamble as an investment, neither do they need the addition of expensive equipment such as pack saddles to make them useful. The main disadvantage in keeping donkeys is that the brush and scrub they eat can encourage deforestation and soil erosion. It remains a puzzle to the agriculturalists and local farmers that were consulted as to why donkeys are common in some areas but are so rare in the rest of Kenya.

Of the three case studies the only one where the introduction of some form of wheeled vehicle might be possible is at Utooni. Here the better paths and the higher level of development mean that a simple wheelbarrow would be both suitable and affordable.

The other carrying aids that women felt might be useful were the rigid yoke or the flexible shoulder pole which would allow them to carry more water at one time. Questions about the usefulness of these devices for carrying water for long distances and of how easy it is for a woman who has been backloading all her life to learn the new technique can only be answered by trying them out.

As was previously discussed, setting up a donkey stocking project would be rather different from setting up a small manufacturing industry. Work in production is not required and the donkeys are self-replicating. If donkeys were made available by an outside agency women might want to purchase them individually from their savings or as a group, or they may need to be offered loans.

It must then be very clear how loans are to be repaid: will the previous suggestions for money making with donkeys be sufficient or does a donkey stocking project need to be carried out in conjunction with some other form of income generation such as roof tile manufacture? It may be possible to manufacture simple, efficient pack saddles or water carrying aids such as the Ethiopian canvas water bag that is carried over a donkey's back.

The manufacture of simple wheelbarrows could have important benefits generating an income as well as saving labour in areas where they are suitable. Small scale production is probably better encouraged within the framework of a small business which has experience of quality production, management and marketing rather than in an institution. In Kenya few women are trained in metal and wood craft so unless we are prepared to look at a long term programme of skills training, benefits from production will not accrue to women.

Women's overall need and desire is for a decent, secure living. They could then control the other factors which keep them in the deprivation trap. Ideally they want to have the opportunity to earn and thus to make their own choices about how to reduce their workload, (for example earning women soon employ impoverished relatives to come and do their donkey work for them). The desire voiced time and again by rural women was for income generating projects. Yet other than in the traditional limited field of handicraft production and in the sale of agricultural surplus there was no evidence of projects which were genuinely producing a profit. Ownership of a donkey does, it seems, provide the opportunity to allow generation of a modest income.

The investigation threw up a lot of further questions that it would be prudent to try to get some answers to at the beginning of any future project intervention.

1. Why are there so few donkeys in each region? Is the reason cultural and if so why have people previously not wanted them? Are there diseases prevalent and if so can they be vaccinated against them with simple training?

2. Could a donkey really generate income through load carrying? Do they do so in areas where donkeys are already used? What is the market saturation point for donkey labour?

3. Could improving panniers for donkeys be beneficial to the load carrying capacity or life of the animal? Are any of the regions suitable for ploughing with donkeys and are any of the ploughs available suitable?

4. Are there any parts of these regions where using an improved wheeled vehicle might be suitable? Could a wheeled vehicle be designed that could cope with very sandy conditions and still be otherwise suitable?

5. Are there any local craftsmen who could build such a thing and how much training would they need? Would working with a small craft business be preferable to an institution?

6. Could a yoke ever be accepted by rural women? If so how can they be manufactured?

7. Do women's groups encompass the poorest people? Are there advantages in working with a group rather than with individuals?

8. Would the group organise communal ownership of an animal or device and if so, how? How would they best like to see financial support organised? How would they pay back loans? Who would be the main beneficiaries?

Many of these questions are extremely difficult to get answers too without a deep inside knowledge of a community. It would be sensible to ask a Kenyan community worker to spend time filling in some of this background.

E. Donkeys in Development

The focus of past efforts to improve rural transport in Africa and Asia has been the ox-cart. Yet in dry marginal lands these can be something of a liability, the outlay is great for a beast that may not survive for long. Neither can ox-carts be used in the remoter areas where there are no roads and the terrain is entirely unsuitable. That is even if the farmer could afford them.

All over the world; Latin America, Asia, Europe and Africa, donkeys are carrying loads on steep or awkward paths, pulling ploughs and simple carts or carrying water. As we have seen, they are hardier and more fertile than other cattle.

Yet in some countries where the poor are not getting any richer the use of donkeys is declining, perhaps because their use is regarded as a manifestation of backwardness. The developed world helps to compound this view with its concentration on the higher status Western style grade cattle and high tech transport planning.

Robert Chambers (25) believes that donkeys are partly despised because of their association with stupidity and obstinacy. He quotes G.K. Chesterton:

"With monstrous head and sickening cry
and ears like errant wings
The devil's walking parody
Of all four-footed things"

Chambers continues:

"perhaps the donkey's hour will come in professional research: or perhaps since it is so tough a beast, so well adapted to bad conditions, it has already achieved a sort of perfection beyond the power of research to improve. This is consistent with Polly Hill's praise of them in Hausaland: 'These small sturdy, tax-free beasts can manage loads of 200lb upwards...' But she notes that they have been overlooked, 'Although donkeys are the local camels of Hausaland, and are the most valuable source of manure, this importance has been neglected in literature - for instance by an FAO report which regards headloading as the only alternative to road, rail and water transport.' Donkeys are important for the earning capacities of rural people. No Nobel prizes have been awarded for work on donkeys."

Some people have always managed without the use of donkeys but it is clear that as a cross-country vehicle, taxi, water raiser and carrier the donkey is hard to match and they have not yet had the attention they deserve.

III CONCLUSION.

These fifteen points summarise the findings from the desk research and from the investigations in Kenya.

A General Conclusions.

- a) In most rural developing countries there is no infrastructure for water distribution. People have to depend on unprotected, unreliable sources often at great distances from their homes.
- b) In many developing countries the rate of improvement in rural supply is low compared to the rate of population growth. Consequently more, rather than fewer, people are having to carry water to their homes, and often for longer distances.
- c) The burden of carrying the household's daily requirement of water falls overwhelmingly to women and children. This work is arduous, time consuming, and can lead to injury, ill health and economic disadvantage. Making the transport of water easier could thus have important economic and health benefits.
- d) A survey of methods available worldwide for water carrying shows that there is considerable scope for making this task easier through the introduction of more efficient transport methods. But attempts to introduce new ideas will have to confront all the problems that are commonly faced with the introduction of new technologies.
- e) A common problem is that men tend to appropriate new technological aids. However, if they decide at the same time to use the aid for fetching the family's water then it might lead to a transfer of work from women to men.

B Conclusions on Kenya.

- a. Improvements in water supply in Kenya should be easier than in many developing countries but they still cannot hope to keep pace with population growth. Installations that have been built are beset by problems and people are moving into drier areas so the proportion who have modern supplies is not expected to increase.

b. It is difficult to generalise about the workload involved in carrying water in Kenya because conditions of supply vary so widely with season, region and particular location. It is clear that for some women the water carrying occupies a significant fraction of the day and that those in the more remote areas which tend to be drier, poorer and less developed have the furthest to travel to supplies.

c. The heavy workload often involved in the carrying of water prevents women in Kenya from participating in other, more beneficial activities such as child care, handicraft production or education.

d. Three project areas in rural Kenya have been identified which could participate in attempts to improve methods of water portering. These are the Kamujene Farmers' Centre in the Diocese of Meru, the area around Kibwezi where Action Aid are working and the Utooni Development Project at Kola Market, Machakos who all work with women's groups.

e. Women's groups provide a useful framework for introducing innovations in domestic labour saving. Many are sufficiently well organised to manage a development project and could find ways of sharing responsibilities and benefits.

f. The burden of water carrying in these places could be alleviated by the use of aids which women do not at present have access to. These include yokes, improved wheelbarrows and particularly donkeys.

g. Donkeys are shown to be of great use for water carrying in some parts of Kenya. Women in the three studied areas were familiar with them, felt they were versatile, cheap and easy to keep and that they could be used to generate an income. However, there appear to be few agencies with any expertise in this subject.

h. The carrying technology associated with donkeys could be improved by such devices as the pack saddle or the Ethiopian waterbag. However if this were to be attempted, an area such as Kitui which has many donkeys would be an appropriate place to start.

j. At the Utooni Development Project conditions were also suitable for the use of simple wheeled vehicles. Manufacturing them in the area might provide the opportunity for the establishment of a small industry which could generate income for the producers, but the viability of this proposition will need careful investigation.

k. The poorer, drier areas in Kenya considered in this study have the most severe problems with water and it is clear that the use of the donkey provides a good solution. However, the introduction of donkeys would be best attempted as part of a development project involving income generation, thus time saved from the work of water carrying could be used to earn cash which is what women regard as their greatest need. Donkey introduction has been little considered by development agencies in the past but could provide an important key to the advancement of poor communities in Kenya.

APPENDIX 3. REFERENCES

1. White, G.F., Bradley, D.J., & White, A.U.; 'Drawers of Water'. Chicago Press. 1972.
2. W.H.O. figures quoted in World Water; Thomas Telford. Nov/Dec 1980.
3. Hebert, J.R.; 'Effects of Water Quality and Water Quantity on Nutritional Status, Findings from South Indian Settlements'. Doctoral Thesis, Harvard University 1984.
4. Ashworth, G. & Bonnerjea; 'The Invisible Decade'. Gower 1985.
5. Abdullah, T., Zeidenstein, S.; 'Village Women of Bangladesh, Prospects for Change'. Pergamon Press 1982.
6. See 4.
7. Central Bureau of Statistics; 'Women in Kenya'. Republic of Kenya. 1978.
8. McSweeney, B.G., & Fredman; 'Lack of Time as an Obstacle to Women's Education The case of Upper Volta'. Comparative Education Review. Jun 1980.
9. Little, K.; 'The Mende of Sierra Leone'. Routledge and Kegan Paul. 1951.
10. Lake Basin Development Authority; 'A Report on Maintenance'. Republic of Kenya 1984.
11. Central Bureau of Statistics; 'The Integrated Rural Surveys 1976-79'. Republic of Kenya. 1980.
12. 'The State of the World's Children 1984'. UNICEF New York 1985.
13. Van Wijk, C.; 'Participation of Women in Water Supply and Sanitation'. Draft. International Reference Centre for Community Water Supply. Rijscuijk, Netherlands 1985.
14. O.D.A. Ex-post Evaluation, Swaziland Rural Water Supply. London, EV303 1983.

15. Feachem, R., et al.; 'Water, Health and Development: an interdisciplinary evaluation'. Tri Med Books Ltd. 1978.
16. Sinclair, A; 'Domestic Water in N. Kitui, Practices, Problems and Potential'. Mimeo I.T.D.G. May 1983.
17. Bedale, E. M; 'Comparison of Energy Expenditure of a Woman carrying Loads in Eight Different Positions'. Medical Research Council of G.B. Industrial Fatigue Research Papers No 29. 1924.
18. Hathway, G; Low Cost Vehicles, Options for Moving People and Goods. I.T.Publications, London. 1985.
19. Carr, M.; 'Blacksmith, Baker, Roofing-Sheet Maker:, Employment for Rural Women in Developing Countries'. I.T.Publications, London. 1984.
20. Republic of Kenya; 'The Development Plan 1984-'89'. Government Press, Nairobi. 1984.
21. Carruthers, I.D.; 'Impact and Economics of Community Water Supply, A Study of Rural Water Investment in Kenya'. Wye College. 1973.
22. World Fertility Survey; 'The Kenyan Fertility Survey 1978, A Summary of Findings'. International Statistical Institute, Luxembourg. 1980.
23. Government of Kenya, Arid and Semi Arid Lands Development Project. A Water Resources Survey for Kitui District. 1980.
24. Hill, A.G. (Ed.); 'Population, Health and Nutrition in the Sahel'. London School of Hygiene and Tropical Medicine. 1985
25. Chambers, R.; 'Rural Development: Putting the Last First'. Longman 1983. London.