

**AT** MICROFICHE  
REFERENCE  
LIBRARY

A project of Volunteers in Asia

Popular Mechanics Hydraulic Ram Reprint No. X346

by: C.A. Crowley

Published by:  
Popular Mechanics  
224 West 57th Street  
New York, NY 10019 USA

Paper copies are \$ 2.75.

Available from:  
Popular Mechanics Plans, Dept 77  
Box 1004, Radio City  
New York, NY 10019 USA

Reproduced from Popular Mechanics. (c) The Hearst  
Corporation. All Rights Reserved.

Reproduction of this microfiche document in any  
form is subject to the same restrictions as those  
of the original document.

# X346

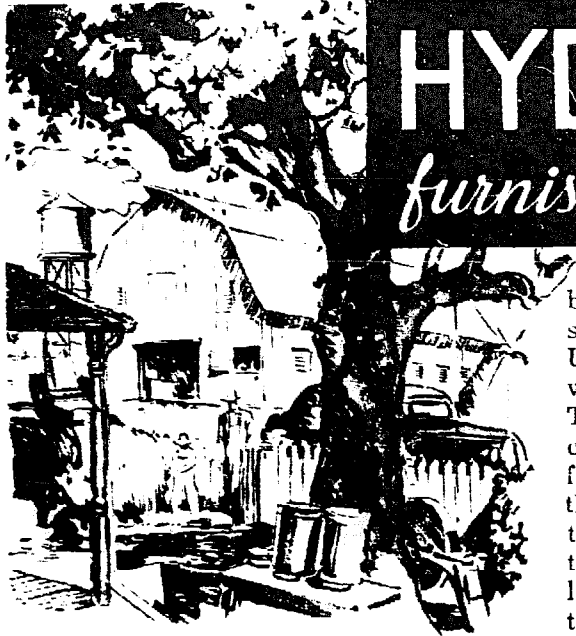

## HYDRAULIC *furnish water supply*

### PART I

**M**ANY rural homes and summer cottages can be furnished with running water from a near-by spring or stream even though its daily flow is modest, by installing a hydraulic ram. This is a pump which takes advantage of a small water fall to lift a portion of the water to a considerable height. Theoretically, a hydraulic ram should lift one-half of the water available twice the height of the fall or  $\frac{1}{20}$  of it twenty times the height of the fall. But the actual efficiency of rams is less and varies considerably. Fig. 1 shows the working parts. Under normal conditions, the ram valve is open, thus allowing water to flow through the ram. As water flows, its velocity increases until the valve is lifted and quickly closed. Since water in motion possesses energy, a considerable pressure is developed. This pressure opens the check valve, thus admitting a quantity of water to the pressure chamber. When enough water has entered to relieve the excess pressure, the check valve automatically closes, thus preventing water from flowing back. At this instant a small volume of air enters through the

breather hole to replenish the air dissolved and carried away by the water. Upon the next stroke of the ram this air will be forced into the pressure chamber. The addition of water to the pressure chamber compresses the air which in turn forces water through the delivery pipe to the reservoir. When the check valve closes, the weight of the ram valve overcomes the pressure against it and drops, thus allowing water to again flow through the tail or discharge pipe, and so the cycle is repeated. Where the water is to be used for drinking it is best to obtain it from a spring,

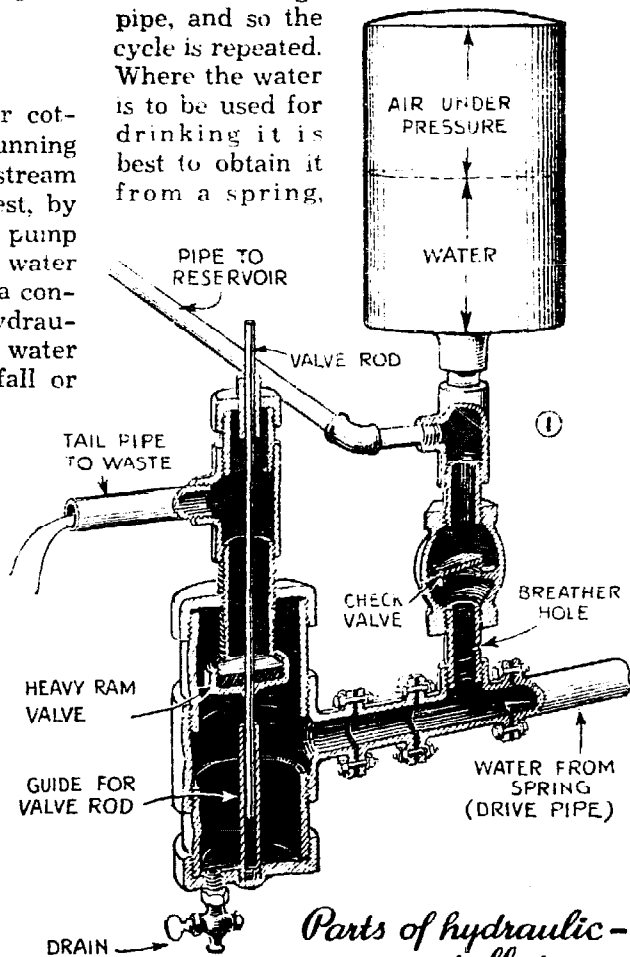

# RAMS

*to country homes*



but if it is to be used for washing, stock watering and other purposes, the supply can be obtained from a small stream.

We shall first explain simplified methods which will enable anyone to determine how much water can be lifted from a spring to the location where it is to be used, and then illustrate methods of surveying the spring and determining the other necessary values.

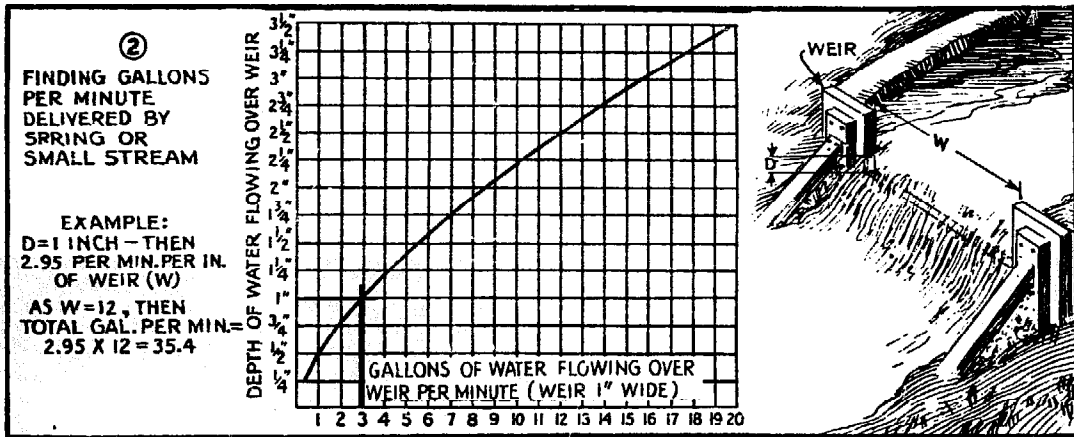

First measure distance *D*, which is the depth of water flowing over the weir, by the method shown in Fig. 3. Locate this value at the left-hand side of the chart, follow across to the curve, and then drop down where the amount of water in gallons per minute for each inch of weir length is given. Multiplying this number by the length of the weir in inches gives the total amount of water passing over the weir per minute

The spring must be surveyed first to find whether it will deliver enough water. To do this it is dammed as shown in Fig. 2, so that all of the water flows over the edge of the board or "weir." The weir must be perfectly level and so arranged that no water can flow under or around it. The flow should be slow and free from turbulence. The depth of the water flowing over it is measured as shown in Fig. 3. First drive a stake a couple of feet above the weir, the top of both stake and weir being level, which can be determined by the method shown in detail A. Then the

distance from the top of the stake to the surface of the water is measured as in detail B. We can now determine the amount of water in number of gals. per min., by referring to Fig. 2. To illustrate the method we will assume that the depth of water flowing over the weir is one inch. We locate one inch on the left-hand side, following across to where this line meets the curve, and drop down to read a trifle below 3, say 2.95, as the gals. per min. for each inch of weir. Next we multiply this by the length of the weir which we will assume to be 25 in., giving a total of 73.75

*Finding depth of water over weir*

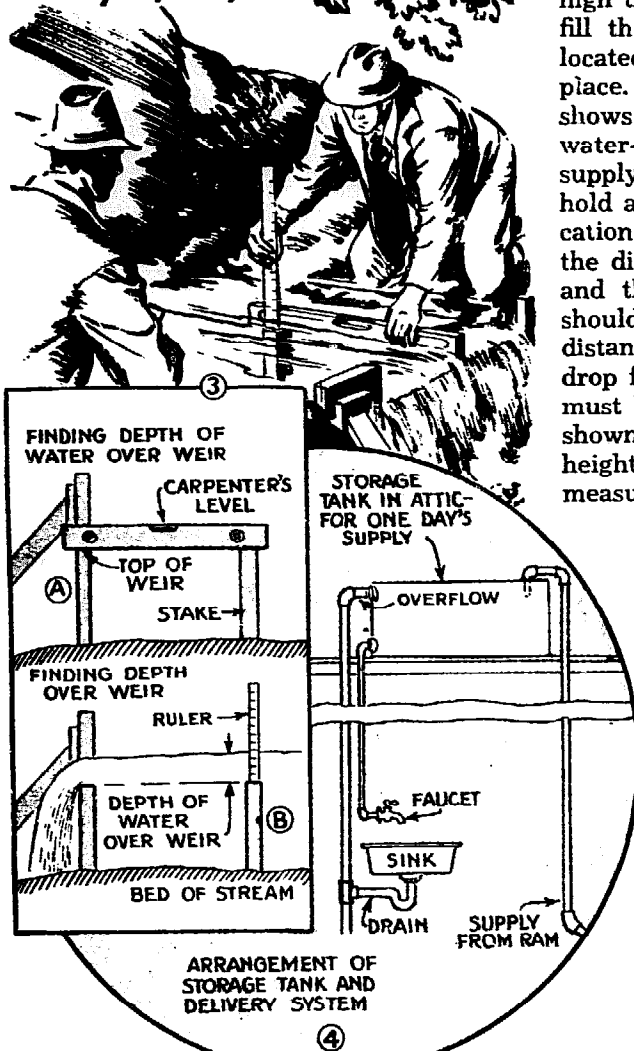

Next, it is necessary to determine how high the ram will have to pump water to fill the supply reservoir, which may be located in the attic or other convenient place. Some use an outside tank. Fig. 4 shows a practical arrangement for the water-supply system. The reservoir or supply tank should be large enough to hold an entire day's supply. With the location of the reservoir tank determined, the distance between the top of the tank and the ground level beside the house should be measured. This is indicated by distance T in Fig. 5. Then the vertical drop from the ground level to the spring must be measured in a series of steps as shown in Fig. 5, in order to determine the height that the water must be raised. The measurements of vertical drop are made

with the use of a surveyor's level and stick. If a surveyor's level is not available you can improvise something that will work with reasonable accuracy from a carpenter's level fitted with sights so that the line of sight will be parallel to the top of the level. For the stick you can use a long pole graduated with numbered markings spaced 6 in. apart. The upper detail of Fig. 6 illustrates how level and stick are used, the level being mounted on a suitable tripod which is fitted with a plumb bob. Set the stick at location X and after adjusting the level sight

⑤ *Finding height ram must lift water*

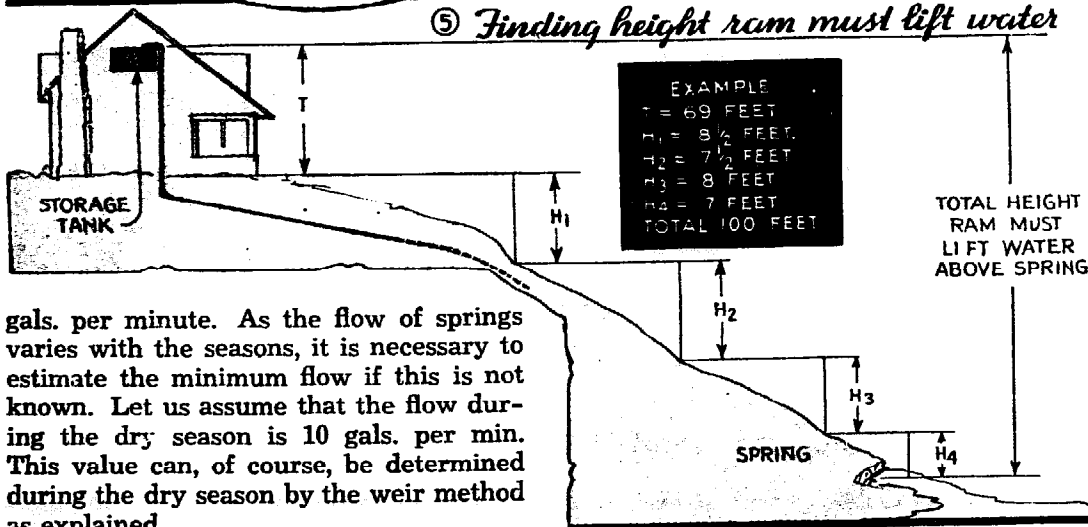

gals. per minute. As the flow of springs varies with the seasons, it is necessary to estimate the minimum flow if this is not known. Let us assume that the flow during the dry season is 10 gals. per min. This value can, of course, be determined during the dry season by the weir method as explained.

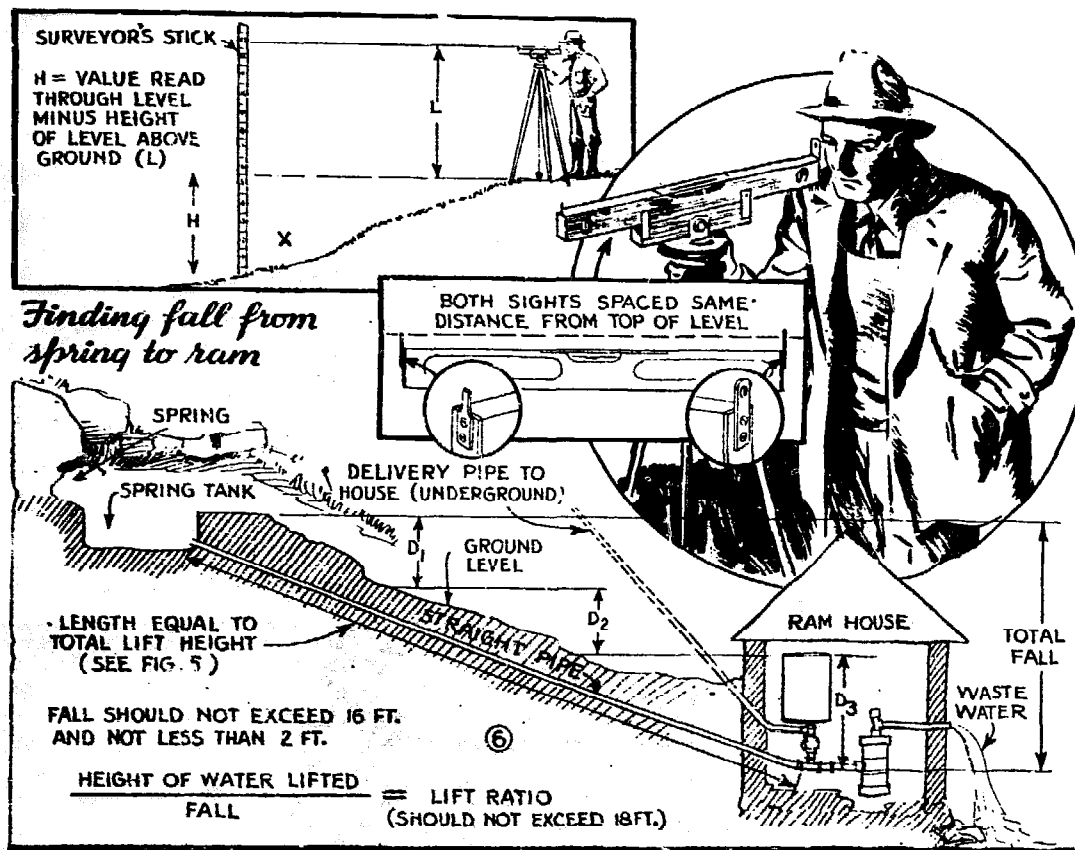

Besides measuring the vertical drop from the top of the reservoir tank to the spring, the additional drop from the spring to the ram, located not over 16 ft. below the spring, should be measured in the same way, using the level system shown in the upper details

over it, noting the height where the line of sight crosses the stick. From this height you subtract  $L$ , which is the distance from the level to the ground, and the remainder is distance  $H$ . Then set the level with the plumb bob at point  $X$  and repeat the process. In this way distances  $H_1$ ,  $H_2$ ,  $H_3$  and  $H_4$  of Fig. 5 are measured. Adding all of these to distance  $T$  gives the height that water must be lifted from the spring to the top of the tank. It is not necessary that the path taken between the house and the spring be straight.

It must then be determined how great a fall of water is available for operating the ram. To do this, locate a point below the level of the spring from which the waste water from the ram can easily drain away. The straight pipe-line distance between the spring and the ram should be about the same as the vertical height to which the ram must lift the water. To continue with the example, we will assume that the top of the supply tank was found

to be 100 ft. from the spring. This means that a pipe at least 100 ft. long will have to be run from the spring, straight but sloping downward, to a place below the spring where the ram will be located. Having determined the ram location, which should not be less than 2 ft. nor more than about 16 ft. below spring level and 100 ft. or more from the spring as shown in Fig. 6, we are ready to find the fall or head available for pumping water. This is the vertical height of the spring above the ram location and is found with a surveyor's level and stick as previously explained. We will assume our survey shows that the total fall (Fig. 6.) is 14 ft. Then from Fig. 7 it is easy to determine whether a spring will pump as much water as is required. Assuming that the ram will be located 14 ft. vertically below the spring, Fig. 6, we deduct 2 ft. to allow for frictional loss in the drive pipe. This leaves 12 ft. as the fall available for pumping water. We will also assume that the requirements are 550

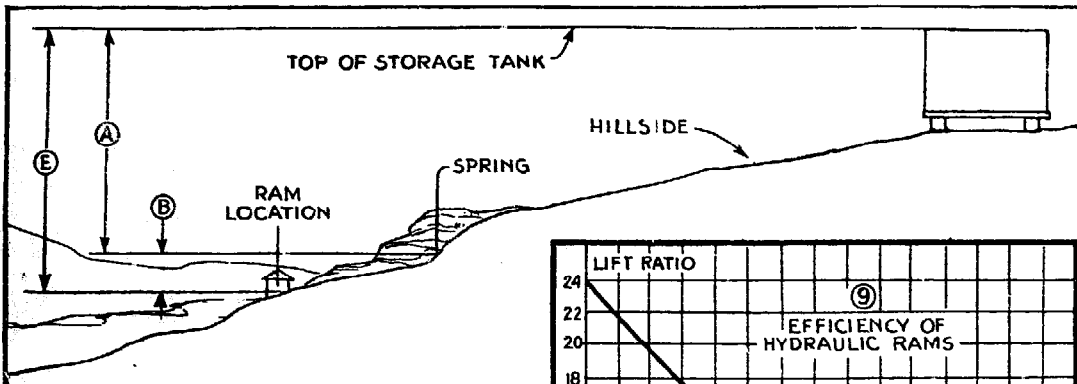

⑦ FINDING SPRING FLOW REQUIRED TO OPERATE RAM	
Method	Example
A—Find vertical height to lift water (Call this A)	A = 100 feet (found by surveying—(Fig. 5))
B—Find vertical fall from spring to ram (Call this B)	B = 14 feet (found by surveying—(Fig. 6))
C—Subtract 2 from B to allow for losses in ram (Call the answer C)	C = 14 - 2 = 12 feet
D—Estimate gallons of water per day required (Call this D)	D = 550 gallons per day (estimated)
E—Add A and B to find total lift (Call this sum E)	E = 100 + 14 = 114 feet
F—Multiply D by E (Call this product F)	F = 550 × 114 = 62,700 foot gallons per day
G—Multiply C by 14.4 and this product by efficiency of ram (Fig. 9) (Call this G)	Since efficiency = 45% (Fig. 9) G = 14.4 × 12 × 45 = 7776
H—Divide F by G to find gallons per minute required of spring	H = 62,700 ÷ 7776 = 8 gallons per minute required from spring

③ FINDING GALLONS OF WATER PER DAY AVAILABLE FROM SPRING	
Method	Example
I—Multiply 14.4 by gallons per minute from spring (Call this product I)	Spring delivers 10 gallons per minute and the fall is 14 feet. Water must be lifted 100 feet above spring. I = 14.4 × 10 = 144
J—Multiply I by C (See Fig. 7) and by the efficiency (See Fig. 9 for C) (Call this product J)	Since C = 14 - 2 = 12 and efficiency 45% J = 144 × 12 × 45 = 77,760
K—Divide J by E to get gallons pumped per day (See Fig. 7 for E)	K = 77,760 ÷ 114 = 682 gallons per day

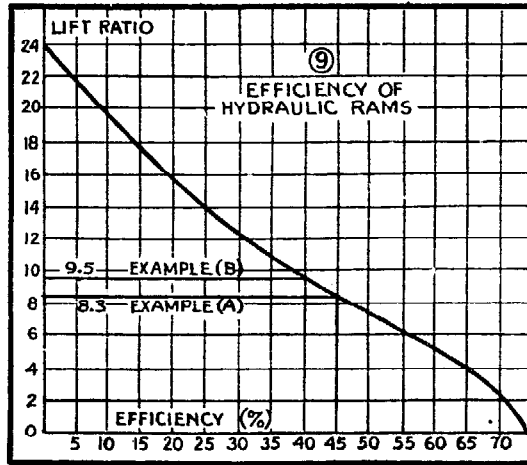

To find the efficiency of a ram, you first determine the lift ratio by dividing the height that water is to be lifted above the ram, by the fall from the spring to the ram

gals. of water per day. Referring to Fig. 6, we add the lift to the fall and multiply this by the number of gals. per day, that is, 550 multiplied by 114 or 62,700. Next, according to G of Fig. 7, the fall available for operating the ram, which is 12 ft., is multiplied by 14.4 which equals 172.8. We must next determine the efficiency of the ram by referring to Fig. 9. To do this we divide the height the water is to be lifted above the ram, or 114 ft., by the fall from the spring to the ram, or 14 ft., to get the lift ratio. In this case 114 divided by 14 equals 8. We locate this at the left side of Fig. 9, example A, follow across to the curve and down to the bottom and read 45 per cent as the efficiency. Multiplying this by 172.8, as shown in Fig. 7, we get 7,776 as the answer. The next step is to divide the first product, or F, by the second product G, or 62,700 divided by 7,776, which equals 8 gals. per min. as the amount of water which the spring will have to supply in order to furnish the required amount of water.

If the spring supplies 12 gals. of water per min. during the dry season, we will be safe in installing the ram. But if, after

making these determinations, it should be found that the spring will not deliver sufficient water, the next thing to do would be to figure how much water could be pumped per day during the dry season. Fig. 8 illustrates the method of making this calculation. Then, after you have found that there is sufficient fall available to operate a ram, the job of figuring the exact size required, and how to install it, comes next. This will be thoroughly covered in the next installment, which will also contain workable methods of making parts cheaply from pipe fittings in case you prefer to make these parts yourself. Hydraulic rams are also manufactured in a number of sizes and varieties, and they have the advantage over simple homemade ones in that they have been developed for long service and minimum trouble.

(To be continued)

### Greeting Cards Are Displayed in Holder of Wire

To avoid having his stock of sample greeting cards thrown about in heaps upon the counter or showcase, one dealer holds them in this novel rack. It consists



Sample greeting and view cards displayed in coils of brass spring are kept in neat order

merely of a length of coiled brass wire, soldered together to form a large hoop. The sample cards are inserted between the spring coils. Customers seldom fail to replace them after making their selections.

### Two Views on One Negative Taken with Aid of Mirror



By reflecting one side of an object in a mirror, you can photograph front and back views in one "shot"

For advertising purposes, where front and rear views of an object must be shown photographically, both views may be taken at once on one negative if a mirror is placed behind the object. The camera is set so that the front of the object is clearly shown and also the reflected image of the back. A sample of this method is shown at the lower left. The finished print may have both views or each view can be enlarged on a separate print. In studios where considerable work of this type is done, quite a saving in negative cost can be made.—J. Modroch, Detroit, Mich.

### Hack-Saw Blades Are Stored in Pipe Nipple

Instead of keeping your hack-saw blades hanging on a nail or lying in a drawer, where they are likely to be scattered around, why not

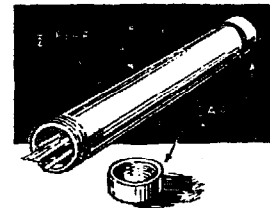

make this simple holder to store them? It is a long pipe nipple fitted with a pipe cap at each end. This idea can be applied to scroll-saw blades by using a shorter nipple.—Ralph R. Spain, Festus, Mo.

# This HYDRAULIC RAM

*is made from pipe fittings*

By C. A. CROWLEY

## Part II—Design, Construction and Installation of Rams

**A**FTER surveying the spring or stream as explained in Part I of this article, we will now proceed with the design and construction of a ram. The initial step is to find the size of the drive pipe, that is, the pipe which runs from the spring to the ram. The chart shown in Fig. 12 makes this easy. First refer to the bottom of the chart and locate the number corresponding to the gallons of water per minute which must be furnished to the ram. Continuing with the example that was followed in Part I, which required 8 gals. per minute, we locate 8 gals. per minute at the bottom of the chart, draw a vertical line to the curve, and at the point where this line crosses the curve, draw a horizontal line to the left-hand side of the chart and find that a ram pipe size between 1¼ and 1½ in. will be required. Accordingly, we will select the nearest larger standard pipe size, or a 1½-in. pipe. The delivery pipe that runs from the ram to the supply tank should be one-half this diameter, or in this case, ¾ in. In all cases where the size of pipe required comes out a fraction under standard size of pipe, then the next larger standard size should be used. In no case should the smaller size be used as this would tend to reduce the rate of flow to an extent which would probably interfere with the satisfactory performance of the installation.

Fig. 10 shows a method of attaching the drive pipe to the crib or spring box. The spring box, preferably of concrete, should be constructed so that all of the water, or a sufficient amount of it, flows into the box. The side from which the excess water is to be allowed to overflow should be made a few inches lower than the rest of the box so that the surplus will flow in the

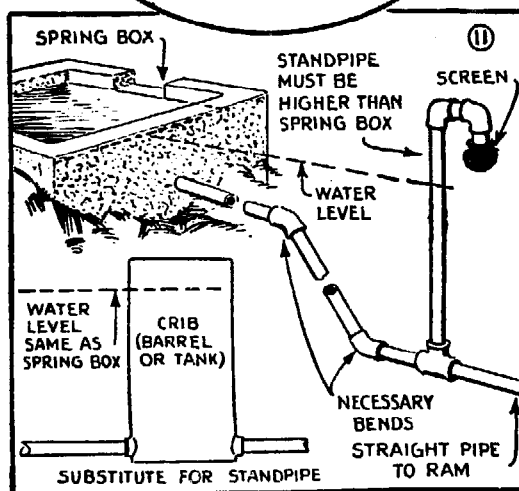
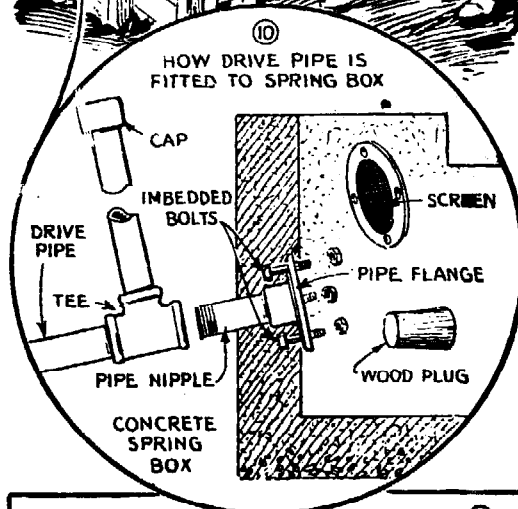



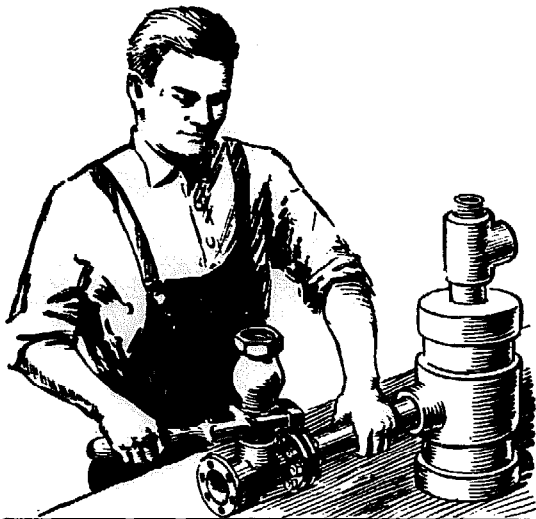

the ram pipe and delivery pipes in order to prevent their freezing. In this case the screen, which ordinarily covers the pipe opening at the spring box, is removed and a wood plug inserted to prevent further flow, after which the cap on the vent pipe is unscrewed so that the draining of the pipe is assured. Then drain cocks at the ram and pressure tank are opened to release all water in the installation.

The ram pipe should be run straight from spring to ram, if possible. If this is impossible, one of the methods shown in Fig. 11 may be used. The standpipe must be of the same or of larger diameter than the drive pipe and must extend vertically to a height a few inches above the level of the water in the spring tank. This pipe has a "goose neck" at the top to prevent the entry of dirt. A screen should also be placed over the open end to prevent insects from entering. Similar cautions are required in the use of the crib which may be used as a substitute for the standpipe.

Having determined the pipe sizes and laid out the ram line, we are ready to construct the ram.

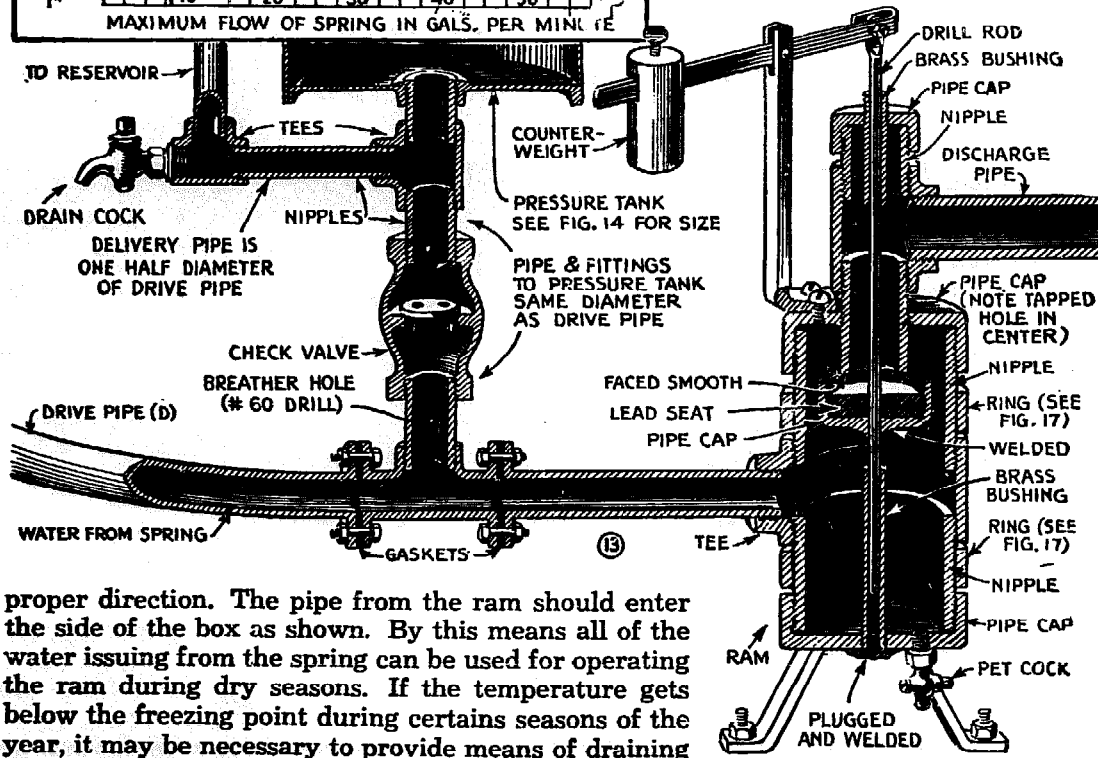
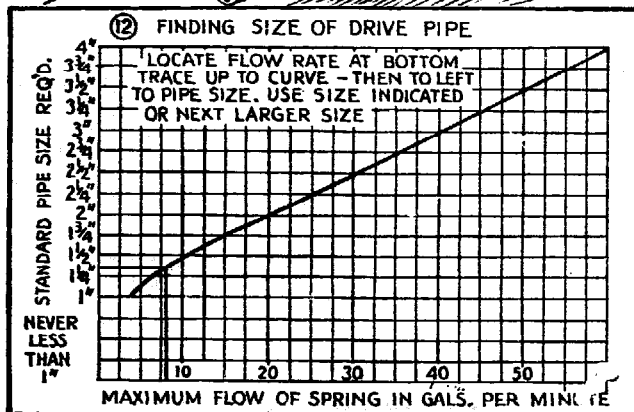

proper direction. The pipe from the ram should enter the side of the box as shown. By this means all of the water issuing from the spring can be used for operating the ram during dry seasons. If the temperature gets below the freezing point during certain seasons of the year, it may be necessary to provide means of draining

Fig. 13 shows details for the assembly of an effective type of ram which can be made from ordinary pipe fittings. Note that all of the dimensions are figured from the diameter and length of the ram pipe as shown in Fig. 14. The pressure tank should have a capacity in gallons approximately equal to the volume of the drive pipe. Applying the simplified formula given in Fig. 14 to our example, we first multiply the diameter of the drive pipe by itself. Thus for a 1½-in. drive pipe, we get 2.25. Next we multiply this by the length of the drive pipe in feet, assumed to be 100 ft. and then by 0.041 to find the size of the pressure tank in gallons. Performing this operation, we get 2.25 times 100 times 0.041 equals 9.2 gallons. A 10-gal. expansion tank of the kind used on hot-water heating systems will be satisfactory. The tank selected should not be smaller than 9.2 gals. and preferably not much over 15 per cent larger. The ram proper is made from



DESIGN DATA TO DETERMINE SIZE OF PIPE, ETC.  
FIG. 14

Procedure	Example
First: Find drive-pipe diameter from Fig. 12. Call this "D"	As 8 gal. per min. is flow from spring, Fig. 12 shows drive pipe should be 1½ in.
Second: Find diameter of delivery pipe. This should be ½ D	½ of 1½ gives ¾ in. for size of delivery pipe. Never use pipe less than ½ in.
Third: Find size of pressure tank in gallons. This is D times D times the length of drive pipe times .041	1½ times 1½ times 100 (length of drive pipe) times .041 equals 9.2 gal. required size of pressure tank
Fourth: Find size of pipe and fittings for ram. This should be 4 times D	Drive-pipe dia. 1½ in. times 4 gives 6 in. for size of ram pipe and fittings
Fifth: Find size of pipe and fittings for discharge pipe. This is 1½ times D	Drive-pipe dia. 1½ in. times 1½ gives 2¼ in. for size of discharge pipe and fittings.

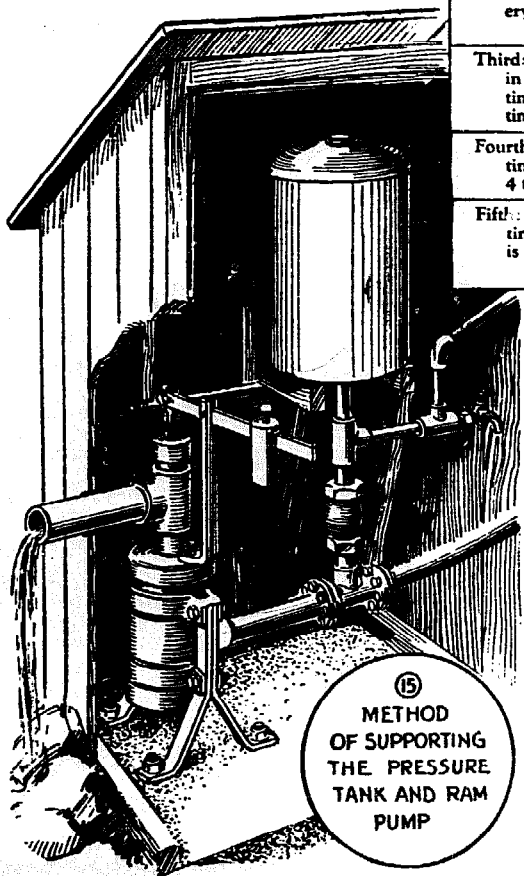

sections of pipe and fittings whose diameters are four times the diameter of the drive pipe. Therefore, in our example, we must use 6-in. pipe and fittings for the ram. The ram discharge pipe should be 1½ times the diameter of the drive pipe. All of these values are given in Fig. 14. The ram valve is made by drilling a hole exactly through the center of a pipe cap and pressing a length of drill rod through it as shown. The drill rod should be welded to the pipe cap as shown to prevent it from slipping. Next, the pipe cap is filled with molten lead as indicated. The purpose of the lead is to form a soft bed which can easily seat on the end of the faced pipe nipple which extends from the top of the ram. This rod is guided by the top insert of brass tubing and a similar length of brass tubing in the bottom cap of the

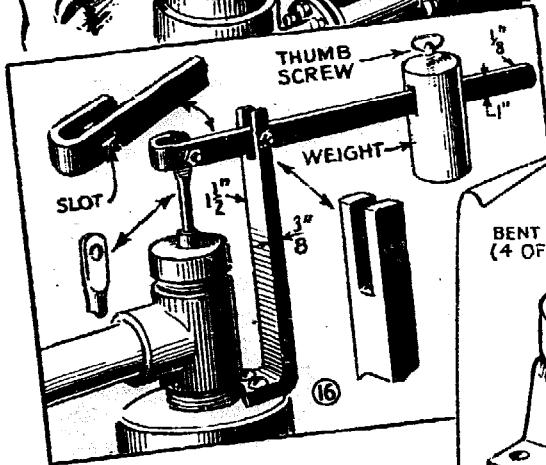
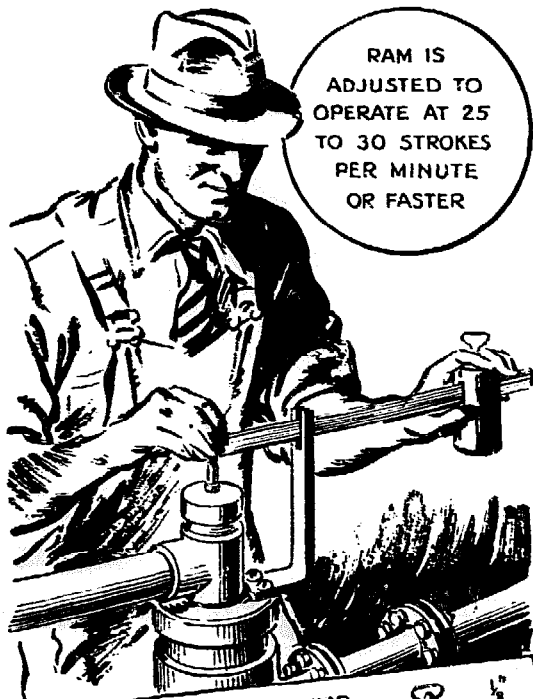

ram as shown. The end of the drill rod which projects through the top pipe cap should be drilled and coupled to the counterbalancing arrangement shown in Fig. 16.

When these parts are properly assembled and the ram installed rigidly, which can be done as shown in Fig. 17, it will be found that there is a position at which the counterweight can be located so that merely touching the lever arm will cause the valve to close or open. The exact location of the weight will be found after the ram has been installed. A length of pipe may be connected to the discharge "tee" in order to guide the tail water away from the ram house. In no

case should this pipe be bent or should fittings be used, as bends would slow down the flow of water and interfere with operations. This, and a good method of mounting both the ram and pressure tank, are shown in Fig. 15.

The check valve between the drive pipe and pressure tank, Fig. 13, should be arranged so that water can flow from the ram pipe into the pressure chamber but not in the reverse direction. A substantial type of check valve of good quality should be used. Unused holes in the pressure tank should be closed carefully with pipe plugs. The tank must be tested for leaks carefully. If there is even a small leak, the "hammer" of the ram will burst it. There is one other important point which must be noted in connection with the assembly of the ram and that is the small breather hole below the check valve. This hole should be drilled with a No. 60 drill. It should be located where it can be inspected easily. The purpose of this hole is to allow the entrance of air immediately after the check valve closes. The air that enters

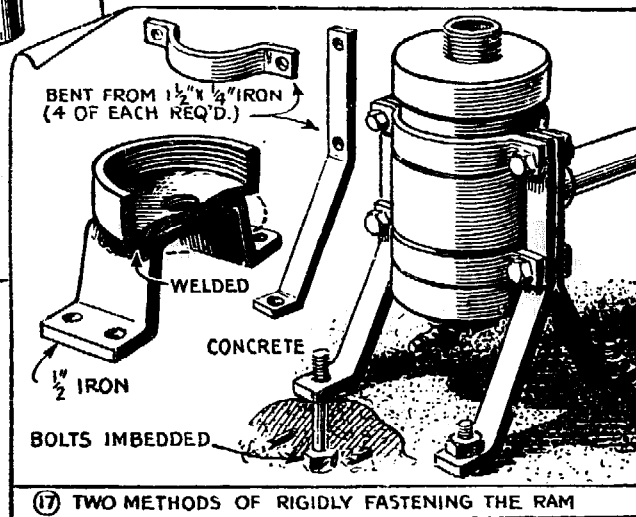

(17) TWO METHODS OF RIGIDLY FASTENING THE RAM

during this period collects under the valve and is forced into the pressure chamber during the next stroke of the ram. If this small hole is omitted, the air in the pressure chamber will slowly decrease, as it is absorbed by the water, and thus no air pressure will be available for lifting the water. When the installation is complete it is only necessary to remove the plug from the ram pipe in the spring box or

crib, and adjust the counterweight until the ram operates at between 25 and 30 strokes per minute or faster.

Commercial types of rams cost from \$15 to \$75, according to size and quality. They are superior, of course, to a ram made up of pipe fittings, and they involve no expense except the occasional replacement of a valve or valve seat. If a homemade ram does not stand up under the constant hammering action, and requires too frequent replacement of the valve, it will, no doubt, be advisable to improve this part of the installation by substituting a high quality manufactured ram. The instructions contained in this article on measuring the stream and determining how high water can be pumped, apply whether the ram is homemade or manufactured.

### Removing Broken Stud Bolts

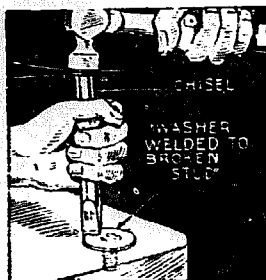

I have found the following method very effective for removing broken stud bolts that project slightly. Just weld a washer to end of the stud and then screw it out of the hole by holding a dull cold chisel at an angle against the edge of the washer and tapping it lightly with a hammer. Care must be taken in welding the washer to avoid warping the work by the intense heat of the torch flame.—Carl B. Powledge, Dale, Tex.

### Shoes Are Clamped to Stand While Shining Them



To simplify the job of shining shoes left by customers, one boy uses a stand on which he clamps the shoes to get at them easily. The standard is made of heavy flat iron to which is bolted an old roller-skate frame.

### Belt Thrown from Moving Pulley without Endangering the Hands

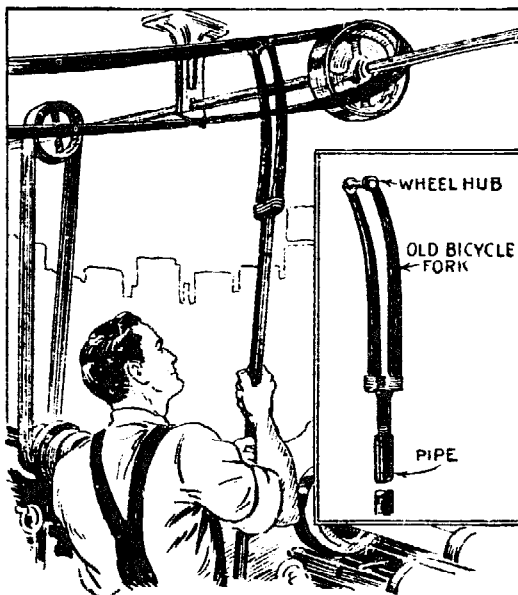

Old bicycle fork fitted with plain wheel hub and long handle throws belts from moving pulleys

In a western factory where it was frequently necessary to remove or put belts on moving pulleys of an overhead jackshaft, this tool was devised to do the job quickly without climbing up a stepladder. The tool also keeps the hands and clothing away from the belts so that there is little possibility of injury. To make the tool, an old bicycle fork is fitted with a hub, adjusted to turn freely, and a length of pipe is attached to the fork to serve as a handle.

### Crotch Lathe Center Easily Made

If you have a geared lathe or drill-press chuck fitted with a tapered shank, the latter can be used in making a crotch center. Just bore a tapered hole in a V-block to take the small tapered end of the shank snugly. Then the shank can be used on either the center or the chuck.

