

AT MICROFICHE
REFERENCE
LIBRARY

A project of Volunteers in Asia

The Construction of a Hydraulic Ram Pump

by: Allen R. Inversin

Published by:
South Pacific Appropriate Technology
Foundation
P.O. Box 6937
Boroko
National Capital District
Papua New Guinea

Paper copies are \$ 3.00.

Available from:
Volunteers in Technical Assistance
1815 North Lynn St. Suite 200
P.O. Box 12438
Arlington, VA 22209 USA

Or in exchange for your publication from:
South Pacific Appropriate Technology
Foundation
P.O. Box 6937
Boroko
National Capital District
Papua New Guinea

Reproduced by permission of the South Pacific
Appropriate Technology Foundation.

Reproduction of this microfiche document in any
form is subject to the same restrictions as those
of the original document.

THE CONSTRUCTION
OF A
HYDRAULIC
RAM PUMP

by A.R. INVERSIN

SOUTH PACIFIC
APPROPRIATE TECHNOLOGY
FOUNDATION

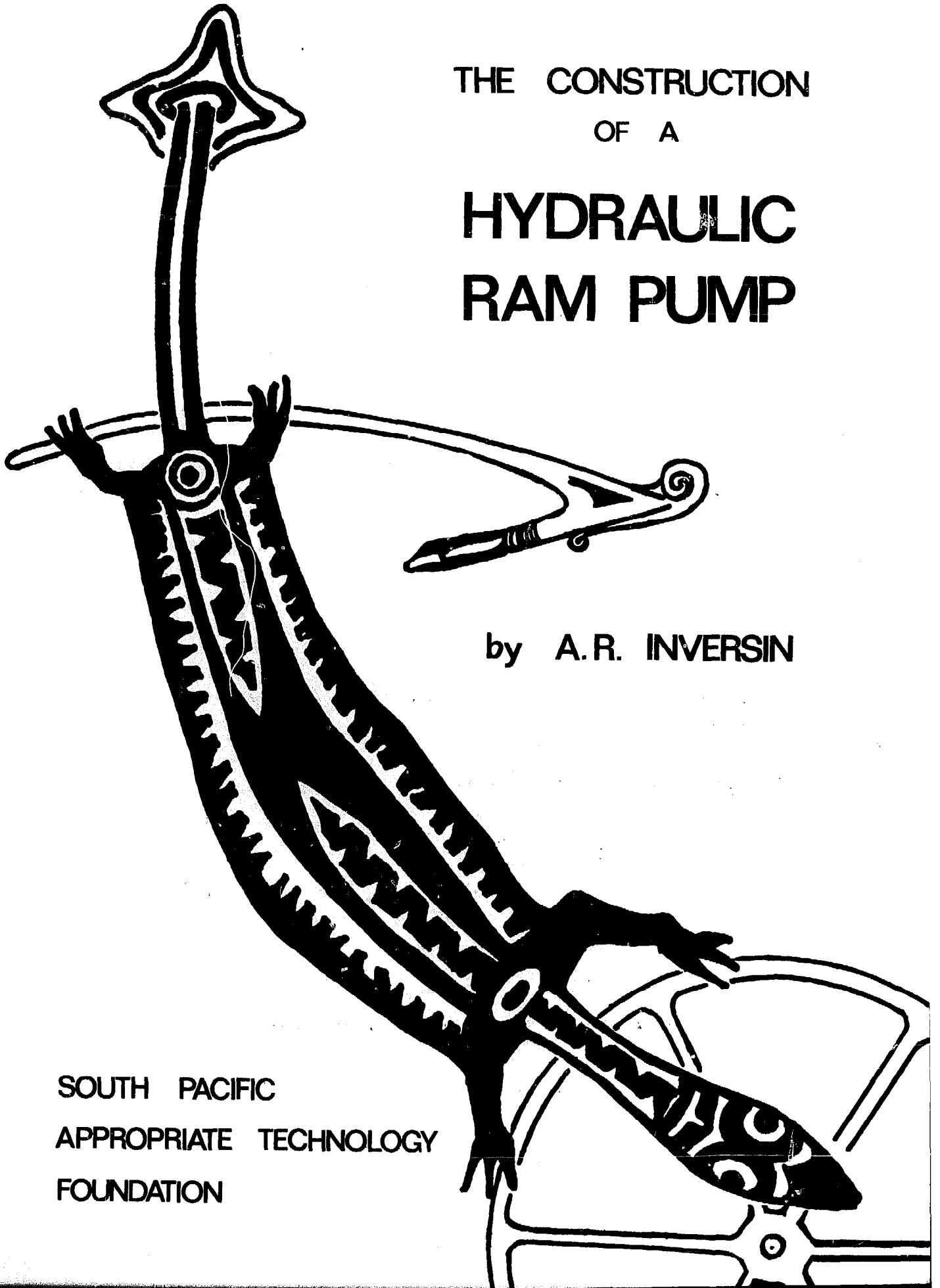

The printing of this booklet was funded by a grant from the Government of New Zealand.

For further information, contact:

A.R. Inversin
Department of Mechanical Engineering
University of Technology
P.O. Box 793
Lae
Morobe Province
Papua New Guinea

OR

South Pacific Appropriate Technology Foundation
P.O. Box 6937
Boroko
Papua New Guinea

SPATF is a project of the Office of Village Development.

THE CONSTRUCTION
OF A
HYDRAULIC RAM PUMP

A.R. Inversin

TABLE OF CONTENTS

INTRODUCTION	1
THE HYDRAULIC RAM PUMP	3
WASTE AND CHECK VALVES	4
Materials Required for Both Valves	5
Tools Required	6
Instructions - Waste Valve	
(making the valve seat)	6
(fastening the valve seat to the reducer bush)	8
(making the valve guide)	9
(fastening the valve guide to the reducer bush)	11
(drilling the valve guide)	12
(making the valve)	
(bushing)	13
(galvanized disk)	14
(steel disk)	14
(rubber disk)	15
(valve assembly and adjustment)	15
(assembling the waste valve)	16
Instructions - Check Valve	
(making the valve seat)	16
(fastening the valve seat in the nipple)	18
(making the valve)	
(preparing the jig for drilling)	19
(galvanized disk)	21
(rubber disk)	21
(assembly)	22
(making the valve guide)	
(bushing)	22
(valve stop)	23
(assembling the check valve)	23
(making the snifter valve)	24
RAM PUMP ASSEMBLY	25

PERFORMANCE INFORMATION

Test Installation	25
Performance Data	26
How to Use the Graph	26
Adjusting the Valve Stroke	28
Effect of Other Variables	
(1) size of air chamber	30
(2) drive pipe diameter	30
(3) mounting of the ram pump	31
(4) mass of the waste valve plunger	31
(5) use of PVC drive pipe	32

NOTES

(1) spring loading the waste valve	33
(2) size of the snifter valve	34
(3) comments on the VITA (by Kindel) and ITDG rams	
(a) design of the waste valve	34
(b) design of the check valve	35
(c) size of the air chamber	35
(d) basic configuration of the ram	35
(e) waste valve adjustments	35
(4) durability	36
(5) modification of the snifter valve	36

INTRODUCTION

This technical bulletin describes the construction of a hydraulic ram pump from commercially available galvanized iron pipe fittings. It also includes information on its performance to assist the reader in making optimum use of this pump and in estimating its performance at a specific site. The methods for ram installation, operation, and trouble shooting are not included since they are no different from those covered in most other literature on rams.

The ram described herein has been tested at drive heads of from 0.5 to 4.0 meters and can be used at still higher heads. It is capable of delivering water to heights of up to 20 times the actual drive head used. The amount of water required to operate the pump and the amount of water delivered depend on a number of factors. For delivery heads about ten times the drive head, the pump can deliver about 2.5 liters/minute (3600 liters/day). Under usual operating conditions, the ram would use 30-40 liters/minute though it is possible to adjust the pump so that less water is used. Under these conditions, efficiencies of 65%-75% should be attainable. This efficiency is comparable to that of commercial rams.

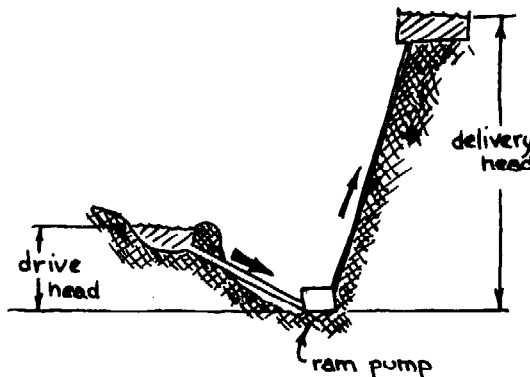

The hydraulic ram pump described in this bulletin ...

- ... requires only commercially available pipe fittings and two homemade valves
- ... can be constructed by following simple, step-by-step instructions requiring no special skills
- ... requires the use of only handtools and a drill press. The use of a lathe and grinder might simplify some aspects of the work but these are not necessary. Neither is a tap and die set required
- ... requires no welding, brazing, or soldering. Studs and nuts and bolts are the primary load carrying members and epoxy adhesive

serves primarily as a sealant and is not subject to large stresses
... should cost about US\$50 (excluding the costs of drive and
delivery pipes, the ram foundation and housing, and gate valves
since these costs are part of any ram installation, whether
homemade or commercial

There are numerous variations to the construction of the ram as
described in this bulletin. The techniques used in its actual construction
may depend on what tools are available. The method described herein avoids
the need for specialized tools and expensive materials to build a ram which
is low-cost and simple, yet rugged and efficient. It is quite probable
that those who have had machine shop experience will prefer alternative
techniques of construction.

An attempt has been made to use the metric system of measurements.
In a number of cases, the English system is used since pipe fittings,
screws and bolts, etc. are still often available according to this system.

Tests are presently continuing to determine the durability of the
various components of the ram and to determine what problems are
encountered in the field. However, after working a year in developing
this unit, it is felt that the major mechanical problems of the design
presented in this bulletin have already been encountered and resolved.

University of Technology
Lae, Papua New Guinea
- September, 1977

THE HYDRAULIC RAM PUMP

A view of the assembled ram pump is shown below. A 3" x 2½" reducer bush and a 2" nipple are used to make the waste and check valves. The construction of these two valves is described in the following pages. The other galvanized iron pipe fittings which are required to complete the construction of the pump are as follows:

3" x 1½" reducer bush (another size reducer bush may be required if a drive pipe smaller or larger than 1½" is used, see the comments on drive pipe diameter on p. 30)

2" x ½" reducer tee (if the delivery pipe is longer than about a hundred meters, using a 2" x ¾" or 2" x 1" tee and the corresponding size delivery pipe would reduce friction losses and permit more water to be delivered)

2" pipe, about 50 cm long,
threaded at both ends

3" x 2" reducer bush

2" male-female elbow (90°)

2" cap

3" tee

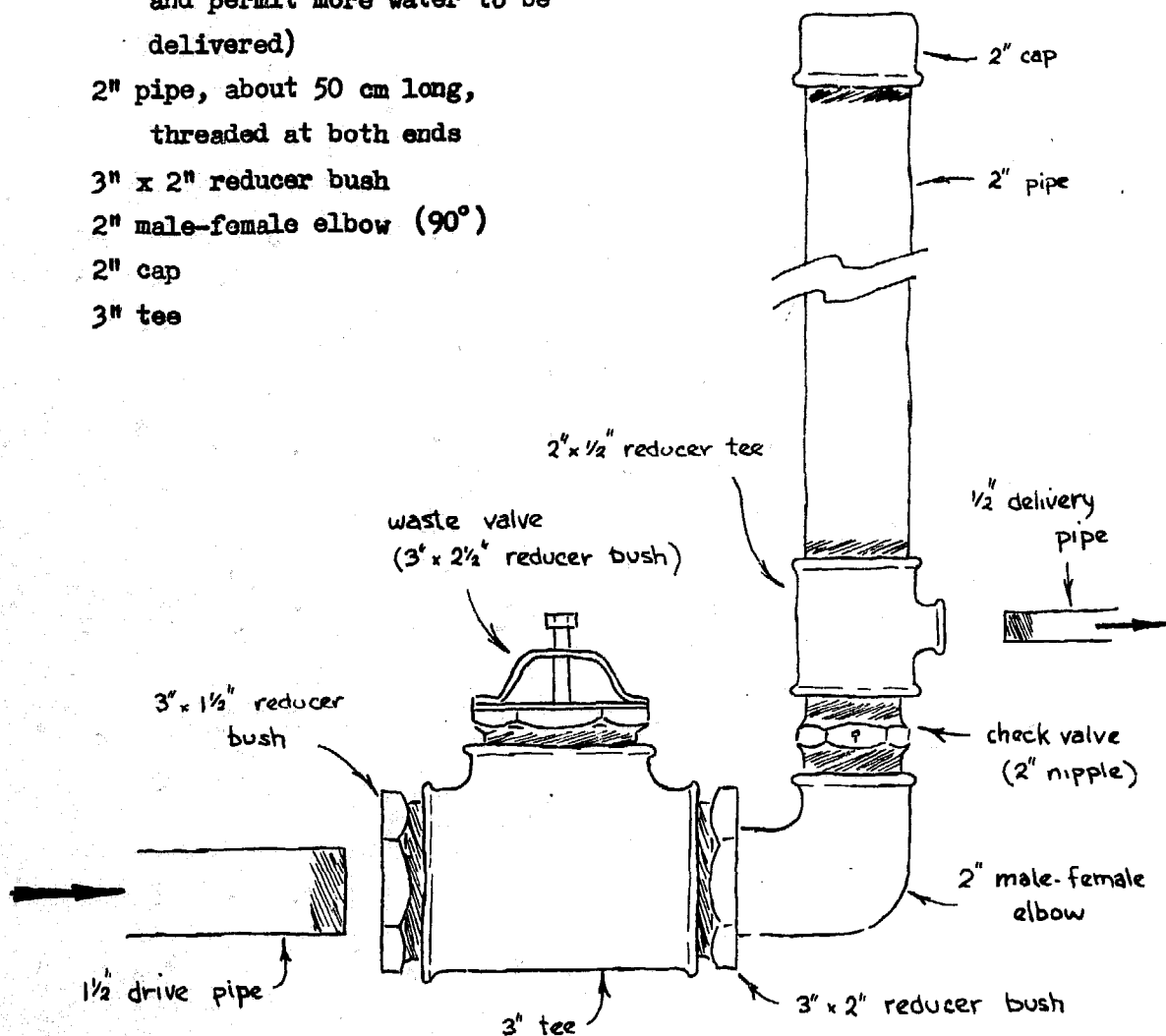

WASTE AND CHECK VALVES

The only two parts of the pump which have to be built are the two valves -- the waste valve and the check valve. Sectional views of these valves are shown below and on the next page. One method for the construction of each valve is described in the following pages. As noted before, alternative methods for their construction may be preferred. In this case, reference can be made to these instructions to obtain dimensions and to note the manner in which the various parts are put together.

WASTE VALVE (drawn actual size)

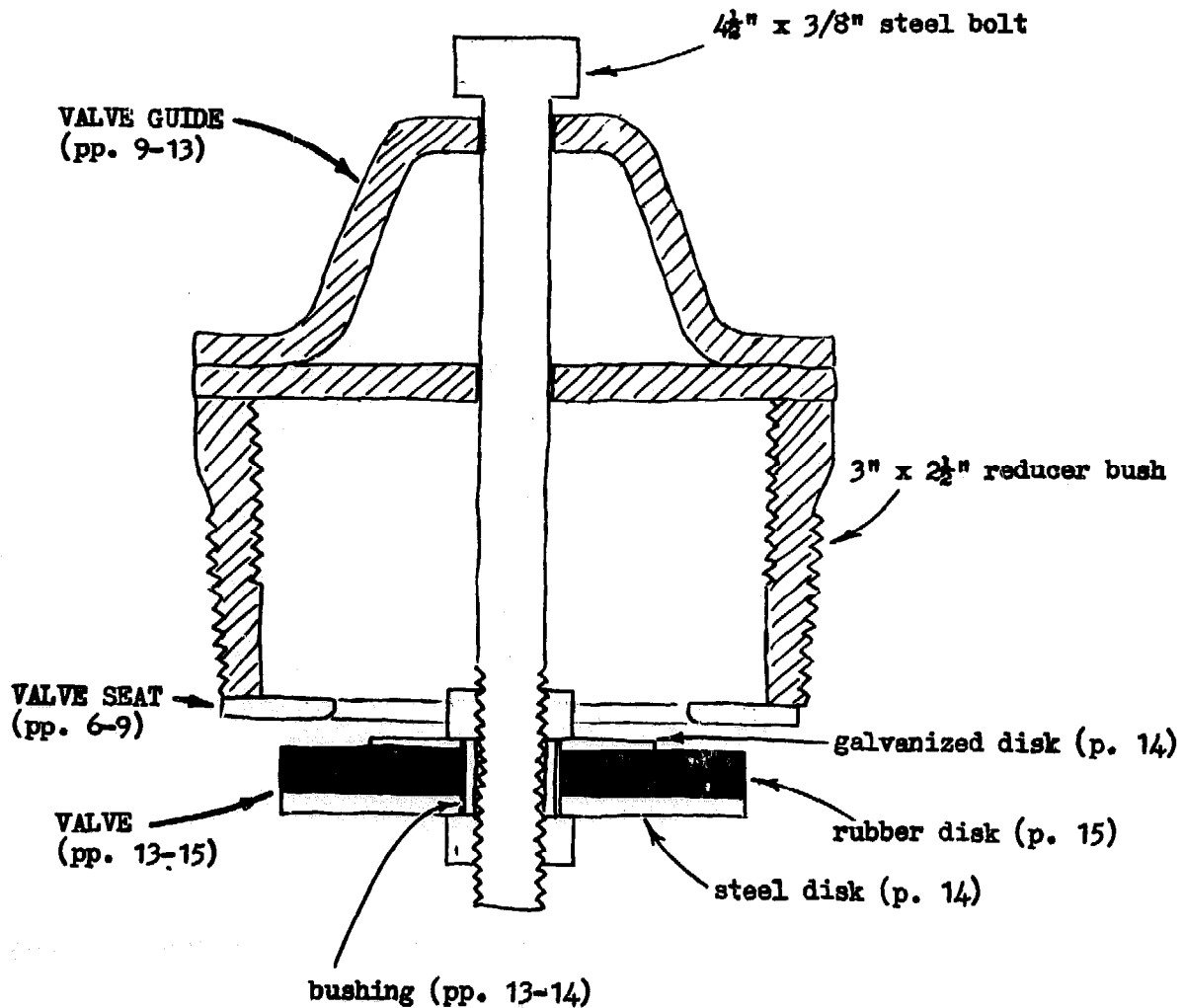

5

CHECK VALVE (drawn actual size)

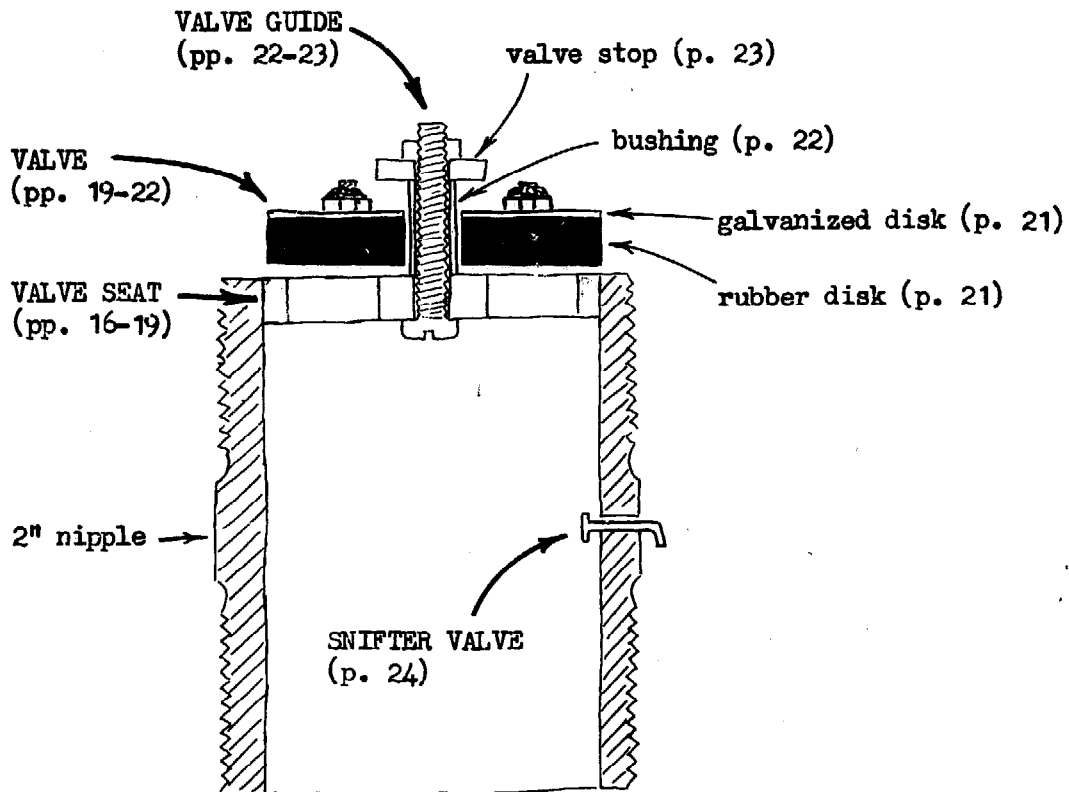

Materials Required for Both Valves

- *1. 3" x 2½" reducer bush
- *2. 3 mm (1/8") steel plate, two pieces each about 10 cm square (thicker plate can be used but it may make construction a little more difficult)
- *3. several steel nails about 2 mm diameter (not larger)
- *4. epoxy adhesive
- *5. 3/4" x 1/8" flat mild steel strip at least 21 cm long (a 3/16" thick strip can be used but it is more difficult to bend)
- *6. ½" x 3/8" steel bolt and two nuts
- *7. ½" diameter steel bolt with a portion of the shank unthreaded or a short length of ½" round rod
- *8. galvanized sheet about 1 mm thick, about 5 cm x 10 cm

- *9. 6 mm ($\frac{1}{4}$ ") insertion rubber, about 7 cm x 12 cm
- *10. 2" nipple
- *11. 6 mm ($\frac{1}{4}$ ") steel plate, about 5 cm square
- *12. $\frac{1}{4}$ " diameter steel bolt with a portion of the shank unthreaded or a short length of $\frac{1}{4}$ " round rod
- *13. three $\frac{3}{8}$ " x $\frac{1}{8}$ " countersunk metal thread screws (or longer) and nuts
- *14. $\frac{1}{2}$ " x $\frac{3}{16}$ " round head screw and nut
- *15. cotter pin or nail 1-2 mm diameter

Tools Required

drill press with complete set of drills
 drill press vise or clamps
 hacksaw
 tin snips, sharp knife, or razor blade (to cut insertion rubber)
 hammer (preferably ball peen)
 center punch
 table vise
 files, round and flat (a set of small files would also be useful)
 scribing compass
 pliers
 emery or sandpaper
 ruler
 square

Instructions - Waste Valve

1. (making the valve seat)

Smooth both faces of the reducer bush (*1) by rubbing each face on emery or sandpaper resting on a flat surface. Remove any high spots with a file.

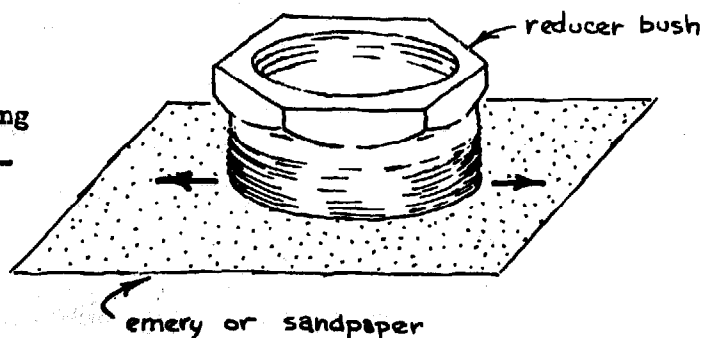

2. Measure this diameter.

Note that this measurement does not include the width of the threads.

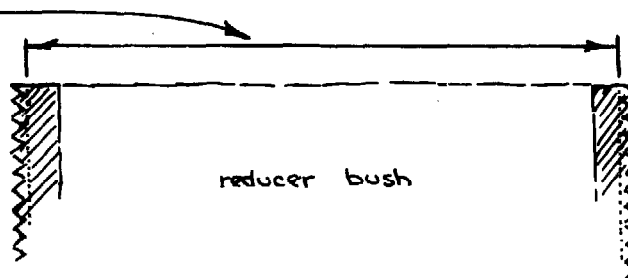

3. Using a flat piece of 3 mm steel plate (*2) ...

... scribe a circle with a diameter equal to the measurement made in step 2.

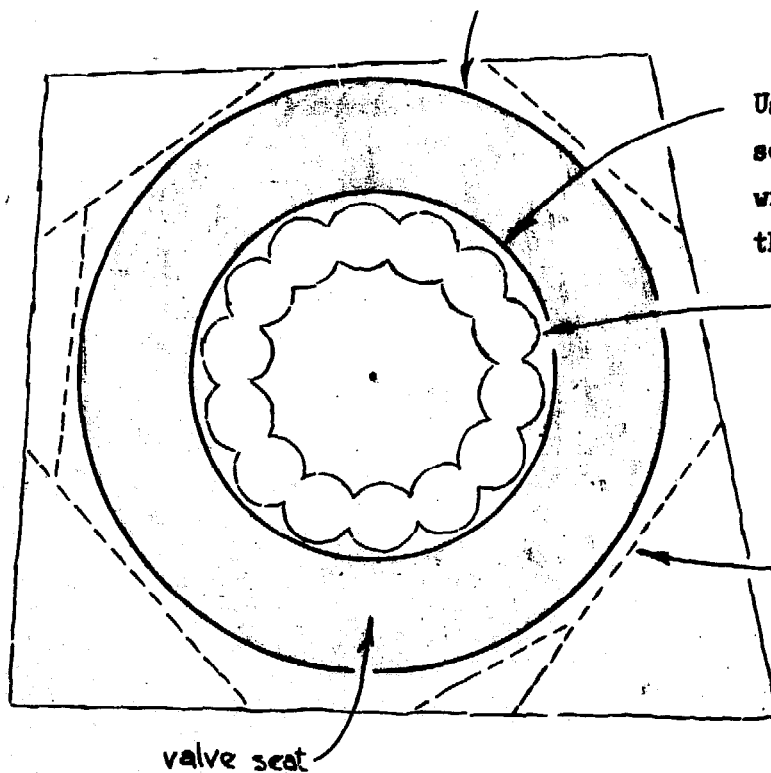

Using the same center, scribe another circle with a radius of 5.0 cm, then ...

... drill a circle of holes to remove the center portion and file the inner circle smooth, then finally ...

... cut around the circle with a hacksaw and file the outside circle smooth

valve seat

4. Round off and smooth one edge of the inner circle of the valve seat.

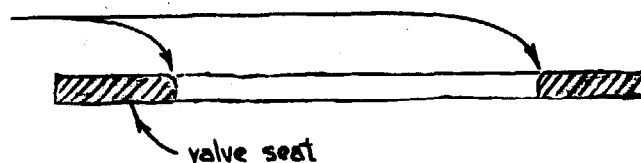

(section view)

5. (fastening the valve seat to the reducer bush)

Carefully center the valve seat on the bush and then drill 3 holes the size of the nails (*3) around the outside of the valve seat into the center of the bush wall as shown and countersink slightly.

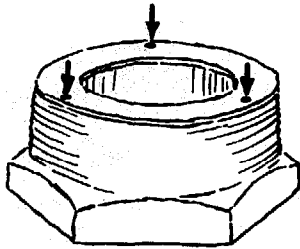

To ensure that the holes in the valve seat and bush are aligned, as soon as each hole is drilled, insert a nail to hold the valve seat in place.

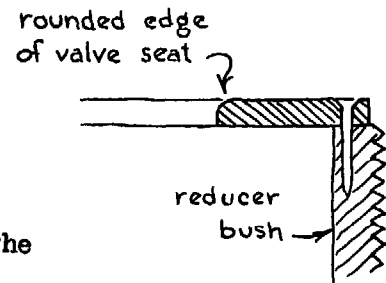

6. Using a drill several times larger, drill three holes through the side of the bush as shown.

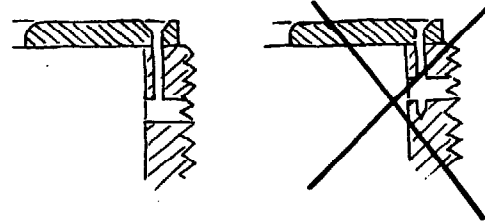

7. With the valve seat and nails in place, make sure that the outside edge of the valve seat does not extend beyond the root of the threads. This can be checked by screwing the reducer bush (with the valve seat in place) into the 3" tee and feeling if there is any resistance as it is screwed in. File any portion which extends beyond.

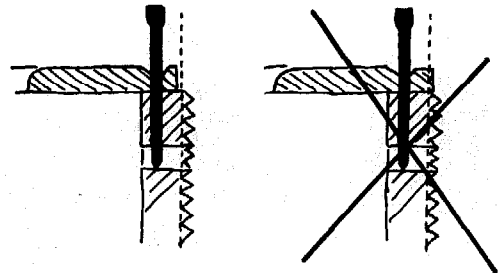

8. Cut off the upper portion of each of the three nails as shown.

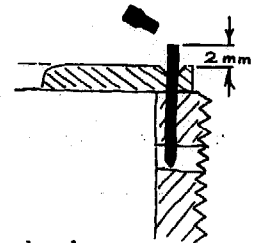

9. Prepare the surfaces of the valve seat and reducer bush to be glued (remove any grease and roughen the surfaces). Then ...

Apply epoxy
on nails and
on surfaces
which touch ...

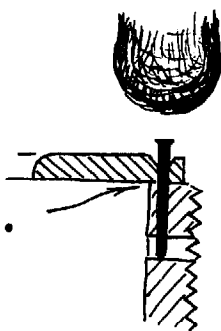

... and hammer nails with
a ball peen hammer to
make rivet heads.

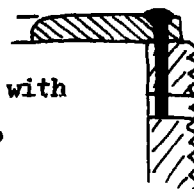

10. Hammer a larger nail with a rounded point through the three holes as shown to bend the foot of the nail rivets. Do not bend the nail rivets too much because they may break.

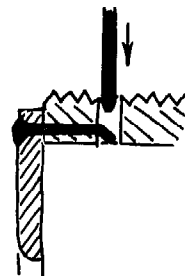

11. When the epoxy has dried, file the heads of the nail rivets. Avoid making deep scratches on the valve seat.

12. (making the valve guide)
Cut two lengths of the flat strip (*5),
one 9 cm long and the other 12 cm long.

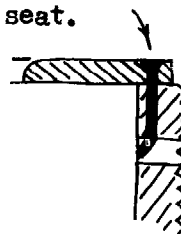

13. Mark the longer length as follows:

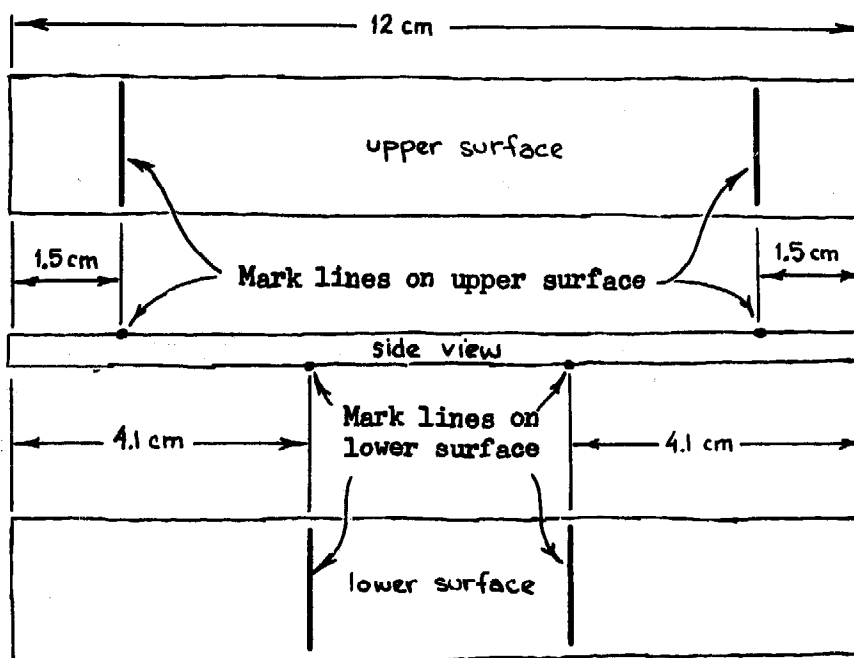

14. Use a vise and hammer to bend this longer length as follows. Note the position of the marks.

(a)

Always keep this piece at right angles to the vise

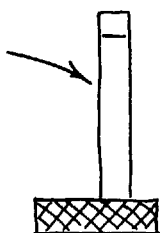

(front view)

Bend over



jaws of vise
(side view)

....



(b) Second bend

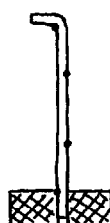

....



(c) Third bend

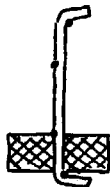

....



(d) Fourth bend

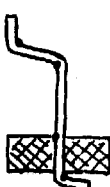

....



.....

After this long piece has been properly bent, it should fit flat over the shorter, flat piece. If not, rebend until it does.

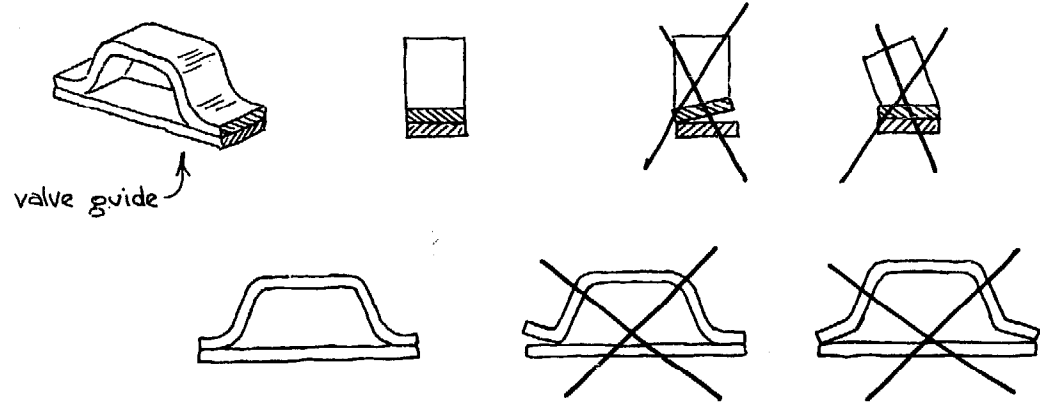

15. (fastening the valve guide to the reducer bush)

Drill a hole the size of the nails (*3) in the center of each end of the valve guide so that each hole ends up above the center of the wall of the reducer bush (see drawing below to the right). Slightly countersink these holes.

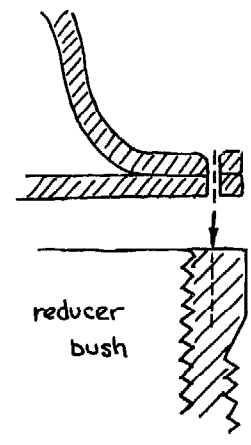
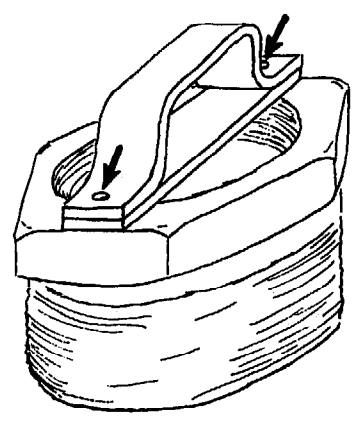

16. Place the flat portion of the valve guide as close to the center of the bush as possible and continue drilling the holes into the bush ...

... then as in step 6, drill through the wall of the bush.

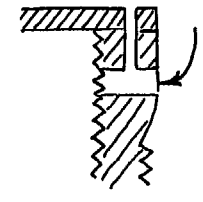
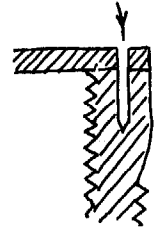
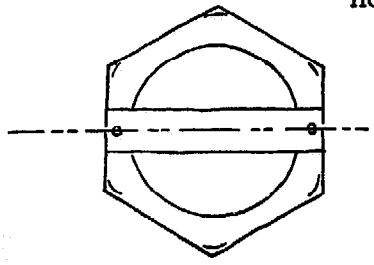

17. Cut the nails to the proper length and prepare the surfaces to be glued as before before (steps 8,9). Glue the two portions of the valve guide to the bush with epoxy. Hammer rivet heads on the nails. Bend the foot of the nail rivets as before (step 10). Set aside to dry.

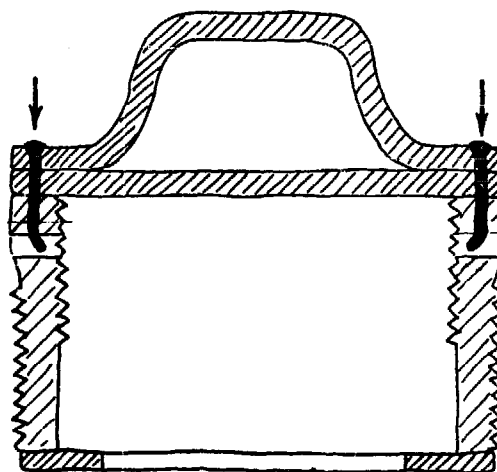

18. (drilling the valve guide)

Determine the center of the valve guide so that it falls as close to the center of the bush as possible.

One way of doing this is to place the bush on a flat surface pushed up against a spacer block and a square. Then ...

... this point is the center of the valve guide if ...

... this distance between this point and the square is constant as the bush is held against the block and rotated.

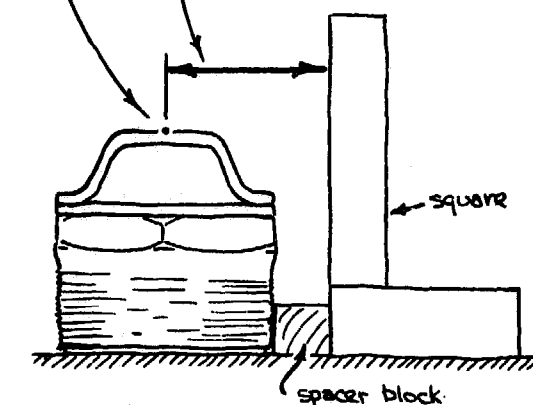

19. Center punch the center and drill a hole about .010" (0.25 mm) larger than the diameter of the shank of the 3/8" bolt (*6) through both portions of the valve guide. Make sure that the valve seat lies completely flat on the drill press table so that the drill is perpendicular to the valve seat.

(If no micrometer or vernier caliper is available to determine the proper drill, select what is thought to be the correct drill. Through a piece of scrap metal the same thickness as used in making the valve guide, drill a hole and insert the 3/8" bolt in almost all the way. Measure the maximum distance the end of the bolt can move from side to side if the piece of scrap metal is held firm. If a 3 mm flat strip was used to make the valve guide, this distance should be 2-3 cm if the hole is of the proper size. If a 5 mm flat strip was used, this distance should be 1.5-2 cm. If the proper drill is not available, an undersized hole can be filed larger.

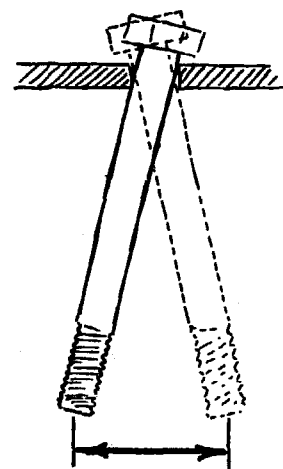
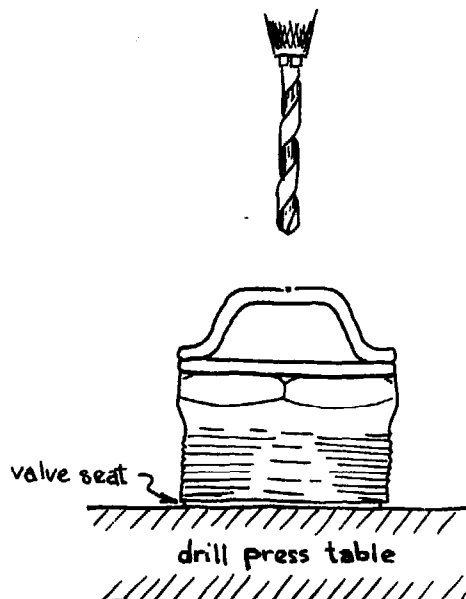

20. (making the valve - bushing)

Using the 1/2" bolt or round rod (*7) ...

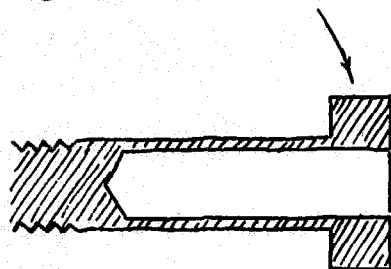

... drill a hole in the center whose diameter is equal to the diameter of the threaded portion of the 3/8" bolt (*6).

21. Cut off a length slightly greater than the sum of the thickness of the steel plate (*2), the galvanized sheet (*8), and rubber (*9).

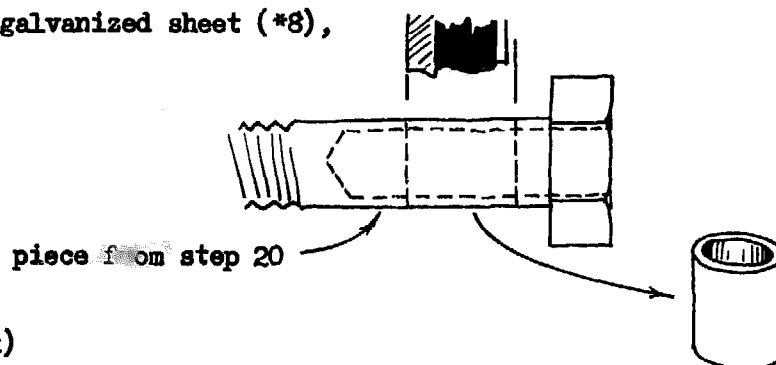

22. (galvanized disk)

Using a piece of galvanized sheet (*8) ...

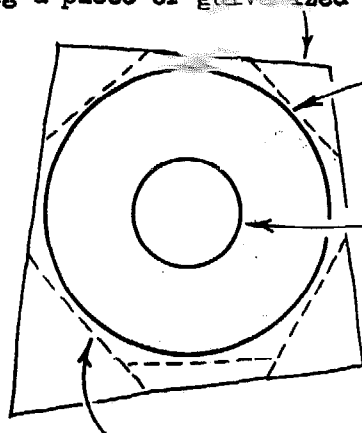

... scribe a circle with a diameter of 4.0 cm.

In the center, drill a hole whose diameter is slightly larger than the diameter of the bushing made in step 21, then ...

... cut around the circle with a hacksaw and file smooth.

23. (steel disk)

Using a piece of 3 mm steel plate (*2) ...

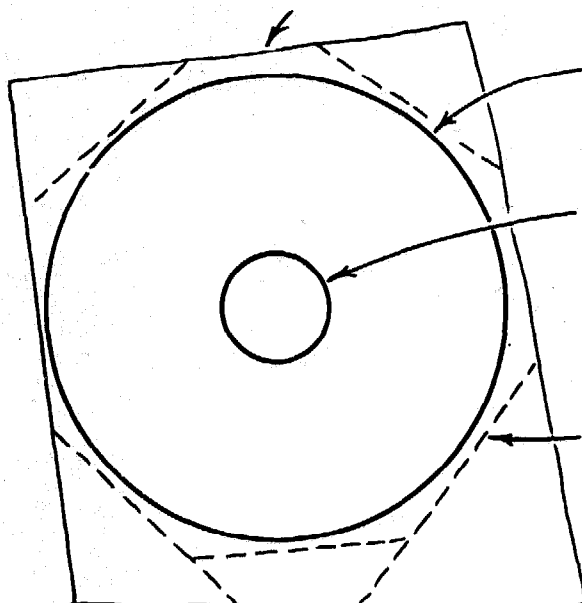

... scribe a circle with a diameter equal to 6.5 cm.

In the center, drill a hole the same size as in step 22, then ...

... cut around the circle with a hacksaw and file smooth.

24. (rubber disk)

In the center of a 7 cm square piece of insertion rubber (*9), drill the same size hole as in steps 22 and 23. A cleaner cut can be made if the rubber is clamped between two pieces of wood before drilling.

25. Align the holes
in the steel disk
(from step 23)
and the rubber
(from step 24) ...

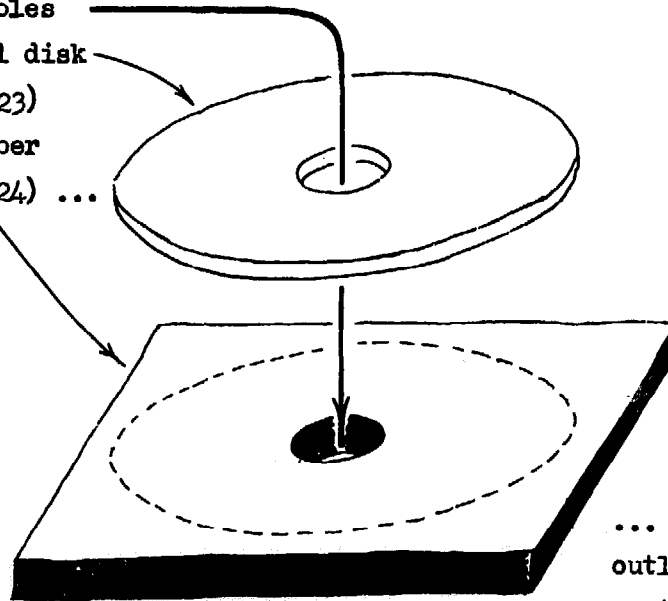

... then trace the
outline of the disk
on the rubber and
cut out rubber disk.

26. (valve assembly and adjustment)

Assemble the valve as shown.

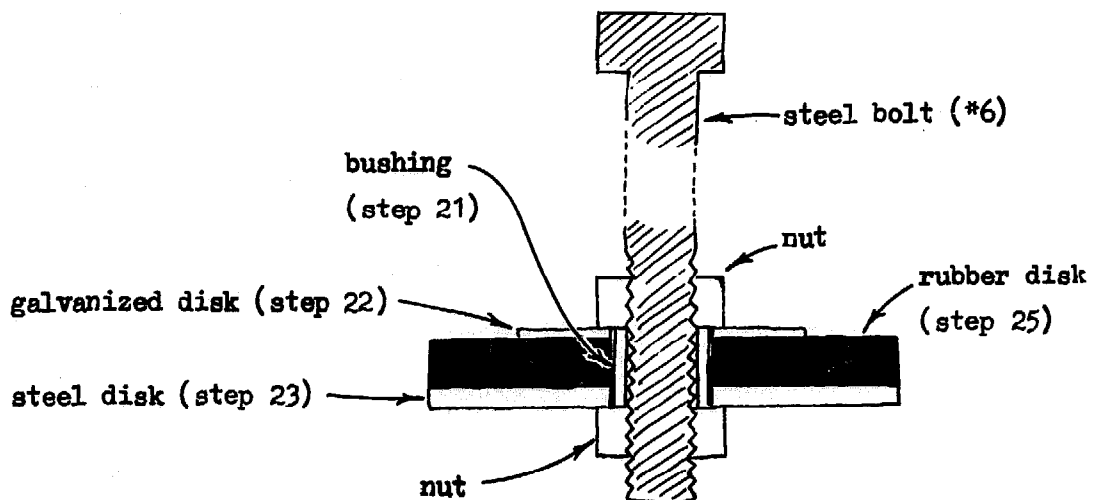

.....

The bushing should be of such a length that when the two nuts are tightened against each other, the disks are free to twist about 1 mm up or down from the horizontal. If the bushing is too long, shorten it until the disks move only a little.

(drawing exaggerated
for illustrative
purposes)

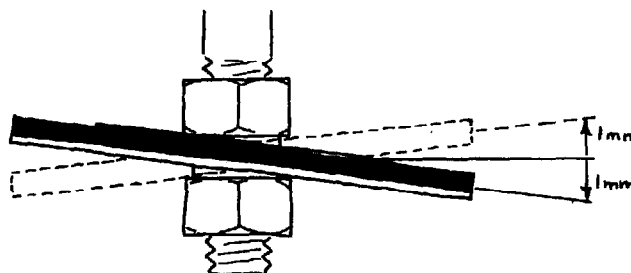

27. (assembling the waste valve)

Put together the entire valve assembly. The valve must be able to move up and down completely freely in the valve guide. If the shank of the bolt has any irregularities or burrs that prevent perfectly free motion, file them off. Also file off any epoxy remaining in the threads of the bush so that it screws easily into the 3" tee.

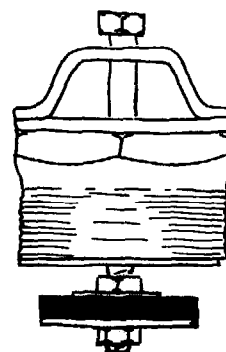

Instructions - Check Valve

1. (making the valve seat)

Measure the inner diameter of this end ...

nipple (*10)

... and smooth the
inside of this end
of the nipple with
a round file.

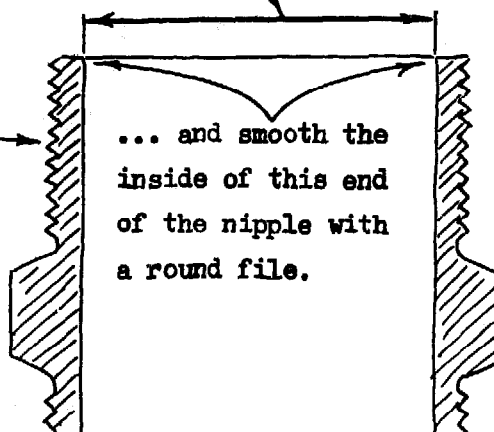

2. Using a piece of $\frac{1}{4}$ " steel plate (*11) ...

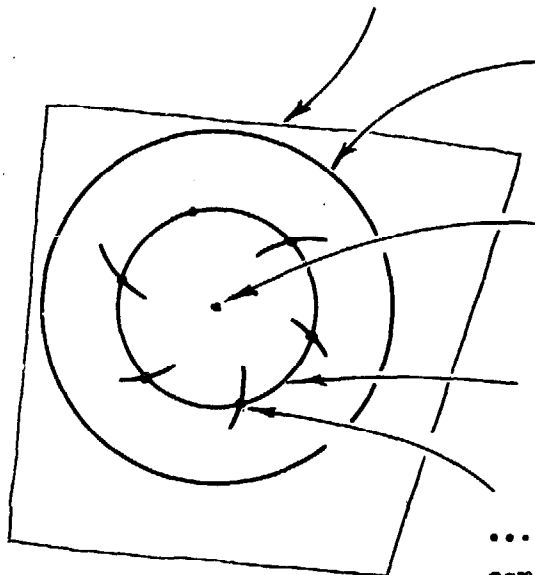

... scribe a circle with a diameter equal to the measurement made in step 1, and then ...

... center punch the center of the circle.

Scribe another circle with a radius of 1.4 cm, then ...

... with the same compass setting, carefully divide this circle by six equally spaced points. Center punch these points.

3. Using the same piece as in the previous step ...

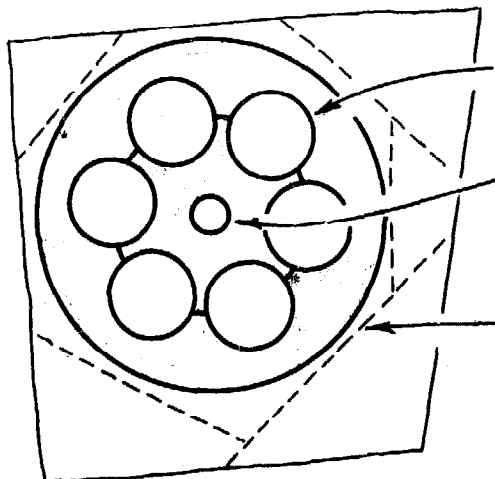

... drill six $\frac{1}{2}$ " holes and ...

... drill a $\frac{3}{16}$ " hole in the center.

Cut around the circle with a hacksaw and file this circle smooth so that this piece fits snugly into the end of the nipple.

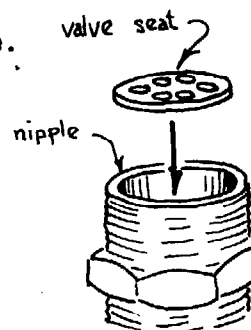

4. (fastening the valve seat in the nipple)

After preparing the surfaces by removing any grease, glue the valve seat so that it is flush with the top of the nipple ...

... then set the nipple upside down on a flat surface to dry.

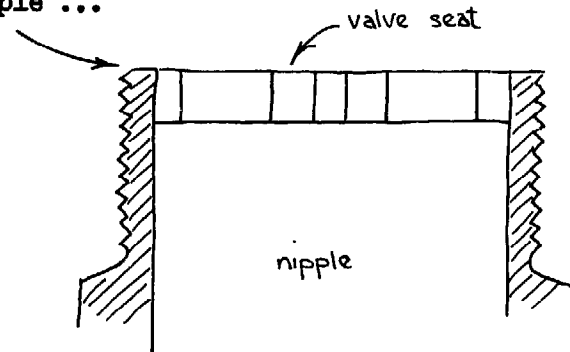

5. After the epoxy has dried ...

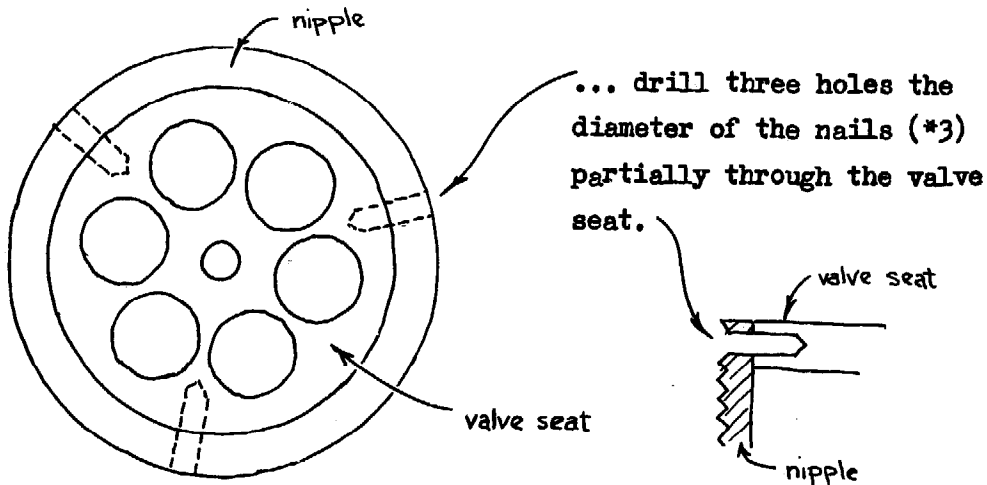

6. Cut three lengths of nails (*3)

long enough to fit into these holes but not so long that they interfere with the threads of the nipple. Glue these nails in position with epoxy and let dry.

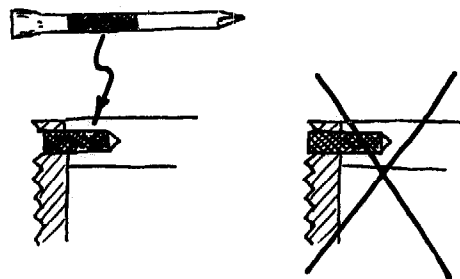

7. Once the epoxy has dried, file the top of the valve seat so that it is completely flat and file away any epoxy which remains in the threads.

8. (making the valve - preparing a jig for drilling)

Take a small scrap of wood and ...

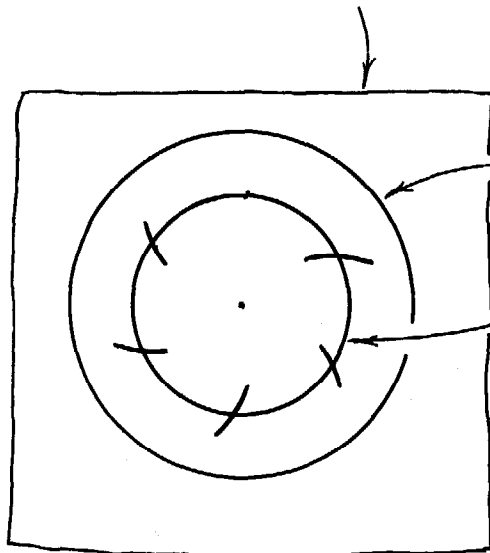

... scribe a circle with a diameter of 4.7 cm.

Using the same center, scribe a circle with a diameter of about 3.0 cm and with the same compass setting, divide this circle by six equally spaced points.

9. Sandwich a piece of insertion rubber (*9) and a piece of galvanized sheet (*8) between two pieces of wood as shown. This sandwich should either be clamped to the drill press table or else a few nails should be driven in around the outside to hold it all together.

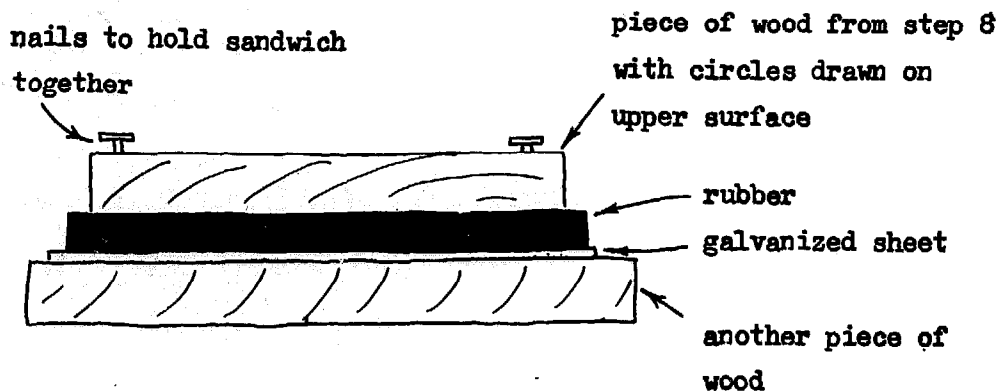

10. Take the sandwich made in the previous step and ...

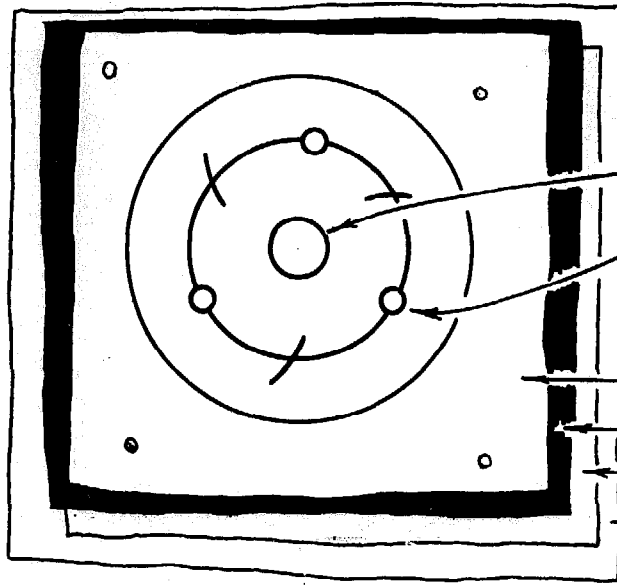

... drill a 5/16" hole in the center, then ...

... drill three equally spaced 1/8" holes.

piece of wood (step 8)

insertion rubber

galvanized sheet

another piece of wood

11. Partially redrill the three 1/8" holes to countersink a short way into the rubber for the head of the screws (*13).

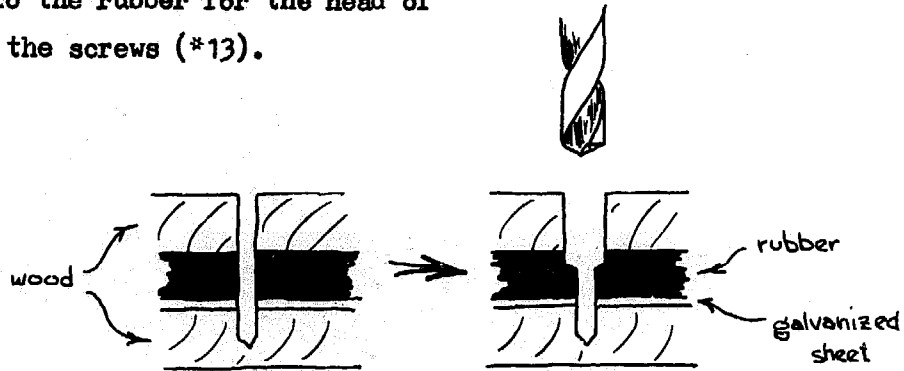

The holes must be countersunk so that the heads of the screws (*13) will end up below the surface of the rubber when assembled.

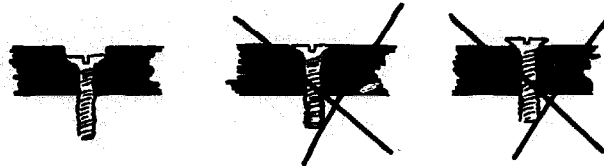

12. (galvanized disk)

Take the sandwich apart, then using the galvanized sheet from the sandwich ...

... carefully scribe a circle with a diameter of 4.7 cm with the 5/16" hole as its center, then ...

... cut around the circle with a hacksaw and file smooth.

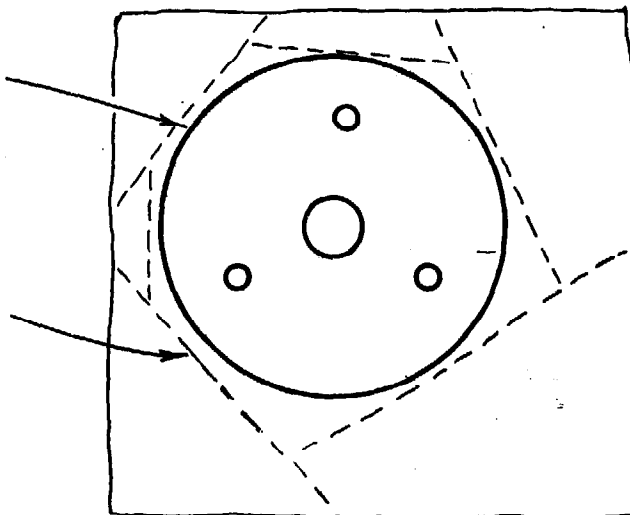

13. (rubber disk)

Align the holes in the galvanized disk with the holes in the rubber, ... then ...

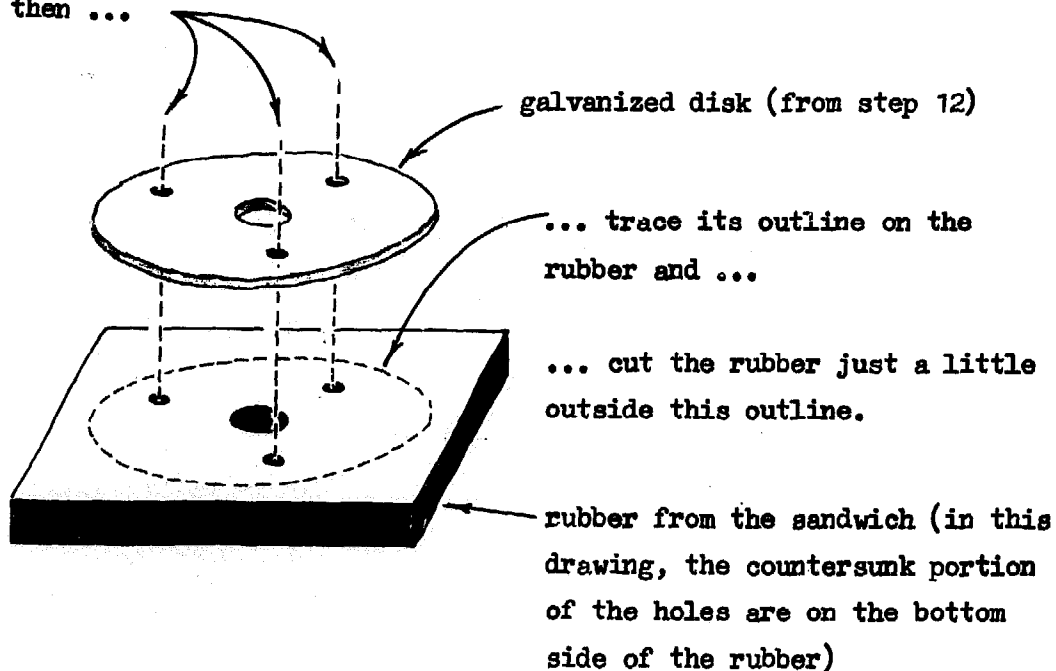

14. (assembly)

Assemble the valve from the galvanized and rubber disks. Push the three 1/8" screws (*13) all the way into the countersunk holes in the insertion rubber and loosely put on the nuts. Do not use a screwdriver to tighten the screws. If they are tightened too much, the rubber will not remain flat. Tighten them finger-tight.

Put a dab of epoxy adhesive on the nuts to hold them in place

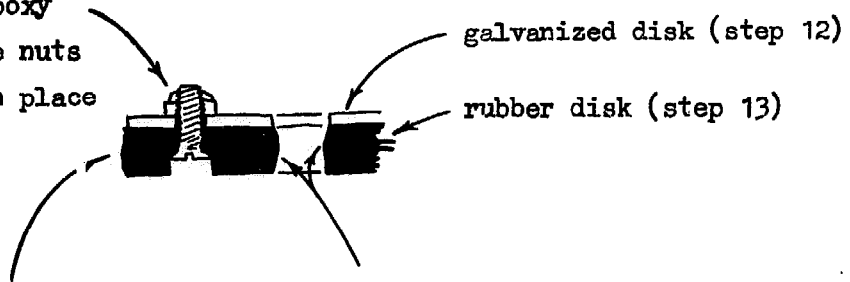

Trim excess rubber off the outside edge making sure that this edge is straight.

Trim excess rubber from the center hole with a small file.



15. (making the valve guide-- bushing)

Using the 1/4" bolt or round rod (*12) ...

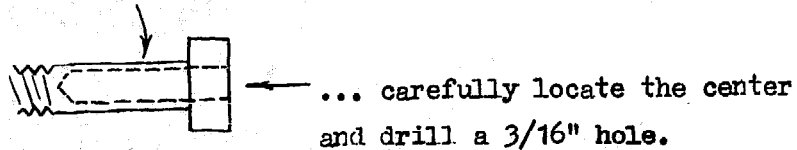

16. From this piece, cut off a section about 1.3 cm long.

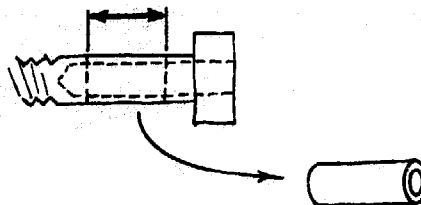

17. (valve stop)

On a scrap piece of 3 mm steel plate (*2) ...

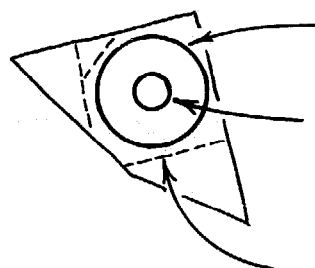

... scribe a circle whose diameter is 1.5 cm.

Center punch the center and drill a 3/16" hole and then ...

... cut around the circle with a hacksaw and file smooth.



18. (assembling the check valve)

Put together the entire valve assembly as shown below.

The valve should
move up and down
very freely

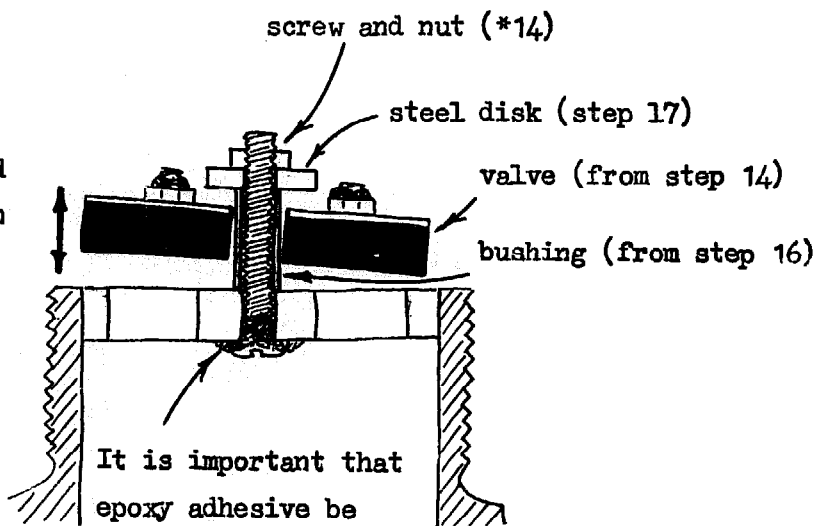

It is important that epoxy adhesive be applied around the head of the screw and on the portion of the thread next to the head before it is inserted, otherwise the valve may leak.

The screw and nut (*14) should be well tightened.

19. Using both a screwdriver and a wrench or pliers, tighten the nut securely. The screwdriver is necessary since the epoxy itself may not hold the screw in place.

Cut the screw a little above the nut and use a center punch to widen the end of the screw slightly. This should prevent the nut from unwinding off. When center punching, rest the head of the screw on a securely held metal rod.

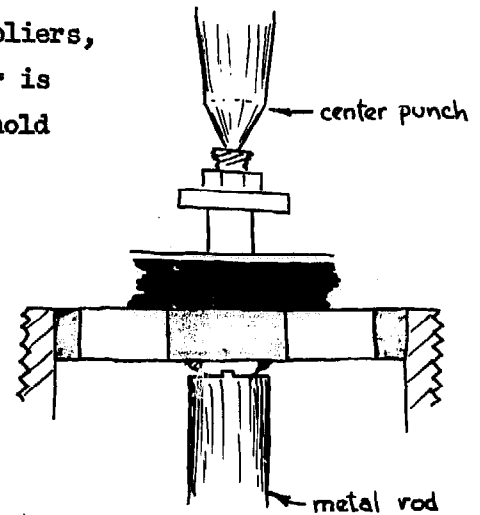

20. (making the snifter valve)

Measure the diameter of the cotter pin or nail (*15) and through one side of the nipple, drill a hole slightly larger than this measurement. (See also NOTES (2), p. 34)

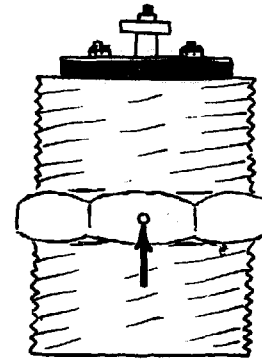

21. Insert the cotter pin or nail through this hole and bend the end. This piece should be free to easily move in and out of the hole about half a centimeter. (Also see note on p. 36.)

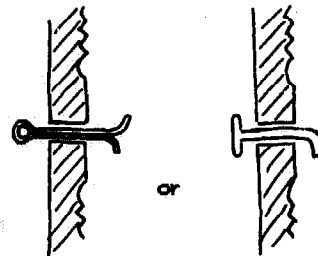

RAM PUMP ASSEMBLY

The pipe fittings listed on p. 3 and the two valves described in the preceding pages are assembled as illustrated on that page. The nipple is installed so that the check valve is on top. Teflon tape or a jointing compound should be used on all threads before screwing the fittings together. The joints at both ends of the half meter length of pipe must be completely leakproof, otherwise the pump may fail to operate properly. Probably the easiest way to verify that the joints are leakproof is to observe the joints for signs of leaking while the pump is in operation. Aside from these two joints, the others are not critical.

When installed on site, the body of the ram should be secured fairly firmly to the ground and both the waste and check valves must be maintained in a vertical position.

PERFORMANCE INFORMATION

Test Installation

The hydraulic ram pump described in this bulletin was installed for testing as illustrated below. The level of water in the stand pipe was maintained at the desired drive head. The drive pipe consisted of about two lengths of galvanized iron pipe leading to the pump. Variable delivery heads were simulated by imposing a known pressure (corresponding to the desired delivery head) on the output.

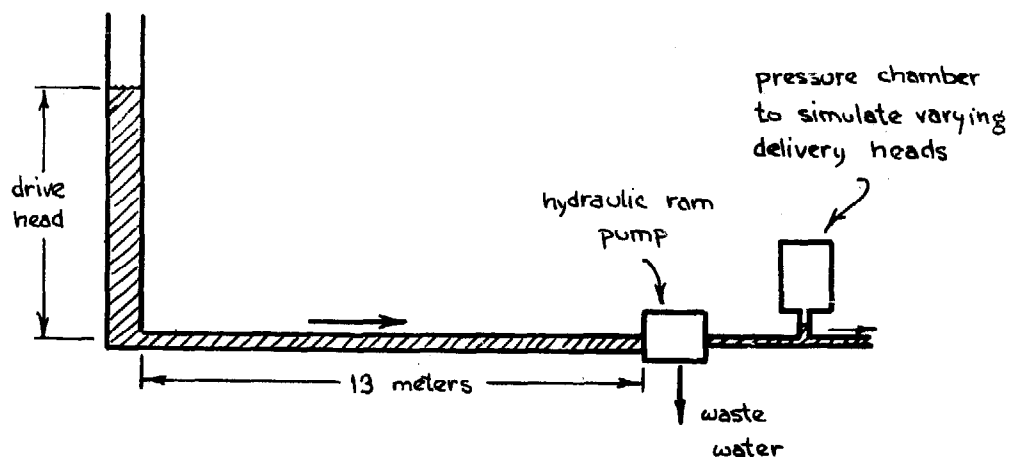

Performance Data

The data presented on the graph on p. 27 is for the ram operating with a 10 mm valve stroke. This valve stroke is the distance the waste valve is permitted to move up and down. It can easily be adjusted to either increase or decrease the rate at which water is used and the rate at which water is delivered by the pump from the values from the graph. Adjustment of the valve stroke is explained on p. 28.

How to Use the Graph

Use of the graph on the next page might best be explained by the use of an example. Suppose that a ram pump with a $1\frac{1}{2}$ " drive pipe is to be located so that the drive head down to the pump is 3.0 meters and the water has to be pumped up to a height of 35 meters above the pump. (Note that the actual length of the delivery pipe may be much longer than 35 meters.)

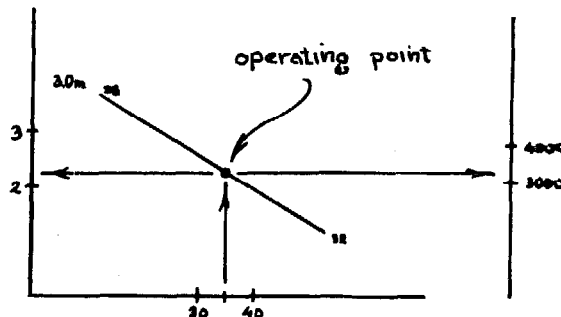

- (1) Find the delivery head along the bottom of the graph.
- (2) Move straight up until the appropriate curve for a drive head of 3.0 meters is reached. This locates the operating point.
- (3) To determine the delivery rate, read the scale directly to the left (about 2.2 liters/min) or to the right (about 3200 l/day).
- (4) To obtain an estimate of how much water will be used by the pump, note the position of the operating point between the two numbers at the end points of the curve and interpolate (about 35 liters/min).

RAM OUTPUT

with the valve stroke set at 10 mm

(Note that the rate at which water is delivered can be increased above that indicated in this graph by increasing the valve stroke, see p. 28.)

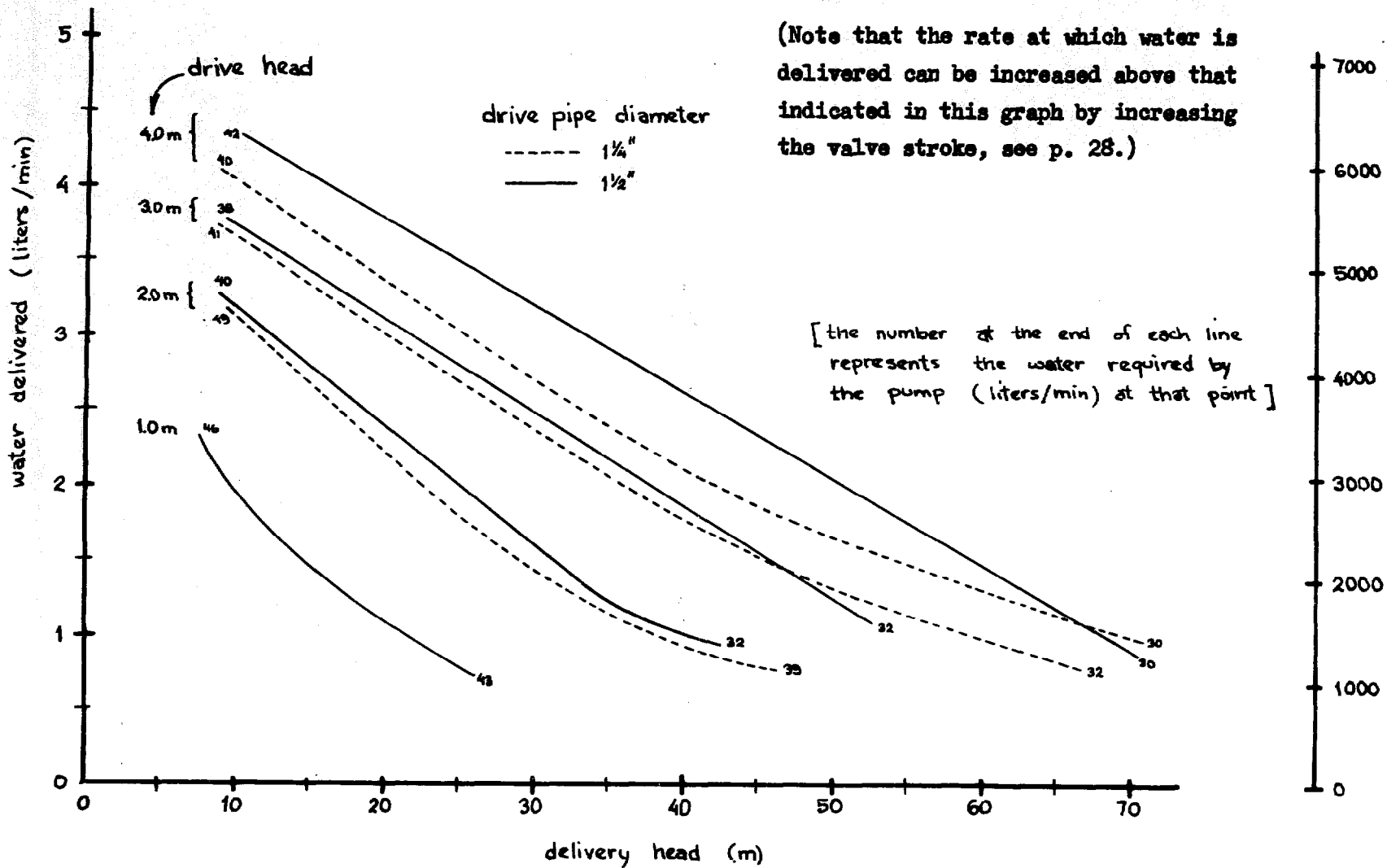

The exact drive and delivery rates for another installation depend on the length and diameter of the drive pipe and delivery pipe. A good estimate of the pump's performance should still be available from the values off the graph.

Adjusting the Valve Stroke

The graph on the previous page only gives performance figures for a valve stroke of 10 mm. But the actual delivery rate can be changed somewhat by varying this stroke. This can be done either by:

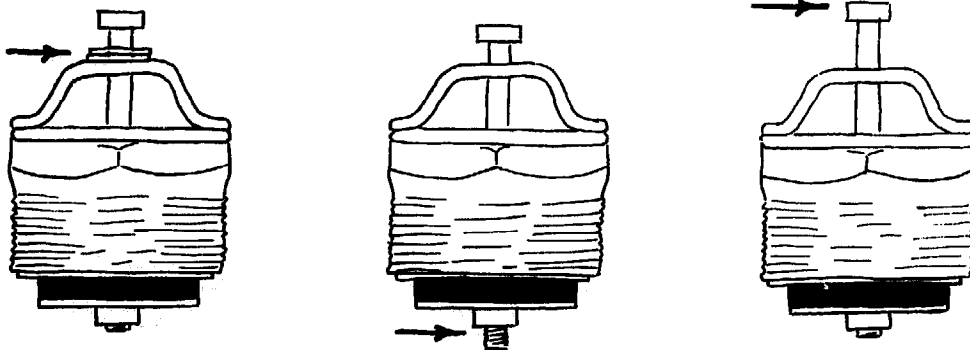

- (1) adding or removing washers
 (2) moving the valve up and down along the threaded portion of the bolt
 (3) using a longer or shorter bolt

Generally, given a site with a specific drive and delivery head, the rate at which water is delivered and the rate at which water is used by the pump both increase by increasing the valve stroke. They will both decrease by decreasing the valve stroke. However the rate at which water is delivered by this pump can not be increased indefinitely by increasing the valve stroke. With increasing valve stroke, the pump's efficiency decreases and the rate at which water is delivered reaches a maximum and then decreases.

The graphs below are included to illustrate a typical variation of drive and delivery rates, efficiency, and frequency (strokes per minute) with valve strokes.

drive head = 2.0 m
delivery head = 20 m

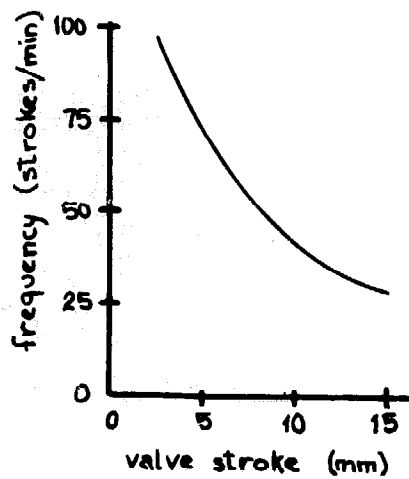
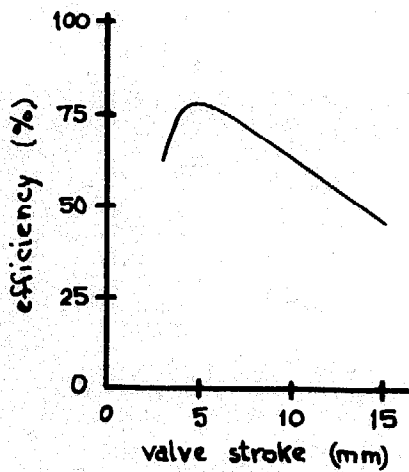
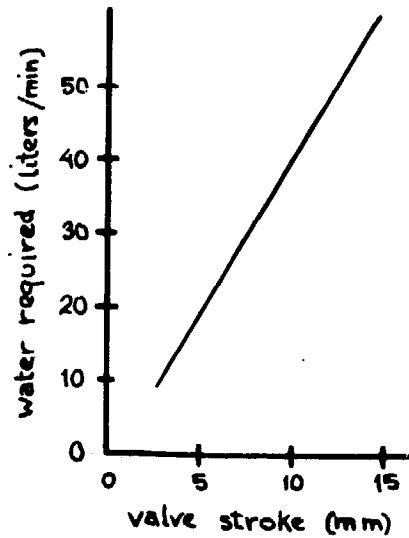
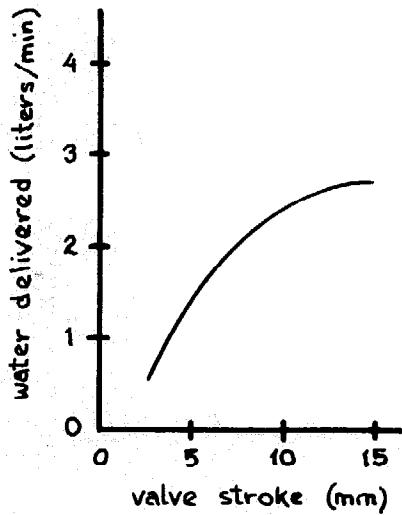

Effects of Other Variables

(1) size of air chamber

The half-meter length of 2" pipe used as the air chamber for this ram seems to be perfectly adequate for the flows delivered by this pump. Increasing the size of the air chamber seems to have negligible effect on its performance.

(2) drive pipe diameter

From the points of view of cost and weight, the smaller the diameter, the better. However, drive pipe diameter also affects the ram's performance. A drive pipe with too small a diameter restricts the flow of water to the pump with the result that the pump delivers less water.

The graph at the right illustrates the effect of the diameter of the drive pipe at the test installation on the rate at which water is delivered by the pump. A large diameter pipe proves an advantage only in cases where larger flows are desired.

It should also be noted that the length of the drive pipe also affects the ram's performance. If a much longer drive pipe is used, its diameter must also be larger to keep losses down.

When low drive heads are used (about a meter or less), friction losses in the drive pipe become more important since there is less head available to overcome them. A larger diameter drive pipe is then necessary to reduce losses and permit sufficient water to reach the pump. (The reason why, on the graph on p. 27, there is no curve for a drive head of 1.0 meters when using a $1\frac{1}{4}$ " drive pipe is that there is insufficient water flowing through to the pump to operate it. This problem is overcome by using a larger diameter drive pipe.)

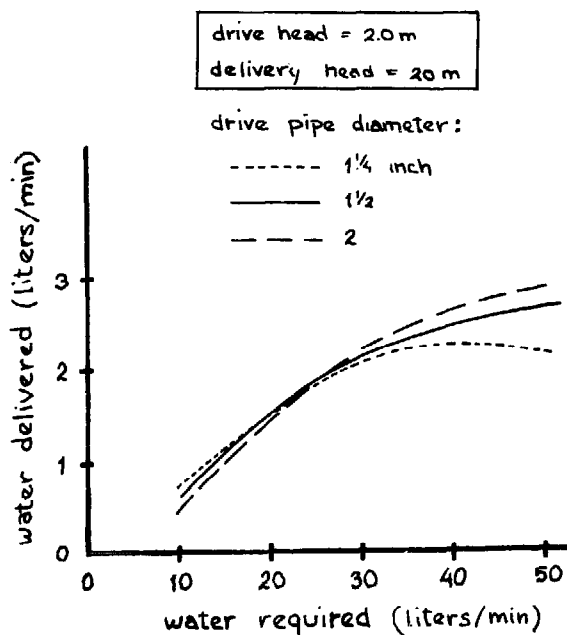

Pipe diameter also has an effect on the valve stroke frequency as is illustrated by the graph at the right. Higher valve stroke frequencies are encountered with larger diameter drive pipes. This may imply a faster wear of the valve shaft and seating rubber (but this is probably of little consequence since wear is small and the parts can be easily replaced).

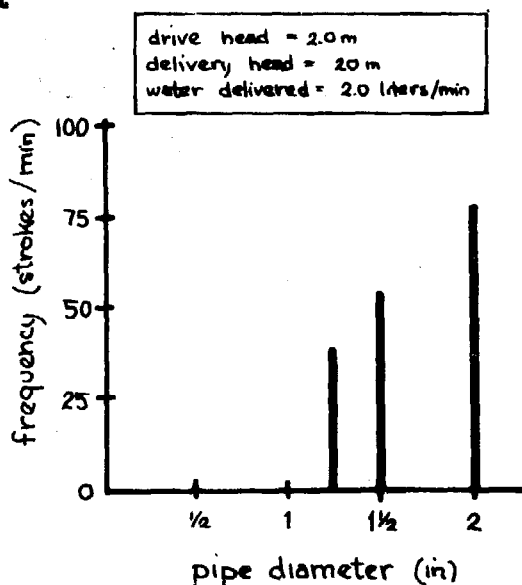

(3) mounting of the ram pump

It is preferable to securely mount the ram pump so that it will remain in its proper operating position in spite of possible tampering, heavy rains or floods, etc. However, tests indicate that whether the pump is rigidly bolted to a concrete foundation or less rigidly secured to a wooden base seems to have little if any effect on the pump's performance.

(4) mass of the waste valve plunger

Increasing the mass of the waste valve plunger by using larger and therefore heavier components has the same effect on the pump's performance as increasing the valve stroke, i.e. it reduces the operating frequency of the ram and generally increases both the quantity of water used by the ram and the quantity delivered by the ram. But for low drive heads or for a drive pipe of too small a diameter, too heavy a plunger might prevent the operation of the pump altogether.

If operating frequencies prove too high (as might be the case with drive heads much larger than 4 meters), the quantity of water delivered by the ram would be small. Though increasing the mass of the plunger would decrease the frequency and increase the rate at which water is delivered, this might possibly reduce the life of

the valve because of the increased inertial forces as the valve closes repeatedly. For such operating conditions, use of a spring would be a better solution, see p. 33.

(5) use of PVC drive pipe

Several trial runs were made using a $1\frac{1}{2}$ " diameter, class 12 rigid PVC pressure pipe (pressure rated to a head of 120 meters). Though it is known that the commonly used galvanized iron pipe is more efficient than PVC, it was felt that use of PVC could prove advantageous on occasions when ram components have to be carried on foot to remote areas.

From the limited testing, it is apparent that though the PVC drive pipe is less efficient as expected, the difference is not enormous. The graphs at the right compare the pump's performance using $1\frac{1}{2}$ " diameter drive pipes of galvanized iron and PVC. Note that in the second graph, the valve stroke is set at 10 mm and that it is possible to somewhat increase the rate at which water is delivered by the ram by increasing this valve stroke.

This data implies that rigid pressure PVC pipe could be used for a drive pipe if necessary. However since

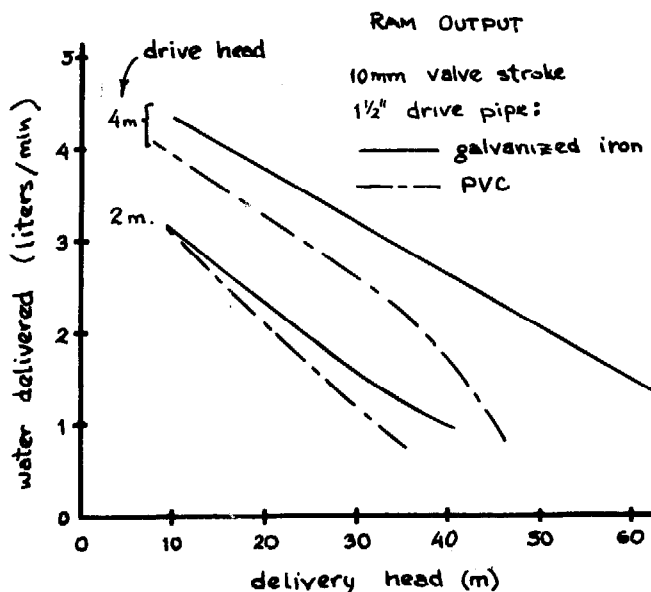
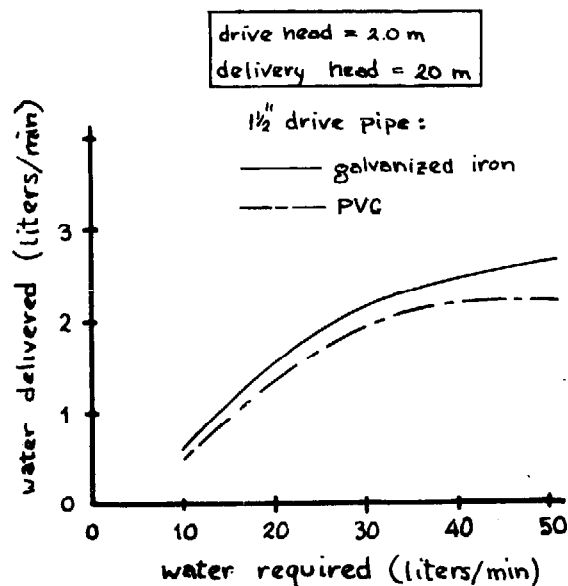

durability tests have not been carried with the PVC drive pipe, it is difficult to state here how much, if any, the life of the pipe would be reduced by the operation of the ram.

If PVC is used, it must be covered with ground or otherwise, both to lend some rigidity to the pipe and to protect it from the sunlight which tends to considerably reduce its life.

NOTES

(1) spring loading the waste valve

If the ram is to be used for drive heads much in excess of 4 meters, operating frequencies become high and the rate at which water is delivered consequently decreases. To increase this rate, a square ground compression spring can be inserted as shown. Because of exposure to air and water, this spring should be made of stainless steel or other rust-free alloy. This spring will keep the valve open longer, increase the quantity of water used by the pump and increase, to a point, the quantity of water delivered. If it is desired to increase the tension, washers need simply be used as is illustrated in the second drawing at the right.

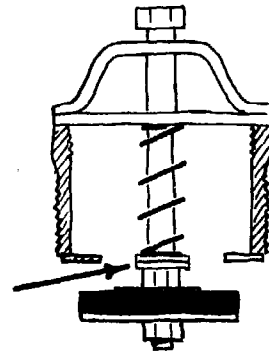
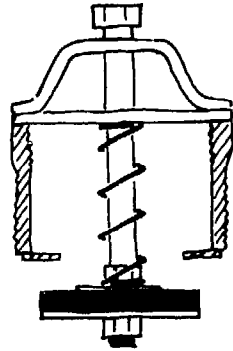

The spring used should have a spring constant of about 10 newtons/cm or 5 pounds/inch. Such springs can be custom-made at low cost by springmakers if the spring constant, the length, and the diameter of the spring are specified.

(2) size of the snifter valve

The exact size of the snifter valve depends on a number of factors but it is not critical. If the hole is too small, the air chamber will fill with water and the ram will pump with a loud, metallic sound, completely different from the sound of a properly operating ram. If this should happen, either drill the hole of the snifter valve slightly larger or use a nail or cotter pin with a slightly smaller diameter.

If the snifter valve hole is too large, then the ram will start operating less efficiently.

(3) comments on the VITA (by Kindel) and ITDG ram designs

Below are briefly described the motivation behind several of the changes made to the VITA and ITDG designs to arrive at the design described in this bulletin:

(a) design of the waste valve

By the nature of its construction, it is difficult to have the spring loaded waste valve squarely strike the valve seat on a continual basis. Consequently, in spite of rounding the lip of the valve seat, it was found that the valve rubber would shear fairly quickly (insertion rubber with a 1/8" thickness would shear in about a month when operating full-time under a two-meter drive head). This was especially pronounced with higher drive heads. The short life of the seating rubber may not have been as pronounced with the VITA or ITDG rams because a smaller diameter waste valve hole resulted in lower forces acting on the plunger. Also Kindel (VITA) may have found in tractor tire rubber a more durable seating rubber than the insertion rubber used in the design presented in this bulletin. However, the smaller diameter waste valve hole resulted, according to tests, in both lowered efficiency and output of the ram.

(b) design of the check valve

The ITDG design appears robust and does away with both the machining required by the VITA valve and a moving part. However, except for low delivery heads, it was found that the back pressure in the air chamber would force portions of the rubber washer slightly down through the holes in the valve plate. This both tended to cut the rubber and to give it permanent bulges until it would not seat properly. This problem was eliminated in the design presented in this bulletin by placing a backing plate on the rubber washer to distribute the back pressure load evenly over the valve seat.

(c) size of the air chamber

Besides introducing more difficulties in the construction, the 3" diameter air chamber used in the VITA design is unnecessarily large for the volume of water delivered by the pump. The one meter length of 2" pipe used in the ITDG design is more of the proper size if that ram can actually pump the volumes of water that it is implied it can. For the volumes pumped by the design described in this bulletin, a half-meter length proved completely sufficient (see p. 30).

(d) basic configuration of the ram

The configuration used in this design is very close to that used with the ITDG ram. The configuration used in the VITA design proves unnecessarily involved.

(e) waste valve adjustments

Both the VITA design and the ITDG version of it require two adjustments, the valve stroke and the spring tension. Tests indicate that this unnecessarily complicates the adjustment of the ram. Efficiency and output of the ram are primarily a function of the ram's frequency (other factors being equal) and whether this is changed by tightening the spring tension or increasing the valve stroke seems unimportant. This can even be verified from the limited test results presented at the end of the ITDG design manual.

(4) durability

To obtain an indication of actual or potential problem areas arising from long-term use of the ram, various versions of the ram have been operating continually for a month at a time. It is now felt that these problem areas have been resolved in the design described in this technical bulletin. Future field testing will determine what further difficulties arise from wear and corrosion.

The only potential source of trouble sensed so far might be with the valve seat of the check valve where rusting may limit its life. This could be overcome by making the valve seat of $\frac{1}{4}$ " brass, aluminum, or stainless steel plate rather than ordinary $\frac{1}{4}$ " steel plate.

(5) modification of the snifter valve

If an old inner tube is available, the cotter pin or nail (*15) can be pushed through a small piece as shown. This will prevent most of the water which otherwise escapes through the snifter valve at each stroke of the waste valve. Though this has a negligible effect on the improvement in efficiency of the ram, it keeps the area around the ram a little drier.

