

AT MICROFICHE REFERENCE LIBRARY

A project of Volunteers in Asia

Dry It, You'll Like It

by: Gen MacManiman

Published by:
Living Foods Dehydrators
P.O. Box 546
Fall City, WA 98024 USA

Paper copies are \$ 4.00.

Available from:
Whole Earth Household Store
Building D
Fort Mason Center
San Francisco, CA 94123 USA

And from:
META Publications
P.O. Box 128
Marblemount, WA 98267 USA

Reproduced by permission of MacManiman Inc.

Reproduction of this microfiche document in any form is subject to the same restrictions as those of the original document.

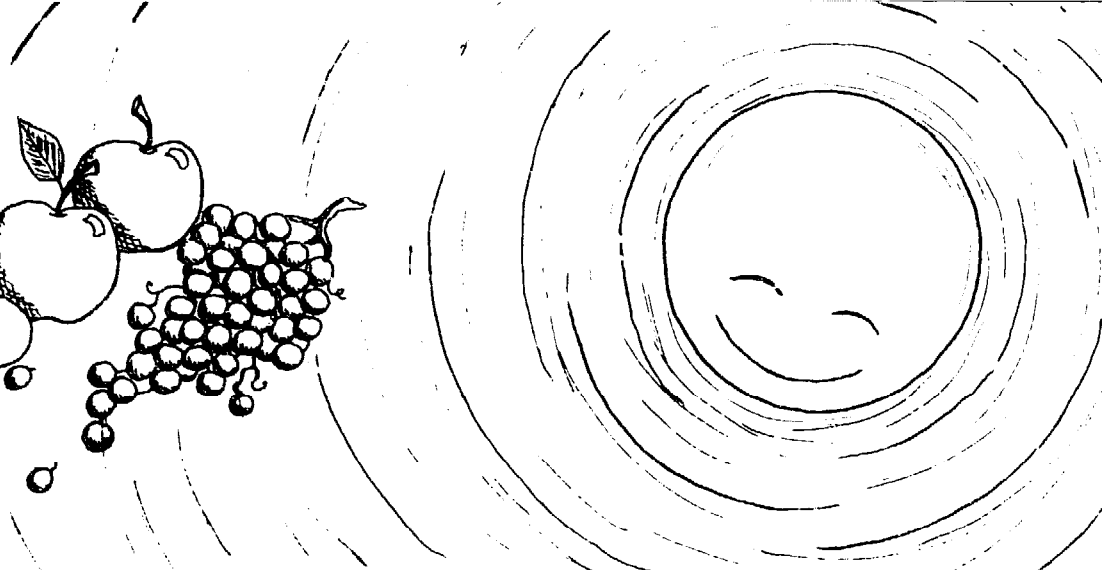
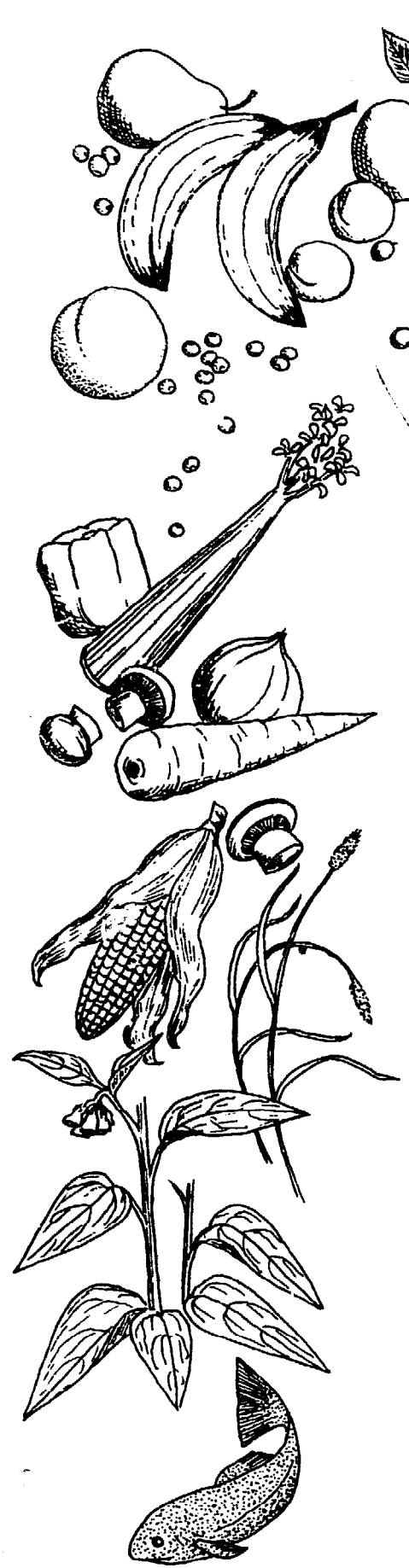

DRY IT

— YOU'LL LIKE IT!

... A BOOK ABOUT DEHYDRATING
FOOD, INCLUDING RECIPES &
PLANS FOR BUILDING YOUR OWN
FOOD DEHYDRATOR

BY GEN MACMANIMAN

DRY IT

→ YOU'LL LIKE IT!

A BOOK ABOUT FOOD DEHYDRATION

BY GEN M~~A~~MANIMAN

FALL CITY, WASHINGTON 98024

U.S.A.

Published by LIVING FOODS DEHYDRATORS
P.O. Box 546
Fall City, Washington 98024

Copyright © 1974 by Gen MacManiman

Printed by Evergreen Printing Company
Seattle, Washington

This book is brought to you with love
from

Paula B. Calderón
Printing, artwork & compilation

Bob MacManiman
Designer, Living Foods Dehydrator

Edward Veasey
Plans & construction details

Gen MacManiman
"Seed woman"

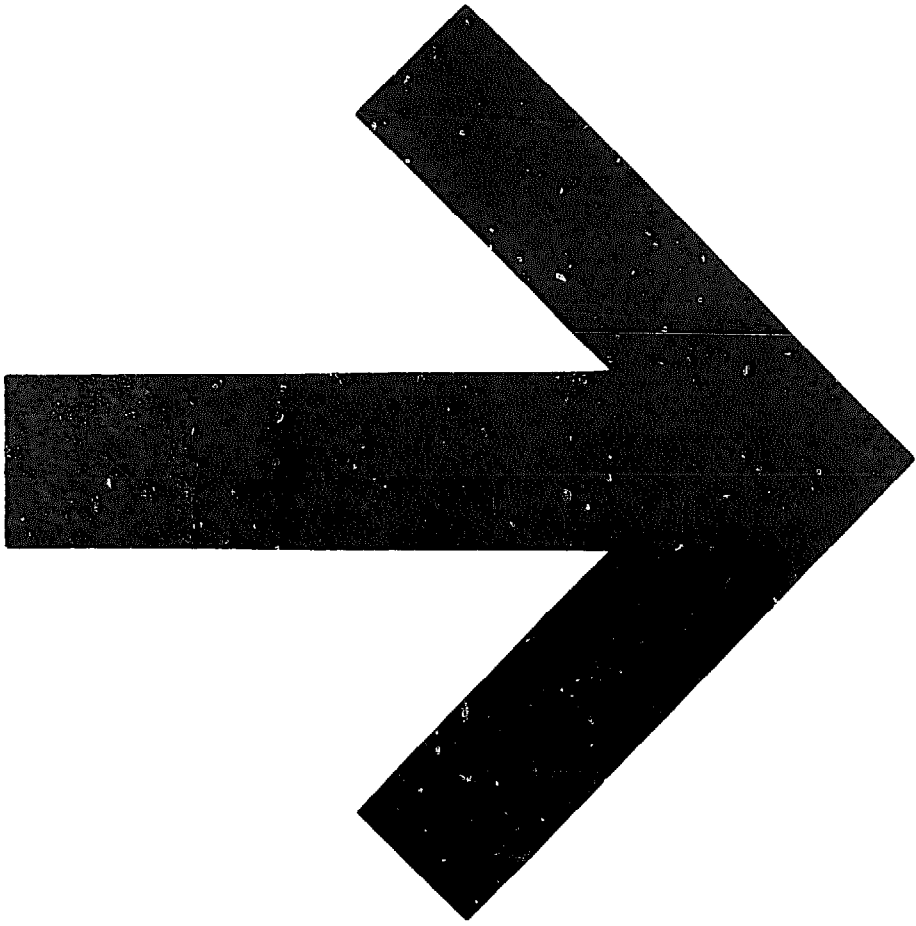

CONTENTS

Getting Started	iii
GENERAL INSTRUCTIONS	
Temperature control	1
Ventilation	1
Tray care	2
Load limits	2
Tray rotation	3
Very juicy foods	3
Strong-smelling foods	4
Storing dried foods	4
FRUIT	
<u>Apples</u>	7
Basic Apple Leather	8
"Apple Butter" Leather	8
Apple-Raisin (or Date) Leather	9
Apple-Fruit Combination Leathers	9
Raw Fruit "Sauces"	9
<u>Apricots</u>	10
Using dried apricots.	10
Apricot Leather & variations	11
<u>Bananas</u>	12
Buying	12
Methods of drying.	12
Banana Leather & variations.	13
Banananut Freezecake	13
<u>Berries</u>	14
General Information.	14

Making berry leathers	14
Apple-Berry Leather	14
Banana-Berry Leather	14
Keeping berry leathers	15
Drying berries	15
Currants	15
Cherries	16
Cranberries & Cranberry Leather	16
Cranberry-Fruit Chews	16
Grapes & Grape Leathers	17
<u>Peaches</u>	18
Peach Leather	18
<u>Pears</u>	19
Pear Leather	19
<u>Plums, Prunes</u>	20
Leathers	20
Thickening with flax seed	20
<u>Pineapple</u>	21
Buying	21
Cutting & drying	21
Pineapple "Lace"	22
<u>Rhubarb</u>	22
Rhubarb-ade	22
Using dried fruits	
Fruit Compote	23
Fruit Tidbits	23

VEGETABLES

Using dried vegetables.	24
---------------------------------	----

VEGETABLES, continued

Methods of drying (general)	25
Leafy vegetables	25
Corn	26
Green beans	26
Onion, leek & garlic	26
Tomatoes	27
Zucchini or cucumber chips	27
Blossoms	27
Vegetable Broth Mix	28
Garlic Broth	29
Mushrooms	29

SEEDS & GRAINS

General	30
Seeds & grains we keep on hand	30
Recipes	
Granola & variations	31
"14-Grain" Wafers	32
Apple & Sprout Wafers	32
Corn Chips	33
Cornapple Crisps	33
Cornapple Chews	34
Varying grain-wafer recipes	34
Cutting crispy wafers	34
Sesame-Pumpkinseed Bits	35
Storing wafers	35
Recrisping	35
Sesame-Banana Crisps	36

SEEDS & GRAINS, continued

Sesame-Sunflower Squares	36
Chia-Fruit Wafers	37
Millet Wafers	37

HEALTHY TREATS FOR GRANDCHILDREN (Confections)

Date-Nut Chewies	38
Jamie's Breakfast Cookies	39
"Cookie Base"	39
Apple Freeze	40
Carob Fudge	40
Making natural citrus flavors	41
Honeyed Orange Peel	41

HERBS

General (picking, cleaning, etc.)	42
Drying	43
Storing	44
Comfrey	44
Chickweed & Chickweed Ointment	45
Nettles	46
Using herbs	47

MEAT & FISH

Fish	48
Storing	49
Beef Jerky	49
Fowl	50
Mincedmeat Leather	50

"AFTERTHOUGHTS"

More ideas & hints 51-52

More on Using Dried Fruits: Soaking 53

New Recipe Ideas

Cottage Cheese-Fruit Combinations 54

Savory Cottage Cheese Combinations 55

Savory Tomato-Cheese Wafers 55

Your Own Pot Cheese

Complete Instructions 56-57

"On the Trail"

Dried Homemade Legume Soups 58

Chicken or Turkey Leather 59

This Page Is for Peanut Butter Lovers

Apple-Peanutbutter Leather 60

Banana-Peanutbutter Leather 60

Variations 60

LIVING FOODS DEHYDRATOR

Plans for Building:

Parts List 62-63

Directions for Construction 64-68

Drawings 69-74

WHY DRY?

We know why we like to dry foods! And depending on our mood, any of the following reasons could come first:

IT IS A FIRST-CLASS WAY TO PRESERVE FOOD: It's cheap & it's easy. Properly-dried food (uncooked, dried quickly at low temperatures) is nutritionally superior to canned food — & no preservatives or other chemicals are required. The on-going electrical drain of a freezer is eliminated. Flavor & appetizing color are maintained. One-sixth or less of the usual storage space is required. Carefully-stored dried foods will keep for several seasons.

DRIED FOOD MEANS INSTANT, TASTY NUTRITION FOR PEOPLE ON THE GO.

Whether "on the go" means lunch on the run during a day full of errands, or a quick meal on the trail with several miles to cover before dark, or a stand-up snack before vacuuming the living room — busy people need real food. Dried fruits, whole-grain wafers, a cup of broth made from dried, powdered vegetables from your own garden — these are real food! Not just empty calories, but good-tasting, life-sustaining food.

THE VARIETY OF FOODS WHICH CAN BE PRESERVED BY DRYING IS ENORMOUS. (Just page through this book!)

Fruits & berries make delicious, quick-energy eating; vegetables go into broth, soups & casseroles, & may be powdered & used for seasoning; herbs brew into delicate, healthful teas, & season many dishes; meat & fish jerky are good anytime, especially when hiking or camping; breads & cereals take the form of crunchy wafers, granola, & whole-grain cookies; confections of fruit, nuts, grains & honey delight your tastebuds and your body.

NOTHING IS WASTED when you have a dehydrator & use it — from small amounts of produce that might ordinarily decompose in a corner of the refrigerator, to an over-abundant zucchinii crop. Almost everything can be dried & used to add nutrition to future meals. And don't forget — it's a year-round activity! With herbs in the spring, berries, fruits & vegetables in the summer & fall, bananas & grains in the winter, our dehydrator is as busy as we want it to be.

We continue to be amazed at the opportunities for creativity in the field of food dehydration. A glance at the recipes in this book will give you the idea... May you have as much fun & good eating as we do!

GETTING STARTED

You will notice immediately that this book is based on a particular food dehydrator, the plans for which are included at the end of the book. But if a small-scale beginning is more to your taste, here are some ideas.

An area with a fairly constant temperature of 95° - 100° is required. To help to locate the spot, a fish tank thermometer (range of 85° - 120°) is useful.

Consider these possibilities:

- . . . top of the refrigerator
- . . . near a hot-water heater (we built a small rack over ours)
- . . . near a furnace
- . . . over a heat register, electric heater or radiator
- . . . an oven with a pilot light (ovens usually are less than ideal — too hot & not enough air movement)
- . . . a rack suspended over a wood range

You may think of others. Remember that  air flow is almost as important as heat for proper drying, & darkness, though not mandatory, is preferred (particularly for herbs). Avoid dusty areas, or devise a protective covering for your rack.

An efficient drying rack can easily be fashioned from hardware cloth, a very stiff metal mesh. Two sides

may be bent down to form "legs" if they are required. However, we suggest covering the hardware cloth with fiberglass window screen, to prevent the food from coming into direct contact with metal. Or use cooking parchment or plastic wrap, as described in the General Instructions.

These ideas should give a good start; once you've begun, you'll think of more. It won't be long before your small-scale beginning increases its proportions.

Foods dried quickly at a temperature of (usually) no more than 100° have their life-force intact. They are vital & life-sustaining. No chemicals or additives are involved — they simply are not needed. And one could hardly ask for better "shelf life." Properly packaged & stored, dried foods will keep for several seasons, & in minimal space. They are delicious & versatile.

We have learned a lot, since we began, & most of it by trial-&-error. Let us share with you the high points, so that you may avoid some obvious pitfalls & continue in your own creative fashion — sharing, we hope, your discoveries with us.

GENERAL INSTRUCTIONS

Remember that ► MOVEMENT OF WARM AIR is the principle of this dehydrator. Conditions at all times should encourage this movement of air. Foods & herbs should be arranged with open spaces between pieces to expedite drying. (After the original wilting or shrinking, materials can be consolidated to make more room available.)

► Loosely arranged material is the rule of thumb!

TEMPERATURE control requires the use of a thermometer to help the operator become familiar with management of various materials to be dried. Temperatures should range between 95° & 105° — not more* than 110° .

► The warmer temperatures require closer supervision so that drying may be stopped at the ideal point.

Temperature is controlled first by proper regulation of the heating unit, & second, by

VENTILATION. The top cover of your dehydrator is more than it may seem! It provides both work



* We want to preserve the whole food — color & flavor; yes; but complete with vitamins, minerals & enzymes.

surface & ventilation control, vital to proper dehydration. Top must be open (pulled forward) to allow for removal of moisture from drying foods, & to help control temperature. Amount of opening will vary, but usually about four inches is ample. (Top should be closed when unit is not in use, to keep interior dust-free.)

The dryer top is designed to be a functional work surface, for preparation & packaging of dried materials. The addition of a small cutting board will help to keep the top smooth & easy to clean.

TRAY CARE is simple & easy. Wiping with a damp cloth is often all that is needed. When necessary, trays can be washed & brushed in a bathtub (or outside, with a hose), towel-dried & replaced in the dehydrator to dry.

▶ Don't overload your trays! They'll hold a lot, but too much weight will cause stretching. The heavy-duty, hardware-cloth tray is designed for weightier items. Reasonable care in handling will assure a long life for the trays.

LOAD LIMITS, ETC. . . . If operation instructions have been followed, the dehydrator should work at full capacity. However, if, for instance, all trays are filled with moist fruit the drying may seem slow at first — but temperature checking & tray

rotation will assure that dehydration proceeds successfully. Tray rotation simply means to keep the food nearest completion on the bottom, so that moisture from other trays won't be transferred to the nearly-dry material. (Remember that heat, & moisture with it, rises.) Turning trays a quarter-turn each time you check the contents of your dryer, will also help ensure even drying.

DRYING VERY JUICY FOODS (fruit leathers, etc.) is easy with the help of a plastic wrap like Saran or Handi-Wrap. 12" x 18" is the approximate size to use on each tray. Fastening the edges here & there with masking tape helps to prevent their curling over the drying food. Parchment paper, such as that used by bakeries, is excellent for "baking" Granola (& Breakfast Cookies ~ see the recipes!).

► There is a best method for using either plastic wrap or parchment paper for efficient dehydration: using the 12" x 18" pieces, place the plastic on the extreme right or left half of the tray, alternating sides with each successive tray (ie., right half of bottom tray, left half of next higher tray, etc.). This will create a back & forth air flow for faster dehydration. Remember ~ although you may carefully space food on top of the paper, the paper itself will

block air flow ~ so don't cover much more than one-half of the tray with the paper or plastic.

ALWAYS LEAVE SPACE ON A TRAY OF DRYING FOOD FOR AIR FLOW! THIS IS ESSENTIAL!

STRONG-SMELLING FOODS, such as fish, should be dried separately & are best not placed directly on trays (use the parchment or plastic wrap). Wash trays after such use to be sure that any odor or residue will not affect the flavor of whatever is dried next.

► CAREFUL STORAGE is vital for keeping foods at peak quality. Correct storage must eliminate moisture, air & light, & at the same time remain convenient. For this purpose, fairly heavy plastic bags are both functional & reuseable.

Store ► small quantities of everything ~ an amount suitable for your own family's needs. This not only makes it simpler for you to use your stored food, but also prevents contamination of large amounts of food should a small quantity, for any reason, begin to spoil. [This is real food ~ no added colors, no chemical preservatives ~ & it can be mighty tempting to a bug! Careful storage will prevent possible insect infestation.]

Putting the food or herb into a small brown paper bag is an ideal first step: the paper both shuts out light & prevents long-term contact of food with plastic, avoiding possible interaction. Fold the bag snugly about the food, then put it into a plastic bag of similar size. Tightly fasten the plastic bag with a twist tab, or fold top down & seal with masking tape. Several small packages may then be put into a large plastic bag, to be sealed in similar fashion. For long-term storage, this bag should go into a third plastic bag, to make three fairly heavy layers of plastic to protect the food; or a large air-tight container would do a good job.

Glass containers are excellent, too, but they do require more shelf room. Careful consideration must be taken to seal jars securely, so that no air or moisture can enter. With all the stored foods, & especially your herbs, ► darkness is vital.

Storing fruit leathers is simple enough... roll your leather first in waxed butcher paper, then put it into plastic bags as required.

Short-term storage, obviously, is less critical & allows for some modification of the rules... No need for three layers of protection if you plan to munch it up within the week!

If at any time an opened package of dehydrated food is less crisp than desired, it can always be re-crisped in the dehydrator. (This is important when grinding herbs & vegetables into powder... They must be completely dry.)

LABEL EVERYTHING! Labeling is part of packaging. It is quite disconcerting to pick up a lovely package of herb tea and wonder just what it is! (When drying several kinds at once, this can happen within minutes of bagging it.) In the herb kingdom there are many look-alikes and even smell-alikes.

▶ The correct name and date, on every package, should be apparent at a glance.



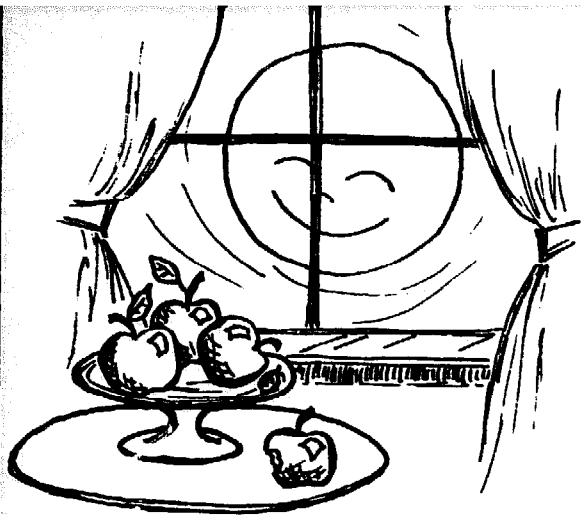

Where better to begin?

APPLES

Apples are the most versatile of all fruits (Johnny Appleseed knew!) Dried apples are no different. . .

APPLES ~ You can slice 'em, dice 'em, chunk 'em, leather 'em & combine 'em ~ with other fruits, with seeds, nuts & grains. They make a binder for dried wafers & confections.

Dry them SLICED, DICED, CHUNKED, even SHREDDED.

▶ 1/4-inch slices are about right. (Keep pieces close to the same size for even drying.) With diced & chunked apples, the smaller pieces dry faster & quality is preserved.

Dry everything ~ even peels & trimmings.

▶ Approximate drying time is about two days.

To use dried apples for a mild, good-tasting juice, just soak apple parts in water (this is where you may use the trimmings.)

A thin slice of apple dried crisp makes delicious munching.

To soften for eating out-of-hand, pour a little water over fruit, drain & let set a few hours in a covered jar. Or

simply leave the package open a day or two & let the moisture in the air soften the apples.

★ APPLE LEATHER (PLAIN)

(This is a basic recipe.)

... a "scroll" of dried puréed fruit. Chewy, delicious, & so simple!

Prepare about one quart chopped apples, removing cores but not skins. Place just enough water in the blender, with a few apple chunks, to start the blending action... keep adding apples until consistency is that of good applesauce.

▶ Prepare plastic wrap: about 12" x 18" held down to tray with a bit of masking tape, to prevent curling. Spread apple purée evenly onto plastic (about 1/4" thick — it gets thinner as it dries).

▶ Approximate drying time: about two days.

VARIATIONS! (This is the fun part)

"APPLE BUTTER" LEATHER

... to the blended apples add:

2 Tbsp. cider vinegar or lemon juice

2 tsp. mixed spices (such as pumpkin pie spice, or your own blend — coriander, nutmeg, etc.)

1/4 cup honey, or to taste

Continue as in basic leather.



APPLES

APPLE-RAISIN (or DATE) LEATHER

- ... soak one cup raisins (or chopped dates) until soft, in water to cover. Blend with the soaking liquid, adding apple chunks until consistency is like thick applesauce.
- ... Proceed as for plain leather.

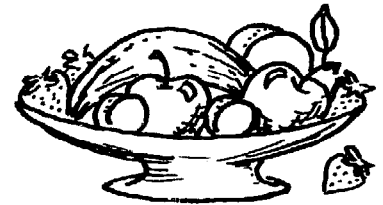

APPLE-FRUIT COMBINATION LEATHERS

- ... Start with a one-to-one ratio; adjust to your own taste... Try blending apples with pitted prunes, dates, plums, peaches, apricots; with bananas... berries... Try them all!

IF IT TASTES GOOD IN THE BLENDER, IT WILL TASTE GOOD AS A LEATHER!

- Blend juicier fruits first, & no water will be needed to start apples blending (for instance, bananas require no water to blend).

... You may wish to blend "seedy" berries alone, then strain & return to blender before adding apples. But remember that seeds are an excellent, concentrated food!

In the making, all of these leathers are delicious sauces, and you may wish to enjoy them that way. Sprinkle a few ground nuts on top for a beautiful raw breakfast.





APRICOTS

— golden nuggets from a nutritional gold mine! Don't forget that the seed, with its strong, almond-y flavor, is almost as important as the fruit in its value to your perfect health.

DRIED, the apricot becomes a year-round delicious fruit, well worth what it may cost in money & effort... organic & tree-ripened, of course!



TO DRY...

Small pieces dry faster & the finished fruit retains its color & flavor. So ► cut small ~ halve the halves, & sometimes even halve the quarters.

► APRICOTS need to be quite dry to KEEP.

Dry until quite hard & completely moisture-free.

STORE in small plastic bags inside of larger ones (several small bags of fruit inside one big one make any amount you wish available easily). Even then, it is well to store inside an airtight container.

CORRECT STORAGE IS SO IMPORTANT!

TO USE THE DRIED FRUIT... soften overnight in water to cover. Enjoy as is, or use the softened fruit & liquid to make leathers or binder for wafers, etc.

APRICOT LEATHER

... So chewy & flavorful with nothing added; the taste is a sweet/tart combination hard to beat!

▶ If the fruit is ripe & soft, the pitted halves will blend with no added liquid. The rule-of-thumb is to begin with enough fruit to get the blender action started; then add a few pieces at a time (blending continuously) until blender capacity is reached.

Pour the purée onto prepared plastic wrap (see General Instructions), smoothing with spatula or jiggling tray until about 1/4" thick — it always varies slightly. If you have a large amount of purée, make more than one leather.

▶ The thicker the leather, the chewier it will be, & the longer the drying time. Thin leathers will dry in less than 24 hours.

~ VARIATIONS ~

- ... honey to sweeten, to taste
- ... combined half & half with apples (add coriander)
- ... add one cup chopped dates to blended apricots
- ... half & half with raspberries (strain out seeds); add honey (this may dry a bit sticky, but we promise no one will mind!)



▶ Apricot purée makes a perfect binder for confections.

Bananas

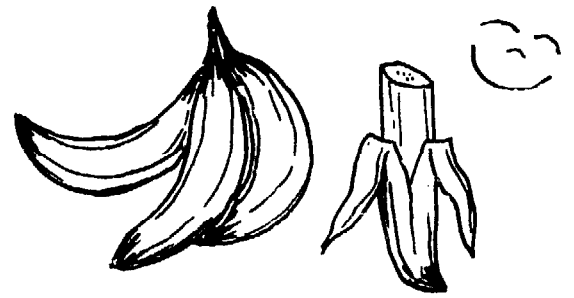

So sweet & versatile! Stalk the markets for bargains of ripe & "overripe" bananas . . . when natural ripening has transformed hard-to-digest starch into sweet, natural sugar. Banana bargains often occur in winter ~ keep you & your dryer busy when local fruit is not available.

DRY WHEN THE BANANAS ARE BEAUTIFULLY SPOTTED WITH BROWN!

There are several methods:

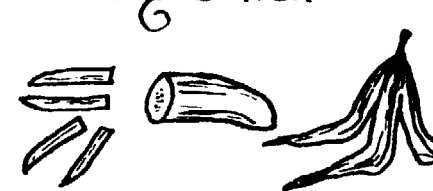
1. Slice directly onto tray (no overlapping) & let dry completely before removing. They may appear to stick, but when dry are easily removed. This method gives excellent color to the finished product.
2. Dry peeled, whole bananas for a day; then stack several at once for mass slicing. This method seems to give chewier consistency to banana bits.
3. "Banana sticks" are made by quartering a half-banana the long way . . .  These pieces dry fastest of all, & do not stick when laid on tray with cut side up. Fun to eat!

☀ BANANA LEATHER ☀

Absolutely no need ever to waste another banana!

▶ Blend your very ripe bananas (those soft, brown-skinned ones) in blender with no added liquid. A wedge of organic lemon (with peel) will give a special flavor.

Pour onto plastic wrap & spread thin... that's all!
Dries in less than 12 hours.

Banana leathers lend themselves to some luxurious VARIATIONS... Try these (for a start!):

- ... Throw in a handful of walnuts at the very end of the blending, so they'll be chunky, not pulverized.
- ... Combine with any tart fruit — apples, apricots.
- ... Play with spices & flavorings — vanilla, coriander...



Roll this one over your tongue!

BANANANUT FREEZECREME

Soak ▶ 4 oz. dried bananas in enough water to make 1½ cups of bananas & liquid

Blend soaked bananas & add ¼ cup oil, 1 tsp. vanilla, & ¼ cup honey... blend in thoroughly. Add 1 cup walnuts & blend briefly (so nuts will still be chunky).

Serve as is, or ▶ soft-freeze, for a most surprising, delicious, creamy, marshmallowy dessert!

BERRIES*

* all kinds —
plus GRAPES
& CURRANTS

IN GENERAL (READ THIS; IT'S IMPORTANT):

Berries are usually so juicy you'll use them in ways slightly different from other fruits. They're excellent for "spiking" leathers — especially apple, which has enough natural pectin to compensate for the extra juiciness.

▶ When making an all-berry leather, it's best to add pectin (or you might experiment with ground flax seed or other meal for thickening). SEE "Grape 'Jam' Leather" in this section.

The following ideas should get you off to a fine start . . . As for flavor combinations, your own tongue is of course the very best judge. Remember the rule: ▶ If it tastes good in your blender, it will taste good as a leather!



APPLE-BERRY LEATHER

Apples are great with virtually any berry. For directions, please refer to "Apple-Fruit Combination Leathers," in the APPLE section. If apples &/or berries are quite tart, add honey to taste.



BANANA-BERRY LEATHER

Yum! Banana-blackberry, banana-raspberry, whatever. You may wish to blend berries first,

BERRIES

then sieve to remove seeds. Return berries to blender & add bananas. (One-to-one is a good banana-berry ratio, but it may easily be varied.) Continue as in basic Apple Leather.

PLEASE NOTE: Because of their sweet juiciness, some of the berry leathers will dry somewhat "tacky." (Don't let that deter you!) These leathers are probably best not kept for extended periods.

TO SIMPLY DRY BERRIES:

Dry whole, freshly-picked berries by spreading over 12 x 18" plastic wrap (refer to GENERAL INSTRUCTIONS)... Handle carefully, so they don't "bleed" & lose precious juice. They will dry quite hard.

A good way to use the thoroughly-dried berries is to grind them fine in a seed grinder & pour a small amount of hot water over, allowing them to steep. Sweeten with honey & enjoy as jam or topping for fruit salad, whatever... may be combined with other fruit for a wintertime leather.

CURRANTS

Dry as above, basically to use in place of raisins where desired. They are less sweet, but very nice in mixed-fruit recipes.

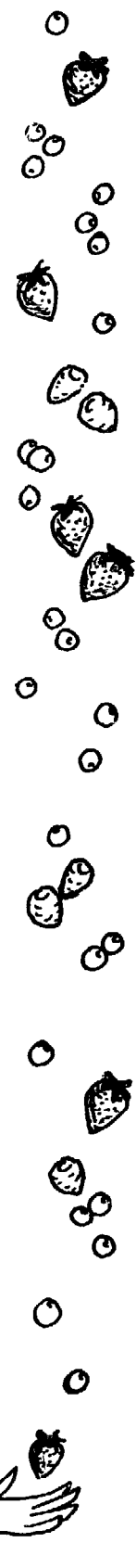

CHERRIES



... May be dried with or without the pits... (they do dry faster with pits removed). If very juicy after pitting, place on parchment paper or plastic wrap for the initial drying.

We can't wait to try CHERRY LEATHER!

CRANBERRIES

May be dried to soak later for refreshing JUICE.

CRANBERRY LEATHER is unexpectedly delicious.

Use dates to sweeten the tart berries:

Soak one cup of pitted, chopped dates in water to cover, until soft. Blend dates & liquid 'til quite smooth, then add about one cup of cranberries. Blend again; continue as in basic Apple Leather.

CRANBERRY-FRUIT CHEWS ~ Something special!

Blend 2 small apples with water as required, as in basic Apple Leather. Add $\frac{1}{2}$ # very ripe cranberries, blending 'til smooth. Add about 1 cup pitted, chopped dates, blending only briefly so dates will be chunky. Stir in 1 cup chopped walnuts. Add honey to taste. Smooth this mixture onto plastic wrap (SEE "Very Juicy Foods" in the General Instructions) ~ Make it very thick, about $\frac{1}{2}$ ". Dry until firm enough to cut into squares ~ they will be delightfully chewy. Do not overdry!



GRAPES

Dry any good seedless grapes, until the "feel" is right, for RAISINS.

GRAPE LEATHER

Combine pulp from Concord grapes with apple & honey to make leather. (SEE "Apple-Fruit Combination Leathers.")

GRAPE "JAM" LEATHER

Blend one quart Concord grapes with one package powdered pectin & $\frac{1}{2}$ cup or more honey. Proceed as with basic Apple Leather.

▶ DON'T FORGET to note your favorite combinations:

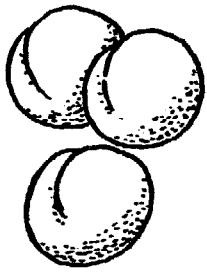

PEACHES

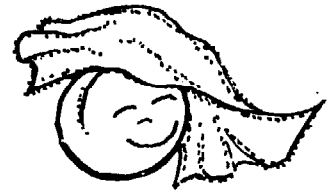

TO DRY PEACHES:

Wash & defuzz with a terry towel (peeling is not necessary). Then cut $\frac{1}{4}$ " slices directly onto the tray. They may seem too juicy, but try it anyway . . . As they dry, the slices stick to the tray, but when completely dry they remove very easily, & retain their great looks.

To use . . . No instructions needed! Just eat & enjoy, although if desired the fruit may be soaked & eaten with cream & a little honey.

PEACH LEATHER

Blend ripe, pitted peaches . . . sweeten with a bit of honey if desired. Add a touch of spice if you like; perhaps ground coriander. Continue as in basic Apple Leather.

The delicate peach flavor is delicious alone, but apples combine with it beautifully, & give the leather a fine consistency with their natural pectin. (Blend the juicy peaches first — no water necessary — adding apple chunks to the purée & continuing to blend. This avoids the need for any extra liquid.) Tuck it away for winter if you can hide it fast enough!

• • • É PEARS

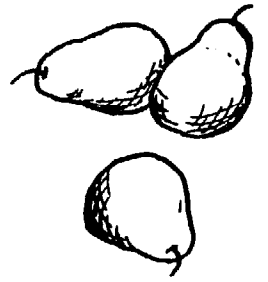

TO DRY PEARS:

Once again, small pieces are the rule of thumb. Quarter the washed fruit — DO NOT PEEL — & then slice thin, for fast drying assures a quality product. (This does not mean accelerated heat. Keep the temperature, as usual, around 100°.)

It is unnecessary even to core pears, since the whole fruit is deliciously edible when dried. You will find your delicate-hued, beautifully-translucent dried pears to be an aesthetic pleasure as well!

PEAR LEATHER

Nothing need be added to pears for leather; perhaps a touch of spice if desired. Follow instructions for Apple Leather. . . pour, dry, & enjoy!

plums, prunes

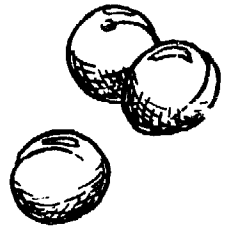

Home-dehydrated prunes excel in every way. . . so little value is lost. The juice of the soaked, reconstituted fruit is even red instead of the brown of commercial prunes.

▶ **FAST DRYING** (small pieces) is the secret! Pit the plums or prunes & quarter them . . . cut even smaller if fruit is extra-large. Lay on tray with skin-side down. These small pieces will be ready days sooner than if dried whole, & will be of better quality.

For LEATHER, prunes are tart & delicious with nothing added, but for sweetness try adding dates or raisins or honey. Prunes combine nicely with apples in leathers. (SEE Apple-Fruit Combination Leathers, for how-to.)

Often a juicy fruit such as prunes will need thickening to make a good leather. You may use about one Tbsp. ground flax seed for each cup blended fruit, for a simple thickening. Flax does not change the fruit taste, except perhaps to mellow tartness. It does seem to give a good texture, & of course it increases nutritional value.

pineapple

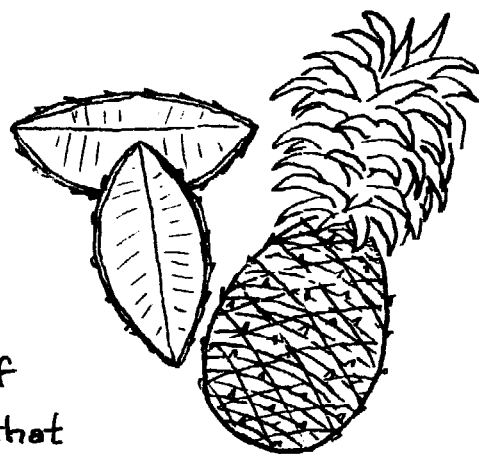

There is really no way to describe the taste of a tidbit of dried pineapple! Be warned that after you have sampled this chewy, indescribably sweet bit of concentrated sunlight & fruit sugar, you'll almost certainly lose any craving for artificial sweets. We believe our pineapple tidbits are an aid to the digestion, so enzyme-rich is this wonderful fruit ~ we often enjoy some after a meal.

► Watch for bargain days & select several pineapples: when golden, slightly soft & fragrant, the fruit will be sweetest.

Wash, even scrub the outside, then quarter the long way. This gives you a pineapple "boat," to assist you in drying this very juicy fruit. Chunk the pineapple by making parallel slices in both directions (don't cut the peel), then slice under the still-attached chunks, next to the peel. With practice, all the pieces will remain intact on the "boat." Now, set the fruit-on-a-boat onto a piece of parchment paper to begin drying.

► These will be heavier than most fruit, so don't overload your trays. When the chunks are less juicy, empty them off their boats to finish drying on parchment or plastic wrap.

And here's what you do with the "boats"...

PINEAPPLE LACE



Scrape the pulp from the pineapple rind onto a piece of plastic wrap (see the "Juicy Fruits" section of the General Instructions). Spread it to a scant $\frac{1}{2}$ " thickness (it gets thin as it dries). Carefully lay banana slices onto the pineapple so that they barely touch each other... as they dry they will shrink.

When it dries, you will have a beautiful fruit "lace" ... Hold it up to the light to fully appreciate it, before biting in!

Bet you haven't thought of this before!

RHUBARB

Tart, dried rhubarb is surprisingly thirst-quenching, & couldn't be easier:

Slice rhubarb into $\frac{1}{4}$ " pieces & dry — that's all!

Although it's nice to nibble dried rhubarb, the following recipe is our favorite way to use it:

RHUBARB-ADE

Throw a handful or two of dried rhubarb into a jug of fresh cool water & let it juice for one or two hours. Sweeten with honey if you like.

Makes a delicious, refreshing drink. Add to punches!

Here are a couple of nice ways to use your dried fruit:

FRUIT COMPOTE

Soak the following dried fruits together, in any amounts you wish, for several hours or overnight:

chopped prunes	peaches
pears	raisins
apricots	chopped dates

(water to cover)

Add chopped dates & sunflower seeds for the last hour or so of soaking.

Makes an especially satisfying breakfast — a delicious dessert.

FRUIT TIDBITS

Soak chopped, dried fruits, in water to cover:

prunes	raisins	(vary amount of each, for different flavor combinations)
peaches	dates	
apricots	etc.	

To about 2 cups of soaked fruit, stir in about 1 cup chopped nuts.

Blend apricots or apple chunks as for leather, & add $1\frac{1}{2}$ cups of the purée to the fruit/nut mixture.

Spread about $\frac{1}{2}$ " thick onto tray prepared with plastic wrap (see General Instructions: "Juicy Fruits"). Dry until surface is dry & fruit feels firm... turn it over onto tray, removing plastic, & continue drying until the exposed side is also dry & firm. Cut into squares & return to dehydrator for a little more drying.

vegetables



The real joy of owning & using a dehydrator becomes evident when you realize that virtually nothing from your garden need ever be wasted again. Every little handful of extras can be dried & saved, complete with vitamins, minerals & enzymes — not to mention their appetizing color! We have dehydrated nearly everything we grow, with many interesting results.

HOW TO USE DRIED VEGETABLES

This whole activity of food dehydration revolves, for us, around the need to preserve the real value of every bit of food. So we are learning to use our wonderful vegetables in their raw state . . . what isn't used fresh from the garden is dried, to be munched later out-of-hand, or powdered in the seed mill. These powdered vegetables add flavor & nutrition to our broths, raw soups, salads, dressings . . . Without a doubt there is many a dish which may be enhanced by such an addition. Some sliced, dried vegetables, like zucchini, make lovely "chips" for dipping. As for additional uses or recipes, we will mostly leave you to your own adventuring. Herewith, some drying information:

VEGETABLES WE HAVE DRIED (so far)

beets	garlic	parsley
cabbage	green beans	parsnip
cabbage blossoms	horseradish	snow peas
carrots & tops	kolrabi	squash
chard	leek	tomatoes
corn	mustard greens	turnips
cucumbers	onion	zucchini

This list is not intended to limit you! Rather, see in it the almost endless possibilities open to you & your dryer.



The following paragraphs contain some methods for drying & tips for using a few specific vegetables. Please remember, ► drying techniques are generally applicable. . . so review your General Instructions.

► Specific hints are listed under the foods to which they apply & of course fit any similar food as well.

ALL LEAFY VEGETABLES

Arrange clean leaves loosely on trays to allow adequate air flow. Drying materials may be consolidated as they shrink, making room for more (keep the new, moister materials on upper trays, as explained in General Instructions). Dry until the leaves crumble when handled & all moisture is gone.



FOR HOW-TO-STORE, SEE GENERAL INSTRUCTIONS.

VEGETABLES

CORN

Husked sweet corn can be dried right on the cob. Remember — they'll be a bit heavy, so don't overload trays. When thoroughly dry, the kernels come right off in the hands: hold an end of the cob in one hand, then grasp & twist the free end with your other hand. The small black Indian corn is especially adaptable to raw-eating. When soaked, it is sweet & delicious in salads, soups. Corn silk is not only useful as an herb, but when dried & powdered can add a nice "corny" flavor to a soup. Don't forget the dried corn chip recipe! (See GRAINS.)



GREEN BEANS

Choose tender, young beans & cut as desired, either strips (which dry fastest) or slices. Dried beans powder nicely in a seed mill for adding to broth, etc.

ONION, LEEK & GARLIC

The lovely green tops, dried & powdered, are mild & delicious . . . a very condiment especially fine in salad dressings. The bulbs, sliced & dried, will save the day when no fresh ones are available.

When drying, ► use parchment to keep that strong flavor from direct contact with the trays.

VEGETABLES

TOMATOES

Cut into small wedges & let each rest on its skin-side to dry. This keeps the juice in so flavor & nutrition are enhanced. Fascinating to chew & a great flavor addition to broths, etc.

ZUCCHINI OR CUCUMBER CHIPS

Slice fairly thin (scant $\frac{1}{4}$ ") — or to personal preference (experiment a little! But try to keep each batch the same size, for even drying). Dry until crisp & use with chip dips — your own, freshly-made, of course. Truly great nibbling!

BLOSSOMS ARE FOOD, TOO!

Blossoms from the garden which land in our salads have included cabbage, parsley, celery & radish flowers.

Violets & wild pansies make delicious & beautiful salad fare . . . Loveliest fresh, of course, but the dried blooms add their subtle nutrients to wintertime salads, too.



Remember to use QUALITY VEGETABLES . . . the end result can't be better than what you start with, so always start with the best!

VEGETABLE BROTH MIX

... to be kept on hand for delicious quick energy (pour boiling water over & let steep a minute). Also makes a great seasoning for other dishes.

Suggested ingredients:

cabbage, carrots, celery (any part), garlic, green beans, horseradish, mushrooms, mustard greens, onion, parsley, peas & pods, peppers, spinach, tomato, watercress, & anything else you think of.

▶ Powder your ingredients & combine as you please. If the right flavor combination eludes you, or you haven't enough ingredients, use any good powdered vegetable broth for a base & add your own "extras."

▶ Broth may be thickened if desired with a spoonful of ground flaxseed. We've also used ground millet, chia, or other seeds, with pleasing results.

▶ Add dried, powdered herbs for even greater nutrition. We use any of a variety — comfrey, nettle, chickweed, malva, plantain, lamb's quarters — any of the edible weeds.



GARLIC BROTH

A fantastic warmer-upper, any time of year:

... to a fresh, hot cupful of vegetable broth (facing page), add one clove of garlic, crushed, a dash of soy sauce, & cayenne, or capsicum, to taste.

Add a little fresh tomato juice (or if you like, blend your broth with a few chunks of tomato), if you have some.

If you're really hungry, make it in a soup bowl — remember the ground flaxseed, to thicken — & add a big handful of sprouts. A real meal!

DON'T FORGET MUSHROOMS!

The first step is to try to pick your mushrooms "clean" — cut them off at ground level & brush off loose dirt & leaves. No need to wash them; if you spread them on trays & allow them to dry about a day (until surface is no longer sticky), you can easily brush off any remaining dirt. Trim if necessary. Replace trays & allow the clean mushrooms to dry thoroughly.

▶ Don't let the initial drying take too long, or the dirt will be firmly embedded as the mushrooms shrivel.

▶ If your mushrooms have come from the grocery, you'll probably want to wash them before dehydrating. Allow them to drain on a towel before putting into dryer.

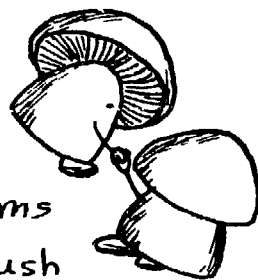

seeds, grains



Those wonderful, living grains & seeds! — give them a chance to nourish your wonderful living body! With a dehydrator, you'll find there's no need to cook the life out of grains... Delicious uncooked wafers, flatbreads & cookies are all possible with dehydration.

► Once you get the "feel" of the recipes which follow, we hope you'll discover there's more than one way to do things. Substitute other grains & seeds; change amounts. We like these recipes, but please don't stop with them! They are just a beginning.

(Some grains & seeds we like to keep on hand:)

Seeds

chia
flax
pumpkin
sesame
sunflower

Grains

barley
millet
oats
rice
rye
sweet corn
wheat

Sprouts

alfalfa
lentils
mung
rice
wheat
other grains

GRANOLA

This is one of our favorite versions. There's probably nothing as adaptable as a granola recipe, so use what you have on hand, & have fun!

Mix together:

- 1/2 cup honey (or more, to taste)
- 1/2 cup hot water
- 1/2 cup oil
- 2 tsp. vanilla



Pour it over

4 to 5 cups oatmeal, in a large bowl
... & allow to soak, while adding (right on top):

- 1 cup raw sunflower seeds
- 1 cup sesame seeds
- 1 cup flax seeds
- 1 cup freshly-grated coconut, if you have it
- 3/4 cup chopped walnuts
- 3/4 cup chopped dates, or raisins or currants

Mix it all together & spread on parchment to dry.
To speed drying, spread thinly. Takes about 2 days —
longer if more honey or water is used in mixing.
Store in plastic bags or jars in refrigerator.

VARIATIONS: Change ingredients &/or amounts as you please. Try adding or substituting chia seeds, fresh wheat germ, almonds, cashews or other nuts, a little brewer's yeast, chopped dried fruit, whatever.

"14-GRAIN" WAFERS

The "14 grains" are as follows:

alfalfa	lentils	rye
barley	millet	sesame
buckwheat	mung beans	wheat
corn	oats	almonds
flax	rice	

Combine in more or less equal amounts & soak as for sprouting. (Sprout if you wish.) Place about a cupful in blender with enough water to blend easily. Add some soaked raisins to sweeten (about $\frac{1}{4}$ cup) & blend until very smooth. If you have them, add $\frac{1}{4}$ cup ground chia seeds (these thicken the mixture immediately, improving texture & food value). Spread evenly over parchment (to scant $\frac{1}{4}$ ") & allow to dry... remove the paper & continue drying on screen until thoroughly dry, turning once or twice. Cut into squares.

APPLE & SPROUT WAFERS

Blend 2-day sprouted grains ("14-grain" mix, if you like) half- & -half with chopped apples in blender, with enough water to support blending action.

Handle as a leather, drying on plastic wrap (see basic Apple Leather). When quite dry, remove the plastic & turn leather to finish drying thoroughly.

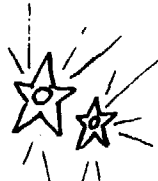
 AN OCCASIONAL REVIEW OF THE GENERAL INSTRUCTIONS (FRONT OF BOOK) HELPS YOU ACHIEVE PERFECT RESULTS! 

CORN CHIPS

(Great with garlic broth!)

Blend until smooth:

- 3 cups fresh tomatoes (somewhat chopped)
- 1/4 cup or more chopped onion
- 3 cloves garlic, crushed (we smash 'em between layers of heavy plastic)
- 2 Tbsp. oil (mild, cold-pressed)
- 1 tsp. each cayenne, dried dillweed (not the seed), & sea salt

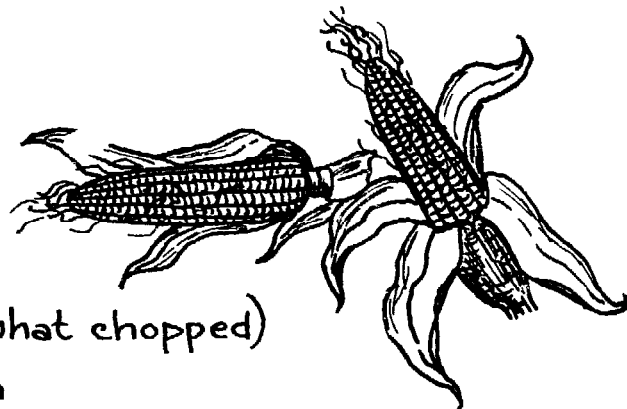

Mix in bowl:

- 3 cups finely ground dried sweet corn (the black Indian corn is our favorite)
 - 1 cup ground flaxseed (for texture — or use all corn)
- Mix it all together & spread as thinly as possible on parchment paper. When it seems quite dry, remove the paper & dry on screen until very crisp.

CORNAPPLE CRISPS

- 1/2 cup ground sweet corn, or black Indian corn
 - 1 cup blended raw apple sauce (see Basic Apple Leather for method)
 - 1/8 tsp. cayenne
 - 1/8 tsp. ground rock salt or sea salt
- Mix together & spread about 1/4" thick on plastic wrap. Dry until crisp, as above.



NOTE: Mixtures containing fruit should be dried on plastic wrap, to prevent sticking.

CORNAPPLE CHEWS

So great you have to have another to believe it!

Soak overnight:

1 cup dried sweet corn (we like the sweet black Indian corn best), in

1 cup water

Put soaked corn & water into blender, with

1 large apple, cored & chopped (with skin)

$\frac{1}{2}$ cup raisins

Blend, adding water as required to keep blades moving, until quite smooth.

Spread $\frac{1}{4}$ " thick on plastic wrap prepared as described in General Instructions. ► Do not overdry. This is a chewy wafer. You'll know when it's ready!

NOTE: Grain wafers can be varied surprisingly with different techniques. The great texture difference between a Cornapple Crisp & a Cornapple Chew is achieved by grinding the dry sweet corn for one; soaking & then blending that same dried corn for the other. Both are great. Try it with other recipes. *Vive la difference!*

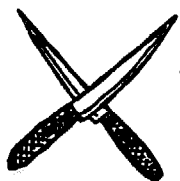

CUTTING CRISPY CRUNCHY WAFERS can be difficult. We generally just break them into pieces, but if you like squares, cut them while dry enough to hold their shape but not so crisp they'll crumble. Use a cutting board & a sharp knife. Then return the squares to the dryer until crisp as desired.

SESAME-PUMPKINSEED BITS

Another favorite — & too easy not to try!

Stir together:

$\frac{1}{2}$ cup honey & $\frac{1}{4}$ cup hot water

Mix in:

2 cups sesame seeds

1 cup pumpkinseeds

Spread about $\frac{1}{4}$ " thick over prepared plastic wrap (see General Instructions). Pat gently into place — the mixture will be crumbly.

Score (cut partially into squares). When firm, remove plastic wrap & turn over to continue drying until crisp. Break into squares along scored lines & dry a little more.

VARIATIONS: — use maple syrup in place of honey
— substitute sunflower seeds & /or nuts for pumpkinseeds
— add chopped dates or raisins



STORE your crackers, wafers, etc. in airtight containers as with anything you want to keep crisp.



RECRISPING: If any of your beautiful crispies — granola, wafers, chips, whatever — should be left out or improperly stored & lose their crunch, simply return them to your dryer until the old snap comes back. Obviously, this will work with anything that needs crisping, whether your own or a commercial variety.

SESAME-BANANA CRISPS

Couldn't be easier or tastier! We consider this recipe to be a classic.

Blend:

very ripe bananas with small wedge of lemon

Mix together:

equal parts puréed bananas & sesame seeds

Spread quite thin (scant $\frac{1}{4}$ ") on plastic wrap & dry...

Remove the plastic & finish drying on screen until very crisp, turning once or twice.

VARIATIONS: - a touch of coriander

- organic orange peel instead of lemon
- add some pumpkin or sunflower seeds for taste & texture variation

SESAME-SUNFLOWER SQUARES (with APPLE)

The apples give these a nice chewy texture.

Mix together:

1 cup apple purée (chopped apples w/skins, & enough water to support blending action)

$\frac{1}{2}$ cup honey

(if desired, add a little vanilla ~ or blend a bit of lemon with the apple purée)

Stir in:

$1\frac{1}{2}$ cups sesame seeds

$1\frac{1}{2}$ cups sunflower seeds

Spread to $\frac{1}{4}$ " on plastic wrap... When quite dry, remove plastic & turn it over to dry until crisp.

CHIA-FRUIT WAFERS

Super energy!

Soak:

$\frac{1}{2}$ cup dried apricots in
1 cup water

Blend:

with a few chopped dates, to sweeten (or honey)

Add:

$\frac{1}{4}$ cup ground chia seeds

Mix together & spread on plastic to dry (about $\frac{1}{4}$ " thick), as described in General Instructions.

NOTE: Chia or flax seeds can be used to thicken any fruit leather or grain wafer. Use chia seeds in very small amounts, as they thicken quickly.

MILLET WAFERS

Mix together:

$\frac{1}{2}$ cup ground millet

1 cup raw blender applesauce (as in plain Apple Leather)

pinch of ground rock salt, or sea salt

Spread $\frac{1}{4}$ " thick on plastic wrap . . . when quite dry, remove plastic & finish drying on screen until thoroughly crisp.

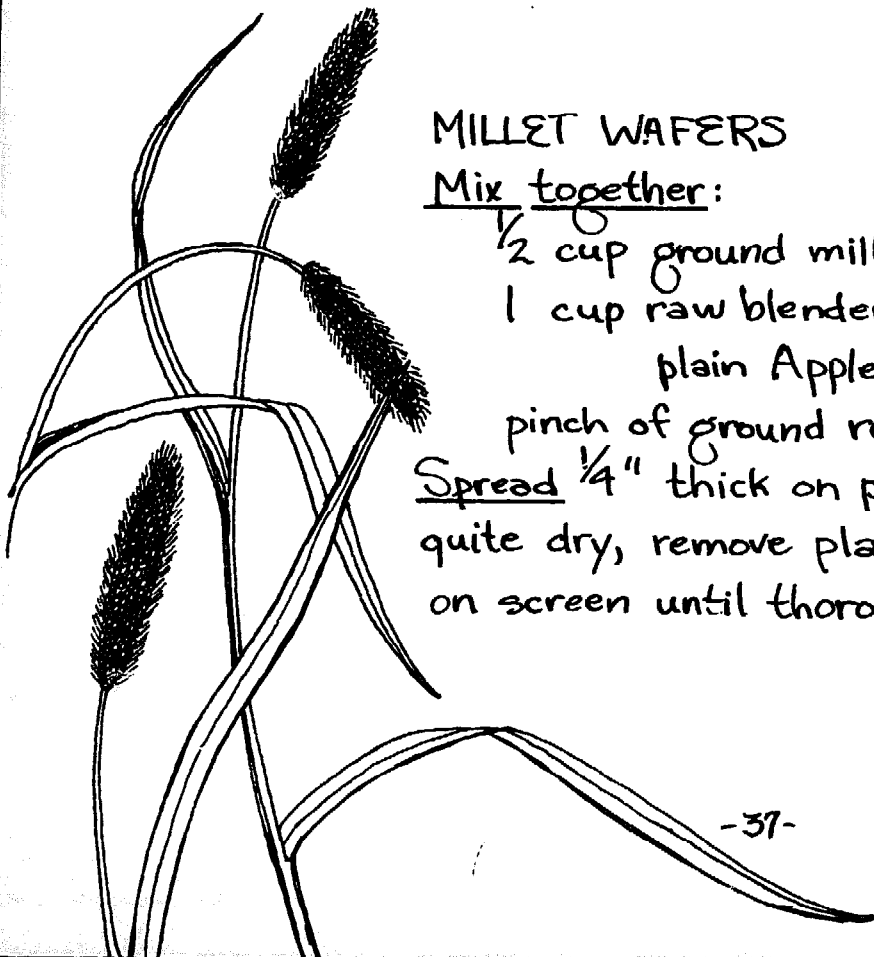

HEALTHY TREATS

FOR GRANDCHILDREN*



artwork by Erika C.

* . . . of any age!

DATE-NUT CHEWIES

Bound to become one of your favorites. . .

Mix together:

2 cups Breakfast Cooky base (following page)

1 cup ground rolled oats, or oat flour

$\frac{1}{3}$ cup sunflower seeds, ground

2 cups chopped dates

1 cup coarsely-chopped walnuts

Spread onto prepared plastic wrap (see General Instructions), about $\frac{1}{4}$ " thick.

Dry until firm enough to cut into squares (make them quite small); then dry the squares a little more.

VARIATIONS: — 1 cup of raisins for 1 cup of the dates
— sunflower seeds instead of nuts

JAMIE'S BREAKFAST COOKIES

So-called because (note the ingredients) they're a meal in themselves.

Blend until smooth:

This is your "cookie base" {

- $\frac{3}{4}$ cup oil
- $\frac{2}{3}$ cup honey
- 3 or 4 large apples, unpeeled, cored & chopped
- 2 tsp. vanilla & /or small wedge organic lemon

Mix in:

- 3 cups rolled oats
- 1 cup sunflower seeds
- 1 cup raisins or chopped dates

Let stand for $\frac{1}{2}$ to 1 hour to allow the oats to soak up flavors.

Drop by spoonful onto parchment paper & dry until firm — one or two days, depending on the texture you prefer. (The soft ones should probably be refrigerated, but ours disappear before keeping becomes a problem.)

VARIATIONS:

- add $\frac{1}{2}$ cup ground flax seed or $\frac{1}{2}$ cup sesame seeds
- add one cup chopped nuts
- add ground coriander to the cookie base

NOTE: The versatile cookie base, above, makes a delicious & unusual fruit-salad topping. It also tastes great all by itself, pudding-style, with maybe a few chopped nuts or crumbled sesame squares on top.

Try it!

APPLE FREEZE (Laurie's favorite)

Surprise! The cooky base (previous page) freezes into a smooth, delicious "ice cream." If desired, a little cream may be stirred in before freezing to make it even more special.

► Freeze in a shallow baking dish — no stirring required!

VARIATION: One night, Apple Freeze came to a potluck all dressed up as a pie, in a simple crust of sesame-seed meal & oil (patted into place before the apple mixture was poured in). The top was garnished with dates & nuts after the filling had set. (Crust may be easily varied, using ground nuts for part of the sesame-seed meal, etc.)

CAROB FUDGE

We wouldn't eat any other kind.

Mix together:

$\frac{1}{3}$ cup honey
 $\frac{1}{3}$ cup water
2 tsp. vanilla

Add:

$\frac{1}{4}$ cup carob powder
1 cup ground sunflower seeds
1 cup ground sesame seeds

Work in:

as many chopped walnuts as the mixture will hold. Pat to $\frac{1}{2}$ " thick on parchment paper & dry until it holds together, approximately 2 days. You want it to be chewy.

VARIATION: substitute 1 cup freshly-grated coconut for the sesame meal (we recommend the fresh only).

For NATURAL CITRUS FLAVORS, always save your organic,* unsprayed orange & lemon peels. Cut into thin strips & dry for future use.

▶ To use, simply powder & add to fruit mixtures, puddings, purées for leathers — any favorite recipe that would benefit from the added citrus tang.

*Never use the peels of non-organically-grown oranges, which are normally subjected to dyes which should not be eaten. Furthermore, they don't taste as good! The peels of naturally-grown oranges & lemons are usually much sweeter.

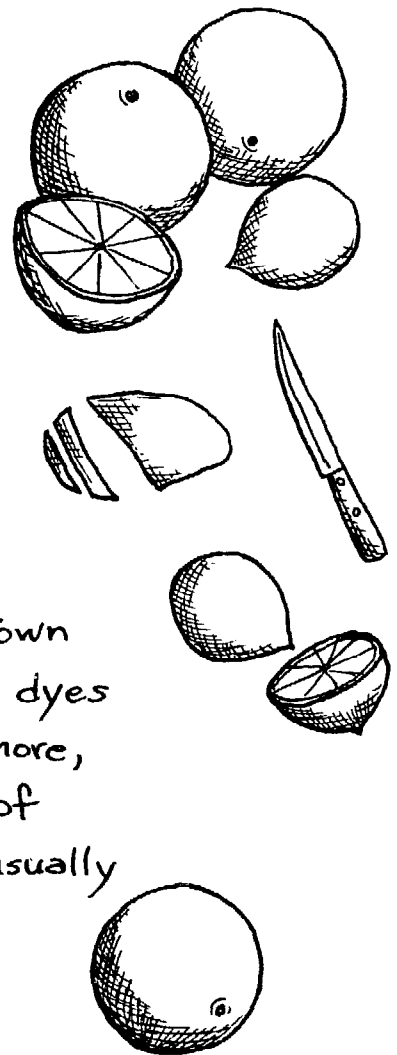

HONEYED ORANGE PEEL

An unexpectedly delightful way to use your dried orange peel.

Simply soak the dried peel in a honey-water syrup (one part honey to one part water), until the peel is soft & saturated with the syrup.

Has a tantalizing, tangy-sweet flavor.

May be stored in the refrigerator (use a small covered jar).

herbs

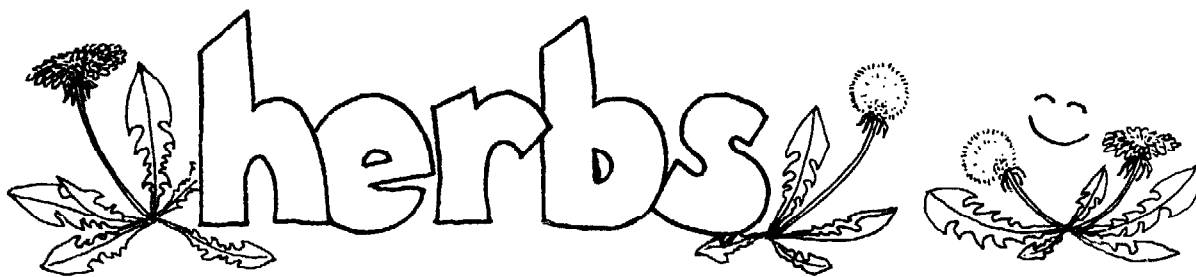

Your dehydrator enables you to produce the best-possible quality dried herbs, with superlative color & flavor.

NOTE: This section is intended primarily to give you some practical information about drying herbs. Our space is too limited to describe individual herbs & their nutritional & medicinal properties. There are some excellent books, including readily-available paperbacks, which do so in detail.*

► We suggest that you purchase such an herbal reference (or several) & discover this fascinating field. Almost every weed in your yard is a useful herb... you might start with the lowly dandelion, or maybe some plantain — even the quack grass. But don't waste them; do it now!

Here is the GENERAL INFORMATION:

Gather each herb "in the season thereof," when it is lush & green, full of chlorophyll. Get in the habit



* Send a stamped, self-addressed envelope if you'd like a list of some of our favorite herbal references.

of carrying a few plastic bags in your pockets whenever you take a walk.

Avoid picking near roads, where herbs are dusty & subjected to automobile exhaust fumes, etc.

PICK CLEAN. The less "garbage" you gather with your herbs (other plants, twigs, dirt, dead leaves, etc.), the less work for you later.

Rainwashed herbs seldom need additional washing. But ► don't pick them dripping wet. Let the sun do some of your work.

Roots need to be scrubbed. If you have a quantity, use your washing machine! First hose off loose dirt, then agitate awhile in a washerful of cold water.

 When you've gathered large amounts of herbs, spread them out on old sheets or big towels (keep each kind separate!) in a darkened room to wilt & shrink up a little before loading dehydrator trays. (Herbs left exposed to light will quickly lose their color.) The wilted leaves take less room in the dryer & dry faster, & while they are spread out you have a chance to cull out large stems, dead leaves, etc., before drying.

DRYING

► Review General Instructions, in the front of this book.

Arrange herbs loosely on dryer trays, to allow adequate air flow. Rotate trays as advised in General Instructions.

The key to high-quality dried herbs is fast drying at low temperatures. NEVER exceed 105°. Most herbs will dry in one day, & the quality will be excellent.

As herbs dry & shrink, consolidate them, making room for more fresh herbs on the upper trays.

STORING

► Make sure your herbs are crackling-dry before packaging. If there is any moisture present, they may be subject to mold & deterioration.

See General Instructions for packaging & storing instructions. Don't forget to label immediately!

Herewith, additional information for some specific herbs:



COMFREY (*Symphytum officinale*)
If the leaves are very large, as they often are, fold them in half lengthwise on a cutting board & slice off the large fleshy center vein & stem. These contain so much moisture they slow down the drying of the leaves (herb quality is best if dried fast). It's wise to

wear gloves to handle the drying leaves if you think you'll be sensitive to their invisible little prickles.*

Comfrey root must be cut into very small pieces before drying, as it becomes rock-hard & almost impossible to grind with standard kitchen equipment.

▶ NEVER attempt to powder it in your blender or seed grinder.

CHICKWEED (*Stellaria media*)

We mention chickweed specifically to include a recipe for chickweed ointment, a "home remedy" we wouldn't be without.



It seems to work on itches of all kinds — insect bites, rashes, surface inflammations on any part of the body. (Read about chickweed's properties & uses in your herbal.)

▶ Gather chickweed when it is most lush & green. Although easily pulled, it is best cut with scissors or clippers, to avoid the dirt that comes up with the roots. Dry thoroughly & powder.

CHICKWEED OINTMENT:

In a small bowl, mix $\frac{1}{4}$ cup dried powdered chickweed with $\frac{1}{2}$ cup home-rendered lard (the commercial kind contains additives).

Let stand in dehydrator several days, until the lard is



*Applies to borage (*Borago officinalis*) as well.

very green, having drawn as much as possible from the chickweed.

Strain, & mix in 1 Tbsp. melted beeswax. The "green" lard will have to be heated a bit more to mix easily, but DO NOT OVERHEAT. The beeswax helps solidify the ointment, which otherwise would melt at skin temperature & be very messy. It also has healing properties of its own.

Pour the ointment into small containers & refrigerate what is not in immediate use.

NETTLES (*Urtica dioica*)

The stinging nettle is such a nutritional boon that everyone should make the effort to gather & dry quantities of them.

Pick with love & gloves. (Latex gloves seem to effectively protect hands from the sting, while allowing freedom of movement.) Even while drying, however, the sting is there; so use gloves for handling throughout the drying process. When dry, crumble the leaves & store in bags as described in General Instructions.



Nettles are incredibly versatile, you'll discover. They make a fine, mild tea — both to drink & to use as a final hair rinse! (They promote a healthy scalp & help prevent graying.) We also add powdered nettles to

USING YOUR HERBS

► Refer to your herbal references for specific uses, especially if you are interested in using herbs for healing. Proceed with caution, but don't be afraid to learn!

Even if you are not yet interested in their healing properties, remember that herbs are food, & may be used to enhance your meals every day. And don't forget the simple pleasure of a fragrant cupful of herb tea...

Teas are perhaps the commonest & easiest way to use dried herbs. There is a whole world of herb teas — strong ones, bland ones, minty ones, tangy, bitter & delicate ones. Refreshing, soothing ones. Learn about them!

► Generally, use a rounded teaspoonful of dried herb per cup, or more, to taste. (It is not necessary to powder herbs for tea.) Pour boiling water over & steep 5 to 15 minutes. Strain; add a bit of honey if you like. (When using roots or woody stems, simmer for 10 to 20 minutes. But NEVER simmer or boil the leaf.)

Every day we use herbs as food. We always keep several little jars of our favorite freshly-powdered dried herbs on hand (comfrey, dandelion, nettles, malva & chickweed, to name a few) to add a terrific vitamin & mineral boost to almost anything we eat.

MEAT & FISH

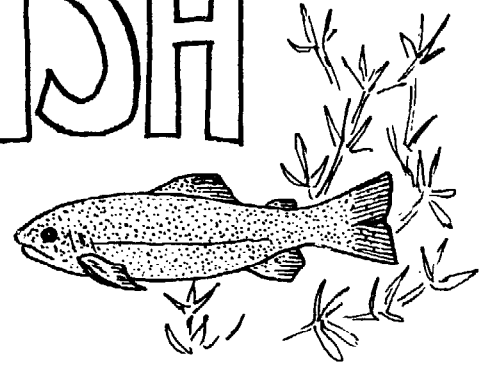

The following "recipes" (methods, actually) are pretty classic; you'll find that drying meat & fish is simple & fast.

FISH

(Salmon, halibut, sole, cod, etc.):

Clean & filet. Be sure to remove all fat skin. Dip the cubed fish ($\frac{1}{2}$ " x 1" is a good size) into soy sauce & dry on a cookie sheet until sufficiently dry to transfer to parchment paper. Dry it quickly; if it will be stored for a long time, dry very hard. If for more or less immediate use, stop the drying at any point desired. This method gives a delicious, almost smoky flavor.

(Smelt, or other small fish):

Clean, but no need to remove bones. Slit down the middle & lay out flat. Dip into soy sauce, or use the "sprinkle" method: occasionally add soy sauce during drying. (This method is a joy for tasters, because it requires a lot of tasting to get the flavor just right.)

When thoroughly dry, the bones can readily be chewed with the fish. Freshly-dried smelt are

a real treat. Be sure to dry them very hard, however, for long-term storage.

▶ We recommend cool, dark storage in tightly-closed jars for all dried fish or meat.

▶ After drying fish, the dehydrator trays should be thoroughly washed to remove any fishy odor. Setting your dehydrator outside in a protected area such as a carport makes fish drying more pleasant, though really fresh fish are never a problem.

BEEF JERKY

Easy, fast, good results.

Start with very lean meat. Remove all visible fat & slice into thin strips.

(Flank steak is the cut usually used for drying: slice it with the grain for chewiness, or against grain for a more tender jerky.)

Sprinkle meat strips with a little quality salt, if desired. The meat strips dry quickly, taste delicious, with no further ado; but if desired may be dipped into or sprinkled with soy sauce for a different, more "smoky" flavor.

Dry very hard for long-term storage; store in tightly-lidded jars in a cool, dark place.

 Try adding bits of jerky to a green salad...

FOWL

Remove any fatty skin or fat tissue. Slice or cut up as desired (keep pieces quite thin, for fast drying). Pieces may be lightly dusted with poultry seasoning before drying, if desired, or with vegetable salt. Dry quickly.

NOVELTY DEPARTMENT: MINCEMEAT LEATHER

For that jar of homemade mincemeat you've been saving.

Purée the mincemeat in your blender & spread evenly over plastic wrap to dry (à la basic Apple Leather), about $\frac{1}{4}$ " thick... voilà! Mincemeat Leather — unexpected & delicious.



"AFTERTHOUGHTS"

... A few more hints, a few more recipes we'd like to share as we go to print again... in no particular order, but we hope you'll use & enjoy them.

In the "HINTS" department:

NEVER use wax paper in your dehydrator. We checked our General Instructions (page 3) & see that although we never suggested using it, we didn't say not to, either... Some users have found out the hard way that even at the suggested low heat, the wax melts into whatever they're drying.

LABEL fruit leathers as you put them on the trays. Just slip a scrap of paper under the edge of the plastic wrap. Leathers can look so much alike — don't lose the recipe for a really terrific one!

DIP white-meat apples into pineapple juice to keep them white as they dry... diluted fresh lemon juice works well, too.

BREAKFAST COOKIES (page 39), we've found, may go directly onto the screens to dry beautifully. Parchment paper is not necessary.

SLICED TOMATOES, also, may be placed directly on screens & dry beautifully.



Slice with the stem (vertically), about $\frac{1}{4}$ " thick. They won't drip through screens & just peel off when dry. Thin ones make great "chips."

ONIONS sliced with the stem rather than across it aren't as prone to yellow when they dry, & will dry into beautiful crescent-shapes.



If you DON'T HAVE A BLENDER & want to make fruit leathers: Some fruits may be ground in a food grinder, then pushed through a Foley food mill; soft fruits can also be pushed through a sieve or ricer. Ripe bananas may be mashed with a potato masher. Leathers will have textures slightly different from the puréed kind; all good. Try them even if you do have a blender.

FRUIT LEATHERS can be made from canned, frozen or soaked dried fruits as well as fresh.

GREEN GRAPES, CRANBERRIES, dry in $\frac{1}{4}$ the time & have nicer color & flavor, if sliced in half instead of drying whole.

Thinly-sliced dried PARSNIPS are crisp & delicious alone or with dips — try them to believe them!

MORE ON USING DRIED FRUITS: SOAKING

Most dried fruits are used "as is," for delicious quick-energy nibbling. But soaking them adds a new dimension to their versatility.

(See again the recipes on page 23.)

▶ As a rule, plan to soak any dried fruit overnight, for good consistency. Use plain water; it quickly becomes sweet juice. Refrigerate what's left — it ferments quickly at room temperature.

▶ Don't forget to USE THE LIQUID from soaked dried fruits — for refreshing drinks, or as all or part of the liquid in puddings, shakes, etc.

DRIED BANANAS are deliciously creamy when reconstituted in rich milk. Add a little vanilla & whiz in your blender for banana cream pudding!

Plain soaked dried bananas will make any breakfast egg nog or milkshake rich & creamy. If the bananas are very thin "chips," they may not even require pre-soaking. Try making your shake with juice, as well as the traditional milk.

When your soaked-fruit combination is too tangy, sweeten it naturally by adding bananas, pears, dates...

NEW RECIPE IDEAS

Would you believe dried cottage cheese? We make our own, & when milk was in great abundance last year, had more than we could use. So we dried it, & the results were mouth-watering.

We prefer our own simple & creamy pot-cheese, but a good commercial variety works as well. A blender gives it the creamy texture we like, or you may push it through a sieve. Ricotta cheese is already smooth & doesn't require puréeing.

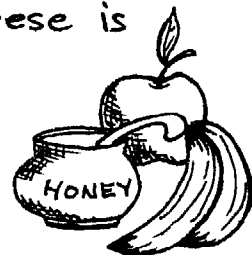

MAKE IT SWEET: With Fruit & Honey

The proportions: About half- & -half (one part cottage cheese to one part puréed fruit), or to taste, plus honey to sweeten. Add flavorings (vanilla, spices) as your taste dictates.



The method: Purée the fruit in your blender as for a fruit leather (see Apple Leather, page 8); add the cottage cheese & blend smooth. Add honey to taste & blend. Dry same as Apple Leather... It's also fun to dry in little leathers, or wafers, about 2"-3" in diameter. Dry to a firm-but-pliable state.

Combinations: Try combining your cottage cheese

with puréed ripe bananas, honey & vanilla (tastes like cheesecake!) — also delicious with puréed apples — apricots — peaches — berries — or combinations of fruit. Or, use no fruit: simply combine with honey & vanilla to taste. They're all delicious; you'll think of more.

MAKE IT SAVORY: With Herbs & Seasonings

Method: Same as for Sweet recipes, facing page.

Possibilities: Season the cheese with a favorite seasoning salt — cayenne — garlic powder or crushed fresh garlic — chili powder — etc.

SAVORY TOMATO-CHEESE WAFERS

Blend tomato, cottage cheese & chili powder to taste. You will use more cottage cheese than tomato, as this makes a thinner mixture. Drop by spoonfuls onto tray prepared with plastic wrap as for leather — each spoonful will spread & dry to a nice, pliable wafer. A delightful hors-d'œuvre or salad accompaniment. Good way to use leftover stewed or canned tomatoes or tomato paste.

NOTE: Cottage cheese may be dried plain & soaked back to soft consistency for later use. Texture will be slightly different. Good for cooking uses.

YOUR OWN POT CHEESE:

Delicious, creamy & a little different each time you make it.

This method works with any milk; we like to use our own creamy goat milk, raw & fresh. You may use skim or whole milk, raw or pasteurized.

► It is the straining that gives the cheese its quality. Nylon organdy is perfect for this purpose: its density is ideal, it washes easily (you can towel it dry), & it lasts indefinitely. A 20" x 20" square is enough.

[We have a friend who strains his cheese with coffee filter papers in a funnel & says it works great.]

In a large stainless steel pan, put 3 quarts of the milk of your choice. You may use it straight from the refrigerator or gently warm it on the stove. Add $\frac{1}{2}$ cup of good buttermilk, your own or a commercial variety. You may scrape a few grains off a tablet of rennet into the milk.*

* Rennet is not necessary & we don't use it, ourselves. It does speed up the process somewhat, but tends to make the watching more critical: once past the "turning point," when you can see the curd & whey begin to separate, the cheese begins to get grainy.

Place the covered pan atop your dehydrator, in back near the ventilation opening, or in any consistently warm place (about 100°). Let it stand until a firm curd is formed — it may take anywhere from 12 to 24 hours, or even longer. It varies a lot, so don't worry if it seems to be taking a long time.

Line a collander with the nylon organdy & set it over a large pan. Carefully dip the thick milk into the lined collander. (If you pour it recklessly, it may run right through your strainer.)

► The consistency of the milk at this point may range from that of thick buttermilk to a firmer curd. It doesn't seem to matter as long as it's thick enough to stay in the collander. Allow it to drain overnight or longer. To finish the draining, pick up the edges of the organdy to form a "bag" of cheese & devise a way to hang it so that more whey can squeeze out (we twist it around a hook we put in just for that purpose). Avoid twisting or squeezing the bag itself — you'll just squeeze out the cheese. Let it drain a few more hours.

The result is a superior soft cottage cheese with a tart cream-cheese sort of flavor. Use it in many ways, from dips to dressings. Mixed with honey & vanilla, it once topped a wedding cake deliciously!

"ON THE TRAIL"



Most of the recipes featured in this book are ideal trail food: lightweight, nutritious & tasty, they fulfill the prime requirements of hikers & backpackers. The following ideas are especially good for this purpose:

DRIED SOUP

Nothing can beat your own delicious soup for flavor & nutrition. Dry it! Thick, homemade legume soups — bean, split pea, lentil — are perfect for drying. A good canned soup works, too.

The method: Briefly purée your thick bean soup, in blender, electric mixer, or with potato masher, until it has a fairly smooth consistency.

Dry same as Apple Leather, page 8, except in 2"-3" wafers (drop from a spoon & spread to uniform $\frac{1}{4}$ " - $\frac{1}{2}$ " thickness).

To use: The dried wafers are excellent just as they are. For a hot, delicious instant soup, drop a few wafers into cup or bowl & cover with boiling water. Steep, stir & enjoy!

► Don't forget that classic, powdered Vegetable Broth, page 28.

More trail food:

CHICKEN OR TURKEY LEATHER

Just as good for at-home munching.

Carefully remove bones from leftover cooked chicken or turkey. Avoid using very fatty pieces, which make the leather too greasy.

Put the bits & pieces of meat into blender, with enough liquid (chicken stock, broth, &/or water) to blend. (A meat grinder may be used.)

Be sure to add any leftover dressing!

Season to your liking: poultry seasoning; garlic or celery salt; cayenne; perhaps a touch of lemon juice or vinegar. Don't over-season — it gets a bit stronger as it dries.

Dry as for Apple Leather, page 8, on trays prepared with plastic wrap.

Cut into squares, or simply tear off pieces to eat.

► For another way to dry fowl, see the recipe on page 50.

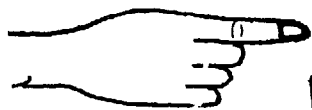

THIS PAGE IS FOR
PEANUT BUTTER LOVERS



Peanut butter added to fruit leathers makes a real confection! Try these:

APPLE-PEANUTBUTTER LEATHER

Prepare 4 cups chopped apples (cored but not peeled) as for basic Apple Leather, page 8.

To the pureed apples, add one cup old-fashioned peanut butter, & honey to taste (honey is optional). Blend together & dry same as basic Apple Leather.



BANANA-PEANUTBUTTER LEATHER

Purée in blender:

3 cups ripe (soft) bananas

Add: 1 cup old-fashioned peanut butter

1 tsp. vanilla

Blend all together, spread onto prepared trays & dry as above.

VARIATIONS:

Add 1 heaping tablespoon carob powder for a rich, chocolate-y taste.

Stir in $\frac{1}{2}$ cup chopped walnuts.

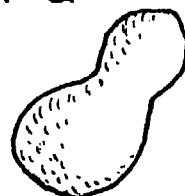

LIVING FOODS DEHYDRATOR

For those would like to build their own —
here's how

| PARTS LIST
| DIRECTIONS FOR CONSTRUCTION
| DRAWINGS

PARTS LIST

DEHYDRATOR CABINET

- 2 Side Panel 24" x 19 $\frac{1}{4}$ "
- 1 Back Panel 23" x 19 $\frac{1}{4}$ "
- 1 Front Panel 24" x 4"
- 1 Door 24" x 14 $\frac{3}{4}$ "
- 1 Lid 22 $\frac{3}{4}$ " x 23 $\frac{3}{8}$ " deep Tempered Hardboard $\frac{1}{4}$ "
- 1 Handle $\frac{1}{2}$ " x $\frac{1}{2}$ " x 4"
- 16 Tracks $\frac{3}{4}$ " x $\frac{3}{4}$ " x 22 $\frac{15}{16}$ "
- 1 Front Upper Brace $\frac{3}{4}$ " x 1 $\frac{1}{2}$ " x 21 $\frac{1}{2}$ "
- 2 Cabinet Hinge 1"
- 2 Flexa Door Catch, Bainbridge Mfg. Co.
Bainbridge Island, Washington 98110, or equiv.
- 1 Wood Knob $\frac{1}{4}$ " diameter
- 4 Legs 1 $\frac{1}{2}$ " x 1 $\frac{1}{2}$ " x 22"
- 12 Flat Head Wood Screws 1 $\frac{1}{2}$ " No. 10 with
finish washers
- 4 Flat Head Wood Screws 2 $\frac{1}{2}$ " No. 6 with
finish washers, or screw nails 6d finish
- $\frac{1}{4}$ lb. Finish Nails 3d
- $\frac{1}{4}$ lb. Finish Nails 4d

Cut from half sheet of
 $\frac{1}{2}$ " plywood

TRAYS

- 24 Tray Frame Sides $\frac{3}{4}$ " x $\frac{3}{4}$ " x $22\frac{3}{4}$ "
- 24 Wood Strips $\frac{1}{8}$ " x $\frac{5}{8}$ " x $22\frac{3}{4}$ " plywood or solid wood
- 24 Plywood Gussets $\frac{1}{8}$ " x 1" x 2"
- 3 Braces $\frac{3}{4}$ " x $\frac{3}{4}$ " x $21\frac{3}{8}$ " for Heavy Duty Tray
- 1 Hardware Cloth $22\frac{1}{2}$ " x $22\frac{1}{2}$ " Mesh $\frac{1}{4}$ " for Heavy Duty Tray
- 5 Fiberglass Screen $22\frac{1}{2}$ " x $22\frac{1}{2}$ "
16/18 mesh/inch, window type
- $\frac{1}{4}$ lb. Atlas Brand $\frac{3}{4}$ " Flat Head Nails or equivalent, or Staples $\frac{1}{2}$ "
- $\frac{1}{4}$ lb. Finish Nails 6d

NOTES

Plywood: $\frac{1}{2}$ " DFPA A-D Interior
Framing: Douglas Fir KD C grade
Glue: Elmer's Glu-All or equivalent

DIRECTIONS FOR CONSTRUCTION

After consulting the parts list, procure & prepare all material. Study all drawings before beginning fabrication.

DEHYDRATOR CABINET ASSEMBLY

Match the panels for appearance & direction of face grain, marking right & left, front & back, on the inside surfaces.

1. TRACKS

On the inside surface of the side panel, lay out the positions of the tracks (see Dwg. 4). Note that the end of the tracks must be held $\frac{1}{2}$ " from the back & front edges of both side panels. Attach the tracks with glue & 3d finish nails, about 5 nails per track, at a slight angle so that the points do not protrude. If nail points do protrude, use a steel file to smooth them off.

2. PANELS

Attach the side panels to the back panel using glue & 4d finish nails driven through the side panel into the edge of the back panel. Similarly, attach the front panel with glue, nailing into the edge of the side panels.

3. FRONT UPPER BRACE

Install the front upper brace (see Dwg. 4) flush with the front edge of the top two tracks. Use glue & wood

screws through from the outside of the side panels (2 screws in each end of brace, $2\frac{1}{2}$ " No. 6 F.H.). Pre-drill holes to avoid splitting. If desired, 2 finish screw nails 6d may be used in each end of the brace — pre-drill holes.

4. LEGS

The lower $16\frac{3}{4}$ " of the leg may be tapered if desired. Attach legs (see Dwg. 1 & 4) using 3 screws per leg, 2 on the side & 1 in front ($1\frac{1}{2}$ " No. 10 F.H. with cup finish washers).

5. DOOR

Set the door in place with a $\frac{1}{8}$ " gap at the bottom for working clearance (see Dwg. 3). Mark the hinge locations & pre-drill the screw holes. Mount the hinges approx. 4" in from the side edge of the door panel. Install the knob on the door face approx. 3" from top edge (see Dwg. 3).

Mount a "Flexa Door Catch," or equivalent, on the inside surface of the third slide from the bottom, both sides (see Dwg. 4). Insert the screw part of the latch into the receiver, leaving the point sticking out. Shut the door so that the screw point marks the inside surface of the door panel. Mount the screw at these points.

TRAY ASSEMBLY

1. FRAME

Accurately cut the frame members with a 45° miter at the ends (see Dwg. 5 & 6). After cutting a $\frac{1}{8}$ " x 1" rabbet diagonally across the ends, assemble each frame using the $\frac{1}{8}$ " plywood gussets, glue, & Atlas $\frac{3}{4}$ " flat head nails or $\frac{1}{2}$ " staples.

2. SCREEN (fiberglass)

Before attaching the screen to the frame, make sure the piece of screening is square-cut. Begin by fastening the screening on one side, securing it with the wood strips nailed or stapled (Atlas $\frac{3}{4}$ " flat head or $\frac{1}{2}$ " staples).

Repeat this fastening technique on the opposite side, making sure the screen is stretched tight & even.

Then secure the other two sides in a similar way.

Trim off any excess screening with a knife. Apply a bead of glue through the screening to anchor firmly (see Dwg. 6). Do not glue the wood strips because the screen may require replacement after much use.

Allow about 24 hours for glue to dry, leaving the tray flat with the wood-strip side up.

3. SCREEN (heavy-duty)

Add to the frame described above three evenly-spaced braces (see Dwg. 5). Glue & nail these braces with 6d finish nails to the frame, as shown.

Square-cut the hardware cloth to accurate dimensions

using wire cutters. This material cannot be stretched or glued, but otherwise the procedure to mount the hardware cloth is the same as for fiberglass screening.

SPECIAL NOTES: 1. HEATER

Although we have successfully used & recommended a thermostatically-controlled, wall-type heater with circulating fan, neither thermostat nor fan is necessary for perfect drying. ► THE PRIMARY CONSIDERATIONS ARE THAT HEAT BE LOW (100°, w/ NOT MORE THAN 10° VARIATION EITHER WAY) & PREFERABLY CONSTANT; & THAT AIR CIRCULATE FREELY. The bottom of the dehydrator is open so that air can enter through &/or around the heater. A gentle current is created as air warmed here rises naturally (no fan needed) toward the opening at the top. ► This moving air dries food quickly, with no danger of mildew — it takes the moisture with it.

A functional low-heat unit ideal for this dehydrator is being manufactured by its designer, Living Foods Dehydrators (Box 546, Fall City, Washington 98024).

Other possibilities (some definitely temporary):

a hot-water radiator under the dryer; a low-wattage (not over 2000) oven or clothes dryer element adapted to 120V; wall heater w/ thermostat, 1200W, 120V, 60C; open waffle iron; hot plate or electric frypan w/ variable control. ► Remember that electrical requirements should be carefully noted & all safety measures

taken:

Keep heat at the required level of 100° , with a variance of $\pm 10^{\circ}$.

2. FIBERGLASS TRAY SCREEN

Do not substitute other material for the fiberglass screen, since this screen is ideal for our design.

The foods in process do not stick to the screening & are easily removed when dry. This material is tough, long-lasting, & is easily washed with plain water. It is available from most builder-supply houses.

In our opinion, this screening is instrumental in turning out superior dried products.

3. LID

[Optional handle is centered on top front & glued & nailed into place.]

Lid is not attached to dehydrator, but simply laid into recessed top. It slides forward to allow the necessary ventilation. (See page 1, GENERAL INSTRUCTIONS).

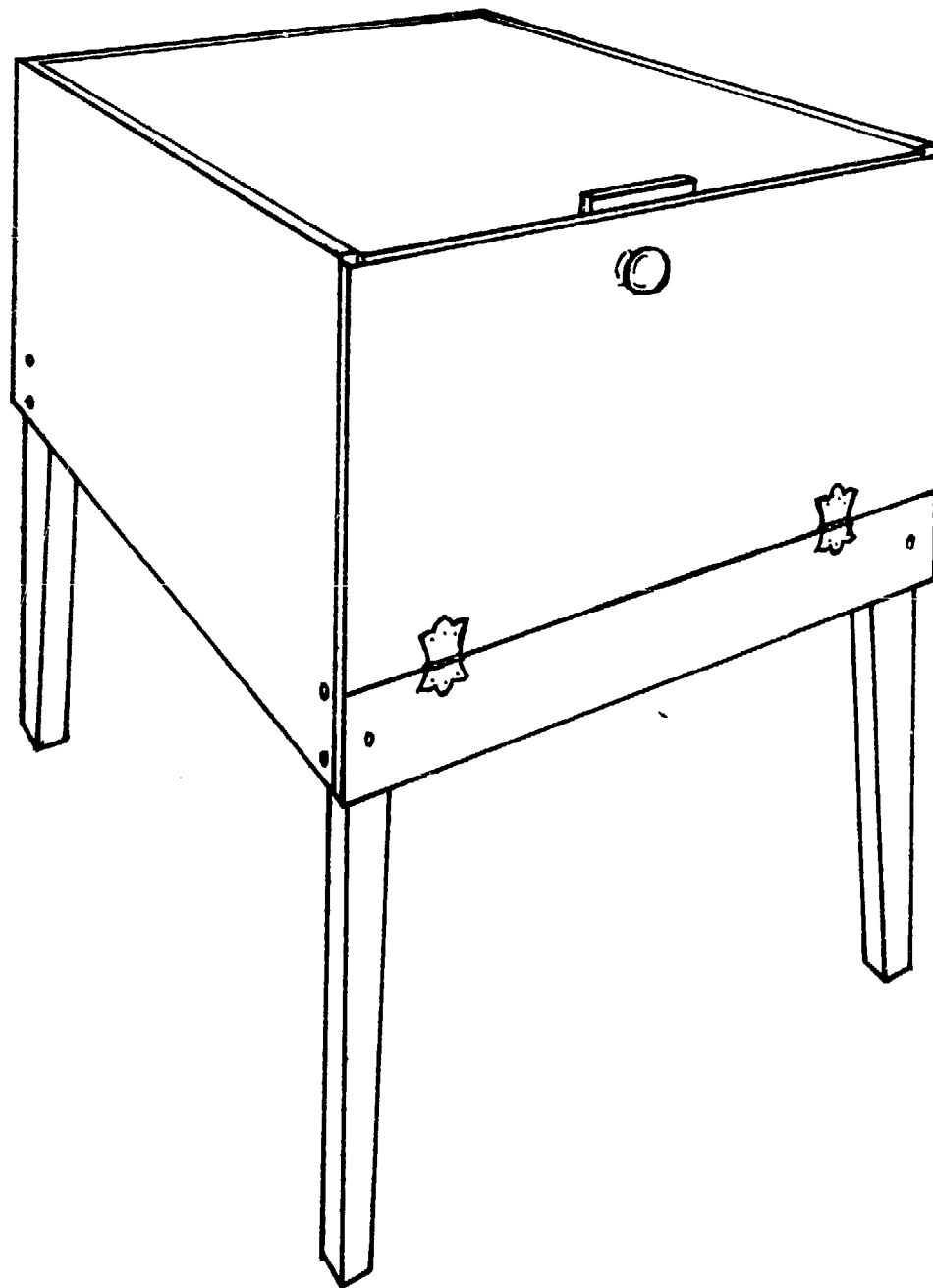

LIVING FOODS DEHYDRATOR

Dwg. 1

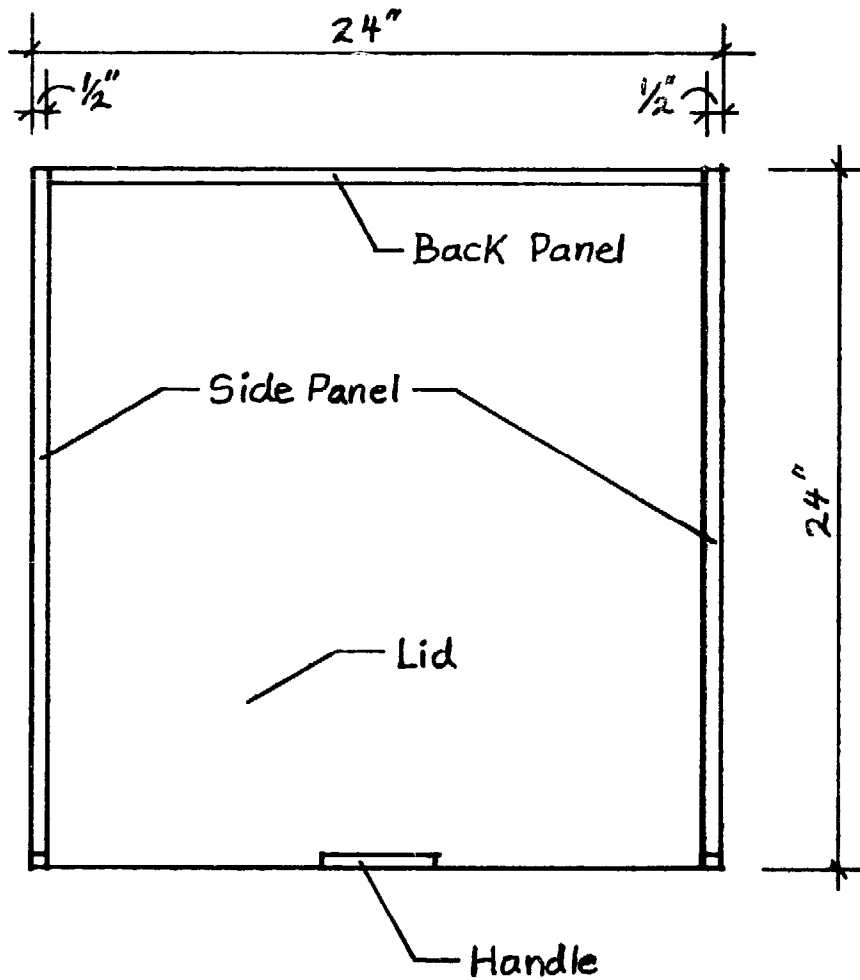

PLAN VIEW OF DEHYDRATOR
Scale $\frac{1}{8}'' = 1''$

Dwg. 2

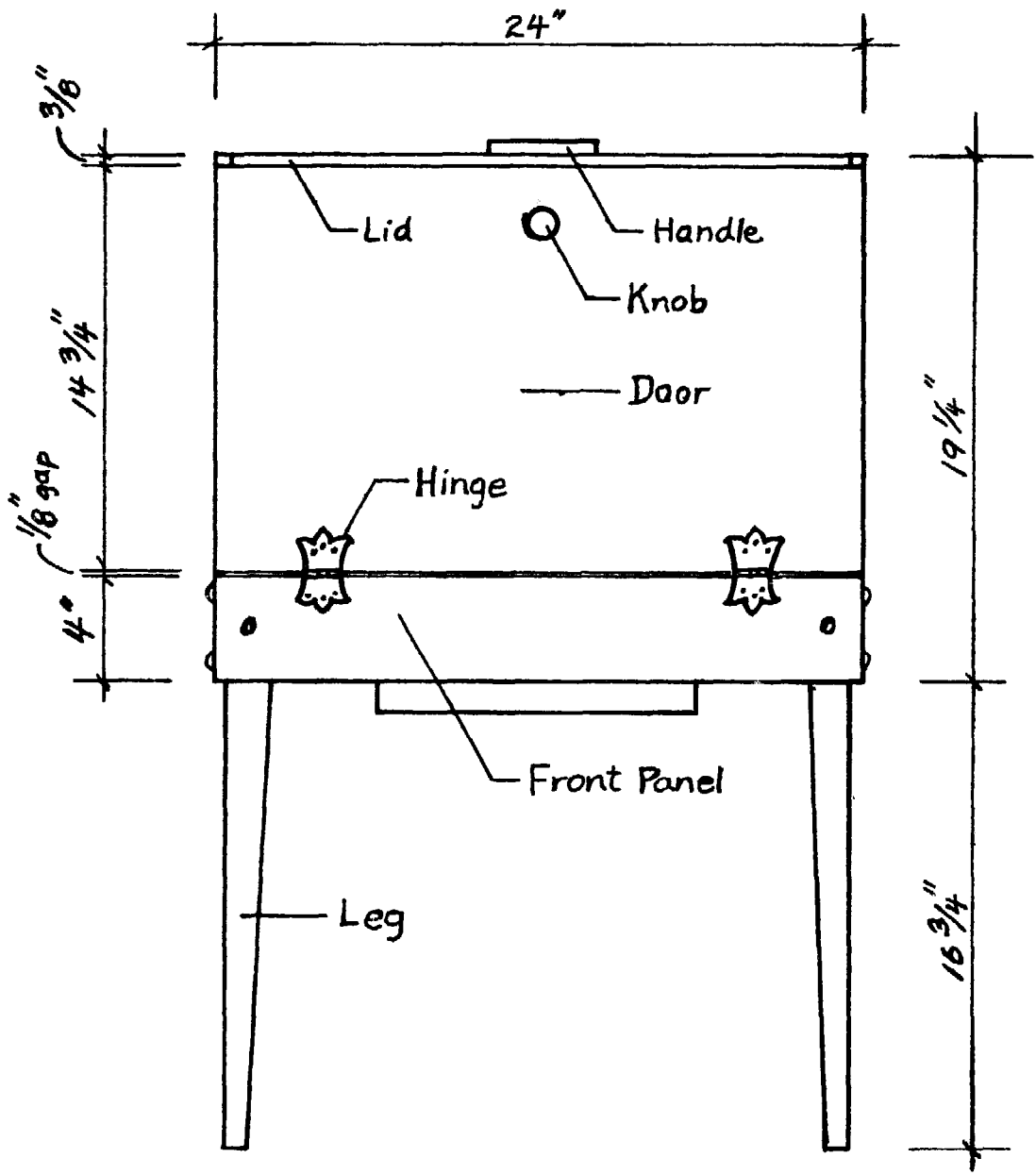

FRONT ELEVATION OF DEHYDRATOR

Scale 1/8"=1"

Dwg. 3

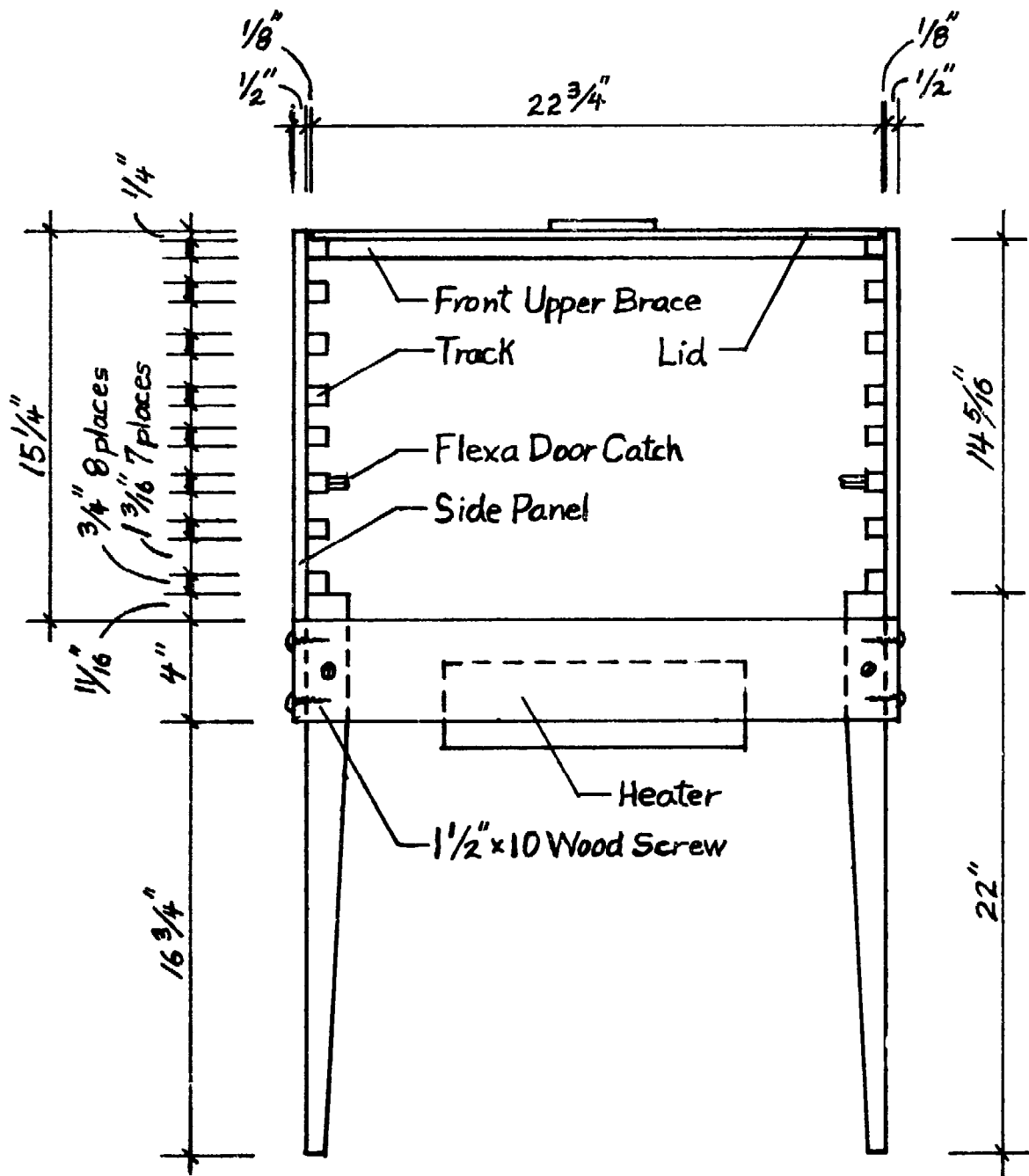

FRONT ELEVATION WITHOUT DOOR & TRAYS

Scale $\frac{1}{8}$ " = 1"

Dwg. 4

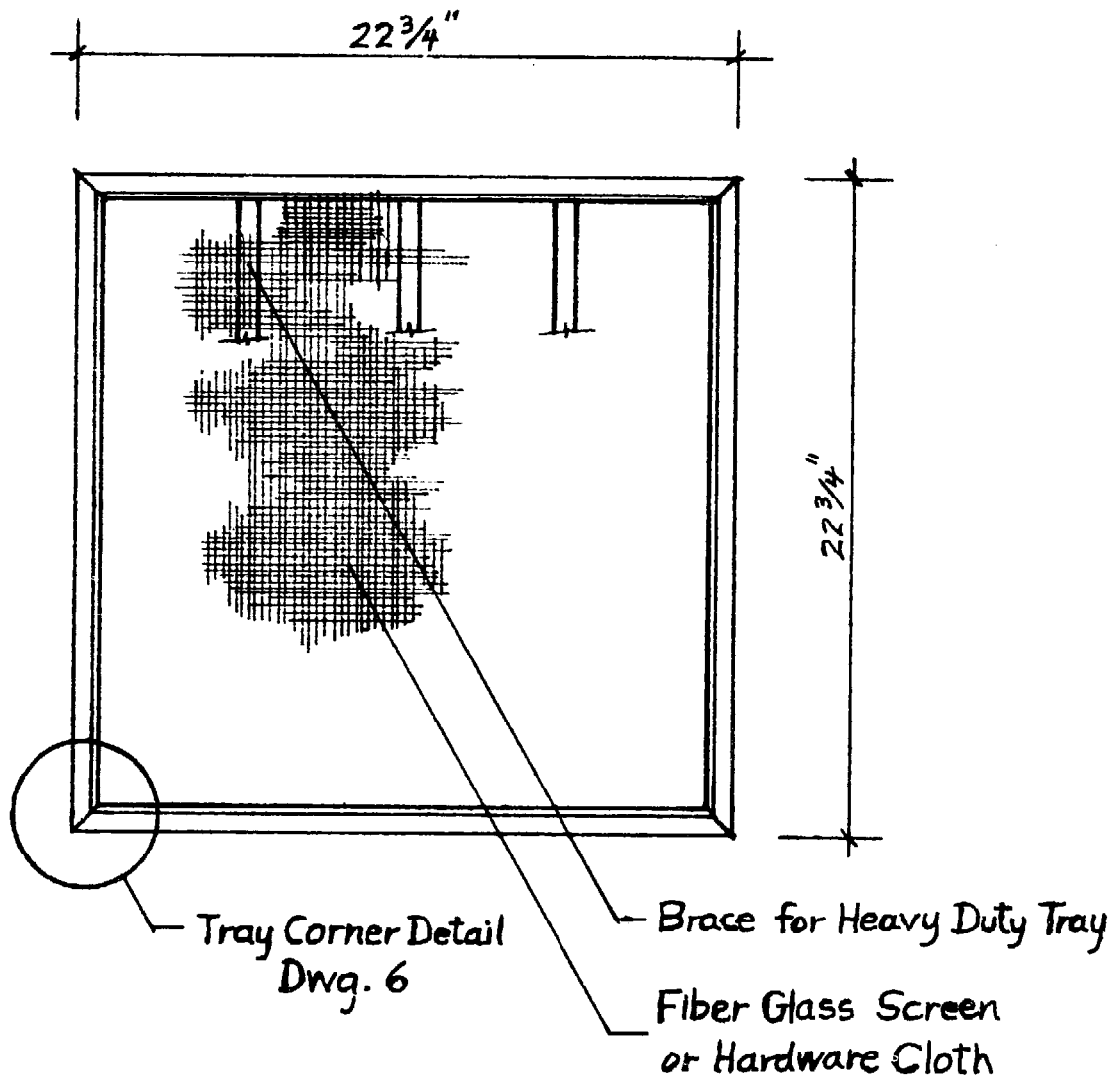

PLAN VIEW OF TRAY
 Scale $\frac{1}{8}"=1"$

Dwg. 5

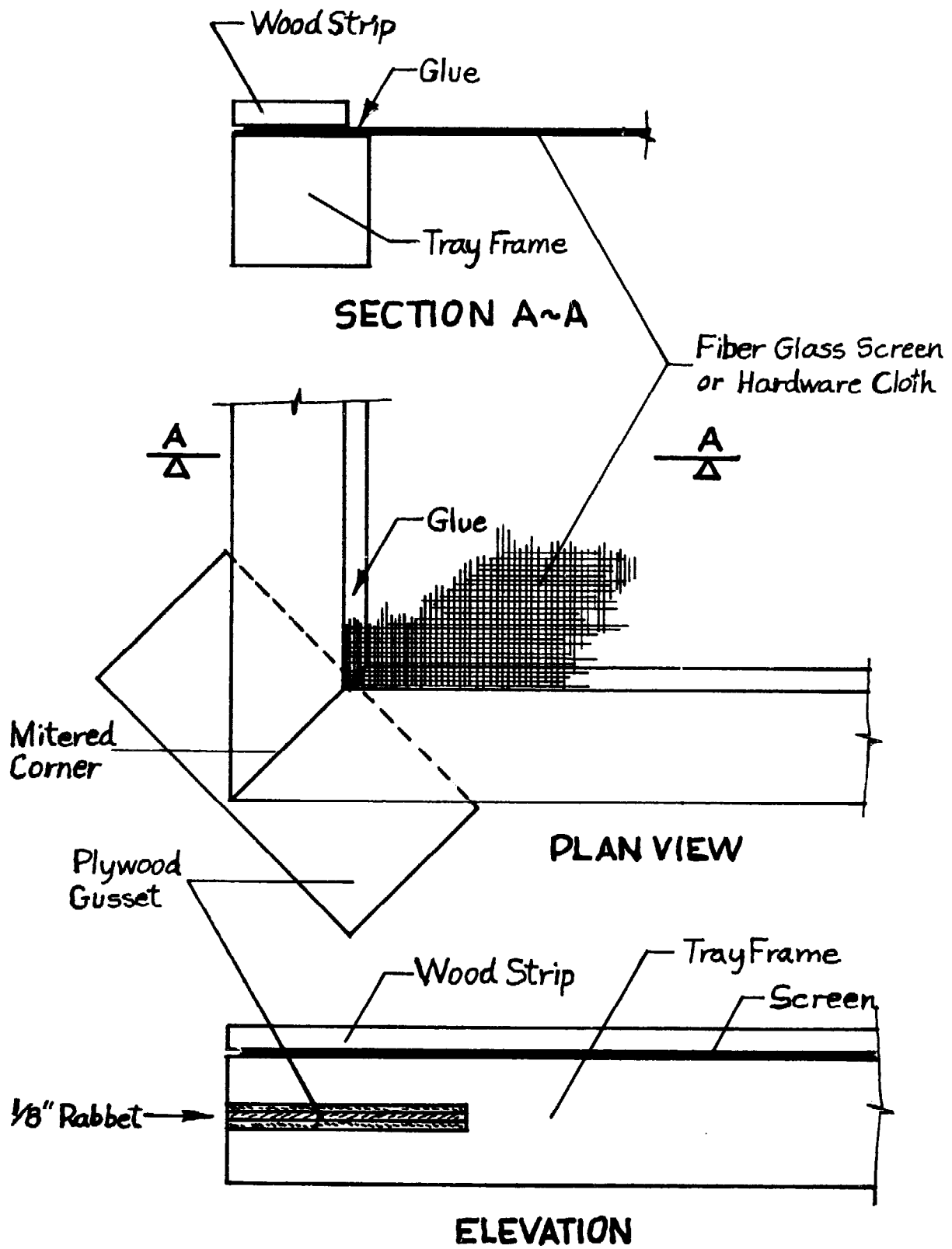

TRAY CORNER DETAIL
 Scale: Full Size

Dwg. 6

PLEASE NOTE:

We manufacture the original Living Foods Dehydrator. It is available complete or in kit form; some parts may be purchased separately. We take pride in good workmanship & prompt service.

For a complete information packet, including descriptions, prices & shipping information, you may write:

LIVING FOODS DEHYDRATORS
P.O. Box 546
Fall City, Washington 98024