

AT MICROFICHE
REFERENCE
LIBRARY

A project of Volunteers in Asia

The Handcart Handbook

by David Tresemer

Published by:

Green River Tools
5 Cotton Mill Road
P.O. Box 1919
Brattleboro, Vermont 05301
USA

Available from:

same as above

Reproduced by permission.

Reproduction of this microfiche document in any form is subject to the same restrictions as those of the original document.

HANDCART HANDBOOK

by David Tresemer

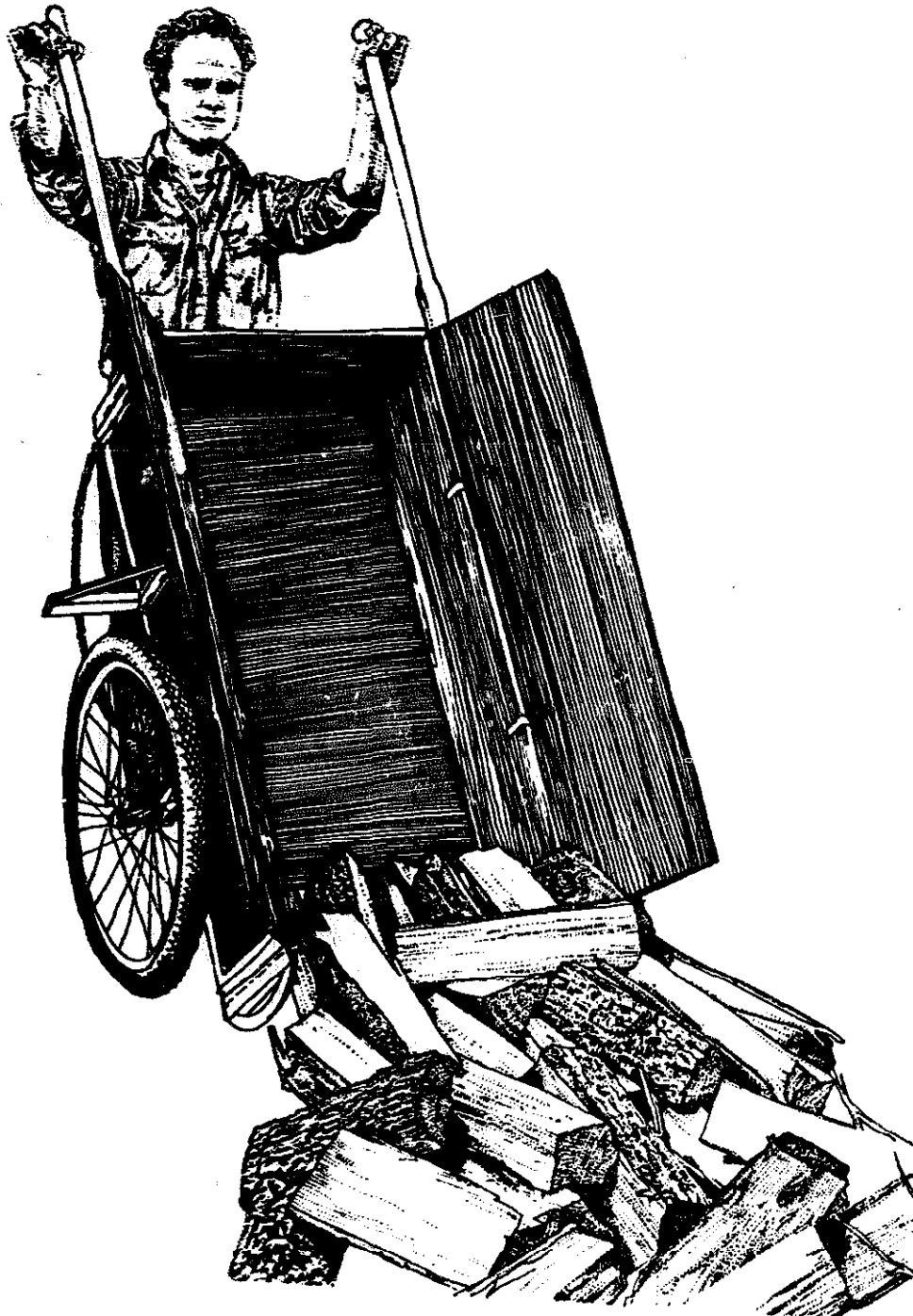

Revised and Expanded Edition

HANDCART HANDBOOK

By David Tresemer

Revised and Expanded Edition

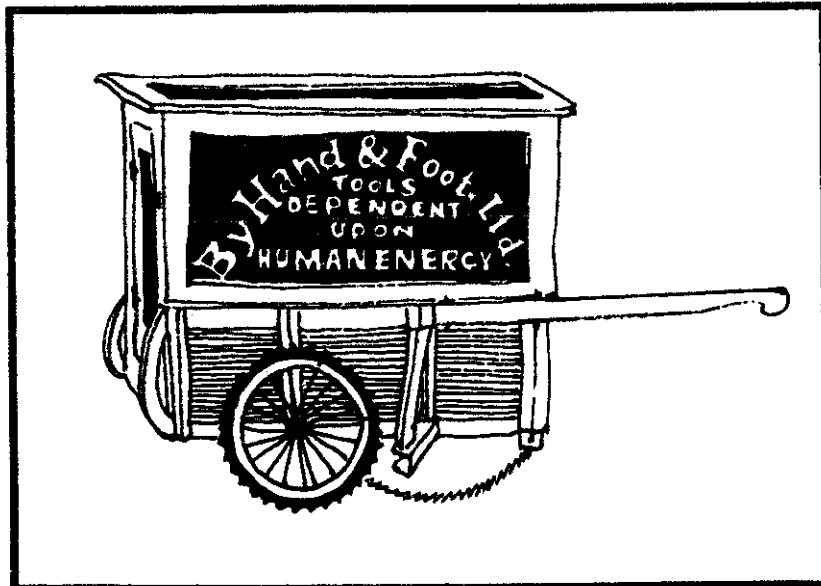

By Hand & Foot, Ltd.

Brattleboro, Vermont

MCMLXXXV

Note on sources:

This is primarily a research report so sources have been given only in special cases. Handcarts are widely advertised and are now made by a large number of local and national manufacturers. At this time, Green River Tools makes the handcart described in this handbook, and also offers accessories for individuals to build their own handcarts.

Figure 2 courtesy of Christian Science Monitor (photo by Gordon Converse); Figure 5 courtesy of China Journal; Figure 7 courtesy of Church of the Latter Day Saints; Figure 8 courtesy of Erwin Tichauer; Figure 10 courtesy of Popular Mechanics; Figures 11 and 12 and cover by Tara Devereux. Grateful acknowledgement is made to others who helped in the design of the cart, used the prototypes, and criticized them: Eliot Coleman, Joe Lamoureux, Dan Darrow, Stephen Bourne, Anne Holst, Florence Durbin, Shaun Murphy, Pamela Kratz, Bob Cannell, Brian Smith, Gerard Moran, Tamara Hardacre, Jillian Farwell, Susan Tresemer, Jack Ruttle, Larry Gay, and Jay Baldwin.

©1985 **By Hand & Foot, Ltd.** All rights reserved.
By Hand & Foot, Ltd., is the research division of Green River Tools.

ISBN 0-938670-04-2

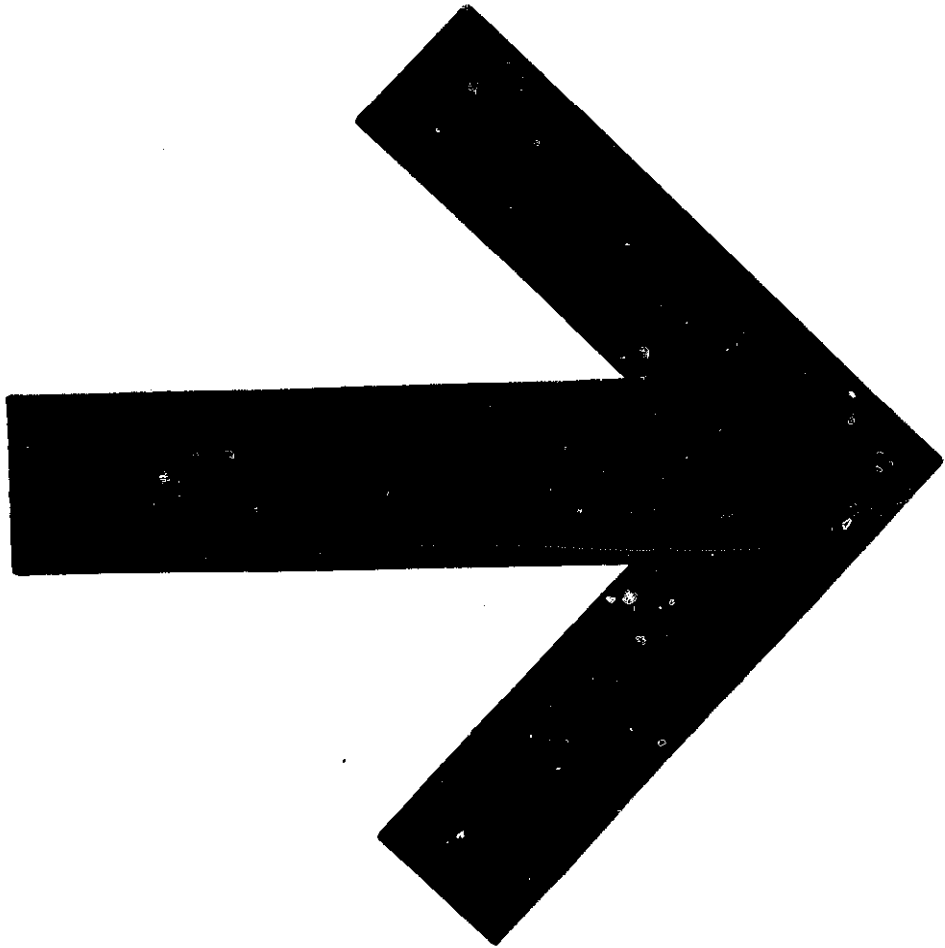

CONTENTS

Handcarts Through History

- A French Rickshaw
- Early Handcarts
- Oriental Rickshaws
- Handcarts in the United States
- Modern Handcarts
- Carrying Heavy Things

The Basic By Hand & Foot Cart

- Frame of Steel
- Body of Wood
- Shafts
- Wheels
- Bicycle Wheels

Remodeling a Garden Way-style Cart

Accessories

- Flare Boards
- Human Harness
- Trailer Hitch
- Sled
- Compost Screen
- The Four Seasons Cart
- Baker's Box
- Taxicab (Vinaigrette)
- Comment on Town Carts
- Animal Cage
- Goat Harness
- Covered Cart
- Winch
- Stone Lifter
- Plastic-laying Device
- Transplant Tray Holder
- Bicycle Attachment
- Backpack, Vallus, and Boat

Technical Note

- How Heavy Is It?
- How Much Can You Handle?

Epilogue



1. Rickshaw in Hong Kong (from the style of 1870). . . .



. . . and the French Vinaigrette in Brattleboro, Vermont (from the style of 1636).

HANDCARTS THROUGH HISTORY

A French Rickshaw

When the weather permits, just before noon on Friday, I treat my town of Brattleboro, Vermont, to an unusual sight: I walk and trot along the streets pulling a two-wheeled vehicle which advertises "Free Rides to Taft's for Lunch." Taft's is a local French restaurant. When people exclaim, "There's the rickshaw man," I correct them—this handcart is French, too. In fact, it is a reproduction of a style of handcart-taxi used in the cities of France in the seventeenth century and predates the introduction of the rickshaw design to Japan by over two hundred years.

Then the fun begins because my prospective passengers must cope with the conundrum of a French rickshaw. French means to them high culture—I am taking them to the best restaurant in town, one whose haute cuisine is described in French and prepared in that tradition—and rickshaw means exploited "coolie" bearing another's burdens. Confusion over this apparent contradiction prompts my passengers as well as passersby to express their opinions freely.

The street opinions range from delight—"Wonderful! We need a dozen of these to get people through this traffic!"—to critical—"It's easier with a horse!"—but every response begins with an uncontrolled giggle. To the observer, the vehicle seems odd, out of place. I had never realized how many heads there were in town until they all turned—and the looks of surprise still haven't ceased.

When I am arranging to give a ride, the passenger invariably hesitates and asks, "Are you sure (you can pull my weight)?" At that point I have found that explanations are less effective than actually climbing into the handcart cab myself and asking the prospective passenger to pull me twenty feet. The look of amazement at the ease with which this is done—the weight balanced over the axle, good bearings on pneumatic tires—always follows this procedure, even on the faces of the stodgiest of lawyers and doctors.

Then I give my passenger a ride. Nervous laughter gives way to hushed awe as the rider experiences a completely different mode of travel, at a more human pace. In a slower time frame, the passenger can notice the details of the passing landscape; if it is preferred, the curtains can be pulled for traveling incognito. The silence of the cart is unexpected; people suddenly realize how noisy their other modes of transportation are.

Many people go through a phase in their ride, which I call the Simon Legree phase, in which they spur the puller on with heartless commands: "Faster" or "Let's get going" or "Giddy-up!" They immediately feel guilty about their own feelings and behavior, and make up for it with something like: "Are you *really* all right?" We have such a strong moral requirement in our democracy that each person carry his or her own weight and personal baggage wherever they go that when one person pulls another it elicits tyranny and guilt in turns! My usual reply



2. One of the millions of handcarts in use in China today, on the Da Ming Gong commune, Sian.

to the rider is that the alternative mode of travel, the automobile (which I prefer to call the petromobile as it is not automatic), requires the enslavement of thousands. The handcart cab uses the energy of only one human to make it go and in a way that is enjoyable for both rider and puller. We both take the ride.

Adults usually relax and settle down after a short time. Children, on the other hand, thrilled by the sight of the thing, often run behind whooping, grabbing onto the back and asking for rides to no place in particular. The joy that children get with this handcart is one of the pleasures of bringing it to town.

Early Handcarts

Despite the rise of the internal combustion engine, there are more two-wheel handcarts in East and West than ever before—millions of them. Most are now used less to haul people than to haul stones and wood and earth, but the origins of the various designs of two-wheel handcarts makes a fascinating story.

Two-wheeled vehicles pulled by humans first appear in Chinese stick-figure pictograms from about the eleventh century B.C. Two-wheeled handcarts are very realistically depicted in stone on the walls of the palace of the Assyrian King Sennacherib, dating from the eighth century B.C. They are shown moving ropes and skids used in transporting large monuments, taking the spoils of war from conquered cities, and carrying the King to oversee his construction projects. Horses were much smaller then; two-wheel chariots were the same size as handcarts today and were likely pulled by people some of the time.

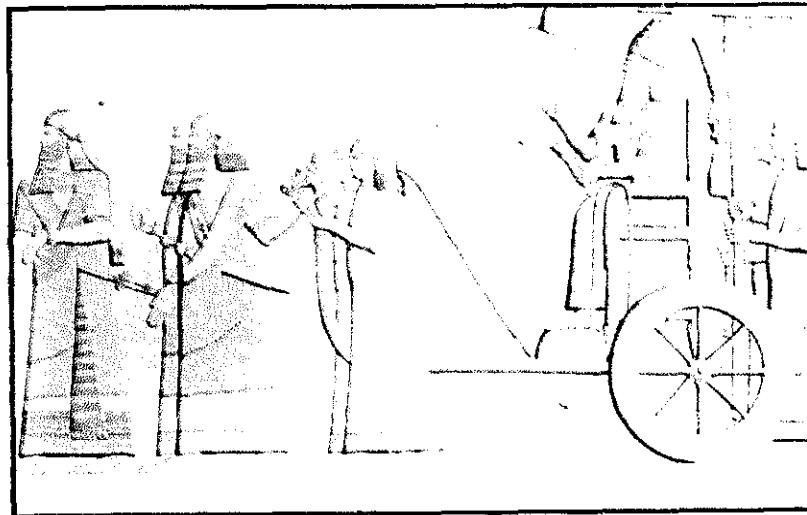

3. Handcarts used in the construction of Nineveh while King Sennacherib looks on, 8th century B.C.

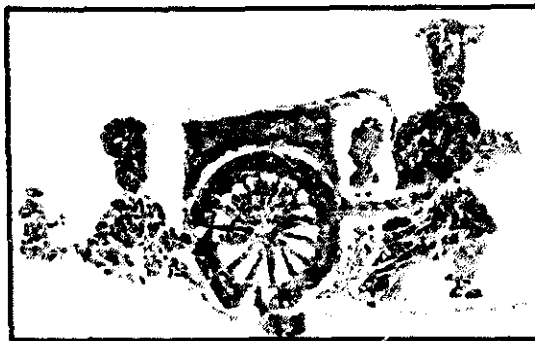

4. Gravestone rubbing of a Han dynasty handcart, 2nd century B.C.

There are several studies of handcarts in scrolls and paintings but my favorite is a fifteenth-century Chinese painting now at the Museum of Art in Columbus, Ohio. It depicts handcarts—one person pulling in front and one person pushing from behind—ascending a steep mountain road to a fantastical city in the clouds. Parts of the road are made of large timbers mortised horizontally into the sheer cliff face! Scenes such as these belie the statement of an anthropologist that carts pulled by hand were impossible until all-metal axle bearings were invented.

What about the development of wheeled conveyances in the West? Recent work, primarily by Joseph Needham and Wang Ling, has shown that many technological designs in general started in China; despite contacts with the West, the transfer was not made for centuries, if at all. This happened with the wheelbarrow and two-wheel handcart. There is no evidence of a wheelbarrow in use in the West until the eleventh century A.D., and use of such aids seems sparse until the fourteenth or fifteenth centuries. The balanced Chinese one-wheel wheelbarrow has *never* made it; the wheelbarrows of the West have for the most part thrown a great deal of the load onto the carrier. Leonardo da Vinci designed a well thought-out two-wheel handcart for roadwork, and such carts were actually used and seem to have increased into the 16th century and later.

The sedan chair (an enclosed box for one passenger to which is attached two parallel poles shouldered by two and occasionally four men), so-called because it was thought to have been invented in Sedan, France, became prominent in the cities of Europe around this time. Did the French and their historians have to invent these chairs because they didn't know about them in the Orient, or did a

chance comment in an engineer's shop by a traveler from the Orient lead to the design? No one knows for sure. One thing is certain in the transfer of technology: the general attitude must be just right before an idea is acceptable. When the Duke of Buckingham ventured out in a sedan chair in London, the crowd turned angry and nearly killed him, shouting that he shouldn't make men do horses' work (horses were bigger by then). But later, sedan chairs became popular in England, too.

Actually, the European sedan chair was not an exact copy of the Chinese chairs—the shafts on the European chair are at the waist, which is much harder on the bearer's body. Human arms are good for manipulating and moving things; they are not good hanging straight down to haul heavy things for long distances (ask anyone who has hauled buckets of water or maple sap). Europeans, particularly the Germans and Swiss, eventually developed an ingenious harness which looked like *Lederhosen* and distributed the weight over the shoulders and sternum. The hands and arms could then be used for balance and guiding.

In 1636, another two-wheel handcart taxicab was "invented" in Paris, using the same European harness attached to the bottom front of a sedan chair-style box. The *vinaigrette*, as it came to be called (it vaguely resembled the two-wheel handcart used by the Parisian vinegar-maker), had a door, windows curtained in velvet, colored interior wallpaper, soft upholstered cushions, and the first shock absorbers of any vehicle. The rich nobles had their own, in which they were pulled about the gardens. King Louis XIV had one called *le soufflet* because the top opened on fair days. They were also available for hire to those who aspired to rise in society but who could not afford their own handcart and tireur (the fellow who pulls). Indeed, they were the first vehicles for hire in the West.

The vinaigrettes were widely used at first, then less so as public transportation by carriage became more sophisticated; with trains they disappeared as suddenly as they had come, though a few have persisted into this century as anachronisms.

Oriental Rickshaws

I mentioned that my reproduction of a French handcart cab predates the rickshaws by two hundred years, but this is only partly true, as the French taxicab is predated by other similar modes of transportation from the East. It certainly proves that the story about a Christian missionary *inventing* the Oriental rickshaw in Japan around 1870 is fairly ridiculous. A modified design of a two-wheeled handcart was indeed introduced from West to East in the 1870s. It soon spread all over the East: 50,000 were in use in Tokyo in 1900. But there were many already existing factors which provided a context to assure its success: the tendency of the inhabitants to hire transportation for short hauls rather than own their means of transportation, a large number of Europeans who could pay for this service, and a positive attitude toward the building of roads, with the capital to build them. For example, rickshaws only came into the Foochow area in the 1920s because all the roads until that time had steps.

Rickshaw—from the Japanese *jinrikisha*, meaning literally "human-power carriage"—involves many people in the movements of a city.

Harry Franck, in *East of Siam* (Century Press, 1926) made these comments about rickshaws in Indo-China in the 1920s:

One's dozing was made all the more fitful by the rattling hubs of the pousse-cholera (meaning push-carts for the ill, although they were pulled, and used for other things)—those iron-tired, almost springless rickshaws of the masses—and

of the larger coolie-pulled baggage and vegetable carts, that made a hubbub beneath our windows all night long like the passing of a regiment of lumber wagons. Sometimes there might be a lull from about two until four in the morning, corresponding somewhat to the daytime siesta, but even then the streets were by no means so nearly deserted as they were around noonday. Plenty of good rickshaws, with wire wheels on large pneumatic tires and ample springs, as noiseless and comfortable a conveyance as those of Peking and far better than the ones to be found in Canton and Southern China in general, plied the streets of Hanoi. But they were used almost exclusively by foreigners, one European each, while the bone-breakers in which even mandarins were glad to save an Indo-China nickel served the natives.

Early in the twentieth century, many of the finest rickshaws were manufactured by the James Birch Company of Burlington, New Jersey, and exported to the major cities of the Orient. When the rickshaws of Hong Kong and other major cities where licenses were required had become so shabby from use that they could not get a license, they were sent to other cities such as Bangkok, where licenses were not required. Travel guides of the time warned visitors to Thailand not to travel by rickshaw. The same process brought new rickshaws to Peking and aged ones to the country for practical work on the farm.



5. Thousands of handcarts assist the rebuilding of the Huai River in North China.

As the rickshaw of the cities declined in used in deference to gasoline-powered transport, another use of the two-wheel handcart expanded—the rugged farm cart. Particularly after World War II in China, there was a great shortage of animal and gasoline power. The country was rebuilt with handcarts and muscle, motivated by the terrific charisma of Mao. The central motto of the Great Leap Forward was “pulling more, running faster,” referring specifically to handcarts. Many locally produced paintings and posters testify to the great pride of accomplishment when many hands were put to a task. According to the *Encyclopedia of China Today* fully half of all transportation of goods up to 1976 was performed by handcarts.

In China, unfortunately, quite recently the attitude has changed as modernization is emphasized. Travellers report that the Chinese hide their handcarts while pointing proudly at the new noisy tractor. The new mood will not do away with handcarts—they always have been there and always will fit niches of transporta-

tion between trucks and human backs. But the new attitude of disdain may undermine a history of accomplishment of which the Chinese can be justifiably proud.

Handcarts in the United States

Handcarts have a history of their own right in the United States. For a hundred years, the Life Saving Service (now assimilated to the Coast Guard) depended on handcarts to pull their equipment along the beaches of the Eastern seashore to the site of a foundering vessel. In good weather horses did the pulling; when winds whipped sand and ice through the air, horses bolted. Eight men were needed to get the 2000 pounds of equipment through the slush and over the dunes.

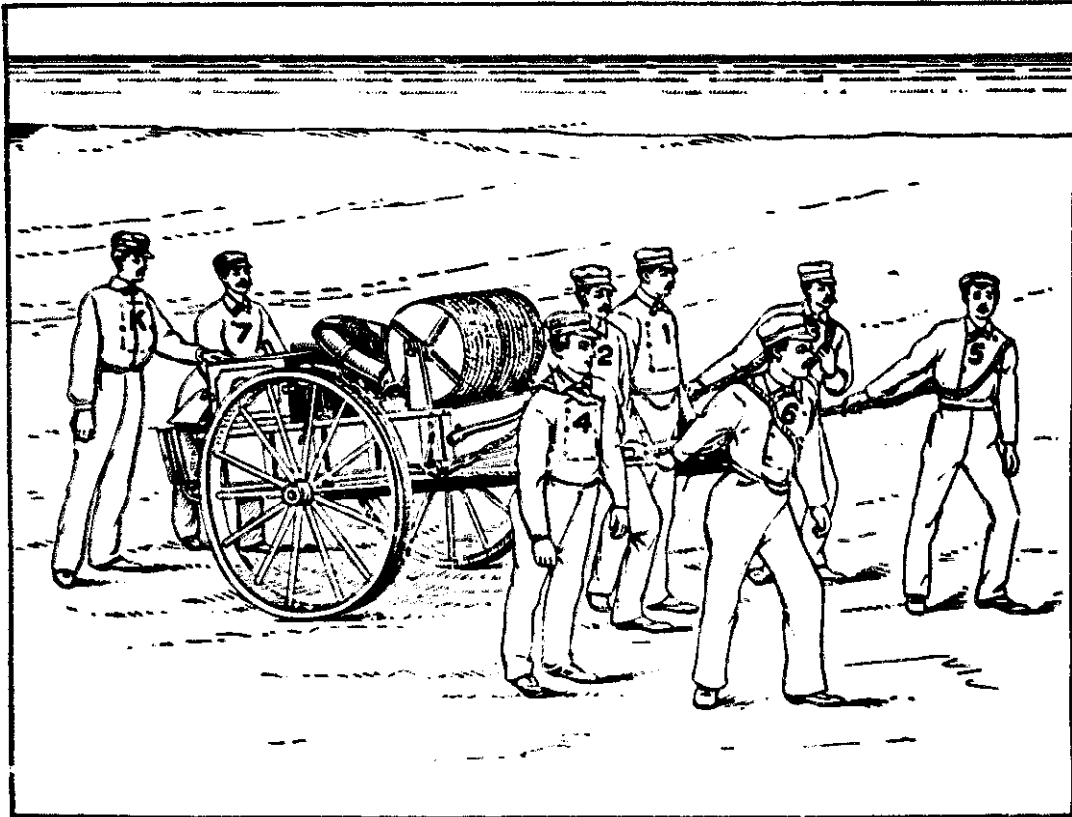

6. The United States Life-Saving Service.

Likewise, two-wheel handcarts were used by firefighters to move their equipment to the location of a fire. Before municipalities had their own fire departments, private companies would race to the scene to claim the reward for being there first. Later, when water and ladder trucks were pulled by specially trained horses, the coils of hose were transported by two-wheel handcarts.

Handcarts have been an important part of many urban areas too, being the vehicle used by apple vendors, ragpickers, knife sharpeners, and a whole range of pushcart peddlers, as well as porters, bakers, and small manufacturers. According to *The Pushcart War* by Jean Merrill, in 1987 there will be a confrontation between the gigantic trucks in New York City and the pushcarts: the pushcarts will win!

Each of these uses of handcarts had and has its fascinating human interest stories. The most gripping handcart story, however, comes from the West. Short of draft animals and already in the late summer of 1856, 3000 Mormons set off from Iowa City to Salt Lake City 1300 miles away, pulling all their belongings

and infants in hastily constructed two-wheel handcarts. Averaging 20 miles a day, most reached Salt Lake City safely before winter. A straggling group was caught in deep snow and many people died before a rescue party could get to them. A recurrent problem had been the seizing up of the all-wood bearings. When they ran out of bacon grease as a lubricant for the wheel hubs, they had to kill buffalo and render the fat before they could go on.



7. The Mormon Handcart Expedition of 1856.

Modern handcarts

Now in the U.S., two-wheel handcarts are becoming popular as never before. Part of the credit goes to a New York advertising executive named Lyman Wood who after WWII moved to Vermont and needed to move stuff around his country place. He remembered the ordnance handcart used on Army bases and adapted its design to a handcart which he called the Countryman's Carryall. He started the Garden Way tool company to sell the Carryall (now more generally sold as the "Garden Way cart") and there are today well over a million such carts (made by Garden Way or their imitators) in use in this country.

The Army-base ordnance cart which was the model for the Countryman's Carryall was itself derived from the street vendor cart of the turn-of-the-century. The Army cart and the street-vendor cart both had high wheels and short shafts and were meant to be pushed slowly through traffic. Pushing, less efficient than pulling, is necessary in crowded street conditions to wend one's way through the moving gaps in the crowd and, for the street vendor, to be able to keep an eye on the produce.

I have had trouble with the Garden Way-style carts. A large Garden Way cart was among my first purchases at my country place, and I quickly broke it—bent the hoop-like shafts, rubbed holes in the hollow struts, bent the plywood in the front end. It was a wobbly thing to begin with and was now even wobblier.

Then three friends were hurt using that style of cart. One was pulling a full load of firewood down the hill at his home, when the pulling hoop caught him in the back of the legs; he fell, the load rolled over him, and his arm was broken.

Another friend was emptying a load of stones. Since the Garden Way cart has no rear gate, that means she had to turn the cart almost entirely upside down. Once the rocks were out, the weight of the cart took over and down it came, the cross-piece of the hoop breaking her nose.

The third friend slit her hand on one of the metal support strips which holds the pieces of plywood together.

Other grisly stories have come my way, but these people I knew. These experiences led me to research into the past of handcarts and to the shop to build designs based on the inventions of the past. I have found that all the design problems in modern handcarts have been solved hundreds of years ago. The design I have come up with is for heavier work, which includes:

- Moving dirt and rocks from excavations, dumping made especially easy with gates on both ends of the body.
- Carrying firewood from tree stump to woodpile to woodstove.
- Moving transplant trays, soil, and compost to the garden.
- Bringing produce in from the garden and orchard: pumpkins, apples, cabbages, etc.
- Taking the “garden trash” to the compost pile: pea and squash vines, corn stalks, etc.
- Moving hay, straw, and small grains from field to barn and from barn to animals.
- Cleaning out animals’ stalls.
- Clamping a board across the top to use as a pair of sawhorses or a stepstool.
- Moving bulky light things: leaves to the leaf pile, branches to the branch pile.
- Moving bulky heavy things like lumber, trash cans, fenceposts, and so forth.

For moving the trashcans out to the curb once a week (a much advertised feature of modern handcarts), and for other light work, the By Hand & Foot cart is overbuilt. The By Hand & Foot design is based on another genealogy, that of farm carts and people taxis, meant to be pulled, and requiring long shafts and bright colors.

If you already own a Garden Way-style handcart, the handbook also covers ways of retrofitting that cart to make it more versatile and less abusive. Several accessories fit the Garden Way-style carts nicely.

Before giving the details of the design, some basic principles must be covered.

Carrying Heavy Things

Carrying heavy things is hard on the body because the strain on certain parts can be large. Even light things which are bulky exert large forces on your back. *Figure 8* emphasizes the main point: If you are carrying heavy or bulky things, it

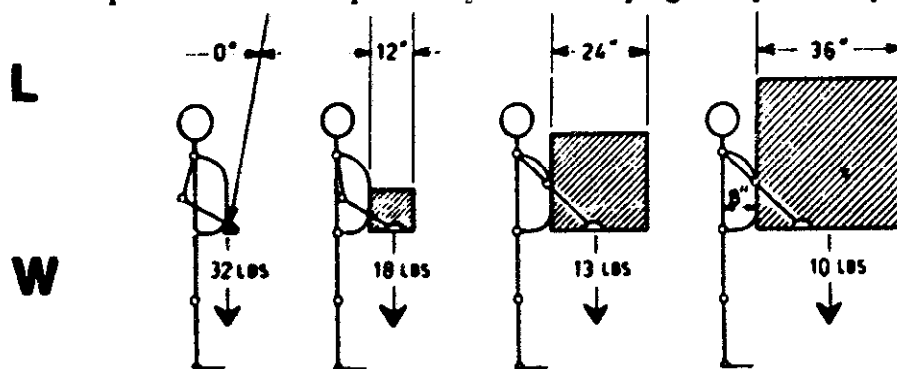

$$(8 + \frac{1}{2}L)(W) = M \quad \approx 250 \text{ INCHPOUNDS}$$

8. Light loads held far away feel the same as heavy loads held closely.

is very important that you get the center of gravity of the weight as close to your center of gravity as possible. This also goes for baskets, whose handles are out from the body; large baskets whose handles are further away should be used to carry light things. In the equation, 8 is the distance in inches from the joints of the lumbar spine to the front of the abdomen, a constant for each individual; L is the length in inches of one side of the object; W is the weight in pounds of the object; M is the biomechanical lifting equivalent, approximately 250 pound-inches in this example.

But your center of gravity is between your hip joints, deep down in your pelvis—how do you get the load inside to that point? You do it by poising the load *over* your center of gravity. Therefore arms are not a good way of carrying heavy things since they hold the load in front of the center of gravity. Also, your arms (and the entire shoulder unit) are connected to the bony support system of your trunk at only two small points where the clavicles attach to the sternum at the top of your chest: They do not have good skeletal support. Arms are better

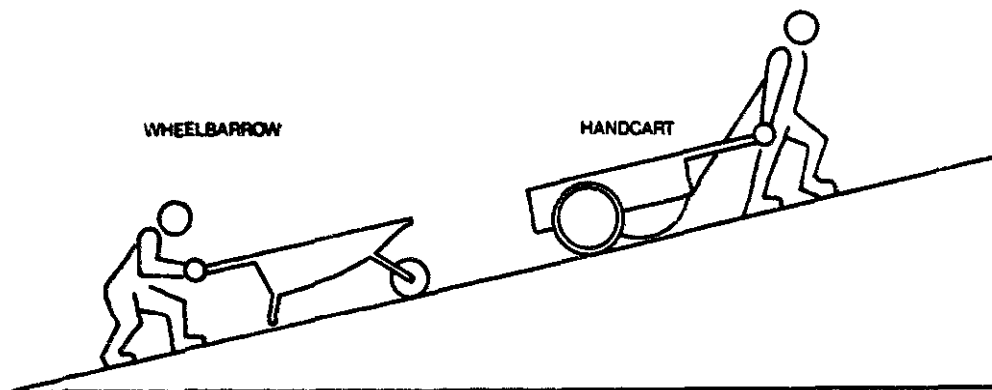

9. Moving 500 pounds up a hill.

for manipulating things—steering, lifting, etc.—and not at bearing burdens for sustained periods.

This is why the By Hand & Foot handcart has parallel shafts, so you have the flexibility to put your center of gravity where it's needed, to lean forward when starting up and to lean backward when slowing down.

On level surfaces, a load can be balanced in a two-wheel handcart by placing it right above the axle. Then the arms need only pull a bit to get going and drag a bit to stop, but there is no strain as the weight is borne by the wheels. On slight slopes with light loads there is also no problem.

On slopes over ten degrees, the weight of the handcart becomes a new factor. Add to this a heavy load—whether it be a large quantity of light stuff or any quantity of heavy stuff—and you have a new force on the body. Though far superior to a wheelbarrow (which at best carries $\frac{2}{3}$ of the load), a steep slope can demand much of a person and a handcart (Figure 9).

% GRADE	WHEELBARROW TENSION (LBS.)*	HANDCART TENSION (LBS.)**
0	133	0
4	180	20
(Maximum grade for major highways, speeds up to 60 m.p.h., is 4.)		
8	193	40
(Maximum grade for streets, speeds up to 40 m.p.h., is 8.)		
10	200	50
(Maximum grade for hilly rural roads, speeds up to 30 m.p.h., is 10.)		
12	206	59
(Maximum grade for roads is 12.)		

* Assumes $\frac{1}{3}$ weight borne by wheel.

** Assumes balanced load.

Carrying demands much, even on flat ground if that ground is soft; then you are forever pulling the cart up and out of its ruts. Knobby tires help a wheel "float" better in soft soil, but beach sand as well as friable garden soil can make transportation difficult with any kind of wheel.

A wheelbarrow is more quickly mired because you are pushing it into the ground. In Figure 9 draw a line from the point where the hand grasps the vehicle through the center of the wheel. For the wheelbarrow the line plows into the ground—your push goes down, making it more difficult to go over obstacles. The line rises with a pulled handcart.

In steep slopes on mucky ground, the arms are hard pressed to tug away at the cart. Pulling forward (which is far more powerful than pushing), the arms tend to pull the body over backwards, and do not successfully link the body's center of gravity with the forces coming from the load. Assistance comes from simple harnesses, which have been used by many handcarters round the world to poise the load over the center of gravity. Once you have tried a harness, you will be amazed at the increase in efficiency and comfort which it affords; it makes a monumental task such as hauling a winter's supply of firewood into an enjoyable one. Their construction and use are described in the accessories section.

THE BASIC BY HAND & FOOT CART

Frame of Steel

Carts and wagons have traditionally had an integrated frame to which are attached the wheels-and-axle and the body. If the body wears out, the structural integrity of the entire cart is not threatened. Rather, the worn piece is replaced. The design used by most modern cart designs is much simpler and more flimsy: the plywood is at once the body and frame.

To understand how this frame works requires a study of the plan drawings and details in Figures 10, 11, and 12, and all the photographs. The purposes of the structural members, named for the analogous pieces made by the British cartwright, are as follows.

The *standard* or *crutch* (see I on Materials List) is traditional in carts and wagons, and is often quite ornate. It supports the cart sides when gates are available at both ends of the cart body. Though missing in most modern garden carts, the standard is extremely important for preventing the sides from bowing out.

One of our tests was to haul a fifty-five-gallon drum half full of sand. Since the drum did not fit into the cart, it exerted terrific pressure against the sides. Yet they held. The best test, however, is moving green firewood, load after load. Modern carts, which have gates but no standards, flunk these tests.

The *bolster* (H) is a support for the standard, a fender for the tire, a step for children getting in and out, and a seat for the *trailer hitch*. The outer edges of the bolster should be ground round since it is a frequently encountered part of the cart. When I first started working with this design, I wrapped the ends of the bolster in cardboard to save my shins; I was accustomed to other carts which do not stick out as far. I have since gotten used to the bolster and appreciate what it does.

The *spar* (C) and *spar brace* (C1) are one unit, but the spar brace does most of the work. The four spars from behind each panel may be omitted since they do not provide much additional strength. The *soles* (D), analagous to the spars but

in the bottom of the cart, should not be omitted: they provide necessary support for the floor.

The *struts* (J) are welded to the bottom rail just forward of the *sole brace* (D1) above the *axle* (M), and to the *gate stop* (F) at the front of the cart. The distance from the bottom rail to the ground is thirteen inches. You may prefer to have the struts shaped at a metalworking shop. If the struts are not perfectly matched, the cart will wobble a bit, but it is very difficult to weld so that all four points, two tires and two struts, touch at the same time. Besides, the earth is seldom perfectly flat. Minor wobbles disappear when the cart is loaded.

The struts are the brakes of the cart—to slow down or stop, push down on the *shafts* (S) to scrape the struts along the ground. They should be of sturdy stuff, not flimsy tubular electrical conduit as in many modern carts. Use a $\frac{3}{8}$ -inch reinforcement bar. These struts do not go across the direction of travel, or they would catch the heels of the carter, as they do in other carts.

One option is to make the struts removable, by welding threaded studs to the cart, and welding plates with holes in them to the ends of the struts. In this case, the gate stop should be 1 x 2 to give room for a threaded stud. With this

MATERIALS LIST—HANDCART

Key	No.	Size and description (use)	P	8	$\frac{3}{16}$ "-dia. \times 1 $\frac{1}{2}$ " bolts, washers, nuts (for flare boards)
A	2	$\frac{1}{2} \times \frac{3}{4} \times \frac{3}{4} \times 48$ " steel angle (top rail) *	Q	2	$\frac{3}{16} \times 2 \times 2$ " steel (trailer hitch tabs, optional)
B	2	$\frac{1}{8} \times \frac{5}{8} \times \frac{5}{8} \times 48$ " steel angle (bottom rail)	R	2	26"-dia. \times 2.125 spoked wheel and tire with extra-wide spindle
C	8	$\frac{1}{8} \times 2 \times 10\frac{3}{4}$ " steel (spar)	S	2	1 $\frac{3}{8} \times 1\frac{3}{4} \times 48$ " ash (shafts)
C1	6	$\frac{1}{8} \times \frac{3}{4} \times \frac{3}{4} \times 13$ " steel angle (spar brace)	T	4	$\frac{3}{8}$ "-dia. \times 2 $\frac{1}{2}$ " bolts, washers, nuts
D	4	$\frac{1}{8} \times 2 \times 21\frac{5}{8}$ " steel (sole)	U	2	$\frac{1}{2} \times 12\frac{3}{4} \times 24$ " plywood (gates)
D1	3	$\frac{1}{8} \times \frac{3}{4} \times \frac{3}{4} \times 24$ " steel angle (sole brace)	V	2	$\frac{1}{2} \times 12 \times 48$ " plywood (side panels)
E	4	$\frac{1}{8} \times \frac{1}{2} \times 1 \times \frac{1}{2} \times 12\frac{3}{4}$ " steel channel (gate channel)	W	1	$\frac{1}{2} \times 24 \times 48$ " plywood (floor)
F	4	$\frac{1}{8} \times 1 \times 1$ " steel (gate stop)	X	2	$\frac{1}{2} \times 12 \times 48$ " pine (flare boards)
G	2	$\frac{1}{8} \times \frac{3}{8} \times 1 \times \frac{3}{8} \times 13\frac{3}{4}$ " steel channel (dumping support)	Y	12	$\frac{1}{8}$ "-dia. \times 1" bolts, with washers, nuts (for V)
H	1	$\frac{3}{16} \times 1 \times 2 \times 1 \times 37\frac{1}{2}$ " steel channel (bolster)	Z	2	2" cotter pins
I	2	$\frac{1}{8} \times \frac{3}{4} \times \frac{3}{4} \times 13$ " steel angle (standard)	Z1	4	$\frac{1}{8} \times \frac{3}{4}$ "-i.d. \times 2"-o.d. washers
J	2	$\frac{3}{8}$ "-dia. \times 44" steel reinforced (strut)	AA	2	4" brass handles and eight $\frac{1}{8}$ "-dia. \times 1" bolts with T-nuts
K	4	$\frac{3}{16} \times 2 \times 2\frac{1}{2}$ " steel (shaft tab)	Misc.:		Redi-Metal or other acid-cleaning solution, 1 pint metal primer, 1 pint metal paint, paint thinner, exterior enamel, penetrating oil.
L	2	$\frac{1}{8} \times \frac{1}{2} \times 1\frac{1}{2} \times \frac{1}{2} \times 15\frac{1}{4}$ " steel channel (axle spar brace)			
M	1	$\frac{3}{4}$ "-dia. \times 37" steel rod (axle)			
N	4	$\frac{1}{8} \times \frac{1}{2} \times 1 \times \frac{1}{2} \times 13$ " steel channel (flare board iron)			
O	4	$\frac{1}{4} \times 1 \times 4\frac{1}{4}$ " steel (flare board hook)			

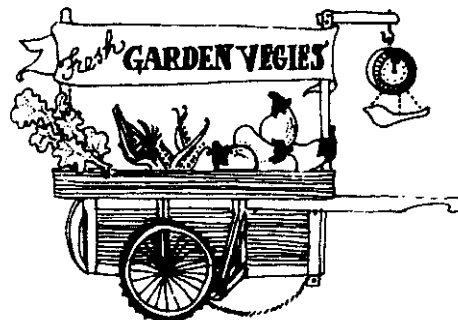
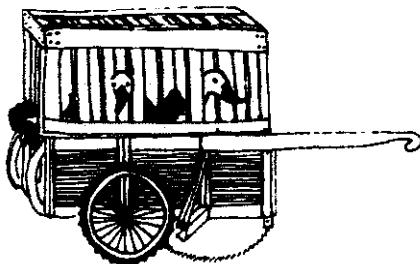

*The 48-inch measurement can also be 47 $\frac{1}{4}$, as described in the text.

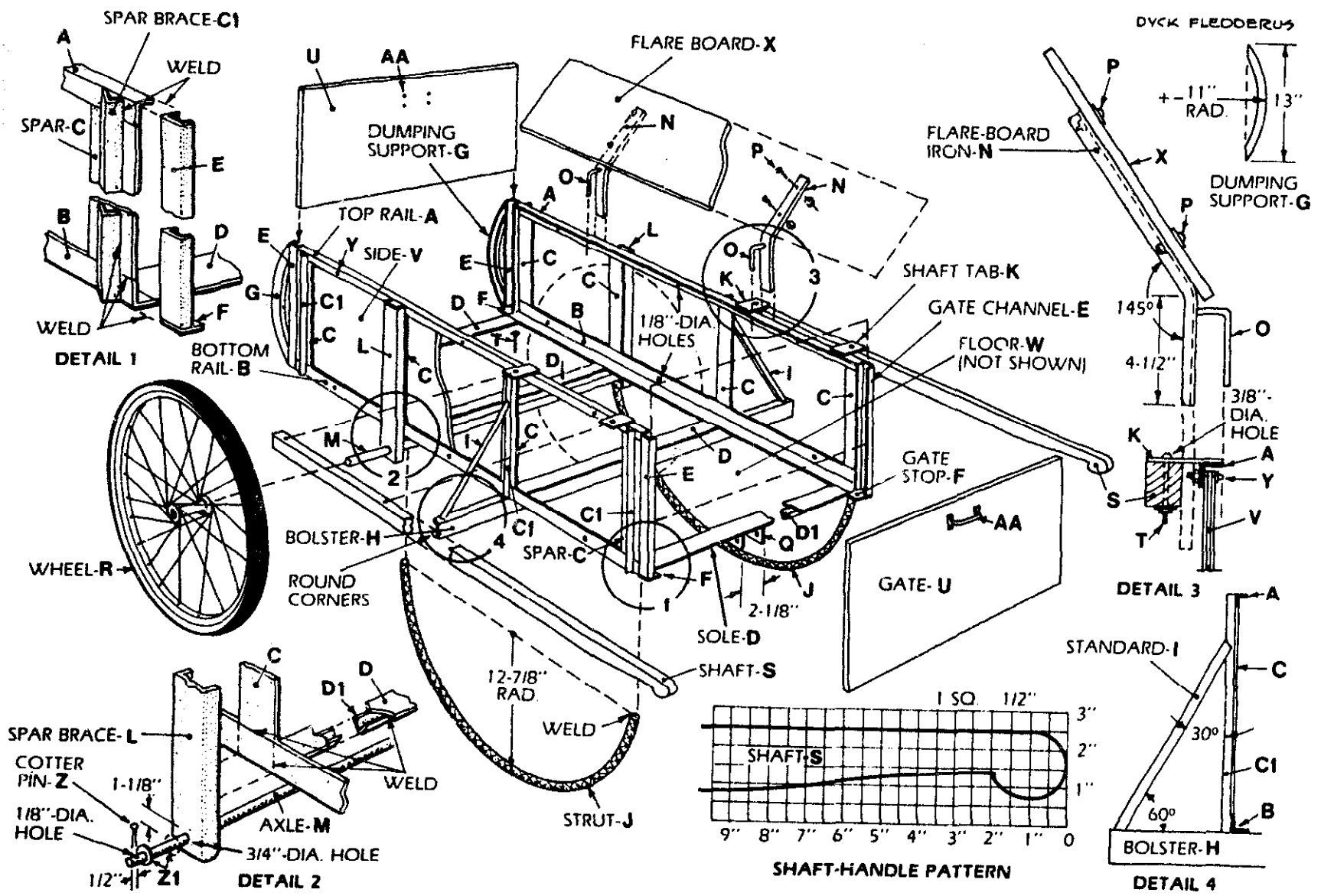

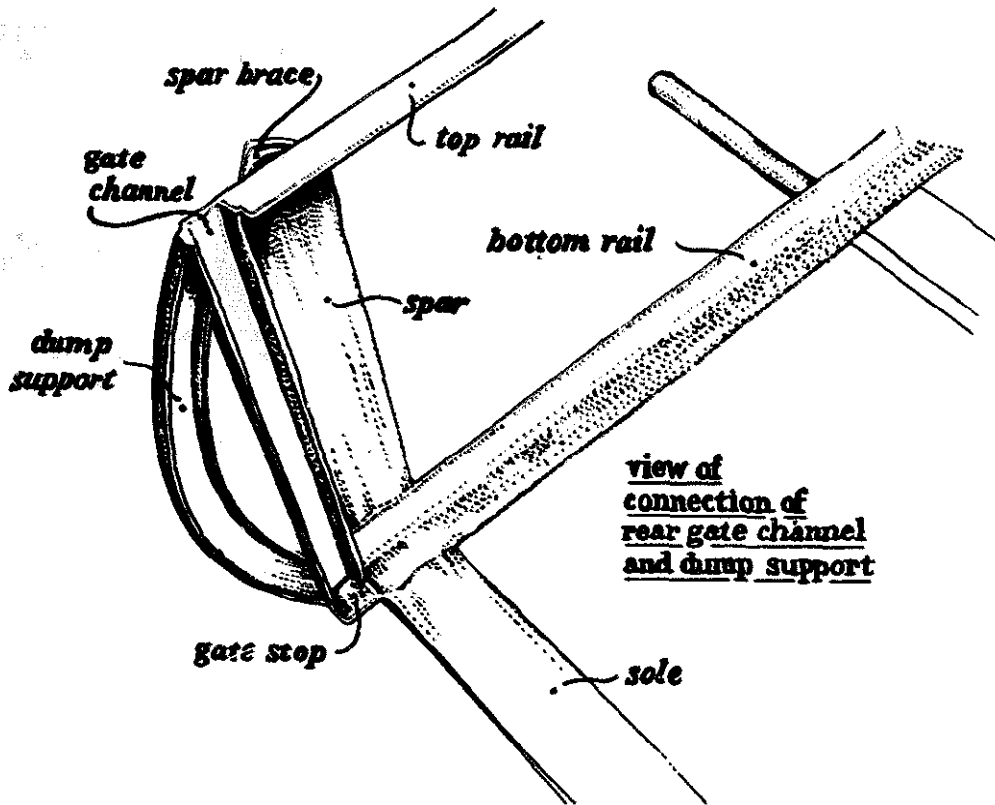

11. View of connection of rear gate channel and dump support.

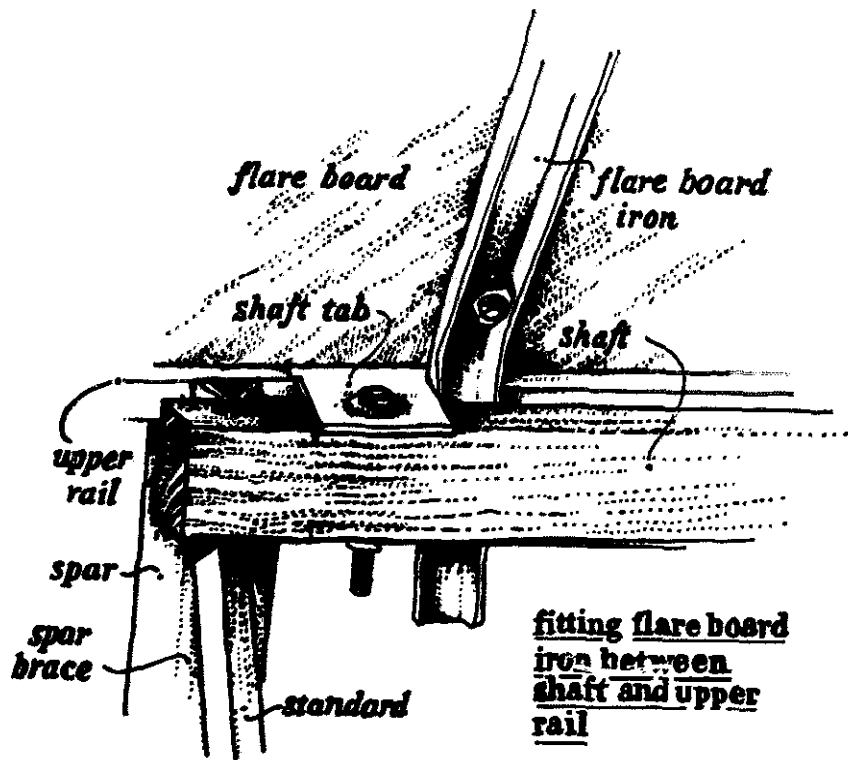

12. Fitting flare board iron between shaft and upper rail.

modification, the struts can be bolted to the cart or taken off, depending on the use. With a smaller goat for pulling, or with a smaller set of wheels, these struts might be too big.

Dispensing with these struts altogether, a forked stick can be set upright between the ground and one shaft to hold up the cart at rest. Another stick between the ground and the rear of the cart, traditionally called a "dog," would prevent the cart from rolling off its forked-stick strut when the cart is parked.

The *dump supports* (G) permit easier tipping up—for dumping loads, as well as for leaning the cart against a wall to get it out of the way. They keep dirt out of the rear *gate channels* (E). They also serve as handles when the rear of the cart needs to be grasped.

The *trailer hitch tabs* (Q) are not only for small riding mowers. They can be used to attach a goat swingle and a human harness. The tabs must be notched before welding over the front sole brace.

The *wheels* (R) are placed to the rear of center because the most dangerous load is one that is placed too far back, tipping the cart up and maybe hitting someone with the knob of the shafts. The load should be centered just in front of the axle so most of the weight is borne by the wheels but the cart rests firmly on the struts. When going up hills, the load should be even more forward. With the wheels placed to the rear, this cart feels heavier when empty than when loaded. With a load of hundreds of pounds balanced over the axle, the shaft can be lifted with one finger.

Does the frame need to be made of metal? You could make it entirely of wood, mortised and tenoned and pegged, using the principles of bolster and standard, just as the ancient Assyrians did three thousand years ago. They also made their wheels entirely of wood. But few knew then and few know now the skills of the wheelwright and cartwright. Welding, however, is competently done by many; even if one does not do it oneself, one can readily find a welding shop which will purchase or scrounge the metal, cut it, weld it, and grind off the sharp edges. The welded frame has the virtues of strength and ease of repair. If the wood body wears out with use, the frame does not fall apart; new panels can be installed. This frame was tested for seven years against the attacks of young farmhands moving wood, boulders, fenceposts, etc., without bending.

1. Construct a jig to hold the side parts at right angles to the bottom during welding. The jig can be made of 2x4 lumber to a finished size of 12x24x48. It is best to weld the cart upside-down, first the bottom (bottom rails, soles, and sole braces), then each side (spars, spar braces, and top rail). When finished, all excess spatter should be tapped or filed away, and messy welds and sharp corners ground down. Welding is best done with a wire-feed welder since the simpler sorts of welders heat the metal so much that the steel pieces bend when cooling. If an arc welder is used, the top rails should be heavier, say $\frac{3}{16}$ stock, or as wide as the bottom rails.

2. Holes are drilled:

a.) in the end of the axle spar, $\frac{3}{4}$ inch diameter, centered $1\frac{1}{8}$ inches from the bottom end, through which to slide the axle (part L, see detail 2 in Figure 10);

b.) through the center of the width of the shaft tabs (K), $\frac{1}{4}$ -inch in diameter, $\frac{5}{8}$ inch in from the outside edge for the two $2\frac{1}{4}$ -inch bolts (T) which hold the shafts in place (see detail 3);

c.) in the center of the trailer hitch tabs (Q), $\frac{1}{2}$ -inch in diameter, for the pin which holds the trailer hitch,

d.) $\frac{1}{2}$ inch from each end of the axle, $\frac{1}{8}$ -inch in diameter, for the two-inch lynch pins (Z), which hold the wheels onto the axle,

e.) in the center of the bolster, $\frac{1}{2}$ -inch in diameter, for the trailer hitch locator pin, three places along the side of each top rail

f.) and three places along the side of each bottom rail, $\frac{1}{8}$ -inch in diameter for the bolts (Y) which hold the side panels in place.

3. The wheels slide on the axle and are held in place by one or more large washers ($\frac{3}{4}$ inch inside

diameter, $\frac{1}{8}$ inch thick, 2 inches outside diameter). The washers (Z1) are held by cotter or lynch pins (Z) set through the end of the axle.

4. Protecting the metal is best done in three steps. First, clean off the rust and dirt, and etch the metal with an acid solution such as "Metalprep", or "Chem-grip", or "Redi-metal" (available from automobile parts stores). Use of these chemicals requires extreme caution (including perhaps a fume mask), but is necessary to ensure a good bond of the paint to the steel. Second, prime the metal to protect it. Third, paint with at least two coats to protect the primer and give the desired color. The "Rustoleum" paint system is a good one. You can expect to use about a pint of primer and a pint of paint, plus thinner. The integrity of the paint coating should be checked once a year. If a patch of rust shows through, the area should be sanded and repainted.

Body of Wood:

High quality exterior grade half-inch plywood is strong enough because of the support given by the spars and soles. I have also made a beautiful cart body from hardwood of my own cutting, in tongue-and-groove boards, varnished to show the grain. A friend has lined a By Hand & Foot cart with squared pine boards, which also works very well and is in fact less expensive than plywood or hardwood. Of course, these options require more bolts through the wood into the soles and spars. Gates made of several pieces require support pieces perpendicular to the joints.

Beautiful as my hardwood body is, I think painted plywood is more practical. Bright colors and contrast between the body and the frame are traditional to country and city carts. Indeed, vendors' carts were often carefully painted with thin stripes just in from the edges, as well as the name of the owner (and, occasionally, of the cartwright) in beautiful lettering. Few people realize that the colors of the United States flag came from the vermilion frame, deep blue panels, and bleached white cloth cover of the Conestoga wagons used before the Revolution.

Large clips can also be attached to the outside of the panels or to the underside of the floor for attaching much used implements for which one does not want to rummage around inside the body of the cart. Handcarts in the Army had an ax, shovel, and mattock clipped to the outside; the Army carts had rings, handles, and clips all over the outer surfaces of the cart. Carts made without struts had the forked-stick strut and "dog" ready in this location: One end of the strut was hinged to the edge of the cart, and the free end clipped up underneath, ready to be dropped down to the ground for parking. When pulling a long ladder or a load of fence posts, both gates will be taken out; the gates themselves could have places for storage somewhere on the cart. I store mine underneath, tucked into the channel of the bolster. Each use of the cart has its companion tools which require easy access on the outside of the cart body.

1. For half-inch plywood, the floor (W) is 24 inches by 48 inches notched at four corners to fit around the gates channels. The two side panels (V) are 12 inches by 47 $\frac{3}{4}$ inches. the gates (U) should be 12 $\frac{3}{4}$ inches by 24 inches, but are cut to fit the gate channels after the frame is made, in case of warpage of the frame during welding.

2. Measure the cart carefully before cutting the wood. Holes or gaps in the wood are then filled, and the panels, floor, and gates are painted with two or more coats of an exterior-grade enamel.

3. After the pieces are cut and painted, lay the floor into place and press the two side panels down so they hold the floor without bolts. Bolt each panel in three places through the top rail and three places through the bottom rail (one-inch bolts, $\frac{1}{8}$ or $\frac{3}{16}$ inches in diameter, with washers at the heads against the wood, and nuts tight against the frame).

4. Finally, attach the two brass handles (AA) to the cart's gates, preferably with protection for the end of the bolt protruding through the wood (as with a "Pal-nut" or "T-nut").

Shafts

The power of the human body must be connected to the cart in as efficient a way as possible.

It is more efficient to pull with shafts than to push a cart. The exceptions are vendors' carts in crowded city streets—these are pushed so that the vendors can keep an eye on their produce. When I lift and push from behind, I also push down, appropriate with a wheel hoe that digs into the ground but not with a load of heavy things. A better use of my power is to lift and pull the cart over obstacles.

Why shafts? The body's center of gravity and power is between the hip-joints. Depending on whether one is speeding up or slowing down, the center of gravity is placed before or behind the place where the hands grip the shafts. If you add turning and tipping, the body must be given great flexibility, much more than that permitted by the small hoops of tubing that most carts provide for handles. To walk outside such a hoop is to walk crookedly, with one's effort mismatched with one's center of power. The weight should be borne from the shafts up through straight arms and down through a straight spine to the center of power. This center will be most of the time exactly between the handgrips. Note that some early handcarts had cross-pieces connecting the shafts, so they ended up looking like the modern hooped carts (Figure 7). The difference is that there was ample room to step inside the hoop, thus fulfilling the need for shafts.

Of the several types of shaft used in other times and places (Figure 13), I prefer style B. Style A is difficult to make and is prone to warping. Styles C and D require careful fitting of the mortise to the tenon, and are more vulnerable to abuse. Style D appears similar to that of many modern carts, but traditionally this style set the cross-piece at least two feet from the cart so the carter could get inside, between the shafts.

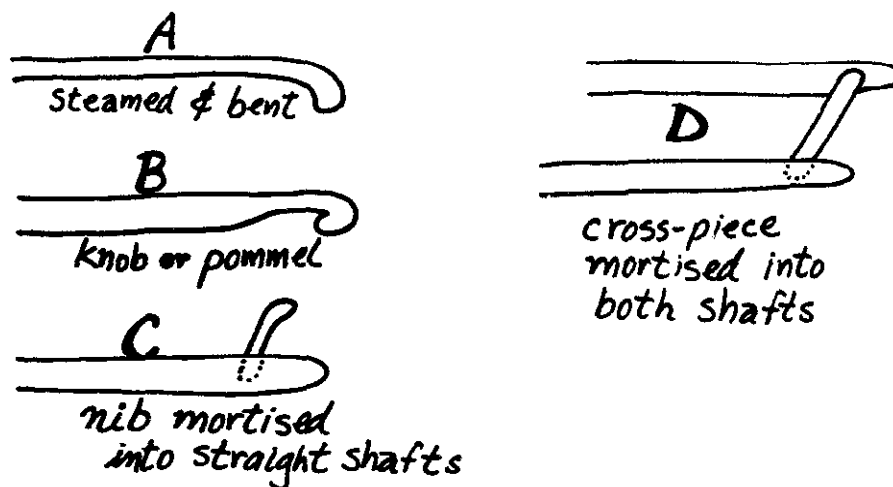

13. Styles of shaft.

1. Make the knob-end shaft (S) of a straight piece of ash, 48 inches long, $1\frac{1}{8}$ inches wide, and $1\frac{1}{4}$ inches deep. The knob is rough cut with a handsaw, and the inside corner finished with rasps, files, and sandpaper. The knob approximates a 2-inch sphere, and the tapered cut is 7 inches long (see detail in Figure 10). It is bolted up under the shaft tabs, and rests firmly against the front two spar braces. This leaves just the right distance between shaft and top rail for the flare board irons (N).
2. A new shaft can be oiled with a light penetrating oil. Through use the knob and front end will gain a finish from the oils of the hand, but the area around the shaft tabs should probably be oiled once a year.

Wheels

The technological marvel which makes a light and sturdy cart widely available is the modern spoked wheel with a pneumatic tire. Wooden wheels are difficult to make, and quite heavy. All-metal wheels usually have a simple bushing and grease fitting over a solid axle which must be cleaned and greased regularly, are somewhat more difficult to turn, and make a bumpier ride. The pneumatic tire, however, is extremely helpful for smoothing bumps and therefore the task of the cart and carter.

The diameter of the wheel has been traditionally between 24 and 48 inches, the larger diameter necessary when the bearings are crude and resisting. Small diameter wheels, even with good bearings and pneumatic tires, do not smooth bumps adequately, they become enmired in soft ground easily, they cause the carter to bend over backwards to move it, and they cause the load to be tilted when underway. Small wheels are fine on hard, smooth, and level cement, as with a "handtruck" or "dolly" in a warehouse, but not for the diverse conditions for which one needs a handcart.

Most of the recent build-it-yourself plans for two-wheel handcarts are built around used bicycle wheels. I do not recommend this since bicycle wheels are made to carry not much over a hundred pounds each in a vertical position. Wheels on bicycles are always vertical in relationship to the forces acting on them, even across a hillside. The force of the load in a two-wheel cart across a hillside, however, pushes across the wheel (Figure 15). A cart wheel must be wider, with thicker spokes, and more strongly made all around.

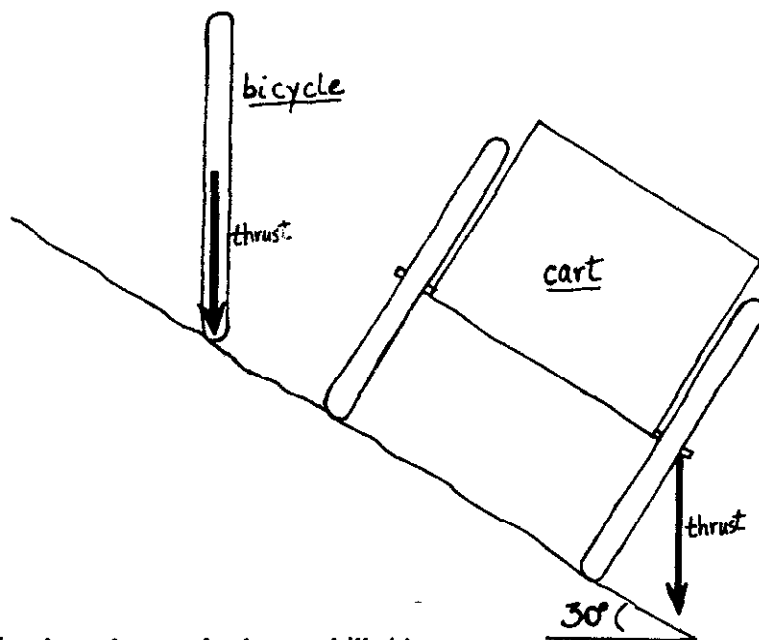

15. Bicycle and cart wheels on a hill side.

The wheel that I prefer is large (26 inches diameter), wide (2.125 inches wide), with thick spokes (.156 inch vs. .080 found in most bicycles) welded to the hub and rim, with heavy tread tire, with inner tube, and with two sealed ball bearing units per wheel. These wheels have been tested by mounting on a cart faced across the side of a hill with a slope of thirty degrees (Figure 15). At 750 pounds, the spokes of the lower wheel began to bow seriously. Much more stress and they would have collapsed, as I have observed bicycle wheels on carts to do. Note that some of the requirements for bicycle wheels, e.g., precise roundness and trueness, are not problems for low-speed applications as in handcarts.

Heavy tread pneumatic tires smooth out the ride for cart, load, and carter by flexing around small bumps and obstacles (Figure 14). The tires should be inflated to at least 30 pounds per square inch (psi), and as high as 50 psi, but the best guide is the shape of the tire when the cart is loaded. When the tire is flattened, the friction will be greater and pulling more difficult. When the tire is rigid, it is easier to turn but it is also readier to burst if it travels over a sharp rock, though we have had no trouble with this in years of work on carts. A slightly depressed tire under a large load indicates the pressure is just right.

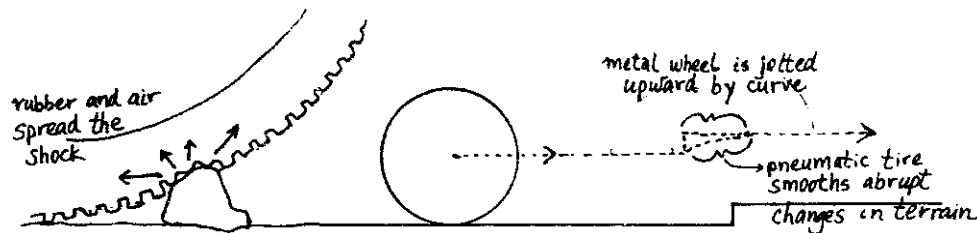

14. Pneumatic tire smoothing bumps.

Every six months or so the cart should be turned over and the wheels spun. There should not be much play from side to side, indicating worn bearings. The wheels should spin free for at least thirty seconds. If there is resistance or a gritty feel to the bearings, then the bearings should be replaced. Although they are sealed, dirt can find a way inside and quickly scars the balls or the bearing race. To replace the bearing units, knock them out with a long thin chisel or old screwdriver inserted through the hub. The new units should be tapped into place only around the edge; if you hammer on the center of the bearing unit, that is, the part that moves with the axle, you may distort the bearing race or damage the balls.

The nickel- or chrome-plated spokes and rim can be painted to match the metal of the frame. Another option is to paint the tires with black tire paint, used by many fire stations to make their firetrucks more attractive.

Bicycle Wheels

If you insist on using bicycle wheels, I recommend using wheels twenty-six inches in diameter with as wide a spindle as can be found. I also recommend changing the spokes to a large diameter (at least to .105 inches, a readily available spoke size). Spokes can be obtained through a local bike shop and the procedure is carefully explained in *Building Bicycle Wheels* by Robert Wright (from Anderson World, Inc., P.O.B. 159, Mountain View, CA) and in *The Bicycle Wheel* by Jobst Brandt (Avocet, Inc., Menlo Park, CA). I believe that a home-made highly tensioned wheel may match the strength of the welded spoke wheels described above.

Since bicycle wheels are usually supported on both sides of the hub, the frame needs to be constructed differently. A second bolster, of the same size as the first, must replace the rear sole brace. Two sections of channel, which we shall call the fenders, must be welded between the ends of the first and second bolsters. To these fenders a plate should be welded with a slot in it directly across from the axle spar, which is drilled with a smaller hole. I have not given dimensions because bicycle wheels vary so much but I include Figure 16 to give the general idea. For a typical bicycle wheel (26 x 1 3/8), a plate 3/16-inch thick, and 2 inches by 2

inches, should be welded to the fender. There should be $3\frac{3}{8}$ inches between this plate and the axle spar. The hole in the axle spar, and the width of the slot in the plate directly across from it, should be $\frac{1}{2}$ inch in diameter.

16. Adapting the frame to a bicycle wheel.

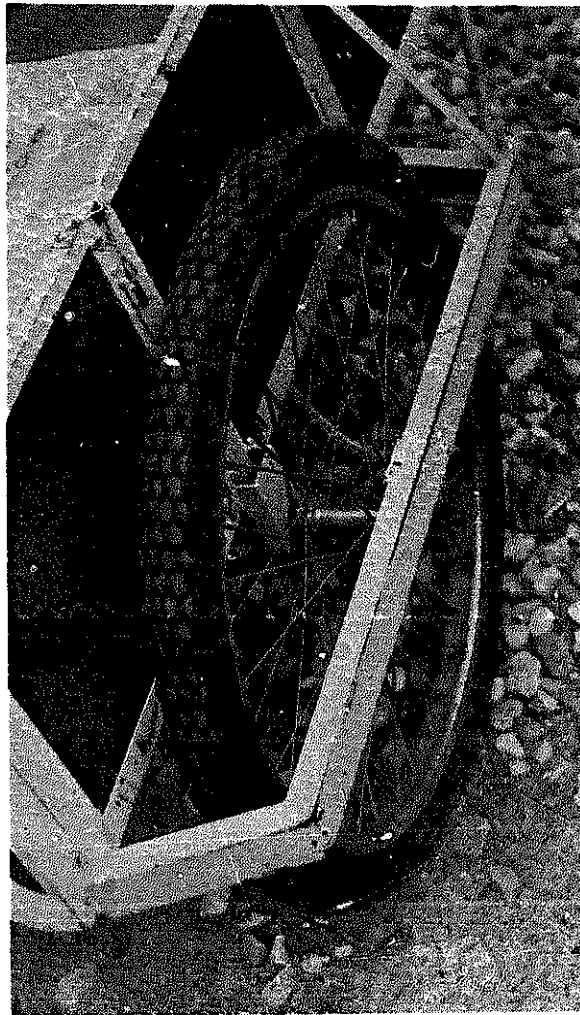

In my experience, bicycle wheels used on carts, not designed for the many shear forces put across the wheels, must be serviced fairly often. The spokes must be kept tight. The bearings and bearing race must be cleaned and repacked regularly, especially since replacement is so expensive.

Remodeling a Garden Way-style cart

In my experience, the popular Garden Way-style carts (made by Garden Way in Charlotte, VT or by any of the many imitators of this style) have several serious design problems. From my research on the historical uses of two-wheel hand-carts, I have found that these problems were solved many years ago by carters who used their vehicles all day every day: They did not tolerate preventable deficiencies. Several of these problems can be solved by retrofitting a Garden Way-style cart, although it will never equal in strength and versatility the modern cart design detailed in this handbook. On the other hand, there are hundreds of thousands of Garden Way-style carts in use, and that is why I offer these plans for improving a tool which many people already have. Even if a Garden Way-style cart can never do all that the sturdier By Hand & Foot cart can do, it can be made to work better and more safely.

1. Wheels and bearings:

The wheels are the strongest part of the Garden Way-style cart. Although in theory a tensioned wheel should be stronger than the welded-spoke wheel used on handcarts, my tests have shown the welded-spoke wheel to be much stronger (the spokes are of much greater girth and the spindle is much wider than any that can be found in tensioned wheels). However, the wheels are not indestructible; too much weight on a side hill can bend the spokes. This requires over nine hundred pounds of dynamic weight on a twenty five-degree side hill! If the wheel is not totally collapsed, it can be repaired by pounding it back into shape. Once in shape again, the wheel will be functional for all jobs except the one that bent it out of shape.

All tires on Garden Way-style carts are of the "smoothie" type, with parallel ribs. For better traction on a side hill, you might wish to substitute a "knobby" type. For rough going, I recommend the substitution of a "thornproof" tube for the regular tubes that are standard. These substitutions usually wait until something has gone wrong with the tire you have.

In a cart that is a few years old, the small donut-shaped units which hold the bearings have often seized up from rust or dirt and should be replaced. If they are gritty or completely rusted up, then the wheel will rotate on the axle, which, being made of soft steel, is not designed for this sort of wear, and will develop worn grooves quickly. You are working against more friction than you ought to when you are pulling a load. The bearings should be replaced.

2. Shafts for power:

I call the Garden Way-style hoop a "butt bumper" because my body wants to stand erect and not crookedly as I walk. The hoop keeps banging into me. Shafts permit the optimum connection of the body's power to the task of pulling and are in every other historical use of handcarts. Also, the most stable area is the front of the cart, atop the struts: When I wish to drop something heavy into the cart without the threat that it might tip over, I must drop it into this area. The hoop makes it impossible to approach this area, but I can get there between shafts. This is the same place where it is comfortable to sit for a rest; such a detail may sound unimportant but, when I am tired, it is very important.

In Figure 17, the same shafts used on the By Hand & Foot cart are simply bolted through the sides at the top edge. The shafts should overlap the top edge nine inches, as little as you can get away with in order to put the body as far forward as possible from the front edge of the cart. In Figure 17, the shafts are bolted to the outside of the top edge of the wide-body cart, but this may feel a bit wide for some people. If you are willing to forego the front gate addition, then the shafts could be mounted on the inside top edge of the large-size cart. They work well on the outside edge of the medium-size (with twenty inch-diameter wheels) cart. One and a half inches must be trimmed off the top of the struts on each side with a hacksaw; this does not weaken the struts, but is necessary to make room for the shafts.

3. Bolster-and Standards Permits Rear and Front Gate:

The Garden-Way style cart does not have a rear gate because the plywood itself is the frame; if the rear panel were removed, the cart would fall apart. If you wish to dump something, you must turn the Garden Way-style cart upside down, which many people find to be a nuisance and dangerous. Recently an accessory has been advertised to cart owners which gives a gate, but holds the sides together with a small hoop of tubing lying across the top of the gate. I find this support



17. Improved Garden Way-style cart.

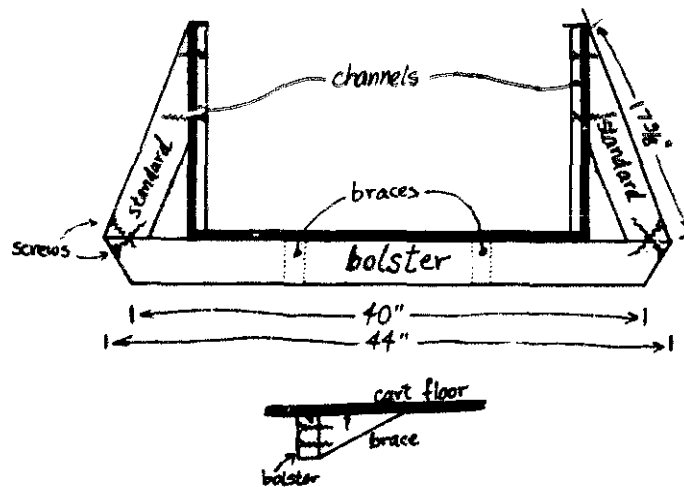

18. Detail of braces and bolster-and-standards, cart upside down.

though necessary, gets in the way, and is made of the same material which is so easily dented by an accidental bump from a piece of firewood. Some Garden Way-style carts give a gate and hope the sides will hold together because of a short braise weld at the two rear corners; in my experience the little weld is inadequate.

Ironically, every other design through history of cart and wagon included rear gates, with sides supported by a bolster-and-standards system. Such an addition to a Garden Way-style cart makes it stronger overall and permits a rear gate for dumping. A bolster-and-standards in front of the wheels permits the addition of a front gate also—good news for cart owners frustrated by stuff falling out the front of their Garden Way-style carts.

1. First the clips which hold the axle must be moved forward $2\frac{3}{4}$ inches.
2. The bolster-and standards assembly is attached at the rear edge of the cart, as shown in Figure 18. The bolster is braced because it is tipped on when the cart is dumped. The top inch of the forward standards is removed for the shafts.
3. The gates are $30\frac{3}{4}$ inches wide, 16 inches high, of half-inch plywood. One gate is the rear panel of the cart with $1\frac{1}{2}$ inches sawn off one end. Each side of the gate is held in place by a pair of channels $\frac{3}{8}$ inch apart, made from wood that is $\frac{3}{4} \times 1 \times 16$. The gate slides in the grooves made by these two pairs of channels. The channels are screwed into the side of the cart and where they meet the top of a standard, the screws are longer and go into the standard. If you dump heavy materials often, the inside channels should be beveled toward the inside so that they are not loosened by bumps on their corners as heavy objects move past.
4. A front bolster-and-standards assembly is necessary if you wish to add a front gate. It is $30\frac{3}{4}$ inches from the rear edge of the cart. The triangular braces are optional for this bolster.

4. Other Accessories:

Several other accessories described in this handbook could be fitted for the Garden Way-style handcart, but I caution against uses which would stress the plywood frame too much. Any experiments in this line fascinate me; I hope you will write about your experiences.

ACCESSORIES

The accessories give the By Hand & Foot Cart special identities, whether as Hay Cart, Baker's Cart, Taxi, etc. Each of these applications has been researched in history, actually built by me, and tested by several people. In several cases, the first version needed to be built again to make it work correctly.

The range of identities is overwhelming, and it is very difficult for me to speak in the same breath of a container for screened compost and a taxicab with wallpapered interior. I have been amazed at the diverse uses I've uncovered for the same basic design of cart. What all these applications share is the basic attribute of "cart": a conveyance of stuff, whether that stuff be firewood, barbed wire, or a well-dressed shopper.

Flare Boards

Flare boards extend the sides of the cart to permit a larger load. They are widespread in farm carts from Britain to China, varying in their width and the angle they make to the side of the cart. For a large load of loose material, flare boards also prevent part of the load from falling between wheel and cart body, thereby fouling the wheels.

With flare boards, I can haul close to a sixth of a cord of wood; if that wood is green, then the weight in the cart can approach eight hundred pounds. This weight is not too much for the cart on even ground, but if the ground is soft, it is too much for me, and I haul a greater number of lighter loads without using flare

boards. With bulky materials such as hay, I find flare boards indispensable (see the cover).

To increase the capacity further, vertical extensions of the gates can be made. I have not found this necessary with hay or grain or firewood or apples (which I prefer to move in hundred-pound bags laid into the cart), but I use a temporary cardboard extension when moving autumn leaves. The cardboard and gate can be removed so the leaves can be dumped onto the leaf compost pile, a better solution than lifting a large container up and out of the cart body as recommended with other carts.

Two or three screw eyes can be attached to the upper edge of each flare board. Strings tied to the eyes are tied over and around a load to the other side, with the same effect as the haypins described in *The Scythe Book*. Another way to hold down a load of loose things is to sit children on top. I have found these flare boards (the third design we tested) to be quite strong even with children sitting on their edge.

Early hay balers were similar in shape to this cart body. Two strings are laid parallel on the floor the length of the cart. Hay is piled in about half way up the flare boards, then stomped down. One flare board can be pressed on top of the bale while the strings are tied.

The flare boards also serve as ramps for wheeling the car up into a pickup truck (Figure 20).



20. Flare boards as ramps.

Finally, flare boards laid across the top rails serve as a step stool (Figure 21). The boards are only stable when resting between the point above the axle and the point above where the strut rests on the ground. The irons resting inside the cart body prevent the boards from sliding off the side of the cart, but they can be clamped to the shafts for greater stability.

1. Cut the flare board iron (part N in Figure 10), and bend 35° to form a 145° angle. Cut and bend the hook (O) to a right angle and weld it against the bend in the main portion of the iron so that the space between them is one inch. Then drill two holes, $\frac{5}{16}$ inch in diameter, into each main piece for bolts (P) connecting them to the boards.

2. The two boards (X) can be made of planed dry $\frac{3}{4}$ -inch pine, 48 inches long, and a width which depends on the task (12 inches good for most purposes).
3. Paint the metal and wood as described above for the cart body, then bolt together with $\frac{5}{16}$ x $1\frac{1}{2}$ bolts (P), the heads against washers on the wood side. Four-sided nuts make an effective lock inside the channel of the main piece.
4. The irons should be placed on the wood so that they ride on the top rail. The front iron rests against the front of the second shaft tab (Figure 12). The rear iron rests against the rear end of the axle spar. This placement of irons will ensure that the flare boards will not slide around. However, it also means that the two boards are not interchangeable; if mixed up, they will be obstacles to the removal of one of the gates.

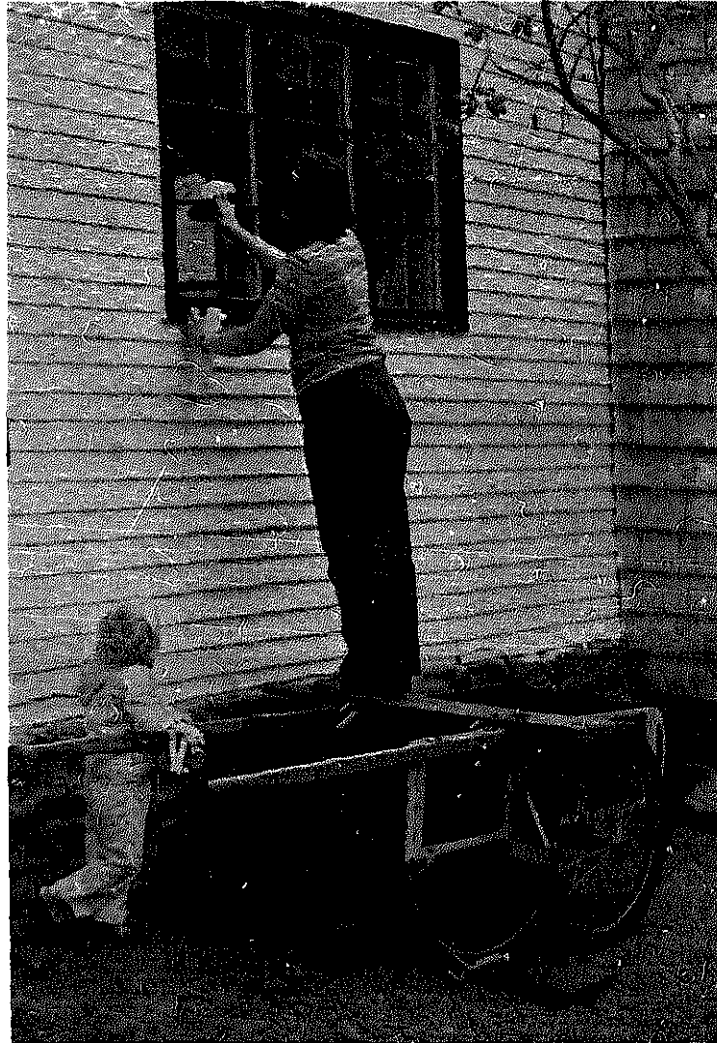

21. Flare boards as stepstool.

Human Harness

The arms and shoulders are connected to the rest of the skeleton by a small joint at the top of the sternum. They are supported by overlapping layers of muscle and tendon. They are meant for moving around and manipulating things, not for carrying heavy loads long distances. Thus, where handcarts were used all day long, the arms were used to guide the shafts but the weight was taken by the bony framework of the body through a shoulder strap or harness.

Harness for humans has many fewer pieces than harness for draught animals, but the fine adjustments are no less complicated. Of course, leather could be used for its good looks, with brass buckles for adjustments, but the two harness types I have adapted from old designs use other, less expensive materials.

There are basically two types of harness, named for the other places we frequently encounter them in our lives:

1. The Shoulder Loop Style: Similar in shape and function to shoulder bags, seat belts, or any kind of sling, this style of harness is widely used in China.

It needs no custom fitting and is simply flung over one shoulder. In other words: put your head and right arm through the loop, and attach the hook to the base of the front of the handcart. There is a cost to this simplicity: after heavy hauling, you begin to feel that your body is being twisted by the pressure mostly going on one shoulder. In that case, change sides every so often (that is, put your head and left arm through the loop). Add a simple pad such as a hand towel for long hauling.

2. The Backpack Style: Similar in shape and function to harnesses on backpacks for camping, this style of harness has been used by the better equipped handcarters through history. It is more complicated than the Shoulder Loop Style, but the fit to the body is much better, which gives more power and comfort.

Putting it on takes some getting used to. A hint is to hold the harness up so that there are no twists (consult the picture), then slip it on like a vest. The only adjustment that needs to be made is the sternum strap. Adjust it so that it keeps the two shoulder straps firmly seated between your chest and the joint of arm and shoulder; if the shoulder straps feel like they are pulling your shoulders and arms backwards, then the sternum strap should be tightened a bit.

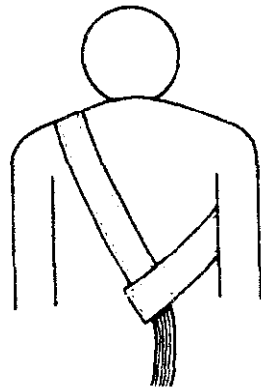

22. Shoulder loop harness.

23. Backpack style harness.

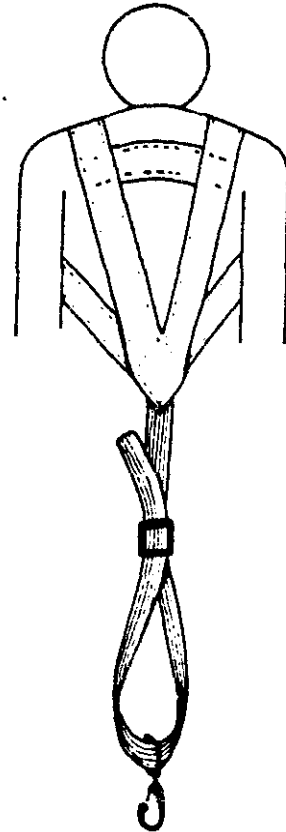

When you pull, you lean forward from your hip joints, and not from your waist. The joint in the middle of the body is between your powerful legs and the large pelvis bone; it is not the weaker vertebrae at the base of your spine. Keep your trunk as straight as you can, though tipped over so the forces act through your center of gravity.

Test to see that you are not using your arms for much of the pulling. If you are, then you should shorten the connection between the harness and the cart. When this length is just right, your arms will be completely available to guide the handcart but will not feel any strain of the load, and you will see how easy it is to pull very large weights without noticing it.

The By Hand & Foot handcart has a handy place to hook the harness, onto the same pin used for the trailer hitch. Other handcarts can easily be fitted for a harness by screwing a large O-ring latch onto the bottom of the front of the cart (Figure 24).

24. Ring for harness clip.

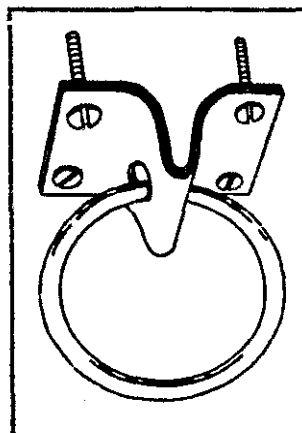

Trailer hitch

When you turn a handcart into a trailer towed by a tractor or riding mower, you tend to forget about it and let the gasoline do the pulling. The By Hand & Foot cart is strong enough to withstand the bumps of travel at 10 miles per hour, although towing quickly a 500 pound load over a ditch can easily create a dynamic load in excess of the 800 pound rated limit. The cart is not designed to go faster than 10 mph, and caution should be exercised about the type of terrain it is used on. Moving children, as shown in Figure 25, should be done slowly, with hands kept inside, and little bodies seated not on the top rail but on the floor of the cart.

Attach the hitch with the pin at one end sticking into the hole in the bolster of the cart. Raise the trailer hitch into place between the trailer hitch tabs and set the clevis pin through tabs and hitch. Finally, attach the hitch to the riding mower or tractor. The hitch is especially long so you will not need to remove the shafts:

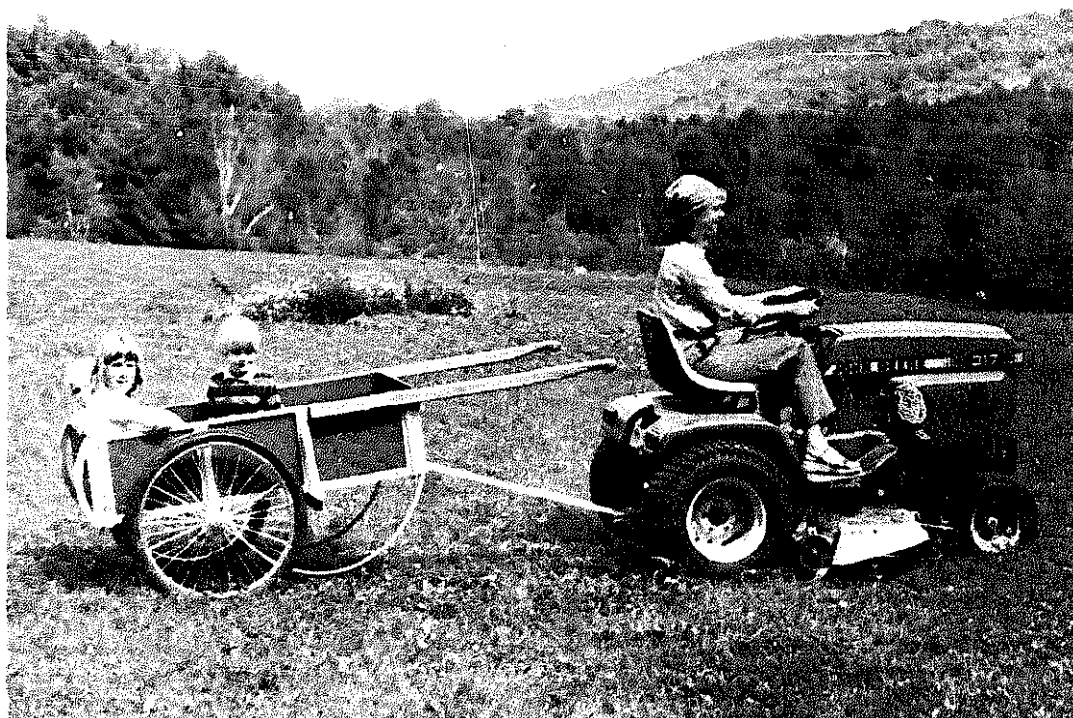

25. Trailer hitch behind riding mower.

when you've reached your destination, instead of going backward and forward several times to get the typical trailer into place for dumping a load, the trailer hitch of this cart can be detached by removing two pins—then you have a handcart again easily maneuvered by hand to dump the load.

1. For the trailer hitch, the following stock is required:

part name	type	thickness	stock size	length	no./cart
main bar	channel	$\frac{3}{16}$	2 x 1	54	1
end of channel	flat	$\frac{1}{4}$	1	2	1
locator pin	rod	$\frac{1}{2}$	$\frac{1}{2}$	1	1
drawbar tabs	flat	$\frac{1}{4}$	2	4	2
spacer of tabs	flat	$\frac{1}{4}$	2	$\frac{3}{4}$	2

2. The 20-degree bend in the main bar is cut and welded at the point where the hitch emerges from beneath the cart, about $19\frac{1}{2}$ inches from the back of the hitch. The descending portion is $34\frac{3}{4}$ inches to the topmost drawbar tab, where the angle is also 20 degrees.

3. Half-inch holes should be drilled through both sides of the main bar about 15 inches from the locator pin. The exact location of this hole is determined after the locator pin is seated firmly in the bolster and the main bar set between the two trailer hitch tabs beneath the front of the cart.

4. Half-inch holes should also be drilled through the drawbar tabs on the hitch to connect with the rear of the power vehicle (Figure 27). The two pins can be bolts with nuts to keep them from vibrating out of the holes, or they can be the fancy and reliable hardened cast iron pins shown in Figure 26.

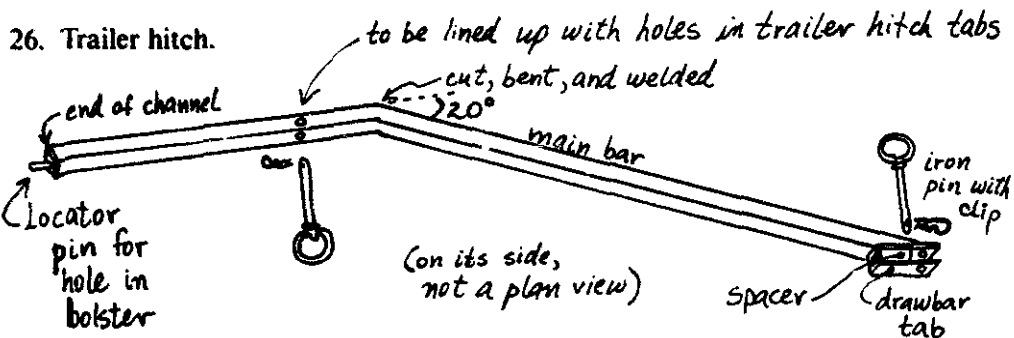

27. End of trailer hitch.

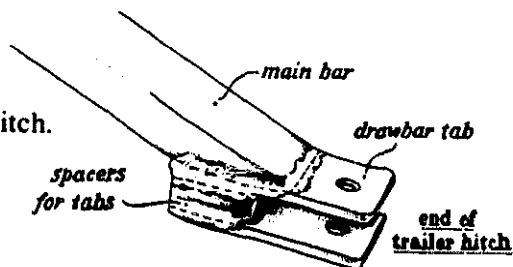

Sled

When ice and snow prevent passage of the wheels, they can be removed and sled runners attached. However, I find that human strength at one tenth to one twentieth horsepower is no match for the one horsepower of Old Bobtail. Nevertheless, runners are an improvement when ice and slush mire wheels, particularly if I have a good harness to improve my pulling efficiency (Figure 28). With a harness, I do not need to hold on with my arms because the runners cut a straight line through the slush. Widespread in the mountain areas of Europe, a human-assisted sled is used primarily for bringing wood and other things down from the mountain on packed snow. Indeed, roads were rolled after snowstorms to give a hard surface for sleds and sleighs. Carlo Italiano's *The Sleighs of my Childhood* (Tundra Books, 1974) shows many other examples of sleds drawn by horses and people from Montreal in the 1930's. Wider runners accommodate less ideal conditions; loose snow is best traversed by toboggan.

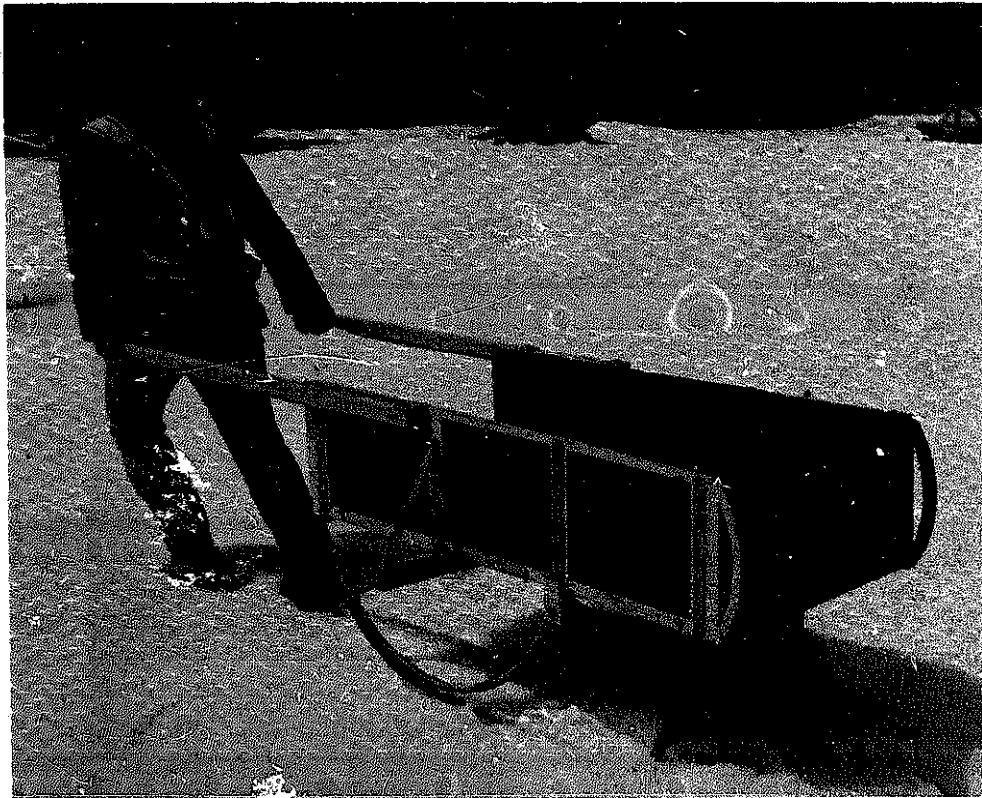

28. Sled and harness.

□ one inch

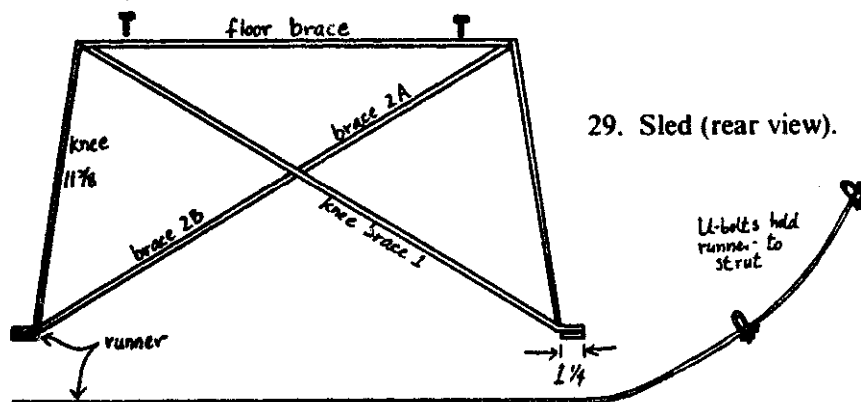

29. Sled (rear view).

1. To make a sled attachment for this cart, the following stock is required:

part name	type	thickness	stock size	length	no./cart
runner	flat	$\frac{1}{8}$	1 (to 2)	43	2
knee	flat	$\frac{1}{4}$	1	$11\frac{7}{8}$	2
knee brace 1	flat	$\frac{1}{4}$	1	24	1
knee brace 2A	flat	$\frac{1}{4}$	1	$10\frac{1}{4}$	1
knee brace 2B	flat	$\frac{1}{4}$	1	$12\frac{1}{4}$	1
floor brace	flat	$\frac{1}{4}$	1	$18\frac{3}{8}$	1

2. The parts of the knee are welded together (Figure 29); they are designed to hold the runners exactly parallel, $21\frac{3}{8}$ inches apart on the inside. If the struts are closer or further apart than this, the knee braces should be shortened or lengthened to accommodate.

3. A $\frac{1}{16}$ -inch hole in each runner, $3\frac{1}{2}$ inches from the rear end, should be countersunk from the bottom so that a tapered-head bolt will fit flush with the bottom and not drag in the ice.

4. The floor brace is bolted through the floor board $7\frac{1}{2}$ inches from the rear of the floor board.

5. The runner is bent gently in the shop so that it can be easily sprung into place along the curve of the struts.

6. The dash is held in place by two U-bolts on each runner, the U part around the strut and the flat bar of the U-bolt secured tightly against the runner.
7. The runners can be treated with a wax or silicone finish to reduce friction and rust. Their bottom edges can also be slightly rounded with a file.

Compost Screen

For potted plants, seed starting mix, and other garden uses, compost and soil must be screened to exclude the particles that are too big, including stones and organic matter that is not yet broken down. A cart can be an excellent base for a compost sifter. It is sturdy enough to support the screen firmly as a shovel is scraped along the wires to coax the small stuff through. And the cart body underneath catches the finished product so it is readily carried away. The screen fits securely into the body of the cart so that none of the compost is lost (Figure 30). Half-inch galvanized woven wire "hardware cloth" is recommended for the screen, but 1/4-inch hardware cloth can be used when the soil needs to be very fine.

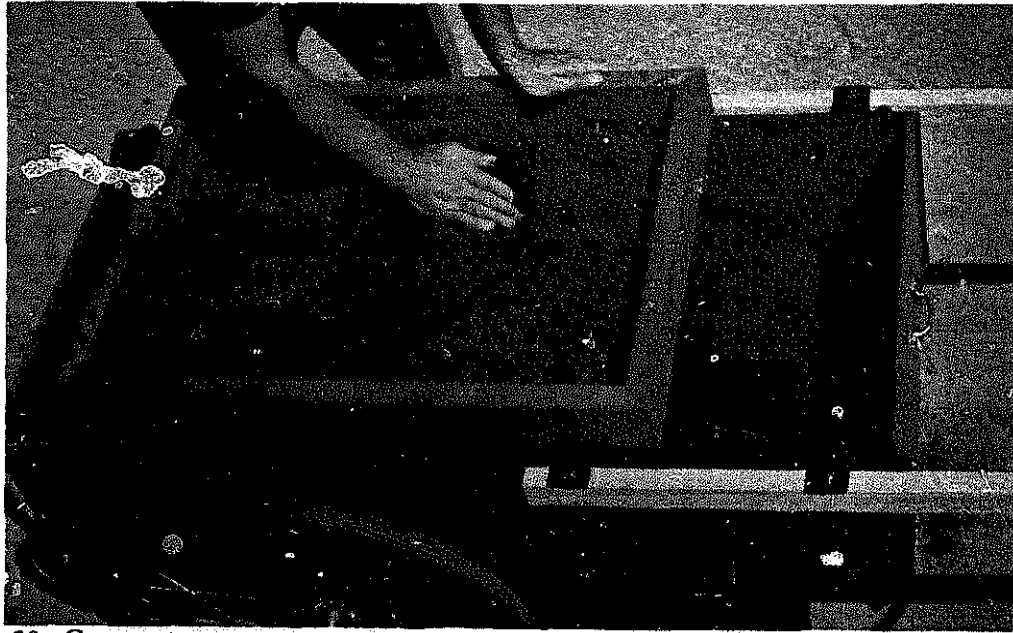

30. Compost screen.

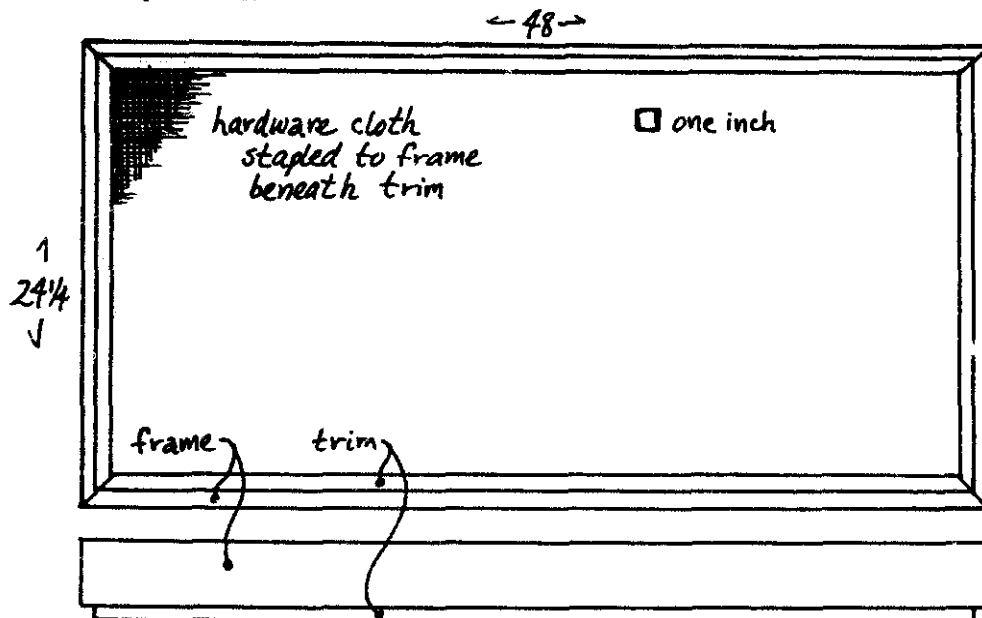

31. Compost screen, plan view. ← 22 1/2 →

1. A list of materials follows, each wooden member beveled at 45 degrees at both ends, in actual inches (nominal in parentheses). Lengths are along the long edge.

part name	stock size	length	no./cart
Frame: length	1½ x 3½ (2 x 4)	48	2
width	1½ x 3½ (2 x 4)	24¼	2
trim: length	¾ x ¾	46½	2
width	¾ x ¾	22½	2

2. The pieces are cut, and stained to preserve the wood. The frame is nailed.
3. Square up the frame by setting it on the top rails, bending until the frame matches the cart body.
4. The hardware cloth is cut to overlap the inner ¼ inch of each member of the frame.
5. The trim pieces are nailed over the edge of the hardware cloth, to better secure the screen to the frame, to cover the cut wire ends, and to hold the screen onto the cart.

The Four Seasons Cart (Farmer's Market Tray)

To display flowers and vegetables, a large shallow tray rests on the top rails at the right height for people to get a good look. A simple upright arch is bolted to the market box: it serves as a sign for the vendor ("New Fane Farm" in Figure 32), bulletin board for items and prices, and support for a scale (behind the vendor's head in Figure 32). The inside of the cart body can be used for extra produce, bags, and the cash box.



32. Les Quatre Saisons.

This design is quite similar to carts found in many outdoor markets. In the cities of France, this type of cart was called Les Quatre Saisons, The Four Seasons, since fresh vegetables and flowers were brought in from the suburbs at

every time of the year. Pictured in Figure 32 is a cart of autumn vegetables and fruits.

For the success of a farmer's market tray, the art of display is at least as important as having fresh, clean, and healthy produce. Textures and colors should be mixed; informative labels with price per pound and perhaps methods of growing ("homegrown organic") should accompany everything; foods which combine should be together (dill with pickling cucumbers, tomatoes with salad greens); etc. All good marketers use these and other techniques. A technique available to the owner of the Four Seasons Cart which is not used by other marketers is wheeling the produce to the customer. This is especially effective on special town fair days.

As I mentioned, open street carts were the only type of handcart which were pushed and not pulled, presumably so the carter could keep an eye on the merchandise so attractively displayed. The shafts can be shortened in this case, easily done by drilling two more holes so only ten inches protrude beyond the end of the cart.

1. The list of materials follows, measurements in actual inches (all the wood is nominally 1 x 6):

part name	stock size	length	no./cart
long side	$\frac{3}{4}$ x $5\frac{3}{4}$	$50\frac{1}{2}$	2
short side	$\frac{3}{4}$ x $5\frac{3}{4}$	18	4
floor boards	$\frac{3}{4}$ x 6	48	6
floor braces	$\frac{3}{4}$ x $5\frac{3}{4}$	18	4
upright-vertical	$\frac{3}{4}$ x $5\frac{3}{4}$	as you wish	1
upright-horizontal	$\frac{3}{4}$ x $5\frac{3}{4}$	as you wish	1

2. All the pieces are nailed together as shown in Figure 33. Small holes must be gouged in the front floor brace to fit over the shaft bolt heads. The wood should be painted, and the border of the side pieces ornamented for an attractive appearance.

3. The market box is made in two symmetrical pieces, hinged together underneath, for easier transportation and storage when not used. When laid onto the cart rails, the halves can be locked together by a hook and eye.

4. Hooks can also be screwed to the cart panels and attached to eyes in the bottom of the market box to keep it from sliding off. The same purpose can be served by attaching blocks to the bottom of the market box which fit snugly into the corners of the cart frame.

5. When moving, the scale should be tied down to keep it from swinging into the upright.

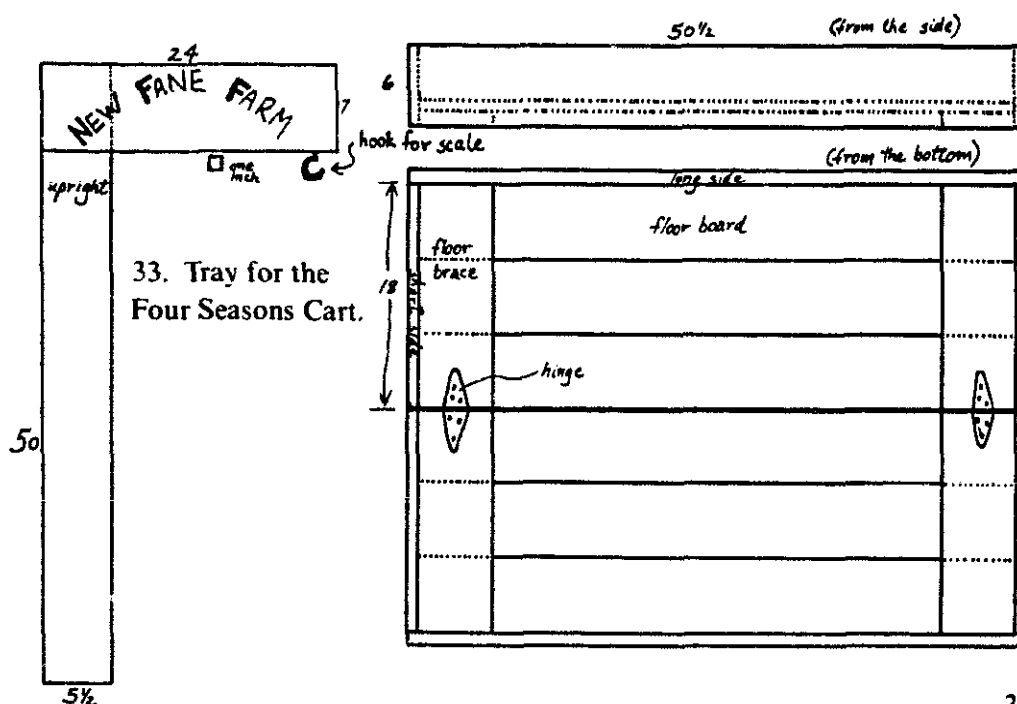

Baker's Box

Urban merchants have transported and displayed their wares in many sorts of two-wheel handcarts. The Street Vendor's Box (Figure 34) is closest to the Baker's Cart, with fresh pies arranged on a shelf just inside the top, and different sorts of breads in bins found inside the side door. Although shelves are not shown here, they are essential to this style of cart and should be designed to maximize easy access of the goods from the top and side.



34. Baker's Box.

1. The list of materials follows, measurements in actual inches (nominal measurements in parentheses):

part name	stock size	length	no./cart
ends			
vertical	$\frac{3}{4} \times 3\frac{3}{4}$ (1 x 4)	32 $\frac{1}{2}$	4
horizontal, top	$\frac{1}{4} \times 2\frac{3}{4}$	24 $\frac{3}{4}$	2
horizontal, bottom	$\frac{1}{4} \times 2$	16 $\frac{3}{4}$	2
plywood	$\frac{1}{2} \times 21\frac{1}{2}$	35	2
sides			
vertical	$\frac{3}{4} \times 2\frac{3}{4}$	17 $\frac{3}{4}$	4
horizontal	$\frac{3}{4} \times 2\frac{3}{4}$	48	2
plywood	$\frac{1}{2} \times 22\frac{3}{4}$	48	2
top			
length	$\frac{3}{4} \times 4\frac{1}{2}$	51 $\frac{3}{8}$	2
cross	$\frac{3}{4} \times 4\frac{1}{2}$	26	2
plywood	$\frac{1}{2} \times 21\frac{3}{4}$	46 $\frac{3}{4}$	1
door			
vertical, hinge side	$\frac{3}{4} \times 3$	30 $\frac{3}{4}$	1
vertical, latch side	$\frac{3}{4} \times 2\frac{1}{2}$	30 $\frac{3}{4}$	1
horizontal	$\frac{3}{4} \times 2\frac{3}{4}$	11 $\frac{1}{4}$	2
inside rails	$\frac{3}{4} \times 6$	40 (approx.)	2

2. Plywood is used here, but since the fir trim acts as a frame, masonite could be used instead. Two boards connected to the side panels of the Street Vendor's Box can be set down inside the top rails and bolted to the side panels of the cart from the inside. This secures the Street Vendor's Box to the cart and sets the box flush with the side of the cart (Figure 35).

3. The ends must be cut a bit at the bottom ($\frac{3}{8}$ inch taken off of the bottom: 12 $\frac{1}{2}$ inches) to fit into the gate channels.

4. The sides fit between the end pieces.

5. Both ends are framed, then the space for the door is cut so that it is hinged to and shuts flush to the trim. A bit of plywood should be left on the latch side as a doorstop. If the box is to be locked, the hinges for the door and top should be attached with locked bolts or one-way screws. A door could also be added at the rear end.

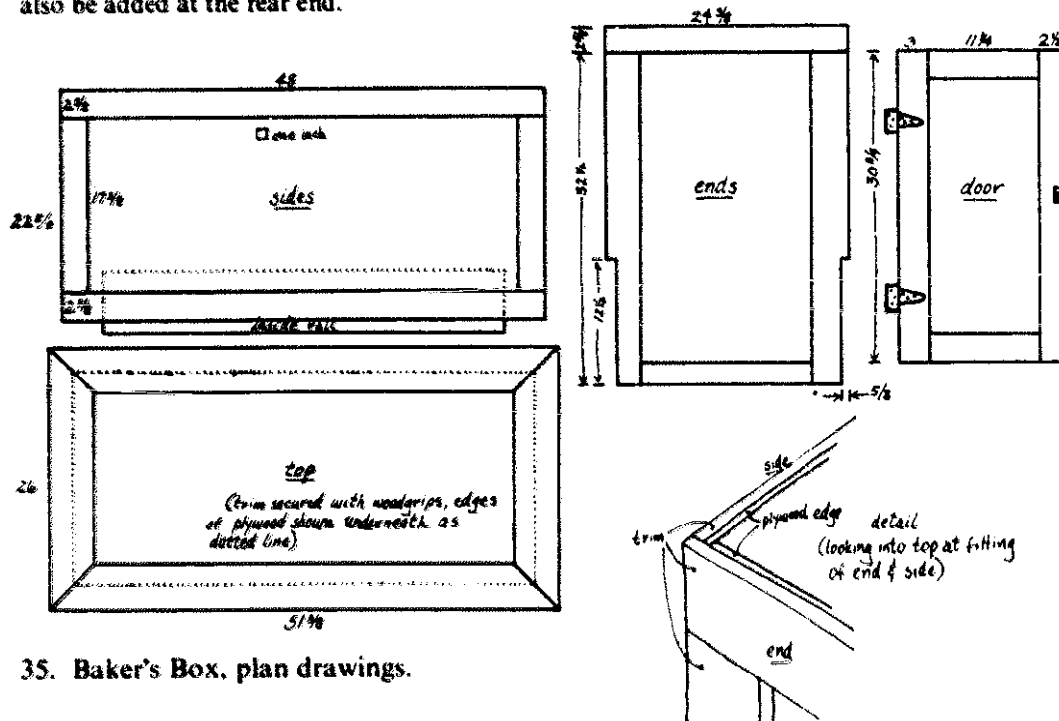

35. Baker's Box, plan drawings.

Toxicab (Vinaigrette)

Most people associate a handcart to move people with the rickshaw (short for Jinrickshaw, meaning man-power car) of the Orient. However, in the cities of France in the seventeenth, eighteenth, and nineteenth centuries the premier taxi was just as widespread and, I think, more elegant (Figures 1 and 36). It was also more practical than the open rickshaw since its windows and door could be closed against the weather. In good weather, the door of some styles could be removed. The nickname Vinaigrette alludes to the similar shape of the containers for smelling salts used then.

The seat can be a chair set over the axle to balance the weight of the passenger. Or it can be a cushion on a simple bench resting on cleats bolted to the taxi frame. I have used both.

The brass handles on the rear of the taxi are for auxiliary power should another carter's help be needed on steep hills with large loads.

An emergency strut needs to be added at the rear of the cart to prevent the whole thing from tipping over backwards. This sort of accident is unlikely with a normal load. But while pulling a person along the street, I have been followed by children who jump up on the back for a ride, hoisting me off the ground a few inches. In Durban, South Africa, the Zulu rickshaw men jump up into the air to impress their passengers—the emergency struts on their two-wheel taxis are very strong, and sometimes have a small wheel attached so that the taxi careens down the road on three wheels for a short distance, while the carter's legs dangle in the air.

Though I have not yet built this variation, a two-seater taxi would have the same sides and door. The sides would be held over the tips of the bolster by braces secured to the side panels. The back and roof would be wider, with a gentler curve. The seat would be curved so that passengers could sit cater-cornered, with their feet together on the floor of the cart (Figure 37).

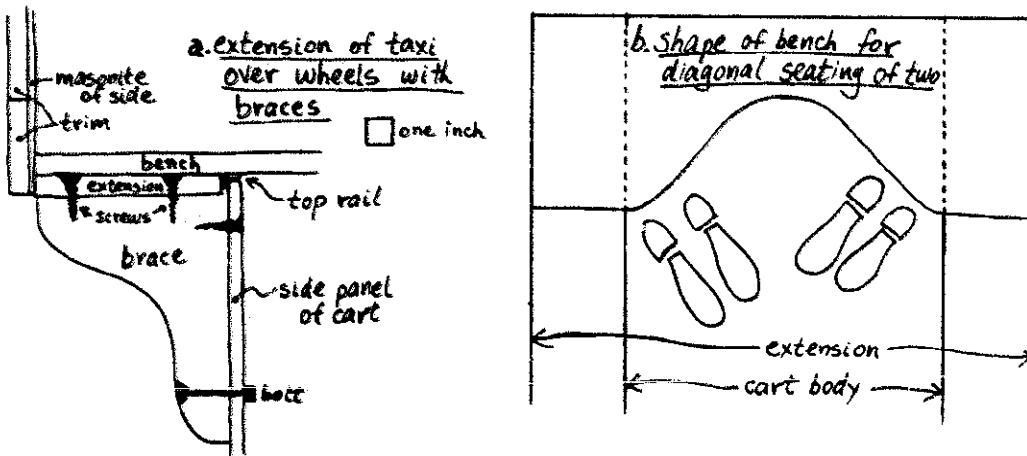

37. Taxi, extension for two-seater.

1. Since there are angles and curves in this taxi, I have not given a list of materials which can, however, be deduced from Figure 36. Basically, the $\frac{1}{4}$ -inch trim pieces also serve as the frame, onto which is mounted $\frac{1}{4}$ -inch tempered masonite, smooth on both sides so it can be painted on the outside, and wallpapered on the inside. Each panel of the taxi is built, then the sides and rear connected, the rear fitting between the sides, then the roof ($\frac{1}{4}$ -inch masonite) added, finally the door hinged in place when the taxi is in place in the cart.
2. The windows, 12 by 24 inches each side, are made out of $\frac{1}{4}$ -inch plate glass so they fit snugly inside holes cut in the masonite; the window trim pieces are identical inside and out and are screwed to each other through the masonite, thus holding the window in place. An option is to mount the front window glass in a frame, and mount that sash in another frame so that the window can be opened.
3. The cleats which are attached to the roof piece are beveled 25 degrees so they will fit snugly against the sides. They are glued and screwed into place with the screw heads countersunk into the masonite.

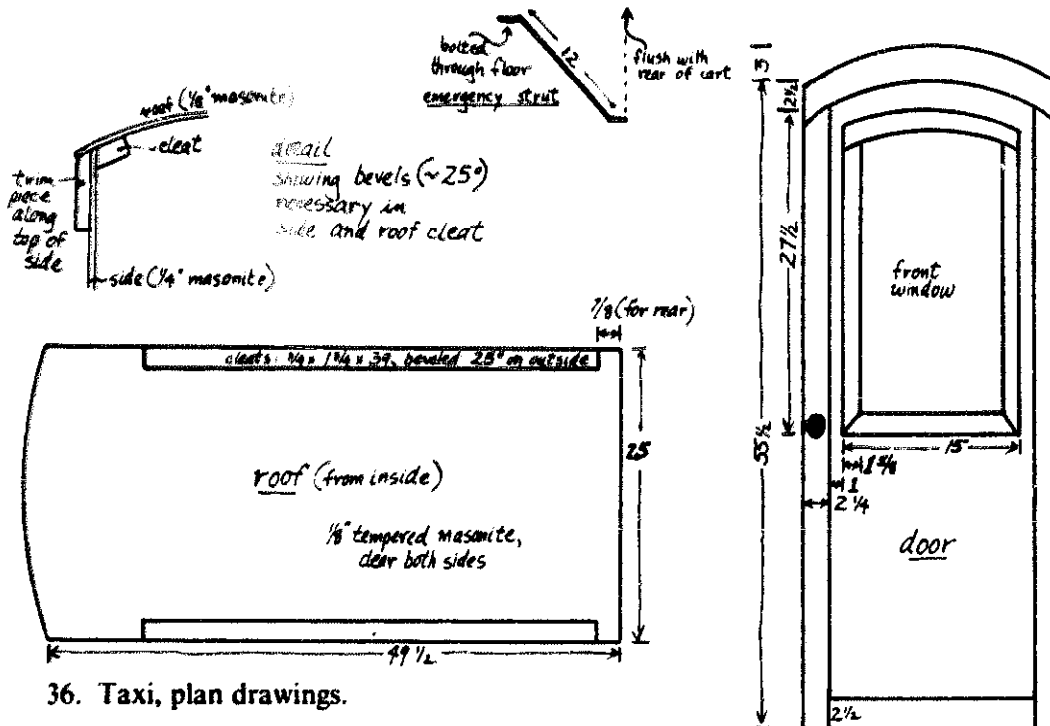

36. Taxi, plan drawings.

Then one cleat is attached to a top horizontal piece with four screws. Then the roof is bent over until the second cleat is in place (which may require a temporary loosening of the connection of the rear panel to the side); four screws are then put through the top horizontal piece into the cleat. A second arch identical to the arch at the top of the rear panel should be attached to the roof and sides in the front of the cart to hold the same arc in the front.

4. The masonite extends below the bottom trim piece on the inside of the cart. The front of the taxi should be flush with the front of the gate channel while the rear of the taxi should be flush with the end of the top rail. Thus the rear gate is left free to be raised so that luggage can be stored beneath the seat.

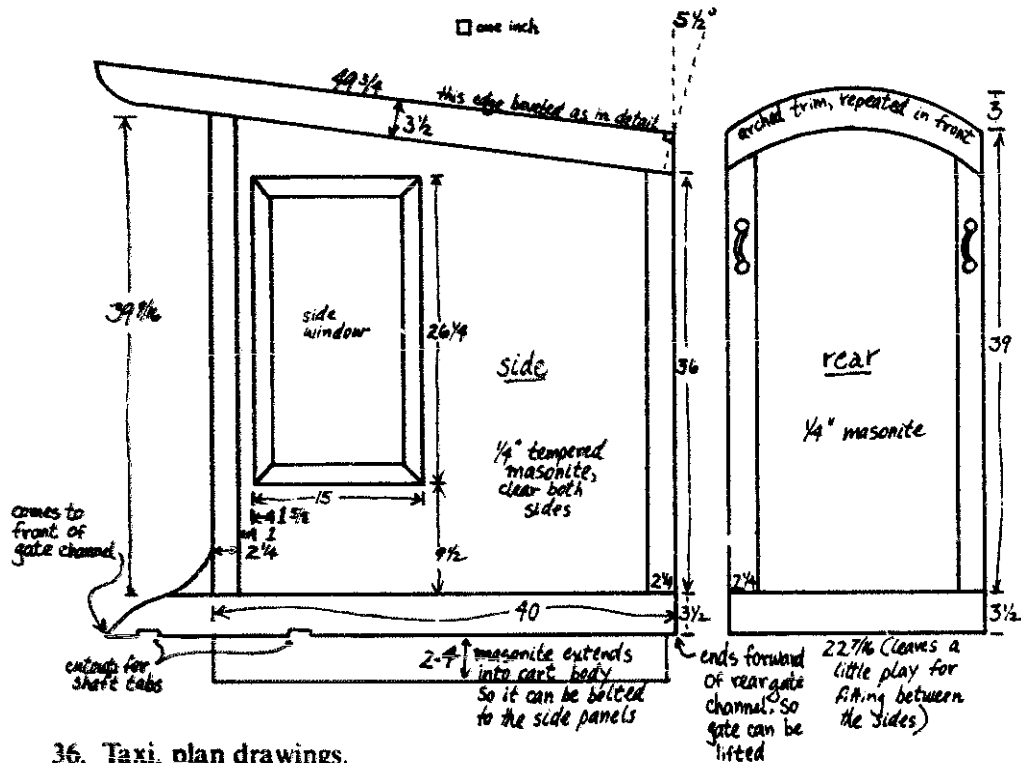

36. Taxi, plan drawings.

5. The door has butt hinges which must be mortised into the sides of the cart and the door. Strips for a doorstep could be $\frac{1}{2} \times \frac{3}{4} \times 40$. A latch from the outside holds the door shut. For storage off of the cart, the door must be unhinged since it is much deeper than the rest of the taxi. Therefore, pin hinges are best.
6. The emergency strut is made from a piece of flat bar ($\frac{3}{16} \times 2 \times 20$) and shaped as shown. It is bolted through the floor so that its back edge is directly beneath the rear of the cart.
7. The taxi should be painted, in two colors to match the decor of the cart body. The spokes and rim of the wheel can also be painted to match the color of the trim. Wallpaper on the inside walls gives the finishing touch.

Comment on Town Carts

The three accessories specifically designed for town use—Baker's Box, Taxicab, and Four Seasons Tray—are three of many types once used in the villages, towns, and cities of the world. However, modern municipalities differ on their attitudes toward new-old things. Many, though not all, municipalities have laws restricting what appears on the roads and sidewalks. A jealous and less innovative merchant may try to prohibit a handcart used for sales. Possible obstacles in local laws should be sniffed out clandestinely. In the municipalities which I have queried, no licenses or fees would be necessary since the handcart taxicab fits no current descriptions. It is not legally a "taxi" because it is not a motorized vehicle. It is not an "itinerant vendor" or "peddler" because a service rather than a thing is sold. One town attorney really enjoyed the way an old conveyance slipped through all the modern definitions.

Some municipalities have wisely encouraged handcarts because they take up little space and because they provide a little spice of variety to an urban area. The modern vision of the human-scale "solar village", as presented in *The Journal of the New Alchemists* (No. 7), has a place for such ways of moving things. Individuals, if not the laws of the towns in which they live, are ready for systems which do not bully them. The taxi has been greeted with great excitement. When most people see it, they laugh. I insist they take a ride. Without exception, there is afterward a deeper enjoyment after feeling what a more human scale of transport

might be like. A college student could well earn a year's tuition by hauling executives across the Boston Common—it would be quicker, and much more fun.

Some people have expressed discomfort at being pulled by another human being because it sets up two classes of people. But think for a minute about the name of the alternative mode of urban travel: the automobile. Automobile means "something that moves by itself." But these days we know better. What makes it go is gasoline, refined from petrochemicals. The name should be "petromobile." Its operation requires complicated systems of manufacture of equipment and provision of fuel, systems which demand menial labor from hundreds of people. Additionally, they foul the city for pedestrians. The handcart taxi is a simple system. Its labor is upright and outdoors, a service job to be respected if not envied. I do not recommend a massive return to this form of transportation—rickshawmen in the Orient died early from being overworked and undernourished—but on a small scale with good rates I think the variety truly delightful.

Animal Cage

Moving animals from one place to another can be time-consuming, heavy, and frustrating. This box has a slatted gate which slides in and out of the rear gate channel. It is designed for poultry of all sorts, as well as adult sheep, year-old pigs, and year-old goats. As in Figure 38, it will move only one of the middle-sized farm animals, but when you move one, the others follow, and this is certainly the easiest way to move that first one. For taller or larger animals, such as calves or sows, the side panels of the cage would have to be taller.

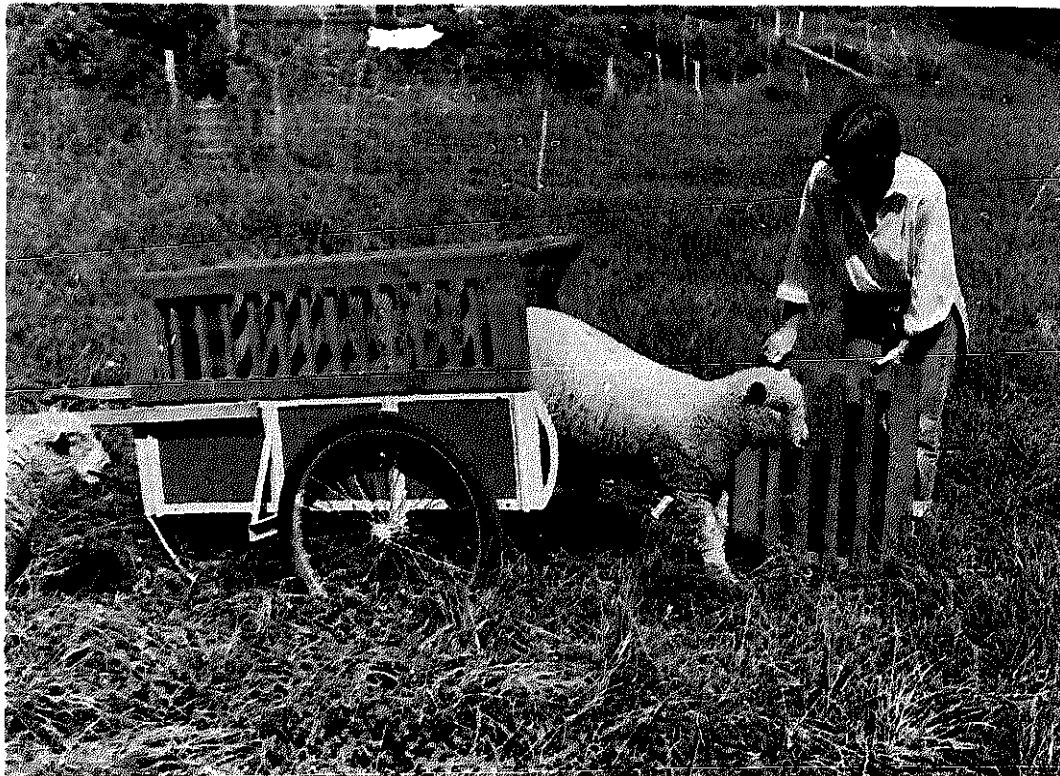

38. Animal cage and sheep.

1. A list of materials follows, with actual measurements (nominal in parentheses):

part name	stock size	length	no./cart
sides			
vertical	$\frac{3}{4} \times 3\frac{1}{2}$ (1 x 4)	9 $\frac{3}{4}$	4
horizontal	$\frac{3}{4} \times 2\frac{1}{4}$	48	
slats	$\frac{3}{4} \times 1$	14	24
gate			
horizontal	$\frac{3}{4} \times 3\frac{1}{2}$ (1 x 4)	24	2
vertical	$\frac{3}{4} \times 3\frac{1}{2}$ (1 x 4)	28	2
slats	$\frac{3}{4} \times 1\frac{1}{4}$	23 $\frac{3}{4}$	4
closed end			
vertical	$\frac{3}{4} \times 3\frac{1}{2}$ (1 x 4)	11 $\frac{3}{8}$	2
horizontal	$\frac{3}{4} \times 3\frac{1}{2}$ (1 x 4)	24	1
plywood	$\frac{3}{8} \times 14$	19 $\frac{1}{8}$	1
top			
length	$\frac{3}{4} \times 3\frac{1}{2}$ (1 x 4)	48	2
width	$\frac{3}{4} \times 3\frac{1}{2}$ (1 x 4)	22 $\frac{1}{2}$	2
slats	$\frac{3}{4} \times 1$	20 $\frac{3}{4}$	12
interior framing members			
vertical	1 $\frac{1}{2} \times 3\frac{1}{2}$ (2 x 4)	25 $\frac{3}{8}$	4
cross piece	1 $\frac{1}{2} \times 5\frac{1}{2}$ (2 x 4)	18 $\frac{3}{8}$	2
nauling strips]	$\frac{3}{4} \times 1$	13 $\frac{3}{8}$	2
for plywood]	$\frac{3}{4} \times 1$	16	1

2. Each panel is made (Figure 39), then the entire thing put together. The pieces of the gate are half-lapped or ship-lapped so that the gate will slide in and out of the gate channel. The joints should be glued during assembly, and nailed preferably with 1 $\frac{1}{4}$ -inch coated nails. Galvanized nails are acceptable. Screws can be used to put the panels together if you anticipate the need to take it apart. Note that the 2 x 4 frame for this cage is a little smaller than the inside of the cart to facilitate insertion (Figure 39). The cage can be bolted through the panels of the cart.

3. The animal cage should be painted or stained with a non-toxic wood preservative. Creosote would not do since it would poison any animal gnawing on the cage.

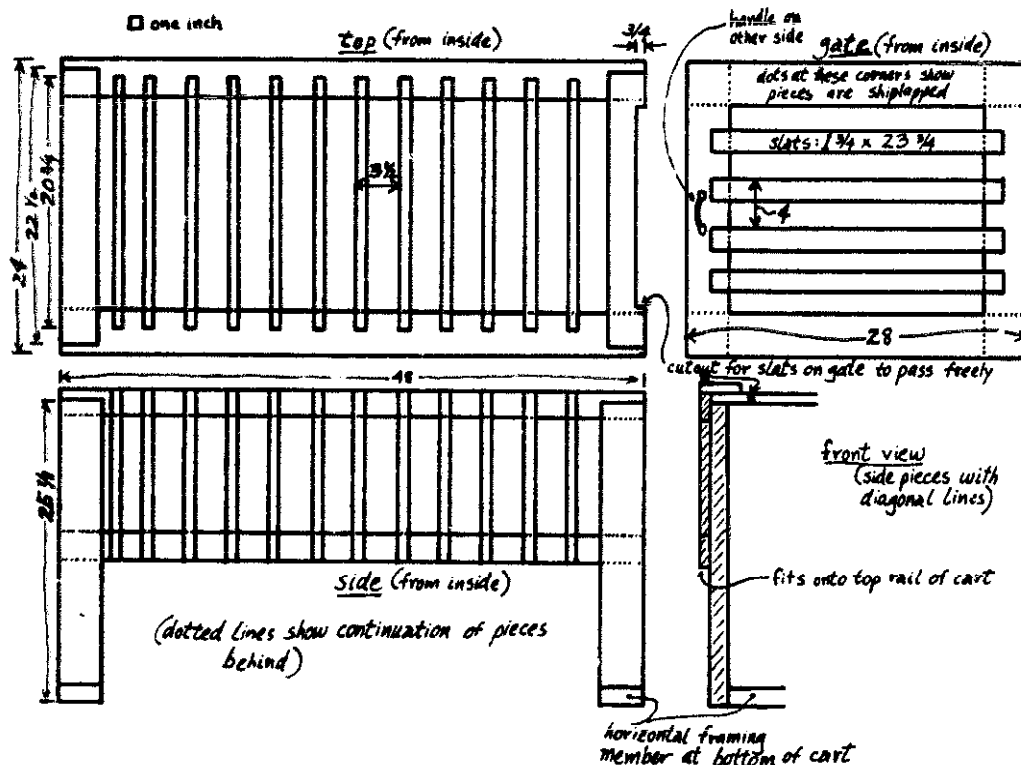

39. Animal cage, plan drawings.

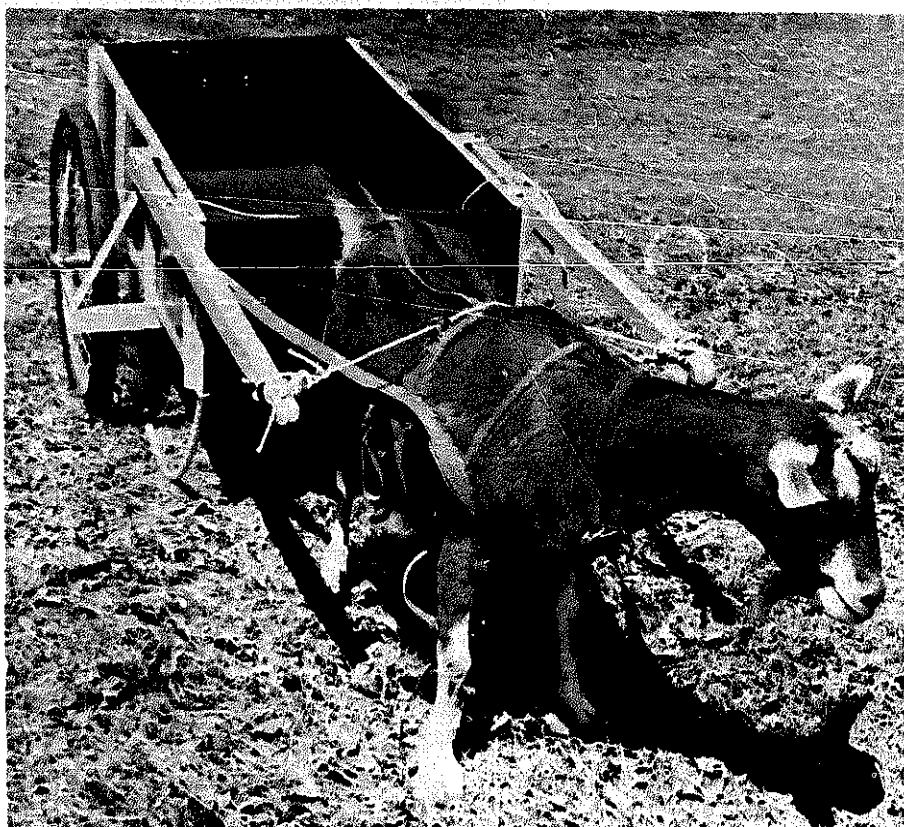

40. Goat harnessed to cart.

Goat Harness

A large buck goat or small pony can pull this cart plus twice his weight. A shorter buck or a doe may need the struts removed.

Ready-made harness and harness parts can be obtained from American Supply House, Box 1114, Columbia, MO 65205, or from Hoegger Supply Company, P.O. Box 331, Fayetteville, GA 30214. However, I recommend you make your own harness. It is cheaper since you need not make every strap adjustable to every size of goat. Adjustments have to be made to fit a purchased harness to this cart anyway, as in the instance of the goat in Figure 40. There are many regional differences in harness of every sort, and a local mentor will be unfamiliar with a style of harness purchased from another area of the country. No one style is better in every respect.

You can make up a harness if you understand its four principal parts:

- a.) The weight-bearing strap over or just behind the shoulders, and tied underneath. A rope or strap between the knobs of the shafts is supported by this saddle, which is often padded. The shafts on this cart are farther apart than shafts on carts specifically for goats, so this connection must be firm.
- b.) A pull strap across the breast with traces attached to the upper or lower front corners of the cart.
- c.) A holdback strap around the rump of the goat and attached forward to the knob of the shafts. This is to prevent the cart hitting the goat at stops.
- d.) A halter and reins, not shown in the photograph. We lead this fairly independent four-year-old doe, and we have not even tried to train her to a halter, a process which takes time and patience. (Dangling a carrot from a stick in front of a goat's nose actually does work for a short period of time.)

Covered Cart

Many of the Mormons in the Handcart Expedition of 1856 covered their two-wheel handcarts in much the same style as a Conestoga covered wagon. The cover was made of white cloth stretched over bent hoops made of pliable wood. The same can be done with this cart, using the slots in the top of the axle spars for the ends of one hoop. Hoops at the front and rear of the cart would have to be attached in another way, perhaps to short sections of the same channel of which the axle spar is made. They should be welded onto the frame. I have not tried this but wanted to pass on the design idea.

Winch

Two steel bars serve as mounts for a rod or pipe. The pipe can act as an axle for a free-rolling spool. This is the safest way I know of to dispense barbed wire, as pictured in Figure 41.

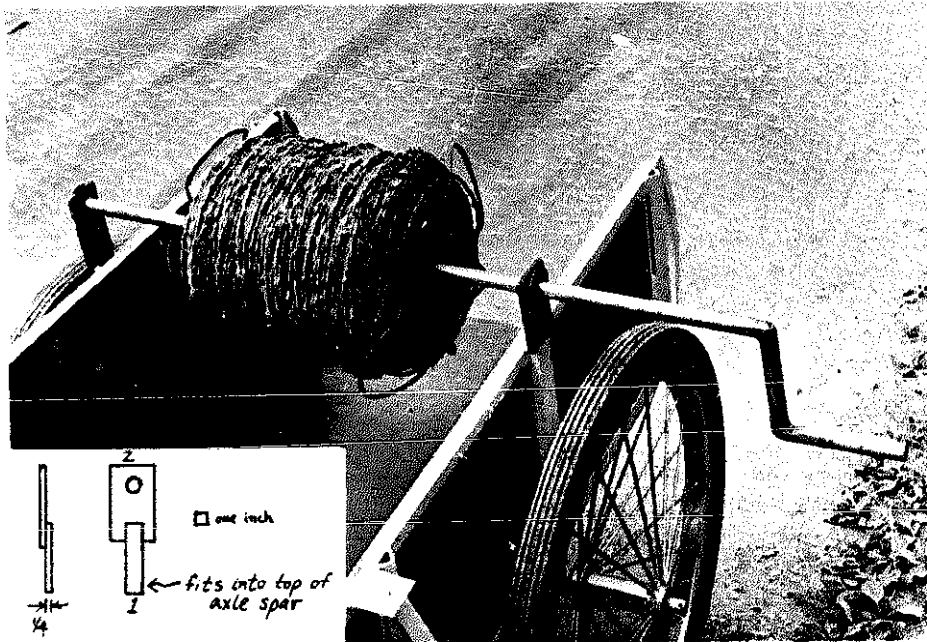

41. Winch for dispensing barbed wire, with detail of winch mounts.

Attach a crank, and you have a winch for pulling something toward you, whether it is to rewind wire or to skid a log out of a cramped spot. It can also include the management of the six-foot kites I flew in my childhood. As long as the force is pulling horizontally or diagonally, the bars will not come out of the axle spars. But as the force begins to pull straight up (such as with a large kite), the bars may well be pulled out and up into the air. In this case, drill a small hole through the axle spar and steel bars and secure them in place with machine screws or bolts. For very large forces (a kite in high wind or a heavy log), tie the struts of the cart to a tree.

Stone Lifter

If I am carrying an awkward and heavy object, I can set it down in the stable area over the struts. In the By Hand & Foot cart, something heavy need be lifted only thirteen inches. But what about something I cannot lift? The stone lifter uses the cart as a lever to pick up things off the ground. The rock pictured in Figures 42 and 43 weighed 165 pounds, which is not a lot for a benchpress machine. But rocks have no handles! The river rocks around here are also rounded and quite slippery and difficult to grasp. I have moved a rock four times as big as the one in



42. Stone lifter, loading up.

the picture with the help of the stone lifter. I first set the lip of the lifter under the stone; I can then prop the front of the cart with a long stick so it won't wheel back while I am working in the rear with the stone (I confess I seldom take this precaution); then I turn the stone onto the lifter by hand or with a pinch bar. I have also used the stone lifter to hoist up a small shed one end at a time so it could be set up on blocks. I have also used it to move that small shed: I picked up one end with the stone lifter, staked one strut to the ground so that the cart would not move, then lifted the other end of the shed until the entire structure tipped into the cart. The shed was four times as large as the cart! I would recommend this only for structures that can be tipped over like large toys.

1. Three pieces of angle iron, $\frac{1}{4} \times 1 \times 1$, 48 inches long, are welded to three shorter pieces of the same size (15 inches long) at an angle of 135 degrees. A flat bar ($\frac{1}{4} \times 1 \times 24$) is welded beneath the three prongs at the front of the lifter (the rear of the cart since the lifter is backed into position). Another flat bar ($\frac{1}{4} \times 1\frac{1}{2} \times 24$) is welded across the ends of the 48-inch pieces. A small tab ($\frac{1}{4} \times 2 \times 4$) is welded in the center of this bar which fits snugly between the trailer hitch tabs and firmly against the front sole brace (cf. Figure 10). Two other tabs attached to this bar complete a strong hook that holds the stone lifter in place.



43. Stone lifter as a lever for heavy things.

Plastic-laying Device

Several types of plastic materials have been used in vegetable production. Based on research on season extension for vegetable crops at the University of New Hampshire, slitted plastic tunnels have become increasingly popular. The slits permit the ventilation of excess heat from the plastic tunnels (a great improvement over other plastic tunnels), yet the cold of a frosty night does not penetrate to the plants. Used mostly by market gardeners, some large home gardens have begun to sprout tunnels in the spring and fall. The plastic comes in five- or six-foot widths, several hundred feet rolled up on a pressed cardboard tube. Other plastics used in the garden include black plastic mulch, Reemay gauze for covering plants, and other sorts of polyethylene sheets for tunnels.

Devices for laying slitted plastics or other plastics are either simple and require many people—a broomstick through the tube held by one person at each end while a third person unrolls the plastic—or are very expensive—a tractor-mounted device costs a couple thousand dollars.

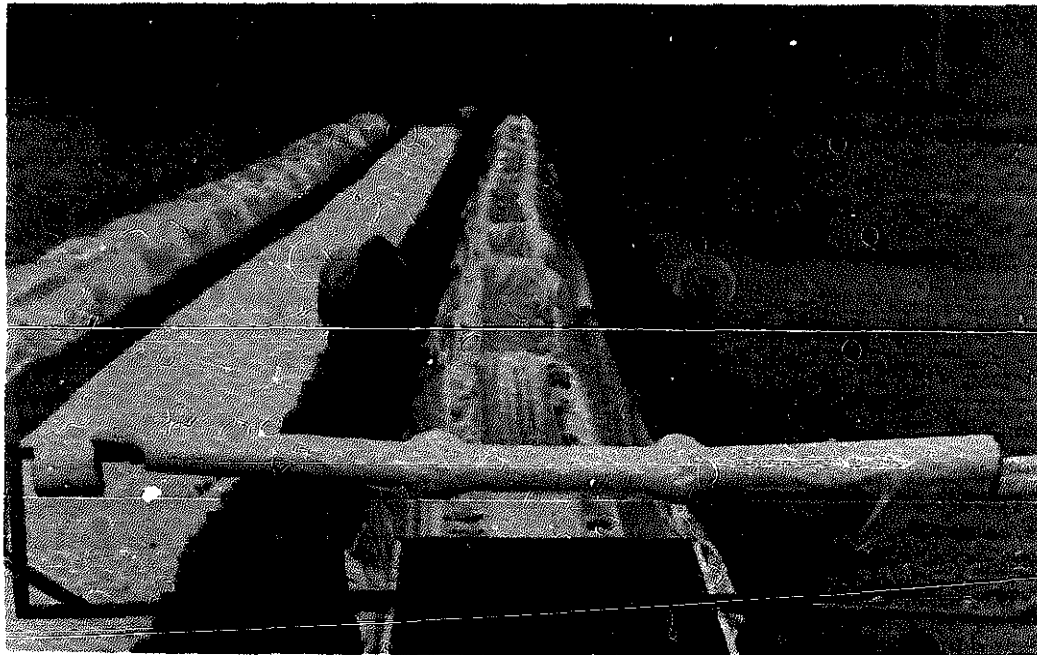

44. View across cart with plastic-laying device, and down the plastic tunnel.

Intermediate is the accessory for the By Hand & Foot cart:

1. One person can unroll and set the slitted row covers. Two people are needed on a windy day.

2. No one has to carry the plastic roll, which is awkward and heavy (a six hundred-foot roll of black plastic mulch weighs over a hundred pounds). The cart also carries from shed to garden the metal hoops needed to hold the row covers in place, as well as a tool for making furrows and burying the edges of the plastic (a hoe is good), and any other tools needed in the garden.

3. With the crank on this laying device, the plastic can be tensioned while laying so it does not droop. And the plastic can be rolled back onto the cardboard tube when it is time to remove. This is an important feature: The plastic can be used another season, a savings in time and money and a reduction in waste.

In Figure 44 are two tunnels of slitted plastics, each covering two rows of sweet corn set out in soil blocks to be ready for the early market. In between is a wide bed of lettuce transplants, also set out in soil blocks, covered by a five-foot width of Reemay gauze, which lets rain through as well as air, but which keeps the ground a few degrees warmer than the surrounding air.

When the proper length has been pulled out, the wedges should be placed in between the cardboard tube and the rod, and the crank tied to the frame. This prevents the roll from moving. Then the plastic is set down over the hoops and pulled tight, with earth being put along the end and edges of the plastic to hold it in place. When the edges have been secured under a furrow of earth up to a point about forty feet away from the cart (as seen in Figure 44), the plastic should be cut off at the roll. (The roll itself is bent in this photo and not the rod.)

Details on how to use and how to build the plastic laying device run to several pages and are available separately from By Hand & Foot.

Transplant Tray Holder

When planting for maximum use of space, the paths are small and the beds wide. When transplanting lettuces or onions, it is a great chore to get the many small plants from the greenhouse or coldframe or nursery into place. The way in which some growers have used the By Hand & Foot cart is to use a longer axle on

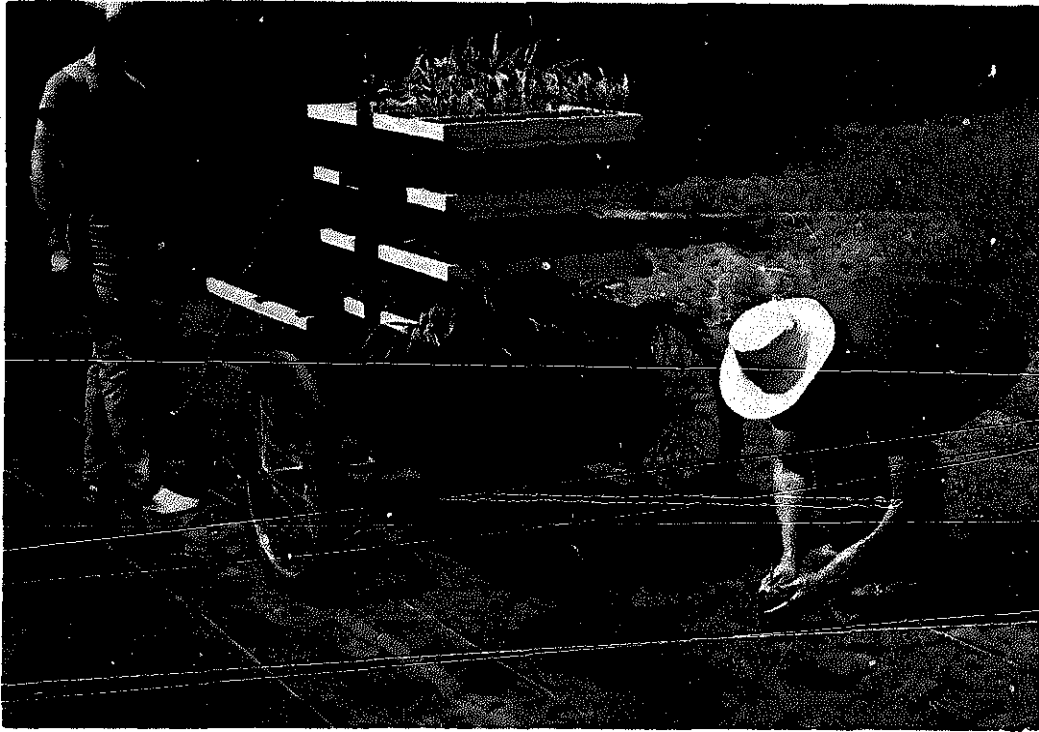

45. Transplant tray holder and wide axle to straddle a wide bed.

the cart. Thus, the cart can be stacked with transplants (I prefer the hardier and more compact soil blocks)—in the cart body, and on a simple platform clamped to the shafts, and on a simple frame which slides into the axle spar—and the wheels fit right in the pathways. For beds which are 42 to 48 inches wide, the following dimensions work well with the By Hand & Foot cart: total length of $\frac{3}{4}$ -inch solid rod is $56\frac{1}{2}$ inches. Holes should be drilled at $\frac{1}{4}$, $5\frac{3}{4}$, and $13\frac{3}{4}$ inches from either end, $\frac{3}{16}$ -inch in diameter, for linch pins which will hold the wheels in place on the axle and the axle in place on the cart frame. If the struts are a problem for plants already laid out in the beds, then a simple dog strut can be used to prop up the cart when it is set down. With two people, there is no need to set the cart down. Especially with soil blocks, one person can take them off the cart and set them in two or three rows within the wide bed fast enough to keep another person busy pulling the cart forward. There's more on this attachment in my *Transplants in Soil Blocks*.

Bicycle Attachment

Two-wheel carts are often found behind bicycles in Europe and the Far East. Many of these carts are very light, almost flimsy. Some are substantial since they have become the transport trucks of some sections of the world. A heavy cart load reduces the maneuverability of a bicyclist, and that could be dangerous. However, the By Hand & Foot cart can be hooked up to a bicycle if the roads are fairly level and the bicycle is a workhorse type (not a delicately balanced racing type). A trailer hitch is made which rises up higher than the riding mower hitch described earlier; make it shorter too so the cart is closer to the bicycle (for which you must remove the shafts). The secret is the solution to the universal joint which attaches the two vehicles. The one I found in Denmark is the best: two pieces of thick rubber tire to fit over the seat post of the bicycle and to bolt to the end of the trailer hitch.

Backpack, Vallus, and Boat

Of the many extensions of the use of two-wheel handcarts, there are three which interested me very much, but which I did not pursue for the By Hand & Foot design. In case someone else gives them a try, I would love to hear about successes and failures. Green River Tools reports that many people purchase the parts of carts, presumably to make the cart that perfectly fits their unique needs, thereby continuing an honorable tradition going back nearly three thousand years.

Recent work with the traditional chi-ki backpack of Korea involved the addition of two wheels. On good roads the load was moved by pulling a cart; on mountainous paths, the load *with the cart* was shouldered. This revised chi-ki is on very light wheels and a tubular aluminum frame. I am suspicious of the weakness of aluminum, but think the versatility of this improved chi-ki very interesting.

On the Roman estates in Gaul, there were not enough harvesters for the grain crops necessary for the Empire. One technique to make harvests more efficient was a two-wheel cart called a "vallus," pushed by an oxen, the shafts guided by hand. Along the front edge of the cart were long fingers with sharp edges, set at the height of the grain heads. As the cart was pushed into the field of ripe grain, the heads were snipped off and fell into the cart. When the cart was full, it was wheeled away to the threshing area. The modern stripper used extensively in Australia was modelled on this idea. I have been working with the vallus in comparison with other harvesting techniques and built two reproductions of Roman designs, but have not yet got the right design.

Carts were often dismantled for crossing water. The frame, covered with waterproof skins, became the boat. The wheels were stored inside. The Red River cart of the animal trappers of the West was dismantled at the river's edge, and the wheels placed on their side beneath the frame; they were not *in* the cart, but were the ballast and frame of the bottom of the boat. I am trying to figure out how I can waterproof the By Hand & Foot Cart so I can paddle to the sea.

TECHNICAL NOTES

How Heavy Is It?

Several people have asked me about the actual forces involved in pulling a handcart. These can be estimated, and are useful for knowing when to stop loading up a handcart. To begin with, Figure 9 can be read for other loads in a simple proportional manner, i.e., for a 300 pound load, multiply the numbers in Figure 9 by $\frac{3}{5}$. However, these numbers are an idealized representation; assumptions made in Figure 9 (and corrections to those assumptions) are:

1.) no rolling resistance, i.e., drag produced by the flexing of the rubber tire. With modern handcarts, this figure is only about 1% of the load weight. However, it rises very quickly when the inflation pressure drops — try to pull a loaded handcart with a flat tire!

2.) no friction, i.e., drag produced by the workings of the bearings at the wheel hub. Normally this is negligible in modern handcarts with ball bearings. In more primitive carts, or in modern carts where grit has seized up the bearings, friction can be considerable. Check that the wheels spin freely and replace the bearings if they don't.

3.) a smooth surface, or no obstacles. Clearly from Figure 14, a wheel surmounting an obstacle travels as if it were going up a steep hill for a short while, then falling down the other side. These effects do not balance but serve to reduce momentum. Formulas exist for estimating the effects of different degrees of roughness of terrain but they are impractical in normal use. This factor is generally far less a problem than the next two.

4.) a balanced load, or the center of gravity of the load evenly balanced over the axle. Here is a table to show how deviations from this ideal affect the weight which you counteract.

Table I. Resistance to pull experienced at end of handcart shafts depending on grade and distance of center of load from axle for loads of 300 and 500 pounds.

distance forward from axle (inches)	— 300 pounds —				— 500 pounds —			
	grade							
	0	4	10	14	0	4	10	14
0	0	12	30	42	0	20	50	69
3	14	18	33	44	25	32	56	74
6	27	30	40	50	45	49	67	83
10	45	47	54	61	75	78	90	102

The figures that are analagous to those in Figure 9 are in the top row, where the distance is zero. Read down the columns to find out how shifting the weight forward affects how much weight you experience when pulling. (If the center of the load is *behind* the axle, the increases are smaller.) Table I shows clearly why an empty cart is heavier than a loaded cart on the level and on small grades: the weight of the cart itself bears down on the handcarter. Values for other load weights can be derived proportionately; e.g., values for 200 pounds are $\frac{2}{3}$ of these for 300 pounds.

5.) a hard surface, or nothing for the cart wheels to sink into. This is quite unrealistic for handcarts which you expect to use around the garden, in the woodlot, and so forth. Engineers have worked out the drag due to the deformation of the soil and it makes sense to take this into account when deciding on how much load to take across a certain type of ground. Below are forces of resistance to a two-wheel handcart resulting from the frictional and cohesive deformation of different soils as calculated from formulas in M. G. Bekker's *Terrain-Vehicle Systems* (Ann Arbor: University of Michigan Press, 1969):

Table II. Resistance to pull depending on soil type and weight of load (pounds)

soil type	weight of load				
	100	200	300	400	500
heavy clay	2	8	17	29	44
unploughed sod	7	17	29	42	57
sandy loam	8	22	40	60	83
dry sand	18	44	76	110	148

Note that in each soil type, the figures start fairly small but rise quickly and accelerate as more weight is put on and the wheels sink in more deeply. In other words, it's more than two times as hard with two times the weight (more like 2½ times as hard). These effects of the soil would be added to the effects of a slope and of load not balanced over the axle (from Table I).

* * * * *

Though the *exact* determination of estimated resistance to pulling could be calculated with many more formulas and measurements of the cart, tire, and soil (cf. Bekker's *Prediction of Design and Performance Parameters in Agro-forestry Vehicles*, Ottawa: National Research Council of Canada, 1983), you now have enough information to determine the approximate forces you must counteract to get your handcart going. The simplest way to estimate is to add together the pounds of resistance in Tables I and II. Let me give you an example. I expect to transport 210 pounds of firewood across a sod field which lies at a slope of grade 4 (ascends 4 feet in 100 horizontal feet). I expect to stack the wood so that the center of the load is six inches ahead of the axle since I plan later to lower the cart backwards down a steep slope toward my wood shed and I do not want to risk the cart tipping over backwards. As you may remember, tipping over is the Achilles heel of handcarts — you see, balancing exactly over the axle may not always be the preferred way of loading. I chose 210 pounds of wood for simplicity in this example because the By Hand & Foot handcart weighs 90 pounds itself (greater indeed than the Garden Way-style carts which average 50 pounds, but much less than the common handcarts of India which average 420 pounds empty!). From Table I, I see I have a basic resistance of 30 pounds; from Table II, I see I have an additional resistance of 29 pounds; the total is 59 pounds of resistance. Let's say the wood is green and heavy, and I want to put on the flare boards and really load it up. I estimate that I will total 500 pounds. From Table I, I see I have a basic resistance of 49 pounds; from Table II, I see I have an additional resistance of 57 pounds; the total is 106 pounds of resistance.

How Much Can You Handle?

Now comes the question: How many pounds of resistance can you handle? Several researchers have asked this question of specific groups: How much can a soldier carry all day and still have the ability to do the same thing the next day and the next? How many boxes can a person lift hour after hour in a warehouse? Even, how many pounds can a handcarter pull through the streets of Calcutta (where 12,000 handcarts are licensed for portage)? The last study seems the most appropriate to us, except that the cart is much cruder (with much higher bearing friction) and the cart and load is typically much heavier (up to 1200 pounds).

The most relevant studies are those of pulling, pushing, and carrying, rather than the more common studies of lifting. Continuous work rather than brief spurts of work is much more difficult, and several researchers have suggested that you should not expect to carry, push, or pull more than 40% of your clothed weight for a long distance. This should keep your peak heart rate at no more than 130 beats per minute.

Asking male industrial workers to determine their own limits, Stover Snook found the following (from *American Industrial Hygiene Journal*, 1970, 31, 579-586):

Table III. Maximum forces and work loads acceptable to various percentages of industrial male workers (pounds)

	90%	75%	50%	25%	10%
Initial pull (surge)	54	62	70	79	87
Sustained pull	32	40	48	56	64
Sustained carry at knuckle height	41	50	59	69	78
Workload (ft. lb./min.)	1524	1766	2035	2304	2546

Wielding a handcart uses these three movements in combination. Other studies have shown that the maximum acceptable weights for women average 65% that of men, with a great deal of overlap.

Forty percent of the clothed weight of an average 150-pound man would be sixty pounds, which is close to the 59-pound average figure for sustained carry in Table III but more than the 48-pound average for sustained pull. The 40% criterion has been found accurate in India and Great Britain: The American workforce does not carry quite so much. Also, people can carry less in front of them than they can on their back or with the aid of shafts.

Another difference is between surges of ability, as in an initial pull, and sustained efforts. Whereas many people will be able to lift a very heavy thing, such as a 100-pound sack so common in agricultural settings, they can do so for only a short height and distance. More and they risk overexerting themselves.

With these qualifications in mind, you can use Table III as a guide to seeing how much you should tackle either in or out of a handcart. It certainly puts into perspective some of the resistances anticipated from Tables I and II. For expected resistance over 60 to 70 pounds, I'll need to take the smaller load of firewood or get some help!

Table III also puts into perspective the tasks undertaken by handcarts in the past. The United States Lifesaving Service pulling a 1200-pound cart across dry

sand dealt with resistances of 225 pounds; add the steep slopes of dunes, and you get easily 800 pounds of resistance. Even with a crew of eight men, you can see why they spent many hours each day in fitness and strength training to be able to accomplish their rescues. Fully equipped, their vehicle could weigh as much as 2000 pounds.

A similar analysis could be applied to the Mormon handcarters, with bearings of green wood, or to the Chinese moving an entire river valley, as illustrated in the early parts of this handbook.

The analyses so far have assumed that you are walking with a handcart and with the weight balanced at your center of gravity (the lesson of Figure 8). When you are leaning over or moving more quickly, the work is more difficult. The work of the rickshaw man, whose load may be well balanced but whose pace is very fast, should be recognized as very heavy. I found it enjoyable to pull the French vinaigrette through Brattleboro at a fast walk and a run on the descending streets. But I did not expect myself to run uphill. Not so with the rickshaw pullers of times past (and present) as is so well presented in Lao She's novel *Rickshaw* (Honolulu: University of Hawaii Press, 1979, originally 1936). From Table III, you can see that the workload figure gives a *rate* at which you carry or pull. If you need to go faster, consult these figures to see if you might be asking too much of yourself.

* * * *

EPILOGUE

Bear your burdens lightly, with a straight back, and sprightly, so that, as the ancient Greek Theocritus said, "as you go, every pebble springs singing from your shoes."

\$4.50

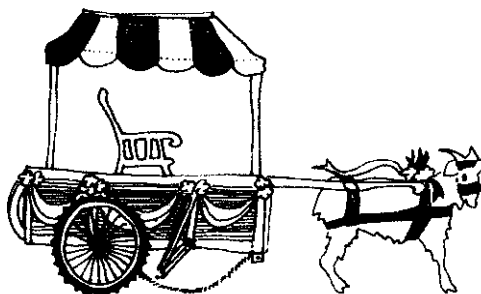

by hand & foot, ltd.®

Tools dependent on human energy.

P. O. Box 611

Brattleboro, Vermont 05301

ISBN 0-938670-04-2