

AT MICROFICHE
REFERENCE
LIBRARY

A project of Volunteers in Asia

Soil Conservation: Project design and Implementation
Using Labour Intensive Techniques

By: Bernard Leblond & Laurent Guerin
UNDP-ILO/INT/81/044

Published by: International Labour Office
ILO Publications
CH-1211
Geneva 22
SWITZERLAND

Available from: International Labour Office
ILO Publications
CH-1211
Geneva 22
SWITZERLAND

Reproduced with permission.

Reproduction of this microfiche document in any form is subject to the same restrictions as those of the original document.

SOIL CONSERVATION PROJECT DESIGN AND IMPLEMENTATION USING LABOUR INTENSIVE TECHNIQUES



UNITED NATIONS
DEVELOPMENT
PROGRAMME



INTERNATIONAL
LABOUR OFFICE

UNDP-IL0/INT/81/044
Interregional Project for Implementation
and Evaluation of Special Public Works Programmes

**SOIL CONSERVATION
PROJECT DESIGN AND IMPLEMENTATION
USING LABOUR INTENSIVE TECHNIQUES**

by

Bernard LEBLOND, Doctor in Earth Sciences

Laurent GUERIN, Adviser in Civil Engineering

Emergency Employment Schemes Branch

Copyright © International Labour Organisation: 1982

Publications of the International Labour Office enjoy copyright under Protocol 2 of the Universal Copyright Convention. Nevertheless, short excerpts from them may be reproduced without authorisation, on condition that the source is indicated. For rights of reproduction or translation, application should be made to the Publications Branch (Rights and Permissions), International Labour Office, CH-1211 Geneva 22, Switzerland. The International Labour Office welcomes such applications.

ISBN 92-2-103395-3

First published 1983

Second impression 1988

The designations employed in ILO publications, which are in conformity with United Nations practice, and the presentation of material therein do not imply the expression of any opinion whatsoever on the part of the International Labour Office concerning the legal status of any country, area or territory or of its authorities, or concerning the delimitation of its frontiers. The responsibility for opinions expressed in signed articles, studies and other contributions rests solely with their authors, and publication does not constitute an endorsement by the International Labour Office of the opinions expressed in them. Reference to names of firms and commercial products and processes does not imply their endorsement by the International Labour Office, and any failure to mention a particular firm, commercial product or process is not a sign of disapproval.

ILO publications can be obtained through major booksellers or ILO local offices in many countries, or direct from ILO Publications, International Labour Office, CH-1211 Geneva 22, Switzerland. A catalogue or list of new publications will be sent free of charge from the above address.

Preface

Soil conservation, of course, occupies an important place, often the most important, in **special public works programmes** in developing countries. Such programmes aim to increase employment and raise the income of the poorest, essentially through the creation of an infrastructure in rural areas that will improve agricultural and forestry production, develop communications and generally improve the quality of life. In view of their employment objectives, the programmes use the available workforce to the maximum, putting the accent on labour-intensive techniques. Such an approach is particularly well suited to soil conservation work from, for example, the construction of anti-erosion terraces or banks, to re-forestation, itself related to the establishment of nurseries. It has been observed that the labour component in such projects is, on average, 70% of the total cost.

Community participation is another important aspect that is shared by soil conservation activities and special public works programmes. Soil conservation is not only limited to isolated, individual interventions; to be effective, it must be undertaken at a community level, developed on the largest scale possible and, consequently, involve all the people concerned. Participation, which assumes grass-roots agreement, is one of the fundamentals of special public works programmes, along with the crucial role played by local Administration representatives and the technical services, in mobilising the workforce.

Finally, the place set aside for soil conservation in the special programmes follows from the fact that the latter deal, by definition, with disadvantaged groups. The zones covered by the programmes tend to be the poorest in natural resources, where the soils are progressively degraded as a result of deforestation and erosion. In this context, special programmes can be seen as contributing, not only to reconstituting and preserving small-scale farmers' capital, that is the land, but also to the protection of the environment.

The present document, prepared by two experienced consultants, Messrs Leblond and Guerin, is part of a series of technical documents published by the International Labour Office within the framework of the UNDP/ILO interregional project for the planning, organisation and execution of special public works programmes.

Soil conservation is a very wide and complex subject which has been fully explored from all points of view. The authors have, therefore, limited themselves to a reminder of the basic thinking concerning soil erosion and an analysis of the labour-intensive techniques employed in the battle against erosion. Justifiably, then, a large part of the study is devoted to the presentation of a methodology for establishing a soil conservation project model that meets the criteria of special public works programmes. Finally, the authors precisely and succinctly set out the rational organisation and successive stages of a labour-intensive operation.

This manual, with its emphasis on a practical approach to the subject, has been written mainly for the national planners, senior engineers and technicians who must establish and execute the programmes in developing countries. Interest in the social and economic aspects of the programme is becoming more intense daily, and the international community contributes active support in the fields of financial and technical assistance.

Long-term in nature but urgent, soil conservation reflects the wish of the poorest communities to preserve and improve their land heritage, so that their own and future generations' basic needs can be assured. That, at least, is the desire expressed here and that should be rewarded by wide distribution of this remarkable work. The authors have drawn on their practical experience and pay all due attention to the socio-economic conditions of the populations concerned, and to the provision of appropriate techniques and instruments.

Maurice Idoux

*Senior adviser
Division for global and
interregional Projects
United Nations
Development Programme
(UNDP)*

The phenomenon of soil conservation is not new. Plato, as early as four centuries before our age, deplored mountain erosion in Greece, but the phenomenon has now reached unprecedented proportions, and, should it continue at the current rate, one third of the world's arable land will be depleted within the next twenty years.

Inclusion of soil conservation schemes in SPECIAL PUBLIC WORKS PROGRAMMES offers the two-fold advantage of responding to an obvious economic imperative and of promoting the intensive use of unskilled labour for implementing works.

This manual, written for engineers and higher-level technicians provides instructions for the design and construction of soil conservation projects using the «labour investment».

It presents in the following order the fundamental notions applying to various sorts of erosion and the possible remedies, a standard methodology for project design and preparation, and guidelines for the organisation, implementation and supervision of works.

	<u>Page</u>
INTRODUCTION	1
CHAPTER A. GENERAL PRINCIPLES	3
A.1. THE DIFFERENT FORMS OF SOIL DEGRADATION	3
A.2. RAINFALL EROSION	3
2.1. Factors in rainfall erosion	3
2.1.1. Rainfall	4
2.1.2. Nature of the soil	4
2.1.3. Slope of the land	5
2.1.4. Vegetation	5
2.1.5. Man	6
2.2. The effects of rainfall erosion	6
2.2.1. Mechanical effects	6
2.2.2. Chemical effects	7
2.3. Integration of rain water erosion factors	7
A.3. SOIL EROSION BY WIND	11
3.1. Wind erosion factors	11
3.2. The effects of wind erosion	11
A.4. OTHER FORMS OF SOIL DEGRADATION	12
4.1. Excessive humidity	12
4.2. Excess of toxic salts	12
4.3. Unsuitable agricultural practices	12
4.4. Socio-economic aspects of soil degradation	13
A.5. LAND USE	13
5.1. Land employment	13
5.2. Land classification	13
5.2.1. Classification system developed by the Soil Conservation Service of the US Department of Agriculture	13
5.2.2. Other classification systems	17
CHAPTER B. EROSION PROTECTION TECHNIQUES	21
B.1. CONSERVATION OF PROTECTED LAND	21
1.1. Forests	21
1.1.1. Role of the forest in soil conservation mechanisms ...	21
1.1.2. Main forest species used in afforestation	22
1.1.3. Preparing a reafforestation plan	27
1.1.4. Ground preparation	28
1.1.5. Seed preparation	30
1.1.6. Afforestation using the direct sowing method	30
1.1.7. Afforestation by planting	32
1.1.8. Maintaining the afforested area	39
1.1.9. Plantation conservation	40

	<u>Page</u>
1.2. Pastures	43
1.2.1. Role of pastures in soil conservation mechanisms	43
1.2.2. Techniques for the creation, conservation and improvement of pastures	43
B.2. CONSERVATION OF CROP LAND	44
2.1. Biological procedures	44
2.1.1. Cover crops	45
2.1.2. Mulching	45
2.1.3. Crop rotation	45
2.1.4. Mixed cropping	45
2.1.5. Lea crops	45
2.1.6. Rotation field-strip cropping	45
2.1.7. Increasing the soil's organic reserves	46
2.2. Farming practices	46
2.2.1. Contour ploughing	47
2.2.2. Contour or slightly inclined ridging	47
2.2.3. Subsoiling and chiselling	49
2.3. Defence networks	49
2.3.1. The role of defence networks and the systems used	49
2.3.2. Main types	50
2.3.3. Dimensions	54
2.4. Bench terraces	60
2.4.1. Terraces constructed at a single go	60
2.4.2. Terraces constructed progressively	63
2.5. Drainage works	64
2.5.1. Characteristics of gully erosion and the role of control works	64
2.5.2. Determining run-off conditions	65
2.5.3. Main types of construction	69
2.6. Bank, channel and gully protection	70
2.6.1. Stabilising banks with vegetation	70
2.6.2. Protection of banks by construction works	70
2.7. Correcting the slope of water courses	73
2.7.1. Role of constructions	73
2.7.2. Type of work	73
2.7.3. Principles of calculating structure dimensions	78
B.3. WIND EROSION PROTECTION TECHNIQUES	81
3.1. Dune stabilisation	81
3.1.1. Conventional techniques for stabilising maritime dunes	81
3.1.2. Techniques for the stabilisation of continental dunes	82
3.1.3. Dune stabilisation by a coating of bituminous products	83
3.2. Crop land protection	83
3.2.1. Windbreaks	83
3.2.2. Other techniques	83
3.3. Pasture protection	84

	<u>Page</u>
CHAPTER C. REHABILITATION TECHNIQUES FOR WATERLOGGED SOILS	85
C.1. AIMS OF DRAINAGE	85
C.2. DIFFERENT TYPES OF DRAINAGE	85
2.1. Open ditches	85
2.2. Underdrains	86
2.2.1. Fascine drains	86
2.2.2. Stone slab drains	86
2.2.3. Drains with stone backfill	87
2.2.4. Wooden box drains	87
2.2.5. Peat drains	87
2.2.6. Earthenware piping drains	87
2.2.7. Concrete drainpipes	87
2.2.8. Bituminous fibre drainpipes	87
2.2.9. Plastic drainpipes	87
2.3. Mole drainage	88
2.4. Subsoiling	89
C.3. DETERMINING THE CHARACTERISTICS OF A DRAINAGE NETWORK	89
3.1. Water movement in a drained soil	89
3.2. Determination of basic data	91
3.2.1. Causes of wetness	91
3.2.2. Optimal water table level	92
3.2.3. Permissible submersion time	92
3.2.4. Type of soil - permeability	93
3.2.5. Intrinsic flow rate of network	94
3.3. Calculating the drainage network	95
3.3.1. Network design	95
3.3.2. Drain depth	96
3.3.3. Drain spacing	97
3.3.4. Drain diameter and length	101
3.3.5. Calculation of collectors	101
CHAPTER D. METHODOLOGY FOR SETTING UP A SOIL CONSERVATION PROJECT	103
D.1. PRELIMINARY STUDIES	103
1.1. Aims	103
1.2. Situation analysis	103
1.2.1. The physical context	103
1.2.2. The socio-economic context	106
1.3. Assessing the extent of possible measures	106
1.3.1. Damage assessment	106
1.3.2. Envisaged investment	107
D.2. DRAFT PROJECT	108
2.1. Aims	108
2.2. Analysis of basic data	108
2.3. Hypothesis of improvements	109

	<u>Page</u>
2.4. Economic analysis	110
2.4.1. The expenditures	110
2.4.2. Income	110
2.4.3. Balance sheet	111
2.5. Selection of improvements	111
D.3. THE PROJECT	111
3.1. Objectives	111
3.2. Field studies	111
3.2.1. Topographic work	111
3.2.2. Survey borings	112
3.3. Project document	112
3.3.1. Written documents	112
3.3.2. Drawings	112
CHAPTER E. PROJECT IMPLEMENTATION	113
E.1. GENERAL SITE ORGANISATION	113
1.1. Survey of local conditions and site reconnaissance	113
1.1.1. Natural constraints	113
1.1.2. Technical and economic constraints	114
1.2. Project planning	115
1.2.1. Objectives of planning	115
1.2.2. Forms of planning and their requirements	116
1.2.3. Planning procedure	117
1.2.4. Bar chart or GANTT chart	118
1.2.5. Time and location chart planning	119
1.2.6. Network or critical path planning	121
1.3. Setting up the site	124
1.3.1. Construction of access roads	124
1.3.2. Construction of site buildings	125
1.3.3. Plant installation	125
1.4. Site management	125
1.4.1. Management technique	125
1.4.2. Personnel management	126
1.4.3. Incentive system	130
1.4.4. Role of project management	131
E.1. TOPOGRAPHICAL STUDIES	132
2.1. Topographical survey	132
2.1.1. Planimetric survey	132
2.1.2. Levelling	133
2.1.3. Composition of a topographic survey team and survey standards	134

	<u>Page</u>
E.3. MARKING AND STAKING OUT THE STRUCTURE	134
3.1. Preparation of the ground plan	134
3.2. Preparation on the ground	134
3.2.1. Main staking out	135
3.2.2. Additional staking	135
3.2.3. Staking report	135
3.2.4. Displaced stakes	135
3.3. Personnel requirements and work output	136
E.4. GROUND PREPARATION	136
4.1. Clearing the land over the area covered by the works	136
4.2. Stripping - subsoiling	137
E.5. EXECUTION OF EARTHWORKS	138
5.1. General comments on soil type and handling	138
5.1.1. Land classification	138
5.1.2. Bank gradients	138
5.1.3. Bulking - consolidation	139
5.2. Tools	141
5.2.1. Trenching tools	141
5.2.2. Tools for loading earth	141
5.2.3. Tools for soil haulage	141
5.2.4. Tools for soil compacting	142
5.3. Manpower	142
5.4. Labour organisation	144
5.5. Earth-moving methods and outputs	144
5.5.1. Trench digging and spoil removal	144
5.5.2. Loading and reworking spoil	146
5.5.3. Spoil haulage	147
5.5.4. Unloading, spreading and compacting	148
5.5.5. Bank grading	149
5.6. Examples of earthworks	149
5.6.1. Construction of a canal or ditch	149
5.6.2. Construction of earth dams	151
E.6. IMPLEMENTATION OF REAFFORESTATION WORK	151
6.1. Nursery work	151
6.2. Planting	152
6.3. Construction of forest tracks	152
6.4. Plantation maintenance	153
6.5. Examples of a plantation: planting along contour lines	153
6.6. Productivity norms	154

	<u>Page</u>
E.7. IMPLEMENTATION OF DRAINAGE WORKS	155
7.1. Installation of a drainage network	155
7.2. Tracing out total trench width	155
7.3. Calculating trench depth	155
7.4. Trench digging	156
7.5. Trimming the trench bottom	157
7.6. Drain laying and backfilling the trench	158
7.7. Manpower and output in manual drainage work	160
E.8. CONSTRUCTION OF MASONRY WORK	160
8.1. Different types of masonry work	160
8.2. Dry-stone masonry work	160
8.3. Normal masonry work	162
8.4. Gabion masonry work	163
E.9. CARRYING OUT CONCRETE WORK	167
9.1. Characteristics of concretes	167
9.2. Concrete preparation	167
9.3. Shuttering	168
9.4. Steel reinforcement	168
9.5. Installing the reinforcement bars	169

APPENDICES

I. STANDARD PLANS	171
II. BIBLIOGRAPHY	205

INTRODUCTION

The soil is one of the essential elements for plant, animal and human life. It is a complex and constantly changing environment which, under normal conditions, is the result of an equilibrium between the forces of soil formation and erosion. In regions covered with vegetation, the humus removed from the soil is usually reconstituted. The natural development of soil with a covering of vegetation is slow; it is estimated that around 3,000-12,000 years are required for the development of 30 cm of soil.

Man extracts from the soil the main part of his food production but increasing demographic pressure forces him to extend land cultivation, intensify production and use techniques that are not always in line with the maintenance of soil fertility. Under the effect of man's mishandling, the equilibrium is disturbed, erosion accelerates and, in many countries, whole regions are hard hit by this degradation and the fall in soil yield - with disastrous consequences for the physical and economic environment.

Soil conservation and related afforestation schemes have assumed increasing importance. This is due to the fact that, in the developing countries, soil erosion has assumed alarming proportions. There is need for environmental preservation and maintenance of ecological balance which, in itself, is very necessary for maintaining increased food production and, indeed, the very living conditions of the world.

Being relatively more labour-intensive, such soil conservation schemes hold a potential for high labour absorption during the construction phase as well as contributing to the development of land infrastructure for increased food production. The relevance lies in the high labour-intensity, quick wage employment generation for unskilled idle rural labourers and resultant infrastructure development.

Soil conservation is the outcome of a balance between the satisfaction of current and long-term needs. It is a national problem in view of its social and political implications - the solution of which far exceeds the technical and financial capabilities of the farmer alone. Implementation of a soil conservation programme, if it is to be successful, must be understood and supported by the population as a whole. This also presupposes technical innovation and collective awareness which will come about only after information and education campaigns.

The present document does not claim to replace the very abundant literature on this subject to which the reader should refer should he require a deeper knowledge of the subject. Its more modest aim is to assist engineers and senior technicians responsible for planning and implementing soil conservation projects. It contains: a review of the basic data on different types of erosion and control measures making intensive use of unskilled labour, standard methods for the design and planning of projects and, finally, guidelines for site organisation, operation and supervision.

Appendices contain a series of standard plans which, although they may, in many cases, suffice to define the work in hand, are no substitution for the specific studies that should be carried out for each site. It should be emphasised that the plans given are not necessarily the only possible solution to a given problem and that in all cases they have to be adapted to local conditions, customs and traditions especially with regard to the maximum use of local resources which should always be systematically pursued.

CHAPTER A

GENERAL PRINCIPLES

A.1. THE DIFFERENT FORMS OF SOIL DEGRADATION

Soil degradation may be due to rain run-off from the soil, the effect of wind, excessive humidity, poor irrigation practice or unsuitable farming techniques.

The most spectacular forms of soil degradation are due to rainfall and wind which reshape the ground relief. Rain water running off over the soil may carry away the main fertile components and even totally strip the top soil which is the basis of agricultural production. The wind may have the same effect by carrying away the fine particles of an unprotected soil, including the main fertile components. The wind may also carry away larger particles, depositing them at a distance and thus covering with sterile sand deposits regions which were previously fertile.

Excessive humidity in the soil is another cause of degradation. The sources of this humidity may be numerous and varied and due either to topographical conditions (low-lying land), rivers overflowing into alluvial plains, excessive rainfall or over-generous irrigation. The consequences are degradation of soil structure and leaching of their chemical components, defective soil aeration with resultant effects on cultivation, low yields or the impossibility to continue agricultural production. Other forms of soil degradation are more insidious, less spectacular but nevertheless just as devastating for the region's agricultural economy. In this case, it is the soil's chemical content that is degraded. These forms of degradation may be due to excessive exploitation as the result of high demographic pressures. In many countries, periods of fallowing which allowed the natural regeneration of the soil have been reduced. The soil's nutrients are not renewed and fertilising is not sufficient. This degradation may also be the result of poor irrigation in an arid climate where the salts brought in by irrigation build up in the soil resulting in salination and alkanisation. Thousands of hectares of fertile land have been rendered unfit for cultivation in this way.

A.2. RAINFALL EROSION

2.1. Factors in rainfall erosion

Atmospheric precipitation is the main cause of rainfall erosion which produces surface run-off that has considerable destructive force. Other factors affecting erosion are the nature of the soil, the slope, vegetation and human activity.

2.1.1. Rainfall

The main characteristics of precipitations are the amount of rain, the intensity and the frequency. Rainfall intensity is one of the most important factors in soil erosion. Rainfall erosivity is the result of the kinetic energy in raindrops striking the soil; the amount of kinetic energy increases with rainfall intensity; it leads to soil compaction and demolition of aggregates.

Rainfall intensity is measured by means of a recording rain gauge.¹

The influence of rainfall intensity increases with increasing soil humidity, i.e. with increasing rainfall frequency. A soil covered by a film of water will disaggregate more readily and will have more intense rain water run-off.

Annual precipitation variations also have an effect on soil loss and years of heavier rainfall produce wash away larger quantities of soil.

2.1.2. Nature of the soil

The susceptibility of soil to erosion depends on the soil's nature and is called erodibility.

Erodibility is difficult to assess since it depends on numerous parameters, the most important of which are soil structure, texture, chemical composition and organic-matter content.

Texture refers to the proportion of different size particles in the soil. The smallest particles are clays and the largest are stones or gravel.

The international system classifies soil texture as follows:

-
- clays with a particle size range less than 0.002 mm

 - silts with a particle size range between 0.002 and 0.02 mm

 - fine sands with a particle size range between 0.02 and 0.2 mm

 - coarse sands with a particle size range between 0.2 and 2.0 mm

 - gravels with a particle size range greater than 2.0 mm

Structure refers to the arrangement of these individual particles in the soil into separate aggregates of different size and shape.

The cohesion of the structure or "structural stability" can be determined by use of Hénin's "instability index", the factors of which are:

- the mean percentage of stable aggregates,
- the fraction of dispersed clay plus loam,
- the fraction of coarse sand.

¹ Recordings in Madagascar have shown that rainfall intensities of less than 1.5 mm/min are rarely erosive, whereas rainfall intensities of over 2 mm/min are always erosive. The figure of 2 mm/min is the cut-off point above which erosion occurs.

In Arkansas, USA, it is estimated that on uncovered, loamy soil with a slight slope (6 per cent), erosion occurs as soon as the rainfall reaches 2.5 mm in 5 minutes.

It is expressed by the equation

$$I_s = \frac{\text{"clay + loam" dispersion}}{\text{stable aggregates} - 0.9 \text{ coarse sands}}$$

Structural stability is an important factor in water run-off and erosion. Stability is due in particular to humic and clayey colloids of soil which hold together sand and alluvial particles. The chemical nature of the bases which are linked to the absorbant complex also plays a role in the structural stability.¹

Disaggregation of the structure results in reduced soil permeability and porosity.

2.1.3. Slope of the land

The speed of rainfall run-off on soil increases with increasing slope, and soil erosion increases with increasing run-off speed.

Run-off flow rate and the amount of particles carried away also vary in relation to the length of the slope.

With a given angle of slope, erosion intensity will depend on:

-
- the nature of the soil

 - vegetation cover

 - precipitation intensity

2.1.4. Vegetation

This is a major factor in controlling soil degradation and acts in several ways:

-
- By protecting the soil from the direct impact of water drops. When rain water is intercepted by the plant covering before it reaches the soil, the height of its fall is reduced and, consequently, its kinetic energy and destructive effect are smaller.

 - By intercepting some of the rainwater which then remains on the foliage and evaporates without increasing the ground run-off volume.

 - By inhibiting ground water run-off due to the matting of roots and accumulated vegetable matter.

 - By enriching the soil with organic material which improves structure and porosity.

Roots and, in particular, the matting of fine roots increase the cohesion of soil particles. Their effect is even greater if they grow densely close to the surface. Dead roots increase the porosity of the soil surface and promote water infiltration. Organic matter resulting from leaf decomposition improves soil structure.

¹ Calcium and magnesium ions allow flocculation and, consequently, greater stability; sodium ions cause dispersion and structural disaggregation.

The effects vary depending on the type of vegetation.

Forest growth has the greatest effect in protecting soil from water erosion. Forest soil contains 2 to 3 per cent of organic material.

A grass covering may also have a significant effect provided the plant coverage is dense.

Fallowing also plays a conserving role depending on the type of vegetation involved (forest fallowing, crop fallowing, bare fallowing).

Crops have a less conservational effect. Resistance to erosion increases with increased density of crops. Forage pasture offers better protection than cereals or hoed crops.

Orchards do not constitute a sufficiently dense vegetation to effectively control erosion.

Research carried out around Lake Aloatra, Madagascar (ref. 1), on the Aristida pastures with slopes of 20 to 36 per cent have shown the following topsoil losses in relation to the density of vegetation coverage:

- 100 per cent covered soil	0.026 t/ha/year
- 40 to 60 per cent covered soil	4 t/ha/year
- 20 per cent covered soil	12 t/ha/year

2.1.5. Man

Man is a prime factor in soil degradation since irrational use of the soil is often at the origin of erosion.

Abusive use of forests and pastures may lead to their destruction; the same applies to abusive clearing of the soil on very steep slopes, unsuitable crops, ignorance of the mechanisms by which organic material is lost from the soil and how it is replaced.

2.2. The effects of rainfall erosion

2.2.1. Mechanical effects

These are due to the impact of water droplets on the soil and the erosive force of rain water run-off. Primary or "splash" erosion is due to the impact of the raindrop on the soil which breaks up the soil particles and may project them up to 60 cm vertically and 1.50 cm horizontally. The energy released by soil particle disaggregation increases with rain intensity.

The finer soil particles are more readily dispersed by the "splash" effect. These particles block the pores in the soil surface decreasing the soil absorption capacity, and the excess water runs off carrying away the fine particles in suspension.

"Splash" erosion can be reduced or prevented by a covering of vegetation which absorbs a large part of the raindrop's kinetic energy.

Water which does not filter through the soil on a watershed runs down the slope. Initially, the run-off is diffuse or forms a sheet of water in minute anastomosing streams. Gradually, these streams hollow out small grooves a few centimetres in width and depth which may carry away fine components up to sand particles of 0.2 mm diameter. This type of erosion may progressively strip the top and most fertile layers of the soil. Cultivation and biological practices may reduce this erosion by modifying soil stability or aggregate size. If such processes are not adequate, mechanical processes may be employed by levelling the land, breaking it down into small fields in which erosion is no longer a danger.

As erosion continues, run-off collects in small rills or channels where its erosive and transporting powers are enormously increased. The rills become gullies and the gullies become progressively deeper and wider forming ravines. If the process is allowed to continue all the top soil may be stripped off.

Where rill or gully erosion takes place, cultivation or biological processes are no longer sufficient to retain the soil. Dividing the land into small fields significantly reduces rill erosion; however, when gully erosion occurs, more extensive collective measures are required. The erosion sediment is carried by gullies, streams and rivers to lakes, dams or, finally, to the sea. Local deposition of sediment can cause great damage to growing crops and silt up drainage and irrigation channels, increasing the danger of flooding.

The end result of uncontrolled water erosion is the loss of soil and destruction of its productive capacity.¹

2.2.2. Chemical effects

Added to soil loss, there are significant losses of fertile components,² in particular mineral salts. Drainage water may contain up to 50 g of calcium nitrate in the case of cultivated land and up to 150 g in the case of bare land.

A rainfall of 10 mm on a soaked soil may carry off 5-15 kg of this fertiliser per hectare.

2.3. Integration of rain water erosion factors

An attempt at an integration study of rain water erosion factors is given in Wischmeier's formula.

¹To give an example of the proportions that this type of erosion can attain, it is estimated that in India, with a total surface area of 3.3 million km², 1.4 million km² are subject to significant soil loss and 6,000 million tonnes of soil are lost each year from a surface area of only 800,000 km² (UNESCO Courier, May 1980).

² In India, it is estimated that 6 million tonnes of fertile components disappear each year, i.e. more than is applied in the form of fertiliser.

Fig. A.1: Diagram of the main natural factors in run-off erosion

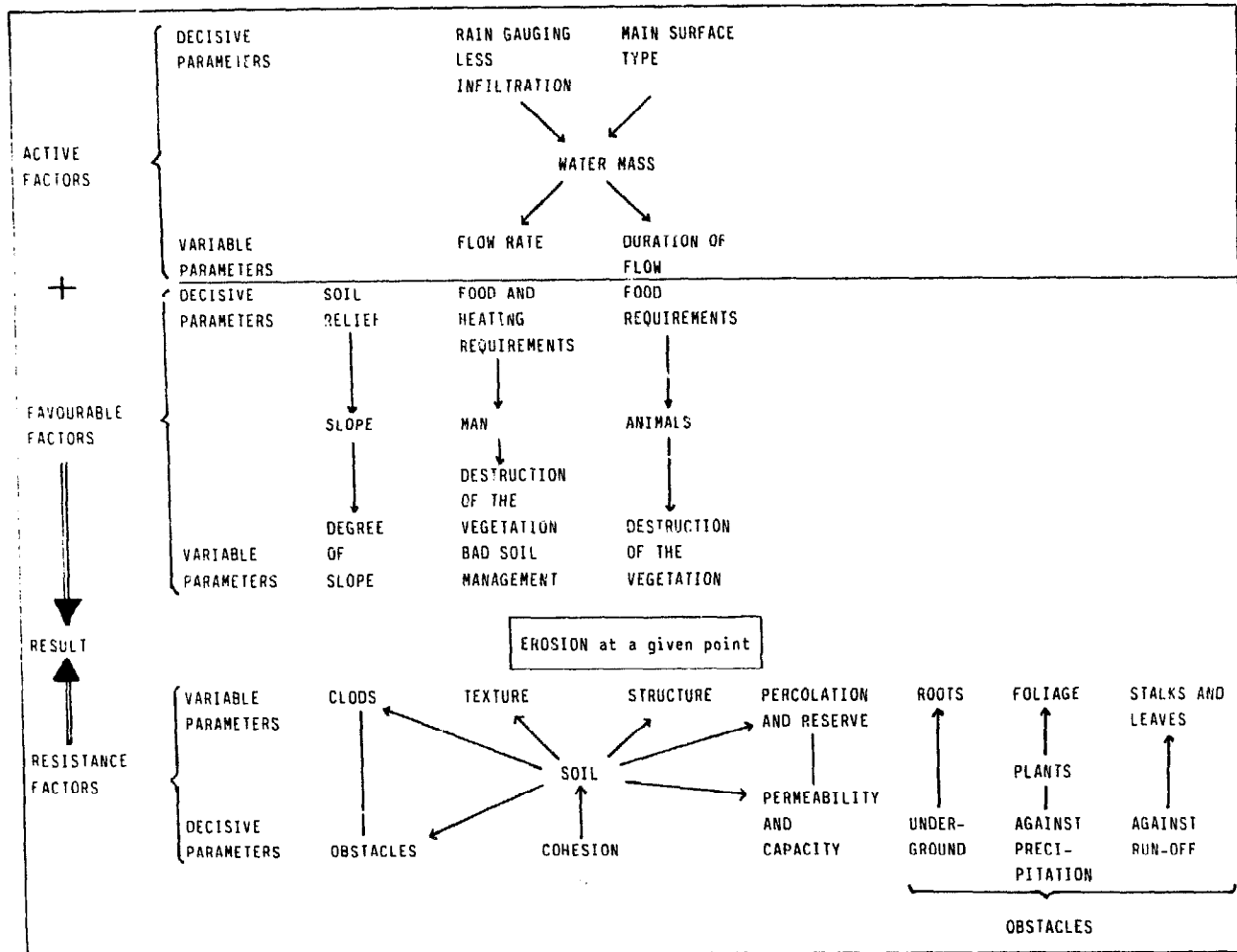

After M. Deloye and H. Rebour 1953 (ref. 11)

This formula, when applied to a specific region, makes it possible to estimate soil loss and determine what erosion control methods should be implemented to ensure that erosion does not exceed the threshold at which it becomes dangerous.

Wischmeier's formula is as follows:

$$A = R (k L S C P)$$

Where:

A is the soil loss in tonnes per acre¹ (1 American short ton = 0.907 kg);
 R is the precipitation erosivity factor or "rain index".

It can be calculated for a rainfall or for the rainfalls over a given period. Generally, a mean annual rainfall index is used.

For a given rainfall:

$$R = \frac{Eg \times Im}{100}$$

where Eg = kinetic energy of the rain in feet/tonne/year;

Im = maximum intensity of the rain in 30 min in inches/hour.

¹ 1 acre is equal to approximately 4,000 m².

To calculate the kinetic energy of rain, it is necessary to have a hyetogram recording in which the rain is broken down into segments of equal intensity in order to establish a duration-intensity ratio.

The relationship between kinetic energy of a rainfall (of regular intensity) and intensity is given by the formula:

$$Eu = 916 + 331 \text{ Log } I_h$$

In which:

Eu = unit kinetic energy in feet/ton/year

I_h = intensity in mm/h

The energy in segment E_h is equal to Eu multiplied by the number of millimetres which have fallen during the segment. The energy is cumulative.

$$E_g = \sum E_h$$

In order to calculate I_m , it is necessary to mark on the recording the 30 min section of the curve in which the largest number of millimetres of rain fell.

K or the "soil index" is a dimensionless factor which measures the relative resistance of a soil to erosion. These values are obtained experimentally.

L.S or the "slope index" is a dimensionless factor; it indicates the effect of the angle and length of the slope (see fig. A.2).

C or the "cultivation index" is the ratio of earth loss of cultivated land under well-defined conditions to that of a continually worked fallow land where C = 1 (fig. A.3).

P or the "water and soil conservation index" is the ratio of earth loss on a field in which soil conservation is practised to that of a cultivated field along the line of maximum slope (fig. A.4).

Fig. A.2: Wischmeier's universal equation (graph giving the values of the factor L.S as a function of the length and percentage of the slope (ref. 23))

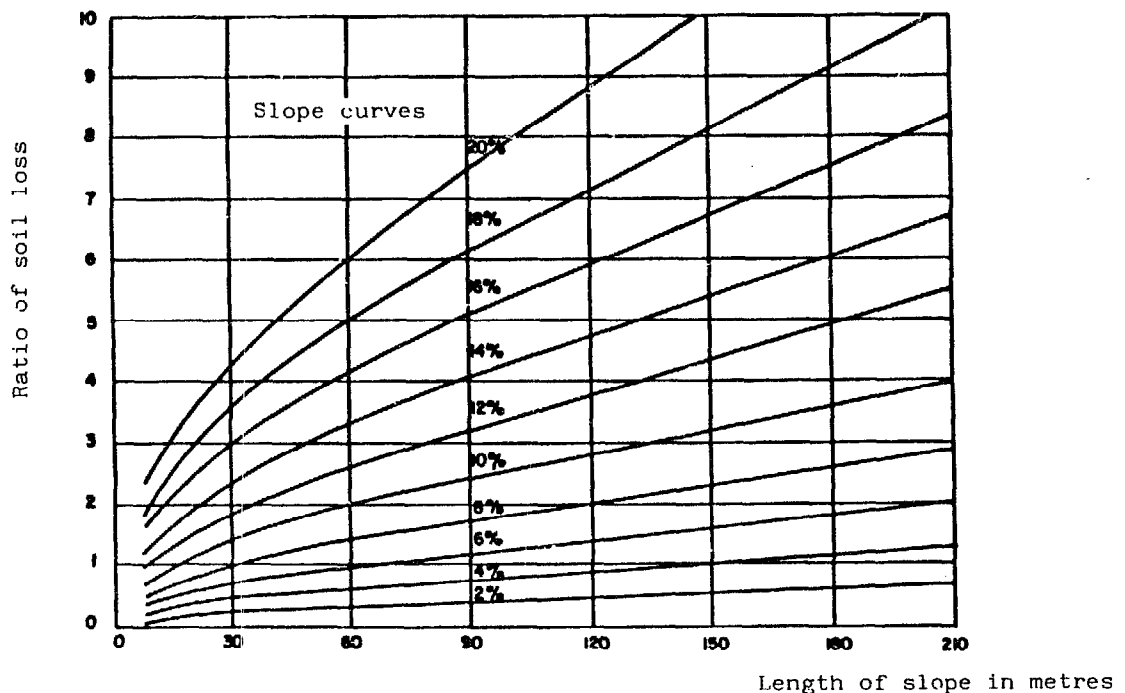

Fig. A.3: Crop coefficient values - C

Type of crop	C
<u>In the United States</u>	
non-hoed crops (rice-cereals)	0.6-0.8
plant covering, green manure	0.3-0.6
fallow and depending on the condition, location, climate	0.3-(1.5)
<u>In Tunisia:</u>	
bare earth - bare fallow land	1
orchards	0.90
wheat	0.71
rotation with cereals	0.40
fodder	0.47
rotation with fodder	0.15-0.23
improved pastures	0.01

For mechanised cultivation, these values should be subjected to a coefficient of 1.3-1.8.

Fig. A.4: Erosion reduction coefficient of soil conservation remedies

Value of P factor: water and soil conservation index in %				
Slope %	Contour line	Rotational	Terraces	
	cultivation L value to be considered: length of field slope	field strip cropping value of L to be con- sidered: length of field slope	the earth in the channel is con- sidered lost Value of L to be considered: distance between channels	the earth in the channel is not con- sidered lost Value of L to be considered: distance between channels
1.1- 2.0	60	30	60	30
2.1 7.0	50	25	50	25
7.1-12.0	60	30	60	30
12.1-18.0	80	40	80	40
18.1-24.0	90	45	90	45

A.3. SOIL EROSION BY WIND

3.1. Wind erosion factors

The erosive effect of wind varies depending on the nature of the vegetation and soil.

The ability of wind to move soil particles depends on wind intensity and particle size. At soil level, wind speed is zero, flow is laminar for a height of a few millimetres and thereafter wind speed increases as the distance from the soil increases as a function of the logarithm of height.

It is estimated that the wind speed required to move the finest soil particles is 15 km/h. The effect of wind varies depending on particle size.

The smallest particles are carried in suspension in air and may form dust storms that move over considerable distances.

Medium-size particles of 0.05-5 mm diameter are carried in a bouncing action over the surface of the ground by a phenomenon called saltation.

The larger particles roll or "creep" along the surface. The saltation effect increases the number of particles in motion as they are carried along; this has an avalanche effect. The amplitude of the phenomenon increases the greater the area of land exposed to the wind.

Vegetation is the best protection against wind since it breaks the force of the wind and reduces the area of exposed land, thus limiting the saltation process.

The soils most susceptible to wind erosion are those of coarse texture and, in particular, fine sands. The soil's level of humidity also plays a role and dry soils offer the lowest resistance to the effect of the wind.

Wind erosion occurs, in particular, in arid and semi-arid regions in which there is a major dry period and light vegetation - part of which disappears totally during the dry season due to over grazing of pastures. The constant action of cattle hooves tends to break up the soil surface and make it more susceptible to wind erosion.

In temperate climates, wind erosion is also encountered on sandy coastal areas due to the soil texture and the absence of sufficiently dense vegetation.

Crops and various farming techniques can also cause erosion. Repeated working of the soil and excessive soil fragmentation during the dry season tend to increase the danger of erosion whereas cultivation techniques which maintain or increase soil surface roughness (ploughing, banking) have a protective effect.

3.2. The effects of wind erosion

Wind erosion has a deleterious effect on the soil:

- by loss of fine soil components, and fertile components in particular, which leads to structural degradation and a reduction in water retention capacity;

- by moving the coarser components which build up behind various obstacles and form dunes which can cover and make sterile entire regions.

Wind erosion also effects vegetation itself. Windborne sand particles have an abrasive effect on grass and crops. The wind increases vaporisation and tends to exhaust the soil's usable water content more rapidly.

A.4. OTHER FORMS OF SOIL DEGRADATION

4.1. Excessive humidity

Excessive humidity in the soil leads to degradation and reduced fertility. Water is an essential component for soil and plant life but excessive quantities have disadvantages due to:

- reduction of chemical and bio-chemical action resulting from oxygen deficiency which prevents oxidation and certain micro-organism life;
- the reduction of soil temperature as a result of excessive surface evaporation;
- its action on plant roots which can no longer penetrate deeply into the soil and which often suffer from parasitic disease promoted by the high humidity;
- the difficulty of cultivating wet soil;
- reduction in crop yield may range from a slight fall to total crop loss.

Excessive humidity can be controlled by drainage.

4.2. Excess of toxic salts

In arid and semi-arid climates, irrigation may lead to the build up of toxic salts in the soil. Each new irrigation flow brings with it a certain quantity of mineral salts. If the water flow is not sufficient to leach the soil, i.e. take the salts down to lower levels where they will not be harmful to plant life, these salts gradually build up in the soil due to vaporisation until they reach concentrations harmful to crops.

In addition to salt concentration (Salinisation), the phenomenon of alkalinisation may occur, i.e. calcium ions are replaced by sodium ions in the absorbant soil components and this leads to degradation of soil structure and reduced permeability.

These phenomena can be controlled by leaching the soil and by suitable draining to evacuate water with a high dissolved-salt content.

4.3. Unsuitable agricultural practices

Intensive agriculture and failure to apply adequate amounts of fertilisers exhaust the soil of its plant nutrients. This form of soil degradation¹ is noted only in passing since measures for remedying this do not come within the framework of labour-intensive work.

¹ There are other forms of degradation such as sedimentation or soil acidification.

1.4. Socio-economic aspects of soil degradation

The main effect of soil degradation is the damage to agricultural activities that result. The harm to agricultural land may be irreversible, or the cost of returning the land to its fertile state may be so high as to be not economically viable.

The farmer's profits must be sufficient to allow him to live and pay other expenses such as fertilisers, seeds, fuel, etc. They must also be sufficient to invest in soil conservation and improvement.

This situation is of course more difficult to achieve in smallholdings with poor soils than on largeholdings with good soils.

As erosion progresses, the farmer's work becomes more difficult, more expensive and less profitable and finishes by becoming impossible. At the regional level, the deleterious effects finally undermined the total structure of social and economic life.

In order to avoid such situations it becomes necessary, wherever possible, to encourage conservation measures which bring together the largest number of farmers in work of value to the collectivity.

A.5. LAND USE

5.1. Land employment

Depending on its characteristics, land is normally classified into two large categories: production land and protection land.

Production land is used for cultivation.

Protection land usually has natural forest or pasture vegetation and plays a major role in the conservation of the cultivated land that is situated downhill.

The balance between production and protection land will vary depending on the country's level of development and may change depending on technical, social and economic conditions.

Although protection land is of less significance from the economic point of view than production land, it has a decisive role in maintaining the country's biological balance.

5.2. Land classification

5.2.1. Classification system developed by the Soil Conservation Service of the US Department of Agriculture

The classification is divided into:

- capability units;
- capability subclasses;
- capability classes; see fig. A.3, crop coefficient values.

The capability units group soils that have about the same influence on crop production and respond in about the same way to the management requirements of common crops.

The subclasses group capability units having similar limitations (erosion hazard, wetness and climatic limitations).

The capability classes describe progressively, in eight stages, the degree of risk to erosion and limitations of use.

The simplified classification is as follows:

Simplified classification

Unit	Sub-class	Class
I		<u>Land suitable for cultivation</u>
	1	Land with annual cultivation
		I Land that can be permanently cultivated and which, when normally rotated, is treated with fertiliser or lime. These are lowlands for which conservation practices are not necessary.
		II Less fertile land with lower yield, often on a slight slope (3 %), where erosion has already taken place by reducing the depth of the arable land. Moderate conservation practices necessary.
	2	Land with intermittent cultivation
		III The soil has to be reconstituted periodically by allowing a vegetation covering to occur, and cultivation takes place only from time to time. This is the case of eroded land with slopes of 10-16 %.
		IV Land where the slope is steeper than in class III and more seriously eroded. Is suitable only for occasional or limited cultivation.
II		<u>Land requiring permanent cover</u>
		V Land not suitable for ploughing but relatively resistant to erosion. Suitable for permanent pasture. Requires careful exploitation.
		VI Land of the above type but which has poor erosion resistance due to physical properties or topography. It can be used for pasture with conservation techniques required from time to time.
		VII Exhausted land. Pronounced erosion that can be reconstituted by grassing or planting with total conservation practices.
III		<u>Non-productive land</u>
		VIII Soils of class VIII are suitable only for natural vegetation, forests, etc. Should not be cleared.

Fig. A.5: Land classification on the basis of susceptibility to run-off erosion (based on a drawing published in the USA)

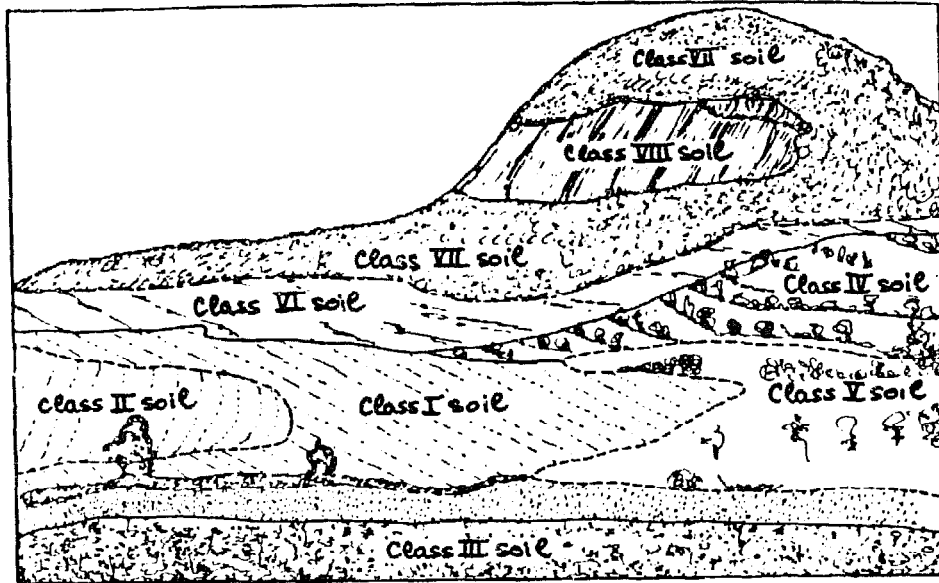

Fig. A.6: Deep gully. Advanced stage of erosion (Upper Volta)



#20

Examples of advanced stage of erosion



Niger



Upper Volta



Upper Volta

5.2.2. Other classification systems

- 5.2.2.1. Classification by degree of run-off erosion (ref. 11), see fig. A.7.
- 5.2.2.2. Classification of land by slope in tropical Africa (ref. 1), see fig. A.8.
- 5.2.2.3. The classification of BEEK and BENNEMA (FAO 1972) (ref. 28). This is a new classification system designed more specifically for developing countries. It incorporates social and economic factors into the technical capability classification.

Fig. A.7: Diagrammatic classification of degrees of run-off erosion

Current or potential state	Apparent effects of erosion	Soil characteristics	Types of remedy
I. Stage of stability	Insignificant, clear run-off water. No apparent erosion	Flat or almost flat land or very slight slopes less than 3 % High permeability: 20 cm/hour (cf. 3.2.4, Ch. D) Dense cover of vegetation Good fertility Good soil cohesion Land well supplied with humus	All types of crop possible No treatments
II. Stage of insidious erosion	Slight run-off of turbid water at very low speed during heavy precipitations No apparent erosion or traces of rills	Slight uniform slopes of less than 3 %, or very intersected slopes of 5-8 % Good permeability: 12-15 cm/hour Light covering of vegetation Moderate fertility Relatively good soil cohesion Land with a relatively good humus content	All crops on contour lines Well planned rotation From time to time, bench terraces Reduced grazing density
III. Stage of initial apparent erosion	Run-off already quite pronounced with moderate precipitation; muddy water flowing at moderate speed Appearance of light patches and stones on surface Shallow gullies appear especially after the soil has been broken up, but do not hinder machines Slight reduction in fertility	Uniform slopes of 5-8 %, or intersected slopes of 10-16 % Small collection basins (1 or 2 hectares) Moderate permeability: 8-10 cm/hour Very slight cover of vegetation Moderate fertility Poorly coherent soils Land with only slight humus content	Alternating crops on contour lines with ½ in annual cover crops Bench terraces often necessary Reduced grazing density

Fig. A.7 (concl.)

Current or potential state	Apparent effects of erosion	Soil characteristics	Types of remedy
IV. Stage of intense erosion	Heavy run-off of muddy water with moderate and heavy precipitation, speed quite high to very high Increase in the number of patches and stones Deep gullies which begin to impair mechanical cultivation	Uniform slopes of 10-16 % or intersected slopes of 20-30 % Watershed of several hectares Low permeability: 2-5 cm/hour No vegetation covering	Alternating permanent grass and cereal cultivation, for example cover crops must dominate in the rotation system Terracing essential Back-sloping terracing necessary on slopes over 15 % Ploughed crops are possible between terraces Low grazing density
V. Stage of dangerous erosion	Pronounced run-off at the slightest rainfall Water carries gravel or aggregates moving at high speed in the event of heavy precipitation Deep gullies preventing the movement of heavy machines Land carried away in blocks	Uniform slopes of 20-30 % or intersected slopes of 45-65 % Large watershed Very low permeability 0.5-1 cm/hour No vegetation cover Mediocre fertility Unstable soils	"Algerian terraces" essential Cover cultivation everywhere, with permanent grass cover on large surfaces Pasture, woods very light grazing density with periodic prohibition
VI. Final stage of erosion	Top soil entirely stripped away	Very steep slopes Very large watersheds Virtually zero permeability No vegetation cover Fertility completely lost Unstable soils	Diversion channel above and below to protect cultivated areas Prohibition of grazing Trial tree-planting on back-sloping terraces

Observations

- 1st column: A given area of land may go successively through the six stages described, commencing with the stage of stability.
- 2nd column: There is a constant danger that the features may deteriorate, but they can regress if the treatment given in column 4 is suitably applied. Where the proposed remedies prove inadequate, it would be necessary to immediately apply the remedies of the next, more serious stage.
- 3rd column: This is merely a list of different features, some of which must exist in combination; however, it is not necessary that all be present.
- 4th column: For each category, there is listed a number of treatments by order of effectiveness; the choice should be made depending on the stage to which the erosion has progressed. Obviously, general remedies (working, fertiliser, etc.) should be applied at all stages. Various stages may coexist in a single plot of land. In general, the erosion starts at the lowest part (watershed effect) and moves progressively upwards.

Fig. A.8: Classification of land on the basis of slope
(in tropical Africa)

Reference 1

Slope %	Land use	Possible cultivation methods	Crops to be avoided	Protective measures
0-3	Various crops	Mechanised cultivation	-	-
3-12	Crops alternating with grass cover	Mechanised cultivation	Precautions to be taken for bush-type culture on bare soil	Absorption or diversion network Contour cultivation
12-25	Crops grassland woodland	Manual cultivation Animal-drawn machines	Bush-type crops on bare soil	Anti-erosion networks Terraces
25	Pasture forestland	Manual cultivation	All	Anti-erosion ditches

CHAPTER B

EROSION PROTECTION TECHNIQUES

B.1. CONSERVATION OF PROTECTED LAND

1.1. Forests

1.1.1. Role of the forest in soil conservation mechanisms

Depending on the climatic zone, a distinction may be made by order of increasing cover:

-
- open forests,

 - light forest formations or deciduous forests,

 - tropical forest formations.
-

The role of the forest in soil conservation mechanisms is due to:

- (a) the forest vegetation which protects the soil against water impact thus reducing the splash effect and disaggregation of the soil structure;
- (b) the organic matter (leaves, roots) which protect the soil against run-off and improve structure, porosity and permeability. This organic matter is rich in nutrient substances.

In their action against run-off, forests play an important role in evening out water flows, increasing their duration and reducing peak flows, which limit the pernicious effects.

In marshy regions, forests have a corrective role since they help to lower the ground-water level.¹

A forest may have a significant influence on the region's climate. Plant transpiration may help to increase the relative humidity of the air; in some regions it also increases precipitation.

Finally, in addition to its protective role, a forest has a role as a biological reserve and a recreation area for man.

Land conservation is based on continuous vegetation cover. It is therefore necessary to protect this cover against the attack of man and animals or to reconstitute or supplement it where it is non-existent or inadequate.

¹ During the nineteenth century, the Lande region of Gascony in France was drained by a vast programme of reforestation using maritime pines.

The main objective of afforestation may be production or protection. The two are not incompatible but the side of afforestation dealt with in this publication is that of protection.

1.1.2. Main forest species used in afforestation

1.1.2.1. Choice of species

These are selected on the basis of the over-all objectives. However, attempts should be made to give preference to types of trees that can also meet production requirements. The varieties used for soil conservation may have the following objectives.

- conservation of soil against run-off erosion;
- recovery of land that has undergone degradation;
- improvement of marshy ground;
- stabilisation and protection of moving soil: coastal sand, continental sand, windscreen, etc.

The variety selected should:

- meet the objectives of the operation;
- be suitable for the environmental conditions;
- offer no cultivation difficulties.

1.1.2.2. Review of the main tree varieties used in afforestation (ref. 13)

The choice of species to be used depends on the climatic conditions and the main objective of the afforestation programme which may be either timber production or soil conservation.

The selected varieties may also have certain susceptibilities depending on the soil condition or the humidity level in the planting zone. Wherever a project is intended for soil conservation, preference should be given to local varieties which are well suited to the situation and, should new varieties prove necessary, prior testing should be carried out.

The main varieties that can be used are categorised below on the basis of the climatic factors playing a predominant role.

(a) Steppe regions with rainfall between 200 and 500 mm (Sahelian and subdesert zone)

This has a patchy grass cover and there are only relatively few bushes and shrubs. Although forestry production is small, it is of vital economic importance since it provides construction materials and firewood and helps in controlling desert encroachment.

Plantation techniques should be designed to exploit natural conditions and counter the competition for water from natural vegetation. Earthworks should be carried out to concentrate and to ensure infiltration of water.

The main varieties used are:

- Acacias (mimosoideae)

Numerous varieties are widely encountered in dry and very dry zones in Africa and Australia. They comprise numerous subspecies and varieties which often have very specific ecological requirements and are well adapted to the severe conditions which they encounter.

They include:

- Acacia laeta: this has very good resistance to drought, is suitable for sandy and rocky soils or to clay subsoils.
- Acacia albida: this is a tree without spines, the trunk of which may grow up to 1 m in diameter in good soil. It provides firewood and forage seeds, and the fruit may be fed to animals. This variety is particularly useful for soil conservation in view of its deep roots and the micro-climate provided by the vegetation cover that it produces in the vicinity of crops.
- Acacia cyanophylla: this variety is used in particular for stabilising dunes; it is used together with tamarisk for wind breaks.
- Acacia raddiana: this is a large acacia found in the most arid regions from Mauritania to the Sudan. It is a variety used for the reafforestation of the driest of regions.
- Acacia Senegal: this is a small spiny tree which grows on sandy, stoney soils and on clay subsoils. It is a good variety which gives excellent results in the reafforestation of arid zones.
- Prosopis juliflora (mimosaceae): this is a small spiny tree; the wood is used by cartwrights and for the production of posts. It is an excellent firewood; planted in very dry regions it is an excellent stabiliser for sand.

- Genus euphorbia

Euphorbia balsamifera: this is a shrub of 2-5 m in size from the very dry regions of the south Sahara. It propagates easily and is widely used for stabilising sands in arid regions.

(b) Dry-climate savannah

Rainfall is between 500 and 1,000 mm with 7 to 8 months of dry season.

The grass cover is more dense than in the preceding case but water is once again the limiting factor. The species selected must be suitable for these conditions.

The main species used are:

- Azidarachia indica (meliaceae): this is a tree which is widespread in the dry areas of India and in the Sudano-Sahelian climate zones. It provides very

good firewood, it requires a light, deep topsoil with a relatively close source of water; it is poorly suited to clay, impermeable soils subject to flooding.

- Anacardium occidentale

- Dalbergia sissoo (papilionaceae): this is a moderate-size, misshapen tree; it is used for poles and stakes and for firewood. It is well adapted to sandy, stoney and poor soils but they must be well drained and deep; it is not suited to clay soils. It is used in erosion control since it is deep rooting and vigorously throws out new shoots and suckers.
- Cassia siamea (caesalpiniceae): used for the production of firewood, poles and for the construction of windbreaks. It can be planted only in rich, healthy soil.
- Acacia scorpioides, this is widespread in Senegal and in the Sudan. The pubescens variety grows well in heavy soils which are subject to flooding; the adstringens variety does well on a dry ground.
- Euphorba turicali: a shrub used for hedges and in lines.
- Acacia mearnsii.
- Terminalia tomentosa.
- Acacia albida.
- Acacia Senegal.
- Prosopis juliflora.

(c) Semi-humid tropical savannah

The rainfall is between 1,000 and 1,300 mm with 3 to 6 consecutive dry months.

The principal species used are:

- Teak (tectona grandis): this requires deep, fertile soil with an adequate water supply and should be well drained. It is an excellent wood for shipbuilding and cabinetmaking.
 - Gmelina arborea: this is a species which is suited to individual reforestation for protective curtains, lines of trees, etc. The tree and the young plants are very hardy and cattle will not graze on them. Propagation is easy. The wood is used for general joinery. The tree needs deep alluvial soil and is susceptible to asphyxia from stagnant water.
 - Cassia siamea.
- Genus eucalyptus: numerous tests have been carried out on their adaptability to semi-humid tropical climates. Numerous species are available. They are suitable for protective forests since they grow rapidly, are robust and well formed. They provide excellent general purpose wood and firewood and can be used to build lines of trees and shelters. The species used include:

- Eucalyptus tereticornis for relatively rich alluvial soils and sandy loams, with the exception of acid soils and dry and superficial soils.
- Eucalyptus grandis, preferentially on loamy, moist and healthy soils.
- Eucalyptus micro-corys requires good soil.
- Eucalyptus robusta grows in more or less salty coastal marshland on heavy soils. It is useful for the reafforestation of waterlogged ground.
- Eucalyptus salyna.
- Eucalyptus urophylla, etc.
- Eucalyptus camaldulensis.
- Eucalyptus deglupta.

- Genus pinaceae: the species in this genus grow in very varied conditions and are a good choice for afforestation work. The species are numerous and the majority are suitable for mediocre and light soils. The wood is used for lumber and general purpose woodwork, etc., and it also is a source of resin.
 - Callitris calcarota.
 - Callitris glauca.
 - Chlorophora excelsa (iroko): this is a large tree which is suitable for cabinetmaking and external joinery.
 - Casuarina equisetifolia (filao): this is a remarkable tree for dune stabilisation and is also used as a windbreak. It is widely used for reafforestation of sandy, low-altitude land. It requires a relatively higher groundwater level but does not tolerate stagnant surface water.

- Bamboos
 - Oxytenanthera abyssinica: this has good resistance to drought, is suitable for dry, superficial and ferruginous soils; it is used for pulp and paper-making and in land maintenance.
 - Bambusa vulgaris: this does not like clayey, compact and salty soils; it is also used in pulp and papermaking.

(d) Tropical and humid savannah

In view of the large number of species that can be grown, it is possible to select those which are best from the qualitative and quantitative point of view. In these climates, afforestation for soil conservation is not usually a requirement.

Tectona grandis:	Planted on a large scale
Comelina arborea:	Planted on a large scale
Cedrella odorata:	Planted on a large scale
Albizia falcata	
Acrocarpus fraxinifolius	
Cassia siamea	

Araucaria eunninghamii:	In mountain climates
Chlorophora excelsa	
Chlorophora regia	
Eucalyptus camaldulensis	
Chlorophora rostrata	
Eucalyptus tereticornis	
Eucalyptus umbellata	
Eucalyptus citriodora	
Eucalyptus cloeziana	
Eucalyptus deglupta	
Eucalyptus saligna:	More difficult from the point of view of rainfall and soil
Eucalyptus grandis:	Very similar to the preceding tree, if not the same species
Eucalyptus pilularis:	Planted on a large scale
Eucalyptus propinqua:	Planted on a large scale
Eucalyptus paniculata:	Planted on a large scale
Pinus merkusii	
Pinus kesiya	
Pinus elliottii:	Has proved successful in madagascar at medium altitude
Pinus insularis	
Pinus taeda	
Pinus caribaea var. caribaea	
Pinus caribaea bahamensis	
Pinus oocarpa:	At low altitudes
Pinus oocarpa, var. ochoterranaï:	At medium altitudes
Pinus pseudostrobus:	At high altitudes
Pinus aptula:	At high altitudes

(e) Temperate climates (Europe)

There is a large number of species used and these should be matched to the specific objectives.

They include the following:

- tall trees (horse chestnut, oak, maple, sycamore, bean tree, ash, wild cherry, nettle tree, elm, plane, poplar, lime tree);
- intermediate or filler trees for cooses;
 - deciduous (service tree, judas tree, alder, birch, horse chestnut, hornbeam, maple, beech, walnut, elm, false acacia, plum, willow, mountain ash);
 - evergreen (arbutus, holm-oak, holly laurel, etc.);
- shrubs for filling out the lower parts of windbreaks and wooded strips:

- deciduous (hawthorn, bladder-senna, guelder rose, dogwood, syringa, elder, tamarisk, blackthorn, bush rose);
- evergreens (laurel, thyme, evergreen thorn, cotoneaster, privet, purslane);
- conifers for hedgerows:
 - cypress and thuya for windbreaks on poor soils;
 - Japanese cedar, sequoia, larch for windbreaks on the sea coast;
 - Lambert cypress, pines.

1.1.3. Preparing a reafforestation plan

Once the objectives of the plan have been established, the main factors to consider when choosing the species most suitable are related to the climate and the soil.

As far as climate is concerned, the rainfall is a predominant factor. The annual number of millimetres of rain is not a sufficient guide in determining the choice of species to be propagated. It is also necessary to make allowance for rain distribution throughout the year and also the regularity of rainfall, so as to specify planting dates and the relevant hazards.

In an arid zone, measures may be necessary to concentrate rainwater run-off to certain points. Suitable techniques can also be used to limit vaporisation (superficial working of the soil, mulch).

As far as a physical survey of the soil is concerned and where a complete pedological study is not possible, auger samples should be taken to determine any limiting factors.

The potential for root development is an essential factor. Obstacles to rooting may be the proximity of a rocky substrata, compacted clay, dense layers of soil, a high level of ground water.

The presence of an upper layer (e.g. of sand) which limits capillary movement of water and thus reduces vaporisation is a limiting factor in arid climates.

Certain species will grow only in a deep layer of light topsoil; other, such as pines, can be used to recolonise thin layers of topsoil where the underlying rock is fissured.

The soil preparation methods will also vary depending on the thickness and nature of the arable soil portion.

The chemical content of the soil will also be a determining factor in the choice of species (presence of calcium, acidity, salinity). Knowledge of the species' chemical requirements is often inadequate, and the results of local experiments may often be a valuable guide to selection.

1.1.4. Ground preparation

1.1.4.1. Methods

These vary considerably and depend on the type of soil, the existing vegetation, topography, the species to be planted, how it is to be used and the local socio-economic conditions.

In certain cases, the introduction of anti-erosion measures is a prerequisite of proper reafforestation. Anti-erosion techniques (terraces, embankments, contour ditches, etc.) will be described under section B.2.

The main operations that can be carried out by hand are:

- clearance,
- preparation of service paths,
- staking-out,
- preparation of planting holes,
- measures designed to accumulate run-off water,
- erosion control work.

It is not always possible to use manual labour; this is for example the case with subsoiling or deep ploughing for which it is necessary to use powerful machines. Vegetation can also be stripped by mechanical means or even by the use of chemicals.

1.1.4.2. Vegetation stripping by manual methods

Manual methods are used, in particular, when:

-
- the type of vegetation cover requires only slight modification prior to planting;
-
- labour is plentiful and cheap;
-
- the ground is not suitable for mechanical stripping (very steep slopes, very wet ground).
-

On grass-covered sites, soil preparation may, in certain cases, be unnecessary. In other cases, the vegetation may be removed:

-
- either in narrow strips 1.5 m wide along the contour lines. The tools used here will be picks and hoes;
-
- or by removing vegetation in a radius of 50-70 cm around the planting holes. This will be done with picks and shovels.
-

On brush-covered sites, soil preparation will be highly labour intensive.

Forest-covered sites do not usually present a soil protection problem and clearing operations are usually intended to replace existing forests by productive forests.

1.1.4.3. Preparing the ground to improve water absorption and retention

These methods are used in arid zones in order to:

-
- eliminate the destructive action of water on pre-existing vegetation;
 - increase the water storage capacity of the soil by undercutting the soil to allow the roots to take, deep ploughing or the use of large planting holes (60 x 60 x 60 cm).
-

With the exception of digging planting holes, these techniques are not labour intensive.

Another technique called the "steppe" method is used on sloping land to collect rainwater (see Appendix, Standard Plan No. 1). The water is retained by a ridge of earth and collects around the planting point.

Other ridges laid out in a "spidery" fashion are used to collect rainwater and direct it towards large planting holes, or collector gullies can be made leading to the planting hole.

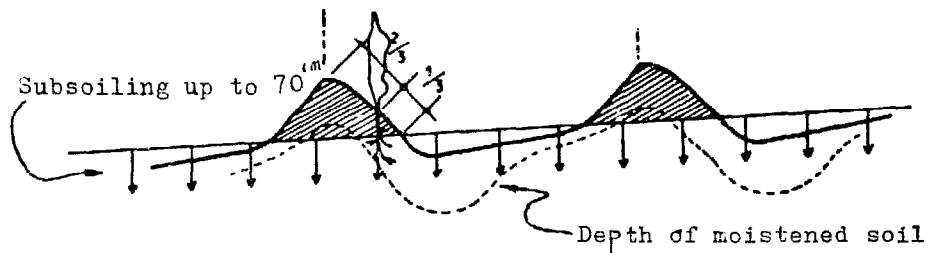

Planting hole (Cape Verde)

1.1.5. Seed preparation

The seeds are those of the species to be planted. They may be found either directly on the soil, under the seeding plant or collected from the seeding plants themselves. One can select species from the local natural forest, or lay out production plots for brought-in species. Seeds may also be obtained from specialised suppliers.

A supply of the correct quality and quantity must be available at the required time.

Before the seeds are used, it is advisable to test them to check their germination qualities.

Certain seeds can be sown as they are collected; others require pretreatment to accelerate germination.

The phenomenon of retarded germination is called dormancy. There are three types, of which each requires specific treatment:

- exogenic dormancy which is related to the properties of the seed pericardium;
- endogenic dormancy which is due to the properties of the embryo or the endosperm;
- mixed dormancy.

The common treatments are as follows:

(a) treatment against exogenic dormancy:

- seed scarification: used for *albizia lebeck*, *cassia gavanica*, *pterocarpus*, etc.;
- treatment with a sulphuric acid solution: used for *acacia scorpioides*, *acacia radiata*, *acacia lebeck*, etc.;
- treatment with boiling water (*acacia scorpioides*, *parkinsonia*, *prosopis*, etc.);

(b) treatment for endogenic dormancy:

- storage in a closed and dark, moist environment;
- chemical treatment (hydrogen peroxide, citric acid, potassium nitrate, etc.);

(c) treatment for mixed dormancy; the various treatment methods may be combined.

The seeds are then treated against insect and rodent attack.

Fig. B.4 shows the treatments to be used for the main species.

1.1.6. Afforestation using the direct sowing method

1.1.6.1. Conditions of use

Direct sowing is in general seldom practiced in afforestation, and then only when certain conditions combine to make it suitable: in particular ample supply of low-cost seed, the use of seeds which do not grow well in a nursery, the use of

seeds which germinate rapidly such as those of pinus radiata, acacia Senegal, acacia scorpioides, acacia mearnsii, cassia siamea, neem.

Direct sowing

Advantages	Disadvantages
Low cost	Heavy seed consumption
No need for nurseries	Irregular seeding

1.1.6.2. Site preparation

Direct sowing is usually successful only if the seed is in close contact with the soil and covered by a fine layer of earth.

The soil must be cleared of vegetation and tilled:

- either over its whole surface,
- or in strips of 1-1.50 m wide,
- or in circular or rectangular plots of 0.60-1 m in width.

In Tanzania, direct sowing is carried out using the "tie ridging method" for crops of cassia siamea. The whole surface is tilled and ridges are hoed up. The main ridges are parallel to the contour lines and the transverse ridges are laid perpendicular to the former to form a frame. This method is very effective in controlling rainwater run-off.

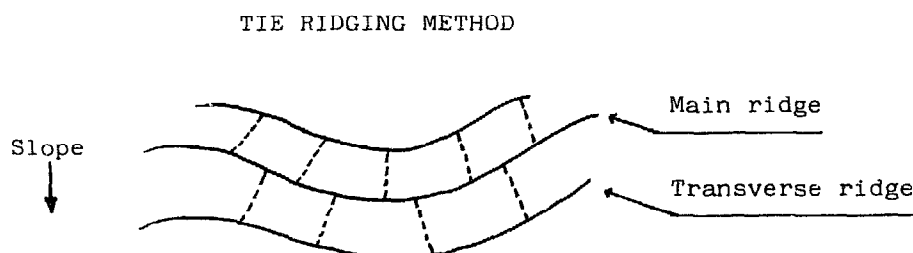

1.1.6.3. Sowing season

Sowing must be carried out whilst the soil is sufficiently moist and warm to permit germination. It usually takes place during the rainy season when a certain depth of soil has already been moistened (approximately 20 cm). In dry regions with irregular rainfall, at the start of the rainy season, it is necessary to wait until the rains have sufficiently set in before sowing is started.

1.1.6.4. Methods of direct sowing

(a) Broadcasting

Sowing can be carried out by hand or mechanically (a seed broadcaster attached to a tractor).

A maximum of 8 ha can be sown per day by hand whereas up to 35 ha per day can be sown using a tractor.

Wherever possible the seed should be covered by a fine layer of earth of a thickness of around two to three times the seed diameter. This can be done by working over with a roller, chains or cords drawn by an animal. When done by hand, 4 days' work per hectare are required to cover the seeds effectively.

This broadcasting technique is widely used for pine plantations.

(b) Drilling

Seeds may be sown in drills either by hand or using a core drill modified to suit the seed diameter.

The distance between drills is 2-2.5 m. The seeds are spaced at 0.30 m to 1 m along the drills. They may be placed in a shallow gully which is then covered with a hoe or rake or in a hole made by the drill.

Productivity is around 0.2 ha/day for manual sowing and 5 ha/day for tractor sowing.

On steep slopes, only manual sowing is possible.

Drill sowing is used for *araucaria augustifolia* in Argentina and *pinus pinea* in Italy.

(c) Dibbling

The seeds are sown on small prepared surfaces which are either circles of 0.5-1 m in diameter or rectangles of 2-4 m x 1.5 m that have been prepared with a hoe.

This method is used for heavy seeds, with two or three seeds being sown in each group.

It has been used for *eucalyptus pilularis* and *eucalyptus grandis* in Australia, for conifers in Mediterranean and mountainous regions (Himalaya, Japan), for *pinus pinaster* and *pinus lariccio* in Italy, and *pinus brutia* in Cyprus.

1.1.7. Afforestation by planting

1.1.7.1. Conditions of use

Planting is the only possible technique for:

- hybrids,
- species which do not produce viable seeds,
- species which reproduce by propagation.

This technique gives better results than direct sowing in dry regions or when there is significant vegetation competition. It also produces a more uniform spacing of plants and this permits better site utilisation.

The cost of planting is higher than that of direct sowing and it is more labour intensive.

1.1.7.2. Production of plants in a nursery

(a) Choice of nursery location

The nursery should be located near to the reforestation site,¹ have a permanent water supply and the topography and composition of the land on which it is located should be suitable for growing.

The main qualities recommended for the nursery land are:

- silico-argillaceous soils containing less than 30 per cent clay;
- a minimum topsoil of 30 cm;
- a light structure;
- moderate water retention;
- good warming capacity;
- good biological activity.

The area of the nursery will depend on the final surface area and density of planting.

(b) Nursery construction

This comprises:

- access paths to the various parts of the nursery;
- the irrigation system;
- the seed beds;
- the transplanting beds;
- covers to protect the beds from the sun. These can be produced using local methods (matting, etc.);
- compost heaps;
- the office/store where the seeds and tools are kept;
- fences.



Compost heap in Burundi

¹ It is advisable to locate the nursery on a site within the planting zone. For a 100 ha oil palm plantation in a tropical forest, one should count on around 15,000 plants and this requires a nursery of 1.5-1.8 ha in size.

(c) Seedbed preparation

The operations involved include:

-
- weeding, dressing;
-
- topping up with a light manured and fertilised topsoil;
-
- preparation of transplanting beds 0.70-1 m in width and approximately 10 m or more in length, well flattened out and with a surface worked into a fine tilth. An insecticide should be applied (dieltrex 4 %, aldrin powder 15 g/m²);
-
- preparation of paths between the beds (30-60 cm wide) which should also be given an insecticide treatment.
-

Watering should be:

- by spray in most cases,
- by soak-irrigation for very fine seeds (eucalyptus).

(d) Sowing the seedbed

This can be done:

- by broadcasting for small seeds (eucalyptus, cypresses, cryptomeria, etc.);
- in drills or one at a time. A drill board or nailed boards are used to ensure regular spacing (see Standard Plan No. 3).

The seeds are covered with soil to a deep of 1.5 times their diameter.

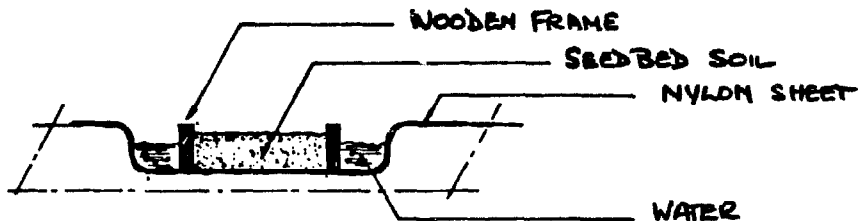

Soak-irrigated seedbed

The seeds may be protected, depending on the species, by a shade. During the rainy season, the seedbed should be protected from the direct impact of raindrops. Watering should be carried out carefully to avoid damping off. Should this occur, the bed should be treated with a copper-based fungicide (5-10 g/l water and 4 l/m²).

(e) Direct sowing in beds and in pots

With this type of sowing it is possible to obtain:

- plants which can be pricked out with bare roots;
- plantlets, leafy plants, large plantlets or large plants (see Standard Plan No. 2).

With direct seeding in pots, it is possible to transplant species with delicate roots (eucalyptus citriodora), and this technique is also used where skilled labour is not available for pricking out.

A more recent method is the use of small plastic bags with 1 mm thick walls, 3.4 cm in length and 2.2 cm in diameter, in which the conifer seed is sown and planted 8 days after germination.

(f) Pricking out

This is the task of transplanting the young seedlings produced in the seedbox.

Using this technique, it is possible to obtain plants that are more robust than with the direct sowing method.

It is done either in beds or pots.

Pricking out in pots is the technique used more and more frequently. The materials used in pot manufacture depend on local availability: compressed earth, pottery, bamboo tubes, banana-tree fibre, etc.

Banana-tree fibre pots can be made using local labour and are an excellent solution.

Polyethylene sachets are used more and more widely but are expensive.

The soil into which the seedlings are pricked out should be enriched with fertiliser (NPK 800 g/m³).

The pricking-out technique usually employed is as follows:

-
- copious watering of the seedboxes;

 - removal and sorting of plants;

 - pricking out;

 - placing in a shaded area;

 - watering morning and evening until the seedlings have taken, and then once a day in the evening;

 - removal of the shade one or two weeks after pricking out;

 - reduction in the number of waterings several weeks before final location to induce the physiological adaptation reaction (lignification).
-

(g) Types of schedules encountered in nurseries

The types of schedules most commonly found in nurseries are shown in fig. B.1.

1.1.7.3. Planting out

(a) Preparation of planting hole

Methods vary depending on the type of soil and the slope.





Where there is a danger of erosion, planting holes are combined with erosion control devices which may be contour furrows, forest benches, terraces, etc. (see fig. B.2).

In an arid climate, the planting holes are combined with arrangements for collecting water as, for example, in the steppe method (see section 1.1.4).

Fig. B.1: Types of trees and relevant nursery materials

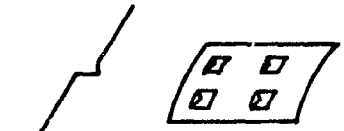
Type of tree	Nursery material used
Tall trees	<ul style="list-style-type: none"> - 2 to 3 year-old young plant pricked out at 0.45-2 m - young tree (approx. 3 years old) at 1.20-2 m - sapling (approx. 4 years old) at 1.50-3.00 m - standards for production poplars
Intermediate or filler trees for copses	<ul style="list-style-type: none"> - deciduous: 2 to 3 year-old young plants - evergreens: 2 to 3 year-old plants in small pots, pricked out
Shrubs	<ul style="list-style-type: none"> - deciduous: 2 to 3 year-old young plants with bare roots, pricked out <ul style="list-style-type: none"> . clusters (3 to 4 years) - evergreens <ul style="list-style-type: none"> . plants in small pots (2 to 3 years) . plants in pots or containers (3 to 5 years)
Conifers	<ul style="list-style-type: none"> - in small pots (2 to 3 years) - in large pots or containers (3 to 5 years)

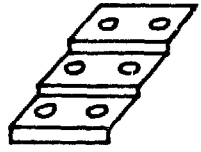
Fig. B.2: Methods of preparing planting holes

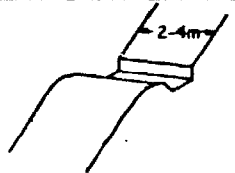
Poor soils		Individual holes	Reference 29
		Individual holes combined with a raked strip	
Deep topsoils		Individual holes	
		Individual holes combined with a terrace	
		Individual terraces	
Deep fertile topsoils		Loam pits	

On rocky or stoney land, the planting holes are usually in the shape of a cube with 30 cm sides. Where the topsoil is deeper the planting holes will be 40-60 cm wide and 30-40 cm deep.

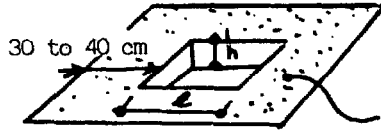

raked strip

	l	h
rocky ground	30 cm	30 cm
deep soil	40/60 cm	30/40 cm

The soil surface around the planting hole may be prepared to promote water infiltration. The grass may simply be raked over on a strip 30-40 cm wide between the hole or whole strips may be tilled. Here again topography, soil type and vegetation will determine the choice of method to be used.

Before the young plant is put in place, the planting hole should be treated against insects.

-
- for termites, use 10 g of 4 per cent dieldrin;
 - for crickets, use baits made of 50 per cent flour, 50 per cent manioc, bran or broken rice to which should be added 5 ml of 20 per cent dieldrin per kg.
-

Where the soil is poor, fertiliser may be placed in the hole.

(b) Planting season

In temperate climates, trees are usually planted just before the end of the growing season in a moist, frost-free soil.

In arid zones, planting takes place at the beginning of the rainy season when the soil is just sufficiently moist to a depth of around 20 cm and when the rainy season is well established to avoid any risk of drought.

(c) Plant spacing

This varies according to the species, resistance to competition, climate, fertility, maintenance techniques, financial factors.

Minimum spacing is 30 cm but, in rare cases (willow branches planted along eroded banks), may be up to 4 m x 4 m or more (10 m x 10 m for acacia albida in a dry region).

The minimum spacing for trees for firewood and pole production is 1.50 m x 1.50 m. Minimum spacing to allow movement of machinery is 3 m x 3 m.

Usually a spacing of 1.80 m between trees is considered normal; however, when a rapid vegetable covering is required, a spacing of 1.20 m x 1.20 m or even 0.60 m x 0.60 m for shrubs may be used.

Some of the spacings commonly used in temperate climates are shown in fig. B.3.

(d) Care of young plants

The handling of young plants during transport from the nursery to the planting area presents several hazards:

- drying of roots,
- exposure to excessive heat or cold,
- physical injury.

Roots must be kept moist and shielded from direct exposure to the sun. If the plants are not to be used immediately, they should be protected by heeling them into an earth bank for several days. The principle of this procedure is shown in the diagram below:

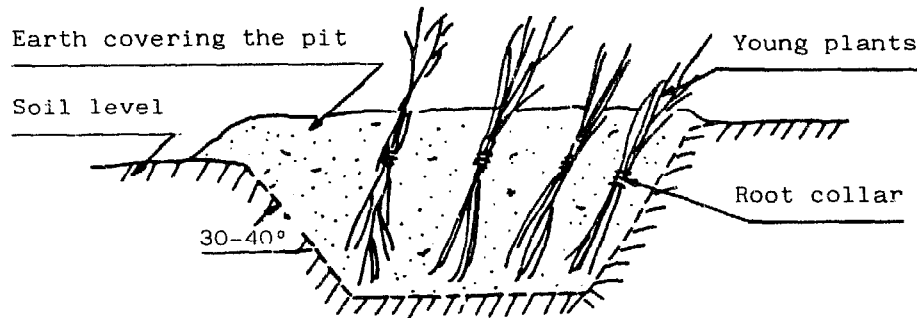

Diagram of heeling-in procedure

(e) Planting out

1. The plastic bag or basket which surrounds the ball of earth is removed from the plant.
2. The plant is placed in a hole without bending the roots under.
3. Earth is placed carefully around the roots and trodden down lightly when the hole is half full.
4. When completing the filling of the hole, the earth should come up to the old soil level, as in the nursery.
5. The earth is once again trodden down lightly.

For planting plants with bare roots, another technique may be used: a furrow is shovelled out and the young plant placed in it. The furrow is then closed and the earth lightly tamped down.

Fig. B.3: Plant spacing

Tall trees as wind breaks	5-10 m
Shrubs and trees in the intermediate spaces	1-2 m
Wooded strips	1.5-2.5 m
Conifers	0.6-2.0 m
Shrub hedges	0.5-0.8 m

1.1.8. Maintaining the afforested area

1.1.8.1. Replacing plants which do not take

This operation is carried out during the first or second year following planting.

A 70 to 75 per cent planting survival rate is considered acceptable. Even in this case, however, if a protective curtain is required or if the failed plantings are all grouped in a single area, replanting should be undertaken.

1.1.8.2. Weeding

It is necessary to eliminate parasitic plants competing with the seedlings. The former may also provide material for running fires. Weeding may be carried out manually, mechanically or chemically.

Maintenance work (cutting, weeding) should be carried out two or three times per year during the first year and once or twice a year during the second year.

1.1.8.3. Management of young plantations

Good management of forestry plantations increases the product value and has indirect advantages on soil and humidity conservation since it increases the owner's involvement in maintaining wooded cover on his soil.

The main operations are:

- Improvement felling

This is the first felling system used in the operation of forests which are growing again. Felling trees whose maintenance is not a paying proposition increases the size and value of the remaining trees.

- Weeding out

This operation increases the survival and growth rate of the species one wishes to conserve by felling the trees around about them. It can be carried out using axes, cleavers or machettes.

- Thinning out

The objective of this operation is to reduce the density of a plantation periodically as the trees grow, in order to promote the growth of the trees one wishes to maintain.

- Trimming

In this operation, the lower branches are removed from the tree to obtain a trunk which is knot-free and of greater economic value. The work can be done with ordinary handsaws or pruning saws.

- Felling

The felling method has an important influence on the effectiveness of the tree cover for soil and humidity conservation purposes. With selective felling, it is possible to maintain the effectiveness of the forest in erosion protection whereas total felling may produce disastrous results.

1.1.9. Plantation conservation

1.1.9.1. Fire protection

Fire is one of the major dangers for a forest. Its effects may go as far as completely destroying the forest's beneficial effect from the point of view of soil protection and economic yield.

Measures may be either preventive or curative.

(a) Preventive measures

- Public education, legislative measures.
- Destruction of flammable vegetation, scrub removal, elimination of dead branches, etc.
- Creation of fire breaks.
- Inclusion of species which are less likely to catch fire.

(b) Curative measures

- Establishment of a fire-fighting service which can rapidly mobilise fire-fighting personnel and material and which operates an alarm system (watchman's rounds), and an adequate network of tracks so that different points in the plantation can be reached rapidly.

The creation of fire break zones, generally 20-30 m in width, may be highly labour intensive. Fire breaks are produced by burying or tearing up flammable material and exposing the bare soil. In accessible zones, this work is usually done with ploughs or disc hoes. Forest roads are also used as fire breaks. Care should be taken not to promote erosion, and forest roads and fire breaks should not be located along the lines on the greatest slope.

The insertion in forest plantations of strips of foliage plants also has a preventive action. The species currently used in tropical zones are: cashew trees, guava trees, mango trees, sisal, agave, furcraea, cypress, callitris, euphorbia.

1.1.9.1. Protection against animal pasturing

Animal pasturing may have deleterious effects on forest plantations and on soil conservation due to:

- animals trampling the soil;
- cattle grazing;
- damage to young plants.

The control measures include:

- grazing prohibitions which are often difficult to enforce;
- fencing-off of plantations (barbed wire, thorny hedges, zeriba, etc.).

Fig. B.4: Reafforestation techniques for selected tropical species

Species	Seed preparation	Sowing procedure	Soil preparation	Planting	Spacing	Maintenance	
						Operation	Int.
Acacia albida	Good and lasting germination potential seep the seeds in boiling water for 24 h	Sow the seeds in plastic sachets 8 cm in dia. and 30 cm deep		4 mth after sowing in holes 40x40x40 cm	10x10 m in cultivated ground, 5x5 m in the open	Weeding	2 years
A. Eggelingü A. Trispinosa A. Laeta	Good germination potential; soak the seeds in water for 48 h	Direct sowing, or in sachets; 5 seeds per unit			4x4 m, 2.5x2.5 m in difficult conditions	Hoing	2 years
Honduras mahogany	Short germination potential	Sow at intervals of 15x15 cm		Transplant when the plants are 0.60-1.20 m in taungya or in the open	2.5-3x2.5-3 m		3-4 years
Balsa	Minute seeds; preparation by carding and batting to separate the seeds; soak in boiling water for 15 min	Sow directly if rain-fall conditions are suitable or sow in pots		Plant out when the plants are 20 cm	4-5x4-5 m in planting holes of 30x30x30	2-3 weeding	1 year
Bambusa arundinaria		Sown in nursery; pricked out in boxes or beds when the plants are 2.5 cm		Planted out when plants are 1.8 m	1.8x1.8 m		
Bambusa oxy- tenanthera	Soak cutting of 0.6-2 m in water for 1-3 days before planting			Plant 2 cuttings at a time	4x4 to 6x6	Weeding	2 years
Cassia siamea	Abundant seeds that keep well; soak for 20 min in sulphuric acid at 36° C for a week	Direct seeding in groups of 5-6 seeds at 2-3 m intervals; saplings may be used	Land ploughed, or ploughed strips if there is danger of erosion; sow in beds at 8x15 cm		2-3 m	Weeding, hoing	1 year
Dalbergia sissoo roxb	High germination potential	Sow direct; plants in bags	Clear and subsoil		2-2.5x2-2.5	Weeding, hoing	2-3 years

Fig. B.4 (concl.)

Species	Seed preparation	Sowing procedure	Soil preparation	Planting	Spacing	Maintenance	
						Operation	Int.
Filac	Minute grains cannot be kept more than 6 mth	Sowing in beds; pricking out when plants are 2 mth old in perforated pots	Very fine screened tilth	Planting out when plants are 50 cm	3x3 m	Watering	1 year
Gmelina arborea roxb	Germination potential of at least 1 year; seed easy to extract with an olive stone remover	Sowing in a nursery 20x20 cm and pricking out plants 3-4 mth after	Ploughed land in strips or on taungya or beds			Light weeding	1-2 years
Neem	Remove the pulp and dry	Direct sowing in drills 3 m apart in taungya if dry season; nursery for 1 year and planting out when suitable	Ploughing; subsoiling		2x2 m	Weeding	
Pines	Germination potential is maintained for 1 year; soak for a few hours	Sow in seedboxes; prick out after 2-3 mth; beds or boxes of 49-100 plants	The earth must be well treated against fungal infection; land ploughed in strips on terraces or, better, fully ploughed	Planting out when the plants are 20-30 cm	2x2 m 3.6x3.6 m in good earth	Grubbing	2 years
Prosopis juliflora DC	Germination potential lasts several years; pound fruit to obtain single seedpod segments then soak in boiling water and allow to macerate for 48 h	Direct sowing on contour furrows with a trench uphill; prick out saplings of 1.5-2.5 cm dia. at base, or plants pricked out in pots for 1 year			3x3 to 6x6 m	Weeding	2-3 years
Teak	Long-term germination potential; burnt land; heating; soak in running water or spread seeds in thin layers on a flat surface; water every other day and allow to dry in sun for 8 days	Sow on deep ploughed land at intervals of 3x3 cm; nursery	Plant out on cleared forest lands; planting out of saplings which must be at least 1.5-2 cm in dia. and 2 m tall	Land cleared of tree stumps and ploughed		2 workings Opening-out	2 years 3rd year

1.2. Pastures

1.2.1. Role of pastures in soil conservation mechanisms

Grazing is one of the most effective and economic means of maintaining and enriching the soil.

Well-maintained grazing land:

-
- protects soil with its vegetation cover against the impact of rainwater drops;

 - holds back superficial runwater run-off;

 - halts humus loss;

 - improves soil stability and structure;

 - improves soil permeability.
-

If the herd remains permanently on the pasture, the majority of the minerals in the forage are returned directly to the soil.

Land may be used in rotation between grazing pastures and crops, which improves crop yield due to:

-
- the provision of nutrients with the grass being ploughed in;

 - maintenance of a more favourable level of soil humidity with structural improvement;

 - a smaller humus loss;

 - reduction of plant disease and damage caused by harmful insects.
-

The use of grazing as a part of soil conservation measures may be employed on different classes of land.

(a) On land suitable for crops. In this case, rotating grazing with crops is preferable to permanent grazing. The length of time the land will be grazed depends on the soil erosion hazards. For example, 2 out of 6 years will be given over to grazing for class I land (USDA classification), 2 out of 4 for class II land, 3 years out of 5 for class III land.

(b) On land not suitable for crops. It is advisable to make a distinction between land for grazing and land for forest plantation. Trees give a more effective cover than grazing pasture on poor soils. Soils in class V are less susceptible to erosion and are more suitable for pasture than soils in classes VI and VII.

1.2.2. Techniques for the creation, conservation and improvement of pastures

(a) Methods

The majority of pasture conservation and improvement techniques, although they have an important conservation role, are not of the labour-intensive type. They are described briefly below:

In the management of grazing areas, measures should be aimed at matching the number of animals to the carrying capacity of the pasture and modifying, where necessary, to the type of grazing (open pastures, pastures with a night park, ranching).

In regenerating an area, suitable measures include the prohibition of an area, or labour-intensive pasture regeneration techniques such as:

- improvement with manuring, tilling, mowing and enrichment by the introduction of new techniques;
- artificial reconstitution of pastures which must be envisaged when the natural pastures are so degraded that no improvement can be expected.

(b) Preparation of soil for sowing and sowing procedure

These techniques are used mainly in regions where the rainfall is sufficiently high for grass cover to develop.

Land preparation includes:

- tillage which should be carried out sufficiently in advance so that the land can settle and firm-up. On steeply sloping land, subject to erosion, tilling should be carried out along the contour lines;
- fertilising: 450-675 kg/ha;
- disc harrowing.

The seeds should be sown with a mechanical broadcaster which gives a more uniform result.

Seeds should be lightly covered with earth by the use of a roller to compact the earth or a tined harrow.

To reduce water loss due to run-off and ensure better seed germination conditions, it may be advisable to carry out some small terracing work (ridges or contour ploughing).

B.2. CONSERVATION OF CROP LAND

2.1. Biological procedures

These procedures are basically of the farming type and seldom call for additional labour. They will be reviewed very briefly.

The biological procedures are based essentially on modifying farming techniques and making rational use of the land. The results of these procedures are:

- mechanical: protecting aggregates against raindrops; obstacles to run-off;
- physical: reconstitution, improvement or maintenance of fertility by the role played by humus.

Biological techniques may be sufficient in themselves to prevent soil degradation on very slight slopes. In other cases, they will be combined with mechanical soil conservation procedures. The main techniques used are:

2.1.1. Cover crops

These give the soil protection against rain and run-off in shrub and arborescent plantations. The cover may be either continuous or in contour strips. The cover may be legumes (pueraria, centrosema, crotalaria, mucuna) or grasses.

2.1.2. Mulching

This consists in covering the soil between crops with a layer of crop residues or "mulch" 10-20 cm thick. When used under shrubs or arborescent plants, this process reduces the impact of raindrops on the soil, hinder run-off and wind erosion:

- it reconstitutes the soil or enriches it with organic material;
- helps to control weeds and reduces evaporation.

The disadvantages are that it tends to promote the hazard of soil leaching in regions with a high rainfall and poses a fire hazard.

2.1.3. Crop rotation

Crop rotation on a given area of land is a process to maintain fertility. Farming techniques also have an erosion control role since humus helps to maintain soil stability. Not all the crops which occur in the rotation process have the same erosion control role. Hoed crops provide favourable ground for erosion. On the other hand, rotations which allow better cover growth in time and space will have a better erosion control effect.

2.1.4. Mixed cropping

Combinations of crops which make it possible to cover the maximum surface area for a maximum time.

2.1.5. Lea crops

After the main crop, a secondary crop is used to cover the soil and protect it against rain and wind erosion.

2.1.6. Rotation field-strip cropping

Strips of different crops are laid out along the contour lines and when a strip is bare the two adjacent strips have a cover crop (see fig. B.5).

Buffer strip cropping employs the same principle. The buffer strips alternate with the tilled strips and are permanently covered with grass or bushes. This system has the disadvantage of reducing the usable crop area.

Fig. B.5: Contour strip cropping

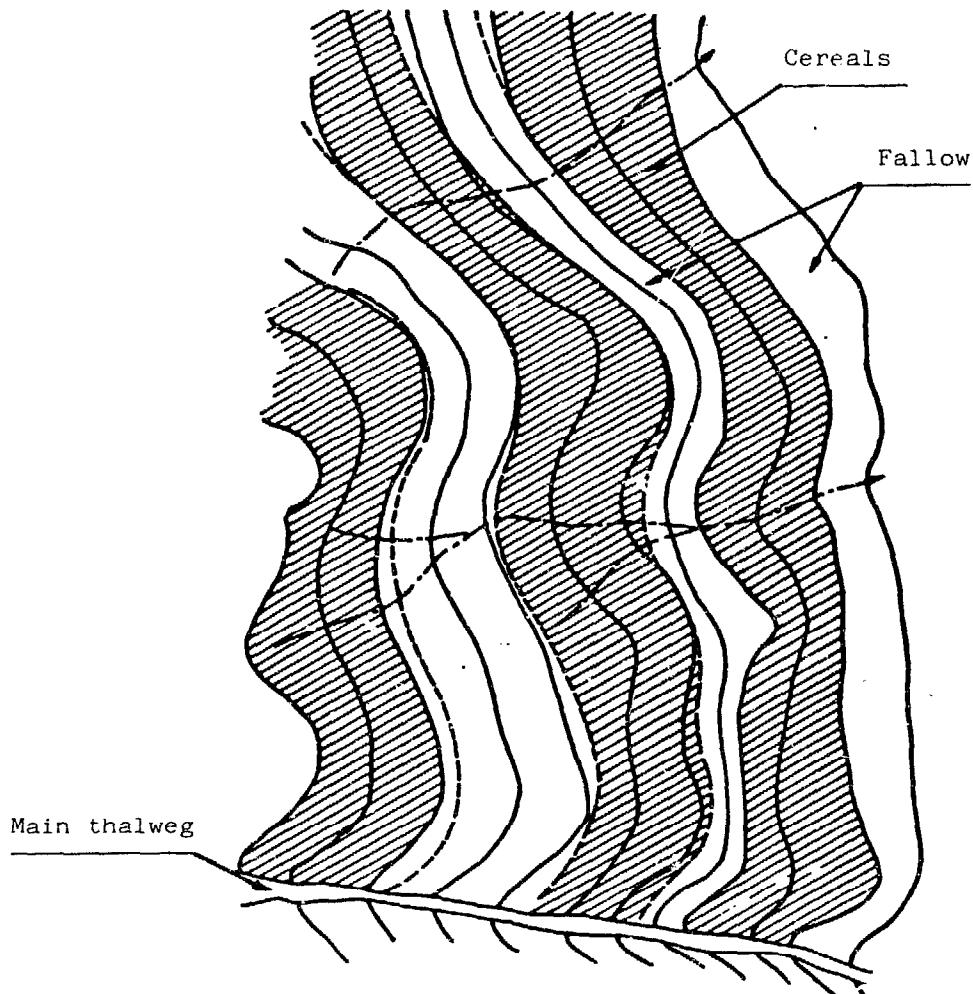

2.1.7. Increasing the soil's organic reserves

Increasing the soil's humus content tends to stabilise the aggregate structure and, in this way, is an erosion control measure; however, the farmer's objective is primarily to maintain and improve the soil's fertility.

The procedures used are ploughing-in crop residues, fallowing, temporary grassland, green manuring and organic manuring.

2.2. Farming practices

Unsuitable farming practices may have mechanical or biological effects which degrade soil structure and make it more liable to erosion.

These may include:

- ploughing in the top layer of soil which is the richest and has the best structure;
- the creation of hard pans caused by continuous ploughing at the same depth;
- compression of clay soils by heavy fertilising;

-
- soil structure destruction;

 - soil pulverisation;

 - destruction of cover vegetation by excessive hoeing.

Good farming practices may suffice to protect less susceptible zones against erosion. They may also be combined with mechanical erosion control works on the high risk zones, and this may help to keep costs down.

Erosion control farming practices may be divided into three main categories:

-
- tilling along contour lines;

 - ridging;

 - subsoiling and chiselling.

2.2.1. Contour ploughing

Ploughing forms a series of furrows close to each other; these should be kept as horizontal as possible. Each furrow helps to retain water. If the furrow is to be effective, its longitudinal slope should not be more than 3 per cent. The directions to be followed should be staked out or there will be a danger of producing counter slopes in which water will build up and erosion may become dangerous.

Maximum furrow capacity will be obtained by wide and adequately deep ploughing. The earth from the furrow should be turned downhill to form a "plug". This method of contour ploughing with the earth being turned downhill is also used for the progressive construction of terraces (see 2.4.2).

If the slope is less than 3 per cent, this ploughing method is sufficient to prevent sheet erosion; flat ploughing is carried out using reversible ploughs and share and mould-board ploughs.

When the contour lines are not parallel, difficulties arising from variations in the width of each strip entail a special ploughing method described in fig. B.6.

2.2.2. Contour or slightly inclined ridging

In this technique, a series of parallel ridges are produced from one end of the field to the other. This method is recommended when the slope, greater than 3 per cent, no longer permits ploughing on the flat. It is a method known to and practised by the African farmer. The erosion control action of the ridge is greater than that of contour ploughing since ridges have a greater water retention capacity.

The ridge may follow the contour line (contour ridging) or be slightly inclined to contour lines if there is a danger of overflowing. In the latter case, the longitudinal slope of the ridge should not exceed 1.5-2 per cent. The characteristics of the ridge vary depending on the type of rainfall, the soil and the crops cultivated.

Fig. B.6: Contour ploughing technique

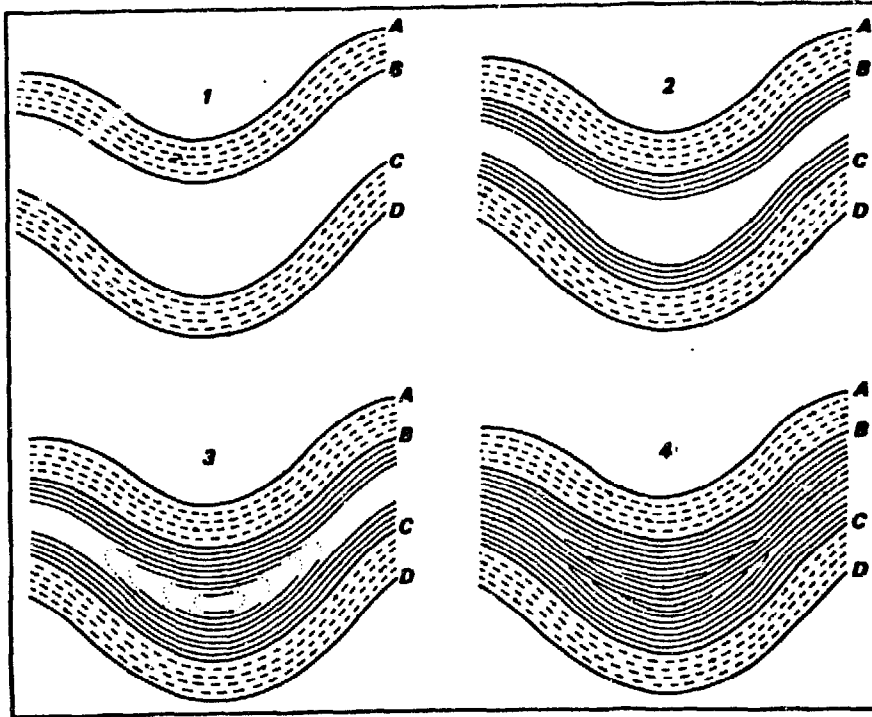

From M. Deloye and H. Rabour (ref. 11)

Contour ploughing. When the contour lines are not parallel, a special ploughing technique is required. An example of this type is shown in illustration 1. The curves A and B and C and D are parallel. Ploughing between these presents no difficulties. Between B and C, however, it is necessary to adopt the following procedure: ploughing is carried out parallel to B and C until it becomes difficult to turn (2). One continues by raising the plough at each turn so as to leave an unploughed space which acts as a turning point (in dotted line) on the axis on the space between B and C (3).

The work is completed by ploughing along this axis (4).

The next furrow is ploughed by following the axis and finishing with a number of furrows parallel to B and C. The final furrow follows these curves.

The heavy lines are the guide furrows.

Common figures for ridges are:

- distance between crests: 0.80-1.50 m;
- ridge height: 0.15-0.40 m.

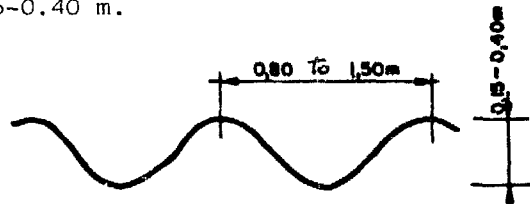

In low-rainfall areas, contour ridges may be tied by clods of earth at intervals of 3-15 m, which ensures total infiltration and increases the soil's water reserve.

Ridging may be carried out using:

- hand hoes;

- share and mould-board ploughs;
- ridgers.

The ridges are usually tied by hand.

Ridging is carried out using techniques similar to those for contour ploughing.

2.2.3. Subsoiling and chiselling

Subsoiling produces a deep scarification of the soil (up to 60 cm deep).

It is used to:

-
- increase permeability;
 - break up a hard pan caused by constant ploughing to the same depth;
 - to deepen the cultivatable layer.
-

Contrary to ploughing or ridging, it does not turn the earth.

Chiselling loosens hard soil when the surface layer is thin and lies directly on rock or a crust. It dislocates hard layers without turning the earth.

After chiselling, the soil is broken up and there will be voids between the blocks which will make it unsuitable for cultivation for at least one year. These voids may be eliminated by the use of a "soil lifter" which is drawn horizontally through the soil by a tractor at a depth of 40-50 cm and lifts and crumbles the soil thus eliminating any holes and making the soil suitable for cultivation immediately.

These soil lifters are fitted directly to the blade of the ripper or a roter such as the "rasette" used in Algeria. In earthworks, ripping is also used to loosen the soil and make it easier for manual work.

Subsoiling and ripping require powerful mechanical equipment and cannot be replaced by manual techniques.

Tractor power varies depending on the compactness of the soil and the depth at which the soil is being worked. In general, use is made of:

-
- tractors of 35-70 hp for subsoiling to a depth of 60 cm;
 - tractors of 60-150 hp for ripping at depths of 50-60 cm;
 - tractors of 60-150 hp for rooting at depths of 30-70 cm.
-

2.3. Defence networks

2.3.1. The role of defence networks and the systems used

Defence networks are intended to protect cultivated zones against rainwater run-off from the higher reaches of the catchment basin. They comprise trenches, tiers, terraces and ridges which either totally absorb the water or divert it into a drain.

Defence networks are used when conventional farming techniques are not sufficient to protect the soil against erosion. This is usually the case when the slope exceeds 2-3 per cent. The earthmoving procedures employed are of the highly labour-intensive type. They are an adjunct to good farming practices and not a substitute for them. They are usually permanent earthworks which can be constructed manually and are intended to protect the soil against water erosion.

Defence networks can be constructed on the basis of two systems depending on climatic conditions and soil permeability, either using:

- the absorption system designed to capture all the water run-off and ensure its infiltration. This system is viable only in areas of low rainfall (less than 700 mm) and where the land is sufficiently permeable;
- the diversion system which is designed to reduce the kinetic energy of run-off water and evacuate it to a specially constructed drain.

Fig. B.7: Suitability of various types of defence measures and their means of construction

Land slope	Horizontal terraces		Defence network				
	Direct construction	Progressive development	Ditches and components	Tiers and components	Terraces	Hollow terraces	Ridges
0-3 %	+ o f t	+ o f	- o f t			+ f t	+ o t
3-12 %	+ o t	+ o f	- c f t	- o f	+ o f t	+ f t	+ o t
12-25 %	- o t	- o f	+ o f	- o f	+ o t	- o f t	- o t
25-50 %	- o t		+ o	+ o	- o t		
>50 %			+ o	+ o			

+ commonly used
 - less commonly used
 o carried out using manual labour
 f carried out using farm implements
 t carried out using tractors or self-propelled equipment

2.3.2. Main types

2.3.2.1. Ditches or tiers

These are usually used on very sloping ground (>25 %) and are constructed along the contour lines (contour ditches).

The distance between the ditches depends on the slope but there is usually a 2 m fall between each ditch.

It is advisable to block off the ditches in a chicane pattern using a hump of earth 50 cm wide every 3 to 25 m to provide a path for men and animals and compensate for the effects of imperfect maintenance of horizontals.

The ditches can be carried out manually with picks and shovels. The tiers on steep slopes can be used for planting. The soil surface on which the fill is deposited is loosened with a pick before hand to promote water infiltration and root penetration (see Standard Plan No. 9).

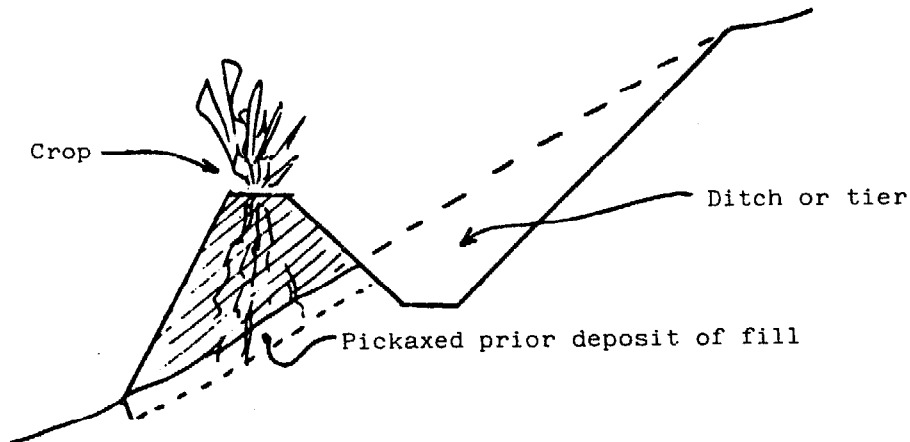

2.3.2.2. Terraces (see Standard Plans Nos. 5-8)

Terraces have a base with a slight counter-slope, part of which has been cut uphill and part in-fill forming a hump downhill (see fig. B.8). The terraces are either horizontal (absorption terraces), or with a slight slope (diversion terraces); the latter are more common.

There is a wide range of different types of terrace depending on the main function (absorption or diversion), the slope, use for crops, and the country. Depending on their function, terraces may be divided into two categories:

- crest-type terraces which have a raised downhill hump and a shallow cut; these are used for absorption;
- channel-type terraces which have a deeper cut cross-section and a low downhill hump; these are used for diversion.

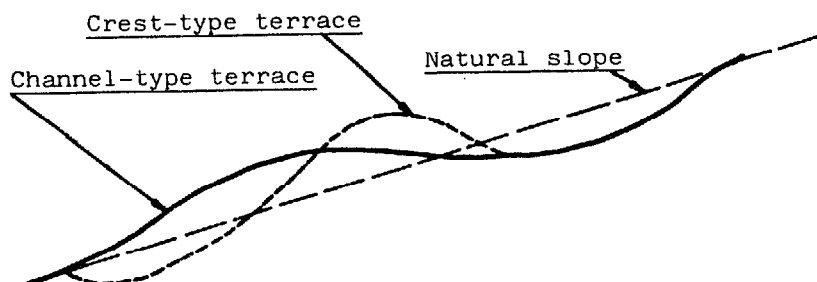
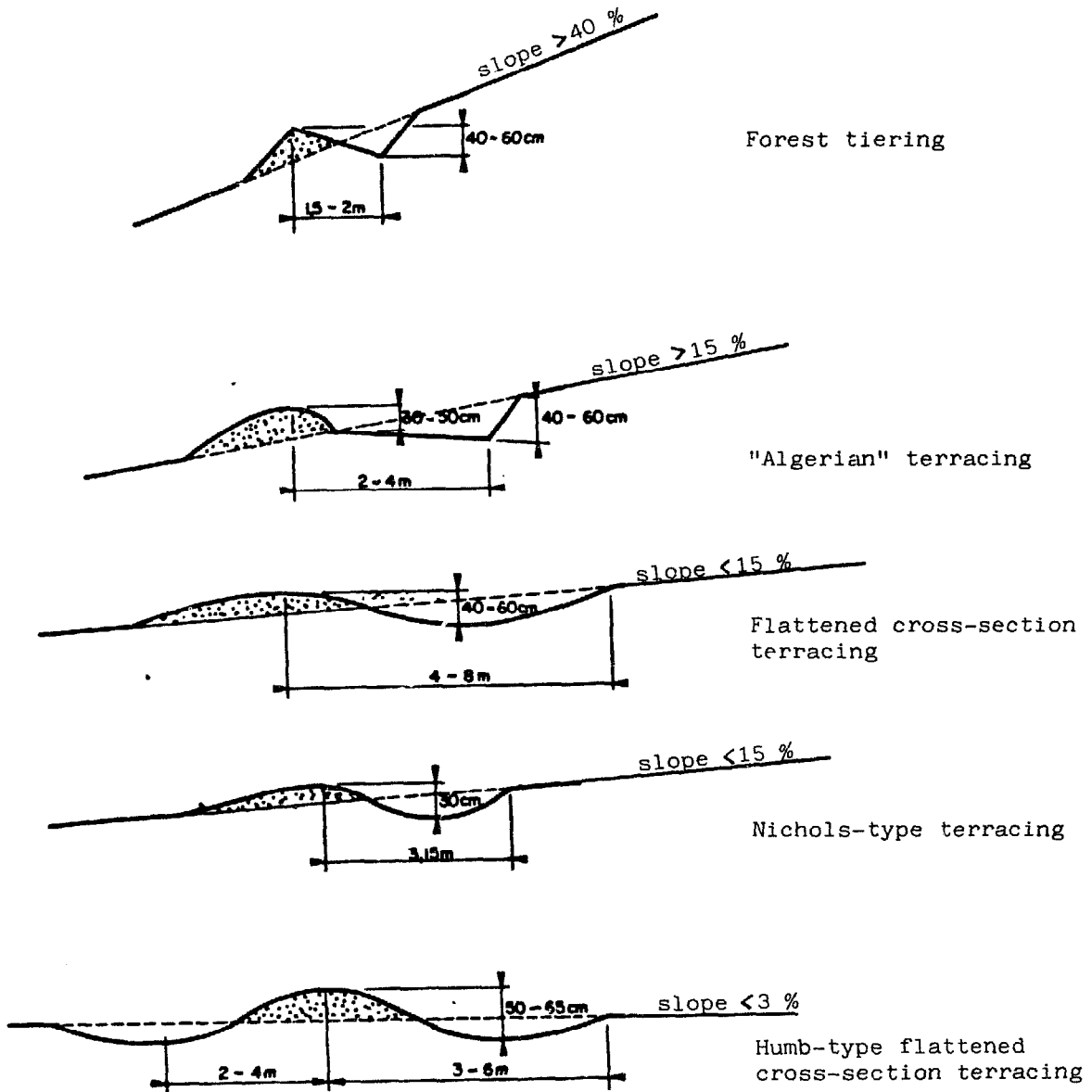

Fig. B.3: Main types of tiering and terracing

Ref. 11



Crest-type terraces are kept on the level. They are used for lightly sloping ground ($\leq 3-4\%$) which is very permeable (sandy).

They are total-absorption terraces and their ends are closed or half-closed in order to form a reservoir. They are used for small fields where there is no good drain. The length of each bench should not be more than 200-300 m to avoid the danger of overflowing.

Channel-type benches are more widely used. There are three main categories depending on their cross-section:

-
- (a) the Algerian-type cross-section (DRS) for land with a slope of more than 15 per cent (normal cross-section terrace);

 - (b) the flattened cross-section of which two types exist: in channel form up to 15 per cent slope and in hump-form for slopes of less than 4 per cent;

 - (c) the improved Nichols-type terraces which is suitable for slopes of up to 15 per cent.
-

(a) "Normal" type terraces

This is the "Algerian" terrace which has a cross-section suitable for slopes of over 10-15 per cent. It is also called a cropping terrace (Tunisia).

To construct it, the platform is slightly inclined 10-15 per cent downwards into the hill in order to protect the recently constructed hump against erosion.

As the earth packs down, the bench takes on its final shape.

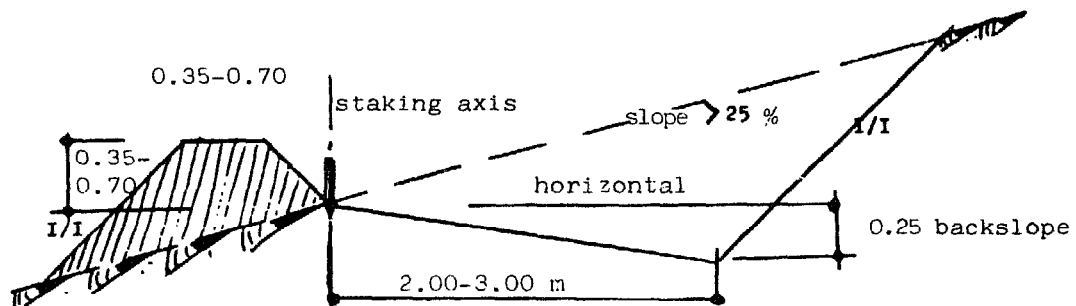

Normal cross-section terrace (Algerian type)

They are suitable for orchard farming since the trees can be planted along the hump, the base of which has been previously subsoiled. It is also possible to widen the hump for this purpose.

(b) Flattened-hump terraces

These terraces do not present any obstacle to movement and are fully cultivatable. They are also called crop terraces.

In the case of a channel-type flattened cross-section (slopes of 4-14%), the earth for the hump is taken from downhill as is the case with the "normal" cross-section.

In the case of the hump-type flattened cross-section or crest terrace, used for slopes of less than 4 per cent, the earth for the ridge is taken from both uphill and downhill.

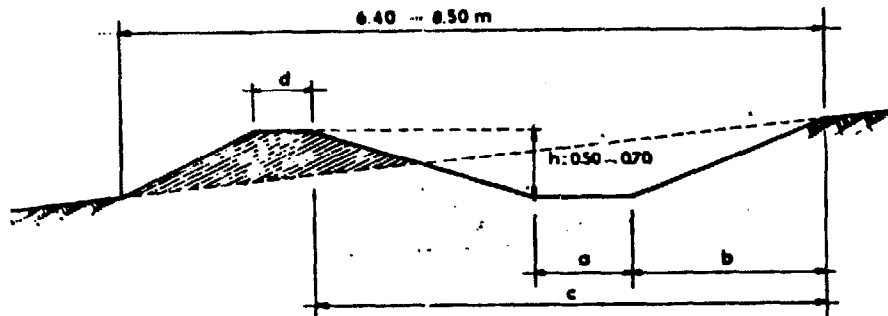

Channel-type flattened cross-section bench terrace (cropping terrace)

(c) Nichols-type terrace

This is used in the south-east of the United States for slopes of 12 to 15 per cent. It is more of a water evacuation ditch dug in solid earth, since the fill for the hump can disappear without any disadvantage.

The channel is 3.15 m wide and 30 cm deep below the ground surface with, if necessary, a 45 cm high hump. It is considered economical and it is easy to maintain.

2.3.2.3. Ridges (see Standard Plan No. 10)

These are used in countries with low rainfall on slopes of less than 5 per cent. They act just like dams and designed to promote rainwater absorption.

They are used in particular in arid zones to retain and promote water infiltration where trees are being planted.



Ridges for steppe-type forest planting

2.3.3. Dimensions

2.3.3.1. Spacing between sections

The spacing should be such that no erosion can occur between terrace, spacing depends on:

- the slope of the ground;
- the vegetation and type of crop;
- the type of soil;
- the rainfall.

Spacing may be determined by means of empirical formulae devised for a given region and based mainly on the slope of the land. The spacing is indicated by the vertical fall H between two terraces. These formulae require correction in relation to the region, the vegetation cover and the soil permeability.

The main formulae used are:

- the RAMSER formula (USA)

$$H = 0.305 \left(a + \frac{P}{b} \right)$$

where H = the fall in m

P = the slope in %

a and b are the coefficients.

For the State of Washington a = 0.58 and p = 1.7. In tropical Africa, a = 2, b = 4 (= 3 in dangerous conditions).

- the formula used in the humid regions of the USA:

slope < 3 % H = 7.5 P + 0.6

slope of 3-8 % H = 9 P + 0.6

slope > 8 % H = 10 P + 0.6

- the SACCARDY formula (Algeria): - the BUGEAT formula (Tunisia)

$$H^3 = 260 P \pm 10$$

$$H = 2.20 + 8 P$$



An example of forest terracing (Cape Verde)

Spacing of "Nichols-type" terraces

Ground slope %	Vertical interval (m)	Horizontal interval (m)
2	1	50
4	1.10	27.50
6	1.18	19
8	1.28	16
10	1.42	14.50
12.5	1.60	13.0
15	1.90	12.0

2.3.3.2. Transverse cross-section of diversion terraces

In choosing the transverse cross-section to adopt for the terrace, use may be made of Standard Plans Nos. 5-8 given in the Appendix, which can be adapted to a large range of climates and soils. The choice in this case will depend solely on the slope. It is also possible to use figure B.9 which shows the type of terrace to use in relation to the ground slope and the type of crop.

Fig. B.9: Guide for selecting terrace cross-sections on the basis of slope and crop (Algeria, ref. 27)

Crop	Ground slope	Type of terrace to be used	% loss of cultivatable surface area
Cereals	2-3%	Horizontal ploughing	0
	3-6%	Strip cultivation	0
	3-5%	Triple-curve terraces	0
	5-12%	Double-curve terraces	0
	12-18%	Triple-curve terraces	5
	18-30%	Flattened-hump terraces with a V cross-section	8
	30-50%	V cross-section terraces	20
Cereals and fruit trees	<18%	Single-curve terraces	0
	<30%	Flattened-hump terraces	0
	<50%	Normal-profile terraces	25
Fruit trees	<30%	Normal-profile flattened-hump terraces	5
	<50%	Normal-profile terraces	25
Vines	<30%	Flattened-hump terraces	10
Pasture and reafforestation	<80%	V cross-section terraces	0

The transverse cross-section of a diversion terrace can be calculated on the basis of:

- (a) run-off rate;
- (b) water speed required to drain this run-off;
- (c) the cross-sections necessary for draining.

(a) The run-off rate depends on the surface area of the catchment basin, the slope, the vegetation cover and the rainfall intensity. It can be calculated using the "rational method", the principle of which is shown in paragraph 2.5.2.

It can also be calculated in a more approximate way, but with adequate precision for type of layout in question, by using the formula:

$$Q = 0.27 A$$

where Q is the run-off rate in m³/s

A the surface area of the catchment basin in hectares.

Terraces with irrigation canal

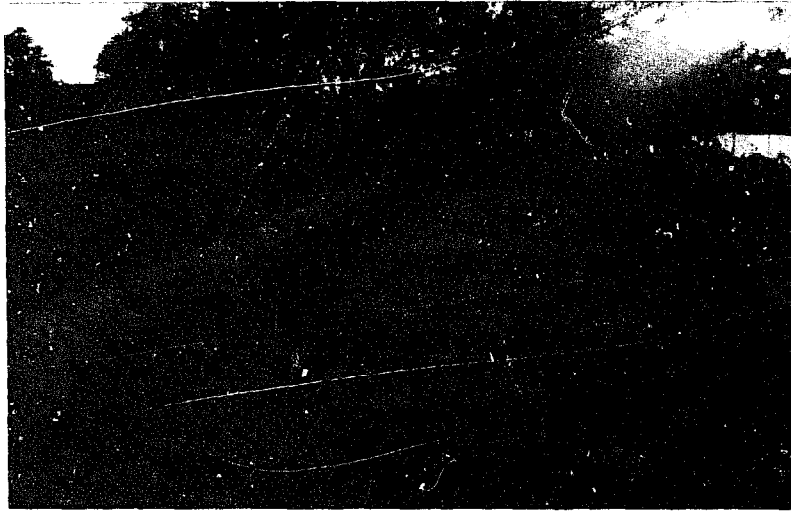

Djibouti



Djibouti

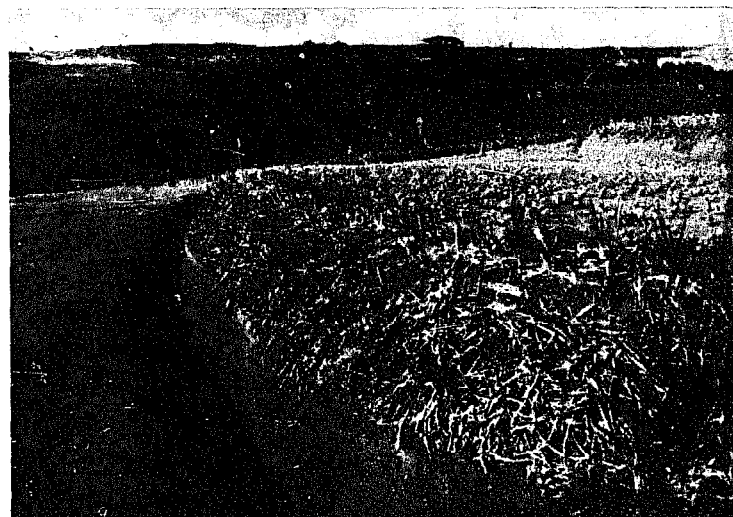

Burundi

(b) The drain-away speed should not exceed 0.45 m/s on sandy soils and 0.60 m/s on other soils.

(c) The drain cross-section can be deduced as follows:

$$\text{Drain cross-section} = \frac{\text{run-off rate}}{\text{threshold speed}}$$

The total transverse cross-section of the terrace should be increased to allow a margin between the water level in the channel and the crest of the bank (usually 10 cm).

2.3.3.3. Longitudinal slope and length of terraces

The slope of a terrace should be set so that the permissible threshold speed is not exceeded. To achieve this:

-
- (a) either select a uniform slope with a variable cross-section and a constant speed, or with a constant cross-section and a variable speed, which does not exceed the threshold speed at the collector drain;
 - (b) either increase the slope of one section or another as and when the flow rate increases.
-

Having determined the flow rate and the minimum channel cross-section, the slope can be calculated using the MANNING-STRICKLER formula (see paragraph 2.5.2). Usually, the terrace slope is less than 5/1,000.

Terrace length is a balance between the run-off rate and the channel flow at the exist with the permissible threshold speed.

Figures B.10 and B.11 give values of terrace lengths and longitudinal slopes.

2.3.3.4. Installation of terraces

There is not particular problem for the installation of absorption terraces. Their relatively short length, possibility of partitioning them off and the absence of drain outlet makes it possible to vary the different parameters (spacing, height, etc.).

Deviation terraces should be built on the basis of a detailed map so that they are adapted to the topography, and the location of collector drains, paths, etc.

The principles to be borne in mind:

-
- (a) locate pathways along the crests or ridges so that they are not touched by the water in the terraces;
 - (b) maintain an approximately constant spacing between a crop strip by "correcting" contour irregularities.
-

Fig. B.10: Terrace lengths and horizontal slopes (ref. 1)

Direction of flow: \longrightarrow

United States

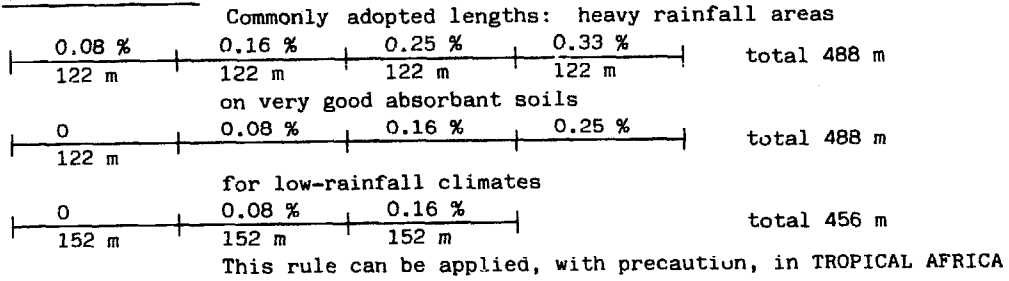

Zaire

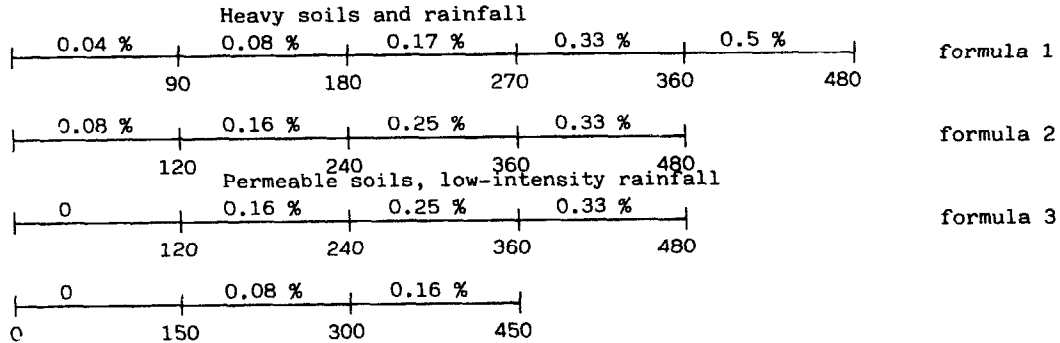

0.33 % is an optimum

WEST AFRICA (from Fournier)

L: 490-550 m, slopes: 0.01-0.02-0.3 %

UPPER VOLTA: L: 200 m, slope: uniform 0.2 % (ditches)

ALGERIA: Virtually uniform slope 0.5 % and 0.3 %, dry zone

TUNISIA: Longitudinal slope 0.5 %, length 400 m

MADAGASCAR: Contour channels and terraces 0.5 % - advisable: 0.2-0.3 %

Fig. B.11: Determination of slope standards for Nichols' terraces as a function of ground slope and the length of the terrace

Terrace length	Sandy ground Maximum slope per thousand for a ground slope of:			Clayey ground Maximum slope per thousand for a ground slope of:		
	5 %	10 %	15 %	5 %	10 %	15 %
0- 30 m	0	0	0	0	0	0
30-120 m	0.2	0.4	0.6	0.8	1.0	1.2
120-210 m	0.6	1.0	1.2	1.6	2.0	2.2
210-300 m	1.0	1.4	2.0	2.4	2.8	3.2
300-390 m	1.2	2.0	2.6	3.2	3.8	4.0
390-480 m	1.6	2.4	3.2	4.0	-	-

2.4. Bench terraces¹

Bench terraces convert sloping land into a series of flat or nearly flat platforms. This process makes it possible to recover for cultivation land on slopes which was too steep for utilisation. They will reduce or completely eliminate run-off and promote water infiltration.

Their construction requires homogeneous, deep and sufficiently permeable soils. The presence of an impermeable layer relatively near the surface is likely to cause saturation of the upper soil layers and cause land slips which may be catastrophic.

There are two main types of terrace, depending on the way in which they are constructed: terraces constructed at a single go and terraces constructive progressively.

2.4.1. Terraces constructed at a single go

This solution usually entails massive earthworks and the construction of retaining walls. It is used only when other procedures for enhancing and conserving soil have proved ineffective. Terraces of this type are justifiable only on good soil.

The main types of terraces are (see Standard Plan No. 12):

-
- earthwork terraces in which the bank is protected at the top by a small earth lip;

 - terraces with grassed banks;

 - stepped terraces with dry stonework walls;

 - irrigation terraces which have an irrigation channel at the top and a drainage channel at the base with a slight back slope;

 - terraces made with stakes and wattle, which are inadvisable in countries where termites abound.
-

The width of a bench terrace depends on the slope. Terrace height is usually equal to or less than 1 m and, in exceptional cases, 1.50 m. They are usually built on slopes of less than 20 %.

Stepped terraces with dry-stone walls and grassed-banked terraces will resist slight run-off.

In heavy rainfall regions, the run-off may degrade the construction. Consequently the terraces are built with a slight back slope with a drainage channel at the base of the next higher terrace. The whole terrace may itself have a slight slope draining the water to a collector drain.

Fig. B.12 shows a typical cross-section of a terrace built at one go and the volume of earthwork required in relation to the natural slope.

¹ Bench terraces have been used since ancient times around the Mediterranean, in the Far East and South America. They are used, in particular, in mountainous areas of high population where there is a shortage of agricultural land.

Fig. B.12: Terrace built at one go (Burundi)



Construction of a terrace
at one go (Lesotho)



Terraces at one go
(Lesotho)

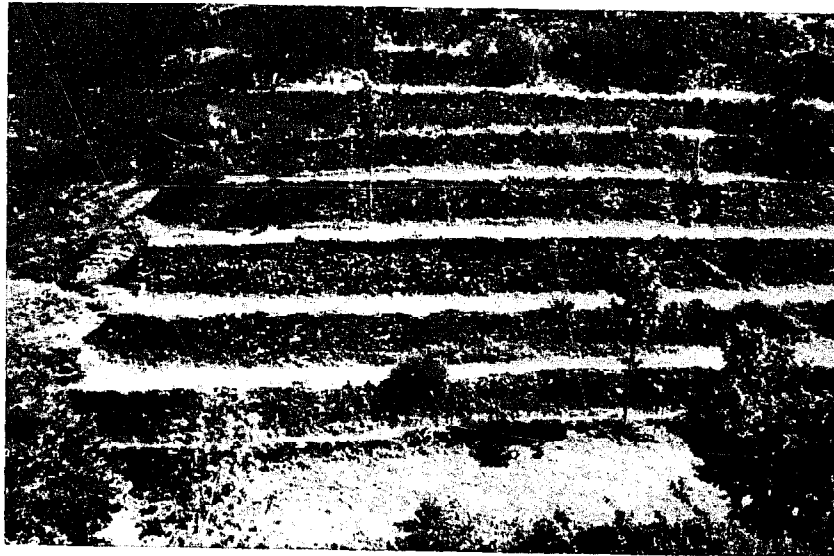

Terraces in dry stones (Gard, France)

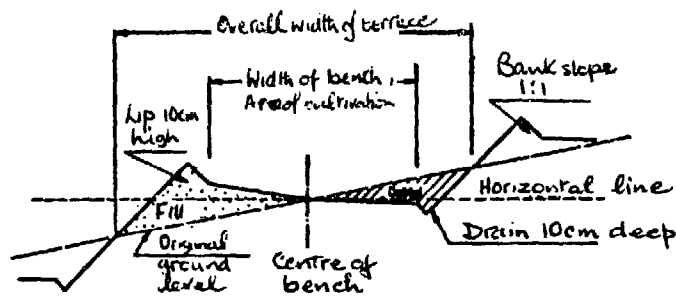

Typical cross-section of a bench terrace

Fig. B.13: Guide to design and construction of bench terraces with 1 m vertical interval

Slope of land	%	5	10	15	20	25	30	35
Width of bench available for cultivation	m	18.50	8.50	5.17	3.50	2.50	1.83	1.36
Total width of bench terrace	m	20.00	10.00	6.67	5.00	4.00	3.33	2.86
No. of benches per 100 m of slope	-	5	10	15	20	25	30	35
Maximum depth of cut	m	0.47	0.45	0.42	0.40	0.37	0.35	0.32
Area of benches available for cultivation per ha	%	0.925	0.850	0.775	0.700	0.625	0.550	0.475
Slope area of riser per ha of benches	m ²	919	1 838	2 758	3 667	4 596	5 515	6 434
Volume of cut per ha of benches	m ³	1 175	1 135	1 077	1 020	963	903	847

2.4.2. Terraces constructed progressively

These are constructed in the same soil and climatic conditions as those described previously but since their progressive construction makes use of agricultural techniques, they are much less labour intensive and, consequently, the costs are lower.

Construction is carried out:

by placing obstacles horizontally or on a slight slope at the point of a future riser.

In the farming that is carried out on the strips marked out in this way, soil is progressively moved from uphill to downhill by continuous downhill ploughing or pickaxing. The land accumulates behind these obstacles and progressively increases in height to form a terrace with a slope which is sufficiently slight not to erode. Terraces obtained in this way are not usually horizontal but have slight downhill slope.

Two types of natural obstacles can be used:

filters and complete solid obstacles.

- (a) Filters. These break the erosive force of the running water and hold back a part of the soil carried in it. They are effective when the erosion is not too severe and can be controlled by farming techniques (ridge cropping, dense vegetation cover, etc.).

The filters may be made of:

-
- piles of stones or crop residues;

 - contour bunds protected by stabilising plants (ados);

 - lines of dense rigid grass;

 - contour hedges;

 - rows of fruit trees or vines.

(b) Complete solid obstacles. These are either bunds of earth on which trees or stabilising plants are planted, or banks or ridges, such as those described in the preceding paragraph, intended initially to constitute defence networks and which are progressively converted into horizontal bench terraces as a result of earth slippage.

2.5. Drainage works

2.5.1. Characteristics of gully erosion and the role of control works

The construction of waterways for rain run-off is intended to prevent rill and gully erosion.

As the watershed increases, the run-off collects into rills which anastomise and deepen as the flow and water speed increase. Subsequently they form channels (from 0.20-2.00 m in depth), and then gullies (with a depth greater than 2 m).

Channels and gullies develop by regressive erosion which tends to stabilise the cross-section of the water course into an equilibrium cross-section; after this, natural vegetation establishes itself and the cross-sectional state is retained.

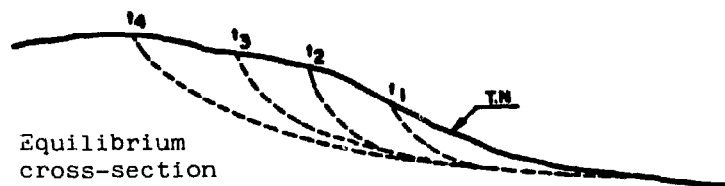

Regressive erosion

Regressive erosion gradually moving downhill in a watershed may finally result in all the soil of a watershed being stripped away before the equilibrium cross-section is reached. In order to conserve this cultivation soil, it is necessary to prevent the progression of this form of erosion.

Even when the equilibrium cross-section has been reached, the erosion is nevertheless likely to start again if the surface conditions of the watershed are modified. Destruction of forests and the cropping of pasture result in an increase in run-off flow rate and renewal of the erosion; at this point the water courses start to develop a new equilibrium cross-section.

The construction of diversion channels (ditches, terraces) also has the effect of concentrating water flow in natural waterways and this results in renewed erosion. Consequently these natural waterways must be arranged prior to the installation of diversion networks if one wishes to ensure that these efforts are not destined to failure.

Effort to control channel and gully erosion require the development of a general plan for the drainage of run-off over the whole watershed, using suitable construction methods.

The two basic data essential for the development of a drainage plan are:

-
- (a) run-off flow rate;
-
- (b) the nature and shape of the beds for draining this water (drainage cross-section).
-

2.5.2. Determining run-off conditions

2.5.2.1. Run-off rates

In the case of catchment basins with a surface area less than 200 ha, determination of peak run-off rate can be made by the rational method given by the equation:

$$Q = 0.00275 C I A$$

where Q = the peak flow in m³/s

C = the run-off coefficient (see fig. B.15)

I = rainfall for a duration equal to the basin's concentration time

A = the surface area of the basin in ha.

The concentration time depends on the total length of the basin and the average slope. This is given by the formula:

$$T_c = 0.018 \left(\frac{L}{\sqrt{S}} \right)^{0.77}$$

where T_c = the concentration time in minutes

L = the maximum water flow distance in metres

S = the slope, ratio of the difference in fall to length.

The rainfall intensity for a period of time equal to the concentration time is determined from intensity/duration ratios. A choice must be made between the return duration (or recurrence period), one usually selects the rainfall intensity of return duration equal to 10 years for small constructions, and a return duration equal to 50 years for larger constructions. Rainfall intensity values in relation to their duration are shown in figure B.14 below.

Fig. B.14: Rainfall patterns in Africa and Madagascar

Climate	Mean annual rainfall (mm)	Intensity-duration characteristics in mm/h			
		Rain of 30 min		Rain of 60 min	
		T = 10 y	T = 50 y	T = 10 y	T = 50 y
Mediterranean	200-1 500	108	-	60	-
Sudano-Sahelian	600-1 300	114	150	75	108
Guinean-equatorial	1 000-3 000	66-120	-	90	-
Madagascar	500-3 000	120	-	42	-

T = return duration

Peak run-off rates should be determined leaving out of consideration any soil conservation measures which may increase the concentration time or reduce run-off coefficients. Where absorption networks have been installed, run-off may be completely halted.

In the case of catchment basins with a surface area greater than 200 ha, it is not possible to use the rational methodology.

In determining peak run-off, it is necessary to use analytical hydrology methods where no hydrometric survey has been carried out. Reference should be made here to specialised hydrology textbooks.

In West Africa, it is possible to use the ORSTOM de RODIER-AUVRAY method which is suitable for catchment basins with a surface area of up to 200 km² (ref. 31).

Fig. B.15: Rational formula - Table of C values

Topography and vegetation	Soil texture		
	Very sandy loam	Loamy clay	Compact clay
Forests:			
. flat, slope 0.5 %	0.10	0.30	0.40
. undulating, slope 5-10 %	0.25	0.35	0.50
. hills, slope 10-30 %	0.30	0.50	0.60
Prairies:			
. flat	0.10	0.30	0.40
. undulating	0.16	0.36	0.55
. hills	0.22	0.42	0.60
Cultivated:			
. flat	0.30	0.50	0.60
. undulating	0.42	0.60	0.70
. hills	0.52	0.72	0.82
Urban zones:			
	30 % impermeable surface	50 % impermeable	70 % impermeable
. flat	0.40	0.55	0.65
. undulating	0.50	0.60	0.80

2.5.2.2. Drainage way cross-sections

The simplest and most widely used method of calculating flows and drainage channel cross-sections is the MANNING-STRICKLER formula as follows:

$$Q = K S R^{2/3} i^{1/2}$$

in which:

Q is the flow rate in cubic metres per second

S the cross-sectional area of the drainage way in m²

R the hydraulic radius

$$R = \frac{S}{p}$$

where p = the perimeter in m

i the longitudinal slope of the water course

K is the coefficient for the surface texture of the drainage way wall.

These values are shown in figure B.16.

Fig. B.16: K values in the MANNING-STRICKLER formula

Characteristics		K
Very smooth walls:	Sand/cement mortar rendering, very smooth; planed planks, sheet metal without protruding welds	100-90
	Smooth mortar rendering	85
Smooth walls:	Planks without careful joints, ordinary rendering, quarry tiles	80
	Smooth concrete; concrete channels with numerous joints	75
	Ordinary masonry; extremely regular earthwork	70
Rough walls:	Irregular earthwork, rough or old concrete, old or roughly built masonry	60
Very rough walls:	Very irregular earthwork with grass; regular rivers with rock beds	50
	Earthwork in poor condition; rivers with pebble beds ..	40
	Completely abandoned earthworks, torrents carrying large blocks	20-15

The water velocity in the channel is equal to the ratio of the flow rate to the cross-section:

$$U_{m/s} = \frac{Q}{S} = K R^{2/3} i^{1/2}$$

For a given type of water course (where the K value has been determined) the MANNING-STRICKLER formula makes it possible to calculate:

- the flow rate, on the basis of a known drainage-way cross-section and slope;
- the drainage-way cross-section where the flow rate and slope are known;
- the slope to be given to the channel where the flow rate and drainage-way cross-section are known.

In erosion protection work, the main parameter to be controlled is the drainage-water velocity. Figure B.17 gives the permissible threshold velocities in these channels.

Fig. B.17: Permissible water velocities in unlined drainage channels (in m/s)

Original surface materials	Clear water without debris	Water transporting colloidal alluvium	Water transporting coarse alluvium: sand, gravel, pebbles
Fine, non-colloidal sand	0.45	0.75	0.45
Sandy, colloidal loam	0.52	0.75	0.60
Loamy, colloidal mud	0.60	0.90	0.60
Muddy, colloidal alluvium	0.60	1.05	0.60
Ordinary compact loam	0.75	1.05	0.67
Volcanic ash	0.75	1.05	0.60
Fine gravel	0.75	1.50	1.12
Compact, very colloidal clay	1.12	1.50	0.90
Mixture of loams and pebbles; non-colloidal	1.12	1.50	1.50
Alluvial colloidal mud	1.12	1.50	1.50
Mixture of colloidal mud and pebbles	1.20	1.65	1.50
Coarse gravel and non-colloidal muds	1.20	1.80	1.95
Pebbles and stones	1.50	1.65	1.95
Schists and volcanic crusts or plates	1.80	1.80	1.50

Table of permissible velocities in grassed channels

Types of vegetation	Permissible velocities (m/s)			
	Clays and loams		Sandy soils	
	Good vegetation	Moderate vegetation	Good vegetation	Moderate vegetation
Bermuda grass - <i>Cynodon dactylon</i>	2.40	1.59	1.50	0.99
Kentucky blue grass - <i>Poa pratensis</i>	1.65	1.11	1.20	0.81
Blue gramma grass - <i>Boutelous gracilis</i>	1.65	1.11	1.20	0.81
<i>Buchloë dactyloides</i>	1.65	1.11	1.20	0.81
Alfalfa - <i>Medicago sativa</i>	0.75	0.51	0.45	0.45

The means of reducing drainage water velocity are:

- Reduce the surface smoothness characteristic K. This may be done by increasing the roughness of the walls of the water course, e.g. by means of a vegetation cover.
- Reduce the hydraulic radius R by increasing the figure for the water perimeter; this may be done using by preference, for waterways of equal cross-section, channels which are large and shallow.
- Reduce the longitudinal slope by placing weirs transversely along the water course.

2.5.3. Main types of construction

2.5.3.1. Natural waterways

These are waterways which naturally collect run-off. When soil conservation works are being undertaken, it may be necessary to make constructions which intercept a larger part of the run-off and concentrate it into natural waterways. This may lead to an increase in the flow rate and cause renewed erosion.

Before soil conservation work is undertaken, it is advisable to improve these waterways if their natural characteristics do not make them suitable for carrying away the water without resultant erosion. One may increase the permissible water velocity by giving the water-course bed a grass protection or by installing anti-erosion constructions at critical sections.

2.5.3.2. Diversion, protection or retention trenches

These are designed to protect crop zones against run-off from upper reaches of the watershed and divert them into a waterway. They also include ditches designed to protect roads, tracks, paths, etc.

They are similar to the ditches, tiers, and terraces shown in Standard Plan No. 9.

2.5.3.3. Grassed channels (cf. Standard Plan No. 13)

These are usually resectioned waterways which have been grassed to ensure that the water velocity does not exceed the threshold value.

They are slightly convex and have a very flattened trapezoidal cross-section:

- the bank slope is very slight, being 4/1-6/1;
- the total width varies depending on the flow rate;
- the channel depth is very small and varies depending on the critical velocity and slope.

Grassing requires careful sowing and favourable climatic conditions when natural grassing is not sufficient. The grass must be carefully supervised. When the channel is very large, a natural vegetation of shrubs and bushes can be allowed to grow. When the transverse slope is very slight, another system used is the American "flood-way" in which the bed width is restricted by two parallel bunds as shown in the diagram below.

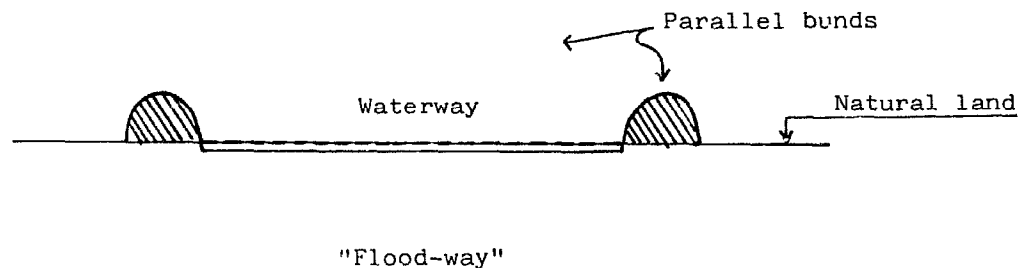

2.6. Bank, channel and gully protection

Bank cave-ins, meander formation and gullying may reduce the area of cropped land. Concave gully banks are undercut by water and gradually retreat. Control measures include the protection of the bank by natural vegetation or by various obstacles or by displacing the cutting power of the current towards the centre of the water course. The techniques employed vary considerably depending on the force of the water, the extent of the phenomenon and local resources.

2.6.1. Stabilising banks with vegetation

The most simple approach is to allow natural vegetation to grow by protecting it against the ravages of cattle, fire and other deleterious elements.

Protection can be provided by fencing off the zone on each side of the gully. The fenced zone should be 3-8 m wider than the gully. If the banks are too steep, earth-moving work may be necessary to provide a shallower slope - a minimum of 1/1 or better still 1/2, on which vegetation can obtain a footing.

The most resistant and least demanding plants will appear the first. These are what are generally called "weeds". They help to prepare the soil and are followed by shrubs and bushes.

Where humus loss is high, the process of vegetation development can be promoted by covering the soil with branches, straw and leaves.

When natural vegetation does not suffice to cover the banks with sufficiently dense growth, a planting programme may be called for, using trees, bushes, creepers, brambles, etc., with preference being given to local species.

Grassing over the banks may ensure good protection. However, this requires well prepared seed and a relatively fertile soil. A variety such as Bermuda grass (*Cynodon dactylon*) which flourishes under difficult conditions and stabilises the soil well, may be used.

Use may also be made of trees such as willows and poplars in wet soil, false acacias in dry soil and privet, wild blackberry and plum, elder, poplars, acacias, etc. A number of grassing techniques may be used; seed broad-casting; sowing in furrows on the upper slopes (1/2); turves, or plants of selected species placed in holes. Where possible, use should be made of seeds or plants taken from close by. Precautions should be taken to protect recently sown area against water erosion. Wire-link fencing of 1 x 3 cm mesh will catch floating debris and ensure protection in this way.

2.6.2. Protection of banks by construction works

2.6.2.1. Summary protection

The methods used vary considerably and depend mainly on local resources. Examples are shown in Standard Plans Nos. 14, 15 and 16.

These measures may include, inter alia:

- branches and reeds laid out on the banks and anchored by stakes;
- anchoring stakes intertwined with steel wire;
- "jacks" or "parrots" made up of tree trunks splayed out, anchored at their base by stones and retained by a chain;
- pallisades made from wood and wattling.

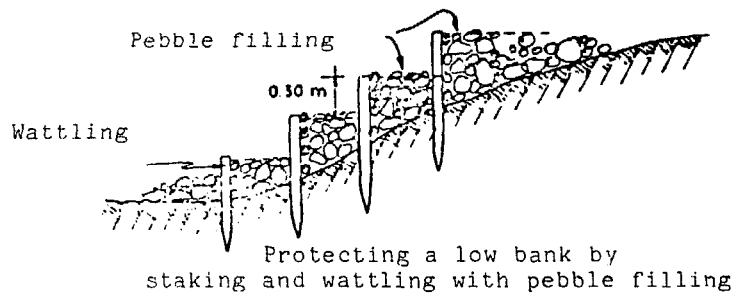

2.6.2.2. Stonework protection (Standard Plan No. 17)

With this technique, the bank is reprofiled to a slope of 2/3 or 1/2 and stone is laid out at random on the bank.

The mean diameter of the stones should be calculated to ensure that they cannot be carried away by the current (Izba formula). The stone facing may be 0.6-1.20 m deep and should be at least 1.5 times the mean diameter of the stones used. When the bank has recently been filled or where the soil is crumbly, a filter layer of gravel should be placed between the bank and the stonework. This layer should be 15-20 cm thick.

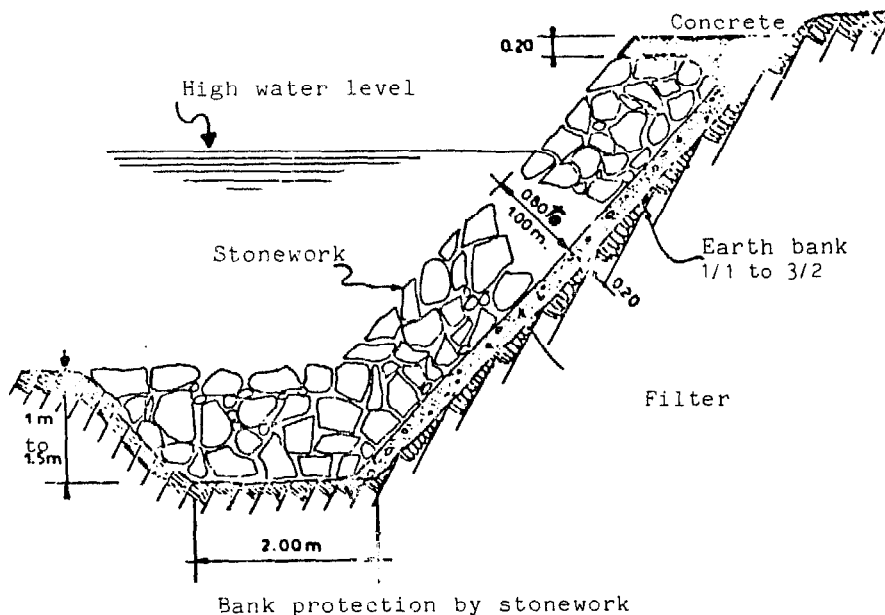

If the base of the bank is accessible at low water, a footing is installed at the stonework base in a trapezoidal trench 1-1.50 m deep and 1-2 m wide at the base.

The advantage of the stonework is that it can be laid at random. It immediately combats any undermining which takes place at the base and thus ensures excellent protection; however, frequent refilling is required at least during the first year.

2.6.2.3. Bank protection with fascines and stonework



Slope protection with fascines

Fascines are used to produce boxes which are then filled with rocks. The fascines which are laid out along the contour lines are held in place by stakes made of freshly cut wood which start off the shrub growth on the bank (see Standard Plan No. 16).

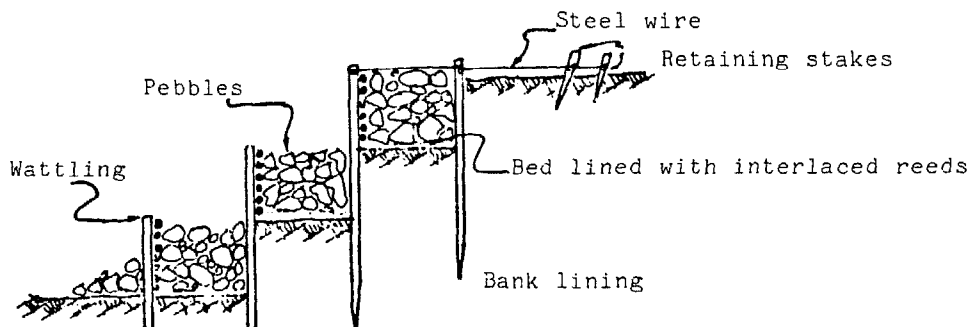

2.6.2.4. Bank protection using gabions (see Standard Plan No. 17)

Gabions are wire mesh packages filled with stone and linked together (see Chapter E). They provide excellent bank protection, in particular since they mould to the shape of the bed as and when undercutting occurs.

When the fill behind the gabions is crumbly, it is advisable to provide protection by a screen of reeds, rushes, etc., or a gravel filter.

2.6.2.5. Bank protection by masonry work

This type of protection is seldom used for crop land since it is much more expensive than random stonework or gabions. In addition, it is much less flexible than the latter and more liable to undercutting.

Where the water carries pebbles of over 0.10 m in size, the masonry work should be made up of blocks approximately 0.60 m in depth and the joints should be filled with bituminous material.

2.6.2.6. Bank protection by groins (see Standard Plans Nos. 18, 19)

Groins are constructions, anchored to the bank, designed to divert the erosive force of the water towards the centre of the water course.

In gullies, the height of the groin is restricted to the section of water in which alluvial drift occurs. The top of the groin rises in steps to the anchoring point on the bank. The groin is directed downstream at an angle of 10-50° to the direction of flow.

The length of the groins should not be more than 1/3 or 1/4 of the bed width to ensure that the water flow is not hindered.

The groins may be made of a variety of materials. The Standard Plans Nos. 18 and 19 give some examples of the most commonly used types of groin. These include:

-
- groins made from logs or fascines;

 - stone rubble groins;

 - gabion groins;

 - masonry work groins;

 - groins with a concrete superstructure.

The gabion groins are simple in design but nevertheless extremely effective. In addition, their construction requires larger quantities of unskilled labour.

2.7. Correcting the slope of water courses

2.7.1. Role of constructions

These transverse constructions are intended to reduce the water energy in steeply sloping water courses and to control regressive erosion.

The principle behind these constructions is to produce waterfalls by creating obstacles to the solid materials transported and to reduce the longitudinal slope between each fall and at the same time the water velocity.

A distinction may be made between provisional constructions which are intended to allow the growth of stabilising vegetation, and permanent constructions.

2.7.2. Type of work

2.7.2.1. Stabilisation by vegetation

The direct stabilisation of the longitudinal profile by means of vegetation is a system used in the US for small or medium-sized gullies. It can be carried out as follows:

-
- (a) By shrub barriers planted across the flow line. The shrubs are planted close together in rows and, in addition, there may be a row of stakes 30 cm downstream. Tree barriers reduce the water flow velocity and allow loam to accumulate behind the dams.
-
- (b) By planting grass turves across the flow line where erosion starts at the head of small gullies. This is an expensive process which can be used when soil does not make direct grassing possible. The flow rates must be low.
-

2.7.2.2. Small temporary dams
(see Standard Plans Nos. 20 and 21)

These are intended to reduce the water velocity, retain fine soil and promote the growth of vegetation upstream.

These works should:

-
- have a height of 30-45 cm;

 - should be spaced relatively close to each other to reduce the water speed to a minimum (virtually zero slope);

 - be anchored at an adequate depth in the base and banks of the gully;

 - be supplemented by overflow collectors of adequate capacity to evacuate flood water during the period of use.
-

A very wide variety of materials are used for the construction of these small dams: earth, piles, steel wire, rubble. In temporary constructions, the materials need not be as resistant as in permanent constructions and the construction need not be so precise. Damage caused by heavy flows of water can be repaired easily at low cost.

The main types of small temporary dams are:

(a) Earth dams

A simple low-height (30-45 cm) earth dam is built across the gully to maintain earth and moisture at the bottom of the water course. A transverse overflow gully is laid out laterally to evacuate flood water. It should be grassed over to provide protection against erosion. These are suitable for small flow rates.

(b) Branch weirs

Weirs made of branches are easy and cheap to build and they are adequate for small flow rates.

In the case of small gullies (2-3 m wide), straw is packed at the base of the gully and held in place by branches fixed to the banks with piles.

It is also possible to use a series of piles laid out across the gully and filled with packed straw.

For larger gullies, the arrangement shown in Standard Plan No. 21 can be used.

The water should flow over the centre of the weir which is kept lower than the sides to ensure that the water does not flow around the outside and over the banks.

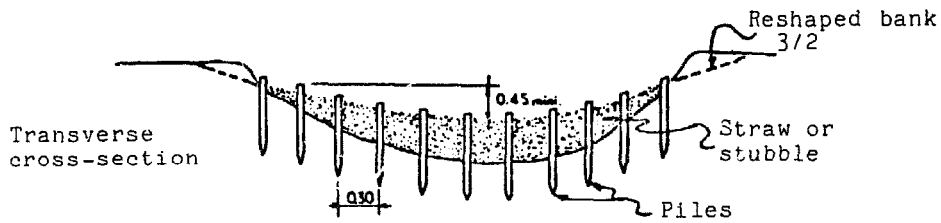

Pile and straw weir

(c) Wire mesh weirs

Wire mesh may be used instead of branches to retain the packed straw for the weir.

(d) Dry-stone weirs

These are used for small and medium gullies on slight slopes and when materials are available in adequate quantities.

These constructions usually have a service life longer than that of the other constructions mentioned above. They are also more flexible and can be more readily adapted to changes in the land by filling up hollows that may occur below the weir.



Example of a dry-stone weir

The most solid are those made from stone slabs placed edge to edge.

Where the stones are more irregular or rounded, they may be held in place by wire mesh.

Dry-stone weirs are usually less than 60 cm in height, but, under exceptional circumstances, may be as high as 1.00 m. In such cases it is essential to ensure that the footing downstream is well protected. The downstream footing should be equal to at least 1.5 times the fall of water.

The overflow lip should be located in the centre of the water course and should be 10-20 cm below the maximum height of the weir. The width of the overflow lip can be calculated from the maximum flow rate using the formula for flow over a solid threshold. This lip may have a dished, rectangular or trapezoidal shape.

With rectangular overflow lip



(e) Gabion weirs

These can be a good substitute for dry-stone weirs when the stone available on site is of poor quality. Gabion check dams have good resistance to water flow and have the same flexibility as dry stonework.

Footings of gabions can be combined with a dry-stone superstructure in small dams to form a base so that the height of the fall can be increased.

2.7.2.3. Small permanent weirs

These are intended to permanently stabilise the longitudinal cross-section of a gully when vegetation growth is not adequate.

Structures of this type are built from materials which are more resistant than those mentioned above and in view of their higher cost, special precautions should be taken in their construction.

The principle is to ensure that the bays between the structures have a slope on which the water will not build up an erosive velocity; this is the deciding factor in spacing the structures.

When the slope is too steep, the number of structures will be excessive and, in this case, secondary check dams can be installed between the main structures, thus increasing the spacing.

The main materials used are dry stone, masonry, gabions and concrete.

The factors entering into the calculation and design of such structures are:

-
- (1) the size of the spillway;

 - (2) the stability of the structure;

 - (3) infiltration of water below the structure which may create leaks and fissures downstream.

It is therefore necessary to have data on:

-
- the peak flows to be evacuated throughout the structure's life;

 - the nature of the foundation land for a depth of at least the height of the structure.

If there is an impermeable layer in the subsoil, the dam foundations should be constructed on this.

In other cases, sufficiently deep trenches should be constructed to divert trickles of water. Examples of this type of structure are shown in the Standard Plan.

In this type of dam, the flow occurs over the crest of the structure by means of dished, curved, rectangular or trapezoidal spillways.

(a) Spill structures (sills, guide channels)

These are intended to halt regressive erosion in a channel or gully in the event of a natural ledge.

In the case of small channels, these structures may be temporary and made from dry stonework or branches. In larger gullies or channels, they will be structures with a chute, made from gabions, masonry or concrete.

(b) Small earthwork dams

Establishment of water reservoirs behind small earthwork dams can help in controlling gully erosion by halting water courses near to their point of origin. These are merely small dams with a height of no more than 3 m and a reservoir capacity of several thousand cubic metres. The design of larger dams is beyond the scope of this document and reference should be made to specialised manuals.

The operating principle of these structures is not erosion protection but the creation of a temporary or permanent water reservoir for use in irrigation, the watering of cattle or fire fighting.

The construction of small dams requires consideration to be taken of the following data:

-
- rainfall patterns;

 - the nature of the feeder zones: surface, vegetation cover, nature of the soils to determine run-off coefficients and discharge volumes;

 - the size of solid flow which may fill the retention basins;

 - the characteristics of the land for the dam foundations: depth, permeability (drill samples).

The dam should be located in a neck of the valley downstream from a hollow in order to minimise the dam dimensions. The ratio between the reservoir capacity and the dam volume should be at least 3.

The dam comprises a barrier, a spillway and intake and discharge structures.

In the case of an earthworks dam approximately 3 m high, the most common construction specifications are as follows:

-
- slope of upstream bank: $1/2-1/3$;

 - slope of downstream bank: $1/2$;

 - height of dam crest above highest water level (freeboard): 0.30 m;

 - height of the dam crest above the normal water level: 0.80 m;

 - crest width: 1.20 m minimum;

 - stripping of earth over the foundation to a depth of 0.20-0.30 m to remove all the topsoil;

 - building of a trench 1.50 m wide along the dam axis down to the impermeable substratum. This trench will be filled with compacted impermeable earth;

 - fill of impermeable clay earth containing no more than 30-40 per cent clay. The fill is laid out in thin layers of 15 cm thick and compacted;

 - the upstream wall of the dam is protected against wave impact by grassing or, if this is not possible, a lining of gravel or dry stonework.
-

The size of the spillway should be calculated to evacuate floods of ten-year intervals. This may account for a major part of the total dam cost. The most simple are natural grassed spillways which must be sufficiently large, shallow and of gentle slope to evacuate flood water at moderate speed. Where construction work requires excavation, the cross-section usually employed is trapezoidal with a slope of $1/4$.

Where adequate grassing cannot be obtained or the discharge to be evacuated is too large, it will be necessary to construct an artificial spillway in gabions, masonry or concrete. Such constructions may not be justifiable for small dams.

A drain channel is provided for exploitation of the water and this is usually made of a concrete tube held in place by concrete collars and protected against undermining.

The sluice pipe is used to evacuate small quantities of excess water without it being necessary for them to flow over the main spillway. It is similar in design to the drain channel.

2.7.3. Principles of calculating structure dimensions

Given below are a few simple formulae for calculating the dimensions of small river structures (weirs, dams).

2.7.3.1. Calculating spillway discharge

Two cases should be considered depending on whether the sill is "wet" or "dry".

(a) Dry sill

It is assumed that the sill is dry when:

$$z > \frac{2H}{S}$$

The flow is calculated by the following general formula:

$$Q = m \sqrt{2g} \cdot H^{3/2} \cdot L$$

in which:

Q = the spillway flow in m³/s

m = the coefficient depending on the shape of the spillway sill

H = the height in m from the crest of the spillway

L = length of spillway in metres.

In practice, the following values are used for m:

-
- profiled spillway sill: m = 0.46;

 - thin wall sill (thickness of the wall is less than the thickness of the water spill): m = 0.40;

 - thick sill (the thickness of the sill is greater or equal to that of the water spill): m = 0.38.
-

(b) Wet sill

A reduction coefficient is applied to the preceding formula. This coefficient is calculated as follows:

$$m' = m \left(1.05 + 0.2 \frac{D}{S} \right) \sqrt[3]{\frac{Z}{H}}$$

where m = coefficient for dry sill

D = total height of water upstream from the sill

S = the height of the sill

Z = the difference in level between the upstream and downstream edges of the spillway

H = height of the head of water on the spillway.

2.7.3.2. Length of the stilling basin

It is possible to use the Rehbok, Schoklitsh and MCD formulae.

The length of the stilling basin must be one or two times the height of the chute.

2.7.3.3. Face slopes for a small earthwork dam

It is possible to empirically adopt the slope values given by Terzaghi's classification (slope = $\frac{\text{height}}{\text{base}}$).

Types of soil	Upstream slope	Downstream slope
Homogeneous soil of wide-ranging particle sizes	2/5	1/2
Homogeneous coarse silt	1/3	5/2
Homogeneous silty clay	2/5	1/2
Sand and gravel with clay core	1/3	2/5

2.7.3.4. Protection against water seepage under the dam

Lane's rule can be used to check that seepage under the dam does not present a danger of leakage.

$$L_v + \frac{L_h}{3} \leq m \cdot h$$

In which:

L_v = the length of the vertical path

L_h = the length of the horizontal path

h = the difference in head between the upstream and downstream sides of the dam

m = Lane's coefficient, the values for which are given below:

Type of foundation	Value of m
Very fine sand	8.5
Fine sand	7.0
Medium sand	6.0
Coarse sand	5.0
Fine gravel	4.0
Medium gravel	3.5
Coarse gravel	3.0
Gravel and sand	2.5
Medium clay	2.0
Compact clay	1.8
Hard clay	1.6

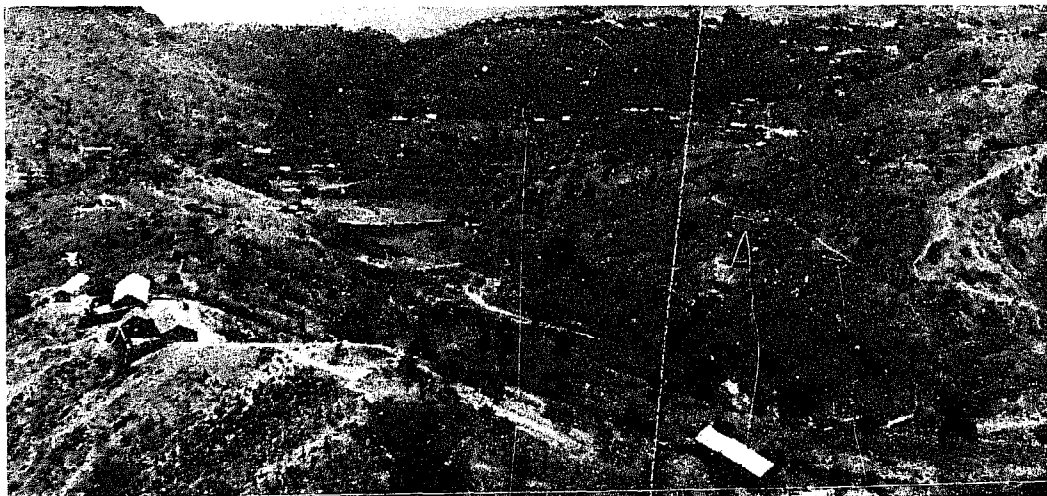

Gully correction structures in Cape Verde

B.3. WIND EROSION PROTECTION TECHNIQUES

3.1. Dune stabilisation

Dunes are large sandy areas which can be moved by the wind when they are not stabilised by vegetation. When moved by the wind, these dunes can cover agricultural zones, render them sterile, block traffic routes, damage housing and result in the abandonment of entire regions.

Sand, when carried by the wind at soil level, forms dunes when confronted with various obstacles: branches, hedges. These move in the direction of the dominant wind and may take on a typical crescentic shape with their tips pointing downwind with a gentle slope facing towards the wind and a much steeper slope facing away from the wind.

There are two major categories of dune: maritime dunes and continental dunes.

- Maritime dunes are found to some degree or other throughout the world on low sandy coasts with regular winds blowing in from the sea.
- Continental dunes form in arid regions and are often the result of vegetation destruction by cattle grazing.

3.1.1. Conventional techniques for stabilising maritime dunes

The most widely used technique was developed in Europe in the nineteenth century and was used successfully to reafforest the Gascogne Landes in France with pinus pinaster. The technique comprises three main phases:

-
- the creation of an artificial "coastal strip";
 - stabilisation of the dunes behind the coastal strip;
 - reafforestation of the stabilised dunes. This dune stabilisation technique is highly labour intensive.
-

(a) Creation of the coastal strip

The objective is to reduce the quantities of sand carried and deposited by the wind by creating a slope which would form an obstacle to the progression of sand particles.

The first step in establishing the coastal bar is to lay out along the beach above the high water mark, a wattling between 0.75 and 1.00 m high made out of wooden stakes sunk into the sand and intertwined with close branches. Where wooden stakes are not available, it is also possible to use sheets of fibro-cement or sheet piling; however, this is expensive and can be envisaged only in special cases.

When the mound of sand that has accumulated behind the wattling has reached a height of 0.50-0.75 m a second wattle barrier is placed on top of the first and this is continued until an equilibrium profile has been obtained, i.e. until the sand grains can no longer pass over the obstacle. This may be reached within a few years with a slope of 30-40 per cent and a height of approximately 10 m.

When the dominant wind is not perpendicular to the beach, groins constructed in the same way are run out from the main wattle fence intended to halt the movement of sand along the barrier. If a single coastal bar is not sufficient, a number can be built parallel to each other.

(b) Dune stabilisation

This is intended to create conditions which are favourable for subsequent reafforestation. This may be carried out with hardy perennial plants, wattle fences or by covering the soil with branches.

Cover plants must ensure good soil coverage, have rapid growth and be resistant to burial by sand. They can be sown or propagated by cuttings. The first rows of plants should be resistant to both the wind and wind-borne sea salt. Seeds may be carried away by the wind and it is advisable to sow during the least windy season or protect the seeds by covering them with straw and branches. Propagation by cuttings often gives the best results.

Some of the species that have been used with success are marram grass (*ammophila arenaria* in Europe and North America), a member of the convolvulaceae family, *ipomea pescaprae* in Madagascar and, in the North Cameroon, *stylosanthes gracilis*, *melinis tenuississima*, *digitaria unifloris*, *cynodon dactylon*, *pennisetum clandestinum*.

Rows of small wattle windbreaks made of cut branches, bamboo, palm leaves, reeds, etc., are used when the vegetative cover is inadequate. These small windbreaks of 0.5-2 m high are laid out in a network of 2-40 m in dimension. Depending on the situation, these windbreaks can also be made up of plants such as *saccharum aegyptiacum*, as in Tunisia.

Another process which can be combined with the preceding one, is to cover the sand with dead branches or other plant debris.

(c) Reafforestation

The reafforestation of stabilised dunes is carried out by means of nursery grown plants. The planting techniques are the same as those described in section B.1. The species used should be resistant to the effects of wind and salt and one cannot expect trees to grow suitably in a strip 200 m wide from the coastal bar. The plants should be close together: a network 1 x 1 m on the wind exposed side and 2 x 2 m on the sheltered side.

In an arid climate, grasses which have been planted to stabilise dunes will compete closely with the young plants for water.

In certain very favourable climates with long rainy periods and high temperatures, it may be possible to plant trees directly without any other method of preparation.

3.1.2. Techniques for the stabilisation of continental dunes

The principles of stabilisation may be the same as those used for maritime dunes but the climatic conditions in arid zones do not always make it possible to use them; this is the case in the Sahara, for example.

The procedures that can be used to reduce soil exposure to the wind are mainly preventive together with pasture and track control. The other procedures used are:

-
- fascines (palm leaves in the Sahara);

 - straw covering and grassing;

 - planting of windbreaks.

3.1.3. Dune stabilisation by a coating of bituminous products

This is a modern technique which has been used for afforestation in the US, Kuwait, India, Pakistan and, recently, in Libya and Tunisia.

A bituminous emulsion is spread over the sand surface and penetrates to a depth of 2-3 cm. When the emulsion dries it forms a crust which provides complete protection against the wind. The emulsion is spread mechanically: a bulldozer-drawn tank and a spray gun. In Libya, each vehicle covered 4 ha per day. It seems that the substance has toxic effects on certain trees (acacia, eucalyptus) if the product is applied after planting. If it is applied before planting, planting work seriously damages the protective layer and reduces its effects.

This technique requires only small amounts of labour, except for conventional planting procedures.

3.2. Crop land protection

3.2.1. Windbreaks

The objective of these is to reduce wind speed to less than 18-25 km/h at which level the wind loses its erosive effect. The windbreaks are composed of trees and shrubs.

The distance protected is proportional to the windbreak height. When the wind is blowing perpendicular to the windbreak, the wind speed is reduced over a distance of up to 20 times the windbreak height.

Wide windbreaks are not necessarily more effective than narrow windbreaks. The best results are obtained when the windbreak height is approximately the same as its width.

By reducing wind speed and increasing humidity, windbreaks reduce vaporisation. Dense windbreaks are more effective from this point of view. They may create a favourable environment for afforestation in a semi-arid zone.

An example of a dense windbreak used in the US uses a number of different species in order to create a dense foliage over the total height of the windbreak. Shrubs are planted densely on the windward side. The central zone is made up of tall trees and the intermediate zones contain trees which are somewhat less tall. The whole has a triangular cross-section which forms a dense vegetation barrier over its total height.

3.2.2. Other techniques

These are cropping techniques which are carried out with normal farming resources and employ little labour. Examples are:

-
- use of cover crops in rotation or in fallow land;

 - leaving crop residues in place as long as possible after harvesting;

 - parallel-strip cropping;

 - tillage which maintains the soil in clods, by avoiding tools which produce too fine a tilth;

 - green manuring.

3.3. Pasture protection

This is a problem which is encountered particularly in extensive semi-arid regions such as the Sahelian regions. Goats and sheep are the wind's best helpers in preparing land for wind erosion.

Control is mainly by limited grazing and banning certain zones.

CHAPTER C

REHABILITATION TECHNIQUES FOR WATERLOGGED SOILS

C.1. AIMS OF DRAINAGE

The aim of drainage is to evacuate water in excess of vegetation and soil requirements. Certain soils have a natural drainage system others do not; these latter require the installation of an artificial drainage system.

Drainage creates in the soil the conditions required for good plant development and promotes soil aeration and root penetration. It improves the soil's physical qualities and makes it possible to reclaim zones which were previously considered unsuitable for cultivation.

In irrigated zones, drainage is linked to leaching techniques to prevent accumulation of toxic salts in the soil and also to prevent gullying and soil erosion.

Drainage techniques are suitable for labour-intensive work in activities for the good of the community.

C.2. DIFFERENT TYPES OF DRAINAGE

2.1. Open ditches

These are the most simple and most widely used. They are suitable for a wide range of flow rates with very slight or zero slopes provided they are of adequate cross-section.

They are most effective from the drainage point of view since they intercept both ground water and surface run-off. Their construction and maintenance are highly labour-intensive when no machines are available.

Their main disadvantages are their size in view of the large area that they take up on crop land and the hindrance they cause to the movement of machines and animals and men. Where the drainage requirement entails only short distances between ditches, the land loss and the hindrance become excessive and preference will be given to underground drainage. Open ditches are therefore used mainly for low density networks and when they are also required to evacuate surface water.

Channels are a type of small open ditch or gully designed to evacuate surface water. Channel networks are usually installed on pasture land or when the agricultural value of the land does not justify the installation of underdrains. The

channels are usually 40-50 cm deep, 0-0.20 m wide at the base and around 1 m wide at the surface. They can be dug by hand or by machine. If they are to remain effective, they require relatively frequent maintenance.

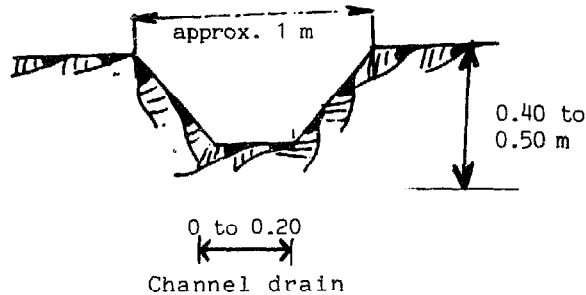

Farming techniques can achieve the same objectives as channels. Beds 8-30 m wide and 0.50 m high are constructed or furrows and ridges cut down the slope with a ditch at the base of the slope to collect the water.

2.2. Underdrains

These are collectors made of drainpipes or other piping material, which are buried in the soil. They can be interconnected between each other and run into a drainage ditch or into a natural collector. They cannot be used to evacuate surface water directly.

This type of drainage is expensive and is suitable only for soils with a high commercial yield. It does however have the advantage of requiring minimum maintenance and to have a long service life if it is correctly installed. Another advantage is that the land over the drain is free for cultivation. A very wide range of materials are used for underdrain construction. Certain are traditional materials and can be of interest in regions where modern drainage materials are difficult to obtain or expensive.

The main types of underdrains are:

2.2.1. Fascine drains

A trench is dug to the required dimensions, the bottom is filled with fascines leaving a space for water drainage. The fascines are covered with the trench backfill.

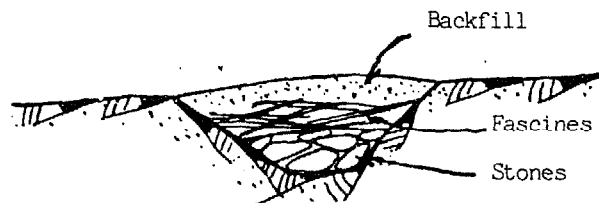

Fascine drain

2.2.2. Stone slab drains

A cavity is produced using stone slabs placed at the bottom of a trench.

2.2.3. Drains with stone backfill

These drains are made with round stones so that the water can run off through the gaps between them. They clog up easily.

2.2.4. Wooden box drains

These are suitable for soft and marshy land. They are made using a wooden box structure with an internal dimension of 7 cm or more. They are used only rarely.

2.2.5. Peat drains

These are used in peaty soils in which the peat itself is used to form the drain.

2.2.6. Earthenware piping drains

These have been used since the beginning of the nineteenth century. They comprise fired clay pipes between 5 and 15 cm in diameter and usually 30 cm in length. Also, they usually have flat ends and consequently they may be moved out of alignment if the earth settles. To overcome this disadvantage, interlocking drain pipes have been produced in the Netherlands. Fired clay pipes are manufactured in brickworks in the same way as tiles. They should be of very good quality if breakage is to be avoided during laying and if they are not to crumble under the effect of water. All defective drains should be eliminated before laying.

2.2.7. Concrete drainpipes

These are used where fired clay pipes are difficult to produce. They are of similar dimensions.

Concrete drainpipes are manufactured using special machinery and drainpipe quality depends on the method of manufacture and the quality of the aggregates used. These aggregates should be permeable to ensure good drainpipe porosity; however, the pores are rapidly blocked by fine soil particles in the water. In acid and peaty soils, the concrete is attacked by sulphates in the water.

2.2.8. Bituminous fibre drainpipes

These drainpipes are made of fibre impregnated with bitumen and moulded under pressure. Holes or slots are made in the pipe to allow water to enter. They are lighter than clay or concrete pipes and are more resistant.

2.2.9. Plastic drainpipes

The use of plastic drainpipes is becoming widespread in all types of agricultural underdrainage work.

They are made of rigid or flexible non-plasticised polyvinylchloride (PVC). There are slots at regular intervals in the pipe walls to allow the passage of water. The diameters used are between 30 mm and 100 mm. The characteristics of rigid PVC drainpipes are shown in fig. C.1.

Fig. C.1: Characteristics of rigid PVC drainpipes

Perforated PVC drainpipe				
Exterior diameter in mm	32	40	50	63
Weight in kg	0.110	0.138	0.195	0.273
Wall thickness in mm	0.8	0.8	0.9	1.0

Rigid PVC drainpipes are produced in 6 m lengths and, in special cases, 9 m lengths. The pipes have slits of 35-40 mm long and 0.5-0.8 mm wide perpendicular to the pipes' axes and at intervals of 20-50 mm depending on the type of soil. The slits are staggered. The drainpipes are joined together by a sleeve.

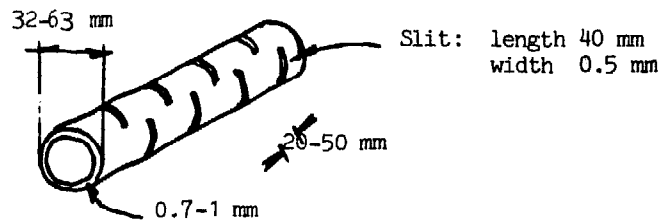

Rigid PVC drainpipe

Flexible PVC drainpipes are supplied in 200-250 m lengths on a drum and are intended for mechanical laying. The pipe itself is corrugated, which ensures greater resistance to crushing and improved flexibility. The main characteristics are as follows:

- Wall thickness: 0.7-1.0 mm
- Connection by T's, sleeves, etc.
- Perforations - circular: 1.5 mm diameter or rectangular 1 x 1.5 - 3 mm
- No. of perforations/m of drain: 600-700
- Surface area of perforations/m of drain: 10-25 cm².

These drainpipes are easily blocked by loam and roots; they are also vulnerable to clogging by ferric hydroxide. During storage before laying they should be protected from sun and weather which causes ageing of the plastic and a deterioration of the mechanical characteristics.

2.3. Mole drainage

Mole drainage is used in plastic and low permeability soils. The technique consists in digging a drain in the soil, without any external support whatever, using a ripper blade fitted with a "mole" - a pointed cylindrical metal tool - which digs a circular drain 0.05-0.12 m in diameter at a depth of 0.60-0.80 m.

These mole holes act as drains but must be closely spaced. They require very special conditions: the soil must be sufficiently plastic, the clay content should

not exceed 30-35 per cent and at the moment they are dug the water content should not be greater than the plasticity limit (ATTERBERG's Plasticity Index). The aggregates should have excellent stability (stability index lower than 1).

The requirements for mole drainage are:

-
- a drain length of less than 80 m between two outlets;
 - a slope between 0.2 and 5 per cent.
-

Mole drainage costs very little but it has a relatively short service life (from three to ten years).

2.4. Subsoiling

Subsoiling is used to mechanically break up hard pans or ploughing compaction which reduce water penetration into the soil.

Subsoiling rapidly changes hydrodynamic characteristics, in particular the soil's hydraulic conductivity and makes it suitable for underdraining. It also loosens and aerates the soil which promotes better root penetration.

C.3. DETERMINING THE CHARACTERISTICS OF A DRAINAGE NETWORK

3.1. Water movement in a drained soil

Water movement in soil is shown diagrammatically in fig. C.2.

It is presumed that the soil is permeable, isotropic and the deep water table is not drained naturally.

Between two rows of drainpipes, the deep water table is convex in shape, the height of the table being at its maximum halfway between the two rows.

A drop of water which infiltrates the soil's surface, first descends vertically into the non-saturated soil under the effect of gravity. When it reaches the water table, it is no longer subject only to gravity and it will flow in the direction of the drain.

Fig. C.2 shows diagrammatically the route taken by water streams depending on their distance from the drain.

Fig. C.2: Water movement in drained soil

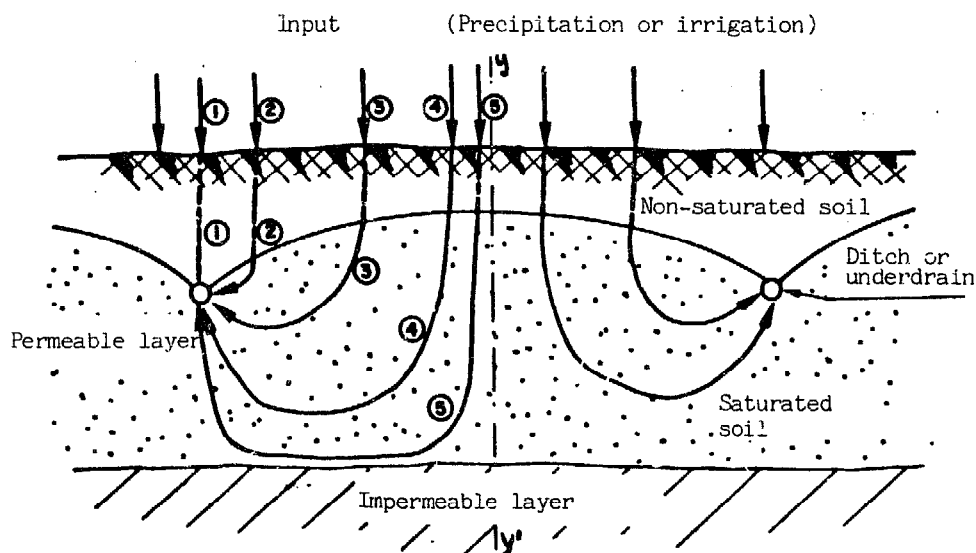

-
- The water drop 1 which falls directly above the drain is subject only to gravity and descends vertically until it reaches the drain.
-
- Water drop 2 reaches the water table close to the drain and finally reaches the drain after travelling a short distance in the saturated soil.
-
- For water drops 3 and 4, the distance travelled in the water table increases. Following predominantly vertical movement in the upper part of the water table, the liquid-flows curve towards the drain and may finally reach it via an upward movement.
-
- Water drop 5 lands the furthest from the drain and its route first descends and then curves when the impermeable layer is reached; it then moves horizontally and the final section ascends towards the drain.
- On the other side of the yy' axis, the situation is symmetrical.
-

When the depth of the permeable layer is small in relationship to the distance between the drains, the flow diagram shows that, in the segment of soil above the drain level, movement is predominantly vertical; below the drain level the movement is predominantly horizontal. The flow diagram differs depending on the depth of the impermeable layer; if this is at the drain level or only slightly below it, horizontal movement in the direction of the drain will predominate. If the impermeable layer is at greater depth, the proportion of vertical movement will be greater. The shape of the water table surface between two drains varies depending on the input rate, the distance between the drains, and the permeability and thickness of the permeable layer.

When the input rate is zero, the water table surface will tend towards the horizontal to reach an equilibrium at drain depth. It may also descend below drain level as a result of capillary losses. If the shape of the water table surface is more convex, it will tend to come closer to the soil's surface the more the distance between the drains is increased or if the thickness or permeability of the draining layer is decreased.

The shape of the water table surface between two drains is, therefore, dependent upon:

- the input rate q ;
- the depth of the permeable layer D ;
- the permeability of the drained layer K ;
- the distance between the drains L .

Fig. C.3.

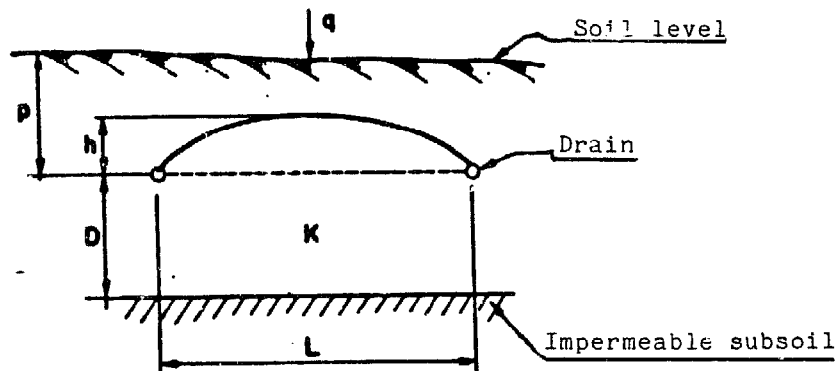

The optimum level of the water table ($p-h$) is the basic datum in drainage problems and it is dependent on crop requirements. The other data are input rate or "characteristic flow rate" q , the depth D and the permeability K of the drained layer.

The interval between the drains is determined on the basis of these parameters.

3.2. Determination of basic data

3.2.1. Causes of wetness

Before trying to solve a problem of soil waterlogging, it is necessary to determine the causes of the wetness. These causes may differ and the control measures should be adapted to each case.

The main causes of soil wetness are:

-
- (a) inflow of run-off water from catchment basins above the zone in question. In such a case, it is necessary to intercept this run-off water and divert it into natural or man-made collectors (cf. Chapter B);

 - (b) river water overflowing into an alluvial plain. In such a case, it is necessary to protect the zone by embankments or to dig drainage ditches to evacuate the flood water in a minimum time compatible with the type of crop;

 - (c) a high underground water table due to specific topographical or geological conditions;

 - (d) a high level of rainfall producing excessive rise in the ground water level or the development of saturated horizons in low permeability soils. In an arid zone, the high level of irrigation required for soil leaching may produce the same effects. In this case, conventional drainage techniques are used;

 - (e) inadequate capacity of natural collectors. This may trap the water and, in such a case, increasing the size of the collector may be sufficient to solve the problem.
-

3.2.2. Optimal water table level

The ability of the top layer of soil to dry out is essential for good rooting of plants and for good agricultural yield. If the water table is permanently too close to the surface of the soil, good rooting will not be possible. A water table which is too low may also have an unfavourable effect since it will not provide adequate capillary water supply during the dry season.

The optimal depth of the water table varies depending on the plant's rooting depth and the soil texture. In a light soil, the water table may be higher than in a heavy soil in which capillary supply is greater.

In the case of leguminous crops for which the roots do not penetrate deeply, the water table should be relatively close to the soil surface (30-60 cm) to ensure optimum yield. This is also the case for grasslands.

Cereals require a water table between 60 and 80 cm below the soil's surface.

Fruit trees require a lower water table of 1-1.50 m or more depending on the species.

3.2.3. Permissible submersion time

Crop submersion covers:

- partial submersion which affects the plant's root system;
- total submersion when the water level rises above soil level and affects the plant stalks.

Total submersion may cause greater damage than partial submersion.

Crop damage caused by submersion depends on:

-
- submersion time;
-
- the point at which submersion occurs in the plant's growth cycle;
-
- the type of plant being grown.
-

In general, submersion of 1-3 days retards development. Submersion of 7-15 days may result in total crop loss.

Grassland may withstand submersion times of 1-2 months prior to the vegetative period. During the vegetative period, submersion for 15 days may reduce yield by 30-50 per cent.

Market garden produce is very sensitive to submersion and even one day's submersion may result in a reduced yield which will vary depending on the species.

Cereals are particularly sensitive to submersion during flowering and grain formation. Maximum loss may be as high as 20 per cent following a three-day submersion.

Fruit trees are highly sensitive to submersion although the results vary considerably depending on the species.

In project planning, one may use the following permissible submersion times:

Market garden crops	1 day
Cereals	3 days
Grassland	7 days

The figure below gives some figures for the effect of submersion on yield:

Fig. C.4: Effects of submersion on yields (maximum loss in percentage of the optimum harvest)

	Submersion time		
	3 days	7 days	15 days
Grassland	-	20	50
Autumn cereals	20	50	100
Spring cereals	20	40	100
Maize	20	80	100
Perennial fodder	10	40	100
Potatoes	50	100	100
Sugar beet	10	50	100
Sunflower	10	40	100

3.2.4. Type of soil - permeability

Permeability is the ability of water to drain down into the soil. It is a significant parameter for calculating a drainage network. Soil permeability depend on texture, porosity and organic-matter content.

A number of formulae relate permeability to soil texture. The most important of these are:

- the SCHLITCHTER formula

$$K_{m/s} = 0.0771 \frac{D^2}{R}$$

This applies when all the soil particles are the same diameter D; the value of R is related to the porosity;

- the HAZEN formula

$$K_{m/s} = 0.01 D_{10}^2$$

D_{10} is the diameter which permits passage of 10 per cent by weight of the portion of the soil made up of particles less than D_{10} .

Use of the formulae will ensure the correct order of magnitude of the results; however, it will not give a sufficiently accurate result for practical purposes.

Direct measurements of permeability is preferable to the use of formulae. This can be done in a laboratory using whole samples or by the direct measurement on soil in situ. The most simple and reliable method is that of ERNST which is also called the "auger-hole method"; the principle is as follows:

A hole is made in the soil with a 4-5 cm auger down as far as the impermeable layer or a depth of 2 m.

As much water as possible is removed from the hole by means of a ladle so as to reduce the ground water level by at least 40 cm. The speed at which the ground water rises in the hole is measured at 5-10 s intervals.

Where:

H is the depth of the hole under the ground water level in cm

S the depth of the impermeable layer below the bottom of the hole in cm

r the diameter of the hole in cm

Y the mean distance between ground water level and the level of the water

Y over a period of time T

K the hydraulic conductivity in m/day.

The hydraulic conductivity is calculated as follows:

$$(a) \quad K = \frac{4\,000\,r^2}{(H + 20\,r) \left(2 - \frac{Y}{H}\right)} \times \frac{\Delta Y}{\Delta t} \text{ if } S \geq 1/2 H$$

$$(b) \quad K = \frac{3\,600\,r^2}{(H + 10\,r) \left(2 - \frac{Y}{H}\right)} \times \frac{\Delta Y}{\Delta t} \text{ if } S = 0 \text{ or if } S < 1/2 H$$

Fig. C.5: ERNST's method

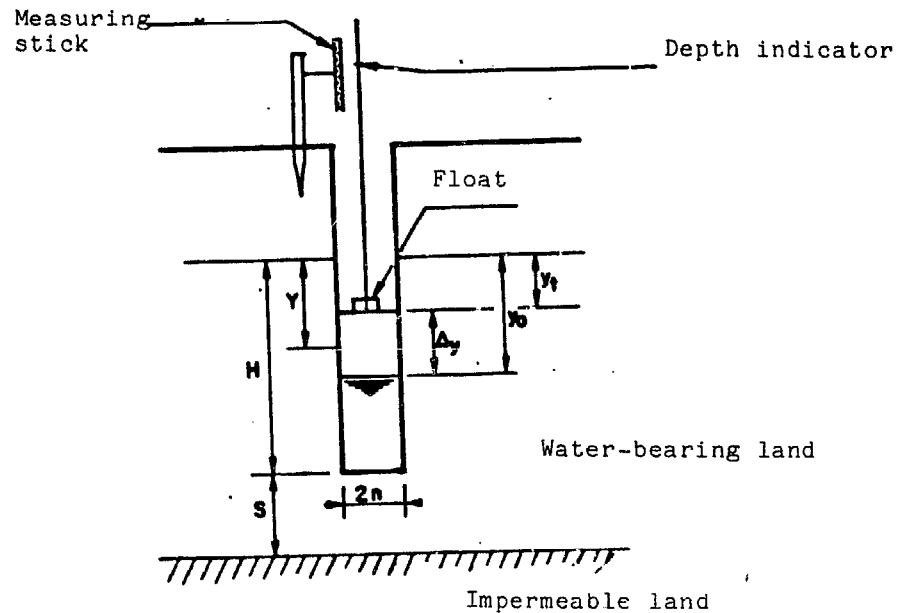

3.2.5. Intrinsic flow rate of network

This is the flow that the drainage network must collect and evacuate in relation to a unit of the land's surface area. The intrinsic flow rate is determined by the following equation:

$$q_c = \frac{1 - e}{0.36} i$$

where q_c = the intrinsic flow rate in l/s/ha

e = the coefficient of evaporation (a dimensionless number lower than 1)

i = critical rainfall intensity in mm/h.

The critical rainfall is the rainfall for a time θ corresponding to the permissible submersion time for a recurrent time T . The values for time θ and recurrence time T depend on agricultural and economic factors.

3.3. Calculating the drainage network

3.3.1. Network design

The design and layout of the drainage network depend primarily on topographical factors. The first task is to locate the thalweg (middle line of a river) and the crest lines. The main collector drains should be located along the thalweg. Minor drains should empty into the main collector drains without ever crossing a crest line.

The minor drains should be laid out at right angles to the lines of greatest slope, i.e. more or less parallel to the contour lines. Where the slope is very slight (less than 0.003), they may be laid out parallel to the slope. The minor drains are also placed at right angles to the ploughing direction (see fig. C.6).

Fig. C.6

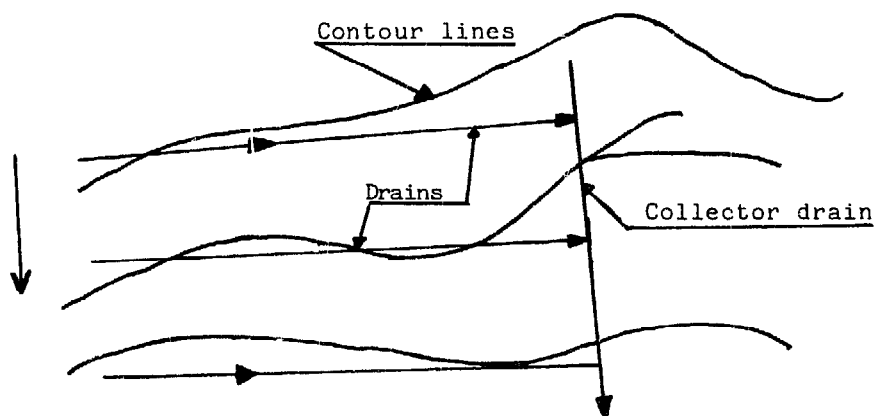

The collectors are always laid out along the line of greatest slope. The main collectors are situated in the main thalwegs and the secondary collectors in the secondary thalwegs.

The layout of drains and collector/drain combinations may vary depending on the terrain, and should therefore be adapted to each specific case. Some typical layouts are shown in fig. C.7.

Fig. C.7: Layout of a drainage network

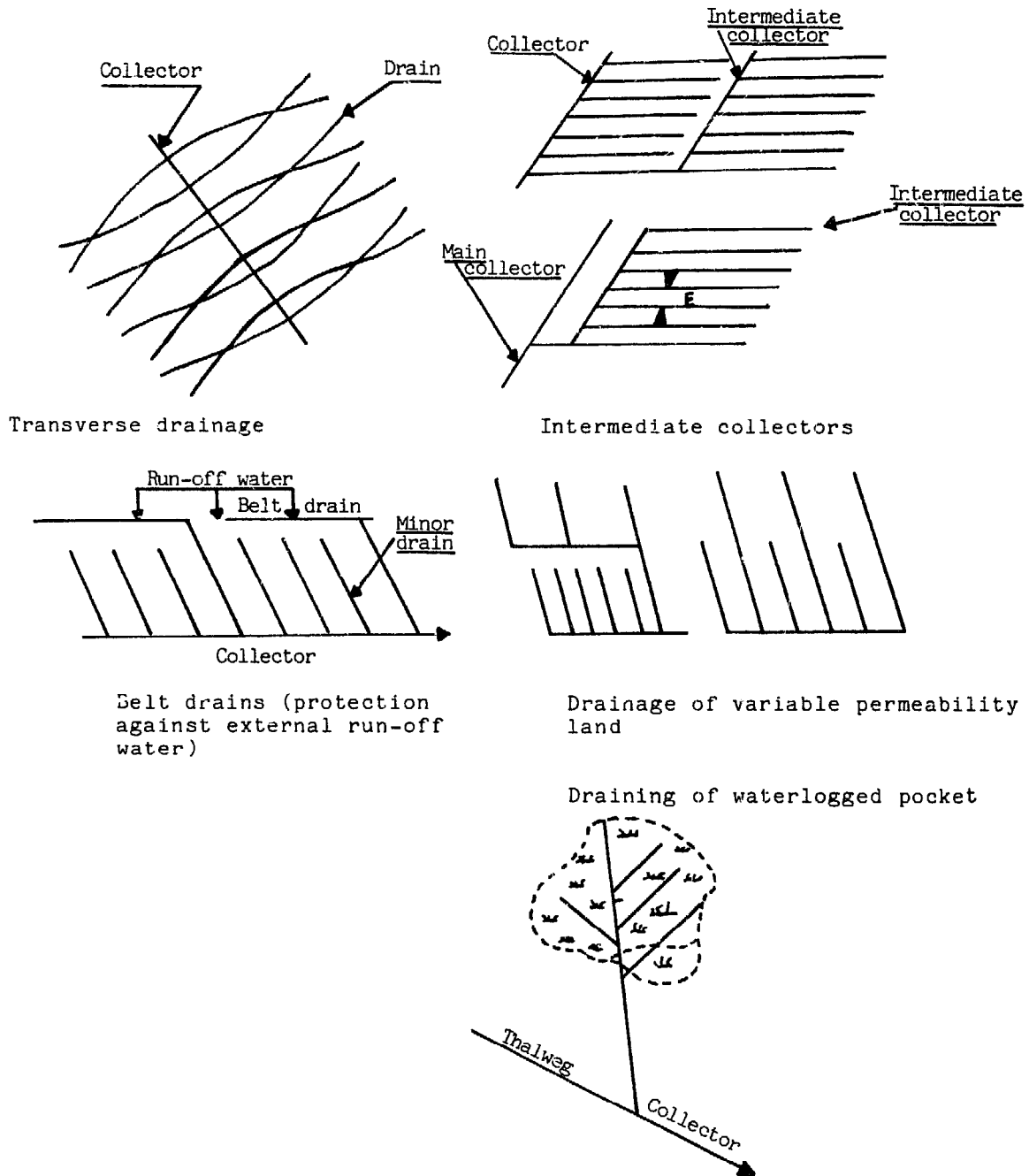

3.3.2. Drain depth

The depth and spacing of drains are two closely linked parameters. As drain depth is increased, spacing between drains may also be increased. In homogeneous land, deep drainage has a certain number of advantages over superficial drainage since:

-
- the water table is lowered further, giving better soil aeration;

 - drains may be more widely spaced, which results in a reduction in drain number and drainage cost;

 - drains are in this way protected against root invasion which tends to clog them.
-

On the other hand, deep drains tend to cause a too rapid fall of the water table in the dry season.

In heterogeneous land, a pedological study should be carried out to determine the most suitable drain depth.

If the permeable soil overlies a very impermeable subsoil, it is preferable not to put the drain into the impermeable layer but to locate it at the borderline of the two layers.

If the impermeable land lies above a permeable subsoil, one should try to locate the drain as deeply as possible in the subsoil.

For practical purposes, drain depth varies between 0.70 m and 1.50 m. A depth of 0.60-0.80 m is considered small; a depth of over 1.20 m is considered as deep drainage.

On very slightly sloping land, the drain depth will depend on drainage slope and the depth of the outlet. It may be necessary to have the drain shallow at the start and deeper as it approaches the outlet to ensure a sufficient slope for the water to drain away effectively.

3.3.3. Drain spacing

3.3.3.1. Selection of methods of calculation

A distinction should be made between two regimes of drain water input and output: the permanent regime and the transitory regime.

A large number of formulae have been developed for calculating drain spacing for the permanent regime. These presuppose constant input. They may be used in Europe and anywhere else where rain is of long duration and low intensity.

In irrigated zones and in regions of high intensity and short duration rainfall, drain water input is not constant and it is therefore necessary to use transitory regime formulae.

Calculating the spacing between drains is easier for the permanent regime than for the transitory regime; moreover, use of the permanent regime formulae is often justifiable even in the transitory regime, especially when precise knowledge about food conditions and hydrological constants is not available.

3.3.3.2. Calculating drain spacing in the permanent regime

(a) The HOOGHOUTD formula

Drain spacing is given by the following formula:

$$L^2 = \frac{8 K_2 d h}{q} + \frac{4 K_1 h^2}{q}$$

where:

- L = the spacing between drains in m
- q = the intrinsic flow rate in m/days or m^3/m^2 of the drained zone
- K_2 = the hydraulic conductivity of the layer below the drain in m/day
- K_1 = the hydraulic conductivity of the layer situated above the drain in m/day
- h = the height of the water table above the drain level halfway between the two drains (in m)
- d = the depth of the equivalent layer. A value which is a function of the spacing between the drains L, the drain radius r and the depth D of the the impermeable layer below the drain (see Fig. C.8).

Use of this formula presupposes that the boundary between the two permeable layers is at drain level, which is not always checked. The calculation is carried out by successive approximations, with d not being known accurately until L is already known.

Fig. C.8: Values of d in the HOOGHOUTD formula

r = 0.10 m	
L → 3m 7.5 10 15 20 25 30 35 40 45 50	L → 50 75 100 150 200 250
D	D
0.5m 0.47 0.48 0.49 0.49 0.50 0.50	0.5m 0.50
0.75 0.60 0.65 0.69 0.71 0.73 0.74 0.75 0.75 0.76 0.76	1 0.96 0.97 0.98 0.99 0.99 0.99
1.00 0.67 0.75 0.80 0.86 0.89 0.91 0.93 0.94 0.96 0.96 0.96	2 1.72 1.80 1.85 1.90 1.92 1.94
1.25 0.70 0.82 0.89 1.00 1.05 1.09 1.12 1.13 1.14 1.14 1.15	3 2.29 2.49 2.65 2.72 2.79 2.83
1.50 0.88 0.97 1.11 1.19 1.25 1.28 1.31 1.34 1.35 1.36	4 2.71 3.04 3.24 3.40 3.58 3.66
1.75 0.91 1.02 1.20 1.30 1.39 1.43 1.49 1.52 1.55 1.57	5 3.02 3.49 3.78 4.12 4.31 4.43
2.00 1.08 1.28 1.41 1.5 1.57 1.63 1.66 1.70 1.72	6 3.23 3.85 4.23 4.70 4.97 5.15
2.25 1.13 1.34 1.50 1.69 1.69 1.76 1.81 1.84 1.86	7 3.43 4.14 4.62 5.22 5.57 5.81
2.50 1.38 1.57 1.69 1.79 1.87 1.94 1.99 2.02	8 3.56 4.38 4.95 5.68 6.15 6.43
2.75 1.42 1.63 1.76 1.88 1.98 2.05 2.12 2.18	9 3.66 4.57 5.23 6.09 6.63 7.00
3.00 1.45 1.67 1.83 1.97 2.08 2.16 2.23 2.29	10 3.74 4.74 5.47 6.45 7.09 7.53
3.25 1.48 1.71 1.88 2.04 2.16 2.26 2.35 2.42	12.5 5.02 5.92 7.20 8.06 8.68
3.50 1.50 1.75 1.93 2.11 2.24 2.35 2.45 2.54	15 5.20 6.25 7.77 8.84 9.64
3.75 1.52 1.78 1.97 2.17 2.31 2.44 2.54 2.64	17.5 5.30 6.44 8.20 9.47 10.4
4.00 1.81 2.02 2.22 2.37 2.51 2.62 2.71	20 6.60 8.54 9.97 11.1
4.50 1.85 2.08 2.31 2.50 2.63 2.76 2.87	25 6.79 8.99 10.7 12.1
5.00 1.88 2.15 2.38 2.58 2.75 2.89 3.02	30 9.27 11.3 12.9
5.50 2.20 2.43 2.65 2.84 3.00 3.15	35 9.44 11.6 13.4
6.00 2.48 2.70 2.92 3.09 3.26	40 11.8 13.8
7.00 2.54 2.81 3.03 3.24 3.43	45 12.0 13.8
8.00 2.57 2.85 3.13 3.35 3.56	50 12.1 14.3
9.00 2.89 3.18 3.43 3.66	60 14.6
10.00 3.23 3.48 3.74	~ 3.88 5.38 6.82 9.55 12.2 14.7
~ 0.71 0.93 1.14 1.33 1.49 2.24 2.58 2.91 3.24 3.56 3.88	

(b) The ERNST formula

The general equation is as follows:

$$h = q \frac{D_v}{K_1} + \frac{qL^2}{8KD} + \frac{qL}{\pi K} L_n \frac{D_o}{u}$$

where:

h = the height of the water table above the level of the drains halfway between the two drains in m

q = the intrinsic flow rate in m/day

D_v = the thickness of the saturated layer above the drain in m

$KD = K_1 D_1 + K_2 D_2$ = the product of the thickness multiplied by the permeability of the various layers in m^2/day

D_2 = the thickness of the lower layer in m

D_1 = the mean flow section of the upper layer with permeability K_1

$L_n \frac{D_o}{\pi K} = R_r$ = radial resistance which is a function of drain position

D_o = thickness of the layer for which the radial resistance has been calculated

u = wettened perimeter of the drain.

Depending on the position of the drain in relation to the boundaries between the layers of different permeabilities, the formulae to be used are as follows:

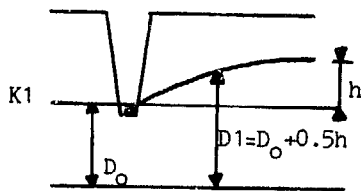

$$h = \frac{9L^2}{8K_1 D_1} + \frac{9L}{\pi K_1} L_n \frac{D_o}{u}$$

Homogeneous soil $D_o < \frac{1}{4} L$

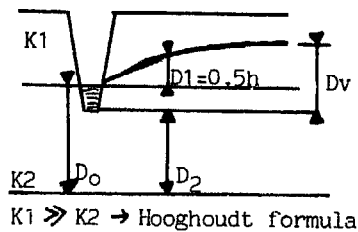

Drain at the boundary of two layers of different permeability
 $K_1 \gg K_2$

$$h = \frac{9L^2}{8(K_1 D_1 + K_2 D_2)} + \frac{9L}{\pi K_2} L_n \frac{D_o}{u}$$

$K_1 \ll K_2$

$$h = \frac{9D_v}{K_1} + \frac{9L^2}{8K_2 D_2} + \frac{9L}{\pi K_2} L_n \frac{D_o}{u}$$

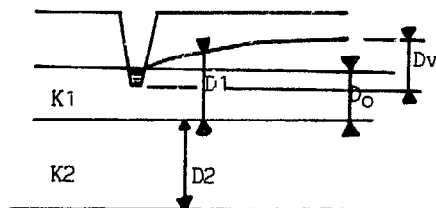

Drain in the upper layer

$$h = \frac{9D_v}{K_1} + \frac{9L^2}{8(K_1 D_1 + K_2 D_2)} + \frac{9L}{\pi K_1} L_n \frac{D_o}{u}$$

3.3.3.3. Calculating drain spacing in the transitory regime

(a) GLOVER-DUMM formula

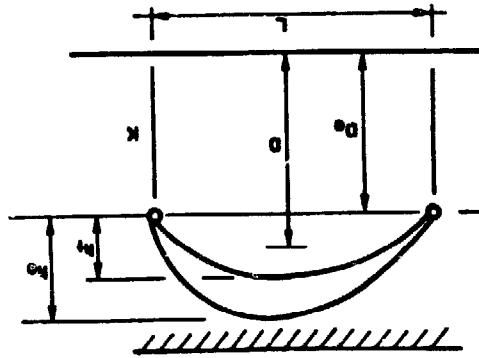

- t/j

$$h_t = h_o \times 1.16 e$$

$$\text{if } \frac{h_t}{h_o} < 0.80$$

$$j = \frac{VL^2}{10 KD}$$

$$D = D_o + \frac{h_o + h_t}{4}$$

$$L^2 = \frac{10 KDt}{V L_n} \left(1.16 \frac{h_o}{h_t} \right)$$

where:

- j = reservoir coefficient (in days)
- V = the effective porosity in per cent
- h_o = the load above the drain at times t
- h_t = the load above the drain at times t
- t = the time expressed in days.

The effective porosity V is given approximately by the square root of the permeability expressed in cm

$$V\% \approx \sqrt{K_{cm}}$$

(b) BOUSSINESQ formula (1903)

This applies when the drain is located on the permeable layer and is expressed as follows:

$$L^2 = \frac{4.5 t K h_o h_t}{V (h_o - h_t)}$$

3.3.4. Drain diameter and length

The choice of drain diameter and length is a function of the plot to be drained and the amount of water to be evacuated.

Drain diameter is usually constant over the whole length and the flow in this drain increased with drain length, i.e. the surface area drained.

The flow rate drained is equal to the product of the surface area drained multiplied by the intrinsic flow rate.

$$Q = S \cdot q_c = L \cdot E \cdot q_c$$

Where the length to be drained becomes too large, drain capacity becomes inadequate. Large diameter drains may therefore be used; in this case the drain length may be longer than for small diameter drains, but the cost is also higher.

(The simplest and the most widely used method is to select the type of drain and its diameter and then calculate the maximum length that can be used.)

The commonly used diameters of underdrains are between 5 and 8 cm. Collectors however may have diameters up to 30 cm.

Fig. C.9 shows the flow rate in drains and collectors depending on gradient and drain diameter.

3.3.5. Calculation of collectors

The flow rate in collectors is equal to the sum of the flow rates in the minor drains which feed into them.

Collector diameter may be variable as a function of flow rate and gradient (see Fig. C.9).

Fig. C.9: Flow rate in drainage collectors (in l/s)

cm/m	Gradients in %													l/s
	0,05	0,06	0,08	0,10	0,12	0,14	0,16	0,18	0,20	0,22	0,25	0,30		
0,05	-	-	-	-	1,70	3,39	3,84	5,23	6,95	5,40	11,3	16,5	0,5	
0,10	-	-	0,90	1,42	2,60	3,92	3,46	7,47	9,82	11,9	16,4	26,2	1	
0,15	-	-	1,10	1,90	3,14	4,80	6,70	9,14	12,03	14,5	21,2	32,1	1,5	
0,20	0,37	0,55	1,26	2,28	3,27	3,64	7,75	10,54	13,50	16,82	23,6	36,4	2	
0,25	0,41	0,65	1,42	2,55	4,10	6,20	8,60	11,81	15,34	18,76	26,0	41,4	2,5	
0,30	0,45	0,73	1,52	2,79	4,56	6,79	9,44	12,94	17,07	20,6	27,3	44,0	3	
0,35	0,49	0,77	1,61	3,02	4,84	7,34	10,22	13,57	18,19	22,2	29,7	43,9	3,5	
0,40	0,52	0,85	1,73	3,22	5,19	7,84	10,93	14,84	19,64	23,8	32,4	44,4	4	
0,45	0,55	0,90	1,80	3,42	5,51	8,34	11,59	15,85	21,24	25,1	34,7	45,6	4,5	
0,50	0,58	0,94	2,00	3,61	5,81	8,74	12,38	16,73	22,8	26,5	36,5	46,8	5	
0,55	0,61	0,99	2,10	3,76	6,09	9,19	12,82	17,32	23,5	27,8	38,5	48,1	5,5	
0,60	0,64	1,03	2,16	3,95	6,36	9,60	13,20	17,80	24,07	29,0	40,2	49,0	6	
0,65	0,66	1,03	2,28	4,11	6,52	9,95	13,62	18,24	24,5	30,3	41,9	50,7	6,5	
0,70	0,69	1,12	2,37	4,27	6,87	10,37	14,44	19,74	26,0	31,4	43,5	52,4	7	
0,75	0,71	1,15	2,45	4,42	7,11	10,74	14,80	20,45	26,82	32,4	45,1	54,3	7,5	
0,80	0,74	1,20	2,53	4,56	7,34	11,02	15,44	21,12	27,80	33,4	46,5	57,8	8	
0,85	0,76	1,23	2,61	4,71	7,57	11,43	15,92	21,40	28,55	34,4	48,0	59,0	8,5	
0,90	0,78	1,27	2,68	4,84	7,79	11,76	16,39	22,40	29,48	35,2	49,3	59,8	9	
0,95	0,80	1,30	2,76	4,97	8,00	12,08	16,84	23,02	30,32	36,6	50,7	60,5	9,5	
1,00	0,82	1,34	2,83	5,05	8,21	12,39	17,33	23,62	31,02	37,5	51,6	62,1	10	
1,25	0,92	1,49	3,16	5,71	9,18	13,84	19,32	26,42	34,75					
1,50	1,01	1,63	3,46	6,27	10,06	15,13	21,17	28,64	38,06					
1,75	1,08	1,77	3,76	6,75	10,86	16,40	22,87	31,25	41,03					
2,00	1,17	1,89	3,99	7,22	11,61	17,53	24,45	34,41	43,32					
2,50	1,30	2,11	4,47	8,07	12,87	19,60	27,32	37,35	49,14					
3,00	1,42	2,31	4,89	8,84	14,18	21,48	29,94							
3,50	1,54	2,50	5,30	9,55	15,36	23,19	32,34							
4,00	1,65	2,67	5,66	10,21	16,41	24,79	34,58							
4,50	1,75	2,83	6,00	10,75	17,42	26,30	36,67							
5,00	1,81	2,93	6,31	11,42	18,36	27,72	38,65							
6,00	2,02	3,27	6,93	12,50	20,11	30,34	43,33							
7,00	2,18	3,54	7,49	13,51	21,72	32,79	45,74							
8,00	2,34	3,78	8,01	14,44	23,22	35,00	48,90							
9,00	2,47	4,00	8,49	15,30	24,63	37,09	51,84							
10,00	2,61	4,22	8,95	16,30	25,97	39,30	54,66							

CHAPTER D

METHODOLOGY FOR SETTING UP A
SOIL CONSERVATION PROJECT

D.1. PRELIMINARY STUDIES

1.1. Aims

Setting up a soil conservation project comes within the framework of an over-all strategy which involves numerous disciplines and follows a logical process in decision making. The first phase of the process is the analysis of the situation from the physical, human and economic point of view. This should provide the necessary factors for deciding on the value of the project, its limitations and advantages, and the economic fundamentals from which it is possible to evaluate the significance of any measures that might be envisaged.

Preliminary studies are the first stage to help in the decision-making process aimed at defining the aims of coherent and well-founded development, and the means to be employed in achieving these aims.

1.2. Situation analysis

This analysis will cover successively: the physical and hydraulic characteristics of the soil degradation and the impact of this degradation on the socio-economic picture in the region. The analysis should comprise a review of all the available data in order to arrive at a first estimation of the measures that might be envisaged.

1.2.1. The physical context

1.2.1.1. Data collection

The data may be obtained following consultation with the relevant national services. The type of the basic data to be collected and the services that may supply this information are as follows:

(a) Cartography

- topographic maps. The most widely used scale is 1/200,000 or 1/100,000. Certain regions may be covered by maps using a scale of 1/50,000 or 1/20,000. In the case of numerous countries (North Africa, West Africa, Madagascar, etc.), maps may be obtained in France from the National Geographic Institute (Institut géographique national);

Fig. D.1: Over-all flow chart for drawing up a soil conservation project

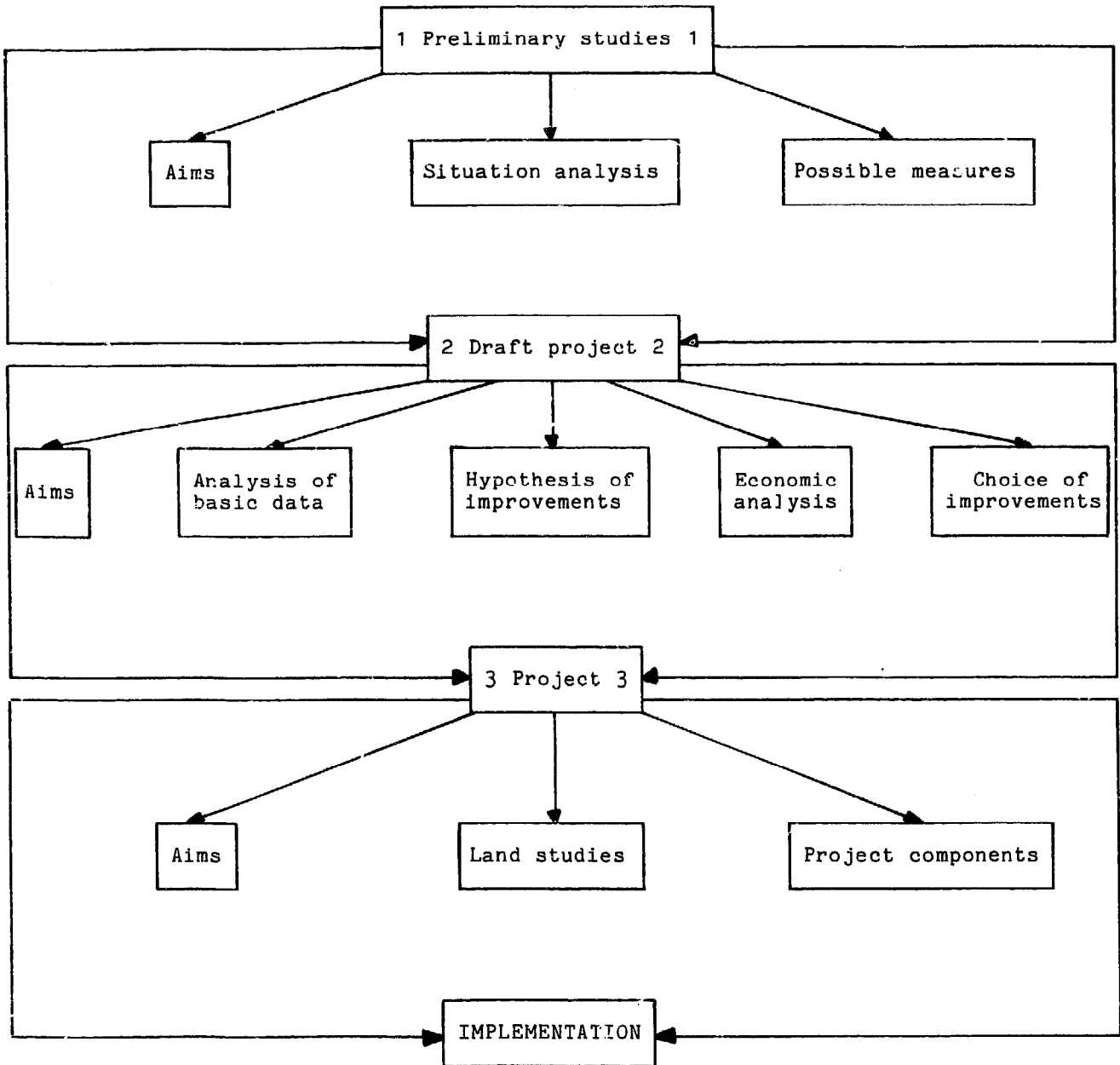

- aerial photographs. Many countries have been covered by aerial photographs on black and white panchromatic film at a scale of approximately 1/50,000,
- satellite photographs (LANDSAT pictures). These may provide interesting information at the regional level.

(b) Geology

Geological maps at a scale 1/1,000,000, 1/500,000 or 1/200,000. These are usually available from the national geological services (BRGM in France), universities, etc.

(c) Pedology

General pedological maps, where they exist, often have a small scale (1/1,000,000). For certain projects, pedological maps may be available with larger scales, and they can be obtained from geological or agricultural services.

(d) Climatology

Usually, all countries have a precipitation observation network which measures daily precipitation.

Climatological stations make more detailed data collection covering rainfall intensity, temperature, evaporation, hygrometry, wind speed and direction, etc.

These data can be obtained from meteorological services, airports and agricultural departments.

(e) Vegetation

Data about the type and distribution of natural vegetation and the density and main species that can be used for afforestation purposes can be obtained from agricultural, water, forest and animal breeding services.

(f) Hydrology

Characteristics of the hydrographic network and the hydrological regime.
Type of hydrometric observations carried out.

1.2.1.2. Data analysis

During the preliminary study, utilisation of the data should make it possible to determine the magnitude of soil degradation phenomena by highlighting the incidence and intensity of the factors behind the degradation.

Soils may be classified according to their erodibility while specifying the type of erosion to which they are subject and the incidence and intensity of the damage caused.

1.2.2. The socio-economic context

1.2.2.1. Data collection

The main data to be collected deal with:

-
- (a) demography: population in the zone in question, agricultural population, number of working people, trends;

 - (b) farming: type of farming (family, industrial, etc.), areas farmed, production (type, yield, costs), agricultural income;

 - (c) soil utilisation: agriculture, animal breeding, forest, industrial or urban zones;

 - (d) animal breeding;

 - (e) agricultural policy, development plans, current legislative measures.
-

1.2.2.2. Data analysis

An over-all review should be made of agricultural activity and soil utilisation in order to specify all sectors which might be affected by soil degradation.

Items which may be damaged or disrupted may be classified under three headings:

- permanent assets such as land, agricultural infrastructure (buildings, irrigation networks), the infrastructure of economic activity (roads, etc.);
- seasonal assets such as crops which may be damaged to different degrees depending on the intensity and period of occurrence of the phenomenon (flooding, crop destruction, etc.);
- economic activity which may be perturbed, due for example to the destruction of communication routes, water run-off or by wind-borne materials which may make cultivated land sterile or seriously compromise a region's industry.

Probable economic growth rates should be estimated in order to determine the growth trend in the value of these assets over coming years.

1.3. Assessing the extent of possible measures

1.3.1. Damage assessment

1.3.1.1. Collecting data about damage

Damage that may occur in the absence of soil conservation measures may be classified into two categories:

- (a) Capital losses, the main one being the loss of land capital under the same heading as other infrastructural assets such as farm buildings, irrigation networks, etc. In estimating capital losses, it is possible to use as a basis estimates of damage that occurred in the past. These should be re-evaluated to bring them in line with current monetary conditions.
- (b) Production losses which may result from reduced soil fertility, flooding, deposition of wind or river-borne sterile soil. Production loss may be a variable phenomenon related to the intensity of the destructed phenomena, the main ones being, precipitation intensity in the case of rain erosion and wind force in the case of wind erosion. In this case, the updated cost of annual damage should be used for calculation.

1.3.1.2. Mean annual damage

The methods that may be used for determining mean annual damage are numerous and related to available statistics:

- where a number of values exist for annual damage, the mean damage should be calculated from the arithmetical mean of damage data;
- when only a single value for annual damage is available and the incidence of this damage is not known, it may be hypothesised that damage is proportional to the intensity of the phenomena which cause it. With a knowledge of the relationship between the phenomenon behind the damage and the incidence of this phenomenon, it is possible to deduce the cost of damage for various incidences and from this assess the mean annual damage cost;
- where a number of damage incidence combinations are available, it is possible to draw a "damage incidence distribution curve" (see fig. D.2).

Mean annual damage is the area bounded by the co-ordinate axes.

1.3.1.3. Future damage

Future damage will vary depending on the forecast economic growth rate for the region. The calculation for mean annual damage should therefore be weighted by the forecast economic growth rate.

1.3.2. Envisaged investment

The amount of future damage at current prices is the sum of envisaged investment. The sum invested may, however, be higher where the planned improvements are expected to result in an increase in the value of agricultural land which, after conservation work, will have higher crop yield. The level of land value increase may be assessed from the amount of increased revenue, at current prices, indexed by the economic growth rate for this type of income.

Fig. D.2: Damage incidence curve

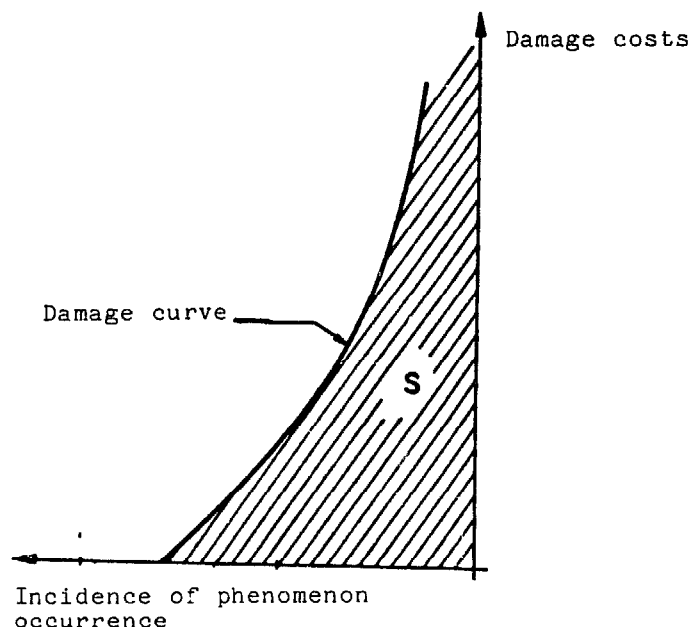

D.2. DRAFT PROJECT

2.1. Aims

Once the draft study has made it possible to assess the value of a soil conservation project and the envisageable investment, the draft project should define the means to be employed to achieve the set aims.

The draft project should define the various possible improvements from both the technical and economic point of view, to permit decision making as to which project will best meet the final objectives. These objectives are often contained in an over-all land improvement policy for the development of a catchment basin. They may be economic, social, political, ecological, etc.

2.2. Analysis of basic data

This analysis should cover all the data relevant to the establishment of the draft project. The basic data collected should usually be supplemented by field studies and surveys and then subjected to detailed analysis so as to form the basis for assessing possible improvements. The analytical methods that can be used are outside the framework of this book. We will, therefore, consider only the main data required in analysing a soil conservation project.

Climatology:

- monthly and annual precipitation: mean values and statistical analysis;
- exceptional daily precipitation with statistical analysis of maximum annual precipitation;
- rainfall studies and determination of relationships between rainfall and rainfall duration for various probabilities.

Morphology of the catchment basin:

- relief;
- gradient characteristics: classes of slope;
- erosion forms: erodibility classification of various sectors of the basin.

Hydrology:

- surface area of catchment basins - boundaries of sub-basins;
- estimation of run-off coefficients;
- determination of flow rates from man-made structures;
- determination of flow rates from collectors.

Pedology:

- general reconnoitring of terrain;
- auger soil samples with sample density depending on land variations and the scale of the project (usually one sample per 5-10 ha);

- collection of soil samples for analysis of physical and chemical properties and permeability;
- determination and mapping of crop suitability categories;
- evaluation of earthworks.

Topography:

- drawing up of plans suitable for the project (1/10,000 to 1/20,000) by direct surveying or by photogrammetry;
- survey of land profiles along the main emissaries with preparation of cross-sections for the main features.

Agriculture .. animal husbandry:

- types of crop;
- crop rotation;
- yields;
- animal density, type of grazing, use of passage routes.

Socio-economics:

- industrial structures;
- agricultural income;
- market and rentable value of land.

2.3. Hypothesis of improvements

When the basic data have been assessed, the project leader may present one or more hypotheses for improvements that are both technically and financially acceptable giving justification for the principle behind the project and the main technical arrangements.

This hypothesis for improvements should be accompanied by the following documents:

- location plan at a scale of 1/20,000 or 1/10,000 from which it is possible to locate the siting of the main structures;
- the main technical arrangements together with the relevant standard plans, and:
 - characteristic flow rates,
 - cross-section and spacing of defence and drainage networks,
 - layout of main and secondary collectors,
 - emissary improvements,
 - standard plans for the main structures,
 - spacing and type of plants,
 - layout of forest roads,
 - requirements for and location of nurseries, etc.;
- over-all assessment of improvement costs with an indication of cost per improved hectare.

2.4. Economic analysis

For each draft project it is necessary to draw up an income and expenditure account, in current prices, for each of the planned conservation measures.

2.4.1. The expenditures include:

- investment: preliminary studies, cost of improvements, land purchases, eviction compensation, etc.;
- maintenance and operating expenses.

These expenditures should be discounted so that they can be compared on a valid economic footing.

2.4.2. Income covers:

- capital appreciation, the main component in a soil conservation project being the anticipated additional discounted income;
- reduction of damage. As a result of the protection measures, damage will be reduced for a given phenomenon recurrence time, i.e. totally eliminated in the case of small recurrent periods. In the damage incidence distribution curve shown in fig. D.3, this will be seen as a reduction in damage costs for given recurrence time. By comparing this curve with the damage curve as it was prior to the improvements, the reduction in the mean annual damage is the area between the two curves. These curves may have a different shape depending on the type of improvement, and their comparison is essential for selecting between different types of improvement. For example, we have shown in fig. D.3 two types of curve that followed improvements. The curve C_1 shows damage distribution incidence following afforestation work. Curve C_2 applies, for example, to an absorption network in an area where there are heavy, low-incidence rainfalls, embankments may be broken with damage which would be greater than the initial damage.

Fig. D.3: Damage incidence distribution

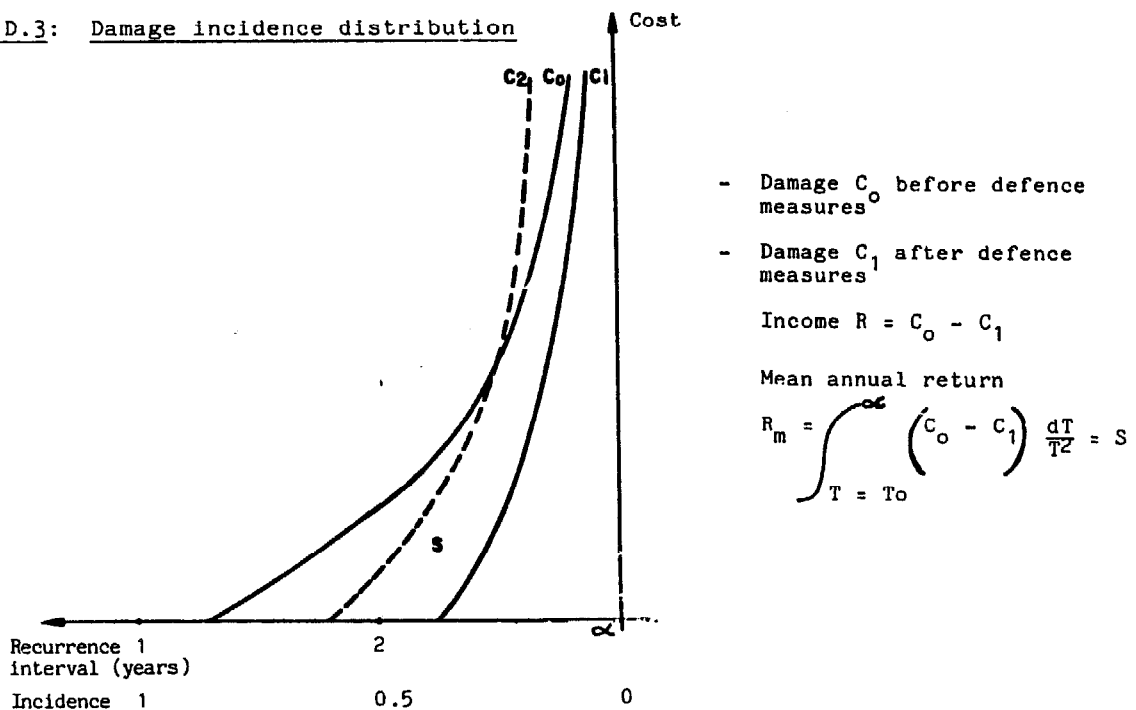

2.4.3. Balance sheet

The balance sheet of income and expenditure makes it possible to define viability and selection criteria.

The main criteria used are:

- Discounted profit, which is the difference between income and expenditure. The improvements are viable if there is a profit at current prices.
- Internal profitability rate, which is the value of the actualisation rate for which the discounted profit is zero. If the improvement is financed by a loan, the internal profitability rate should not be greater than the loan interest rate.
- The relative gain at discounted prices, which is equal to the quotient of receipts. This makes it possible to choose between various independent projects.
- Cost benefit ratio.

2.5. Selection of improvements

The draft projects make it possible to define the alternative improvements intended to achieve a stipulated objective and which are technically and economically feasible. They also provide the factors for making a choice; however, this will not always be guided by the economic factor alone but may also take into account other criteria, e.g. social, political, etc.

D.3. THE PROJECT

3.1. Objectives

Once the draft project has permitted the selection of a possible type of improvement, the project itself covers the drawing up of all the necessary items for the implementation.

The project covers additional field studies and the preparation of documents and drawings.

3.2. Field studies

3.2.1. Topographic work

- preparation of plans at a scale of 1/2,000 or 1/5,000 with contour lines at intervals of 0.25 m for slight gradients and up to 0.5-1 m for steeper gradients
- longitudinal profiles of natural water outlets and main collectors at a scale of 1/2,000 for the horizontals and 1/100 or 1/50 for the verticals;
- cross-sections of outlets and all salient points at a scale of 1/100 or 1/50.

3.2.2. Survey borings

The technique and depth of sample borings and the analyses to be carried out on them will vary depending on the type of work envisaged.

For plantation work, it is necessary to determine soil type, humidity and the difficulty of digging planting holes, by carrying out a sample boring of 1.00 m in depth every 10 ha or so.

For cut-and-fill earthwork, trenching difficulty should be assessed.

For drainage works, it is necessary to determine soil type and in particular permeability. Soil analyses are carried out on samples taken with an auger at a depth greater than the maximum drain depth and at a rate of one sample every 10 ha; it is also necessary to dig a trench every 50 ha to make a descriptive soil survey.

For the construction of small dams, it is necessary to dig one or more trenches along the axis of the structure to a depth equal to the height of the finished structure in order to determine soil types and permeability.

3.3. Project documents

These comprise a description of the project and assessment of expenditure.

They comprise:

3.3.1. Written documents:

-
- (a) an explanatory memorandum describing the project principle and the main technical arrangements;

 - (b) a descriptive estimate which enumerates and describes the work to be carried out and the origin, quality and preparation of materials;

 - (c) specifications for the work to be carried out by a commercial firm;

 - (d) an analysis and breakdown of prices;

 - (e) a quantity estimate which calculates the expenses for each item of work;

3.3.2. Drawings:

-
- (f) a location map at a scale of 1/20,000;

 - (g) a map of the defence network at a scale of 1/2,000;

 - (h) a longitudinal profile of the collectors and the emissaries;

 - (i) drawings of the structures at a suitable scale (1/20 or 1/50).

CHAPTER E

PROJECT IMPLEMENTATION¹

This chapter describes the operation of soil conservation work sites in which priority is given to labour-intensive procedures using untrained manpower, little skilled labour, a large number of simple tools and few machines.

E.1. GENERAL SITE ORGANISATION

1.1. Survey of local conditions and site reconnaissance

Before opening a site, the site manager should make a prior visit to the location to survey the major natural, technical and economic constraints so that he can decide on the work procedures and conditions.

1.1.1. Natural constraints

The main constraint is climate which may make it necessary to halt work at the site for some period during the year, either because of frost which prevents masonry and concreting work being carried out or due to excessive heat which may inconvenience workers and reduce output. The rainy season may also prevent certain types of work being carried out or be an impediment to haulage or materials supplies.

Water flow should be investigated before work is carried out on water courses. Ravine or gully rectification and dam construction should be carried out at the lowest water level or the work may be severely damaged or even totally destroyed during the construction period by the arrival of flood water. Nevertheless, if the work cannot be carried out at any other period or if the flood calendar is not sufficiently regular, additional protection such as the installation of coffer dams with water diversions, should be planned. However, this type of additional protection is usually expensive. Economic optimisation should be sought between the

¹ This chapter covers only the general principles of site organisation and project implementation. Soil conservation work does not, in fact, necessitate any special organisation and the guidelines for other types of work are applicable without any major adaptation. Reference should be made to Training Course No. III "Project design, implementation and evaluation", which has been produced as part of the Inter-regional Project for Planning and Administration of Special Public Works Projects.

cost of additional protection and the danger of the structure being destroyed during building. For the small structures described in this document, additional protection is not usually necessary and would be too expensive in relation to the danger of the structure being destroyed during building.

The sanitary conditions in the region are another natural constraint, and are particularly important for the satisfactory progress of labour-intensive works. Information should be obtained about the risk of any epidemic so that the necessary safety and control measures can be taken on site. Since water is a major vector of epidemic disease, the hygiene of the water being used should be the subject of particular attention.

1.1.2. Technical and economic constraints

Site access should be assured. During the site reconnaissance, note should be taken on the condition of existing roads and tracks, their distance from the construction site and any need for the construction of new access routes.

Supplies of materials should be established by examining the potential of existing quarries, the quality of the materials they supply, delivery capabilities and prices. Employment can be increased when use is made of local materials which are available close by and can be exploited without great difficulty using rudimentary techniques.

At the project design stage, it is essential to ensure that these materials are available in adequate quantity, have suitable characteristics and can be processed at a rate which meets site requirements. In addition, the manpower required for materials exploitation, processing and haulage should be assessed carefully before a decision is taken on reliance on local materials.

In this way, a reinforced concrete weir would require large quantities of sand, gravel and cement and would ideally be constructed using capital-intensive methods. Its replacement by a stonework weir might be envisaged. In such a case, it would be necessary to ensure that the necessary quantity of quarry stones was available, that the stone would be of sufficient hardness and that the haulage distances would not be excessive. If these requirements were not met, the advantage to be drawn from using these materials would be eliminated by the high cost of vehicles for their transport.

For non-quarry materials such as wood, fuel, cement and steel, the supply and price factors should be examined.

Supplies of equipment. It is necessary to assess the number of tools and machines required on the site: conditions for the purchase of new equipment, local resources and the condition of available second-hand material. Supplies of new equipment may take a long time in arriving and it is advisable to make allowance for this when plans are prepared. The possibility of manufacturing certain simple tools and having equipment maintained and repaired by local craftsmen should be considered. If local resources are inadequate, plans may be made to train local craftsmen or equip the site with its own resources (small workshop, etc.).

Local manpower and supervisory workers should be selected taking into account:

- local availability of unskilled workers;
- local availability of skilled workers such as blacksmiths, masons, etc.;
- availability of supervisory workers: foremen, topography technicians, etc.;
- working conditions: working hours, social structure, public holidays;
- cash wages and payment in kind.

Consideration should also be given to seasonal variations which may be very marked in certain cases, and be a major constraint for work which requires continuous progression. For example, in river bank protection work, which is normally carried out during the dry season, the time factor may be of particular importance; a marked seasonal shortage of labour may make it necessary to change the type of protection work or the haulage technique (use of haulage vehicles in operations for which they are particularly viable). Completion of the work in stages or segments might be a possible compromise where there is a temporary labour shortage.

The lack of skilled workers may also be a deciding factor in the design of the structure. A gabion or stonework retaining wall would require less skilled workers than a reinforced concrete structure. On the other hand, it would be necessary to use much larger quantities of materials to achieve the same strength. Consequently the structure will probably take longer to build and its commissioning will be delayed.

1.2. Project planning

1.2.1. Objectives of planning

Operational planning is an essential management tool which will make it possible to pursue a strategy or tactic, to keep control of the numerous factors that may affect final cost, and ensure the best use of available labour. The objectives of planning are those stipulated by task sequencing, work preparation and organisation, and work control and follow-up. These entail the drafting of various documents, the type and precision of which are directly related to the type of work being managed. With these documents it should be possible to have a precise idea of the abstract factors in a site, to highlight interdependence between various activities and pick out those operations which demand the project manager's greatest attention in relation to the numerous constraints that have been foreseen: rainy season, religious holidays, harvesting, etc.

Depending on the size and complexity of the project, it may be necessary to break down the site into activities, operations and basic tasks, the repetition of which over a given cycle calls for specific attention and analysis. Planning is therefore a task for a technician with a thorough experience of building sites, men, working methods, the various presentation techniques and with a good mind for analysis and review. It is a task for a specialist.

1.2.2. Forms of planning and their requirements

It will be necessary to select between various existing planning procedures, all of which have certain advantages and weaknesses. In deciding the suitability of the planning procedure for the project in question, three factors should be taken into consideration:

- (a) Project complexity. The criterion affecting the choice of presentation system is that of the complexity of the works. The majority of works involved in a soil conservation programme are relatively simple and the interdependence between the various tasks or operations is direct and relatively uncomplicated. Experience has shown that a choice of one of the following three types of presentation would meet the requirements of nearly all programmes:
 - bar chart or GANTT chart planning;
 - time and location chart planning;
 - network or critical path planning.
- (b) Exploitation of the document. The programming technique will depend on the skill of the workers using it. It will therefore differ depending on whether the user is the engineer in charge of the project, the staff responsible for programme accounting, the works supervisor or the foreman.
- (c) Type of works. This will also affect the choice of programming technique:
 - work covering a large area (reafforestation, dune stabilisation, etc.);
 - linear work (ravine correction, erosion control ditches, etc.);
 - work carried out at a given point (small dam, weir, etc.).

The factors which are being planned may, of course, also have an effect on the programming technique:

- labour requirements;
- material and tool supplies;
- plant rotation and maintenance;
- general works organisation;
- repetitive cycles of basic tasks;
- general progress and supervision of the project;
- financing schedule, etc.

Clarity and ease of interpretation are prime requirements in planning and an effort should be made to present information simply, by giving a self-explanatory and precise picture of the problem being analysed. The highlighting of interdependence between various operations is a fundamental requirement; this makes it possible to pick out critical tasks which should be given major attention.

It should also be noted that planning is merely a hypothesis, although the most realistic possible, for scheduling the various tasks in a project. It must therefore be possible to correct it and, if necessary, modify or adapt it flexibly to any change of work plan.

1.2.3. Planning procedure

All planning commences with collecting various items of information and calculating the basic technical data:

- assessment of available labour in the project zone;
- volumes and quantities for each task;
- probable performance for each basic task in view of specific climatic conditions, in particular;
- special site requirements: storage, water, access road, etc.;
- various constraints (rainy season, harvesting, religious holidays, etc.);
- allocation of funds;
- labour, equipment, tool requirements;
- availability of equipment, tools, etc.

The various tasks involved in the completion of the project are then placed in a logical sequence. Any form of depiction can be used: arrows, rectangles, bars, etc.; then one adds to the list those tasks which can be carried out in parallel and the ordering tasks (ordering of supplies, rotation of vehicles, requests for topographic studies, for example). In this way, one obtains an initial picture which highlights the task sequencing. The diagram will be supplemented with information on the basic times for each activity, the labour and mechanical resources to be employed and all the constraints which can be seen so far. A number of diagrams are drawn up in this way in order to identify the most economic programming.

The sequencing of operations is the most delicate part of planning and requires maximum attention. Once these studies have been done, the work's programme can be presented in the most suitable form.

In the following paragraphs we will examine in sequence the planning of a single construction site using the three most commonly used methods (bar charting, time and location charting and critical path planning). The example in question is the general organisation of a site of 8 km of protective embankment combined with an irrigation channel (see fig. E.1).

Fig. E.1: Cross-section of channel and embankment

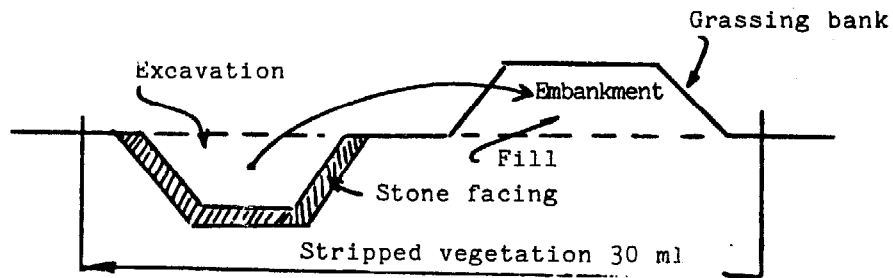

The list of the main operations is as follows:

Task	Operation	Direction of advance	Gang No.	Gang size	Duration (weeks)
A	Install site	0 ————— 8 km	4	5	3
B	Strip vegetation	0 ————— 8 km	1	20	13
C	Excavation	0 ————— 8 km	2	200	12
D	Fill	0 ————— 8 km	3	100	12
E	Stone facing	8 ————— 0 km	1 + 2	-	5
F	Grassing	0 ————— 8 km	3	-	1

This lists the main operational tasks. The ordering operations, which are of zero duration but nevertheless place constraints, have been omitted to facilitate comprehension. These may related to the ordering of stones, cement, etc.

1.2.4. Bar chart or GANTT chart

The type of chart proposed by GANTT is easily read and requires little skill on the part of the person producing it. One lists, on the left-hand side of the chart, usually from top to bottom, the various operations to be carried out in their logical order of execution and on the horizontal scale the time schedule to a convenient scale. Horizontally, against each operation, are drawn rectangles, or lines, proportional in length to the time the operation will take.

Fig. E.2.

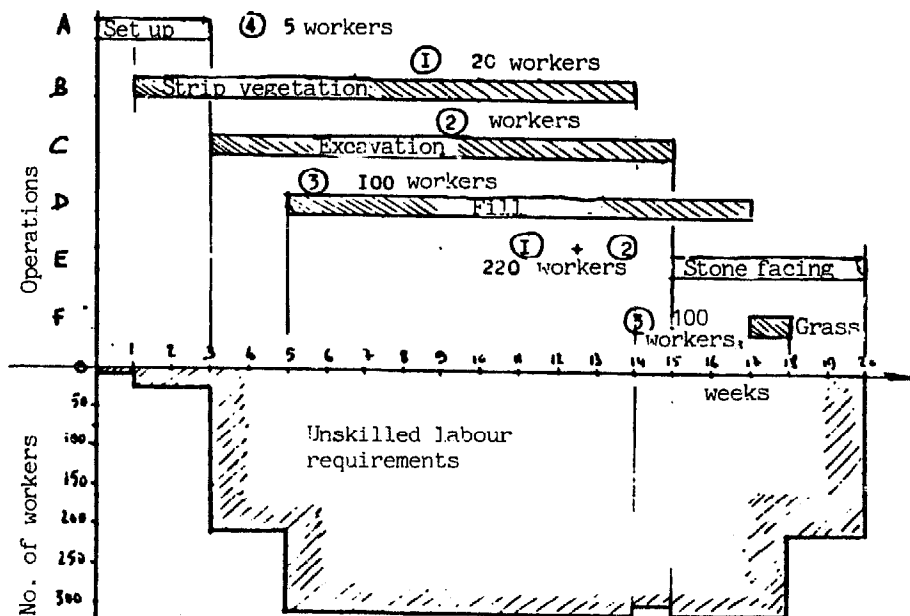

To the lower section of the planning chart it is possible to add a diagram indicating labour, tool, equipment, etc, requirements. Improvements can also be made by joining up the various operations by arrows (linked GANTT chart) to show gang movements during operation of the site.

The major disadvantage of this type of diagram is that it does not show the various relationships that exist between different tasks, especially in the case of complex projects. It is also difficult to supervise project progress since the spatial relationships of the tasks are not shown.

Nevertheless, this type of diagrammatic presentation is very useful and is usually used for planning simple construction sites, summarising detailed scheduling that has been analysed by other methods, and for displaying to a large number of people, and in particular the workers themselves, the results of these analyses.

1.2.5. Time and location chart planning

This is an extension of the GANTT-type bar chart. However, it can be used only for linear and narrow sites such as: bank protection works, linear soil conservation works, forest tracks, embankments; or for tall and narrow structures: retaining walls, weirs, small dams, which entail successive repetition of the same activities.

The basis for drawing up a time and location chart is very simple and entails merely plotting on a chart points against Y co-ordinates (time in a convenient scale) and an X co-ordinate (the chainage of the project).

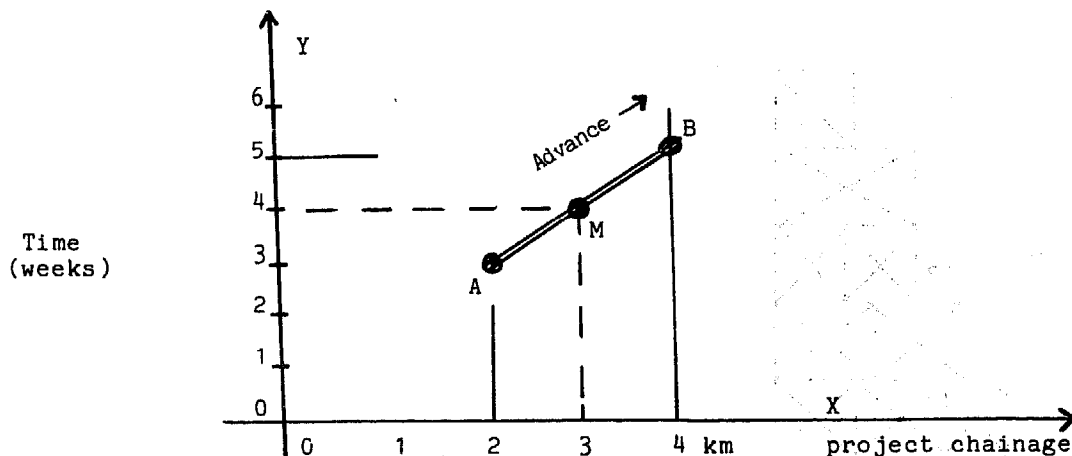

Using this technique, points A and B are defined in both time and space. Point A is therefore located at the 2 km chainage at the start of the third week; point B is at the 4 km chainage at the start of the fifth week. The line joining A and B therefore represents a two-week task being carried out between the 2 km and 4 km chainages of the project (an erosion control ditch, for example). The direction of advance of this task is of course defined as going from left to right. If a check is made on the advance of the work at the start of the fourth week, it will be necessary to ensure that the 3 km chainage (point M on the chart) has been reached as foreseen in the diagram. One can therefore see the value of this method in site supervision and control, since one can detect at an early date any delay or anomaly and rapidly make the necessary organisational changes.

It is possible to add to the chart a longitudinal section of the work under construction on which are marked the main features which may act as constraints: river to be crossed, cemetery, etc. This diagram should be drawn parallel to the X axis above or below the chart.

Any isolated point on the chart will show a task of 0 duration at the specific point of the site. This will be an order task (for example, ordering the supply of steel, cement, etc. to the site). A vertical line represents a task being carried out at one specific point of the site (construction of a weir, for example), and the duration of the task will be shown by the distance covered by this line on the selected time scale. Two parallel lines indicate operations carried out simultaneously by two teams at different locations:

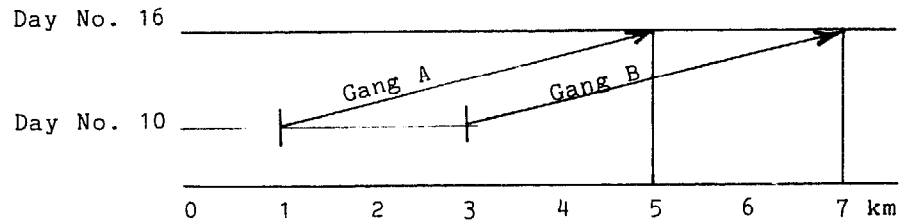

Tall and slender projects are shown using the same principle; however, for ease in reading the planning chart, the time scale is shown on the X co-ordinate and the height of the structure on the Y co-ordinate as is shown in fig. E.3.

Fig. E.3.

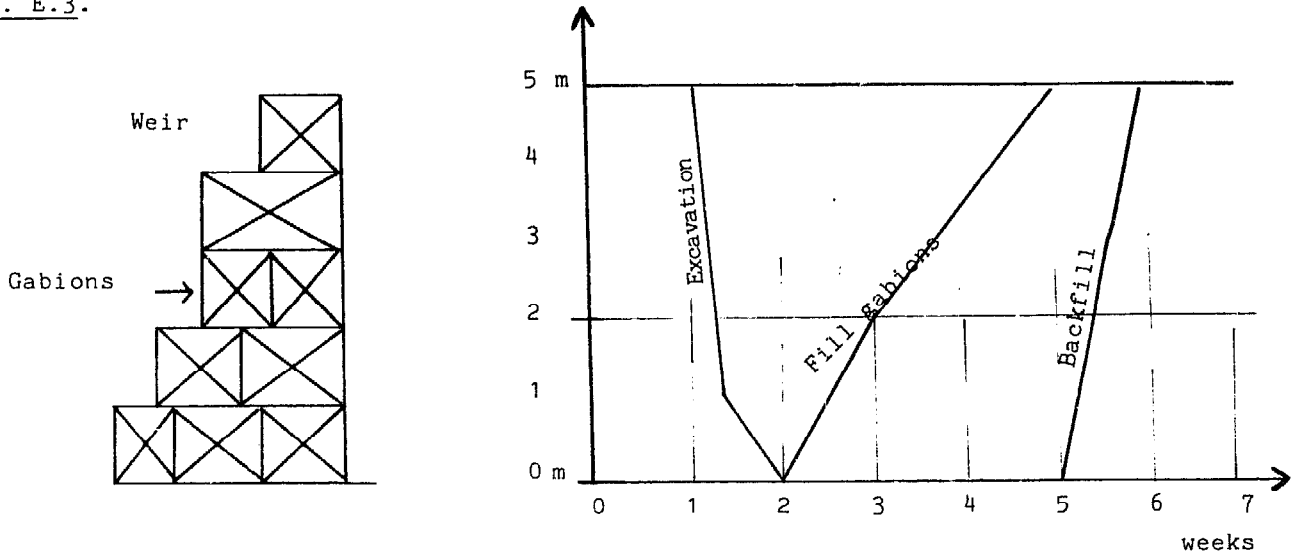

The example of the construction of an embankment and irrigation channel previously plotted on a GANTT-type bar chart looks as follows when plotted on a time and location chart.

Fig. E.4.

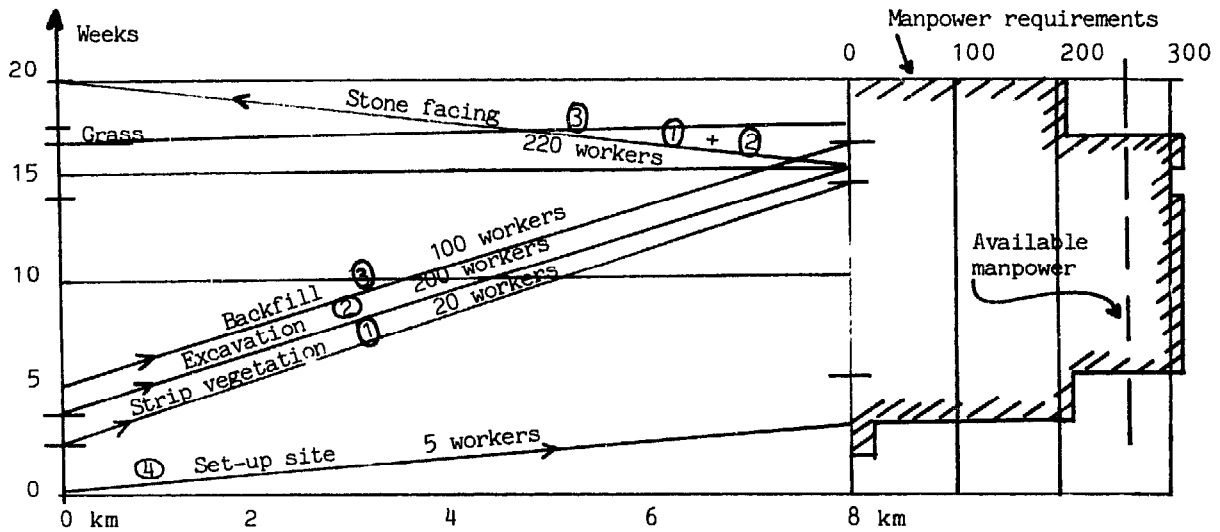

Reading this type of chart poses no major difficulty. The main components of the project are shown, the operations are located in time and space, and the logic behind the programming and scheduling of tasks is indicated. The actual advance of the work can be plotted on the chart in dotted lines and any delays will show up clearly. A diagram showing resource requirements (manpower, materials, equipment) can be added to the right of the chart.

1.2.6. Network or critical path planning

Various systems of network planning exist, all based on the project graph theory. The PERT (Programme Evaluation and Research Task), or critical path system, is the one most commonly used and shows the sequence of operations by a more or less complex closed network of arrows and peaks.

The "critical path" is made up of a number of activities for which the completion times cannot be increased without delaying the final date of completion of the whole project.

Developing an arrow diagram is carried out in two steps. The first step is to identify the operations in their logical order of completion, noting those which are interdependent. This first step will provide the project's logic chart; the required resources are not yet taken into consideration. The second step is to deploy these resources (manpower, time, materials) between the various operations so as to optimise production time and costs.

When the network has been completed, the "critical" activities should be identified so that particular attention can be paid to them during the course of the work. It is usually advisable to present the results in the form of a bar chart which is more easily read and used by the workers themselves.

Developing a network diagram requires the use of special terms, the most important of which are given below:

Network or graph: a chart comprising peaks joined by straight or curved lines, usually orientated.

Event: beginning or end of an activity. Requires no resources. The event is shown by a circle in which are indicated: the event's chronological number, and the earliest and latest finish dates.

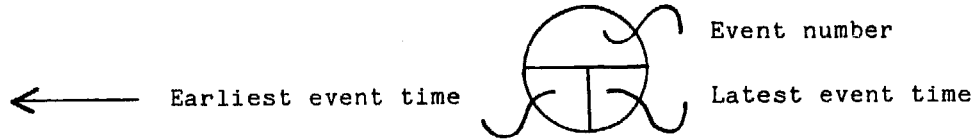

Task or activity: shown by a line, the length of which is independent of the actual time required to complete it. This line ends in an arrow which shows task sequence.

Logical sequence: this is a sequence of interdependent tasks, the order of which cannot be changed.

Node: this is an event at which several activities finish or from which several activities commence. A node may initiate a number of operations. It is a strategic stage in the course of the work. In the case of large, complex projects, the network can be broken down into more or less extensive charts starting from these main linkage points.

Earliest event time: starting from the initial event at time zero, the sequence of the arrows is traced and the durations of the successive tasks are added together. When a number of paths coincide on a single event, this event will be given the time of the longest path.

Latest event time: a backward path is made over the network starting from the final event and taking successively the duration of each of the basic tasks. If a number of paths converge on a given event, this event will be given the time of the shortest path.

Free float: is the difference between the latest event time and the earliest event time.

Dummy activity: this is a broken line joining two events showing an interdependence and linking two events in different sequences. A dummy activity is of zero duration.

Network construction method (practical example): i.e. a weir foundation construction site comprising the following activities:

No.	Job	Duration (days)	Immediately preceding job
A	Set-up site	2	Commencement of site
B	Marking out	1	A
C	Construct shuttering	4	A
D	Prepare steel reinforcement	2	A
E	Excavation	2	B
F	Install shuttering	2	C-E
G	Install steel reinforcement	1	D-F
H	Place concrete	2	Conclusion of site

This list of jobs will be classified by order of sequence in the table below which forms the links in the network (see fig. E.5):

Fig. E.5.

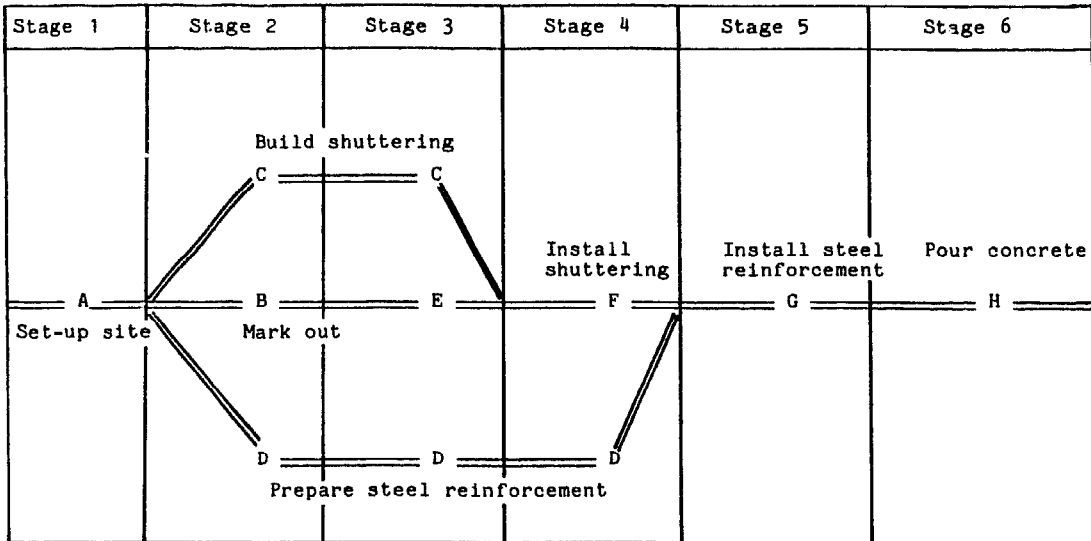

The network will then be laid out using the symbols described above to which will be added the earliest and latest times for each event.

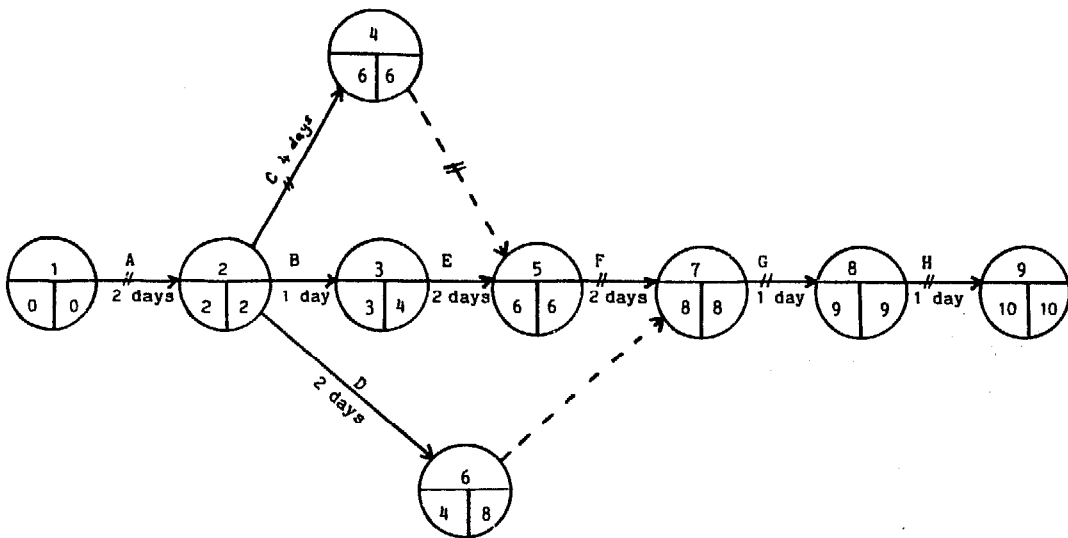

The "floats" for each event (latest event time minus earliest event time). critical path (--->) will be the one which passes through the events with a zero float.

In this way it will be seen that job D can suffer a four-day delay (8-4) without any repercussion on the final completion of the project. On the other hand, any delay in the completion of job C will have repercussions on the final completion date.

It will be seen that jobs 4/5 and 6/7 are "dummy" activities. They require no resources but indicate respectively that jobs F and G cannot start until jobs C and D have been completed.

The same principle is used below to show the critical path method for the construction of the 8 km embankment and irrigation channel. The stage classification method will be used. It will be noted, however, that for this type of site, certain constraints have to be introduced. They are as follows:

- job B starts one week after the start of job A
- job C starts two weeks after the start of job B
- job D starts two weeks after the start of job C
- job E starts after completion of jobs B and C
- job F starts after completion of job D.

Allowance can be made for these constraints by distinguishing in each job that part which must be carried out independently of the others and that part which has to be carried out simultaneously to others.

Scheduling the tasks by stage:

Stage 1	Stage 2	Stage 3	Stage 4	Stage 5
A (1 day)	A (2 days)	C (2 days)	C (2 days)	F
	B	B	B	E
			D	

Fig. E.6: Diagram development

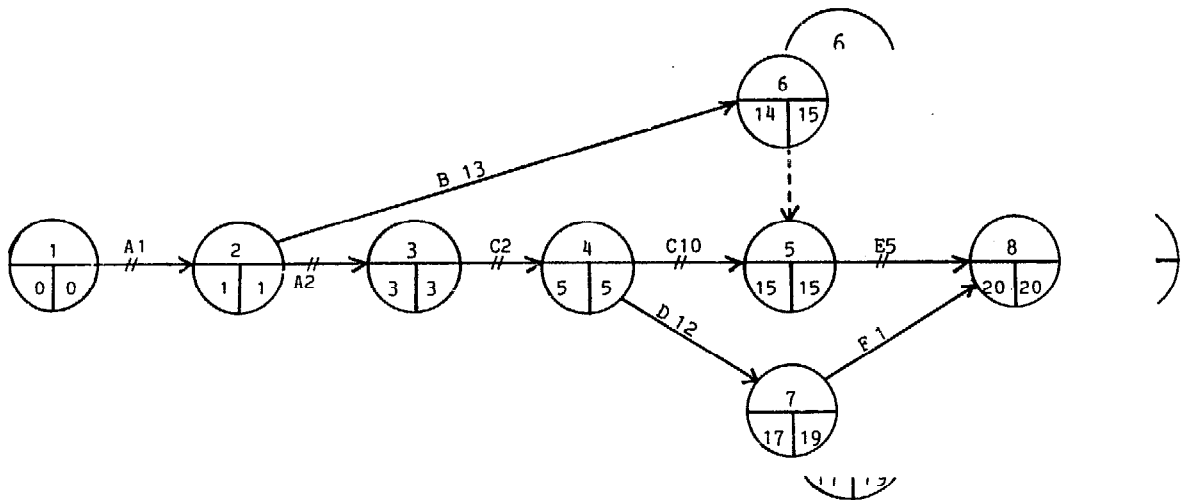

1.3. Setting up the site

1.3.1. Construction of access roads

When access to the site is difficult, an access road will be necessary for supplying the site with equipment and materials. The works supervisor should ensure, during the course of the work, that the necessary signs are in position to protect the road construction workers and to avoid accidents.

1.3.2. Construction of site buildings

The buildings (offices, sheds, accommodation for the works supervisor and workers, mess room, etc.) should be located at a relative distance from the site and the access road to avoid noise and dust.

The workshop and store should be built as close as possible to the site to avoid expensive transport.

A shed should be built in a dry place for storing the cement.

1.3.3. Plant installation

Plant should be stored where it is protected from dust and direct sunlight if possible; preference should be given to an area which is not muddy or sandy.

Fuel reserves should be stored in the shade away from accommodation and the plant storage area.

The area around plant and fuel stores should be kept clean to avoid fire hazards.

1.4. Site management

1.4.1. Management technique

(a) Site supplies

Good site planning depends especially on the site being well supplied with the necessary equipment and materials. Delays in supplies may make it necessary to halt the work of a gang and this may affect the whole site; the consequence of this is always an increase in costs.

From the opening of the site, the works supervisor should have a schedule of supply requirements for the various stages of the work. This should be kept up to date as the work advances and steps should be taken in advance to ensure that suppliers are able to meet deadlines and supply the necessary quantities.

At the same time, a stock of the most common spare parts should be established and this should be managed to ensure security of supplies.

(b) Quantity measurements

It is necessary to measure the work actually completed and the quantities of materials used and to compare this with the estimates made prior to the work. In the case of earthworks, these estimates are based mainly on measurements of surface areas and lengths intended to calculate the volumes involved.

Quantity measurement also covers estimation of all the other factors involved in cost calculation: fuel consumed, transport distances, etc.

These estimations may be entrusted to a quantity surveyor.

(c) Productivity improvement

This involves improving gang output and organising the various tasks to avoid individual gangs being idle.

To achieve this, the foreman should ensure that:

- the workers' capabilities and competence are used to the best effect;
- the gangs are homogeneous;
- the best workers or the best gangs are encouraged (incentives, bonuses, etc.);
- the most suitable tools are used;
- the workers' welfare is looked after (housing, food, etc.).

(d) Works progress reports

Daily progress reports should be drawn up and signed by the foreman.

The planning should be updated each week; if the planned tempo has not been kept, the site supervisor should be informed immediately.

Fig. E.5.

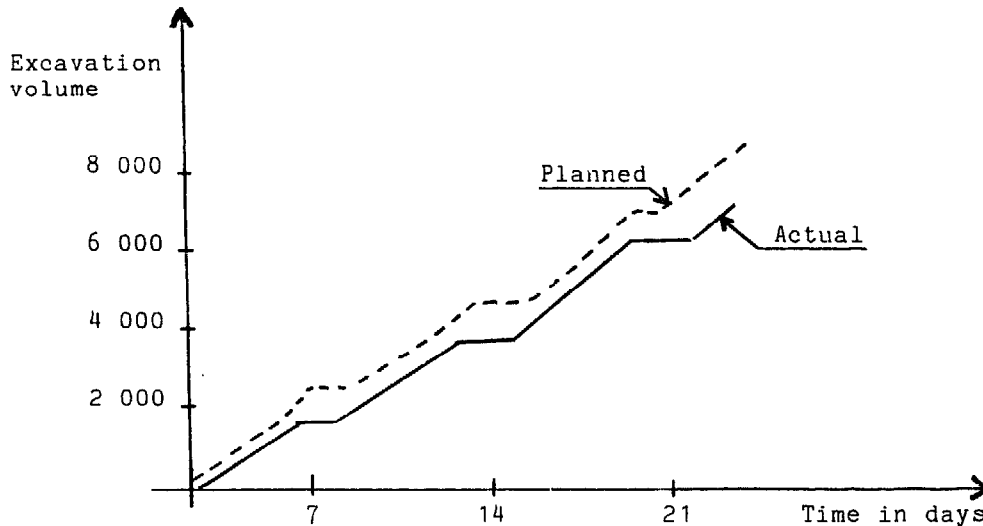

1.4.2. Personnel management

(a) Recruitment of workers

Special labour-intensive public works programmes require special personnel management which are matched to the specific social objectives of these programmes. Voluntary worker participation can be obtained only by suitable prior preparation, which may be of an administrative nature, and make use of public information and awareness campaigns.

When the project exceeds a certain level of workers and time, it is necessary to organise a volunteer recruitment and handling programme; the volunteers themselves should be classified by specific criteria to the jobs they will be expected to carry out taking into account their special abilities. On recruitment, each worker should receive an individual work card which may be based on the model shown below.

Fig. E.8.

<u>Work card</u>	
Group (E)	Photo
Name	
.....	
Sex	Age
Place of residence	
No. of dependants	
Profession	
.....	
Qualifications	
.....	
No. Issued on	

RECTO

Work periods				
Work details				End
Date	Project	Post No.	Checked	Date checked
25.2	SEGOU reaf- foresta- tion	17	Signa- ture	12.4. Signature

VERSO

A weekly attendance sheet (fig. E.9) should be drawn up for each worker, bearing only his family name, given name and address (with, where necessary, any special capabilities), designed for checking off the number of hours and days worked for calculating pay (or related benefits in kind). Depending on the size of the site, this tally will be kept by a tallyman, foreman or works supervisor himself.

Fig. E.9.

Site									No.										
<u>Work attendance sheet</u>																			
Name																			
Category												Hourly wage							
Gang												Month						19..	
Week		Mon.	Tues.	Wed.	Thurs.	Fri.	Sat.	Sun.	Week's total										
From to																			
From to																			
From to																			
From to																			
From to																			
From to																			
From to																			
Worker's signature		Work supervisor's initials																	

Registration No.	Worker designation				Work done		Wage		Remarks
	Name	Personnel card No.	Wages/h	No. of rations per day	Hours	Days	Cash	Kind	

Weekly payroll

(b) Site regulations

The provisions applied should be in line with local customs and current legislation.

The regulations should specify:

- working hours;
- duration of the working week;

- method of payment;
- possible sanctions (for absence, late arrival, etc.).

Regulations may be established in consultation with workers' representatives.

(c) Worker remuneration

The level of remuneration should be set by the competent authorities taking into account the specific nature of the work. Since these are community development programmes carried out by volunteers, remuneration may be lower than the minimum legal wage or paid in the form of benefits in kind.

Payment should be carried out at regular intervals on a daily or weekly basis. The works supervisor should ensure that the necessary funds are available in order to avoid delays in payment. In the case of payment in kind (food rations, for example), care should be taken not to diverge from local tastes which might be a source for discontent.

(d) Transport and quartering

To the extent possible, efforts should be made to recruit manpower locally; however, when the site is at a distance from the workers' homes, it is advisable to organise their transport to the workplace, or if necessary their quartering on the work site by providing lodging, food and adequate sanitary facilities.

(e) Worker training

On small sites and on short-term work, worker training may be rudimentary and aimed primarily at the correct handling of the relevant tools.

In the case of larger and long-term sites, this training should be backed up by training aimed at providing workers with the knowledge necessary for them to take over responsibility for the correct operation and maintenance of the completed project (introduction to modern agricultural techniques, retraining of local craftsmen, reading and writing, etc.).

(f) Human relations, conflicts

The works supervisor should ensure that volunteers receive a warm welcome and are fully informed of the purpose of the work entrusted to them. Volunteers should also be divided up into gangs, where necessary taking into account existing social or community structures.

In special public works programmes, the involvement of the population in question usually leads to collective self-discipline. However, the coexistence of heterogeneous social groups (different ethnic origins) living together for a limited period under artificial conditions may result in conflicts.

The works supervisor should assert his authority and ensure correct progress of the project. To this end, he must ensure that the site regulations are observed and that a good community spirit exists on the site. Any infraction should be sanctioned accordingly.

(g) Health, safety and working conditions

Suitable working conditions will be laid down by practice and legislation; they will have an effect on work productivity and continuity.

Sanitary facilities should be related to the size of the site and the distance from the workers' homes.

Safety and health requirements should be applied. For example:

- for excavations, cuttings, trenches and ditches, it is necessary to ensure the stability of any banks which are higher than 1.20 m;
- for work carried out in water, it is necessary to ensure that the water is clean and harmless and avoid risks of drowning and cave-ins.

Every isolated site employing more than ten workers should have an emergency medical kit for first aid which may be carried out by a volunteer who has received prior training or by the works supervisor himself.

In the case of work sites employing more than 50 workers, there should be a nurse or health worker who can provide first aid and treat common diseases (malaria, headaches, dysentery).

In the case of sites employing more than 500 workers or work lasting more than 12 months, it is necessary to provide a small mobile dispensary with a bed and a permanent nurse for every 250 workers.

1.4.3. Incentive system

In all firms employing workers, incentives are desirable to encourage better results. Recompense is therefore given for good results obtained either individually or by the gang as a whole. Praise or rewards may be made and additional holidays given. However, such procedures may prove unsuccessful especially in the case of short-term work. It will therefore often be necessary to turn to:

- the finish-and-go system,
- piecework payment.

(a) The finish-and-go system

This system is particularly attractive to workers, such as small farmers, agricultural workers, etc., who see the special public works programme as a supplement to their main job - agriculture. The interest for them is to finish their work early and return home so that they can possibly spend the rest of the day on this main job. The system also suits agricultural workers who are not usually accustomed to regular working hours.

It is possible to determine a task which lasts for several days, although this is not usually desirable, nor always permitted by legislation. There is a danger that this practice may lead to five daily attendance cards being given for three days' actual work and this is clearly open to abuse. Usually, preference is given to daily tasks; since the result is extra work for skilled workers, the tasks are essentially simple ones, such as for example, digging a certain length of trench of uniform cross-section.

(b) Piecework systems

Where local legislation permits, piecework systems offer numerous advantages, in particular where a standard wage rate is fixed for each task and the worker (or gang) receives a fixed amount for each unit of work carried out. The advantages and disadvantages of these systems are as follows:

Advantages	Disadvantages
<p>the worker is able to earn more than the normal daily wage in return for higher output;</p> <p>his output will be higher since his wage depends directly on the effort he puts into his work;</p> <p>these systems promote individual discipline and require less supervision;</p> <p>the worker himself attempts to improve the efficiency of his working method;</p> <p>when, instead of an individual, it is a gang which is doing piecework, the gang will organise itself to ensure maximum effectiveness and the most active members will encourage the others to work harder;</p> <p>in certain cases, where the situation allows, the workers will be able to stipulate their own working hours.</p>	<p>in attempting to achieve higher output, the worker may neglect quality and safety;</p> <p>if the rates are too low, the incentive to work hard may be lost, or the worker may work too hard to the detriment of his health;</p> <p>differences in earnings between harder workers and less hard workers may sometimes cause resentment;</p> <p>these systems are more complex to apply than a daily wage or a finish-and-go system.</p>

1.4.4. Role of project management

The project management is responsible for the correct implementation of planning. The main tasks are:

- work programming;
- work implementation;
- supervision and control.

Work programming requires an over-all long-term view of the project and should be the responsibility of the project manager. Carrying out the work requires daily supervision which will be the responsibility of the works supervisor.

Responsibilities of project manager	Responsibilities of works supervisor
<ul style="list-style-type: none"> - programming - budgeting and budget control - forecasting - recruitment of assistants - training - research - public relations - selection of main items of equipment - wage negotiations - project control 	<ul style="list-style-type: none"> - implementation of work - quality and productivity control - recruitment and payment of workers - purchasing of materials - discipline - transport and organisation of manpower - supervision of equipment and plant - maintenance of buildings and roads

E.2. TOPOGRAPHICAL STUDIES

Topographical studies may prove necessary in numerous cases, in particular for projects on hilly ground or which cover a large area.

It is difficult, within the framework of this document, to specify precise methodology and the type of topographical studies that should be foreseen since the characteristics of the soil conservation projects within a special public works programme may vary considerably. We will therefore not do more than indicate certain general principles for topographical studies and invite the reader to refer to the numerous specialised documents in this field.

2.1. Topographical survey

A survey comprises:

- (a) the planimetric survey which picks out the various natural features of the terrain or a structure;
- (b) the levelling survey in which the altitude of these natural features is measured.

2.1.1. Planimetric survey

The planimetric survey is carried out by the measurement of distances and angles. The instruments required are:

Distance measurements

- the surveyor's chain (20 m in length);
- the measuring rod in wood or metal of 4-5 m in length fitted with a spirit level for checking horizontals and a plumb line for measuring horizontal distances on slopes greater than 2 or 3 per cent;
- a folding 2-m rule for measuring the details of the structure.

Angle measurements

- goniometers, the most commonly used being the theodolite; these comprise two plates one of which is graduated to permit the measurement of angles;
- surveyor's squares for locating points and features at an angle of 45 ° to each other;
- optical square which replaces the surveyor's square;
- plane table, a type of goniograph with which it is possible to measure the relative position of a number of points;
- compasses with which it is possible to measure differences between magnetic azimuths.

2.1.2. Levelling

Two procedures are usually used:

- direct levelling for horizontal sites;
- indirect levelling for inclined sites.

Direct levelling is carried out using a level and a levelling staff.

Since the level can be used only for horizontal sights, it is necessary on steeply sloping ground, to carry out a series of levelling sights. This procedure, called change-point levelling, is illustrated in fig. E.10.

Fig. E.10.

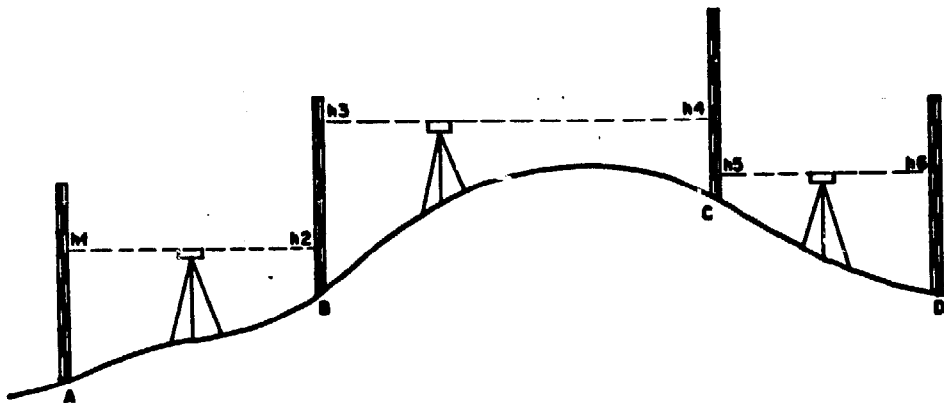

In indirect levelling, the difference in level between two points is calculated by measuring the angle formed between a straight line linking these two points and the horizontal, and the distance between the two points. This method requires the use of theodolites or clinometers. The latter are particularly well suited to rapid reconnaissance surveys and allow gradients to be measured with a precision of around 1/1,000th.

The indirect leveling method is illustrated in fig. E.11 below.

Fig. E.11.

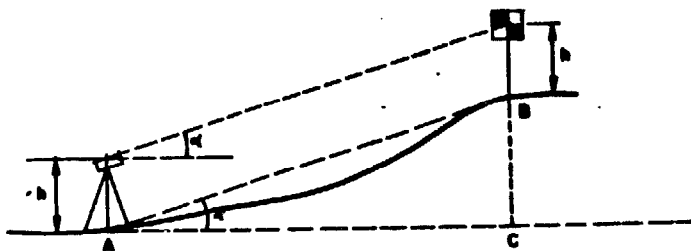

2.1.3. Composition of a topographic survey team and survey standards

The composition of a topographic survey team will vary depending on the slope and difficulties of the terrain. A basic team will usually comprise:

- topographic surveyor;
- one or two staff men;
- two chain men;
- two labourers, to carry the levelling stakes.

The density of levelling points generally accepted for different surveying scales is as follows:

Surveying scale	No. of levelling points per ha
1/10 000th	1
1/5 000th	2
1/2 000th	6-10
1/1 000th	15-30
1/500 th	20-100

E.3. MARKING AND STAKING OUT THE STRUCTURE

Marking out a structure consists in indicating the axes and the external dimensions on the ground. This is done by means of stakes which should be precisely located in relation to fixed reference points. The marking out operations should be carried out in the presence of the project manager and the works supervisor.

3.1. Preparation of the ground plan

The structure should be depicted by a ground plan and by elevations and sections. The ground plan is drawn up by indicating on a tracing paper the main axes and the measurement of angles and altitude.

3.2. Preparation on the ground

The transverse or longitudinal axis of the structure should be indicated by two fixed reference points which would be either boundary stones set in concrete or concrete boundary posts in which a nail is set in the upper part to act as a reference point. The number and altitude of the reference point should be marked on the boundary stone.

The fixed reference points should be located outside the external limits of the work and should be sufficiently visible not to be damaged during the course of the work. They should remain in place throughout the duration of the work and their co-ordinates and altitude are usually incorporated in the general levelling survey of the area.

3.2.1. Main staking out

This is used to define:

- for works of engineering construction: the axes;
- for earthworks: the axis of the route, the longitudinal profile, the curves, the location of the cross-sections.

Staking out is carried out using hard-wood, square or circular cross-section stakes, 50 cm in length. In loose soil, the stakes should be driven home with a sledgehammer; on rocky land, they should be cemented into holes made with a jumper bar.

The stake heads should be painted to ensure that they are clearly visible, and each stake should be numbered and referred in plan and altitude to the fixed reference points.

The stake head should be set at the exact measurement of the future ground level if this is not more than 30 cm higher or lower, or an exact number of decimals above or below.

3.2.2. Additional staking

This is carried out from the main stakes and indicates the boundaries of the works, such as the edges of trenches or banks. These stakes are not levelled and they should be painted in a different colour to that of the main stakes.

3.2.3. Staking report

This document should be drawn up in the presence of the works supervisor who should indicate the number of the profiles, and the position and altitude of the reference points.

Example:

Part of structure	No. of stakes	Position of stakes		Distance between stakes	Height of earth-works	Comments
		Alignments and curves	Slopes and sections			

3.2.4. Displaced stakes

Before the work is started, the main stakes which are located within the area covered by the works should be displaced at a constant distance outside the boundary of the structure. This displaced staking should also be levelled in relation to the axis stakes as shown in fig. E.12 below:

Fig. E.12.

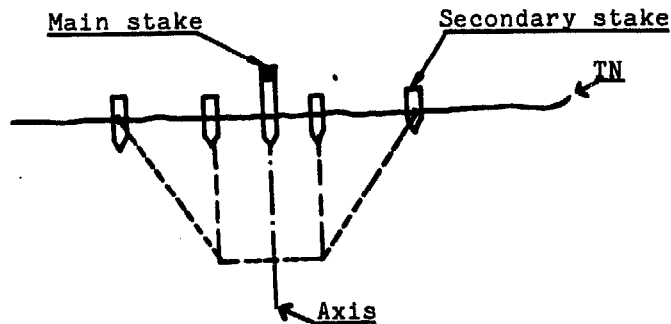

3.3. Personnel requirements and work output

The personnel required for the marking and staking out will be provided by the basic topographical survey team as listed above. On normal ground, such a team should have an output of 4-6 km per day.

Material required for marking out work should comprise, as a minimum:

- a level for determining altitudes;
- a goniometer for the marking out proper;
- two levelling staffs;
- a surveyor's chain (or steel tape);
- stakes;
- cement, sand, water for the installation of the main fixed reference points;
- paint for marking the stakes.

E.4. GROUND PREPARATION

4.1. Clearing the land over the area covered by the works

In soil conservation projects, land clearance will be limited to preparing the areas of work such as channels, embankments and earth dams with a supplementary margin for the movement of workers and plant.

Land clearing consists in eliminating any vegetation which would hinder the progress of the works or might lead to their deterioration.

For manual work, the tools used will vary considerably depending on the country. The main types are the machette, hatchet, axe, hoe, fork, pick, pruning saw, scythe, sickle and hand winch.

Output norms are related primarily to the density of the vegetation. Land types may be classified into various groups. For manual clearing work, five categories can be distinguished as shown in fig. E.13.

Fig. E.13.

Category	Characteristics	Manual output	Observations
Grass savannah	No vegetation higher than 1 m; a few sparse shrubs	Between 200 and 300 m ² per day/man	Output depends on climate and site organisation
Shrub savannah	Scattered bushes; thorny vegetation; land covered with perennial grasses; numerous shrubs	between 100 and 200 m ² per day/man	An alternative is to use a chain pulled between two tractors
Wooded savannah	Semi-arid tropical regions; dense vegetation; thorny brush; numerous shrubs; thickly wooded; some large trees	Between 50 and 100 m ² per day/man	Tree stumps and trunks and brush are left in place; they are burnt on site 3 weeks after having been felled
Forest	Hard and soft wood; large diameter trees forming a vault	Unusual work within the frame-work of soil conservation projects	Six men and a winch can fell about 10 trees per day; animal haulage might be envisaged
Equatorial forest	Hard and soft woods; very large trees; widespread vaulting		

4.2. Stripping - subsoiling

The stripping operation entails the removal of topsoil over a depth of 20-30 cm in areas which are to be filled. Normal trenching methods are used.

Subsoiling is a deep scarification (up to 60 cm) intended to increase soil permeability or break up a hard pan. It is used in arid zones to prepare the soil prior to reforestation work. It requires powerful mechanical plant (tractors of 35-70 hp for subsoiling to a depth of 60 cm).

Instead of subsoiling the soil may also be loosened with a pick axe under the area to be covered with ridges in which trees are to be planted.

The following productivity data for light stripping and subsoiling were collected in the Philippines. The soil is loosened by a plough before being shovelled clear and the stumps removed by hand.

Soil	Non-cohesive soil; fields of sugar cane which have been cut and burnt, and in which there remains two or three stumps or roots per square metre
Method	Four successive ploughings; followed by removal of the remaining roots by three passes with a bamboo scraper and three times handpicking

Gang composition: 2 ploughs, 1 scraper, 2 labourers handpicking

Productivity	Over-all: 165 m ² per hour per gang
	Per operation: first ploughing: 250 m ² per hour per plough subsequent " : 490 m ² per hour per plough bamboo scraper: 490 m ² per hour per scraper handpicking: 250 m ² per labourer

E.5. EXECUTION OF EARTHWORKS

5.1. General comments on soil type and handling

5.1.1. Land classification

The type of land will determine:

- the working method to be used;
- the choice of equipment to be used;
- output and, consequently, the cost of earthworks.

Soil type has a considerable effect on trenches and the shape to be given to cuts and fills. A distinction may be made between:

- loose soil which may be excavated without previous loosening;
- rocky soils which may be loosened.

Loose soils may be classified as follows:

Light soils	Dry topsoil, dry sand, fine gravel
Ordinary soil	Moist topsoil, firm soil mixed with sand, wet sand, compact clayey sand, compact clayey fine gravel, large gravel, peat
Heavy soil	Firm soil mixed with stones, clay soil, compact clay, large gravel, clay, marl, broken rubble
Very heavy soil	Wet clay, compact marl, consistent rubble, soft quarry stone, brittle slate, faulted limestone, decomposed rock

Rocky ground may be classified as follows:

Soft rock	Soft limestone, chalk, sandstone, compact slate, conglomerates
Hard rock	Granite and gneiss, hard limestone
Very hard rock	Granite and compact gneiss, quartzite, syenite, basalt

5.1.2. Bank gradients

The slope of a bank should always be less than the angle of repose that would be formed in a bank abandoned to the action of weathering. It is defined by the ratio $H = \tan i$ where H is the height of the bank, B its base and i the angle of the bank $\frac{H}{B}$ to the horizontal.

Fig. E.14.

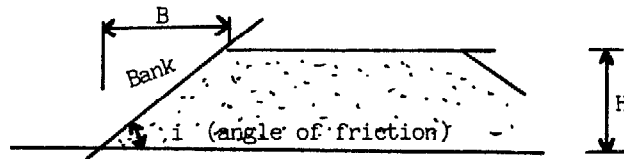

Knowledge of the angle of repose is essential in ensuring the stability of earthworks and in estimating the area they will occupy and the volume of earth to be moved.

The angle of repose in a slope will depend basically on the type of soil and its consistency. The angle is higher for dry soils than for wet or submerged soils, and higher on natural banks than on filled banks.

Generally accepted values for angles of repose are given in tabular form in fig. E.15.

Fig. E.15: Angle of repose for banks $\text{tgi} = \frac{H}{L}$

Type of soil	Banks cut in natural ground		Banks cut in dumped soil Filled banks	
	Dry land	Waterlogged land	Dry land	Waterlogged land
Hard rock	5/1	5/1	1/1	1/1
Soft or fractured rock	3/2	3/2	1/1	1/1
Rock debris, scree, pebbles	1/1	4/5	1/1	4/5
Subsoil mixed with stones and topsoil	1/1	1/2	2/3	1/2
Clayey soil, clay, marl	4/5	1/3	2/3	1/3
Gravel, non-clayey coarse sand	2/3	1/2	2/3	1/3
Non-clayey fine sand	1/2	1/3	1/2	1/3

5.1.3. Bulking - consolidation

Soil, when extracted, increases in volume. This is called bulking. There are three types:

- the coefficient of initial bulking F which is measured when the soil has just been extracted:

$$F = \frac{V - V_0}{V_0}$$

- the coefficient of persistent bulking F' which is measured after consolidation:

$$F' = \frac{V' - V_0}{V_0}$$

- the coefficient of consolidation which is the decrease in the apparent volume of soil which has consolidated completely in relation to the initial volume of newly extracted soil:

$$T = \frac{V - V'}{V}$$

Fig. E.16.

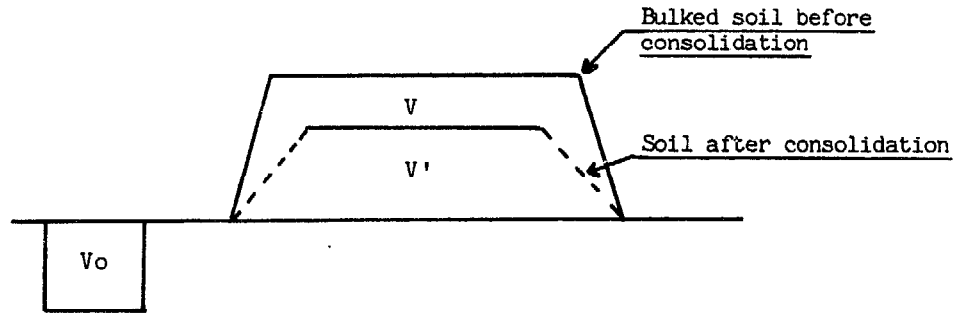

Fig. E.17: Values of coefficients of bulking and consolidation

Type of soil	Coefficient of bulking		Coefficient of soil consolidation T
	Initial F	Persistent F	
Topsoil, sand	10-15 %	1-1.5 %	8-12 %
Gravel	15-20 %	1.5-2 %	12-15 %
Heavy soil mixed with sand	20-25 %	2-4 %	15-17 %
Clayey soil	25-30 %	4-6 %	17-19 %
Clay	30-35 %	6-7 %	19-21 %
Marl	35-40 %	7-8 %	21-23 %
Very compact clay and marl	40-65 %	8-15 %	23-30 %
Scree	30-40 %	8-15 %	17-18 %
Hard core (ine)	40-65 %	25-40 %	10-15 %

Knowledge of coefficients of bulking and consolidation is important in carrying out earthworks.

To produce a fill with a final volume V' , it is necessary to place a provisional bulked volume (before consolidation) of $V = \frac{V'}{1 + T}$ and excavate an in situ volume of

$$V_o = \frac{V}{1 + F}$$

5.2. Tools

The tools used for manual earth moving are either hand tools or portable mechanical tools.

5.2.1. Trenching tools

The main manual tools are:

- The pickaxe. This is made of steel and has a point at one end and a blade at the other; the wooden shaft is about 1 m in length. The point blunts rapidly when used in hard soil; it can be repaired by welding on a new spike. A smith and his mate can repair 30-40 pickaxes per day. It is necessary to expect that about 20 per cent of the stock of pickaxes will be in for repair.
- The pick. This is a pickaxe with a point at each end for use in soft rock.
- The wedge. This is made of steel and struck with a 2 kg sledgehammer to break fissured rock.
- The crowbar. A steel lever 1.20 m in length used to break fissured rock.

Portable mechanical tools include:

- Pneumatic spades which are used in heavy soil of compact clay or marl. They have an output of 5-10 times higher than the hand pickaxe.
- Pneumatic picks which are used to break soft or fissured rock. They have an output 5-10 times higher than the pick, wedge and crowbar which they replace.

They can be handled by one man alone and receive their compressed air supply from a small mobile motor compressor.

5.2.2. Tools for loading earth

For loading excavated earth, use is made of:

- the shovel which can be used for excavating very loose earth. It is made of a steel blade weighing 1.0-1.5 kg fixed to a wooden shaft 1.20 m in length. A shovel load usually weighs 2.5-3 kg; lumps weighing more than 5 kg are loaded by hand;
- the fork which has teeth 3-4 cm apart and is used to grade stoney materials by size.

5.2.3. Tools for soil haulage

Depending on the country, local resources and haulage distances, the following means are employed:

- wicker baskets;
- hoppers carried on the back;
- 2-man bamboo stretchers;
- 40-60-litre wheelbarrows.

For larger capacities and haulage distances (greater than 100 m), animal-drawn equipment is used, such as:

- pack saddle with a capacity of: 100-150 kg for an ox,
70-120 kg for a mule,
60-100 kg for a donkey,
120-150 kg for a camel;
- single-axle cart with a capacity of: 400 kg for an ox, donkey or horse,
and 1,000-1,200 kg for a pair of oxen;
- sledge with a capacity of 400 kg for 2 m² and 2,000 kg for 7 m²;
- shaft, piece of wood to each side of which the animals are harnessed.

Where animal haulage is not available, it may be necessary to use light mechanical haulage equipment: motor barrows, dumpers, etc.

Example of productivity

HAULAGE AND UNLOADING OF HOMOGENEOUS
LOOSE MATERIALS (by ox cart)

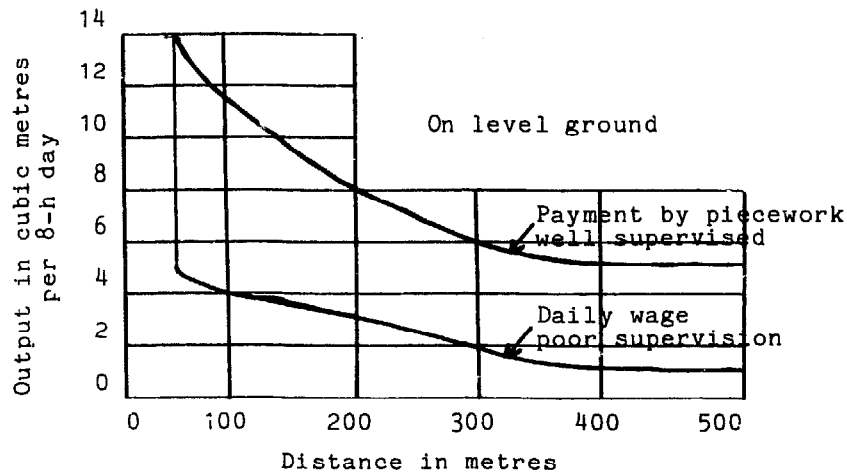

The upper curve shows the outputs attainable with good organisation and supervision, with payment by piecework. The lower curve shows the outputs attained under poor supervision, with daily rated payment.

Mean cart capacity: 0.315 m³.

5.2.4. Tools for soil compacting

The simplest soil compacting tools are hand tampers manipulated by a single worker and pneumatic tampers also operated by a single worker and supplied with compressed air by a small motor compressor.

5.3. Manpower

Earth moving is ideal for the employment of large numbers of unskilled workers and meets perfectly the objectives of labour-intensive work in which manpower utilisation is a solution to the economic problems of a developing country.

However, there are conditions and limits for the use of manpower in this way, and the factors affecting working conditions and output include:

- climate;
- workers' health;
- nutritional status;
- local customs which govern periods of work, job distribution, inacceptability of certain types of work (work with feet in water, etc.);
- skill in the use of certain tools;
- the conditions under which the project is being carried out;
- the way in which workers are paid.

The example below clearly illustrates the differences in output that can be expected depending on the level of organisation and supervision.

LOADING, HAULAGE AND UNLOADING HOMOGENEOUS LOOSE SOIL
(using buffalo-drawn bamboo scraper)

The soil is previously loosened by ploughing. The scraper can also be used for grading or spreading loose soil. Average output:

soil tipped in large piles (e.g. by a dump truck):	5 m ³ /hour
soil tipped in small piles (e.g. by a buffalo cart):	25 m ³ /hour
scraper maximum haulage capacity:	0.05 m ³

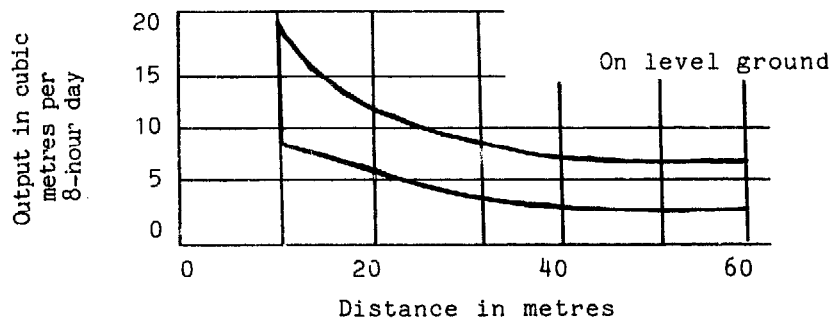

The upper curve shows the outputs that are obtainable with good organisation and supervision, with payment by piecework. The lower curve shows outputs attainable with poor supervision and daily rated payment.

The special factors affecting productivity include:

- age and condition of buffalo;
- proximity of water for buffalo;
- soil type;
- slope of haulage route.

5.4. Labour organisation

A manual earth-moving site comprises: a site supervisor, four men or gang leaders, labourers, water carriers where necessary, a topography team, a tallyman and a watchman for the equipment.

There is usually one gang leader for every 20-25 men depending on the difficulty of the work.

The basic gang comprises:

- either one man with a pickaxe and shovel;
- or two men: one with a pickaxe and the other with a shovel;
- or three men, with two pickaxes and a shovel for very hard ground, or one pickaxe and two shovels in softer ground.

The way in which manpower is used may vary depending on the means employed. Either the earth moving can be done entirely by manpower or by manpower in combination with local resources such as animals or mechanical plant. The type of soil and haulage distances will often decide the solution to be employed. Where the haulage distances are large, it may be better to excavate and load by hand and haul mechanically. Certain work cannot be done by hand, such as subsoiling and ripping; manpower is a back-up here.

Finally, certain earth-moving jobs are suitable for piecework payment; this applies to ditching and banking in particular.

5.5. Earth-moving methods and outputs

5.5.1. Trench digging and spoil removal

In very loose ground, trenches may be dug directly with a shovel; in harder ground, the soil is first loosened and then removed with a shovel; in hard ground, pickaxes, wedges or crowbars may be required.

The work may advance along the axis of the trench using two or three workers: the first loosens the soil with a pickaxe while the second (and third) follow and shovel out the spoil or deepen the trench. This is the procedure usually used for narrow trenches.

For wider trenches, the workers may be arranged in a line and work perpendicular to the trench axis.

Fig. E.18.

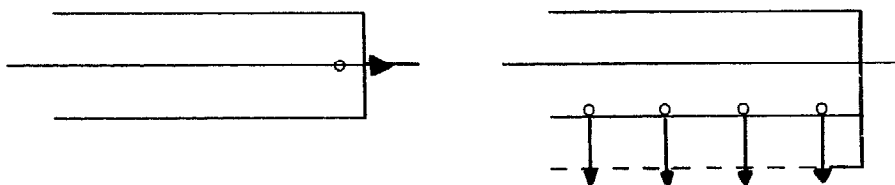

Trench digging methods are shown in the diagrams below:

Fig. E.19: Terrace construction

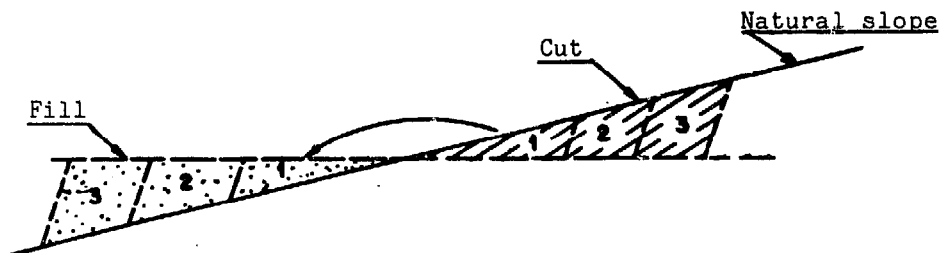
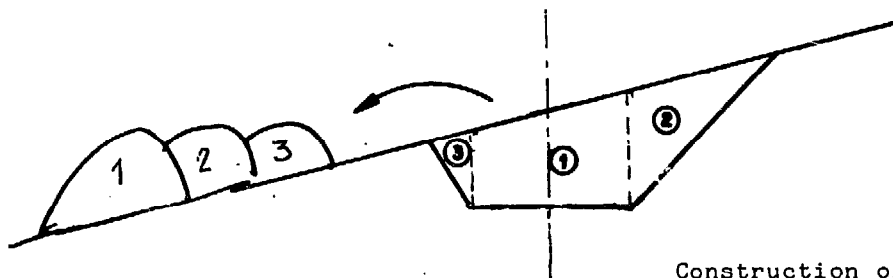

Fig. E.20: Construction of a protection ditch

Deep trenches should be dug as follows:



Construction of a protection ditch with spoil thrown downhill

Output in earthworks varies considerably depending on soil characteristics and trench size.

Soil cohesion, density and adherence are the main factors influencing output; other factors such as soil water content may also play a role.

Cohesion is the measure of soil hardness and directly affects the output of the pickaxe man.

Density affects the shoveller's output.

Soil adherence to the tools affects the output of both pickaxe and shovel men.

Worker deployment also has a great effect on output. Workers should be sufficiently spread out (about 2 m apart) so that they do not get in each other's way.

Under optimal conditions, maximal output of workers using hand tools is as follows:

Fig. E.21: Output in manual earthworks

Type of soil	Daily output (m ³ /md)
Light soil	5.0-7.0
Ordinary soil	3.5-5.0
Heavy soil	2.5-3.5
Very heavy soil	1.0-2.5

In the case of narrow ditches, workers are hindered and output lowered by about 20 per cent if the trench is less than 1.20 m wide or over 2 m deep.

Some common outputs and the breakdown between digging and spoil removal are shown in fig. E.22.

Fig. E.22: Common values for output in trench digging

Soil type	Cubic metres excavated and thrown 1 m in an 8-hour day	Breakdown of 8-hour day	
		Excavation (hours)	Spoil removal pitching or loading (hours)
Topsoil (loam, sand, etc.)	3.0	5.0	3.0
Marly or clay soil, moderately compact	2.0	5.3	2.7
Hard, compact soil	1.5	5.7	2.3
Chalky soil	1.5	5.6	2.4
Waterlogged soil	1.0	5.3	2.2
Moderately hard laterite	1.0	6.7	1.3
Very hard laterite	0.8	7.0	1.0
Soft rock worked with pick or wedge	0.6	7.0	1.0

5.5.2. Loading and reworking spoil

A worker can throw a shovelful of earth 3-4 m horizontally or 1.5-1.6 m vertically.

A throw of a distance d and a height h is given by the equation:

$$d + 2h = 4 \text{ metres.}$$

When earth has to be thrown further than that of which a shoveller is capable, a relay may be established. When the earth is to be thrown horizontally, shovellers are placed in a line at intervals of 3-4 m. When the earth is to be thrown upwards, the shovellers are placed on successive steps at distances given by the equation $d + 2h = 4 \text{ m}$.

The output of a shoveller will vary depending on the density of the soil, the method used and the skill of the worker. It also varies depending on the loading height: it falls rapidly when this exceeds shoulder height.

Under optimal working conditions, the following maximum outputs can be expected:

Fig. E.23: Maximum shovelling output in loading or picking up soil

Type of operation	Hourly output in m ³ of bulked soil			
	Light soil	Ordinary soil	Heavy soil	Very heavy soil
Simple shovel throw	1.5-1.0	1.0-0.8	0.8-0.6	0.6-0.4
Loading a wheelbarrow	2.5-2.0	2.0-1.5	1.5-1.0	1.0-0.8
Loading a truck	2.0-1.5	1.5-1.0	1.0-0.8	0.6-0.4
Loading a cart	1.5-1.0	1.0-0.8	0.8-0.6	0.6-0.4
Loading a lorry	1.0-0.8	0.8-0.6	0.6-0.4	0.4-0.3

5.5.3. Spoil haulage

The main means of haulage are shown in section 4.2.

The simplest means are usually used for haulage distances of less than 100 m. The wheelbarrow is the most common and has a capacity of 40-60 litres. A wheelbarrow pusher can complete a return journey of 30 m in each direction whilst a shoveller is filling a 50-litre barrow.

Animals or mechanical equipment are used for haulage of more than 100 m. Animal haulage requires flat ground or the haulage should be downhill with the empty return being uphill.

The theoretical output for transport equipment is given by the formula:

$$R_t = \frac{1}{2} C_u \times V$$

in which: C_u is the payload capacity

V is the haulage speed in km/h.

Fig. E.24 gives examples of theoretical outputs.

Fig. E.24: Theoretical output of various types of haulage equipment

Equipment	C_u (t)	V (km/h)	$R_1 = \frac{1}{2} C_u \times V$	Remarks
(a) Small haulage equipment				
Wheelbarrow, 50 l	0.075	3	0.12	
Cart - 1 horse, 750 l	1.125	3	1.7	
Cart - 2 horses, 1 500 l	2.250	3	3.4	
Motor barrow, 300 l	0.450	5	1.12	3 wheels, 3 hp
Small dumper, 350 l	0.525	5	1.3	4 wheels, 4 hp
Small dumper, 600 l	0.900	6	2.7	4 wheels, 8 hp

Wheelbarrow haulage: Output and gang composition for natural gradients of 0-5 per cent (good haulage track).

Fig. E.25.

Haulage distance (m)	Volume of material (m ³)		No. of workers			
	In situ	Bulked	Loading	Haulage	Spreading	Compaction
0-20	13.5	17.0	2.0	1.0	1.0	1.0
20-40	10.5	13.5	1.5	1.0	1.0	1.0
40-60	8.5	10.5	1.0	1.0	1.0	1.0
60-80	6.5	8.0	1.0	1.0	0.5	0.5
80-100	5.5	7.0	0.5	1.0	0.5	0.5

A buffalo-drawn steel scraper gives good results for loading, haulage and unloading of homogeneous loose soil for haulage distances of up to 100 m.

The diagram below shows mean outputs for the scraper which has a mean capacity of 0.075 m³ on flat ground.

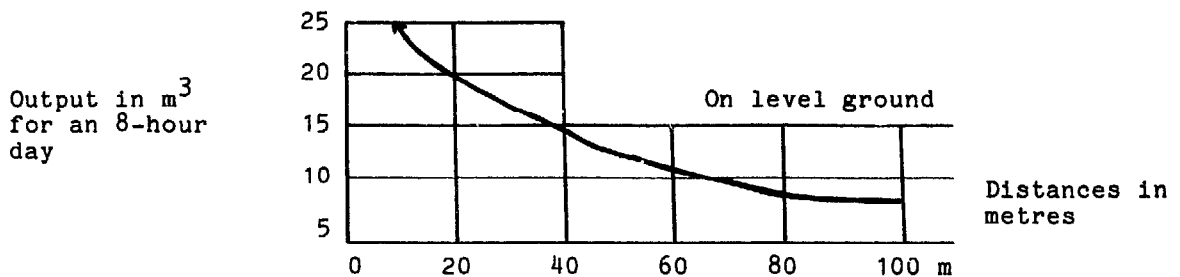

5.5.4. Unloading, spreading and compacting

After unloading, manual spreading can be carried out at a rate of 2-4 m³/h/man. The work varies however depending on whether the spoil is normal or compacted. Normal spoil is usually encountered in the type of soil conservation work described here, with the exception of fill for dams.

Ordinary spoil should be cleaned of mud, running soil, peat, sods, stumps and vegetable debris. It should be tipped over the total height of the dump, without being compacted.

Compacted soil should be prepared in the same way, then evened out in horizontal layers 15-25 cm thick over the total height of the platform. Since compacting is often inadequate on the edges of banks, the structure may be 20-40 m oversized on each side. Each layer should be dampened and then carefully compacted with hand tampers or drawn rollers to the specifications laid down. Before each new layer is spread, the base should be scarified, then dampened. The gradient of the bank slope should be checked using a jig fitted with a spirit level.

Output for manual compacting is 1.2-1.5 m³/h using hand tampers and 10-15 times higher using a drawn roller.

5.5.5. Bank grading

The definitive gradient is given to the bank by cuts made with a pickaxe about every 10 m.

The slope is trimmed working from top to bottom.

Workers are placed along a horizontal line at intervals of about 1.5 m. The gradient is checked by stretching a line between two cuts.

5.6. Examples of earthworks

5.6.1. Construction of a canal or ditch

The various operations involved are as follows:

-
- (a) mark and stake out the canal;

 - (b) on the existing soil, stake the width of the ditch;

 - (c) run a line between the stakes and, using a pickaxe, mark the boundaries of the trench;

 - (d) excavate a trench with vertical sides to the finished depth of the ditch;

 - (e) dig a trench 30 cm wide with the planned shape of the ditch, every 5 m;

 - (f) stretch a line between these and mark out the edges of the ditch with a pickaxe;

 - (g) roughly dig out the banks;

 - (h) give final shape to the banks;

 - (i) check levels with a spirit level;

 - (j) check the cross-section with a jig.

Fig. E.26: Ditch digging technique

Staking out the final dimensions of ditch

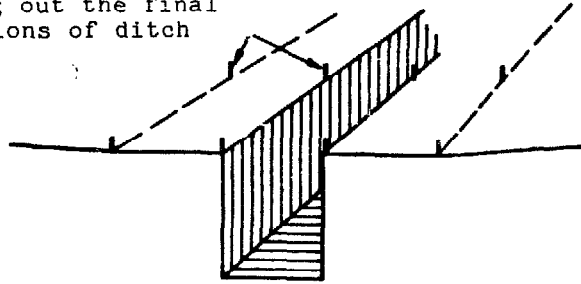

Phase 1: Staking out the final width and vertical excavation down to specified depth

Trench 30 cm wide to definitive shape

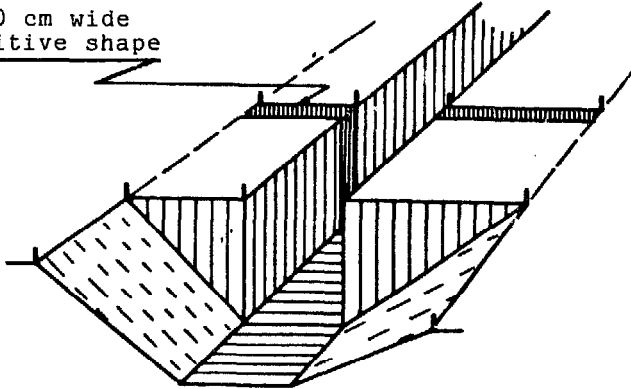

Phase 2: Excavation of a trench to final width of the ditch

Phase 3: Shaping

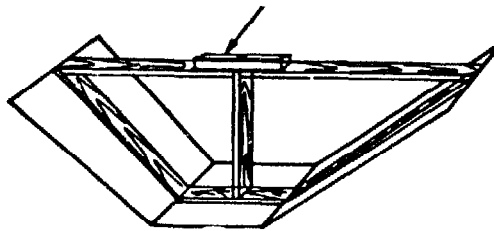

Phase 4: Checking the cross-section with a spirit level

5.6.2. Construction of earth dams

The various operations involved are as follows:

- set up site, mark out dam, additional reconnaissance;
- construction of a coffer dam for temporarily diverting the water course;
- strip vegetation and trees from basin;
- prepare borrow zone;
- remove topsoil from foundation area;
- fill foundations to natural ground level;
- install take-off and emptying pipe;
- bring in filtration materials;
- install foot drains;
- fill;
- civil engineering work for take-off and feedback;
- civil engineering work for flood escape;
- cover banks;
- install hydraulic equipment;
- finishing work.

E.6. IMPLEMENTATION OF REAFFORESTATION WORK

Reafforestation techniques have been described in Chapter B. Given below are the principle working methods and outputs.

6.1. Nursery work

This comprises:

- nursery construction;
- seedbed construction;
- sowing in seedbeds, plant beds or pots;
- pricking out into plant beds or pots;
- watering;
- plant transport.

The tools used are: hoes, pickaxes, spades, shovels, rakes, spirit levels, lines, stakes, watering cans, secateurs, polyethylene sachets, etc.

Nursery work requires large amounts of manpower. Work times depend mainly on the type of plants being grown and the type of care being given. A basis can be taken 0.3-0.6 hours per plant which, for various plant spacings, gives the following work times:

Plant spacing (m)	No. of plants/ha	Work times	
		Minimum days/ha	Maximum days/ha
3.0 x 3.0	1 100	47	94
2.5 x 2.5	1 600	68	136
2.0 x 2.5	2 000	86	172
2.0 x 2.0	2 500	107	214
1.5 x 2.0	3 300	141	282
1.5 x 1.5	4 400	188	376

6.2. Planting

Preparatory work includes marking out, staking out, clearing and soil preparation.

The tools used for planting are the same as those used in trenching, i.e. shovels, pickaxes, hoes, lines.

The basic gang comprises two workers: the first digs the planting hole, the second transports the young plants in pots, sacks or baskets, places them in the holes and completes the planting operation. In certain cases, a single worker may do the whole operation himself.

The workers advance in a more or less straight or diagonal line; the gang leader being slightly ahead of the rest. Other workers ensure a constant supply of materials.

Planting holes should be sufficiently wide and deep to take the whole root system without crushing the roots against each other. Roots should not be bent in towards the centre of the hole, and should be fully covered with earth. To ensure the plant is covered to the right depth, hold it at the earth mark whilst the hole is filled with soil. Soil should be placed around the plant with care and trodden down when the hole is half full and then trodden down once again when the hole is completely full.

A foreman should follow up the line of planters to check a proportion of the plants to ensure that they are vertical and do not come out of the ground when pulled from the tip.

Under the best working conditions, when using hand tools, gangs can plant 100-500 trees in an 8-hour working day. This level of output will vary depending on the difficulties of the site (topography, density of vegetation cover, type of soil, soil preparation, etc.).

6.3. Construction of forest tracks

This comprises basically earth-moving work.

According to the FED productivity norms in Rwanda, forest track construction requires 7.6 hours of work per cubic metre of earth moved.

6.4. Plantation maintenance

Plantation maintenance requirements are considerable during the first two years (replacement of plants that do not take, weeding) and then decrease regularly thereafter.

Maximum output for weeding is 200-300 m² per man-day.

Clearing around young plants requires a man-day for 200 plants.

In Mohanda (Burundi), maintenance requirements for a plantation of 3,000 callitris plants/ha have been estimated at 0.3 h/plant, i.e. 128 7-hour working days per hectare per year.

6.5. Examples of a plantation: planting along contour lines

Fig. E.27: Planting along contour lines

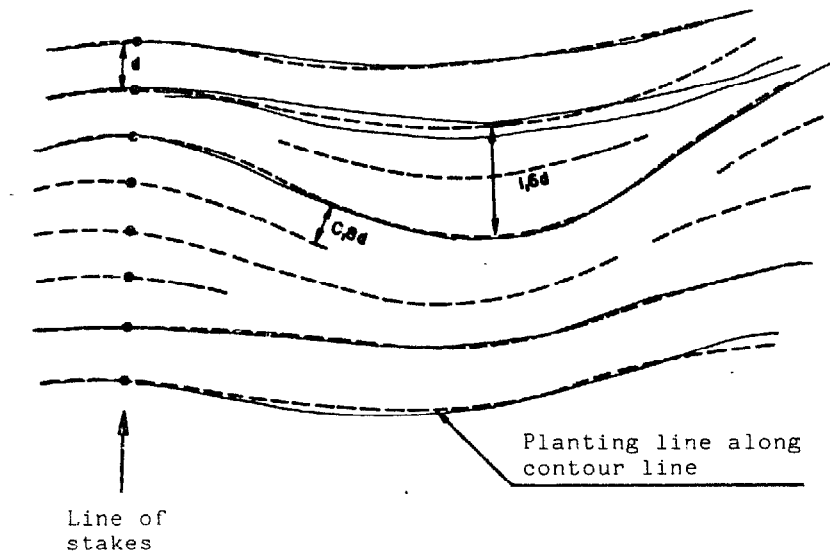

With an interval d between plants, a line of stakes is inserted perpendicular to the slope and spaced at d from each other.

A first row of trees is planted along the contour line using a spirit level d in length.

Subsequent rows are planted in a similar manner; however, when the distance between the trees is less than $0.8 d$, a new row is started.

When the distance between rows is $1.6 d$ or more, an additional row should be inserted until the space between the rows falls to $0.8 d$.

Planting in an arid zone.
Arrangement designed to
concentrate surface run-off



6.6. Productivity norms

Manpower requirements in man-days/ha with a density of 2,500 plants/ha, covering nursery work, planting and maintenance: ranging from 272 to 478 man-days in Burundi.

Some typical outputs (Rwanda):

-
- filling sachets: 0.03 man-days per plant;

 - pricking out sachets: 0.01-0.02 man-days per plant;

 - planting: 100 plants per 7-hour day;

 - hole digging and planting: 300 plants per man-day;

 - holing: number of holes per man-day
 - in rocky soil: 24-30
 - in stony soil: 30-45
 - in deep soil: 40-50

 - plant care: 200 per man-day, i.e. 300-400 m²;

 - creating a windbreak by direct sowing: 24 man-days for 100 m comprising staking out, tilling, sowing, mulching, separation, three thinning outs, separation or natural regeneration followed by thinning out;

 - creating a windbreak by planting: 22 man-days for 100 m for plants in three rows and a spacing of 2 m.
-

E.7. IMPLEMENTATION OF DRAINAGE WORKS

7.1. Installation of a drainage network

The collectors are marked out in the same way as the ditches.

The drains which are grouped in parallel lines can be marked out as follows:

- mark out the first drain in relation to fixed reference points;
- mark out a line perpendicular to the first drain, and this is staked out at distances equal to the drain spacing;
- mark out a second perpendicular line which is staked out in the same way as the first;
- trace a line between the points staked out on the perpendiculars, marking on this line the specified drain length;
- stake out the whole drain network with stakes every 30 m or so.

Fig. E.28: Installation of a drain network

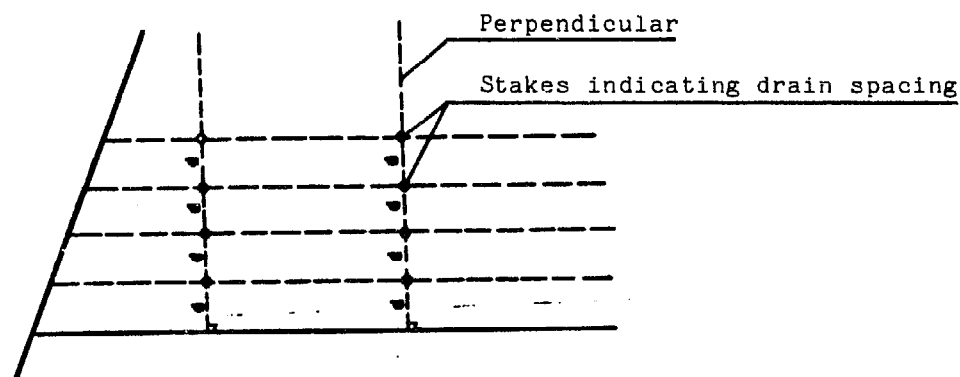

7.2. Tracing out total trench width

Drainage trenches intended for laying of underdrains vary in width between 0.30 and 0.70 m at ground level and 0.06 and 0.20 m at the base.

The trench is marked out on the ground by a line of pickets.

A line between the pickets marks the trench axis; along this a groove is marked with a pickaxe.

The line is subsequently moved sideways to the external limit of the trench and a second groove is marked along this line.

The line itself is a 30-m length of string attached at each end to a wooden stake.

7.3. Calculating trench depth

The mean depth and the minimal drain gradient are known.

The level is obtained using a dumpy level.

A 20-cm wooden stake is hammered into soil level approximately every 50 m if there is no rapid change in gradient.

A surveyor's staff is placed alongside each stake.

The elevation of each stake is noted from a single surveying point.

The depth of the trench is then calculated whilst maintaining a relatively uniform slope, and the relevant depth is written on each marker.

7.4. Trench digging

The tools used may vary slightly depending on the country. In general, the following are used for manual trenching:

-
- an ordinary garden spade for removing the sod and the topsoil layer;

 - a fork and pickaxe for excavating the top layer of stony soil;

 - a draining spade which has a blade 40-50 cm in length and 10-15 cm in width, arranged in direct prolongation of the shaft. The long edges of the blade are curved slightly inwards;

 - a scraper which is used to finish the trench bottom and produce the correct slope. It is made from a piece of curved metal 30-35 cm in length, shaped and sharpened at the end. The shaft is 2-3 m in length and is at 40-50° to the blade. Blade diameter should be matched to the diameter of the drainage pipe.
-

It is necessary to start digging the drain at the lowest point, working uphill so that any excess water will drain away as the work advances.

Fig. E.29: Digging a drainage trench

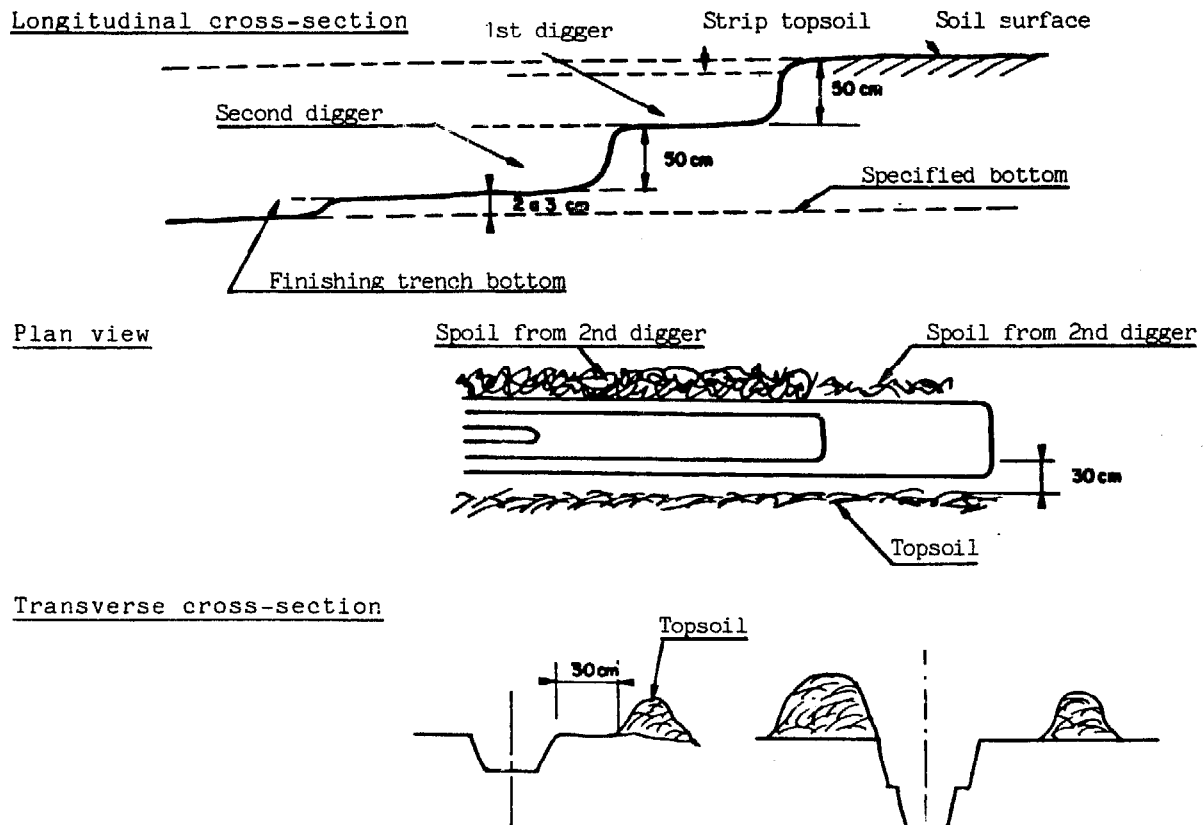

The first digger cuts up the sod and removes the topsoil. This topsoil is placed on the right of the trench about 30 cm from the trench edge leaving a pathway for the pipe layer. This topsoil is the first to be used when the trench is backfilled.

The trench is then dug with a draining spade to a depth of approximately 50 cm. The spoil is thrown onto the left bank of the trench.

The second digger works approximately 3 m behind the first digger. He deepens the trench but to a smaller width and throws his spoil onto the left bank of the trench. He digs the trench an additional 50 cm approximately. If necessary, the trench is further deepened by a third digger who works in the same way as the second.

The trench obtained in this way will be slightly shallower than that specified for the drain.

7.5. Trimming the trench bottom

For this operation one uses the scraper and wooden or steel staffs on which are mounted adjustable rectangular crosspieces ("boning rods").

The object here is to dig the trench to the depth marked on the markers and to connect these points by a uniform gradient.

Using the scraper, the trench bottom is smoothed and compacted to receive the drainage pipe.

The trimming process is shown diagrammatically below:

Fig. E.30: Trimming a trench bottom

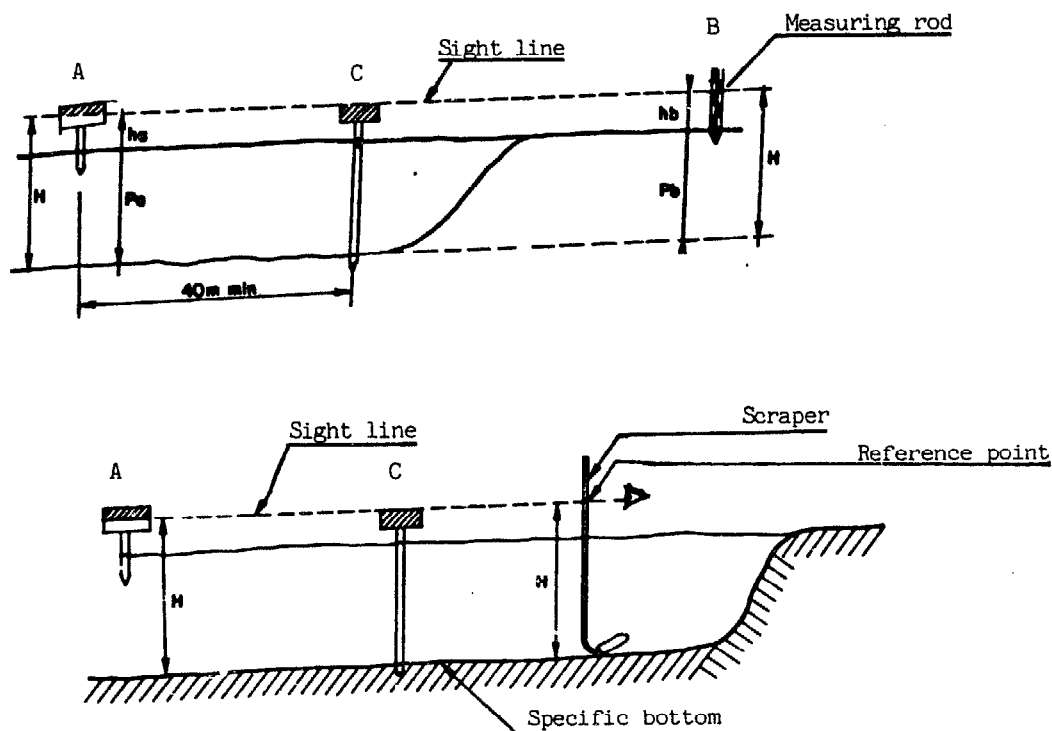

At point A marked by a stake, where the depth P_a of the trench is known, one places a fixed boning rod adjusted to height h_a above the ground. The height of the boning rod above the bottom of the trench is equal to $P_a + h_a = H$.

At point B where the depth P_b of the trench is also known, one places a marker at a height h_b above the ground so that $h_b + P_b = H$.

At point C, one places a marker of a length such that it will form a sight line between A, C and B.

To trim the trench depth, the worker uses the scraper on which a mark has been drawn at height H.

The correct trench depth is reached when a sight line is established between the mark on the scraper shaft and the crosspieces A and C.

On flat ground, checking the gradient is more difficult and it is preferable to have the work done by a topography survey team comprising an operator and two assistants.

7.6. Drain laying and backfilling the trench

The tools used for laying earthenware or concrete pipes are:

- a long-handled tile hook to pick up the pipe and lay it in the trench bottom;
- a steel pick hammer for cutting or holing the pipes when being laid.

The drainpipes are brought to the site on a trailer or on stretchers. They are placed in piles of 30-35 pipes every 10 m or so and at a distance of 3-4 m from the trench.

The pipes are laid starting at the highest point. The pipe layer picks them up with the tile hook and places them on the trench bottom, striking them sharply several times on the edge with the iron hook to seat them together properly.

When it is necessary to turn the pipes round a curve, this is done by cutting the pipes at an angle with the pick hammer.

When placing together drainpipes of different diameters, the joints are covered with earthenware corks.

Long drains (6 m) are put together outside the ditch and then laid in whole sections on the trench bottom.

Long concertina-type PVC drains are not designed for manual laying and are laid directly on the trench bottom by drainage machines. In certain countries, these machines have almost entirely replaced manual labour. They do not come within the framework of this report on labour-intensive public works. It should merely be noted that there are two types:

- machines which dig the trench;
- machines which dig the trench and also lay the drainage pipes.

The trench is backfilled first by covering the drainpipe with topsoil which was laid separately alongside the trench. Subsequently, backfilling is carried out by shovel using the remainder of the spoil and then lightly compacting.

Fig. E.31: Main drainage tools

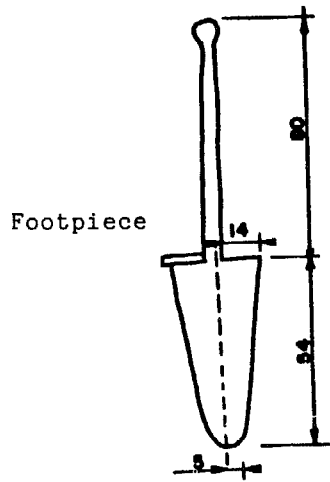

Footpiece

Drainage spade

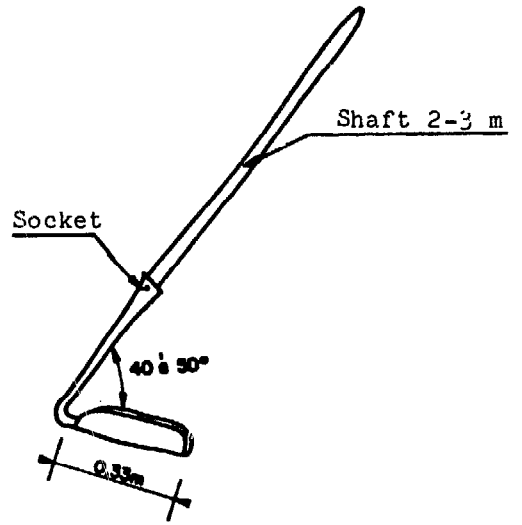

Scraper

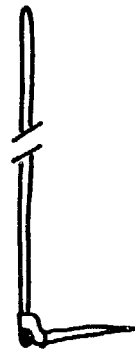

Tile hook

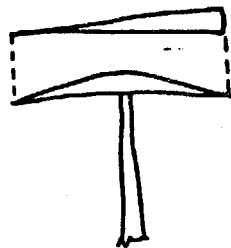

Pick hammer

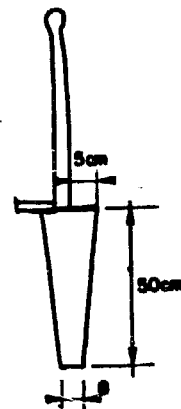

Small drainage spade

7.7. Manpower and output in manual drainage work

A drainage site usually comprises:

- a skilled site supervisor and 4-8 workers whose jobs are divided up as follows:
 - earthworks: 2-4 workers depending on the trench depth;
 - pipe transport: 1 worker;
 - pipe unloading: 1 worker;
 - pipe laying: 1 worker;
 - backfilling the trench: 1 or 2 workers.

Under very good conditions (loose earth), a good drainage worker can advance 6-8 m of ordinary 0.8 m depth trench per hour.

Under these conditions, a gang comprising a site supervisor and four diggers can lay 250 m of drain per day. Output of only half this may nevertheless be considered normal.

E.8. CONSTRUCTION OF MASONRY WORK

8.1. Different types of masonry work

The term masonry work covers all types of structures made from stone. Masonry work is used in soil conservation projects for the construction of gully or ravine erosion protection work when the necessary materials are found in adequate quantity close to the site.

One may distinguish between three types of masonry work:

- dry-stone masonry work in which stones are fitted together without binder;
- normal masonry work in which the gaps between the stones are filled with cement or lime mortar;
- gabion masonry work in which the stones are held together in a metal mesh cage.

8.2. Dry-stone masonry work

When they are subject to the action of water, dry-stone facings should be made of blocks of a sufficient weight to resist the action of the current.

Stone size may be calculated on the basis of current speed using, for example, IZBASH's formula:

$$V_{\max} = 0.6 \sqrt{2g \frac{P_s - P}{P} \Delta}$$

in which:

V_{\max} is the maximum current speed at high water

Δ is the rock diameter

g is the acceleration of gravity (9.81 m/s^2)

$\frac{P_s - P}{P}$ = density of the material under water.

In principle, the thickness of the dry-stone facing should be at least 30 cm. When stones are placed on erodable material, it is necessary to place between the stones and the bank a filter made up of a gravel bed of 10-20 cm in thickness.

Mean output for stone breaking by hammer may be estimated as follows:

Mean dimension after breaking	Approx. mean output per man-day of 8 hours
135 mm	1,40 m ³
50 mm	0,80m ³
45 mm	0,75 m ³
40 mm	0,70 m ³
30 mm	0,55 m ³
11 mm	0,10 m ³

The method of constructing dry-stone facings is as follows:

- shape and compact the bank;
- place the stones by laying them perpendicular to the bank surface so that their greatest length is in the thickness of the facing;
- insertion of larger stones, called headers, which are anchored at a depth of approximately 20 cm into the bank, at a distance of one every m².

Stones should be fitted together with the minimum of voids; if necessary, these voids can be filled with stone fragments.

Fig. E.32: Construction of a dry-stone facing

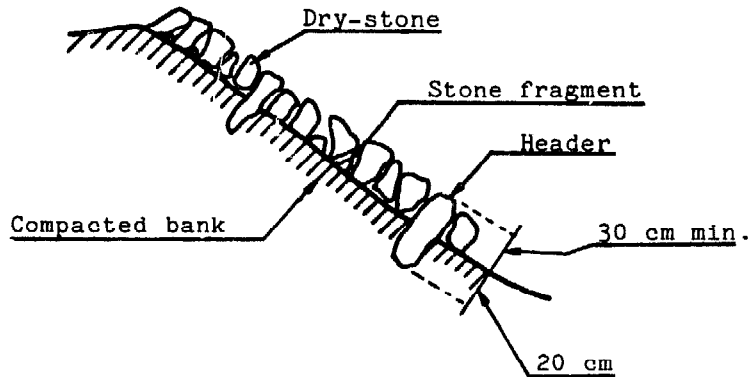

The table below shows the number of man-hours required per m² of dry-store facing constructed manually at thicknesses of 15 and 20 cm.

Material	Man-hours per m ²	
	15 cm thick	20 cm thick
Brick	0.55	0.60
Sandstone/limestone	0.60	0.65
Granite	0.65	0.75

These figures presuppose that the stones, in the required sizes, have been supplied from a quarry in the immediate vicinity of the site.

8.3. Normal masonry work

The stone used for this type of work may be natural stone of 20-40 cm in the largest plane or cut stone of various dimensions. Stone cutting is specialised work and cut stones are used only rarely.

The stones are bound together with cement mortar when the structure is exposed to running water.

The outputs given below presuppose that the materials are brought to the immediate vicinity of the site.

Wall thickness in cm	Mean thickness of stones	
	15 cm	30 cm
30	5 mh/m ²	4.0 mh/m ²
60	7 mh/m ²	5.5 mh/m ²
90	10 mh/m ²	8.0 mh/m ²

It can be taken that the time required per square metre is divided equally between the mason and the labourer.

For a mortar-bonded wall, it is also necessary to take into account:

- manual mixing of cement or lime mortar: 8.5 man-hours per m³;
- mortar jointing as the work advances: 1.0 man-hours per m².

Approximate quantity of mortar required:

Thickness of wall in cm	Mean thickness of stones	
	15 cm	30 cm
30	0.07 m ³	0.05 m ³
60	13.00 m ³	10.00 m ³
90	20.00 m ³	15.00 m ³

The cement content of a mortar is as follows: 350-400 kg of cement per cubic metre of dry sand. If the sand is very fine and made up of grains of less than 0.5 mm, the quantity of cement should increase by 20-25 per cent.

The amount of mixing water (in litres) should be 25 per cent of the weight of the cement plus 6 per cent of the weight of the sand, i.e. 220 litres of water for mortar containing 350 kg of cement/m³ sand and 238 litres of water for a mortar containing 450 kg cement/m³ sand.

Mortar is checked by modelling it by hand. The ball of mortar should be firm and plastic, not stick to the skin and, when dropped from a height of 20 cm, should not fracture.

Constructing a mortar-bonded wall comprises the following operations:

- construction of concrete footings at the base of the structure (ordinary concrete for small structures, steel reinforced concrete for larger structures);
- laying stones on a thick layer of mortar (bed of mortar);
- settling the bricks against each other by striking them with a hammer and filling the voids with stone fragments without moving the larger stones;
- laying headers 40 cm long at intervals of approximately 1 m² to ensure a good bond with the bank;
- cleaning the joints by removing mortar runs;
- pointing; in which the joints are cleaned to a depth of 3 cm before the mortar sets, and then finishing them with a fine sand mortar with a cement content of 600 kg cement/m³ sand.

8.4. Gabion masonry work

Characteristics

Gabions are boxes made out of metal mesh filled with carefully aligned stones.

A distinction is made between: cage gabions (1 m high) used for the main body work of structures; and footing gabions (0.50 m high) used for the body work of foundations which may be subject to deformation.

Fig. E.33: Common sizes of gabions

Type	Length (m)	Width (m)	Height (m)	Weight (mesh 120-100) in kg
Footing gabions	2	1	0.50	9.8
	3	1	0.50	14.0
	4	1	0.50	18.2
	5	1	0.50	22.4
	6	1	0.50	26.6
Cage gabions	2	1	1	14.0
	3	1	1	19.6
	4	1	1	25.2
	5	1	1	30.8
	6	1	1	36.4



Weir made from gabions and dry-stone work (Cape Verde)

The gabion walls are made of galvanised steel wire, with a double twist hexagonal mesh. The most common mesh sizes are 100 x 120 mm. When using mesh of this size, the size of the smallest filling stones should be at least 160 mm, and the weight of the stones around 5-10 kg.

To ensure that the gabions do not lose their shape when stacked, adjacent sides are held together by steel wire.

Method of manufacturing a stone-filled gabion (cf. fig. E.34)

-
- (a) the wire mesh is cut to shape and laid out flat;
-
- (b) the walls are folded in to form a box and the edges are tied together;
-
- (c) the gabion is located in its final position;
-
- (d) the edges are bound to the adjacent gabion;
-
- (e) the bottom is anchored to the ground using steel stakes rammed into the soil;
-
- (f) the stone filling is commenced;
-
- (g) fit in the internal trusses;
-
- (h) continuation of filling whilst adjusting the internal trusses as and when necessary;
-
- (i) closing the cover and tying the upper edges together with those of the adjacent gabion.
-

The tools required include:

- wire cutters;
- pliers;
- jumper bar or steel stake;
- wooden blocks to wedge the stones;
- a sledgehammer to drive home the jumper bar.

Fig. E.34: Assembly and installation of wire mesh gabions

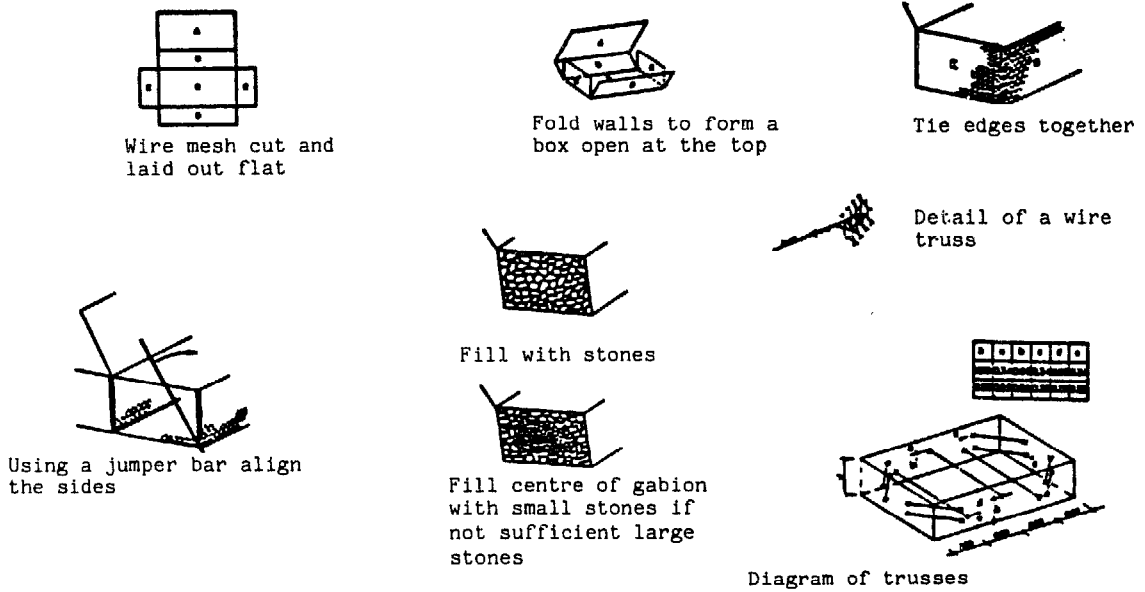

Trusses
Gabion 4x1x0.50

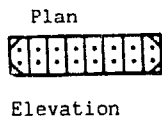

Gabion 0.5 m high used for footings

Trusses
Gabion 4x1x1

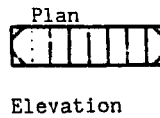

Gabions 1 m high used for the main body of the structure on the footing or foundation

Gabion 2x1x1

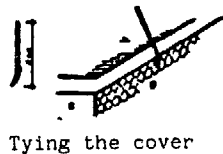
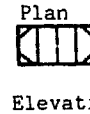

Tying the cover



Tying the edge of the cover with adjacent gabions

Unit weight

Truss	Height	Weight (kg)	Weight (kg)
4x1x0.50	0.50	11.8	11.8
4x1x1	1.00	23.6	23.6
2x1x1	1.00	11.8	11.8
4x1x0.50	0.50	11.8	11.8
4x1x1	1.00	23.6	23.6
2x1x1	1.00	11.8	11.8

Gabions can be installed using unskilled labour and they meet perfectly the objectives of labour-intensive projects.



Weir in stone masonry

Front view



Detail

E.9. CARRYING OUT CONCRETE WORK

9.1. Characteristics of concretes

Concrete is obtained by mixing sand and gravel (called aggregates) with cement and water which act as the binder.

There are numerous categories of concrete:

-
- lean concrete with a cement content of 250 kg cement per cubic metre of aggregate;

 - rich concrete with a cement content of 450-600 kg of cement per cubic metre of aggregate;

 - normal concrete with a cement content of 350 kg cement per cubic metre of aggregate.
-

To obtain good quality concrete, it is necessary to use suitable aggregates and to avoid the use of friable materials, reduce voids to the minimum and ensure good adhesion between aggregates.

The choice of materials plays an important role in concrete quality.

The aggregates should be correctly graded with components of various dimensions to minimise the size of voids. It is advisable to use well-known quarries where the aggregates are always produced using the same materials and under the same conditions.

The sand should be sharp.

The water should be clear, odourless and contain less than 2 g/l of dissolved salts. Water containing organic matter or sulphates which attack ordinary cement should be avoided.

9.2. Concrete preparation

A simple mix (by volume) for a batch of concrete is as follows:

-
- a 50 kg sack of cement;

 - two 70-l barrow loads of gravel;

 - a 70-l barrow load of sand;

 - 20-30 l of water depending on the ambient temperature.
-

Another way of proportioning concrete constituents is to use bottomless crates with a known capacity. A crate 60 cm on each side and 28 cm deep will have a capacity of 0.1 m³.

Concrete should normally be mixed in a concrete mixer. The aggregate is shovelled in first, followed by the cement; the mixture is first turned dry and then water is added. Mixing lasts two minutes and should produce a homogeneous concrete.

Lower category concretes can be mixed by hand in small quantities.

On small sites, the concrete is usually transported to the placement site by wheelbarrow. The time between mixing and placing should not exceed 20 minutes in moderately warm weather.

The concrete should not be dropped from a height during placing since this may cause segregation of aggregates. When it is placed in wooden shuttering, the latter should be clean, watertight and wetted prior to placing. When a large height of concrete is to be placed, it should be poured in successive layers.

The concrete should then be compacted by tamping, rodding or vibration to improve its consolidation. Compacting can be done by hand tampers and this is suitable for shallow layers (20 cm).

Rodding is carried out by thrusting a steel rod into the placed concrete.

Vibration is the most effective procedure; it is carried out using a compressor and a vibrating needle.

Once the concrete has been placed, after-care is required for around two weeks to ensure that the water does not vaporise too rapidly; this is called curing. After-care may be carried out by covering the concrete with a curing agent or with constantly moistened sacking, etc.

Shuttering may be removed after 21 days of drying.

9.3. Shuttering

These are moulds, usually made from wood, in which the steel reinforcement is placed and the concrete is poured. They must be constructed robustly and be suitable for their task.

Usually planks of 2-3 cm thickness are used and the distance of the reinforcement rods between themselves and from the walls of the shuttering should be sufficient to allow the correct placement of the concrete and leave a free space of at least the maximum size of the aggregate.

A distinction is made between the ordinary shuttering which is used for parts of the structure which are underground or not visible, and high-quality shuttering used for exterior walls.

9.4. Steel reinforcement

The main purpose of the steel reinforcement in reinforced steel concrete is to accept the tensile stresses to which the concrete may be subjected. The strength of a reinforced steel concrete structure depends not only on the quality of the concrete but also on the correct layout of the steel reinforcement bars.

Two categories of reinforcement bar are usually used:

- smooth mild steel bars:

limit of elasticity: $2,400 \text{ kg/cm}^2$;

maximum permissible working load: $1,600 \text{ kg/cm}^2$;

relatively poor adherence;

- high-adherence steel bars:

- limit of elasticity: $4,200 \text{ kg/cm}^2$;
- maximum working load: $2,800 \text{ kg/cm}^2$.

Since high-adherence steel bars are scarcely more expensive than plain round bars whilst they are 75 per cent stronger, it is advisable to use the former in the majority of cases.

A reinforcement plan designed for high-adherence steel bars should under no circumstances be carried out with plain round bars.

Steel bar reinforcement is prepared in the following phases:

- the steel rods are cut to the lengths required by the reinforcement plan;
- loose rust is removed by means of a wire brush;
- the rods are bent to shape on a bending bench;
- the individual rods are assembled using annealed steel wire and the assembled components are labelled.

Bending radii (R) of steel rods should not exceed the following values:

mild steel plain round rods	R = 3 \emptyset
high-adherence steel	R = 5 \emptyset
boxes, hoops, hairpins in mild steel	R = 2 \emptyset

9.5. Installing the reinforcement bars

The main concern in installing reinforcement bars is to ensure maintenance of the distances between the steel and the shuttering walls. Steel reinforcement too close to the wall is poorly protected against corrosion. The bars oxidise and this results in blistering which may spall the wall.

To ensure that the distances between the rods and the shuttering walls are maintained during concrete placement, use is made of concrete wedges. Since these wedges are embedded in the concrete, they must be rot resistant.

Steel reinforcement sections awaiting installation

Steel reinforcement which is left on the site awaiting installation is likely to be bent and then unbent, intentionally or otherwise. This is likely to cause fissures in the rods, especially those of high-adherence steel which is relatively brittle. Consequently, it is advisable to have such reinforcements made from mild steel.

Storage of reinforcements

Steel reinforcements should be stored away from moisture.

For prolonged storage, it is necessary to avoid contact with the soil. Ensure that during storage rods of different diameters and different strengths are not mixed up, which may result in subsequent errors on the site.

APPENDIX I

STANDARD PLANS

<u>Title</u>	<u>Standard Plan No.</u>	<u>Page</u>
Planting techniques	1-2-3	172, 173, 174
Diversion network	4	175
Standard terrace cross-sections	5-6-7-8	176, 177, 178, 179
Protection ditch	9	180
Ridges	10	181
Progressively constructed terraces	11	182
Bench terraces	12	183
Grassed channels	13	184
Bank stabilisation	14-15-16-17	185, 186, 187, 188
Bank protection	18-19	189, 190
Gully correction	20-21-22-23	191, 192, 193, 194
Stone dams	24	195
Weir	25-26-27	196, 197, 198
Small earth dam	28	199
Drainage techniques	29-30-31-32	200, 201, 202, 203

PLANTING TECHNIQUES

SOIL PREPARATION FOR PLANTING IN ARID ZONES

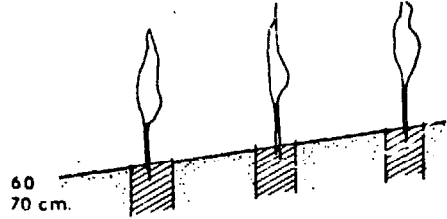

ROUTING

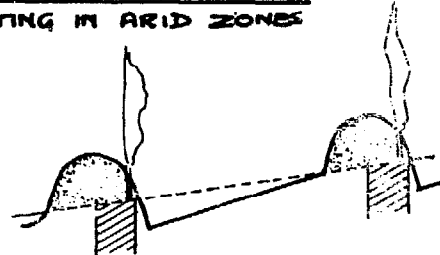

ROUTING IN COMBINATION WITH RIDGES

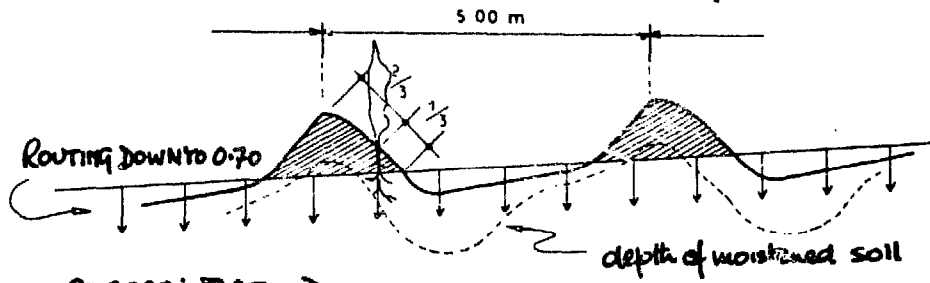

STEPPE METHOD

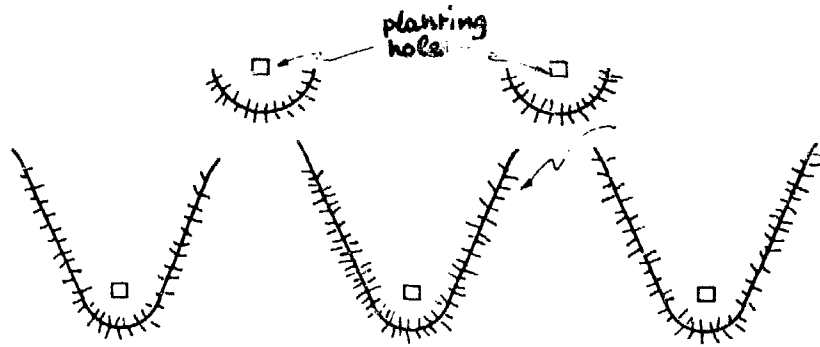

SPIDER'S LEGS

STANDARDS PLAN	1
-------------------	---

PLANTING TECHNIQUES

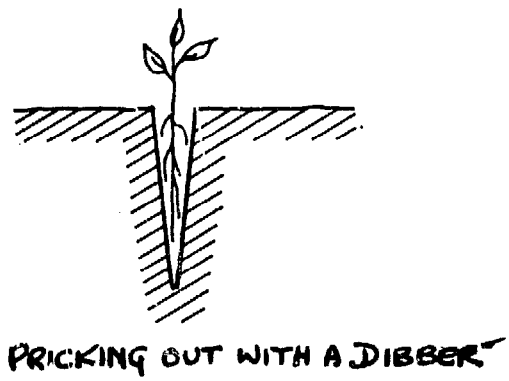
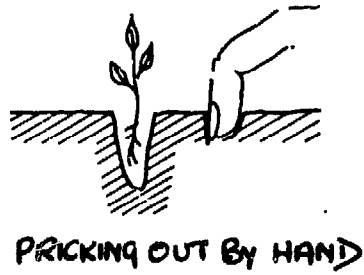
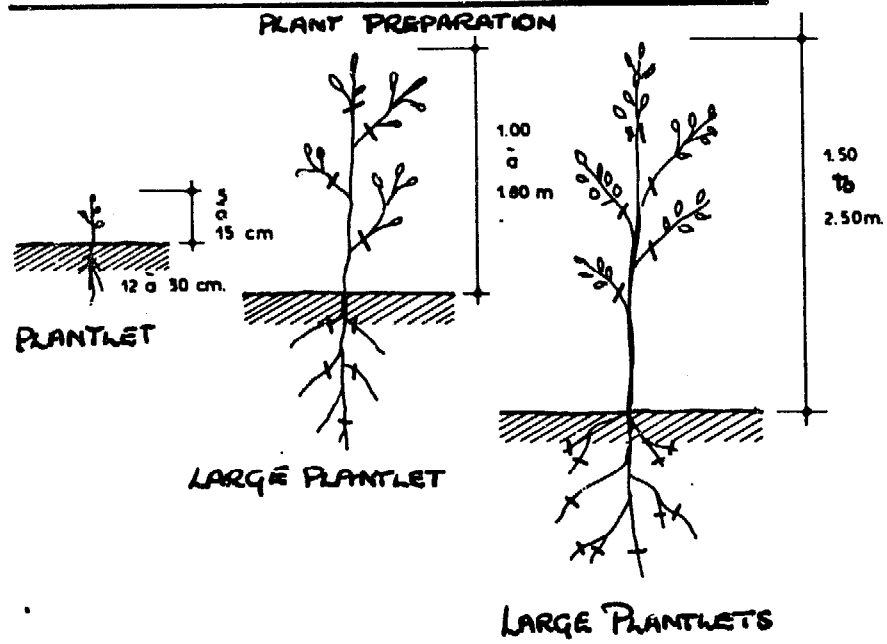

STANDARD PLAN	2
---------------	---

PLANTING TECHNIQUES

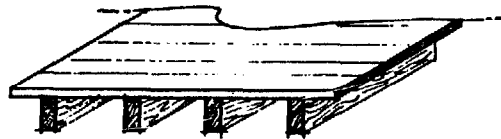
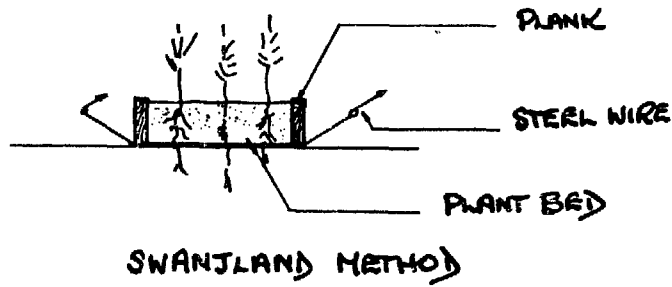
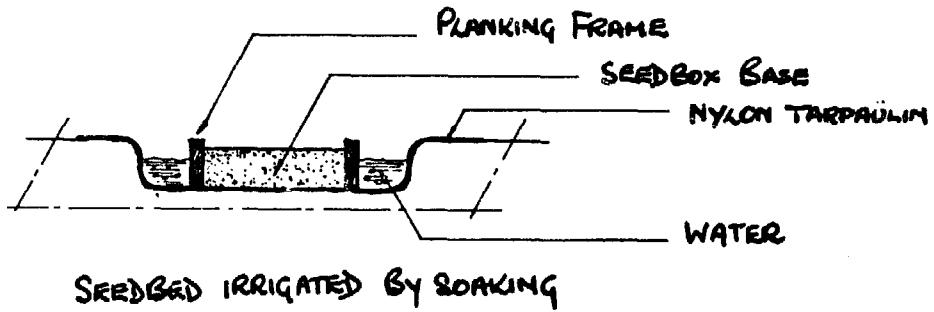

DRILL BOARD

STANDS PLAN	3
----------------	---

DIVERSION NETWORK

DIAGRAM

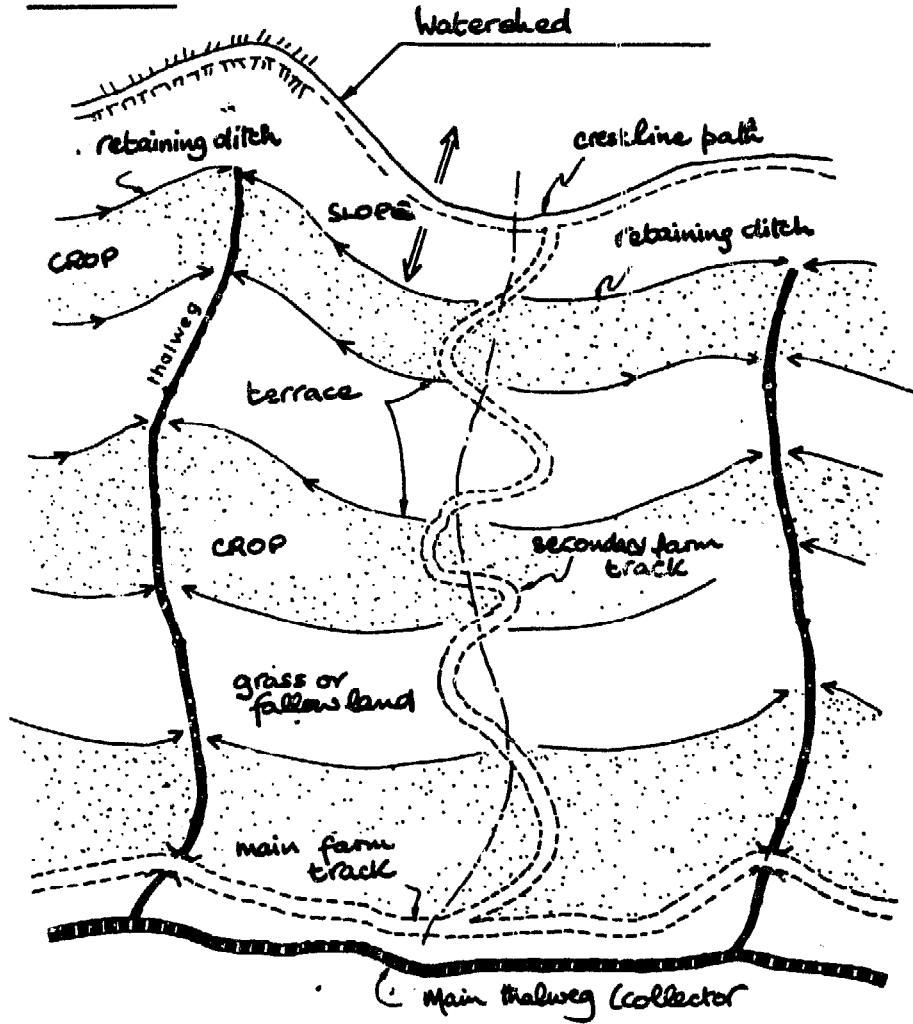

Standard plan	4
---------------	---

STANDARD TERRACE CROSS-SECTIONS

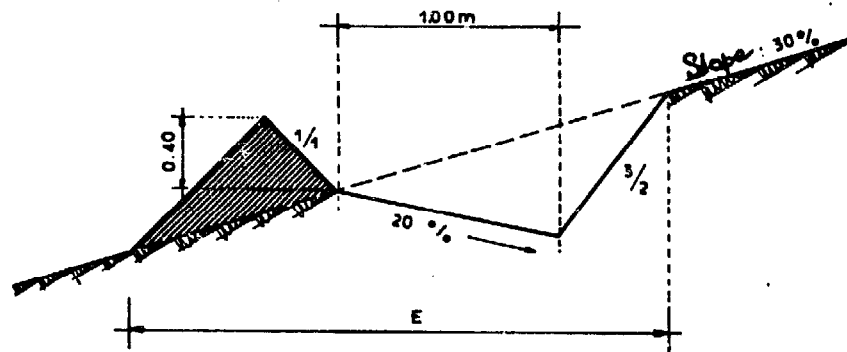

FOREST TERRACE

Slope %	Excavation cross-section m. ²	Effective height m.	Effective cross-section m. ²	Total width m.
20	0.27	0.30	0.54	2.60
30	0.35	0.30	0.51	2.80
50	0.39	0.30	0.51	2.95

STANDARD PLAN 5

STANDARD TERRACE CROSS-SECTIONS

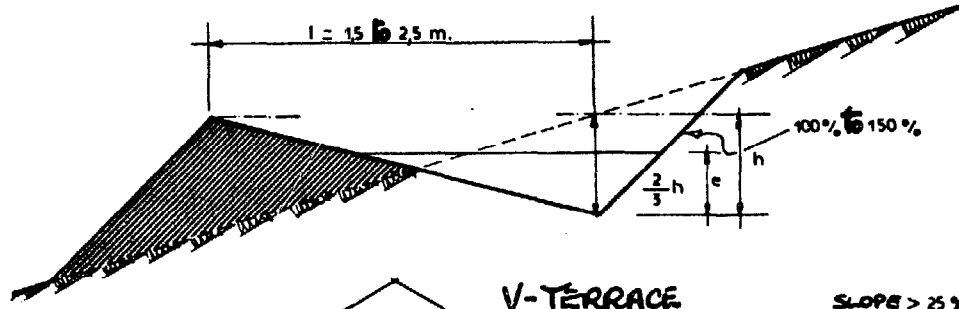

V-TERRACE

SLOPE > 25%

$l = 4h = 1.5 \text{ to } 2.50 \text{ m.}$

$e = \frac{2}{3}h$

NORMAL-SECTION TERRACE

'Algerian' terrace type

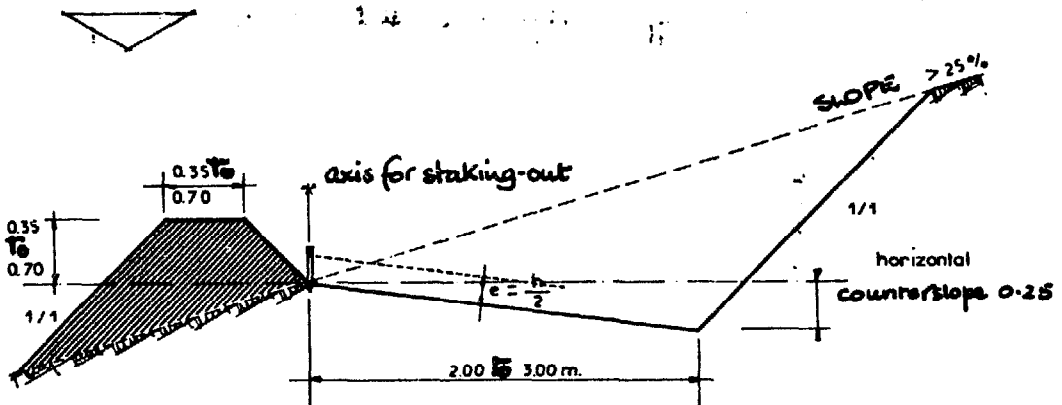

STANDARD PLAN 6

STANDARD TERRACE CROSS-SECTIONS

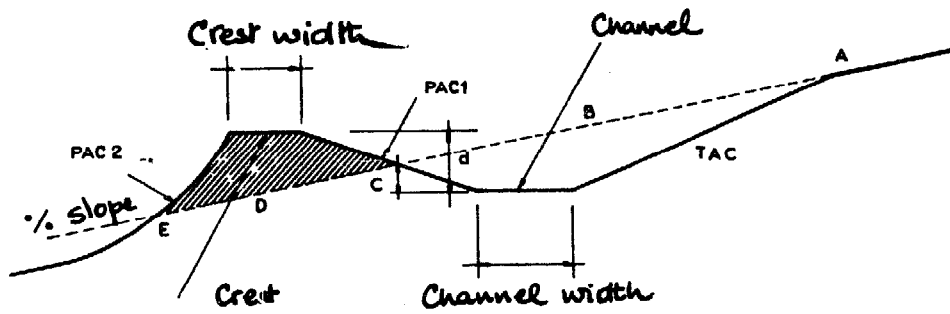

CONVENTIONAL CROPPING TERRACE

(USA)

Example of a table for calculating the dimensions of a diversion terrace

Length in a Field slope %	Channel dimensions Crest height required (in mm)					Mean gradients		
	60	120	180	240	300	TAC b/h	PAC1 b/h	PAC2 b/h
1 & 2	0,24	0,27	0,30	0,36	0,36	10/1	10/1	10/1
3	0,21	0,27	0,30	0,33	0,36	6/1	8/1	8/1
4 & 5	0,21	0,27	0,30	0,33	0,33	6/1	8/1	8/1
6	0,21	0,24	0,27	0,30	0,30	6/1	8/1	8/1
7 & 8	0,21	0,24	0,27	0,30	0,30	4/1	6/1	6/1
10	0,18	0,24	0,27	0,30	0,30	4/1	4/1	5/1
11	0,18	0,24	0,27	0,30	0,30	4/1	4/1	6/1
12 & 13	0,18	0,24	0,27	0,30	0,30	4/1	4/1	4/1
14	0,18	0,24	0,27	0,30	0,30	4/1	4/1	3/1
15	0,18	0,21	0,27	0,30	0,30	4/1	4/1	2,5/1

Standard plan	7
---------------	---

STANDARD TERRACE CROSS-SECTIONS

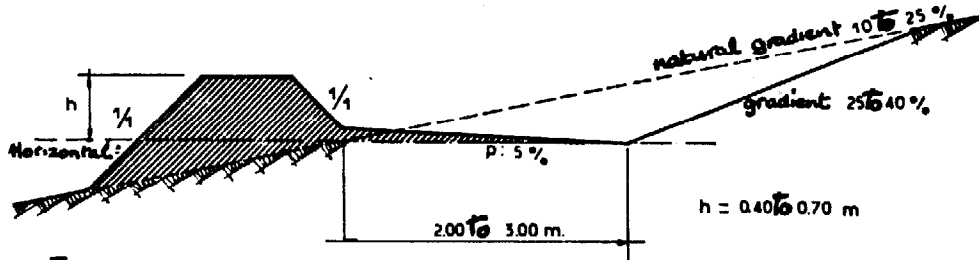

FLATTENED-HUMP TERRACE

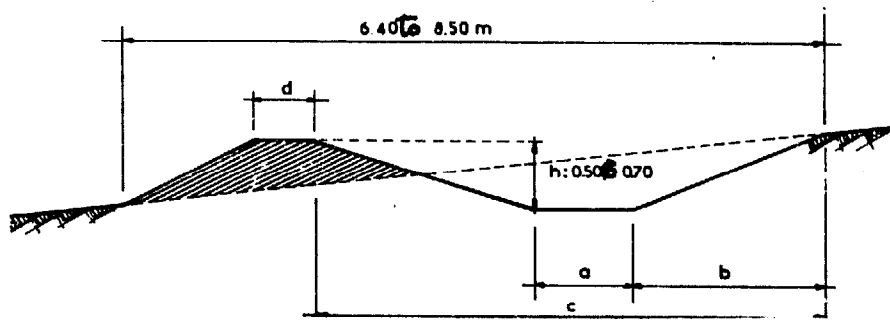

CHANNEL-TYPE FLATTENED CROSS-SECTION TERRACE (CROPPING TERRACE)

land gradient	size in metres					Tered width m	Channel section m	usable height m	usable section m
	a	b	c	d	h				
4 to 6%	1.50	2.00	6.00	0.50	0.60	8.50	1.03	0.50	1.75
6 to 10%	1.00	2.00	5.30	0.60	0.70	7.30	0.95	0.60	1.80
10 to 14%	0.	2.20	5.00	0.40	0.80	6.40	0.85	0.70	1.60

Standard plan

8

PROTECTION DITCH

STANDARD CROSS-SECTION OF ALGERIAN TYPE

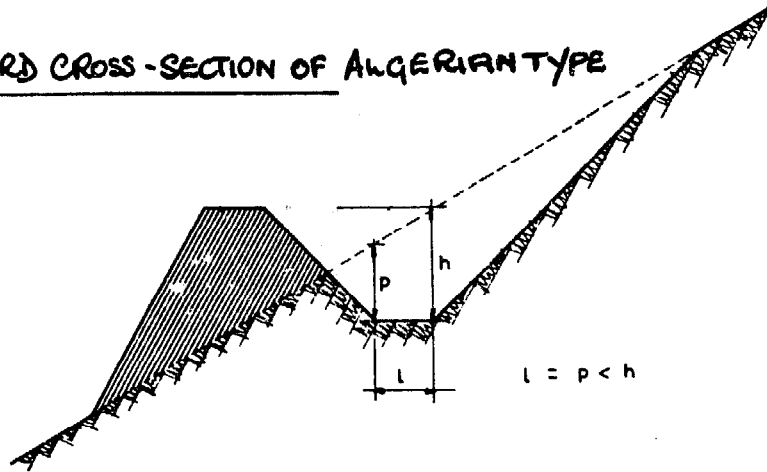

DITCH CHARACTERISTICS

$p = l$ for

Type of soil	run-off coefficient	Surface area of catchment basin above ditch (hectares)									
		1	2	3	4	5	6	7	8	9	10
Rocky, clayey	1	0.50	0.76	0.85	1.00	1.10	1.20	1.30	1.40	1.50	1.60
Bare, fallow land	0.9	0.50	0.65	0.80	0.95	1.05	1.15	1.25	1.35	1.40	1.50
Ploughed grassland	0.8	0.45	0.65	0.75	0.90	1.02	1.10	1.20	1.25	1.35	1.45
Bushy grassland	0.7	0.40	0.60	0.70	0.85	0.95	1.00	1.10	1.20	1.30	1.40
Well wooded land or protected by walls or terraces	0.6	0.35	0.50	0.65	0.75	0.80	0.90	1.00	1.05	1.15	1.25
Longitudinal gradient of ditch		1	0.5	0.4	0.3	0.2	0.2	0.15	0.15	0.15	0.15

STANDARD PLAN	9
---------------	---

RIDGES

RIDGES (ALGERIA)

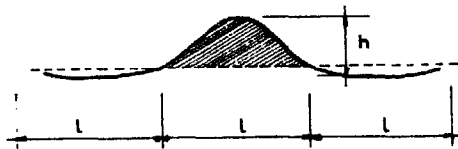

h = 1.00 to 2.00 m.
 l = 300 to 500 m

RIDGES FOR STEPPE-TYPE FOREST PLANTING

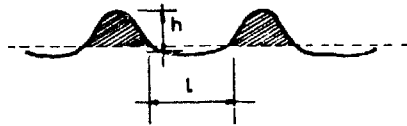

l = base width
 h = 0.70 m.

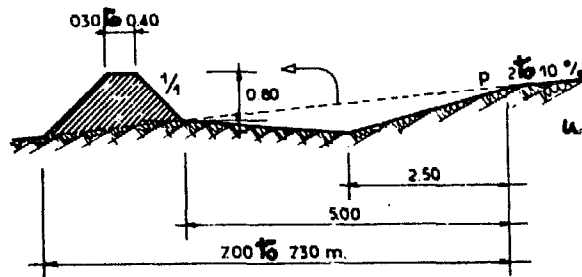

TABIA

usable width 3.6 m to 13.4 m

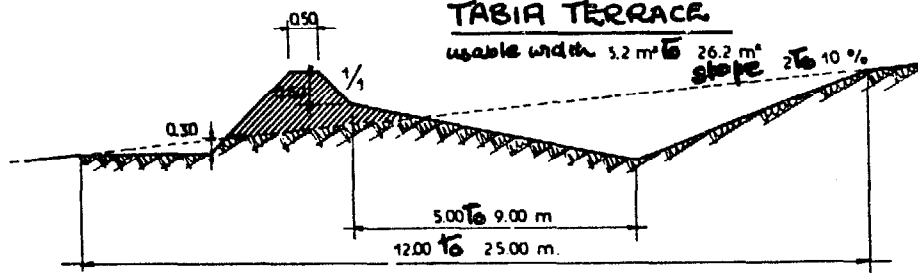

TABIA TERRACE

usable width 5.2 m to 26.2 m
 slope 2 to 10%

STANDING
 PLAN

10

PROGRESSIVELY CONSTRUCTED TERRACES

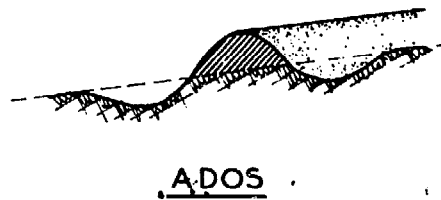
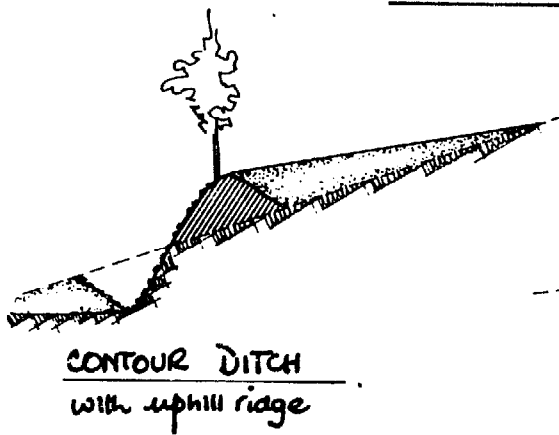
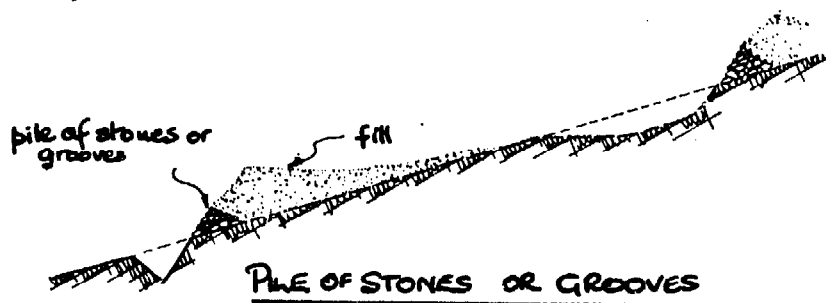
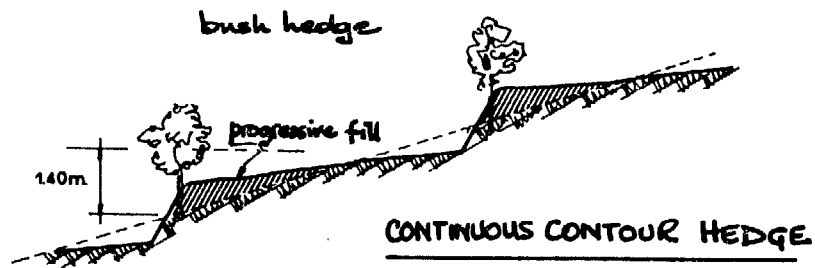

BENCH TERRACES

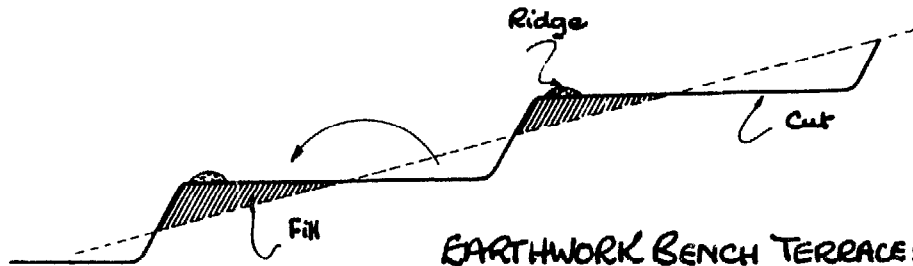

EARTHWORK BENCH TERRACES
with bank protected by an earth ridge

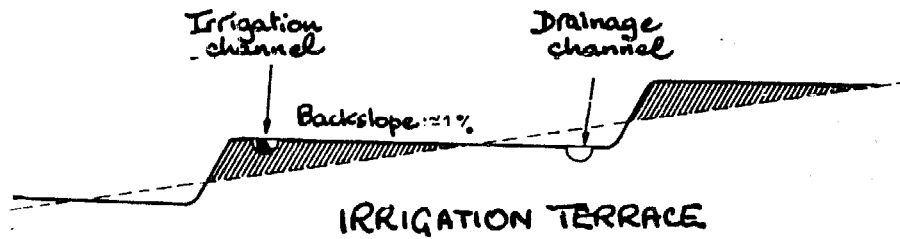

IRRIGATION TERRACE

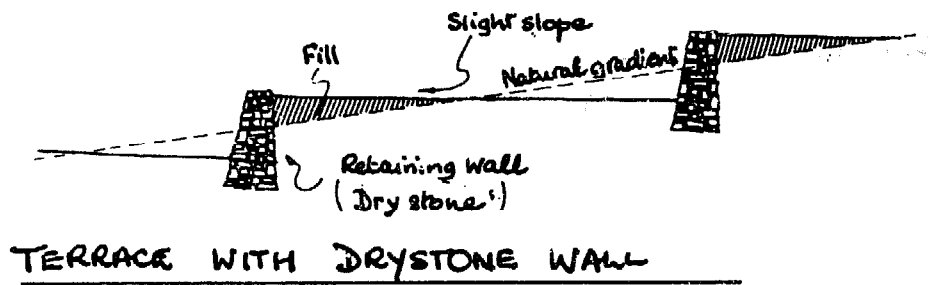

TERRACE WITH DRYSTONE WALL

Standard
plan

12

GRASSED CHANNELS

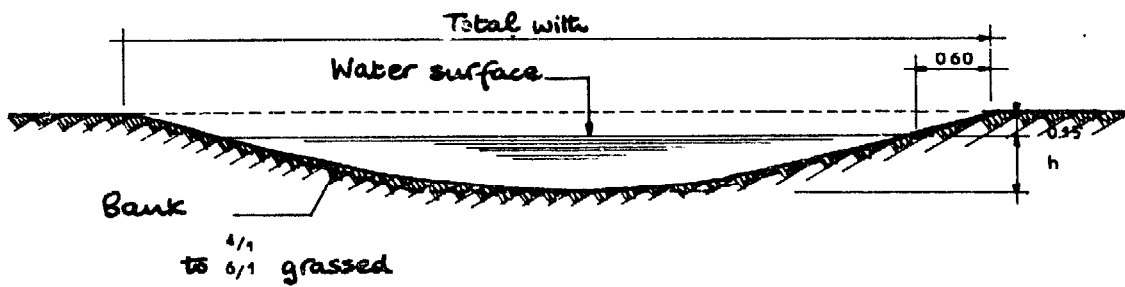

VALUES OF h AS A FUNCTION OF THE SPEED AND THE GRADIENT (in metres)

Slope Speed	0.5 %	1 %	2 %	3 %	4 %	5 %	6 %	8 %	10 %	12 %	14 %
0.9 m/s	0.54	0.33	0.21	0.15	0.12	0.12	0.09	0.09	0.06	0.06	0.03
1.2 m/s	0.81	0.54	0.30	0.24	0.18	0.15	0.15	0.12	0.09	0.09	0.09
1.5 m/s		0.72	0.42	0.30	0.18	0.15	0.18	0.15	0.15	0.12	0.09

Total width can vary depending on the flow as calculated by the
MANNING-STRICKLER formula

BANK STABILISATION

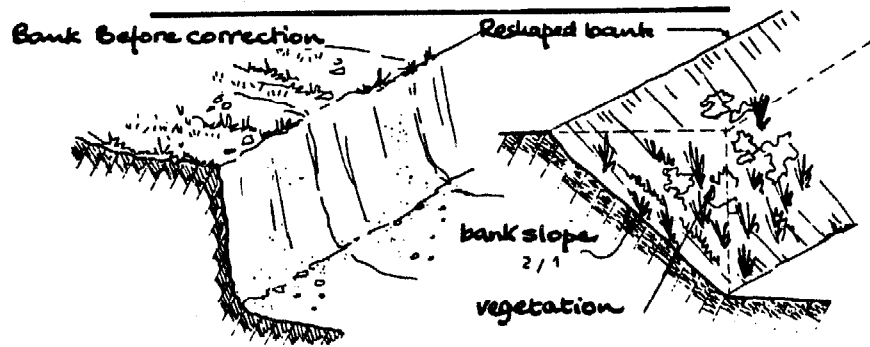

BANK STABILISATION BY VEGETATION

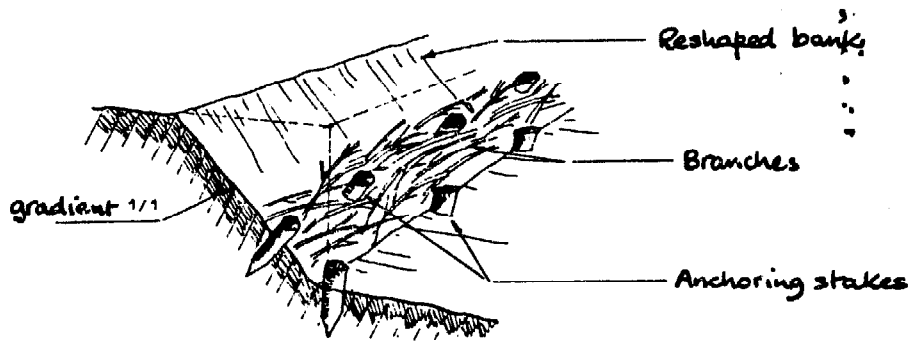

STABILISATION USING BRANCHES

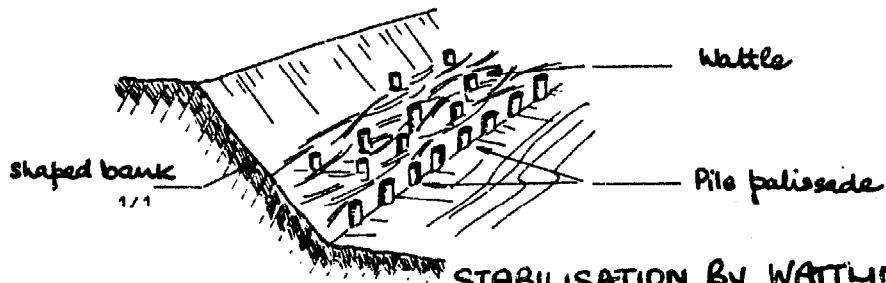

STABILISATION BY WATTLING

BANK STABILISATION

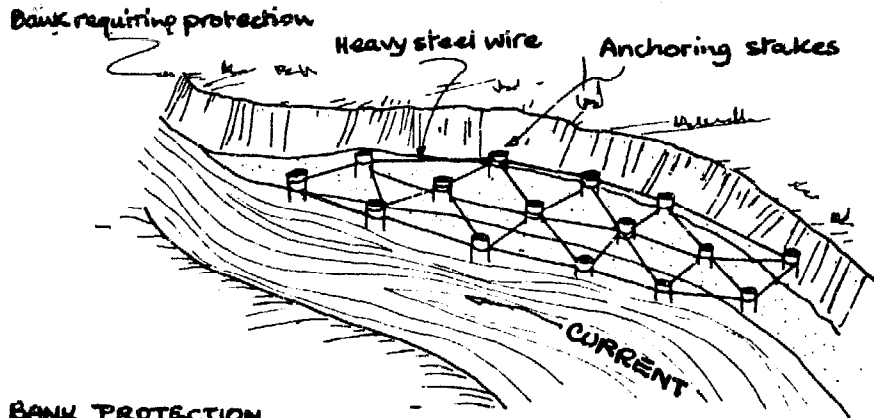

BANK PROTECTION BY ANCHORING STAKES intertwined with steel wire

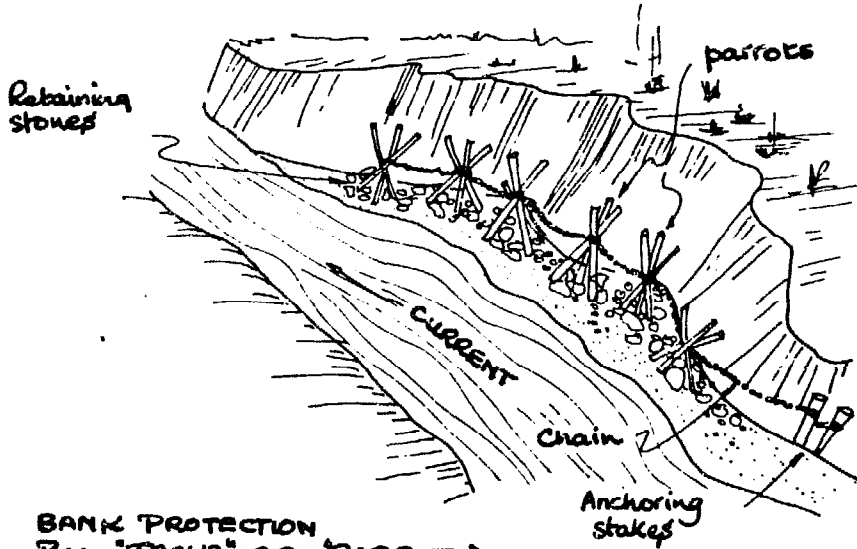

BANK PROTECTION BY "JACKS" OR "PARROTS"

Standard
plan

15

BANK STABILISATION

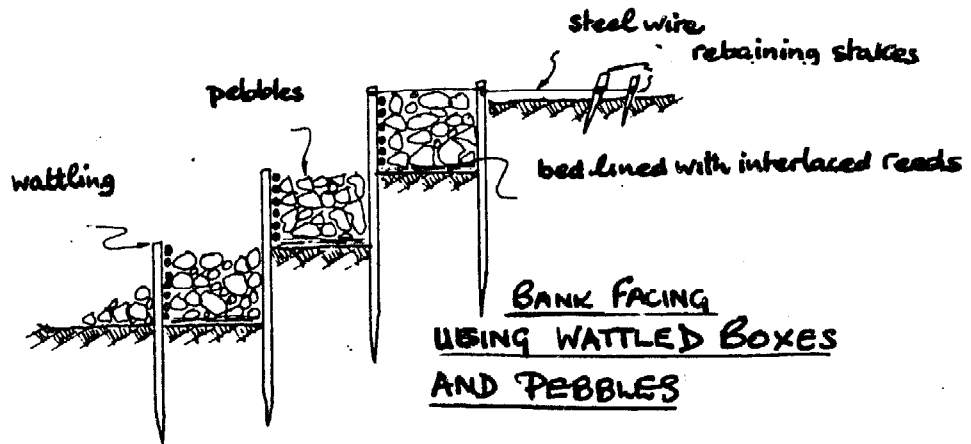
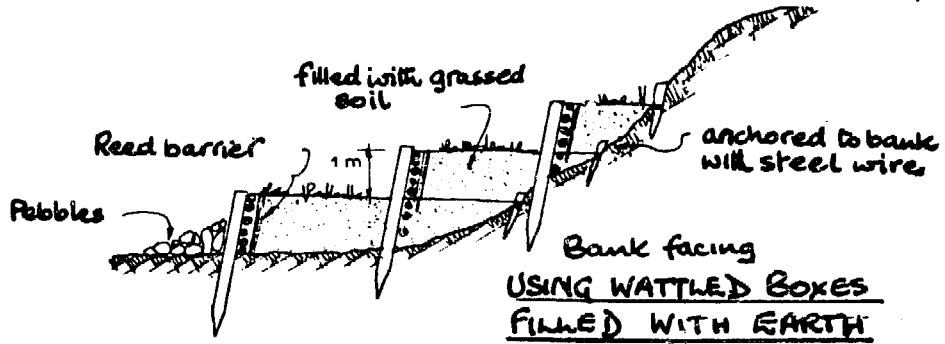
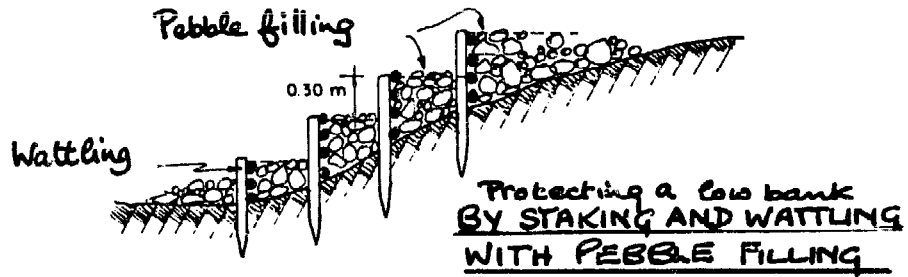

BANK STABILISATION

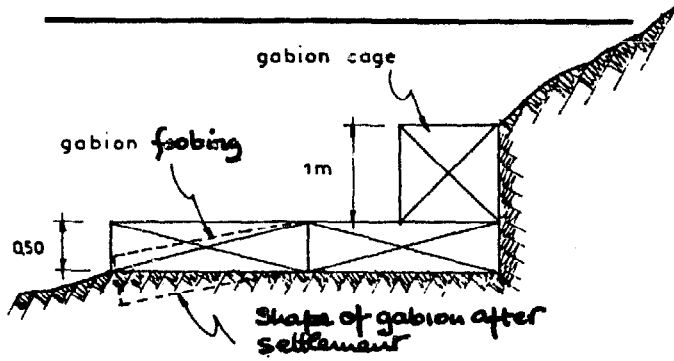

**BANK PROTECTION
USING GABIONS**

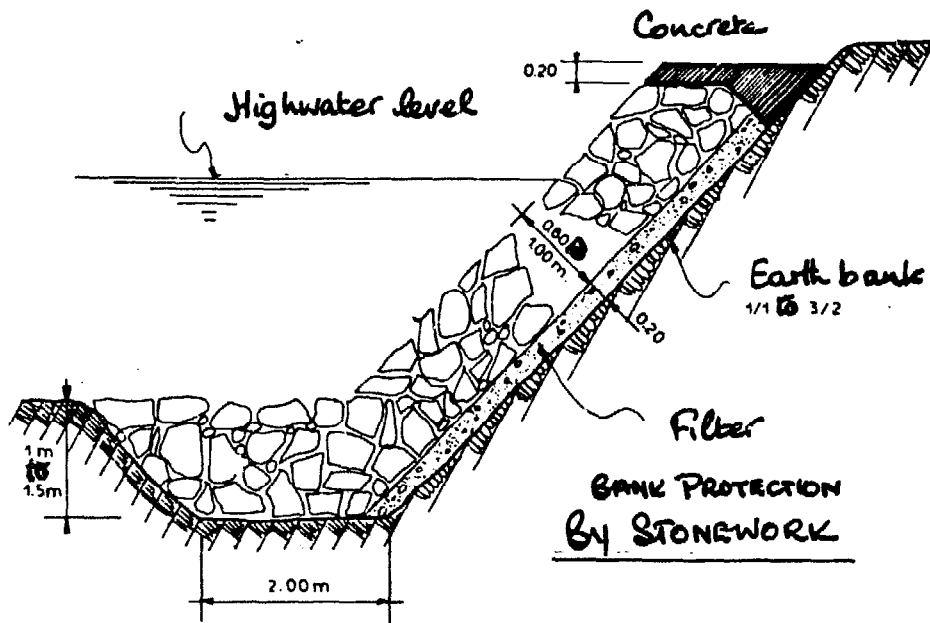

**BANK PROTECTION
BY STONEWORK**

Standard plan	17
---------------	----

BANK PROTECTION

LOG GROINS

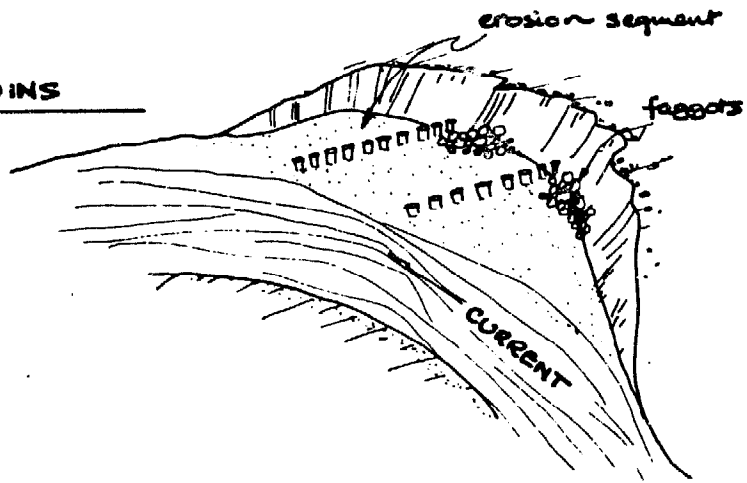

PARROT GROINS

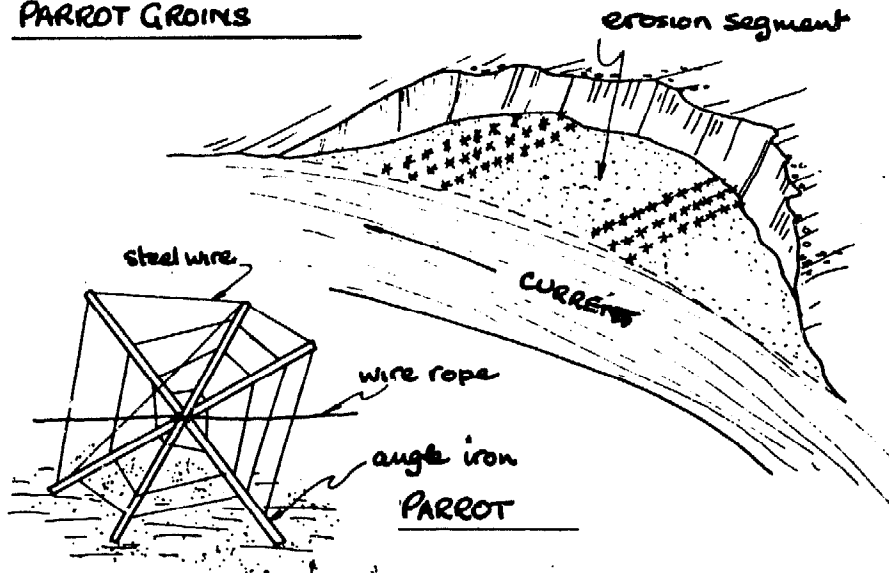

Standard
plan

BANK PROTECTION

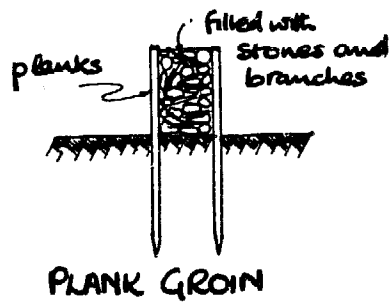
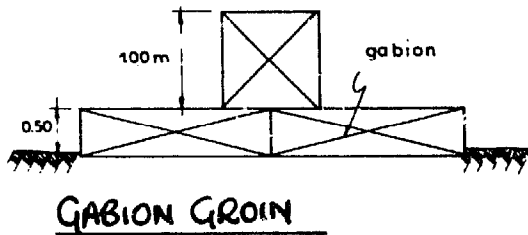
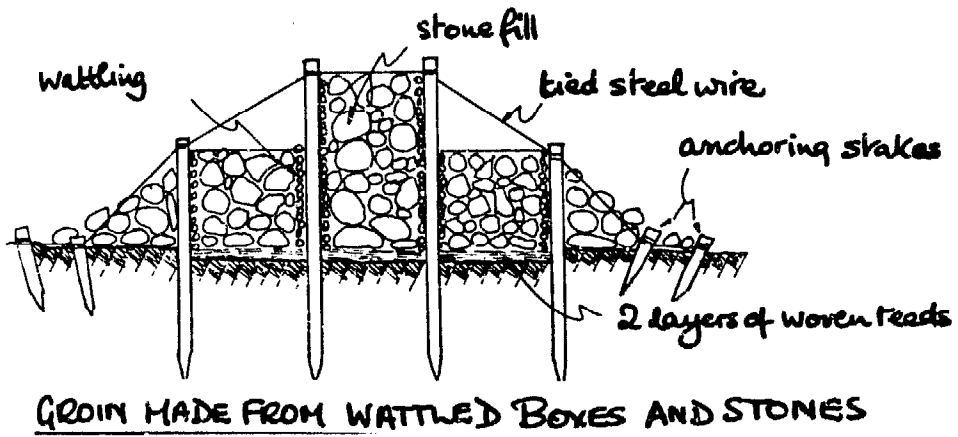
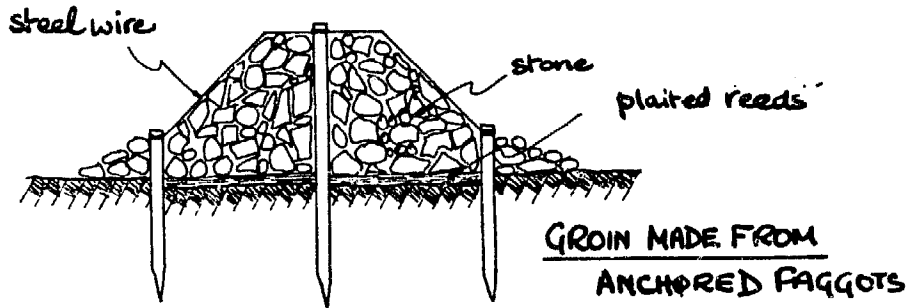

Standard plan	19
---------------	----

Gully Correction

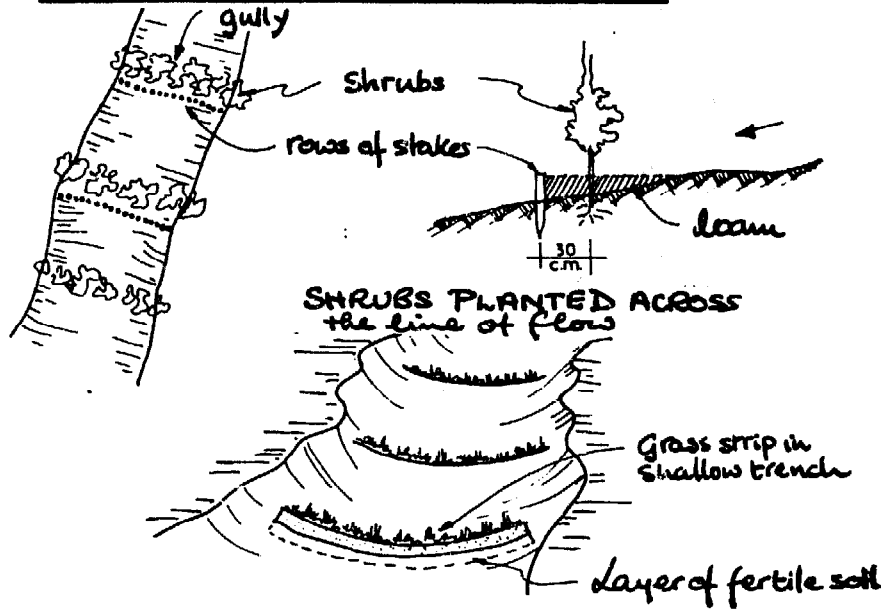

SODS LAID ACROSS A GULLY

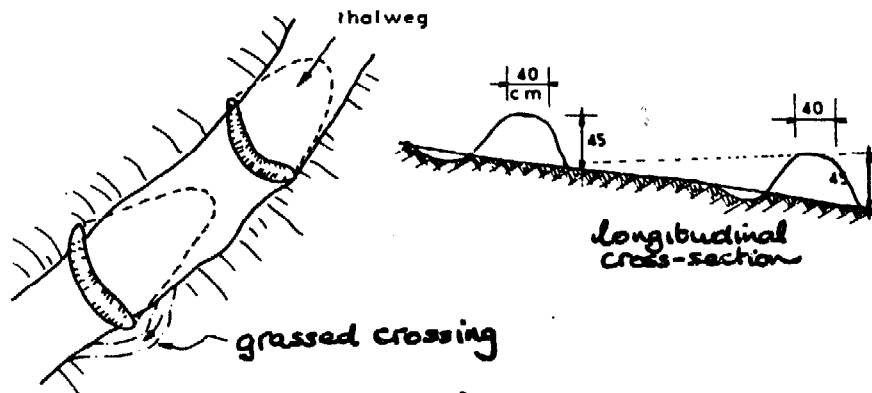

SMALL EARTH DAM

Standard plan	20
---------------	----

GULLY CORRECTION

Temporary structures

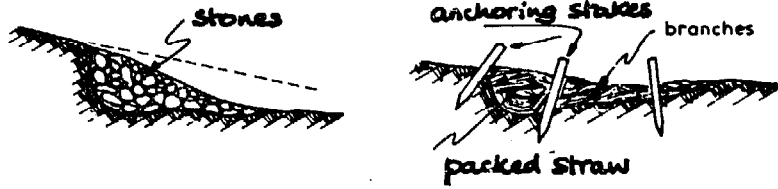

FILLING A GULLY CHUTE



PICKET AND STRAW DAM

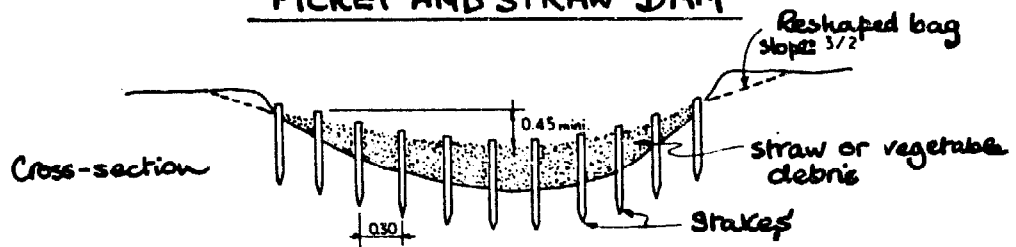

FAGGOT DAM

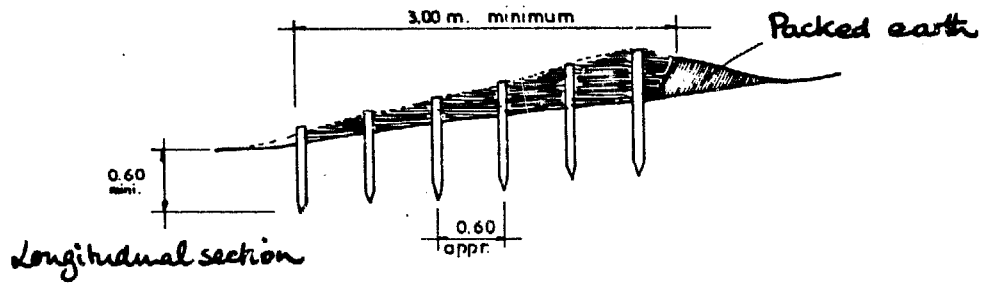

Standard
plan

21

Gully Correction

SMALL DRYSTONE DAMS

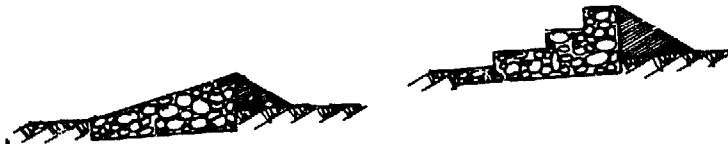
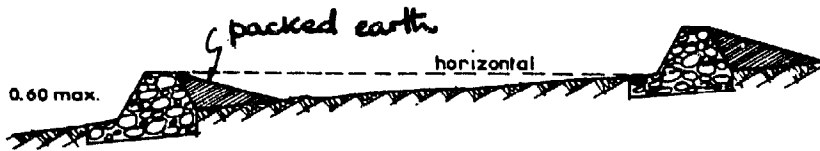

Various profiles used (h = ≤ 0.60 m.)

GULLY CORRECTION

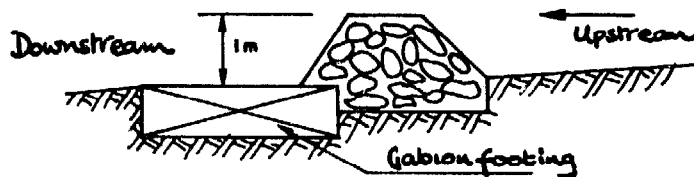

DRYSTONE AND GABION DAM

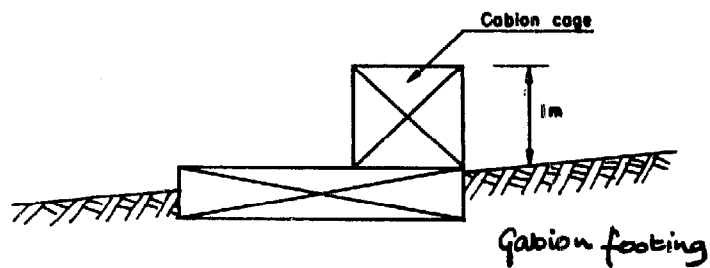

GABION DAM

Standard
plan

STONE DAMS

MASONRY DAM

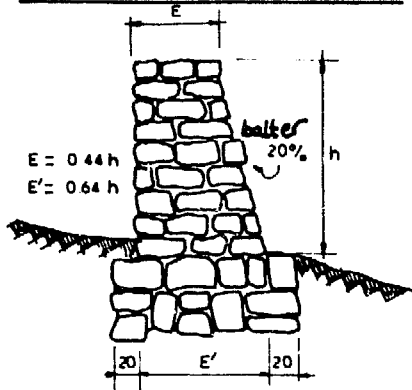

DESIGN PRINCIPLE

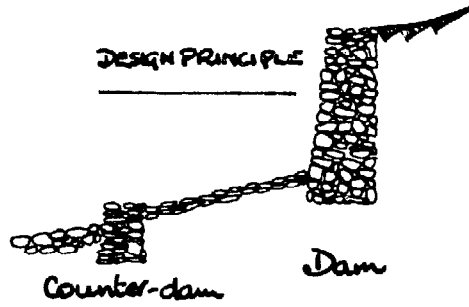

DRYSTONE DAM

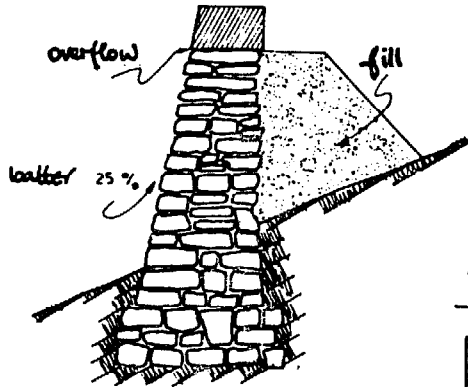

SILL SHAPE

A) Rectangular

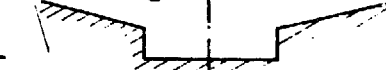

B) Trapezoidal

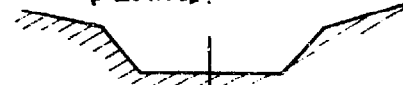

C) Curved

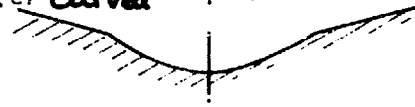

ELEVATION OF FOUNDATIONS

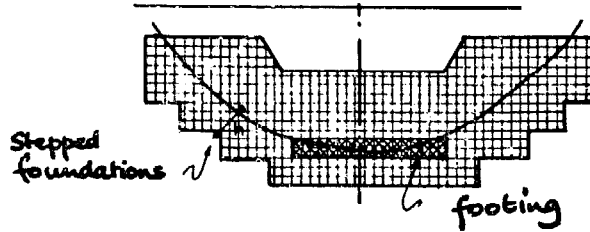

Standard plan.

WEIR

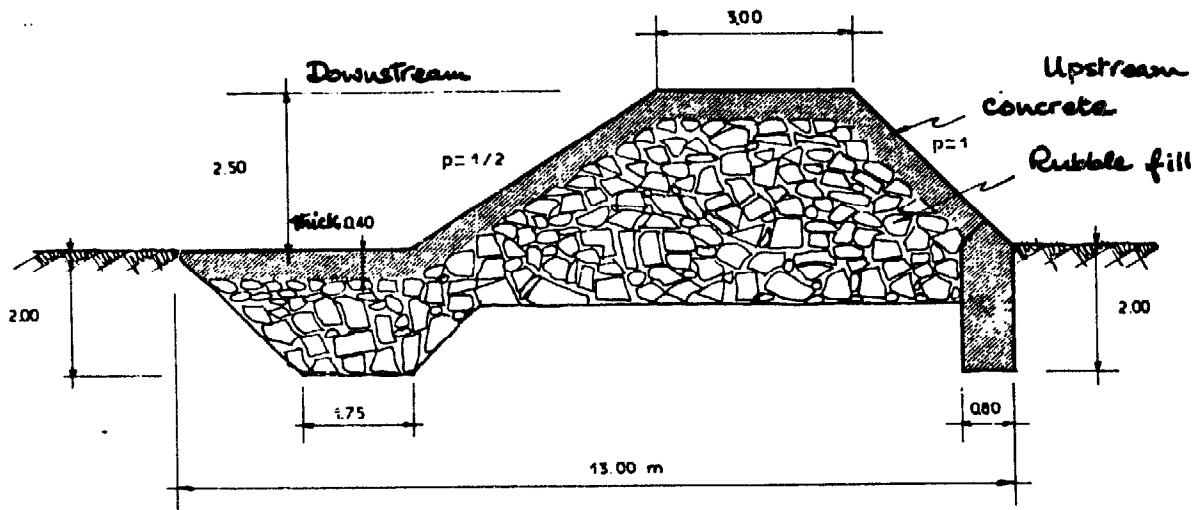

WEIR MADE FROM RUBBLE FILL FACED WITH CONCRETE

fall of 2.50 m.

Standard plan	25
------------------	----

WEIR

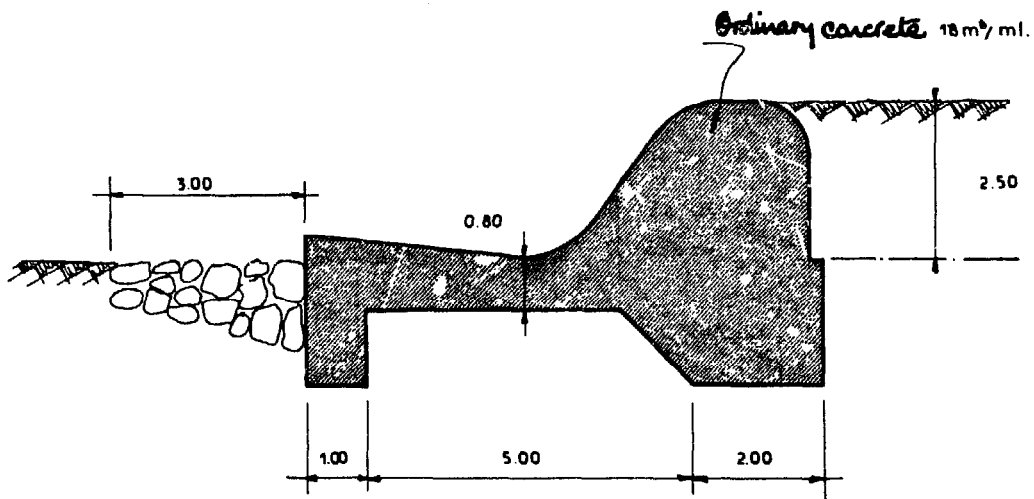

CONCRETE WEIR

fall of 2.50m.

Standard
plan

26

WEIR.

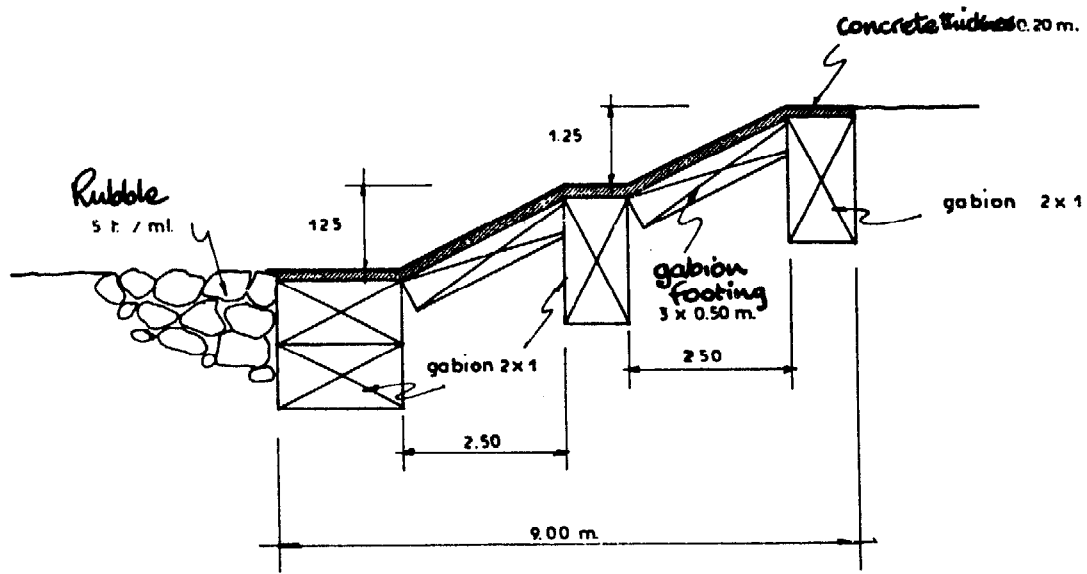

WEIR MADE FROM GABIONS AND CONCRETE

fall of 2.50 m.

Standard plan	27
------------------	----

SMALL EARTH DAM

Standard cross-section of a small earth dam

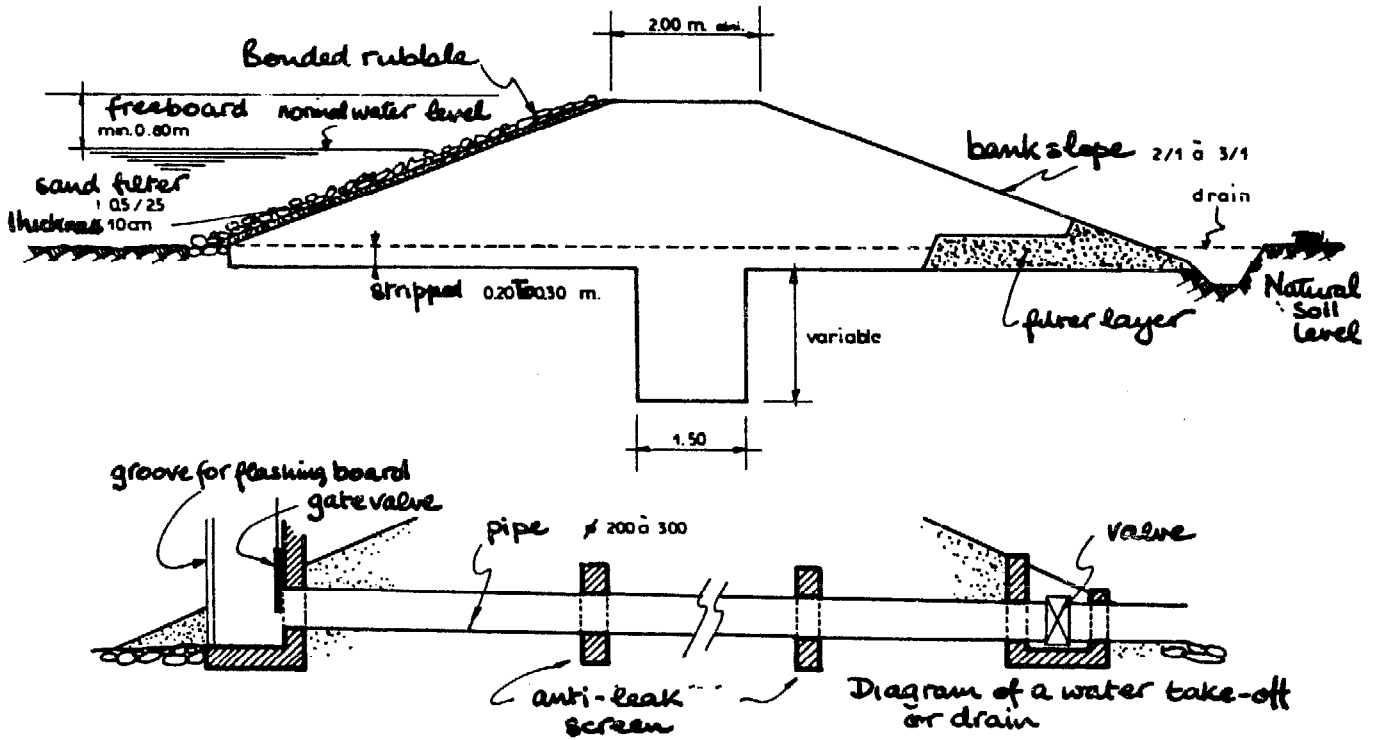

DRAINAGE TECHNIQUES

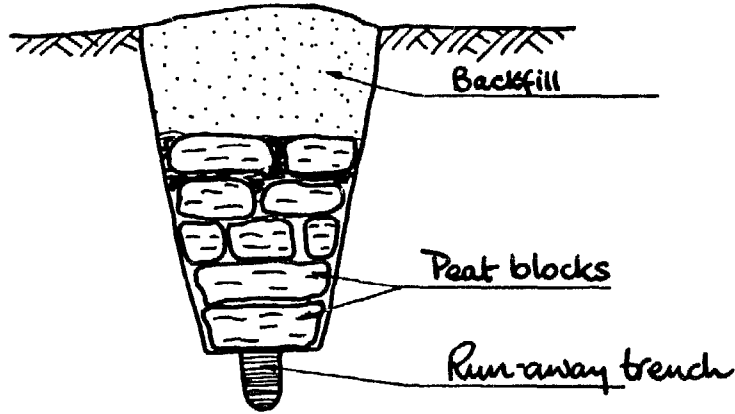

PEAT DRAIN

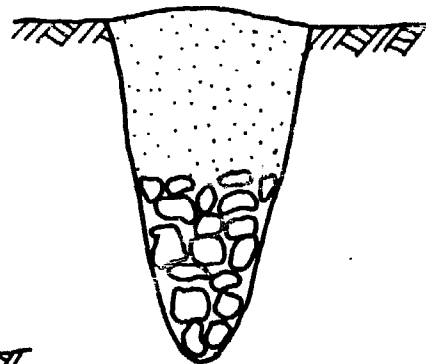

DRAIN TRENCH FILLED WITH RUBBLE

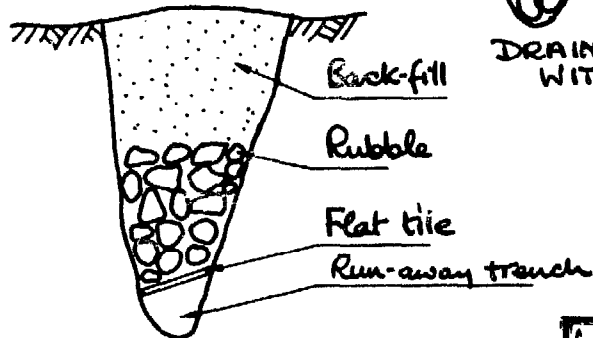

TILE AND RUBBLE DRAIN

Standard
plan

DRAINAGE TECHNIQUES

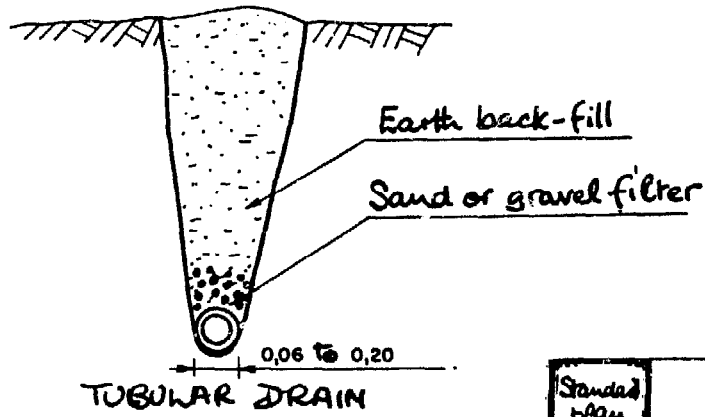
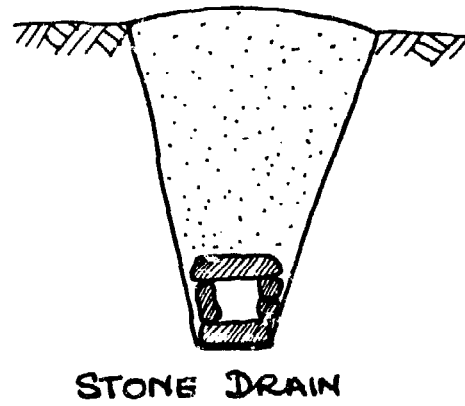
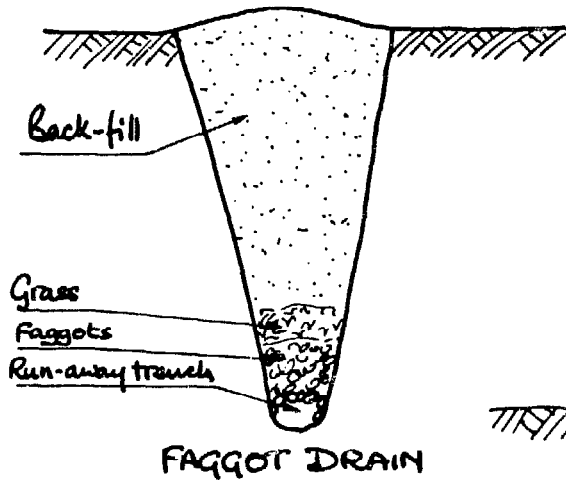

Standard
plan

30

DRAINAGE TECHNIQUES

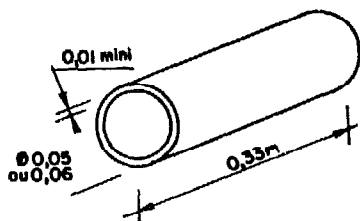

EARTHENWARE DRAINPIPE

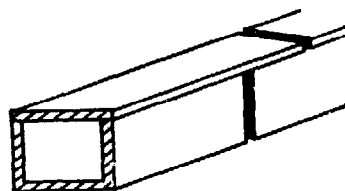

WOODEN DRAIN



Drain sleeve connection

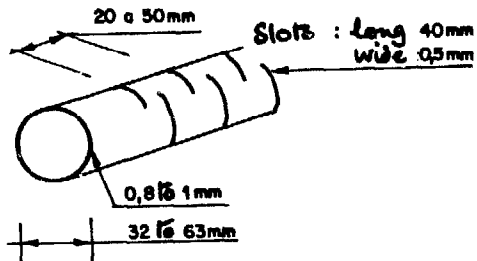

RIGID PVC DRAIN

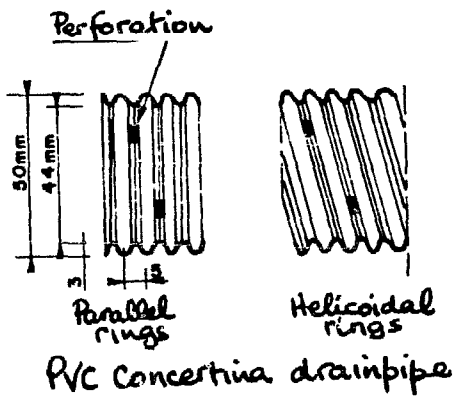

DRAINAGE TECHNIQUES

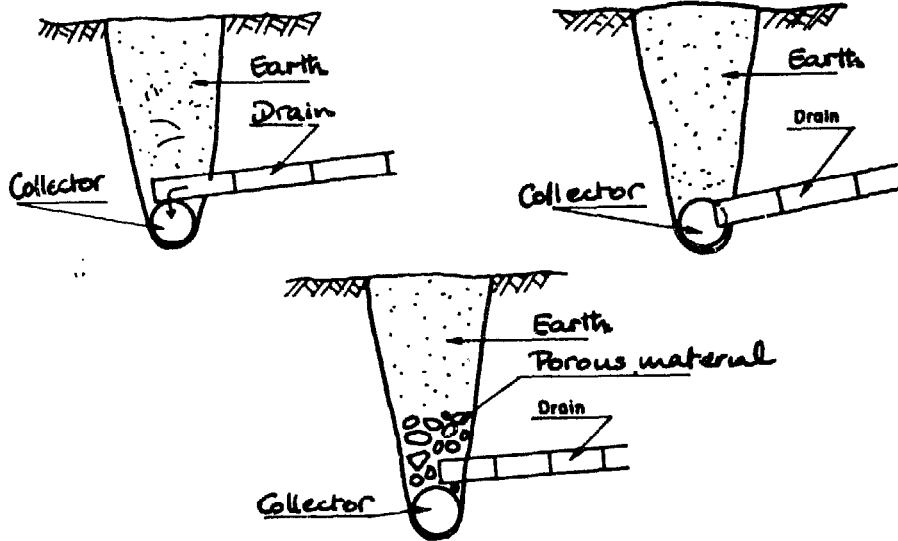

DIFFERENT METHODS OF CONNECTING DRAINS TO COLLECTORS

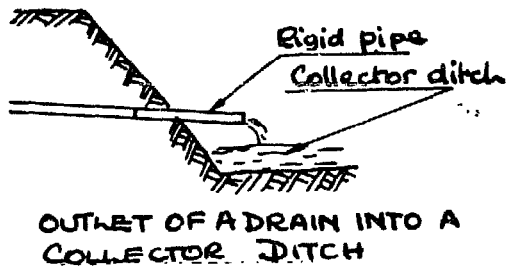
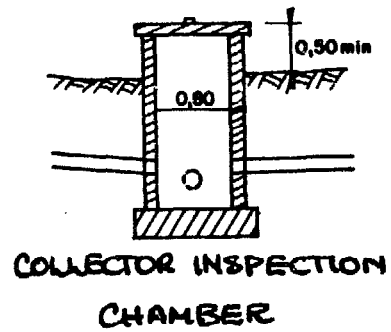
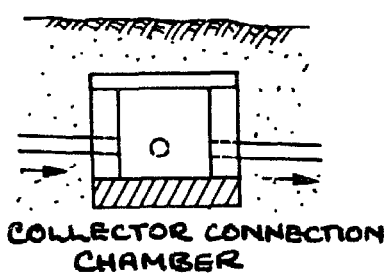

APPENDIX II

BIBLIOGRAPHY

Reference

- 1 CTFT. Conservation des sols au Sud du Sahara. Collection Techniques rurales en Afrique, No. 12, 1969.
- 2 Soil Conservation Service of the US Department of Agriculture. Soil conservation manual, Washington, 1950.
- 3 Ministère de la Coopération. Mémento de l'agronome. Collection Techniques rurales en Afrique, 1974.
- 4 BRGM. Drainage agricole en rapport avec l'irrigation et la salinité. Bulletin du Bureau de recherches géologiques et minières. Section III, No. 2, 1978.
- 5 FAO. Drainage of salty soils. Irrigation and Drainage Paper, No. 16, Rome, 1973.
- 6 FAO. Drainage of heavy soils. Irrigation and Drainage Paper, No. 6, Rome, 1971.
- 7 United Nations. Earthmoving by manual labour and machines. Flood Control Series, No. 17, Bangkok, 1961.
- 8 FAO. Méthodes et machines pour le drainage par canalisations en poterie et autres matériaux. Energie et machines agricoles, Bulletin No. 6.
- 9 Ministère de l'Agriculture: Agriculture et forêt. Bulletin technique d'information, No. 347-348, March-April 1980.
- 10 FAO. A manual on establishment techniques in man-made forest, February 1973.
- 11 M. DELOYE and H. REBOUR. La conservation de la fertilité des sols. Collection des techniques agricoles méditerranéennes, 1953.
- 12 FAO. Soil conservation for developing countries. Soil Bulletin No. 30.
- 13 Ministère de la Coopération: Mémento du forestier. Collection Techniques rurales en Afrique.
- 14 GOOR et al. Les méthodes de plantations forestières en zones arides. FAO, Rome, 1964.
- 15 PONCET, A. Reboisement de protection. Aspects techniques et économiques, 1974.
- 16 L. GUEPIN/P. GARNIER. Guide pratique des chefs de chantier. Bit, 1981.
- 17 A.I. FRASER. A manual on the planting of man-made forests, FAO, 1973.
- 18 W.F.J. van BEERS. Some monographs for the calculation of drain spacings. International Institute for Land Reclamation and Improvement. Bulletin No. 8.
- 19 M. POIREE and Ch. OLLIER. Assainissement agricole. Editions Eyrolles, Paris, 1973.
- 20 Paul JACOBSON. New methods of bench terracing steep slopes. SCS. USA, December 1962.

Reference

- 21 L. SACCARDY. Note sur le calcul des banquettes de restauration des sols. Terres et eaux. Algérie, 1950.
- 22 L. BUGEAT: Cours de conservation des sols, Tunis, 1957.
- 23 Centre de recherche du génie rural en Tunisie. L'équation universelle des pertes du sol, par M. WISCHMEIER. Calcul des paramètres agricoles, pédologiques, climatiques et utilisation de l'équation. SCET. CSOP, 1963.
- 24 Ministère de l'Agriculture. Retenues collinaires. La Documentation française, Paris, 1963.
- 25 SOGETHA. Techniques rurales en Afrique. Les ouvrages en gabions. Ministère de la Coopération, 1965.
- 26 A. LENCASTRE. Manuel d'hydraulique générale. Editions Eyrolles, Paris, 1976.
- 27 R. Benoît de COIGNACQ. Travaux de DSR. Ecole des conducteurs de travaux. Polycopié, Algérie, 1958.
- 28 BEEK, K.J. and BENNEMA, J. Land evaluation for agricultural land use planning; an ecological methodology. Landbou Hogeschool, Wageningen. FAO, doc. 8 B.22.
- 29 H. DIENER. Programme pilote de travaux à haute intensité de main-d'oeuvre dans la province de Muramvya (Burundi): les travaux de reboisement. BIT, Genève, 1979.
- 30 Les petits ouvrages en gabions. Collection Techniques rurales en Afrique.
- 31 J. RODIER and C. AUVRAY. Estimation des débits de crues décennales pour des bassins versants de superficie inférieure à 200 km² en Afrique occidentale. ORSTOM, 1975.
- 32 Guidelines for the Organisation of Special Labour-Intensive Works Programmes. ILO, Emile COSTA, Sunhil GUHA, Ibrahim HUSSAIN, Nguyen T.B. THUY and Aimé FARDET:
- 33 Introduction aux programmes spéciaux de travaux publics. Ph. GARNIER, T.B. THUY, L. GUERIN. BIT, Genève, 1981.
- 34 Normes pratiques de rendement pour les principaux travaux exécutés par des techniques à haute intensité de main-d'oeuvre (titre provisoire BIT, à paraître.