

AT MICROFICHE
REFERENCE
LIBRARY
A project of Volunteers in Asia

Raising Healthy Poultry Under Primitive Conditions

By: Dr. W. Malcolm Reid, Dr. Gene M. Pesti &
Dr. M.A. Hammarlund

Published by: Christian Veterinary Missions
Division of World Concern
Box 33000
Seattle WA 948133
U.S.A.

Available from: Christian Veterinary Missions
Division of World Concern
Box 33000
Seattle WA 948133
U.S.A.

Reproduced with permission.

Reproduction of this microfiche document in any form is subject to the same restrictions as those of the original document.

Raising Healthy Poultry Under Primitive Conditions

by

Dr. W. Malcolm Reid

Dr. Gene M. Pesti

Dr. M. A. Hammarlund



A Publication of Christian Veterinary Mission

Division of World Concern

Box 33000

Seattle, Washington 98133

USA

Copyright by
CHRISTIAN VETERINARY MISSION

This booklet, in part or its entirety may be copied, reproduced or adapted to meet local needs, without permission from the authors or publisher, provided credit is given to Christian Veterinary Mission and the authors.

These provisions apply provided the parts reproduced are distributed free or at cost—not for profit. Christian Veterinary Mission would appreciate being sent a copy of any materials in which text or illustrations have been adapted. For reproduction on a commercial basis, permission must first be obtained from Christian Veterinary Mission.

THIS IS AN EXPERIMENTAL FIRST EDITION

It can be improved with your help. If you are a veterinarian, veterinary technician, poultry producer, animal husbandry worker, missionary, development worker or anyone with ideas or suggestions for ways this booklet could be changed to better meet the needs of your people, please write to the authors at Christian Veterinary Mission, 19363 FREMONT AVE. M. SEATTLE, WA. 98133

Thank you for your help.

TABLE OF CONTENTS

SECTION 1

Introduction	7
--------------------	---

SECTION II

Getting Started - Securing Stock	11
--	----

SECTION III

Types of Chickens and Breeding Practices	15
--	----

SECTION IV—Housing And Equipment

A. Housing	19
B. Waterers	21
C. Feeders	22
D. Cages	24

SECTION V—Management

A. Incubating and Hatching	29
B. Candling Eggs	30
C. Brooding	31
D. Rearing	34
E. Layers	36
F. Breeders	40
G. Records	40

SECTION VI—Nutrition

A. Introduction to Poultry Nutrition and Feeding	43
B. Ingredient Sources to Meet Nutrient Needs	43
1. Feedstuffs Rich in Energy	44
2. Feedstuffs Rich in Protein and Amino Acids	45
3. Vitamin Supplements	47
4. Mineral Supplements	48
5. Water	50
6. Non-nutritive Feed Additives	50
C. Sources of Poultry Feeds	51
D. Feeding Systems	51
E. Quality Assurance	52
F. Formulation for Feed Rations	52
G. Sample Feed Formulas	52
H. Feed Mixing and Delivery	52

SECTION VII—Poultry Health Programs

A. Prevention versus Treatment.....	59
B. Classification of Disease of Chickens.....	60
C. Mortality.....	67
D. Post Mortem (Autopsy) Examinations.....	67
E. Diagnosis of Disease Problems.....	70
F. Predators, Rodents, and Other Pests.....	70

SECTION VIII—Marketing

A. Eggs.....	75
B. Meat.....	75
C. Financing.....	76
D. Contracts.....	76

SECTION IX—Other Kinds of Poultry

A. Ducks.....	79
B. Geese.....	79
C. Guinea Fowl.....	80
D. Turkeys.....	80
E. Pigeons.....	81
F. Quails.....	81

SECTION X—Other Information

A. Glossary.....	85
B. Useful References.....	89
C. Acknowledgements.....	91
D. Authors.....	91

Section I

Introduction



Introduction

More people raise poultry than any other food-producing animal. They may begin as a hobby for pleasure, to produce their own food, or for profit. This booklet may be regarded as a primer on essential methods of keeping poultry healthy. Suggestions are made on how to expand into a small-scale poultry farm under primitive conditions.

Since chickens are the most common domesticated bird raised on farms, villages and even in towns or cities, they will be used to illustrate poultry management which may also apply with some modifications for ducks, geese, turkeys, guinea fowl, quail, and pigeons. Some contrasts between chickens and other species are made in Section 9.

Many poultry producers have started by rearing a few birds as pets. Associated income, which was at first regarded as "pin-money", may grow into plans for a larger commercial enterprise. Optimistic hopes for financial returns may mislead the producer into too rapid expansion if careful planning has not taken place.

The best advice: "Start small the first year and let financial success govern your rate of expansion. Keep careful records!" Many financial failures have come from attempts to start with large flocks without knowing the best sources and costs of high-producing chicks, feed, methods of disease prevention, or marketing. This booklet may assist small-scale poultry operators as they expand into a successful commercial enterprise. Large scale poultry production is a specialized agricultural industry which will require further study of more detailed textbooks (See Section 10).

Section 2

Getting Started - Securing Stock

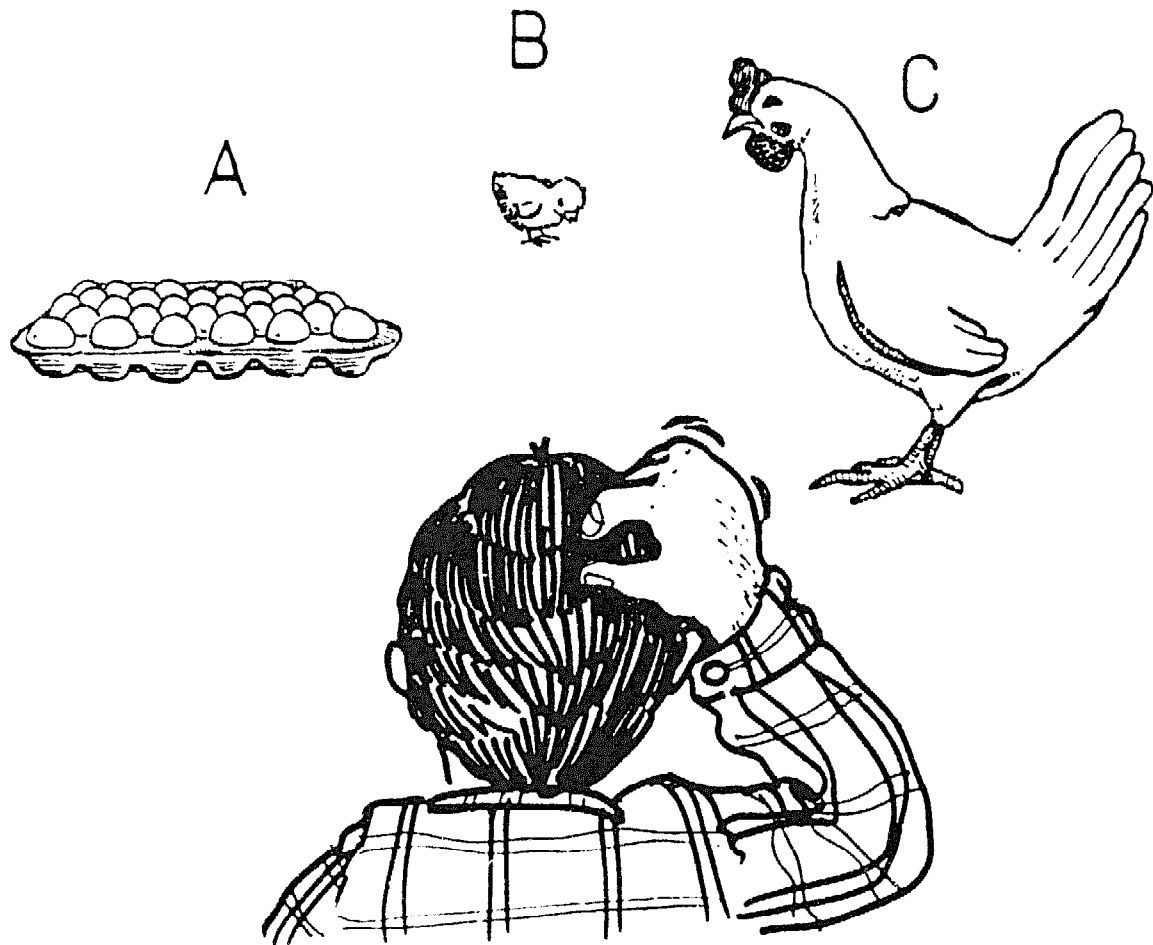

Which one shall I order?

GETTING STARTED - SECURING STOCK

Chickens are conveniently purchased and moved to new locations at four different stages in their lives:

1) As day-old baby chicks. This is the most common method of starting or restocking a poultry operation. Advantages: Since day-old chicks are nourished by stored yolk for 2 or 3 days, they do not require food or water during shipment to new quarters. Disadvantages: during shipment there is danger of smothering if overheated or getting chilled in freezing temperature. Although newly hatched baby chicks require more heat than humans, groups of 25 generate sufficient heat to be comfortable in a cardboard shipping box if some ventilation holes are provided and moderate room temperatures can be maintained. Watering and feeding will be necessary if shipments are delayed more than 3 days.

2) Purchase of hatching eggs secured from good breeding stock makes another convenient method of getting started. Although eggs may be easily broken if insecurely packed, temperature changes are less critical than with baby chicks. The producer must be prepared to incubate the eggs as soon as they are received. Hatching eggs cannot be stored for much longer than a week even if maintained at the optimum temperature of 10°C (50°F).

Natural incubation requires availability of a "broody" hen, turkey, duck or other bird. Although numbers of eggs set under a hen may be limited to 12-14, other birds sometimes incubate larger numbers of eggs. Hatching still larger numbers of chicks requires use of a mechanical incubator for artificial incubation. Success with this method is dependant upon skill and care of a the hatchery operator. If eggs from disease-free stock are obtained, care must be taken to prevent contamination by eggs or fowls from other sources. Percentage of hatch depends upon egg fertility, nutrition of the dam, condition of the egg shell, genetic constitution of the parents, egg storage time and temperature before incubation.

3) Purchase of started chicks three weeks or more of age saves the beginner from supplying equipment and the time-consuming tasks associated with brooding. These include use of artificial heat, initiation of chicks into feeding and drinking and sometimes early vaccinations.

4) Purchase of started pullets ready to lay at about 20 weeks of age relieves the customer of numerous rearing tasks. Advantages: males and inferior female culls are eliminated before purchase. Males are often destroyed as day-old chicks in the hatchery after sexers have examined the vent under strong light or by noting genetic feathering differences inherited from selected parent lines. Vaccination and other disease prevention procedures may have been accomplished. Disadvantage: added costs are usually charged on a per bird basis for these services.

Section 3

Types of Chickens Breeding Practices

WE NEED
GOOD PARENTS -
"HYBRIDS" !



TYPES OF CHICKENS AND BREEDING PRACTICES

Poultry producers generally make a choice in selecting their stock from three types of birds:

Dual-purpose chickens are reared to produce both eggs and meat. Most young males are sacrificed after 2 or 3 months for meat while females are maintained for a year or more to produce eggs. Females are also salvaged for meat after egg production declines. Dual-purpose birds are generally preferred for backyard flocks, while larger commercial poultry producers generally specialize in either meat or eggs.

Egg-layer strains have been selected for good egg production. Surplus males are often eliminated on hatch-day after sexing since they are usually genetically inferior for meat production. Spent females may be salvaged for meat after their egg production drops below 50%. Their salvage value is minimal because of their small size.

Meat chickens, often known as broilers or fryers, are reared from strains selected for rapid growth. Both male and female lines are selected from parent stock which produce rapid meat production. Some of these hybrid strains produce a bird weighing 2 kilos (4.4 lbs.) in 7 weeks after being fed less than 4 kilos (8.8 lbs.) of a well-balanced diet.

Primary breeding companies with hybrids. Specialized breeding organizations have developed feed-efficient strains of these three types of chickens. They are produced by cross-breeding techniques and go by the general name of "hybrids". This cross breeding brings about gene combinations which excel in production of eggs or meat over that of either parent. Superior qualities produced by new gene combinations are attributed to "hybrid vigor". These hybrid strains are now so popular with modern poultry producers that they have abandoned use of such dual-purpose breeds as Rhode Island Reds, New Hampshire, Cornish, or Barred Plymouth Rocks. Improved hybrid strains of White Leghorns produce white eggs while brown or tinted egg strains usually have some White Leghorn ancestry.

These breeding companies require years of work to test dozens of strains and hundreds of progeny. Certain inbred or synthetic strains which combine well are then selected to become the great-grandparents or grandparents of chicks sold to poultry producers. Strain crosses known as the male and the female lines are established and sold separately to hatchery organizations which rear them together as their "breeder flocks". All hatching eggs are derived from such breeders.

Poultry producers purchasing these hybrid chicks have at first been reluctant to pay for the necessary increased cost for these hybrid

chicks. However, if the purchase price of feed consumed is also calculated, the cost of the hybrids is more than compensated for. Unfortunately this hybrid vigor is rapidly lost by interbreeding the hybrid birds. The producer needs to renew the male and female lines of breeder stock in each generation.

Names of many of these hybrid strains are now recognized by poultry producers on a world-wide basis. Broiler strains are often named for the breeder organizations such as Arbor Acres, Cobb, H & N, Hubbard, Indian River, Peterson, Pilch, Ross, Shaver, Vantress, and Vedette. Some of the egg-type strains have been produced by Babcock, HyLine, DeKalb, Hisex, and Tatum. Names of some dual-purpose strains would include: DeKalb-Warren 6-Sal-Link (USA), Hardy sex-linked (USA), Kabir (Israel), Label (France), Nera sex-linked (Japan), Parks Hybrids, and Stino's White Baladi (Egypt).

Dual-purpose breeds are still preferred in many parts of the world where brooding hens are used to hatch and start chicks. A running debate has continued in many countries on whether to select native breeds or imported hybridized stock. Advantages sometimes cited for native breeds include: disease resistance inherited from long natural exposure, and local customer preference for these more "tasty" and "chewy" birds. Differences in taste may be due to scavenged feedstuffs such as garlic, insects, herbs, and manure. Slow growth probably produces the more "chewy" meat. National pride has sometimes influenced local decisions. Imported disease-free hybrids may grow faster, have better feed conversion, and produce more eggs. Natural inbreeding of backyard flocks results in low productivity for both meat and eggs.

By introducing imported males to breed with native hens, some of the advantages of hybrid vigor can be inexpensively incorporated in village-wide programs where producers are still dependant upon natural hatching and brooding. A happy "marriage" of improved egg production, growth and disease resistance from the males and local characteristics is thereby achieved. The program calls for elimination of all native cocks and substituting the surplus males coming from imported lines which have been selected for high productivity. Better egg and sometimes better meat production has been reported from such programs in Egypt, Ghana and India. The imported male chicks are inexpensive as they are otherwise often discarded in the hatchery.

Section 4

Housing and Equipment

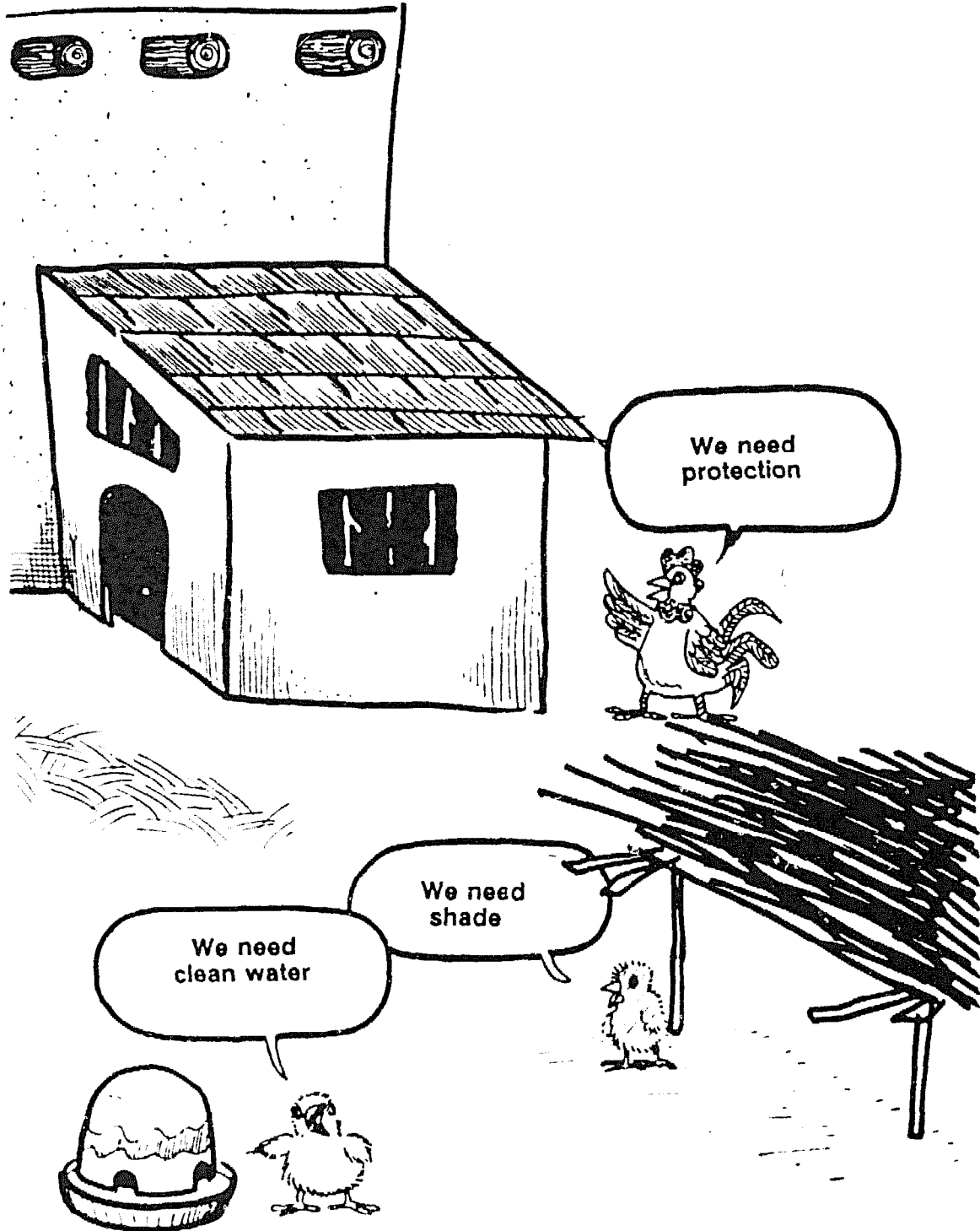

HOUSING AND EQUIPMENT

A. Housing is considered essential to protect chickens from predators, rain, wind, and temperature extremes. Although the ancestral jungle fowls roost in trees at night, mortality losses are often high. Nocturnal attacks from dogs, cats, rats, owls, hawks and other predators may destroy even adults chickens. Protective housing is very desirable (Fig. 1-4). if properly constructed and managed the house may also protect against the spread of diseases and parasites. Satisfactory houses have been built from wood, stone, concrete, adobe, brick, bamboo, and sheet metals. Materials available and designs used vary so greatly from different areas that detailed plans may best be secured from local authorities. Several essentials need to be considered before building a house.

Fig. 1. Free range management

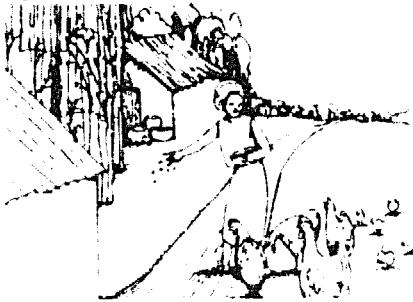

Fig. 2. Night shelter for partially controlled range

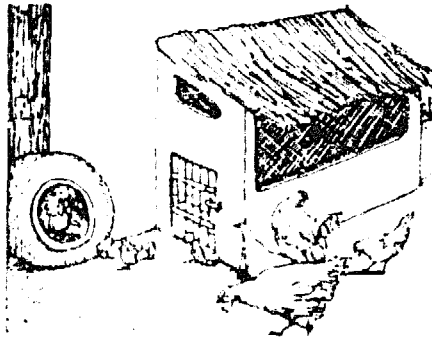

Fig. 3. Gable chicken house

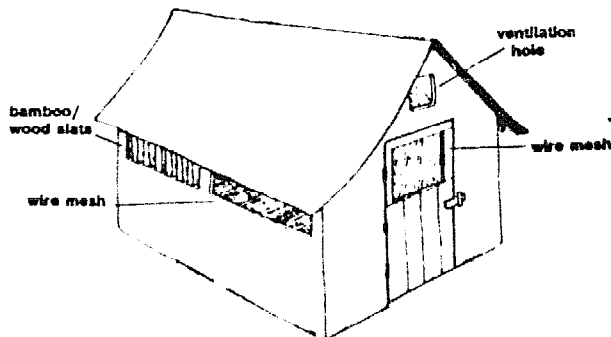
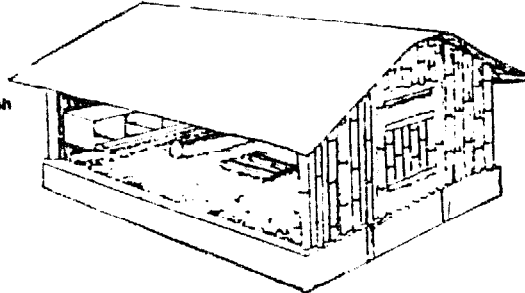

Fig. 4. Deep litter house for confinement rearing



1) Location. The house needs to be properly oriented to 1) protect against wind but permit some air movement, 2) prevent too much heat from the sun, and 3) to insure sufficient drainage to prevent wet floors. In hot climates available shade and roof overhang may need consideration. In the northern hemisphere windows are often oriented to leave an open southern exposure. If built in deep valleys there may be insufficient air circulation. Objectionable odors or houseflies breeding in poultry houses have forced some poultry units to move from developing suburbs.

2) Temperature Control. Temperature extremes in hot and cold weather create stressful conditions in poultry houses. Over heating of drinking water may be dangerous in hot climates. Frozen waterers create special problems in cold weather. Specialized construction plans adapted to local conditions may be available from local experts.

3) Ventilation. Air movement within the house is essential to prevent smothering (Fig. 3). Chickens need more fresh air per unit of body weight than any other class of livestock. Wide open sides or windows may be desired in hot climates. Air movement should not be blocked by bushes or other buildings. Ventilators and/or fans may be essential in large commercial houses.

4) Insulation. Health of poultry is often promoted by insulating roofs and sidewalls against both cold and hot weather. Advice on materials and engineering recommendations should be sought locally before building large houses.

5) Moisture Control. Large quantities of water are consumed by chickens. Layers may require more than a liter per day in hot climates. In humid climates high humidity may result in wet droppings which cause disease problems. Adequate drainage in the house floor may assist in moisture control. To prevent moisture problems some producers have selected management programs using slatted or wire floors.

6) Space. Crowded chickens are unhappy and unproductive. Minimum requirements for birds housed in a moderate climate with plenty of ventilation are as follows: 15 birds per square meter up to 6 weeks of age, 5 birds per square meter up to 16 weeks, and 3 to 4 birds per square meter for older birds. Higher temperatures, excess humidity, or wet litter increase required floor space requirements. In cages, 10 to 20 layers may be placed per square meter of floor space. Larger white and brown egg layers require proportionately greater floor space, as calculated by weight.

7) Framing. Availability of local materials and construction methods will determine the type of framing. Internal pillars may be required to support the roof against heavy wind or snow. Special strength is required over doors, windows and if tile roofing is used.

8) Roof. The roof should be entirely rainproof. Thatch, sheet metal, tile, shingles or wood covered by roll roofing materials may be used. An overhang of up to one meter on the south side (northern hemisphere) may provide shade in summer but permit sun to enter the house during winter. The amount of overhang to give this advantage varies with the latitude.

9) Floor. Although concrete floors with embedded wire mesh to keep rats out are desirable, more houses have dirt or heavy clay floors because of expense. Adequate drainage should be planned. Types of floors vary with different management systems which include deep litter, and suspended floors made of slats or wire. Convenient clean-out systems for manure need to be considered.

10) Animal and Bird Protection. Nocturnal protection against dogs, cats, rats, weasels, owls and day-time protection against wild animals, hawks and eagles should be planned. Wire mesh is often

used. Although foraging in pasture may be satisfactory during the day, greater protection is usually required at night.

B. Waterers. *Chickens of any age should never be left without clean, cool water!* Chickens need water every 15 to 20 minutes. Making certain that water supplies are adequate is one of the most important jobs of the caretaker. Waterers adapted for various ages of chickens are illustrated (Fig. 5). The simplest waterer is a tin can inverted into a soup or pie plate (Fig. 6). Punch a hole about 1.5 cm (0.5 in.) from the open end of the tin can. Fill the can with water and cover it with the plate. With one hand on the plate and one on the tin can, quickly invert both. The position of the punched hole and the vacuum in the tin can will regulate the water level in the plate. Smaller cans are suitable for chicks but larger ones must be substituted as growing birds require more water.

Waterers

Fig. 5. Chick waterer

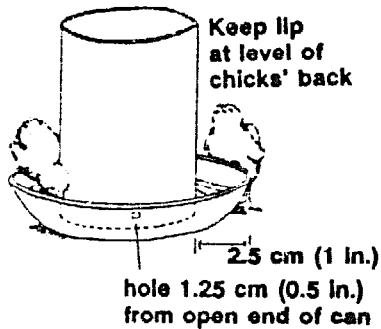

Fig. 6. Parts of waterer

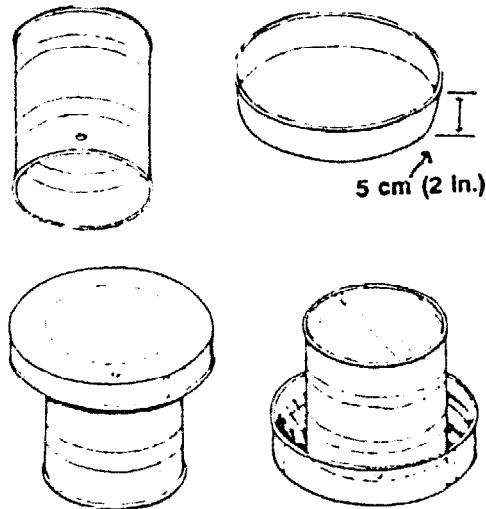

Fig. 7. Clay waterer

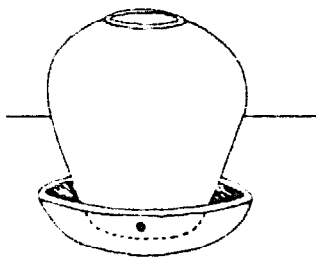

Fig. 8. Bottle waterer Fig. 9. Gourd waterer

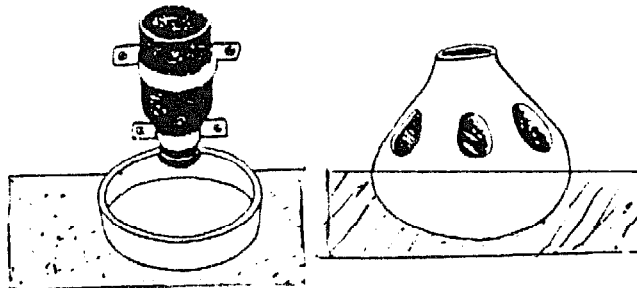

Fig. 10. Slat holder

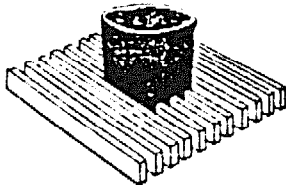
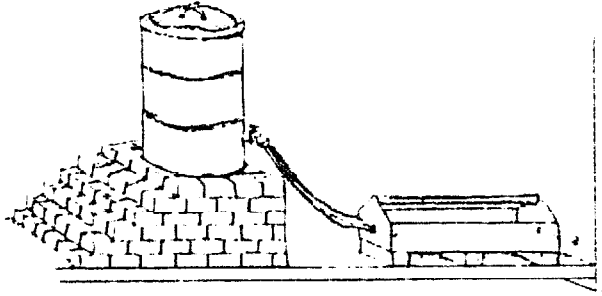
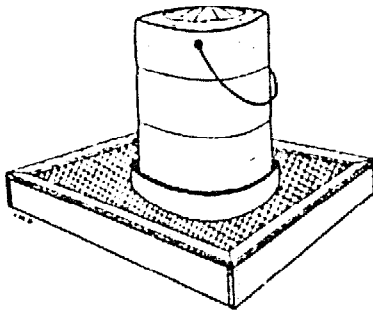

Fig. 12. Automatic waterer

Fig. 11. Waterer suspended to keep litter dry



Other waterers can be fashioned using a clay pot and shallow plate with a hole or groove in the lip (Fig. 7). A removable bottle strapped to the wall or a stand can be adjusted at a convenient height above a dish (Fig. 8). A gourd submerged in the ground for stability has holes of convenient size cut in the sides (Fig. 9).

Various automatic devices have been invented to preclude refilling waterers so frequently (Fig. 12). Illustrated is one built with a clean 50 gallon oil drum connected to a galvanized sheet metal trough 10 cm (4 in.) high. Flow of inlet water into the drinker is adjusted by a faucet and an overflow pipe leading outside the house. The top of the waterer needs to be protected by a spinner (a bar that rotates so chickens cannot roost on it). All waterers need frequent checking to see that water is constantly available but that no overflow goes into the litter. To keep the litter dry, each waterer is often placed on a flat board between slats (Fig. 10) or suspended on a wire-floored platform 9 cm (3 1/2 in.) above the litter (Fig. 1).

Slime molds begin to grow in waterers if they are not washed frequently. This should not be allowed to happen. A long handled brush is often used to clean out debris. Waterers need periodic cleaning with a brush. Some authorities suggest that this be done daily.

C. Feeders. Providing a continuous supply of feed for chickens is one of the major tasks of the poultry producer. Elongated trough-type feeders with overhanging lips on both sides may be constructed of wood, metal or bamboo (Figs. 13-20). Sufficient linear feeder space along the trough should be provided for all birds to feed at once. Otherwise timid birds may starve to death while others resort to cannibalism. Suggestions on linear space/bird: chicks 0-8 weeks 2.5 cm (1 in.), 9-16 weeks 7.6 cm (3 in.), breeder pullets 10.2 cm (4.0 in.), layer hybrids 3.8 cm (1.5 in.), caged layers and turkeys 7.6 cm (3.0 in.), ducks 5.0 cm (2 in.), and geese 6.4 cm (2.5 in.).

Feeders

Fig. 13. Chick feeder

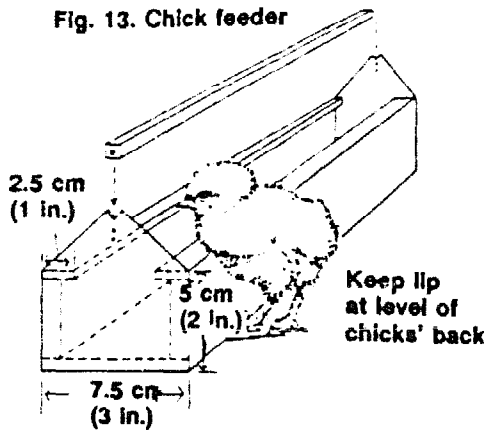

Fig. 14. Older chick feeder

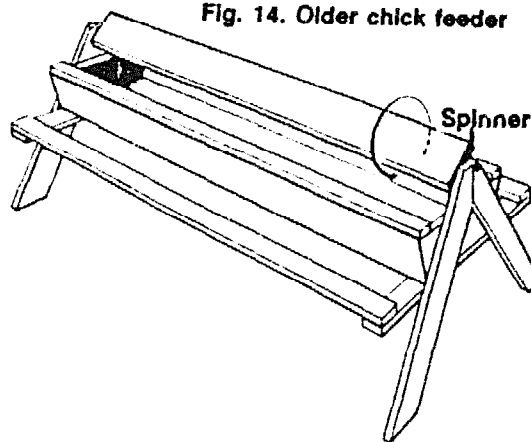

Fig. 15. Hanging feeder

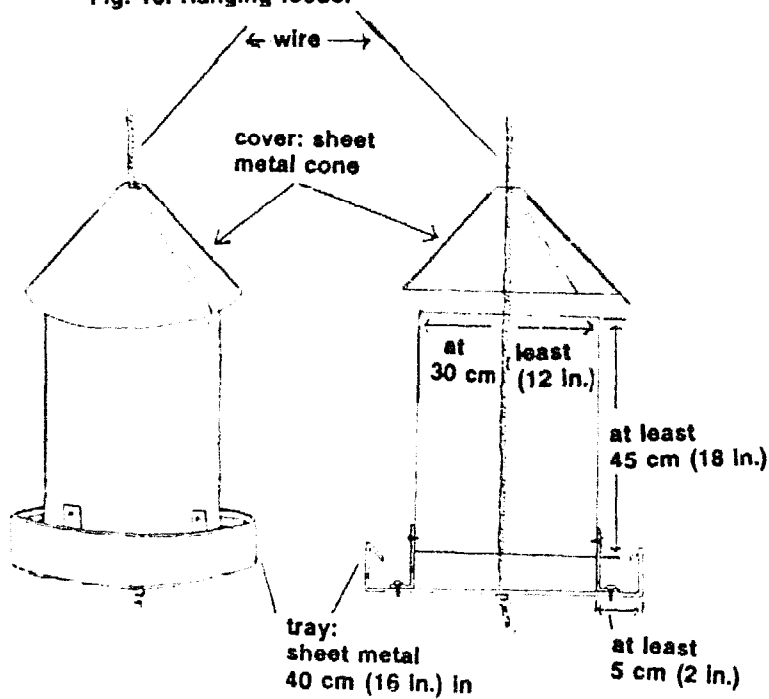

Fig. 16,17,18. Lip overhang

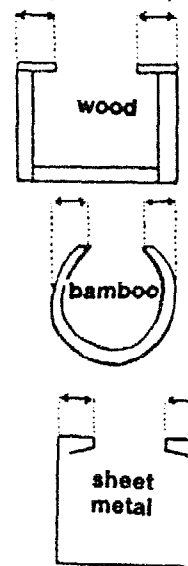

Fig. 19. Hanging feeder - bamboo

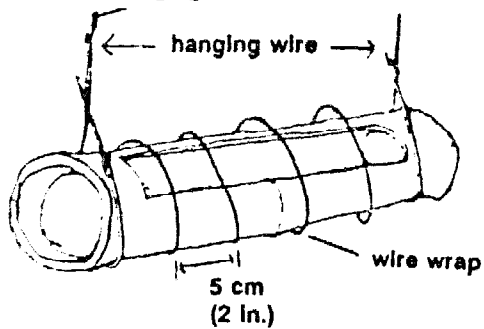
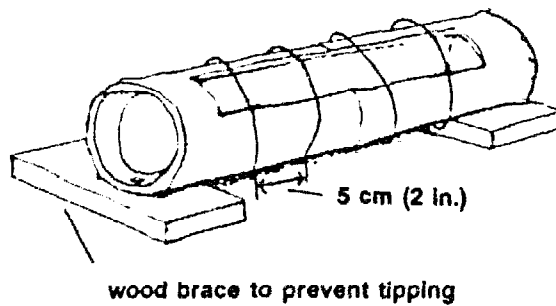

Fig. 20. Stationary feeder - bamboo



D. Cages. Craftsmen can fabricate cages if supplied with welded wire mesh with wire 2 mm (1/8 in.) in diameter. For the frame and dividers wire size is spaced 2.5 x 5 cm (1 x 2 in.). A piece cut 3.66 m x 1.5 m (12 x 5 ft.) provides the form for 3 colony cages or 16 double cages (Figs. 21 and 22). Four dividers plus end pieces cut 40 x 45 cm (16 x 18 in.) will make three colony cages or 17 for 16 double cages spaced 22.8 cm (9 in.) apart. A flexible metal wire is used to bind the dividers to the frame. The front is made from wire mesh with larger openings (5 x 10 cm, 2 x 4 in.). Doors may be cut in as indicated in Fig. 23. Floors should slant downward 7.6 cm (3 in.) back to front so eggs will roll through a 5 cm (2 in.) gap in the front and rest upon the upturned floor for easy collection (Fig. 26). Bamboo or slats may be substituted for wire floors (Figs. 24, 25). Feeders and waterers may be made of sheet metal or bamboo and hung tightly to the front of the cage. Spacing is important to prevent spillage of water or feed. Double cages accommodate 2 layers each while colony cages permit 6 if they have been severely debeaked.

A system of double hanging is illustrated (Fig. 27). A correct slant of 7.6 cm (3 in.) to the floor is required to permit eggs to roll out without damage (Fig. 26).

Making Wire Cages

Fig. 21. Feeder and waterer location

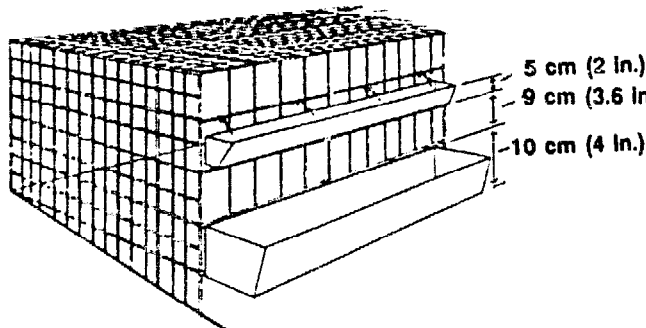

Fig. 24. Floors may be slatted

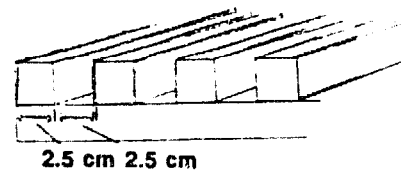

Fig. 22. Form for cage from wire mesh

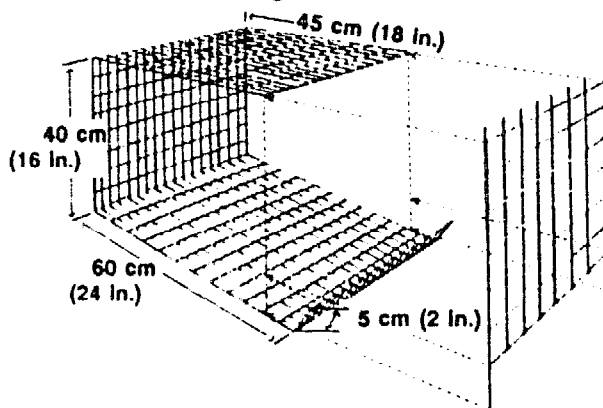

Fig. 25. Floors may be bamboo

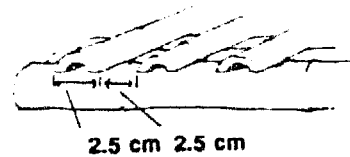

Fig. 26. Slanted floor for egg roll out

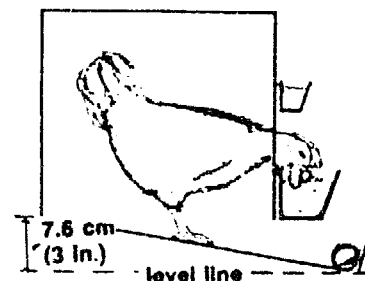

Fig. 23. Cage front and sliding door

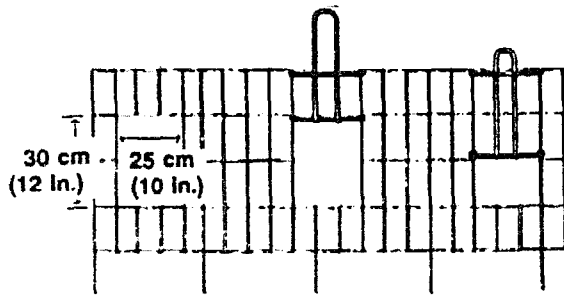
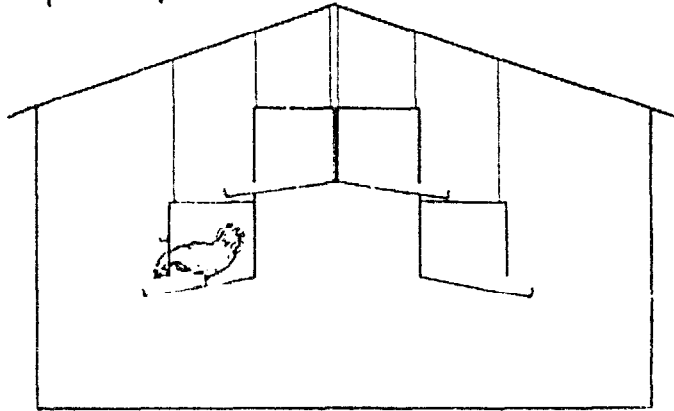

Fig. 27. Four cages hung staggered from ceiling



Section 5

Management

BABIES
NEED HEAT !

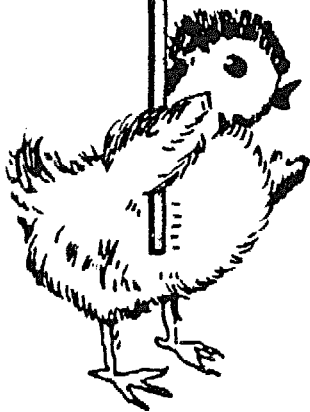

TO GROW
WE NEED
LOTS OF FEED !



MANAGEMENT

A. Incubating and Hatching. New poultry producers must choose between natural incubation of fertile eggs with broody hens or using an incubator. Natural incubation under broody hens or substitute turkeys, ducks, capons or geese requires little care from the poultry producer. However, it severely limits flock size and growth, and presents the possibility of disease transmission which may be controlled in artificial incubation programs. Most commercial poultry producers have come to rely upon a hatchery industry which has developed methods of artificially hatching large numbers of eggs.

Home-constructed incubators are still used for small flocks in some areas where the commercial hatchery business is not well developed. If a constant supply of electricity or kerosine is available, inexpensive incubators can be purchased or constructed which will hatch small numbers of eggs (Fig. 28). For chicken eggs the incubator must contain a thermostat (Fig. 29) which can be adjusted to maintain a constant temperature of 39.4°C which is the approximate temperature of naturally incubated eggs. Relative humidity should be maintained between 45 and 65% by use of water pans and adjusting the air flow. Chicks begin to hatch at 21 days and are often stronger if left unassisted. Although a few stragglers may live if given assistance, they are often too weak to survive. A small still-air, 50-egg capacity electric incubator can be built using a heat lamp with temperature regulated by a gas-filled thermostat. Eggs should be "turned back and forth" about 4 times a day during the early weeks of incubation. Mark each egg with an "x" to judge a turn of 45° each time but do not rotate.

Fig. 28. A homemade incubator

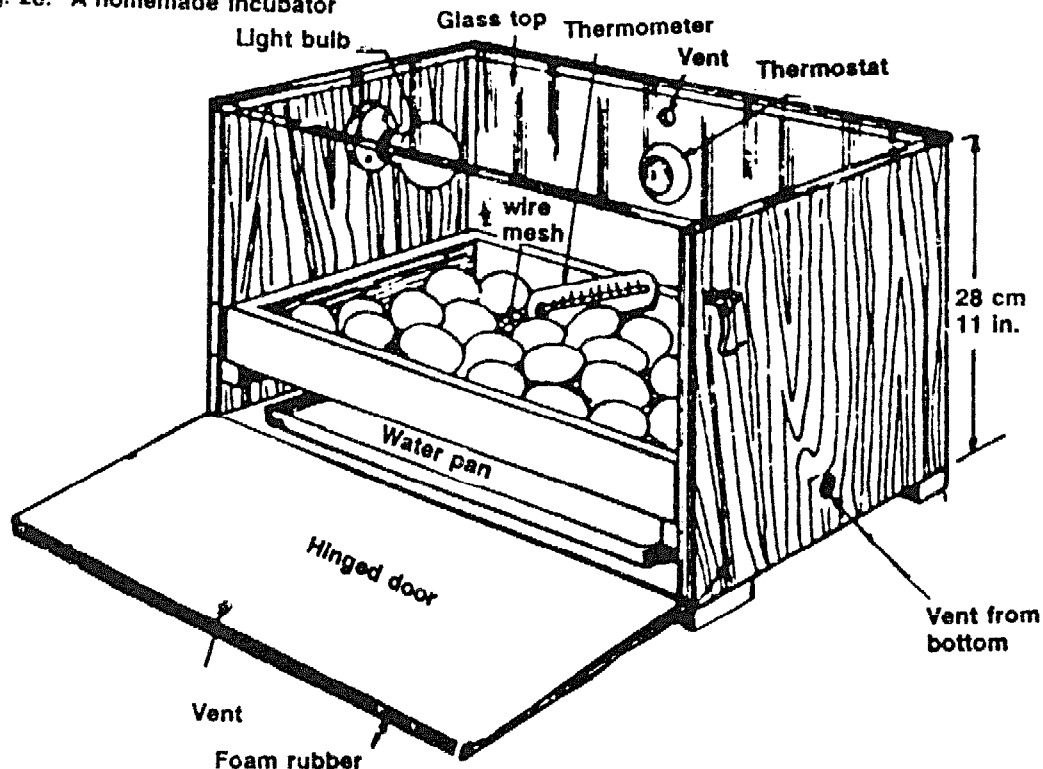

Fig. 29. Gas filled thermostat

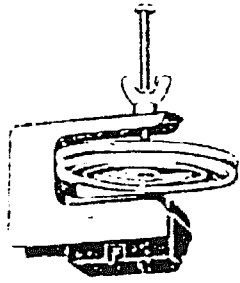

Fig. 30. Egg candler

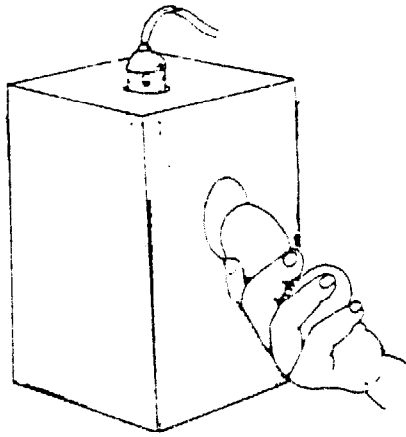
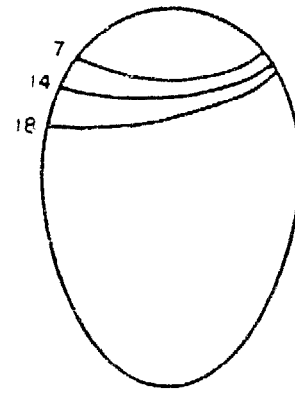

Fig. 31. Size of air cell after 7, 14, 18 days of incubation



Since mechanical failures with home operated equipment are frequent, most poultry producers have come to rely on commercially operated hatcheries which employ mammoth forced draft incubators. These are designed to mechanically turn the eggs several times a day. Temperature should be maintained between 37.5 and 37.6 degrees with 50 to 60% relative humidity. For the nineteenth and twentieth days, the temperature should be dropped to 36.1 to 37.2% with an increase in relative humidity to 75% just before the highest rate of hatching is reached. These recommendations depend on the type of incubator and size of the eggs being hatched, so pay careful attention to manufacturers recommendations. A back-up alarm system may automatically start a standby electric generator in case of power failure. Each incubator may well be provided with filtered air to prevent bacterial contamination from other incubators within the hatchery. Eggs are transferred from the incubator to a hatching unit on the 18th day of incubation.

A good commercial hatchery will supervise disease control on the breeder farm to prevent introducing diseases into the hatchery. Hatchery-transmitted diseases have been costly in the past. Thus the older custom of accepting hatching eggs furnished by individual breeders sometimes known as "custom hatching", has been discontinued. A thorough washing and disinfecting of equipment is essential for sanitary clean-up after each hatch. Services for vaccination, debeaking and sexing are often provided along with supervision of the breeder farms to prevent egg-transmitted diseases such as pullorum and mycoplasma. Most of the newly hatched chicks are sold and delivered directly to the customer at one day of age. Some hatcheries brood and sell started chicks or pullets.

B. Candling Eggs. Progress in the developing embryo during incubation can be observed by rotating an egg in a beam of light. A simple candler can be made by putting a 3 cm (1-1/8 in.) hole to a can or box holding a 15-50 watt light bulb (Fig. 30). A flash light or narrow

beam of sunlight in a dark room may also be used. Normal shrinkage of the air cell during incubation is shown (Fig. 31). If the airsac is more than 1 1/4 cm (1/2 in.) deep, the egg is probably spoiled.

Infertile eggs (white shells only) can be detected after 4-5 days of incubation. Two or three days longer may be required for tinted or brown eggs. If thin blood vessels may be seen as emerging from a dark red spot, the egg is fertile and the chick developing. If yolks and whites are clear the eggs remain edible, although laws prohibit their sale in some countries. Candling is also possible at 18 days while eggs are being transferred to the hatcher. Infertile eggs remain clear, contaminated eggs are detected by a darkened embryo inside and the absence of an air cell.

C. Brooding. If baby chicks are artificially hatched, the producer must assume the task of the mother hen in a role known as brooding. The attendant takes on serious responsibility for hourly attention during the critical early stages in the life of a flock of chicks. Constant inspection during the first two days may determine the difference between success and failure of a flock. In many countries women demonstrating maternal instincts do the best job of brooding during the critical first weeks. Three necessities must be constantly attended to: heat, feed and water.

Heat for a brooder may be provided by electricity (Fig. 32-33), gas (Fig. 34), kerosene (Fig. 37), charcoal (Fig. 35) wood, coal, straw, or solar heat. Preparations include testing and adjusting the heat source 24 hours before the chicks arrive. The old rule of thumb for maximum brooder temperature has been 35°C (95°F) for the first week, and a decrease of 2.8°C (5°F) for each succeeding week until 21°C (70°F) is reached. Lethargic breeds of chicks require more heat than genetically active breeds. Thus some authorities suggest a starting temperature of 30-35°C, varying with breeds. A range of temperatures in the brooding area gives chicks a choice in selecting an optimum temperature.

Types of Brooders

Fig. 32. Light bulb brooder

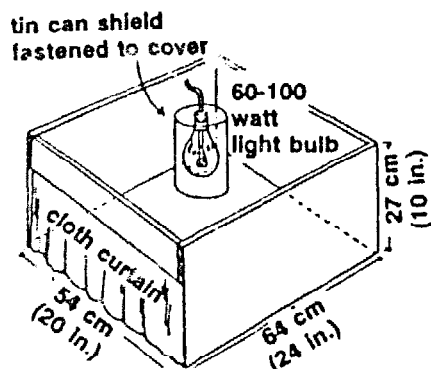

Fig. 33. Infra-red heat lamp

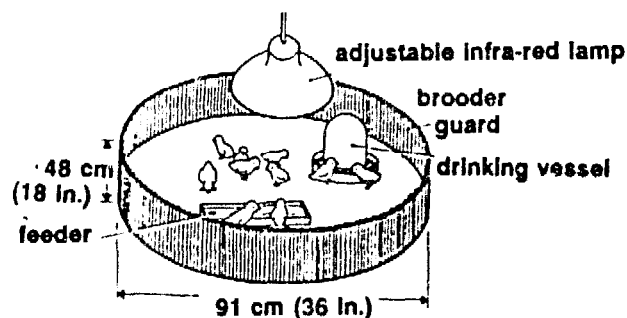

Fig. 34. Gas brooders with hood

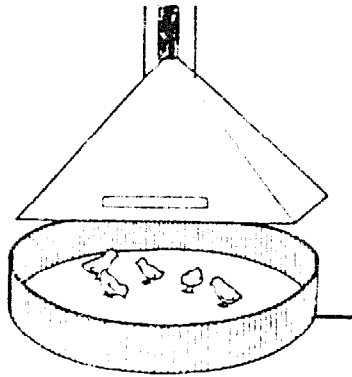

Fig. 35. Oil barrel - charcoal

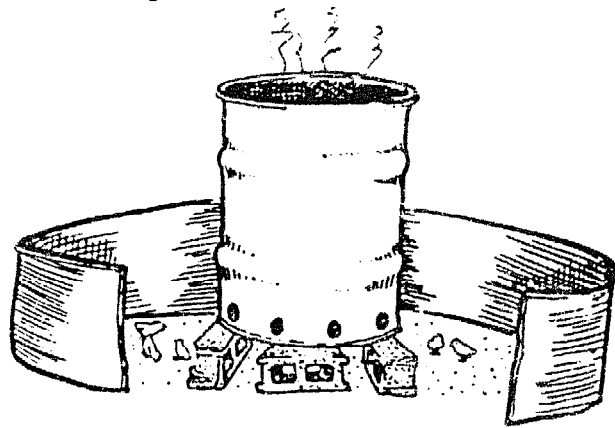

Fig. 36. Basket brooder

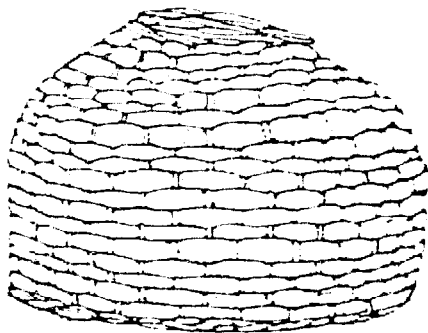
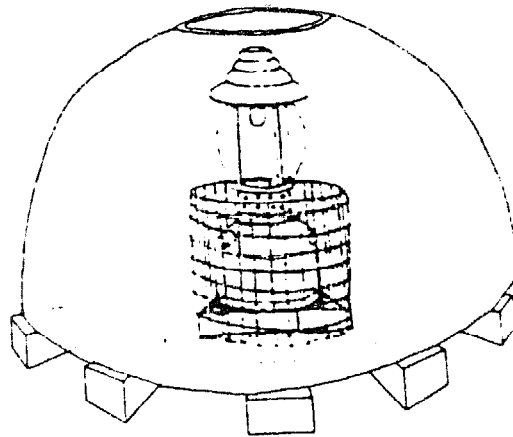

Fig. 37. Kerosine brooder



An inverted box-type brooder with a protected light bulb hanging 20 cm (8 in.) from the floor furnishes a satisfactory brooder for about 50 chicks (Fig. 32). A confined area outside will permit chicks to run outside through the cloth curtain. An infra-red light bulb adjusted to hang 45 cm (18 in.) from the floor is a good heat source for small numbers of chicks (Fig. 33). A hood, which is usually constructed of sheet metal, may be hung or suspended by small posts or bricks with the edge 10-12 cm (3-4 in.) above the floor. Basket brooders may be constructed with a kerosine lamp propped up on bricks as a heat source. Caution to prevent fires is required with any heat source.

For the first week a cardboard ring known as a "chick guard" or "brooder guard" is often placed beyond the rim of the brooder to prevent chicks from wandering too far from the heat source (Figs. 33-35). An experienced observer will be guided in temperature regulation by the chick behavior (Figs. 38-41). Less experienced care takers should frequently record the temperatures indicated by a thermometer located at the level of the chicks' backs. If chicks are huddled together and making the chirping sounds of discomfort, more heat may be necessary. If chicks are distributed in a ring as far possible

from the heat source, less heat should be furnished (Fig. 40). Constant attention for young chicks is especially important because outside temperature changes alter the amount of supplemental heat necessary.

Brooder Management

Fig. 38.

Chicks too cold. Lower lamp.

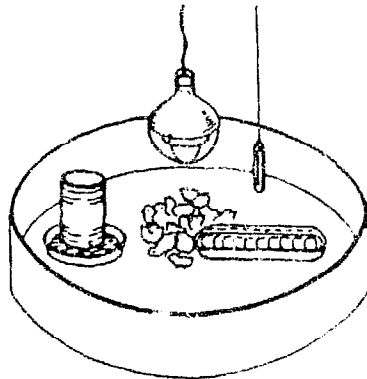

Fig. 39.

All is well; conditions just right.

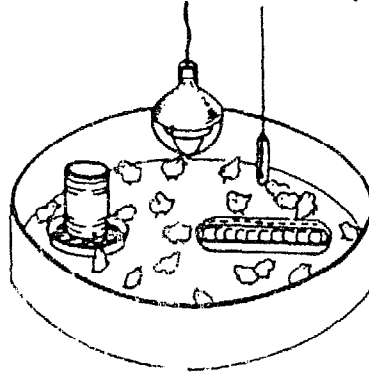

Fig. 40.

Chicks too hot. Raise lamp.

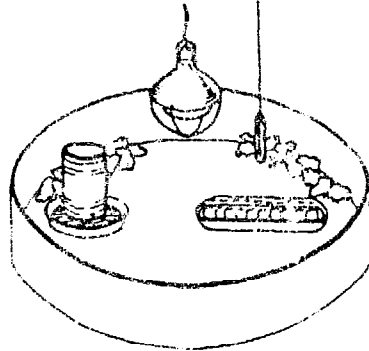

Fig. 41

Cold draft. Plug it up.

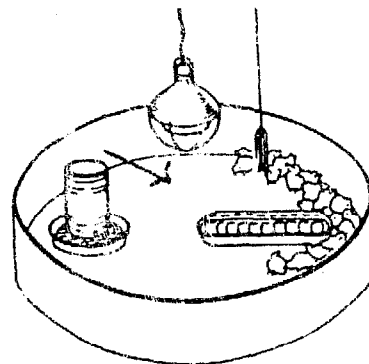
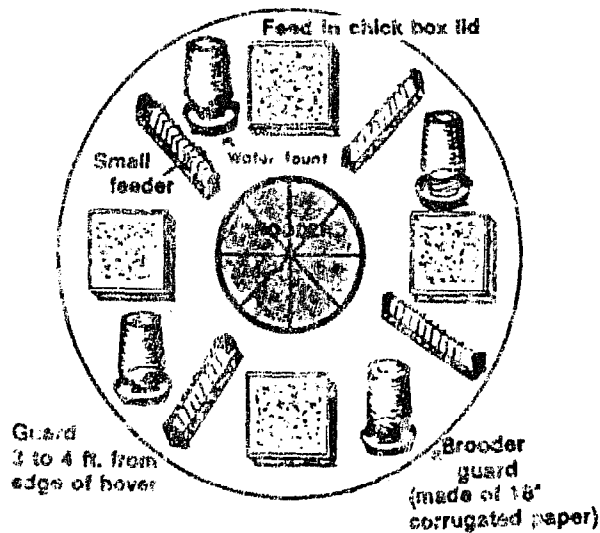

Fig. 42. Feed and water placement within brooker guard. Arrangement of 4 waterers and box lids (temporary) to be replaced by feeders.



Feed must be presented in a manner that will attract the curious chick during its first day of brooding. Mixed mash, or crumbles spread out on newspapers or an inverted box top is frequently used. Four feeder and 4 watering stations are often placed alternately just inside the brooder ring (Fig. 4). Place baby chicks right on top of the feed. During the first week temporary box-top feeding stations are gradually replaced with 4 small chick feeders. Each 100 chicks requires 2.5 m (199 in.) of feeding space.

Water must be found by each chick during the first day even if some must be picked up by hand and their beaks inserted in the water. During the first 2 weeks no chick should be more than 1 m (3 ft.) from a waterer and thereafter not more than 3.5 m (10 ft). Daily requirement of water for 100 chicks approximates 2 liters during the first week. Size of the waterers will need to be increased as the chickens grow (Figs. 5-12). One hundred hens in lay may require 36 liters or more per day. Spillage on to the litter needs to be guarded against (Figs. 10-11).

D. Rearing. Use of added heat in brooders may be discontinued after 3 weeks, or earlier in warm climates. The producer has a choice of different systems of management. The flock may be reared on free range (Fig. 1), limited range (Fig. 2), in pens, in cages or in confinement within houses (Fig. 3 and 4).

Advantages of range rearing include 1) reduced feed costs as birds secure much of their own diets by scavenging for green fodder, insects, and by scratching in manure from large animals, and 2) reduced housing costs. Disadvantages include 1) loss from predators, and 2) it requires close flock shepherding. A limited range requires less flock supervision.

Advantages of pen rearing include more protection from weather and predators. Disadvantages include the cost and responsibility for furnishing all essential nutrients in the feed and cost of complete feeding, fencing, and problems arising from wet pens in rainy weather which may result in disease and parasite problems.

Cages save space and if suspended to avoid contact with droppings, birds may be protected against some diseases and tick parasites. They have a higher initial cost and require a convenient manure disposal system.

Confinement rearing permits greater protection against predators and may prevent disease if sanitary measures exclude visitors, older chickens, pets, or fomites. All essential nutrients must be furnished in the feed. Recommended space per bird should be 650 sq. cm (100 sq. in.) for the first 5 weeks, and increased to 2,750 sq. cm (3 sq. ft) as it reaches maturity. The floor is usually covered with 5 to 10 cm (2-4 inches) of litter. Type of litter selected depends

upon local availability and cost. Preferred materials include: peat moss, chopped oat, rice, or wheat straw, softwood or hardwood chips, sawdust (only after 4 weeks), shredded corn stalks, ground corn cobs (some danger from molds), broadleaf leaves, rice, peanut or coffee bean hulls, shredded sugar cane stalks, newspapers, and sand (last choice). Poor quality litter requires somewhat greater floor space to stay dry. If litter becomes wet due to leakage of waterers or rain, wet material should be replaced. Fine grass, straw or hard particles of incompletely ground feedstuffs may cause a blockage known as "crop-bound" (Fig. 43). If such chickens are otherwise healthy they should be sacrificed for meat since there is no practical remedy to relieve this condition.

Fig. 43. Crop-bound chicken



Fig. 44. Killing a chicken for a post mortem examination

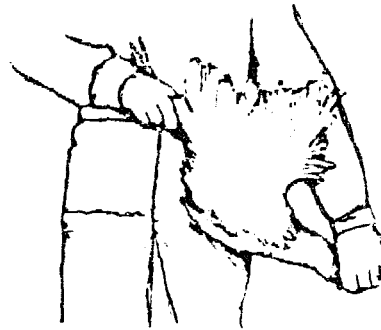

Fig. 45. Metal cone for weighing

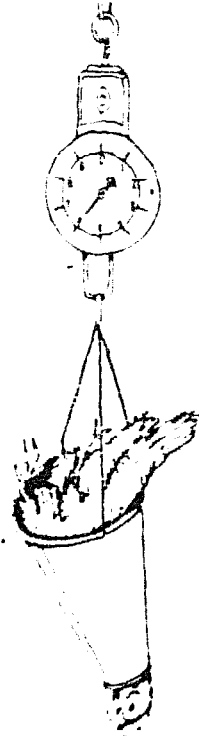

Fig. 46. Zones for debeaking

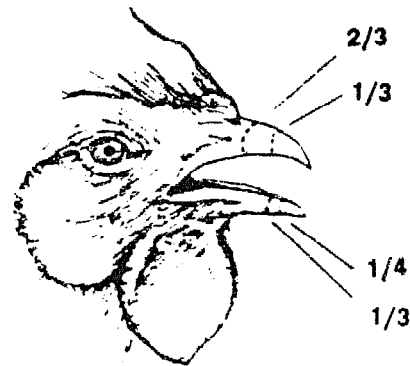
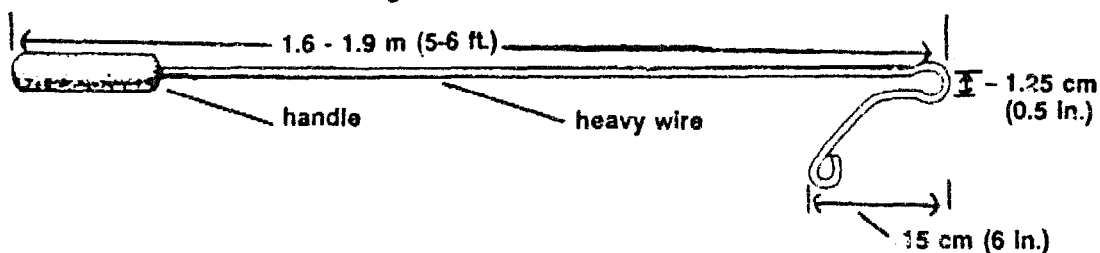

Fig. 47. A catching hook



Cannibalism. Debeaking is a method of cutting or burning off the tip of the upper and lower beaks (Fig. 46). If properly done this minor operation prevents cannibalism which is a bad habit of pecking at feathers or injured areas of other birds. Some broiler and layer producers order debeaking of all birds at the hatchery. For broilers, only about 1/3rd of the top beak is removed. For layers which will be alive longer, 1/3rd to 2/3rds of the upper and 1/4th to 1/3rd of the lower beak is removed. Scissors or a sharp knife may be used if a debeaking machine is not available. Dip the freshly cut beak into feed if bleeding occurs. With birds on the range equal amounts of each beak should be removed only after the onset of cannibalism. Cutting too deep into the nares should be avoided.

Other methods of preventing cannibalism are sometimes required. At the first sign of feather pulling or blood the victims should be removed from the pen. Raising the birds in very dim light, a practice known as "dark house brooding" is an effective means of preventing cannibalism. This requires a windowless house, fan ventilation, and dim light furnished by a few small light bulbs. At least .5 foot candles (5.4 lux) of light must be provided. Care is critical in placement of feeders and waterers to prevent birds from becoming dehydrated and losing weight in the dark.

E. Layers. Debates continue over which is the best management system for layers. Free-range provides access to sunlight (which prevents rickets) and gives birds access to green fodder. Eggs from such sources have sometimes sold at a premium because of increased pigmentation in egg yolks. However, general production costs are considerably higher than eggs produced with confinement rearing. Scavenging for feed on range may save some costs for feed. Partial restriction by fencing provides increased protection but may also increase exposure to diseases and parasites if pens get wet.

Confinement rearing on litter in floor pens, on elevated slatted floors (Fig. 52), or in cages is now widely practiced. This requires a feed source which is nutritionally fully balanced. Capital investment for housing is lower with litter on floor pens than cages. Cages conserve space, facilitate egg collection, save on labor costs but are expensive to install. Manure accumulations under cages or raised slatted floors sometimes creates housefly problems as they breed in damp manure.

Additional lighting applied at the proper time in the life cycle of hens may greatly increase egg production. With leghorn types the optimum time to increase lighting exposure is usually at 20 weeks of age. With dual-purpose breeds 21 weeks and broiler breeders 22 weeks is often the best time. Instructions in management guides often provided by breeding organizations should be closely followed. These instruct on weight of the pullet (Fig. 45) at the time increased light is to be applied. Add one hour of light each week until 15 hours total

is reached. Egg size may remain small if increased lighting occurs too early. Switching lights on and off during the night is another management program sometimes used to stimulate feed consumption and rate of growth of broilers. In large commercial operations light switches are controlled by time clocks.

Another factor in numbers of eggs produced is the regular daily collection. If a yard hen is permitted to keep her eggs in the nest, her production may be limited to 30 eggs per year in two clutches of 12-15 each. If collected daily she may lay 120 eggs. If 15 hours of daylight are provided she may lay 250 eggs.

Nests. With floor-pen management nests should be provided for layers before they begin to lay. They may be constructed of wood (Fig. 48), sheet metal, wire mesh, clay, mud bricks, or woven mats (Fig. 50). Individual nests should provide a space of about 0.12 cubic m (1 cubic ft.). They may be placed on the floor (Fig. 48), on stilts (Fig. 49) or against the wall and in the darkest part of the house (Fig. 51). They should be lined with fresh litter and kept clean to prevent production of dirty eggs. If tiered or hung above the floor, nests should be provided with a perch in front. Colony nests, which may be used by several birds at one time, may be satisfactory if they are four times the size of a single nest.

With large slatted floor houses, nests are arranged for the convenience of the caretaker (Fig. 52).

Nests

Fig. 48. Individual wooden nest on floor

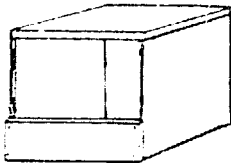

Fig. 49. Double nest of wood on stilts

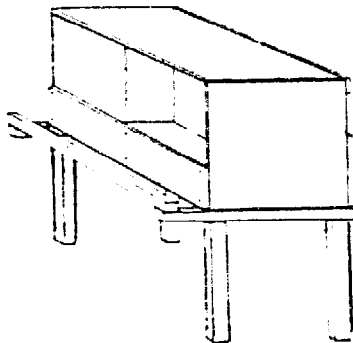

Fig. 50. Basket made of reeds and clay

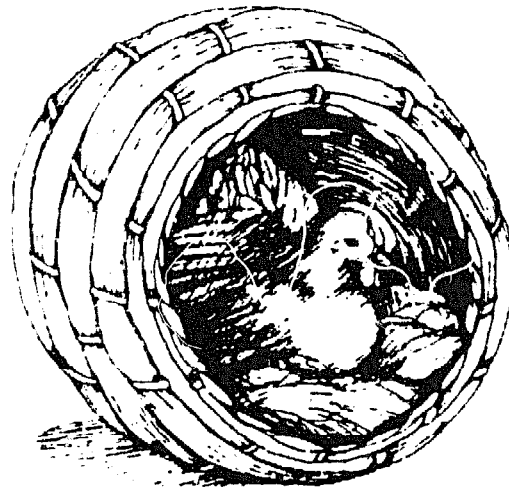

Fig. 51. Nests hung against the back wall.
Perch is hinged for night closure

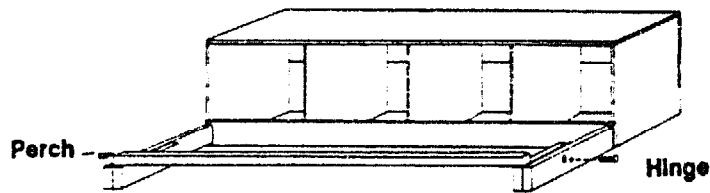
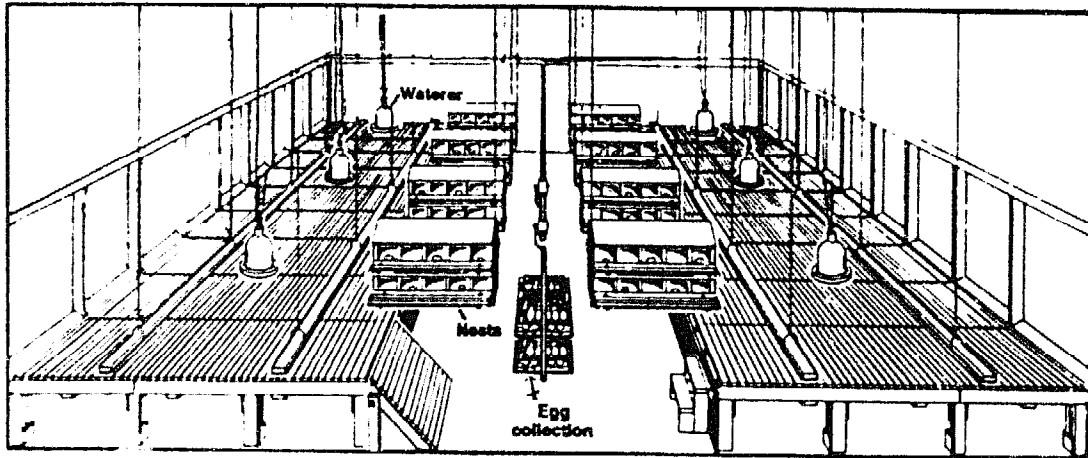

Fig. 52. Slatt-litter house with convenient egg collection



Eggs should be collected frequently and stored in a cool place to prevent rapid deterioration in quality. Some producers make 3-5 collections a day in hot weather. Eggs held at 37°C (99°F) drop drastically in quality after 3 days while they may keep 100 days at 3°C (37°F). Three degrees may be best for long term storage, but 10°C (50°F) is fine for shorter periods. These guides are for commercial eggs only.

Hatching eggs require special care and should not be kept more than about 10-14 days.

Roosts. Since birds traditionally sleep in trees, they are comfortable if the producer provides roosts. However, roosts are unnecessary. Hens require about 20 cm (9 in.) of roost space per bird. Roosts do concentrate droppings which may be salvaged for fertilizer. If roosts are built, house design should be planned for ease in cleaning out droppings.

Culling is the practice of removing non-layers from a flock. Considerable savings in feed costs can be effected by periodically catching and removing unproductive birds from the flock. However, caution in selection is suggested since birds which have recently molted may recover their ability to lay after a period of rest. A "catching hook" (Fig. 47) facilitates their recovery. Signs of a non-layer are a shriveled, pale, scaly comb, yellow pigment in the eye ring and the beak, dry rough wattles, small, round, yellow (Fig. 54), puckered vent (Fig. 56) with space between the two pubic bones for only 1 finger (Fig.

58), and 2 fingers between the pubic and breast (keel) bones. Note that the reference to pigmentation applies only to genetically yellow skinned birds receiving yellow pigments in the feed. In contrast, active layers have large, red, waxy combs, bleached eye ring and beak, soft and smooth wattles (Fig. 53), large, oval, moist, bleached vent (Fig. 55), with room for 3 fingers (Fig. 57) between pubic and 5 fingers between pubic and breast bones. Since even good layers may sometimes take 2-3 week pauses between clutches, caution is necessary to prevent the accidental selection of some potential good layers.

Layers vs. Non-layers

Fig. 53. Hen in lay

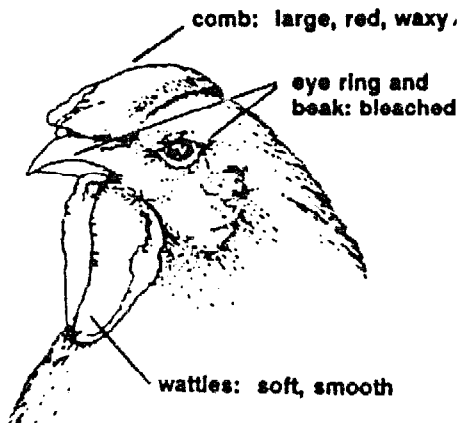

Fig. 54. Non-layer

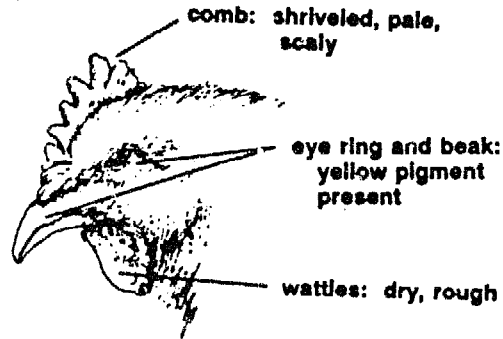

Fig. 55. Hen in lay

vent: large, oval, moist, bleached

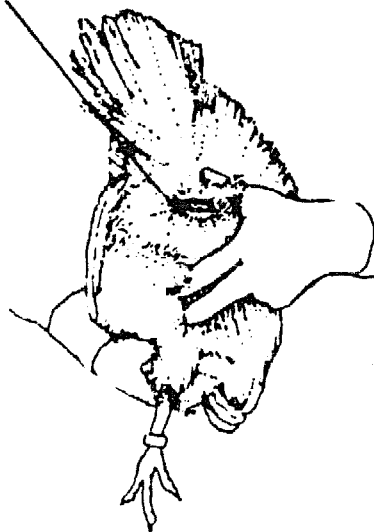

Fig. 56. Non-layer

vent: small, puckered, dry, yellow

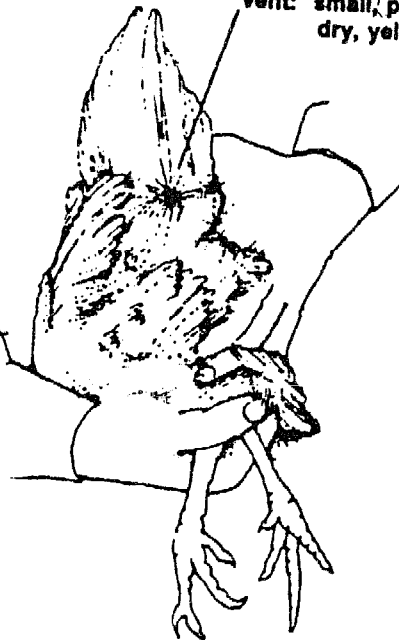

Fig. 57. Hen in lay: 3 fingers

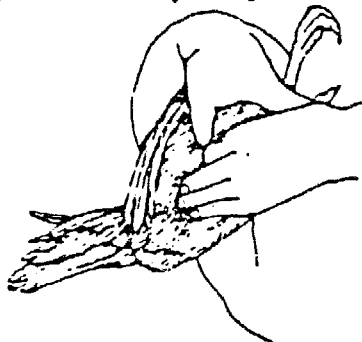
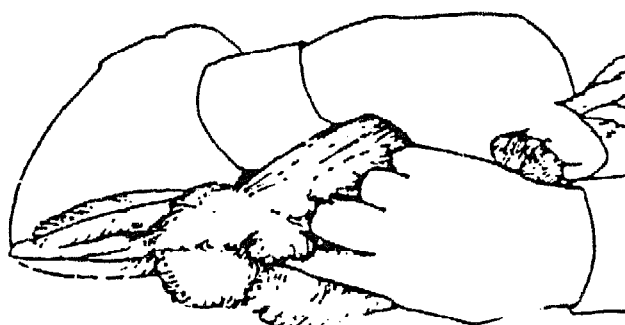
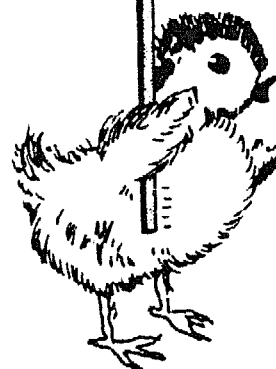
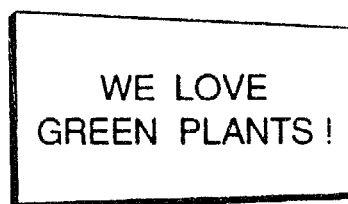
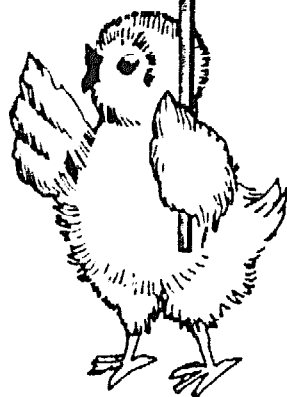
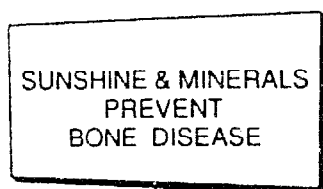

Fig. 58. Non-layer: 1 finger



F. Breeders. Each of the commercial breeding establishments selling male or female parent stock provides a manual with suggestions for rearing their birds to obtain optimum production of meat or eggs in the offspring. To judge maturity rate, birds are selected at frequent intervals to be weighed as flock samples (Fig. 45). Placing the bird in a cone-shaped metal container head first is a convenient method. Different directions are sometimes given for feeding and rearing male and female lines. Since the price of these breeders as baby chicks may be several times the cost of other chicks, all management suggestions are usually closely followed.

G. Records. Daily records should be made on charts conveniently located within the poultry house. Ruled lines with the calendar date on a card or paper attached to a clipboard are suggested. These should include space to record mortality, date of delivery of chicks, feed delivery date and source, feed consumption, daily egg production and records of any management or disease problems. Although this chore is distasteful to many poultry producers, these records become invaluable in planning for future poultry projects and disease control programs.



Section 6

Nutrition

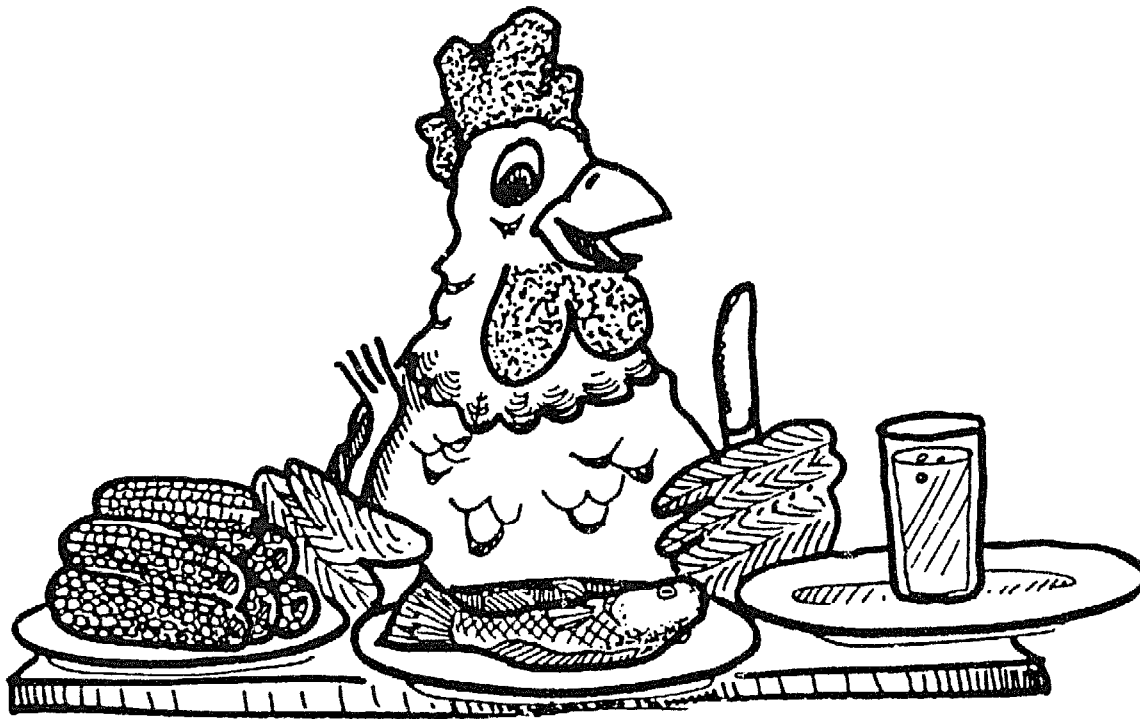

Energy

Proteins

Minerals

POULTRY HEALTH PROGRAMS

A. Prevention versus Treatment. PREVENTION IS THE KEY TO CONTROL OF POULTRY DISEASES. The poultry producer may think first of a drug treatment in case of a disease outbreak. Such a response, learned from treating human ailments, starts with the wrong premise for control of poultry diseases. He/she needs to remember: 1) drugs are expensive, 2) treatment must involve the entire flock, 3) to catch each bird individually requires much effort if treatment is given by mouth or injection, 4) if given by feed or water special mixing equipment may be required, 5) specific medication is generally successful only after a specific disease has been accurately diagnosed, 6) too long a delay frequently occurs before treatment can be instituted 7) indiscriminate use of antibiotics leads to the establishment of resistant strains of bacteria. Prevention is generally accomplished by:

1) Vaccination for specific diseases such as Newcastle, and fowl pox.

2) Blood testing breeder hens to locate and eliminate carriers of such diseases as pullorum and chronic respiratory disease (CRD). Chicks should be purchased only from blood-tested pullorum mycoplasma-free breeders.

3) Providing nutritionally balanced feeds complete with essential vitamins, minerals, amino acids, and energy to prevent nutritional deficiency diseases.

4) Feeding recommended levels of anticoccidial drugs to broilers if available for the first two months to prevent coccidiosis losses. Some recommended high levels for breeders or layers may prevent sufficient exposure to permit oocysts and prevent protective immunity.

5) Enforcing sanitary rules as:

a) Never introduce older birds into a young flock.

b) Prevent visitors (including neighbors), wild flying birds, rodents and especially other poultrymen from entering poultry houses.

c) Avoid visiting neighbor's flocks and returning to your own without a complete change of footwear and clothing.

d) Keep dirty crates, egg cartons, feed sacs and other contaminated items from poultry houses.

e) Establish an "All in, all out" rule to keep birds of one age together.

f) Practice a sanitary clean-up and waiting period (2-week minimum) before introducing a new flock to previously used pens. Exposure to direct sunlight kills many organisms.

g) Promptly remove dead birds and dispose of them by burning, deep burial or a specially constructed deep pit. Composting methods in tight containers has proved successful if large numbers of birds must be disposed of.

NUTRITION

A. Introduction to Poultry Nutrition and Feeding

If poultry is permitted to forage in open fields or barnyards, birds usually manage to obtain enough of a balanced diet to survive. A household flock of 10 to 20 birds may require no feed in addition to table scraps, green fodder and insects from nearby gardens. Slightly larger flocks survive better if fed a few handfuls of corn or other grain. Encouraged by the income from the sale of these scavenger flocks, the planner may be tempted to greatly expand flock size, sometimes forgetting that this may require the purchase of most of the feed. Plans must be made to provide a balanced diet with prospects for enough financial return to justify the added expense.

The producer may be well-advised to start small and increase flock size gradually after some experience with feeding and marketing poultry. Commercial producers calculate that 50 to 70 percent of the expense of producing chickens is due to the cost of the feedstuffs. Thus advance planning for a reliable supply of feed is necessary. As birds grow, their feed requirements increase each day. "Full feeding", a practice of keeping feed in front of the birds at all times, is often recommended. Estimates should be made on the total feed requirements to rear the flock to market age. Weight of feed required will be at least 2 or more times the expected market weight of fast-growing meat birds. A feed conversion ratio (feed weight divided by market weight of the birds) of 2 is considered good for broilers. To obtain such a ratio requires 1) good broiler breeder stock 2) a nutritious and well-balanced diet 3) good management and 4) disease control. The sale value of the bird minus the cost of the feed may be more important than the feed conversion ratio. Less expensive feed sometimes leads to slower growth but a greater profit.

Many poultry producers have lost all profits due to flock starvation when essential feedstuffs have unexpectedly disappeared from the market. Other losses, which may go undetected by the producer, occur due to nutritional deficiency diseases. Since grain products constitute the bulk of many mixed poultry feeds, competition with human food supplies becomes a major consideration. The enterprising poultry producer usually expends considerable effort in locating inexpensive feed ingredients which are unsuitable for human consumption.

Although the backyard producer has come to think of grain as the ideal supplement for scavenging chickens, a variety of feed ingredients is essential if chickens are to be raised in confinement. To insure rapid growth and egg production most commercial producers have come to rely upon a nutritionally balanced mixed feed given as mash, crumbles, or pellets.

B. Ingredient Sources to Meet Nutrient Needs:

For optimal performance some 40 different chemical substances,

or nutrients, have been identified as essential in the diet. A brief summary of six classes of ingredients is presented here:

1. Feedstuffs Rich in Energy. Hunger is the driving force which stimulates a chicken to eat and satisfy its energy requirement. Energy is required for muscular activity to carry on chemical processes like digestion and for producing heat. The feed ingredients must be proportionately balanced with energy-containing foods to supply all nutrients in proper ratios.

Feedstuffs providing energy are often subdivided into three categories: carbohydrates, fats (lipids) and proteins. Although surplus proteins do furnish energy, their need to satisfy growth requirements plus their added cost makes them too expensive to consider for energy alone. Carbohydrate sources may be subdivided into starches, sugars and cellulose (a fibrous plant tissue). Starches and sugars usually furnish a major portion of the energy requirements. These are usually supplied by feeding grains. Although celluloses (indigestible fibers) may be a major constituent of the feed, they are not utilized by poultry. Fats or oils provide an added energy reserve. If measured by weight they produce more than twice the energy yielded by carbohydrates or proteins. The energy value of feeds is usually expressed in terms of kcal or Joules per unit of feed. Both are metric system units for expressing energy, kcal are specific measures of heat energy. One cal = 4.184 Joules = heat required to raise 1.0 gram of water one degree C. Fats yield about 9 kcal per gram, while carbohydrates and proteins yield about 4 kcal of metabolizable energy for each gram.

Feedstuffs Which Contribute to Energy Needs

Corn (Maize). This cereal is the preferred energy source in many poultry diets and often constitutes as much as 60 to 70% of the ration. Corn based diets must be supplemented for deficiencies with certain amino acids, vitamins and minerals. Yellow corn is preferred over white if yellow pigmentation of egg yolks or skin color is preferred by consumers.

Wheat Although frequently more expensive than corn, wheat may be used up to 70% of the diet. By-products of flour manufacturing such as wheat middlings and bran may also be used. Bran contains considerable fiber which cannot be used by poultry, but is a source of some vitamins.

Other grains are also supplied as energy sources. Each one has somewhat different nutritional properties. *Sorghums (milo, millet, kafir corn), barley, and oats* are frequently used. Crushing or grinding is usually recommended and in some feedstuffs husks should be removed if possible.

Rice screenings are sometimes included in poultry rations after lighter husks have been removed. Such products must be fed while fresh after winnowing.

Cassava (manioc) roots contain large quantities of starch and may be incorporated in levels up to 25% of mixed feeds after drying to remove toxic hydrocyanic acid.

Potatoes and yams (sweet potatoes) have been used as a short-term energy substitute for grain products.

Molasses may be used in levels up to 5% as a carbohydrate source.

Cane juice has been used at 60% in broiler diets. Cane juice and molasses are valuable sources of energy, but they contain almost no protein.

Fats - oils and tallow from plant or animal sources are sometimes added to mixed feeds to supplement energy supplies. Between 3 and 6% of the ration is generally recommended.

The birds energy intake needs to be in balance with the protein and other nutrient intakes for the optimum utilization of the diet for meat and egg production.

2. Feedstuffs Rich in Proteins and Amino Acids. All new body cells of a baby chick are synthesizing distinctive new proteins from as many as 20 different amino acids. Amino acids, the building blocks of proteins, are derived from plant and animal feedstuffs. Some amino acids cannot be synthesized by chickens (arginine, lysine, histidine, leucine, isoleucine, valine, methionine, phenylalanine, tryptophan, and threonine). They are called essential, or indispensable, amino acids and must be present in each poultry ration. Other amino acids can be synthesized only in some situations (cystine, glycine, serine and tyrosine).

General signs of amino acid or protein deficiencies include growth depression, abnormal feather development, decline in egg production, and especially reduced egg size in laying hens. Deficiency of the amino acid lysine causes lack of pigment deposit in black or reddish colored feathers. One-third of the protein in a hen's diets may come along with energy from the grain source. The key to protein feeding is to compliment the chosen grain source. Most grains are low in lysine and high in methionine, so the best protein supplements are likely to be legume and/or animal protein meals, which are high in lysine and low in methionine.

Feedstuffs Which Contribute to Protein Needs

1) Plant Sources. Soybeans and Soybean oil meal. Soybean protein is rich in lysine, and therefore an excellent compliment to grain proteins. Soybeans must be cooked or heat treated to destroy growth-inhibiting substances. Heat processed whole beans make an excellent high protein (36%), high energy, supplement. Meals with the oil removed are excellent protein supplements containing approximately 44-49% protein.

Peanut Meal (Groundnut) may contain 47% protein but is deficient in some amino acids, particularly lysine, methionine and cystine.

Cottonseed Meal may contain up to 43% protein but a toxic compound ("gossypol") must be removed by special treatment before it is fed. If the meal is not treated growth depression occurs in chicks and egg yolks are discolored.

Meals from sunflower, safflower, sesame, tung nut, kapok oil, palm kernel, rubber seed, copra, field peas, navy, lima, winged, and other beans together with brewers and distillers by-products have been used for protein supplementation. Each product can be fed at low levels, but all have limitations which need to be considered in feed formulation. The amounts of these meals that may be economically fed are dependent on the source of each ingredient. The best approach is to buy from a reliable source, and learn from trial and error how much of each ingredient can be fed. If the source and quality of an ingredient changes, the birds response may also change.

2) Animal Sources. Meals made from fish, meat, blood, offal (visceral wastes), and feathers, contain varying levels of essential amino acids and minerals. Phosphate supplements are often expensive and animal protein meals are usually good sources of available phosphorus. Surplus dairy products such as milk and whey are also good sources of scarce amino acids and some essential minerals. Buttermilk is an excellent supplement to grain-based diets; it increases palatability and adds nutrients. It may be poured on the feed in the trough. To prevent mold formation, add only enough for a few hours consumption in hot climates, and not more than will be consumed in one day, even in cool climates.

3) Synthetic Amino Acids. Two amino acids, lysine and methionine, that often limit the nutritional quality of feedstuffs, are now available at competitive prices as feed supplements from commercial manufacturing processes. Synthetic methionine hydroxy analog is also available as an economic methionine source for poultry. This analog is quickly converted to methionine in the bird's body, taking advantage of waste nitrogen available in the bird.

Other Ingredients

Many other ingredients may be included in poultry diets if available at reasonable prices. These include grain crops and animal and plant by-products. Each contains different amounts of protein, energy, vitamins and minerals. Examples: bananas, carob pods, coconut products, copra meal, cowpeas, dried dates, gram, horse beans, alfalfa (lucerne) meal, lupins, lobster waste, manioc, millet, molasses, palm kernel cake, pineapple leaf meal, rice bran, rice paddy, simsim (sesame) cake, snails, sweet potatoes, dried worm meals,

and yucca products.

3. Vitamin Supplements. Some 13 different vitamins are required to produce healthy chickens. Deficiency symptoms (Table 1) sometimes indicate the absence of one specific vitamin, but more frequently, these symptoms indicate shortages of several vitamins and/or minerals.

TABLE 1. SIGNS OF VITAMIN DEFICIENCIES AND NATURAL SOURCES

Vitamin	Signs of Deficiency	Rich Sources
Vitamin A retinol	"nutritional roup" ataxia, eye infections, urate deposits, reduced egg production poor hatchability	green forage corn gluten meal yellow corn (carotene) fish oil
Vitamin D	rickets, soft bones, poor growth, feather- reduced egg production	chicks in sunlight synthesize this vitamin
Vitamin E tocopherol	"crazy chick disease" encephalomalacia, edema, muscular dystrophy poor hatchability	alfalfa meal, vegetable oils wheat germ
Vitamin K	hemorrhaging, poor blood clotting	alfalfa green pasture fish meal
Vitamin B ₁ thiamin	"star gazing" loss of appetite, weight loss, convulsions laying stops	leafy feedstuffs milk and grain products oil seed meals
Vitamin B ₂ riboflavin ²	curled toe paralysis, reduced growth and hatchability	alfalfa, green grass milk by-products fermentation products
Pantothenic acid	dermatitis of feet, poor growth and feathering, lesions of mouth, eye lids	alfalfa, green grasses, milk products distillers' fermentation products
Nicotinic acid niacin Vitamin B ₆	slipped tendon (perosis) hock enlargement poor feathering dermatitis poor growth & coordination, convulsions	wheat middlings corn gluten meal alfalfa milk products soybean meal meat and fish meals
Biotin	poor growth, dermatitis in feet, mouth, eyes, slipped tendon, reduced hatchability	green pasture soybean meal, grains, dried yeast milk products

Folacin folic acid	poor growth slipped tendon anemia, poor feathering and hatchability	leafy vegetables
Choline	slipped tendon = "perosis" poor growth and egg production	fish and milk products soybean meal
Vitamin B ₁₂	anemia, poor growth and hatchability animal manures	fish and animal by-products

Many of the vitamins are readily available in grains, green fodder or natural fermentation products if scavenger management is used. The B complex vitamins appear in yeasts and fermented animal manures. Supplemental B complex vitamins and vitamin A are sometimes furnished in small poultry operations by providing cut-up green fodder. Although vitamins from this source deteriorate rapidly, they may be preserved by drying. For this reason alfalfa meal is often used as a feed supplement. The poultry producer should be on the lookout for milk by-products such as whey and brewery waste products when vitamin supplements are needed.

The alternative to natural feed sources for vitamins is the inclusion of a concentrate as a feed supplement. Most of the vitamins are inexpensively produced from chemical processes or from fermentation waste products. Concentrates of vitamins as well as trace mineral additives are available commercially. Shipping charges are low since only small quantities are required. For example a typical premix added at the rate of 0.05% of the diet provides (per kg/diet): vitamin A, 5,500 IU; vit. D₃, 1100 ICU; vit. E, 11 IU; riboflavin, 4.4 mg; Ca pantothenate, 12 mg; nicotinic acid, 44 mg; choline Cl, 220 mg; vit. B₁₂, 6.6 mcg; vit. B₆, 2.2 mg; menadione, 1.1 mg; folic acid, 0.55 mg; d-biotin, 0.11 mg; thiamine, 2.2 mg (as thiamine mononitrate); and an antioxidant to increase the vitamin stability. Purchase of such a premix should be seriously considered by any poultry producer who must mix his/her own feed.

4. Mineral Supplements. Nine or more inorganic elements are often classified as essential minerals. They must be supplemented to the diet if absent from the major feedstuffs. Calcium, phosphorus, sodium, potassium and chloride must be present in relatively large quantities. Potassium is generally available from practical ingredients, while sodium and chloride are provided by salt. Calcium and phosphorous supplements need to be carefully balanced. Suggested feed levels for calcium are 0.9 to 1.0% for pullet starter and broiler feeds, and 3% for layer feeds. Since large quantities of these minerals, with costly shipping charges, are required, a local supply of limestone and bone

meal is desirable. Calcium and phosphorus are necessary for good bone structure and egg shells. An absence of either, or a vitamin D deficiency, causes a condition of soft bones called rickets. A balance of 2 parts of calcium to 1 part of available phosphorus should be maintained for growing chickens. Two-thirds of the phosphorous from plant materials is considered non-available. Layers need no more than 0.32% available phosphorus. Cooked or pasteurized hatchery waste containing egg shells has been used as a source of calcium. Crushed limestone or oyster shells are often provided in separate containers so hens may supplement their diet by free choice of calcium. This practice is unnecessary if layer feed formulation is properly balanced.

**TABLE 2. SIGNS OF DEFICIENCIES
IN ORGANIC ELEMENTS AND FEED SOURCES**

Inorganic Elements	Deficiency Signs	Feed Sources
calcium	rickets, soft bones thin egg shell growth retardation	oyster shell ground limestone (low or no fluorine) bone meal
phosphorus (phosphates)	rickets reduced egg production thin egg shells	cereals bone & fish meals defluorinated phosphates milk products
sodium	poor growth cannibalism	common salt animal products
potassium	poor growth	plant feedstuffs
iron	anemia	plant & animal products
manganese	slipped tendon (perosis) "star-gazing"	rice hulls wheat middlings
selenium	severe anemia exudative diathesis poor egg production	fish meals brewers yeast
iodine	goiter	fish meal brewers yeast

Several other inorganic mineral elements are required in minute quantities (Table 2). Since these "trace" elements are light in weight they may be shipped inexpensively in trace-mineral premixes. Recommended levels have been established for iron, iodine, zinc, manganese, copper, magnesium and selenium. The trace mineral status of feedstuffs is highly dependent on the quantity present in the soils in which they were grown. When all the feed ingredients in a diet come from one geographic region, the chance of trace mineral deficiencies in animals is greatly increased. Other trace elements which may be important under special conditions include fluoride, nickel, tin, and vanadium.

Diseases caused by trace mineral deficiencies include: iron— anemia, iodine--goiter, and zinc—enlarged hock joints. The absence of dietary selenium causes a disease condition with appearance of gelatinous green pustules under the skin (“exudative diathesis”). This condition appears in limited areas of the world. In other areas selenium levels are high enough to prove toxic to large animals. Feedstuffs grown in soils containing low selenium levels require added traces at the level of 0.2 mg per kilogram of diet. A typical mineral premix used at the rate of 0.05% to the diet would add in mg per kilogram of diet: Manganese, 60; Zinc, 50; Iron, 30; Copper, 5; Iodine, 1.5; Selenium, 0.1. Wood ashes often provide many of the trace elements in scavenger poultry management.

Supplying insoluble grit in the form of small stones has sometimes been recommended for confinement rearing to assist the gizzard in grinding feedstuffs. However many feeding trials indicate that this practice is no longer considered necessary when feed ingredients are routinely ground. Scavengers or yard chicken will search out their own grit sources.

5. Water. Chickens require free access to clean, preferably cool drinking water at all times. All growth, body maintenance, activity, and egg production requires water. Water makes up 85% of the body weight of a chick. Although chicks can survive for several days or even weeks without feed, a 20% weight loss due to water deprivation results in death. Molting may be induced by short periods of water deprivation (1 to 2 days). Complete water deprivation may result in death in less than one day in hot weather. Water requirements are greatly increased for body cooling during hot weather. After initiation of the panting reflex, water losses from the lungs are greatly increased.

Chickens are particularly sensitive to poisoning with common salt if it is accidentally introduced in the water or added in excess amounts to feed. Water contamination from cadmium, chromium, copper, mercury and zinc should also be monitored. Using water from wells high in chloride may cause permanent change in hens resulting in poor quality of egg shells.

A condition known as “flushing” can result when hens are deprived of water for short periods in hot weather. Overconsumption after access to water is resumed resulting in diarrhea.

6. Non-nutritive feed additives. Since mixed feeds are universally used in large commercial poultry enterprises, the inclusion of non-nutritive substances as feed additives is a convenient method of insuring a uniform intake. These additives, which are manufactured, distributed and advertised by commercial companies, are sold as concentrates diluted by feedstuff carriers. They include: 1) medications: antibiotics, anticoccidials, insecticides and vermicides; 2) growth producing factors such as certain organic arsenicals; 3) chemical preservatives such as antioxidants to prevent rancidity in fats; 4) antifungal agents to pre-

vent molds from producing toxic substances; 5) detoxicants such as ferrous sulphate to reduce the toxicity of gossypol; and 6) yellow pigments ("carotenoid products") to color skin and egg yolks when consumers have expressed a preference.

To protect human health all of these additives must pass stringent governmental safety tests before their use is permitted as feed additives.

C. Sources of Poultry Feeds. The aspiring poultry producer faces three possible choices for finding a suitable feed source: 1st) prepare his/her own feeds from locally available grains and supplementing with as many natural feedstuffs as possible; 2nd) mix feeds using locally secured grains plus protein supplements and adding imported concentrates which contain essential mineral and vitamin supplements; or 3rd) rely upon a poultry feed manufacturer to supply nutritionally balanced feed for each class of poultry. If a reasonably-priced mixed feed is available, the small poultry producer may develop a good working relationship with a reputable dealer. Producers may best rely on a mutual exchange and trust developed with a feed dealer. Feed manufacturers may employ a nutritionist to guide in feed formulation. Production comparisons with different diets should be encouraged by the poultry producer and the feed manufacturer. Results should be compared using two or more feedstuffs under identical conditions. More than one trial may be required and statistical comparisons should be considered before firm conclusions are warranted.

D. Feeding Systems. Producers with a few scavenging birds may first want to supplement their birds' diet. Green feeds may be grown in season for birds on range. Chickens, turkeys and other fowl will harvest them directly, or they may be cut, dried and stored for feeding to birds in cages. Green pastures are excellent, high protein, high vitamin, feeds for all types of poultry. The importance of storing water (damming streams, irrigation, winter crops) to keep pastures green and growing out of season cannot be overemphasized. Alfalfa, clover and many local grasses make excellent forage crops. Energy and mineral supplements are usually required to improve performance by range birds. Scavenging birds can be given grain or concentrate premixes made by mixing grain with some protein and mineral supplements. Concentrates for range fed birds may contain the energy and vitamin and mineral levels of mixed feeds. The protein supplement is left out if the birds are consuming plenty of high protein, growing plants.

Poultry may be fed a small amount of a concentrate feed and then all of a cheap, bulky feed that they will eat. Rice bran with rubber seed meal or palm kernel cake can make an adequate supplement to banana or cassava wastes fed ad libitum.

If the market for chicken meat or eggs is adequate to justify ex-

pansion, the producer may consider mixing his/her own feed. There are advantages to using a large number of ingredients in any formula, thus making available a good balance of amino acids and adequate vitamin levels more likely. If commercial vitamin and trace mineral supplements are not available, reasonable levels can often be achieved with local ingredients. Animal by-products, milk by-products like whey and buttermilk, milling products like wheat bran and middlings, all make good vitamin-rich ingredients for poultry feeds. Finally, if available, complete mixed feeds may be purchased.

E. Quality Assurance. More important than the type of any ingredient used is its quality. Corn may be universally recognized as an excellent feedstuff for poultry. However, corn with certain types of mold growing on it can be deadly. The value of any feedstuff should be determined by its ability to promote growth or egg production. Possible growth inhibiting contaminants in ingredients always need to be considered. These include weed seeds, molds, vermin pellets (which may also carry disease with them), toxic chemicals, unusually high levels of one nutrient in a certain ingredient (like high calcium in fish meal), and insect larvae. **Buyer Beware!**

F. Formulas for Feed Rations. A new poultry producer faced with feeding problems for the first time frequently asks: "What feed formula should I use?" From thousands of successful formulations, there can be no simple answer. Possible feedstuffs vary in content of nutritional constituents, availability in different areas, and cost. Formulas for chickens are often classed as starter, grower, finisher, layer, or breeder rations and they vary with breeds, climate and other classes of poultry. Large manufacturers may change formulation daily or weekly depending upon cost and the availability of substitute ingredients.

Several years of study in poultry nutrition are required to formulate a feed which includes all essential ingredients and is cost competitive. More is known about the nutrition of poultry than any other animal including man. Most large feed companies employ a nutritionist who makes use of computer technology in formulating a least-cost ration.

Such formulas are often considered confidential. References on feed formulation (Section 10) provide outlines of the essential tools required.

G. Sample Feed Formulas. Beginning poultry producers may want to start with a simplified feed formula like one of those listed below. Ingredients are listed in percentages which may be weighed out in kilos or pounds. If chicks are kept indoors 1/2 kg of stabilized cod liver oil or a commercial vitamin supplement must be added to each 100 kg of feed.

H. Feed Mixing and Delivery. After the feedstuffs required in the formula are assembled, the laborious task of feed mixing can be undertaken. Some ingredients are ground in a hammer mill to provide a fine meal. Bulky ingredients may be poured out on a concrete slab

and lesser ingredients, including premixes, are placed on top. Premixes include vitamins, minerals or anticoccidial drugs are used in small quantities. Your own premixes may be prepared by diluting the essential additive with 1-5 kilos of corn or another ingredient. This mixture is blended by turning several times in a closed container (Figs. 59, 60 and 61) or in a plastic bag. All ingredients are turned over several times with a shovel, hoe, or in a feed mixer. As the enterprise grows, mixing the larger quantities of feed may require a mechanical mixer. A hand crank or an electric motor should rotate the drum for several minutes to assure thorough mixing. Rations are usually fed as a dry mash. More sophisticated feed mills use heat and pelleting machinery to produce crumbles or pellets which improve growth and feed efficiency. Although some mixed feed can be stored for a month or two, speed of deterioration of nutrients varies with different ingredients and holding environments. In hot climates some ingredients begin to deteriorate within a week.

Feed Mixers

Fig. 59. Tumble mixer with hand crank. Excellent as a premixer with a 5 gallon can. A 50 gallon oil drum can mix up to 50 kilos of feed

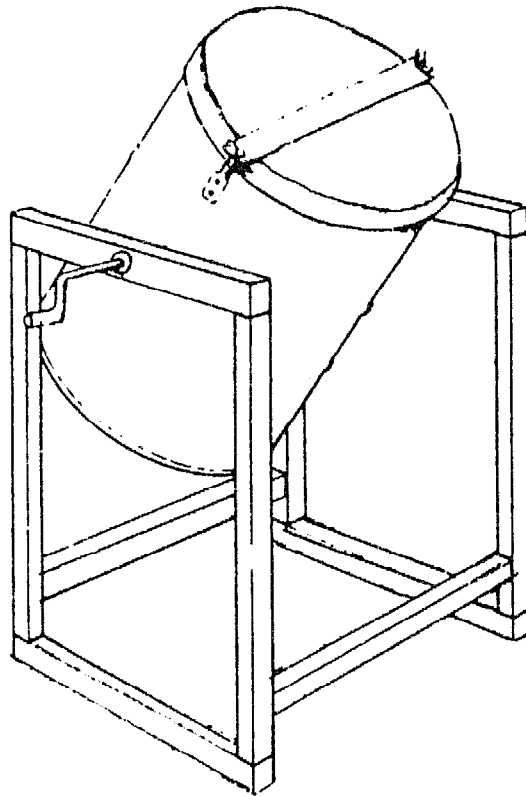

Fig. 60. End view of the same mixer

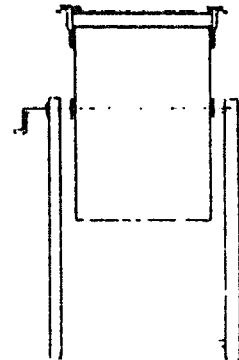
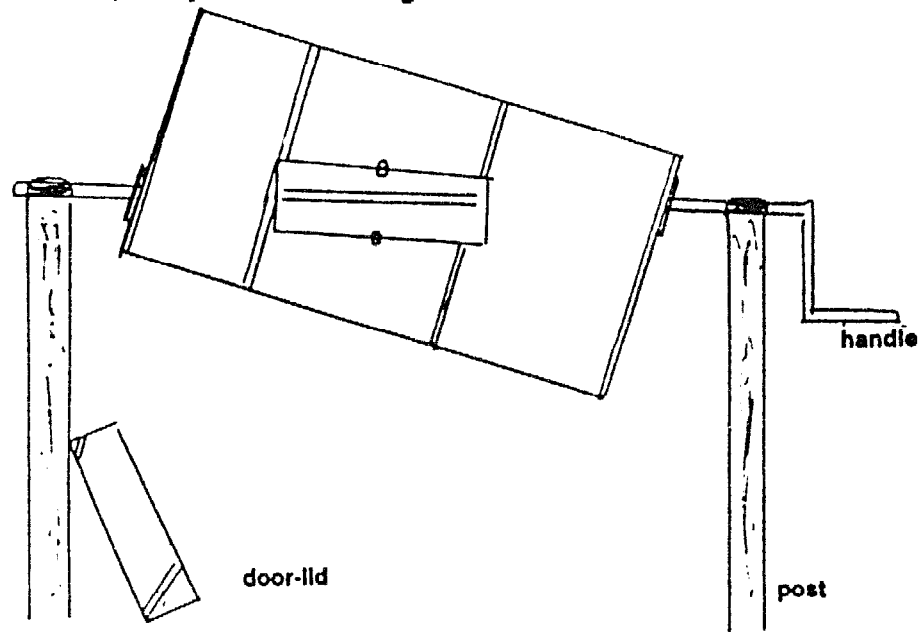

Fig. 61. Another mounting for a clean 50 gallon oil drum requires a specially fabricated locking door



Many poultry producers have come to rely upon feed manufacturers to purchase and assemble the ingredients. Specialized heavy equipment is employed to mix and bag the feed. Bulk delivery systems may save expense and labor if storage bins and good roads are available. Unfortunately many producers have been disappointed when substitution has been made in the feed formula by the manufacturer. A loss of reputation is often the best control over the unreliable substitutions sometimes made in a feed mill. Governments sometimes require tags indicating minimal ingredient levels within the bag.

Many aids for transporting the feed to the premises and into the house have been devised. Feed wastage needs to be guarded against. A common rule with a trough-type feeder: "never fill the feeder more than half full".

SAMPLE RATIONS FOR EGG LAYING OR DUAL PURPOSE CHICKENS

Ingredients	Starter	Starter	Grower	Layers
	A	B		
	Weeks: 1-8	1-8	9-20	20+
	Percentage			
Ground or finely cracked grain	49.5	29.5	49.5	21.5
Grain milling by-products	20.0	20.0	-	25.0
Wheat bran or rice bran	-	15.0	30.0	15.0
Soybean oil or legume seed oil meal	10.0	-	5.0	15.0
Meat, fish, poultry scraps or meals	10.0	10.0	10.0	10.0
Alfalfa or other dried forage	5.0	5.0	-	5.0
Ground nut, sesame cotton seed meal	-	15.0	-	-
Dried whey or distillers by-product	3.0	3.0	5.0	-
Steamed bone meal or geed grade phosphate	-	2.0	-	3.0
Salt	.5	.5	.5	.5
TOTAL	100	100	100	100

SAMPLE RATIONS FOR COMMERCIAL BROILER PRODUCTION

Ingredients	Starter	Grower-Finisher	Withdrawal
	Weeks: 1-3	3-10	last week
	Percentage		
Ground or finely cracker grain	58.65	63.15	68.20
Soybean, or legume seed meal	31.00	22.50	16.50
Corn gluten meal 65%	3.00	4.00	
Meat, fish, poultry scraps or meals	5.00	5.00	5.00
Fat (feed grade)	3.00	4.00	4.00
Crushed limestone or oyster shells	.65	.65	.65
Feed grade phosphate	1.25	1.25	1.25
Salt	.25	.25	.25
Methionine supplement	.15	.15	.10
Trace mineral mix and vitamin premix	.05	.05	.05
TOTAL	100	100	100

SAMPLE RATIONS FOR LAYING CHICKENS FED IN SRI LANKA

Ingredients	Chicks	Chicks	Layers
	(0-8 weeks)	(8-18 weeks)	
	Percentage		
Tambagalla (sorghum)	239.5	44.5	41.5
Rice bran	7.0	23.0	19.5
Fish meal	10.0	12.0	8.5
Coconut meal	25.0	20.0	18.5
Gingelly (<i>Sesamum indicum</i>) cake	12.0	-	2.0
Shell grit	-	-	6.5
Salt	0.5	0.5	0.5
TOTAL	100.0	100.0	100.0
Added per 100 kg:			
Potassium iodide (g)	0.14	0.145	0.145
Choline chloride (21.7%) (g)	555	530	540

SAMPLE RATIONS FOR LAYING CHICKEN FED IN ZAIRE

Ingredients	Starter Week: 1-8	Grower 8-24	Layers 24+	Layer Concentrate*
 Percentage			
Maize, ground	33.0	40.0	40.0	20.0
Millet, ground	22.0	15.0	20.0	18.0
Rice, dehulled, ground	11.0	-	-	-
Rice, paddy, ground	-	10.0	10.0	10.0
Fish meal	7.5	7.0	3.0	4.0
Meat meal	-	-	3.0	5.0
Skim milk, powder	5.0	6.0	-	-
Yeast, dried	3.0	1.0	1.0	-
Groundnut cake meal	9.0	12.5	12.0	25.0
Alfalfa meal	7.5	5.0	7.0	12.0
Dicalcium phosphate	0.5	1.0	0.5	2.0
Oyster shells	1.0	2.0	3.0	3.0
Salt	0.5	0.5	0.5	1.0
TOTAL	100	100	100	100

*To be fed free choice with a grain.

SAMPLE RATIONS FOR LAYING CHICKENS FED IN URUGUAY

Ingredients	Layers	Chicks
 Percentage	
Ground maize	40.0	40.5
Ground wheat	5.0	20.0
Sorghum	3.0	-
Ground barley	20.0	16.0
Bran	10.0	-
Meat meal	7.0	15.0
Ground sunflower cake	10.0	7.0
Oyster shells	4.0	1.0
Salt	1.0	0.5
TOTAL	100	100

Section 7

Poultry Health Problems

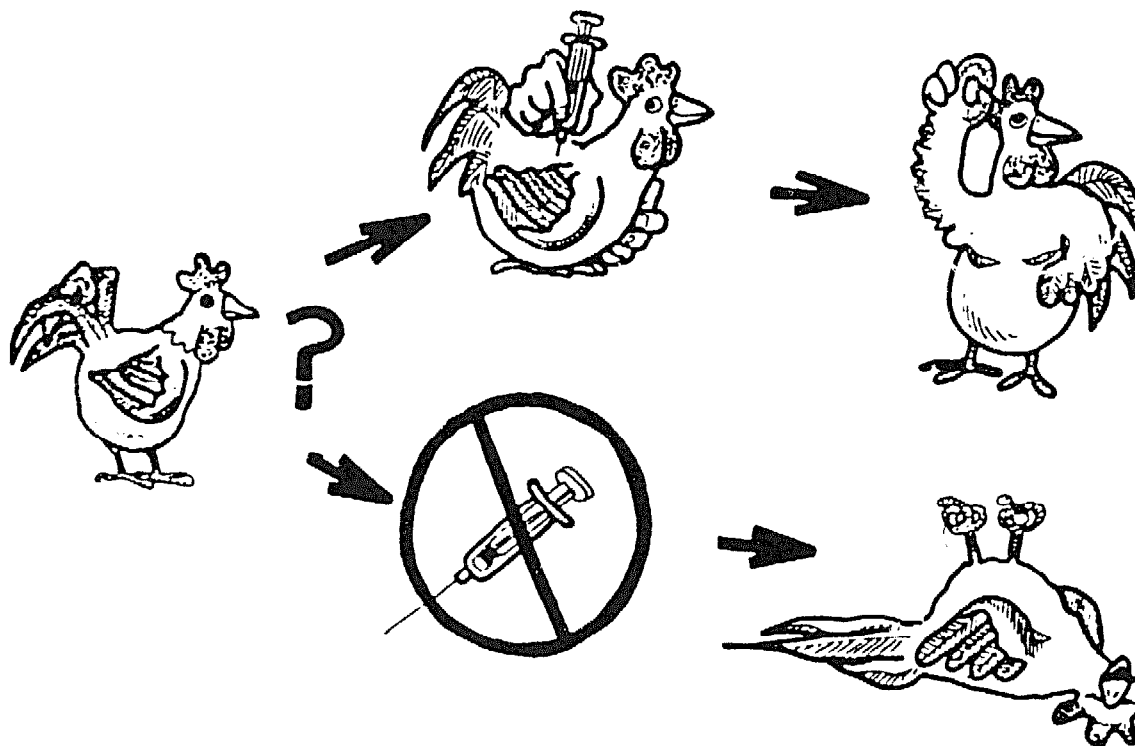

POULTRY HEALTH PROGRAMS

A. Prevention versus Treatment. PREVENTION IS THE KEY TO CONTROL OF POULTRY DISEASES. The poultry producer may think first of a drug treatment in case of a disease outbreak. Such a response, learned from treating human ailments, starts with the wrong premise for control of poultry diseases. He/she needs to remember: 1) drugs are expensive, 2) treatment must involve the entire flock, 3) to catch each bird individually requires much effort if treatment is given by mouth or injection, 4) if given by feed or water special mixing equipment may be required, 5) specific medication is generally successful only after a specific disease has been accurately diagnosed, 6) too long a delay frequently occurs before treatment can be instituted 7) indiscriminate use of antibiotics leads to the establishment of resistant strains of bacteria. Prevention is generally accomplished by:

1) Vaccination for specific diseases such as Newcastle, and fowl pox.

2) Blood testing breeder hens to locate and eliminate carriers of such diseases as pullorum and chronic respiratory disease (CRD). Chicks should be purchased only from blood-tested pullorum mycoplasma-free breeders.

3) Providing nutritionally balanced feeds complete with essential vitamins, minerals, amino acids, and energy to prevent nutritional deficiency diseases.

4) Feeding recommended levels of anticoccidial drugs to broilers if available for the first two months to prevent coccidiosis losses. Some recommended high levels for breeders or layers may prevent sufficient exposure to permit oocysts and prevent protective immunity.

5) Enforcing sanitary rules as:

a) Never introduce older birds into a young flock.

b) Prevent visitors (including neighbors), wild flying birds, rodents and especially other poultrymen from entering poultry houses.

c) Avoid visiting neighbor's flocks and returning to your own without a complete change of footwear and clothing.

d) Keep dirty crates, egg cartons, feed sacs and other contaminated items from poultry houses.

e) Establish an "All in, all out" rule to keep birds of one age together.

f) Practice a sanitary clean-up and waiting period (2-week minimum) before introducing a new flock to previously used pens. Exposure to direct sunlight kills many organisms.

g) Promptly remove dead birds and dispose of them by burning, deep burial or a specially constructed deep pit. Composting methods in tight containers has proved successful if large numbers of birds must be disposed of.

B. Classification of Diseases of Chickens. Diseases of chickens with a few examples may be classified under seven different causes: 1) bacteria (fowl cholera, coryza, fowl typhoid, mycoplasma, pullorum); 2) virus (fowl pox, Newcastle, infectious bronchitis); 3) internal parasites (tapeworms, roundworms); 4) external parasites (lice, mites, ticks); 5) protozoa (coccidia, blackhead); 6) fungus (fungus infections and toxins produced by molds); 7) nutritional deficiency (rickets, see Section 6).

1) Bacterial diseases. Bacteria from infected birds may be demonstrated by culturing, staining and examination with a light microscope. Various types of selective media are used to demonstrate pathogenic species. Several important bacterial diseases are now controlled or eradicated from poultry flocks in many countries. Control of pullorum disease, also known as "bacillary white diarrhea", is a good example of cooperative disease control. It causes a chalky-white diarrhea and severe mortality in newly hatched chicks. The liver, heart or lungs may show enlargement and reddish spots. Since it is transmitted chiefly to chicks through eggs from infected hens and chick to chick during hatching, blood testing of all breeder flocks and removing carriers over a period of years has almost eradicated this disease in many countries. Through voluntary effort good hatcheries have systematically carried out this blood-testing program with a minimum of governmental supervision. A person buying baby chicks should request only pullorum-clean stock. Fowl typhoid, caused by another bacterium belonging to the same genus (*Salmonella*), is likewise detected and controlled in a similar manner.

More recently mycoplasmosis, caused by a much smaller bacterium belonging to the genus (*Mycoplasma*), has become a breeder farm-hatchery-controlled disease. It is sometimes known as "air sac disease" or CRD (Chronic Respiratory Disease) which causes coughing, sneezing and pus formation in the air sacs. Chicks derived from *Mycoplasma*-infected breeders are susceptible to secondary bacterial infections. These infections are more prevalent after vaccination or other stresses. Once newly hatched chicks are mycoplasma-clean, more sanitary precautions are required to keep the disease from reinfesting flock premises than in the case of pullorum disease. An eradication approach is required to eliminate mycoplasmosis.

2) Viral diseases. Although viruses are so small they can be demonstrated only with an electron microscope, their presence or absence may be detected by blood testing the flock. Since treatment with antibiotics is not successful, emphasis is placed on vaccination. Before starting a vaccination program seek help from local veterinarians, poultry health experts, or poultry extension agencies

on sources of vaccine and need for vaccination against specific diseases. They will know the local needs which vary greatly in different areas. Vaccines successful in some areas may be ineffective in others due to differences in strains and manufacturing methods. They will be aware of precautions necessary to prevent accidental introduction of new diseases if live-virus vaccines are to be used. Some examples of diseases controlled by vaccination:

Newcastle (Raniket Disease in Asia) is often the most feared disease by poultry producers throughout the world. Symptoms include sneezing, gasping, tremors, paralysis, and decreased egg production. Mortality may be as high as 100%. Vaccinating all the birds in a village or area has been successful in controlling this disease. Useful vaccine strains vary in different areas and may be administered by individual injection, via drinking water, or incorporated into pelleted feeds.

Marek's disease vaccine is used on practically every broiler, breeder and commercial egg pullet in the hatcheries in the USA. This vaccination prevents leg paralysis and a cancerous-type of tumor on the internal organs of young chickens.

Fowl pox, a highly contagious disease, is readily transmitted from one bird to the next by mosquitoes. Scabs or ulcers form on the comb, wattles, around the eyes, and in the mouth and throat. Vaccine is often administered by inserting a specially designed needle into the wing web. Care must be taken to prevent feathers from removing the vaccine from the needle. Protection requires mosquito control and vaccinating birds which are likely to be exposed.

Other vaccination programs. Vaccination is also practiced to prevent: Infectious Bronchitis, Infectious Laryngotracheitis, Avian Encephalomyelitis, and Infectious Bursal Disease ("Gumboro"). Somewhat different vaccination programs have been used with the bacterial diseases Infectious Coryza, Fowl Cholera, Fowl Typhoid (never in breeders) as well as the protozoan disease causing Coccidiosis. Methods of administration vary with each disease and type of vaccine. Always follow vaccine manufacturers recommendations on methods of vaccine storage and administration.

3) Internal Parasites (roundworms, tapeworms, flukes) frequently appear during post mortem examinations. The producer may be unduly alarmed by the presence of a single or a few parasites recovered from the digestive system or other parts of the body. Harmless host-parasite relationships have developed after many generations of exposure to parasites. However, crowding or other rearing practices sometimes produce heavy infections which require corrective measures. Control efforts should first be directed to breaking the life cycle to reduce reinfections. A few management changes may make this possible. Treatment to reduce the parasite load may also be desired.

Piperazine removes the intestinal roundworm if given in water or feed (Fig. 62). Problems with heavy loads in successive crops of broilers have been eliminated by giving monthly treatments for several months. Since the recently hatched young worms do more damage than adults, benefits come largely from eliminating adult females producing eggs. The dosage should be calculated at the rate of 50 to 200 mg of piperazine per bird depending on the body weight. Piperazine preparations are available as various salts so that dosage needs to be adjusted to include only the piperazine portion. Best results come from water medication when birds are thirsty thus assuring high drug levels in the gut. Suggestions for identifying and controlling some worm parasites are presented in Table III.

Fig. 62. Large roundworms and cecal worms

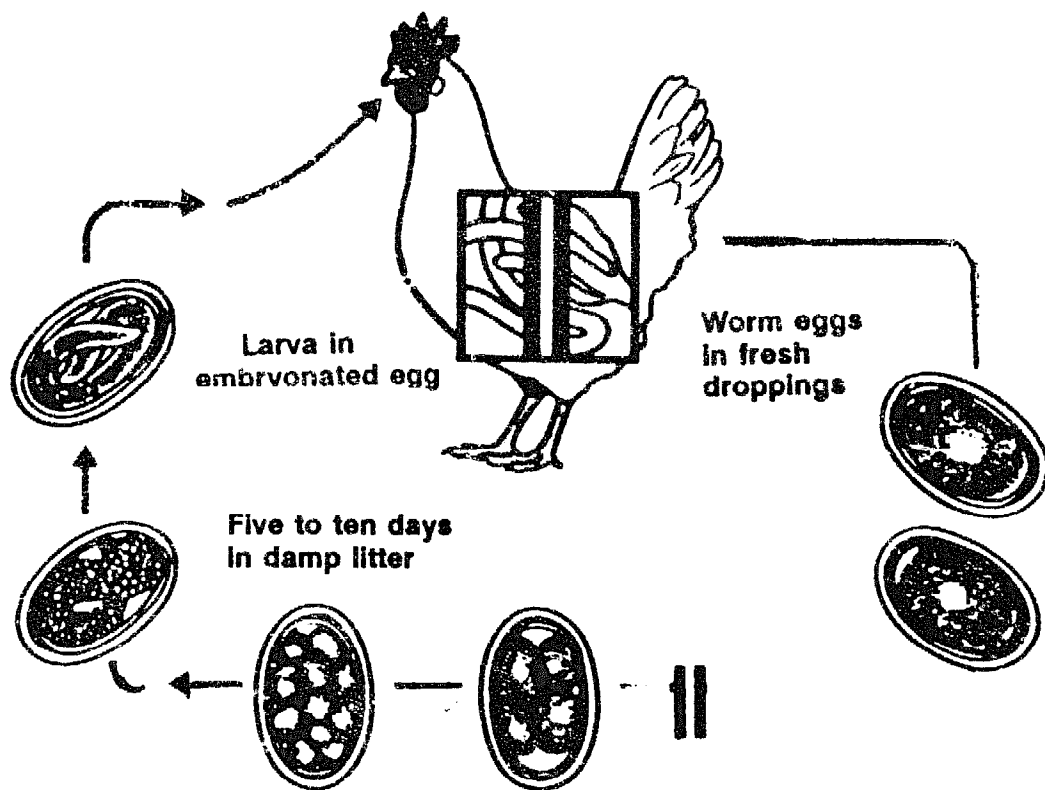

Break the life cycle || by treating the birds to remove adult female worms or remove infective embryonated eggs in litter

TABLE 3. Control of worm parasites.

Parasite	Location	Prevention	Treatment
Roundworm (Nematoda) intestinal worm (<i>Ascaridia</i>) 5-10 cm long	Upper small intestine	Treat monthly to remove female worms laying eggs	Piperazine in drinking water 50-200 mg/bird; birds need to consume medicated water rapidly (water starve before treatment)
Cecal worm (<i>Heterakis</i>) 0.5-1.5 cm long	Cecum	Prevent turkeys from ranging with chickens; worms transmit the protozoan parasite of blackhead	Phenothiazine 0.5-1 g/bird 0.5-1.5 cm long Levamisole™ 16 mg/lb body wt. (worm removal will not prevent blackhead)
Capillarids, hair-like roundworms often laced deep in tissues (<i>Capillaria</i> spp.)	Crop, esophagus, intestine	Sanitation to prevent eggs from being consumed; control insect intermediate hosts control if involved in life cycle	Administer in the feed 0.0009-0.0013% Hygromycin B or 0.004% Coumaphos
"Gape worm", red worms male and female joined in Y formation. Causes choking in turkeys and chickens	Trachea	Sanitation, confinement rearing, move from earth-worm infested ranges.	Experimental drugs will remove but none are approved or practical Levamisole 16 mg/lb (not approved in USA)
Tapeworms (Cestoda) several species each with a different intermediate host	Intestine	Identify the species; break the life cycle by control of the intermediate host	Butynorate (approved in USA in combination with piperazine and phenothiazine treatment often caused more damage than the tapeworm)
Flukes (Trematoda) flatworms - dozens of species - leaf-like	Any organs of the bird	Break the life cycle which usually involves a snail host	None

4) External parasites such as *northern fowl mites*, *young ticks*, *lice*, and *fleas* may be recognized while handling birds. Others such as *roost mites*, *adult soft ticks* and *bed bugs* feed periodically at night and will not be seen in daytime. They may be discovered by deep probing in cracks or crevices with a sharp instrument near roosting areas.

Mites, distinguished by the presence of 8 legs, often build to destructive numbers that cause blood loss and emaciation. Northern fowl mites, which live continuously on the bird, may blacken the vent region when in large numbers. The roost mite may go unnoticed as it hides between the cracks in daylight. Both may be controlled by dusting, dipping or spraying with insecticides directly on birds or the premises.

Lice: several species of lice may be found hidden among the feathers on the neck, under the wings, or around the vent. A few isolated specimens, which feed largely on feathers need not cause great concern. Heavy infestations may call for dipping, spraying or dusting with insecticides.

Fleas are occasionally found in numbers warranting treatment. The stick-tight flea becomes rather permanently attached in clumps around the face. Use insecticides as directed for mites.

Bed Bugs large concentrations of this former human pest sometimes occur in poultry houses. They may be controlled by using insecticides as directed for mites.

Ticks. The "soft tick" may cause severe blood losses and transmit diseases. Larval ticks (6 legs) with a diameter of 1-3 mm remain on the bird and may be found under the wings engorged with blood. Much larger adults (8 legs) up to one cm long hide in cracks around roosting areas. Larval ticks are treated on the bird while the premises must be treated for control of adults.

Chiggers are microscopic larvae of mites which penetrate the skin of turkeys causing blister-like lesions. Although they drop off after two or three weeks, lesions cause carcass disfigurement. For prevention avoid using weed-infested ranges for turkeys.

Mosquitoes may transmit diseases, cause significant blood losses and irritation prevents normal egg production. Control measures require destruction of larvae found in standing water near poultry houses.

Blackflies transmit a malaria-like disease particularly destructive to turkeys and ducks. These gnat-like flies breed in running streams making control difficult. Areas where blackflies are common are generally unsuitable for turkey development.

Houseflies and other nuisance flies may multiply around poultry establishments and produce severe public relation problems. Moist litter under cages provides an ideal breeding area for fly larvae. Improper management of manure has brought on legal closure of some

farms by troubled neighbors. Although large numbers of flies may be killed by use of poisoned baits (Bomyl™, Erythrosine™, Methomyl™), efforts directed at adults are generally less effective than treating larvae in manure. Various chemicals may be added to manure. Larvadex™, is a feed additive which gets in the manure through the feed. Keeping manure piles dry by preventing leaks from roofs or waterers is a good precautionary measure. Birds themselves usually prevent larval development if they have access to scratch in the manure where larvae are present.

Chemical control of external parasites using insecticides has long been practiced. With large flocks, insecticides may be applied directly on the bird by dusting, or high pressure sprays. Spraying, fogging, or dusting is used in houses or on litter. Some producers use nest or dusting box treatments.

With small flocks birds may be individually dipped by submerging them in a tub containing a suitable insecticide. In the USA only 8 of 90 effective drugs have been approved for direct use on birds. Use of chlorinated hydrocarbons (eg. Lindane), although highly effective against external parasites, is strictly forbidden. Long use of an insecticide often makes further use ineffective due development of drug resistant insects.

Currently approved insecticides in the USA include:

Carbaryl (Sevin™)—1 lb. 5% dust on 100 birds or 40 sq. ft. of litter; 1-2 gallons of 0.5% spray applied to 1000 sq. ft of litter or 1 gal./100 sprayed directly on the birds. Used for control of mites, lice, fleas, ticks and bed bugs.

Cycromazine (Larvadex™)—5 parts/million in mixed feed for fly larvae control. Used as a "feed through" feed additive.

Dichlorvos (DDVP™, Vapon™)—0.5% diluted spray on manure for fly larvae control.

Malathion (Cythion™)—4 or 5% dust, 1 lb./100 birds, or 50 sq. ft. applied to litte., 1-2 gals. diluted spray (0.5)/1000 sq. ft. Same directions as Carbaryl. Extended use has reduced effectiveness in many areas.

Nicotine Sulfate (Black Leaf 40™)—painted on roosts for roost mite control. Caution: Note restrictions and directions on label; toxic on skin of birds or operator.

Permethrin (Ambush™, Atroban™, Ectiban™, Permaban™, Praemix™, Pounce™)—1 lb/100 birds 0.25% dust; 1 gal diluted spray to 100 birds. For control of mites, lice, fleas, ticks and bed bugs.

Stiufos (Rabon™, Tetrachlorvinphos)—1 lb. 3% dust/300 birds; 1 gal diluted spray/100 birds or 1000 sq. ft. litter. Effective for direct use on all external parasites.

Producers must follow all label restrictions on the use of any

insecticide.

5) Protozoan Diseases

Coccidiosis is a much feared disease caused by parasitic protozoa which invade the intestine causing diarrhea (which is sometimes bloody) and sudden mortality. Infection results when the bird picks up large numbers of oocysts from the litter (Fig. 63). These microscopic oocysts, which are very resistant to disinfectants, are found almost everywhere chickens are raised. Exposure to a few oocysts at a time gradually induces a protective immunity in many flocks. Thus severe coccidiosis is rare if birds are widely disbursed on range, but is common under crowded conditions. Although potent anticoccidial drugs have been discovered, these are used for prevention rather than for treatment which is usually initiated too late to prevent losses.

Fig. 63. Life Cycle of Coccidia and Severity of Infection

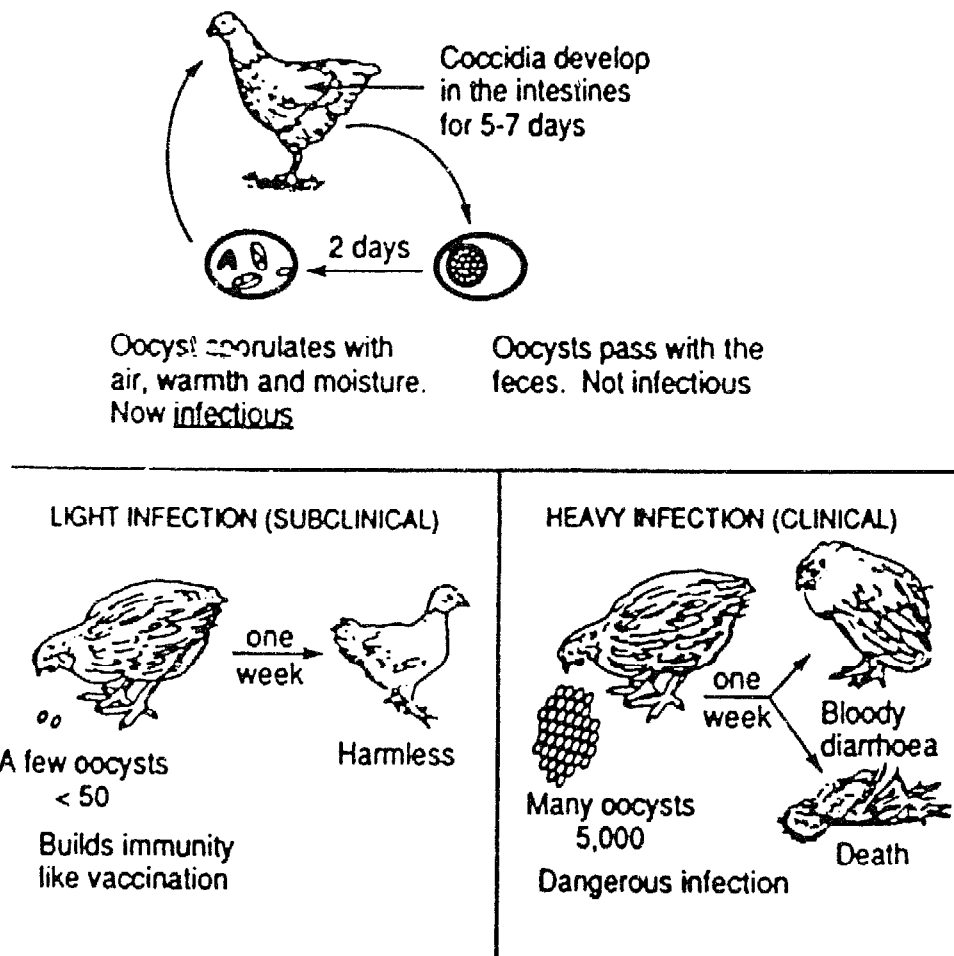

Feed manufacturers usually select one drug to be incorporated in broiler feeds on the basis of price and effectiveness against the several strains and species of coccidia in the area. After extended use resistant strains of coccidia appear so that the drug used is often rotated. Higher levels are sometimes avoided for floor breeders or

layers and discontinued at 8 weeks to permit some natural exposure and immunity development. Anticoccidials currently available with a recommended percentage for broilers in mixed feed:

1. **Amprol™** (amprolium) [MSD-AGVET]—0.0125%
2. **Butynorate** (Tinostat™) [Salsbury]—0.0375% (for turkeys)
3. **Clopidol™** (metichlorpindol) [Rhome-Poulenc]—0.0125%
4. **Halofuginone** (Stenerol™) [Hoechst-Roussell]—0.0003%
5. **Lasalocid** (Avatech™) [Hoffmann-La Roche]—0.0075-0.0125%
6. **Madurimicin** (Cygro™) [Cyanamid]—0.0005-0.0006%
7. **Monensin** (Elancoban™) [Elanco]—0.01-0.0125%
8. **Narasin** (Montiban™) [Elanco]—0.006-0.008%
9. **Nicarbazin** (Nicarb™) [MSD-AGVET]—0.0125%
10. **Salinomycin** (Nicrazin™, BioCox™, Coxistat™, Sacox™) [Kaken, Agri-Bio, Pfizer, Hoechst]—0.0044-0.0066%
11. **Sulfaquinoxaline** (SQ™) [MSD-AGVET]—0.0125% (no longer approved in USA)
12. **Zoalene™** (DOT, Zoamix™) [Salsbury]—0.0125%

Blackhead (Histomoniasis) is a protozoan disease causing ulcers on the liver and cecum and yellow feces. The disease is transmitted through the eggs of the cecal worm to chickens and turkeys. The worm is common in chickens but they are relatively resistant to the disease. Turkeys are much more susceptible to blackhead than chickens. The cardinal rule for prevention—“never rear turkeys with chicken”.

6. Fungi or molds. A form of plant life identified by presence of large numbers of microscopic spores and filaments, may cause disease directly or produce toxins harmful to poultry. One genus (*Aspergillus*) common in wet litter sometimes invades lungs causing greenish-yellowish nodules. Fungi which grow in stored feeds high in moisture content may produce toxins (eg., aflatoxin). Dampness which produces conditions favorable for fungal growth in poultry house litter and in stored feedstuffs should be avoided.

C. Mortality. Some mortality is to be expected during growing and laying periods. An excess of over one percent per month indicates serious problems which may require veterinary assistance if available. Remove sick and dead birds from the house. Dead birds should be buried deep, burned or placed in a disposal pit to prevent dogs or wild animal from transmitting disease from the carcasses.

D. Post Mortem (Autopsy) Examinations. With serious disease problems the services of a veterinary diagnostic laboratory should be consulted if available. If unavailable the producer may be able to make a tentative diagnosis after making a post mortem examination. Diagnostic laboratories prefer to receive a few live birds taken as typical flock samples. Rapid post mortem changes often obscure

diagnostic signs if dead birds are submitted. Live birds may be painlessly killed by stretching the neck while the head is bent back around the thumb (Fig. 44). Lesions or color changes will be more easily recognized if normal birds have been previously observed while dressing or processing them (Figs. 64,65,66).

Anatomy of Chickens

Fig. 64. External features

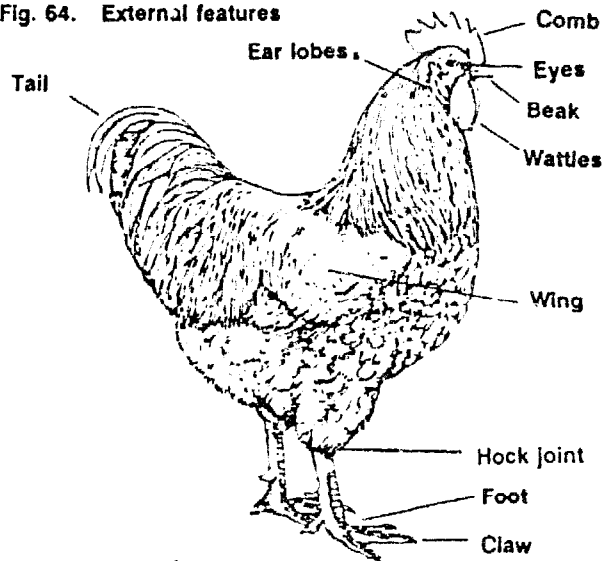

Fig. 65. Internal organs

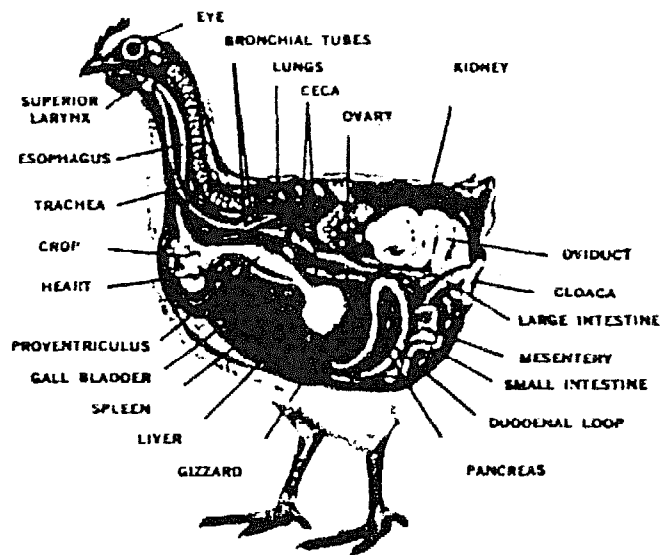
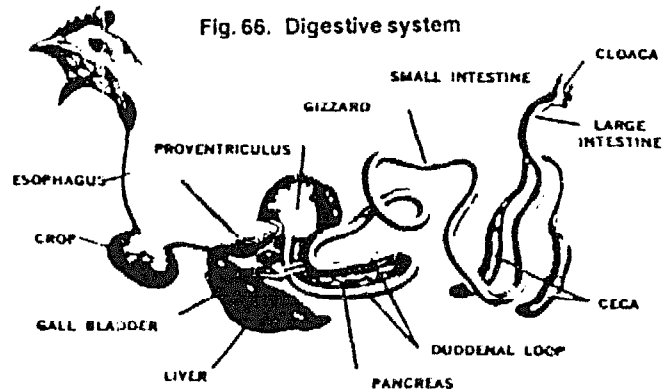

Fig. 66. Digestive system



First examine the birds externally. Look between the feathers for mites, ticks, lice or fleas. Watch for skin lesions in nonfeathered areas, which may indicate fowl pox. Cut open the mouth, esophagus and crop looking for active bleeding, ulcers, rough surfaces, abnormal lumps or excess mucus. To examine internal organs make a cut through the skin from the vent to the tip of the breast (keel) bone revealing the viscera. The cut is continued forward on each side through the ribs and breast muscles using heavy scissors. The legs are then pushed out and down from the body until they become disjointed at the hip and lie flat. The keel bone is then raised revealing the heart, lungs, and digestive tract. After removing the entire digestive tract examine the crop, esophagus, proventriculus, gizzard, intestines and ceca both internally and externally for ulcers, bleeding, parasites and other signs of disease (Fig. 66). The liver, heart, kidneys, reproductive organs, and lungs should be examined for abnormal color, spots, or pus pockets. Trachea and lungs are examined for excess mucus, plugs, hemorrhage, inflammation, and consolidation of the lungs (pneumonia). Muscles should be examined for discoloration or lesions. Search for swellings of nerves especially under muscles of the thigh, wings and neck. Watch for soft bones and abnormal lumps for tumors or rickets.

An excellent diagnostic guide listing changes in color and lesions organ by organ is available in The HyLine Redbook. Typical lesions may be recognized after study of colored illustrations in Salsbury's Manual of Diseases of Poultry or The Diseases of Poultry (see Section 10 for book listings).

Drug treatments. Poultry producers waste large sums of money on medication treating undiagnosed disease conditions with little financial return in flock improvement. Drugs have a valid use in treatment of certain diseases after a specific diagnosis has been made by competent diagnostic laboratories. Drugs available in different countries differ greatly. Listed below are drugs sometimes recommended with some technical names of diseases which may be diagnosed. Both dosages and any withdrawal recommendations must be exactly followed.

Blackhead (histomoniasis)—Furazolidone Furoxone (nf-180™, Furox™ (0.022% = 200 g/ton), Nitrasone (Histostat-50™) (0.01875%) in feed for prevention; dangerous for ducks, and geese. Although Dimetridizole and Ipronidazole are effective, they are no longer legal in USA.

Cholera, fowl—sulfa drugs in water, Oxytetracycline (Terramycin™), Aureomycin™, Novobiocin, Lincomycin, Spectinomycin™ in feed.

Chronic Respiratory Disease (CRD)—Chlortetracycline, Ery-

thromycin, Furoxone or Furazolidone, Oxytetracycline, Spectinomycin, Tylosin. Culture and sensitivity tests are particularly helpful (effective in producing mycoplasma free breeder flocks by egg dipping).

Coccidiosis—for preventive drugs see part 5 above.

Colibacillosis—*E. coli* (Furazolidone) or Tetracycline antibiotics in feed, Neomycin and Erythromycin are partially effective. Culture and sensitivity tests are better than indiscriminate use in breeders.

Coryza, infectious—Erythromycin, sulfa drugs, Penicillin and Tetramycin.

Enteritis, ulcerative (Quail disease)—Furoxone (Furazolidone), Chlortetracycline, or Bacitracin in feed, Streptomycin in water or feed.

Erysipelas in turkeys—Penicillin, Streptomycin, or Tetracyclines—may increase carrier rate in turkeys—intramuscular.

Insecticides. See part 4 above.

Salmonellosis—Furoxone, Furazolidone, Sulfonamides.

Staphylococcosis—Novobiocin, Erythromycin, Tetracyclines, Streptomycin; Culture and sensitivity tests desirable.

Worm parasites—piperazine, Wormal™, Hygromycin B™, Levimiscle™ (not approved in USA; each species should be identified before drug recommendation is made).

All of these drugs have definite limits on maximum and/or optimum dosage to prevent toxicity. Each had appropriate lengths of treatment, and number of days for withdrawal before birds may be slaughtered for human consumption. In the United States changing regulations for feed medication are updated annually in the Feed Additive Compendium.

E. Diagnosis of Disease Problems. An accurate diagnosis may be more important for future planning than for immediate therapy. Complete diagnosis often involves visiting the flock, a post mortem laboratory examination, microscopic examinations, blood tests, bacterial or egg embryo subculturing, and inoculation tests made on clean birds.

An experienced poultry producer can often detect the early onset of a disease by quietly observing flock behavior. The first sign of a disease outbreak is often a decrease in feed or water consumption. The observer should watch for huddling, wet or bloody feces, listen for coughing, sneezing or gasping, and notice any distinctive odors. Layers may show reduced egg production.

F. Predators, Rodents, and Other Pests

The poultry producer may have serious problems with predators such as hawks, owls, cats, foxes, weasels and other wild animals. At night flocks may be partially protected by providing tight buildings for confinement. Wild birds should be excluded by covering all open-

ings with wire mesh. Legs of cages may be protected against crawling pests by furnishing sheet metal shields (Fig. 67) or by placing each leg in a can containing kerosine.

Fig. 67. Bamboo cage house with a thatched roof. Note the protective barriers on the legs to keep out rodents and snakes

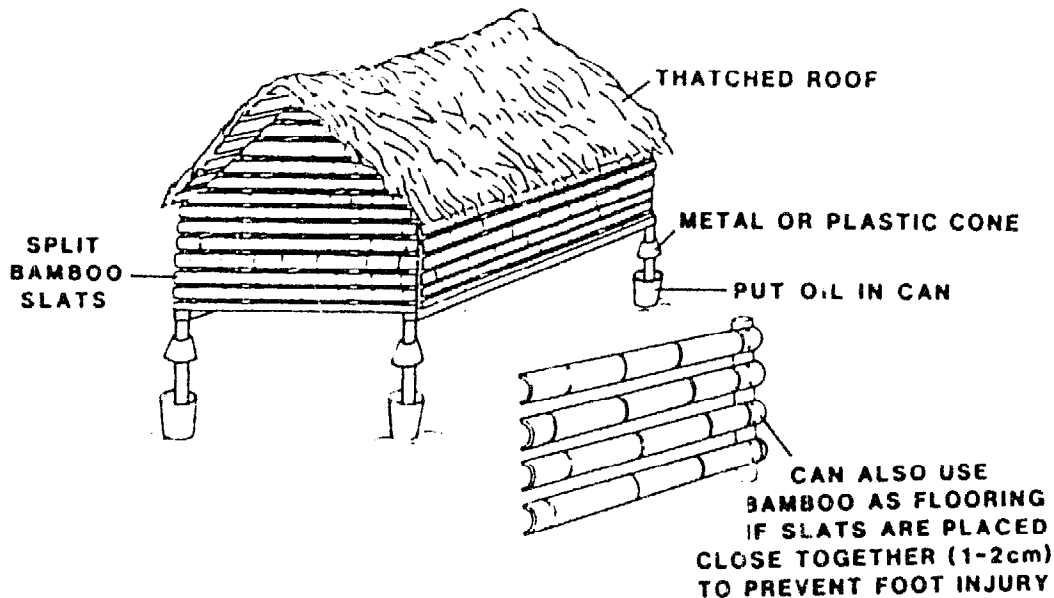

Rats, mice and other rodents are often attracted by feed and may eat sufficient quantities to produce economic losses. Their presence may go unnoticed by the producer since they feed mostly at night. Since trash, weeds, and junk around the house provide hiding places, they should be removed. Rats may be killed by baiting, fumigating, trapping or shooting. Several kinds of baits are frequently available for control. One type illustrated by WarfarinTM kills rats by preventing blood coagulation. Although harmless to chickens, caution is called for around children, pigs, dogs and cats. Follow published directions to attract pests and to avoid hazards to humans.

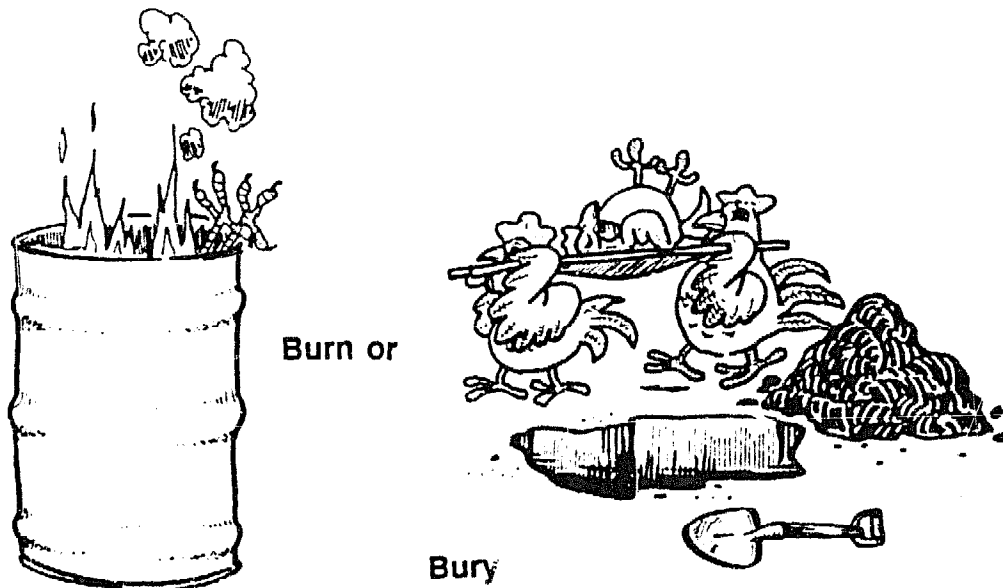

Section 8

Marketing

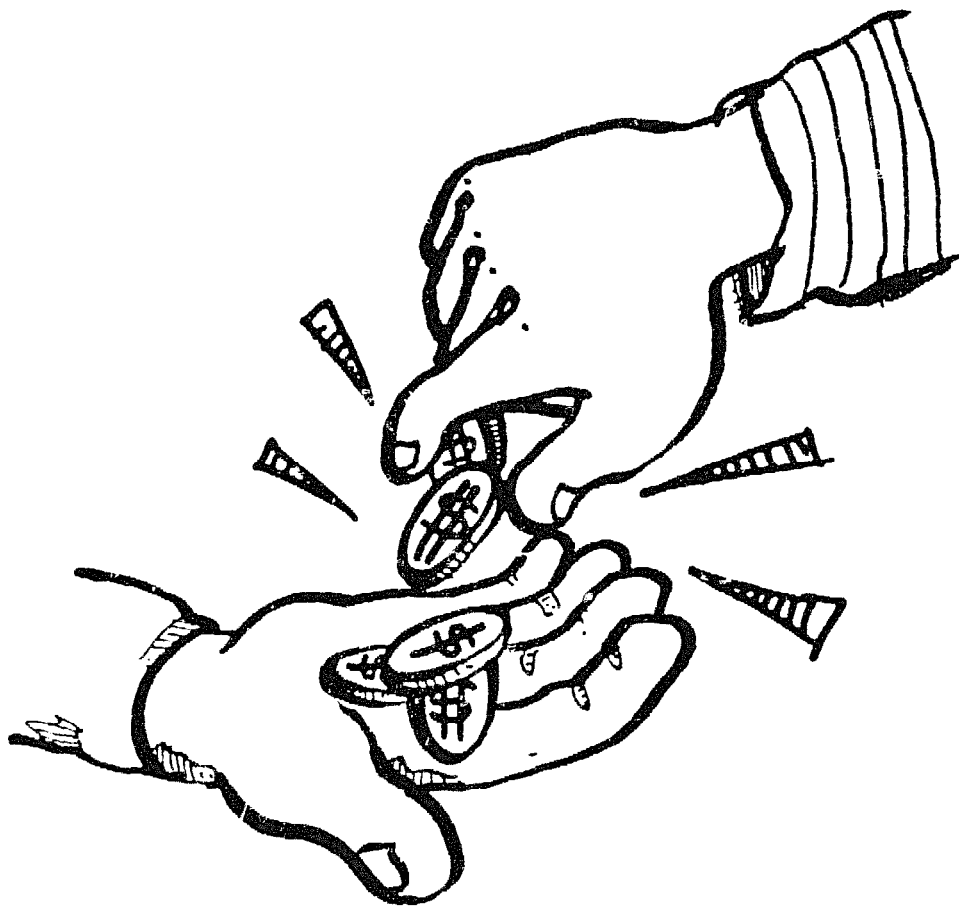

MARKETING

A thorough study of the potential poultry market must precede any plans to expand production. Both eggs and meat are perishable commodities so storage and transportation to market are major factors in success. Financial failure often occurs if prices drop or the method of transporting products to market is cut off.

A. Eggs. Egg quality diminishes rapidly at higher temperatures or if left in the sun. In hot weather some producers gather eggs as frequently as 5 times a day and move them to cool storage. Ideal storage temperature is 4 to 13°C (40 to 50°F). Since refrigerators are seldom available under primitive conditions, temporary cool storage is sometimes improvised by using a cave or burying eggs in a clay pot in a shaded area. They may be placed on straw or a mat and covered with a damp cloth or straw. Soil around the pot should be moist without standing water.

Three other methods of storing eggs for home consumption may prolong their keeping qualities. 1) Oil in the form of a thin film will prolong quality for three weeks or longer if stored under 10°C. Eggs should be dipped in a light mineral or cooking oil such as coconut oil. The oil temperature should be about 11°C higher than room temperature. If reused, the oil should be filtered and sterilized by heating to 116°C. 2) Water glass. Eggs are maintained in solution of one part water glass (sodium silicate) to 5 parts of previously boiled but cooled water. Eggs keep for several months if covered and stored in a cool place. 3) Lime water solution is made by mixing 2.3 kg of finely powdered quick lime with 6 liters of boiled but cooled water. After the solution has settled overnight eggs may be stored for more than a month.

Soiled eggs may be cleaned by rubbing them lightly with fine sandpaper, emery cloth or steel wool. Washing is generally discouraged as it may cause bacterial contaminants to be drawn inside the egg through the shell. Since eggs vary greatly in size, they are sometimes sold by weight. In the United States they are graded by weight into 5 sizes: small 35-42 grams, medium 43-49 g, large 50-56, extra large 57-63 g and jumbo 65 g and over. Defective eggs may be detected by candling to remove eggs with cracks, blood spots, mold, rot, or parasites using candling methods (Section 5). Attractive packaging in cardboard or plastic containers serves for protection and customer appeal.

B. Meat. Carcass quality deteriorates so rapidly at room temperature that chickens are frequently sold live and dressed by the customer. Although cooking kills all harmful bacteria in chicken meat, "food poisoning" due to bacterial growth may occur if there is extended

storage of either cooked or raw poultry meat at room temperature. Refrigeration methods of preserving dressed poultry has revolutionized the poultry industry. With assembly-line procedures, elaborate processing plants use mass production methods of dressing, storage, and shipment. Broilers may be shipped on ice for thousands of miles by refrigerated trucks. If frozen they may be held for several months and shipped by boat around the world. Development of these large scale methods has resulted in great reductions in the price and availability of poultry meat. Since the risk of spoilage is reduced by shipping freshly frozen birds, this method is preferred in some countries.

C. Financing. Enlarging a poultry enterprise usually requires financial assistance in the form of short-term or long-term loans. Small poultry farmers generally have had good records for loan repayments. Possible funding sources would include:

a. International agencies. The World Bank, Oxfam, U.S./A.I.D., UNICEF and others agencies sponsor rural development programs with funding assistance.

b. Others. Cooperatives, banks, credit unions, women's groups, chick suppliers, feed manufacturers, integrated poultry companies, and local money lenders may be good credit sources for capital funds required in building facilities. They may also finance short term loans to purchase chicks and feed.

c. Government agencies. In the USA federal and state agricultural loan programs have been established through administrative or agricultural extension networks. Secondary school (4H or FFA in the USA) poultry projects have often initiated young people into careers with the poultry industry.

D. Contracts. Lenders may work out purchase agreements with growers. Drawing up specific management and repayment schedules may help to overcome lender reluctance. Details may include: records of past experience, a current balance sheet, projected income statement, chronological management plan, schedule for visits by advisory personnel, and a marketing and repayment plan.

Section 9

Other Kinds Of Poultry

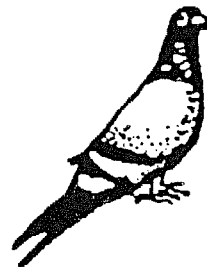
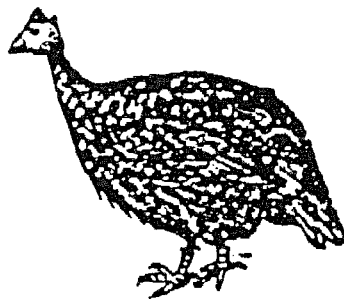
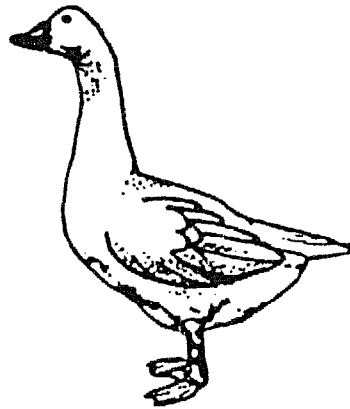
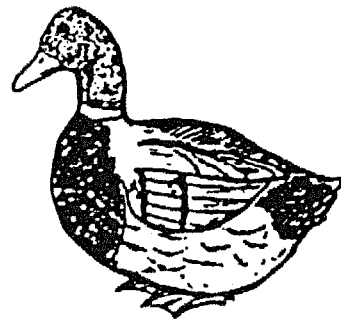
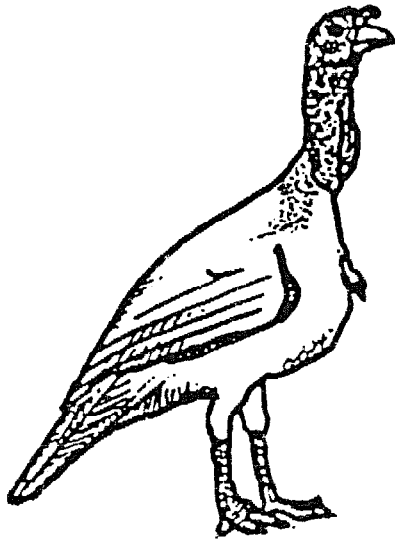

OTHER KINDS OF POULTRY

A. Ducks. Domestic ducks are often easier to care for than chickens. They are hardy, disease-resistant, versatile and their meat is popular with expert cooks. Three of the principal breeds raised for meat are the White Pekin, popular in United States, Aylesbury, popular in England, and Muscovy which originated in South America. The larger Muscovy, often classed with geese, is popular in villages.

If there is a local market for duck eggs, Indian Runner and Khaki Campbell breeds may lay up to 350 eggs per year. Due to the strong taste of duck eggs, local acceptance varies widely in different areas. Duck eggs are larger than chicken eggs but they may spoil if kept longer than a week under less than ideal conditions.

Ducks can be raised using the same equipment as chickens. Waterers should be deep enough for them to submerge their heads (also true of geese). At least one drake should be kept for six females although many villagers have adopted a 1:2 ratio. Ducks for breeding do not require a pond or stream to lay, but they may produce better if water is provided. Duck eggs take 28 days to hatch and ducklings require added heat at 32°C (90°F) for the first week after hatching. They should be kept dry and warm for 4 weeks. They do well on starter pellets but wet mash fed twice a day is preferred by some raisers. On range they forage for themselves feeding on grasses, insects, snails, slugs, and require but an occasional handful of grain. In some areas they require little supplemental feed as they range over large farm areas. Night confinement is desirable to collect eggs which are mostly laid at night or early in the morning. In some parts of the world duck pens are erected over water so the droppings can fertilize fish ponds. Ducks should not be held by the legs but by the wings or neck. Since both ducks and geese are difficult to pluck, a system of dipping freshly killed carcasses in hot melted wax has been devised. After the wax is hardened, feathers are rapidly removed together with the wax.

B. Geese. Domestic geese are raised for their meat, large eggs, feathers, and sometimes their ability to weed crops or act as watch dogs. They are large, hardy, aggressive, noisy birds that need little attention when mature. Geese may live for 30 years. They are preferred by some because they may be hardier than ducks and subsist largely on grass. Of nine recognized breeds, African and Chinese do best in the tropics. No brooder is needed for goslings, but they should be kept warm and dry for the first few weeks. In the presence of the mother no outside shelter is required unless weather is extremely cold. Lock up goslings at night to protect them from predators. Although they like to swim, they do not need water to breed. Ideally, starter feed for geese should contain 20 to 22 percent protein in pellet form. They

can go to range at 2 to 6 weeks. If pasture is plentiful, geese do not need more than 1 kg (2 lbs.) of supplemental feed per bird in a week for satisfactory growth.

C. Guinea Fowl. Meat of guinea fowl is prized in some countries for its wild gamebird-like taste. They are valued for watch dog services on some farms. Guineas are wilder than other poultry, hide their nests, and do not take to confinement rearing as well as chickens. They should be left in the nest to attract the females back again. A broody hen makes a better mother than a female guinea fowl. Keets (hatchlings) are hatched after 28 days of incubation. Ideally they are started on 24% protein diets which can be reduced to 15% protein in the grower mash. Eggs are somewhat smaller than hen's eggs and their production is usually limited to less than 100 per year. In some areas a market demand for guinea eggs has developed. If fed late in the afternoon they may return to shelter for the night. At 18 weeks of age they may weigh up to 1.5 kg (3½ lbs.) when marketed for meat.

D. Turkeys. Originally a hardy bird of the North American forests, domesticated turkeys have been bred for large size and as an inexpensive meat source. The two most common breeds, Bronze and Whites, have difficulty in reproducing because of the heavy weight of the males and their poor fertility. Poults are prone to panic and can break their necks by running into fences, or they may pile up and suffocate each other. They may drown themselves in a low dish of water or jump into a bucket of water. They may starve if not encouraged to start eating. A caretaker can attract them to food by finger tapping on a board making a pecking sound near the feed. Bright colors such as red will attract them to feeders or waterers.

Turkeys frequently suffer from a disease known as blackhead. Signs include yellow feces with large rounded lesions on the liver. The causative agent, a protozoan parasite, also mildly affects chickens. The protozoan parasite is usually transmitted via a cecal worm - a nematode about one centimeter long which lives in the cecum, or blind sac at the lower end of the intestine. Heavy losses in turkeys are prevented by following the rule: "never raise turkeys and chickens together". Coccidiosis, although due to different species from chickens, may require preventive methods similar to those of chickens.

One gobbler (tom) is needed for each four or five hens. However, with artificial insemination, only one is needed for each ten hens. Poults need 28% protein in the starter feed which may be reduced to 20% in grower and 15% in finisher feed.

Until recently turkeys have been known as a luxury bird raised largely for festive occasions. Their large size, 8 to 15 kg (18-35 lbs.) has limited carcass storage without refrigeration. Development of smaller breeds, confinement rearing, together with deboning and cut

up processing, has greatly increased market demand. They are now competitive with beef and broilers to satisfy a growing demand for meat.

E. Pigeons. Once established, a pigeon colony can be practically self-sustaining. Larger breeds such as White King and Giant Homer are preferred to the common Rock Pigeon which throngs city parks.

A breeding pair will produce ten or more squabs (young pigeons) each year, two at a time. Squabs are usually eaten when 25 to 30 days old when completely feathered, but before they begin to fly. Any waterproof house will do for housing if protected against cats, dogs, snakes and rats. In Egypt, especially designed shelters, or cotes, are built for recovery of the manure, which is more valuable for fertilizer than the harvest of squabs.

F. Quails. Quail meat and quail eggs are sometimes featured on menus of fancy hotels to satisfy a demand for a wild-bird taste. Both the bob white quail and the much smaller Japanese quail (Coturnix coturnix japonica) are raised commercially. They are generally reared in confined batteries. The Japanese quail are more prolific since they grow to breeding maturity in 6 weeks.

Section 10

Further Information Acknowledgements

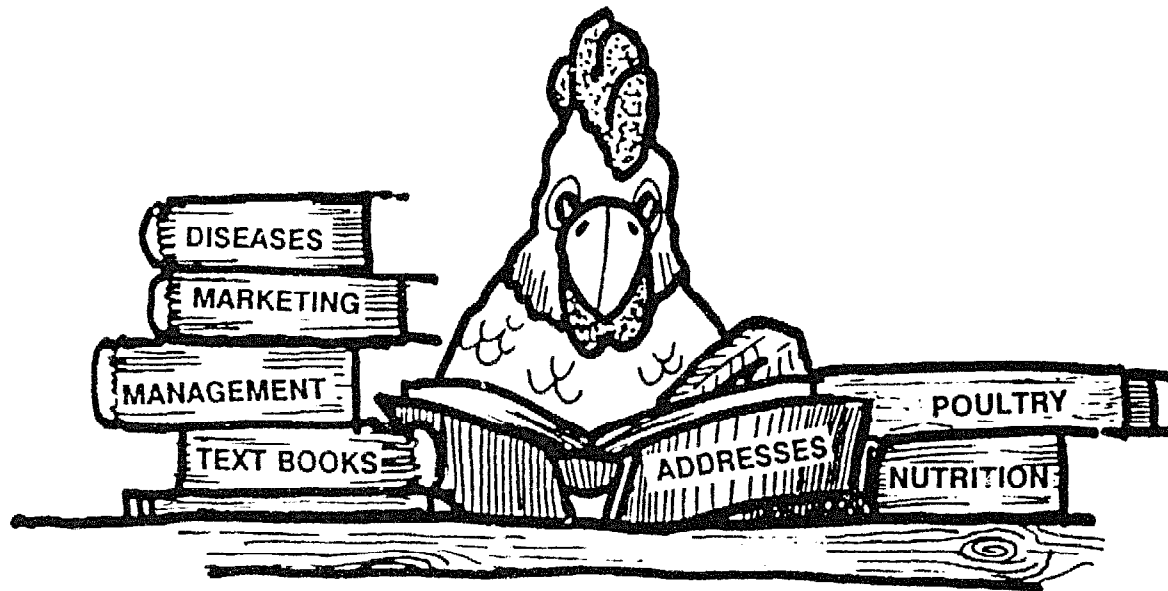

OTHER INFORMATION

A. Glossary—Definitions of Poultry Related Terminology

Abscess - a localized collection of pus within a cavity usually surrounded by inflamed tissue.

Acute - a short and severe course as applied to a disease.

Additive - an ingredient added to a basic feed mix.

Agglutination test - serological test to determine antibody levels; example: used to detect Salmonella pullorum, the agent causing pullorum disease.

Air cell - air space in egg between shell membranes due to CO₂ and H₂O evaporation.

Air sacs - part of bird respiratory system (lungs, air sacs, bones).

Albumen - egg white.

Albumin - class of water soluble proteins

Allantois - extra-embryonic membrane in an egg

Amino Acid - one of the organic acids which form the building blocks from which proteins are built.

Anemia - a condition in which there is a deficiency in hemoglobin content or number of red blood corpuscles.

Antibiotic - a chemical substance produced by microorganisms which has the ability to destroy bacteria or other microorganisms.

Antioxidant - A chemical feed additive used to protect certain nutrients from oxidation.

"As hatched" = "Straight run" - unsexed birds from a hatchery; half males and half females, generally used with broilers - rarely layers.

Aspergillosis - a diseased condition caused by a specific fungus present in damp litter.

Bacteria - one-celled, microscopic plants some of which are beneficial while others cause diseases.

Bacterin - similar to a vaccine, but protects against bacterial diseases; produced from dead organisms.

Billing - a pecking action of poultry spilling out feed from a feeder.

Breed - a selected, closely related group of birds having a common ancestry.

Broiler - a chicken marketed for meat at 6-12 weeks of age. from getting chilled.

Brooder - heat distributing equipment used for young chicks

Brooder Ring (hover guard or chick guard) - a small wall usually made of cardboard used around a brooder to keep chicks from getting chilled.

Broody - condition of a hen which is ready to set on a clutch of eggs.

Bursa = bursa of Fabricious - A sac or pouch in the connective tissue located just inside the vent.

Candle - to examine the contents of an egg by beaming a strong light source (from a candler) through the contents.

Cannibalism - a bad habit of chickens pecking on themselves or other birds. Feather pulling is often the first sign of trouble.

Cecum - a blind pouch at the junction of the small and large intestine.

Chick - young, unsexed chicken.

Chigger - larval mites which cause intense itching in humans, blisters on turkeys.

Chronic - a disease condition of long duration in contrast to acute.

Cloaca - the common chamber into which the intestinal, generative, and urinary tracts discharge.

Clutch - a group of eggs laid in a series without missing a day; a group of chicks hatched by a broody hen.

Coccidiosis - a protozoan disease causing losses in chickens or turkeys. The parasites are called coccidia

Cocciostat (anticoccidial) - A drug which inhibits development of coccidia usually administered in the feed.

Cock - male, 1 year or older.

Cockerel - male, less than 1 year of age.

Comb - a fleshy head projection.

Concentrate - A feedstuff especially rich in distinctive nutrients.

Confinement - A system of management wherein birds are kept in an enclosure.

Congestion - an excessive accumulation of blood.

Crest - tuft of feathers on head.

Crop - an enlargement of the esophagus in front of the chest.

Crumbles - a preparation consisting of medium size granules prepared from pelleted feed.

Custom hatching - hatching for hire - once popular - now discontinued in the USA to prevent disease transmission in the hatchery.

Cull - a bird no longer useful for production purposes. Also used as a verb: to cull.

Debeak - removal of a portion of the beak by use of a hot iron or scissors.

Disease - any deviation from a condition of health.

Disinfectant - a chemical agent used in killing microorganisms.

Dub or dubbing - comb removal - to prevent physical (cage) or damage

from freezing.

Dusting - natural activity of birds rolling in dirt or dust to remove parasites.

Extension - adult education, especially farming methods.

Feces - droppings excreted from the digestive tract.

Feed efficiency - the ratio derived by dividing the weight of feed consumed by the body weight of the bird.

Floor eggs - eggs laid on floor versus cage or nest - undesirable.

Floor pen - a pen where chicks are usually reared on litter in contrast to cage operations.

Floor layer - hen which lays floor eggs.

Fluff - Soft downy feathers in masses on certain parts of fowls.

Fryer - Broiler - young chicken, 6-12 weeks of age, of either sex that has tender meat, a soft pliable smooth skin and a flexible breastbone.

Full-feeding (ad libitum) - having feed in front of animals at all times.

Fumigate - a procedure using fumes to disinfect a given area.

Fungi = Molds - lower forms of plant life which invade tissue such as combs of poultry. They may produce toxins in feedstuffs.

Germinal disc - little white spot on yolk = site the new embryo.

Giblets - edible viscera (gizzard, liver, heart and neck).

Hackles - narrow pointed feathers on neck.

Haugh units - method of measuring internal egg quality on broken-out eggs (wt. of egg and albumen height).

Hock Joint - Joint in lower leg just above the foot.

Hover or brooder - canopy or cover of a brooding device that supplies or retains heat for brooding chicks.

Hen - female greater than 1 year of age (or in lay).

Hybrid - offspring from parents of different breeds, varieties or species.

Hybrid Vigor, (heterosis) - an increased vigor or capacity for growth often occurring in crossbred animals or plants.

Incubation - the process of maintaining eggs under conditions favorable for the development of the embryos.

- insures peace.

Infection - a contamination with any disease-producing substance such as bacteria or viruses.

Inflammation - a condition in which tissues manifest swelling, redness, heat and pain.

Integration - combinations of different poultry operations under one management (e.g., hatching, rearing, processing).

Internal layer - an egg released from the ovary which misses the

journey down the oviduct; yolk is retained in the body cavity.

Keel bone - the breast bone to which breast muscles are attached.

Lesion - an abnormal structural change in an organ due to injury or disease.

Litter - absorbent material placed on the floor of a chicken house.

Marek's disease - a cancer-type disease affecting younger chicks.

Metabolic - the chemical and physical process going on in living tissues.

Meat spots - eggs which contain pieces of hen tissue in the albumen.

Nares - nostrils.

Necropsy or autopsy - to perform a post mortem examination.

Newcastle disease - a serious virus disease causing high mortality.

Nick - genetic combinations of male and female lines which produce desired characteristics in offspring.

Oil gland = preen gland = uropygial gland - at base of tail used by bird to oil feathers, preening; removed during processing.

Oocyst - an egg-like structure which is the infectious stage causing coccidiosis.

Parasites - live organisms which invade tissues or live at the expense of other organisms sometimes causing diseases.

Peck order - established social order in flocks - insures peace.

Pellet - a formed large granule of mixed feed prepared by heat treatment in the feed mill.

Pipping - embryo breaks shell and starts to hatch, egg is then called a pip.

Post mortem = autopsy = necropsy - examination of a dead bird in an attempt to determine the cause of death.

Poult - unsexed turkey chick.

Premix - a blended mixture of such ingredients as vitamins or minerals combined with a small quantities of a carrier to facilitate transfer to a bulk mixer.

Protozoa - one-celled organisms belonging to the animal kingdom.

Proventriculus - the glandular stomach of birds.

Pullet - young hen less than one year old.

Ration - the diet of an animal.

Replacement stock - Young birds brought in to replace worn-out breeders or layers.

Rickets - a disease caused by vitamin D deficiency resulting in soft bone structure.

Salmonella - a genus of bacteria containing species which cause

digestive disturbances in humans or in birds (eg. pullorum disease).

Self-feeder - an automatic feed hopper that lets feed down as the bird eats.

Set - to start eggs for incubation under a hen or in an incubator.

Sexer - an expert at determining the sex usually done by examining the vent on day-old birds using a strong light.

Sexing - determining the sex, usually done on day-old birds.

Sign - Any objective evidence of an abnormality such as coughing, sneezing or vomiting.

Species - a distinctive category in animal or plant classification constituting a subclass under genus.

Straight run - Unsexed chicks or poult as they come from the hatchery.

Strain - A closely related group of birds within the same breed.

Stress - a stimulus which may lower resistance to disease such as chilling, moving, or loud or frightening sounds.

Supplement - a feed additive used to improve the nutritive balance.

Toxin - a poisonous substance produced by certain bacteria or fungi, and proteins from animal or plant sources.

Trachea - the thin-walled air tube.

Tumor - new tissue produced by abnormal cellular growth which is unrelated physiologically to neighboring cells.

Vaccine - usually a suspension of killed or modified live organisms used to protect against a specific infectious disease.

Vent - the common outlet for the urinary and digestive tracts of birds.

Virus - an infectious agent too small to detect with light microscopes, but usually demonstrated under electron microscopes; many diseases of poultry are caused by viruses.

Viscera - the internal organs in the body cavity.

Vitamin - an organic compound required in the diet that plays an essential role in body metabolism.

Wattles - a fleshy often bright colored piece of skin hanging from the throat of birds.

B. Useful References.

GENERAL

a. Anonymous. Undated. Arbor Acres Broiler Breeders Feeding and Management. Arbor Acres Farm, Inc., Glastonbury, Connecticut 06033, USA.

b. Ensinger, M. 1980. Poultry Science. 2nd Ed. Interstate Printers & Publishers, Danville, Illinois.

c. Nesheim, M.C., Austic, R. , Card, L. 1979. Poultry Production. 12th ed., Lea & Febiger, Philadelphia. Used as the beginning textbook in many poultry departments. Presents orientation on commercial poultry operations.

d. North, Mack O. 1986. Commercial Chicken Production Manual. 3rd ed. AVI Publishing Co., New York. Contains extensive data on development of commercial poultry enterprises.

Elementary, or nontechnical

a. French, Kenneth M. 1981. Practical Poultry Raising. Peace Corps Information and Exchange. Manual Number 11. 1990 R St. N.W., Washington, DC 20520. For sale by National Public Information Service, Springfield, Va 22161. Excellent material on how to start a small scale poultry enterprise. Describes the role of extension workers introducing people to poultry development.

b. Florea, J.H. 1977. ABC of Poultry Raising: A Complete Guide for the Beginner or Expert. 2nd Ed. Dover Publications Inc., NY. 142 p.

c. Hy-Line™. Red Book: Management and disease control. For sale Hy-Line Indian River Co., Box 65190, West Des Moines, IA 50265.

Nutrition and Feed Formulation

a. Tables of Feed Compositions, Publication 1684, National Academy of Sciences, National Research Council, Washington, DC. 1964. These tables show average nutritive contents of most available poultry feedstuffs found in different parts of the world.

b. National Research Council Nutrient Requirements of Poultry. 8th Edition. 1984. Washington, DC. Deficiency diseases are herein described.

c. Scott, M. L., Nesheim, M. C., and Young, R. J., Nutrition of the Chicken. 3rd Ed. 1982. published by M. L. Scott and Associates, Ithaca, NY. A textbook describing feed formulation to meet the nutritional requirements.

d. Halbrook, E.R., W. J. Mueller, W. W. Thomann, H. Engler, 1965. FAO Agricultural Development Paper No. 82. Poultry Feeding in Tropical and Subtropical Countries. Food and Agriculture Organization of the United Nations, Rome.

Diseases

a. Copeland, J. W. Newcastle disease in poultry. A new food pellet vaccine. Australian Centre for International Agricultural Research. Canberra, A. C. T. 2501. A convenient method of administering vaccine to backyard flocks.

b. Hofstad, M. S., Calnek, B. W., Helmboldt, C. F., Reid, W. M., Yoder, H. W., Jr. 1984. Diseases of Poultry, 8th ed. Iowa State University Press, Ames. 948 pp. Excellent reference work for advanced students.

c. Salsbury Manual of Poultry Diseases. 7th ed. Solvay Animal Health, Inc., Mendota Heights, MN. Excellent colored illustrations and description of 52 diseases in English, French, and Spanish. Free of charge to customers.

d. Feed Additive Compendium. A guide to use of drugs in medicated animal feeds. The Miller Publishing Company, 12400 Whitewater Drive, Minnetonka, MN 55343. Revised annually with FDA approved changes.

C. Acknowledgements.

The authors wish to acknowledge assistance of numerous individuals who have offered information and made suggestions on materials presented. Special mention should be made of:

Dr. Ahmed Dardiri, USDA Plum Island Disease Center, Greenport, NY 11944.

Dr. David J. Farrell, The University of New England, Department of Biochemistry, Microbiology and Nutrition, Armidale, N.W.S. 2351, Australia.

Dr. J. David French, Extension Poultry Veterinarian, College of Agriculture, The University of Georgia, Athens, GA 30602.

Drs. Henry L. Fuller, Leo S. Jensen, Hardy M. Edwards, Jr., Department of Poultry Science, The University of Georgia, Athens, GA 30602.

Dr. D. Earl Goodman, Tubeville, SC 29162.

Dr. Maxcy P. Nolin, Jr., Department of Entomology, The University of Georgia, Athens, GA 30602.

Permission was granted to reproduce illustrations by the 1) Peace Corps Information Service from Practical Poultry Raising; 2) Solvay Animal Health, Mendota Heights, MN, for diagrams from Salsbury Manual of Poultry Disease; 3) Will Graves 1985 Raising Poultry Successfully, Williamson Publishing, Charlotte, VT 05445; 4) Broiler Breeders Feeding and Management, Arbor Acres Farm, Inc. Glastonbury, CT 06033; and 5) original drawings by Eric L. Johnson, The University of Georgia, College of Veterinary Medicine, Class of 1991.

D. Authors.

W. MALCOLM REID

Professor Emeritus of Poultry Science (Parasitology)

Department of Poultry Science

University of Georgia, Athens, Georgia 30602

Telephone number: (404)542-0412 FAX number: (404)542-1827

B.S., 1932, Monmouth College

M.S., 1937, Kansas State University

Ph.D., 1941, Kansas State University

D. Sci., 1950, Monmouth College

Alumni Foundation Distinguished Professor of Poultry Science 1964
Fellow of the American Association for Advancement of Science 1954
and of the Poultry Science Association 1974.

Special Service Award of the American Association of Avian Pathologists

Dr. Reid has made consultation trips to 29 countries at the request of governmental agencies or pharmaceutical companies. Research activity at the University of Georgia included publication of some 300 papers related to parasite control with special emphasis on coccidiosis and worm parasites. He is coeditor of three editions of the Diseases of Poultry published by the American Association of Avian Pathologists. As Head of U. S. Aid project in Egypt (1952-1955) he planned importation of 130,000 baby chicks as layer stock to Egypt which was distributed widely in villages in Egypt. He held a "shuttle" missionary appointment to Bolivia in 1986 with the Christian Veterinary Mission.

GENE M. PESTI

Associate Professor of Poultry Science and Animal Nutrition

Department of Poultry science

University of Georgia, Athens, GA 30602

Telephone number: (404) 542-1351 FAX number: (404) 542-1827

B.S.A., 1972, The Ohio State University

M.S., 1976, Auburn University

Ph.D., 1980, University of Wisconsin-Madison

Dr. Pesti teaches poultry husbandry, economic management, and nutrition to undergraduate and post-graduate students. His research activity includes some 80 papers related to nutrition and management of poultry, and he has authored bulletins and computer software for undergraduate instruction. In 1987 he was a Visiting Research Fellow at the University of New England in Armidale, N.S.W., Australia.

M. A. HAMMARLUND

Consulting Poultry Veterinarian

P. O. Box 7698

Riverside, CA 92513

Telephone (714) 687-2373

B.S., 1953, Kansas State University

D.V.M. 1973, Kansas State University

Dr. Hammarlund is a practicing veterinarian in Riverside, California with special interest in diseases of poultry. He is a veterinary graduate of Kansas State University. Before locating in California he was employed at the Ralston Purina Co. in St. Louis, Missouri, doing poultry disease research. Dr. Hammarlund held a "shuttle missionary appointment to Bolivia in 1989 with the Christian Veterinary Mission