

AT MICROFICHE
REFERENCE
LIBRARY

A project of Volunteers in Asia

Conservation Farming for Small Farmers in the
Humid Tropics: Techniques and Tools

by: Ray Wijewardene

Published by:

International Institute of Tropical
Agriculture/Sri Lanka Program
133 Dharmapala Mawatha
Colombo 7
Sri Lanka

Paper copies are \$ 1.00.

Available from:

International Institute of Tropical
Agriculture/Sri Lanka Program
133 Dharmapala Mawatha
Colombo 7
Sri Lanka

Reproduced by permission of the International
Institute of Tropical Agriculture, Sri Lanka
Program.

Reproduction of this microfiche document in any
form is subject to the same restrictions as those
of the original document.

Techniques & Tools

CONSERVATION FARMING



for small farmers
in the humid tropics

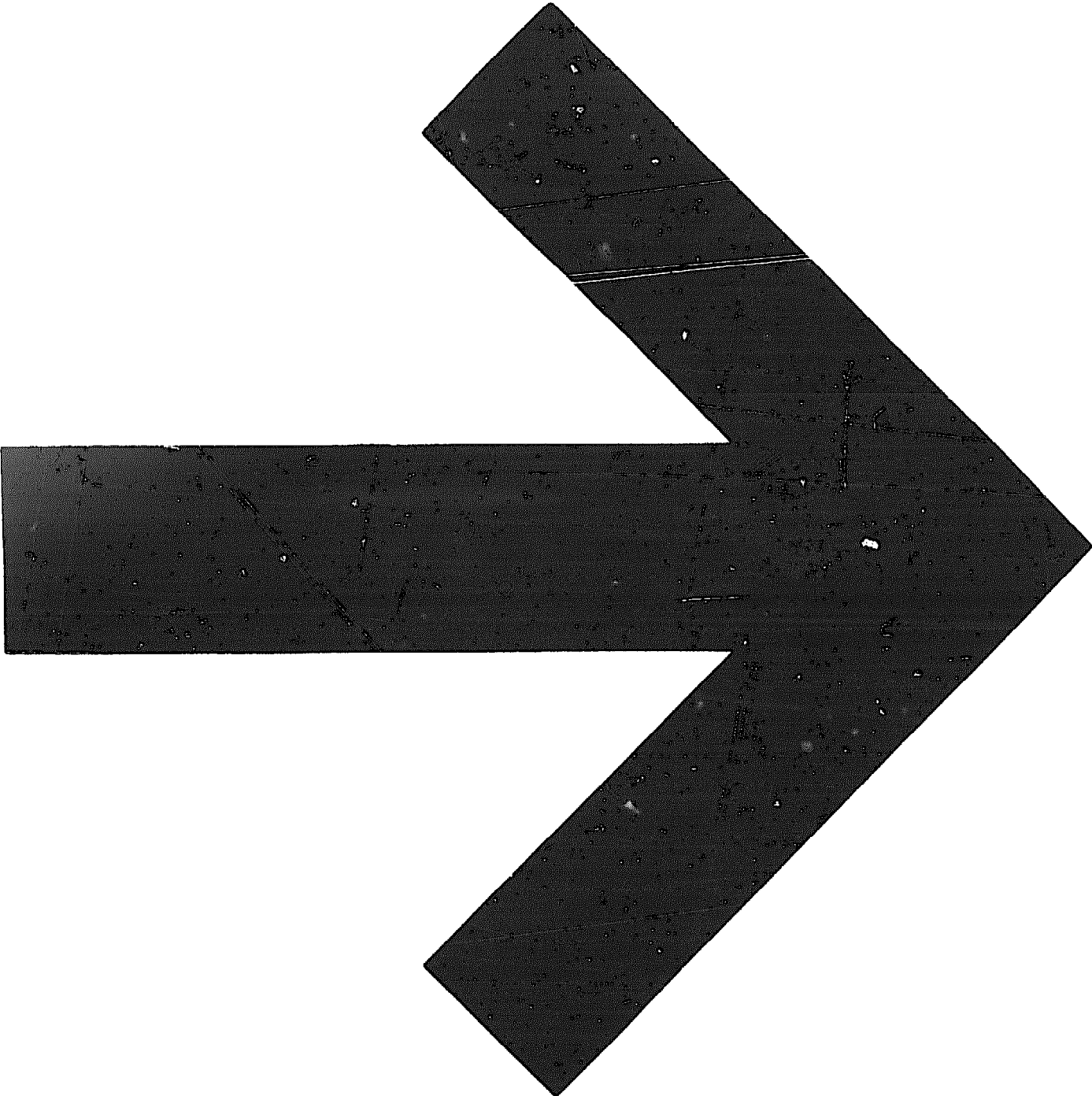

Index

1

No-till Farming

- a. Background 2
- b. Conserving Soil, Fertility, Water, Energy and Time 2
- c. How it is done 3

2

Preparing for 'No-till' Farming

- a. Crops which may be grown 'no-till' 4
- b. Soils suitable for 'no-till' 4
- c. Techniques on well-drained soils 4
 - Contact herbicide application 4
 - Injection planting 4
 - Pre-emergence herbicide application 4
 - Contact-plus-pre-emergent herbicides 4
 - Fertilizer application 5
 - Hand weeding 5
 - Post emergence herbicides 5
- d. Techniques on imperfectly drained soils 5
- e. Precautions 6
 - Timeliness 6
 - Soils 6
 - Mulch 6
 - Stubble 6

3

Tools

- Herbicide Applicators** 7
 - Using the MICRON-HERBI 7
 - Using the CP-15 8
 - Mixing the Chemicals 9
 - Do's and don't's for handling agrochemicals 10
- No-Till Planters** 11
 - IITA 'Punch' planter 11
 - IITA 'Rolling Injection Planter' (RIP) 12
 - IITA Fertilizer Applicator 14

4

Techniques for Herbicide Usage

- Herbicide Suggestions** 15
 - ROUNDUP 15
 - PARAQUAT 15
 - PRIMEXTRA 15
 - GALEX & LASSO 15

5

Economics of No-till

16

6

Recycling— Fertility Regenerating Systems

- Live-Mulch Systems 17
- Avenue Cropping Systems 18

1 No-till Farming

Background

No-till farming is as old as agriculture. It was practised by primitive farmers who felled and burned a patch of forest, and pressed their seed into the ash-mulched soil. Any weeds were desiccated by the burn before seeding.

Subsequent crops, however, were smothered by weeds blowing in from around the patch. With inadequate forest material to burn these weeds the farmer resorted to tillage — turning the soil — to bury the weeds competing with his crops.

Later man evolved the plough to turn the soil more quickly when harnessed to a draught animal.

Conserving Soil

But wind and rain then eroded the bare, tilled soil. This was particularly acute in the tropics characterised by storms of high intensity and soils slow to regenerate their eroded fertility. Lal^{1,2} showed in Nigeria that losses through erosion could be as high as 1 ton per hectare per month on tilled soils of just a gently ten-percent slope even when under a crop of maize. This erosion could be reduced by about 98% through leaving the soil untilled (i.e. 'no-till'). In 1976 Lal's research also showed that retaining of a cover or 'mulch' over the surface of the soil (not buried as with

ploughing) on that ten-percent slope, reduced erosion losses from over 200 tonnes per hectare per year to a bare 0.2 tonnes. Water run-off was likewise reduced from 42% of the rainfall falling on bare soil to less than 2.5% on mulched soils — thus showing a remarkable increase in the ability of the soil to absorb rainfall.

Conserving Fertility

To cope with erosion the small-farmer in the tropics, evolved the practice of shifting his plot, thus allowing it to regain fertility under forest fallow, usually for a period of five to fifteen years. While this practice was acceptable in earlier times, pressures of population on limited land resources now makes shifting cultivation inappropriate as cleared and burned patches are given less and less time to regenerate. There is now an acute need for a practical and viable alternative to shifting cultivation: one which will enable a sustained and permanent agriculture.

Conserving Water

It takes, on average, 20 tonnes of water to grow one kilogram of rice, but only about one quarter of this is used by the plant. Most of the water is used to soften the soil for tillage and for submersion of weeds. Using minute quantities

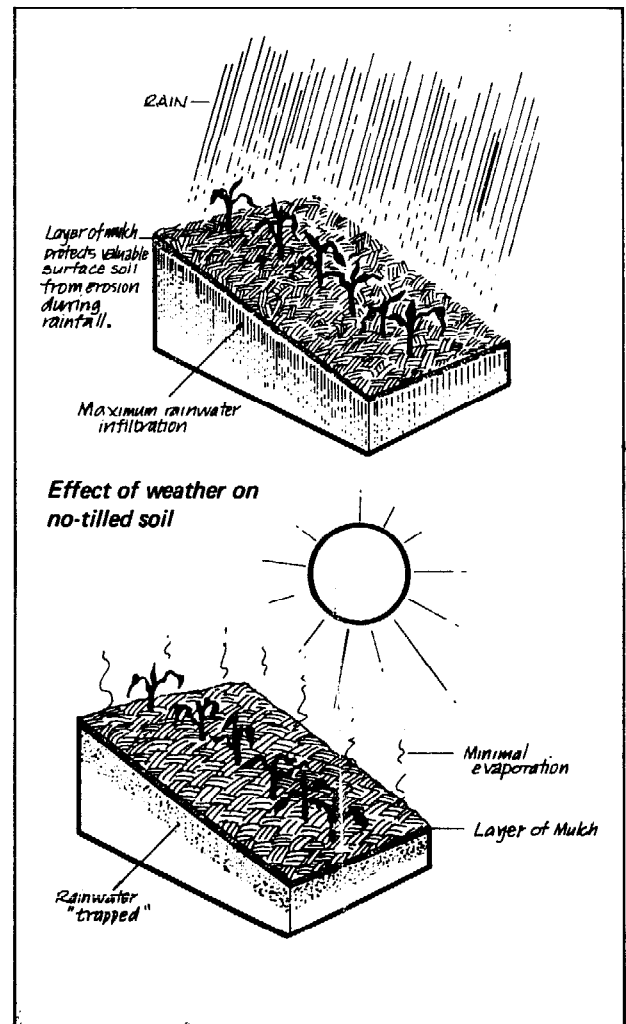
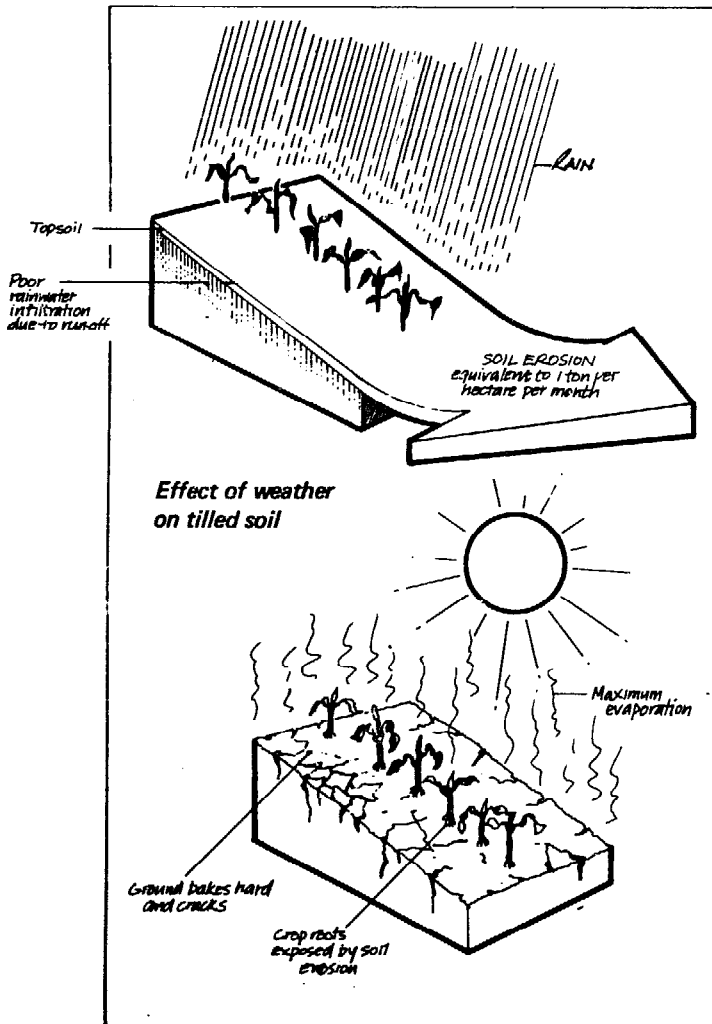

of herbicide instead of laborious tillage for weed control has enabled well over 50% saving in the water used for growing rice.

With upland crops, such as maize, beans, etc. No-till and mulching techniques increase the capacity of the soil to absorb and retain water, (thus) greatly diminishing the effect of drought.

Conserving Energy and Time.

It is not often realised that tillage of a hectare of land just ten centimetres deep involves the physical movement of 1300 tonnes of soil with each pass . . . a massive earth moving task involving great drudgery. No-till techniques have shown a remarkable reduction in this effort to less than one-tenth the energy and time used for conventional farming both in temperate agriculture³ as well as in tropical small-holder farming.⁴

These dramatic savings enable at least a five times increase in productivity of the farmer without having to use tractor-power; whilst almost eliminating the drudgery and low productivity which have hitherto been the small farmers' lot in the developing world. A simple package of tools and techniques has been evolved which enables the small farmer in the tropics to increase his productivity substantially. By minimising losses of soil, fertility and water, a sustained agriculture is achieved.

How it is done

The 'no-till' technique eliminates the need for tillage by controlling weeds with minute quantities of herbicide. Generally two herbicides are used; one, a total weedicide acts — like a plough — to kill all surface weed growth. But unlike the plough, it leaves all the dead organic matter as a mulch on the surface of the undisturbed soil, very much as in the forest situation. The other is a selective herbicide which is applied after the crop is sown to inhibit the emergence and growth of weed seeds still within the soil whilst selectively having no effect on the seeded crop. The activity of the

selective herbicide often lasts several weeks and ideally until the crop has a good start in growth over the weeds.

Special seeders (planters) have been designed to inject the seed through the herbicide-dessicated mulch and into the soil at a correct depth for good germination.

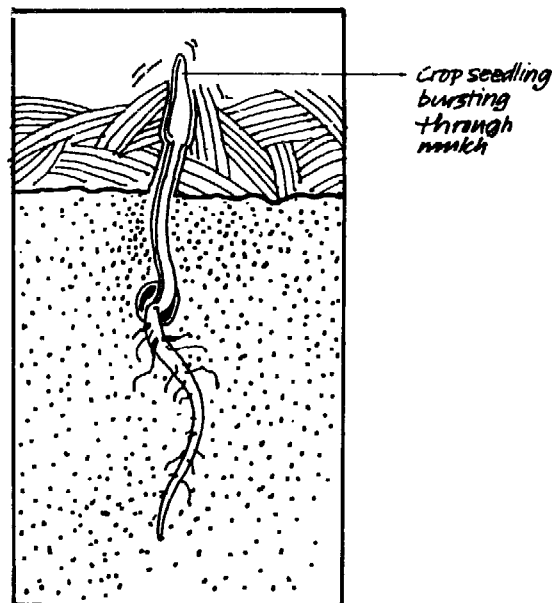

As with conventional tillage, farming experience and skill can be developed in the selection of herbicides (as with tools) and in the timeliness of operations which are usually conducted much earlier in the season than with tillage systems. Tools for 'no-till' farming are generally much lower in cost than tools for tillage farming over the same area and cover the area in very much less time — usually taking one tenth as long!

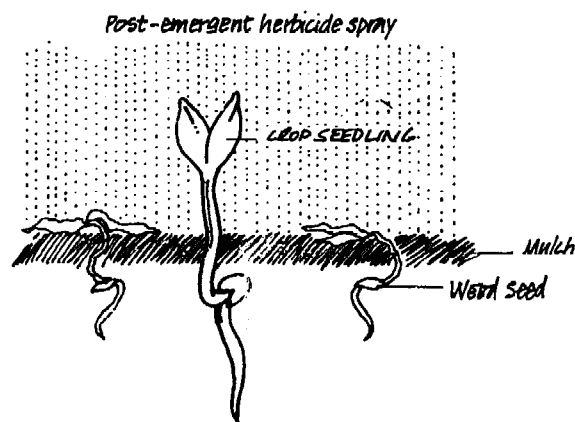

Weed seeds inhibited by post-emergent herbicide spray, allowing crop to develop unhindered

References

1. Lal, R. 'Role of Mulching Techniques in Tropical Soil & Water Management.' IITA Technical Bulletin 1 May 1975
2. Lal, R. 'Soil Erosion Problems on an Alfisol in Western Nigeria and their Control' IITA monograph No. 1 1976
3. Mathews, J. 'Energy Consumption in Agricultural Field Work' SPAN 18, 1, (25-26) 1975
4. Wijewardena, R. 'Energy Conserving Farming Systems for the Humid Tropics' (47-53) AMA Spring 1980

2 Preparing for 'No-till' Farming

a. Crops which may be grown by 'no-till'

Theoretically, most (if not all) arable crops can productively be grown by 'no-till'. Tropical plantation agriculture (oil-palm, rubber, coconut, cocoa etc.) has used both the 'no-till' as well as the 'live-mulch' technique (growing tree crops through a living mulch, which is usually a leguminous cover-crop) for decades with substantial long-term improvements to the soil and its water-holding capacity.

However, the techniques for alternative weed control have so far only been fully investigated for,

1. Maize
2. Grain-legumes (soya, cowpea, ground-nut, etc.)
3. Rice (upland)

Tropical (arable) crops currently being researched for the 'no-till' method include:

1. Rice (lowland)
2. Sorghums
3. Peppers, chilli and capsicum
4. Roots and Tubers (cassava, yams, etc.)

b. Soils suitable for 'no-till'

Generally, crops grown in well-drained soils (reddish-brown-earths, etc.) respond best to 'no-till' techniques. Crops grown in imperfectly-drained soils which are lower in the soil-slope catena, do not always respond as well as when they

are grown on laboriously raised-beds or on puddled, levelled and drained fields. If, however, these preparations have already been carried out for an earlier crop, it is then quite simple to move towards 'no-till' techniques.

The importance of **mulch** cannot be over-emphasised for successful 'no-till' farming. On bare or totally grazed soils — as in many semi-arid regions — 'no-till' techniques do not perform well.

c. No-till techniques on well-drained soils

Contact-herbicide application

The procedure for 'no-till' follows traditional practices. Instead of laboriously ploughing and harrowing to control weeds, the field is initially given an overall application of a contact (total) herbicide (ideally one with systemic* action) which kills all the surface weed-growth, and leaves it as a desiccated mulch over the surface of the soil. Weed seeds are not turned under to revive when next the soil is inverted by a plough or cultivating implement. Nor is soil left bare to bake and crust as with conventional tillage, with the inevitable need for subsequent tillage to break up the clods and redevelop 'tilth'.

*Systemic' action relates to the ability of some agro-chemicals to be absorbed and translocated through a plant from point of contact, thus being very much more effective in their action.

Injection Planting

The seed to be sown is then 'injection planted' through the mulch and into the soil. Special injection planters have been developed for this, to leave the surface mulch undisturbed except for the area over the injected seed, and through which the seed emerges. Two types of injection planters have been developed. (1)

The 'Punch' planter suitable for use on small farms of less than half a hectare. (2) The rolling-injection-planter (RIP) which was developed for larger farms in single or multi-row models.

The injection planter is designed to pierce the mulch and open a narrow slot in the soil into which the seed is deposited and subsequently firmed over. Depth of planting is also regulated.

Pre-emergence herbicide application

Still in the soil, however, are weed seeds which would emerge with or shortly after the crop and need to be eliminated (in conventional practice) by subsequent hoeing. Such weed seeds can also germinate and develop between the time of the first (contact) herbicide application and the seeding or planting of the cultured crop. Therefore, in 'no-till' farming, a selective, pre-emergent, herbicide is applied to kill germinating weed seed while selectively permitting the seed of the cultured crop to emerge. The activity of the pre-emergent herbicide usually persists for several weeks to enable the cultured crop to achieve a substantial start over any weeds which may subsequently emerge, and then shade them into submission. It is usually **not** a good practice to give so strong an application of selective pre-emergent herbicide as to selectively sterilize the soil. This could lead to problems with the growing of subsequent crops of other species due to residual activity. In any case, 75 to 80 percent weed control is usually all that is necessary, as the achievement of a higher standard — say 95% control — is usually at such high additional cost as to be uneconomic.

Contact-plus-pre-emergent herbicides

In some circumstances it is expedient to apply a light dose of a quick-acting contact herbicide (such as paraquat/GRAMOXONE) mixed with the pre-emergent herbicide. The contact herbicide kills any weeds which may have emerged since the preceding application of, say, a total contact herbicide (such as glyphosate/ROUNDUP) as the

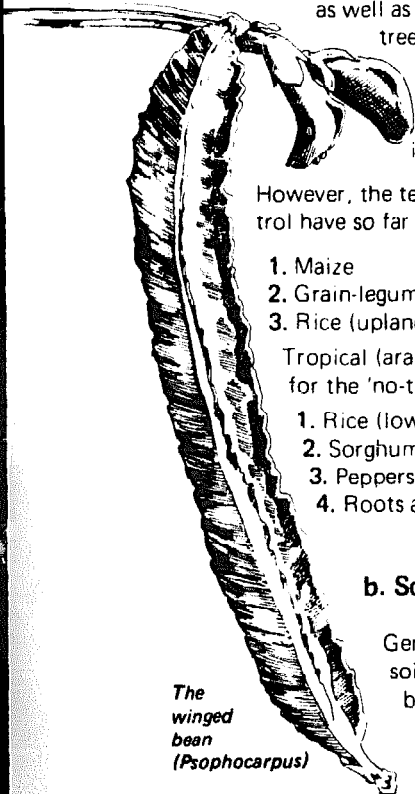

The winged bean (*Psophocarpus*)

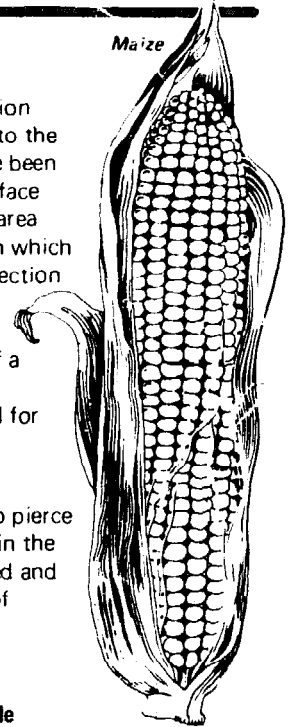

Maize

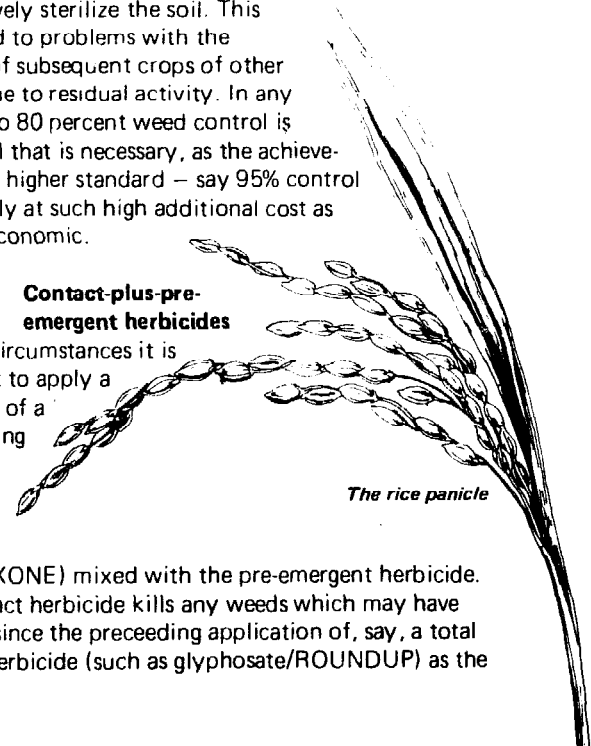

The rice panicle

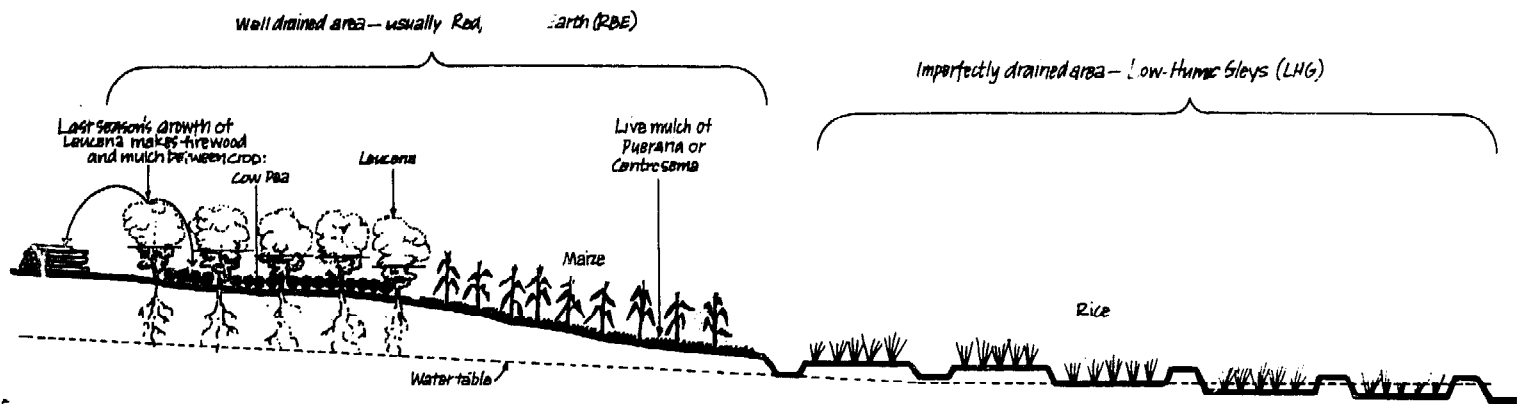

latter takes some ten to fourteen days to be fully effective. The pre-emergent selective herbicide component, meanwhile, moves into the soil to constrain the emergence of any remaining weed seeds while the crop develops selectively unimpeded.

Fertiliser Application

'No-till' systems are NOT - repeat NOT - to be considered as alternatives to the application of chemical fertiliser where such is recommended for high yields. Most modern crop varieties have been bred for response of high inputs of fertiliser. No-till techniques do however ensure that fertiliser when applied is not washed away by rainfall and is generally found to greatly improve the effectiveness of the applied fertilisers, which are usually very expensive.

A special fertiliser band applicator has been developed to enable the basal fertiliser to be applied as a band just alongside the row of emerging seedlings, and also, for a later application of the top dressing (usually urea).

Hand Weeding

The need for hand-weeding is greatly reduced by the use of contact and pre-emergent herbicides, which are primarily intended to help the cultured crop get off to a good start ahead of the weeds. Research has shown that the first three to four weeks of a crop's growth are the most critical period. Subsequent, occasional rogueing of weeds by hand is beneficial to the crops which follow as it prevents the re-seeding of weeds. ("One year's weeds, seven year's seed!" - Old English saying).

Post emergent herbicides

Sometimes (as with rice) it is expedient to apply the selective herbicide shortly after the cultured crop has emerged, and with it some weeds too. The post-emergent herbicide is then intended to kill the emerging weed selectively by contact as well as any weed-seeds still in the soil (if it also has pre-emergent activity).

d. Techniques on imperfectly drained soils

Rice being one of the few crops which grow under imperfectly drained swampy conditions, still needs to germinate in association with air (i.e. under aerobic conditions) and until its roots have developed. (Rice, though adapted to marshy, anaerobic, soil conditions, is not an aquatic plant). Thus, either the rice seedling is laboriously transplanted into a paddy field after its roots have developed (thus providing it a head start of some three weeks over any weeds which might subsequently emerge) or else rice seed is broadcast onto the surface of a levelled and drained but saturated field. The emerging radicle then works its way into the moist soil,

while the seed itself is on the surface of the field, in contact with the air. Once the root system has developed (i.e. when the seedling is about 5 cm. tall,) then the seed and root zone can safely be submerged.

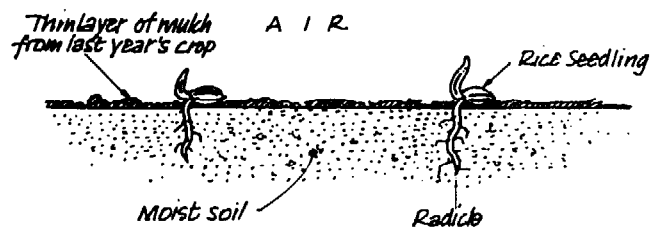

Poor emergence of the rice seed if seeded into saturated soils is believed to be due to the lack of adequate oxygen in the water of warm tropical rice fields. Apparently the irrigation water is cooler, temperate countries has much higher oxygen content and germination is not a problem if the rice seed is submerged when sown. This background knowledge is important when sowing rice into imperfectly drained soils (low-humic-gleys or LHGs), as injection is not recommended under these conditions.

When dealing with LHG soils, it is best to ensure that -

- i) All stubble and surface weed-growth are either grazed or harvested short.

At least two weeks is allowed after harvesting or grazing for the weeds (or ratoon rice) to emerge and be growing actively, before spraying the first contact, systemic (total) herbicide such as ROUNDUP. This will then ensure good contact of the herbicide with the actively growing weeds to achieve a good kill. This first herbicide application should take place about two weeks before the planned date for seeding. Two days before seeding, the field should be given a second herbicide application of a quick acting contact herbicide such as Paraquat to finally kill any weeds which may still have emerged. The field itself will be quite moist and level after the preceding rice crop so there is no need to level it again. Perhaps some of the surface drains could be revived whilst the bunds are being repaired. Pre-germinated seed is then broadcast onto the moist and weed-free field at the standard rate of about 60 to 90 kg/ha, and ten to fourteen days later an application is made of selective post-emergent herbicide to eradicate any weed seedlings which may have emerged simultaneously with the rice.

While the procedures for 'no-till' farming of rice on

imperfectly drained soils may appear somewhat complicated, they are, in fact, quite easily mastered and enable very good crops to be grown with less than one-tenth the labour and time involvement of conventional tillage systems.

e. Precautions

Timeliness

Timing is usually critical ('the right operation at the right time' is the axiom of good farming the world over). Generally, the seeding of no-till crops occurs earlier in the season than with tilled crops delayed by the time and effort of tillage. So plans for seeding generally need to be advanced several weeks — usually between two and four weeks.

Soils

Seeding (planting) needs to be undertaken into moist soils; **not** wet or sticky soils. Attempts to plant into wet soils will usually be frustrated by the blockages of the seeding points of the planter; and poor germination, in any case! Injection planting is best timed for when soils are just moist enough for germination, **and** when continued rainfall is ensured. (Otherwise should there be a lull in the weather after the first rains, the farmer may be caught out!) It is **always** preferable to seed (plant) into soils covered by a mulch as this also keeps the jaws or points of the planter clean and enables rapid, trouble-free planting.

Mulch

"How much mulch?" This differs with the crop. Usually a mulch cover which shows hardly any exposed soil is excellent. A thicker mulch will help smother weeds, but will also impede the emergence of the crop being seeded. When using a thick mulch of rice or wheat straw on wet fields the acids of decomposition could also impede crop emergence and growth. Therefore short stubble is preferred as a mulch on rice fields. If the stubble or straw in the field is long, a light burn is usually beneficial as erosion is negligible on levelled and banded fields.

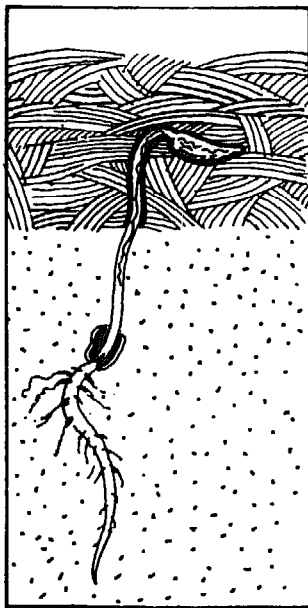

Stubble

Allied to mulch is stubble and the question is often asked "how long should the stubble be?" Ideally, stubble should be as short as possible, and if long should be grazed or burned before herbicide application. With ratooning crops

such as rice or sorghum the ratoon crop emerging from a short stubble is easily controlled with an application of contact (ideally systemic) herbicide on the actively growing green portions of the ratoon. However, if applied on the dead vegetation or on brown stems, no chemical action takes place, and the herbicide is wasted. Always try to spray contact herbicide only onto actively growing, green material!

Grass cover provides excellent mulch as long as the grass is short (and growing actively) when sprayed. Otherwise too much herbicide is required to obtain coverage. A field of grass closely-mown or short-grazed to about 3 to 5 centimetres and then left to grow for two or three weeks provides an ideal mulch which is easily controlled by herbicide and is not too dense for the crop to emerge through.



3 Tools

a. Herbicide Applicators

The problem with conventional spraying systems — knapsack or tractor-mounted — is the high volume of liquid required; usually about 400 to 500 litres per hectare (40 to 50 gallons per acre). It is logistically impossible for the small farmer to carry this volume on his back, and cover half a hectare of land thoroughly (even if such a quantity of water is available near at hand).

It was necessary therefore to look for alternative spraying systems which would drastically reduce the volume of liquid carried by the farmer and still provide effective coverage. Two very appropriate herbicide applicators have emerged which reduce the volume of liquid required to about 1/10th of that needed by conventional sprayers.

1. The Micron 'HERBI' manufactured by:
Micron Sprayers Ltd.,
Bromyard,
Herefordshire,
England HR7 4HU

and

2. The 'CP-15' knapsack sprayer with VLV-50 nozzle manufactured by:
Cooper Pegler Ltd.,
Burgess Hill,
Sussex,
England RH15 9LA

Both these differ from conventional sprayers in that they produce an even swathe of herbicide, about 1m in width composed of droplets within a limited size range of about 200 microns. It is the evenness of droplet size and droplet distribution across the swathe that is believed to account for the effectiveness of the applied herbicide at the greatly reduced dilutions referred to above.

In the case of the 'HERBI' the droplets are produced by centrifugal action when herbicide is dripped steadily on to a spinning disc.

With the 'CP-15' sprayer a similar effect is achieved by supplying the herbicide through a specially calibrated nozzle at a regulated pressure.

Using the Micron HERBI

Three nozzle sizes are provided on the MICRON applicator, the smallest is blue, the medium yellow and the largest is red. For practical purposes when spraying herbicide the yellow nozzle is used and this provides a flow of 125 ml/minute, which at 1/2 meter/second walking speed (i.e. 125 ml over 30 square meters) provides an applied volume of about 40 litres per hectare.* This is reasonable and adequate for comprehensive coverage of the ground.

$$\text{*i.e. } \frac{125}{1,000} \times \frac{10,000}{30} = 41.6$$

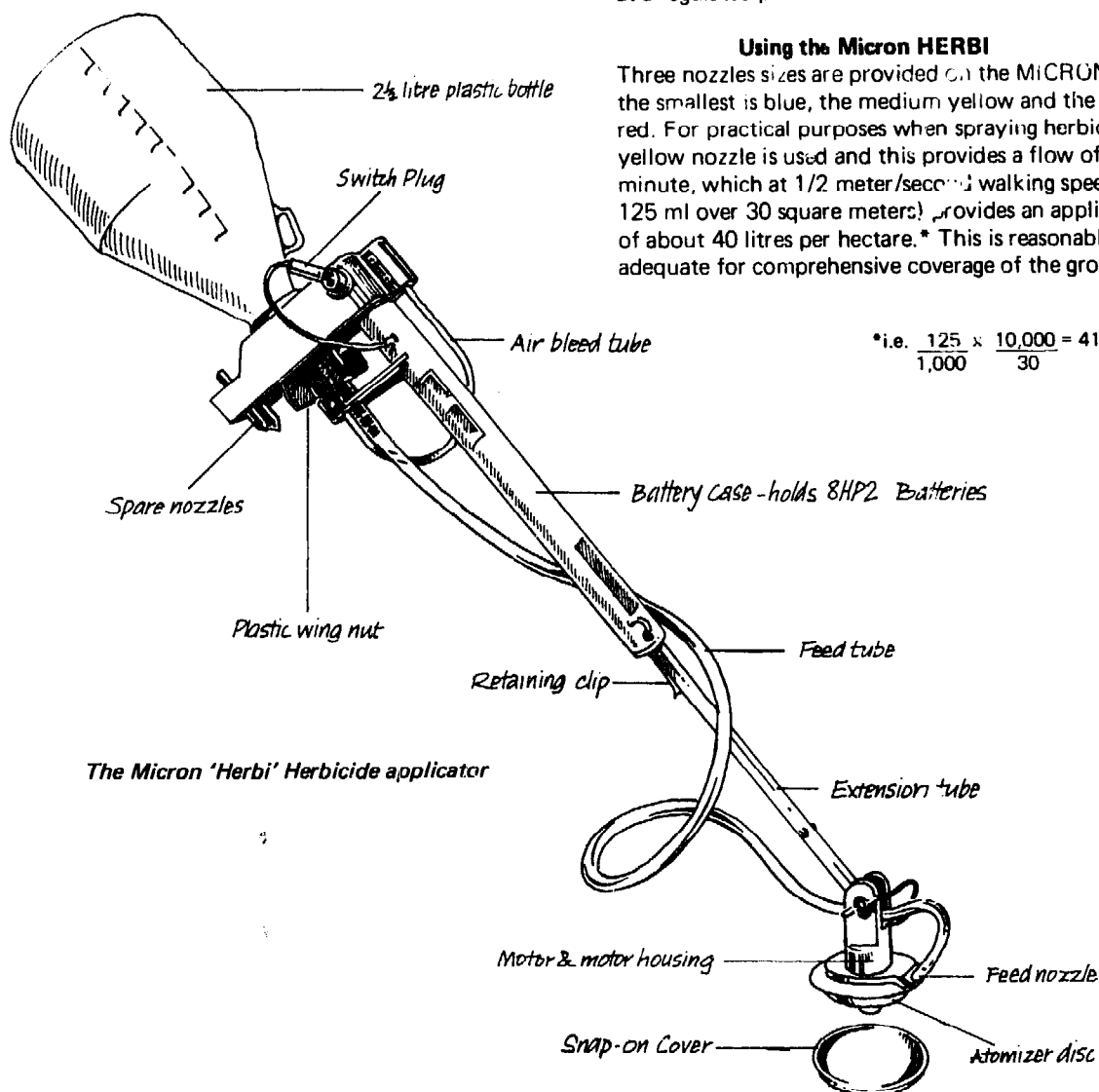



During spraying the head containing the spinning disc should be held horizontally about 20 centimetres (see illustration) above the crop or mulch so that the spray falls evenly over the surface as one walks over it.

walking speed is critical, so time yourself to achieve the required 1/2 meter/second speed, by gauging your walking

speed over a 30 metre distance, which should be covered in exactly 1 minute. On harder surfaces, one tends to walk faster and on softer (e.g. in wet paddy fields) one often walks very much slower. So learn to gauge the correct speed.

The effective swathe width is 1 metre, so lay out ropes 1 metre apart in the field to be sprayed and walk with the head of the applicator at the correct 20 cm height over this rope. After the first 'no-till' crop is established — which will be at plant spacings of even fractions of a metre, we use the line of stubble as the spraying line. For example, with rice seeded 6 rows to a metre (i.e. at 15 cm between rows) one would need to walk down every 6th row to achieve the 1 metre swathe width.

Detail of the spray action of the Micron Herbi atomizer

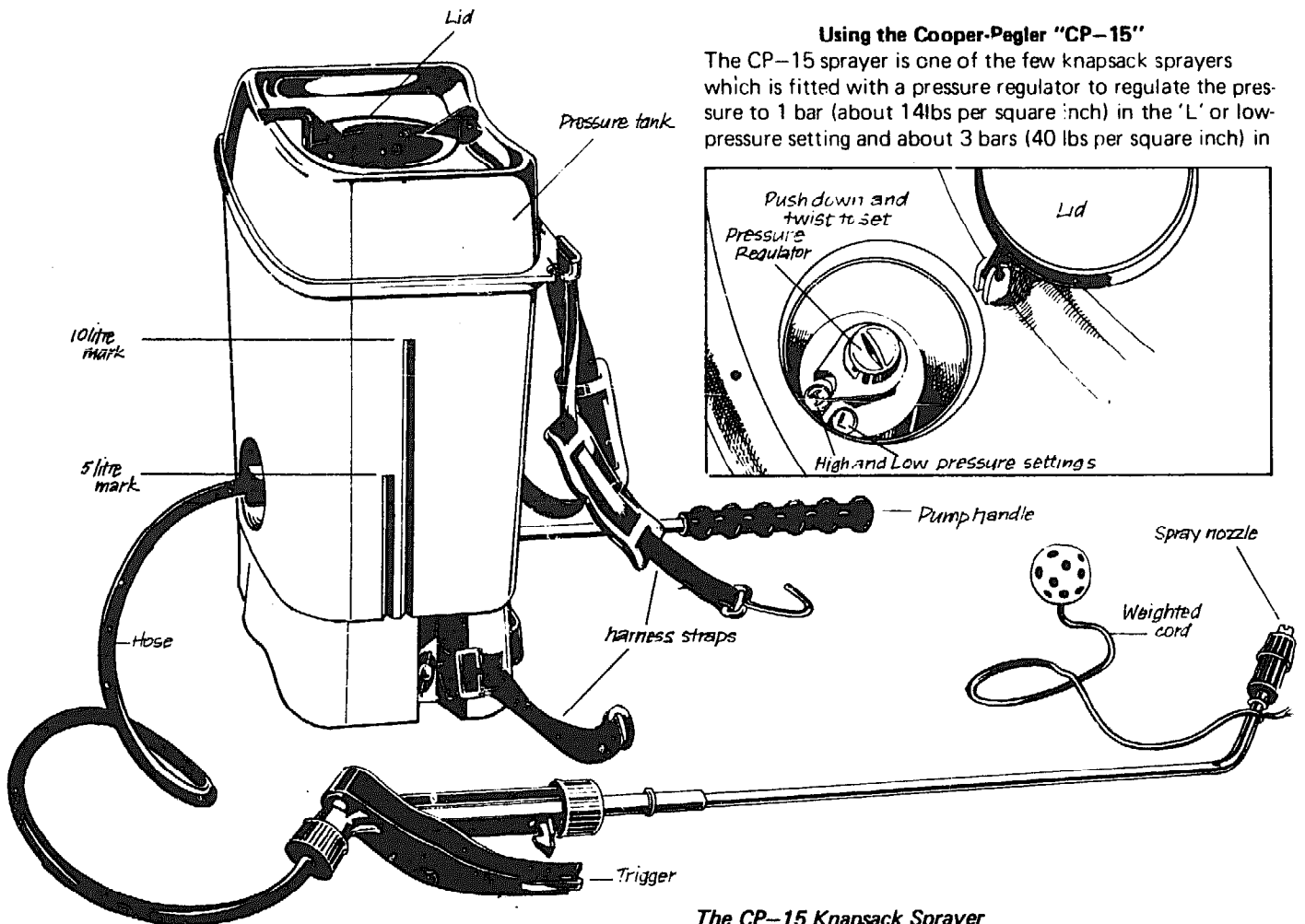
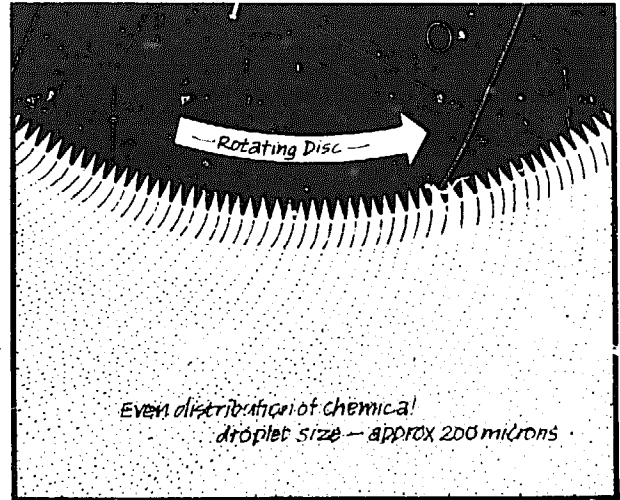

Using the Cooper-Pegler "CP-15"

The CP-15 sprayer is one of the few knapsack sprayers which is fitted with a pressure regulator to regulate the pressure to 1 bar (about 14lbs per square inch) in the 'L' or low-pressure setting and about 3 bars (40 lbs per square inch) in

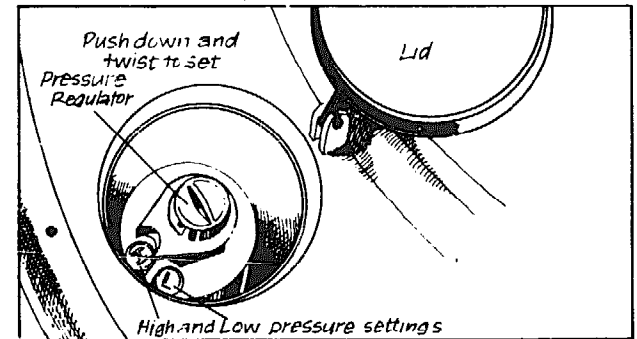

The CP-15 Knapsack Sprayer

the 'H' or high-pressure setting. The 'L' low-pressure, setting is used for herbicide spraying and in conjunction with the VLV-50 (Floodjet-type) nozzle provides a flow rate of 250 ml/minute over an effective swathe width of 1 metre, for a coverage of about 40 litres per hectare,* when walking at 1 metre per second. Guide ropes 1m apart should be laid out on the field in the same way as with the 'Herbi'. (The 'H' setting which produces a much finer droplet size being used effectively for insecticide spraying).

$$\frac{250 \times 10,000}{1,000 \times 60} = 41.6$$

The flat swathe of the spray is clearly visible, and the correct width is obtained by holding the nozzle at 50 cm over the field or vegetation to be covered. A chain or weighted cord 50 cm long, is often hung from just behind the nozzle so that it touches the field stubble, thus ensuring the correct height is maintained.

As the CP-15 knapsack sprayer is fitted with a pressure regulator, the operation of the regulating valve can be heard, and it is only necessary to pump the handle occasionally – say, once in 4 to 6 paces and very gently – to keep up this pressure. There is thus very little effort required to operate this very precise sprayer.

Mixing of the chemical (product*) in the correct ratio with water for even coverage

Let us say, for instance that the required product application rate is 2.5 litres per hectare. Then since the total volume of liquid applied by both the Herbi and CP-15 is 40 litres per hectare, 37.5 litres of water must be mixed with 2.5 litres of product* to achieve the required dilution for spraying one hectare of land (i.e. a dilution of 15 : 1). Similarly if the recommended product application rate is 5 litres per hectare then 35 litres of water must be added (i.e. 7 : 1) and so on.

However, since the Herbi is supplied with a bottle of 2.5 litre capacity and the "CP-15" with a tank of 15 litres capacity, marked in 5 litre graduations (i.e. 5, 10 and 15 litre marks) it is necessary to mix only enough herbicide as is required at any one time. The table below shows the amount of product that must be measured out into the container of the sprayer, and then diluted to the mark with water, at various recommended product application rates and for different container volumes.

The spray pattern of the CP-15

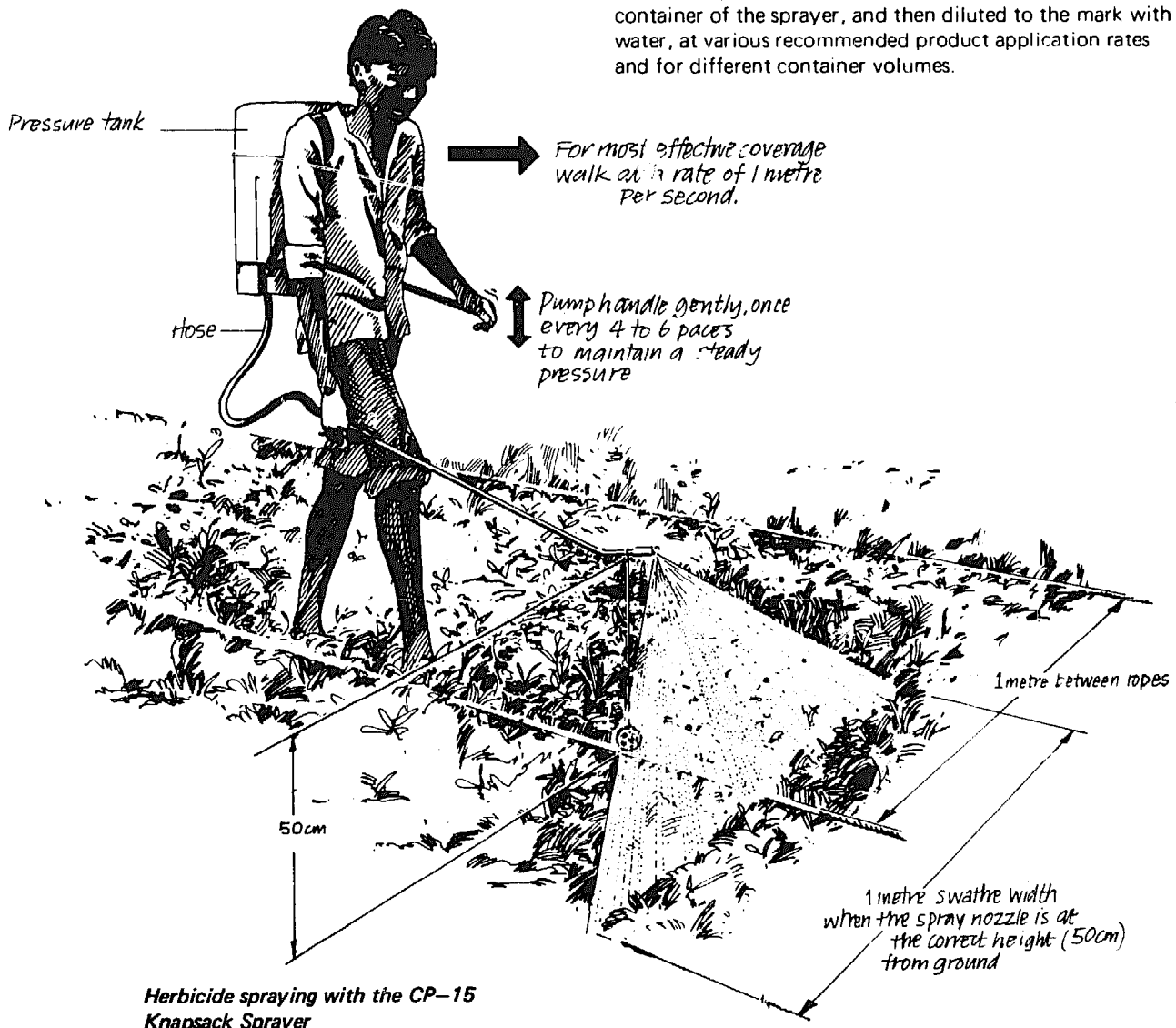

Herbicide spraying with the CP-15 Knapsack Sprayer

Recommended Product Application Rate litres/hectare	Applicator Container Volume-litres			
	'Herbi'	'CP-15'		
	2.5	5	10	15
1	60 mls	125 mls	250 mls	375 mls
1.25	75 mls	150 mls	300 mls	450 mls
1.50	90 mls	185 mls	370 mls	555 mls
2	125 mls	250 mls	500 mls	750 mls
2.25	150 mls	300 mls	600 mls	900 mls
3	190 mls	375 mls	750 mls	1125 mls
4	250 mls	500 mls	1000 mls	1500 mls
5	300 mls	600 mls	1200 mls	1800 mls

Measured Product Volume mls

Measured Product Volume mls

Top Container up to mark with clean water!

For example, if one is using the CP-15 sprayer and wishes to spray a quarter of a hectare, then the total volume of liquid to be applied would be $40 \times 1/4 \text{ litre} = 10 \text{ litres}$. If the recommended product application rate is 3 litres per hectare, then to find the correct amount of product that has to be measured out read down the left hand side of the table to find the volume row corresponding to 3 litres of product* per hectare i.e. the sixth row down. Now read across the row to find the column corresponding to an applicator container volume of 10 litres, i.e. the third column in the square where the row and column meet is a figure of 750 mls. This then is the amount of product that must be measured into the "CP-15", tank and which should then be topped up to the 10 litre mark with clear water.

Precautions for handling pesticides

All pesticides including herbicides should be treated with care and respect.

- DO : Wash your hands and any other contaminated parts of your body with soap and water after using pesticides.
- DO : Wash out your herbicide applicator carefully with clean water and soap after use.
- DO : Mix only the amount of herbicide that is required for immediate use.
- DO : Only store pesticides in the clearly marked container supplied by manufacturer, out of reach of children and farm animals.
- DO : Keep pesticide away from contact with food or drinking water supplies.
- DON'T : Pour excess pesticide into streams, ponds, rivers or other water.
- DON'T : Use empty pesticide containers for other purposes until they are thoroughly washed, several times, with soap and water and no further smell remains.

Droplet pattern (life size) of Micron Herbi sprayer

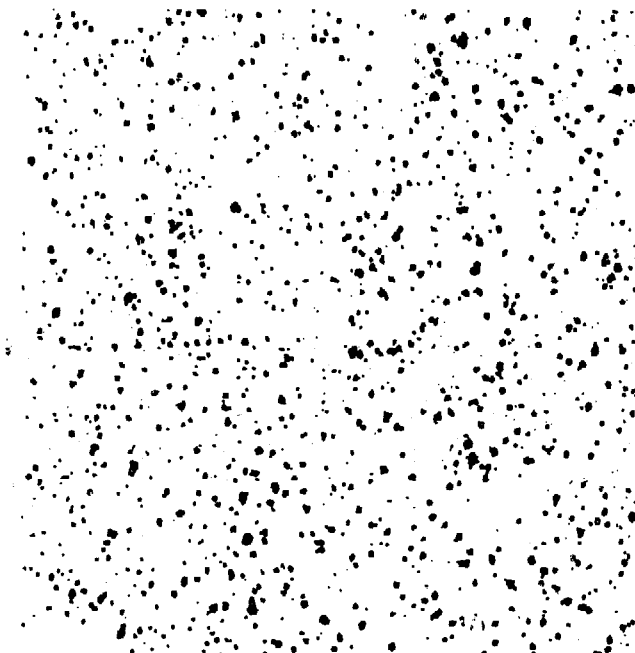

Droplet pattern (life size) of CP-15 sprayer

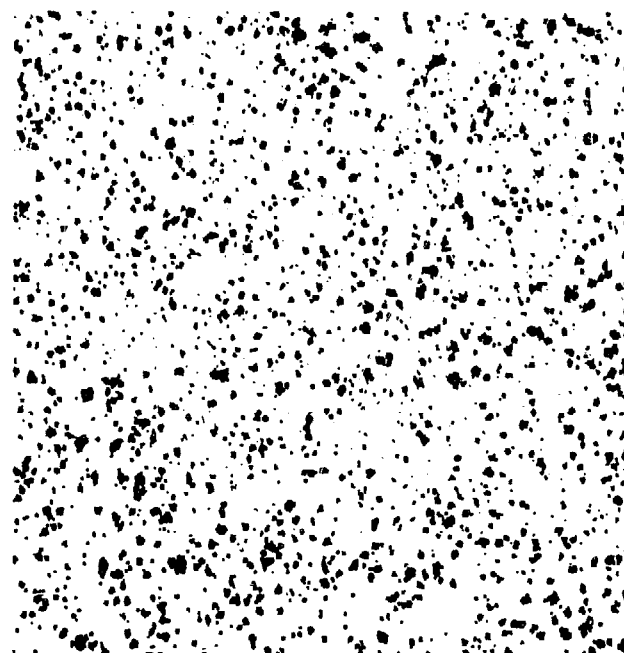

No-Till Planters

The IITA automatic-feed 'Punch' planter

Specially designed for very low-cost construction, yet capable of accurate seeding, the 'Punch' planter was developed from the early American design (circa 1900) of hand-fed 'Jab' planter. Working Drawings are available. See inside back cover.

The correct 'slide' must be selected for the seed being planted. The slide with the 15 mm diameter hole is used for large seeds, such as maize (corn), while the slide with the 10 mm diameter hole is preferred for smaller seeds such as rice and cowpea. With maize, one seed per 'hill' is usual, while cowpea and rice are often seeded using two and 6 to 8 seeds per hill, respectively.

The compactor pad, attached to the swivelling 'jaw-arm' is about 25 cm from the jaws. This is intended to provide accurate spacing of 25 cm between 'hills'.

Fill the hopper half-full with seed. Then lift the planter off the ground to check its operation. On raising the compactor pad, the jaw arm should open smoothly to drop the seed, while the slide moves in to the hopper simultaneously to collect a metered quantity of seed. When the pad is released the jaws should close **very securely**, (permitting no ingress of soil) while the slide is simultaneously extracted from the hopper to expose the metered seed in the hole, which then fall into the closed jaws, ready for the next operation.

In use it is best the first season to lay a rope along the lines to be planted. This will not be required thereafter as the lines of stubble will be clearly visible and enable one to maintain accurately spaced rows.

The operator walks backwards with the line to his right. This is curiously enough, easier than planting while walking forwards, and appreciably faster!

The 'punch-planting' operation is in three stages — all three blended into one smooth cycle.

- Stage 1** The operator has his back to the line to be planted and punches the point of the planter into the soil, through the mulch, at an angle of about 20 degrees to the vertical, and as far as the depth — plate will permit (the depth of seeding can thus be regulated). The seed is already within the jaws.
- Stage 2** The planter is levered forward, the jaw still in the soil, so that the compactor now presses onto the soil or mulch and causes the jaws to open and deposit the seed in the soil. The jaws open no further than is permitted by the stopper block.
- Stage 3** Further levering of the planter forward hinges the planter about the compactor-pad and the jaws are

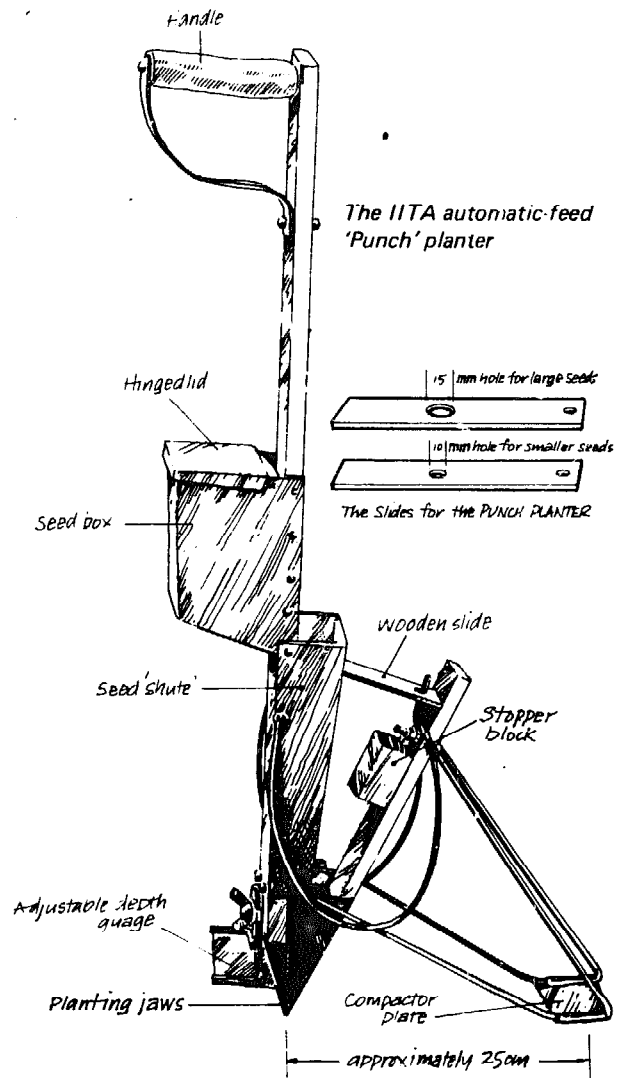

thus extracted in the open position. Raising one arm further releases the tension on the spring which closes the jaws **after** the planter comes out of the soil. If the jaws close while in the soil, they invariably pinch a large chunk of soil which clogs the planter.

- Stage 1 repeat** but also taking a short step backwards and aiming the compactor pad at the preceding, open, hole with seed. The jaws then insert into the soil approximately 25 cm from the preceding hole, while the compactor pad presses down, when the planter is levered forward, over and to compact soil over the seed.

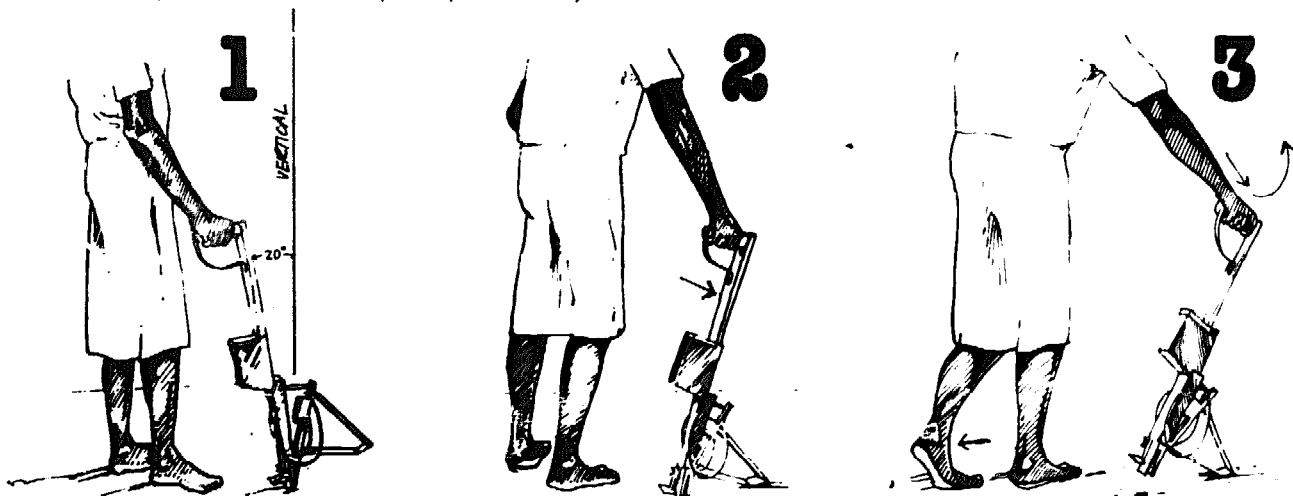

A little practice enables one to do this in a smooth circular movement of the arm, at the rate of about one 'punch' per second or an average of 3600 'hills' per hour. Planting maize at a stand of 30,000 to 40,000 'hills' per hectare, takes about 10 hours.

Always listen for the sound of the seed dropping into the jaws as the planter comes out of the soil. Should you not hear this, then check the metering slide which may be blocked.

The IITA 'Rolling-Injection-Planter' – RIP

This was designed to achieve an appreciably higher rate of injection planting, than the one hill-per-second rate achievable with the 'Punch' planter; and is better suited to the farmer with more than 1/2 a hectare of land.

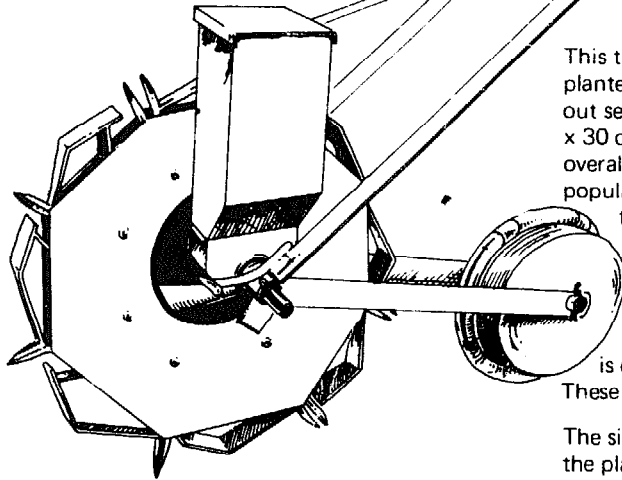

*The IITA 'Rolling-Injection-Planter' – RIP
Single row model*

This three-row planter may also be used as a two-row planter – either the centre planter is removed or left without seed in its hopper. The plant spacing will then be 15 cm x 30 cm as required for soya or cowpea, and to provide an overall plant-population of 220,000 'hills' per hectare. This population is sometimes also recommended for high-tillering varieties of rice.

The single-row model can conveniently be transported to the field with its compactor-wheel swivelled forward, and pushed, wheel-barrow style.

The multi-row planter, being heavier for penetration, is equipped with a pair of wheels for transport only. These are removed when reaching the field.

The single-row planter is conveniently pushed forward along the planting row, while the multi-row planter is drawn, backwards, as pulling requires less effort. Both, the single-row and multi (3) row, planters were originally designed for an in-row spacing of 25 cm but more recent research suggested better overall weed control with the closer spacing of 15 cm.

The RIP is available as a single-row model for planting of crops such as maize, cow peas, etc. at relatively wide inter-row spacings, and achieves a sustained planting speed of 3 'hills' per second or over 10,000 hills per hour. Maize can therefore be planted in about 3½ hours per hectare (that is about 35,000 hills).

The RIP is also available as a multi-row model (ideally three-rows planted simultaneously) but which can also be converted, quickly for planting one-row or two-rows. The three planter-units are 'ganged' 15 cm apart to expedite the close-row planting of small-grain-cereals such as rice, wheat, oats, etc. As the in-row spacing for which the planter is designed is 15 cm, this provides an overall planting distance of 15 cm x 15 cm for a population of 440,000 hills per hectare such as is now recommended for rice.

Seed metering

The planters are provided with a seed-metering reel suited to any of four sizes of seed.

- No. 1 15 mm diameter, 4 mm deep, for maize and long-grained rice
- No. 2 10 mm diameter, 4 mm deep, for medium grain length rice and cowpea
- No. 3 7.5 mm diameter, 4 mm deep, for mung-bean, cowpea
- No. 4 5.0 mm diameter, 3 mm deep, for smaller seed.

Select the end of the metering reel which has the metering hole required, and ensure this is located in the hopper



Transporting the single row model to the field

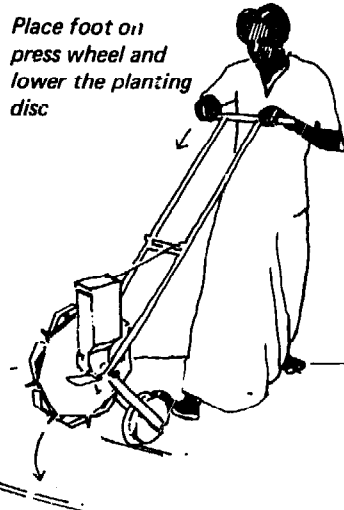

Place foot on press wheel and lower the planting disc

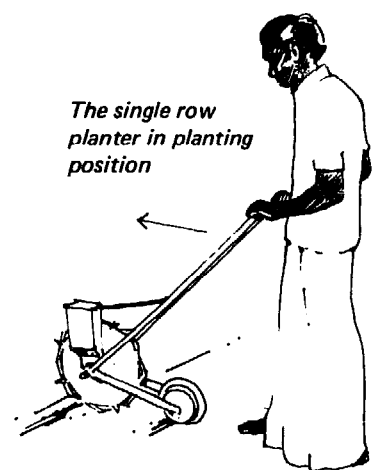

The single row planter in planting position

Then one row of holes or another is covered by the band to blank off the size of hole within the hopper which is not required.

After the planter is assembled, adjust the setting of the rubber flaps so as just to touch the metering reel. This ensures that any surplus seed is gently brushed off by the flaps within the hopper so that only the metered seed passes under the flaps, through the funnels, and into the respective planting jaws.

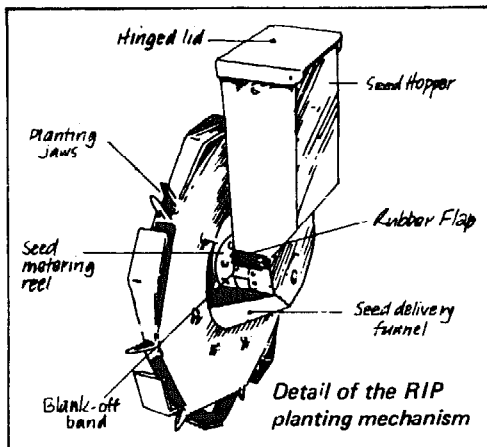
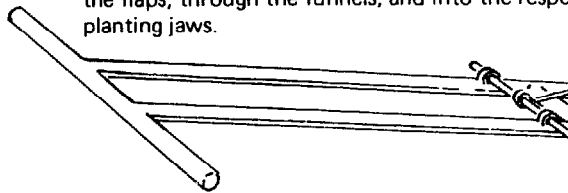

Planting

Half fill each hopper with seed. All hoppers should have roughly the same quantity. This will enable you to see after a few rows of planting, whether the seeding rate through all the hoppers is equal. If not, the rubber flaps may need adjustment.

Line up the planter alongside the planting row (ropes should preferably have been laid first, at 1 metre spacings) and push the single-row-planter — or pull the multi-row-planter. Keeping the nearest planting disc about 7 to 8 cms from the rope.

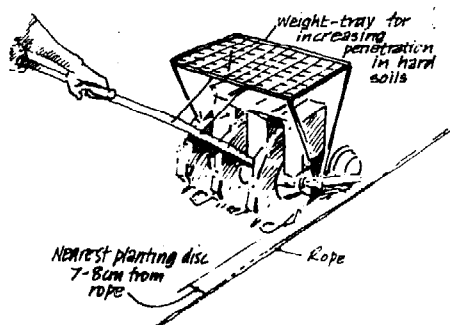

Extra care should be taken when turning the RIP to prevent soil from blocking the planting jaws

Planting with the Multi-Row planter

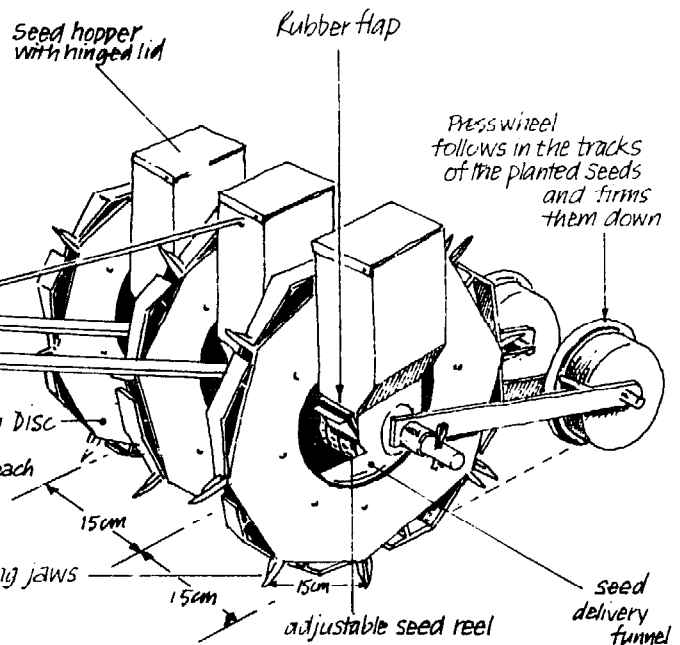
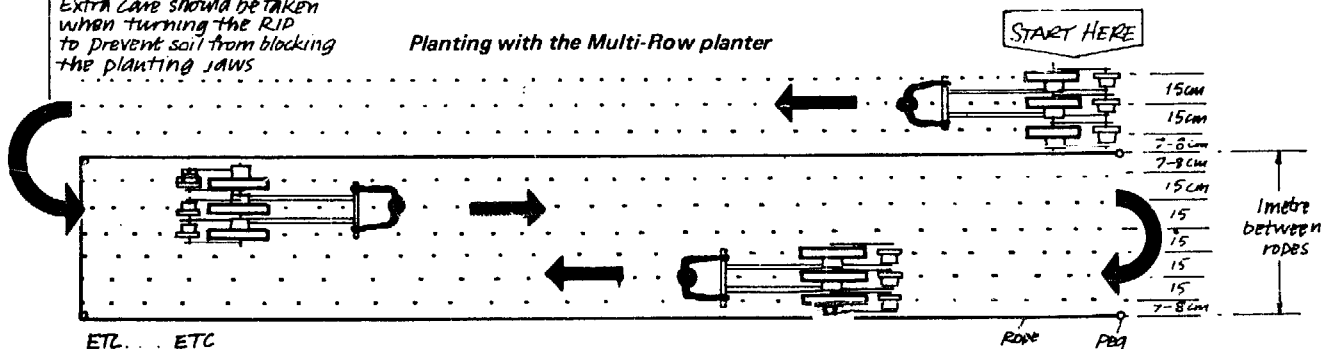

The IITA 'Rolling-Injection-Planter' — RIP Multi-row model

For the return run, position the planter on the other side of the rope, also 7 to 8 cms from it. This ensures continuity of the 15 cm between-row spacing; 2 runs (i.e. 6 rows) covering a planting width of one metre.

Speed of planting should be between 1/2 and 1 metre per second, too fast a speed sometimes results in seed being thrown out of the planter.

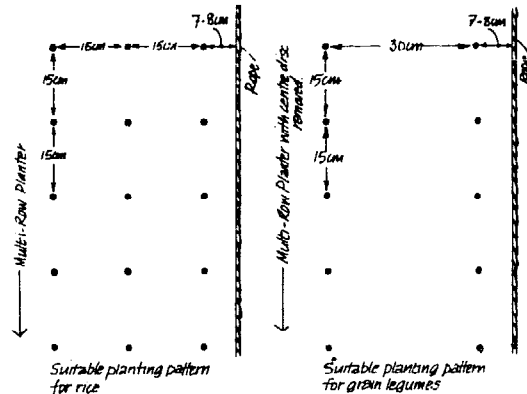

Precautions

1. **DO NOT** use the planter to inject seed into wet soils! Not only will germination be very poor, but the seeds will tend to stick around the jaws, and work their way in, thus causing blockages.
2. **DO** watch the flow of seed coming under the rubber flaps and trickling through the funnel into the jaws. Stop and check if the flow in any planter stops. Ideally the soil should be just moist after the first rains.

3. **DO** Try to ensure that you are planting through at least 2 cms of mulch. This helps wipe the injector-jaws as they go in and out of the soil and ensure that no lumps of soil work their way into the jaws.
4. **DO** Watch the jaws as they rotate to ensure they are clean and not clogged.
5. **DO** Check depth of planting, as rice prefers very shallow planting (no more than 1 cm deep). Maize can cope with deeper planting, even to 5 cms depth, as their seedlings are much stronger than the delicate rice seedling. It may be necessary to remove the compactor wheels when planting rice, to ensure better emergence of the seedling. On harder soils it may be necessary to weight the planter with a heavy sack laid on the weight tray.
6. **DO NOT** turn the planter with the injector jaws in the soil. Raise the handle to lift the planters out of the soil and with their weight carried by the compactor wheels before turning. This is **much** easier. If one turns the planter with the jaws in the soil, soil is collected which clogs the jaws.

The Weight Tray has Two Functions

1. As a load carrier when transporting the planter to the field. Sprayer, chemicals, fertilizer, seed can all be carried to the field on the tray as the planter is pulled (or pushed) to the field.
2. For extra weight when injecting seed into heavy soils.

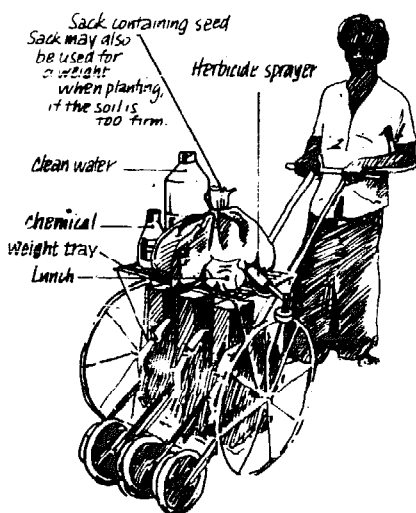

The planter with weight tray loaded

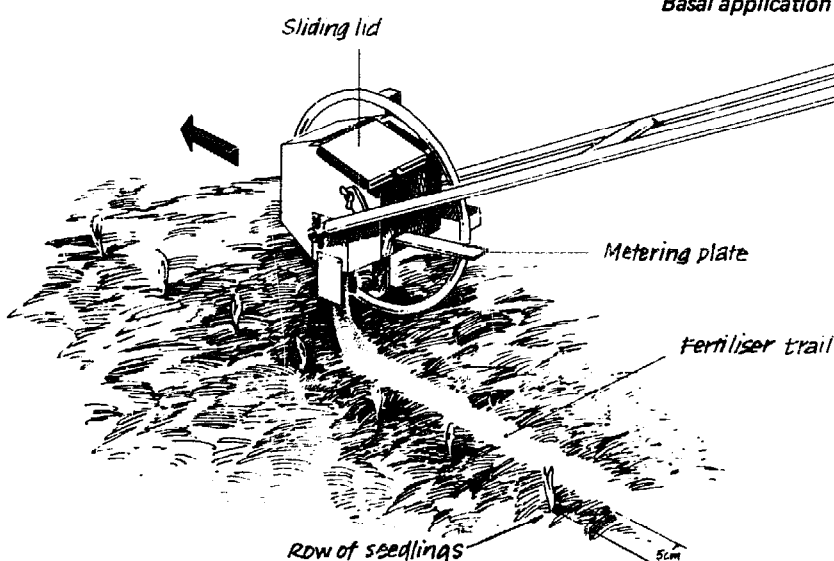

Fertilizer Applicator

This tool has been developed to, very quickly, dibble an accurately metered band of fertilizer beside a row of seedlings or plants.

The basal application can be banded a few days after emergence, and so has to be deposited, on the mulch, about 5 cm away from the line of plants. The operator should walk with the line of plants to his left. Likewise when applying a top-dressing of urea.

As the metering of flow is related to the number of revolutions made by the wheel, it is not very sensitive to speed. Fertilizer can thus be applied, very quickly and accurately, at a brisk walking pace.

Fertilizers vary in consistency. Thus the applicator should be calibrated before use. A cup is suspended below the outlet spout and the quantity of fertilizer flowing into it when the applicator is propelled over, 10 metres can be measured and the metering slide adjusted until the required rate is obtained.

The following formula and examples will help calculate this:

When: Q = Application rate required in kilograms per hectare (kg/ha)
 S = Inter-row plant spacing in metres
 R = Rate of flow required in grammes per metre (g/m)

Then: $R = \frac{Q \times 1000}{10000} \times S$ or $\frac{Q \times S}{10}$

Example:

if $Q = 50$ kg/ha
 $S = 0.75$ m
 $R = \frac{50 \times 0.75}{10} = 3.75$ gm/metre

When calibrating, propel the applicator for 10 metres. The quantity of fertilizer flowing into the cup should be adjusted on the metering plate to be as near as possible to 37.5 grammes. In the field this rate of application will be maintained as long as the consistency of the fertilizer does not vary.

Precautions

ALWAYS wash the applicator, thoroughly, and immediately after use.

ALWAYS apply some oil on the axle, bearings, and onto the helical coil to prevent these parts rusting.

Basal application of fertilizer

4 Techniques for Herbicide Usage

Herbicide Suggestions

These suggestions are **provisional** and represent some of the herbicides, in sequence and in combination, which have been tested in the field and found to work satisfactorily.

There are many other excellent herbicides which we have not yet got around to evaluating. When we do, we will

include these in future supplements.

There are several variations from the basic recommendations above, and with experience these will enable farmers to reduce the herbicide required considerably. Much depends on the magnitude of his weed problem and how effectively he is **managing** it. It also helps to understand the action of these herbicides.

Herbicide suggestions for use with three crops (Rice, Maize, Grain-legumes)

	RICE	MAIZE	GRAIN-LEGUMES Cowpea Soya, etc.
Pre-planting operation	ROUNDUP @ 3 l/ha applied 8 – 12 days before seeding followed by	ROUNDUP @ 3 l/ha applied 8 – 12 days before seeding followed by –	ROUNDUP @ 3 l/ha applied 8 – 12 days before seeding followed by --
Early Pre/Post planting	PARAQUAT @ 2 l/ha applied 1 – 2 days before seeding followed by either	PARAQUAT @ 2 l/ha mixed with either PRIMEXTRA @ 3 l/ha or GALEX @ 2-3 l/ha or LASSO @ 2-3 l/ha applied 1 to 2 days after seeding	PARAQUAT @ 2 l/ha mixed with either GALEX @ 2-3 l/ha or LASSO @ 2-3 l/ha applied immediately or 1 day after seeding
Late Post-planting	RILOFF-H @ 1.0 l/ha applied 10 days after seeding or MACHETE @ 1.5 l/ha applied 5 days after seeding or PROPANIL-M @ 5 l/ha applied 20 days after seeding	Not necessary	Not necessary

ROUNDUP is a contact, systemic herbicide which needs to be applied to actively growing foliage so that it is absorbed and translocated through the plant. Nearly all plants are killed by ROUNDUP, action first being visible in about 7 days and taking up to 15 days for total kill. In higher doses of 5 – 8 l/ha it is also effective in translocating through, and achieving a permanent kill on 'Imperata' and similar rhizomatous, perennial grasses. Weeds must not be cut back or disturbed for at least 7 days after spraying. Do not mix any other chemicals with ROUNDUP. This soon destroys its effectiveness. ROUNDUP is thus best applied by itself and is usually recommended for use at high rates of 5 to 8 litres per hectare in 400 to 500 litres of water per hectare. Applied CDA or VLV, and at low dilutions with, say, 40 litres per hectare of water, trials have shown that application rates of ROUNDUP can be halved; hence the suggestion in this brochure to use only 3 litres per hectare of this rather expensive herbicide.

However, as there is always some weed seed which emerges during the two-weeks or so in which the ROUNDUP is taking effect, it is always advisable to **also** apply a quick acting contact herbicide such as PARAQUAT at a low-rate of 2 litres per hectare within a day or two of the planting.

PARAQUAT is also a contact herbicide but not very systemic. It desiccates nearly all weeds very promptly (within a day or two) and especially quickly in bright

sunlight. As it is not very systemic in action it has little lasting effect on a plant which has substantial reserves in its roots and protected growing points such as the grasses.

If one crop is to be planted very quickly after another and there are negligible perennial weeds, (only very little weed growth after harvest), it is often possible to dispense with the pre-plant-application of ROUNDUP and instead apply only the pre-emergent herbicide (GALEX, PRIMEXTRA, etc.) *mixed with* PARAQUAT at higher rates, say, 3 to 4 litres per hectare. The PARAQUAT kills the light surface weeds by contact action while the pre-emergent herbicide goes into the upper layers of the soil to prevent the emergence of weed seeds.

PRIMEXTRA is a pre-emergent herbicide containing atrazine – the latter being a very effective selective herbicide when growing maize.

LASSO and GALEX are also pre-emergent herbicides which spread into the upper layers of the soil to prevent the emergence of weed seeds other than the grain-legumes which they do not effect. LASSO, GALEX and PRIMEXTRA can all be mixed with PARAQUAT in the spray tank before application, and can thus be applied together – each to serve its specific functions – so saving the necessity for duplicating the spraying operation. Some herbicide formulations can be mixed; others can not as they are incompatible. An example of the latter is ROUNDUP.

5 Economics of No-till

Apart from the better weed control achieved by the 'no-till' techniques, they are also very cost effective, even when compared with buffalo-tillage or tractor-tillage.

The following table presents contract rates for tractor and buffalo tillage in Sri-Lanka during early 1980 compared with costs for 'no-till' operations. The differences were more marked by the end of 1980 as both animal-tillage as well as tractor-tillage rates had escalated alarmingly!

Similar cost comparisons could be expected in other tropical countries.

Apart from its apparent cost effectiveness, research trials over the past several years have established the amount of energy and time conserved through adoption of the 'no-till' techniques.

For example, the traditional manual (slash, burn and till) methods of 'cultivating' an upland plot of maize and cowpea, seeding and weeding it, takes on average some 500 man-hours per hectare to raise the crops to maturity.

Farmed 'no-till' the man-hours are reduced to between 30 and 50 per hectare – less than one-tenth – without recourse to 'tractorisation'. Yields are also higher, with better weed control, particularly when the crops are young and sensitive.

COSTS FOR WEED CONTROL IN SRI-LANKA (1979/80 Season)

Cultivation versus 'zero-tillage' (Costs in SL Rs/acre)

A	tractors buffalo 'no-till'		
Pre-planting/ Seeding weed control			
First ploughing	262	206	–
Spray 'Roundup' (3 l/ha)	–	–	376
Second ploughing	165	132	–
Levelling	65	65	–
Spray 'Paraquat' (2 l/ha) (usually with pre-emergent)	–	–	53
Bunds cleaning and plastering	151	151	75
CDA/VLV Spraying charges*	–	–	40
Sub-total	SL. Rs.643	554	544
B			
Post-planting weed control			
Hand-weeding (manual)	165	165	–
Spray RILOF-H or MACHETE (1.5 l/ha)	–	–	93
or 3-4 DPA + MCPA (4 l/ha) (1 l/ha)	–	–	or 71
Total costs	SL. Rs. 808	719	637

Note: To the costs for tractor and buffalo tillage on irrigated lands must be added the real cost for irrigation at between SL Rs. 300 to 500 per acre-foot of water. The cost of irrigation water for weed control, apart from that required for crop-growth, is in the order of a further Rs. 1000 per acre.

* Spraying costs @ 4m-hr/ac + costs for sprayer and batteries

Comparison of Man-power Requirements for "No-Till" and Conventionally tilled Fields Over Two Successive Seasons Using Hand-Tools Only. Fashola, Nigeria (1978)

Field Operation	First Season Man-hrs/ha		Second Season Man-hrs/ha	
	Conv.	No-till	Conv.	No-till
A. Field Preparation:				
a. Burning	4	4		
b. Clearing, slashing	132		76	
c. Manual tillage & ridging	127		85	
d. CDA Spray, (contact-herbicide)		8		6
B. Seeding (maize and cowpea)				
a. Manual planting (low population)	35		35	
b. Planting; – RIP (Rotary Injection Planter) (25 x 75 = 53,000 stand/ha)		13 ¹		9
C. Pest control				
a. Manual weeding, – once ²	190	4	150	3
b. CDA spray (pre-emergent-herbicide)		9		5
c. CDA spray (cowpea) insecticide, – thrice		2		2
D. Fertilizer application:				
a. Manual dibbling along rows	25		25	
b. Using IITA fertilizer band applicator ³		8		8
Totals:				
a. Man-hrs per hectare	513	48	371	33
b. Yields maize/cowpea kg/ha ⁴	600/500	1773/2020	500/400	1112/1820

Notes

- Two additional men were employed to lay ropes for lining up the planting rows during the first season only. The line of stubble provided ample lining for the second and subsequent seasons planting.
- Occasional manual spot weeding was undertaken on no-till plots to eradicate resistant weeds.
- The fertiliser-band-applicator was used for basal application on both maize and cowpea, and for top-dressing, also on maize.
- Yields obtained by the farmer from conventionally tilled plots had to be approximated.
- Crops grown were maize and cowpea, planted on separate fields.

6 Recycling — Fertility Regenerating Systems

To conserve soil, water and fertility is clearly fundamental. But to strive further towards recycling and regenerating natural fertility systems must be the next goal.

Two such systems, presently being researched, already show promise.

Live-Mulch Systems

The importance of growing leguminous cover crops in the soils under plantation crops — coconut, rubber, oil-palm — is well established. The extension of this practice into arable farming is currently being investigated and already shows great potential.

Basically, the intention is to replace a complexity of weeds with one — a fast-growing, easily controlled perennial legume which will quickly smother other weeds while spreading rapidly over the surface. That such cover crops constitute a very rapid restorative for eroded, and depleted soils is already well established in a number of countries. They are also easily controlled with herbicides such as ROUNDUP, PARAQUAT, or 2,4-D. However, the concept has progressed to the retention of this perennial cover crop as a year-round fertility regenerator and soil cover, while still using it as a mulch for arable crops, by spraying it lightly with a **plant-growth regulator** (PGR). This puts it into dormancy for about two or three months while arable crops (such as maize, okra, sorghum, etc.) are injection-planted through the mulch to grow in the humus-rich soil, without appreciable competition from the cover crops for fertility or moisture. After the crops have been harvested the leguminous cover crops shake-off their dormancy and continue to develop normally with their soil regenerating function.

Among the cover crops investigated in this role so far are

PUERARIA	javanica
CENTROSEMA	pubescens
ARACHIS	prostrata
STYLOSANTHUS	humilis
PSOPHOCARPUS	palustris & tetragonolobus

Psophocarpus has the additional advantage of producing a high-protein bean (winged-bean) for human consumption,

which becomes a valuable by-product of the system during the non-cropping season.



Leguminous cover plant (winged bean) recovers from PGR and climbs harvested crop (maize)



Injection planting through live mulch

Research continues towards identifying varieties of such cover crops which best fulfil the range of criteria desirable in such covers, which are:

1. Perennial (for year round growth)
2. Non-photo sensitive (for year round productivity)
3. Drought resistant
4. Weed suppressing (by their aggressive spread)
5. Food crop providing (e.g. the winged-bean)
6. Soil regenerative and protective
7. PGR-regulated in dormancy when required

Research is likewise current into a range of suitable PGRs which will extend the need for simple hand tools for 'no-till' farming.

Avenue Cropping Systems

The technique of 'avenue-cropping' was developed from traditional forest regenerating practices and begins with the planting of rows of quick-growing leguminous trees (such as *Leucaena leucocephala* and *Gliricidia* Sp.) spaced about 0.5 metres apart within rows and about 2.0 metres apart between rows.

At the beginning of the rains and the arable cropping season, the rows of trees are lopped at about half-metre above ground level and all the light twigs and leafy material laid as a mulch in the avenues. The more woody material is stacked separately as valuable firewood.

The crops to be grown are then injection-planted through the mulch in the avenues – sometimes preceded by a light spray of mixed contact and selective herbicides if weeds are abundant, (usually they are not, as the dense shade under the profusely growing leguminous trees during the 'off' or dry season successfully smothers nearly all weed growth). The crops grow vigorously through the mulch-covered soil and so do the rows of tree crops, the latter causing little (if any) interference to the arable crops growing alongside. These are then harvested while the leguminous trees continue to develop, raising fertility from the sub-soil regions

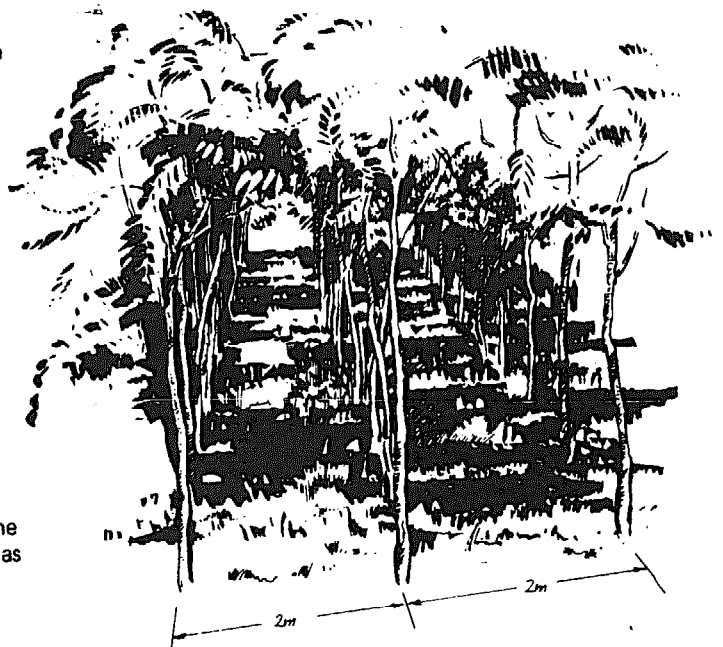

Avenue of Leucaena – before lopping and planting crop, notice dense shade which restricts weed growth

into which their roots have penetrated, to be re-cycled again with the next cropping season.

These new fertility-regenerating farming systems and the simple tools used with them are potentially the most exciting innovation in tropical agriculture of recent years. They have particular application for the small farmer who, otherwise faces the spectre of reduced productivity with the escalation in prices, of inorganic chemical fertilisers, and the logistics (200 to 300 kilograms per hectare) of using them.

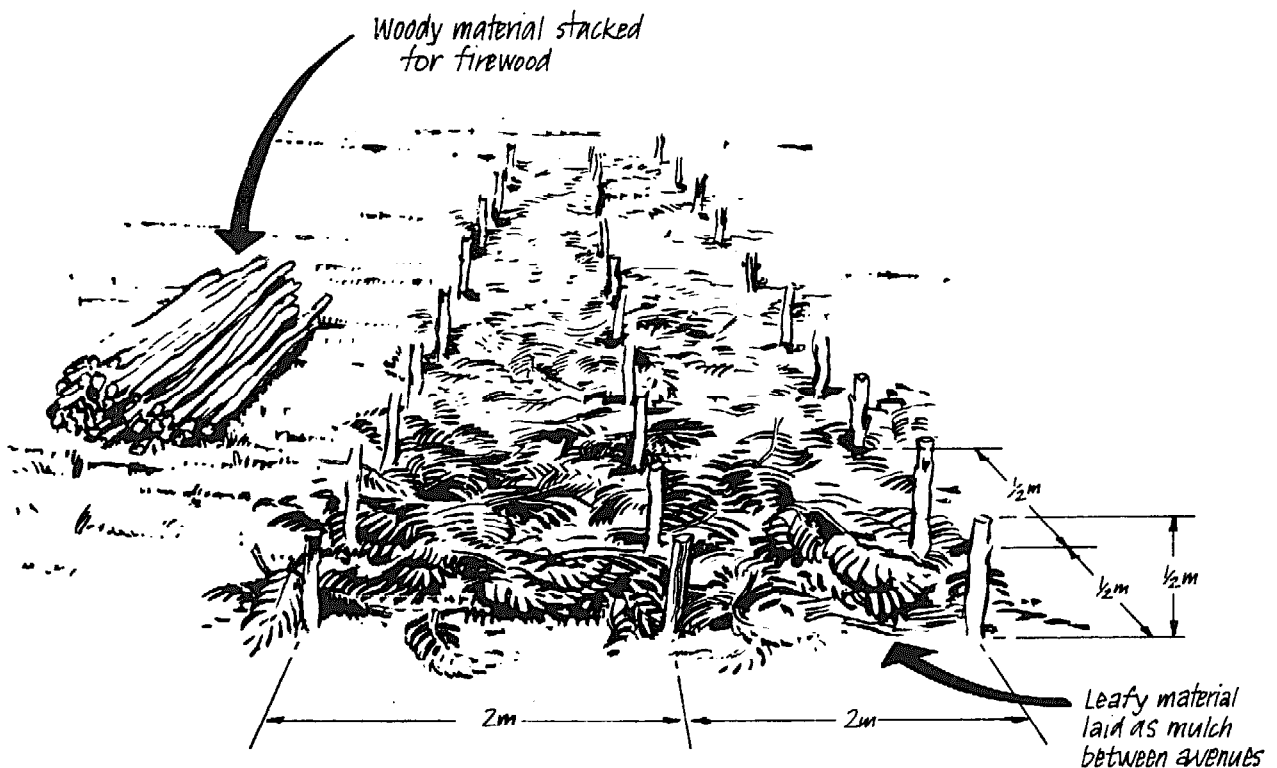

The Avenues prior to injection planting

Avenue trees allowed to develop until the start of the next season, when they are lopped again at 1/2 metre height

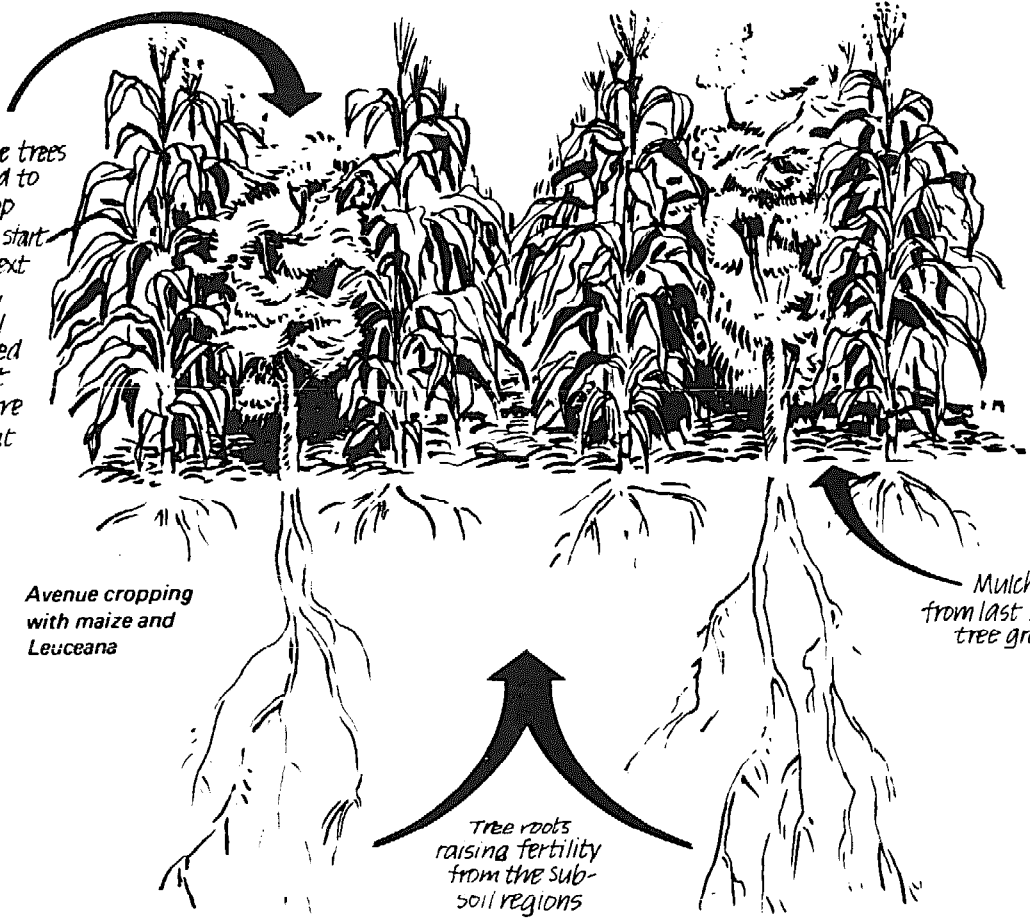

Avenue cropping with maize and Leuceana

Mulch from last season's tree growth

Tree roots raising fertility from the sub-soil regions

Leuceana



Dedicated to: Ernest Abeyratne and Rattan-Lal who pioneered the importance of minimum tillage and of mulch in tropical farming.

Written by: Ray Wijewardene

Designed & illustrated by: Andrew Crane

Editorial advice from: Tony Moody

Typed by: Victor Perera

Working Drawings by: Navasero, Wickramasinghe and Rajapakse

Compiled by: I.I.T.A. — Sri-Lanka Program, Colombo

Supported by: Ludwig Ebner and Gustav Muller of CIBA-GEIGY AG, Basel.
V.I.T.A. (Volunteers for International Technical Assistance) Washington.
G.A.T.E. (German Agency for Technical Assistance) and G.T.Z., Eschborn.
Sri-Lanka Ministry of Agriculture
Many small farmers in West-Africa and Sri-Lanka who now farm 'no-till'.

Additional copies priced at S'L-Rs. 25 or U.S. \$1 or St. £0.50 plus postage.

Drawings of planters and fertiliser-applicator, per set; S'L-Rs. 50 or U.S. \$2 or St. £1.00 plus postage (printing costs only).

IITA — Sri-Lanka Program,
133, Dharmapala Mawatha, Colombo 7,
Sri-Lanka.