

AT MICROFICHE
REFERENCE
LIBRARY

A project of Volunteers in Asia

Better Farming Series No. 14, Farming with
Animal Power

Published by:
Food and Agriculture Organization of the
United Nations
Via delle Terme di Caracalla
00100 Rome
Italy

Paper copies are \$ 1.50.

Available from:
UNIPUB
P.O. Box 433
Murray Hill Station
New York, NY 10157 USA

Reproduced by permission of the Food and
Agriculture Organization of the United Nations.

Reproduction of this microfiche document in any
form is subject to the same restrictions as those
of the original document.

farming with animal power

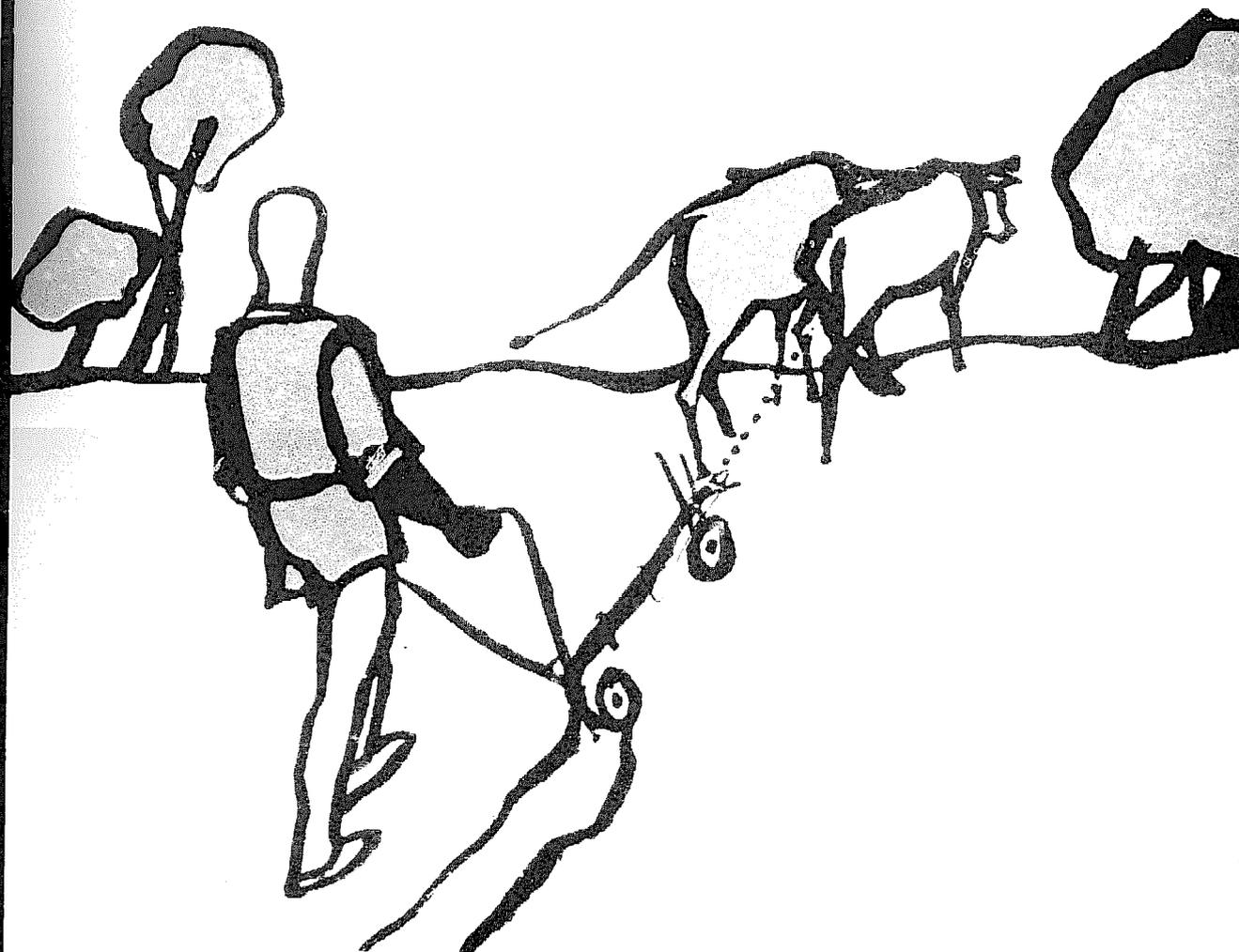

BETTER FARMING SERIES

Twenty-six titles have been published in this series, designed as handbooks for a two-year intermediate level agricultural education and training course. They may be purchased as a set or as individual documents.

FIRST YEAR

1. The plant: the living plant; the root
2. The plant: the stem; the buds; the leaves
3. The plant: the flower
4. The soil: how the soil is made up
5. The soil: how to conserve the soil
6. The soil: how to improve the soil
7. Crop farming
8. Animal husbandry: feeding and care of animals
9. Animal husbandry: animal diseases; how animals reproduce

SECOND YEAR

10. The farm business survey
11. Cattle breeding
12. Sheep and goat breeding
13. Keeping chickens
14. Farming with animal power
15. Cereals
16. Roots and tubers
17. Groundnuts
18. Bananas
19. Market gardening
20. Upland rice
21. Wet paddy or swamp rice
22. Cocoa
23. Coffee
24. The oil palm
25. The rubber tree
26. The modern farm business

Farming with animal power

**Published by arrangement with the
Institut africain pour le développement économique et social
B.P. 8008, Abidjan, Côte d'Ivoire**

FOOD AND AGRICULTURE ORGANIZATION OF THE UNITED NATIONS

Rome 1977

First printing 1977

ISBN 92-5-100157-X

© French edition, Institut africain pour
le développement économique et social (INADES) 1971

© English edition, FAO 1977

PREFACE

This manual is a translation and adaptation of "La culture attelée," published by the Agri-Service-Afrique of the Institut africain pour le développement économique, et social (INADES), and forms part of a series of 26 booklets. Grateful acknowledgement is made to the publishers for making available this text, which it is hoped will find widespread use at the intermediate level of agricultural education and training in English-speaking countries.

The original texts were prepared for an African environment and this is naturally reflected in the English version. However, it is expected that many of the manuals of the series — a list of which will be found on the inside front cover — will also be of value for training in many other parts of the world. Adaptations can be made to the text where necessary owing to different climatic and ecological conditions.

Applications for permission to issue this manual in other languages are welcomed. Such applications should be addressed to: Director, Publications Division, Food and Agriculture Organization of the United Nations, Via delle Terme di Caracalla, 00100 Rome, Italy.

The author of this English version is Mr. A.J. Henderson, former Chief of the FAO Editorial Branch.

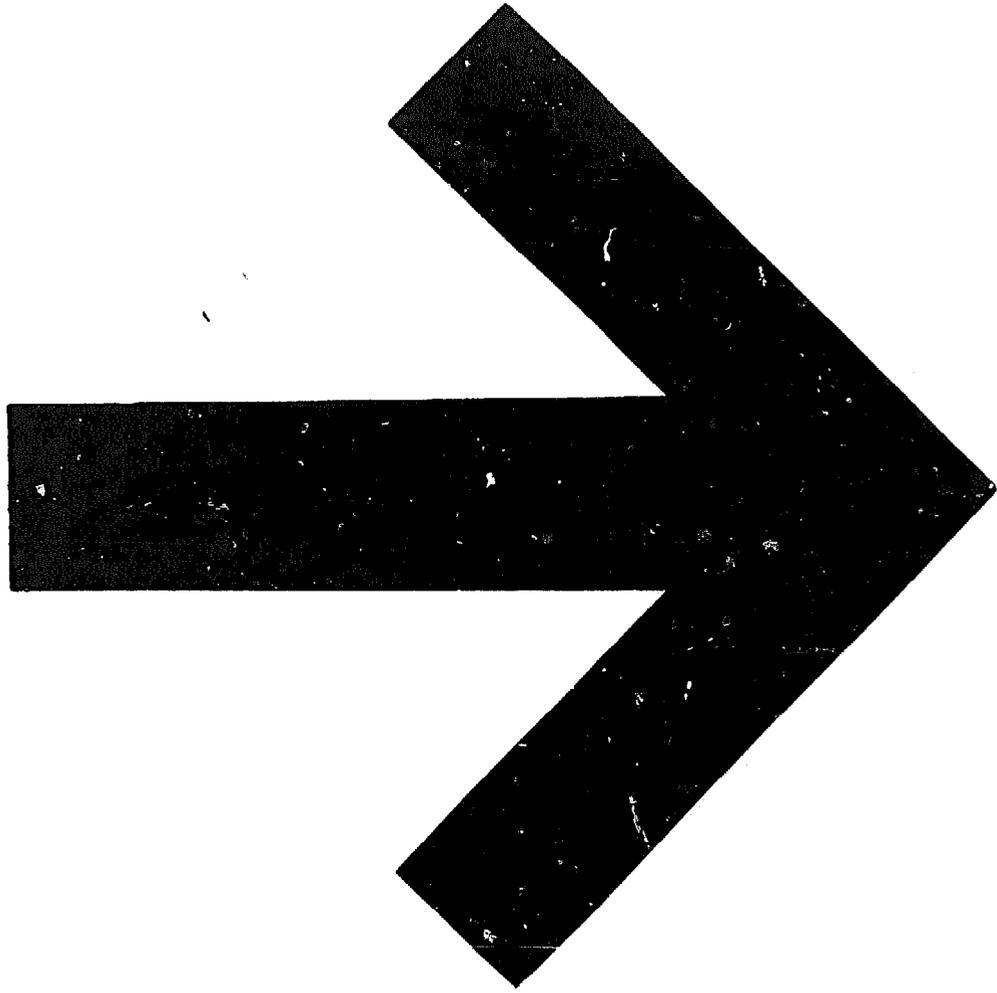

OUTLINE OF COURSE

● Introduction	3
● Choosing and preparing fields	9
Size and shape of fields	9
Marking the boundaries of a field	10
Grubbing out the trees in the field	12
Get permission to farm for a long time	12
Choose the right crops and rotation	13
● Working animals	14
Oxen	14
Choosing oxen for farm work	14
Training oxen	17
Harnessing oxen with a yoke	18
How to train oxen	22
How many hours a day can oxen work?	26
How to feed working oxen	27
Looking after working oxen	29
Donkeys	31
Horses	38
Mules	39
Camels	40
● Tools for use with animal power	41
Choice of tools	41
The plough	42
The harrow	42
The Manga cultivator	43
The seed drill	44
The cart	45
Other tools	46

● Income from animal power	47
What animal power costs	48
Buying animals and tools	48
Amortization	49
Interest	50
The animals' food	51
Upkeep and repair of tools	51
What animal power brings in	52
● Mechanized farming	54
● Some examples of animal power farming	56
● Suggested question paper	57

FARMING WITH ANIMAL POWER

INTRODUCTION

In traditional farming
all the work in the fields
is done by hand,
with very few tools,
by man-power alone.

Everything is carried on the head.
Each trip you carry
only a small amount of goods —
a basket of cocoa beans,
of groundnuts,
of rice,
a can of oil,
a load of wood.

With animal power
for tilling, sowing, hoeing and transport
you can make use of the strength of animals.

With animal power
the farmer gets less tired.
He lives better.
Farming is done better.
Fields are bigger.
Harvests are finer.

The farmer can pay
for the animals and tools.
He has more money
than when he does everything by hand.

For example:

At Agoudou-Manga (Central African Empire),
with traditional farming,
the farmer makes 8 000 CFA francs a year.

With animal power,
He can make 30 000 francs.
Each year he repays part of the cost of the oxen,
the plough, and the cultivator, that is, 12 000 francs.
So he has left: $30\ 000 - 12\ 000 = 18\ 000$ francs.
Thus he makes 10 000 francs more
than with traditional farming.

In Upper Volta (Mossi country),
with traditional farming,
the farmer makes 17 000 francs.

With animal power
he can make 66 000 francs.
Each year he pays 29 000 francs for the donkey,
the cultivator, fertilizers and pesticides.
So he has left $66\ 000 - 29\ 000 = 37\ 000$ francs.
Thus he makes 19 000 francs more
than with traditional farming.

With animal power the farmer can:

- save time,
because work is done much faster with animals;
- get farming jobs done in good time;
- do some of his jobs better;
- have bigger fields.

Saving time

Work is done much faster with animals.

For example:

At Niangoloki (Upper Volta),
to grow a hectare of groundnuts,
that is, an area equal to a football field,
190 eight-hour days are needed each year
if work is done by hand.

But with animal power
only 145 eight-hour days are needed each year.

To grow a hectare of food crops
such as millet, maize or sorghum
requires 85 working days a year
if work is done by hand.

With animal power
only 57 working days a year are needed.

The time the farmer saves
by using animal power
should be used to work other fields.

But although the work is done more quickly,
the farmer has to spend some time
in looking after his oxen, his donkey,
in training them and feeding them.

Getting jobs done in good time

We saw in an earlier course (Booklet No. 7)
that crop yields are much better
if the sowing is done at the right time.

For example:

Cotton sown at the beginning of the rains
yields 656 kilogrammes per hectare;
but cotton sown one month after the first rains
yields only 240 kilogrammes per hectare.

Sowing seed and applying fertilizer by hand
on a one-hectare field requires 30 working days.

With animal power,
sowing the seed and applying the fertilizer
requires 4 working days.

Animal power is very useful
chiefly because with it you can
get certain jobs done well and quickly.

Doing jobs better

Animal power also helps to work the soil better.

Tilling is more regular and deeper
(see Booklet No. 7, page 8).

Sowing in rows
(see Booklet No. 7, page 15)
is done at a good density
(see Booklet No. 1, page 16).

Intercultivations are done more often
(see Booklet No. 7, page 21).

Harvesting is quicker.

Bigger fields

With animal power,
as the work is done more quickly,
the farmer makes better use of his time
and can farm bigger fields.

For example:

At Niangoloko (Upper Volta),
a farmer works by hand
a field of 1 hectare.

With animal power
he can work a field of 2 to 4 hectares.

**But, to farm with animal power,
you must:**

- make a good choice of fields
and lay them out well, that is:
choose fertile land;
lay out big, rectangular fields;
clear all the fields and grub out all the trees;
- make a good choice of crops;
- make a good choice of oxen and donkeys;
- train the animals well:
teach them to work;
- feed the animals well:
a well-fed animal is strong,
so make a reserve of food for the dry season;
- take good care of the animals;
- make a good choice of tools,
and take care of them;
- work out correctly
what animal power costs
and what it brings in.

CHOOSING AND PREPARING FIELDS

Choose land where plants grow well;
if you see tall herbage,
the land there is good.

If you can, choose fields near your house,
so as not to lose time getting there and back.
All the time spent getting to and fro
is time lost on the fields.

Size and shape of fields

The fields should be big,
and especially they should be very long.
If a field is very short,
you lose a lot of time turning the oxen
at the end of the field.
You get more tired turning the plough.

The fields should have a regular shape;
they should be rectangles.
That shape makes it easier to plough,
to sow in rows,
to hoe and cultivate.

If you must have several fields,
make them as close to each other as possible,
so as not to lose time
getting from one to the other
with the animals and tools.

Marking the boundaries of a field

A good field must have its proper boundaries.
Before preparing your field,
mark out its boundaries.

You will need to know how to measure your field.

Example: You want to make a field of 1 hectare.

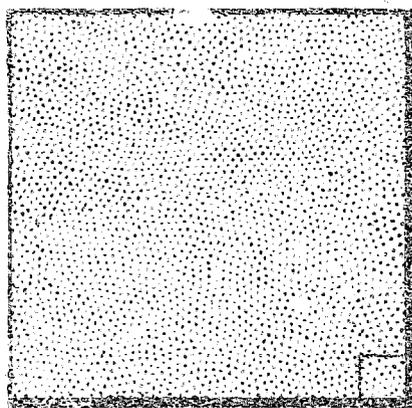

Field of 1 hectare

This field should be
either square
or rectangular.
This means that
its corners must be
right angles.

Square corner
(right angle)

How to make
a right angle

The corner
of this booklet
is a right angle.

Measure
4 metres along side OA
and 3 metres along side OB.

Now the length of AB
should be 5 metres.

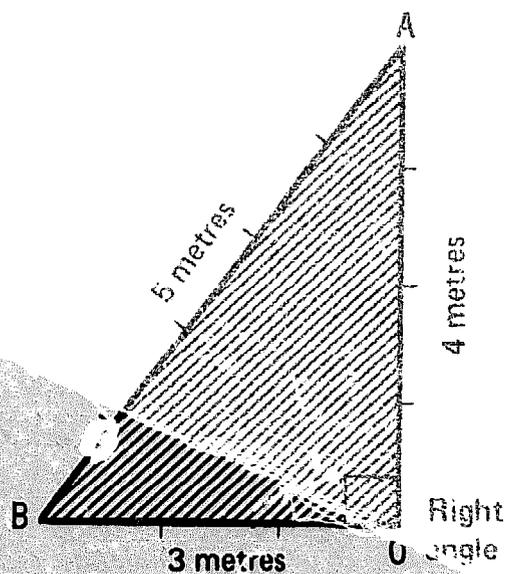

● Why make a field with right-angled corners?

- It is easy to calculate the area of such a field.
You can reckon better the density of sowing
(see Booklet No. 1, page 26).
You know how much fertilizer to apply.
You know whether the field yields a good
or a poor harvest.

- It is easier to till with animals.

HOW TO CALCULATE THE AREA OF A FIELD

To calculate the area of a field
with right angles at the corners,
multiply the length by the width of the field.

Example: a field is 100 metres long
and 100 metres wide;
its area is $100 \times 100 = 10\,000$ square metres (m^2).

A square metre is a square
measuring 1 metre in length
and 1 metre in width.

One hectare = $10\,000 \text{ m}^2$

Example: a field is 200 metres long
and 50 metres wide;
its area is $200 \times 50 = 10\,000 \text{ m}^2$.
It is also 1 hectare.

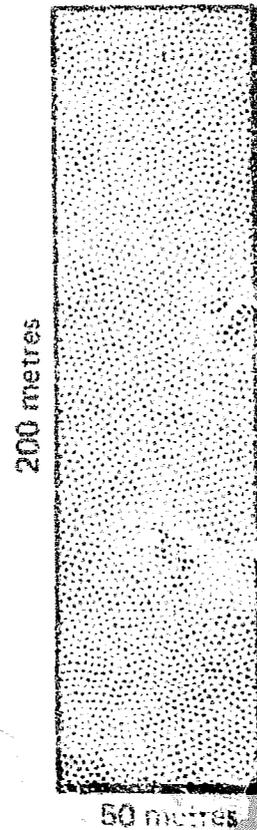
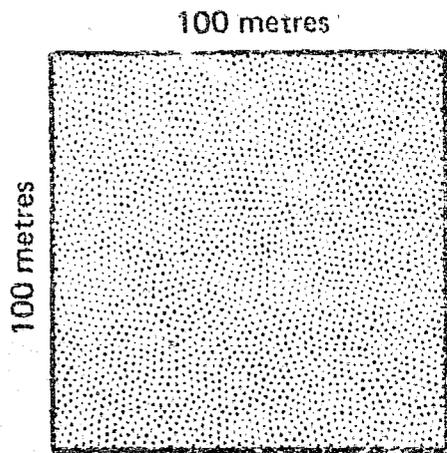

Two fields of 1 hectare

A field which is 71 metres long
and 71 metres wide
has an area of $71 \times 71 = 5\,041 \text{ m}^2$.

A field which is 100 metres long
and 50 metres wide
has an area of $100 \times 50 = 5\,000 \text{ m}^2$.

These are both fields of half a hectare.

In order to work with animal power:

- **Grub out all the trees in the field**

You cannot use animal power on fields with tree stumps.
You must grub out the tree stumps
so as not to break your tools
(see Booklet No. 6, page 21).

This requires a lot of work,
but once it is done, it is done for good.
It does not have to be done again every year.

Each year grub out the trees
on a part of the field.
At the end of two or three years
the whole field is cleared.

In savanna country you need 120 working days
to clear a hectare and grub out the tree stumps.
Do this during the dry season
when there is not too much other work.

- **Get permission to farm for a long time**

Before grubbing out the trees,
ask the land authorities for permission
to farm the field for a very long time,
so as to get the benefit of your work.

- **Choose the right crops and rotation**

When you use animal power,
you must include **fodder for the animals**
in your crop rotation
(see Booklet No. 5, page 27)..

For example:

Grow a **fallow crop** (see Booklet No. 5, page 23)
and cereals such as rice or maize or sorghum
as **supplementary feeds** (see Booklet No. 8, page 14).

Grow more cash crops
such as cotton or groundnuts.
With the extra money earned,
pay off the cost of the oxen and the tools.

After the cash crops,
raise food crops for your family.

The food crops will benefit
from the remains of the fertilizers
used on the cash crops.
The harvest will be better.
You will get enough food for your family
from a smaller field.

Using animal power
means you have to use a good crop rotation.

WORKING ANIMALS

OXEN

Choosing oxen for farm work

You should choose:

- **Big and rather heavy oxen**

The bigger an ox is,
the stronger it is.
An ox that is too small
cannot do much work.

Some oxen are too small
for clearing the land and deep ploughing.

- **Healthy oxen**

The animals must breathe easily
and not cough.
The bones and muscles must be well developed.
The legs, especially, must be strong.
The hocks (joints) must be well formed,
the hoofs must be solid and smooth.

An animal that walks with difficulty
is not good for work.
Look at how an animal walks
and you will see
whether it will make a good working ox.

The horns must be hard;
they must not be tender.
You cannot put a head yoke (see page 19)
on an ox with broken horns.
The neck must be short and strong.

- **Oxen not too difficult to train**

If an ox is vicious,
you cannot train it easily.

Bulls are castrated

in order to make them easier to train.

But they should not be castrated too young.

Wait 18 to 24 months before castrating a bull,
for then it will be stronger for work.

But in that case it must be separated from the herd
so that it does not cover the cows.

If an ox is spiritless and lazy
it is not good for training,
for it will not do much work.

- **Oxen of the same size**

If one ox is bigger than the other,
the yoke cannot fit well.

Then the yoke bothers the oxen
and they cannot work well.

If one ox is stronger than the other,
the strength of the stronger ox
is not fully used.

- **Oxen of about the same age**

They will be able to work together
for several years.

- **Oxen of the right age**

Do not take animals that are too old.
Oxen that are too old are difficult to train.
After being trained
they will work for fewer years
than oxen trained when young.

Do not take animals that are too young.
They are not strong enough;
they have not finished growing.
Their bones are not hard enough.
An animal that works when it is too young
does not grow.

At the age of 2 or 3 years,
you can begin to train oxen.
If you begin early,
the oxen get into good habits.
But before the age of 4,
let them do only light work.

At the age of 4 years,
oxen are strong enough to work hard.
You can then keep them for several years.
Oxen can work up to the age of 10 years.

Training oxen

Oxen can be very useful
if they are well trained.

**When oxen are very well trained,
one man alone can drive them
and hold the plough.**

**If the oxen are not well trained,
three people are needed:
one in front to lead;
one at the side, to make the oxen go forward;
one behind, to hold the plough.**

It takes time to train oxen well,
but this time is not wasted.
Afterwards, only one man will be needed
to drive the oxen and hold the plough.

**Once oxen are trained,
they should be harnessed fairly often.**

Never leave them too long
without harnessing them.
If you do not harness your oxen for 6 months,
they will lose their good habits.
In the dry season
when there is no ploughing or cultivating to do,
harness your oxen for transport.
Then they will not lose their good habits.

HARNESSING OXEN WITH A YOKE

A yoke is a piece of wood placed on the heads or necks of oxen which is used for pulling farm implements. The yoke must be made of strong wood; it must not be too heavy; it should weigh 6 to 9 kilogrammes.

● The neck yoke

There are neck yokes for harnessing a single ox, and yokes for harnessing two oxen together. The yoke is placed on the neck of the animals. When the oxen pull, the yoke settles down in the right place. Farmers can easily make such a yoke, or the village blacksmith or carpenter can do it. It is used mainly for zebu oxen which have a longer and weaker neck than some other oxen.

With the neck yoke you cannot make the animals walk backward because the yoke is not fastened to them.

With the neck yoke the animals have more freedom but they more easily spoil the crops during cultivation.

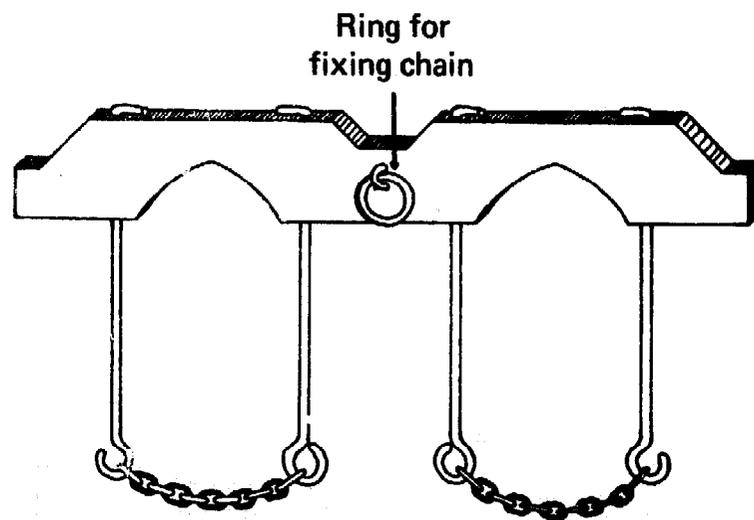

Double neck yoke for two oxen

- **The head yoke**

The head yoke is placed behind the horns and is tied to them with rope or thongs of leather. In order not to injure the animal, put a pad of straw or kapok wrapped in cloth between the yoke and the head.



Hook for fixing chain

Head yoke

A yoke with its chains costs between 1 500 and 2 000 CFA francs.

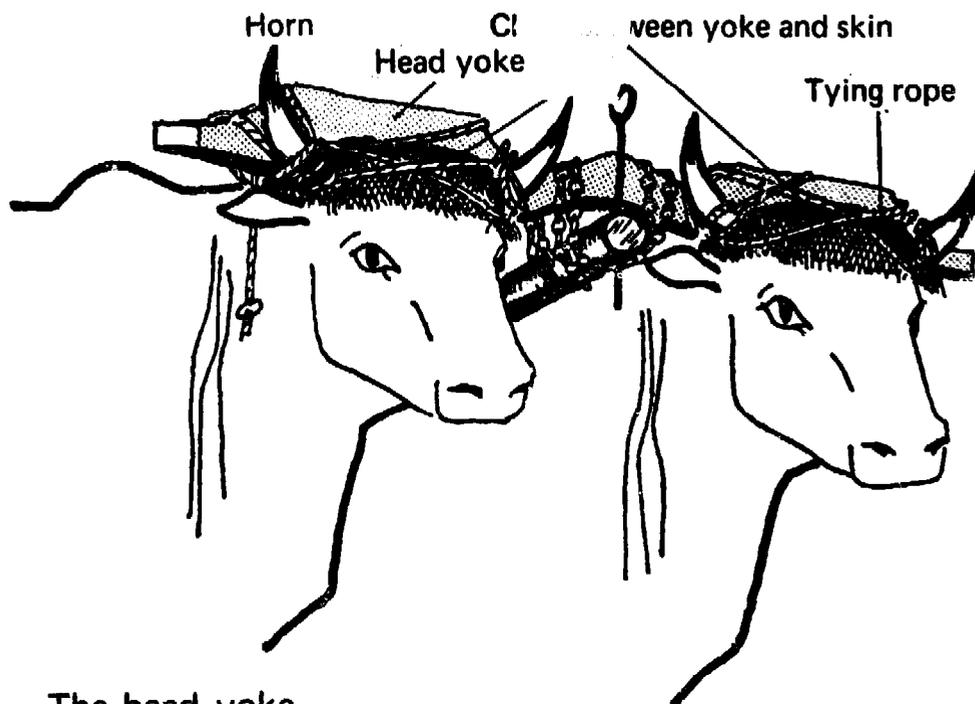

The head yoke is mostly used for oxen other than zebus. This yoke gradually develops the neck muscles. So do not start with work that is too tiring.

- **The single yoke**

The single yoke
is used to harness one animal.
A chain is fixed
to either side of the single yoke.

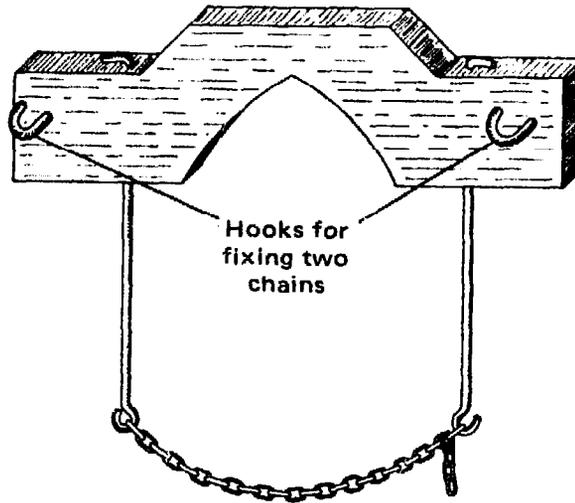

Single neck yoke

It can also be used as a collar,
in the same way as for donkeys (see page 37).

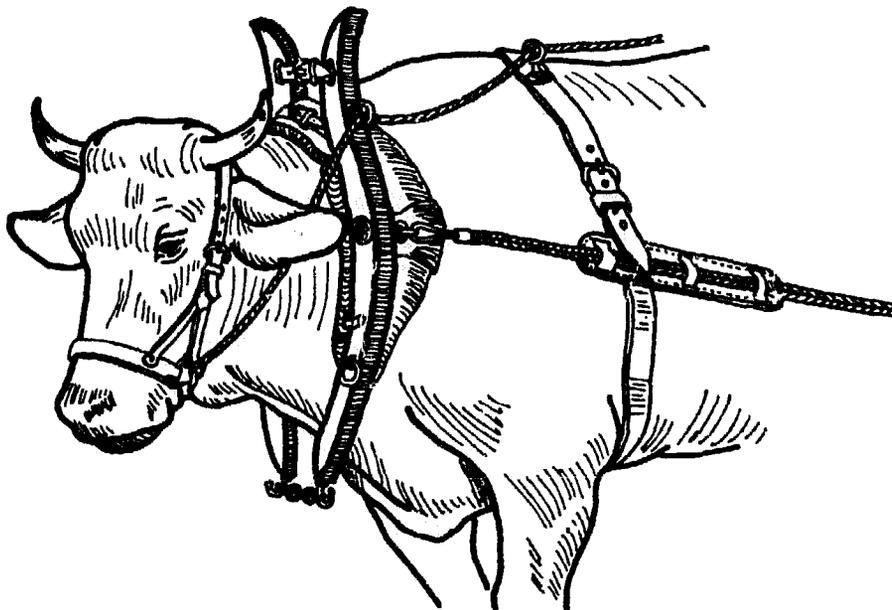

Ox with collar

How long should the yoke be?

The yoke should be rather short.

The oxen should be quite close to each other.
But there should be 20 to 25 centimetres
between the two oxen
so that the chain that pulls the tool
does not bother them.

So the yoke should be 1.10 to 1.30 metres long.

If the animals have large horns,
make the yoke a little longer.

For certain work,

like ridging or cultivating between rows of crops,
longer yokes are sometimes used,
so that there are two rows of crops
between the two animals.

So you must have two yokes,
a **short yoke** and a **long yoke**.

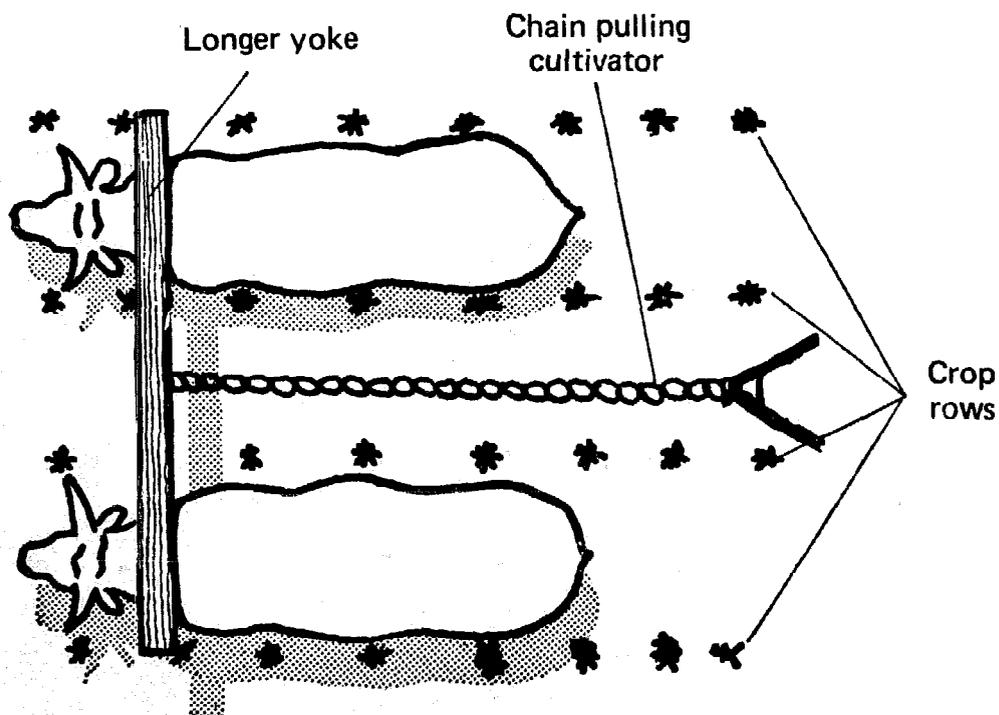

Two oxen harnessed with a long yoke for cultivating

HOW TO TRAIN OXEN

You have chosen two oxen of the same age,
the same size and the same strength.

- **Men and oxen must get used to each other**

Before beginning to train your oxen,
you must get them used to
being with men.

Putting the animals in a modern pasture
is itself enough to make the animals used to
the presence of men.

If a man is unkind to his oxen,
if he hits them,
the oxen will be afraid of the man
and become vicious.

If a man looks after his oxen well,
they become quieter.

The man and the animals
must become friends.

- **Teaching oxen to wear the yoke**

Two days before beginning the training,
tie the oxen for a few hours to a tree.
The animals will get used to being tied,
and will be quieter.

Always put the same ox
on the same side of the yoke.

The left-hand ox must always be on the left,
and the right-hand ox must always be on the right.

To get young oxen used to the yoke,
you can put the ox which is to be trained
along with an ox already trained.
Be sure to put the left-hand ox always on the left,
and the right-hand ox on the right.

When tie the oxen to be trained
to the same yoke for 2 or 3 days.
Let them go free for 2 or 3 hours,
but keep an eye on them.
To prevent them moving too much,
tie a rope to a foreleg
and loop it round the animal's back.

On the fifth day,
get the oxen to walk in a straight line.
Do not hit them.
You need a lot of patience.
It is better to drive the oxen from behind;
then the trainer disturbs them less.

When the animals are used to
wearing the yoke
and to walking side by side,
tie a chain or a rope
to the middle of the yoke,
and to the other end of the chain or rope
fix a piece of wood weighing about 40 kilogrammes.

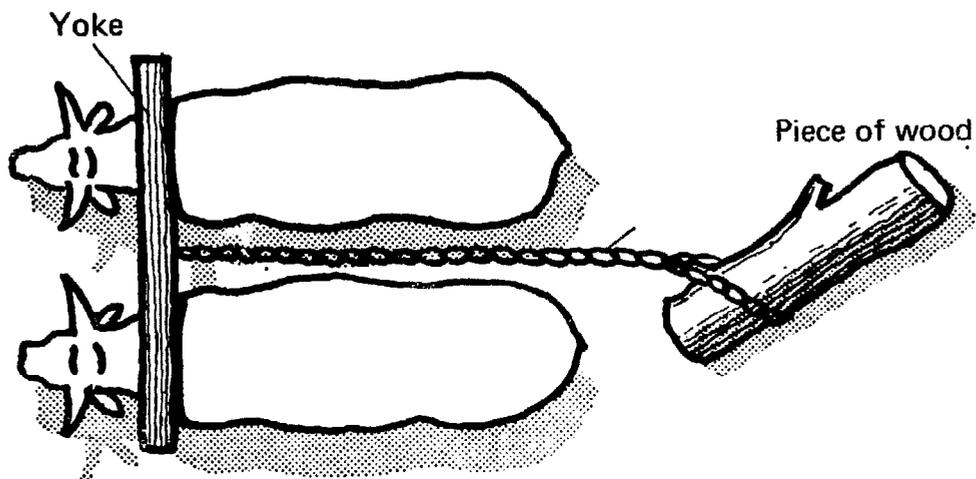

Training oxen

When the oxen are used to wearing the yoke,
 and to walking while dragging something,
 you must teach them to walk straight ahead,
 to stop,
 to turn to the left,
 to turn to the right.

You can get oxen to obey at the words:

<i>Hu</i>	Forward
<i>Hoo</i>	Stop
<i>Dia</i>	Left
<i>Ya</i>	Right

The driver's voice
 should be the chief means of driving the oxen.

You have to do the same movements
 over and over again.

The oxen learn to obey by this means.
 To get them to obey better,
 you can give each one a name,
 and give them orders by calling their names.

You must teach the oxen
 to walk steadily in a straight line.

At the beginning of training,
use the oxen only for **light work**,
such as cultivation and light transport.

Gradually make them do **more tiring work**.
After ten days,
harness the oxen to a plough (see page 42).

The oxen must walk in a straight line,
and pull steadily.
To begin with,
do a light ploughing (see Booklet No. 7, page 8).

At the end of each furrow,
let the animals rest for 1 or 2 minutes.

In this way the oxen
gradually become used to all kinds of work,
and the farmer
also becomes used to handling the tools.

In some places there are **animal training stations**
where the farmer can learn how to train his oxen.

Remember' that oxen should not do very tiring work
before they are 4 years old (see page 16).

The animals must do some work such as transport
even outside the main farming season;
they must not lose the habit of work.

HOW MANY HOURS A DAY CAN OXEN WORK?

When a man works, he gets tired.
When an ox works, it gets tired.

We know too that oxen need
plenty of time
to find their food
and digest it.

For tiring work like ploughing,
**oxen should not be worked
for more than 5 hours a day.**

For less tiring work,
like light transport,
oxen can be worked a little longer.

It is best to make the oxen work
when the sun is not too hot,
early in the morning.
When it is very hot,
the oxen get tired more quickly, and work less.

You must not work the oxen too long.
They will get too tired
and will fall sick.
The farmer must know his oxen well,
so that he can judge
what work they can do and remain well.

How to feed working oxen

A man who does not eat well
cannot work well.

An ox that does not eat well
cannot work well.

Working oxen must be well fed.

We know that cattle need
a lot of time to feed.

An ox that works
has less time to get its food
than animals that do not work.

So rich pastures near the village
must be kept for working oxen,
and grass or hay
must be taken to them in their shed.

You must store green fodder for the dry season,
by making silage or hay (see Booklet No. 8, page 28).

**You must also give working oxen
feed supplements.**

An ox that works 5 hours a day
must have, besides green fodder,
a feed supplement.

A well-fed ox
works well and does not get thin.

The oxen stay well,
can be used for a longer time,
and then sold for a good price.
You spend money to feed the oxen well,
but you earn more by their work
and by selling them.

**You are advised to give working oxen every day
2 feed units for light work,
and 3 feed units for heavy work
(see Booklet No. 8, page 13).**

**This feed supplement is provided by:
2.5 kilogrammes of rice bran mixed
with crushed maize, or
2.5 kilogrammes of rice bran mixed
with crushed sorghum, or
6 kilogrammes of groundnut stems and leaves, or
5 kilogrammes of good brush hay.**

**You must also give the oxen
a mineral supplement every day.**

**For example,
calcium carbonate mixed with
dicalcium phosphate.**

And do not forget a salt lick.

**Even when the animals are not working,
you must give them enough to eat.**

**If you do not do this,
when you need them for working,
they will be too weak,
they will take too long doing the work;
sowing will be late,
and the harvest will not be so good.**

**Without good feeding,
animal power is useless.**

Looking after working oxen

The cattle shed

Working oxen

must be able to rest.

To shelter them from the wind, sun and rain,
build a shed for them.

Use wood, millet straw,
other local materials.

The shed should not cost much.

Next to the shed,
make a paddock.

In the paddock put feeding racks or troughs
for the feed supplement
you give the oxen (see page 27).

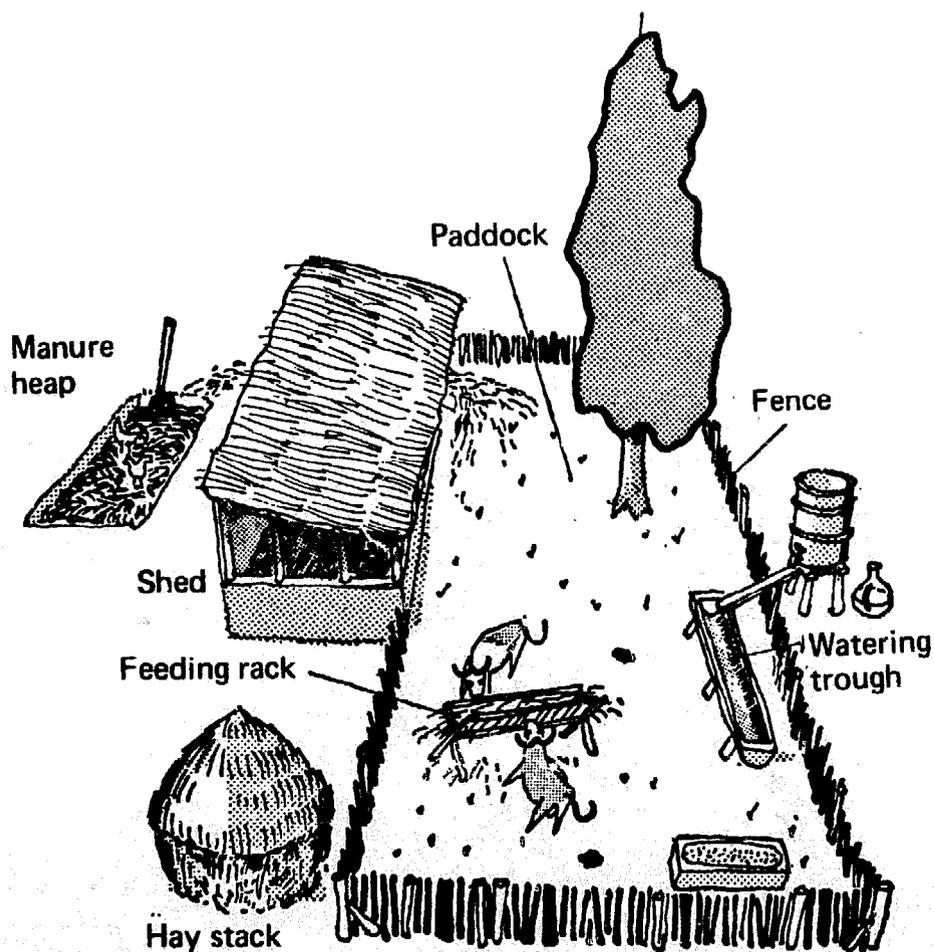

Watching over the health of working oxen

- Every week look to see if the oxen have ticks. Ticks prevent oxen from working well; the animals get restless, walk with difficulty, and lose their strength. You can kill ticks with paraffin or mineral oil. They can also be cut out.
- Look out for any injuries. If an ox is injured, find out why. Has it got a thorn in its foot? Has a piece of wood or iron torn its skin? To avoid hurting the oxen, the yoke must be well placed (see page 19); make sure that the cloth is in place.

When you have found what hurts the ox, take away the cause of the injury. Do not make the ox work. It is better to lose a few days' work than to lose an ox.

You must treat the wound.

Clean the wound with hot water. Add disinfectant to the water to prevent the wound getting infected, for example, soap, or potassium permanganate or cresol. Wash the wound often. A wound that is kept clean soon heals.

DONKEYS

A donkey is much like a horse.
It is smaller and not so strong.
It has a big head with big ears.
Its feet are slender but firm.
The leg ends in a single hoof.

The donkey is not as strong as the ox.
It is useful for light work
such as harrowing, hoeing and sowing.
Two donkeys harnessed side by side
can do ploughing in light soils.

The donkey is very useful for transport.
It walks easily over rough tracks.

A donkey costs much less than an ox.
It is seldom ill
and it is easy to feed and look after.

Choosing a donkey for farm work

Like oxen, a working donkey must:

- be in good health;
- have strong feet;
- have hard hoofs.

A donkey can be trained from the age of 18 months.

Feeding donkeys

Donkeys eat grass and herbage.
A donkey's stomach has only one gut;
it has no rumen.
Donkeys are not ruminants.

A donkey needs **several hours at pasture**
and some **hay** during the night.
When a donkey is working,
give a **feed supplement**
such as 1 kilogramme of crushed millet or sorghum
mixed with rice bran.

A donkey likes **very clean water** to drink.
But do not let it drink
at once after working
when it is hot and sweating.
If a donkey is used to carry water,
let it drink while at the spring.

Do not leave a donkey at large,
but keep it in a paddock (see Booklet No. 8, page 32),
or tie it with a long rope to a post
so that it cannot damage the crops.

Housing donkeys

Make a shelter for the donkeys
as you did for the oxen.

Build a wall

on the side where the wind blows most often.

The shelter will protect the donkeys from wind and rain.

Put **straw** on the floor.

The donkeys will rest better,
and there will be **manure** for the fields.

A donkey needs an area

3 metres long

by 1.75 metres wide.

For the donkey's feed supplement,
make a **feed trough**

from a hollowed tree trunk,
or from a barrel cut in half.

Fix the trough to the wall
so that the donkey cannot knock it over.

For the hay

make a **rack**

(a kind of ladder
made of bamboo).

Then the hay

will not get mixed
with the manure
and will always
be clean.

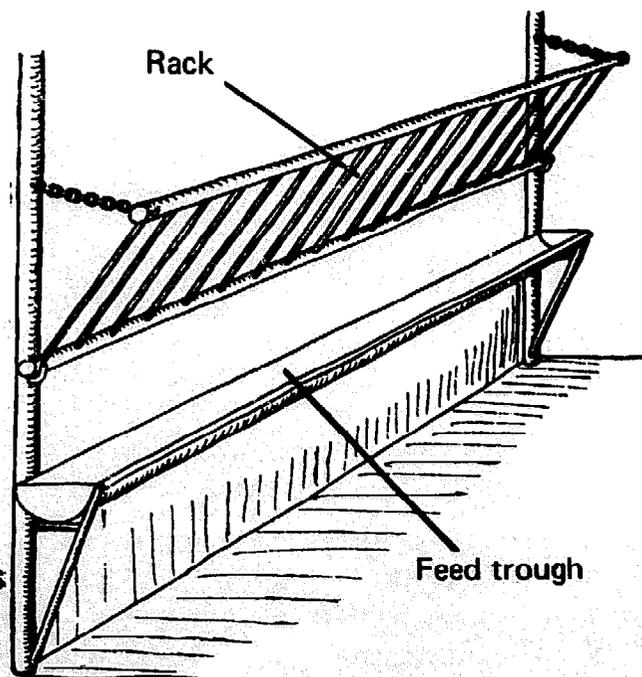

The shelter for donkeys
and horses
is called a **stable**.

Looking after donkeys

To prevent diseases,
brush the donkey's coat every day
with a sort of metal brush
called a **curry-comb**.

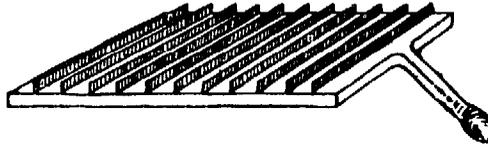

A **curry-comb**

Like that, your donkey will always be clean.

- **Pests: ticks**

Like oxen,
donkeys may have ticks.
Kill them with paraffin or mineral oil.
They can also be cut out.
Ticks may also be found on the ears.
Do not forget to deal with them.

- **Diseases**

Donkeys are resistant to diseases
except **sleeping sickness** (trypanosomiasis).
The animal husbandry services
have medicaments
for treating this illness,
and others
to prevent the animals falling ill.

There are no donkeys in forest regions
because of the sleeping sickness.

Donkeys at work

● Carrying loads

Put a **pack-saddle** on the donkey's back.

A pack-saddle is made of

- two pads placed on the donkey's back;
- a piece of leather or plaited rope called a **back-strap** which is fixed to the pads;
- thongs of leather or rope called **girths** which hold the pack saddle on the animal's back.

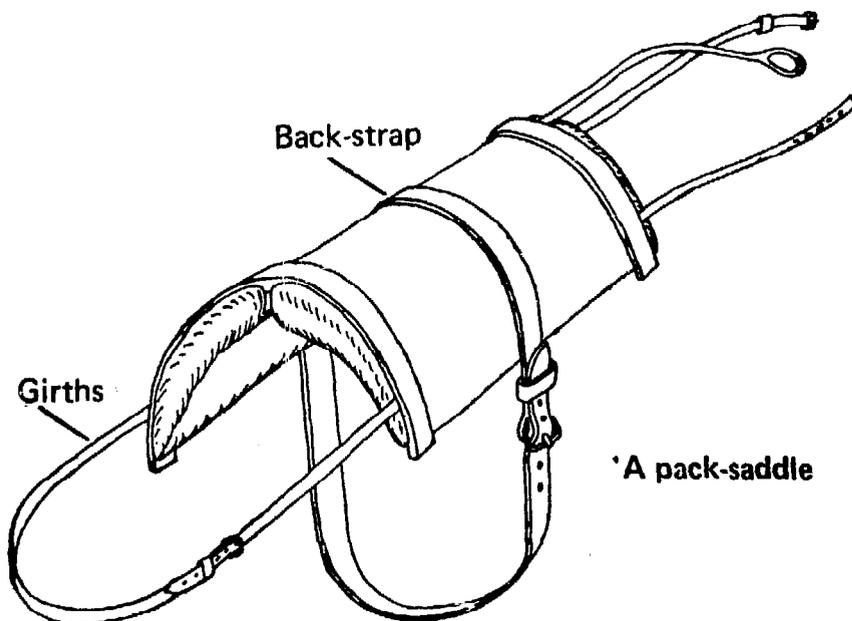

- Baskets are fixed on the pack-saddle.

You can easily make a pack-saddle yourself.

The pads are made with

old sacks stuffed with grass and sewn up.

The back-strap and the girths

can be made of leather or plaited rope.

The donkey must get used to carrying the pack-saddle.

At first put it on without a load,
then gradually increase the load.

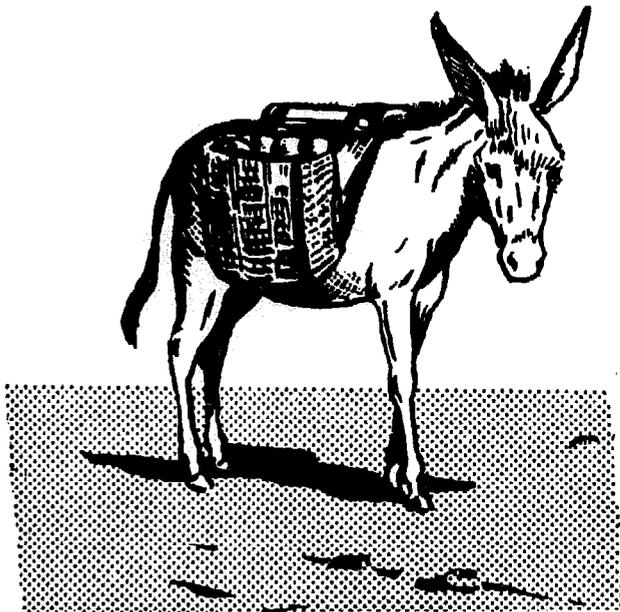

Donkey with pack-saddle

A donkey can carry
100 kilogrammes of goods
over long distances
and bad tracks.

A donkey can also pull a light cart.
Do not put a load of more than 300 kilogrammes
in the cart.

The pack-saddle is used
for carrying loads in places
where a cart cannot go.

● **Pulling carts or implements**

When a donkey is to pull a cart or an implement,
give it a **collar** (see page 37)
or a **breast-strap** (see page 38)
and fix a chain to each side of it.

A donkey is not as strong as an ox.
But it can easily pull a harrow,
a hoe or a seed drill.
Two donkeys can plough in light soil.

You can harness a donkey with a collar

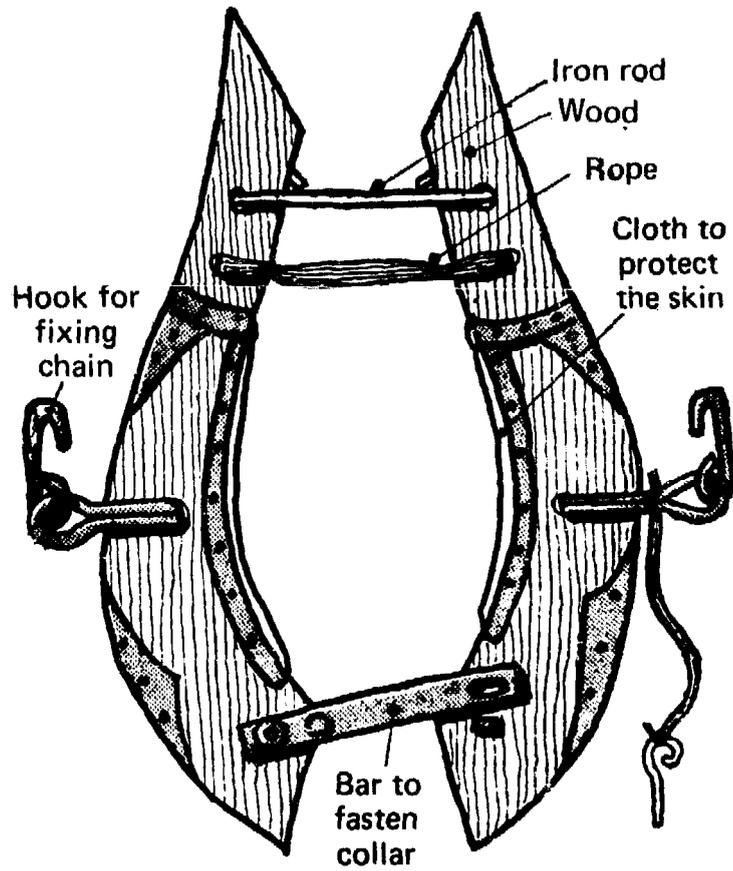

Donkey collar

It is difficult to make a good collar.

It must not hurt the donkey.

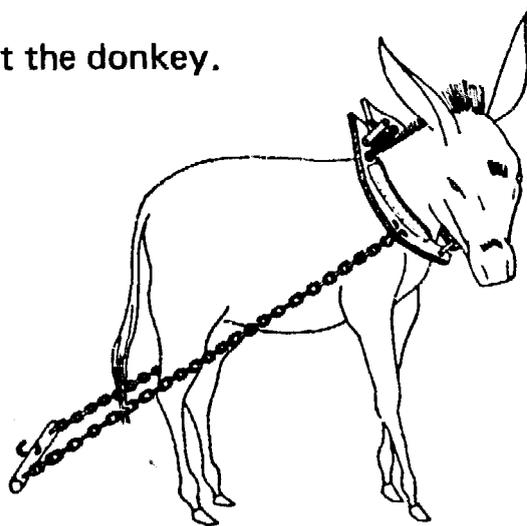

Donkey with collar

HORSES

In Africa, horses, saddled,
are chiefly used for carrying people.

But they can also be used for pulling farm implements.
For that the horse has a collar (see page 37)
or a breast-strap.

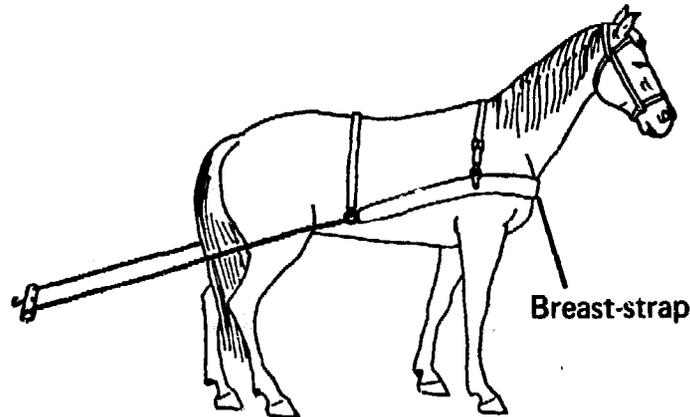

Horse with breast-strap

The horse is stronger than the donkey
but more difficult to train well.

- These words are useful to learn:
a male horse is called a **stallion**;
a female is called a **mare**;
a young horse is called a **colt** or **foal**.
- A horse needs the same care as a donkey.
- Like the donkey, the horse eats grass.
When it is working,
give it a feed supplement every day,
such as 2 to 4 kilogrammes of crushed millet or sorghum
mixed with rice bran, for light work,
and 4 kilogrammes of millet for heavy work.

MULES

Mules are the offspring
of a mare and a donkey.

Mules are strong
and resistant to diseases
except sleeping sickness.

They are very useful in hilly places,
on steep slopes,
because they walk very well
on difficult paths.

Mules often have a bad character,
but if they are trained without harshness,
with a lot of patience,
they are more obedient.

Mules need
the same care
and the same food
as donkeys.

In some places
you find animals called hinnies.
A hinny is the offspring
of a stallion and a she-donkey.

CAMELS

Camels are also called **dromedaries**.

Camels withstand heat well.

They are chiefly used for transport
with a pack-saddle (see page 35),
but they can also be given a breast-strap (see page 38)
or a collar (see page 37).

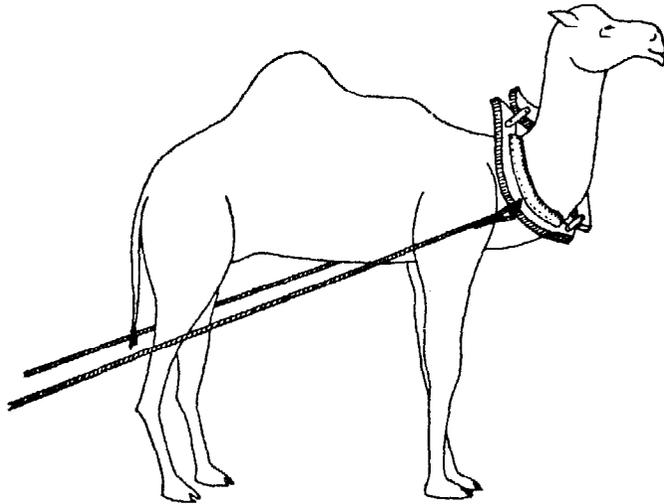

Camel with collar

Food

Camels eat **rough and coarse herbage**,
even when it is dry.

They need 6 to 7 hours a day at pasture.

When they are working in the day
they go to pasture at night.

But they need 3 or 4 hours rest during the day.

They need 15 litres of water a day.

But they can store up water,
and drink every 3 or 4 days
up to 80 litres of water.

TOOLS FOR USE WITH ANIMAL POWER

CHOICE OF TOOLS

In choosing tools look for those that are:

- **light,**
- **strong,**
- **simple,**
- **not too dear.**

**You do not have to buy
all your tools at once.**

**It is best to buy first
the tools that are most useful
and that enable you to
get your work done in good time.**

For example:

**If you have sandy soil
(see Booklet No. 4, page 17),
ploughing will not make big clods.**

**So it is useless to buy a harrow
(see Booklet No. 7, page 12).
A big branch will do the job.**

**There are many makers of tools,
many different brands.**

**You must buy tools of a brand
that is well known in your country,
for it is easier to get them mended.**

**Choose strong tools,
even if they cost a little more.**

They will last longer.

The plough

Handles for holding the plough

Usually simple ploughs are used.

A plough is made up of a **ploughshare**, a **mouldboard** and two **handles**.

A plough costs between 5 000 and 15 000 CFA francs

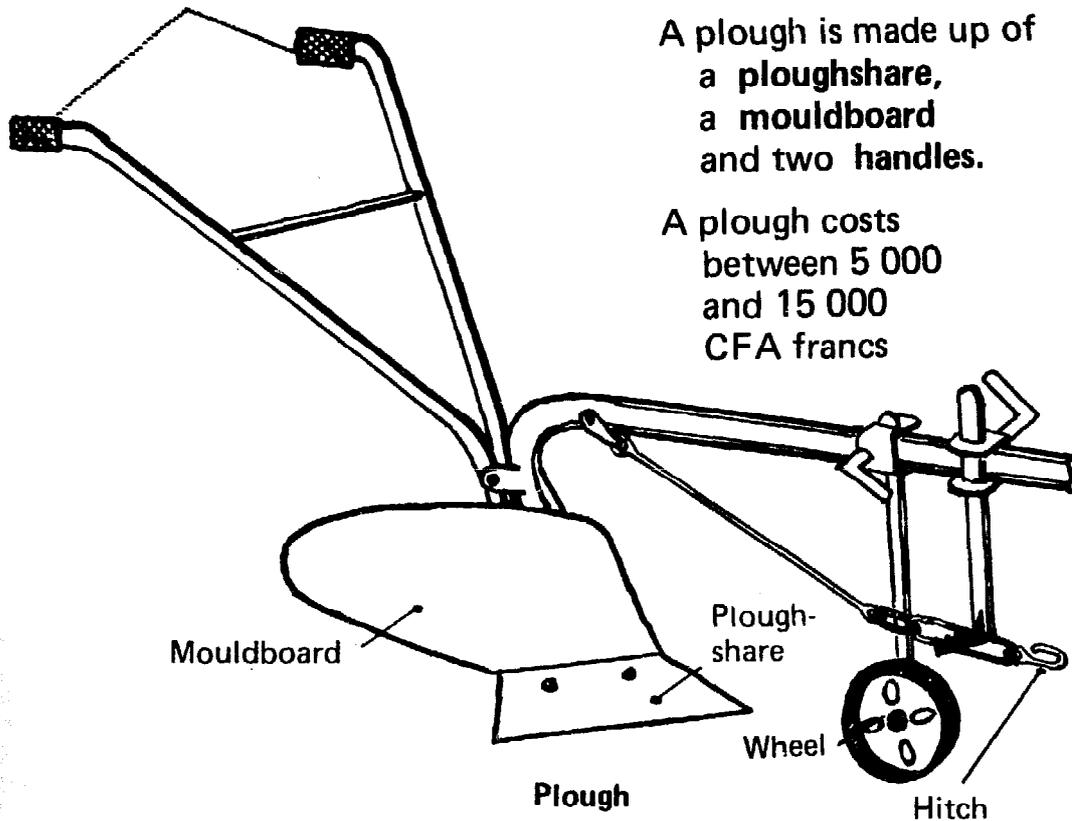

The harrow

The harrow is used for breaking clods.
A harrow costs between 2 000 and 5 000 francs.

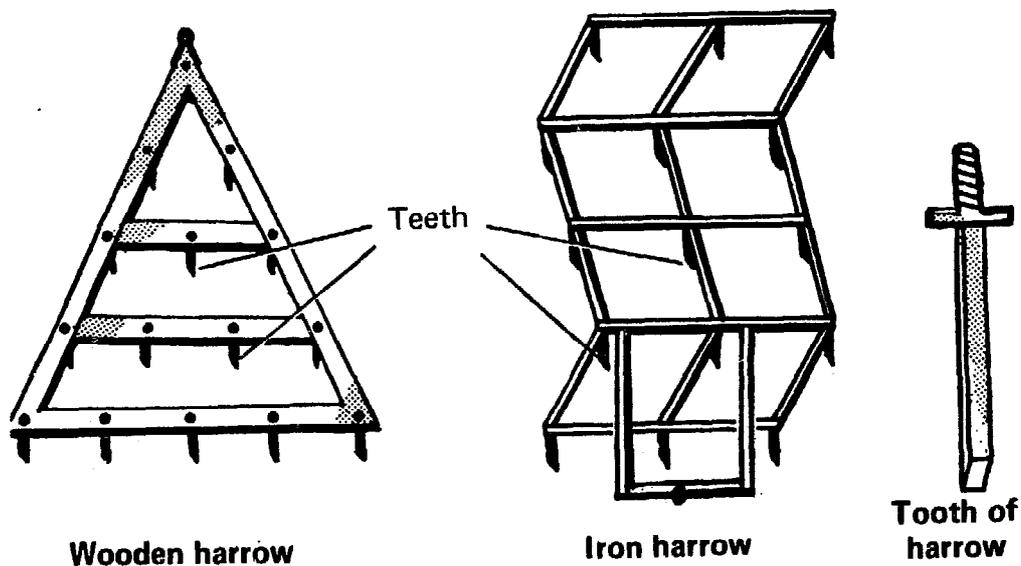

The Manga cultivator

This cultivator is used in Upper Volta.
It is drawn by donkeys or oxen.

It has five tines or teeth.

It is chiefly used for **preparing the soil**
before sowing.

In light, sandy soil
the Manga cultivator does the same job as a **plough**.

It is a very useful tool,
because, if you change certain parts,
it can do all sorts of work.

It is in fact a multi-purpose implement.

- if you fix a marking bar on the machine
it can **draw the seed rows**.
- if you fix hoeing tines
it does **intercultivations**.
- if you fix two ploughshares
it will **earth up** the crops.
- if you fix only one slanting ploughshare
it can be used as a **plough**.

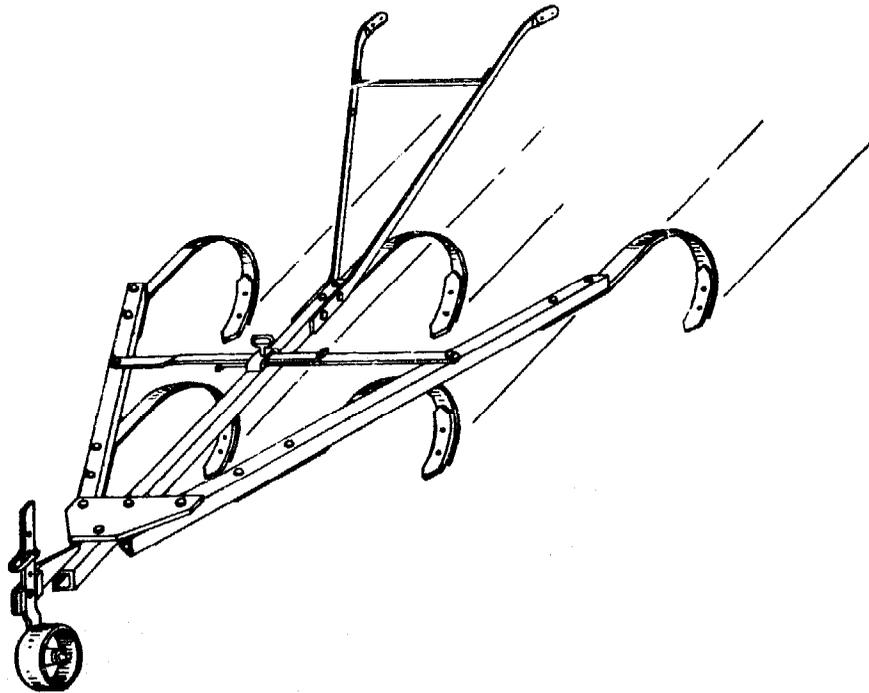

The Manga cultivator costs about 15 000 francs

The seed drill

The seed drill

is used for putting seeds in the earth.

To sow seeds of different sizes such as millet, sorghum, cotton or groundnuts, a part of the machine has to be changed.

There are different parts for each size of seed.

The seed drill is **difficult to regulate.**

You must follow the advice of the dealer who sells the drill, or of the extension service technician.

Oxen can pull

a seed drill that sows several rows at once.

A seed drill costs a lot:

between 9 000 and 15 000 CFA francs.

Several farmers can get together to buy a drill between them.

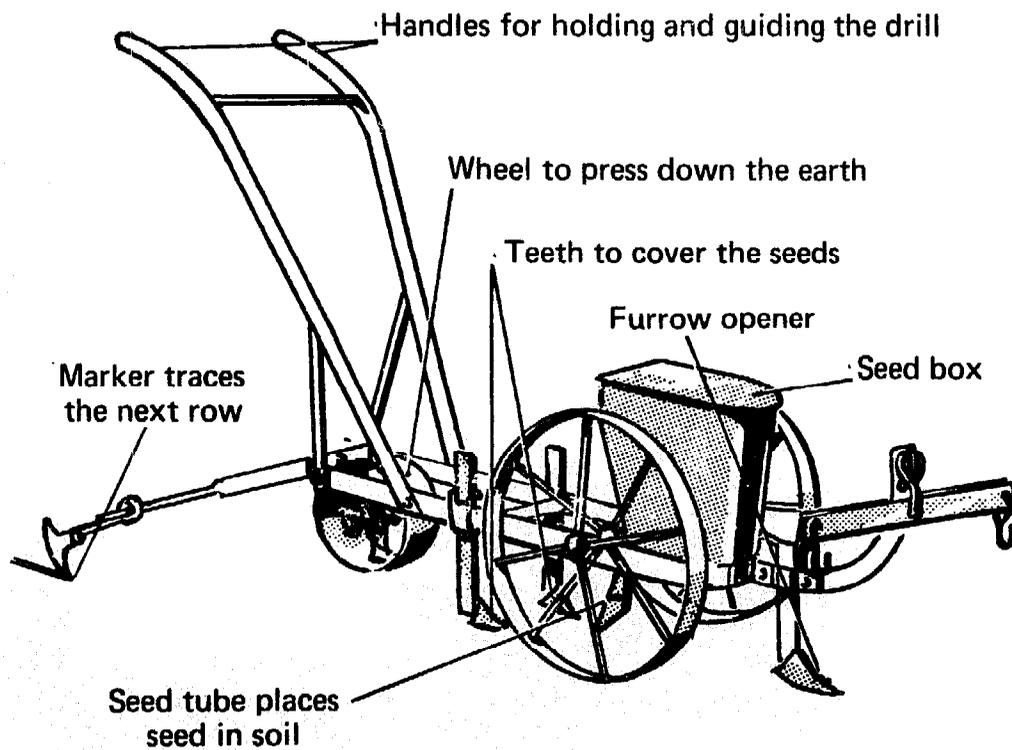

Seed drill

The cart

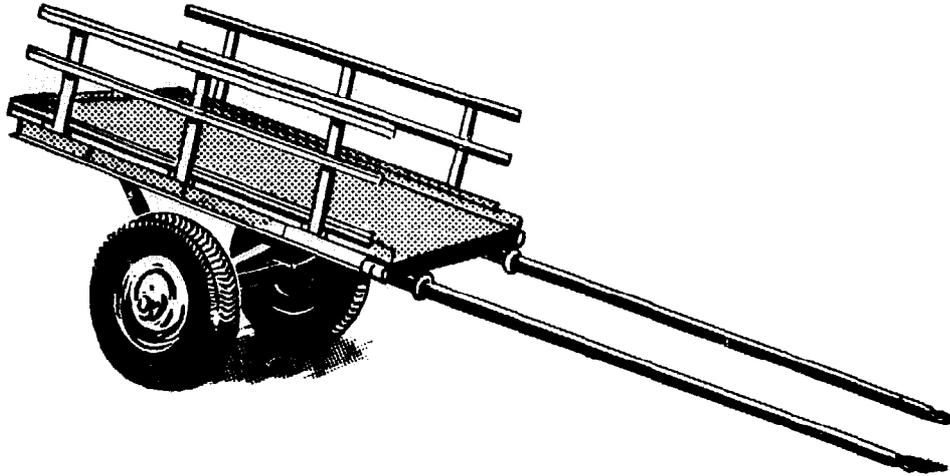

Cart

A cart costs between 25 000 and 30 000 CFA francs.

It is very useful for carrying
manure, harvests, wood, water.

You can also transport
things for other farmers.

Some kinds have iron wheels,
others have tires.

Oxen can pull a cart
loaded with 1 000 kilogrammes of goods.

OTHER TOOLS

- **Groundnut lifting plough**

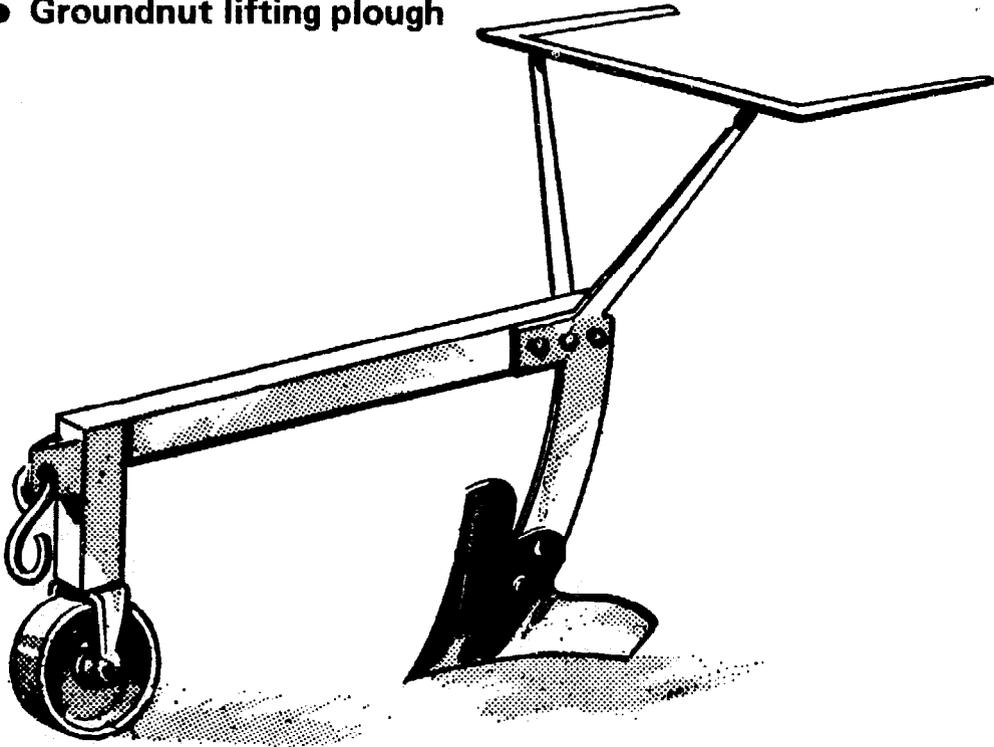

Lifting plough

- **Reaper**

It is used for cutting cereals,
for example, rice.

- **Fertilizer spreader**

A good farmer

takes care of his tools;
knows how to mend them;
protects them from rain.

INCOME FROM ANIMAL POWER

Farming with animal power is costly.
The farmer spends money
on buying his animals and tools,
on feeding and looking after the animals,
on mending the tools.

The animals get old,
the tools wear out.
After five or six years,
you have to buy new oxen
and new tools.

The farmer must know
how much money he spends
on farming with animal power.
He must know what it costs him.

The farmer also knows
how much money he makes from working by hand.
He knows
how much money he gets from working with animals.
**So he knows how much more money he gets
from the use of animal power.**

**The extra money earned with the animal power,
less the money spent on it,
is the income from animal power.**

WHAT ANIMAL POWER COSTS

To know what animal power costs,
you must know what you have to spend on:

- buying animals and tools;
- feeding the animals;
- the upkeep and repair of the tools.

Prices vary from country to country and from region to region.

The prices given here
do not apply to all of Africa.

They are only two examples.

● Buying animals and tools

Let us take two farmers,
Toumba and Gambarara.

Toumba and Gambarara each buy

a plough	8 000 francs
a pair of oxen	<u>32 000</u> francs

They each spend 40 000 francs (CFA)

Toumba buys a plough for 8 000 francs.

In 5 years the plough is worn out.

Toumba has to buy another one.

He needs money.

But he never thought of putting aside any money.

So he cannot buy a new plough.

Toumba cannot use his oxen any more.

He cannot farm with animal power.

Gambarara also buys a plough for 8 000 francs.

At the end of 5 years the plough is worn out.

But Gambarara has put some money aside every year.

So he can buy a new plough

and go on farming with animal power.

How much money must be put aside?

Putting money aside
to replace tools or oxen
is called **amortization**.

- **To replace a plough**

The plough costs 8 000 francs.

It lasts 5 years.

To get 8 000 francs in 5 years,
you must put aside each year

$$\frac{8\ 000}{5} = 1\ 600 \text{ francs.}$$

These 1 600 francs are the amortization of the plough.

- **To replace the oxen**

The oxen cost 32 000 francs.

After 6 years they are too old
and are sold for 20 000 francs.

In 6 years the oxen have lost in value

$$32\ 000 \text{ francs less } 20\ 000 \text{ francs} = 12\ 000 \text{ francs.}$$

In order to have enough money in 6 years' time
to buy new oxen

a farmer must put money aside every year
for the amortization of the oxen, that is:

$$\frac{12\ 000}{6} \text{ francs} = 2\ 000 \text{ francs.}$$

For the amortization of the plough and the oxen
the farmer must put aside every year

$$1\ 600 \text{ francs plus } 2\ 000 \text{ francs} = 3\ 600 \text{ francs.}$$

Amortization means putting aside every year
the money to replace your tools and oxen.

Interest

Gambara buys

a plough	8 000 francs
two oxen	<u>32 000</u> francs
Gambara spends	40 000 francs

But Gambara hasn't got 40 000 francs.
So he asks a friend or a bank to lend him the money.

His friend, or a bank that has 40 000 francs,
could use the money
to buy a shop and do business.

The 40 000 francs would bring in money.

**This is why the friend or the bank
that lends you money
asks you to pay back more.**

If the bank lends you 100 francs for one year,
and asks you to pay back 105 francs at the end of the year,
and say that the bank asks for
5 percent (5%) interest.

The extra 5 francs
are the price you must pay
for the loan of 100 francs for one year.

For a farmer who is lent 40 000 francs,
interest at 5% a year works out as follows:

$$\frac{40\,000 \text{ francs} \times 5}{100} = 2\,000 \text{ francs interest each year.}$$

**Interest is the money a farmer must pay
each year for the use of money lent to him**

Each year Gambara must put aside
in order to pay for his oxen and his plough:

Amortization	3 600 francs
Interest	<u>2 000 francs</u>
Total	5 600 francs

To replace his animals and his plough,
Gambara puts aside each year 5 600 francs

● **The animals' food**

Gambara gives a feed supplement
to his working oxen (see page 27).
Each animal gets 2 kilogrammes of sorghum
on days when it works.

Instead of giving the sorghum to the animals
Gambara could have sold the sorghum
at, say, 12 francs a kilogramme.

Gambara should know
how much money he could have got for this food.

Each working day
the food for the two oxen costs him:
4 kilogrammes X 12 francs = 48 francs.

The oxen work 100 days a year.
Their food costs him:
48 francs X 100 = 4 800 francs.

● **Upkeep and repair of tools**

Work wears out tools.
They must be mended,
the ploughshare must be replaced.
Gambara spends 500 francs a year
for mending tools.

● **Gambara reckons**

what animal power farming costs him:

amortization	3 600 francs
interest	2 000 francs
animals' food.	4 800 francs
upkeep of tools.	<u>500 francs</u>
Total	10 900 francs

● **Gambara reckons**

what animal power farming brings in:

Before he used animal power

Gambara earned:

for cotton	26 francs X 300 kg ..	7 800 francs
for food crops	20 francs X 100 kg ..	2 000 francs
for groundnuts	15 francs X 200 kg ..	<u>3 000 francs</u>
Total		12 800 francs

With animal power,

Gambara earns more money
because he gets bigger yields:

for cotton	26 francs X 800 kg ..	20 800 francs
for food crops	20 francs X 400 kg ..	8 000 francs
for groundnuts	20 francs X 600 kg ..	<u>12 000 francs</u>
Total		40 800 francs

By using animal power

Gambara has earned more, namely,
40 800 francs less 12 800 francs = 28 000 francs.

But Gambara has spent 10 800 francs
for the costs of animal power farming.

So the animal power has brought in,
has raised his income by
28 000 francs less 10 900 francs = 17 100 francs

**Before using animal power,
you must work out
how much more income you can earn by it.**

For animal power to bring in more money,
you must be able to farm 3 or 4 hectares of land
and have, in addition, 2 hectares of fallow land
to feed the oxen.

If the oxen work
less than 100 days,
they cost too much.
The amortization and the interest
to be paid per working day
are too costly.

Look at the example once more:

For amortization and interest
on his oxen and tools,
Gambara must pay 5 600 francs.

If the oxen work 100 days,
amortization and interest cost him:
$$\frac{5\ 600\ \text{francs}}{100} = 56\ \text{francs a day}$$

If the oxen work 50 days,
amortization and interest cost him:
$$\frac{5\ 600\ \text{francs}}{50} = 112\ \text{francs a day}$$

If a farmer has not got enough land
to keep his oxen working,
he can combine with other farmers,
so as to give the oxen more work.

MECHANIZED FARMING

**With a tractor,
the work is done more quickly.**

A tractor can work all day.
It does not get tired like oxen.

There is no delay in sowing.
You can farm bigger fields.
You can carry heavy loads.
You can clear land more easily.

But

**You need a lot of money
to buy a tractor.**

A tractor costs
between 700 000 francs and 1 000 000 francs.

You also need plenty of money
to buy the tools.

A plough to use with a tractor
costs much more
than a plough for oxen.
It is bigger and more complicated.

You also need plenty of money
to buy petrol (gasolene);
to buy lubricating oil;
to pay for repairs;
to pay insurance.

**You must know how to drive the tractor
and make good use of the tools.**

**You must know how to mend the tractor
if there is no garage in your village.
Repairs are costly.**

**To pay for all this,
you must farm a lot of land,
say 50 hectares.
You must grow crops
that bring in a lot of money.**

**In many places
the agricultural service has tractors.**

**Farmers can pay
to have these tractors work
in their fields.**

You can hire them.

SOME EXAMPLES OF ANIMAL POWER FARMING

At Korhogo (Ivory Coast)

animal power enables farmers
to farm fields 3 times as big,
and to harvest 3 times as much on the same area.
The harvest is 9 times as big.

At Darou (Senegal)

with animal power
fields twice as big were farmed,
and the farmers earned
twice as much.

At Banfora (Upper Volta)

with animal power
one man can farm more than 2 hectares
instead of 1 hectare.

At Ouaka (Central African Empire)

the production of cotton per family is:
157 kilogrammes without animal power,
473 kilogrammes with animal power.

SUGGESTED QUESTION PAPER

FILL IN THE MISSING WORDS

With animal power you can make use of the of animals.
You can farm fields.

You must in the fields
in order not to break your tools.

Animals that can be used are
or or

Oxen are strong enough to work at the age of

Oxen are harnessed with a

The left-hand ox must always remain on the

The right-hand ox must always remain on the

Oxen can work hours a day.

When oxen are working give them a supplement.

It is best to choose
that are light, strong, simple and not too dear. A good farmer takes
care of his tools.

He them and them from the rain.

With a work is done more quickly,
but it costs a lot of

ANSWER THE FOLLOWING QUESTIONS

At what age should oxen be harnessed?

How should tools be chosen?

What is a feed supplement?

Do you know an animal training station near where you live?

Where is it?

What sort of oxen should be chosen for work?

Two oxen bought in 1964 cost 30 000 francs. They are resold in 1970
for 18 000 francs. Calculate the annual amortization.

If you are going to use animal power, how should the fields be laid out?

FAO SALES AGENTS AND BOOKSELLERS

Antilles, Netherlands	Boekhandel St. Augustinus, Abraham de Veerstraat 12, Willemstad, Curaçao.
Argentina	Editorial Hemisferio Sur S.R.L., Librería Agropecuaria, Pasteur 743, Buenos Aires.
Australia	Hunter Publications, 58A Gipps Street, Collingwood, Vic. 3086; The Assistant Director, Sales and Distribution, Australian Government Publishing Service, P.O. Box 84, Canberra, A.C.T. 2600, and Australian Government Publications and Inquiry Centres in Canberra, Melbourne, Sydney, Perth, Adelaide and Hobart.
Austria	Gerold & Co., Buchhandlung und Verlag, Graben 31, 1011 Vienna.
Bangladesh	Agricultural Development Agencies in Bangladesh, P.O. Box 5045, Dacca 5.
Barbados	Cloister Bookstore Ltd., Hincks Street, Bridgetown.
Belgium	Service des publications de la FAO, M.J. De Lannoy, rue du Trône 112, 1050 Brussels. CCP 000-0808993-13.
Bolivia	Los Amigos del Libro, Perú 3712, Casilla 450, Cochabamba; Mercado 1315, La Paz; René Moreno 26, Santa Cruz; Junin esq. 6 de Octubre, Oruro.
Brazil	Livraria Mestre Jou, Rua Guaipá 518, São Paulo 10; Rua Senador Dantas 19-S205/206, Rio de Janeiro.
Brunei	MPH Distributors Sdn. Bhd., 71/77 Stamford Road, Singapore 6 (Singapore).
Canada	Renouf Publishing Co. Ltd., 2182 Catherine St. West, Montreal, Que. H3H 1M7.
Chile	Biblioteca, FAO Oficina Regional para América Latina, Av. Providencia 871, Casilla 10095, Santiago.
China	China National Publications Import Corporation, P.O. Box 88, Peking.
Colombia	Litexsa Colombiana Ltda., Calle 55, N° 16-44, Apartado Aéreo 51340, Bogotá.
Costa Rica	Librería, Imprenta y Litografía Lehmann S.A., Apartado 10011, San José.
Cuba	Instituto del Libro, Calle 19 y 10, N° 1002, Vedado.
Cyprus	MAM, P.O. Box 1722, Nicosia.
Denmark	Ejnar Munksgaard, Norregade 6, Copenhagen S.
Dominican Rep.	Fundación Dominicana de Desarrollo, Casa de las Gárgolas, Mercedes 4, Santo Domingo.
Ecuador	Su Librería Cia. Ltda., García Moreno 1172, Apartado 2556, Quito.
El Salvador	Librería Cultural Salvadoreña S.A., Avenida Morazán 113, Apartado Postal 2296, San Salvador.
Finland	Akateeminen Kirjakauppa, 1 Keskuskatu, Helsinki.
France	Editions A. Pedone, 13 rue Soufflot, 75005 Paris.
Germany, F.R.	Alexander Horn internationale Buchhandlung, Spiegelgasse 9, Postfach 3340, Wiesbaden.
Ghana	Fides Enterprises, P.O. Box 1628, Accra.
Greece	« Eleftheroudakis », 4 Nikis Street, Athens.
Guatemala	Distribuciones Culturales y Técnicas « Artemis », Quinta Avenida 12-11, Zona 1, Guatemala City.
Guyana	Guyana National Trading Corporation Ltd., 45-47 Water Street, Georgetown.
Haiti	Max Bouchereau, Librairie « A la Caravelle », B.P. 111B, Port-au-Prince.
Honduras	Editorial Nuevo Continente S. de R.L., Avenida Cervantes 1230-A, Apartado Postal 380, Tegucigalpa.
Hong Kong	Swindon Book Co., 13-15 Lock Road, Kowloon.
Iceland	Snaebjörn Jónsson and Co. h.f., Hafnarstraeti 9, P.O. Box 1131, Reykjavik.
India	Oxford Book and Stationery Co., Scindia House, New Delhi; 17 Park Street, Calcutta.
Indonesia	P.T. Gunung Agung, 6 Kwitang, Djakarta.
Iran	Iran Book Co. Ltd., 127 Nadershah Avenue, P.O. Box 14-1532, Tehran; Economist Tehran, 99 Sevom Esfand Avenue, Tehran (sub-agent).
Iraq	National House for Publishing, Distributing and Advertising, Rashid Street, Baghdad.
Ireland	The Controller, Stationery Office, Dublin.
Israel	Emanuel Brown, P.O. Box 4101, 35 Allenby Road and Nachlat Benyamin Street, Tel Aviv; 9 Shlomzion Hamalka Street, Jerusalem.
Italy	Distribution and Sales Section, Food and Agriculture Organization of the United Nations, Via delle Terme di Caracalla, 00100 Rome; Libreria Scientifica Dott. L. De Biasio « Aeiou », Via Meravigli 16, 20123 Milan; Libreria Commissionaria Sansoni « Licosa », Via Lamarmora 45, C.P. 552, 50121 Florence.
Jamaica	Teachers Book Centre Ltd., 96 Church Street, Kingston.
Japan	Maruzen Company Ltd., P.O. Box 5050, Tokyo Central 100-31.
Kenya	Text Book Centre Ltd., P.O. Box 47540, Nairobi.
Korea, Rep. of	The Eul-Yoo Publishing Co. Ltd., 5 2-Ka, Chong-ro, Seoul.

FAO SALES AGENTS AND BOOKSELLERS

Kuwait	Saeed & Samir Bookstore Co. Ltd., P.O. Box 5445, Kuwait.
Lebanon	Dar Al-Maaret Liban S.A.L., place Riad El-Solh, B.P. 2320, Beirut.
Luxembourg	Service des publications de la FAO, M.J. De Lannoy, rue du Trône 112, 1050 Brussels (Belgium).
Malaysia	MPH Distributors Sdn. Bhd., 9A Jalan 14/20, Section 14, Petaling, Jaya.
Mauritius	Nalanda Company Limited, 30 Bourbon Street, Port Louis.
Mexico	Dilitsa, Puebla 182-D, Apartado 24-448, Mexico City 7, D.F.
Morocco	Librairie « Aux Belles Images », 281 avenue Mohammed V, Rabat.
Netherlands	N.V. Martinus Nijhoff, Lange Voorhout 9, The Hague.
New Zealand	Government Printing Office: Government Bookshops at Rutland Street, P.O. Box 5344, Auckland; Mulgrave Street, Private Bag, Wellington; 130 Oxford Terrace, P.O. Box 1721, Christchurch; Princes Street, P.O. Box 1104, Dunedin; Alma Street, P.O. Box 857, Hamilton.
Nicaragua	Incusa-Culturama, Camino de Oriente, Apartado C105, Managua.
Nigeria	University Bookshop (Nigeria) Ltd., University of Ibadan, Ibadan.
Norway	Johan Grundt Tanum Bokhandel, Karl Johansgt. GT 41-43, Oslo 1.
Pakistan	Mirza Book Agency, 65 The Mall, Lahore 3.
Panama	Distribuidora Lewis S.A., Edificio Dorasol, Calle 25 y Avenida Balboa, Apartado 1634, Panama 1.
Peru	Libreria Distribuidora Santa Rosa, Jirón Apurimac 375, Lima.
Philippines	The Modern Book Company, 928 Rizal Avenue, Manila.
Poland	Ars Polona-Ruch, Krakowskie Przedmiescie 7, Warsaw.
Portugal	Livraria Bertrand, S.A.R.L., Apartado 37, Amadora; Livraria Portugal, Dias y Andrade Ltda., Apartado 2681, Rua do Carmo 70-74, Lisbon-2; Edições ITAU, Avda. República 46A c/v-E, Lisbon-1.
Romania	Ilexim, Calea Grivitei N° 64-66, B.P. 2001, Bucarest.
Saudi Arabia	University Bookshop, Airport Road, P.O. Box 394, Riyadh.
Senegal	Librairie Africa, 58 Av. Georges Pompidou, B.P. 1240, Dakar.
Singapore	MPH Distributors Sdn. Bhd., 71/77 Stamford Road, Singapore 6.
Somalia	« Samater's », P.O. Box 936, Mogadishu.
Spain	Mundi Prensa Libros S.A., Castelló 37, Madrid 1; Libreria Agricola, Fernando VI 2, Madrid 4.
Sri Lanka	M.D. Gunasena and Co. Ltd., 217 Norris Road, Colombo 11.
Switzerland	Librairie Payot S.A., Lausanne et Genève; Buchhandlung und Antiquariat, Heinimann & Co., Kirchgasse 17, 8001 Zurich.
Surinam	VACO nv in Surinam, P.O. Box 1841, Domineenstraat 26/32, Paramaribo.
Sweden	C.E. Fritzes Kungl. Hovbokhandel, Fredsgatan 2, 103 27 Stockholm 16.
Tanzania	Dar es Salaam Bookshop, P.O. Box 9030, Dar es Salaam.
Thailand	Suksapan Panit, Mansion 9, Rajadamnern Avenue, Bangkok.
Togo	Librairie du Bon Pasteur, B.P. 1164, Lomé.
Trinidad and Tobago	The Book Shop, 111 Frederik Street, Port of Spain.
Turkey	Güven Bookstores, Güven Bldg., P.O. Box 145, Müdafaâ Cad. 12/5, Kizilay-Ankara; Güven Ari Bookstores, Ankara Cad. No. 45, Cağaloglu-Istanbul; Güven Bookstore, S.S.K. Konak Tesisleri P-18, Konak-Izmir.
United Kingdom	Her Majesty's Stationery Office, 49 High Holborn, London WC1V 6HB (callers only); P.O. Box 569, London SE1 9NH (trade and London area mail orders); 13a Castle Street, Edinburgh EH2 3AR; 41 The Hayes, Cardiff CF1 1JW; 80 Chichester Street, Belfast BT1 4JY; Brazennose Street, Manchester M60 8AS; 258 Broad Street, Birmingham B1 2HE; Southey House, Wine Street, Bristol BS1 2BQ.
United States of America	UNIPUB, 345 Park Avenue South, New York, N.Y. 10010; mailing address: P.O. Box 433, Murray Hill Station, New York, N.Y. 10016.
Uruguay	Juan Angel Peri, Alzaibar-1328, Casilla de Correos 1755, Montevideo.
Venezuela	Blume Distribuidora S.A., Av. Rómulo Gallegos esq. 2a. Avenida, Centro Residencial « Los Almendros », Torre 3, Mezzanina, Ofc. 6, Urbanización Montecristo, Caracas.
Yugoslavia	Jugoslovenska Knjiga, Terazije 27/11, Belgrade; Cankarjeva Založba, P.O. Box 201-IV, Ljubljana; Prosveta Terazije 16, P.O. Box 555, 11001 Belgrade.
Other countries	Requests from countries where sales agents have not yet been appointed may be sent to: Distribution and Sales Section, Food and Agriculture Organization of the United Nations, Via delle Terme di Caracalla, 00100 Rome, Italy.