

AT MICROFICHE
REFERENCE
LIBRARY

A project of Volunteers in Asia

Basic Soil Improvement for Everyone

by: James M. Corven

Published by:

Volunteers in Technical Assistance
1815 North Lynn St., Suite 200
P.O. Box 12438
Arlington, VA 22209 USA

Available from:

Volunteers in Technical Assistance
1815 North Lynn St., Suite 200
P.O. Box 12438
Arlington, VA 22209 USA

Reproduced by permission of Volunteers in
Technical Assistance.

Reproduction of this microfiche document in any
form is subject to the same restrictions as those
of the original document.

**BASIC SOIL IMPROVEMENT
FOR EVERYONE**

by James M. Corven

illustrations by Linda Jacobs

published by

**Volunteers in Technical Assistance (VITA)
1815 North Lynn Street, Suite 200
Arlington Virginia 22209 USA**

March 1983

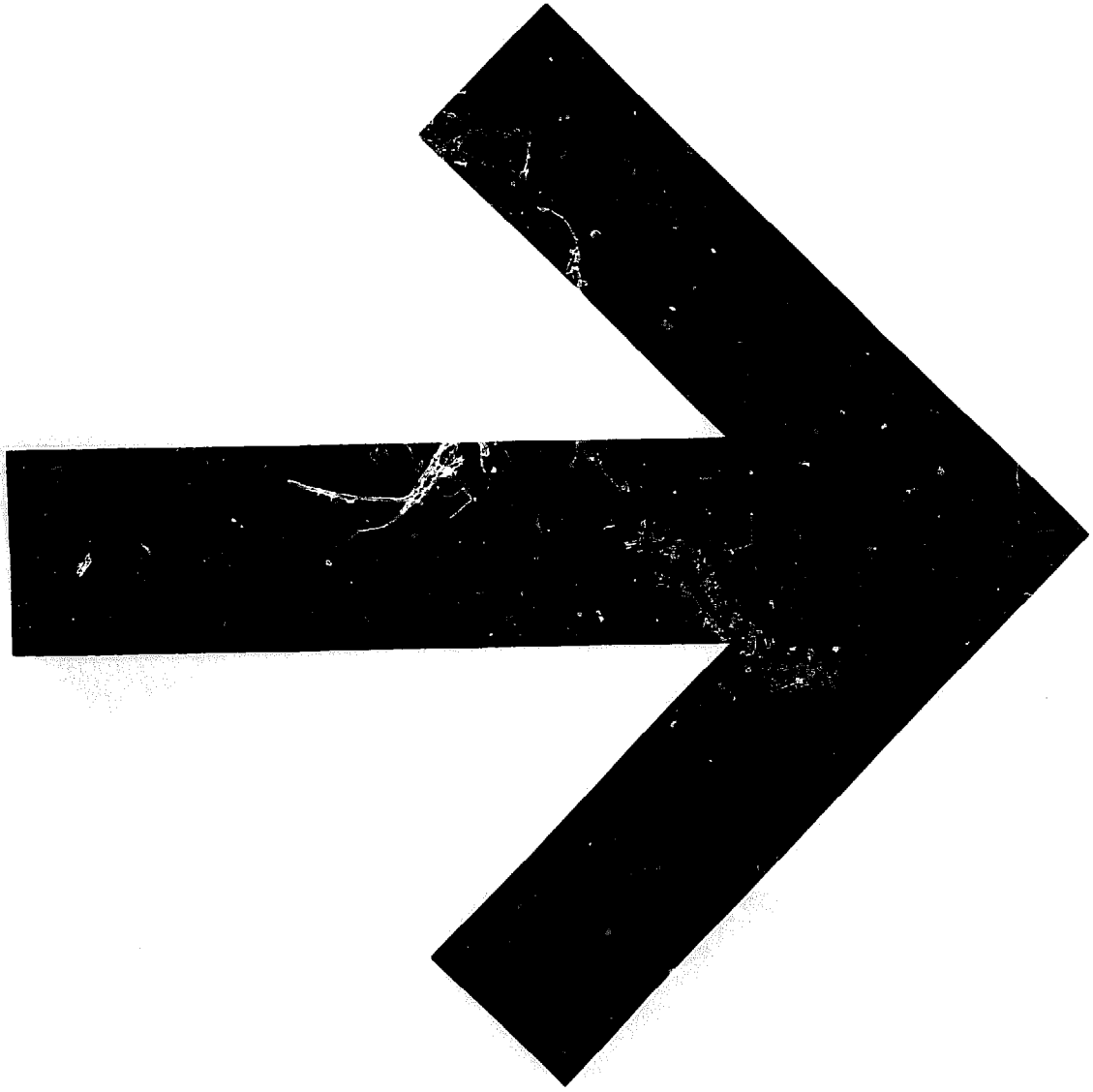

TABLE OF CONTENTS

FORWARD	i
INTRODUCTION	iii
I. WHAT IS SOIL?	1
II. TILLAGE	3
Introduction	3
U-Bar Tillage	3
Double-digging	4
Plowing--chisel plow	6
Low-till Cropping	8
III. COMPOST	10
Compost is Easy to Prepare	11
Preparing Compost	12
Speed Composting	16
Simple Speed Composting Formula	17
IV. MULCH	18
Advantages/Disadvantages	18
Sheet Mulching	19
V. FERTILIZING	20
VI. MORE NITROGEN	22
VII. SUMMARY	23
VIII. FURTHER READING	24
IX. APPENDICES	25
Composting Considerations	
Save Your Soil	
Carbon/Nitrogen Ratios and Nitrogen Content	
of Compost Materials	
Legumes for Green Manuring	
Functions of Various Nutrients	

FORWARD

All people--despite artistic pretensions, civilization, and many technologies--owe their existence to a six-inch layer of topsoil and the fact that it rains.

As topsoils are destroyed at record rates, especially in the tropics, many people are learning how to produce necessary food crops using methods based on the basic principles of nature. By working with the natural forces of our Earth rather than trying to force ourselves against these energies we find our efforts are smoother, easier, and more productive.

The forces of nature are powerful and can work with us or against us depending upon what we are doing. By coordinating our work with the biological and physical energies of the Earth (which will continue in nature despite our intentions) we can enlist the strongest allies we can possibly find. By resisting or ignoring these realities we oppose the very forces that sustain our living Earth.

Everyone has the choice and can adopt the direction of his own preference. This booklet was prepared to assist, in a small way, those wishing to take advantage of the positive energies of nature and to benefit from them in their efforts to produce better food in a sustainable system.

INTRODUCTION

Tropical soils are often nutrient poor because of leaching by heavy rains. This results in deficient soils that produce low food yields. Repeated plantings of similar crops without replacing the soil nutrients (plant foods) can rapidly exhaust the soil of its ability to support a bountiful, pest resistant, nutritious crop. The farmer is forced to move to new fertile areas over and over again.

This problem can be avoided with the use of a few basic practices. The methods described in this guide, when properly adapted to local conditions, can contribute greatly to the improvement of agricultural soils. Improved soil fertility means increased harvests and more food.

If you feel your land is not producing as much as it should and you want to improve the fruits of your hard labor, you are invited to try a few of the ideas offered on the following pages. If you are having problems with poor plant growth, decreasing harvests, and insects spoiling your crops, you should be pleased with your new results.

"When we see land as a community to which we belong, we may begin to use it with love and respect. There is no other way for land to survive the impact of mechanized man."

- Aldo Leopold, A Sand County Almanac

I. WHAT IS SOIL?

Soil is the loose, outermost layer of the Earth in which plants grow. Soil is a very interesting mixture of materials. Good fertile soil made up of organic matter and minerals takes nature years to build. Healthy soil produces good yields because of these contents plus the tiny plants and animals growing underground. Like a busy city, the bacteria, fungi, and most important, the earthworms, maintain the biological vigor of your soil.

Land rich in natural minerals and organic matter produces high yields of nutritious food. Poor land, lacking minerals or organics, cannot yield good crops.

Good farming methods maintain the soil's fertility and result in high harvests year after year. Poor methods exhaust the soil's wealth, encourage loss of soil through erosion, and make successful farming impossible.

ORGANIC MATTER

This portion of your soil is the result of accumulation and natural decay of plants (leaves and stems) and animal manures. You can add good organic matter to your land simply by returning all parts of your crops that you do not eat or feed to your animals. Loss of organics occurs by erosion, burning of brush, and improper tillage.

We do know that:

- Organic matter contains the elements needed for plant nutrition; this is measurable in soil tests.
- Organic matter absorbs and releases minerals needed by plants at about the rate at which plants require them. Organic matter also contains and slowly releases into the soil potassium, phosphorus, and nitrogen as it is decomposed.
- Organic matter is important for the ability of sandy soils in the dry tropics to nourish plants.

The ecologically oriented approach to agriculture employs various methods for recycling or maintaining organic matter. The following chapters discuss these methods.

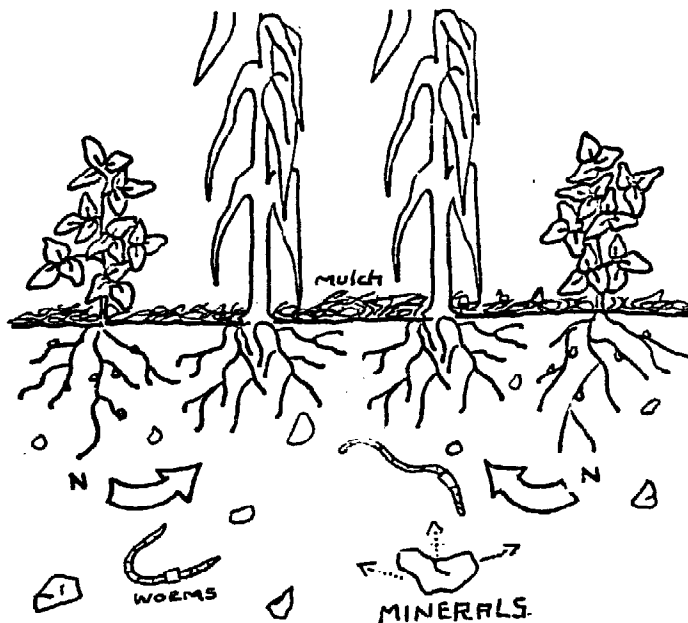

An Agricultural Ecosystem

MINERALS

The major nutrients required by your plants are actually minerals. The sources of minerals include the rocks and stones, manures, and the organic materials added to the soil.

Minerals present in the soil are made usable to your plants by living micro-organisms. The soil bacteria, for example, feed on the manure and plant residues and convert many minerals into the form required by your plants.

You can think of it like this: the soil is the stomach of your plants. Feed the soil properly and your plants will grow and flourish. Starve the soil and the plants will suffer.

For an account of the specific minerals important to good agricultural production see Appendix V.

II. TILLAGE

INTRODUCTION

Tillage refers to the mechanical work done to soil such as plowing, discing, and cultivating. All of these practices produce benefits, including loosening of hard soil, aeration, and weed control. Improper tillage can also disrupt important soil structure, increase erosion, and promote nutrient losses. It is often very expensive and requires hard work to till your land.

By using a combination of methods carefully adapted to your local conditions you can eliminate all but a minimal amount of tilling. Minimal tillage methods reduce work, increase soil fertility, control weeds, and conserve water.

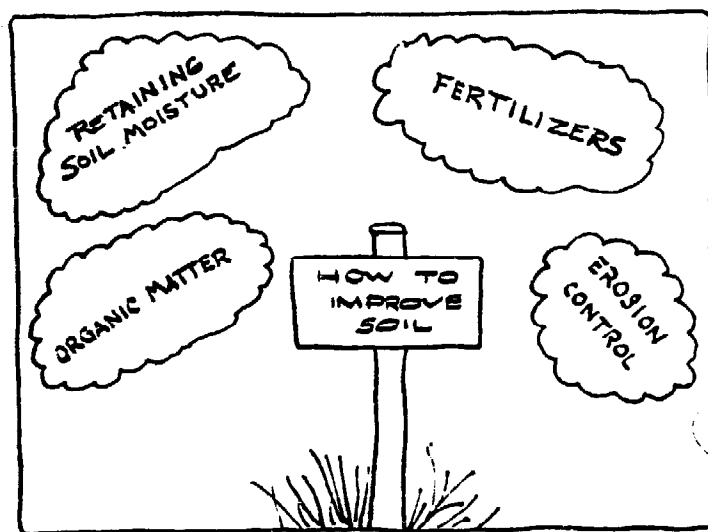

U-BAR TILLAGE

This simple implement can loosen soil in preparation of medium to small sized plots with much less work than a shovel or plow.

- Advantages:

1. Easy to build; sturdy implement.
2. Reduces manual labor. No soil lifting.

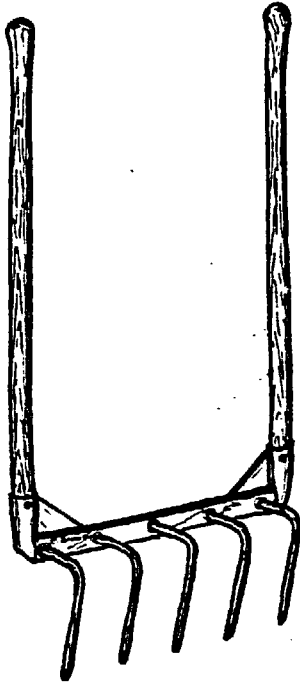

3. Does not promote soil erosion.
4. Improves soil aeration and tilth.
5. Will not cause rapid soil drying.
6. Design can be varied according to soil and use. Using the standard design you can change the handle height, number of spikes, length of spikes, and width of the bar to fit your needs.

● Disadvantages:

1. Not available commercially--usually homemade.

The wide-row or "bed" created by u-bar tillage has many advantages over simple rows. The area actually planted is a much greater portion of the land, soil compaction is avoided, weed growth is reduced, and drainage is improved.

This is an easily made tool that can allow expanded manual tillage while actually reducing your work in soil preparation.

DOUBLE-DIGGING

● Advantages:

1. Beneficial with a variety of soils.
2. Produces high yields in small areas.
3. Improves drainage and water runoff during heavy rains.
4. Loosens soil; reduces compaction.
5. Increases water retention during dry periods.
6. Done with simple tools; low cost.
7. Healthy plants are more resistant to insects.

● Disadvantages:

1. Very hard work the first time.
2. One person can prepare only a small area.

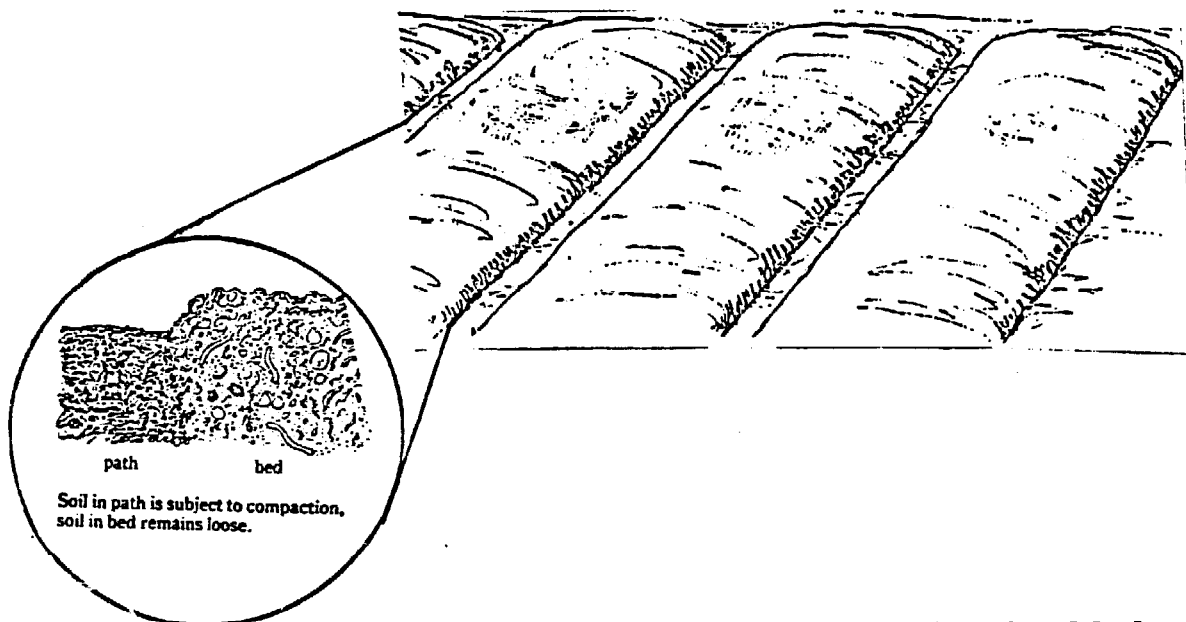

Your prepared beds should look like this. Place seeds at proper spacing, but fill the whole bed.

Double-digging simply means digging deeper into the soil and creating elevated planting "beds." These beds become your permanent growing area with narrow paths between.

Make the beds a convenient width so you can reach at least to the middle for planting, weeding, and harvesting. One meter is a typical width.

You never need to step on the beds so the soil remains loose and requires little tillage each season. Beds, like rows, should run across any slope to slow water runoff and reduce erosion.

PLOWING--CHISEL PLOW

- Advantages:

1. Loosens hard soil, promotes aeration.
2. Improves water drainage.
3. Reduces soil erosion by wind and water.
4. Conserves soil moisture in arid regions.
5. Mixes soil, increases mineral availability.
6. Appropriate for large area of cultivation.

- Disadvantages:

1. Requires a tractor or draft animals.
2. Consumes expensive fuel for operation.

THE CHISEL PLOW

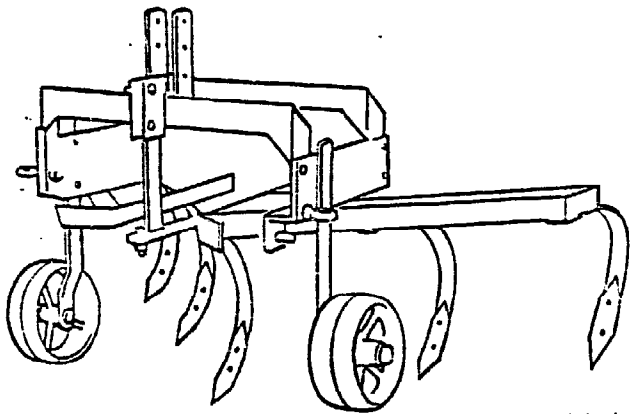

A chisel plow with depth wheels

DIAGRAM SHOWING RELATIVE DEPTH OF FLOW

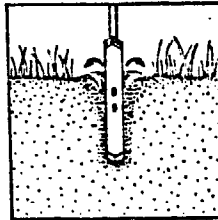

CHISEL POINT

NOTE: ARROWS INDICATE SOIL DISTRIBUTION

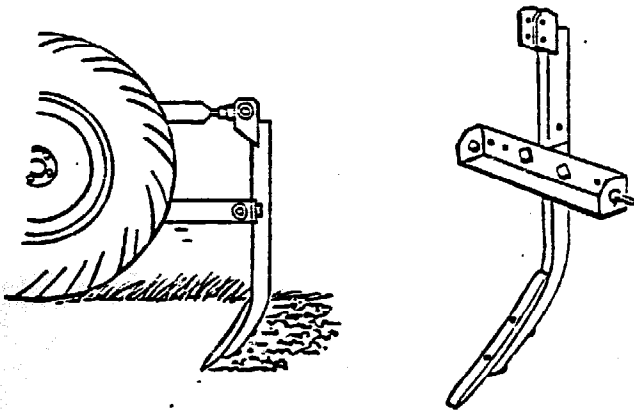

Chisel plow bit

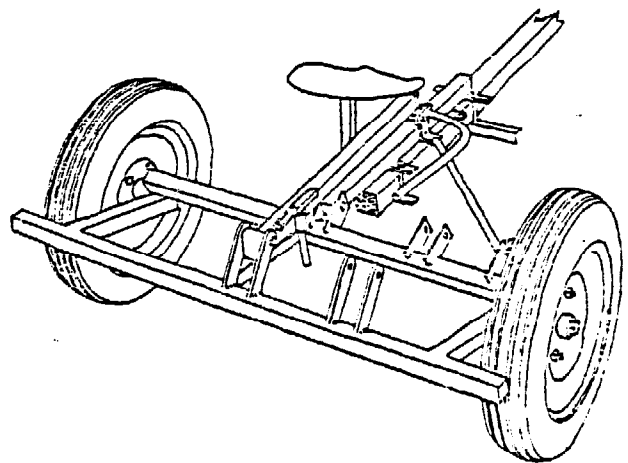

Toolbar for chisel plow

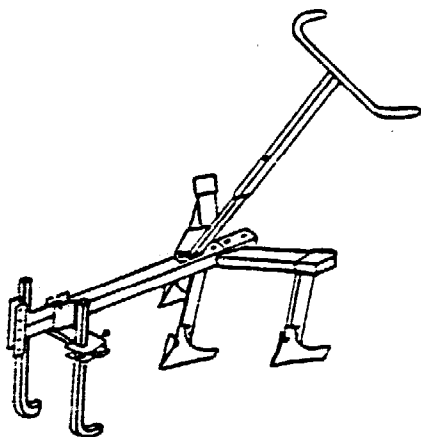

UNIBAR

This is a lightweight, multi-purpose animal-drawn implement designed for use in the more arid areas of the tropics. It is made from square-section bar and square-section hollow tube and is fitted with two skids for support. The tool can be used for ploughing, ridging, ridge splitting, weeding, hoeing, rigid and spring tine cultivating.

LOW-TILL CROPPING

- Advantages:

1. No need for heavy agricultural equipment.
2. Long-term soil improvement and increase in fertility.
3. Reduced weed problems.
4. Minimal fuel costs, if any.
5. Uses simple low-cost tools.
6. Reduces erosion.
7. Excellent conservation of water.
8. Lower soil temperatures for better plant growth.
9. Allows for a permanent ground cover of legumes.

- Disadvantages:

1. Requires large quantities of mulch material (see Mulch)
2. Not usable on hard, compacted soils.

If your land is already hard, the chisel plow is recommended for loosening. Remember that in many cases the cause of hard soil is the repeated use of heavy equipment (tractors, harvesters, etc.) and the lack of organic materials. (Moldboard plowing, for example, actually worsens the compaction, encourages weeds, and increases erosion.) The long-term solution is to minimize mechanical tillage and to increase the soil humus.

The Beginning

1. Clear land, chop weeds; lay on ground.
2. Plow or loosen soil if compacted.
3. Cover area with mulch.
4. Spread manure.

Note: Adjust this cycle to your local planting calendar.

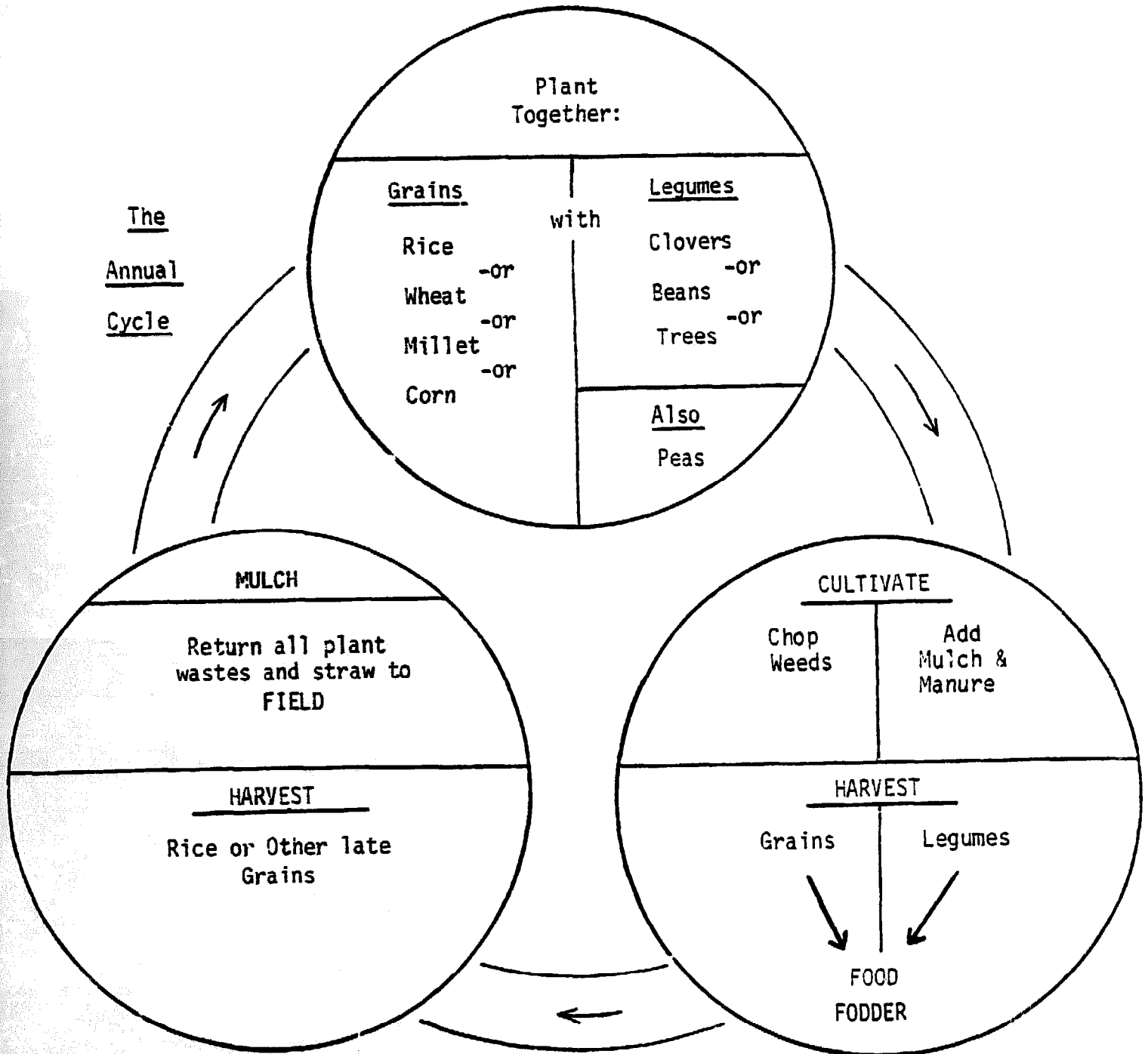

III. COMPOST

WHAT IS COMPOST?

Compost is the material produced by the decay of organic matter. Composting uses Nature's processes to recycle soil nutrients and improve soil structure. The decay of organic wastes produces a rich material that will improve the growth of any crop.

WHY USE COMPOST?

- To loosen and improve hard, compacted soil.
- To increase water holding in the soil.
- To fertilize: compost adds a balanced fertilizer using normally wasted materials.

WHAT CAN BE COMPOSTED?

Anything that will rot works. Choose your materials according to what is available to you. Here's a list of good things to include:

- * Animal manure--all kinds: chicken, cattle, horse, pig, etc. (Not human)
- * Garden trash--weeds, stalks, leaves, pods, etc.
- * Rice husks
- * Coconut trash
- * Sugarcane waste
- * Leaves
- * Water hyacinth
- * Corn stalks and husks
- * Bean plants
- * Kitchen wastes
- * Spoiled food
- * Sawdust
- * Banana skins and leaves
- * Crushed animal bones
- * Seaweed

Remember animal waste products such as meat and fish scraps are good too, but may attract hungry dogs and flies to your pile.

For a detailed chart and explanation of carbon/nitrogen ratios refer to Appendix III.

COMPOST IS EASY TO PREPARE

To get good yields from your crops, the soil should have sufficient plant foods.

Chemical fertilizers supply these plant foods. But farmyard manure or compost or any other organic manure added to the soil will not only supply plant foods but also add organic matter, which is also needed by the soil.

Organic fertilizers have one more advantage. You can prepare them yourself easily and cheaply from animal manure and farm wastes.

The most common compost among these is from farmyard manure. It is made from dung, urine, and litter. But many farmers do not take enough care in preparing this manure. They keep the manure in heaps, exposed to the sun and the rain; they do not conserve the cattle urine at all. As a result, much of the plant food in the manure is lost.

Also, farmers may not have sufficient farmyard manure for applying to all their fields. But they have a large quantity of farm wastes available. This they can convert into fertilizer by composting.

Good compost can also be prepared from farm wastes such as crop stubbles, sugarcane trash, banana skins and stumps, weeds, and vegetable wastes. This material can be composted in pits or heaps.



PREPARING COMPOST

First, chop or crunch under a roller all hard materials like sugarcane stubbles, dry stalks, etc.

Split up and cut all the soft but bigger-sized materials like banana stumps.

Dig a pit approximately 1.5m x 1.5m x .5m deep. Heap all the available refuse round the pit.

To make the material decompose easily, you should use a "starter." The starter can be dung or urine. If these are not available, well-decomposed manure, tank silt, or surface scraping from forests can be used.

To make a good compost, you also need some ash and dry earth.

First, put the refuse in the pit in a layer about a foot high. Sprinkle 16 gallons (four or five buckets) of water and a thick paste made with 60 pounds (two buckets) of dung in 16 gallons of water. Spread half a basket of ash and one basket of the starter on the layer.

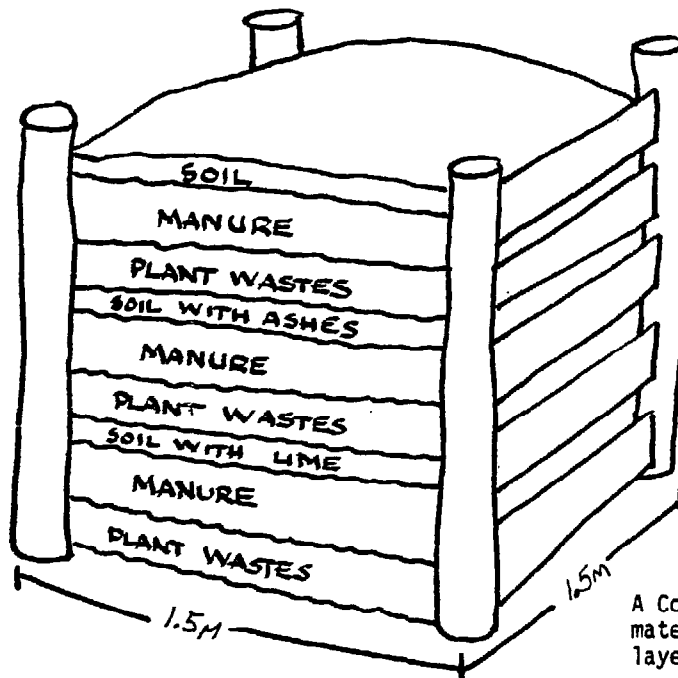

A Compost Pile. Organic materials are added in layers and kept moist.

Put the second layer of trash over this.

Five such layers will bring the heap two feet above the ground level. Cover this with a three-inch layer of soil on the top.

See to it that you fill the pit completely in a day or two.

The manure will be ready for use in six to eight months.

Compost prepared this way is twice as rich in plant foods as farmyard manure.

The farm wastes can also be composted above ground.



COMPOST FROM SUGARCANE TRASH

A very good compost can be made from sugarcane trash.

First, dig a pit 15 feet long, eight feet broad and two feet deep. The pit should be as near an irrigation channel as possible. This will maintain sufficient moisture in the pit for decomposition.

Spread a foot-high layer of sugarcane trash in the pit.

Sprinkle a dung-and-water mixture over this layer.

Make up similar layers, until the material rises three feet above the ground.

Cover this with a layer of earth.

COMPOST FROM FOREST LEAVES

Spread a layer of forest leaves in the pit. Sprinkle sufficient water.

Spread a layer of earth on this.

Fill until the material rises two feet above the ground level.

Use around your crops when the leaves are crumbly and decayed.



COMPOST FROM PADDY HUSK

To prepare a powdery manure from paddy husk, spread a ten-inch layer of husk in the cattle-shed. Over this, spread a nine-inch layer of paddy straw or other litter.

The top layer should be renewed from time to time, but the layer of husk should be allowed to remain in the shed for six weeks.

After six weeks, remove the paddy husk and compost it in a pit.

It turns into an excellent manure in about nine months.

COMPOST FROM WATER HYACINTH

Water hyacinth compost is best prepared in pits or in overground heaps.

In areas with a low rainfall, water hyacinth should be composted in pits. In wet areas, however, it should be composted in overground heaps.

Dig a pit of any convenient size, depending on the quantity of the weed available.

- * Collect the weed from the water.
- * Spread it loosely in a layer about a foot deep in the pit, or on the ground. Do not trample upon the weed while making the heap.
- * On this spread a "starter," such as cowdung, canal mud, urine-soaked earth or prepared compost, one to two inches thick.
- * Pile up water hyacinth and the starter in alternate layers until the heap rises to a convenient height, of say, six feet.
- * Give the top a conical shape, and plaster it with mud and cowdung.



You can prepare three to four or more such heaps at a time.

After about a month, the heap will shrink down to half of its height. Give the heap a complete turning. If you have more than one heap, turn all the heaps and mix two or three heaps together to make one. Give the top of the heap a conical shape again and plaster with mud.

Give another turning to the heap after about a month.

The compost will be ready after about three to four months, depending on the season.

For every 100 kilograms of fresh water hyacinth you will get about ten kilograms of mature compost.

Compost prepared this way from water hyacinth is four times as rich as farmyard manure.

One ton of such compost having 30 percent moisture will give about:

- * 32 pounds of nitrogen, which is as good as 160 pounds of ammonium sulphate,
- * 17 pounds of phosphoric acid, which is as good as 106 pounds of super-phosphate, and
- * 39 pounds of potash, which is as good as 78 pounds of muriate of potash.

A ton of water hyacinth compost will be worth about 5 US dollars of fertilizers.

SPEED COMPOSTING

Speed composting, developed at the University of California-Berkeley, requires that all materials either be chopped into small particles (large kitchen scraps, weeds, straw) or already come in small sizes (grass, leaves), and that the slower decaying materials such as wood, twigs, eggshells and bones not be used.

The volume of the compost pile should be no less than one cubic meter, to allow the generation and retention of heat. Ingredients must be layered by categories (dry, green and manure) so that the pile builder can estimate the ratio of the different materials (see below). Essential to the speed composting method are:

- * frequent turning,
- * proper moisture levels,
- * sufficient amounts of nitrogen to promote decomposition.

A "formula" for composting this way follows.

When you are ready to build your compost pile, keep in mind the diversity of composting methods. You probably will want to devise a somewhat different formula based on your own situation.

SIMPLE SPEED COMPOSTING FORMULA

1. Loosen the soil in the area where the pile is to be built.
2. Build a bin no smaller than 3m x 3m x 3m.
3. Layer compost ingredients as follows:
Bottom layer--approximately 6" of absorbent material (straw or sawdust).
4" of green garden and kitchen wastes.
2" of manure, possible mixed with soil.
3" to 6" dry roughage (dry grass, leaves, or sawdust).
4. Repeat this layering until the bin is full, sprinkling the layers with water as you go.
5. Every second or third day, turn the pile with a pitchfork (see diagram below): turn the outer layers inward, mixing thoroughly from top to bottom. Turning the pile every day speeds up the decomposition process.
6. Keep pile moist but not water-logged.
7. Compost should be ready to spread on your garden in about one month.

IV. MULCH

Mulching is an excellent way to improve your soil and increase yields. By imitating what nature does, mulching simply means that we cover the land with layers of organic materials to reap the benefits of richer soil.

- Advantages:

1. Increases soil organic content.
2. Reduces soil erosion.
3. Inhibits weeds.
4. Conserves moisture in the soil.
5. Keeps soil cool during hot seasons.
6. Reduces labor and expenses.

- Disadvantages:

In cool climates it may slow warming of the soil by the sunshine in the spring.

What do you use for mulch? Try anything you have available, for example:

- | | |
|----------------|--------------------------|
| * Compost | * Rice hulls |
| * Crop wastes | * Sugarcane wastes |
| * Leaves | * Peanut shells |
| * Sawdust | * Paper/cardboard sheets |
| * Straw or hay | * Grass clippings |

Remember: you never need to remove mulch materials. They will slowly decay into the soil just like good compost.



Sheet mulching is the most complete way to gain the benefits of mulch. You can change these directions some to fit your own resources.

1. Chop down all large weeds. Lay plants down on the soil.



C. SHEETS OF MATERIAL
B. MANURE OR COMPOST
A. PLANTED WEEDS

2. Apply layer of compost or manure. Cover with sheets of paper or large leaves.

3. Cover with a deep layer of any mulch materials listed on the previous page.

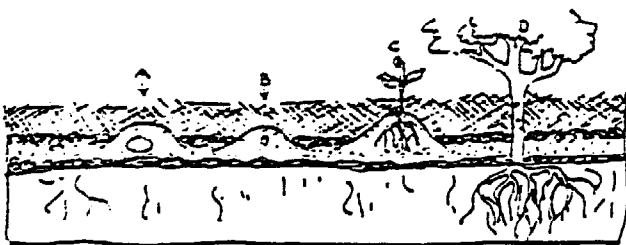
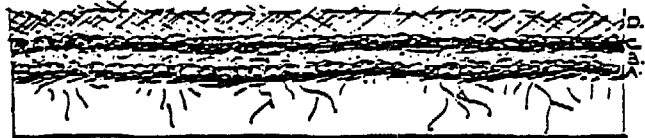

4. Appearance after planting. Place seeds (corn, beans, etc.) down into the hills of earth. Young plants (tomatoes, peppers) are also set into hills of dirt inside the mulch.

V. FERTILIZING

Fertilizer is the food you provide to your soil and crops. Gardens will yield more and better vegetables after good fertilizing. Even large fruit trees should receive regular feeding. Healthy plants will also suffer fewer insect problems. Improper fertilizing wastes time, money, and has little benefit for your land.

- Compost and mulch both are excellent fertilizers.
- Legume plants also help soil by adding nitrogen.







A soil test is the best way to know what your soil needs. Also, the growth of certain crops can be an indication of the health of the soil.

Appendix V provides information on specific nutrients, their sources, and deficiency symptoms.

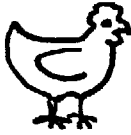
Fertilizer can be applied as follows:

1. Spread it over the area some time before planting (recommended for fresh manure).
2. Apply small amounts just below and beside seeds during planting (composting).
3. Side-dress plants two or three times during the growing season (composting).
4. Intercropping with legumes (beans) provides a good source of nitrogen. (See Appendix IV.)
5. Spraying leaves or watering with solutions of natural fertilizers gives rapid feeding during times of stress (early growth, blossoming, drought). Solutions can be made from aged "manure tea," mild detergents, and commercial fish emulsions.

NUTRIENT CONTENT OF MANURE

	% NITROGEN	% PHOSPHATE
	2.4	1.4
	1.1	0.8
	0.7	0.3
	0.7	0.3
	0.6	1.4
	0.6	0.2
	0.5	0.3

VI. MORE NITROGEN

Nitrogen is essential for proper growth of both plants and animals. It is especially important for crops like rice, corn, and other grains. Normally crops cannot directly use the nitrogen from the air (80 percent of the earth's atmosphere is nitrogen) but rely on a special group of soil bacteria and algae to "fix" the nitrogen for them. Healthy soil is rich in these microbes and will have plenty of available nitrogen for your crops.

Legumes are plants that have the ability to "capture" these beneficial microbes within their roots. Wherever these plants occur, the soil nitrogen will increase. Legumes include beans, peas, clovers, and some nitrogen-fixing trees and are often called "green manure" because they are so beneficial to your other crops.

Proper use of legumes is to keep them in close association with all other crops. Intercropping them in between rows of corn, rice, or others, will provide a living source of nitrogen. Sometimes people prefer to rotate certain crops by, for example, planting a field with a legume before the corn is planted. Grains like corn or rice should then be followed by something that does not need much nitrogen (another legume, for example). Corn should never be planted repeatedly on the same land without fertilizing or green manuring first.

Legumes also provide excellent forage for your livestock or can be left to compost right back into the soil to increase humus. Returning the plants to the soil will do ble your added nitrogen as well as adding potassium, minerals, and trace elements.

Clovers, in addition to green manuring, will effectively crowd out weeds that compete for your soil's nutrients and shade the ground against water loss by evaporation.

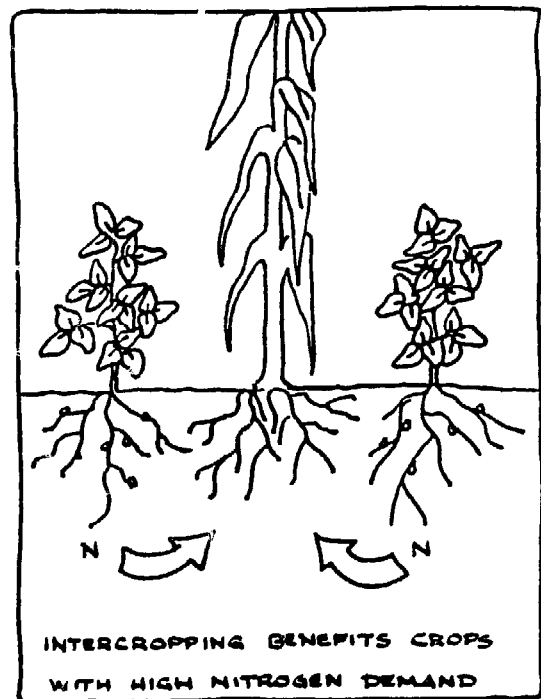

VII. SUMMARY

1. The fertility of your soils determines, in large part, the productivity of your land.
2. Proper tillage and feeding of soils will greatly increase yields; you control the productivity of your land.
3. Small-scale intensive tillage is recommended for household gardens and small plots. Minimum tillage with heavy mulching is more practical for larger fields.
4. Gardeners and farmers can provide their own complete, inexpensive fertilizer with properly prepared compost and mulch.
5. Green manuring and crop rotation with legumes should be part of everyone's farming practices.
6. All of the ideas in this guide will help produce higher soil fertility, improved humus content, reduced loss of valuable topsoil (erosion), and better water retention.
7. Everyone following this guide will have to adapt specific methods to local conditions and available resources. Every point described can be changed a little to fit the individual's resources without decreasing its overall effectiveness.

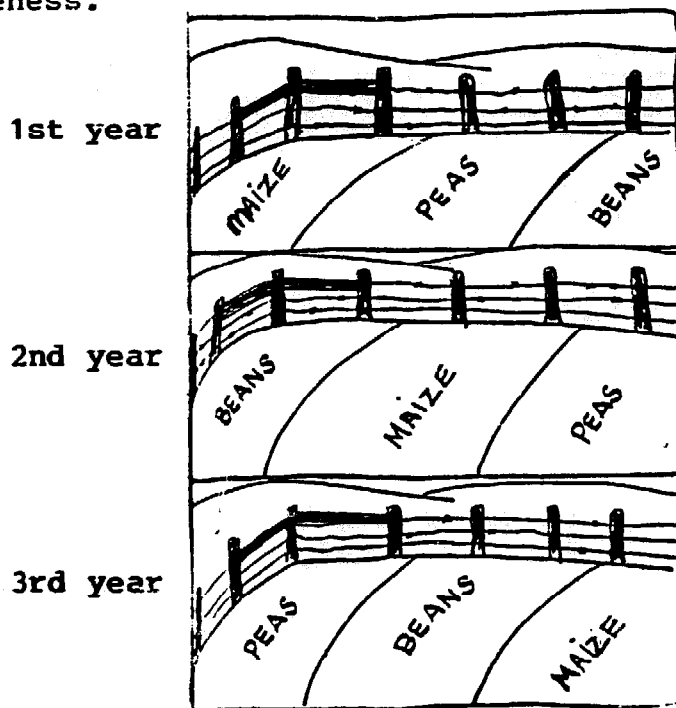

Composting: A Study of the Processes and its Principles,
Clarence Golueke, Rodale Press

MULCH

Perma-Culture II, Bill Mollison, Tagari Books, 1979, pp.
40-45

Also see "Low-Till Cropping" references.

FERTILIZING

Organic Fertilizing, Rodale Press, Emmaus, Pa. 18904

Soil Fertility and Fertilizers, L. Tisdale and W.C.
Nelson, MacMillan Co., N.Y. 1966.

MORE NITROGEN

Small-Scale Grain Raising, Gene Logsdon, Rodale Press,
1977, pp. 218-235.

Nitrogen Fixation By Legumes in the Tropics, by Bouldin,
D.R., et. al., Cornell International Agriculture
Mimeograph No. 75, Cornell University, Ithaca, NY, 1979.

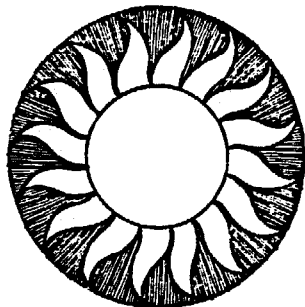

APPENDIX I

COMPOSTING CONSIDERATIONS

NUMBER OF TURNINGS:

Zero
1 - 2
4 - 5

READY IN:

4 to 6 months
2 to 3 months
two weeks if shredded

PILE WILL NOT HEAT UP MEANS:

1. Not enough nitrogenous material used to make initial C/N ratio below 30/1. This means too much sawdust, wood chips, paper or straw was used, all of which have very high C/N ratios because of their high cellulose and lignin content. Correct by adding more of a good nitrogen source.
2. Too much water initially applied. This suffocates the aerobic organisms and the cool-living anaerobes take over, producing ammonia and putrid smells. This is remedied by frequent turning or layering into a long-term compost.

STRONG SMELL OF AMMONIA MEANS:

1. C/N ratio is below 30/1 in the initial stage. Too much high nitrogen source was added in the beginning. This can be corrected by adding old leaves, straw, sawdust, or shredded paper in small amounts.
2. Too much limestone or other element high in Ca CO_3 was added in the beginning. This is difficult to remedy, but adding acid leaf litter and wet garbage may help. Next time, add the calcium to the soil rather than to the compost pile.

INDICATIONS OF FINISHED COMPOST:

1. Ammonia smell is absent.
2. The temperature has completely cooled down.
3. The compost is crumbly, dark, and sweet smelling.
4. At least three species of arthropods are present. Examples are both the sow and pill bug, ground beetle (carabid), and centipede.

INDICATIONS OF SEMI-FINISHED COMPOST THAT CAN BEST FINISH UP IN THE SOIL:

1. Slight smell of ammonia present.
2. The temperature has started to decline but steam still comes off.
3. Possibly one or two species of arthropods are present.

APPENDIX II

SAVE YOUR SOIL

The wealth of every farm is in the fertile topsoil. If the topsoil is lost, all is lost.

Every year a farmer might lose some of the topsoil without knowing. Although erosion may seem to happen very slowly, it will keep lowering productivity and rob your most valuable resource. Fortunately, a good farmer knows how to help Nature reduce erosion and build new soil to keep improving the level of productivity.

Nature takes many years to make one inch of topsoil but this amount can be lost in just one growing season. On hilly fields the loss is even faster.

* How is topsoil lost?

Wind blows off the fine soil which is so important to good soil structure.



Water during and after rain can wash away topsoil either as a sheet or by eating out gullies. Gullies can grow with each rainfall and make working the field impossible.

Tillage practices can increase erosion by leaving loose topsoil open to wind and water.

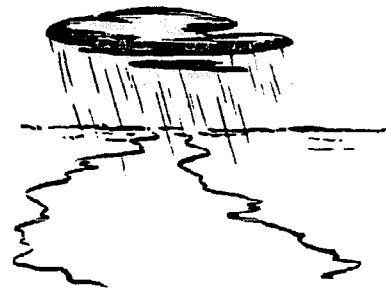

* How is erosion controlled?

Nature has provided farmers with several ways to save the topsoil and even improve the land. Depending on your type of land, climate, crops, and resources you can choose the best approach.

A. The soil should never be left bare and exposed to wind, water, and sun. Protect the soil at all times with either cover crops (see "More Nitrogen" section), mulch, or regular

crops. This is simple but does require careful planning and attention to your practices. For example, burning must always be done while the soil is still moist and immediately followed by a planting or mulching.

B. Plowing and cultivating breaks the natural holding structure of the topsoil and must be minimized or even completely avoided on slopes.

C. Strip crops and rows should run across the slope to help slow water flow. This also helps conserve water on your land rather than letting it wash away. Remember, moving water is lost to you if you don't catch it.

D. Build soil fertility and humus. Rich topsoil is not as likely to blow away in dry winds. Follow the suggestions for composting and mulching in this booklet.

E. Trees can hold large amounts of soil, block the wind, and provide a good crop for your farm. Choose trees that grow well, yield a good crop in your area (fruits, nuts, wood) and take advantage of as many as you can. Tree crops are the best choice for steep slopes too.



The major threat to farm production in the world today is soil erosion. Do not neglect your land's topsoil and you can have many years of successful farming.



APPENDIX III

**CARBON/NITROGEN RATIOS AND NITROGEN CONTENT
OF COMPOST MATERIALS**

Material	Percent Nitrogen (Dry Basis)	C/N Ratio	Percent Moist (Fresh Basis)
Human urine	15-18	0.8	97
Fish scraps	6.5-10	4	80
Poultry manure	6.3	4	75
Human feces	5.5-6.5	6-10	66-80
Meat scraps	5.1	6	65
Fresh grass clippings	4.0	12	95
Sun-dried grass clippings	2.4	19	40
Raw garbage	2.15	25	90
Mixed fresh garden debris	2.0	20	80
Cow manure	1.7	27	80
Seaweed	1.9	19	90
Fresh leaves	1.5	30	80

Oat straw	1.05	48	25
Dry leaves	1.0	45	40
Raw sawdust	0.25	208	5

Note: The overall C/N ratio of a good compost pile will be below "30." This means materials with a ratio number above 30 (i.e. sawdust, straw, or leaves) should be mixed with materials with a ratio lower than 30 (i.e. manures, urine, grass).

DETERMINING THE CARBON/NITROGEN RATIO OF YOUR COMPOST

Charasteristic Ingredient	Lbs Fresh Weight	Percent Moisture	Percent Nitrogen, Dry Basis	C/N Ratio
Chicken manure	50	50	6.00	4
Sawdust	50	5	0.11	511
Food garbage	50	80	2.15	25
Dry leaves	75	25	1.00	45
Grass clippings	50	95	4.00	12
Total	275.0			

1. List the various ingredients in your compost and site the approximate weight for each. Using the data from the table above, list for each ingredient the fresh weight, percent moisture, percent nitrogen, and the C/N ratio. If the specific material you are using does not appear on the table, estimate the characteristics by comparing it to similar material. See examples above.

2. Determine from the assembled data the following quantities for each ingredient.
- a. the pounds dry weight by subtracting from the fresh weight the percentage of moisture
 - b. the pounds nitrogen by multiplying the dry weight by the percent nitrogen contained on a dry-weight basis
 - c. the pounds carbon by multiplying the pounds nitrogen by the carbon/nitrogen ratio.

See example below.

3. Compute for the total compost the cumulative moisture content by dividing the total dry weight by the total fresh weight.

$$\text{Example: } \frac{144.5}{275.0} = 53\%$$

4. Compute for the total compost the cumulative carbon to nitrogen ratio by dividing the total pounds carbon by total pounds nitrogen.

$$\text{Example: } \frac{62.8}{2.33} = 27\%$$

	Lbs	Lbs Nitrogen	Lbs Carbon
Chicken manure	25.0	1.50	6.0
Sawdust	47.5	.05	25.0
Food garbage	10.0	.22	5.4
Dry leaves	56.0	.56	25.2
Grass clippings	2.5		1.2
Totals	141.0	2.33	2.8

Appendix IV

Legumes for green manuring.

Beans/Peas

Kidney (red) bean
Lima bean
Sword (Jack) bean (perennial)
Hyacinth bean
Soya bean
Tepary bean (dry climates)
Yam bean
Cow pea (dry climates)
Groundnuts (peanuts)
Pigeon pea (perennial)
Chick-pea (dry climates)
Lentils (cool climates)
Field pea (cool climates)
Winged bean
Tarwi
Velyet bean

Clovers/Forages

Sunnhemp
Vetches
Desmodiums
Glycine
Mimosa
Vigna
Alfalfa
Sweet clover
Red clover
Kudzu

Trees

Carob (dry climates)	Leucaena
Honey locust	Black locust
Acacia (dry climates)	Albizia
Sesbania	Colliandra
Pterocarpus	Rosewood
Tamarind	

Functions of Various Nutrients

Sources

pH

A pH test is a measurement of the acidity or alkalinity of soil, i.e., soil reaction. It is essential for determining the lime requirement of the soil. Generally, tropical soils in areas of heavy rainfall tend to be acidic. In dry regions the soils are usually more alkaline.

- o To reduce acidity (sourness) add Dolomitic lime (5-10 pounds per 100 square ft.) or wood ashes.
- o To reduce alkalinity (pH) add manure (½ inch layer).
- o Good compost will improve the pH of all soils.

Nitrogen

Stimulates growth above ground. Aids in the utilization of phosphorus, potash, and other nutrient elements in the soil. An excess of nitrogen is harmful-must be used in balanced ratio with other plant foods.

- 1-Fresh Manure 4-Urine 7-Coffee grounds
- 2-Compost 5-Fish Scraps 8-Cottonseed meal
- 3-Legumes 6-Blood

Phosphorus

Stimulates early root formation and growth. Hastens maturity of crops. Increases ratio of grain and fruit to stalk. Usually present only in small amounts. Quickly exhausted and must be replenished.

- 1-Compost 4-Rock Phosphate
- 2-Bone Meal 5-Fish Scraps
- 3-Manure (rabbit)

Potassium

A general tonic for all types of plants. Improves quality of the yield. Promotes stamina and sturdy growth. Availability of potassium for plant consumption is influenced by the presence of other elements in the soil, such as calcium, nitrogen, and phosphorus.

- 1-Compost & Mulch 5-Seaweed
- 2-Wood Ashes 6-Greensand
- 3-Sawdust 7-Crushed Granite
- 4-Hulls & Shells
(rice, cocoa, & cottonseed)

Calcium

Inexpensive but important. Forms a structural part of the walls of plant cells. Reduces toxic acidity. Increases availability of nitrogen and other elements.

- 1-Compost & Mulch 4-Limestone
- 2-Eggshells 5-Dolomitic Lime
- 3-Bone Meal 6-Sea Shells, crushed

Magnesium

Usually occurs in nature with calcium salts, and has many similar characteristics. Aids in assimilation of phosphorus by the plant. Is essential in the formation of chlorophyll. A deficiency causes chlorosis.

- 1-Compost
- 2-Dolomitic Lime
- 3-Ocean Water

Note: Items are listed in order of overall benefit and economy.