

# Installing the Deck Railing

## OVERVIEW

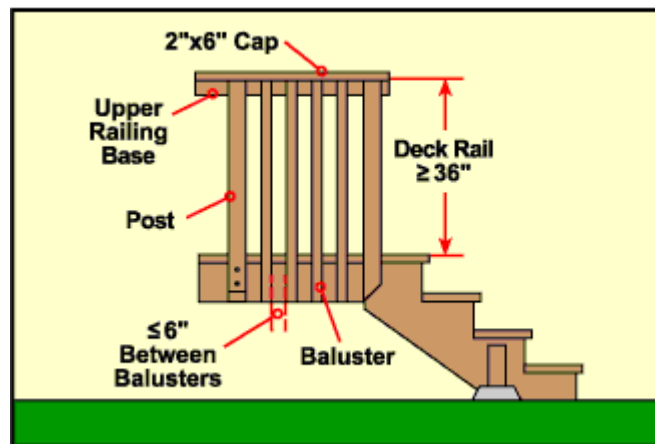

### Introduction

Deck railings are important to both the safety and the aesthetic appearance of your deck. In other words, a railing is the perfect blend of "strong and good-looking".

A deck railing must be built to comply with your local code requirements. For instance, a deck rail should be at least 36" tall and should not have any gaps that are greater than 6". To ensure its stability, the railing should be securely attached to the deck frame as opposed to the deck surface.

To make your deck railing attractive, you can design a fancy railing that still complies with your local building codes. A simple and visually appealing solution is to create a railing with vertical balusters spaced 4" to 6" apart. This is the approach we will cover in this tutorial.

### BEFORE YOU START...

#### SKILL LEVEL & TIME TO COMPLETE

Time to complete this project depends on the size of the deck and the level of help available, the times listed here are for two people on a 10'x 30' deck with the house defining two sides of the deck.

- Beginner - 2 to 3 days
- Intermediate - 1 to 2 days
- Advanced - about 1 day

 **CAUTION** Check with your local building department to get the deck railing requirements for your area.

 **COMMON MISTAKE** Railing posts should be no more than 72" apart. You run the risk of the railings sagging if the span is too great.

## STEPS

1. Refer to your deck plans to determine the location of the railing posts. Along the outer joists and joist header, mark the location of each post using a square. Mark both edges of each post, which should be 4" apart.

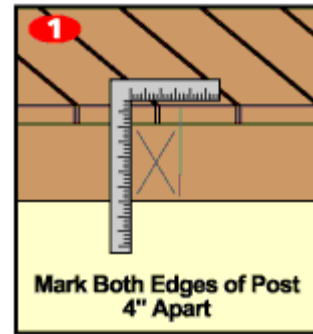

2. If your deck surface overhangs the edge of the deck framing, use a handsaw or reciprocating saw to cut notches in the deck so that the posts can fit squarely against the deck framing.

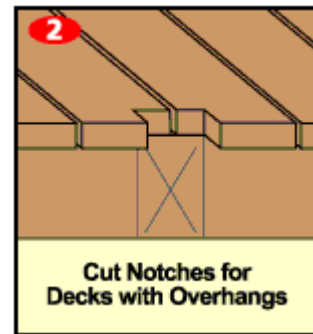

3. Determine the correct height of the railing posts. Assuming the finished height is 36", you will need to add the thickness of the deck surface (usually 1-1/2") and the height of the joists (usually 5-1/2"). Squarely cut all the railing posts to length using a miter saw.

Notch out the bottom of each post for a more stable and attractive finish. Measure up from the bottom 7" (joist height + decking thickness). Set your circular saw to a depth of 1-1/2" and cut the post at this mark. Then cut every 1/2" to the end of the post. Use a hammer and chisel to clean out the notch.

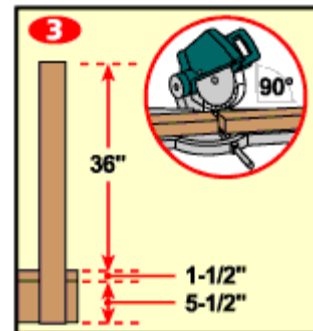

4. For a more attractive post base, click the corner with the miter saw set at 45 degrees.

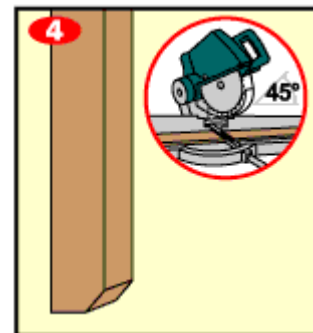

5. Pre-drill that base of the posts with 2 holes for the lag bolts. After the drilling 2 holes all the way through the base of each post, drill holes about 1/2" deep with a larger bit to counter-sink the lag bolt heads.

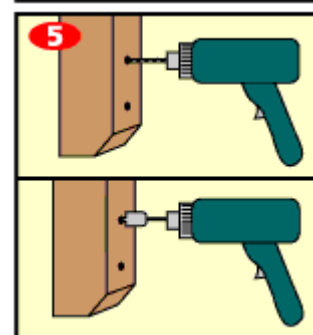

6. Install the railing posts using 2 lag bolts each. Use a socket wrench to drive them into place.

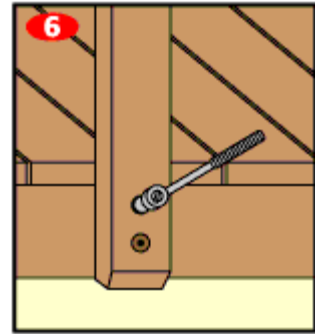

7. Using 2x4 lumber, measure and cut the upper railing base. Install the upper railing base to the top of the posts using 2 screws per post.

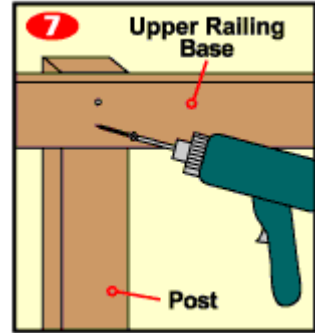

8. When installing the balusters, you can run them all the way down to the deck frame or you can install a lower railing that supports the bottoms of the balusters.

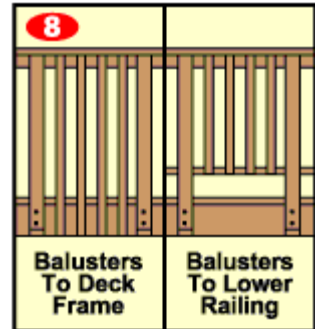

9. Measure the distance between each set of posts. Calculate the number of balusters you will need to maintain an equal distance between all balusters. Remember the balusters should be no more than 6" apart. Mark the location of each baluster on the top railing and lower railing or joist.

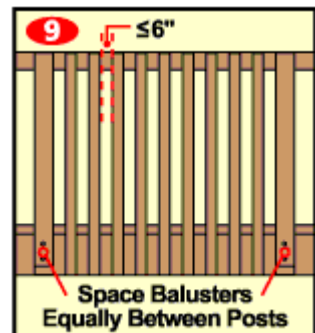

10. Measure and cut the balusters to length. For an attractive appearance, cut the bottoms of the balusters at a 45-degree angle. Using 2 screws at the top and 2 screws at the bottom, install the balusters.

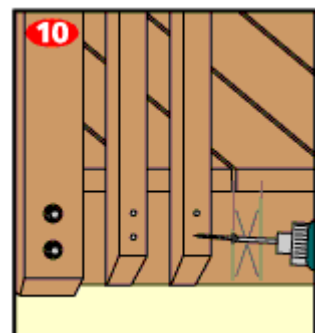

11. To top off your railing project, install a 2x6 cap on top of the upper railing base and posts. Miter the corners at 45-degree angles. Use screws to screw the railing cap to the 2x4 upper railing base.

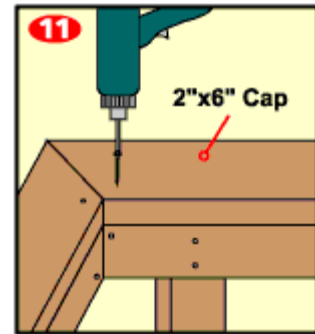

## SHOP LIST

### Materials Needed

- 4" x 4" Posts
- 2" x 4" Lumber
- 2" x 6" Lumber
- Lag bolts
- Washers
- Screws
- Silicone Caulk

### Tools Needed

- Miter saw
- Circular saw
- Hand saw
- Chisel
- Square
- Socket wrench
- Screw gun/Drill
- Drill bits
- Hammer
- Reciprocating saw
- Tape measure