

THE LAST SKEPTIC OF SCIENCE

by René



"The Book Mensa Tried To Stop"

THE LAST SKEPTIC OF SCIENCE

by René

Revised
Copyright © 1998

formerly

MENSA LECTURES © 1990

Illustrations by Subi

Edited for logic and context by Stu Lucas & Ed Hughes

All rights reserved.

No part of this book may be reproduced in any form or by any electrical or mechanical means including information storage and retrieval systems without permission in writing from the publisher, except by a reviewer, who may quote passages in review and by authors using this work for direct quotations.

ISBN Pending

Published by: **R. René**
31 Burgess Place
Passaic New Jersey
pz 07055 USA

*To Donald
from [signature]*

IRREVERENT QUOTATIONS

"Science is the belief in the ignorance of experts!"

Richard Feynman 1965 Nobel Laureate

"Theory is good, but it does not prevent things from existing."

Jean-Martin Charcot

"One of the tragedies of life is the murder of a beautiful theory by a brutal gang of facts."

La Rochefoucauld

"Scientific research consists in seeing what everyone else has seen, but thinking what no one else has thought."

A. Szent-Gyorgyi

"There is something fascinating about science. One gets such wholesale returns of conjecture out of such a trifling investment of fact."

Mark Twain

"Because it is the privilege of fools to discover more than the wise, who know all and need discover nothing and therefore end up knowing nothing."

Colin De Silva

"To raise new questions, new possibilities, to regard old problems from a new angle requires creative imagination and marks real advances in science."

Albert Einstein

"New and stirring things are belittled because if they are not belittled, the humiliating question arises: Why then are you not taking part in them?"

H. G. Wells

"A new scientific truth does not triumph by convincing its opponents and making them see the light, but rather because its opponents eventually die, and a new generation grows up that is familiar with it."

Max Planck

"There is a principle which is a bar against all information, which is proof against all arguments and which cannot fail to keep a man in ever lasting ignorance — that principle is contempt prior to investigation."

Herbert Spencer

"Authorities", "disciples", and "schools" are the curse of science and do more to interfere with the work of the scientific spirit than all its enemies."

T. H. Huxley

TABLE OF CONTENTS

NAME	PAGE	CHAPTER
Relevant Sayings	b	
Table of Contents	c	
Illustrations & Charts	d	
Acknowledgment	e	
Foreword	f	
Science History & Religion	1	1
The Earth's Rotation	11	2
The Equatorial Bulge	17	3
Testing for Roll-Over	27	4
Thumps & Bumps	31	5
Roll-Over	43	6
Gravitational Anomalies	57	7
Gravity Doesn't Suck	69	8
Snaky Moon	77	9
Newton Lied	83	10
The René Electro-Scope	89	11
René's Electric Gravity	97	12
Relativity Negated	101	13
René's Red Shift	109	14
Volcanoes	115	15
Light Madness	125	16
Lost In Time	129	17
Particles & Sparticles	139	18
Paleo-magnetism	143	19
Atomic Beasties	147	20
Mostly Questions	159	21
The Mensa War	173	22
The Orion Experiment addendum	177	
Good Books To Read	183	
Index	185	

ILLUSTRATIONS

#	SUBJECT	PAGE	#	SUBJECT	PAGE
1A	Royal Payoff	4	8A	Recurving Moon	71
1B	Five Horsemen	6	8B	Escaping Moon	71
2A	Mating Stars	11	9A	Regular Moons	77
2B	Wise Brits & Dip Shits	12	9B	Normal Snaky Moon	77
3A	Equatorial Bulge	17	9C	Retrograde Snaky Moon	78
3B	Cascade Theory	18	9D	Cross the X	78
3C	U-Tube	18	9E	Non-Revoving Moon	80
3D	Angle of Bulge	21	9F	Revolving Moon	81
3E	Slope of Bulge	21	11A	Approaching Moons	91
3F	RDF Chart	23	11B	Electro-Scope	92
4A	Tilting Ball	27	11C	René Electro-Scope	93
4B	Flotation	28	12A	Clinch Balloon	98
4C	Air Floating Ball	29	12B	Two Clinch Balloon	99
4D	Wood Flywheel	30	13A	Two Set Test	102
4E	Gimbaleed Flywheel	30	13B	Three Set Test	103
5A	Weber Detector	32	13C	Bent Light	104
5B	Explo-Lapser	34	14A	Tug of War	109
5C	Particle Movement	34	14B	Layered Balls	110
5D	Torsion Balance	35	14C	Exploding Balls	110
5E	Cavendish Balance	36	15A	God on the Valve	115
5F	Cavendish's Balls	36	15B	Te Lapa	117
5G	Cross Attractions	37	15C	Gnomes & Trolls	118
5H	Four Monkeys	38	15D	Right Hand Rule	119
5I	René's Ball	39	15E	Baby Volcano	121
5J	Floating Pan	39	16A	Sky Photons	126
6A	Heat Pump	46	17A	Polka Dot Aliens	129
6B	Ice Warehouse	51	17B	Fineous Map	130
7A	Antipodal Tides	59	19A	Dip Needle	143
7B	Barycenter	60	19B	Azimuths	143
7C	Anti-gravity Tide	60	19C	Random Azimuths	144
7D	Eclipse	61	19D	Core Samples	144
7E	Spring Scale	62	20A	Slickers & Bumpkins	148
7F	Deep Well	63	20B	Atomic Beastie Cage	148
7G	Free Fall	64	20C	Fuel Rod	149
7H	Mine Shaft	66	20D	Wildcat's Ass	153
7I	Saros Cycle	67	20E	Spent Fuel	154
7J	Variable Aphelion	67			

CHARTS

SUBJECT	PAGE	SUBJECT	PAGE
Radii of Balance	24	Eddington's Eclipse Stars	104
Moon Phases & Distances 1990	67	Relativity Formula	106
General Gravity Formula	70	René's Numbers	111
Newton's Densities	84	Crushing Strengths	116
Planetary Kepler Numbers	87	Atomic Accomplishments	147

ACKNOWLEDGMENT

This is the page where writers acknowledge the people who helped them in their task. I am grateful to my mother who supplied the funds necessary to self-publish "Mensa Lectures - The Last Skeptic Of Science", the forerunner of this book. She also stood between me and starvation a few years later. I also want to posthumously give credit to two people. The first, Peter Ross, a technical genius who was my mentor and the other, Rick Iacobelli, one of my best friends, who understood my work.

It should be noted, that the years between the writing and publication of this book also cost me the love of my life. I called her Pixie and she was my friend, my lover and my wife. She is also an extraordinary cook, an artist in oils, and an extremely intelligent sounding board. For as long as she could, she provided total and unquestioning support without which I could never have started, yet alone completed, any of my writings. Unknown to me, her friends pronounced me to be that most detestable of men, "**A KNOW IT ALL**", which is about four steps lower than that abomination known as a "**SMART ASS**". One sad day, unfortunately, she left me. Still, she was a great help, and I remain grateful.

Special thanks to Subi, the artist, who took my crude sketches and illustrated them so well. And Chris Wolfer, artist and son-in-law, who took over Subi's work when I needed a few more drawings. Then there is Stu Lucas, who generously gave up time that could have been spent on his own writing projects and instead edited two of my books.

I want to personally thank John Cook, and John LaVista for keeping my computer running and upgraded so it could do the job required. My adopted brother John Cook also rescued me from the streets when I became homeless. Both of these men cheered me on with actions, not words. The debt I owe to both can never be repaid. These men are true friends.

FOREWORD

My research into things scientific began in 1965 when certain scientific anomalies had become so familiar to me that I failed to realize that writing down the results of my research would read like fantasy to others who hadn't had that kind of exposure. A war with American Mensa forced me to this realization, so I decided to provide post-publication footnotes from these books I had read over the years. More trouble! I spent two full months of ninety hour weeks trying to locate, re-read and document as much of this material as I could find. After I had gathered it all together, I figured that I was done with that Herculean task. But then I was told that I'd need permission to use the footnotes and quotations from the publishers or authors.

I had always been under the impression that if you credited a source, then you could use direct quotes. Well, the way things are now, maybe you can — and maybe you can't.

Requests for these permissions were time consuming and very difficult to come by. Very few gave their consent. I have decided that I would never try to control another author's text, by this ruse which is why my statement on the title page reads as it does.

I was born an iconoclast. The authoritarian abuse I have been subjected to over the years has turned me into a kicker of the behinders of both societal and scientific sacred cows. In today's 'politically correct' country I sometimes feel that I am the last non-religious scientific skeptic. This book is intended for liberal-minded adults who may also have a touch of skepticism. It includes profanity, a disgust of organized religions and a hostility of all governments in general and of the US government in particular — all justifiable in my view! Of you the reader, all I ask is that you evaluate my work with an open mind.

Lack of money cut short my college years. However, I did receive years of one-on-one intensive training from a technical genius named Peter Ross. This man had one of the finest technical minds in the world and I became his eager, Igor. Dr. Frankenstein Ross, with malice aforethought, hammered open my mind. In the beginning, Pete gave me splitting headache after splitting headache as he showed me that much of what I thought I knew for sure was ... Bullshit. On 9/16/87 he was shot dead in his own house, with his own gun while talking to the police, by a man named John H. Brown III. An assistant prosecutor told me a few months later that John Brown was residing in a funny farm. Pete's family believes he was in Rahway Prison, yet nobody seems sure about anything, because he was walking the streets as a free man three short years later. I smell the CIA.

The irony of the situation is that my genius friend (who was truly a bit crazy) is dead, while the completely sane murderer who shot him may have spent time at a funny farm.

Peter left me a legacy of a mind so open that when I shake my head everything I think I know falls out. I'm not complaining. Frankly, I prefer to be empty-headed rather than have a closed mind like most of the experts I have met. You have probably heard this definition: An expert is a person who spends his life learning more and more about less and less in one field, until this "expert" knows absolutely everything about absolutely nothing. I despise most "experts". Yet, every once in a while (as much as I hate to admit

it) I meet one who somehow slipped through the system and actually maintains an open mind.

Besides, I am prone to exaggerate. When I use the words "all" and "every", they simply mean "most". I sarcastically refer to professional scientists as philosophers because I simply can't help myself. I slowly and painfully developed my material over 25 years. I occasionally use the words "bullshit and asshole" because they are so much more appropriate than politically correct euphemisms.

Major portions of this work have been exposed to many Mensa scientists who have pooh-poohed, tut-tutted and even resorted to magic to defeat my arguments. At least, magic is what I call it when you present theory piled on theory, instead of hard proof of refutation. The summer following original publication I submitted about 100 letters to various Mensa professional scientists, limiting my questions only to their particular areas of expertise. Only 30 responded and almost all in effect, wrote, "*I know you're wrong but I can't quite prove it.*"

Our professional scientists have us believing that all the crucial "I's" of science are dotted, and all that's left is to cross a few "T's". However, my arithmetic "Unproof of Gravity" negates Newton's attraction of mass for mass. Actual testing of my two-leaf electroscope proves that Coulomb's Law of Electro-statics needs modification. This, in turn, negates much of particle physics and demonstrates that the theories we have on electricity are, if not in error, at least incomplete. I show Newton, "the Father of Modern Science", to be at best, a hypocrite by examining the "Principia." And I provide observational proof that the Earth's bulge is at least much smaller than we were told. I demonstrate that many of our scientific basic assumptions are either unproven, or worse unprovable. Thus modern science is operating on faith just like any other religion. Many of the so-called "LAWS" of science are only tenets, or paradigms of this somewhat organized religion called science.

Everything we think we know about astronomy and astro-physics hangs by a thread after I dissect the famous weighing of the Earth by Cavendish . My dissection of Hubble's Law and Einstein's Relativity offers rich speculation, but severely questions the proofs the philosophers have provided. This book offers strong evidence that our planet is subject to periodic and cataclysmic "Roll-Overs" which leads to new viewpoints on geology, paleontology and history. I also offer evidence that Carl Sagan and other prophets of the "Hot House Effect" are wrong. The Earth's climate has been cooling off for the last thousand years.

I have tried to make my work understandable to the average reader who has an interest in science. I hope that the reader will also gain a better understanding of many of the more obscure aspects and assumptions of modern science.

Now you are entitled to believe anything that you want to. However, remember that when observational data or experiment conflicts with a theory, no matter how beautiful the theory or how impressive the credentials of its author, a rational person pitches out the theory.

HISTORY, RELIGION & SCIENCE

Our Emotional Belief System (our **EBS**) is, to our minds, as the operating system is to that diabolical and fiendish machine known as the computer. Here the operating system is a program that sets limits to all the machine's functions and tells the machine not only what data and controls it will respond to, but also exactly how it will respond. In a computer the operating system must be loaded into memory each time the machine is turned on.

In people, the **EBS** takes many years to load. Year after year, the loading process continues. In the end our opinions, actions and thought processes become familiar and therefore comfortable, standardized to the common uniformity of society. Our **EBS** is capable of modification to some degree, but neither brain nor computer can function outside the limits imposed by **EBS** in mankind, or the operating system in a computer.

Religion is one of the great molders of our **EBS**. As children, long before our critical facilities develop, we are imprinted by our parents and our society's opinions of right and wrong, of good and evil, of expectations and hopefully, the ability to tell "Shit from Shinola". These opinions are mainly derived from prevailing religious beliefs and vary from country to country and from era to era. For example, as a member of a modern Christian society, we are imprinted with the biblical edict "*Thou shalt not kill*".

However, in a warrior society, the young men are schooled to drool for the opportunity to chop up their first real live enemy. Our society's women deplore violence, but in a warrior society women actively seek out the warriors. In most cases our imprinting will control the operation of our minds for the rest of our lives.

All philosophy is rooted in our **EBS**. This is originally seeded by cultural osmosis when we are babies. Our parents prepare us to see things the way they "are", or rather the same way as they see them. Our **EBS** is reinforced by religion and education long before our logic centers are mature. Church and school teach us not to ask questions which our elders either can't, or won't answer.

As adults, when our **EBS** is threatened by contrary facts or logic, we either bias our perception of the facts, ignore them completely, or become irrational. Whether philosopher or longshoreman, anything that threatens one's rice bowl, pride, prestige, or **EBS** will be met with irrational anger. This is an intensely "human" reaction. It also happens to be the reaction of most of the other animals on the planet.

I believe hypnosis to be an excellent demonstration of the power inherent in a person's **EBS**. The hypnotist, by modification of a susceptible hypnotic subject's **EBS**, can control all sensory input enabling the subject to see or hear only what the hypnotist commands. The subject may be given input that is contrary to reality or logic, or may be commanded to ignore sights or sounds that exist. It then becomes obvious that the hypnotist is in control of the subject's **EBS**. In a less dramatic but equally powerful fashion, a person's **EBS** will govern, in every day life, what one is allowed to think about, what logic one may use for decision making, and what evidence may be considered.

For thousands of years scientists were called 'natural philosophers', and because it's more inclusive and much less mechanistic term than 'scientist', I prefer to use it. Our modern era seems to require super-specialization, so severe that almost all training is now done by rote memory and restricted to a single subject. The early natural philosophers were people who retained the ability to marvel at the wonder in the world and ask questions that usually only occur to children and fools like me. But unlike either a child or a fool, authoritarian answers always failed to settle their minds.

In the Third century BC, a Greek natural philosopher named Eratosthenes calculated the diameter of the Earth, producing a value that was remarkably close to modern figures. On a specific day he caused the angle of elevation of the sun at high noon to be measured in two Egyptian cities whose distance, one from the other, was known. We have been taught that all our ancestors thought that the world was flat. However, before this experiment could even be attempted, Eratosthenes had to sense that the Earth was a sphere. The concept that the Earth was flat came later.

During the Second Century AD, the Greek nation matured, lost its delusions of world empire and turned inward. A Greek natural philosopher living in Alexandria at the mouth of the Nile bore the Egyptian name of Ptolemy. He gained fame as an astronomer and introduced the idea of an Earth centered universe. Ptolemy used the simple observation that the heavens wheel across Earth's sky, and from this he theorized that the entire universe must be revolving around a stationary and stable Earth.

Ptolemy embedded all the celestial bodies in a series of invisible, transparent, concentric hemispherical shells, or spheres. This theory indirectly led man back onto a flat world where the oceans cascaded over its dangerous edges. Obviously, if the oceans cascaded then the Earth had to be flat.

His theory necessitated additions called epicycles to explain the sometime retrograde, loopy, motion of some planets. They were later used whenever future observations, or unexplained astronomical data, were discovered. These were smaller, "wheel within a wheel" shells that were affixed to, and rotated on, the main shells. When revision was needed, the natural philosophers had but to add another epicycle to make things right. For over one thousand years Ptolmaic Astronomy seemed to explain all the motions of the planets.

This was simplistic thinking at its best. But the early Christian church not only accepted the idea, but whole-heartedly endorsed it. Between wars of conquest and those of religious differences, the various population-decimating plagues, and extreme religious fanaticism, western civilization suffered intermittent catastrophes and destructions; until the only education available was that provided by ... Mother Church! Paptic Rome, in the Dark Ages for the next 1300 years, slavishly taught Ptolemaic astronomy. The Church also silenced inquiring voices with threats of ex-communication. If that failed, Mother Church was not adverse to issuing special invitations to dissident thinkers commanding their appearance as guest of honor at church-sponsored public barbecues.

But another flame was lit, and the expansion of human knowledge flared in the period of western history known as the Renaissance. In the early 1500's a Polish monk by the name of Copernicus (1473-1543), already imbued with the certainty that the world was a

sphere, postulated that Earth not only rotated on its axis but that it, along with the all the other planets, revolved around the Sun.

In 1529 a German monk, Martin Luther, "protested" the strict Roman Catholic rules and formed the Lutherans, the first sect of the "Protest-ants". Here local parishioners had a say about their church's affairs, as opposed to being absolutely ruled by a remote bureaucracy headed by a sovereign foreign Pope. This schism has never healed.

In the hysteria that followed both the Protestant separation and the new astronomy, another monk, Bruno Giordano (1548-1600), was barbequed (burned at the stake) for heresy. He was an agitator in other political areas, but his heresy had nothing to do with God. He was roasted because he no longer believed in the Ptolemaic universe.

Shortly before the invention of the telescope, a Danish noble named Tycho Brahe (1546-1601) developed an intense interest in astronomy. He was an extremely wealthy aristocrat and in 1592 King Frederick II, impressed with his work, gave him the island of Hveen, and supplied funding for the creation of the Uranienborg observatory. In essence, Tycho was the Danish astronomer royal and Uranienborg, the royal observatory.

Hveen became self sufficient as Tycho set up various trade shops and a foundry. The island also housed and fed the craftsmen and artisans that he hired to help execute his designs. He was an ingenious creator and during his life-time he created the most precise pre-telescopic observational equipment that had ever been built. With these wondrous toys he made the most accurate celestial measurements ever made. He spent years gathering ever more accurate data which inadvertently set the stage for the annihilation of the Ptolemaic geocentric theory.

When it became apparent that his data was not conforming with the geocentric theory, Tycho attempted to add yet another cyclic patch to the crazy quilt of epicycles that the Ptolemaic theory had become. Tycho was not a wild-eyed reformer. The adjectives "rich" and "noble" are antithetical to reform, but by 1584 he had grown desperate enough to add the grand daddy of all epicycles to the system because of the conflict between his data and accepted Astronomy.

It was a major revision because he now claimed that all the other planets orbited the Sun. His last epicycle had almost made the transition from Earth centered to a helio-centered solar system and unfortunately, he left the Sun still revolving around a geocentric Earth. In its time it was a valiant effort, and most scientific historians consider this to have been the last epicycle. And it was ... of the Ptolemaic era.

When his last epicycle failed he began to suspect that perhaps something was rotten in Denmark after all. Only religious fanatics were still speaking of the tinkling of heavenly music generated by the turning of the celestial spheres, and heard by only the righteous. Men and women of the Renaissance were 'diggin' the syncopated beats of different drummers instead of the stifling regimented forms of proper chamber music.

We'll never know whether or not he was punished for theorizing counter to the prevailing Emotional Belief System regarding the geo-centric theory. But what is known is that the young and very religious new king, Christian IV, rewarded Tycho's fourteen years of

hard labor with the typical Royal Payoff. He was forced to forfeit Hveen, the observatory, all his painfully created toys and submit to exile.

The charge was that he abused his peasants. This was true enough, but he had always abused his peasants. Uniquely, what king, before or since, has ever sided with a peasant over one of his nobles? Fortunately, either by fate or planning, Tycho was already in contact with Kepler (1571-1630), a known disciple of Copernicus. I believe that Tycho's old desperation resurfaced when the new data still didn't fit the great revision he himself had proposed.

In 1599, Tycho made some financial arrangements with Kepler that were scanty at best. After all the years, Tycho had to have known he would never be mathematician enough to discover the new astronomy that his data so seductively promised. But Kepler was recognized as one of the finest mathematicians in Europe and Tycho didn't want his life's work, all that raw data painfully collected over the years, to go to the grave with him. He had given it his all and honorably failed.

Tycho died in exile before he could actually turn over his data, Kepler then had to fight tooth and nail against Tycho's stupid and typically arrogant aristocratic heirs. Kepler ended the unequal battle when he simply took the data and ran. By 1605, from this precision data, Kepler created the three laws of planetary motion. These are still in use today to predict the future position of the planets.

Men just as intelligent as we, some more so, had accepted the Ptolemaic theory without question for 14 centuries. That tells us a great deal about people and their **EBS**. Contrary to the self praise today's scientists heap on each other, science is still a field of very human endeavor and subjected to the same raw emotionalism as any other. Threaten rice bowl or ego and scientists are quicker to fight than longshoremen. The only difference is that they use cutting words instead of cargo hooks, fists, feet and teeth.

Galileo (1564-1642) lived a long, full life because he knew when to "see the light". When push came to shove he 'confessed' to heretical thoughts about the universe in general and our solar system in particular and recanted just before he was to be tried on heresy charges by the Jesuits. Since trial and conviction were synonymous, he would have been forced to join Giordano Bruno, previously roasted at the stake.

Oddly enough, it had been previously resolved by the natural philosophers that the truth concerning what revolved about which was to be determined by whether or not Venus exhibited phases. Galileo, with his new telescope, knew the truth. He could clearly see those phases. This demonstrated that Venus, at least, if not all the planets, directly orbited the sun; not the Earth as Tycho's last epicycle had "proved". However, knowing the truth and being able to prove it are neither ammunition nor armor against the deeply

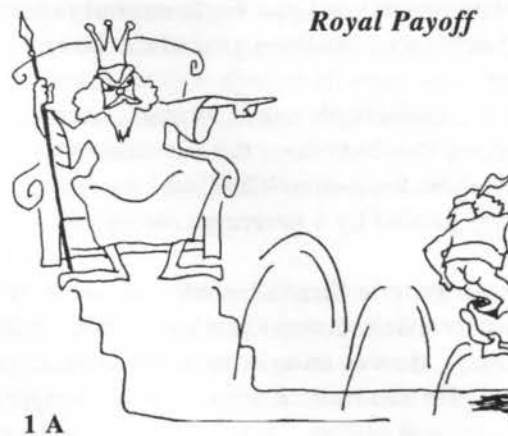

1 A

seated **EBS** in the mind of a selfish and high placed man of authority.

For an example of power politics and total hypocrisy at its worst, while Galileo was finishing his life under church-instituted house arrest (and being cured by "re-education", a panacea that authority has always been extremely fond of), the ever-hypocritical Jesuits (Mother Church's science & political wing) were using Copernician theory and his telescopes to accurately predict lunar and solar eclipses for the heathen Chinese Emperor. It is still speculated that they had delusions of converting a billion Chinese to Catholicism, and no doubt ruling the world with this army of converts.

Historically we have the interesting spectacle of the early Christians rejecting the hypocrisy of the orthodox Rabbis and forming their own church under the sign of the fish. The fish evolved into a cross. Then much later, the Lutherans rejected the hypocrisy and the pomp of the Roman Catholic church which had become a political colossus that now sat astride and controlled the western world. Kepler avoided most of the general religious nastiness of the era by being Lutheran, thus not under the control of the Vatican in Rome.

In 1687 Newton released his theory of gravitation. This states that every mass has an intrinsic, somewhat 'magical' property to attract all the other mass in the universe simultaneously with a force between each of the masses proportional to their product masses divided by the square of the distance between them. Just why Newton's equations work, at least locally, is still not understood at all. Nonetheless, this new philosophy ascended to the throne vacated when Ptolemaic astronomy was destroyed. Centuries later, our space age began and NASA's astronauts reaffirmed our belief in Newtonian gravity.

For over a thousand years much of Christianity reflected the Old Testament wherein God was depicted as ...

a cruel God, a vindictive God, a jealous God!

During that period philosophers believed that our Earth was sculpted by forces that were generated by unbelievable volcanoes, humongous oceanic waves, incredible cyclonic storms, and world-shaking earth quakes. This was the philosophy now called "Catastrophism" and it was in harmony with the religious thought of that time.

But the New Testament unveiled a ...

just and merciful God!

Catastrophism began to fade as the younger geo-philosophers began to believe that our world was molded by slow and subtle processes. This is the philosophy of gradual "Uniformitarianism" and it too, is in harmony with the religious beliefs of our time. Louis Agassiz and Charles Lyell spearheaded this idea and when the smoke of battle had cleared away, Catastrophism was defeated leaving all such thoughts strictly the domain of the unreconstructed basement crackpot.

In some ways our **EBS** helps us to survive. It may be a damn good thing that each of us is issued, at birth, a pair of rose-colored glasses. For most of us, even the contentious members of mankind, have a great innate need to belong and be accepted by our friends,

family, tribe, clan, state or society. The rose-colored glasses, by filtering out some of the reality's raw nakedness, limit objective scrutiny; since no institution or individual can come away clean from a completely objective study.

There are five, not four horsemen of the Apocalypse. War, Famine, Plague, Pestilence and the fifth one, organized Religion!

Five Horsemen



Because of these serious afflictions, large segments of man's slowly gained technical knowledge have been lost time after time. Consider how Eratosthenes' calculation of the Earth's diameter was lost because of Ptolemy, which allowed other pious philosophers to declare that the religious righteous could hear the tinkle of heavenly music made by these rotating spheres. As Christianity gained in numbers, wealth, and power its priests became the new arbiters of science in the west. In the east and northern portion of Africa the Apocalyptic horsemen destroyed a sprouting science. It should be noted that the modern world's first "university" was located in Timbuktoo in North Africa.

The centuries roll by but human nature seems fixed. Although the Vatican's Castrati Chorus has been abolished and the Inquisition is on hold, the priests of today's scientific religion are just as mentally rigid as were their ancestors. I have been actually told by a very brilliant practicing scientist that "*If I were to doubt anything I know, I couldn't get any work done*". I kid you not!

I couldn't help but notice as I have scurried through this life that "experts" usually add only decimal points to existing knowledge. True breakthroughs are usually accomplished by the efforts of outsiders who, in ignorance, try the impossible. Whether they win, lose, or draw, they are usually called basement crackpots by the priests of modern science. Tesla, whose individual accomplishments exceeded any other in recent history is still regarded as a crackpot by academics because he lacked 'credentials'. Breakthroughs also happen through serendipity, but only to those whose minds are still free and curious.

I repeat my premise. Our experts seem to spend their lives learning more and more, about less and less, until they know absolutely everything about absolutely nothing. When they achieve this exalted state they know every reason why something new cannot be done. With a few pooh-poohs and a couple of tut-tuts they can completely dispense with any new, and therefore impossible, idea.

Historically the greatest "assumers" have been the natural philosophers! They have proven time and time again, that when it comes to assuming they have no peers. Perhaps the fault lies in the academic system that now turns out degreed experts by the millions and post graduate natural philosophers by the hundreds of thousands. It seems that all aspiring young philosophers must take 6 credits of pooh-pooh and 8 credits of tut-tut before they can graduate. Each academic expert attains his position by being a student whose forte is rote learning. Since the only correct answer to any question is that which the teacher thinks is true, the rote learners always have the right answers and in time they inherit the mantle of expert.

Conversely, thinkers who dare to question the assumptions of the day, are weeded out by their Wizard of Oz teacher, who one day, will himself declare other rote learners as experts. And forever after, each new expert will assume that what he or she has learned by lecture and book decades before is still, and will always be, the ultimate truth.

I know from personal experience that experts have a ritual which they invoke at the first sign of any anomaly that might suggest even a tiny threat to any of their assumptions. They first ejaculate the sacred word "Impossible", which actuates the closing of the titanium doors that guard their mind. Then they take a little peek to see if the heretic who presented the anomaly has been scared away. If not they will recite, like a rosary, whatever physical "Law" that is applicable to the situation. frequently a few which are not. For good measure, they will toss in some erroneous "facts". I have yet to hear an expert say "*Golly-Gee Whiz, that sure is strange. I have to think about this.*" Daniel Boorstin said it was the assumptions or illusions of knowledge which were and are man's greatest deterrent to progress. He was so right.

We are directed by our scientific tutors to look back in time and laugh at the beliefs of our ancestors. The experts of today use examples of previous beliefs to show how stupid mankind was before 'science' came to our rescue. Well my ancestors, the common people, were taught their stupidity by the ancestors of today's experts! I agree that my ancestors were just as stupid as we are for accepting much of what we are told. I also firmly believe that someday our descendants will laugh at us for much of what we now believe to be scientific gospel.

The history of the scientific religion is replete with countless examples of leading experts later caught, with their pants down. For example, in 1790, the French Academy of Scientists became tired of unwashed peasants sending them meteorites. They unanimously declared that since there were no rocks in the sky there were no meteorites.

When Wilbur and Orville Wright, two bicycle mechanics, were actually flying at Kittyhawk, the physics professors of the world were still writing in local Sunday newspapers that man could never attain powered flight. Recently, after almost a hundred year hiatus there was dramatic progress in superconductivity because somebody threw away

the theory. Experts can always prove why something new cannot work — even when it does.

We are never told that many of our scientific “Laws” are based on either unprovable or unproven assumptions. When an accredited philosopher invents a theory that is not defeated by another accredited genius in some reasonable period of time, his theory becomes a scientific law by default. The “proposer” is then elevated to Scientific Saint-hood and his law — now carrying his name — becomes untouchable and unimpeachable. Any future questions concerning it are classed as heresy. In any organization, “*don’t make waves*” is the standing order of the day. Internal dissenters are usually squelched by subtle hints about the common rice bowl. If that fails, they are cast forth.

Organized science is a political organization that acts in many respects like organized religions. Any outsider crass enough to question an expert is inadvertently trampling on that particular group’s collective ego and threatening their collective rice bowls. He becomes an enemy! He will also be called a basement crackpot, since he has interfered with the Emotional Belief System.

Unfortunately, much of our **EBS** is loaded before our critical reasoning facilities are developed. School systems that consistently reward the rote learner and just as consistently punish the thinker who questions, are great contributors to a society’s uniform **EBS**.

Religion is the second greatest contributor. Many of us are ultimately brainwashed into blindly accepting authoritarian pronouncements as the gospel. A few resist longer, but in the end most of us learn to confine our critical facilities to problems involving our own self-interest.

Our individual **EBS** controls what we are allowed to think about, how we think and even what evidence we will consider. This is the reason why new, or startling ideas, or any questioning of basic assumptions is viewed as heresy — and is then met with anger, hostility and irrationality. In the end, an expert who has learned best by rote will choose a pupil, who also learns best by rote, to eventually become the new expert. All organizations strive to preserve the status quo. People with high IQ’s are no more immune to these social processes than are morons.

Sometimes our beliefs are harmless and ridiculous like knocking on wood for good luck or avoiding a black cat to prevent bad luck. However, whenever fanaticism sets in, our beliefs invariably become destructive. Although we generally associate fanaticism with religion, fanatics come in all sizes, shapes, sexes, colors and mental persuasions. There are patriotic, political and even scientific fanatics, all of whom surrender the little critical reasoning they have, to their leaders. Fanatics are especially dangerous because they believe that only they are the possessors of the real truth. Because of this, they are subject to vicious surges of self righteous anger which can blow away their last shred of rationality and logic.

Our modern philosophers have failed to provide room for the criticism that used to be an integral part of science. Instead, they have crowded around the feed-trough of government and private grants, while wearing out their arms in mutual back-scratching. They

have deluded themselves into believing that science has grown much too complicated to be understood by anyone but a fellow expert. They believe that any future progress can add only another decimal to already existing knowledge. They also believe that progress can only be made by one of their own — a scholar who carries the proper credentials. However, to believe this, they are very ignorant of the history of their own religion. When any group fails to supply its own criticism, there will inevitably be some nasty outsider, like me, willing to do it for them.

Now you are entitled to believe anything that you want. However, remember that when observational data or experiment conflicts with a theory, no matter how beautiful the theory or how impressive the credentials of its author, a rational person pitches out the theory.

THE EARTH'S ROTATION

In the early '40s I made my first visit to New York's Hayden Planetarium, where I was told that the Earth was created, 500 million years before, when a star (obviously male, and obviously in lust) closely approached our poor little virginal Sun. In the orgiastic fury that followed, the interloper using his gravitation, pulled solar eggs from our Sun which he then shot through with star sperm. Once he got what he wanted, he slid out of our neighborhood leaving behind masses of hot solar matter orbiting their mother, the Sun. This matter ultimately cooled and condensed into the celestial bodies of our solar system.

Mating Stars

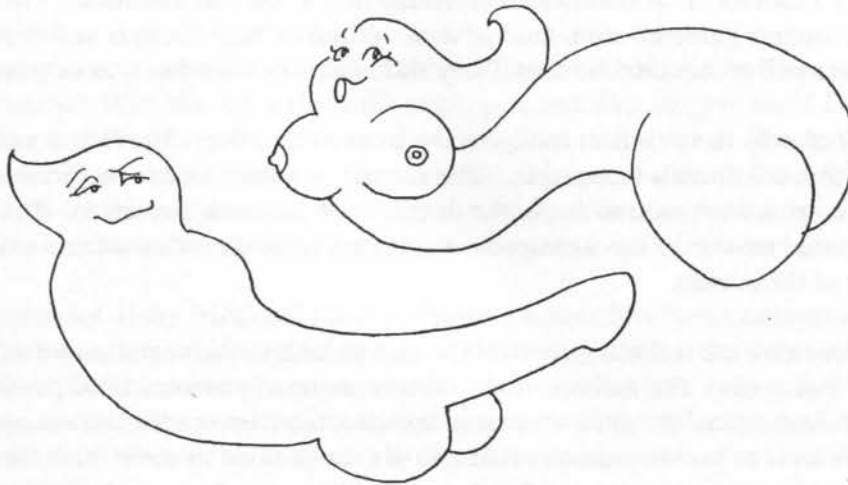

2 A

That old theory of stellar mating has been replaced by a modern version of the La Place theory. Today we are told that our planets coalesced from dust and rock fragments that were part of a rotating giant cloud that formed both the Sun and its planets. Planets are the part that didn't get sucked into the sun. We are also told this original motion accounts for both the current revolution and rotation of all the solar bodies. But this theory was concocted before we knew that Venus has a retrograde rotation (still unexplained) and that space is filled with radiation, magnetic fields, space dust and other stuff in general. This forever concept of rotation has stuck in my craw like a fish bone for over 45 years.

By the time our philosophers finally accepted the fact that our smoothly spinning world is a sphere, the Earth had been sufficiently mapped to accurately determine that the northern hemisphere contained most of the land masses. Since rocks are heavier than water, it seemed evident to those philosophers that our freely supported Earth was "top heavy". It should "Roll-Over" changing the existing polar axis of rotation and allowing the circumferential line of heaviest mass to form the new equator, thereby attaining dynamic stability. However, since this hadn't happened, although the smooth rotation of the Earth demanded dynamic balance, to balance the load they postulated a hypothetical super-sized southern polar continent which they named Antarctica.

According to geo-physicists who speak of our top heavy world, "*The final position of the pole is one that places the continents as well as possible on top of the equatorial*

bulge. This puts the pole in the equatorial Pacific, as it might be expected.”¹

Subsequent exploration since the late 1400's produced South Africa, North America and South America. When the exploration reached 60 degrees south, it was acknowledged that “Antarcticus” could not be large enough to balance the Earth's “top heavy” rotation.

Then in 1840 Antarctica was finally discovered. That year an American named Charles Wilkes followed the coast of Antarctica for 1500 miles proving it to be a continent. However, as large as it was it still did not have enough mass to give us the rotational stability which we exhibit.

In 1957, for the first time in human history, almost every nation agreed to cooperate and participate in a year of exploring our entire planet in depth. It was called the International Geophysical Year (IGY). Antarctica received the lion's share of attention. The participating philosophers gathered mountains of data, retired to their citadels and thirtyfive years later are still processing the data. Very little ever trickled down to us peasants.

I have heard of only three (other) results of the work done there. The first was the sonic mapping of that continent's topography. The second was that the net vectorial motion of the world's oceans was positive and in the direction of the earth's rotation. The third was that the vectorial motion of the atmosphere was in the same direction as, and exceeding the velocity of the oceans.

Let's examine these other findings of the IGY that pertain to the vectorial velocity of atmosphere and ocean. The motions of the oceans are most pronounced in the frigid seas that encircle Antarctica. At south 40 degree latitude, the Roaring Forties are aptly named. This west to east movement of air and sea was known to the British Navy by the late 1700s and kept as a naval secret for the next 100 years. As a result British warships would be sighted in the Atlantic one day, and a few weeks later would be seen in the Pacific.

Other European naval powers knew that this was — “impossible” so they erroneously assumed that the British had so many warships that they were re-using the names to confuse everyone.

The British Navy was very clever. Instead of fighting, for months on end, the head winds and the head seas of the closest Westward Cape, the Royal Navy would run with the wind and current toward the Eastward Cape. They could change oceans in a matter of weeks. This military secret was kept even from the British commercial interests. As a direct result the merchant fleets of the world suffered thousands of shipwrecks and tens of thousands of marine casualties during those years by continuing to sail westward, into wind and wave because the map distance was shorter.

Wise Brits & Dip Shits

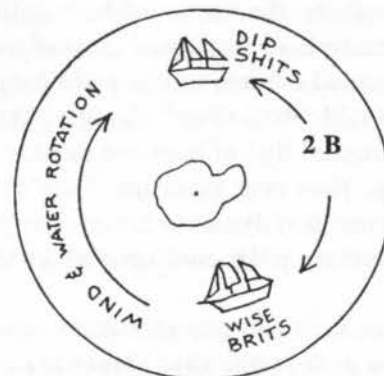

Shortly after the IGY scientists had released the information on the winds and oceans I developed the Rene' theory of rotation. I could easily picture the air masses driving the seas toward the east, and the sea in turn driving the Earth's rotation. Each by friction! But what drives the atmosphere? Can it be the solar wind? Nah! Could electricity have a major effect on a planet? Impossible!

Or is it? In August 1972 there occurred the largest observed solar flare of the century. The radiation levels increased dramatically and the following effect was noted. *"Moreover, contrary to general expectation, the eruption (solar) clearly affected the rotation of the earth and thus the length of our days! The day of August 8, 1972 was ten milliseconds longer than August 7. This deviation was greater than any which had yet been measured for the length of a single day. In the weeks that followed, the earth, so to speak "ran slow." Then slowly it regained its old tempo and turned as fast as before."*²

The accepted rate of decrease in rotation for the Earth is about 1.6 milliseconds for a whole century.³ With six times that shift coming in one day, forgive me if I doubt that our rotation is the result of the rotation of any original stellar mass. If our rotation is due to initial inertia, how do we account for the return to normal speed? Once you put the brake to a fly wheel only an input of energy can bring it back to former speed. In this case both the braking effect and the acceleration required incredible energy.

A left hand proof of my frictional rotation should be found in the examination of airless moons. I believe they will be found to have either zero rotation or a very slow one similar to our Moon. Our Moon has a once a month rotation which is exactly equal to its revolution. There is little rotational data on the other moons in our solar system but what there is would seem to indicate that they are also fixed to their periods of revolution..

If Newton and Galileo could see and study the Jovian moons with hand built primitive telescopes, one would think that in the centuries that have passed, just one of our astro-philosophers would have wasted his time in acquiring data on the various moons. The astro-philosophers claim to have super accurate gear with which they tell us all about stars and galaxies billions of light years distant. You would think that just for "drill" as we used to say in the Army, every once in a while, that they would take a quick peek in our back yard.

Some astronomical apologists have claimed that the 200 inch Palomar scope can not focus on something as close as our Moon. As far as I can tell from the second hand astronomy text I recently purchased, there is absolutely no reason why the largest of telescopes cannot focus on the Moon, the planets and their moons. Wouldn't it have been great if the Palomar scope had looked at the Apollo 11 mission site while they fired off a powerful flare? How preoccupied can you get as you learn more and more about less and less?

For 20 years I have cursed the experts who control our large telescopes. They remind me of Big Time Charley, friend of the working girl, who each Friday night blows his whole pay playing big shot. He buys rounds at the local gin-mill while his wife and kids starve at home. Our experts keep trying to see the end of the universe while we starve at home, wishing that just once they would look a little closer to home and determine whether other

airless moons are rotating. If they are not rotating, or if the rotation is very slow, it would tend to prove that the solar wind interacts with a body with no atmosphere by producing either a very slow rotation or none. Moons with an atmosphere should have a faster rotation.

Time has modified our picture of the universe. The Earth is now estimated to be five billion years old, space has dust in it, and powerful radiation roars throughout space. Space friction must exist and no matter how slight, over a five billion year period of time every planet should have zero rotation.

I predict that each planet's atmosphere, with the exception of Venus, will be found to rotate faster than that planet's surface, thus proving Rene's Rotation. As far as Venus is concerned, if the rotation of the atmosphere is also retrograde then the planet's rotational speed will be found to be increasing. If not, then the planet will be decreasing in rotational speed. I also predict that the decrease will be such that the planet will lose all rotation in a few thousand years. It will then begin to slowly accelerate toward normal rotation.

When you predict, you go way out on a shaky limb and give all your enemies a sharp chain saw and tree climbing spikes. I only hope that my predictions are as accurate as Velikovsky's and not as bad as Newton's.

It should not take a rocket scientist to see that if the net vectorial winds in the direction of rotation exceed the net vectorial ocean currents in that same direction and these also exceed the Earth's rotational speed, then the frictional drag of the seas and the air masses must contribute something to the rotation of our planet. And if we concede something — why not all?

We are taught that the rotation of the Earth is due to the original impetus caused by the circular contraction of the space matter that formed our planet. When I was young, the world was only 500 million years old, and we believed that space was the perfect vacuum and was completely devoid of matter. Ergo, there was no friction to retard our planet and it would rotate forever with no retardation except for the claims of a minuscule degradation in velocity due to the gravitational effects of the Moon. The Earth's rotation is still subject to unaccountable variations in rotation. It speeds up or slows down for no reason we know and in recent years the Astronomical gurus have added several "leap seconds" to compensate for the Earth's slower rotation. I find fault with this assumption because if all gravity is measured and calculated from the dead, exact center (as Newton claims) of the bodies concerned, how can the rotation be affected?

As I grew older the Earth aged much faster than I did. I would add a year or two, but the geo-philosophers would add 100 million years or so to the age of the Earth. My scientific skepticism began to suspect that the original impetus theory was a bit flawed. When the Earth celebrated its billionth birthday I knew, without positive proof, that unless some outside force was applying power, our Earth should long ago have stopped its rotational whirl through the solar system. Isn't it strange that when the Earth was 500 million years old the Moon was degrading our rotational speed by the same amount as it is today when the Earth is billions of years old.

When the atomic clock brought us the news that during some years the Earth increases its rotational speed, did our philosophers throw out the original impetus theory? Certainly not! They added on an 'epicycle' of strange movements of masses of internal magma to account for it. A spinning ice skater, by bringing his arms closer to his body, can increase his speed of rotation. The geo-philosophers call this the conservation of angular momentum. They figure this as the cause of increased rotation. They suppose that strange and mysterious gnomes inhabit the center of the Earth who magically move mountains of magma. Lo! The Earth's rotation speeds up or slows down accordingly.

A few years ago while reading "The Discoverers", by Daniel Boorstin, I caught a hint of a Faraday machine that might duplicate the driven rotation of objects. The experiment is written up in one of the thirteen Faraday diaries which I tried to locate so that I might poke through them and see whether or not this gadget would make an appropriate model of the solar system. The Newark, NJ Library has them, but unfortunately, they had been microfilmed by a special sub miniature process and the only film reader that could read the text broke, and was thrown away. The interconnected library system produced Howorth's work from the 1890's but failed to get me a copy of the Faraday journals. Someday, when I can afford it, I shall pursue this.

I don't believe that we fully understand the mechanics of rotating bodies. This anomaly takes us back to when we first learned to ride a bicycle. In the beginning that two wheeler was extremely unstable because one had to simultaneously maintain balance and pedal to attain motion. For most of us success came only after someone else balanced us and then gave a shove. As soon as we started to move, the bike became stable even at a very low velocity.

Was this stability due to our momentum or was it from the fly wheel effect of the slowly rotating wheels? We must eliminate the flywheel effect as indicated by the following observation. The old 74 cubic inch Harley Davidson, on which I learned to ride, weighed almost a thousand pounds. Its wheels weighed at least ten times as much as those of a bicycle, and yet both machines attained stability at the same low speed.

If based on the momentum (mass times velocity) the machine weighs 40 times more and should become stable at much lower speeds than the bike but this is simply not the case. However, if you insist that basic stability is due to momentum, then you open up another can of worms.

Let us try a little thought experiment. Somewhere out there in this great big world of ours there is a man, 170 pounds whose only passion in life is riding his 30 pound bicycle. He is determined to pedal his bike all over the world. We first consider our sweating bicyclist pedaling from west to east on a road on the equator in Brazil. His ground speed is five miles per hour, and if we add this to the Earth's equatorial rotational speed of 1035 mph, his total momentum is 200 pounds total weight times 1040 miles per hour. This comes to 208,000 pound miles per hour.

A few months later our imaginary cyclist is freezing his ass off pedaling at 5 miles per hour on a stationary ice field at the 80th parallel north. He is going from east to west, and here the Earth's rotational speed is only 180 miles per hour and his momentum is now 200 pounds times 175 mph. His momentum of 35,000 pound miles per hour is only about

one sixth of that which he had on the equator. Does this mean that he must pedal at 1035 miles per hour to attain the same stability he had at two miles per hour on the equator?

We instinctively realize that this is not true and that neither latitude nor direction has anything to do with stability. If neither momentum nor fly wheel effect account for this increase in stability, what does?

A car taking a curve uncovers another rotational anomaly. We know from experience that the smoothest turning, with the least tire scrub and outward throw to the passengers, results when a car is being slowly accelerated throughout a turn. Driving at a constant velocity or de-accelerating doesn't give the same results. Therefore expert drivers say it's best, whenever possible, to brake on the straight approach to a curve and then gently apply power as one drives through it. You can easily prove that for yourself.

However, by theory, any amount of acceleration should cause higher instantaneous speeds which should increase the tendency to either skid out or overturn the car. Yet this doesn't happen. I haven't the faintest idea why a bike or motorcycle becomes stable at such slow speeds, nor do I understand why acceleration helps smooth out a turn. But it does seem to me (a sneaking suspicion) that something is lacking in our basic understanding of momentum and rotation.

Now you are entitled to believe anything that you want. However, remember that when observational data or experiment conflicts with a theory, no matter how beautiful the theory or how impressive the credentials of its author, a rational person pitches out the theory.

1. p. 275, "THE ROTATION OF THE EARTH", Munk & MacDonald, Cambridge University Press, 1975
2. p. 50, "THE UNEXPLAINED", Boschke, Pocket Books, 1978
3. p. 46, Ibid.

THE EQUATORIAL BULGE

Without the counterbalancing mass of that hypothetical continent of 'Antarcticus', natural philosophers sought another explanation for the smoothness in our observable rotational stability. They postulated a huge deformation girdling our equator in the form of a bulge that supposedly acts as a humongous flywheel, providing the dynamic rotational stability we enjoy. [Yes, I'm aware that our Earth's rotation isn't perfectly smooth. There are some (mostly unexplained) wobbles, and the polar axis precesses like a gyroscope — all of which tend to minutely slow down the rotation. Nonetheless, it's apparently much better at maintaining a constant rotation than anything we can build — no matter how "frictionless" the bearings.] Newton, by using an imaginary water filled tunnel, drilled from the pole to the Earth's center and thence to the equator, "proved" that the centrifugal force of our rotation gave us a radial bulge of 17.1 miles.¹

Our modern philosophers have tinkered with the bulge over the years shrinking it now by almost 25%. The "CRC Handbook of Chemistry & Physics" lists the Earth's polar radius as 6356.912 km and the equatorial radius as 6378.553 km. This reduces the radial bulge to 13.51 miles. More recent values have again decreased it.

Equatorial Bulge

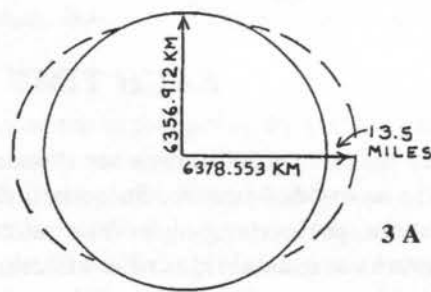

I've never believed in the concept of the equatorial bulge. A short time after I first heard of it, I went to a world globe, turned it upside down to verify that all the oceans of the world are hydraulically linked one to the other. In effect, if the bulge exists, there is a 13.5 mile high column of water at the equator. This was so lacking in credibility that I began to trace the concept of the bulge back in time.

The books I've read over the years, written by professional philosophers, told me that a French mathematician and peer of Newton by the name of Cassini had taken geodetic measurements and proved that Newton was right. Bullshit! Cassini while running the first long line geodetic survey of modern times, allegedly proved that Newton was wrong, and that the poles were bulged instead of the equator. Cajori has this to say, "*In France Jacques Cassini was misled, by somewhat inaccurate geodetic measurements taken over a comparatively short meridian, to the belief that the Earth was elongated at the poles.*"² Given the crude survey instruments of the time I wonder how anyone measured anything.

Text book explanations of the bulge are very simplistic. They lead one to believe that the bulge is supported only by the centrifugal force generated from the Earth's rotation. According to the CRC, the centrifugal forces acting at the Earth's equator amount to a little over 3.3 dynes which is a very tiny force. If it takes 980 dynes to support a gram of water then 3.3 dynes wouldn't hold up much of a water column. In response to this reasoning, John Cook, a personal friend and fellow Mensan, promptly created the Cascade Effect. To explain this I will use water although any plastic mass would ultimately

behave in the same manner. If these 3 dynes of centrifugal force sent .1 mm of water to the equator this would reduce the level of the polar seas by an equal amount thereby increasing the polar gravitational attraction while diminishing the attraction at the equator. He argued that this upset of balance allows the centrifugal force to draw more water from the poles. This begins a cascade effect that terminates when the equatorial radius is 13.43 miles greater than the polar radius.

CASCADE THEORY SHOWING GRADUAL MOVEMENT OF WATER FROM POLE TO EQUATOR

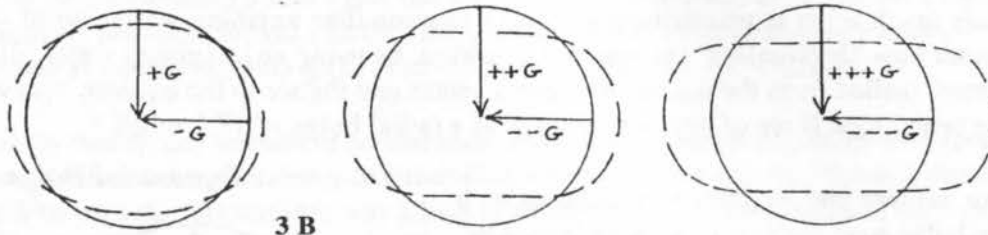

EACH TIME THE BULGE IS BIGGER

Since the equatorial oceans are nowhere near 13 miles deep, the rock of the Earth itself had to be molded into the bulge before the upper mantle cooled enough to lose its plasticity. After performing observational experiments a bit after the turn of the century to measure the crustal tides of the Earth, Michaelson, who measured the speed of light, outraged his contemporary philosophers by reporting that these tides were minimal, and that they were of the same magnitude as would be expected if the Earth were made of cast steel. If the Earth resembles cast steel how can there be an Equatorial bulge of such magnitude?

I decided to actually test the height of water that small forces could support. I cut a piece of cardboard to a 7 inch diameter. To this I mounted a perpendicular piece of rectangular cardboard along the radius, which I started at the center. To this I mounted a piece of transparent plastic tubing shaped as a U. The width of the U was 3 inches (7.62 cm) and it was about 3 inches high. I filled this tube with colored water and arranged it so that the inner leg was very close to the center of the disk.

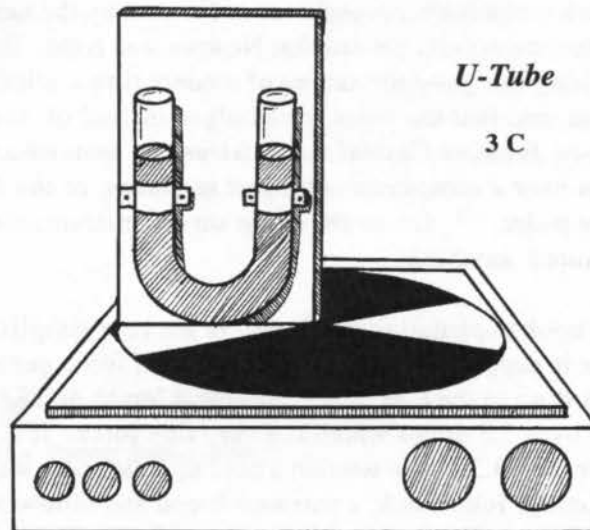

By calculation, shown below, the actual force when this U-Tube device was placed on a turntable of an old 45 rpm (.75 rps) record player, was 169 dynes.

$$\text{C Force} = \frac{V^2}{\text{Radius}} \quad \text{where } V = 2 \times \text{Pi} \times 7.62 \text{ Rad} \times .75 \text{ rps} = 35.9 \text{ cm/sec}^2$$

$$\text{C Force} = \frac{(35.9) \times (35.9)}{7.62 \text{ cm}} = 169 \text{ dynes}$$

Say what? In my mechanical experiment 169 dynes holds up less than 1 mm of water. But by some arithmetically concocted miracle, Saint Newton makes 3.3 dynes hold up a 13 mile column. The mechanical magnification of rotational cause attributed to the Cascade Effect is almost 22 million to 1. Also, if less than one millimeter of rise caused the bulge, what miracle prevented it from further increase. After all, the Polar Seas still hold lots of water to continue the effect.

The astro-philosophers claim that the Sun also rotates and it too must have a bulge. Although the *CRC Handbook* lists a factor for solar oblateness, the given polar and equatorial diameters don't reflect this. They are relatively equal, and there can be no discernible bulge.

A high school physics teacher sprang some Einstein on me at this point, by claiming the water in the U-tube didn't rise because the system was "non inertial" whatever that means. I reported that when I doubled the speed of rotation, the water visibly rose. I innocently asked just when did the system become "inertial"? I pointed out to him that if the universe is expanding, our galaxy is traveling, our Sun whirling, and our revolving Earth rotating around the Sun, there is nowhere, nohow a "non-inertial" system. In his ignorance of Newton's work, he also disputed that the bulge was due to centrifugal force. He confirms the old saying about them as can — do; them as can't, teach or criticize.

Further calculations showed that a centrifugal force of the same magnitude as those arising from the Earth's rotation could only be produced by using a 6 3/4 inch radius at .07 rps, or a 5 1/4 radius at .08 rps. To actually measure the rise one would need to build the U-tube as an inclined manometer of low slope with a radius of at least 12 inches or use a spiraled tube to shorten the length necessary to read the microscopic increment of rise.

From a table (page F-184 of the *CRC Handbook*) we find that the polar gravity is 983.217 dynes and the equatorial gravity is 978.039 - 3.373 dynes of centrifugal force for a total of 974.666 dynes. Using these figures, Newton's gravitational formula, the g constant of (6.66 -E8), and the mass of the Earth in grams (5.979 E27), we can calculate both polar and equatorial radii.

$$\text{distance}^2 \text{ (cm)} = \frac{\text{gravitational constant} \times \text{mass of Earth (gm)}}{\text{gravitational force (dynes)}}$$

$$\text{new polar radius (cm)} = \frac{6.66 \text{ -E}08 \times 5.979 \text{ E}27}{983.217} = 6363.949 \text{ km}$$

$$\text{new equatorial radius (cm)} = \frac{6.66 \cdot 10^8 \times 5.979 \cdot 10^{27}}{974.666} = 6391.804 \text{ km}$$

By subtracting the official polar radius as shown in the CRC from the one above we find a new polar radius that is larger:

$$6363.949 \text{ km} - 6356.912 = 7.037 \text{ km}$$

The same process applied to the equatorial radius results in a new equatorial radius that is larger:

$$6391.804 \text{ km} - 6378.553 = 13.251 \text{ km}$$

By subtracting the new equatorial radius from the polar radius we find that the new bulge to be

$$6391.804 \text{ km} - 6363.949 \text{ km} = 27.855 \text{ km}$$

This is 17.3 miles, which is slightly larger than Newton's original figure. I needed a method by which I could begin to actually measure the Earth's bulge without having to "borrow" a \$90,000 theodolite. Observation is always a better proof than some mathematical magician's magic. A year or so passed. Then on Saturday July 16, 1988, I awoke in the gray light of dawn with one of the larger organs in my body throbbing and pulsing and swollen with blood.

I refer here to my perverted brain. On a younger man, excess blood usually resides in a different location at wake-up. But alas, when you are my age, it takes more than a wake-up to wake, up! My demented mind thought that it saw a way to prove that the Equatorial Bulge was but a Fig-Newton of Isaac's imagination.

That afternoon with the temperature pushing 100, I drove with a friend to Pennsylvania to recover his pet house plants. Between the heat and the smog I was left with burning eyes and a bit of nausea. I spent most of the trip leaned back with my eyes closed mentally re-examining my idea. The day wasn't a total waste because I found no error in either logic or arithmetic in the experiment I had devised to physically measure the equatorial bulge.

Using the drawing below and plane trigonometry, we can determine the tangent of angle B extended to point A, which would be the Earth's surface if there were a bulge. If we divide 6378.553 km by 6356.912 km, we get the tangent of 1.003404. This tangent produces an angle of 45.09736 degrees. However, if there were no bulge then angle B would be exactly 45 degrees. Therefore the slope must be equal to angle B, minus 45 degrees, or .09736 degrees.

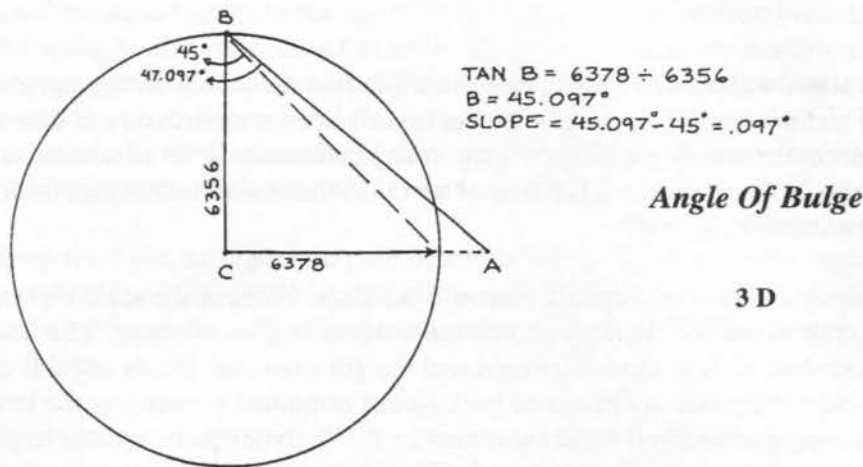

By trig again the tangent of this angle, times a run of 100 feet, would give us a 2.03 inch rise. This angle must represent the average slope of the bulge and we can expect to find some slope near this amount between the 20th and the 60th parallel.

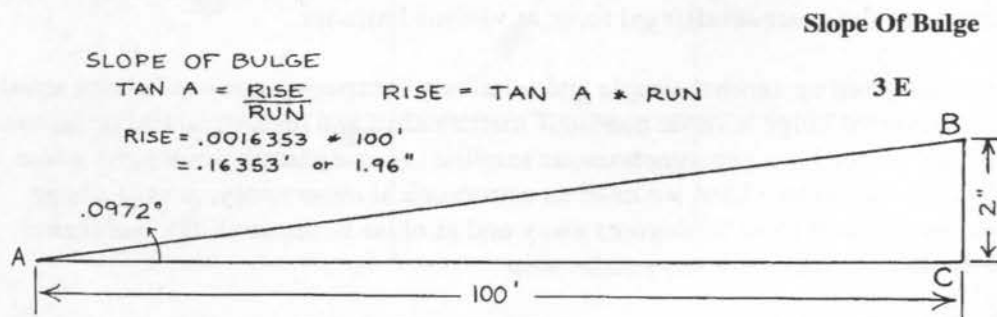

Since we know the average slope we can now test Newton's mathematical proof of the bulge against physical observation. All we need now is a field, over 200 feet on a side, that is flooded with a few inches of water. We set up a low, stable platform in the center of the field. On top of this platform we set up a common builder's level. We level up the instrument and drop a plumb bob to mark the exact center. From that center mark we tape exactly 100 feet in each of the four cardinal directions (North-East-South & West), and set up four vertical stakes. Assume that we've chosen a day without wind, since we wish to mark the exact water level at each of our stakes, without waves or ripples.

We now take the elevation from our instrument's sight path to the water level at the Eastern stake. For this example we find that our cross hairs are 50 inches above the water. When we swing to the West we find this elevation is identical. Next we swing to the North and we should record 52 inches because of the 2 inch drop per 100 foot of run. To the South we should record 48 inches for the same reason. If there is a bulge there must be a slope! But what if all our elevation measurements come out the same?

We've come a long way in our search for the truth. We started out in the Middle Ages looking for the philosophic balancing continent of Antarctica. We saw Newton prove that the Equatorial Bulge existed and we heard Cassini's report that the poles were

bulged. We tested the action by spinning a U-Tube and now the moment of truth is at hand.

I can state, without any fear of contradiction that no matter the era, no matter the equipment and no matter the latitude, no surveyor has ever recorded such a north/south differential. In the real world of surveying, if any difference in level is noted at even 100 feet of distance (even if only a fraction of an inch) the instrument is sent back for repair. Is there another argument?

Perhaps our instrument cannot measure the slope because the same forces are at work on both ends of the bubble level and the ends of the bodies of water. The level of the water is controlled by both the centrifugal and the gravitational forces and this condition could only exist if the rate of change of both forces remained constant as the latitude changed. The actual gravitational force increases by 5.178 dynes from equator to pole while the centrifugal force is declining from 3.373 dynes at the equator to zero at the poles. There can be no matching differences. So much for that approach!

I tried to actually calculate these forces, but was unable to locate data on the radius of the small circles that constitute each latitude, if the Earth is bulged. I needed this information to determine the exact centrifugal force at various latitudes.

Also, I have conjured up another simple and relatively inexpensive way to find the actual size of the equatorial bulge without nebulous mathematics and theoretical finagle factors. The first thing we need is a geo-synchronous satellite (geographically stationary) whose location is over the ocean. Then we need an astronomical observatory, or even a large portable scope, located 15 to 20 degrees away and as close to the satellite's meridian as possible. It also requires a US navy radar ship.

We first position the ship directly below the satellite. Then using simultaneous measurements of the angle of elevation from the telescope to the satellite, and the altitude of the satellite above the ship, we can accurately calculate the bulge. By using simple trig and this data, the bulge could be measured by subtracting the angular altitude from the measured altitude.

I sent a registered letter suggesting this test to Captain Anawalt of the US Naval Observatory. My suggestion was totally ignored. Responding to a similar letter, the British Naval Observatory located at Cambridge, Newton's Alma Mater, gave me the old pooh-pooh and a couple of tut-tuts. But at least they answered my letter. A professional astronomer, also a member of Mensa, told me my idea wouldn't work because even big telescopes couldn't see the satellites. Six months later, on the cover of the September '90 issue of "*Sky & Telescope*" magazine various satellites were photographed using a 14 inch reflector telescope.

I have also been told by another Mensan that radio-telescopes have "proven" that Newton's bulge exists. The Philosophers who operate the radio telescopes bombard us with their great discoveries. They claim they can measure the movement of the Earth's tectonic plates and that they also detect a microscopic wobble of the Earth with a period of two weeks and a movement of less than two feet. This type of freely flowing verbal garbage makes headlines almost every other month.

I call this 'bullshit' because I used, in the age before Loran, Radio Direction Finders (RDF) on small fishing boats. RDF isn't too accurate, but the inaccuracy has nothing to do with technology or the frequencies used. RDF is inaccurate because electro-magnetic radiation is subjected to three dimensional distortion by other magnetic and electric fields. The best results that can be obtained on large naval vessels, running the best equipment with highly trained operators, is plus or minus two degrees at 150 miles range.³

The drawing below traces an exaggerated path of a boat following such a radio signal. There is no doubt that if you follow the signal all the way in, you will reach the tower. But the accuracy of each sequential heading toward that tower is both distance and interference dependent.

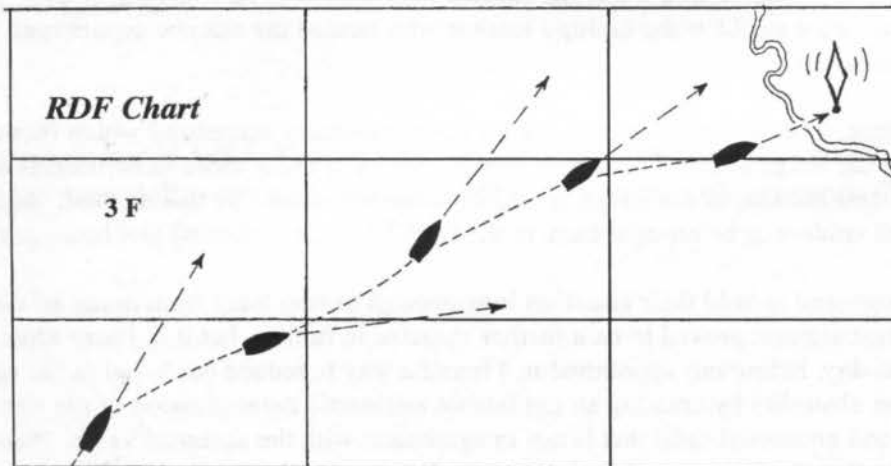

There is also the fading and increasing of common radio signals here on Earth. Do you think you it's possible to point a directional antenna at these shifting, drifting transitory signals, and absolutely locate the transmitter? We know that space is filled with wandering electro-magnetic fields. But if gravity affects light (per Einstein), it must also affect radio waves.

You cannot aim an antenna into space with precision and say with any accuracy what direction a signal comes from. Loran signals which originate within a few thousand miles from the user right here on Earth have a repeatability in reading of 50 yards but a possible error in position of 1500 feet.⁴ Arrays of large radio telescopes, like the Very Large Array (VLA in New Mexico) are tuned individually to a specific stellar target. When accuracy of location is desired, the aiming results are averaged. To me, this is like trying to predict the exact path a pin ball will take after it hits the second bumper.

Do you still believe that our geophysical philosophers know what they are talking about? Map makers have long known that large area maps never overlay. Is this because they have added corrections for a bulge that is a figment of Isaac Newton's imagination? Despite the philosophical claims about the size of the bulge and the philosophers knowledge of gravity, they can not yet get their experimental value of gravity to agree with the alleged shape and size of the Earth.

For almost 300 years the concept of a huge equatorial bulge has been accepted as a fact because Newton "proved" it existed. If he was right, why can large scale charts not be brought into agreement? Perhaps Cassini was chiding the severe and humorless Newton with a bit of Gaelic wit when he insisted that the poles were bulged.

I know that an equatorial bulge must exist. My only argument is its magnitude! I speak in terms of millimeters and the philosophers talk about miles because they know that our stability depends on some mechanism.

I have twice exercised futility in attempting to get a high school physics class to do some of the simple experiments I performed. Each time the principal had me interviewed by the head of the science department. I have zero talent for this kind of thing and each time I spent days polishing up a presentation, which I was never subsequently allowed to give. Each time I was classed as a wayward student who needed to be straightened out. The first time, I was twice as old as the biology teacher who headed the science department. But it made no difference.

The last time, a rather prim person used the same imaginary tunnels by which Newton had calculated the bulge to be 17.1 miles. This guy verbally used those same tunnels as a proof that no matter the size of the bulge, it could not be determined by this method. Again I was a wayward student to be brought back to the fold.

I never managed to hold their attention long enough to stop them from doing all the talking. My last attempt proved to be a further exercise in futility, but it did bear some fruit. On the last day, before our appointment, I found a way to reduce our belief in the equatorial bulge to an absurdity by creating an irrefutable arithmetic determination of the size of both the polar and equatorial radii that is not in agreement with the accepted value. Please understand that the following is tongue in cheek because I don't believe in the bulge. However, if there is one then it must be the size outlined below.

The logic is simply that unless the forces on polar and equatorial oceans are exactly balanced, the waters of the equatorial seas would either continuously increase or decrease thereby draining dry the polar seas. If not, they would drain themselves down by returning water to the poles. Thus the polar gravitational force has to equal the equatorial gravitational force minus the rotational force.

Using only the data from the CRC Handbook on the accepted radii, the law of gravity, and the formula for centrifugal force, I wrote a program to find where the radii of balance were. Printed below is a section of the table the program produced.

RADII OF BALANCE

E Radius (km)	E G F (dynes)	P Radius (km)	Polar G F (dynes)	C F (dynes)	E G F (dynes)
6373.194	983.736	6362.271	980.3668	3.3705	980.3652
6373.195	983.736	6362.270	980.3664	3.3705	980.3656
6373.196	983.736	6362.269	980.3660	3.3705	980.3658
6373.197	983.737	6362.268	980.3658	3.3705	980.3662
6373.198	983.737	6362.267	980.3654	3.3705	980.3666
* E = Equatorial	P = Polar	F = Force	C = Centrifugal	G = Gravity	

The equatorial radius must be 6373.197 km and the polar 6362.269 km leaving a bulge of exactly 10.927 km or 6.79 miles. For you geologists, this is 50 % smaller than the 13.51 miles found in the books. Each time we set out to find the dimensions of **the bulge** we wind up with still another answer. These radii are about as slippery as an eel in a mud puddle.

However, if there is no bulge (or a very small one) we are left with the original question. What makes our axis so stable? If there is only a little bulge we must be then held fixed in space by some type of bearings which we will examine in the next section.

Now you are entitled to believe anything that you want. However, remember that when observational data or experiment conflicts with a theory, no matter how beautiful the theory or how impressive the credentials of its author, a rational person pitches out the theory.

* * * * *

In the early winter of 1997, Topcon Inc., a manufacturer of geodetic survey equipment loaned me a theodolite and a survey grade GPS. I named the observations the Orion experiment and it is found on page 177.

1. p. 427, "NEWTON'S PRINCIPIA", Cajori, University of California Press, 1934
- 2 p. 664, Ibid.
3. p. 933, "AMERICAN PRACTICAL NAVIGATOR", Bowditch, US Government Document, 1977
4. p. 1002, Ibid.

RENÉ BEARINGS

In "Cataclysms of the Earth" author Hugh Auchincloss Brown (HAB) believed in the Earth's bulge. He speculated that, despite the bulge, the Earth did periodically "Roll-Over", thus changing the polar axis and acquiring a new equator. He postulated that the mechanism was usually the vast accumulations of polar ice whose centers of gravity were displaced from the axis, and whose off-center rotation would thereby provide a force that would drive them to become the new equator.

A few years ago, I foolishly tried to prove that an unbalanced load at a pole should be able to topple a freely supported rotating Earth, despite a significant equatorial bulge. For \$ 10 I purchased a second-hand 16-pound bowling ball to become my model of a planet. I had a friend use his lathe to groove out a healthy channel around the equatorial circumference, which we filled evenly with over a pound of lead. We thus turned the bowling ball into a model of a planet with an incredibly massive bulge. Next, we drilled a hole an inch from the poles and filled it with an ounce of lead, creating a load eccentric to the pole. This represented the center of gravity of say, a polar ice mass.

According to HAB this eccentric load would cause the ball to roll-over against the stabilizing force provided by the lead bulge. The problem was to provide freely-supported bearings to simulate floating in space. My first choice was a tub of mercury. But I estimated that I'd need over a hundred dollars worth of liquid mercury to float the ball and allow it to be freely rotated.

I knew it would float on mercury, since even lead floats on mercury. However, since a floating object displaces its own weight, I would probably need over 20 pounds of mercury. Mercury is more expensive than silver. For weeks I wondered how I could beg, borrow, or steal sufficient mercury for the job. At night I dreamed about going into a 'mercury bank', grabbing the 20 pounds of mercury I needed and running like hell. In my dreams I forget I'm crippled!

However, one day a stray thought did visit. Could I fool the ball and float it in less than its weight in mercury? What would happen if I placed a slightly larger form, molded to the ball's shape, under it. Suppose I used only about .015 of an inch of clearance. Calculation showed that the ball would sink into the mercury less than 2 inches. If my idea were valid only 7 ounces of mercury would be required. Could the physics books, which clearly state that a floating object must displace its weight in supporting fluid, be wrong?

To test the oddball, but practical idea, I took a 400 ml beaker and then found a half empty plastic power steering fluid container that would fit inside it. The container

Tilting Ball

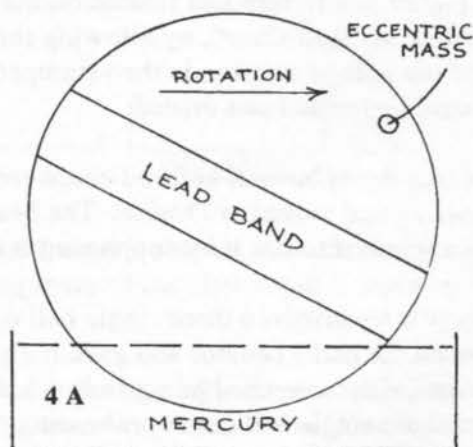

weighed 138 grams, so I put it in the beaker and added water until it floated. Removing the container, I weighed it and found it was floating 138 grams of mass on 45 grams of water.

If I had fooled the water, then I could fool the mercury. And I could do much better if the outer diameter of the container conformed to the inner diameter of the beaker.

It took a few days but I finally figured out that, contrary to what the physics books state, an object floats because the per unit hydraulic pressure due to the height of the surrounding liquid supports the bottom of the floating object. Philosophers should rewrite their physics books.

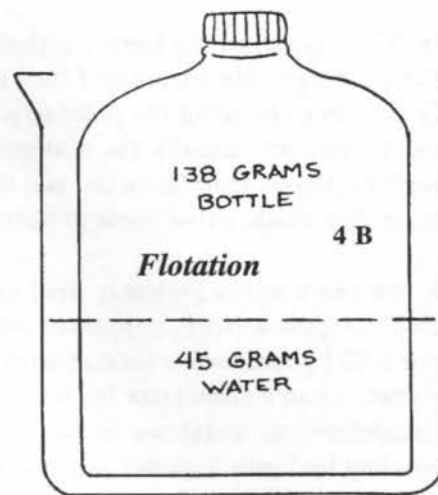

I have since found out that when they manufacture bowling balls, an extra weight is cast internally into the otherwise homogenous material. This gives each ball a preferred line of heaviest mass, which is necessary so that finger holes can be later drilled in reference to this line. After manufacturing, the exact position of the extra mass that has been embedded can no longer be determined. So the ball is placed in a fixture and floated on mercury where it is rotated. Spinning the ball forces the ball to "Roll-Over", by allowing the line of heaviest mass to form its new equator. The top pole of rotation is then stamped with a mark, indicating where the finger holes should be located and drilled.

As fate would have it, before I could come up with the mercury and make the formed bowl we had moved to Florida. The heavy bowling ball was left behind, but not before we attempted to test it by supporting it on a series of strange supports.

My first try involved three single ball conveyor bearings in a triangle. I wound a string around the ball's equator and gave it a yank. When it dropped onto the bearings it immediately screeched to a grinding halt. Failure # 1! It took a little while to figure out that those single ball conveyor bearings were supported by another set of bearings underneath. Bearings only work without skidding, when the rotation is in the direction of the bearing race. If it is across the bearing there is more friction.

A new plan of attack was needed. I contacted Brunswick Corporation and spoke with A.J. Dabrowski, the project manager for the ball manufacturing division. He told me that the balls were no longer floated and rotated on mercury to find their natural poles. Now they used a bearing of high pressure air ... it was cheaper, cleaner and faster.

Ahah! I could do that! I figured I would create an air bearing and float the ball. I bought a large pipe coupling for another 10 bucks and then had a chamfer turned on the top edge to throttle the escaping air. The original set screw hole was re-tapped to hold a \$5 gas cock to control the air feed. I used silicon rubber as a gasket and bolted the sleeve down to a board. Then I took it to a friend's garage to be tested.

I plugged in a 150 pounds of air and the ball burped, but rose in the air. Eureka! Suc-

cess was mine. Losers never win and winners never quit, or something like that. That's what I thought. However, the unit continued to emit a Bronx cheer, — a raspberry sound which only intensified when I tried to spin the ball. It, too, ground to an immediate halt. Failure # 2!

Later I figured out that the surface of the ball and the chamfer of the top edge of that former pipe coupling had, more or less, caused the air to pass between two parallel plates. This had induced a resonance of about 25 cycles per second. It was causing the ball's surface to act as a flute reed, vibrating the ball up and down. This was what made the raspberry noise while increasing the friction between ball and sleeve on the down strokes. Instead of making a neat air bearing all I'd done was create an elaborate "whoopie" cushion!

Hell! But I could beat that too! I would create a sharp edge at the top of the bearing. So I took a large tomato can and fastened in an air feed pipe which I aimed down. The can's length provided a large plenum to stabilize the flow of air. I also packed the lower chamber with steel wool and put a pierced baffle plate over it. I knew that the sharp top lip of the can would greatly reduce the frequency of oscillation, and I hoped that all those baffles would also reduce the vibration. Test day came and I cranked in the air. Now the sonuvagun thought it was a seventeen pound jack hammer! It began to pound the heavy metal table on which it sat about 4 times a second. You could have set a clock by it! I had succeeded in reducing the frequency of oscillation but it was still — Failure # 3!

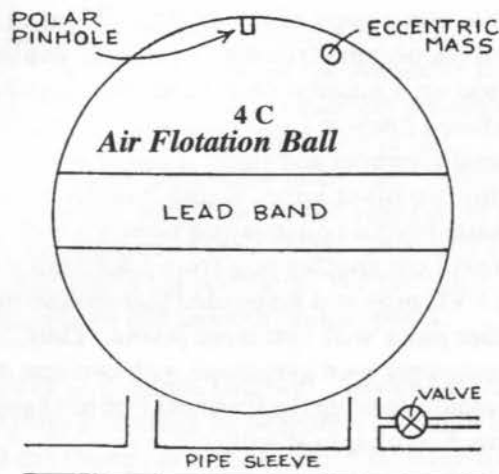

Okay, dammit, I could still beat it. I would make a water bearing, since water is much denser than air and offers more resistance to high frequency waves. I would use a much lower pressure and thereby cut the discharge velocity. This should also lower the frequency. So I changed the fittings (another \$10 I didn't have) and then jacked in a garden hose. The ball floated and then spun to the side of the rim and plastered itself against it. Failure # 4! This documentation of the experimental process is not meant to try the reader's patience, so bear with me. There is a happy ending.

In Florida I tried again to overpower a rotating bulge with a load eccentric to the pole. This time I built a 6 inch circular flywheel out of a one inch thick board. I used a piece of 1/2 inch dowel as a shaft, and I rounded the lower end so that it could be restrained in an oiled mating hole in a base board, thereby restraining it to one location. By using a length of string, like winding a toy gyroscope, I could spin it up to a fast rotation.

I drilled a hole down the center of the top of the shaft and bored a funnel into it. On an upward angle, I drilled another hole into the center at the bottom of that center hole. I then inserted and glued a plastic straw into that hole which sealed the end of it. Now I

could pour steel BBs down the funnel into the straw while the unit was rotating. This would act as an eccentric load. Then I tried it. All that happened was that the flywheel developed a slight wobble. It did not overpower the unit and “Roll-Over” as HAB predicted.

To begin my next adventure I had to wangle my way into a machine shop. A few miles down the road there was an open shed welding and machine shop that also had a nice scrap pile of steel shapes. I’d purchased a few pieces of scrap material and had gotten to know Larry, the owner. One day I gave him a copy of the original “Mensa Lectures” and we became friendly. I jokingly explained that I was on a mission from God. He laughed, but before I knew it I was on a lathe, fabricating a metal flywheel and shaft. I mounted this fly-wheel with two pivot joints, fixing it inside a plastic ring made from a collar sawed from a 3 inch plastic pipe.

Next I cut another ring from a 3.5 inch piece of PVC pipe and suspended that around the other piece with two more pivots. Thus, I created my own gyroscope with two sets of gimbals, leaving the flywheel free to change direction of spin at will.

To the outer ring I tied a loop of string, so that I could suspend the unit and wind up the string by twisting the unit. When the unit is let free it starts to spin. By placing the flywheel shaft perpendicular to the string the flywheel spins like a penny on a table until it gains sufficient spin. Then, faster than the eye can follow, smoothly “Rolls-Over” and spins perpendicular to the string.

This finally convinced me of what everybody else had known for centuries. If the Earth has an equatorial bulge, no amount of eccentric loading near the poles could cause it to “Roll-Over.” However, as we will discover later, there is a massive amount of evidence that our world has indeed “Rolled-Over”. If there is no bulge, then it must be fixed and held stable by some type of bearings, René’ Bearings. Then if this is true, our Earth must have either a daily wobble, or it must thump as do all other unbalanced and rigidly fixed rotating masses. The thumps are discussed in the next section.

Now you are entitled to believe anything that you want. However, remember that when observational data or experiment conflicts with a theory, no matter how beautiful the theory or how impressive the credentials of its author, a rational person pitches out the theory.

Wood Flywheel

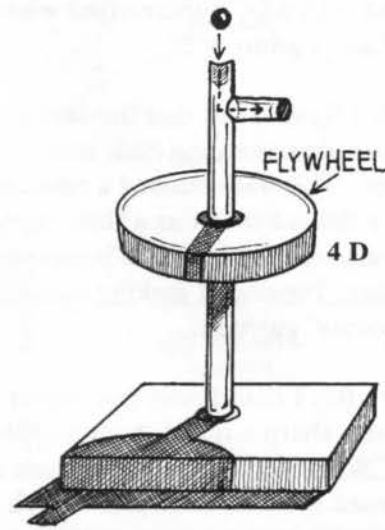

Gimballed Flywheel

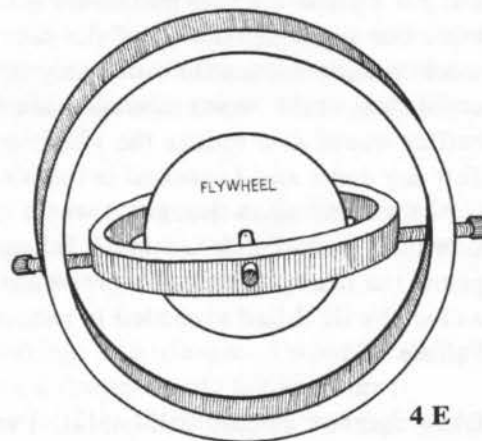

THUMPS & BUMPS

The Earth is a sphere that rotates at an appreciable clip. If we take a three foot fan rotating at 1050 rpm, we find that a point on the periphery is moving at about 112 miles per hour. If we take a chunk from the end of one blade, we would induce a vibration. This vibration might be held in check by the shaft bearings, but a thump would be evident. However, if our fan did not have bearings, but was rotating in free space, it would wobble in order to relieve the imbalance. Also, it would no longer thump! Yet our high speed fan is a tinker-toy in comparison to the rotational speed of our dynamically unbalanced Earth's equator. It rotates to meet fate at over 1000 miles per hour without a daily wobble!

Let's try an experiment using only our minds. Suppose that at this instant, by some miracle, the Earth is in perfect dynamic balance. Then suppose one of the Antarctic ice shelves calves an ice berg the size of the State of New Jersey, which is entirely possible. Simultaneously, a volcano blows a whole tropical island into dust dispersing in the atmosphere, while a modern reservoir is being filled with water some place else. Another earthquake breaks an earth dam somewhere, and a whole lake flows to the sea, just as a sandstorm rearranges a desert by blowing a few cubic miles of sand away. This may seem an unlikely scenario but similar mass moving events happen daily. We have just lost perfect balance, a fact that has been long ignored by our modern philosophers.

Our thought experiment proves our Earth cannot be in dynamic balance. Any unbalanced rotating mass must wobble, unless the axis is tightly restrained by bearings, and then it must thump against its bearings. The period of the thump, or wobble, must be related to the period of rotation as well as the magnitude of the disturbances. These, admittedly, may be such that only very sensitive instruments will be able to detect them.

However, almost every tire dealer in the country now has a dynamic wheel-balancing machine that not only detects very slight imbalances, but also tells the mechanic what size tire balancing weights to snap on and exactly where to place them. This machine works by detecting stresses which result in microscopic deformations in the thick drive shaft. Sensors translate these movements into data, which the machine's CPU then uses to calculate the masses and positions that will balance your wheels.

I contacted an engineer working for the American Hofmann Corporation. This firm specializes in wheel balancing machinery, and he wrote, *"What we can say is that if a body is spinning, it will rotate about its center of mass unless constrained otherwise, such as by a shaft with bearings ... If the center of mass does not lie on the axis joining the centers of the bearings, then forces will be exerted on the bearings when the rotor spins. If the bearings are not rigidly connected to infinite mass, then the bearing housings will vibrate."*

But our philosophers assume that any Equatorial Bulge exactly cancels any effects from imbalance. A rotating wheel and tire constitutes a flywheel, and as you can see from the engineer's statement this is patently untrue. The flywheel effect alone can not compensate for dynamic unbalance. For many years I had assumed that our out of balance

condition, no matter how little or great, would register as a daily wobble. Decades passed, and technology improved to the point where even a minute wobble should have been detected. When I became positive that this wobble did not exist, I was forced to the conclusion that our polar axis is held by some type of bearings — whether they be magnetic, electrical or provided by some force we have yet to discover. I call them Rene' Bearings. Either that or the entire Earth is cradled by the matrix of space itself which somehow acts as bearings. But no matter the type of bearings, our dynamically unbalanced Earth should thump with a period somehow related to its rotation.

On January 17, 1984, the New York Times ran a feature story on a 15 year old scientific snipe hunt. The story really began over 70 years ago with Einstein's elusive gravity waves. These waves are assumed to be composed of 'gravitons' which travel at the speed of light and are the particles that propagate the force of gravity.

Neither the gravity waves, nor the "gravitons", have ever been detected. Astro-physics philosophers figured the waves were too weak, and subsequently decided that extra strong gravity waves would be generated by either supernova being converted into a black hole, or by the simpler collapse of a giant exploding star. Supernovas are extremely rare. So they logically decided to concentrate their efforts on giant collapsing exploding stars which I shall hereafter, sarcastically, refer to as— explo-lapsers. The philosophers believed that with billions of galaxies in the universe, there ought to be a detectable explosion most of the time. They also believed that during such an explosion, the star in question will change its shape from football to pancake 1000 times a second.

In 1969 Joseph Weber of the University of Maryland began the gravity wave snipe hunt when he responded to this theory by creating an instrument called the Weber Detector. The apparatus consists of a large, vertical, aluminum cylinder, standing at the right angle junction of two long tubes. The entire apparatus is shock-absorber mounted to be as vibration free as possible.

The cylinder is dimensioned to resonate at 1000 cycles per second. A laser beam is bounced from the end of one tube to the end of the other by reflecting from a mirror at their junction in the main cylinder. Any motion is then led to a Michelson interferometer,

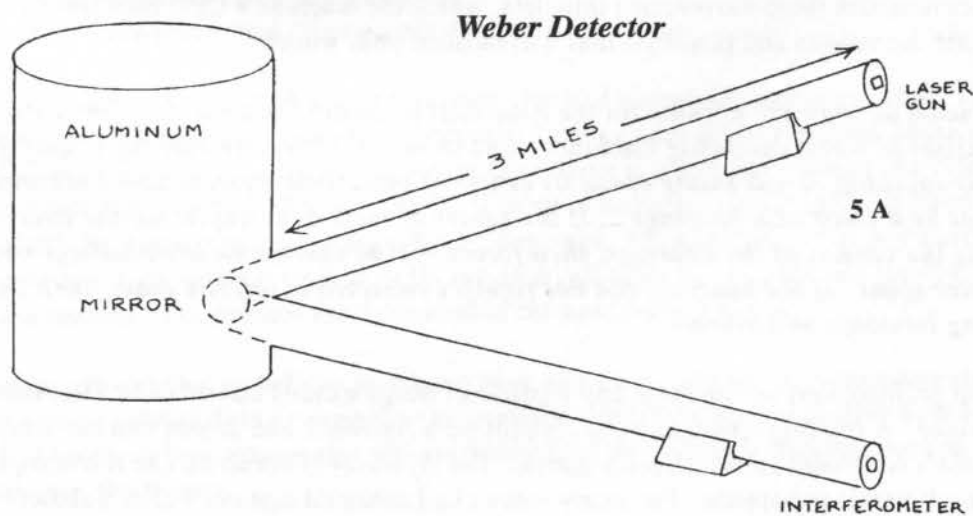

which can detect even the most microscopic vibration. Of course, if the Earth itself should shake the tubes and the cylinder, this too will be detected. ¹

By the time 1984 rolled around, each sequential failure of the Weber detectors was met with increased determination to build detectors with bigger cylinders and longer tubes. On the model we are speaking of, the tubes are 3 miles long. Gigantic Weber detectors located near Rome and Geneva, were finally detecting disturbances. Eureka! Gravity waves at last!

Then came the sting! Almost 718 minutes later another exploding star was detected shaking the universe. And every 718 minutes thereafter the detectors reported that the universe was being shaken. In the article that Mensa never printed all those years before, I had claimed that this vibration was somehow linked to the sidereal day. The same national Chairman of Mensa who gave me all that grief about the original book wrote me to the effect that 718 minutes was *"a strange number that doesn't quite tie into the earth's rotation."*

A sidereal day is the time that it takes the Earth to rotate once. The period of rotation is 23 hr - 56 min - 4.5 sec. This totals 86164.5 seconds, half of which is 43,082.25 sec or 718.0375 min. The difference is .0375 which amounts to .005%. Not being a "scientist", like Rudolph, I believe that's close enough for the popular press.

Weber claimed to have succeeded in detecting these very elusive gravity waves. But his claims were premature. I found out, after this book was originally published, that by 1973 the periodic thumps had displayed a 12 hour periodicity, and had been officially tied to the Earth's rotation. ² In this age of Orwellian "Newspeak" these experiments were reported as great successes. However, in reality, they were some of the most crushing defeats ever suffered by organized science attempting to verify a "theory". They had spent hundreds of millions and serendipitously found the thumps needed to corroborate my theory that the Earth's axis is fixed by bearings, specifically Rene' Bearings. I know nothing of the nature of these bearings but I suspect they're electro-magnetic. Isn't everything?

These spectacular failures were not caused by flaws in the Weber detectors, but by the theory behind them. Any object can only change its shape by movement of its mass. By Einstein's decree the velocity of any mass is limited to the speed of light. If it can be shown that the velocity of any mass, even stellar material, has exceeded this limit, then Einstein's elegant Relativity Theories join Ptolemy's geo-centric universe as philosophical garbage.

To simplify this matter, I shall conveniently forget Einstein's other rules regarding the volume of mass at extremely high velocities and assume that, in an exploding star, matter can move up to the speed of light. Under these conditions, there must be some maximum diameter that an explo-lapser can have while it changes shape, 1000 times per second from football to pancake. If that star is larger than this critical diameter then some parts of its mass must move faster than the speed of light. This would void the very "LAW" that this experiment was designed to prove!

To begin to solve this problem, I had to choose the parameters of deformation to apply to

a star that doesn't know whether its a football or a pancake. I realize going in that, no matter what parameters are chosen, the cry of "Not so!" is sure to be raised.

The philosophers will complain that the words, "football" and "pancake" are only symbolic approximations. However, in an attempt to be fair, I limited the 'football' to a length 1.2 times the star's diameter and the 'pancake' to height of .8 diameters. That leaves us with a short football and a very fat pancake.

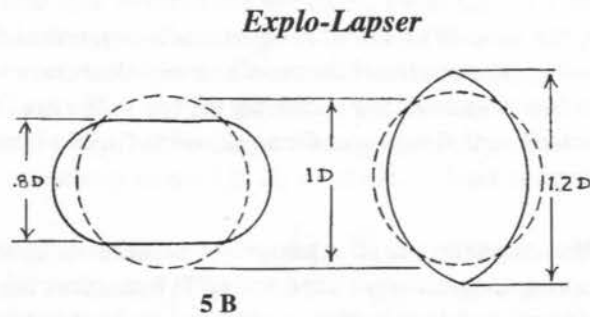

My first attempt at solving this problem involved volumetric changes. Six hours later I was buried in a ream of scrap paper, and I had given up in total confusion. The following morning, with the dawn, I saw the light. If the first change from sphere to football was ignored, it became obvious that a particle of mass had to move from the top center of the pancake to the nose of the football and then back to the top center of the pancake to complete one cycle.

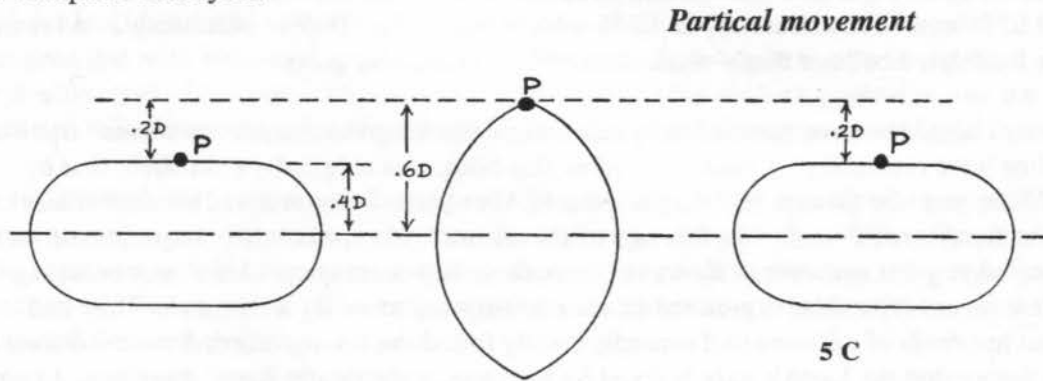

The previous sketch shows the movement of particle P during one cycle. Particle P must move .2 diameters up and .2 diameters down for a total movement of .4 diameters per cycle.

In one second the total movement must be 400 diameters and if we divide this into the speed of light, we find that the maximum diameter that any giant explo-lapsing star can be is 465 miles. This is a giant star???

$$\text{Maximum Diameter} = 186,000 \text{ miles per sec} / 400 \text{ diameters per second} = 465 \text{ miles}$$

Even if we reduced our parameters to a football of 1.1 diameters and a pancake of .9 diameters our giant star would still be less than 1000 miles in diameter. Our Sun, if the philosophers are correct, is only medium sized but a shape distortion of only .04 % at 1000 cycles would negate the Theory of Relativity as the movement of some particles would then exceed the speed of light.

In the last decade they have polished up their story and now claim that the shape distortion won't even begin until the star has shrunk to 400 miles in diameter.

Beginning in 1969, the astro-philosophers of at least 10 countries have spared little effort, or expenditure of public funds, in an attempt to change the Theory of Relativity into the Law of Relativity by detecting those elusive "gravity waves".

In February '84, I prepared a short paper on the Weber Gravity Detectors. This was dutifully ignored by all the journals I wrote to. The June '87 issue of the "*Scientific American*" carried an article written by four men, three Ph.D.s and one with only a master's degree in physics. Each one of them was an expert on the never yet detected gravity wave. In nine pages complete with full color illustrations and diagrams, they describe the wonders that will be discovered when the various governments of the world donate a few more hundred millions, to create larger and more sensitive Weber Detectors. Never once did they mention the sidereal thumps of the huge detectors already at work in Rome and Geneva.

I wrote an article specifically for "*Scientific American*" in rebuttal to this article. During a phone conversation with the Editor of the magazine, he claimed that he was only a poor journalist doing the best he could and that he had no choice but to rely solely on the credentials of the writers for their material. I reminded him that I had read and enjoyed his magazine when it was understandable to laymen with some knowledge of science. But I also noted that this current "reliance" on scientific credentials had caused much of the writing in his magazine to pass into the realm where only another so-called expert could understand the subject matter. His magazine is not a specialized scientific journal and I feel that if science writers cannot transmit a concept to me in plain English, then they are probably out of their element. People who intentionally obfuscate their meaning with 'wrong speak' want their readers to "*bamastanin the framastats to cause the kanoddle to wronce.*"

Three hundred years ago when Newton postulated gravity, he clearly stated that he did not know whether the force would be found to be attractive or repulsive but only that it must exist. Like him, I don't know whether Rene' bearings affix our planetary axis, or if an unknown field cushions the whole Earth. Nor do I know if this force is magnetic, electrical or a yet to be discovered force. Nor do I care that recognizing the very existence of these bearings constitutes an attack on three hundred years of celestial mechanics. I only know that the Rene' Bearings must exist!

Newton allegedly solved the puzzle of gravity 300 years ago by declaring that gravity was caused by the innate attraction of one mass for another. That general force is proportional to the product of the masses involved and inversely proportional to the square of the distances between them.

$$\text{Gravitational Force} = \frac{\text{mass \#1} \times \text{mass \#2}}{\text{distance} \times \text{distance}}$$

John Michell later invented the torsion balance, which in 1785 Coulomb used to measure electrostatic forces. These forces are measured by the twisting of the long supporting wire according to Hooke's Law of the stress and deformation in

Torsion Balance

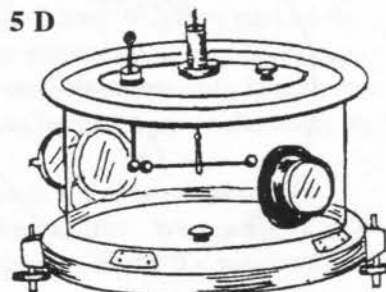

elastic materials. I have always wondered why Hooke's Law is considered to be inaccurate for a spring scale in scientific work but is accepted for measuring electrical charges and weighing the Earth.

Cavendish Balance

In 1794 Cavendish modified a torsion balance to measure gravitational effects. Coulomb had made no effort to shield the apparatus from the effects of gravity as he considered them to be too minute to affect his testing. The suspending wire on the Cavendish balance was long and today's philosophers tell me that there is a natural voltage difference of 10 to 80 volts for every foot of elevation anywhere on Earth.³

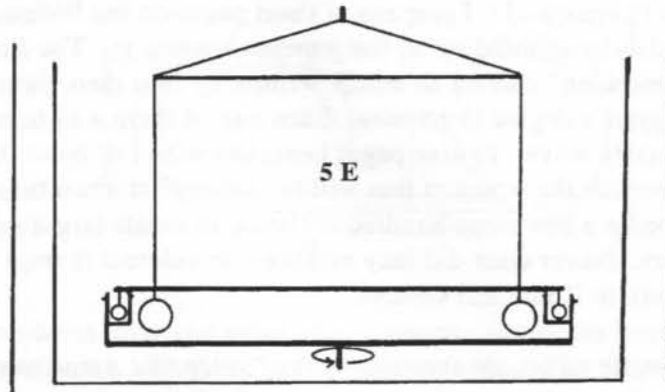

Like Coulomb, Cavendish made no attempt to shield his balance from electrical effects. But also he didn't apply any finagle factors. (I was failing college physics lab until I learned to apply finagle factors to my experimental data, the same as everyone else.) Could some of the force that deviated his Cavendish's balls have been electro-static? Bear in mind that the electric forces are incredibly stronger than those of gravity. If we admit to some — why not ... all?

What originally attracted my skepticism was the fact that writers fail to agree on the composition of Cavendish's balls. He has balls of iron one says; He has balls of lead, writes another; No! He has golden balls, avers a third. Perhaps like Joseph's Biblical coat he had balls of every color! How did he measure and weigh his balls so accurately that his original figures basically agree with today's estimates? Has everyone repeated his errors? His experimental results were released posthumously by his wife. Even the experiment itself was suggested by his parish priest but, of course, no credit is extended to him.

Cavendish's Balls

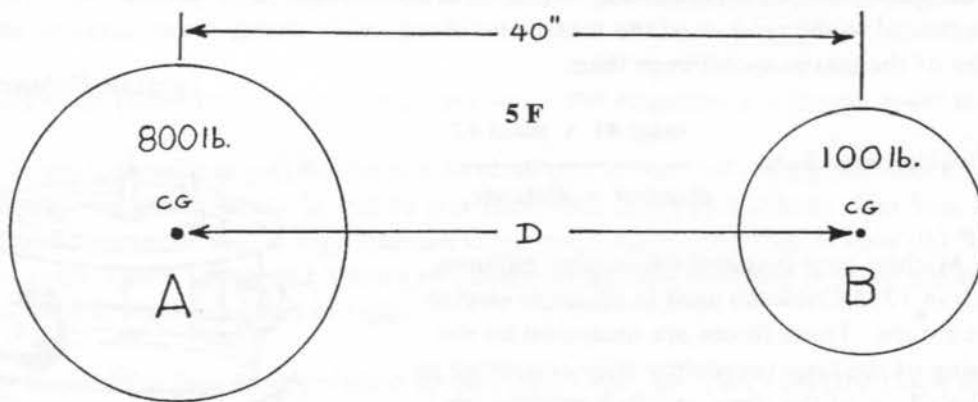

Another of Newton's tenets demands that when figuring gravitational forces, only the centers of mass need be used in calculating the distance of mass from mass. In essence, the original Cavendish experiment totally ignored Newton's theorem and measured the force between two masses as shown.

My previous complaints about Saint Newton are small potatoes compared to my major complaint. I have read a great deal of Newton's "Principia" and I find this amazing information: ***"If to every point of a spherical surface there tend equal centripetal forces decreasing as to the square of the distances from those points, I say, that a corpuscle placed within that surface will not be attracted by those forces anyway."*** ⁴

What this means is that there is mysteriously no attraction of any particle of mass for any other particle of mass residing in a mono-molecular layer. How one would decide the boundaries of this strange effect I do not presume to know. Later, in Anomaly # 12 in Chapter 7, I will show the most probable reason for this amazing sentence.

For the sake of calculation assume that the mass of ball A is 800 pounds and the mass of ball B is 100 pounds. The distance between the centers is 40 inches. For ease in computation I have eliminated g from the calculations. Therefore by Newton's Law of Gravitation the general force will be:

$$\text{Force} = \frac{800 \times 100}{40 \times 40} = \frac{80000}{1600} = 50$$

If we accept this reasoning, then we must agree that each of the Cavendish balls (and the Earth itself for that matter) is also composed of concentric mono-molecular spherical

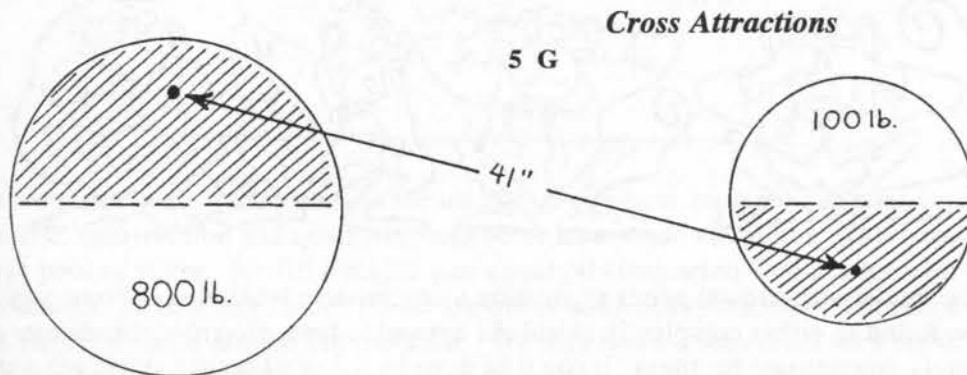

shells. Looking at the sketch we see that each molecular layer of each concentric layer of the individual spheres is a part of a larger concentric shell and therefore part of the same layer. In which case, if Newton is right, none of the molecules of any layer can attract any molecules of that particular layer, so the only attraction possible is the cross attraction of the top hemisphere of each ball for the bottom hemisphere of the other ball.

We see that the distance between the center of gravity of each set of hemispheres is greater than the original distance between the centers of the spheres. We see also that the mass of each hemisphere is exactly half of its respective sphere. Since we are dealing

with two separate halves, the force found must be multiplied by two. Recalculating, we find:

$$\text{Force} = \frac{400 \times 50}{41 \times 41} = \frac{20000}{1681} = 11.897 \times 2 = 23.97$$

This is about one half of the force found by the Cavendish method. What happens now to the gravitational constant? What happens to the mass and density of the Earth and consequently to the mass and density of every celestial body in the solar system? All of them calculated from the results of this experiment! What happens to the mass of our galaxy and even, the mass of the universe?

The Cavendish experiment provided the first experimental proof of Newton's "LAW" of gravity. Most of what we are 'absolutely sure' we know is derived from his results. The professional philosophers can pooh-pooh and tut-tut until Hell freezes over, but until they seriously address the problems associated with this experiment, they will keep playing games with themselves and everyone else around.

I call for square one re-testing! Much of physics beckons ever more loudly. I can hear the most basic experiments calling out to the philosophers of the world, "Test me! Test me again!" Unfortunately the philosophers are as arrogant as the last of the three ancient monkeys of myth. While the individual monkeys are forever enjoined to see no evil, hear no evil, and speak no evil, the "open minded" philosophers seem as arrogant of the last monkey shown on the extreme right. This fourth monkey is deaf, dumb and blind!



The Cavendish experiment needs replication using modern technology. Some way must also be found to either completely shield the apparatus from electro-static charges or to accurately compensate for them. It could be done by using a Faraday shield but nothing will ever happen until minds open up!

I propose a new test, an observational test, for Newton's gravity. My experiment will measure the time it takes for three separate masses to attract each other. The gravitational force of attraction will accelerate each object toward the other two, and we can determine this acceleration from the time involved before they touch. From that acceleration, we can then calculate the actual forces of attraction and compare them with Newton's formula and Cavendish's gravitational constant.

Suppose we obtained three thin wall hollow spheres of brass about 10 centimeters in

diameter, and then fill them with 3000 grams of brass. This would leave an air space on the top of about 150 cc's and thereby cause each sphere to float above its equator when placed in mercury. By so arranging the center of gravity we would also stabilize them against wobble.

Suppose we send our spheres out to be precision ground by a process similar to that which creates ball bearings. By adding a bit of weight to the two lightest balls we would then have three balls equal in diameter at 10 cm. and equal in weight at 3200 grams. We chose these materials because they are non magnetic, and won't respond to stray electro-magnetic fields. For the want of a better name let us call these three spheres Rene's Brass Balls.

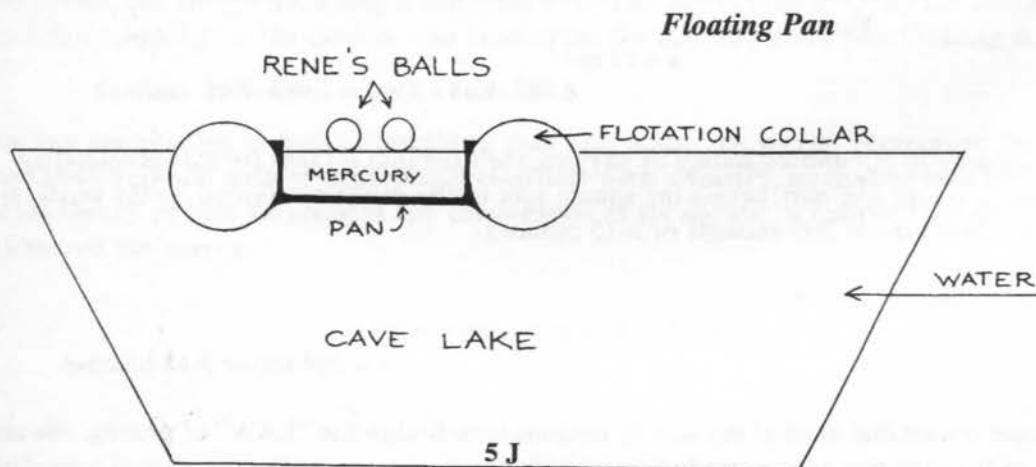
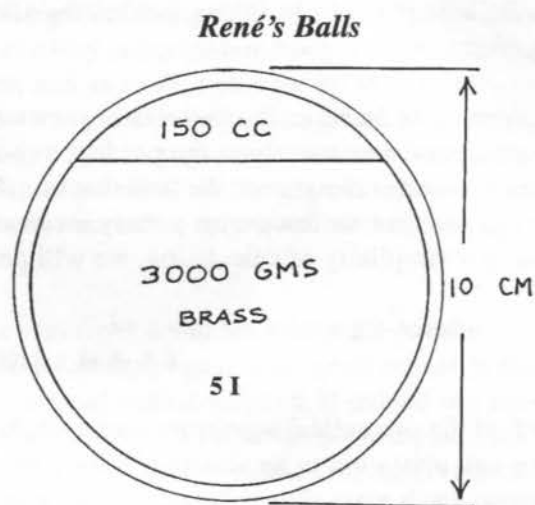

Now we must locate a deep cave in the middle of nowhere, far from vibrations caused by traffic, construction and quarrying, and other man-made vibrations. There we create a large pool of water. We fill a plastic pan about 30 centimeters in diameter with about 6 centimeters of mercury. Since this container is quite heavy we must then create a large foam flotation collar around the container. We thus make a heavy, but very stable and vibration-free mercury bath.

We place the pan into the pool and we now have a liquid floating in a liquid, deep in the earth. This should dampen out all extraneous vibrations short of an earth quake. The sketch shows the floating pan.

We now arrange a very precise triangular rack that has an internal separator of plastic to keep the balls about one millimeter apart as they float. When all wave motions have been dampened out and stopped, we turn on our very high speed movie camera to record this new proof of Newton's gravity. We slowly lift out the plastic, thus smoothly freeing the balls. By this time, each atom of each ball should have processed the information

ROLL-OVER

Throughout this book I will use the word “Roll-Over” which is a concept that HAB (Hugh Achincloss Brown) proposed in his book “*Catyclisms of the Earth*”. In fact, my research and discoveries over the past 25 years have all been prompted by, or directed toward proving or disproving HAB’s “Roll-Over” theory.

I’m an inventor, and this led me to study many of the various engineering disciplines. This, in turn, led to a great interest in things scientific. I did not set out to discover anything. My path was chosen for me about 25 years ago when I read HAB’s book.

During my first reading, on three separate occasions, I threw his book against the wall. His theories violated my (EBS) Emotional Belief System. He insisted on telling me things that I knew could not be true.

One of his beliefs was that erosion is not the main reason that we must dig down, approximately 3 feet per thousand years to uncover artifacts of the present epoch. He believes that the Earth constantly accretes matter by a natural reversal of Einstein’s matter to energy process. In HAB’s process the plants use the sunlight and photosynthesis to create matter. Bang! The book hit the wall.

Later, I remembered a hunting trip when I had to dismantle a stone wall to get at and kill a wounded squirrel who had scrambled into it. The bottom rocks of the wall were over a foot below the surfaces of the adjacent pasture. Now, farmers don’t dig footing ditches when they build a field-separation stone wall. On another trip I found the site of an old cabin whose dirt floor was lower than the surface of the surrounding field. I pictured a rainy day and laughed at the builder because his floor would be a puddle until I figured out that the roof had protected the inside for years from falling leaves and wind blown dust while the outside accreted matter. This allowed me to see that it was only my preconceptions that had been insulted — not my logic.

His theories intrigued me because they provided a better explanation for many anomalies of geology and paleontology than did the official scientific party line. To provide relief from my world of heavy construction labor, I started out to prove him wrong. After all these years, although I have proved him wrong in some minor points, his main ideas stand and his book has become my bible. It also directly led to most of my discoveries, and to the scientific skeptic that writes these words today.

HAB did not believe in Ice Ages. Instead, he argued that the Earth periodically “Rolls-Over” every 3500 to 7500 years, physically changing the surface location of the poles of rotation and thereby defining a new equator. When this happens the new poles maintain approximately the same axial tilt as the old because the solar system is driven and controlled by the immense electrical generation of the Sun. Buried in the Faraday diaries of which I shall speak of later are the results of an experiment that demonstrated rotation, revolution and tilt of bodies by electricity.

HAB believed that world epochs are defined by the geographical location of the current pole during that era. According to HAB, this present epoch should be called “The Ant-

arctic Period.” This epoch began after the last Roll-Over, about 5500 BC. During the previous epoch the major ice cap was centered in the depression we now call the Sudan Basin. That epoch lasted for 4500 years, from 10,000 BC to 5500 BC.

Think about it, if the pyramids and the sphinx are a bit older than we think, they were once buried under the Sudan Ice Cap. The epoch before that formed the Hudson Bay Basin. That epoch lasted for 7000 years from 17,000 BC to 10,000 BC. And the one before that centered in the Caspian Sea Basin and lasted only 5,000 years.

To visualize a Roll-Over, one must first picture a perfectly spherical, balanced and homogenous Earth that is floating in space, where there is no up nor down. Then one must add a small surface mass near to the poles, and then begin to rotate the world. At this time, this eccentric polar mass would twist around and migrate to the new equator.

Our professional uniformitarian philosophers ardently believe in a “natural” uniformitarian universe, a universe that admits no catastrophe! A “Roll-Over” would be the ultimate catastrophe, and they blithely ignore any evidence pointing in that direction. They also believe that the present poles of rotation have remained the same since the Earth formed. However, they do believe in Ice Ages, which are periods of world wide glaciation, that at times have sent ice clear down to the equator. And if that isn’t catastrophic, no matter the time periods involved, I guess I don’t understand the meaning of the word.

To our current philosophers, the Ice Ages alternate with periods of great heat during which the polar regions support tropical plants and animals. They believe this because our planet is littered with physical evidence of so-called eras of glaciation right down to the equator. They have chosen to ignore the simple fact that fossils can only be the result of a natural catastrophe, which temporarily suspends the normal decay cycle the same way that the catastrophe of martial law suspends civil rights.

A European grammar school teacher named Bernardi invented the Ice Age theory. In 1836 Louis Agassiz, a scoffer, visited a Swiss glacier in order to gather ammunition with which to bury Bernardi.

He saw for himself the moraines (mounds of pebbles and rocks), the striated, polished rocks and the erratic boulders. The moraines were nice and the rocks were pretty. But it was the erratic boulders, some left on mountain tops, some in valleys, and most of them hundreds of miles from their points of origins, that turned Agassiz, the scoffer, into the most forceful proponent of the theory.

At first, it was believed that there had been only one Ice Age which had somehow cascaded down from the North Pole, as far south as New York City before it retreated. But as the decades passed, similar evidence poured in from all over the world, including the currently torrid equatorial regions of Brazil and Africa. Instead of these anomalous observations sounding the death knell of the Ice Age theory, the Uniformitarians invented bigger and better ice ages and extended them further and further back in time. According to the philosophers, the Earth’s average or mean temperature has varied greatly over the eons.

If the average temperature climbs until the Arctic Sea is warm enough to grow sufficient

foliage on the surrounding shores; warm enough to sustain tremendous herds of mammoths and other large herbivores; warm enough to mature semi-tropical fruit, warm enough to grow coral in the surrounding sea and warm enough for those shores and rivers to harbor crocodiles, then we must be talking of an average polar temperature of around 70 degrees. If the North Pole is warm we must assume that the southern pole must also be warm. If both northern and southern seas warm up 40 degrees, wouldn't the equatorial seas approach boiling and become too hot to sustain life? ¹

But even if I could accept this notion, my mind boggles at how enough foliage was able to grow to keep the great leaf and grass gulpers gassed up during the six months of winter darkness. Has anybody ever found a grass that could grow in the dark? Or tree leaves? Elephants are primarily leaf eaters and need well over a hundred pounds of fodder a day. They need forests which cannot grow, no matter the temperature, where the Sun is always below 21 degrees in elevation. Each tree's shadow would starve any close neighbors.

Then eons pass and the poles gradually cool. The tropical animals slowly retreat toward the tropics. Some other species stay behind and evolve into arctic animals. And every once in a while the glaciation extends clear to the equator and the tropical animals are lifted off the planet by either God or animal loving spacemen who supply space for them and care for them in immense zoos until conditions improve back on Earth. From an ice age to a warm era we are looking at a mean temperature shift of well over one hundred degrees at both poles and equator.

Which is ridiculous! The polar regions of every planet, whose poles are close to 90 degrees to the plane of orbit, are much colder than that planet's equator, provided that planet is not still red hot. This is because the incoming sunlight at the poles has a great angle of incidence. Here on Earth, even if our axis were not inclined over 22 degrees to the equatorial plane, the polar regions would still be cold. Look at how the local temperature drops every night. The ratio of equatorial heat to polar cold for our planet is fixed depending on various factors such as internal heat, atmosphere, extent of water, inclination of axis, and the output of the Sun.

For over 150 years, mechanisms that could create Ice Ages have been postulated, one after the other. Each in turn are hailed at first, then later discarded for another newer one until, Phoenix-like, the old ones again become resurrected. The dust blanket theory is being revived today by Sagan in his nuclear winter theory. With this theory something (Meteor — Volcano — H-bomb) stirs up enough dust to shroud the planet. This dust has magical property in that it doesn't settle, resulting in ... a severe and long term drop in the temperature. I grant a temperature drop because some of it stays suspended for a few years, but the major effects do wear off as the dust settles. To suppose dust not to eventually settle, no matter the particulate size, is to believe in magic.

The rest of the theories are all based upon some mechanism that alternately raises and lowers the planetary temperature by altering the sun's output, or by varying the Earth's orbit or even the inclination. Some part of each theory always reduces planetary temperatures, because each philosophical genius realizes that cold is vital to the formation of ice. However, what they never take into account is that cold is only one half of the process. The other half is heat. Just like a refrigerator needs a hot compressor, an Ice Age is dependent on a heat pump.

The larger the area of glaciation, the larger must be that heat pump. A growing glacier must receive more water than it loses by melt off, or calving of ice bergs, plus the direct evaporation of ice into vapor (sublimation). To create cold, your kitchen refrigerator is totally dependent on an outside energy source (usually electric) but in the past a flame has also been used to provide the energy for removing (pumping) the heat from the inside box to the "outside" heat exchanger. To build a glacier, water must be evaporated from a warm sea, transported as clouds to the arctic areas, or high elevations, and then be precipitated out as snow. Then that cold dry air must return to the warm sea, to start the cycle again.

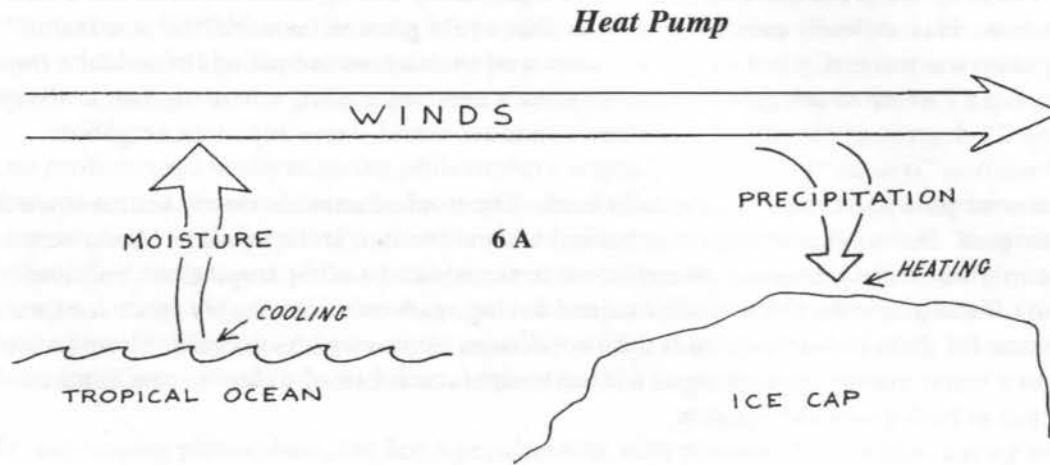

However, the evaporation rate of any ocean is completely dependent upon four things; the air temperature, plus the humidity of that air, the temperature of the body of water, and the surface area involved. As each drop of water vaporizes from the ocean, a large quantity of heat (heat of vaporization) stays locked-up in the vapor itself, and this latent heat is incidental to the temperature of the air. It is transportation of this vapor that removes heat and chills the ocean. When such humid air is cooled over a glacier, or at the high elevations, precipitation occurs. Then the heat of vaporization is released. Thus the transfer of heat from an ocean reduces its ability to create vapor, and the transfer of heat to a glacier reduces its ability to create ice. This is one of the limits to the growth of a world wide Ice Age.

As glaciation extends southward, another check on growth occurs. As the volume of the glaciers increases, the volume of the seas must decrease. This decreases the surface area, which reduces the effective rate of evaporation. These two limits tend to severely limit the heat pumps ability to glaciare on a world wide basis. Since both hemispheres must glaciare simultaneously, the heat pump necessary to glaciare to the 40th parallel, let alone drive them down to the equator, would have to be magical.

Since I was a kid I have been told that a temperature drop of only two degrees would precipitate the next ice age. Bullshit! All this would do is decrease the world's already shaky food supply and build-up a bit more permafrost in the northern regions. A large enough temperature drop might even freeze all the oceans, but no amount of cold can produce worldwide glaciation. When someone parrots worldwide glaciation to me, I feel just like that irate old lady does in the hamburger commercial when she screams,

"Where's the beef?" What I want to know is "Where's the heat pump?" It's very cold in Siberia, yet there are no Siberian Glaciers because Siberia is too far distant from an oceanic heat pump.

During the next Roll-Over, already overdue since the epochs have seemed to average less than 5,000 years, I believe the new equator will be the great circle that passes through the center of the ice mass in Greenland and the center of the ice mass in Antarctica. This should place one of the new poles at 5 N. Latitude and 60 E. Longitude and the other at 5 S. Latitude and 60 W. Longitude. For the next few paragraphs my descriptions (north, south, east and west) of the following areas are as shown on a current map. The first polar region will encompass Somalia, eastern Ethiopia, eastern Saudi Arabia, western India, Ceylon, and northern Madagascar. The second polar region will be a water pole about 900 miles west of the Galapagos Islands and contain Clipperton Island, Easter Island, and the Marquesas.

The temperate zone from the first pole would run through all of eastern Africa, Turkey, Iraq, Iran, southern Russia, most of India, Tibet, Burma, Malaysia, Sumatra and Madagascar. The temperate zone from the second pole would include Hawaii, the south western United States, Mexico, Central America, Ecuador, Peru and the Cook Islands. The tropical zones should hold eastern Australia, New Zealand, Antarctica, Cape Verdi Islands, eastern Brazil, western Africa, Spain, Portugal, Ireland, Great Britain, Iceland, Greenland eastern Siberia, Alaska, the Marshall Islands, and the Gilbert Islands. Strictly by chance New York City will remain at the same approximate latitude.

The destruction to land surfaces, mountain ranges, river beds and life forms would be incredible, because the rotational velocity at the equator is 15 degrees per hour, or 900 knots (per hour). The velocity of those parts of the Earth's surface moving to new poles and a new equator would equal this speed, as land surfaces move under adjacent oceans. The inertia of the oceans will force them to maintain both velocity and direction, will result in indescribable tidal waves. Even the atmosphere would tend to continue on its course, creating continental-size hurricanes, carrying tornadoes and devastating winds to those sections not already drowned. The Van Allen shield will also collapse allowing great radiation to bathe the surface.

Around 1200 AD, the Greenland ice cap began to expand and the northern seas around it became ice-choked for much of the year. This had to, and did have a corresponding effect on the world's climate. At about the turn of the millennium there was a Norse colony located on the northern end of Greenland. One year an extra cold winter froze the sea and it has never thawed again. Howorth has this to say, "*Now, in the north of Greenland the glaciers seem undoubtedly to have been growing and extending over districts where formerly a more temperate climate prevailed, notably in the days of the Norwegian settlement.*" ²

In Britain, where it had been balmy, fireplaces were installed in castles. The Swiss glaciers crept over some Roman roads, a lot of farm land and a very productive silver mine. None of the above has yet been given back by the glaciers. One lost Norse colony of Leifsburdir, Vinland was actually located in Narragansett Bay, Rhode Island between 986 and 1035 AD. There are twenty-nine points of agreement in placement with the actual chronicles. One, shaky by conventional standards, claims that for over 20 years it

never snowed, and the winters were frost free. ³

Early navigators kept looking for the northwest passage with a persistence that bordered on manic. It was as if they knew it existed, but were baffled that they could no longer find it. This passage does exist — our atomic subs use it frequently as a fast passage between the Atlantic and the Pacific. The only problem is that it is now covered with ice. However, in a world with a bit more warmth in the high latitudes, summer passage might have been possible, even to the ships of old. A slightly warmer planet might also explain how Hannibal was able to move his small African forest elephants over the Alps.

In the mid 1500s the Spanish had working orange groves in Charleston, South Carolina. Try to duplicate that feat today. Two centuries later, the new center of American orange groves had dropped into central Georgia. Then another freeze, just before the turn of the century, drove it further south to Fernandino Beach, Florida. Then another freeze sent it down to Saint Augustine and yet another to Orlando. The freeze of 1989 destroyed many groves in the Orlando area and damaged even those on the edges of the Everglades.

Slightly to the northwest of Orlando, near the Florida Gulf coast, are two counties named Orange and Citrus. But you'd be hard pressed to find a single orange tree, let alone any groves there. Since it's still fairly open country, I know that condos didn't run them out. The cold has driven the oranges southward over 300 miles in 450 years. That's a mile every 18 months. Florida orange growers have no place left to retreat to now. They are pinned on the borders of the Everglades, and oranges don't grow in swamps.

Forty year old memories are treacherous things at best, but on a trip to the Daytona motorcycle races when I was 17, I remember seeing palm trees before we hit the South Carolina border. I also remember talking with an old man in the middle of nowhere, North Carolina, who had hunted "gator" as a boy. And there was Spanish Moss all the way through Georgia. A few years back, I sent off letters to the various historical societies of Georgia and the Carolinas, asking about the northern limits of specific species in colonial times. I asked Georgia about Spanish Moss. I asked South Carolina about Spanish Moss, palm trees and alligators. North Carolina about alligators and palm trees. Georgia never answered, and South Carolina wanted 6 dollars to do a genealogical study of either gators or palm trees, I'm not quite sure which. However, Charleston, SC was renowned for its Spanish Moss just before the Civil War.

Jerry L. Cross of the North Carolina Historical Society placed alligators as far north as Albemarle Sound in colonial times. The north end of Albemarle Sound is about 25 miles from Virginia. I then wrote to Virginia on a hunch, and learned that gators had once lived in The Great Dismal Swamp. This would mean that the gator has been driven southward well over 150 miles since Colonial Times. Of course, this retreat might easily be blamed on man, who has been known to exterminate a species or two. Or three or more!

Gators used to be seen as far north as Saint Louis in the early 1800s. Today Spanish Moss is scarce north of the Georgia line and the palms disappear about the middle of South Carolina. Also, the manatees, who become comatose if the water temperature goes under 60 degrees, are no longer found in the Gulf area around Pensacola, which is much less developed than south Florida. So much for Carl Sagan's hothouse effect!

Antarctica was discovered in 1818, and shortly thereafter sections of the coast were mapped by whaling ships. Those old maps show coastal details now buried under hundreds of feet of ice. The rate of accretion seems to be more than a foot per year. Tall radio towers left at Little America by Richard Byrd in 1929 are now halfway buried in the ice.

Recently a large supply plane was recovered from under 30 feet of ice in Antarctica after being parked there for only 15 years. This would indicate a growth rate of two feet a year and substantiate the coastal accumulation of ice since 1818. If you believe that ice can float boulders then it can surely float an airplane since the density of an airplane is much less than that of rock.

The Vatican has records dating back 1000 years that show that coastal areas of Greenland were once green, hence the name. None of this, contrary to the expert's great expectations, could have happened without growth of the great ice caps.

The Greenland cap covered a squadron of planes that were abandoned during WW2. A salvage team is searching for another flight of planes lost in 1942. ⁴ They are buried 260 feet deep in the ice. A previous squadron has been rescued from under 40 feet of ice. Is the cap growing? Are the planes sinking? If they are, how can glaciers carry huge boulders up mountain sides?

Most icebergs are calved toward the end of winter. If ice caps were actually decreasing, glaciers that reach the ocean would melt away — producing water instead of icebergs. Thus each winter, on average, there would be fewer and smaller icebergs, and the summer beaches of Antarctica would be expanding. Neither of these conditions have been observed, and the evidence points to polar caps that are expanding, not shrinking, as the "Hot House Effect" demands. It is politically correct to speak of "Global Warming" caused by mankind's various exhalations but it is too soon to tell if the temperature rise will overcome the already existing tendency toward a cooler climate.

But let's examine more closely the objects that are classified as the proofs of an ice age. They are: sand and gravel moraines, striated rocks, polished rock surfaces, and (especially) erratic boulders. With the single exception of erratic boulders which are very impressive, impressive enough to act as keystones for the Ice Age Theory, rivers and creeks do the same thing with the sand and gravel in their beds and on their banks. The Ice Agers believe that the same ice that grinds a deep lake basin out of granite gently molds mounds of sand and gravel and passes peacefully over low mountain ranges of soft material only to grind out another deep lake basin in granite.

According to Ice Age proponents erratic boulders, some of incredible size, are the ultimate proof that there are Ice Ages. In fact, wherever they are found becomes a new area visited by yet another Ice Age. Here is what Mr. Cox has to tell us about erratic boulders:

"(1) In Maine, erratics on Mount Katadin have been transported at least 18 km and uplifted 1000 meters.

(2) Erratics in the Adirondack Mountains, New York, have been transported at least 100 km and uplifted 900 meters.

(3) On the Allegany Plateau, central New York, rocks are supposed to have been moved

160 km and lifted 500 meters vertically.

(4) On Killington Peak, Green Mountains, Vermont, rocks have been transported possibly 80 km and lifted 900 meters, apparently, by the ice.”⁵

(5) They have also been moved from the Laurentian Plateau (with an average altitude of 1600 feet) west and southwest to within a few miles of the Rocky Mountains onto a plateau whose altitude is 4200 feet. This is an average distance of over 700 miles.⁶

If you ever visit New Jersey, take a look at the monster boulder (middle-sized erratic) that lives at the corner of Rock Road and Doremus Ave in Glen Rock. It, and all its millions of cousins all over the planet, are supposed to have been carried by the ice and deposited where they are found. Some wound up at much higher elevations than their original location. The only pertinent question is, can ice actually carry rock? I don't mean drag or push, I mean lift up and carry!

The problem is that ice that can do this sort of a thing is no longer found on the planet. We have trillions of tons of regular ice, but this special stuff hasn't been seen since the end of the last Ice Age! This special ice had a compressive strength much stronger than the current ice. Lab tests show that our modern ice crumbles if we ask it to push a lousy 7 miles of itself along a super-slick, friction-free level path. Our current glaciers and ice fields come to a halt as soon as they reach level ground, let alone a hill. The only way we can get them to climb a hill is by pouring a lot of ice water on their top.

It is claimed that water alone created New Jersey's shore line. However, the experts assume that Long Island is a terminal moraine of the last Ice Age. I find it difficult to distinguish between the two. Every stream and river bed shows polished rocks, and water has been known to heave a boulder or two. In England, a lighthouse has to be rebuilt every 20 years; because the North Sea periodically bombards it with 2 ton boulders. A broken dam in California swept chunks of concrete, weighing up to 10,000 tons, miles downstream.

In 1958 the glacier in Lituyo Bay, Alaska, calved an ice berg which drove a giant wave, 1720 feet high (over a third of a mile) onto the far shore, sweeping away a forest. And this wave was a tinker-toy compared to the size of waves necessary to sweep erratic boulders to the tops of mountains. This would require humongous waves generated by an entire ocean being torn from its basin. This, of course, is — impossible!! At least, in a uniformitarian universe! These are not killer waves nor tsunamis, these are humongous waves generated when a “Roll-Over” forces the land to twist in front of an ocean moving at the average Earth's rotational speed of 1000 mph.

Suppose we rented a huge, empty, rectangular frozen food warehouse for a rather simple experiment. We first create a holding tank in one corner marked point A and then fill it with 10 tons of water which we turn to ice. Then we install a number of recording thermometers, about four feet off the floor, all over the building. Now we turn off the refrigeration unit.

Where do you think we would find the warmest temperature? Wouldn't it be at point D, the point furthest from the ice pile? Assume this temperature was 55 degrees. Now we turn the refrigerating unit back on and bring add another 10 tons of ice in corner A.

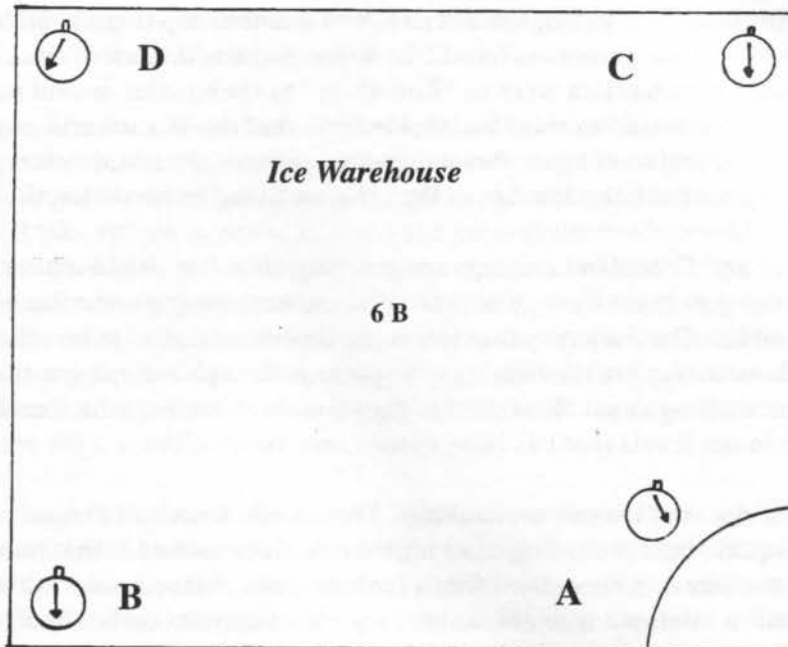

Wouldn't the same place still be the coldest? And wouldn't each of the other thermometers record it cooler than before? I submit that this is precisely what is happening and has been happening for the past 1000 years and probably since the last "Roll-Over." If there is a "Hot House Effect", that is causing "Global Warming", it has not stopped this natural occurrence but only slowed it down.

Fifty years ago, hills in Alaska were hydraulically mined for gold by jets of water powerful enough to sluice entire hills onto huge riffle boards. Sand, gravel, rocks, plant scraps, and the organic muck was washed away leaving the much denser gold lying in the riffles. The muck — black, viscous and very smelly— was comprised of strange materials. For in it could be found fur, fin, and feather mixed with teeth, bone, scale, hide, hoof and hair from both extant and extinct creatures of land, sea and lake. But even stranger, these scraps had been torn from creatures with very diverse habitats ranging from the Tropic to the Polar. And, believe it or not, the scraps were not fossilized. Similar finds, usually in caves or grottoes, have been reported all over the world.⁷ A bone cave was found outside Cumberland, Maryland, in 1912. They found bones of extant and extinct animals, from boreal to tropical, completely fractured, scattered and mixed.⁸

I submit that these fish, animals and plants were swept up by seas cascading over vast land surfaces, and then deposited in nooks and crannies as the waters drained off. I admit that the thought of a miles-high wave sweeping a continent to the bedrock, crushing and grinding everything as it scours that continent is ... mind boggling. However, to paraphrase a famous fictional detective, "*Watson, after the impossible is eliminated then what ever is left, no matter how improbable, must be the truth!*"

Before you laugh at HAB's theory as I once did, turn a world globe up-side-down and take a long and serious look at Antarctica. Notice the eccentricity of the continental area in relation to the pole (center of rotation). There are over 5,000,000 square miles of ice,

some of it two miles deep, that has depressed the bedrock into an immense bowl. The Smithsonian museum in Washington has an 8 foot diameter topological globe, and liberally scattered over it are numerous bowl-like depressions with ancient river beds that radiate outward. If Antarctica were to "Roll-Over" to the equator, would not the tremendous melt off gouge radiating river beds? I believe that this is a natural process that has been repeated over and over again down through the eons. As I said before, the polar regions of each epoch are the Ice Ages. We are now living in the Antarctic Ice Age.

If the Antarctic and Greenland ice caps are growing, then it is only a matter of time before the forces generated by both eccentric ice masses overcome the Rene' Bearings that hold us stable. The only question left is the determination as to how fast the caps are growing and how strong are the bearings. Popular philosophical opinion blames the oceans' rise on melting caps. There are at least four possible explanations for the world wide increase in sea levels that has been noted recently.

The first is that the land masses are sinking. I reject this because I cannot believe that our core of "liquid" iron is cooling at so high a rate. The second is that the water may be coming from the massive burning of fossil fuels that has characterized the last 100 years of our civilization. Believe it or not, anytime we burn a hydro-carbon fuel, vast quantities of water vapor are generated. Some of the increase is undoubtedly due to this but I seriously doubt that it would directly account for more than an inch. The third is that the planet passed through a huge cloud of icy debris and this one time occurrence might account for another inch or two. The last is the most probable and involves the warming of the oceans by one means or another. This thermal expansion could easily account for the observed increase in sea level. This does not mean that the polar caps are receding. More heat would tend to pump more precipitation at the polar caps and actually cause them to increase unless the temperature rise was excessive.

A periodic "Roll-Over" would not only account for the general mass extinctions of animals down through the ages, but also the finding of mass fossils and even impressions of rain drops found frozen in rocks. Think about it, all fossils result when the normal processes of decay and erosion are somehow suspended. This can only happen during an incredible global catastrophe. Coal is not created from trees that have miraculously escaped the natural processes of decay. It is formed by cataclysm where whole forests are buried and crushed under water and earth.

HAB believed that the average period between each "Roll-over" is about 3500 years. He claimed that 7500 years have elapsed since our last one and that we are long overdue for the next. If he is right then periodic planetary destruction has many times destroyed man's attempts at civilization. If he is right, our current civilization hangs by a Damocletian thread. Our philosophers believe wholeheartedly in the Ice Age theory. They believe the last Ice Age ended about 10,000 years ago and that there are hundreds of thousands of years between Ice Ages. However, they offer no explanations for the maps of Piri Reis or those of Ortoneus Finneus. A Finneus map is shown in Chapter 17.

Most geophysical theories have little importance to every day living. But the HAB theories are vital as they deal with civilization itself. A polar shift would be a planetary disaster because of the tremendous surface destruction. Even the atmosphere would be torn apart, creating continent sized hurricanes and tornadoes of unimaginable force as the

whole planet struggled to regain equilibrium. These forces of wind, sea, earthquake and volcano would destroy the habitats of man, beast and plant. including any civilization that man has managed to build since the last "Roll-Over."

The few people who live through this catastrophe will shed civilization's veneer and regress to a primitive, sheer survival, mode of existence not because they forgot how their civilization was put together, but because they lost the tools and the manpower. Once again they will take refuge in caves which make great shelters when your world has literally turned up-side-down. However, since caves are cold and damp even in the summer, they make lousy permanent homes. They are also limited in number, and if every cave in the world were inhabited, the total world population would be small indeed. Just about as many as would survive a "Roll-over." When we find traces of habitation by these "Cavemen", what we are finding are the life styles of the few survivors who trembled on the edge of extinction.

As the Earth "heals", any sane "Caveman" will leave for the valleys and, I'll bet, never cast a remorseful glance over their shoulders. It will be a few thousand years before the population will increase to the point where civilization again becomes possible. Naturally, after a "Roll-Over", the new ice caps begin to build at the poles as the old ones are rapidly melting at the equator. This theory is the only one that accounts for the anomalous artifacts that have been found embedded in coal seams and in the workings of deep mines. HAB's theory also accounts for the tropical animals, especially mammoths, found quick-frozen on the shores of the Arctic sea.

The Roll-Over, or a Velikovskian catastrophe, may have been more recent than anyone suspects. The remains of a decaying giant sloth were found under a ledge, in South America around the turn of the century. The South American Indians call this creature the Jemisch and still fear it because its skin is armored. Don Francisco Moreno brought both the bones and the decaying skin of a specimen of this "long extinct" animal to England. Our modern experts claim that the skin was preserved in an ice-cold cave, but if this is true, then why do the Indians point to the huge tracks of an unknown carnivore and claim they are made by a Jemisch? ⁹

Shortly before Daniel Boone opened up the Kentucky region, a captured white woman was taken to work at gathering salt in a place the Indians called Big Bone Lick. She described a vast boneyard of tusks, ribs and giant skulls that were protruding from the ground in various states of decay. Today the town of Big Bone, Kentucky is very near the place she described in her diary. ¹⁰

The plains Indians told the early explorers that their ancestors had hunted elephant-type creatures who leaned against trees when they slept, just like modern elephants do. ¹¹ Just before our Civil War, a stone statute was found in Copan, Mexico upon which was carved the heads of two elephants. ¹² In 1864, two men found a pendant in some peat near the Holly Oak railroad station in northern Delaware. It was a picture of a woolly mammoth carved upon a fossilized whelk shell. ¹³

Around 1872, a farmer in Louisa County, Iowa, found a pipe in his fields. It was in the shape of a tuskless elephant and was carved from a piece of fine sandstone. ¹⁴ About the same time, another small pendent was plowed out of a field near Doylestown, Pennsylva-

nia. On one side was chiseled the picture of a spear and arrow-wounded elephant fighting an Indian.¹⁵

The town of Paredon lies 500 miles north of Mexico City. Near it and lying under 60 feet of dirt, tangled bones and smashed stone structures is an ancient city that once had a population of 50,000. The bones of people, domestic animals and elephants are intermingled. These elephants were domesticated because many of the tusks have rings of silver on them.¹⁶ The only question left to answer here is which ocean crashed over their city.

Moab is situated in eastern Utah next to the Colorado border. In 1924, a pictograph of a mastodon, chiseled in the solid rock, was found in the nearby Colorado Canyon.¹⁷ A little over 20 years ago, in Flora Vista, New Mexico, a small stone slab was found near some Indian ruins thought to date back to 800 years. Chiseled onto it are 55 signs and pictures, two of which are of elephants.¹⁸ In 1928, the unfossilized skull of a Camelops with dried flesh clinging to it, was found in Utah. This animal is supposed to have been extinct for a half a million years, and the bone should be stone. It was studied at the University of Chicago and pronounced to be of much more recent vintage.¹⁹ The extinction of all these animals is currently linked to the end of the last ice age. This makes no sense. Here is a case where tropical animals survived 100,000 years of Ice Age and then, when it was over, allegedly curled up and died!

Today we are rapidly heading toward a one world state. Every major city on the planet is cosmopolitan, and even the most homogenous of them has enclaves of other races living there. Suppose a world wide cataclysm struck and shattered our civilization while reducing the world's population to 1 % of its previous teeming numbers. Would not the survivors tend to become tribal and exclude those of other races? All things being equal, this would ultimately result in a situation where the main tribes in an area would be of the previous predominant race, but interposed would be small tribes of other races. Would you be surprised if I told you that prior to our modern era, just such a tribal situation as described above existed on every continent?

In the Atlas Mountains of North Africa were found a tribe of blue eyed blond and fair whites as late as the early 1800s.²⁰ The Mandan Indians of North America who lived on the upper reaches of the Missouri River were found to be lighter skinned and of different appearance from the surrounding Indian tribes. They also had many members whose eyes were gray or blue and whose hair was fair.²¹ At the turn of the century there were 13 tribes of white Eskimos living around Victoria Island in northern Canada. They were not the result of cross-breeding, because ten of the tribes thought the only white people in the world were in their own tribes.²² Throughout the entire Pacific, the Polynesians have traditions that claim that there were many white tribes living on the various islands before the influx of white men that began in the 1800s.²³ A tribe of 50,000 light skinned natives called Tarifuroro were living on a limestone plateau in central New Guinea in the early 1930s.²⁴ The Koreans in northern Asia have been found by DNA analysis, to be composed of three separate racial types, Chinese, Siberian and White.²⁵

In the Atlantic side of Colombia, South America, there were villages of whites that had lived there centuries before the Spanish conquistadors arrived.²⁶ Early visitors to Madagascar reported that a red race lived there whose appearance was very similar to the

India
region
be ye
that t
also b
doubt
wood
norm
answ

When
veget
while
the de
ever,
profil
quant
quant
would
readin
usual

Now
when
ful th
pitch

1. p. 7
Projec
2. p. 4
3. p.
4. P.
5. p.
Projec
13:25,
6. P.
Projec
7. p. 6
Projec
Geolo
8. p. 6
Projec
Smiths

Indians of eastern America.²⁷ Just before the turn of the century, in the Congo-Zambesi regions of central Africa, about 15 % of the families, no matter the tribe, were found to be yellow skinned. There were also copper skinned peoples scattered about.²⁸ I maintain that these anomalous peoples are further evidence of the Earth's periodic "Roll-Overs". I also believe that coal and oil are also products of these periodic cataclysms. There is no doubt that coal is derived from organic materials because we frequently see leaves and wood grains patterned in the coal. The only question left is the method by which the normal processes of decay are bypassed in order to produce the coal. The only logical answer is — Cataclysm!

When a whole ocean roars over most of a continent, the surface is scoured clean of all vegetation, which is then transported to and dropped off in natural bowls and depressions while the water drains away. The deposits may be hundreds of feet deep and compress to the degree that fossilization takes place to produce the coal beds we mine today. However, the creation of oil is alternately believed to be organic and inorganic. The organic profile fits better, but the petroleum experts lack a source sufficient to produce the vast quantities that are found. Picture that same rampaging ocean also dumping immense quantities of fish into other depressions just like it did the trees. The fossilization process would then create the beds we use for oil. This would explain the different Carbon 13 readings they find and the fact that salt domes and sedimentary sands and shales are usually found in conjunction with oil fields.

Now you are entitled to believe anything that you want. However, remember that when observational data or experiment conflicts with a theory, no matter how beautiful the theory or how impressive the credentials of its author, a rational person pitches out the theory.

1. p. 700, "UNKNOWN EARTH: A Handbook Of Geological Enigmas, Corliss, The Sourcebook Project, 1980, Extracted from "Much About Muck", Anon, Pursuit, 2:, p. 68, October, 1969
2. p. 474, "ICE OR WATER", Howorth, Longmans and Co., 1905
3. p. 19, "MENZA BULLETIN", Brown, July/August 1986
4. P. ?, "FLYING", Garvey, V-117: 6-7, February '90
5. p. 40, "UNKNOWN EARTH: A Handbook Of Geological Enigmas", Corliss, The Sourcebook Project, 1980, Extracted from "Problems in the Glacial Theory", Cox, Creation Research Society, 13:25, 1976
6. P. 57, "UNKNOWN EARTH: A Handbook Of Geological Enigmas", Corliss, The Sourcebook Project, 1980, Extracted from "Erratics at Highlands in North-Western America", 15:209, 1878
7. p. 698, "UNKNOWN EARTH: A Handbook Of Geological Enigmas, Corliss, The Sourcebook Project, 1980 Extracted from "Origin Of The Muck-Silt Deposits At Fairbanks, Alaska", Tuck, Geological Society of America Bulletin, 51:, p. 1295, 1940
8. p 662, "UNKNOWN EARTH: A Handbook Of Geological Enigmas, Corliss, The Sourcebook Project, 1980 Extracted from "A Pleistocene Cave Deposit Of Western Maryland", Gidley, Smithsonian Institution Annual Report, p. 281, 1918

9. p. 301, "INCREDIBLE LIFE: A Handbook Of Biological Mysteries", Corliss, The Sourcebook Project, 1979 Extracted from "The Jemisch, Or Great Ground Sloth", Anon, English Mechanic, 72:, P. 118, 1900
10. p. 139, "FOLLOW THE RIVER", J.A. Thom, Ballantine Books, 1981
11. p. 296, "INCREDIBLE LIFE: A Handbook Of Biological Mysteries", Corliss, The Sourcebook Project, 1979 Extracted from "Men And Elephants In America", Johnson, Scientific Monthly, 75:, p. 215, 1952
12. p. 475, "ANCIENT MAN: A Handbook Of Puzzling Artifacts", Corliss, The Sourcebook Project, 1978 Extracted from "Pre-Columbian Representations Of The Elephant In America", De Anda, American Antiquity, 30:, P261, 1965
13. P. 469, "ANCIENT MAN: A Handbook Of Puzzling Artifacts", Corliss, The Sourcebook Project, 1978 Extracted from "'Early Man At Holly Oak, Delaware", Thomas, Science, 192:, p. 756, 1976
14. p. 472, "ANCIENT MAN: A Handbook Of Puzzling Artifacts", Corliss, The Sourcebook Project, 1978 Extracted from "'The Elephant Pipe", Farquharson, American Antiquarian, 2:, p67, 1879 13.
15. p. 466, "ANCIENT MAN: A Handbook Of Puzzling Artifacts", Corliss, The Sourcebook Project, 1978 Extracted from "The Lenape Stone", Greene, NEARA Newsletter, 7:, P. 16, 1872
16. p. 689, "ANCIENT MAN: A Handbook Of Puzzling Artifacts", Corliss, The Sourcebook Project, 1978 Extracted from "Elephant Remains In Mexico", Anon., American Antiquarian, 25:, p. 1903
17. p. 465, "ANCIENT MAN: A Handbook Of Puzzling Artifacts", Corliss, The Sourcebook Project, 1978 Extracted from "The Moab Mastadon Pictograph", Anon, Scientific Monthly, 41:, p378, 1935
18. p. 581, "ANCIENT MAN: A Handbook Of Puzzling Artifacts", Corliss, The Sourcebook Project, 1978 Extracted from "The Riddle Of America's Elephant Slabs", Harris, Science Digest, 69:, p. 74, March 1971
19. p. 636, "UNKNOWN EARTH: A Handbook Of Geological Enigmas", Corliss, The Sourcebook Project, 1980 Extracted from "Skull Promises Geological Upset", Anon., Science News Letter, 14:81, 1928
20. p. 691, "ANCIENT MAN: A Handbook Of Puzzling Artifacts", Corliss, The Sourcebook Project, 1978 Extracted from "White Race of the Atlas", Anon., American Journal of Science, 1:32:400, 1837
21. p. 692, "ANCIENT MAN: A Handbook Of Puzzling Artifacts", Corliss, The Sourcebook Project, 1978 Extracted from "A Sketch of the Mandan Indians", Hayden, American Journal of Science, 2:34:57, 1862
22. p. 697, "ANCIENT MAN: A Handbook Of Puzzling Artifacts", Corliss, The Sourcebook Project, 1978 Extracted from "A Tribe of White Eskimoes", MacRitchie, Nature, 90:133, 1912
23. p. 699, "ANCIENT MAN: A Handbook Of Puzzling Artifacts", Corliss, The Sourcebook Project, 1978 Extracted from "White Immigrants in Polynesian Tradition", Anon., Nature, 125:614, 1930
24. p. 699, "ANCIENT MAN: A Handbook Of Puzzling Artifacts", Corliss, The Sourcebook Project, 1978 Extracted from "A New Tribe of Light Skinned Natives in New Guinea", Anon., Science, 85:16, Mar. 6, 1937
25. p. 700, "ANCIENT MAN: A Handbook Of Puzzling Artifacts", Corliss, The Sourcebook Project, 1978 Extracted from "The Koreans", Anon., Science, 95:10, June 26, 1942
26. p. 701, "ANCIENT MAN: A Handbook Of Puzzling Artifacts", Corliss, The Sourcebook Project, 1978 Extracted from "White Indians of Darien", Fairchild, Science, 60:235, 1924
27. p. 703, "ANCIENT MAN: A Handbook Of Puzzling Artifacts", Corliss, The Sourcebook Project, 1978 Extracted from "The Red Race of Madagascar", Anon., Science, 5:266, 1897
28. p. 703, "ANCIENT MAN: A Handbook Of Puzzling Artifacts", Corliss, The Sourcebook Project, 1978 Extracted from "The Yellow Men of Central Africa", Verner, American Anthropologist, 5:539, 1903

GRAVITATIONAL ANOMALIES

Many of our scientific "Laws" have associated observational anomalies that tell us (should we care to listen) that this "Law" may well be only the best "Theory" currently available. For over twenty years gravitational anomalies have gravitated to me. Some I collected, but most collected me! As a scientific skeptic, it is anomalies to the various scientific Laws that catch my interest — not the examples that show conformity. Some of them caused me to concentrate on Newton's "Law" of Gravity. Professional philosophers, on the other hand, tend to either ignore anomalies, or casually sweep them aside while expounding more simplistic explanations.

Throughout the history of science, each generation of experts have been in basic harmonious agreement with each other. They will cat and dog each other over one decimal place, but usually manage to avoid serious confrontation. Their basic assumptions are those which form a consensus of opinion and effectively set the parameters of that generation's science. Teaching, research, discussion and even evidence are bounded by these informal parameters. Any thought or research which deviates from this consensus, threatens their Emotional Belief Systems and induces rage and invective from the "open minded" priests and laymen of this modern religion we call science.

Here is a story that I received second-hand from a student of MIT, one of the more prestigious technical school in the world. A few years ago one of their non-technical and non-tenured professors decided to investigate cold fusion. He thought that the "experts" had too hastily given it a bad rap. Using his own money for apparatus and supplies, his own basement for a laboratory, he began to experiment in his own spare time. All would have been well if his results were negative. However, he let it be known that he had results which corroborated some of the original investigators' claims. When the term ended, despite a very favorable evaluation by all his students, the school did not renew his contract.

Later you will read of other recent examples of "closed minded" men of education and science, examples in which I will name the schools because I have first hand knowledge. If this destroys the myth about the "open minded" priests of the modern religion of science, so be it!

Individually each gravitational anomaly is fairly harmless, but taken as a group, they constitute a plague on Newton's house of Gravity. We are told that the Moon's orbit is the result of gravitational attraction of Earth, Moon and Sun, each for the other, which counter-balances the Moon's inertia. We are told that all matter regardless of density or mass accelerates at the same rate, that spring scales are not to be used for scientific work, and that the tides are caused by the attractive pull of the Moon and Sun on our oceans. We have been taught this, we believe these things to be true and yet ...

During the last 20 years, this scientific skeptic has become ever more dissatisfied with our concept of gravity, which was postulated late in the 1600s when little was known about electro-magnetic forces. A scientific "Law" is never defeated by the simple swirl of a pen. It dies a very slow death that begins with the wide spread dissemination of

anomalies. One magic day, major cracks appear, and some new genius proposes a new theory. But normally the old guard, consisting of the best rote learners of the era, fight tooth and nail defending the old theories. However, they die off, leaving the field to the young philosophers, who can adjust to the new theory. They will one day, in turn, fight some other new theory to the death. The problem is that as a theory ages it gains tenure, it gathers the respect of age, and is automatically transformed into another irrefutable scientific "Law".

Anomaly # 1: Relative attraction

My mind is so obstinately skeptical that the tides, which are used by the philosophers to verify the "Law" of gravity, are seen by me as anomalous to that very "LAW". By tides, I mean the daily periodic variation in the surface level of the oceans, bays, gulfs, inlets, and estuary regions of tidal rivers that are independent of wind and barometric changes.

Since ancient times our northern European ancestors have known that the passage of the Moon was somehow related to the tides. I specifically use Europe because, as you will soon find out, people in other parts of the world either had no chance to observe the tides, or lived where the tides followed a solar cycle.

Newton saw the chance to explain both the tides he was familiar with and the necessity of making them relate to the theory. Although he "proved" to the satisfaction of northern European philosophers that tides are caused by the Moon's attractive gravity, there are observable tides that do not directly conform to his theory.

Even in Europe, the moon being at its zenith does not match the apex of the tides. When a lab experiment shows results that are anomalous to the current popular theory, the results can be easily swept under a rug. But when you have a natural phenomenon that is daily observable by millions of people, then either the theory must be bent to conform to the facts, or the facts must be bent to conform to the theory. I believe, in this instance, that the facts have been bent.

The "*American Practical Navigator*" hereafter called the APN is the bible of us salty sea-going types, and it has this to say about the tides in general, "*It is often said of science that the ability to predict a natural event is indicative of understanding. Since tides are the most accurately predictable oceanographic phenomena, one could easily assume that physical oceanographers truly understand them. Unfortunately, this is not true; significant gaps remain.*"¹

In explaining the tides, the text books list the ratio of the Moon's attraction to the Sun on our oceans as 11/5 or 2.2 to 1. Over the years however, whenever I actually performed the calculations I arrived at a slightly different number.

	SUN	MOON
Mass (kg)	1.991 E30	7.354 E22
Earth Distance (km)	1.495 E08	3.844 E05

$$\text{Sun force} = 1.991 \text{ E}30 / (1.495 \text{ E}08)^2 = 8.908 \text{ E}13$$

$$\text{Moon force} = 7.353 \text{ E}22 / (3.844 \text{ E}05)^2 = 4.976 \text{ E}11$$

$$\text{Relative force} = \text{Sun force} / \text{Moon force} = 8.908 \text{ E}13 / 4.976 \text{ E}11 = 179$$

These numbers indicate that the relative attraction of the Sun to the Moon is 179 to 1. It says that the Sun pulls 179 times harder than the Moon! No matter the time of month or the time of year the Sun always pulls harder. Quite by accident, I discovered that the official ratio of 2.2 Moon to 1 Sun could be obtained by cubing the distances involved in the Newtonian formula.

$$\text{Force from Body} = \text{Body Mass} / (\text{Body Distance})^3$$

$$\text{Moon force} = 7.354 \text{ E}22 \times (3.844 \text{ E}05)^3$$

$$\text{Sun force} = 1.991 \text{ E}30 \times (1.495 \text{ E}08)^3$$

$$\text{Relative force} = \text{Moon force} / \text{Sun force} = 1294713 / 595864 = 2.172$$

This number is very close to the accepted book ratio of 11/5 (2.2) and in agreement with the textbook statements that the Moon pulls harder than the Sun. Should Newton's "Law" be amended to read distance cubed? Any mathematician worthy of the name, by adding in unnecessary or obfuscating quantities and extraneous concepts, can prove absolutely anything. But does this make it true? Years after I figured this out I find in the APN this, "*This is due to the fact that the differential forces vary inversely as the cube of the distance.*"²

Anomaly # 2: Antipodal tides

Did you know that:

1. Many areas of the world have only one high tide per day? This is called a diurnal tide pattern. Conversely, areas with two high tides per day are called semi-diurnal. The tides in Matlacha, Florida, where we lived for a few years, are intermittently diurnal and semi-diurnal. I haven't the faintest notion what this is called but it blew my mind as I watched the tide not change from the window near my computer that faced the salt water canal behind our home.

2. Maximum high tides are supposed to occur simultaneously at the sub-lunar point and at the antipode which is the diametrically opposed location.³

However, if you live near the ocean and can compare the time of the tides in relation to the physical passage of the Moon you find that a great time difference exists between the actual events.

The highest tides are usually delayed for two or three days after the supposed cause. These are the observable facts

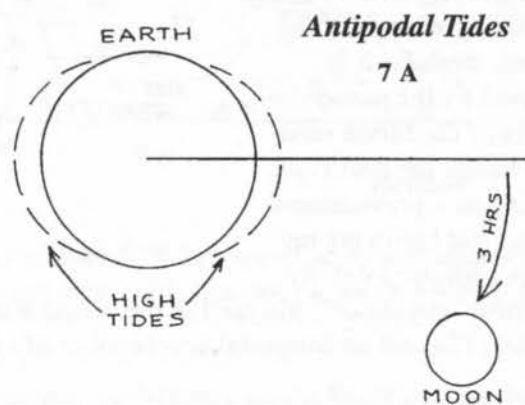

that I classed as anomalous and which needed resolution if I was to remain a believer in the innate attraction of mass for mass. Tidal pattern differences of each area are blamed on a different period of oscillation of not only the particular ocean but also the configuration of a particular location. The tidal predictions themselves are not calculated but empirically predicted from past records. They can easily make these claims for coastal harbors and bays but as we will shortly see there are islands in the center of the Pacific where the configurations are all identical but which have very different tidal patterns. In short they are practical projections based on actual experience ... not theory.

It took a few years but I finally had the entire confusion cleared up with the help of a very mathematical friend and the "American Practical Navigator". First the mathematical philosophers throw away Newton's point center concept and use the center of mass of the Earth/Moon system which they call the Barycenter.

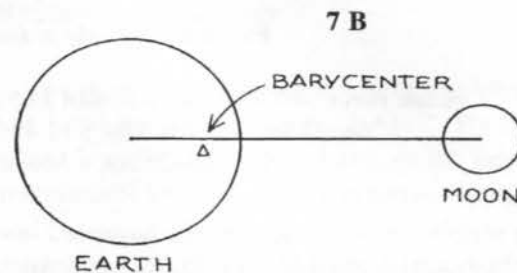

They calculate from this as if it were a point and they then convert the forces to acceleration, add in another Earth radius (which changes the terms to distance cubed), and then ... throw away that extra radius. No joke — despite this arithmetic trickery they claim the mathematicians prerogative of tossing in (or out) small quantities, claiming they mean nothing to the final result.

The same jokers who will spend a life time calculating Pi to the skillionth decimal place casually discard the radius of the earth when it suits their purpose to do so. Then they brilliantly determine that the acceleration at the sublunar point is toward the moon and that the sign of this acceleration is positive. They now calculate the acceleration at the antipodal point and find that the sign of the acceleration is negative and is therefore directed away from the Moon. They then allege that this decrease in acceleration raises the tides at the antipodal point.

This poor skeptic was flabbergasted, here they had found and proven that anti-gravity exists without realizing what they had done. Perhaps it is caused by the pseudo-mass of the Moon rotating inside the Earth and acting as a gravitational lens. Not believing my eyes I whipped out my faithful "copulator", plugged in the actual numbers and found a sublunar acceleration of +.0001128 and an antipodal acceleration of -.001073 just like they said.

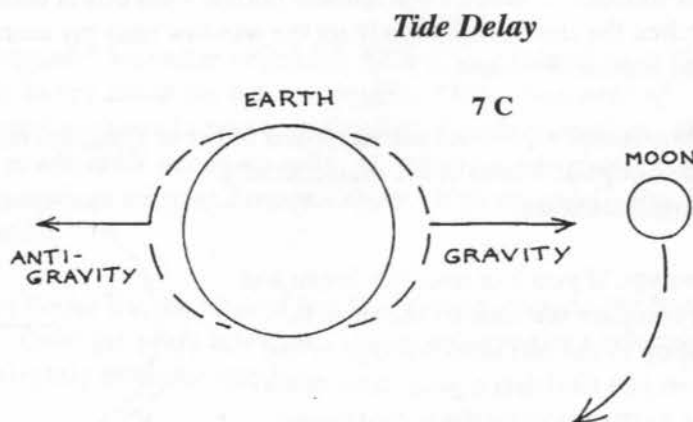

Thinks I to myself this is it. Any thing ol' Mother Earth can do by accident we can duplicate. But when I tried to raise a lousy couple of million dollars to investigate the fact that the earth acts as a gravity lens and creates anti-gravity, everybody laughed at me. The same philosophers who can prove that the accelerations are negative will not believe that the Earth must be a gravity lens. Gee! I wonder why?

Anomaly # 3: Tahiti's Tide

Although much of the Pacific has diurnal tides both Tahiti and Tuesday Island have four tides a day. At both locations the tides react only to the Sun. In fact, the native word for midnight is the same as the word for high water. A travel guide to Tahiti has this to say, "*Tahiti has a very unusual tidal situation: high tide is always between noon and 2 pm., and then again around midnight.*"⁴ Each Pacific atoll is very similar so it can't be configuration causing this difference. How can this be when the National Science Foundation (NSF) personally assured me that they already knew everything there was to know about gravity! They wrote me letters to prove this.

Anomaly # 4: Tidal Time Lag

The APN showed by use of vector analysis of the tractive forces why the perfect tide lags the Moon by 45 degrees, which equates to a time delay of 3 hours at the sublunar point.⁵ The philosophers tell me that gravitons travel with the speed of light. If this is true, and it must be because after all, they are the high priests of science, why should there be a three hour tidal delay when the moon is less than 2 light seconds away and the Sun is but 8 light minutes away from the Earth?

Anomaly # 5: Solar Eclipse

The port of Colon, Panama, had a solar eclipse shortly after high noon on February 26, 1979. I chose this eclipse because the latitudes of both Sun and Moon were such on that day that they almost matched the Latitude of this Port. Therefore, both bodies were almost directly overhead when the eclipse occurred. Examining the *East Coast Tide Book* for that year I found that the High tide in Colon took place about a half hour before the eclipse. This led the "perfect tide" by 3.5 hours which represents an error of over 50% between theory and observation. If I had turned in a lab experiment in a physics class with this poor a result I would have flunked.

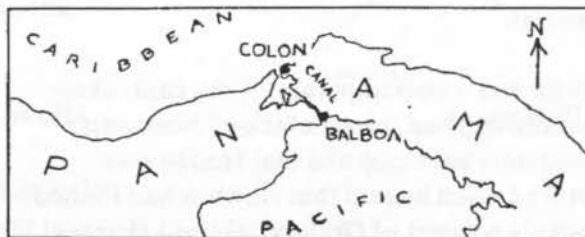

7 D

Eclipse

The port of Balboa, Panama lies southeast across the Isthmus on the Pacific. Lacking a

tide book for the West Coast, I called NOAA for information. Mr. Simpson was kind enough to read me the data for that year. Here the effect was delayed 3 hours and 8 minutes which is only 8 minutes after the perfect tide. This is in close conformity to the prediction.

Mr. Simpson also called my attention to the fact that the ultimate high tides from this eclipse would be delayed for two days! Do you wonder why I find the tides to be anomalous to Newton's theory, and why I believe that the mathematics has been contrived to prove a prior assumption?

The tidal heights here on the New Jersey coast almost doubled in the mid 70's. I had a boat at that time and I became aware of this when it began to rise and fall five feet at my dock in Seabright, NJ. It did the same in Lawrence Harbor. My old chart of the area claimed the tidal range was only 30 inches. The range is still 5 feet.

Anomaly # 6: Near Zero Tides

The following quotation makes me wonder if the Mediterranean is Moon and Sun proofed? *"But early scientists who lived in the Mediterranean area did not become aware of the tides until the classic India campaign of Alexander the Great. The tides exist in the Mediterranean to only a slight degree so when Alexander's soldiers reached the Indian Ocean in 320 B.C., they must have been amazed to see its tides rising and sinking every twelve hours."* ⁶

Anomaly # 7: Spring Scales

Did you know that spring scales are shunned by the scientific world? They are classed as notoriously inaccurate for scientific work because a weight on a sensitive spring scale will oscillate as time passes. Also, springs get "tired" and stretch. Each time you check the test weight the result is slightly different. The spring scale is constructed on Hooke's Law, which states that the stress in a material is proportional to the deformation of that material.

Hooke was a contemporary of the cantankerous Newton, and some nefarious Newtonian castigators have claimed that Hooke was justified when he said that Newton had filched Hooke's concept of Gravity. Gravid charges indeed!

During solar eclipses, both basement crackpots and scientists have reported anomalous weight changes on spring scales. This for example was a report from MIT found in the "Physical Review, *"The difficulty is that this relative increase of about 2.7×10^{-4} re-*

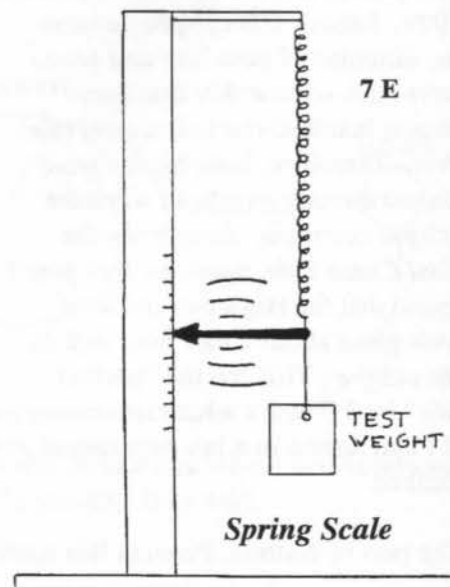

*corded here would require an increase of tension of 1.2 KG. as calculated from the results of our paper on the period of a torsion pendulum. This is 5% of the total weight of the pendulum bob, 23.4 kg. (51.5 lb.), and is far greater than classical theories of gravitation can explain. Results of this order of magnitude have been consistently observed in Harvard over a period of 17 years.”*⁷

I have written to MIT's Physics Department a few times over the years seeking more information. I wasn't at all surprised that ... my letters were universally ignored. But no one, not even a crackpot, has reported this from beam balance scales. Perhaps the spring scale reports the changes in that which we call gravity and is a truly accurate scale.

Anomaly # 8: Torsion Pendulums

Did you know that scientists who play with torsion pendulums report anomalies with the distance squared concept of gravitational attraction? They have found that as the distance decreases the force increases beyond the expectations of gravitational theory. Since the mass of the pendulum remains constant the increase in force must be represented by some power less than the square of the distance. Strange things happen to torsion pendulums during eclipses. So strange that some investigators have postulated an unknown force. Oddly, these people are not basement crackpots, they are big league accredited academic experts.

The same article listed above goes on to speak of the change in periodicity of oscillating torsion pendulums during solar eclipses. It concludes, *“that classical gravitation theory needs to be modified to interpret his (and ours) experimental results.”* *“Both our experimental findings and those of Allais cause one to question whether the classical laws of gravitation hold without modification.”*⁸

Instead of these anomalies creating a hard look at Newton's "Law", they are being reflected as a search for a fifth force and even a sixth force. I have no doubt that if they look long enough and hard enough they will find (like the old epicycles) as many forces as they need to accommodate the data. Either that, or we will continue to ignore the anomalies.

Anomaly # 9: Deep Water Wells

Did you know that the water level in deep wells and mines is at its lowest when the Moon is crossing the longitude of each location?

This phenomenon becomes especially apparent in wells that are located in the tropics where the Moon can pass directly overhead and thus can actually be seen reflected in the well. At this time the Moon is as physically close to that mass of water as it will get during that day.

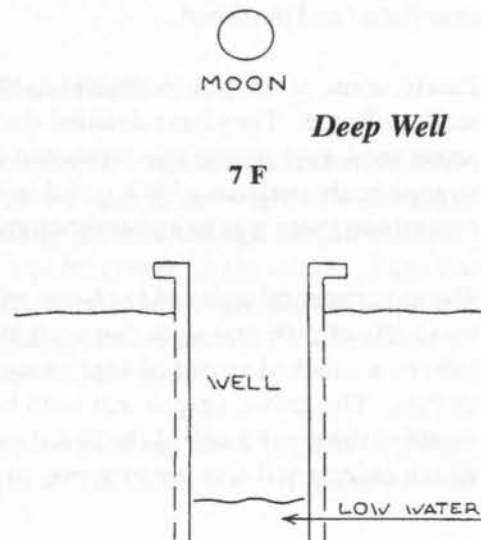

The philosophers have decided that gravity waves move at the speed of light, so I should expect a delay of only one second in reaching high water after the Moon passes over the well. According to theory the Moon should exert the maximum attraction at this time and one would suppose that the water level would be at its highest. Instead we get, you guessed it, low water. This was discovered by Walter B. Lambert studying Earth tides for the government in a publication back in 1936. ⁹

How can this be when, as you will shortly see, the NSF told me that they already knew everything there was to know about gravity!

Anomaly # 10: Free Fall

In 1923, Dr. Charles F. Brush conducted extensive testing on the acceleration of various materials in a free fall vacuum drop tube .

The tube used then had state of the art electro-mechanical sensors and timers. He reported that the acceleration of different test specimens showed detectable differences. Specimens that had higher densities and atomic weights like platinum, gold and lead fell the fastest. Those of lighter densities and atomic weights such as aluminum, carbon and water were slower, while slightly heavier sulfur and selenium were oddly in a slowpoke class of their own. ¹⁰

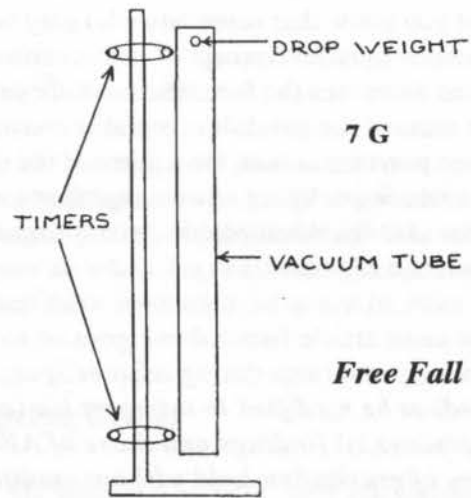

Shades of Aristotle! For a over half a century the other physical philosophers have ignored Dr. Brush's work. He was very fortunate that he hadn't tested some Lenz basalt, as this material falls in fits and starts. If he had reported these results, he would have been certified and delivered to the rubber room at the Newton Valley Funny Farm for deviant scientists. Anytime anyone reports results that are anomalous to the theories of the era, they are either ignored or professionally excoriated and punished.

Lately, some of our philosophers have acknowledged similar results by re-examining the work of Etvos. They have decided that any discrepancies in Newton's Law actually prove the Law because any substance found to be anomalous must obviously contain strange basic particles. How can this be when the NSF told me that they already knew everything there was to know about gravity!

The experimental study of the force which we call gravity began with Galileo, who had iron balls of different sizes and weights, according to legend. One day, to the oohs and aahs of a shocked crowd of spectators, he dropped both of his iron balls from the Tower of Pisa. The crowd agreed that both balls had hit the ground at the same time. This sounded the death knell of the two thousand year old Aristotelian view that the speed with which objects fall was proportional to the mass of the object.

The ancient concept of scientific truth seems to have lain somewhere between dogmatism and rhetoric, with the most sophisticated speaker eventually being classed as the noblest philosopher of them all. Come to think about it, nothing much has changed! Today it tends to be the most published rote learner who is the noblest philosopher of all. Galileo's main contribution to science was not his discovery of the periodicity of pendulums, nor the fact that he probably constructed the first practical telescopes of modern times, nor even his adamant belief that the planets revolved about the Sun. He is justly famous for being the first philosopher to use experiments to test theories.

Anomaly # 11: Ocean Pressures

I have been unable to verify a recurrent hint, usually veiled, that the pressure of water at great ocean depths does not conform with the theoretical pressure that should be recorded. I have heard that pressures are a bit less. If this is true it would constitute another direct assault on our concept of gravity. An experiment using a special deep water probe could verify or nullify these reports.

During September 1990, the Scripps Institution of Oceanography measured changes in a test weight as it descended in the ocean. I strongly suspect that the NSF financed this experiment. On 4/23/87 I proposed the same test to the National Science Foundation. I received a letter that told me that, "*Newton's theory of gravity ... is a well studied and well confirmed branch of physics. As a consequence we do not support proposals which propose studying such well-known phenomena.*" They also wrote, "*While these ideas are interesting they do not fit directly into most programs at the Foundation.*"

This was good news and bad news. The good news was that they really didn't know what they were doing and thus failed to find that a discrepancy probably exists between depth and pressure. The bad news is precisely the same thing. Had someone thought of this experiment themselves then they would have known that you can't trust a depth gauge, calibrated by current assumptions, to determine actual depth. For this experiment you must use a marked vertical anchor line and then compare the actual depth with the observed pressure readings.. Even the readings of sophisticated sonar or a transponder are not as accurate as a line because of the different temperatures of the various layers of water.

Anomaly # 12: Mine-shaft

I also began to wonder if modern scales that utilize either a magnetic field or the piezo-electric principle might be accurate enough to check the change in weight of a test mass as it is taken deep into a mine. The paradox of gravity is that although all calculations must be done as if the entire mass resides at the pin point center, at the center of the Earth a test weight should weigh... nothing! Therefore, the decline in weight should be predictable as to depth, and if the scale is sensitive enough this change should be detectable while descending the four miles to the bottom of our deepest mine.

Before I could even attempt to interest a scale company in doing the test I had to know the theoretical change in weight that was to be expected, in order to see if today's scales were sensitive enough for the job.

To test this I wrote a computer program to investigate change of weight due to depth in any homogeneous large sphere. I did this by sectioning the sphere in pieces so that the pull of gravity by mass above it, could be subtracted from the pull of the mass remaining below.

A quick check of the math of a shaft to the center of the Earth showed that the centers of mass would be equi-distant and therefore would cancel each other resulting in zero gravity. I ran my program and I was totally amazed at my first result.

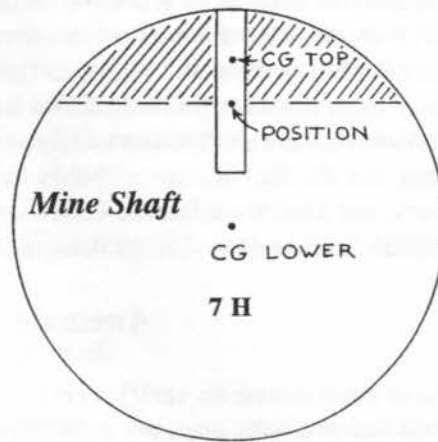

At one hundred feet into the mine-shaft, my figures showed that not only would a mass weigh nothing but that it would be repelled toward the surface because the top pull was greater than the bottom pull. Well, I've been a few hundred feet down in tunnels, and know this is not true. The program had a major error in logic or arithmetic.

I spent a week and never found my error. It always gave me bad numbers. No matter what diameter of test sphere used or the increment of depth, I got the same strange results. The center of mass of the material above you, no matter how small that mass is, is always so much closer to you than is the center of the mass that's below, that the figures always show an upward pull.

I have a sneaky suspicion that Newton did the same calculation when he decided that all the forces cancel each other on any particle in the shell of a sphere and that the only force on a descending body is due to the remaining mass and distance to center of the sphere that is left underneath. Conventional wisdom states that a descending scale will record heavier for a while because of the assumed iron core, but recent tests have destroyed this assumption. How can this be when the NSF told me that ...

Anomaly # 13: The Moon's strange orbit

There are several 'strangenesses' about the Moon's orbit. The first strangeness concerns itself with the variable inclination of the Moon's orbit to the plane of the ecliptic. This plane is set by the center of the Earth in its yearly orbit. During an 18 year period, the Moon bobs up and down through this plane like a merry-go-round pony. This 10 degree oscillation produces the Saros cycle, but one might think that after a few billion years of crossing the plane of maximum attraction from Sun and Earth that this motion should have dampened out eons ago. Today the Moon should be as calm as an old plow horse, placidly plodding the path of the ecliptic instead of acting like a prankish colt, popping up and down for eternity. The fact that there is not even a measurable degradation of this motion is used as a great argument in favor of frictionless space. However, this oscillation would also be possible if the Moon spent some of each orbit being actively repelled by the Earth.

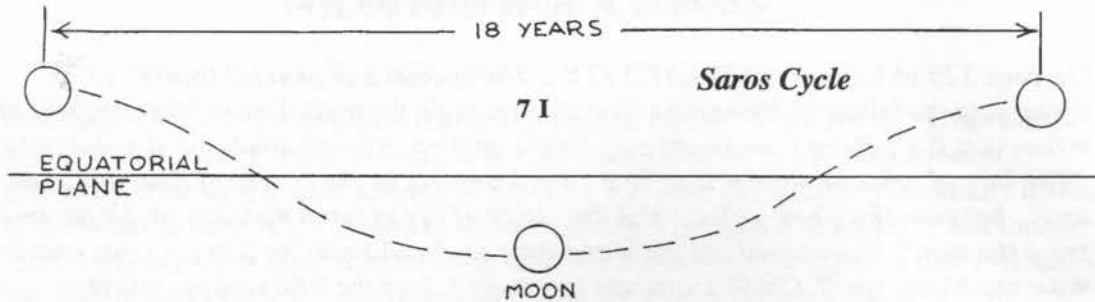

Despite the fact that space is filled with rock and metal fragments, hydrogen dust, solar winds, and electro-magnetic fields we still believe that there is zero friction to the movements of celestial bodies?

There is a very weird relationship between perigee, apogee and phase. When plotted as a graph of full and new Moons the shape resembles an hourglass where the full Moon and the new Moon exchange places every 6 months. The apogee does not occur at the most logical period, which is the new moon nor does the perigee occur at the full Moon. Furthermore, the points of apogee and perigee slowly rotate around the Earth over the course of a year.

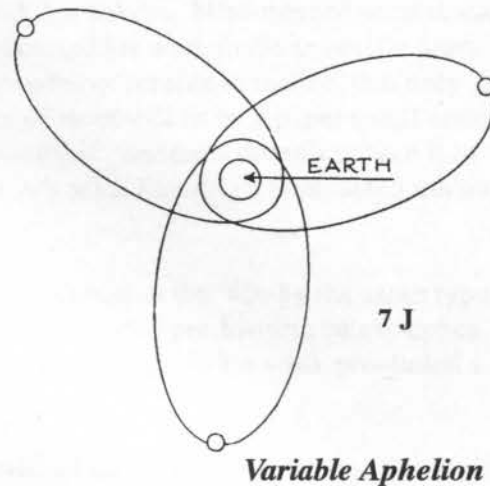

Let's examine the strangeness of the Moon's orbit. First the strangeness is shown on the table below. The perigee (farthest distance) of the orbit is extremely variable, varying up to 13,000 km and it is closer when they coincide with new or full moons.¹¹

PHASES AND DISTANCES FROM EARTH IN 1990 (distances in earth radii)

	1st Q	Full	Last Q	New
Date\Distance	01/04 / 58.309	01/11 / 58.428	01/18 / 63.132	01/26 / 60.441
Date\Distance	02/02 / 58.039	02/09 / 59.876	02/17 / 63.400	02/25 / 58.407
Date\Distance	03/04 / 58.279	03/11 / 61.806	03/19 / 62.874	03/26 / 57.246
Date\Distance	04/02 / 58.677	04/10 / 63.205	04/18 / 61.648	04/25 / 56.126
Date\Distance	05/01 / 59.252	05/09 / 63.669	05/17 / 60.888	05/24 / 56.028
Date\Distance	05/31 / 60.902	06/08 / 63.491	06/16 / 59.274	06/22 / 56.474
Date\Distance	06/29 / 61.643	07/08 / 62.372	07/15 / 58.613	07/22 / 57.808
Date\Distance	07/29 / 62.876	08/06 / 61.174	08/15 / 57.875	08/21 / 59.141
Date\Distance	08/28 / 63.374	09/05 / 59.152	09/11 / 57.886	09/19 / 61.137
Date\Distance	09/27 / 63.045	10/04 / 57.814	10/11 / 58.448	10/18 / 62.358
Date\Distance	10/26 / 62.666	11/02 / 56.781	11/09 / 58.964	11/17 / 63.503
Date\Distance	11/25 / 61.370	12/02 / 55.931	12/09 / 60.510	12/17 / 63.710
Date\Distance	12/25 / 59.822	12/31 / 56.090		

Anomaly # 14: A different law

On page 125 of Einstein's "*RELATIVITY .. The special and general theory*" while discussing the failure of Newtonian Gravity to explain the perihelion of Mercury, Einstein writes that if a different law of attraction were applied to the calculations of a planet that "*The line of orbit would not then be a closed one but in the course of time would fill up ... between the circle of least and the circle of the greatest distance of the planet from the sun.*" If we substitute the Moon for planet and Earth for Sun isn't that exactly what our Moon does? Could a different law apply? And the NSF told me that they already knew everything ...

Now you are entitled to believe anything that you want. However, remember that when observational data or experiment conflicts with a theory, no matter how beautiful the theory or how impressive the credentials of its author, a rational person pitches out the theory.

1. p. 754, "AMERICAN PRACTICAL NAVIGATOR", Bowditch, US Documents, 1977
2. p. 761, Ibid.
3. p. 763, Ibid.
4. p. 26, "CRUISING GUIDE TO TAHITI", Davock, Wescott Cone Pub. Co., 1975
5. p. 761, "AMERICAN PRACTICAL NAVIGATOR", Bowditch, US Documents, 1977
6. p. 152, "THE UNEXPLAINED", Boschke, Pocket Books, 1978
7. p. 655, "MYSTERIOUS UNIVERSE: A Handbook Of Astronomical Anomalies, Corliss, The Sourcebook Project, 1979 Extracted from "1970 Solar Eclipse as Seen by a Torsion Pendulum", Saxl & Allen, Physical Review D, 3:3, p. 823, 1971
8. p. 655, Ibid.
9. p. 209, "CATAclysms OF THE EARTH", Brown, Freedeed, 1967 Extract from government publication titled "REPORT OF EARTH TIDES 1936-1938", Lambert, U.S. Coast and Geodetic Survey, 1936-38
10. p. 680, "MYSTERIOUS UNIVERSE", A Handbook Of Astronomical Anomalies, Corliss, The Sourcebook Project, 1979 Extracted from "Some New Experiments in Gravity", C. Brush, American Philosophical Society, 63:p. 57-61, 1924
11. p. D-6, "ASTRONOMICAL ALMANAC", US Document, 1990

GRAVITY DOESN'T SUCK

On March 19, 1987, I discovered that gravity doesn't suck. I called it my "**Unproof of Gravity**" and I verified that something is very wrong with the Newtonian concept of gravity by creating a simple arithmetic proof. I was then in a quandary because I had no idea of what to do with the information. Being unwashed, uncouth, abrasive and unlettered, I already knew that "scientific journals" would never print anything that I wrote. The high priests of science surely wouldn't tolerate an outsider trespassing in their domain. It is now over a decade later and after years of trying, I know that my wild and crazy hunch was right.

I was in high school when the great Velikovsky flap occurred. This man wrote a book called "**Worlds in Collision**" which used ancient myth and writings, including the Bible to prove that a global catastrophe had struck the Earth sometime between the last Ice Age and before writing became widespread. I watched the whole world of science castrate his work and then go on to cauterize the wound with hot pokers. Mini-minded mental mid-gets pompously asserted that he should have submitted his work to the scientific journals. These high-minded refuters either didn't understand, or refused to realize, that only inchy-pinchy increases of a single decimal place type of work will fit on a paper small enough for a journal. A man who paints a bold new scientific panorama doesn't reduce it in size to fit a few journal pages. The scope of this man's work required a book-sized document. As does mine!

Hugh Auchincloss Brown (**HAB**) was similarly attacked in the '60s by the same type of ideological idiots because (again) his book dealt with other pre-historic catastrophes. It was titled "**Cataclysms of the Earth**". Here again the scope of his work precluded a journal sized format.

When I finally prepared a paper on my "**Unproof of Gravity**" I sent a letter of inquiry to various physics journals and science magazines. Only one of them even bothered to answer my letter. You don't think that my title, "Gravity Doesn't Suck!", had something to do with this, do you?

In the scientific world reading outside one's field is usually classed as poor use of valuable time. Still, the discovery that gravity doesn't suck was the direct result of wasting my time reading about and examining anomalies that professional philosophers would never waste such time on. I was attempting to arrange the various gravitational anomalies in some logical order. But then I was trapped, once again, by the strange orbit of the Moon.

As we saw in the chart in the last section, the Moon's distance from Earth varies greatly during each lunar month and as I rechecked some of the data on these distances, I had a moment of inspiration. I would do an actual calculation using the "Law" of Gravity to find the gravitational forces of both Sun and Earth at one particular moment in time.

To simplify the calculations and the visualization, I would choose a time when the Saros cycle was crossing the solar plane, and when the Earth was as far from the Sun as it gets

(during a northern summer), and during apogee (when the moon's orbit is as far from the Earth as it gets), and during a solar eclipse (that period in time when the Moon is exactly lined up between Sun & Earth).

I chose apogee because no matter what the calculations using the "Law" of Gravity formula showed, we know by observation, that the Moon is at its limit of range and must move closer to the Earth. The choice of the Earth/Sun distance was arbitrary so I chose aphelion. The data was taken from the 54th edition of the CRC Chemistry & Physics Handbook.

	Sun	Earth	Moon
Distance from Earth (km)	1.520 E08	————	4.0550 E05
Mass (kg)	1.991 E30	5.979 E24	————

By subtracting the Earth/Moon distance from the Earth/Sun distance I determined the Sun/Moon distance.

$$\text{Earth/Sun distance} - \text{Earth/ Moon distance} = \text{Moon/Sun distance}$$

$$1.520 \text{ E08} - 4.055 \text{ E05} = 1.498 \text{ E08}$$

Physics allows us to isolate the forces on a body. Since we are interested only in the relative forces on the same body (the Moon) we can simplify the gravitational formula by eliminating the gravitational constant and the mass of the Moon each time we calculate. Using Newton's full formula $F = g \times M1 \times M2 / D^2$ gives an identical relative force as calculations using $F = M / D^2$.

From the general formula listed below we can now calculate the individual forces of Sun and Earth upon the Moon.

$$\text{RELATIVE FORCE} = \frac{\text{MASS}}{\text{DISTANCE}^2}$$

$$\begin{aligned} \text{Sun Force} &= \text{Sun Mass} / \text{Moon-Sun dist} \times \text{Moon-Sun dist} \\ &= 1.991 \text{ E30} / 1.498 \text{ E08} \times 1.498 \text{ E08} = 8.872 \text{ E13} \end{aligned}$$

$$\begin{aligned} \text{Earth Force} &= \text{Earth Mass} / \text{Earth-Moon dist} \times \text{Earth-Moon dist} \\ &= 5.979 \text{ E24} / 4.055 \text{ E05} \times 4.055 \text{ E05} = 3.636 \text{ E13} \end{aligned}$$

$$\text{SUN FORCE} / \text{MOON FORCE} = \text{RELATIVE FORCE}$$

$$8.872 \text{ E13} / 3.636 \text{ E13} = 2.44$$

I found that the Sun's force was stronger. In fact, it is over twice as powerful! This of course is IMPOSSIBLE! If the Moon is to maintain its orbit around the Earth, not

only must the Earth force be consistently stronger to counteract the Sun's pull, but it must also be strong enough to act as a tether on the Moon and re-curve it toward the Earth, especially when it is at apogee. Only when the Sun's force is less than the Earth's, should the Moon begin to re-curve back toward the Earth. Remember that we picked the moment in time when the Moon was as far from the Earth as it gets.

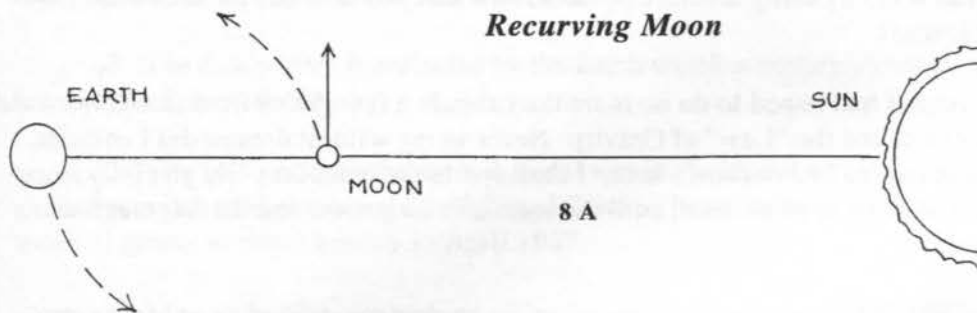

From my calculations we see that the Sun's force exceeds that of the Earth and the Moon must respond by veering slightly toward the Sun. In this instance, the Earth's attraction decreases even faster; and the Sun's attraction increases even faster, thereby increasing the Sun's relative force and accelerating this movement away from the Earth. We know by observation that this does not happen. Despite the "Law" of Gravity, the Moon re-curves toward the Earth.

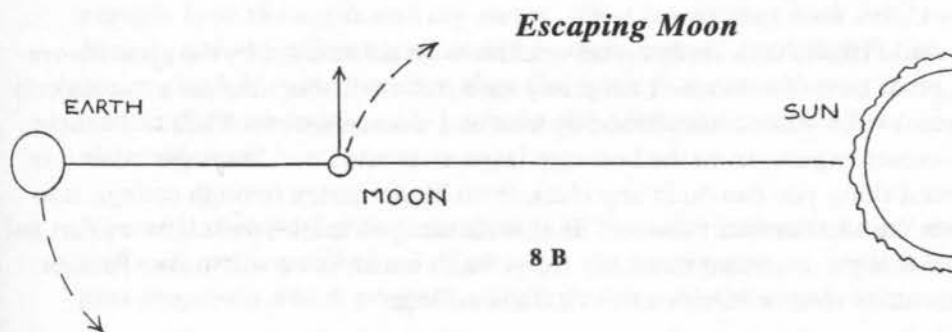

If the forces were equal, the Moon would continue on its path which at this moment is tangential to both Sun & Earth. This path would see a weakening of both Earth & Sun attraction due to the increasing distance.

Total solar eclipses at the maximal range, on which I based my calculations, are much rarer than regular total eclipses but they do happen. The simple fact is that during the entire week of every new moon, no matter whether the Moon is at perigee or apogee, the Sun force is stronger and the Moon should move toward the stronger force!

According to the previous calculations, the Moon has no reason to orbit the Earth. This is in direct opposition with the standard cliché in the text books, "*it is obvious that...*"! I can only make the Earth force exceed the Sun force if I "force" the calculation by using distance cubed in place of distance squared. Then the Earth force becomes many times

larger than the Sun's force, and this opens up another can of gravitational worms (or wormholes?), because Cavendish weighed the Earth and established the gravitational constant by using distance squared, not distance cubed.

Subsequent philosophers using his figures and the distance square concept have calculated the masses of everything in the universe. And if you obtain the masses from the experimental force by using distance squared, how can you now use distance cubed to obtain the forces?

For many years I had hoped to do no more than abrade a few grains from that cornerstone of our science called the "Law" of Gravity. Never in my wildest dreams did I envision cracking it in half as I have shown here. I shall spend the rest of my life gleefully stomping on this cornerstone of science, until the rock is in fragments and the fragments are just moldy dust!

I have been attacked countless times by scientific apologists, most of them Mensa members, for not being able to offer a strong theory to replace the one I destroyed. This is grammar school orthodoxy! This is how the teachers ultimately destroy the bright kids who ask heterodox questions and are capable of original thinking.

Only on a TV show is it the coroner's job to find the murderer. I make no apology for leaving the new theory of gravity to the next Newton. Isn't it more than enough to have done what was denied the millions of physicists who were born and died all over the world since Newton's time. The real question here is, "Why didn't they discover my "Unproof?" Or ... perhaps they did as we shall see in the next section.

Someday I would like to do a study on the academic levels attained by the great innovators and the great men of science. I am pretty sure that I will find that the great majority of the important work was accomplished by men and women without Ph.D.s. I believe that schools create experts from the best rote learners available. I know for a fact that the single worst thing you can do in any class, from kindergarten through college, is to ask a question the teacher can't answer. In that instant you mark yourself as a smart-ass! If there is one thing a dominant authority figure can't stand, it's a smart-ass. Perhaps that is why so many men in Mensa never finished college.

Not that I will ever live to see the religion of science cast out its major tenet and repeal Newton's Law of Gravity. But each time someone reads about my "Unproof" that day comes closer.

Someday this glaring anomaly will trip a trigger in some ingenious mind and out will pop a new set of equations absolutely proving forever that ... Newton was wrong! I predict that when that happens an anti-gravity engine will be just around the corner. At the present time we send our astronauts less than 350 miles into the sky. To accomplish this feat we strap them on top of the equivalent of a million pounds of TNT. Real space starts between the planets, not between Earth and Moon, and surely not below the protection of the Van Allen belt. Only an anti-gravity engine will allow us to lift the 6 foot of radiation shielding we must have to protect us from the radiation of the Van Allen shield and the deadly radiation from first medium solar flare after we pass through the shield. ¹

Since I unleashed my "Unproof" I have been told some very strange and wondrous things about celestial mechanics by my fellow Mensans some of whom have become very angry, hostile, bombastic, nasty, and just this side of violent. They have such outlandish claims:

1. The Sun's force is actually centered on the Earth/Moon barycenter and that isolating the forces on the Moon is not allowed.
2. The Sun's force is reflected by the Earth which completely cancels out the force of the Sun on the Moon.
3. The best one (as referred to before) was in the letter I received from the chief guru of gravitational physics at the National Science Foundation after I applied for a series of grants to retest gravity in April 1987.

April 29, 1987

Dear Mr. Rene'

Thank you for your letter of 4/24/87. As you correctly computed the force that the sun exerts on the moon is almost 3 times greater than the force the earth exerts on the moon. However, the conclusion which you attempt to draw from this fact is fallacious.

The error in your reasoning is due to the fact that you neglected to take into consideration the force that the sun exerts on the earth. The sun attracts both the earth and the moon. That is why they both orbit the sun. However, they orbit it together due to their mutual attraction for each other which is indeed weaker than the sun's force on either of them. This weaker force therefore only perturbs the dominant motion of each body about the sun.

Newton's theory of gravity as applied to the solar system is a well studied and well confirmed branch of physics. As a consequence we do not support proposals which propose studying such well-known phenomena.

Sincerely,

Arthur Komar

*Program Director for
Gravitational Physics*

I have no idea what he is talking about. He seems to be saying that not only am I not allowed to separate the forces but also that there is a magical bond between Earth and Moon that is unbreakable. In fact, all my "Unproof" does is examine the bond of each for the other. I am guilty of jokingly calling the Earth a gravitational lens but it seems that he has turned the Earth into a gravitational mirror. To his credit he also called it "Newton's theory of gravity", but I'll bet if I had submitted a lame brained proposal to

turn Newton's theory into a "Law" then the NSF would have supported it. The barycenter concept concocted by Newton states that the center of gravity of the Moon is located inside the Earth, because if both bodies were placed on a teeter-totter the balance point would be located inside the Earth. He then declares the Earth and Moon are to be treated mathematically as one body. I call this Bullshit because this "theory" is in direct contradiction to the observable fact that the Earth and Moon are two separate bodies. Look up at the Moon tonight and then you tell me that Earth and Moon are one.

I can reduce their concept of Barycenter to the ridiculous by proving that the center of gravity of most planet's moons lie within the parent planet. I can prove that almost each and every celestial body is one with the Sun, because the so-called Barycenters of most of them, planets, moons, asteroids, and even comets lie within that incredible massive body.

I am not trying to be a sophist, but if this were true then gravity would be a meaningless concept. If something is an integral part of another thing we need no gravity to hold it there. These apologists would negate 500 years of physics and resort to magic just to save Newton's theory.

Newton complained bitterly in letters to friends that others were ascribing to him the notion that matter has an innate property to attract other matter. Yet if you read the "Principia" it is hard to escape this conclusion. Josiah Gibbs, who once said that a physicist must be at least half sane but that there are no limits on a mathematician, was a most perceptive man.

If my data, logic and arithmetic are correct, the "Law" (or even the "Theory") of Gravity is erroneous, and much of modern science will have to be thrown down the chute. A decade has passed, and although I sent the first edition of my book free to many physicists, mathematicians and other professionals no one ever responded. Not even a thank you. I do know that the post office "lost" almost half of the ones I sent to friends and acquaintances, but even accounting for a 50 % mortality I should have received some comments if my work hadn't so upset their EBS.

I subsequently mailed letters to another 100 Mensa professionals asking questions about my ideas only in each ones field of expertise. I received about 30 answers and each one solemnly declared words to the effect that, *"I know you're wrong, but I can't quite prove it."*

I spent most of my life working as a carpenter and this would be like me telling a builder that he is building a roof wrong but not being able to prove it. The only reason they didn't prove me wrong was because they couldn't. The pedantic experts would gleefully nail me to a cross and light a fire under me if it were legal.

My "**Unproof**" has knocked the cornerstone from under Newton's celestial mechanics, Einstein's relativity, Hubble's expanding universe and the Big Bang. They will also have to throw away black holes, quasars, giant exploding stars, neutron stars, super strings and hundreds of other useless theories. This may well explain why our 40 year multi-trillion dollar search for hydrogen fusion was completely futile.

Our philosophers will now have to go back to Square One, an action I believe to be long overdue! Not to worry, Oh Great Philosophers, for this will enhance your rice bowl, not destroy it. Three hundred years of science will now have to be re-configured. This time, Oh great and arrogant philosophers, create no more natural laws — only beautiful theories. Let theories remain just that — theories. No more — no less.

Now you are entitled to believe anything that you want. However, remember that when observational data, or experiment conflicts with a theory no matter how beautiful the theory or how impressive the credentials of its author, a rational person pitches out the theory.

1. p. 39, "RADIATION BELTS AROUND THE EARTH", James Van Allen, Scientific American, March, 1959

SNAKY MOON

A few weeks before I discovered my "Unproof" of gravity, my wife and I had set up a dinner party for the following Friday night. I prepared a short paper and gave a copy to each of my friends who were interested in that sort of thing, hoping that they might take the time to find the holes in it, if any.

In that document I pointed out that the Moon, relative to the Earth had very variable momentum. One of my friends concentrated on this and a month or two later claimed to have derived a unique concept of the Moon's orbit that put my "Unproof" in jeopardy.

His "new" concept was contrary to everything we have been taught since antiquity; contrary to every sketch and diagram we ever saw, and contrary to everything we ever heard. His Moon didn't directly orbit the Earth at all. What it did was to follow a sinuous path around the Sun while it interweaved with the Earth. With this concept it made no difference if the Sun pulled harder on the Moon than the Earth did.

We, the common people have been taught to believe, that the moon directly orbits the Earth like race horses circle a race track. The following drawing is not to scale and the left side shows the non-retrograde Moon as it directly orbits the Earth. If our moon was retrograde it would orbit as shown on the right.

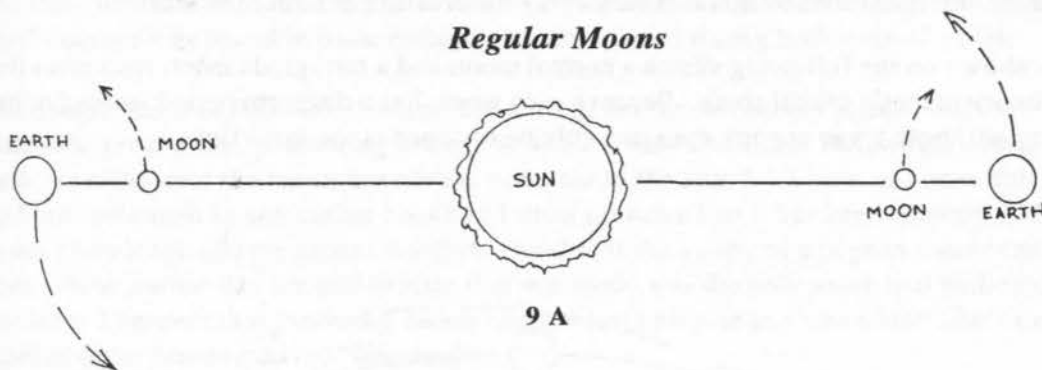

The orbits of snaky moons would approximately be like the next set of drawings. The first shows a snaky moon with a normal orbit.

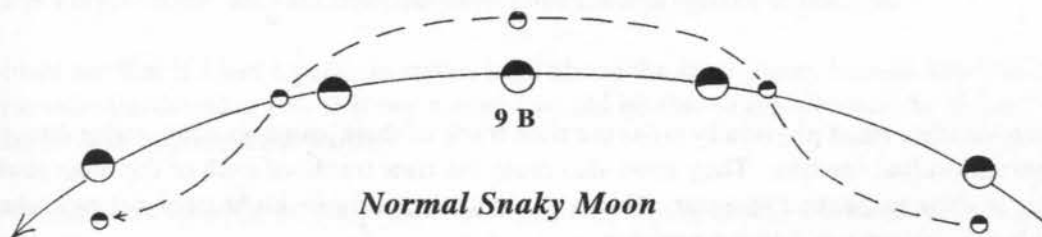

The next drawing shows a snaky moon with a retrograde orbit.

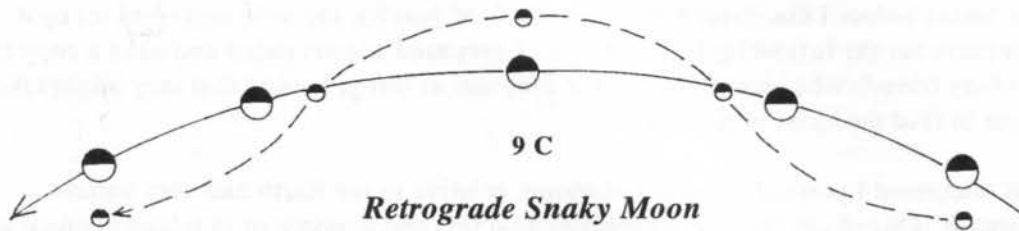

For a few weeks I believed his snaky moon concept to be true because it also brought the Moon in harmony with Kepler's third law and it eliminated the twin problems of the Moon's tremendous variation in kinetic energy and momentum as it completed each orbit.

However, about a month later I saw that if our Moon behaves in this fashion then all 33 moons of the solar system, each moonlet and ring fragment, including our artificial satellites, must also sinusoidally interweave with their primary. Scrutinizing the 13 Jovian moons, some of which revolve in retrograde motion, I saw that sinusoidal interweaving couldn't possibly be true unless the philosophers declare some of the moons and artificial satellites as special cases. To my mind declaring special cases in this instance would be no different than Tycho Brahe's desperate additions of epicycles to the Ptolmaic theory. Obfuscations of this sort only delay the creation of better theories.

As shown on the following sketch a normal moon and a retrograde moon each cross the primary planet's orbital track. Because each moon has a different period, sooner or later they will both try to occupy the same volume of space at the same time.

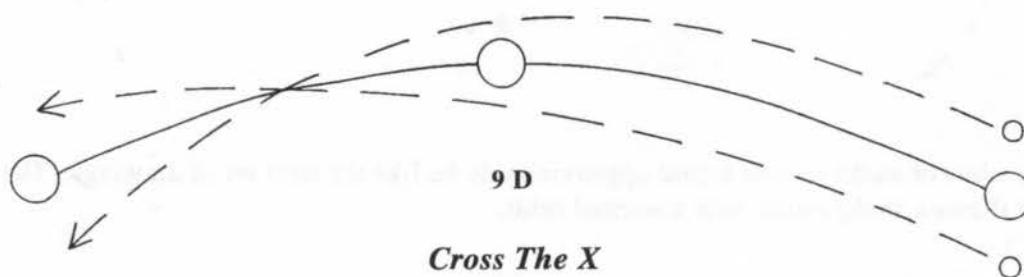

Each satellite must physically cross the time track of their primary's orbit, twice during their individual months. They must also cross the time tracks of each of the other satellites in their respective systems. This is equivalent to a figure eight stock car race where each car crosses the X twice each lap.

In a one car race (one moon) there is absolutely no chance for a collision but as the

number of cars (moons) increases, even if the track is made bigger the frequency of collisions must increase. Should a race continue for a long enough period of time then it is a certainty that even in a two car race there will ultimately be that final collision. Add to this the complications that would result if one or more of the cars were running the track the wrong way which is what retrograde moons do.

The frequency of accidents in a cross the X race is drastically reduced by the individual drivers skilled use of accelerator, brake and steering wheel. However, consider the situation where celestial bodies are crossing the X. Here, if the Law of Gravity is true, there is no driver and each body is being blindly attracted (steered) by gravity toward each other. Instead of brakes there is only pedal to the metal acceleration.

Jupiter has 13 moons (some of which are retrograde), a few hundred moonlets and a few million ring fragments. If we consider only Io, Europa and Ganymede (Jupiter's three closest moons) we have five crossings of Jupiter's orbital track every 85 hours or one crossing every 17 hours. The number of crossings per Jovian year by all 13 moons is phenomenal and if sinusoidal interweaving were the rule, there should be chaos surrounding the planet instead of the tranquillity which our probes have reported.

From the day I handed my "snaky moon" friend the paper on my "Unproof", our 35 years of friendship began to deteriorate. It would take almost four more years before I found out that the modern astronomers, the wise men of modern times, similar to their counterparts, the wise men of antiquity, had kept the snaky moon concept a secret. My friend had also "neglected" to tell me that he hadn't created the snaky moon concept and that "his" concept was found in basic college astronomy texts dating back over 40 years.

The confirmation of this came from an old college text on astronomy printed in 1959. A statement proclaims, "*A drawing exactly to scale would show that the annual orbits of both the earth and the moon are always concave to the sun.*"¹ I have not been able to find this statement in any earlier books so I must presume that it has been recently added to our knowledge of astronomy. Another friend sent me a copy of a page in some other book whose author had the gall to state that our moon was the only moon that slithered this way. I suspect that the Snaky Moon was the last epicycle and was added after some other outsider discovered my "Unproof".

Drawn to scale or not drawn to scale, there is no way the orbit of the Moon can always be concave to the Sun. No matter how far we stretch out the interweave, a moon's motion must alternate between convex and concave. Since those same people also claim that Moon and Earth both rotate around their common center of gravity (meta-center) then the Earth's orbit should also alternate between concave and convex to the Sun.

I could see that if I had a perch in space, high above the solar plane, I could watch both Moon and Earth and in less than two weeks I would be able to see whether the Moon interwove or encircled the Earth.

Over the years I played with this concept repeatedly trying to find a way to absolutely prove the snaky moon was erroneous. A few years after the original publication of this book I took a long roll of paper tape and laid out the track of our Earth as a continuous line in the center and with the Moon's distance laid out to scale as a point from the

Earth's track. I then used its distance as a radius from each day's planetary time track advancing the heading by 28/360 degrees each day. The figure drawn was a cycloid and was not sinusoidal. I did the same thing on large drawing paper for Metis and Almathea, two Jovian moons, and again cycloids developed.

I finally found out by calculation that the centrifugal force of each planet almost equals the gravitational force on that planet. But what amazed me was that these forces also equaled each other whether the Moon circled the Earth or the Sun. This question arose, **"If a body moves convex to the point of orbit how can there be centrifugal force?"** I defy anyone to make a mechanical model that demonstrates this! Thinking about this question finally pointed the way. On February 6, 1993, almost six years after I created my "Unproof", I found the answer. To begin we need the definition of the words revolve and revolution.

Revolve: "To orbit a central point."

Revolution: "Orbital motion about a point especially as distinguished from axial rotation." ²

Then we need the full description of this theory as found in an astronomy text:

"Because the earth and moon revolve around a common center between them once a month while they are making the annual journey around the sun, the orbit of each one relative to the sun is slightly wavy. What we have called the "earth's orbit" is strictly the orbit of the center of mass of the earth-moon system. Imagine the earth and moon joined by a stout rod between their centers; the center of mass is the point of support of the rod for which the two would balance ..." ³

It finally dawned on me that to orbit, to revolve means to encircle a single point. To do this the orbiting body would have to completely change direction by 360 degrees. If the direction toward the Sun in the following drawing is considered to be heading 180 degrees then the Moon in the drawing has the following headings at the points shown. The drawing on the next page shows this sinusoidal motion and I refused to take the liberty to smooth out the curve by moving the Moon a bit.

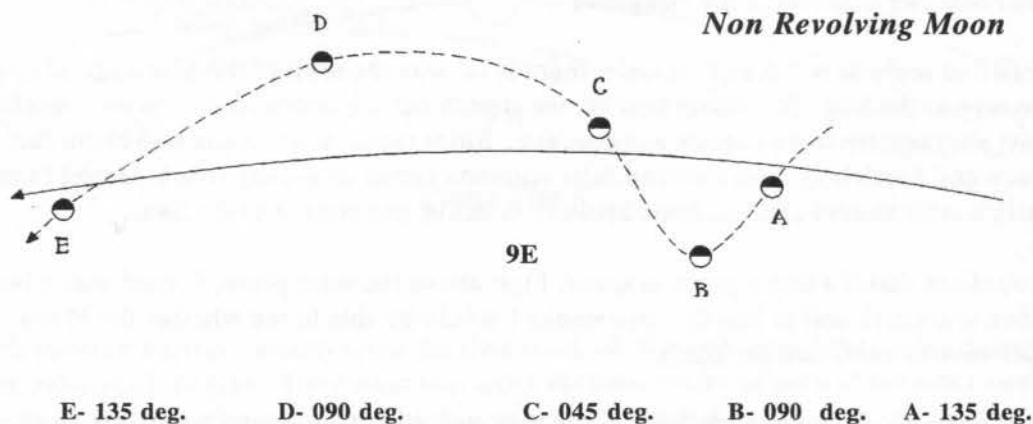

Here the Moon never “encircles” the Earth and therefore cannot be considered to “mutually revolve” about the Earth. On the drawing below the moon actually revolves 360 degrees and fulfills the requirements of revolution. It **orbits** the Earth!

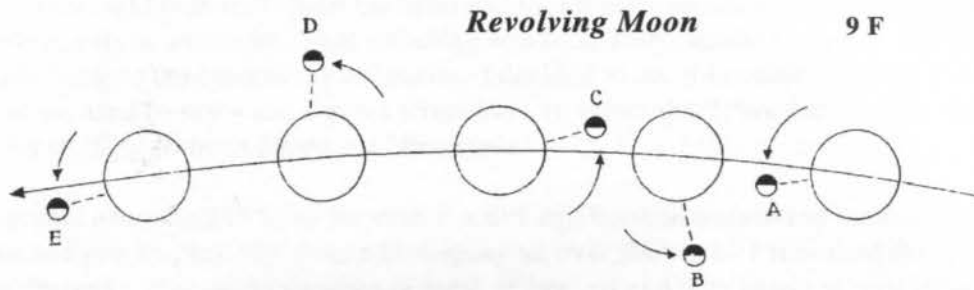

E - 270 deg. D - 180 deg. C - 090 deg. B - 000 deg. A - 360 deg.

Now you are entitled to believe anything that you want. However, remember that when observational data or experiment conflicts with a theory, no matter how beautiful the theory or how impressive the credentials of its author, a rational person pitches out the theory.

Addendum

In the early fall of '98 I saw another photo of Jupiter and its rings and this time a bell rang! The philosophers tell us that the rings are made up of moonlets. If these moonlets were doing the snakey dance they would have photographed as a long sinuous snake. Since they don't, they must be orbiting the planet. Therefore, unless the philosophers want to plead special case, all moons must directly orbit the planet and my “Unproof of Gravity” stands.

I must add here that almost 30 years ago, Walter C. Wright Jr. also discovered what I would later call my “Unproof of Gravity”. He believes that all the bodies in the universe repel each other because they are magnetic. He maintains an exhibition of his theory in his home town of Fairfield, CA.

1. p. 122, “ASTRONOMY”, Baker, Van Nostrand, 1959
2. p. 1058, “THE AMERICAN HERITAGE DICTIONARY”,
The Houghton Mifflin Company, 1982
3. p. 122, “ASTRONOMY”, Baker, Van Nostrand, 1959

NEWTON LIED

Just about every time I put pen to paper or opened my big mouth about my "Unproof", I was beaten and belabored about the head and shoulders with the dull and blunt instrument called appeals to authority. That authority was Issac Newton, the mathematician, who quickly became the bane to my existence. I decided to see if I couldn't "get da goods on im" as we used to say when I was a street kid. To effect this I "wasted" a good bit of my time by sniffing through Newton's "*Principia*."

The gospel according to Saint Newton is a difficult book to understand because both the topics and proofs play hop-scotch by leaping all over the book. I scan read the entire thing dropping blue marker papers in areas of interest and then began to zero in on errors, poor deductions and leaps in faith. In mathematics, unlike religion, leaps in faith are not tolerated. The only mandate in mathematics is that in each step of a proof the value must be valid, the terms appropriate and the logic impeccable. Not that mathematicians seem to pay much attention to these strictures but, at least, that's the way it is supposed to be.

On June 11, 1987, the newspapers carried an Associated Press release about a college kid from the University of Chicago. He had won a prize for proving one of Newton's calculations off by 15 %. The student wondered how the professional philosophers had missed this one error for 300 years. During my wanderings through the murk of Newton's work I discovered that many of his arithmetic values were not only wrong, by modern standards but also different each time they were listed. I was not too surprised to find that many of his predictions were also wrong and I also stumbled on a mind boggling boo-boo. He based one of his most important proofs on an assumption I had whimsically proven untrue many years before while writing one of my Mensa columns. What bothered me at the time was how the professional philosophers of three hundred years missed finding what I found in the "*Principia*." Imagine my surprise when a retired professional physicist, a Mensan, showed amazement because I had read Newton's book. He had never read the book nor did he know anyone who had. Unlike that young scientist, all I received for my efforts was abuse.

Without further preamble I firmly state that Newton was the mathematician who might have been responsible for that old adage, "*Figures don't lie but liars do figure.*" He allegedly spent 20 years writing the "*Principia*" where in a fashion, typical to mathematicians, he would "prove" something and then later use that proof as a stepping stone to prove something else. By a succession of proofs he eventually proved that the force of gravity is determined from the product of each mass divided by the square of the distances between their exact centers.

Many years later in "Newton's Clock" I found this statement by Ivars Peterson, "Moreover, historian Richard S. Westfall has pointed out that Newton wasn't entirely immune to the temptation to adjust calculations and data to fit his preferred theories."¹ Where I come from this is called lying!

Newton's Power of Attraction:

The cause of gravity is supposed to be the innate property of mass to attract all other mass. The reading of the "Principia" leads to no other conclusion. Because many of Newton's peers preferred the Descartes theories to his action at a distance without mediation of any other entity, Newton later began to vacillate and many times vigorously objected to that interpretation. In a series of letters to Bently written around 1692 he wrote, "*You sometimes speak of gravity as essential and inherent to matter. Pray, do not ascribe that notion to me;*" ²

In a later letter he states, "*It is inconceivable, that inanimate brute matter, should, without the mediation of something else, which is not material, operate upon and affect other matter without mutual contact, ...*" He continues, "*That gravity should be innate, inherent, and essential to matter, so that one body may act upon another at a distance through a vacuum, without the mediation of any thing else, by and through which their action and force may be conveyed from one to another, is to me so great an absurdity, that I believe no man, who has in philosophical matters a competent faculty of thinking, can ever fall into it.*" ³ These statements, so contradictory to the way we think of gravity, caused me to begin a very close examination of his book.

Newton's Planetary Order:

While speaking of the density of the various planets and their distance from the Sun, he believed that "*the denser bodies always possess the nearer places,*" ⁴ The densities of the bodies are all in grams per cc. Pluto has been left off the list because of the recent controversy regarding its density. The first column lists the actual position of the planets, the second column lists the planets in order of their decreasing density and the third column lists the modern densities. A star indicates a match between his prediction and actuality. ⁵

Newton's Densities

Newton's Prediction	Position By Density	Actual Densities
Mercury	Earth	5.519
Venus	Mercury	5.431
Earth	Venus	5.256
* Mars	Mars	3.907
Jupiter	Neptune	2.272
Saturn	Uranus	1.650
Uranus	Jupiter	1.337
Neptune	Saturn	0.688

Mars is the only match making his success rate one for eight. This is only as accurate as pure chance would dictate. His power of scientific prediction was dismal!

Newton's Densities of the Bodies:

The modern density of the Moon is listed as 3.342 and it is 1.41 for the Sun. ⁶ In this section I will show that he calculates three entirely different densities for the moon and

that each is greatly in error. To compute the percentage of his error I subtract the smaller from the larger and then divide by the smaller. First he makes a statement that the relative densities of the bodies are as follows: ⁷

Newton	Sun = 100	Jupiter = 94.5	Saturn = 67	Earth = 400
Today's Densities	Sun = 1.41	Jupitor = 1.337	Saturn = .688	Earth = 5.519

All the following statements were made by Newton:

1. Jupiter's density would be 1.332
 $(1.337 - 1.332) / 1.332 = .0037$ $1.41 \times .945 = 1.332$
the error is .37 %
2. Saturn's density would be .944
 $(.9447 - .688) / .688 = .373$ $1.41 \times .67 = .9447$
the error is 37.3 %
3. Earth's density would be 5.64
 $(5.64 - 5.519) / 5.519 = .0219$ $1.41 \times 4 = 5.64$
the error is 2.2 %

Then he sets the value of the Moon's density in relation to the Earth and the Sun. ⁸

1. Moon's density is 4891/4000 of the Earth's
 $(6.748 - 3.342) / 3.342 = 1.019$ $(5.519 \times 4891) / 4000 = 6.748$
the error is 102 %
2. Moon's density is 4.4815 times the Sun's
 $6.789 - 3.342) / 3.342 = 103.1$ $1.41 \times 4.815 = 6.789$
the error is 103 %

Again we find new values for the Moon in relation to Earth & Sun. ⁹

1. Moon is denser than the Earth by 23 to 16
 $(7.933 - 3.342) / 3.342 = 1.373$ $(5.519 \times 23) / 16 = 7.933$
the error is 137 %
2. Moon is denser than Sun by 5.7 times
 $(8.037 - 3.342) / 3.342 = 1.404$ $1.41 \times 5.7 = 8.037$
the error is 104 %

Only one out of 7 is correct and one more is close.

Newton's Magnetic Attraction:

According to Newton, the power of a magnet diminishes as to the cube of the distance. ¹⁰ Magnetic fields which are easy to test, vary by the square of the distance. Newton's gravity, which is impossible to test, seems to vary by the cube.

Newton's Tidal Gravitation:

Newton claims the Moon's force on the sea is 4.4815 times greater than that of the Sun while our current value is 2.2 to 1. ¹¹

$$(4.4815 - 2.2) / 2.2 = 1.037 \quad \text{the error is 103 \%}$$

The Erroneous Assumption:

These errors are microscopic when compared to the assumption by which he “proved” that the Moon was held in orbit by the force of attractive gravity. Here he writes, “*Suppose several moons to revolve about the earth, as in the system of Jupiter or Saturn; the periodic times of these moons (by argument of induction) would observe the same law Kepler found to obtain among the planets; and therefore their centripetal forces would be inversely as the squares of the distances from the centre of the earth, by Prop. I of this book.*” “... And therefore the force which retains the moon in it’s orbit is that very force which we commonly call gravity;”¹²

He is loosely referring to Kepler’s Harmonic Law, which states that a planet’s orbital distance cubed divided by the period squared gives a constant that should be the same for each planet.

$$\text{KEPLER NO.} = \frac{(\text{DISTANCE})^3}{(\text{PERIOD})^2}$$

And... it is absolutely true ... for every planet.

Kepler’s third law, contrary to what you may have been told, is the only mechanism that can calculate the orbit of a planet from its period and conversely the period from the orbit. Kepler’s Harmonic Law states that the cubes of the mean distance of the planets from the Sun are proportional to the squares of their times of revolution about the Sun. The key word here is the Sun and please note that mass means nothing, only velocity counts.

Kepler was a mathematician by training and an astrologer for survival and although he lived in dire poverty, even with Tycho’s stipend, he was faithful to his charge. He patiently and methodically tested idea after idea against Brahe’s hard observational facts. In this time and place there were no computers, slide rules, or logarithms. Even the “Ten Place Trig Tables” by Vega were far in the future. For this Herculean task his only weapons were the goose quill pen and expensive paper. He was also called on to defend his possession of the raw data from the heirs of Tycho. It took 20 years, but he discovered the three geometric laws of planetary motion. Later Newton would use the Kepler Laws as the basis for his three laws of motion and the theory of gravity.

One day, years before, I had focused my scientific skepticism on Kepler’s third law. I couldn’t believe that the planets discovered since Kepler’s time would conform. How could his law possibly be valid? There is no mention of mass here and the distance is cubed not squared. Why should the orbits be in harmony with the time of revolution? If true then the forces that govern planetary motion must be based on velocity and inertia, not upon mass. I had to test theory with calculation.

I had called on my computer, to “compulate” the Harmonic truth for all nine planets. I fed in the radii of the orbits in Earth units (AU) and the periods in sidereal years (SY). I would compare each planets Kepler number to that of the Earth by subtracting the smaller from the larger and then multiply this by 100 to obtain the deviation from Kepler’s Law as a percentage.¹³

Planetary Kepler Numbers

Planet	Dist.(AU)	Period (SY)	Kepler #	Deviation (%)
Mercury	.38744	.240899	1.002175	.217
Venus	.72281	.615185	.997840	.215
Earth	1.00000	1.000000	1.000000	.000
Mars	1.52330	1.880820	.999221	.007
Jupiter	5.20250	11.861300	1.000856	.008
Saturn	9.54070	29.456800	1.000851	.008
Uranus	19.19000	84.008100	1.001342	.134
Neptune	30.08600	164.784000	1.002913	.291
Pluto	39.50700	248.350000	.999755	.002

The greatest deviation was for Neptune, with an error of less than three tenths of a per cent proving that this law works. I would suggest that the very small deviation for Pluto is caused by greater accuracy in the data on this planet. Pluto has been recently subjected to an intense scrutiny with modern instruments. Our philosophers are probably complacent about the old data on the other planets, data that was mostly obtained before the modern era of exquisite instrumentation. I would also suggest that the physical orbits of the planets may not be as precise on a year to year basis as we suppose. I will also predict that all planetary motion will be found to vary in such a way that Kepler's Harmonic Law will be found to be even more accurate than these figures show.

Here is a Law that needs no finagle factors because it just plain works even though it has been modified down through the centuries to produce slightly more accurate answers. It is in almost total harmony with observational data. No need here for a philosopher to arrogantly tell me that I don't understand and/or infer that I am too stupid to ever understand. But we are told that it is the force of gravity that governs the motions of the planets. How do they isolate the individual forces that are involved with planetary motion? They must use simultaneous equations.

But they are dealing with 10 forces at the same time and equations can only absolutely solve a problem when there is only one unknown. If there are two unknown values you get multiple answers. So gravitational solutions must be like ordering in a Chinese restaurant: one force- "Gloop" A and 9 force "Gloop" B, Won-ton and flied lice on side. This poor skeptic sees the possibility of an infinite number of approximate answers.

In the original book, "Mensa Lectures", I calculated the Kepler number for the all 32 moons of the system and found that the numbers ranged 3.239 -E07 to 5.074 -E01. This is a spread of over 1.5 million or 6 magnitudes. Newton had erroneously assumed that Kepler's original law would also apply to 32 known moons of our system.

After publication I found out from a quasi friendly Mensa Astronomer that the astronomers had kept another secret from my physics books and even the CRC Handbook. Kepler numbers are now derived by adding the orbited body's mass to that of the satellite in question, multiplying that by the satellite's period squared and dividing that product by the satellite's distance cubed. I did a few and found it resulted in much better answers but I leave all of this to the next interested person.

Prepare ye now the stake, the faggots and the torch for I am about to utter heretical thoughts. I believe that the moons and planets are acted upon by electrical forces generated by the Sun. I feel it reasonable to believe that there must be at least some additional forces at work on the system.

We are told that Newton wrote the "Principia" over a period of twenty years. My findings indicate that either this otherwise meticulous man did not proof read his copy or that the Father of modern science developed and used any figures that would prove whatever contention he was concerned with at the time. I also find it incredibly strange that these errors were not found and made public during the 301 years since the publication of the "Principia."

Were the priests of the scientific religion so blind? Why should a heavy construction hard hat, a man without academic credentials, a man who is a basement crack pot have to point out the obvious?

Now you are entitled to believe anything that you want. However, remember that when observational data or experiment conflicts with a theory, no matter how beautiful the theory or how impressive the credentials of its author, a rational person pitches out the theory.

1. p. 87, "NEWTON'S CLOCK", Peterson, W.H. Freeman, 1993
2. p. 633, "NEWTON'S PRINCIPIA", Cajori, University of California, 1934
3. p. 634, Ibid.
4. p. 566, Ibid
5. p. F-160, "CRC Handbook of Chemistry and Physics", 54th edition
6. p F-169, Ibid.
7. p. 417, "NEWTON'S PRINCIPIA", Cajori, University of California, 1934
8. p. 482, Ibid.
9. p. 595, Ibid.
10. p. 414, Ibid.
11. p. 482, Ibid.
12. p. 409, Ibid.
13. p. F-169, "CRC Handbook of Chemistry and Physics", 54th edition

THE RENÉ ELECTRO-SCOPE

In my last year of high school I read Immanuel Velikovsky's "*Worlds in Collision*" and was exposed to his theories. He believed and offered some proof that Venus had been ejected by Jupiter as a comet which then erratically wandered about the solar system almost colliding with Earth. It also upset the orbit of Mars so that it, too, came sliding near the Earth a few hundred years later. He made his predictions in 1946 and he was vilified by the high priests of science years before the first space probe would leave the ground. The strangest thing is that many of those predictions were subsequently shown to be true by space probes and I know of not one of his predictions that have been proven to be wrong.

In the late '60s another book, "*Cataclysms of the Earth*", exposed me to Hugh Auchincloss Brown's (HAB's) belief that the planets were held in orbit by the combined repulsion of all the stars and the Sun. I had to reject that theory because if that were true our planets would be pushed to some point halfway to the nearest star.

Around the turn of this century, Tesla had predicted that the Sun was an incredible charged electrical body and was therefore creating what we now call the solar wind. He claimed that it had the incredible electro-static charge of $50 + E 18$ esu and an electrical pressure of 216 billion volts.

Tesla, the man who is barely ever mentioned in physics books, single-handedly in the course of a few short months invented and developed alternating and polyphase power including generators, motors, transformers, controllers and switching. Today, the politically correct "creator" is Westinghouse. Another first for Tesla was radio. I know the books give it to Marconi but Tesla won an immense patent fight over radio against Marconi. Before the turn of the century, Tesla was demonstrating radio controlled models of warships to the Navy Department. In fact, Marconi studied under Tesla for a while.

He also created extremely high voltage and high frequency equipment and appeared frequently on the lecture stages with his usual sartorial elegance ruined by the fact that his long hair was standing on end due to the immense static electric fields he had created. Reporters and other visitors to his lab on Green Street in New York were always astounded to find that he could throw a switch and the plaster ceiling would light up as if it were made of fluorescent lights invented 30 years later.

There were no bulbs mounted on the ceiling! He had induced the air itself to glow. He could also create, and hold in his hand the greatest electrical enigma of them all, ball lightning. The modern religion of science ignores him because he had few academic credentials and never kowtowed to the rote learning pedantic professional philosophers who considered him to be a crack-pot. After all they were the learned Ph.D.s and he was but a clever tinkerer, an uneducated piss-ant! Time has determined that they were the crack pots and piss-ants, not Tesla. They were wrong and as usual, he was right.

We now know that the Sun is very highly charged. The only thing still in doubt is the magnitude of both charge and voltage. I used to think, "*Wouldn't it be delightful if*

charge and voltage were ultimately found to be close to Tesla's original values?"

Ultimately I was disappointed in this when I discovered Mr. Bailey, a modern source, who claims that the Sun's charge is negative and 1.5×10^{28} esu.¹ This value is 300 million times higher than Tesla's number. From the zero electrical charge at the turn of the century to Tesla's number and now to this fantasmagorical number, the Sun's charge is increasing faster than the age of the universe. Mr. Bailey also shows that this charge produces a field of -3.0×10^{17} volts at the distance of the Earth's orbit.

Because of this gargantuan charge, I can safely make the statement that each body in our solar system must be charged to some degree. An electric field is very pervasive and affects all matter. There are no electrically neutral materials! No matter the magnitude or polarity of this electric force, it must either reduce or increase the Sun's alleged gravitational force on the bodies of the solar system.

Even if the Earth were at zero charge, there must still be attraction between Sun and planet. The experts worry about electric forces on molecules, atoms and the so-called basic particles, but will never mention these forces when speaking on a planetary or cosmic scale. After all isn't a planet or a star only a collection of atoms?

However, if we limit our consideration to the majority of the stars which should be identical in charge we can see that they would indeed repulse one another. This would account for the observations that show the universe to be expanding. It would also account for those few which move counter to the general trend. As you are about to discover, these bodies would be respond to the attraction found when two bodies are not charged with the same polarity and identical voltage.

This is much more believable than the Big Bang scenario that starts out with a black hole, from which even light can't escape, and then it explodes driving out mere matter to form our universe. And don't bother to tell me that the start wasn't a black hole because what else can you call something that envelopes all the mass of the universe in a tiny volume.

To top that off there is no real evidence that black holes actually exist despite the tout job done by the astro-physicist in general and Stephen Hawkings in particular. Their existence has been predicated on two things, the first is Newtonian gravity and the second is Einstein's Relativity. Later we will examine Relativity and I will drive great wedges of doubt into your **EBS** on that mathematical spectacle.

In time, I came to believe that electrical forces control the mechanics of the solar system and universe and that they are also responsible for revolution, rotation and axial tilt of the various planets and the motions of the moons. Were the only force that of attraction of mass for mass, the planets who bear ring fragments would demonstrate chaos in their orbits instead of the sedate minuet that the space probes reported. I keep good company! HAB, Tesla, and Faraday also believe in an electric universe.

Both Velikovsky and HAB maintained that collisions between solar system bodies are very rare, because as each approached the other, both bodies would tend to develop an equal charge because both would then be at equal distance from the Sun and would tend to have identical electrical charges from the Sun. Identical charges and polarity cause

repulsion. Mutual repulsion would also explain the twisting away, one from the other, of two of Saturn's moons that was photographed by NASA a few years back.

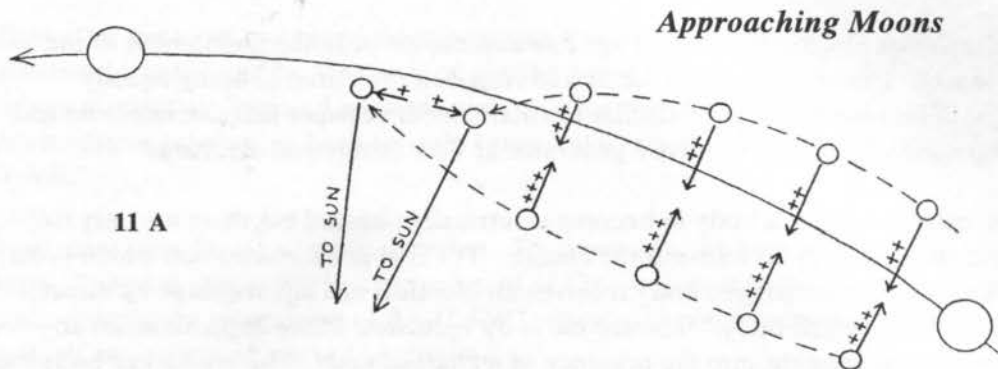

My beliefs were bolstered down through the years by trivial thoughts slowly and painfully acquired. One of the first tidbits was that electrical insulation, similar to heat insulation and the flow of heat, just decreases the flow of current through it. There is no way to totally insulate from electricity.

Reinforcement came when I dissected the original Cavendish experiment. Two centuries of replication of this experiment have been equally flawed because there has never been any attempt to zero out electro-static forces. The use of the torsion pendulum especially during eclipses lead scientists to say, *“Observations in the present case were recorded alternately with the pendulum grounded and with it charged to + 4900 volts, but only the grounded results are presented in this paper. Somewhat different, and at times unexpected, effects were noted when the pendulum was charged electrically.”*²

In the late '50s NASA had a recurring problem with an electrical device in a satellite. It was a low voltage unit that worked perfectly on the ground but failed as soon as it hit space. One day someone put the unit in a vacuum chamber and captured the failure on film. The film showed coronas emanating from the exposed portions of the circuitry. Space was supposed to be the perfect electrical insulator.

It was a surprise to everyone but me. After all, our fluorescent lights are highly evacuated and they conduct current. In fact, once the current starts to flow, the internal resistance dips so low that if it weren't for the ballast (inductive choke) the circuit breaker would blow.

There is also something very wrong with our basic electric theory! We are told that electrons travel easier in metals because the higher density causes the atoms to lie closer together. By this thinking the electrical resistance of compressed air should be decreased because compression drives the atoms of air closer and closer.

When I was 17, in the era before our government convinced us we were all rich, every gas station had a spark plug cleaning and testing machine. First we would sand blast the plug clean and then re-set the gap. Then we would put it into the tester and simulate, by using compressed air, the pressures found in an operating engine cylinder. A used plug which

was firing beautifully without pressure could become very erratic under pressure. No matter what the theorist claim, I know that closer atoms do not necessarily decrease the resistance. So much for theory!

I also believe that electric forces will one day explain the puzzling phenomena of the ringed planets. The moonlets, fragments and ring dust, by virtue of being equally charged, will be found to behave similar to small pieces of paper that can dance on and off the top sphere of an electro-static generator as they charge and discharge.

There are many ways for a body to become electrically charged but there are only two ways for a charged body to transmit the charge. The first is by conduction which is the process by which an uncharged body receives an identical and equal charge by direct contact with the charged body. The second is by induction which happens when an uncharged body is brought into the presence of a charged body. The uncharged body then picks up an opposite polarity of charge. I see an anomaly here that prevents me from predicting what type of charge the planets will have.

My confusion is explained by these examples. If I connect by wire, or touch the two bodies, this is conduction. If I put a resistor in series from one to the other I should find that this is still conduction, but the second body would have a lesser charge. However, if there is a gap between the two bodies an inductive charge will be placed on the second body and this charge, according to the books, will be of opposite polarity. But is not air also a conductor? Is not a vacuum also a conductor? Both to a lesser degree than a wire, to be sure, but how can the polarity change in the manner so found? I believe that these examples point to the need for a better explanation of charging by electro-static forces.

I shall pause here to quote Coulomb's law of electro-static attraction and repulsion. ***"If both charges have the same sign, the force is repulsive. If the two charges have opposite signs, the force is attractive."*** This statement was derived from the action exhibited by an instrument called a gold Leaf electro-scope.

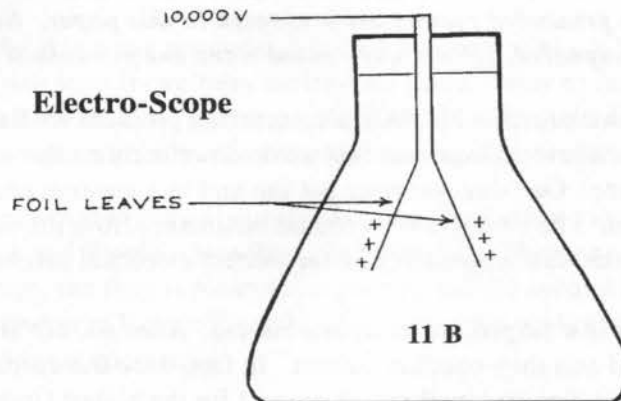

This device consists of a glass jar, which prevents air currents from disturbing the two fine gold foil leaves contained within. These leaves are connected in parallel to a conductor which extends from the top of the jar. When a charge is placed on the device, regardless of its polarity, the leaves will always repel each other. Contrary to the official explanation this instrument proves only that identical charges repel.

I had been perplexed for years over the problems of polarity and transmission of electric forces in the solar system. If I assumed that the Sun charged the planets by induction each planet would have an opposite but lesser charge. This was good because it provided the attraction needed to hold the planets in their orbits. However, the moons would then

have approximately the same charge and would be repelled from their primaries and this was bad. If I assumed that the planets charged by conduction, both the planets and the moons would be repelled. This was even worse!

Time after time I re-examined these concepts and over the years, my sick mind had wondered what would be the result of placing a similar polarity but a different potential on two electrically isolated adjacent plates. What would these plates do? But each time this madness entered my head I would immediately reject it because it was contrary to the "LAW."

Time after time I walked away defeated. Then one day, my perverted mind saw a ray of hope. Suppose electricity had never heard of Coulomb or read the physics books. Suppose, contrary to man's idea of the "LAW", electricity saw any lesser quantity as negative to itself and attracted instead of repelled.

On Sunday afternoon (May 17, 1987) my buddy John Cook examined my sketch of two charged hypothetical plates and pronounced my theory viable. Before that day died I had slapped together the first René Two Leaf Electro-Scope.

A first test of this device took place on May 28, 1987 in Professor Lary Wasserman's Physics lab located in the Passaic County Community College in Paterson, NJ. He provided the two different voltage electro-static generators that were necessary to provide the same polarity but a different voltage to the separate plates.

When tested, the plates attracted each other thus proving that every Physics book in the world needs revision. This discovery in basic electro-static forces, which is being ignored and resisted means that the statement in all the Physics books should be revised to read, "Only charges that have the same polarity and are equal in charge repel. All other charges attract." Physicists, rewrite the goddamn books!

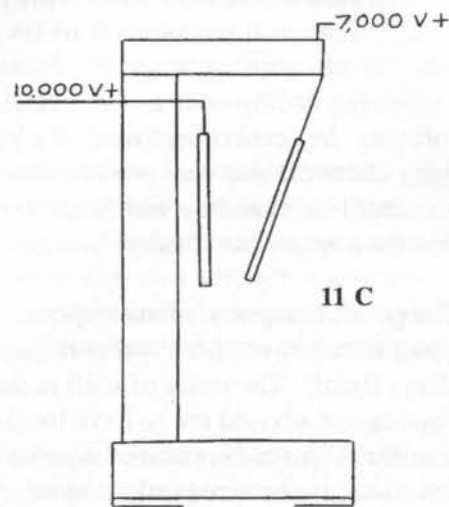

René Electro-Scope

I do not believe that the electro-static forces between the Sun and the planets can ever be repulsive because my Two Leaf Electro-Scope proves that only identical charges can repel. Unless there is magic, there is no possible mechanism that could charge all the planetary objects the same as that incredible electric furnace we call the Sun. Therefore there must be some attraction produced by the differential in voltage and charge. This electro-static force must modify by some degree that tether force which we call gravity. Is this so hard to believe?

Coulomb's law clearly states that the electrical force is dependent on the product of the charges. If this is true then there can be no such thing as a zero charge because zero times any quantity is still zero. The philosophers tell us that electrical forces are many orders of magnitude higher than the gravitational force. If we compare the gravitational

force with the electric force found between a proton and an electron, the electric force is found to be 2.13×10^{39} times higher.

This ratio is indecent! It is similar to comparing the mass of a drop of water to that of a million Suns. Coulomb claimed that the gravitational forces were negligible in comparison to the puny electric forces he had available and yet ... any suggestion that electric forces act on celestial bodies has always been met with howls of rage from subsequent philosophers.

A few months after I tested my Two Leaf Electro-Scope the "Herald News", a local North New Jersey paper, did an interview and photo session. Then they declined to print the story because the editor didn't think that the probable negation of Coulomb's Law was newsworthy.

During this period a great "what if" of self-doubt struck. What if the electro-static generators I used were giving out different polarity? Professor Wasserman had retired from his position the same day we had run the experiment and although I had been assured that all those electro-static generators have the same polarity I wanted to repeat the experiment just to be sure. This time I would assess each generator's polarity beforehand.

Exercising futility once again, I called over 25 Physics professors at the various local colleges. My experiment needed a lousy half hour but they seemed to believe that I was lying about the one very positive test I made. So sure were they that I was wasting their precious time that they would not even call Professor Wasserman. Their **EBS** told them that the physics book had to be right.

The general response to my requests was typified by the following direct and phonetic quote from one erudite local college professor type philosopher, "Book never long- book allays light!" The irony of it all is that one of the assholes from the National Science Foundation advised me to have local professors judge my work. To this day no one has acknowledged testing one of my two leaf electro-scopes. However, one bitter enemy must have because he arrogantly told me, "*Your electro-scope would work but we physicists speak of charge, while you speak of voltage.*" I still haven't figured out what he meant.

We have seen that phase and lunar distance are strangely related. Now picture how the charge on a moon must vary as it orbits its primary. At some short period during the first and last quarter when it is the same distance from the Sun as the planet it orbits, it must have an identical charge as the planet. At that time it must be actively repelled by the planet until the charge is no longer identical. This has never been taken into account by celestial mathematicians nor even discussed.

In each system the basic acquired charge would be different according to the planet's distance from the Sun. Would that not cause the Kepler numbers of the various moons into a different range for each system such as my computations showed?

I also believe that electric forces will one day explain the puzzling phenomena of the ringed planets. The moonlets, fragments and ring dust, by virtue of being charged equally to those in their immediate vicinity, will be found to behave as do small pieces of paper

that can dance on and off the top sphere of an electro-static generator as they charge and discharge.

In January of 1991, Dr. Richard Cyert, President of one of the colleges of Carnegie-Mellon University promised me that he would have my Two Leaf Electro-Scope tested and re-examined. In a letter to him I predicted that the academics would do no more than pooh-pooh and tut-tut the instrument. The following May, I received a letter from him that stated: *"I cannot interest anyone in our electrical engineering department on the matter of your electro-scope. You are correct in your assumption that it has been "pooh-poohed" into oblivion. I can do nothing further on the matter."*

I would have hand delivered a Two Leaf Electro-Scope to Pittsburgh had anyone been willing to test it. They could have knocked a cheap and dirty one up in a few minutes from a couple of sticks and some aluminum foil had they desired. Isn't it strange that no one would test? Or did they, when no one was looking?

It gets worse. In the Fall of '91 I conducted a contest for students at MIT. The prize was \$ 200 if they could prove my "Unproof" wrong. They gave it a gallant attempt. As part of the contest package I mailed each of them a collapsible René Two Leaf Electro-Scope made out of popsicle sticks, foil and a paper clip. I asked them to test it in their physics lab. Every student wrote back that that if they got caught trying something like that they feared they would be thrown out of school.

There are some really bright kids who are great physics students up at MIT and as far as I'm concerned that school doesn't deserve them. As a consolation prize I sent them a copy of "Mensa Lectures" and a few wrote that if they were caught reading extraneous material like my book they feared for their school career. It seems science is also enmeshed in Political Correctness. You can't tell me that one so-called government "intelligence" agency or another hasn't covertly put the fear of the devil of non-conformity into these kids.

I suspect that future research will show space to be a much better conductor than is now assumed. I also believe that the electric constant for space, currently given as unity, will be ultimately found to decrease as to the distance from the Sun. This is because the solar wind must attenuate as it radiates outward.

Now you are entitled to believe anything that you want. However, remember that when observational data or experiment conflicts with a theory, no matter how beautiful the theory or how impressive the credentials of its author, a rational person pitches out the theory.

[The main body of the page contains extremely faint, illegible text, likely bleed-through from the reverse side of the paper.]

1. p. 601, "MYSTERIOUS UNIVERSE: A Handbook Of Astronomical Anomalies, Corliss, The Sourcebook Project, 1979, Extracted from "Existence of Net Electrical Charges on Stars", Bailey, Nature, 186: p. 508-510, 1960
2. p. 655, "MYSTERIOUS UNIVERSE: A Handbook Of Astronomical Anomalies, Corliss, The Sourcebook Project, 1979, Extracted from "1970 Solar Eclipse as Seen by a Torsion Pendulum", Saxl & Allen, Physical Review D, 3:3, P.823, 1971

RENÉ'S ELECTRIC GRAVITY

Shortly after I first tested the René Two Leaf Electro-scope I had a series of connected thoughts. Given that the Sun is highly charged, and there is no longer any doubt that this is true, would not the outer most layer of the Earth's atmosphere be charged? Would not each particle of that mono-molecular layer have the same identical charge and repel all other particles in that layer? Would the forces from each particle cancel out the way Newton assumed that the particles would cancel out the attraction of gravity? If so, wouldn't this place a compressive pressure on the next lower layer? And each subsequent layer after that?

I thought up an experiment to test the premise but before we proceed I wish to reiterate some facts:

1. Electrical forces, similar to the so-called gravitational forces, are also diminished as to the square of the distances involved.
2. Gravity, which is reputed to attract all the other mass anywhere in the universe, depends for its propagation on the completely elusive and never detected Gravity Wave.
3. Electricity, on the other hand, is not quite so magic a force and we know much about its behavior. The fact is that all matter, even dielectrics, are affected by an electrical field. Bear in mind that although we measure electricity from the ground plane of the Earth and call it zero, we have no idea of the actual value or the polarity of our reference plane.
4. The immense solar charge has been found to be negative polarity, therefore Earth's charge must also be negative although of a lesser charge. My electroscope proves that some of the attractive force which tethers planet to sun must be electric.

The actual densities of the inner planets are probably much less than are now supposed. I no longer see any difficulty in electric forces supplying most or even all of the attraction necessary to keep the planets tethered to their orbits. I gratefully leave the final solution of all these problems to the next Newton.

I can think of no way to test the Newtonian assumption of mono-molecular cancellation of gravity but we can test for mono-molecular electro-static cancellation with the following experiment.

Suppose we take a mylar party balloon and attach to its mouth a tubing T. Sealed to the outlet with shut off valves is the lower end of a very sensitive inclined manometer. We shut off valve A, disconnect the tube from the T and open valve B. The tube is then used to fill the balloon. When filled we shut valve B and replace the flexible tube. Then we open both valves slowly and simultaneously to keep an equal pressure on both ends of the manometer so that the level of the liquid will not surge.

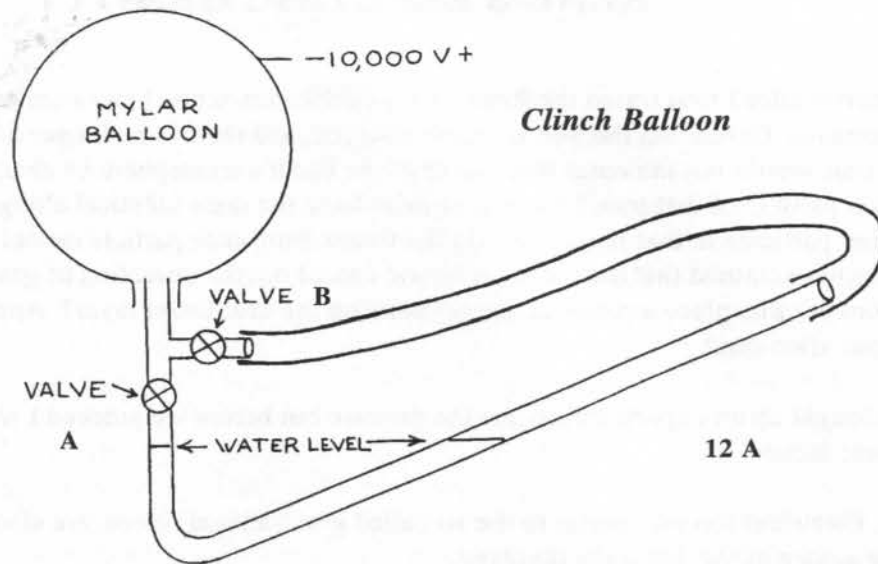

Then we shut valve A again and connect the surface of the balloon to an electro-static generator. The skin must acquire a charge. Will the electrical stress cause the skin to compress and thereby increase the static pressure inside the balloon? Will it instead expand the skin, decreasing the internal pressure? I believe that each charged particle being of identical polarity and equal voltage will repel the other thereby increasing the internal pressure. Only if the skin does not respond to the electrical stress can Newton's theory of gravity remain unchanged.

If the skin contracts, could not this molecular pressure be construed as gravity? Picture mono-molecular layer after layer contracting and each adding slightly to the pressure on the masses involved. Dr. Brush during his 1923 vacuum tube drop test experiments, while self-admittedly teetering on the edge of experimental error, found that denser objects accelerate faster and conductors more slowly. This shows that conductors have a slightly different gravitational potential than non-conductors. Why should this happen if no component of gravity is electrical?

Suppose we add another larger balloon over the first set up. All we need this time is one inlet valve. We fill the inner balloon with air and then pour water into the manometer. Then we blow just enough air into the outer balloon to raise the manometer a tiny bit. We seal off valve A. We attach one electrical connection to each balloon, the inner one through the stopper and the outer one to the skin.

We charge the inner balloon and record the rise in the manometer level. Then we charge the outer balloon and see if there is an additional rise in the manometer.

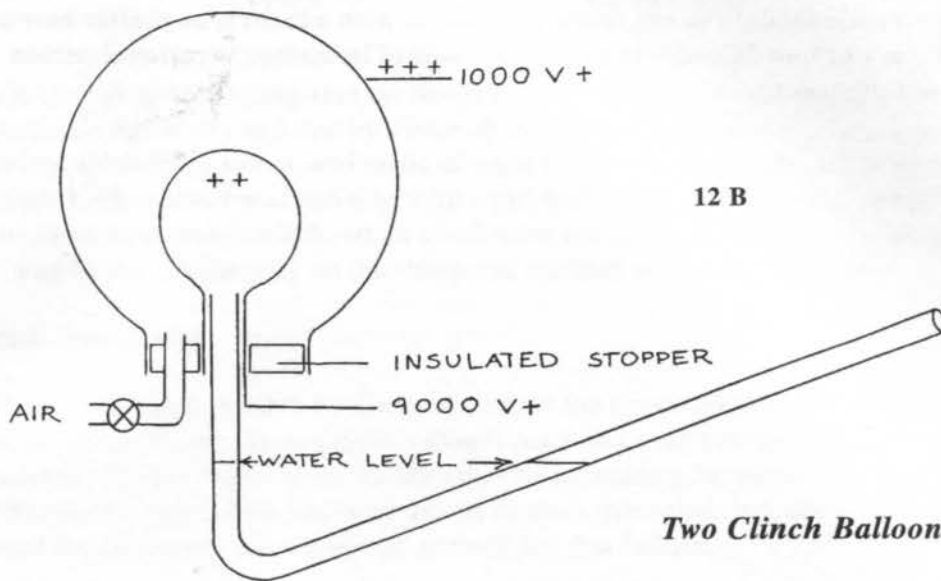

If I am right there would be another pressure increase noted on the manometer. If this happens we can now see each successive layer adding a bit more pressure not only on the entrapped air but also an increasing electrical pressure to each atom. Could this increasing electrical pressure be the force that we call gravity and currently ascribe to the magical property of mass to attract each and every other particle of mass?

This experiment is simple and cheap because you can build an inclined manometer but it does require access to a physics lab for the electro-static generators. The experiment has never been performed because after failing to get any one to re-test the Rene' Two Leaf Electro-scope I was not stupid enough to try to get lab time for this. I have no doubt that today's philosophers will talk this simple experiment to death but, just like their peers in the ancient fable, no one will go into the barn and actually count the damn cow's teeth!

It has been many years since I paid any attention to the statements of the particle-philosophers. About the time they "discovered" the hundredth basic particle, I abandoned all hope. When they ran out of decent names and began to attach names and properties to them like Love, Strangeness, Bottomness, Charm etc. my credulity was stretched to the limit. However, no matter what they are discovering, think they are discovering or are lying about, is of no great moment compared to the fact that all of their experimentation is done by using intense magnetic and static electric fields. If "basic" particles respond to these forces and if celestial bodies are composed of basic particles, why is it that any hint that celestial bodies may respond to the same forces is always met with derision by "open-minded" experts?

How accurate can the results be of any experiment that uses high electric charges as do cyclotrons and bevatrons and all the other "trons" if our basic understanding of Coulomb's "Law" is flawed? How can you tell us that basic particles wink in and out of existence when you don't even know if they are attracting or repelling during that incredibly small slice of time when you claim to have observed them?

Now you are entitled to believe anything that you want. However, remember that when observational data or experiment conflicts with a theory, no matter how beautiful the theory or how impressive the credentials of its author, a rational person pitches out the theory.

[The following text is extremely faint and illegible, appearing to be bleed-through from the reverse side of the page.]

RELATIVITY NEGATED

I would love to be able to say that on November 2, 1987, that I was hard at work examining Einstein's Relativity and that by virtue of incredible impeccable intellect, considerable cogitation, splatters of sweat, and loads of logic I discovered a defect in his theory. But the simple truth is that I was gabbing with a girl buddy, doodling on a pad, listening to the radio and scratching an itch, when a bell went off in my crazed and demented mind. I saw a way to place Relativity on the sharp and spiraled horns of a dilemma.

Special Relativity

The theory fabricated in 1905 by Einstein utilized the Lorentz-Fitzgerald equations to denote that velocity affects an object's shape, mass and even the rate of its time. After Michelson & Morley failed to detect the ether by measuring the velocity of light, Lorentz and Fitzgerald created their transformations to show that relativistic effects could have distorted the apparatus just enough to account for that failure.

Einstein applied this series of mathematical assumptions to a hypothesis called Special Relativity. This states that the length of an object shortens, its mass increases, and its rate of time slows as the object gains velocity. What I have never seen discussed is what is supposed to happen to the width and height of an object. These phenomena are alledged to be exponentially proportional to the velocity, which means that the mass of an object approaches infinity at the speed of light. Each of these phenomena is determined by some relationship to the formula called Gamma.

$$\frac{1}{\sqrt{1 - (v^2/c^2)}}$$

Einstein slipped Special Relativity to us. Eleven years later, in 1916, he boggled the world again with ... General Relativity. We were hit with the old one-two punch and neither our poor old Newtonian world, nor our universe, would ever be the same again.

Like many others, as a kid I was a science fiction fan despite the fact that I could visualize the incredible distances between stars. Such distances are so vast, that if man was ever to attain practical star travel, his ships would have to exceed the speed of light. Also they would have to do this without gaining infinite mass because this, in turn, would require infinite power. Without such capability, presumably man would forever be virtual prisoners in this solar system!

If we discount the deranged particle philosophers, who babble on about basic particles, there is no valid proof for either of Einstein's theories. Despite this, today's astronomy, astro-physics, and cosmology are all based on the assumption that Relativity is a natural "LAW" ... not just a theory!

The fact is that Special Relativity was 66 years old when an attempt to prove time dilation was made. It started on October 4, 1971, when four atomic clocks were loaded as freight aboard a series of commercial air liners. ¹

The experiment was conducted to measure the difference in time due to the rotation of the

Earth. The first flight flew east and the second trip went westward. Each direction necessarily involved zig-zag flight patterns, transfers of the equipment from one craft to another, and layovers all along the way. Just as many passengers today, the atomic clocks spent large periods of time waiting for the next flight.

Four clocks were deemed necessary, since atomic clocks are subject to time rate changes that can approach 1000 nano seconds per day. The philosophers figured that by doing statistical manipulations to all four of these clocks they could get a handle on the unpredictable rate shifts. The expected difference in time due to the effects from relativity were minus 40 nano seconds for the eastward trip and plus 275 nano seconds for the westward trip. In desperation, just to prove Special Relativity, they had the nerve to use clocks whose error rate was 25 times greater than the expected loss of time on the eastward trip.

The experiment lasted over 12 days. And in the end the philosophers involved, of course, proved that Einstein was right. Naturally they allowed for the stopovers, possible positions, plausible courses, likely winds, apparent speeds, and the probable delays; and then ... the predicted rate of time using Special Relativity was found to match the observed. When they had finished the interpolations, extrapolations, and least squaring of the deviations the match was almost perfect and the Theory of Special Relativity became another "LAW" of nature.

I could spend a few hundred hours in additional nit-picking, but I have conjured up a much better test for Special Relativity. It's a fairly simple test, and I'm surprised that the professional philosophers have never thought of it.

What I propose is simply placing two accurate clocks, one earthbound at the pole and the other on a satellite that is in geo-synchronous orbit above the equator. This will provide us with two relatively stable platforms of known relative velocity due to the Earth's rotation. The satellite's 26,000 miles of altitude plus the 3800 miles of Earth's radius would demand a relative velocity about 7800 mph (2.1666 m/sec).² By monitoring the clocks for a year (not possible on interrupted airplane flights) our philosophers will be able

to determine if the Lorentz-Fitzgerald transformations hold true. If time dilation truly exists within that year, without any finagle factors or intermittent airplane rides, there will be a time difference of .00214 seconds. This experiment will give us, for the first time, a bold hold on Relativity. They will be able to either verify relativistic time or declare it to be ... Bullshit.

But let us assume that this experiment proves that time dilation is a reality. We could then collect and record data throughout the year, and in due time would have an array of data that can be then used to detect the absolute composite vectorial motion of our Sun.

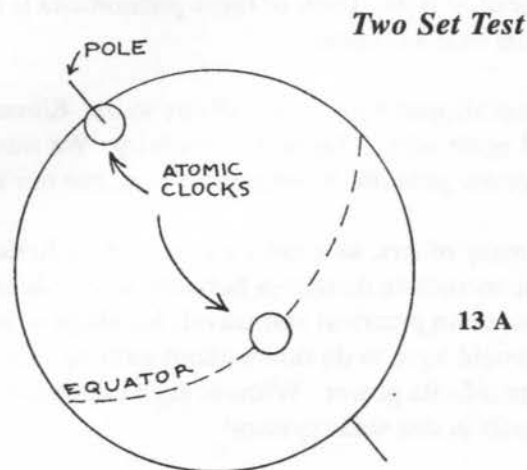

The Earth changes its direction in relation to the Sun's path every moment of every day of the year. At certain times its orbit must be going somewhat in the direction of the Sun and 6 months later it must be going somewhat away from the Sun's path. By comparing the time changes we will know the Sun's vectorial velocity in relation to the Equatorial plane.

We could then launch a solar satellite at right angles to our solar plane, and set this probe to orbit the Sun at the same distance of the Earth and with the same period. In this manner, both solar orbital motions would cancel each other out. That probe should carry a cluster of atomic clocks which would then record only the Sun's travel. By comparing the data from the orbiting clocks with our polar clocks, we should be able to determine both the direction and velocity of our Sun, unless its motions is at right angles to our solar plane.

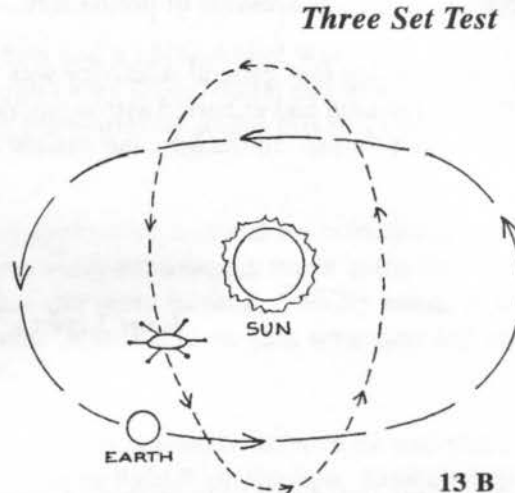

However, if all this be found true, then Special Relativity has been placed on the horns of a Special Dilemma. Einstein based his theory of special relativity on two postulates (assumptions). The first postulate is that "*Absolute uniform motion cannot be detected.*" Thus, we have a theory that, if it can be shown to work, will prove that its own first postulate is invalid.

Einstein's second postulate for Special Relativity is that the speed of light is constant and independent of the velocity of its source. This assumption is one of the basic tenets of today's organized science. It is classed as gospel even though — to the best of my knowledge — no one, no where, no how ever seriously tested this assumption ... if it could be tested.

It was originally claimed that light is an electro-magnetic entity and that all the electro-magnetic frequencies were propagated at the same velocity, the speed of light! If you question this you are told that Clark Maxwell proved it mathematically, and that Michelson/Morley proved it when they measured the speed of light in the late 1800s. Obviously, what a mathematician proves, or does not prove, has never been of much great consequence to me. To again paraphrase Josiah Gibbs, a physicist must be at least half sane, but there are no restrictions on a mathematician.

The Michelson experiments recorded only the average speed of light over a number of trials. The distance was necessarily always less than one hundred miles. The only evidence pertaining to the long distance velocity of electro-magnetic waves comes from our deep space probes. One of these left the solar system a few years ago and NASA noted a drop in the frequencies of transmission. NASA also had to change the frequencies by which they communicated with the Voyager probe that toured all the outer planets. Did the first ship accelerate from an unknown cause as it left our system? Is the consistency of interstellar space different? Did the velocity of the electro-magnetic propagation

change?

General Relativity

The General Theory fabricated by Einstein in 1916, has only one postulate, which is the equivalence of mass. It predicts that mass will bend light, retard time, and that all planets will have a precession of perihelion.

I find it intriguing that general relativity was “proved” before special relativity. To test his theory, Einstein had exhorted astronomers to test for the bending of light from stars that were very “close” to the Sun, but visible only during a solar eclipse.

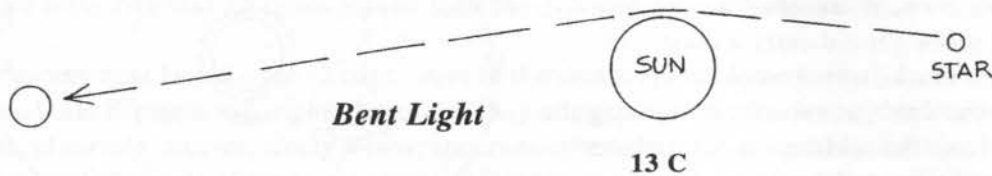

His theory predicted that light from such stars would be bent 1.7 seconds of arc at this time. ³ During the solar eclipse of 1919, Eddington sallied forth to take the necessary photos during a solar eclipse. Actually, when the plates were examined, Eddington threw half away because they did not agree with the prediction. Then he averaged the rest of his observations, and announced (in headlines around the world) that mass attracts the massless photon thus ‘proving’ Einstein’s Theory. In Einstein’s book, “Relativity” the rectangular coordinates of the bending of only seven of the stars used were listed. ⁴ He also listed the corrected values derived from his theory for these stars. Paper is cheap, so why he never listed the data for all the stars is beyond my ken. Maybe he was lazy.

Trusting no professional philosopher, I did my own arithmetic on the seven samples provided. I found that the average movement for the calculated motions was .508 seconds of arc. I took the square root of the sum of the squares of the two coordinates, added them and divided by 7.

Eddington’s Eclipse Stars

Star #	1st Co-ord	2nd Co-ord	Deviation
1	.22	.02	.221
2	.31	.43	.530
3	.10	.74	.746
4	.12	.87	.878
5	.04	.40	.402
6	.09	.32	.332
7	.85	.09	.854
			3.963

Average = 3.963 / 7 = .566 seconds of arc

Despite Eddington casting out those bad plate devils, and despite all the mathematical machinations, these figures are still a long way from the predicted 1.7 seconds of arc. Of course, he never listed all the data so I have no way of knowing if the rest of the stars showed bending much greater to compensate for these. In any event Einstein, genius, savant and saint declared, "*The results of the measurements confirmed the theory in a thoroughly satisfactory manner.*"⁵

In 1919 the only person who knew that the Sun had a photosphere was Tesla. Professional philosophers didn't believe it. Although every professional astronomer knows that all atmospheres bend light by refraction they conveniently forget this fact under the magic spell of Relativity!

To the best of my knowledge no one has ever applied corrections for refractions on Eddington's data, nor on any of the other nine separate attempts made in the last 70 years by astronomers to prove Relativity by roughly the same method.⁶ Every attempt failed, but all of them did show a bending of the light. It seems to me that what they are measuring is the refraction of the Sun's photosphere.

The gravitational red shift predicted by Einstein is supposed to affect time and would be reflected in a 2 millionths shift in the wavelength of light from the Sun. Einstein himself, in 1920, declared that "*If the displacement of spectral lines towards the red by the gravitational potential does not exist, then the general theory of relativity will be untenable.*"⁷ By 1924 an astronomer allegedly detected the effect, not on our own Sun which is but 8 light-minutes away, but on the dwarf star companion of Sirius which is many light years away.

To this day the only planet that has a detectable precession of perihelion in its orbit is Mercury. Newton used this to prove his gravity of attraction. Einstein used it to prove the gravity of the space/time continuum. Naturally Einstein's "space time" bending of gravity supposedly negates Newtonian gravity.

General relativity is based upon the assumption of the equivalence of mass which means that all mass falls at the same rate in the same gravitational field. This assumption was what I was questioning when I requested a grant from the National Science Foundation to re-test falling objects. Starting with Dr. Brush in 1923, many of our more astute philosophers have found that this assumption is simply not true. They are then labeled (crack pots) which effectively prevents having to deal mentally or physically with their reports.

Some current philosophers are finally responding to these anomalous effects. They were beginning to add Tycho Brahe type "epicycles" to Newton's gravity by postulating a fifth (and even a sixth) force. I think they have quit, but one never knows, do one? Recent experiments with floating balls in water and using hoops of aluminum and bismuth have already shown that the equivalence of mass is an erroneous assumption. What can now be said of General Relativity, with its one and only postulate threatened with destruction.

If a man predicates a theory on two postulates, one of which is self defeating and the other unproven; and then he subsequently creates another theory based on yet another erroneous assumption, we should be very careful in calling his work "LAWS" and even more careful with any additional theories derived from these laws. And I speak here

specifically of Hawking, Sagan, Asimov, etc — all champions of those still undetected and directly undetectable Black Holes. These experts have piled uncertainty on top of uncertainty to absolutely determine what's certain.

Milton Monson, ⁸ a theoretical physicist — by coupling the fact that velocity is equal to distance divided by time, and by using Einstein's Relativity formulas that respectively deal with the shrinking of objects due to their velocity and the time dilation at that speed — has reduced the "Theory" of Relativity to a complete absurdity. He arithmetically proves that the velocity of a photon would be zero in a space ship that was moving at the speed of light. No one would see a flashlight aimed toward the front of the ship.

Gamma, the basic Relativity equation, is listed here:

$$G = \frac{1}{\sqrt{1 - (V^2 / C^2)}}$$

When the velocity is equal to the speed of light, we get:

$$G = \frac{1}{\sqrt{1 - (3E+8)^2 / (3E+8)^2}} = \frac{1}{\sqrt{1 - 1}} = \frac{1}{\sqrt{0}}$$

If you consider the square root of zero to be infinity, then G equals one divided by the largest number imaginable which is zero. Therefore, the distance traveled by the photon is zero meters; and the time of travel is zero seconds. Since the velocity is distance divided by time, we have:

$$V = \frac{0 \text{ meters}}{0 \text{ seconds}} = 0 \text{ meters per second}$$

We have the bizarre condition that the velocity of a beam light emitted by a flash light, already moving at the speed of light, is not moving at all.

If a velocity of ...

0 meters per second is not ...

ABSURD ...

the word has no meaning!

1.
2.
3.
4.
5.
6.
The
Sch
7.
8.

Now you are entitled to believe anything that you want. However, remember that when observational data or experiment conflicts with a theory, no matter how beautiful the theory or how impressive the credentials of its author, a rational person pitches out the theory.

1. p. 166, "AROUND THE WORLD ATOMIC CLOCKS ...", Science-Vol. 177, Hafele, July 14 1972
2. Using Gama we find the orbiting second to be the reciprocal of $1 - \text{the square root of } ((2.166 * 2.166) / (186000 * 186000))$ or .999999999932195 sec
 the polar clocks records in a year $3600 * 24 * 365.25 = 31,557,600.00000000$ sec
 the time differential times the seconds in a year gives us 31,557,599.99786024
 subtracting smaller from larger gives total time change = .002139 sec
3. p. 127, "RELATIVITY THE SPECIAL AND GENERAL THEORY", Einstein, Bonanza, 1961
4. p. 129, Ibid.
5. p. 128, Ibid.
6. p. 674, "MYSTERIOUS UNIVERSE: A Handbook Of Astronomical Anomalies, Corliss, The Sourcebook Project, 1979, Extracted from "The Einstein Shift - An Unsettled Problem", Schmeidler, Sky & Telescope, 27:217, p. 217, 1964
7. p. 132, "RELATIVITY THE SPECIAL AND GENERAL THEORY", Einstein, Bonanza, 1961
8. p. 118, "PHYSICS IS CONSTIPATED", Monson, Monson Enterprises, 1983

RENÉ'S RED SHIFT

In 1929, Hubble discovered that the light from distant galaxies was usually shifted toward the red in proportion to the distance of that galaxy: the greater the distance, the greater the shift. He conceived Hubble's Law which states that the velocity of recession (V) of stars and galaxies is given by the formula $V = H * D$, where H is equal to the Hubble constant and D is the distance.

Over the last 60 years, each time a larger telescope showed us a larger universe, his constant (H) has been decreased. This was necessary to avoid the conclusion that some galaxies were exceeding the speed of light. This continuous reduction resulted in a constant that is now about 10% of its original value and it's still shrinking. ¹ I find it to be incredible that despite this amount of shrinkage, Hubble's "LAW" is still considered as valid.

Before Hubble could create this law he had to make a number of postulates:

1. That the speed of light is constant no matter the distance of travel.
2. That each galaxy contains the same proportion of stars of different color.
3. That Einstein's gravitational red shift either does not exist, or is so minute as to play no real part in these affairs.
4. That the red shift is entirely due to the Doppler effect of that galaxy's relative velocity.

If we examine these postulates, or assumptions, one by one we find that the first is still unproven and unprovable. The second assumption seems very reasonable, for why shouldn't a just and merciful God in a uniformitarian and benevolent, democratic universe create all galaxies to be equal. The third assumption is strange because Einstein in his book claimed that Hubble proved General Relativity by finding the Red shift. Either way this is another unprovable assumption. It is interesting to note that, despite this, most philosophers still believe in both Hubble and Einstein.

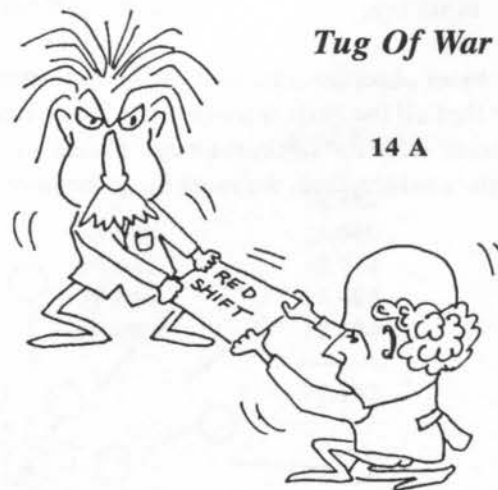

The fourth assumption is also unprovable. We are told that the red shift is related only to the speed of recession, and that both this shift and the density of the universe is the same in all directions. Not too long ago we were told that this expanding universe can be represented by a balloon that has dots marked on the skin, and that galactic separation is demonstrated by the movement of dot away from dot as the balloon is blown up. This is

a rather poor analogy because our universe is volumetric and the rubber of a balloon is only a thin skin. And of course a painted dot on a balloon would also expand as the balloon is inflated. Since I made this statement in 1989 they now use a raising lump of bread dough with raisins in it for their example. However, for this example to have value they must admit that space is the ether of antiquity!

If we accept either analogy then the only position of observation that would satisfy both equi-directiveness of red shift and equal density in every direction is that we must be located, despite the philosophers denial, at the very center of the universe, wherever that may be.

I have invented a mental experiment which will help demonstrate this. We start with a number of small steel spheres similar to large ball bearings. The center one will be painted red and be hollowed out to contain a radio receiver, a detonating circuit and a blasting cap. Around this central ball let us place a thin concentric layer of a primary detonating explosive and then surround this with a layer of high explosive.

Now we glue on a layer of blue bearings and plaster them in place with another layer of explosives. We continue this process for a number of layers, each of a different color and each plastered in with high explosives until it is as big as a basketball. If we take the unit into outer space and detonate it, we would find that the outer layer of ball bearings have the fastest velocity, and each subsequent inner layer less.

Only to an observer stationed on the red center ball would the direction of observation show that all the balls were moving away, and that those with the fastest velocity of recession were the farthest away. Therefore, for all practical intent and purpose of Hubble's assumption, we must be at the privileged center of the exploding — oops,

Layered Balls

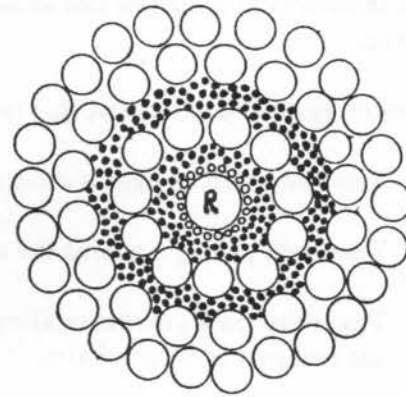

14 B

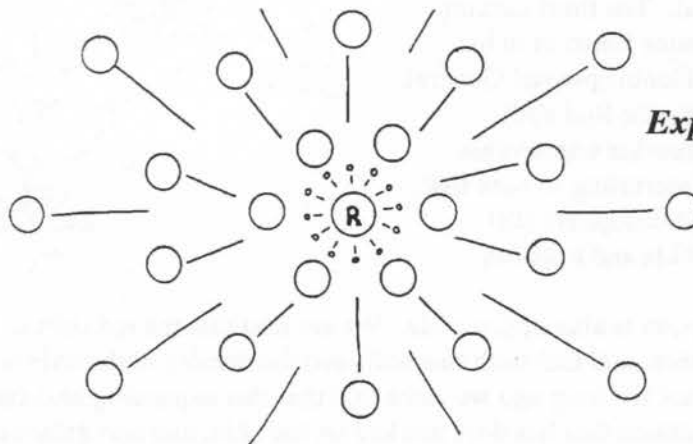

Exploding Balls

14 C

expanding — universe. Whether it is the space/time continuum or the stars that are expanding we must still be at the center.

A few hundred years ago the philosophers began to laugh at people who believed in an Earth-centered universe. But now, I feel that our philosophers have led us in a big circle right back to where they had us over four hundred years ago. If the universe is as our current crop of philosophers believe it to be, then the universe really does revolve around our solar system. As the Howard Cosel of science would say, (No offense Howard) "*Out there are bill-li-uns and bill-li-uns of stars*" and if these figures are correct then the odds, as incredible as it seems, are just as many billions to one against this occurrence. But what the Hell! The center has to be somewhere, and here is just as good a place as any.

With the "facts" as currently presented by the philosophers there is no other rational conclusion possible. However, if the speed of light should decrease by only a millimeter per second for each thousand light years traveled, then Hubble's "LAW" and all our present precious theories of Cosmology are down the drain.

The philosophers claim that is unscientific to propose a theory which can not be proved by experiment. Well I submit to you that all theories that are derived from the belief that the velocity of light is constant are then unscientific. I state again for the record, Michelson & Morley never even attempted to prove that the velocity of light is constant. That is an assumption. What they did was to measure its velocity.

A fellow Mensan sent me a copy of a small chart that listed a few nebulae, with their distances in millions of light years and their Red Shift in Km/Sec. My perverted mind thought it saw a pattern. Indeed, there had to be a pattern if the person who drew up the chart multiplied correctly. I divided the distance into the shift, and Lo, there was a pattern! It produced a constant which I call the René number.

René's Numbers

Cluster	Distance	km/s	René Numbers
Virgo	78	1,200	15.384
Ursa Major	1,000	15,000	15.000
Corona Borealis	1,400	22,000	15.714
Bootes	2,500	39,000	15.600
Hydra	3,960	61,000	15.404
			77.102

Average $77.102 / 5 = 15.42$

By averaging them I created the René constant that says that the speed of light diminishes almost 15.5 km per second per million light years of travel. From this constant I derived René's Law of Tired Light. In simple terms my "law" states that the distance of any galaxy, in millions of light years, equals the René constant (RK) divided by the Red Shift (RS) or $D = RS / RK$.

However, because of Einstein's theories, scientific apologists are now claiming that it is only the space/time continuum (what ever the Hell that means) which is expanding and thus carrying with it relatively passive galaxies. Hence, it's not the stars themselves that are moving away from the Big Bang.

The distance between two atoms in a solid is only about 2 Angstroms. A decrease in velocity of 15.5 km per million light years would give us a shift in wave length over a hundred mile test path of $2.62E-13$ Angstroms. If we bounce a laser beam off the Moon our test path would be about 500,000 miles, which would give us a shift of only $6.13E-18$ Angstroms. Do you really believe that we can detect differences this tiny ?

My law needs no such assumption and deals only with each galaxy's basic distance. My constant is derived from the simplest possible interpretation of the same data and my constant is as valid as Hubble's. My constant denies that the universe is expanding which negates the Big Bang, ubiquitous Black Holes, quasars, pulsars and all the other weird and wonderfully imaginative celestial objects that our astro-philosophers talk of.

As far as a Red Shift, one does not have to scan the limits of space to find a brilliant example of one. Every day of your life the rising and setting sun exhibits a red shift. We were on a trip last year when I finally noticed that the rising sun was red. Later that day I also noticed that the setting sun was red. I don't mean the sky I mean the sun itself. Then it dawned on me that the sun is always red when it is low on the horizon. In fact, the lower it is the redder it is, whether it is rising or setting. No matter the season, the humidity, the temperature, or the latitude, a low sun is always red.

Conversely a high sun is normally white/yellow. The only thing that seems to make a difference is the length of the atmospheric path that the light must travel. If you want to believe that the humidity of the path is always constant and is filtering out the white/yellow that's your choice. I believe that the speed of the light is simply being slowed down by the length of the atmospheric path.

I was never able to accept the Big Bang. I now find that there are some famous philosophers who are coming to the same conclusions. One of them is a Swedish Nobel Laureate Hannes Alfvén, who sees the universe as one where plasmas are driven more by electricity than gravity. He is also at war with the mathematicians who construct mathematical models based on mathematical manipulations instead of on theories resulting from experiments. I sent him a letter telling him about my two leaf electro-scope and the assumption of the constancy of the velocity of light. However, he never responded. None of them ever do.

The next question, yet to be answered by science, pertains to the velocity of transmission of the different frequencies of light. The philosophers tell us that light is just another frequency in the electro-magnetic spectrum. Radio waves of different frequencies seem to travel at different velocities, and the various particles travel at different velocities and frequencies. But they make a special case for light.

During the Super Nova of 1987, the different types of radiation arrived at different times. If memory serves me, some of it was delayed up to two weeks after the nova was first seen. After 20 years of suspecting this phenomenon existed, I finally found a source.

*“Light and radio waves travel at c only in a vacuum. In a medium they go more slowly, which is the cause of refraction. Thin as it is, the ionized interstellar gas slows radio waves and also disperses them, lower frequencies having slower speeds.”*²

In my original book I asked the question, do the different frequencies of light have the same velocity in the same media. I believed that simple question was one of the most penetrating of this century.

A few years ago the newspapers flipped out because a young scientist had found a different value for the speed of sound in air. I immediately suspected that he had only used a different frequency! Later I would find that the higher the frequency, the faster sound travels in air.³

As another example, the epicenter of an earthquake is located by the difference in time that is recorded by two different frequency waves generated by a quake. One wave is assumed to make a longer trip through a different material (the molten core). But perhaps they simply travel at different speeds. It may even be possible to test the lower frequency radio waves against those in the mid-range. It is my understanding that the speed of transmission of electricity in a conductor is also less than that of light. Can this be an indication of a trend? The lower the frequency, the lower the speed of transmission?

Until such testing is done, the constancy of the velocity of light remains in doubt. It was not provable at the turn of the century, it is not provable today, nor will it be, I feel, by the turn of this century. However, much can be learned if my question proves positive on the slower waves. Recently I found out that the velocity of Telluric (Earth) waves does vary according to their frequency. The effect is known as dispersion. For over 30 years NASA has also had problems with variations in the velocities of both radio and light in space.

Now you are entitled to believe anything that you want. However, remember that when observational data or experiment conflicts with a theory, no matter how beautiful the theory or how impressive the credentials of its author, a rational person pitches out the theory.

1. p. 614, “MYSTERIOUS UNIVERSE: A Handbook Of Astronomical Anomalies, Corliss, 1979, Sourcebook Project, Extracted from “Was There Really A Big Bang”, Burbidge, Nature, 233: p. 36, 1971
2. p. 196, “STARS”, James B. Kaler, Scientific American library, 1992
3. p. E-49, “HANDBOOK OF CHEMISTRY & PHYSICS”, 54th edition, CRC Press,

VOLCANOES

Newton, in his infinite wisdom, decreed that the Earth had a very high density. It is simply not considered scientific to doubt Newton, so in order to satisfy this requirement our geo-philosophers compelled us to believe that Earth's central core is composed of a 1500 mile diameter ball of high temperature iron or nickle-iron combination. This core is surrounded by a thousand mile thick jacket composed of high density liquid rock called magma. Our "solid" earth surface is in turn floating on a 175 mile thick crust, composed of relatively light rock. All of these assumptions are unproven. Yet, they have been piled one on top of one another like layers of the very rock they supposedly represent.

Before the atomic age started we were told that Earth's internal heat was caused by the compression associated with the Earth's creation. As each bit of mass attracted the other the heat from thermal collisions caused our Earth to become a molten sphere, which slowly congealed as this heat bled off into space. Since the advent of nuclear fission they now tell us that the magma is kept liquid by the heat from fission of certain radioactive materials inherent in the original material.

Other philosophers also tell us that the Earth is over 4.5 billion years old. If I divide the depth of our 175 mile thick crust by this amount of time, I find that the crust must have solidified at an average rate of .002 inches per year. With the solidification rate this low I can confidently state that our mantle must be in a very precarious thermal balance. A slightly higher rate of radioactive decay would result in a molten planet and a slight decrease would have resulted in a solid planet. I can only conclude that a very gentle and loving god controls the Earth's radioactive heat valve just so.

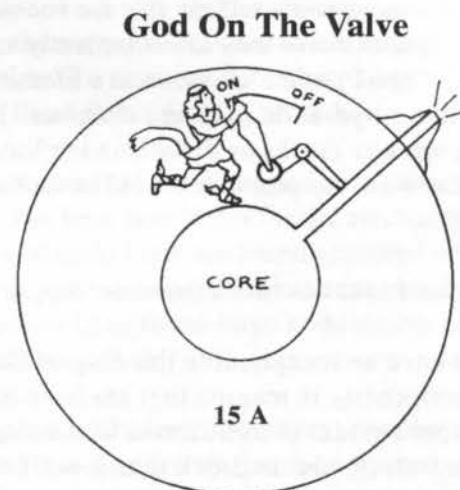

With the advent of plate tectonics we are told that the magma is also slowly boiling. Although this roiling has been going on for 5 billion years the magma remains in a non-homogenous state. It is this lack of homogeneity that allegedly evidences itself by helping to physically change our rate of rotation year by year.

The geo-philosophers claim that this slow boiling, or turnover, as hotter matter rises and cooler stuff sinks, causes the continental plates to move. In moving, the continents stretch, tear, or climb on top of each other. Where plate meets plate one section is thrust up as mountains, while the other is thrust down (subducted), back into the magma as in the oceanic trenches. These actions are caused by the spreading of the continents in other zones where the magma is being forced to ooze out of the top of the mantle. They then claim that all the stretching zones are located under the oceans because the mantle is thinner there. Why the crust is thinner under the oceans where there is more convective cooling and accordingly where faster solidification should take place, is never quite explained. ¹

Our geological philosophers know all this to be true but they have somehow failed to address the simplest and most basic problem in geology. How does our 175 mile thick pile of common rock support itself? We know by testing that the crushing resistance of granite (a very strong rock) is about 20,000 psi. If our concept of gravity is not erroneous, then a column of this rock only 3.5 miles high should crush itself. If our continents were instead composed of mild steel, anything over 3 miles would be unsafe. Limestone should crush out at a depth of 1 mile.

Crushing Strengths

Material	Crushing (psi)	Density (lb/ft ³)	Column Height (miles)
Limestone	5,500	150	1.0
Granite	20,000	150	3.5
Steel	60,000	550	3.0

I have had people tell me that the rocks withstand the pressures beyond their crushing strength because they are completely supported by the surrounding rock. A couple of years ago I put the question to a Mensa physicist, asking how a ball of limestone would fare in a hydraulic pressure chamber. His response was that the hydraulic fluid would exploit any cracks or defects in the limestone, causing the ball to shatter below 5500 PSI. Otherwise, the pressure would be uniformly distributed, and the ball would crush at 5500 PSI.

Again I ask, how does the crust support itself?

We have an inexplicable thinning of the crust under our oceans — an inexplicable lack of homogeneity in magma that has been boiling for billions of years. We also enjoy just the proper amount of radioactive heat being supplied to keep the crust from either melting or congealing, plus bedrock that doesn't crush no matter the how heavy the load. Until some geological genius can resolve these anomalies I will remain skeptical of their theories.

Like HAB before me, I also believe that vulcanism is strictly a surface effect and has no connection with the internal magma which may or may not even exist. He led me to believe that vulcanism results from the passage of heavy electrical ground currents in the lower resistance volcanic regions. Or simply put, wherever there are heavy ground currents there is vulcanism of one type or another. I know that lava is melted rock, but the existence of heavy dense magma is still a completely unproven assumption.

Some volcanoes gently puke out their lava, while others literally blow their tops. Any geologist will tell you that the fairly common heavy hard rock known as trap rock is igneous, and therefore was formed by volcanic action. However, no one seems to be able to point to any known volcano that is presently producing such rock. Most, if not all, volcanoes produce lavas that are soft and of comparatively light density.

I sent letters to a few vulcanologists asking if they could tell me where trap rock, or other tough, dense igneous rock, is being currently formed by active volcanoes. I received only one reply to my letters, which told me that magma is instantly redefined as lava as it

comes out of the ground. This, of course, told me nothing! Still, glass and pumice type materials are found by every volcano, but not trap rock. Why not? Are our modern uniformitarian volcanoes different from their catastrophic ancestors?

Either volcanologists don't know the answer — or there are none! In my dictionary magma is defined as, "*The molten matter under the earth's crust from which igneous rock is formed by cooling.*"

I've watched bulldozers cut the volcanic rock in Iceland, and I've seen the roads in Hawaii being plowed clean by bulldozers, removing fresh lava after eruptions. But the quickest way I know to wreck a bulldozer, without using plastic explosives, is to try to cut into trap rock with it. Trap rock is very dense, mean stuff and even the dumbest operating engineer in the world knows that.

My big question about how such vast amounts of electrical currents could be generated was serendipitously answered during the International Geophysical Year of 1957. Unfortunately by then, our professional philosophers had already lost the ability to add one to one and consistently come up with two. They failed to see that if the oceans generally move west/east in relation to the planet's surface, then what we have is an immense conductor (salt water) moving past a magnetic field. For showing them that this would generate electricity, shouldn't I be allowed to call them Rene' Earth Currents?

By this simple and obvious method, a tremendous amount of low voltage direct current must be generated and flow into the Earth itself. The best candidates for the electrical junctions are the deep sea nodules of manganese and nickel that are found scattered on all ocean floors. Until very recently it was believed that these nodules took thousands of years to grow. However, deepsea divers in the Pacific have found large nodules that have formed on and around sunken World War Two military debris.

These nodules are the junctions where the ocean passes the electrical current into the Earth. Any time a current flows from one material into another, the junction formed at the point of contact acts as a breeding ground for certain materials. For example, in the case of aluminum house wiring, oxides of aluminum are created. These oxides increase the electrical resistance and allow heat to generate at the junction. If this heat build-up is trapped, sooner or later a fire will result. Improperly ventilated aluminum wiring was allowed to be used in houses because our legislator's common sense was overridden by the siren call of the aluminum industry's money.

There are also other phenomena that must be derived from these ocean-created electrical currents. In the Pacific there are underwater light flashes that help guide Polynesian sailors to the nearest land. They are called Te Lapa. These sailors, both modern and ancient, know that these flashes of light head straight for the nearest land like an airport's glide lights point to a runway.



Other electrical phenomena include incredible phosphorescent marine displays in the Pacific Ocean.

Our Earth must be both a generator of electricity and a motor. It uses some of this electricity to reinforce our feeble magnetic field, which must be initialized by the interaction of our electrically conductive atmosphere and the solar wind. The atmosphere must be under much greater electrical pressure than the oceans. I believe that lightning discharges relieve these excess charges.

When we look at a volcano what we are seeing is, in essence, the effect caused by the flow of an electrical current. The higher the current flow the greater the amount of heat. If that heat is not carried away as fast as it is being generated the temperature rises. Eventually this process will create a pool of lava. And once the rock is molten the electrical resistance drops. This causes an ever greater current flow which creates ever higher heats. I know from a previous experiment, where Pete and I accidentally created a miniature electric volcano, that molten compounds have a very low electrical resistance. Rock is a very good heat insulator, but if it's heated long enough, at some point all hell must break loose!

If there is running water in the area a great deal of that heat will be carried off, which results in hot springs. If water is entrapped it will create steam, and the temperature and pressure will continue to build. Geysers are the periodic venting of this steam pressure. Steam can only cool a furnace by escaping. If the rock being heated contains water of crystallization quantities of steam will again be the result.

A volcano can be compared to a high pressure boiler. The surrounding rock acts as a pressure vessel the same way as does the steel shell of a boiler. If the safety vent clogs and the furnace keeps firing, then the pressure will increase and a boiler, no matter what it is made of, will eventually be blown to smithereens. A steam boiler must use a high pressure pump to force water in against the operating pressure.

I can understand the initial explosion of a volcano, but how can an active volcano pump in the water against all that pressure the second time? Any water near this activity must be driven away by the pressure, not sucked in. It is beyond my imaginative powers to comprehend how that same volcano can explode time and time again after it has wrecked

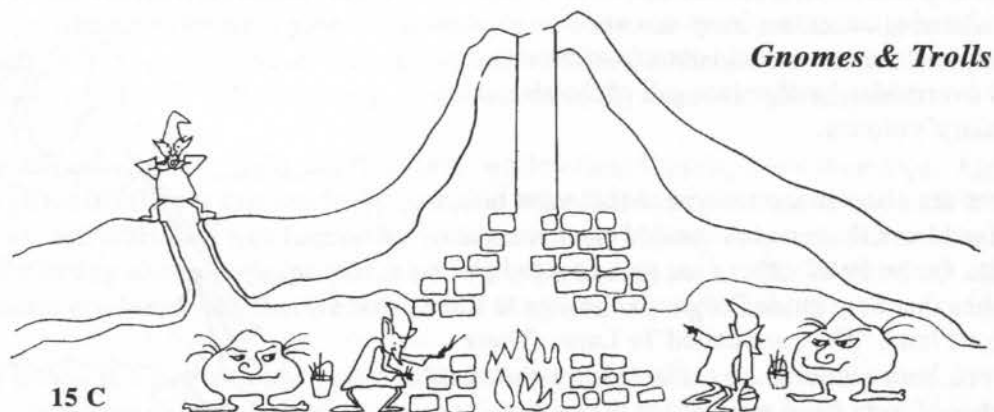

the original containment chamber. Do nasty buggers like Rock Trolls and Gnomes rebuild the rock boiler, restock it with water and then with spiteful malice re-open the magma valves?

Some volcanic explosions are so powerful however, that I no longer believe they are caused by just steam. There are a number of reasons for this statement. If the geophilosophers are correct, in that magma rises in "pipes" to the volcanic chambers, then these previously melted materials can contain no water of crystallization, since this is the only way water can be fed into a volcano without the use of a high pressure pump. Only if the magma melted the walls of the volcano could any new water of crystallization be supplied to create new steam. But this process would also entail a heat exchange, which would tend to cool the magma below its solidification point and thereby plug the vent.

It could be argued that volcanoes create water by natural chemical processes, and I have little doubt that they do. I could even believe that they might transmute elements. Our ignorance of what happens at such heat and pressures is profound. However, no matter the water supply, steam cannot blow a mountain apart! The simple explanation for this is that there is a critical pressure beyond which steam cannot rise no matter how great the temperature. This pressure is 3,200 PSI. ²

While 3,200 PSI is classed as a high pressure for a man made-boiler, it is minute as far as explosives pressures in general are concerned. When man fires a bullet or a shell, he uses slow burning gun powder to accelerate high density metal projectiles at gun chamber pressures that are ten times higher. In addition, a long barrel and slow burning powders provide a long duration directional impulse to the projectiles. These bullets or shells are also streamlined, elongated, and made to axially spin by rifling in the barrel for maximum range and flight stability. But a volcano can only use an instantaneous, omni-directional blast to propel jagged chunks of light density rock. How can this be?

We find a quote by Boschke, "*It is reported that debris was hurled eighteen miles into the sky and fragments of rock flew as far as one thousand miles away*". ³ The huge guns on battleships have a range of 25 miles, but even they cannot fire a shell 18 miles high into the sky.

There are unexplained static electric and magnetic phenomena associated with volcanoes which tell us, should we care to listen, that it is the Earth's electrical currents, not magically moving mountains of magma, that are the cause of vulcanism.

I also believe that the Earth's rotation and our magnetic field are irrevocably linked. The various explanations of the Earth's magnetic field have a long history. Sir William Gilbert, royally pronounced that the Earth itself was a permanent magnet. Newton declared that the Earth's density was five times that of water. The then philosophers concurred that the Earth

Right Hand Rule

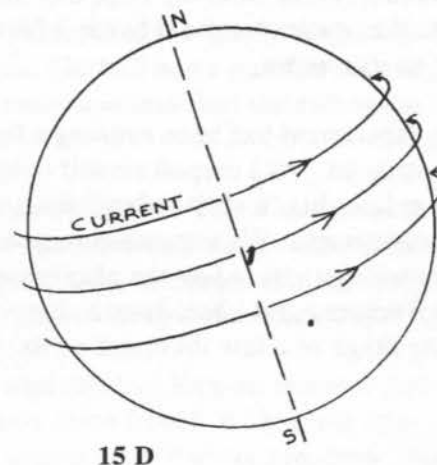

must have a large core of solid iron. Later philosophers would melt that core, and then belatedly realize that there are no "hot" magnetic solids.

All magnetism disappears well below 1000° F. Until recently the iron oxides in the crust were held responsible for the Earth's magnetic field. However, a new geo-philosopher has postulated that the center of the Earth is composed of a new iron-nickel alloy that has properties unlike anything we know about. For this material the Curie point is in the thousands of degrees. I propose that he call this imaginative alloy "Mustbee"!

I have shown that the ocean flow must generate vast electrical currents. The only real question is how these Earth currents enhance our magnetic field. The answer is simple. It is generated and polarized by the right hand rule! The Earth currents flowing from west to east will create a magnetic field with (by convention) the north magnetic pole toward the north. But before you tell me that I am wrong or crazy, do please explain what happens to the electricity that our moving oceans must create.

At least some of the tremendous explosive power exhibited by volcanoes must come from some other source. I suspect that volcanoes powered by electricity, and involving high heats and pressures, may be creating some very strange compounds by transmutation of the elements lying within. I mentioned before that Pete Ross and I once accidentally made a baby volcano that burped lava the way an old fashioned coffee pot perks coffee. Peter, the genius, had told me that we could make a fortune by creating "Znortneys". So I went out and bought the basic supplies and materials, while Pete fabricated our furnace (pot) from a 25 gallon steel drum. Common lime was our refractory lining and the heat source was an arc created by two large, 3 inch diameter graphite electrodes powered by a large electric arc welding machine.

The time was late December, 1977, and the place, an unheated warehouse in Fort Lee, NJ, just north of the George Washington Bridge which served as Peter's shop/laboratory and playground. Despite the cold, we put in a few pounds of our secret material into the "pot" and turned on the power.

The gas and electricity to the building were both turned off, but Pete had somehow slipped the electric power past the dead meter seals. At that time I was still running continual fevers from my crippling arthritis and I was unable to cope with the cold. In fact, after our experiment began I found it expedient to drape myself over our hot "pot" just to stay warm.

The experiment had been running a few days when I arrived one night to find Pete very preoccupied. As I draped myself over the "pot", I noticed that he had hooked into the power lines his "Lab Standard" meters. They were denoting a power consumption of only 240 watts. We were supposed to terminate the experiment that night but now his attention was riveted on the phenomenon of a very large arc being sustained by a very small power input. Yet, despite that low input the heat emission seemed to have remained in the range of a few thousand watts.

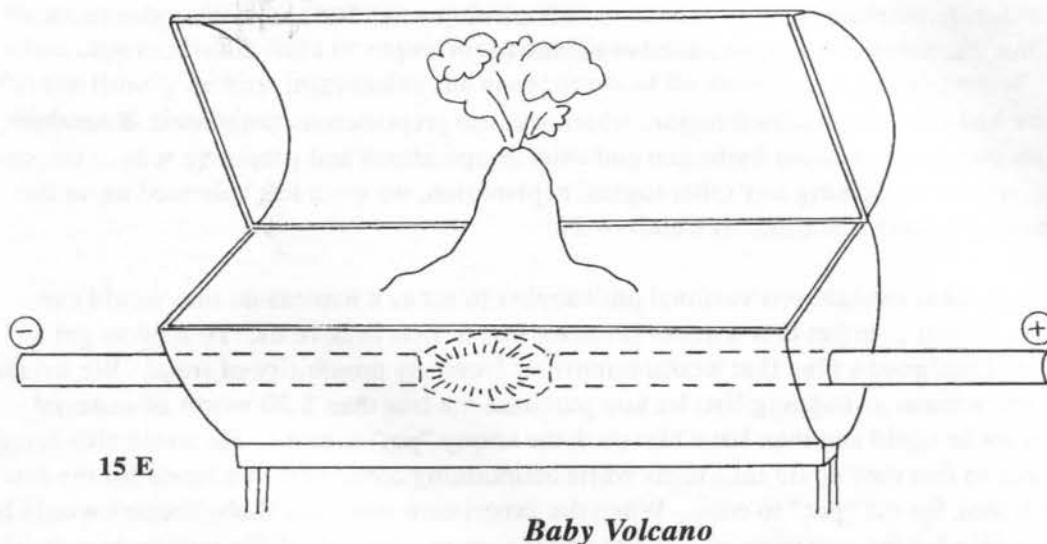

The following night when the real excitement started, I was at home with another fever. However a photographer, who was a mutual friend was present when our "pot" decided to grow a baby volcano. The cone was percolating hot viscous material in the same manner that a volcano vomits up lava. Becoming a little concerned at this unprecedented phenomenon, Pete lowered the power to slow the volcano's growth. However, this had no effect, so he poked the bubbling mound with a rod of tool steel, in order to knock it down. Bang! At least a half inch of the rod vaporized, and a tight beam of blue white light shot diagonally towards the roof.

Melting the end off a half inch steel rod usually takes a considerable amount of energy and time. Meanwhile, the volcano was still increasing its flow of "lava", so Pete switched the power completely off. Still, the volcano continued to grow. Thinking the switch defective, Pete physically ripped out the power leads. By this time the cone was a foot high and still growing, even though the power had been torn out! In desperation Pete succeeded in breaking open its walls, and threw in a new supply of the original material. We later came to believe that the volcano died because the new material shorted out internally self-generated electric currents.

The next morning I found Pete sorting through the contents of the "pot". We had successfully created "Znortneys"! That was the good news. The bad news was that the quantity was minute, the quality lousy and the commercial value was less than the cost of the power that would be consumed.

In poking through the contents we noticed tiny coppery nodules. This was strange because we had used no compound with any elements that exceeded atomic number 20. In fact, by testing with reagents, Peter also found a few other elements, including tin, in the batch. We cleaned up the mess and stored a few bottles of sample material away.

How were we to explain the excess of exothermic heat that had kept me warm at 240 watts that last night? Where did the heavier elements come from? What about that strange light? Each discussion lead back to the ... impossible! Had we somehow caused a transmutation of elements? The philosophers tell us that there are only two atomic

processes, fission and fusion, that can transmute elements. We had to discount fission because that requires heavy radioactive elements.

All we had left was sustained fusion, which was too preposterous to believe. Everyone knows that fusion without hydrogen and solar temperatures and pressures was ... Impossible! However, lacking any other logical explanation, we were left balanced us on the horns of a helluva dilemma. A Catch — 22!

Without a heavyweight professional philosopher to act as a witness no one would ever believe us, but ... to get that witness someone had to first believe us. To help us get a witness I designed a plan that would remove us from any possibility of fraud. We would give our witness a shopping list, let him purchase the less than \$ 20 worth of material wherever he could and then have him pack the empty "pot" himself. He could also bring a helper so that they could take turns while maintaining constant surveillance for the few days it took for the "pot" to cook. When the experiment was over the witnesses would be responsible for the gathering of samples and the testing thereof. If the witnesses were the only ones who touched the experiment, we couldn't be accused of doping the pot.

I sent out dozens of letters over the years to no avail. Indeed, someplace along the line, I sent a letter to a Oreste Battista, "mad man of science". He had earned this fabulous nickname by, if you can imagine this, becoming knowledgeable in more than one field of science. We began a back and forth phone thing that culminated in his agreement to test one of our samples. And we had agreed that if any elements higher than atomic number 20 were found, he would be our witness for a re-play of the experiment.

Boy, I was sure that I had finally succeeded. He tested the material and sent me a copy of the test. But then he reneged on his promise. I guess he thought we had doctored the samples. His list had elements on it right up to bismuth (At. No. 83) which is heavier than lead. It is also one of the last non-radioactive elements in the periodic table. Pete had always worried about our pot ultimately creating fissionable material. It seemed we had come very close.

Enter next a man who was big in the search for fusion, in fact he headed the effort in a mighty research institute. He had been featured in a newspaper story where he had stated that he no longer believed that fusion energy was possible. Sez I to myself, here is a disillusioned person. And since drowning people clutch at straws, maybe, just maybe, he might be willing to waste his time as a witness to a re-run. I fired off a letter and in due time I received his reply. He told me that he would send us some literature telling us how to build el-cheapo radiation detectors so that we could safely rerun the experiment without him. I needed a witness; I got an offer of schematics.

It has been over 20 years since that single experiment, and I was never able to obtain a witness. Pete, the genius, is dead. My illusions about the ideals of science also died, and I became a scientific skeptic. I have come to class most of the professional philosophers equal to royalty. My grandfather, an Italian anarchist and a farmer, had a saying about royalty, "*Nugio forgeta dey so fulla da shits, dey maka guda composto*".

Now you are entitled to believe anything that you want. However, remember that when observational data or experiment conflicts with a theory, no matter how beautiful the theory or how impressive the credentials of its author, a rational person pitches out the theory.

1. p. 452, "UNKNOWN EARTH: A Handbook Of Geological Enigmas, Corliss, The Sourcebook Project, 1979, Extracted from "Critique Of Hypothesis Of Continental Drift", Oppenheim, American Association of Petroleum Geologists Bulletin, 51:, p. 1354, 1967
2. p. E-18, "HANDBOOK of CHEMISTRY & PHYSICS, 54th edition, CRC Press
3. p. 130, "THE UNEXPLAINED", Boschke, Pocket Books, 1978

LIGHT MADNESS

In my high school physics class I argued that our atmosphere could not be a mixture. It had to be a weak compound because the percentages of the constituent gasses did not significantly change, according to their densities, with an increase in elevation. Naturally, since that wasn't in the book, I was wrong. And after expressing that possibility I had nothing but trouble with the teacher.

Over a decade later NASA released full-colored pictures of the Earth taken from space. Separating the blackness of space from the Earth is a thin band of brilliant cobalt blue. I knew then that our atmosphere fluoresced, and I suspected that the cause was electrical energy from the Sun. I had no proof!

Thirty years passed and in October 1990, I was living in Matlacha, Florida. My (now ex-) wife and I were driving east down Pine Island Road toward Fort Myers when I looked at the unlimited horizon provided by that very flat state. And I saw, for the first time, something I had been looking at all my life.

I scanned as much of the horizon as I could from the van. Then, with a new insight, I pulled the van off the road. My ex-wife is an artist, gifted with a very fine eye for light and color. I asked her to scan the sky, in all directions, from horizon to zenith and describe the colors as she did. She saw what I saw, and what you can see too! The light blue of the sky at the horizon deepens with elevation and becomes a deep electric blue at the zenith.

A lifetime of watching the sky told me that this was true no matter the time of year, the geographical location or the position of the Sun. I was almost positive that I had discovered the reason why our sky is blue and that reason isn't because our atmosphere scatters the blue light. I also knew how Tesla had made his ceiling glow. In both cases the air is excited into fluorescence by high voltage electricity. Tesla's effect was probably from a Tesla coil feeding another coil wrapped around the ceiling of his room. Our sky's effect is from the intensive electric stimulation provided by the mind-boggling charge on that star we call the Sun.

I resumed our drive, and then as I waited for her in a mall parking lot, I mulled over the problem of proof. I realized that if our sky was fluorescing, the longer the atmospheric path the more photons created. Conversely, the shorter the path, the fewer. This thought agreed with visual observation. When we look straight up our sight path is through an atmospheric tunnel that is only a hundred miles long. When we look toward the horizon we are looking through a much longer tunnel.

By the time we drove home I had figured out a way to prove my hypothesis. I needed to find a long forgotten camera light meter that was buried somewhere in our house. However, this instrument was on vacation. We tore up the house for two weeks trying to find it. It successfully evaded our collective clutches. Just as I began to seriously consider buying another meter at a second-hand camera store (which I couldn't afford), it went belly up, surrendering to my ex-wife.

If I was right the photon emission of each section of the sky would tell the story. However, to accurately measure this I had to make the lens very directional. This problem was solved by using a black page snatched from our photo album, rolling it into a paper tube, and taping it around the lens. I checked the unit on the house walls. Convinced that it was very directional, I boldly went out into the cloudless Florida sunshine.

I first aimed the tube at the zenith and noted that the meter registered 3.2. As I lowered the tube toward the horizon, it began to climb and registered 6.5 near the horizon. This recurred at any direction I chose to point it, which proved that the lower elevations emit four times as many photons as does the zenith.

If our atmosphere were composed of other gasses, or if Earth were located at some other distance from that electric generator that is our Sun, our sky might be yellow-green like Venus or the dull red of Mars. It might even have been pink like the Easter Bunny's eyes. But whatever the composition of gasses in a planet's atmosphere, they will glow. Is this why more light reaches the Venusian surface than was expected? This is contrary to what the physics books tell us about the scattering of light. Our

atmosphere fluoresces in exactly the way that Tesla fluoresced the very air of his lab's ceiling all those years ago.

Four months later, we were driving north through Georgia nearing the border. It was Feb. 26, 1991, and there was less than a half hour to sunset. Bored with the road and covertly watching my wife catching a cat nap on the co-pilot's seat, I looked off to the right to see an almost full moon rising. It provided the distraction I needed after driving all day. I am always amazed at the size of the Moon as it clears the horizon. I can remember reading books by its light when I camped out as a kid.

I was wondering if it was as bright as I remembered, when a question formed! How could a chunk of gray-brown rock be so bright after a journey of almost a quarter of a million miles? Two weeks later we were back in Florida and I hit the library. An encyclopedia provided the information that the Sun's luminosity in space is 141,400 lux at right angles. That figure is reduced by 27 % coming through our atmosphere, which gives us 103,222 lux, again at right angles when it is at the zenith on a clear day. Since a lux equals .0929 foot candles, Earth's surface receives 9,589 foot candles of light on a clear day.

The reflectivity of a common mirror is 80 %. So let us imagine that we have a mirror orbiting just above our atmosphere, and aimed to reflect the Sun to the ground at night.

Sky Photons

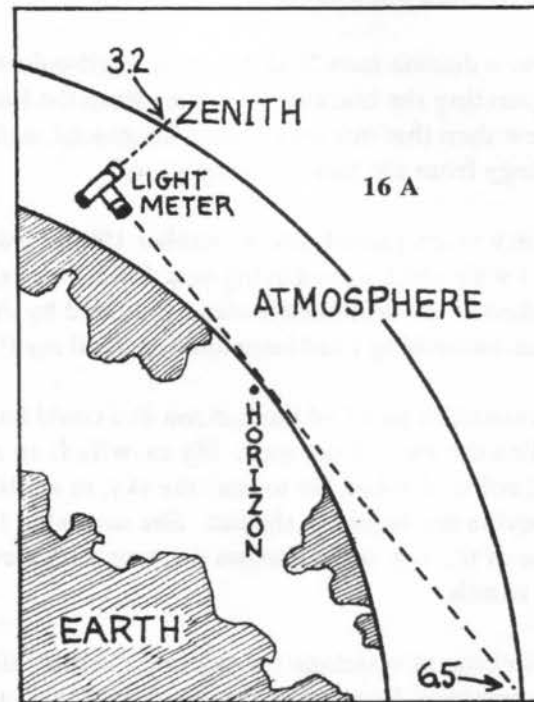

It would reflect 113,120 lux which would be reduced by the atmosphere to 82,577 lux. It would also be further reduced by the spreading of the beam.

If the Moon's surface was like a mirror then 113,120 lux would obviously be reflected. However, at the range of 1080 miles (one lunar radius) from the Moon the intensity would be reduced by half to 56,560 lux. Each time we double the distance, the light intensity reduces by 1/2 and at 138,240 miles from the Moon the reflected light would be down to 883 lux. At 233,280 miles (Earth distance) it is about 800 lux. After passing through our atmosphere it would then reduce to 584 lux or 54 foot candles.

However, obviously the moon is not a mirror. In 1976 the astronomers gave it an albedo (surface reflection) of .086 (roughly 8 %) which gives us a surface value of 12,160 lux. Since then it has been increased to 12 %. To avoid making the calculations again I will keep the old value. On its reflected trip to Earth, moonlight's final value would be reduced to about 62 lux after getting through our atmosphere. This is 5.7 foot candles.

At my request a photographer, Lee Kuersten, who works in Harmon's Photo in South Fort Myers, measured the moon's brightness using a 1 degree spot meter. This gave a reading of ASA 100 at F 5.6 at 1/100 of a second. I contacted Tom Bell, product specialist, at the Kodak information service in Rochester NY and he converted this to foot candles for me. It came to 800 ft. candles. This is the figure for a Moon with a mirrored surface — not one of gray-brown rock.

If we concede that the Moon's surface is dirty gray-brown rock and dust, divide these 800 foot candles by the 5.7 expected by calculation, then the Moon is 140 times too bright.

As comedian Red Buttons used to say, "*Strange things are happening!*" Since I can't believe that the Moon's surface is emitting photons, I feel that the Moon must have a very thin atmosphere that is fluorescing just like ours. Why didn't NASA tell us about this, after all they were supposed to have been there.

The evening of Dec. 16, 1994, differed from the typical Friday nights that come with being alone because just before I slipped into sleep, I devised yet another simple test for the equatorial bulge. Since it deals with the fluorescence of our sky I placed it in this section instead of with the other test for the bulge because here there are less pages to renumber and re-index.

Assume the Earth to be a perfect sphere. Then no matter where you are on the Earth's surface the distance to the horizon will be identical. Assume now that you have a telescope mounted on a portable stand and attached to that instrument is a very sensitive and highly directional light meter. The lens is always set to exactly the same height above sea level (a few meters). This should be done in a bay close enough to the water so that the center height of the lens can be directly measured

On a perfect sphere the decrease in photons entering the lens, will depend only on the angle of elevation and will not be sensitive to either the observing latitude nor the direction the meter is aimed at. The photons along any equal elevation sight path should be equal on any comparably clear day. Naturally, sighting into distant cloud banks is not allowed.

If there is an equatorial bulge, then the photons detected on any equal elevation path will be greatest on east/west shots and the lower the latitude the higher the photons. This is because an equatorial bulge would produce a horizontal sight path that is appreciably longer at the equator. I am going to leave the gory details to some younger mind.

Now you are entitled to believe anything that you want. However, remember that when observational data or experiment conflicts with a theory, no matter how beautiful the theory or how impressive the credentials of its author, a rational person pitches out the theory.

LOST IN TIME

The International Geophysical Year (IGY) ended 35 years ago and to this day the philosophers, although in agreement that the polar caps are melting, are still in contention as to their age with estimates ranging from 7 to 100 million years. These estimates are the result of a great number of man-years spent in studying and applying the various politically correct scientific laws and theories. Yet, after all of that effort they seem to have made some hellacious errors, since their estimates disagree by two orders of magnitude. If the Antarctic cap is this old, what can we say about two early maps that show the continent free of ice? How old must they be?

I doubt very much that either of these maps are millions of years old. The same applies to any "legendary" sources. I find it hard to believe that any of our ancestors drifted downwind to Antarctica on log rafts, then using bongo drums as sonic sources they mapped this huge continent on sheep skins, while calmly wandering on the top of the two mile high ice cap. 'Tiz a puzzlement, especially because we weren't even human seven million years ago!

I prefer to believe that the Antarctic ice cap is much more modern, rather than believe that little green aliens, with purple polka-dots, handed a map over to early European mapmakers.

Both of these ancient maps are in basic agreement with the recently discovered topology that shows the mountain ranges and rivers. The oldest of these maps was owned by Piri Ibn Haji Memmed, a Turkish Admiral in the early 1500s, whom we call Piri Reis. For too many years experts, who seemingly have never even examined it, have denied the authenticity of this map. They also deny the obvious, in that it depicted Antarctica. To them the Piri Reis map is a fortunate figment of someone's imagination — but still a figment.

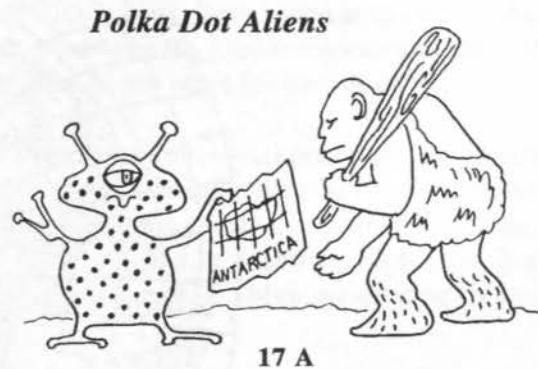

One of the problems is that the map's distortion of the continent doesn't conform to our standard map projections. All flat maps are distorted by the various projections used to force a spherical surface onto a flat plane required for a map. All such projections are latitude dependent.

However, after the IGY's comprehensive effort showed the same mountain ranges and ancient rivers as the Piri Reis map, there was no longer any doubt. In fact, I believe that his map constitutes a pre-historical proof of a previous epoch before the last "Roll Over". Even if the continent were not ice-covered, our immediate ancestors could not have mapped this immense area, simply because the technology did not exist until almost three hundred years after the map was already in the hands of Piri Reis. I believe that at the time that the map was created, Antarctica was not located at the pole but at a different,

and more temperate latitude.

What is needed is an expert cartographer teamed up with a good computer programmer (please, not an enhancer). A computer could then be used to compare the Piri Reis map with the various possible computer projections of modern Antarctica, thereby determining the best fit for latitude and orientation at the time the original map was made.

If Antarctica was originally mapped at a location of different latitude, this would be considered proof that it was mapped before the last "Roll Over". It would also indicate that in pre-historic times man had attained a level of technology at least comparable to the 1600s of our present epoch. And obviously, it would also show that the technology had been lost when the civilization was smashed into oblivion during that "Roll-Over."

There is another map about which there can be little argument. This map was created by Ortonius Finneus in 1532 and it shows the location of the pole, the rim mountains, rivers and a continent that appears mostly ice free. Look at how the tip of S. America (bottom) comes so close. ¹

Finneous Map

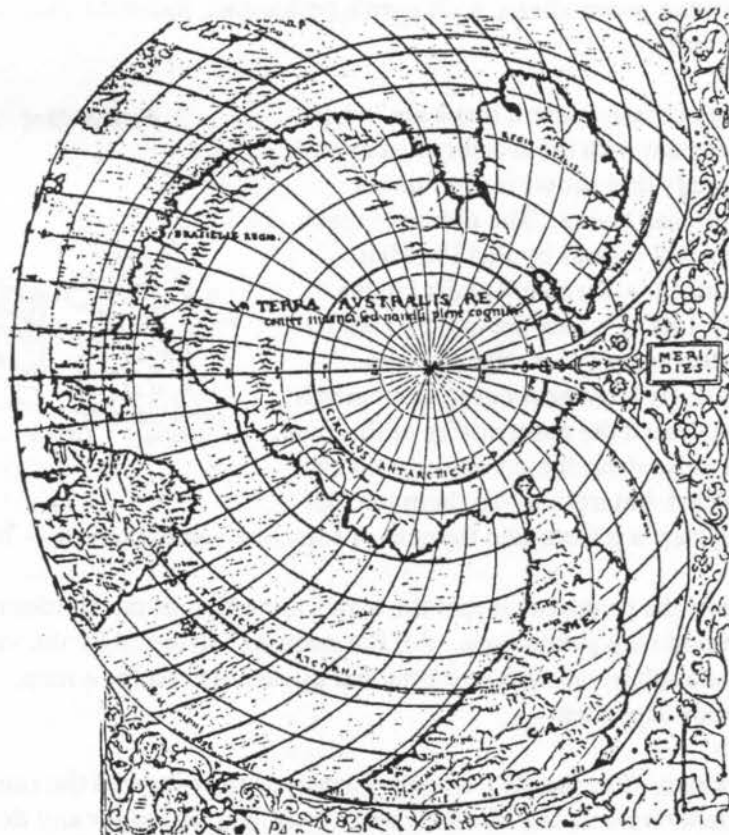

17 B

Cartographers, by necessity, are the world's greatest copycats and this map was either copied from earlier charts that must date back thousands of years, or was delivered by malevolent aliens. I say malevolent, and I mean malevolent because if that was the case then the map is not as accurate as it should be. The pole is a little off, South America

angles in from the wrong longitude etc. And please remember that in the 1500s sailing ships did not dare probe the high polar latitudes.

In 1961, Captain Burroughs, Chief of the United States Air Force Cartographic Section said, "*It is our opinion that the accuracy of the cartographic features shown in the Ortoneus Finneus map suggests, beyond a doubt, that it also was compiled from accurate source maps of Antarctica.*" ²

What we are dealing with here is the historical fact that time and time again, technical knowledge and artifacts are lost for hundreds, or thousands of years or even epochs until they are re-discovered. The Wm. F. Corliss books contain an endless list of inexplicable artifacts, which have been dug up in one place or another only to be re-buried by the experts in basements and vaults in the museums of the world. An artifact that does not fit the modern scientist's **EBS** is usually casually hidden and quickly forgotten.

We were told in high school that trigonometry was invented by the Arabs in the early Middle Ages. But this skeptic believes that trig was simply redeveloped after it was lost for almost three thousand years. The ancient Chinese dug a 1000 mile long canal about a thousand years before Christ. Our experts would have us believe that this project was accomplished using sticks, stones, eyeball engineering, muscle and bone. Garbage!

The odds against haphazardly digging a thousand mile, water level ditch are astronomical. The engineering for the ancient Suez Canal was simple in comparison. You did know that our modern canal was re-created, didn't you? Here, since both ends of the canal were at sea level, a small test ditch dug between the Mediterranean and the Red Sea would have established a convenient water level bench mark for the whole job.

Before a canal can be successfully created there are certain vital pre-requisites. There must be a well developed geometry. It is not enough to know that the Earth is a sphere; one must also know the approximate diameter to determine the curvature. Very long survey lines require precision instruments (optical?) and Trig tables with at least five decimal accuracy. A feeding earthworm blindly digs a hole. Man, modern or ancient, does not do this.

Any expert who believes unlimited manpower, with poke and hope engineering, can create a 1,000 mile long functioning canal has never really looked out the window of his ivory tower at a construction site. Or if he has, he misinterprets the hurly-burly of a number of seemingly crude and stupid men aimlessly wandering by. In reality, construction uses *highly trained people who follow very exacting and well planned directions.*

How much mathematics were necessary to build an analog computer? Two Greek sponge divers in 1900 were salvaging a ship that had sunk in 65 BC off the island of Antikythera. They brought up a corroded bronze artifact that when examined was found to be a mechanism containing complex gear chains that predicted the motions of Sun, Moon and planets. ³

After 20 years of laborious hand calculation Delauney, in 1860, published the most precise Moon Tables ever printed. Despite this, the author of "Newton's Clock" had this to say, "*But even the interminable tables, which allowed the moon's position at a*

given time to be calculated with greater precision than ever before, failed to match the accuracy of observational data from ancient Greece.”⁴

There exists in Sacsayhuaman, Peru, an intricately carved monolithic stone pyramid. The thought that this single piece of monolithic stone was dragged over hill and dale from a distant quarry is mind boggling. But even more unbelievable is that this huge thing is now upside-down in the ground!

Surrounding this site are 60 foot high stone walls whose stones have been ground, one to the other, in situ. They are so precise that not even a knife blade can be inserted between them. One of these wall stones weighs 200,000 tons, and this four hundred million pound block of stone was apparently quarried over 200 miles away! Ruins such as this are found on every continent and are called ante-diluvian, meaning that they were built before the “mythical” flood. They are also referred to as cyclopean structures because a race of huge cyclops were thought to have erected them.

Tremendous stone structures are found on every continent and even on islands in the Pacific. On Ponape in Micronesia there is a stone city which has canals large enough to float a battleship. The city could have housed two million people, yet the stone is not native to the island. There are over ninety islands in the area, totaling eleven miles square built of cribbed basaltic slivers.⁵

On Malden and Raratonga we find basalt roads that lead into the sea. On Tonga-Tabu there are two 70 ton columns that are capped with a 25 ton cap stone.

The Titanic which weighed a mere 45,000 tons, slipped on the ways during construction and it took the shipbuilders, using modern derricks and hydraulic jacks, over a month to straighten out the problem. In 1979, behind the dam site at Abu Simbel, the Egyptians tried to move an 80 foot statue to a new location and found that modern equipment wasn't equal to the task. They left it to be submerged.

On the shores of Lake Titicaca there exists the lost city of Tiahuanaco. The lake is now 12,644 feet above sea level. Berlitz says it is *“too high for corn to grow, for cats to live, for white women to give birth, and certainly too high for a population large enough to have built and carved the enormous stones that comprise the city.”⁶*

A single Tiahuanacan stone is 36 feet long by 7 feet and weighs 170 tons.⁷ The city was originally on the lake, but the shoreline has since tilted from its old level as shown by old strand marks. Uniquely, the lake has fresh water sharks and sea horses in it. When the Inca's conquered the territory, the city had already been long abandoned. Both lake and city are above the tree line where very few domestic plants will grow. At that altitude grain plants, including corn, will not ripen. At the present time only potatoes and other root tubers grow there, and the region accordingly can only support a small population. Even if the world climate were warmer back then, nothing much would change because of the altitude. Altitude is synonymous with cold no matter the latitude. There are, after all, glaciers on the Equator at the present time.

If this city was built and populated at that altitude how did the people find food and fuel? If not, when did it elevate? We are talking here of an elevation of over two miles. Did

this take place in the last 3,000 years? Or is this city a vestige from one of the previous epochs?

Many pieces of exquisitely crafted ancient jewelry have baffled the experts for years. They simply could not understand how the known tools of antiquity could produce such quality.

In 3000 BC, the Egyptians already knew how to do exchange-electroplating to plate antimony on copper vessels. They placed antimony sulfide, "Kohl" in a solution of vinegar and salt in a container and then inserted the copper to be plated. ⁸

Almost 40 years ago I saw a color photo of a wooden box that had been found in Iraq and labeled "mysterious object". The boards had been coated and caulked with pitch and there were two wide green-blue slashes of color down one side. Not being a philosopher, I had no trouble in identifying this mysterious object. I had just built a quite similar one for a customer. It took the experts about ten more years before they decided that this was a plating tank and that the flask-shaped clay bottles found adjacent to the tank were batteries.

The objects, 2000 years old, had been discovered by a German archaeologist in a dig outside of Bagdad in 1937 and had been stored away all those years. The bottles each held an iron rod which was inside a copper cylinder. In 1957 an American scientist made an exact replica and poured in vinegar. The result was, of course, an electric battery. ⁹

These ancient peoples had known and used electricity. Today these artifacts reside in the Bagdad Museum (unless we blew it away during the "Desert Storm" using one of our smart bombs). How did the ancients create such fine jewelry? The same way we do, they used lenses and electro-plating!

The separation of aluminum from bauxite without electricity is a very difficult chemical process. But ancient aluminum trinkets have been found in China, and it even seems the ancient Greeks had a word for it. Chow Chu (265-316), a Chinese General, was buried with an alloy girdle that was composed of 85 % aluminum. Platinum has a very high melting temperature, impossible to attain today without a gas driven torch. But ancient platinum jewelry has been found in both Peru and the Middle East.

Man's favorite pastime, total war, probably accounts for some of the lost knowledge. Local natural catastrophe accounts for a good deal more. Yet when we find an object as weird as an up-side down monolithic step pyramid, then nothing makes sense. If one dared to offend today's scientific priesthood, then one could postulate that the quarrying and transportation of this monolithic monstrosity was accomplished by a people who could control gravity, or who had a higher technology than we do. If it wasn't intentionally constructed that way, the only other possibility is a natural catastrophe of astonishing proportions.

In 1988, a small wooden model was discovered at Saqqara in an Egyptian tomb, dated at about 200 BC. It was placed in a wooden box labeled "wooden bird models" and stored in the basement of the Cairo museum, until Dr. Messiha discovered it was actually a model airplane that could fly. The down curved wing bore the same proportions and

outline of a once secret American plane that was a low speed, low powered and high capacity aircraft. ¹⁰ Another coincidence?

Coal mines seem to produce a fairly reliable number of objects that organized science wishes would stay lost. The following are listed according to date of publication. A chunk of "green" Colorado coal was mined from a seam 300 feet from the surface. It contained a corroded iron thimble. ¹¹

A spoon was recovered intact from a piece of Pennsylvania bituminous coal. It was sent to the Smithsonian where not only was it severely pooh-pooed, but the "experts" told the old ladies who found it not to waste their time. When they returned the spoon it was broken. ¹²

And there is the infamous Salsburg cube, a small cube of unknown metal with unknown writing on all six faces. It was pulled out of a coal mine a thousand feet beneath the ground, and now rests on a forgotten shelf in some museum.

Quarries are also high on the list as places where strange objects turn up after having been lost for millennia. Something as mundane as a nail can destroy one's belief in the orthodox. A block of sandstone removed from deep in a 20 year old quarry was found to have a rusty nail embedded in it. ¹³

Excavations also turn up objects that destroy our carefully contrived geological and paleontological time tables. Blasters in Dorchester recovered a broken bell-shaped metallic vessel about 4.5 inches high and 6.5 inches at the base. A beautifully formed silver floral bouquet was inlaid on it. The vessel had been embedded in rock found about 15 feet below the surface. ¹⁴

If you found the preceding items hard to believe you are about to have your mind totally wrecked. This is a necessary prerequisite for a truly open mind to develop. Over the ages a tremendous amount of evidence has been unearthed, literally, that shows that man has been on this planet in his modern form for millions of years. Either that, or our accepted paleontological time-table is totally erroneous.

The most publicized human fossil footprints are in the bedrock of the Paluxy River in Glen Rose, Texas. I have seen pictures of these tracks frozen in the rocks ages ago. The first thing your eye tracks are the 30 inch wide prints of a web-footed dinosaur who was apparently going about his business. But then you realize that the overlaid moccasin clad feet were going about the business of stalking old web foot. To give scale to the picture the photographer placed a 12 inch ruler along side of the human's print.

The book also reported that as usual the Paleo-philosophers, who were much too busy to examine the site, had agreed, in absentia, that the tracks were fraudulent. Then, as now, they were absolutely sure that a hundred million years separated the first man from the last dinosaur. No one ever explained the fraud and the years rolled by.

Then a few years ago a group of fanatics, whose literal belief in the Bible caused them to believe that the Earth was created only 10,000 years ago, entered the Paluxy River Valley. To prove this contention they made a film called, appropriately enough ... "Footprints in

Stone!". A literal belief in the Bible would, of course, make man and the dinosaur contemporary neighbors.

Then Glen J. Kubon showed up according to John Noble Wilford, who reported the incident in the June 17, 1986 New York Times. Mr. Kubon, "an expert on dinosaur tracks" first found that the Paluxy River was real. Next Mr. Kubon discovered that the rocks were real and later that the web foot tracks cast in those whitish rocks were likewise real.

With the stage thus set for his greatest discovery, he proceeded to find that the "Manprints" (which showed separate left and right feet) were not what they seemed to be. They were really the tracks of a completely unknown three-toed, if flat-footed, dinosaur. They were made by a gay saurian, tip-toeing through the tulips, while leaving crystal clear heel marks cast in white rock and subliminal toe prints cast in rusty and blue gray rock!

The story gets better. At first Kubon's peers (other Paleontologists) refused to believe him, since he is a computer programmer by day and a student of weird tracks only by night. The philosophers were bothered by a few things like the different colored rock in the toe's prints, and and by the fact that no other flat-footed three-toed dinosaur, or bird, has ever been found.

Still Mr. Kubon persisted, and found completely logical and scientific reasons to explain away their fears. Some of the "human" tracks were made by the snouts and tails of other dinosaurs as they also strolled about. Nevermind the absence of their tracks, they were lightweights. The different coloring of the rocks around the toe marks was caused by the deposition of different material in the toe holes. This explanation thus made everything different and the philosophers have accepted this as current gospel. Even the religious fanatics, after being exposed to Kubon's devastating logic, agreed to withdraw the movie.

I prefer to believe that Kubon cut class the day contemporary mammal tracks were studied. Perhaps, if he were to wear a pair of moccasins in his back yard after a snow storm he would be shocked at how closely his foot prints resembled the original photos of the Paluxy Rocks.

There are old stone fortifications whose surfaces have been in part vitrified (turned to glass), as in a kiln, or as if they were at ground zero in an atomic bomb test. The process requires extreme heat. There's a tunnel in solid rock in Vail, Oregon (shaped like a Quonset hut) that is over 40 feet in height. It has vitrified walls and goes straight into a mountain. How far? Who knows? The Government sealed off the area the night it was discovered over 30 years ago. The picture was published in a now extinct newspaper, the "*Morning Call*" from Paterson, NJ.

What we are never told is that from all over the globe fossil tracks have been discovered and then discounted. As you read about them, remember that only a natural catastrophe can preserve such an ephemeral thing like a footprint. Also it's only "luck" that finds them. Let's start with the oldest reports and work our way up.

Bare feet molded into a slab of limestone in St. Louis were found by the French

voyageurs. ¹⁵ A few decades later, both human footprints and animal tracks were found under 20 feet of sand on the east bank of the Connecticut River near Hadley, Mass. ¹⁶

Near a small town called Waneta in the old Dakota Territory close to the mouth of the Cheyenne River, there is a large exposed surface rock of magnesian-limestone which shows the human tracks of someone running. ¹⁷ About the same time the bare footed tracks of a whole family were found in hard rock sandstone on the edge of a hundred foot cliff that overlooks the Harpeth River. The edge had eroded away one track until only half remains. This report predates 1882. By now the rest may have also eroded away. ¹⁸

Tracks in sandstone are also found in the State Prison Quarry at Carson City, Nevada. The tracks are of a hominid and the rock is dated to the Pliocene. But before you could blink, the nay-sayers were at it absolutely proving, sight unseen, that the tracks were those of a ground sloth. ¹⁹

In 1891, hundreds of human footprints were found in yellow limestone in a rocky glade near Irondale, Mo. ²⁰ Footprints were also found pressed into volcanic ash in a dam site in Demirkopru, Turkey. They are believed to be 250,000 years old because geological study shows that the last volcanic activity in Turkey was that long ago. ²¹

So much for footprints which are easily explained away. How about anomalous human skeletons? One would think that such evidence would be unassailable. But where there's a will there's a way. In 1873 a man personally extracted a bone fragment deeply incised with figures of animals from solid rock dating from the Miocene, 800 feet beneath the top of a cliff. The Miocene period ranged from 10 to 25 millions of years ago. ²²

Here's another puzzlement: Human bones were found by rock hounds in strata, judged to be 100 million years old, after a mining company had stripped off 15 feet of overburden and at least 6 feet of solid rock in a desert in Utah. The bones were sent to the University of Utah for testing. But the experts never quite got around to testing them. The experts did the same with my electroscope. I predict that in another decade or so some expert will claim his Ph.D. on why these bones were phony. ²³

Another human skull found in hard siliceous limestone near Lake Texcoco. Not another word was ever heard. ²⁴ Around 1865 another human skull was removed from under 153 feet of five intermittent beds of volcanic ash and gravel. ²⁵

After over 50 years of reports of miners finding human artifacts and bones an ivory tower expert finally admits that some of the gravel deposits are middle tertiary (25-40 million years old). However, since all these things were discovered by unwashed and unlettered blue collar workers, these "objects" probably all fell down from surface cracks to where they were found. Since only blue collar people work in mines, by these standards, there will never be any acceptable proof. ²⁶

In 1929 the remnants of a mastodon were found 22 feet down under Stanford College at the same level that a human skull was previously found. The bones are thought to be two to three million years old, which would make the skull the same age. ²⁷

While on the subject, lets hear it for the pygmies and giants of yore. In 1837, a huge graveyard was discovered near Cochocton, Ohio. It contained only the bodies of pyg-

mies. ²⁸ Forty years later another vast graveyard containing pigmies was found in Coffee County, Tennessee. It was reportedly similar to those previously found in White County and other places in middle Tennessee. ²⁹

Then 7 years later, near the junction of the Missouri and Hart Rivers in the frontier town of Mandan, a 100 acre cemetery was found which contained the bones of giants. ³⁰ In 1885, outside of Gasterville, Pennsylvania, a mound covering a stone vault was opened and inside was a skeleton that measured 7 feet two inches. The stones which covered the vault were covered with inscriptions which have never been deciphered. The remains were sent to the hallowed Smithsonian, from whom never a word was heard. ³¹

Now you are entitled to believe anything that you want. However, remember that when observational data or experiment conflicts with a theory, no matter how beautiful the theory or how impressive the credentials of its author, a rational person pitches out the theory.

1. p. 90, "WE ARE NOT THE FIRST", Tomas, Bantam, 1971
2. p. 90, Ibid.
3. p. 452, "ANCIENT MAN: A Handbook Of Puzzling Artifacts", Corliss, The Sourcebook Project, 1979, Extracted from "Unwordly Mechanics", de Solla Price, Natural History, 71:, P. 8, March 1962
4. p. 216, "NEWTON'S CLOCK", Peterson, W.H. Freeman, 1993
5. p. 255, "ANCIENT MAN: A Handbook Of Puzzling Artifacts", Corliss, The Sourcebook Project, 1979, Extracted from "Prehistoric Structures On Ponape", Anon., Science, 5:, p. 284, 1885
6. p. 76, "MYSTERIES FROM FORGOTTEN WORLDS", Berlitz, Doubleday, 1972
7. p. 248, "ANCIENT MAN: A Handbook Of Puzzling Artifacts", Corliss, The Sourcebook Project, 1979, Extracted from "The Ancient Ruins Of Tiahuanacu", Anon., Pan American Union Bulletin, 37:, p. 513, 1913
8. p. 443, Ibid., Extracted from "Ancient Electroplating", Anon., Scientific American Publishing Co. Annual Log, p. 85, 1933
9. p. 453, Ibid.
Extracted from "Electric Batteries Of 2,000 Years Ago", Schalb, Science Digest, 41: April 1957
10. p. 454, Ibid.
Extracted from "The Little Wooden Airplane", Anon., Pursuit, 5:, 1972
11. p. 653, Ibid.
Extracted from "Eve's Thimble", Adams, American Antiquarian, 5:331, 1883
12. p. 654, Ibid.
Extracted from "A Curiosity From Coal", Wiant, Creation Research, 13:74, 1976

13. p. 651, Ibid.
Extracted from "Report of the British Assoc.", Brewster, pt. 2, 51, 1844
14. p. 656, Ibid.
Extracted from "A Relic of a By-Gone Age", Anon., Scientific American, 7:298, 1852
15. p. 637, Ibid.
Extracted from "Remarks on the Prints of Human Feet", Schoolcraft, American Journal of Science, 1:5:223, 1822
16. p. 648, Ibid.
Extracted from "Impressions (Chiefly Tracks) on Alluvial Clay", Hitchcock, American Journal of Science, 2:19:391, 1855
17. p. 649, Ibid.
Extracted from "Human Footprints in the Stratified Rock", Hubbell, Popular Science monthly, 22:262, 1882
18. p. 644, Ibid.
Extracted from "Alleged Human Footprints in Tennessee Rocks", Anon., Scientific American, 47:388, 1882
19. p. 645, Ibid.
Extracted from "The Nevada Biped Tracks", Cope, American Naturalist, 17:69, 1883
20. p. 647, Ibid.
Extracted from "An Ancient Grave", Anon., American Antiquarian, 13:179, 1891
21. p. 649, Ibid.
Extracted from "Ancient Human footprints", Barnaby, Nature, 254:553, 1975
22. p. 661, Ibid.
Extracted from "On the Probable existence of Man During The Miocene Period", Calvert, Anthropological Institute Journal, 3:127, 1873
23. p. 662, Ibid.
Extracted from "The Case of the Bones in Stone", Barnes, Desert Magazine, 38:36, Feb. 1975
24. p. 666, Ibid.
Extracted from "Fossil Man In Mexico", Anon., American Naturalist, 18:920, 1884
25. p. 669, Ibid.
Extracted from "Alleged Discovery of an Ancient Human Skull in California, Anon., American Journal of Science, 2:42:424, 1866
26. p. 670, Ibid.
Extracted from "Review of the Evidence Relating to Auriferous Gravel Man in America," Holmes, Smithsonian Institution Annual Report, p. 419, 1899
27. p. 673, Ibid.
Extracted from "Human Skull Found Deep Under Stanford Campus", Anon., Science, Feb. 1, 1929
28. p. 681, Ibid.
Extracted from "Pigmies", Anon., Gentleman's Magazine, 3:8:182, 1837
29. p. 681, Ibid.
Extracted from "A Pigmy Graveyard in Tennessee", Anon., Anthropological Institute Journal, 6:100, 1876
30. p. 682, Ibid.
Extracted from "A Prehistoric Cemetary, Anon., Scientific American, 48:296, 1883
31. p. 683, Ibid.
Extracted from "Giant Skelton in Pennsylvania Mound", Anon., American Antiquarian, 7:52, 1885

PARTICLES & SPARTICLES

During the middle ages wisemen (philosophers) argued over the number of angels that could dance on the head of a pin. Although not one of these geniuses had ever seen an angel, the only logical parameter to the rhetorical discussion was that they assumed that angels were diminutive, to say the least, and that some finite number could minuet on the head of a common straight pin.

I find today's particle physicists and cosmologists have regressed and are similarly engaged. Ever since Einstein resolved Relativity, Hawking hustled black holes, and Heisenberg uttered uncertainty they have been hard at it — hyping new “angels”. As of April, 1971 there were 17 stable basic particles in addition to the electron, the proton and the neutron. There were also 66 mesons and 44 baryons for a grand total of 130 basic particles. ¹ There was no mention of fermions, leptons or quarks. I couldn't be bothered running down today's totals, but I would bet that this already phenomenal number has been greatly increased in the intervening decades.

When last I heard the particle physicists and their associated mathematicians, had been working their magic in ten dimensions. Today they have expanded their consciousness to enable them to envision 26 dimensions simultaneously. That's 22 more than us unenlightened common folks can see. Only the first three dimensions can be demonstrated. However, we can increase the number to four if we agree to accept “time” as a dimension. Time is unique in that it is the only one of the three that doesn't require active participation to use. Whether you are watching it or not it passes. It is with these 22 extra, folded-in dimensions with which these magicians now work their wonders. Is it any wonder that Dr. Peter S. Ruchman's book on Einstein, “ $E = MC^2$ ” is subtitled “*The Bigger the Belfry, The More Room for the Bats*”.

Unless these philosophers are lying, I must believe they have deluded themselves into thinking their mathematical constructs are real. This delusion is circular. Once the four dimension barrier is breached, the greater the hallucination, the more dimensions there are to be found. I can categorically state that if they actually approached any of these 22 dimensions with their pen and pencil weapons unholstered, they would not only meet all the fiends in hell but also all the multi-dimensional people-eating monsters of fable. That's my story and I'm sticking to it!

By some subtle, exotic and arcane mathematical reasoning they have also decided that the proton is stable. So stable, in fact that proton decay is a matter of a million trillion trillion years. ² To test this belief over the years they have taken to habitating the lowest levels of old mine shafts just like rock trolls of yesteryear. There they have buried a number of huge water tanks using the rock on top to protect the tanks against most cosmic rays. Most of these tanks are filled with triple distilled water, with embedded and surrounding appropriate detectors. Because of the immense number of atoms (protons) in each tank, they predicted that around 1000 protons, per tank per year, would be subject to decay. ³ But, after decades of searching, they have failed to find a single verified case of proton decay.

Of course they may also be waiting for a quark internal to some proton to cause it to

decay. They claim this happens when an X particle leaps into existence, changes the quark, and then vanishes. ⁴ I think the quark changes back, but they didn't say and I am not sure. Note, these are the same breed of birds who disparaged Hoyle's steady state universe because it required the birth of a single simple atom of new material per cubic meter per billion years. ⁵ Is an X particle that comes and goes any more believable than the birth of a single hydrogen atom?

This same quark which apparently has failed to decay a single proton in a single underground tank for almost 20 years is the same strange beast that has a "strong force" for other quarks. When this behavior is found in people they correctly label that person a "prevert". However, they tell us that quarks are attracted by a strong force which grows exponentially stronger the greater the distance grows between them.

If this attraction were true then the Strong Force would equal some constant times distance to an Nth power or $SF = k * D^n$.

In this case the quarks would drag the protons, which would drag the atoms, which would be dragging matter together instead of allowing the universe to expand as we are told. At the very least, the expansion of the universe would be slowing down and we would know that the universe was closed, and not open. Oops! I know! The strong force terminates at some very short distance.

Talk about epicycles! These people are frightening. They are not the half sane physicists that Joshua Gibbs chided but certifiable mathematical lunatics. They work as handmaidens to the cosmologists who daily drag us deeper into the pit of irrational temptation.

The following is a blunt statement from David Lindley who in his book, "*The End Of Physics*" writes, "*Modern cosmology theories are built on ideas that have no proven validity, if one insists on the old-fashioned standard of empirical evidence.*" ⁶

Between the particle loons and the cosmologists they have created the theory of "Supersymmetry" which doubles the already unbelievable number of basic particles in one shot. They now claim that each particle has a very massive (comparatively speaking) partner. They believe this even though after six decades of atom smashing not a single super particle has turned up. ⁷ So now they're saying that these particles are inherently undetectable! Wow!

These super particles are collectively known as "Sparticles". Each partner particle gets an "S" in front of its name such as selectron, sneutron and snuetrino. When the "S" won't phonetically work such as in the word sphoton, they add an "ino" to the end producing such words as photino and gluino.

David Lindley closes his book with this statement, "*The theory of everything will be, in precise terms, a myth. A myth is a story that makes sense within its own terms, offers explanations for everything we can see around us, but can be neither tested nor disproved. A myth is an explanation that everyone agrees on because it is convenient to agree on it, not because its truth can be demonstrated. This theory of everything, this myth, will indeed spell the end of physics.*"

Thank God that our legislators finally smellinoed the sroses and skilled the Supercolliderino.

Now you are entitled to believe anything that you want. However, remember that when observational data or experiment conflicts with a theory, no matter how beautiful the theory or how impressive the credentials of its author, a rational person pitches out the theory.

1. p. F-236, "HANDBOOK OF CHEMISTRY & PHYSICS", 54TH edition, CRC Press
2. p. 165, "THE END OF PHYSICS", Lindley, 1993, Basic Books
3. p. 165, Ibid.
4. p. 165, Ibid.
5. p. 144, Ibid.
6. p. 205, Ibid.
7. p. 192, Ibid.

PALEO-MAGNETISM

Paleo-magnetism is the branch of geology that deals with the residual magnetic orientation of rocks whose magnetic orientation was aligned as the volcanic lavas of that epoch solidified into rock. We shall start by investigating the evidence of magnetic pole reversal. I can not deny the evidence, for it is literally written in stone. But I do absolutely refute the current conclusions that insist that the poles reverse polarity by purely electromagnetic methods.

The geo-philosophers believe that the magnetic poles occasionally change their polarity by some mysterious method and in a non-catastrophic manner. Our professional philosophers believe in a uniformitarian universe where a cataclysm such as a planetary "Roll-Over" is unthinkable. However, their **EBS** allows them to use dip needles on the rock samples to prove this contention.

They use a rotary core drill to take samples and split off a layer to be tested. They mark the top and then use a dip needle to determine the polarity of the era in that location when the rock solidified. By their standards this test absolutely proves that the field itself reverses. However, this test would show similar results if the poles physically shifted.

Believing that they have proven their original contention they determine the age of the samples and then they draw a chart of the Earth's magnetic reversals.

A few years ago, I thought I had worked out a way to make the samples tell the whole story. Instead of a dip needle I would use a sensitive magnetic compass, and determine the azimuth of magnetic north or south of each sample. I would choose only samples taken between the latitudes of 45 north to 45 south.

The reason for this is that the magnetic poles and the poles of rotation are never coincident nor diametrically opposed. Since a magnetic pole may be thousands of miles from the true pole, and even discounting local variation, the orientation of samples taken within 45 degrees from a true pole may indicate a pole reversal.

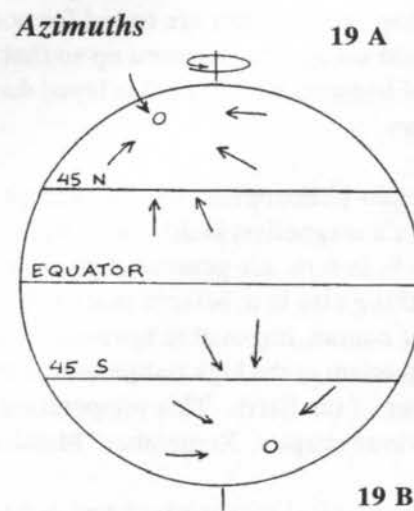
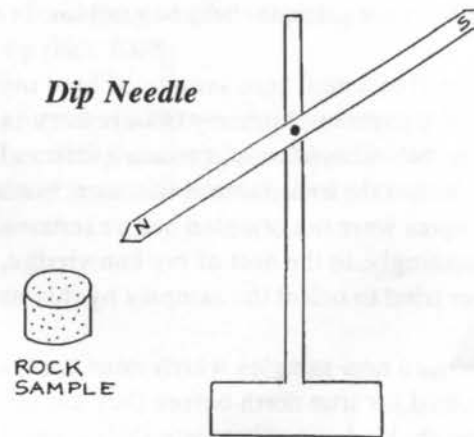

It is impossible for us to determine now the actual location of any pole in ages past, so we can only use samples from the middle latitudes where the variation is always less than 45 degrees. If the magnetic poles electrically reverse, then azimuths taken to the nearest pole from these samples will seldom show any east or west orientation. The greatest majority will always be within 45 degrees of either pole. However, if the poles themselves shift by "Roll-Over", then azimuths will be random.

In need of actual core samples, I hied myself to the the Lamont-Douherty Observatory in Palisade, NY where I was graciously offered the use of data. I then discovered that their cored samples were not oriented before removal. Amazingly, to the best of my knowledge, no one had ever tried to orient the samples by this method.

We need new samples which must first be carefully marked for true north before they are cored. To do this it might be desirable to pre-drill a small hole on the exact northern edge of where the sample core edge will be. In addition, then each sample split off from the core need only be marked with a magic marker to indicate the top. Before they are tested for polarity each sample should always be shimmed up so that the layers are level because all sediment is layed down in horizontal layers.

The geo-philosophers will not accept the fact that the Earth's magnetism is driven by Rene' ground currents which, in turn, are generated by the east to west movement of the oceans. To believe anything else is to believe that the Earth contains a huge internal permanent magnet. This is, of course, impossible because there are no known magnets that can maintain their magnetism at the high temperatures that the same geo-philosophers insist exist in the center of the Earth. This temperature is called the Curie point which was discussed in a previous chapter. Remember "Mustbee!"

In the original manuscript I had gone on to say, "**Presumably they might have speculated that the heat and the pressures existing in the Earth's core might atomically alter iron to maintain magnetism, but so far as I know, no one has suggested this**". Even if it there were a "hot" magnet there are only two ways to reverse a permanent magnet: The first is to physically turn it over, end for end and the second is to surround it with the coils of a magnet machine and zonk it with a large bunch of amperes. Magnetss only respond to ampere-turns.

The first corresponds to a simple physical Roll-Over which the uniformitarian mind set

Random Azimuths

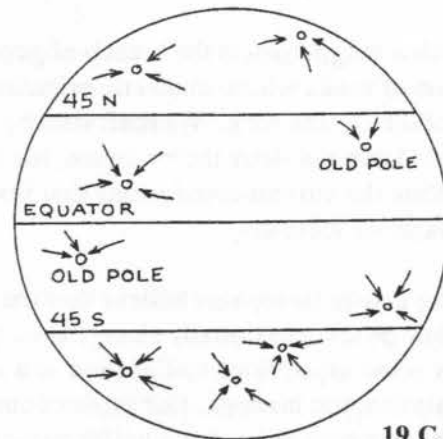

19 C

Core Samples

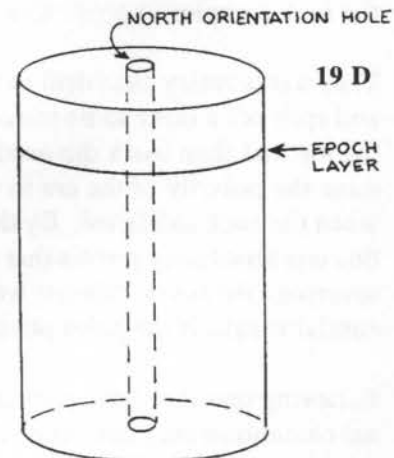

19 D

denies could possibly happen. For the second, they are stuck with an electrical whack because there is no coil of wire around the Earth. There is only one shorted turn, no matter whether the conductor be air, water or the Earth itself. Any change in the permanent magnetic state of our Earth would have to be accomplished by an incredible number of amperes, an electrical whack of unimaginable proportions. Unfortunately for them, this whack could only be generated by an unimaginable planetary catastrophic on the order of Velikovsky's "*World's In Collision*".

Even if they were to agree that the Rene' Earth Currents caused our magnetism, they still could not show how these currents could, first, reverse in flow and then secondly, increase enough to reverse the whole magnetic field. I'm afraid the geo-philosophers are stuck with a Roll-Over no matter how much it screws up their EBS.

Now you are entitled to believe anything that you want. However, remember that when observational data or experiment conflicts with a theory, no matter how beautiful the theory or how impressive the credentials of its author, a rational person pitches out the theory.

ATOMIC BEASTIES

I know that the Five Horsemen of the Apocalypse will ride, as they have never ridden before, when the world runs out of fossil fuels. Despite this fact, I despise the entire atomic industry. They have lied to us from day one of the Manhattan Project. Here is a list of this industry's major known accomplishments. Judging by how long some of them were kept secret there are probably many more disasters that remain unknown.

Great Atomic Accomplishments

- 1942 The first fission pile was made critical under Chicago University Stadium.
- 1943 Oak Ridge begins to produce U-235 for uranium bombs. The electrical output of the TVA was 9 billion kw/hr of which 75 % went into military applications. New York Times, January 1, p. 14
- 1944 Three reactors put on line at Hanford Washington.
- 1945 First plutonium bomb tested. 110 pounds of U-235 destroys Hiroshima. 35 pounds of P-239 destroys Nagasaki.
- 1952 First H-bomb tested.
- 1952 NRX reactor suffered complete destruction of core at Chalk River Canada
- 1955 EBR-1 serious meltdown of reactor core.
- 1957 Fire released plutonium over Denver, Rocky Flats, CO
- 1957 First commercial reactor on line at Shippingport, PA, on December 18,
- 1957 Windscale 1 core burn, 11 tons of Plutonium vaporized, Coast of England.
- 1957 Kasli Atomic Plant —thousands of civilian deaths during first year. Permanent contamination of thousands of square miles of Ural Mountain farms, Zyshtym USSR
- 1958 Fire in refueling room, Chalk River Canada
- 1958 Used fuel rods in Chelyabinsk, USSR melt down.
- 1959 USS Savannah, world's first and last atomic powered merchant ship launched.
- 1961 SL-1 reactor killed 3 men in small core explosion, Idaho Falls
- 1963 USS Thresher reactor accident, off Cape Cod
- 1965 Two more fires at Rocky Flats.
- 1966 Core meltdown, Fermi reactor Detroit MI
- 1969 Reactor contaminated reactor building, Lycem Switzerland
- 1969 Another fire released 2,000 kg Plutonium, Rocky Flats CO
- 1970 Dresden II reactor out of control, Morris IL
- 1970 Savannah River weapons plant has two sequential fuel rod meltdowns.
- 1975 Browns Ferry fire destroyed control cables and plant came close to meltdown, Decatur, AL
- 1979 Partial meltdown at TMI.
- 1986 Complete meltdown at Chernobyl, USSR.

As a kid, I cheered on the peaceful atom because it was presented as the scientific wonder of the twentieth century. However, each passing year has found me a bit more convinced that, compared to the smooth talking, heavy duty, big money motivated government slickers, we are all country bumpkins.

We have been slickered by the fastest and smoothest talking bunch of snake oil salesmen since John D. Rockefeller was financed by the Rothschilds to give up his horse drawn medicine show to play in oil. In fact, it is his descendants who still run his medicine

show but now it is on a worldwide basis.

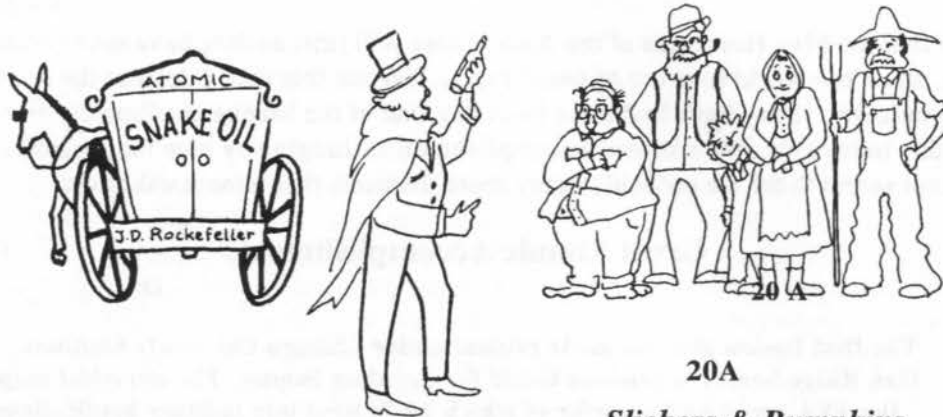

20A

Slickers & Bumpkins

Fifty years ago our government celebrated the unlocking of the atom by a wonderful fireworks show. When it was over, two Japanese cities had been incinerated. This stamped "paid" to the overdue bill that was tendered when the Japs pulled the sneak attack on Pearl Harbor. War is Hell! Not content with this spectacular display, our gubmint slickers immediately began to tout us bumpkins on a strange new beastie. We were told that if we took this here atom reactor beastie into our barnyard we would have safe, cheap and unlimited electric power. However, because we couldn't have just any yokel owning one of these atomic beasties, everything about them had to be classified top secret.

During the late 40's some atomic secrets were slowly allowed to leak out of the government's crypt. The first secret was that it was impossible to build a larger A-bomb. They claimed that no matter the quantity of fissile material used, any amount that exceeded the critical mass would not detonate. Therefore, reactors using a few hundred pounds of fissionable material would be perfectly safe.

Atomic Beastie Cage

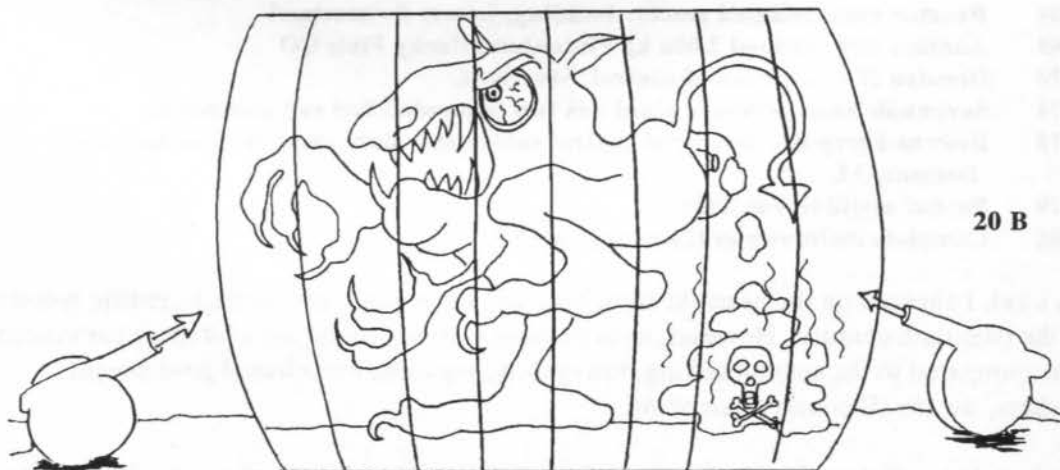

20 B

The next secret was that the all important control rods would be made of cadmium. This is a fairly strong metal capable of being forcibly reinserted even if a pile is distorted by

the heat from a partial meltdown. The next one was that, as an added precaution, each reactor would be surrounded by explosively driven cadmium spears which could be fired into the guts and instantly kill the atomic beastie if it ever dared get too fractious. The last was that we shouldn't worry ourselves about the terribly poisonous manure that they leave behind, because our old friend science would very shortly find a way to neutralize it.

There were rumors about disasters during the next thirty years but each time you gubmint slickers had pooh-poohed them. I had an ex-friend scream at me for over 30 years to show him even one case where anyone was killed by the atomic beastie. Shortly after Chernobyl, our friendship foundered. When TMI went out of control, I was forced to examine the original claims and compare them with the results. When no one was looking you slickers had changed some of the conditions of sale. Instead of a few hundred pounds of fuel per reactor you used ... a hundred tons; instead of expensive cadmium control rods you dared to use.... soft and crumbly, cheap graphite (pencil lead); instead of surrounding the atomic beastie's cage with the explosively fired cadmium spears you used ... nothing. Your experts had unilaterally decided that that this here atomic beastie wouldn't hurt a fly. And instead of finding a cure for the crap left trailing behind this strange beastie you have left it soaking in pools or buried it under the Earth's rug.

Fuel Rod

I have reached the point where I want to holler out; Just a goldurn, cotton pickin minute, Slick! You told me that this here atomic beastie would reduce the chunk that energy takes out of my pay but somehow, each year, it takes a bigger chunk. You told me that this here atomic beastie would relieve the drain on conventional energy sources. But I know that the TVA, the place where the fuel rods are manufactured, has become the world's largest coal consumer despite having tremendous hydroelectric capacity. If atomic energy gives off so dang much energy why do you still burn coal? Slick, I begin to suspect that if the atomic fuel were not so heavily subsidized by our Gubmint, that the entire atomic power program would be economically unfeasible.

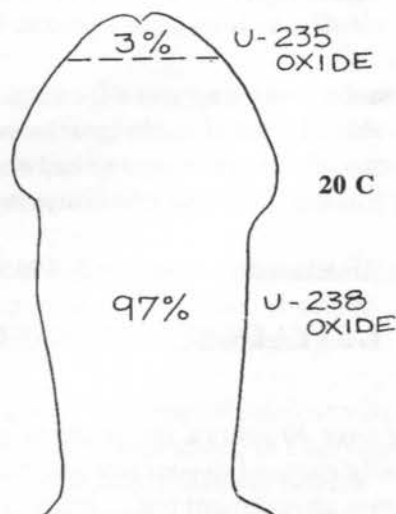

I want you to know, Slick, that this old city bumpkin grew up to be a Mensa member and, despite all these years of lies, propoganda and dis-information, I was finally able to calculate the theoretical maximum efficiency of these mean machines we call reactors. It takes 100,000 SWU's (Separative Work Units - pronounced swoos) to fuel a 1,000 megawatt plant for a year. A SWU is the amount of electrical power that it takes to enrich 1 kg of fuel to the necessary enrichment of 3%. Assuming that this 3% does all the work, then 100,000 SWU's are equal to 3,000 kg of nuclear fuel.

The beasties were sold to us based on Einstein's indisputable equation: $E = M \times C^2$. The theoretical power obtainable from one gram of material should equal 100 million kilowatt hours of power. This means that ten grams should run our plant for an hour. As there are 8,760 hours in a year, our plant should consume 87.6 kg of fuel in that time. If

we divide by the fuel it actually uses, we find an efficiency of ... 2.9 %.

Compare this with the 40 % efficiency of a conventional fossil fuel plant, and then tell me that we bumpkins haven't been slickered. Slick, your mean machine is one of the least efficient machines that man has ever produced, and this figure does not include the great amount of time that reactors are off line due to one little desperate emergency or another.

However, Slick, if we consider the reactor as a super producer of radioactive crap, now we are talking MACHINE! Your reactors then become superlative machines with the incredible efficiency rating of 97.1 %. This is one of the highest machine efficiencies that man has ever obtained. And Slick, you sneaky old snake oil salesman, I couldn't help but notice that lately you have been touting breeder reactors. You figure if it worked once it should work twice. What really scares me, Slick, is that you are probably right. There have been a billion new suckers born since the first reactor went on line, and all us bumpkins want to believe that you wouldn't poison the only world we've got for a few trillion dollars more.

Why is it, Slick, that despite the fact that every country in the world has at least one experimental reactor most information is still top secret. It makes this bumpkin wonder if the big secret, the only secret, is to keep us, the bumpkins of the world, in the dark! Slick, never before in the history of mankind has one of man's machines worked so efficiently, so long or at a greater cost, to produce so much highly poisonous crap!

I also love the way you slickers successively hid each atomic fuck-up under the lid provided by the incredibly democratic atomic secrets act! For over 40 years, Slick, you insisted that atomic energy had never killed anyone. You hid the British Windscale and the Russian Chelyabinsk disasters.

Dateline London- January 2, 1988: An article in the New York Times was headlined...

BRITAIN SUPPRESSED DETAILS OF '57 ATOMIC DISASTER

For over 30 years a fire at the Windscale reactor in Britain, so severe that the plant was finally encased in concrete was hidden: not from our government and surely not from Russia government but ... from the people of both our countries in particular, and the people of the world in general. The radiation release was less severe than Chernobyl but more so than TMI, whatever the hell that means. The British government has excused themselves for this suppression on the grounds that it would have made our government (of the people and by the people and for the people) mad at them for giving anti-nuke ammunition to the people. I kid you not!

If a nation as small as Britain with her much higher population density could successfully hide this disaster, I wonder what our government has hidden from us in the wide open spaces of our more sparsely populated states? I even wonder, Slick, if you have secret reactors hidden near major population centers. I can't help but wonder where the Linden, NJ, power pipe got the 946 megawatts that was being sucked into New York City just before the famous blackout. Is there a reactor hidden near there? A small reactor?

Across the Delaware River near Belvedere, NJ I see two immense atomic type cooling towers built at a plant that is allegedly run on conventional fuel. The number of high tension towers that radiate from this plant tells me it generate a great deal of power, and if such a plant is not atomic it must use a considerable amount of conventional fuel. Why anyone would install this type of extremely expensive, cooling units if they weren't needed!

At first glance, because it sits next to an oil tank farm, you assume that it burns trucked in oil. A close look, however, shows that the tanks are all corroded and most would leak any oil placed in them. Then you discover that it must burn coal because a brand new trestle crosses the Delaware, connecting the plant to a rail line on the New Jersey side. Oops! When you take a close look there is rust on the brand new rails, and the old bro-mide about grass and busy streets spring into your mind. The main rail line is also in a sorry state for the amount of coal cars it should handle for a large capacity plant. All that's left is a high pressure gas line. However, the close neighbors, mostly dairy farmers, never saw them installing any type of pipeline. Tiz a puzzlement!

This type of cooling tower quickly became the symbol of atomic power generation because they are vital to the safe operation of these plants. In conventional fuel plants runaway boilers are quickly brought under control by the safety valve venting excess steam to the atmosphere (its only water) and by the fuel valves being quickly closed. Within seconds the high pressure emergency is over.

In the atomic plant a years worth of fuel is available right in the reactor pit and not only is the runaway exponential but the speed of fusion is in milliseconds. In case of a runaway the control rods are "scrammed" back into the pile (a slow process) and the extra heat is removed by the immense radiator called the cooling tower.

That same year, 1957, saw the Kasli Plant in Russia self-destruct with thousands of civillian deaths (the first year)and permanent contamination of thousands of square miles of farms. This is an area roughly equal to half of the state of New Jersey.

In 1958, the very next year, you slickers and our arch enemy (the horrible Russian Bear) actually conspired together to deny the melt down of used fuel rods stored in Chelyabinsk. That disaster poisoned a few hundred square miles of land which to this day remain uninhabitable.

On October 5, 1966, the Enrico Fermi Reactor in Michigan ran away and then for some reason, still unknown, stopped. Now you claim that there wasn't much damage done but that story never saw the light of day did it, Slick? In 1979, there was the Three Mile Island incident that you are still lying about. What you have never openly admitted, Slick, is that TMI suffered a partial meltdownand that the control rods have never been fully inserted. What you haven't yet told us is that the rods still haven't been pulled from that reactor because no one can enter.

As of June '82, I knew for a fact that the badly damaged TMI reactor was still critical (running) because the rods could not be reinserted. This means that the steam is either being vented or used for power generation. On 12/7/87, the papers carried a story that the clean up was years behind schedule because sections of the pile had not only fused

together during the accident (meltdown) but were also unsafe to approach after all these years. More bullshit but a little closer to the truth. On August 31, 1989, the News-Press of Fort Myers FL carried an article under news from Pennsylvania with the headline...

“CRACKS CONFIRMED IN REACTOR LINING”

The story relates how the investigation “required a newly developed radiation resistant color television camera and specially designed tools to brush debris from the area ... through forty feet of water.” They still don’t know if the cracks of the thin stainless steel liner extend into the five inch thick carbon steel reactor vessel.

Obviously that reactor is still not shut down. If the reactor were shut down, there wouldn’t be radiation in the dome at those levels nor debris in the pool, which should be kept spotless lest a pump should fail. And when pumps fail the temperature rises; and when the temperature rises, the reaction increases. Slick, the old rods are still in there and each month they are deteriorating into ever more poisonous and dangerous crap. Another truth still hidden from us by the secrecy acts.

Then came Chernobyl, Slick, and one big ugly atomic beastie finally tore his way out of the sack. From the 1986 edition of the “McGraw Hill Science and Technology Encyclopedia” I have found out that the odds against a meltdown are 5 billion to 1, and in volume 12 on page 139, in the last paragraph on the page it calls TMI a partial meltdown. I will sleep better tonight, Slick, knowing that we can’t have another Chernobyl for at least a million years because of the way you slickers fix the odds!

The atomic cycle starts with the mining of uranium ore which must be crushed, leached and treated to separate the uranium compounds which, after much refinement, consists of two oxides whose uranium content is 99.3% U-238 (uranium) and .7% U-235 (fissile material).

These are then converted to uranium hexafluoride which is shipped to the Oak Ridge separation plant, where the lighter U-235 compound is separated from the U-238. Both are made into dioxides, and then the U-238 dioxide is enriched with the U-235 dioxide until the concentration of U-235 is around 3%. This mixture is known as enriched fuel, which is pounded into pellets and then loaded into long hollow stainless steel tubes called fuel rods. All atomic fuel is created in one of three Gubmint owned enrichment plants. These plants are safely operated by international conglomerates like Dupont and Union Carbide, companies similar to the one that gassed all those people in Bhopal, India a few years ago.

Believe it or not ... a large reactor contains over 100 tons of fuel. Since this is an oxide the total uranium content is about 85%, or only 170,000 pounds, and of this 5100 pounds is U-235. You slickers tell us that an A-Bomb requires 110 pounds of U-235 so if I believe you, which I do not, then that plant contains only 46 bombs worth of material. Despite the fact that they have led us to believe that plain Uranium (U-238) is not a fissionable material, it will fission if smacked with fast neutrons. The U-235 is fissile because it need only contain a critical mass in the shape of a sphere for it to explode in hell fire fury.

A power plant is a place that creates steam by heat and uses the resulting steam to drive turbines, which then turn the electric generators. Whether the plant burns fossil fuels or uses the heat from fissile fuels, the energy cycle begins in the ground. We mine for coal and uranium and drill for gas and oil. A fossil fuel plant attains an overall efficiency of almost 40% leaving 60% of the energy to run up the stack or into the heat exchangers. Fossil fuel plants damage the environment by creating acid rain. The worst case disaster in a fossil fuel plant is that a boiler explodes. But conventional fuel boilers can be shut down within seconds by simply shutting off the fuel feed and venting the steam.

A reactor goes critical by the removal of the control rods. The reaction and heat generation are exponential and the criticality is delicately controlled by the in and out movement of the rods. This means that reactors are always balanced barely on the edge of control.

The rods are made of soft graphite (pencil lead) instead of strong cadmium to keep the cost of the plant down. When the rods are in, they absorb fast neutrons and stop the process. As they are withdrawn the neutron levels increase exponentially. A reactor is always delicately balanced by the continual movement of the control rods and the influx of coolant. This works as long as the average activity and associated heat is uniform. Slick, you know that any screw-up at all starts a potential meltdown which can only be stopped by trying to shove a graphite noodle up a wild atomic cat's ass.

Suppose a small section should exponentially fission and generate a local hot spot. Before the average temperature climbed enough to give a warning, and possibly even before the radiation detectors could isolate that small increase, a local spot would be super heated. The walls of the control rod sleeve would already be distorted to where the rod could no longer be inserted. If the rods were made from very strong material and hydraulically driven it would be possible to jam them back in. But our control rods are made from pencil lead! Is this what happened at TMI, Slick?

Slick, isn't the heat build up explosive in a melt down? Doesn't that make a helluva lot of steam? A thin shelled dome of reinforced concrete is not a good material for resisting tensile loads. When the pressure is raised inside a containment dome the entire shell is placed in tension. Even an increase of one psi translates into 144 pounds per square foot loading. In a dome that bridges a few hundred feet a few pounds of internal pressure would be enough to make it behave like Mt. Saint Helens!

And some reactors have flat topped containment vessels. ¹ There is a picture of one taken at Windscale that is at least 40 foot in diameter. Even a pound of pressure would probably blow the lid off this container.

Wildcat's Ass

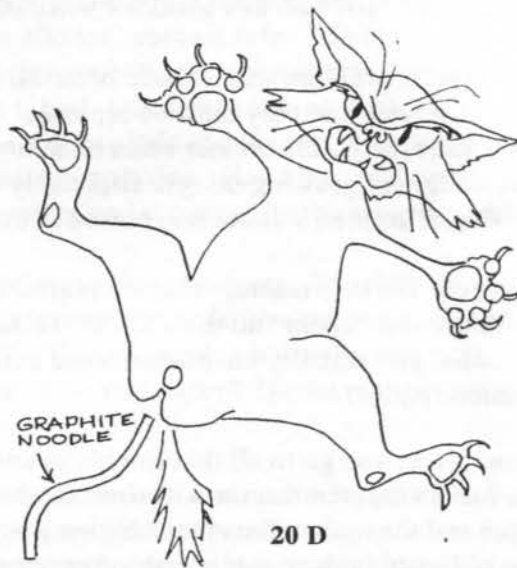

Slick, didn't you have to vent TMI like crazy? Let's see, wasn't it a high pressure hydrogen bubble that miraculously formed in the dome? So while you babbled us with the bullshit about that mysterious hydrogen bubble that had to be vented, you were using every trick in the book to get rid of the excess steam. You had the turbines screaming, you were pumping in the entire Susquahanna River and you were venting all that shit into the cooling towers and releasing it into the air, weren't you, Slick? At some stage you finally pumped in boron to help moderate the reaction. I guess we should thank you for preventing a Chernobyl type disaster.

Thank you, Slick!

And that plant farted, didn't it? And that fart released scads of wonderful crap like strontium 89 & 90 which gets into the milk and helps young bones grow doesn't it? So does iodine 131! And we also thank you, Slick, for a bountiful supply of cesium 137 and barium 140. Isn't all this good for what ails us?

The biggest problem with atomic beasties, Slick, is that the fuel rods get "spent" after a year in service and they must be replaced. Some of the U-238 is transmuted into Pu-239, while the U-235 creates other obnoxious substances even more inimical to the health and welfare of growing things. Especially baby things! Hasn't the cancer rate increased each year, until now about one person in three will get it?

However, the tiny reactors that are placed in the space probes work year after year and don't become "spent" do they, Slick? Is that because they have less than critical mass and what you actually have when a rod gets "spent" is not a limp dick but a rampant diamond cutter?

Now, Slick, you go to all that trouble to enrich the fuel so that the reactor will work in the first place and then you tell us that a higher percentage of fissile fuels is going to stop the reactor. Bullshit! It takes little imagination to see that the problem is going to be one of maintaining control. Isn't "spent" a new-speak word invented by your scientific and academic flunkies to keep us bumpkins off your ass?

For some very strange reason the "spent" fuel rods are not all reprocessed. Those that are, vent radio-active gasses and create some horrible beastie crap that must be buried. Shipping those rods to the reprocessing plant is quite a problem isn't it, Slick? Those are the huge trucks we see in the middle of the night with the small radiation placards on them. Despite the fact that they are lined with tons of lead they still spray radio-activity around, don't they, Slick?

Aren't most of the rods left in the pools on the plant grounds now? Imagine that, Slick!

Spent Fuel

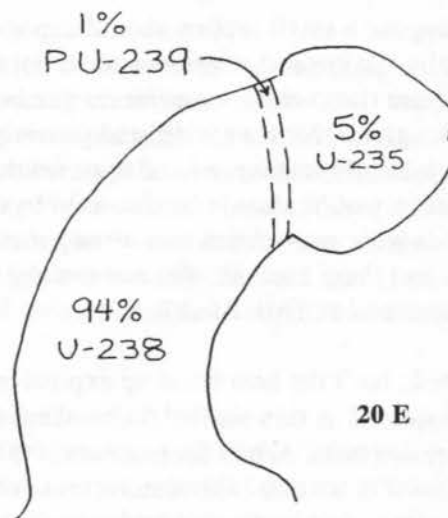

Forty years of beastie shit stored all over the world in pools. There are over 110 reactors in this country alone and each generates at least a couple of tons of weapons grade material a year. Yet the DOE maintains two reactors at Hanford that do nothing but generate weapons grade beastie shit. These reactors, contrary to what we are told, are of the same design as the ill fated Chernobyl reactor; they are almost 50 years old and getting very tired.

Slick, if the figures in the "*Handbook of Energy and Technology*" are accurate it would cost only \$740 to reprocess a kg of the shit that makes a bomb. Why is a "Gubmint" that joyfully spends over \$700 for a screw driver suddenly cost conscious when it comes to the manufacture of city busting bombs? By reprocessing some of these waste materials at least the Hanford reactors could be shut down. I'll bet the cost of operation of these two weapons reactors amounts to tens of thousands of dollars for every kg that they produce.

Since day one, Slick, you have told me that an A-bomb could not be made larger than the Hiroshima type. This is supposed to make the 100 ton reactors safe. The philosophers under your control swear on their little mercenary souls that temperature and pressure have no effect on nuclear reactions. In effect, if true, this means that no matter how much U-235 is placed together only the critical mass will explode and the rest of the material will simply be vaporized during a Hiroshima sized explosion. Hey Slick, picture this ... **Bang!** And a 100 tons of bad beastie shit vaporizes and scatters into the prevailing wind.

The U-235, we are told, will only respond (fission) to slow neutrons. To safely accomplish this a moderator must be used along with fuel rods in order to slow down the fast neutrons that are being generated by the U-235. This moderator is usually water. If the U-235 can't explode why is the water necessary as a moderator? Do the reactors we send into space contain water, Slick? I thought not!

And if the U-235 responds only to slow neutrons, how does a critical mass which is generating fast neutrons go off by itself? If pressure and temperature do not affect the emission of radioactive particles, why is it necessary to slam a less than critical mass together with high explosives to create a baby A-bomb? To the best of my knowledge every explosion generates only great temperatures and pressures.

The amount of energy that it takes to create 1 kg of enriched fuel is called a SWU. You claim, Slick, that it takes only 2500 kw/hrs of electric power to create a SWU. This bumpkin realizes that this figure is critical to atomic power industry. If it takes much more power then the entire atomic industry is a macabre joke because we would then be in the unviable position of having paid humongously to destroy our environment and kill ourselves.

A few years ago a SWU sold for about \$130. If we divide 2500 kw/hr into this we get a kw/hr cost of 5.2 cents which was about the cost of commercial power at that time. This cost does not reflect the mining, the transportation, the fluoride process, maintenance, labor, depreciation or amortization. If the power cost of any other commercial product were this high, the market price would be at least ten times higher. The difference between these figures must approximate the amount of Gubmint subsidy. Slick, I no longer wonder why there are no private companies manufacturing atomic beastie food. By stealing our money you can afford to subsidize every power plant in the world.

Somehow, Slick, I don't believe you any more! As a bright eyed kid I remembered reading that the entire output of the TVA, the largest power complex in the world at that time, took three months to create the materials that went into the first bomb. This was verified when I found the January 1, 1944 article in the *New York Times*. Before we continue, instead of the official 100 pounds of U-235 per bomb let's use the more realistic figure of 20 pounds. Therefore about 2,250,000,000 kw/hr was used to generate less than 50 pounds of weapons grade material. This is 450,000,000 kw/hr per pound. Today you claim that it takes 33 SWU's or 82,500 kw/hr to create 1 kg or 2.2 pounds of weapons grade material. This is 37,500 kw/hr per pound.

Here's the problem, Slick! If you told the truth in 1943 about the amount of energy necessary to create the material, then you are lying now. For both statements to be true you would have had to improve the efficiency of the process over 120,000 per cent. We like to think that our engineers greatly improve efficiencies over the years, but this is not usually true. Track any product back to the first lab prototype and the improvement in efficiency is always much less than 100%. For the separative process to have increased in efficiency 12,000 times would be a miracle.

The armed forces of the world have many atomic powered ships, the various Merchant Marines have none. Warships are designed for speed and range, not fuel economy. A destroyer at flank speed burns over 16,000 gallons an hour of fuel oil. Merchant ships burn less because they are not trying to set speed records but fuel consumption is always an expensive consideration with ships. On July 21, 1959, the Savannah, the world's first atomic powered merchant ship came down the ways in Camden NJ. If atomic power is economical, why was this ship also the last?

And last but not least, Slick, you have bullshitted us into believing that our atomic industry does not create any more radioactivity than existed in the first place. U-238 shows almost zero radioactivity. From this material comes tens of tons of U-235 and Pu-239 every year. Pu-239 has a half life of 240,000 years!

In October '89, I bought a second hand book entitled "*Poisoned Power*", written by two medical doctors. The book holds an excerpt from an article on the fast breeder reactors written by Edward Teller and published in the August 21, 1967, edition of "*Nuclear News*". ²

"But if you put together two tons of plutonium in a breeder, one tenth of one percent of this material could become critical...."

"In an accident involving a plutonium reactor, a couple of tons of plutonium can melt. I don't think anybody can foresee where one or two or five percent of this plutonium will find itself and how it will get mixed with other material. A small fraction of the original charge can become a great hazard."

A Great Hazard! Leaping Lizards, Slick, does that mean that the father of the H-bomb, E. Teller, is telling us that a reactor can explode like an A-bomb?

It seems to me that one tenth of one percent is four pounds and my mentor, Pete Ross, over twenty years ago told me that only 4 pounds was the amount of material used to

make a plutonium A-bomb! He also told me that 10 pounds of U-235 made a standard uranium bomb. Was I told the truth, Slick? Pete was a personal friend of Leo Szliard of Manhattan Project fame. Did Leo tell Pete and if he did, were they lies?

Pete's father, King Ross, did secret research for the government during WW2. He was another genius and periodically during the early 1940's, four men would simultaneously come to see him at his tiny house in Edgewater, NJ. Three of them were Fermi, Einstein, and Tesla. Come to think of it, Slick, Pete's father was also murdered near his secret lab at Bush Terminal. They never caught his killer and his family never did find the lab. But you wouldn't know anything about that, would you?

This book also showed how you slickers, with your lies about "SAFE" radiation levels, have medically guaranteed a cancerous future for most of us. The book also told about the Price-Anderson Act of 1957. This act was passed in response to a Brookhaven study that showed that a disaster of a 100 megawatt plant would involve 7 billion in damages to property alone. Had the reactors of the time been as large as they are today the damage at that time would have been 50 billion. And that was the cost in 1950 dollars.

Since the insurance industry absolutely does not insure against any damage to person or property from a nuclear accident of any sort, this act was necessary so that our friendly utilities could bring us the atomic beastie. This act says that the Government will co-insure with the private utility. The total liability for all claimants is limited to 60 million to the utility and 500 million to the Government.

This is a total of 560 million for all the property and people in an area that may be as large as the state of Rhode Island. And it will happen in a populated area because reactors are only built on the outskirts of major population centers. You can't sell much electricity where population is sparse. Isn't it strange that no one in the news media ever tells us about things like this. I am a fairly informed person but this was news to me. How about you, Slick?

In 1957 this would have amounted to 8 cents on a dollar of damages. At the 50 billion figure it would have been a penny on the dollar. After 35 years of government created inflation, if the current value of your house is \$ 100,000 you will be entitled to ... a grand total of \$ 70 dollars before you pay the lawyer that sued the government to get it. And that magnificent sum includes the damages if your wife, kids and dog are fried.

Now you are entitled to believe anything that you want. However, remember that when observational data or experiment conflicts with a theory, no matter how beautiful the theory or how impressive the credentials of its author, a rational person pitches out the theory, especially if the theorist is a sophisticated liar.

1. p. 1603, "THE ILLUSTRATED SCIENCE AND INVENTION ENCYCLOPEDIA", STUTTMAN, 1974
2. p. 151, "POISONED POWER", Gofman & Tamplin, Rodale, 1971

MOSTLY QUESTIONS

New ideas or questions that probe the behinders of sacred cows whether social, religious, political or scientific are now, and have always been, viewed as heresy by those who are dedicated to maintaining the status quo. This is especially true for organizations of professional wisemen in a field under attack. People in control will not stand for heterodox opinions.

A high IQ has nothing to do with this most human mental disorder. People respond to emotional issues emotionally and any issue which threatens ego, rice bowl or status becomes an emotional issue. Their **EBS** tells them all they need to know about the issue at hand.

There are Mensans who have asked me, "*Rene', you're not a scientist, why do you care about science?*" I usually evade an answer because I consider that to be a truly dumb question.

I care for two reasons: First, science promised me something that religion could not. It promised an "open minded" approach to life and that it would never resort to authority in a dispute. It failed to deliver on its promise and it has degenerated into another paternalistic religion.

Second, because only "open minded" scientific thinking can defeat the horrendous problems I see directly in front of us as the result of planetary over-population by the masses and the total slavery being imposed by our masters. Most of the world's problems have always been generated by these same demons. As a result of this, we will be hammered first into the straight jacket of a one world Global Plantation which will then reduce us to the most abject slavery the world has ever seen. It will be a slavery enforced by computers and radio receiver slave collars that will blow off your head for crimes as simple as close tresspass to our masters!

In the past the rebels took to the deserts, the mountains, and the forests and fought there to keep the traditions of freedom alive. There are no hiding places from today's technology. If we fail to discern the real problem of over-population from the politically correct pseudo problems our politicians and social workers and shrinks babble about, we will become quasi-starving ant creatures, wearing electronic death collars, whose survival is at the complete whim of the new nobility of billionaires who will run that ant hill.

About 20 years ago James Caan starred in a futuristic picture called, "*ROLLER BALL*". In it he was a super athlete who became the talk of the world because of his ability to survive the deadly game. There were only 10 corporations left in that world and they ruled with iron hands. Everyone should have to see that picture once a year so that they may know our rapidly approaching future.

The proof of this statement can be found in the ratio of CEO salaries compared to the people they employ. In the 1970s that ratio was about 10 to 1; it has climbed to about 30 to 1 and is still climbing. We used to laugh at India because while 99 % of the people were dirt poor they supported their nobility with yearly tithes (gifts?) of precious jewels

equal to the noble's weight.

Our democratic dream is crumbling even as I write because of the recent onslaught of immigration by English illiterate, ignorant and religiously fanatical immigrants fleeing their own fouled and stripped ant hills, who carry with them the very mind-set that ruined their ant hills in the first place.

Witless fanatics waving banners and praying to God will destroy the type of thinking that might have saved us. Fanaticism is always destructive to someone. Where would be the fun for the priests in running the power trip called organized religion if you couldn't turn your fanatics loose on the non-believers?

Although we generally associate fanaticism with religion, fanatics come in all sizes, shapes, sexes, colors and persuasions. There are patriotic, political and even scientific fanatics, all of whom have surrendered their critical reasoning to their usually shrewd but equally demented leaders. Fanatics are dangerous because they believe that only they and their equally stupid associates possess the truth. Beware their surges of self righteous anger.

- What was once an integral part of the scientific routine, self criticism, no longer works. Today's philosophers break their own arms by patting their own backs congratulating themselves for being able to get so close to the government trough.

They tell us that science is now much too complicated to be understood by anyone but another expert in their field. They contend that progress will only add another decimal place to existing knowledge and that when the decimal is added it will be by one of their own. After years of their lies, half truths, bombast and abuse I am only too ready, willing and able to supply criticism by the truck load.

During the past year I have been receiving reports from people who have the original edition written in 1989, that some professional philosophers are beginning to tout those ideas. You don't think ... Nah!

- As I have shown, our Earth cannot be in perfect balance and this requires either an equatorial bulge or some type of planetary bearings to maintain the stability it exhibits. Without these René Bearings our freely supported Earth would respond by immediately Rolling-Over, bringing the great circle line of heaviest mass to a new equator, thereby changing our existing polar axis. And with each new imbalance it would again slightly re-align the equator.

If this rotation depended solely upon the inertia of the planet, how did the solar flare of 1972 slow the planet down by 10 milliseconds in one day? This was greater than any slowdown ever measured before. How did the earth slowly regain its rotational velocity if it isn't being driven by some solar generated force?

- The meteorologists claim that our weather is driven by wind and barometric pressure. I believe our weather is the result of the movement of our polar air masses and that they are exclusively motorized by the action of the electric forces generated by the solar wind. The polar winds drive our climate, and they in turn are powered and con-

trolled by the solar winds. The solar wind also drives a west to east movement of the air which "scrubs" the oceans, moving them from west to east which, in turn, drags the sea with it, providing the torque to rotate planet.

I believe that the oceanless planets like Mercury, Mars and Venus rotate very slowly compared to Earth being driven primarily by direct electromagnetic effects. On the other hand, the alleged "gas" giants rotate rapidly because of their extensive and thick atmospheres. I also believe that the future will see the densities of the solid planet's decrease and those of the "gas" giants increase drastically. A rock is a rock, is a rock!

- Newton's equatorial bulge, allegedly created by the centrifugal force of rotation, does not stand up to either mathematics, the rigor of a mechanical test or direct observation. How can 3 dynes of force hold up a column of water 13 and a half miles high? Why doesn't the turntable test shoot the water out of the U-tube? Why don't local surveyors see the slope which must result if there is a bulge? Why did a Mensa geodetic surveyor fail to find the error in the test I derived if it is so erroneous?

I have been told that radio telescopes can accurately measure the Earth and detect the slightest shifting of tectonic plates sliding past each other. That's about the same as the joker who said he found another star's planets by computer enhancement of that star's light in October, 1984.

That's in the same league as NASA, who alleges that Houston could discriminate the microscopic Apollo capsule from the Moon's surface when the lunar Lander was descending and was less than 9,000 feet of altitude from the Moon's surface. Not only that, but NASA supposedly had time to check out the orbit, and then decide whether their run for the surface was "Go" or "No-Go". All this at the end of a distance related 2.6 second radio delay in the transmission loop.

- Our experts make miracles for us, the uninitiated, everyday. They make megabuck Gravity Detectors and then gawk in amazement when they detect an exploding giant star or a super nova inverting to a black hole in syncopation with half of Earth's sidereal day.

Neither the gravity wave nor the graviton created by supernovas or giant collapsing exploding stars has ever been detected by the philosophers. Silly theories create stupid results! Why are they trying to prove Relativity by negating the very principle they seek to prove? If mass can move faster than the speed of light, then there is no sense to the Weber gravity detector. If not, then these "giant" stars must be awfully small.

If attractive gravity worked, Rene's Balls would pull each other into contact. As it is now, they will all probably wind up pinned against the eastern rim. I don't know why, but the Lamont-Douherly people, perched on the Palisades in New York, report this type of behavior from objects floated in the caves they have dug under the cliffs.

- The fact that the tides are antipodal precludes attractive gravity despite the mathematical magic that shows anti-gravity. The tidal patterns of diurnal, semi-diurnal and quasi-diurnal tides add to the confusion. If the tides in these northern latitudes follow a 6 hour and 15 minute period, how can we be sure that the perfect tide, said to be

exactly 45 degrees behind the Moon's passage, isn't 45 degrees **before** the Moon's passage? In this case it would be a repulsive tide.

Why are tides in a tropical well at their lowest when the moon is directly overhead? How do the Newtonian apologists explain the fact that during an eclipse the highest tides are always delayed for a few days?

The tidal predictions themselves are not calculated but empirically predicted from past records. Why is the tide for Tahiti and some of the other mid-Pacific islands always high at midnight? What about the zero tides that are found in the Mediterranean Sea? This leads me to think that tides may be more the result of a wobble in the Earth than derived from Sun and Moon. They surely doubled in height during the 70's along the central New Jersey coast.

- The reason why spring scales were shunned for years was because they are sensitive to forces we do not understand. Why did the experts denigrate the scales instead of the theory of gravity?

What causes the anomalous effects that the torsion pendulum scientists are recording during solar eclipses? Why is it that not one of them has the balls either to answer my letters or declare gravity to be a fig-Newton of his imagination?

Why was Dr. Brush so hounded 70 years ago when he reported anomalies in free fall experiments? I proposed to the NSF to hang a really long vacuum drop tube from the side of a building and I was told they already knew everything about gravity. This is "open minded" science at work?

Why was Scripps Institute funded in 1990 to do the experiment I had suggested to the NSF in 1987? Why did the great scientist in charge of that experiment never answer my letter? Did the NSF fund this as I suspect? The Navy was involved and as far as I know only the NSF can call out the Navy for science. Or is it naval intelligence that activates both?

Why do my mine-shaft calculations not agree with attractive gravity? Why should that portion of mass above you not count if gravity is a natural law as we have been told?

- After all the ages the up and down merry-go-round motion of the Moon's Saros cycle should have settled out if only Sun and Earth pull at it.

Why should my "Unproof" still stand after six years of angry and desperate attacks if it is fallacious? A material body should have no choice but to go with the flow and obey the strongest force. Since the solar pull is much stronger, why isn't our Moon lost to us every month? Either the law of gravity is erroneous or the laws of motion are not true. Pick one! But you can't have both.

If the sinousoidal Moon concept is true then the definition of rotation must be changed. And even if true, both Earth and Moon cannot be "always concave to the Sun" as is claimed in the astronomy texts. And if true, why are the rings of Jupiter and Saturn photographed as rings and not long wavy snakes? Please remember that for 2,000 years

those same texts written by the "wisemen" said that the universe revolved about the Earth. Do you believe in an accident free "cross the X race" where each car has no steering wheels or brakes and some of the cars are going in the wrong direction? If not, then you must reject their sinuousoidal moon concept.

- If Newton edited his "Principia", and he had 20 years to do so, why didn't he edit out his erroneous values? Was he a man who would use whatever was handy to prove his point of the moment? Wouldn't that make him the unprincipled liar that I believe him to be? So much of his work has been found in error over the years that all that is left are the equatorial bulge and gravity and I have destroyed them.

The most confusing thing about his work is that he denied that gravity was an innate property of mass. He claimed that thought to be an absurdity. Why did he leave completely unanswered what he thought gravity to be? He also based his gravity on the false assumption that the Moon obeyed Kepler's law in the form it was then.

- I believe gravity to be no more than the attraction and repulsion exhibited by immense magnitudes of electricity. Alternate attraction and repulsion would help to explain the Saros cycle and the dance of the orbiting moonlets and ring particles. Repulsion would better explain the observed tides because it is a known fact that falling water is repelled by a static field.

The Sun generates an incredible charge at a phenomenal voltage. This must affect celestial mechanics to some degree but our philosophers have absolutely proven for 300 years that only gravity counts. Why is it so impossible for them to see that electricity **must** play a part?

An astronomer went looking for a new planet on the basis of barely measurable perturbations in another planet's orbit. Damn, if one wasn't finally found. It was nowhere near where it was supposed to be, nor did the technician who actually found it get the credit, but that's what class war is all about.

Someday, another Newton is going to come along and supply us with calculations that prove that both rotation and revolution, and the planetary and lunar tethers, are electrical. Space is not resistive to electrical currents. Perhaps a pure vacuum is, but not once ions begin to surge. I would not at all be surprised to find a healthy electrical charge on our planet despite the fact that to satisfy the tether force needed there must be a great discrepancy between the Earth's charge and the Sun's. However, I'm sure that the force needed will be found much less than now thought because I believe our Earth's official 'density' to be much too high.

- There is also something very wrong with our basic electric theory! If electrons traveled easier in atoms that are closer together (metals), then why does compression of the air so greatly increase the electrical resistance?

The René Two Leaf Electro-Scope proves that what we think of the attraction and repulsion of static charges is not true. Why have I been totally unsuccessful in getting it retested? Do they so fear the truth because their entire career hangs on their omniscience? Open minded thinking and the scientific method can't hold a candle compared to

a flame like that burning their asses.

All the Physics books need rewriting and the René Two Leaf Electro-scope proves Coloumb's statement should be revised to read, "Only identical charges, no matter the polarity, repel. All other charges attract." Physicists, rewrite the goddamn books!

- Would a single mylar balloon hooked to a manometer show an increase in internal pressure when strongly charged? Each particle should repel the next and something should happen to the surface of that balloon and be reflected by internal pressure. It's hard to imagine strain without stress. Perhaps it would even decrease the pressure, but a sensitive manometer should show some change.

Would two differently charged balloons, one internal to the other, show a compression of the inner balloon under the strain of a differential charge? If it did, wouldn't this be a demonstration of electric gravity?

- Doesn't my electro-scope show that particle physicists know not whereof they speak? How can you use high intensity electro-static fields to test particles if you are not aware that the electro-static law itself needs modification?

Oh Great Particle-Philosophers, how can you tell us that some basic particles twinkle in and out of existence when you don't even know if they are being attracted or repelled during the nano-pico second of their brief existence?

So much of what we believe true in cosmology is based on Einstein's Relativity. But what truth can there be in Relativity if time after time, astronomers who conduct honest observations, unlike Eddington, cannot find his gravitationally bent light.

- The propeller plane time dilation experiment was ridiculous. Clocks flown zig-zag in different aircraft, at different ground speeds, unsure of their position is not the way to prove anything. Satellite clocks in equatorial and polar orbits would give us the truth. But again, the philosophers don't want to hear any truth different from the truth in their physics Bibles.

Time and time again the astronomical philosophers were forced to revise Hubble's constant to save the "Law" of Relativity. Each time a bigger telescope enabled us see further, we found that Hubble's law was allowing a few more galaxies to exceed the speed of light. Solution, decrease Hubble's constant. Isn't a reduction of 90 percent a bit much?

His constant is based on the assumption that light doesn't tire no matter the distance. Perhaps it does and I reiterate that Michelson and Morley did not test to find if the speed of light was a constant. Our philosophers have read into their results what they wanted to see there.

The René constant of tired light uses the same observable facts and shows that light gets tired and that galactic velocities may not be anywhere in the ranges we think they are. The galaxies themselves are no longer physically being driven apart by the Big Bang. In fact, if they are then we would have to be back at the center of things, as shown by René's exploding balls. An observer in the center of an explosion would see all the balls

moving away and show those the farthest away to have the fastest velocity.

- Because Newton convinced us that our Earth was so massive, those who followed believed our magnetism was integral to a core of magnetic iron. We lost the magnet but kept the iron. Now, of course, our core is thought to be liquid iron surrounded by high density liquid stone. The problem with all this theory is that the only liquid stone we can find is that extruded from volcanoes, and all of that forms relatively light material like pumice. If the Earth is as old as they say, and it was once liquid as they say, then the cooling rate is extremely slow and counter balanced by just the right quantity of radioactive heat. Why is it that we can exactly maintain the 175 mile thick crust? Isn't this a very precarious thermal balance, at best controlled by a gentle, loving, uniformitarian God? A little more heat and the surface melts a little less and the core would freeze into a solid.

- How could our rocks support themselves unless gravity was mostly a surface effect? Rocks that we see at the bases of tall cliffs should explode outward at the top of a hammer because of the tremendous loads they support. In fact, since rocks are not at all malleable, any brisant explosion such as miners or hard rock tunnel men create should bring down incredible amounts of rock on cliff faces. Why doesn't this happen?

- Our sky is fluorescent, which can be proven by attaching a black paper tube to a light meter. This electrical ionization of our atmosphere also gives the sky its blue temperature color and must drive some of the atoms to tremendous heats for it to show blue. The blue of the sky deepens from horizon to zenith because less atmosphere equals less florescence. This in turn proves that tremendous quantities of electricity must bombard our Earth. In addition, the oceans as they flow through our magnetic lines of force must generate even more electricity and conduct it into the ground.

- I believe that ground electricity, not magma, is the cause of vulcanism. The experts laugh but Pete Ross created an electric volcano. Can they? Can the professors that taught them do it? Our artificial volcano transmuted elements and gave off excess heat. Can any of them do that without the emission of deadly radiation? How unfortunate that no expert ever agreed to come and see it done while Pete was alive.

Most volcanic explosions are so powerful that steam must be ruled out as the prime cause. How do you reintroduce water into the volcanic chamber (boiler) without a high pressure pump? How can steam, with a limit of 3200 psi, blast rocks hundreds of miles without the benefit of a rifled barrel? How are the static electric and magnetic phenomena associated with volcanoes to be explained if volcanoes are not primarily an electric phenomena?

- How can the philosophers explain the maps of Piri Ris and Finneus that show Antarctica's river valleys and mountain ranges which are now buried under a mile or two of ice? They claim the first to be a fraud and the second they ignore. Original copies of the Finneus map have been in libraries for centuries, so any claims of fraud in that direction are ludicrous. The very least that these two maps prove is one of the three following points:

1. The ice is not very old.
2. There are friendly aliens about ... or more likely,

3. The Earth has "Rolled-Over", creating new poles.

- The human race painfully gains knowledge and then just as painfully loses it. The 1,000 mile long ancient Chinese canal was not done by guess and by God as some Mensans, totally ignorant of construction, have claimed to me. It was executed with malice aforethought using sophisticated leveling devices, at least rudimentary trigonometry and not only knowledge that the world was a sphere, but also a knowledge of the approximate diameter.

In Sacsayhuaman, Peru a carved monolithic stone pyramid is buried up-side-down. It weighs over 40 million pounds and was quarried over 200 miles away. There it sits and our philosophers ignore it. Hell, they don't even want to tell you about few stones of red granite in the great Pyramid that weigh over 100 tons apiece. Do you still believe that a stone this size was hauled up a ramp?

Cyclopean ruins are found on every continent and are called antei-deluvian structures, meaning that they were built before the "mythical" flood. Immense stone structures are even found on certain Pacific islands. Some sit on basalt arranged as a crib, and then there are basaltic roads that lead into the ocean.

Our experts fail to explain Tiahuanaco sitting there two miles above sea level. Do they actually think it was built there? And if so, how did the sharks and sea horses get into Lake Titicaca? Or do they think that the pre-Incans were so enthralled at the idea of swimming in ice cold water with sharks that bite that they built the city as a spa?

They can't even explain how we lost the knowledge of electricity over the past two millennia. The Near East had batteries and the Far East made aluminum. In both west and east platinum jewelry has been found, and very high heats are required to work this element into jewelry.

- Our geo-philosophers tell us that the magnetic poles reverse their polarity from time to time. The Earth has only one shorted turn in its coil, and to toggle the magnetic poles it would need the kind of ground current that boggles the mind. Where would they get it from in a uniformitarian universe? Once again they believe in magic while preaching against it.

I would bet that if paleo-magnetic core samples were oriented prior to their removal, they would show that the old poles had a random orientation. Wouldn't this prove that our planet does "Roll-Over" rather than that the poles magnetic fields reversed?

- This leads us to so-called Ice Ages. Our experts believe in periods of world wide glaciation that at times grows ice clear down to the equator. They must believe because the same evidence that they find in temperate zones exists in equatorial regions. I too, believe in Ice Ages. The Antarctic ice age is on right now. There is always an Ice Age occurring where ever the poles happen to be.

Then they would have us believe in anti ice ages ("interglacial peroids") so warm, that elephant type creatures could be fed during a 6 month night by the profusion of grasses, bushes and trees grown in the now tropical climate of the polar regions. On again, off

again, Ice Ages would have to occur with their incredible shifts of temperature in both the formerly torrid tropics and the formerly frozen poles.

What they have never provided was a believable mechanism for this process, but they all wind up with a drop in the planetary temperature. They all fail to take into account that glaciers require a heat pump. The more widespread the ice, the larger the heat pump that is needed to evaporate and transport the prodigious amounts of water that will form the ice.

In their zeal to be politically correct, "open-minded" scientists, they fail even to acknowledge that only growing ice caps can calve ice bergs. Yet they tell us that we are now in the beginning stages of a hot house effect.

The popular philosophical opinion about the rising oceans is to blame it on melting polar caps. If this were true then the Antarctic beaches the Russians mapped in the early 1800s would be again exposed. The most probable cause is that the oceans have expanded due to less than a degree temperature change. A more logical cause would be the great number of active volcanoes that lie under the Pacific. Unfortunately this heat will prime the polar heat pump and pile up even more ice.

- If we re-examine what are considered absolute proofs of ice ages, we see that moving water also produces similar, if not exactly the same results. Erratic boulders were more likely carried by tidal waves that reached to the sky. Waves like these would carry more boulders, bigger boulders, faster and further than any sheet of ice. The only proof of ice ages are the depressed basins that dot the globe. The newest one to be formed lies under the Antarctica ice sheet.

Until a few short years ago the expert water-philosophers denied both the existence of giant storm waves and giant tidal waves. Then the Lituyo Bay glacier dropped a berg into its sound which drove a giant wave, a third of a mile high, (1720 feet) onto the far shore, sweeping away a forest. And it did it in front of witnesses. Can you imagine the size of the wave it would take to over run an entire continent? A wave so tall and broad that when it finally collapses it is in the middle of a continent, it begins to selectively drop the sweepings of its travels. First it lets go of the giant boulders, then the smaller rocks, then the carcasses it has created in its journey and last of all, the plant life.

Coal, anyone? Pile up a forest and cover it with dirt. Oil? Dump all the fish from a sea into a basin and cover with sand. Bone caves? Let the shattered carcasses swirl into a cave. Anything is possible when the Earth twists under its oceans at the equatorial rotational speed of 1000 mph.

- We have been told by some anonymous genius that a temperature drop of only two degrees would start the next Ice Age. We would lose more of our already precarious food supply, but even were it to get cold enough for the oceans to freeze, there would be no world wide glaciation. No heat pump, no ice sheets. Have you ever heard of a Siberian Glacier?

Despite Carl Sagan's pessimistic pronouncements about the hot house effect, it has been growing colder for the last thousand years. Want to try growing oranges in South Caro-

lina? The people in their tourist information centers did not know the area's history. Nor did the people in Pensacola's Historical society who failed to provide me with the requested information on the presence of manatees before the turn of the century. Or maybe you think you will see a gator in the "old muddy" near St. Louis next summer?

I'll bet you that Carl Sagan wouldn't put a dime on the chances of the survival of young gators if a breeding pair were put back into the Dismal Swamp in Virginia! How about it Carl, want to go down to the Florida Panhandle coast and count manatees next summer? Should we wait a few years for your global warming effect to melt the Greenland ice cap enough to free the buried airplanes without digging and blasting for them?

- Before you laugh at HAB's theory as I once did, turn a world globe upside-down and take a long look at Antarctica. You will see that the center of the ice mass is greatly eccentric to the center of rotation; 5,000,000 square miles of ice up to two miles deep is a tremendous unbalancing force on a spinning planet. Without an equatorial bulge the only question left to ponder is, how strong are the Rene' Bearings?

HAB believed that we were in the closing moments of this epoch. He believed this because each epoch is only about 3500 years long, and this one has lasted over 7,000 years so far. I don't know what to believe about that, but I do believe that the Earth does "Roll-Over", at fairly frequent intervals, producing the catastrophe that suspends the normal processes of erosion and decay, and leaving behind fossils in the rocks plus even impressions of rain drops, small animal tracks and jelly fish. And when it happens the magnetosphere collapses and lets the deadly radiation of space pour onto whatever sections of the Earth are in daylight.

Few people live through this catastrophe, and those that do revert to tiny tribes of uneducated and uncivilized nomads trying desperately to eke out survival in caves. They will stay in them only until conditions improve. Go ask a spelunker what it's like to make a camp in a cold, damp cave.

Because our Earth periodically "Rolls-Over", this does not mean that an additional astronomical catastrophe is impossible. To this day no one really knows what hit Siberia in 1908. These are natural disasters over which we have absolutely no control. However, there are three more world wide disasters that will try to overwhelm us in the next decade. We already discussed the population problem which AIDS may well ameliorate to some degree. Ameliorate hell! It may do the whole job and wipe out humanity first and human beings second. I have heard that it genetically alters the make-up of the cells, and if that's true there can be no cure. If pushed hard enough we lose our humanity so that human beings may survive.

- The next disaster is called atomic energy, and we were lied to right from the very beginning of the atomic age. Where are the cadmium control rods we were promised? What happened to the cadmium spears to disembowel the atomic beastie when it got fractious? Not if, when? And why did we create death pits from hell that hold a hundred tons of fuel when we were led to believe the reactors would be much smaller? Where is the scientific solution to the problem of the atomic beastie's deadly crap that we were promised fifty years ago? A half century of empty promises from death wishing, controlling, moronic bastards that now dare to propose the Breeder Reactor as a solution?

I truly believe that the regular uranium fuel rods are just batteries that have been created and charged with their deadly energy by the use of coal, water power and oil. If this process were so economically feasible, why does the TVA still use most of the coal mined in the world after almost 50 years of production? If the fuel rods weren't so heavily subsidized we wouldn't have an atomic industry would we, Slick? But because everything is so secret we will never find out, will we Slick?

Why is it, Slick, that everything is still locked up behind the secrecy act of World War II? With every country bigger than my home town of Paterson, NJ operating an experimental reactor, is it any wonder why I say that the only secret left is to keep us bumpkins uninformed.

Accident after accident has racked the industry on a world wide basis. Some of them have resulted in disasters and most were swept under the rug. I also wonder if the big power companies don't have small secret reactors hidden in big buildings on their grounds and maybe even a few big reactors that we haven't been told about yet.

- I have been told that all the power generating reactors in this country are "Boiling Water" types. They are constructed of reinforced concrete built into the shape of a right cylinder with a diameter of about 40 feet and a height of at least 30 feet. Separating the "boiling water" from the concrete is a stainless steel liner that is at least 2 inches thick. They are supposed to have an operating pressure of 560 psi which would load the walls and flat end caps with 80,640 pounds per square foot.

The total pressure trying to separate walls and end caps is over 100 million pounds. Unfortunately, the reactor's stainless steel liner carries little or none of these loads because it is on the inside of the pit leaving only the ferro-concrete to resist these tremendous tensile forces. All tensile loads in this composite material are carried by the steel construction re-bars whose design loads are limited to 20,000 pounds per square inch.

The end caps must resist these loads while acting as a flat plate. The ends cannot be dome shaped because the control rods must be continually moved in and out of the pile. If two intersecting steel beams were used to restrain this load, each would have a bending moment of 3 trillion inch pounds, which would require a section modulus of 150,000 to restrain. No such beam is made.

If we use 4 intersecting beams, the load on each beam is only 25 million pounds, which gives a bending moment of 1.5 trillion, requiring a section modulus of only 75,000. Again there is no such beam. In fact the largest stock beam made is 48 inches, deep 22 inches wide, and weighs 1000 pounds per foot, and this beam's section modulus is only 20,000.

All of this leads me to believe that the true operating pressure of the reactor pit is less than 10 psi. This pressure would be more in line with the name, "Boiling Water". Since the steam turbines which actually turn the generators would be incredibly inefficient at this pressure, the low pressure steam must enter a very large heat converter and heat the water that is returning from the turbines. However, since you can't get either more heat nor a higher temperature from an exchanger, this water must then go to a "pony boiler" where conventional fuels jack the pressure to the 560 psi that the turbines require.

With steam there is a pressure to temperature ratio that is constant. The temperature of steam at 560 psi is 479° F. Add the normal atmospheric pressure of 14.7 psi and we get a water temperature of 482° F. Water at 10 psi has a temperature of 240° F and holds only about a third of the energy that it does at 482° F. This means that the conventional fuel provides the other two thirds of the BTU of these power plants. This is an incredible price to pay for poisoning the planet with radioactive wastes for which no one has yet solved the waste disposal problem.

- I also wonder, Slick, if you have secret reactors hidden near major population centers. I can't help but question where the Linden, NJ, power pipe got the 946 megawatts that was being sucked into New York City just before the famous blackout of 1976. Is there a reactor hidden near there? A small reactor? Perhaps near Keasbey?

The Martin's Creek power plant is located just across the Delaware River from Belvidere, NJ. The sign at their entrance proclaims them to be a conventional fuel plant. However, for some obscure reason they built two humongous cooling towers of the type that symbolizes atomic power plants.

The reason that these towers are needed in atomic plants is to allow the reactors a place to spill an amazing amount of heat in a very short time. If a conventional plant gets a little too hot, the safety valves lift, venting the steam to the air and the fuel is instantly shut down. The very nature of the atomic beast called a reactor is that it is always precariously perched on the edge of disaster.

Why would any company put up expensive atomic style cooling tower unless they were running a reactor or planning to run one very soon? Are they fooling you, Slick? Or are you fooling us again?

When you ship the "used" fuel rods, don't the trucks carry little radiation cards and sneak down the highways in the middle of the night? My guess is they carry three drivers and extra fuel tanks and never stop rolling until they reach their destination. Why is that, if everything is so safe? I have been told by a very bitter atomic engineer dying of cancer in New York City that each rod must be entombed in a thick lead coffin and that despite that protection, a motorcyclist tooling by in the opposite direction at 60 miles an hour sustains a small dose. What are the truck drivers getting? How about the civilian cars that drive behind that truck for an hour or so?

If this industry is so safe, why hasn't the Price-Anderson act been revoked? Is it because you know that there is not enough money left in this bleeding, gut-wounded country to pay for a Chernobyl-type accident? And why does the insurance industry absolutely refuse to insure against any damage from any sort of nuclear accident? Price-Anderson's limit of 560 million is peanuts should a Chernobyl-type accident happen up-wind from a major population center. The people who lived would probably wind up with pennies on the dollar, and that's before they paid their attorney.

- Each time you insert a new fuel rod you create a thousand pounds of long lived radioactive materials that simply did not exist before. Each time a little accident forces a plant to vent to air or ground, a little more long lived radiation is added to the environment. Contrary to what the assholes who feed us propaganda say, we are creating

immense amounts of radioactive materials that were not originally stored in mother Earth.

Each time a TMI, Chernobyl, Windscale, Kasli or Chelyabinsk blows up more land and sea is contaminated. That contamination enters more deeply into the food chain, further increasing each of our personal intakes of radio-nuclides. The charts of permissible radiation are all based on external exposure and allow at least a hundred times the true permissible exposure. But when a particle is ingested or inhaled there is no permissible limit.

Right then and there you are 100 % guaranteed a cancerous future. That particle doesn't even have to originate on your continent. A piece of plutonium ash falls on your face during a rain storm and you lick your lips.

The real leaders of this and every country are the heads of old line of super-rich families of international, non-Christian bankers who have no allegiance to any country. They are not the political figureheads we love to hate. What really scares the hell out of me is that these people, our moneyed nobility, are so stupid that they are believing their own atomic propaganda.

Hey guys, listen up, no matter how many billions you have scattered out all over the world, no matter how much food and water you have squirreled away for you, your family and your descendants, you have to be told:

“THERE AIN'T NO PLACE TO HIDE!”

And that also goes for their paid flunkys, the academics and professional scientists who suck up to them. You created this mess and you must finally accept responsibility for it and help straighten it out.

And always remember that ... **you are entitled to believe anything that you want. However, remember that when observational data or experiment conflicts with a theory, no matter how beautiful the theory or how impressive the credentials of its author, a rational person pitches out the theory.**

THE MENSA WAR

In '84 I began to write a column for the local North New Jersey local monthly Mensa newsletter, "*Imprint*". I titled it "*One Man's Opinion*", specifically to disconnect my opinions from both Mensa and the newsletter. From the very first column normally liberal-minded, laid-back, Mensans responded with cheers and jeers; the jeers emanating from a vociferous minority. This pattern repeated with many of my subsequent columns. It took almost three years for me to ascertain that I aroused emotions because I was trampling on society's religious, social and scientific sacred cows. I finally came to understand that "knee-jerk" reactions were prompted by the human operating system, which I named the Emotional Belief System (**EBS**).

On March 19, 1987, I made a significant scientific discovery which I call my "Unproof" of gravity. We moved to Florida and in 1989, I created a series of lectures based on scientific anomalies and certain scientific discoveries I had made over the years. I prepared 12 lectures which I began to giving on a monthly basis to the local Fort Myers area Mensan group.

The first three lectures were presented to an increasingly hostile audience. All the local Mensa officials came to the second and third lectures specifically to shout me down. They used personal attacks while they sat in my living room noshing on the goodies and slurping the soft drinks I had provided. It turned out that even Mensans want to hear the same old fairy tales.

I next decided to transcribe my lectures into a non-fiction book which I self-published. I felt that sooner or later my book would start a ruckus, but I thought that some mediocre minded physics professor, from Jerkwater U, would lead the attack. I never dreamed that it would be Ralph G. Rudolph, the then Chairman of American Mensa.

We had previously corresponded when he wrote a column asking for input on Mensa's national monthly magazine, "*The Bulletin*". Back in 1985, this magazine had agreed to print a sequential series of three articles I had written. They printed two but failed to print the last, which contained the conclusion. Because of this broken promise I sought the Chairman's help. I sent him copies and he became progressively critical of my work while resorting to authority to prove me wrong. Resorting to authority is not scientific. I decided to end the acrimony by sending him a friendly fairy tale about René, the fool who heard, and followed a different drummer.

In February, 1990, I mailed 100 complimentary copies of my book to various people including Rudolph. I also sent checks for ads promoting the book to various Mensa publications.

In March I received a phone call from Mensa headquarters telling me that the ad for the national "*Bulletin*" could not be accepted because I hadn't sent in my dues during the previous four months. The fact that Mensa had already deposited my check for the ad 3 weeks before, or that my membership would not expire until March, 31 made no difference. In addition, non-members are allowed to purchase ads in the "*Bulletin*".

THE ORION EXPERIMENT

History

By the late 1500s enough of the Earth had been charted to show that the northern hemisphere contained most of the land mass. The scientists of the time believed that there must be an immense land mass hidden in the southern oceans to maintain the Earth's rotational stability. This hypothetical continent was called Antarctica.

The maps by the end of the 1600s, showed that no matter how massive Antarctica might be, even if it existed, that it would still be too small to balance the northern land masses. Since something was providing rotational stability they theorized that the Earth must have a significant equatorial bulge. Issac Newton in his "*Principia*" eventually "proved" that the radial bulge was **17.1** miles. Today's accepted figure has been reduced to **13.2** miles.

My Interest

I first learned of the Equatorial Bulge when I was a **15** year old high school student. The thought that both bedrock and ocean were piled up to a height of over **13** miles on the equator was fantastic. A few years later I turned over a world globe and saw that all the seas and oceans were hydraulically linked. In that instant the concept of this huge bulge lost all its credibility.

Science claims that the centrifugal force from Earth's rotation warped the molten rocks and that it now holds the miles of water on the equator. As a drop of water from the polar ocean migrates to the equator the force of gravity on the drop beneath it must increase. As that drop reaches the equatorial sea the centrifugal force on it increases and force of gravity upon it must decrease. This process allows the next drop an even easier passage. All the available water from all the seas and oceans should now lie on the equator. What is it that prevents this from happening?

Twenty-five years later, I studied celestial navigation and found that the angle of elevation observed by a sextant sight needed a number of corrections applied before it was usable. The *Nautical Almanac* contains several tables with these corrections. There is a correction for dip. The amount depends of the height of your eye above sea level. At **1** meter it is **1.8** minutes of arc and at **155** feet it is **12.1** minutes. The correction for refraction can be as high as **5.3** minutes at very low elevation sights and decreases to zero if the object sighted is above **81°**. There is also a temperature and pressure correction which begins at **- 6.9** to **+ 6.9** minutes at low elevations and then rapidly decreases to **.1** minute of arc at shots of **50°** in elevation. Above this, there is no correction.

However, the most surprising thing is that there is no correction for the Equatorial Bulge. And even more surprising is the fact that navigators usually work to a quarter of a mile accuracy no matter which stars they use or where they are on this Earth when they take the sights..

With the advent of GPS (Global Positioning Systems) every place on Earth should have needed map adjustments of **3** to **5** nautical miles (**3.5** to **5.75** statute miles) but that didn't happen. Our Northeast coast which was surveyed two hundred years ago stayed the same.

Not too long ago I created a glass U-tube which I filled with water. I then mounted it vertically on a **45** rpm turn table with one leg in the center of rotation so that the centrifugal force in the outer

leg was equal to that of the Earth's equator. I discovered that the 3 dynes of calculated force raised the water level so slightly that it was imperceptible to the naked eye. Then we are told that this same 3 dynes holds up 13 miles of rock and water.

1987

In the spring of this year, I realized that all star locations are set in a spherical sky and are measured from the pole and this figure is subtracted from 90° and the result is their declination (latitude). If the Earth was also a perfect sphere then the central angle would absolutely define the latitude. However, if the Earth is not a perfect sphere because of the Equatorial bulge I saw that I could use the stars to determine the shift in latitude that must exist. Because of that I also saw that this shift in latitude must be accompanied by an increase in the radius of the small circle of latitude. This increase at each latitude must also comprise some proportional part of the difference found at the equator between the polar and equatorial radii.

The René Method

I finally saw that this was not a complex problem but one that could be solved by plane trigonometry. In the northern hemisphere all the stars, when they pass your longitude (meridian) are both at the peak of their elevation and are directly south. By setting up an observation site whose position was located using a survey grade GPS (Geophysical Positioning System) I could measure the elevation of bright stars with a one second arc theodolite as they culminate. Because of this, the chosen site must provide a clear view of the southern sky.

The Star Select Program

Before you can observe you need to know which of the stars will pass on your meridian on the night you chose and during the hours that you intend to observe. You need to print out the selected stars, the time that they will cross your meridian and the rest of the important data. Your program must also select only those stars bright enough to be easily seen and those whose declinations (latitudes) show that when they cross the meridian they will be higher in elevation than 20° , so that they can be seen over trees and shrubs, and under 60° so that they may be comfortably observed. All of this data must be accurately and selectively copied from the current *Astronomical Almanac* into the program's data bank.

The '97 *Astronomical* and *Nautical Almanacs* contain all the information needed but I had to sort them and copy the data on 32 stars to the data bank. The computer program I wrote prints the information and time of meridian passing for a chosen date at each location. Naturally the year ran out before we could do the sights necessitating purchasing the new editions of both almanacs.

1997

My great thought for the year was to contact several manufacturers of survey gear to see if they would loan me this equipment. **Topcon** Inc. agreed to locate my site and lend me the theodolite. On the cold clear night of **February 21, 1998** I was fortunate enough to get professional surveyor, Juan Almonte, and his helper, Jose DeLeon, to volunteer to operate this modern and very complex instrument to observe the selected star's elevations.

RADIUS OF EARTH GRS80

Latitude (°)	Radius (km.)	Latitude (°)	Radius (km.)
90	6356.752	40	6369.275
85	6356.914	35	6371.078
80	6357.394	30	6372.771
75	6358.178	25	6374.302
70	6359.242	20	6375.624
65	6360.556	15	6376.698
60	6362.078	10	6377.489
55	6363.764	05	6377.974
50	6365.562	00	6378.137
45	6367.418		

According to the **GRS80** ellipsoidal Earth reference the (Polar radius) $AP = AB' = 6356.752$ km. and the (Equatorial radius) $AD' = 6378.137$ km. The difference (total bulge) $DD' = AD' - AP = 6378.137 - 6356.752 = 21.385$ km.

Assuming a spherical Earth, with this information, and the use of triangle I of the Earth's Side View A below, we can calculate both the radius of the spherical small circle of latitude (AC) and the distance of this plane from the equatorial plane (BC) = $(B'C)$ '.

$$AC = \text{Cos } 40 \times AB = \text{Cos } 40 \times 6356.752 = 4869.554 \text{ km.}$$

$$BC = \text{Sin } 40 \times AB = \text{Sin } 40 \times 6356.752 = 4086.041 \text{ km.}$$

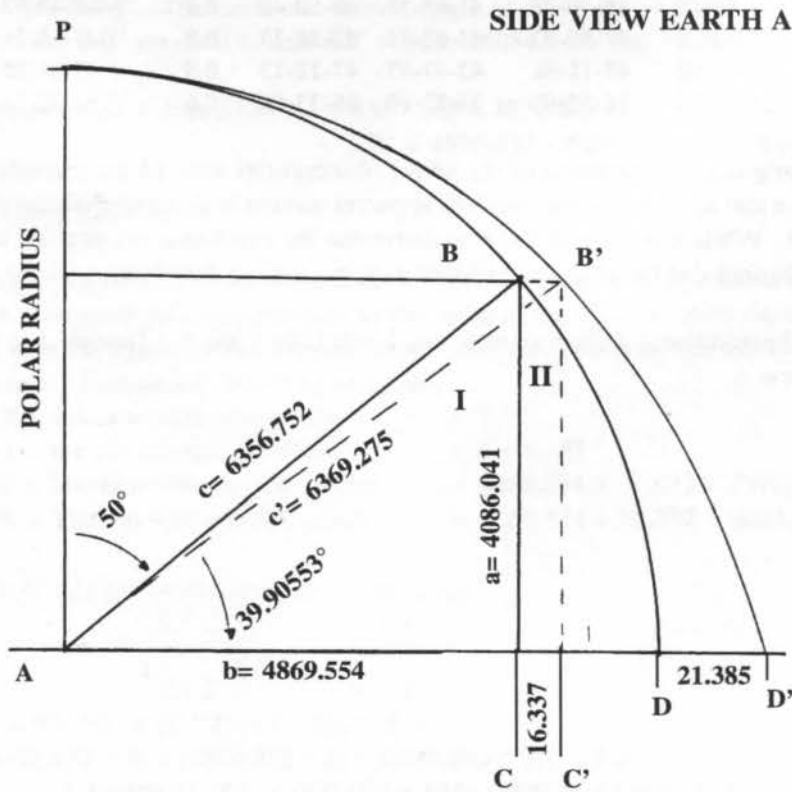

The geodetic radius of **6369.275** km. is chosen from the line marked the 40th latitude on the preceding GRS80 chart. Using triangle II we can find the new central angle B'AC'.

$$\begin{aligned} \sin B'AC' &= 4086.041 / 6369.275 = 39.905533^\circ \text{ therefore angle } BAB' = \\ &40 - 39.905533 = .09446^\circ \times 60 = \text{therefore angle } BAB' = 5.667 \text{ minutes of arc.} \end{aligned}$$

This is the amount of displacement of the latitude which should be subtracted from each stars elevation.

Now we need to calculate AC' to determine BB' which is the radial increase. AC' =

$$\begin{aligned} \cos BAC' \times AB' &= \cos 39.905533 \times 6369.275 = \\ &4885.891 \text{ km. therefore } BB' \text{ (the additional radius) =} \\ &AC' - AC = 4885.891 - 4869.554 = 16.337 \text{ km.} \end{aligned}$$

The observation site was in Surgent Park, Clifton, NJ and the site location determined by survey grade GPS is **40.867741667** N latitude by **74.190508333** W longitude.

Although every star that passes your zenith can be used, I chose only the six brightest stars of Orion because I didn't need an astronomer to pick them out.

TABLE OF RESULTS

Star (d-m-s)	Cal Colat (d-m-s)	Cal ElOb. (d-m-s)	Colat (d-m-s)	Ob. Elv (d-m-s)	R+T&P (-m)	Cor Elv d-m-s)	Dif. (arc s)
Rigel	49-04-34	40-55-26	49-03-35	40-56-25	1.2	40-55-13	13
Belletr	34-31-22	55-28-38	34-30-55	55-29-05	0.7	55-28-23	15
1852	41-10-22	48-49-38	41-09-20	48-50-40	0.8	48-49-52	14
Alnilam	42-04-28	47-55-32	42-03-43	47-56-17	0.8	47-55-29	03
Alnitak	42-48-58	47-11-58	42-47-47	47-12-13	0.8	47-11-25	33
Betelg	33-27-52	56-32-08	33-27-10	56-32-50	0.6	56-32-14	06

The average angular displacement of the above observations was **14** arc seconds which equals **.003888°**. As a star approaches the zenith its apparent motion is almost horizontal for an extended period of time. While it is often difficult to determine the exact moment of peak, this is compensated for by the fact that the change in altitude is very small at that time.

To solve for the additional radius we must use Earth Side View B. Triangle 1 is the same as in Earth Side View A.

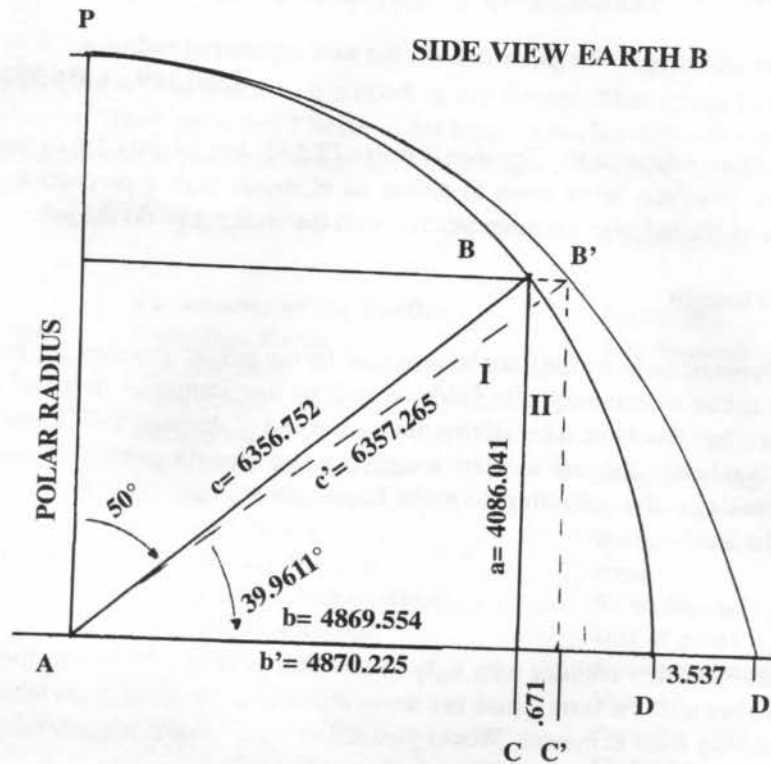

This time we know by observation that our decrease in angle is equal to 14 seconds which is = $14 / 3600 = .0038888^\circ$. Therefore our central angle of triangle 2 is $B'AC' = 40 - .0038888 = 39.9961111^\circ$. For BB' we need to find AB' which = $4086.041 / \sin 39.99611 = 6357.265$ km.

Now we calculate $AC' = \cos 39.99611 \times 6357.265 = 4870.225$ km.
 $BB' = 4870.225 - 4869.554 = .671$ km.

The New Equatorial Radius

Since the bulge was created by the centrifugal force of our rotation it is probable that the bulge of each latitude is in someway proportionate to the bulge at the equator. And since the centrifugal force varies as to the square of the distance from the center of rotation this will involve the squaring of these radii. I set up the following variables:

- 1. X = the new equatorial radius = ?
- 2. Y = the old equatorial radius = 6378.137
- 3. Z = The new 40th parallel radius = $4869.554 + .671 = 4870.225$
- 4. V = The old 40th parallel radius = $4869.554 + 16.337 = 4883.891$

A proportion of this nature can be obtained by using

$$\frac{X^2}{Z^2} = \frac{Y^2}{V^2}$$

therefore $X = \{(Y^2) \times (Z^2) / (V^2)\}^{.5} =$
 $\{(6378.137^2) \times (4870.225^2) / (4883.890^2)\}^{.5} =$
 $\{(40680631.590) \times (23719091.550) / (23852391.300)\}^{.5} =$
 $\{(40680631.590) \times (.994411472)\}^{.5} =$

$$(40453286.289)^{.5} = 6360.289 \text{ km.}$$

The new equatorial bulge = the polar radius - the new equatorial radius =
 $6360.289 - 6356.752 = 3.537 \text{ km.}$

According to this calculation the Equatorial Bulge (3.537) km. is only 1/6 of the accepted figure. Since I realize there are better ways to define an ellipsoid than a proportion, I leave the final determination of the bulge to a mathematician with the training to do the job.

A Heretical Thought

The Earth's dynamic stability may not be provided by the bulge. Perhaps our Earth is cradled and stabilized by subtle electro-magnetic fields created by that immense electrical generator we call our Sun. It is a fact that huge solar storms during the end of August, 1972 slowed our rotation. It is also a fact that before the year was out, something else brought us back up to speed. The forces involved in braking and accelerating the entire Earth is humongus. Where did all this energy come from if not the Sun?

Conclusion

When a beautiful theory collides with ugly observational facts it's time to throw out the theory. Would you rather trust the stars which are never anomalous or pendulums which always become anomalous during solar eclipses? Would you rather trust simple trigonometry in which I have never observed a flaw or theories which are always flawed?

I call on the US Coast & Geodetic people to verify my experiment. They have the people and the equipment. A five degree grid should be applied to the United States and each land intersection should be used as an observing site. I can furnish a star selection printout once I know the exact location, the probable date of observation and the time frame. These printouts are personalized as to location, date and time and I print out seven consecutive nights in case of delay.

I truly believe that had it been a bit warmer that night and had we a bit more help, that we would have obtained a displacement in the range of 3 or 4 arc seconds. This would mean that the Equatorial Bulge is even smaller than this experiment showed.

The old question about our rotational stability surfaces once again. Is 3.539 km. (or even less) sufficient to account for the rotational stability we have? And if not, what provides it? And if this force is not mechanical, are we perhaps cradled in space by the immense electrical fields created by the Sun? I suggest that we may not yet know everything.

* * * * *

On 10/1/98 similar papers were submitted to two science magazines, a few dozen Senators, Representatives, the NSF people and the US Geological survey. Few responded and those that did suggested peer review via science publication.

Catch 22!

GOOD BOOKS TO READ

I placed HAB's book first because his book is my Bible. That is not to say that his book is without error. They exist but I believe his basic theories to be of immense importance to our civilization and perhaps to our continued survival as a species.

Author	Title	Publisher
H.A. Brown	Cataclysms of the Earth	Freededeeds
William Corliss	Unknown Earth	The Sourcebook Project
	Ancient Man	
	Mysterious Universe	
	Incredible Life	
Milton Monson	Physics is Constipated	Monson Enterprises Inc.
I. Velikovsky	Worlds in Collision	Dell
Goffman & Tamplin	Poisoned Power	Rodale
Pringle & Spigelman	The Nuclear Barons	Avon
Kervran/Abehsera	Biological Transmutations	Swan House
Charles Fort	Fortean Prophecies	Out of print
Daniel Boorstin	The Discoverers	Random House
Jonathon Swift	Gulliver's Travels	Modern
Margaret Cheney	Tesla Man out of time	Prentice Hall
W. H. Peterson	Newton's Clock	Freeman
David Lindly	The End Of Physics	Basic Books
Peter McWilliams	Ain't Nobody's Business If You Do	Prelude Press
Norman Macbeth	Darwin Retried	Gambit
Broad & Wade	Betrayers of the Truth	Simon/Schuster
Cerf & Navinsky	The Experts Speak	Pantheon
J.& K. Collier	VoteScam - The Stealing of America	Victoria House Press
Des Griffen	Decent Into Slavery	Emmissary Publications
René	NASA Mooned America!	Self Published

INDEX

- Abu Simbel- 132
 Agassiz, Louis- 5, 44
 Antarctica- 12, 49, 52, 129, 130, 131, 164, 165, 166
 Antikythera- 131
 Aristotle- 64
 Atomic clocks- 101, 102
 Bagdad Museum, 133
 Bernardi- 44
 Boorstin, Daniel- 15
 Brahe, Tycho- 3, 4, 78, 86
 Brown, Hugh Achincloss (HAB)- 27, 43, 44, 51, 52, 53, 69, 89, 90, 116, 167
 Bruno, Giordano- 3, 4
 Brush, Charles- 64, 105, 161
 Burroughs, Captain- 131
 Cassini- 17, 21, 24
 Cavendish- 36, 37, 38, 72
 Chelyabinsk- 169
 Chernobyl, 149, 150, 152, 154, 155, 169
 Chow Chu- 133
 Maxwell, Clark- 103
 Cochocton, 137
 Cook, John- 17
 Copernicus- 2, 4, 5
 Coulomb- 35, 36, 92, 93, 94, 162
 Curie point- 144
 Cyclopean structures- 132
 Cyert, Richard- 94
 Demirkopru, Turkey- 136
 Eddington- 104, 105
 Einstein- 32, 33, 43, 68, 74, 101, 102, 103, 104, 105, 106, 109, 111, 139, 157, 163
 Elephant- 45, 48, 53, 54
 Emotional Belief System (EBS)- 1, 5, 8, 43, 94, 143, 162
 Epicycle- 3, 4
 Equatorial bulge- 12, 17, 127, 128
 Eratosthenes- 2, 6
 Faraday- 15, 43
 Fermi- 157
 Finneus, Ortoneus- 52, 130, 131, 164
 Galileo- 4, 13, 64, 65
 Giants- 137
 Gibbs, Josiah- 74, 103, 140
 Gilbert, William- 119
 Greenland- 47, 49, 52
 Hadley, MA- 135
 Alfvén, Hannes- 112
 Haveen- 3, 4
 Hooke- 36, 62
 Hubble, 74, 109, 163
 International Geophysical Year (IGY)- 12, 13, 117, 129
 Irondale, MO- 136
 Kepler- 4, 5, 86, 87, 88, 162
 Kasli, Russia- 151
 Krisocki, Steve- 111
 Kubon, Glen- 134, 135
 Lambert, Walter B.- 64
 Lamont-Douherty- 144, 160
 La Place- 11
 Lituyo Bay- 50
 Lorentz-Fitzgerald- 101, 102
 Luther, Martin- 3
 Lyle, Charles- 5
 Malden & Raratonga- 132
 Mammoth- 45, 53
 Marconi- 89
 Mastodon- 54, 136
 Michelson & Morley- 18, 101, 103, 111, 163,
 Michell, John- 35
 Milton Monson- 106
 Newton, Issac- 5, 13, 14, 17, 19, 20, 21, 22, 24, 35, 37, 38, 40, 41, 57, 58, 62, 63, 64, 69, 70, 72, 73, 74, 83, 101, 105, 115, 119, 160, 161, 163
 Paluxy River- 134
 Lowell, Percival- 162
 Pigmies- 137
 Piri Reis- 52, 129, 130
 Ponape- 132
 Price-Anderson- 169
 Principia- 83, 88
 Ptolemy- 2, 3, 5, 6, 33, 78
 Pyramid- 165
 Red shift- 109, 111, 112
 Relativity, General- 101, 104, 105, 109
 Relativity, Special- 102, 103
 Rene's Balls- 160
 Rene' Bearings- 159, 167
 Rene' Two Leaf Electro-Scope- 92, 93, 94, 95, 162, 163
 Roll-Over, 11, 27, 30, 43, 44, 47, 50, 51, 52, 53, 129, 130, 143, 144, 167
 Ross, Pete- 120, 121, 122, 156
 Sacsayhuaman- 131, 165
 Sagan, Carl- 166
 Salsburg- 134
 Saqqara- 133
 Saros cycle- 66
 Savannah- 156
 Scripps Institute- 65
 Steinmetz- 157
 Suez Canal- 131
 SWUs- 149
 Sziliard, Leo- 157
 Tahiti- 61, 160
 Tambough, Clyde- 162
 Te Lapa- 117
 Teller, Edward- 156
 Tesla, Nikola- 6, 89, 90, 105, 157
 Texcoco- 136
 Three Mile Island (TMI), 149, 150, 151, 154, 169
 Tiahuanca, 132, 165
 Titicaca- 165
 Titanic- 132
 Tonga-Tabu- 132
 TVA- 149
 Vail, OR- 135
 Velikovsky, Immanuel- 69, 89, 90, 145
 Waneta, IL- 136
 Weber, Joseph- 32, 33, 35
 Windscale- 150, 151, 169
 Wright, Wilbur & Orville- 7
 Wilkes, Charles- 12