

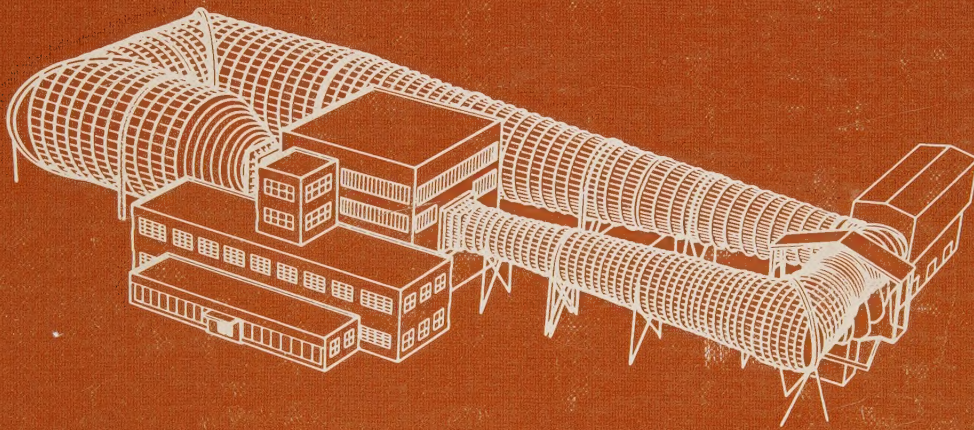

Wind Tunnels of NASA



NATIONAL AERONAUTICS AND SPACE ADMINISTRATION



Digitized by the Internet Archive
in 2022 with funding from
Kahle/Austin Foundation

<https://archive.org/details/windtunnelsofnas0000dona>

Wind Tunnels of NASA

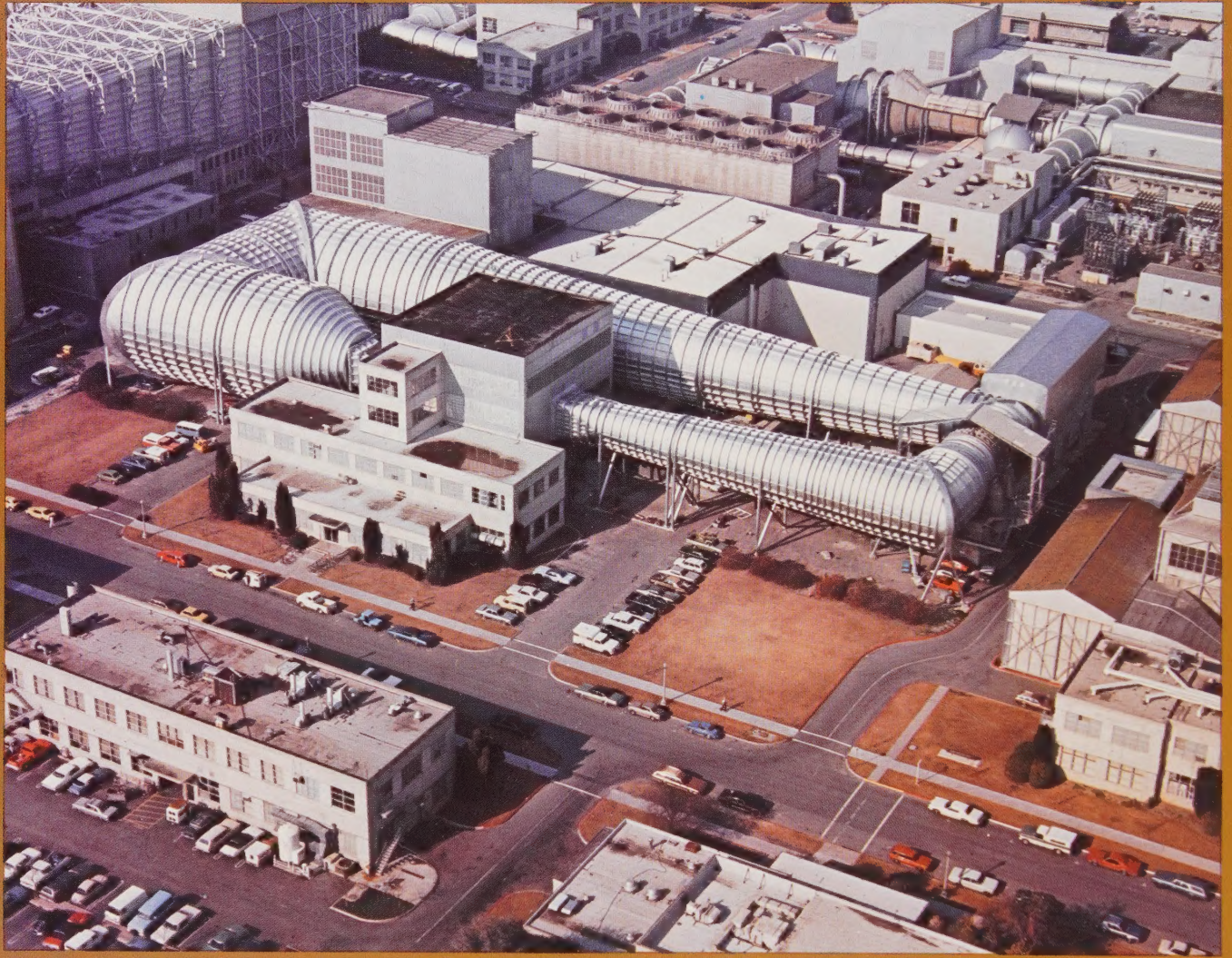

Wind Tunnels of NASA

Donald D. Baals and William R. Corliss

PROPERTY OF
CLACKAMAS COMMUNITY COLLEGE
WITHDRAWN
LIBRARY



Scientific and Technical Information Branch

NATIONAL AERONAUTICS AND SPACE ADMINISTRATION

Washington, D.C.

1981

Library of Congress Cataloging in Publication Data

Baals, Donald D.

Wind tunnels of NASA.

(NASA SP ; 440)

Includes index.

Supt. of Docs. no.: NAS 1.21:440

1. Wind tunnels. I. Corliss, William R. II. Title.

III. Series.

TL567.W5B2

629.134'52

81-607811

AACR2

Foreword

Although wind tunnels are among the most important tools of aeronautical research, these facilities have remained the least understood. Some say this is partly because the instrumentation and calibration are complicated and difficult to understand and partly because the researchers that use wind tunnels too often speak in language intended for their peers and invented for their particular disciplines. Whatever the reason, this book goes a long way toward bridging the gap between engineer and layman. *Wind Tunnels of NASA* is both factual and readable.

By no means an inventory of wind tunnels, the book does not even contain a complete listing of current facilities—that being one element in its readability. The purpose of the book is to describe the contribution of these remarkable research facilities to the science of flight. What the text deals with are topics such as these: Why are wind tunnels useful? What do they do superbly well, and how? What have they done that is so great? How did they develop, and what forms did this development take? What are their typical problems and limitations? What are the pitfalls in scaling, calibration, and instrumentation? Are there unexpected surprises when one goes from tunnels to full-size aircraft? Where are we now in wind tunnel research? *Wind Tunnels* answers these questions very well.

NASA's wind tunnels form the basis for the book, but Air Force, university, and industry facilities are also considered and the wind tunnels of other countries are assessed to some extent.

The photographs used in the book contribute significantly to one's level of understanding. A person viewing a modern wind tunnel for the first time sees a huge, ungainly warehouse-like structure of unexpected corners and jointed appendages having no architectural merit. From above, however, wind tunnels take on a different appearance. To some

they resemble huge worms attempting to hide in blockhouses. Indeed, the structures are often so large that they can be viewed in their entirety only from the air, and the best photographs are obtained from helicopters. Only in these overhead views do the corners and appendages achieve a purposeful unity. Photos taken inside the tunnels, showing engineers and their models at work, are often more revealing and instructive, although here, too, much is perplexing to the untrained eye.

Through a happy combination of text and pictures the book dispels much puzzlement. It also demonstrates that wind tunnels are truly individual and unique in function and suggests the quality of service they have given to the nation's technological advances in aerospace.

Wind Tunnels of NASA is co-authored by an aeronautical engineer with more than 40 years of NASA wind tunnel expertise and by a highly respected engineering and science writer. Donald D. Baals has been with NASA and its predecessor, the National Advisory Committee for Aeronautics (NACA), since 1939 and has continued to serve the agency as a senior research associate since retirement. Among his many honors have been the NASA Medal for Exceptional Service (1971) and the NASA Public Service Award (1976) for his role in planning the National Transonic Facility. Mr. Baals lives in Newport News, Virginia.

William R. Corliss, a science publisher and freelance author, has written a number of publications for NASA, including *The Interplanetary Pioneers* and *NASA Sounding Rockets*. He lives in Glen Arm, Maryland.

WILLIAM S. AIKEN, JR.
Office of Aeronautics and Space Technology
National Aeronautics and
Space Administration

Frontispiece: The 16-foot wind tunnel at Ames Research Center.

Opposite Ch. 1: Sketch of the Wright brothers' 1901 wind tunnel.

Opposite Ch. 2: The variable density tunnel at Langley Field, March 15, 1929.

Opposite Ch. 3: Interior view of the Langley full-scale tunnel.

Opposite Ch. 4: Turning vanes in the Langley 16-foot high-speed tunnel.

Opposite Ch. 5: The Ames 6 × 6-foot supersonic wind tunnel with supporting facilities.

Opposite Ch. 6: The "bugle" of the Langley 9 × 6-foot thermal structures tunnel.

Opposite Ch. 7: The Langley V/STOL wind tunnel flanked by the model preparation shop.

Opposite Ch. 8: The National Transonic Facility under construction at Langley in 1979.

Contents

Chapter 1. Whirling Arms and the First Wind Tunnels	1
Chapter 2. A Heritage Lost and Regained	9
Chapter 3. Through the Barnstorming Days to World War II	19
Chapter 4. Propellers to Jets: The Impetus of World War II	31
Chapter 5. The Era of High-Speed Flight	49
Chapter 6. Wind Tunnels in the Space Age	75
Chapter 7. The Post-Sputnik Renaissance of Aeronautics	101
Chapter 8. The Wind Tunnels of the Future	123
Afterword	149
Index	151

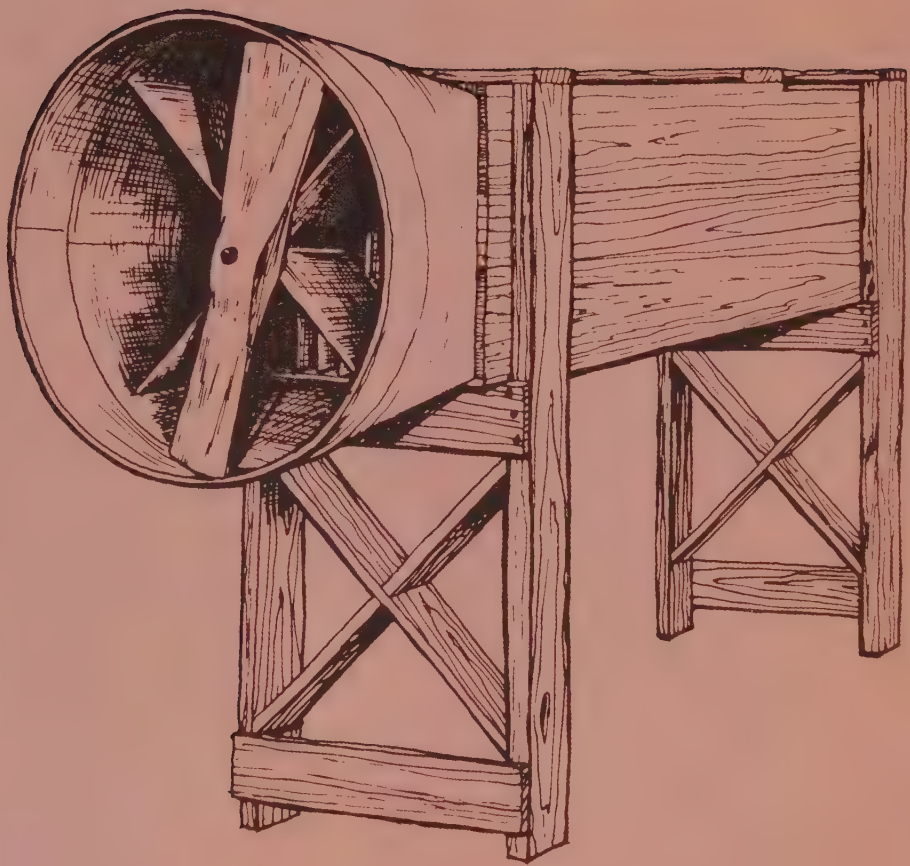

Chapter 1

Whirling Arms and the First Wind Tunnels

The would-be aeronauts of the nineteenth century closely studied the flight of birds and began building flying machines patterned after avian structures. Their birdlike craft failed miserably. They quickly realized that in reality they knew nothing about the lift and drag forces acting on surfaces cutting through the atmosphere. To fly, man first had to understand the flow of air over aircraft surfaces. This meant that he had to build instrumented laboratories in which wings, fuselages, and control surfaces could be tested under controlled conditions. Thus it is not surprising that the first wind tunnel was built a full 30 years before the Wrights' success at Kitty Hawk.

The wind tunnel is indispensable to the development of modern aircraft. Today no aeronautical engineer would contemplate committing an advanced aircraft design to flight without first measuring its lift and drag properties and its stability and controllability in a wind tunnel. Tunnel tests first, free-flight tests later, is the proper order of things.

On the End of a Whirling Arm

The utility of the wind tunnel is obvious today, but it was not the first aerodynamic test device. Early experimenters realized that they needed a machine to replace nature's capricious winds with a steady, controllable flow of air. They recognized, as Leonardo da Vinci and Isaac Newton had before them, that they could either move their test model through the air at the required velocity or they could blow the air past a stationary model. Both approaches were employed in the early days of aeronautics.

First, relatively steady natural wind sources were searched out. Models were mounted above wind-swept ridges and in the mouths of blowing caves. Even here, the perversity of nature finally forced experi-

menters to turn to various mechanical schemes for moving their test models through still air. The simplest and cheapest contrivance for moving models at high speeds was the whirling arm—a sort of aeronautical centrifuge.

Benjamin Robins (1707–1751), a brilliant English mathematician, was the first to employ a whirling arm. His first machine had an arm 4 feet long. Spun by a falling weight acting on a pulley and spindle arrangement, the arm tip reached velocities of only a few feet per second.

Robins mounted various blunt shapes—pyramids, oblong plates, etc.—on the arm tip and spun them in different orientations. He concluded that “all the theories of resistance hitherto established are extremely defective.” Different shapes, even though they presented the same area to the airstream, did not always have the same air resistance or drag. The manifestly complex relationship between drag, model shape, model orientation, and air velocity defied the simple theory propounded earlier by Newton and made ground testing of aircraft all the more important to the infant science of flight.

Sir George Cayley (1773–1857) also used a whirling arm to measure the drag and lift of various airfoils. His whirling arm was 5 feet long and attained tip speeds between 10 and 20 feet per second. Armed with test data from the arm, Cayley built a small glider that is believed to have been the first successful heavier-than-air vehicle in history. In 1804 Cayley built and flew an unmanned glider with a wing area of 200 square feet. By 1852 he had a triplane glider design that incorporated many features of modern aircraft, but manned, powered aircraft were still half a century away.

Although Cayley performed many aerodynamic experiments and designed precocious airplane models,

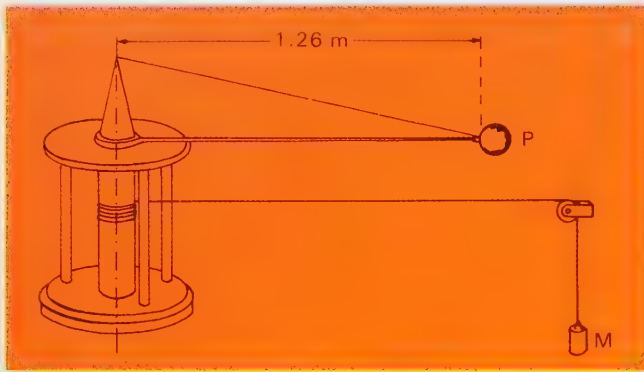

Benjamin Robins, the British mathematician, proved that air resistance was a critical factor in the flight of projectiles in 1746. His apparatus consisted of a whirling arm device in which weight (M) turned a drum and rotated the test object (P).

his major contribution to flight was one of design philosophy. Before Cayley, would-be aeronauts believed that the propulsion system should generate *both* lift and forward motion at the same time, as birds and helicopters do. Cayley said, "Make a surface support a given weight by the application of power to the resistance of air." In other words, use an engine to create forward motion and let the motion develop lift via the wings. This separation of propulsion and lift functions, simple though it sounds, was a revolutionary change in the way people thought about aircraft. One need not build planes with flapping wings! A whole new horizon in aircraft design opened up.

Looking for Something Better

The whirling arm provided most of the systematic aerodynamic data gathered up to the end of the nineteenth century. Its flaws, however, did not go unnoticed. Test results were adversely influenced as the arm's eggbeater action set all the air in the vicinity in rotary motion. Aircraft models on the end of an arm in effect flew into their own wakes. With so much turbulence, experimenters could not determine the true relative velocity between the model and air. Furthermore, it was extremely difficult to mount instruments and measure the small forces exerted on the model when it was spinning at high speeds. Something better was needed.

That something better was a "wind tunnel." This utterly simple device consists of an enclosed passage through which air is driven by a fan or any appropriate *drive system*. The heart of the wind tunnel is the *test section*, in which a scale *model* is supported in a carefully *controlled airstream*, which produces a flow of air about the model, duplicating that of the full-scale aircraft. The aerodynamic characteristics of the model and its flow field are directly measured by appropriate balances and *test instrumentation*. The wind tunnel, although it appears in myriad forms, always retains the five identifying elements italicized above. The wind tunnel's great capacity for controlled, systematic testing quickly rendered the whirling arm obsolete.

The unique role and capabilities of a wind tunnel can best be appreciated by recognizing the aerody-

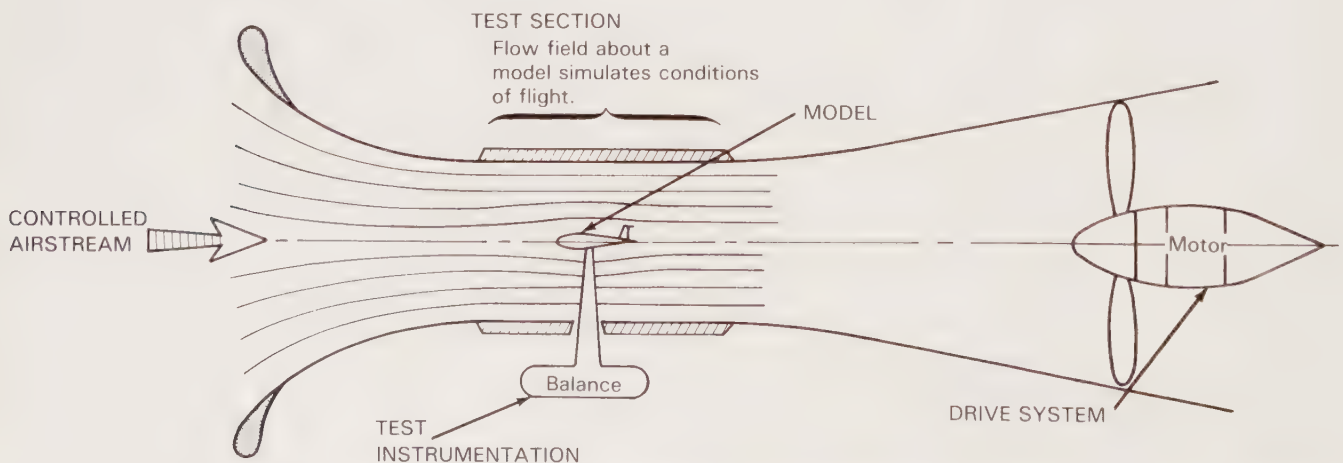

To test the flight characteristics of an aircraft without actually flying it, aerodynamicists mount a model of the plane in a wind tunnel. Fans set up a flow of air that simulates flight through the atmosphere under the desired conditions. The lift forces and air resistance (drag) can be measured by instruments attached to the model. By changing the model's angle of attack and orientation, stability and controllability can be assessed.

dynamic forces and moments acting on an aircraft in flight. The three basic forces are *lift*, *drag*, and *side force* as measured in an axis system referenced to the direction of flight of the aircraft. The drag force is along (but reversed to) the flight path; the lift and side forces are at right angles to it. In a wind tunnel, the axial centerline of the test section defines the direction of the oncoming wind—the aerodynamic equivalent of the flight path. The ease of measuring aerodynamic forces relative to the tunnel axis on a model held stationary in the airstream opened a new era in aerodynamic experimentation.

Frank H. Wenham (1824–1908), a Council Member of the Aeronautical Society of Great Britain, is generally credited with designing and operating the first wind tunnel in 1871. Wenham had tried a whirling arm, but his unhappy experiences impelled him to urge the Council to raise funds to build a wind tunnel. In Wenham's words, it "had a trunk 12 feet long and 18 inches square, to direct the current horizontally, and in parallel course." A fan-blower upstream of the model, driven by a steam engine, propelled air down the tube to the model.

Wenham mounted various shapes in the tunnel, measuring the lift and drag forces created by the air rushing by. For such a simple experiment, the results were of great significance to aeronautics. Wenham and his colleagues were astounded to find that, at low angles of incidence, the lift-to-drag ratios of test surfaces could be surprisingly high—roughly 5 at a 15 degree angle of attack. Newton's aerodynamic theories were much less optimistic. With such high lift-to-drag ratios, wings could support substantial loads, making powered flight seem much more attainable than previously thought possible. These researches also revealed the effect of what is now called aspect ratio: long, narrow wings, like those on modern gliders, provided much more lift than stubby wings with the same areas. The wind tunnel idea was already paying off handsomely.

With the advent of the wind tunnel, aerodynamicists finally began to understand the factors that controlled lift and drag, but they were still nagged by the question of model scale. Can the experimental results obtained with a one-tenth scale model be applied to the real, full-sized aircraft? Almost all wind tunnel tests were and still are performed with scale models because wind tunnels capable of handling full-sized aircraft are simply too expensive.

In a classic set of experiments, Osborne Reynolds (1842–1912) of the University of Manchester demon-

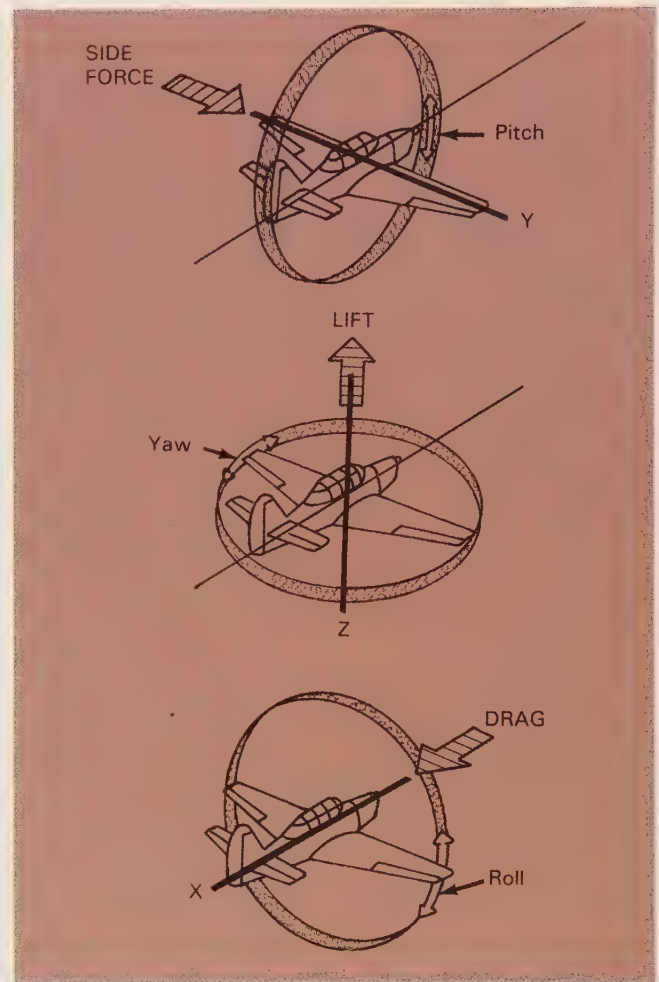

The three basic forces acting on an airplane are lift, drag, and side force. The airplane is capable of three basic movements: pitch, yaw, and roll.

strated that the airflow pattern over a scale model *would be the same* for the full-scale vehicle if a certain flow parameter were the same in both cases. This factor, now known as the Reynolds number, is a basic parameter in the description of all fluid-flow situations, including the shapes of flow patterns, the ease of heat transfer, and the onset of turbulence.

Flight Before Flying

It is easy to invent a flying machine; more difficult to build one; to make it fly is everything.

Otto Lilienthal

Otto Lilienthal (1848–1896) has been called the world's first true aviator. Although he built no powered aircraft, his hang gliders made him world

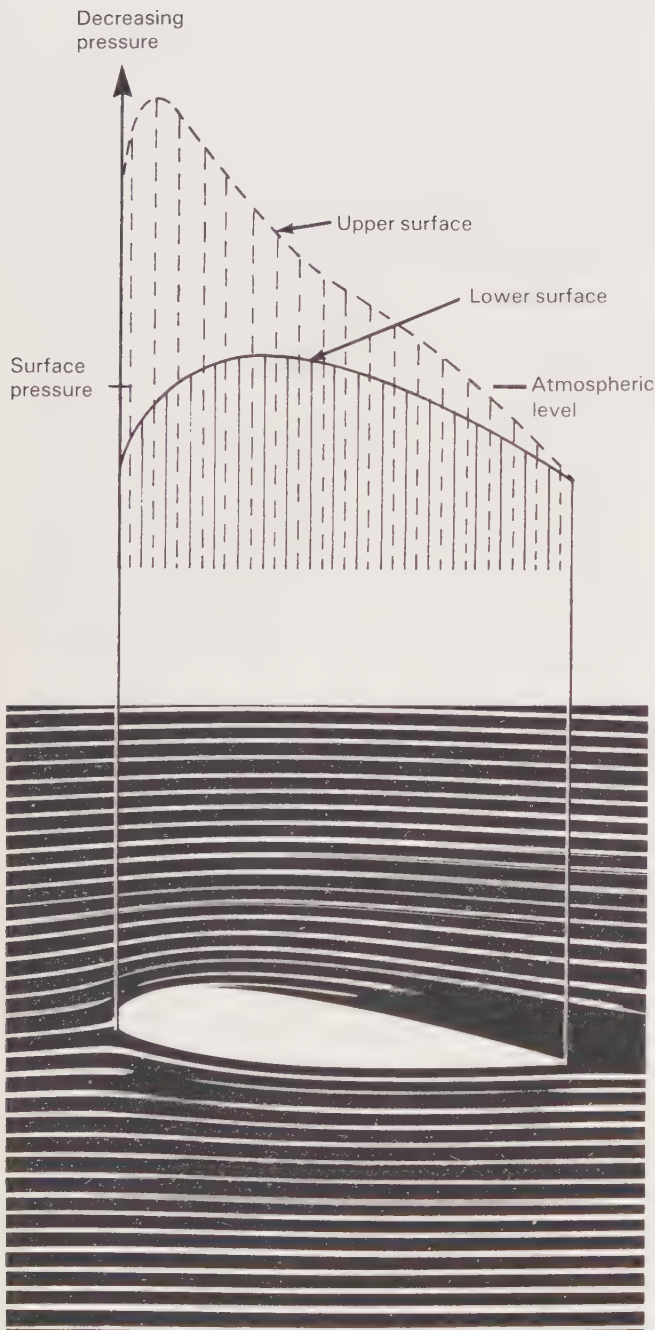

A wing generates lift by deflecting a mass of air downward, producing an upward reaction force on the wing in accord with Newton's third law of motion. The downward turning of air is shown graphically by the streamlines around the wing. The lifting force can be calculated by measuring the mass of airflow affected by the wing and the downward component of velocity added to it. The lifting force can also be obtained by integrating air pressure along the top of the wing and subtracting it from that along the bottom of the wing. The net lifting force for the wing of a modern jet transport is about 150 pounds per square foot.

famous and generated great enthusiasm for manned flight. Starting in 1891, Lilienthal flew—actually glided—over 2500 times, covering 270 yards in his longest attempt. He amassed more air time than all his predecessors combined.

Lilienthal's hang glider experiments were preceded by his whirling arm tests of various lifting surfaces. Between 1866 and 1889 he built several whirling arms, ranging from 6-1/2 to 23 feet in diameter. On the basis of these tests, he concluded incorrectly that flight using flat airfoils was definitely impossible. He turned next to cambered surfaces. Even here, his test data were discouraging with respect to powered flight. Undaunted by his pessimistic lab results, Lilienthal could not resist trying to fly. And he really did fly in the sense that he could control his glider's course over long distances. He lacked only an engine and propeller.

In stark contrast to the delicate birdlike gliders of Lilienthal was the steam-driven Goliath of Sir Hiram Maxim (1840–1916). An American living in England, Maxim had made a fortune with his famous machine gun. His goal in aeronautics was powered, manned flight. With considerable wealth behind him, he built large elaborate testing facilities and aircraft to match his immense aspirations.

Maxim first tested airfoils. His whirling arm was 64 feet in diameter, as befitted his brute force approach. The arm boasted elaborate instrumentation to measure lift, drag, and relative air velocity. A wind tunnel, however, was the main focus of Maxim's experimental work, and he built it in heroic dimensions. It was 12 feet long, with a test section 3 feet square. Twin coaxial fans mounted upstream and driven by a steam engine blew air into the test section at 50 miles per hour. The tunnel and whirling arm proved to Maxim that cambered airfoils provided the most lift with the least drag. He obtained a lift-to-drag ratio of 14 for a cambered airfoil at 4 degree angle of attack—a spectacular performance for the late 1800s. He was also the first to detect the effects of aerodynamic interference, where the total drag of a structure exceeded the sum of the drags of the individual components. He cautioned, therefore, that "the various members constituting the frame of a flying machine should not be placed in close proximity to each other."

Consistent with his no-nonsense philosophy, Maxim built an 8000-pound flying machine with a wing area of 4000 square feet. (The wing area of today's DC-10 is only 3550 square feet, but it supports an aircraft weight of 550 000 pounds.) Two

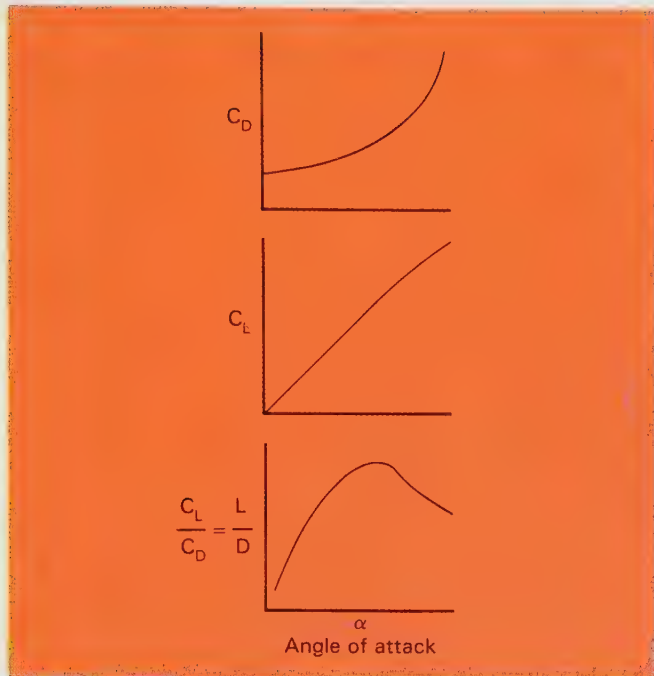

The curves show typical wind tunnel-derived values of the drag coefficient (C_D), the lift coefficient (C_L), and the lift-to-drag ratio (equal to C_L/C_D) as functions of the wing's angle of attack.

Early aerodynamicists had to develop a methodology for applying scale-model data to full-scale aircraft. Obviously, the drag forces depended on model size, air density, and airspeed. Newton showed that the aerodynamic force on a given shape (e.g., an aircraft at a given angle of attack) is directly proportional to the area (S), air density (ρ), and the square of the air velocity (V^2). In equation form: $D = C_D S \rho V^2$ where D is the drag force and C_D is a nondimensional drag coefficient determined experimentally from scale-model tests.

Drag coefficients obtained from wind tunnel tests can be used to predict the drag force on a full-scale aircraft by inserting in the equation the full-scale values of S , ρ , and V . Although there are recognized pitfalls in applying the drag equation, they can be circumvented, and this approach is used today to scale up wind tunnel test data to full-scale aircraft.

Newton showed that the term $(\frac{1}{2} \rho V^2)$ represented the energy of the air due to its motion. It is referred to as the "dynamic pressure." Throughout the modern world, the numerical value of the aerodynamic drag, lift, and other coefficients (C_D , C_L , et al.) is referenced to the dynamic pressure as follows:

$$D = C_D S (\frac{1}{2} \rho V^2)$$

180-horsepower steam engines turned propellers 17.8 feet in diameter. For 1894 this was a fantastic machine. It was propelled along a 2000-foot track that was designed to hold the craft down and keep it from actually flying. In a test, the aircraft developed so much lift that it tore loose from the test track and wrecked itself. Maxim considered the experiment a success and turned his attention elsewhere.

The scene shifted to America. Samuel P. Langley (1834–1906) was the first major aeronautical figure in the United States. Mathematician, astronomer, and Secretary of the Smithsonian Institution, Langley turned to aeronautics in 1886. Like his contemporaries, he began by assessing the performance of various airfoils. Langley built a whirling arm 60 feet in diameter that was spun by a 10-horsepower engine and was capable of attaining speeds of 100-mph. Langley covered much the same ground as Wenham, Maxim, and others. He was optimistic about powered flight, stating that "so far as mere power to sustain heavy bodies in the air by mechanical flight goes, such mechanical flight is possible with engines we now have."

Samuel Langley's whirling arm experiments were not without their frustrations. Located outdoors, the apparatus was frequently disturbed by winds and the self-created mass of air swirling around the arm. So annoying were Langley's problems that the Wright brothers, watching from Dayton, turned to the wind tunnel as their major test facility.

Langley is perhaps best known for the failures of his Aerodromes, but his highly successful unmanned, powered gliders have been slighted by many aeronautical historians. His late-model gliders were propelled by tiny 1-horsepower steam engines that carried them for distances up to $3/4$ mile. Langley believed that these flights proved the potential of manned, powered flight.

The Wright Brothers Put It All Together

Wilbur (1867–1912) and Orville (1871–1948) Wright, operating from the unlikely background of bicycle manufacturers, built their first flying machine in August 1899. It was a simple, 5-foot span, unmanned biplane kite rigged so that it could be maneuvered by twisting or warping the wings (somewhat like birds do for control). Kite tests led to the construction of their first unpowered manned glider in 1900. Twelve test flights with glider No. 1 proved

that their pitch and roll controls worked. The glider, however, was generating far less lift and more drag than they expected.

To find out why their first glider did not perform as predicted, the Wrights set up a remarkably simple experiment using *natural* winds to compare the relative lifting forces of flat and cambered surfaces. In effect, they built an aerodynamic balance that showed unequivocally which of two test airfoils developed more lift. This “wind tunnel without walls” confirmed the Wrights’ growing belief that the accepted aerodynamic design tables they were using were seriously in error.

Sobered by these revelations, the Wrights increased the wing area of glider No. 2 to 290 square feet. The initial trial flights at Kitty Hawk disappointed them still further. The highly cambered wings created pitching movements that could not be controlled. After several near disasters, airfoil curvature was reduced, and the craft behaved much better.

The Wrights returned to Dayton with mixed feelings. Glider No. 2 had flown, but, from the standpoint of their expectations, the 1901 Kitty Hawk tests were a disaster. Their morale sagged. “Having set out with absolute faith in the scientific data, we were driven to doubt one thing after another, till finally after two years of experimentation, we cast it all aside, and decided to rely entirely upon our own investigations.”

They began with a comprehensive series of experiments with a wide variety of airfoils. In the short span of 3 months these tests produced the basic data needed for building their 1902 glider and the powered aircraft to follow. During this short span of time, the Wrights leapfrogged other aerodynamicists the world over.

The first tests were exploratory and utilized an unconventional testing machine: a bicycle with a third wheel mounted horizontally on the front of the frame. Two test shapes were mounted on the wheel, and the bicycle was pedaled rapidly (up to 15 mph) up and down the streets of Dayton. The airfoil being tested would produce a torque in one direction, but this was counterbalanced by an opposite torque from a reference shape. The rotating balance was brought into equilibrium by changing the airfoil’s angle of attack. Data from the impromptu rig were crude, but they reinforced the Wrights’ decision to reject existing handbook data. They had to write their own handbook, and for that they needed a wind tunnel.

The first tunnel consisted of a square tube for channeling the air, a driving fan, and a two-element balance mounted in the airstream. One balance element was a calibrated plane surface; the other was a cambered test surface inclined at the same angle but in the opposite direction. When the wind tunnel was brought up to speed, the vane-type balance turned one way or the other, thereby indicating the relative lifting forces. The preliminary results from the makeshift tunnel were so encouraging that the Wrights immediately built a larger and more sophisticated facility with a 16-square-inch test section. Here they obtained the critical data they needed for their first manned, powered aircraft.

They did make one mistake—they installed the tunnel’s two-bladed fan upstream. Shields, screens, and a honeycomb grid did cut down the turbulence, but it was a curious lapse for the detail-conscious Wrights. Recognizing that their laboratory itself was the return path for the air rushing out of the tunnel test section at 25–35 mph, they forbade the moving of objects and people while taking data.



Working replica of the 1901 Wright brothers wind tunnel in the National Air and Space Museum. (Photo, National Air and Space Museum)

WHIRLING ARMS AND THE FIRST WIND TUNNELS

The heart of any successful wind tunnel is its balance system—the apparatus that measures the aerodynamic forces acting on the model. The Wrights built two balances—one for lift and a second for drag. The balances never measured actual forces; they simply compared test airfoils with reference airfoils or the forces on calibrated flat surfaces. This approach allowed the Wrights to rapidly pit one airfoil against another and select the best from many configurations.

The Wright brothers returned to Kitty Hawk in late summer 1902 to build glider No. 3. It was only slightly larger than the 1901 version, with a wing area of 305 square feet, a 32-foot wing span, and a weight of 116.5 pounds minus the pilot.

For straight-ahead gliding the craft worked well. The lift-to-drag ratio was approximately 8, a one-third increase over their earlier gliders. Pitch control was excellent, but turns were a problem. To turn, the plane had to be rolled in the direction of the turn. This was accomplished by warping the wings; that is, one wing panel would be twisted to increase the tip's angle of attack, while the other wing's panel would

be twisted in the opposite direction. The high wing, however, created excessive drag and tended to wheel the craft in a direction opposite from that intended. The addition of a rudder linked to the wing-warping control solved this problem.

The famous 1903 Wright Flyer followed the 1902 glider design closely, except for the addition of twin counterrotating propellers 8-1/2 feet in diameter driven by a 12-horsepower gasoline engine. Back again at Kitty Hawk, on the morning of December 17, 1903, with Orville at the controls, the Flyer headed into a 20-mph wind. After a short run of 40 feet, it rose into the air under its own power and flew for 120 feet. Three more flights were made that morning, with the longest lasting 59 seconds and covering 862 feet on the ground, or about 1/2 mile in the air. The Flyer was slightly damaged on the last landing, and before repairs could be made a gust of wind turned it over and destroyed it. It never flew again.

The historic Wright Flyer has been rebuilt and is now on display at the National Air and Space Museum in Washington, D.C.



The rebuilt Wright Flyer in the National Air and Space Museum. The Apollo 11 capsule is in the foreground and the Spirit of St. Louis overhead. (Photo, National Air and Space Museum)

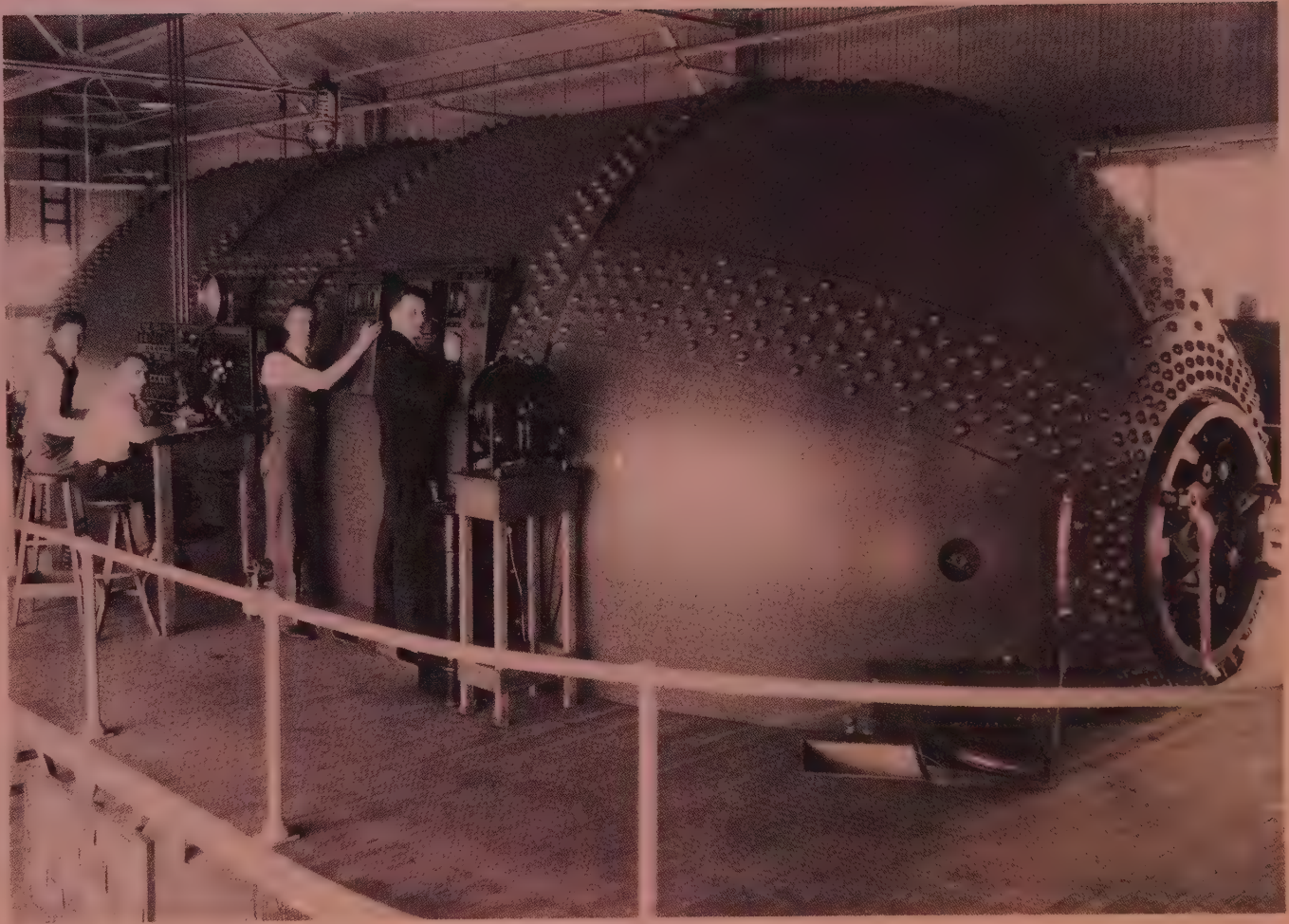

Chapter 2

A Heritage Lost and Regained

The Wright's success over the windswept dunes of Kitty Hawk was followed by a strange hiatus. Man had successfully flown in a powered machine; but the world said in effect, "So what?" If aircraft were merely mechanical diversions, wind tunnels were even less important.

However, events soon reversed this descent into the depths of indifference. Europe was restless and its countries quarrelsome. Military planners were plotting strategies for conflicts that seemed to draw closer every day. Then, in 1908, Wilbur Wright startled the European aviation community—to say nothing of the generals. At Le Mans, France, in August 1908, he demonstrated absolute mastery of the air with precise control of his Flyer. One flight lasted 1-1/2 hours. An occasional prestigious passenger was treated to a ride. The Wrights' barnstorming revolutionized Europe's thoughts on aviation. One Flyer passenger, Major B. F. S. Baden-Powell, president of the British Aeronautical Society, ventured "...that Wilbur Wright is in possession of a power which controls the fate of nations is beyond dispute."

While the United States government would not even purchase an off-the-shelf flying machine, European countries began to pour major resources into aeronautical development, including, by necessity, wind tunnels. Between 1903 and the start of World War I in 1914, the countries of Europe wrested technical leadership in aviation away from the United States. Centralized government-funded aeronautical laboratories were built in England, France, Germany, Italy, and Russia—but not in America. When the Great War began, France had 1400 military aircraft; Germany, 1000; Russia, 800; and Great Britain, 400. The U.S. flying machine inventory was 23.

The Wind Tunnel Comes of Age

The Europeans designed and built their aerial fleets with the help of at least a dozen major wind tunnels. In contrast, wind tunnel facilities in the United States

prior to World War I were almost nonexistent, as shown in the table. As might be expected, it was in Europe that many of the technical foundations for modern wind tunnels were laid.

Post-Wright Brothers Wind Tunnels

Date	Size	Individual	Location
1901	16 × 16 in.	Wright Bros.	Dayton, Ohio
1901	6 × 6 ft	Zahm	Catholic University, USA
1903	2 ft diameter	Stanton	National Physical Laboratory, England
1903	1 × 1 m	Crocco	Rome, Italy
1904	1.2 m diameter	Riabouchinsky	Koutchino, Moscow, Russia
1908	2 × 2 m	Prandtl	Göttingen, Germany
1909	1.5 m diameter	Eiffel	Champ de Mars, France
1910	4 × 4 ft		National Physical Laboratory, England
1912	7 × 7 ft		National Physical Laboratory, England
1912	2 m diameter	Eiffel	Auteuil, France
1912		Junkers	Aachen, Germany
1913	8 × 8 ft	Zahm	Washington Navy Yard, USA
1914	4 × 4 ft	Hunsaker	MIT, USA
1916	2.2 × 2.2 m	Prandtl	Göttingen, Germany
1917	5.5 ft diameter	Durand	Stanford University, USA
1917	7 ft diameter	Curtiss	Hempstead, New York, USA
1918	7 × 14 ft		National Physical Laboratory, England
1918	4.5 ft octagon		Bureau of Standards, USA
1919	4 × 4 ft	Ober	MIT, USA
1919	7.5 ft diameter	Durand	Stanford University, USA

An Earthbound American Aeronautical Pioneer

The first post-Wright wind tunnel laboratory dedicated to aeronautical research was built in America, despite what was just said about the lack of aeronautical interest in this country. Almost coincident with the Wrights' small developmental wind tunnel, Albert Zahm, a professor at Catholic University in Washington, D.C., began operating a wind tunnel with the unheard of test section dimensions of 6 × 6 feet. Who sponsored this tunnel? Not the U.S. government and not Catholic University, but a wealthy industrialist, Hugo Mattullath, who saw a commercial future in aviation far beyond the frail, almost ridiculous craft then straining to stay aloft for a few moments.

The Zahm facility was remarkable, not only because of its size but also by virtue of its unique methods of instrumentation, calibration, and application to aeronautical research. A test section 40 feet long and 6 feet square employed flow straighteners of honeycomb and cheesecloth to assure homogeneous flow. Zahm's ingenious pressure gages had sensitivities of a millionth of an atmosphere; that is, the pressure exerted by only 1/3 inch of air. With this impressive research facility, Zahm did pioneering work on the drag of dirigible hulls. Most important, he was the first to look closely at the drag losses due to

the friction of air flowing over aircraft surfaces. Contrary to the belief of Langley and most of his predecessors, Zahm demonstrated that skin friction was indeed a major element of drag at subsonic speeds.

The momentum of the Wrights, followed so closely by Zahm's important contributions (now almost forgotten), should have maintained U.S. leadership in aerodynamics despite official indifference. Unhappily, Mattullath died before he saw anything approaching practical commercial results. Without financial support, work ground to a halt at Zahm's tunnel. In 1908 it was closed down completely.

The European Tunnels

The wind tunnels built in Europe between the time of the flights at Kitty Hawk and the termination of World War I can be divided into two categories: (1) pioneering research facilities of modest proportions and (2) much larger tunnels engendered by military requirements.

Russia's first important wind tunnel was built in 1904 by D. Riabouchinsky, an eminent and well-to-do scientist. Using his own funds, he constructed a complete aerodynamic research laboratory at Koutchino, not far from Moscow. His wind tunnel's test section was a substantial 1.2 meters in diameter and possessed an upstream cylindrical hood to collimate and remove the turbulence from the airflow. Excellent technical data emanated from Riabouchinsky's laboratory until 1920.

In France, Gustave Eiffel, of Tower fame, also built a private aerodynamics laboratory with personal monies. Eiffel's interest in aerodynamics went back to the turn of the century, when he had dropped bodies of various shapes from his Tower to test air resistance. His 1909 wind tunnel on the Champ de Mars was 1.5 meters in diameter and of the open-jet type; that is, the return airflow was not channeled by special walls. Air jetting from a special nozzle was directed into the test section at speeds up to 20 meters per second and was routed back to the nozzle by the walls of the building rather than a separate return passage. Eiffel ran over 4000 tests in this rather primitive facility before he moved on to a larger, second-generation tunnel with higher air speeds.

In Göttingen, under the direction of the famed aerodynamicist Ludwig Prandtl, the world's first continuous-circuit, return-flow wind tunnel was put into operation in 1908. The high efficiency of this design,



Albert Zahm's "air tunnel" built at Catholic University, Washington, DC, in 1901 with funds from an industrial sponsor. (Courtesy University of Notre Dame Archives)

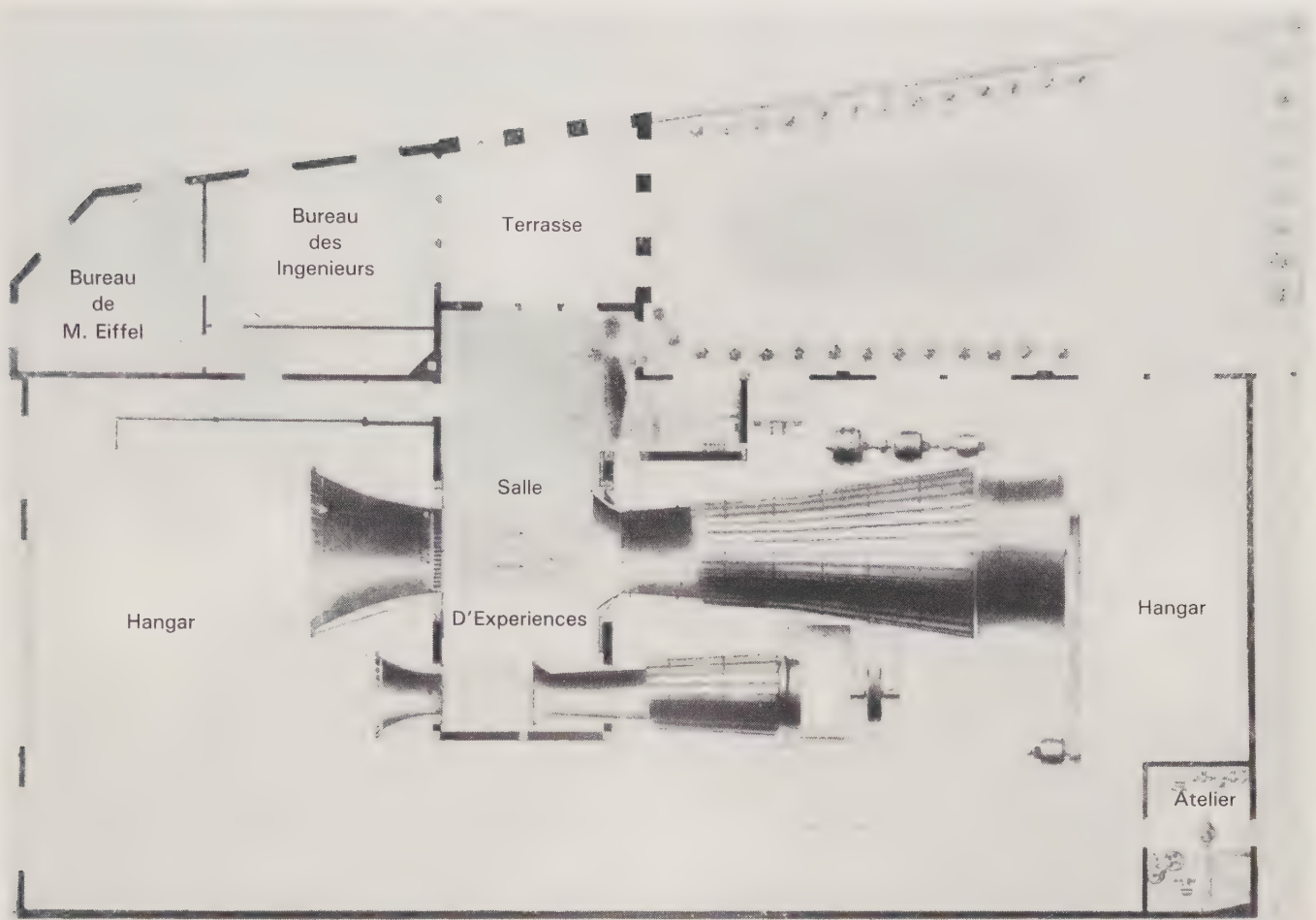

Eiffel's second-generation wind tunnel at Auteuil in 1912. Like the first Eiffel tunnel, this was of the nonreturn type, that is, without a specially constructed duct for the returning air.

the incorporation of vanes at the corners to turn the flow, and the use of strategically positioned screens and honeycombs to homogenize and quiet airflow made the Göttingen tunnel a standard to emulate. In his tunnel, Prandtl tested a variety of airfoils, streamlined bodies, and aircraft components. He also measured for the first time pressure distributions over rotating propeller blades.

England, the third of the major European powers soon to be at war, had constructed wind tunnels at the government-supported National Physical Laboratory (NPL) in London. A small tunnel had been built in 1903 by Thomas Stanton. The first of several large tunnels made its debut in 1912. Inside the 7 × 7-foot test section, elaborate flow straighteners and baffles encouraged the English tunnel designers to claim the “stadiest aerodynamic current in the world.” Basic aerodynamic research was the ostensible goal of NPL and its tunnels, but few denied (in Europe, at least)

that aircraft might change the rules of war. H. G. Wells had summed up the feelings of many Englishmen when, in response to Bleriot’s 1909 flight across the channel, he wrote, “In spite of our fleet, this is no longer, from the military point of view, an inaccessible island.”

Europe’s Second Generation of Tunnels

Gustave Eiffel next proceeded to build a bigger, faster tunnel based on his Champ de Mars design. Located at Auteuil, it boasted a test section 2 meters (6.56 feet) in diameter and a wind velocity of 32 meters per second (105 feet per second). A smaller tunnel sharing the same drive motor reached a wind speed of 40 meters per second (131 feet per second)—the fastest tunnel built as of 1912. In addition to the customary research on airfoils, propellers, and so on,

Eiffel carried out the first wind tunnel tests of complete aircraft configurations, that is, wings, fuselage, tail, and landing gear, in model form. For example, a model of the famed Nieuport fighter was tested for power requirements, stability and control, and pressure distributions. Eiffel applied a "coefficient of enlargement" to predict flight characteristics of the full-scale aircraft. Without doubt, the systematic tests of various French military aircraft designs led to the outstanding performance of French aircraft during World War I.

Whereas the French tunnel was directed more toward practical aircraft design, Prandtl's second-generation tunnel at Göttingen contributed more to basic wind tunnel design. In fact, most of the world's large wind tunnels built over the last half century have been based on the Göttingen second-generation model. Prandtl incorporated two features that have now become standard: (1) a stilling chamber just upstream of the test section where flow disturbances can die out, and (2) a contraction cone at the entrance to the test section. This section helps create a uniform air velocity across the tunnel test section and also reduces turbulence. The performance of the 1916 Prandtl tunnel was outstanding in terms of size (7.35-foot test section), wind speed (170-feet per second), and flow quality (i.e., lack of turbulence). Too late to contribute much to the German war effort, it nonetheless launched a new era in tunnel design and

provided a timely base for U.S. aeronautical research, which the war had proven woefully inadequate.

Great Britain's second-generation tunnel went into operation at the National Physical Laboratory (NPL) in 1918—also too late for the war. The salient feature of the NPL design was size: the tunnel configuration consisted of two 7 × 7-foot tunnels united into a single 7 × 14-foot test section. Called a "duplex tunnel," it was ideally suited for tests of models of complete aircraft configurations. At this stage in wind tunnel development, one of the primary contributions of the NPL was a sophisticated means of supporting the model and measuring the forces and turning moments along and about the plane's three axes. NPL scientists claimed they could detect force changes as small as 1/10 000 pound. This represented an improvement of four orders of magnitude in 50 years.

What Was America Doing All This Time?

By the time World War I began, leadership in aerodynamic research had incontrovertibly shifted to Europe. The United States, in fact, contributed no first-line aircraft to the war. This does not mean that aerodynamic research had come to a complete standstill in America. Some government decision makers

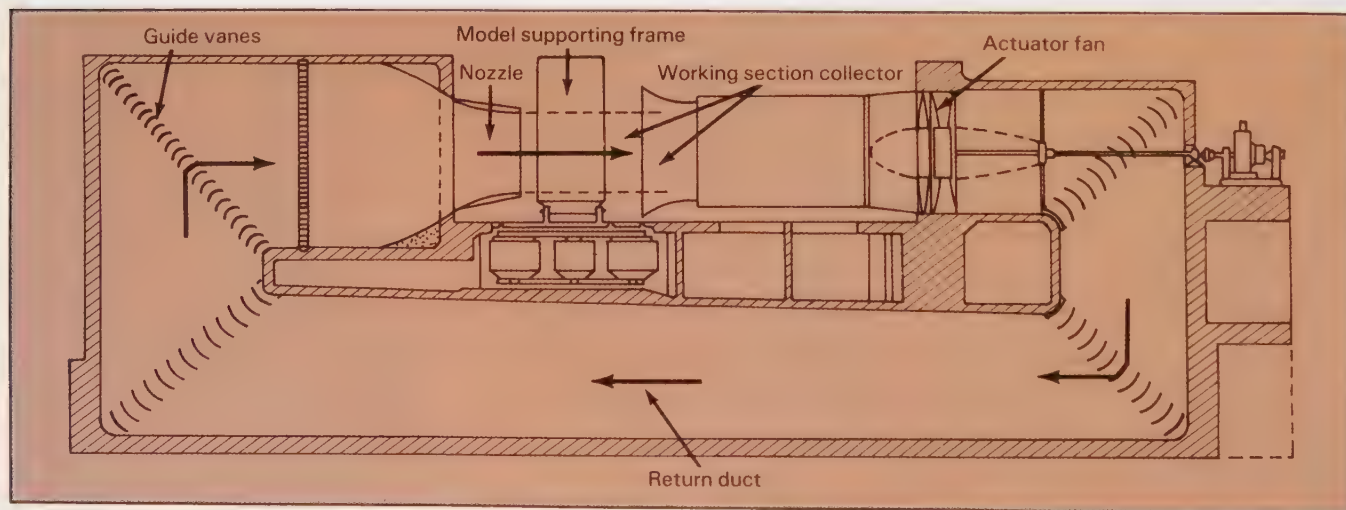

Prandtl's second-generation wind tunnel was built at Göttingen in 1916. It is a model for modern wind tunnels. Starting from the test section, the tunnel expands slowly in cross section as the air moves clockwise around the circuit, through the fan, and around the corners. Just before the test section containing the model, the air enters a stilling chamber where tunnel-generated turbulence is allowed to die out. Finally, the low-speed air is accelerated in a contraction cone or nozzle—a unique feature of this tunnel. The nozzle was a major advance in making the air velocity at the entrance of the test section uniform.

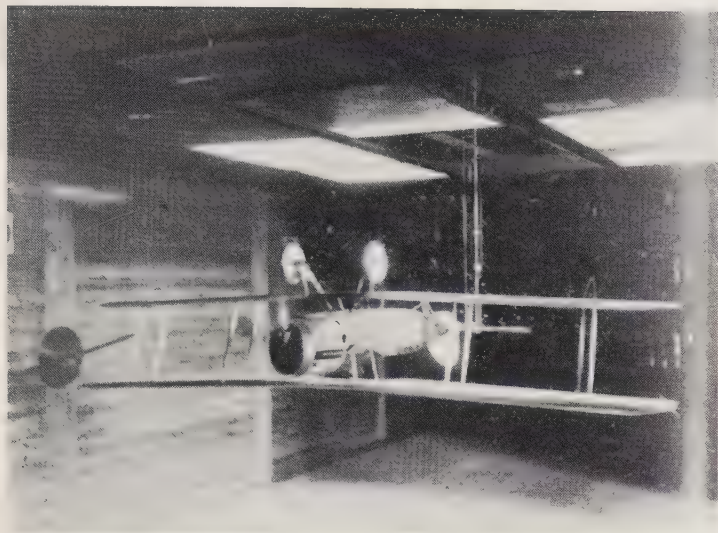

National Physical Laboratory duplex wind tunnel with a biplane model in place for lift and drag measurements. (It was easier to measure lift forces when the plane was upside down.) (Photo, National Physics Laboratory)

and influential citizens recognized the sad situation, but America's response to the European challenge remained inadequate throughout World War I.

Just before hostilities began, Albert Zahm once again applied his talents to wind tunnel design, this time in a rather unlikely place, the Washington Navy Yard. Working for the Navy's Aerodynamical Laboratory, Zahm built an 8 × 8-foot tunnel in 1913 to generate aerodynamic data for future naval aircraft. An ingenious feature of his new tunnel was the use of a 4 × 4-foot insert that reduced the cross-sectional area by four and thereby increased airspeed in the test section. With the insert, speeds of 160 mph were attained—values equal to the diving speeds of many military aircraft of that period.

Two significant early American tunnels were the 5.5-foot tunnel built by Durand at Stanford University for propeller research and the 4.5-foot octagonal tunnel constructed in Washington in 1918 by the National Bureau of Standards (NBS) for research on air turbulence and boundary layer phenomena. In addition to accomplishing some fundamental work on aerodynamics, the NBS tunnel facility hired Hugh Dryden, who would eventually become a Director of the National Advisory Committee for Aeronautics (NACA) and in later years, Deputy Administrator of the National Aeronautics and Space Administration (NASA).

The National Advisory Committee for Aeronautics was in its birth throes during this time period. That

the United States was now an aeronautical backwater was fully realized by such prominent men as Alexander Graham Bell, Alexander Walcott (Secretary of the Smithsonian), and many members of the prestigious National Academy of Sciences. Support in the Academy led to the appointment of a Presidential Commission in December 1912, which was charged with investigating the desirability of a national aeronautical laboratory similar to those which had proven so successful in Europe. The Commission did recommend establishment of such a facility, but the report was buried in the archives through an organizational oversight. No governmental action was taken.

Moving ahead on their own, the regents of the Smithsonian Institution decided in 1913 to reopen Langley's old laboratory in Washington. To this end, the Smithsonian sent Albert Zahm and Jerome Hunsaker overseas to visit European aeronautical facilities with a view to duplicating them in America. The report of their trip, published in 1914, made it all too clear how far behind the United States was in aeronautical research. In February 1915, the Smithsonian regents submitted to Congress a "memorial on the need for a National Advisory Committee for Aeronautics." Appropriate NACA enabling legislation was subsequently enacted as a rider to the Naval Appropriation Act, signed March 3, 1915.

The responsibility of the new NACA was to "supervise and direct the scientific study of the problems of flight, with a view to their practical solution. . . ." The act also provided for the construction of aeronautical research facilities, and a laboratory site was established in 1917 near Hampton, Virginia, on Chesapeake Bay. Fittingly, it was named Langley Field.

The original plan called for a joint Army-Navy-NACA experimental airfield, but the American entry into World War I caused the military services to abandon this idea. However, NACA persevered with its plan and immediately began constructing a laboratory building at Langley Field. It also began drawing up plans for its first wind tunnel.

The First NACA Annual Report to Congress demonstrated that the Committee members saw the future with surprising clarity:

The Committee is of the opinion that aeronautics has made such rapid strides that when the war is over there will be found available classes of aircraft and a trained personnel for their operation, which will rapidly force aeronautics into commercial fields, involving developments of which today we barely dream.

NACA Wind Tunnel No. 1

Newly formed Langley Memorial Aeronautical Laboratory (LMAL) began operations in 1917 with almost no experience in wind tunnel design and operation. There was no cadre of experienced researchers nor a broad background of wind tunnel experience; NACA engineers were reduced to copying European technology. With relatively minor changes, the first Langley wind tunnel was patterned after one located at the British National Physical Laboratory. The first wind tunnel of NACA was therefore obsolete when it was built.

In fact, so inexperienced were the NACA personnel that they chose to build first a one-fifth-scale model of the English tunnel rather than an actual operating tunnel. The primary purpose of the so-called Model Tunnel was to get some fast first-hand operating experience and, hopefully, improve the NPL tunnel design.

Bolstered by experience with the model, they next built NACA Wind Tunnel No. 1—a low-speed tunnel with no return circuit for the air passing through the test section. A 200-horsepower electric motor generated airspeeds of 90 mph in the 5-foot-diameter circular test section. (The British National Physical Laboratory already had a tunnel with an area five times larger.)

Nevertheless, it was a beginning. Operation began on June 11, 1920. Honeycomb sections and screens ensured good airflow quality around the models, and the electric motor provided precise control of airspeed. The supersensitive NPL balance was adopted for measuring forces and torques. Scale models of the famous Curtiss Jenny—operating in the wake of a rotating propeller—were tested to evaluate propeller slipstream effects. But the data obtained from this and other tests were not realistic enough to be useful in aircraft design. Wind tunnel No. 1 was really a learning tool—something to get the United States back into

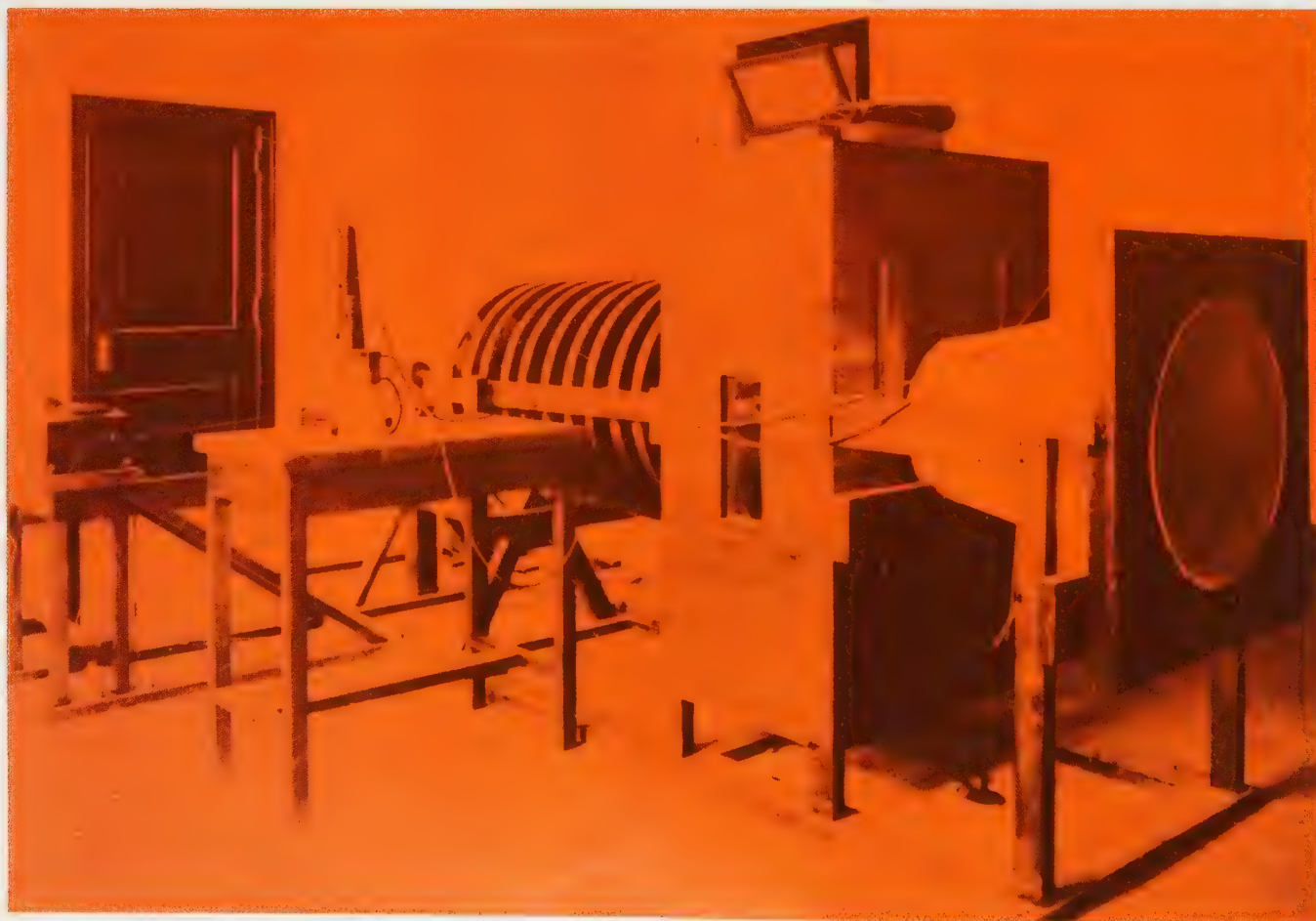

A one-fifth-scale model helped NACA engineers at Langley design NACA wind tunnel No. 1. Various arrangements of screens and honeycombs were tested to minimize air turbulence in the test section.

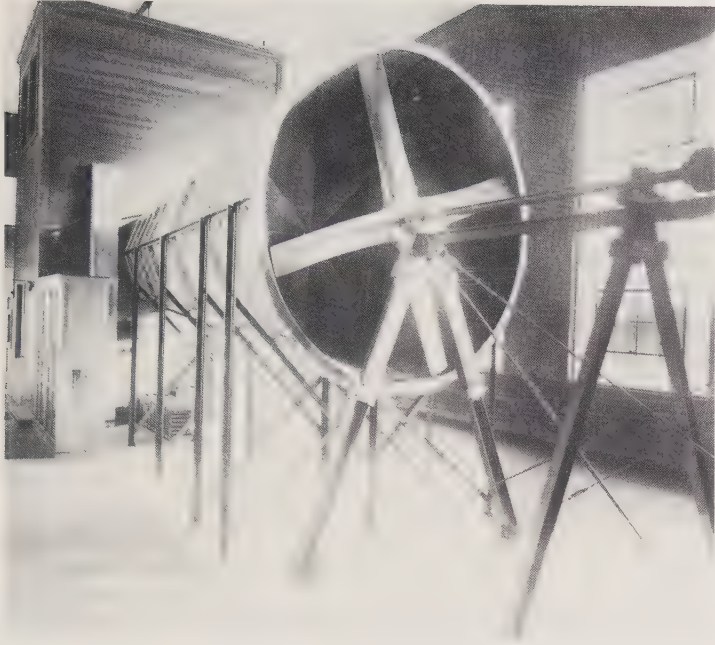

NACA wind tunnel No. 1 was completed in 1920 at Langley Field, Virginia. It was essentially a carbon copy of a 10-year-old English wind tunnel.

aeronautical research. From the standpoint of research results, tunnel No. 1 was relatively unproductive, but it must also be recorded that within 3 years a new tunnel had been built—one that leapfrogged all the tunnels then in operation in Europe. The new tunnel was called the Variable Density Tunnel (VDT).

The Variable Density Tunnel and Scale Effects

By 1921 more than a score of wind tunnels had been constructed the world over. But all those of substantial size were operating at normal atmospheric pressures. This meant that the experimental results obtained using scale models in the tunnels were open to question because a special parameter called the Reynolds number did not match those encountered in the actual flights of full-scale aircraft. In other words, the Reynolds number of 1/20-scale models being tested at operational flight velocities would be too low by a factor of 20. Reynolds' classic experiments had shown that airflow conditions could be radically different for model and full-scale aircraft. Since the Reynolds number is also proportional to air density, an obvious solution to the problem of scale effects would be to test 1/20-scale models at a pressure of 20 atmospheres. The Reynolds number would

then be the same in the wind tunnel tests and actual full-scale flights.

In June 1921 NACA's Executive Committee boldly decided to build a wind tunnel in which air pressures could be varied. Max Munk, formerly of Göttingen and now a NACA Technical Assistant, proposed building a wind tunnel in a big tank that could be pressurized to 20 atmospheres. The result was Langley Laboratory's Variable Density Tunnel (VDT).

The design of the VDT was a major engineering challenge, for it was the first high-pressure tunnel of any size. The pressure tank wall was a massive structure 34.5 feet long and 15 feet in diameter with steel walls 2-1/8 inches thick. To minimize the tank volume and the quantity of structural steel required (85 tons), an annular flow scheme was adopted. The test section was made 5 feet in diameter to match NACA

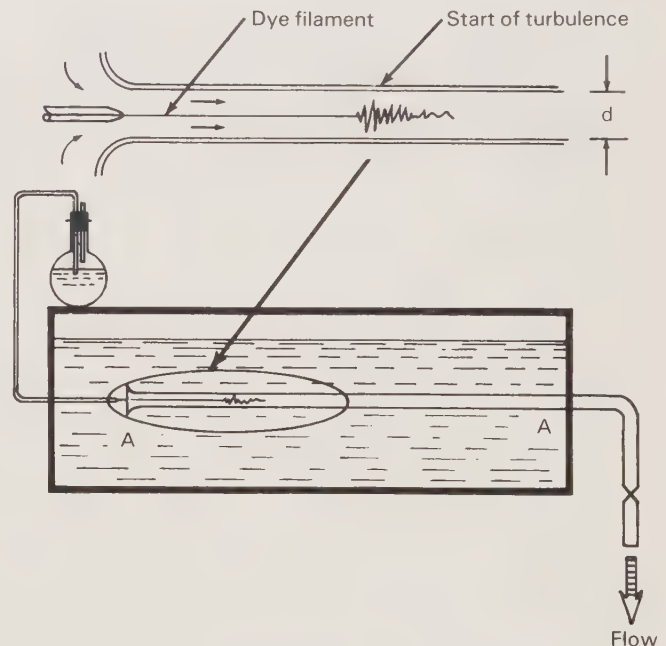

Wherever fluids flow—in pipes, through an automobile radiator, or across an aircraft wing—engineers use the Reynolds number to calculate flow characteristics. Osborne Reynolds had demonstrated in 1883 that the motion of a fluid may be either laminar or turbulent, and that the change from one to the other may be abrupt. In Reynolds' fundamental experiment, the flow of fluid through tube A-A was made visible by injecting dye into the bell-mouthed tube as a thin filament of fluid. During laminar flow, the dye filament flowed unperturbed down the tube. As the flow velocity of the fluid was increased and turbulence set in, the thin filament of dye broke up and spread through the tube. This transition always occurred when the ratio $\rho V d / \mu$ was the same, where ρ = density, V = velocity, d = pipe diameter, and μ = fluid viscosity. This ratio is now known as the Reynolds number.

WIND TUNNELS OF NASA

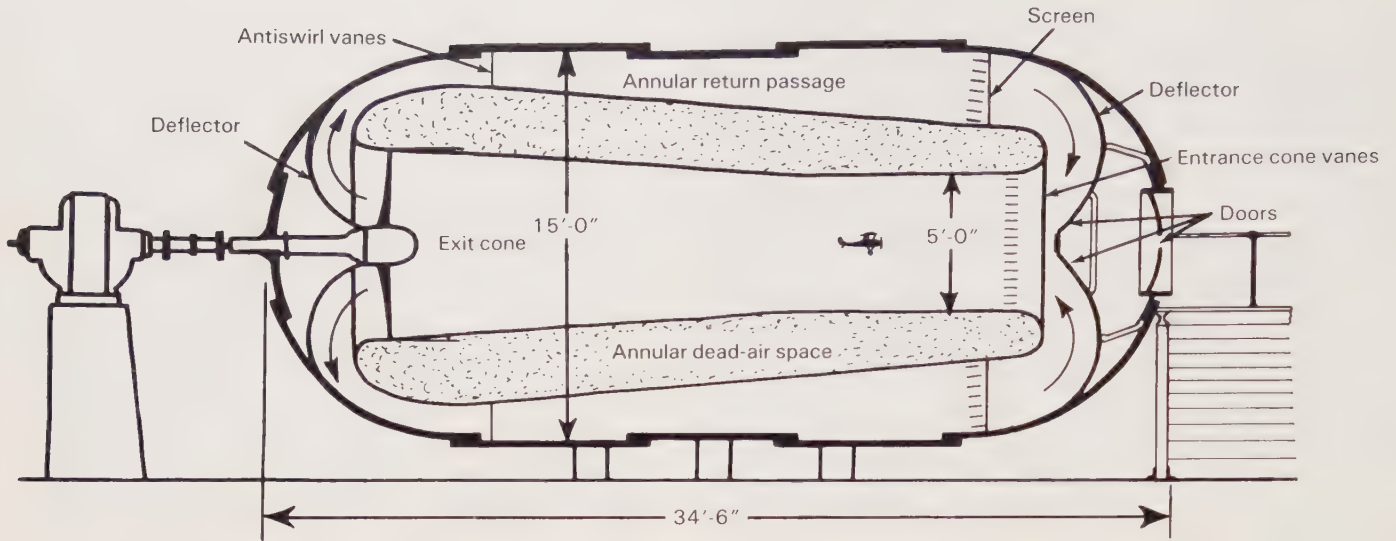

Cross section of the variable density tunnel showing the annular flow of returning air.

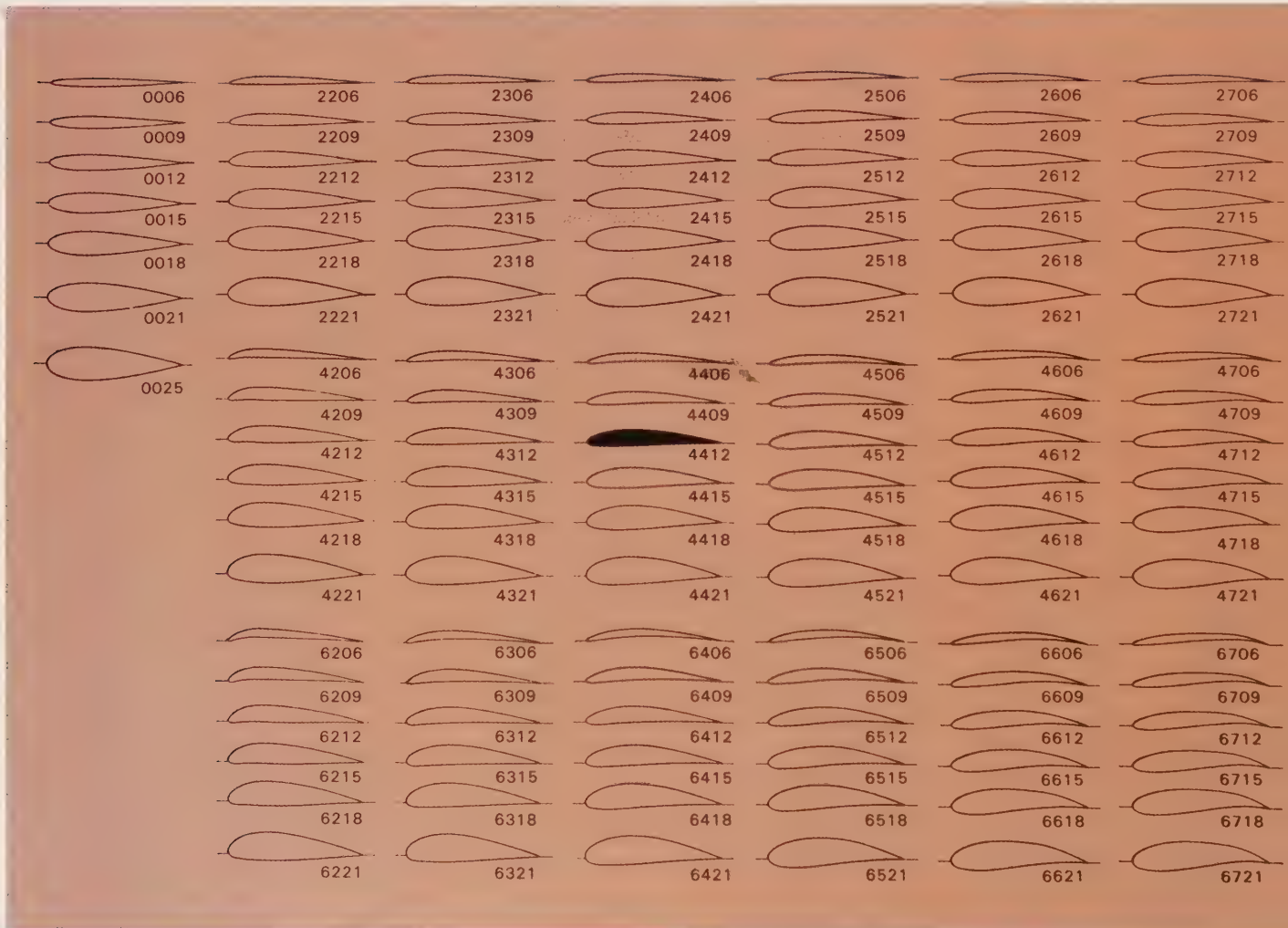

Cross sections of the early series of NACA airfoils (from TR 460).

A HERITAGE LOST AND REGAINED

Wind Tunnel No. 1. The maximum air velocity was only 50 mph, but it was the high pressure that was important.

By March 1923 the VDT was operational. It quickly established itself as the primary source for aerodynamic data at high Reynolds numbers. Models of all manner of aircraft were tested, ranging from ponderous Zeppelins to military airplanes. Probably the main contribution of the VDT to aviation came in 1933 with the publication of NACA Technical Report 460, in which aerodynamic data for 78 related airfoil sections were presented. Like much NACA research, the information in this rather dry, highly technical report eventually found its way into the designs of

spectacularly successful aircraft—the DC-3 transport (still operating in many areas), the B-17 Flying Fortress, and the famous twin-tailed P-38 that helped check the Japanese Zeros in World War II.

Operation of the VDT was not without trials and tribulations. It was partially destroyed by fire in August 1927, but the pressure tank enclosing it was not seriously damaged, and it was rebuilt and again operational by December 1930. It was the VDT above all that established NACA as a technically competent research organization. It was a technological quantum jump that rejuvenated American aerodynamic research and, in time, led to some of the best aircraft in the world.

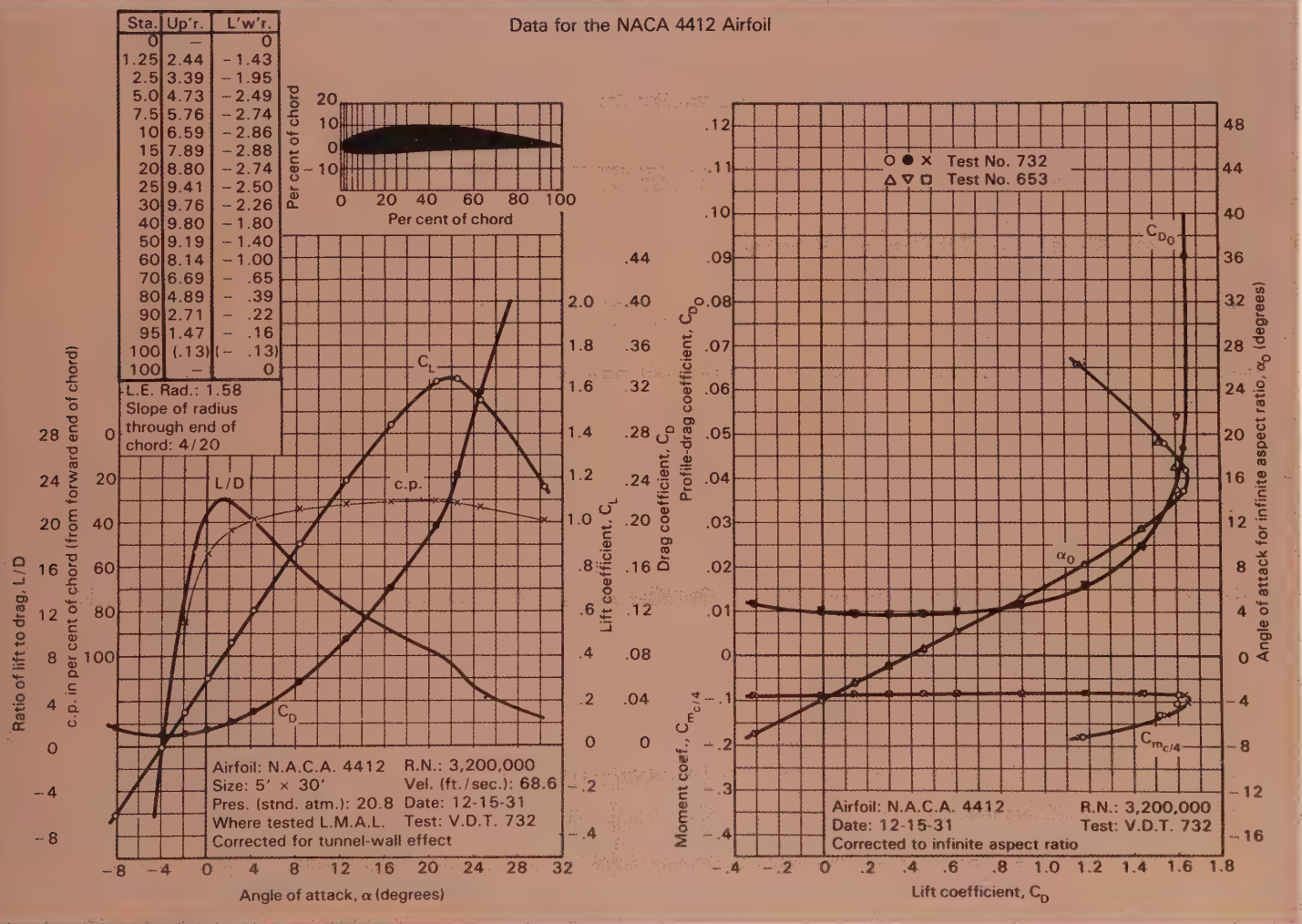

NACA's classic Technical Report 460, published in 1933, contained airfoil reference data in this format. An aircraft designer could refer to lift and drag curves for each of 78 airfoils and choose the one best suited to his application. Because these data were measured at the Reynolds numbers actually encountered in flight, scale effects were minimized. No aircraft designer could afford to be without the systematic and comprehensive NACA TR 460.

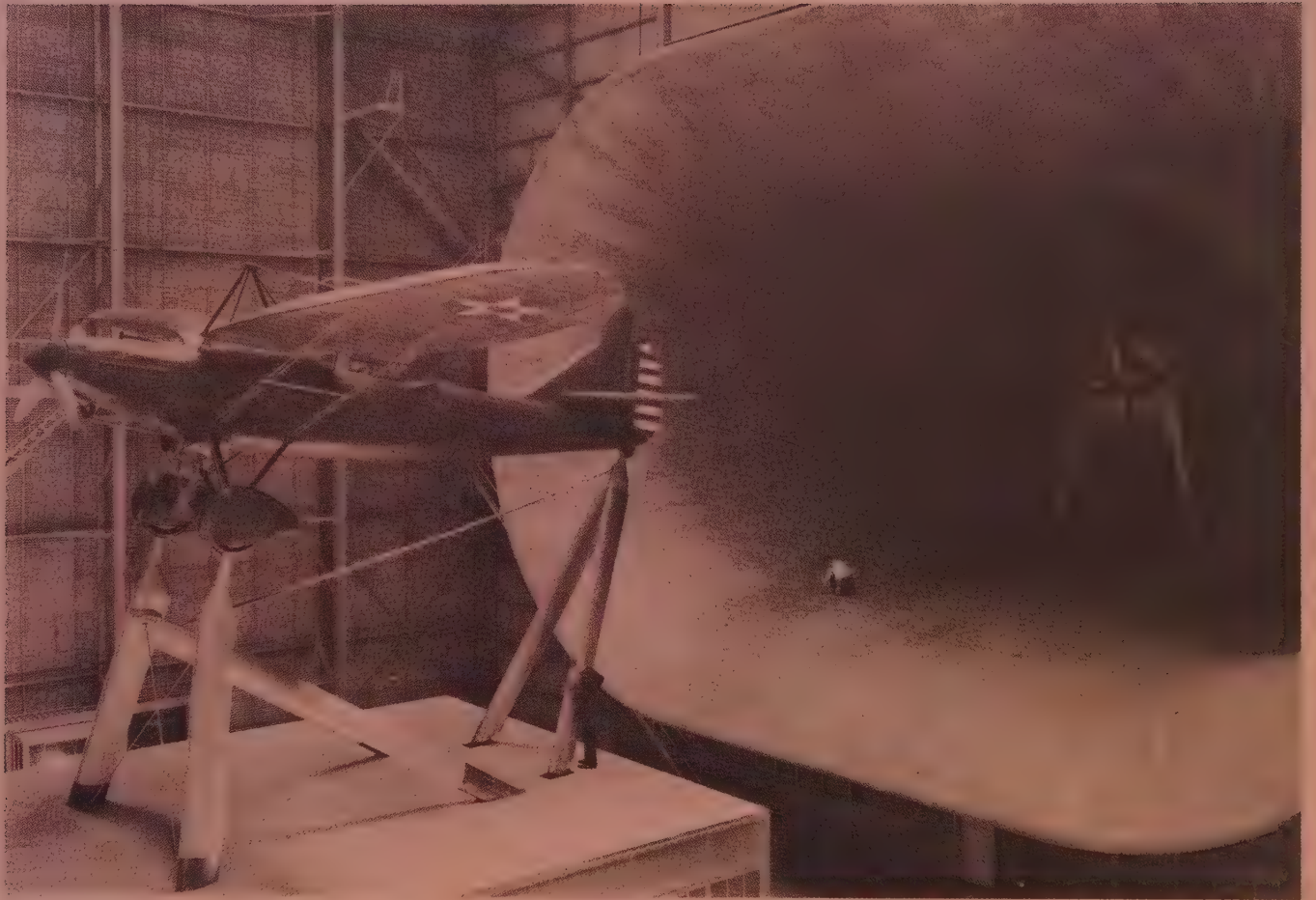

Chapter 3

Through the Barnstorming Days to World War II

Building a Wind Tunnel Complex at Langley

By the late 1920s, aviation was definitely here to stay—not only militarily but commercially. Airmail service had begun, as had embryonic air travel. Then in 1927 Lindbergh flew solo across the Atlantic. The possibilities of flight mushroomed. Flying had commercial potential as well as unplumbed military possibilities. In consequence, NACA's research facility at Langley Field was so much in demand that NACA decided to scrap Wind Tunnel No. 1 and replace it with two new wind tunnels in the same building. These would be added to the now-famous variable density tunnel to form a tunnel complex superior to anything in Europe.

The first tunnel to be constructed in the old building was the same size as tunnel No. 1—5 feet in diameter. What made the new 5-foot tunnel different? Its test section was tilted 90 degrees and was built vertically for detailed studies of aircraft spinning. Spinning was a poorly understood phenomenon in the 1920s. All too often when an aircraft lost speed and rolled off on one wing, it developed a spinning motion about a vertical axis from which recovery was difficult and sometimes impossible. The so-called “tail-spin” killed many unwary pilots in those barnstorming days; it is still a major design concern today.

By creating conditions that caused models to spin in the tunnel, spin-recovery procedures could be worked out on the ground without danger to pilots and planes. This simulation involved a special “spinning balance”—a vertical axis on which the aircraft model was mounted and by which forces and

moments could be measured. Thus the conditions that forced the model to spin (autorotate) in the tunnel could be established. Of course, free-flying aircraft are not anchored to a vertical axis, and Langley engineers were already thinking about “free-spinning” tunnels in which the models were completely unattached.

The second tunnel replacing tunnel No. 1 was the 7 × 10-foot Atmospheric Wind Tunnel (AWT), operational in 1930. The AWT was designed as an aerodynamic research tool to study high-lift wings and general problems of stability and control. The choice of tunnel shape and dimensions showed rare technical foresight in regard to future aircraft sizes. So useful was the AWT that NACA added four tunnels of the same size in the years that followed. A unique feature of the AWT was a six-component, floating-frame balance that could measure each of the three forces and three moments exerted along and about the spatial axes of the tunnel airstream.

A critical problem tackled by the AWT was that of landing speed reduction. The airfoil shape desired for high-speed, low-drag flight is quite different from the high-lift profile required for landing at low speeds. The basic wing had several arrangements of flaps that created high lift when lowered for landing and takeoff but provided low drag when retracted at cruise speeds. Such flaps are still seen on today's aircraft.

A second objective of the AWT was measuring pressures at specific spots on the wings and flaps. These local pressures varied significantly from one area to another, especially during aircraft maneuvers. The readings from pressure detectors on the aircraft surfaces enabled the structures engineer to design the lightest wing to withstand aerodynamic loads.



NACA's 5-foot vertical wind tunnel at Langley.

NACA Cleans Up Aircraft Designs

The aircraft of the 1920s were anything but streamlined by modern standards. Landing gears were not retractable, and the engines themselves, particularly the finned cylinders, were largely exposed for better air cooling. The large drag penalties of these awkward protuberances were unappreciated at first. The actual magnitude of this problem was uncovered almost accidentally.

In 1917 William F. Durand had published one of the first NACA Reports (Technical Report 17) describing his propeller research in a 5.5-foot wind

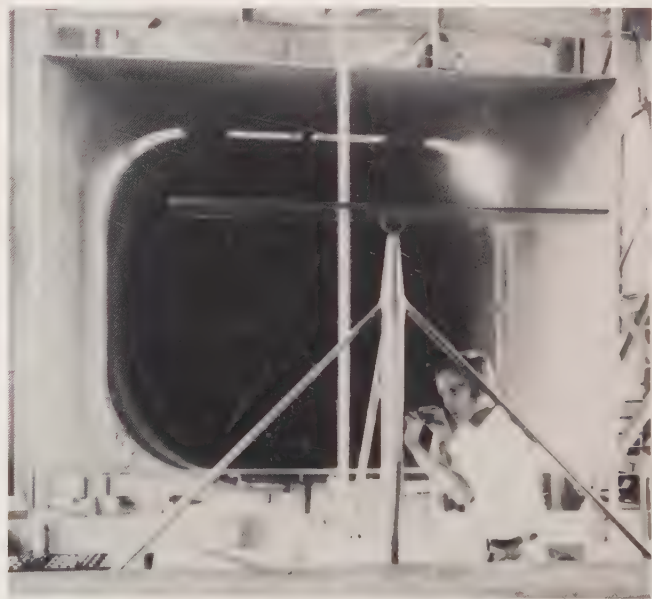

The 7 × 10-foot atmospheric wind tunnel of 1930 was the predecessor of a long line of similarly sized tunnels.

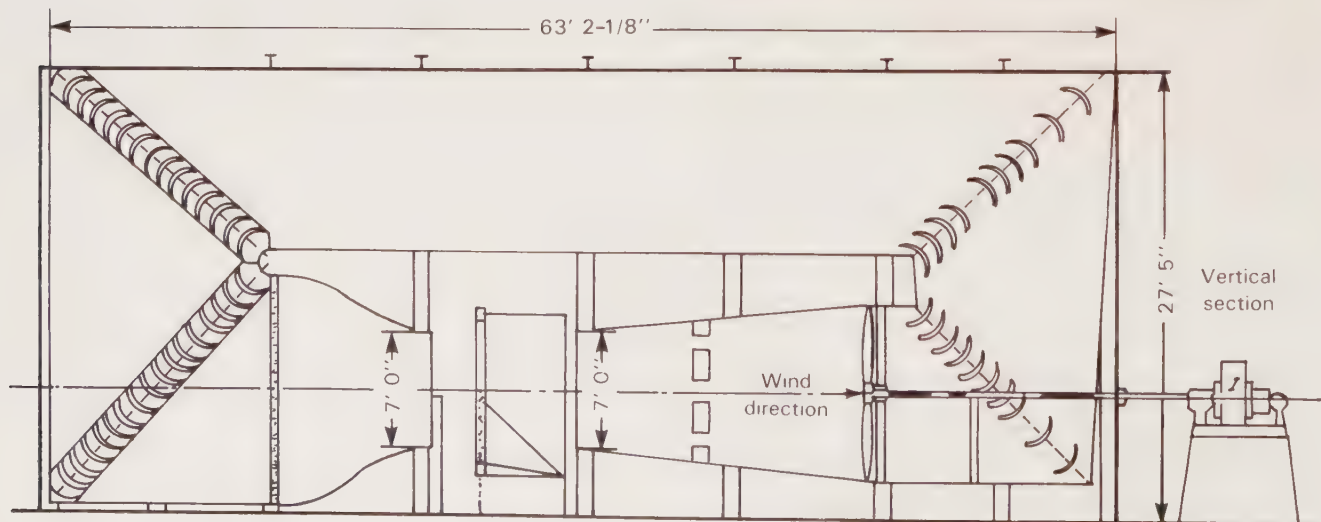

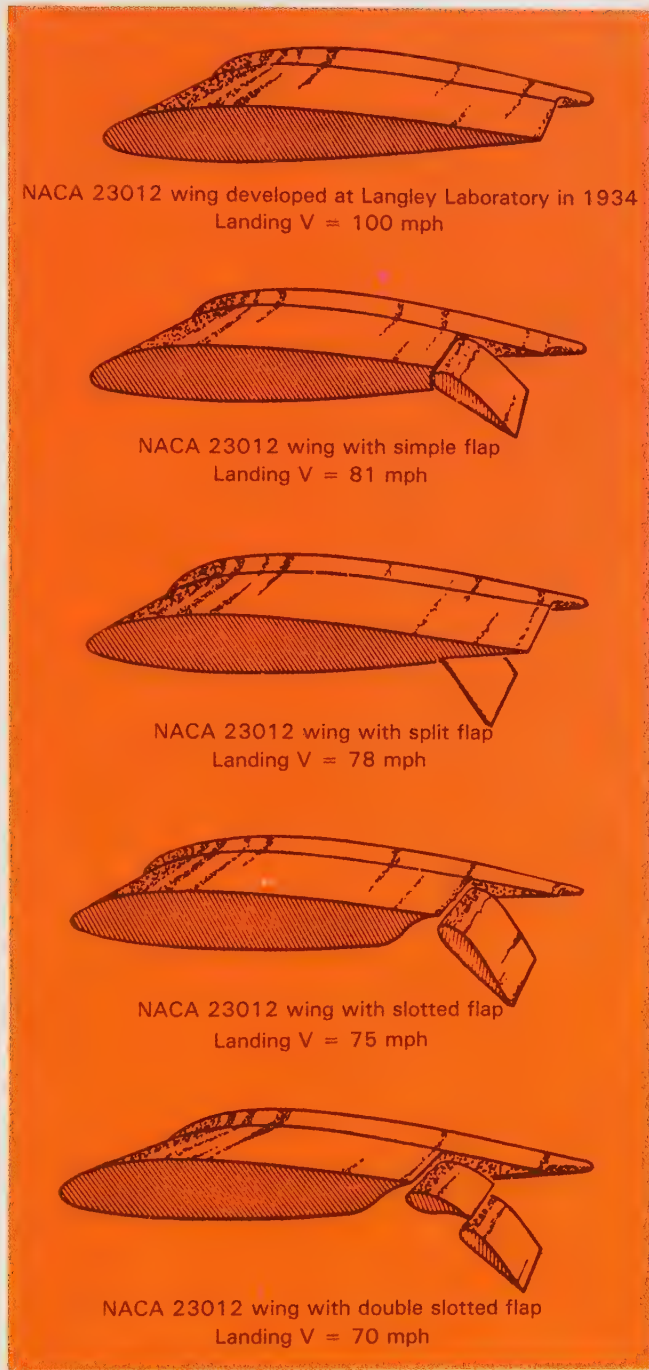

Steps taken to modify wings for increased lift during landing.

tunnel at Stanford University in California. When NACA later tried to correlate Durand's wind tunnel data with the results of its own flight tests, large discrepancies appeared. Why did the isolated propeller tests at Stanford disagree with Langley tests of propeller-plus-fuselage?

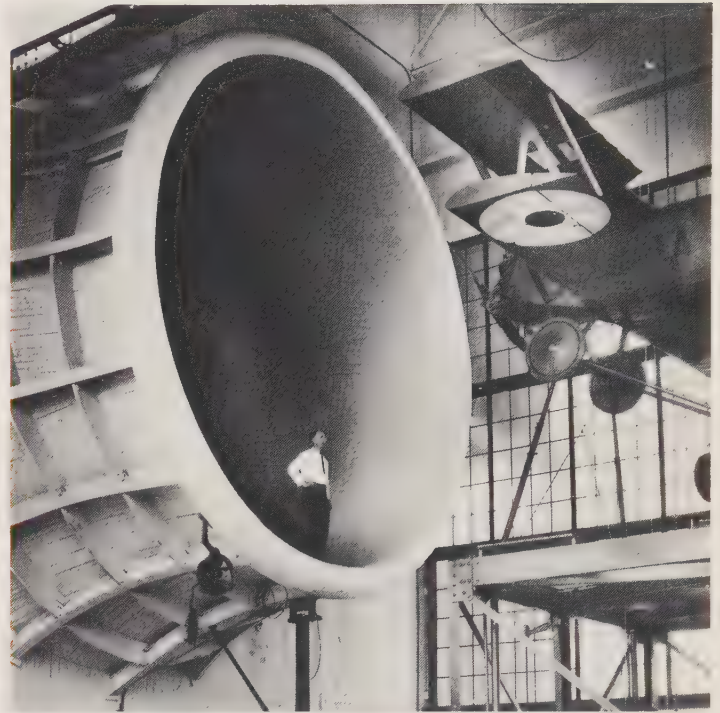

The Sperry M-1 Messenger was the first full-scale airplane tested in the propeller research tunnel in mid-1927. Note the removal of the outer wing panels which would have extended beyond the 20-foot throat diameter.

To resolve this problem, George Lewis, NACA Director of Research, decided to build a special wind tunnel for propeller research. He proposed that it be big enough to test the actual fuselages and their engines along with the propellers. This was a radical proposal because it meant going from the customary tunnels 5 feet in diameter to one on the order of 20 feet in diameter. Nevertheless, the propeller/fuselage puzzle had to be resolved. Design of the new tunnel commenced in the spring of 1925. The new Propeller Research Tunnel (PRT) went into operation in July 1927. It was a giant, with two 1000-horsepower diesel submarine engines (courtesy of the U.S. Navy) turning a 27-foot, 8-bladed propeller. The test section air velocity was only 110 mph, but, with a 20-foot stream of air to play with, the entire fuselage with operating engine and propeller could be tested. The results of research with the PRT were far reaching and, in one instance, most surprising to the experts.

The PRT demonstrated almost at once that exposed landing gears contributed up to 40 percent of fuselage drag. Engineers quickly went to work and designed retractable landing gears—surely a simple solution, but one that did not come about until the

real magnitude of the landing gear drag penalty was appreciated. Second, the PRT demonstrated that multiengine aircraft perform best when the engines and their nacelles are in line with the wing-chord plane. These findings did much to shape the DC-3 transport and the B-17 and B-24 bombers of World War II.

Most startling of all was the discovery that the protruding cylinders typical of the air-cooled engines of the 1920s contributed almost one-third the drag of the entire fuselage. Aircraft designers had let the cylinders and their cooling fins stick out in the airstream for maximum cooling, but now it was apparent that the drag penalty was too high. The cylinders had to be covered with a streamlined cowling.

After a systematic study by Fred Weick of many engine cowlings in the PRT, the famous NACA Cowl was born in late 1928, less than 18 months after the

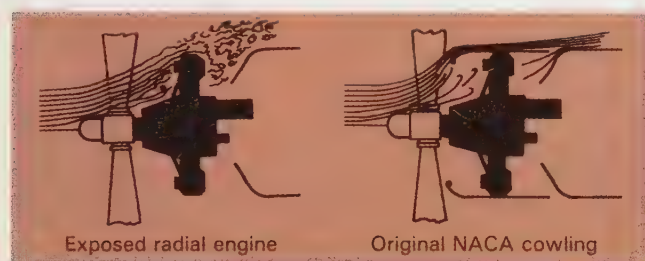

Air streaming past the cooling fins of exposed engine cylinders breaks up into turbulent flow, greatly increasing drag. The addition of a simple cowling reduces drag markedly and improves engine cooling as well.

new tunnel was placed in operation. Not only did the cowl reduce drag dramatically, but engine cooling was improved as well, confounding that engineering intuition that had stuck the finned cylinders directly in the external airstream.

A Depression Bargain: The Full-Scale Tunnel

The initial NACA Langley wind tunnel complex was complete by 1929—and it was churning out high-quality aerodynamic research data. *The Aeroplane* of London stated in envious terms:

The only people so far who have been able to get at something like accurate results from wind tunnel experiments are the workers at the experimental station at Langley Field. . . .

Despite the praise from abroad, Langley wind tunnel designers saw a clearcut need for still another tunnel—a full-scale tunnel.

Although the small variable density tunnel gave aircraft designers confidence in scaling up test results from models, several research areas could be explored only with full-scale models or with the actual aircraft. To illustrate, how does the rotating propeller affect aircraft controllability? What interference effects are created by aircraft components? Most important, drag penalties due to external struts, surface gaps, air leaks, engine cooling installation, and so on, can be



The first public use of the new NACA cowl was on the Lockheed Vega. In February 1929 a Vega flew nonstop from Los Angeles to New York in 18 hours and 13 minutes. With the new cowling it averaged 177 mph, compared with 157 mph before modification. So important was the NACA cowling that the National Aeronautical Association awarded NACA its first Collier Trophy in 1929. (Photo, Lockheed-California Company)

assessed best at full-scale sizes. Under the leadership of Smith J. De France, the design of the Full-Scale Wind Tunnel (FST) began at Langley in 1929, at the very start of the Depression. Using funds appropriated before the Depression, NACA was able to buy materials and labor at bargain prices. In addition, a large reservoir of talented but now unemployed aeronautical engineers became available to NACA. As an interesting historical note, three members of the original FST staff—Smith J. De France, Abe Silverstein, and Harry J. Goett—eventually became NACA/NASA Center Directors.

The cavernous test section of the FST could accommodate a modest two-story house. It was 30 × 60 feet, with an open throat that facilitated the installation of full-size aircraft. Downstream, two propellers, each driven by a separate 4000-horsepower electric motor, circulated air through the test section at speeds between 25 and 118 mph. The air circuit similar to that of the earlier PRT, was of the double-return type; that is, the airflow from the dual propellers was split right and left into two streams. Doubling back between the test section and the building's wall, the streams reunited prior to the throat of the test section. Operational in the spring of 1931, the FST tunnel building (434 × 222 feet and 90 feet high) became a hard-to-ignore landmark at Langley.

When the drag tests in the FST indicated surprisingly large performance penalties from external struts

and other exposed installations, a procession of military aircraft was dispatched to Langley for “drag cleanup tests.” Here the drag penalties associated with various types of surface roughness, air scoops, antennas, and other surface excrescences were carefully measured in comparison to an aerodynamically smooth aircraft. Practically every high-performance aircraft used by the United States during World War II was checked out in the FST.

A strange hodgepodge of other vehicles also underwent aerodynamic tests in the FST because of its large size. Dirigibles, submarines, radar antennas, gliding parachutes, inflatable airplanes, and free-flying models were just a few of the vehicles and machines tested. So useful has the FST been to general aerodynamic research that it was completely rehabilitated after 46 years of active, useful life. In 1977, when the refurbished tunnel had been returned to operation, experiments were conducted on solutions to landing problems of the supersonic transport—a vehicle concept not even remotely envisioned by the original tunnel designers.

Wind Tunnels Accelerate to Mach 1

Through 1932 NACA's wind tunnels were all subsonic. Indeed, one might ask why NACA should even consider building higher-speed wind tunnels when supersonic flight was contemplated only by a few visionaries. Actually, NACA began designing its first high-speed tunnel in 1927, a time when commercial aircraft still cruised at 100 to 150 mph. The *raison d'être* for a high-speed tunnel was that while most airplanes were a long way from the sonic barrier, their propeller tips were not. Actually, some racing planes and military craft had already reached Mach 0.5 (about 350 mph). Already a few aerodynamicists could see where the future lay; they began studying this new speed regime.

When Joseph S. Ames became Chairman of NACA in 1927, he gave priority to high-speed wind tunnels and the development of transonic and supersonic research capabilities. Shortly thereafter, John Stack of Langley initiated design studies of a small, high-speed tunnel. One of his first obstacles was the lack of electrical power to run such a tunnel at Langley. The power required to operate a wind tunnel varies as the third power of the wind velocity. Existing wind tunnels rarely topped 120 mph, only one-sixth the speed of sound. The number 6 raised to the third

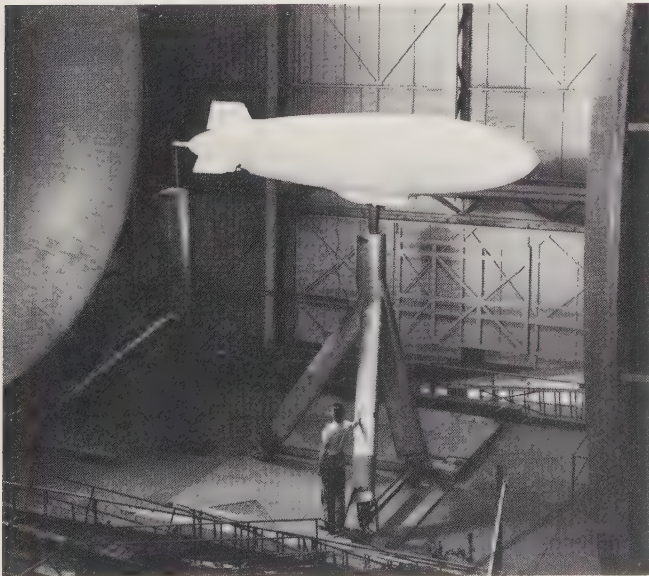

A scale model of an airship under test in the full-scale tunnel.



The Langley 11-inch high-speed tunnel. High-pressure air being discharged from the nearby variable density tunnel was injected at an annular port immediately downstream from the test section. Entraining still or low-speed air in the tunnel, the injector pulled tunnel air along with it at high velocities. Speeds near Mach 1 were attained in the test section, but test durations usually lasted only about 1 minute.

power is 216, a stupendous increase in power requirements for Mach 1 operation. In searching for a power source, Langley engineers noted that a large reservoir of energy was stored in the 5200 cubic feet of air compressed to 20 atmospheres in the variable density tunnel—energy that was thrown away each time the tank was blown down to change models. Dr. Lewis asked, “Why not use it?” That is, why not pipe the VDT exhaust through a much smaller tunnel and use its jet as a high-speed windstream. Thus the Langley 11-inch High-Speed Tunnel (11" HST) was born.

The 11-inch HST was set on end, with the test section oriented vertically. Small models were aimed downward into the mainstream air entering at the

bottom of the tunnel. A special design feature of the 11-inch HST was the use of an annular injector *downstream* from the test section. The blast of high-velocity air from the VDT exhaust entrained the slower moving mainstream air and accelerated it to high speeds. Both were exhausted upward from a cone-shaped nozzle. The injection scheme permitted runs of only about 1 minute before the VDT's pressure plummeted to useless values. These short runs, however, were sufficient to demonstrate the sharp rise in drag, the loss of lift, and the changes in pitching moments that occur near Mach 1.

So successful was the 11-inch tunnel that a bigger one with a 24-inch test section was quickly designed. It was put into operation in October 1934 and also used the exhaust air from the VDT. The first Langley schlieren system was installed in this tunnel. Engineers were now able to view the dynamic phenomena occurring as air near Mach 1 flowed over airfoils and fuselages. By simultaneously viewing flow phenomena and recording the pressure distributions over various wings and propellers, aerodynamicists could pinpoint isolated areas where shock waves formed or airflows separated and therefore limited the useful speed of the entire airfoil. By correcting airfoil design at these local trouble spots, the performance potential of the entire airfoil could be raised.

With the help of the 24-inch High-Speed Tunnel, NACA in 1939 was able to develop and provide aerodynamic data on a family of new high-speed airfoils for the American aviation industry. These airfoils quickly found their way into the high-speed aircraft propellers that powered the 500-mph American fighters that dominated the skies in the latter part of World War II.

The First Big High-Speed Tunnel

Even while the 11- and 24-inch HSTs were carrying out their first investigations of the mysterious Mach 1 regime, it was obvious they had two serious shortcomings. First, the rapid blowdown of the VDT restricted tests to less than a minute. Second, the tunnels were so small that model sizes were limited to dimensions of only a few inches. NACA needed a high-speed tunnel big enough to test sizeable models of complete aircraft on a continuous basis. Consequently, in 1933, Manly J. Hood and Russell G. Robinson, both at Langley, formed a design group for the purpose of unshackling high-speed aerody-

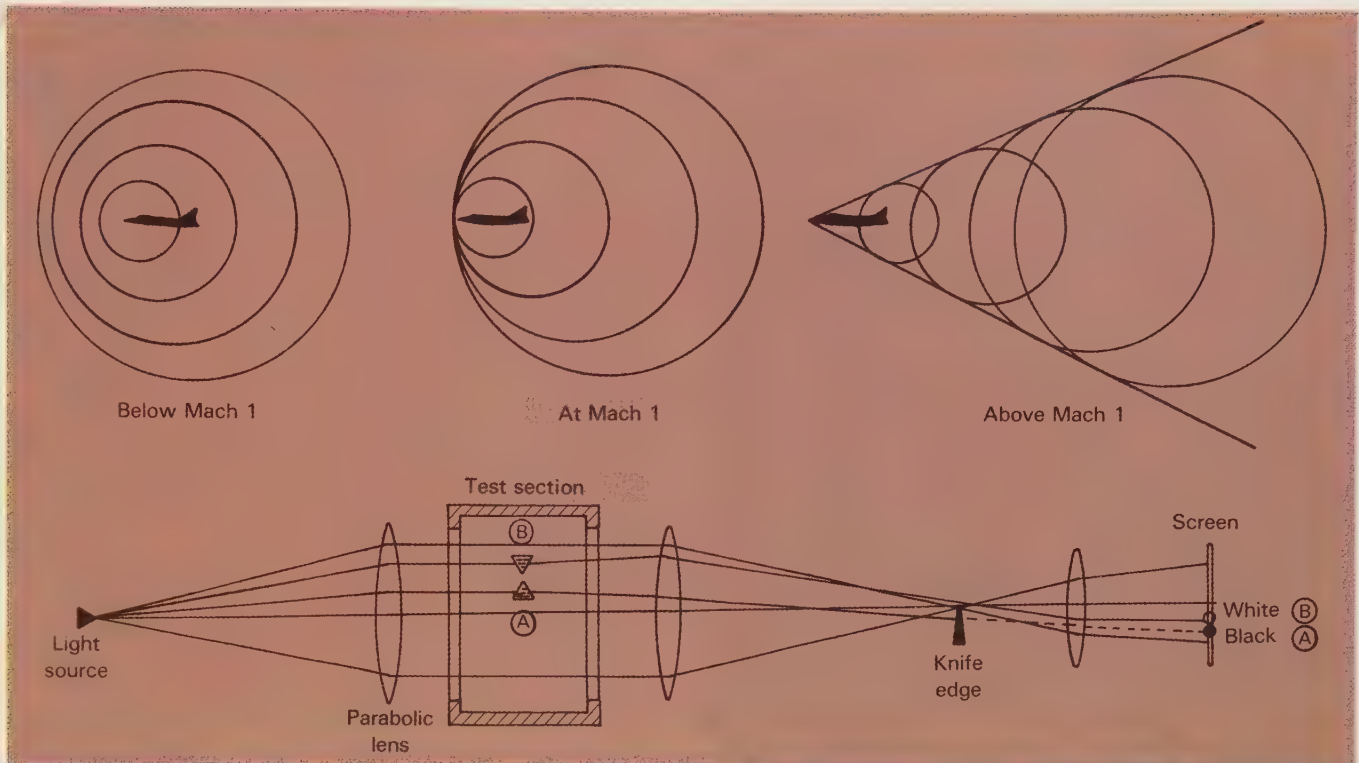

(Top) The origin of shock waves. (Bottom) Shock waves can be seen only rarely under natural conditions. In the controlled conditions existing in a wind tunnel, shock waves can be made sharply visible by means of a schlieren optical system. First, a small but intense source of light outside the test section illuminates the test section through a parabolic lens. A second lens collects the light rays on the other side of the test section and focuses them on a sharp edge (called a knife edge). Any air disturbances in the wind tunnel will deflect the light rays up or down, depending on the changes in air density. Triangles A and B show how high- and low-pressure disturbances, respectively, will bend the rays. Light rays bent downward will be intercepted by the knife edge and create a dark area on the screen; those bent upward form light areas. The net effect is that changes in air density produced by shock waves and other flow disturbances show up as dark and light areas on the screen. (Right) A schlieren photograph of shock waves around a model in a supersonic tunnel.

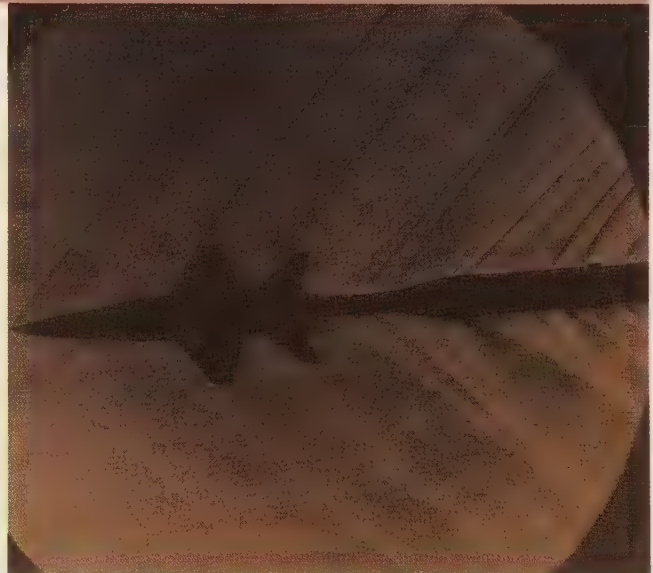

dynamic research from the VDT restrictions of short run duration and small size.

The resultant tunnel, completed in March 1936, was 8 feet in diameter. Driven continuously by an immense 8000-horsepower electric motor, airspeeds of 575 mph (Mach 0.75) were attained. Later, in February 1945, airspeeds were increased to Mach 1 by replacing the 8000-horsepower motor with one developing 16 000 horsepower.

The engineers designing the new tunnel immediately encountered two problems that had not been

serious in low-speed tunnels. The first problem involved an effect discovered in 1738 by the Swiss mathematician Daniel Bernoulli. Bernoulli observed that as the velocity of flow in a duct is increased by constricting the cross-sectional area, the static pressure of the fluid drops. In wind tunnel design, this means that the air pressure in the chamber containing the high-velocity test section will be lower than in the rest of the tunnel. Thus, for the new tunnel, the test chamber had to withstand a powerful, inwardly directed pressure.



The 24-inch high-speed tunnel also relied on the variable density tunnel for high-pressure air. Shown here outside the variable density tunnel building at Langley, the 24-inch tunnel, like the earlier 11-inch high-speed tunnel, was mounted vertically.

Ordinarily, Langley engineers would have solved this problem by simply building a welded steel pressure vessel around the test section. But these were Depression days and to help put unskilled people to work it was decided to build the whole tunnel of reinforced concrete. An igloo-like structure around the test section had walls that were 1 foot thick. The igloo was essentially a low-pressure chamber—just the opposite of the VDT. Operating personnel located inside the igloo were subjected to pressures equivalent to 10 000 feet altitude and had to wear oxygen masks and enter through airlocks.

The second new problem was created when the mechanical energy of the huge fan was added as heat to the airstream. (This heat equals that from the engines of 100 compact cars.) High temperatures could damage the tunnel structure and the enclosed equipment. To avoid making the igloo into an oven, a small amount of heated air was bled off the tunnel walls and released outside, removing its contained heat in the process. The discharged hot air was replaced by cool air pulled in from the outside. The heat bled off in this manner must equal exactly the heat added by the fan—in this case the removal of only about 1 percent of the mainstream airflow was required. This stratagem is still employed in many of today's high-speed tunnels operating at atmospheric pressure.



The Langley 8-foot high-speed tunnel. The test section was housed in the concrete igloo. A heat exchanger is shown above the tunnel. This was necessary to remove the large quantities of heat generated by the big fan.

The resulting 8-foot high-speed tunnel was unique—something no other country possessed. Since World War II was right around the corner, the tunnel had strategic value. The first tests, in fact, evaluated the effects of machine gun and cannon fire on the lift and drag properties of wing panels. This led logically to checking the effects of rivet heads, lapped joints, slots, and other irregularities on drag. Such tests demonstrated drag penalties as high as 40 percent over aerodynamically smooth wings. Aircraft manufacturers quickly switched to flush rivets and joints.

New high-speed propellers and engine cowlings also emerged from tests in the 8-foot tunnel, but the story of the P-38 dive recovery flap is more spectacular proof of the value of wind tunnels during wartime.

The Lockheed P-38 Lightning was the high-speed, twin-boom fighter that helped beat back the threat of the Japanese Zeros in the South Pacific. When first introduced into squadron service in 1941, pilots were plagued by heavy buffeting during high-speed dives. On several occasions, their dives steepened and they could not pull out. Lockheed's test pilot for the P-38, Ralph Virden, lost his life trying to solve the dive problem. Shortly after Virden's death, the Army asked NACA for help. Some tests were made in the Langley 30 × 60-foot full-scale tunnel, but the crucial tests took place using one-sixth-scale models in

the new 8-foot high-speed tunnel. The tests indicated that, above 475 mph, the P-38's wings lost lift and the tail buffeted, leading to a strong downward pitching motion of the plane. Controls stiffened up

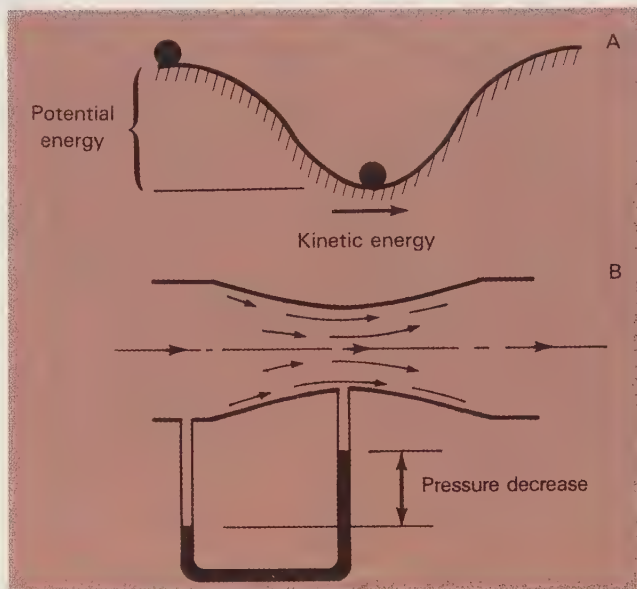

(A) As the ball rolls down the hill, the loss of potential energy is converted into kinetic energy, illustrating the law of conservation of energy. (B) Likewise in fluid flow, an increase of fluid velocity (kinetic energy) is balanced by a decrease in static pressure (potential energy). This is Bernoulli's principle.

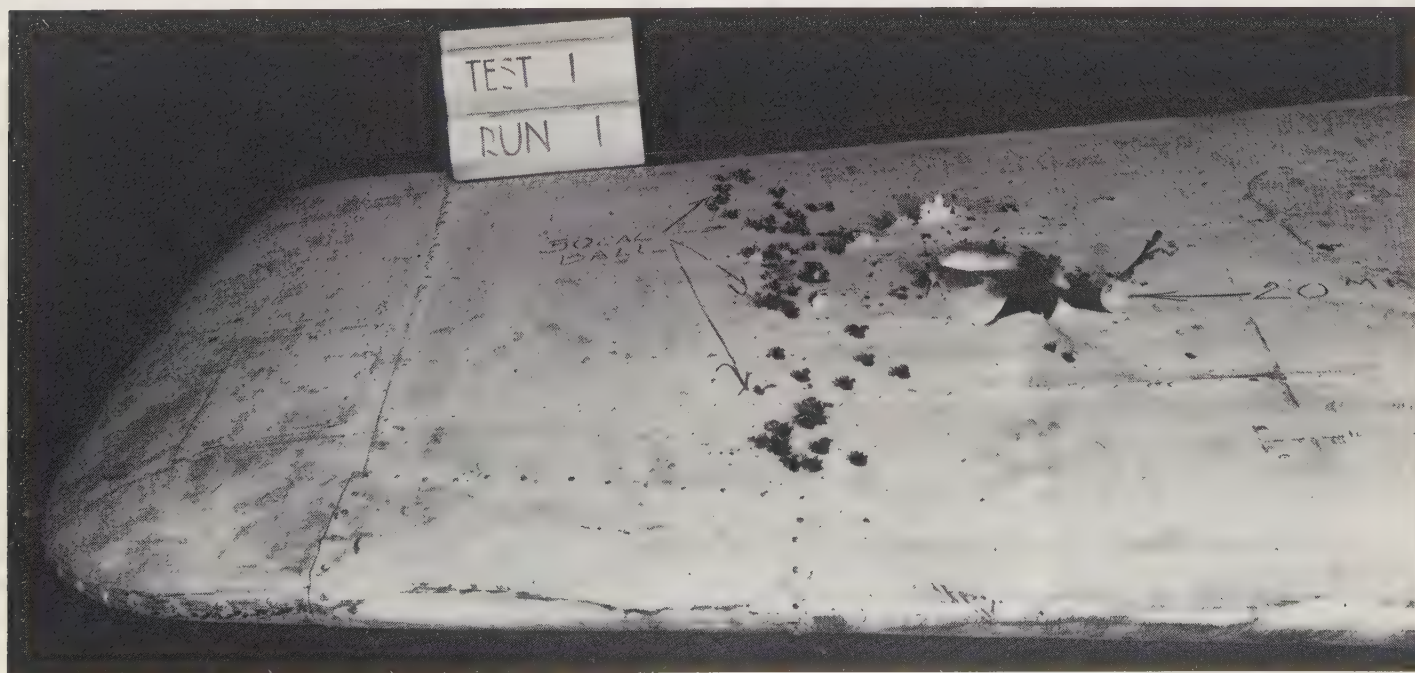

A bullet-riddled wing section undergoing aerodynamic tests in the 8-foot high-speed tunnel.

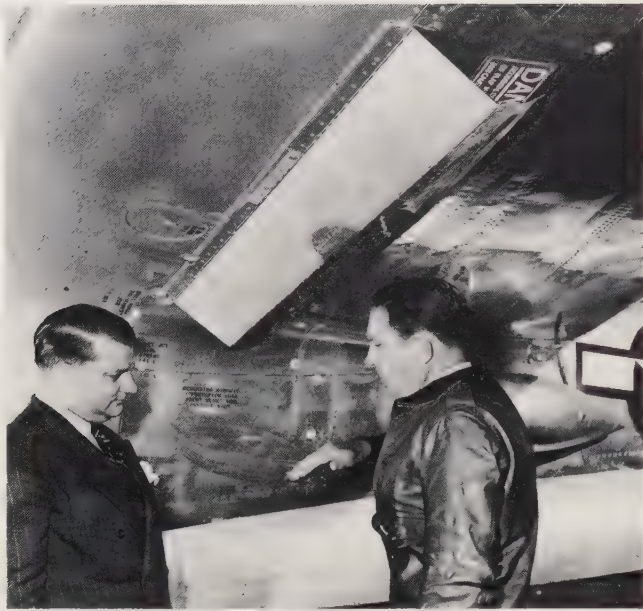

A P-38 showing the dive-recovery flap that evolved from Langley tests. (Photo, Lockheed-California Company)

and lost their capability to pull the P-38 out of its steepening dive. In addition, the buffeting could cause structural failure, as it had in Virden's case.

Langley's answer to the P-38 dive problem was the addition of a wedge-shaped dive-recovery flap on the lower surface of the wings. Aerodynamic refinement of the dive-recovery flap was continued in a coordinated program with Lockheed engineers and the new Ames Aeronautical Laboratory, just south of San Francisco, in the latter's new 16-foot high-speed tunnel. The dive-recovery flaps ultimately saw service on the P-47 Thunderbolt, the A-26 Invader, and the P-59 Airacobra, America's first jet aircraft.

Free Flight of Wind Tunnel Models

The purpose of a wind tunnel is to simulate flight, but in the conventional tunnel the models of full-scale aircraft are attached to supports so that aerodynamic forces can be measured. The models are not free. A plane's maneuverability cannot be gauged completely with these restrictions on motion.

Since full-scale aircraft are expensive to build, test fly, and modify—to say nothing of the possible loss of test pilots—Langley engineers decided to build a free-flight wind tunnel. The basic idea was to let a model glide in a wind tunnel that is actually tilted at the aircraft's glide angle. Thus the unpowered

model, nose tilted down at its glide angle, remains stationary and horizontal in the rising airstream of the tilted tunnel, much like a hawk or buzzard hovers in air currents. Maneuverability and flight performance are tested as a "pilot" outside the wind tunnel manipulates the model's control surfaces via electrical signals sent through thin wires trailing behind the model.

Two of these tiltable free-flight wind tunnels were constructed at Langley: the first, 5 feet in diameter, in 1937 and the second, 12 feet across, in 1939. These tunnels were useful with radically new aircraft where no reservoir of flight experience was available, namely, tailless aircraft, planes with delta and skewed wings, and vertical takeoff and landing/short takeoff and landing (VTOL/STOL) vehicles. The 12-foot free-flight tunnel was used into the early 1950s, when it was supplanted by powered models flown in the Langley full-scale tunnel, which had ample flying room in its 30 × 60-foot test section.

A Nineteen-Foot, High-Pressure Giant

Langley's 19-foot Pressure Tunnel required approximately 5000 tons of steel to contain its 2-1/2 atmospheres pressure. An 8000-horsepower electric motor driving a 34.5-foot propeller was needed to create a 300-mph velocity at the test section. Oper-

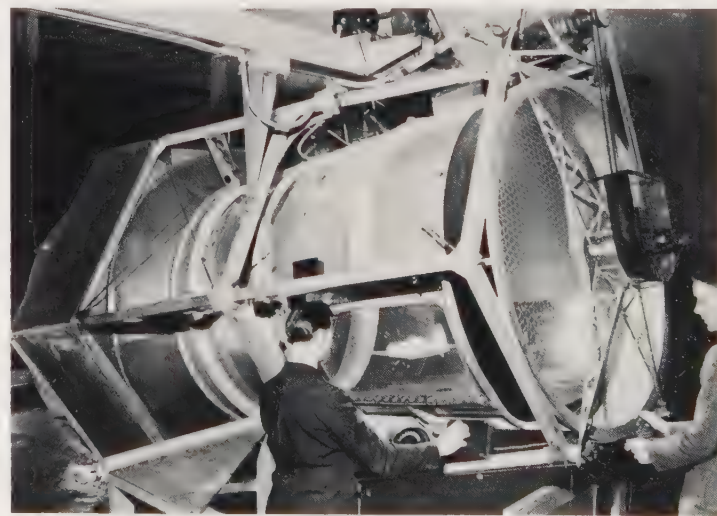

The NACA free-flight wind tunnel investigated airplane stability and control characteristics using free-flying models.

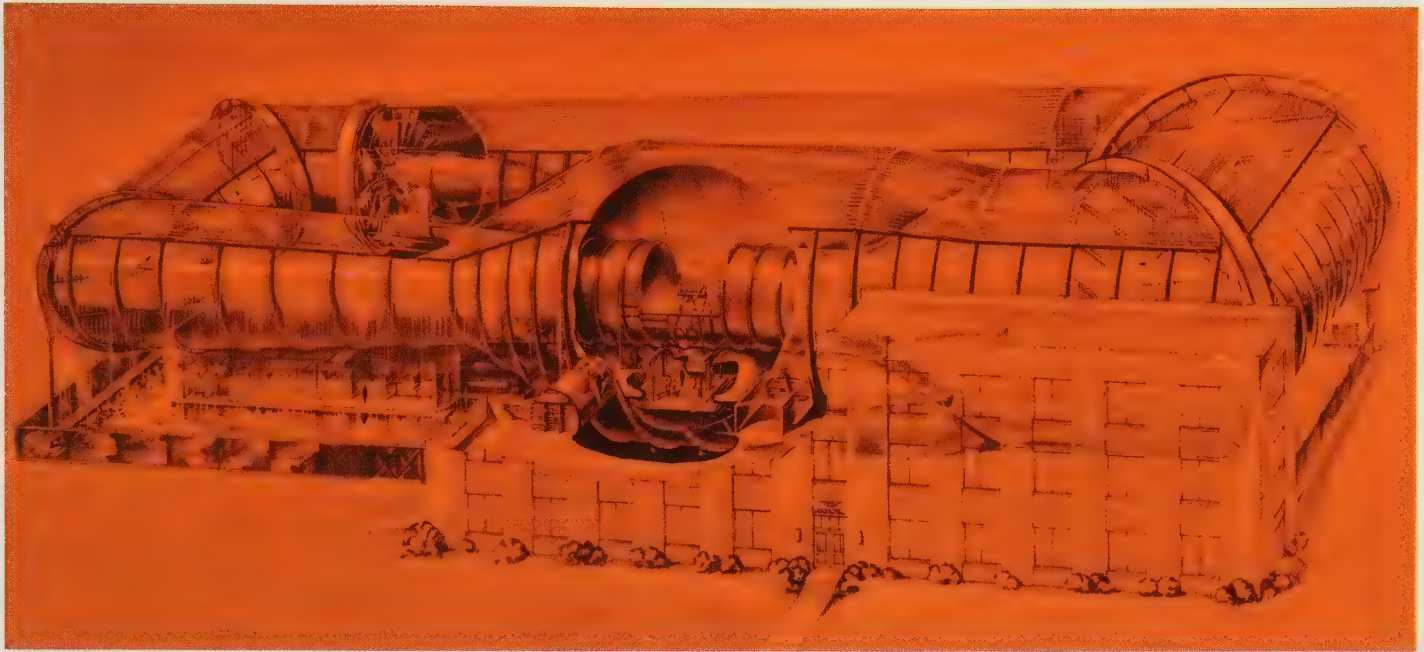

The 19-foot pressure tunnel at Langley Field.

ators of this tunnel, like deep-sea divers, had to enter and leave their working quarters through a decompression chamber. Why build such a monster?

The 19-foot pressure tunnel was a response to NACA's continuing concern over scale effects. Could its results with models be applied with confidence to full-scale aircraft? The small variable density tunnel had provided some of the answers, but to reach full-scale Reynolds numbers, the aerodynamicists needed a bigger tunnel operating at high pressures. (Reynolds number is proportional to both size and air density.)

The result—the 19-foot high-pressure tunnel—was the first attempt anywhere to combine large size and high pressure in a single facility.

Beginning operation in 1939, this tunnel helped develop the A-20, the B-32, the F-8U, and other World War II military aircraft. Later, as more advanced variable density tunnels came on line, the 19-foot tunnel was assigned to research in aeroelasticity and flutter at high speeds. In 1959, after major conversion work, it became the Transonic Dynamics Tunnel.



Chapter 4

Propellers to Jets: The Impetus of World War II

By the mid-1930s the wind tunnels of NACA had helped transform the “wire-and-rag” biplanes that fought the War to End Wars into all-metal, low-wing monoplanes. The sleek Douglas DC-3 was already flying passengers coast to coast. The first U.S. Flying Fortresses were aloft, and Supermarine Spitfires streaked peacefully across the skies above England. Progress in the air had been rapid, but for the second time war threatened to scrap reasonable timetables of development.

It was the pre-World War I situation all over again. European countries, feeling the tension growing as the Nazis marshalled German resources, began to pour more and more money into aeronautical research. American aeronautical leaders realized that the acceleration of foreign research was seriously eroding this country’s leadership. The superb NACA wind tunnel facilities were no longer the biggest and the best. America was not building supersonic wind tunnels and testing turbojet and rocket engines like the Europeans. The easy answer was that the country was just pulling out of the Great Depression and was preoccupied with economics rather than far-away European war jitters.

Nevertheless, the widening gaps in aeronautical research were recognized in report after report. In October 1938 NACA urged the construction of a whole new aeronautical laboratory at Sunnyvale, California, as well as the expansion of the Langley facilities. To justify its recommendations, NACA pointed out that Germany had multiplied its aeronautical facilities tenfold and boasted five research centers to America’s one. Italy had even built an entire city, Guidonia, devoted exclusively to aeronautical research. In late 1938 even an isolationist Congress saw another European war on the horizon.

Just days before the Nazi invasion of Poland, Congress authorized the new Sunnyvale facility. On December 20, 1940, NACA quietly broke ground for the new laboratory at Moffett Field, California. (This facility is now the Ames Research Center of NASA.)

Langley expanded too by opening up a whole new West Area and staking out a site for a new 16-foot high-speed wind tunnel, a stability tunnel, and other research facilities in November 1940.

As the European conflict intensified, a special NACA committee, headed by Charles A. Lindbergh, was appointed to see if the United States was doing enough in aeronautics. It was not, according to the report issued by Lindbergh and his committee. American facilities for aircraft engine research “are inadequate,” stated the report. Prewar reluctance to spend funds on research had evaporated, and by mid-1940 Congress had authorized a NACA Flight Propulsion Laboratory to be built near the Cleveland Municipal Airport. Like the Langley and Ames sites, it would also require new wind tunnels, but of radically different design, as befitted its different mission.

The expansion of NACA research came none too soon. Germany flew its first turbojet aircraft on August 27, 1939. Both Great Britain and Germany had operational jet fighters by the end of the war. America did not, but it was close behind. Germany also led the way with the pulse-jet V-1 and the rocket-powered V-2 ballistic missile, technologies the Allies had ignored. Actually, all the new (though belated) NACA facilities were employed during the war, but less for radical innovation than for perfecting huge fleets of high-performance fighters and bombers. In the long run, the immense fleets of more conventional weapons made all the difference in the victory.

The War-Time Tunnels at Ames

Moffett Field, the site of the new NACA Ames Laboratory, was located 40 miles south of San Francisco. A cadre of experienced wind tunnel designers had been moved from Langley to the West Coast to oversee the construction of the new test facilities. The main theme at Ames was ostensibly high-speed aerodynamics, but the overriding military need of the moment was the testing of new aircraft designs at moderate speeds (about 250 mph) on an urgent basis. There was no time and no need for inventing new aircraft and airfoils.

In May 1940 construction began on two 7×10 -foot wind tunnels patterned after the 7×10 -foot Atmospheric Wind Tunnel built at Langley in 1930. The

two Ames tunnels were identical in design, with a closed-throat, single-return circuit operating at atmospheric pressure. Airspeeds in the test section reached about 250 mph. An air-interchange tower provided the necessary cooling. The first tunnel was completed in March 1941; by fall of that year both were responding to a flood of military requests. The tunnel staffs went on two- and three-shift operations to accommodate the new aircraft designs.

Despite the press of war work, the engineers at the 7×10 -foot tunnels were able to eke out some original research results. For example, the programs investigating propeller slipstream effects and air inlets pioneered new technology, as did a novel effort to predict the flying qualities of aircraft through coordinated wind tunnel tests and actual flight research.



The two wartime 7×10 -foot wind tunnels built at Ames. The test sections are in the blocklike buildings on the left-hand sides of the air circuits.

PROPELLERS TO JETS: THE IMPETUS OF WORLD WAR II

This latter led to a system of wind tunnel testing that predicted those aircraft parameters which would best satisfy specific flight parameters, such as maneuverability, stick forces, response of controls, and so on. This empirical link between what a pilot desires in a full-scale plane and what the wind tunnel can test at the model stage was considered one of the outstanding research contributions of Ames Laboratory during World War II.

The third wind tunnel built at Ames was a giant—16 feet in diameter at the test section—that represented a major advance in wind tunnel design and construction. Operating near the speed of sound (about twice the speed of the 7 × 10-foot tunnels), the 16-foot tunnel required a 27 000-horsepower electric motor—the most powerful tunnel drive system in operation anywhere. The tunnel configuration was fairly conventional, with a closed-throat, single-return circuit. The completion of the 16-foot high-speed facility was opportune: early December 1941, just a few days before Pearl Harbor.

The new American fighter aircraft about to go into active service desperately needed large-scale testing at the speeds attainable in the 16-foot tunnel. Many craft, now classics to airplane buffs, went through the facility: the Lockheed P-38, the Bell P-39, the Curtiss

P-40, the Republic P-47, and the North American P-51. All these planes were pushing toward Mach 1 and were encountering problems unknown at lower speeds. During the war, the new Ames tunnel operated with three shifts per day, often 6 days per week, in order to get these aircraft ready for active duty.

The P-51 Mustang posed a typical development problem. During early flight tests a strange rumbling noise emanated from the bowels of the aircraft. Because this might presage some sort of structural failure, the cause had to be found. Designers decided that tests in the 16-foot tunnel might discover the source of the vibrations faster than actual flight tests. Consequently, the outer portions of the P-51 wings were removed and the aircraft fuselage-plus-wing-stubs was squeezed into the 16-foot tunnel. It was a close fit, but the ploy worked. The first runs traced the rumbling to the belly scoop. Merely lowering the leading edge of the scoop until it was outside the fuselage boundary layer immediately eliminated the vibrations. This modification was incorporated in over 14 000 P-51s manufactured during the war.

A more serious problem plaguing aircraft designers in the early 1940s was whether the newly developed NACA laminar flow airfoils would improve performance at high speeds. Soon after the 16-foot tunnel's

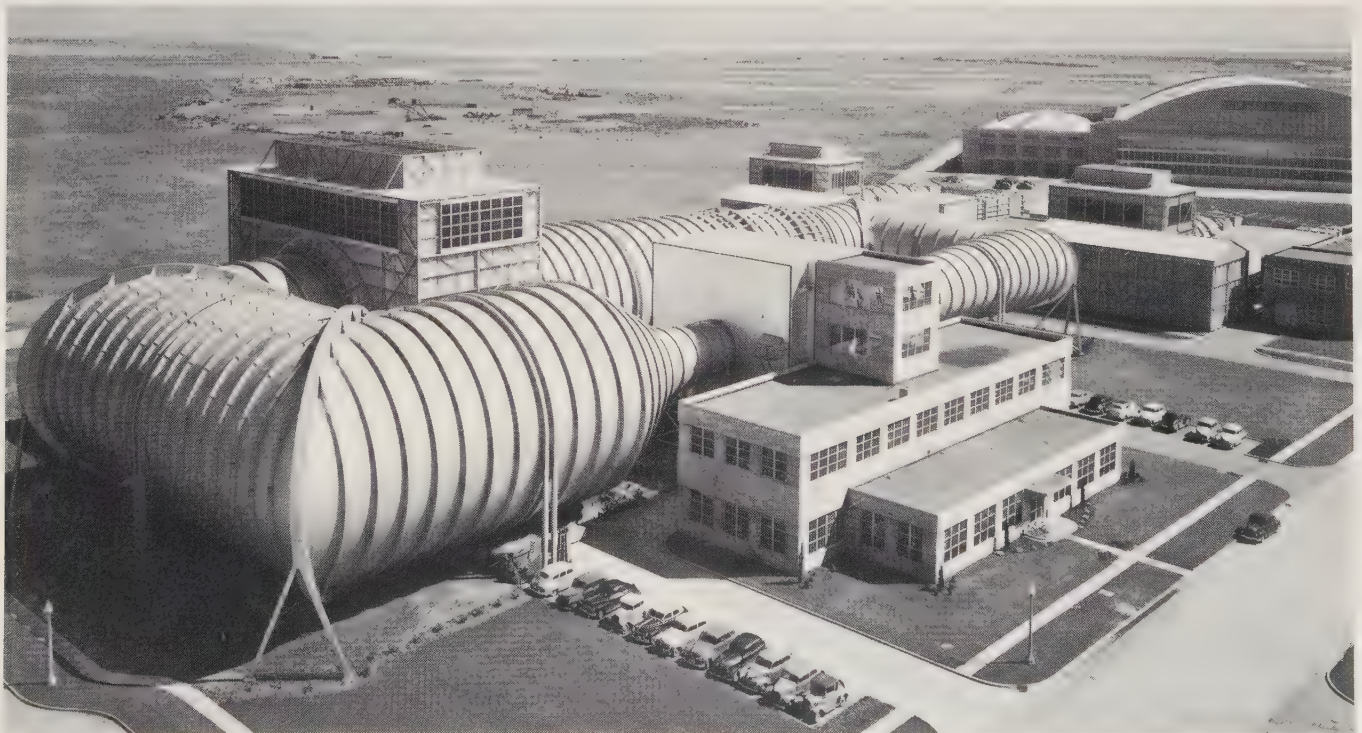

This photograph, taken June 10, 1942, illustrates the size of the Ames 16-foot wind tunnel. Note the diminutive automobiles and the two-story building in front.



A North American XP-51B with outer wing panels removed undergoing tests in the Ames 16-foot high-speed tunnel.

inauguration, NACA aerodynamicists ran tests on full-scale wings. For the first time, they obtained data on full-size wings at high speeds and high Reynolds numbers.

The fourth war-time wind tunnel built at Ames departed from the high-speed theme that was supposedly Ames' reason for being. In fact, this new tunnel could not generate test section velocities beyond a paltry 230 mph. Yet this low-speed tunnel was an invaluable addition to NACA's repertoire of tunnels because it was *big*: 40 × 80 feet at the test section. It was big enough to handle all but the largest bombers and transports—with their engines operating. The low airspeeds did not matter because the purpose of the tunnel was to examine the takeoff and landing characteristics of aircraft. These two periods of flight are extremely sensitive in terms of lift, drag, and stability. Full-scale tests in the 40 × 80-foot tunnel led to seemingly small improvements that actually meant a great deal in aircraft operations. For example, after tunnel tests, the Douglas XSBD-2 dive bomber was provided with a modified wing-flap system that lowered landing speeds from 90 to 84 mph. When landing on carriers, these few miles per hour gave the pilot much better control and, in addition, significantly reduced the energy that had to be absorbed by the carrier's aircraft arresting gear.

The technical challenge of the 40 × 80-foot tunnel was its sheer physical size. The facility covered 8 acres, and the air circuit was just over 1/2 mile long (2700 feet). Six 40-foot-diameter fans, each powered by a 6000-horsepower electric motor maintained airflow at

230 mph or less (these are still tornado velocities). Construction began in late 1941, the mammoth construction task sorely taxing the resources of the new center. Two and a half years later, in June 1944, the 40 × 80-foot full-scale tunnel went into operation.

In later years this tunnel became the primary facility for investigating the flying characteristics of full-scale helicopters and vertical takeoff and landing (VTOL) aircraft. In the case of the VTOL craft, the tunnel tests explored the critical flight regime where the craft makes the transition from powered lift at low forward speeds to wing-borne lift at high speeds.

Inadvertently, the 40 × 80-foot tunnel also helped study the structural failures of advanced helicopter rotors and new VTOL aircraft. In each instance of unplanned failure, tunnel damage was slight, and the facility was back in operation quickly. Since the tests were well instrumented, the causes of failure were soon found, leading to successful modifications.

So successful was the 40 × 80-foot tunnel in testing full-scale aircraft that 35 years after its initial startup, tunnel power was increased to 135 000 horsepower, raising the maximum speed to about 330 mph (Mach 0.45). Modifications were begun to incorporate a new leg with an 80 × 120-foot test section. The largest fighter-bombers, helicopters, and VTOL/STOL aircraft will be accommodated here.

Filling a Wind Tunnel with Water

During World War II NACA engineers at Ames decided to try combining three desirable wind tunnel

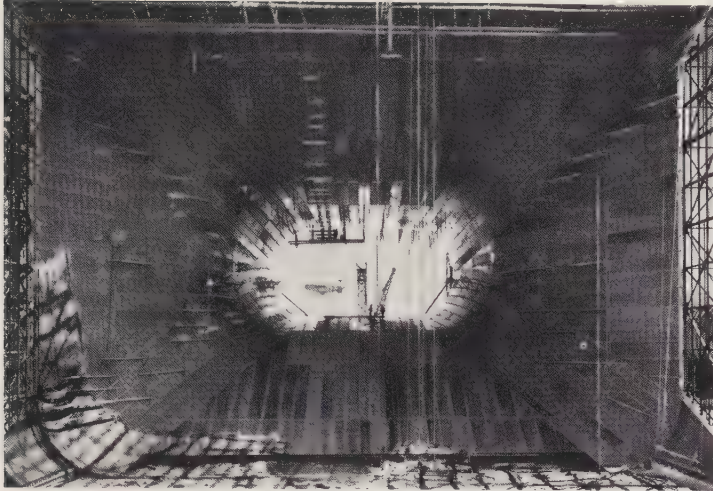

The cavernous entrance cone and test section of the Ames 40 x 80-foot full-scale wind tunnel.



An F-84 Thunderjet has room to spare in the test section of the Ames 40 x 80-foot tunnel.

characteristics in a single tunnel. These coveted qualities were and still are:

1. High Reynolds numbers
2. High subsonic speeds
3. Very low airstream turbulence

Previously, tunnel designers had set their sights on only one or two of these objectives in a tunnel design, mainly because each goal requires considerable engineering finesse. Striving for all three in the same tunnel posed too big a challenge in the early days of tunnel design.

The new tunnel that took shape on the Ames drawing boards certainly had a different look about it. Basically, it was a 12-foot tunnel at the test section, but just before the test section was a rather grotesque bulge some 43 feet in diameter. Low-turbulence

screens located here smoothed out the airflow, thus achieving one of the goals. High-speed flow was obtained by brute force—a 12 000-horsepower electric drive system. By examining the tunnel corners, one can discover a clue as to how high Reynolds numbers were achieved. Instead of the usual sharp, mitered 90-degree corners, the tunnel high-speed airstream is turned in small angular steps. Such step-wise construction withstands high pressures much better than sharp-angled turns. Obviously (at least to an engineer), high Reynolds numbers were reached by pressurizing the tunnel. Six atmospheres pressure was the goal, although this specification was later reduced to five. Shell plate thickness approached 2 inches in many places. The total structural weight was 3000 tons.

The high-pressure integrity of this massive shell was tested by filling it with water—a rather novel idea to the layman but a wonderful idea to safety engineers. Multiply the miniature violence of a pricked rubber balloon millions of times and you will understand why no one wanted to pump an untested tunnel up to 6 atmospheres of air pressure, and especially not to the 9 atmospheres (50 percent over-pressure) required to prove safety. The energy of the compressed air at 9 atmospheres would have been

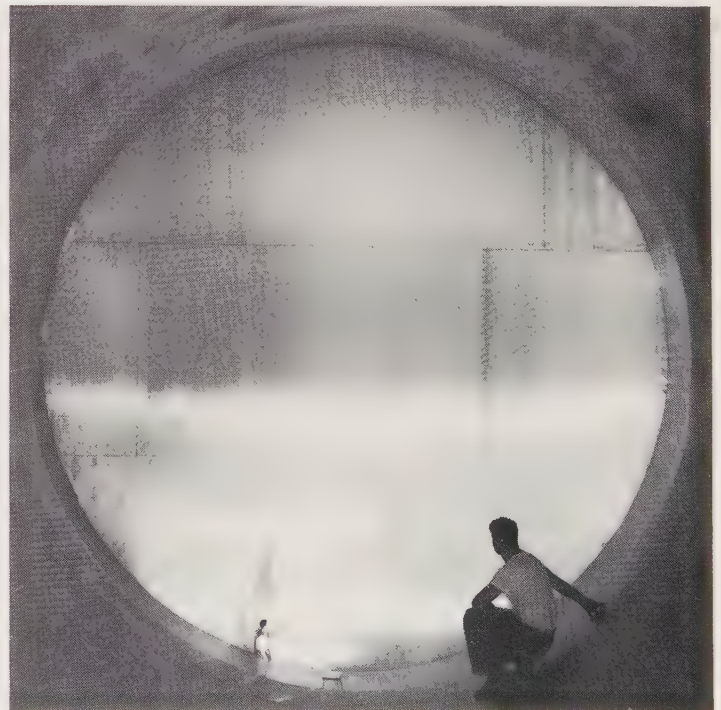

Fine-mesh antiturbulence screens inside the settling chamber of the 12-foot pressure tunnel at Ames.



High-speed air circulating in the 12-foot pressure tunnel is turned by several angular stages rather than a single 90 degree corner. The spherical bulge houses the antiturbulence screens.

sufficient to blow the entire 3000-ton tunnel 1/2 mile high. While an air-filled tunnel was a bomb, a water-filled tunnel was safe because water is essentially incompressible. Of course, it might rupture like a harpooned waterbed, but the results would be far less catastrophic than chunks of 2-inch-thick steel plate raining down on the Sunnyvale countryside.

The filling took a week: 5 000 000 gallons (20 800 tons) of water. Of course, the tunnel foundations had to be built with this immense temporary load in mind. The foundation survived the first pressure test, but as the internal pressure crept up toward 9 atmospheres, there was a terrific report, and a high-pressure jet of water sprayed the area. A steel plate had ruptured.

Inspection and analysis proved that the rupture resulted from stress concentration at the joint of two plates of different thickness. The failure was not serious, and repairs were made promptly.

On the second try the tunnel passed the hydrostatic test successfully. Both NACA and later NASA profited from this experience. Thirty years later, during the design of the National Transonic Facility, NASA

reviewed hydrostatic pressure tests and decided to apply similar tests to the new facility, which had to withstand an operating pressure of 9 atmospheres.

When the 12-foot pressure tunnel commenced operation in July 1946, all eyes were focused on tunnel calibration, air velocity, air turbulence, and flow uniformity. All performance requirements were met, assuring a long productive life of aerodynamic research.

The unique capabilities of the 12-foot tunnel—large size, high Reynolds numbers, and low turbulence—were used to explore the performance of low-aspect-ratio straight wings, swept wings, and delta wings with different cambers and flap systems. This effort led to important performance increases on the Convair F-102 and F-106 fighters through the use of conical camber on the leading edges of the delta wings. Space reentry vehicles depended heavily on the 12-foot tunnel for the assessment of scale effects, even though the tunnel tests were limited to subsonic speeds.

Perhaps the tunnel's greatest contribution was in the development and testing of wing landing-flap systems at high Reynolds numbers. Almost all our modern military and commercial aircraft have benefited from this research. More recently, the low-turbulence qualities of the tunnel have been exploited in critical laminar-flow-control experiments in the development of fuel-efficient, long-range transports.

A Sixteen-Foot Twin on the East Coast

Following the war-stimulated congressional authorization, Langley began expanding into its new West Area in November 1940. Langley already had an 8-foot high-speed wind tunnel in operation, but it was too small for many engineering problems cropping up on new military aircraft—especially where the propulsion system had to be tested. Consequently, plans for the construction of a twin of the Ames 16-foot high-speed tunnel were approved. It had to be a lower-speed version of the Ames facility for the simple reason that Langley did not have sufficient electrical power to run it any higher than Mach 0.7. However, the tunnel's awesome size opened up new research horizons.

The 16-foot tunnel, in fact, was perfect for solving the cooling problems being encountered with air-cooled aircraft engines. With few exceptions, most U.S. fighters and bombers in the air and in devel-

opment depended on air-cooled engines. For every horsepower delivered to the propeller shaft, roughly 2 horsepower of waste heat had to be removed by cooling air flowing past the engine fins and through the exhaust system. True, these engines could be tested on the ground and even in actual flight. But ground testing did not duplicate high-speed airflow into and out of the engine nacelle, and flight testing was costly, time consuming, and very limited in terms of onboard instrumentation. In the 16-foot tunnel, subsonic high-speed flight conditions could be duplicated quickly and cheaply. Full-size engines were mounted in the tunnel and operated at various power levels while hundreds of thermocouples measured temperatures at critical spots. When hot spots were discovered, the cowling and internal baffling could be modified on the spot. New tests could be run immediately, in contrast to long drawn-out flight tests. Wind tunnel testing played a major role in the resounding success of American air-cooled aircraft engines during the war.

Far from being limited to power plant testing, the 16-foot tunnel also tested high-speed propellers and even the shapes of the first atomic weapons. It was not the biggest or fastest NACA wind tunnel, but it was important. In later years, this tunnel was increased in power (see Chapter 5).

Two End-of-the-War Workhorses

So useful was the NACA 7 × 10-foot atmospheric wind tunnel of 1930 vintage that the onset of World

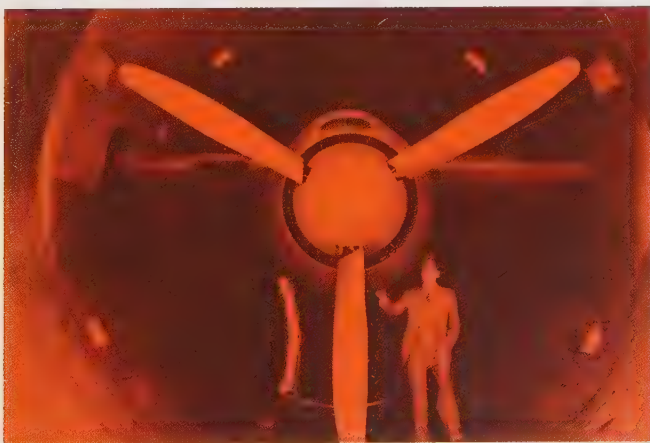

Front view of the engine nacelle of the Douglas XA-26 bomber in the Langley 16-foot high-speed tunnel.

War II produced a 4-year backlog of test requests by the Army and Navy. Congressional authority to construct two more 7 × 10-foot tunnels at Langley, in addition to those already operational at Ames, was quickly forthcoming. The tunnels were built side by side and both went into operation in 1945.

One tunnel had a maximum airspeed of 300 mph, while the second could reach Mach 0.9 (about 675 mph). A 14 000-horsepower electric fan powered the latter, but a 1600-horsepower electric fan sufficed for the former, as one would expect from the law that power requirements increase as the cube of the speed. Originally, neither 7 × 10-foot tunnel incorporated any unique or startling design features, but later ingenious modifications greatly enhanced their value in aerodynamic research.

In 1956, as interest in VTOL and STOL craft intensified, a 17 × 17-foot test section was installed in the settling chamber upstream of the test section in the 300-mph, 7 × 10-foot tunnel. The settling chamber provided appropriate conditions for testing craft making the transition from hovering to cruising flight. Whereas the test area of the 300-mph tunnel was expanded for low-speed work, the test section of its high-speed twin was constricted by a carefully designed “bump.” Air flowing over the bump was accelerated to the transonic range even though the main airflow remained subsonic. This modification, though crude, led to a qualitative exploration of the transonic range that was just opening up after the conclusion of World War II. Many of the early X-series of aircraft that helped pierce the sound barrier went through tests on the transonic “bump” in this tunnel.

Ironing Out the Eddies

In the 1930s the wind tunnel evolutionary tree had split into two main branches:

1. The branch concerned with scale effects and the reach toward the higher Reynolds numbers characteristic of actual flight. The Langley tunnel species growing on this branch were the variable density tunnel, the full-scale tunnel, and the 19-foot pressure tunnel.
2. The branch dealing with high-speed effects, as represented by the 24-inch high-speed tunnel and the 8-foot high-speed tunnel.

A third branch sprouted unexpectedly in the late 1930s when Eastman Jacobs and his associates at



A six-propeller aircraft model is shown installed in the modified settling chamber of the Langley low-speed 7 × 10-foot tunnel.



An early version of the X-2 research aircraft undergoes tests on the transonic "bump" of the Langley high-speed 7 × 10-foot wind tunnel. Local airflow over the bump reaches the speed of sound.

Langley were assessing the performance of wings developed in the VDT. For some unexplained reason, the wings usually performed better in actual flight than wind tunnel tests had predicted—a strange turn-about because one generally expected laboratory tests to be more optimistic than flight results. Careful research demonstrated that the performance gap was due to undetected turbulence in Langley's wind tunnels. The atmosphere outdoors was actually quieter and more homogeneous than that in the best wind tunnels.

In contrast to wind gusts and other large-scale turbulence in the atmosphere, the wind tunnel's fans and air-guiding structures induced fine-scale random fluctuations in local air velocity and flow angle. This microscopic "weather" disturbed the thin boundary layer of air next to the surface of the wind tunnel models. Lift, drag, and other measurements were compromised in ways that could not be corrected for.

Wind tunnel designers employ two techniques to tranquilize microscopic air turbulence. In the first, the airstream is simply squeezed into a duct with a much smaller cross-sectional area. In effect, the squeezing or contraction irons out some of the dis-

orderly airflow—an aerodynamic mangle, as it were. Modern low-turbulence tunnels usually have a contraction section in which the flow area is reduced by a factor of 15 or more. The second technique uses a settling or stilling chamber upstream of the contraction section. In this chamber, baffles and screens (some with wire as thin as human hairs) smooth out the flow by breaking up the eddies.

Although these two principles were recognized in the late 1930s by the NACA engineers contemplating their first low-turbulence tunnel, no one had ever built a large tunnel using high contraction ratios in combination with a settling chamber packed with honeycomb and fine-meshed screens. Would such a tunnel work at the high Reynolds numbers demanded? Before investing in a full-scale, pressurized tunnel of such novel design, it seemed wise to build a cheap model to work out any unexpected engineering problems that might arise.

At this period (the late 1930s), the desirability of low turbulence in wind tunnels was not widely appreciated. Funds for a “low-turbulence” tunnel would have been difficult to justify. Aircraft icing, however, was a “hot” topic. The model of the low-turbulence tunnel was therefore designated the “NACA Ice Tunnel.” Fabricated from plywood with an inner lining of sheet metal, the ice tunnel was completed in

April 1938. The contraction ratio was 19.6 to 1, with a test section 7.5 feet high and 3 feet wide. Airspeed was 155 mph. True to its announced purpose, the tunnel walls were insulated with a thick wrapping of crude insulation, and refrigerating equipment of sorts was added. This consisted simply of an open tank of ethylene glycol cooled by blocks of dry ice, with the cold mixture pumped through coils that cooled air drawn from the tunnel. Ice actually did form on the leading edge of an airfoil during one of the early, rather perfunctory tests, and the ice tunnel fulfilled its announced purpose.

By October 1940, however, aircraft icing had been forgotten and an array of honeycomb and screening had been installed upstream of the test section. As the tunnel designers had hoped, the air in the test section was almost devoid of turbulence, and a new horizon for aerodynamic research was opened.

The plywood and tin model did its job well. Not only was it employed to perform useful research in its own right, but it also served as a design base for a more permanent facility—the so-called Low-Turbulence Pressure Tunnel (LTPT). In the LTPT, a heavy steel shell replaced the flimsy plywood and tin because the tunnel was to be pressurized to 10 atmospheres. The test section was 7.5 × 3 feet. The contraction ratio was a bit smaller than the model

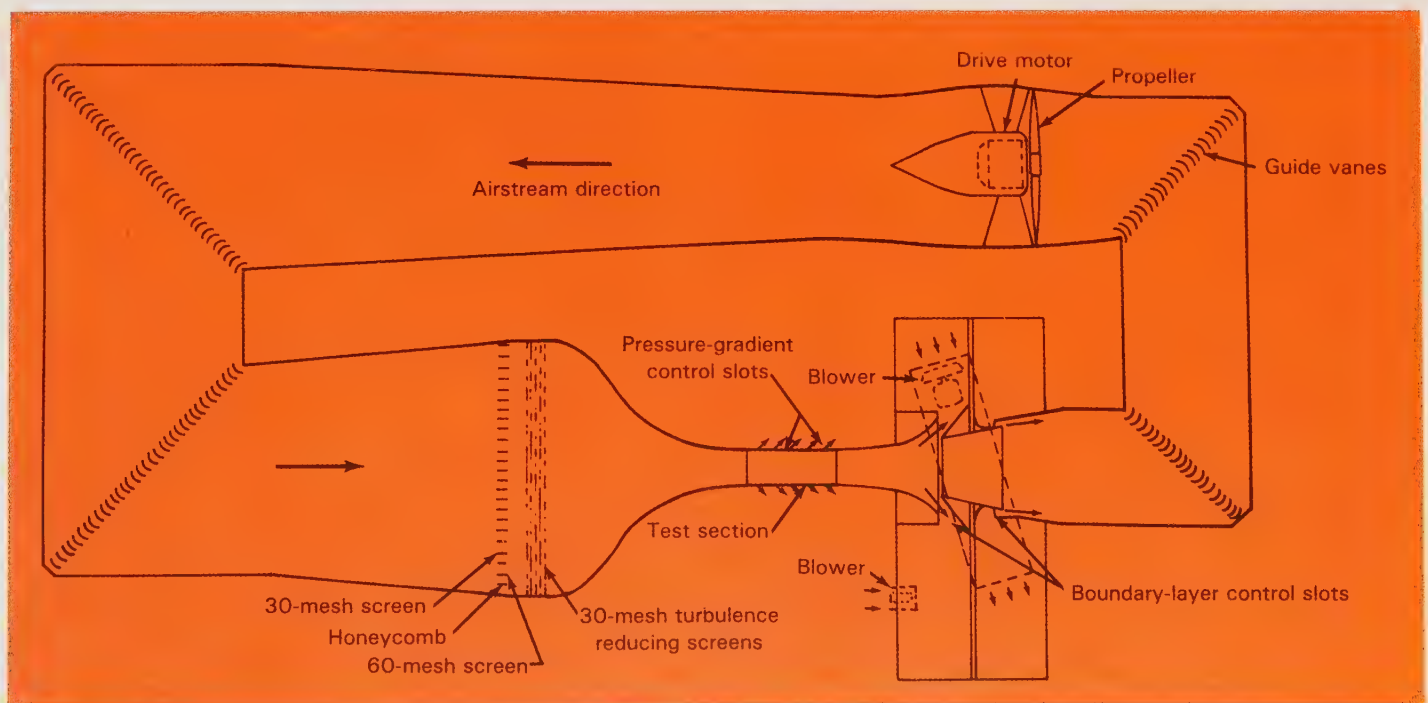

Schematic of the Langley two-dimensional, low-turbulence tunnel, also known as the ice tunnel.

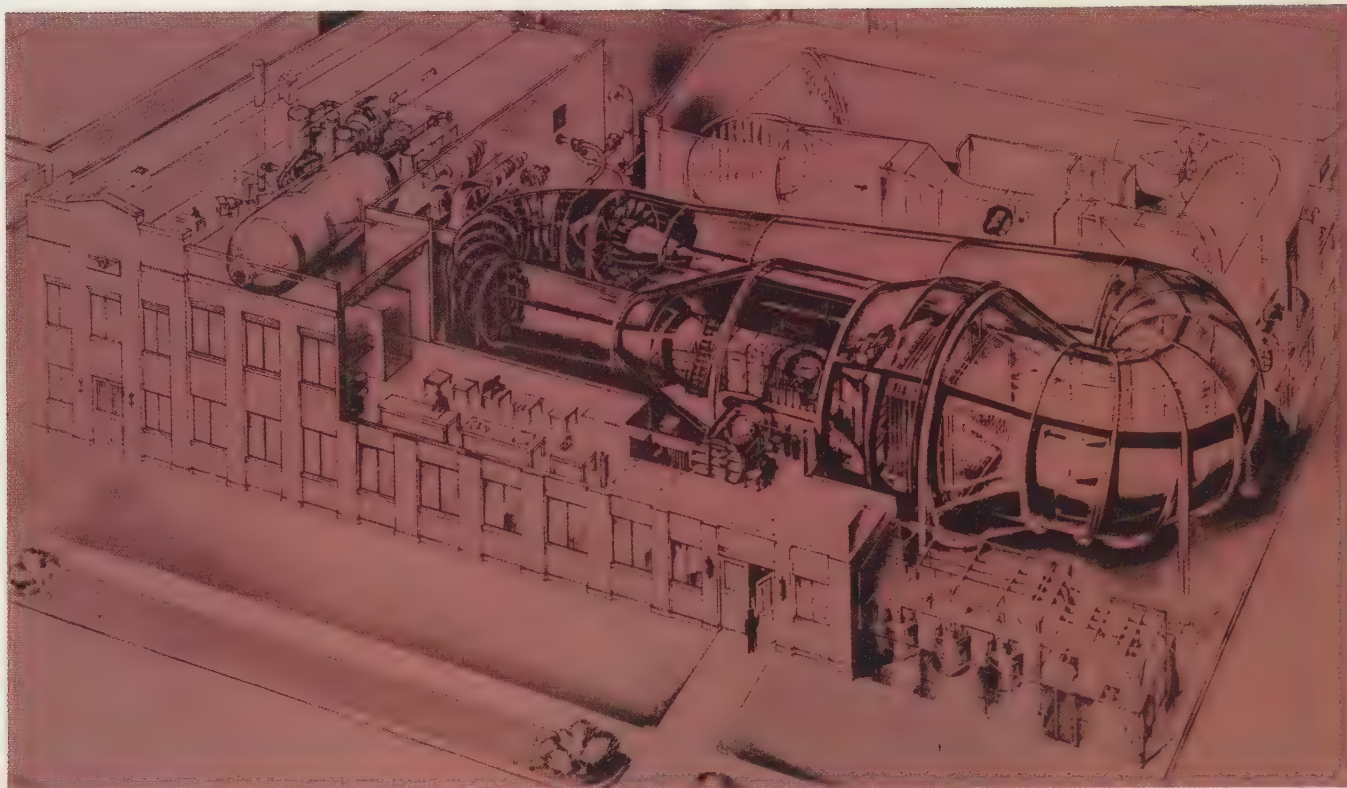

Phantom drawing of the Langley two-dimensional, low-turbulence pressure tunnel (LTPT) in foreground. The ice tunnel is in the background.

(17.6 to 1), but 11 screening elements were installed so that the turbulence levels approached those encountered in the natural atmosphere.

When the LTPT commenced operation in the spring of 1941, it began war work on a crash basis. With its unique low-turbulence-flow characteristics, it was an ideal tool with which to explore the capabilities of a revolutionary type of wing—the newly conceived laminar-flow airfoil. The practical consequences of the new wing were far reaching and of utmost importance in the war effort. It was “fortunate” that Langley engineers, via their ice tunnel, had just the right instrument on hand at the right time.

What was behind this prescience? As noted earlier, Osborne Reynolds had demonstrated in 1883 two types of fluid flow in his classic pipe-flow experiments. The first, *turbulent flow*, is characterized by high skin friction, which duly translates into high aircraft drag. The second, *laminar flow*, occurs when the layers of air slide smoothly over one another without breaking up into swirls and eddies. Skin friction in laminar flow is very low—typically one-fifth of that in

turbulent flow. If the airflow over a fighter or bomber wing could be made mostly laminar, its range could be increased markedly because less fuel would be expended in fighting drag. The low-turbulence pressure tunnel was made to order to explore laminar flow because its airflow was so quiet and smooth that the layers of air sliding over the test wings were not disturbed by tunnel-induced turbulence.

Eastman Jacobs and his associates at Langley knew that the laminar flow of air over a wing was inherently unstable and that it broke up into turbulence just beyond the leading edge of the wing. However, Reynolds, Prandtl, and other aerodynamic theorists had predicted that if the layer of air closest to the wing surface (the boundary layer) was moving into a region of decreasing pressure, the laminar nature of the flow could be stabilized. Pursuing this lead with the earlier ice tunnel and the new LTPT, they developed a whole new series of laminar-flow airfoils. These, when translated into practical wings, had the potential for greatly reduced drag compared to the old wings with fully turbulent boundary layers. Ames aerodynamicists used their 1 × 3.5-foot tunnel to re-

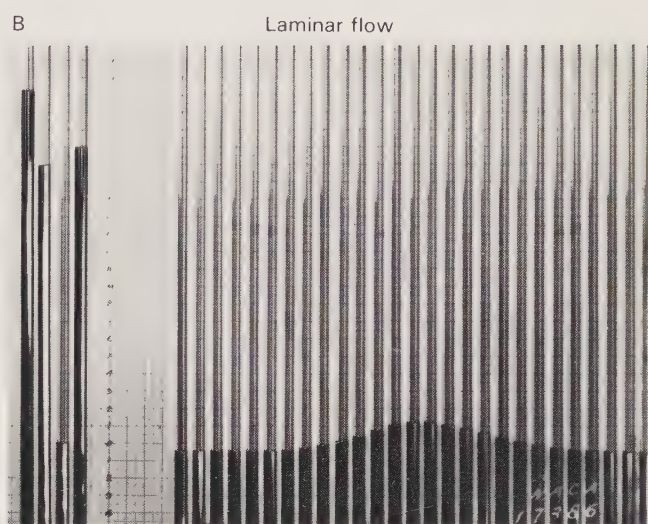
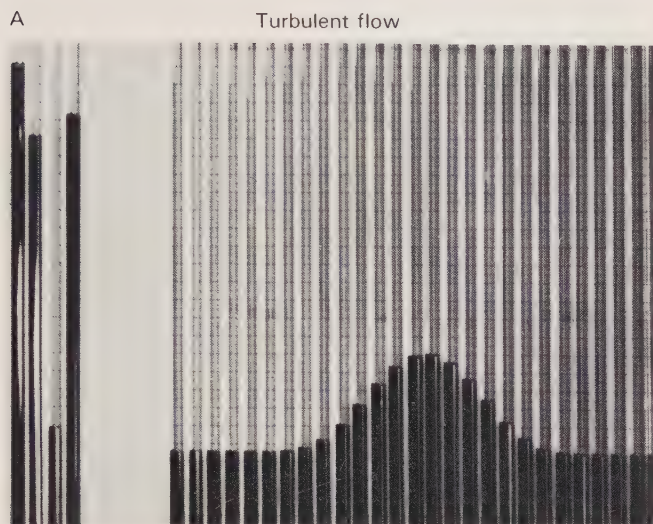

A wake-survey rake in the Langley ice tunnel measures air pressures with a series of manometers. (A) Pressures across the wake at zero lift; the hump is proportional to airfoil drag. (B) When airflow is laminar, the drag is reduced.



A P-51 at Langley in December 1951. The great range of this fighter was credited to the new NACA 6-series, low-drag wing, developed in NACA's low-turbulence tunnel. With less fuel needed to fight drag, the P-51 could escort bombers all the way to Berlin, drastically cutting bomber losses. (Photo courtesy EAA Air Museum Foundation)

fine airfoil contours and establish performance characteristics in the transonic range. The best of the new laminar-flow, low-drag airfoils (called the "6-series") was quickly adopted by the designers of advanced World War II fighters and bombers. This airfoil family still contributes to wing design in today's subsonic jets and propeller-driven aircraft.

Tailspin: The Pilots' Terror

The most dreaded type of tailspin is the "flat spin" in which the aircraft whirls to the ground out of control like a maple seedpod. Fear of tailspin was justified in the early days of flight. Many pilots died fighting their all but useless controls in a vain effort to recover. Even today, approximately 10 percent of all military aircraft accidents and 25 percent of the fatalities are attributed to stall and spin accidents. During the period 1965–1971 some 250 U.S. military planes were lost in such mishaps. Considering the cost of aircraft and the incalculable value of lives lost, it is far cheaper to thoroughly check out aircraft in wind tunnels before introducing them to military operations.

The NACA began its spin research in the 1920s, employing three techniques:

1. Drop tests of aircraft models from high buildings.
2. A 5-foot vertical wind tunnel in which typical models were subjected to rotation tests.
3. Flight tests of various full-scale aircraft.

The objective was to provide aircraft designers with criteria with which they could get an early qualitative feel for whether planes on their drawing boards would have acceptable spin-recovery characteristics.

Such rule of thumb guidelines were of course no substitute for the testing of the final models in wind tunnels or for flight testing of the actual aircraft.

NACA ultimately built a series of two free-spinning vertical tunnels at Langley. A 15-foot-diameter spin tunnel was placed in operation in 1935. Langley's present 20-foot Free Spinning Tunnel began its work in 1941. In all these tunnels, air is drawn upward through the test section by a fan at the top. After passing through the fan, the air circulates through turning vanes that direct it down into an annular return passage and up through the test section again. The current 20-foot free-spinning tunnel has a 1300-horsepower motor that provides 100 foot per second air in the test section. Spin tunnels are extremely simple. No provisions need be made for mounting a model or measuring aerodynamic forces. A rising column of air is all that is needed.

The researcher launches the aircraft model into the rising air by hand from a platform. A flick of the hand imparts a spin and, as the model spins downward, the operator increases the tunnel wind speed until the model's fall is just balanced by the uprushing air, like a circling hawk buoyed by rising thermals. Then the control surfaces of the model, which are

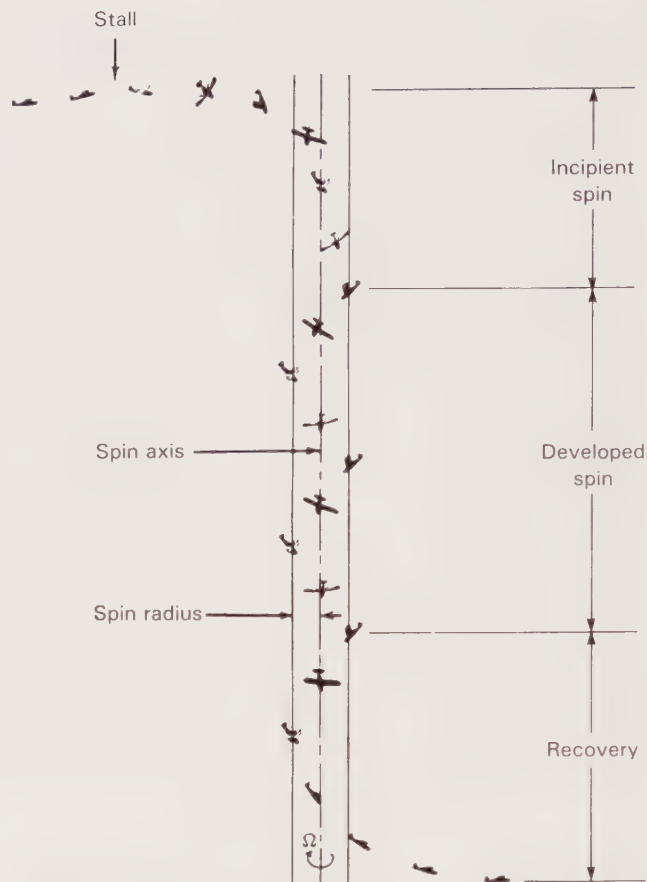

Time sequence of an aircraft in a spin. A free-spinning tunnel can study the regime of the developed spin and the initiation of recovery.

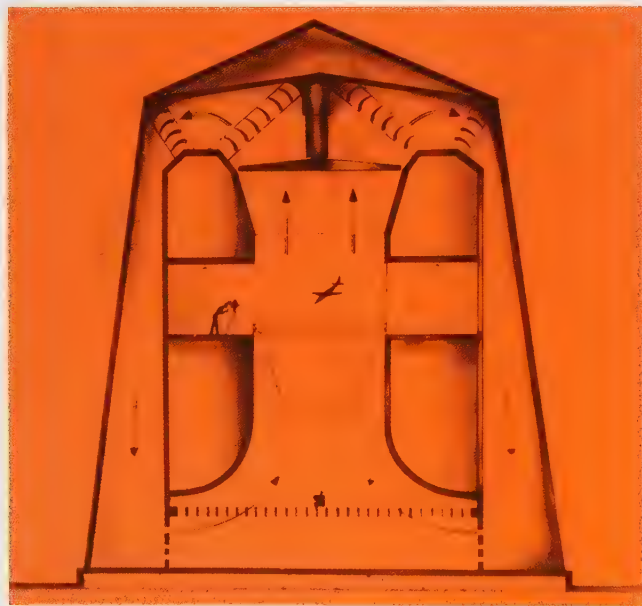

Cross section of the Langley 20-foot spin tunnel. Air flows up through the center and down the annular space between the test section and the building walls. Models are launched into the ascending airstream by hand in Frisbee fashion.

driven by tiny electric servo-actuators, are activated electromagnetically to initiate recovery from the spin.

During World War II, every fighter, light bomber, attack plane, and trainer—over 300 designs—had to be tested in Langley's spin tunnels. Subsequently, over half of these aircraft were modified in some way to ensure that their controls would be able to pull them out of a spin.

After the war came the jets with their small swept wings and long heavy fuselages. The whole spin recovery picture changed with these bulletlike craft. A set of spin recovery rules had to be evolved in the spin tunnels. But a new problem had arisen. Because of their small sizes, the spin models often exhibited aerodynamic characteristics quite different from their full-scale prototypes. A full-scale spin tunnel to solve this problem was out of the question. But a small spin model could be modified locally (via wing leading-edge radius, fuselage strakes, vortex generators, etc.) to make it behave as if it were of larger scale. The Ames 12-foot pressure tunnel was uniquely suited for

this task, for it could span the Reynolds number test range from model to full-scale flight. This unlikely combination of facilities solved the problem of model scale and reinforced the validity of the free-spinning model technique.

The value of spin tests can be illustrated with two modern aircraft, the F-4 fighter and the variable-sweep F-111 fighter-bomber. In the former, spin tunnel tests demonstrated that two types of spins were possible: a steep, nose-down spin from which recovery was easy and, second, a deadly flat spin. The steep spin had occurred occasionally in peacetime service but posed no real problem. The flat spin was not encountered until the plane entered combat in Vietnam, when more severe maneuvers and inexperienced pilots combined to create conditions unanticipated by the plane designers. The Langley spin-tunnel team quickly found a new piloting technique that allowed pilots to recover from this kind of spin.

Focusing on the variable-sweep F-111, Langley spin tests found an uncontrollable type of spin in the designs first tested. This spin occurred only under flight conditions well outside those expected during actual service. Nevertheless, Langley aerodynamicists provided the manufacturer with data for an emergency spin recovery parachute and recommended that it be incorporated on test aircraft. The manufacturer (General Dynamics) did install the chute on the aircraft scheduled to perform stall tests. It was a fortunate decision because in flight tests the aircraft did enter this uncontrollable spin mode, and both plane and pilot were saved by the chute. A design fix later eliminated this type of spin.

Swirl and Turn

In the early days of wind tunnel design, every effort was made to make airflow in the tunnel test section as uniform as possible. Only under such idealized conditions could the aerodynamic forces acting on a plane in level flight be measured accurately. Unfortunately, aircraft do not remain long in level, straight-ahead flight; they roll, turn, and pitch. When an airplane rolls, the wing tips move much faster than the wing near the fuselage. The aerodynamic pressure built up by virtue of the wing's rotation produces a force opposite to that desired by the pilot for the roll maneuver. Aircraft designers wanted to know just how large this roll-created resist-

ing or "damping" force was. They also wanted to know more about the forces encountered when an airplane flew in a curved flight path.

To answer such questions, NACA built a special Stability Tunnel at Langley. Placed in operation in 1941, it was a simple, continuous-flow wind tunnel. It had two interchangeable test sections, each about 6



Inside the Langley stability tunnel, rim-driven rotating paddles set the air swirling to simulate the rolling action of the model.

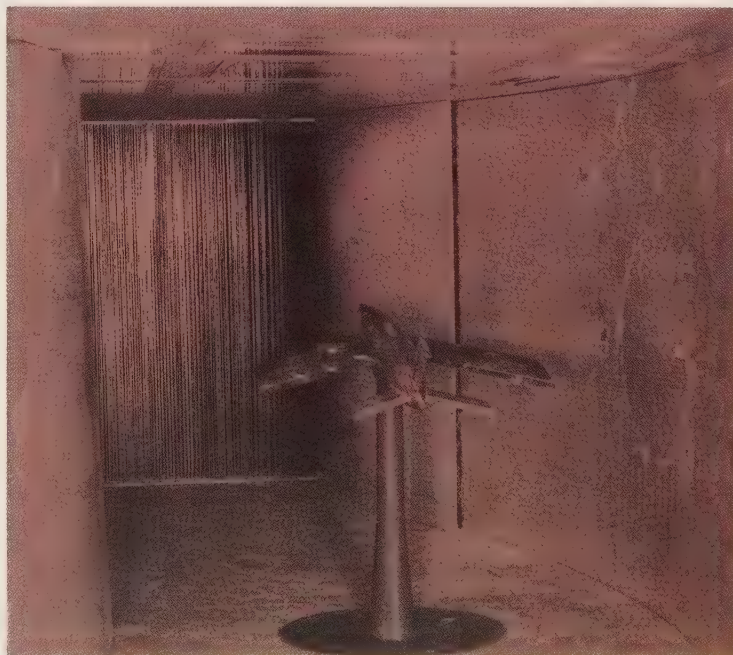

A model aircraft encounters a turning airstream inside the Langley stability tunnel.

feet in size. Into the first test section was built a set of rotating paddles that started the air swirling as if it were a giant (but gentle) eggbeater. The second tunnel section actually had a curve built into it to simulate curved flight.

For many years the stability tunnel provided data for predicting the maneuvering performance of aircraft and missiles. Its eventual demise was hastened by the perfection of oscillating model techniques, which could be employed in conventional tunnels, as well as better free-flight, powered models that could be flown in the cavernous full-scale tunnel. In 1958 the stability tunnel was dismantled and reassembled on the campus of Virginia Polytechnic Institute and State University at Blacksburg, Virginia, where it now functions as an educational and research and development tool.

A Tunnel for Engines

Testing aircraft engines, whether reciprocating or jet, tries the mettle of wind tunnel designers. Simply blowing ambient air around a closed circuit is completely inadequate. Aircraft engines operate at

pressures all the way from 1 atmosphere to 0.1 atmosphere and less. Large air-exhauster pumps must be added to the conventional tunnel to simulate high altitudes. Furthermore, high altitudes also mean very low temperatures: -50°F and lower. In consequence, a huge refrigeration system must also be installed. A unique requirement appears when the engine is operated in the tunnel—as it usually is. Something has to be done with the hot exhaust. It cannot be recirculated because it is contaminated with combustion products. It must be captured and removed from the circulating airstream—a real engineering challenge.

Lewis Flight Propulsion Laboratory, near Cleveland, Ohio, tackled the engine wind tunnel design task during World War II. In fact, the first big facility built at Lewis was the Altitude Wind Tunnel. It was rushed to completion in early 1944 and was immediately applied to testing B-29, P-47, and XTB2D-1 engine-propeller combinations. In less than a year, however, a full-scale YP-80A Shooting Star (with clipped wings) was mounted in the Lewis altitude tunnel to explore the operation of that revolutionary development, the turbojet engine.

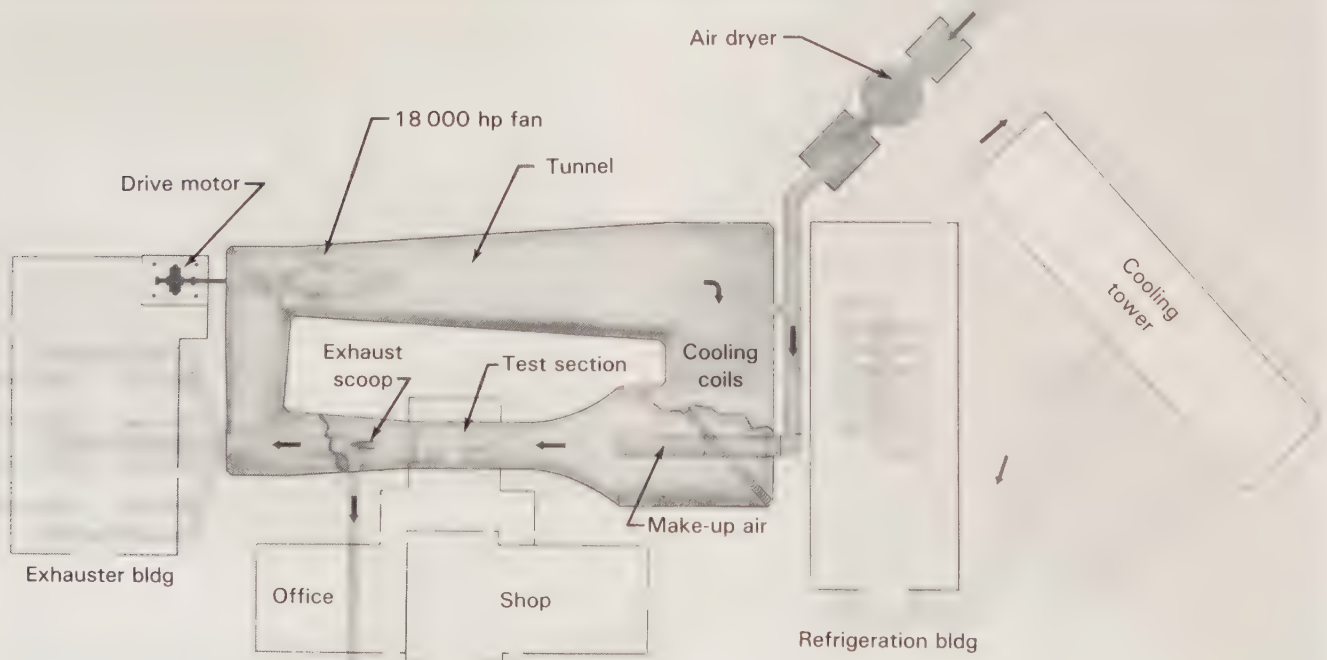

Layout of the Lewis altitude wind tunnel, showing equipment necessary to purge combustion products, control air pressure, and reduce air temperatures.

The Lewis tunnel met the high-altitude and low-temperature requirements by incorporating four reciprocating-type exhaustor units (7000 horsepower total) and a 21 000-ton refrigeration unit that cooled tunnel air passing by its coils down to -50°F . The singular feature was the exhaust air scoop immediately downstream of the engine under test. It collected the hot combustion products and removed them from the tunnel. To replace the lost air, engineers injected clean air just ahead of the engine being tested. The resulting wind tunnel, while belonging to the same species as those at Langley and Ames, had three unique components: exhaustor, refrigerator, and exhaust scoop.

Engines, inherently more complex than airfoils, were adorned with much more instrumentation in wind tunnel tests. Tests requiring 1000 simultaneous readings were common. For example, to check out

engine performance, one measured power level, engine RPM, fuel flow, supercharger setting, cowl flap opening, and hundreds of separate temperatures, pressures, and forces. All these data had to be collected, recorded, and analyzed. While this seemed an instrumentation nightmare in 1944, it was really a harbinger of things to come in the approaching missile and space ages.

“Hot Jobs for a Cold Tunnel”

So read a 1977 headline. The text that followed described the 1944 Lewis Icing Research Tunnel, the world’s largest. Passengers on today’s commercial airliners hear nothing of the terror of icing, which 30 years ago could render a plane uncontrollable in a few minutes, as heavy layers of ice collected on wings and control



The Lockheed YP-80A aircraft installed in the Lewis altitude wind tunnel.

surfaces. During World War II, over 100 cargo planes enroute over the Hump from India to China were lost, most because of severe icing. Aircraft icing is not as critical today because these problems are solved first on the ground in the Lewis icing research tunnel.

Externally, the Lewis icing research tunnel has the lines of a conventional subsonic wind tunnel. Inside, a 4160-horsepower electric motor generates 300-mph air in a 6 × 9-foot test section. There the similarity ends. The first departure from conventionality is the 2100-ton refrigeration system that can cool the air down to -40° F. However, cold air by itself cannot produce icing. There must be water vapor and droplets in the air to condense and freeze on the aircraft surfaces. The appropriate atmospheric conditions are created by a battery of atomizers upstream of the test section. The aircraft in the test section is thus forced to fly through a cold, supersaturated cloud of air,

resulting in rapid ice buildup on the craft. As the deadly layers grow, heating elements in the crucial aircraft components go into action, and the detached ice shards fly off downstream. Cameras record the whole sequence to show engineers where to make improvements in the de-icing system.

The icing wind tunnel shell is insulated by a 3-inch layer of fiberglass to help keep the tunnel cold. In a strange turnabout, some parts of the tunnel must be heated to keep ice from accumulating and thus spoiling the experiment. The observation windows, for example, are electrically de-iced, like the rear windows on some automobiles. Downstream of the test section, internally circulated steam de-ices turning vanes that would otherwise become clogged with ice and block airflow. Through the judicious application of heat and cold, the tunnel works, and modern air travelers need not worry about aircraft icing.

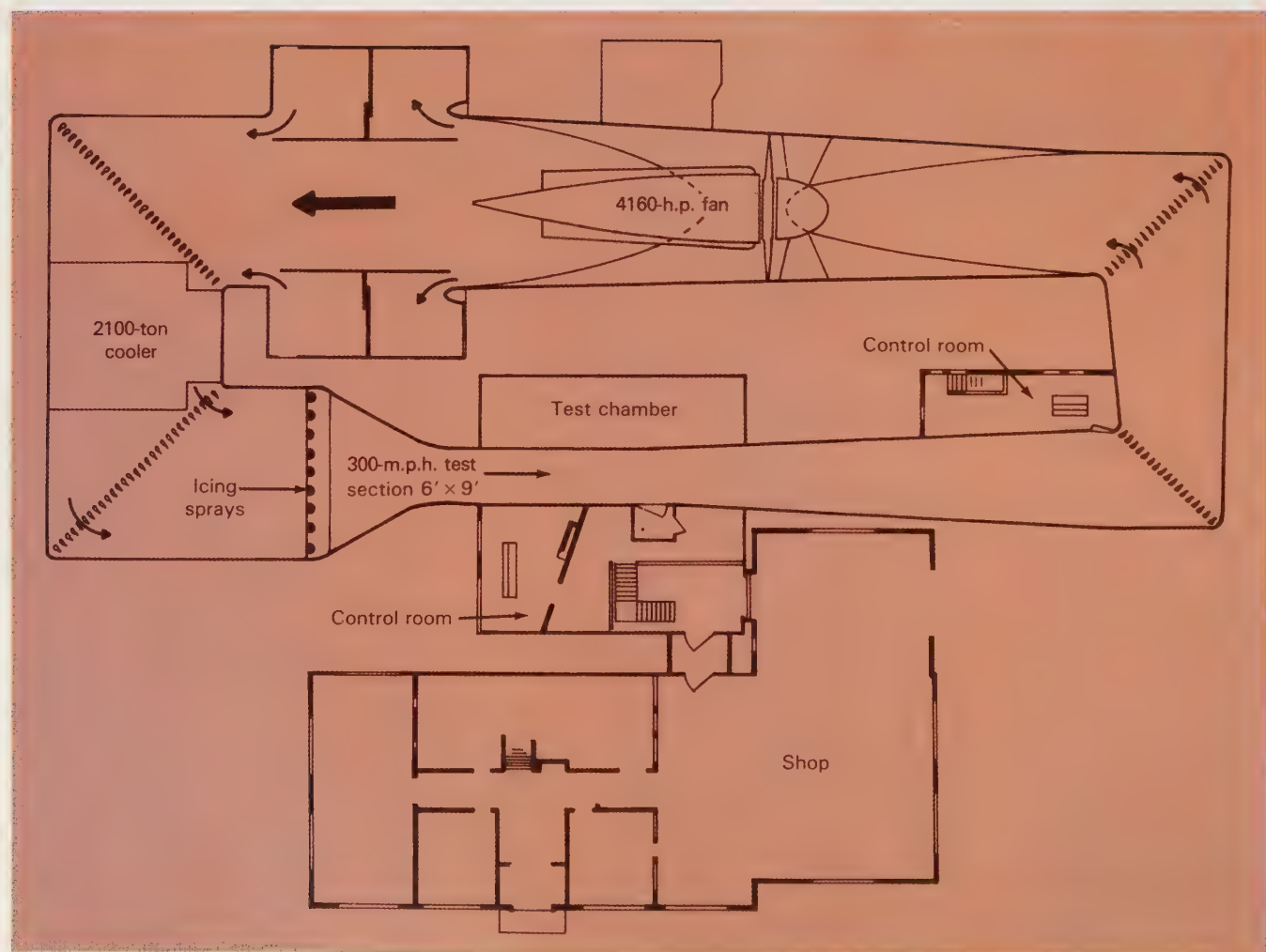

Plan of the Lewis icing research tunnel.

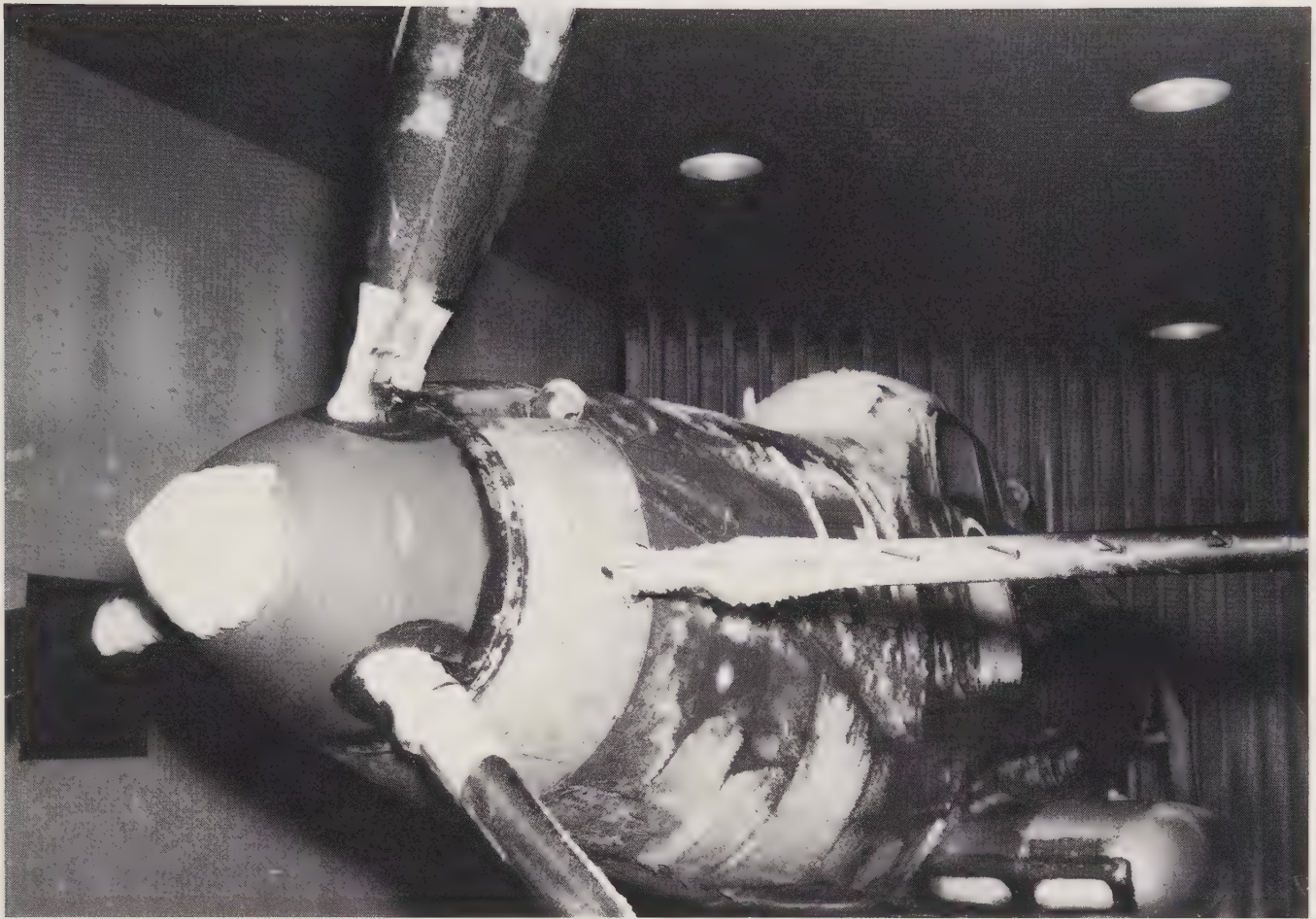

Ice sheets adhere to the rotating propeller and nose of a fighter in the Lewis Icing Tunnel.



Chapter 5

The Era of High-Speed Flight

To the aeronautical pioneers of the early 1900s, a sustained speed of 100 mph would have seemed an incredible goal. Yet aircraft speed records fell with great regularity in the 1920s and 1930s. In September 1948, the F-86 jet fighter reached a speed of 670 mph. Forty years earlier only a madman would have suggested that such speeds were possible. In 1948 a new generation of “madmen” were dreaming of planes flying several times the speed of sound and of rockets leaving the Earth’s atmosphere. But surely 670 mph was fast enough for anyone. Was there any real need for higher speeds?











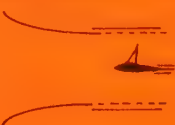

The stark military reality of 1948 was that a single flying machine, whether manned or unmanned, whether jet or rocket driven, could carry as much destructive power as an entire fleet of World War II bombers. The atom bomb, of course, made high-speed delivery systems of crucial importance in the buildup of weapons during the Cold War. Ironically, the United States, which had developed the atomic bomb, was well behind Germany in designing advanced weapons delivery systems. The jet engine, the long-range rocket, the swept wing, and the guided missile—here was where the United States lagged and NACA wind tunnels would help the most.

By the end of the 1948–1957 decade, jets would fly at 1200 mph, the ICBM would be a reality, and the first artificial satellite would be in orbit. The wartime subsonic wind tunnels, which had been used with such effectiveness by NACA, had to be supplemented immediately by faster-than-sound facilities. Although NACA planners could not foresee the coming explosive developments in flight, NACA launched a crash program to design and build three large supersonic wind tunnels, one each at the Langley, Ames, and Lewis centers during the closing days of the war. A whole new wind tunnel technology had to be conceived, plotted out on drawing boards, and turned into practical hardware.

How Supersonic and Subsonic Tunnels Differ

“Breaking the sound barrier” was a popular theme as planes flew faster and faster in the late 1940s. It turned out that wind tunnels also ran up against a sound barrier of sorts. At that seemingly magic speed, the velocity of sound, strange things begin to happen. In a wind tunnel, for example, as more and more power is applied to the fans, airflow in the narrowest part of the test section chokes up at Mach 1, the speed of sound. No matter how fast the driving fans turn, the air velocity in this part of the test section remains at Mach 1. The brute-force approach does not work. The same sort of choking occurs in the narrow throat of a rocket engine. Nevertheless, the hot exhaust gases of rocket engines travel faster than sound. They accelerate past Mach 1 as they expand in the rocket engine nozzle. Supersonic wind tunnels employ the same nozzle expansion to reach supersonic speeds.

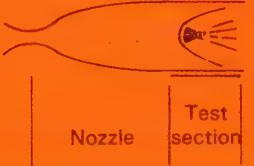
Apparently contrary to logic, the test models in a supersonic wind tunnel are mounted downstream of the throat section where the choking occurs. Here, in the nozzle, the cross-sectional area of the tunnel is increasing. However, the velocity of the air is *not* decreasing, rather it is accelerating as all the energy pumped into the air by the fans and stored in the forms of compression and heat energy is converted to kinetic energy. The rocket engine works the same way except that the energy is added by burning fuel rather than by fans. Airflow becomes supersonic once it passes the throat or point of smallest cross-sectional area. This fact of thermodynamics leads to the apparently contradictory situation in which test models are placed at the narrowest part of a *subsonic* tunnel (where airspeed is logically the greatest) but downstream from the narrow throat of a *supersonic* tunnel (where common sense says airspeed should be slowing down).

Speed Regime	Typical flow (model)	Nozzle/test section	Compression ratio	Drive system
Subsonic ($M \approx 0$ to 0.7)			1.0+	
Transonic ($M \approx 0.7$ to 1.2)			1.1	
Supersonic ($M \approx 1.2$ to 5)			2 ($M = 2$)	
Hypersonic ($M > 5$)			20 ($M \approx 5$)	

Characteristics of wind tunnels designed for the different speed regimes.

The nozzle or expanding portion of the supersonic test section has a unique shape for each value of the supersonic Mach number. The ratio of test section area to throat area is 1.69 for Mach 2 and 536 for Mach 10. Thus, to encompass a range of different Mach numbers, the shape of the nozzle in a supersonic wind tunnel must be variable. This can be accomplished by interchangeable nozzle blocks, flexible nozzle walls, or some variant thereof. This required change in nozzle shape is the first of three major distinctions between supersonic and subsonic wind tunnels.

The second important difference between subsonic and supersonic tunnels is the magnitude of the energy losses in the air circuit. In subsonic tunnels the fans need only increase air pressure a modest 10 percent or so to compensate for the energy losses induced by the tunnel walls, models, apparatus, turning vanes, and so on. In a Mach 2 tunnel, however, the fan pressure must be increased by approximately 100 percent. Thus the simple fan becomes a compressor consisting of several stages of fans. A Mach 5 tunnel requires a pressure ratio of about 20, necessitating several multi-stage compressors in series.

Obviously, a much larger amount of power is consumed by these big compressors than by the simple fans in subsonic tunnels, suggesting that the flow losses around the circuit of the supersonic tunnel are much higher for some reason associated with supersonic aerodynamics. The reason is that tremendous energy losses occur in the shock waves immediately downstream from the test section, where the mainstream air decelerates from supersonic to subsonic speeds. These shock-wave energy losses are inherent in all supersonic flow. In the supersonic wind tunnel, the electrically driven fans or compressors must supply this extra energy.

The third and final important engineering difference between subsonic and supersonic tunnels involves the tunnel air itself. Not only must it be clean, that is, free from oil, vapor, dust, and foreign particles, but in addition condensation of the contained water vapor must be avoided. As the tunnel air expands in the nozzle and latent heat is turned into kinetic energy, air temperature falls. Condensation of contained moisture is very likely, but condensation can be avoided by drying the air to extremely low dew points (e.g., -100° F).

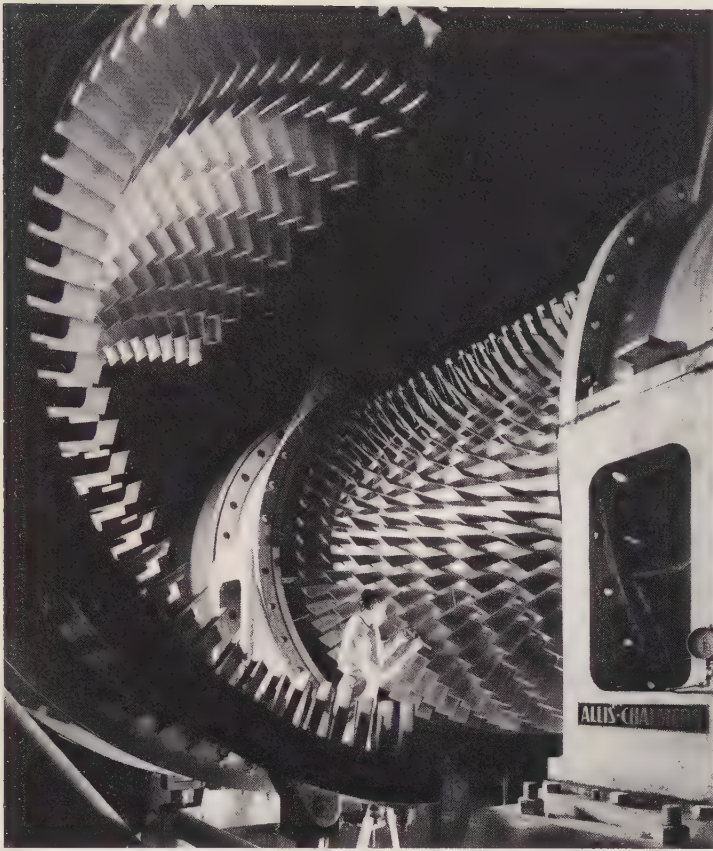

A multistage compressor for supersonic wind tunnel use, showing a section of the stator removed. Each ring of blades constitutes a stage.

The First Round of Big Supersonic Tunnels

The development of large supersonic wind tunnels was accelerated by the emergence of the swept wing as a means of reducing supersonic drag. In 1945 Robert T. Jones of Langley (independent of the earlier work of Adolph Buseman) proposed that the sound barrier would be pierced more easily if an aircraft's wings were swept back. Initial NACA validation of the swept-wing concept near Mach 1 was carried out at Langley by free-fall tests of a systematic series of wing-body models dropped from high-flying aircraft. Drag was determined from measurements of the model acceleration during free fall. The first supersonic test in the United States of Jones' suggestion was made in the Langley 9-inch supersonic tunnel by Macon C. Ellis and Clinton Brown. Tests with a streamlined section of wire at a large angle of sweep indicated a dramatic reduction of drag in the

supersonic range. Later tests with a slender delta wing at Mach 1.75 fully verified Jones' theory. Thus the race for supersonic aircraft supremacy began.

In February 1945 NACA began designing its first large supersonic wind tunnel at Langley. The war was still on and an accelerated construction schedule called for the tunnel to be in operation by the end of 1945—and on a budget of only \$900 000! Langley aerodynamic engineers had been operating their tiny 9-inch experimental supersonic tunnel for 3 years. They now faced the Herculean task of building a vastly more powerful 4 × 4-foot tunnel in just 10 months.

Mach 2 was the goal. To attain this in a 4 × 4-foot test section, given the limited electrical power then available (6000 horsepower), the tunnel engineers had to cut the tunnel operating pressure back to 1/4 atmosphere. Even so, the air compressor had to handle 860 000 cubic feet of air per minute at a compression ratio of 2. The compressor was the key to the whole design, and, as it turned out, the key to the schedule. A seven-stage axial-flow compressor, one of the largest contemplated up to 1945, was aerodynamically designed by Langley. To help make the tough schedule, however, NACA assigned the mechanical design and actual fabrication to an industrial contractor. In the fall of 1945, the electrical drive motor and sections of the steel shell began arriving at Langley, but just when the scheduled goal seemed within reach, the construction of the compressor was halted by a 2-year strike. The tunnel did not begin operation until May 20, 1948.

Finally on the line, the 4 × 4-foot supersonic tunnel made up for lost time. Many well-known military aircraft and space vehicles were tested through the years: the famous Century Series fighters (F-102, F-105, etc.), the B-58 supersonic bomber, the X-2 research aircraft, and so on. So valuable was the tunnel that new drive motors were installed in 1950, bringing the power up from 6000 horsepower to 45 000 horsepower (continuous) and 60 000 horsepower (for half an hour). The uprated tunnel remained in service until 1977, when it was dismantled. Its drive motors, cooling towers, and some support facilities were incorporated into the new National Transonic Facility (NTF) being built on the same site.

On the west coast in 1945, Ames was also exploring the supersonic range with an experimental tunnel. Their pioneer facility, in fact, had a 1 × 3-foot test section—considerably larger than the 9-inch tunnel at Langley. A 10 000-horsepower array of compressors permitted operation at Mach 2.2 at 4 atmospheres

WIND TUNNELS OF NASA

- | | |
|-----------------|--------------------------------|
| 1 Control panel | 5 Compressor |
| 2 Test section | 6 Drive motors |
| 3 Cooling coils | 7 Dry air storage tank |
| 4 Cooling tower | 8 Vacuum pumps and compressors |

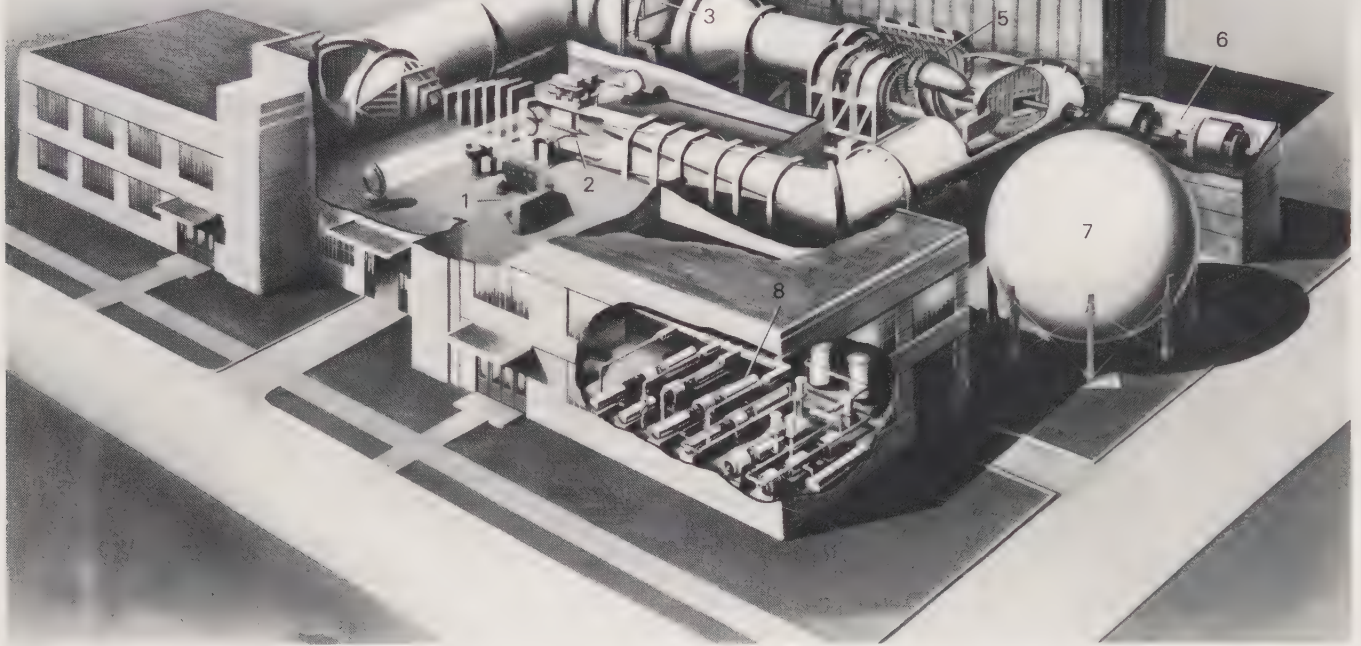

The Ames 6 × 6-foot supersonic wind tunnel with supporting facilities.

pressure. A second supersonic tunnel of the same size operated intermittently off the tremendous amount of energy stored in the compressed air of the nearby 12-foot pressure tunnel. Ames was also ahead in the matter of funding. The U.S. Navy provided \$4.5 million to NACA to build a 6 × 6-foot supersonic facility for use in developing future naval aircraft and missiles. Not only was the resulting tunnel bigger than Langley's but it also incorporated two important new features that vastly increased productivity.

Conventional supersonic tunnels of the day had to shut down and change nozzle contours every time tests were to be run at different Mach numbers. H. Julian (Harvey) Allen, known for his low-drag airfoil research and later Director of the Ames Research Center, conceived an ingenious way to modify the nozzle contour in a continuous way while the tunnel was still in operation. Basically, one wall of the nozzle is kept fixed while the opposite wall slides axially, presenting a changing contour. Thus the tunnel nozzle is asymmetric but variable. The key to the whole idea was the recognition that unique contours could be found, using one fixed wall and one moving wall, that would provide uniform supersonic air velocities

over a range of Mach numbers. In the 6 × 6-foot tunnel, the range was from Mach 1.3 to Mach 1.8. Later wind tunnels, notably the Ames 9 × 7-foot Unitary Plan Wind Tunnel (Mach 1.55 to Mach 2) and the Langley Unitary Plan Tunnel (Mach 1.5 to Mach 4.6), employed this novel concept.

A visually arresting feature of the Ames 6 × 6-foot supersonic tunnel was its futuristic 50-inch-diameter glass windows through which an observer viewed the gleaming, mirror-surface, stainless steel walls of the test section. The huge glass disks, though, were not made to impress visitors. They were ground almost perfectly flat (i.e., optically flat) and had negligible internal flaws. The windows were larger than the 40-inch Yerkes refracting telescope lens, which until then was the largest optically perfect piece of cast glass. Through these glass ports passed the schlieren light beams that helped researchers visualize the flow of the supersonic air around the models in the tunnel. Any optical flaws in the windows would, of course, have distorted the pictures.

The Ames 6 × 6-foot supersonic tunnel did much to solve the mysteries of flight beyond Mach 1. Not only were new wing shapes developed for efficient

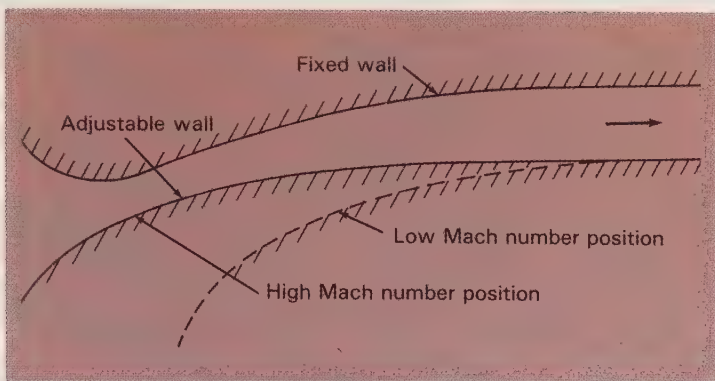

An adjustable asymmetric supersonic nozzle. Wind tunnel Mach numbers can be varied by sliding the lower section back and forth.

supersonic flight, but pioneering work was carried out in the areas of supersonic dynamic stability, aircraft control, panel flutter, and air inlet design. This tunnel, perhaps more than any other NACA wind tunnel, removed the label *terra incognita* from the supersonic map.

In this time period, at the Lewis Flight Propulsion Laboratory, adjacent to the Cleveland Municipal Airport, a supersonic propulsion tunnel was taking form on the drawing boards that some characterized as “an 87 000-horsepower bugle aimed at the heart of Cleveland!” This was the largest (8 × 6 feet) and most complex of the postwar Big Three supersonic tunnels. The “bugle” label was not too far from the truth because it had been decided to make this an open (nonreturn) tunnel; that is, with no recirculation of the air. Tunnel air, engine exhaust gases, and a great deal of noise would be vented into the Ohio countryside.

The mission at Lewis was the testing of aircraft power plants. An engine exhaust catcher had sufficed in the earlier altitude wind tunnel, but the advent of big turbojets and ramjets spewing huge amounts of hot gases made this device impracticable for full-scale engine testing. The following open circuit was devised instead. A seven-stage, 18-foot axial-flow compressor upstream of the test section duplicated engine inlet conditions at Mach 2, 35 000 feet altitude. Aft of the 8 × 6-foot test section, the hot air, filled with combustion products, was vented. The bugle, however, was muted by massive concrete walls and elaborate acoustical mufflers (called Helmholtz resonators) in the diffuser walls. It was not exactly quiet, but downtown Cleveland remained acoustically unruffled.



An aircraft model mounted inside the test section of the Ames 6 × 6-foot supersonic tunnel. The 50-inch-diameter circular glass windows are precisely ground and almost free of imperfections so that schlieren photos can be taken.

Clever solutions sometimes create unexpected new problems, and so it was with the Lewis open-circuit tunnel. The major problem was the moisture in the 150 000 pounds of air drawn in from the outside every minute. The air had to be dried in huge beds of activated alumina so that moisture would not condense in the tunnel. After each run, the alumina beds had to be heated for several hours to reactivate them.

Eventually the 8 × 6-foot supersonic tunnel was converted into a closed circuit by adding a return leg. For some engine tests, recirculation of the air was acceptable—and certainly much quieter. However, special doors allowed easy conversion to open-circuit operation when the engine exhaust gases were inimical to the test at hand. The return leg carrying subsonic air was later exploited by inserting a 9 × 15-foot subsonic test section for studying VTOL/STOL aircraft configurations.

Commencing in 1948, numerous turbojet and ramjet engines passed through the Lewis tunnel. Also, models of supersonic fighters were mounted in the test section with complete simulation of engine inlet and exit airflows. As America entered the Space Age, rocket-powered vehicles were also tested in model form to determine such parameters as nozzle efficiency, controllability, and heating problems during flight.

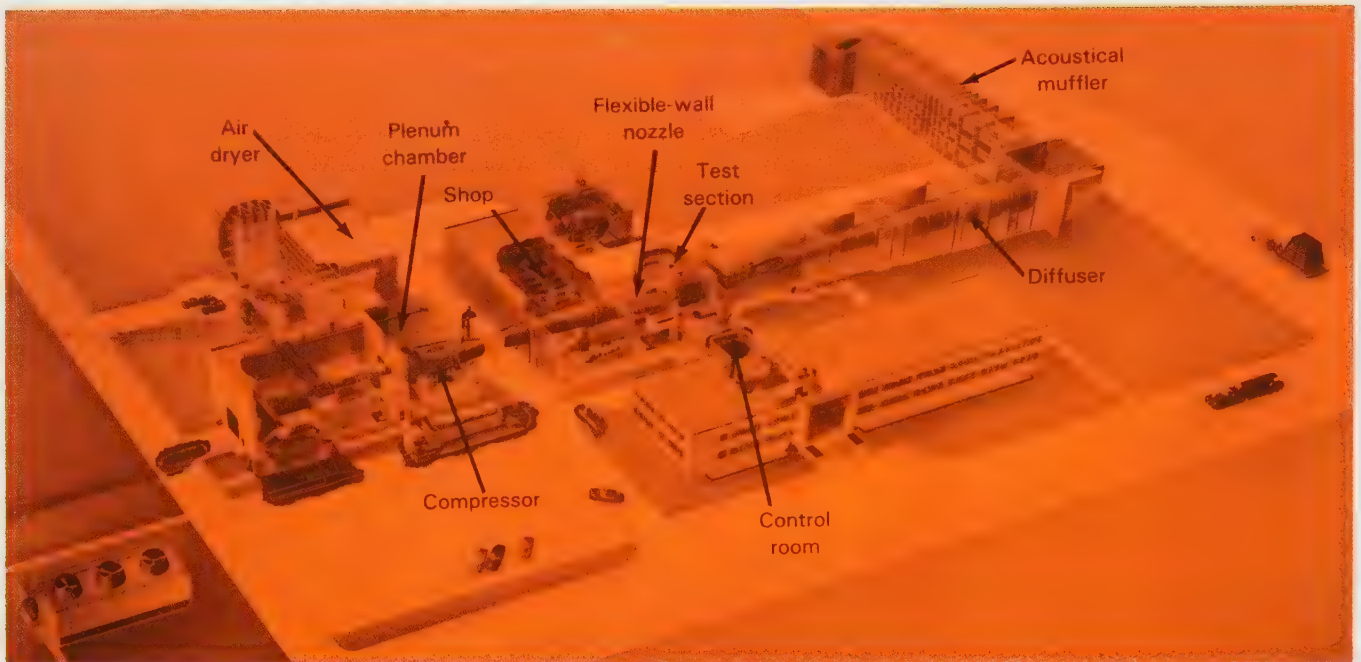

The first supersonic tunnel built at Lewis had an 8 × 6-foot supersonic test section. Doors downstream from the sound muffler permitted either open- or closed-circuit operation.



Nozzle drag tests on the General Dynamics F-16 inside the supersonic test section of the Lewis 8 × 6-foot tunnel.

The Scotch Tape Enigma

The test sections of supersonic tunnels display a mirrorlike surface for a very good reason—the least scratch or imperfection will disturb the airflow and the accuracy of the tests. The presence of unwanted flow disturbances show up emphatically on schlieren photos of the empty tunnel. Just a few cracks or scratches will generate a criss-cross, Scotch-plaid pattern of diagonal Mach lines. Each Mach line is a small shock wave that commences at the site of the imperfection and projects at an angle dependent on the speed of the air in the tunnel. At Mach 1, the Mach lines are perpendicular to the flow; at Mach 2, the angle is 30 degrees (the angle whose sine is 1/2); and in general, at Mach M , the angle is $\arcsin 1/M$.

To illustrate how these curious Mach lines are produced by tiny irregularities in the tunnel walls, small pieces of Scotch tape just 0.003-inch thick placed on the tunnel wall give rise to strong artificial Mach lines on schlieren photos. The pieces of tape, however, are well within the subsonic boundary layer which extends to 0.3 inch—100 times the thickness of the tape. Yet the influence of the bits of tape is felt across the boundary layer. Disturbances like the Mach lines are undesirable in wind tunnel tests. The test section of each supersonic tunnel must be finished to a level

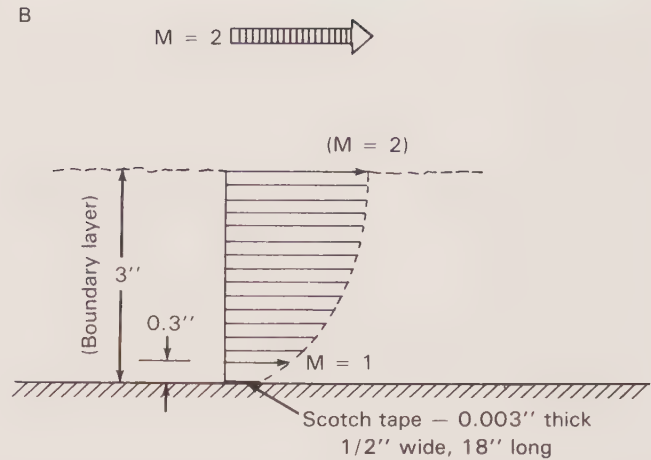
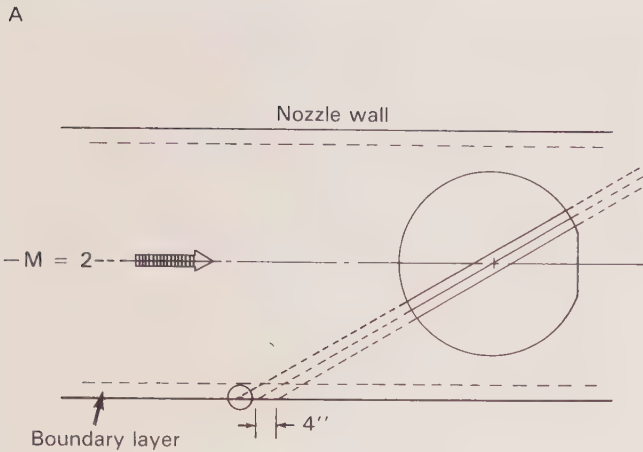

Tiny imperfections in the wall of a supersonic wind tunnel will generate Mach lines that can be seen in schlieren photos. (A) At Mach 2, the lines make 30 degree angles with the tunnel axis. (B) Scotch tape 0.003 inch thick will create Mach lines even though the tape is well within the subsonic boundary layer of air.

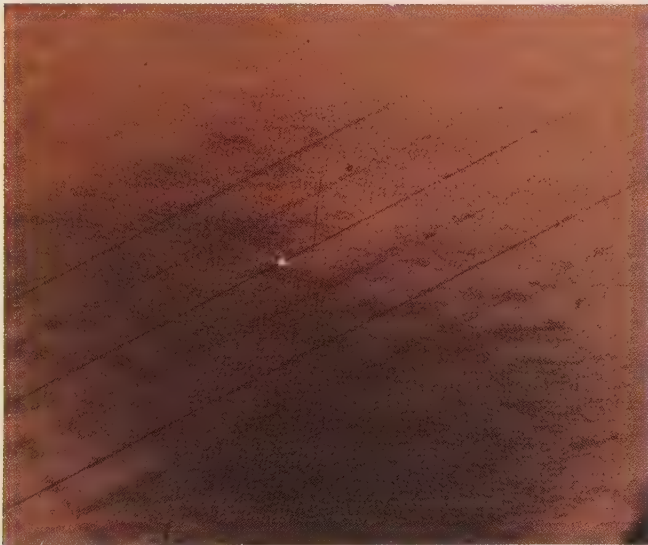

Schlieren photo of several Mach lines generated by strips of Scotch tape on one wall (air velocity = Mach 2).

of accuracy and smoothness much finer than that represented by the Scotch tape. Schlieren photos of the empty tunnel quickly reveal where reworking of the nozzle surface is required.

Ballistic Missiles and Spacecraft Penetrate the Hypersonic Range

No manned supersonic aircraft fought in World War II. In fact, the first manned supersonic flight had to wait until October 10, 1947, when the Bell X-1

rocket plane exceeded the speed of sound. Nevertheless, the German V-2 ballistic missile penetrated the hypersonic range early in the war. The first V-2s fell on England in 1944 at speeds of Mach 5 (3400 mph) and were completely invulnerable to fighter interception. When the Allies captured the V-2 test facilities at Peenemünde on the Baltic, they discovered, to their surprise, a 0.4-meter (1.2-foot) wind tunnel that could attain Mach 5 on an intermittent basis. In addition, a 1-meter (3.3-foot) continuous-flow tunnel capable of Mach 10 was under construction for the purpose of testing the German A-9 and A-10 intercontinental ballistic missiles destined for the bombardment of the United States. Hypersonic flight had thus leapfrogged the supersonic range. There was much debate about whether ballistic missiles would ever amount to much in a military sense, but the technically astounding V-2s made it imperative to at least explore this new range of flight.

There is no clear-cut beginning of the hypersonic range of flight. Generally, speeds above Mach 5 are considered hypersonic. This is the speed at which aerodynamic heating becomes important in aircraft design.

Hypersonic wind tunnels, like their supersonic cousins, employ the expanding nozzle principle to accelerate subsonic air to speeds faster than sound. Of course, the area ratio of the nozzle is much greater for hypersonic tunnels because the Mach 1 air at the nozzle throat must be accelerated so much more. To attain Mach 5, an area ratio (test section area divided by nozzle area) of 25 is required. The ratio jumps to

536 for Mach 10. Consequently, hypersonic test sections are fed through tiny nozzles that expand into grossly larger test sections. Pressure ratios must rise dramatically too—from 1.1 at Mach 1, to 20 at Mach 5, and 350 at Mach 10. Such high-pressure ratios increase the number of compressor stages and naturally demand more power. The hypersonic power requirements for continuous operation are so large that intermittent wind tunnels are common. In the intermittent tunnel, energy is stored, usually as compressed air, and then released suddenly to force a large quantity of air through the diminutive throat of the nozzle in a short period of time.

So far, these considerations seem just simple extrapolations of supersonic tunnel design. But a new factor emerges as the tunnel air accelerates to hypersonic velocities: The air temperature drops dramatically as the air's latent heat is transformed into energy of motion. In a Mach 5 tunnel, for example, air at 200° F in the settling chamber before the nozzle will cool to -350° F in the test section. This is close to the point at which air liquefies—not condensation of contained moisture but actual liquefaction of the air

itself. To prevent liquefaction, tunnel air must be heated before it enters the settling chamber. In a Mach 10 tunnel, for example, the settling chamber air will typically be at a temperature of 3000° F and a pressure of 100 atmospheres. The hypersonic tunnel therefore resembles a rocket engine—a hot, high-pressure one—although the ultimate energy source is not rocket fuel but stored compressed air.

NACA's First Hypersonic Tunnels

So formidable were the design problems of hypersonic tunnels in 1945 that Langley, under the leadership of John V. Becker, chose to build a pilot model first. It was small, with an 11-inch test section, and powered by releasing the air in a 50-atmosphere pressure tank through the nozzle and test section into a vacuum receiving tank. With high pressure on one side and very low pressure on the other, pressure ratios up to several thousand could be maintained for about 100 seconds. An electrical resistance heater raised the air temperature in the settling chamber to

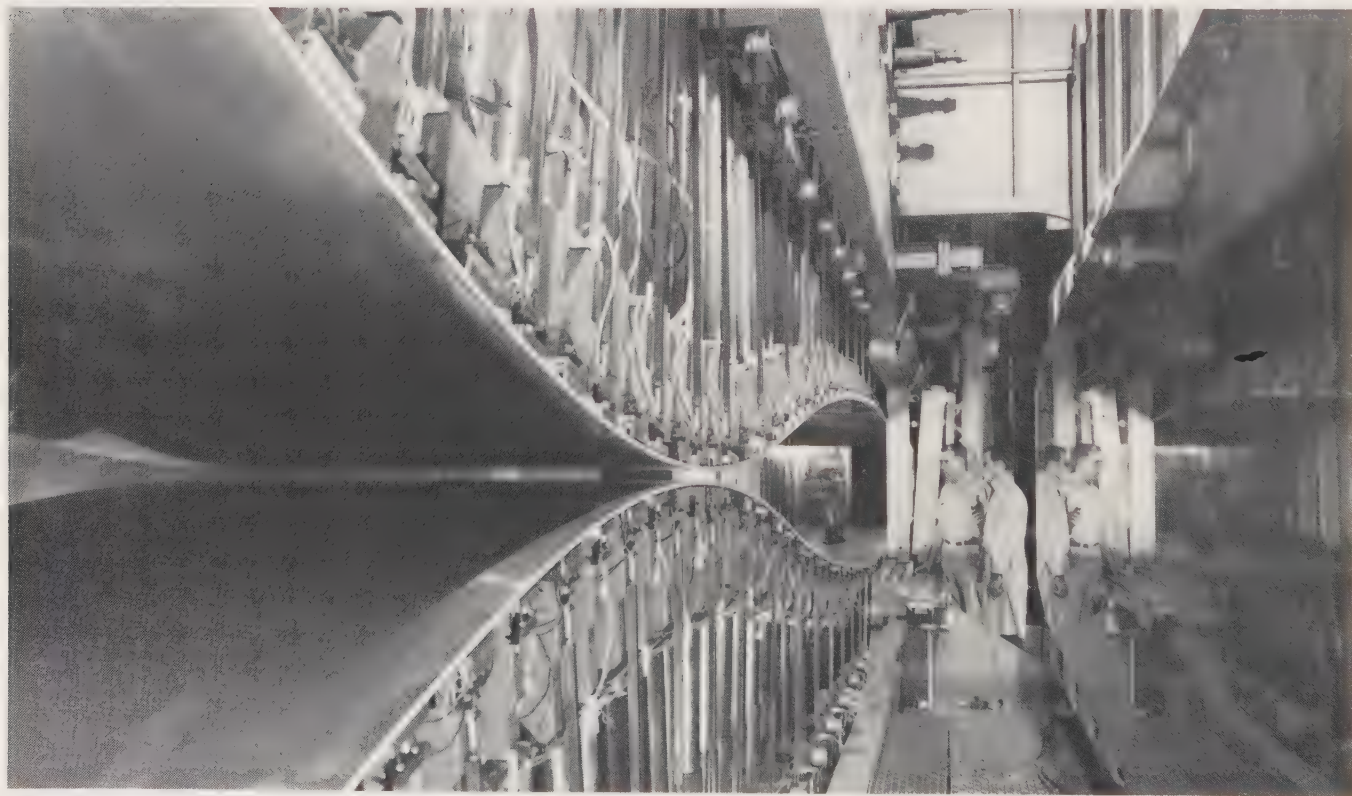

A hypersonic wind tunnel nozzle at AEDC (von Karman Facility) made from two opposed flexible plates. The large area ratios required for hypersonic velocities lead to very small nozzle throats and widely flaring nozzle walls downstream. (Photo, USAF Arnold Engineering Development Center)

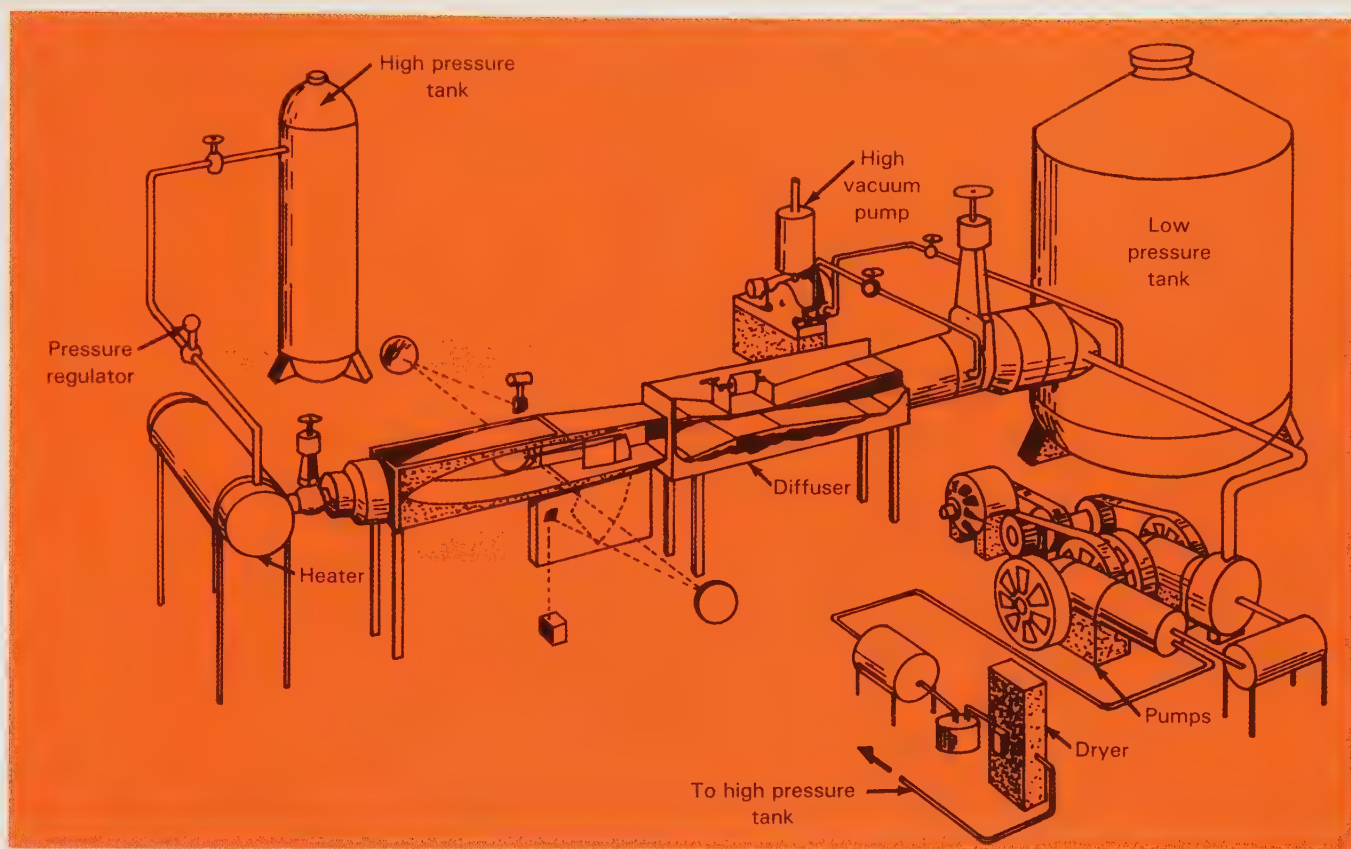

In 1945 Langley built a pilot hypersonic tunnel with an 11-inch test section. To reach high pressure ratios, air from a pressure tank was blown through the test section into an evacuated tank.

900° F to forestall liquefaction of the expanding air in the nozzle. This pilot model was small but flexible—and it worked. The whole apparatus would have fit easily inside an average house.

In 1946 Alfred J. Eggers of Ames began designing a 10 × 14-inch continuous-flow hypersonic tunnel with provisions for varying the Mach number. For power, the pressurizing pumps from the adjacent 12-foot pressure tunnel forced air through electrical heaters, into the nozzle, and finally into a battery of vacuum pumps. The key to varying the Mach number continuously lay in a variable-geometry nozzle and diffuser located downstream from the test section. The role of the diffuser was to control the location and strength of the so-called normal shock that would parasitically consume considerable tunnel power. Coaxing this tunnel up to hypersonic Mach numbers was much like tuning a musical instrument. The secret was to start the tunnel at a low Mach setting with the power-consuming normal shock located far down in the diffuser. Then, with the tunnel running, the nozzle and diffuser throats were narrowed down,

thereby increasing the test Mach number but without changing the losses in the power-consuming shock wave located in the diffuser. In the process the Mach number in the test section was increased and the power efficiency of the whole tunnel maximized. As with the Langley blowdown tunnel, the Ames facility was a place to learn more about hypersonic flow and how to design better tunnels in the future.

A Wind Tunnel Firing Range

High-powered rifle bullets travel faster than sound. Given a large enough propulsive charge, bullets can penetrate the hypersonic range. Why not fashion bullets resembling hypersonic models and fire them out of guns and carefully watch them with instruments as they streak by? Although the idea sounds a bit radical, it is quite sound—provided that a properly instrumented firing range is available.

NACA owned several ideal firing ranges: the supersonic wind tunnels at Ames, Langley, and

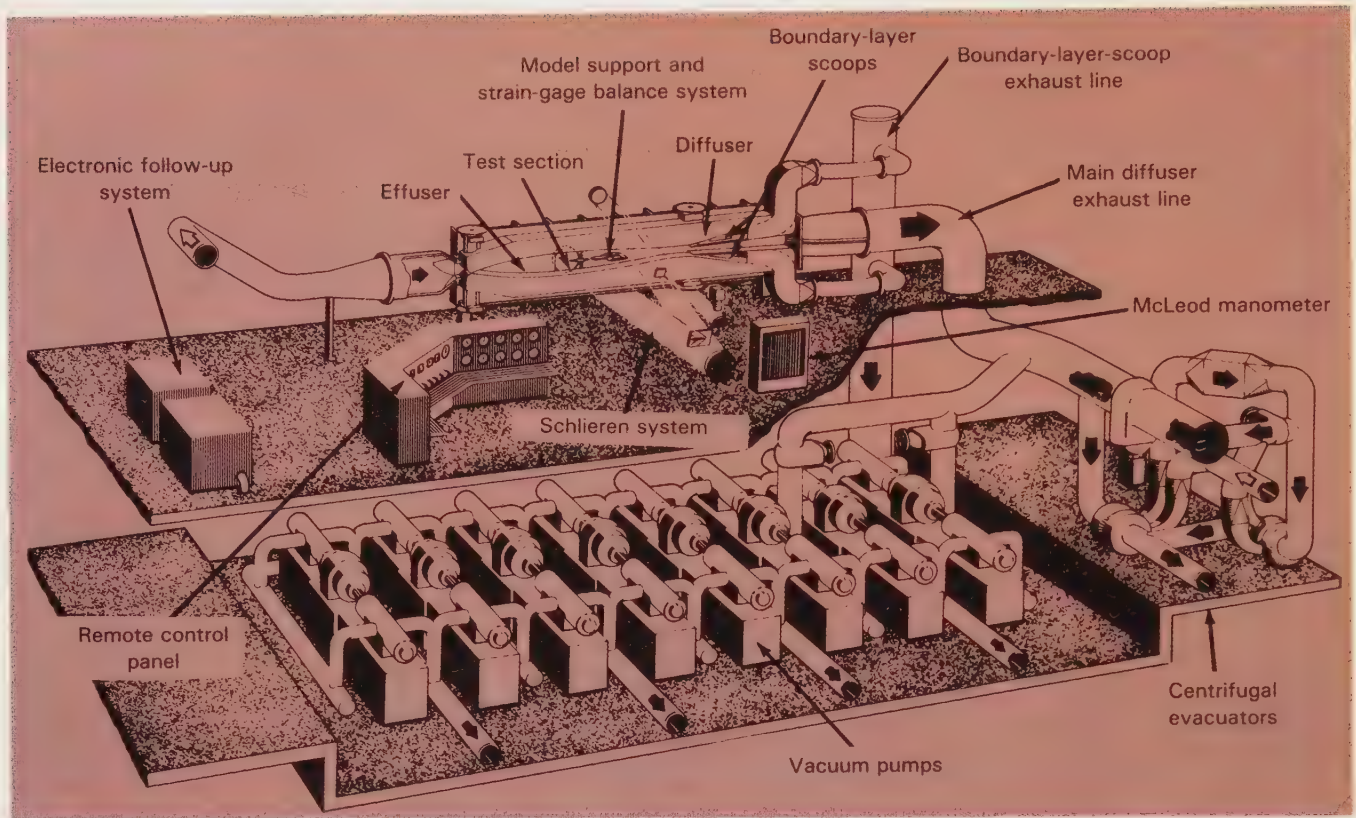

The first Ames hypersonic tunnel, with a test section of 10 × 14 inches. High-pressure air was supplied by the adjacent 12-foot pressure tunnel. Note the large battery of vacuum pumps.

Lewis. Not only did these wind tunnels have much of the appropriate instrumentation, they could provide a supersonic airstream for the bullets to fly into, thus extending their ranges into the hypersonic realm. In other words, the gun-launched models could be fired upstream to attain very high *relative* velocities. To illustrate: a gun firing a model at 4000 feet per second upstream in a tunnel operating at Mach 2 produces a *relative* Mach number of 7; the combination of 8000 feet per second and Mach 3 results in a relative Mach number of 15. Such high Mach numbers in a conventional wind tunnel would normally call for fantastically large expansion-ratio nozzles with the attendant danger of air liquefaction. However, with the supersonic wind tunnel actually operating at only Mach 2 or Mach 3, air liquefaction was no concern at all. The relative Mach number was what counted experimentally. Furthermore, the test Reynolds numbers would be realistically high, as would the air temperatures at critical points on the model. There was little doubt that a "counterflow" facility would solve some of the design problems of hypersonic wind tunnels, but what new problems would arise?

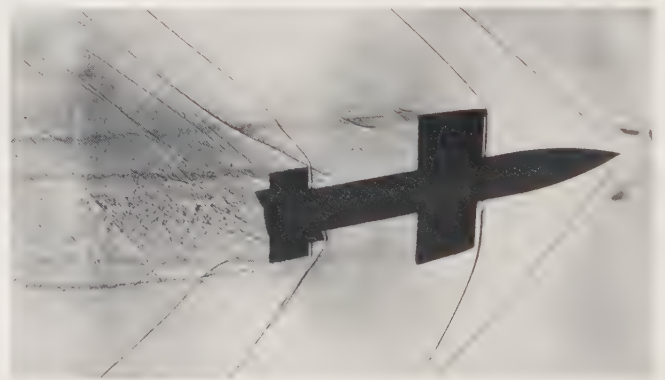

Shock waves appear as shadows trailing away from this 7-inch model. The model was fired from a 3-inch smooth-bore naval gun into still air at Mach 1.6.

The concept of a counterflow tunnel was proposed by H. Julian Allen at Ames in 1946, but his so-called supersonic free-flight tunnel did not become a reality until late 1949. First, the problem of firing winged models from a gun with a cylindrical barrel had to be solved. Special sabots or projectile carriers were developed that enclosed the noncylindrical models while they were inside the gun. The sabots peeled off as the

model left the muzzle heading upstream into the wind tunnel test section. Inside the test section, the flight of the model was "stopped" by a light flash about 1/3 microsecond long. Photos of the bulletlike models streaking up the tunnel provided more insight into hypersonic airflow than the experimenters had dared hope. The high-temperature turbulent gases in the shock waves and boundary layers cast clear-cut shadows on the screens. (These shadowgraphs are not schlieren photos. They have the same origin as thermal shadows cast by hot air rising from a home radiator on a bright winter day or from a hot roadway in the summer.) In the Ames supersonic free-flight tunnel the shadowgraphs revealed all the intricacies of hypersonic airflow around various projecting portions of the model—a sort of aerodynamic X-ray of tunnel airflow.

A High Pressure Tank Farm at Langley

As NACA probed the hypersonic flight regime of missiles and spacecraft, a complete break with conventional facility design was necessary. Hypersonic testing requires very high temperature air at very high speeds, necessitating large pressure ratios and power inputs. Because of power limitations, short-duration runs typified the hypersonic tunnel. The traditional wind tunnel was not adaptable to this kind of operation, and a complete break with past tunnel design philosophy seemed necessary for the expeditious exploration of the hypersonic realm.

A different basic wind tunnel concept was developed at Langley in the late 1940s. It recognized that the general need in hypersonic experimentation was a supply of very hot, high-pressure air for short periods

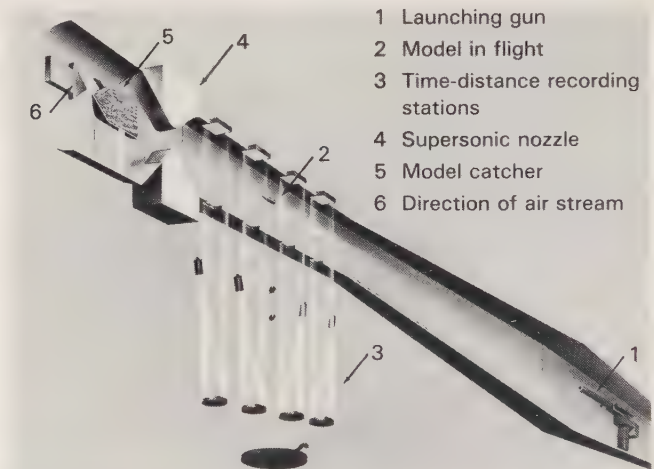
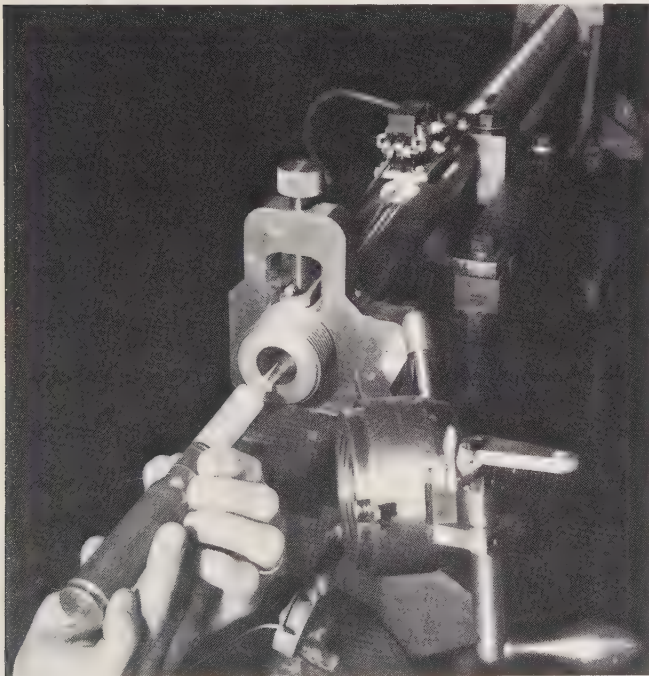

(Top left) Loading the gun in the Ames supersonic free-flight tunnel. (Top right) Schematic drawing of the Ames supersonic free-flight tunnel. (Bottom left) Shadowgraph of sabot separation. (Bottom right) Diagram of sabot operation.

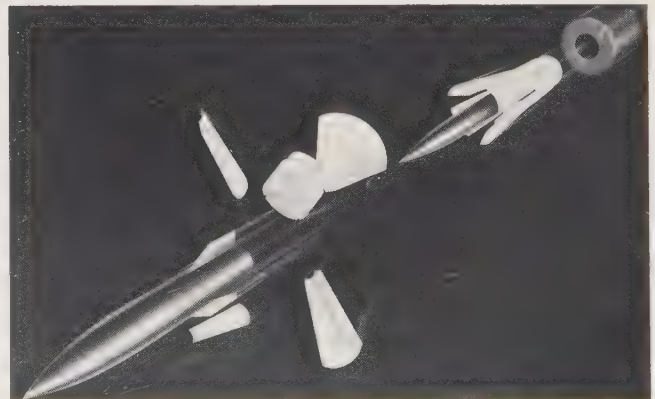
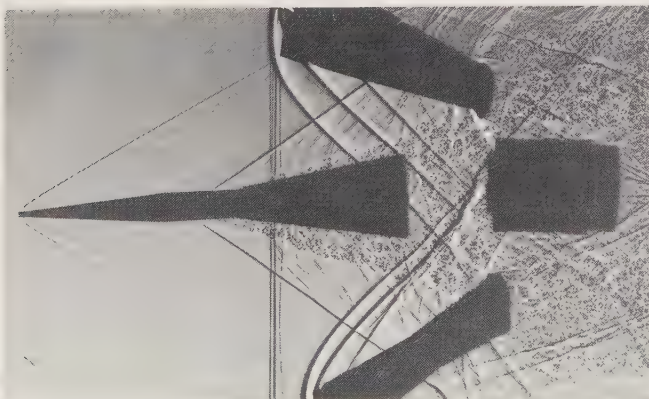

of time. This source of hot, pressurized air could be centralized and parceled out in bursts to individual test cells on demand. Diverse experiments could then be set up in the independent test cells without tying down a huge, expensive wind tunnel for days or even weeks.

Placed in operation in 1951, the Langley Gas Dynamics Laboratory consisted of a central tank farm capable of storing 19 000 cubic feet of air at 340 atmospheres pressure. At this pressure the air was 40 percent the density of water and weighed approximately 500 000 pounds. By feeding this air through several test cells into large vacuum tanks, pressure ratios at the beginning of an experiment could approach 10 000 to 1. No continuously operating tunnel could match that. To heat the air and prevent liquefaction in the test cells, huge steam and electric resistance heaters heated the air to 680° F and 1040° F, respectively.

The test cells of the Gas Dynamics Laboratory generally operated at speeds between Mach 1.5 and Mach 8.0. Typical test sections were approximately 20 inches. In later years, when models of various space-

craft had to be tested at reentry speeds, the facility substituted pure nitrogen and helium for air and provided this medium at 3500° F at pressures up to 340 atmospheres.

The Slotted Wall Revolutionizes Transonic Research

The awakening interest in the hypersonic speed range, with its exotic new facility concepts, tended to mask a quiet revolution that was taking place in facility designs at more modest speeds—the subsonic/transonic flight regime. Aerodynamicists had long been concerned that the flow within the confines of the test section walls might not represent the actual conditions of flight in free air—where the real aircraft disturbs the surrounding air to distances several times the dimensions of the plane. If wind tunnel walls are introduced a shorter distance away, the natural streamlines of flow near the test vehicle are strongly modified—possibly producing misleading test results. Furthermore, tunnel wall interference effects would

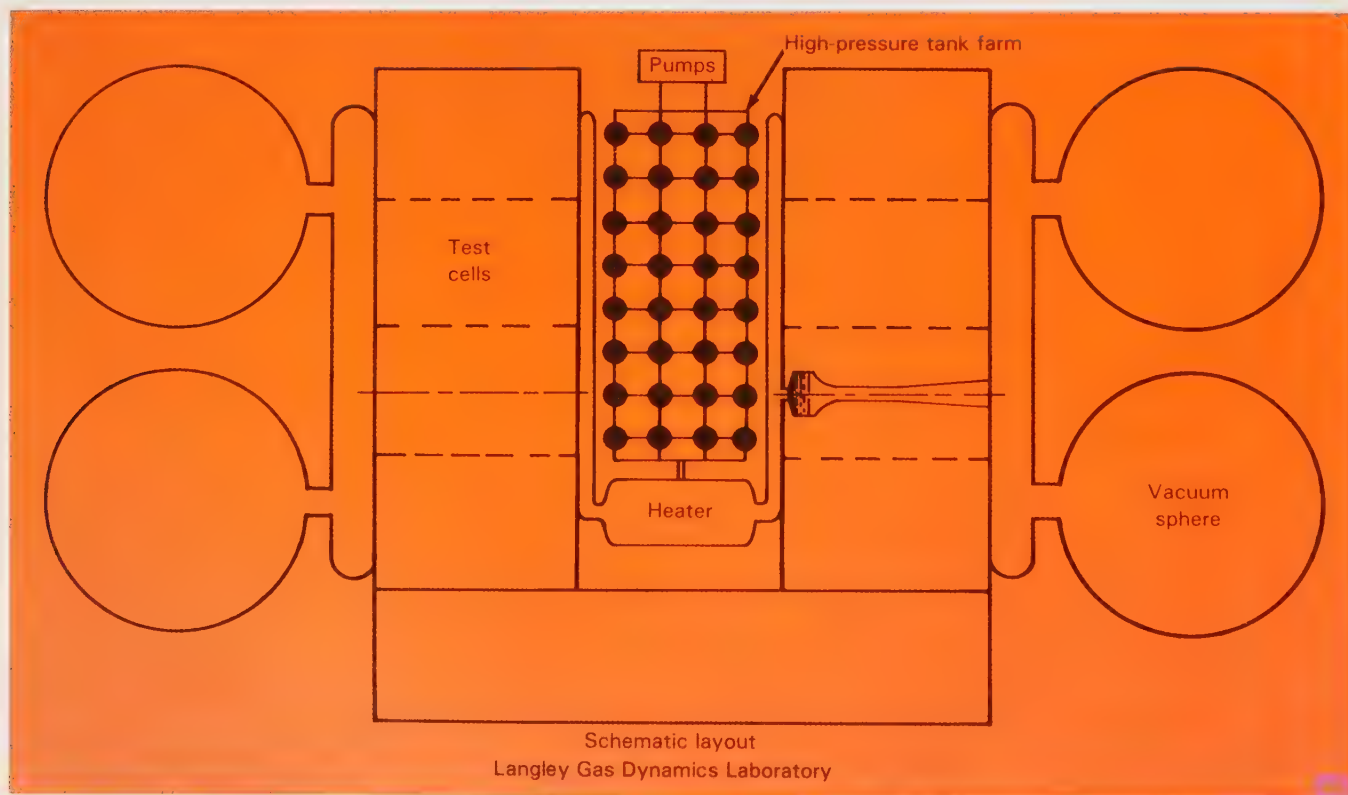

Arrangement of the Langley Gas Dynamics Laboratory. High-pressure air was released through the various test cells, as required, into the vacuum spheres.

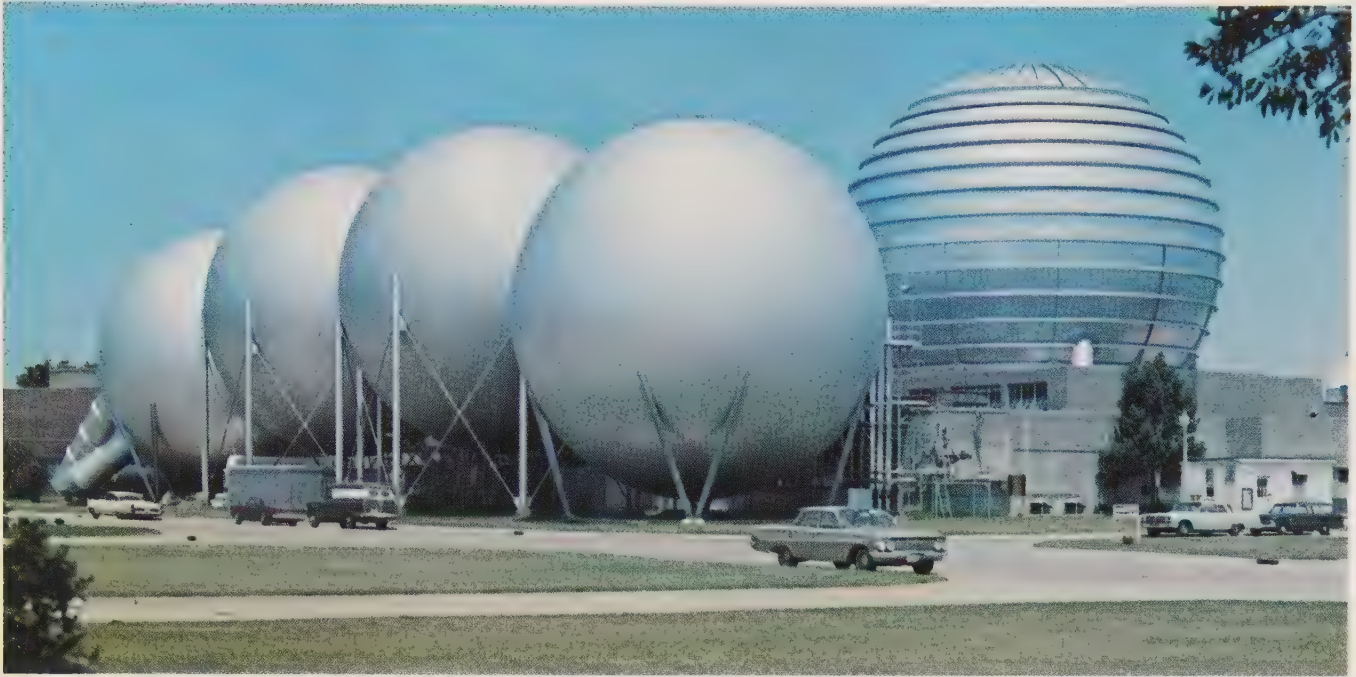

The Langley Gas Dynamics Laboratory. Vacuum spheres are in the foreground.

be expected to become more severe as test speeds approach Mach 1, where the tunnel choking phenomenon dominates the flow picture.

Early wind tunnel experimenters recognized that solid test section walls created unwanted interference, and they tried to circumvent it by making the models very small—typically 1 percent of the test section area near Mach 1. However, the smaller the model, the lower the Reynolds number and the less these tests simulated true flight conditions. A second approach eliminated the wind tunnel walls altogether and utilized an unconfined, open jet of air. Unfortunately, as the jet emerged from the tunnel, the streamlines began to diverge and once again the tests were compromised. Of course, wind tunnels continued to be built and used despite the disturbing effects of the walls. Everyone knew that wall interference was there, but they also knew that it became most serious when the airflow began to choke in the transonic range.

Since wind tunnel walls unduly strangled the flow streamlines around a model and the complete absence of walls (the open-jet idea) distorted the streamlines in the other direction, perhaps some sort of “partial wall” would more effectively simulate free-air conditions. In 1946 Ray Wright at Langley analyzed the potentialities of a partially open or slotted wind tunnel wall. His results suggested that

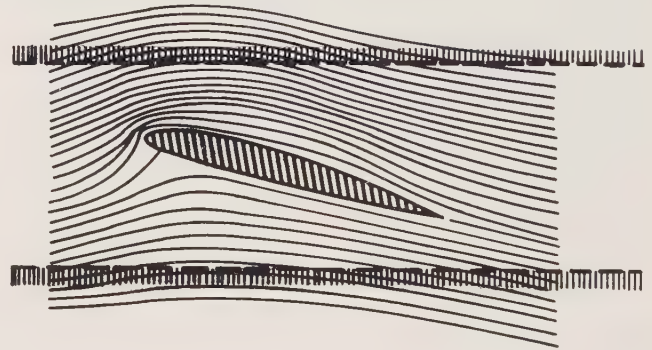

Without the constraining effect of the wind tunnel walls, the streamlines around an airfoil would extend well beyond the tunnel wall.

slots occupying only about 6 percent of the wall would be the happy compromise that would closely duplicate free-air conditions. Strictly speaking, Wright’s analysis was applicable only to low-speed flows, but Langley aerodynamicists, led by John Stack, immediately recognized in this simple proposal the possibility of solving the serious problems they had been having with wind tunnel testing near Mach 1.

All supersonic aircraft would have to fly through the transonic range—at least briefly. Knowing what happened in this transition zone was critical to the supersonic fighters and bombers being planned in

the postwar era. The slotted wall concept therefore was quickly wrapped in military security.

The immediate question was whether the analytical promise of the slotted wall would be realized in practice. Langley promptly built a 12-inch slotted-wall test section to test the concept. The pilot tunnel was a success, demonstrating much less wall interference and reduced choking effects. Wind tunnel airspeed could be increased continuously through Mach 1 by merely increasing the fan speed, a desirable but hitherto unattainable goal.

The benefits of the slotted wall were not without cost—an unfortunate fact of life in engineering. The price was measured in terms of additional fan power and it was high—about twice as much as for a tunnel with solid walls. No one quibbled about the price at NACA, for a good transonic tunnel was worth far more. During this period, Langley happened to be in the process of repowering its huge 16-foot high-speed wind tunnel in order to boost airspeeds into the low supersonic range. The opportunity to convert it into a transonic tunnel was seized immediately. Langley also went ahead with plans to build a new 8-foot slotted-wall tunnel (later known as the 8-foot transonic pressure tunnel) designed from its inception around the new concept. However, the quickest way to apply the slotted-wall concept was by modifying the operational 8-foot high-speed tunnel. In February 1950 this tunnel was shut down, and slotted walls were installed in the amazingly short period of 21 days.

Nowhere in the annals of aeronautical history can one find a more convincing argument supporting fundamental research than in the success story of the slotted-wall tunnel. A serendipitous chain of events led from low-speed aerodynamic analysis to a breakthrough idea, and then by intuitive extrapolation to transonic speeds—a long-sought technical prize. No amount of long-range planning could have devised this scenario. The revolutionary slotted-wall invention ultimately led directly to the discovery of the famous Area Rule, which in turn spawned a whole new generation of aircraft. So important was the slotted wall in aviation research that in 1951 John Stack and his associates at Langley received the coveted Collier Trophy for their work.

The Area Rule and the F-102 Story

The Cold War and the Korean War were stark realities in the early 1950s. The U.S. Air Force

urgently needed a supersonic fighter to maintain air superiority. In 1951 several purportedly supersonic aircraft were on the drawing boards. Engineers had sketched out smooth, sleek fuselages with thin wings and powerful jet engines. These craft looked supersonic, and the data from rocket-propelled models suggested that they would be supersonic in actual flight. In reality, the so-called transonic region from Mach 0.9 to Mach 1.1 had not yet been explored systematically in wind tunnels. Bulletlike aircraft, as it turned out, were *not* the sole answer to supersonic flight.

To remedy the acknowledged deficiency in transonic research, the NACA had begun operating its 8-foot high-speed wind tunnel with a slotted wall at Langley Field in early 1950. This newly modified tunnel, which attained transonic speeds, arrived on the scene at an opportune moment.

One of the hopefully supersonic fighters being built in 1951 was the Convair delta-wing YF-102, with the world's most powerful jet engine, the Pratt and Whitney J-57, and knife-edge delta wings. Convair aerodynamicists were sure their projectile-shaped plane would easily penetrate the Mach 1 barrier. By mid-1952 Convair and the Air Force were committed to the construction of two YF-102 prototypes. A production line was being set up in San Diego for the manufacture of hundreds more. The newly modified Langley 8-foot high-speed tunnel, however, was generating disturbing data suggesting that transonic drag (air resistance) for the YF-102 might be much higher than expected. In August 1952 a scale model of the YF-102 was mounted in the tunnel. To Convair's dismay, the model displayed such high drag in the vicinity of Mach 1 that there was serious doubt that even the powerful J-57 engine could push the YF-102 through the sound barrier.

Following the YF-102 model tests, NACA and Convair engineers went over the data together at Langley. At this time, NACA aerodynamicists described some of the surprising discoveries they had been making concerning transonic drag. Richard T. Whitcomb and his team at the 8-foot high-speed tunnel had been studying various aircraft configurations at transonic speeds in their slotted-wall tunnel. As the high-speed air flowed around the models, they expected to see shock waves forming near the noses of the models, but they were startled to find additional strong shock waves established behind the trailing edges of the wings. Obviously, the unexpected high drags being measured were

caused by the planes having to overcome the energy losses created by these extra shock waves. The YF-102s being built in San Diego would never go supersonic burdened with these aerodynamic anchors.

Happily, Whitcomb's tests also provided a way out that was almost as surprising as the original discovery of the extra set of shock waves. The YF-102's smooth, streamlined fuselage should be replaced with a wasplike waist and a bulging tail in such a way that the *total cross-sectional area* of wings, fuselage, and tail (not just the fuselage area) should be that of an ideal streamlined body. Thus the fuselage should be constricted where the wings were attached and then expanded at their trailing edges. Aircraft designed according to Whitcomb's Area Rule looked almost grotesque and were dubbed "flying coke bottles." Nevertheless, the wind tunnel data were convincing, and the Convair engineers went back to San Diego to incorporate the suggested changes into their YF-102 model.

Convair returned to Langley in May 1953 with a modified YF-102 model. New wind tunnel tests showed substantial drag reduction. Additional changes were suggested to follow the Area Rule more closely. The model was revised once again, and in October 1953, checked again in the high-speed tunnel. These tests promised that the YF-102, designed according to the Area Rule, would now meet Air Force supersonic requirements.

At this time, it was too late to change the YF-102 prototypes and the first aircraft on the production line. Besides, there was still some hope that the drag problem might not be as severe as the Langley wind tunnel tests had indicated. The first YF-102 prototype roared down the runway at Muroc Air Force Base, California, on October 24, 1953. Unfortunately, the J-57 engine flamed out on takeoff and the craft was damaged beyond repair on landing. On January 11, 1954, the second prototype flew successfully. But as flight tests proceeded, it became clear that the Langley wind tunnel data were indeed correct—the YF-102 would not go supersonic in level flight.

The Air Force was in a quandary; it needed the new aircraft in its inventory but it also wanted them to be supersonic. Hugh Dryden, Director of NACA, assured Air Force General Nathan Twining that NACA had the answer to transonic drag reduction and had already passed the information on to Convair and other aircraft companies. With this

knowledge, the Air Force halted the Convair F-102 production line.

Convair had not been idle following the wind tunnel revelations at Langley. In just 117 working days during 1954 they redesigned the YF-102 according to the Area Rule and built a new prototype. The new aircraft, designated the YF-102A, had the prescribed wasp waist, bulbous fairings on the tail, a sharper nose and canopy, and a more powerful version of the J-57 jet engines. On December 20, 1954, at Lindbergh Field near San Diego, the prototype left the runway and, while still climbing, pierced the sound barrier. Using the Area Rule, the top speed of the YF-102A increased by about 25 percent. With flight success, the Air Force restarted the Convair production line, this time to build 870 F-102As and 340 "advanced" F-102As, designated F-106s. The F-106s have become the primary interceptors defending the continental United States into the early 1980s.

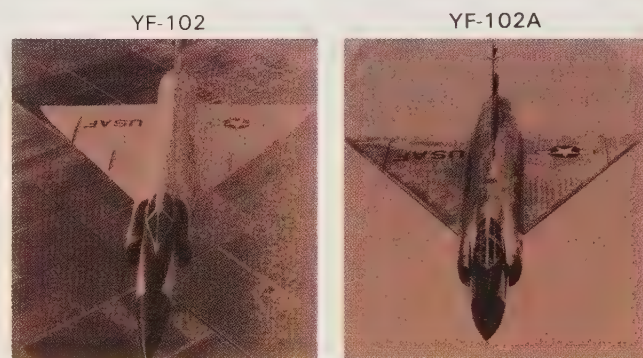

The YF-102 and YF-102A side by side. The narrowing of the YF-102A fuselage near the wings was dictated by the Area Rule and enabled the craft to become supersonic. Without the Area Rule, the YF-102 prototype never attained supersonic speeds in level flight.

New Round of Transonic Tunnels

With the Langley 8-foot and 16-foot high-speed tunnels now operational with slotted walls, tunnel designers could turn their attention to three other problems plaguing the operation of transonic wind tunnels: (1) high humidity and fog, (2) high turbulence levels in main stream flow, and (3) relatively low Reynolds numbers.

Fog and moisture in the tunnels were the most pressing problems. All the early tunnels operating near the speed of sound drew in outside air for cooling purposes. During the humid summer days, when moist outside air mixed with the mainstream flow,



The Langley 16-foot high-speed tunnel with the slotted wall installed to convert it to transonic operation. (The top half of the test section is shown open.)

cooling due to expansion in the high-speed nozzle was sufficient to create fog so dense that the model was obscured. Droplets of water condensing on the model and instruments hampered data collection and upset tunnel calibration. This was hardly the controlled environment customarily promised by wind tunnels. The obvious solution eliminated the source of moisture, that is, the cooling air from outside. In the new 8-foot transonic pressure tunnel, which became operational at Langley in 1953, a fine-grid water-cooled coil in the airstream removed excess heat but added no moisture to the circulating air. This fine grid plus an array of screens and a high tunnel contraction ratio smoothed out the turbulent air to partially solve the second operational problem. To increase Reynolds numbers (the third problem), the tunnel was operated at pressures up to 2 atmospheres.

The designs of a long series of aircraft, including the Grumman F-9F and Convair B-58 supersonic bomber, were experimentally validated in the 8-foot transonic pressure tunnel. Later, rocket launch vehicles, reentry nose cones, the Viking spacecraft, the Space Shuttle, and many other famous craft did their tours in this tunnel.

On the west coast, NACA engineers quickly exploited the slotted wall. The Ames 16-foot high-speed tunnel, which had been operating since 1941 with a 27 000-horsepower drive, was repowered to 110 000 horsepower. The quadrupling of the power level made it possible to operate in the transonic range with a 14-foot ventilated test section wall. As the adjective "ventilated" implies, the Ames transonic tunnel differed markedly from the Langley slotted-wall approach. Replacing the slots were a mesh of holes in the test section walls which attenuated the reflections of shock waves generated by the model. Another unique feature was the flexible wall upstream of the test section. By activating a jack, tunnel operators could adjust the shape of the supersonic nozzle and thus attain various supersonic airspeeds.

The Ames 14-foot transonic tunnel—the most powerful in the world—commenced operation in late 1955. It had cost only \$2 million to build in 1941; but the repowering, the new transonic test section, and other modifications cost an additional \$9 million in 1955. The investment was worthwhile. With its large size and attainable speeds of Mach 0.6 to Mach

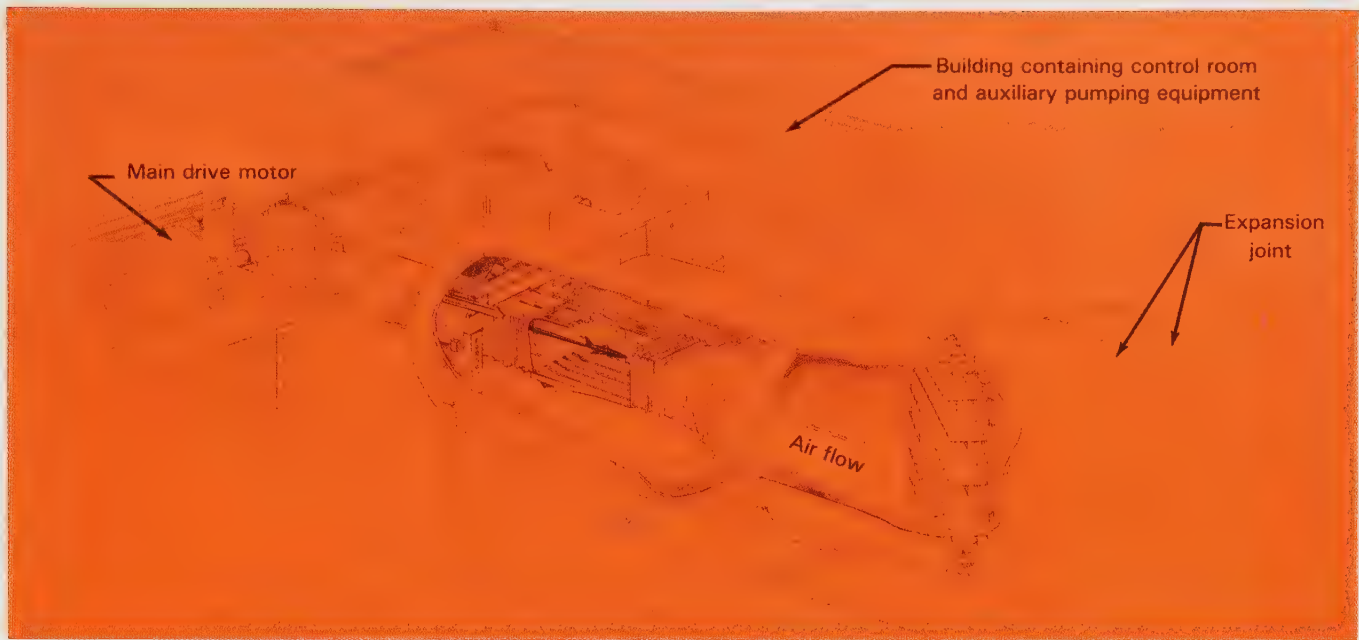

Plan of the Langley 8-foot transonic pressure tunnel.

Coordination and Cooperation: The National Unitary Plan

The technological audacity of the German missiles and jet fighters made American leaders resolve never again to lag behind in aeronautical research. To assure technical leadership, the Federal Government proposed a coordinated national plan of facility construction that would encompass not only NACA, but the Air Force, industry, and the universities as well. An early version of the so-called Unitary Plan envisaged 33 large transonic, supersonic, and hypersonic wind tunnels costing almost \$1 billion. The Unitary Plan Act that was finally passed by Congress on October 27, 1949, was more modest in scale but still most impressive.

The Unitary Plan was spearheaded by the Air Force and to the Air Force went the cornerstone facility: a new aeronautical research center located near abundant hydroelectric power. Tullahoma, Tennessee, on the vast TVA hydroelectric grid, was selected as the site of the Air Engineering Development Center (AEDC), now known as the Arnold Engineering Development Center. Initial plans called for two 16-foot supersonic wind tunnels, a jet engine altitude test chamber, an aeronautical laboratory, and other support facilities. Dedicated by President Truman on June 25, 1951, AEDC has grown through the years to more than 40 test units, including 18 wind tunnels. Typical of the scale of AEDC construction is the Propulsion Wind Tunnel Facility, which consists of



In 1955 the Ames 14-foot transonic tunnel began operations incorporating a "ventilated" wall.

1.2, it produced accurate simulation of air inlets, operating propellers, and even full-scale missiles. The 14-foot tunnel was particularly useful in solving the stability problems of large, fuel-laden rocket launch vehicles. These thin-skinned structures carried millions of pounds of sloshing fuel as they pushed through the aerodynamically critical transonic range. With accurate wind tunnel data, launch vehicle designers could better guarantee the structural integrity of large rockets.



Aerial view of the Air Force's Arnold Engineering Development Center (AEDC) in Tullahoma, Tennessee. (Photo, AEDC)

two separate 16-foot tunnels spanning collectively the range from Mach 0.2 to Mach 4.75. Here full-scale fully operational turbojets and ramjets can be tested under conditions simulating aircraft and missile installations. In the early 1980s, AEDC's \$440 million Aeropropulsion Systems Test Facility (ASTF) will go into operation, making AEDC the world's most complete aerospace ground test complex.

The original Unitary Plan included a NACA proposal for a separate National Supersonic Research Center, but this was dropped in view of the scope and depth of the Tullahoma complex. Instead, NACA's existing facilities were upgraded and repowered. Further, NACA's role in the development of aeronautics took a new direction under the Unitary Plan: industrial development work, that is, commercial aircraft, while AEDC focused on military aeronautics.

NACA had anticipated such an assignment and, in 1949, had set up a Project Office for the Unitary Wind Tunnels Program. This office was established at Ames, with John F. Parsons as Chief, reporting directly to the NACA Director. Each of the three NACA centers was involved. A large transonic/supersonic wind tunnel complex would be built at Ames;

Langley would have a new supersonic tunnel; and at Lewis there would be a large supersonic tunnel dedicated to propulsion system integration.

The Ames Unitary Plan Wind Tunnel Complex

The best-laid plans change in the face of hard realities, and the Ames Unitary Plan tunnel was no exception. The initial plan called for a single tunnel with an 8-foot test section that had *both* transonic and supersonic capability. This could not be, for two reasons: (1) differing test section size requirements and (2) vastly different compressor requirements. At transonic speeds, for example, the frontal area of the model being tested should be only 1 percent or less of the test section area for good results; however, at high Mach numbers, as the shock waves slope downstream more nearly parallel to the aircraft axis, smaller test sections for the same size model are very satisfactory. In the matter of the wind tunnel compressor, a single-stage fan suffices up to about Mach 1.2, but higher speeds demand multistage compressors with thousands of blades. No single tunnel can properly cover the entire range of aircraft and missile flight.

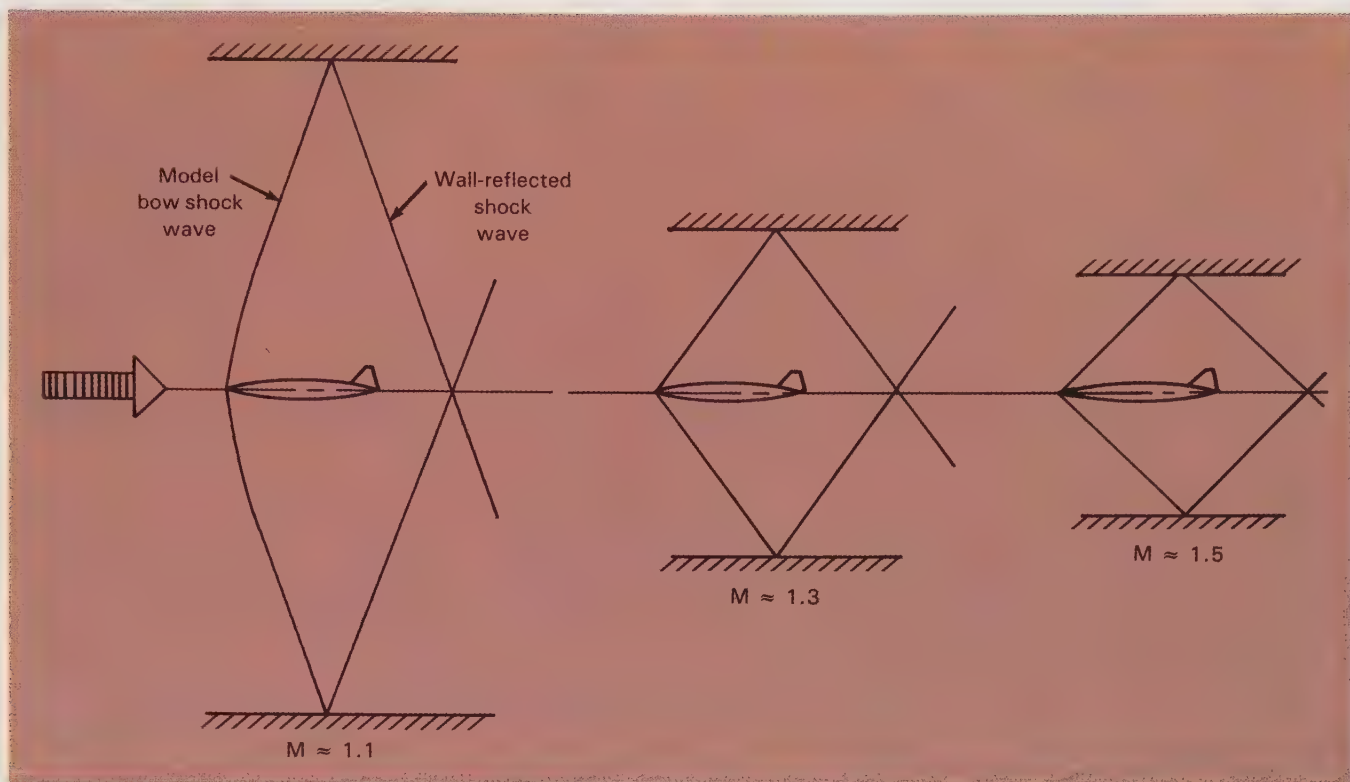

The length of the so-called test rhombus in a supersonic tunnel increases at higher Mach numbers as wall-reflected shock waves cross the axis farther downstream. A model of a given size can be tested in smaller tunnels at higher Mach numbers.

Consequently, the Ames Unitary Plan Wind Tunnel, under the guidance of Ralph Huntsberger, became in effect three separate test sections driven by a giant centralized power plant consisting of four tandem-coupled, variable-speed electric motors capable of 180 000 horsepower on a continuous basis and 240 000 horsepower for 30 minutes. The transonic test section spanned 11×11 feet, while the two supersonic sections were somewhat smaller: 9×7 feet and 8×7 feet. A 3-stage compressor drove the transonic legs; an 11-stage compressor, the two supersonic legs. Giant valves 20 feet in diameter and weighing 250 tons shunted the centrally supplied air from one supersonic leg to another. Although construction of this impressive complex was finished in 1955, a blade failure in a compressor delayed full facility operation with the transonic leg until late 1957.

The west coast segment of the aerospace industry quickly capitalized on the nearby Ames facilities. The famed Boeing fleet of commercial transports and the Douglas DC-8, DC-9, and DC-10 were all tested at great length. Cruise efficiencies were improved and

landing performance enhanced. These craft went on to dominate the world commercial aircraft market. In addition, practically all modern military aircraft, such as the F-111 fighter, the C-5A transport, and the B-1 bomber, went through the Ames Unitary Plan tunnels. Indeed, it is not overstating the importance of the tunnels to claim that almost all high-performance U.S. aircraft flying today or about to fly have been tested at Ames. In later years, almost all NASA manned space vehicles, including the Space Shuttle, were tested in the Ames Unitary Plan tunnel complex.

A Small Tunnel for Fast Missiles

According to the Unitary Plan, Langley's new tunnel was to be devoted to the aerodynamic development of high-speed missiles. It had to be a supersonic tunnel, of course, but it could be relatively small because the missiles to be tested traveled at such high Mach numbers that their shock waves would sweep way back. The tunnel designers, under the leadership of Herbert A. (Hack) Wilson, chose a 4×4 -foot cross section. Two separate test sections were built; one

WIND TUNNELS OF NASA

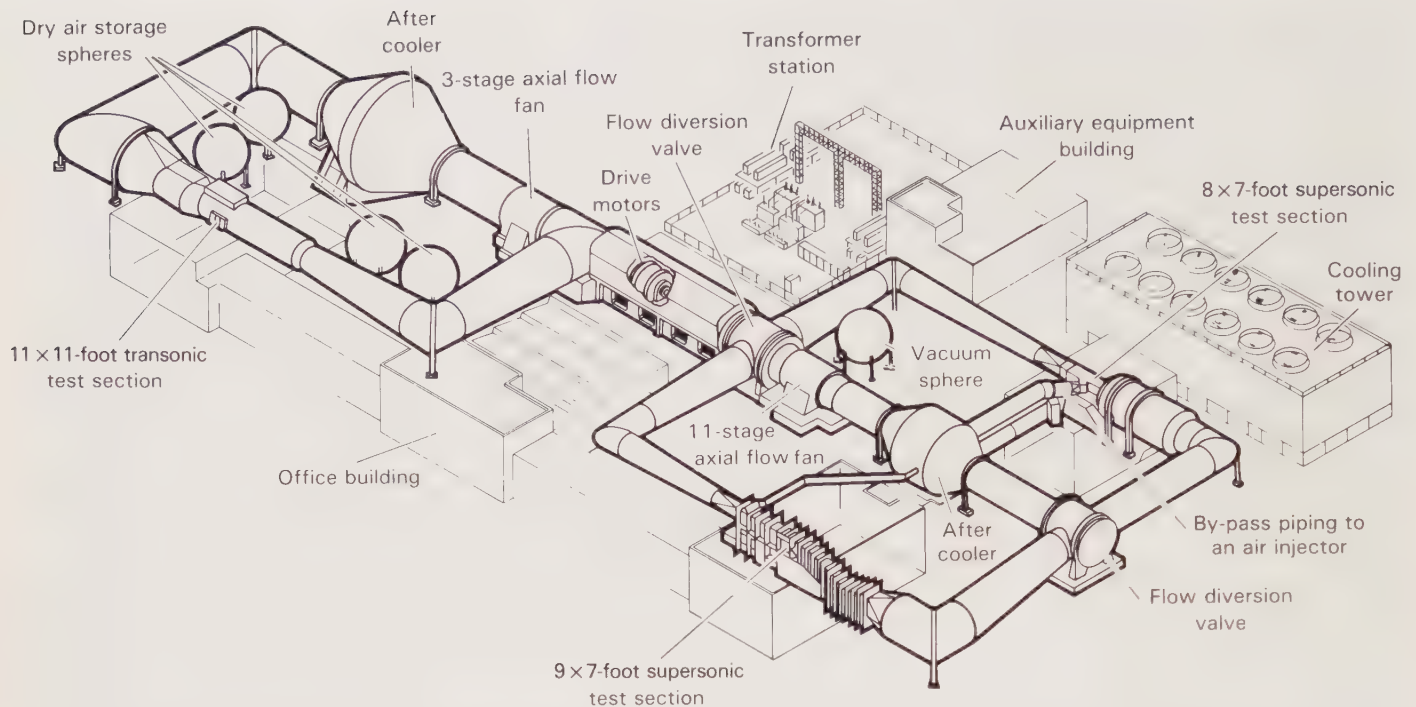

The Ames Unitary Plan wind tunnel actually consisted of three separate test sections fed by a centralized power source. One test section was transonic; the other two were supersonic.



A 1/6-scale model in the Ames 11-foot Unitary Plan transonic tunnel. Note the rows of wall perforations.

covered the range from Mach 1.5 to Mach 2.9; the other, Mach 2.3 to Mach 4.6. The valves and ducts permitted tunnel operators to select one or the other section. Each test section was equipped with the Ames-developed asymmetric nozzle with a sliding block that varied the Mach number in the test section.

The major challenge in designing and building this tunnel was the power source: the compressors. The compression ratios needed varied from 1.3 to 16. The solution involved a complex of six commercially available compressors (the largest were normally used in blast furnaces) driven by a family of electric motors totaling 100 000 horsepower. Although small, the Langley Unitary Plan supersonic tunnel was something of a plumber's nightmare, with a maze of ducting, valves, and drive motors.

A long series of missiles passed through the 4 x 4-foot tunnel, where they were tested for high-speed performance, stability and control, maneuverability, jet-exhaust effects, and other performance factors. A novel feature of missile evaluation was the need to duplicate the extreme range of orientations that missiles pass through in normal flight; that is, they perform maneuvers that manned aircraft would never attempt. Despite the original dedication of this tunnel to missile development, it had been in operation



Under the Unitary Plan, Langley built a supersonic tunnel with two test sections that spanned Mach numbers 1.5 through 4.6. Shown here is the battery of six compressors needed to supply compression ratios between 1.3 and 16. The corresponding family of electric-drive motors was rated at 100 000 horsepower.

scarcely a year before the now-famous McDonnell F-4 Phantom was being tested in model form. Later, the X-15, the F-111, and various supersonic transport configurations, as well as models of space vehicles, could be found mounted in the test section.

Testing Full-Size Supersonic Jet Engines

The NACA Lewis wind tunnel group had already wrestled with the special problems of testing operating subsonic engines, with their attendant floods of combustion products and ear-splitting noise levels. With the advent of the Unitary Plan, Lewis was assigned the task of providing a supersonic tunnel large enough to encompass full-scale jet and rocket engines. The central problem was not building a supersonic tunnel per se, but rather adding to the basic tunnel the auxiliary equipment that would properly simulate the air density, temperature, humidity, and purity at anticipated operating conditions. This was compounded because supersonic tunnels achieve their

high velocities by expanding air through a nozzle; as this air expands, it cools rapidly and there may be condensation of contained water vapor. Consequently, control of the engine environment and the facility environment becomes much more difficult.

Under the leadership of Abe Silverstein and Eugene Waslewski, the basic test section was sized at 10 × 10 feet and incorporated a symmetrical, flexible-wall supersonic nozzle. The design of the flexible wall was a great engineering challenge. Carefully polished 10-foot-wide stainless steel plates, 1-3/8 inches thick and 76 feet long, had to be bent to conform to a range of nozzle shapes covering the Mach range from 2.0 to 3.5. A series of hydraulic-operated jack screws positioned the flexible plates to an accuracy of 0.001 inch. Twenty-five years of successful operation have demonstrated the reliability of the system.

Because the earlier Lewis 8 × 6-foot propulsion tunnel had proven much more useful after it had been converted into an optional open- or closed-circuit facility, Lewis engineers decided to design the supersonic tunnel for dual operation from the start.

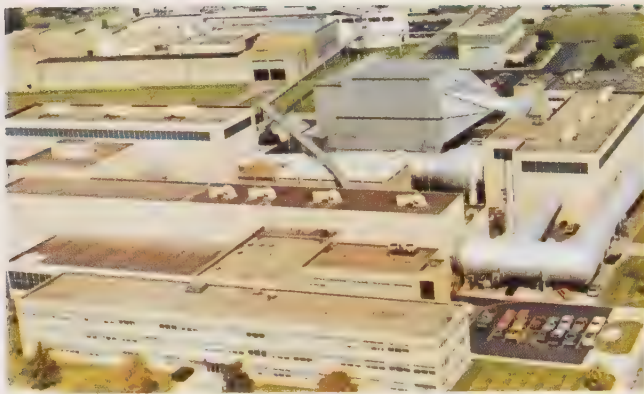
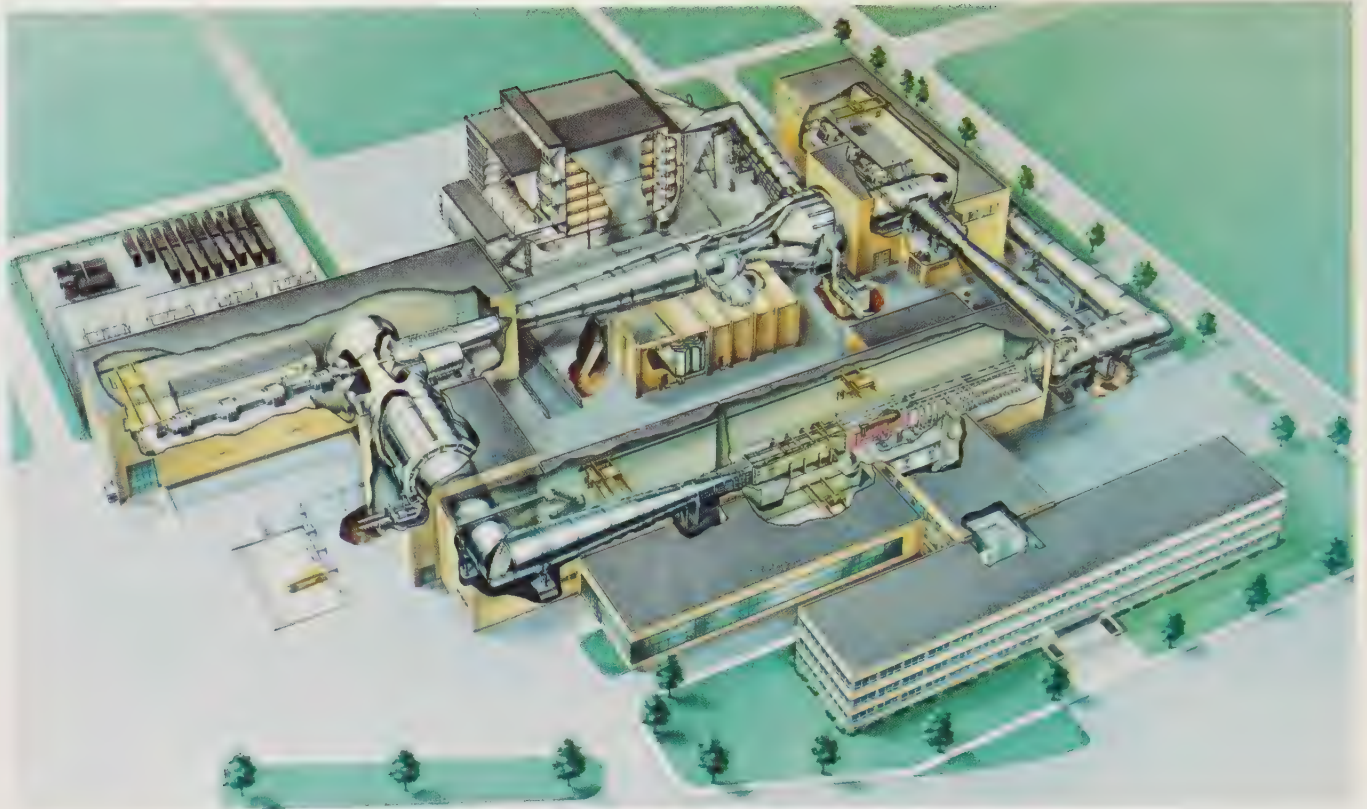

The Lewis 10 × 10-foot supersonic wind tunnel built under the Unitary Plan.

The new tunnel operated as a closed system in its “aerodynamic mode” and as an open system in the “propulsion mode.” In the former mode, it operates like a conventional supersonic tunnel. An 8-stage compressor driven by four electric motors (150 000 horsepower total) feeds up to 4.6 million cubic feet of air per minute into a cooler, which is followed by a 10-stage compressor (100 000 horsepower). In this, its simplest and more conventional mode, the Lewis tunnel is most impressive in terms of size and power.

The propulsion mode is much more demanding. Since the tunnel runs as an open cycle, incoming air must be dried and heated while exhaust air must be muffled by a huge baffle to avoid deafening the local

populace. The intake air dryer employs 1900 tons of activated alumina that dehumidifies 1 ton of air per second to a dewpoint of -40° during a 2-hour run. A 4-hour reactivation cycle must follow. In addition to the air dryer, an air-heater was added upstream to keep the air expanding in the nozzle from reaching temperatures far below anticipated flight conditions. Even with these efforts to control input air conditions, the tunnel nozzle expands the air a bit too far at the higher Mach numbers, and it is impossible to simulate altitudes below 55 000 feet where the air is more dense.

The usefulness of the Lewis 10 × 10-foot supersonic propulsion tunnel has not been severely compromised by this limitation. The jet engines powering such famous aircraft as the Navy F-14 and USAF F-111 were tested at Lewis. In addition, the Space Shuttle liquid-rocket engines were checked for heating effects on the space vehicle’s structures. Looking to the future, the Lewis supersonic propulsion tunnel was designed with ample capability for testing the engines of the next generations of aircraft, air-breathing missiles, and manned spacecraft, whatever they may be.

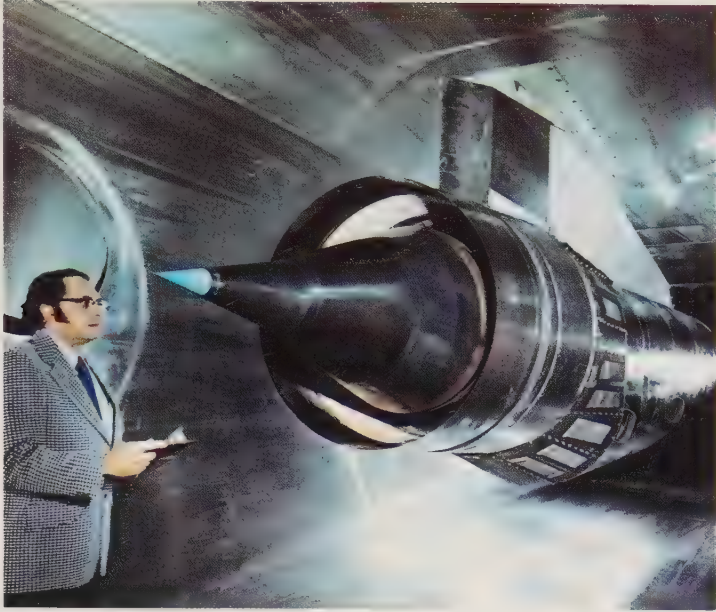

A full-sized jet engine installed in the Lewis Unitary Plan 10 × 10-foot supersonic wind tunnel.

An Exercise in Wind Tunnel Complexity

With the Unitary Plan tunnels in place, it is an opportune time to stand back and take a look at what 60 years of NACA/NASA wind tunnel development had wrought. Most designers recall with nostalgia the good old days of NACA wind tunnel No. 1 of 1920 vintage. In a simple, nonreturn circuit largely constructed of wood, a 200-horsepower electric motor driving a wooden propeller generated air speeds as high as 90 mph (Mach 0.1). The complete wind tunnel with its test chamber and attached shop area was housed within a small laboratory building that also served as the return passage for the air.

From the day of the Red Baron with his scarf streaming in the breeze to the modern-day fighter pilot in his pressurized G-suit, the design of wind tunnels underwent a similar increase in sophistication. Nowhere is this transition more evident than in the NACA wind tunnels of the Unitary Plan. These three NACA facilities, which came on line in 1955,

represented a landmark in wind tunnel design by any criterion—size, cost, performance, or complexity.

The Langley Unitary Plan wind tunnel is the smallest of the three Unitary facilities insofar as test section size and power are concerned. But the complexities of the drive system and air ducting to attain speeds of Mach 5 provide an interesting contrast with NACA wind tunnel No. 1—a facility of equivalent test section size. As one knowledgeable visitor was heard to comment, “It looks more like an oil refinery under a roof rather than a wind tunnel.”

It is interesting to compare the concentration of power relative to test section area. The NACA wind tunnel No. 1 with its 200-horsepower drive, required only 10 horsepower per square foot to attain Mach 0.1. The Langley Unitary Plan tunnel, in comparison, demands 6250 horsepower per square foot at Mach 4.6 and 10 atmospheres pressure.

Nowhere in wind tunnel design has change been more rapid than in the area of data acquisition systems. In wind tunnel No. 1 all raw data were collected manually and then laboriously reduced over a period of days (and often weeks) after the test was run. As late as 1940, substantial amounts of wind tunnel data were collected manually. Forces were often measured on commercial platform scales emblazoned “Honest Weight.”

In contrast, the electronics-filled control room is the heart of the Langley Unitary Plan tunnel operation. Data on pressures, forces, and temperatures are collected remotely and automatically from 85 separate data channels. Each channel is sampled at rates as high as 64 data points per second, incomparably faster than a human could record them. The resulting raw data are processed through on-site computers to reduce the data to coefficient form—lift, drag, pitching moment, and so on. These reduced data are then presented almost instantaneously on TV screens or printed out on automated plotters in real time. Despite the manifest differences in sophistication, complexity, and power, both wind tunnels—NACA No. 1 and the Langley Unitary Plan facility—made aeronautical history. Their different levels of technology accurately mirrored the machines they were testing.

(Overleaf) The Langley Unitary Plan supersonic wind tunnel, completed in 1955.

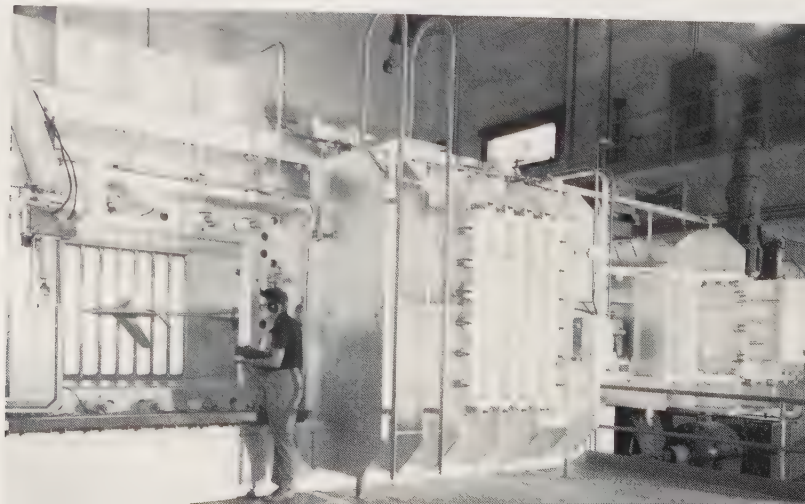
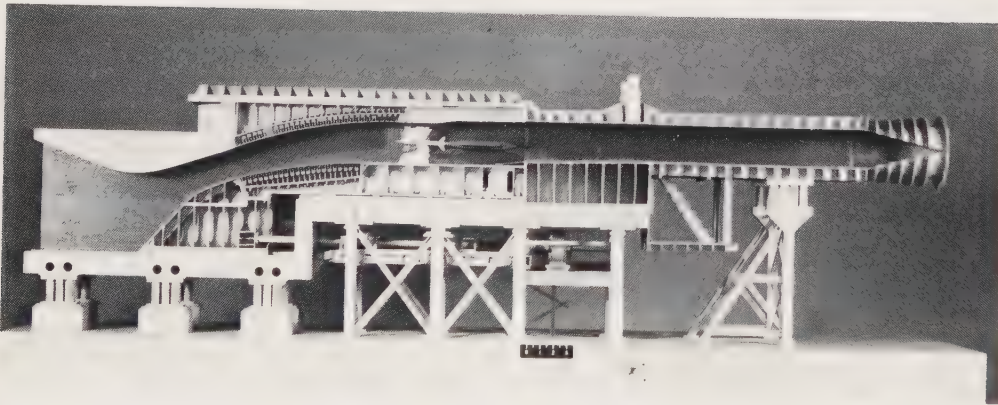
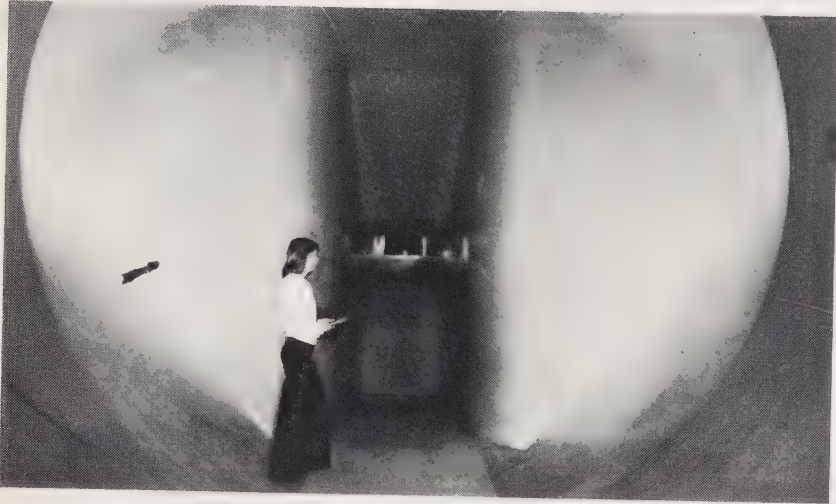

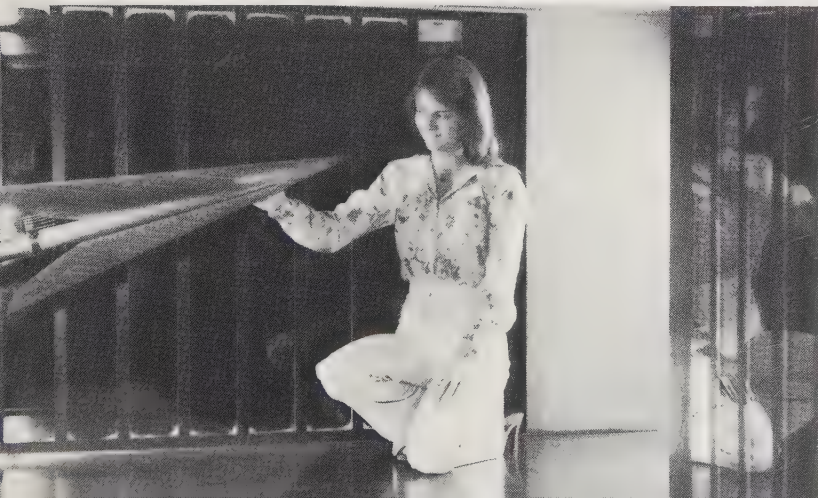
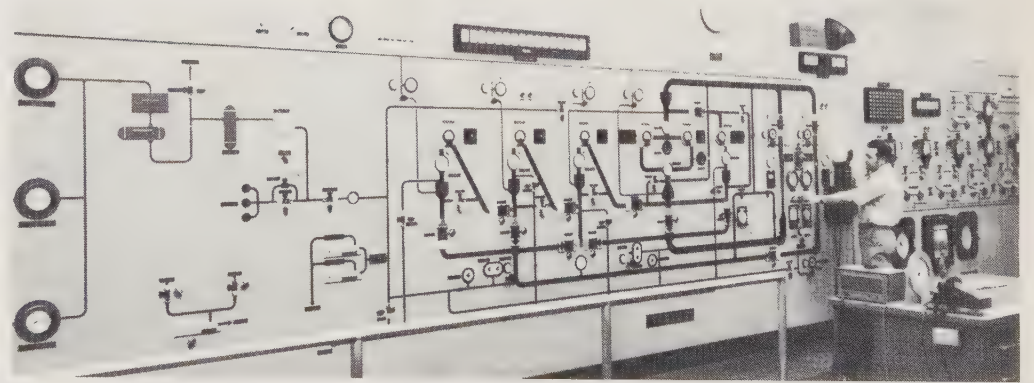
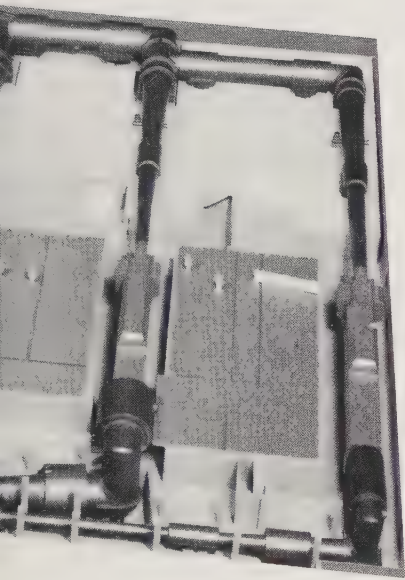

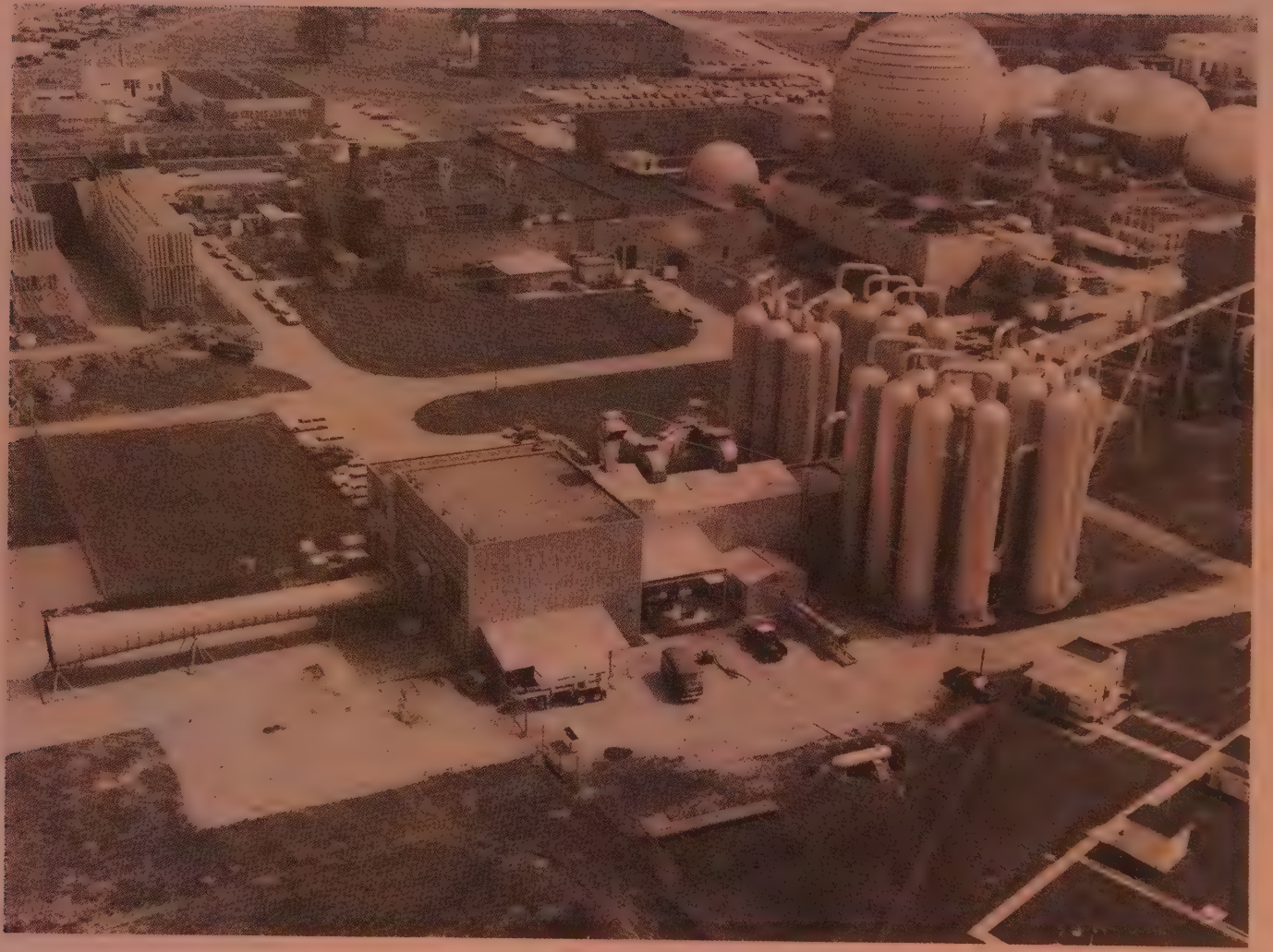

Chapter 6

Wind Tunnels in the Space Age

The Space Age is usually said to begin with the launch of Sputnik 1 on October 4, 1957. But the Sputniks were not really the first vehicles to enter outer space—the long-range missiles were. The ICBMs in particular penetrate well beyond the Earth's atmosphere. As these weapons carriers arch over and fall back, slamming into the atmosphere at very high speed, their kinetic energies are suddenly converted into heat. Reentry heating is so severe that an unprotected missile and its warhead can be destroyed upon reentry into the atmosphere. This Space Age problem arose in the mid-1950s, several years before Sputnik.

NACA began work on the atmospheric entry problem as soon as it was recognized. In spite of a substantial commitment of NACA personnel and facilities, the solution of this critical problem was slowed by two serious deficiencies: ignorance of what was really happening from an analytical standpoint and the lack of test facilities that could duplicate the temperatures, speeds, and gas dynamics typical of missile reentry.

How ICBMs Are Spared Thermal Destruction

The air temperatures around the nose of a reentering ICBM may reach tens of thousands of degrees—hotter than the surface of the Sun. Part of the heat is generated outside the boundary layer surface by shock-wave compression. This part is dissipated harmlessly into the surrounding air. The rest of the heat arises within the boundary layer, which is in contact with the missile structure and has the opportunity to melt or damage the vehicle and its contents. Structural heating can be reduced if more of the heat can be shifted outside the boundary layer.

Intuitively, one would think that sleek sharp-pointed missiles would be best for the atmospheric

penetration. In 1952 H. Julian Allen, of NACA's Ames Aeronautical Laboratory, showed analytically that this was not true. The nose cone should be blunt instead. When a blunt-nosed missile enters the atmosphere, a powerful bow shock wave builds up that generates much more heat outside the boundary layer than is the case with a sharp-pointed nose. This revolutionary and unanticipated development was not announced by NACA until 1957 because of its military implications. The blunt nose cone was an important conceptual breakthrough not only for missiles but the future Mercury, Gemini, and Apollo blunt reentry capsules.

But how could the blunt nose cone idea be tested realistically? The conventional hypersonic wind tunnel could not duplicate the sudden increase in air density as the missile plunged into the stationary, ever denser atmosphere at speeds in the range of 15 000 mph.

The earlier Ames counterflow tunnel provided a clue. If a model nose cone is fired from a gun upstream through the air rushing out of a supersonic nozzle, reentry conditions are closely simulated. The gun provides hypervelocities in the neighborhood of 15 000 mph, while a trumpet-shaped supersonic nozzle discharging at Mach 5 into a vacuum creates a volume of ever-denser air with decreasing Mach number in the upstream direction. Analysis showed that the flight history of the nose-cone-shaped bullet would indeed be similar to that of a full-scale reentering nose cone. The aerodynamic heating and thermal stresses would be closely duplicated. Reassured by the computation, Ames built its Small-Scale Atmospheric Entry Simulator, which effectively bridged the gap between wind tunnel and flight testing of missiles. Initial success with the small-scale simulator led to the construction of a larger version in 1958.

But first let's allow politics to catch up to technology.

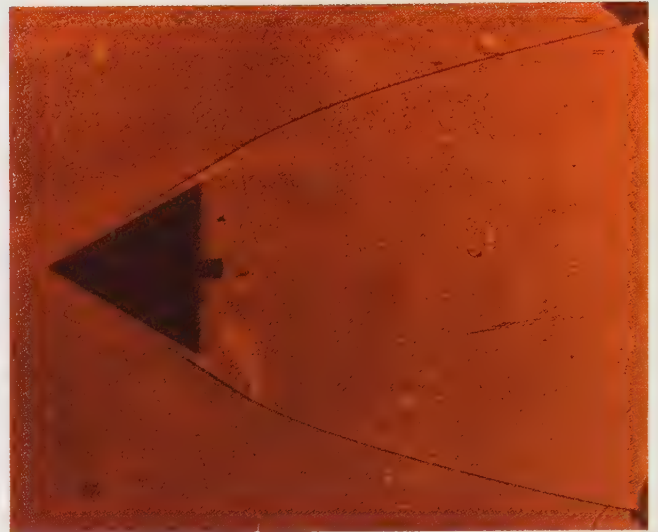
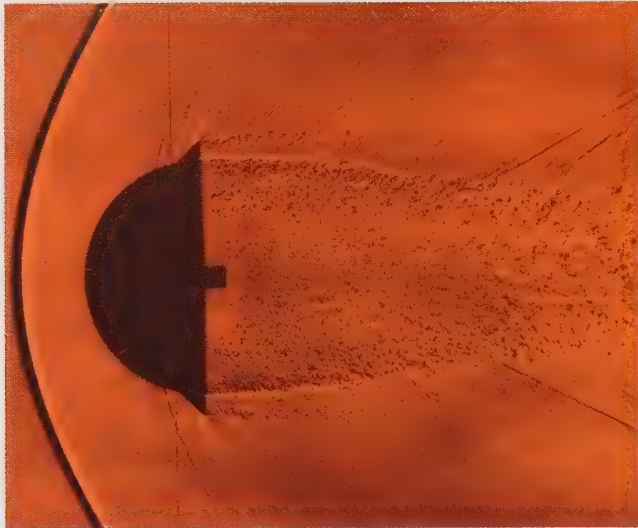

Bow shock waves produced by blunt and sharp-pointed reentry bodies. The strong shock wave from the blunt body dissipates energy far out into the flow field and thereby reduces local body heating.

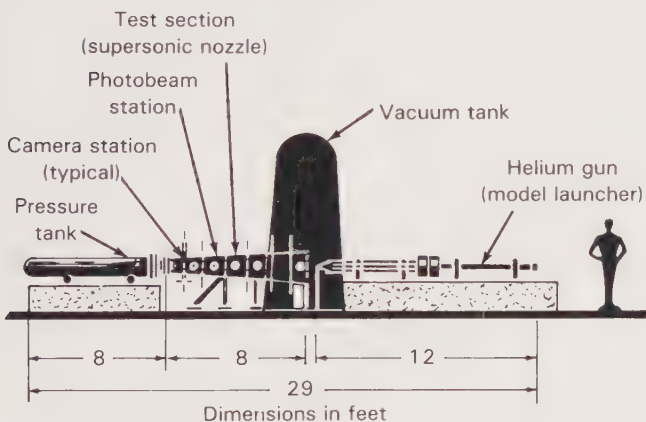

The small-scale atmospheric entry simulator located at Ames Research Center.

New Goals as NACA Becomes Part of NASA

Less than a year after Sputnik was orbited, President Eisenhower signed the National Aeronautics and Space Act of 1958. NACA was the nucleus of the new NASA organization. Its centers at Ames, Lewis, and Langley were now designated NASA Research Centers. Also absorbed were NACA's Flight Research Center at Edwards, California, and the NACA rocket-launching facility at Wallops Island, Virginia. From the Army came Werner von Braun's rocket group at Huntsville, Alabama; the Naval Research Laboratory (NRL), Washington, D.C., transferred its Project Vanguard team of scientists; and the California Insti-

tute of Technology's Jet Propulsion Laboratory (JPL), Pasadena, California, became a close associate of the new National Aeronautics and Space Administration (NASA). In terms of long-range goals, America's vision had suddenly expanded from aircraft and missiles to satellites, manned space flight, and probes to the other planets. Wind tunnel testing would be essential for the ambitious launch and reentry vehicles projected. In terms of wind tunnel test facilities, though, only JPL was able to add significantly to NACA's already large inventory of wind tunnels and aerodynamic research facilities.

The Jet Propulsion Laboratory brought with it two wind tunnels: a 20-inch supersonic tunnel that had been completed in 1948 and a 21-inch hypersonic tunnel that had become operational in 1954. The former was one of the first to employ a flexible nozzle in its range from Mach 1.3 to Mach 5.6. The latter, the hypersonic facility, was a particularly significant addition to the existing NACA spectrum of tunnels. Covering the range from Mach 4 to Mach 11, with continuous-flow capability, it operated at pressures up to 715 psia and temperatures to 1350° F. The nozzle throat necked down to a minimum of less than 1/30 inch, giving an expansion ratio of 842 between throat and test section. Between the throat and test section there was a long flexible-wall nozzle contoured by an array of remotely controlled hydraulic jacks to an accuracy of 1/1000 inch or better. JPL had constructed these two tunnels for its Army missile work. They were a welcome addition to newly formed NASA.

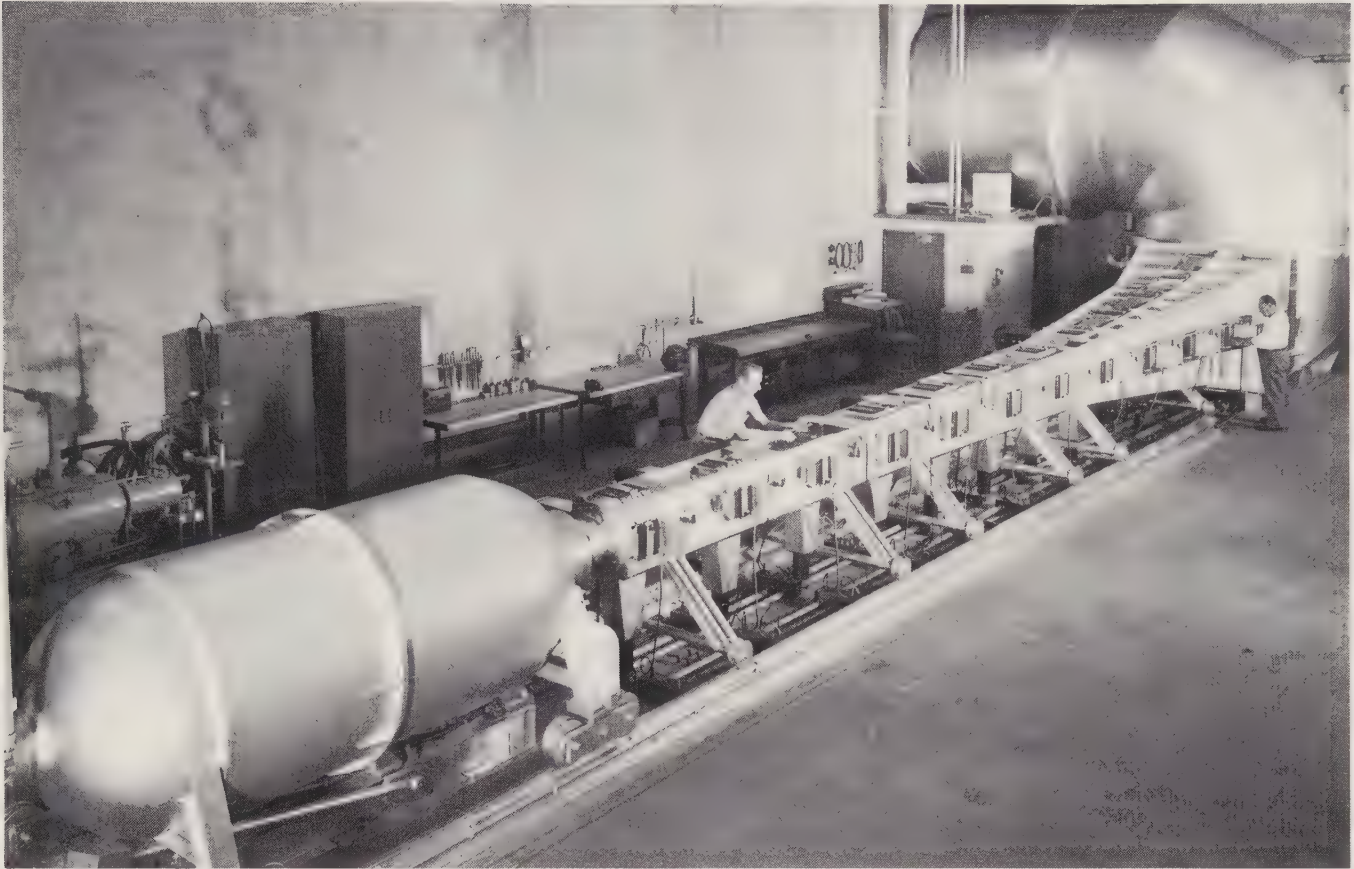

A larger version of the Ames atmospheric entry simulator in 1958.

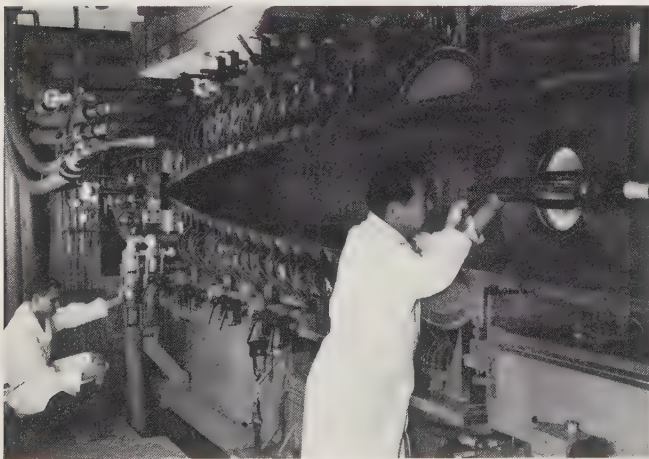

Remotely controlled jacks altered the shape of the nozzle of the JPL 21-inch hypersonic wind tunnel. (Photo, Jet Propulsion Laboratory)

NASA Wind Tunnels: Early Thoughts

The initial NASA wind tunnel inventory, even with NACA and JPL facilities combined, could not

meet the new and ambitious requirements projected by NASA. It was an exciting time. Not only were there accelerated plans to overtake the Russian lead in space, but also the first “A” in NASA could not be neglected—it stood for “aeronautics.” On the aeronautics side, supersonic transports, VTOL craft, and variable-sweep aircraft were on the immediate horizon. The country was expanding in several technological directions at once. One question NASA had to answer immediately involved wind tunnels. Because they took a long time to build, should extant facilities and those under construction be modified in accordance with NASA objectives, and if so, how? Must new tunnels be built to meet the sudden acceleration of space technology?

Regardless of the answers, pre-NASA momentum was so great that some NACA-planned wind tunnels inevitably carried over into the NASA era with scarcely any modifications. The three carry-overs were all located at Langley. The fact that they were pre-Sputnik in concept did not make them any less valuable or interesting.

The Langley Carry-Over Tunnels

The Langley full-scale wind tunnel, which dated back to the 1931 biplane era, would seem to be an unlikely candidate for new aerospace assignments. But its cavernous 30 × 60-foot test section and relatively low air velocities made it ideal for testing models of more modern aircraft in actual free flight, particularly stall characteristics.

The free-flight test arrangement was simple. A carefully balanced, lightweight model was actually flown in the tunnel. Of course, it remained stationary to observers but its forward speed was effectively that of the wind tunnel air. Operating propellers produced thrust or, for jets, a jet of high-pressure air supplied through a slack hose sufficed. Three pilots, one each for pitch, roll, and yaw control, sent signals through a slack power and control cable. By carefully observing the model's behavior under different conditions of flight, observers could spot weak points in the design

before the aircraft was too far into the extremely expensive development cycle. For example, poor stall performance might cause the model to roll violently and possibly enter a spin. It was much better for this to happen with the model than a piloted full-scale prototype. In a similar fashion, model testing of VTOL aircraft during the critical transition from hovering to cruising flight ironed out design deficiencies cheaply and safely. The piloting of VTOL craft was in fact so tricky that when full-scale versions were ready for prototype flight tests, one test pilot first "flew" the aircraft model in the full-scale tunnel to get a feel for the response of the aircraft to the controls during the critical transition from hovering to forward flight.

A second and unusual tunnel that NASA inherited was designed to explore the formidable and poorly understood area of aeroelasticity. Modern aircraft, especially wings, are obviously elastic. Jet transport wings droop toward the ground during taxiing; of

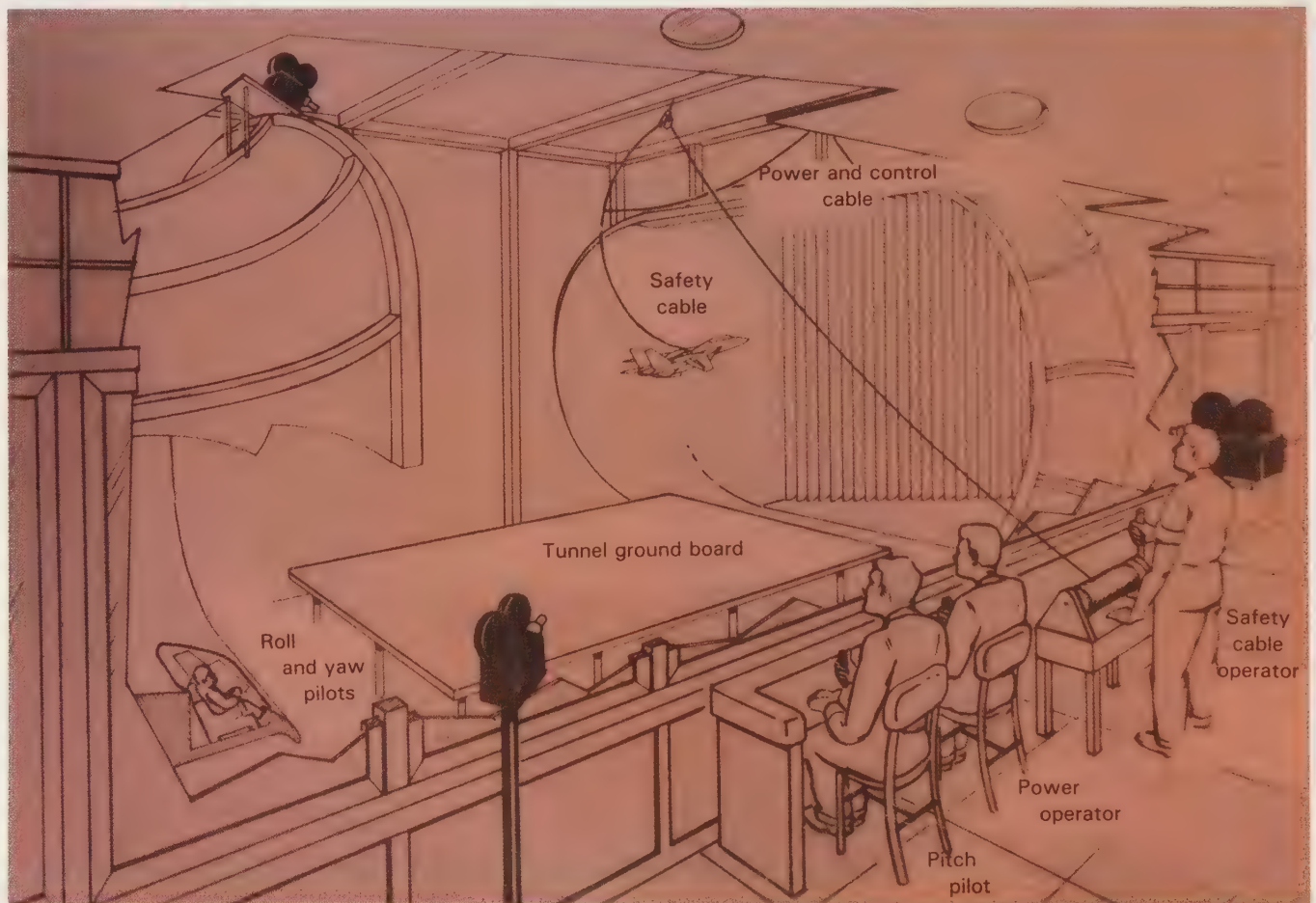

Flying powered models in the Langley full-scale wind tunnel. Jet engines were simulated by air jets fed by a slack hose.



A powered model of the Harrier VTOL fighter flying in the Langley full-scale wind tunnel.

course, the wing droopiness disappears in normal flight because of the lift forces. But what happens to these flexible wings as the aircraft accelerates to high speeds? Will the wings start oscillating and be torn apart? Transonic aerodynamics further complicated an already complex aeroelastic problem—there was no clear answer to this question. Aircraft designers needed definitive wind tunnel tests to assure them that their thin-winged aircraft would not experience flutter under any anticipated flight conditions.

Flutter had been recognized as a problem for many years, but research was limited largely to the study of aircraft components. It was the Boeing Company, during the development of the radical swept-wing B-47 in the late 1940s, that first recognized the need to test dynamically and elastically scaled models of the *complete aircraft*. The model could not be rigidly supported as in the past; it had to have the freedom to move as a free body in response to the applied loads. This represented a formidable task for the wind tunnel designer.

In 1954 NACA began the difficult task of converting the Langley 19-Foot Pressure Tunnel for dynamic

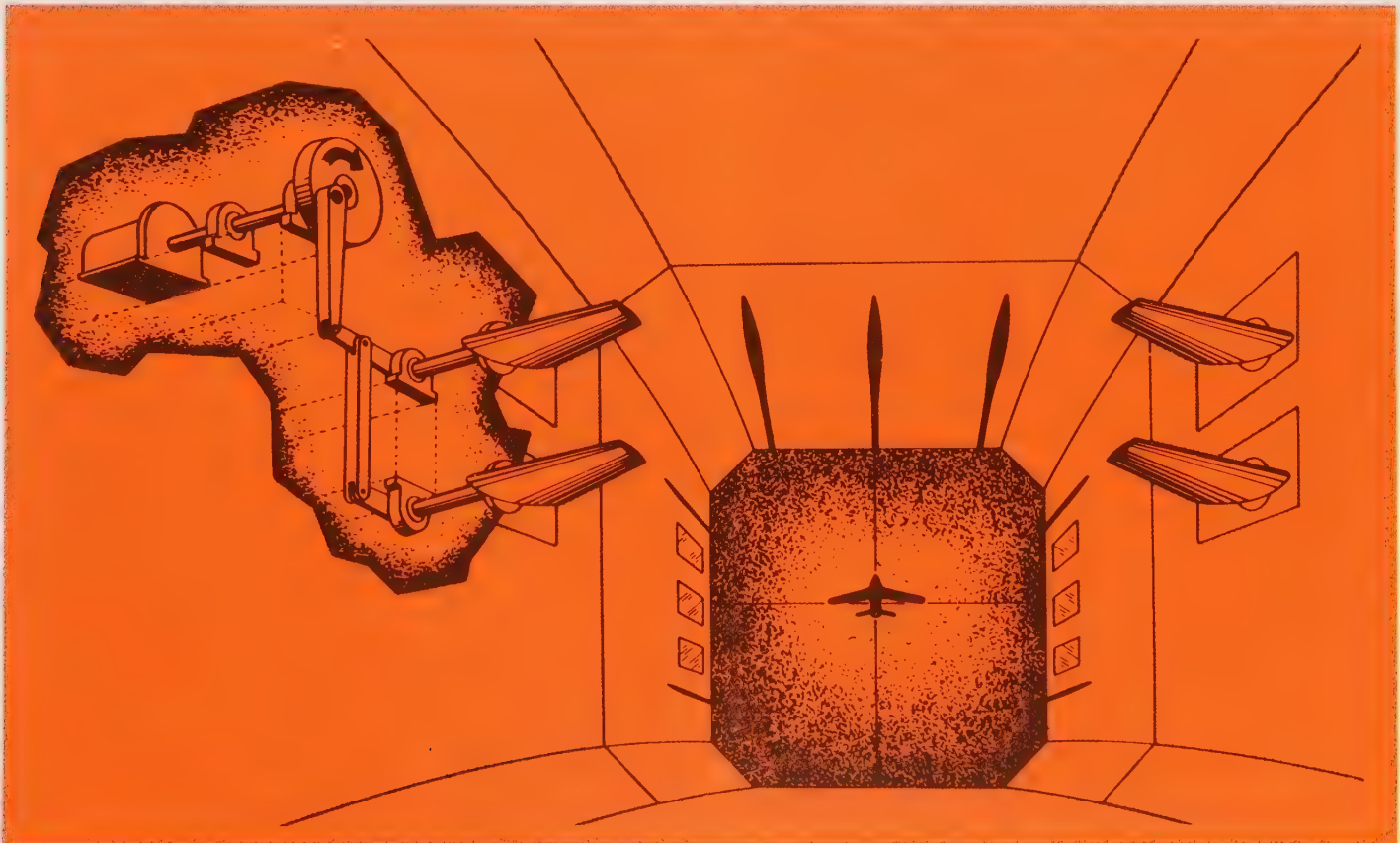

Motor-driven oscillator vanes in the transonic dynamics tunnel created turbulent air to test the response of aircraft to varying aerodynamic forces.

testing of aircraft structures. The old circular test section was reduced to 16 × 16 feet, and slotted walls were added for transonic operation. A new 20 000-hp electric drive motor was installed; the tunnel designers knew that it would not come close to the desired speed of Mach 1.2 at required pressure levels. But they had an ace in the hole. They simply substituted freon for air. Freon, a fluorocarbon widely used in refrigerators, transmits sound at only half the velocity as air. A given Mach number and dynamic pressure could be attained with about one-half the power needed for an air-filled tunnel. Reynolds numbers also increased with freon—and that was advantageous. So, too, was the duplication of a key flutter parameter, Froudes number, which is used when gravity terms are involved in the equations.

In addition to the energy-efficient use of freon to make a slow tunnel appear faster (a concept borrowed from the Low-Turbulence Pressure Tunnel of the 1940s) the Transonic Dynamics Tunnel was provided with special oscillator vanes upstream of the test section to create controlled gusty air to simulate aircraft response to gusts. A new model support system was devised that freed the model so that it could pitch and plunge as the wings started oscillating in response to the fluctuating airstream.

Early in 1960, after 8 years of intensive design and calibration, the Langley Transonic Dynamics Tunnel, the world's first aeroelastic testing tunnel, was ready for its first occupant. Fate had already selected the model to be tested: the Lockheed Electra.

September 29, 1959, was warm and humid in Buffalo, Texas. At 11:07 p.m., Braniff Flight 542, an Electra turboprop, cruising lazily overhead, made a routine report. One minute later there was a blinding flash, a deafening roar, and the Electra crashed without survivors. Investigation of the accident revealed that the left wing had failed, leading to the general disintegration of the aircraft and a fire. There was no trace of metal fatigue—no inkling as to the cause of the catastrophe. The Electra was conservatively designed and had been thoroughly tested. It turned out not to be a fluke accident. On March 17, 1960, another Electra crashed at Tell City, Indiana. Its right wing was found 11 000 feet from the crash site. It now seemed clear that violent flutter had torn the wings off the two craft. The critical question was, what had triggered the wing fluttering?

The new transonic dynamics tunnel had just been calibrated; a one-eighth scale model of the Electra, complete with rotating propellers, was quickly readied

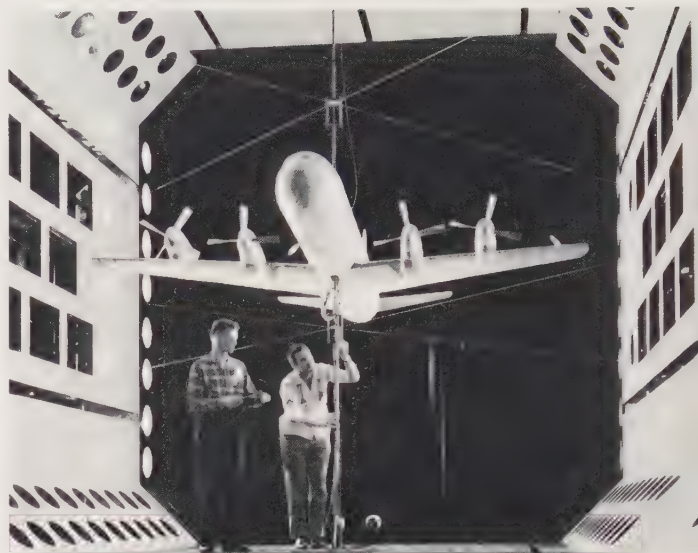

A powered model of the Lockheed Electra mounted in the transonic dynamics tunnel. Crashes of two of these planes were linked to the dynamic coupling of engine gyroscopic torques to wing flutter.

for testing. The elaborate Electra model could even simulate changing fuel loads and different engine-mount structural characteristics. These properties had suddenly become important because a Lockheed engineer had suggested that the Electra had stimulated the catastrophic fluttering all by itself through the coupling of engine gyroscopic torques, propeller forces and moments, and the aerodynamic forces acting on the wings. The engineers had a term for it—propeller-whirl flutter.

Working with great urgency (130 Electras were still flying, though at reduced speeds), NASA, Lockheed, and Boeing personnel found first that the structural safety margins of the Electra far exceeded requirements. However, as they reduced the stiffness of the outboard engine mounts, the gyroscopic torques of the engine-propeller combination led to a wobbling motion with a frequency of 3 cycles per second. This frequency was identical to the natural flutter frequency of the wings. The catastrophic flutter stimulus had been found. The wrenching of the engine reinforced the wing oscillations until the wing fell off. The fatal resonance could build up and tear the plane apart in 30 seconds. No one could explain how the engine mounts might have been weakened—possibly during previous hard landings or violent storms—but the wind tunnel simulations fit the real accident situations perfectly. All the Electra engine mounts were strengthened, and the aircraft has been operating successfully and safely ever since.

The Electra was not the only aircraft with flutter problems to be tested in the transonic dynamics tunnel. The original C-141 military transport encountered severe tail flutter. The F-15 fighter's horizontal tail also fluttered, and the F-16 fighter with external wing pods in some positions produced wing flutter. Modern aircraft are designed to bend under loads—but not too far—and it is the role of the wind tunnel to assure that the Electra story is never repeated.

The transonic dynamics tunnel, however, could not simulate structural problems at supersonic speeds. At supersonic speeds, thermal heating changed the situation. For example, a wing slicing through the atmosphere at Mach 3 might experience temperatures of 500° to 600° F on the thin metallic wing surfaces due to aerodynamic heating, while the sheltered heavy wing spars might run at only 100° F. Theoretical analysis suggested a dangerous decrease in wing stiffness that might alter the dynamics of the whole aircraft. Something akin to the Electra situation might recur at Mach 3 because of this nonuniform heating. Thermal simulation at high Mach numbers required a different kind of wind tunnel.

The new tunnel, the third NACA carry-over, had to duplicate Mach 3 flight conditions and be big enough to test large-scale models. A 9 × 6-foot tunnel seemed about right, but running it at Mach 3 at the required pressure and temperature would take about 1 million horsepower—a level of electrical power Langley could not hope to provide on a continuous basis. Therefore, the tunnel had to operate intermittently, drawing on stored energy. A big tank farm storing 130 000 cubic feet of air at 600 psi was sufficient for a run of a few minutes. To duplicate more closely the heating encountered by Mach 3 aircraft, the test section was preceded by a stainless steel heat exchanger fired by propane burners that heated the test section air to between 300° and 600° F. The result—an unusually noisy monster—was named the 9 × 6-foot Thermal Structures Tunnel.

The thermal structures tunnel quickly ran into a brand new sort of problem. The aircraft designers wanted to measure the integrity of the model under simulated aerodynamic and thermal forces, but when the tunnel was turned on, a shock wave propagated down the nozzle and slammed into the model. Another shock wave jarred it from the opposite direction when the tunnel was shut down. To protect the rather fragile models from such heavy-handed treatment, temporary model shields had to be devised. A second approach was to remotely insert the model

after the tunnel got up to Mach 3 speed and retract it before shutdown.

Noise was a perpetual problem with the thermal structures tunnel. Like the open-circuit tunnels at Lewis, it was a colossal bugle that set all the ducks on the adjacent marshland into scared flight. A long sound diffuser was added to muffle the roar. Nevertheless, so unpleasant was the downstream vicinity that an elaborate 5-minute sequence of warning signals was set up to warn personnel in the area.

Actually, some good was derived from the high-intensity, low-frequency noise spewing out of this tunnel. The noise spectrum nicely simulated the roar emanating from large booster rocket engines. Various space vehicle structures, sensitive instruments, and astronaut communications systems (complete with astronauts) were tested in the tunnel's noise field.

It was only fitting that this facility, whose roar shook the Earth, met its end on September 30, 1971, when its 600-psi tank farm blew up. The debris filled the air, smashed several parked cars, but hurt no one. Some of the tank farm piping had failed because of metal fatigue. The thermal structures tunnel had done its job.

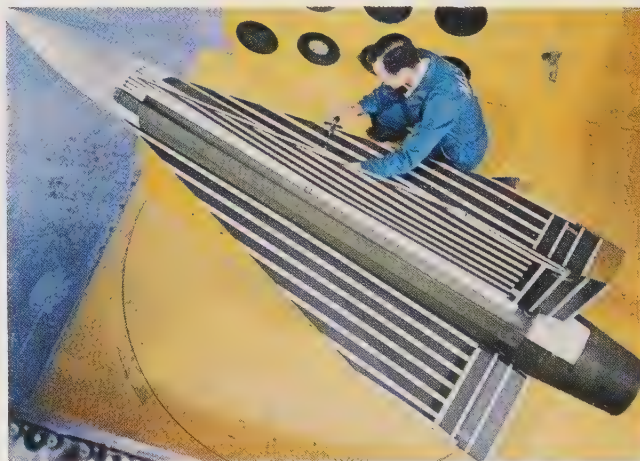

Model of a delta-winged craft in the thermal structures tunnel.

Needed: Air Hotter Than the Sun's Surface

A spacecraft returning from the Moon and reentering the Earth's atmosphere far exceeds the speed of the ballistic missiles that "leisurely" fall planetward from the fringes of the atmosphere. When spacecraft heading home from the Moon impact the atmosphere,

it is like hitting a fiery wall. Temperatures above that of the surface of the Sun prevail around the exposed forward surfaces. These spacecraft are, in essence, artificial meteors; and it is common knowledge that natural meteors are mostly consumed in their white-hot descent through the atmosphere. To design the spacecraft heat shield, terrestrial wind tunnels are used to simulate flow conditions characteristic of reentry speeds in the neighborhood of 37 000 feet per second for lunar reentry and 50 000 feet per second and above for planetary reentry. If wind tunnel simulation were to prove impossible, the spacecraft designer could never be certain that a fatal error in design concept or some undiscerned flaw in the heat shield might lead to the destruction of the vehicle. To preclude such a grave consequence, rocket-launched unmanned flight vehicles are used, where practicable, to validate the integrity of the vehicle design.

The term hypersonic has been used to define the speed regime above about Mach 5, at which heating of the air becomes an overriding factor in vehicle design. In hypersonic wind tunnel operation (below Mach 10 with gas heated to prevent liquefaction), it is assumed that the air streaming by the body behaves as a perfect gas, as defined by the laws of thermodynamics. However, as space vehicles progress into the regime of orbital entry speeds, the strong shock wave generated near the nose of the body produces a very large temperature increase (and a pressure increase as well) that will change the chemical composition of the streaming air. These are often referred to as "real gas" effects. The oxygen and nitrogen molecules in the air tend to dissociate and may become electrically charged and form an ionized sheath around the entry vehicle. This sheath can block the transmission of electromagnetic radiation. The dramatic communications blackout experienced by the first Mercury capsule during reentry illustrates the phenomena. This is called the regime of hypervelocity flight. To reproduce this group of extreme conditions in terrestrial laboratories, aerodynamicists have designed exotic facilities that are usually called wind tunnels, but that stretch the definition considerably.

A fact of life faced by the designer of a very high speed wind tunnel is the extreme temperature of the air entering the nozzle that accelerates the air to the desired speeds. Just before the nozzle, in the stilling chamber, the wind tunnel air is essentially at rest. After accelerating through the nozzle and impacting the nose of the spacecraft model in the test section,

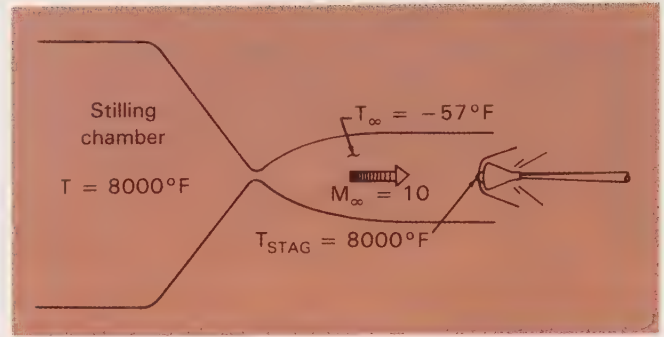

Profile of a hypersonic wind tunnel illustrating how the temperature is roughly the same within the stilling chamber and where the flow has stagnated in front of the model.

the air is once again at rest. Since no energy has been added between these two stations, the temperatures of the air at both stations will be the same. Now a spacecraft entering the Earth's atmosphere at, for example, Mach 10, will experience a stagnation air temperature at the nose of approximately 8000° F. The implication for wind tunnels is that somehow the air in the stilling chamber must be heated to 8000° F (or even higher for higher velocities) to reproduce stagnation reentry temperatures on the model. Such temperatures approach those of the Sun's surface and far exceed those normally available in industrial and scientific laboratories.

Types of Reentry Test Facilities

One reason why temperatures approaching that of the Sun's surface are hard to duplicate is that most structural materials will melt away if exposed to such temperatures for an appreciable length of time. Long-duration hypersonic facilities operating at more moderate temperatures (approximately 3000° F) are practicable, but this is not true with hypervelocity facilities. The reentry vehicle designer must settle for intermittent testing—perhaps a fraction of a second duration—to preserve the structural integrity of the facility. Even so, full duplication of reentry temperatures, pressures, and velocities is beyond the reach of terrestrial test equipment, and partial simulation becomes a fact of life. Assessing the adequacy of the simulation and designing experiments to minimize the uncertainties become major challenges in providing reliable test results for the spacecraft designer to go on.

Conventional Hypersonic Wind Tunnel

The development of high-temperature heat exchangers, such as the pebble-bed storage heater, made possible the high-performance hypersonic wind tunnel operating on an intermittent basis. In a typical cycle, air is compressed to high pressure, dried, then stored in large tanks. At the same time, a large bed of ceramic pebbles is heated for several hours to incandescence by a gas-fired burner. A typical run begins by opening a throttling valve, allowing high-pressure air to surge through the heater, picking up heat as it goes, and then expanding the heated gas to hypersonic speeds in the nozzle. High temperatures in the settling chamber are required to prevent the liquefaction of the air as it expands to very low tem-

peratures in the nozzle. Stagnation temperatures of 3500° F at pressures of several hundred atmospheres provide test Mach numbers from 6 to 15 for run durations on the order of 1 minute. Even during such short exposures, the nozzle throat must be water cooled, for the heat transfer to the wall is highest in this region. Although “real-gas effects” are not simulated in such a tunnel, valid force and pressure data, as well as selective heat transfer data, can be obtained on relatively large models.

For hypersonic runs at more moderate temperatures (2000° F), *continuous operation* can be obtained by providing an array of continuously operating compressors with air heating provided by electrical resistance heaters. The resulting compressor and drive motor installation, as well as the tunnel cooling requirements, is substantial.

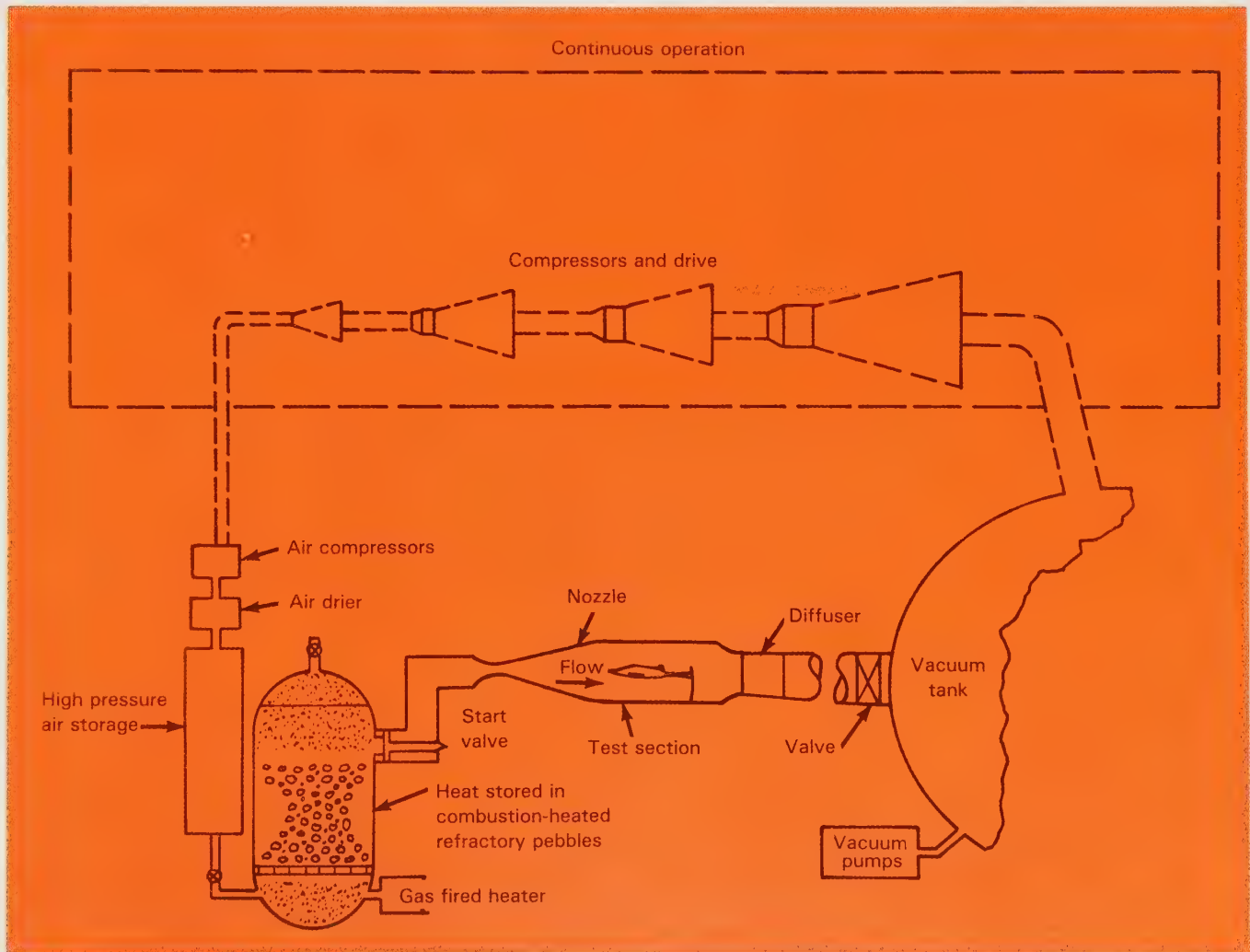

An intermittent hypersonic tunnel fed by high-pressure air storage (solid lines), modified for continuous operation with the addition of compressors (dotted lines).

Impulse Wind Tunnels

Impulse tunnels depend on the explosive release of energy to create extremely high temperatures and pressures in the test gas (which need not be air). This energy-rich burst of gas expands through a nozzle to hypervelocity speeds, and in a fleeting 10 to 100 milliseconds sweeps past the model mounted in the test section. The two basic types of impulse tunnels that provide hypervelocity flows are termed "hotshot" and "shock." They differ mainly in the way in which energy is added to the test gas. In the hotshot tunnel, an initial charge of nitrogen test gas is heated by an electric-arc discharge, which generates pressures up to 2000 atmospheres and temperatures to 10 000° F. The high-pressure gas ruptures a diaphragm and then expands through a nozzle to the test section with a useful run time of approximately 100 milliseconds. Note that the highly energized gas serves as the test medium. Typical Mach numbers from 8 to 25 are produced.

The *shock tunnel* on the other hand, uses an initial, primary shock wave—created from the rupture of the primary diaphragm by the high-pressure expansion of driver gas—to accelerate and compress the driven-tube gas. When the shock wave hits the relatively small nozzle throat, it is fully reflected, acting to decelerate the test gas briefly and further compress it

into an arrested, hot, high-pressure condition. It is this "driven gas" that bursts through a restraining diaphragm into the expanding nozzle. For a few milliseconds the model in the test section is enveloped by the driven gas at stagnation temperatures up to 20 000° F and velocities to 15 000 feet per second. Happily, the response of modern wind tunnel instrumentation is so fast that meaningful results can be gathered even in these short periods of time.

The Expansion Tube

The hotshot and shock tunnels still fall short of the reservoir pressures and temperatures required to duplicate reentry from orbital trajectories. Impossible as it seems, the gas flows in these intermittent devices generally follow the laws of a steady thermodynamic process. To duplicate more closely reentry ambient conditions and to avoid even more stringent reservoir conditions, it is necessary to turn to a process that adds energy to the flow after it has been expanded to a supersonic state, thus averting the necessity of containing the full-flow energy at stagnation. The expansion tube, developed by Langley scientists, does this.

The expansion tube process begins like that of a shock tube, with the rupture of a high-pressure diaphragm separating the driver gas from the test gas.

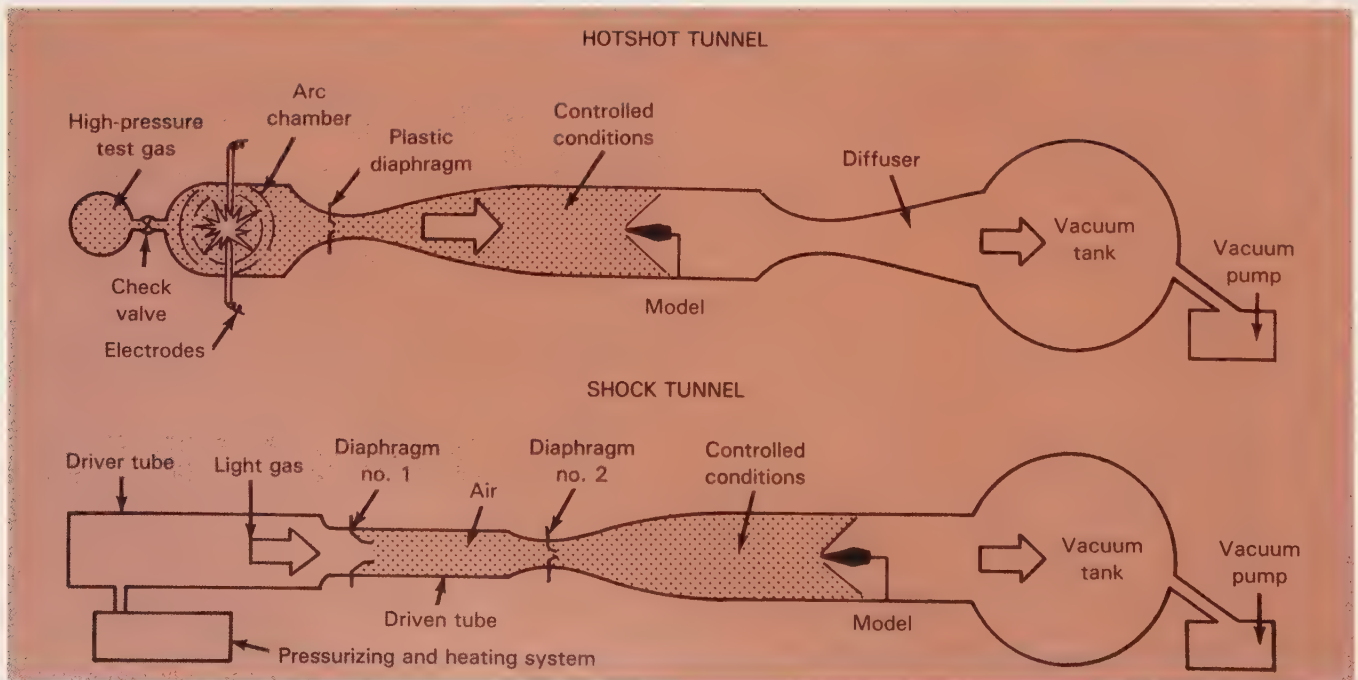

Two types of impulse tunnels.

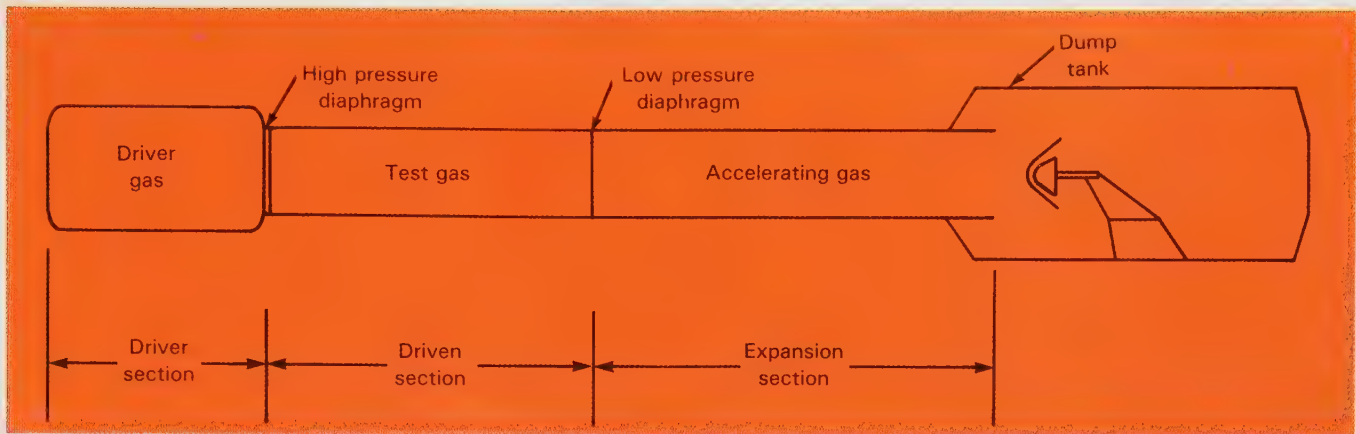

Expansion tubes employ two stages to accelerate gas to high velocities. The driver gas bursts through the high-pressure diaphragm and pushes the test gas ahead of it. The test gas in turn bursts the second diaphragm and expands into an acceleration section and then into the dump tank containing the model.

The resulting shock wave, which proceeds through the test gas, encounters a second, low-pressure diaphragm, which ruptures on contact. Because of the very low pressure of the accelerating gas in the third chamber, the test gas is expanded, cooled, and accelerated in a downstream direction, thus greatly increasing its flow energy. Thus the test gas has been processed first by a shock wave, which heats and accelerates it, and then by an expansion wave, which cools and further accelerates it. The test gas arrives at the test section at a relatively low static temperature and pressure but moving at very high speed—close to typical reentry speeds of 25 000 feet per second. For perhaps 200 to 300 microseconds the model is engulfed by a test flow moving as fast as a reentry vehicle but still rather rarefied and cool, just like the upper atmosphere. Instrument response on the order of a microsecond permits acquisition of valuable data. Different gases or mixtures of gases may be used in the test chamber, thus simulating various planetary atmospheres.

Advanced Counterflow Tunnels

In earlier counterflow tunnels, the firing of projectiles upstream into supersonic wind tunnels generated hypersonic test conditions, but simulation fell well short of the actual reentry conditions. In the late 1950s, however, model launchers (the guns) had attained muzzle velocities of 25 000 to 30 000 feet per second, and impulse tunnels could create air velocities of 10 000 to 15 000 feet per second. Mach numbers of 80 or more could therefore be generated by shooting solid projectiles into the bulletlike masses

of gas shot out of impulse tunnels. Although reentry conditions are closely simulated, it is almost impossible to measure local aerodynamic parameters on the tiny, free-flying models in test periods limited to less than a millisecond. Nevertheless, one can determine model stability, gross aerodynamic characteristics, radiative characteristics of the nose shock, and even some heat-transfer parameters.

Arc-Jets

The hotshot tunnel, with its short-duration arc and its run times on the order of 100 milliseconds, has a companion facility known as the *arc-jet*, which can operate continuously. Here the test gas is preheated in the stilling chamber upstream of the nozzle by means of a continuous electric arc. The heated gas, reaching temperatures of 10 000 to 20 000° F, is injected under pressure into the nozzle. Flow can be sustained for several minutes but only at relatively low-density levels and supersonic Mach numbers. Power requirements for major facilities are tremendous—some requiring over 100 000 kilowatts. The arc-jet is an extremely valuable facility for testing spacecraft heatshield materials under the high heating rates associated with planetary reentry. The test stream, however, is subject to contamination from the arc.

Facilities Employing Test Gases Other Than Air

The realm of test gases is limited only by the ingenuity of the experimenter. Helium, for instance,

liquefies at just a few degrees above absolute zero, thereby permitting expansion of room-temperature helium to Mach numbers approaching 30 without liquefaction. Unfortunately, helium differs appreciably from air in molecular weight and thermodynamic characteristics. Helium tunnels play an important role in studying basic fluid mechanics, but their results require careful interpretation for application to space vehicle design. Hypersonic tests in high-molecular-weight gases (such as Freon C_2F_4 and C_2F_6) provide excellent simulation of the density ratio across the shock and the real-gas effects experienced by blunt bodies during reentry. Some facilities employ the actual constituents of planetary atmospheres (combinations of helium, hydrogen, nitrogen, etc.) to study the entry problem into neighboring planets.

The Roles of Ames, Langley, and Lewis in Hypersonic Research

Most of the hypersonic/hypervelocity facilities just mentioned emerged in some form during the 1950s and early 1960s at Ames, Langley, and Lewis centers. Ames tended to focus on the extreme temperature problems encountered by space vehicles returning to Earth from outer space, whereas Langley's main thrust was in the area of relatively large facilities applicable to hypersonic cruise aircraft and reentry vehi-

cles—including winged reentry. Lewis concentrated on the propulsion aspects. As the era of NACA drew to a close in 1958, the NACA Centers had already embarked on space-related research that later would provide the technical foundation for NASA space programs.

Hypersonic and Space-Oriented Wind Tunnels at Ames

A Large Blowdown Hypersonic Tunnel

In 1957 Ames engineers began designing a large wind tunnel that could subject larger models than previously possible to airspeeds between Mach 5 and

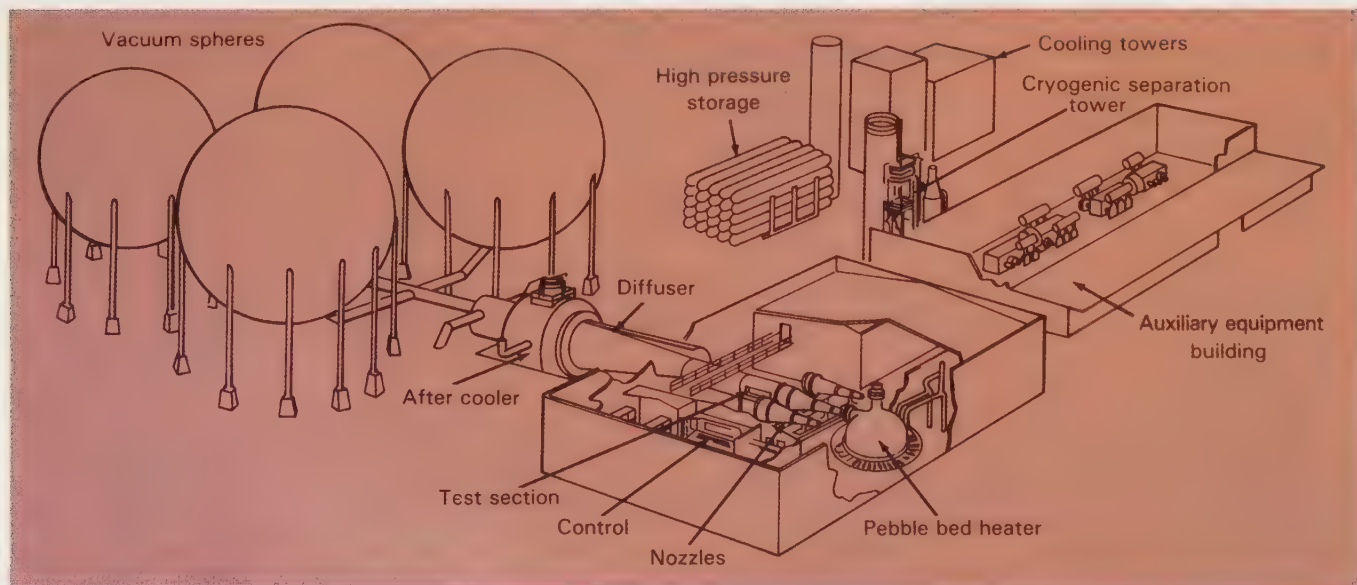
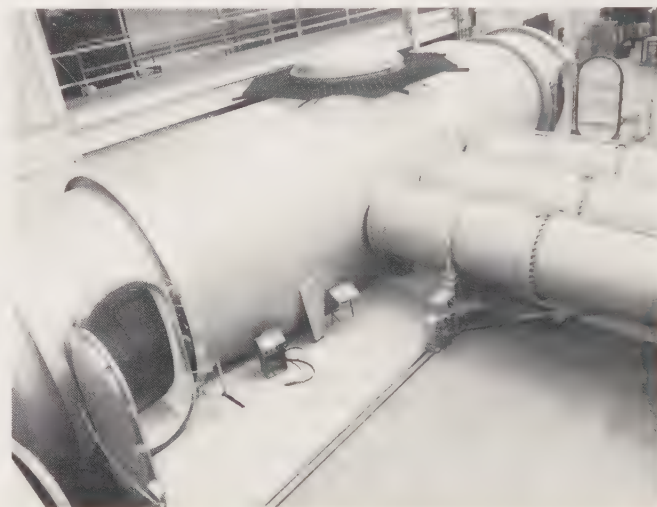

Arrangement of the components of the Ames 3.5-foot hypersonic wind tunnel. Flow was from the high-pressure tank farm, through the gas-fired pebble-bed heater, through the nozzle and test section, and into the vacuum spheres. Photo shows test cabin and nozzles.

Mach 10 for several minutes. This 3.5-foot hypersonic tunnel filled the gap between the continuously operating supersonic tunnels and the short bursts of very high temperature, very high velocity air available in the hotshot and shock-tube facilities. Compressed gas (air or a simulated planetary atmosphere) from a tank farm was released through a gas-fired pebble-bed heater into a helium-cooled nozzle. Four separate interchangeable nozzles were built for operation at Mach 5, 7, 10, and 14. The Mach 14 nozzle was not used, however, because of unexpected problems with the pebble-bed heater.

The heater was built like a battleship with steel plate 8 inches thick. Its 125-ton charge of aluminum oxide and zirconium oxide pebbles was heated to incandescence by a gas-fired burner. Air temperatures of 3000° F were reached easily but, at the 4000° F needed for Mach 14 operation, dust from the incandescent pebbles sandblasted the nozzle to near destruction. Mach 10 was the upper limit. (Note that 3000° F air would have liquefied in the Mach 14 nozzle.)

By mid-1975 thousands of blowdowns, during which air was heated above the melting point of steel, had taken their toll. A flange between the nozzle and heater failed, spewing high-pressure gas and incandescent pebbles over a wide area. The tunnel building was damaged severely and numerous fires kindled in the surrounding area, but no one was hurt. Six months later the 3.5-foot tunnel was back in operation.

The 3.5-foot hypersonic tunnel was first applied to basic aerodynamic research in the Mach 5 to Mach 10 range. In 1965 it was made more versatile when nitrogen and carbon dioxide testing became possible. These gases were used to simulate entry into the atmospheres of other planets. The major work of the facility, however, centered on winged reentry vehicles that could return from outer space, maneuver in the Earth's atmosphere, and then land at a preselected site. Most of the aerodynamic testing of the NASA Space Shuttle and its progenitors was done in this workhorse hypersonic facility.

A Mach 50 Wind Tunnel: The Chimera of Helium

The problem with air is that it liquefies too easily. To prevent liquefaction in a hypersonic tunnel, the air must be heated to several thousand degrees Fahrenheit. As the Ames 3.5-foot hypersonic tunnel proved, heating creates its own problems. But why

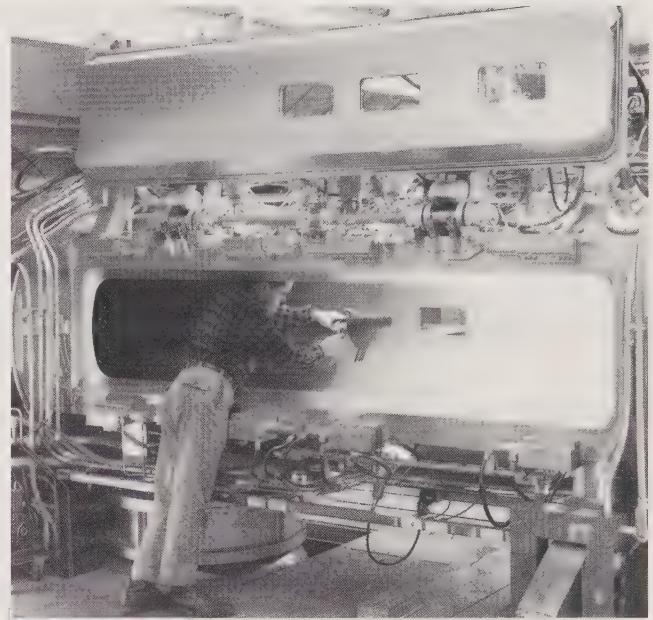

An engineer adjusts the model of a reentry body in the test section of the 3.5-foot hypersonic tunnel at Ames Research Center.

not use helium instead of air? It does not liquefy until almost absolute zero (-459° F).

As early as 1961, Ames built a 20-inch helium hypersonic tunnel. It was so successful that a Mach 50 tunnel with a 28-inch test section was placed in operation in late 1965. It employed a simple blowdown scheme. Helium pressurized at more than 1000 atmospheres was discharged through a fixed nozzle into vacuum storage tanks. Even with helium, modest preheating to 1500° F was required to prevent liquefaction. A considerable amount of basic research at extremely high Mach numbers and Reynolds numbers was carried out in this tunnel during the 1960s.

But helium is an ideal or noble gas. It is definitely far removed from air, which is the medium bathing aircraft and reentering spacecraft. Helium is monatomic, not diatomic. Its basic thermodynamic properties differ radically from those of air. The simulation of upper atmosphere realities was poor. Consequently, interest in the Ames helium tunnel eventually waned and it was razed in 1970. The helium tunnel did, however, provide experimental checks on analytical techniques that could then be applied validly to diatomic gases.

An Electric-Arc-Heated Supersonic Tunnel

While the transient, impulse-type facilities may be sufficient for the aerodynamicist, the solution of heat-shield materials problems is not advanced by such

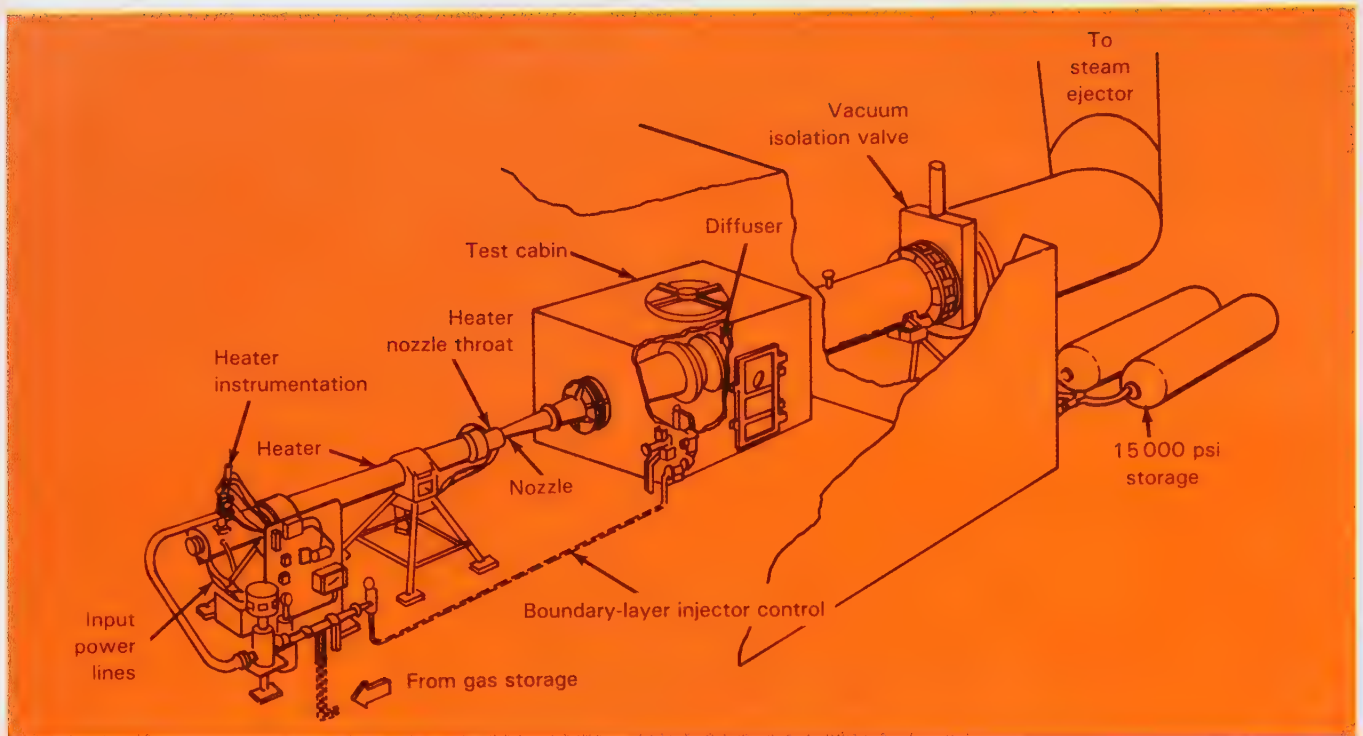

This helium blowdown tunnel at Ames attained Mach 50. Despite its very low liquefaction point, the helium had to be heated to 1500° F to preclude any liquefaction during expansion.

brief exposures to high-velocity gases. Heat testing requires exposure over time—at least several minutes. Ames constructed its Advanced Entry Simulator in 1970 for this sort of thermal testing. Airspeeds in this facility are relatively low—Mach 2 to Mach 5—but the models are subjected to intense heating for up to 5 minutes. Furthermore, the heat comes from two separate sources: (1) a supersonic gas heated by an electric arc-jet (Mach 2 to Mach 5) and (2) a 125-kilowatt argon plasma radiation source. The latter heat source simulates the glowing cap of incandescent gas that builds up in front of a reentering blunt space vehicle. The heat radiated from the gas cap, which is in addition to that conducted and transferred by convection, is of vital importance to the survivability of spacecraft heat shields. By providing these two controllable heat inputs, the relative importance of radiative and convective heating during reentry can be determined. The airspeeds in this simulator were at least an order of magnitude lower than those typical of planetary reentry, so that true environmental heating conditions were not adequately duplicated. Therefore, the main use of this facility had to be the screening of materials for possible construction of heat shields in planetary spacecraft.

Promising materials could then be subjected to more rigorous tests in other facilities.

A Shock Wave Cannon

By detonating a mixture of hydrogen and oxygen in the breech block of a large-caliber cannon, Ames engineers were able to create gas velocities of 14 000 feet per second, with stagnation temperatures of about 18 000° F at the model surface. The exploding gas first ruptures a restraining diaphragm, causing a shock wave to race down a tube containing the test gas. The shock wave compresses the test gas and forces it through an expanding nozzle into a 1-foot test section. Although uniform flow conditions prevail around the model for only about 100 milliseconds (the blink of an eye), instrument response is fast enough to make useful measurements.

The Ames explosion-activated shock tube went into service in 1957 with a 1-foot test section. The test section was increased to 42 inches in 1967. The explosion of hydrogen is a straightforward way to generate high-velocity shock waves, but the technique is messy because of the condensation of combustion products (water) in the driver tube. This facility was finally deactivated in 1972.

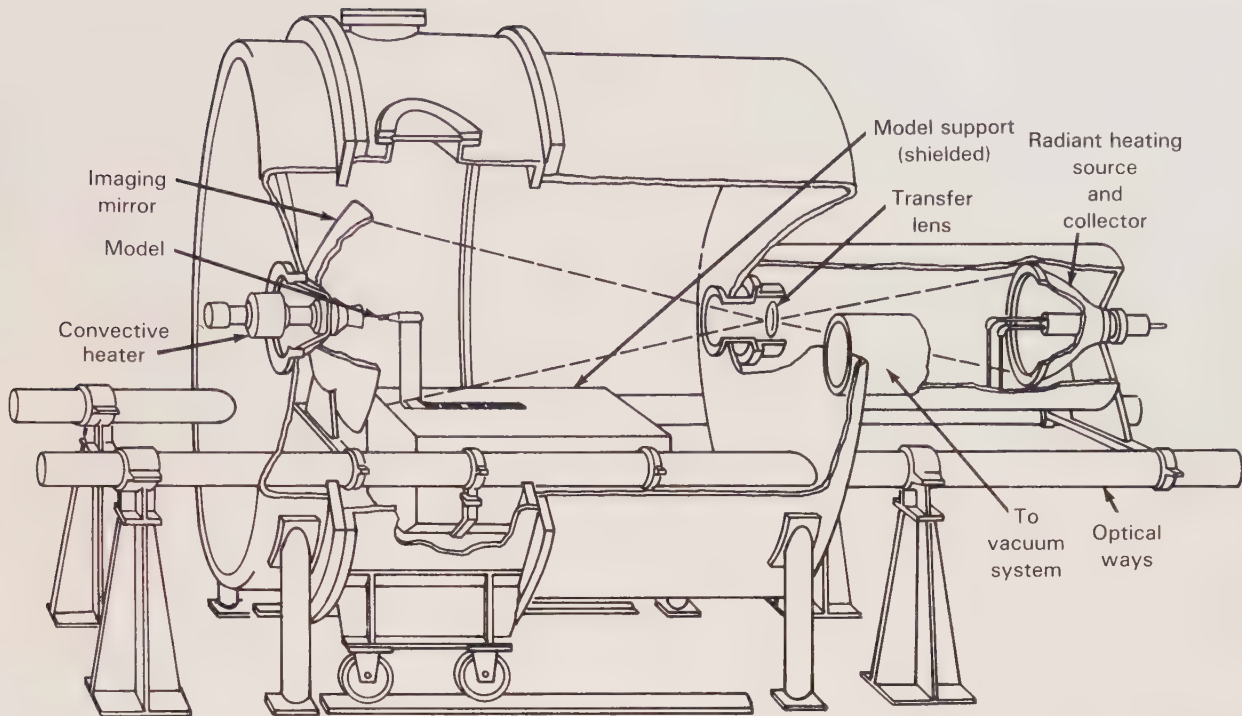

In the Ames advanced entry simulator an arc-jet provided airflows from Mach 2 to Mach 5. Heat radiation from the hot-gas cap was simulated by a radiant energy source focused on the model by a lens.

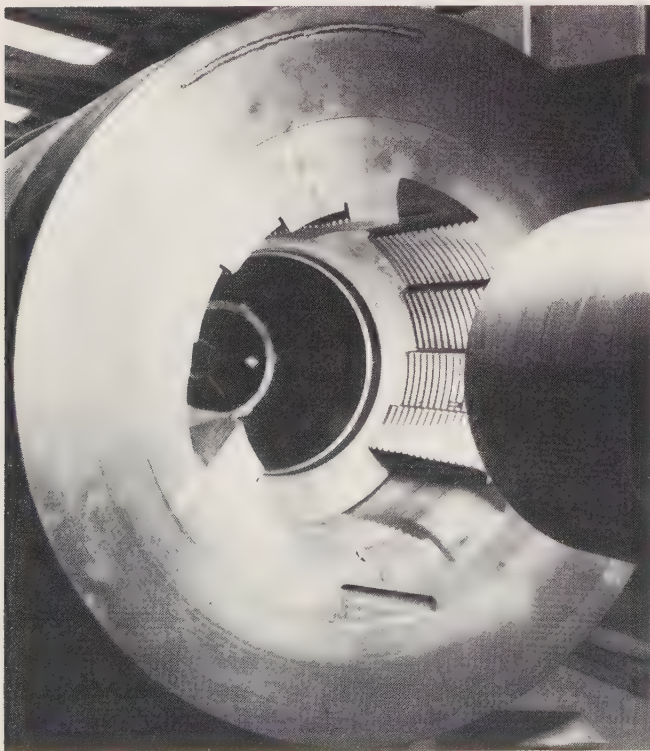

A mixture of hydrogen and oxygen was detonated in the breech block of this large cannon at Ames to create high-velocity gas for a shock tube.

The Ames Electric-Arc Shock Tube

Electric explosions also produce high-energy shock waves. In place of a cannon, the Ames Electric-Arc Shock Tube used a giant bank of electrical capacitors capable of storing 1 megajoule. When this capacitor bank was discharged through electrodes in the driver section of the shock tube, the 600 000-ampere current produced a blinding flash and an incandescent shock wave that pushed the test gas ahead of it through the driven tube. Velocities up to 48 000 feet per second were recorded at the model in the first tests in 1965. By 1974, however, after various improvements and using test gas of hydrogen and helium, shock velocities of 144 000 feet per second (44 kilometers per second) were reached. Such velocities and gases are typical of spacecraft operations in Jupiter's atmosphere. Under such fleeting conditions (a few microseconds) conventional wind tunnel measurements of lift, drag, and so on, are next to impossible. Instruments cannot respond quickly enough. Instead, instrumentation focuses on the temperatures and radiation spectra of the shock wave system formed around the model. With the help of aerodynamic theory, the shock waves tell a great deal about the forces and heating of the simulated spacecraft.

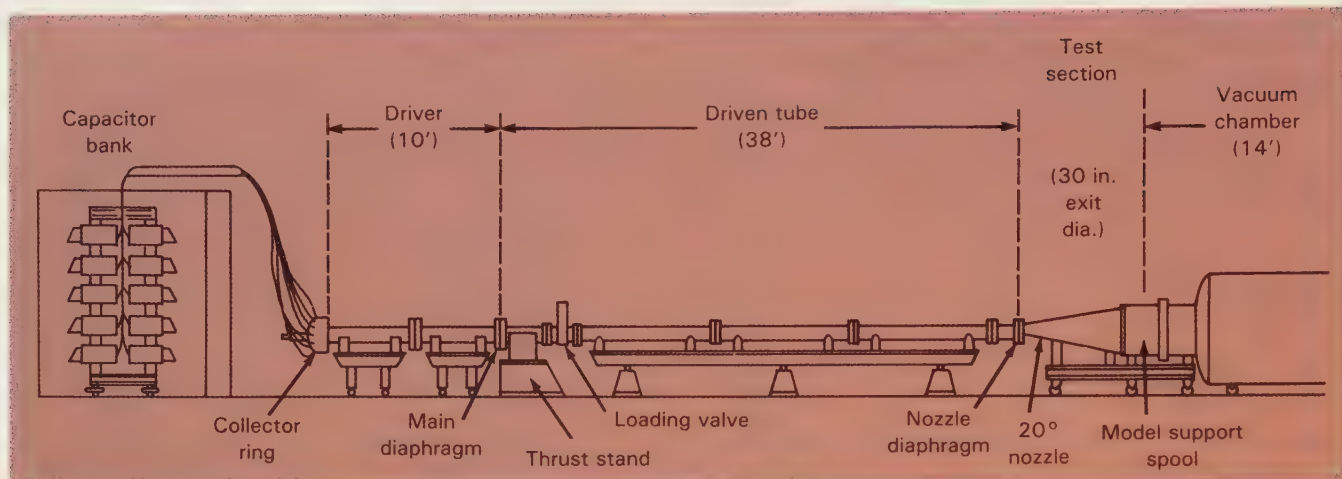

In this shock tube, a capacitor bank discharged 600 000 amperes, creating an incandescent shock wave. The driven gas (usually a mixture of hydrogen and helium) reached velocities as high as 144 000 feet per second.

Super Furnaces for Realistic Testing of Reentry Heat Shields

Shock tubes and other intermittent test facilities are completely inadequate for heat shield studies. There must be time for the heat shield temperature to rise to the point at which the protective material ablates and erodes under the scouring action of the incandescent planetary atmosphere. Complete thermal simulation is impossible on the ground. As with the previously described equipment used in testing ICBM nose cones and reentry shields for the Mercury, Gemini, and Apollo programs, no terrestrial test equipment can contain gases at reentry temperatures for the several minutes required.

The Ames Thermal Protection Laboratory was built solely for the purpose of solving the reentry materials problem, which spans a mission spectrum from Earth reentry to probes colliding with Jupiter's thick atmosphere. Like the earlier Langley Gas Dynamics Laboratory, the basic concept was to supply, from a central source, a bank of test cells (ten in this instance) with appropriate input and discharge conditions for a wholesale onslaught on the planetary reentry problem.

The common input available at all ten test cells was a colossal direct-current power supply of 110 000 kilowatts capacity, with a short-duration rating of 165 000 kilowatts. Forty thousand cubic feet of air at 200 atmospheres pressure were also available, as were large quantities of argon, helium, and carbon dioxide. Each test cell terminated in a common plenum evacuated by a five-stage steam ejector.

The equipment in the test cells was always in a state of flux responding to new experimental objectives.

The bulk of the tests involved electric arc-jet heating. Most of these arc-jets were of modest size; that is, 20 000 to 50 000 kilowatts, except for that in the 165 000 kilowatt Giant Planet Facility. This arc-jet consumed power equivalent to that needed to propel the ocean liner S.S. *United States* at 35 knots. Of special interest is the 35-kilowatt laser added to one of the cells in 1971. The primary goal was the simulation of radiation heating from the incandescent gas cap surrounding the heat shield during reentry, but it was also employed to test the effects of possible laser weapons and the radiation from nuclear weapons.

In operation since the early 1960s, the Thermal Protection Laboratory helped find solutions to many vexing heat shield problems associated with the Space Shuttle, planetary probes, and ICBMs.

Super Guns for Reentry Simulation

In their quest for ever-higher gas velocities, wind tunnel designers Alvin Seiff and Thomas Canning at Ames once again turned to the old counterflow principle in which a model is fired from a gun into an on-rushing stream of air (or some other gas). The counterflow principle had been used to good effect in the supersonic and hypersonic ranges, but could the reentry speeds of 50 000 feet per second at Jupiter be matched? Heretofore, the gun had always launched the bullet/model into a continuous flow of air. Why not employ an intermittent tunnel, since counterflow tests are essentially transitory anyway? Explosive-combustion shock tunnels could easily generate an ample slug of air traveling at 14 000 feet per second

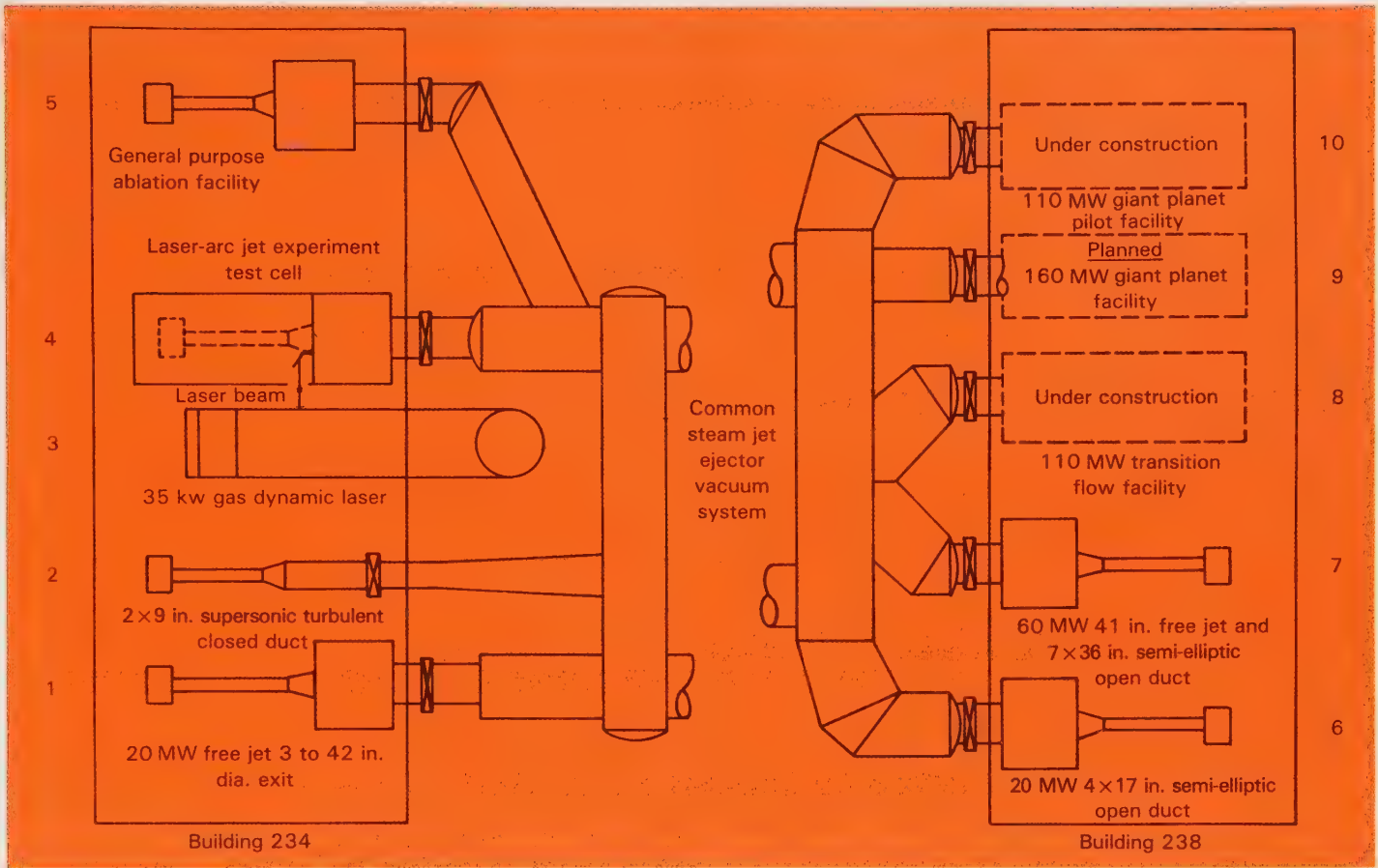

The Ames Thermal Protection Laboratory consisted of 10 test cells containing a wide variety of equipment to simulate reentry conditions.

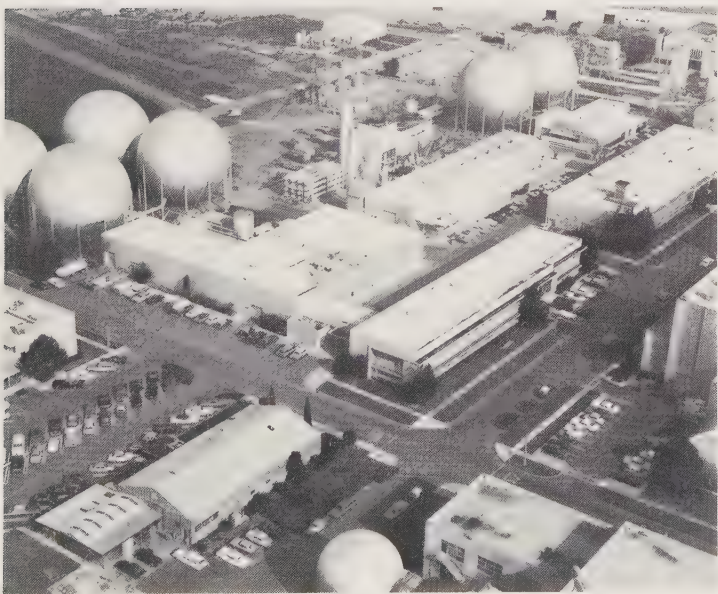

Aerial view of the Thermal Protection Laboratory at Ames showing (upper right) the pipes leading to the common vacuum system.

or more. On the other side of the firing range, the so-called light-gas guns could, in the late 1960s, produce muzzle velocities of 30 000 feet per second. The relative velocity of the model and onrushing shock wave was thus 44 000 feet per second. With these improvements a counterflow, free-flight wind tunnel could, for a very brief moment, nicely simulate reentry Mach numbers, Reynolds numbers, and gas-cap heating conditions.

The Ames facility that capitalized on these developments looked little like the usual wind tunnel. A 70-foot-long combustion-driven shock tube created the 14 000 feet per second shock in a 3.5-foot test section. From the other direction came tiny models propelled by a 1.5-inch (37-mm) light-gas gun at between 2000 and 30 000 feet per second. The bullet of gas and bulletlike model met at a relative velocity of up to 44 000 feet per second—but just where was not easy to predict. The timing of the firing of the two guns had to be synchronized precisely; otherwise, the photographic equipment waiting at the expected juncture would record nothing at all. Shutter speeds



Two guns firing at each other at the Ames Hypersonic Free-Flight Aerodynamic Facility. The shock tube (left) fires a gaseous bullet at the light-gas gun (right), which shoots a small model into the onrushing gas.

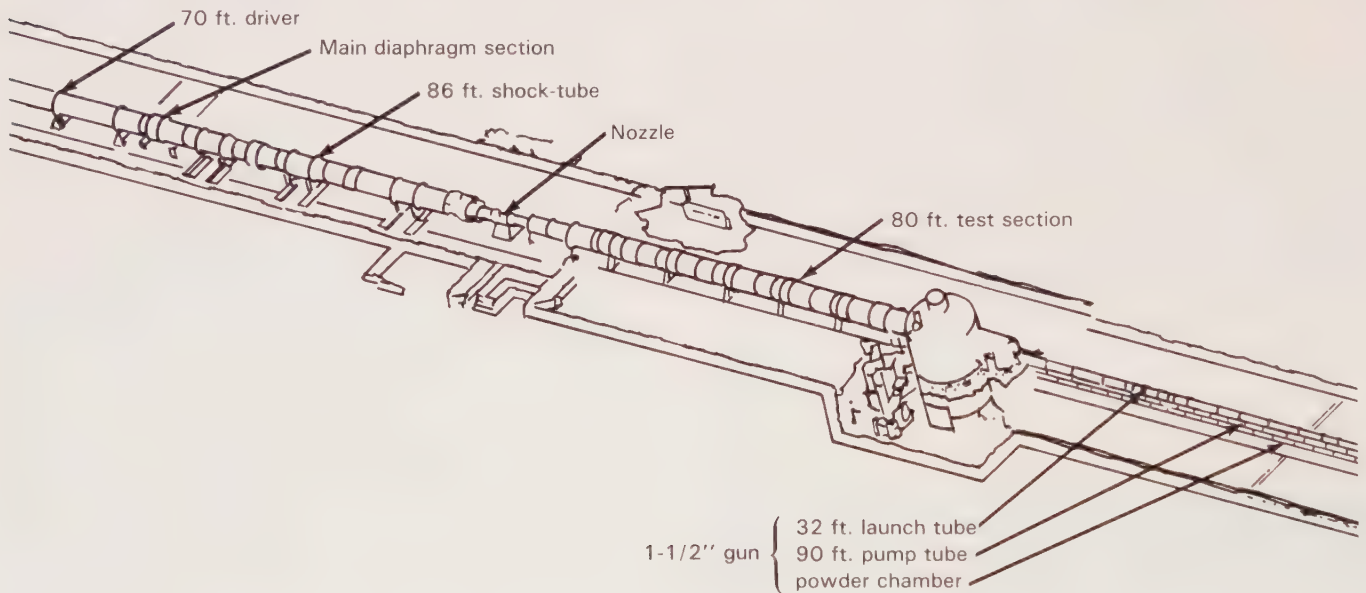

were measured in billionths of a second, highlighting the brevity of the encounter.

The Suicidal Wind Tunnel

Where can one go after arc-jet and counterflow tunnels? The escape velocity for Jupiter (and therefore the velocity of an impacting space probe) is approximately 200 000 feet per second—far above the reach of the counterflow tunnel. One does not need to resort to electrostatic or electromagnetic acceleration to achieve this velocity—a lowly chemical explosive can do it, providing it is properly shaped to focus its energy. In 1965 a Russian scientist proposed that the shaped charge originally developed for piercing thick

steel armor be adapted to the task of accelerating shock waves. The resulting device, looking little like a wind tunnel, is called a Voitenko compressor.

The Voitenko compressor initially separates a test gas from a shaped charge with a malleable steel plate. When the shaped charge detonates, most of its energy is focused on the steel plate, driving it forward and pushing the test gas ahead of it. Ames translated this idea into a self-destroying shock tube. A 66-pound shaped charge accelerated the gas in a 3-cm glass-walled tube 2 meters in length. The velocity of the resulting shock wave was a phenomenal 220 000 feet per second. The apparatus exposed to the detonation was, of course, completely destroyed, but not before useful data were extracted.

WIND TUNNELS IN THE SPACE AGE

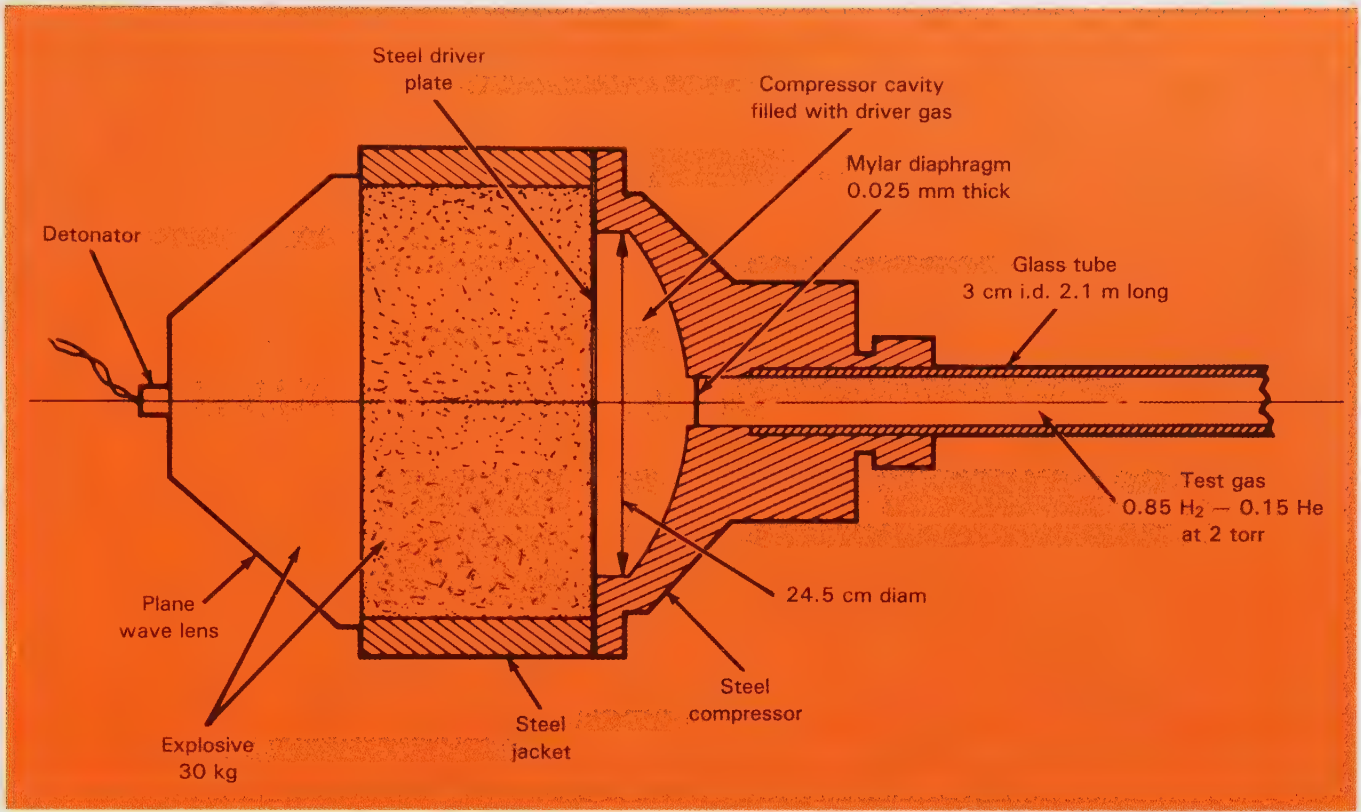

Cross section of the shaped charge and input device of the Voitenko compressor-driven shock tube.

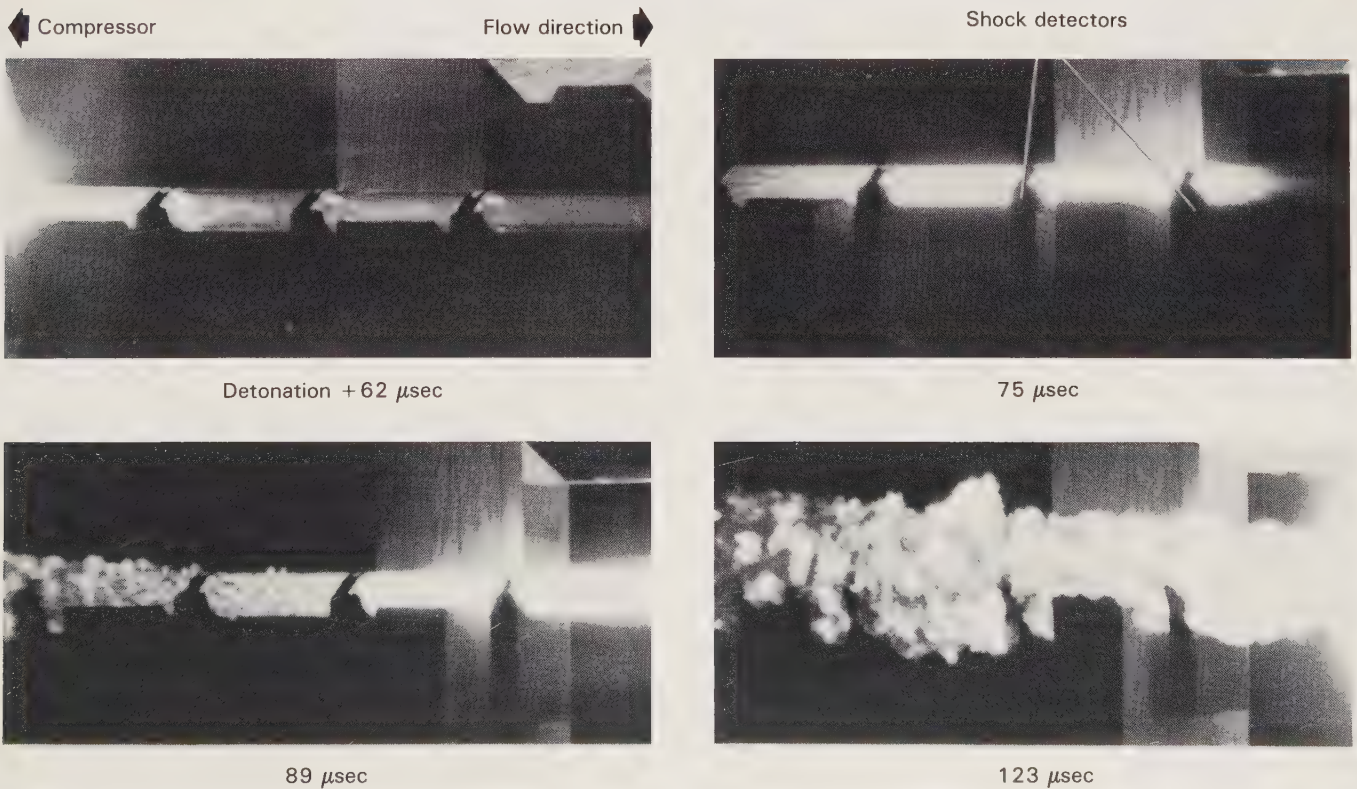

Frames taken a few microseconds apart show the progressive destruction of the glass shock tube in the Ames Voitenko compressor.

The clue to the success of this expendable device is the observation that the disintegration of the glass tube, in which the model is mounted, lags behind the shock wave in the gas by about 15 tube diameters. High-speed photos, taken via mirrors by cameras protected underground, clearly show the gaseous shock wave well ahead of the wave of physical destruction. This fantastic instrument, so far removed from Wenham's primitive wind tunnel, is the only known "practical" method for generating such extreme velocities.

Langley's New Space-Related Wind Tunnels

When the Langley Aeronautical Laboratory was transferred to NASA it was renamed the Langley Research Center. The name change and switch from NACA to NASA signified a change in emphasis rather than a radically new mission. Indeed, Langley had been researching high-speed flight, developing heat-resistant materials and structures, and firing multi-stage research rockets from Wallops Island, Virginia, for almost a decade. With its several hypersonic wind tunnels and wide experience with rocket testing, Langley became a cornerstone of NASA's space effort. With a mandate to place man into space and on the Moon quickly, NASA drew heavily on Langley's expertise and facilities. The Space Task Group, which led the Mercury, Gemini, and Apollo programs, was staffed mainly from Langley personnel.

There was already in place at Langley a wide spectrum of hypersonic/hypervelocity facilities. To meet the new challenges of manned space flight and NASA's aeronautical assignment, three important new wind tunnels were built during the 1960s.

A Quantum Jump in Hypersonic Tunnel Capability

The Langley Continuous Flow Hypersonic Tunnel, under the guidance of Eugene Love, entered the planning stage in 1958, essentially the same time NASA was formed. Preceding hypersonic tunnels had been blowdown facilities. Runs were short—just a few minutes at most—and data productivity and experimental versatility were wanting. The goals for the new tunnel were ambitious: continuous operation at Mach numbers up to 12.

The first major problem facing the tunnel engineers was the very high pressure ratio (about 700) that had

to be maintained continuously for Mach 12 operation. Initially, six big air compressors were to be lined up in series, the output of the first feeding the input of the second, and so on down the line. The high-pressure air would then pass through a square nozzle, 1-1/4 inches on a side at the throat, and into a test section 31 inches square. Discharge was to be into a vacuum sphere. The system worked on paper, but the sixth and final compressor in the chain pushed the state of the art too far. It had to be dropped, and the design goal was compromised to Mach 10.

Heat was the second major worry. It had to be added in the settling chamber before the nozzle to prevent air liquefaction in the nozzle and then extracted ahead of the vacuum sphere to maintain the

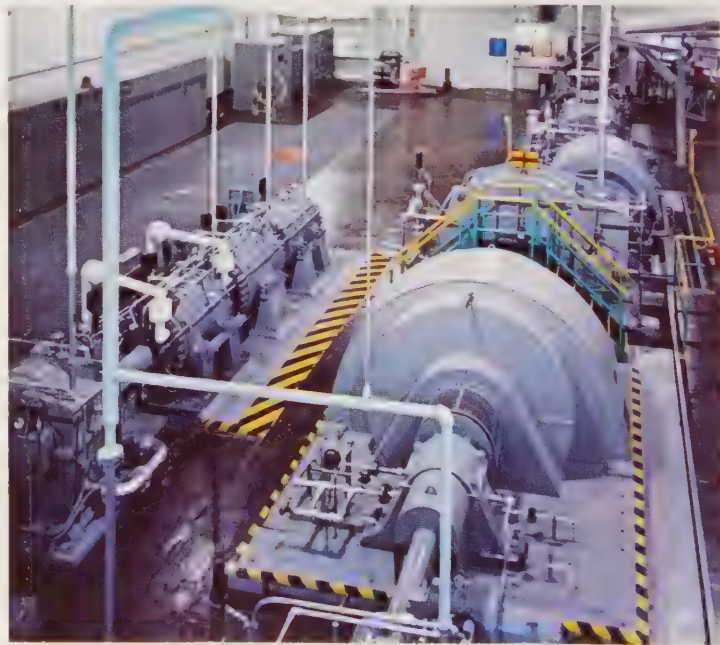
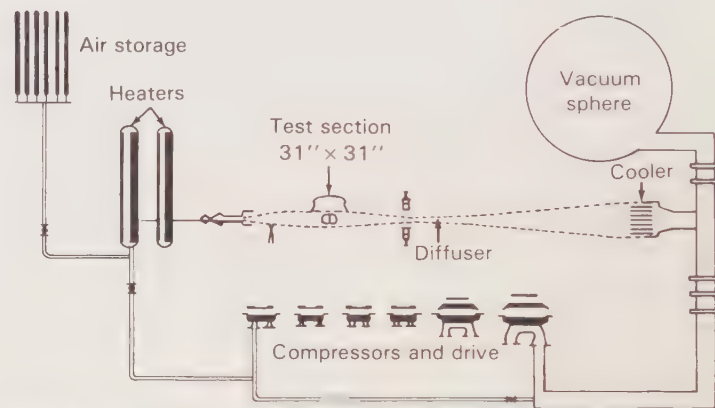

A linear array of five compressors feeding the Langley continuous-flow hypersonic tunnel. This facility achieved a Mach 10 flow through a test section 31 inches square on a continuous basis.

sphere's structural integrity and protect the downstream compressors. Adding heat was relatively simple: a 13 000-kilowatt electric resistance heater in the settling chamber raised the air temperature to 1450° F. The air temperature dropped rapidly in the nozzle as heat energy was converted to kinetic energy. But in the vacuum sphere, the process reversed as the air slowed down. The kinetic energy was transformed back into heat. A large water cooler had to be installed to pull the temperature of the air in the vacuum sphere down to about 100° F. Another hot spot was located in the nozzle throat where the air was dense, moving at Mach 1, and still about 1450° F. Distilled water circulating within the nozzle walls kept temperatures within bounds.

The continuous flow hypersonic tunnel went on line in 1962 with blowdown capabilities only. Two years later the addition of a compressor system con-

verted it to continuous operation. Through the years, this facility has been applied primarily to the study of the aerodynamic performance and heat transfer on winged reentry vehicles, such as the Space Shuttle.

A Million-Horsepower Methane Blowtorch

Officially known as the 8-foot High-Temperature Structures Tunnel, the goal of this facility was the realistic testing of flight structures under the stresses and high temperatures of hypersonic flight. In charge of this effort was Langley's Robert Howell. Existing hypersonic tunnels, even though capable of continuous flow, could not duplicate the structural problems encountered at these high velocities. Test section size was the basic limitation. Small-scale models were adequate for aerodynamic testing, but the buildup of thermal stresses in complex aerospace vehicles could



In the 8-foot test section of the Langley high-temperature structures tunnel, models are subjected to a Mach 7 gas flow provided by a huge methane burner.

best be studied under full-scale conditions where internal structures could be duplicated.

The Langley 9 × 6-foot thermal structures tunnel, which went on line in 1956, was the right size but it only reached Mach 3; Mach 7 was the target of the new 8-foot tunnel. At this airspeed, the energy requirement was prodigious: 1 000 000 horsepower. The electrical equivalent (746 000 kilowatts) represented the full capacity of a very large commercial electrical generating station. Electrical power plants in the Langley region could not divert such a large block of power even for a few minutes; a methane blowtorch was offered as a solution. By burning methane in air at very high pressures and expanding the combustion products through a hypersonic nozzle, Mach 7 could be attained in an 8-foot test section. But would the combustion products of methane (mostly carbon dioxide and water vapor) simulate air closely enough? Analysis showed that the flow parameters would deviate less than 10 percent. The methane torch was worth a try.

The heart of the new tunnel was the methane burner, which required the combustion of 1000 pounds of methane gas per second at 270 atmospheres pressure and a temperature of 3500° F. These conditions were well beyond the state of the art in the late

1950s, but 200 atmospheres at 3000° F seemed attainable. The construction contracts were awarded in 1960. Cold test runs of the completed tunnel occurred in 1964, but high-temperature runs had to wait until 1968.

The high temperature structures tunnel, because of the copious combustion products, had to be of the nonreturn type; that is, the gases are not recirculated. A huge tank farm and methane storage complex feed fuel to the burner. The flow is through the nozzle, then through the test section, past an annular injector that lowers the exit pressure during startup, and finally out through a diffuser into a swampy area. Portions of flight vehicles to be tested can be inserted into the gas stream as quickly as one second, and withdrawn in the same period. Pieces of failed test structures simply fly out the aft end of the tunnel into the uninhabited swamp.

This unique tunnel came too late to be useful in the Apollo Program, but it has been of immense benefit in testing the Space Shuttle and hypersonic aircraft. In fact, it was almost as if the tunnel were designed specifically for the Space Shuttle. Its test conditions have been ideal for full-scale testing of the insulating tiles that preserve the integrity of the Space Shuttle during reentry. It represents still another case of serendipity, for the high temperature structures tunnel was conceived almost 20 years before the Space Shuttle was built.

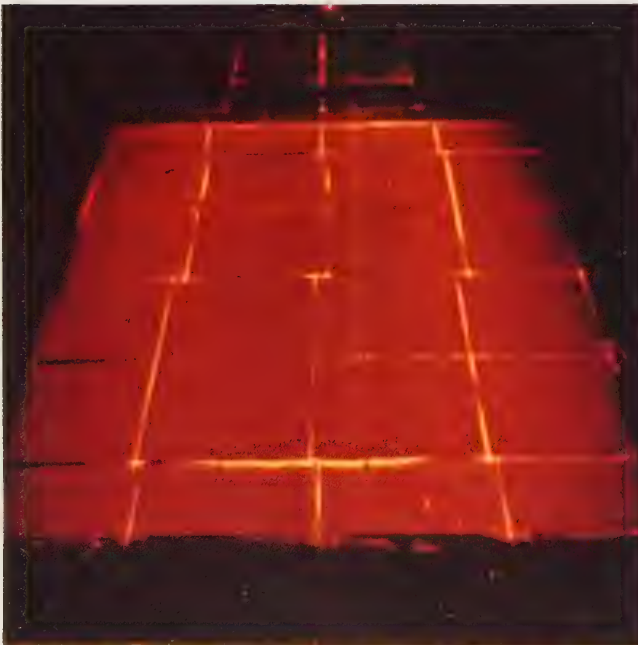

Tests in the Langley 8-foot high temperature structures tunnel (Mach 7, temperature 3000° F) subject Space Shuttle tiles to typical reentry conditions. The bright glow in the simulated tile gaps is indicative of high local heating rates.

Learning to Avoid the Perils of a Hot-Gas Cap

As explained earlier in this chapter, an important fraction of the heat that eats away at the nose of a reentering spacecraft radiates from the incandescent cap of gas that piles up between the nose of the vehicle and the nose shock. Ames Research Center developed several shock tubes and other high-velocity devices to study the high-temperature gas properties in this critical region. Langley aerodynamicists, in the never-ending search for effective hypervelocity simulation, introduced the Hot-Gas Radiation Research Laboratory in 1969. The core facilities included a high-performance, 6-inch-diameter arc-driven shock tube and a 6-inch-diameter expansion tube. These facilities are driven by the discharge of a 10-megajoule energy storage bank. The expansion tube consisted of three stages: (1) a driver section typically filled with helium at 350 atmospheres (for unheated operation), (2) a driven section containing the test gas at about 0.05 atmosphere, and (3) an acceleration section at

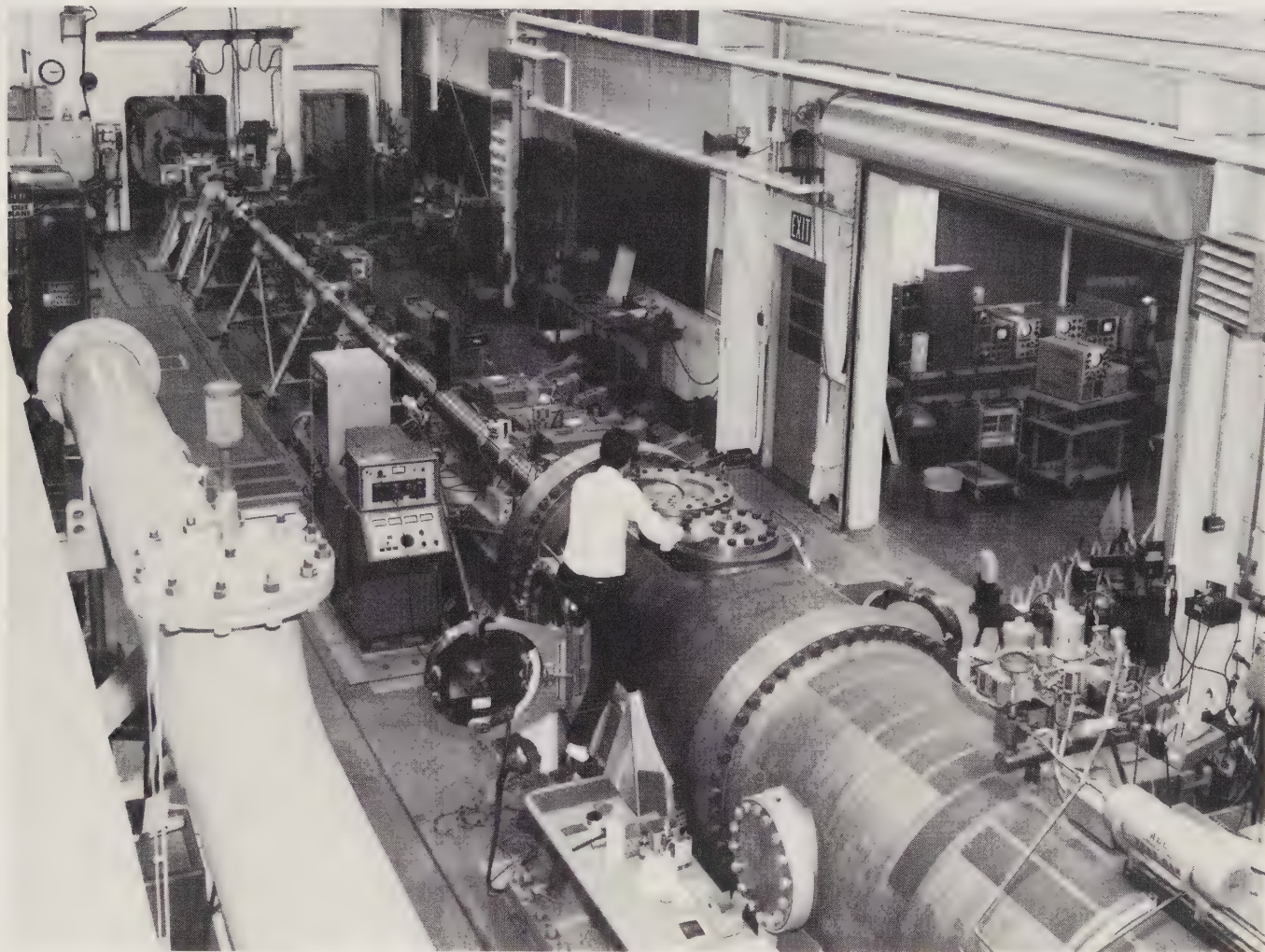

The 6-inch expansion tube looking upstream. The man is adjacent to the test section.

about 0.0005 atmosphere. After rupture of the diaphragm in the driver section, the pressure ratio across the three stages builds up to several million—a ratio sufficient to reach Mach 15 and flow velocities to 25 000 feet per second. Separating the second and third stages is a gossamer-like plastic diaphragm about one-tenth the thickness of this page. Its strength is just sufficient to withstand the initial pressure difference between the second and third stages. Upon rupture by the shock wave in the driven section, the attendant expansion doubles the velocity of the gas entering the expansion section.

The pulse of test gas impacting the model lasts only about 300 microseconds, but it is smooth and possesses a very low turbulence level. This is followed by the impact of the high-pressure driver gas which strikes the model with a sledgehammer-like blow. Instrument response must be faster than a microsec-

ond to provide meaningful test data. Furthermore, a boundary layer builds up quickly around the walls of the test section so that only the central core of gas—about 3 inches in diameter—is really useful. Despite these time and space limitations, surprisingly good schlieren photos, pressure measurements, heat transfer information, and other flow data can be recorded in the fraction of a thousandth of a second of useful run time.

Testing a Hypersonic Ramjet at Lewis Research Center

At hypersonic speeds, the turbojet engine gives way to a much simpler air-breathing engine: the ramjet. The high-speed compressors and turbines of the turbojet are forgotten in the ramjet because the high-velocity air scooped up by the engine intake reaches

WIND TUNNELS OF NASA

pressures sufficient for engine operation as it “rams” into the combustion chamber. Langley Research Center, in association with the Garrett Corporation, designed a hypersonic ramjet research engine for in-flight testing on the X-15 rocket plane at Mach 6. This engine, however, was strictly experimental and incorporated several untested features, such as the use of hydrogen fuel in a combustion chamber operating at about 5000° F. Rather than risk a pilot by mounting this veritable bomb on the X-15, NASA asked Lewis Research Center to test the engine on the ground first. In 1970 NASA-Lewis already had the

key elements for a large blowdown hypersonic tunnel in place at its Plum Brook station on Lake Erie, 50 miles west of Cleveland. The relative remoteness of the Plum Brook facility made it an ideal place to test what was bound to be a very noisy engine. For heat transfer research, a large 5000-psi tank farm had been installed there plus an induction-heated, graphite, pebble-bed heater capable of raising a test gas to 3500° F. To solve the chronic problem of oxidation of the graphite heater at extreme operating temperatures, inert gaseous nitrogen was initially passed through the heater. The controlled addition of

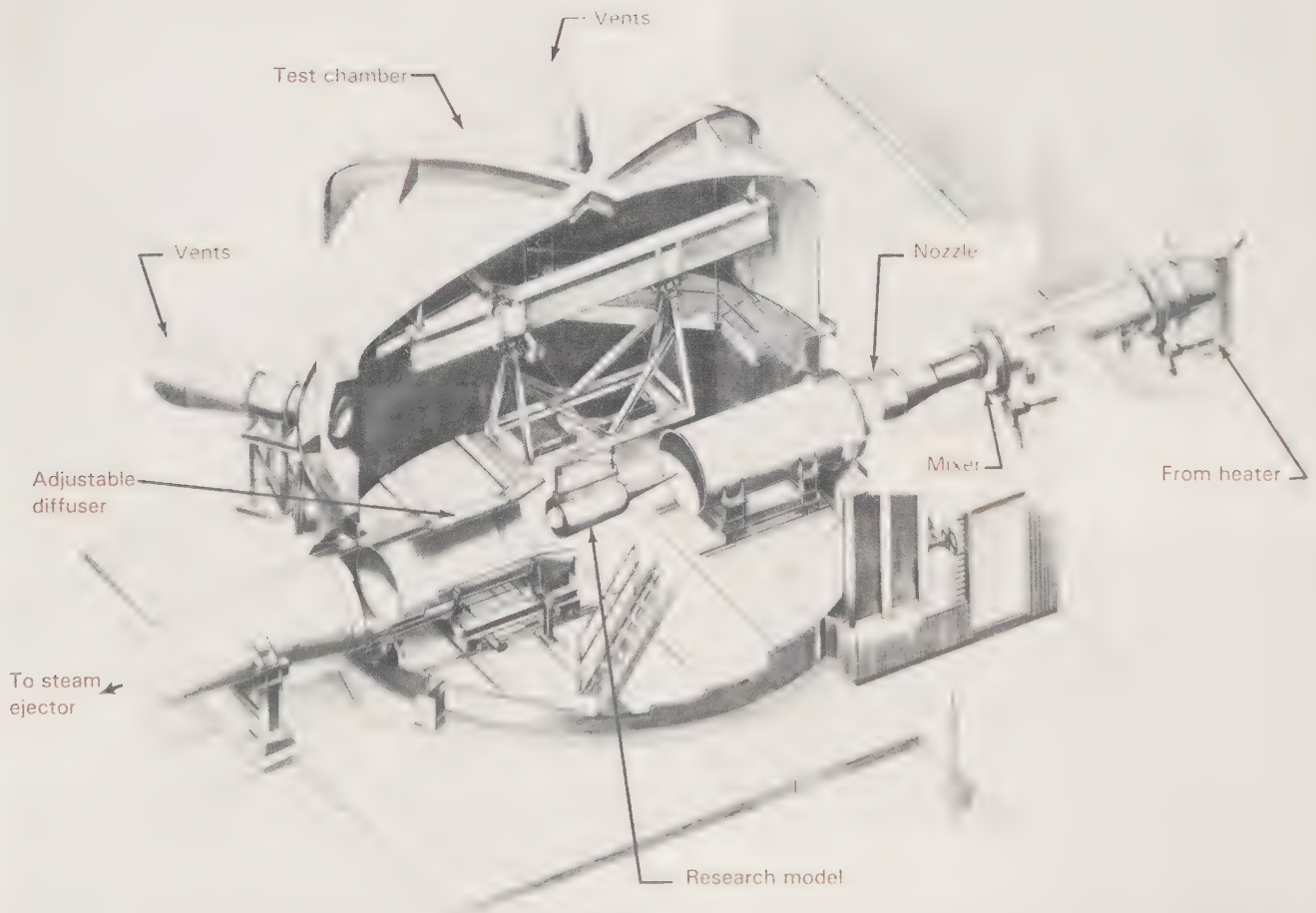

A hypersonic tunnel was built at Lewis Research Center to test a full-scale ramjet engine. This blowdown tunnel operated between Mach 5 and Mach 7 with a hydrogen-burning ramjet under test.

oxygen to the nitrogen stream *downstream* of the heater but ahead of the test section provided a test medium that matched the constituents of atmospheric air in supporting combustion.

To convert the heat-transfer equipment into a hypersonic tunnel, Lewis personnel added three 42-inch water-cooled nozzles sized for Mach 5, 6, and 7 operation. A large steam ejector served to reduce tunnel pressures to those typical of high altitudes.

A full-scale "boilerplate" hypersonic engine was installed in the Plum Brook tunnel. Aerodynamically it conformed to the basic design, but there were no restrictions on structure weight for the ground tests. The engine did operate properly, burning hydrogen fuel successfully, but the thrust levels were lower than anticipated. Nevertheless, the tests were considered successful, auguring well for the eventual construction of a flight-model hypersonic ramjet and Mach 6 operation with air-breathing rather than rocket engines.



Full-scale "boilerplate" version of a hypersonic ramjet mounted in the Lewis hypersonic tunnel.



Chapter 7

The Post-Sputnik Renaissance of Aeronautics

During the 1960s, while public attention was focused on NASA's manned and unmanned spacecraft, aircraft technology took several bold steps forward. Although in the shadow of the space program, U.S. subsonic jet transports captured the world commercial market and became indispensable to intercontinental travel. Along came the variable-sweep wing and the supercritical airfoil—developments not nearly as spectacular as the Apollo 11 lunar landing in July 1969, but nevertheless invaluable to more efficient flight in the atmosphere. And of course atmospheric flight is infinitely more frequent than space flight. The helicopter, too, grew to technological maturity during this period. Supersonic transports were also on the drawing boards. Far from being eclipsed by space feats, aeronautics prospered as never before. It was the Jet Age, with its jet set and jet lag and all the excitement of thousands of sleek, powerful craft crisscrossing the world at nearly the speed of sound.

The preceding chapter records NASA's response to its space flight assignments in the area of wind tunnels. Emphasis was on hypersonic and hypervelocity wind tunnels, arc-jets and shock tubes, and tunnels for testing the effect of aerodynamic heating on spacecraft structures. These facilities had to be built quickly to win the space race, as it was called during the decade after Sputnik. On the aeronautics side, NASA had inherited an impressive inventory of facilities from NACA consisting of several dozen wind tunnels at the Ames, Langley, and Lewis laboratories. Many of these were modern and already laboring at the forefront of technology. There were only a few obvious gaps in the spectrum, and NASA quickly rectified these shortcomings with three new tunnels, all possessing unique or modestly revolutionary features.

The New NASA Aeronautical Wind Tunnels

The Langley V/STOL Wind Tunnel

One would expect wind tunnel technology to become simpler when test speeds are reduced from 100 000 mph in the exotic atmospheres of other planets to a mere 100 mph in the Earth's familiar air. This would be true if one were testing, say, a Piper Cub, but V/STOL craft introduce a whole new set of problems for the wind tunnel designer. At the simplest level, there are two new enigmas to puzzle out: (1) how to keep the strong downwash from the fans or jets generating vertical lift from radically disturbing the airflow in the test section and (2) how to duplicate the airflow near the ground at low forward speeds.

The latter problem is also encountered when testing automobiles in wind tunnels. Neither the automobile nor the V/STOL aircraft encounters uniform vertical distributions of air velocity due to tunnel-wall boundary-layer effects. In automobile testing, a wind tunnel ground board moving at the speed of the free-stream air pulls the boundary layer along with it, making the vertical velocity distribution uniform. The same strategy suffices in V/STOL wind tunnels.

In the case of flow disturbances created by downwash, the tunnel designer has two options. He can make the test section so large with respect to the model that the wall effects are negligible or he can build test section walls with variable openings to dampen the effects of downwash much like wall slots in transonic tunnels.

The benefits of large tunnel size were effectively exploited in the Ames 40 × 80-foot tunnel where full-scale powered V/STOL aircraft were successfully



The slotted wall, one of the Tinkertoy interchangeable wall sections that helped reduce wall interference in the V/STOL wind tunnel.

tested. To provide similar V/STOL research capability on a more modest scale, the Langley low-speed 7 × 10-foot tunnel was provided in 1956 with a roomy 17-foot-square test section as a modification of the settling chamber. In 1968, a 9 × 15-foot test section (with model support and data acquisition system) was inserted in the 175-mph return leg of the Lewis 8 × 6-foot supersonic wind tunnel. This was NASA's first V/STOL facility devoted solely to propulsion system integration. This modification of an already existing tunnel proved invaluable in helping integrate propulsion systems into V/STOL aircraft. Meanwhile, a wind tunnel specially designed for and devoted completely to the investigation of V/STOL problems was under construction at Langley. This facility was brought on line in December 1970.

The Langley V/STOL tunnel was simple and low powered when compared to the power-hungry titans built for the space program. A meager 8000-horsepower electric drive system was ample for the 230 mph speed desired. The test section was large—14.5 feet

high by 21.75 feet wide. Special vanes were placed ahead of the tunnel fan to quickly cut off all air circulation for zero-velocity tests. So far, the design and construction of such an unaspiring tunnel would seem child's play. The challenging design problems came with the test section walls and ground board. Unlike any tunnels built before, the V/STOL tunnel test section walls were built on the Tinkertoy principle. They could be changed from solid to slotted to semi-open simply by interchanging wall sections. Proper wall selection could radically reduce the flow disturbances caused by the aircraft's downwash. The moving-belt ground board was also new and unusual. Traveling at speeds up to 80 mph, the moving-belt ground board was a massive structure riding on a wheeled dolly and transported into position on railroad tracks. The dollies and tracks also conveyed the test models into the tunnel. The models could be checked out and calibrated beforehand on their individual dollies in a huge model preparation shop. Once ready they could be trundled into the tunnel



A model of a VTOL aircraft with tilting engines mounted over the moving ground board of the V/STOL wind tunnel.

test section. The sheer versatility of this tunnel attracted a large array of models ranging from helicopters to VTOL jet fighters to supersonic transports.

The Ludwig Tube Tunnel at Marshall Space Flight Center

When NASA was formed it acquired Wernher von Braun's Army rocket group at Huntsville, Alabama. These launch-vehicle experts formed the nucleus of NASA's Marshall Space Flight Center. Large rockets, like the Saturn 5, were their stock in trade. Nevertheless, the Marshall aerodynamicists did develop a special wind tunnel that had application to high-performance aircraft as well. This tunnel, called a Ludwig tube after the German who suggested it in 1955, was built to simulate the aerodynamic loads buffeting large launch vehicles as they rose through the atmosphere reaching speeds between Mach 0.2 and Mach 2.0. Coincidentally, the Reynolds numbers attained by the Ludwig tube approached those encountered during cruise by full-scale jet transports, such as the Boeing 707 and Douglas DC-8. The con-

ventional NASA wind tunnels could not adequately duplicate these high Reynolds numbers.

The 32-inch Ludwig tube built at Marshall Space Flight Center was hardly complex, being only a long tube of constant diameter capable of storing air at 50 atmospheres pressure. The model to be tested was positioned in a test section that was sealed within the tube by a downstream diaphragm—*not* upstream as in shock tubes. When this frangible diaphragm was ruptured, the air in the tube expanded, rushing past the model in the process. The run times were short, but for a half second or less the model was bathed in airflow that was constant in pressure and temperature and displayed very little turbulence.

The most significant characteristic of Marshall's Ludwig tube was the high Reynolds number achieved—roughly three times that in conventional existing wind tunnels. This capability found immediate application in basic fluid dynamic research as well as the determination of aerodynamic forces acting on launch vehicles. Unfortunately, the Ludwig tube had limited use in testing winged aircraft because of

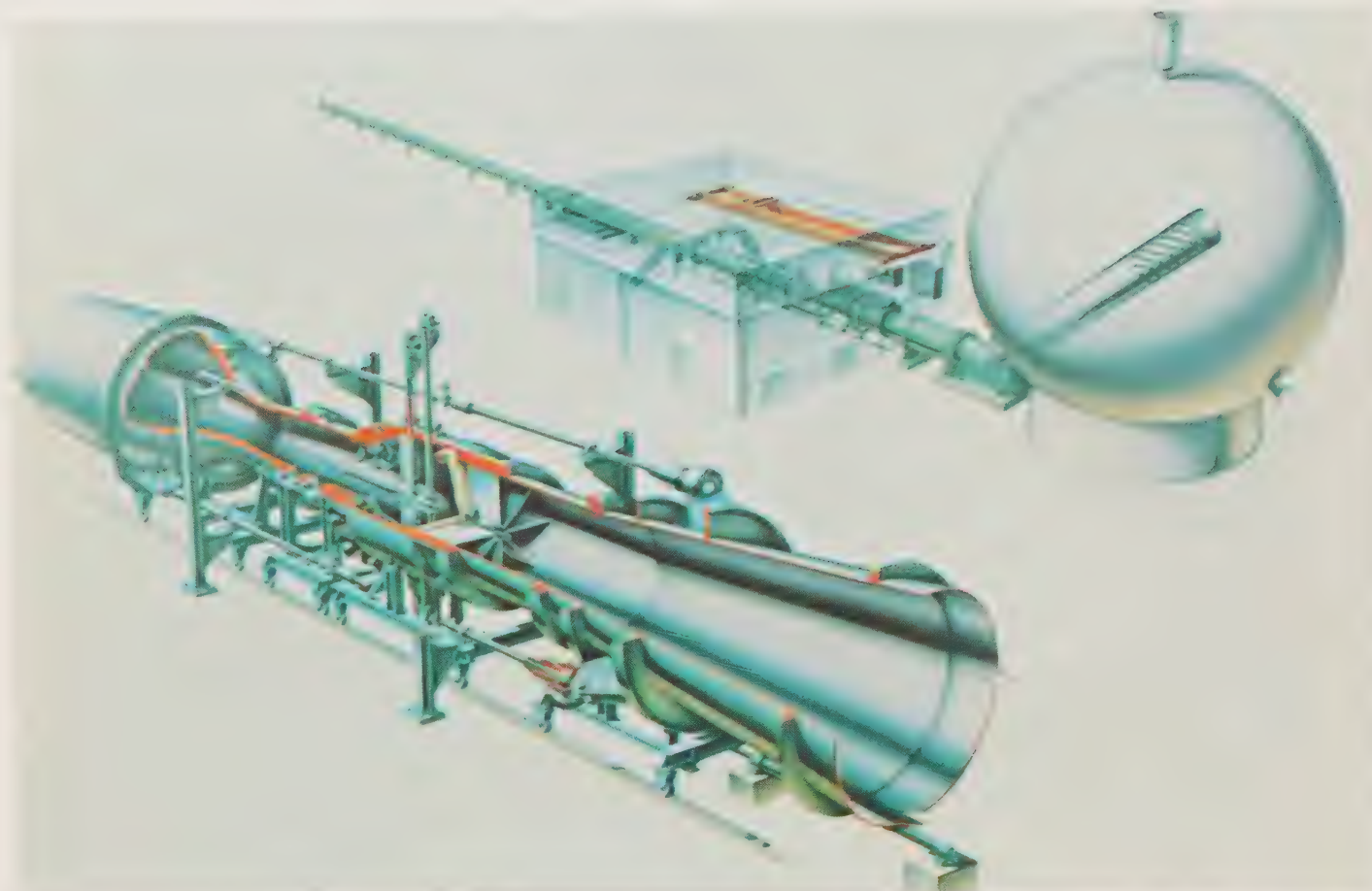

Phantom drawing of the Ludwig tube wind tunnel built at Marshall Space Flight Center for aerodynamic research on launch vehicles.

the high stresses encountered and the consequent distortions of the models. For example, a model of a jet transport (18-inch wing span) could be distorted by 1-1/2 tons of lift force—an impossible load to withstand. Thus, for high Reynolds number testing of winged aircraft, some new facility approach was required.

A Dilemma Resolved by Cold Logic

In the 1950s, the slotted-wall wind tunnel made it possible to simulate transonic flight—at least in terms of flight Mach number. Unfortunately, that most ubiquitous aerodynamic parameter, the Reynolds number, was not matched accurately. In fact, none of the transonic wind tunnels built up through the 1960s came within an order of magnitude of duplicating the true flight Reynolds numbers of transport aircraft. The reason was not hard to find: The models employed in transonic tests were too small. Since the Reynolds number is directly proportional to model

length, those aerodynamic effects dependent on the Reynolds number were distorted in wind tunnel tests.

The penalty for poor simulation of the Reynolds number is best seen in the complex nature of transonic flow over an airfoil. In subsonic flight, up to about Mach 0.8, the air flowing over the upper surface of the airfoil accelerates to supersonic speeds and terminates in a shock wave standing almost vertically on the airfoil surface. At the base of the shock wave, the boundary layer of air thickens and pulls away from the surface, creating a broad wake of fluctuating flow. This region of separated flow changes the airfoil's lift, drag, pitching moment, and other flight parameters. At the low Reynolds numbers available in conventional transonic wind tunnels, the vertical shock wave sprouts forward farther on the airfoil than it would if the true Reynolds numbers prevailed. Consequently, the region of separated flow in the tests is larger than it should be and the measured flight performance of the model more pessimistic than need be. However, no one knew how to correct

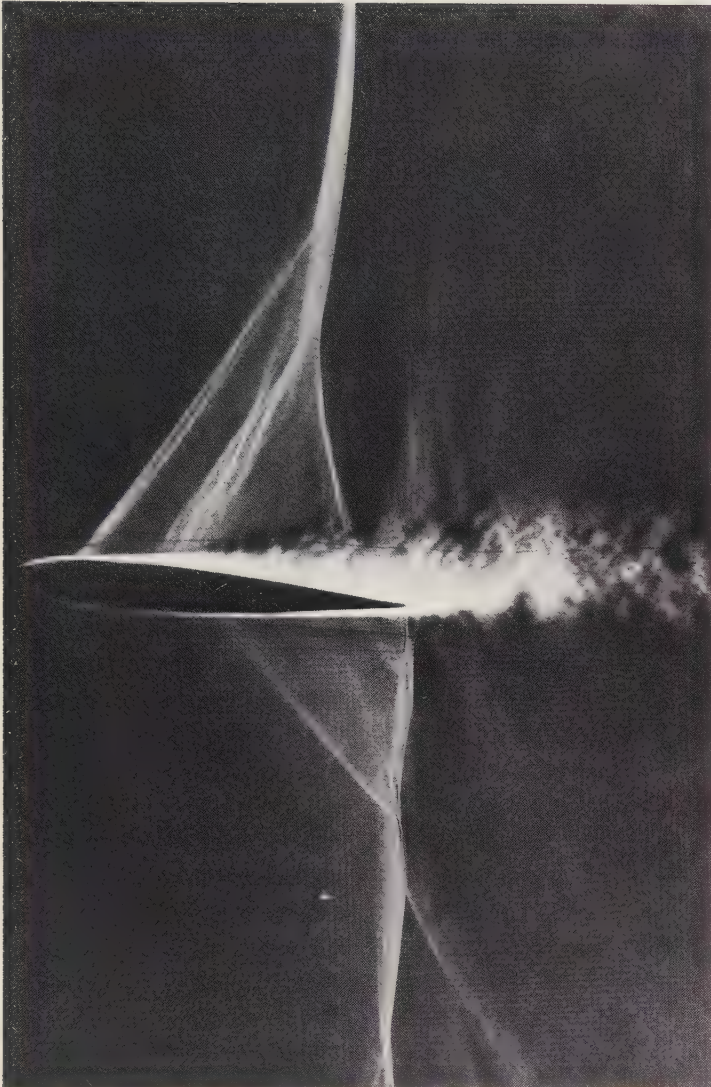

Schlieren photograph of transonic flow over an airfoil. The nearly vertical shock wave is followed by boundary layer separation that adversely affects lift, drag, and other flight parameters.

for the pessimism, and aircraft were overdesigned to be safe.

So pervasive are transonic conditions that any solution to poor Reynolds number simulation would have a far-reaching impact. Military aircraft fight at transonic speeds, and subsonic transports cruise at shock-limited Mach numbers. The tips of whirling helicopter rotor blades penetrate the transonic region. An ascending space launch vehicle encounters maximum dynamic pressure and buffeting in the transonic regime. For a reentering spacecraft, stability and control are most critical in this same speed range.

In searching for a solution, the mathematical make-up of the Reynolds number (applicable to either a gas

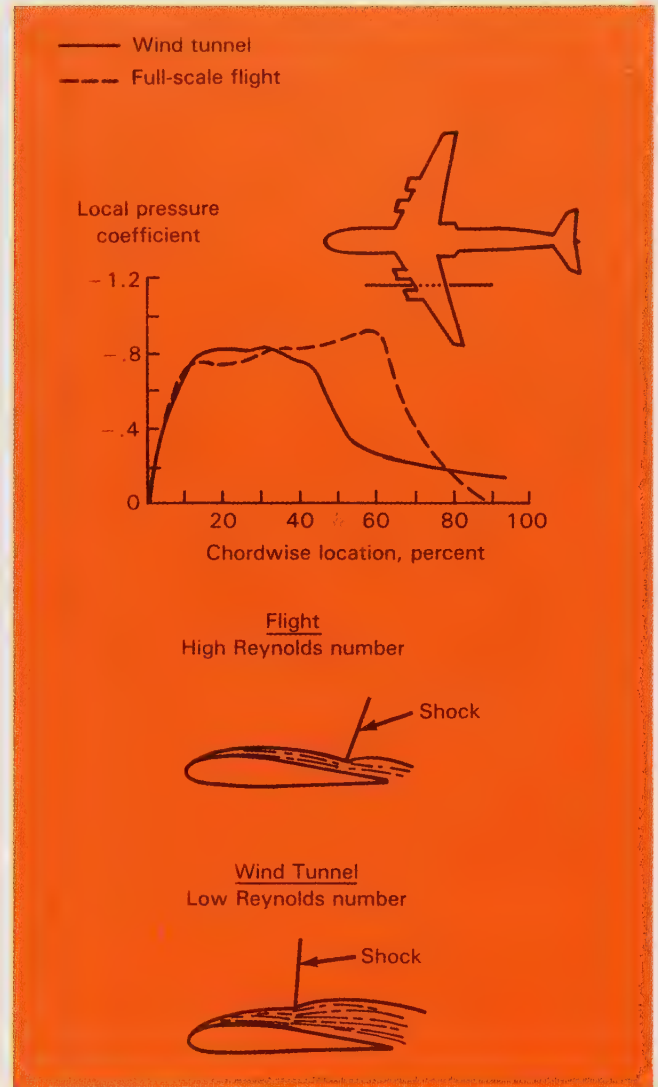

Wind tunnel measurements of shock-wave-induced flow separation are pessimistic when compared with actual flight data. The discrepancy is due to the inability of most wind tunnels to simulate high Reynolds numbers.

or liquid) provides clues:

$$\text{Reynolds number} = \frac{\text{density} \times \text{velocity} \times \text{length}}{\text{viscosity}}$$

A classic way to increase Reynolds number is to increase the air density by raising the tunnel pressure. However, this stratagem, when carried to extremes, greatly increases the model loads, stresses, and deflections—as experienced with the Marshall Ludwig Tube. Velocity cannot be changed arbitrarily, for the test Mach number must be maintained. In addition, model length must be kept small because of tunnel cost. (Drive power increases as the square of the tunnel dimension; the cost of the tunnel shell increases

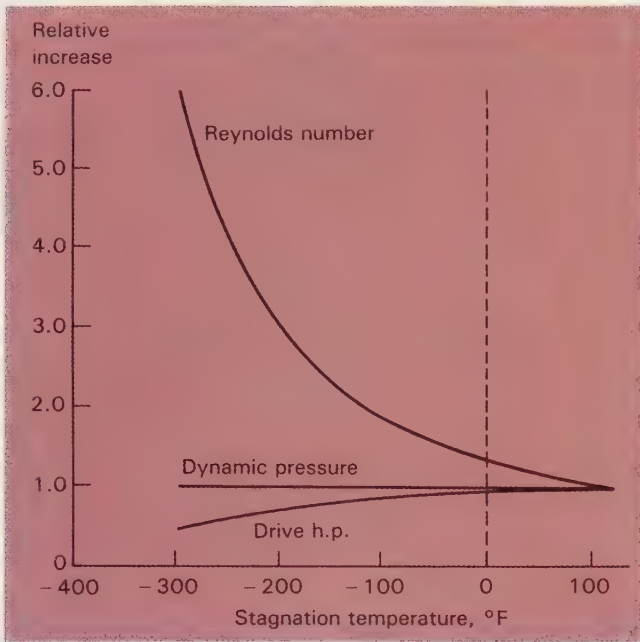

At very low temperatures, the Reynolds number rises dramatically as the viscosity of the test gas drops. The drive power also decreases.

as the cube of the tunnel dimension.) Gases other than air, such as freon, are suspect because experiments have shown that the positions of shock waves in other gases could vary substantially from those in air. There is only one adjustable parameter left: air viscosity. Nature cooperates by permitting air viscosity to be reduced by lowering air temperature. Better yet, a cold wind tunnel requires less drive power in addition to providing higher Reynolds numbers for the model in the test section.

Langley Pilot Cryogenic Tunnel

This double advantage of temperature reduction was recognized in 1945, but it was not until the early 1970s that wind tunnel engineers gave serious thought to going far down into cryogenic temperatures and operating a tunnel just above the liquefaction temperature of air. The so-called cryogenic wind tunnel promised to solve at last the Reynolds number problem. By evaporating liquid nitrogen (-320°F) directly into the tunnel stream, the test section temperature could be reduced from the usual 120°F to about -300°F . The Reynolds number would respond

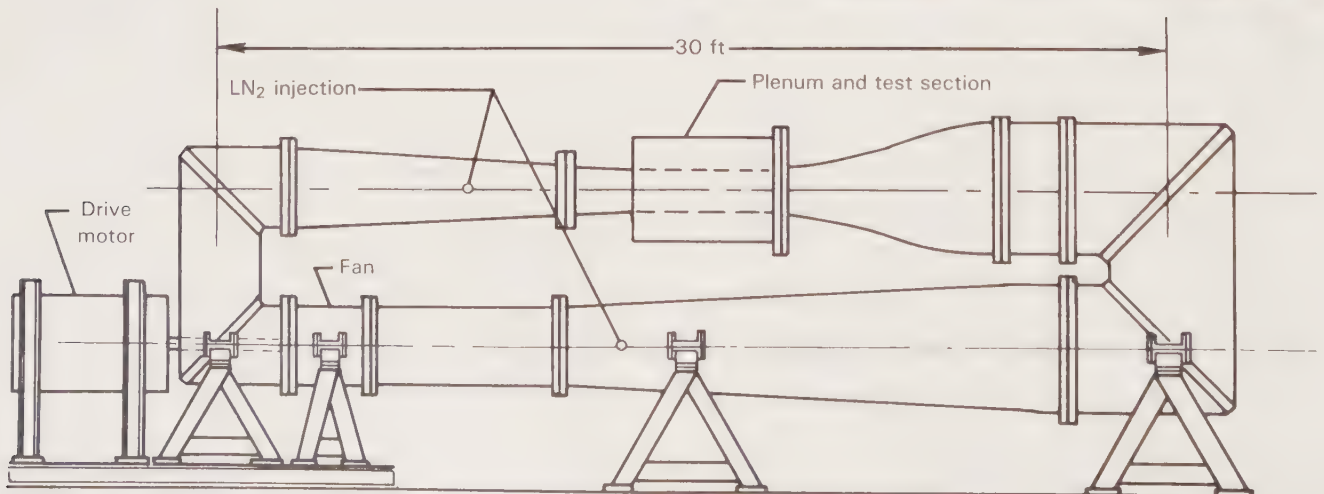
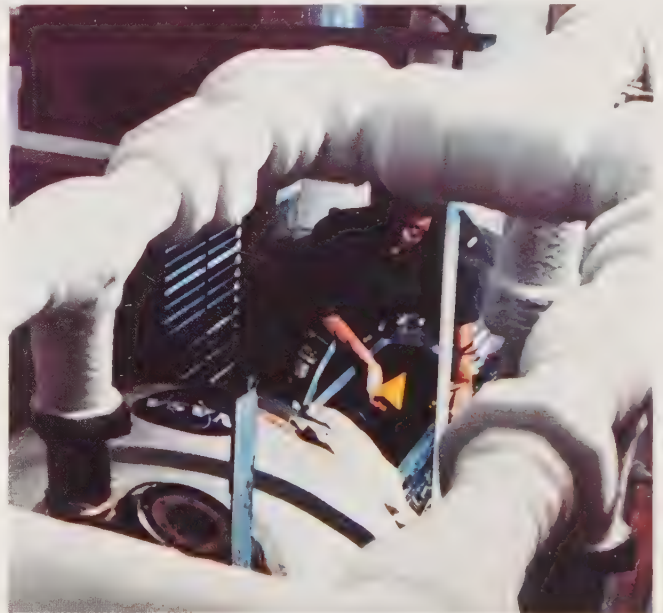

The 13.5-inch pilot transonic cryogenic tunnel constructed at Langley is distinguished by its heavily insulated components. (Photo by Bruce Frisch, courtesy Astronautics and Aeronautics)

by raising by a factor of 6. Power to drive the tunnel would be halved at the same time.

In the late summer of 1972, Langley decided to erect a pilot cryogenic transonic wind tunnel. The test section was octagonal in shape and 13.5 inches from face to face. The tunnel operated at 5 atmospheres pressure up to Mach 1.2. Built under a sense of great urgency, the first tunnel runs began in September 1973. Tests quickly proved that the evaporated liquid nitrogen maintained a surprisingly uniform temperature distribution. More important, during tunnel operation at wide ranges of pressures and temperatures, but at the same Mach numbers and Reynolds numbers, pressure distributions and shock locations on a test airfoil remained remarkably constant as predicted. In other words, the concept of a cryogenic transonic wind tunnel was sound.

The small (0.3-meter) pilot cryogenic tunnel turned out to be an important research tool in its own right. At first it helped define the limits of cryogenic operation by determining how cold the tunnel could be operated without exceeding liquefaction boundaries. Then it was turned over to the Space Shuttle Program, where it assessed Reynolds number effects on rocket-nozzle-hinge moments and base drag. The importance of duplicating true Reynolds numbers was emphasized when the base drag measurements proved that similar data from NASA's noncryogenic tunnels of lower Reynolds number were seriously in error.

The Role of Wind Tunnels in Modern Aeronautical Research

The X-15 at the Edge of Space

In one sense, the X-15 was a true spacecraft, for it could reach altitudes of 67 miles where 99.999 percent of the Earth's atmosphere lay below. Its main mission was hypersonic research, not setting altitude records. The X-15 was conceived to put into practice what engineers had learned from theory and from hypersonic wind tunnels with small-scale models. It was a rocket-propelled plane that was released at 45 000 feet by a B-52 jet. Safely separated from its carrier plane, the pilot ignited the rocket engine which sent the craft climbing to the fringes of the atmosphere. The X-15 first flew on September 17, 1959. Although NASA was already in existence at this time, no one believed that man would orbit the Earth in less than 2 years, or

that the rather ungainly X-15 was blazing a trail for the reusable Space Shuttle.

A dozen different NASA wind tunnels at Langley and Ames contributed to the development of the X-15. The major portion of the high-Mach development work fell on the Langley 11-inch hypersonic tunnel, which could reach Mach 6.8—the approximate speed goal of the X-15. Tunnel logs verify that fully 50 percent of the runs at the 11-inch tunnel during the life of the facility were in support of the X-15. Here the early aerodynamic heating measurements were made along with the stability and control tests and the loading distribution studies. The distinctive wedge-shaped vertical tail of the X-15 emerged from the hypersonic stability work.

Some gun-launched models of the X-15 were fired in the Ames free-flight tunnels to obtain shadowgraphs of the shock-wave patterns between Mach 3.5 and Mach 6.0. At lower supersonic speeds the Langley Unitary Plan supersonic tunnel generated the huge mass of data on aerodynamic forces and heat transfer needed for X-15 design. Lewis Research Center carried out jet-plume and rocket-nozzle studies in its supersonic propulsion facilities. In the subsonic realm, where the delicate and dangerous X-15/B-52 separation occurred, exhaustive tests were carried out in the Langley 7 × 10-foot high-speed wind tunnel. From these tests came the precise combinations of X-15 control settings and release attitudes that assured safe and clean separation.

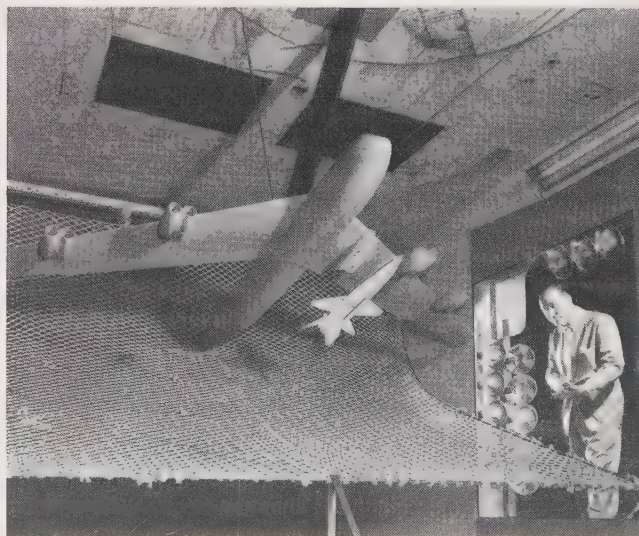

The B-52 model with the X-15 model suspended below a wing in the Langley 7 × 10-foot high-speed wind tunnel for separation tests.

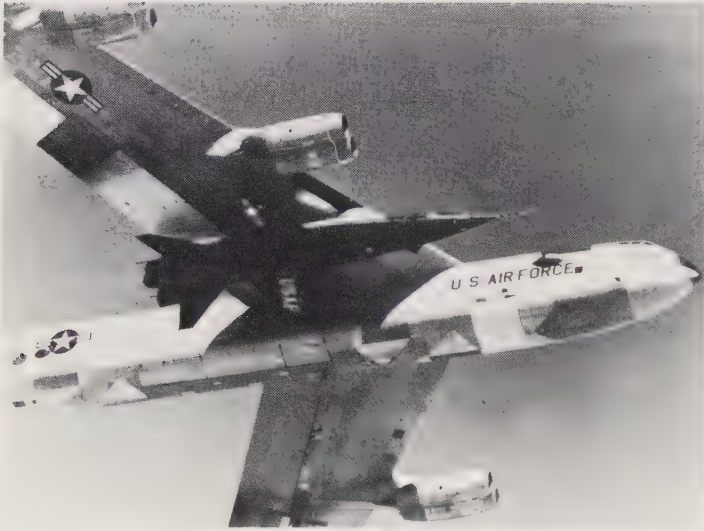

B-52 in flight with the X-15 attached.

Various versions of the X-15 aircraft flew over a 10-year period. It has been called the most successful of all research aircraft. Few would quarrel with this judgment. The X-15 program ended in 1968, but its direct descendant, the Space Shuttle, follows in its wake.

Aerial Metamorphosis: Variable-Sweep Wings

The ideal airplane should operate at high efficiency at all speeds and altitudes. Fixed-wing aircraft do not permit this "Garden of Eden." The large-span, straight-winged craft that has good cruise efficiency at low-to-moderate subsonic speeds sprouts intense shock waves on the wings in the transonic and supersonic ranges. Drag rises and performance falls. Sweeping the wings back into a V-shape reduces the

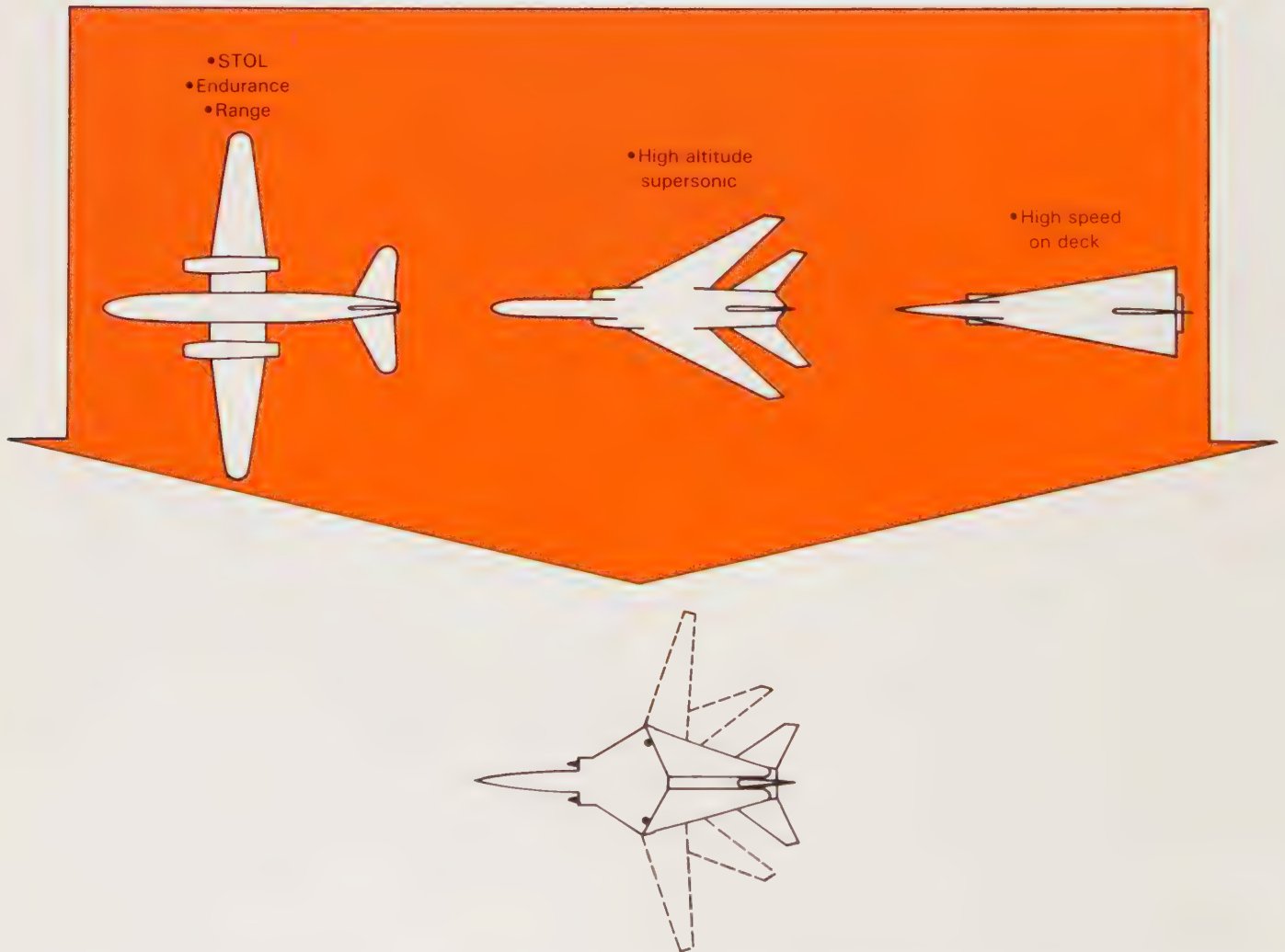

Wing configurations desirable for different missions. An aircraft with variable-sweep wings can operate effectively in all three regimes.

drag considerably. For supersonic operation on-the-deck (a few hundred feet off the ground), to sneak in under radar coverage, the wings should be folded even farther back until they nearly disappear. The ideal all-around airplane, therefore, flaunts a pair of variable-sweep wings, like those of a falcon, that permit it to soar and swoop with the same equipment.

The value of variable sweep was recognized in the 1940s when the Bell X-5 was conceived. NACA had tested the X-5 at its High-Speed Flight Station in California, beginning in 1951. It was a promising design, fulfilling the performance expectations of the variable-sweep proponents, but for one problem: In addition to pivoting the wings they also had to be moved fore and aft along the fuselage as the sweep angle changed. This was an awkward motion to mechanize, but wing translation was necessary to

keep the center of the lift close to the center of gravity and to keep the craft stable and controllable.

Working with variable-sweep wings in various wind tunnels, NASA engineers found a way to eliminate wing translation altogether. They simply moved the wing pivots out on the wings instead of close to the fuselage. The inner sections of the wings remained fixed, but the outboard panels swung back and forth. The new configuration was stable and performed well at all sweep angles. This breakthrough was translated into the General Dynamics F-111 long-range fighter-bomber, the Grumman F-14, and the North American/Rockwell B-1 supersonic bomber.

During the development of variable-sweep-wing aircraft, the integrated family of NASA wind tunnels worked together at all flight regimes to iron out problems and to answer those unexpected questions that

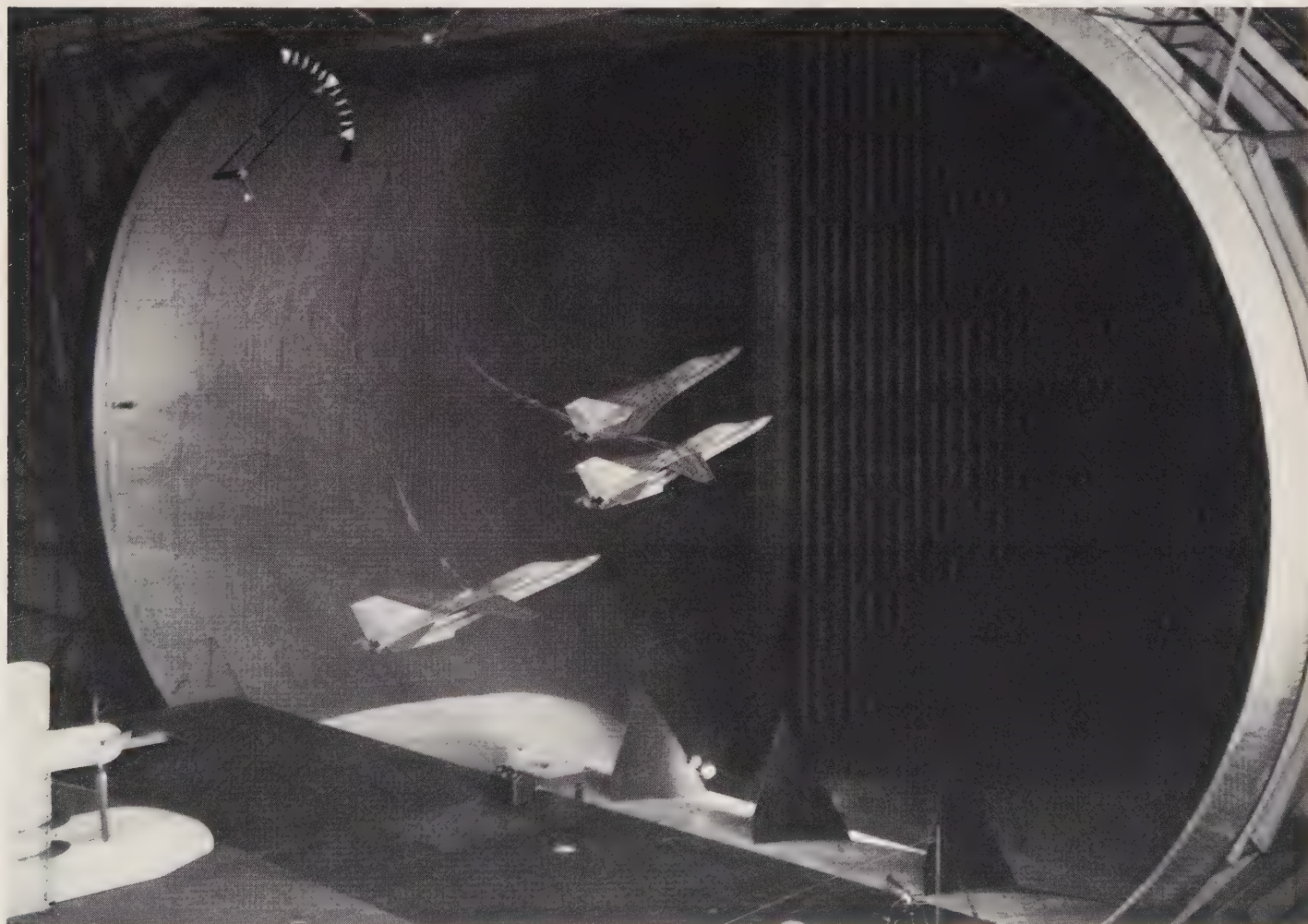

A powered model of the F-111 fighter-bomber sweeps its wings during free-flying tests in the Langley full-scale wind tunnel.

always arise when proving out radically new designs. At one time, the adequacy of the Area Rule was questioned in predicting the drag of various variable-sweep models. To dispel this doubt, four different models were designed, built, and tested by NASA in just 13 days. Such quick response illustrates the value of wind tunnels in keeping high-priority programs on schedule by wringing answers out of small models rather than full-scale flight testing. Another area of great concern was the response of the craft to wind gusts while flying supersonic, on-the-deck missions. The variable-sweep aircraft is like a bullet at this time, with its wings folded as far back as possible and the fuselage providing most of the lift. Would a sudden wind gust or maneuver send the plane tumbling like a rock? The answer from the wind tunnels was no. In fact, with the wings swept fully back the pilot would have the smoothest ride of all on-the-deck and still be able to maneuver quickly enough to follow the terrain contours—an intuitively surprising finding.

The Supersonic Transport

Commercial supersonic flight differs from military supersonic flight in several important ways. The supersonic transport (SST) must first of all cruise efficiently and economically at supersonic speeds over intercontinental distances; military planners cannot rank cost factors as high as commercial operators must. In addition, the supersonic transport must be able to fly into metropolitan airports on a routine basis under the same safety and environmental restrictions as subsonic aircraft. Wind tunnels have helped the SST approach these goals, but complete success has been elusive. These differences account for the fact that the United States does not yet fly supersonic transports, whereas American supersonic fighters and bombers have been in operation for over two decades.

The NACA wind tunnels that NASA absorbed in 1958 were already attacking the special problems posed by the SST. The design of transports for the supersonic cruise phase moved along quickly with the help of advances in computers and new techniques in aerodynamic computation. But in the “off-design” areas, such as takeoff and landing, transonic acceleration, stability and control, and inlet performance, mathematics faltered and wind tunnels bore the main load. By 1962 the NASA centers at Langley and Ames had evolved two basic SST configurations that looked promising: a variable-sweep-wing craft and a canard delta-wing configuration. NASA was thus

well prepared when in June of the next year (1963), President Kennedy announced a National Supersonic Transport Program to develop an economically attractive American SST. With many outside contractors brought in to accelerate the SST program, NASA began running some of its wind tunnels 24 hours a day to keep up with design evaluation and to discover effective solutions to the many new problems arising.

The SST program was vulnerable on several counts. The requirement to show profitable operation was, in the early 1960s, difficult to meet. More than anything else, though, the problems of noise and possible atmospheric pollution scuttled the American supersonic transport. The general tenor of the times militated against costly, environmentally questionable, technological enterprises; the national SST effort was terminated in 1971. Now, roughly two decades later, technical advances by NASA and others make the SST look more attractive economically, environmentally, and from the standpoint of safe operation.

Understanding the Sonic Boom

When North American Aviation started dive tests of their new F-86 fighter in 1949, residents of southern California began reporting many mysterious explosions. Thus arose the first sonic boom complaints. For North American, the solution was simple: move the dive tests out over the Pacific. Even today, supersonic flight of the Concorde transport is generally restricted



Three views of an SST configuration drawn entirely by a computer. Such analytical techniques proved inadequate for “off-design” portions of the SST mission, such as stability under various aerodynamic forces. Wind tunnel testing was necessary.

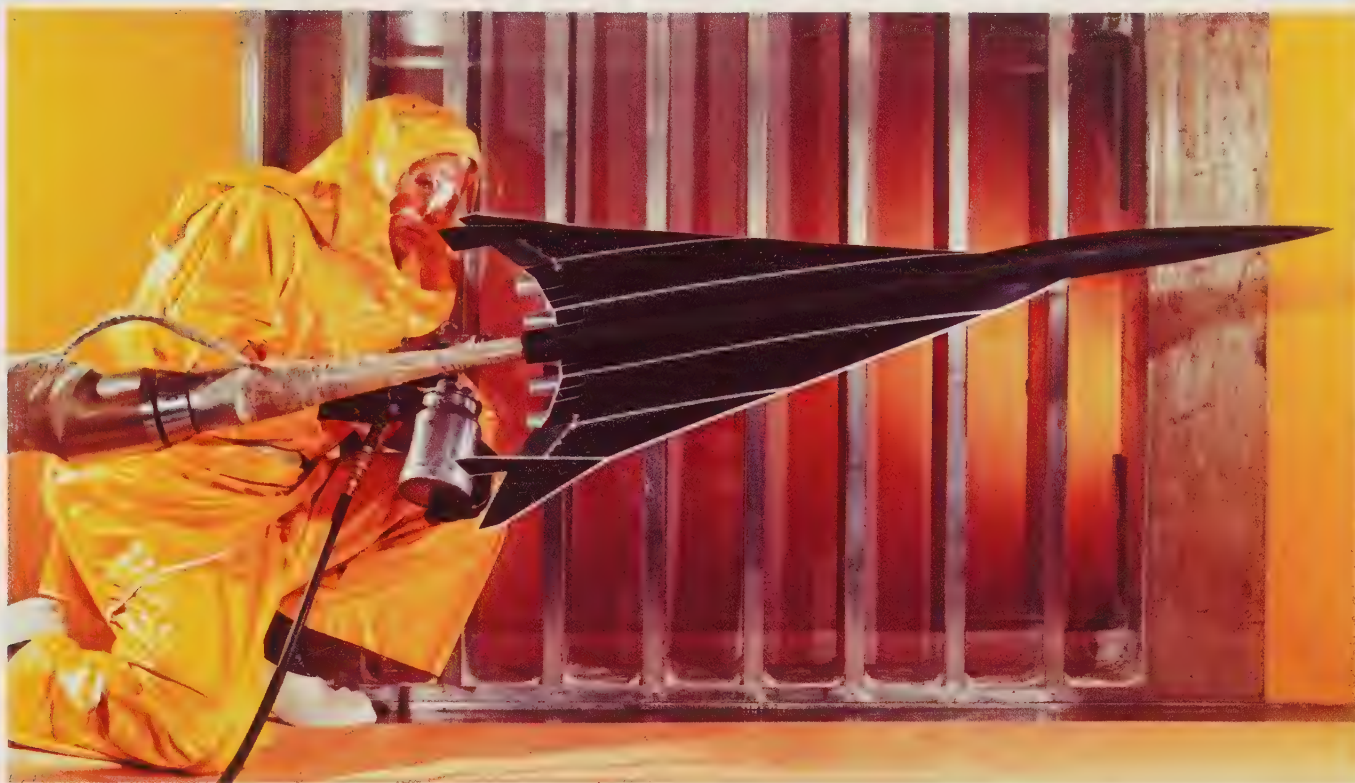

Preparation of an SST model in the Langley unitary tunnel.



An SST model in the cavernous test section of the Ames 40 × 80-foot tunnel.

to the sky over the ocean. What causes these annoying and sometimes window-cracking booms? Can they be muffled?

Aerodynamicists immediately recognized the sonic boom as a groundward extension of a supersonic aircraft's shock wave system. The myriad shock waves set up near the aircraft coalesce at great distances into sharply defined bow and tail waves, producing double booms when they pass over a ground-based observer. Given the vicissitudes of the atmosphere, sonic booms were much like the weather—hard to predict and practically impossible to change. Scientists could identify sonic booms, but they did not understand them well in theory or practice.

A start was made in 1952 when G. B. Whitham, from the United Kingdom, presented a theory that satisfactorily described the generation of shock waves around a supersonic aircraft and their attenuation through the atmosphere. This gave aerodynamicists a model to check out in supersonic wind tunnels. An unusual impasse arose at this point because most supersonic wind tunnels had small test sections. The typical wind tunnel aircraft model practically filled the test section. How could shock wave attenuation

with distance be measured under such crowded conditions? Since the wind tunnels could not be greatly enlarged because of cost, the models had to shrink. Absurdly tiny models—0.25 to 1 inch in size—were tested in the Ames and Langley supersonic wind tunnels. With such miniaturization, the tunnel walls were up to 150 body lengths away from the models. The Lilliputian models generated shock waves all right, but they were so weak that new pressure sensors had to be conceived. Further, tunnel conditions had to be held more nearly uniform because slight changes in humidity or compressor speed would create transient flow conditions that confused the shock wave data. By taking great care, Whitham's theory of sonic booms was verified in the idealized environment of the wind tunnel.

Outside the wind tunnels, confirmations of the theory were plagued by the same factors that made tunnel testing difficult. Variations in atmospheric pressure and temperatures—on top of ever-present turbulence—upset expected results time and time again. New instrumentation and better flight-test techniques ultimately led to great improvements in sonic boom measurement and prediction. Theory finally coincided reasonably well with experiment, but the manipulation of aircraft parameters has led to only modest suppression of the sonic boom under cruise conditions. Until some sort of aircraft "silencer" can be devised, commercial supersonic flight will probably remain over water.

Making Wings Thicker to Go Faster: The Supercritical Airfoil

Most commercial jet transports cruise between Mach 0.7 and Mach 0.8. Since speed is the airlines' main selling point, why not push cruising speeds closer to Mach 1? The local shock waves that form over the wing surfaces close to Mach 1 are the culprits. Airflow separates beyond them, creating precipitous increases in drag and buffeting. All the tricks of the trade—thinner wings, more sweepback, new wing silhouettes—generated increases in subsonic cruise speeds but only with unacceptable increases in structural weight. It seemed as if subsonic flight performance had maximized.

Richard T. Whitcomb, of Area Rule fame, thought otherwise. In the late 1960s, drawing on wind tunnel experience and his own unique understanding of transonic airflow, Whitcomb shattered the fetters of conventional wisdom by subtly reshaping wing cross



Tiny SST models used in sonic boom research in wind tunnels.

sections into what was termed a "supercritical" airfoil. These new airfoils displayed (1) well-rounded noses rather than the sharp edges intuition would suggest for higher speeds, (2) relatively flat upper surfaces that weakened the shock waves and pushed them farther back on the wings, and (3) a sharply down-curved trailing edge that increased lift. Tests in Langley's 8-foot transonic pressure tunnel suggested that the supercritical wing might allow a 10 percent increase in cruise speed before flow separation became serious.

The tests of the new airfoil in the Langley tunnel were greatly compromised by the small sizes of the models. Small models mean low Reynolds numbers and tests that are characterized by premature flow separation, which tends to mask the predicted improvements of the supercritical airfoil. Only with very elaborate and careful experiments were the experimenters able to demonstrate the potential of the new wing. Unfortunately, wind tunnel results were just not convincing enough for aircraft manufacturers to risk billions of dollars on a revolutionary new wing design. The only recourse was flight testing the new wing full-scale on the actual aircraft. The Navy

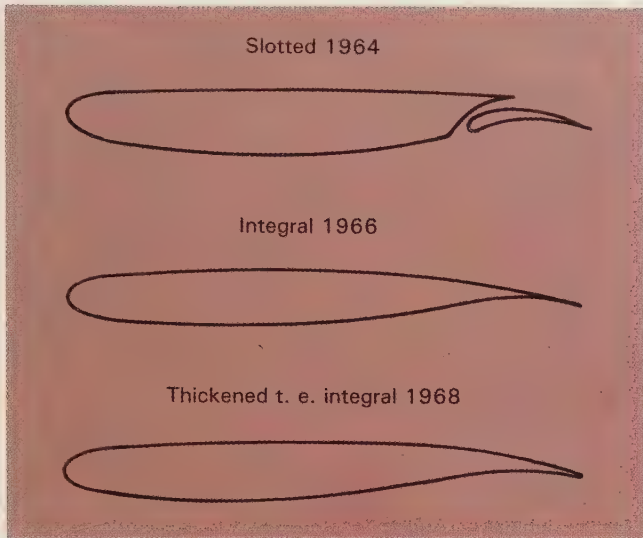

Cross sections of three supercritical airfoils. These are considerably blunter and thicker than conventional transonic airfoils.

Vought F-8U fighter was selected as the test aircraft. It flew with supercritical wings in March 1971. The flight tests completely confirmed the wind tunnel results.

Now convinced of the great future utility of the supercritical wing, NASA presented the wind tunnel and flight test results to U.S. industry at a special conference in 1972. Aircraft manufacturers went back to their drawing boards and computers only to emerge with a surprising discovery. Don't use the supercritical wing to increase cruise speed (which had been the goal all along); rather, hold current cruise

speeds at Mach 0.8 and increase wing thickness using the supercritical shapes. A thicker wing could be made strong enough with less structural weight (the major payoff) and allow aircraft to carry considerably more fuel and thereby increase range.

The new supercritical wings are found in new subsonic transports, business jets, STOL aircraft, and remotely piloted vehicles. The blunt leading edge of the supercritical wing leads to better takeoff, landing, and maneuvering performance. Consequently, even aircraft way down in the subsonic range, such as crop-duster planes and small private aircraft, are adopting the new airfoil shapes.

Above all, the story of the supercritical wing is one of individual vision, perseverance, and intimate knowledge—all in the face of a general conviction that aeronautical research had reached a plateau. Whitcomb, helped by NASA's sophisticated wind tunnels and their capable staffs, was able to shake the aeronautical community from its lethargy.

Stalking the Trailing Vortex

The layman sees vortices in the bathtub drain water and in the small whirlwinds of leaves on sun-warmed hillsides. Unseen are the vortices spawned by all lifting surfaces. A subsonic aircraft deposits long trails of vortices from its wing tips. These invisible whirlwinds persist for several miles behind a large plane. A light plane following a large jet in an airport landing pattern may be flipped over on its back by the larger plane's vortices. Landing-pattern separation distances are largely dictated by these vortices. Obviously the



Wind tunnels provided crucial data in the development of the supercritical wing. (Left) Tunnel tests. (Right) Resulting aircraft.

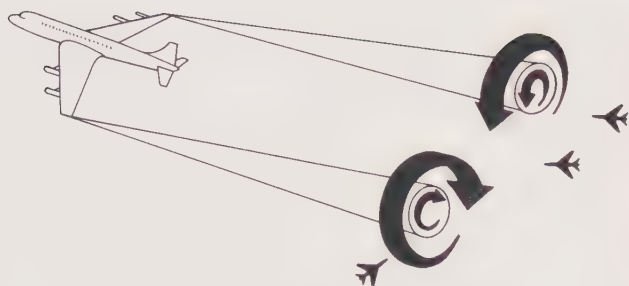

(Above) The formation of trailing vortices behind large planes endangers closely following light aircraft. (Right) Smoke injection makes a trailing vortex visible.

traffic-handling capacity of an airport could be increased if trailing vortices could be subdued.

The Langley V/STOL and the Ames 40 × 80-foot tunnels bore the brunt of vortex research. Airspeed was slow, and these tunnels were big enough to accommodate large models. All manner of schemes were tried to attenuate the vortices: propellers at the wing tips, trailing tip parachutes, air injection into the vortex cores, and other stratagems. All succeeded to some degree but brought with them unacceptable aircraft performance penalties. However, tunnel tests also demonstrated that modest modifications of normal aircraft equipment also suppressed vortex formation. Landing gear doors, landing flap deployment, and changes in wing spoiler deflection showed promise.

Pursuing these leads, NASA equipped a Boeing 747 research plane with smoke generators and began flight tests at its Flight Research Center in California. The selective deflection of the B-747's spoilers and wing flaps effectively pulled the teeth of the strong vortices. A Cessna T-37 light plane flying behind the modified B-747 was able to approach up to 1.5 miles without undue tossing about. Compare this to the usual separation distance in a standard landing pattern of about 7 miles. The vortex reduction program is not yet complete, but the flight tests and wind tunnel results are most encouraging.

Birds Have Winglets; Why Not Planes?

The earliest attempts at flight featured mechanical contraptions that emulated the wings of birds. Dismal failures they were, and interest shifted to fixed



airfoils and separate thrust makers. However, photographs of birds in flight, particularly soaring birds like the eagles and vultures, kept showing wing tips bent nearly straight up. Did the birds know something aircraft designers did not?

Airflow in the vicinity of a plane's wing tip is complex. Here the higher pressure air beneath the wing flows out and up to mix with the lower-pressure air from above the lift-producing wing. A swirling motion ensues, and a trailing vortex forms. Not only do these trailing or wake vortices endanger closely fol-



The selective deployment of spoilers and wing flaps on this Boeing 747 reduced the strength of the trailing vortices.



Osprey with spread wing tip feathers. © 1978, William J. Flor.

lowing aircraft, they induce extra drag. This so-called drag due to lift may represent 40 to 50 percent of the total aircraft drag. Suppressing these tip vortices could significantly increase cruise performance. Aerodynamicists surmised that the birds' bent wing tips somehow suppressed this type of drag.

As early as 1897, Lanchester, in England, obtained a patent on vertical surfaces installed on wing tips. More vertical surfaces were tried down the years with scant success. In 1974 Richard Whitcomb of NASA started on a different tack. Instead of simple, flat endplates, he tried small vertical airfoils dubbed "winglets." When properly curved and aligned with the local airflow, the lateral forces created by the winglets tended to oppose vortex circulation around the wing tip and, in turn, reduce the lift-induced drag. The idea sounded attractive.

Wind tunnel tests were in order. A long series of experiments in Langley's 8-foot transonic pressure tunnel confirmed Whitcomb's intuition and computations. Vortex drag was reduced by 10 to 20 percent and the drag of the entire aircraft by 4 to 8 percent. Small though the numbers seem, the overall impact on fuel consumption is large for a thirsty jet.

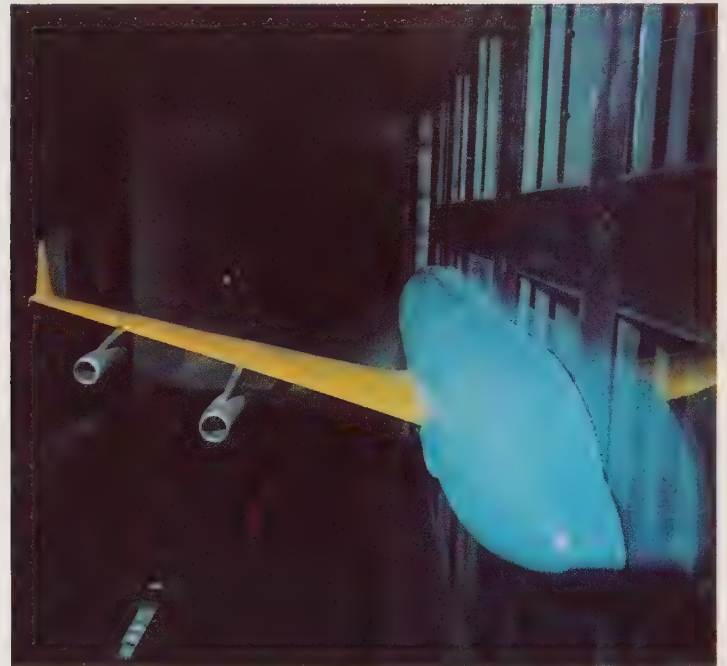

Half an aircraft mounted in the Langley 8-foot transonic pressure tunnel to measure the wing bending moments generated by a winglet.

Winglets had a competitor. By simply extending the span of the wing, aircraft designers could also reduce vortex drag. Which was better, longer wings or winglets? Longer wing spans made aircraft more difficult to handle at terminals—a minus for long wings. Both winglets and longer wings tended to bend the wings at their roots, necessitating more structural weight. Halved aircraft models split lengthwise were subjected to wind tunnel tests to compare the bending moments created by the competing approaches. The tests favored winglets.

Even though the winglet concept is very new, some business jets have already adopted them and reported increased range and cruise altitude. The greatest potential value of the winglets may lie in retrofitting 600-plus KC-135 Air Force jet cargo/tankers. Equipped with winglets 9 feet tall, the aerial refueling range could be increased up to 400 miles. The cumulative fuel savings of the entire KC-135 fleet might reach 25 million gallons annually, which over the next 20 years would amount to over \$500 million savings at 1980 fuel prices. Apparently, evolution carried the soaring birds in a cost-effective direction millions of years ago when it gave them feathered winglets.



An Air Force KC-135 cargo/tanker with winglets.

Spacecraft in Terrestrial Wind Tunnels

Outer space offers no appreciable resistance to the flight of spacecraft. It is only during the launch, reentry, and landing phases of space missions that NASA's wind tunnels contribute to space vehicle design. It is impossible to relate all the wind tunnel experiments that preceded the hundreds of U.S. spacecraft and launch vehicles. The Viking soft-landing mission to Mars has been selected to portray the aerodynamic problems of terrestrial launch and entry into a thin but palpable alien atmosphere. The Space Shuttle illustrates the manifold tests required to operate successfully at the fringes of the atmosphere and return to a landing on Earth.

Viking: From Terra Firma to the Rock-Strewn Surface of Mars

Even on the launch pad, the wind tunnel plays a role. The winds, which in Florida can be of hurricane force, exert forces on the launch vehicle that must be well understood before the rocket and its payload are designed. After launch, high winds in the upper atmosphere tend to make the ascending vehicle pitch and yaw. Viking, with its unusual hammerhead shape at launch, was particularly sensitive to the over-

turning moments created by winds and to the heavy buffeting induced by local shock waves. These had to be evaluated early in the design cycle. During the Viking Program the 10 × 10-foot supersonic wind tunnel at Lewis was called on to investigate aerodynamic heating, the level of buffeting, and shock wave interference in the Mach 2 to Mach 3.5 range. The mundane but critical design problem of deciding when to jettison the huge 14-foot Viking nose shroud was solved in the Lewis 8 × 6-foot supersonic tunnel. (Note that these tunnels were not built with the Viking application in mind at all.)

The density of the Martian atmosphere, which is composed mostly of carbon dioxide, is only a few percent that of the Earth. Far from simplifying the mission—less aerodynamic heating, and so on—the very thin atmosphere could not provide the braking forces needed to slow the Viking Lander down to near-zero velocity for a soft landing. Three separate stages of deceleration had to be used: a high-drag aeroshell, a large parachute, and retrorockets for the final delicate touchdown.

As the entry vehicle hurtled toward the planet at 14 600 feet per second, the first concerns were the possible disturbance of the trajectory by the Martian atmosphere and aerodynamic heating of the aeroshell. Drag data at entry speed came from the high-speed ballistic ranges at Ames where true flight veloc-



The Viking mission sequence. Wind tunnel support was required from launch through event 3 and from event 12 to the soft landing on Mars.

ities, the CO₂ atmosphere, and actual Reynolds numbers could all be duplicated. Aerodynamic heating became serious in the hypersonic range, where the CO₂ piled up in front of the aeroshell, creating an incandescent shock wave. NASA, Air Force, and commercial wind tunnels all pitched in to simulate the wide span of speeds, pressures, and CO₂ densities. A half dozen wind tunnels at Langley alone were called on to provide aerodynamic design data for the aeroshell up to the moment of parachute deployment.

The aeroshell slowed the entry vehicle down to 1230 feet per second; then the parachute reduced the velocity to about 200 feet per second. Naturally, the tenuous atmosphere permitted parachute operation at much higher speeds than in the terrestrial atmosphere. Would the parachute work properly in the wake of the large, flattish aeroshell? The Langley transonic dynamics tunnel was the lead facility here. It helped define the chute size, the canopy shape, the length of the shroud lines, and the pressures on the lander as it descended.

Once the Viking Lander settled on to the Martian surface, the role of the wind tunnel would seem to be ended. Not so! The tenuous Martian atmosphere is sometimes whipped by 100-mph winds. The transonic dynamics tunnel was again pressed into service. A model of the Viking Lander, mounted on a turntable on the tunnel floor, answered many not so obvious questions. For example, the tunnel tests indicated that the extendable lander instrument boom had to



Viking was launched by a Titan-2 rocket. The bulging payload atop the cluster of three rockets generated complex shock waves as the launch vehicle pushed through the transonic range.

be at least 10 feet long to reach beyond the distorting flow field set up by the blast from the lander's retro-rockets. Also, the winds could overcool the radioisotope power generators unless they were protected by wind screens. All these seemingly small details had to be checked out, for overconfidence in terrestrial engineering techniques could well spell disaster on a planet as alien as Mars. Wind tunnels had to recreate Mars on Earth.

Flying the Space Shuttle in Wind Tunnels

The Space Shuttle is a reusable launch vehicle that can orbit 65 000 pounds plus a crew of four to seven.

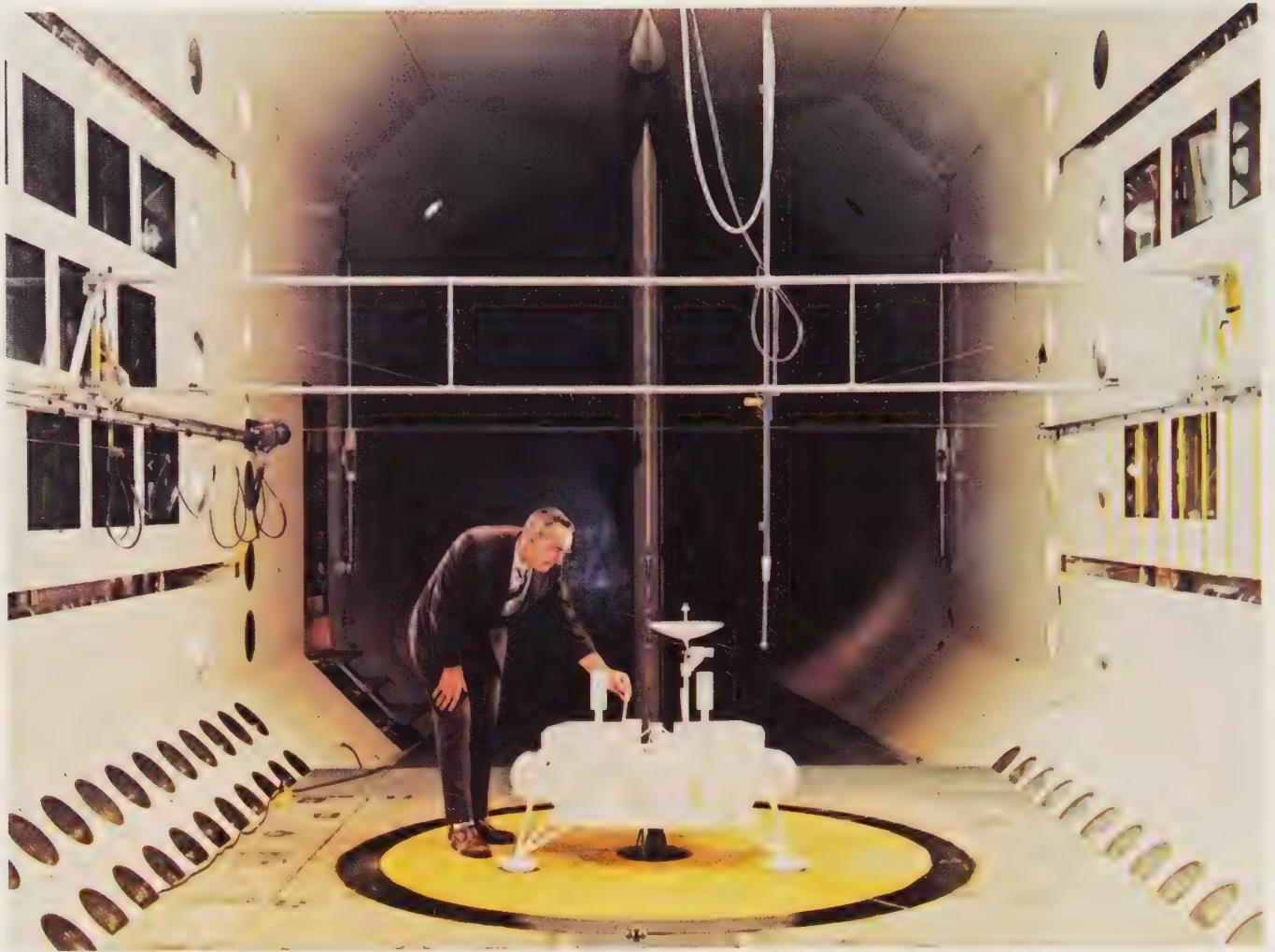

Viking Lander model in the Langley transonic dynamics tunnel for a flow-field survey.

It is launched vertically with the help of two recoverable solid-rocket boosters plus an expendable liquid propellant tank. The Shuttle can deorbit itself, reenter, and fly and land much like a normal airplane. Except for orbital maneuvering, the most critical Space Shuttle operations occur in the sensible atmosphere. Wind tunnels played an important part in the design and development scenario. Since the Shuttle is a hybrid spacecraft/aircraft of unusual shape operating under extreme flight conditions, theory alone could not handle all the complex flow conditions encountered from launch to orbit to landing.

The Space Shuttle wind tunnel support involved every major NASA facility as well as help from the Air Force and industry. At least 50 different wind tunnels participated in this national effort. Upwards of 100 000 hours (almost 25 years) of wind tunnel time testifies to the scope of the program. Aerodynamic loads had to be defined, as did structural heat-

ing, stability and control parameters, flutter/buffet boundaries, propulsion system integration, and the intricate factors controlling rocket and fuel tank separation. The Space Shuttle was one of the biggest challenges to the NASA wind tunnel complex.

As with Viking, the Langley transonic dynamics tunnel was assigned to check out the effects of high wind loads on the Space Shuttle and its ground service tower. The next phase of the mission, as seen through the eyes of NASA wind tunnels, ranged from launch (Mach 0) to Mach 5, the point at which the solid-rocket boosters were cut loose. Tunnels at Ames and Langley were used to explore this speed range, while the Lewis 10 × 10-foot supersonic wind tunnel explored the effects of base heating on the launch vehicle. One of the most effective wind tunnels during this phase of the investigation was a small blow-down facility at Marshall Space Flight Center—the 14 × 14-inch Trisonic Wind Tunnel. Too small to

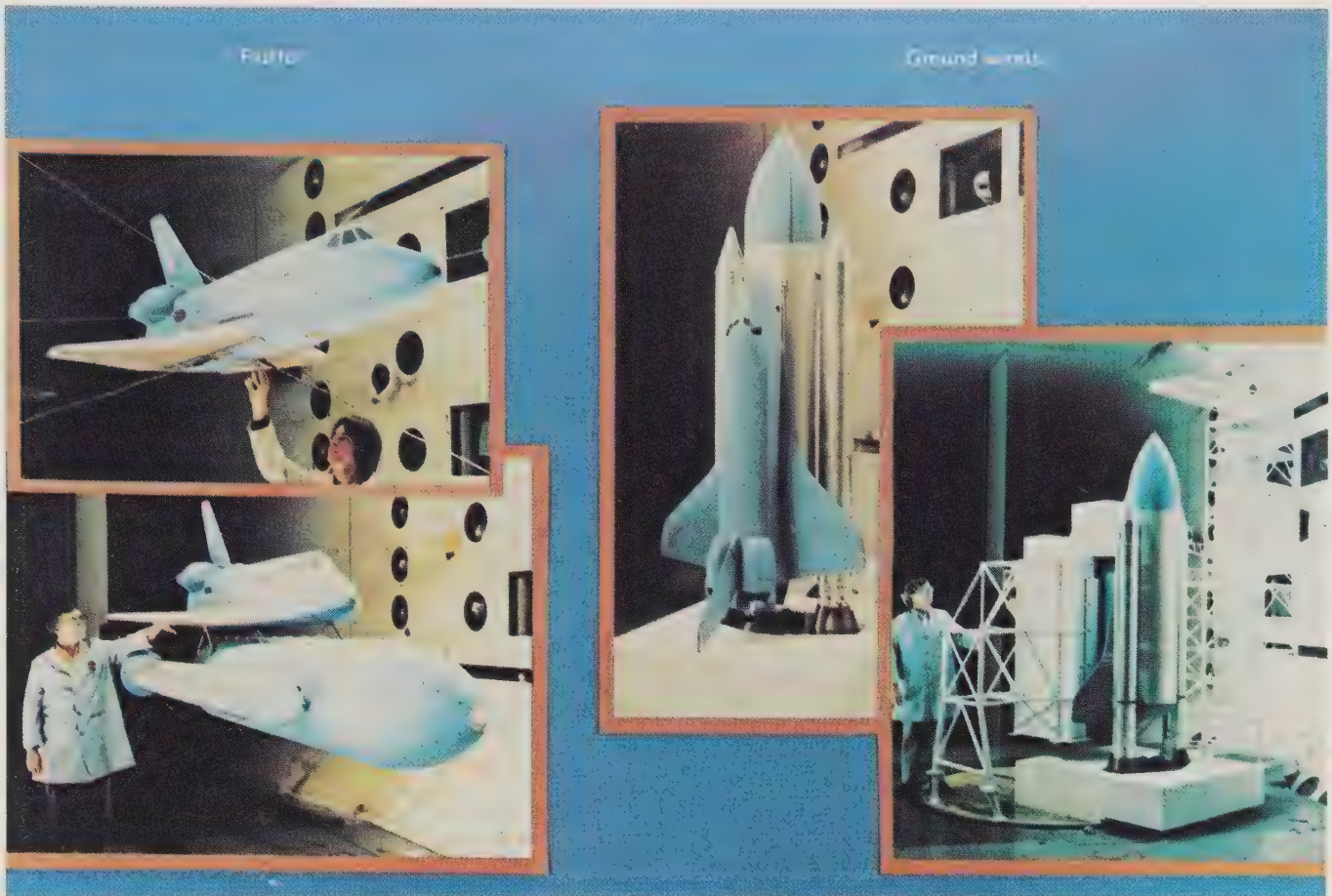

Space Shuttle models were tested in various NASA wind tunnels simulating the different phases of launch, flight, and landing.

be called a major facility, it nonetheless provided 10 000 hours of Space Shuttle tests, mainly in the area of launch vehicle design and rocket and fuel tank separation. This small, intermittent tunnel may well have been the largest single contributor of time to the Space Shuttle effort.

The overriding concern during the atmospheric reentry of the Space Shuttle is aerodynamic heating. Engineers relied almost completely on wind tunnel data because theory was deficient at the high angle of attack presented by the vehicle plowing into the Earth's atmosphere. The phenomena of vortex flow and the separation of flow on the lee sides of the fuselage and wings are not well understood. Contrary to expectations, lee-side heating at some angles was found to be higher than that for zero angle of attack. The heat transfer studies for the Space Shuttle were carried out in various tunnels at the NASA centers at Ames, Langley, Houston, and the Air Force Arnold Engineering Development Center. As discussed

earlier, the Langley 8-foot high temperature structures tunnel was large enough to test complete arrays of full-sized tiles used for Shuttle thermal protection.

A hallmark of the Space Shuttle is its maneuverability. Before its aircraft-type controls (elevators, rudder, etc.) become useful in the lower atmosphere, the Shuttle depends on reaction controls, that is, small jets that orient the vehicle. In case of an emergency, reaction controls must be able to maneuver the craft as much as 1000 miles cross range. But how do these reaction jets perform as they interact with the thin but high-velocity flow of air past the body of the Shuttle? This is one more instance in which wind tunnels were invaluable in detailing what would happen in a hard to calculate situation.

The Space Shuttle approaches its chosen airport and lands without power. During the approach it has an extremely high sink rate of about 75 feet per second. The feasibility of this phase of Shuttle flight, which would have to be repeated routinely many



The Space Shuttle and 747 carrier aircraft joined during a test flight.

times during future operations, had to be tested exhaustively. To do this, the Shuttle was released from a Boeing 747 and made dead-stick landings in 1977. Preceding this seemingly straightforward demonstration were long series of wind tunnel runs that had drastic effects on the final 747-Shuttle configuration. First, a large afterbody fairing had to be added to the Shuttle itself to reduce drag and heavy buffeting on the 747 vertical tail. Six tunnels from NASA and more from industry and universities worked on the fairing problem. In addition, two small vertical fins were found necessary on the 747 to provide more directional stability while it was carrying the Shuttle

piggyback. The wind tunnel work paid off, for the unpowered landing tests confirmed the performance predictions for the mated vehicles and the crucial separation event. Without thorough testing with models beforehand, two large, expensive craft and their crews would have been in jeopardy from the undefined aerodynamic interference. This sparing of men and machines through preflight testing is no different in the Space Age than it was for the Wright brothers and their successors. Aerospace vehicles not yet conceived will doubtless "fly" in NASA's wind tunnels before they embark for Alpha Centauri and beyond.



A model of the Space Shuttle in the Langley 22-inch helium tunnel at Mach 20. The flow is made visible by bombardment of an electron beam.



Chapter 8

Wind Tunnels of the Future

What will the future bring to this symbiotic partnership of aerospace vehicles and wind tunnels? The immediate future, not surprisingly, will probably be shaped primarily by the same force that is now revolutionizing transportation technology: fuel economy. Of course the military craft will always require more and more speed, but energy conservation cannot be entirely ignored here either. In looking toward outer space, the oft-mentioned manned mission to Mars, or any ambitious extraterrestrial undertaking for that matter, will be tied to the construction of an efficient, economical method of propelling large payloads into orbit. This can only mean the Space Shuttle and its descendants. Saving energy and money through reusable space vehicles are the predominant forces. Before looking further into the wind tunnel crystal ball, we should examine near-future aerospace vehicles and their missions a bit more carefully to see what fresh demands they may place on wind tunnels.

The Demands of Near-Future Aerospace Vehicles on Wind Tunnels

Advanced Commercial Aircraft

An Energy Saving Transport

When a contemporary trans-Atlantic transport rises from the runway, roughly 40 percent of its weight is fuel, compared to only 10 to 15 percent payload. The cost advantages in shifting some of the 40 percent fuel load to profitable payload are manifest. Even with many years of airplane improvements behind us, promising areas remain for further research and possible fuel savings.

It is the aircraft drag that consumes fuel wastefully. The frontier in drag reduction is drastically cutting skin friction. Today's airfoils operate with the boundary layer almost entirely in a turbulent state. If the layers of air close to the wing and fuselage would

smoothly slide over one another without stirring up local eddies and vortices, skin friction drag would plummet. This smooth or laminar flow can be encouraged by smooth surfaces and carefully controlled pressure gradients, but large areas over the wings still break up into turbulence even with the best precautions. A better way to induce substantial regions of laminar flow is to suck small amounts of air from the boundary layer through thin slots in the aircraft structures. But boundary layer suction takes energy as well as additional equipment on the airplane. Better ways of promoting laminar flow must be found, for the payoff is high. Studies show that with everything considered, fuel consumption can be reduced up to 30 percent by actively creating large areas of laminar flow on the wings, fuselage, engine nacelles, and control surfaces. For a long-range transoceanic flight, the payload fraction could almost double to 30 percent.

Uncharacteristically, it is the shortcomings of wind tunnels that partially deter the development of aircraft with laminar flow control. To date it has been impossible to create extensive areas of laminar flow on models in wind tunnels at Mach numbers and Reynolds numbers typical of full-sized aircraft. The airflow in many existing wind tunnels has so much turbulence, noise, and other flow disturbances in it that it prematurely induces turbulent flow over the model. It is difficult to discover new ways of maintaining laminar flow over airfoils when the experimental equipment is a major culprit. NASA is now studying new ways to modify tunnels at Langley and Ames to remove this limitation on laminar flow research.

Spreading Out the Load

Commercial air transports are essentially winged box cars—a bit more streamlined perhaps, but still containers with appendages to provide lift and propulsion and control forces. However, if a cargo plane



An idealized transport configuration with laminar flow control (LFC) applied to the wings, struts, engine nacelles, and fuselage. By reducing fuel consumption with LFC, payload fractions can be raised to about 30 percent, a large increase over current aircraft.

is made large enough, with the wings growing proportionally, the wings will eventually become cavernous enough to hold cargo in addition to the fuel they customarily store today. This concept of “distributed load transports” becomes feasible at wing spans of 500 feet and gross weights of 3 million pounds (about four times the weight of contemporary wide-body cargo planes). Aircraft of this size could begin competing with ocean-going freighters on intercontinental runs.

It is more than a question of size. With cargo weight out in the wings, the lift forces are largely balanced where they are created. The bending moments on the wing roots are thus diminished, greatly reducing structural weight. Estimates put the payload fraction of a very large distributed-load cargo plane at 40 to 50 percent, compared to 10 to 15 percent today, with direct operating costs per ton-mile only a fraction of those of today’s smaller air freighters.

Aerial behemoths of this size are not easily designed, built, and operated, especially with existing ground facilities. Considering only that portion of the challenge affecting wind tunnels, an aerodynamicist would certainly question the ability of existing tunnels to simulate the Reynolds numbers encountered with wings thick enough to walk into. (The Reynolds number increases directly with size.) Transonic tunnels now operating could attain Reynolds numbers of about 15×10^6 for the model of such an

aircraft. The real aircraft, however, would have a Reynolds number of roughly 125×10^6 based on the wing chord. The consequences of an order of magnitude lower test Reynolds number would be an over-conservative design—due primarily to the wind tunnel predicting a lower cruise Mach number than actually would prevail on the full-size plane. Faced with pessimistic wind tunnel data, the designer would likely elect to provide a thinner wing, with an attendant weight increase, to attain the desired speed. Cargo space would then be sacrificed needlessly.

Fortunately, a new NASA wind tunnel, designated the National Transonic Facility, will be in operation at Langley in 1982. This tunnel will be able to provide full-scale tests of the various proposed configurations of the distributed-load aerial freighters.

V/STOL Aircraft: Slow and Complex

A pithy saying among aerodynamicists is that a single helicopter blade faces more aerodynamic problems in one revolution than a fixed-wing aircraft meets in its entire lifetime. Despite the low speeds of helicopters, the rotor tips whip around near the speed of sound. Blades are sensitive to both Reynolds number and Mach number effects. The same holds true for winged craft with tilting rotors. In fact, aerodynamic difficulties are multiplied in the potentially unstable transition region where vehicle lift is transferred from the rotors to the wings. Very large wind



A swept-wing span-loader concept. The cargo space is inside the thick wings. (Courtesy The Boeing Company)

tunnels with air speeds of 200 to 300 mph are essential to the successful evolution of future rotorcraft.

After a hiatus of several years, interest in STOL aircraft has been renewed. The market for STOL craft transcends big-city commuter traffic. Bush pilots, geologists, and others need STOL vehicles for operations in underdeveloped countries and in the widening search for new energy sources.

The extra lift needed for STOL comes from two sources: the downward vectoring of the jet thrust and additional wing lift from additional forced circulation of air around the wing. For example, a NASA quiet, short-haul research aircraft (QSRA) being studied at Ames employs upper wing surface blowing to more than double the lift over that of a conventional wing. Runways less than 1500 feet long are sufficient for

planes of this type. Another promising STOL transport design has wing flaps that deflect the jet exhaust downward from underwing engines to increase lift at takeoff. Many other powered-lift concepts are being investigated. They all must be tested in wind tunnels to check the designs before committing pilots and expensive equipment to flight tests.

The main problem in powered-lift STOL is model size. The models must be large enough to adequately duplicate engine airflow and exhaust patterns and the complicated wing-flap systems. If models are too small, the Reynolds numbers will be low, and flow separation over the flaps will be premature, leading to pessimistic results. Tunnel wall boundary effects are also important considerations that fade with increasing tunnel size. What this means is that V/STOL



The XV-15 tilt-rotor research aircraft undergoing tests in the Ames 40 × 80-foot tunnel. The critical transition occurs when the rotors tilt forward for horizontal flight.



A V/STOL fighter concept in the Ames 40 × 80-foot tunnel.



A model being tested in the Langley V/STOL tunnel employs upper-surface blowing over the large flaps to turn the engine jets downward for powered lift.

wind tunnels using scale models should be very large. Full-scale testing necessitates tunnels on the order of 100 feet in diameter at the test section. (A new leg being added to the Ames full-scale tunnel will provide a suitable 80 × 120-foot test section.)

Future Military Aircraft and Missiles

Military aerospace vehicles have more freedom relative to commercial aircraft in regard to economy, efficiency, and safety. It is not surprising therefore to find many aerodynamically radical military craft in

WIND TUNNELS OF THE FUTURE

various stages of research and development. The demands that they will make on NASA or Air Force wind tunnels will be correspondingly more severe than those for civilian craft.

Even though the B-1 bomber may not enter mass production, large, manned, supersonic bombers are still being considered. Variable-sweep wings, such as those on the F-111, are also in the running. In one design for on-the-deck, high-speed flight, the wings sweep so far back that they disappear into the fuselage. Vehicle lift then comes from the fuselage alone. Finally, there is the almost grotesque pivot wing that seems intuitively unstable. Yet NACA

wind tunnel tests demonstrated acceptable flying qualities for the pivot wing as early as 1946. It is still a candidate for future supersonic bombers as well as commercial transports.

Fighters must fly faster than bombers. Designers now talk of aerial battles at Mach 4.5 above an altitude of 100 000 feet. At these near-hypersonic speeds, intense shock wave interaction has led to the consideration of scimitar-shaped wings that seem to come right out of Buck Rogers and H. G. Wells. Even stranger are the swept-forward wings that seem the antithesis of streamlining. Actually, it makes no difference in drag reduction at high speeds whether the



A bomber with pivoting wings rotated back almost flush with the fuselage for high-speed flight. Body lift is sufficient for high-speed flight at low altitudes. (Courtesy Rockwell International)



A flight model of the experimental NASA pivot-wing AD-1. The wing is shown canted in the high-speed position. At low speeds it is perpendicular to the fuselage axis.



A model of a Mach 4.5 interceptor with scimitar wings undergoing tests in a wind tunnel at Arnold Engineering Development Center. (Photo, AEDC)

wings are swept forward or backward. But in terms of boundary layers and flow separation, the swept-forward wing promises significantly higher lift-to-drag ratios in maneuvering flight and better low-speed performance. Swept-forward wings are still in the embryonic stage, but wind tunnels are already amassing the aerodynamic data needed for preliminary design.

Quasi-hypersonic fighters would be impressive, but most future aerial battles would probably occur at transonic speeds. The key criterion to success here would be maneuverability near Mach 1. A NASA/Air Force program called HiMAT (Highly Maneuverable Aircraft Technology) has the goal of 8-g turns at Mach 0.9 at an altitude of 25 000 feet—a formidable technical challenge. Some configurations employ movable, two-dimensional nozzles at the trailing edges of the wing/fuselage fed by jet-engine exhaust to induce extra lift. Testing at the Langley 16-foot transonic tunnel helped prove this concept. To fill the gap between wind tunnel tests and costly flight testing, HiMAT uses a remotely controlled, reduced-scale prototype released from a B-52 at 45 000 feet.

Although maneuverability may be the key to aerial dogfights, military missions such as air defense interception and reconnaissance want as much speed as possible. This means true hypersonic flight—Mach 5 and above. At present no American aircraft is capable of sustained hypersonic flight. In fact, the X-15 was the only real manned hypersonic craft ever built in the United States, but its rockets could provide power for only a few minutes because of their high fuel consumption rate. The key to sustained hypersonic flight is the Supersonic Combustion Ramjet or SCRAMJET, which uses high-energy hydrogen as a fuel burning oxygen from the atmosphere.

The development of a SCRAMJET and its integration into a hypersonic aircraft are fraught with the kinds of difficulties that only wind tunnels can help. Local airflow fields change radically with the angle of attack and Mach number in a SCRAMJET, especially around the aircraft's forebody and engine inlet. In addition, vehicle surface temperatures may reach 2000° F at Mach 6 and an altitude of 100 000 feet. The liquid hydrogen fuel consumed by the SCRAMJET makes it an ideal coolant for these hot spots, but



Full-scale mockup of a fighter with swept-forward wings. (Photo, Rockwell International)

WIND TUNNELS OF THE FUTURE



HiMAT is released from its B-52 mother ship in this artist's conception. (HiMAT = Highly Maneuverable Aircraft Technology.) Maneuverability is achieved by canard control surfaces.



The HiMAT experimental aircraft on the ground.

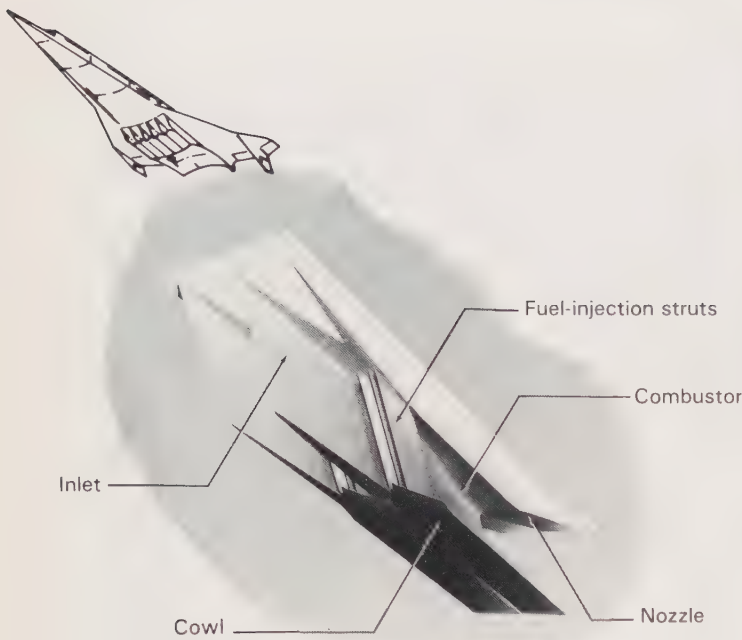

The SCRAMJET geometry is radically different from that of conventional jet engines. Wind tunnel tests are essential in defining the airflow patterns near the inlets and nacelles.

wind tunnel experience will be essential in proving such a radical cooling system embedded in an equally radical aircraft.

At Langley, a 20-megawatt arc-heated wind tunnel, called the SCRAMJET Facility, has been built to explore air flow around and through a small-scale operational SCRAMJET. To move on to full-scale testing, a much larger tunnel, such as the Langley 8-foot high-temperature structures tunnel, would have to be modified to incorporate an oxygen-replenished core to sustain combustion.

As manned military aircraft look more and more like unmanned missiles, the missiles themselves are becoming more sophisticated aerodynamically and look more like aircraft. Early missile design centered on brute-force propulsion and accurate guidance and control, with aerodynamic performance being secondary. Now missile engineers are drawing heavily on the immense backlog of wind tunnel experience with manned supersonic aircraft and space vehicles of all sorts. Probably the most important of the new unmanned missiles is the air-launched cruise missile. It is actually a small aircraft. A leading design incorporates variable-sweep wings that retract completely into the fuselage for ease of stowage on the carrier aircraft. Once launched, the wings extend for long-range cruise. Such craft have long been a familiar



An air-launched cruise missile. (Photo, The Boeing Company)

sight in wind tunnels. A large body of relevant experience is already available.

Beyond the Space Shuttle

During the early 1980s, the Space Shuttle will be the key to quick, easy, and economical access to outer space. It is only the first step in the development of a space transportation system that promises an order of magnitude reduction in payload costs through the recovery and reuse of the orbiting portion of the launch system. The 1981 Space Shuttle will carry about 65 000 pounds into low Earth orbit at an estimated cost of about \$300 per pound. Larger shuttles based on the same technology will likely double the payload and cut the cost in half. To those visionaries who foresee vast space enterprises—orbital industrial manufacturing, manned scientific stations, staging platforms for ambitious missions to the other planets—even advanced shuttle craft could not carry the anticipated cargoes of men and materials. The proponents talk in terms of 100 000 tons per year into space at costs a factor of ten lower than today.

Several immense launch vehicles are under study. The Heavy-Lift Launch Vehicle is a huge, recoverable rocket system launched vertically like the launch vehicles of Apollo days. Other concepts take advantage of lifting surfaces and air-breathing engines to carry vehicles high into the sensible atmosphere where rockets can take over and insert large payloads into orbit. The proposed craft are truly gigantic: One winged supersonic launcher weighs 5 million pounds with a wing area of 50 000 square feet—over ten times the wing area of the Concorde. Single stage to orbit launchers combine all the flight regimes of supersonic aircraft, vertical launch vehicles, and reentering spacecraft; their immense sizes outstrip the capacities of most wind tunnels.



A possible configuration of a heavy-lift launch vehicle. Taking off vertically, like the Space Shuttle, this launcher could place up to 500 tons into low Earth orbit. Both stages are recoverable. (Photo, The Boeing Company)

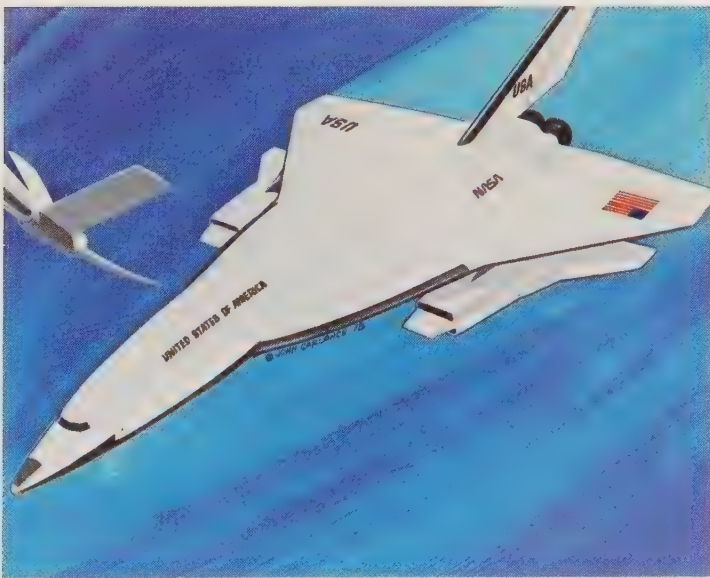

Large future launch vehicles may take off horizontally like conventional aircraft. Air-breathing engines would take the launcher to Mach 3.5 at 60 000 feet, after which separation would take place, with rockets propelling the second stage into orbit.

The Next Generation of Wind Tunnels

Time and again, technological advances have embarrassed the most astute planners. While we can think ahead toward the advanced aerospace vehicles of the future, it is almost a certainty that breakthroughs in flight technology and/or wind tunnel capabilities will make today's best thinking obsolete. Remember the surprises of Sputnik, the Area Rule, the blunt entry shape, and the supercritical airfoil. Nevertheless, the future must be faced rationally, and some general observations are in order.

First in importance is the fact that whatever happens, NASA's wind tunnel complex, which has a current replacement value upwards of \$1 billion, will best serve the future if it possesses a broad base of capabilities. Second, the average age of existing major NASA tunnels was roughly 25 years in 1980. The recently refurbished Langley full-scale wind tunnel will celebrate its 50th birthday in 1981. Even the big Unitary Plan tunnels, usually considered

WIND TUNNELS OF NASA

modern, had been in operation for 25 years in 1980. America's wind tunnel inventory is aging and there is no room for complacency.

The third generality concerns the increasing reliance on wind tunnels in aircraft design development. Whereas the venerable DC-3 needed only about 100 hours of tunnel time, the B-52 bomber took 10 000 hours. By the time the first Space Shuttle flew, it had accumulated 100 000 hours in wind tunnel time. New aircraft are becoming more complex, with demands for increased speed, altitude, temperature, and overall size and weight. Deficiencies in design are incredibly expensive to correct in production models. It is no wonder that engineers rely more and more on wind tunnel testing early in the development cycle.

Happily, there are compensating factors. Thanks to the electronic revolution, wind tunnel controls are better, and there is much more automation of instrumentation and data gathering. A tunnel-hour today is much more productive than it was a few years ago.

A more subtle observation is that today's bigger tunnels better simulate the actual Reynolds numbers encountered in full-scale flight. This circumvents the laborious building of a fund of experience at reduced Reynolds numbers (often in several different tunnels) and subsequent time-consuming and often questionable extrapolation to full-scale conditions.

Aerodynamicists look forward to the future; they now speak of electronic wind tunnels. What they really mean is that aerodynamic theory has improved considerably and electronic computers have more than kept pace so that the mathematical prediction of the performance characteristics of aircraft and their components is much more accurate. Not only can simple aircraft components be studied in depth without recourse to the wind tunnel but, in some situations, complete vehicle configurations. Real wind tunnels, of course, will be called on for research, validation of calculations, and performance assessment where theory falters.

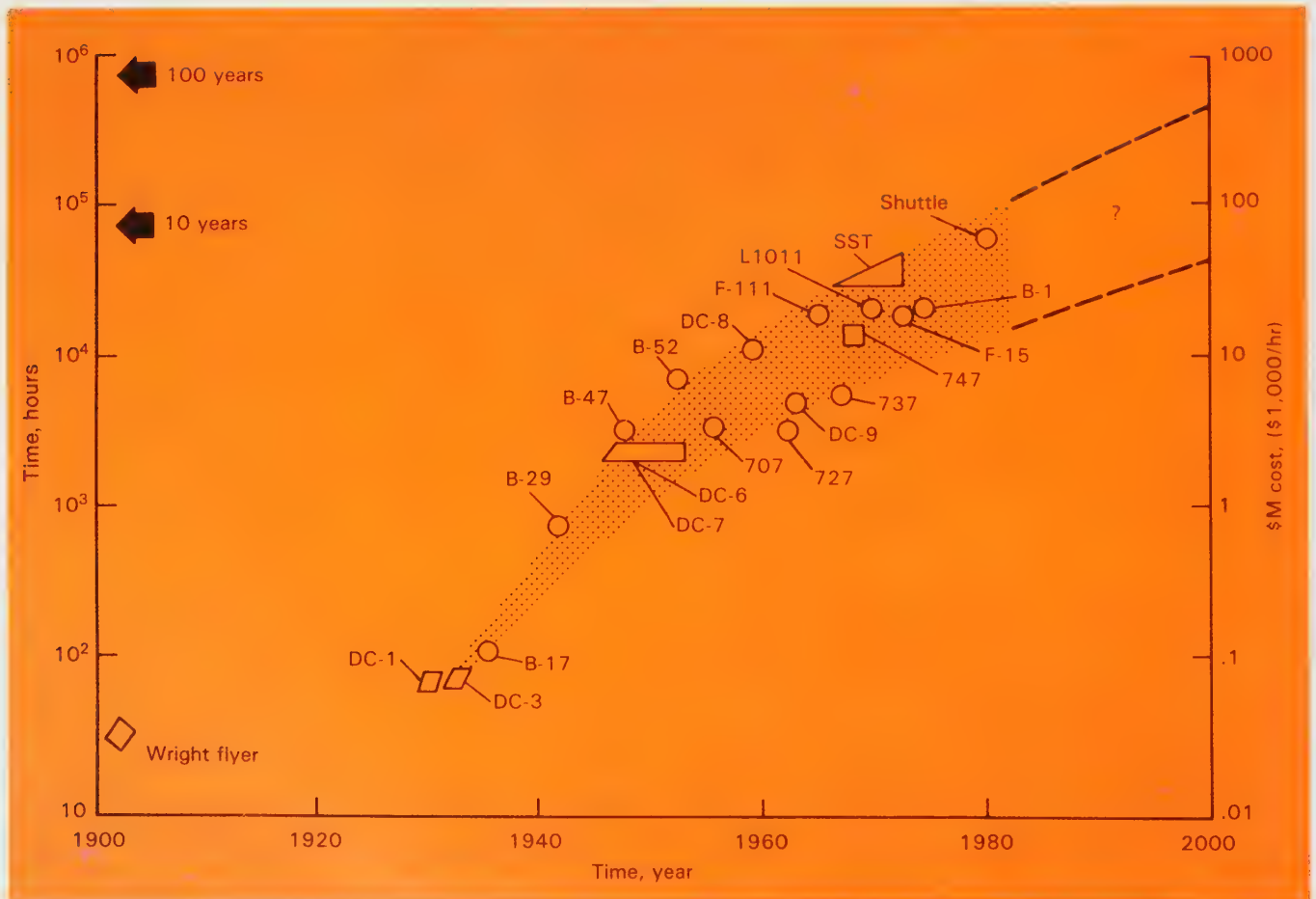

The number of wind tunnel tests required for new aircraft has risen by several orders of magnitude during the past half century.

The Big Cold One: The National Transonic Facility

For almost half a century, the transonic regime of flight has preoccupied aerodynamicists. Almost all modern commercial, military, and aerospace craft fly near, in, or through the transonic regime. True simulation of full-scale transonic Reynolds numbers did not become possible until a complete break was made with conventional wind tunnel design in 1973, when the NASA 0.3-meter transonic cryogenic tunnel went on line at Langley. It was cost that deterred the construction of full-scale conventional wind tunnels in the transonic regime. If either high pressure or large size were used to achieve full-scale Reynolds numbers, the cost of the tunnel shell and drive equipment would have been prohibitive. The key, as the 0.3-meter cryogenic tunnel proved, was decreasing air

temperatures and therefore the viscosity factor in the denominator of the Reynolds number.

The national need for a big transonic tunnel was recognized in the 1960s, and extensive studies of various alternatives began in 1966. They all ran up against the brick wall of high cost until the cryogenic option was proven feasible in 1973. NASA exploited its cryogenic success immediately by proposing a 2.5-meter cryogenic transonic tunnel. At this time, the U.S. Air Force was considering an intermittent high-pressure Ludwig-tube tunnel to meet its transonic test requirements. Rather than build both expensive facilities, the Federal Government decided in 1974 to construct a single National Transonic Facility (NTF) at Langley, based on NASA cryogenic developments, to serve all U.S. commercial, military, and scientific requirements. The NTF should come on line in 1982 at a total cost of \$85 million—the

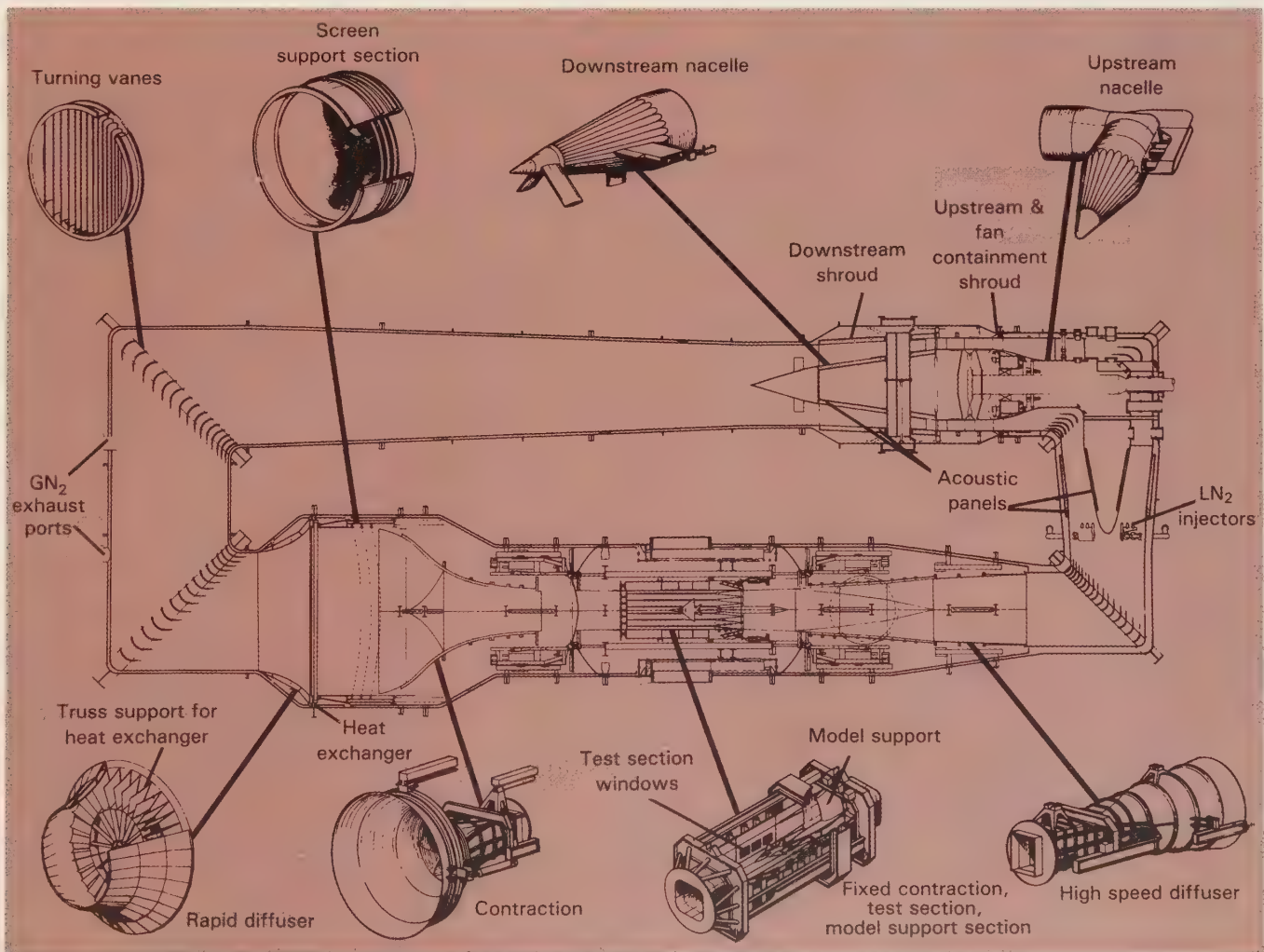

The circuit diagram of the National Transonic Facility.

most ambitious and expensive wind tunnel ever built.

Langley razed the old 4-foot supersonic pressure tunnel to make room for the NTF. The drive motors, buildings, and cooling towers were spared (saving \$20 million) and became an integral part of the new tunnel. The NTF circuit arrangement does not appear revolutionary; it is a single-return and fan-driven tunnel, with a 2.5-meter slotted-wall test section. Conventionality ends there. The 120 000-horsepower electric drive includes a two-speed gear turning a fan incorporating controllable pitch. In the tunnel itself, test section isolation valves will be installed. Shell pressures will vary from a near vacuum to 9 atmospheres, while test gas temperatures range from -300° to 175° F. The NTF will operate continuously in one of two modes: the cryogenic mode, in which up to 1200 pounds per second of liquid nitrogen will be injected and gasified and a conventional, noncryogenic mode using air as the test medium. Although the tunnel can operate continuously in both modes, the cost of the cryogenic mode is very high, but no higher than that of noncryogenic tunnels operating at equivalent test conditions. To achieve high-quality, silent flow,

the tunnel designers placed four fine-mesh screens in the settling chamber and 3500 square feet of sound-absorbing panels at strategic locations. Fortunately, the low drive power demands in a cryogenic tunnel also reduce noise levels. The NTF is expected to be the quietest of all transonic facilities.

Like most modern scientific and engineering facilities, the NTF is highly computerized—four separate computers, in fact. These computers will handle data acquisition and display, tunnel and test model control, data base management, communications, and facility monitoring. Data acquisition rates will reach 50 000 points per second, so that even very short runs (minutes rather than hours) in the cryogenic mode can still be highly productive. The NTF epitomizes modern, computerized, highly automated scientific facilities. It should give the United States a full 5-year lead over other countries. It will provide aspiring young aerodynamicists the wherewithal to design the aerospacecraft of the future.

Big Enough for Astronauts to See

At Ames, NASA is upgrading the already impressive 40×80 -foot tunnel to higher speeds and even



The National Transonic Facility under construction at Langley in 1980.

larger size—specifically a dual-section tunnel 40 × 80 feet and 80 × 120 feet, which will be one of the world's largest manmade structures and visible to the naked eye from low Earth orbit.

The original Ames 40 × 80-foot tunnel began operation in 1944 and has seen over 100 aircraft in its test section, spanning 35 years of aviation history, from World War II fighters to the Space Shuttle. Why modify such a successful facility? The primary driving force is the need to test evolving VTOL craft full scale. These vehicles are becoming bigger and faster. To flight test them without wind tunnel trials can lead to disaster, as the history of VTOL flight has repeatedly demonstrated. For example, two U.S. rotary-wing aircraft did bypass full-scale tunnel tests and subsequently crashed during flight testing. One of them encountered technical problems so serious that the \$400 million development program was terminated. In contrast, three other VTOL aircraft did

take advantage of the Ames 40 × 80-foot tunnel. They too failed dramatically at first, but the technical difficulties were resolved in the wind tunnel prior to flight testing, and these craft eventually succeeded.

Of crucial importance in VTOL testing is the elimination of tunnel wall interference. Ames engineers, however, were originally stymied in their plans to both expand the 40 × 80-foot test section to 80 × 120 feet and raise airspeeds to 300 knots. It would have cost far too much to reach both objectives. Instead, a compromise was reached. Tunnel power was raised to 135 000 horsepower—enough to attain 300 knots in the 40 × 80-foot test section—yet still sufficient to drive an 80 × 120-foot nonreturn leg at more than 100 knots. The old 40 × 80-foot single-return circuit would remain essentially intact, but a large, complex system of turning vanes and louvers would deflect flow into the grafted 80 × 120-foot leg when desired.

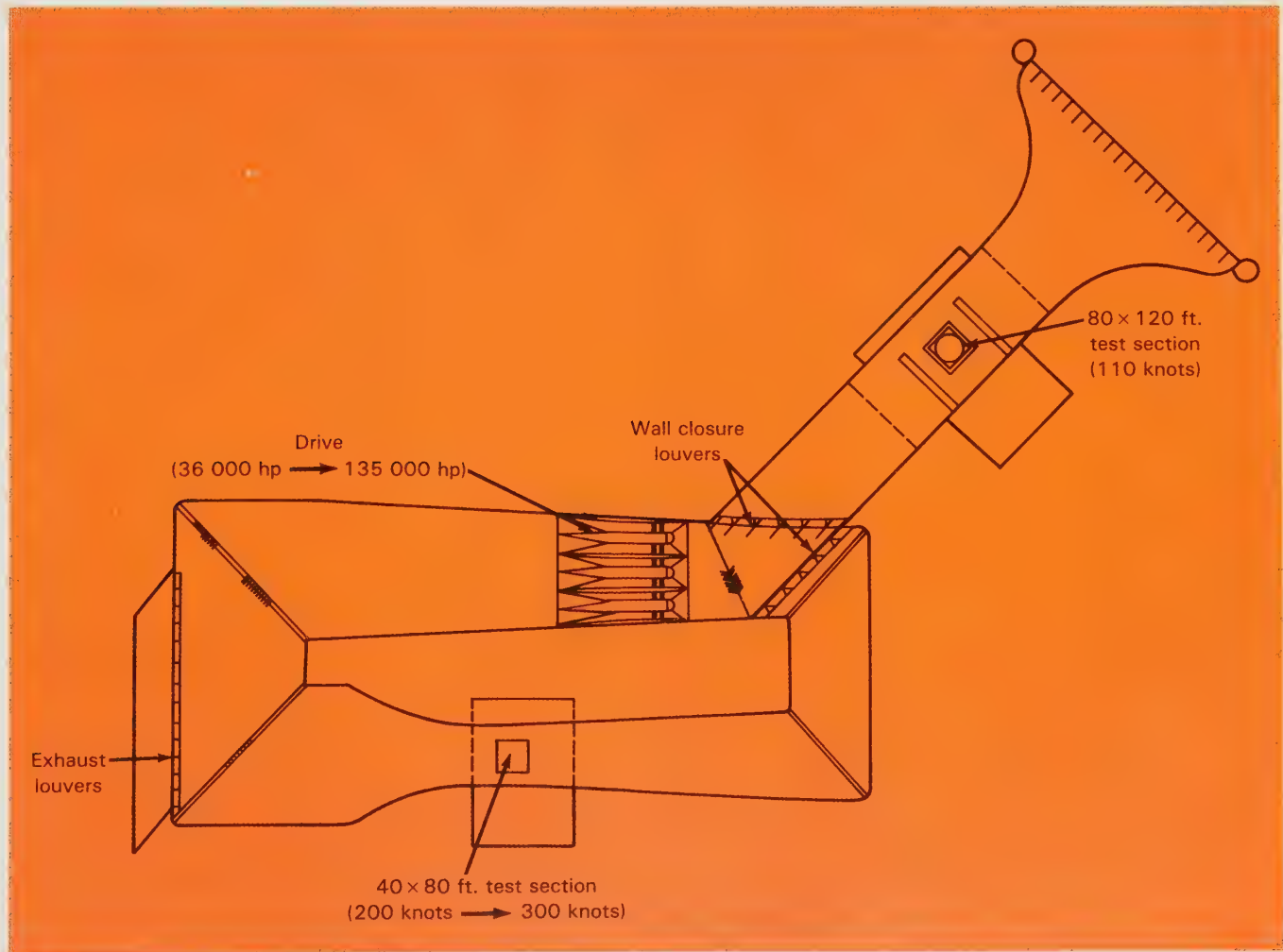

Circuit diagram of the Ames 40 × 80-foot modified tunnel with the 80 × 120-foot test section grafted on.

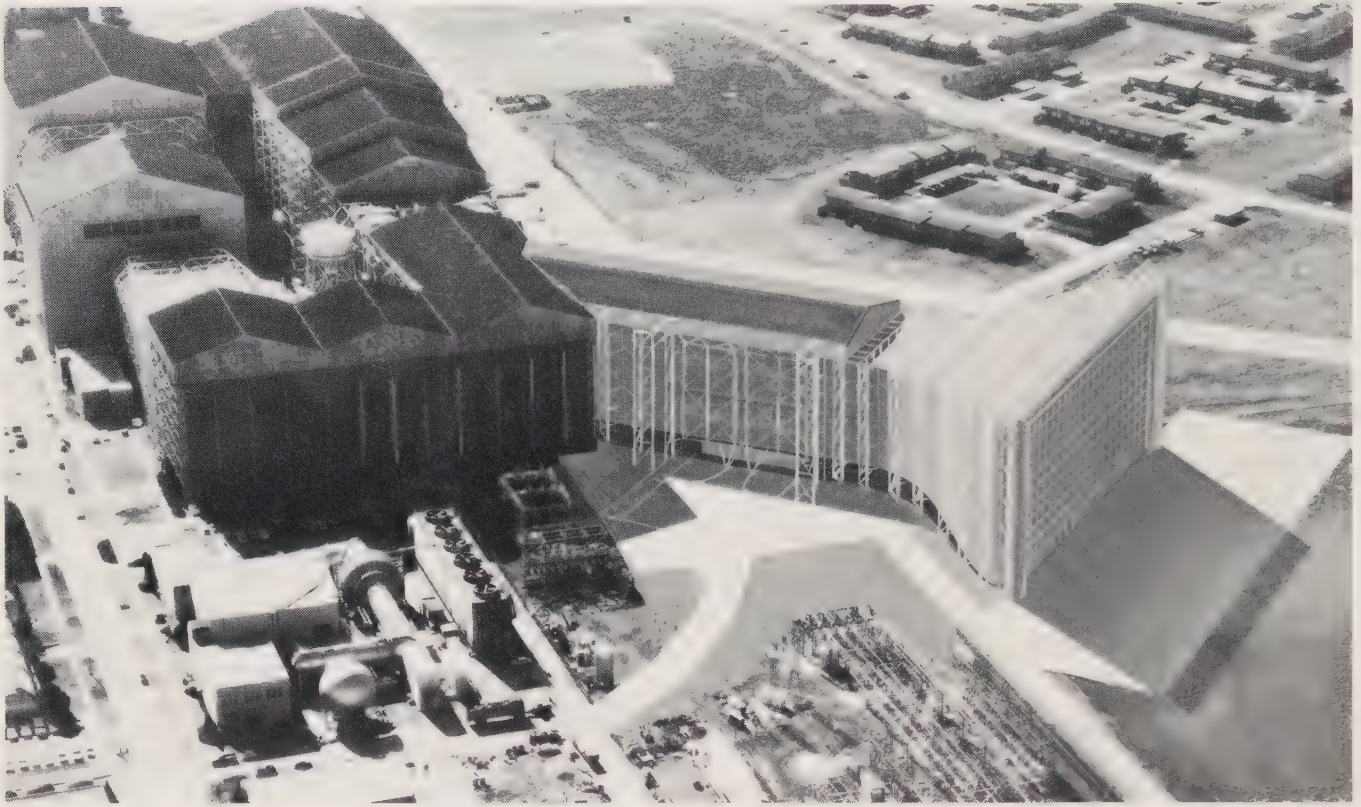

In this artist's sketch, the 80 × 120-foot addition threatens to dominate the original Ames 40 × 80-foot wind tunnel.

Modifications of existing structures can frequently be more frustrating than building a new one. A central problem in this instance was replacing the original six 6000-horsepower drive motors with a 135 000-horsepower system, all the while maintaining the same space. Drive system engineering had fortunately improved greatly in 35 years. By using modern synchronous motors with controllable-pitch fans and solid state variable-frequency speed controls, the new drive system was squeezed into the existing motor support structure. Miniaturization, however, was not the goal in the 80 × 120-foot appendage to the old tunnel circuit. The new structure, in fact, was big enough to remind the viewer of the hoary adage about the “tail wagging the dog.”

The Electronic Wind Tunnel

With very few exceptions, the potential of a new discovery in aerodynamics will not be realized until it is fully validated in three ways: (1) through theoretical analysis, (2) in wind tunnels, and (3) in actual flight testing. The discovery may arise in either theory or practice, but these three confirmations must occur

for it to be widely accepted. This triad is the cornerstone of aeronautical progress.

The famed NACA cowl of 1928 vintage had its genesis more in experiment than theoretical analysis. In contrast, the revolutionary swept wing came from the theoretical work of the German scientist Adolph Buseman in 1935 (and independently by Robert Jones of NACA in 1944). Both testing and analysis concurred that these ideas were sound and they duly reached fruition. The supercritical wing, though, was a classic example of an incomplete triad. Both tunnel tests and flight tests demonstrated that the new airfoil held great promise in the subsonic regime, but a firm theoretical basis for the concept did not exist. Therefore, general acceptance by the aircraft industry was not forthcoming. Without theoretical underpinnings, interest in the supercritical wing waned. (The blunt, thick wing also defied conventional wisdom that high-speed efficient wings had to be very thin with small leading edge radii.) The analytical cavalry came to the rescue only after a nationwide effort by aerodynamicists and mathematicians finally put the supercritical wing on a rational basis. The triad was complete and success assured.

In actuality, the theoretical leg of the supercritical wing triad was propped up not only by better theory

WIND TUNNELS OF THE FUTURE

but by powerful, recently acquired supercomputers. These were at last powerful enough to handle the myriad terms in the complicated aerodynamic equations. The computer revolution had at last invaded the field of aerodynamics—just in time to validate the supercritical wing.

The ultimate goal of computational aerodynamics is the mathematical simulation of airflow over a complete aircraft free of any approximations over the entire speed range from subsonic to hypersonic flight. In principle, the computer can do the wind tunnel's job faster and cheaper with its flowing electrons. In addition, computational aerodynamics is not restricted by the usual wind tunnel concerns of Reynolds numbers, high temperatures, wall interference, flow quality, and so on. The Reynolds number can be made any value desired just by punching it into the

computer. Flow can be mathematically perfect, and the air temperature can be pushed high enough to vaporize the simulated aircraft or lower than the liquefaction temperature of air without incurring the usual practical wind tunnel problems. These advantages make computational aerodynamics a most promising field for future exploitation.

Let us dwell a moment longer on the favorable aspects of the electronic wind tunnel. Dean Chapman, in his 1979 Dryden Lectureship for Research, dramatized the great speed of today's supercomputers. For less than \$1000 and 30 minutes of computer time one can now numerically simulate flow over an airfoil using certain equations. The same computational task using the computers available 20 years ago would have cost \$10 million and taken 30 years to complete.

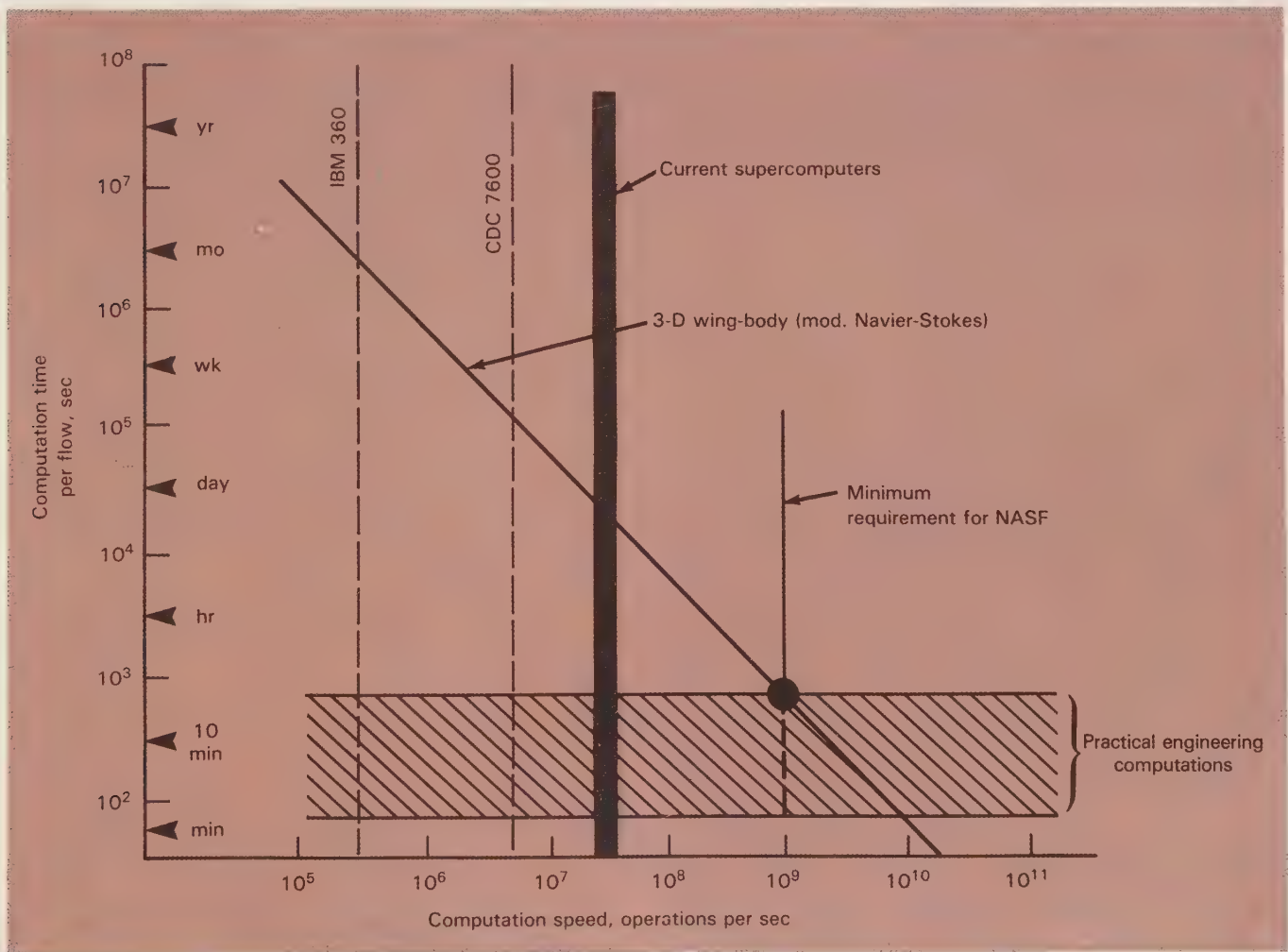

The computer time required to perform a specific aerodynamic computation is plotted against computation speed. Present supercomputers are fast approaching the speeds desired for practical operations at the proposed National Aerodynamics Simulation Facility. (Ames)

But there are problems even in our modern electronic Garden of Eden. The mathematical description of fluid motion is embodied in the basic Navier-Stokes equations, which were propounded in 1827. The complete equations are highly complex, involving 60 partial derivative terms. The present generation of computers can handle the Navier-Stokes equations as applied to a complete aircraft only if various approximations are made. At high angles of attack and high Mach numbers, where flow separation may occur, computational aerodynamics still leaves much to be desired. To improve the electronic wind tunnel, special purpose data processors are being designed especially for handling the Navier-Stokes equations.

The National Aerodynamic Simulation Facility

Both electronic and hardware wind tunnels will help shape the future of flight—a symbiotic partnership. For this partnership to prosper, the electronic wind tunnel must be nurtured like the long sequence of nuts-and-bolts facilities described in earlier chapters. To this end, a National Aerodynamic Simulation Facility (NASF) has been conceived at Ames that would, like the National Transonic Facility, serve the needs of NASA, the military, science, and industry. The NASF would first of all complement wind tunnels in the aerodynamic design process. It would also be a valuable tool for advanced research in the field of fluid dynamics. It would strive to broach the fundamental limitations of today's embryonic electronic wind tunnels, namely, inadequate computational speeds, too-small memories, inappropriate computer design (architecture), and poor numerical flow models (algorithms).

The computer requirements of the proposed NASF are impressive, even in terms of modern computer superlatives. One billion arithmetic operations per second are specified—approximately 25 times the speed of current computers. The memory storage needed would be 100 times greater than present memory capacities: at least 40 million words, extensible to several hundred million words. Are the Navier-Stokes equations this intimidating? When one realizes that the simulated flow field could encompass 500 000 mathematical points and that the equations themselves are unusually complex, the answer must be yes. In fact, the NASF is only an intermediate goal. Really good flow-field simulation

would demand a trillion arithmetic operations per second (1000 times the NASF objective), with a corresponding expansion of computer memory. Computer speeds have been increasing by a factor of ten every 8 years, so a 1000-fold increase is not an idle dream.

So much for delving into the future, but the National Aerodynamic Simulation Facility is not yet reality. The best estimates indicate that the cost of assembling the computers, software, and personnel would rival that of the National Transonic Facility (about \$85 million). It is an investment in the future that we can delay but not avoid. The history of wind tunnels and flight have repeatedly demonstrated that bold steps forward go hand in hand with technological leadership.

Advanced Wind Tunnel Technology

Frank Wenham operated the world's first wind tunnel in 1871. It took more than a century to advance to large, slotted-wall tunnels with cryogenic cooling that make full-scale testing at transonic speeds feasible and cost effective. Is there still room for improvement? While there are no quantum jumps in tunnel capabilities on the immediate horizon, several promising schemes for enhancing overall tunnel capabilities are well worth pursuing.

A Wall That Shapes Itself to a Streamline

As long as we have had subsonic wind tunnels, the tunnel walls have distorted the flow of air around the models in the test sections. In most subsonic tests, the experimenter can make simple corrections for wall interference. In transonic and V/STOL simulations, however, the corrections falter. Of course, one can always decrease the size of the model relative to the test section, but miniaturization of the model always compromises the accuracy of the tests, and complete, accurate simulation of aerodynamic reality once again escapes the experimenter.

The concept of an adjustable test section wall is not new. It is novel for a wind tunnel to automatically shape the contours of its test section to fit the streamlines surrounding the model. If an adaptive or self-streamlining wall fits smoothly over the pattern of airflow, no wall disturbances will be created to propagate toward the model and upset the testing. The idea sounds good, but can it be accomplished? If the

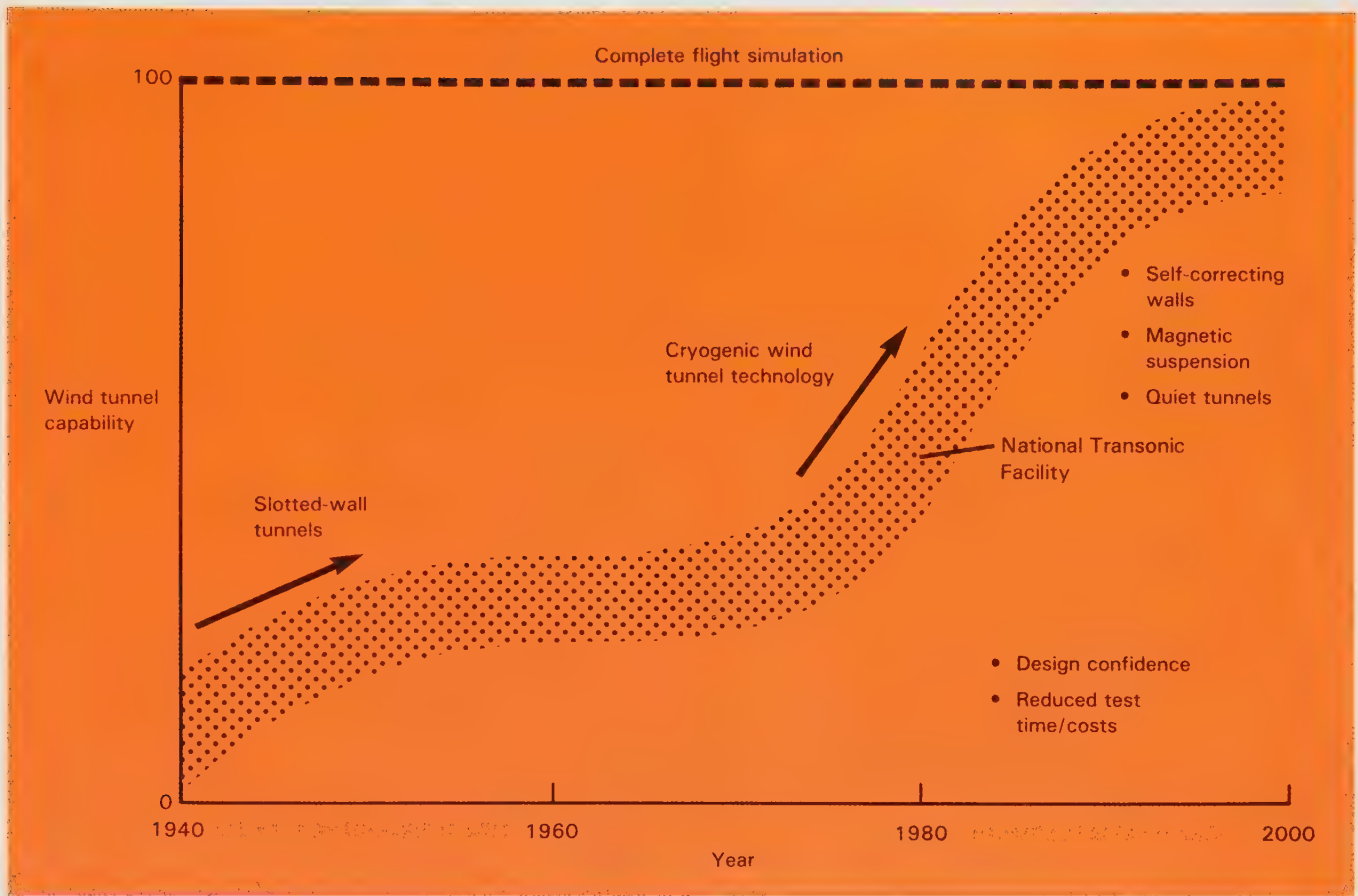

General wind tunnel capabilities as a function of time.

wall can somehow “feel” the streamlines and adjust itself accordingly, the answer must be yes. Given the wall shape and the wall pressure distribution, aerodynamic theory can tell whether or not the tunnel wall conforms to a free-air streamline. The wall contours are then adjusted to make the walls fit better, several times if necessary. It goes without saying that computers are heavily involved in calculating the degree of fit.

In both the United States and Europe, experiments with adaptive (or streamline) walls are progressing well, mainly on a two-dimensional basis, although three-dimensional trials will come soon. An encouraging feature of the early experiments is the discovery that a coarse adjustment of the walls can often reduce wall interference to the point at which the traditional mathematical corrections are once again adequate.

Without Visible Means of Support

Unfortunately, the tunnel walls are not the only objects degrading measurements and distorting the

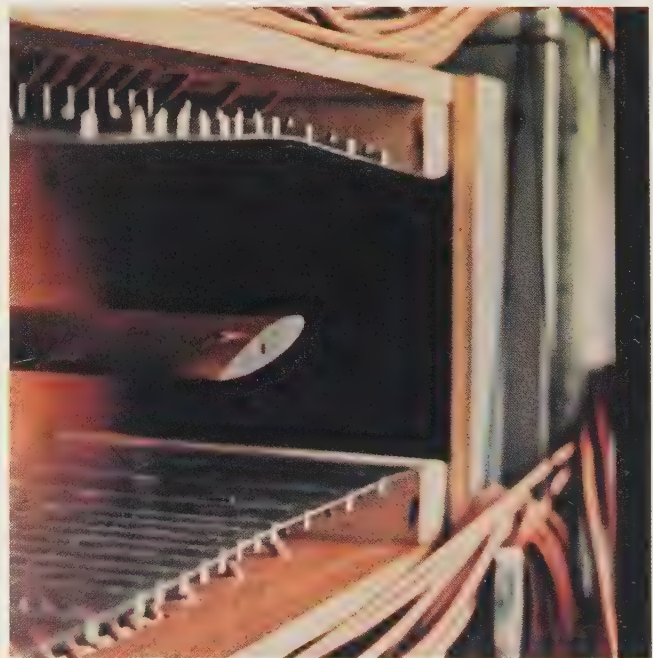

An airfoil in a small wind tunnel with adaptive walls that conform automatically to the streamlines established by the airfoil under test.



Supersonic transport model with its aerodynamically clean sting support. The cutaway of the model reveals the components of an internal balance.

airflow through the test section. Even the Wrights realized that their measurements of forces in their primitive tunnels were grossly in error because of aerodynamic forces exerted on the supports holding the model in the airstream. These so-called tare forces (from the Arabic "tarha" meaning "deduction") may exceed the forces on the model itself. The Wrights circumvented this unwelcome discovery by comparing test airfoils against a reference airfoil on a balance where tare forces canceled each other out. This is a good trick when only comparisons are wanted, but absolute aerodynamic forces must be measured if airfoil and aircraft performance is to be predicted. A search for better model support systems was initiated.

The early use of thin wires to support the model led to unforeseen disaster: The wind drag on the wires sometimes exceeded the model drag by a factor of 10. Streamlined support struts, shielded from the airstream by close-fitting fairings, sent the tare drag plummeting. The resulting distortion of the airflow over the model, however, introduced a whole new universe of unwanted problems. In the early 1940s, the development of electric strain-gage balances permitted experimenters to house the sensors directly *within* the model and then support it from the rear on a sting. This was a great improvement aerodynamically, even though the model had a bit of a bulge at the rear to accommodate the sting. It was

better, but far from perfect, particularly at high angles of attack.

How can one support a model in a stream of air without any physical support? We cannot manipulate gravity, but we can generate powerful magnetic fields that will in effect negate gravity. In fact, the magnetic levitation of tracked vehicles has already become a reality. The magnetic suspension of models in wind tunnels is feasible, especially in the light of recent developments in superconductivity. Not only can magnetic fields support an aircraft model in a stream of air, but it is perfectly possible to measure aerodynamic forces magnetically as well. The magnetic lines of force can transmit the three components of force and the three moments exerted on an airframe to the supporting magnetic coils without interfering in any way with the flow of air. There is even the possibility that the model can be "flown" magnetically; that is, the supporting magnetic fields can be varied to accelerate and maneuver the craft, measuring the changing aerodynamic forces in the process. Magnetic suspension and magnetic balances seem almost too good to be true after decades of frustrating aerodynamic distortions from physical supports.

Scientists at the French ONERA first demonstrated the magnetic suspension of a model on a small wind tunnel in the late 1950s. Researchers at the Massachusetts Institute of Technology followed soon after.

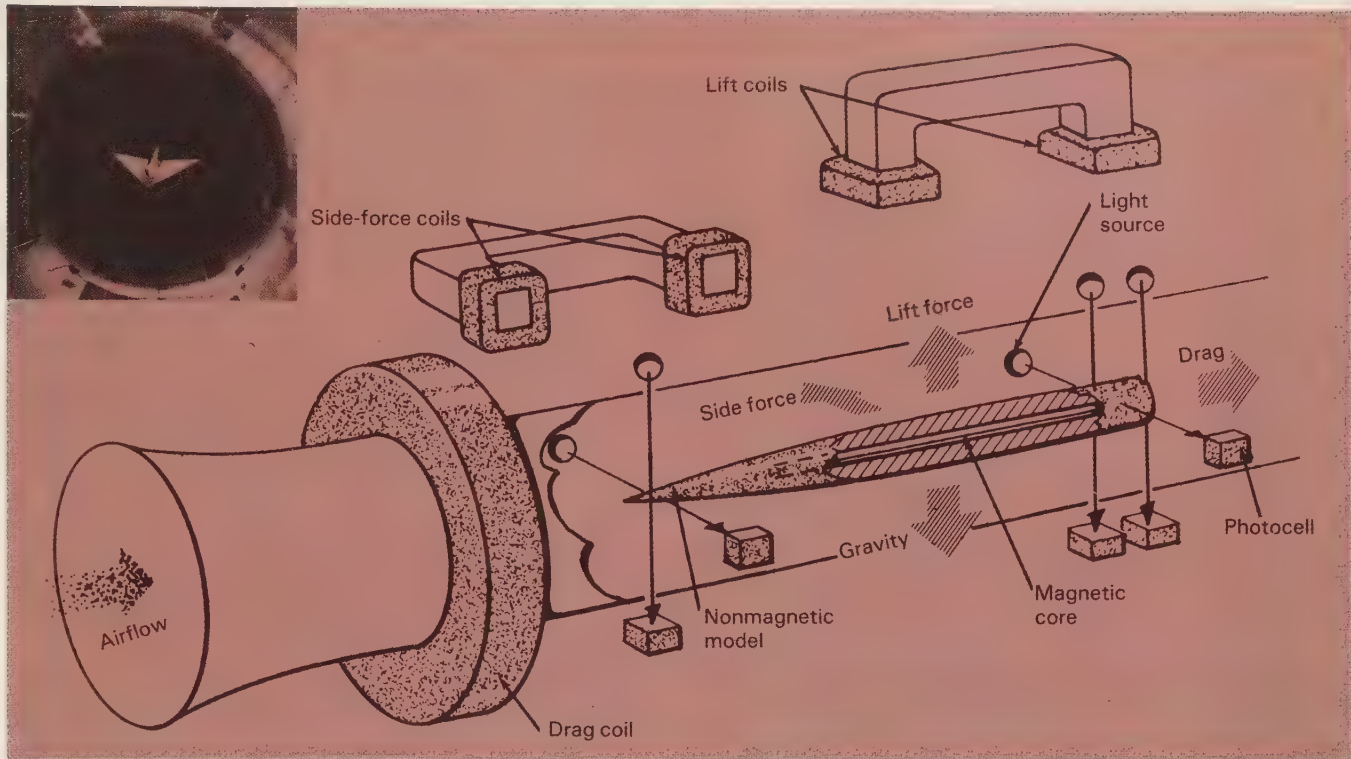

Components of a magnetic model-balance system. (Insert) A small MIT experimental magnetic suspension system.

Now aerodynamicists in many countries are experimenting with the concept.

Smoothing the Free-Stream Flow

Once the effects of test section walls and model supports have been either eliminated or compensated for, one might anticipate an aerodynamic nirvana. Nature and machines are not so kind. In wind tunnels, at least, one must still contend with the flow disturbances caused by the drive system and the flow channels leading up to the test section. There are three levels of air disturbance: (1) macroscopic eddies, swirls, and currents; (2) smaller-scale turbulence within the airstream; and (3) molecular-level noise propagated by sound waves. Ideally, all these disturbances should be rendered negligible before the airstream reaches the test section. This, of course, never happens, but one can try.

The main battle with unsteady airflow is fought in the settling chamber upstream from the test section. Here the usual honeycombs and fine-mesh screens strain out the random currents and vortices. The long

stilling chamber muffles the discordance even more. As the airstream emerges from the stilling chamber in a good tunnel, the large-scale disturbances have been attenuated to the point at which only the most sensitive flow-measuring instrumentation can detect them.

Noise is a different phenomenon; it is propagated on the molecular level rather than the convective level. Noise slips through the honeycombs and screens preceding the test section with little attenuation, like talking through a screen door. Noise must be stopped at its source. Consequently, modern wind tunnel practice calls for installation of sound-absorbing walls in the tunnel circuit near the major acoustic sources (the fans especially). If the noise peaks at certain frequencies, absorbing resonators tuned to the offending frequencies are very effective.

Progress in ironing out wrinkles in wind tunnel airflow, from large-scale errant zephyrs to acoustic vibrations, has been slow but steady. An easily measured criterion of success is the distance along a surface air will travel before the boundary layer changes from laminar to turbulent flow. The better

the initial air quality, the farther the air flows along the surface before the crucial transition. The better wind tunnels can closely duplicate the air encountered in atmospheric flight.

A Wind Tunnel Is Only as Good as its Instrumentation

The Internal Balance

Wind tunnels have always had a unique advantage over flight testing in that absolute forces and moments could be measured with respect to a fixed reference—the tunnel itself, which is firmly footed in the earth. The standard instrument for determining the three force components (lift, drag, and side force) and the three moments (pitch, roll, and yaw) is the internal balance. In modern practice strain gages inside the balance register forces and moments as changes in electrical resistance. One might surmise that the design of such an instrument would provide little challenge, but in the wind tunnel temperatures may range from those of liquid nitrogen to the incandescence of reentry. Further, the balance must be small enough to fit inside tiny models. Balance errors must be held to 0.1 percent or less, whether measuring ounces or several tons. Thus the wind tunnel internal balance is no ordinary instrument.

Typical of the latest generation of internal balance is the one designed for the National Transonic Facility. Only 3.5 inches in diameter, it can register vertical loads as high as 10 tons and axial loads of 1 ton. (Such forces are encountered in high-speed pressurized tunnels even though the tests are with small models.)

A Force Is the Sum of the Surface Pressures

Even though it is built like a fine watch, the internal balance measures only whole-body forces. The aerodynamicist also wants to know how well individual aircraft components are performing. Where has flow separation occurred? Do the lift forces along the wing conform to theoretical predictions? A highly instrumented model may require 500 or more tiny pressure sensors located strategically over its surface. In early wind tunnel experimentation, a myriad of tiny pressure orifices, each connected by a small, flexible tube to fluid-filled glass tube manometers outside the tunnel, registered the pressures. The thousands of feet of thin, flexible tubing and long

pipe organ banks of glass manometers made this approach clumsy, eye straining, and tedious for the clipboard-toting technicians. Happily, the electronic revolution swept away spaghetti-like lines feeding manometer tubes and replaced them with solid state pressure sensors that can be electronically scanned at rates of 10 000 readings per second. This development alone has greatly reduced the cost of wind tunnel research.

The Laser Hologram

The aerodynamicist has long bemoaned the invisibility of air. He has gone to great lengths to make airflow patterns visible by introducing into the airstream filaments of smoke, tufts of thread, and, more recently, neutrally buoyant, luminescent bubbles of helium. If the changes in air density are large enough, as in shock waves, schlieren photography or shadowgraphs can help visualize airflow. Now, arriving almost hand in hand with today's electronic wizardry, the laser hologram has added a new dimension to flow visualization in wind tunnels. Using relatively simple optics, the light from a powerful laser can be split into two separate beams, one passing through the tunnel test section and the other bypassing it. When recombined on a photographic plate, the beams form an interference pattern (called a hologram) that captures the pattern of density gradients within the test section at that instant. Later, the hologram can be rendered into a shadowgraph, schlieren photo, or interferogram and examined at leisure. Holographic flow visualization is now used routinely in small research facilities. But the greatest benefit may well be found in energy savings in the larger tunnels, where the mass of data stored in a single hologram eliminates the need for repeat runs to acquire the same data by more conventional methods.

Laser Velocimeter

That extraordinary device, the laser, also functions like radar in that its light can be reflected from objects to fix their positions and velocities. But what would a laser radar see of interest in a wind tunnel? Lasers have such high resolution that the light reflected from fine particles normally caught up in the airstream can be detected and converted via the Doppler effect into a measurement of air velocity. Although normal contaminants in air are frequently sufficient, stronger reflections result when oil

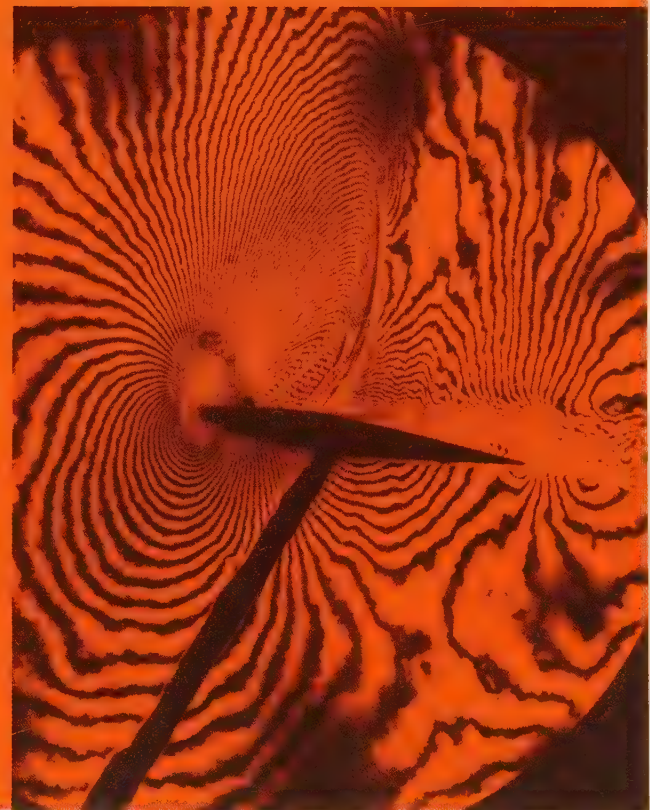
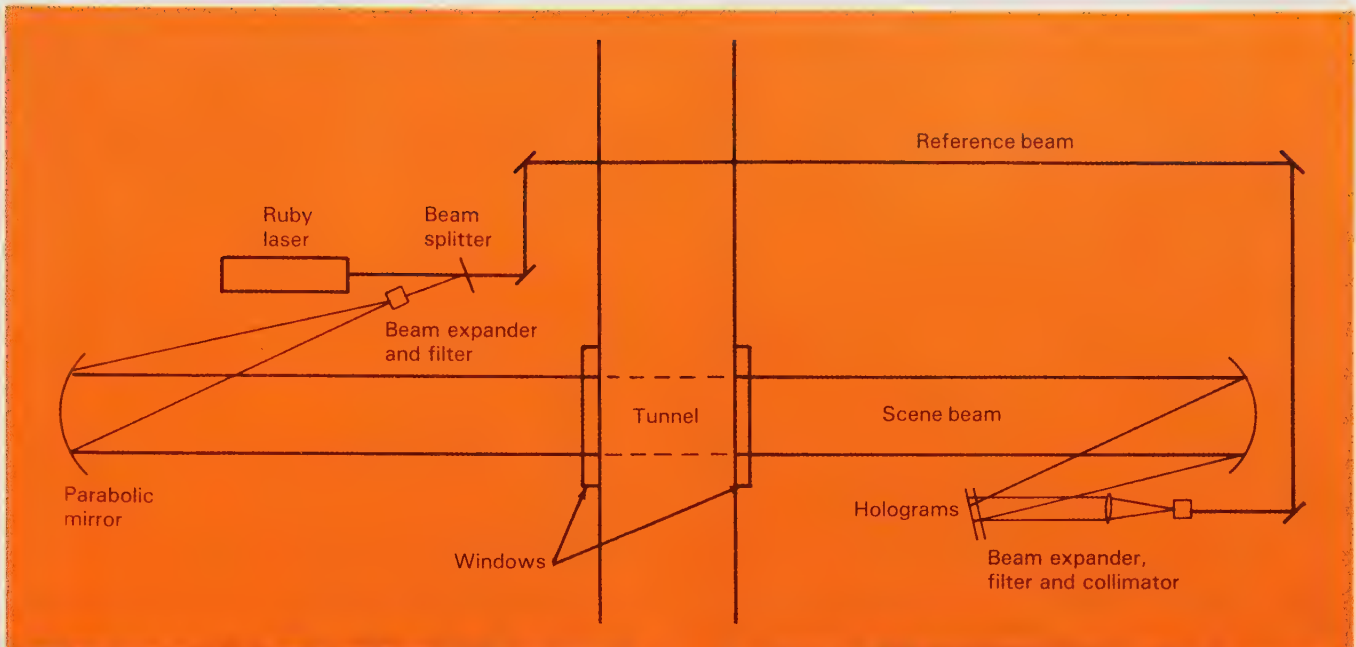

Optical diagram of a real-time holographic interferometer. The fringes are created by density changes in the test section air.

droplets a few microns in diameter are added to the airstream. The laser velocimeter, as it is called, possesses a great advantage over conventional velocity sensors, such as pitot tubes and yaw heads, because the beams of laser light do not disturb airflow at all.

This is the long-sought ideal of nonintrusive instrumentation.

A laser velocimeter has been installed in the Langley V/STOL tunnel to survey the flow fields around airfoils and aircraft fuselages. The laser beam

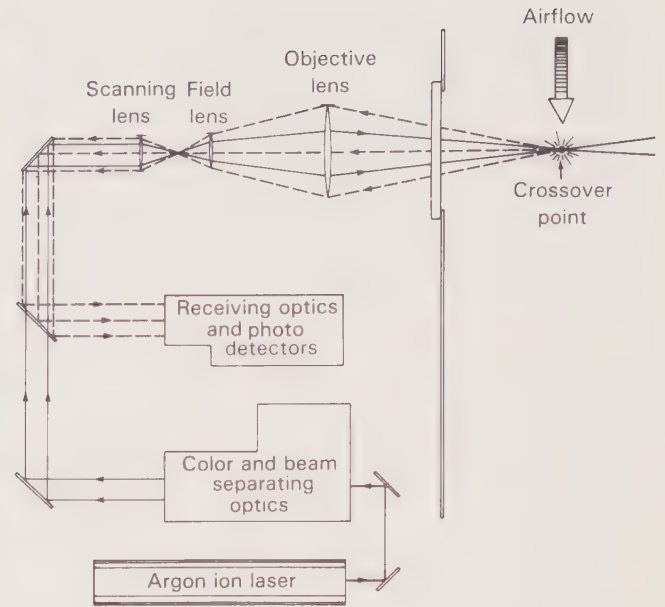
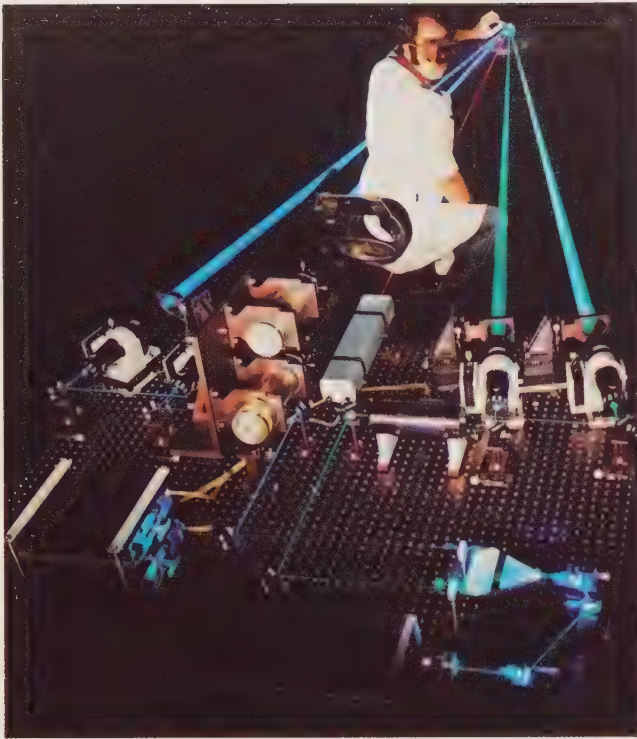

(Left) Laser velocimeter being tested at Ames. (Above) Diagram of laser velocimeter. Laser light reflected by particles in the airstream are analyzed for Doppler effect, giving particle and air velocity.

is first split into two components, which then cross at adjustable points within the tunnel. By using two beams of laser light, two velocity components in two different planes can be determined at the same time. With proper adjustment of the optics, air velocities can be scanned at will throughout the region of interest. During recent experiments with wings at high angles of attack, velocimeter data quantitatively mapped the flow field above the wing, where the traditional smoke-flow patterns provided only a qualitative picture. With its high sampling rate, the laser velocimeter can even provide a "moving picture" of changing flow fields, but with numbers rather than images. It is a powerful diagnostic tool that does not distort airflow and can be connected directly to a computer, thus bypassing error-prone humans.

Computer Controls and Data Acquisition

The hallmark of modern scientific research is the computerization of all measuring devices, the direct analysis of the data gathered, and the automatic display of digested information in forms palatable to human observers. The Wrights were able to make do with the visual observation of test airfoils mounted on a bicycle, but aerodynamic research depends more and more heavily on computers—so much so that a

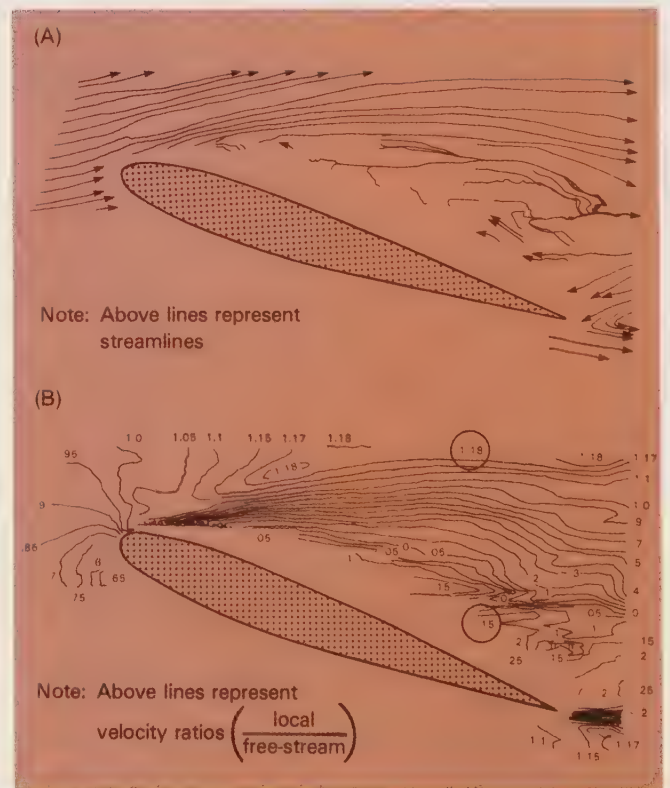

(A) Laser velocimeter measurements of flow streamlines and (B) velocity ratios. The negative signs indicate flow reversal. Validating smoke-flow photographs confirm the laser velocimeter measurements, including flow reversal.

wind tunnel must now shut down when its computer falters. Computers not only collect and process the data but they also control the tunnel itself. This is now the norm, not an extreme example of computerization.

The National Transonic Facility typifies the modern trend toward tunnel/computer symbiosis. Four computers handle the functions of data acquisition and display, data base management, process monitoring and communication, and tunnel and model control. Tunnel control means just that. The various aspects of tunnel operation are monitored continuously and automatically. When these parameters stray too far from the norm, the computer sounds the alarm and takes appropriate remedial action, even shutting the tunnel down when personnel and equipment are in danger.

A test in the tunnel can be completely programmed from tunnel startup to shutdown. Changes in Mach number, air temperature, and the attitude

and configuration of the model are also brought under the jurisdiction of the computers. Up to 384 channels of data flow into the computer at rates up to 50 000 points per second. At the behest of the test operator, various plots and displays can be generated almost instantaneously for real-time evaluation. Parameters being measured can be compared within 2 seconds with theoretical expectations or with data from previous runs by calling in information stored in memory banks.

Old-timers in wind tunnel research can recall how, back in the 1920s, the two engineers with the sharpest eyes would peer through tunnel observation ports, read the balance scales, and call out their readings to the recorder. It would be days, sometimes weeks, before the data were processed and the test director knew what his tunnel had wrought. Of course, there were computers of sorts in those days, but they were slow, error prone, and also went out to lunch.

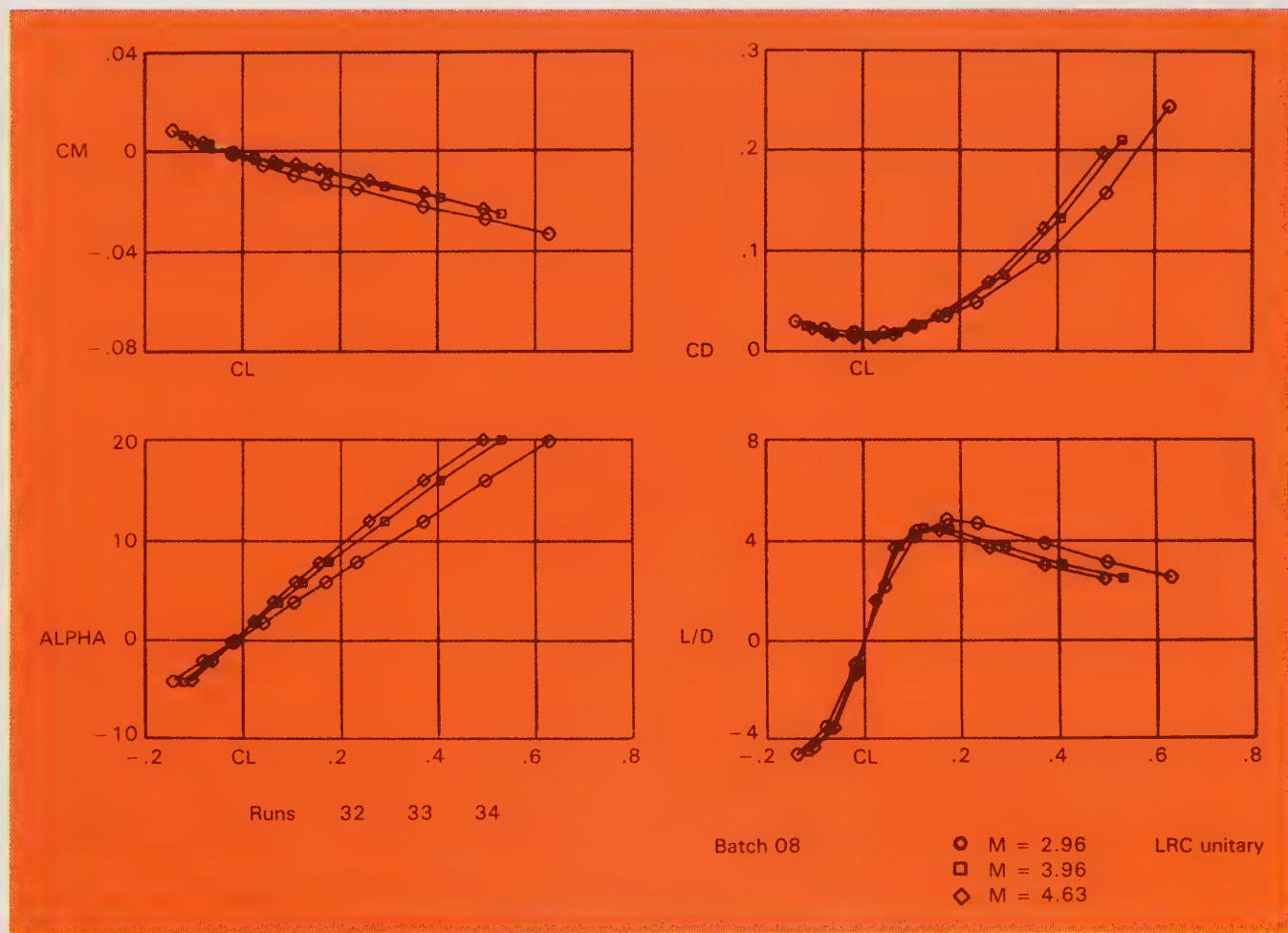

Computer-generated displays such as these are available almost instantly in modern wind tunnel tests.

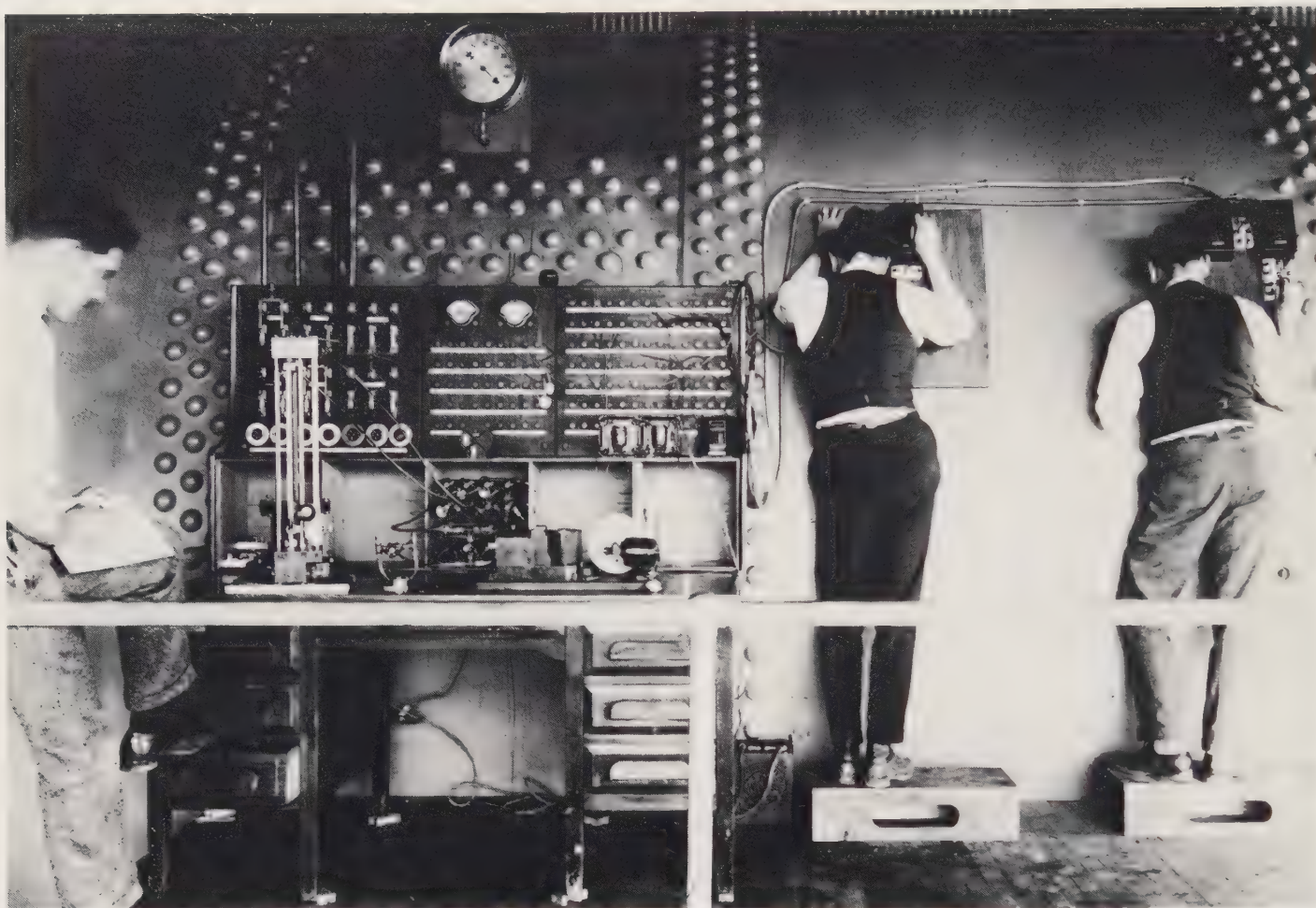

Two engineers reading balances located inside the Langley variable density wind tunnel in 1923.

The control room of a big, up to date wind tunnel resembles that of an electric power plant—buttons, lights, switches, and displays everywhere. Bit by bit, though, the computer is taking over the monitoring of displays and the pushing of buttons. Today, the impact of the marriage of the wind tunnel and computer is large—tomorrow it will be profound. As Leo Cherne has asserted, “The *computer* is incredibly fast, accurate, and stupid. *Man* is unbelievably slow, inaccurate, and brilliant. The *marriage of the two* is a force beyond comprehension.”

The Future Role of the Wind Tunnel

With extensive computerization, self-streamlining walls, laser-based instrumentation, cryogenic operation, and magnetic model suspension, wind tunnel technology is unquestionably keeping pace with the rapidly advancing state of the art in scientific research. No plateau of development or technological hardening of the arteries seems in sight.

The basic engineering mission of the wind tunnel will remain the same as it has been for a century: pioneering aerodynamic research followed by performance validation of new aircraft designs and subsequent refinement of configurations. In addition, wind tunnel validation of new theoretical concepts will always be part of aerodynamic progress.

Through the years, wind tunnels have always been able to respond quickly to unexpected problems, such as the Electra catastrophes. A national concern of today is energy conservation. With the U.S. commercial airliner fleet consuming approximately 10 billion gallons of aviation fuel annually, a 1 percent improvement in aircraft efficiency would save an immense amount of fuel. NASA’s goal in reducing aviation’s fuel consumption is not a mere 1 percent but rather 25 to 50 percent. This would be a remarkable accomplishment. Since drag reduction is the key to achieving this goal, NASA’s inventory of wind tunnels will once again be called on for solutions.

WIND TUNNELS OF THE FUTURE



Control consoles for the Lewis 10 × 10-foot supersonic wind tunnel, 1980.

Afterword

The wind tunnel in all its forms has carried the burden of technical advance in aeronautics as well as in space. While the contributions of some facilities have the hallmark of greatness, the technical impact of others has been only transitory. The elements of wind tunnel greatness, distilled from 60 years of NACA/NASA tunnel operation, are fundamental—timeliness in meeting a technical need, excellence of design, research versatility, and direction by an innovative and technically competent staff.

Of these four elements, the most important is the staff. Ronald Smelt, in a recent Florence Guggenheim Memorial Lecture (Lisbon, Portugal, September 1978) pointed out that “. . . in every aeronautical center, it is noteworthy that once the resource was available, there grew up around the facilities a group of people who knew how to use them, and use them wisely. . . . Past history of aero-

nautical laboratories has clearly shown that the building of the superb team is of greater importance than the building of the superb facility.”

The wind tunnels of NASA and their staffs constitute a national resource of great value. From the frail wood and fabric aircraft of World War I and the sputtering rockets of early pioneers, aerospace technology has progressed to supersonic transports spanning the oceans, space probes to the planets, and manned landings on the Moon. Soon, winged space vehicles will routinely return from orbit to a precision landing on spaceship Earth. The wind tunnels of NASA (and those of its predecessor NACA) have been in the forefront of this pioneering technology. Dedicated to the service of all mankind, these facilities and their staffs promise a future generation of flight that challenges the imagination.

Index

- adaptive (streamline) walls, 138, 139
- aerodynamic heating, 55, 75, 81, 82, 96, 117, 118
- aerodynamic interference, 4
- Aerodynamical Laboratory, 13
- aeroelasticity/flutter, 29, 78–80
- Aeronautical Society of Great Britain, 3, 9
- Aeroplane, The*, 22
- Aeropropulsion Systems Test Facility, 66
- airfoils, 1–7, 11, 16, 20, 24
 - cambered, 4, 6, 36
 - high-speed, 24
 - flow fields, 144
 - laminar-flow, 33, 36, 40
 - NACA 4-digit series, 16
 - pressure distribution, 4
 - streamlines, 4, 61
 - supercritical, 101, 112, 113, 131, 136, 137
 - transonic flow, 105
 - typical VDT data, 17
 - Wright brothers, 6
- aircraft
 - airship, 23
 - ballistic missile, 49, 55
 - Bell P-39, 33, 47
 - Bell P-59 Airacobra, 29
 - Bell X-1, 55
 - Bell X-2 research, 38, 51
 - Bell X-5, 109
 - Bell XV-15, 126
 - Boeing ALCM, 130
 - Boeing B-17 Flying Fortress, 17, 22, 31
 - Boeing B-29, 44
 - Boeing B-47, 79
 - Boeing B-52, 107, 108, 128, 129, 132
 - Boeing 707, 103
 - Boeing 747, 114, 120
 - Boeing KC-135, 115, 116
 - C-141 military transport, 81
 - Century Series fighters, 51
 - Cessna T-37, 114
 - Consolidated B-24, 22
 - Convair B-32, 29
 - Convair B-58 supersonic bomber, 51, 64
 - Convair F-102, 36, 51, 62, 63
 - Convair F-106, 36, 63
 - Convair F-111, 70, 127
 - Curtiss Jenny, 14
 - Curtiss P-40, 33
 - distributed load transport, 124, 125
 - Douglas A-20, 29
 - Douglas A-26, 28
 - Douglas DC-3, 17, 22, 31, 132
 - Douglas DC-8, 67, 103
 - Douglas DC-9, 67
 - Douglas DC-10, 4, 67
 - Douglas observation plane, 18
 - Douglas XA-26, 37
 - Douglas XSBD-2, 34
 - Douglas XTB2D-1, 44
 - energy efficient/transport, 35, 123, 146
 - F-15, 81
 - General Dynamics F-16, 54, 81
 - General Dynamics F-111, 43, 67, 69, 109
 - Grumman F-9F, 64
 - Grumman F-14, 70, 109
 - Harrier (VTOL), 79
 - HiMAT, 128, 129
 - ICBM, 49, 75, 90
 - laminar flow control (LFC), 124, 125
 - Langley aerodromes, 5
 - Lockheed C-5A, 67
 - Lockheed Electra, 80, 81
 - Lockheed P-38 Lightning, 17, 27, 28, 33
 - Lockheed P-80, 44, 45
 - Lockheed Vega, 22
 - Maxim flying machine, 4
 - McDonnell F-4, 43
 - McDonnell F-4 Phantom, 69
 - NASA AD-1 pivot wing, 127
 - NASA QSRA, 125
 - North American B-1 bomber, 67, 109, 127
 - North American F-86, 49, 110
 - North American P-51 Mustang, 33, 34, 41
 - North American X-15, 69, 98, 107, 108, 128
 - Piper Cub, 101
 - pivot-wing bomber, 127
 - powered lift, 125, 126
 - Republic F-84 Thunderjet, 35
 - Republic F-105, 51
 - Republic P-47 Thunderbolt, 28, 33, 44
 - scimitar-wing, 127
 - Sperry M-1 Messinger, 21
 - Spirit of St. Louis*, 7
 - Supermarine Spitfires, 31
 - Supersonic bomber, 127
 - supersonic transport, 69, 101, 103, 110–112
 - swept-forward wing, 128
 - Vought F-8U, 29, 113
 - V/STOL, 28, 34, 37, 53, 78, 79, 101–103, 124–126, 135, 138
 - V/STOL fighter, 126
 - Wright flyer, 7
 - XP-51B, 34
 - Zeppelins, 17
- Allen, H. Julian, 52, 58, 75
- Ames, Joseph S., 23
- Ames Aeronautical Laboratory, 28, 75
- Ames Laboratory, 32–37, 40, 45, 49, 52, 57, 66, 85, 88, 89, 101, 107, 118, 123, 134
- Ames Research Center, 28, 31, 52, 87, 96
- Ames Thermal Protection Laboratory, 90, 91
- antiturbulence screens, 35, 36, 38, 39, 64
- Apollo, 7
- arc-jet, 85, 90, 92, 101
- Area Rule, the, 62, 63, 110, 112, 131
- Arnold Engineering Development Center (AEDC), 56, 65, 66, 119, 127
- aspect ratio, 3
- axial-flow compressor, 51, 53

- Baden-Powell, Major B.F.S., 9
- balances
 - electric strain gage, 140
 - internal, 140, 142
 - magnetic, 140, 141
- ballistic range (Ames), 57, 116
- Becker, John V., 56
- Bell, Alexander Graham, 13
- Bernoulli, Daniel, 25
- Bernoulli principle, 25, 27
- Bleriot, Louis, 11
- blunt nose cone, 75, 76, 95, 131
- Boeing Company, 79, 80
- “boilerplate,” 99

WIND TUNNELS OF NASA

- boundary layer, 40, 54, 55, 59, 75, 97, 101, 104, 105, 123
- Brown, Clinton, 51
- buffeting, 27, 112, 116, 120
- Buseman, Adolph, 51, 136
- California Institute of Technology, 76
- Catholic University, 10
- Canning, Thomas, 90
- Cayley, Sir George, 1
- Champ de Mars, 9, 11
- Chapman, Dean, 137
- Cherne, Leo, 146
- Collier Trophy, 22, 62
- computational aerodynamics, 136, 137
- computer-generated display, 145
- Concorde*, 110–112
- Convair, 62, 63
- counterflow principle, 90–92
- cowling, NACA Cowl (1928), 22, 136
- cryogenic, 133
- data acquisition systems, 71, 134, 144–146
- daVinci, Leonardo, 1
- Dayton, Ohio (see "Wright Bros."), 5, 6
- DeFrance, Smith J., 23
- dive recovery flap, 27, 28
- Doppler effect, 143, 144
- downwash, 101, 102
- drag, 1, 5, 7, 22, 23, 27, 40, 41, 51, 62, 63, 108, 115, 120, 142
- "drag cleanup test," 23
- drag coefficient, 5
- driven gas, 84, 85
- Dryden, Hugh, 13, 63
- Dryden Flight Research Center, 114
- Dryden Lectureship for Research (1979), 137
- Durand, William F., 13, 20, 21
- Eggers, Alfred J., 57
- Eiffel, Gustave, 10–12
- Eisenhower, President Dwight D., 76
- electron-beam flow visualization, 121
- electronic wind tunnel, 132, 136–138
- Ellis, Macon C., 51
- engines
- air-cooled, 20, 22, 36, 37
 - cowling, 27
 - hypersonic ramjet, 98, 99
 - jet, 49, 69, 71
 - nacelle, 37
 - Pratt and Whitney J-57, 62, 63
 - ramjet, 53, 97–99
 - rocket, 49, 107
 - Scramjet, 130
 - supersonic combustion ramjet, 128
- turbojet, 44, 53, 97
- turboprop, 80
- expansion tube, 84, 85
- Flight Research Center (Calif.), 114
- Florence Guggenheim Memorial Lecture (1978), 149
- flutter, 79, 80, 119
- flying coke bottles, 63
- force system, 3, 142
- free-fall tests, 51
- Froudes number, 80
- Garrett Corporation, 98
- gliders, 1–7
- Goett, Harry J., 23
- Göttingen, Germany, 10–12, 15
- Göttingen University, 15
- High-Speed Flight Station (Calif.), 109
- holographic interferogram, 143
- holographic interferometer, 143
- Hood, Manly J., 24
- Hot-gas Radiation Research Laboratory, 96
- Howell, Robert, 95
- Hunsaker, Jerome, 13
- Huntsberger, Ralph, 67
- hypersonic flight regime, 55, 59
- hypervelocity flight regime, 82
- interference effects, 22
- interferogram, 142
- Jacobs, Eastman, 37, 40
- Jet Propulsion Laboratory (JPL), 76, 77
- Jones, Robert T., 51, 136
- Kennedy, President John F., 110
- Kitty Hawk, 1, 6, 7, 9, 10
- laminar flow, 15, 36, 40, 41, 123, 141
- laminar flow control (LFC), 35, 124
- Lanchester, W.F., 115
- landing-flap systems, 36
- Langley, Samuel P., 5
- Langley Field, 13, 19–29, 36–45, 49–52, 56, 57, 62–67, 77, 78, 81, 85, 94, 101, 102, 107, 110, 117–119, 123, 133
- Langley Memorial Aeronautical Laboratory (LMAL), 14, 94
- Langley Research Center, 14, 19, 22, 28, 31
- laser hologram, 142
- laser velocimeter, 142–144
- launch vehicle
- heavy-lift, 130, 131
 - supersonic airbreathing, 130, 131
- Le Mans, France, 9
- Lewis, George W., 21, 23
- Lewis Flight Propulsion Laboratory, Cleveland, Ohio, 41, 44, 53, 58, 66, 85, 101
- Lewis Research Center, Cleveland, Ohio, 31, 69, 97–99, 107
- Plum Brook, 98
- lift, 3, 5, 7, 20, 21, 27, 40, 41, 79, 104, 142
- lift coefficient, 5
- lift-to-drag ratio, 3, 5
- light gas gun, 91, 92
- Lilienthal, Otto, 3, 4
- Lindbergh, Charles, 19, 31
- Lindbergh Field, 63
- liquefaction, 56–60, 86–88, 94, 106, 107
- Lockheed Corp., 80
- Love, Eugene, 94
- Mach lines, 54, 55
- magnetic suspension, 141
- Manchester, University of, 3
- manometers, 41, 58, 142
- glass tube, 142
 - electronic, 142
- Marshall Space Flight Center, 103, 104, 118
- Massachusetts Institute of Technology, 140, 141
- Mattullath, Hugo, 10
- Maxim, Sir Hiram, 4, 5
- moments, 142
- moment system, 3
- moving belt ground board, 101–103
- Munk, Max, 15
- NACA Laboratories, Sunnyvale, California, Moffett Field, 31, 32
- National Academy of Science, 13
- National Advisory Committee for Aeronautics (NACA), 13–24, 29, 31, 34–38, 41–43, 49–53, 57, 59, 62–66, 69, 71, 75–77, 85, 94, 101
- National Aeronautics and Space Administration (NASA), 13, 67, 71, 76–78, 85, 94, 98, 101–103, 107–112, 117–120, 123, 131, 133, 138, 146, 149
- National Aerodynamics Simulation Facility (NASF/Ames), 137, 138
- National Aeronautics and Space Act of 1958, 76
- National Air and Space Museum, 6, 7
- National Bureau of Standards, 13
- National Physical Laboratory (NPL), 11–14
- National Supersonic Transport Program, 110

- Naval Research Laboratory (NRL), 76
 Navier-Stokes equations, 138
 Newton, Isaac, 1, 5
 noise, 141
 North American Aviation, 110
 nozzle, 49–52, 56, 58, 64, 68, 76,
 81–85, 88, 96
 asymmetric supersonic, 52, 53, 68,
 71
 flexible wall, 54, 56, 69, 77

 oscillator vanes, 79, 80
 ONERA, France, 140

 Parsons, John F., 66
 Prandtl, Ludwig, 10–12, 40
 projectile carrier (see “sabot”), 58
 propellers, 31, 32, 37
 propellers, high-speed, 37

 radar, 142
 “real-gas” effects, 82, 83, 85, 86
 Reynolds, Osborne, 3, 15, 40
 Reynolds number, 3, 15–17, 29, 35–39,
 43, 58, 61–64, 80, 87, 91,
 103–107, 112, 117, 123, 124, 132,
 133, 136
 Riabouchinsky, D., 10
 Robins, Benjamin, 1, 2
 Robinson, Russell G., 24

 sabot (see “projectile carrier”), 58, 59
 satellite, 49
 scale effects, 29, 37
 schlieren optical system, 24, 25, 52–55,
 97, 105, 142
 Seiff, Alvin, 90
 shadowgraphs, 58, 59, 76, 142
 shock waves, 25, 54, 57–59, 62, 67, 75,
 76, 81, 82, 84, 85, 88, 89, 91,
 104, 105, 107, 108, 111, 112
 shock wave cannon, 88
 side force, 3, 142
 Silverstein, Abe, 23, 69
 slotted wall, 60–63, 102
 Smelt, Ronald, 149
 Smithsonian Institution, 5, 13
 sonic barrier, 24, 49
 sonic boom, 110–112
 spacecraft, 81, 82, 89, 116
 Space Shuttle, 64, 67, 70, 87, 90, 95,
 96, 107, 108, 116–123, 130, 132,
 135
 Space Task Group, 94
 Span-loader, 125
 speed regime, 50
 spin, 19, 41, 78
 spin-recovery, 41–43
 Sputnik, 75–77, 101, 131
 S.S. *United States*, 90

 stability and control, 20, 29
 Stack, John, 23, 61, 62
 Stanford University, 13, 21
 Stanton, Thomas, 11
 streamlines, 61
 surface pressures, 142

 tailspin (“flat spin”), 19, 41
 tare forces, 140
 trailing vortex, 113, 114
 transonic “bump,” 37, 38
 transonic flight regime, 104, 105, 133
 turbulence, 12, 38, 63, 103, 123, 141
 turbulent flow, 15, 40, 41, 141
 Twining, General Nathan, 63

 V-1, 31
 V-2, 31, 35
 ventilated wall, 64, 65, 68, 102
 Viking Lander, 116–118
 Viking Program, 116
 Viking spacecraft, 64
 Virden, Ralph, 27, 28
 Virginia Polytechnic Institute and State
 University, 44
 Voitenko compressor, 92, 93
 von Braun, Wernher, 76, 103

 Walcott, Alexander, 13
 wall interference, 60, 61, 101, 102,
 125, 135, 138
 Wallops Island, Virginia, 76, 94
 wake-survey rake, 41
 Washington Navy Yard, 13
 Waslewski, Eugene, 69
 Weick, Fred, 22
 Wells, H. G., 11
 Wenham, Frank H., 3, 5, 94, 138
 whirling arm, 1–5
 Whitcomb, Richard T., 62, 63,
 112, 113, 115
 Whitham, G. B., 111, 112
 Wilson, Herbert A. (Hack), 67
 wind tunnels (general)
 advanced counterflow, 85
 air-interchange tower, 26
 annular return, 16, 42
 arc-jet, 85
 balances, 7, 19
 basic elements, 2
 choking, 49
 compression ratio, 50
 compressors, 50, 51, 53, 66, 68–70,
 83, 94
 computer control, 145
 condensation, 50, 53, 63, 64, 69, 70
 contraction cone (also nozzle), 12
 contraction section, 39
 control room, 146
 counterflow facility, 58, 90, 91
 cryogenic, 106
 design characteristics, 50
 drive system, 50
 electronic, 132, 138
 elements of greatness, 149
 energy losses, 50
 exhaust air scoop, 45
 expansion tube, 84, 85
 explosive-combustion shock, 90
 flight simulation capability, 139
 free-flight, 28, 78
 free-spinning, 19
 gases other than air, 85–87
 high-speed, 24, 37
 hotshot, 84, 85
 hypersonic, 55, 56, 82
 impulse, 84, 85
 injector-drive, 23, 24
 low-turbulence, 35, 39
 Ludwig tube, 103, 132
 NASA complex, 131
 nozzle/test section, 50
 propulsion, 44
 quiet tunnel, 141
 reentry test facilities, 82, 83
 shock, 84
 shock tube, 92
 speed regimes, 50
 staff, 149
 stilling chamber (also settling
 chamber), 12, 39, 102, 141
 subsonic, 49
 supersonic, 49
 supersonic free-flight, 58, 59
 test hours required, 132
 test rhombus, 66, 67
 transonic, 61, 63
 vanes, 12
 wind tunnels (Ames)
 advanced entry simulator, 88, 89
 electric arc jet, 90
 electric arc shock tube, 89, 90
 explosion-activated shock tube, 88, 89
 hypersonic free-flight aerodynamic
 facility, 91, 92
 small-scale atmospheric entry
 simulator, 75–77
 supersonic free-flight, 107
 thermal protection laboratory, 90, 91
 Unitary Plan, 67, 68, 131
 Voitenko compressor driven shock
 tube, 93, 94
 10 × 14-inch continuous flow
 hypersonic, 57, 58
 20-inch helium hypersonic, 87
 28-inch (Mach 50) helium, 87, 88
 1 × 3-foot supersonic, 51
 1 × 3-foot supersonic blowdown, 52

WIND TUNNELS OF NASA

- 1 × 3.5-foot tunnel, 40
- 3.5-foot hypersonic, 86, 87
- 6 × 6-foot supersonic, 48, 52, 53
- 7 × 10-foot, 32
- 8 × 7-foot supersonic, 67
- 9 × 7-foot transonic, 52, 67
- 11 × 11-foot transonic, 67, 68
- 12-foot pressure, 35, 36, 42, 52, 57, 58
- 14-foot transonic, 64, 65
- 16-foot high-speed, 33, 64
- 40 × 80-foot, 34, 35, 101, 111, 114, 126, 134–136
- wind tunnels (JPL)
 - 20-inch supersonic, 76
 - 21-inch hypersonic, 76, 77
- wind tunnels (Langley)
 - continuous flow hypersonic, 94, 95
 - full-scale (FST), 22–24, 27, 28, 37, 78, 79, 109, 131
 - Gas Dynamics Laboratory, 59–61, 90
 - gases other than air, 96
 - high-speed 7 × 10-foot, 37, 38
 - hot-gas radiation research laboratory, 96
 - low-speed 7 × 10-foot, 37, 38, 102
 - low-turbulence (ice) (LTT), 39–41
 - low-turbulence pressure (LTPT), 39, 40, 80
 - NACA ice tunnel, 39
 - National Transonic Facility, 36, 51, 122, 124, 133, 134, 142, 145
 - No. 1, 14, 15, 19, 71
 - propeller research tunnel (PRT), 21–23
 - SCRAMJET facility, 130
 - stability, 31, 43
 - transonic dynamics, 29, 79–81, 117–119
 - Unitary tunnel, 72, 73
 - Unitary Plan, 52, 65–71, 107, 111, 131
- variable density (VDT), 15–19, 22–26, 29, 37, 38, 146
- V/STOL, 100–103, 114, 126, 143
- 6-inch arc-driven shock tube, 96
- 6-inch expansion tube, 96, 97
- 9-inch supersonic, 51
- 11-inch high-speed, 23, 24, 26
- 11-inch hypersonic, 56, 57, 107
- 13.5-inch pilot cryogenic, 106, 107
- 22-inch helium (Mach 20), 121
- 24-inch high-speed, 24, 26, 37
- 0.3 meter transonic cryogenic, 133
- 4-foot supersonic pressure, 134
- 4 × 4-foot supersonic, 51
- 5-foot free-flight, 28
- 5-foot vertical, 19, 20, 41
- 8-foot high-speed, 25–28, 36, 37, 62, 63
- 8-foot high temperature structures, 95, 119, 130
- 8-foot transonic pressure, 62–65, 112, 113, 115
- 7 × 10-foot Atmospheric Wind Tunnel (AWT), 19, 20
- 7 × 10-foot high-speed, 107
- 9 × 6-foot thermal structures, 74, 81, 96
- 12-foot free-flight, 28
- 15-foot spin, 42
- 16-foot high-speed, 30, 31, 36, 37, 62–64
- 16-foot transonic, 128
- 17 × 17-foot test section (LS 7 × 10), 37
- 19-foot high-pressure, 28, 29, 37, 79
- 20-foot spin, 42
- wind tunnels (Lewis)
 - altitude tunnel, 44, 45, 53
 - icing research, 45–47
 - supersonic propulsion, 107
 - Unitary Plan, 69, 71
 - 42-inch hypersonic propulsion (Plum Brook), 98, 99
- 8 × 6-foot supersonic, 53, 54, 69, 102
- 8 × 10-foot supersonic, 116
- 9 × 15-foot V/STOL, 53
- 10 × 10-foot supersonic propulsion, 69–71, 116, 118, 147
- wind tunnels (Marshall)
 - 14 × 14-inch transonic, 118, 119
 - 32-inch Ludwig tube, 103–105
- wind tunnels (non NASA)
 - Eiffel/Autevil, 11
 - Eiffel/Champ de Mars, 10
 - Navy 8 × 8-foot, 13
 - NPL duplex, 12, 13
 - post-Wright brothers, 9
 - Prandtl first-generation, 10
 - Prandtl second-generation, 12
 - Stanford propeller research, 21
 - Wright brothers, 6
 - Zahm, 10
- wing
 - bullet-damaged, 27
 - delta, 81
 - laminar flow, 41
 - landing flaps, 19, 21
 - pivot, 127
 - scimitar, 127
 - supercritical, 113
 - swept, 49, 51, 79, 108, 112, 136
 - swept-forward, 127
 - variable-sweep, 43, 101, 108–110, 127
- wing drooping, 79
- wing fluttering, 80
- winglets, 115, 116
- World War II, 55
- Wright brothers, 1, 5, 120, 140
- Wright, Ray, 61
- Wright, Orville, 5, 6, 7, 9, 140
- Wright, Wilbur, 5, 6, 7, 9, 140
- Zahm, Albert, 10, 13

TL 567 .W5 B2

Baals, Donald D.

Wind tunnels of NASA

DATE DUE

DEC 21 1993			

CLACKAMAS COMMUNITY COLLEGE LIBRARY

TL567.W5 B2

Wind tunnels of NASA /

Baals, Donald D.



3 3119 00125 9646