

...c89

c89 is the name of the Dec ANSI C compiler. Other compilers exist for example: `acc` - SUN's ANSI Compiler, `cc` - non-ANSI compiler, `gcc` - Gnu C compiler and whole host of proprietary compilers (`tcc` - TURBO C)

...together.

Even though we deal with UNIX and C nearly all the forthcoming discussions are applicable to MSDOS and other operating systems

...CEILIDH

A ceilidh (pronounced Kay-Lee) is an informal gathering for conversation, music, dancing, songs and stories. Concise OED.

Dave.Marshall@cm.cf.ac.uk
Wed Sep 14 10:06:31 BST 1994

Programming in C UNIX System Calls and Subroutines using C,

© A. D. Marshall 1994-9

Substantially Updated March 1999



Next: [Copyright](#)

Search for Keywords in C Notes

[Keyword Searcher](#)

Download Postscript Version of Notes

[Click Here to Download](#) Course Notes. **Local Students Only.**

Algorithm Animations

[Direct link to Java Algorithm Animations \(C related\)](#)

C COURSEWARE

Lecture notes + integrated exercises, solutions and marking

- **Contents**
- **The Common Desktop Environment**
 - **The front panel**
 - **The file manager**
 - **The application manager**
 - **The session manager**
 - **Other CDE desktop tools**
 - **Application development tools**
 - **Application integration**
 - **Windows and the Window Manager**
 - **The Root Menu**
 - **Exercises**
- **C/C++ Program Compilation**
 - **Creating, Compiling and Running Your Program**
 - **Creating the program**
 - **Compilation**
 - **Running the program**
 - **The C Compilation Model**
 - **The Preprocessor**
 - **C Compiler**
 - **Assembler**
 - **Link Editor**
 - **Some Useful Compiler Options**
 - **Using Libraries**
 - **UNIX Library Functions**
 - **Finding Information about Library Functions**
 - **Lint -- A C program verifier**
 - **Exercises**
- **C Basics**
 - **History of C**
 - **Characteristics of C**
 - **C Program Structure**
 - **Variables**
 - **Defining Global Variables**
 - **Printing Out and Inputting Variables**
 - **Constants**
 - **Arithmetic Operations**
 - **Comparison Operators**
 - **Logical Operators**
 - **Order of Precedence**
 - **Exercises**
- **Conditionals**
 - **The `if` statement**
 - **The `?` operator**
 - **The `switch` statement**
 - **Exercises**
- **Looping and Iteration**

- [The for statement](#)
- [The while statement](#)
- [The do-while statement](#)
- [break and continue](#)
- [Exercises](#)
- [Arrays and Strings](#)
 - [Single and Multi-dimensional Arrays](#)
 - [Strings](#)
 - [Exercises](#)
- [Functions](#)
 - [void functions](#)
 - [Functions and Arrays](#)
 - [Function Prototyping](#)
 - [Exercises](#)
- [Further Data Types](#)
 - [Structures](#)
 - [Defining New Data Types](#)
 - [Unions](#)
 - [Coercion or Type-Casting](#)
 - [Enumerated Types](#)
 - [Static Variables](#)
 - [Exercises](#)
- [Pointers](#)
 - [What is a Pointer?](#)
 - [Pointer and Functions](#)
 - [Pointers and Arrays](#)
 - [Arrays of Pointers](#)
 - [Multidimensional arrays and pointers](#)
 - [Static Initialisation of Pointer Arrays](#)
 - [Pointers and Structures](#)
 - [Common Pointer Pitfalls](#)
 - [Not assigning a pointer to memory address before using it](#)
 - [Illegal indirection](#)
 - [Exercise](#)
- [Dynamic Memory Allocation and Dynamic Structures](#)
 - [Malloc, Sizeof, and Free](#)
 - [Calloc and Realloc](#)
 - [Linked Lists](#)
 - [Full Program: queue.c](#)
 - [Exercises](#)
- [Advanced Pointer Topics](#)
 - [Pointers to Pointers](#)
 - [Command line input](#)
 - [Pointers to a Function](#)
 - [Exercises](#)
- [Low Level Operators and Bit Fields](#)
 - [Bitwise Operators](#)
 - [Bit Fields](#)
 - [Bit Fields: Practical Example](#)

- **A note of caution: Portability**
- Exercises
- **The C Preprocessor**
 - **#define**
 - **#undef**
 - **#include**
 - **#if -- Conditional inclusion**
 - **Preprocessor Compiler Control**
 - **Other Preprocessor Commands**
 - Exercises
- **C, UNIX and Standard Libraries**
 - **Advantages of using UNIX with C**
 - **Using UNIX System Calls and Library Functions**
- **Integer Functions, Random Number, String Conversion, Searching and Sorting: <stdlib.h>**
 - **Arithmetic Functions**
 - **Random Numbers**
 - **String Conversion**
 - **Searching and Sorting**
 - Exercises
- **Mathematics: <math.h>**
 - **Math Functions**
 - **Math Constants**
- **Input and Output (I/O): <stdio.h>**
 - **Reporting Errors**
 - **perror()**
 - **errno**
 - **exit()**
 - **Streams**
 - **Predefined Streams**
 - **Redirection**
 - **Basic I/O**
 - **Formatted I/O**
 - **Printf**
 - **scanf**
 - **Files**
 - **Reading and writing files**
 - **sprintf and scanf**
 - **Stream Status Enquiries**
 - **Low Level I/O**
 - Exercises
- **String Handling: <string.h>**
 - **Basic String Handling Functions**
 - **String Searching**
 - **Character conversions and testing: <ctype.h>**
 - **Memory Operations: <memory.h>**
 - Exercises
- **File Access and Directory System Calls**
 - **Directory handling functions: <unistd.h>**

- **Scanning and Sorting Directories:** `<sys/types.h>`,
`<sys/dir.h>`
- **File Manipulation Routines:** `unistd.h`, `sys/types.h`, `sys/stat.h`
 - **File Access**
 - `errno`
 - **File Status**
 - **File Manipulation:** `stdio.h`, `unistd.h`
 - **Creating Temporary Files:** `<stdio.h>`
- **Exercises**
- **Time Functions**
 - **Basic time functions**
 - **Example time applications**
 - **Example 1: Time (in seconds) to perform some computation**
 - **Example 2: Set a random number seed**
 - **Exercises**
- **Process Control:** `<stdlib.h>`, `<unistd.h>`
 - **Running UNIX Commands from C**
 - `execl()`
 - `fork()`
 - `wait()`
 - `exit()`
 - **Exercises**
- **Interprocess Communication (IPC), Pipes**
 - **Piping in a C program:** `<stdio.h>`
 - `popen()` -- Formatted Piping
 - `pipe()` -- Low level Piping
 - **Exercises**
- **IPC: Interrupts and Signals:** `<signal.h>`
 - **Sending Signals** -- `kill()`, `raise()`
 - **Signal Handling** -- `signal()`
 - `sig_talk.c` -- complete example program
 - **Other signal functions**
- **IPC: Message Queues:** `<sys/msg.h>`
 - **Initialising the Message Queue**
 - **IPC Functions, Key Arguments, and Creation Flags:** `<sys/ipc.h>`
 - **Controlling message queues**
 - **Sending and Receiving Messages**
 - **POSIX Messages:** `<mqueue.h>`
 - **Example: Sending messages between two processes**
 - `message_send.c` -- creating and sending to a simple message queue
 - `message_rec.c` -- receiving the above message
 - **Some further example message queue programs**
 - `msgget.c`: Simple Program to illustrate `msgget()`
 - `msgctl.c` Sample Program to Illustrate `msgctl()`
 - `msgop.c`: Sample Program to Illustrate `msgsnd()` and `msgrcv()`
 - **Exercises**

- **IPC:Semaphores**
 - **Initializing a Semaphore Set**
 - **Controlling Semaphores**
 - **Semaphore Operations**
 - **POSIX Semaphores: <semaphore.h>**
 - **`semaphore.c`: Illustration of simple semaphore passing**
 - **Some further example semaphore programs**
 - **`semget.c`: Illustrate the `semget()` function**
 - **`semctl.c`: Illustrate the `semctl()` function**
 - **`semop()` Sample Program to Illustrate `semop()`**
 - **Exercises**
- **IPC:Shared Memory**
 - **Accessing a Shared Memory Segment**
 - **Controlling a Shared Memory Segment**
 - **Attaching and Detaching a Shared Memory Segment**
 - **Example two processes communicating via shared memory: `shm_server.c, shm_client.c`**
 - **`shm_server.c`**
 - **`shm_client.c`**
 - **POSIX Shared Memory**
 - **Mapped memory**
 - **Address Spaces and Mapping**
 - **Coherence**
 - **Creating and Using Mappings**
 - **Other Memory Control Functions**
 - **Some further example shared memory programs**
 - **`shmget.c`: Sample Program to Illustrate `shmget()`**
 - **`shmctl.c`: Sample Program to Illustrate `shmctl()`**
 - **`shmop.c`: Sample Program to Illustrate `shmat()` and `shmdt()`**
 - **Exercises**
- **IPC:Sockets**
 - **Socket Creation and Naming**
 - **Connecting Stream Sockets**
 - **Stream Data Transfer and Closing**
 - **Datagram sockets**
 - **Socket Options**
 - **Example Socket Programs:`socket_server.c, socket_client`**
 - **`socket_server.c`**
 - **`socket_client.c`**
 - **Exercises**
- **Threads: Basic Theory and Libraries**
 - **Processes and Threads**
 - **Benefits of Threads vs Processes**
 - **Multithreading vs. Single threading**
 - **Some Example applications of threads**
 - **Thread Levels**
 - **User-Level Threads (ULT)**
 - **Kernel-Level Threads (KLT)**
 - **Combined ULT/KLT Approaches**

- [Threads libraries](#)
- [The POSIX Threads Library: `libpthread`, `<pthread.h>`](#)
 - [Creating a \(Default\) Thread](#)
 - [Wait for Thread Termination](#)
 - [A Simple Threads Example](#)
 - [Detaching a Thread](#)
 - [Create a Key for Thread-Specific Data](#)
 - [Delete the Thread-Specific Data Key](#)
 - [Set the Thread-Specific Data Key](#)
 - [Get the Thread-Specific Data Key](#)
 - [Global and Private Thread-Specific Data Example](#)
 - [Getting the Thread Identifiers](#)
 - [Comparing Thread IDs](#)
 - [Initializing Threads](#)
 - [Yield Thread Execution](#)
 - [Set the Thread Priority](#)
 - [Get the Thread Priority](#)
 - [Send a Signal to a Thread](#)
 - [Access the Signal Mask of the Calling Thread](#)
 - [Terminate a Thread](#)
- [Solaris Threads: `<thread.h>`](#)
 - [Unique Solaris Threads Functions](#)
 - [Suspend Thread Execution](#)
 - [Continue a Suspended Thread](#)
 - [Set Thread Concurrency Level](#)
 - [Readers/Writer Locks](#)
 - [Readers/Writer Lock Example](#)
 - [Similar Solaris Threads Functions](#)
 - [Create a Thread](#)
 - [Get the Thread Identifier](#)
 - [Yield Thread Execution](#)
 - [Signals and Solaris Threads](#)
 - [Terminating a Thread](#)
 - [Creating a Thread-Specific Data Key](#)
 - [Example Use of Thread Specific Data: Rethinking Global Variables](#)
- [Compiling a Multithreaded Application](#)
 - [Preparing for Compilation](#)
 - [Debugging a Multithreaded Program](#)
- [Further Threads Programming: Thread Attributes \(POSIX\)](#)
 - [Attributes](#)
 - [Initializing Thread Attributes](#)
 - [Destroying Thread Attributes](#)
 - [Thread's Detach State](#)
 - [Thread's Set Scope](#)
 - [Thread Scheduling Policy](#)
 - [Thread Inherited Scheduling Policy](#)
 - [Set Scheduling Parameters](#)
 - [Thread Stack Size](#)
 - [Building Your Own Thread Stack](#)

- **Further Threads Programming:Synchronization**
 - **Mutual Exclusion Locks**
 - **Initializing a Mutex Attribute Object**
 - **Destroying a Mutex Attribute Object**
 - **The Scope of a Mutex**
 - **Initializing a Mutex**
 - **Locking a Mutex**
 - **Lock with a Nonblocking Mutex**
 - **Destroying a Mutex**
 - **Mutex Lock Code Examples**
 - **Mutex Lock Example**
 - **Using Locking Hierarchies: Avoiding Deadlock**
 - **Nested Locking with a Singly Linked List**
 - **Solaris Mutex Locks**
 - **Condition Variable Attributes**
 - **Initializing a Condition Variable Attribute**
 - **Destroying a Condition Variable Attribute**
 - **The Scope of a Condition Variable**
 - **Initializing a Condition Variable**
 - **Block on a Condition Variable**
 - **Destroying a Condition Variable State**
 - **Solaris Condition Variables**
 - **Threads and Semaphores**
 - **POSIX Semaphores**
 - **Basic Solaris Semaphore Functions**
- **Thread programming examples**
 - **Using `thr_create()` and `thr_join()`**
 - **Arrays**
 - **Deadlock**
 - **Signal Handler**
 - **Interprocess Synchronization**
 - **The Producer / Consumer Problem**
 - **A Socket Server**
 - **Using Many Threads**
 - **Real-time Thread Example**
 - **POSIX Cancellation**
 - **Software Race Condition**
 - **Tgrep: Threaded version of UNIX grep**
 - **Multithreaded Quicksort**
- **Remote Procedure Calls (RPC)**
 - **What Is RPC**
 - **How RPC Works**
 - **RPC Application Development**
 - **Defining the Protocol**
 - **Defining Client and Server Application Code**
 - **Compiling and running the application**
 - **Overview of Interface Routines**
 - **Simplified Level Routine Function**
 - **Top Level Routines**
 - **Intermediate Level Routines**

- [Expert Level Routines](#)
- [Bottom Level Routines](#)
- [The Programmer's Interface to RPC](#)
 - [Simplified Interface](#)
 - [Passing Arbitrary Data Types](#)
 - [Developing High Level RPC Applications](#)
 - [Defining the protocol](#)
 - [Sharing the data](#)
 - [The Server Side](#)
 - [The Client Side](#)
- [Exercise](#)
- [Protocol Compiling and Lower Level RPC Programming](#)
 - [What is rpcgen](#)
 - [An rpcgen Tutorial](#)
 - [Converting Local Procedures to Remote Procedures](#)
 - [Passing Complex Data Structures](#)
 - [Preprocessing Directives](#)
 - [cpp Directives](#)
 - [Compile-Time Flags](#)
 - [Client and Server Templates](#)
 - [Example rpcgen compile options/templates](#)
 - [Recommended Reading](#)
 - [Exercises](#)
- [Writing Larger Programs](#)
 - [Header files](#)
 - [External variables and functions](#)
 - [Scope of externals](#)
 - [Advantages of Using Several Files](#)
 - [How to Divide a Program between Several Files](#)
 - [Organisation of Data in each File](#)
 - [The Make Utility](#)
 - [Make Programming](#)
 - [Creating a makefile](#)
 - [Make macros](#)
 - [Running Make](#)
- [Program Listings](#)
 - [hello.c](#)
 - [printf.c](#)
 - [swap.c](#)
 - [args.c](#)
 - [arg.c](#)
 - [average.c](#)
 - [cio.c](#)
 - [factorial](#)
 - [power.c](#)
 - [ptr_arr.c](#)
 - [Modular Example](#)
 - [main.c](#)
 - [WriteMyString.c](#)
 - [header.h](#)

- [Makefile](#)
- [static.c](#)
- [malloc.c](#)
- [queue.c](#)
- [bitcount.c](#)
- [lowio.c](#)
- [print.c](#)
- [cdir.c](#)
- [list.c](#)
- [list_c.c](#)
- [fork_eg.c](#)
- [fork.c](#)
- [signal.c](#)
- [sig_talk.c](#)
- [Piping](#)
 - [plot.c](#)
 - [plotter.c](#)
 - [externals.h](#)
- [random.c](#)
- [time.c](#)
- [timer.c](#)

Online Marking of C Programs --- CEILIDH

- [Ceilidh - On Line C Tutoring System](#)
 - [Why Use CEILIDH ?](#)
 - [Introduction](#)
 - [Using Ceilidh as a Student](#)
 - [The course and unit level](#)
 - [The exercise level](#)
 - [Interpreted language exercises](#)
 - [Question/answer exercises](#)
 - [The command line interface \(TEXT CEILIDH ONLY\)](#)
 - [Advantages of the command line interface](#)
 - [General points](#)
 - [Conclusions](#)
 - [How Ceilidh works, Ceilidh Course Notes, User Guides etc.](#)
 - [References](#)
- [About this document...](#)

Dave Marshall
29/3/1999

Ceilidh Guides

- [General Overview of Ceilidh](#)
- [Student's Guide to CEILIDH](#)
- [Course developer's Guide to CEILIDH](#)
- [Installer's Guide to CEILIDH](#)
- [Question/answer exercises in Ceilidh](#)
- [Teacher's Guide to CEILIDH](#)
- [Tutor's Guide to CEILIDH](#)
- [Ceilidh System Changes](#)

Dave.Marshall@cm.cf.ac.uk
Wed Sep 14 10:06:31 BST 1994

Ceilidh Notes

- [Ceilidh Notes 1](#) --- Introduction
- [Ceilidh Notes 2](#) --- Basics
- [Ceilidh Notes 3](#) --- If and Switch
- [Ceilidh Notes 4](#) --- Loops
- [Ceilidh Notes 5](#) --- Array and structures
- [Ceilidh Notes 6](#) --- Pointers
- [Ceilidh Notes 7](#) --- Functions
- [Ceilidh Notes 8](#) --- File I/O
- [Ceilidh Notes 9](#) --- Process management
- [Ceilidh Notes 10](#) --- Questionnaire

Dave.Marshall@cm.cf.ac.uk
Wed Sep 14 10:06:31 BST 1994

Ceilidh Papers

- [General Overview of Ceilidh](#)
- [AUTOMATIC PROGRAM ASSESSMENT SYSTEM](#)
- [The command line interface ceilidh](#)
- [Courseware to support the teaching of programming](#)
- [The Design Document for Ceilidh](#)
- [The "oracle" program](#)
- [Policy on Plagiarism and Late Handing in of Work](#)
- [Question/answer exercises in Ceilidh](#)
- [Ceilidh Statistics Package](#)
- [Ceilidh System Changes](#)

Dave.Marshall@cm.cf.ac.uk
Wed Sep 14 10:06:31 BST 1994



Next: [Books](#) **Up:** [Programming in C](#) **Previous:** [Programming in C](#)

Copyright

All notes here are copyrighted. All copying *etc.* is not permitted.

© David Marshall 1994

Dave.Marshall@cm.cf.ac.uk
Wed Sep 14 10:06:31 BST 1994



Next: [Header files](#) Up: [Programming in C](#) Previous: [Exercises](#)

Writing Larger Programs



This Chapter deals with theoretical and practical aspects that need to be considered when writing larger programs.

When writing large programs we should divide programs up into modules. These would be separate source files. `main()` would be in one file, `main.c` say, the others will contain functions.

We can create our own library of functions by writing a *suite* of subroutines in one (or more) modules. In fact modules can be shared amongst many programs by simply including the modules at compilation as we will see shortly..

There are many advantages to this approach:

- the modules will naturally divide into common groups of functions.
- we can compile each module separately and link in compiled modules (more on this later).
- UNIX utilities such as **make** help us maintain large systems (see later).

-
- [Header files](#)
 - [External variables and functions](#)
 - [Scope of externals](#)
 - [The Make Utility](#)
 - [Make Programming](#)
 - [Creating a makefile](#)
 - [Make macros](#)
 - [Running Make](#)
-

Dave.Marshall@cm.cf.ac.uk
Wed Sep 14 10:06:31 BST 1994



Next: [Advantages of using UNIX with C](#) Up: [Programming in C](#) Previous: [Running Make](#)

UNIX and C

There is a very close link between C and most operating systems that run our C programs. Almost the whole of the UNIX operating system is written in C. This Chapter will look at how C and UNIX interface together.

We have to use UNIX to maintain our file space, edit, compile and run programs *etc.* (Appendix

However UNIX is much more useful than this:

- [Advantages of using UNIX with C](#)
 - [Using UNIX System Calls and Library Functions](#)
 - [File and Directory Manipulation](#)
 - [Directory handling functions](#)
 - [File Manipulation Routines](#)
 - [errno](#)
 - [Process Control and Management](#)
 - [Running UNIX Commands from C](#)
 - [execl\(\)](#)
 - [fork\(\)](#)
 - [wait\(\)](#)
 - [exit\(\)](#)
 - [Piping in a C program](#)
 - [popen\(\) - Formatted Piping](#)
 - [pipe\(\) - Low level Piping](#)
 - [Interrupts and Signals](#)
 - [Sending Signals - kill\(\)](#)
 - [Receiving signals - signal\(\)](#)
 - [Times Up!!](#)
 - [Exercises](#)
-

Dave.Marshall@cm.cf.ac.uk
Wed Sep 14 10:06:31 BST 1994



Next: [Why Use CEILIDH ?](#) **Up:** [Programming in C](#) **Previous:** [Exercises](#)

Ceilidh - On Line C Tutoring System



-
- [Why Use CEILIDH ?](#)
 - [Introduction](#)
 - [Using Ceilidh as a Student](#)
 - [The course and unit level](#)
 - [The exercise level](#)
 - [Interpreted language exercises](#)
 - [Question/answer exercises](#)
 - [The command line interface \(TEXT CEILIDH ONLY\)](#)
 - [Advantages of the command line interface](#)
 - [General points](#)
 - [Conclusions](#)
 - [How Ceilidh works, Ceilidh Course Notes, User Guides etc.](#)
 - [References](#)
-

Dave.Marshall@cm.cf.ac.uk
Wed Sep 14 10:06:31 BST 1994



Next: [Compiler Options](#) **Up:** [Programming in C](#) **Previous:** [References](#)

Common C Compiler Options



Here we list common C Compiler options. They can be tagged on to the compiler directive. Some take an additional argument.

E.g.

```
c89 -c -o prog prog.c
```

The `-o` option needs an argument, `-c` does not.

-
- [Compiler Options](#)
-

Dave.Marshall@cm.cf.ac.uk
Wed Sep 14 10:06:31 BST 1994



Next: [Buffer Manipulation](#) **Up:** [Programming in C](#) **Previous:** [Compiler Options](#)

C Standard Library Functions



Listed below are nearly all the ANSI C standard library functions.

The header file where related definitions are stored are given. These may vary on some systems so check local reference manuals.

A brief description is include with all parameter types. More info can be obtained from online man calls or reference manuals.

- [Buffer Manipulation](#)
 - [Character Classification and Conversion](#)
 - [Data Conversion](#)
 - [Directory Manipulation](#)
 - [File Manipulation](#)
 - [Input and Output](#)
 - [Stream I/O](#)
 - [Low level I/O](#)
 - [Mathematics](#)
 - [Memory Allocation](#)
 - [Process Control](#)
 - [Searching and Sorting](#)
 - [String Manipulation](#)
 - [Time](#)
-

Dave.Marshall@cm.cf.ac.uk
Wed Sep 14 10:06:31 BST 1994



Next: [hello.c](#) Up: [Programming in C](#) Previous: [Time](#)

Program Listings



Here we give complete program listings that illustrate points in the course.

- [hello.c](#)
- [printf.c](#)
- [swap.c](#)
- [args.c](#)
- [arg.c](#)
- [average.c](#)
- [cio.c](#)
- [factorial](#)
- [power.c](#)
- [ptr_arr.c](#)
- [Modular Example](#)
 - [main.c](#)
 - [WriteMyString.c](#)
 - [header.h](#)
 - [Makefile](#)
- [static.c](#)
- [malloc.c](#)
- [queue.c](#)
- [bitcount.c](#)
- [lowio.c](#)
- [print.c](#)
- [cdir.c](#)
- [list.c](#)
- [list_c.c](#)
- [fork_eg.c](#)
- [fork.c](#)
- [signal.c](#)
- [sig_talk.c](#)
- [Piping](#)
 - [plot.c](#)
 - [plotter.c](#)
 - [externals.h](#)
- [random.c](#)
- [time.c](#)
- [timer.c](#)

Wed Sep 14 10:06:31 BST 1994



Next: [About this document ...](#) **Up:** [Programming in C](#) **Previous:** [timer.c](#)

Using Dec Workstations and Unix



Dave.Marshall@cm.cf.ac.uk
Wed Sep 14 10:06:31 BST 1994



Up: [Programming in C](#) **Previous:** [Using Dec Workstations and Unix](#)

About this document ...

This document was generated using the [LaTeX₂HTML](#) translator Version 0.5.3 (Wed Jan 26 1994) Copyright © 1993, [Nikos Drakos](#), Computer Based Learning Unit, University of Leeds.

The command line arguments were:

latex2html CE.tex.

The translation was initiated by Dave.Marshall@cm.cf.ac.uk on Wed Sep 14 10:06:31 BST 1994

Dave.Marshall@cm.cf.ac.uk
Wed Sep 14 10:06:31 BST 1994



Next: [The Minimum C Program](#) **Up:** [Programming in C](#) **Previous:** [Exercises - Using X Windows](#)
[Editing and](#)

The C Program

In this Chapter we will look at the basic elements of C programming. We will firstly look at the basic C program structure and then how to compile and run programs.

- [The Minimum C Program](#)
 - [A more useful minimal C program](#)
 - [Creating, Compiling and Running Your Program](#)
 - [Creating the program](#)
 - [Compilation](#)
 - [Running the program](#)
 - [The C Compilation Model](#)
 - [The Preprocessor](#)
 - [C Compiler](#)
 - [Assembler](#)
 - [Link Editor](#)
 - [Using Libraries](#)
 - [Characteristics of C](#)
 - [History of C](#)
 - [Exercises](#)
-

Dave.Marshall@cm.cf.ac.uk
Wed Sep 14 10:06:31 BST 1994



Next: [About This Course](#) **Up:** [Programming in C](#) **Previous:** [Copyright](#)

Books

- Brian W Kernighan and Dennis M Ritchie, The C Programming Language 2nd Ed, Prentice-Hall, 1988.
- Kenneth E. Martin, C Through UNIX, WCB Group, 1992.
- Keith Tizzard, C for Professional Programmers, Ellis Horwood, 1986.
- Chris Carter, Structured Programming into ANSI C, Pittman, 1991.
- C. Charlton, P. Leng and Janet Little, A Course on C, McGraw Hill, 1992.
- G. Bronson and S. Menconi, A First Book on C: Fundamentals of C Programming (2nd ed.), West Publishing, 1991.
- Any book on ANSI C will probably do, some UNIX may help.

Dave.Marshall@cm.cf.ac.uk
Wed Sep 14 10:06:31 BST 1994



Next: [Course Material and On-line facilities](#) **Up:** [Programming in C](#) **Previous:** [Books](#)

About This Course

This course aims to teach a sound basis of C PROGRAMMING.

We will start with basic ideas and hopefully extend these to include some advanced features of C. We will particularly look at how C uses pointers, references low level memory and bytes and how it interfaces with the operating system.

-
- [Course Material and On-line facilities](#)
 - [Exercises - Using X Windows, Editing and UNIX Basics](#)
-

Dave.Marshall@cm.cf.ac.uk
Wed Sep 14 10:06:31 BST 1994

.
.
.
.
.
.
.
.
.
.
.

Dave Marshall
1/5/1999

Contents

- [Contents](#)
- [The Common Desktop Environment](#)
 - [The front panel](#)
 - [The file manager](#)
 - [The application manager](#)
 - [The session manager](#)
 - [Other CDE desktop tools](#)
 - [Application development tools](#)
 - [Application integration](#)
 - [Windows and the Window Manager](#)
 - [The Root Menu](#)
 - [Exercises](#)
- [C/C++ Program Compilation](#)
 - [Creating, Compiling and Running Your Program](#)
 - [Creating the program](#)
 - [Compilation](#)
 - [Running the program](#)
 - [The C Compilation Model](#)
 - [The Preprocessor](#)
 - [C Compiler](#)
 - [Assembler](#)
 - [Link Editor](#)
 - [Some Useful Compiler Options](#)
 - [Using Libraries](#)
 - [UNIX Library Functions](#)
 - [Finding Information about Library Functions](#)
 - [Lint -- A C program verifier](#)
 - [Exercises](#)
- [C Basics](#)
 - [History of C](#)
 - [Characteristics of C](#)
 - [C Program Structure](#)
 - [Variables](#)
 - [Defining Global Variables](#)
 - [Printing Out and Inputting Variables](#)
 - [Constants](#)
 - [Arithmetic Operations](#)
 - [Comparison Operators](#)
 - [Logical Operators](#)
 - [Order of Precedence](#)
 - [Exercises](#)
- [Conditionals](#)
 - [The `if` statement](#)
 - [The `?` operator](#)
 - [The `switch` statement](#)

- [Exercises](#)
- [Looping and Iteration](#)
 - [The `for` statement](#)
 - [The `while` statement](#)
 - [The `do-while` statement](#)
 - [break and continue](#)
 - [Exercises](#)
- [Arrays and Strings](#)
 - [Single and Multi-dimensional Arrays](#)
 - [Strings](#)
 - [Exercises](#)
- [Functions](#)
 - [void functions](#)
 - [Functions and Arrays](#)
 - [Function Prototyping](#)
 - [Exercises](#)
- [Further Data Types](#)
 - [Structures](#)
 - [Defining New Data Types](#)
 - [Unions](#)
 - [Coercion or Type-Casting](#)
 - [Enumerated Types](#)
 - [Static Variables](#)
 - [Exercises](#)
- [Pointers](#)
 - [What is a Pointer?](#)
 - [Pointer and Functions](#)
 - [Pointers and Arrays](#)
 - [Arrays of Pointers](#)
 - [Multidimensional arrays and pointers](#)
 - [Static Initialisation of Pointer Arrays](#)
 - [Pointers and Structures](#)
 - [Common Pointer Pitfalls](#)
 - [Not assigning a pointer to memory address before using it](#)
 - [Illegal indirection](#)
 - [Exercise](#)
- [Dynamic Memory Allocation and Dynamic Structures](#)
 - [Malloc, Sizeof, and Free](#)
 - [Calloc and Realloc](#)
 - [Linked Lists](#)
 - [Full Program: `queue.c`](#)
 - [Exercises](#)
- [Advanced Pointer Topics](#)
 - [Pointers to Pointers](#)
 - [Command line input](#)
 - [Pointers to a Function](#)
 - [Exercises](#)
- [Low Level Operators and Bit Fields](#)
 - [Bitwise Operators](#)
 - [Bit Fields](#)

- [Bit Fields: Practical Example](#)
 - [A note of caution: Portability](#)
 - [Exercises](#)
- [The C Preprocessor](#)
 - [#define](#)
 - [#undef](#)
 - [#include](#)
 - [#if -- Conditional inclusion](#)
 - [Preprocessor Compiler Control](#)
 - [Other Preprocessor Commands](#)
 - [Exercises](#)
- [C, UNIX and Standard Libraries](#)
 - [Advantages of using UNIX with C](#)
 - [Using UNIX System Calls and Library Functions](#)
- [Integer Functions, Random Number, String Conversion, Searching and Sorting: <stdlib.h>](#)
 - [Arithmetic Functions](#)
 - [Random Numbers](#)
 - [String Conversion](#)
 - [Searching and Sorting](#)
 - [Exercises](#)
- [Mathematics: <math.h>](#)
 - [Math Functions](#)
 - [Math Constants](#)
- [Input and Output \(I/O\): <stdio.h>](#)
 - [Reporting Errors](#)
 - [perror\(\)](#)
 - [errno](#)
 - [exit\(\)](#)
 - [Streams](#)
 - [Predefined Streams](#)
 - [Redirection](#)
 - [Basic I/O](#)
 - [Formatted I/O](#)
 - [Printf](#)
 - [scanf](#)
 - [Files](#)
 - [Reading and writing files](#)
 - [sprintf and sscanf](#)
 - [Stream Status Enquiries](#)
 - [Low Level I/O](#)
 - [Exercises](#)
- [String Handling: <string.h>](#)
 - [Basic String Handling Functions](#)
 - [String Searching](#)
 - [Character conversions and testing: <ctype.h>](#)
 - [Memory Operations: <memory.h>](#)
 - [Exercises](#)
- [File Access and Directory System Calls](#)
 - [Directory handling functions: <unistd.h>](#)

- [Scanning and Sorting Directories: <sys/types.h>, <sys/dir.h>](#)
- [File Manipulation Routines: unistd.h, sys/types.h, sys/stat.h](#)
 - [File Access](#)
 - [errno](#)
 - [File Status](#)
 - [File Manipulation:stdio.h, unistd.h](#)
 - [Creating Temporary Files:<stdio.h>](#)
 - [Exercises](#)
- [Time Functions](#)
 - [Basic time functions](#)
 - [Example time applications](#)
 - [Example 1: Time \(in seconds\) to perform some computation](#)
 - [Example 2: Set a random number seed](#)
 - [Exercises](#)
- [Process Control: <stdlib.h>, <unistd.h>](#)
 - [Running UNIX Commands from C](#)
 - [execl\(\)](#)
 - [fork\(\)](#)
 - [wait\(\)](#)
 - [exit\(\)](#)
 - [Exercises](#)
- [Interprocess Communication \(IPC\), Pipes](#)
 - [Piping in a C program: <stdio.h>](#)
 - [popen\(\) -- Formatted Piping](#)
 - [pipe\(\) -- Low level Piping](#)
 - [Exercises](#)
- [IPC:Interrupts and Signals: <signal.h>](#)
 - [Sending Signals -- kill\(\), raise\(\)](#)
 - [Signal Handling -- signal\(\)](#)
 - [sig_talk.c -- complete example program](#)
 - [Other signal functions](#)
- [IPC:Message Queues:<sys/msg.h>](#)
 - [Initialising the Message Queue](#)
 - [IPC Functions, Key Arguments, and Creation Flags: <sys/ipc.h>](#)
 - [Controlling message queues](#)
 - [Sending and Receiving Messages](#)
 - [POSIX Messages: <mqueue.h>](#)
 - [Example: Sending messages between two processes](#)
 - [message_send.c -- creating and sending to a simple message queue](#)
 - [message_rec.c -- receiving the above message](#)
 - [Some further example message queue programs](#)
 - [msgget.c: Simple Program to illustrate msgget\(\).](#)
 - [msgctl.c Sample Program to Illustrate msgctl\(\).](#)
 - [msgop.c: Sample Program to Illustrate msgsnd\(\) and msgrcv\(\).](#)
 - [Exercises](#)
- [IPC:Semaphores](#)

- [Initializing a Semaphore Set](#)
- [Controlling Semaphores](#)
- [Semaphore Operations](#)
- [POSIX Semaphores: <semaphore.h>](#)
- [semaphore.c: Illustration of simple semaphore passing](#)
- [Some further example semaphore programs](#)
 - [semget.c: Illustrate the semget\(\) function](#)
 - [semctl.c: Illustrate the semctl\(\) function](#)
 - [semop\(\) Sample Program to Illustrate semop\(\)](#)
- [Exercises](#)
- [IPC:Shared Memory](#)
 - [Accessing a Shared Memory Segment](#)
 - [Controlling a Shared Memory Segment](#)
 - [Attaching and Detaching a Shared Memory Segment](#)
 - [Example two processes communicating via shared memory: shm_server.c, shm_client.c](#)
 - [shm_server.c](#)
 - [shm_client.c](#)
 - [POSIX Shared Memory](#)
 - [Mapped memory](#)
 - [Address Spaces and Mapping](#)
 - [Coherence](#)
 - [Creating and Using Mappings](#)
 - [Other Memory Control Functions](#)
 - [Some further example shared memory programs](#)
 - [shmget.c:Sample Program to Illustrate shmget\(\)](#)
 - [shmctl.c: Sample Program to Illustrate shmctl\(\)](#)
 - [shmop.c: Sample Program to Illustrate shmop\(\) and shmdt\(\)](#)
 - [Exercises](#)
- [IPC:Sockets](#)
 - [Socket Creation and Naming](#)
 - [Connecting Stream Sockets](#)
 - [Stream Data Transfer and Closing](#)
 - [Datagram sockets](#)
 - [Socket Options](#)
 - [Example Socket Programs:socket_server.c,socket_client](#)
 - [socket_server.c](#)
 - [socket_client.c](#)
 - [Exercises](#)
- [Threads: Basic Theory and Libraries](#)
 - [Processes and Threads](#)
 - [Benefits of Threads vs Processes](#)
 - [Multithreading vs. Single threading](#)
 - [Some Example applications of threads](#)
 - [Thread Levels](#)
 - [User-Level Threads \(ULT\)](#)
 - [Kernel-Level Threads \(KLT\)](#)
 - [Combined ULT/KLT Approaches](#)
 - [Threads libraries](#)
 - [The POSIX Threads Library:libpthread, <pthread.h>](#)

- [Creating a \(Default\) Thread](#)
- [Wait for Thread Termination](#)
- [A Simple Threads Example](#)
- [Detaching a Thread](#)
- [Create a Key for Thread-Specific Data](#)
- [Delete the Thread-Specific Data Key](#)
- [Set the Thread-Specific Data Key](#)
- [Get the Thread-Specific Data Key](#)
- [Global and Private Thread-Specific Data Example](#)
- [Getting the Thread Identifiers](#)
- [Comparing Thread IDs](#)
- [Initializing Threads](#)
- [Yield Thread Execution](#)
- [Set the Thread Priority](#)
- [Get the Thread Priority](#)
- [Send a Signal to a Thread](#)
- [Access the Signal Mask of the Calling Thread](#)
- [Terminate a Thread](#)
- [Solaris Threads: <thread.h>](#)
 - [Unique Solaris Threads Functions](#)
 - [Suspend Thread Execution](#)
 - [Continue a Suspended Thread](#)
 - [Set Thread Concurrency Level](#)
 - [Readers/Writer Locks](#)
 - [Readers/Writer Lock Example](#)
 - [Similar Solaris Threads Functions](#)
 - [Create a Thread](#)
 - [Get the Thread Identifier](#)
 - [Yield Thread Execution](#)
 - [Signals and Solaris Threads](#)
 - [Terminating a Thread](#)
 - [Creating a Thread-Specific Data Key](#)
 - [Example Use of Thread Specific Data: Rethinking Global Variables](#)
- [Compiling a Multithreaded Application](#)
 - [Preparing for Compilation](#)
 - [Debugging a Multithreaded Program](#)
- [Further Threads Programming: Thread Attributes \(POSIX\)](#)
 - [Attributes](#)
 - [Initializing Thread Attributes](#)
 - [Destroying Thread Attributes](#)
 - [Thread's Detach State](#)
 - [Thread's Set Scope](#)
 - [Thread Scheduling Policy](#)
 - [Thread Inherited Scheduling Policy](#)
 - [Set Scheduling Parameters](#)
 - [Thread Stack Size](#)
 - [Building Your Own Thread Stack](#)
- [Further Threads Programming: Synchronization](#)
 - [Mutual Exclusion Locks](#)

- [Initializing a Mutex Attribute Object](#)
- [Destroying a Mutex Attribute Object](#)
- [The Scope of a Mutex](#)
- [Initializing a Mutex](#)
- [Locking a Mutex](#)
 - [Lock with a Nonblocking Mutex](#)
- [Destroying a Mutex](#)
- [Mutex Lock Code Examples](#)
 - [Mutex Lock Example](#)
 - [Using Locking Hierarchies: Avoiding Deadlock](#)
- [Nested Locking with a Singly Linked List](#)
- [Solaris Mutex Locks](#)
- [Condition Variable Attributes](#)
 - [Initializing a Condition Variable Attribute](#)
 - [Destroying a Condition Variable Attribute](#)
 - [The Scope of a Condition Variable](#)
 - [Initializing a Condition Variable](#)
 - [Block on a Condition Variable](#)
 - [Destroying a Condition Variable State](#)
 - [Solaris Condition Variables](#)
- [Threads and Semaphores](#)
 - [POSIX Semaphores](#)
 - [Basic Solaris Semaphore Functions](#)
- [Thread programming examples](#)
 - [Using `thr_create\(\)` and `thr_join\(\)`](#)
 - [Arrays](#)
 - [Deadlock](#)
 - [Signal Handler](#)
 - [Interprocess Synchronization](#)
 - [The Producer / Consumer Problem](#)
 - [A Socket Server](#)
 - [Using Many Threads](#)
 - [Real-time Thread Example](#)
 - [POSIX Cancellation](#)
 - [Software Race Condition](#)
 - [Tgrep: Threaded version of UNIX `grep`](#)
 - [Multithreaded Quicksort](#)
- [Remote Procedure Calls \(RPC\)](#)
 - [What Is RPC](#)
 - [How RPC Works](#)
 - [RPC Application Development](#)
 - [Defining the Protocol](#)
 - [Defining Client and Server Application Code](#)
 - [Compiling and running the application](#)
 - [Overview of Interface Routines](#)
 - [Simplified Level Routine Function](#)
 - [Top Level Routines](#)
 - [Intermediate Level Routines](#)
 - [Expert Level Routines](#)
 - [Bottom Level Routines](#)

- [The Programmer's Interface to RPC](#)
 - [Simplified Interface](#)
 - [Passing Arbitrary Data Types](#)
 - [Developing High Level RPC Applications](#)
 - [Defining the protocol](#)
 - [Sharing the data](#)
 - [The Server Side](#)
 - [The Client Side](#)
- [Exercise](#)
- [Protocol Compiling and Lower Level RPC Programming](#)
 - [What is `rpcgen`](#)
 - [An `rpcgen` Tutorial](#)
 - [Converting Local Procedures to Remote Procedures](#)
 - [Passing Complex Data Structures](#)
 - [Preprocessing Directives](#)
 - [cpp Directives](#)
 - [Compile-Time Flags](#)
 - [Client and Server Templates](#)
 - [Example `rpcgen` compile options/templates](#)
 - [Recommended Reading](#)
 - [Exercises](#)
- [Writing Larger Programs](#)
 - [Header files](#)
 - [External variables and functions](#)
 - [Scope of externals](#)
 - [Advantages of Using Several Files](#)
 - [How to Divide a Program between Several Files](#)
 - [Organisation of Data in each File](#)
 - [The Make Utility](#)
 - [Make Programming](#)
 - [Creating a makefile](#)
 - [Make macros](#)
 - [Running Make](#)

Dave Marshall

1/5/1999

Subsections

- [What is a Pointer?](#)
 - [Pointer and Functions](#)
 - [Pointers and Arrays](#)
 - [Arrays of Pointers](#)
 - [Multidimensional arrays and pointers](#)
 - [Static Initialisation of Pointer Arrays](#)
 - [Pointers and Structures](#)
 - [Common Pointer Pitfalls](#)
 - [Not assigning a pointer to memory address before using it](#)
 - [Illegal indirection](#)
 - [Exercise](#)
-

Pointers

Pointers are a fundamental part of C. If you cannot use pointers properly then you have basically lost all the power and flexibility that C allows. The secret to C is in its use of pointers.

C uses *pointers* a lot. **Why?:**

- It is the only way to express some computations.
- It produces compact and efficient code.
- It provides a very powerful tool.

C uses pointers explicitly with:

- Arrays,
- Structures,
- Functions.

NOTE: Pointers are perhaps the most difficult part of C to understand. C's implementation is slightly different **DIFFERENT** from other languages.

What is a Pointer?

A pointer is a variable which contains the address in memory of another variable. We can have a pointer to any variable type.

The *unary* or *monadic* operator **&** gives the "address of a variable".

The *indirection* or dereference operator ***** gives the "contents of an object *pointed to* by a pointer".

To declare a pointer to a variable do:

```
int *pointer;
```

NOTE: We must associate a pointer to a particular type: You can't assign the address of a **short int** to a **long int**, for instance.

Consider the effect of the following code:

```
int x = 1, y = 2;
int *ip;

ip = &x;

y = *ip;

x = ip;

*ip = 3;
```

It is worth considering what is going on at the *machine level* in memory to fully understand how pointer work. Consider Fig. 9.1. Assume for the sake of this discussion that variable `x` resides at memory location 100, `y` at 200 and `ip` at 1000. **Note** A pointer is a variable and thus its values need to be stored somewhere. It is the nature of the pointers value that is *new*.

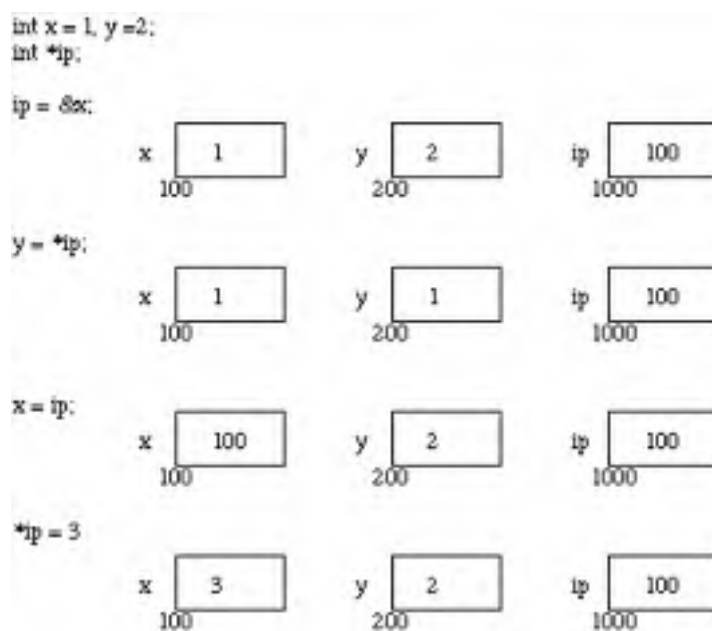

Fig. 9.1 Pointer, Variables and Memory Now the assignments `x = 1` and `y = 2` obviously load these values into the variables. `ip` is declared to be a **pointer to an integer** and is assigned to the address of `x` (`&x`). So `ip` gets loaded with the value 100.

Next `y` gets assigned to the **contents of** `ip`. In this example `ip` currently **points** to memory location 100 -- the location of `x`. So `y` gets assigned to the values of `x` -- which is 1.

We have already seen that C is not too fussy about assigning values of different type. Thus it is perfectly **legal** (although not all that common) to assign the current value of `ip` to `x`. The value of `ip` at this instant is 100.

Finally we can assign a value to the contents of a pointer (`*ip`).

IMPORTANT: When a pointer is declared it does not point anywhere. You must set it to point somewhere before you use it.

So ...

```
int *ip;

*ip = 100;
```

will generate an error (program crash!!).

The correct use is:

```
int *ip;
int x;

ip = &x;
*ip = 100;
```

We can do integer arithmetic on a pointer:

```
float *flp, *flq;

*flp = *flp + 10;

++*flp;

(*flp)++;

flq = flp;
```

NOTE: A pointer to any variable type is an address in memory -- which is an integer address. A pointer is definitely NOT an integer.

The reason we associate a pointer to a data type is so that it knows how many bytes the data is stored in. When we increment a pointer we increase the pointer by one ``block'' memory.

So for a character pointer `++ch_ptr` adds 1 byte to the address.

For an integer or float `++ip` or `++flp` adds 4 bytes to the address.

Consider a float variable (`fl`) and a pointer to a float (`flp`) as shown in Fig. 9.2.

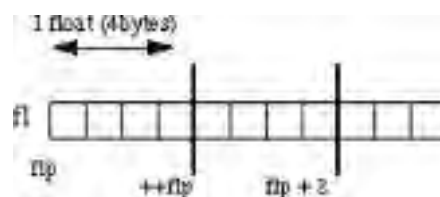

Fig. 9.2 Pointer Arithmetic Assume that flp points to fl then if we increment the pointer (++flp) it moves to the position shown 4 bytes on. If on the other hand we added 2 to the pointer then it moves 2 **float positions i.e 8 bytes** as shown in the Figure.

Pointer and Functions

Let us now examine the close relationship between pointers and C's other major parts. We will start with functions.

When C passes arguments to functions it passes them by value.

There are many cases when we may want to alter a passed argument in the function and receive the new value back once to function has finished. Other languages do this (*e.g.* var parameters in PASCAL). C uses pointers explicitly to do this. Other languages mask the fact that pointers also underpin the implementation of this.

The best way to study this is to look at an example where we must be able to receive changed parameters.

Let us try and write a function to swap variables around?

The usual function *call*:

```
swap(a, b)  WON'T WORK.
```

Pointers provide the solution: ***Pass the address of the variables to the functions and access address of function.***

Thus our function call in our program would look like this:

```
swap(&a, &b)
```

The Code to swap is fairly straightforward:

```
void swap(int *px, int *py)
{
    int temp;
    temp = *px;
    /* contents of pointer */
    *px = *py;
    *py = temp;
}
```

We can return pointer from functions. A common example is when passing back structures. *e.g.*:

```
typedef struct {float x,y,z;} COORD;

main()

{  COORD pl, *coord_fn();
  /* declare fn to return ptr of
   COORD type */

  ....
  pl = *coord_fn(...);
  /* assign contents of address returned */
  ....
}

COORD *coord_fn(...)

{  COORD p;

  .....
  p = .....;
  /* assign structure values */

  return &p;
  /* return address of p */
}
```

Here we return a pointer whose contents are immediately **unwrapped** into a variable. We must do this straight away as the variable we pointed to was local to a function that has now finished. This means that the address space is free and can be overwritten. It will not have been overwritten straight after the function has quit though so this is perfectly safe.

Pointers and Arrays

Pointers and arrays are very closely linked in C.

Hint: think of array elements arranged in consecutive memory locations.

Consider the following:

```
int a[10], x;
int *pa;

pa = &a[0]; /* pa pointer to address of a[0] */

x = *pa;
/* x = contents of pa (a[0] in this case) */
```

The diagram shows a horizontal row of 10 empty boxes representing array elements. Above the first box is the number '0' and above the last box is the number '9'. Below the first box is the label 'pa' and below the last box is the label 'pa+i'. Below the first two boxes is the label 'pa++pa'.

Fig. 9.3 Arrays and Pointers

To get somewhere in the array (Fig. 9.3) using a pointer we could do:

$pa + i \equiv a[i]$

WARNING: There is no bound checking of arrays and pointers so you can easily go beyond array memory and overwrite other things.

C however is much more subtle in its link between arrays and pointers.

For example we can just type

```
pa = a;
```

instead of

```
pa = &a[0]
```

and

```
a[i] can be written as *(a + i).
```

i.e. $\&a[i] \equiv a + i$.

We also express pointer addressing like this:

```
pa[i]  $\equiv$  *(pa + i).
```

However pointers and arrays are different:

- A pointer is a variable. We can do
pa = a and pa++.
- An Array is not a variable. a = pa and a++ ARE ILLEGAL.

This stuff is very important. Make sure you understand it. We will see a lot more of this.

We can now understand how arrays are passed to functions.

When an array is passed to a function what is actually passed is its initial elements location in memory.

So:

```
strlen(s)  $\equiv$  strlen(&s[0])
```

This is why we declare the function:

```
int strlen(char s[]);
```

An equivalent declaration is : `int strlen(char *s);`

since `char s[] \equiv char *s`.

`strlen()` is a **standard library** function (Chapter 18) that returns the length of a string. Let's look at how we may write a function:

```
int strlen(char *s)
{ char *p = s;

  while (*p != '\0');

  p++;
  return p-s;
}
```

Now lets write a function to copy a string to another string.
strcpy() is a standard library function that does this.

```
void strcpy(char *s, char *t)
{ while ( (*s++ = *t++) != '\0'); }
```

This uses pointers and assignment by value.

Very Neat!!

NOTE: Uses of Null statements with while.

Arrays of Pointers

We can have arrays of pointers since pointers are variables.

Example use:

Sort lines of text of different length.

NOTE: Text can't be moved or compared in a single operation.

Arrays of Pointers are a data representation that will cope efficiently and conveniently with variable length text lines.

How can we do this?:

- Store lines end-to-end in one big `char` array (Fig. 9.4). `\n` will delimit lines.
- Store pointers in a different array where each pointer points to 1st char of each new line.
- Compare two lines using `strcmp()` standard library function.
- If 2 lines are out of order -- swap pointer in pointer array (*not text*).

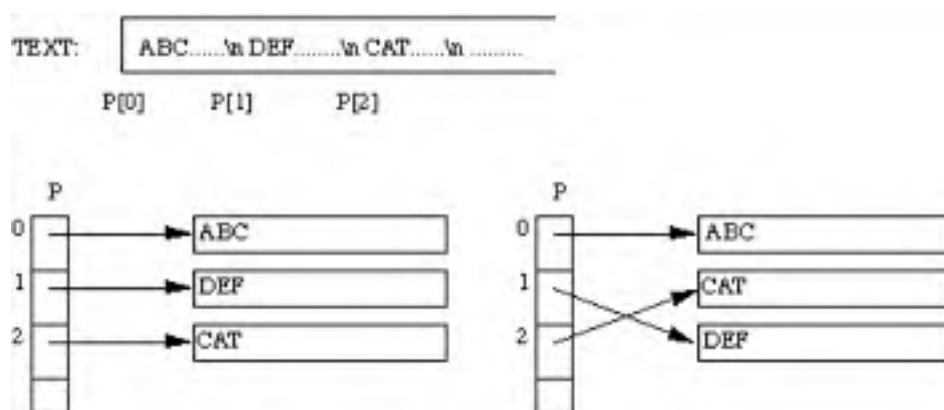

Fig. 9.4 Arrays of Pointers (String Sorting Example)

This eliminates:

- complicated storage management.
- high overheads of moving lines.

Multidimensional arrays and pointers

We should think of multidimensional arrays in a different way in C:

A 2D array is really a 1D array, each of whose elements is itself an array

Hence

`a[n][m]` notation.

Array elements are stored row by row.

When we pass a 2D array to a function we must specify the number of columns -- the number of rows is irrelevant.

The reason for this is pointers again. C needs to know how many columns in order that it can jump from row to row in memory.

Consider `int a[5][35]` to be passed in a function:

We can do:

```
f(int a[][35]) {.....}
```

or even:

```
f(int (*a)[35]) {.....}
```

We need parenthesis `(*a)` since `[]` have a higher precedence than `*`

So:

```
int (*a)[35]; declares a pointer to an array of 35 ints.
```

```
int *a[35]; declares an array of 35 pointers to ints.
```

Now lets look at the (subtle) difference between pointers and arrays. Strings are a common application of this.

Consider:

```
char *name[10];
```

```
char Aname[10][20];
```

We can legally do `name[3][4]` and `Aname[3][4]` in C.

However

- `Aname` is a true 200 element 2D char array.
- access elements via
 $20 * \text{row} + \text{col} + \text{base_address}$
in memory.
- `name` has 10 pointer elements.

NOTE: If each pointer in `name` is set to point to a 20 element array then and only then will 200 chars be set aside (+ 10 elements).

The advantage of the latter is that each pointer can point to arrays be of different length.

Consider:

```
char *name[] = { ``no month'', ``jan'',  
``feb'', ... };  
char Aname[][15] = { ``no month'', ``jan'',  
``feb'', ... };
```

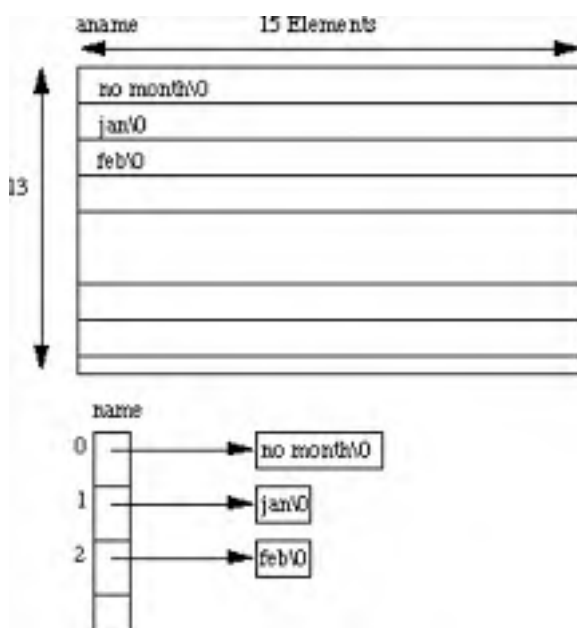

Fig. 2D Arrays and Arrays of Pointers

Static Initialisation of Pointer Arrays

Initialisation of arrays of pointers is an ideal application for an internal static array.

```
some_fn()
{ static char *months = { ``no month'',
  ``jan'', ``feb'',
  ...};
}
```

static reserves a private permanent bit of memory.

Pointers and Structures

These are fairly straight forward and are easily defined. Consider the following:

```
struct COORD {float x,y,z;} pt;
struct COORD *pt_ptr;
```

```
pt_ptr = &pt; /* assigns pointer to pt */
```

the `—>` operator lets us access a member of the structure pointed to by a pointer.*i.e.*:

```
pt_ptr—>x = 1.0;
```

```
pt_ptr—>y = pt_ptr—>y - 3.0;
```

Example: Linked Lists

```
typedef struct { int value;
  ELEMENT *next;
} ELEMENT;
```

```
ELEMENT n1, n2;
```

```
n1.next = &n2;
```

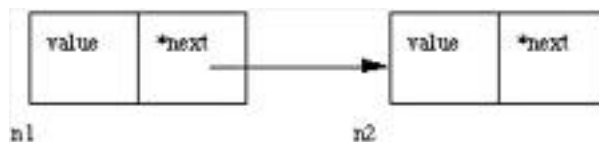

Fig. 1 Linking Two Nodes **NOTE:** We can only declare `next` as a pointer to `ELEMENT`. We cannot have a element of the variable type as this would set up a **recursive** definition which is **NOT ALLOWED**. We are allowed to set a pointer reference since 4 bytes

are set aside for any pointer.

The above code links a node n1 to n2 (Fig. 9.6) we will look at this matter further in the next Chapter.

Common Pointer Pitfalls

Here we will highlight two common mistakes made with pointers.

Not assigning a pointer to memory address before using it

```
int *x;

*x = 100;

we need a physical location say: int y;

x = &y;
*x = 100;
```

This may be hard to spot. **NO COMPILER ERROR**. Also x could some random address at initialisation.

Illegal indirection

Suppose we have a function `malloc()` which tries to allocate memory dynamically (at run time) and returns a pointer to block of memory requested if successful or a `NULL` pointer otherwise.

```
char *malloc() -- a standard library function (see later).
```

Let us have a pointer: `char *p;`

Consider:

```
*p = (char *) malloc(100); /* request 100 bytes of memory */

*p = 'y';
```

There is mistake above. What is it?

No * in

```
*p = (char *) malloc(100);
```

Malloc returns a pointer. Also `p` does not point to any address.

The correct code should be:

```
p = (char *) malloc(100);
```

If code rectified one problem is if no memory is available and `p` is `NULL`.
Therefore we can't do:

```
*p = 'y';
```

A good C program would check for this:

```
p = (char *) malloc(100);  
if ( p == NULL)  
{ printf("`Error: Out of Memory \n'");  
  exit(1);  
}  
*p = 'y';
```

Exercise

Exercise 12453

Write a C program to read through an array of any type using pointers. Write a C program to scan through this array to find a particular value.

Exercise 12454

Write a program to find the number of times that a given word(i.e. a short string) occurs in a sentence (i.e. a long string!).

Read data from standard input. The first line is a single word, which is followed by general text on the second line. Read both up to a newline character, and insert a terminating null before processing.

Typical output should be:

```
The word is "the".  
The sentence is "the cat sat on the mat".  
The word occurs 2 times.
```

Exercise 12455

Write a program that takes three variable (a, b, b) in as separate parameters and rotates the values stored so that value a goes to be, b, to c and c to a.

Dave Marshall
1/5/1999

Subsections

- [Malloc, Sizeof, and Free](#)
 - [Calloc and Realloc](#)
 - [Linked Lists](#)
 - [Full Program: queue.c](#)
 - [Exercises](#)
-

Dynamic Memory Allocation and Dynamic Structures

Dynamic allocation is a pretty unique feature to C (amongst high level languages). It enables us to create data types and structures of any size and length to suit our programs need within the program.

We will look at two common applications of this:

- dynamic arrays
- dynamic data structure *e.g.* linked lists

Malloc, Sizeof, and Free

The Function `malloc` is most commonly used to attempt to ``grab" a continuous portion of memory. It is defined by:

```
void *malloc(size_t number_of_bytes)
```

That is to say it returns a pointer of type `void *` that is the start in memory of the reserved portion of size `number_of_bytes`. If memory cannot be allocated a `NULL` pointer is returned.

Since a `void *` is returned the C standard states that this pointer can be converted to any type. The `size_t` argument type is defined in `stdlib.h` and is an *unsigned type*.

So:

```
char *cp;  
cp = malloc(100);
```

attempts to get 100 bytes and assigns the start address to `cp`.

Also it is usual to use the `sizeof()` function to specify the number of bytes:

```
int *ip;
ip = (int *) malloc(100*sizeof(int));
```

Some C compilers may require to cast the type of conversion. The (int *) means coercion to an integer pointer. Coercion to the correct pointer type is very important to ensure pointer arithmetic is performed correctly. I personally use it as a means of ensuring that I am totally correct in my coding and use cast all the time.

It is good practice to use sizeof() even if you know the actual size you want -- it makes for device independent (portable) code.

sizeof can be used to find the size of any data type, variable or structure. Simply supply one of these as an argument to the function.

SO:

```
int i;
struct COORD {float x,y,z};
typedef struct COORD PT;

sizeof(int), sizeof(i),
sizeof(struct COORD) and
sizeof(PT) are all ACCEPTABLE
```

In the above we can use the link between pointers and arrays to treat the reserved memory like an array. **i.e** we can do things like:

```
ip[0] = 100;
```

or

```
for(i=0;i<100;++i) scanf("%d",ip++);
```

When you have finished using a portion of memory you should always free() it. This allows the memory **freed** to be available again, possibly for further malloc() calls

The function free() takes a pointer as an argument and frees the memory to which the pointer refers.

Calloc and Realloc

There are two additional memory allocation functions, Calloc() and Realloc(). Their prototypes are given below:

```
void *calloc(size_t num_elements, size_t element_size);
```

```
void *realloc( void *ptr, size_t new_size);
```

Malloc does not initialise memory (to **zero**) in any way. If you wish to initialise memory then use calloc. Calloc there is slightly more

computationally expensive but, occasionally, more convenient than malloc. Also note the different syntax between `calloc` and `malloc` in that `calloc` takes the number of desired elements, `num_elements`, and `element_size`, `element_size`, as two individual arguments.

Thus to assign 100 integer elements that are all initially zero you would do:

```
int *ip;
ip = (int *) calloc(100, sizeof(int));
```

Realloc is a function which attempts to change the size of a previous allocated block of memory. The new size can be larger or smaller. If the block is made larger then the old contents remain unchanged and memory is added to the end of the block. If the size is made smaller then the remaining contents are unchanged.

If the original block size cannot be resized then realloc will attempt to assign a new block of memory and will copy the old block contents. Note a new pointer (of different value) will consequently be returned. You **must** use this new value. If new memory cannot be reallocated then realloc returns NULL.

Thus to change the size of memory allocated to the `*ip` pointer above to an array block of 50 integers instead of 100, simply do:

```
ip = (int *) calloc( ip, 50);
```

Linked Lists

Let us now return to our linked list example:

```
typedef struct { int value;
                ELEMENT *next;
} ELEMENT;
```

We can now try to grow the list dynamically:

```
link = (ELEMENT *) malloc(sizeof(ELEMENT));
```

This will allocate memory for a new link.

If we want to deassign memory from a pointer use the `free()` function:

```
free(link)
```

See Example programs (queue.c) below and try exercises for further practice.

Full Program: queue.c

A queue is basically a special case of a linked list where one data element joins the list at the left end and leaves in an ordered fashion at the other end.

The full listing for `queue.c` is as follows:

```
/*          */
/* queue.c          */
/* Demo of dynamic data structures in C          */

#include <stdio.h>

#define FALSE 0
#define NULL 0

typedef struct {
    int    dataitem;
    struct listelement *link;
}         listelement;

void Menu (int *choice);
listelement * AddItem (listelement * listpointer, int data);
listelement * RemoveItem (listelement * listpointer);
void PrintQueue (listelement * listpointer);
void ClearQueue (listelement * listpointer);

main () {
    listelement listmember, *listpointer;
    int    data,
           choice;

    listpointer = NULL;
    do {
Menu (&choice);
switch (choice) {
    case 1:
        printf ("Enter data item value to add ");
        scanf ("%d", &data);
        listpointer = AddItem (listpointer, data);
        break;
    case 2:
        if (listpointer == NULL)
            printf ("Queue empty!\n");
        else
            listpointer = RemoveItem (listpointer);
        break;
    case 3:
        PrintQueue (listpointer);
        break;

    case 4:
        break;

    default:
        printf ("Invalid menu choice - try again\n");
        break;
}
    } while (choice != 4);
    ClearQueue (listpointer);
} /* main */

void Menu (int *choice) {

    char    local;
```

```
printf ("\nEnter\t1 to add item,\n\t2 to remove item\n\n\t3 to print queue\n\t4 to quit\n");
do {
local = getchar ();
if ((isdigit (local) == FALSE) && (local != '\n')) {
printf ("\nyou must enter an integer.\n");
printf ("Enter 1 to add, 2 to remove, 3 to print, 4 to quit\n");
}
} while (isdigit ((unsigned char) local) == FALSE);
*choice = (int) local - '0';
}

listelement * AddItem (listelement * listpointer, int data) {

listelement * lp = listpointer;

if (listpointer != NULL) {
while (listpointer -> link != NULL)
listpointer = listpointer -> link;
listpointer -> link = (struct listelement *) malloc (sizeof (listelement));
listpointer = listpointer -> link;
listpointer -> link = NULL;
listpointer -> dataitem = data;
return lp;
}
else {
listpointer = (struct listelement *) malloc (sizeof (listelement));
listpointer -> link = NULL;
listpointer -> dataitem = data;
return listpointer;
}
}

listelement * RemoveItem (listelement * listpointer) {

listelement * temp;
printf ("Element removed is %d\n", listpointer -> dataitem);
temp = listpointer -> link;
free (listpointer);
return temp;
}

void PrintQueue (listelement * listpointer) {

if (listpointer == NULL)
printf ("queue is empty!\n");
else
while (listpointer != NULL) {
printf ("%d\t", listpointer -> dataitem);
listpointer = listpointer -> link;
}
printf ("\n");
}

void ClearQueue (listelement * listpointer) {

while (listpointer != NULL) {
listpointer = RemoveItem (listpointer);
}
}
```

Exercises

Exercise 12456

Write a program that reads a number that says how many integer numbers are to be stored in an array, creates an array to fit the exact size of the data and then reads in that many numbers into the array.

Exercise 12457

Write a program to implement the linked list as described in the notes above.

Exercise 12458

Write a program to sort a sequence of numbers using a binary tree (Using Pointers). A binary tree is a tree structure with only two (possible) branches from each node (Fig. 10.1). Each branch then represents a false or true decision. To sort numbers simply assign the left branch to take numbers less than the node number and the right branch any other number (greater than or equal to). To obtain a sorted list simply search the tree in a depth first fashion.

EG. SORT 9 11 2 5 3 6 1

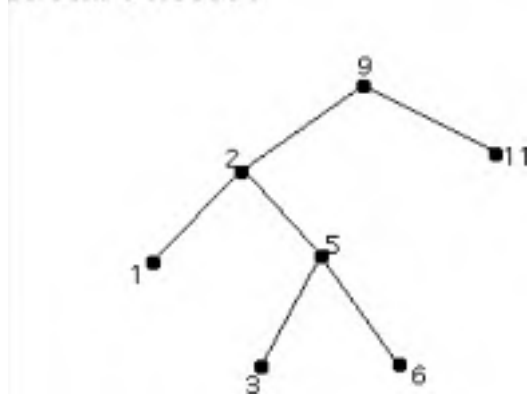

Fig. 10.1 Example of a binary tree sort Your program should: Create a binary tree structure. Create routines for loading the tree appropriately. Read in integer numbers terminated by a zero. Sort numbers into numeric ascending order. Print out the resulting ordered values, printing ten numbers per line as far as possible.

Typical output should be

```
The sorted values are:  
 2  4  6  6  7  9 10 11 11 11  
15 16 17 18 20 20 21 21 23 24  
27 28 29 30
```

Subsections

- [Pointers to Pointers](#)
- [Command line input](#)
- [Pointers to a Function](#)
- [Exercises](#)

Advanced Pointer Topics

We have introduced many applications and techniques that use pointers. We have introduced some advanced pointer issues already. This chapter brings together some topics we have briefly mentioned and others to complete our study C pointers.

In this chapter we will:

- Examine pointers to pointers in more detail.
- See how pointers are used in command line input in C.
- Study pointers to functions

Pointers to Pointers

We introduced the concept of a pointer to a pointer previously. You can have a pointer to a pointer of any type.

Consider the following:

```
char ch; /* a character */
char *pch; /* a pointer to a character */
char **ppch; /* a pointer to a pointer to a character */
```

We can visualise this in Figure 11.1. Here we can see that `**ppch` refers to memory address of `*pch` which refers to the memory address of the variable `ch`. But what does this mean in practice?

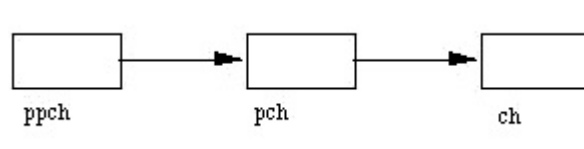

Fig. 11.1 Pointers to pointers Recall that `char *` refers to a (NULL terminated string. So one common and convenient notion is to declare a pointer to a pointer to a string (Figure 11.2)

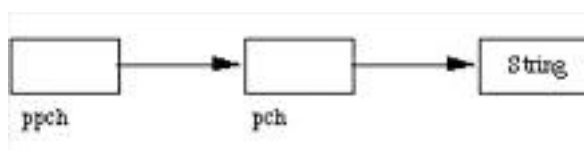

Fig. 11.2 Pointer to String Taking this one stage further we can have several strings being pointed to by the pointer (Figure 11.3)

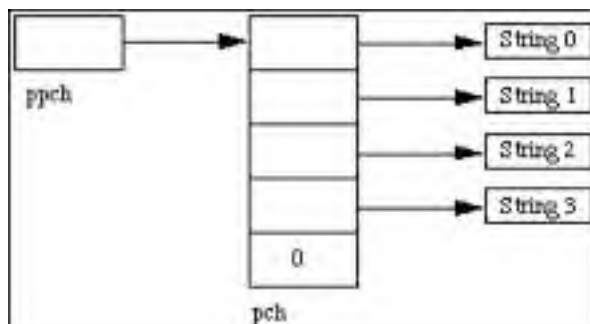

Fig. 11.3 Pointer to Several Strings We can refer to individual strings by `ppch[0]`, `ppch[1]`, Thus this is identical to declaring `char *ppch[]`.

One common occurrence of this type is in C command line argument input which we now consider.

Command line input

C lets read arguments from the command line which can then be used in our programs.

We can type arguments after the program name when we run the program.

We have seen this with the compiler for example

```
c89 -o prog prog.c
```

`c89` is the program, `-o prog prog.c` the arguments.

In order to be able to use such arguments in our code we must define them as follows:

```
main(int argc, char **argv)
```

So our `main` function now has its own arguments. These are the only arguments `main` accepts.

- **argc** is the number of arguments typed -- including the program name.
- **argv** is an array of strings holding each command line argument -- including the program name in the first array element.

A simple program example:

```
#include<stdio.h>

main (int argc, char **argv)
{ /* program to print arguments
  from command line */

  int i;

  printf(``argc = %d\n\n'',argc);

  for (i=0;i<argc;++i)
    printf(``argv[%d]: %s\n'',
           i, argv[i]);
}
```

Assume it is compiled to run it as args.

So if we type:

```
args f1 ``f2'' f3 4 stop!
```

The output would be:

```
argc = 6

argv[0] = args
argv[1] = f1
argv[2] = f2
argv[3] = f3
argv[4] = 4
argv[5] = stop!
```

NOTE: ● argv[0] is program name.
● argc counts program name
● Embedded `` '' are ignored.
Blank spaces delimit end of arguments.
Put blanks in `` '' if needed.

Pointers to a Function

Pointer to a function are perhaps on of the more confusing uses of pointers in C. Pointers to functions are not as common as other pointer uses. However, one common use is in a passing pointers to a function as a parameter in a function call. (Yes this is getting confusing, hold on to your hats for a moment).

This is especially useful when alternative functions maybe used to perform similar tasks on data. You can pass the data and the function to be used to some *control* function for instance. As we will see shortly the C standard library provided some basic sorting (`qsort`) and searching (`bsearch`)

functions for free. You can easily embed your own functions.

To declare a pointer to a function do:

```
int (*pf) ();
```

This simply declares a pointer `*pf` to function that returns and `int`. No actual function is *pointed* to yet.

If we have a function `int f()` then we may simply (!!) write:

```
pf = &f;
```

For compiler prototyping to fully work it is better to have full function prototypes for the function and the pointer to a function:

```
int f(int);  
int (*pf) (int) = &f;
```

Now `f()` returns an `int` and takes one `int` as a parameter.

You can do things like:

```
ans = f(5);  
ans = pf(5);
```

which are equivalent.

The `qsort` standard library function is very useful function that is designed to sort an array by a *key* value of *any type* into ascending order, as long as the elements of the array are of fixed type.

`qsort` is prototyped in (`stdlib.h`):

```
void qsort(void *base, size_t num_elements, size_t element_size,  
           int (*compare)(void const *, void const *));
```

The argument `base` points to the array to be sorted, `num_elements` indicates how long the array is, `element_size` is the size in bytes of each array element and the final argument `compare` is a pointer to a function.

`qsort` calls the `compare` function which is user defined to compare the data when sorting. Note that `qsort` maintains its data type independence by giving the comparison responsibility to the user. The compare function must return certain (`integer`) values according to the comparison result:

less than zero

: if first value is less than the second value

zero

: if first value is equal to the second value

greater than zero

: if first value is greater than the second value

Some quite complicated data structures can be sorted in this manner. For example, to sort the following structure by `integer` key:

```
typedef struct {
    int    key;
    struct other_data;
} Record;
```

We can write a compare function, `record_compare`:

```
int record_compare(void const *a, void const *b)
{   return ( ((Record *)a)->key - ((Record *)b)->key );
}
```

Assuming that we have an array of `array_length` `Records` suitably filled with data we can call `qsort` like this:

```
qsort( array, arraylength, sizeof(Record), record_compare);
```

Further examples of standard library and system calls that use pointers to functions may be found in Chapters [15.4](#) and [19.1](#).

Exercises

Exercise 12476

Write a program `last` that prints the last `n` lines of its text input. By default `n` should be 5, but your program should allow an optional argument so that

```
last -n
```

prints out the last `n` lines, where `n` is any integer. Your program should make the best use of available storage. (Input of text could be by reading a file specified from the command or reading a file from standard input)

Exercise 12477

Write a program that sorts a list of integers in ascending order. However if a `-r` flag is present on the command line your program should sort the list in descending order. (You may use any sorting routine you wish)

Exercise 12478

Write a program that reads the following structure and sorts the data by keyword using `qsort`

```
typedef struct {
    char    keyword[10];
    int     other_data;
} Record;
```

Exercise 12479

An *insertion sort* is performed by adding values to an array one by one. The first value is simply stored at the beginning of the array. Each subsequent value is added by finding its ordered position in the array, moving data as needed to accommodate the value and inserting the value in this position.

Write a function called `insort` that performs this task and behaves in the same manner as `qsort`, *i.e* it can sort an array by a *key* value of *any type* and it has similar prototyping.

Dave Marshall
1/5/1999

Subsections

- [Bitwise Operators](#)
 - [Bit Fields](#)
 - [Bit Fields: Practical Example](#)
 - [A note of caution: Portability](#)
 - [Exercises](#)
-

Low Level Operators and Bit Fields

We have seen how pointers give us control over low level memory operations.

Many programs (*e.g.* systems type applications) must actually operate at a low level where individual bytes must be operated on.

NOTE: The combination of pointers and bit-level operators makes C useful for many low level applications and can almost replace assembly code. (Only about 10 % of UNIX is assembly code the rest is C!!.)

Bitwise Operators

The *bitwise* operators of C are summarised in the following table:

Table: Bitwise operators

&	AND
	OR
^	XOR
~	One's Compliment
	0 → 1
	1 → 0
<<	Left shift
>>	Right Shift

DO NOT confuse & with &&: & is bitwise AND, && logical AND. Similarly for | and ||.

\sim is a unary operator -- it only operates on one argument to right of the operator.

The shift operators perform appropriate shift by operator on the right to the operator on the left. The right operator must be positive. The vacated bits are filled with zero (*i.e.* There is **NO** wrap around).

For example: $x \ll 2$ shifts the bits in x by 2 places to the left.

So:

if $x = 00000010$ (binary) or 2 (decimal)

then:

$x \gg 2 = 0 \Rightarrow x = 00000000$ or 0 (decimal)

Also: if $x = 00000010$ (binary) or 2 (decimal)

$x \ll 2 = 00001000 \Rightarrow x = 00001000$ or 8 (decimal)

Therefore a shift left is equivalent to a multiplication by 2.

Similarly a shift right is equal to division by 2

NOTE: Shifting is much faster than actual multiplication (*) or division (/) by 2. So if you want fast multiplications or division by 2 *use shifts*.

To illustrate many points of bitwise operators let us write a function, `Bitcount`, that counts bits set to 1 in an 8 bit number (`unsigned char`) passed as an argument to the function.

```
int bitcount(unsigned char x)
{
    int count;
    for (count=0; x != 0; x>>=1);
        if ( x & 01)
            count++;
    return count;
}
```

This function illustrates many C program points:

- for loop *not* used for simple counting operation
- $x \gg 1 \Rightarrow x = x \gg 1$
- for loop will repeatedly shift right x until x becomes 0
- use expression evaluation of $x \& 01$ to control if
- $x \& 01$ **masks** of 1st bit of x if this is 1 then `count++`

Bit Fields

Bit Fields allow the packing of data in a structure. This is especially useful when memory or data storage is at a premium. Typical examples:

- Packing several objects into a machine word. *e.g.* 1 bit flags can be compacted -- Symbol tables in compilers.
- Reading external file formats -- non-standard file formats could be read in. *E.g.* 9 bit integers.

C lets us do this in a structure definition by putting *:bit length* after the variable. *i.e.*

```
struct packed_struct {
    unsigned int f1:1;
    unsigned int f2:1;
    unsigned int f3:1;
    unsigned int f4:1;
    unsigned int type:4;
    unsigned int funny_int:9;
} pack;
```

Here the `packed_struct` contains 6 members: Four 1 bit **flags** `f1..f3`, a 4 bit `type` and a 9 bit `funny_int`.

C automatically packs the above bit fields as compactly as possible, provided that the maximum length of the field is less than or equal to the integer word length of the computer. If this is not the case then some compilers may allow memory overlap for the fields whilst other would store the next field in the next word (see comments on bit fields portability below).

Access members as usual via:

```
pack.type = 7;
```

NOTE:

- Only n lower bits will be assigned to an n bit number. So type cannot take values larger than 15 (4 bits long).
- Bit fields are **always** converted to integer type for computation.
- You are allowed to mix ``normal'' types with bit fields.
- The unsigned definition is important - ensures that no bits are used as a \pm flag.

Bit Fields: Practical Example

Frequently device controllers (*e.g.* disk drives) and the operating system need to communicate at a low level. Device controllers contain several **registers** which may be packed together in one integer (Figure 12.1).

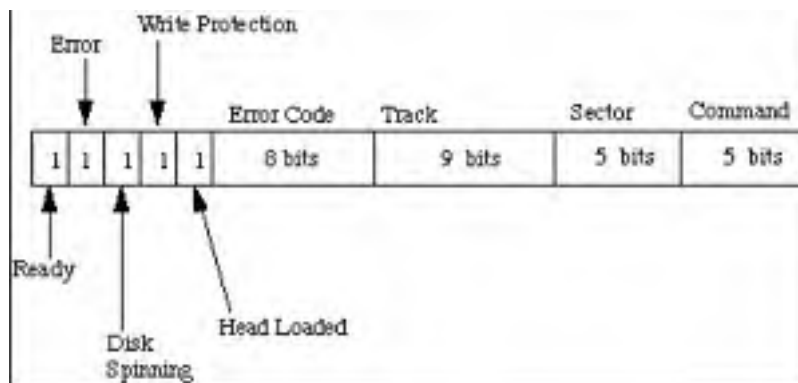

Fig. 12.1 Example Disk Controller Register We could define this register easily with bit fields:

```
struct DISK_REGISTER {
    unsigned ready:1;
    unsigned error_occured:1;
    unsigned disk_spinning:1;
    unsigned write_protect:1;
    unsigned head_loaded:1;
    unsigned error_code:8;
    unsigned track:9;
    unsigned sector:5;
    unsigned command:5;
};
```

To access values stored at a particular memory address, `DISK_REGISTER_MEMORY` we can assign a pointer of the above structure to access the memory via:

```
struct DISK_REGISTER *disk_reg = (struct DISK_REGISTER *) DISK_RE
```

The disk driver code to access this is now relatively straightforward:

```
/* Define sector and track to start read */

disk_reg->sector = new_sector;
disk_reg->track = new_track;
disk_reg->command = READ;

/* wait until operation done, ready will be true */

while ( ! disk_reg->ready ) ;

/* check for errors */

if (disk_reg->error_occured)
    { /* interrogate disk_reg->error_code for error type */
      switch (disk_reg->error_code)
        {
          .....
        }
    }
```

A note of caution: Portability

Bit fields are a convenient way to express many difficult operations. However, bit fields do suffer from a lack of portability between platforms:

- integers may be signed or unsigned
- Many compilers limit the maximum number of bits in the bit field to the size of an `integer` which may be either 16-bit or 32-bit varieties.
- Some bit field members are stored left to right others are stored right to left in memory.
- If bit fields too large, next bit field may be stored consecutively in memory (overlapping the boundary between memory locations) or in the next word of memory.

If portability of code is a premium you can use bit shifting and masking to achieve the same results but not as easy to express or read. For example:

```
unsigned int  *disk_reg = (unsigned int *) DISK_REGISTER_MEMORY;
/* see if disk error occurred */

disk_error_occured = (disk_reg & 0x40000000) >> 31;
```

Exercises

Exercise 12507

Write a function that prints out an 8-bit (unsigned char) number in binary format.

Exercise 12514

Write a function `setbits(x,p,n,y)` that returns `x` with the `n` bits that begin at position `p` set to the rightmost `n` bits of an unsigned char variable `y` (leaving other bits unchanged).

E.g. if $x = 10101010$ (170 decimal) and $y = 10100111$ (167 decimal) and $n = 3$ and $p = 6$ say then you need to strip off 3 bits of y (111) and put them in x at position `10xxx010` to get answer `10111010`.

Your answer should print out the result in binary form (see Exercise [12.1](#) although input can be in decimal form.

Your output should be like this:

```
x = 10101010 (binary)
y = 10100111 (binary)
setbits n = 3, p = 6 gives x = 10111010 (binary)
```

Exercise 12515

Write a function that inverts the bits of an unsigned char `x` and stores answer in `y`.

Your answer should print out the result in binary form (see Exercise [12.1](#) although input can be in decimal form.

Your output should be like this:

```
x = 10101010 (binary)
x inverted = 01010101 (binary)
```

Exercise 12516

Write a function that rotates (**NOT shifts**) to the right by n bit positions the bits of an unsigned char x. ie no bits are lost in this process.

Your answer should print out the result in binary form (see Exercise [12.1](#) although input can be in decimal form.

Your output should be like this:

```
x = 10100111 (binary)
x rotated by 3 = 11110100 (binary)
```

Note: All the functions developed should be as concise as possible

Dave Marshall
1/5/1999

Subsections

- [#define](#)
- [#undef](#)
- [#include](#)
- [#if -- Conditional inclusion](#)
- [Preprocessor Compiler Control](#)
- [Other Preprocessor Commands](#)
- [Exercises](#)

The C Preprocessor

Recall that preprocessing is the first step in the C program compilation stage -- this feature is unique to C compilers.

The preprocessor more or less provides its own language which can be a very powerful tool to the programmer. Recall that all preprocessor directives or commands begin with a #.

Use of the preprocessor is advantageous since it makes:

- programs easier to develop,
- easier to read,
- easier to modify
- C code more transportable between different machine architectures.

The preprocessor also lets us customise the language. For example to replace { ... } block statements delimiters by PASCAL like `begin ... end` we can do:

```
#define begin {  
#define end }
```

During compilation all occurrences of `begin` and `end` get replaced by corresponding `{` or `}` and so the subsequent C compilation stage does not know any difference!!!.

Lets look at `#define` in more detail

#define

Use this to define constants or any macro substitution. Use as follows:

```
#define <macro> <replacement name>
```

For Example

```
#define FALSE 0
#define TRUE !FALSE
```

We can also define small "functions" using #define. For example max. of two variables:

```
#define max(A,B) ( (A) > (B) ? (A):(B) )
```

? is the ternary operator in C.

Note: that this does not define a proper function max.

All it means that wherever we place max(C†,D†) the text gets replaced by the appropriate definition. [† = any variable names - not necessarily C and D]

So if in our C code we typed something like:

```
x = max(q+r,s+t);
```

after preprocessing, if we were able to look at the code it would appear like this:

```
x = ( (q+r) > (r+s) ? (q+r) : (s+t));
```

Other examples of #define could be:

```
#define Deg_to_Rad(X) (X*M_PI/180.0)
/* converts degrees to radians, M_PI is the value
of pi and is defined in math.h library */

#define LEFT_SHIFT_8 <<8
```

NOTE: The last macro LEFT_SHIFT_8 is only valid so long as replacement context is valid *i.e.*
x = y LEFT_SHIFT_8.

#undef

This commands undefined a macro. A macro **must** be undefined before being redefined to a different value.

#include

This directive includes a file into code.

It has two possible forms:

```
#include <file>

or

#include ``file''
```

<file> tells the compiler to look where system include files are held. Usually UNIX systems store files in `\usr\include\` directory.

``file'' looks for a file in the current directory (where program was run from)

Included files usually contain C prototypes and declarations from header files and **not** (algorithmic) C code (SEE next Chapter for reasons)

#if -- Conditional inclusion

`#if` evaluates a constant integer expression. You **always** need a `#endif` to delimit end of statement.

We can have *else etc.* as well by using `#else` and `#elif` -- else if.

Another common use of `#if` is with:

```
#ifdef
    -- if defined and
#ifndef
    -- if not defined
```

These are useful for checking if macros are set -- perhaps from different program modules and header files.

For example, to set integer size for a portable C program between TurboC (on MSDOS) and Unix (or other) Operating systems. Recall that TurboC uses 16 bits/integer and UNIX 32 bits/integer.

Assume that if TurboC is running a macro `TURBOC` will be defined. So we just need to check for this:

```
#ifdef TURBOC
    #define INT_SIZE 16
#else
    #define INT_SIZE 32
#endif
```

As another example if running program on MSDOS machine we want to include file `msdos.h` otherwise a `default.h` file. A macro `SYSTEM` is set (by OS) to type of system so check for this:

```
#if SYSTEM == MSDOS
    #include <msdos.h>
#else
    #include ``default.h''
#endif
```

Preprocessor Compiler Control

You can use the `cc` compiler to control what values are set or defined from the command line. This gives some flexibility in setting customised values and has some other useful functions. The `-D` compiler option is used. For example:

```
cc -DLINELENGTH=80 prog.c -o prog
```

has the same effect as:

```
#define LINELENGTH 80
```

Note that any `#define` or `#undef` **within** the program (`prog.c` above) **override** command line settings.

You can also set a symbol without a value, for example:

```
cc -DDEBUG prog.c -o prog
```

Here the value is assumed to be 1.

The setting of such flags is useful, especially for debugging. You can put commands like:

```
#ifdef DEBUG
    print("Debugging: Program Version 1");
#else
    print("Program Version 1 (Production)");
#endif
```

Also since preprocessor command can be written anywhere in a C program you can filter out variables etc for printing *etc.* when debugging:

```
x = y *3;

#ifdef DEBUG
    print("Debugging: Variables (x,y) = \", x, y");
#endif
```

The `-E` command line is worth mentioning just for academic reasons. It is not that practical a command. The `-E` command will force the compiler to stop after the preprocessing stage and output the current state of your program. Apart from being debugging aid for preprocessor commands and also as a useful initial learning tool (try this option out with some of the examples above) it is not that commonly used.

Other Preprocessor Commands

There are few other preprocessor directives available:

#error

text of error message -- generates an appropriate compiler error message. *e.g*

```
#ifdef OS_MSDOS
#include <msdos.h>
#elifdef OS_UNIX
#include ``default.h''
#else
#error Wrong OS!!
#endif
```

line

number "string" -- informs the preprocessor that the number is the next number of line of input. "string" is optional and names the next line of input. This is most often used with programs that translate other languages to C. For example, error messages produced by the C compiler can reference the file name and line numbers of the original source files instead of the intermediate C (translated) source files.

Exercises

Exercise 12529

Define a preprocessor macro `swap(t, x, y)` that will swap two arguments `x` and `y` of a given type `t`.

Exercise 12531

Define a preprocessor macro to select:

- the least significant bit from an `unsigned char`
- the *n*th (assuming least significant is 0) bit from an `unsigned char`.

Dave Marshall
1/5/1999

Subsections

- [Advantages of using UNIX with C](#)
 - [Using UNIX System Calls and Library Functions](#)
-

C, UNIX and Standard Libraries

There is a very close link between C and most operating systems that run our C programs. Almost the whole of the UNIX operating system is written in C.

This Chapter will look at how C and UNIX interface together. *

We have to use UNIX to maintain our file space, edit, compile and run programs *etc.*.

However UNIX is much more useful than this:

Advantages of using UNIX with C

- **Portability** -- UNIX, or a variety of UNIX, is available on many machines. Programs written in *standard* UNIX and C should run on any of them with little difficulty.
- **Multuser / Multitasking** -- many programs can share a machines processing power.
- **File handling** -- hierarchical file system with many file handling routines.
- **Shell Programming** -- UNIX provides a powerful command interpreter that understands over 200 commands and can also run UNIX and user-defined programs.
- **Pipe** -- where the output of one program can be made the input of another. This can done from command line or within a C program.
- **UNIX utilities** -- there over 200 utilities that let you accomplish many routines without writing new programs. *e.g.* make, grep, diff, awk, more
- **System calls** -- UNIX has about 60 system calls that are at the *heart* of the operating system or the *kernel* of UNIX. The calls are actually written in C. All of them can be accessed from C programs. Basic I/O, system clock access are examples. The function `open()` is an example of a system call.
- **Library functions** -- additions to the operating system.

Using UNIX System Calls and Library Functions

To use system calls and library functions in a C program we simply call the appropriate C function.

Examples of standard library functions we have met include the higher level I/O functions -- `fprintf()`, `malloc()` ...

Aithmetic operators, random number generators -- `random()`, `srandom()`, `lrand48()`, `drand48()` **etc.** and basic C types to string conversion are memebers of the `stdlib.h` standard library.

All math functions such as `sin()`, `cos()`, `sqrt()` are standard math library (`math.h`) functions and others follow in a similar fashion.

For most system calls and library functions we have to include an appropriate header file. **e.g.** `stdio.h`, `math.h`

To use a function, ensure that you have made the required `#includes` in your C file. Then the function can be called as though you had defined it yourself.

It is important to ensure that your arguments have the expected types, otherwise the function will probably produce strange results. `lint` is quite good at checking such things.

Some libraries require extra options before the compiler can support their use. For example, to compile a program including functions from the `math.h` library the command might be

```
cc mathprog.c -o mathprog -lm
```

The final `-lm` is an instruction to link the maths library with the program. The manual page for each function will usually inform you if any special compiler flags are required.

Information on nearly all system calls and library functions is available in manual pages. These are available on line: Simply type `man` function name.

e.g. `man drand48`

would give information about this random number generator.

Over the coming chapters we will be investigating in detail many aspects of the C Standard Library and also other UNIX libraries.

Subsections

- [Arithmetic Functions](#)
 - [Random Numbers](#)
 - [String Conversion](#)
 - [Searching and Sorting](#)
 - [Exercises](#)
-

Integer Functions, Random Number, String Conversion, Searching and Sorting: `<stdlib.h>`

To use all functions in this library you must:

```
#include <stdlib.h>
```

There are three basic categories of functions:

- Arithmetic
- Random Numbers
- String Conversion

The use of all the functions is relatively straightforward. We only consider them briefly in turn in this Chapter.

Arithmetic Functions

There are 4 basic integer functions:

```
int abs(int number);  
long int labs(long int number);  
  
div_t div(int numerator, int denominator);  
ldiv_t ldiv(long int numerator, long int denominator);
```

Essentially there are two functions with integer and long integer compatibility.

abs

functions return the absolute value of its `number` arguments. For example, `abs(2)` returns 2 as does `abs(-2)`.

div

takes two arguments, `numerator` and `denominator` and produces a quotient and a remainder of the integer division. The `div_t` structure is defined (in `stdlib.h`) as follows:

```
typedef struct {
    int quot; /* quotient */
    int rem; /* remainder */
} div_t;
```

(ldiv_t is similarly defined).

Thus:

```
#include <stdlib.h>
....

int num = 8, den = 3;
div_t ans;

ans = div(num,den);

printf("Answer:\n\t Quotient = %d\n\t Remainder = %d\n", \
ans.quot,ans.rem);
```

Produces the following output:

```
Answer:
Quotient = 2
Remainder = 2
```

Random Numbers

Random numbers are useful in programs that need to simulate random events, such as games, simulations and experimentations. In practice no functions produce truly random data -- they produce *pseudo-random* numbers. These are computed from a given formula (different generators use different formulae) and the number sequences they produce are repeatable. A *seed* is usually set from which the sequence is generated. Therefore if you set the same seed all the time the same set will be computed.

One common technique to introduce further randomness into a random number generator is to use the time of the day to set the seed, as this will always be changing. (We will study the standard library time functions later in [Chapter 20](#)).

There are many (pseudo) random number functions in the standard library. They all operate on the same basic idea but generate different number sequences (based on different generator functions) over different number ranges.

The simplest set of functions is:

```
int rand(void);
void srand(unsigned int seed);
```

rand() returns successive pseudo-random numbers in the range from 0 to $(2^{15})-1$.

srand() is used to set the seed. A simple example of using the time of the

day to initiate a seed is via the call:

```
srand( (unsigned int) time( NULL ) );
```

The following program `card.c` illustrates the use of these functions to simulate a pack of cards being shuffled:

```
/*  
** Use random numbers to shuffle the "cards" in the deck. The se  
** argument indicates the number of cards. The first time this  
** function is called, srand is called to initialize the random  
** number generator.  
*/  
#include <stdlib.h>  
#include <time.h>  
#define TRUE 1  
#define FALSE 0  
  
void shuffle( int *deck, int n_cards )  
{  
    int i;  
    static int first_time = TRUE;  
  
    /*  
    ** Seed the random number generator with the current time  
    ** of day if we haven't done so yet.  
    */  
    if( first_time ){  
        first_time = FALSE;  
        srand( (unsigned int)time( NULL ) );  
    }  
  
    /*  
    ** "Shuffle" by interchanging random pairs of cards.  
    */  
    for( i = n_cards - 1; i > 0; i -= 1 ){  
        int where;  
        int temp;  
  
        where = rand() % i;  
        temp = deck[ where ];  
        deck[ where ] = deck[ i ];  
        deck[ i ] = temp;  
    }  
}
```

There are several other random number generators available in the standard library:

```
double drand48(void);  
double erand48(unsigned short xsubi[3]);  
long lrand48(void);  
long nrand48(unsigned short xsubi[3]);  
long mrand48(void);  
long jrand48(unsigned short xsubi[3]);  
void srand48(long seed);  
unsigned short *seed48(unsigned short seed[3]);  
void lcong48(unsigned short param[7]);
```

This family of functions generates uniformly distributed pseudo-random numbers.

Functions `drand48()` and `erand48()` return non-negative double-precision floating-point values uniformly distributed over the interval $[0.0, 1.0)$.

Functions `lrand48()` and `rand48()` return non-negative long integers uniformly distributed over the interval $[0, 2^{**31})$.

Functions `mrnd48()` and `jrnd48()` return signed long integers uniformly distributed over the interval $[-2^{**31}, 2^{**31})$.

Functions `srand48()`, `seed48()`, and `lcong48()` set the seeds for `drand48()`, `lrand48()`, or `mrnd48()` and one of these should be called first.

Further examples of using these functions is given in Chapter [20](#).

String Conversion

There are a few functions that exist to convert strings to integer, long integer and float values. They are:

```
double atof(char *string) -- Convert string to floating point value.
int atoi(char *string) -- Convert string to an integer value
int atol(char *string) -- Convert string to a long integer value.
double strtod(char *string, char *endptr) -- Convert string to a
floating point value.
long strtol(char *string, char *endptr, int radix) -- Convert
string to a long integer using a given radix.
unsigned long strtoul(char *string, char *endptr, int radix) --
Convert string to unsigned long.
```

Most of these are fairly straightforward to use. For example:

```
char *str1 = "100";
char *str2 = "55.444";
char *str3 = "    1234";
char *str4 = "123four";
char *str5 = "invalid123";

int i;
float f;

i = atoi(str1); /* i = 100 */
f = atof(str2); /* f = 55.44 */
i = atoi(str3); /* i = 1234 */
i = atoi(str4); /* i = 123 */
i = atoi(str5); /* i = 0 */
```

Note:

- Leading blank characters are skipped.
- Trailing illegal characters are ignored.
- If conversion cannot be made zero is returned and `errno` (See Chapter [17](#)) is set with the value `ERANGE`.

Searching and Sorting

The `stdlib.h` provides 2 useful functions to perform general searching and sorting of data on any type. In fact we have already introduced the `qsort()` function in Chapter 11.3. For completeness we list the prototype again here but refer the reader to the previous Chapter for an example.

The `qsort` standard library function is very useful function that is designed to sort an array by a *key* value of *any type* into ascending order, as long as the elements of the array are of fixed type.

`qsort` is prototyped (in `stdlib.h`):

```
void qsort(void *base, size_t num_elements, size_t element_size,
           int (*compare)(void const *, void const *));
```

Similarly, there is a binary search function, `bsearch()` which is prototyped (in `stdlib.h`) as:

```
void *bsearch(const void *key, const void *base, size_t nel,
              size_t size, int (*compare)(const void *, const void *))
```

Using the same `Record` structure and `record_compare` function as the `qsort()` example (in Chapter 11.3):

```
typedef struct {
    int    key;
    struct other_data;
} Record;

int record_compare(void const *a, void const *b)
{ return ( ((Record *)a)->key - ((Record *)b)->key );
}
```

Also, Assuming that we have an array of `array_length` `Records` suitably filled with data we can call `bsearch()` like this:

```
Record key;
Record *ans;

key.key = 3; /* index value to be searched for */
ans = bsearch(&key, array, arraylength, sizeof(Record), record_co
```

The function `bsearch()` return a pointer to the field whose key filed is filled with the matched value of `NULL` if no match found.

Note that the type of the `key` argument **must** be the same as the array elements (`Record` above), even though only the `key.key` element is required to be set.

Exercises

Exercise 12534

Write a program that simulates throwing a six sided die

Exercise 12535

Write a program that simulates the UK National lottery by selecting six different whole numbers in the range 1 - 49.

Exercise 12536

Write a program that read a number from command line input and generates a random floating point number in the range 0 - the input number.

Dave Marshall
1/5/1999

Subsections

- [Math Functions](#)
- [Math Constants](#)

Mathematics: <math.h>

Mathematics is relatively straightforward library to use again. You **must** `#include <math.h>` and must **remember** to link in the math library at compilation:

```
cc mathprog.c -o mathprog -lm
```

A common source of error is in forgetting to include the `<math.h>` file (and yes experienced programmers make this error also). Unfortunately the C compiler does not help much. Consider:

```
double x;  
x = sqrt(63.9);
```

Having not seen the prototype for `sqrt` the compiler (by default) assumes that the function returns an `int` and converts the value to a `double` with meaningless results.

Math Functions

Below we list some common math functions. Apart from the note above they should be easy to use and we have already used some in previous examples. We give no further examples here:

```
double acos(double x) -- Compute arc cosine of x.  
double asin(double x) -- Compute arc sine of x.  
double atan(double x) -- Compute arc tangent of x.  
double atan2(double y, double x) -- Compute arc tangent of y/x.  
double ceil(double x) -- Get smallest integral value that exceeds x.  
double cos(double x) -- Compute cosine of angle in radians.  
double cosh(double x) -- Compute the hyperbolic cosine of x.  
div_t div(int number, int denom) -- Divide one integer by another.  
double exp(double x) -- Compute exponential of x  
double fabs (double x ) -- Compute absolute value of x.  
double floor(double x) -- Get largest integral value less than x.  
double fmod(double x, double y) -- Divide x by y with integral quotient  
and return remainder.  
double frexp(double x, int *exp_ptr) -- Breaks down x into mantissa  
and exponent of no.  
labs(long n) -- Find absolute value of long integer n.  
double ldexp(double x, int exp) -- Reconstructs x out of mantissa and  
exponent of two.
```

```
ldiv_t ldiv(long number, long denom) -- Divide one long integer by
another.
double log(double x) -- Compute log(x).
double log10 (double x ) -- Compute log to the base 10 of x.
double modf(double x, double *intptr) -- Breaks x into fractional and
integer parts.
double pow (double x, double y) -- Compute x raised to the power y.
double sin(double x) -- Compute sine of angle in radians.
double sinh(double x) - Compute the hyperbolic sine of x.
double sqrt(double x) -- Compute the square root of x.
void srand(unsigned seed) -- Set a new seed for the random number
generator (rand).
double tan(double x) -- Compute tangent of angle in radians.
double tanh(double x) -- Compute the hyperbolic tangent of x.
```

Math Constants

The `math.h` library defines many (often neglected) constants. It is always advisable to use these definitions:

`HUGE` -- The maximum value of a single-precision floating-point number.

`M_E` -- The base of natural logarithms (e).

`M_LOG2E` -- The base-2 logarithm of e.

`M_LOG10E` - The base-10 logarithm of e.

`M_LN2` -- The natural logarithm of 2.

`M_LN10` -- The natural logarithm of 10.

`M_PI` -- π .

`M_PI_2` -- $\pi/2$.

`M_PI_4` -- $\pi/4$.

`M_1_PI` -- $1/\pi$.

`M_2_PI` -- $2/\pi$.

`M_2_SQRTPI` -- $2/\sqrt{\pi}$.

`M_SQRT2` -- The positive square root of 2.

`M_SQRT1_2` -- The positive square root of 1/2.

`MAXFLOAT` -- The maximum value of a non-infinite single- precision floating point number.

HUGE_VAL -- positive infinity.

There are also a number a machine dependent values defined in `#include <value.h>` -- see `man value` or `list value.h` for further details.

Dave Marshall
1/5/1999

Subsections

- [Reporting Errors](#)
 - [perror\(\)](#)
 - [errno](#)
 - [exit\(\)](#)
 - [Streams](#)
 - [Predefined Streams](#)
 - [Redirection](#)
 - [Basic I/O](#)
 - [Formatted I/O](#)
 - [Printf](#)
 - [scanf](#)
 - [Files](#)
 - [Reading and writing files](#)
 - [sprintf and sscanf](#)
 - [Stream Status Enquiries](#)
 - [Low Level I/O](#)
 - [Exercises](#)
-

Input and Output (I/O): `stdio.h`

This chapter will look at many forms of I/O. We have briefly mentioned some forms before will look at these in much more detail here.

Your programs will need to include the standard I/O *header* file so do:

```
#include <stdio.h>
```

Reporting Errors

Many times it is useful to report errors in a C program. The standard library `perror()` is an easy to use and convenient function. It is used in conjunction with `errno` and frequently on encountering an error you may wish to terminate your program early. Whilst not strictly part of the `stdio.h` library we introduce the concept of `errno` and the function `exit()` here. We will meet these concepts in other parts of the Standard Library also.

`perror()`

The function `perror()` is prototyped by:

```
void perror(const char *message);
```

`perror()` produces a message (on standard error output -- see Section [17.2.1](#)), describing the last error encountered, returned to `errno` (see below) during a call to a system or library function. The argument string `message` is printed

first, then a colon and a blank, then the message and a newline. If `message` is a NULL pointer or points to a null string, the colon is not printed.

errno

`errno` is a special system variable that is set if a system call cannot perform its set task. It is defined in `#include <errno.h>`.

To use `errno` in a C program it must be declared via:

```
extern int errno;
```

It can be manually reset within a C program (although this is uncommon practice) otherwise it simply retains its last value returned by a system call or library function.

exit()

The function `exit()` is prototyped in `#include <stdlib.h>` by:

```
void exit(int status)
```

Exit simply terminates the execution of a program and returns the `exit status` value to the operating system. The `status` value is used to indicate if the program has terminated properly:

- it exist with a `EXIT_SUCCESS` value on successful termination
- it exist with a `EXIT_FAILURE` value on unsuccessful termination.

On encountering an error you may frequently call an `exit(EXIT_FAILURE)` to terminate an errant program.

Streams

Streams are a portable way of reading and writing data. They provide a flexible and efficient means of I/O.

A Stream is a file or a physical device (*e.g.* printer or monitor) which is manipulated with a **pointer** to the stream.

There exists an internal C data structure, `FILE`, which represents all streams and is defined in `stdio.h`. We simply need to refer to the `FILE` structure in C programs when performing I/O with streams.

We just need to declare a variable or pointer of this type in our programs.

We do not need to know any more specifics about this definition.

We must **open** a stream before doing any I/O,

then access it

and then close it.

Stream I/O is **BUFFERED**: That is to say a fixed "chunk" is read from or written to a file via some temporary storage area (the buffer). This is illustrated in Fig. 17.1. NOTE the file pointer actually points to this buffer.

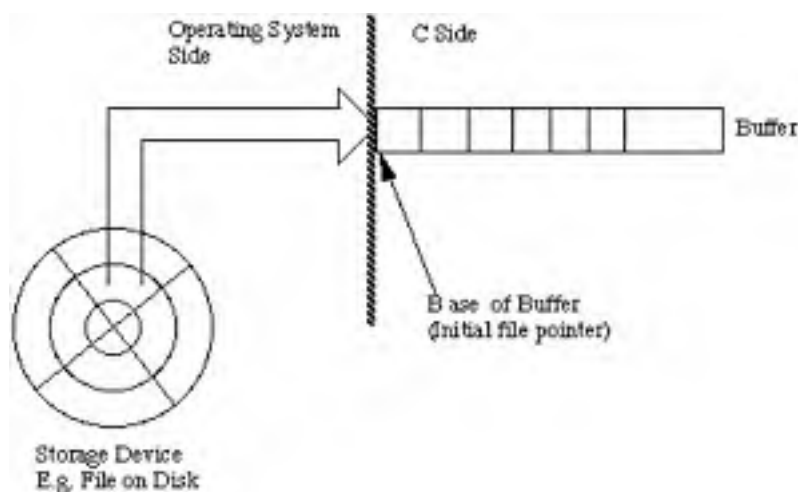

Fig. 17.1 Stream I/O Model This leads to efficient I/O but **beware**: data written to a buffer does not appear in a file (or device) until the buffer is flushed or written out. (`\n` does this). Any abnormal exit of code can cause problems.

Predefined Streams

UNIX defines 3 predefined streams (in `stdio.h`):

```
stdin, stdout, stderr
```

They all use text as the method of I/O.

`stdin` and `stdout` can be used with files, programs, I/O devices such as keyboard, console, *etc.* `stderr` **always** goes to the console or screen.

The console is the default for `stdout` and `stderr`. The keyboard is the default for `stdin`.

Predefined streams are automatically open.

Redirection

This is how we override the UNIX default predefined I/O defaults.

This is not part of C but operating system dependent. We will do redirection from the command line.

> -- redirect `stdout` to a file.

So if we have a program, `out`, that usually prints to the screen then

```
out > file1
```

will send the output to a file, `file1`.

< -- redirect `stdin` from a file to a program.

So if we are expecting input from the keyboard for a program, `in` we can read similar input from a file

```
in < file2.
```

| -- *pipe*: puts `stdout` from one program to `stdin` of another

```
prog1 | prog2
```

e.g. Sent output (usually to console) of a program direct to printer:

```
out | lpr
```

Basic I/O

There are a couple of function that provide basic I/O facilities.

probably the most common are: `getchar()` and `putchar()`. They are defined and used as follows:

- `int getchar(void)` -- reads a char from `stdin`
- `int putchar(char ch)` -- writes a char to `stdout`, returns character written.

```
int ch;  
  
ch = getchar();  
(void) putchar((char) ch);
```

Related Functions:

```
int getc(FILE *stream),  
int putc(char ch, FILE *stream)
```

Formatted I/O

We have seen examples of how C uses formatted I/O already. Let's look at this in more detail.

Printf

The function is defined as follows:

```
int printf(char *format, arg list ...) --
```

prints to `stdout` the list of arguments according specified format string.
Returns number of characters printed.

The **format string** has 2 types of object:

- **ordinary characters** -- these are copied to output.
- **conversion specifications** -- denoted by % and listed in Table [17.1](#).

Table: Printf/scanf format characters

Format Spec (%)	Type	Result
c	char	single character
i,d	int	decimal number
o	int	octal number
x,X	int	hexadecimal number
		lower/uppercase notation
u	int	unsigned int
s	char *	print string
		terminated by \0
f	double/float	format -m.ddd...
e,E	"	Scientific Format
		-1.23e002
g,G	"	e or f whichever
		is most compact
%	-	print % character

Between % and format char we can put:

- **(minus sign)**

-- left justify.

integer number

-- field width.

m.d

-- m = field width, d = precision of number of digits after decimal point
or number of chars from a string.

So:

```
printf("%-2.3f\n", 17.23478);
```

The output on the screen is:

```
17.235
```

and:

```
printf("VAT=17.5%\n");
```

...outputs:

```
VAT=17.5%
```

scanf

This function is defined as follows:

```
int scanf(char *format, args...) -- reads from stdin and puts input  
in address of variables specified in args list. Returns number of chars read.
```

Format control string similar to `printf`

Note: The ADDRESS of variable or a pointer to one is required by `scanf`.

```
scanf(``%d'', &i);
```

We can just give the name of an array or string to `scanf` since this corresponds to the start address of the array/string.

```
char string[80];  
scanf(``%s'', string);
```

Files

Files are the most common form of a stream.

The first thing we must do is *open* a file. The function `fopen()` does this:

```
FILE *fopen(char *name, char *mode)
```

`fopen` returns a pointer to a `FILE`. The `name` string is the name of the file on disc that we wish to access. The `mode` string controls our type of access. If a file cannot be accessed for any reason a `NULL` pointer is returned.

```
Modes include: ``r'' -- read,  
               ``w'' -- write and  
               ``a'' -- append.
```

To open a file we must have a stream (file pointer) that *points* to a `FILE` structure.

So to open a file, called *myfile.dat* for reading we would do:

```
FILE *stream, *fopen();  
/* declare a stream and prototype fopen */  
  
stream = fopen(``myfile.dat'', ``r'');
```

it is good practice to to check file is opened correctly:

```
if ( (stream = fopen( ``myfile.dat'',  
                    ``r'')) == NULL)  
{ printf(``Can't open %s\n'',  
        ``myfile.dat'');  
  exit(1);  
}  
.....
```

Reading and writing files

The functions `fprintf` and `fscanf` a commonly used to access files.

```
int fprintf(FILE *stream, char *format, args..)  
int fscanf(FILE *stream, char *format, args..)
```

These are similar to `printf` and `scanf` except that data is read from the *stream* that must have been opened with `fopen()`.

The stream pointer is automatically incremented with `ALL` file read/write functions. We **do not** have to worry about doing this.

```
char *string[80]
FILE *stream, *fopen();

if ( (stream = fopen(...)) != NULL)
    fscanf(stream, ``%s'', string);
```

Other functions for files:

```
int getc(FILE *stream), int fgetc(FILE *stream)
int putc(char ch, FILE *s), int fputc(char ch, FILE *s)
```

These are like getchar, putchar.

getc is defined as preprocessor MACRO in stdio.h. fgetc is a C library function. Both achieve the same result!!

```
fflush(FILE *stream) -- flushes a stream.
```

```
fclose(FILE *stream) -- closes a stream.
```

We can access predefined streams with fprintf **etc.**

```
fprintf(stderr, ``Cannot Compute!!\n'');

fscanf(stdin, ``%s'', string);
```

sprintf and sscanf

These are like fprintf and fscanf except they read/write to a string.

```
int sprintf(char *string, char *format, args..)
int sscanf(char *string, char *format, args..)
```

For Example:

```
float full_tank = 47.0; /* litres */
float miles = 300;
char miles_per_litre[80];

sprintf(miles_per_litre, ``Miles per litre
= %2.3f'', miles/full_tank);
```

Stream Status Enquiries

There are a few useful stream enquiry functions, prototyped as follows:

```
int feof(FILE *stream);
int ferror(FILE *stream);
void clearerr(FILE *stream);
int fileno(FILE *stream);
```

Their use is relatively simple:

feof()

-- returns true if the stream is currently at the end of the file. So to read a stream, `fp`, line by line you could do:

```
while ( !feof(fp) )  
    fscanf(fp, "%s", line);
```

ferror()

-- reports on the error state of the stream and returns true if an error has occurred.

clearerr()

-- resets the error indication for a given stream.

fileno()

-- returns the integer file descriptor associated with the named stream.

Low Level I/O

This form of I/O is **UNBUFFERED** -- each read/write request results in accessing disk (or device) directly to fetch/put a specific number of **bytes**.

There are no formatting facilities -- we are dealing with bytes of information.

This means we are now using binary (and not text) files.

Instead of file pointers we use **low level** file handle or file descriptors which give a unique integer number to identify each file.

To Open a file use:

```
int open(char *filename, int flag, int perms) -- this returns a file  
descriptor or -1 for a fail.
```

The `flag` controls file access and has the following predefined in `fcntl.h`:

```
O_APPEND, O_CREAT, O_EXCL, O_RDONLY, O_RDWR, O_WRONLY + others  
see online man pages or reference manuals.
```

`perms` -- best set to 0 for most of our applications.

The function:

```
creat(char *filename, int perms)
```

can also be used to create a file.

```
int close(int handle) -- close a file
```

```
int read(int handle, char *buffer,  
unsigned length)
```

```
int write(int handle, char *buffer, unsigned length)
```

are used to read/write a specific number of bytes from/to a file (handle) stored or to be put in the memory location specified by `buffer`.

The `sizeof()` function is commonly used to specify the `length`.

`read` and `write` return the number of bytes read/written or -1 if they fail.

```
/* program to read a list of floats from a binary file */
/* first byte of file is an integer saying how many */
/* floats in file. Floats follow after it, File name got from */
/* command line */

#include<stdio.h>
#include<fcntl.h>

float bigbuff[1000];

main(int argc, char **argv)

{   int fd;
    int bytes_read;
    int file_length;

    if ( (fd = open(argv[1],O_RDONLY)) = -1)
        { /* error file not open */....
          perror("Datafile");
          exit(1);
        }
    if ( (bytes_read = read(fd,&file_length,
        sizeof(int))) == -1)
        { /* error reading file */...
          exit(1);
        }
    if ( file_length > 999 ) { /* file too big */ ....}
    if ( (bytes_read = read(fd,bigbuff,
        file_length*sizeof(float))) == -1)
        { /* error reading open */...
          exit(1);
        }
    }
}
```

Exercises

Exercise 12573

Write a program to copy one named file into another named file. The two file names are given as the first two arguments to the program.

Copy the file a block (512 bytes) at a time.

```
Check:  that the program has two arguments
         or print "Program need two arguments"
         that the first name file is readable
         or print "Cannot open file .... for reading"
         that the second file is writable
         or print "Cannot open file .... for writing"
```

Exercise 12577

Write a program `last` that prints the last n lines of a text file, by n and the file name should be specified from command line input. By default n should be 5, but your program should allow an optional argument so that

```
last -n file.txt
```

prints out the last n lines, where n is any integer. Your program should make the best use of available storage.

Exercise 12578

Write a program to compare two files and print out the lines where they differ. Hint: look up appropriate string and file handling library routines. This should not be a very long program.

Dave Marshall
1/5/1999

Subsections

- [Basic String Handling Functions](#)
 - [String Searching](#)
- [Character conversions and testing: ctype.h](#)
- [Memory Operations: <memory.h>](#)
- [Exercises](#)

String Handling: <string.h>

Recall from our discussion of arrays (Chapter 6) that strings are defined as an array of characters or a pointer to a portion of memory containing ASCII characters. A `string` in C is a sequence of zero or more characters followed by a `NULL` (`\0`) character:

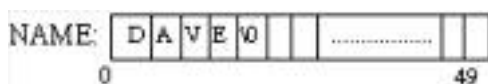

It is important to preserve the `NULL` terminating character as it is how C defines and manages variable length strings. **All** the C standard library functions require this for successful operation.

In general, apart from some *length-restricted functions* (`strncat()`, `strncmp()` and `strncpy()`), unless you create strings by hand you should not encounter any such problems. You should use the many useful string handling functions and not really need to *get your hands dirty* dismantling and assembling strings.

Basic String Handling Functions

All the string handling functions are prototyped in:

```
#include <string.h>
```

The common functions are described below:

`char *strcpy (const char *dest, const char *src)` -- Copy one string into another.

`int strcmp(const char *string1, const char *string2)` - Compare string1 and string2 to determine alphabetic order.

`char *strncpy(const char *string1, const char *string2)` -- Copy string2 to string1.

`char *strerror(int errnum)` -- Get error message corresponding to specified error number.

`int strlen(const char *string)` -- Determine the length of a string.

`char *strncat(const char *string1, char *string2, size_t n)` -- Append n characters from string2 to string1.

```
int strncmp(const char *string1, char *string2, size_t n) --  
Compare first n characters of two strings.  
char *strncpy(const char *string1, const char *string2, size_t n)  
-- Copy first n characters of string2 to string1.  
int strcasecmp(const char *s1, const char *s2) -- case insensitive  
version of strcmp().  
int strncasecmp(const char *s1, const char *s2, int n) -- case  
insensitive version of strncmp().
```

The use of most of the functions is straightforward, for example:

```
char *str1 = "HELLO";  
char *str2;  
int length;  
  
length = strlen("HELLO"); /* length = 5 */  
(void) strcpy(str2, str1);
```

Note that both `strcat()` and `strcpy()` both return a copy of their first argument which is the destination array. Note the order of the arguments is **destination array** followed by **source array** which is sometimes easy to get the wrong around when programming.

The `strcmp()` function **lexically** compares the two input strings and returns:

Less than zero

-- if `string1` is lexically less than `string2`

Zero

-- if `string1` and `string2` are lexically equal

Greater than zero

-- if `string1` is lexically greater than `string2`

This can also confuse beginners and experience programmers forget this too.

The `strncat()`, `strncmp()` and `strncpy()` copy functions are string restricted version of their more general counterparts. They perform a similar task but only up to the first `n` characters. Note the the `NULL` terminated requirement may get violated when using these functions, for example:

```
char *str1 = "HELLO";  
char *str2;  
int length = 2;  
  
(void) strcpy(str2, str1, length); /* str2 = "HE" */
```

str2 is NOT NULL TERMINATED!! -- BEWARE

String Searching

The library also provides several string searching functions:

```
char *strchr(const char *string, int c) -- Find first occurrence of  
character c in string.
```

`char *strrchr(const char *string, int c)` -- Find last occurrence of character `c` in string.

`char *strstr(const char *s1, const char *s2)` -- locates the first occurrence of the string `s2` in string `s1`.

`char *strpbrk(const char *s1, const char *s2)` -- returns a pointer to the first occurrence in string `s1` of any character from string `s2`, or a null pointer if no character from `s2` exists in `s1`

`size_t strspn(const char *s1, const char *s2)` -- returns the number of characters at the beginning of `s1` that match `s2`.

`size_t strcspn(const char *s1, const char *s2)` -- returns the number of characters at the beginning of `s1` that **do not** match `s2`.

`char *strtok(char *s1, const char *s2)` -- break the string pointed to by `s1` into a sequence of tokens, each of which is delimited by one or more characters from the string pointed to by `s2`.

`char *strtok_r(char *s1, const char *s2, char **lasts)` -- has the same functionality as `strtok()` except that a pointer to a string placeholder `lasts` must be supplied by the caller.

`strchr()` and `strrchr()` are the simplest to use, for example:

```
char *str1 = "Hello";
char *ans;

ans = strchr(str1, 'l');
```

After this execution, `ans` points to the location `str1 + 2`

`strpbrk()` is a more general function that searches for the first occurrence of any of a group of characters, for example:

```
char *str1 = "Hello";
char *ans;

ans = strpbrk(str1, 'aeiou');
```

Here, `ans` points to the location `str1 + 1`, the location of the first `e`.

`strstr()` returns a pointer to the specified search string or a null pointer if the string is not found. If `s2` points to a string with zero length (that is, the string ""), the function returns `s1`. For example,

```
char *str1 = "Hello";
char *ans;

ans = strstr(str1, 'lo');
```

will yield `ans = str + 3`.

`strtok()` is a little more complicated in operation. If the first argument is not `NULL` then the function finds the position of any of the second argument characters. However, the position is remembered and any subsequent calls to `strtok()` will start from this position if on these subsequent calls the first argument is `NULL`. For example, If we wish to break up the string `str1` at each space and print each token on a new line we could do:

```
char *str1 = "Hello Big Boy";
char *t1;

for ( t1 = strtok(str1, " ");
      t1 != NULL;
      t1 = strtok(NULL, " ") )

printf("%s\n",t1);
```

Here we use the for loop in a non-standard counting fashion:

- The initialisation calls `strtok()` loads the function with the string `str1`
- We terminate when `t1` is `NULL`
- We keep assigning tokens of `str1` to `t1` until termination by calling `strtok()` with a `NULL` first argument.

Character conversions and testing: `ctype.h`

We conclude this chapter with a related library `#include <ctype.h>` which contains many useful functions to convert and test *single* characters. The common functions are prototypes as follows:

Character testing:

```
int isalnum(int c) -- True if c is alphanumeric.
int isalpha(int c) -- True if c is a letter.
int isascii(int c) -- True if c is ASCII .
int iscntrl(int c) -- True if c is a control character.
int isdigit(int c) -- True if c is a decimal digit
int isgraph(int c) -- True if c is a graphical character.
int islower(int c) -- True if c is a lowercase letter
int isprint(int c) -- True if c is a printable character
int ispunct (int c) -- True if c is a punctuation character.
int isspace(int c) -- True if c is a space character.
int isupper(int c) -- True if c is an uppercase letter.
int isxdigit(int c) -- True if c is a hexadecimal digit
```

Character Conversion:

```
int toascii(int c) -- Convert c to ASCII .
tolower(int c) -- Convert c to lowercase.
int toupper(int c) -- Convert c to uppercase.
```

The use of these functions is straightforward and we do not give examples here.

Memory Operations: `<memory.h>`

Finally we briefly overview some basic memory operations. Although not strictly string functions the functions are prototyped in `#include <string.h>`:

```
void *memchr (void *s, int c, size_t n) -- Search for a character in a buffer .
int memcmp (void *s1, void *s2, size_t n) -- Compare two buffers.
void *memcpy (void *dest, void *src, size_t n) -- Copy one buffer into another .
void *memmove (void *dest, void *src, size_t n) -- Move a number of bytes from one buffer lo another.
void *memset (void *s, int c, size_t n) -- Set all bytes of a buffer to a given character.
```

Their use is fairly straightforward and not dissimilar to comparable string operations (except the exact length (`n`) of the operations must be specified as there is no natural termination here).

Note that in all case to **bytes** of memory are copied. The `sizeof()` function comes in handy again here, for example:

```
char src[SIZE],dest[SIZE];
int  isrc[SIZE],idest[SIZE];

memcpy(dest,src, SIZE); /* Copy chars (bytes) ok */
memcpy(idest,isrc, SIZE*sizeof(int)); /* Copy arrays of ints */
```

`memmove()` behaves in exactly the same way as `memcpy()` except that the source and destination locations may overlap.

`memcmp()` is similar to `strcmp()` except here *unsigned bytes* are compared and returns less than zero if `s1` is less than `s2` *etc.*

Exercises

Exercise 12584

Write a function similar to `strlen` that can handle unterminated strings. Hint: you will need to know and pass in the length of the string.

Exercise 12585

Write a function that returns true if an input string is a palindrome of each other. A palindrome is a word that reads the same backwards as it does forwards *e.g* ABBA.

Exercise 12586

Suggest a possible implementation of the `strtok()` function:

1. using other string handling functions.
2. from first pointer principles

How is the storage of the tokenised string achieved?

Exercise 12587

Write a function that converts all characters of an input string to upper case characters.

Exercise 12591

Write a program that will reverse the contents stored in memory in bytes. That is to say if we have n bytes in memory byte n becomes byte 0, byte $n-1$ becomes byte 1 *etc.*

Dave Marshall
1/5/1999

Subsections

- [The front panel](#)
- [The file manager](#)
- [The application manager](#)
- [The session manager](#)
- [Other CDE desktop tools](#)
- [Application development tools](#)
- [Application integration](#)
- [Windows and the Window Manager](#)
- [The Root Menu](#)
- [Exercises](#)

The Common Desktop Environment

In order to use Solaris and most other Unix Systems you will need to be familiar with the Common Desktop Environment (CDE). Before embarking on learning C with briefly introduce the main features of the CDE.

Most major Unix vendors now provide the CDE as standard. Consequently, most users of the X Window system will now be exposed to the CDE. Indeed, continuing trends in the development of Motif and CDE will probably lead to a convergence of these technologies in the near future. This section highlights the key features of the CDE from a Users perspective.

Upon login, the user is presented with the CDE Desktop (Fig. 1.1). The desktop includes a front panel (Fig. 1.2) , multiple virtual workspaces, and window management. CDE supports the running of applications from a file manager, from an application manager and from the front panel. Each of the subcomponents of the desktop are described below.

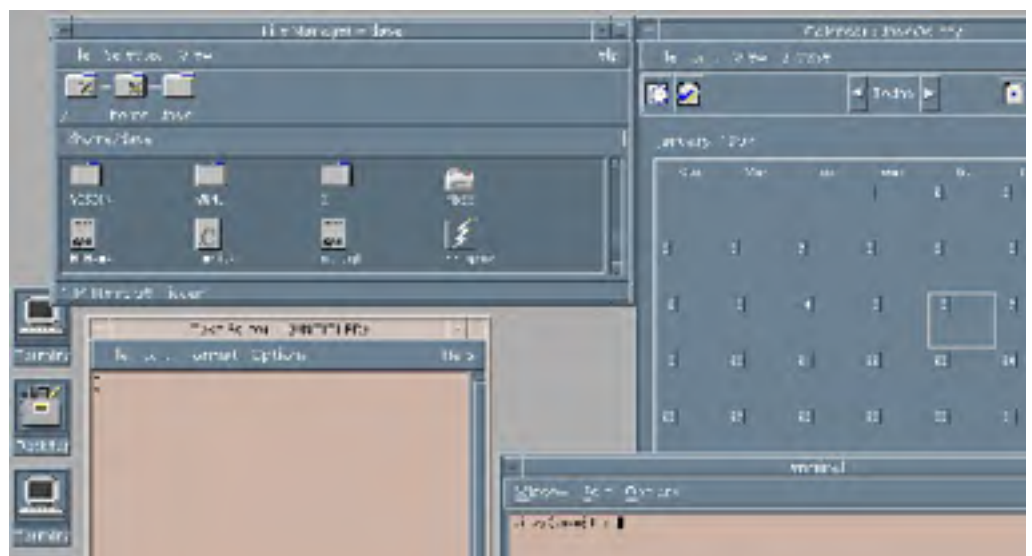



Fig. 1.1 Sample CDE Desktop

The front panel

The front panel (Fig. 1.2) contains a set of icons and popup menus (more like roll-up menus) that appear at the bottom of the screen, by default (Fig. 1.1). The front panel contains the most regularly used applications and tools for managing the workspace. Users can drag-and-drop application icons from the file manager or application manager to the popups for addition of the application(s) to the associated menu. The user can also manipulate the default actions and icons for the popups. The front panel can be locked so that users can't change it. A user can configure several virtual workspaces -- each with different backgrounds and colors if desired. Each workspace can have any number of applications running in it. An application can be set to appear in one, more than one, or all workspaces simultaneously.

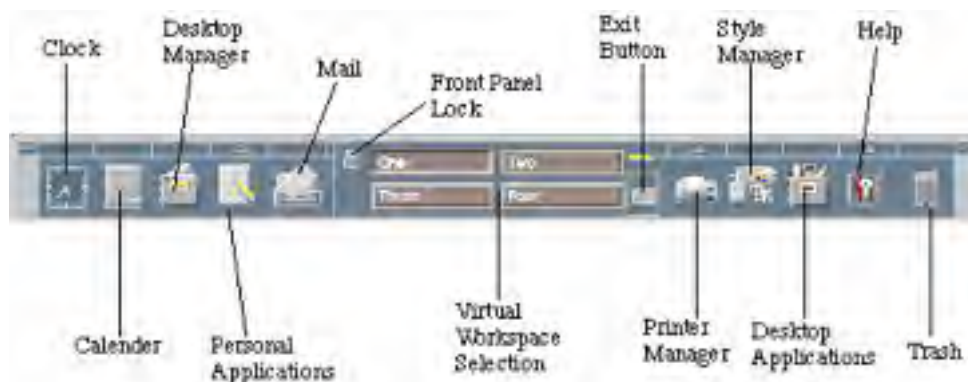

Fig. 1.2 Clients, Servers and Xlib

The file manager

CDE includes a standard file manager. The functionality is similar to that of the Microsoft Windows, Macintosh, or Sun Open Look file manager. Users can directly manipulate icons associated with UNIX files, drag-and-drop them, and launch associated applications.

The application manager

The user interaction with the application manager is similar to the file manager except that it is intended to be a list of executable modules available to a particular user. The user launches the application manager from an icon in the front panel. Users are notified when a new application is available on a server by additions (or deletions) to the list of icons in the application manager window. Programs and icons can be installed and pushed out to other workstations as an integral part of the installation process. The list of workstations that new software is installed on is configurable. The application manager comes preconfigured to include several utilities and programs.

The session manager

The session manager is responsible for the start up and shut down of a user session. In the CDE, applications that are made *CDE aware* are warned via an X Event when the X session is closing down. The application responds by returning a string that can be used by the session manager at the user's next login to restart the application. CDE can remember two sessions per user. One is the *current* session, where a snapshot of the currently running applications is saved. These applications can be automatically restarted at the user's next login. The other is the default login, which is analogous to starting an X session in the Motif window manager. The user can choose which of the two sessions to use at the next login.

Other CDE desktop tools

CDE 1.0 includes a set of applications that enable users to become productive immediately. Many of these are available directly from the front panel, others from the desktop or personal application managers. Common and productive desktop tools include:

Mail Tool

-- Used to compose, view, and manage electronic mail through a GUI. Allows the inclusion of attachments and communications with other applications through the messaging system.

Calendar Manager

-- Used to manage, schedule, and view appointments, create calendars, and interact with the Mail Tool.

Editor

-- A text editor with common functionality including data transfer with other applications via the clipboard, drag and drop, and primary and quick transfer.

Terminal Emulator

-- An *xterm* terminal emulator.

Calculator

-- A standard calculator with scientific, financial, and logical modes.

Print Manager

-- A graphical print job manager for the scheduling and management of print jobs on any available printer.

Help System

-- A context-sensitive graphical help system based on Standard Generalized Markup Language (SGML).

Style Manager

-- A graphical interface that allows a user to interactively set their preferences, such as colors, backdrops, and fonts, for a session.

Icon Editor

-- This application is a fairly full featured graphical icon (pixmap) editor.

Application development tools

CDE includes two components for application development. The first is a shell command language interpreter that has built-in commands for most X Window system and CDE functions. The interpreter is based on ksh93 (The Korn Shell), and should provide anyone familiar with shell scripts the ability to develop X, Motif, and CDE applications.

To support interactive user interface development, developers can use the Motif Application Builder. This is a GUI front end for building Motif applications that generates C source code. The source code is then compiled and linked with the X and Motif libraries to produce the executable binary.

Application integration

CDE provides a number of tools to ease integration. The overall model of the CDE session is intended to allow a straightforward integration for virtually all types of applications. Motif and other X toolkit applications usually require little integration.

The task of integrating in-house and third party applications into a desktop, often the most difficult aspect of a desktop installation, is simplified by CDE. The power and advantage of CDE functionality can be realized in most cases without recompiling applications.

For example, Open Look applications can be integrated through the use of scripts that perform front-end execution of the application and scripts that perform pre- and post-session processing.

After the initial task of integrating applications so that they fit within session management, further integration can be done to increase their overall common *look-and-feel* with the rest of the desktop and to take advantage of the full range of CDE functionality. Tools that ease this aspect of integration include an *Icon Editor* used to create colour and monochrome icons. Images can be copied from the desktop into an icon, or they can be drawn freehand.

The *Action Creation Utility* is used to create action entries in the action database. Actions allow applications to be launched using desktop icons, and they ease administration by removing an application's specific details from the user interface.

The *Application Gather* and *Application Integrate* routines are used to control and format the application manager. They simplify installations so that applications can be accessible from virtually anywhere on the network.

Windows and the Window Manager

From a user's perspective, one of the first distinguishing features of Motif's *look and feel* is the *window frame* (Fig. 1.3). Every application window is contained inside such a frame. The following items appear in the window frame:

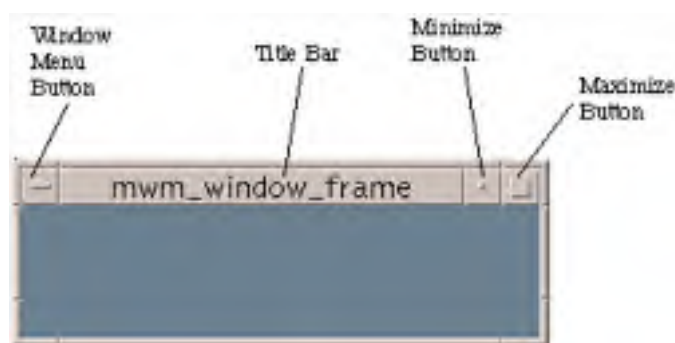

Fig. 1.3 The Motif Window Frame

Title Bar

-- This identifies the window by a text string. The string is usually the name of the application program. However, an application's resource controls the label (Chapter [1.1](#)).

Window Menu

-- Every window under the control of *mwm* has a window menu. The application has a certain amount of control over items that can be placed in the menu. The *Motif Style Guide* insists that certain commands are always available in this menu and that they can be accessed from either mouse or keyboard selection. Keyboard selections are called *mnemonics* and allow routine actions (that may involve several mouse actions) to be called from the keyboard. The action from the keyboard usually involves pressing two keys at the same time: the *Meta* key [1.1](#) and another key. The default window menu items and *mnemonics* are listed below and illustrated in Fig. [1.4](#):



Fig. 1.4 The Window Menu

- **Restore (Meta+F5)** -- Restore window to previous size after iconification (*see* below).
- **Move (Meta+F7)** -- Allows the window to be repositioned with a drag of the mouse.
- **Size (Meta+F8)** -- Allows the size of the window to be changed by dragging on the corners of the window.
- **Minimize (Meta+F9)** -- Iconify the window.
- **Maximize (Meta+F10)** -- Make the window the size of the root window, usually the whole of the display size.
- **Lower (Meta+F3)** -- Move the window to the bottom of the window stack. Windows may be *tiled* on top of each other (*see* below). The front window being the top of the stack.
- **Close (Meta+F4)** -- Quit the program. Some simple applications (Chapter [1.1](#)) provide no *internal* means of termination. The `close` option being the only means to achieve this.

Minimize Button

-- another way to iconify a window .

Maximize Button

-- another way to make a window the size of the root window .

The window manager must also be able to manage multiple windows from multiple client applications. There are a few important issues that need to be resolved. When running several applications together, several windows may be displayed on the screen. As a result, the display may appear cluttered and hard to navigate. The window manager provides two mechanisms to help deal with such problems:

Active Window

-- Only one window can receive input at any time. If you are selecting a graphical object with a mouse, then it is relatively easy for the window manager to detect this and schedule appropriate actions related to the chosen object. It is not so easy when you enter data or make selections directly from the keyboard. To resolve this only one window at a time is allowed *keyboard focus*. This window is called the *active window*. The selection of the active window will depend on the system configuration which the user typically has control over. There are two common methods for selecting the active window:

Focus follows pointer

-- The active window is the window underneath mouse pointer.

Click-to-type

-- The active window is selected, by clicking on an area of the window, and remains active until another window is selected no matter where the mouse points.

When a window is made active its appearance will change slightly:

- Its outline frame will become shaded.
- The cursor will change appearance when placed in the window.
- The window may jump, or be *raised* to the top of the window stack.

The exact appearance of the above may vary from system to system and may be controlled by the user by setting environment settings in the window manager.

Window tiling

-- Windows may be stacked on top of each other. The window manager tries to maintain a three-dimensional *look and feel* . Apart from the fact that buttons, dialog boxes appear to be elevated from the screen, windows are shaded and framed in a three-dimensional fashion. The top window (or currently active window) will have slightly different appearance for instance.

The window menu has a few options for controlling the tiling of a window. Also a window can be brought to the top of the stack, or *raised* by clicking a part of its frame.

Iconification

-- If a window is currently active and not required for input or displaying output then it may be *iconified* or *minimised* thus reducing the screen clutter. An icon (Fig. 1.5) is a small graphical symbol that represents the window (or application). It occupies a significantly less amount of screen area. Icons are usually arranged around the perimeter (typically bottom or left side) of the screen. The application will still be running and occupying computer memory. The window related to the icon may be reverted to by either double clicking on the icon, or selecting *Restore* or *Maximise* from the icon's window menu.

Figure 1.5: Sample
Icon from Xterm
Application



The Root Menu

The *Root Menu* is the main menu of the window manager. The root menu typically is used to control the whole display, for example starting up new windows and quitting the desktop. To display the Root menu:

- Move the mouse pointer to the Root Window.
- Hold down the left mouse button.

The default Root Menu has the following The root menu can be customised to start up common applications for example. The root menu for the *mwm* (Fig. 1.6) and *dtwm* (Fig. 1.7) have slightly different appearance but have broadly similar actions, which are summarised below:



Fig. 1.6 The *mwm* Root Menu 

Fig. 1.7 The CDE *dtwm* Root Menu

Program

(*dtwm*) -- A sub-menu is displayed that allows a variety of programs to be called from the desktop, for example to create a new window. The list of available programs can be customised from the desktop.

New Window

(*mwm*) -- Create a new window which is usually an *Xterm* window.

Shuffle Up

-- Move the bottom of the window stack to the top.

Shuffle Down

-- Move the top of the window stack to the bottom.

Refresh

-- Refresh the current screen display.

Restart

-- Restart the Workspace.

Logout

(*dtwm*) -- Quit the Window Manager.

Exercises

Exercise 12158

Exercise~\ref{ex.cde1}

Add an application to the application manager

Exercise 12159

Practice opening, closing and moving windows around the screen and to/from the background/foreground. Get used to using the mouse and its buttons for such tasks.

Exercise 12160

Figure out the function of each of the three mouse buttons. Pay particular attention to the different functions the buttons in different windows (applications) and also when the mouse is pointing to the background.

Exercise 12161

Find out how to resize windows etc. and practice this.

Exercise 12162

Fire up the texteditor of your choice (You may use *dtppad* (basic but functional), *textedit* application (SOLARIS basic editor), *emacs/Xemacs*, or

vi) and practice editing text files. Create any files you wish for now. Figure out basic options like cut and paste of text around the file, saving and loading files, searching for strings in the text and replacing strings.

Particularly pay attention in getting used to using the Key Strokes and / or mouse to perform the above tasks.

Exercise 12163

Use Unix Commands to

1. Copy a file (created by text editor or other means) to another file called spare.
2. Rename your original file to b called new.
3. Delete the file spare.
4. Display your original file on the terminal.
5. Print your file out.

Exercise 12164

Familiarise yourself with other UNIX functions by creating various files of text etc. and trying out the various functions listed in handouts.

Dave Marshall
1/5/1999

Subsections

- [Directory handling functions: <unistd.h>](#)
 - [Scanning and Sorting Directories: <sys/types.h>, <sys/dir.h>](#)
 - [File Manipulation Routines: unistd.h, sys/types.h, sys/stat.h](#)
 - [File Access](#)
 - [errno](#)
 - [File Status](#)
 - [File Manipulation:stdio.h, unistd.h](#)
 - [Creating Temporary Files:<stdio.h>](#)
 - [Exercises](#)
-

File Access and Directory System Calls

There are many UNIX utilities that allow us to manipulate directories and files. `cd`, `ls`, `rm`, `cp`, `mkdir` *etc.* are examples we have (hopefully) already met.

We will now see how to achieve similar tasks from within a C program.

Directory handling functions: <unistd.h>

This basically involves calling appropriate functions to traverse a directory hierarchy or inquire about a directories contents.

`int chdir(char *path)` -- changes directory to specified path string.

Example: C emulation of UNIX's `cd` command:

```
#include<stdio.h>
#include<unistd.h>

main(int argc, char **argv)
{
    if (argc < 2)
    { printf(`Usage: %s
      <pathname> \n', argv[0]);
      exit(1);
    }
    if (chdir(argv[1]) != 0)
    { printf(`Error in chdir \n');
      exit(1);
    }
}
```

```
char *getwd(char *path) -- get the full pathname of the current
working directory. path is a pointer to a string where the
pathname will be returned. getwd returns a pointer to the string
or NULL if an error occurs.
```

Scanning and Sorting Directories: <sys/types.h>, <sys/dir.h>

Two useful functions (On BSD platforms and **NOT** in multi-threaded application) are available

```
scandir(char *dirname, struct direct **namelist, int (*select)
(),
int (*compar)()) -- reads the directory dirname and builds an array of
pointers to directory entries or -1 for an error. namelist is a pointer to an
array of structure pointers.
```

(*select)() is a pointer to a function which is called with a pointer to a directory entry (defined in <sys/types> and should return a non zero value if the directory entry should be included in the array. If this pointer is NULL, then all the directory entries will be included.

The last argument is a pointer to a routine which is passed to `qsort` (see `man qsort`) -- a built in function which sorts the completed array. If this pointer is NULL, the array is not sorted.

```
alphasort(struct direct **d1, **d2) -- alphasort() is a built in routine
which will sort the array alphabetically.
```

Example - a simple C version of UNIX `ls` utility

```
#include <sys/types.h>
#include <sys/dir.h>
#include <sys/param.h>
#include <stdio.h>

#define FALSE 0
#define TRUE !FALSE

extern int alphasort();

char pathname[MAXPATHLEN];

main() { int count,i;
        struct direct **files;
        int file_select();

        if (getwd(pathname) == NULL )
            { printf("Error getting path\n");
              exit(0);
            }
        printf("Current Working Directory = %s\n",pathname);
```

```
count =
    scandir(pathname, &files, file_select, alphasort);

/* If no files found, make a non-selectable menu item */
if (count <= 0)
    {
        printf(`No files in this directory\n`);
        exit(0);
    }
printf(`Number of files = %d\n`,count);

for (i=1;i<count+1;++i)
    printf(`%s  `,files[i-1]->d_name);
printf(`\n`); /* flush buffer */
}
```

```
int file_select(struct direct  *entry)

{if ((strcmp(entry->d_name, `.`) == 0) ||
    (strcmp(entry->d_name, `..`) == 0))
    return (FALSE);
else
    return (TRUE);
}
```

scandir returns the current directory (.) and the directory above this (..) as well as all files so we need to check for these and return FALSE so that they are not included in our list.

Note: scandir and alphasort have definitions in sys/types.h and sys/dir.h.
MAXPATHLEN and getwd definitions in sys/param.h

We can go further than this and search for specific files: Let's write a modified file_select() that only scans for files with a .c, .o or .h suffix:

```
int file_select(struct direct  *entry)

{char *ptr;
  char *rindex(char *s, char c);

  if ((strcmp(entry->d_name, `.`)== 0) ||
      (strcmp(entry->d_name, `..`) == 0))
      return (FALSE);

  /* Check for filename extensions */
  ptr = rindex(entry->d_name, '.')
  if ((ptr != NULL) &&
      ((strcmp(ptr, `.c`) == 0)
       || (strcmp(ptr, `.h`) == 0)
       || (strcmp(ptr, `.o`) == 0) ))
```

```
        return (TRUE);  
    else  
        return (FALSE);  
}
```

NOTE: `rindex()` is a string handling function that returns a pointer to the last occurrence of character `c` in string `s`, or a NULL pointer if `c` does not occur in the string. (`index()` is similar function but assigns a pointer to 1st occurrence.)

The function `struct direct *readdir(char *dir)` also exists in `<sys/dir.h>` to return a given directory `dir` listing.

File Manipulation Routines: unistd.h, sys/types.h, sys/stat.h

There are many system calls that can applied directly to files stored in a directory.

File Access

`int access(char *path, int mode)` -- determine accessibility of file.

`path` points to a path name naming a file. `access()` checks the named file for accessibility according to `mode`, defined in `#include <unistd.h>`:

R_OK

- test for read permission

W_OK

- test for write permission

X_OK

- test for execute or search permission

F_OK

- test whether the directories leading to the file can be searched and the file exists.

`access()` returns: 0 on success, -1 on failure and sets `errno` to indicate the error. See `man` pages for list of errors.

errno

`errno` is a special system variable that is set if a system call cannot perform its set task.

To use `errno` in a C program it must be declared via:

```
extern int errno;
```

It can be manually reset within a C program other wise it simply retains its last value.

`int chmod(char *path, int mode)` change the mode of access of a file. specified by `path` to the given `mode`.

`chmod()` returns 0 on success, -1 on failure and sets `errno` to indicate the error. Errors are defined in `#include <sys/stat.h>`

The access mode of a file can be set using predefined macros in `sys/stat.h` - see `man pages` -- or by setting the mode in a 3 digit octal number.

The rightmost digit specifies owner privileges, middle group privileges and the leftmost other users privileges.

For each octal digit think of it a 3 bit binary number. Leftmost bit = read access (on/off) middle is write, right is executable.

So 4 (octal 100) = read only, 2 (010) = write, 6 (110) = read and write, 1 (001) = execute.

so for access mode 600 gives user read and write access others no access. 666 gives everybody read/write access.

NOTE: a UNIX command `chmod` also exists

File Status

Two useful functions exist to inquire about the files current status. You can find out how large the file is (`st_size`) when it was created (`st_ctime`) *etc.* (see `stat` structure definition below. The two functions are prototyped in `<sys/stat.h>`

```
int stat(char *path, struct stat *buf),
int fstat(int fd, struct
stat *buf)
```

`stat()` obtains information about the file named by `path`. Read, write or execute permission of the named file is not required, but all directories listed in the `path` name leading to the file must be searchable.

`fstat()` obtains the same information about an open file referenced by the argument descriptor, such as would be obtained by an `open` call (Low level I/O).

`stat()`, and `fstat()` return 0 on success, -1 on failure and sets `errno` to indicate the error. Errors are again defined in `#include <sys/stat.h>`

`buf` is a pointer to a `stat` structure into which information is placed concerning the file. A `stat` structure is define in `#include <sys/types.h>`, as follows

```
struct stat {
    mode_t    st_mode;        /* File mode (type, perms) */
    ino_t     st_ino;        /* Inode number */
    dev_t     st_dev;        /* ID of device containing */
```

```

    dev_t      st_rdev;      /* a directory entry for this fil.
                          /* ID of device */
                          /* This entry is defined only for
                          /* char special or block special
nlink_t      st_nlink;     /* Number of links */
uid_t        st_uid;       /* User ID of the file's owner */
gid_t        st_gid;       /* Group ID of the file's group */
off_t        st_size;      /* File size in bytes */
time_t       st_atime;     /* Time of last access */
time_t       st_mtime;     /* Time of last data modification
time_t       st_ctime;     /* Time of last file status chang.
                          /* Times measured in seconds sinc.
                          /* 00:00:00 UTC, Jan. 1, 1970 */
long         st_blksize;   /* Preferred I/O block size */
blkcnt_t     st_blocks;    /* Number of 512 byte blocks allo
}

```

File Manipulation:stdio.h, unistd.h

There are few functions that exist to delete and rename files. Probably the most common way is to use the `stdio.h` functions:

```
int remove(const char *path);
int rename(const char *old, const char *new);
```

Two system calls (defined in `unistd.h`) which are actually used by `remove()` and `rename()` also exist but are probably harder to remember unless you are familiar with UNIX.

```
int unlink(const char *path) -- removes the directory entry named by
path
```

`unlink()` returns 0 on success, -1 on failure and sets `errno` to indicate the error. Errors listed in `#include <sys/stat.h>`

A similar function `link(const char *path1, const char *path2)` creates a linking from an existing directory entry `path1` to a new entry `path2`

Creating Temporary Files:<stdio.h>

Programs often need to create files just for the life of the program. Two convenient functions (plus some variants) exist to assist in this task. Management (deletion of files etc) is taken care of by the Operating System.

The function `FILE *tmpfile(void)` creates a temporary file and opens a corresponding stream. The file will automatically be deleted when all references to the file are closed.

The function `char *tmpnam(char *s)` generate file names that can safely be used for a temporary file. Variant functions `char *tmpnam_r(char *s)` and `char *tempnam(const char *dir, const char *pfx)` also exist

NOTE: There are a few more file manipulation routines not listed here see `man` pages.

Exercises

Exercise 12675

Write a C program to emulate the `ls -l` UNIX command that prints all files in a current directory and lists access privileges etc. DO NOT simply `exec ls -l` from the program.

Exercise 12676

Write a program to print the lines of a file which contain a word given as the program argument (a simple version of `grep` UNIX utility).

Exercise 12677

Write a program to list the files given as arguments, stopping every 20 lines until a key is hit.(a simple version of `more` UNIX utility)

Exercise 12678

Write a program that will list all files in a current directory and all files in subsequent sub directories.

Exercise 12679

Write a program that will only list subdirectories in alphabetical order.

Exercise 12680

Write a program that shows the user all his/her C source programs and then prompts interactively as to whether others should be granted read permission; if affirmative such permission should be granted.

Exercise 12681

Write a program that gives the user the opportunity to remove any or all of the files in a current working directory. The name of the file should appear followed by a prompt as to whether it should be removed.

Dave Marshall
1/5/1999

Subsections

- [Basic time functions](#)
 - [Example time applications](#)
 - [Example 1: Time \(in seconds\) to perform some computation](#)
 - [Example 2: Set a random number seed](#)
 - [Exercises](#)
-

Time Functions

In this chapter we will look at how we can access the clock time with UNIX system calls.

There are many more time functions than we consider here - see `man` pages and standard library function listings for full details. In this chapter we concentrate on applications of timing functions in C

Uses of time functions include:

- telling the time.
- timing programs and functions.
- setting number seeds.

Basic time functions

Some of the basic time functions are prototypes as follows:

```
time_t time(time_t *tloc) -- returns the time since 00:00:00 GMT, Jan. 1, 1970, measured in seconds.
```

If `tloc` is not `NULL`, the return value is also stored in the location to which `tloc` points.

`time()` returns the value of time on success.

On failure, it returns `(time_t) -1`. `time_t` is typedefed to a long (int) in `<sys/types.h>` and `<sys/time.h>` header files.

```
int ftime(struct timeb *tp) -- fills in a structure pointed to by tp, as defined in <sys/timeb.h>:
```

```
struct timeb
{
    time_t time;
    unsigned short millitm;
    short timezone;
    short dstflag;
};
```

The structure contains the time since the epoch in seconds, up to 1000 milliseconds of more precise interval, the local time zone (measured in minutes of time westward from Greenwich), and a flag that, if nonzero, indicates that Day light Saving time applies locally during the appropriate part of the year.

On success, `ftime()` returns no useful value. On failure, it returns `-1`.

Two other functions defined *etc.* in `#include <time.h>`

```
char *ctime(time_t *clock),  
char *asctime(struct tm *tm)
```

`ctime()` converts a long integer, pointed to by `clock`, to a 26-character string of the form produced by `asctime()`. It first breaks down `clock` to a `tm` structure by calling `localtime()`, and then calls `asctime()` to convert that `tm` structure to a string.

`asctime()` converts a time value contained in a `tm` structure to a 26-character string of the form:

```
Sun Sep 16 01:03:52 1973
```

`asctime()` returns a pointer to the string.

Example time applications

we mentioned above three possible uses of time functions (there are many more) but these are very common.

Example 1: Time (in seconds) to perform some computation

This is a simple program that illustrates that calling the time function at distinct moments and noting the different times is a simple method of timing fragments of code:

```
/* timer.c */  
  
#include <stdio.h>  
#include <sys/types.h>  
#include <time.h>  
  
main()  
{ int i;  
  time_t t1,t2;  
  
  (void) time(&t1);  
  for (i=1;i<=300;++i)  
    printf(``%d %d %d\n'',i, i*i, i*i*i);
```

```
        (void) time(&t2);
        printf(``\n Time to do 300 squares and
        cubes= %d seconds\n'', (int) t2-t1);
    }
```

Example 2: Set a random number seed

We have seen a similar example previously, this time we use the `lrand48()` function to generate of number sequence:

```
/* random.c */
#include <stdio.h>
#include <sys/types.h>
#include <time.h>

main()
{ int i;
  time_t t1;

  (void) time(&t1);
  srand48((long) t1);
  /* use time in seconds to set seed */
  printf(``5 random numbers
  (Seed = %d):\n'', (int) t1);

  for (i=0;i<5;++i)
    printf(``%d ', lrand48());
  printf(``\n\n''); /* flush print buffer */
}
```

`lrand48()` returns non-negative long integers uniformly distributed over the interval $(0, 2^{31})$.

A similar function `drand48()` returns double precision numbers in the range $[0.0, 1.0)$.

`srand48()` sets the seed for these random number generators. It is important to have different seeds when we call the functions otherwise the same set of pseudo-random numbers will generated. `time()` always provides a unique seed.

Exercises

Exercise 12708

Write a C program that times a fragment of code in milliseconds.

Exercise 12709

Write a C program to produce a series of floating point random numbers in the ranges (a) 0.0 - 1.0 (b) 0.0 - n where n is any floating point value. The seed should be set so that a unique sequence is guaranteed.

Dave Marshall
1/5/1999

Subsections

- [Running UNIX Commands from C](#)
 - [execl\(\)](#)
 - [fork\(\)](#)
 - [wait\(\)](#)
 - [exit\(\)](#)
 - [Exercises](#)
-

Process Control: <stdlib.h>, <unistd.h>

A *process* is basically a single running program. It may be a "system" program (*e.g* login, update, csh) or program initiated by the user (textedit, dbxtool or a user written one).

When UNIX runs a process it gives each process a unique number - a process ID, `pid`.

The UNIX command `ps` will list all current processes running on your machine and will list the `pid`.

The C function `int getpid()` will return the `pid` of process that called this function.

A program usually runs as a single process. However later we will see how we can make programs run as several *separate* communicating processes.

Running UNIX Commands from C

We can run commands from a C program just as if they were from the UNIX command line by using the `system()` function. **NOTE:** this can save us a lot of time and hassle as we can run other (proven) programs, scripts *etc.* to do set tasks.

`int system(char *string)` -- where `string` can be the name of a unix utility, an executable shell script or a user program. `System` returns the exit status of the shell. `System` is prototyped in `<stdlib.h>`

Example: Call `ls` from a program

```
main()
{ printf("Files in Directory are:\n");
  system("`ls -l`");
}
```

system is a call that is made up of 3 other system calls: `execl()`, `wait()` and `fork()` (which are prototyped in `<unistd.h>`)

execl()

`execl` has 5 other related functions -- see man pages.

`execl` stands for *execute* and *leave* which means that a process will get executed and then terminated by `execl`.

It is defined by:

```
execl(char *path, char *arg0, ..., char *argn, 0);
```

The last parameter must always be 0. It is a *NULL terminator*. Since the argument list is variable we must have some way of telling C when it is to end. The NULL terminator does this job.

where `path` points to the name of a file holding a command that is to be executed, `arg0` points to a string that is the same as `path` (or at least its last component).

`arg1 ... argn` are pointers to arguments for the command and 0 simply marks the end of the (variable) list of arguments.

So our above example could look like this also:

```
main()
{ printf(`Files in Directory are:\n');
  execl(`/bin/ls', `ls', `-l', 0);
}
```

fork()

`int fork()` turns a single process into 2 identical processes, known as the *parent* and the *child*. On success, `fork()` returns 0 to the child process and returns the process ID of the child process to the parent process. On failure, `fork()` returns -1 to the parent process, sets `errno` to indicate the error, and no child process is created.

NOTE: The child process will have its own unique PID.

The following program illustrates a simple use of `fork`, where two copies are made and run together (multitasking)

```
main()
{ int return_value;

    printf(``Forking process\n'');

    fork();
    printf(``The process id is %d
        and return value is %d\n",
        getpid(), return_value);
    execl(`/bin/ls/','`ls','`-l'',0);
    printf(``This line is not printed\n'');
}
```

The Output of this would be:

```
Forking process
The process id is 6753 and return value is 0
The process id is 6754 and return value is 0
two lists of files in current directory
```

NOTE: The processes have unique ID's which will be different at each run.

It also impossible to tell in advance which process will get to CPU's time -- so one run may differ from the next.

When we spawn 2 processes we can easily detect (in each process) whether it is the child or parent since fork returns 0 to the child. We can trap any errors if fork returns a -1. **i.e.:**

```
int pid; /* process identifier */

pid = fork();
if ( pid < 0 )
    { printf(``Cannot fork!!\n'');
      exit(1);
    }
if ( pid == 0 )
    { /* Child process */ ..... }
else
    { /* Parent process pid is child's pid */
      .... }
}
```

wait()

`int wait (int *status_location)` -- will force a parent process to wait for a child process to stop or terminate. `wait()` return the pid of the child or -1 for an error. The exit status of the child is returned to `status_location`.

exit()

`void exit(int status)` -- terminates the process which calls this function and returns the `exit status` value. Both UNIX and C (forked) programs can read the status value.

By convention, a status of 0 means *normal termination* any other value indicates an error or unusual occurrence. Many standard library calls have errors defined in the `sys/stat.h` header file. We can easily derive our own conventions.

A complete example of forking program is originally titled `fork.c`:

```
/* fork.c - example of a fork in a program */
/* The program asks for UNIX commands to be typed and inputted to
/* The string is then "parsed" by locating blanks etc. */
/* Each command and corresponding arguments are put in a args arr.
/* execvp is called to execute these commands in child process */
/* spawned by fork() */

/* cc -o fork fork.c */

#include <stdio.h>
#include <sys/types.h>
#include <unistd.h>

main()
{
    char buf[1024];
    char *args[64];

    for (;;) {
        /*
        * Prompt for and read a command.
        */
        printf("Command: ");

        if (gets(buf) == NULL) {
            printf("\n");
            exit(0);
        }

        /*
        * Split the string into arguments.
        */
        parse(buf, args);

        /*
        * Execute the command.
        */
        execute(args);
    }
}

/*
* parse--split the command in buf into
* individual arguments.
*/
parse(buf, args)
```

```
char *buf;
char **args;
{
    while (*buf != NULL) {
        /*
         * Strip whitespace. Use nulls, so
         * that the previous argument is terminated
         * automatically.
         */
        while ((*buf == ' ') || (*buf == '\t'))
            *buf++ = NULL;

        /*
         * Save the argument.
         */
        *args++ = buf;

        /*
         * Skip over the argument.
         */
        while ((*buf != NULL) && (*buf != ' ') && (*buf != '\t'))
            buf++;
    }

    *args = NULL;
}

/*
 * execute--spawn a child process and execute
 * the program.
 */
execute(args)
char **args;
{
    int pid, status;

    /*
     * Get a child process.
     */
    if ((pid = fork()) < 0) {
        perror("fork");
        exit(1);
    }

    /* NOTE: perror() produces a short error message on the sta-
     error describing the last error encountered during a c-
     a system or library function.
     */

    /*
     * The child executes the code inside the if.
     */
    if (pid == 0) {
        execvp(*args, args);
        perror(*args);
        exit(1);
    }

    /* NOTE: The execv() vnd execvp versions of execl() are us-
     number of arguments is unknown in advance;
     The arguments to execv() and execvp() are the name
     of the file to be executed and a vector of strings con-
     ing the arguments. The last argument string must be
     lowed by a 0 pointer.

     execlp() and execvp() are called with the same argument
     execl() and execv(), but duplicate the shell's actio-
     searching for an executable file in a list of directo
```



```
        The directory list is obtained from the environment.
    */
}

/*
 * The parent executes the wait.
 */
while (wait(&status) != pid)
    /* empty */ ;
}
```

Exercises

Exercise 12727

Use `popen()` to pipe the `rwwho` (UNIX command) output into `more` (UNIX command) in a C program.

Dave Marshall
1/5/1999

Subsections

- [Piping in a C program: <stdio.h>](#)
 - [popen\(\) -- Formatted Piping](#)
 - [pipe\(\) -- Low level Piping](#)
 - [Exercises](#)
-

Interprocess Communication (IPC), Pipes

We have now began to see how multiple processes may be running on a machine and maybe be controlled (spawned by `fork()` by one of our programs.

In numerous applications there is clearly a need for these processes to communicate with each exchanging data or control information. There are a few methods which can accomplish this task. We will consider:

- Pipes
- Signals
- Message Queues
- Semaphores
- Shared Memory
- Sockets

In this chapter, we will study the piping of two processes. We will study the others in turn in subsequent chapters.

Piping in a C program: <stdio.h>

Piping is a process where the input of one process is made the input of another. We have seen examples of this from the UNIX command line using `|`.

We will now see how we do this from C programs.

We will have two (or more) `forked` processes and will communicate between them.

We must first open a *pipe*

UNIX allows two ways of opening a pipe.

`popen()` -- Formatted Piping

`FILE *popen(char *command, char *type)` -- opens a pipe for I/O where the command is the process that will be connected to the calling process thus creating the *pipe*. The type is either ```r"` - for reading, or ```w"` for writing.

`popen()` returns is a stream pointer or NULL for any errors.

A pipe opened by `popen()` should always be closed by `pclose(FILE *stream)`.

We use `fprintf()` and `fscanf()` to communicate with the pipe's stream.

pipe () -- Low level Piping

`int pipe(int fd[2])` -- creates a pipe and returns two file descriptors, `fd[0]`, `fd[1]`. `fd[0]` is opened for reading, `fd[1]` for writing.

`pipe()` returns 0 on success, -1 on failure and sets `errno` accordingly.

The standard programming model is that after the pipe has been set up, two (or more) cooperative processes will be created by a fork and data will be passed using `read()` and `write()`.

Pipes opened with `pipe()` should be closed with `close(int fd)`.

Example: Parent writes to a child

```
int pdes[2];

pipe(pdes);
if ( fork() == 0 )
    { /* child */
        close(pdes[1]); /* not required */
        read( pdes[0]); /* read from parent */
        .....
    }
else
    { close(pdes[0]); /* not required */
      write( pdes[1]); /* write to child */
      .....
    }
```

An further example of piping in a C program is `plot.c` and subroutines and it performs as follows:

- The program has two modules `plot.c` (main) and `plotter.c`.
- The program relies on you having installed the freely **gnuplot** graph drawing program in the directory `/usr/local/bin/` (in the listing below at least) -- this path could easily be changed.
- The program `plot.c` calls **gnuplot**
- Two Data Stream is generated from Plot
 - `y = sin(x)`
 - `y = sin(1/x)`

- 2 Pipes created -- 1 per Data Stream.
- ° **Gnuplot** produces ``live'' drawing of output.

The code listing for plot.c is:

```
/* plot.c - example of unix pipe. Calls gnuplot graph drawing package
graphs from within a C program. Info is piped to gnuplot */
/* Creates 2 pipes one will draw graphs of y=0.5 and y = random 0
/* the other graphs of y = sin (1/x) and y = sin x */

/* Also user a plotter.c module */
/* compile: cc -o plot plot.c plotter.c */

#include "externals.h"
#include <signal.h>

#define DEG_TO_RAD(x) (x*180/M_PI)

double drand48();
void quit();

FILE *fp1, *fp2, *fp3, *fp4, *fopen();

main()
{
    float i;
    float y1,y2,y3,y4;

    /* open files which will store plot data */
    if ( ((fp1 = fopen("plot11.dat","w")) == NULL) ||
        ((fp2 = fopen("plot12.dat","w")) == NULL) ||
        ((fp3 = fopen("plot21.dat","w")) == NULL) ||
        ((fp4 = fopen("plot22.dat","w")) == NULL) )
        { printf("Error can't open one or more data files\n");
          exit(1);
        }

    signal(SIGINT,quit); /* trap ctrl-c call quit fn */
    StartPlot();
    y1 = 0.5;
    srand48(1); /* set seed */
    for (i=0;;i+=0.01) /* increment i forever use ctrl-c to quit :
        { y2 = (float) drand48();
          if (i == 0.0)
              y3 = 0.0;
          else
              y3 = sin(DEG_TO_RAD(1.0/i));
          y4 = sin(DEG_TO_RAD(i));

          /* load files */
          fprintf(fp1,"%f %f\n",i,y1);
          fprintf(fp2,"%f %f\n",i,y2);
          fprintf(fp3,"%f %f\n",i,y3);
          fprintf(fp4,"%f %f\n",i,y4);

          /* make sure buffers flushed so that gnuplot */
          /* reads up to data file */
          fflush(fp1);
          fflush(fp2);
          fflush(fp3);
          fflush(fp4);

          /* plot graph */
          PlotOne();
          usleep(250); /* sleep for short time */
        }
}
```

```
}

void quit()
{ printf("\nctrl-c caught:\n Shutting down pipes\n");
  StopPlot();

  printf("closing data files\n");
  fclose(fp1);
  fclose(fp2);
  fclose(fp3);
  fclose(fp4);

  printf("deleting data files\n");
  RemoveDat();
}
```

The plotter.c module is as follows:

```
/* plotter.c module */
/* contains routines to plot a data file produced by another prog
/* 2d data plotted in this version
/*****

#include "externals.h"

static FILE *plot1,
           *plot2,
           *ashell;

static char *startplot1 = "plot [] [0:1.1]'plot11.dat' with lines
                          'plot12.dat' with lines\n";

static char *startplot2 = "plot 'plot21.dat' with lines,
                          'plot22.dat' with lines\n";

static char *replot = "replot\n";
static char *command1= "/usr/local/bin/gnuplot> dump1";
static char *command2= "/usr/local/bin/gnuplot> dump2";
static char *deletfiles = "rm plot11.dat plot12.dat plot21.dat p
static char *set_term = "set terminal x11\n";

void
StartPlot(void)
{ plot1 = popen(command1, "w");
  fprintf(plot1, "%s", set_term);
  fflush(plot1);
  if (plot1 == NULL)
    exit(2);
  plot2 = popen(command2, "w");
  fprintf(plot2, "%s", set_term);
  fflush(plot2);
  if (plot2 == NULL)
    exit(2);
}

void
RemoveDat(void)
{ ashell = popen(deletfiles, "w");
  exit(0);
}

void
StopPlot(void)
{ pclose(plot1);
```

```
        pclose(plot2);
    }

void
PlotOne(void)
{ fprintf(plot1, "%s", startplot1);
  fflush(plot1);

  fprintf(plot2, "%s", startplot2);
  fflush(plot2);
}

void
RePlot(void)
{ fprintf(plot1, "%s", replot);
  fflush(plot1);
}
```

The header file externals.h contains the following:

```
/* externals.h */
#ifndef EXTERNALS
#define EXTERNALS

#include <stdio.h>
#include <stdlib.h>
#include <math.h>

/* prototypes */

void StartPlot(void);
void RemoveDat(void);
void StopPlot(void);
void PlotOne(void);
void RePlot(void);
#endif
```

Exercises

Exercise 12733

Setup a two-way pipe between parent and child processes in a C program. i.e. both can send and receive signals.

Dave Marshall
1/5/1999

Subsections

- [Sending Signals -- kill\(\), raise\(\)](#)
 - [Signal Handling -- signal\(\)](#)
 - [sig_talk.c -- complete example program](#)
 - [Other signal functions](#)
-

IPC:Interrupts and Signals:

<signal.h>

In this section will look at ways in which two processes can communicate. When a process terminates abnormally it usually tries to send a signal indicating what went wrong. C programs (and UNIX) can trap these for diagnostics. Also user specified communication can take place in this way.

Signals are software generated interrupts that are sent to a process when a event happens. Signals can be synchronously generated by an error in an application, such as `SIGFPE` and `SIGSEGV`, but most signals are asynchronous. Signals can be posted to a process when the system detects a software event, such as a user entering an interrupt or stop or a kill request from another process. Signals can also be come directly from the OS kernel when a hardware event such as a bus error or an illegal instruction is encountered. The system defines a set of signals that can be posted to a process. Signal delivery is analogous to hardware interrupts in that a signal can be blocked from being delivered in the future. Most signals cause termination of the receiving process if no action is taken by the process in response to the signal. Some signals stop the receiving process and other signals can be ignored. Each signal has a default action which is one of the following:

- The signal is discarded after being received
- The process is terminated after the signal is received
- A core file is written, then the process is terminated
- Stop the process after the signal is received

Each signal defined by the system falls into one of five classes:

- Hardware conditions
- Software conditions
- Input/output notification
- Process control
- Resource control

Macros are defined in `<signal.h>` header file for common signals.

These include:

`SIGHUP 1 /* hangup */`

`SIGINT 2 /* interrupt */`

SIGQUIT 3 /* quit */	SIGILL 4 /* illegal instruction */
SIGABRT 6 /* used by abort */	SIGKILL 9 /* hard kill */
SIGALRM 14 /* alarm clock */	
SIGCONT 19 /* continue a stopped process */	
SIGCHLD 20 /* to parent on child stop or exit */	

Signals can be numbered from 0 to 31.

Sending Signals -- `kill()` , `raise()`

There are two common functions used to send signals

`int kill(int pid, int signal)` - a system call that send a signal to a process, `pid`. If `pid` is greater than zero, the signal is sent to the process whose process ID is equal to `pid`. If `pid` is 0, the signal is sent to all processes, except system processes.

`kill()` returns 0 for a successful call, -1 otherwise and sets `errno` accordingly.

`int raise(int sig)` sends the signal `sig` to the executing program. `raise()` actually uses `kill()` to send the signal to the executing program:

```
kill(getpid(), sig);
```

There is also a UNIX command called `kill` that can be used to send signals from the command line - see `man` pages.

NOTE: that unless caught or ignored, the `kill` signal terminates the process. Therefore protection is built into the system.

Only processes with certain access privileges can be killed off.

Basic rule: *only processes that have the same user can send/receive messages.*

The `SIGKILL` signal cannot be caught or ignored and will always terminate a process.

For example `kill(getpid(), SIGINT);` would send the interrupt signal to the id of the calling process.

This would have a similar effect to `exit()` command. Also `ctrl-c` typed from the command sends a `SIGINT` to the process currently being.

`unsigned int alarm(unsigned int seconds)` -- sends the signal `SIGALRM` to the invoking process after `seconds` seconds.

Signal Handling -- `signal()`

An application program can specify a function called a signal handler to be invoked when a specific signal is received. When a signal handler is invoked on receipt of a signal, it is said to catch the signal. A process can deal with a signal in one of the following ways:

- The process can let the default action happen
- The process can block the signal (some signals cannot be ignored)
- the process can catch the signal with a handler.

Signal handlers usually execute on the current stack of the process. This lets the signal handler return to the point that execution was interrupted in the process. This can be changed on a per-signal basis so that a signal handler executes on a special stack. If a process must resume in a different context than the interrupted one, it must restore the previous context itself

Receiving signals is straightforward with the function:

```
int (*signal(int sig, void (*func)()))() -- that is to say the function
signal() will call the func functions if the process receives a signal sig.
Signal returns a pointer to function func if successful or it returns an error to
errno and -1 otherwise.
```

`func()` can have three values:

SIG_DFL

-- a pointer to a system default function `SIG_DFL()`, which will terminate the process upon receipt of `sig`.

SIG_IGN

-- a pointer to system ignore function `SIG_IGN()` which will disregard the `sig` action (**UNLESS** it is `SIGKILL`).

A function address

-- a user specified function.

`SIG_DFL` and `SIG_IGN` are defined in `signal.h` (standard library) header file.

Thus to ignore a `ctrl-c` command from the command line. we could do:

```
signal(SIGINT, SIG_IGN);
```

TO reset system so that `SIGINT` causes a termination at any place in our program, we would do:

```
signal(SIGINT, SIG_DFL);
```

So lets write a program to trap a `ctrl-c` but not quit on this signal. We have a

function `sigproc()` that is executed when we trap a `ctrl-c`. We will also set another function to quit the program if it traps the `SIGQUIT` signal so we can terminate our program:

```
#include <stdio.h>

void sigproc(void);

void quitproc(void);

main()
{ signal(SIGINT, sigproc);
  signal(SIGQUIT, quitproc);
  printf(`ctrl-c disabled use ctrl-\\ to quit\n');
  for(;;); /* infinite loop */
}

void sigproc()
{ signal(SIGINT, sigproc); /* */
  /* NOTE some versions of UNIX will reset signal to default
   after each call. So for portability reset signal each time */

  printf(`you have pressed ctrl-c\n');
}

void quitproc()
{ printf(`ctrl-\\ pressed to quit\n');
  exit(0); /* normal exit status */
}
```

sig_talk.c -- complete example program

Let us now write a program that communicates between child and parent processes using `kill()` and `signal()`.

`fork()` creates the child process from the parent. The `pid` can be checked to decide whether it is the child (`== 0`) or the parent (`pid = child process id`).

The parent can then send messages to child using the `pid` and `kill()`.

The child picks up these signals with `signal()` and calls appropriate functions.

An example of communicating process using signals is `sig_talk.c`:

```
/* sig_talk.c --- Example of how 2 processes can talk */
/* to each other using kill() and signal() */
/* We will fork() 2 process and let the parent send a few */
/* signals to it`s child */

/* cc sig_talk.c -o sig_talk */
```

```
#include <stdio.h>
#include <signal.h>

void sighup(); /* routines child will call upon sigtrap */
void sigint();
void sigquit();

main()
{ int pid;

  /* get child process */

  if ((pid = fork()) < 0) {
    perror("fork");
    exit(1);
  }

  if (pid == 0)
  { /* child */
    signal(SIGHUP,sighup); /* set function calls */
    signal(SIGINT,sigint);
    signal(SIGQUIT, sigquit);
    for(;;); /* loop for ever */
  }
  else /* parent */
  { /* pid hold id of child */
    printf("\nPARENT: sending SIGHUP\n\n");
    kill(pid,SIGHUP);
    sleep(3); /* pause for 3 secs */
    printf("\nPARENT: sending SIGINT\n\n");
    kill(pid,SIGINT);
    sleep(3); /* pause for 3 secs */
    printf("\nPARENT: sending SIGQUIT\n\n");
    kill(pid,SIGQUIT);
    sleep(3);
  }
}

void sighup()

{ signal(SIGHUP,sighup); /* reset signal */
  printf("CHILD: I have received a SIGHUP\n");
}

void sigint()

{ signal(SIGINT,sigint); /* reset signal */
  printf("CHILD: I have received a SIGINT\n");
}

void sigquit()

{ printf("My DADDY has Killed me!!!\n");
  exit(0);
}
```

Other signal functions

There are a few other functions defined in `signal.h`:

`int sighold(int sig) -- adds sig to the calling process's signal mask`

`int sigrelse(int sig)` -- removes `sig` from the calling process's signal mask

`int sigignore(int sig)` -- sets the disposition of `sig` to `SIG_IGN`

`int sigpause(int sig)` -- removes `sig` from the calling process's signal mask and suspends the calling process until a signal is received

Dave Marshall
1/5/1999

Subsections

- [Initialising the Message Queue](#)
- [IPC Functions, Key Arguments, and Creation Flags: <sys/ipc.h>](#)
- [Controlling message queues](#)
- [Sending and Receiving Messages](#)
- [POSIX Messages: <mqueue.h>](#)
- [Example: Sending messages between two processes](#)
 - [message_send.c -- creating and sending to a simple message queue](#)
 - [message_rec.c -- receiving the above message](#)
- [Some further example message queue programs](#)
 - [msgget.c: Simple Program to illustrate msgget\(\).](#)
 - [msgctl.c Sample Program to Illustrate msgctl\(\).](#)
 - [msgop.c: Sample Program to Illustrate msgsnd\(\) and msgrcv\(\).](#)
- [Exercises](#)

IPC:Message Queues:<sys/msg.h>

The basic idea of a *message queue* is a simple one.

Two (or more) processes can exchange information via access to a common system message queue. The *sending* process places via some (OS) message-passing module a message onto a queue which can be read by another process (Figure 24.1). Each message is given an identification or `type` so that processes can select the appropriate message. Process must share a common `key` in order to gain access to the queue in the first place (subject to other permissions -- see below).

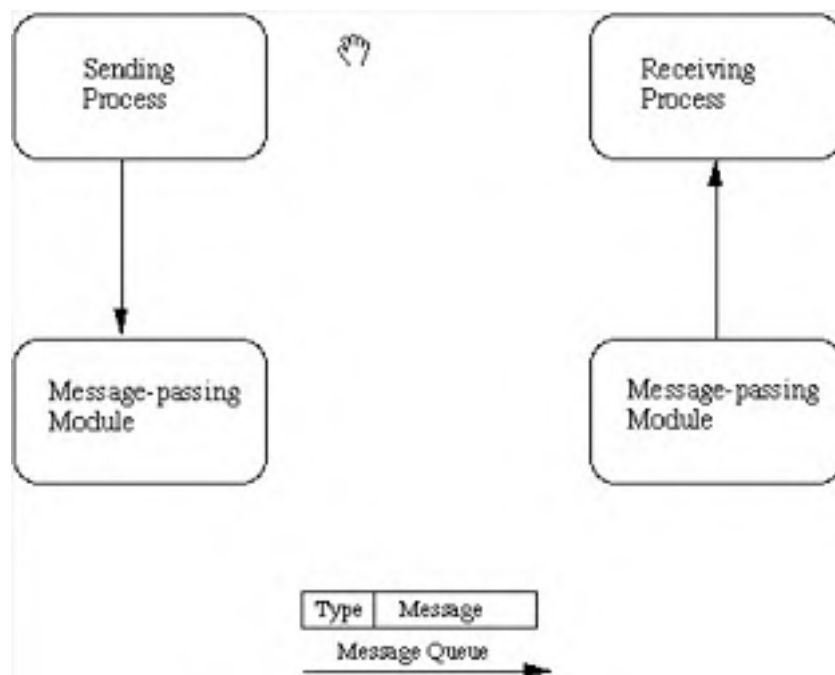

Fig. 24.1 Basic Message Passing IPC messaging lets processes send and receive messages, and queue messages for processing in an arbitrary order. Unlike the file byte-stream data flow of pipes, each IPC message has an explicit length. Messages can be assigned a specific type. Because of this, a server process can direct message traffic between clients on its queue by using the client process PID as the message type. For single-message transactions, multiple server processes can work in parallel on transactions sent to a shared message queue.

Before a process can send or receive a message, the queue must be initialized (through the `msgget` function see below) Operations to send and receive messages are performed by the `msgsnd()` and `msgrcv()` functions, respectively.

When a message is sent, its text is copied to the message queue. The `msgsnd()` and `msgrcv()` functions can be performed as either blocking or non-blocking operations. Non-blocking operations allow for asynchronous message transfer -- the process is not suspended as a result of sending or receiving a message. In blocking or synchronous message passing the sending process cannot continue until the message has been transferred or has even been acknowledged by a receiver. IPC signal and other mechanisms can be employed to implement such transfer. A blocked message operation remains suspended until one of the following three conditions occurs:

- The call succeeds.
- The process receives a signal.
- The queue is removed.

Initialising the Message Queue

The `msgget()` function initializes a new message queue:

```
int msgget(key_t key, int msgflg)
```

It can also return the message queue ID (`msqid`) of the queue corresponding to the key argument. The value passed as the `msgflg` argument must be an octal integer with settings for the queue's permissions and control flags.

The following code illustrates the `msgget()` function.

```
#include <sys/ipc.h>
#include <sys/msg.h>

...

key_t key; /* key to be passed to msgget() */
int msgflg /* msgflg to be passed to msgget() */
int msqid; /* return value from msgget() */
```

```
...
key = ...
msgflg = ...

if ((msqid = msgget(key, msgflg)) == &ndash;1)
{
    perror("msgget: msgget failed");
    exit(1);
} else
    (void) fprintf(stderr, &ldquo;msgget succeeded");
...
```

IPC Functions, Key Arguments, and Creation Flags: <sys/ipc.h>

Processes requesting access to an IPC facility must be able to identify it. To do this, functions that initialize or provide access to an IPC facility use a `key_t key` argument. (`key_t` is essentially an `int` type defined in <sys/types.h>)

The `key` is an arbitrary value or one that can be derived from a common seed at run time. One way is with `ftok()`, which converts a filename to a key value that is unique within the system. Functions that initialize or get access to messages (also semaphores or shared memory see later) return an ID number of type `int`. IPC functions that perform read, write, and control operations use this ID. If the key argument is specified as `IPC_PRIVATE`, the call initializes a new instance of an IPC facility that is private to the creating process. When the `IPC_CREAT` flag is supplied in the flags argument appropriate to the call, the function tries to create the facility if it does not exist already. When called with both the `IPC_CREAT` and `IPC_EXCL` flags, the function fails if the facility already exists. This can be useful when more than one process might attempt to initialize the facility. One such case might involve several server processes having access to the same facility. If they all attempt to create the facility with `IPC_EXCL` in effect, only the first attempt succeeds. If neither of these flags is given and the facility already exists, the functions to get access simply return the ID of the facility. If `IPC_CREAT` is omitted and the facility is not already initialized, the calls fail. These control flags are combined, using logical (bitwise) OR, with the octal permission modes to form the flags argument. For example, the statement below initializes a new message queue if the queue does not exist.

```
msqid = msgget(ftok("/tmp",
key), (IPC_CREAT | IPC_EXCL | 0400));
```

The first argument evaluates to a `key` based on the string `"/tmp"`. The second argument evaluates to the combined permissions and control flags.

Controlling message queues

The `msgctl()` function alters the permissions and other characteristics of a

message queue. The owner or creator of a queue can change its ownership or permissions using `msgctl()`. Also, any process with permission to do so can use `msgctl()` for control operations.

The `msgctl()` function is prototypes as follows:

```
int msgctl(int msqid, int cmd, struct msqid_ds *buf )
```

The `msqid` argument must be the ID of an existing message queue. The `cmd` argument is one of:

IPC_STAT

-- Place information about the status of the queue in the data structure pointed to by `buf`. The process must have read permission for this call to succeed.

IPC_SET

-- Set the owner's user and group ID, the permissions, and the size (in number of bytes) of the message queue. A process must have the effective user ID of the owner, creator, or superuser for this call to succeed.

IPC_RMID

-- Remove the message queue specified by the `msqid` argument.

The following code illustrates the `msgctl()` function with all its various flags:

```
#include<sys/types.h>
#include <sys/ipc.h>
#include <sys/msg.h>
...
if (msgctl(msqid, IPC_STAT, &buf) == -1) {
    perror("msgctl: msgctl failed");
    exit(1);
}
...
if (msgctl(msqid, IPC_SET, &buf) == -1) {
    perror("msgctl: msgctl failed");
    exit(1);
}
...
```

Sending and Receiving Messages

The `msgsnd()` and `msgrcv()` functions send and receive messages, respectively:

```
int msgsnd(int msqid, const void *msgp, size_t msgsz,
           int msgflg);

int msgrcv(int msqid, void *msgp, size_t msgsz, long msgtyp,
           int msgflg);
```

The `msqid` argument **must** be the ID of an existing message queue. The `msgp` argument is a pointer to a structure that contains the type of the message and its text. The structure below is an example of what this user-defined buffer might look like:

```
struct mymsg {
    long      mtype;    /* message type */
    char mtext[MSGSZ]; /* message text of length MSGSZ */
}
```

The `msgsz` argument specifies the length of the message in bytes.

The structure member `mtype` is the received message's type as specified by the sending process.

The argument `msgflg` specifies the action to be taken if one or more of the following are true:

- The number of bytes already on the queue is equal to `msg_qbytes`.
- The total number of messages on all queues system-wide is equal to the system-imposed limit.

These actions are as follows:

- If `(msgflg & IPC_NOWAIT)` is non-zero, the message will not be sent and the calling process will return immediately.
- If `(msgflg & IPC_NOWAIT)` is 0, the calling process will suspend execution until one of the following occurs:
 - The condition responsible for the suspension no longer exists, in which case the message is sent.
 - The message queue identifier `msqid` is removed from the system; when this occurs, `errno` is set equal to `EIDRM` and -1 is returned.
 - The calling process receives a signal that is to be caught; in this case the message is not sent and the calling process resumes execution.

Upon successful completion, the following actions are taken with respect to the data structure associated with `msqid`:

- `msg_qnum` is incremented by 1.
- `msg_lspid` is set equal to the process ID of the calling process.
- `msg_stime` is set equal to the current time.

The following code illustrates `msgsnd()` and `msgrcv()`:

```
#include <sys/types.h>
#include <sys/ipc.h>
#include <sys/msg.h>

...

int msgflg; /* message flags for the operation */
struct msgbuf *msgp; /* pointer to the message buffer */
int msgsz; /* message size */
long msgtyp; /* desired message type */
int msqid /* message queue ID to be used */
```

```
...

msgp = (struct msgbuf *)malloc((unsigned)(sizeof(struct msgbuf)
- sizeof msgp->mtext + maxmsgsz));

if (msgp == NULL) {
(void) fprintf(stderr, "msgop: %s %d byte messages.\n",
"could not allocate message buffer for", maxmsgsz);
exit(1);

...

msgsz = ...
msgflg = ...

if (msgsnd(msqid, msgp, msgsz, msgflg) == -1)
perror("msgop: msgsnd failed");
...
msgsz = ...
msgtyp = first_on_queue;
msgflg = ...
if (rtrn = msgrcv(msqid, msgp, msgsz, msgtyp, msgflg) == -1)
perror("msgop: msgrcv failed");
...

```

POSIX Messages: <mqueue.h>

The POSIX message queue functions are:

`mq_open()` -- Connects to, and optionally creates, a named message queue.

`mq_close()` -- Ends the connection to an open message queue.

`mq_unlink()` -- Ends the connection to an open message queue and causes the queue to be removed when the last process closes it.

`mq_send()` -- Places a message in the queue.

`mq_receive()` -- Receives (removes) the oldest, highest priority message from the queue.

`mq_notify()` -- Notifies a process or thread that a message is available in the queue.

`mq_setattr()` -- Set or get message queue attributes.

The basic operation of these functions is as described above. For full function prototypes and further information see the UNIX `man` pages

Example: Sending messages between two processes

The following two programs should be compiled and run *at the same time* to

illustrate basic principle of message passing:

message_send.c

-- Creates a message queue and sends one message to the queue.

message_rec.c

-- Reads the message from the queue.

message_send.c -- creating and sending to a simple message queue

The full code listing for `message_send.c` is as follows:

```
#include <sys/types.h>
#include <sys/ipc.h>
#include <sys/msg.h>
#include <stdio.h>
#include <string.h>

#define MSGSZ      128

/*
 * Declare the message structure.
 */

typedef struct msgbuf {
    long    mtype;
    char    mtext[MSGSZ];
} message_buf;

main()
{
    int msqid;
    int msgflg = IPC_CREAT | 0666;
    key_t key;
    message_buf sbuf;
    size_t buf_length;

    /*
     * Get the message queue id for the
     * "name" 1234, which was created by
     * the server.
     */
    key = 1234;

    (void) fprintf(stderr, "\nmsgget: Calling msgget(%#lx, \
    %#o)\n",
    key, msgflg);

    if ((msqid = msgget(key, msgflg )) < 0) {
        perror("msgget");
        exit(1);
    }
    else
        (void) fprintf(stderr, "msgget: msgget succeeded: msqid = %d\n",
        msqid);

    /*
     * We'll send message type 1
     */

    sbuf.mtype = 1;
```

```
(void) fprintf(stderr, "msgget: msgget succeeded: msqid = %d\n");
(void) strcpy(sbuf.mtext, "Did you get this?");
(void) fprintf(stderr, "msgget: msgget succeeded: msqid = %d\n");
buf_length = strlen(sbuf.mtext) + 1 ;

/*
 * Send a message.
 */
if (msgsnd(msqid, &sbuf, buf_length, IPC_NOWAIT) < 0) {
    printf ("%d, %d, %s, %d\n", msqid, sbuf.mtype, sbuf.mtext,
           perror("msgsnd"));
    exit(1);
}

else
    printf("Message: \"%s\" Sent\n", sbuf.mtext);

    exit(0);
}
```

The essential points to note here are:

- The Message queue is created with a basic `key` and message flag `msgflg = IPC_CREAT | 0666` -- create queue and make it read and appendable by all.
- A message of type (`sbuf.mtype`) 1 is sent to the queue with the message `"Did you get this?"`

message_rec.c -- receiving the above message

The full code listing for `message_send.c`'s companion process, `message_rec.c` is as follows:

```
#include <sys/types.h>
#include <sys/ipc.h>
#include <sys/msg.h>
#include <stdio.h>

#define MSGSZ      128

/*
 * Declare the message structure.
 */

typedef struct msgbuf {
    long    mtype;
    char    mtext[MSGSZ];
} message_buf;

main()
{
    int msqid;
    key_t key;
    message_buf rbuf;
```

```
/*
 * Get the message queue id for the
 * "name" 1234, which was created by
 * the server.
 */
key = 1234;

if ((msqid = msgget(key, 0666)) < 0) {
    perror("msgget");
    exit(1);
}

/*
 * Receive an answer of message type 1.
 */
if (msgrcv(msqid, &rbuf, MSGSZ, 1, 0) < 0) {
    perror("msgrcv");
    exit(1);
}

/*
 * Print the answer.
 */
printf("%s\n", rbuf.mtext);
exit(0);
}
```

The essential points to note here are:

- The Message queue is opened with `msgget` (message flag `0666`) and the *same* key as `message_send.c`.
- A message of the *same* type 1 is received from the queue with the message `"Did you get this?"` stored in `rbuf.mtext`.

Some further example message queue programs

The following suite of programs can be used to investigate interactively a variety of message passing ideas (see exercises below).

The message queue **must** be initialised with the `msgget.c` program. The effects of controlling the queue and sending and receiving messages can be investigated with `msgctl.c` and `msgop.c` respectively.

msgget.c: Simple Program to illustrate msgget()

```
/*
 * msgget.c: Illustrate the msgget() function.
 * This is a simple exerciser of the msgget() function. It prompts
 * for the arguments, makes the call, and reports the results.
 */

#include <stdio.h>
```

```
#include <sys/types.h>
#include <sys/ipc.h>
#include <sys/msg.h>

extern void exit();
extern void perror();

main()
{
    key_t key; /* key to be passed to msgget() */
    int msgflg, /* msgflg to be passed to msgget() */
        msqid; /* return value from msgget() */

    (void) fprintf(stderr,
        "All numeric input is expected to follow C conventions:\n");
    (void) fprintf(stderr,
        "\t0x... is interpreted as hexadecimal,\n");
    (void) fprintf(stderr, "\t0... is interpreted as octal,\n");
    (void) fprintf(stderr, "\totherwise, decimal.\n");
    (void) fprintf(stderr, "IPC_PRIVATE == %#lx\n", IPC_PRIVATE);
    (void) fprintf(stderr, "Enter key: ");
    (void) scanf("%li", &key);
    (void) fprintf(stderr, "\nExpected flags for msgflg argument
are:\n");
    (void) fprintf(stderr, "\tIPC_EXCL =\t%#8.8o\n", IPC_EXCL);
    (void) fprintf(stderr, "\tIPC_CREAT =\t%#8.8o\n", IPC_CREAT);
    (void) fprintf(stderr, "\towner read =\t%#8.8o\n", 0400);
    (void) fprintf(stderr, "\towner write =\t%#8.8o\n", 0200);
    (void) fprintf(stderr, "\tgroup read =\t%#8.8o\n", 040);
    (void) fprintf(stderr, "\tgroup write =\t%#8.8o\n", 020);
    (void) fprintf(stderr, "\tother read =\t%#8.8o\n", 04);
    (void) fprintf(stderr, "\tother write =\t%#8.8o\n", 02);
    (void) fprintf(stderr, "Enter msgflg value: ");
    (void) scanf("%i", &msgflg);

    (void) fprintf(stderr, "\nmsgget: Calling msgget(%#lx,
%#o)\n",
key, msgflg);
    if ((msqid = msgget(key, msgflg)) == -1)
    {
        perror("msgget: msgget failed");
        exit(1);
    } else {
        (void) fprintf(stderr,
            "msgget: msgget succeeded: msqid = %d\n", msqid);
        exit(0);
    }
}
```

msgctl.c Sample Program to Illustrate msgctl()

```
/*
 * msgctl.c: Illustrate the msgctl() function.
 *
 * This is a simple exerciser of the msgctl() function. It allow
 * you to perform one control operation on one message queue. It
 * gives up immediately if any control operation fails, so be
 * careful
 * not to set permissions to preclude read permission; you won't
 * be
 * able to reset the permissions with this code if you do.
 */
#include <stdio.h>
```

```
#include <sys/types.h>
#include <sys/ipc.h>
#include <sys/msg.h>
#include <time.h>

static void do_msgctl();
extern void exit();
extern void perror();
static char warning_message[] = "If you remove read permission
for \
    yourself, this program will fail frequently!";

main()
{
    struct msqid_ds buf; /* queue descriptor buffer for IPC_STAT
                        and IP_SET commands */
    int cmd, /* command to be given to msgctl() */
        msqid; /* queue ID to be given to msgctl() */

    (void) fprintf(stderr,
        "All numeric input is expected to follow C conventions:\n");
    (void) fprintf(stderr,
        "\t0x... is interpreted as hexadecimal,\n");
    (void) fprintf(stderr, "\t0... is interpreted as octal,\n");
    (void) fprintf(stderr, "\totherwise, decimal.\n");

    /* Get the msqid and cmd arguments for the msgctl() call. */
    (void) fprintf(stderr,
        "Please enter arguments for msgctls() as requested.");
    (void) fprintf(stderr, "\nEnter the msqid: ");
    (void) scanf("%i", &msqid);
    (void) fprintf(stderr, "\tIPC_RMID = %d\n", IPC_RMID);
    (void) fprintf(stderr, "\tIPC_SET = %d\n", IPC_SET);
    (void) fprintf(stderr, "\tIPC_STAT = %d\n", IPC_STAT);
    (void) fprintf(stderr, "\nEnter the value for the command: ");
    (void) scanf("%i", &cmd);

    switch (cmd) {
        case IPC_SET:
            /* Modify settings in the message queue control structure.
            */
            (void) fprintf(stderr, "Before IPC_SET, get current
            values:");
            /* fall through to IPC_STAT processing */
            case IPC_STAT:
                /* Get a copy of the current message queue control
                * structure and show it to the user. */
                do_msgctl(msqid, IPC_STAT, &buf);
                (void) fprintf(stderr, ]
                "msg_perm.uid = %d\n", buf.msg_perm.uid);
                (void) fprintf(stderr,
                "msg_perm.gid = %d\n", buf.msg_perm.gid);
                (void) fprintf(stderr,
                "msg_perm.cuid = %d\n", buf.msg_perm.cuid);
                (void) fprintf(stderr,
                "msg_perm.cgid = %d\n", buf.msg_perm.cgid);
                (void) fprintf(stderr, "msg_perm.mode = %#o, ",
                buf.msg_perm.mode);
                (void) fprintf(stderr, "access permissions = %#o\n",
                buf.msg_perm.mode & 0777);
                (void) fprintf(stderr, "msg_cbytes = %d\n",
                buf.msg_cbytes);
                (void) fprintf(stderr, "msg_qbytes = %d\n",
                buf.msg_qbytes);
                (void) fprintf(stderr, "msg_qnum = %d\n", buf.msg_qnum);
                (void) fprintf(stderr, "msg_lspid = %d\n",
```

```
        buf.msg_lspid);
(void) fprintf(stderr, "msg_lrpid = %d\n",
        buf.msg_lrpid);
(void) fprintf(stderr, "msg_stime = %s", buf.msg_stime ?
ctime(&buf.msg_stime) : "Not Set\n");
(void) fprintf(stderr, "msg_rtime = %s", buf.msg_rtime ?
ctime(&buf.msg_rtime) : "Not Set\n");
(void) fprintf(stderr, "msg_ctime = %s",
        ctime(&buf.msg_ctime));
if (cmd == IPC_STAT)
    break;
/* Now continue with IPC_SET. */
(void) fprintf(stderr, "Enter msg_perm.uid: ");
(void) scanf ("%hi", &buf.msg_perm.uid);
(void) fprintf(stderr, "Enter msg_perm.gid: ");
(void) scanf("%hi", &buf.msg_perm.gid);
(void) fprintf(stderr, "%s\n", warning_message);
(void) fprintf(stderr, "Enter msg_perm.mode: ");
(void) scanf("%hi", &buf.msg_perm.mode);
(void) fprintf(stderr, "Enter msg_qbytes: ");
(void) scanf("%hi", &buf.msg_qbytes);
do_msgctl(msqid, IPC_SET, &buf);
break;
case IPC_RMID:
default:
    /* Remove the message queue or try an unknown command. */
do_msgctl(msqid, cmd, (struct msqid_ds *)NULL);
break;
}
exit(0);
}

/*
 * Print indication of arguments being passed to msgctl(), call
 * msgctl(), and report the results. If msgctl() fails, do not
 * return; this example doesn't deal with errors, it just reports
 * them.
 */
static void
do_msgctl(msqid, cmd, buf)
struct msqid_ds *buf; /* pointer to queue descriptor buffer */
int cmd, /* command code */
    msqid; /* queue ID */
{
    register int rtrn; /* hold area for return value from msgctl()
*/

    (void) fprintf(stderr, "\nmsgctl: Calling msgctl(%d, %d,
%s)\n",
        msqid, cmd, buf ? "&buf" : "(struct msqid_ds *)NULL");
    rtrn = msgctl(msqid, cmd, buf);
    if (rtrn == -1) {
        perror("msgctl: msgctl failed");
        exit(1);
    } else {
        (void) fprintf(stderr, "msgctl: msgctl returned %d\n",
            rtrn);
    }
}
}
```

msgop.c: Sample Program to Illustrate msgsnd() and msgrcv()

```
/*
 * msgop.c: Illustrate the msgsnd() and msgrcv() functions.
 *
 * This is a simple exerciser of the message send and receive
 * routines. It allows the user to attempt to send and receive as
many
 * messages as wanted to or from one message queue.
 */

#include <stdio.h>
#include <sys/types.h>
#include <sys/ipc.h>
#include <sys/msg.h>

static int ask();
extern void exit();
extern char *malloc();
extern void perror();

char first_on_queue[] = "-> first message on queue",
full_buf[] = "Message buffer overflow. Extra message text\
discarded.";

main()
{
    register int    c; /* message text input */
    int    choice; /* user's selected operation code */
    register int    i; /* loop control for mtext */
    int    msgflg; /* message flags for the operation */
    struct msgbuf    *msgp; /* pointer to the message buffer */
    int    msgsz; /* message size */
    long    msgtyp; /* desired message type */
    int    msqid, /* message queue ID to be used */
        maxmsgsz, /* size of allocated message buffer */
        rtn; /* return value from msgrcv or msgsnd */
    (void) fprintf(stderr,
        "All numeric input is expected to follow C conventions:\n");
    (void) fprintf(stderr,
        "\t0x... is interpreted as hexadecimal,\n");
    (void) fprintf(stderr, "\t0... is interpreted as octal,\n");
    (void) fprintf(stderr, "\totherwise, decimal.\n");
    /* Get the message queue ID and set up the message buffer. */
    (void) fprintf(stderr, "Enter msqid: ");
    (void) scanf("%i", &msqid);
    /*
     * Note that <sys/msg.h> includes a definition of struct
msgbuf
     * with the mtext field defined as:
     * char mtext[1];
     * therefore, this definition is only a template, not a
structure
     * definition that you can use directly, unless you want only
to
     * send and receive messages of 0 or 1 byte. To handle this,
     * malloc an area big enough to contain the template - the size
     * of the mtext template field + the size of the mtext field
     * wanted. Then you can use the pointer returned by malloc as a
     * struct msgbuf with an mtext field of the size you want. Note
     * also that sizeof msgp->mtext is valid even though msgp
isn't
     * pointing to anything yet. Sizeof doesn't dereference msgp,
but
     * uses its type to figure out what you are asking about.
     */
    (void) fprintf(stderr,
        "Enter the message buffer size you want:");
    (void) scanf("%i", &maxmsgsz);
}
```

```
if (maxmsgsz < 0) {
    (void) fprintf(stderr, "msgop: %s\n",
        "The message buffer size must be >= 0.");
    exit(1);
}
msgp = (struct msgbuf *)malloc((unsigned)(sizeof(struct
msgbuf)
    - sizeof msgp->mtext + maxmsgsz));
if (msgp == NULL) {
    (void) fprintf(stderr, "msgop: %s %d byte messages.\n",
        "could not allocate message buffer for", maxmsgsz);
    exit(1);
}
/* Loop through message operations until the user is ready to
quit. */
while (choice = ask()) {
    switch (choice) {
    case 1: /* msgsnd() requested: Get the arguments, make the
call, and report the results. */
        (void) fprintf(stderr, "Valid msgsnd message %s\n",
            "types are positive integers.");
        (void) fprintf(stderr, "Enter msgp->mtype: ");
        (void) scanf("%li", &msgp->mtype);
        if (maxmsgsz) {
            /* Since you've been using scanf, you need the loop
below to throw away the rest of the input on the
line after the entered mtype before you start
reading the mtext. */
            while ((c = getchar()) != '\n' && c != EOF);
            (void) fprintf(stderr, "Enter a %s:\n",
                "one line message");
            for (i = 0; ((c = getchar()) != '\n'); i++) {
                if (i >= maxmsgsz) {
                    (void) fprintf(stderr, "\n%s\n", full_buf);
                    while ((c = getchar()) != '\n');
                    break;
                }
                msgp->mtext[i] = c;
            }
            msgsz = i;
        } else
            msgsz = 0;
        (void) fprintf(stderr, "\nMeaningful msgsnd flag is:\n");
        (void) fprintf(stderr, "\tIPC_NOWAIT = \t%#8.8o\n",
            IPC_NOWAIT);
        (void) fprintf(stderr, "Enter msgflg: ");
        (void) scanf("%i", &msgflg);
        (void) fprintf(stderr, "%s(%d, msgp, %d, %#o)\n",
            "msgop: Calling msgsnd", msqid, msgsz, msgflg);
        (void) fprintf(stderr, "msgp->mtype = %ld\n",
            msgp->mtype);
        (void) fprintf(stderr, "msgp->mtext = \");
        for (i = 0; i < msgsz; i++)
            (void) fputc(msgp->mtext[i], stderr);
        (void) fprintf(stderr, "\">\n");
        rtn = msgsnd(msqid, msgp, msgsz, msgflg);
        if (rtn == -1)
            perror("msgop: msgsnd failed");
        else
            (void) fprintf(stderr,
                "msgop: msgsnd returned %d\n", rtn);
        break;
    case 2: /* msgrcv() requested: Get the arguments, make the
call, and report the results. */
        for (msgsz = -1; msgsz < 0 || msgsz > maxmsgsz;
            (void) scanf("%i", &msgsz))
            (void) fprintf(stderr, "%s (0 <= msgsz <= %d): ",
```

```
        "Enter msgsz", maxmsgsz);
(void) fprintf(stderr, "msgtyp meanings:\n");
(void) fprintf(stderr, "\t 0 %s\n", first_on_queue);
(void) fprintf(stderr, "\t>0 %s of given type\n",
    first_on_queue);
(void) fprintf(stderr, "\t<0 %s with type <= |msgtyp|\n",
    first_on_queue);
(void) fprintf(stderr, "Enter msgtyp: ");
(void) scanf("%li", &msgtyp);
(void) fprintf(stderr,
    "Meaningful msgrcv flags are:\n");
(void) fprintf(stderr, "\tMSG_NOERROR =\t%#8.8o\n",
    MSG_NOERROR);
(void) fprintf(stderr, "\tIPC_NOWAIT =\t%#8.8o\n",
    IPC_NOWAIT);
(void) fprintf(stderr, "Enter msgflg: ");
(void) scanf("%i", &msgflg);
(void) fprintf(stderr, "%s(%d, msgp, %d, %ld, %#o);\n",
    "msgop: Calling msgrcv", msqid, msgsz,
    msgtyp, msgflg);
rtrn = msgrcv(msqid, msgp, msgsz, msgtyp, msgflg);
if (rtrn == -1)
    perror("msgop: msgrcv failed");
else {
    (void) fprintf(stderr, "msgop: %s %d\n",
        "msgrcv returned", rtrn);
    (void) fprintf(stderr, "msgp->mtype = %ld\n",
        msgp->mtype);
    (void) fprintf(stderr, "msgp->mtext is: \");
    for (i = 0; i < rtrn; i++)
        (void) fputc(msgp->mtext[i], stderr);
    (void) fprintf(stderr, "\n");
}
break;
default:
    (void) fprintf(stderr, "msgop: operation unknown\n");
    break;
}
}
exit(0);
}

/*
 * Ask the user what to do next. Return the user's choice code.
 * Don't return until the user selects a valid choice.
 */
static
ask()
{
    int response; /* User's response. */

    do {
        (void) fprintf(stderr, "Your options are:\n");
        (void) fprintf(stderr, "\tExit =\t0 or Control-D\n");
        (void) fprintf(stderr, "\tmsgsnd =\t1\n");
        (void) fprintf(stderr, "\tmsgrcv =\t2\n");
        (void) fprintf(stderr, "Enter your choice: ");

        /* Preset response so "^D" will be interpreted as exit. */
        response = 0;
        (void) scanf("%i", &response);
    } while (response < 0 || response > 2);

    return(response);
}
```

Exercises

Exercise 12755

Write a 2 programs that will both send and messages and construct the following dialog between them

- (Process 1) Sends the message "Are you hearing me?"
- (Process 2) Receives the message and replies "Loud and Clear".
- (Process 1) Receives the reply and then says "I can hear you too".

Exercise 12756

Compile the programs `msgget.c`, `msgctl.c` and `msgop.c` and then

- investigate and understand fully the operations of the flags (access, creation *etc.* permissions) you can set interactively in the programs.
- Use the programs to:
 - Send and receive messages of two different message `types`.
 - Place several messages on the queue and inquire about the state of the queue with `msgctl.c`. Add/delete a few messages (using `msgop.c` and perform the inquiry once more.
 - Use `msgctl.c` to alter a message on the queue.
 - Use `msgctl.c` to delete a message from the queue.

Exercise 12757

Write a *server* program and two *client* programs so that the *server* can communicate privately to *each client* individually via a *single* message queue.

Exercise 12758

Implement a *blocked* or *synchronous* method of message passing using signal interrupts.

Dave Marshall
1/5/1999

Subsections

- [Initializing a Semaphore Set](#)
 - [Controlling Semaphores](#)
 - [Semaphore Operations](#)
 - [POSIX Semaphores: <semaphore.h>](#)
 - [semaphore.c: Illustration of simple semaphore passing](#)
 - [Some further example semaphore programs](#)
 - [semget.c: Illustrate the semget\(\) function](#)
 - [semctl.c: Illustrate the semctl\(\) function](#)
 - [semop\(\) Sample Program to Illustrate semop\(\)](#)
 - [Exercises](#)
-

IPC:Semaphores

Semaphores are a programming construct designed by E. W. Dijkstra in the late 1960s. Dijkstra's model was the operation of railroads: consider a stretch of railroad in which there is a single track over which only one train at a time is allowed. Guarding this track is a semaphore. A train must wait before entering the single track until the semaphore is in a state that permits travel. When the train enters the track, the semaphore changes state to prevent other trains from entering the track. A train that is leaving this section of track must again change the state of the semaphore to allow another train to enter. In the computer version, a semaphore appears to be a simple integer. A process (or a thread) waits for permission to proceed by waiting for the integer to become 0. The signal if it proceeds signals that this by performing incrementing the integer by 1. When it is finished, the process changes the semaphore's value by subtracting one from it.

Semaphores let processes query or alter status information. They are often used to monitor and control the availability of system resources such as shared memory segments.

Semaphores can be operated on as individual units or as elements in a set. Because System V IPC semaphores can be in a large array, they are extremely heavy weight. Much lighter weight semaphores are available in the threads library (see `man semaphore` and also Chapter 30.3) and POSIX semaphores (see below briefly). Threads library semaphores must be used with mapped memory . A semaphore set consists of a control structure and an array of individual semaphores. A set of semaphores can contain up to 25 elements.

In a similar fashion to message queues, the semaphore set must be initialized using `semget()`; the semaphore creator can change its ownership or permissions using `semctl()`; and semaphore operations are performed via the `semop()` function. These are now discussed below:

Initializing a Semaphore Set

The function `semget()` initializes or gains access to a semaphore. It is prototyped by:

```
int semget(key_t key, int nsems, int semflg);
```

When the call succeeds, it returns the semaphore ID (`semid`).

The `key` argument is a access value associated with the semaphore ID.

The `nsems` argument specifies the number of elements in a semaphore array. The call fails when `nsems` is greater than the number of elements in an existing array; when the correct count is not known, supplying 0 for this argument ensures that it will succeed.

The `semflg` argument specifies the initial access permissions and creation control flags.

The following code illustrates the `semget()` function.

```
#include <sys/types.h>
#include <sys/ipc.h>
#include <sys/sem.h>

...
key_t key; /* key to pass to semget() */
int semflg; /* semflg to pass to semget() */
int nsems; /* nsems to pass to semget() */
int semid; /* return value from semget() */

...

key = ...
nsems = ...
semflg = ...
if ((semid = semget(key, nsems, semflg)) == -1) {
    perror("semget: semget failed");
    exit(1); }
else
    ...
```

Controlling Semaphores

`semctl()` changes permissions and other characteristics of a semaphore set. It is prototyped as follows:

```
int semctl(int semid, int semnum, int cmd, union semun arg);
```

It must be called with a valid semaphore ID, `semid`. The `semnum` value selects a semaphore within an array by its index. The `cmd` argument is one of the following control flags:

GETVAL

-- Return the value of a single semaphore.

SETVAL

-- Set the value of a single semaphore. In this case, `arg` is taken as `arg.val`, an int.

GETPID

-- Return the `PID` of the process that performed the last operation on the semaphore or array.

GETNCNT

-- Return the number of processes waiting for the value of a semaphore to increase.

GETZCNT

-- Return the number of processes waiting for the value of a particular semaphore to reach zero.

GETALL

-- Return the values for all semaphores in a set. In this case, `arg` is taken as `arg.array`, a pointer to an array of unsigned shorts (see below).

SETALL

-- Set values for all semaphores in a set. In this case, `arg` is taken as `arg.array`, a pointer to an array of unsigned shorts.

IPC_STAT

-- Return the status information from the control structure for the semaphore set and place it in the data structure pointed to by `arg.buf`, a pointer to a buffer of type `semid_ds`.

IPC_SET

-- Set the effective user and group identification and permissions. In this case, `arg` is taken as `arg.buf`.

IPC_RMID

-- Remove the specified semaphore set.

A process must have an effective user identification of owner, creator, or superuser to perform an `IPC_SET` or `IPC_RMID` command. Read and write permission is required as for the other control commands. The following code illustrates `semctl ()`.

The fourth argument `union semun arg` is optional, depending upon the operation requested. If required it is of type `union semun`, which must be *explicitly* declared by the application program as:

```
union semun {
    int val;
    struct semid_ds *buf;
    ushort *array;
} arg;

#include <sys/types.h>
#include <sys/ipc.h>
#include <sys/sem.h>

union semun {
    int val;
    struct semid_ds *buf;
    ushort *array;
} arg;

int i;
int semnum = ....;
```

```
int cmd = GETALL; /* get value */

...
i = semctl(semid, semnum, cmd, arg);
if (i == -1) {
    perror("semctl: semctl failed");
    exit(1);
}
else
...

```

Semaphore Operations

`semop()` performs operations on a semaphore set. It is prototyped by:

```
int semop(int semid, struct sembuf *sops, size_t nsops);
```

The `semid` argument is the semaphore ID returned by a previous `semget()` call. The `sops` argument is a pointer to an array of structures, each containing the following information about a semaphore operation:

- The semaphore number
- The operation to be performed
- Control flags, if any.

The `sembuf` structure specifies a semaphore operation, as defined in `<sys/sem.h>`.

```
struct sembuf {
    ushort_t    sem_num;        /* semaphore number */
    short       sem_op;        /* semaphore operation */
    short       sem_flg;        /* operation flags */
};
```

The `nsops` argument specifies the length of the array, the maximum size of which is determined by the `SEMOPM` configuration option; this is the maximum number of operations allowed by a single `semop()` call, and is set to 10 by default. The operation to be performed is determined as follows:

- A positive integer increments the semaphore value by that amount.
- A negative integer decrements the semaphore value by that amount. An attempt to set a semaphore to a value less than zero fails or blocks, depending on whether `IPC_NOWAIT` is in effect.
- A value of zero means to wait for the semaphore value to reach zero.

There are two control flags that can be used with `semop()`:

IPC_NOWAIT

-- Can be set for any operations in the array. Makes the function return without changing any semaphore value if any operation for which `IPC_NOWAIT` is set cannot be performed. The function fails if it tries to decrement a semaphore more than its current value, or tests a nonzero semaphore to be equal to zero.

SEM_UNDO

-- Allows individual operations in the array to be undone when the process exits.

This function takes a pointer, `sops`, to an array of semaphore operation structures. Each structure in the array contains data about an operation to perform on a semaphore. Any process with read permission can test whether a semaphore has a zero value. To increment or decrement a semaphore requires write permission. When an operation fails, none of the semaphores is altered.

The process blocks (unless the `IPC_NOWAIT` flag is set), and remains blocked until:

- the semaphore operations can all finish, so the call succeeds,
- the process receives a signal, or
- the semaphore set is removed.

Only one process at a time can update a semaphore. Simultaneous requests by different processes are performed in an arbitrary order. When an array of operations is given by a `semop()` call, no updates are done until all operations on the array can finish successfully.

If a process with exclusive use of a semaphore terminates abnormally and fails to undo the operation or free the semaphore, the semaphore stays locked in memory in the state the process left it. To prevent this, the `SEM_UNDO` control flag makes `semop()` allocate an undo structure for each semaphore operation, which contains the operation that returns the semaphore to its previous state. If the process dies, the system applies the operations in the undo structures. This prevents an aborted process from leaving a semaphore set in an inconsistent state. If processes share access to a resource controlled by a semaphore, operations on the semaphore should not be made with `SEM_UNDO` in effect. If the process that currently has control of the resource terminates abnormally, the resource is presumed to be inconsistent. Another process must be able to recognize this to restore the resource to a consistent state. When performing a semaphore operation with `SEM_UNDO` in effect, you must also have it in effect for the call that will perform the reversing operation. When the process runs normally, the reversing operation updates the undo structure with a complementary value. This ensures that, unless the process is aborted, the values applied to the undo structure are cancel to zero. When the undo structure reaches zero, it is removed.

NOTE: Using `SEM_UNDO` inconsistently can lead to excessive resource consumption because allocated undo structures might not be freed until the system is rebooted.

The following code illustrates the `semop()` function:

```
#include <sys/types.h>
#include <sys/ipc.h>
#include <sys/sem.h>

...
int i;
int nsops; /* number of operations to do */
int semid; /* semid of semaphore set */
struct sembuf *sops; /* ptr to operations to perform */

...

if ((semid = semop(semid, sops, nsops)) == -1)
{
    perror("semop: semop failed");
    exit(1);
}
else
(void) fprintf(stderr, "semop: returned %d\n", i);
...
```

POSIX Semaphores: <semaphore.h>

POSIX semaphores are much lighter weight than are System V semaphores. A POSIX semaphore structure defines a single semaphore, not an array of up to twenty five semaphores. The POSIX semaphore functions are:

`sem_open()` -- Connects to, and optionally creates, a named semaphore

`sem_init()` -- Initializes a semaphore structure (internal to the calling program, so not a named semaphore).

`sem_close()` -- Ends the connection to an open semaphore.

`sem_unlink()` -- Ends the connection to an open semaphore and causes the semaphore to be removed when the last process closes it.

`sem_destroy()` -- Initializes a semaphore structure (internal to the calling program, so not a named semaphore).

`sem_getvalue()` -- Copies the value of the semaphore into the specified integer.

`sem_wait()`, `sem_trywait()` -- Blocks while the semaphore is held by other processes or returns an error if the semaphore is held by another process.

`sem_post()` -- Increments the count of the semaphore.

The basic operation of these functions is essence the same as described above, except note there are more specialised functions, here. These are not discussed further here and the reader is referred to the online `man` pages for further details.

semaphore.c: Illustration of simple semaphore passing

```
/* semaphore.c --- simple illustration of dijkstra's semaphore an.
 *
 * We fork() a child process so that we have two processes run.
 * Each process communicates via a semaphore.
 * The respective process can only do its work (not much here)
 * When it notices that the semaphore track is free when it ret.
 * Each process must modify the semaphore accordingly
 */

#include <stdio.h>
#include <sys/types.h>
#include <sys/ipc.h>
#include <sys/sem.h>

union semun {
    int val;
    struct semid_ds *buf;
    ushort *array;
};

main()
{ int i,j;
  int pid;
  int semid; /* semid of semaphore set */
  key_t key = 1234; /* key to pass to semget() */
  int semflg = IPC_CREAT | 0666; /* semflg to pass to semget() */
  int nsems = 1; /* nsems to pass to semget() */
  int nsops; /* number of operations to do */
  struct sembuf *sops = (struct sembuf *) malloc(2*sizeof(struct
  /* ptr to operations to perform */

  /* set up semaphore */

  (void) fprintf(stderr, "\nsemget: Setting up semaphore: semget
  %#o\n",key, nsems, semflg);
  if ((semid = semget(key, nsems, semflg)) == -1) {
  perror("semget: semget failed");
  exit(1);
  } else
  (void) fprintf(stderr, "semget: semget succeeded: semid =\
  %d\n", semid);

  /* get child process */

  if ((pid = fork()) < 0) {
  perror("fork");
  exit(1);
  }

  if (pid == 0)
  { /* child */
  i = 0;

  while (i < 3) { /* allow for 3 semaphore sets */

  nsops = 2;

  /* wait for semaphore to reach zero */
```

```
sops[0].sem_num = 0; /* We only use one track */
sops[0].sem_op = 0; /* wait for semaphore flag to become z
sops[0].sem_flg = SEM_UNDO; /* take off semaphore asynchro

sops[1].sem_num = 0;
sops[1].sem_op = 1; /* increment semaphore -- take control
sops[1].sem_flg = SEM_UNDO | IPC_NOWAIT; /* take off semap

/* Recap the call to be made. */

(void) fprintf(stderr, "\nsemop:Child Calling semop(%d, &s
for (j = 0; j < nsops; j++)
{
(void) fprintf(stderr, "\n\t\sops[%d].sem_num = %d, ", j, sops[
(void) fprintf(stderr, "sem_op = %d, ", sops[j].sem_op);
(void) fprintf(stderr, "sem_flg = %#o\n", sops[j].sem_flg);
}

/* Make the semop() call and report the results. */
if ((j = semop(semid, sops, nsops)) == -1) {
perror("semop: semop failed");
}
else
{
(void) fprintf(stderr, "\tsemop: semop returned %d\n", j);

(void) fprintf(stderr, "\n\nChild Process Taking Control of Tra
sleep(5); /* DO Nothing for 5 seconds */

nsops = 1;

/* wait for semaphore to reach zero */
sops[0].sem_num = 0;
sops[0].sem_op = -1; /* Give UP Control of track
sops[0].sem_flg = SEM_UNDO | IPC_NOWAIT; /* take off sem

if ((j = semop(semid, sops, nsops)) == -1) {
perror("semop: semop failed");
}
else
{
(void) fprintf(stderr, "Child Process Giving up Control o
sleep(5); /* halt process to allow parent to catch
}
++i;
}
}
else /* parent */
{ /* pid hold id of child */

i = 0;

while (i < 3) { /* allow for 3 semaphore sets */

nsops = 2;

/* wait for semaphore to reach zero */
sops[0].sem_num = 0;
sops[0].sem_op = 0; /* wait for semaphore flag to become z
sops[0].sem_flg = SEM_UNDO; /* take off semaphore asynchro

sops[1].sem_num = 0;
```

- The process then gives up control of the *track* `sops[1].sem_op = -1`
- an additional sleep operation is then performed to ensure that the other process has time to access the semaphore before a subsequent (same process) semaphore read.

Note: There is no synchronisation here in this simple example and we have no control over how the OS will schedule the processes.

Some further example semaphore programs

The following suite of programs can be used to investigate interactively a variety of semaphore ideas (see exercises below).

The semaphore **must** be initialised with the `semget.c` program. The effects of controlling the semaphore queue and sending and receiving semaphore can be investigated with `semctl.c` and `semop.c` respectively.

semget.c: Illustrate the semget() function

```
/*
 * semget.c: Illustrate the semget() function.
 *
 * This is a simple exerciser of the semget() function. It prompts
 * for the arguments, makes the call, and reports the results.
 */

#include <stdio.h>
#include <sys/types.h>
#include <sys/ipc.h>
#include <sys/sem.h>

extern void exit();
extern void perror();

main()
{
    key_t key; /* key to pass to semget() */
    int semflg; /* semflg to pass to semget() */
    int nsems; /* nsems to pass to semget() */
    int semid; /* return value from semget() */

    (void) fprintf(stderr,
        "All numeric input must follow C conventions:\n");
    (void) fprintf(stderr,
        "\t0x... is interpreted as hexadecimal,\n");
    (void) fprintf(stderr, "\t0... is interpreted as octal,\n");
    (void) fprintf(stderr, "\totherwise, decimal.\n");
    (void) fprintf(stderr, "IPC_PRIVATE == %#lx\n", IPC_PRIVATE);
    (void) fprintf(stderr, "Enter key: ");
    (void) scanf("%li", &key);

    (void) fprintf(stderr, "Enter nsems value: ");
    (void) scanf("%i", &nsems);
    (void) fprintf(stderr, "\nExpected flags for semflg are:\n");
    (void) fprintf(stderr, "\tIPC_EXCL = \t%#8.8o\n", IPC_EXCL);
```

```
(void) fprintf(stderr, "\tIPC_CREAT = \t%#8.8o\n",
IPC_CREAT);
(void) fprintf(stderr, "\towner read = \t%#8.8o\n", 0400);
(void) fprintf(stderr, "\towner alter = \t%#8.8o\n", 0200);
(void) fprintf(stderr, "\tgroup read = \t%#8.8o\n", 040);
(void) fprintf(stderr, "\tgroup alter = \t%#8.8o\n", 020);
(void) fprintf(stderr, "\tother read = \t%#8.8o\n", 04);
(void) fprintf(stderr, "\tother alter = \t%#8.8o\n", 02);
(void) fprintf(stderr, "Enter semflg value: ");
(void) scanf("%i", &semflg);
(void) fprintf(stderr, "\nsemget: Calling semget(%#lx, %
    %#o)\n",key, nsems, semflg);
if ((semid = semget(key, nsems, semflg)) == -1) {
    perror("semget: semget failed");
    exit(1);
} else {
    (void) fprintf(stderr, "semget: semget succeeded: semid =
%d\n",
    semid);
    exit(0);
}
}
```

semctl.c: Illustrate the semctl() function

```
/*
 * semctl.c: Illustrate the semctl() function.
 *
 * This is a simple exerciser of the semctl() function. It lets y
 * perform one control operation on one semaphore set. It gives u
 * immediately if any control operation fails, so be careful not
to
 * set permissions to preclude read permission; you won't be able
to
 * reset the permissions with this code if you do.
 */

#include <stdio.h>
#include <sys/types.h>
#include <sys/ipc.h>
#include <sys/sem.h>
#include <time.h>

struct semid_ds semid_ds;

static void do_semctl();
static void do_stat();
extern char *malloc();
extern void exit();
extern void perror();

char warning_message[] = "If you remove read permission\
    for yourself, this program will fail frequently!";

main()
{
    union semun arg; /* union to pass to semctl() */
    int cmd, /* command to give to semctl() */
        i, /* work area */
        semid, /* semid to pass to semctl() */
        semnum; /* semnum to pass to semctl() */

    (void) fprintf(stderr,
        "All numeric input must follow C conventions:\n");
```

```
(void) fprintf(stderr,
    "\t0x... is interpreted as hexadecimal,\n");
(void) fprintf(stderr, "\t0... is interpreted as octal,\n");
(void) fprintf(stderr, "\totherwise, decimal.\n");
(void) fprintf(stderr, "Enter semid value: ");
(void) scanf("%i", &semid);

(void) fprintf(stderr, "Valid semctl cmd values are:\n");
(void) fprintf(stderr, "\tGETALL = %d\n", GETALL);
(void) fprintf(stderr, "\tGETNCNT = %d\n", GETNCNT);
(void) fprintf(stderr, "\tGETPID = %d\n", GETPID);
(void) fprintf(stderr, "\tGETVAL = %d\n", GETVAL);
(void) fprintf(stderr, "\tGETZCNT = %d\n", GETZCNT);
(void) fprintf(stderr, "\tIPC_RMID = %d\n", IPC_RMID);
(void) fprintf(stderr, "\tIPC_SET = %d\n", IPC_SET);
(void) fprintf(stderr, "\tIPC_STAT = %d\n", IPC_STAT);
(void) fprintf(stderr, "\tSETALL = %d\n", SETALL);
(void) fprintf(stderr, "\tSETVAL = %d\n", SETVAL);
(void) fprintf(stderr, "\nEnter cmd: ");
(void) scanf("%i", &cmd);

/* Do some setup operations needed by multiple commands. */
switch (cmd) {
    case GETVAL:
    case SETVAL:
    case GETNCNT:
    case GETZCNT:
        /* Get the semaphore number for these commands. */
        (void) fprintf(stderr, "\nEnter semnum value: ");
        (void) scanf("%i", &semnum);
        break;
    case GETALL:
    case SETALL:
        /* Allocate a buffer for the semaphore values. */
        (void) fprintf(stderr,
            "Get number of semaphores in the set.\n");
        arg.buf = &semid_ds;
        do_semctl(semid, 0, IPC_STAT, arg);
        if (arg.array =
            (ushort *)malloc((unsigned)
                (semid_ds.sem_nsems * sizeof(ushort)))) {
            /* Break out if you got what you needed. */
            break;
        }
        (void) fprintf(stderr,
            "semctl: unable to allocate space for %d values\n",
            semid_ds.sem_nsems);
        exit(2);
}

/* Get the rest of the arguments needed for the specified
   command. */
switch (cmd) {
    case SETVAL:
        /* Set value of one semaphore. */
        (void) fprintf(stderr, "\nEnter semaphore value: ");
        (void) scanf("%i", &arg.val);
        do_semctl(semid, semnum, SETVAL, arg);
        /* Fall through to verify the result. */
        (void) fprintf(stderr,
            "Do semctl GETVAL command to verify results.\n");
    case GETVAL:
        /* Get value of one semaphore. */
        arg.val = 0;
        do_semctl(semid, semnum, GETVAL, arg);
}
```



```
break;
case GETPID:
    /* Get PID of last process to successfully complete a
       semctl(SETVAL), semctl(SETALL), or semop() on the
       semaphore. */
    arg.val = 0;
    do_semctl(semid, 0, GETPID, arg);
    break;
case GETNCNT:
    /* Get number of processes waiting for semaphore value to
       increase. */
    arg.val = 0;
    do_semctl(semid, semnum, GETNCNT, arg);
    break;
case GETZCNT:
    /* Get number of processes waiting for semaphore value to
       become zero. */
    arg.val = 0;
    do_semctl(semid, semnum, GETZCNT, arg);
    break;
case SETALL:
    /* Set the values of all semaphores in the set. */
    (void) fprintf(stderr,
        "There are %d semaphores in the set.\n",
        semid_ds.sem_nsems);
    (void) fprintf(stderr, "Enter semaphore values:\n");
    for (i = 0; i < semid_ds.sem_nsems; i++) {
        (void) fprintf(stderr, "Semaphore %d: ", i);
        (void) scanf("%hi", &arg.array[i]);
    }
    do_semctl(semid, 0, SETALL, arg);
    /* Fall through to verify the results. */
    (void) fprintf(stderr,
        "Do semctl GETALL command to verify results.\n");
case GETALL:
    /* Get and print the values of all semaphores in the
       set.*/
    do_semctl(semid, 0, GETALL, arg);
    (void) fprintf(stderr,
        "The values of the %d semaphores are:\n",
        semid_ds.sem_nsems);
    for (i = 0; i < semid_ds.sem_nsems; i++)
        (void) fprintf(stderr, "%d ", arg.array[i]);
    (void) fprintf(stderr, "\n");
    break;
case IPC_SET:
    /* Modify mode and/or ownership. */
    arg.buf = &semid_ds;
    do_semctl(semid, 0, IPC_STAT, arg);
    (void) fprintf(stderr, "Status before IPC_SET:\n");
    do_stat();
    (void) fprintf(stderr, "Enter sem_perm.uid value: ");
    (void) scanf("%hi", &semid_ds.sem_perm.uid);
    (void) fprintf(stderr, "Enter sem_perm.gid value: ");
    (void) scanf("%hi", &semid_ds.sem_perm.gid);
    (void) fprintf(stderr, "%s\n", warning_message);
    (void) fprintf(stderr, "Enter sem_perm.mode value: ");
    (void) scanf("%hi", &semid_ds.sem_perm.mode);
    do_semctl(semid, 0, IPC_SET, arg);
    /* Fall through to verify changes. */
    (void) fprintf(stderr, "Status after IPC_SET:\n");
case IPC_STAT:
    /* Get and print current status. */
    arg.buf = &semid_ds;
    do_semctl(semid, 0, IPC_STAT, arg);
```

```
do_stat();
break;
case IPC_RMID:
/* Remove the semaphore set. */
arg.val = 0;
do_semctl(semid, 0, IPC_RMID, arg);
break;
default:
/* Pass unknown command to semctl. */
arg.val = 0;
do_semctl(semid, 0, cmd, arg);
break;
}
exit(0);
}

/*
 * Print indication of arguments being passed to semctl(), call
 * semctl(), and report the results. If semctl() fails, do not
 * return; this example doesn't deal with errors, it just reports
 * them.
 */
static void
do_semctl(semid, semnum, cmd, arg)
union semun arg;
int cmd,
    semid,
    semnum;
{
    register int i; /* work area */

    void fprintf(stderr, "\nsemctl: Calling semctl(%d, %d, %d,
",
        semid, semnum, cmd);
    switch (cmd) {
    case GETALL:
        (void) fprintf(stderr, "arg.array = %#x\n",
            arg.array);
        break;
    case IPC_STAT:
    case IPC_SET:
        (void) fprintf(stderr, "arg.buf = %#x\n", arg.buf);
        break;
    case SETALL:
        (void) fprintf(stderr, "arg.array = [", arg.buf);
        for (i = 0; i < semid_ds.sem_nsems; i++) {
            (void) fprintf(stderr, "%d", arg.array[i]);
            if (i < semid_ds.sem_nsems)
                (void) fprintf(stderr, ", ");
        }
        (void) fprintf(stderr, "]\n");
        break;
    case SETVAL:
    default:
        (void) fprintf(stderr, "arg.val = %d\n", arg.val);
        break;
    }
    i = semctl(semid, semnum, cmd, arg);
    if (i == -1) {
        perror("semctl: semctl failed");
        exit(1);
    }
    (void) fprintf(stderr, "semctl: semctl returned %d\n", i);
}
```

```
    return;
}

/*
 * Display contents of commonly used pieces of the status
structure.
 */
static void
do_stat()
{
    (void) fprintf(stderr, "sem_perm.uid = %d\n",
        semid_ds.sem_perm.uid);
    (void) fprintf(stderr, "sem_perm.gid = %d\n",
        semid_ds.sem_perm.gid);
    (void) fprintf(stderr, "sem_perm.cuid = %d\n",
        semid_ds.sem_perm.cuid);
    (void) fprintf(stderr, "sem_perm.cgid = %d\n",
        semid_ds.sem_perm.cgid);
    (void) fprintf(stderr, "sem_perm.mode = %#o, ",
        semid_ds.sem_perm.mode);
    (void) fprintf(stderr, "access permissions = %#o\n",
        semid_ds.sem_perm.mode & 0777);
    (void) fprintf(stderr, "sem_nsems = %d\n",
semid_ds.sem_nsems);
    (void) fprintf(stderr, "sem_otime = %s", semid_ds.sem_otime ?
        ctime(&semid_ds.sem_otime) : "Not Set\n");
    (void) fprintf(stderr, "sem_ctime = %s",
        ctime(&semid_ds.sem_ctime));
}
}
```

semop () Sample Program to Illustrate semop ()

```
/*
 * semop.c: Illustrate the semop() function.
 *
 * This is a simple exerciser of the semop() function. It lets yo
 * to set up arguments for semop() and make the call. It then
reports
 * the results repeatedly on one semaphore set. You must have rea
 * permission on the semaphore set or this exerciser will fail.
(It
 * needs read permission to get the number of semaphores in the s
 * and to report the values before and after calls to semop().)
 */

#include <stdio.h>
#include <sys/types.h>
#include <sys/ipc.h>
#include <sys/sem.h>

static int      ask();
extern void     exit();
extern void     free();
extern char     *malloc();
extern void     perror();

static struct semid_ds  semid_ds;          /* status of semapho
static char  error_mesg1[] = "semop: Can't allocate space for %
        semaphore values. Giving up.\n";
static char  error_mesg2[] = "semop: Can't allocate space for %d
        sembuf structures. Giving up.\n";
```

```
main()
{
    register int    i;    /* work area */
    int    nsops;    /* number of operations to do */
    int    semid;    /* semid of semaphore set */
    struct sembuf  *sops; /* ptr to operations to perform */

    (void) fprintf(stderr,
        "All numeric input must follow C conventions:\n");
    (void) fprintf(stderr,
        "\t0x... is interpreted as hexadecimal,\n");
    (void) fprintf(stderr, "\t0... is interpreted as octal,\n");
    (void) fprintf(stderr, "\totherwise, decimal.\n");
    /* Loop until the invoker doesn't want to do anymore. */
    while (nsops = ask(&semid, &sops)) {
        /* Initialize the array of operations to be performed.*/
        for (i = 0; i < nsops; i++) {
            (void) fprintf(stderr,
                "\nEnter values for operation %d of %d.\n",
                i + 1, nsops);
            (void) fprintf(stderr,
                "sem_num(valid values are 0 <= sem_num < %d): ",
                semid_ds.sem_nsems);
            (void) scanf("%hi", &sops[i].sem_num);
            (void) fprintf(stderr, "sem_op: ");
            (void) scanf("%hi", &sops[i].sem_op);
            (void) fprintf(stderr,
                "Expected flags in sem_flg are:\n");
            (void) fprintf(stderr, "\tIPC_NOWAIT =\t%#6.6o\n",
                IPC_NOWAIT);
            (void) fprintf(stderr, "\tSEM_UNDO =\t%#6.6o\n",
                SEM_UNDO);
            (void) fprintf(stderr, "sem_flg: ");
            (void) scanf("%hi", &sops[i].sem_flg);
        }

        /* Recap the call to be made. */
        (void) fprintf(stderr,
            "\nsemop: Calling semop(%d, &sops, %d) with:",
            semid, nsops);
        for (i = 0; i < nsops; i++)
        {
            (void) fprintf(stderr, "\nsops[%d].sem_num = %d, ", i,
                sops[i].sem_num);
            (void) fprintf(stderr, "sem_op = %d, ", sops[i].sem_op);
            (void) fprintf(stderr, "sem_flg = %#o\n",
                sops[i].sem_flg);
        }

        /* Make the semop() call and report the results. */
        if ((i = semop(semid, sops, nsops)) == -1) {
            perror("semop: semop failed");
        } else {
            (void) fprintf(stderr, "semop: semop returned %d\n", i);
        }
    }
}

/*
 * Ask if user wants to continue.
 *
 * On the first call:
 * Get the semid to be processed and supply it to the caller.
 * On each call:
 * 1. Print current semaphore values.
 * 2. Ask user how many operations are to be performed on the ne.
```

```
*      call to semop. Allocate an array of sembuf structures
*      sufficient for the job and set caller-supplied pointer to
that
*      array. (The array is reused on subsequent calls if it is b
*      enough. If it isn't, it is freed and a larger array is
*      allocated.)
*/
static
ask(semidp, sopsp)
int *semidp; /* pointer to semid (used only the first time) */
struct sembuf **sopsp;
{
    static union semun    arg; /* argument to semctl */
    int    i; /* work area */
    static int    nsops = 0; /* size of currently allocated
        sembuf array */
    static int    semid = -1; /* semid supplied by user */
    static struct sembuf *sops; /* pointer to allocated array

if (semid < 0) {
    /* First call; get semid from user and the current state of
        the semaphore set. */
    (void) fprintf(stderr,
        "Enter semid of the semaphore set you want to use: ");
    (void) scanf("%i", &semid);
    *semidp = semid;
    arg.buf = &semid_ds;
    if (semctl(semid, 0, IPC_STAT, arg) == -1) {
        perror("semop: semctl(IPC_STAT) failed");
        /* Note that if semctl fails, semid_ds remains filled
            with zeros, so later test for number of semaphores will
            be zero. */
        (void) fprintf(stderr,
            "Before and after values are not printed.\n");
    } else {
        if ((arg.array = (ushort *)malloc(
            (unsigned)(sizeof(ushort) * semid_ds.sem_nsems))
            == NULL) {
            (void) fprintf(stderr, error_mesg1,
                semid_ds.sem_nsems);
            exit(1);
        }
    }
}
/* Print current semaphore values. */
if (semid_ds.sem_nsems) {
    (void) fprintf(stderr,
        "There are %d semaphores in the set.\n",
        semid_ds.sem_nsems);
    if (semctl(semid, 0, GETALL, arg) == -1) {
        perror("semop: semctl(GETALL) failed");
    } else {
        (void) fprintf(stderr, "Current semaphore values are:");
        for (i = 0; i < semid_ds.sem_nsems;
            (void) fprintf(stderr, " %d", arg.array[i++]));
        (void) fprintf(stderr, "\n");
    }
}
/* Find out how many operations are going to be done in the
next
    call and allocate enough space to do it. */
(void) fprintf(stderr,
    "How many semaphore operations do you want %s\n",
    "on the next call to semop()?");
(void) fprintf(stderr, "Enter 0 or control-D to quit: ");
i = 0;
if (scanf("%i", &i) == EOF || i == 0)
```

```
    exit(0);
if (i > nsops) {
    if (nsops)
        free((char *)sops);
    nsops = i;
    if ((sops = (struct sembuf *)malloc((unsigned)(nsops *
        sizeof(struct sembuf)))) == NULL) {
        (void) fprintf(stderr, error_mesg2, nsops);
        exit(2);
    }
}
*sopsp = sops;
return (i);
}
```

Exercises

Exercise 12763

Write 2 programs that will communicate **both ways** (*i.e.* each process can read and write) when run concurrently via semaphores.

Exercise 12764

Modify the `semaphore.c` program to handle synchronous semaphore communication semaphores.

Exercise 12765

Write 3 programs that communicate together via semaphores according to the following specifications: `sem_server.c` -- a program that can communicate independently (on different semaphore tracks) with two clients programs.

`sem_client1.c` -- a program that talks to `sem_server.c` on one track.

`sem_client2.c` -- a program that talks to `sem_server.c` on another track to `sem_client1.c`.

Exercise 12766

Compile the programs `semget.c`, `semctl.c` and `semop.c` and then

- investigate and understand fully the operations of the flags (access, creation *etc.* permissions) you can set interactively in the programs.
- Use the programs to:
 - Send and receive semaphores of 3 different semaphore `tracks`.
 - Inquire about the state of the semaphore queue with `semctl.c`. Add/delete a few semaphores (using `semop.c` and perform the inquiry once more.
 - Use `semctl.c` to alter a semaphore on the queue.
 - Use `semctl.c` to delete a semaphore from the queue.

1/5/1999

Subsections

- [Accessing a Shared Memory Segment](#)
 - [Controlling a Shared Memory Segment](#)
 - [Attaching and Detaching a Shared Memory Segment](#)
 - [Example two processes communicating via shared memory: shm_server.c, shm_client.c](#)
 - [shm_server.c](#)
 - [shm_client.c](#)
 - [POSIX Shared Memory](#)
 - [Mapped memory](#)
 - [Address Spaces and Mapping](#)
 - [Coherence](#)
 - [Creating and Using Mappings](#)
 - [Other Memory Control Functions](#)
 - [Some further example shared memory programs](#)
 - [shmget.c: Sample Program to Illustrate shmget\(\)](#)
 - [shmctl.c: Sample Program to Illustrate shmctl\(\)](#)
 - [shmop.c: Sample Program to Illustrate shmat\(\) and shmdt\(\)](#)
 - [Exercises](#)
-

IPC: Shared Memory

Shared Memory is an efficient means of passing data between programs. One program will create a memory portion which other processes (if permitted) can access.

In the Solaris 2.x operating system, the most efficient way to implement shared memory applications is to rely on the `mmap()` function and on the system's native virtual memory facility. Solaris 2.x also supports System V shared memory, which is another way to let multiple processes attach a segment of physical memory to their virtual address spaces. When write access is allowed for more than one process, an outside protocol or mechanism such as a semaphore can be used to prevent inconsistencies and collisions.

A process creates a shared memory segment using `shmget()`. The original owner of a shared memory segment can assign ownership to another user with `shmctl()`. It can also revoke this assignment. Other processes with proper permission can perform various control functions on the shared memory segment using `shmctl()`. Once created, a shared segment can be attached to a process address space using `shmat()`. It can be detached using `shmdt()` (see `shmop()`). The attaching process must have the appropriate permissions for `shmat()`. Once attached, the process can read or write to the

segment, as allowed by the permission requested in the attach operation. A shared segment can be attached multiple times by the same process. A shared memory segment is described by a control structure with a unique ID that points to an area of physical memory. The identifier of the segment is called the `shmid`. The structure definition for the shared memory segment control structures and prototypes can be found in `<sys/shm.h>`.

Accessing a Shared Memory Segment

`shmget()` is used to obtain access to a shared memory segment. It is prototyped by:

```
int shmget(key_t key, size_t size, int shmflg);
```

The `key` argument is a access value associated with the semaphore ID. The `size` argument is the size in bytes of the requested shared memory. The `shmflg` argument specifies the initial access permissions and creation control flags.

When the call succeeds, it returns the shared memory segment ID. This call is also used to get the ID of an existing shared segment (from a process requesting sharing of some existing memory portion).

The following code illustrates `shmget()`:

```
#include <sys/types.h>
#include <sys/ipc.h>
#include <sys/shm.h>

...

key_t key; /* key to be passed to shmget() */
int shmflg; /* shmflg to be passed to shmget() */
int shmid; /* return value from shmget() */
int size; /* size to be passed to shmget() */

...

key = ...
size = ...
shmflg = ...

if ((shmid = shmget (key, size, shmflg)) == -1) {
    perror("shmget: shmget failed"); exit(1); } else {
    (void) fprintf(stderr, "shmget: shmget returned %d\n", shmid);
    exit(0);
}

...
```

Controlling a Shared Memory Segment

`shmctl()` is used to alter the permissions and other characteristics of a shared memory segment. It is prototyped as follows:

```
int shmctl(int shmid, int cmd, struct shmid_ds *buf);
```

The process must have an effective `shmid` of owner, creator or superuser to perform this command. The `cmd` argument is one of following control commands:

SHM_LOCK

-- Lock the specified shared memory segment in memory. The process must have the effective ID of superuser to perform this command.

SHM_UNLOCK

-- Unlock the shared memory segment. The process must have the effective ID of superuser to perform this command.

IPC_STAT

-- Return the status information contained in the control structure and place it in the buffer pointed to by `buf`. The process must have read permission on the segment to perform this command.

IPC_SET

-- Set the effective user and group identification and access permissions. The process must have an effective ID of owner, creator or superuser to perform this command.

IPC_RMID

-- Remove the shared memory segment.

The `buf` is a structure of type `struct shmid_ds` which is defined in `<sys/shm.h>`

The following code illustrates `shmctl()`:

```
#include <sys/types.h>
#include <sys/ipc.h>
#include <sys/shm.h>

...

int cmd; /* command code for shmctl() */
int shmid; /* segment ID */
struct shmid_ds shmid_ds; /* shared memory data structure to
                           hold results */
...

shmid = ...
cmd = ...
if ((rtrn = shmctl(shmid, cmd, shmid_ds)) == -1) {
    perror("shmctl: shmctl failed");
    exit(1);
}
...
```

Attaching and Detaching a Shared Memory Segment

`shmat()` and `shmdt()` are used to attach and detach shared memory segments. They are prototypes as follows:

```
void *shmat(int shmid, const void *shmaddr, int shmflg);

int shmdt(const void *shmaddr);
```

`shmat()` returns a pointer, `shmaddr`, to the head of the shared segment associated with a valid `shmid`. `shmdt()` detaches the shared memory segment located at the address indicated by `shmaddr`

. The following code illustrates calls to `shmat()` and `shmdt()`:

```
#include <sys/types.h>
#include <sys/ipc.h>
#include <sys/shm.h>

static struct state { /* Internal record of attached segments. */
    int shmid; /* shmid of attached segment */
    char *shmaddr; /* attach point */
    int shmflg; /* flags used on attach */
} ap[MAXnap]; /* State of current attached segments. */
int nap; /* Number of currently attached segments. */

...

char *addr; /* address work variable */
register int i; /* work area */
register struct state *p; /* ptr to current state entry */
...

p = &ap[nap++];
p->shmid = ...
p->shmaddr = ...
p->shmflg = ...

p->shmaddr = shmat(p->shmid, p->shmaddr, p->shmflg);
if(p->shmaddr == (char *)-1) {
    perror("shmop: shmat failed");
    nap--;
} else
    (void) fprintf(stderr, "shmop: shmat returned %#8.8x\n",
p->shmaddr);

...
i = shmdt(addr);
if(i == -1) {
    perror("shmop: shmdt failed");
} else {
    (void) fprintf(stderr, "shmop: shmdt returned %d\n", i);
}

for (p = ap, i = nap; i--; p++)
    if (p->shmaddr == addr) *p = ap[--nap];

}

...
```

Example two processes communicating via shared memory: shm_server.c, shm_client.c

We develop two programs here that illustrate the passing of a simple piece of memory (a string) between the processes if running simultaneously:

shm_server.c

-- simply creates the string and shared memory portion.

shm_client.c

-- attaches itself to the created shared memory portion and uses the string (printf).

The code listings of the 2 programs no follow:

shm_server.c

```
#include <sys/types.h>
#include <sys/ipc.h>
#include <sys/shm.h>
#include <stdio.h>

#define SHMSZ 27

main()
{
    char c;
    int shmid;
    key_t key;
    char *shm, *s;

    /*
     * We'll name our shared memory segment
     * "5678".
     */
    key = 5678;

    /*
     * Create the segment.
     */
    if ((shmid = shmget(key, SHMSZ, IPC_CREAT | 0666)) < 0) {
        perror("shmget");
        exit(1);
    }

    /*
     * Now we attach the segment to our data space.
     */
    if ((shm = shmat(shmid, NULL, 0)) == (char *) -1) {
        perror("shmat");
        exit(1);
    }

    /*
     * Now put some things into the memory for the
     * other process to read.
     */
    s = shm;

    for (c = 'a'; c <= 'z'; c++)
        *s++ = c;
    *s = NULL;

    /*
     * Finally, we wait until the other process
     * changes the first character of our memory

```

```
    * to '*', indicating that it has read what
    * we put there.
    */
    while (*shm != '*')
        sleep(1);

    exit(0);
}
```

shm_client.c

```
/*
 * shm-client - client program to demonstrate shared memory.
 */
#include <sys/types.h>
#include <sys/ipc.h>
#include <sys/shm.h>
#include <stdio.h>

#define SHMSZ    27

main()
{
    int shmid;
    key_t key;
    char *shm, *s;

    /*
     * We need to get the segment named
     * "5678", created by the server.
     */
    key = 5678;

    /*
     * Locate the segment.
     */
    if ((shmid = shmget(key, SHMSZ, 0666)) < 0) {
        perror("shmget");
        exit(1);
    }

    /*
     * Now we attach the segment to our data space.
     */
    if ((shm = shmat(shmid, NULL, 0)) == (char *) -1) {
        perror("shmat");
        exit(1);
    }

    /*
     * Now read what the server put in the memory.
     */
    for (s = shm; *s != NULL; s++)
        putchar(*s);
    putchar('\n');

    /*
     * Finally, change the first character of the
     * segment to '*', indicating we have read
     * the segment.
     */
    *shm = '*';

    exit(0);
}
```

POSIX Shared Memory

POSIX shared memory is actually a variation of mapped memory. The major differences are to use `shm_open()` to open the shared memory object (instead of calling `open()`) and use `shm_unlink()` to close and delete the object (instead of calling `close()` which does not remove the object). The options in `shm_open()` are substantially fewer than the number of options provided in `open()`.

Mapped memory

In a system with fixed memory (non-virtual), the address space of a process occupies and is limited to a portion of the system's main memory. In Solaris 2.x virtual memory the actual address space of a process occupies a file in the swap partition of disk storage (the file is called the backing store). Pages of main memory buffer the active (or recently active) portions of the process address space to provide code for the CPU(s) to execute and data for the program to process.

A page of address space is loaded when an address that is not currently in memory is accessed by a CPU, causing a page fault. Since execution cannot continue until the page fault is resolved by reading the referenced address segment into memory, the process sleeps until the page has been read. The most obvious difference between the two memory systems for the application developer is that virtual memory lets applications occupy much larger address spaces. Less obvious advantages of virtual memory are much simpler and more efficient file I/O and very efficient sharing of memory between processes.

Address Spaces and Mapping

Since backing store files (the process address space) exist only in swap storage, they are not included in the UNIX named file space. (This makes backing store files inaccessible to other processes.) However, it is a simple extension to allow the logical insertion of all, or part, of one, or more, named files in the backing store and to treat the result as a single address space. This is called mapping. With mapping, any part of any readable or writable file can be logically included in a process's address space. Like any other portion of the process's address space, no page of the file is not actually loaded into memory until a page fault forces this action. Pages of memory are written to the file only if their contents have been modified. So, reading from and writing to files is completely automatic and very efficient. More than one process can map a single named file. This provides very efficient memory sharing between processes. All or part of other files can also be shared between processes.

Not all named file system objects can be mapped. Devices that cannot be treated as storage, such as terminal and network device files, are examples of objects that cannot be mapped. A process address space is defined by all of the files (or portions of files) mapped into the address space. Each mapping is sized and aligned to the page boundaries of the system on which the process is executing. There is no memory associated with processes themselves.

A process page maps to only one object at a time, although an object address may be the subject of many process mappings. The notion of a "page" is not a property of the mapped object. Mapping an object only provides the potential for a process to read or write the object's contents. Mapping makes the object's contents directly addressable by a process. Applications can access the storage resources they use directly rather than indirectly through read and write. Potential advantages include efficiency (elimination of unnecessary data copying) and reduced complexity (single-step updates rather than the read, modify buffer, write cycle). The ability to access an object and have it retain its identity over the course of the access is unique to this access method, and facilitates the sharing of common code and data.

Because the file system name space includes any directory trees that are connected from other systems via NFS, any networked file can also be mapped into a process's address space.

Coherence

Whether to share memory or to share data contained in the file, when multiple process map a file simultaneously there may be problems with simultaneous access to data elements. Such processes can cooperate through any of the synchronization mechanisms provided in Solaris 2.x. Because they are very light weight, the most efficient synchronization mechanisms in Solaris 2.x are the threads library ones.

Creating and Using Mappings

`mmap()` establishes a mapping of a named file system object (or part of one) into a process address space. It is the basic memory management function and it is very simple.

- First `open()` the file, then
- `mmap()` it with appropriate access and sharing options
- Away you go.

`mmap` is prototypes as follows:

```
#include <sys/types.h>
#include <sys/mman.h>

caddr_t mmap(caddr_t addr, size_t len, int prot, int flags,
             int fildes, off_t off);
```

The mapping established by `mmap()` replaces any previous mappings for specified address range. The flags `MAP_SHARED` and `MAP_PRIVATE` specify the mapping type, and one of them must be specified. `MAP_SHARED` specifies that writes modify the mapped object. No further operations on the object are needed to make the change. `MAP_PRIVATE` specifies that an initial write to the mapped area creates a copy of the page and all writes reference the copy. Only modified pages are copied.

A mapping type is retained across a `fork()`. The file descriptor used in a `mmap` call need not be kept open after the mapping is established. If it is closed, the mapping remains until the mapping is undone by `munmap()` or be replacing in with a new mapping. If a mapped file is shortened by a call to `truncate`, an access to the area of the file that no longer exists causes a `SIGBUS` signal.

The following code fragment demonstrates a use of this to create a block of scratch storage in a program, at an address that the system chooses.:

```
int fd;
caddr_t result;
if ((fd = open("/dev/zero", O_RDWR)) == -1)
    return ((caddr_t)-1);

result = mmap(0, len, PROT_READ|PROT_WRITE, MAP_SHARED, fd, 0);
(void) close(fd);
```

Other Memory Control Functions

`int mlock(caddr_t addr, size_t len)` causes the pages in the specified address range to be locked in physical memory. References to locked pages (in this or other processes) do not result in page faults that require an I/O operation. This operation ties up physical resources and can disrupt normal system operation, so, use of `mlock()` is limited to the superuser. The system lets only a configuration dependent limit of pages be locked in memory. The call to `mlock` fails if this limit is exceeded.

`int munlock(caddr_t addr, size_t len)` releases the locks on physical pages. If multiple `mlock()` calls are made on an address range of a single mapping, a single `munlock` call is release the locks. However, if different mappings to the same pages are mlocked, the pages are not unlocked until the locks on all the mappings are released. Locks are also released when a mapping is removed, either through being replaced with an `mmap` operation or removed with `munmap`. A lock is transferred between pages on the 'copy-on-write' event associated with a `MAP_PRIVATE` mapping, thus locks on an address range that includes `MAP_PRIVATE` mappings will be retained transparently along with the copy-on-write redirection (see `mmap` above for a discussion of this redirection)

`int mlockall(int flags)` and `int munlockall(void)` are similar to `mlock()` and `munlock()`, but they operate on entire address spaces. `mlockall()` sets locks on all pages in the address space and `munlockall()`

removes all locks on all pages in the address space, whether established by `mlock` or `mlockall`.

`int msync(caddr_t addr, size_t len, int flags)` causes all modified pages in the specified address range to be flushed to the objects mapped by those addresses. It is similar to `fsync()` for files.

`long sysconf(int name)` returns the system dependent size of a memory page. For portability, applications should not embed any constants specifying the size of a page. Note that it is not unusual for page sizes to vary even among implementations of the same instruction set.

`int mprotect(caddr_t addr, size_t len, int prot)` assigns the specified protection to all pages in the specified address range. The protection cannot exceed the permissions allowed on the underlying object.

`int brk(void *endds)` and `void *sbrk(int incr)` are called to add storage to the data segment of a process. A process can manipulate this area by calling `brk()` and `sbrk()`. `brk()` sets the system idea of the lowest data segment location not used by the caller to `addr` (rounded up to the next multiple of the system page size). `sbrk()` adds `incr` bytes to the caller data space and returns a pointer to the start of the new data area.

Some further example shared memory programs

The following suite of programs can be used to investigate interactively a variety of shared ideas (see exercises below).

The semaphore **must** be initialised with the `shmget.c` program. The effects of controlling shared memory and accessing can be investigated with `shmctl.c` and `shmop.c` respectively.

shmget.c: Sample Program to Illustrate shmget()

```
/*
 * shmget.c: Illustrate the shmget() function.
 *
 * This is a simple exerciser of the shmget() function. It
 * prompts
 * for the arguments, makes the call, and reports the results.
 */

#include <stdio.h>
#include <sys/types.h>
#include <sys/ipc.h>
#include <sys/shm.h>

extern void    exit();
extern void    perror();
```

```
main()
{
    key_t key; /* key to be passed to shmget() */
    int shmflg; /* shmflg to be passed to shmget() */
    int shmids; /* return value from shmget() */
    int size; /* size to be passed to shmget() */

    (void) fprintf(stderr,
        "All numeric input is expected to follow C conventions:\n");
    (void) fprintf(stderr,
        "\t0x... is interpreted as hexadecimal,\n");
    (void) fprintf(stderr, "\t0... is interpreted as octal,\n");
    (void) fprintf(stderr, "\totherwise, decimal.\n");

    /* Get the key. */
    (void) fprintf(stderr, "IPC_PRIVATE == %#lx\n", IPC_PRIVATE);
    (void) fprintf(stderr, "Enter key: ");
    (void) scanf("%li", &key);

    /* Get the size of the segment. */
    (void) fprintf(stderr, "Enter size: ");
    (void) scanf("%i", &size);

    /* Get the shmflg value. */
    (void) fprintf(stderr,
        "Expected flags for the shmflg argument are:\n");
    (void) fprintf(stderr, "\tIPC_CREAT = \t%#8.8o\n",
IPC_CREAT);
    (void) fprintf(stderr, "\tIPC_EXCL = \t%#8.8o\n", IPC_EXCL);
    (void) fprintf(stderr, "\towner read =\t%#8.8o\n", 0400);
    (void) fprintf(stderr, "\towner write =\t%#8.8o\n", 0200);
    (void) fprintf(stderr, "\tgroup read =\t%#8.8o\n", 040);
    (void) fprintf(stderr, "\tgroup write =\t%#8.8o\n", 020);
    (void) fprintf(stderr, "\tother read =\t%#8.8o\n", 04);
    (void) fprintf(stderr, "\tother write =\t%#8.8o\n", 02);
    (void) fprintf(stderr, "Enter shmflg: ");
    (void) scanf("%i", &shmflg);

    /* Make the call and report the results. */
    (void) fprintf(stderr,
        "shmget: Calling shmget(%#lx, %d, %#o)\n",
        key, size, shmflg);
    if ((shmids = shmget(key, size, shmflg)) == -1) {
        perror("shmget: shmget failed");
        exit(1);
    } else {
        (void) fprintf(stderr,
            "shmget: shmget returned %d\n", shmids);
        exit(0);
    }
}
```

shmctl.c: Sample Program to Illustrate shmctl()

```
/*
 * shmctl.c: Illustrate the shmctl() function.
 *
 * This is a simple exerciser of the shmctl() function. It lets y
 * to perform one control operation on one shared memory segment.
 * (Some operations are done for the user whether requested or
 * not.
 * It gives up immediately if any control operation fails. Be
```

```
careful
 * not to set permissions to preclude read permission; you won't
 be
 *able to reset the permissions with this code if you do.)
 */

#include <stdio.h>
#include <sys/types.h>
#include <sys/ipc.h>
#include <sys/shm.h>
#include <time.h>
static void do_shmctl();
extern void exit();
extern void perror();

main()
{
    int cmd; /* command code for shmctl() */
    int shmid; /* segment ID */
    struct shmctl_ds shmctl_ds; /* shared memory data structure to
        hold results */

    (void) fprintf(stderr,
        "All numeric input is expected to follow C conventions:\n");
    (void) fprintf(stderr,
        "\t0x... is interpreted as hexadecimal,\n");
    (void) fprintf(stderr, "\t0... is interpreted as octal,\n");
    (void) fprintf(stderr, "\totherwise, decimal.\n");

    /* Get shmid and cmd. */
    (void) fprintf(stderr,
        "Enter the shmid for the desired segment: ");
    (void) scanf("%i", &shmid);
    (void) fprintf(stderr, "Valid shmctl cmd values are:\n");
    (void) fprintf(stderr, "\tIPC_RMID =\t%d\n", IPC_RMID);
    (void) fprintf(stderr, "\tIPC_SET =\t%d\n", IPC_SET);
    (void) fprintf(stderr, "\tIPC_STAT =\t%d\n", IPC_STAT);
    (void) fprintf(stderr, "\tSHM_LOCK =\t%d\n", SHM_LOCK);
    (void) fprintf(stderr, "\tSHM_UNLOCK =\t%d\n", SHM_UNLOCK);
    (void) fprintf(stderr, "Enter the desired cmd value: ");
    (void) scanf("%i", &cmd);

    switch (cmd) {
        case IPC_STAT:
            /* Get shared memory segment status. */
            break;
        case IPC_SET:
            /* Set owner UID and GID and permissions. */
            /* Get and print current values. */
            do_shmctl(shmid, IPC_STAT, &shmctl_ds);
            /* Set UID, GID, and permissions to be loaded. */
            (void) fprintf(stderr, "\nEnter shm_perm.uid: ");
            (void) scanf("%hi", &shmctl_ds.shm_perm.uid);
            (void) fprintf(stderr, "Enter shm_perm.gid: ");
            (void) scanf("%hi", &shmctl_ds.shm_perm.gid);
            (void) fprintf(stderr,
                "Note: Keep read permission for yourself.\n");
            (void) fprintf(stderr, "Enter shm_perm.mode: ");
            (void) scanf("%hi", &shmctl_ds.shm_perm.mode);
            break;
        case IPC_RMID:
            /* Remove the segment when the last attach point is
                detached. */
            break;
        case SHM_LOCK:
            /* Lock the shared memory segment. */

```

```
        break;
    case SHM_UNLOCK:
        /* Unlock the shared memory segment. */
        break;
    default:
        /* Unknown command will be passed to shmctl. */
        break;
}
do_shmctl(shmid, cmd, &shmid_ds);
exit(0);
}

/*
 * Display the arguments being passed to shmctl(), call shmctl(),
 * and report the results. If shmctl() fails, do not return; this
 * example doesn't deal with errors, it just reports them.
 */
static void
do_shmctl(shmid, cmd, buf)
int    shmid, /* attach point */
      cmd; /* command code */
struct shmctl_ds *buf; /* pointer to shared memory data struct
{
    register int    rtrn; /* hold area */

    (void) fprintf(stderr, "shmctl: Calling shmctl(%d, %d,
buf)\n",
        shmid, cmd);
    if (cmd == IPC_SET) {
        (void) fprintf(stderr, "\tbuf->shm_perm.uid == %d\n",
            buf->shm_perm.uid);
        (void) fprintf(stderr, "\tbuf->shm_perm.gid == %d\n",
            buf->shm_perm.gid);
        (void) fprintf(stderr, "\tbuf->shm_perm.mode == %#o\n",
            buf->shm_perm.mode);
    }
    if ((rtrn = shmctl(shmid, cmd, buf)) == -1) {
        perror("shmctl: shmctl failed");
        exit(1);
    } else {
        (void) fprintf(stderr,
            "shmctl: shmctl returned %d\n", rtrn);
    }
}
if (cmd != IPC_STAT && cmd != IPC_SET)
    return;

/* Print the current status. */
(void) fprintf(stderr, "\nCurrent status:\n");
(void) fprintf(stderr, "\tshm_perm.uid = %d\n",
    buf->shm_perm.uid);
(void) fprintf(stderr, "\tshm_perm.gid = %d\n",
    buf->shm_perm.gid);
(void) fprintf(stderr, "\tshm_perm.cuid = %d\n",
    buf->shm_perm.cuid);
(void) fprintf(stderr, "\tshm_perm.cgid = %d\n",
    buf->shm_perm.cgid);
(void) fprintf(stderr, "\tshm_perm.mode = %#o\n",
    buf->shm_perm.mode);
(void) fprintf(stderr, "\tshm_perm.key = %#x\n",
    buf->shm_perm.key);
(void) fprintf(stderr, "\tshm_segsz = %d\n", buf->shm_segsz);
(void) fprintf(stderr, "\tshm_lpid = %d\n", buf->shm_lpid);
(void) fprintf(stderr, "\tshm_cpid = %d\n", buf->shm_cpid);
(void) fprintf(stderr, "\tshm_nattch = %d\n", buf->shm_nattch);
(void) fprintf(stderr, "\tshm_atime = %s",
    buf->shm_atime ? ctime(&buf->shm_atime) : "Not Set\n");
```

```
(void) fprintf(stderr, "\tshm_dtime = %s",
    buf->shm_dtime ? ctime(&buf->shm_dtime) : "Not Set\n");
(void) fprintf(stderr, "\tshm_ctime = %s",
    ctime(&buf->shm_ctime));
}
```

shmop.c: Sample Program to Illustrate shmat() and shmdt()

```
/*
 * shmop.c: Illustrate the shmat() and shmdt() functions.
 *
 * This is a simple exerciser for the shmat() and shmdt() system
 * calls. It allows you to attach and detach segments and to
 * write strings into and read strings from attached segments.
 */

#include <stdio.h>
#include <setjmp.h>
#include <signal.h>
#include <sys/types.h>
#include <sys/ipc.h>
#include <sys/shm.h>

#define MAXnap 4 /* Maximum number of concurrent attaches. */

static ask();
static void catcher();
extern void exit();
static good_addr();
extern void perror();
extern char *shmat();

static struct state { /* Internal record of currently attached
segments. */
    int shmidx; /* shmidx of attached segment */
    char *shmaddr; /* attach point */
    int shmflg; /* flags used on attach */
} ap[MAXnap]; /* State of current attached segments. */

static int nap; /* Number of currently attached segments. */
static jmp_buf segvbuf; /* Process state save area for SIGSEGV
catching. */

main()
{
    register int action; /* action to be performed */
    char *addr; /* address work area */
    register int i; /* work area */
    register struct state *p; /* ptr to current state entry */
    void (*savefunc)(); /* SIGSEGV state hold area */
    (void) fprintf(stderr,
        "All numeric input is expected to follow C conventions:\n");
    (void) fprintf(stderr,
        "\t0x... is interpreted as hexadecimal,\n");
    (void) fprintf(stderr, "\t0... is interpreted as octal,\n");
    (void) fprintf(stderr, "\totherwise, decimal.\n");
    while (action = ask()) {
        if (nap) {
            (void) fprintf(stderr,
                "\nCurrently attached segment(s):\n");
            (void) fprintf(stderr, " shmidx address\n");
            (void) fprintf(stderr, "-----\n");
            p = &ap[nap];
        }
    }
}
```

```
while (p-- != ap) {
    (void) fprintf(stderr, "%6d", p->shmid);
    (void) fprintf(stderr, "%#11x", p->shmaddr);
    (void) fprintf(stderr, " Read%s\n",
        (p->shmflg & SHM_RDONLY) ?
        "-Only" : "/Write");
}
} else
    (void) fprintf(stderr,
        "\nNo segments are currently attached.\n");
switch (action) {
case 1: /* Shmat requested. */
    /* Verify that there is space for another attach. */
    if (nap == MAXnap) {
        (void) fprintf(stderr, "%s %d %s\n",
            "This simple example will only allow",
            MAXnap, "attached segments.");
        break;
    }
    p = &ap[nap++];
    /* Get the arguments, make the call, report the
       results, and update the current state array. */
    (void) fprintf(stderr,
        "Enter shmid of segment to attach: ");
    (void) scanf("%i", &p->shmid);

    (void) fprintf(stderr, "Enter shmaddr: ");
    (void) scanf("%i", &p->shmaddr);
    (void) fprintf(stderr,
        "Meaningful shmflg values are:\n");
    (void) fprintf(stderr, "\tSHM_RDONLY = \t%#8.8o\n",
        SHM_RDONLY);
    (void) fprintf(stderr, "\tSHM_RND = \t%#8.8o\n",
        SHM_RND);
    (void) fprintf(stderr, "Enter shmflg value: ");
    (void) scanf("%i", &p->shmflg);

    (void) fprintf(stderr,
        "shmop: Calling shmat(%d, %#x, %#o)\n",
        p->shmid, p->shmaddr, p->shmflg);
    p->shmaddr = shmat(p->shmid, p->shmaddr, p->shmflg);
    if (p->shmaddr == (char *)-1) {
        perror("shmop: shmat failed");
        nap--;
    } else {
        (void) fprintf(stderr,
            "shmop: shmat returned %#8.8x\n",
            p->shmaddr);
    }
    break;
case 2: /* Shmdt requested. */
    /* Get the address, make the call, report the results,
       and make the internal state match. */
    (void) fprintf(stderr,
        "Enter detach shmaddr: ");
    (void) scanf("%i", &addr);

    i = shmdt(addr);
    if (i == -1) {
        perror("shmop: shmdt failed");
    } else {
        (void) fprintf(stderr,
            "shmop: shmdt returned %d\n", i);
        for (p = ap, i = nap; i--; p++) {
            if (p->shmaddr == addr)
                *p = ap[--nap];
        }
    }
}
}
```

```
    }
  }
  break;
case 3: /* Read from segment requested. */
  if (nap == 0)
    break;

  (void) fprintf(stderr, "Enter address of an %s",
    "attached segment: ");
  (void) scanf("%i", &addr);

  if (good_addr(addr))
    (void) fprintf(stderr, "String @ %#x is `%s'\n",
      addr, addr);
  break;

case 4: /* Write to segment requested. */
  if (nap == 0)
    break;

  (void) fprintf(stderr, "Enter address of an %s",
    "attached segment: ");
  (void) scanf("%i", &addr);

  /* Set up SIGSEGV catch routine to trap attempts to
  write into a read-only attached segment. */
  savefunc = signal(SIGSEGV, catcher);

  if (setjmp(segvbuf)) {
    (void) fprintf(stderr, "shmop: %s: %s\n",
      "SIGSEGV signal caught",
      "Write aborted.");
  } else {
    if (good_addr(addr)) {
      (void) fflush(stdin);
      (void) fprintf(stderr, "%s %s %#x:\n",
        "Enter one line to be copied",
        "to shared segment attached @",
        addr);
      (void) gets(addr);
    }
  }
  (void) fflush(stdin);

  /* Restore SIGSEGV to previous condition. */
  (void) signal(SIGSEGV, savefunc);
  break;
}
}
exit(0);
/*NOTREACHED*/
}
/*
** Ask for next action.
*/
static
ask()
{
  int response; /* user response */
  do {
    (void) fprintf(stderr, "Your options are:\n");
    (void) fprintf(stderr, "\t^D = exit\n");
    (void) fprintf(stderr, "\t 0 = exit\n");
    (void) fprintf(stderr, "\t 1 = shmat\n");
    (void) fprintf(stderr, "\t 2 = shmdt\n");
    (void) fprintf(stderr, "\t 3 = read from segment\n");
    (void) fprintf(stderr, "\t 4 = write to segment\n");
```

```
(void) fprintf(stderr,
    "Enter the number corresponding to your choice: ");

/* Preset response so "^D" will be interpreted as exit. */
response = 0;
(void) scanf("%i", &response);
} while (response < 0 || response > 4);
return (response);
}
/*
** Catch signal caused by attempt to write into shared memory
segment
** attached with SHM_RDONLY flag set.
*/
/*ARGSUSED*/
static void
catcher(sig)
{
    longjmp(segbuf, 1);
    /*NOTREACHED*/
}
/*
** Verify that given address is the address of an attached
segment.
** Return 1 if address is valid; 0 if not.
*/
static
good_addr(address)
char *address;
{
    register struct state      *p; /* ptr to state of attached
segment */

    for (p = ap; p != &ap[nap]; p++)
        if (p->shmaddr == address)
            return(1);
    return(0);
}
```

Exercises

Exercise 12771

Write 2 programs that will communicate via shared memory and semaphores. Data will be exchanged via memory and semaphores will be used to synchronise and notify each process when operations such as memory loaded and memory read have been performed.

Exercise 12772

Compile the programs `shmget.c`, `shmctl.c` and `shmop.c` and then

- investigate and understand fully the operations of the flags (access, creation *etc.* permissions) you can set interactively in the programs.
- Use the programs to:
 - Exchange data between two processes running as `shmop.c`.
 - Inquire about the state of shared memory with `shmctl.c`.
 - Use `semctl.c` to lock a shared memory segment.
 - Use `semctl.c` to delete a shared memory segment.

Exercise 12773

Write 2 programs that will communicate via mapped memory.

Dave Marshall
1/5/1999

Subsections

- [Socket Creation and Naming](#)
 - [Connecting Stream Sockets](#)
 - [Stream Data Transfer and Closing](#)
 - [Datagram sockets](#)
 - [Socket Options](#)
 - [Example Socket Programs:socket_server.c,socket_client](#)
 - [socket_server.c](#)
 - [socket_client.c](#)
 - [Exercises](#)
-

IPC:Sockets

Sockets provide point-to-point, two-way communication between two processes. Sockets are very versatile and are a basic component of interprocess and intersystem communication. A socket is an endpoint of communication to which a name can be bound. It has a type and one or more associated processes.

Sockets exist in communication domains. A socket domain is an abstraction that provides an addressing structure and a set of protocols. Sockets connect only with sockets in the same domain. Twenty three socket domains are identified (see `<sys/socket.h>`), of which only the UNIX and Internet domains are normally used. Solaris 2.x Sockets can be used to communicate between processes on a single system, like other forms of IPC.

The UNIX domain provides a socket address space on a single system. UNIX domain sockets are named with UNIX paths. Sockets can also be used to communicate between processes on different systems. The socket address space between connected systems is called the Internet domain.

Internet domain communication uses the TCP/IP internet protocol suite.

Socket types define the communication properties visible to the application. Processes communicate only between sockets of the same type. There are five types of socket.

A stream socket

-- provides two-way, sequenced, reliable, and unduplicated flow of data with no record boundaries. A stream operates much like a telephone conversation. The socket type is `SOCK_STREAM`, which, in the Internet domain, uses Transmission Control Protocol (TCP).

A datagram socket

-- supports a two-way flow of messages. A on a datagram socket may receive messages in a different order from the sequence in which the messages were sent. Record boundaries in the data are preserved. Datagram sockets operate much like passing letters back and forth in the mail. The socket type is `SOCK_DGRAM`, which, in the Internet domain,

uses User Datagram Protocol (UDP).

A sequential packet socket

-- provides a two-way, sequenced, reliable, connection, for datagrams of a fixed maximum length. The socket type is `SOCK_SEQPACKET`. No protocol for this type has been implemented for any protocol family.

A raw socket

provides access to the underlying communication protocols.

These sockets are usually datagram oriented, but their exact characteristics depend on the interface provided by the protocol.

Socket Creation and Naming

`int socket(int domain, int type, int protocol)` is called to create a socket in the specified domain and of the specified type. If a `protocol` is not specified, the system defaults to a protocol that supports the specified socket type. The socket handle (a descriptor) is returned. A remote process has no way to identify a socket until an address is bound to it. Communicating processes connect through addresses. In the UNIX domain, a connection is usually composed of one or two path names. In the Internet domain, a connection is composed of local and remote addresses and local and remote ports. In most domains, connections must be unique.

`int bind(int s, const struct sockaddr *name, int namelen)` is called to bind a path or internet address to a socket. There are three different ways to call `bind()`, depending on the domain of the socket.

- For UNIX domain sockets with paths containing 14, or fewer characters, you can:

```
#include <sys/socket.h>
...
bind (sd, (struct sockaddr *) &addr, length);
```

- If the path of a UNIX domain socket requires more characters, use:

```
#include <sys/un.h>
...
bind (sd, (struct sockaddr_un *) &addr, length);
```

- For Internet domain sockets, use

```
#include <netinet/in.h>
...
bind (sd, (struct sockaddr_in *) &addr, length);
```

In the UNIX domain, binding a name creates a named socket in the file system. Use `unlink()` or `rm ()` to remove the socket.

Connecting Stream Sockets

Connecting sockets is usually not symmetric. One process usually acts as a server and the other process is the client. The server binds its socket to a previously agreed path or address. It then blocks on the socket. For a `SOCK_STREAM` socket, the server calls `int listen(int s, int backlog)`, which specifies how many connection requests can be queued. A client initiates a connection to the server's socket by a call to `int connect(int s, struct sockaddr *name, int namelen)`. A UNIX domain call is like this:

```
struct sockaddr_un server;
...
connect (sd, (struct sockaddr_un *)&server, length);
```

while an Internet domain call would be:

```
struct sockaddr_in;
...
connect (sd, (struct sockaddr_in *)&server, length);
```

If the client's socket is unbound at the time of the connect call, the system automatically selects and binds a name to the socket. For a `SOCK_STREAM` socket, the server calls `accept(3N)` to complete the connection.

`int accept(int s, struct sockaddr *addr, int *addrlen)` returns a new socket descriptor which is valid only for the particular connection. A server can have multiple `SOCK_STREAM` connections active at one time.

Stream Data Transfer and Closing

Several functions to send and receive data from a `SOCK_STREAM` socket. These are `write()`, `read()`, `int send(int s, const char *msg, int len, int flags)`, and `int recv(int s, char *buf, int len, int flags)`. `send()` and `recv()` are very similar to `read()` and `write()`, but have some additional operational flags.

The flags parameter is formed from the bitwise OR of zero or more of the following:

MSG_OOB

-- Send "out-of-band" data on sockets that support this notion. The underlying protocol must also support "out-of-band" data. Only `SOCK_STREAM` sockets created in the `AF_INET` address family support out-of-band data.

MSG_DONTROUTE

-- The `SO_DONTROUTE` option is turned on for the duration of the operation. It is used only by diagnostic or routing programs.

MSG_PEEK

-- "Peek" at the data present on the socket; the data is returned, but not consumed, so that a subsequent receive operation will see the same data.

A `SOCK_STREAM` socket is discarded by calling `close()`.

Datagram sockets

A datagram socket does not require that a connection be established. Each message carries the destination address. If a particular local address is needed, a call to `bind()` must precede any data transfer. Data is sent through calls to `sendto()` or `sendmsg()`. The `sendto()` call is like a `send()` call with the destination address also specified. To receive datagram socket messages, call `recvfrom()` or `recvmsg()`. While `recv()` requires one buffer for the arriving data, `recvfrom()` requires two buffers, one for the incoming message and another to receive the source address.

Datagram sockets can also use `connect()` to connect the socket to a specified destination socket. When this is done, `send()` and `recv()` are used to send and receive data.

`accept()` and `listen()` are not used with datagram sockets.

Socket Options

Sockets have a number of options that can be fetched with `getsockopt()` and set with `setsockopt()`. These functions can be used at the native socket level (`level = SOL_SOCKET`), in which case the socket option name must be specified. To manipulate options at any other level the protocol number of the desired protocol controlling the option of interest must be specified (see `getprotoent()` in `getprotobyname()`).

Example Socket

Programs: `socket_server.c`, `socket_`

These two programs show how you can establish a socket connection using the above functions.

`socket_server.c`

```
#include <sys/types.h>
#include <sys/socket.h>
#include <sys/un.h>
#include <stdio.h>

#define NSTRS      3          /* no. of strings */
#define ADDRESS   "mysocket" /* addr to connect */

/*
 * Strings we send to the client.
 */
char *strs[NSTRS] = {
    "This is the first string from the server.\n",
    "This is the second string from the server.\n",
```

```
        "This is the third string from the server.\n"
};

main()
{
    char c;
    FILE *fp;
    int fromlen;
    register int i, s, ns, len;
    struct sockaddr_un saun, fsaun;

    /*
     * Get a socket to work with.  This socket will
     * be in the UNIX domain, and will be a
     * stream socket.
     */
    if ((s = socket(AF_UNIX, SOCK_STREAM, 0)) < 0) {
        perror("server: socket");
        exit(1);
    }

    /*
     * Create the address we will be binding to.
     */
    saun.sun_family = AF_UNIX;
    strcpy(saun.sun_path, ADDRESS);

    /*
     * Try to bind the address to the socket.  We
     * unlink the name first so that the bind won't
     * fail.
     *
     * The third argument indicates the "length" of
     * the structure, not just the length of the
     * socket name.
     */
    unlink(ADDRESS);
    len = sizeof(saun.sun_family) + strlen(saun.sun_path);

    if (bind(s, &saun, len) < 0) {
        perror("server: bind");
        exit(1);
    }

    /*
     * Listen on the socket.
     */
    if (listen(s, 5) < 0) {
        perror("server: listen");
        exit(1);
    }

    /*
     * Accept connections.  When we accept one, ns
     * will be connected to the client.  fsaun will
     * contain the address of the client.
     */
    if ((ns = accept(s, &fsaun, &fromlen)) < 0) {
        perror("server: accept");
        exit(1);
    }

    /*
     * We'll use stdio for reading the socket.
     */
    fp = fdopen(ns, "r");
}
```

```
/*
 * First we send some strings to the client.
 */
for (i = 0; i < NSTRS; i++)
    send(ns, strs[i], strlen(strs[i]), 0);

/*
 * Then we read some strings from the client and
 * print them out.
 */
for (i = 0; i < NSTRS; i++) {
    while ((c = fgetc(fp)) != EOF) {
        putchar(c);

        if (c == '\n')
            break;
    }
}

/*
 * We can simply use close() to terminate the
 * connection, since we're done with both sides.
 */
close(s);

exit(0);
}
```

socket_client.c

```
#include <sys/types.h>
#include <sys/socket.h>
#include <sys/un.h>
#include <stdio.h>

#define NSTRS      3          /* no. of strings */
#define ADDRESS    "mysocket" /* addr to connect */

/*
 * Strings we send to the server.
 */
char *strs[NSTRS] = {
    "This is the first string from the client.\n",
    "This is the second string from the client.\n",
    "This is the third string from the client.\n"
};

main()
{
    char c;
    FILE *fp;
    register int i, s, len;
    struct sockaddr_un saun;

    /*
     * Get a socket to work with. This socket will
     * be in the UNIX domain, and will be a
     * stream socket.
     */
    if ((s = socket(AF_UNIX, SOCK_STREAM, 0)) < 0) {
        perror("client: socket");
        exit(1);
    }

    /*
```

```
    * Create the address we will be connecting to.
    */
    saun.sun_family = AF_UNIX;
    strcpy(saun.sun_path, ADDRESS);

/*
 * Try to connect to the address. For this to
 * succeed, the server must already have bound
 * this address, and must have issued a listen()
 * request.
 *
 * The third argument indicates the "length" of
 * the structure, not just the length of the
 * socket name.
 */
    len = sizeof(saun.sun_family) + strlen(saun.sun_path);

    if (connect(s, &saun, len) < 0) {
        perror("client: connect");
        exit(1);
    }

/*
 * We'll use stdio for reading
 * the socket.
 */
    fp = fdopen(s, "r");

/*
 * First we read some strings from the server
 * and print them out.
 */
    for (i = 0; i < NSTRS; i++) {
        while ((c = fgetc(fp)) != EOF) {
            putchar(c);

            if (c == '\n')
                break;
        }
    }

/*
 * Now we send some strings to the server.
 */
    for (i = 0; i < NSTRS; i++)
        send(s, strs[i], strlen(strs[i]), 0);

/*
 * We can simply use close() to terminate the
 * connection, since we're done with both sides.
 */
    close(s);

    exit(0);
}
```

Exercises

Exercise 12776

Configure the above `socket_server.c` and `socket_client.c` programs for your system and compile and run them. You will need to set up socket ADDRESS definition.

Dave Marshall
1/5/1999

Subsections

- [Processes and Threads](#)
 - [Benefits of Threads vs Processes](#)
 - [Multithreading vs. Single threading](#)
 - [Some Example applications of threads](#)
 - [Thread Levels](#)
 - [User-Level Threads \(ULT\)](#)
 - [Kernel-Level Threads \(KLT\)](#)
 - [Combined ULT/KLT Approaches](#)
 - [Threads libraries](#)
 - [The POSIX Threads Library: `libpthread`, `<pthread.h>`](#)
 - [Creating a \(Default\) Thread](#)
 - [Wait for Thread Termination](#)
 - [A Simple Threads Example](#)
 - [Detaching a Thread](#)
 - [Create a Key for Thread-Specific Data](#)
 - [Delete the Thread-Specific Data Key](#)
 - [Set the Thread-Specific Data Key](#)
 - [Get the Thread-Specific Data Key](#)
 - [Global and Private Thread-Specific Data Example](#)
 - [Getting the Thread Identifiers](#)
 - [Comparing Thread IDs](#)
 - [Initializing Threads](#)
 - [Yield Thread Execution](#)
 - [Set the Thread Priority](#)
 - [Get the Thread Priority](#)
 - [Send a Signal to a Thread](#)
 - [Access the Signal Mask of the Calling Thread](#)
 - [Terminate a Thread](#)
 - [Solaris Threads: `<thread.h>`](#)
 - [Unique Solaris Threads Functions](#)
 - [Suspend Thread Execution](#)
 - [Continue a Suspended Thread](#)
 - [Set Thread Concurrency Level](#)
 - [Readers/Writer Locks](#)
 - [Readers/Writer Lock Example](#)
 - [Similar Solaris Threads Functions](#)
 - [Create a Thread](#)
 - [Get the Thread Identifier](#)
 - [Yield Thread Execution](#)
 - [Signals and Solaris Threads](#)
 - [Terminating a Thread](#)
 - [Creating a Thread-Specific Data Key](#)
 - [Example Use of Thread Specific Data: Rethinking Global Variables](#)
 - [Compiling a Multithreaded Application](#)
 - [Preparing for Compilation](#)
 - [Debugging a Multithreaded Program](#)
-

Threads: Basic Theory and Libraries

This chapter examines aspects of threads and multiprocessing (and multithreading). We will first study a little theory of threads and also look at how threading can be effectively used to make programs more efficient. The C thread libraries will then be introduced. The following chapters will look at further thread issues such as synchronisation and practical examples.

Processes and Threads

We can think of a **thread** as basically a *lightweight* process. In order to understand this let us consider the two main characteristics of a process:

Unit of resource ownership

-- A process is allocated:

- a virtual address space to hold the process image
- control of some resources (files, I/O devices...)

Unit of dispatching

- A process is an execution path through one or more programs:

- execution may be interleaved with other processes
- the process has an execution state and a dispatching priority

If we treat these two characteristics as being independent (as does modern OS theory):

- The unit of resource ownership is usually referred to as a **process** or task. This Processes have:
 - a virtual address space which holds the process image.
 - protected access to processors, other processes, files, and I/O resources.
- The unit of dispatching is usually referred to a **thread** or a lightweight process. Thus a thread:
 - Has an execution state (running, ready, etc.)
 - Saves thread context when not running
 - Has an execution stack and some per-thread static storage for local variables
 - Has access to the memory address space and resources of its process
- all threads of a process share this when one thread alters a (non-private) memory item, all other threads (of the process) sees that a file open with one thread, is available to others

Benefits of Threads vs Processes

If implemented correctly then threads have some advantages of (multi) processes, They take:

- Less time to create a new thread than a process, because the newly created thread uses the current process address space.
- Less time to terminate a thread than a process.
- Less time to switch between two threads within the same process, partly because the newly created thread uses the current process address space.
- Less communication overheads -- communicating between the threads of one process is simple because the threads share everything: address space, in particular. So, data produced by one thread is immediately available to all the other threads.

Multithreading vs. Single threading

Just as we can have multiple processes running on some systems we can have multiple threads running:

Single threading

-- when the OS does not recognize the concept of thread

Multithreading

-- when the OS supports multiple threads of execution within a single process

Figure 28.1 shows a variety of models for threads and processes.

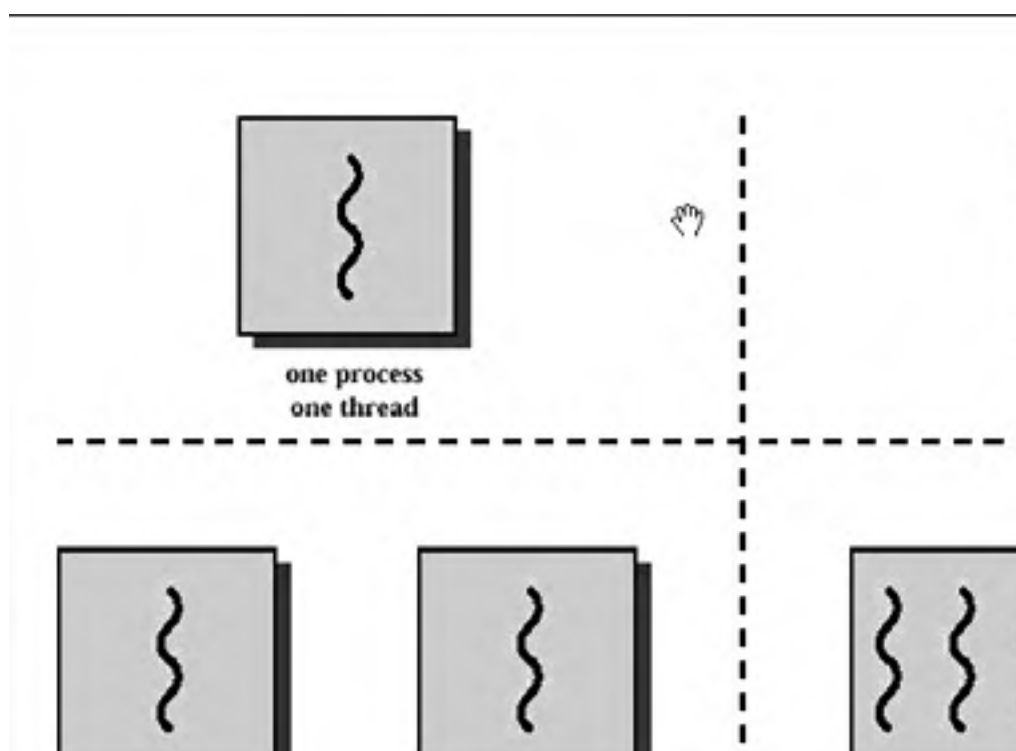

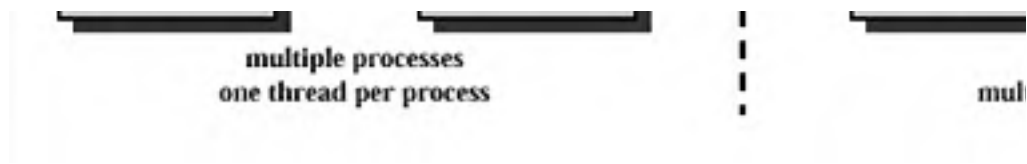

Fig. 28.1 Threads and Processes Some example popular OSs and their thread support is:

MS-DOS

-- support a single user process and a single thread

UNIX

-- supports multiple user processes but only supports one thread per process

Solaris

-- supports multiple threads

Multithreading your code can have many benefits:

- Improve application responsiveness -- Any program in which many activities are not dependent upon each other can be redesigned so that each activity is defined as a thread. For example, the user of a multithreaded GUI does not have to wait for one activity to complete before starting another.
- Use multiprocessors more efficiently -- Typically, applications that express concurrency requirements with threads need not take into account the number of available processors. The performance of the application improves transparently with additional processors. Numerical algorithms and applications with a high degree of parallelism, such as matrix multiplications, can run much faster when implemented with threads on a multiprocessor.
- Improve program structure -- Many programs are more efficiently structured as multiple independent or semi-independent units of execution instead of as a single, monolithic thread. Multithreaded programs can be more adaptive to variations in user demands than single threaded programs.
- Use fewer system resources -- Programs that use two or more processes that access common data through shared memory are applying more than one thread of control. However, each process has a full address space and operating systems state. The cost of creating and maintaining this large amount of state information makes each process much more expensive than a thread in both time and space. In addition, the inherent separation between processes can require a major effort by the programmer to communicate between the threads in different processes, or to synchronize their actions.

Figure 28.2 illustrates different process models and thread control in a single thread and multithreaded application.

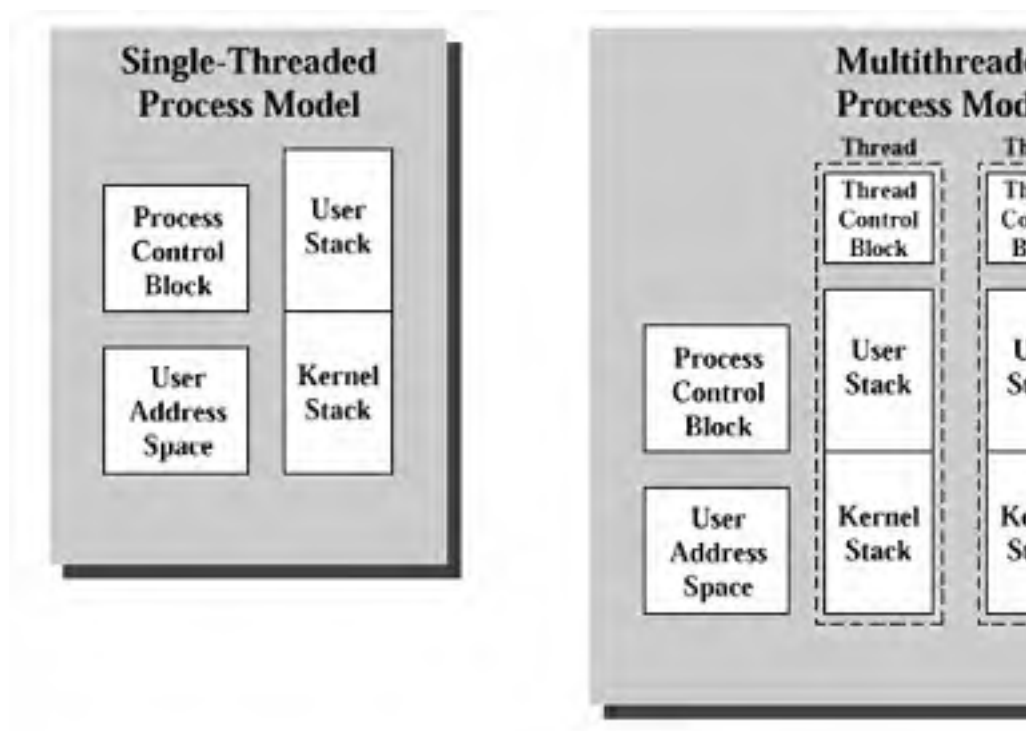

Fig. 28.2 Single and Multi- Thread Applications

Some Example applications of threads

:

Example : A file server on a LAN

- It needs to handle several file requests over a short period
- Hence more efficient to create (and destroy) a single thread for each request
- Multiple threads can possibly be executing simultaneously on different processors

Example 2: Matrix Multiplication

Matrix Multiplication essentially involves taking the rows of one matrix and multiplying and adding corresponding columns in a second matrix *i.e.*:

$$\begin{pmatrix} a_{11} & a_{12} & a_{13} \\ a_{21} & a_{22} & a_{23} \\ a_{31} & a_{32} & a_{33} \end{pmatrix} \begin{pmatrix} b_{11} & b_{12} & b_{13} \\ b_{21} & b_{22} & b_{23} \\ b_{31} & b_{32} & b_{33} \end{pmatrix} = \begin{pmatrix} a_{11}b_{11} + a_{12}b_{21} + a_{13}b_{31} & a_{11}b_{12} + a_{12}b_{22} + a_{13}b_{32} & a_{11}b_{13} + a_{12}b_{23} + a_{13}b_{33} \\ a_{21}b_{11} + a_{22}b_{21} + a_{23}b_{31} & a_{21}b_{12} + a_{22}b_{22} + a_{23}b_{32} & a_{21}b_{13} + a_{22}b_{23} + a_{23}b_{33} \\ a_{31}b_{11} + a_{32}b_{21} + a_{33}b_{31} & a_{31}b_{12} + a_{32}b_{22} + a_{33}b_{32} & a_{31}b_{13} + a_{32}b_{23} + a_{33}b_{33} \end{pmatrix}$$

Fig. 28.3 Matrix Multiplication (3x3 example) Note that each *element* of the resultant matrix can be computed independently, that is to say by a different thread.

We will develop a C++ example program for matrix multiplication later (see Chapter [□](#)).

Thread Levels

There are two broad categories of thread implementation:

- User-Level Threads -- Thread Libraries.
- Kernel-level Threads -- System Calls.

There are merits to both, in fact some OSs allow access to both levels (*e.g.* Solaris).

User-Level Threads (ULT)

In this level, the kernel is not aware of the existence of threads -- All thread management is done by the application by using a thread library. Thread switching does not require kernel mode privileges (no mode switch) and scheduling is application specific

Kernel activity for ULTs:

- The kernel is not aware of thread activity but it is still managing process activity
- When a thread makes a system call, the whole process will be blocked but for the thread library that thread is still in the running state
- So thread states are independent of process states

Advantages and inconveniences of ULT

Advantages:

- Thread switching does not involve the kernel -- no mode switching
- Scheduling can be application specific -- choose the best algorithm.
- ULTs can run on any OS -- Only needs a thread library

Disadvantages:

- Most system calls are blocking and the kernel blocks processes -- So all threads within the process will be blocked
- The kernel can only assign processes to processors -- Two threads within the same process cannot run simultaneously on two processors

Kernel-Level Threads (KLT)

In this level, All thread management is done by kernel No thread library but an API (system calls) to the kernel thread facility exists. The kernel maintains context information for the process and the threads, switching between threads requires the kernel Scheduling is performed on a thread basis.

Advantages and inconveniences of KLT

Advantages

- the kernel can simultaneously schedule many threads of the same process on many processors blocking is done on a thread level
- kernel routines can be multithreaded

Disadvantages:

- thread switching within the same process involves the kernel, *e.g* if we have 2 mode switches per thread switch this results in a significant slow down.

Combined ULT/KLT Approaches

Idea is to combine the best of both approaches

Solaris is an example of an OS that combines both ULT and KLT (Figure 28.4:

- Thread creation done in the user space
- Bulk of scheduling and synchronization of threads done in the user space
- The programmer may adjust the number of KLTs
- Process includes the user's address space, stack, and process control block
- User-level threads (threads library) invisible to the OS are the interface for application parallelism
- Kernel threads the unit that can be dispatched on a processor
- Lightweight processes (LWP) each LWP supports one or more ULTs and maps to exactly one KLT

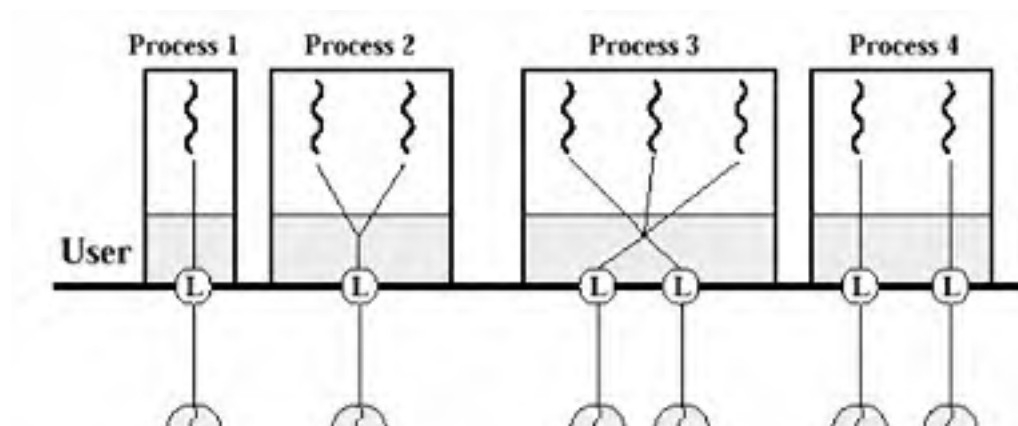

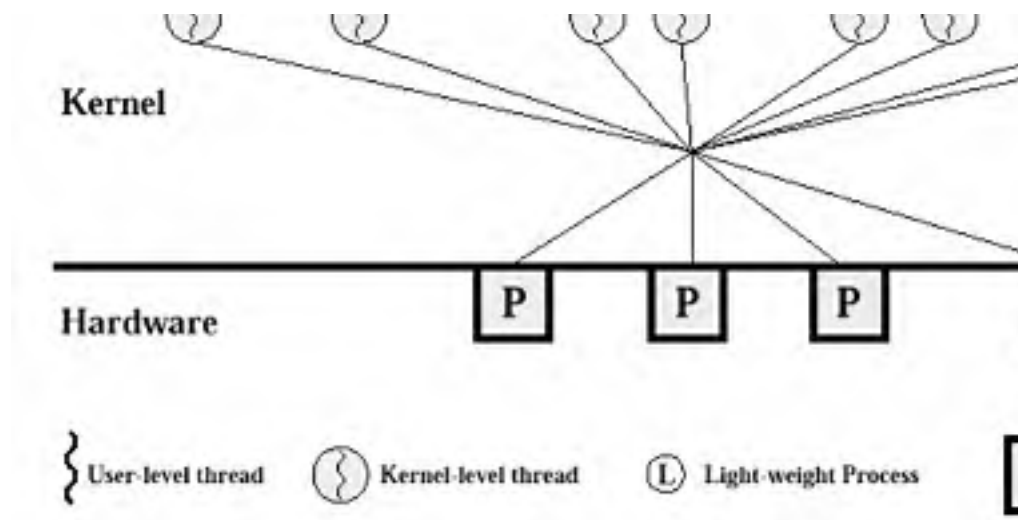

Fig. 28.4 Solaris Thread Implementation

Threads libraries

The interface to multithreading support is through a subroutine library, `libpthread` for POSIX threads, and `libthread` for Solaris threads. They both contain code for:

- creating and destroying threads
- passing messages and data between threads
- scheduling thread execution
- saving and restoring thread contexts

The POSIX Threads

Library: `libpthread`, `<pthread.h>`

Creating a (Default) Thread

Use the function `pthread_create()` to add a new thread of control to the current process. It is prototyped by:

```
int pthread_create(pthread_t *tid, const pthread_attr_t *tattr,
void* (*start_routine)(void *), void *arg);
```

When an attribute object is not specified, it is `NULL`, and the *default* thread is created with the following attributes:

- It is unbounded
- It is nondetached
- It has a default stack and stack size
- It inherits the parent's priority

You can also create a default attribute object with `pthread_attr_init()`

function, and then use this attribute object to create a default thread. See the Section [29.2](#).

An example call of default thread creation is:

```
#include <pthread.h>
pthread_attr_t tattr;
pthread_t tid;
extern void *start_routine(void *arg);
void *arg;
int ret;
/* default behavior*/
ret = pthread_create(&tid, NULL, start_routine, arg);

/* initialized with default attributes */
ret = pthread_attr_init(&tattr);
/* default behavior specified*/
ret = pthread_create(&tid, &tattr, start_routine, arg);
```

The `pthread_create()` function is called with `attr` having the necessary state behavior. `start_routine` is the function with which the new thread begins execution. When `start_routine` returns, the thread exits with the exit status set to the value returned by `start_routine`.

When `pthread_create` is successful, the ID of the thread created is stored in the location referred to as `tid`.

Creating a thread using a NULL attribute argument has the same effect as using a default attribute; both create a default thread. When `tattr` is initialized, it acquires the default behavior.

`pthread_create()` returns a zero and exits when it completes successfully. Any other returned value indicates that an error occurred.

Wait for Thread Termination

Use the `pthread_join` function to wait for a thread to terminate. It is prototyped by:

```
int pthread_join(pthread_t tid, void **status);
```

An example use of this function is:

```
#include <pthread.h>
pthread_t tid;
int ret;
int status;
/* waiting to join thread "tid" with status */
ret = pthread_join(tid, &status);
/* waiting to join thread "tid" without status */
ret = pthread_join(tid, NULL);
```

The `pthread_join()` function blocks the calling thread until the specified thread terminates. The specified thread must be in the current process and must not be detached. When `status` is not NULL, it points to a location that is set to the exit status of the terminated thread when `pthread_join()` returns

successfully. Multiple threads cannot wait for the same thread to terminate. If they try to, one thread returns successfully and the others fail with an error of `ESRCH`. After `pthread_join()` returns, any stack storage associated with the thread can be reclaimed by the application.

The `pthread_join()` routine takes two arguments, giving you some flexibility in its use. When you want the caller to wait until a specific thread terminates, supply that thread's ID as the first argument. If you are interested in the exit code of the defunct thread, supply the address of an area to receive it. Remember that `pthread_join()` works only for target threads that are nondetached. When there is no reason to synchronize with the termination of a particular thread, then that thread should be detached. Think of a detached thread as being the thread you use in most instances and reserve nondetached threads for only those situations that require them.

A Simple Threads Example

In this Simple Threads fragment below, one thread executes the procedure at the top, creating a helper thread that executes the procedure `fetch`, which involves a complicated database lookup and might take some time.

The main thread wants the results of the lookup but has other work to do in the meantime. So it does those other things and then waits for its helper to complete its job by executing `pthread_join()`. An argument, `pbe`, to the new thread is passed as a stack parameter. This can be done here because the main thread waits for the spun-off thread to terminate. In general, though, it is better to `malloc()` storage from the heap instead of passing an address to thread stack storage, which can disappear or be reassigned if the thread terminated.

The source for `thread.c` is as follows:

```
void mainline (...)
{
    struct phonebookentry *pbe;
    pthread_attr_t tattr;
    pthread_t helper;
    int status;
    pthread_create(&helper, NULL, fetch, &pbe);
    /* do something else for a while */
    pthread_join(helper, &status);
    /* it's now safe to use result */
}
void fetch(struct phonebookentry *arg)
{
    struct phonebookentry *npbe;
    /* fetch value from a database */
    npbe = search (prog_name)
    if (npbe != NULL)
```

```
*arg = *npbe;
pthread_exit(0);
}
struct phonebookentry {
char name[64];
char phonenumber[32];
char flags[16];
}
```

Detaching a Thread

The function `pthread_detach()` is an alternative to `pthread_join()` to reclaim storage for a thread that is created with a detachstate attribute set to `PTHREAD_CREATE_JOINABLE`. It is prototyped by:

```
int pthread_detach(pthread_t tid);
```

A simple example of calling this function to detach a thread is given by:

```
#include <pthread.h>
pthread_t tid;
int ret;
/* detach thread tid */
ret = pthread_detach(tid);
```

The `pthread_detach()` function is used to indicate to the implementation that storage for the thread `tid` can be reclaimed when the thread terminates. If `tid` has not terminated, `pthread_detach()` does not cause it to terminate. The effect of multiple `pthread_detach()` calls on the same target thread is unspecified.

`pthread_detach()` returns a zero when it completes successfully. Any other returned value indicates that an error occurred. When any of the following conditions are detected, `pthread_detach()` fails and returns the an error value.

Create a Key for Thread-Specific Data

Single-threaded C programs have two basic classes of data: local data and global data. For multithreaded C programs a third class is added: **thread-specific data (TSD)**. This is very much like global data, except that it is private to a thread.

Thread-specific data is maintained on a per-thread basis. TSD is the only way to define and refer to data that is private to a thread. Each thread-specific data item is associated with a key that is global to all threads in the process. Using the key, a thread can access a pointer (`void *`) that is maintained per-thread.

The function `pthread_keycreate()` is used to allocate a key that is used to identify thread-specific data in a process. The key is global to all threads in the process, and all threads initially have the value `NULL` associated with the key when it is created.

`pthread_keycreate()` is called once for each key before the key is used.

There is no implicit synchronization. Once a key has been created, each thread can bind a value to the key. The values are specific to the thread and are maintained for each thread independently. The per-thread binding is deallocated when a thread terminates if the key was created with a destructor function. `pthread_keycreate()` is prototyped by:

```
int pthread_key_create(pthread_key_t *key, void (*destructor) (vo
```

A simple example use of this function is:

```
#include <pthread.h>
pthread_key_t key;
int ret;
/* key create without destructor */
ret = pthread_key_create(&key, NULL);
/* key create with destructor */
ret = pthread_key_create(&key, destructor);
```

When `pthread_keycreate()` returns successfully, the allocated `key` is stored in the location pointed to by `key`. The caller must ensure that the storage and access to this key are properly synchronized. An optional destructor function, `destructor`, can be used to free stale storage. When a key has a non-NULL destructor function and the thread has a non-NULL value associated with that key, the destructor function is called with the current associated value when the thread exits. The order in which the destructor functions are called is unspecified.

`pthread_keycreate()` returns zero after completing successfully. Any other returned value indicates that an error occurred. When any of the following conditions occur, `pthread_keycreate()` fails and returns an error value.

Delete the Thread-Specific Data Key

The function `pthread_keydelete()` is used to destroy an existing thread-specific data key. Any memory associated with the key can be freed because the key has been invalidated and will return an error if ever referenced. (There is no comparable function in Solaris threads.)

`pthread_keydelete()` is prototyped by:

```
int pthread_key_delete(pthread_key_t key);
```

A simple example use of this function is:

```
#include <pthread.h>
pthread_key_t key;
int ret;
/* key previously created */
ret = pthread_key_delete(key);
```

Once a `key` has been deleted, any reference to it with the `pthread_setspecific()` or `pthread_getspecific()` call results in the `EINVAL` error.

It is the responsibility of the programmer to free any thread-specific resources before calling the delete function. This function does not invoke any of the destructors.

`pthread_keydelete()` returns zero after completing successfully. Any other returned value indicates that an error occurred. When the following condition occurs, `pthread_keycreate()` fails and returns the corresponding value.

Set the Thread-Specific Data Key

The function `pthread_setspecific()` is used to set the thread-specific binding to the specified thread-specific data key. It is prototyped by :

```
int pthread_setspecific(pthread_key_t key, const void *value);
```

A simple example use of this function is:

```
#include <pthread.h>
pthread_key_t key;
void *value;
int ret;

/* key previously created */
ret = pthread_setspecific(key, value);
```

`pthread_setspecific()` returns zero after completing successfully. Any other returned value indicates that an error occurred. When any of the following conditions occur, `pthread_setspecific()` fails and returns an error value.

Note: `pthread_setspecific()` does *not* free its storage. If a new binding is set, the existing binding must be freed; otherwise, a *memory leak can occur*.

Get the Thread-Specific Data Key

Use `pthread_getspecific()` to get the calling thread's binding for key, and store it in the location pointed to by value. This function is prototyped by:

```
int pthread_getspecific(pthread_key_t key);
```

A simple example use of this function is:

```
#include <pthread.h>
pthread_key_t key;
void *value;
/* key previously created */
value = pthread_getspecific(key);
```

Global and Private Thread-Specific Data Example

Thread-Specific Data Global but Private

Consider the following code:

```
body() {
...
while (write(fd, buffer, size) == -1) {
if (errno != EINTR) {
fprintf(mywindow, "%s\n", strerror(errno));
exit(1);
}
}
...
}
```

This code may be executed by any number of threads, but it has references to two global variables, `errno` and `mywindow`, that really should be references to items private to each thread.

References to `errno` should get the system error code from the routine called by this thread, not by some other thread. So, references to `errno` by one thread refer to a different storage location than references to `errno` by other threads. The `mywindow` variable is intended to refer to a `stdio` stream connected to a window that is private to the referring thread. So, as with `errno`, references to `mywindow` by one thread should refer to a different storage location (and, ultimately, a different window) than references to `mywindow` by other threads. The only difference here is that the threads library takes care of `errno`, but the programmer must somehow make this work for `mywindow`. The next example shows how the references to `mywindow` work. The preprocessor converts references to `mywindow` into invocations of the `mywindow` procedure. This routine in turn invokes `pthread_getspecific()`, passing it the `mywindow_key` global variable (it really is a global variable) and an output parameter, `win`, that receives the identity of this thread's window.

Turning Global References Into Private References Now consider this code fragment:

```
thread_key_t mywin_key;
FILE *_mywindow(void) {
FILE *win;
pthread_getspecific(mywin_key, &win);
return(win);
}
#define mywindow _mywindow()

void routine_uses_win( FILE *win) {
...
}
void thread_start(...) {
...
make_mywin();
...
routine_uses_win( mywindow )
...
}
```

The `mywin_key` variable identifies a class of variables for which each thread has its own private copy; that is, these variables are thread-specific data. Each thread calls `make_mywin` to initialize its window and to arrange for its instance

of `mywindow` to refer to it. Once this routine is called, the thread can safely refer to `mywindow` and, after `mywindow`, the thread gets the reference to its private window. So, references to `mywindow` behave as if they were direct references to data private to the thread.

We can now set up our initial Thread-Specific Data:

```
void make_mywindow(void) {
FILE **win;
static pthread_once_t mykeycreated = PTHREAD_ONCE_INIT;
pthread_once(&mykeycreated, mykeycreate);
win = malloc(sizeof(*win));
create_window(win, ...);
pthread_setspecific(mywindow_key, win);
}
void mykeycreate(void) {
pthread_keycreate(&mywindow_key, free_key);
}
void free_key(void *win) {
free(win);
}
```

First, get a unique value for the key, `mywin_key`. This key is used to identify the thread-specific class of data. So, the first thread to call `make_mywin` eventually calls `pthread_keycreate()`, which assigns to its first argument a unique key. The second argument is a destructor function that is used to deallocate a thread's instance of this thread-specific data item once the thread terminates.

The next step is to allocate the storage for the caller's instance of this thread-specific data item. Having allocated the storage, a call is made to the `create_window` routine, which sets up a window for the thread and sets the storage pointed to by `win` to refer to it. Finally, a call is made to `pthread_setspecific()`, which associates the value contained in `win` (that is, the location of the storage containing the reference to the window) with the key. After this, whenever this thread calls `pthread_getspecific()`, passing the global key, it gets the value that was associated with this key by this thread when it called `pthread_setspecific()`. When a thread terminates, calls are made to the destructor functions that were set up in `pthread_key_create()`. Each destructor function is called only if the terminating thread established a value for the key by calling `pthread_setspecific()`.

Getting the Thread Identifiers

The function `pthread_self()` can be called to return the ID of the calling thread. It is prototyped by:

```
pthread_t pthread_self(void);
```

Its use is very straightforward:

```
#include <pthread.h>
pthread_t tid;
tid = pthread_self();
```

Comparing Thread IDs

The function `pthread_equal()` can be called to compare the thread identification numbers of two threads. It is prototyped by:

```
int pthread_equal(pthread_t tid1, pthread_t tid2);
```

Its use is straightforward to use, also:

```
#include <pthread.h>
pthread_t tid1, tid2;
int ret;
ret = pthread_equal(tid1, tid2);
```

As with other comparison functions, `pthread_equal()` returns a non-zero value when `tid1` and `tid2` are equal; otherwise, zero is returned. When either `tid1` or `tid2` is an invalid thread identification number, the result is unpredictable.

Initializing Threads

Use `pthread_once()` to call an initialization routine the first time `pthread_once()` is called -- Subsequent calls to have no effect. The prototype of this function is:

```
int pthread_once(pthread_once_t *once_control,
void (*init_routine)(void));
```

Yield Thread Execution

The function `sched_yield()` to cause the current thread to yield its execution in favor of another thread with the same or greater priority. It is prototyped by:

```
int sched_yield(void);
```

It is clearly a simple function to call:

```
#include <sched.h>
int ret;
ret = sched_yield();
```

`sched_yield()` returns zero after completing successfully. Otherwise -1 is returned and `errno` is set to indicate the error condition.

Set the Thread Priority

Use `pthread_setschedparam()` to modify the priority of an existing thread. This function has no effect on scheduling policy. It is prototyped as follows:

```
int pthread_setschedparam(pthread_t tid, int policy,  
const struct sched_param *param);
```

and used as follows:

```
#include <pthread.h>  
pthread_t tid;  
int ret;  
struct sched_param param;  
int priority;  
/* sched_priority will be the priority of the thread */  
sched_param.sched_priority = priority;  
/* only supported policy, others will result in ENOTSUP */  
  
policy = SCHED_OTHER;  
/* scheduling parameters of target thread */  
ret = pthread_setschedparam(tid, policy, &param);
```

`pthread_setschedparam()` returns zero after completing successfully. Any other returned value indicates that an error occurred. When either of the following conditions occurs, the `pthread_setschedparam()` function fails and returns an error value.

Get the Thread Priority

```
int pthread_getschedparam(pthread_t tid, int policy, struct  
schedparam *param) gets the priority of the existing thread.
```

An example call of this function is:

```
#include <pthread.h>  
pthread_t tid;  
sched_param param;  
int priority;  
int policy;  
int ret;  
/* scheduling parameters of target thread */  
ret = pthread_getschedparam (tid, &policy, &param);  
/* sched_priority contains the priority of the thread */  
priority = param.sched_priority;
```

`pthread_getschedparam()` returns zero after completing successfully. Any other returned value indicates that an error occurred. When the following condition occurs, the function fails and returns the error value set.

Send a Signal to a Thread

Signal may be sent to threads in a similar fashion to those for process as follows:

```
#include <pthread.h>  
#include <signal.h>  
int sig;  
pthread_t tid;  
int ret;  
ret = pthread_kill(tid, sig);
```

`pthread_kill()` sends the signal `sig` to the thread specified by `tid`. `tid`

must be a thread within the same process as the calling thread. The `sig` argument must be a valid signal of the same type defined for `signal()` in `<signal.h>` (See Chapter 23)

When `sig` is zero, error checking is performed but no signal is actually sent. This can be used to check the validity of `tid`.

This function returns zero after completing successfully. Any other returned value indicates that an error occurred. When either of the following conditions occurs, `pthread_kill()` fails and returns an error value.

Access the Signal Mask of the Calling Thread

The function `pthread_sigmask()` may be used to change or examine the signal mask of the calling thread. It is prototyped as follows:

```
int pthread_sigmask(int how, const sigset_t *new, sigset_t *old);
```

Example uses of this function include:

```
#include <pthread.h>
#include <signal.h>
int ret;
sigset_t old, new;
ret = pthread_sigmask(SIG_SETMASK, &new, &old); /* set new mask */
ret = pthread_sigmask(SIG_BLOCK, &new, &old); /* blocking mask */
ret = pthread_sigmask(SIG_UNBLOCK, &new, &old); /* unblocking */
```

`how` determines how the signal set is changed. It can have one of the following values:

SIG_SETMASK

-- Replace the current signal mask with `new`, where `new` indicates the new signal mask.

SIG_BLOCK

-- Add `new` to the current signal mask, where `new` indicates the set of signals to block.

SIG_UNBLOCK

-- Delete `new` from the current signal mask, where `new` indicates the set of signals to unblock.

When the value of `new` is `NULL`, the value of `how` is not significant and the signal mask of the thread is unchanged. So, to inquire about currently blocked signals, assign a `NULL` value to the `new` argument. The `old` variable points to the space where the previous signal mask is stored, unless it is `NULL`.

`pthread_sigmask()` returns a zero when it completes successfully. Any other returned value indicates that an error occurred. When the following condition occurs, `pthread_sigmask()` fails and returns an error value.

Terminate a Thread

A thread can terminate its execution in the following ways:

- By returning from its first (outermost) procedure, the threads start routine; see `pthread_create()`
- By calling `pthread_exit()`, supplying an exit status
- By termination with POSIX cancel functions; see `pthread_cancel()`

The `void pthread_exit(void *status)` is used to terminate a thread in a similar fashion to the `exit()` for a process:

```
#include <pthread.h>
int status;
pthread_exit(&status); /* exit with status */
```

The `pthread_exit()` function terminates the calling thread. All thread-specific data bindings are released. If the calling thread is not detached, then the thread's ID and the exit status specified by `status` are retained until the thread is waited for (blocked). Otherwise, `status` is ignored and the thread's ID can be reclaimed immediately.

The `pthread_cancel()` function to cancel a thread is prototyped:

```
int pthread_cancel(pthread_t thread);
```

and called:

```
#include <pthread.h>
pthread_t thread;
int ret;
ret = pthread_cancel(thread);
```

How the cancellation request is treated depends on the state of the target thread. Two functions,

`pthread_setcancelstate()` and `pthread_setcanceltype()` (see `man` pages for further information on these functions), determine that state.

`pthread_cancel()` returns zero after completing successfully. Any other returned value indicates that an error occurred. When the following condition occurs, the function fails and returns an error value.

Solaris Threads: <thread.h>

Solaris has many similarities to POSIX threads. In this section, we focus on the Solaris features that are not found in POSIX threads. Where functionality is virtually the same for both Solaris threads and for pthreads, (even though the function names or arguments might differ), only a brief example consisting of the correct include file and the function prototype is presented. Where return values are not given for the Solaris threads functions, see the appropriate `man` pages.

The Solaris threads API and the pthreads API are two solutions to the same problem: building parallelism into application software. Although each API is complete in itself, you can safely mix Solaris threads functions and pthread functions in the same program.

The two APIs do not match exactly, however. Solaris threads supports functions that are not found in pthreads, and pthreads includes functions that are not supported in the Solaris interface. For those functions that do match, the associated arguments might not, although the information content is effectively the same.

By combining the two APIs, you can use features not found in one to enhance the other. Similarly, you can run applications using Solaris threads, exclusively, with applications using pthreads, exclusively, on the same system.

To use the Solaris threads functions described in this chapter, you must link with the Solaris threads library `-lthread` and include the `<thread.h>` in all programs.

Unique Solaris Threads Functions

Let us begin by looking at some functions that are unique to Solaris threads:

- Suspend Thread Execution
- Continue a Suspended Thread
- Set Thread Concurrency Level
- Get Thread Concurrency

Suspend Thread Execution

The function `thr_suspend()` immediately suspends the execution of the thread specified by a target thread, (`tid` below). It is prototyped by:

```
int thr_suspend(thread_t tid);
```

On successful return from `thr_suspend()`, the suspended thread is no longer executing. Once a thread is suspended, subsequent calls to `thr_suspend()` have no effect. Signals cannot awaken the suspended thread; they remain pending until the thread resumes execution.

A simple example call is as follows:

```
#include <thread.h>

thread_t tid; /* tid from thr_create() */
/* pthreads equivalent of Solaris tid from thread created */
/* with pthread_create() */
pthread_t ptid;
int ret;
ret = thr_suspend(tid);
/* using pthreads ID variable with a cast */
ret = thr_suspend((thread_t) ptid);
```

Note: `pthread_t tid` as defined in `pthread` is the same as `thread_t tid` in Solaris threads. `tid` values can be used interchangeably either by assignment or through the use of casts.

Continue a Suspended Thread

The function `thr_continue()` resumes the execution of a suspended thread. It is prototypes as follows:

```
int thr_continue(thread_t tid);
```

Once a suspended thread is continued, subsequent calls to `thr_continue()` have no effect.

A suspended thread will **not** be awakened by a signal. The signal stays pending until the execution of the thread is resumed by `thr_continue()`.

`thr_continue()` returns zero after completing successfully. Any other returned value indicates that an error occurred. When the following condition occurs, `thr_continue()` The following code fragment illustrates the use of the function:

```
thread_t tid; /* tid from thr_create()*/  
/* pthreads equivalent of Solaris tid from thread created */  
/* with pthread_create()*/  
pthread_t ptid;  
int ret;  
ret = thr_continue(tid);  
/* using pthreads ID variable with a cast */  
ret = thr_continue((thread_t) ptid)
```

Set Thread Concurrency Level

By default, Solaris threads attempt to adjust the system execution resources (LWPs) used to run unbound threads to match the real number of active threads. While the Solaris threads package cannot make perfect decisions, it at least ensures that the process continues to make progress. When you have some idea of the number of unbound threads that should be simultaneously active (executing code or system calls), tell the library through `thr_setconcurrency(int new_level)`. To get the number of threads being used, use the function `thr_getconcurrency(int(void))`:

`thr_setconcurrency()` provides a hint to the system about the required level of concurrency in the application. The system ensures that a sufficient number of threads are active so that the process continues to make progress, for example:

```
#include <thread.h>  
int new_level;  
int ret;  
  
ret = thr_setconcurrency(new_level);
```

Unbound threads in a process might or might not be required to be simultaneously active. To conserve system resources, the threads system ensures by default that enough threads are active for the process to make progress, and that the process will not deadlock through a lack of concurrency. Because this might not produce the most effective level of concurrency, `thr_setconcurrency()` permits the application to give the threads system a hint, specified by `new_level`, for the desired level of concurrency. The actual number of simultaneously active threads can be larger or smaller than `new_level`. Note that an application with multiple compute-bound threads can fail to schedule all the runnable threads if `thr_setconcurrency()` has not been called to adjust the level of execution resources. You can also affect the value for the desired concurrency level by setting the `THR_NEW_LW` flag in `thr_create()`. This effectively increments the current level by one.

`thr_setconcurrency()` a zero when it completes successfully. Any other returned value indicates that an error occurred. When any of the following conditions are detected, `thr_setconcurrency()` fails and returns the corresponding value to `errno`.

Readers/Writer Locks

Readers/Writer locks are another unique feature of Solaris threads. They allow simultaneous read access by many threads while restricting write access to only one thread at a time.

When any thread holds the lock for reading, other threads can also acquire the lock for reading but must wait to acquire the lock for writing. If one thread holds the lock for writing, or is waiting to acquire the lock for writing, other threads must wait to acquire the lock for either reading or writing. Readers/writer locks are slower than mutexes, but can improve performance when they protect data that are not frequently written but that are read by many concurrent threads. Use readers/writer locks to synchronize threads in this process and other processes by allocating them in memory that is writable and shared among the cooperating processes (see `mmap(2)`) and by initializing them for this behavior. By default, the acquisition order is not defined when multiple threads are waiting for a readers/writer lock. However, to avoid writer starvation, the Solaris threads package tends to favor writers over readers. Readers/writer locks must be initialized before use.

Initialize a Readers/Writer Lock

The function `rwlock_init()` initialises the readers/writer lock. it is prototypes in `<synch.h>` or `<thread.h>` as follows:

```
int rwlock_init(rwlock_t *rwlp, int type, void * arg);
```

The readers/writer lock pointed to by `rwlp` and to set the lock state to unlocked. `type` can be one of the following

USYNC_PROCESS

-- The readers/writer lock can be used to synchronize threads in this process and other processes.

USYNC_THREAD

-- The readers/writer lock can be used to synchronize threads in this process, only.

Note: that `arg` is currently ignored.

`rwlock_init()` returns zero after completing successfully. Any other returned value indicates that an error occurred. When any of the following conditions occur, the function fails and returns the corresponding value to `errno`.

Multiple threads must not initialize the same readers/writer lock simultaneously. Readers/writer locks can also be initialized by allocation in zeroed memory, in which case a type of `USYNC_THREAD` is assumed. A readers/writer lock must not be reinitialized while other threads might be using it.

An example code fragment that initialises Readers/Writer Locks with Intraprocess Scope is as follows:

```
#include <thread.h>

rwlock_t rwlp;
int ret;
/* to be used within this process only */
ret = rwlock_init(&rwlp, USYNC_THREAD, 0);
Initializing Readers/Writer Locks with Interprocess Scope
#include <thread.h>
rwlock_t rwlp;
int ret;
/* to be used among all processes */
ret = rwlock_init(&rwlp, USYNC_PROCESS, 0);
```

Acquire a Read Lock

To acquire a read lock on the readers/writer lock use the `rw_rdlock()` function:

```
int rw_rdlock(rwlock_t *rwlp);
```

The readers/writer lock pointed to by `rwlp`. When the readers/writer lock is already locked for writing, the calling thread blocks until the write lock is released. Otherwise, the read lock is acquired.

`rw_rdlock()` returns zero after completing successfully. Any other returned value indicates that an error occurred. When any of the following conditions occur, the function fails and returns the corresponding value to `errno`.

A function `rw_tryrdlock(rwlock_t *rwlp)` may also be used to attempt to

acquire a read lock on the readers/writer lock pointed to by `rwlp`. When the readers/writer lock is already locked for writing, it returns an error. Otherwise, the read lock is acquired. This function returns zero after completing successfully. Any other returned value indicates that an error occurred.

Acquire a Write Lock

The function `rw_wrllock(rwlock_t *rwlp)` acquires a write lock on the readers/writer lock pointed to by `rwlp`. When the readers/writer lock is already locked for reading or writing, the calling thread blocks until all the read locks and write locks are released. Only one thread at a time can hold a write lock on a readers/writer lock.

`rw_wrllock()` returns zero after completing successfully. Any other returned value indicates that an error occurred.

Use `rw_trywrllock(rwlock_t *rwlp)` to attempt to acquire a write lock on the readers/writer lock pointed to by `rwlp`. When the readers/writer lock is already locked for reading or writing, it returns an error.

`rw_trywrllock()` returns zero after completing successfully. Any other returned value indicates that an error occurred.

Unlock a Readers/Writer Lock

The function `rw_unlock(rwlock_t *rwlp)` unlocks a readers/writer lock pointed to by `rwlp`. The readers/writer lock must be locked and the calling thread must hold the lock either for reading or writing. When any other threads are waiting for the readers/writer lock to become available, one of them is unblocked.

`rw_unlock()` returns zero after completing successfully. Any other returned value indicates that an error occurred.

Destroy Readers/Writer Lock State

The function `rwlock_destroy(rwlock_t *rwlp)` destroys any state associated with the readers/writer lock pointed to by `rwlp`. The space for storing the readers/writer lock is not freed.

`rwlock_destroy()` returns zero after completing successfully. Any other returned value indicates that an error occurred.

Readers/Writer Lock Example

The following example uses a bank account analogy to demonstrate readers/writer locks. While the program could allow multiple threads to have concurrent read-only access to the account balance, only a single writer is allowed. Note that the `get_balance()` function needs the lock to ensure that the addition of the checking and saving balances occurs atomically.

```
rwlock_t account_lock;
float checking_balance = 100.0;
float saving_balance = 100.0;
...
rwlock_init(&account_lock, 0, NULL);
...
float
get_balance() {
float bal;
rw_rdlock(&account_lock);
bal = checking_balance + saving_balance;
rw_unlock(&account_lock);
return(bal);
}
void
transfer_checking_to_savings(float amount) {
rw_wrlock(&account_lock);
checking_balance = checking_balance - amount;
saving_balance = saving_balance + amount;
rw_unlock(&account_lock);
}
```

Similar Solaris Threads Functions

Here we simply list the similar thread functions and their prototype definitions, except where the complexity of the function merits further exposition. .

Create a Thread

The `thr_create()` routine is one of the most elaborate of all the Solaris threads library routines.

It is prototyped as follows:

```
int thr_create(void *stack_base, size_t stack_size,
void *(*start_routine) (void *), void *arg, long flags,
thread_t *new_thread);
```

This function adds a new thread of control to the current process. Note that the new thread does not inherit pending signals, but it does inherit priority and signal masks.

`stack_base` contains the address for the stack that the new thread uses. If `stack_base` is `NULL` then `thr_create()` allocates a stack for the new thread with at least `stack_size` bytes. `stack_size` Contains the size, in number of bytes, for the stack that the new thread uses. If `stack_size` is zero, a default size is used. In most cases, a zero value works best. If `stack_size` is not zero, it must be greater than the value returned by `thr_min_stack(void)` inquiry function.

There is no general need to allocate stack space for threads. The threads library allocates one megabyte of virtual memory for each thread's stack with no swap space reserved.

`start_routine` contains the function with which the new thread begins

execution. When `start_routine` returns, the thread exits with the exit status set to the value returned by `start_routine`

`arg` can be anything that is described by `void`, which is typically any 4-byte value. Anything larger must be passed indirectly by having the argument point to it.

Note that you can supply only one argument. To get your procedure to take multiple arguments, encode them as one (such as by putting them in a structure).

`flags` specifies attributes for the created thread. In most cases a zero value works best. The value in `flags` is constructed from the bitwise inclusive OR of the following:

THR_SUSPENDED

-- Suspends the new thread and does not execute `start_routine` until the thread is started by `thr_continue()`. Use this to operate on the thread (such as changing its priority) before you run it. The termination of a detached thread is ignored.

THR_DETACHED

-- Detaches the new thread so that its thread ID and other resources can be reused as soon as the thread terminates. Set this when you do not want to wait for the thread to terminate. Note - When there is no explicit synchronization to prevent it, an unsuspended, detached thread can die and have its thread ID reassigned to another new thread before its creator returns from `thr_create()`.

THR_BOUND

-- Permanently binds the new thread to an LWP (the new thread is a bound thread).

THR_NEW_LWP

-- Increases the concurrency level for unbound threads by one. The effect is similar to incrementing concurrency by one with `thr_setconcurrency()`, although `THR_NEW_LWP` does not affect the level set through the `thr_setconcurrency()` function. Typically, `THR_NEW_LWP` adds a new LWP to the pool of LWPs running unbound threads.

When you specify both `THR_BOUND` and `THR_NEW_LWP`, two LWPs are typically created -- one for the bound thread and another for the pool of LWPs running unbound threads.

THR_DAEMON

-- Marks the new thread as a daemon. The process exits when all nondaemon threads exit. Daemon threads do not affect the process exit status and are ignored when counting the number of thread exits.

A process can exit either by calling `exit()` or by having every thread in the process that was not created with the `THR_DAEMON` flag call `thr_exit()`. An application, or a library it calls, can create one or more threads that should be ignored (not counted) in the decision of whether to exit. The `THR_DAEMON` flag identifies threads that are not counted in

the process exit criterion.

`new_thread` points to a location (when `new_thread` is not `NULL`) where the ID of the new thread is stored when `thr_create()` is successful. The caller is responsible for supplying the storage this argument points to. The ID is valid only within the calling process. If you are not interested in this identifier, supply a zero value to `new_thread`.

`thr_create()` returns a zero and exits when it completes successfully. Any other returned value indicates that an error occurred. When any of the following conditions are detected, `thr_create()` fails and returns the corresponding value to `errno`.

Get the Thread Identifier

The `int thr_self(void)` to get the ID of the calling thread.

Yield Thread Execution

`void thr_yield(void)` causes the current thread to yield its execution in favor of another thread with the same or greater priority; otherwise it has no effect. There is no guarantee that a thread calling `thr_yield()` will do so.

Signals and Solaris Threads

The following functions exist and operate as do `pthread`s.

`int thr_kill(thread_t target_thread, int sig)` sends a signal to a thread.

`int thr_sigsetmask(int how, const sigset_t *set, sigset_t *oset)` to change or examine the signal mask of the calling thread.

Terminating a Thread

The `void th_exit(void *status)` to terminates a thread.

The `int thr_join(thread_t tid, thread_t *departedid, void **status)` function to wait for a thread to terminate.

Therefore to join specific threads one would do:

```
#include <thread.h>
thread_t tid;
thread_t departedid;
int ret;
int status;
/* waiting to join thread "tid" with status */
ret = thr_join(tid, &departedid, (void*)&status);
/* waiting to join thread "tid" without status */
ret = thr_join(tid, &departedid, NULL);
/* waiting to join thread "tid" without return id and status */
ret = thr_join(tid, NULL, NULL);
```

When the `tid` is `(thread_t) 0`, then `thread_join()` waits for any undetached thread in the process to terminate. In other words, when no thread identifier is specified, any undetached thread that exits causes `thread_join()` to return.

To join any threads:

```
#include <thread.h>
thread_t tid;
thread_t departedid;
int ret;
int status;
/* waiting to join thread "tid" with status */
ret = thr_join(NULL, &departedid, (void **)&status);
```

By indicating `NULL` as thread id in the `thr_join()`, a join will take place when any non detached thread in the process exits. The `departedid` will indicate the thread ID of exiting thread.

Creating a Thread-Specific Data Key

Except for the function names and arguments, thread specific data is the same for Solaris as it is for POSIX.

`int thr_keycreate(thread_key_t *key, void (*destructor) (void *value))` allocates a key that is used to identify thread-specific data in a process.

`int thr_setspecific(thread_key_t key, void *value)` binds value to the thread-specific data key, key, for the calling thread.

`int thr_getspecific(thread_key_t key, void **valuep)` stores the current value bound to key for the calling thread into the location pointed to by valuep.

In Solaris threads, if a thread is to be created with a priority other than that of its parent's, it is created in `SUSPEND` mode. While suspended, the threads priority is modified using the `int thr_setprio(thread_t tid, int newprio)` function call; then it is continued.

An unbound thread is usually scheduled only with respect to other threads in the process using simple priority levels with no adjustments and no kernel involvement. Its system priority is usually uniform and is inherited from the creating process.

The function `thr_setprio()` changes the priority of the thread, specified by `tid`, within the current process to the priority specified by `newprio`.

By default, threads are scheduled based on fixed priorities that range from zero, the least significant, to the largest integer. The `tid` will preempt lower priority threads, and will yield to higher priority threads. For example:

```
#include <thread.h>
thread_t tid;
int ret;
int newprio = 20;
/* suspended thread creation */
ret = thr_create(NULL, NULL, func, arg, THR_SUSPEND, &tid);
/* set the new priority of suspended child thread */
ret = thr_setprio(tid, newprio);
/* suspended child thread starts executing with new priority */

ret = thr_continue(tid);
```

Use `int thr_getprio(thread_t tid, int *newprio)` to get the current priority for the thread. Each thread inherits a priority from its creator. `thr_getprio()` stores the current priority, `tid`, in the location pointed to by `newprio`.

Example Use of Thread Specific Data: Rethinking Global Variables

Historically, most code has been designed for single-threaded programs. This is especially true for most of the library routines called from C programs. The following implicit assumptions were made for single-threaded code:

- When you write into a global variable and then, a moment later, read from it, what you read is exactly what you just wrote.
- This is also true for nonglobal, static storage.
- You do not need synchronization because there is nothing to synchronize with.

The next few examples discuss some of the problems that arise in multithreaded programs because of these assumptions, and how you can deal with them.

Traditional, single-threaded C and UNIX have a convention for handling errors detected in system calls. System calls can return anything as a functional value (for example, `write` returns the number of bytes that were transferred). However, the value `-1` is reserved to indicate that something went wrong. So, when a system call returns `-1`, you know that it failed.

Consider the following piece of code:

```
extern int errno;

...

if (write(file_desc, buffer, size) == -1)
{ /* the system call failed */
    fprintf(stderr, "something went wrong, error code = %d\n", er
    exit(1);
}
```

Rather than return the actual error code (which could be confused with normal return values), the error code is placed into the global variable `errno`. When the system call fails, you can look in `errno` to find out what went wrong.

Now consider what happens in a multithreaded environment when two threads fail at about the same time, but with different errors.

- Both expect to find their error codes in `errno`,
- **but** one copy of `errno` cannot hold both values.

This global variable approach simply does not work for multithreaded programs. Threads solves this problem through a conceptually new storage class: *thread-specific data*.

This storage is similar to global storage in that it can be accessed from any procedure in which a thread might be running. However, it is private to the thread: when two threads refer to the thread-specific data location of the same name, they are referring to two different areas of storage.

So, when using threads, each reference to `errno` is thread-specific because each thread has a private copy of `errno`. This is achieved in this implementation by making `errno` a macro that expands to a function call.

Compiling a Multithreaded Application

There are many options to consider for header files, define flags, and linking.

Preparing for Compilation

The following items are required to compile and link a multithreaded program.

- A standard C compiler (`cc`, `gcc` *etc*)
- Include files:
 - `<thread.h>` and `<pthread.h>`
 - `<errno.h>`, `<limits.h>`, `<signal.h>`, `<unistd.h>`
- The Solaris threads library (`libthread`), the POSIX threads library (`libpthread`), and possibly the POSIX realtime library (`libposix4`) for semaphores
- MT-safe libraries (`libc`, `libm`, `libw`, `libintl`, `libnsl`, `libsocket`, `libmalloc`, `libmapmalloc`, and so on)

The include file `<thread.h>`, used with the `-lthread` library, compiles code that is upward compatible with earlier releases of the Solaris system. This library contains both interfaces: those with Solaris semantics and those with POSIX semantics. To call `thr_setconcurrency()` with POSIX threads, your program needs to include `<thread.h>`.

The include file `<pthread.h>`, used with the `-lpthread` library, compiles code

that is conformant with the multithreading interfaces defined by the POSIX 1003.1c standard. For complete POSIX compliance, the define flag `_POSIX_C_SOURCE` should be set to a (long) value ≥ 199506 , as follows:

```
cc [flags] file... -D_POSIX_C_SOURCE=N (where N 199506L)
```

You can mix Solaris threads and POSIX threads in the same application, by including both `<thread.h>` and `<pthread.h>`, and linking with either the `-lthread` or `-lpthread` library. In mixed use, Solaris semantics prevail when compiling with `-D_REENTRANT` flag set $\geq 199506L$ and linking with `-`

`lthread`, whereas POSIX semantics prevail when compiling with `D_POSIX_C_SOURCE` flag set $\geq 199506L$ and linking with `-lpthread`.

Defining `_REENTRANT` or `_POSIX_C_SOURCE`

Linking With `libthread` or `libpthread`

For POSIX threads behavior, load the `libpthread` library. For Solaris threads behavior, load the `libthread` library. Some POSIX programmers might want to link with `-lthread` to preserve the Solaris distinction between `fork()` and `fork1()`. All that `-lpthread` really does is to make `fork()` behave the same way as the Solaris `fork1()` call, and change the behavior of `alarm()`.

To use `libthread`, specify `-lthread` last on the `cc` command line.

To use `libpthread`, specify `-lpthread` last on the `cc` command line.

Do not link a *nonthreaded* program with `-lthread` or `-lpthread`. Doing so establishes multithreading mechanisms at link time that are initiated at run time. These *slow down* a single-threaded application, waste system resources, and produce misleading results when you debug your code.

Note: For C++ programs that use threads, use the `-mt` option, rather than `-lthread`, to compile and link your application. The `-mt` option links with `libthread` and ensures proper library linking order. (Using `-lthread` might cause your program to crash (core dump).

Linking with `-lposix4` for POSIX Semaphores

The Solaris semaphore routines (see Chapter 30.3) are contained in the `libthread` library. By contrast, you link with the `-lposix4` library to get the standard POSIX semaphore routines (See Chapter 25)

Debugging a Multithreaded Program

The following list points out some of the more frequent oversights and errors that can cause bugs in multithreaded programs.

- Passing a pointer to the caller's stack as an argument to a new thread.
- Accessing global memory (shared changeable state) without the protection of a synchronization mechanism.

- Creating deadlocks caused by two threads trying to acquire rights to the same pair of global resources in alternate order (so that one thread controls the first resource and the other controls the second resource and neither can proceed until the other gives up).
- Trying to reacquire a lock already held (recursive deadlock).
- Creating a hidden gap in synchronization protection. This is caused when a code segment protected by a synchronization mechanism contains a call to a function that frees and then reacquires the synchronization mechanism before it returns to the caller. The result is that it appears to the caller that the global data has been protected when it actually has not.
- Mixing UNIX signals with threads -- it is better to use the `sigwait()` model for handling asynchronous signals.
- Forgetting that default threads are created `PTHREAD_CREATE_JOINABLE` and must be reclaimed with `pthread_join()`. **Note**, `pthread_exit()` does not free up its storage space.
- Making deeply nested, recursive calls and using large automatic arrays can cause problems because multithreaded programs have a more limited stack size than single-threaded programs.
- Specifying an inadequate stack size, or using non-default stacks. And, note that multithreaded programs (especially those containing bugs) often behave differently in two successive runs, given identical inputs, because of differences in the thread scheduling order.

In general, multithreading bugs are statistical instead of deterministic. Tracing is usually a more effective method of finding order of execution problems than is breakpoint-based debugging.

Dave Marshall
1/5/1999

Subsections

- [Creating, Compiling and Running Your Program](#)
 - [Creating the program](#)
 - [Compilation](#)
 - [Running the program](#)
 - [The C Compilation Model](#)
 - [The Preprocessor](#)
 - [C Compiler](#)
 - [Assembler](#)
 - [Link Editor](#)
 - [Some Useful Compiler Options](#)
 - [Using Libraries](#)
 - [UNIX Library Functions](#)
 - [Finding Information about Library Functions](#)
 - [Lint -- A C program verifier](#)
 - [Exercises](#)
-

C/C++ Program Compilation

In this chapter we begin by outlining the basic processes you need to go through in order to compile your C (or C++) programs. We then proceed to formally describe the C compilation model and also how C supports additional libraries.

Creating, Compiling and Running Your Program

The stages of developing your C program are as follows. (See Appendix [□](#) and exercises for more info.)

Creating the program

Create a file containing the complete program, such as the above example. You can use any ordinary editor with which you are familiar to create the file. One such editor is *textedit* available on most UNIX systems.

The filename must by convention end ".c" (full stop, lower case c), *e.g.* *myprog.c* or *progtest.c*. The contents must obey C syntax. For example, they might be as in the above example, starting with the line `/* sample` (or a blank line preceding it) and ending with the line `*/` (or a blank line following it).

Compilation

There are many C compilers around. The `cc` being the default Sun compiler. The GNU C compiler `gcc` is popular and available for many platforms. PC users may also be familiar with the Borland `bcc` compiler.

There are also equivalent C++ compilers which are usually denoted by `cc` (*note* upper case CC. For example Sun provides CC and GNU `gcc`. The GNU compiler is also denoted by `g++`

Other (less common) C/C++ compilers exist. All the above compilers operate in essentially the same manner and share many common command line options. Below and in Appendix [\[\]](#) we list and give example uses many of the common compiler options. However, the **best** source of each compiler is through the online manual pages of your system: *e.g.* `man cc`.

For the sake of compactness in the basic discussions of compiler operation we will simply refer to the `cc` compiler -- other compilers can simply be substituted in place of `cc` unless otherwise stated.

To Compile your program simply invoke the command `cc`. The command must be followed by the name of the (C) program you wish to compile. A number of compiler options can be specified also. We will not concern ourselves with many of these options yet, some useful and often essential options are introduced below -- See Appendix [\[\]](#) or online manual help for further details.

Thus, the basic compilation command is:

```
cc program.c
```

where *program.c* is the name of the file.

If there are obvious errors in your program (such as mistypings, misspelling one of the key words or omitting a semi-colon), the compiler will detect and report them.

There may, of course, still be logical errors that the compiler cannot detect. You may be telling the computer to do the wrong operations.

When the compiler has successfully digested your program, the compiled version, or executable, is left in a file called *a.out* or if the compiler option `-o` is used : the file listed after the `-o`.

It is more convenient to use a `-o` and filename in the compilation as in

```
cc -o program program.c
```

which puts the compiled program into the file `program` (or any file you name following the "-o" argument) **instead** of putting it in the file `a.out` .

Running the program

The next stage is to actually run your executable program. To run an executable in UNIX, you simply type the name of the file containing it, in this case *program* (or *a.out*)

This executes your program, printing any results to the screen. At this stage there may be run-time errors, such as division by zero, or it may become evident that the program has produced incorrect output.

If so, you must return to edit your program source, and recompile it, and run it again.

The C Compilation Model

We will briefly highlight key features of the C Compilation model (Fig. 2.1) here.

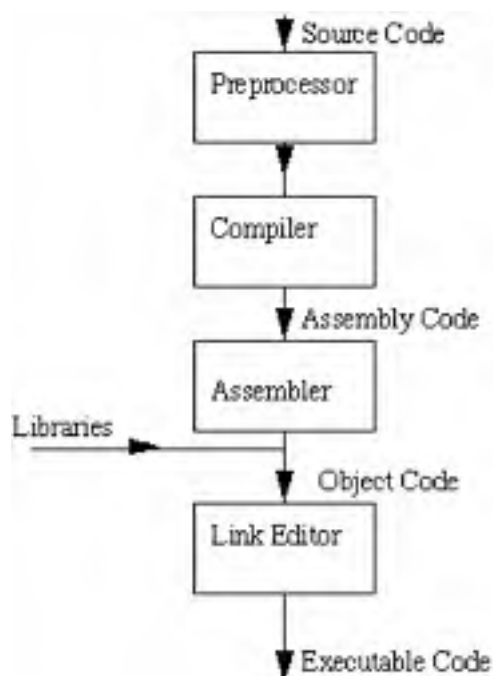

Fig. 2.1 The C Compilation Model

The Preprocessor

We will study this part of the compilation process in greater detail later (Chapter 13). However we need some basic information for some C programs.

The Preprocessor accepts source code as input and is responsible for

- removing comments
- interpreting special *preprocessor directives* denoted by #.

For example

- `#include` -- includes contents of a named file. Files usually called **header files**. *e.g*
 - `#include <math.h>` -- standard library maths file.
 - `#include <stdio.h>` -- standard library I/O file
- `#define` -- defines a symbolic name or constant. Macro substitution.
 - `#define MAX_ARRAY_SIZE 100`

C Compiler

The C compiler translates source to assembly code. The source code is received from the preprocessor.

Assembler

The assembler creates object code. On a UNIX system you may see files with a `.o` suffix (`.OBJ` on MSDOS) to indicate object code files.

Link Editor

If a source file references library functions or functions defined in other source files the **link editor** combines these functions (with `main()`) to create an executable file. External Variable references resolved here also. **More on this later** (Chapter 34).

Some Useful Compiler Options

Now that we have a basic understanding of the compilation model we can now introduce some useful and sometimes essential common compiler options. Again see the online `man` pages and Appendix [□](#) for further information and additional options.

-c

Suppress the linking process and produce a `.o` file for each source file listed. Several can be subsequently linked by the `cc` command, for example:

```
cc file1.o file2.o ..... -o executable
```

-llibrary

Link with object libraries. This option must follow the source file arguments. The object libraries are archived and can be standard, third party or user created libraries (We discuss this topic briefly below and also in detail later (Chapter 34). Probably the most commonly used library is the math library (`math.h`). You must link in this library explicitly if you wish to use the maths functions (**note** do not forget to `#include <math.h>` header file), for example:

```
cc calc.c -o calc -lm
```

Many other libraries are linked in this fashion (see below)

-Ldirectory

Add directory to the list of directories containing object-library routines. The linker always looks for standard and other system libraries in `/lib` and `/usr/lib`. If you want to link in libraries that you have created or installed yourself (unless you have certain privileges and get the libraries installed in `/usr/lib`) you **will** have to specify where you files are stored, for example:

```
cc prog.c -L/home/myname/mylibs mylib.a
```

-Ipathname

Add pathname to the list of directories in which to search for `#include` files with relative filenames (not beginning with slash `/`).

BY default, The preprocessor first searches for `#include` files in the directory containing source file, then in directories named with `-I` options (if any), and finally, in `/usr/include`. So to include header files stored in `/home/myname/myheaders` you would do:

```
cc prog.c -I/home/myname/myheaders
```

Note: System library header files are stored in a special place (`/usr/include`) and are not affected by the `-I` option. System header files and user header files are included in a slightly different manner (see Chapters [13](#) and [34](#))

-g

invoke debugging option. This instructs the compiler to produce additional symbol table information that is used by a variety of debugging utilities.

-D

define symbols either as identifiers (`-Didentifer`) or as values (`-Dsymbol=value`) in a similar fashion as the `#define` preprocessor command. For more details on the use of this argument see Chapter [13](#).

For further information on general compiler options and the GNU compiler refer to Appendix [4](#).

Using Libraries

C is an extremely small language. Many of the functions of other languages are not included in C. *e.g.* No built in I/O, string handling or maths functions.

What use is C then?

C provides functionality through a rich set function libraries.

As a result most C implementations include *standard* libraries of functions for many facilities (I/O *etc.*). For many practical purposes these may be

regarded as being part of C. But they may vary from machine to machine. (*cf* Borland C for a PC to UNIX C).

A programmer can also develop his or her own function libraries and also include special purpose third party libraries (*e.g.* NAG, PHIGS).

All libraries (except standard I/O) need to be explicitly linked in with the `-l` and, possibly, `-L` compiler options described above.

UNIX Library Functions

The UNIX system provides a large number of C functions as libraries. Some of these implement frequently used operations, while others are very specialised in their application.

Do Not Reinvent Wheels: It is wise for programmers to check whether a library function is available to perform a task before writing their own version. This will reduce program development time. The library functions have been tested, so they are more likely to be correct than any function which the programmer might write. This will save time when debugging the program.

Later chapters deal with all important standard library issues and other common system libraries.

Finding Information about Library Functions

The UNIX manual has an entry for all available functions. Function documentation is stored in *section 3* of the manual, and there are many other useful system calls in *section 2*. If you already know the name of the function you want, you can read the page by typing (to find about `sqrt`):

```
man 3 sqrt
```

If you don't know the name of the function, a full list is included in the introductory page for section 3 of the manual. To read this, type

```
man 3 intro
```

There are approximately 700 functions described here. This number tends to increase with each upgrade of the system.

On any manual page, the SYNOPSIS section will include information on the use of the function. For example:

```
#include <time.h>

char *ctime(time_t *clock)
```

This means that you must have

```
#include <time.h>
```

in your file before you call `ctime`. And that function `ctime` takes a pointer to type `time_t` as an argument, and returns a string (`char *`). `time_t` will probably be defined in the same manual page.

The DESCRIPTION section will then give a short description of what the function does. For example:

```
ctime() converts a long integer, pointed to by clock, to a
26-character string of the form produced by asctime().
```

Lint -- A C program verifier

You will soon discover (if you have not already) that the C compiler is pretty vague in many aspects of checking program correctness, particularly in type checking. Careful use of prototyping of functions can assist modern C compilers in this task. However, There is still no guarantee that once you have successfully compiled your program that it will run correctly.

The UNIX utility `lint` can assist in checking for a multitude of programming errors. Check out the online manual pages (`man lint`) for complete details of `lint`. It is well worth the effort as it can help save many hours debugging your C code.

To run `lint` simply enter the command:

```
lint myprog.c.
```

`Lint` is particularly good at checking type checking of variable and function assignments, efficiency, unused variables and function identifiers, unreachable code and possibly memory leaks. There are many useful options to help control `lint` (see `man lint`).

Exercises

Exercise 12171

Enter, compile and run the following program:

```
main()
{ int i;

  printf("\t Number \t\t Square of Number\n\n");

  for (i=0; i<=25;++i)
    printf("\t %d \t\t\t %d \n",i,i*i);

}
```

Exercise 12172

The following program uses the math library. Enter compile and run it correctly.

```
#include <math.h>

main()

{ int i;

    printf("\t Number \t\t Square Root of Number\n\n");

    for (i=0; i<=360; ++i)
        printf("\t %d \t\t\t %d \n",i, sqrt((double) i));

}
```

Exercise 12173

Look in `/lib` and `/usr/lib` and see what libraries are available.

- Use the `man` command to get details of library functions
- Explore the libraries to see what each contains by running the command `ar t libfile`.

Exercise 12174

Look in `/usr/include` and see what header files are available.

- Use the `more` or `cat` commands to view these text files
- Explore the header files to see what each contains, note the `include`, `define`, type definitions and function prototypes declared in them

Exercise 12175

Suppose you have a C program whose main function is in `main.c` and has other functions in the files `input.c` and `output.c`:

- What command(s) would you use on your system to compile and link this program?
- How would you modify the above commands to link a library called `process1` stored in the standard system library directory?
- How would you modify the above commands to link a library called `process2` stored in your home directory?
- Some header files need to be read and have been found to located in a `header` subdirectory of your home directory and also in the current working directory. How would you modify the compiler commands to account for this?

Exercise 12176

Suppose you have a C program composed of several separate files, and they include one another as shown below:

Figure 1.5: Sample Icon from Xterm

Application

File	Include Files
main.c	stdio.h, process1.h
input.c	stdio.h, list.h
output.c	stdio.h
process1.c	stdio.h, process1.h
process2.c	stdio.h, list.h

- Which files have to be recompiled after you make changes to `process1.c`?
- Which files have to be recompiled after you make changes to `process1.h`?
- Which files have to be recompiled after you make changes to `list.h`?

Dave Marshall
1/5/1999

Subsections

- [Attributes](#)
 - [Initializing Thread Attributes](#)
 - [Destroying Thread Attributes](#)
 - [Thread's Detach State](#)
 - [Thread's Set Scope](#)
 - [Thread Scheduling Policy](#)
 - [Thread Inherited Scheduling Policy](#)
 - [Set Scheduling Parameters](#)
 - [Thread Stack Size](#)
 - [Building Your Own Thread Stack](#)
-

Further Threads Programming: Thread Attributes (POSIX)

The previous chapter covered the basics of threads creation using default attributes. This chapter discusses setting attributes at thread creation time.

Note that only pthreads uses attributes and cancellation, so the API covered in this chapter is for POSIX threads only. Otherwise, the functionality for Solaris threads and pthreads is largely the same.

Attributes

Attributes are a way to specify behavior that is different from the default. When a thread is created with `pthread_create()` or when a synchronization variable is initialized, an attribute object can be specified. **Note:** however that the default attributes are usually sufficient for most applications.

Impottant Note: Attributes are specified *only at thread creation time*; they **cannot** be altered while the thread is **being used**.

Thus three functions are usually called in tandem

- Thread attribute intialisation -- `pthread_attr_init()` create a default `pthread_attr_t tattr`
- Thread attribute value change (unless defaults appropriate) -- a variety of `pthread_attr_*` functions are available to set individual attribute values for the `pthread_attr_t tattr` structure. (see below).
- Thread creation -- a call to `pthread_create()` with appropriate attribute values set in a `pthread_attr_t tattr` structure.

The following code fragment should make this point clearer:

```
#include <pthread.h>

pthread_attr_t tattr;
pthread_t tid;
void *start_routine;
void arg;
int ret;

/* initialized with default attributes */
ret = pthread_attr_init(&tattr);

/* call an appropriate functions to alter a default value */
ret = pthread_attr_*(&tattr, SOME_ATTRIBUTE_VALUE_PARAMETER);

/* create the thread */
ret = pthread_create(&tid, &tattr, start_routine, arg);
```

In order to save space, code examples mainly focus on the attribute setting functions and the initializing and creation functions are omitted. These **must** of course be present in all actual code fragments.

An attribute object is opaque, and cannot be directly modified by assignments. A set of functions is provided to initialize, configure, and destroy each object type. Once an attribute is initialized and configured, it has process-wide scope. The suggested method for using attributes is to configure all required state specifications at one time in the early stages of program execution. The appropriate attribute object can then be referred to as needed. Using attribute objects has two primary advantages:

- First, it adds to code portability. Even though supported attributes might vary between implementations, you need not modify function calls that create thread entities because the attribute object is hidden from the interface. If the target port supports attributes that are not found in the current port, provision must be made to manage the new attributes. This is an easy porting task though, because attribute objects need only be initialized once in a well-defined location.
- Second, state specification in an application is simplified. As an example, consider that several sets of threads might exist within a process, each providing a separate service, and each with its own state requirements. At some point in the early stages of the application, a thread attribute object can be initialized for each set. All future thread creations will then refer to the attribute object initialized for that type of thread. The initialization phase is simple and localized, and any future modifications can be made quickly and reliably.

Attribute objects require attention at process exit time. When the object is initialized, memory is allocated for it. This memory must be returned to the system. The pthreads standard provides function calls to destroy attribute objects.

Initializing Thread Attributes

The function `pthread_attr_init()` is used to initialize object attributes to their default values. The storage is allocated by the thread system during execution.

The function is prototyped by:

```
int pthread_attr_init(pthread_attr_t *tattr);
```

An example call to this function is:

```
#include <pthread.h>
pthread_attr_t tattr;
int ret;
/* initialize an attribute to the default value */
ret = pthread_attr_init(&tattr);
```

The default values for attributes (`tattr`) are:

Attribute	Value	Result
scope	PTHREAD_SCOPE_PROCESS	New thread is
		unbound -
		not
		permanently
		attached to
		LWP.
detachstate	PTHREAD_CREATE_JOINABLE	Exit status
		and thread are
		preserved
		after the
		thread
		terminates.
stackaddr	NULL	New thread
		has
		system-allocated stack
		address.
stacksize	1 megabyte	New thread
		has
		system-defined
		stack size.
		priority New thread

		inherits
		parent thread
		priority.
inheritsched	PTHREAD_INHERIT_SCHED	New thread
		inherits
		parent thread
		scheduling
		priority.
schedpolicy	SCHED_OTHER	New thread
		uses
		Solaris-defined
		fixed priority
		scheduling;
		threads run
		until
		preempted by a
		higher-priority
		thread or
		until they
		block or
		yield.

This function zero after completing successfully. Any other returned value indicates that an error occurred. If the following condition occurs, the function fails and returns an error value (to `errno`).

Destroying Thread Attributes

The function `pthread_attr_destroy()` is used to remove the storage allocated during initialization. The attribute object becomes invalid. It is prototyped by:

```
int pthread_attr_destroy(pthread_attr_t *tattr);
```

A sample call to this functions is:

```
#include <pthread.h>
pthread_attr_t tattr;
int ret;
/* destroy an attribute */
ret = pthread_attr_destroy(&tattr);
```

Attributes are declared as for `pthread_attr_init()` above.

`pthread_attr_destroy()` returns zero after completing successfully. Any other returned value indicates that an error occurred.

Thread's Detach State

When a thread is created detached (`PTHREAD_CREATE_DETACHED`), its thread ID and other resources can be reused as soon as the thread terminates.

If you do not want the calling thread to wait for the thread to terminate then call the function `pthread_attr_setdetachstate()`.

When a thread is created nondetached (`PTHREAD_CREATE_JOINABLE`), it is assumed that you will be waiting for it. That is, it is assumed that you will be executing a `pthread_join()` on the thread. Whether a thread is created detached or nondetached, the process does not exit until all threads have exited.

`pthread_attr_setdetachstate()` is prototyped by:

```
int pthread_attr_setdetachstate(pthread_attr_t *tattr, int detachstate);
```

`pthread_attr_setdetachstate()` returns zero after completing successfully. Any other returned value indicates that an error occurred. If the following condition occurs, the function fails and returns the corresponding value.

An example call to detach a thread with this function is:

```
#include <pthread.h>
pthread_attr_t tattr;
int ret;
/* set the thread detach state */
ret = pthread_attr_setdetachstate(&tattr, PTHREAD_CREATE_DETACHED);
```

Note - When there is no explicit synchronization to prevent it, a newly created, detached thread can die and have its thread ID reassigned to another new thread before its creator returns from `pthread_create()`. For nondetached (`PTHREAD_CREATE_JOINABLE`) threads, it is very important that some thread join with it after it terminates -- otherwise the resources of that thread are not released for use by new threads. This commonly results in a memory leak. So when you do not want a thread to be joined, create it as a detached thread.

It is quite common that you will wish to create a thread which is detached from creation. The following code illustrates how this may be achieved with the standard calls to initialise and set and then create a thread:

```
#include <pthread.h>
pthread_attr_t tattr;
pthread_t tid;
void *start_routine;
void arg;
int ret;

/* initialized with default attributes */
ret = pthread_attr_init(&tattr);
ret = pthread_attr_setdetachstate(&tattr, PTHREAD_CREATE_DETACHED);
ret = pthread_create(&tid, &tattr, start_routine, arg);
```

The function `pthread_attr_getdetachstate()` may be used to retrieve the thread create state, which can be either detached or joined. It is prototyped by:

```
int pthread_attr_getdetachstate(const pthread_attr_t *tattr, int
```

`pthread_attr_getdetachstate()` returns zero after completing successfully. Any other returned value indicates that an error occurred.

An example call to this function is:

```
#include <pthread.h>
pthread_attr_t tattr;
int detachstate;
int ret;

/* get detachstate of thread */
ret = pthread_attr_getdetachstate (&tattr, &detachstate);
```

Thread's Set Scope

A thread may be bound (`PTHREAD_SCOPE_SYSTEM`) or an unbound (`PTHREAD_SCOPE_PROCESS`). Both these types of types are accessible **only** within a given process.

The function `pthread_attr_setscope()` to create a bound or unbound thread. It is prototyped by:

```
int pthread_attr_setscope(pthread_attr_t *tattr, int scope);
```

Scope takes on the value of either `PTHREAD_SCOPE_SYSTEM` or `PTHREAD_SCOPE_PROCESS`.

`pthread_attr_setscope()` returns zero after completing successfully. Any other returned value indicates that an error occurred and an appropriate value is returned.

So to set a bound thread at thread creation one would do the following function calls:

```
#include <pthread.h>

pthread_attr_t attr;
pthread_t tid;
void start_routine;
void arg;
int ret;

/* initialized with default attributes */
ret = pthread_attr_init (&tattr);
/* BOUND behavior */
ret = pthread_attr_setscope(&tattr, PTHREAD_SCOPE_SYSTEM);
ret = pthread_create (&tid, &tattr, start_routine, arg);
```

If the following conditions occur, the function fails and returns the corresponding value.

The function `pthread_attr_getscope()` is used to retrieve the thread scope, which indicates whether the thread is bound or unbound. It is prototyped by:

```
int pthread_attr_getscope(pthread_attr_t *tattr, int *scope);
```

An example use of this function is:

```
#include <pthread.h>

pthread_attr_t tattr;
int scope;
int ret;

/* get scope of thread */
ret = pthread_attr_getscope(&tattr, &scope);
```

If successful the appropriate (`PTHREAD_SCOPE_SYSTEM` or `PTHREAD_SCOPE_PROCESS`) will be stored in `scope`.

`pthread_attr_getscope()` returns zero after completing successfully. Any other returned value indicates that an error occurred.

Thread Scheduling Policy

The POSIX draft standard specifies scheduling policy attributes of `SCHED_FIFO` (first-in-first-out), `SCHED_RR` (round-robin), or `SCHED_OTHER` (an implementation-defined method). `SCHED_FIFO` and `SCHED_RR` are optional in POSIX, and **only** are supported for *real time bound threads*.

However Note, currently, only the Solaris `SCHED_OTHER` default value is supported in pthreads. Attempting to set policy as `SCHED_FIFO` or `SCHED_RR` will result in the error `ENOSUP`.

The function is used to set the scheduling policy. It is prototyped by:

```
int pthread_attr_setschedpolicy(pthread_attr_t *tattr, int policy)
```

`pthread_attr_setschedpolicy()` returns zero after completing successfully. Any other returned value indicates that an error occurred.

To set the scheduling policy to `SCHED_OTHER` simply do:

```
#include <pthread.h>
pthread_attr_t tattr;
int ret;

/* set the scheduling policy to SCHED_OTHER */
ret = pthread_attr_setschedpolicy(&tattr, SCHED_OTHER);
```

There is a function `pthread_attr_getschedpolicy()` that retrieves the scheduling policy. But, currently, it is not of great use as it can only return the (Solaris-based) `SCHED_OTHER` default value

Thread Inherited Scheduling Policy

The function `pthread_attr_setinheritsched()` can be used to the inherited scheduling policy of a thread. It is prototyped by:

```
int pthread_attr_setinheritsched(pthread_attr_t *tattr, int inher
```

An `inherit` value of `PTHREAD_INHERIT_SCHED` (the default) means that the scheduling policies defined in the creating thread are to be used, and any scheduling attributes defined in the `pthread_create()` call are to be ignored. If `PTHREAD_EXPLICIT_SCHED` is used, the attributes from the `pthread_create()` call are to be used.

The function returns zero after completing successfully. Any other returned value indicates that an error occurred.

An example call of this function is:

```
#include <pthread.h>
pthread_attr_t tattr;
int ret;

/* use the current scheduling policy */
ret = pthread_attr_setinheritsched(&tattr, PTHREAD_EXPLICIT_SCHED
```

The function `pthread_attr_getinheritsched(pthread_attr_t *tattr, int *inherit)` may be used to inquire a current threads scheduling policy.

Set Scheduling Parameters

Scheduling parameters are defined in the `sched_param` structure; **only** priority `sched_param.sched_priority` is supported. This priority is an integer value the higher the value the higher a thread's priority for scheduling. Newly created threads run with this priority. The `pthread_attr_setschedparam()` is used to set this structure appropriately. It is prototyped by:

```
int pthread_attr_setschedparam(pthread_attr_t *tattr,
const struct sched_param *param);
```

and returns zero after completing successfully. Any other returned value indicates that an error occurred.

An example call to `pthread_attr_setschedparam()` is:

```
#include <pthread.h>
pthread_attr_t tattr;
int newprio;
sched_param param;

/* set the priority; others are unchanged */
newprio = 30;
param.sched_priority = newprio;

/* set the new scheduling param */
ret = pthread_attr_setschedparam (&tattr, &param);
```

The function `pthread_attr_getschedparam(pthread_attr_t *tattr, const struct sched_param *param)` may be used to inquire a current thread's priority of scheduling.

Thread Stack Size

Typically, thread stacks begin on page boundaries and any specified size is rounded up to the next page boundary. A page with no access permission is appended to the top of the stack so that most stack overflows result in sending a `SIGSEGV` signal to the offending thread. Thread stacks allocated by the caller are used as is.

When a stack is specified, the thread should also be created `PTHREAD_CREATE_JOINABLE`. That stack cannot be freed until the `pthread_join()` call for that thread has returned, because the thread's stack cannot be freed until the thread has terminated. The only reliable way to know if such a thread has terminated is through `pthread_join()`.

Generally, you do not need to allocate stack space for threads. The threads library allocates one megabyte of virtual memory for each thread's stack with no swap space reserved. (The library uses the `MAP_NORESERVE` option of `mmap` to make the allocations.)

Each thread stack created by the threads library has a red zone. The library creates the red zone by appending a page to the top of a stack to catch stack overflows. This page is invalid and causes a memory fault if it is accessed. Red zones are appended to all automatically allocated stacks whether the size is specified by the application or the default size is used.

Note: Because runtime stack requirements vary, you should be absolutely certain that the specified stack will satisfy the runtime requirements needed for library calls and dynamic linking.

There are very few occasions when it is appropriate to specify a stack, its size, or both. It is difficult even for an expert to know if the right size was specified. This is because even a program compliant with ABI standards cannot determine its stack size statically. Its size is dependent on the needs of the particular runtime environment in which it executes.

Building Your Own Thread Stack

When you specify the size of a thread stack, be sure to account for the allocations needed by the invoked function and by each function called. The accounting should include calling sequence needs, local variables, and information structures.

Occasionally you want a stack that is a bit different from the default stack. An obvious situation is when the thread needs more than one megabyte of stack space. A less obvious situation is when the default stack is too large. You might be creating thousands of threads and not have enough virtual memory to handle the gigabytes of stack space that this many default stacks require.

The limits on the maximum size of a stack are often obvious, but what about the limits on its minimum size? There must be enough stack space to handle all of the stack frames that are pushed onto the stack, along with their local variables, and so on.

You can get the absolute minimum limit on stack size by calling the macro `PTHREAD_STACK_MIN` (defined in `<pthread.h>`), which returns the amount of stack space required for a thread that executes a `NULL` procedure. Useful threads need more than this, so be very careful when reducing the stack size.

The function `pthread_attr_setstacksize()` is used to set this a thread's stack size, it is prototyped by:

```
int pthread_attr_setstacksize(pthread_attr_t *tattr, int stacksize);
```

The `stacksize` attribute defines the size of the stack (in bytes) that the system will allocate. The size should not be less than the system-defined minimum stack size.

`pthread_attr_setstacksize()` returns zero after completing successfully. Any other returned value indicates that an error occurred.

An example call to set the stacksize is:

```
#include <pthread.h>

pthread_attr_t tattr;
int stacksize;
int ret;

/* setting a new size */
stacksize = (PTHREAD_STACK_MIN + 0x4000);
ret = pthread_attr_setstacksize(&tattr, stacksize);
```

In the example above, `size` contains the size, in number of bytes, for the stack that the new thread uses. If `size` is zero, a default size is used. In most cases, a zero value works best. `PTHREAD_STACK_MIN` is the amount of stack space required to start a thread. This does not take into consideration the threads routine requirements that are needed to execute application code.

The function `pthread_attr_getstacksize(pthread_attr_t *tattr, size_t *size)` may be used to inquire about a current threads stack size as follows:

```
#include <pthread.h>

pthread_attr_t tattr;
int stacksize;
int ret;
/* getting the stack size */
ret = pthread_attr_getstacksize(&tattr, &stacksize);
```

The current size of the stack is returned to the variable `stacksize`.

You may wish to specify the base address of thread's stack. The function `pthread_attr_setstackaddr()` does this task. It is prototyped by:

```
int pthread_attr_setstackaddr(pthread_attr_t *tattr, void *stackaddr);
```

The `stackaddr` parameter defines the base of the thread's stack. If this is set to non-null (NULL is the default) the system initializes the stack at that address.

The function returns zero after completing successfully. Any other returned value indicates that an error occurred.

This example shows how to create a thread with both a custom stack address and a custom stack size.

```
#include <pthread.h>

pthread_attr_t tattr;
pthread_t tid;
int ret;
void *stackbase;
int size = PTHREAD_STACK_MIN + 0x4000;
stackbase = (void *) malloc(size);
/* initialized with default attributes */
ret = pthread_attr_init(&tattr);
/* setting the size of the stack also */
ret = pthread_attr_setstacksize(&tattr, size);
/* setting the base address in the attribute */
ret = pthread_attr_setstackaddr(&tattr, stackbase);
/* address and size specified */
ret = pthread_create(&tid, &tattr, func, arg);
```

The function `pthread_attr_getstackaddr(pthread_attr_t *tattr, void **stackaddr)` can be used to obtain the base address for a current thread's stack address.

Dave Marshall
1/5/1999

Subsections

- [Mutual Exclusion Locks](#)
 - [Initializing a Mutex Attribute Object](#)
 - [Destroying a Mutex Attribute Object](#)
 - [The Scope of a Mutex](#)
 - [Initializing a Mutex](#)
 - [Locking a Mutex](#)
 - [Lock with a Nonblocking Mutex](#)
 - [Destroying a Mutex](#)
 - [Mutex Lock Code Examples](#)
 - [Mutex Lock Example](#)
 - [Using Locking Hierarchies: Avoiding Deadlock](#)
 - [Nested Locking with a Singly Linked List](#)
 - [Solaris Mutex Locks](#)
 - [Condition Variable Attributes](#)
 - [Initializing a Condition Variable Attribute](#)
 - [Destroying a Condition Variable Attribute](#)
 - [The Scope of a Condition Variable](#)
 - [Initializing a Condition Variable](#)
 - [Block on a Condition Variable](#)
 - [Destroying a Condition Variable State](#)
 - [Solaris Condition Variables](#)
 - [Threads and Semaphores](#)
 - [POSIX Semaphores](#)
 - [Basic Solaris Semaphore Functions](#)
-

Further Threads Programming:Synchronization

When we multiple threads running they will invariably need to communicate with each other in order *synchronise* their execution. This chapter describes the synchronization types available with threads and discusses when and how to use synchronization.

There are a few possible methods of synchronising threads:

- Mutual Exclusion (Mutex) Locks
- Condition Variables
- Semaphores

We wil frequently make use of *Synchronization objects*: these are variables in memory that you access just like data. Threads in different processes can communicate with each other through synchronization objects placed in threads-controlled shared memory, even though the threads in different processes are generally invisible to each other.

Synchronization objects can also be placed in files and can have lifetimes beyond that of the creating process.

Here are some example situations that require or can profit from the use of synchronization:

- When synchronization is the only way to ensure consistency of shared data.
- When threads in two or more processes can use a single synchronization object jointly. Note that the synchronization object should be initialized by only one of the cooperating processes, because reinitializing a synchronization object sets it to the unlocked state.
- When synchronization can ensure the safety of mutable data.
- When a process can map a file and have a thread in this process get a record's lock. Once the lock is acquired, any other thread in any process mapping the file that tries to acquire the lock is blocked until the lock is released.
- Even when accessing a single primitive variable, such as an integer. On machines where the integer is not aligned to the bus data width or is larger than the data width, a single memory load can use more than one memory cycle. While this cannot happen on the SPARC architectures, portable programs cannot rely on this.

Mutual Exclusion Locks

Mutual exclusion locks (mutexes) are a common method of serializing thread execution. Mutual exclusion locks synchronize threads, usually by ensuring that only one thread at a time executes a critical section of code. Mutex locks can also preserve single-threaded code.

Mutex attributes may be associated with every thread. To change the default mutex attributes, you can declare and initialize a mutex attribute object and then alter specific values much like we have seen in the last chapter on more general POSIX attributes. Often, the mutex attributes are set in one place at the beginning of the application so they can be located quickly and modified easily.

After the attributes for a mutex are configured, you initialize the mutex itself. Functions are available to initialize or destroy, lock or unlock, or try to lock a mutex.

Initializing a Mutex Attribute Object

The function `pthread_mutexattr_init()` is used to initialize attributes associated with this object to their default values. It is prototyped by:

```
int pthread_mutexattr_init(pthread_mutexattr_t *mattr);
```

Storage for each attribute object is allocated by the threads system during execution. `mattr` is an opaque type that contains a system-allocated attribute object. The possible values of `mattr`'s scope are `PTHREAD_PROCESS_PRIVATE` (the default) and `PTHREAD_PROCESS_SHARED`. The default value of the `pshared` attribute when this function is called is `PTHREAD_PROCESS_PRIVATE`, which means that the initialized mutex can be used within a process.

Before a mutex attribute object can be reinitialized, it must first be destroyed by `pthread_mutexattr_destroy()` (see below). The `pthread_mutexattr_init()` call returns a pointer to an opaque object. If the object is not destroyed, a memory leak will result. `pthread_mutexattr_init()` returns zero after completing successfully. Any other returned value indicates that an error occurred.

A simple example of this function call is:

```
#include <pthread.h>

pthread_mutexattr_t mattr;
int ret;

/* initialize an attribute to default value */

ret = pthread_mutexattr_init(&mattr);
```

Destroying a Mutex Attribute Object

The function `pthread_mutexattr_destroy()` deallocates the storage space used to maintain the attribute object created by `pthread_mutexattr_init()`. It is prototyped by:

```
int pthread_mutexattr_destroy(pthread_mutexattr_t *mattr);
```

which returns zero after completing successfully. Any other returned value indicates that an error occurred.

The function is called as follows:

```
#include <pthread.h>

pthread_mutexattr_t mattr;
int ret;

/* destroy an attribute */
ret = pthread_mutexattr_destroy(&mattr);
```

The Scope of a Mutex

The scope of a mutex variable can be either process private (intraprocess) or system wide (interprocess). The function `pthread_mutexattr_setpshared()` is used to set the scope of a mutex attribute and it is prototype as follows:

```
int pthread_mutexattr_setpshared(pthread_mutexattr_t *mattr, int :
```

If the mutex is created with the `pshared` (POSIX) attribute set to the `PTHREAD_PROCESS_SHARED` state, and it exists in shared memory, it can be shared among threads from more than one process. This is equivalent to the `USYNC_PROCESS` flag in `mutex_init()` in Solaris threads. If the mutex `pshared` attribute is set to `PTHREAD_PROCESS_PRIVATE`, only those threads created by the same process can operate on the mutex. This is equivalent to the `USYNC_THREAD` flag in `mutex_init()` in Solaris threads.

`pthread_mutexattr_setpshared()` returns zero after completing successfully. Any other returned value indicates that an error occurred.

A simple example call is:

```
#include <pthread.h>

pthread_mutexattr_t mattr;
int ret;

ret = pthread_mutexattr_init(&mattr);

/* resetting to its default value: private */
ret = pthread_mutexattr_setpshared(&mattr, PTHREAD_PROCESS_PRIVATE);
```

The function `pthread_mutexattr_getpshared(pthread_mutexattr_t *mattr, int *pshared)` may be used to obtain the scope of a current thread mutex as follows:

```
#include <pthread.h>
pthread_mutexattr_t mattr;
int pshared, ret;

/* get pshared of mutex */ ret =
pthread_mutexattr_getpshared(&mattr, &pshared);
```

Initializing a Mutex

The function `pthread_mutex_init()` to initialize the mutex, it is prototyped by:

```
int pthread_mutex_init(pthread_mutex_t *mp, const pthread_mutexattr_t *mattr);
```

Here, `pthread_mutex_init()` initializes the mutex pointed at by `mp` to its default value if `mattr` is `NULL`, or to specify mutex attributes that have already been set with `pthread_mutexattr_init()`.

A mutex lock must not be reinitialized or destroyed while other threads might be using it. Program failure will result if either action is not done correctly. If a mutex is reinitialized or destroyed, the application must be sure the mutex is not currently in use. `pthread_mutex_init()` returns zero after completing successfully. Any other returned value indicates that an error occurred.

A simple example call is:

```
#include <pthread.h>

pthread_mutex_t mp = PTHREAD_MUTEX_INITIALIZER;
pthread_mutexattr_t mattr;
int ret;

/* initialize a mutex to its default value */
ret = pthread_mutex_init(&mp, NULL);
```

When the mutex is initialized, it is in an unlocked state. The effect of `mattr` being `NULL` is the same as passing the address of a default mutex attribute object, but without the memory overhead. Statically defined mutexes can be initialized directly to have default attributes with the macro `PTHREAD_MUTEX_INITIALIZER`.

To initialise a mutex with non-default values do something like:

```
/* initialize a mutex attribute */
ret = pthread_mutexattr_init(&mattr);

/* change mattr default values with some function */
ret = pthread_mutexattr_*();

/* initialize a mutex to a non-default value */
ret = pthread_mutex_init(&mp, &mattr);
```

Locking a Mutex

The function `pthread_mutex_lock()` is used to lock a mutex, it is prototyped by:

```
int pthread_mutex_lock(pthread_mutex_t *mp);
```

`pthread_mutex_lock()` locks the mutex pointed to by `mp`. When the mutex is already locked, the calling thread blocks and the mutex waits on a prioritized queue. When `pthread_mutex_lock()` returns, the mutex is locked and the calling thread is the owner. `pthread_mutex_lock()` returns zero after completing successfully. Any other returned value indicates that an error occurred.

Therefore to lock a mutex `mp` one would do the following:

```
#include <pthread.h>
pthread_mutex_t mp;
int ret;

ret = pthread_mutex_lock(&mp);
```

To unlock a mutex use the function `pthread_mutex_unlock()` whose prototype is:

```
int pthread_mutex_unlock(pthread_mutex_t *mp);
```

Clearly, this function unlocks the mutex pointed to by `mp`.

The mutex must be locked and the calling thread **must** be the one that last locked the mutex (*i.e. the owner*). When any other threads are waiting for the

mutex to become available, the thread at the head of the queue is unblocked. `pthread_mutex_unlock()` returns zero after completing successfully. Any other returned value indicates that an error occurred.

A simple example call of `pthread_mutex_unlock()` is:

```
#include <pthread.h>

pthread_mutex_t mp;
int ret;

/* release the mutex */
ret = pthread_mutex_unlock(&mp);
```

Lock with a Nonblocking Mutex

The function `pthread_mutex_trylock()` to attempt to lock the mutex and is prototyped by:

```
int pthread_mutex_trylock(pthread_mutex_t *mp);
```

This function attempts to lock the mutex pointed to by `mp`. `pthread_mutex_trylock()` is a nonblocking version of `pthread_mutex_lock()`. When the mutex is already locked, this call returns with an error. Otherwise, the mutex is locked and the calling thread is the owner. `pthread_mutex_trylock()` returns zero after completing successfully. Any other returned value indicates that an error occurred.

The function is called as follows:

```
#include <pthread.h>
pthread_mutex_t mp;

/* try to lock the mutex */
int ret; ret = pthread_mutex_trylock(&mp);
```

Destroying a Mutex

The function `pthread_mutex_destroy()` may be used to destroy any state associated with the mutex. It is prototyped by:

```
int pthread_mutex_destroy(pthread_mutex_t *mp);
```

and destroys a mutex pointed to by `mp`.

Note: that the space for storing the mutex is not freed.

`pthread_mutex_destroy()` returns zero after completing successfully. Any other returned value indicates that an error occurred.

It is called by:

```
#include <pthread.h>
pthread_mutex_t mp;
int ret;

/* destroy mutex */
ret = pthread_mutex_destroy(&mp);
```

Mutex Lock Code Examples

Here are some code fragments showing mutex locking.

Mutex Lock Example

We develop two small functions that use the mutex lock for different purposes.

- The `increment_count` function() uses the mutex lock simply to ensure an atomic update of the shared variable, `count`.
- The `get_count`() function uses the mutex lock to guarantee that the (long long) 64-bit quantity `count` is read atomically. On a 32-bit architecture, a long long is really two 32-bit quantities.

The 2 functions are as follows:

```
#include <pthread.h>
pthread_mutex_t count_mutex;
long long count;

void increment_count()
{ pthread_mutex_lock(&count_mutex);
  count = count + 1;
  pthread_mutex_unlock(&count_mutex);
}

long long get_count()
{ long long c;
  pthread_mutex_lock(&count_mutex);
  c = count;
  pthread_mutex_unlock(&count_mutex);
  return (c);
}
```

Recall that reading an integer value is an atomic operation because integer is the common word size on most machines.

Using Locking Hierarchies: Avoiding Deadlock

You may occasionally want to access two resources at once. For instance, you are using one of the resources, and then discover that the other resource is needed as well. However, there could be a problem if two threads attempt to claim both resources but lock the associated mutexes in different orders.

In this example, if the two threads lock mutexes 1 and 2 respectively, then a **deadlock** occurs when each attempts to lock the other mutex.

Thread 1	Thread 2
<code>/* use resource 1 */</code>	<code>/* use resource 2 */</code>
<code>pthread_mutex_lock(&m1);</code>	<code>pthread_mutex_lock(&m2);</code>
<code>/* NOW use resources 2 + 1 */</code>	<code>/* NOW use resources 1 + 2 */</code>
<code>pthread_mutex_lock(&m2);</code>	<code>pthread_mutex_lock(&m1);</code>
<code>pthread_mutex_lock(&m1);</code>	<code>pthread_mutex_lock(&m2);</code>

The best way to avoid this problem is to make sure that whenever threads lock multiple mutexes, they do so in the same order. This technique is known as lock hierarchies: order the mutexes by logically assigning numbers to them. Also, honor the restriction that you cannot take a mutex that is assigned n when you are holding any mutex assigned a number greater than n .

Note: The `lock_lint` tool can detect the sort of deadlock problem shown in this example.

The best way to avoid such deadlock problems is to use lock hierarchies. When locks are always taken in a prescribed order, deadlock should not occur. However, this technique cannot always be used :

- sometimes you must take the mutexes in an order other than prescribed.
- To prevent deadlock in such a situation, use `pthread_mutex_trylock()`. One thread must release its mutexes when it discovers that deadlock would otherwise be inevitable.

The idea of *Conditional Locking* use this approach:

Thread 1:

```
pthread_mutex_lock(&m1);
pthread_mutex_lock(&m2);

/* no processing */
pthread_mutex_unlock(&m2);
pthread_mutex_unlock(&m1);
```

Thread 2:

```
for (; ; ) {
    pthread_mutex_lock(&m2);
    if(pthread_mutex_trylock(&m1)==0)
        /* got it! */
        break;
```

```
/* didn't get it */
pthread_mutex_unlock(&m2);
}
/* get locks; no processing */
pthread_mutex_unlock(&m1);
pthread_mutex_unlock(&m2);
```

In the above example, thread 1 locks mutexes in the prescribed order, but thread 2 takes them out of order. To make certain that there is no deadlock, thread 2 has to take mutex 1 very carefully; if it were to block waiting for the mutex to be released, it is likely to have just entered into a deadlock with thread 1. To ensure this does not happen, thread 2 calls `pthread_mutex_trylock()`, which takes the mutex if it is available. If it is not, thread 2 returns immediately, reporting failure. At this point, thread 2 must release mutex 2, so that thread 1 can lock it, and then release both mutex 1 and mutex 2.

Nested Locking with a Singly Linked List

We have met basic linked structures in Section [10.3](#), when using threads which share a linked list structure the possibility of deadlock may arise.

By nesting mutex locks into the linked data structure and a simple amendment of the link list code we can prevent deadlock by taking the locks in a prescribed order.

The modified linked is as follows:

```
typedef struct node1 {
    int value;
    struct node1 *link;
    pthread_mutex_t lock;
} node1_t;
```

Note: we simply amend a standard singly-linked list structure so that each node containing a mutex.

Assuming we have created a variable `node1_t ListHead`.

To remove a node from the list:

- first search the list starting at ListHead (which itself is never removed) until the desired node is found.
- To protect this search from the effects of concurrent deletions, lock each node before any of its contents are accessed.

Because all searches start at ListHead, there is never a deadlock because the locks are always taken in list order.

- When the desired node is found, lock both the node and its predecessor since the change involves both nodes.

Because the predecessor's lock is always taken first, you are again protected from deadlock.

The C code to remove an item from a singly linked list with nested locking is as follows:

```
node_t *delete(int value)
{
    node_t *prev,
            *current;
    prev = &ListHead;

    pthread_mutex_lock(&prev->lock);
    while ((current = prev->link) != NULL)
    {
        pthread_mutex_lock(&current->lock);
        if (current->value == value)
        {
            prev->link = current->link;
            pthread_mutex_unlock(&current->lock);
            pthread_mutex_unlock(&prev->lock);
            current->link = NULL;
            return(current);
        }
        pthread_mutex_unlock(&prev->lock);
        prev = current;
    }
    pthread_mutex_unlock(&prev->lock);
    return(NULL);
}
```

Solaris Mutex Locks

Similar mutual exclusion locks exist for in Solaris.

You should include the `<synch.h>` or `<thread.h>` libraries.

To initialize a mutex use `int mutex_init(mutex_t *mp, int type, void *arg)`. `mutex_init()` initializes the mutex pointed to by `mp`. The `type` can be one of the following (note that `arg` is currently ignored).

USYNC_PROCESS

-- The mutex can be used to synchronize threads in this and other processes.

USYNC_THREAD

-- The mutex can be used to synchronize threads in this process, only.

Mutexes can also be initialized by allocation in zeroed memory, in which case a type of `USYNC_THREAD` is assumed. Multiple threads must not initialize the same mutex simultaneously. A mutex lock must not be reinitialized while other threads might be using it.

The function `int mutex_destroy (mutex_t *mp)` destroys any state associated with the mutex pointed to by `mp`. **Note** that the space for storing the mutex is not freed.

To acquire a mutex lock use the function `mutex_lock(mutex_t *mp)` which locks the mutex pointed to by `mp`. When the mutex is already locked, the calling thread blocks until the mutex becomes available (blocked threads wait on a prioritized queue).

To release a mutex use `mutex_unlock(mutex_t *mp)` which unlocks the

mutex pointed to by `mp`. The mutex must be locked and the calling thread must be the one that last locked the mutex (the owner).

To try to acquire a mutex use `mutex_trylock(mutex_t *mp)` to attempt to lock the mutex pointed to by `mp`. This function is a nonblocking version of `mutex_lock()`

Condition Variable Attributes

Condition variables can be used to atomically block threads until a particular condition is true. Condition variables are *always* used in conjunction with mutex locks:

- With a condition variable, a thread can atomically block until a condition is satisfied.
- The condition is tested under the protection of a mutual exclusion lock (mutex).
 - When the condition is false, a thread usually blocks on a condition variable and atomically releases the mutex waiting for the condition to change.
 - When another thread changes the condition, it can signal the associated condition variable to cause one or more waiting threads to wake up, acquire the mutex again, and reevaluate the condition.

Condition variables can be used to synchronize threads among processes when they are allocated in memory that can be written to and is shared by the cooperating processes.

The scheduling policy determines how blocking threads are awakened. For the default `SCHED_OTHER`, threads are awakened in priority order. The attributes for condition variables must be set and initialized before the condition variables can be used.

As with mutex locks, the condition variable attributes must be initialized and set (or set to `NULL`) before an actual condition variable may be initialized (with appropriate attributes) and then used.

Initializing a Condition Variable Attribute

The function `pthread_condattr_init()` initializes attributes associated with this object to their default values. It is prototyped by:

```
int pthread_condattr_init(pthread_condattr_t *cattr);
```

Storage for each attribute object, `cattr`, is allocated by the threads system during execution. `cattr` is an opaque data type that contains a system-allocated attribute object. The possible values of `cattr`'s scope are `PTHREAD_PROCESS_PRIVATE` and `PTHREAD_PROCESS_SHARED`. The default

value of the `pshared` attribute when this function is called is `PTHREAD_PROCESS_PRIVATE`, which means that the initialized condition variable can be used within a process.

Before a condition variable attribute can be reused, it must first be reinitialized by `pthread_condattr_destroy()`. The `pthread_condattr_init()` call returns a pointer to an opaque object. If the object is not destroyed, a memory leak will result.

`pthread_condattr_init()` returns zero after completing successfully. Any other returned value indicates that an error occurred. When either of the following conditions occurs, the function fails and returns the corresponding value.

A simple example call of this function is :

```
#include <pthread.h>

pthread_condattr_t cattr;
int ret;

/* initialize an attribute to default value */
ret = pthread_condattr_init(&cattr);
```

Destroying a Condition Variable Attribute

The function `pthread_condattr_destroy()` removes storage and renders the attribute object invalid, it is prototyped by:

```
int pthread_condattr_destroy(pthread_condattr_t *cattr);
```

`pthread_condattr_destroy()` returns zero after completing successfully and destroying the condition variable pointed to by `cattr`. Any other returned value indicates that an error occurred. If the following condition occurs, the function fails and returns the corresponding value.

The Scope of a Condition Variable

The scope of a condition variable can be either process private (intraprocess) or system wide (interprocess), as with mutex locks. If the condition variable is created with the `pshared` attribute set to the `PTHREAD_PROCESS_SHARED` state, and it exists in shared memory, it can be shared among threads from more than one process. This is equivalent to the `USYNC_PROCESS` flag in `mutex_init()` in the original Solaris threads. If the mutex `pshared` attribute is set to `PTHREAD_PROCESS_PRIVATE` (default value), only those threads created by the same process can operate on the mutex. Using `PTHREAD_PROCESS_PRIVATE` results in the same behavior as with the `USYNC_THREAD` flag in the original Solaris threads `cond_init()` call, which is that of a local condition variable. `PTHREAD_PROCESS_SHARED` is equivalent to a global condition variable.

The function `pthread_condattr_setpshared()` is used to set the scope of a

condition variable, it is prototyped by:

```
int pthread_condattr_setpshared(pthread_condattr_t *cattr, int psh
```

The condition variable attribute `cattr` must be initialised first and the value of `pshared` is either `PTHREAD_PROCESS_SHARED` or `PTHREAD_PROCESS_PRIVATE`.

`pthread_condattr_setpshared()` returns zero after completing successfully. Any other returned value indicates that an error occurred.

A sample use of this function is as follows:

```
#include <pthread.h>

pthread_condattr_t cattr;
int ret;

/* Scope: all processes */
ret = pthread_condattr_setpshared(&cattr, PTHREAD_PROCESS_SHARED)

/* OR */
/* Scope: within a process */
ret = pthread_condattr_setpshared(&cattr, PTHREAD_PROCESS_PRIVATE
```

The function `int pthread_condattr_getpshared(const pthread_condattr_t *cattr, int *pshared)` may be used to obtain the scope of a given condition variable.

Initializing a Condition Variable

The function `pthread_cond_init()` initializes the condition variable and is prototyped as follows:

```
int pthread_cond_init(pthread_cond_t *cv, const pthread_condattr_t *
```

The condition variable which is initialized is pointed at by `cv` and is set to its default value if `cattr` is `NULL`, or to specific `cattr` condition variable attributes that are already set with `pthread_condattr_init()`. The effect of `cattr` being `NULL` is the same as passing the address of a default condition variable attribute object, but without the memory overhead.

Statically-defined condition variables can be initialized directly to have default attributes with the macro `PTHREAD_COND_INITIALIZER`. This has the same effect as dynamically allocating `pthread_cond_init()` with null attributes. No error checking is done. Multiple threads must not simultaneously initialize or reinitialize the same condition variable. If a condition variable is reinitialized or destroyed, the application must be sure the condition variable is not in use.

`pthread_cond_init()` returns zero after completing successfully. Any other returned value indicates that an error occurred.

Sample calls of this function are:

```
#include <pthread.h>

pthread_cond_t cv;
pthread_condattr_t cattr;
int ret;

/* initialize a condition variable to its default value */
ret = pthread_cond_init(&cv, NULL);

/* initialize a condition variable */ ret =
pthread_cond_init(&cv, &cattr);
```

Block on a Condition Variable

The function `pthread_cond_wait()` is used to atomically release a mutex and to cause the calling thread to block on the condition variable. It is prototyped by:

```
int pthread_cond_wait(pthread_cond_t *cv, pthread_mutex_t *mutex);
```

The mutex that is released is pointed to by `mutex` and the condition variable pointed to by `cv` is blocked.

`pthread_cond_wait()` returns zero after completing successfully. Any other returned value indicates that an error occurred. When the following condition occurs, the function fails and returns the corresponding value.

A simple example call is:

```
#include <pthread.h>

pthread_cond_t cv;
pthread_mutex_t mutex;
int ret;

/* wait on condition variable */
ret = pthread_cond_wait(&cv, &mutex);
```

The blocked thread can be awakened by a `pthread_cond_signal()`, a `pthread_cond_broadcast()`, or when interrupted by delivery of a signal. Any change in the value of a condition associated with the condition variable cannot be inferred by the return of `pthread_cond_wait()`, and any such condition must be reevaluated. The `pthread_cond_wait()` routine always returns with the mutex locked and owned by the calling thread, even when returning an error. This function blocks until the condition is signaled. It atomically releases the associated mutex lock before blocking, and atomically acquires it again before returning. In typical use, a condition expression is evaluated under the protection of a mutex lock. When the condition expression is false, the thread blocks on the condition variable. The condition variable is then signaled by another thread when it changes the condition value. This causes one or all of the threads waiting on the condition to unblock and to try to acquire the mutex lock again. Because the condition can change before an awakened thread returns from `pthread_cond_wait()`, the condition that caused the wait must be retested before the mutex lock is acquired.

The recommended test method is to write the condition check as a while loop that calls `pthread_cond_wait()`, as follows:

```
pthread_mutex_lock();

while(condition_is_false)
    pthread_cond_wait();
pthread_mutex_unlock();
```

No specific order of acquisition is guaranteed when more than one thread blocks on the condition variable. Note also that `pthread_cond_wait()` is a cancellation point. If a cancel is pending and the calling thread has cancellation enabled, the thread terminates and begins executing its cleanup handlers while continuing to hold the lock.

To unblock a specific thread use `pthread_cond_signal()` which is prototyped by:

```
int pthread_cond_signal(pthread_cond_t *cv);
```

This unblocks one thread that is blocked on the condition variable pointed to by `cv`. `pthread_cond_signal()` returns zero after completing successfully. Any other returned value indicates that an error occurred.

You should always call `pthread_cond_signal()` under the protection of the same mutex used with the condition variable being signaled. Otherwise, the condition variable could be signaled between the test of the associated condition and blocking in `pthread_cond_wait()`, which can cause an infinite wait. The scheduling policy determines the order in which blocked threads are awakened. For `SCHED_OTHER`, threads are awakened in priority order. When no threads are blocked on the condition variable, then calling `pthread_cond_signal()` has no effect.

The following code fragment illustrates how to avoid an infinite problem described above:

```
pthread_mutex_t count_lock;
pthread_cond_t count_nonzero;
unsigned count;

decrement_count()
{ pthread_mutex_lock(&count_lock);

    while (count == 0)
        pthread_cond_wait(&count_nonzero, &count_lock);
    count = count - 1;
    pthread_mutex_unlock(&count_lock);
}

increment_count()
{ pthread_mutex_lock(&count_lock);
    if (count == 0)
        pthread_cond_signal(&count_nonzero);
    count = count + 1;
    pthread_mutex_unlock(&count_lock);
}
```

You can also block until a specified event occurs. The function `pthread_cond_timedwait()` is used for this purpose. It is prototyped by:

```
int pthread_cond_timedwait(pthread_cond_t *cv,  
                           pthread_mutex_t *mp, const struct timespec *abstime);
```

`pthread_cond_timedwait()` is used in a similar manner to `pthread_cond_wait()`: `pthread_cond_timedwait()` blocks until the condition is signaled or until the time of day, specified by `abstime`, has passed. `pthread_cond_timedwait()` always returns with the mutex, `mp`, locked and owned by the calling thread, even when it is returning an error. `pthread_cond_timedwait()` is also a cancellation point.

`pthread_cond_timedwait()` returns zero after completing successfully. Any other returned value indicates that an error occurred. When either of the following conditions occurs, the function fails and returns the corresponding value.

An example call of this function is:

```
#include <pthread.h>  
#include <time.h>  
  
pthread_timestruc_t to;  
pthread_cond_t cv;  
pthread_mutex_t mp;  
timestruct_t abstime;  
int ret;  
  
/* wait on condition variable */  
  
ret = pthread_cond_timedwait(&cv, &mp, &abstime);  
  
pthread_mutex_lock(&m);  
to.tv_sec = time(NULL) + TIMEOUT;  
to.tv_nsec = 0;  
  
while (cond == FALSE)  
{  
    err = pthread_cond_timedwait(&c, &m, &to);  
    if (err == ETIMEDOUT)  
        { /* timeout, do something */  
            break;  
        }  
}  
pthread_mutex_unlock(&m);
```

All threads may be unblocked in one function: `pthread_cond_broadcast()`. This function is prototyped as follows:

```
int pthread_cond_broadcast(pthread_cond_t *cv);
```

`pthread_cond_broadcast()` unblocks all threads that are blocked on the condition variable pointed to by `cv`, specified by `pthread_cond_wait()`. When no threads are blocked on the condition variable, `pthread_cond_broadcast()` has no effect.

`pthread_cond_broadcast()` returns zero after completing successfully. Any

other returned value indicates that an error occurred. When the following condition occurs, the function fails and returns the corresponding value.

Since `pthread_cond_broadcast()` causes all threads blocked on the condition to contend again for the mutex lock, use carefully. For example, use `pthread_cond_broadcast()` to allow threads to contend for varying resource amounts when resources are freed:

```
#include <pthread.h>

pthread_mutex_t rsrc_lock;
pthread_cond_t rsrc_add;
unsigned int resources;

get_resources(int amount)
{ pthread_mutex_lock(&rsrc_lock);
  while (resources < amount)
    pthread_cond_wait(&rsrc_add, &rsrc_lock);

  resources -= amount;
  pthread_mutex_unlock(&rsrc_lock);
}

add_resources(int amount)
{ pthread_mutex_lock(&rsrc_lock);
  resources += amount;
  pthread_cond_broadcast(&rsrc_add);
  pthread_mutex_unlock(&rsrc_lock);
}
```

Note: that in `add_resources` it does not matter whether `resources` is updated first or if `pthread_cond_broadcast()` is called first inside the mutex lock. Call `pthread_cond_broadcast()` under the protection of the same mutex that is used with the condition variable being signaled. Otherwise, the condition variable could be signaled between the test of the associated condition and blocking in `pthread_cond_wait()`, which can cause an infinite wait.

Destroying a Condition Variable State

The function `pthread_cond_destroy()` to destroy any state associated with the condition variable, it is prototyped by:

```
int pthread_cond_destroy(pthread_cond_t *cv);
```

The condition variable pointed to by `cv` will be destroyed by this call:

```
#include <pthread.h>

pthread_cond_t cv;
int ret;

/* Condition variable is destroyed */
ret = pthread_cond_destroy(&cv);
```

Note that the space for storing the condition variable is not freed.

`pthread_cond_destroy()` returns zero after completing successfully. Any

other returned value indicates that an error occurred. When any of the following conditions occur, the function fails and returns the corresponding value.

Solaris Condition Variables

Similar condition variables exist in Solaris. The functions are prototyped in `<thread.h>`.

To initialize a condition variable use `int cond_init(cond_t *cv, int type, int arg)` which initializes the condition variable pointed to by `cv`. The `type` can be one of `USYNC_PROCESS` or `USYNC_THREAD` (See Solaris mutex (Section [30.1.9](#) for more details). Note that `arg` is currently ignored.

Condition variables can also be initialized by allocation in zeroed memory, in which case a type of `USYNC_THREAD` is assumed. Multiple threads must not initialize the same condition variable simultaneously. A condition variable must not be reinitialized while other threads might be using it.

To destroy a condition variable use `int cond_destroy(cond_t *cv)` which destroys a state associated with the condition variable pointed to by `cv`. The space for storing the condition variable is not freed.

To wait for a condition use `int cond_wait(cond_t *cv, mutex_t *mp)` which atomically releases the mutex pointed to by `mp` and to cause the calling thread to block on the condition variable pointed to by `cv`.

The blocked thread can be awakened by `cond_signal(cond_t *cv)`, `cond_broadcast(cond_t *cv)`, or when interrupted by delivery of a signal or a fork. Use `cond_signal()` to unblock one thread that is blocked on the condition variable pointed to by `cv`. Call this function under protection of the same mutex used with the condition variable being signaled. Otherwise, the condition could be signaled between its test and `cond_wait()`, causing an infinite wait. Use `cond_broadcast()` to unblock all threads that are blocked on the condition variable pointed to by `cv`. When no threads are blocked on the condition variable then `cond_broadcast()` has no effect.

Finally, to wait until the condition is signaled or for an absolute time use `int cond_timedwait(cond_t *cv, mutex_t *mp, timestruct_t abstime)`. Use `cond_timedwait()` as you would use `cond_wait()`, except that `cond_timedwait()` does not block past the time of day specified by `abstime`. `cond_timedwait()` always returns with the mutex locked and owned by the calling thread even when returning an error.

Threads and Semaphores

POSIX Semaphores

Chapter 25 has dealt with semaphore programming for POSIX and System V IPC semaphores.

Semaphore operations are the same in both POSIX and Solaris. The function names are changed from `sema_` in Solaris to `sem_` in pthreads. Solaris semaphore are defined in `<thread.h>`.

In this section we give a brief description of Solaris thread semaphores.

Basic Solaris Semaphore Functions

To initialize the function `int sema_init(sema_t *sp, unsigned int count, int type, void *arg)` is used. `sema.type` can be one of the following):

USYNC_PROCESS

-- The semaphore can be used to synchronize threads in this process and other processes. Only one process should initialize the semaphore.

USYNC_THREAD

-- The semaphore can be used to synchronize threads in this process.

`arg` is currently unused.

Multiple threads **must not** initialize the same semaphore simultaneously. A semaphore **must not** be reinitialized while other threads may be using it.

To increment a Semaphore use the function `int sema_post(sema_t *sp)`. `sema_post` atomically increments the semaphore pointed to by `sp`. When any threads are blocked on the semaphore, one is unblocked.

To block on a Semaphore use `int sema_wait(sema_t *sp)`. `sema_wait()` to block the calling thread until the count in the semaphore pointed to by `sp` becomes greater than zero, then atomically decrement it.

To decrement a Semaphore count use `int sema_trywait(sema_t *sp)`. `sema_trywait()` atomically decrements the count in the semaphore pointed to by `sp` when the count is greater than zero. This function is a nonblocking version of `sema_wait()`.

To destroy the Semaphore state call the function `sema_destroy(sema_t *sp)`. `sema_destroy()` to destroy any state associated with the semaphore pointed to by `sp`. The space for storing the semaphore is not freed.

Subsections

- [Using `thr_create\(\)` and `thr_join\(\)`](#)
 - [Arrays](#)
 - [Deadlock](#)
 - [Signal Handler](#)
 - [Interprocess Synchronization](#)
 - [The Producer / Consumer Problem](#)
 - [A Socket Server](#)
 - [Using Many Threads](#)
 - [Real-time Thread Example](#)
 - [POSIX Cancellation](#)
 - [Software Race Condition](#)
 - [Tgrep: Threaded version of UNIX grep](#)
 - [Multithreaded Quicksort](#)
-

Thread programming examples

This chapter gives some full code examples of thread programs. These examples are taken from a variety of sources:

- The sun workshop developers web page <http://www.sun.com/workshop/threads/share-code/> on threads is an excellent source
- The web page <http://www.sun.com/workshop/threads/Berg-Lewis/examples.html> where examples from the *Threads Primer* Book by D. Berg and B. Lewis are also a major resource.

Using `thr_create()` and `thr_join()`

This example exercises the `thr_create()` and `thr_join()` calls. There is not a parent/child relationship between threads as there is for processes. This can easily be seen in this example, because threads are created and joined by many different threads in the process. The example also shows how threads behave when created with different attributes and options.

Threads can be created by any thread and joined by any other.

The main thread: In this example the main thread's sole purpose is to create new threads. Threads A, B, and C are created by the main thread. Notice that thread B is created suspended. After creating the new threads, the main thread exits. Also notice that the main thread exited by calling `thr_exit()`. If the main thread had used the `exit()` call, the whole process would have exited. The main thread's exit status and resources are held until it is joined by thread C.

Thread A: The first thing thread A does after it is created is to create thread D. Thread A then simulates some processing and then exits, using `thr_exit()`. Notice that thread A was created with the `THR_DETACHED` flag, so thread A's resources will be immediately reclaimed upon its exit. There is no way for thread A's exit status to be collected by a `thr_join()` call.

Thread B: Thread B was created in a suspended state, so it is not able to run until thread D continues it by making the `thr_continue()` call. After thread B is continued, it simulates some processing and then exits. Thread B's exit status and thread resources are held until joined by thread E.

Thread C: The first thing that thread C does is to create thread F. Thread C then joins the main thread. This action will collect the main thread's exit status and allow the main thread's resources to be reused by another thread. Thread C will block, waiting for the main thread to exit, if the main thread has not yet called `thr_exit()`. After joining the main thread, thread C will simulate some processing and then exit. Again, the exit status and thread resources are held until joined by thread E.

Thread D: Thread D immediately creates thread E. After creating thread E, thread D continues thread B by making the `thr_continue()` call. This call will allow thread B to start its execution. Thread D then tries to join thread E, blocking until thread E has exited. Thread D then simulates some processing and exits. If all went well, thread D should be the last non-daemon thread running. When thread D exits, it should do two things: stop the execution of any daemon threads and stop the execution of the process.

Thread E: Thread E starts by joining two threads, threads B and C. Thread E will block, waiting for each of these thread to exit. Thread E will then simulate some processing and will exit. Thread E's exit status and thread resources are held by the operating system until joined by thread D.

Thread F: Thread F was created as a bound, daemon thread by using the `THR_BOUND` and `THR_DAEMON` flags in the `thr_create()` call. This means that it will run on its own LWP until all the non-daemon threads have exited the process. This type of thread can be used when you want some type of "background" processing to always be running, except when all the "regular" threads have exited the process. If thread F was created as a non-daemon thread, then it would continue to run forever, because a process will continue while there is at least one thread still running. Thread F will exit when all the non-daemon threads have exited. In this case, thread D should be the last non-daemon thread running, so when thread D exits, it will also cause thread F to exit.

This example, however trivial, shows how threads behave differently, based on their creation options. It also shows what happens on the exit of a thread, again based on how it was created. If you understand this example and how it flows, you should have a good understanding of how to use `thr_create()` and `thr_join()` in your own programs. Hopefully you can also see how easy it is to create and join threads.

The source to multi_thr.c:

```
#define _REENTRANT
#include <stdio.h>
#include <thread.h>

/* Function prototypes for thread routines */
void *sub_a(void *);
void *sub_b(void *);
void *sub_c(void *);
void *sub_d(void *);
void *sub_e(void *);
void *sub_f(void *);

thread_t thr_a, thr_b, thr_c;

void main()
{
    thread_t main_thr;

    main_thr = thr_self();
    printf("Main thread = %d\n", main_thr);

    if (thr_create(NULL, 0, sub_b, NULL, THR_SUSPENDED|THR_NEW_LWP, &
        fprintf(stderr, "Can't create thr_b\n"), exit(1);

    if (thr_create(NULL, 0, sub_a, (void *)thr_b, THR_NEW_LWP, &thr_a
        fprintf(stderr, "Can't create thr_a\n"), exit(1);

    if (thr_create(NULL, 0, sub_c, (void *)main_thr, THR_NEW_LWP, &th
        fprintf(stderr, "Can't create thr_c\n"), exit(1);

    printf("Main Created threads A:%d B:%d C:%d\n", thr_a, thr_b, thr
    printf("Main Thread exiting...\n");
    thr_exit((void *)main_thr);
}

void *sub_a(void *arg)
{
    thread_t thr_b = (thread_t) arg;
    thread_t thr_d;
    int i;

    printf("A: In thread A...\n");

    if (thr_create(NULL, 0, sub_d, (void *)thr_b, THR_NEW_LWP, &thr_d
        fprintf(stderr, "Can't create thr_d\n"), exit(1);

    printf("A: Created thread D:%d\n", thr_d);

    /* process
    */
    for (i=0;i<1000000*(int)thr_self();i++);
    printf("A: Thread exiting...\n");
    thr_exit((void *)77);
}

void * sub_b(void *arg)
{
    int i;

    printf("B: In thread B...\n");

    /* process
```

```
*/

for (i=0;i<1000000*(int)thr_self();i++);
printf("B: Thread exiting...\n");
thr_exit((void *)66);
}

void * sub_c(void *arg)
{
void *status;
int i;
thread_t main_thr, ret_thr;

main_thr = (thread_t)arg;

printf("C: In thread C...\n");

if (thr_create(NULL, 0, sub_f, (void *)0, THR_BOUND|THR_DAEMON, N
    fprintf(stderr, "Can't create thr_f\n"), exit(1);

printf("C: Join main thread\n");

if (thr_join(main_thr, (thread_t *)&ret_thr, &status))
    fprintf(stderr, "thr_join Error\n"), exit(1);

printf("C: Main thread (%d) returned thread (%d) w/status %d\n", i

/* process
*/

for (i=0;i<1000000*(int)thr_self();i++);
printf("C: Thread exiting...\n");
thr_exit((void *)88);
}

void * sub_d(void *arg)
{
thread_t thr_b = (thread_t) arg;
int i;
thread_t thr_e, ret_thr;
void *status;

printf("D: In thread D...\n");

if (thr_create(NULL, 0, sub_e, NULL, THR_NEW_LWP, &thr_e))
    fprintf(stderr, "Can't create thr_e\n"), exit(1);

printf("D: Created thread E:%d\n", thr_e);
printf("D: Continue B thread = %d\n", thr_b);

thr_continue(thr_b);
printf("D: Join E thread\n");

if(thr_join(thr_e, (thread_t *)&ret_thr, &status))
    fprintf(stderr, "thr_join Error\n"), exit(1);

printf("D: E thread (%d) returned thread (%d) w/status %d\n", thr.
ret_thr, (int) status);
```

```
/* process
*/

for (i=0;i<1000000*(int)thr_self();i++);
printf("D: Thread exiting...\n");
thr_exit((void *)55);
}

void * sub_e(void *arg)
{
int i;
thread_t ret_thr;
void *status;

printf("E: In thread E...\n");
printf("E: Join A thread\n");

if(thr_join(thr_a,(thread_t *)&ret_thr, &status))
    fprintf(stderr,"thr_join Error\n"), exit(1);

printf("E: A thread (%d) returned thread (%d) w/status %d\n", ret_thr,
printf("E: Join B thread\n");

if(thr_join(thr_b,(thread_t *)&ret_thr, &status))
    fprintf(stderr,"thr_join Error\n"), exit(1);

printf("E: B thread (%d) returned thread (%d) w/status %d\n", thr_b,
printf("E: Join C thread\n");

if(thr_join(thr_c,(thread_t *)&ret_thr, &status))
    fprintf(stderr,"thr_join Error\n"), exit(1);

printf("E: C thread (%d) returned thread (%d) w/status %d\n", thr_c,
for (i=0;i<1000000*(int)thr_self();i++);

printf("E: Thread exiting...\n");
thr_exit((void *)44);
}

void *sub_f(void *arg)
{
int i;

printf("F: In thread F...\n");

while (1) {
    for (i=0;i<10000000;i++);
    printf("F: Thread F is still running...\n");
}
}
```

Arrays

This example uses a data structure that contains multiple arrays of data. Multiple threads will concurrently vie for access to the arrays. To control this access, a mutex variable is used within the data structure to lock the entire array and serialize the access to the data.

The main thread first initializes the data structure and the mutex variable. It then sets a level of concurrency and creates the worker threads. The main thread then blocks by joining all the threads. When all the threads have exited, the main thread prints the results.

The worker threads modify the shared data structure from within a loop. Each time the threads need to modify the shared data, they lock the mutex variable associated with the shared data. After modifying the data, the threads unlock the mutex, allowing another thread access to the data.

This example may look quite simple, but it shows how important it is to control access to a simple, shared data structure. The results can be quite different if the mutex variable is not used.

The source to `array.c`:

```
#define _REENTRANT
#include <stdio.h>
#include <thread.h>

/* sample array data structure */
struct {
    mutex_t data_lock[5];
    int     int_val[5];
    float   float_val[5];
} Data;

/* thread function */
void *Add_to_Value();

main()
{
    int i;

    /* initialize the mutexes and data */
    for (i=0; i<5; i++) {
        mutex_init(&Data.data_lock[i], USYNC_THREAD, 0);
        Data.int_val[i] = 0;
        Data.float_val[i] = 0;
    }

    /* set concurrency and create the threads */
    thr_setconcurrency(4);

    for (i=0; i<5; i++)
        thr_create(NULL, 0, Add_to_Value, (void *) (2*i), 0, NULL);

    /* wait till all threads have finished */
    for (i=0; i<5; i++)
        thr_join(0,0,0);

    /* print the results */
    printf("Final Values.....\n");

    for (i=0; i<5; i++) {
        printf("integer value[%d] =\t%d\n", i, Data.int_val[i]);
        printf("float value[%d] =\t%.0f\n\n", i, Data.float_val[i]
    }
}
```

```
return(0);
}

/* Threaded routine */
void *Add_to_Value(void *arg)
{
int inval = (int) arg;
int i;

for (i=0;i<10000;i++){
    mutex_lock(&Data.data_lock[i%5]);
    Data.int_val[i%5] += inval;
    Data.float_val[i%5] += (float) 1.5 * inval;
    mutex_unlock(&Data.data_lock[i%5]);
}

return((void *)0);
}
```

Deadlock

This example demonstrates how a deadlock can occur in multithreaded programs that use synchronization variables. In this example a thread is created that continually adds a value to a global variable. The thread uses a mutex lock to protect the global data.

The main thread creates the counter thread and then loops, waiting for user input. When the user presses the Return key, the main thread suspends the counter thread and then prints the value of the global variable. The main thread prints the value of the global variable under the protection of a mutex lock.

The problem arises in this example when the main thread suspends the counter thread while the counter thread is holding the mutex lock. After the main thread suspends the counter thread, it tries to lock the mutex variable. Since the mutex variable is already held by the counter thread, which is suspended, the main thread deadlocks.

This example may run fine for a while, as long as the counter thread just happens to be suspended when it is not holding the mutex lock. The example demonstrates how tricky some programming issues can be when you deal with threads.

The source to `susp_lock.c`

```
#define _REENTRANT
#include <stdio.h>
#include <thread.h>

/* Prototype for thread subroutine */
void *counter(void *);

int count;
```



```
mutex_t count_lock;

main()
{
char str[80];
thread_t ctid;

/* create the thread counter subroutine */
thr_create(NULL, 0, counter, 0, THR_NEW_LWP|THR_DETACHED, &ctid);

while(1) {
    gets(str);
    thr_suspend(ctid);

    mutex_lock(&count_lock);
    printf("\n\nCOUNT = %d\n\n", count);
    mutex_unlock(&count_lock);

    thr_continue(ctid);
}

return(0);
}

void *counter(void *arg)
{
int i;

while (1) {
    printf("."); fflush(stdout);

    mutex_lock(&count_lock);
    count++;

    for (i=0;i<50000;i++);

    mutex_unlock(&count_lock);

    for (i=0;i<50000;i++);
}

return((void *)0);
}
```

Signal Handler

This example shows how easy it is to handle signals in multithreaded programs. In most programs, a different signal handler would be needed to service each type of signal that you wanted to catch. Writing each of the signal handlers can be time consuming and can be a real pain to debug.

This example shows how you can implement a signal handler thread that will service all asynchronous signals that are sent to your process. This is an easy way to deal with signals, because only one thread is needed to handle all the signals. It also makes it easy when you create new threads within the process, because you need not worry about signals in any of the threads.

First, in the main thread, mask out all signals and then create a signal handling thread. Since threads inherit the signal mask from their creator, any new threads created after the new signal mask will also mask all signals. This idea is key, because the only thread that will receive signals is the one thread that does not block all the signals.

The signal handler thread waits for all incoming signals with the `sigwait()` call. This call unmask the signals given to it and then blocks until a signal arrives. When a signal arrives, `sigwait()` masks the signals again and then returns with the signal ID of the incoming signal.

You can extend this example for use in your application code to handle all your signals. Notice also that this signal concept could be added in your existing nonthreaded code as a simpler way to deal with signals.

The source to `thr_sig.c`

```
#define _REENTRANT
#include <stdio.h>
#include <thread.h>
#include <signal.h>
#include <sys/types.h>

void *signal_hand(void *);

main()
{
    sigset_t set;

    /* block all signals in main thread. Any other threads that are
       created after this will also block all signals */

    sigfillset(&set);

    thr_sigsetmask(SIG_SETMASK, &set, NULL);

    /* create a signal handler thread. This thread will catch all
       signals and decide what to do with them. This will only
       catch nondirected signals. (I.e., if a thread causes a SIGFPE
       then that thread will get that signal. */

    thr_create(NULL, 0, signal_hand, 0, THR_NEW_LWP|THR_DAEMON|THR_DE'

while (1) {
    /*
     Do your normal processing here....
     */
} /* end of while */

return(0);
}

void *signal_hand(void *arg)
{
    sigset_t set;
    int sig;

    sigfillset(&set); /* catch all signals */

while (1) {
```

```
/* wait for a signal to arrive */

switch (sig=sigwait(&set)) {

    /* here you would add whatever signal you needed to catch */
    case SIGINT : {
        printf("Interrupted with signal %d, exiting...\n", sig);
        exit(0);
    }

    default : printf("GOT A SIGNAL = %d\n", sig);
    } /* end of switch */
} /* end of while */

return((void *)0);
} /* end of signal_hand */
```

Another example of a signal handler, sig_kill.c:

```
/*
 * Multithreaded Demo Source
 *
 * Copyright (C) 1995 by Sun Microsystems, Inc.
 * All rights reserved.
 *
 * This file is a product of SunSoft, Inc. and is provided for
 * unrestricted use provided that this legend is included on all
 * media and as a part of the software program in whole or part.
 * Users may copy, modify or distribute this file at will.
 *
 * THIS FILE IS PROVIDED AS IS WITH NO WARRANTIES OF ANY KIND INC.
 * THE WARRANTIES OF DESIGN, MERCHANTABILITY AND FITNESS FOR A PA
 * PURPOSE, OR ARISING FROM A COURSE OF DEALING, USAGE OR TRADE P
 *
 * This file is provided with no support and without any obligati
 * part of SunSoft, Inc. to assist in its use, correction, modifi
 * enhancement.
 *
 * SUNSOFT AND SUN MICROSYSTEMS, INC. SHALL HAVE NO LIABILITY WIT
 * TO THE INFRINGEMENT OF COPYRIGHTS, TRADE SECRETS OR ANY PATENT
 * FILE OR ANY PART THEREOF.
 *
 * IN NO EVENT WILL SUNSOFT OR SUN MICROSYSTEMS, INC. BE LIABLE F
 * LOST REVENUE OR PROFITS OR OTHER SPECIAL, INDIRECT AND CONSEQU
 * DAMAGES, EVEN IF THEY HAVE BEEN ADVISED OF THE POSSIBILITY OF
 * DAMAGES.
 *
 * SunSoft, Inc.
 * 2550 Garcia Avenue
 * Mountain View, California 94043
 */

/*
 * Rich Schiavi writes:    Sept 11, 1994
 *
 * I believe the recommended way to kill certain threads is
 * using a signal handler which then will exit that particular
 * thread properly. I'm not sure the exact reason (I can't rememb
 * if you take out the signal_handler routine in my example, you
 * you describe, as the main process dies even if you send the
 * thr_kill to the specific thread.
 *
 * I whipped up a real quick simple example which shows this usin
 * some sleep()s to get a good simulation.
```

```
*/

#include <stdio.h>
#include <thread.h>
#include <signal.h>

static thread_t one_tid, two_tid, main_thread;
static void *first_thread();
static void *second_thread();
void ExitHandler(int);

static mutex_t first_mutex, second_mutex;
int first_active = 1 ;
int second_active = 1;

main()
{
    int i;
    struct sigaction act;

    act.sa_handler = ExitHandler;
    (void) sigemptyset(&act.sa_mask);
    (void) sigaction(SIGTERM, &act, NULL);

    mutex_init(&first_mutex, 0 , 0);
    mutex_init(&second_mutex, 0 , 0);
    main_thread = thr_self();

    thr_create(NULL,0,first_thread,0,THR_NEW_LWP,&one_tid);
    thr_create(NULL,0,second_thread,0,THR_NEW_LWP,&two_tid);

    for (i = 0; i < 10; i++){
        fprintf(stderr, "main loop: %d\n", i);
        if (i == 5) {
            thr_kill(one_tid, SIGTERM);
        }
        sleep(3);
    }
    thr_kill(two_tid, SIGTERM);
    sleep(5);
    fprintf(stderr, "main exit\n");
}

static void *first_thread()
{
    int i = 0;

    fprintf(stderr, "first_thread id: %d\n", thr_self());
    while (first_active){
        fprintf(stderr, "first_thread: %d\n", i++);
        sleep(2);
    }
    fprintf(stderr, "first_thread exit\n");
}

static void *second_thread()
{
    int i = 0;

    fprintf(stderr, "second_thread id: %d\n", thr_self());

    while (second_active){
        fprintf(stderr, "second_thread: %d\n", i++);
    }
}
```

```
        sleep(3);
    }
    fprintf(stderr, "second_thread exit\n");
}

void ExitHandler(int sig)
{
    thread_t id;

    id = thr_self();

    fprintf(stderr, "ExitHandler thread id: %d\n", id);
    thr_exit(0);
}
```

Interprocess Synchronization

This example uses some of the synchronization variables available in the threads library to synchronize access to a resource shared between two processes. The synchronization variables used in the threads library are an advantage over standard IPC synchronization mechanisms because of their speed. The synchronization variables in the threads libraries have been tuned to be very lightweight and very fast. This speed can be an advantage when your application is spending time synchronizing between processes.

This example shows how semaphores from the threads library can be used between processes. Note that this program does not use threads; it is just using the lightweight semaphores available from the threads library.

When using synchronization variables between processes, it is important to make sure that only one process initializes the variable. If both processes try to initialize the synchronization variable, then one of the processes will overwrite the state of the variable set by the other process.

The source to `ipc.c`

```
#include <stdio.h>
#include <fcntl.h>
#include <sys/mman.h>
#include <synch.h>
#include <sys/types.h>
#include <unistd.h>

/* a structure that will be used between processes */
typedef struct {
    sema_t mysema;
    int num;
} buf_t;

main()
{
    int i, j, fd;
    buf_t *buf;

    /* open a file to use in a memory mapping */
    fd = open("/dev/zero", O_RDWR);

    /* create a shared memory map with the open file for the data
```

```
    structure that will be shared between processes */
buf=(buf_t *)mmap(NULL, sizeof(buf_t), PROT_READ|PROT_WRITE, MAP_

/* initialize the semaphore -- note the USYNC_PROCESS flag; this is
   the semaphore visible from a process level */
sema_init(&buf->mysema, 0, USYNC_PROCESS, 0);

/* fork a new process */
if (fork() == 0) {
    /* The child will run this section of code */
    for (j=0;j<5;j++)
    {
        /* have the child "wait" for the semaphore */

        printf("Child PID(%d): waiting...\n", getpid());
        sema_wait(&buf->mysema);

        /* the child decremented the semaphore */

        printf("Child PID(%d): decrement semaphore.\n", getpid());
    }
    /* exit the child process */
    printf("Child PID(%d): exiting...\n", getpid());
    exit(0);
}

/* The parent will run this section of code */
/* give the child a chance to start running */

sleep(2);

for (i=0;i<5;i++)
{
    /* increment (post) the semaphore */

    printf("Parent PID(%d): posting semaphore.\n", getpid());
    sema_post(&buf->mysema);

    /* wait a second */
    sleep(1);
}

/* exit the parent process */
printf("Parent PID(%d): exiting...\n", getpid());

return(0);
}
```

The Producer / Consumer Problem

This example will show how condition variables can be used to control access of reads and writes to a buffer. This example can also be thought as a producer/consumer problem, where the producer adds items to the buffer and the consumer removes items from the buffer.

Two condition variables control access to the buffer. One condition variable is used to tell if the buffer is full, and the other is used to tell if the buffer is empty. When the producer wants to add an item to the buffer, it checks to see if the buffer is full; if it is full the producer blocks on the `cond_wait()` call,

waiting for an item to be removed from the buffer. When the consumer removes an item from the buffer, the buffer is no longer full, so the producer is awakened from the `cond_wait()` call. The producer is then allowed to add another item to the buffer.

The consumer works, in many ways, the same as the producer. The consumer uses the other condition variable to determine if the buffer is empty. When the consumer wants to remove an item from the buffer, it checks to see if it is empty. If the buffer is empty, the consumer then blocks on the `cond_wait()` call, waiting for an item to be added to the buffer. When the producer adds an item to the buffer, the consumer's condition is satisfied, so it can then remove an item from the buffer.

The example copies a file by reading data into a shared buffer (producer) and then writing data out to the new file (consumer). The `Buf` data structure is used to hold both the buffered data and the condition variables that control the flow of the data.

The main thread opens both files, initializes the `Buf` data structure, creates the consumer thread, and then assumes the role of the producer. The producer reads data from the input file, then places the data into an open buffer position. If no buffer positions are available, then the producer waits via the `cond_wait()` call. After the producer has read all the data from the input file, it closes the file and waits for (joins) the consumer thread.

The consumer thread reads from a shared buffer and then writes the data to the output file. If no buffers positions are available, then the consumer waits for the producer to fill a buffer position. After the consumer has read all the data, it closes the output file and exits.

If the input file and the output file were residing on different physical disks, then this example could execute the reads and writes in parallel. This parallelism would significantly increase the throughput of the example through the use of threads.

The source to `prod_cons.c`:

```
#define _REENTRANT
#include <stdio.h>
#include <thread.h>
#include <fcntl.h>
#include <unistd.h>
#include <sys/stat.h>
#include <sys/types.h>
#include <sys/uio.h>

#define BUFSIZE 512
#define BUFCNT 4

/* this is the data structure that is used between the producer
   and consumer threads */

struct {
    char buffer[BUFCNT][BUFSIZE];
    int byteinbuf[BUFCNT];
    mutex_t buflock;
```

```
        mutex_t donelock;
        cond_t adddata;
        cond_t remdata;
        int nextadd, nextrem, occ, done;
} Buf;

/* function prototype */
void *consumer(void *);

main(int argc, char **argv)
{
    int ifd, ofd;
    thread_t cons_thr;

    /* check the command line arguments */
    if (argc != 3)
        printf("Usage: %s <infile> <outfile>\n", argv[0]), exit(0)

    /* open the input file for the producer to use */
    if ((ifd = open(argv[1], O_RDONLY)) == -1)
        {
            fprintf(stderr, "Can't open file %s\n", argv[1]);
            exit(1);
        }

    /* open the output file for the consumer to use */
    if ((ofd = open(argv[2], O_WRONLY|O_CREAT, 0666)) == -1)
        {
            fprintf(stderr, "Can't open file %s\n", argv[2]);
            exit(1);
        }

    /* zero the counters */
    Buf.nextadd = Buf.nextrem = Buf.occ = Buf.done = 0;

    /* set the thread concurrency to 2 so the producer and consumer c.
       run concurrently */

    thr_setconcurrency(2);

    /* create the consumer thread */
    thr_create(NULL, 0, consumer, (void *)ofd, NULL, &cons_thr);

    /* the producer ! */
    while (1) {

        /* lock the mutex */
        mutex_lock(&Buf.buflock);

        /* check to see if any buffers are empty */
        /* If not then wait for that condition to become true */

        while (Buf.occ == BUFCNT)
            cond_wait(&Buf.remdata, &Buf.buflock);

        /* read from the file and put data into a buffer */
        Buf.byteinbuf[Buf.nextadd] = read(ifd, Buf.buffer[Buf.next.

        /* check to see if done reading */
        if (Buf.byteinbuf[Buf.nextadd] == 0) {

            /* lock the done lock */
            mutex_lock(&Buf.donelock);

            /* set the done flag and release the mutex lock */
            Buf.done = 1;
```



```
        mutex_unlock(&Buf.donelock);

        /* signal the consumer to start consuming */
        cond_signal(&Buf.adddata);

        /* release the buffer mutex */
        mutex_unlock(&Buf.buflock);

        /* leave the while loop */
        break;
    }

    /* set the next buffer to fill */
    Buf.nextadd = ++Buf.nextadd % BUFCNT;

    /* increment the number of buffers that are filled */
    Buf.occ++;

    /* signal the consumer to start consuming */
    cond_signal(&Buf.adddata);

    /* release the mutex */
    mutex_unlock(&Buf.buflock);
}

close(ifd);

/* wait for the consumer to finish */
thr_join(cons_thr, 0, NULL);

/* exit the program */
return(0);
}

/* The consumer thread */
void *consumer(void *arg)
{
    int fd = (int) arg;

    /* check to see if any buffers are filled or if the done flag is
    while (1) {

        /* lock the mutex */
        mutex_lock(&Buf.buflock);

        if (!Buf.occ && Buf.done) {
            mutex_unlock(&Buf.buflock);
            break;
        }

        /* check to see if any buffers are filled */
        /* if not then wait for the condition to become true */

        while (Buf.occ == 0 && !Buf.done)
            cond_wait(&Buf.adddata, &Buf.buflock);

        /* write the data from the buffer to the file */
        write(fd, Buf.buffer[Buf.nextrem], Buf.byteinbuf[Buf.nextrem]);

        /* set the next buffer to write from */
        Buf.nextrem = ++Buf.nextrem % BUFCNT;

        /* decrement the number of buffers that are full */
        Buf.occ--;
```

```
        /* signal the producer that a buffer is empty */
        cond_signal(&Buf.remdata);

        /* release the mutex */
        mutex_unlock(&Buf.buflock);
    }

    /* exit the thread */
    thr_exit((void *)0);
}
```

A Socket Server

The socket server example uses threads to implement a "standard" socket port server. The example shows how easy it is to use `thr_create()` calls in the place of `fork()` calls in existing programs.

A standard socket server should listen on a socket port and, when a message arrives, fork a process to service the request. Since a `fork()` system call would be used in a nonthreaded program, any communication between the parent and child would have to be done through some sort of interprocess communication.

We can replace the `fork()` call with a `thr_create()` call. Doing so offers a few advantages: `thr_create()` can create a thread much faster than a `fork()` could create a new process, and any communication between the *server* and the new thread can be done with common variables. This technique makes the implementation of the socket server much easier to understand and should also make it respond much faster to incoming requests.

The server program first sets up all the needed socket information. This is the basic setup for most socket servers. The server then enters an endless loop, waiting to service a socket port. When a message is sent to the socket port, the server wakes up and creates a new thread to handle the request. Notice that the server creates the new thread as a detached thread and also passes the socket descriptor as an argument to the new thread.

The newly created thread can then read or write, in any fashion it wants, to the socket descriptor that was passed to it. At this point the server could be creating a new thread or waiting for the next message to arrive. The key is that the server thread does not care what happens to the new thread after it creates it.

In our example, the created thread reads from the socket descriptor and then increments a global variable. This global variable keeps track of the number of requests that were made to the server. Notice that a mutex lock is used to protect access to the shared global variable. The lock is needed because many threads might try to increment the same variable at the same time. The mutex lock provides serial access to the shared variable. See how easy it is to share information among the new threads! If each of the threads were a process, then a significant effort would have to be made to share this information among the processes.

The client piece of the example sends a given number of messages to the server. This client code could also be run from different machines by multiple users, thus increasing the need for concurrency in the server process.

The source code to `soc_server.c`:

```
#define _REENTRANT
#include <stdio.h>
#include <sys/types.h>
#include <sys/socket.h>
#include <netinet/in.h>
#include <string.h>
#include <sys/uio.h>
#include <unistd.h>
#include <thread.h>

/* the TCP port that is used for this example */
#define TCP_PORT 6500

/* function prototypes and global variables */
void *do_chld(void *);
mutex_t lock;
int service_count;

main()
{
    int sockfd, newsockfd, clilen;
    struct sockaddr_in cli_addr, serv_addr;
    thread_t chld_thr;

    if((sockfd = socket(AF_INET, SOCK_STREAM, 0)) < 0)
        fprintf(stderr, "server: can't open stream socket\n"), exit(0);

    memset((char *) &serv_addr, 0, sizeof(serv_addr));
    serv_addr.sin_family = AF_INET;
    serv_addr.sin_addr.s_addr = htonl(INADDR_ANY);
    serv_addr.sin_port = htons(TCP_PORT);

    if(bind(sockfd, (struct sockaddr *) &serv_addr, sizeof(serv_addr))
    0)
        fprintf(stderr, "server: can't bind local address\n"), exit(0);

    /* set the level of thread concurrency we desire */
    thr_setconcurrency(5);

    listen(sockfd, 5);

    for(;;){
        clilen = sizeof(cli_addr);
        newsockfd = accept(sockfd, (struct sockaddr *) &cli_addr,
        &clilen);

        if(newsockfd < 0)
            fprintf(stderr, "server: accept error\n"), exit(0);

        /* create a new thread to process the incoming request */
        thr_create(NULL, 0, do_chld, (void *) newsockfd, THR_DETACHED,
        &chld_thr);

        /* the server is now free to accept another socket request */
    }
```

```
    }
    return(0);
}

/*
 * This is the routine that is executed from a new thread
 */

void *do_chld(void *arg)
{
    int mysocfd = (int) arg;
    char data[100];
    int i;

    printf("Child thread [%d]: Socket number = %d\n", thr_self(), mysocfd);

    /* read from the given socket */
    read(mysocfd, data, 40);

    printf("Child thread [%d]: My data = %s\n", thr_self(), data);

    /* simulate some processing */
    for (i=0;i<1000000*thr_self();i++);

    printf("Child [%d]: Done Processing...\n", thr_self());

    /* use a mutex to update the global service counter */
    mutex_lock(&lock);

    service_count++;
    mutex_unlock(&lock);

    printf("Child thread [%d]: The total sockets served = %d\n", thr_self(), service_count);

    /* close the socket and exit this thread */
    close(mysocfd);
    thr_exit((void *)0);
}
```

Using Many Threads

This example shows how easy it is to create many threads of execution in Solaris. Because of the lightweight nature of threads, it is possible to create literally thousands of threads. Most applications may not need a very large number of threads, but this example shows just how lightweight the threads can be.

We have said before that anything you can do with threads, you can do without them. This may be a case where it would be very hard to do without threads. If you have some spare time (and lots of memory), try implementing this program by using processes, instead of threads. If you try this, you will see why threads can have an advantage over processes.

This program takes as an argument the number of threads to create. Notice that all the threads are created with a user-defined stack size, which limits the amount of memory that the threads will need for execution. The stack size for a given thread can be hard to calculate, so some testing usually needs to be done to see if the chosen stack size will work. You may want to change the stack size in this program and see how much you can lower it before things stop working. The Solaris threads library provides the `thr_min_stack()` call, which returns the minimum allowed stack size. Take care when adjusting the size of a threads stack. A stack overflow can happen quite easily to a thread with a small stack.

After each thread is created, it blocks, waiting on a mutex variable. This mutex variable was locked before any of the threads were created, which prevents the threads from proceeding in their execution. When all of the threads have been created and the user presses Return, the mutex variable is unlocked, allowing all the threads to proceed.

After the main thread has created all the threads, it waits for user input and then tries to join all the threads. Notice that the `thr_join()` call does not care what thread it joins; it is just counting the number of joins it makes.

This example is rather trivial and does not serve any real purpose except to show that it is possible to create a lot of threads in one process. However, there are situations when many threads are needed in an application. An example might be a network port server, where a thread is created each time an incoming or outgoing request is made.

The source to `many_thr.c`:

```
#define _REENTRANT
#include <stdio.h>
#include <stdlib.h>
#include <thread.h>

/* function prototypes and global variables */
void *thr_sub(void *);
mutex_t lock;

main(int argc, char **argv)
{
    int i, thr_count = 100;
    char buf;

    /* check to see if user passed an argument
       -- if so, set the number of threads to the value
          passed to the program */

    if (argc == 2) thr_count = atoi(argv[1]);

    printf("Creating %d threads...\n", thr_count);

    /* lock the mutex variable -- this mutex is being used to
       keep all the other threads created from proceeding */

    mutex_lock(&lock);

    /* create all the threads -- Note that a specific stack size is
```

```
    given.  Since the created threads will not use all of the
    default stack size, we can save memory by reducing the threads
    stack size */

for (i=0;i<thr_count;i++) {
    thr_create(NULL,2048,thr_sub,0,0,NULL);
}

printf("%d threads have been created and are running!\n", i);
printf("Press <return> to join all the threads...\n", i);

/* wait till user presses return, then join all the threads */
gets(&buf);

printf("Joining %d threads...\n", thr_count);

/* now unlock the mutex variable, to let all the threads proceed
mutex_unlock(&lock);

/* join the threads */
for (i=0;i<thr_count;i++)
    thr_join(0,0,0);

printf("All %d threads have been joined, exiting...\n", thr_count
return(0);
}

/* The routine that is executed by the created threads */

void *thr_sub(void *arg)
{
/* try to lock the mutex variable -- since the main thread has
locked the mutex before the threads were created, this thread
will block until the main thread unlock the mutex */

mutex_lock(&lock);

printf("Thread %d is exiting...\n", thr_self());

/* unlock the mutex to allow another thread to proceed */
mutex_unlock(&lock);

/* exit the thread */
return((void *)0);
}
```

Real-time Thread Example

This example uses the Solaris real-time extensions to make a single bound thread within a process run in the real-time scheduling class. Using a thread in the real-time class is more desirable than running a whole process in the real-time class, because of the many problems that can arise with a process in a real-time state. For example, it would not be desirable for a process to perform any I/O or large memory operations while in realtime, because a real-time process has priority over system-related processes; if a real-time process requests a page fault, it can starve, waiting for the system to fault in a new page. We can limit this exposure by using threads to execute only the instructions that need to run in realtime.

Since this book does not cover the concerns that arise with real-time programming, we have included this code only as an example of how to promote a thread into the real-time class. You must be very careful when you use real-time threads in your applications. For more information on real-time programming, see the Solaris documentation.

This example should be safe from the pitfalls of real-time programs because of its simplicity. However, changing this code in any way could have adverse effects on your system.

The example creates a new thread from the main thread. This new thread is then promoted to the real-time class by looking up the real-time class ID and then setting a real-time priority for the thread. After the thread is running in realtime, it simulates some processing. Since a thread in the real-time class can have an infinite time quantum, the process is allowed to stay on a CPU as long as it likes. The time quantum is the amount of time a thread is allowed to stay running on a CPU. For the timesharing class, the time quantum (time-slice) is 1/100th of a second by default.

In this example, we set the time quantum for the real-time thread to infinity. That is, it can stay running as long as it likes; it will not be preempted or scheduled off the CPU. If you run this example on a UP machine, it will have the effect of stopping your system for a few seconds while the thread simulates its processing. The system does not actually stop, it is just working in the real-time thread. When the real-time thread finishes its processing, it exits and the system returns to normal.

Using real-time threads can be quite useful when you need an extremely high priority and response time but can also cause big problems if it not used properly. Also note that this example must be run as root or have root execute permissions.

The source to `rt_thr.c`:

```
#define _REENTRANT
#include <stdio.h>
#include <thread.h>
#include <string.h>
#include <sys/priocntl.h>
#include <sys/rtpriocntl.h>

/* thread prototype */
void *rt_thread(void *);

main()
{

/* create the thread that will run in realtime */
thr_create(NULL, 0, rt_thread, 0, THR_DETACHED, 0);

/* loop here forever, this thread is the TS scheduling class */
while (1) {
    printf("MAIN: In time share class... running\n");
```

```
    sleep(1);
}

return(0);
}

/*
 * This is the routine that is called by the created thread
 */

void *rt_thread(void *arg)
{
    pinfo_t pinfo;
    pparms_t pparms;
    int i;

    /* let the main thread run for a bit */
    sleep(4);

    /* get the class ID for the real-time class */
    strcpy(pinfo.pc_clname, "RT");

    if (prctl(0, 0, PC_GETCID, (caddr_t)&pinfo) == -1)
        fprintf(stderr, "getting RT class id\n"), exit(1);

    /* set up the real-time parameters */
    pparms.pc_cid = pinfo.pc_cid;
    ((rtparms_t *)pparms.pc_clparms)->rt_pri = 10;
    ((rtparms_t *)pparms.pc_clparms)->rt_tqsecs = 0;

    /* set an infinite time quantum */
    ((rtparms_t *)pparms.pc_clparms)->rt_tqsecs = RT_TQINF;

    /* move this thread to the real-time scheduling class */
    if (prctl(P_LWPID, P_MYID, PC_SETPARMS, (caddr_t)&pparms) == -1)
        fprintf(stderr, "Setting RT mode\n"), exit(1);

    /* simulate some processing */
    for (i=0;i<100000000;i++);

    printf("RT_THREAD: NOW EXITING...\n");
    thr_exit((void *)0);
}
```

POSIX Cancellation

This example uses the POSIX thread cancellation capability to kill a thread that is no longer needed. Random termination of a thread can cause problems in threaded applications, because a thread may be holding a critical lock when it is terminated. Since the lock was held before the thread was terminated, another thread may deadlock, waiting for that same lock. The thread cancellation capability enables you to control when a thread can be terminated. The example also demonstrates the capabilities of the POSIX thread library in implementing a program that performs a multithreaded search.

This example simulates a multithreaded search for a given number by taking random guesses at a target number. The intent here is to simulate the same type of search that a database might execute. For example, a database might create threads to start searching for a data item; after some amount of time, one or more threads might return with the target data item.

If a thread guesses the number correctly, there is no need for the other threads to continue their search. This is where thread cancellation can help. The thread that finds the number first should cancel the other threads that are still searching for the item and then return the results of the search.

The threads involved in the search can call a cleanup function that can clean up the threads resources before it exits. In this case, the cleanup function prints the progress of the thread when it was cancelled.

The source to `posix_cancel.c`:

```
#define _REENTRANT
#include <stdio.h>
#include <unistd.h>
#include <stdlib.h>
#include <sys/types.h>
#include <pthread.h>

/* defines the number of searching threads */
#define NUM_THREADS 25

/* function prototypes */
void *search(void *);
void print_it(void *);

/* global variables */
pthread_t  threads[NUM_THREADS];
pthread_mutex_t lock;
int tries;

main()
{
    int i;
    int pid;

    /* create a number to search for */
    pid = getpid();

    /* initialize the mutex lock */
    pthread_mutex_init(&lock, NULL);
    printf("Searching for the number = %d...\n", pid);

    /* create the searching threads */
    for (i=0;i<NUM_THREADS;i++)
        pthread_create(&threads[i], NULL, search, (void *)pid);

    /* wait for (join) all the searching threads */
    for (i=0;i<NUM_THREADS;i++)
        pthread_join(threads[i], NULL);

    printf("It took %d tries to find the number.\n", tries);
}
```

```
/* exit this thread */
pthread_exit((void *)0);
}

/*
   This is the cleanup function that is called when
   the threads are cancelled
*/

void print_it(void *arg)
{
    int *try = (int *) arg;
    pthread_t tid;

    /* get the calling thread's ID */
    tid = pthread_self();

    /* print where the thread was in its search when it was cancelled
    printf("Thread %d was canceled on its %d try.\n", tid, *try);
    }

    /*
       This is the search routine that is executed in each thread
    */

    void *search(void *arg)
    {
        int num = (int) arg;
        int i=0, j;
        pthread_t tid;

        /* get the calling thread ID */
        tid = pthread_self();

        /* use the thread ID to set the seed for the random number genera
        srand(tid);

        /* set the cancellation parameters --
           - Enable thread cancellation
           - Defer the action of the cancellation
        */

        pthread_setcancelstate(PTHREAD_CANCEL_ENABLE, NULL);
        pthread_setcanceltype(PTHREAD_CANCEL_DEFERRED, NULL);

        /* push the cleanup routine (print_it) onto the thread
           cleanup stack. This routine will be called when the
           thread is cancelled. Also note that the pthread_cleanup_push
           call must have a matching pthread_cleanup_pop call. The
           push and pop calls MUST be at the same lexical level
           within the code */

        /* pass address of `i' since the current value of `i' is not
           the one we want to use in the cleanup function */

        pthread_cleanup_push(print_it, (void *)&i);

        /* loop forever */
        while (1) {
            i++;

            /* does the random number match the target number? */
            if (num == rand()) {

                /* try to lock the mutex lock --
                   if locked, check to see if the thread has been
```

```
        if not locked then continue */

while (pthread_mutex_trylock(&lock) == EBUSY)
    pthread_testcancel();

/* set the global variable for the number of tries */

    tries = i;

    printf("thread %d found the number!\n", tid);

/* cancel all the other threads */
    for (j=0;j<NUM_THREADS;j++)
        if (threads[j] != tid) pthread_cancel(threads[j]);

/* break out of the while loop */
break;
}

/* every 100 tries check to see if the thread has been cancelled
   if the thread has not been cancelled then yield the th
   LWP to another thread that may be able to run */

if (i%100 == 0) {
    pthread_testcancel();
    sched_yield();
}
}

/* The only way we can get here is when the thread breaks out
   of the while loop. In this case the thread that makes it here
   has found the number we are looking for and does not need to r
   the thread cleanup function. This is why the pthread_cleanup_
   function is called with a 0 argument; this will pop the cleanu
   function off the stack without executing it */

pthread_cleanup_pop(0);
return((void *)0);
}
```

Software Race Condition

This example shows a trivial software race condition. A software race condition occurs when the execution of a program is affected by the order and timing of a threads execution. Most software race conditions can be alleviated by using synchronization variables to control the threads' timing and access of shared resources. If a program depends on order of execution, then threading that program may not be a good solution, because the order in which threads execute is nondeterministic.

In the example, `thr_continue()` and `thr_suspend()` calls `continue` and `suspend` a given thread, respectively. Although both of these calls are valid, use caution when implementing them. It is very hard to determine where a thread is in its execution. Because of this, you may not be able to tell where the thread will suspend when the call to `thr_suspend()` is made. This behavior can cause problems in threaded code if not used properly.

The following example uses `thr_continue()` and `thr_suspend()` to try to

control when a thread starts and stops. The example looks trivial, but, as you will see, can cause a big problem.

Do you see the problem? If you guessed that the program would eventually suspend itself, you were correct! The example attempts to flip-flop between the main thread and a subroutine thread. Each thread continues the other thread and then suspends itself.

Thread A continues thread B and then suspends thread A; now the continued thread B can continue thread A and then suspend itself. This should continue back and forth all day long, right? Wrong! We can't guarantee that each thread will continue the other thread and then suspend itself in one atomic action, so a software race condition could be created. Calling `thr_continue()` on a running thread and calling `thr_suspend()` on a suspended thread has no effect, so we don't know if a thread is already running or suspended.

If thread A continues thread B and if between the time thread A suspends itself, thread B continues thread A, then both of the threads will call `thr_suspend()`. This is the race condition in this program that will cause the whole process to become suspended.

It is very hard to use these calls, because you never really know the state of a thread. If you don't know exactly where a thread is in its execution, then you don't know what locks it holds and where it will stop when you suspend it.

The source to `sw_race.c`

Tgrep: Threaded version of UNIX grep

`Tgrep` is a multi-threaded version of `grep`. `Tgrep` supports all but the `-w` (word search) options of the normal `grep` command, and a few options that are only available to `Tgrep`. The real change from `grep`, is that `Tgrep` will recurse down through sub-directories and search all files for the target string. `Tgrep` searches files like the following command:

```
find <start path> -name "<file/directory pattern>" -exec \ (Line 1
grep <options> <target> /dev/null {} \;
```

An example of this would be (run from this `Tgrep` directory)

```
% find . -exec grep thr_create /dev/null {} \;
./Solaris/main.c: if (thr_create(NULL,0,SigThread,NULL,THR_DAEMON
./Solaris/main.c:     err = thr_create(NULL,0,cascade,(void
./Solaris/main.c:     err = thr_create(NULL,0,search_thr,(v
%
Running the same command with timex:
real      4.26
user      0.64
sys       2.81
```

The same search run with `Tgrep` would be

```
% {\tt Tgrep} thr_create
./Solaris/main.c: if (thr_create(NULL,0,SigThread,NULL,THR_DAEMON,
./Solaris/main.c:     err = thr_create(NULL,0,cascade,(void
./Solaris/main.c:     err = thr_create(NULL,0,search_thr,(v
%
Running the same command with timex:
real      0.79
user      0.62
sys       1.50
```

`Tgrep` gets the results almost four times faster. The numbers above were gathered on a SS20 running 5.5 (build 18) with 4 50MHz CPUs.

You can also filter the files that you want `Tgrep` to search like you can with `find`. The next two commands do the same thing, just `Tgrep` gets it done faster.

```
find . -name "*.c" -exec grep thr_create /dev/null {} \;
and
{\tt Tgrep} -p '.*\.c$' thr_create
```

The `-p` option will allow `Tgrep` to search only files that match the "regular expression" file pattern string. This option does NOT use shell expression, so to stop `Tgrep` from seeing a file named foobar.c you must add the "\$" meta character to the pattern and escape the real "." character.

Some of the other `Tgrep` only options are `-r`, `-C`, `-P`, `-e`, `-B`, `-S` and `-Z`. The `-r` option stops `Tgrep` from searching any sub-directories, in other words, search only the local directory, but `-l` was taken. The `-C` option will search for and print "continued" lines like you find in Makefile. Note the differences in the results of `grep` and `Tgrep` run in the current directory.

The `Tgrep` output prints the continued lines that ended with the "character. In the case of `grep` I would not have seen the three values assigned to `SUBDIRS`, but `Tgrep` shows them to me (Common, Solaris, Posix).

The `-P` option I use when I am sending the output of a long search to a file and want to see the "progress" of the search. The `-P` option will print a "." (dot) on `stderr` for every file (or groups of files depending on the value of the `-P` argument) `Tgrep` searches.

The `-e` option will change the way `Tgrep` uses the target string. `Tgrep` uses two different pattern matching systems. The first (with out the `-e` option) is a literal string match call Boyer-Moore. If the `-e` option is used, then a MT-Safe PD version of regular expression is used to search for the target string as a regexp with meta characters in it. The regular expression method is slower, but `Tgrep` needed the functionality. The `-Z` option will print help on the meta characters `Tgrep` uses.

The `-B` option tells `Tgrep` to use the value of the environment variable called `TGLIMIT` to limit the number of threads it will use during a search. This option has no affect if `TGLIMIT` is not set. `Tgrep` can "eat" a system alive, so the `-B` option was a way to run `Tgrep` on a system with out having other users scream at you.

The last new option is `-S`. If you want to see how things went while `Tgrep` was searching, you can use this option to print statistic about the number of files, lines, bytes, matches, threads created, etc.

Here is an example of the `-S` options output. (again run in the current directory)

```
% {\tt Tgrep} -S zimzap

----- {\tt Tgrep} Stats. -----
Number of directories searched:      7
Number of files searched:           37
Number of lines searched:           9504
Number of matching lines to target:  0
Number of cascade threads created:   7
Number of search threads created:    20
Number of search threads from pool:  17
Search thread pool hit rate:         45.95%
Search pool overall size:            20
Search pool size limit:              58
Number of search threads destroyed:  0
Max # of threads running concurrently: 20
Total run time, in seconds.          1
Work stopped due to no FD's: (058)   0 Times, 0.00%
Work stopped due to no work on Q:    19 Times, 43.18%
Work stopped due to TGLIMITS: (Unlimited) 0 Times, 0.00%
-----
%
```

For more information on the usage and options, see the man page `Tgrep`

The `Tgrep.c` source code is:

```
/* Copyright (c) 1993, 1994 Ron Winacott
/* This program may be used, copied, modified, and redistributed
/* for ANY purpose, so long as this notice remains intact.

#define _REENTRANT

#include <stdio.h>
#include <string.h>
#include <stdlib.h>
#include <unistd.h>
#include <assert.h>
#include <errno.h>
#include <signal.h>
#include <ctype.h>
#include <sys/types.h>
#include <time.h>
#include <sys/stat.h>
#ifdef __sparc
#include <note.h> /* warlock/locklint */
#else
#define NOTE(s)
#endif
#include <dirent.h>
#include <fcntl.h>
#include <sys/uio.h>
#include <thread.h>
#include <synch.h>

#include "version.h"
```

```
#include "pmatch.h"
#include "debug.h"

#define PATH_MAX 1024 /* max # of characters in a path name */
#define HOLD_FDS 6 /* stdin,out,err and a buffer
#define UNLIMITED 99999 /* The default tglimit */
#define MAXREGEXP 10 /* max number of -e options */

#define FB_BLOCK 0x00001
#define FC_COUNT 0x00002
#define FH_HOLDNAME 0x00004
#define FI_IGNCASE 0x00008
#define FL_NAMEONLY 0x00010
#define FN_NUMBER 0x00020
#define FS_NOERROR 0x00040
#define FV_REVERSE 0x00080
#define FW_WORD 0x00100
#define FR_RECUR 0x00200
#define FU_UNSORT 0x00400
#define FX_STDIN 0x00800
#define TG_BATCH 0x01000
#define TG_FILEPAT 0x02000
#define FE_REGEXP 0x04000
#define FS_STATS 0x08000
#define FC_LINE 0x10000
#define TG_PROGRESS 0x20000

#define FILET 1
#define DIRT 2
#define ALPHASIZ 128

/*
 * New data types
 */

typedef struct work_st {
    char *path;
    int tp;
    struct work_st *next;
} work_t;

typedef struct out_st {
    char *line;
    int line_count;
    long byte_count;
    struct out_st *next;
} out_t;

typedef struct bm_pattern { /* Boyer - Moore pattern
    short p_m; /* length of pattern string
    short p_r[ALPHASIZ]; /* "r" vector
    short *p_R; /* "R" vector
    char *p_pat; /* pattern string
} BM_PATTERN;

/*
 * Prototypes
 */

/* bmpmatch.c */
extern BM_PATTERN *bm_makepat(char *);
extern char *bm_pmatch(BM_PATTERN *, register char *);
extern void bm_freepat(BM_PATTERN *);
/* pmatch.c */
extern char *pmatch(register PATTERN *, register char *, int *);
extern PATTERN *makepat(char *string, char *);
```

```
extern void freepat(register PATTERN *);
extern void printpat(PATTERN *);

#include "proto.h" /* function prototypes of main.c */

void *SigThread(void *arg);
void sig_print_stats(void);

/*
 * Global data
 */

BM_PATTERN      *bm_pat; /* the global target read only after ma
NOTE(READ_ONLY_DATA(bm_pat))

PATTERN         *pm_pat[MAXREGEXP]; /* global targets read only
NOTE(READ_ONLY_DATA(pm_pat))

mutex_t global_count_lk;
int      global_count = 0;
NOTE(MUTEX_PROTECTS_DATA(global_count_lk, global_count))
NOTE(DATA_READABLE_WITHOUT_LOCK(global_count)) /* see prnt_stats

work_t  *work_q = NULL;
cond_t  work_q_cv;
mutex_t work_q_lk;
int     all_done = 0;
int     work_cnt = 0;
int     current_open_files = 0;
int     tglimit = UNLIMITED; /* if -B limit the number of thre.
NOTE(MUTEX_PROTECTS_DATA(work_q_lk, work_q all_done work_cnt \
current_open_files tglimit))

work_t  *search_q = NULL;
mutex_t search_q_lk;
cond_t  search_q_cv;
int     search_pool_cnt = 0; /* the count in the pool now */
int     search_thr_limit = 0; /* the max in the pool */
NOTE(MUTEX_PROTECTS_DATA(search_q_lk, search_q search_pool_cnt))
NOTE(DATA_READABLE_WITHOUT_LOCK(search_pool_cnt)) /* see prnt_sta
NOTE(READ_ONLY_DATA(search_thr_limit))

work_t  *cascade_q = NULL;
mutex_t cascade_q_lk;
cond_t  cascade_q_cv;
int     cascade_pool_cnt = 0;
int     cascade_thr_limit = 0;
NOTE(MUTEX_PROTECTS_DATA(cascade_q_lk, cascade_q cascade_pool_cnt
NOTE(DATA_READABLE_WITHOUT_LOCK(cascade_pool_cnt)) /* see prnt_s
NOTE(READ_ONLY_DATA(cascade_thr_limit))

int     running = 0;
mutex_t running_lk;
NOTE(MUTEX_PROTECTS_DATA(running_lk, running))

sigset_t set, oldset;
NOTE(READ_ONLY_DATA(set oldset))

mutex_t stat_lk;
time_t  st_start = 0;
int     st_dir_search = 0;
int     st_file_search = 0;
int     st_line_search = 0;
int     st_cascade = 0;
int     st_cascade_pool = 0;
int     st_cascade_destroy = 0;
int     st_search = 0;
```



```
int      st_pool = 0;
int      st_maxrun = 0;
int      st_worknull = 0;
int      st_workfds = 0;
int      st_worklimit = 0;
int      st_destroy = 0;
NOTE(MUTEX_PROTECTS_DATA(stat_lk, st_start st_dir_search st_file_
    st_line_search st_cascade st_cascade_pool \
    st_cascade_destroy st_search st_pool st_maxrun \
    st_worknull st_workfds st_worklimit st_destroy))

int      progress_offset = 1;
NOTE(READ_ONLY_DATA(progress_offset))

mutex_t  output_print_lk;
/* output_print_lk used to print multi-line output only */
int      progress = 0;
NOTE(MUTEX_PROTECTS_DATA(output_print_lk, progress))

unsigned int  flags = 0;
int      regexp_cnt = 0;
char      *string[MAXREGEXP];
int      debug = 0;
int      use_pmatch = 0;
char      file_pat[255]; /* file patten match */
PATTERN *pm_file_pat; /* compiled file target string (pmatch()) */
NOTE(READ_ONLY_DATA(flags regexp_cnt string debug use_pmatch \
    file_pat pm_file_pat))

/*
 * Locking ording.
 */
NOTE(LOCK_ORDER(output_print_lk stat_lk))

/*
 * Main: This is where the fun starts
 */

int
main(int argc, char **argv)
{
    int      c, out_thr_flags;
    long     max_open_files = 0l, ncpus = 0l;
    extern int  optind;
    extern char *optarg;
    NOTE(READ_ONLY_DATA(optind optarg))
    int      prio = 0;
    struct stat sbuf;
    thread_t  tid, dtid;
    void      *status;
    char      *e = NULL, *d = NULL; /* for debug flags */
    int      debug_file = 0;
    int      err = 0, i = 0, pm_file_len = 0;
    work_t    *work;
    int      restart_cnt = 10;

    flags = FR_RECUR; /* the default */

    thr_setprio(thr_self(), 127); /* set me up HIGH */
    while ((c = getopt(argc, argv, "d:e:bchilnsvwru:f:p:BCSZzHP:"))
        switch (c) {
#ifdef DEBUG
        case 'd':
            debug = atoi(optarg);
            if (debug == 0)
                debug_usage();

```

```
    d = optarg;
    fprintf(stderr,"tgrep: Debug on at level(s) ");
    while (*d) {
        for (i=0; i<9; i++)
            if (debug_set[i].level == *d) {
                debug_levels |= debug_set[i].flag;
                fprintf(stderr,"%c ",debug_set[i].level);
                break;
            }
        d++;
    }
    fprintf(stderr,"\n");
    break;
    case 'f':
        debug_file = atoi(optarg);
        break;
#endif /* DEBUG */
    case 'B':
        flags |= TG_BATCH;
        if ((e = getenv("TGLIMIT"))) {
            tglimit = atoi(e);
        }
        else {
            if (!(flags & FS_NOERROR)) /* order dependent! */
                fprintf(stderr,"env TGLIMIT not set, overriding -B\n");
            flags &= ~TG_BATCH;
        }
        break;
    case 'p':
        flags |= TG_FILEPAT;
        strcpy(file_pat,optarg);
        pm_file_pat = makepat(file_pat,NULL);
        break;
    case 'P':
        flags |= TG_PROGRESS;
        progress_offset = atoi(optarg);
        break;
    case 'S': flags |= FS_STATS;      break;
    case 'b': flags |= FB_BLOCK;      break;
    case 'c': flags |= FC_COUNT;      break;
    case 'h': flags |= FH_HOLDNAME;  break;
    case 'i': flags |= FI_IGNCASE;    break;
    case 'l': flags |= FL_NAMEONLY;  break;
    case 'n': flags |= FN_NUMBER;     break;
    case 's': flags |= FS_NOERROR;    break;
    case 'v': flags |= FV_REVERSE;    break;
    case 'w': flags |= FW_WORD;       break;
    case 'r': flags &= ~FR_RECUR;     break;
    case 'C': flags |= FC_LINE;       break;
    case 'e':
        if (regex_cnt == MAXREGEXP) {
            fprintf(stderr,"Max number of regexp's (%d) excee-
                MAXREGEXP);
            exit(1);
        }
        flags |= FE_REGEXP;
        if ((string[regex_cnt] = (char *)malloc(strlen(optarg)
            fprintf(stderr,"tgrep: No space for search string
            exit(1);
        }
        memset(string[regex_cnt],0,strlen(optarg)+1);
        strcpy(string[regex_cnt],optarg);
        regex_cnt++;
        break;
    case 'z':
    case 'Z': regex_usage();
```

```
        break;
    case 'H':
    case '?':
    default : usage();
    }
}

if (!(flags & FE_REGEXP)) {
    if (argc - optind < 1) {
        fprintf(stderr,"tgrep: Must supply a search string(s)
        "and file list or directory\n");
        usage();
    }
    if ((string[0]=(char *)malloc(strlen(argv[optind])+1))!=NULL)
        fprintf(stderr,"tgrep: No space for search string(s)\n");
        exit(1);
    }
    memset(string[0],0,strlen(argv[optind])+1);
    strcpy(string[0],argv[optind]);
    regexp_cnt=1;
    optind++;
}

if (flags & FI_IGNCASE)
    for (i=0; i<regexp_cnt; i++)
        uncase(string[i]);

#ifdef __lock_lint
/*
** This is NOT something you really want to do. This
** function calls are here ONLY for warlock/locklint !!!
*/
pm_pat[i] = makepat(string[i],NULL);
bm_pat = bm_makepat(string[0]);
bm_freepat(bm_pat); /* stop it from becoming a root */
#else
    if (flags & FE_REGEXP) {
        for (i=0; i<regexp_cnt; i++)
            pm_pat[i] = makepat(string[i],NULL);
            use_pmatch = 1;
        }
    else {
        bm_pat = bm_makepat(string[0]); /* only one allowed */
    }
#endif

flags |= FX_STDIN;

max_open_files = sysconf(_SC_OPEN_MAX);
ncpus = sysconf(_SC_NPROCESSORS_ONLN);
if ((max_open_files - HOLD_FDS - debug_file) < 1) {
    fprintf(stderr,"tgrep: You MUST have at least ONE fd "
    "that can be used, check limit (>10)\n");
    exit(1);
}
search_thr_limit = max_open_files - HOLD_FDS - debug_file;
cascade_thr_limit = search_thr_limit / 2;
/* the number of files that can be open */
current_open_files = search_thr_limit;

mutex_init(&stat_lk,USYNC_THREAD,"stat");
mutex_init(&global_count_lk,USYNC_THREAD,"global_cnt");
mutex_init(&output_print_lk,USYNC_THREAD,"output_print");
mutex_init(&work_q_lk,USYNC_THREAD,"work_q");
mutex_init(&running_lk,USYNC_THREAD,"running");
cond_init(&work_q_cv,USYNC_THREAD,"work_q");
mutex_init(&search_q_lk,USYNC_THREAD,"search_q");
```

```
cond_init(&search_q_cv, USYNC_THREAD, "search_q");
mutex_init(&cascade_q_lk, USYNC_THREAD, "cascade_q");
cond_init(&cascade_q_cv, USYNC_THREAD, "cascade_q");

if ((argc == optind) && ((flags & TG_FILEPAT) || (flags & FR_
    add_work(".", DIRT);
    flags = (flags & ~FX_STDIN);
}
for ( ; optind < argc; optind++) {
    restart_cnt = 10;
    flags = (flags & ~FX_STDIN);
    STAT_AGAIN:
    if (stat(argv[optind], &sbuf)) {
        if (errno == EINTR) { /* try again !, restart */
            if (--restart_cnt)
                goto STAT_AGAIN;
        }
        if (!(flags & FS_NOERROR))
            fprintf(stderr, "tgrep: Can't stat file/dir %s, %s
                argv[optind], strerror(errno));
        continue;
    }
    switch (sbuf.st_mode & S_IFMT) {
    case S_IFREG :
        if (flags & TG_FILEPAT) {
            if (pmatch(pm_file_pat, argv[optind], &pm_file_le
add_work(argv[optind], FILET);
        }
        else {
            add_work(argv[optind], FILET);
        }
        break;
    case S_IFDIR :
        if (flags & FR_RECUR) {
            add_work(argv[optind], DIRT);
        }
        else {
            if (!(flags & FS_NOERROR))
                fprintf(stderr, "tgrep: Can't search directory
                    "-r option is on. Directory ignored.\n
                    argv[optind]);
        }
        break;
    }
}

NOTE(COMPETING_THREADS_NOW) /* we are goinf threaded */

if (flags & FS_STATS) {
    mutex_lock(&stat_lk);
    st_start = time(NULL);
    mutex_unlock(&stat_lk);
#ifdef SIGNAL_HAND
    /*
    ** setup the signal thread so the first call to SIGINT will
    ** only print stats, the second will interupt.
    */
    sigfillset(&set);
    thr_sigsetmask(SIG_SETMASK, &set, &oldset);
    if (thr_create(NULL, 0, SigThread, NULL, THR_DAEMON, NULL)) {
        thr_sigsetmask(SIG_SETMASK, &oldset, NULL);
        fprintf(stderr, "SIGINT for stats NOT setup\n");
    }
    thr_yield(); /* give the other thread time */
#endif /* SIGNAL_HAND */
}
```

```
thr_setconcurrency(3);

if (flags & FX_STDIN) {
    fprintf(stderr,"tgrep: stdin option is not coded at this S
    exit(0); /* XXX Need to fix this S
    search_thr(NULL); /* NULL is not understood in search_th
    if (flags & FC_COUNT) {
        mutex_lock(&global_count_lk);
        printf("%d\n",global_count);
        mutex_unlock(&global_count_lk);
    }
    if (flags & FS_STATS) {
mutex_lock(&stat_lk);
    prnt_stats();
mutex_unlock(&stat_lk);
}
    exit(0);
}

mutex_lock(&work_q_lk);
if (!work_q) {
    if (!(flags & FS_NOERROR))
        fprintf(stderr,"tgrep: No files to search.\n");
    exit(0);
}
mutex_unlock(&work_q_lk);

DP(DLEVEL1,"Starting to loop through the work_q for work\n")

/* OTHER THREADS ARE RUNNING */
while (1) {
    mutex_lock(&work_q_lk);
    while ((work_q == NULL || current_open_files == 0 || tgli
        all_done == 0) {
        if (flags & FS_STATS) {
            mutex_lock(&stat_lk);
            if (work_q == NULL)
                st_worknull++;
            if (current_open_files == 0)
                st_workfds++;
            if (tglimit <= 0)
                st_worklimit++;
            mutex_unlock(&stat_lk);
        }
        cond_wait(&work_q_cv,&work_q_lk);
    }
    if (all_done != 0) {
        mutex_unlock(&work_q_lk);
        DP(DLEVEL1,"All_done was set to TRUE\n");
        goto OUT;
    }
    work = work_q;
    work_q = work->next; /* maybe NULL */
    work->next = NULL;
    current_open_files--;
    mutex_unlock(&work_q_lk);

    tid = 0;
    switch (work->tp) {
        case DIRT:
            mutex_lock(&cascade_q_lk);
            if (cascade_pool_cnt) {
if (flags & FS_STATS) {
                mutex_lock(&stat_lk);
                st_cascade_pool++;
                mutex_unlock(&stat_lk);
            }
        }
    }
}
```

```
work->next = cascade_q;
cascade_q = work;
cond_signal(&cascade_q_cv);
    mutex_unlock(&cascade_q_lk);
    DP(DLEVEL2, ("Sent work to cascade pool thread\n"))
}
else {
mutex_unlock(&cascade_q_lk);
err = thr_create(NULL, 0, cascade, (void *)work,
    THR_DETACHED|THR_DAEMON|THR_NEW_LWP
    , &tid);
DP(DLEVEL2, ("Sent work to new cascade thread\n"));
thr_setprio(tid, 64); /* set cascade to middle */
if (flags & FS_STATS) {
    mutex_lock(&stat_lk);
    st_cascade++;
    mutex_unlock(&stat_lk);
}
}
break;
case FILET:
mutex_lock(&search_q_lk);
if (search_pool_cnt) {
    if (flags & FS_STATS) {
        mutex_lock(&stat_lk);
        st_pool++;
        mutex_unlock(&stat_lk);
    }
    work->next = search_q; /* could be null */
    search_q = work;
    cond_signal(&search_q_cv);
    mutex_unlock(&search_q_lk);
    DP(DLEVEL2, ("Sent work to search pool thread\n"))
}
else {
    mutex_unlock(&search_q_lk);
    err = thr_create(NULL, 0, search_thr, (void *)work,
        THR_DETACHED|THR_DAEMON|THR_NEW_LWP
        , &tid);
    thr_setprio(tid, 0); /* set search to low */
    DP(DLEVEL2, ("Sent work to new search thread\n"));
    if (flags & FS_STATS) {
        mutex_lock(&stat_lk);
        st_search++;
        mutex_unlock(&stat_lk);
    }
}
break;
default:
    fprintf(stderr, "tgrep: Internal error, work_t->tp no\n");
    exit(1);
}
if (err) { /* NEED TO FIX THIS CODE. Exiting is just wrong */
    fprintf(stderr, "Could not create new thread!\n");
    exit(1);
}
}

OUT:
if (flags & TG_PROGRESS) {
    if (progress)
        fprintf(stderr, ".\n");
    else
        fprintf(stderr, "\n");
}
/* we are done, print the stuff. All other threads are parked
if (flags & FC_COUNT) {
```

```
        mutex_lock(&global_count_lk);
        printf("%d\n", global_count);
        mutex_unlock(&global_count_lk);
    }
    if (flags & FS_STATS)
        prnt_stats();
    return(0); /* should have a return from main */
}

/*
 * Add_Work: Called from the main thread, and cascade threads to
 * and directory names to the work Q.
 */
int
add_work(char *path, int tp)
{
    work_t      *wt, *ww, *wp;

    if ((wt = (work_t *)malloc(sizeof(work_t))) == NULL)
        goto ERROR;
    if ((wt->path = (char *)malloc(strlen(path)+1)) == NULL)
        goto ERROR;

    strcpy(wt->path, path);
    wt->tp = tp;
    wt->next = NULL;
    if (flags & FS_STATS) {
        mutex_lock(&stat_lk);
        if (wt->tp == DIRTY)
            st_dir_search++;
        else
            st_file_search++;
        mutex_unlock(&stat_lk);
    }
    mutex_lock(&work_q_lk);
    work_cnt++;
    wt->next = work_q;
    work_q = wt;
    cond_signal(&work_q_cv);
    mutex_unlock(&work_q_lk);
    return(0);
ERROR:
    if (!(flags & FS_NOERROR))
        fprintf(stderr, "tgrep: Could not add %s to work queue. Ig:
            path);
    return(-1);
}

/*
 * Search thread: Started by the main thread when a file name is
 * on the work Q to be searched. If all the needed resources are
 * a new search thread will be created.
 */
void *
search_thr(void *arg) /* work_t *arg */
{
    FILE      *fin;
    char      fin_buf[(BUFSIZ*4)]; /* 4 Kbytes */
    work_t    *wt, *std;
    int       line_count;
    char      rline[128];
    char      cline[128];
    char      *line;
    register char *p, *pp;
    int       pm_len;
    int       len = 0;
}
```

```
long          byte_count;
long          next_line;
int           show_line; /* for the -v option */
register int  slen,plen,i;
out_t        *out = NULL; /* this threads output list */

thr_setprio(thr_self(),0); /* set search to low */
thr_yield();
wt = (work_t *)arg; /* first pass, wt is passed to use. */

/* len = strlen(string);*/ /* only set on first pass */

while (1) { /* reuse the search threads */
    /* init all back to zero */
    line_count = 0;
    byte_count = 0;
    next_line = 0;
    show_line = 0;

    mutex_lock(&running_lk);
    running++;
    mutex_unlock(&running_lk);
    mutex_lock(&work_q_lk);
    tglimit--;
    mutex_unlock(&work_q_lk);
    DP(DLEVEL5,("searching file (STDIO) %s\n",wt->path));

    if ((fin = fopen(wt->path,"r")) == NULL) {
        if (!(flags & FS_NOERROR)) {
            fprintf(stderr,"tgrep: %s. File \"%s\" not search.
                strerror(errno),wt->path);
        }
        goto ERROR;
    }
    setvbuf(fin,fin_buf,_IOFBF,(BUFSIZ*4)); /* XXX */
    DP(DLEVEL5,("Search thread has opened file %s\n",wt->path
    while ((fgets(rline,127,fin)) != NULL) {
        if (flags & FS_STATS) {
            mutex_lock(&stat_lk);
            st_line_search++;
            mutex_unlock(&stat_lk);
        }
        slen = strlen(rline);
        next_line += slen;
        line_count++;
        if (rline[slen-1] == '\n')
            rline[slen-1] = '\0';
        /*
        ** If the uncase flag is set, copy the read in line (
        ** To the uncase line (cline) Set the line pointer to
        ** cline.
        ** If the case flag is NOT set, then point line at rl
        ** line is what is compared, rline is waht is printed
        ** match.
        */
        if (flags & FI_IGNCASE) {
            strcpy(cline,rline);
            uncase(cline);
            line = cline;
        }
        else {
            line = rline;
        }
        show_line = 1; /* assume no match, if -v set */
        /* The old code removed */
        if (use_pmatch) {
            for (i=0; i<regexp_cnt; i++) {
```



```
        if (pmatch(pm_pat[i], line, &pm_len)) {
            if (!(flags & FV_REVERSE)) {
                add_output_local(&out,wt,line_count,
                                byte_count,rline);
                continue_line(rline,fin,out,wt,
                              &line_count,&byte_count
            )
            }
            else {
                show_line = 0;
            } /* end of if -v flag if / else block */
            /*
            ** if we get here on ANY of the regexp ta
            ** jump out of the loop, we found a singl
            ** match so, do not keep looking!
            ** If name only, do not keep searching t
            ** file, we found a single match, so close the file,
            ** print the file name and move on to the next file.
            */
            if (flags & FL_NAMEONLY)
                goto OUT_OF_LOOP;
            else
                goto OUT_AND_DONE;
        } /* end found a match if block */
    } /* end of the for pat[s] loop */
}
else {
    if (bm_pmatch( bm_pat, line)) {
        if (!(flags & FV_REVERSE)) {
            add_output_local(&out,wt,line_count,byte_
                            continue_line(rline,fin,out,wt,
                                          &line_count,&byte_count);
        }
        else {
            show_line = 0;
        }
        if (flags & FL_NAMEONLY)
            goto OUT_OF_LOOP;
    }
}
OUT_AND_DONE:
    if ((flags & FV_REVERSE) && show_line) {
        add_output_local(&out,wt,line_count,byte_count,rl
                        show_line = 0;
    }
    byte_count = next_line;
}
OUT_OF_LOOP:
    fclose(fin);
    /*
    ** The search part is done, but before we give back the F
    ** and park this thread in the search thread pool, print
    ** local output we have gathered.
    */
    print_local_output(out,wt); /* this also frees out nodes
    out = NULL; /* for the next time around, if there is one
ERROR:
    DP(DLEVEL5,("Search done for %s\n",wt->path));
    free(wt->path);
    free(wt);

    notrun();
    mutex_lock(&search_q_lk);
    if (search_pool_cnt > search_thr_limit) {
        mutex_unlock(&search_q_lk);
        DP(DLEVEL5,("Search thread exiting\n"));
        if (flags & FS_STATS) {
            mutex_lock(&stat_lk);
```

```
        st_destroy++;
        mutex_unlock(&stat_lk);
    }
    return(0);
}
else {
    search_pool_cnt++;
    while (!search_q)
        cond_wait(&search_q_cv, &search_q_lk);
    search_pool_cnt--;
    wt = search_q; /* we have work to do! */
    if (search_q->next)
        search_q = search_q->next;
    else
        search_q = NULL;
    mutex_unlock(&search_q_lk);
}
}
/*NOTREACHED*/
}

/*
 * Continue line: Speacial case search with the -C flag set. If y
 * searching files like Makefiles, some lines may have escape cha
 * contine the line on the next line. So the target string can be
 * no data is displayed. This function continues to print the esc
 * until there are no more "\" chars found.
 */
int
continue_line(char *rline, FILE *fin, out_t *out, work_t *wt,
              int *lc, long *bc)
{
    int len;
    int cnt = 0;
    char *line;
    char nline[128];

    if (!(flags & FC_LINE))
        return(0);

    line = rline;
AGAIN:
    len = strlen(line);
    if (line[len-1] == '\\') {
        if ((fgets(nline, 127, fin)) == NULL) {
            return(cnt);
        }
        line = nline;
        len = strlen(line);
        if (line[len-1] == '\n')
            line[len-1] = '\0';
        *bc = *bc + len;
        *lc++;
        add_output_local(&out, wt, *lc, *bc, line);
        cnt++;
        goto AGAIN;
    }
    return(cnt);
}

/*
 * cascade: This thread is started by the main thread when direct
 * are found on the work Q. The thread reads all the new file, an
 * names from the directory it was started when and adds the name
 * work Q. (it finds more work!)
 */
```

```
*/
void *
cascade(void *arg) /* work_t *arg */
{
    char          fullpath[1025];
    int           restart_cnt = 10;
    DIR           *dp;

    char          dir_buf[sizeof(struct dirent) + PATH_MAX];
    struct dirent *dent = (struct dirent *)dir_buf;
    struct stat   sbuf;
    char          *fpath;
    work_t        *wt;
    int           fl = 0, dl = 0;
    int           pm_file_len = 0;

    thr_setprio(thr_self(),64); /* set search to middle */
    thr_yield(); /* try to give control back to main thread */
    wt = (work_t *)arg;

    while(1) {
        fl = 0;
        dl = 0;
        restart_cnt = 10;
        pm_file_len = 0;

        mutex_lock(&running_lk);
        running++;
        mutex_unlock(&running_lk);
        mutex_lock(&work_q_lk);
        tglimit--;
        mutex_unlock(&work_q_lk);

        if (!wt) {
            if (!(flags & FS_NOERROR))
                fprintf(stderr,"tgrep: Bad work node passed to cascade\n");
            goto DONE;
        }
        fpath = (char *)wt->path;
        if (!fpath) {
            if (!(flags & FS_NOERROR))
                fprintf(stderr,"tgrep: Bad path name passed to cascade\n");
            goto DONE;
        }
        DP(DLEVEL3,("Cascading on %s\n",fpath));
        if (( dp = opendir(fpath)) == NULL) {
            if (!(flags & FS_NOERROR))
                fprintf(stderr,"tgrep: Can't open dir %s, %s. Ignored.\n",
                    fpath,strerror(errno));
            goto DONE;
        }
        while ((readdir_r(dp,dent)) != NULL) {
            restart_cnt = 10; /* only try to restart the interrupted 10 :

                if (dent->d_name[0] == '.') {
                    if (dent->d_name[1] == '.' && dent->d_name[2] == '\0')
                        continue;
                    if (dent->d_name[1] == '\0')
                        continue;
                }

                fl = strlen(fpath);
                dl = strlen(dent->d_name);
                if ((fl + 1 + dl) > 1024) {
                    fprintf(stderr,"tgrep: Path %s/%s is too long. "
                        "MaxPath = 1024\n",
                        fpath, dent->d_name);
                }
            }
        }
    }
}
```

```
continue; /* try the next name in this directory */
}
strcpy(fullpath, fpath);
strcat(fullpath, "/");
strcat(fullpath, dent->d_name);

RESTART_STAT:
    if (stat(fullpath, &sbuf)) {
if (errno == EINTR) {
    if (--restart_cnt)
        goto RESTART_STAT;
}
if (!(flags & FS_NOERROR))
    fprintf(stderr, "tgrep: Can't stat file/dir %s, %s. "
        "Ignored.\n",
        fullpath, strerror(errno));
goto ERROR;
}

    switch (sbuf.st_mode & S_IFMT) {
    case S_IFREG :
if (flags & TG_FILEPAT) {
    if (pmatch(pm_file_pat, dent->d_name, &pm_file_len)) {
        DP(DLEVEL3, ("file pat match (cascade) %s\n",
            dent->d_name));
        add_work(fullpath, FILET);
    }
}
    else {
        add_work(fullpath, FILET);
        DP(DLEVEL3, ("cascade added file (MATCH) %s to Work Q\n",
            fullpath));
    }
    break;
    case S_IFDIR :
        DP(DLEVEL3, ("cascade added dir %s to Work Q\n", fullpath));
        add_work(fullpath, DIRT);
        break;
    }
}

    ERROR:
closedir(dp);
    DONE:
free(wt->path);
free(wt);
notrun();
mutex_lock(&cascade_q_lk);
if (cascade_pool_cnt > cascade_thr_limit) {
    mutex_unlock(&cascade_q_lk);
    DP(DLEVEL5, ("Cascade thread exiting\n"));
    if (flags & FS_STATS) {
        mutex_lock(&stat_lk);
        st_cascade_destroy++;
        mutex_unlock(&stat_lk);
    }
    return(0); /* thr_exit */
}
else {
    DP(DLEVEL5, ("Cascade thread waiting in pool\n"));
    cascade_pool_cnt++;
    while (!cascade_q)
        cond_wait(&cascade_q_cv, &cascade_q_lk);
    cascade_pool_cnt--;
    wt = cascade_q; /* we have work to do! */
}
```

```
        if (cascade_q->next)
        cascade_q = cascade_q->next;
        else
        cascade_q = NULL;
        mutex_unlock(&cascade_q_lk);
    }
    }
    /*NOTREACHED*/
}

/*
 * Print Local Output: Called by the search thread after it is do.
 * a single file. If any oputput was saved (matching lines), the
 * displayed as a group on stdout.
 */
int
print_local_output(out_t *out, work_t *wt)
{
    out_t      *pp, *op;
    int        out_count = 0;
    int        printed = 0;
    int        print_name = 1;

    pp = out;
    mutex_lock(&output_print_lk);
    if (pp && (flags & TG_PROGRESS)) {
        progress++;
        if (progress >= progress_offset) {
            progress = 0;
            fprintf(stderr, ".");
        }
    }
    while (pp) {
out_count++;
if (!(flags & FC_COUNT)) {
    if (flags & FL_NAMEONLY) { /* Pint name ONLY ! */
if (!printed) {
    printed = 1;
    printf("%s\n", wt->path);
}
}
else { /* We are printing more then just the name */
if (!(flags & FH_HOLDNAME)) /* do not print name ? */
    printf("%s :", wt->path);
if (flags & FB_BLOCK)
    printf("%ld:", pp->byte_count/512+1);
if (flags & FN_NUMBER)
    printf("%d:", pp->line_count);
printf("%s\n", pp->line);
}
}
        op = pp;
        pp = pp->next;
        /* free the nodes as we go down the list */
        free(op->line);
        free(op);
    }
    mutex_unlock(&output_print_lk);
    mutex_lock(&global_count_lk);
    global_count += out_count;
    mutex_unlock(&global_count_lk);
    return(0);
}

/*
 * add output local: is called by a search thread as it finds mat.
 * the matching line, it's byte offset, line count, etc are store
 */
```

```
* search thread is done searching the file, then the lines are p
* a group. This way the lines from more then a single file are n
* together.
*/
int
add_output_local(out_t **out, work_t *wt,int lc, long bc, char *l
{
    out_t      *ot,*oo, *op;

    if (( ot = (out_t *)malloc(sizeof(out_t))) == NULL)
        goto ERROR;
    if (( ot->line = (char *)malloc(strlen(line)+1)) == NULL)
        goto ERROR;

    strcpy(ot->line,line);
    ot->line_count = lc;
    ot->byte_count = bc;

    if (!*out) {
        *out = ot;
        ot->next = NULL;
        return(0);
    }
    /* append to the END of the list, keep things sorted! */
    op = oo = *out;
    while(oo) {
        op = oo;
        oo = oo->next;
    }
    op->next = ot;
    ot->next = NULL;
    return(0);
ERROR:
    if (!(flags & FS_NOERROR))
        fprintf(stderr,"tgrep: Output lost. No space. "
                "[%s: line %d byte %d match : %s\n",
                wt->path,lc,bc,line);
    return(1);
}

/*
 * print stats: If the -S flag is set, after ALL files have been
 * main thread calls this function to print the stats it keeps on
 * search went.
 */
void
prnt_stats(void)
{
    float a,b,c;
    float t = 0.0;
    time_t st_end = 0;
    char    tl[80];

    st_end = time(NULL); /* stop the clock */
    fprintf(stderr,"\n----- Tgrep Stats. -----
    fprintf(stderr,"Number of directories searched:          %d\
        st_dir_search);
    fprintf(stderr,"Number of files searched:                %d\
        st_file_search);
    c = (float)(st_dir_search + st_file_search) / (float)(st_end
    fprintf(stderr,"Dir/files per second:                    %3.
        c);
    fprintf(stderr,"Number of lines searched:                %d\
        st_line_search);
    fprintf(stderr,"Number of matching lines to target:      %d\
```

```
    global_count);

    fprintf(stderr,"Number of cascade threads created:      %d\
    st_cascade);
    fprintf(stderr,"Number of cascade threads from pool:   %d\
    st_cascade_pool);
    a = st_cascade_pool; b = st_dir_search;
    fprintf(stderr,"Cascade thread pool hit rate:         %3.
    ((a/b)*100));
    fprintf(stderr,"Cascade pool overall size:            %d\
    cascade_pool_cnt);
    fprintf(stderr,"Cascade pool size limit:              %d\
    cascade_thr_limit);
    fprintf(stderr,"Number of cascade threads destroyed:  %d\
    st_cascade_destroy);

    fprintf(stderr,"Number of search threads created:     %d\
    st_search);
    fprintf(stderr,"Number of search threads from pool:   %d\
    st_pool);
    a = st_pool; b = st_file_search;
    fprintf(stderr,"Search thread pool hit rate:          %3.
    ((a/b)*100));
    fprintf(stderr,"Search pool overall size:             %d\
    search_pool_cnt);
    fprintf(stderr,"Search pool size limit:               %d\
    search_thr_limit);
    fprintf(stderr,"Number of search threads destroyed:   %d\
    st_destroy);

    fprintf(stderr,"Max # of threads running concurrently: %d\
    st_maxrun);
    fprintf(stderr,"Total run time, in seconds.           %d\
    (st_end - st_start));

    /* Why did we wait ? */
    a = st_workfds; b = st_dir_search+st_file_search;
    c = (a/b)*100; t += c;
    fprintf(stderr,"Work stopped due to no FD's:  (%.3d)      %d
    search_thr_limit,st_workfds,c);
    a = st_worknull; b = st_dir_search+st_file_search;
    c = (a/b)*100; t += c;
    fprintf(stderr,"Work stopped due to no work on Q:      %d '
    st_worknull,c);
#ifdef __lock_lint /* it is OK to read HERE with out the lock !
    if (tglimit == UNLIMITED)
        strcpy(tl,"Unlimited");
    else
        sprintf(tl,"  %.3d  ",tglimit);
#endif
    fprintf(stderr,"Work stopped due to TGLIMIT:  (%.9s) %d Times
    tl,st_worklimit,c);
    fprintf(stderr,"Work continued to be handed out:      %3.
    100.00-t);
    fprintf(stderr,"-----
}

/*
 * not running: A glue function to track if any search threads or
 * threads are running. When the count is zero, and the work Q is
 * we can safely say, WE ARE DONE.
```

```
*/
void
notrun (void)
{
    mutex_lock(&work_q_lk);
    work_cnt--;
    tglimit++;
    current_open_files++;
    mutex_lock(&running_lk);
    if (flags & FS_STATS) {
        mutex_lock(&stat_lk);
        if (running > st_maxrun) {
            st_maxrun = running;
            DP(DLEVEL6, ("Max Running has increased to %d\n", st_maxrun));
        }
        mutex_unlock(&stat_lk);
    }
    running--;
    if (work_cnt == 0 && running == 0) {
        all_done = 1;
        DP(DLEVEL6, ("Setting ALL_DONE flag to TRUE.\n"));
    }
    mutex_unlock(&running_lk);
    cond_signal(&work_q_cv);
    mutex_unlock(&work_q_lk);
}

/*
 * uncase: A glue function. If the -i (case insensitive) flag is
 * target string and the read in line is converted to lower case b
 * comparing them.
 */
void
uncase(char *s)
{
    char          *p;

    for (p = s; *p != NULL; p++)
        *p = (char)tolower(*p);
}

/*
 * SigThread: if the -S option is set, the first ^C set to tgrep
 * print the stats on the fly, the second will kill the process.
 */

void *
SigThread(void *arg)
{
    int sig;
    int stats_printed = 0;

    while (1) {
        sig = sigwait(&set);
        DP(DLEVEL7, ("Signal %d caught\n", sig));
        switch (sig) {
            case -1:
                fprintf(stderr, "Signal error\n");
                break;
            case SIGINT:
                if (stats_printed)
                    exit(1);
                stats_printed = 1;
                sig_print_stats();
        }
    }
}
```



```
        break;
    case SIGHUP:
        sig_print_stats();
        break;
    default:
        DP(DLEVEL7, ("Default action taken (exit) for signal %d\n", si
        exit(1); /* default action */
    }
}

void
sig_print_stats(void)
{
    /*
    ** Get the output lock first
    ** Then get the stat lock.
    */
    mutex_lock(&output_print_lk);
    mutex_lock(&stat_lk);
    prnt_stats();
    mutex_unlock(&stat_lk);
    mutex_unlock(&output_print_lk);
    return;
}

/*
 * usage: Have to have one of these.
 */
void
usage(void)
{
    fprintf(stderr, "usage: tgrep <options> pattern <{file,dir}>..\n");
    fprintf(stderr, "Where:\n");
#ifdef DEBUG
    fprintf(stderr, "Debug      -d = debug level -d <levels> (-d0 f
    fprintf(stderr, "Debug      -f = block fd's from use (-f #)\n");
#endif
    fprintf(stderr, "      -b = show block count (512 byte blo
    fprintf(stderr, "      -c = print only a line count\n");
    fprintf(stderr, "      -h = do not print file names\n");
    fprintf(stderr, "      -i = case insensitive\n");
    fprintf(stderr, "      -l = print file name only\n");
    fprintf(stderr, "      -n = print the line number with the
    fprintf(stderr, "      -s = Suppress error messages\n");
    fprintf(stderr, "      -v = print all but matching lines\n");
#ifdef NOT_IMP
    fprintf(stderr, "      -w = search for a \"word\"\n");
#endif
    fprintf(stderr, "      -r = Do not search for files in all
           "sub-directories\n");
    fprintf(stderr, "      -C = show continued lines (\"\\\"\\\"\\\"\\\"\\
    fprintf(stderr, "      -p = File name regexp pattern. (Quo
    fprintf(stderr, "      -P = show progress. -P 1 prints a D
           "      for each file it finds, -P 10 ;
           "      on stderr for each 10 files it
    fprintf(stderr, "      -e = expression search.(regexp) Mor
    fprintf(stderr, "      -B = limit the number of threads to
    fprintf(stderr, "      -S = Print thread stats when done.\
    fprintf(stderr, "      -Z = Print help on the regexp used.
    fprintf(stderr, "\n");
    fprintf(stderr, "Notes:\n");
    fprintf(stderr, "      If you start tgrep with only a director
    fprintf(stderr, "      and no file names, you must not have th
    fprintf(stderr, "      set or you will get no output.\n");
    fprintf(stderr, "      To search stdin (piped input), you must
```

```
fprintf(stderr,"          Tgrep will search ALL files in ALL \n")
fprintf(stderr,"          sub-directories. (like */* */*/* */*/*/
fprintf(stderr,"          if you supply a directory name.\n");
fprintf(stderr,"          If you do not supply a file, or directo
fprintf(stderr,"          and the -r option is not set, the curre
fprintf(stderr,"          directory \"\" will be used.\n");
fprintf(stderr,"          All the other options should work \"lik
fprintf(stderr,"          The -p patten is regexp, tgrep will sea
fprintf(stderr,"          the file names that match the patten\n"
fprintf(stderr,"\n");
fprintf(stderr,"          Tgrep Version %s\n",Tgrep_Version);
fprintf(stderr,"\n");
fprintf(stderr,"          Copy Right By Ron Winacott, 1993-1995.\n"
fprintf(stderr,"\n");
exit(0);
}

/*
 * regexp usage: Tell the world about tgrep custom (THREAD SAFE)
 */
int
regexp_usage (void)
{
    fprintf(stderr,"usage: tgrep <options> -e \"pattern\" <-e ...
        \"<{file,dir}>...\n");
    fprintf(stderr,"\n");
    fprintf(stderr,"metachars:\n");
    fprintf(stderr,"    . - match any character\n");
    fprintf(stderr,"    * - match 0 or more occurrences of pervio
    fprintf(stderr,"    + - match 1 or more occurrences of pervio
    fprintf(stderr,"    ^ - match at begining of string\n");
    fprintf(stderr,"    $ - match end of string\n");
    fprintf(stderr,"    [ - start of character class\n");
    fprintf(stderr,"    ] - end of character class\n");
    fprintf(stderr,"    ( - start of a new pattern\n");
    fprintf(stderr,"    ) - end of a new pattern\n");
    fprintf(stderr,"    @(n)c - match <c> at column <n>\n");
    fprintf(stderr,"    | - match either pattern\n");
    fprintf(stderr,"    \\ - escape any special characters\n");
    fprintf(stderr,"    \\c - escape any special characters\n");
    fprintf(stderr,"    \\o - turn on any special characters\n");
    fprintf(stderr,"\n");
    fprintf(stderr,"To match two diffrent patterns in the same
    fprintf(stderr,"Use the or function. \n"
        "ie: tgrep -e \"(pat1)|(pat2)\" file\n"
        "This will match any line with \"pat1\" or \"pat2\" in
    fprintf(stderr,"You can also use up to %d -e expresions\n",MA
    fprintf(stderr,"RegExp Pattern matching brought to you by Mar
    exit(0);
}

/*
 * debug usage: If compiled with -DDEBUG, turn it on, and tell th
 * how to get tgrep to print debug info on different threads.
 */
#ifdef DEBUG
void
debug_usage (void)
{
    int i = 0;

    fprintf(stderr,"DEBUG usage and levels:\n");
    fprintf(stderr,"-----
    fprintf(stderr,"Level                                code\n");
    fprintf(stderr,"-----
    fprintf(stderr,"0                                    This message.\n");
    for (i=0; i<9; i++) {
```

```
        fprintf(stderr,"%d                %s\n",i+1,debug_set[i]
    }
    fprintf(stderr,"-----
    fprintf(stderr,"You can or the levels together like -d134 for
    fprintf(stderr,"1 and 3 and 4.\n");
    fprintf(stderr,"\n");
    exit(0);
}
#endif
```

Multithreaded Quicksort

The following example `tquick.c` implements the quicksort algorithm using threads.

```
/*
 * Multithreaded Demo Source
 *
 * Copyright (C) 1995 by Sun Microsystems, Inc.
 * All rights reserved.
 *
 * This file is a product of SunSoft, Inc. and is provided for
 * unrestricted use provided that this legend is included on all
 * media and as a part of the software program in whole or part.
 * Users may copy, modify or distribute this file at will.
 *
 * THIS FILE IS PROVIDED AS IS WITH NO WARRANTIES OF ANY KIND INC.
 * THE WARRANTIES OF DESIGN, MERCHANTABILITY AND FITNESS FOR A PA
 * PURPOSE, OR ARISING FROM A COURSE OF DEALING, USAGE OR TRADE P
 *
 * This file is provided with no support and without any obligati
 * part of SunSoft, Inc. to assist in its use, correction, modifi
 * enhancement.
 *
 * SUNSOFT AND SUN MICROSYSTEMS, INC. SHALL HAVE NO LIABILITY WIT
 * TO THE INFRINGEMENT OF COPYRIGHTS, TRADE SECRETS OR ANY PATENT
 * FILE OR ANY PART THEREOF.
 *
 * IN NO EVENT WILL SUNSOFT OR SUN MICROSYSTEMS, INC. BE LIABLE F
 * LOST REVENUE OR PROFITS OR OTHER SPECIAL, INDIRECT AND CONSEQU
 * DAMAGES, EVEN IF THEY HAVE BEEN ADVISED OF THE POSSIBILITY OF
 * DAMAGES.
 *
 * SunSoft, Inc.
 * 2550 Garcia Avenue
 * Mountain View, California 94043
 */

/*
 * multiple-thread quick-sort. See man page for qsort(3c) for in
 * Works fine on uniprocessor machines as well.
 *
 * Written by: Richard Pettit (Richard.Pettit@West.Sun.COM)
 */

#include <unistd.h>
#include <stdlib.h>
#include <thread.h>

/* don't create more threads for less than this */
#define SLICE_THRESH 4096

/* how many threads per lwp */
#define THR_PER_LWP 4
```

```
/* cast the void to a one byte quantity and compute the offset */
#define SUB(a, n)      ((void *) (((unsigned char *) (a)) + ((n)

typedef struct {
    void      *sa_base;
    int       sa_nel;
    size_t    sa_width;
    int       (*sa_compar)(const void *, const void *);
} sort_args_t;

/* for all instances of quicksort */
static int threads_avail;

#define SWAP(a, i, j, width) \
{ \
    int n; \
    unsigned char uc; \
    unsigned short us; \
    unsigned long ul; \
    unsigned long long ull; \
    \
    if (SUB(a, i) == pivot) \
        pivot = SUB(a, j); \
    else if (SUB(a, j) == pivot) \
        pivot = SUB(a, i); \
    \
    /* one of the more convoluted swaps I've done */ \
    switch(width) { \
    case 1: \
        uc = *((unsigned char *) SUB(a, i)); \
        *((unsigned char *) SUB(a, i)) = *((unsigned char *) SUB(a, j)); \
        *((unsigned char *) SUB(a, j)) = uc; \
        break; \
    case 2: \
        us = *((unsigned short *) SUB(a, i)); \
        *((unsigned short *) SUB(a, i)) = *((unsigned short *) SUB(a, j)); \
        *((unsigned short *) SUB(a, j)) = us; \
        break; \
    case 4: \
        ul = *((unsigned long *) SUB(a, i)); \
        *((unsigned long *) SUB(a, i)) = *((unsigned long *) SUB(a, j)); \
        *((unsigned long *) SUB(a, j)) = ul; \
        break; \
    case 8: \
        ull = *((unsigned long long *) SUB(a, i)); \
        *((unsigned long long *) SUB(a, i)) = *((unsigned long long *) SUB(a, j)); \
        *((unsigned long long *) SUB(a, j)) = ull; \
        break; \
    default: \
        for(n=0; n<width; n++) { \
            uc = ((unsigned char *) SUB(a, i))[n]; \
            ((unsigned char *) SUB(a, i))[n] = ((unsigned char *) SUB(a, j))[n]; \
            ((unsigned char *) SUB(a, j))[n] = uc; \
        } \
        break; \
    } \
}

static void *
_quickstort(void *arg)
{
    sort_args_t *sargs = (sort_args_t *) arg;
    register void *a = sargs->sa_base;
    int n = sargs->sa_nel;
    int width = sargs->sa_width;
    int (*compar)(const void *, const void *) = sargs->sa_compar;
```

```
register int i;
register int j;
int z;
int thread_count = 0;
void *t;
void *b[3];
void *pivot = 0;
sort_args_t sort_args[2];
thread_t tid;

/* find the pivot point */
switch(n) {
case 0:
case 1:
    return 0;
case 2:
    if ((*compar)(SUB(a, 0), SUB(a, 1)) > 0) {
        SWAP(a, 0, 1, width);
    }
    return 0;
case 3:
    /* three sort */
    if ((*compar)(SUB(a, 0), SUB(a, 1)) > 0) {
        SWAP(a, 0, 1, width);
    }
    /* the first two are now ordered, now order the second two */
    if ((*compar)(SUB(a, 2), SUB(a, 1)) < 0) {
        SWAP(a, 2, 1, width);
    }
    /* should the second be moved to the first? */
    if ((*compar)(SUB(a, 1), SUB(a, 0)) < 0) {
        SWAP(a, 1, 0, width);
    }
    return 0;
default:
    if (n > 3) {
        b[0] = SUB(a, 0);
        b[1] = SUB(a, n / 2);
        b[2] = SUB(a, n - 1);
        /* three sort */
        if ((*compar)(b[0], b[1]) > 0) {
            t = b[0];
            b[0] = b[1];
            b[1] = t;
        }
        /* the first two are now ordered, now order the second two
        if ((*compar)(b[2], b[1]) < 0) {
            t = b[1];
            b[1] = b[2];
            b[2] = t;
        }
        /* should the second be moved to the first? */
        if ((*compar)(b[1], b[0]) < 0) {
            t = b[0];
            b[0] = b[1];
            b[1] = t;
        }
        if ((*compar)(b[0], b[2]) != 0)
            if ((*compar)(b[0], b[1]) < 0)
                pivot = b[1];
            else
                pivot = b[2];
    }
    break;
}
if (pivot == 0)
    for(i=1; i<n; i++) {
```

```
        if (z = (*compar)(SUB(a, 0), SUB(a, i))) {
            pivot = (z > 0) ? SUB(a, 0) : SUB(a, i);
            break;
        }
    }
    if (pivot == 0)
        return;

    /* sort */
    i = 0;
    j = n - 1;
    while(i <= j) {
        while((*compar)(SUB(a, i), pivot) < 0)
            ++i;
        while((*compar)(SUB(a, j), pivot) >= 0)
            --j;
        if (i < j) {
            SWAP(a, i, j, width);
            ++i;
            --j;
        }
    }

    /* sort the sides judiciously */
    switch(i) {
    case 0:
    case 1:
        break;
    case 2:
        if ((*compar)(SUB(a, 0), SUB(a, 1)) > 0) {
            SWAP(a, 0, 1, width);
        }
        break;
    case 3:
        /* three sort */
        if ((*compar)(SUB(a, 0), SUB(a, 1)) > 0) {
            SWAP(a, 0, 1, width);
        }
        /* the first two are now ordered, now order the second two */
        if ((*compar)(SUB(a, 2), SUB(a, 1)) < 0) {
            SWAP(a, 2, 1, width);
        }
        /* should the second be moved to the first? */
        if ((*compar)(SUB(a, 1), SUB(a, 0)) < 0) {
            SWAP(a, 1, 0, width);
        }
        break;
    default:
        sort_args[0].sa_base = a;
        sort_args[0].sa_nel = i;
        sort_args[0].sa_width = width;
        sort_args[0].sa_compar = compar;
        if ((threads_avail > 0) && (i > SLICE_THRESH)) {
            threads_avail--;
            thr_create(0, 0, _quicksort, &sort_args[0], 0, &tid);
            thread_count = 1;
        } else
            _quicksort(&sort_args[0]);
        break;
    }
    j = n - i;
    switch(j) {
    case 1:
        break;
    case 2:
        if ((*compar)(SUB(a, i), SUB(a, i + 1)) > 0) {
            SWAP(a, i, i + 1, width);
        }
    }
```

```
    }
    break;
case 3:
    /* three sort */
    if ((*compar)(SUB(a, i), SUB(a, i + 1)) > 0) {
        SWAP(a, i, i + 1, width);
    }
    /* the first two are now ordered, now order the second two */
    if ((*compar)(SUB(a, i + 2), SUB(a, i + 1)) < 0) {
        SWAP(a, i + 2, i + 1, width);
    }
    /* should the second be moved to the first? */
    if ((*compar)(SUB(a, i + 1), SUB(a, i)) < 0) {
        SWAP(a, i + 1, i, width);
    }
    break;
default:
    sort_args[1].sa_base      = SUB(a, i);
    sort_args[1].sa_nel      = j;
    sort_args[1].sa_width    = width;
    sort_args[1].sa_compar   = compar;
    if ((thread_count == 0) && (threads_avail > 0) && (i > SLICE_')
        threads_avail--;
        thr_create(0, 0, _quicksort, &sort_args[1], 0, &tid);
        thread_count = 1;
    } else
        _quicksort(&sort_args[1]);
    break;
}
if (thread_count) {
    thr_join(tid, 0, 0);
    threads_avail++;
}
return 0;
}

void
quicksort(void *a, size_t n, size_t width,
           int (*compar)(const void *, const void *))
{
    static int ncpus = -1;
    sort_args_t sort_args;

    if (ncpus == -1) {
        ncpus = sysconf( _SC_NPROCESSORS_ONLN);

        /* lwp for each cpu */
        if ((ncpus > 1) && (thr_getconcurrency() < ncpus))
            thr_setconcurrency(ncpus);

        /* thread count not to exceed THR_PER_LWP per lwp */
        threads_avail = (ncpus == 1) ? 0 : (ncpus * THR_PER_LWP);
    }
    sort_args.sa_base = a;
    sort_args.sa_nel = n;
    sort_args.sa_width = width;
    sort_args.sa_compar = compar;
    (void) _quicksort(&sort_args);
}
```

Dave Marshall
1/5/1999

Subsections

- [What Is RPC](#)
 - [How RPC Works](#)
 - [RPC Application Development](#)
 - [Defining the Protocol](#)
 - [Defining Client and Server Application Code](#)
 - [Compiling and running the application](#)
 - [Overview of Interface Routines](#)
 - [Simplified Level Routine Function](#)
 - [Top Level Routines](#)
 - [Intermediate Level Routines](#)
 - [Expert Level Routines](#)
 - [Bottom Level Routines](#)
 - [The Programmer's Interface to RPC](#)
 - [Simplified Interface](#)
 - [Passing Arbitrary Data Types](#)
 - [Developing High Level RPC Applications](#)
 - [Defining the protocol](#)
 - [Sharing the data](#)
 - [The Server Side](#)
 - [The Client Side](#)
 - [Exercise](#)
-

Remote Procedure Calls (RPC)

This chapter provides an overview of Remote Procedure Calls (RPC) RPC.

What Is RPC

RPC is a powerful technique for constructing distributed, client-server based applications. It is based on extending the notion of conventional, or local procedure calling, so that the called procedure need not exist in the same address space as the calling procedure. The two processes may be on the same system, or they may be on different systems with a network connecting them. By using RPC, programmers of distributed applications avoid the details of the interface with the network. The transport independence of RPC isolates the application from the physical and logical elements of the data communications mechanism and allows the application to use a variety of transports.

RPC makes the client/server model of computing more powerful and easier to program. When combined with the ONC RPCGEN protocol compiler (Chapter 33) clients transparently make remote calls through a local procedure interface.

How RPC Works

An RPC is analogous to a function call. Like a function call, when an RPC is made, the calling arguments are passed to the remote procedure and the caller waits for a response to be returned from the remote procedure. Figure 32.1 shows the flow of activity that takes place during an RPC call between two networked systems. The client makes a procedure call that sends a request to the server and waits. The thread is blocked from processing until either a reply is received, or it times out. When the request arrives, the server calls a dispatch routine that performs the requested service, and sends the reply to the client. After the RPC call is completed, the client program continues. RPC specifically supports network applications.

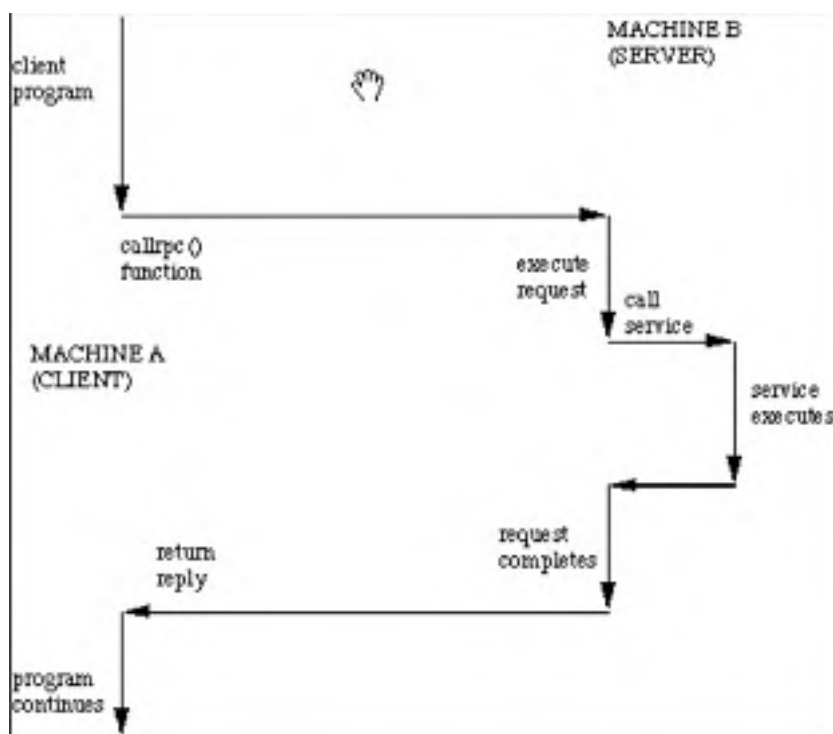

Fig. 32.1 Remote Procedure Calling Mechanism A remote procedure is uniquely identified by the triple: (program number, version number, procedure number) The program number identifies a group of related remote procedures, each of which has a unique procedure number. A program may consist of one or more versions. Each version consists of a collection of procedures which are available to be called remotely. Version numbers enable multiple versions of an RPC protocol to be available simultaneously. Each version contains a number of procedures that can be called remotely. Each procedure has a procedure number.

RPC Application Development

Consider an example:

A client/server lookup in a personal database on a remote machine. Assuming that we cannot access the database from the local machine (via NFS).

We use UNIX to run a remote shell and execute the command this way. There are some problems with this method:

- the command may be slow to execute.
- You require an login account on the remote machine.

The RPC alternative is to

- establish an server on the remote machine that can repond to queries.
- Retrieve information by calling a query which will be quicker than previous approach.

To develop an RPC application the following steps are needed:

- Specify the protocol for client server communication
- Develop the client program
- Develop the server program

The programs will be compiled seperately. The communication protocol is achieved by generated stubs and these stubs and rpc (and other libraries) will need to be linked in.

Defining the Protocol

The easiest way to define and generate the protocol is to use a protocol compiler such as `rpcgen` which we discuss in Chapter 33.

For the protocol you must identify the name of the service procedures, and data types of parameters and return arguments.

The protocol compiler reads a definitio and automatically generates client and server stubs.

`rpcgen` uses its own language (RPC language or RPCL) which looks very similar to preprocessor directives.

`rpcgen` exists as a standalone executable compiler that reads special files denoted by a `.x` prefix.

So to compile a RPCL file you simply do

```
rpcgen rpcprog.x
```

This will generate possibly four files:

- `rpcprog_clnt.c` -- the client stub
- `rpcprog_svc.c` -- the server stub
- `rpcprog_xdr.c` -- If necessary XDR (external data representation)

filters

- `rpcprog.h` -- the header file needed for any XDR filters.

The external data representation (XDR) is an data abstraction needed for machine independent communication. The client and server need not be machines of the same type.

Defining Client and Server Application Code

We must now write the the client and application code. They must communicate via procedures and data types specified in the Protocol.

The service side will have to register the procedures that may be called by the client and receive and return any data required for processing.

The client application call the remote procedure pass any required data and will receive the retruned data.

There are several levels of application interfaces that may be used to develop RPC applications. We will briefly disuss these below before exapnading thhe most common of these in later chapters.

Compiling and running the application

Let us consider the full compilation model required to run a RPC application. Makefiles are useful for easing the burden of compiling RPC applications but it is necessary to understand the complete model before one can assemble a convenient makefile.

Assume the the client program is called `rpcprog.c`, the service program is `rpcsvc.c` and that the protocol has been defined in `rpcprog.x` and that `rpcgen` has been used to produce the stub and filter files: `rpcprog_clnt.c`, `rpcprog_svc.c`, `rpcprog_xdr.c`, `rpcprog.h`.

The client and server program must include `(#include "rpcprog.h"`

You must then:

- compile the client code:

```
cc -c rpcprog.c
```

- compile the client stub:

```
cc -c rpcprog_clnt.c
```

- compile the XDR filter:

```
cc -c rpcprog_xdr.c
```

- build the client executable:

```
cc -o rpcprog rpcprog.o rpcprog_clnt.o rpcprog_xdr.c
```

- compile the service procedures:

```
cc -c rpcsvc.c
```

- compile the server stub:

```
cc -c rpcprog_svc.c
```

- build the server executable:

```
cc -o rpcsvc rpcsvc.o rpcprog_svc.o rpcprog_xdr.c
```

Now simply run the programs `rpcprog` and `rpcsvc` on the client and server respectively. The server procedures must be registered before the client can call them.

Overview of Interface Routines

RPC has multiple levels of application interface to its services. These levels provide different degrees of control balanced with different amounts of interface code to implement. In order of increasing control and complexity. This section gives a summary of the routines available at each level.

Simplified Interface Routines

The simplified interfaces are used to make remote procedure calls to routines on other machines, and specify only the type of transport to use. The routines at this level are used for most applications. Descriptions and code samples can be found in the section, Simplified Interface @ 3-2.

Simplified Level Routine Function

`rpc_reg()` -- Registers a procedure as an RPC program on all transports of the specified type.

`rpc_call()` -- Remote calls the specified procedure on the specified remote host.

`rpc_broadcast()` -- Broadcasts a call message across all transports of the specified type. Standard Interface Routines The standard interfaces are divided into top level, intermediate level, expert level, and bottom level. These interfaces give a developer much greater control over communication parameters such as the transport being used, how long to wait before responding to errors and retransmitting requests, and so on.

Top Level Routines

At the top level, the interface is still simple, but the program has to create a client handle before making a call or create a server handle before receiving calls. If you want the application to run on all transports, use this interface. Use of these routines and code samples can be found in Top Level Interface

`clnt_create()` -- Generic client creation. The program tells `clnt_create()` where the server is located and the type of transport to use.

`clnt_create_timed()` Similar to `clnt_create()` but lets the programmer specify the maximum time allowed for each type of transport tried during the creation attempt.

`svc_create()` -- Creates server handles for all transports of the specified type. The program tells `svc_create()` which dispatch function to use.

`clnt_call()` -- Client calls a procedure to send a request to the server.

Intermediate Level Routines

The intermediate level interface of RPC lets you control details. Programs written at these lower levels are more complicated but run more efficiently. The intermediate level enables you to specify the transport to use.

`clnt_tp_create()` -- Creates a client handle for the specified transport.

`clnt_tp_create_timed()` -- Similar to `clnt_tp_create()` but lets the programmer specify the maximum time allowed. `svc_tp_create()` Creates a server handle for the specified transport.

`clnt_call()` -- Client calls a procedure to send a request to the server.

Expert Level Routines

The expert level contains a larger set of routines with which to specify transport-related parameters. Use of these routines

`clnt_tli_create()` -- Creates a client handle for the specified transport.

`svc_tli_create()` -- Creates a server handle for the specified transport.

`rpcb_set()` -- Calls `rpcbind` to set a map between an RPC service and a network address.

`rpcb_unset()` -- Deletes a mapping set by `rpcb_set()`.

`rpcb_getaddr()` -- Calls `rpcbind` to get the transport addresses of specified RPC services.

`svc_reg()` -- Associates the specified program and version number pair with

the specified dispatch routine.

`svc_unreg()` -- Deletes an association set by `svc_reg()`.

`clnt_call()` -- Client calls a procedure to send a request to the server.

Bottom Level Routines

The bottom level contains routines used for full control of transport options.

`clnt_dg_create()` -- Creates an RPC client handle for the specified remote program, using a connectionless transport.

`svc_dg_create()` -- Creates an RPC server handle, using a connectionless transport.

`clnt_vc_create()` -- Creates an RPC client handle for the specified remote program, using a connection-oriented transport.

`svc_vc_create()` -- Creates an RPC server handle, using a connection-oriented transport.

`clnt_call()` -- Client calls a procedure to send a request to the server.

The Programmer's Interface to RPC

This section addresses the C interface to RPC and describes how to write network applications using RPC. For a complete specification of the routines in the RPC library, see the `rpc` and related `man` pages.

Simplified Interface

The simplified interface is the easiest level to use because it does not require the use of any other RPC routines. It also limits control of the underlying communications mechanisms. Program development at this level can be rapid, and is directly supported by the `rpcgen` compiler. For most applications, `rpcgen` and its facilities are sufficient. Some RPC services are not available as C functions, but they are available as RPC programs. The simplified interface library routines provide direct access to the RPC facilities for programs that do not require fine levels of control.

Routines such as `rusers` are in the RPC services library `librpcsvc`. `rusers.c`, below, is a program that displays the number of users on a remote host. It calls the RPC library routine, `rusers`.

The `program.c` program listing:

```
#include <rpc/rpc.h>
#include <rpcsvc/rusers.h>
#include <stdio.h>

/*
 * a program that calls the
 * rusers() service
 */

main(int argc, char **argv)
{
    int num;
    if (argc != 2) {
        fprintf(stderr, "usage: %s hostname\n",
            argv[0]);
        exit(1);
    }

    if ((num = rnusers(argv[1])) < 0) {
        fprintf(stderr, "error: rusers\n");
        exit(1);
    }

    fprintf(stderr, "%d users on %s\n", num, argv[1] );
    exit(0);
}
```

Compile the program with:

```
cc program.c -lrpcsvc -lnsl
```

The Client Side

There is just one function on the client side of the simplified interface
`rpc_call()`.

It has nine parameters:

```
int
rpc_call (char *host /* Name of server host */,
          u_long prognum /* Server program number */,
          u_long versnum /* Server version number */,
          xdrproc_t inproc /* XDR filter to encode arg */,
          char *in /* Pointer to argument */,
          xdr_proc_t outproc /* Filter to decode result */,
          char *out /* Address to store result */,
          char *nettype /* For transport selection */);
```

This function calls the procedure specified by `prognum`, `versum`, and `procnum` on the host. The argument to be passed to the remote procedure is pointed to by the `in` parameter, and `inproc` is the XDR filter to encode this argument. The `out` parameter is an address where the result from the remote procedure is to be placed. `outproc` is an XDR filter which will decode the result and place it at this address.

The client blocks on `rpc_call()` until it receives a reply from the server. If the server accepts, it returns `RPC_SUCCESS` with the value of zero. It will return a non-zero value if the call was unsuccessful. This value can be cast to the type `clnt_stat`, an enumerated type defined in the RPC include files (`<rpc/rpc.h>`) and interpreted by the `clnt_sperrno()` function. This function

returns a pointer to a standard RPC error message corresponding to the error code. In the example, all "visible" transports listed in `/etc/netconfig` are tried. Adjusting the number of retries requires use of the lower levels of the RPC library. Multiple arguments and results are handled by collecting them in structures.

The example changed to use the simplified interface, looks like

```
#include <stdio.h>
#include <utmp.h>
#include <rpc/rpc.h>
#include <rpcsvc/rusers.h>

/* a program that calls the RUSERSPROG
 * RPC program
 */

main(int argc, char **argv)

{
    unsigned long nusers;
    enum clnt_stat cs;
    if (argc != 2) {
        fprintf(stderr, "usage: rusers hostname\n");
        exit(1);
    }

    if( cs = rpc_call(argv[1], RUSERSPROG,
        RUSERSVERS, RUSERSPROC_NUM, xdr_void,
        (char *)0, xdr_u_long, (char *)&nusers,
        "visible") != RPC_SUCCESS ) {
        clnt_perrno(cs);
        exit(1);
    }

    fprintf(stderr, "%d users on %s\n", nusers, argv[1] );
    exit(0);
}
```

Since data types may be represented differently on different machines, `rpc_call()` needs both the type of, and a pointer to, the RPC argument (similarly for the result). For `RUSERSPROC_NUM`, the return value is an unsigned long, so the first return parameter of `rpc_call()` is `xdr_u_long` (which is for an unsigned long) and the second is `&nusers` (which points to unsigned long storage). Because `RUSERSPROC_NUM` has no argument, the XDR encoding function of `rpc_call()` is `xdr_void()` and its argument is `NULL`.

The Server Side

The server program using the simplified interface is very straightforward. It simply calls `rpc_reg()` to register the procedure to be called, and then it calls `svc_run()`, the RPC library's remote procedure dispatcher, to wait for requests to come in.

`rpc_reg()` has the following prototype:

```
rpc_reg(u_long prognum /* Server program number */,
        u_long versnum /* Server version number */,
        u_long procnum /* server procedure number */,
        char *procname /* Name of remote function */,
        xdrproc_t inproc /* Filter to encode arg */,
        xdrproc_t outproc /* Filter to decode result */,
        char *nettype /* For transport selection */);
```

`svc_run()` invokes service procedures in response to RPC call messages. The dispatcher in `rpc_reg()` takes care of decoding remote procedure arguments and encoding results, using the XDR filters specified when the remote procedure was registered. Some notes about the server program:

- Most RPC applications follow the naming convention of appending a `_1` to the function name. The sequence `_n` is added to the procedure names to indicate the version number `n` of the service.
- The argument and result are passed as addresses. This is true for all functions that are called remotely. If you pass `NULL` as a result of a function, then no reply is sent to the client. It is assumed that there is no reply to send.
- The result must exist in static data space because its value is accessed after the actual procedure has exited. The RPC library function that builds the RPC reply message accesses the result and sends the value back to the client.
- Only a single argument is allowed. If there are multiple elements of data, they should be wrapped inside a structure which can then be passed as a single entity.
- The procedure is registered for each transport of the specified type. If the type parameter is `(char *)NULL`, the procedure is registered for all transports specified in `NETPATH`.

You can sometimes implement faster or more compact code than can `rpcgen`. `rpcgen` handles the generic code-generation cases. The following program is an example of a hand-coded registration routine. It registers a single procedure and enters `svc_run()` to service requests.

```
#include <stdio.h>
#include <rpc/rpc.h>
#include <rpcsvc/rusers.h>

void *rusers();

main()
{
    if(rpc_reg(RUSERSPROG, RUSERSVERS,
              RUSERSPROC_NUM, rusers,
              xdr_void, xdr_u_long,
              "visible") == -1) {
        fprintf(stderr, "Couldn't Register\n");
        exit(1);
    }
    svc_run(); /* Never returns */
    fprintf(stderr, "Error: svc_run returned!\n");
    exit(1);
}
```

`rpc_reg()` can be called as many times as is needed to register different programs, versions, and procedures.

Passing Arbitrary Data Types

Data types passed to and received from remote procedures can be any of a set of predefined types, or can be programmer-defined types. RPC handles arbitrary data structures, regardless of different machines' byte orders or structure layout conventions, by always converting them to a standard transfer format called external data representation (XDR) before sending them over the transport. The conversion from a machine representation to XDR is called serializing, and the reverse process is called deserializing. The translator arguments of `rpc_call()` and `rpc_reg()` can specify an XDR primitive procedure, like `xdr_u_long()`, or a programmer-supplied routine that processes a complete argument structure. Argument processing routines must take only two arguments: a pointer to the result and a pointer to the XDR handle.

The following XDR Primitive Routines are available:

```
xdr_int() xdr_netobj() xdr_u_long() xdr_enum()
xdr_long() xdr_float() xdr_u_int() xdr_bool()
xdr_short() xdr_double() xdr_u_short() xdr_wrapstring()
xdr_char() xdr_quadruple() xdr_u_char() xdr_void()
```

The nonprimitive `xdr_string()`, which takes more than two parameters, is called from `xdr_wrapstring()`.

For an example of a programmer-supplied routine, the structure:

```
struct simple {
    int a;
    short b;
} simple;
```

contains the calling arguments of a procedure. The XDR routine `xdr_simple()` translates the argument structure as shown below:

```
#include <rpc/rpc.h>
#include "simple.h"

bool_t xdr_simple(XDR *xdrsp, struct simple *simplep)
{
    if (!xdr_int(xdrsp, &simplep->a))
        return (FALSE);
    if (!xdr_short(xdrsp, &simplep->b))
        return (FALSE);
    return (TRUE);
}
```

An equivalent routine can be generated automatically by `rpcgen` (See Chapter 33).

An XDR routine returns nonzero (a C TRUE) if it completes successfully, and zero otherwise.

For more complex data structures use the XDR prefabricated routines:

```
xdr_array() xdr_bytes() xdr_reference()
xdr_vector() xdr_union() xdr_pointer()
xdr_string() xdr_opaque()
```

For example, to send a variable-sized array of integers, it is packaged in a structure containing the array and its length:

```
struct varintarr {
    int *data;
    int arrlen;
} arr;
```

Translate the array with `xdr_array()`, as shown below:

```
bool_t xdr_varintarr(XDR *xdrsp, struct varintarr *arrp)
{
    return(xdr_array(xdrsp, (caddr_t)&arrp->data,
                    (u_int *)&arrp->arrlen, MAXLEN, sizeof(int), xdr_in
    )
}
```

The arguments of `xdr_array()` are the XDR handle, a pointer to the array, a pointer to the size of the array, the maximum array size, the size of each array element, and a pointer to the XDR routine to translate each array element. If the size of the array is known in advance, use `xdr_vector()` instead as is more efficient:

```
int intarr[SIZE];

bool_t xdr_intarr(XDR *xdrsp, int intarr[])
{
    return (xdr_vector(xdrsp, intarr, SIZE, sizeof(int), xdr_int))
}
```

XDR converts quantities to 4-byte multiples when serializing. For arrays of characters, each character occupies 32 bits. `xdr_bytes()` packs characters. It has four parameters similar to the first four parameters of `xdr_array()`.

Null-terminated strings are translated by `xdr_string()`. It is like `xdr_bytes()` with no length parameter. On serializing it gets the string length from `strlen()`, and on deserializing it creates a null-terminated string.

`xdr_reference()` calls the built-in functions `xdr_string()` and `xdr_reference()`, which translates pointers to pass a string, and struct simple from the previous examples. An example use of `xdr_reference()` is as follows:

```
struct finalexample {
    char *string;
    struct simple *simplep;
} finalexample;

bool_t xdr_finalexample(XDR *xdrsp, struct finalexample *finalp)
{
    if (!xdr_string(xdrsp, &finalp->string, MAXSTRLEN))
        return (FALSE);
    if (!xdr_reference(xdrsp, &finalp->simplep, sizeof(struct sim
```

```
        return (FALSE);
    return (TRUE);
}
```

Note that `xdr_simple()` could have been called here instead of `xdr_reference()`.

Developing High Level RPC Applications

Let us now introduce some further functions and see how we develop an application using high level RPC routines. We will do this by studying an example.

We will develop a remote directory reading utility.

Let us first consider how we would write a local directory reader. We have seen how to do this already in Chapter 19.

Consider the program to consist of two files:

- `lls.c` -- the main program which calls a routine in a local module `read_dir.c`

```
/*
 * lls.c: local directory listing main - before RPC
 */
#include <stdio.h>
#include <strings.h>
#include "rls.h"

main (int argc, char **argv)
{
    char    dir[DIR_SIZE];

    /* call the local procedure */
    strcpy(dir, argv[1]); /* char dir[DIR_SIZE] is comin
read_dir(dir);

    /* spew-out the results and bail out of here! */
    printf("%s\n", dir);

    exit(0);
}
```

- `read_dir.c` -- the file containing the *local* routine `read_dir()`.

```
/* note - RPC compliant procedure calls take one input and
return one output. Everything is passed by pointer. Retu
values should point to static data, as it might have to
survive some while. */
#include <stdio.h>
#include <sys/types.h>
#include <sys/dir.h> /* use <xpg2include/sys/dirent.h> (
<sys/dirent.h> for X/Open Portability Guide, issue 2
#include "rls.h"

read_dir(char *dir)
/* char dir[DIR_SIZE] */
{
    DIR * dirp;
```

```
struct direct *d;
printf("beginning ");

/* open directory */
dirp = opendir(dir);
if (dirp == NULL)
    return(NULL);

/* stuff filenames into dir buffer */
dir[0] = NULL;
while (d = readdir(dirp))
    sprintf(dir, "%s%s\n", dir, d->d_name);

/* return the result */
printf("returning ");
closedir(dirp);
return((int)dir); /* this is the only new line from
}

```

- the header file `rls.h` contains only the following (for now at least)

```
#define DIR_SIZE 8192
```

Clearly we need to share the size between the files. Later when we develop RPC versions more information will need to be added to this file.

This local program would be compiled as follows:

```
cc lls.c read_dir.c -o lls
```

Now we want to modify this program to work over a network: Allowing us to inspect directories of a remote server across a network.

The following steps will be required:

- We will have to convert the `read_dir.c`, to run on the server.
 - We will have to register the server and the routine `read_dir()` on the server/.
- The client `lls.c` will have to call the routine as a remote procedure.
- We will have to define the protocol for communication between the client and the server programs.

Defining the protocol

We can use simple `NULL`-terminated strings for passing and receiving the directory name and directory contents. Furthermore, we can embed the passing of these parameters directly in the client and server code.

We therefore need to specify the program, procedure and version numbers for client and servers. This can be done automatically using `rpcgen` or relying on predefined macros in the simplified interface. Here we will specify them manually.

The server and client must agree *ahead of time* what logical addresses they will use (The physical addresses do not matter they are hidden from the application developer)

Program numbers are defined in a standard way:

- 0x00000000 - 0x1FFFFFFF: Defined by Sun
- 0x20000000 - 0x3FFFFFFF: User Defined
- 0x40000000 - 0x5FFFFFFF: Transient
- 0x60000000 - 0xFFFFFFFF: Reserved

We will simply choose a *user defined value* for our program number. The version and procedure numbers are set according to standard practice.

We still have the `DIR_SIZE` definition required from the local version as the size of the directory buffer is required by both client and server programs.

Our new `rls.h` file contains:

```
#define DIR_SIZE 8192
#define DIRPROG ((u_long) 0x20000001) /* server program (suite)
#define DIRVERS ((u_long) 1) /* program version number */
#define READDIR ((u_long) 1) /* procedure number for look-up *
```

Sharing the data

We have mentioned previously that we can pass the data as simple strings. We need to define an XDR filter routine `xdr_dir()` that shares the data. Recall that only one encoding and decoding argument can be handled. This is easy and defined via the standard `xdr_string()` routine.

The XDR file, `rls_xrd.c`, is as follows:

```
#include <rpc/rpc.h>

#include "rls.h"

bool_t xdr_dir(XDR *xdrs, char *objp)
{ return ( xdr_string(xdrs, &objp, DIR_SIZE) ); }
```

The Server Side

We can use the original `read_dir.c` file. All we need to do is register the procedure and start the server.

The procedure is registered with `registerrpc()` function. This is prototyped by:

```
registerrpc(u_long prognum /* Server program number */,
            u_long versnum /* Server version number */,
            u_long procnum /* server procedure number */,
            char *procname /* Name of remote function */,
            xdrproc_t inproc /* Filter to encode arg */,
            xdrproc_t outproc /* Filter to decode result */);
```

The parameters are similarly defined as in the `rpc_reg` simplified interface

function. We have already discussed the setting of the parameter with the protocol `rls.h` header files and the `rls_xrd.c` XDR filter file.

The `svc_run()` routine has also been discussed previously.

The full `rls_svc.c` code is as follows:

```
#include <rpc/rpc.h>
#include "rls.h"

main()
{
    extern bool_t xdr_dir();
    extern char * read_dir();

    register_rpc(DIRPROG, DIRVERS, READDIR,
                read_dir, xdr_dir, xdr_dir);

    svc_run();
}
```

The Client Side

At the client side we simply need to call the remote procedure. The function `callrpc()` does this. It is prototyped as follows:

```
callrpc(char *host /* Name of server host */,
        u_long prognum /* Server program number */,
        u_long versnum /* Server version number */,
        char *in /* Pointer to argument */,
        xdrproc_t inproc /* XDR filter to encode arg */,
        char *out /* Address to store result */,
        xdr_proc_t outproc /* Filter to decode result */);
```

We call a local function `read_dir()` which uses `callrpc()` to call the remote procedure that has been registered `READDIR` at the server.

The full `rls.c` program is as follows:

```
/*
 * rls.c: remote directory listing client
 */
#include <stdio.h>
#include <strings.h>
#include <rpc/rpc.h>
#include "rls.h"

main (argc, argv)
int argc; char *argv[];
{
    char    dir[DIR_SIZE];

    /* call the remote procedure if registered */
    strcpy(dir, argv[2]);
    read_dir(argv[1], dir); /* read_dir(host, directory) */

    /* spew-out the results and bail out of here! */
    printf("%s\n", dir);

    exit(0);
}
```

```
}  
  
read_dir(host, dir)  
char *dir, *host;  
{  
    extern bool_t xdr_dir();  
    enum clnt_stat clnt_stat;  
  
    clnt_stat = callrpc ( host, DIRPROG, DIRVERS, READDIR,  
                        xdr_dir, dir, xdr_dir, dir);  
    if (clnt_stat != 0) clnt_perrno (clnt_stat);  
}
```

Exercise

Exercise 12833

Compile and run the remote directory example `r1s.c` *etc*. Run both the client and server locally and if possible over a network.

Dave Marshall
1/5/1999

Subsections

- [What is rpcgen](#)
 - [An rpcgen Tutorial](#)
 - [Converting Local Procedures to Remote Procedures](#)
 - [Passing Complex Data Structures](#)
 - [Preprocessing Directives](#)
 - [cpp Directives](#)
 - [Compile-Time Flags](#)
 - [Client and Server Templates](#)
 - [Example rpcgen compile options/templates](#)
 - [Recommended Reading](#)
 - [Exercises](#)
-

Protocol Compiling and Lower Level RPC Programming

This chapter introduces the `rpcgen` tool and provides a tutorial with code examples and usage of the available compile-time flags. We also introduce some further RPC programming routines.

What is `rpcgen`

The `rpcgen` tool generates remote program interface modules. It compiles source code written in the RPC Language. RPC Language is similar in syntax and structure to C. `rpcgen` produces one or more C language source modules, which are then compiled by a C compiler.

The default output of `rpcgen` is:

- A header file of definitions common to the server and the client
- A set of XDR routines that translate each data type defined in the header file
- A stub program for the server
- A stub program for the client

`rpcgen` can optionally generate (although we *do not* consider these issues here -- see `man` pages or recommended reading):

- Various transports
- A time-out for servers
- Server stubs that are MT safe
- Server stubs that are not main programs
- C-style arguments passing ANSI C-compliant code
- An RPC dispatch table that checks authorizations and invokes service routines

`rpcgen` significantly reduces the development time that would otherwise be spent developing low-level routines. Handwritten routines link easily with the `rpcgen` output.

An `rpcgen` Tutorial

`rpcgen` provides programmers a simple and direct way to write distributed applications. Server procedures may be written in any language that observes procedure-calling conventions. They are linked with the server stub produced by `rpcgen` to form an executable server program. Client procedures are written and linked in the same way. This section presents some basic `rpcgen` programming examples. Refer also to the `man rpcgen` online manual page.

Converting Local Procedures to Remote Procedures

Assume that an application runs on a single computer and you want to convert it to run in a "distributed" manner on a network. This example shows the stepwise conversion of this program that writes a message to the system console.

Single Process Version of `printmsg.c`:

```
/* printmsg.c: print a message on the console */
#include <stdio.h>
main(int argc, char *argv[])

{
    char *message;
    if (argc != 2) {
        fprintf(stderr, "usage: %s <message>\n", argv[0]);
        exit(1);
    }
    message = argv[1];
    if (!printmessage(message)) {
        fprintf(stderr, "%s: couldn't print your message\n", argv[0]);
        exit(1);
    }
    printf("Message Delivered!\n");
    exit(0);
}

/* Print a message to the console.
 * Return a boolean indicating whether
 * the message was actually printed. */
printmessage(char *msg)

{
    FILE *f;
    f = fopen("/dev/console", "w");
    if (f == (FILE *)NULL) {
        return (0);
    }
}
```

```
    }  
    fprintf(f, "%s\n", msg);  
    fclose(f);  
    return(1);  
}
```

For local use on a single machine, this program could be compiled and executed as follows:

```
$ cc printmsg.c -o printmsg  
$ printmsg "Hello, there."  
Message delivered!  
$
```

If the `printmessage()` function is turned into a *remote procedure*, it can be called from anywhere in the network. `rpcgen` makes it easy to do this:

First, determine the data types of all procedure-calling arguments and the result argument. The calling argument of `printmessage()` is a string, and the result is an integer. We can write a protocol specification in RPC language that describes the remote version of `printmessage`. The RPC language source code for such a specification is:

```
/* msg.x: Remote msg printing protocol */  
program MESSAGEPROG {  
    version PRINTMESSAGEVERS {  
        int PRINTMESSAGE(string) = 1;  
    } = 1;  
} = 0x20000001;
```

Remote procedures are always declared as part of remote programs. The code above declares an entire remote program that contains the single procedure `PRINTMESSAGE`.

In this example,

- `PRINTMESSAGE` procedure is declared to be:
 - the procedure 1,
 - in version 1 of the remote program
- `MESSAGEPROG`, with the program number `0x20000001`.

Version numbers are incremented when functionality is changed in the remote program. Existing procedures can be changed or new ones can be added. More than one version of a remote program can be defined and a version can have more than one procedure defined.

Note: that the program and procedure names are declared with all capital letters. This is not required, but is a good convention to follow. Note also that the argument type is string and not `char *` as it would be in C. This is because a `char *` in C is ambiguous. `char` usually means an array of characters, but it could also represent a pointer to a single character. In RPC language, a null-terminated array of `char` is called a string.

There are just two more programs to write:

- The remote procedure itself

The RPC Version of `printmsg.c`:

```
/*
 * msg_proc.c: implementation of the
 * remote procedure "printmessage"
 */

#include <stdio.h>
#include "msg.h" /* msg.h generated by rpcgen */

int * printmessage_1(char **msg, struct svc_req *req)

{
    static int result; /* must be static! */
    FILE *f;

    f = fopen("/dev/console", "w");
    if (f == (FILE *)NULL) {
        result = 0;
        return (&result);
    }
    fprintf(f, "%s\n", *msg);
    fclose(f);
    result = 1;
    return (&result);
}
```

Note that the declaration of the remote procedure `printmessage_1` differs from that of the local procedure `printmessage` in four ways:

- It takes a pointer to the character array instead of the pointer itself. This is true of all remote procedures when the `'- ' N` option is not used: They always take pointers to their arguments rather than the arguments themselves. Without the `'- ' N` option, remote procedures are always called with a single argument. If more than one argument is required the arguments must be passed in a struct.
- It is called with two arguments. The second argument contains information on the context of an invocation: the program, version, and procedure numbers, raw and canonical credentials, and an `SVCXPRT` structure pointer (the `SVCXPRT` structure contains transport information). This information is made available in case the invoked procedure requires it to perform the request.
- It returns a pointer to an integer instead of the integer itself. This is also true of remote procedures when the `'- ' N` option is not used: They return pointers to the result. The result should be declared static unless the `'- ' M` (multithread) or `'- ' A` (Auto mode) options are used. Ordinarily, if the result is declared local to the remote procedure, references to it by the server stub are invalid after the remote procedure returns. In the case of `'- ' M` and `'- ' A` options, a pointer to the result is passed as a third argument to the procedure, so the result is not declared in the procedure.
- An `_1` is appended to its name. In general, all remote procedures

calls generated by rpcgen are named as follows: the procedure name in the program definition (here `PRINTMESSAGE`) is converted to all lowercase letters, an underbar (`_`) is appended to it, and the version number (here `1`) is appended. This naming scheme allows multiple versions of the same procedure.

- The main client program that calls it:

```
/*
 * rprintmsg.c: remote version
 * of "printmsg.c"
 */

#include <stdio.h>
#include "msg.h" /* msg.h generated by rpcgen */

main(int argc, char **argv)

{
    CLIENT *clnt;
    int *result;
    char *server;
    char *message;

    if (argc != 3) {
        fprintf(stderr, "usage: %s host
message\n", argv[0]);
        exit(1);
    }

    server = argv[1];
    message = argv[2];

    /*
     * Create client "handle" used for
     * calling MESSAGEPROG on the server
     * designated on the command line.
     */

    clnt = clnt_create(server, MESSAGEPROG, PRINTMESSAGEVERS,

if (clnt == (CLIENT *)NULL) {
    /*
     * Couldn't establish connection
     * with server.
     * Print error message and die.
     */

    clnt_pcreateerror(server);
    exit(1);
}

/*
 * Call the remote procedure
 * "printmessage" on the server
 */

result = printmessage_1(&message, clnt);
if (result == (int *)NULL) {
    /*
     * An error occurred while calling
     * the server.
     * Print error message and die.
     */
```

```
        clnt_perror(clnt, server);
        exit(1);
    }

    /* Okay, we successfully called
     * the remote procedure.
     */

    if (*result == 0) {

        /*
         * Server was unable to print
         * our message.
         * Print error message and die.
         */

        fprintf(stderr, "%s: could not print your message\n", arg);
        exit(1);
    }

    /* The message got printed on the
     * server's console
     */

    printf("Message delivered to %s\n", server);
    clnt_destroy( clnt );
    exit(0);
}
```

Note the following about Client Program to Call printmsg.c:

- First, a client handle is created by the RPC library routine `clnt_create()`. This client handle is passed to the stub routine that calls the remote procedure. If no more calls are to be made using the client handle, destroy it with a call to `clnt_destroy()` to conserve system resources.
- The last parameter to `clnt_create()` is `visible`, which specifies that any transport noted as `visible` in `/etc/netconfig` can be used.
- The remote procedure `printmessage_1` is called exactly the same way as it is declared in `msg_proc.c`, except for the inserted client handle as the second argument. It also returns a pointer to the result instead of the result.
- The remote procedure call can fail in two ways. The RPC mechanism can fail or there can be an error in the execution of the remote procedure. In the former case, the remote procedure `printmessage_1` returns a `NULL`. In the latter case, the error reporting is application dependent. Here, the error is returned through `*result`.

To compile the remote `rprintmsg` example:

- compile the protocol defined in `msg.x`: `rpcgen msg.x`.

This generates the header files (`msg.h`), client stub (`msg_clnt.c`), and server stub (`msg_svc.c`).

- compile the client executable:

```
cc rprintmsg.c msg_clnt.c -o rprintmsg -lnsl
```

- compile the server executable:

```
cc msg_proc.c msg_svc.c -o msg_server -lnsl
```

The C object files must be linked with the library `libnsl`, which contains all of the networking functions, including those for RPC and XDR.

In this example, no XDR routines were generated because the application uses only the basic types that are included in `libnsl`. Let us consider further what `rpcgen` did with the input file `msg.x`:

- It created a header file called `msg.h` that contained `#define` statements for `MESSAGEPROG`, `MESSAGEVERS`, and `PRINTMESSAGE` for use in the other modules. This file **must** be included by both the client and server modules.
- It created the client stub routines in the `msg_clnt.c` file. Here there is only one, the `printmessage_1` routine, that was called from the `rprintmsg` client program. If the name of an `rpcgen` input file is `prog.x`, the client stub's output file is called `prog_clnt.c`.
- It created the server program in `msg_svc.c` that calls `printmessage_1` from `msg_proc.c`. The rule for naming the server output file is similar to that of the client: for an input file called `prog.x`, the output server file is named `prog_svc.c`.

Once created, the server program is installed on a remote machine and run. (If the machines are homogeneous, the server binary can just be copied. If they are not, the server source files must be copied to and compiled on the remote machine.)

Passing Complex Data Structures

`rpcgen` can also be used to generate XDR routines -- the routines that convert local data structures into XDR format and vice versa.

let us consider `dir.x` a remote directory listing service, built using `rpcgen` both to generate stub routines and to generate the XDR routines.

The RPC Protocol Description File: `dir.x` is as follows:

```
/*
 * dir.x: Remote directory listing protocol
 *
 * This example demonstrates the functions of rpcgen.
 */

const MAXNAMELEN = 255; /* max length of directory entry */
```

```
typedef string nametype<MAXNAMELEN>; /* director entry */
typedef struct namenode *namelist; /* link in the listing */
/* A node in the directory listing */

struct namenode {
    nametype name; /* name of directory entry */
    namelist next; /* next entry */
};

/*
 * The result of a READDIR operation
 *
 * a truly portable application would use
 * an agreed upon list of error codes
 * rather than (as this sample program
 * does) rely upon passing UNIX errno's
 * back.
 *
 * In this example: The union is used
 * here to discriminate between successful
 * and unsuccessful remote calls.
 */

union readdir_res switch (int errno) {
    case 0:
        namelist list; /* no error: return directory listing */
    default:
        void; /* error occurred: nothing else to return */
};

/* The directory program definition */

program DIRPROG {
    version DIRVERS {
        readdir_res
        READDIR(nametype) = 1;
    } = 1;
} = 0x20000076;
```

You can redefine types (like `readdir_res` in the example above) using the `struct`, `union`, and `enum` RPC language keywords. These keywords are not used in later declarations of variables of those types. For example, if you define a union, `my_un`, you declare using only `my_un`, and not `union my_un`. `rpcgen` compiles RPC unions into C structures. Do not declare C unions using the union keyword.

Running `rpcgen` on `dir.x` generates four output files:

- the header file, `dir.h`,
- the client stub, `dir_clnt.c`,
- the server skeleton, `dir_svc.c`, and
- the XDR routines in the file `dir_xdr.c`.

This last file contains the XDR routines to convert declared data types from the host platform representation into XDR format, and vice versa. For each RPCL data type used in the `.x` file, `rpcgen` assumes that `libns1` contains a routine whose name is the name of the data type, prepended by the XDR routine header `xdr_` (for example, `xdr_int`). If a data type is defined in the

.x file, `rpcgen` generates the required `xdr_` routine. If there is no data type definition in the .x source file (for example, `msg.x`, above), then no `_xdr.c` file is generated. You can write a .x source file that uses a data type not supported by `libnsl`, and deliberately omit defining the type (in the .x file). In doing so, you must provide the `xdr_` routine. This is a way to provide your own customized `xdr_` routines.

The server-side of the `REaddir` procedure, `dir_proc.c` is shown below:

```
/*
 * dir_proc.c: remote readdir
 * implementation
 */

#include <dirent.h>
#include "dir.h" /* Created by rpcgen */

extern int errno;

extern char *malloc();
extern char *strdup();

readdir_res *
readdir_1(nametype *dirname, struct svc_req *req)

{
    DIR *dirp;
    struct dirent *d;
    namelist nl;
    namelist *nlp;

    static readdir_res res; /* must be static! */

    /* Open directory */
    dirp = opendir(*dirname);

    if (dirp == (DIR *)NULL) {
        res.errno = errno;
        return (&res);
    }

    /* Free previous result */
    xdr_free(xdr_readdir_res, &res);

    /*
     * Collect directory entries.
     * Memory allocated here is free by
     * xdr_free the next time readdir_1
     * is called
     */

    nlp = &res.readdir_res_u.list;
    while (d = readdir(dirp)) {
        nl = *nlp = (namenode *);
        malloc(sizeof(namenode));
        if (nl == (namenode *) NULL) {
            res.errno = EAGAIN;
            closedir(dirp);
            return(&res);
        }
        nl->name = strdup(d->d_name);
        nlp = &nl->next;
    }
}
```

```
    }

    *nlp = (namelist)NULL;

    /* Return the result */
    res.errno = 0;
    closedir(dirp);
    return (&res);
}
```

The Client-side Implementation of implementation of the READDIR procedure, rls.c is given below:

```
/*
 * rls.c: Remote directory listing client
 */

#include <stdio.h>
#include "dir.h" /* generated by rpcgen */

extern int errno;

main(int argc, char *argv[])

{
    CLIENT *clnt;
    char *server;
    char *dir;
    readdir_res *result;
    namelist nl;

    if (argc != 3) {
        fprintf(stderr, "usage: %s host
        directory\n", argv[0]);
        exit(1);
    }

    server = argv[1];
    dir = argv[2];

    /*
     * Create client "handle" used for
     * calling MESSAGEPROG on the server
     * designated on the command line.
     */

    cl = clnt_create(server, DIRPROG, DIRVERS, "tcp");

    if (clnt == (CLIENT *)NULL) {
        clnt_pcreateerror(server);
        exit(1);
    }

    result = readdir_1(&dir, clnt);

    if (result == (readdir_res *)NULL) {
        clnt_perror(clnt, server);
        exit(1);
    }

    /* Okay, we successfully called
     * the remote procedure.
     */

    if (result->errno != 0) {
```

```
/* Remote system error. Print
 * error message and die.
 */

errno = result->errno;
perror(dir);
exit(1);
}

/* Successfully got a directory listing.
 * Print it.
 */

for (nl = result->readdir_res_u.list;
     nl != NULL;
     nl = nl->next) {
    printf("%s\n", nl->name);
}

xdr_free(xdr_readdir_res, result);
clnt_destroy(cl);
exit(0);
}
```

As in other examples, execution is on systems named local and remote. The files are compiled and run as follows:

```
remote$ rpcgen dir.x
remote$ cc -c dir_xdr.c
remote$ cc rls.c dir_clnt.c dir_xdr.o -o rls -lnsl
remote$ cc dir_svc.c dir_proc.c dir_xdr.o -o dir_svc -lnsl
remote$ dir_svc
```

When you install `rls` on system local, you can list the contents of `/usr/share/lib` on system remote as follows:

```
local$ rls remote /usr/share/lib
ascii
eqnchar
greek
kbd
marg8
tabclr
tabs
tabs4
local$
```

`rpcgen` generated client code does not release the memory allocated for the results of the RPC call. Call `xdr_free()` to release the memory when you are finished with it. It is similar to calling the `free()` routine, except that you pass the XDR routine for the result. In this example, after printing the list, `xdr_free(xdr_readdir_res, result);` was called.

Note - Use `xdr_free()` to release memory allocated by `malloc()`. Failure to use `xdr_free to()` release memory results in memory leaks.

Preprocessing Directives

`rpcgen` supports C and other preprocessing features. C preprocessing is

performed on `rpcgen` input files before they are compiled. All standard C preprocessing directives are allowed in the `.x` source files. Depending on the type of output file being generated, five symbols are defined by `rpcgen`. `rpcgen` provides an additional preprocessing feature: any line that begins with a percent sign (%) is passed directly to the output file, with no action on the line's content. Caution is required because `rpcgen` does not always place the lines where you intend. Check the output source file and, if needed, edit it.

The following symbols may be used to process file specific output:

```
RPC_HDR
    -- Header file output
RPC_XDR
    -- XDR routine output
RPC_SVC
    -- Server stub output
RPC_CLNT
    -- Client stub output
RPC_TB
    -- Index table output
```

The following example illustrates the use of `rpcgen`'s pre-processing features.

```
/*
 * time.x: Remote time protocol
 */
program TIMEPROG {
    version TIMEVERS {
        unsigned int TIMEGET() = 1;
    } = 1;
} = 0x20000044;

#ifdef RPC_SVC
%int *
%timeget_1()
%{
% static int thetime;
%
% thetime = time(0);
% return (&thetime);
%}
#endif
```

cpp Directives

`rpcgen` supports C preprocessing features. `rpcgen` defaults to use `/usr/ccs/lib/cpp` as the C preprocessor. If that fails, `rpcgen` tries to use `/lib/cpp`. You may specify a library containing a different `cpp` to `rpcgen` with the `-Y` flag.

For example, if `/usr/local/bin/cpp` exists, you can specify it to `rpcgen` as follows:

```
rpcgen -Y /usr/local/bin test.x
```

Compile-Time Flags

This section describes the `rpcgen` options available at compile time. The following table summarizes the options which are discussed in this section.

Option	Flag	Comments
C-style	'-' N	Also called Newstyle mode
ANSI C	'-' C	Often used with the -N option
MT-Safe code	'-' M	For use in multithreaded environments
MT Auto mode	'-' A	-A also turns on -M option
TS-RPC library	'-' b	TI-RPC library is default
<code>xdr_inline count</code>	'-' i	Uses 5 packed elements as default, but other number may be specified

Client and Server Templates

`rpcgen` generates sample code for the client and server sides. Use these options to generate the desired templates.

Flag	Function
'-' a	Generate all template files
'-' Sc	Generate client-side template
'-' Ss	Generate server-side template
'-' Sm	Generate makefile template

The files can be used as guides or by filling in the missing parts. These files are in addition to the stubs generated.

Example `rpcgen` compile options/templates

A C-style mode server template is generated from the `add.x` source by the command:

```
rpcgen -N -Ss -o add_server_template.c add.x
```

The result is stored in the file `add_server_template.c`.

A C-style mode, client template for the same `add.x` source is generated with the command line:

```
rpcgen -N -Sc -o add_client_template.c add.x
```

The result is stored in the file `add_client_template.c`.

A make file template for the same `add.x` source is generated with the command line:

```
rpcgen -N -Sm -o mkfile_template add.x
```

The result is stored in the file `mkfile_template`. It can be used to compile the client and the server. If the `-a` flag is used as follows:

```
rpcgen -N -a add.x
```

`rpcgen` generates all three template files. The client template goes into `add_client.c`, the server template to `add_server.c`, and the makefile template to `makefile.a`. If any of these files already exists, `rpcgen` displays an error message and exits.

Note - When you generate template files, give them new names to avoid the files being overwritten the next time `rpcgen` is executed.

Recommended Reading

The book *Power Programming with RPC* by John Bloomer, O'Reilly and Associates, 1992, is the most comprehensive on the topic and is essential reading for further RPC programming.

Exercises

Exercise 12834

Use `rpcgen` to generate and compile the `rprintmsg` listing example given in this chapter.

Exercise 12835

Use `rpcgen` to generate and compile the `dir` listing example given in this chapter.

Exercise 12836

Develop a Remote Procedure Call suite of programs that enables a user to search for specific files or filtered files in a remote directory. That is to say you can search for a named file *e.g. file.c* or all files named `*.c` or even `*.x`.

Exercise 12837

Develop a Remote Procedure Call suite of programs that enables a user to `grep` files remotely. You may use code developed previously or unix system calls to implement `grep`.

Exercise 12838

Develop a Remote Procedure Call suite of programs that enables a user to *list* the contents of a named remote files.

Dave Marshall
1/5/1999

Subsections

- [Header files](#)
 - [External variables and functions](#)
 - [Scope of externals](#)
 - [Advantages of Using Several Files](#)
 - [How to Divide a Program between Several Files](#)
 - [Organisation of Data in each File](#)
 - [The Make Utility](#)
 - [Make Programming](#)
 - [Creating a makefile](#)
 - [Make macros](#)
 - [Running Make](#)
-

Writing Larger Programs

This Chapter deals with theoretical and practical aspects that need to be considered when writing larger programs.

When writing large programs we should divide programs up into modules. These would be separate source files. `main()` would be in one file, `main.c` say, the others will contain functions.

We can create our own library of functions by writing a *suite* of subroutines in one (or more) modules. In fact modules can be shared amongst many programs by simply including the modules at compilation as we will see shortly..

There are many advantages to this approach:

- the modules will naturally divide into common groups of functions.
- we can compile each module separately and link in compiled modules (more on this later).
- UNIX utilities such as **make** help us maintain large systems (see later).

Header files

If we adopt a modular approach then we will naturally want to keep variable definitions, function prototypes *etc.* with each module. However what if several modules need to share such definitions?

It is best to centralise the definitions in one file and share this file amongst the modules. Such a file is usually called a **header file**.

Convention states that these files have a `.h` suffix.

We have met standard library header files already *e.g.*:

```
#include <stdio.h>
```

We can define our own header files and include then our programs via:

```
#include ``my_head.h''
```

NOTE: Header files usually **ONLY** contain definitions of data types, function prototypes and C preprocessor commands.

Consider the following simple example of a large program (Fig. 34.1) .

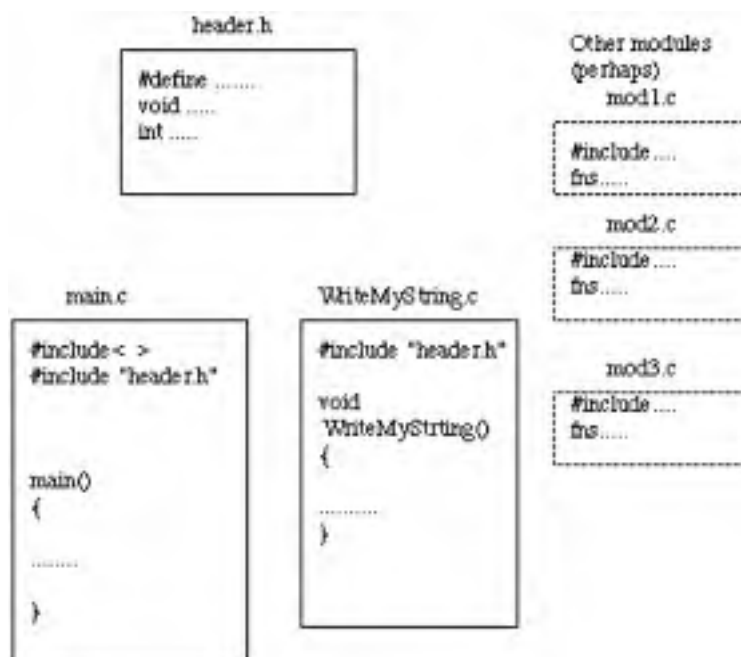

Fig. 34.1 Modular structure of a C program The full listings `main.c`, `WriteMyString.c` and `header.h` as as follows:

main.c:

```
/*
 * main.c
 */
#include "header.h"
#include <stdio.h>

char *AnotherString = "Hello Everyone";

main()
{
    printf("Running...\n");

    /*
     * Call WriteMyString() - defined in another file
     */
    WriteMyString(MY_STRING);

    printf("Finished.\n");
}
```

WriteMyString.c:

```
/*
 * WriteMyString.c
 */
extern char *AnotherString;

void WriteMyString(ThisString)
char *ThisString;
{
    printf("%s\n", ThisString);
    printf("Global Variable = %s\n", AnotherString);
}
```

header.h:

```
/*
 * header.h
 */
#define MY_STRING "Hello World"

void WriteMyString();
```

We would usually compile each module separately (more later).

Some modules have a `#include "header.h"` that share common definitions.

Some, like *main.c*, also include standard header files also.

`main` calls the function `WriteMyString()` which is in *WriteMyString.c* module.

The function prototype `void` for `WriteMyString` is defined in *Header.h*

NOTE that in general we must resolve a tradeoff between having a desire for each `.c` module to have access to the information it needs solely for its job and the practical reality of maintaining lots of header files.

Up to some moderate program size it is probably best to one or two header files that share more than one modules definitions.

For larger programs get UNIX to help you (see later).

One problem left with module approach:

SHARING VARIABLES

If we have global variables declared and instantiated in one module how can pass knowledge of this to other modules.

We could pass values as parameters to functions, BUT:

- this can be laborious if we pass the same parameters to many functions and / or if there are long argument lists involved.

- very large arrays and structures are difficult to store locally -- memory problems with stack.

External variables and functions

``Internal'' implies arguments and functions are defined inside functions --

Local

``External'' variables are defined outside of functions -- they are potentially available to the whole program (Global) but **NOT necessarily**.

External variables are always permanent.

NOTE: That in C, all function definitions are external. We CANNOT have embedded function declarations like in PASCAL.

Scope of externals

An external variable (or function) is not always totally global.

C applies the following rule:

The scope of an external variable (or function) begins at its point of declaration and lasts to the end of the file (module) it is declared in.

Consider the following:

```
main()
{ .... }

int what_scope;
float end_of_scope[10]

void what_global()
{ .... }

char alone;

float fn()
{ .... }
```

main cannot see what_scope or end_of_scope but the functions what_global and fn can. ONLY fn can see alone.

This is also the one of the reasons why we should **prototype** functions before the body of code **etc.** is given.

So here main will not know anything about the functions what_global and fn. what_global does not know about fn but fn knows about what_global since it is declared above.

NOTE: The other reason we **prototype** functions is that some

checking can be done the parameters passed to functions.

If we need to refer to an external variable before it is declared or if it is defined in another module we must declare it as an extern variable. **e.g.**

```
extern int what_global
```

So returning to the modular example. We have a global string AnotherString declared in main.c and shared with WriteMyString.c where it is declared extern.

BEWARE the extern prefix is a **declaration** NOT a **definition**. **i.e NO STORAGE** is set aside in memory for an extern variable -- it is just an announcement of the property of a variable.

The actual variable must only be defined once in the whole program -- you can have as many extern declarations as needed.

Array sizes must obviously be given with declarations but are not needed with extern declarations. **e.g.:**

```
main.c:    int arr[100];
```

```
file.c:    extern int arr[];
```

Advantages of Using Several Files

The main advantages of spreading a program across several files are:

- Teams of programmers can work on programs. Each programmer works on a different file.
- An object oriented style can be used. Each file defines a particular type of object as a datatype and operations on that object as functions. The implementation of the object can be kept private from the rest of the program. This makes for well structured programs which are easy to maintain.
- Files can contain all functions from a related group. For Example all matrix operations. These can then be accessed like a function library.
- Well implemented objects or function definitions can be re-used in other programs, reducing development time.
- In very large programs each major function can occupy a file to itself. Any lower level functions used to implement them can be kept in the same file. Then programmers who call the major function need not be distracted by all the lower level work.
- When changes are made to a file, only that file need be re-compiled to rebuild the program. The UNIX make facility is very useful for rebuilding multi-file programs in this way.

How to Divide a Program between Several Files

Where a function is spread over several files, each file will contain one or more functions. One file will include main while the others will contain functions which are called by others. These other files can be treated as a library of functions.

Programmers usually start designing a program by dividing the problem into easily managed sections. Each of these sections might be implemented as one or more functions. All functions from each section will usually live in a single file.

Where objects are implemented as data structures, it is usual to keep all functions which access that object in the same file. The advantages of this are:

- The object can easily be re-used in other programs.
- All related functions are stored together.
- Later changes to the object require only one file to be modified.

Where the file contains the definition of an object, or functions which return values, there is a further restriction on calling these functions from another file. Unless functions in another file are told about the object or function definitions, they will be unable to compile them correctly.

The best solution to this problem is to write a header file for each of the C files. This will have the same name as the C file, but ending in `.h`. The header file contains definitions of all the functions used in the C file.

Whenever a function in another file calls a function from our C file, it can define the function by making a `#include` of the appropriate `.h` file.

Organisation of Data in each File

Any file must have its data organised in a certain order. This will typically be:

- A preamble consisting of `#defined` constants, `#included` header files and `typedefs` of important datatypes.
- Declaration of global and external variables. Global variables may also be initialised here.
- One or more functions.

The order of items is important, since every object must be defined before it can be used. Functions which return values must be defined before they are called. This definition might be one of the following:

- Where the function is defined and called in the same file, a full declaration of the function can be placed ahead of any call to the function.
- If the function is called from a file where it is not defined, a prototype should appear before the call to the function.

A function defined as

```
float find_max(float a, float b, float c)
{ /* etc ... */
```

would have a prototype of

```
float find_max(float a, float b, float c);
```

The prototype may occur among the global variables at the start of the source file. Alternatively it may be declared in a header file which is read in using a `#include`.

It is important to remember that all C objects should be declared before use.

The Make Utility

The *make* utility is an intelligent program manager that maintains integrity of a collection of program modules, a collection of programs or a complete system -- does not have to be programs in practice can be any system of files (*e.g.* chapters of text in book being typeset).

Its main use has been in assisting the development of software systems.

Make was originally developed on UNIX but it is now available on most systems.

NOTE: Make is a programmers utility not part of C language or any language for that matter.

Consider the problem of maintaining a large collection of source files:

```
main.c f1.c ..... fn.c
```

We would normally compile our system via:

```
cc -o main main.c f1.c ..... fn.c
```

However, if we know that some files have been compiled previously and their sources have not changed since then we could try and save overall compilation time by linking in the object code from those files say:

```
cc -o main main.c f1.c ... fi.o .. fj.o ... fn.c
```

We can use the C compiler option (Appendix [□](#)) `-c` to create a `.o` for a given module. For example:

```
cc -c main.c
```

will create a `main.o` file. We do not need to supply any library links here as these are resolved at the linking stage of compilation.

We have a problem in compiling the whole program in this *long hand* way however:

- It is time consuming to compile a .c module -- if the module has been compiled before and not been altered there is no need to recompile it. We can just link the object files in. However, it will not be easy to remember which files are in fact up to date. If we link in an old object file our final executable program will be wrong.
- It is error prone and laborious to type a long compile sequence on the command line. There may be many of our own files to link as well as many system library files. It may be very hard to remember the correct sequence. Also if we make a slight change to our system editing command line can be error prone.

If we use the **make** utility all this control is taken care of by make. In general only modules that have older object files than source files will be recompiled.

Make Programming

Make programming is fairly straightforward. Basically, we write a sequence of commands which describes how our program (or system of programs) can be constructed from source files.

The construction sequence is described in makefiles which contain *dependency rules* and *construction rules*.

A dependency rule has two parts - a left and right side separated by a :

```
left side : right side
```

The `left side` gives the names of a *target(s)* (the names of the program or system files) to be built, whilst the `right side` gives names of files on which the target depends (eg. source files, header files, data files)

If the *target* is **out of date** with respect to the constituent parts, *construction rules* following the dependency rules are obeyed.

So for a typical C program, when a make file is run the following tasks are performed:

1. The makefile is read. Makefile says which object and library files need to be linked and which header files and sources have to be compiled to create each object file.
2. Time and date of each object file are checked against source and header files it depends on. If any source, header file later than object file then files have been altered since last compilation **THEREFORE** recompile object file(s).

3.

Once all object files have been checked the time and date of all object files are checked against executable files. If any later object files will be recompiled.

NOTE: Make files can obey any commands we type from command line. Therefore we can use makefiles to do more than just compile a system source module. For example, we could make backups of files, run programs if data files have been changed or clean up directories.

Creating a makefile

This is fairly simple: just create a text file using any text editor. The *makefile* just contains a list of file dependencies and commands needed to satisfy them.

Lets look at an example makefile:

```
prog: prog.o f1.o f2.o
    c89 prog.o f1.o f2.o -lm etc.

prog.o: header.h prog.c
    c89 -c prog.c

f1.o: header.h f1.c
    c89 -c f1.c

f2.o: ---
    ----
```

Make would interpret the file as follows:

1.

prog depends on 3 files: prog.o, f1.o and f2.o. If any of the object files have been changed since last compilation the files must be relinked.

2.

prog.o depends on 2 files. If these have been changed prog.o must be recompiled. Similarly for f1.o and f2.o.

The last 3 commands in the makefile are called *explicit rules* -- since the files in commands are listed by name.

We can use *implicit rules* in our makefile which let us generalise our rules and save typing.

We can take

```
f1.o: f1.c
    cc -c f1.c

f2.o: f2.c
    cc -c f2.c
```

and generalise to this:

```
.c.o:    cc -c $<
```

We read this as `.source_extension.target_extension: command`

`$<` is shorthand for file name with `.c` extension.

We can put comments in a makefile by using the `#` symbol. All characters following `#` on line are ignored.

Make has many built in commands similar to or actual UNIX commands. Here are a few:

```
break      date      mkdir

> type     chdir     mv (move or rename)
          cd       rm (remove)    ls
          cp (copy)  path
```

There are many more see manual pages for make (online and printed reference)

Make macros

We can define *macros* in make -- they are typically used to store source file names, object file names, compiler options and library links.

They are simple to define, *e.g.*:

```
SOURCES    = main.c f1.c f2.c
CFLAGS     = -g -C
LIBS       = -lm
PROGRAM    = main
OBJECTS     = (SOURCES: .c = .o)
```

where `(SOURCES: .c = .o)` makes `.c` extensions of `SOURCES` `.o` extensions.

To reference or invoke a macro in make do `$(macro_name)`. *e.g.*:

```
$(PROGRAM) : $(OBJECTS)
$(LINK.C) -o $@ $(OBJECTS) $(LIBS)
```

NOTE:

- `$(PROGRAM) : $(OBJECTS)` - makes a list of dependencies and targets.
- The use of an internal macros *i.e.* `$$`.

There are many internal macros (see manual pages) here a few common ones:

```
$$      -- file name part of current dependent (minus .suffix).
$$      -- full target name of current target.
$$<    -- .c file of target.
```

An example makefile for the WriteMyString modular program discussed in the above is as follows:

```
#
# Makefile
#
SOURCES.c= main.c WriteMyString.c
INCLUDES=
CFLAGS=
SLIBS=
PROGRAM= main

OBJECTS= $(SOURCES.c:.c=.o)

.KEEP_STATE:

debug := CFLAGS= -g

all debug: $(PROGRAM)

$(PROGRAM): $(INCLUDES) $(OBJECTS)
    $(LINK.c) -o $$ $(OBJECTS) $(SLIBS)

clean:
    rm -f $(PROGRAM) $(OBJECTS)
```

Running Make

Simply type `make` from command line.

UNIX automatically looks for a file called `Makefile` (note: capital M rest lower case letters).

So if we have a file called `Makefile` and we type `make` from command line. The `Makefile` in our current directory will get executed.

We can override this search for a file by typing `make -f make_filename`

e.g. `make -f my_make`

There are a few more `-options` for makefiles -- see manual pages.

Dave Marshall
1/5/1999

About this document ...

**Hands On: C/C++ Programming and
Unix Application Design:
UNIX System Calls and Subroutines using C,
Motif, C++**

This document was generated using the [LaTeX2HTML](#) translator Version 97.1
(release) (July 13th, 1997)

Copyright © 1993, 1994, 1995, 1996, 1997, [Nikos Drakos](#), Computer Based
Learning Unit, University of Leeds.

The command line arguments were:

latex2html -split 3 -no_navigation C.

The translation was initiated by Dave Marshall on 1/5/1999

Dave Marshall
1/5/1999

Subsections

- [History of C](#)
 - [Characteristics of C](#)
 - [C Program Structure](#)
 - [Variables](#)
 - [Defining Global Variables](#)
 - [Printing Out and Inputting Variables](#)
 - [Constants](#)
 - [Arithmetic Operations](#)
 - [Comparison Operators](#)
 - [Logical Operators](#)
 - [Order of Precedence](#)
 - [Exercises](#)
-

C Basics

Before we embark on a brief tour of C's basic syntax and structure we offer a brief history of C and consider the characteristics of the C language.

In the remainder of the Chapter we will look at the basic aspects of C programs such as C program structure, the declaration of variables, data types and operators. We will assume knowledge of a high level language, such as PASCAL.

It is our intention to provide a quick guide through similar C principles to most high level languages. Here the syntax may be slightly different but the concepts exactly the same.

C does have a few surprises:

- Many High level languages, like PASCAL, are highly disciplined and structured.
- **However beware** -- C is much more flexible and free-wheeling. This freedom gives C much more **power** that experienced users can employ. The above example below (`mystery.c`) illustrates how bad things could really get.

History of C

The *milestones* in C's development as a language are listed below:

- UNIX developed c. 1969 -- DEC PDP-7 Assembly Language
- BCPL -- a user friendly OS providing powerful development tools developed from BCPL. Assembler tedious long and error prone.
- A new language ``B" a second attempt. c. 1970.
- A totally new language ``C" a successor to ``B". c. 1971

- By 1973 UNIX OS almost totally written in ``C".

Characteristics of C

We briefly list some of C's characteristics that define the language and also have led to its popularity as a programming language. Naturally we will be studying many of these aspects throughout the course.

- Small size
- Extensive use of function calls
- Loose typing -- unlike PASCAL
- Structured language
- Low level (BitWise) programming readily available
- Pointer implementation - extensive use of pointers for memory, array, structures and functions.

C has now become a widely used professional language for various reasons.

- It has high-level constructs.
- It can handle low-level activities.
- It produces efficient programs.
- It can be compiled on a variety of computers.

Its main drawback is that it has poor error detection which can make it off putting to the beginner. However diligence in this matter can pay off handsomely since having learned the rules of C we can break them. Not many languages allow this. This if done properly and carefully leads to the power of C programming.

As an extreme example the following C code (`mystery.c`) is actually *legal C* code.

```
#include <stdio.h>

main(t,_,a)
char *a;
{return!0<t?t<3?main(-79,-13,a+main(-87,1-_,
main(-86, 0, a+1 )+a)):1,t<_?main(t+1,_, a ):3,main ( -94, -27+t
)&&t == 2 ?_<13 ?main ( 2, _+1, "%s %d %d\n" ):9:16:t<0?t<-72?mai
t,"@n'+,#'/*{}w+/w#cdnr/+,{}r/*de}+,*{**+,/w#{+,/w#q#n+,/#{1,+,/n
,/+#n+,/#;#q#n+,/+k#;*,/r : 'd*'3,}{w+K w'K:'+}e#';dq#'l q#'d'K
+k#;q#'r}eKK#}w'r}eKK{nl}'/#;#q#n')}{#}w')}{nl}'/+n';d}rw' i;#
l}!/n{n#'; r{#w'r nc{nl}'/{l,+K {rw' iK;[{nl}'/w#q#\
n'wk nw' iwK{KK{nl}!/w{%l##w# ' i; :{nl}'/*{q#ld;r'}{nlwb!/*de}'
; ;{nl}'-{}rw]'+,}##'*)#nc,' #nw]'+kd'+e}+;\
#'rdq#w! nr'/ ' ) }+}{rl#{n' ' )# }'+}##(!!/"
:t<-50?_==*a ?putchar(a[31]):main(-65,_,a+1):main((*a == '/')+t,
+1 ):0<t?main ( 2, 2 , "%s"):*a=='/'|main(0,main(-61,*a, "!ek;dc
i@bK'(q)-[w]*%n+r3#l,{}:\nuwloca-0;m .vpbks,fxntdCeghiry"),a+1);}
```

It will compile and run and produce meaningful output. Try this program out. Try to compile and run it yourself. [Alternatively you may run it from here and see the output.](#)

Clearly nobody ever writes code like or at least should never. This piece of code actually one an international Obfuscated C Code Contest <http://reality.sgi.com/csp/iocc> The standard for C programs was originally the features set by Brian Kernighan. In order to make the language more internationally acceptable, an international standard was developed, ANSI C (American National Standards Institute).

C Program Structure

A C program basically has the following form:

- Preprocessor Commands
- Type definitions
- Function prototypes -- declare function types and variables passed to function.
- Variables
- Functions

We must have a `main()` function.

A function has the form:

```
type function_name (parameters)
{
    local variables

    C Statements
}
```

If the type definition is omitted C assumes that function returns an **integer** type. **NOTE:** This can be a source of problems in a program.

So returning to our first C program:

```
/* Sample program */
main()
{
    printf( ``I Like C \n'' );
    exit ( 0 );
}
```

NOTE:

- C requires a semicolon at the end of **every** statement.
- `printf` is a **standard** C function -- called from `main`.
- `\n` signifies newline. **Formatted output** -- more later.

- `exit()` is also a standard function that causes the program to terminate. Strictly speaking it is not needed here as it is the last line of `main()` and the program will terminate anyway.

Let us look at another printing statement:

```
printf(``. \n.1 \n..2 \n...3 \n');
```

The output of this would be:

```
.  
.1  
..2  
...3
```

Variables

C has the following simple data types:

C type	Size (bytes)	Lower bound	Upper bound
char	1	—	—
unsigned char	1	0	255
short int	2	-32768	+32767
unsigned short int	2	0	65536
(long) int	4	-2^{31}	$+2^{31} - 1$
float	4	$-3.2 \times 10^{+38}$	$+3.2 \times 10^{+38}$
double	8	$-1.7 \times 10^{+308}$	$+1.7 \times 10^{+308}$

The Pascal Equivalents are:

C type	Pascal equivalent
char	char
unsigned char	—
short int	integer
unsigned short int	—
long int	longint
float	real
double	extended

On UNIX systems all `ints` are `long ints` unless specified as `short int` explicitly.

NOTE: There is **NO** Boolean type in C -- you should use `char`, `int` or (better) `unsigned char`.

`Unsigned` can be used with all `char` and `int` types.

To declare a variable in C, do:

```
var_type list variables;
```

```
e.g. int i,j,k;  
     float x,y,z;  
     char ch;
```

Defining Global Variables

Global variables are defined above `main()` in the following way:-

```
        short number,sum;  
int bignumber,bigsum;  
char letter;  
  
main()  
{  
  
}
```

It is also possible to pre-initialise global variables using the `=` operator for assignment.

NOTE: The `=` operator is the same as `:=` is Pascal.

For example:-

```
        float sum=0.0;  
int bigsum=0;  
char letter='A';  
  
main()  
{  
  
}
```

This is the same as:-

```
        float sum;  
int bigsum;  
char letter;  
  
main()  
{  
  
    sum=0.0;  
    bigsum=0;  
    letter='A';  
  
}
```

...but is more efficient.

C also allows multiple assignment statements using `=`, for example:

```
a=b=c=d=3;
```

...which is the same as, but more efficient than:

```
        a=3;
b=3;
c=3;
d=3;
```

This kind of assignment is only possible if all the variable types in the statement are the same.

You can define your own types use typedef. This will have greater relevance later in the course when we learn how to create more complex data structures.

As an example of a simple use let us consider how we may define two new types real and letter. These new types can then be used in the same way as the pre-defined C types:

```
        typedef real float;
        typedef letter char;
```

Variables declared:

```
        real sum=0.0;
        letter nextletter;
```

Printing Out and Inputting Variables

C uses formatted output. The `printf` function has a special formatting character (%) -- a character following this defines a certain format for a variable:

```
        %c -- characters
        %d -- integers
        %f -- floats
```

e.g. `printf(``%c %d %f'',ch,i,x);`

NOTE: Format statement enclosed in ``...'', variables follow after. Make sure order of format and variable data types match up.

`scanf()` is the function for inputting values to a data structure: Its format is similar to `printf`:

i.e. `scanf(``%c %d %f'',&ch,&i,&x);`

NOTE: `&` before variables. Please accept this for now and **remember** to include it. It is to do with pointers which we will meet later (Section [17.4.1](#)).

Constants

ANSI C allows you to declare *constants*. When you declare a constant it is a bit like a variable declaration except the value cannot be changed.

The `const` keyword is to declare a constant, as shown below:

```
int const a = 1;
const int a =2;
```

Note:

- You can declare the `const` before or after the type. Choose one and stick to it.
- It is usual to initialise a `const` with a value as it cannot get a value *any other way*.

The preprocessor `#define` is another more flexible (see Preprocessor Chapters) method to define *constants* in a program.

You frequently see `const` declaration in function parameters. This says simply that the function is **not** going to change the value of the parameter.

The following function definition used concepts we have not met (see chapters on functions, strings, pointers, and standard libraries) but for completeness of this section it is included here:

```
void strcpy(char *buffer, char const *string)
```

The second argument `string` is a C string that will not be altered by the string copying standard library function.

Arithmetic Operations

As well as the standard arithmetic operators (+ - * /) found in most languages, C provides some more operators. There are some notable differences with other languages, such as Pascal.

Assignment is = *i.e.* `i = 4; ch = 'y';`

Increment ++, Decrement - which are more efficient than their long hand equivalents, for example:- `x++` is faster than `x=x+1`.

The ++ and - operators can be either in post-fixed or pre-fixed. With pre-fixed the value is computed before the expression is evaluated whereas with post-fixed the value is computed after the expression is evaluated.

In the example below, `++z` is pre-fixed and the `w-` is post-fixed:

```
int x,y,w;

main()
{
    x=((++z)-(w-)) % 100;
}
```

This would be equivalent to:

```
int x,y,w;

main()
{
    z++;
    x=(z-w) % 100;
    w-;
}
```

The % (modulus) operator only works with integers.

Division / is for both integer and float division. So be careful.

The answer to: $x = 3 / 2$ is 1 even if x is declared a float!!

RULE: If both arguments of / are integer then do integer division.

So make sure you do this. The correct (for division) answer to the above is $x = 3.0 / 2$ or $x = 3 / 2.0$ or (better) $x = 3.0 / 2.0$.

There is also a convenient **shorthand** way to express computations in C.

It is very common to have expressions like: $i = i + 3$ or $x = x * (y + 2)$

This can written in C (generally) in a **shorthand** form like this:

$$expr_1 op = expr_2$$

which is equivalent to (but more efficient than):

$$expr_1 = expr_1 op expr_2$$

So we can rewrite $i = i + 3$ as $i += 3$

and $x = x * (y + 2)$ as $x *= y + 2$.

NOTE: that $x *= y + 2$ means $x = x * (y + 2)$ and **NOT** $x = x * y + 2$.

Comparison Operators

To test for equality is ==

A warning: Beware of using ``=''' instead of ``=='', such as writing accidentally

```
if ( i = j ) .....
```

This is a perfectly **LEGAL** C statement (syntactically speaking) which copies the value in "j" into "i", and delivers this value, which will then be interpreted as TRUE if j is non-zero. This is called **assignment by value** -- a key feature of C.

Not equals is: !=

Other operators < (less than) , > (grater than), <= (less than or equals), >= (greater than or equals) are as usual.

Logical Operators

Logical operators are usually used with conditional statements which we shall meet in the next Chapter.

The two basic logical operators are:

&& for logical AND, || for logical OR.

Beware & and | have a different meaning for bitwise AND and OR (*more on this later* in Chapter [12](#)).

Order of Precedence

It is necessary to be careful of the meaning of such expressions as $a + b * c$

We may want the effect as either

$(a + b) * c$

or

$a + (b * c)$

All operators have a priority, and high priority operators are evaluated before lower priority ones. Operators of the same priority are evaluated from left to right, so that

$a - b - c$

is evaluated as

$(a - b) - c$

as you would expect.

From high priority to low priority the order for all C operators (we have not met all of them yet) is:

```
( ) [ ] -> .  
! ~ - * & sizeof cast ++ -  
      (these are right->left)  
* / %  
+ -  
< <= >= >  
== !=  
&  
& |
```

```

- - .
&&
||
?:      (right->left)
= += -= (right->left)
,      (comma)

```

Thus

```
a < 10 && 2 * b < c
```

is interpreted as

```
( a < 10 ) && ( ( 2 * b ) < c )
```

and

```

a =
b =
  spokes / spokes_per_wheel
  + spares;

```

as

```

a =
( b =
  ( spokes / spokes_per_wheel )
  + spares
);

```

Exercises

Write C programs to perform the following tasks.

Exercise 12270

Input two numbers and work out their sum, average and sum of the squares of the numbers.

Exercise 12271

Input and output your name, address and age to an appropriate structure.

Exercise 12272

Write a program that works out the largest and smallest values from a set of 10 inputted numbers.

Exercise 12273

Write a program to read a "float" representing a number of degrees Celsius, and print as a "float" the equivalent temperature in degrees Fahrenheit. Print your results in a form such as

100.0 degrees Celsius converts to 212.0 degrees Fahrenheit.

Exercise 12274

Write a program to print several lines (such as your name and address). You may use either several printf instructions, each with a newline character in it, or one printf with several newlines in the string.

Exercise 12275

Write a program to read a positive integer at least equal to 3, and print out all possible permutations of three positive integers less or equal to than this value.

Exercise 12276

Write a program to read a number of units of length (a float) and print out the area of a circle of that radius. Assume that the value of pi is 3.14159 (an appropriate declaration will be given you by ceilidh - select setup).

Your output should take the form: The area of a circle of radius ... units is ... units.

If you want to be clever, and have looked ahead in the notes, print the message Error: Negative values not permitted. if the input value is negative.

Exercise 12277

Given as input a floating (real) number of centimeters, print out the equivalent number of feet (integer) and inches (floating, 1 decimal), with the inches given to an accuracy of one decimal place.

Assume 2.54 centimeters per inch, and 12 inches per foot.

If the input value is 333.3, the output format should be:

333.3 centimeters is 10 feet 11.2 inches.

Exercise 12278

Given as input an integer number of seconds, print as output the equivalent time in hours, minutes and seconds. Recommended output format is something like

7322 seconds is equivalent to 2 hours 2 minutes 2 seconds.

Exercise 12279

Write a program to read two integers with the following significance.

The first integer value represents a time of day on a 24 hour clock, so that 1245 represents quarter to one mid-day, for example.

The second integer represents a time duration in a similar way, so that 345 represents three hours and 45 minutes.

This duration is to be added to the first time, and the result printed out in the same notation, in this case 1630 which is the time 3 hours and 45 minutes after 12.45.

Typical output might be Start time is 1415. Duration is 50. End time is 1505.

There are a few extra marks for spotting.

Start time is 2300. Duration is 200. End time is 100.

Dave Marshall
1/5/1999

Subsections

- [The `if` statement](#)
 - [The `?` operator](#)
 - [The `switch` statement](#)
 - [Exercises](#)
-

Conditionals

This Chapter deals with the various methods that C can control the *flow* of logic in a program. Apart from slight syntactic variation they are similar to other languages.

As we have seen following logical operations exist in C:

`==`, `!=`, `||`, `&&`.

One other operator is the unitary - it takes only one argument - *not* !.

These operators are used in conjunction with the following statements.

The `if` statement

The `if` statement has the same function as other languages. It has three basic forms:

```
if (expression)
    statement
```

...or:

```
if (expression)
    statement1
else
    statement2
```

...or:

```
if (expression)
    statement1
else if (expression)
    statement2
else
    statement3
```

For example:-

```
int x, y, w;

main()
{
    if (x>0)
    {
        z=w;
        .....
    }
    else
    {
        z=y;
        .....
    }
}
```

The ? operator

The ? (*ternary condition*) operator is a more efficient form for expressing simple `if` statements. It has the following form:

$$expression_1 \text{ ? } expression_2 \text{ : } expression_3$$

It simply states:

$$\text{if } expression_1 \text{ then } expression_2 \text{ else } expression_3$$

For example to assign the maximum of `a` and `b` to `z`:

$$z = (a>b) \text{ ? } a \text{ : } b;$$

which is the same as:

```
if (a>b)
    z = a;
else
    z=b;
```

The switch statement

The C `switch` is similar to Pascal's `case` statement and it allows multiple choice of a selection of items at one level of a conditional where it is a far neater way of writing multiple `if` statements:

```
switch (expression) {
    case item1:
```

```
    statement1;  
    break;  
case item2:  
    statement2;  
    break;  
    ⋮           ⋮           case itemn:  
    statementn;  
    break;  
default:  
    statement;  
    break;  
}
```

In each case the value of *item_i* must be a constant, variables are not allowed.

The `break` is needed if you want to terminate the `switch` after execution of one choice. Otherwise the next case would get evaluated. **Note:** This is unlike most other languages.

We can also have **null** statements by just including a `;` or let the switch statement **fall through** by omitting any statements (see *e.g.* below).

The `default` case is optional and catches any other cases.

For example:-

```
    switch (letter)  
{  
case `A`:  
case `E`:  
case `I`:  
case `O`:  
case `U`:  
    numberofvowels++;  
    break;  
  
case ` `:  
    numberofspaces++;  
    break;  
  
default:  
    numberofconstants++;  
    break;  
}
```

In the above example if the value of `letter` is ``A'`, ``E'`, ``I'`, ``O'` or ``U'` then `numberofvowels` is incremented.

If the value of `letter` is `` '` then `numberofspaces` is incremented.

If none of these is true then the default condition is executed, that is `numberofconstants` is incremented.

Exercises

Exercise 12304

Write a program to read two characters, and print their value when interpreted as a 2-digit hexadecimal number. Accept upper case letters for values from 10 to 15.

Exercise 12305

Read an integer value. Assume it is the number of a month of the year; print out the name of that month.

Exercise 12306

Given as input three integers representing a date as day, month, year, print out the number day, month and year for the following day's date.

Typical input: 28 2 1992 Typical output: Date following 28:02:1992 is 29:02:1992

Exercise 12307

Write a program which reads two integer values. If the first is less than the second, print the message up. If the second is less than the first, print the message down. If the numbers are equal, print the message equal. If there is an error reading the data, print a message containing the word Error and perform `exit(0);`

Dave Marshall
1/5/1999

Subsections

- [The for statement](#)
 - [The while statement](#)
 - [The do-while statement](#)
 - [break and continue](#)
 - [Exercises](#)
-

Looping and Iteration

This chapter will look at C's mechanisms for controlling looping and iteration. Even though some of these mechanisms may look familiar and indeed will operate in standard fashion most of the time. **NOTE:** some non-standard features are available.

The for statement

The C `for` statement has the following form:

```
for (expression1; 2; expression3)
    statement;
or {block of statements}
```

expression₁ initialises; *expression₂* is the terminate test; *expression₃* is the modifier (which may be more than just simple increment);

NOTE: C basically treats `for` statements as `while` type loops

For example:

```
int x;

main()
{
    for (x=3; x>0; x-)
    {
        printf("x=%d\n", x);
    }
}
```

...outputs:

```
x=3
x=2
x=1
```

...to the screen

All the following are legal for statements in C. The practical application of such statements is not important here, we are just trying to illustrate peculiar features of C for that may be useful:-

```
for (x=0; ((x>3) && (x<9)); x++)  
  
for (x=0,y=4; ((x>3) && (y<9)); x++,y+=2)  
  
for (x=0,y=4,z=4000;z; z/=10)
```

The second example shows that multiple expressions can be separated a ,.

In the third example the loop will continue to iterate until z becomes 0;

The while statement

The `while` statement is similar to those used in other languages although more can be done with the `expression` statement -- a standard feature of C.

The `while` has the form:

```
while (expression)  
    statement
```

For example:

```
int x=3;  
  
main()  
{ while (x>0)  
    { printf("x=%d\n", x);  
      x-;  
    }  
}
```

...outputs:

```
x=3  
x=2  
x=1
```

...to the screen.

Because the `while` loop can accept expressions, not just conditions, the following are all legal:-

```
while (x-);  
while (x=x+1);  
while (x+=5);
```

Using this type of expression, only when the result of `x-`, `x=x+1`, or `x+=5`, evaluates to 0 will the while condition fail and the loop be exited.

We can go further still and perform complete operations within the while **expression**:

```
while (i++ < 10);

while ( (ch = getchar()) != 'q')
    putchar(ch);
```

The first example counts `i` up to 10.

The second example uses C standard library functions (See Chapter 18) `getchar()` - reads a character from the keyboard - and `putchar()` - writes a given char to screen. The while loop will proceed to read from the keyboard and echo characters to the screen until a 'q' character is read. **NOTE:** This type of operation is used a lot in C and not just with character reading!! (See Exercises).

The do-while statement

C's do-while statement has the form:

```
do
    statement;
while (expression);
```

It is similar to PASCAL's repeat ... until **except** do while **expression** is true.

For example:

```
int x=3;

main()
{ do {
    printf("x=%d\n", x-);
}
while (x>0);
}
```

..outputs:-

```
x=3
x=2
x=1
```

NOTE: The postfix `x-` operator which uses the current value of `x` while printing and **then** decrements `x`.

break and continue

C provides two commands to control how we loop:

- `break` -- exit form loop or switch.
- `continue` -- skip 1 iteration of loop.

Consider the following example where we read in integer values and process them according to the following conditions. If the value we have read is negative, we wish to print an error message and abandon the loop. If the value read is great than 100, we wish to ignore it and continue to the next value in the data. If the value is zero, we wish to terminate the loop.

```
while (scanf( ``%d'', &value ) == 1 && value != 0) {  
    if (value < 0) {  
        printf( ``Illegal value\n'' );  
        break;  
        /* Abandon the loop */  
    }  
    if (value > 100) {  
        printf( ``Invalid value\n'' );  
        continue;  
        /* Skip to start loop again */  
    }  
    /* Process the value read */  
    /* guaranteed between 1 and 100 */  
    ....;  
    ....;  
} /* end while value != 0 */
```

Exercises

Exercise 12327

Write a program to read in 10 numbers and compute the average, maximum and minimum values.

Exercise 12328

Write a program to read in numbers until the number -999 is encountered. The sum of all number read until this point should be printed out.

Exercise 12329

Write a program which will read an integer value for a base, then read a positive integer written to that base and print its value.

Read the second integer a character at a time; skip over any leading non-valid (i.e. not a digit between zero and ``base-1") characters, then read valid characters until an invalid one is encountered.

Input	Output
10 1234	1234
8 77	63 (the value of 77 in base 8, octal)
2 1111	15 (the value of 1111 in base 2, binary)

The base will be less than or equal to 10.

Exercise 12330

Read in three values representing respectively

a capital sum (integer number of pence),

a rate of interest in percent (float),

and a number of years (integer).

Compute the values of the capital sum with compound interest added over the given period of years. Each year's interest is calculated as

$\text{interest} = \text{capital} * \text{interest_rate} / 100;$

and is added to the capital sum by

$\text{capital} += \text{interest};$

Print out money values as pounds (pence / 100.0) accurate to two decimal places.

Print out a floating value for the value with compound interest for each year up to the end of the period.

Print output year by year in a form such as:

Original sum 30000.00 at 12.5 percent for 20 years

Year	Interest	Sum
1	3750.00	33750.00
2	4218.75	37968.75
3	4746.09	42714.84
4	5339.35	48054.19
5	6006.77	54060.96
6	6757.62	60818.58
7	7602.32	68420.90
8	8552.61	76973.51
9	9621.68	86595.19
10	10824.39	97419.58

Exercise 12331

Read a positive integer value, and compute the following sequence: If the number is even, halve it; if it's odd, multiply by 3 and add 1. Repeat this process until the value is 1, printing out each value. Finally print out how many of these operations you performed.

Typical output might be:

```
Inital value is 9
Next value is 28
Next value is 14
Next value is 7
Next value is 22
Next value is 11
Next value is 34
Next value is 17
Next value is 52
Next value is 26
Next value is 13
Next value is 40
Next value is 20
Next value is 10
Next value is 5
Next value is 16
Next value is 8
Next value is 4
Next value is 2
Final value 1, number of steps 19
```

If the input value is less than 1, print a message containing the word

```
Error
```

and perform an

```
exit( 0 );
```

Exercise 12332

Write a program to count the vowels and letters in free text given as standard input. Read text a character at a time until you encounter end-of-data.

Then print out the number of occurrences of each of the vowels a, e, i, o and u in the text, the total number of letters, and each of the vowels as an integer percentage of the letter total.

Suggested output format is:

```
Numbers of characters:
a 3 ; e 2 ; i 0 ; o 1 ; u 0 ; rest 17
Percentages of total:
a 13%; e 8%; i 0%; o 4%; u 0%; rest 73%
```

Read characters to end of data using a construct such as

```
char ch;
while(
    ( ch = getchar() ) >= 0
) {
    /* ch is the next character */    ....
}
```

to read characters one at a time using `getchar()` until a negative value is returned.

Exercise 12333

Read a file of English text, and print it out one word per line, all punctuation and non-alpha characters being omitted.

For end-of-data, the program loop should read until "getchar" delivers a value ≤ 0 . When typing input, end the data by typing the end-of-file character, usually control-D. When reading from a file, "getchar" will deliver a negative value when it encounters the end of the file.

Typical output might be

```
Read
a
file
of
English
text
and
print
it
out
one
```

etc.

Dave Marshall
1/5/1999

Subsections

- [Single and Multi-dimensional Arrays](#)
 - [Strings](#)
 - [Exercises](#)
-

Arrays and Strings

In principle arrays in C are similar to those found in other languages. As we shall shortly see arrays are defined slightly differently and there are many subtle differences due the close link between array and pointers. We will look more closely at the link between pointer and arrays later in Chapter [9](#).

Single and Multi-dimensional Arrays

Let us first look at how we define arrays in C:

```
int listofnumbers[50];
```

BEWARE: In C Array subscripts start at **0** and end one less than the array size. For example, in the above case valid subscripts range from 0 to 49. This is a **BIG** difference between C and other languages and does require a bit of practice to get in *the right frame of mind*.

Elements can be accessed in the following ways:-

```
thirdnumber=listofnumbers[2];  
listofnumbers[5]=100;
```

Multi-dimensional arrays can be defined as follows:

```
int tableofnumbers[50][50];
```

for two dimensions.

For further dimensions simply add more []:

```
int bigD[50][50][40][30].....[50];
```

Elements can be accessed in the following ways:

```
anumber=tableofnumbers[2][3];  
tableofnumbers[25][16]=100;
```

Strings

In C Strings are defined as arrays of characters. For example, the following defines a string of 50 characters:

```
char name[50];
```

C has no string handling facilities built in and so the following are all illegal:

```
char firstname[50],lastname[50],fullname[100];

firstname= "Arnold"; /* Illegal */
lastname= "Schwarznegger"; /* Illegal */
fullname= "Mr"+firstname
+lastname; /* Illegal */
```

However, there is a special library of string handling routines which we will come across later.

To print a string we use printf with a special **%s** control character:

```
printf(``%s'',name);
```

NOTE: We just need to give the name of the string.

In order to allow variable length strings the `\0` character is used to indicate the end of a string.

So we if we have a string, `char NAME[50];` and we store the ``DAVE'` in it its contents will look like:

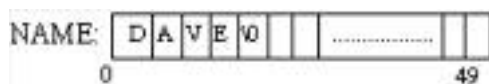

Exercises

Exercise 12335

Write a C program to read through an array of any type. Write a C program to scan through this array to find a particular value.

Exercise 12336

Read ordinary text a character at a time from the program's standard input, and print it with each line reversed from left to right. Read until you encounter end-of-data (see below).

You may wish to test the program by typing

```
prog5rev | prog5rev
```

to see if an exact copy of the original input is recreated.

To read characters to end of data, use a loop such as either

```
char ch;  
while( ch = getchar(), ch >= 0 ) /* ch < 0 indicates end-
```

or

```
char ch;  
while( scanf( "%c", &ch ) == 1 ) /* one character read */
```

Exercise 12337

Write a program to read English text to end-of-data (type control-D to indicate end of data at a terminal, see below for detecting it), and print a count of word lengths, i.e. the total number of words of length 1 which occurred, the number of length 2, and so on.

Define a word to be a sequence of alphabetic characters. You should allow for word lengths up to 25 letters.

Typical output should be like this:

```
length 1 : 10 occurrences  
length 2 : 19 occurrences  
length 3 : 127 occurrences  
length 4 : 0 occurrences  
length 5 : 18 occurrences  
....
```

To read characters to end of data see above question.

Dave Marshall
1/5/1999

Subsections

- [void functions](#)
 - [Functions and Arrays](#)
 - [Function Prototyping](#)
 - [Exercises](#)
-

Functions

C provides functions which are again similar most languages. One difference is that C regards `main()` as function. Also unlike some languages, such as Pascal, C does not have *procedures* -- it uses functions to service both requirements.

Let us remind ourselves of the form of a function:

```
returntype fn_name(parameterdef1, parameterdef2, ...)  
  
{  
    localvariables  
    functioncode  
}
```

Let us look at an example to find the average of two integers:

```
float findaverage(float a, float b)  
{ float average;  
>     average=(a+b)/2;  
     return(average);  
}
```

We would **call** the function as follows:

```
main()  
{     float a=5,b=15,result;  
     result=findaverage(a,b);  
     printf("average=%f\n",result);  
}
```

Note: The return statement passes the result back to the main program.

void functions

The `void` function provide a way of emulating PASCAL type procedures.

If you do not want to return a value you must use the return type `void` and miss out the `return` statement:

```
void squares()
{ int loop;

    for (loop=1;loop<10;loop++);
        printf("%d\n",loop*loop);

}

main()

{    squares();
}
```

NOTE: We must have `()` even for no parameters unlike some languages.

Functions and Arrays

Single dimensional arrays can be passed to functions as follows:-

```
float findaverage(int size,float list[])

{ int i;
  float sum=0.0;

  for (i=0;i<size;i++)
    sum+=list[i];
  return(sum/size);
}
```

Here the declaration `float list[]` tells C that `list` is an array of float. **Note** we do not specify the dimension of the array when it is a **parameter** of a function.

Multi-dimensional arrays can be passed to functions as follows:

```
void printtable(int xsize,int ysize,
               float table[][5])

{ int x,y;

  for (x=0;x<xsize;x++)
  { for (y=0;y<ysize;y++)
    printf("\t%f",table[x][y]);

    printf("\n");
  }
}
```

Here `float table[][5]` tells C that `table` is an array of

dimension $N \times 5$ of float. **Note** we must specify the second (and subsequent) dimension of the array **BUT** not the first dimension.

Function Prototyping

Before you use a function C must have *knowledge* about the type it returns and the parameter types the function expects.

The ANSI standard of C introduced a new (better) way of doing this than previous versions of C. (Note: All new versions of C now adhere to the ANSI standard.)

The importance of prototyping is twofold.

- It makes for more structured and therefore easier to read code.
- It allows the C compiler to check the *syntax* of function calls.

How this is done depends on the scope of the function (See Chapter [34](#)). Basically if a functions has been **defined** before it is used (called) then you are ok to merely use the function.

If NOT then you must *declare* the function. The declaration simply states the type the function returns and the type of parameters used by the function.

It is usual (and therefore **good**) practice to prototype all functions at the start of the program, although this is not strictly necessary.

To *declare* a function prototype simply state the type the function returns, the function name and in brackets list the type of parameters in the order they appear in the function definition.

e.g.

```
int strlen(char []);
```

This states that a function called `strlen` returns an integer value and accepts a single string as a parameter.

NOTE: Functions can be prototyped and variables defined on the same line of code. This used to be more popular in pre-ANSI C days since functions are usually prototyped separately at the start of the program. This is still perfectly legal though: order they appear in the function definition.

e.g.

```
int length, strlen(char []);
```

Here `length` is a variable, `strlen` the function as before.

Exercises

Exercise 12346

Write a function `replace` which takes a pointer to a string as a parameter, which replaces all spaces in that string by minus signs, and delivers the number of spaces it replaced.

Thus

```
char *cat = "The cat sat";
n = replace( cat );
```

should set

```
cat to "The-cat-sat"
```

and

```
n to 2.
```

Exercise 12347

Write a program which will read in the source of a C program from its standard input, and print out all the starred items in the following statistics for the program (all as integers). (Note the comment on tab characters at the end of this specification.)

Print out the following values:

Lines:

- * The total number of lines
- * The total number of blank lines
(Any lines consisting entirely of white space should be considered as blank lines.)
The percentage of blank lines ($100 * \text{blank_lines} / \text{lines}$)

Characters:

- * The total number of characters after tab expansion
- * The total number of spaces after tab expansion
- * The total number of leading spaces after tab expansion
(These are the spaces at the start of a line, before any visible character; ignore them if there are no visible characters)
- The average number of
characters per line
characters per line ignoring leading spaces
leading spaces per line
spaces per line ignoring leading spaces

Comments:

- * The total number of comments in the program
- * The total number of characters in the comments in the program excluding the `"/"` and `"*/"` themselves
The percentage of number of comments to total lines
The percentage of characters in comments to characters

Identifiers:

We are concerned with all the occurrences of "identifiers" in

```
program where each part of the text starting with a letter,
and continuing with letter, digits and underscores is consi-
to be an identifier, provided that it is not
    in a comment,
    or in a string,
    or within primes.
Note that
    "abc\"def"
the internal escaped quote does not close the string.
Also, the representation of the escape character is
    '\\ '
and of prime is
    '\ '

Do not attempt to exclude the fixed words of the language,
treat them as identifiers. Print
* The total number of identifier occurrences.
* The total number of characters in them.
The average identifier length.
```

Indenting:

- * The total number of times either of the following occurs:
 - a line containing a ")" is more indented than the preceding
 - a line is preceded by a line containing a "{" and is less indented than it.
- The "{" and ")" must be ignored if in a comment or string or primes, or if the other line involved is entirely comment. A single count of the sum of both types of error is required.

NOTE: All tab characters ("") on input should be interpreted as multiple spaces using the rule:

```
"move to the next modulo 8 column"
where the first column is numbered column 0.
col before tab | col after tab
-----+-----
          0   |      8
          1   |      8
          7   |      8
          8   |     16
          9   |     16
         15   |     16
         16   |     24
```

To read input a character at a time the skeleton has code incorporated to read a line at a time for you using

```
char ch;
ch = getchar();
```

Which will deliver each character exactly as read. The "getline" function then puts the line just read in the global array of characters "linec", null terminated, and delivers the length of the line, or a negative value if end of data has been encountered.

You can then look at the characters just read with (for example)

```
switch( linec[0] ) {
case ' ': /* space ..... */
    break;
case '\t': /* tab character .... */
    break;
case '\n': /* newline ... */
    break;
....
} /* end switch */
```

End of data is indicated by scanf NOT delivering the value 1.

Your output should be in the following style:

Total lines	126
Total blank lines	3
Total characters	3897
Total spaces	1844
Total leading spaces	1180
Total comments	7
Total chars in comments	234
Total number of identifiers	132
Total length of identifiers	606
Total indenting errors	2

You may gather that the above program (together with the unstarred items) forms the basis of part of your marking system! Do the easy bits first, and leave it at that if some aspects worry you. Come back to me if you think my solution (or the specification) is wrong! That is quite possible!

Exercise 12348

It's rates of pay again!

Loop performing the following operation in your program:

Read two integers, representing a rate of pay (pence per hour) and a number of hours. Print out the total pay, with hours up to 40 being paid at basic rate, from 40 to 60 at rate-and-a-half, above 60 at double-rate. Print the pay as pounds to two decimal places.

Terminate the loop when a zero rate is encountered. At the end of the loop, print out the total pay.

The code for computing the pay from the rate and hours is to be written as a function.

The recommended output format is something like:

```
Pay at 200 pence/hr for 38 hours is 76.00 pounds
Pay at 220 pence/hr for 48 hours is 114.40 pounds
Pay at 240 pence/hr for 68 hours is 206.40 pounds
Pay at 260 pence/hr for 48 hours is 135.20 pounds
Pay at 280 pence/hr for 68 hours is 240.80 pounds
Pay at 300 pence/hr for 48 hours is 156.00 pounds
Total pay is 928.80 pounds
```

The ``program features" checks that explicit values such as 40 and 60 appear only once, as a `#define` or initialised variable value. This represents good programming practice.

Dave Marshall
1/5/1999

Subsections

- [Structures](#)
 - [Defining New Data Types](#)
 - [Unions](#)
 - [Coercion or Type-Casting](#)
 - [Enumerated Types](#)
 - [Static Variables](#)
 - [Exercises](#)
-

Further Data Types

This Chapter discusses how more advanced data types and structures can be created and used in a C program.

Structures

Structures in C are similar to records in Pascal. For example:

```
struct gun
{
    char name[50];
    int magazinesize;
    float calibre;
};

struct gun arnies;
```

defines a new structure `gun` and makes `arnies` an instance of it.

NOTE: that `gun` is a **tag** for the structure that serves as shorthand for future declarations. We now only need to say `struct gun` and the body of the structure is implied as we do to make the `arnies` variable. The tag is **optional**.

Variables can also be declared between the `}` and `;` of a struct declaration, **i.e.:**

```
struct gun
{
    char name[50];
    int magazinesize;
    float calibre;
} arnies;
```

struct's can be pre-initialised at declaration:

```
struct gun arnies={"Uzi",30,7};
```

which gives arnie a 7mm. Uzi with 30 rounds of ammunition.

To access a member (or field) of a struct, C provides the `.` operator. For example, to give arnie more rounds of ammunition:

```
arnies.magazineSize=100;
```

Defining New Data Types

`typedef` can also be used with structures. The following creates a new type `agun` which is of type `struct gun` and can be initialised as usual:

```
typedef struct gun
{
    char name[50];
    int magazinesize;
    float calibre;
} agun;

agun arnies={"Uzi",30,7};
```

Here `gun` still acts as a **tag** to the struct and is optional. Indeed since we have defined a new data type it is not really of much use,

`agun` is the new data type. `arnies` is a variable of type `agun` which is a structure.

C also allows arrays of structures:

```
typedef struct gun
{
    char name[50];
    int magazinesize;
    float calibre;
} agun;

agun arniesguns[1000];
```

This gives `arniesguns` a 1000 guns. This may be used in the following way:

```
arniesguns[50].calibre=100;
```

gives Arnie's gun number 50 a calibre of 100mm, and:

```
itscalibre=arniesguns[0].calibre;
```

assigns the calibre of Arnie's first gun to `itscalibre`.

Unions

A union is a variable which may hold (at different times) objects of different sizes and types. C uses the `union` statement to create unions, for example:

```
        union number
        {
        short shortnumber;
        long longnumber;
        double floatnumber;
        } anumber
```

defines a union called `number` and an instance of it called `anumber`. `number` is a union **tag** and acts in the same way as a tag for a structure.

Members can be accessed in the following way:

```
printf("%ld\n", anumber.longnumber);
```

This clearly displays the value of `longnumber`.

When the C compiler is allocating memory for unions it will always reserve enough room for the largest member (in the above example this is 8 bytes for the double).

In order that the program can keep track of the type of union variable being used at a given time it is common to have a structure (with union embedded in it) and a variable which flags the union type:

An example is:

```
typedef struct
{ int maxpassengers;
  } jet;

typedef struct
{ int liftcapacity;
  } helicopter;

typedef struct
{ int maxpayload;
  } cargoplane;

typedef union
{ jet jetu;
  helicopter helicopteru;
  cargoplane cargoplaneu;
} aircraft;

typedef struct
{ aircrafttype kind;
  int speed;
  aircraft description;
} an_aircraft;
```

This example defines a base union `aircraft` which may either be `jet`, `helicopter`, or `cargoplane`.

In the `an_aircraft` structure there is a `kind` member which indicates which structure is being held at the time.

Coercion or Type-Casting

C is one of the few languages to allow *coercion*, that is forcing one variable of one type to be another type. C allows this using the cast operator `()`. So:

```
int integernumber;
float floatnumber=9.87;

integernumber=(int)floatnumber;
```

assigns 9 (the fractional part is thrown away) to `integernumber`.

And:

```
int integernumber=10;
float floatnumber;

floatnumber=(float)integernumber;
```

assigns 10.0 to `floatnumber`.

Coercion can be used with any of the simple data types including `char`, so:

```
int integernumber;
char letter='A';

integernumber=(int)letter;
```

assigns 65 (the ASCII code for `'A'`) to `integernumber`.

Some typecasting is done automatically -- this is mainly with integer compatibility.

A good rule to follow is: **If in doubt cast.**

Another use is to make sure division behaves as requested: If we have two integers `internumber` and `anotherint` and we want the answer to be a float then :

```
e.g.
floatnumber =
(float) internumber / (float) anotherint;
```

ensures floating point division.

Enumerated Types

Enumerated types contain a list of constants that can be addressed in integer values.

We can declare types and variables as follows.

```
enum days {mon, tues, ..., sun} week;  
  
enum days week1, week2;
```

NOTE: As with arrays first enumerated name has index value 0. So `mon` has value 0, `tues` 1, and so on.

`week1` and `week2` are variables.

We can define other values:

```
enum escapes { bell = '\a',  
             backspace = '\b', tab = '\t',  
             newline = '\n', vtab = '\v',  
             return = '\r'};
```

We can also override the 0 start value:

```
enum months {jan = 1, feb, mar, ....., dec};
```

Here it is implied that `feb = 2` *etc.*

Static Variables

A **static** variable is local to particular function. However, it is only initialised once (on the first call to function).

Also the value of the variable on leaving the function remains **intact**. On the next call to the function the `static` variable has the same value as on leaving.

To define a `static` variable simply prefix the variable declaration with the `static` keyword. For example:

```
void stat(); /* prototype fn */  
  
main()  
{ int i;  
  
  for (i=0;i<5;++i)  
    stat();  
}
```

```
stat()
{ int auto_var = 0;
  static int static_var = 0;

  printf( ``auto = %d, static = %d \n'',
         auto_var, static_var);
  ++auto_var;
  ++static_var;
}
```

Output is:

```
auto_var = 0, static_var= 0
auto_var = 0, static_var = 1
auto_var = 0, static_var = 2
auto_var = 0, static_var = 3
auto_var = 0, static_var = 4
```

Clearly the `auto_var` variable is created each time. The `static_var` is created once and remembers its value.

Exercises

Exercise 12386

Write program using enumerated types which when given today's date will print out tomorrow's date in the for 31st January, for example.

Exercise 12387

Write a simple database program that will store a persons details such as age, date of birth, address *etc.*

Dave Marshall

1/5/1999



Next: [Running Make Up: Writing Larger Programs](#) Previous: [Creating a makefile](#)

Make macros

We can define *macros* in make - they are typically used to store source file names, object file names, compiler options and library links.

They are simple to define, *e.g.*:

```
SOURCES = main.c fl.c B.c
CFLAGS = -g -C
LIBS = -lm
PROGRAM = main
OBJECTS = $(SOURCES).c.o
```

where (SOURCES: .c = .o) makes .c extensions of SOURCES .o extensions.

To reference or invoke a macro in make do \$(macro_name).*e.g.*:

```
$(PROGRAM) : $(OBJECTS)
$(LINK.C) -o $@ $(OBJECTS) $(LIBS)
```

NOTE:

- \$(PROGRAM) : \$(OBJECTS) - makes a list of dependencies and targets.
- The use of an internal macros *i.e.* \$@.

There are many internal macros (see manual pages) here a few common ones:

```
$star - file name part of current dependent (minus .suffix).
$@ - full target name of current target.
$< - .c file of target.
```

Appendix [.](#) contains an example makefile for the WriteMyString modular program discussed in the last Chapter.

Dave.Marshall@cm.cf.ac.uk
Wed Sep 14 10:06:31 BST 1994



Next: [UNIX and C](#) **Up:** [Writing Larger Programs](#) **Previous:** [Make macros](#)

Running Make

Simply type `make` from command line.

UNIX automatically looks for a file called `Makefile` (note: capital M rest lower case letters).

So if we have a file called `Makefile` and we type `make` from command line. The `Makefile` in our current directory will get executed.

We can override this search for a file by typing `make -f make_filename`

e.g. `~ make -f my_make`

There are a few more `-options` for makefiles - see manual pages.

Dave.Marshall@cm.cf.ac.uk
Wed Sep 14 10:06:31 BST 1994



Next: [Using UNIX System Calls and Library Functions](#) **Up:** [UNIX and C](#) **Previous:** [UNIX and C](#)

Advantages of using UNIX with C

- **Portability** - UNIX, or a variety of UNIX, is available on many machines. Programs written in *standard* UNIX and C should run on any of them with little difficulty.
- **Multiuser / Multitasking** - many programs can share a machines processing power.
- **File handling** - hierarchical file system with many file handling routines.
- **Shell Programming** - UNIX provides a powerful command interpreter that understands over 200 commands and can also run UNIX and user-defined programs.

- **Pipe** - where the output of one program can be made the input of another. This can done from command line or within a C program.
- **UNIX utilities** - there over 200 utilities that let you accomplish many routines without writing new programs. *e.g.* make, grep, diff, awk, more
- **System calls** - UNIX has about 60 system calls that are at the *heart* of the operating system or the *kernel* of UNIX. The calls are actually written in C. All of them can be accessed from C programs. Basic I/O, system clock access are examples. The function `open()` is an example of a system call.
- **Library functions** - additions to the operating system.

Dave.Marshall@cm.cf.ac.uk
Wed Sep 14 10:06:31 BST 1994



Next: [File and Directory Manipulation](#) **Up:** [UNIX and C](#) **Previous:** [Advantages of using UNIX with C](#)

Using UNIX System Calls and Library Functions

To use system calls and library functions in a C program we simply call the appropriate C function (Appendix [□](#)).

We have already met some system calls when dealing with low level I/O - `open()`, `creat()`, `read()`, `write()` and `close()` are examples.

Examples of standard library functions we have met include the higher level I/O functions - `fopen()`, `fprintf()`, `sprintf()`, `malloc()` ...

All math functions such as `sin()`, `cos()`, `sqrt()` and random number generators - `random()`, `seed()`, `lrand48()`, `drand48()` etc. are standard math library functions.

NOTE: most standard library functions will use system calls within them.

For most system calls and library functions we have to include an appropriate header file. e.g. `stdio.h`, `math.h`

Information on nearly all system calls and library functions is available in manual pages. These are available on line: Simply type `man` function name.

e.g. `~man drand48`

would give information about this random number generator.

All system calls and library functions have been listed in a previous handout.

We have already seen examples of string handling library functions. For the rest of this course we will study the application of a few more system and library functions.

Dave.Marshall@cm.cf.ac.uk
Wed Sep 14 10:06:31 BST 1994



Next: [Directory handling functions](#) **Up:** [UNIX and C](#) **Previous:** [Using UNIX System Calls and Library Functions](#)

File and Directory Manipulation

There are many UNIX utilities that allow us to manipulate directories and files. `cd`, `ls`, `rm`, `cp`, `mkdir` *etc.* are examples we have (hopefully) already met.

We will now see how to achieve similar tasks from within a C program.

- [Directory handling functions](#)
 - [File Manipulation Routines](#)
 - [errno](#)
-

Dave.Marshall@cm.cf.ac.uk
Wed Sep 14 10:06:31 BST 1994



Next: [Running UNIX Commands from C](#) Up: [UNIX and C](#) Previous: [errno](#)

Process Control and Management

A *process* is basically a single running program. It may be a "system" program (e.g. login, update, csh) or program initiated by the user (textedit, dbxtool or a user written one).

When UNIX runs a process it gives each process a unique number - a process ID, `pid`.

The UNIX command `ps` will list all current processes running on your machine and will list the `pid`.

The C function `int getpid()` will return the `pid` of process that called this function.

A program usually runs as a single process. However later we will see how we can make programs run as several separate communicating processes.

- [Running UNIX Commands from C](#)
 - [execl\(\)](#)
 - [fork\(\)](#)
 - [wait\(\)](#)
 - [exit\(\)](#)
 - [Piping in a C program](#)
 - [popen\(\) - Formatted Piping](#)
 - [pipe\(\) - Low level Piping](#)
 - [Interrupts and Signals](#)
 - [Sending Signals - kill\(\)](#)
 - [Receiving signals - signal\(\)](#)
-

Dave.Marshall@cm.cf.ac.uk
Wed Sep 14 10:06:31 BST 1994



Next: [Exercises](#) Up: [UNIX and C](#) Previous: [Receiving signals - signal\(\)](#)

Times Up!!

The last topic we will at in this course is how we can access the clock time with UNIX system calls.

There are many more time functions - see `man` pages and handouts.

Uses of time functions include:

- telling the time.
- timing programs and functions.
- setting random number seeds.

`time_t time(time_t *tloc)` - returns the time since 00:00:00 GMT, Jan. 1, 1970, measured in seconds.

If `tloc` is not NULL, the return value is also stored in the location to which `tloc` points.

`time()` returns the value of time on success.

On failure, it returns `(time_t) -1`. `time_t` is typedefed to a long (int) in `<sys/types.h>` and `<sys/time.h>` header files.

`int ftime(struct timeb *tp)` - fills in a structure pointed to by `tp`, as defined in `<sys/timeb.h>`:

```
struct timeb
{
    time_t time;
    unsigned short millitm;
    short timezone;
    short dstflag;
};
```

The structure contains the time since the epoch in seconds, up to 1000 milliseconds of more precise interval, the local time zone (measured in minutes of time westward from Greenwich), and a flag that, if nonzero, indicates that Day light Saving time applies locally during the appropriate part of the year.

On success, `ftime()` returns no useful value. On failure, it returns `-1`.

Two other functions defined *etc.* in `#include <time.h>`

```
char *ctime(time_t *clock), char *asctime(struct tm *tm)
```

`ctime()` converts a long integer, pointed to by `clock`, to a 26-character string of the form produced by `asctime()`. It first breaks down `clock` to a `tm` structure by calling `localtime()`, and then calls `asctime()` to convert that `tm` structure to a string.

asctime() converts a time value contained in a tm structure to a 26-character string of the form:

```
Sun Sep 16 01:03:52 1973
```

asctime() returns a pointer to the string.

Example 1: Time (in seconds) to perform some computation:

```
/* timer.c */

#include <stdio.h>
#include <sys/types.h>
#include <time.h>

main()
{ int i;
  time_t t1,t2;

  (void) time(&t1);
  for (i=1;i=300;++i)
    printf("%d %d %d\n",i, i*i, i*i*i);
  (void) time(&t2);
  printf("\n Time to do 300 squares and
  cubes= %d seconds\n", (int) t2-t1);
}
```

Example 2: Set a random number seed

```
/* random.c */
#include <stdio.h>
#include <sys/types.h>
#include <time.h>

main()
{ int i;
  time_t t1;

  (void) time(&t1);
  srand48((long) t1);
  /* use time in seconds to set seed */
  printf("5 random numbers
  (Seed = %d):\n", (int) t1);
  for (i=0;i<5;++i)
    printf("%d ", lrand48());
  printf("\n\n"); /* flush print buffer */
}
```

lrand48() returns non-negative long integers uniformly distributed over the interval (0, 2**31).

A similar function drand48() returns double precision numbers in the range [0.0,1.0).

srand48() sets the seed for these random number generators. It is important to have different seeds when we call the functions otherwise the same set of pseudo-random numbers will be generated. time() always provides a unique seed.



Next: [Exercises](#) **Up:** [UNIX and C](#) **Previous:** [Receiving signals - signal\(\)](#)

Dave.Marshall@cm.cf.ac.uk
Wed Sep 14 10:06:31 BST 1994



Next: [Ceilidh - On Line C Tutoring System Up: UNIX and C](#) **Previous:** [Times Up!!](#)

Exercises

1. Write a program to print the lines of a file which contain a word given as the program argument (a simple version of `grep` UNIX utility).
[View Solution](#)

(unit8:File Input/Output:ex.grp)
2. Write a program to list the files given as arguments, stopping every 20 lines until a key is hit.(a simple version of `more` UNIX utility)
[View Solution](#)
3. Use `popen()` to pipe the `rwho` (UNIX command) output into `more` (UNIX command) in a C program.
[View Solution](#)
4. Setup a two-way communication between parent and child processes in a C program. i.e. both can send and receive signals.
[View Solution](#)
5. Write a C program to emulate the `ls -l` UNIX command that prints all files in a current directory and lists access privileges etc. DO NOT simply `exec ls -l` from the program.
[View Solution](#)
6. Write a C program to produce a series of floating point random numbers in the ranges
(a) 0.0 - 1.0
[View Solution](#)

(b) 0.0 - n where n is any floating point value. The seed should be set so that a unique sequence is guaranteed.
[View Solution](#)
7. Write a C program that times a fragment of code in milliseconds.
[View Solution](#)
8. Write a program that will list all files in a current directory and all files in subsequent sub directories.
[View Solution](#)
9. Write a program that will only list subdirectories in alphabetical order.
[View Solution](#)

10. Write a program that shows the user all his/her C source programs and then prompts interactively as to whether others should be granted read permission; if affirmative such permission should be granted.

[View Solution](#)

11. Write a program that gives the user the opportunity to remove any or all of the files in a current working directory. The name of the file should appear followed by a prompt as to whether it should be removed.

[View Solution](#)



Next: [Ceilidh - On Line C Tutoring System](#) **Up:** [UNIX and C](#) **Previous:** [Times Up!!](#)

Dave.Marshall@cm.cf.ac.uk
Wed Sep 14 10:06:31 BST 1994



Next: [Introduction Up: Ceilidh - On Line C Tutoring System](#) **Previous:** [Ceilidh - On Line C Tutoring System](#)

Why Use CEILIDH ?

CEILIDH  provides the following:

- On line course notes
- Automatic Assessment of C programs
- Template programs are provided to start you on an exercise. This means less typing.
- Automatic Compilation of programs
- Programs can be run against test data and user specified data
- CEILIDH will be used to help mark your coursework.
- You are allowed to resubmit your program for marking by CEILIDH. This lets you try to improve your mark.

PLEASE NOTE:

- CEILIDH marks a program in many ways: it analyses style, efficiency, 'prettiness' and output.
- It is fussy about its output. TO GET FULL MARKS you will need to emulate the output almost exactly as the question requests. So read the questions CAREFULLY.
- Get plenty of practice using CEILIDH and submitting and marking exercise before your first assessments are due.
- If used properly CEILIDH should be very useful in helping you learn C.
- A C++ module is also available.(Not covered by this lecture course).

What follows is a modified version of student notes provided with system from Nottingham University. The Xwindow bits are new.

Dave.Marshall@cm.cf.ac.uk
Wed Sep 14 10:06:31 BST 1994



Next: [Using Ceilidh as a Student](#) **Up:** [Ceilidh - On Line C Tutoring System](#) **Previous:** [Why Use CEILIDH ?](#)

Introduction

Ceilidh is an on-line coursework administration and auto-marking facility designed to help both students and staff with programming courses. It helps students by informing them of the coursework required of them, and by permitting them to submit their work on the computer, instead of having to print things out and hand them in. It also marks programs directly, and informs the student and teacher of the mark awarded. The marking uses a comprehensive variety of static and dynamic metrics to assess the quality of submitted programs, of which details are in the paper by Zin and Foxley[1] (a copy of which may be stored on-line in Ceilidh, see below). Ceilidh also provides students with on-line access to notes, examples and solutions, and provides tutors with extensive course monitoring and tracking facilities.

This document is a guide for student users of the Ceilidh system.

The Ceilidh system acts in a number of ways for students, tutors and teachers, and can support a variety of different courses.

There are different facilities for students (reading notes and coursework definitions, looking at examples, developing programs, submitting and marking work), and tutors (observing submitted work and marks) and teachers (amending course material, setting up exercises, performing plagiarism tests). The appropriate facilities are offered to appropriate users by the Ceilidh system itself, which takes note of the login identification of the user and compares it with lists of authorised users.

Dave.Marshall@cm.cf.ac.uk
Wed Sep 14 10:06:31 BST 1994



Next: [The course and unit level](#) **Up:** [Ceilidh - On Line C Tutoring System](#) **Previous:** [Introduction](#)

Using Ceilidh as a Student

There are two ways of calling the Ceilidh system. Ceilidh may be used to support several courses in your department. You can either enter the system at a general level, and then choose the particular course you are studying, or you can enter directly into the particular course you are interested in.

To enter the system at the general level, the appropriate command (which should have been set up by your computer systems administrator) is

```
xceilidh (Xwindows version --- recommended)
```

or

```
ceilidh (text based version)
```

Upon issuing the command xceilidh (or ceilidh) you will be greeted with the menu shown in figure .

Note: Example menus are shown in this document. Menus seen in practice may vary slightly from those shown, since the actual menu you are offered reflects only those facilities available at the time.

xceilidh is the X-Windows based version which you should use as it is easier and more intuitive. However, the text based version ceilidh does have a few more features. These are not that important though. I will list features of both. ceilidh uses abbreviations for commands. xceilidh has buttons to press



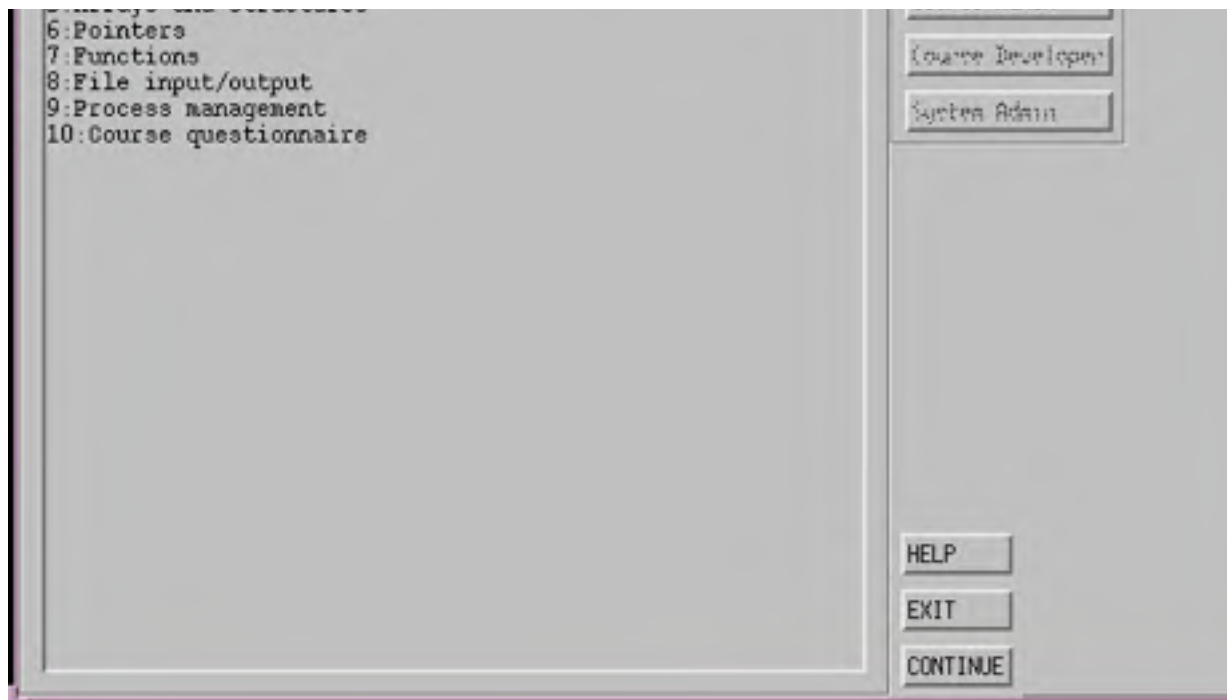

(text version is like this)

```
-----  
CEILIDH system level menu  
lc   list course titles           | sc   move to named course  
vp   view papers                  | pp   print papers  
clp  change printer               | h    for more help  
co   make a comment to teacher   | q    quit this session  
fs   find student                 | ft   find tutees  
=====
```

System level command:

```
-----
```

Fig. 1 System Level Ceilidh Menu

This is the "system" level of Ceilidh and represents a department wide view of the system.

The commands which are available at this point are as follows.

lc

(text ceilidh only) in X the courses available appear on main window. This command tells you which courses are available and supported by the Ceilidh system, their full title and their abbreviation.

vp

(text ceilidh only) If you are interested, you can use the vp command to view various papers describing the workings of the Ceilidh system. A typical response to this command would be The stored papers are:

```
ASQA   : Automated Software Quality Assessment  
CAL    : The Ceilidh Courseware System  
CLI    : The command line interface ceilidh  
Courseware : Courseware to support the teaching of programmin  
Install : Installer's Guide  
Oracle  : The "oracle" output recogniser
```

Qu-ans : The question/answer marking program
Student : Student Guide to Ceilidh
Teacher : Teacher Guide to Ceilidh

Choose a paper :

which lists a selection of the available papers. If you reply with the short name of the paper (the first word on the line), the paper will be shown on the screen a page at a time through a paging command such as "more". Diagrams may not appear correctly.

It is possible to print a given paper which looks interesting using the pp command. Some papers containing diagrams may not view or print nicely on devices without appropriate facilities.

h

(Help button) The h command offers a little more information on the significance of the different commands available to you in the Ceilidh system. This command is available at various points when you are using Ceilidh, and should give help relevant at the time.

q

(Exit button) This is the "quit" command to leave the Ceilidh system, and to return to your ordinary UNIX shell.

For courses with student registers, the following commands are also available

fs

(Find Student Button) To find details about any student registered on any of the courses supported by the system.

ft

(Find Tutor) To find details of the tutees of a specified tutor.

See below for discussion of the clp and co commands, both of which occur at many places in Ceilidh.

In general you will wish to move fairly soon to work on a specific course which you are studying. A particular course is entered using the sc (select course) command highlighting c course in window or by typing for example

sc

followed by return to enter the course "c" in text based version. (You must use lower case/upper case (small and capital) letters exactly as requested. If the given name is not a valid course, all available course names will be listed and a valid one should be selected.)

-
- [The course and unit level](#)
 - [The exercise level](#)
 - [Interpreted language exercises](#)
 - [Question/answer exercises](#)
-

Next: [The course and unit level](#) **Up:** [Ceilidh - On Line C Tutoring System](#) **Previous:**
[Introduction](#)

Dave.Marshall@cm.cf.ac.uk
Wed Sep 14 10:06:31 BST 1994



Next: [Advantages of the command line interface](#) **Up:** [Ceilidh - On Line C Tutoring System](#)
Previous: [Question/answer exercises](#)

The command line interface (TEXT CEILIDH ONLY)

This is a completely new interface in which, instead of using menus, each Ceilidh facility is represented by a UNIX command. It can be used on any terminal. Because there are no menus in this system, it is recommended that you use it only after some experience of the menu system.

To use this facility, there are two things you must do. First execute

```
~ceilidh/bin.cli/set.env
```

to set up an appropriate environment. You will need to check with your teacher just where the ~ceilidh directory is on the machine. This needs to be done once only (unless at a later stage you wish to reset your environment).

In order to use these commands, the directory containing them must be included in your PATH variable. To do this, type

```
source ~ceilidh/bin.cli/source.csh
```

at the start of each logged-on session during which you wish to use Ceilidh.

From here on, type

```
commands
```

to get a list of Ceilidh commands currently available, or

```
status
```

to show the currently set course, unit and exercise. The commands follow generally the pattern of the menu commands, but a few have had to be renamed to avoid clashes with existing commands. A typical starting sequence might be

Command	Purpose
commands	See commands available
set.cse pr1	Select course "pr1"
commands	See extra course commands
lu	List unit titles
set.unit 4	Set a particular unit
lx	List exercise titles
set.ex 4	Select exercise to solve

vq	View question
setup	Set up program skeleton
ep	Edit program
cm	Compile program
run	Run program
sub	Submit
cks	Check submitted

-
- [Advantages of the command line interface](#)
 - [General points](#)
-

Dave.Marshall@cm.cf.ac.uk
Wed Sep 14 10:06:31 BST 1994



Next: [How Ceilidh works](#)[Ceilidh Course Notes](#), **User Up:** [Ceilidh - On Line C Tutoring System](#) **Previous:** [General points](#)

Conclusions

The Ceilidh system is an essential part of your learning process; learn to make good use of it.

Dave.Marshall@cm.cf.ac.uk
Wed Sep 14 10:06:31 BST 1994



Next: [References](#) Up: [Ceilidh - On Line C Tutoring System](#) Previous: [Conclusions](#)

How Ceilidh works, Ceilidh Course Notes, User Guides etc.

- [Ceilidh Licence Details](#)
- [Ceilidh papers](#) --- How Ceilidh works, marks etc.
- [Ceilidh C Course Notes](#) --- Alternative to what you have been reading.
- [Ceilidh User Guides](#)

Dave.Marshall@cm.cf.ac.uk
Wed Sep 14 10:06:31 BST 1994



Next: [Common C Compiler Options](#) **Up:** [Ceilidh - On Line C Tutoring System](#) **Previous:**
[How Ceilidh works](#)[Ceilidh Course Notes](#), [User](#)

References

1. Abdullah Mohd Zin and Eric Foxley, "Automatic Program Quality Assessment System", Proceedings of the IFIP Conference on Software Quality, S P University, Vidyanagar, INDIA (March 1991).

Dave.Marshall@cm.cf.ac.uk
Wed Sep 14 10:06:31 BST 1994



Next: [C Standard Library Functions](#) **Up:** [Common C Compiler Options](#) **Previous:** [Common C Compiler Options](#)

Compiler Options

- `-c` Suppress linking with `ld(1)` and produce a `.o` file for each source file. A single object file can be named explicitly using the `-o` option.
- `-C` Prevent the C preprocessor from removing comments.
- `-E` Run the source file through the C preprocessor, only. Sends the output to the standard output, or to a file named with the `-o` option. Includes the cpp line numbering information. (See also, the `-P` option.)
- `-g` Produce additional symbol table information for `dbx(1)` and `dbxtool(1)`. When this option is given, the `-O` and `-R` options are suppressed.
- `-help` Display helpful information about compiler.
- `-Ipathname`
Add pathname to the list of directories in which to search for `#include` files with relative filenames (not beginning with slash `/`). The preprocessor first searches for `#include` files in the directory containing sourcefile, then in directories named with `-I` options (if any), and finally, in `/usr/include`.
- `-llibrary` Link with object library `library` (for `ld(1)`). This option must follow the sourcefile arguments.
- `-Ldirectory`
Add directory to the list of directories containing object-library routines (for linking using `ld(1)`).
- `-M` Run only the macro preprocessor on the named C programs, requesting that it generate makefile dependencies and send the result to the standard output (see `make(1)` for details about makefiles and dependencies).
- `-o outputfile`
Name the output file `outputfile`. `outputfile` must have the appropriate suffix for the type of file to be produced by the compilation (see `FILES`, below). `outputfile` cannot be the same as sourcefile (the compiler will not overwrite the source file).
- `-O[level]` Optimize the object code. Ignored when either `-g` or `-a` is used. `-O` with the level omitted is equivalent to `-O2`. `level` is one of:

- 1 Do postpass assembly-level optimization only.
- 2 Do global optimization prior to code generation, including loop optimizations, common subexpression elimination, copy propagation, and automatic register allocation. -O2 does not optimize references to or definitions of external or indirect variables.

If the optimizer runs out of memory, it tries to recover by retrying the current procedure at a lower level of optimization and resumes subsequent procedures at the original level.

-P Run the source file through the C preprocessor, only. Puts the output in a file with a .i suffix. Does not include cpp-type line number information in the output

Dave.Marshall@cm.cf.ac.uk
Wed Sep 14 10:06:31 BST 1994



Next: [Character Classification and Conversion](#) **Up:** [C Standard Library Functions](#) **Previous:** [C Standard Library Functions](#)

Buffer Manipulation

`#include <memory.h>`

`void *memchr (void *s, int c, size_t n)` - Search for a character in a buffer.

`int memcmp (void *s1, void *s2, size_t n)` - Compare two buffers.

`void *memcpy (void *dest, void *src, size_t n)` - Copy one buffer into another .

`void *memmove (void *dest, void *src, size_t n)` - Move a number of bytes from one buffer lo another.

`void *memset (void *s, int c, size_t n)` - Set all bytes of a buffer to a given character.

Dave.Marshall@cm.cf.ac.uk

Wed Sep 14 10:06:31 BST 1994



Next: [String Manipulation](#) **Up:** [C Standard Library Functions](#) **Previous:** [Process Control](#)

Searching and Sorting

```
#include <stdlib.h>
```

```
void *bsearch(void *key, void *base, size_t num, size_t width, int (*compare)(void *elem1,  
void *elem2)) - Perform binary search.
```

```
void qsort(void *base, size_t num, size_t width, int (*compare)(void *elem1, void *elem2)) -  
Use the quicksort algorithm to sort an array.
```

Dave.Marshall@cm.cf.ac.uk
Wed Sep 14 10:06:31 BST 1994



Next: [Time Up: C Standard Library Functions](#) **Previous:** [Searching and Sorting](#)

String Manipulation

`#include <string.h>`

`char *strcpy(char *dest, char *src)` - Copy one string into another.

`int strcmp(char *string1, char *string2)` - Compare string1 and string2 to determine alphabetic order.

`char *strcpy(char *string1, char *string2)` - Copy string2 to string1.

`char *strerror(int errnum)` - Get error message corresponding to specified error number.

`int strlen(char *string)` - Determine the length of a string.

`char *strncat(char *string1, char *string2, size_t n)` - Append n characters from string2 to string1.

`int strncmp(char *string1, char *string2, size_t n)` - Compare first n characters of two strings.

`char *strncpy(char *string1, char *string2, size_t n)` - Copy first n characters of string2 to string1.

`char *strnset(char *string, int c, size_t n)` - Set first n characters of string to c.

`char *strchr(char *string, int c)` - Find last occurrence of character c in string.

Dave.Marshall@cm.cf.ac.uk
Wed Sep 14 10:06:31 BST 1994



Next: [Program Listings](#) **Up:** [C Standard Library Functions](#) **Previous:** [String Manipulation](#)

Time

`#include <time.h>`

`char *asctime (struct tm *time)` - Convert time from `struct tm` to string.

`clock_t clock(void)` - Get elapsed processor time in clock ticks.

`char *ctime(time_t *time)` - Convert binary time to string. `double difftime(time_t time2, time_t time1)` - Compute the difference between two times in seconds.

`struct tm *gmtime (time_t *time)` - Get Greenwich Mean Time (GMT) in a `tm` structure.

`struct tm *localtime(time_t *time)` - Get the local time in a `tm` structure.

`time_t time(time_t *timeptr)` - Get current times as seconds elapsed since 0 hours GMT 1/1/70.

Dave.Marshall@cm.cf.ac.uk
Wed Sep 14 10:06:31 BST 1994



Next: [Data Conversion](#) **Up:** [C Standard Library Functions](#) **Previous:** [Buffer Manipulation](#)

Character Classification and Conversion

`#include <ctype.h>`

`int isalnum(int c)` - True if `c` is alphanumeric.

`int isalpha(int c)` - True if `c` is a letter.

`int isascii(int c)` - True if `c` is ASCII .

`int iscntrl(int c)` - True if `c` is a control character.

`int isdigit(int c)` - True if `c` is a decimal digit.

`int isgraph(int c)` - True if `c` is a graphical character.

`int islower(int c)` - True if `c` is a lowercase letter.

`int isprint(int c)` - True if `c` is a printable character.

`int ispunct (int c)` - True if `c` is a punctuation character.

`int isspace(int c)` - True if `c` is a space character.

`int isupper(int c)` - True if `c` is an uppercase letter.

`int isxdigit(int c)` - True if `c` is a hexadecimal digit.

`int toascii(int c)` - Convert `c` to ASCII .

`tolower(int c)` - Convert `c` to lowercase.

`int toupper(int c)` - Convert `c` to uppercase.

Dave.Marshall@cm.cf.ac.uk
Wed Sep 14 10:06:31 BST 1994



Next: [Directory Manipulation](#) **Up:** [C Standard Library Functions](#) **Previous:** [Character Classification and Conversion](#)

Data Conversion

`#include <stdlib.h>`

`double atof(char *string)` - Convert string to floating point value.

`int atoi(char *string)` - Convert string to an integer value.

`int atol(char *string)` - Convert string to a long integer value.

`char *itoa(int value, char *string, int radix)` - Convert an integer value to a string using given radix.

`char *ltoa(long value, char *string, int radix)` - Convert long integer to string in a given radix.

`double strtod(char *string, char *endptr)` - Convert string to a floating point value.

`long strtol(char *string, char *endptr, int radix)` - Convert string to a long integer using a given radix.

`unsigned long strtoul(char *string, char *endptr, int radix)` - Convert string to unsigned long.

Dave.Marshall@cm.cf.ac.uk
Wed Sep 14 10:06:31 BST 1994



Next: [File Manipulation](#) **Up:** [C Standard Library Functions](#) **Previous:** [Data Conversion](#)

Directory Manipulation

`#include <dir.h>`

`int chdir(char *path)` - Change current directory to given path.

`char *getcwd(char *path, int numchars)` - Returns name of current working directory.

`int mkdir(char *path)` - Create a directory using given `path` name.

`int rmdir(char *path)` - Delete a specified directory.

Dave.Marshall@cm.cf.ac.uk

Wed Sep 14 10:06:31 BST 1994



Next: [Input and Output](#) **Up:** [C Standard Library Functions](#) **Previous:** [Directory Manipulation](#)

File Manipulation

`#include <sys/stat.h>` and `#include <sys/types.h>`

`int chmod(char *path, int pmode)` - Change permission settings of a file.

`int fstat(int handle, struct stat *buffer)` - Get file status information.

`int remove(char *path)` - Delete a named file.

`int rename(char *oldname, char *newname)` - rename a file.

`int stat(char *path, struct stat *buffer)` - Get file status information of named file.

`unsigned umask(unsigned pmode)` - Set file permission mask.

Dave.Marshall@cm.cf.ac.uk

Wed Sep 14 10:06:31 BST 1994



Next: [Stream I/O](#) **Up:** [C Standard Library Functions](#) **Previous:** [File Manipulation](#)

Input and Output

- [Stream I/O](#)
 - [Low level I/O](#)
-

Dave.Marshall@cm.cf.ac.uk
Wed Sep 14 10:06:31 BST 1994



Next: [Memory Allocation](#) **Up:** [C Standard Library Functions](#) **Previous:** [Low level I/O](#)

Mathematics

`#include <math.h>`

`int abs (int n)` - Get absolute value of an integer.

`double acos(double x)` - Compute arc cosine of x.

`double asin(double x)` - Compute arc sine of x.

`double atan(double x)` - Compute arc tangent of x.

`double atan2(double y, double x)` - Compute arc tangent of y/x.

`double ceil(double x)` - Get smallest integral value that exceeds x.

`double cos(double x)` - Compute cosine of angle in radians.

`double cosh(double x)` - Compute the hyperbolic cosine of x.

`div_t div(int number, int denom)` - Divide one integer by another.

`double exp(double x)` - Compute exponential of x.

`double fabs (double x)` - Compute absolute value of x.

`double floor(double x)` - Get largest integral value less than x.

`double fmod(double x, double y)` - Divide x by y with integral quotient and return remainder.

`double frexp(double x, int *expPtr)` - Breaks down x into mantissa and exponent of no.

`labs(long n)` - Find absolute value of long integer n.

`double ldexp(double x, int exp)` - Reconstructs x out of mantissa and exponent of two.

`ldiv_t ldiv(long number, long denom)` - Divide one long integer by another.

`double log(double x)` - Compute log(x).

`double log10 (double x)` - Compute log to the base 10 of x.

`double modf(double x, double *intPtr)` - Breaks x into fractional and integer parts.

`double pow (double x, double y)` - Compute x raised to the power y.

`int rand (void)` - Get a random integer between 0 and 32.

`int random(int max_num)` - Get a random integer between 0 and `max_num`.

`void randomize(void)` - Set a random seed for the random number generator.

`double sin(double x)` - Compute sine of angle in radians.

`double sinh(double x)` - Compute the hyperbolic sine of `x`.

`double sqrt(double x)` - Compute the square root of `x`.

`void srand(unsigned seed)` - Set a new seed for the random number generator (`rand`).

`double tan(double x)` - Compute tangent of angle in radians.

`double tanh(double x)` - Compute the hyperbolic tangent of `x`.

Dave.Marshall@cm.cf.ac.uk
Wed Sep 14 10:06:31 BST 1994



Next: [Process Control](#) **Up:** [C Standard Library Functions](#) **Previous:** [Mathematics](#)

Memory Allocation

`#include <malloc.h>`

`void *calloc(size_t num_elems, size_t elem_size)` - Allocate an array and initialise all elements to zero .

`void free(void *mem_address)` - Free a block of memory.

`void *malloc(size_t num_bytes)` - Allocate a block of memory.

`void *realloc(void *mem_address, size_t new_size)` - Reallocate (adjust size) a block of memory.

Dave.Marshall@cm.cf.ac.uk
Wed Sep 14 10:06:31 BST 1994



Next: [Searching and Sorting](#) **Up:** [C Standard Library Functions](#) **Previous:** [Memory Allocation](#)

Process Control

include <stdlib.h>

void abort(void) - Abort a process.

int execl(char *path, char *arg0, char *arg1,..., NULL) - Launch a child process (pass command line).

int execlp(char *path, char *arg0, char *arg1,..., NULL) - Launch child (use PATH pass command line).

int execv(char *path, char *argv[]) - Launch child (pass argument vector).

int execvp(char *path, char *argv[]) - Launch child (use PATH, pass argument vector).

void exit(int status) - Terminate process after flushing all buffers.

char *getenv(char *varname) - Get definition of environment variable,

void perror(char *string) - Print error message corresponding to last system error.

int putenv(char *envstring) - Insert new definition into environment table.

int raise(int signum) - Generate a C signal (exception).

void (*signal(int signum, void(*func)(int signum [, int subcode])))(int signum) - Establish a signal handler for signal number `signum`.

int system(char *string) - Execute a UNIX (or resident operating system) command.

Dave.Marshall@cm.cf.ac.uk

Wed Sep 14 10:06:31 BST 1994



Next: [printf.c](#) **Up:** [Program Listings](#) **Previous:** [Program Listings](#)

hello.c

```
#include <stdio.h>
main()
{
    (void) printf("Hello World\n");
    return (0);
}
```

Dave.Marshall@cm.cf.ac.uk
Wed Sep 14 10:06:31 BST 1994



Next: [Modular Example](#) **Up:** [Program Listings](#) **Previous:** [power.c](#)

ptr_arr.c

```
#define ARRAY_SIZE 10    /* Number of characters in array */
/* Array to print */
char array[ARRAY_SIZE] = "012345678";

main()
{
    int index; /* Index into the array */

    for (index = 0; index < ARRAY_SIZE; index++) {
        (void)printf(
            "&array[index]=0x%x (array+index)=0x%x array[index]=0x%x\n",
            &array[index], (array+index), array[index]);
    }
    return (0);
}
```

Dave.Marshall@cm.cf.ac.uk
Wed Sep 14 10:06:31 BST 1994



Next: [main.c](#) **Up:** [Program Listings](#) **Previous:** [ptr_arr.c](#)

Modular Example

We list here three C modules that comprise of the large program example. The Makefile is also included.

- [main.c](#)
 - [WriteMyString.c](#)
 - [header.h](#)
 - [Makefile](#)
-

Dave.Marshall@cm.cf.ac.uk
Wed Sep 14 10:06:31 BST 1994



Next: [malloc.c](#) **Up:** [Program Listings](#) **Previous:** [Makefile](#)

static.c

```
#include <stdio.h>

void stat();

main() {
    int counter;    /* loop counter */

    for (counter = 0; counter < 5; counter++) {
        stat();
    }
}

void stat()
{ int temporary = 1;
  static int permanent = 1;

  (void)printf("Temporary %d Permanent %d\n",
              temporary, permanent);
  temporary++;
  permanent++;
}
```

Dave.Marshall@cm.cf.ac.uk
Wed Sep 14 10:06:31 BST 1994



Next: [queue.c](#) **Up:** [Program Listings](#) **Previous:** [static.c](#)

malloc.c

```
#include <stdlib.h>      /* using ANSI C standard libraries */
#include <malloc.h>

main()
{
    char *string_ptr;

    string_ptr = malloc(80);
}
```

Dave.Marshall@cm.cf.ac.uk
Wed Sep 14 10:06:31 BST 1994



Next: [bitcount.c](#) Up: [Program Listings](#) Previous: [malloc.c](#)

queue.c

```
/* Corrected 19/3/90 - no longer leaves queue in memory! */
/* Note UNIX would clear the dynamically allocated memory */
/* when the program ends */
/*          */
/* queue.c          */
/* Demo of dynamic data structures in C          */

#include <stdio.h>

#define FALSE 0
#define NULL 0

typedef struct {
    int      dataitem;
    struct listelement *link;
}           listelement;

void Menu (int *choice);
listelement * AddItem (listelement * listpointer, int data);
listelement * RemoveItem (listelement * listpointer);
void PrintQueue (listelement * listpointer);
void ClearQueue (listelement * listpointer);

main () {
    listelement listmember, *listpointer;
    int      data,
            choice;

    listpointer = NULL;
    do {
        Menu (&choice);
        switch (choice) {
            case 1:
                printf ("Enter data item value to add ");
                scanf ("%d", &data);
                listpointer = AddItem (listpointer, data);
                break;
            case 2:
                if (listpointer == NULL)
                    printf ("Queue empty!\n");
                else
                    listpointer = RemoveItem (listpointer);
                break;
            case 3:
                PrintQueue (listpointer);
                break;
            case 4:
                break;

            default:
                printf ("Invalid menu choice - try again\n");
                break;
        }
    } while (choice != 4);
}
```

```
    ClearQueue (listpointer);
}    /* main */

void Menu (int *choice) {

    char    local;

    printf ("\nEnter\t1 to add item,\n\t2 to remove item\n\
\t3 to print queue\n\t4 to quit\n");
    do {
        local = getchar ();
        if ((isdigit (local) == FALSE) && (local != '\n')) {
            printf ("\nyou must enter an integer.\n");
            printf ("Enter 1 to add, 2 to remove, 3 to print, 4 to quit\n");
        }
    } while (isdigit ((unsigned char) local) == FALSE);
    *choice = (int) local - '0';
}

listelement * AddItem (listelement * listpointer, int data) {

    listelement * lp = listpointer;

    if (listpointer != NULL) {
        while (listpointer -> link != NULL)
            listpointer = listpointer -> link;
        listpointer -> link = (struct listelement *) malloc (sizeof (listelement));
        listpointer = listpointer -> link;
        listpointer -> link = NULL;
        listpointer -> dataitem = data;
        return lp;
    }
    else {
        listpointer = (struct listelement *) malloc (sizeof (listelement));
        listpointer -> link = NULL;
        listpointer -> dataitem = data;
        return listpointer;
    }
}

listelement * RemoveItem (listelement * listpointer) {

    listelement * temp;
    printf ("Element removed is %d\n", listpointer -> dataitem);
    temp = listpointer -> link;
    free (listpointer);
    return temp;
}

void PrintQueue (listelement * listpointer) {

    if (listpointer == NULL)
        printf ("queue is empty!\n");
    else
        while (listpointer != NULL) {
            printf ("%d\t", listpointer -> dataitem);
            listpointer = listpointer -> link;
        }
    printf ("\n");
}

void ClearQueue (listelement * listpointer) {

    while (listpointer != NULL) {
        listpointer = RemoveItem (listpointer);
    }
}
```

Dave.Marshall@cm.cf.ac.uk
Wed Sep 14 10:06:31 BST 1994



Next: [lowio.c](#) Up: [Program Listings](#) Previous: [queue.c](#)

bitcount.c

```
/* binary counting example -counts bits set to 1 in an 8 bit number */

/* acc -o bitcount bitcount.c on SUNS */
/* c89 -o bitcount bitcount.c on DECS */

#include <stdio.h>

unsigned char bitcount(unsigned char); /* prototype */

main()

{ unsigned char i8,count;
  int i;

  printf("Enter number (0 - 255 decimal)\n");
  scanf("%d",&i);

  if (( i < 0 ) || ( i > 255))
    { printf("Error:Number out of range = %d\n", i);
      exit(1);
    }

  i8 = (unsigned char) i;

  count = bitcount(i8);

  printf("\n\nNumber of bits set to 1 in %d = %d\n",i,count);
}

unsigned char bitcount(unsigned char x)

{ unsigned char count;

  for (count = 0; x!=0; x>>=1)
    if ( x & 01 )
      ++count;

  return count;
}
```

Dave.Marshall@cm.cf.ac.uk
Wed Sep 14 10:06:31 BST 1994



Next: [print.c](#) **Up:** [Program Listings](#) **Previous:** [bitcount.c](#)

lowio.c

```
/****** lowio.c *****/

#include <fcntl.h>
#include <stdio.h>
#define PERMS 0600 /* r,w permission owner only (octal no.)*/

void inputtext (char *buf, int fd);
void display (char *buf, int fd);

main () {
    char    buf[BUFSIZ];
    int     fd1,
           fd2,
           t;

    if ((fd1 = creat ("iotest", PERMS)) == -1) {
        printf ("Cannot open file with creat\n");
        exit (1);
    }

    inputtext (buf, fd1);

    close (fd1);

    if ((fd2 = open ("iotest", 0, O_RDONLY)) == -1) {
        printf ("Cannot open file\n");
        exit (1);
    }
    display (buf, fd2);
    close (fd2);
}

void inputtext (char *buf, int fd1) {
    register int    t;

    printf ("Enter lines of text, end with quit\n");
    do {
        for (t = 0; t < BUFSIZ; t++)
            buf[t] = '\0';
        gets (buf);

        if (write (fd1, buf, BUFSIZ) != BUFSIZ) {
            printf ("Error in writing\n");
            exit (1);
        }
    } while (strcmp (buf, "quit"));
}

void display (char *buf, int fd2) {
    for (;;) {
        if (read (fd2, buf, BUFSIZ) == 0)
            return;
        printf ("%s\n", buf);
    }
}
```

Dave.Marshall@cm.cf.ac.uk
Wed Sep 14 10:06:31 BST 1994



Next: [cdirc](#) Up: [Program Listings](#) Previous: [lowio.c](#)

print.c

```
/* *****  
 * print -- format files for printing *  
 * ***** */  
#include <stdio.h>  
#include <stdlib.h> /* ANSI Standard only */  
  
int verbose = 0; /* verbose mode (default = false) */  
char *out_file = "print.out"; /* output filename */  
char *program_name; /* name of the program (for errors) */  
int line_max = 66; /* number of lines per page */  
  
main(int argc, char *argv[])  
{  
    void do_file(char *); /* print a file */  
    void usage(void); /* tell user how to use the program */  
  
    /* save the program name for future use */  
    program_name = argv[0];  
  
    /*  
     * loop for each option.  
     * Stop if we run out of arguments  
     * or we get an argument without a dash.  
     */  
    while ((argc > 1) && (argv[1][0] == '-')) {  
        /*  
         * argv[1][1] is the actual option character.  
         */  
        switch (argv[1][1]) {  
            /*  
             * -v verbose  
             */  
            case 'v':  
                verbose = 1;  
                break;  
            /*  
             * -o<name> output file  
             * [0] is the dash  
             * [1] is the "o"  
             * [2] starts the name  
             */  
            case 'o':  
                out_file = &argv[1][2];  
                break;  
            /*  
             * -l<number> set max number of lines  
             */  
            case 'l':  
                line_max = atoi(&argv[1][2]);  
                break;  
            default:  
                (void)fprintf(stderr, "Bad option %s\n", argv[1]);  
                usage();  
        }  
    }  
    /*
```

```
        * move the argument list up one
        * move the count down one
        */
        argv++;
        argc--;
    }

    /*
    * At this point all the options have been processed.
    * Check to see if we have no files in the list
    * and if so, we need to process just standard in.
    */
    if (argc == 1) {
        do_file("print.in");
    } else {
        while (argc > 1) {
            do_file(argv[1]);
            argv++;
            argc--;
        }
    }
    return (0);
}

/*****
 * do_file -- dummy routine to handle a file
 *
 * Parameter
 *     name -- name of the file to print
 *****/
void do_file(char *name)
{
    (void)printf("Verbose %d Lines %d Input %s Output %s\n",
        verbose, line_max, name, out_file);
}

/*****
 * usage -- tell the user how to use this program and
 *         exit
 *****/
void usage(void)
{
    (void)fprintf(stderr, "Usage is %s [options] [file-list]\n",
        program_name);
    (void)fprintf(stderr, "Options\n");
    (void)fprintf(stderr, "  -v          verbose\n");
    (void)fprintf(stderr, "  -l<number> Number of lines\n");
    (void)fprintf(stderr, "  -o<name>   Set output filename\n");
    exit (8);
}

```

Dave.Marshall@cm.cf.ac.uk
Wed Sep 14 10:06:31 BST 1994



Next: [list.c](#) Up: [Program Listings](#) Previous: [print.c](#)

cdir.c

```
/* cdir.c program to emulate unix cd command */
/* cc -o cdir cdir.c */

#include<stdio.h>
/* #include<sys/dir.h> */

main(int argc, char **argv)
{
    if (argc < 2)
        { printf("Usage: %s <pathname>\n", argv[0]);
          exit(1);
        }

    if (chdir(argv[1]) != 0)
        { printf("Error in \"chdir\"\n");
          exit(1);
        }
}
```

Dave.Marshall@cm.cf.ac.uk
Wed Sep 14 10:06:31 BST 1994



Next: [list_c.c](#) Up: [Program Listings](#) Previous: [cdirc.c](#)

list.c

```
/* list.c - C version of a simple UNIX ls utility */

/* c89 list.c -o list */

/* need types.h and dir.h for definitions of scandir and alphasort */
#include <sys/types.h>
#include <sys/dir.h>

/* definition for getwd ie MAXPATHLEN etc */
#include <sys/param.h>

#include <stdio.h>

#define FALSE 0
#define TRUE !FALSE

/* prototype std lib functions */
extern int alphasort();

/* variable to store current path */
char pathname[MAXPATHLEN];

main()
{ int count,i;
  struct direct **files;
  int file_select();

  if (getwd(pathname) == NULL )
    { printf("Error getting path\n");
      exit(1);
    }
  printf("Current Working Directory = %s\n",pathname);

  count =
    scandir(pathname, &files, file_select, alphasort);

  /* If no files found, make a non-selectable menu item */
  if (count <= 0) {
    printf("No files in this directory\n");
    exit(0);
  }

  printf("Number of files = %d\n",count);

  for (i=1;i<count+1;++i)
    { printf("%s  ",files[i-1]->d_name);
      if ( ( i % 4) == 0) printf("\n");
    }
}
```

```
    printf("\n"); /* flush buffer */
}

int
file_select(struct direct *entry)
{ /* ignore . and .. entries */
    if ((strcmp(entry->d_name, ".") == 0) ||
        (strcmp(entry->d_name, "..") == 0))
        return (FALSE);
    else
        return (TRUE);
}
```

Dave.Marshall@cm.cf.ac.uk
Wed Sep 14 10:06:31 BST 1994



Next: [swap.c](#) **Up:** [Program Listings](#) **Previous:** [hello.c](#)

printf.c

```
#include <stdio.h>

char char1;    /* first character */
char char2;    /* second character */
char char3;    /* third character */

main()
{
    char1 = 'A';
    char2 = 'B';
    char3 = 'C';
    (void)printf("%c%c%c reversed is %c%c%c\n",
                char1, char2, char3,
                char3, char2, char1);
    return (0);
}
```

Dave.Marshall@cm.cf.ac.uk
Wed Sep 14 10:06:31 BST 1994



Next: [fork_eg.c](#) **Up:** [Program Listings](#) **Previous:** [list.c](#)

list_c.c

```
/* list_c.c - list C realted files ie .c .o .h files */

/* c89 list_c.c -o list_c */

#include <sys/types.h>
#include <sys/dir.h>
#include <sys/param.h>
#include <stdio.h>

#define FALSE 0
#define TRUE !FALSE

extern int alphasort();
char *rindex(char *s, char c);

char pathname[MAXPATHLEN];

main()
{ int count,i;
  struct direct **files;
  int file_select();

(char *) getwd(pathname);
printf("Current Working Directory = %s\n",pathname);

  count =
    scandir(pathname, &files, file_select, alphasort);

  /* If no files found, make a non-selectable menu item */
  if (count <= 0) {
    printf("No files in this directory\n");
    exit(0);
  }

  printf("Number of files = %d\n",count);

  for (i=0;i<count;++i)
    { printf("%s ",files[i]->d_name);
      if ( (i % 4) == 0) printf("\n");
    }

  printf("\n"); /* flush buffer */
}

int
file_select(struct direct *entry)
{
  char *ptr;
  char tmp[MAXPATHLEN];

  if ((strcmp(entry->d_name, ".") == 0) ||
      (strcmp(entry->d_name, "..") == 0))
```

```
    return (FALSE);

/* Check for .c or .o or .h filename extensions */
ptr = rindex(entry->d_name, '.');
if ((ptr != NULL) &&
    ((strcmp(ptr, ".c") == 0) || (strcmp(ptr, ".h") == 0) || (strcmp(ptr, ".o"
    return (TRUE);
}
```

Dave.Marshall@cm.cf.ac.uk
Wed Sep 14 10:06:31 BST 1994



Next: [fork.c](#) **Up:** [Program Listings](#) **Previous:** [list_c.c](#)

fork_eg.c

```
/* fork_eg.c --- simple eg of fork in UNIX */

main()
{ int return_value;

  printf("Forking process\n");
  fork();
  printf("The process id is %d and return value is %d\n",getpid(),return_value)
  execl("/bin/ls/","ls","-l",0);
  printf("This line is not printed\n");
}
```

Dave.Marshall@cm.cf.ac.uk
Wed Sep 14 10:06:31 BST 1994



Next: [signal.c](#) Up: [Program Listings](#) Previous: [fork_eg.c](#)

fork.c

```
/* fork.c - example of a fork in a program */
/* The program asks for UNIX commands to be typed and inputted to a string*/
/* The string is then "parsed" by locating blanks etc. */
/* Each command and corresponding arguments are put in a args array */
/* execvp is called to execute these commands in child process */
/* spawned by fork() */

/* c89 -o fork fork.c */

#include <stdio.h>

main()
{
    char buf[1024];
    char *args[64];

    for (;;) {
        /*
         * Prompt for and read a command.
         */
        printf("Command: ");

        if (gets(buf) == NULL) {
            printf("\n");
            exit(0);
        }

        /*
         * Split the string into arguments.
         */
        parse(buf, args);

        /*
         * Execute the command.
         */
        execute(args);
    }
}

/*
 * parse--split the command in buf into
 * individual arguments.
 */
parse(buf, args)
char *buf;
char **args;
{
    while (*buf != NULL) {
        /*
         * Strip whitespace. Use nulls, so
         * that the previous argument is terminated
         * automatically.
         */
        while ((*buf == ' ') || (*buf == '\t'))
            *buf++ = NULL;
```

```
    /*
    * Save the argument.
    */
    *args++ = buf;

    /*
    * Skip over the argument.
    */
    while ((*buf != NULL) && (*buf != ' ') && (*buf != '\\t'))
        buf++;
}

*args = NULL;
}

/*
 * execute--spawn a child process and execute
 * the program.
 */
execute(args)
char **args;
{
    int pid, status;

    /*
    * Get a child process.
    */
    if ((pid = fork()) < 0) {
        perror("fork");
        exit(1);
    }

    /* NOTE: perror() produces a short error message on the standard
    error describing the last error encountered during a call to
    a system or library function.
    */
}

/*
 * The child executes the code inside the if.
 */
if (pid == 0) {
    execvp(*args, args);
    perror(*args);
    exit(1);

    /* NOTE: The execl() vnd execvp versions of execl() are useful when the
    number of arguments is unknown in advance;
    The arguments to execl() and execvp() are the name
    of the file to be executed and a vector of strings contain-
    ing the arguments. The last argument string must be fol-
    lowed by a 0 pointer.

    execlp() and execvp() are called with the same arguments as
    execl() and execv(), but duplicate the shell's actions in
    searching for an executable file in a list of directories.
    The directory list is obtained from the environment.
    */
}

/*
 * The parent executes the wait.
 */
while (wait(&status) != pid)
    /* empty */ ;
}
```

Dave.Marshall@cm.cf.ac.uk
Wed Sep 14 10:06:31 BST 1994



Next: [sig_talk.c](#) **Up:** [Program Listings](#) **Previous:** [fork.c](#)

signal.c

```
#include <signal.h>

main()
{
    signal(SIGINT, SIG_IGN);

    /*
     * pause() just suspends the process until a
     * signal is received.
     */
    pause();
}
```

Dave.Marshall@cm.cf.ac.uk
Wed Sep 14 10:06:31 BST 1994



Next: [Piping Up: Program Listings](#) Previous: [signal.c](#)

sig_talk.c

```
/* sig_talk.c --- Example of how 2 processes can talk */
/* to each other using kill() and signal() */
/* We will fork() 2 process and let the parent send a few */
/* signals to it`s child */

/* acc sig_talk.c -o sig_talk on SUNS */
/* c89 sig_talk.c -o sig_talk on DECS */

#include <stdio.h>
#include <signal.h>

void sighup(); /* routines child will call upon sigtrap */
void sigint();
void sigquit();

main()
{ int pid;

  /* get child process */

  if ((pid = fork()) < 0) {
    perror("fork");
    exit(1);
  }

  if (pid == 0)
  { /* child */
    signal(SIGHUP,sighup); /* set function calls */
    signal(SIGINT,sigint);
    signal(SIGQUIT, sigquit);
    for(;;); /* loop for ever */
  }
  else /* parent */
  { /* pid hold id of child */
    printf("\nPARENT: sending SIGHUP\n\n");
    kill(pid,SIGHUP);
    sleep(3); /* pause for 3 secs */
    printf("\nPARENT: sending SIGINT\n\n");
    kill(pid,SIGINT);
    sleep(3); /* pause for 3 secs */
    printf("\nPARENT: sending SIGQUIT\n\n");
    kill(pid,SIGQUIT);
    sleep(3);
  }
}

void sighup()

{ signal(SIGHUP,sighup); /* reset signal */
  printf("CHILD: I have received a SIGHUP\n");
}

void sigint()

{ signal(SIGINT,sigint); /* reset signal */
```

```
    printf("CHILD: I have received a SIGINT\n");  
}  
  
void sigquit()  
{ printf("My DADDY has Killed me!!!\n");  
  exit(0);  
}
```

Dave.Marshall@cm.cf.ac.uk
Wed Sep 14 10:06:31 BST 1994



Next: [plot.c](#) **Up:** [Program Listings](#) **Previous:** [sig_talk.c](#)

Piping

Three modules make up a program that pipes output to a graphdrawing package, `gnuplot` To Run this system you must have `gnupolt` installed.

- [plot.c](#)
 - [plotter.c](#)
 - [externals.h](#)
-

Dave.Marshall@cm.cf.ac.uk
Wed Sep 14 10:06:31 BST 1994



Next: [time.c](#) Up: [Program Listings](#) Previous: [externals.h](#)

random.c

```
/* random.c - simple example of setting random number seeds with time */
/* c89 random.c -o random */

#include <stdio.h>
#include <sys/types.h>
#include <time.h>

main()
{ int i;
  time_t t1;

  (void) time(&t1);

  srand48((long) t1); /* use time in seconds to set seed */

  printf("5 random numbers (Seed = %d):\n", (int) t1);
  for (i=0;i<5;++i)
    printf("%d ", lrand48());
  printf("\n\n"); /* flush print buffer */

  /* lrand48() returns non-negative long integers
   uniformly distributed over the interval (0, ~2**31)
  */
}
```

Dave.Marshall@cm.cf.ac.uk
Wed Sep 14 10:06:31 BST 1994



Next: [timer.c](#) **Up:** [Program Listings](#) **Previous:** [random.c](#)

time.c

```
#include <sys/types.h>
#include <sys/times.h>

main()
{
    struct tms before, after;

    times(&before);

    /* ... place code to be timed here ... */

    times(&after);

    printf("User time: %ld seconds\n", after.tms_utime -
        before.tms_utime);
    printf("System time: %ld seconds\n", after.tms_stime -
        before.tms_stime);

    exit(0);
}
```

Dave.Marshall@cm.cf.ac.uk
Wed Sep 14 10:06:31 BST 1994



Next: [Using Dec Workstations and Unix](#) **Up:** [Program Listings](#) **Previous:** [time.c](#)

timer.c

```
/* timer.c - simple example of timing a piece of code */
/* c89 timer.c -o timer */

#include <stdio.h>
#include <sys/types.h>
#include <time.h>

main()
{ int i;
  time_t t1,t2;

  (void) time(&t1);

  for (i=1;i<=300;++i) printf("%d %d %d\n",i, i*i, i*i*i);

  (void) time(&t2);

  printf("\nTime to do 300 squares and cubes= %d seconds\n", (int) t2-t1);
}
```

Dave.Marshall@cm.cf.ac.uk
Wed Sep 14 10:06:31 BST 1994



Next: [args.c](#) **Up:** [Program Listings](#) **Previous:** [printf.c](#)

swap.c

```
/* exchange values */

#include <stdio.h>

void swap(float *x, float *y);

main()
{
    float x, y;

    printf("Please input 1st value: ");
    scanf("%f", &x);
    printf("Please input 2nd value: ");
    scanf("%f", &y);
    printf("Values BEFORE 'swap' %f, %f\n", x, y);
    swap(&x, &y); /* address of x, y */
    printf("Values AFTER 'swap' %f, %f\n", x, y);
    return 0;
}

/* exchange values within function */

void swap(float *x, float *y)
{
    float t;

    t = *x; /* *x is value pointed to by x */
    *x = *y;
    *y = t;
    printf("Values WITHIN 'swap' %f, %f\n", *x, *y);
}
```

Dave.Marshall@cm.cf.ac.uk
Wed Sep 14 10:06:31 BST 1994



Next: [arg.c](#) Up: [Program Listings](#) Previous: [swap.c](#)

args.c

```
#include <stdio.h>

main(int argc, char **argv)

{ /* program to print arguments from command line */

    int i;

    printf("argc = %d\n\n",argc);
    for (i=0;i<argc;++i)
        printf("argv[%d]: %s\n",i, argv[i]);
}
```

Dave.Marshall@cm.cf.ac.uk
Wed Sep 14 10:06:31 BST 1994



Next: [average.c](#) **Up:** [Program Listings](#) **Previous:** [args.c](#)

arg.c

```
\* program to read command line input and open files specified */

#include <stdio.h>

main(argc, argv)
int argc;
char **argv;
{
    int c;
    FILE *from, *to;

    /*
     * Check our arguments.
     */
    if (argc != 3) {
        fprintf(stderr, "Usage: %s from-file to-file\n", *argv);
        exit(1);
    }

    /*
     * Open the from-file for reading.
     */
    if ((from = fopen(argv[1], "r")) == NULL) {
        perror(argv[1]);
        exit(1);
    }

    /*
     * Open the to-file for appending.  If to-file does
     * not exist, fopen will create it.
     */
    if ((to = fopen(argv[2], "a")) == NULL) {
        perror(argv[2]);
        exit(1);
    }

    /*
     * Now read characters from from-file until we
     * hit end-of-file, and put them onto to-file.
     */
    while ((c = getc(from)) != EOF)
        putc(c, to);

    /*
     * Now close the files.
     */
    fclose(from);
    fclose(to);
    exit(0);
}
```

Wed Sep 14 10:06:31 BST 1994



Next: [cio.c](#) Up: [Program Listings](#) Previous: [arg.c](#)

average.c

```
#include <stdio.h>

float data[5]; /* data to average and total */
float total; /* the total of the data items */
float average; /* average of the items */

main()
{
    data[0] = 34.0;
    data[1] = 27.0;
    data[2] = 45.0;
    data[3] = 82.0;
    data[4] = 22.0;

    total = data[0] + data[1] + data[2] + data[3] + data[4];
    average = total / 5.0;
    (void)printf("Total %f Average %f\n", total, average);
    return (0);
}
```

Dave.Marshall@cm.cf.ac.uk
Wed Sep 14 10:06:31 BST 1994



Next: [factorial](#) **Up:** [Program Listings](#) **Previous:** [average.c](#)

cio.c

```
\* program to echo keyboard input to screen */
#include <stdio.h>

/* copy input to output */

main()
{
    int c;

    while ((c = getchar()) != EOF)
        putchar(c);
}
```

Dave.Marshall@cm.cf.ac.uk
Wed Sep 14 10:06:31 BST 1994



Next: [power.c](#) **Up:** [Program Listings](#) **Previous:** [cio.c](#)

factorial

```
\* e.g use of functions factorials *\
\* fact(n) = n*(n-1)*....2*1 *\

#include <stdio.h>

main()
{
    int n, m;

    printf("Enter a number: ");
    scanf("%d", &n);

    m = fact(n);
    printf("The factorial of %d is %d.\n", n, m);
    exit(0);
}

fact(n)
int n;
{
    if (n == 0)
        return(1);

    return(n * fact(n-1));
}
```

Dave.Marshall@cm.cf.ac.uk
Wed Sep 14 10:06:31 BST 1994



Next: [ptr_arr.c](#) **Up:** [Program Listings](#) **Previous:** [factorial](#)

power.c

```
#include <stdio.h>

int    power (int m, int n);

main () {
    int    i;

    printf ("power\t 2^power\t -3^power\n");
    for (i = 0; i < 10; ++i)
        printf ("%5d \t%8d \t%8d\n", i, power (2, i), power (-3, i));
    return 0;
}

int    power (int base, int n) {
    int    i,
           p;
    p = 1;
    for (i = 1; i <= n; ++i)
        p *= base;
    return p;
}
```

Dave.Marshall@cm.cf.ac.uk
Wed Sep 14 10:06:31 BST 1994



Next: [Exercises - Using X Windows Editing and Up: About This Course](#) **Previous:** [About This Course](#)

Course Material and On-line facilities

Obviously you have been provided with the course notes that you are reading.

In addition several on line facilities will be employed in this course.

- **Ceilidh** - an online tutoring and program marking facility (see Appendix [1](#) for details). All exercises given can be answered in Ceilidh. Some alternative C course notes are also available. Ceilidh will mark any exercise submitted very quickly.
- All program listings are available in the `/well/dave/C/EXAMPLES` directory. Feel free to copy these to help speed up your writing of programs. Mind Ceilidh helps with this also by providing skeleton programs.
- The course notes are also on-line. Run the `mosaic` program and select `comma lecture notes`.

We will be using the departments Dec Workstations which are unix based.

If you have not use unix or a workstation before do not worry the first tutorial session is to be used for this purpose.

Details on how to use the system are in Appendix [1](#). Also try the exercises that follow.

Dave.Marshall@cm.cf.ac.uk
Wed Sep 14 10:06:31 BST 1994



Next: [The C Program](#) **Up:** [About This Course](#) **Previous:** [Course Material and On-line facilities](#)

Exercises - Using X Windows, Editing and UNIX Basics

1. Practice opening, closing and moving windows around the screen and to/from the background/foreground. Get used to using the mouse and its buttons for such tasks.
2. Figure out the function of each of the three mouse buttons. Pay particular attention to the different functions the buttons in different windows (applications) and also when the mouse is pointing to the background.
3. Find out how to resize windows etc. and practice this.
4. Fire up `textedit` application and practice editing text files. Create any files you wish for now. Figure out basic options like cut and paste of text around the file, saving and loading files, searching for strings in the text and replacing strings.

Particularly pay attention in getting used to using the Key Strokes and / or mouse to perform the above tasks.

5. Use Unix Commands (see Appendix [1](#)) to
 1. Copy a file (created by text editor or other means) to another file called spare.
 2. Rename your original file to be called new.
 3. Delete the file spare.
 4. Display your original file on the terminal.
 5. Print your file out.
6. Familiarise yourself with other UNIX functions by creating various files of text etc. and trying out the various functions listed in handouts.

Dave.Marshall@cm.cf.ac.uk
Wed Sep 14 10:06:31 BST 1994



Next: [File Manipulation Routines](#) **Up:** [File and Directory Manipulation](#) **Previous:** [File and Directory Manipulation](#)

Directory handling functions

This basically involves calling appropriate functions.

`int chdir(char *path)` - changes directory to specified path string.

Example: C emulation of UNIX's `cd` command:

```
#include<stdio.h>

main(int argc,char **argv)
{
    if (argc < 2)
        { printf("Usage: %s
          <pathname> \n",argv[0]);
          exit(1);
        }
    if (chdir(argv[1]) != 0)
        { printf("Error in chdir\n");
          exit(1);
        }
}
```

`char *getwd(char *path)` - get the full pathname of the current working directory. `path` is a pointer to a string where the pathname will be returned. `getwd` returns a pointer to the string or `NULL` if an error occurs.

`scandir(char *dirname, struct direct ***namelist, int (*select)(), int (*compar)())` - reads the directory `dirname` and builds an array of pointers to directory entries or `-1` for an error. `namelist` is a pointer to an array of structure pointers.

`(*select)()` is a pointer to a function which is called with a pointer to a directory entry (defined in `<sys/types>` and should return a non zero value if the directory entry should be included in the array. If this pointer is `NULL`, then all the directory entries will be included.

The last argument is a pointer to a routine which is passed to `qsort` (see `man qsort`) - a built in function which sorts the completed array. If this pointer is `NULL`, the array is not sorted.

`alphasort(struct direct **d1, **d2)` - `alphasort()` is a built in routine which will sort the array alphabetically.

Example - a simple C version of UNIX `ls` utility

```
#include <sys/types.h>
#include <sys/dir.h>
#include <sys/param.h>
#include <stdio.h>

#define FALSE 0
#define TRUE !FALSE

extern int alphasort();

char pathname[MAXPATHLEN];

main() { int count,i;
        struct direct **files;
        int file_select();

        if (getwd(pathname) == NULL )
            { printf("Error getting path\n");
              exit(0);
            }
        printf("Current Working Directory = %s\n",pathname);
        count =
            scandir(pathname, &files, file_select, alphasort);

        /* If no files found, make a non-selectable menu item */
        if (count <= 0)
            { printf("No files in this directory\n");
              exit(0);
            }
        printf("Number of files = %d\n",count);
        for (i=1;i<count+1;++i)
            printf("%s ",files[i-1]->d_name);
        printf("\n"); /* flush buffer */
    }

int file_select(struct direct *entry)

    {if ((strcmp(entry->d_name, ".") == 0) ||
        (strcmp(entry->d_name, "..") == 0))
        return (FALSE);
    else
        return (TRUE);
    }
```

scandir returns the current directory (.) and the directory above this (..) as well as all files so we need to check for these and return FALSE so that they are not included in our list.

Note: scandir and alphasort have definitions in sys/types.h and sys/dir.h. MAXPATHLEN and getwd definitions in sys/param.h

We can go further than this and search for specific files: Let's write a modified file_select() that only scans for files with a .c, .o or .h suffix:

```
int file_select(struct direct *entry)

{char *ptr;
 char *rindex(char *s, char c);

if ((strcmp(entry->d_name, ".") == 0) ||
    (strcmp(entry->d_name, "..") == 0))
    return (FALSE);

/* Check for filename extensions */
ptr = rindex(entry->d_name, '.');
if ((ptr != NULL) &&
    ((strcmp(ptr, ".c") == 0)
     || (strcmp(ptr, ".h") == 0)
     || (strcmp(ptr, ".o") == 0) ))
    return (TRUE);
else
    return(FALSE);
}
```

NOTE: rindex() is a string handling function that returns a pointer to the last occurrence of character c in string s, or a NULL pointer if c does not occur in the string. (index() is similar function but assigns a pointer to 1st occurrence.)



Next: [File Manipulation Routines](#) **Up:** [File and Directory Manipulation](#) **Previous:** [File and Directory Manipulation](#)

Dave.Marshall@cm.cf.ac.uk
Wed Sep 14 10:06:31 BST 1994



Next: [errno](#) **Up:** [File and Directory Manipulation](#) **Previous:** [Directory handling functions](#)

File Manipulation Routines

`int access(char *path, int mode)` - determine accessibility of file.

`path` points to a path name naming a file. `access()` checks the named file for accessibility according to `mode`, defined in `#include <unistd.h>`:

`R_OK`

- test for read permission

`W_OK`

- test for write permission

`X_OK`

- test for execute or search permission

`F_OK`

- test whether the directories leading to the file can be searched and the file exists.

`access()` returns: 0 on success, -1 on failure and sets `errno` to indicate the error. See `man` pages for list of errors.

Dave.Marshall@cm.cf.ac.uk

Wed Sep 14 10:06:31 BST 1994



Next: [Process Control and Management](#) **Up:** [File and Directory Manipulation](#) **Previous:** [File Manipulation Routines](#)

errno

`errno` is a special system variable that is set if a system call cannot perform its set task.

To use `errno` in a C program it must be declared via:

```
extern int errno;
```

It can be manually reset within a C program other wise it simply retains its last value.

`int chmod(char *path, int mode)` change the mode of access of a file. specified by `path` to the given `mode`.

`chmod()` returns 0 on success, -1 on failure and sets `errno` to indicate the error. Errors are defined in `#include <sys/stat.h>`

The access mode of a file can be set using predefined macros in `sys/stat.h` - see `man` pages - or by setting the mode in a a 3 digit octal number.

The rightmost digit specifies owner privileges, middle group privileges and the leftmost other users privileges.

For each octal digit think of it a 3 bit binary number. Leftmost bit = read access (on/off) middle is write, right is executable.

So 4 (octal 100) = read only, 2 (010) = write, 6 (110) = read and write, 1 (001) = execute.

so for access mode 600 gives user read and write access others no access. 666 gives everybody read/write access.

NOTE: a UNIX command `chmod` also exists

```
int stat(char *path, struct stat *buf), int fstat(int fd, struct stat *buf)
```

`stat()` obtains information about the file named by `path`. Read, write or execute permission of the named file is not required, but all directories listed in the `path` name leading to the file must be searchable.

`fstat()` obtains the same information about an open file referenced by the argument descriptor, such as would be obtained by an `open` call (Low level I/O).

`buf` is a pointer to a `stat` structure into which information is placed concerning the file. A `stat` structure is define in `#include <sys/types.h>`, see `man` pages for more information.

`stat()`, and `fstat()` return 0 on success, -1 on failure and sets `errno` to indicate the error. Errors are again defined in `#include <sys/stat.h>`

`int unlink(char *path)` - removes the directory entry named by `path`

`unlink()` returns 0 on success, -1 on failure and sets `errno` to indicate the error. Errors listed
in `#include <sys/stat.h>`

NOTE: There are a few more file manipulation routines (Appendix [□](#)).



Next: [Process Control and Management](#) **Up:** [File and Directory Manipulation](#) **Previous:** [File Manipulation Routines](#)

Dave.Marshall@cm.cf.ac.uk
Wed Sep 14 10:06:31 BST 1994



Next: [execl\(\)](#) **Up:** [Process Control and Management](#) **Previous:** [Process Control and Management](#)

Running UNIX Commands from C

We can run commands from a C program just as if they were from the UNIX command line by using the `system()` function. **NOTE:** this can save us a lot of time and hassle as we can run other (proven) programs, scripts *etc.* to do set tasks.

`int system(char *string)` - where string can be the name of a unix utility, an executable shell script or a user program. System returns the exit status of the shell.

Example: Call `ls` from a program

```
main()
{ printf("Files in Directory are:\n");
  system("ls -l");
}
```

`system` is a call that is made up of 3 other commands: `execl()`, `wait()` and `fork()`

-
- [execl\(\)](#)
 - [fork\(\)](#)
 - [wait\(\)](#)
 - [exit\(\)](#)
-

Dave.Marshall@cm.cf.ac.uk
Wed Sep 14 10:06:31 BST 1994



Next: [popen\(\) - Formatted Piping](#) **Up:** [Process Control and Management](#) **Previous:** [exit\(\)](#)

Piping in a C program

Piping is a process where the input of one process is made the input of another. We have seen examples of this from the UNIX command line using `|`.

We will now see how we do this from C programs.

We will have two (or more) `forked` processes and will communicate between them.

We must first open a *pipe*

UNIX allows two ways of opening a pipe.

-
- [popen\(\) - Formatted Piping](#)
 - [pipe\(\) - Low level Piping](#)
-

Dave.Marshall@cm.cf.ac.uk

Wed Sep 14 10:06:31 BST 1994



Next: [Sending Signals - kill\(\)](#) **Up:** [Process Control and Management](#) **Previous:** [pipe\(\) - Low level Piping](#)

Interrupts and Signals

In this section will look at ways in which two processes can communicate. When a process terminates abnormally it usually tries to send a signal indicating what went wrong. C programs (and UNIX) can trap these for diagnostics. Also user specified communication can take place in this way.

The process uses *signals* which can be numbered 0 to 31. Macros are defined in `signal.h` header file for common signals.

These include:

```
SIGHUP 1 /* hangup */
SIGQUIT 3 /* quit */
SIGABRT 6 /* used by abort */
SIGALRM 14 /* alarm clock */
SIGCONT 19 /* continue a stopped process */
SIGCHLD 20 /* to parent on child stop or exit */
SIGINT 2 /* interrupt */
SIGILL 4 /* illegal instruction */
SIGKILL 9 /* hard kill */
```

-
- [Sending Signals - kill\(\)](#)
 - [Receiving signals - signal\(\)](#)
-

Dave.Marshall@cm.cf.ac.uk
Wed Sep 14 10:06:31 BST 1994



Next: [The exercise level](#) Up: [Using Ceilidh as a Student](#) Previous: [Using Ceilidh as a Student](#)

The course and unit level

In the X based version these are both in the main window

In the text based version: When you have selected a particular course, the menu shown in figure  should now be displayed on the screen.



```
-----  
Course and unit menu for course "pr1" unit "1"  
lu   list unit titles           | su   set unit code  
lx   list unit exercis titles  | sx   move to named exercis (1)  
lux  list units and exercises | state current exercis stata  
vn   view notes on the screen  | pn   print notes on letter13  
csun read course summary      | usun read unit summary  
vm   view all marks           |  
clp  change printer           | h    for more help  
co   make a comment to teacher | q    quit  
-----  
Unit command:  
-----
```

Figure 17.1: Unit and Course Level Ceilidh Menu (text version only)

This menu is identical whether it is obtained from the system level of Ceilidh using the `sc` command, or by entering Ceilidh with a `-c` argument.

We are now in a chosen course. The various possible commands have the following significance.

lu

(text only - list unit :the units are automatically listed in X version once the course has been selected)

Each course is divided into a number of units, rather like the chapters of a book. This option lists the name of each unit, giving you a brief outline of the course as a whole. Typical output might be

```
Units in course pr1  
Unit 1: Background  
Unit 2: Elementary programming  
Unit 3: Conditionals  
Unit 4: Loops  
Unit 5: Functions  
Unit 6: Miscellany  
Unit 7: Arrays and structures  
Unit 8: File input and output  
Unit 9: Pointers
```

lux

(text only) This command lists all units and exercises within these units.

csum

(Course Summary button) If the teacher remembers to keep the information up-to-date, this command gives you a summary of the timetable for your course, with

details of the courseworks to be set, and the hand-in dates for each one.

state

(text only - See message of the day MOTD) As a course progresses exercises are opened, made late and then closed. This command gives a summary of the state of each exercise.

Select Unit Button (su)

This command enables you to select a chosen unit of the course. The menu remains the same, apart from the currently selected unit number which is included at the top of the menu. Commands below which relate to a specific unit use the currently selected unit number.

Unit Summary Button (usum)

This will list a brief summary of the currently selected unit, usually at the level of section headings in the notes.

View Notes Button (vn)

This command (view notes) allows you to view on-line the notes for the current unit of the course.

q

(text only) This is the command to quit the system. If you entered Ceilidh at the course level with a command such as

```
ceilidh -c pr1
```

the quit will return you to your shell. If you entered the course level from the system level using first

```
ceilidh
```

and then

```
sc pr1
```

for example, the quit returns you to the system level of Ceilidh, and you will need another quit to return to your shell.

Your current unit and exercise will be noted, so that when you re-enter Ceilidh, you will default to the same unit and exercise as when you left. If you wish to quit without saving your current state, use q!

instead.

Make Comment Button (co)

At many points in the Ceilidh system, the system allows you to make comments to the course teacher. Comments are always welcome. Comments may be a request for help ("What do you mean by in this week's question?"), a criticism of the system ("I think the mark it gave me was not fair"), or an apology for the late hand-in of work ("Sorry but I had an examination ..."). Please feel free to use this facility; the teacher will try to answer most queries. The comments are sent using email to the teacher in charge of the course.

Change Printer (clp)

- may not work !! Whenever you use a command which involves printing some information, the computer chooses the printer which it thinks is most convenient. This is done by looking at where you are on campus. Sometimes the computer chooses the wrong printer (it cannot always tell exactly where you are on a network), so there is a facility for you to choose a particular printer by name. You will be told appropriate printer names in class.

To work on your coursework, you will need to move from the "unit" level of Ceilidh into the "exercise" level.

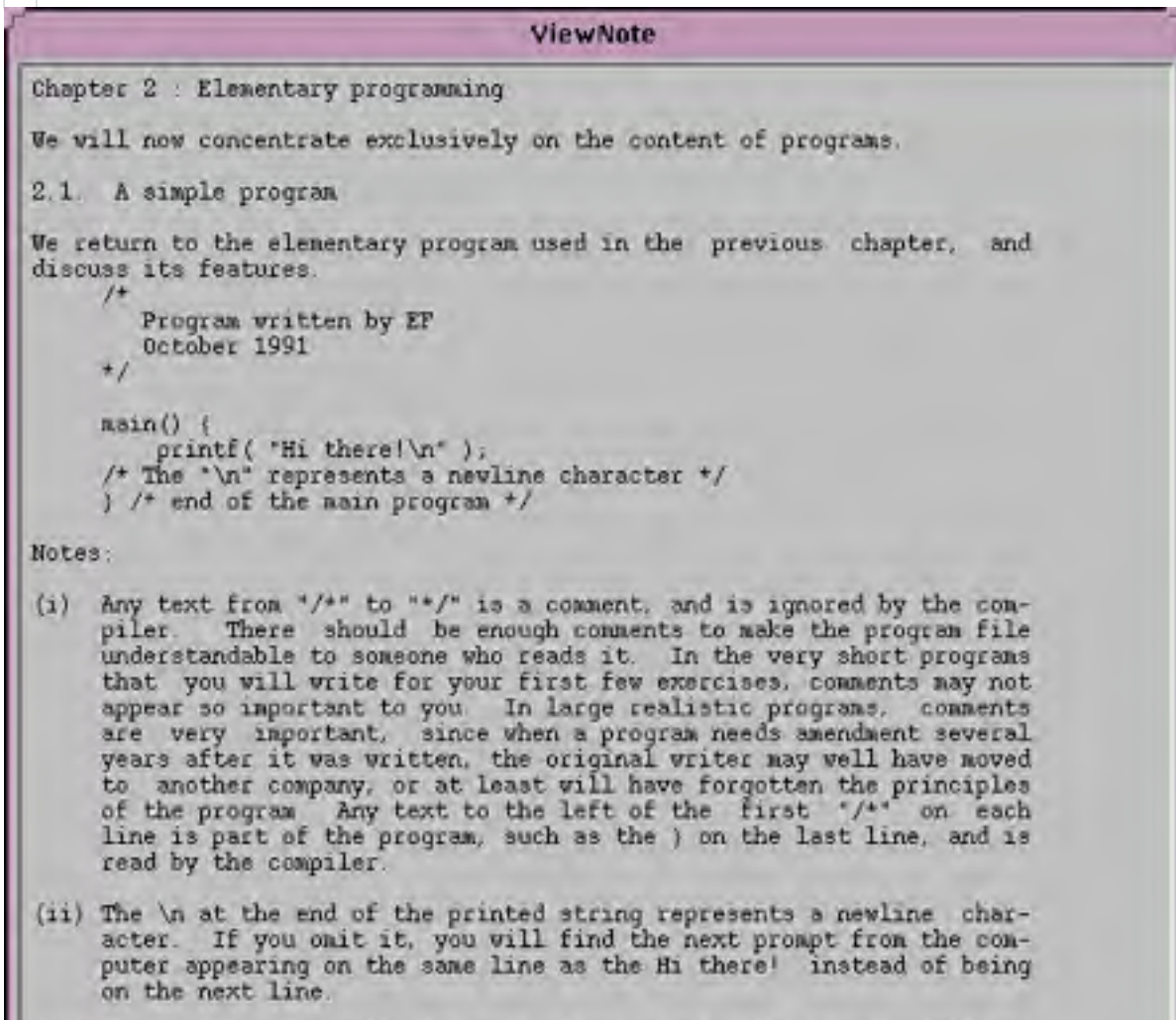

```
ViewNote

Chapter 2 : Elementary programming

We will now concentrate exclusively on the content of programs.

2.1. A simple program

We return to the elementary program used in the previous chapter, and
discuss its features.
/*
   Program written by EF
   October 1991
*/

main() {
    printf( "Hi there!\n" );
/* The "\n" represents a newline character */
} /* end of the main program */

Notes:

(i) Any text from "/*" to "*/" is a comment, and is ignored by the com-
piler. There should be enough comments to make the program file
understandable to someone who reads it. In the very short programs
that you will write for your first few exercises, comments may not
appear so important to you. In large realistic programs, comments
are very important, since when a program needs amendment several
years after it was written, the original writer may well have moved
to another company, or at least will have forgotten the principles
of the program. Any text to the left of the first "/*" on each
line is part of the program, such as the ) on the last line, and is
read by the compiler.

(ii) The \n at the end of the printed string represents a newline char-
acter. If you omit it, you will find the next prompt from the com-
puter appearing on the same line as the Hi there! instead of being
on the next line.
```

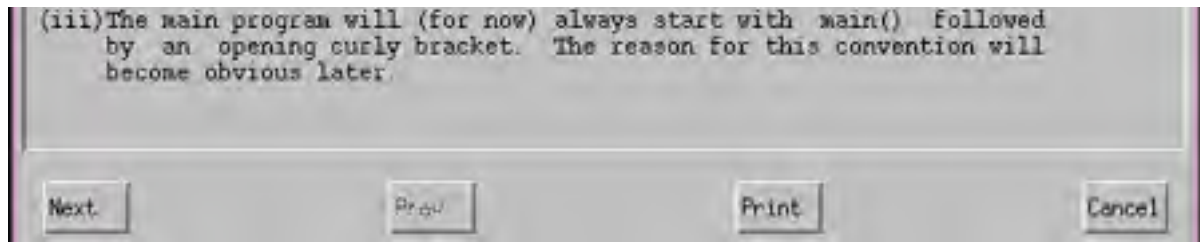

Fig.  Example of X version view notes window



Next: [The exercise level Up: Using Ceilidh as a Student](#) **Previous:** [Using Ceilidh as a Student](#)

Dave.Marshall@cm.cf.ac.uk
Wed Sep 14 10:06:31 BST 1994



Next: [Interpreted language exercises](#) **Up:** [Using Ceilidh as a Student](#) **Previous:** [The course and unit level](#)

The exercise level

If, for a given coursework, you are asked to solve a nominated coursework exercise in a this week's unit of the course, you will perhaps first select the appropriate unit using the, Select Unit (su) command, then list the names of all the exercises in this unit appear in the main window (or using the command

lx

at the course/unit level, and then enter the required exercise using

sx 2

for example, to select exercise 2 of the current unit.)

In X highlight the exercise you want and press Select Unit button.

IN X: Do Exercise moves you to a new level and a new window: The exercise level.

IN TEXT VERSION: It is worth noting that at the course level, while the sx (select a particular exercise) command moves you to another level, the "exercise level" with another menu, the su (select a unit) command leaves you at the course level with the same menu. You can move around the different units in a course at will without changing your level in the system. To attempt exercises you must enter the exercise level, which has different menus depending on the type of exercise you are asked to complete. These exercises include compiled language exercises, interpreted language exercises, question/answer exercises and text submission (essay) exercises. For the moment will will consider the compiled language exercise menu.

If you type

sx 1

to select exercise 1 in the current unit of the course you will see the menu given in Fig. .

This is the level at which most of your work will be undertaken. Each exercise will have been set up by the teacher, and will include a question, a skeleton solution, and all the necessary testing information.

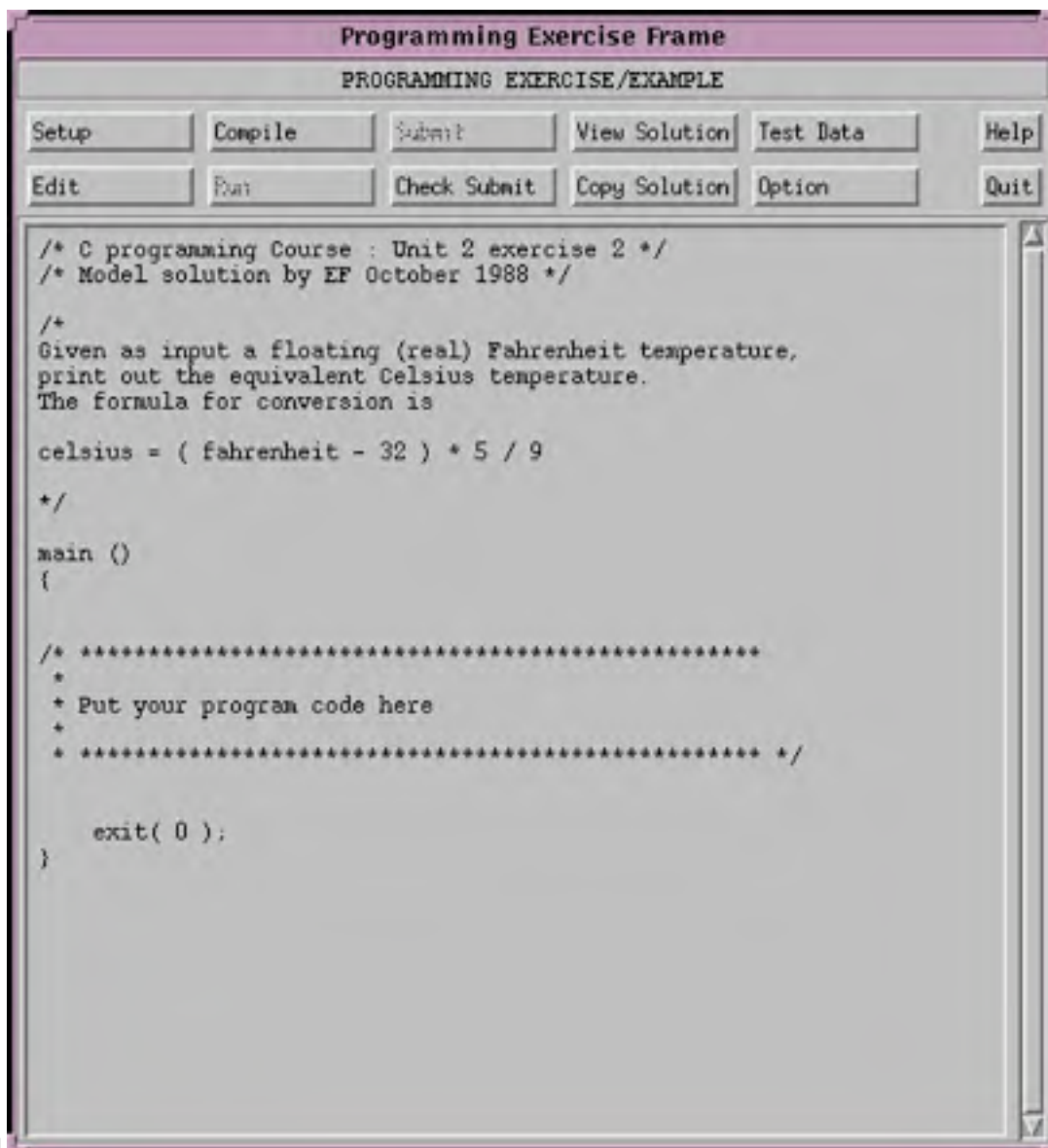

(text version ceilidh looks like this)

```
Compiled language menu for course "pr1" unit "1" exercise "1"
vq   view question on the screen | pq   print question on draft13
co   make a comment to teacher   | set  set up coursework
h    for context help           | H    for general help
q    to return to calling menu   |
ed   edit your program          | cm   compile your program
cv   compile verbose            | cks  check whether submitted OK
run  run your executable        | rut  run yours against test data
sub  submit/mark your program   | std  look at the test data
vs   view solution program      | ps   print sol'n program on draft13
cp   get copy of solution       |
rex  run solution executable    | rxt  run sol'n against test data
=====
Type compiled language command:
```

Fig. 1. Exercise Level Ceilidh Menu

Your normal sequence of activity at this level might be as follows. First use view question (vq) to look at the question, or print question (pq) to print it out. You may need to study the question for a while before attempting its solution on the computer. It may be sensible to view or print it at least a day before the laboratory session during which you solve the problem.

You will then use

setup (set)

to set up a skeleton solution. This command typically puts an outline of the required program into your directory, to give you a flying start in solving the problem. In more complex exercises later in the course, it may set up other data files as well.

A textedit window will be brought up to edit it.

At this stage you can start to develop your program, using the commands

Edit (ed)

to edit your program,

Compile (cm)

to compile it (if the compilation fails, go back to ed to correct the error with the editor, and then try compilation again), and

Run

to try running your program. It is up to you to think of appropriate tests when running your program, to convince yourself that it is running correctly.

cv

(Text only - see Options button in X Version to set verbose compilation) This command is given as an alternative to the cm command. When used it will compile your program more verbosely, giving compiler

warning messages which can help identify problems in your solution.

db

(text only) If this option has been set up by the course developer, it offers debugging facilities to you.

Note: Not all of the options in the menu will appear on the at all times; if there is no executable, for example, the running options will not appear or appear ghosted in XCEILIDH. If you have not executed set to obtain an outline program, the ed command for editing your program will not be shown.

Once you have successfully compiled your program and tested it to your satisfaction, the system is ready to mark and submit it. It does this by looking at your program source code (checking that it is indented correctly, for example), and running your compiled program against various sets of test data and seeing that it produces the correct results. At this stage you may wish to use the following commands.

rut

(text only - see OPTIONS button to set this in X version) This runs your compiled program against the first set of test data used by the marking process, and enables you to see whether it appears to produce sensible answers.

std (show test data)

This shows you each set of test data being used by the marking process. The teacher reserves the right to change the test data at any time, since your program should generally work on absolutely any data which it receives.

When you have performed enough tests to convince you that your program is correct (and only then) you should ask the system to mark and submit it using the

```
submit button (sub command).
```

The computer's response will be something like that shown in figure .

```
-----  
Analysis of Dynamic Correctness  
      item  mark  out of  
      Simple test  
      Negative distance  
      Check "feet" "ins"  
      Inches > 12  
      Negative inches  
Score for Dynamic Correctness is      .0%  
  
Mark summary  
      category  mark  out of  
      Dynamic correctness  
      C++ typographic style  
      C++ complexity measure  
      C++ program features  
Overall mark awarded  
-----
```

 Figure 17.2: Output from the marking command

The significance of this output is as follows.

Firstly your compiled program is run against several sets of test data. The system looks in the output generated by your program for evidence that you have produced the correct answer; this can be a non-trivial operation if your program does not print its results clearly! Each test produces one line of output, giving you a brief summary of the test, and the score you have been awarded. Different tests will be marked out of different totals, depending on the importance of the test.

The marks from these runs against test data are then combined into a single "dynamic test" result for your program. This result is then scaled out of a particular value, and the next few lines give marks for various "static tests" (tests performed by looking at your program source,

rather than by executing it) such as "typographic style" (your program layout, choice of identifiers, use of comments, etc, see the ASQA paper[1] for details, a copy is stored on the Ceilidh system) "complexity" (the complexity of your program is compared with the complexity of the course developer's model solution; the two should not differ by too large a factor) and lastly "features" (the computer looks for specific good or bad programming features associated with this particular coursework).

All these marks are then combined with their weightings into a single mark which you are awarded. The Ceilidh system retains a copy of your program and of the mark awarded for future reference.

If you are happy with the mark awarded, you can quit at this stage. Alternatively, you may try to improve your mark and try again. It is your last mark which is recorded as your actual mark for this coursework.

To check that the mark has been correctly stored by the computer, use the command

```
check submission button (cks)
```

which will show you what the computer has recorded. You should always use this checking facility after every exercise.

There is also a command at the course/unit level `vm` which lets you view ALL your marks submitted so far.

Note:

- Do not waste hours trying to obtain an extra mark or two. It is a misguided waste of your time. Once you have achieved a good overall mark, leave the Ceilidh system and work on your other courses!
- Do not use the system to find bugs in your program. Design and test your program thoroughly yourself before you submit it to Ceilidh for marking.

Other commands at this level are:

View Solution (`vs`), Print Solution (`ps`), Copy Solution (`cp`)

: These commands are available only after the hand-in date of the coursework, and let you view the solution (`vs`) to the coursework, print the solution (`ps`), and copy the solution into your own directory (`cp`) so that you can try it out yourself.

`rex`, `rxt`

(text only - see OPTIONS Button): These commands allow you to run the course developer's compiled program interactively (`rex`) to see that it works the way you expected, and to run it against the first set of test data (`rxt`) to see the output which it gives. This may give you ideas on how to layout your output. These options may not exist if there is insufficient space on the disc for the teacher to store executable versions of all the solutions.

When you quit (`q`) from the exercise level of Ceilidh, you return to the course level of Ceilidh, where you may perform other activities, or execute another quit to leave Ceilidh completely.



Next: [Interpreted language exercises](#) **Up:** [Using Ceilidh as a Student](#) **Previous:** [The course and unit level](#)

Dave.Marshall@cm.cf.ac.uk
Wed Sep 14 10:06:31 BST 1994



Next: [Question/answer exercises](#) **Up:** [Using Ceilidh as a Student](#) **Previous:** [The exercise level](#)

Interpreted language exercises

The menu and process for interpreted language exercises is similar to the compiled language menu described in the previous section. The compilation commands are, of course, excluded.

Dave.Marshall@cm.cf.ac.uk
Wed Sep 14 10:06:31 BST 1994



Next: [The command line interface \(TEXT CEILIDH ONLY\)](#) **Up:** [Using Ceilidh as a Student](#)
Previous: [Interpreted language exercises](#)

Question/answer exercises

The exercise level menu for these exercises is completely different from that of the Compiled Language menu shown above.

For Question/Answer exercises you are given the following menu.

```
Question/answer exercise menu for course "tst" unit "1" exercise "qu":
vq   view questions           | pq   print questions
ans  answer questions and submit | cks  check submitted
h    help                     | q    return to calling menu
Type question/answer command:
```

The X windows one is similar We will not use this much in our course.

The options have significance as follows.

vq

This allows you to view the questions before attempting to answer them. The pq command can then be used to obtain a printout of these questions.

ans

When you are happy you know the answers to the questions set, you can enter your solutions using the ans command. This will then ask you the questions one at a time and read your response. Answers may be a choice between a few options, a word or a short sentence. To quit the exercise before answering all the questions type q as your answer.

cks

This command allows you to check that your mark has been submitted correctly, and to check your answers.

Some question/answer exercises are purely for collecting answers, such as those to the end-of-course questionnaire. Other will involve answers which are marked. The questions should make clear which of these cases holds.

Dave.Marshall@cm.cf.ac.uk
Wed Sep 14 10:06:31 BST 1994



Next: [General points](#) **Up:** [The command line interface \(TEXT CEILIDH ONLY\)](#) **Previous:**
[The command line interface \(TEXT CEILIDH ONLY\)](#)

Advantages of the command line interface

With this interface, you can execute other non-Ceilidh commands or even log out at any point. When you resume, the course, unit and exercise will remain set just as when you last issued a Ceilidh command (although you may choose to execute "status" to check the settings). This interface will be particularly useful for the "pr2" course, in which you need to perform all compilations yourself.

With this interface there is never any need to use "q" to quit the various levels of Ceilidh.

At any time, type

```
commands
```

to remind yourself of the commands currently available. The command

```
status
```

shows the currently set course, unit and exercise.

Typing

```
~ceilidh/bin.cli/set.env
```

will clear out the currently set values for course, unit and exercise. You will then need to use "set.cse", "set.unit" etc to reset them to the values you require.

Dave.Marshall@cm.cf.ac.uk
Wed Sep 14 10:06:31 BST 1994



Next: [Conclusions](#) **Up:** [The command line interface \(TEXT CEILIDH ONLY\)](#) **Previous:**
[Advantages of the command line interface](#)

General points

At certain times, the teacher may close a complete course, or a unit, or an exercise. These perhaps represent parts of the course which are under development, or which must be kept unmodified for administrative reasons.

Dave.Marshall@cm.cf.ac.uk
Wed Sep 14 10:06:31 BST 1994



Next: [Low level I/O](#) **Up:** [Input and Output](#) **Previous:** [Input and Output](#)

Stream I/O

`#include <stdio.h>`

`void clearerr(FILE *file_pointer)` - Clear error indicator of stream,

`int fclose(FILE *file_pointer)` - Close a file,

`int feof(FILE *file_pointer)` - Check if end of file occurred on a stream.

`int ferror(FILE *file_pointer)` - Check if any error occurred during file I/O.

`int fflush(FILE *file_pointer)` - Write out (flush) buffer to file.

`int fgetc(FILE *file_pointer)` - Get a character from a stream.

`int fgetpos(FILE *file_pointer, fpos_t current_pos)` - Get the current position in a stream.

`char *fgets(char *string, int maxchar, FILE *file_pointer)` - Read a string from a file.

`FILE *fopen(char *filename, char *access_mode)` - Open a file for buffered I/O.

`int fprintf(FILE *file_pointer, char *format_string, args)` - Write formatted output to a file,

`int fputc(int c, FILE *file_pointer)` - Write a character to a stream.

`int fputchar(int c)` - Write a character to `stdout`.

`int fputs(char *string, FILE *file_pointer)` - Write a string to a stream.

`size_t fread(char *buffer, size_t size, size_t count, FILE *file_pointer)` - Read unformatted data from a stream into a buffer.

`FILE *freopen(char *filename, char *access mode, FILE *file_pointer)` - Reassign a file pointer to a different file.

`int fscanf(FILE *file_pointer, char *format string, args)` - Read formatted input from a `stream`.

`int fseek(FILE *file_pointer, long offset, int origin)` - Set current position in file to a new location.

`int fsetpos(FILE *file pointer, fpos_t *current pos)` - Set current position in file to a new location.

`long ftell(FILE *file_pointer)` - Get current location in file.

`size_t fwrite(char *buffer, size_t size, size_t count FILE *file_pointer)` - Write unformatted data from a buffer to a stream.

`int getc(FILE *file_pointer)` - Read a character from a `stream`.

`int getchar(void)` - Read a character from `stdin`.

`char *gets(char *buffer)` - Read a line from `stdin` into a buffer.

`int printf(char *format_string, args)` - Write formatted output to `stdout`.

`int putc(int c, FILE *file_pointer)` - Write a character to a `stream`.

`int putchar(int c)` - Write a character to `stdout`.

`int puts(char *string)` - Write a string to `stdout`.

`void rewind(FILE *file_pointer)` - Rewind a file.

`int scanf(char *format_string, args)` - Read formatted input from `stdin`.

`void setbuf(FILE *file_pointer, char *buffer)` - Set up a new buffer for the stream.

`int setvbuf(FILE *file_pointer, char *buffer, int buf_type, size_t buf size)` - Set up new buffer and control the level of buffering on a stream.

`int sprintf(char *string, char *format_string, args)` - Write formatted output to a `string`.

`int sscanf(char *buffer, char *format_string, args)` - Read formatted input from a `string`.

`FILE *tmpfile(void)` - Open a temporary file.

`char *tmpnam(char *file_name)` - Get temporary file name.

`int ungetc(int c, FILE *file_pointer)` - Push back character into `stream`'s buffer

Dave.Marshall@cm.cf.ac.uk
Wed Sep 14 10:06:31 BST 1994



Next: [Mathematics](#) **Up:** [Input and Output](#) **Previous:** [Stream I/O](#)

Low level I/O

`#include <stdio.h>` and may also need some of `#include <stdarg.h>`, `#include <sys/types.h>`,
`#include <sys/stat.h>`, `#include <fcntl.h>`.

`int close (int handle)` - Close a file opened for unbuffered I/O.

`int creat(char *filename, int pmode)` - Create a new file with specified permission setting.

`int eof (int handle)` - Check for end of file.

`long lseek(int handle, long offset, int origin)` - Go to a specific position in a file.

`int open(char *filename, int oflag, unsigned pmode)` - Open a file for low-level I/O.

`int read(int handle, char *buffer, unsigned length)` - Read binary data from a file into a buffer.

`int Write(int handle, char *buffer, unsigned count)` - Write binary data from a buffer to a file.

Dave.Marshall@cm.cf.ac.uk

Wed Sep 14 10:06:31 BST 1994



Next: [WriteMyString.c](#) **Up:** [Modular Example](#) **Previous:** [Modular Example](#)

main.c

```
/*
 * main.c
 */
#include "header.h"
#include <stdio.h>

char *AnotherString = "Hello Everyone";

main()
{
    printf("Running...\n");

    /*
     * Call WriteMyString() - defined in another file
     */
    WriteMyString(MY_STRING);

    printf("Finished.\n");
}
```

Dave.Marshall@cm.cf.ac.uk
Wed Sep 14 10:06:31 BST 1994



Next: [header.h](#) **Up:** [Modular Example](#) **Previous:** [main.c](#)

WriteMyString.c

```
/*
 * WriteMyString.c
 */
extern char *AnotherString;

void WriteMyString(ThisString)
char *ThisString;
{
    printf("%s\n", ThisString);
    printf("Global Variable = %s\n", AnotherString);
}
```

Dave.Marshall@cm.cf.ac.uk
Wed Sep 14 10:06:31 BST 1994



Next: [Makefile](#) **Up:** [Modular Example](#) **Previous:** [WriteMyString.c](#)

header.h

```
/*
 * header.h
 */
#define MY_STRING "Hello World"

void WriteMyString();
```

Dave.Marshall@cm.cf.ac.uk
Wed Sep 14 10:06:31 BST 1994



Next: [static.c](#) **Up:** [Modular Example](#) **Previous:** [header.h](#)

Makefile

```
#
# Makefile
#
SOURCES.c= main.c WriteMyString.c
INCLUDES=
CFLAGS=
SLIBS=
PROGRAM= main

OBJECTS= $(SOURCES.c:.c=.o)

.KEEP_STATE:

debug := CFLAGS= -g

all debug: $(PROGRAM)

$(PROGRAM): $(INCLUDES) $(OBJECTS)
    $(LINK.c) -o $@ $(OBJECTS) $(SLIBS)

clean:
    rm -f $(PROGRAM) $(OBJECTS)
```

Dave.Marshall@cm.cf.ac.uk
Wed Sep 14 10:06:31 BST 1994



Next: [plotter.c](#) Up: [Piping](#) Previous: [Piping](#)

plot.c

```
/* plot.c - example of unix pipe. Calls gnuplot graph drawing package to draw
   graphs from within a C program. Info is piped to gnuplot */
/* Creates 2 pipes one will draw graphs of y=0.5 and y = random 0-1.0 */
/* the other graphs of y = sin (1/x) and y = sin x */
/* c89 -o plot plot.c plotter.c - ON DECS */
/* acc -o plot plot.c plotter.c - ON SUNS */

#include "externals.h"
#include <signal.h>

#define DEG_TO_RAD(x) (x*180/M_PI)

double drand48();
void quit();

FILE *fp1, *fp2, *fp3, *fp4, *fopen();

main()
{   float i;
    float y1,y2,y3,y4;

    /* open files which will store plot data */
    if ( ((fp1 = fopen("plot11.dat","w")) == NULL) ||
        ((fp2 = fopen("plot12.dat","w")) == NULL) ||
        ((fp3 = fopen("plot21.dat","w")) == NULL) ||
        ((fp4 = fopen("plot22.dat","w")) == NULL) )
        { printf("Error can't open one or more data files\n");
          exit(1);
        }

    signal(SIGINT,quit); /* trap ctrl-c call quit fn */
    StartPlot();
    y1 = 0.5;
    srand48(1); /* set seed */
    for (i=0;;i+=0.01) /* increment i forever use ctrl-c to quit prog */
        { y2 = (float) drand48();
          if (i == 0.0)
              y3 = 0.0;
          else
              y3 = sin(DEG_TO_RAD(1.0/i));
          y4 = sin(DEG_TO_RAD(i));

          /* load files */
          fprintf(fp1,"%f %f\n",i,y1);
          fprintf(fp2,"%f %f\n",i,y2);
          fprintf(fp3,"%f %f\n",i,y3);
          fprintf(fp4,"%f %f\n",i,y4);

          /* make sure buffers flushed so that gnuplot reads up to data file */
          fflush(fp1);
          fflush(fp2);
          fflush(fp3);
          fflush(fp4);

          /* plot graph */
          PlotOne();
        }
}
```

```
        usleep(250); /* sleep for short time */
    }
}

void quit()
{ printf("\nctrl-c caught:\n Shutting down pipes\n");
  StopPlot();

  printf("closing data files\n");
  fclose(fp1);
  fclose(fp2);
  fclose(fp3);
  fclose(fp4);

  printf("deleting data files\n");
  RemoveDat();
}
```

Dave.Marshall@cm.cf.ac.uk
Wed Sep 14 10:06:31 BST 1994



Next: [externals.h](#) Up: [Piping](#) Previous: [plot.c](#)

plotter.c

```
/* plotter.c module */
/* contains routines to plot a data file produced by another program */
/* 2d data plotted in this version */
/*****

#include "externals.h"

static FILE *plot1,
            *plot2,
            *ashell;

static char *startplot1 = "plot [] [0:1.1]'plot11.dat' with lines, 'plot12.dat'
                          with lines\n";

static char *startplot2 = "plot 'plot21.dat' with lines, 'plot22.dat' with line
static char *replot = "replot\n";
static char *command1= "/usr/local/bin/gnuplot> dump1";
static char *command2= "/usr/local/bin/gnuplot> dump2";
static char *deletfiles = "rm plot11.dat plot12.dat plot21.dat plot22.dat";
static char *set_term = "set terminal x11\n";

void
StartPlot(void)
{ plot1 = popen(command1, "w");
  fprintf(plot1, "%s", set_term);
  fflush(plot1);
  if (plot1 == NULL)
    exit(2);
  plot2 = popen(command2, "w");
  fprintf(plot2, "%s", set_term);
  fflush(plot2);
  if (plot2 == NULL)
    exit(2);
}

void
RemoveDat(void)
{ ashell = popen(deletfiles, "w");
  exit(0);
}

void
StopPlot(void)
{ pclose(plot1);
  pclose(plot2);
}

void
PlotOne(void)
{ fprintf(plot1, "%s", startplot1);
  fflush(plot1);

  fprintf(plot2, "%s", startplot2);
  fflush(plot2);
```

```
    }  
  
void  
RePlot(void)  
{ fprintf(plot1, "%s", replot);  
  fflush(plot1);  
}
```

Dave.Marshall@cm.cf.ac.uk
Wed Sep 14 10:06:31 BST 1994



Next: [random.c](#) **Up:** [Piping](#) **Previous:** [plotter.c](#)

externals.h

```
/* externals.h */
#ifndef EXTERNALS
#define EXTERNALS

#include <stdio.h>
#include <stdlib.h>
#include <math.h>

/* prototypes */

void StartPlot(void);
void RemoveDat(void);
void StopPlot(void);
void PlotOne(void);
void RePlot(void);
#endif
```

Dave.Marshall@cm.cf.ac.uk
Wed Sep 14 10:06:31 BST 1994



Next: [fork\(\)](#) **Up:** [Running UNIX Commands from C](#) **Previous:** [Running UNIX Commands from C](#)

execl()

`execl` has 5 other related functions - see `man` pages.

`execl` stands for *execute* and *leave* which means that a process will get executed and then terminated by `execl`.

It is defined by:

```
execl(char *path, char *arg0, ..., char *argn, 0);
```

The last parameter must always be 0. It is a *NULL terminator*. Since the argument list is variable we must have some way of telling C when it is to end. The NULL terminator does this job.

where `path` points to the name of a file holding a command that is to be executed, `arg0` points to a string that is the same as `path` (or at least its last component).

`arg1 ... argn` are pointers to arguments for the command and 0 simply marks the end of the (variable) list of arguments.

So our above example could look like this also:

```
main()
{ printf("Files in Directory are:\n");
  execl("/bin/ls", "ls", "-l", 0);
}
```

Dave.Marshall@cm.cf.ac.uk
Wed Sep 14 10:06:31 BST 1994



Next: [wait\(\)](#) Up: [Running UNIX Commands from C](#) Previous: [execl\(\)](#)

fork()

`int fork()` turns a single process into 2 identical processes, known as the *parent* and the *child*. On success, `fork()` returns 0 to the child process and returns the process ID of the child process to the parent process. On failure, `fork()` returns -1 to the parent process, sets `errno` to indicate the error, and no child process is created.

NOTE: The child process will have its own unique PID.

The following program illustrates a simple use of `fork`, where two copies are made and run together (multitasking)

```
main()
{ int return_value;

  printf("Forking process\n");
  fork();
  printf("The process id is %d
  and return value is %d\n",
  getpid(), return_value);
  execl("/bin/ls", "ls", "-l", 0);
  printf("This line is not printed\n");
}
```

The Output of this would be:

```
Forking process
The process id is 6753 and return value is 0
The process id is 6754 and return value is 0
two lists of files in current directory
```

NOTE: The processes have unique ID's which will be different at each run.

It is also impossible to tell in advance which process will get to CPU's time - so one run may differ from the next.

When we spawn 2 processes we can easily detect (in each process) whether it is the child or parent since `fork` returns 0 to the child. We can trap any errors if `fork` returns a -1. *i.e.:*

```
int pid; /* process identifier */

pid = fork();
if ( pid < 0 )
  { printf("Cannot fork!\n");
    exit(1);
  }
if ( pid == 0 )
  { /* Child process */
    ...
  }
```

```
... }  
else  
  { /* Parent process pid is child's pid */  
  ... }
```

Dave.Marshall@cm.cf.ac.uk
Wed Sep 14 10:06:31 BST 1994



Next: [exit\(\)](#) **Up:** [Running UNIX Commands from C](#) **Previous:** [fork\(\)](#)

wait()

`int wait (int *status_location)` - will force a parent process to wait for a child process to stop or terminate. `wait()` return the pid of the child or -1 for an error. The exit status of the child is returned to `status_location`.

Dave.Marshall@cm.cf.ac.uk
Wed Sep 14 10:06:31 BST 1994



Next: [Piping in a C program](#) **Up:** [Running UNIX Commands from C](#) **Previous:** [wait\(\)](#)

exit()

`int exit(int status)` - terminates the process which calls this function and returns the `exit status` value. Both UNIX and C (forked) programs can read the status value.

By convention, a status of 0 means *normal termination* any other value indicates an error or unusual occurrence. Many standard library calls have errors defined in the `sys/stat.h` header file. We can easily derive our own conventions.

A complete example of forking program is in Appendix [1](#) and is originally titled `fork.c`

Dave.Marshall@cm.cf.ac.uk
Wed Sep 14 10:06:31 BST 1994



Next: [pipe\(\) - Low level Piping](#) **Up:** [Piping in a C program](#) **Previous:** [Piping in a C program](#)

popen () - Formatted Piping

`FILE *popen(char *command, char *type)` - opens a pipe for I/O where the command is the process that will be connected to the calling process thus creating the *pipe*. The type is either `"r"` - for reading, or `"w"` for writing.

`popen ()` returns is a stream pointer or `NULL` for any errors.

A pipe opened by `popen ()` should always be closed by `pclose(FILE *stream)`.

We use `fprintf ()` and `fscanf ()` to communicate with the pipe's stream.

Dave.Marshall@cm.cf.ac.uk
Wed Sep 14 10:06:31 BST 1994



Next: [Interrupts and Signals](#) **Up:** [Piping in a C program](#) **Previous:** [popen\(\) - Formatted Piping](#)

pipe () - Low level Piping

`int pipe(int fd[2])` - creates a pipe and returns two file descriptors, `fd[0]`, `fd[1]`. `fd[0]` is opened for reading, `fd[1]` for writing.

`pipe()` returns 0 on success, -1 on failure and sets `errno` accordingly.

The standard programming model is that after the pipe has been set up, two (or more) cooperative processes will be created by a fork and data will be passed using `read()` and `write()`.

Pipes opened with `pipe()` should be closed with `close(int fd)`.

Example: Parent writes to a child

```
int pdes[2];

pipe(pdes);
if ( fork() == 0 )
{ /* child */
  close(pdes[1]); /* not required */
  read( pdes[0]); /* read from parent */
  .....
}
else
{ close(pdes[0]); /* not required */
  write( pdes[1]); /* write to child */
  .....
}
```

An example of piping in a C program is `plot.c` and subroutines and is detailed in Appendix [1](#).

Dave.Marshall@cm.cf.ac.uk
Wed Sep 14 10:06:31 BST 1994



Next: [Receiving signals - signal\(\)](#) **Up:** [Interrupts and Signals](#) **Previous:** [Interrupts and Signals](#)

Sending Signals - `kill()`

`int kill(int pid, int signal)` - send a signal to a process, `pid`. If `pid` is greater than zero, the signal is sent to the process whose process ID is equal to `pid`. If `pid` is 0, the signal is sent to all processes, except system processes.

`kill()` returns 0 for a successful call, -1 otherwise and sets `errno` accordingly.

There is also a UNIX command called `kill` - see man pages.

NOTE: that unless caught or ignored, the `kill` signal terminates the process. Therefore protection is built into the system.

Only processes with certain access privileges can be killed off.

Basic rule: *only processes that have the same user can send/receive messages.*

The `SIGKILL` signal cannot be caught or ignored and will always terminate a process.

For example `kill(getpid(), SIGINT);` would send the interrupt signal to the id of the calling process.

This would have a similar effect to `exit()` command. Also `ctrl-c` typed from the command sends a `SIGINT` to the process currently being.

`unsigned int alarm(unsigned int seconds)` - sends the signal `SIGALRM` to the invoking process after `seconds` seconds.

Dave.Marshall@cm.cf.ac.uk
Wed Sep 14 10:06:31 BST 1994



Next: [Times Up!! Up: Interrupts and Signals](#) **Previous:** [Sending Signals - kill\(\)](#)

Receiving signals - `signal()`

`int (*signal(int sig, void (*func)()))()` - that is to say the function `signal()` will call the `func` functions if the process receives a signal `sig`. `signal` returns a pointer to function `func` if successful or it returns an error to `errno` and `-1` otherwise.

`func()` can have three values:

`SIG_DFL`

- a pointer to a system default function `SIG_DFL()`, which will terminate the process upon receipt of `sig`.

`SIG_IGN`

- a pointer to system ignore function `SIG_IGN()` which will disregard the `sig` action (UNLESS it is `SIGKILL`).

A function address

- a user specified function.

`SIG_DFL` and `SIG_IGN` are defined in `signal.h` (standard library) header file.

Thus to ignore a `ctrl-c` command from the command line. we could do:

```
signal(SIGINT, SIG_IGN);
```

TO reset system so that `SIGINT` causes a termination at any place in our program, we would do:

```
signal(SIGINT, SIG_DFL);
```

So lets write a program to trap a `ctrl-c` but not quit on this signal. We have a function `sigproc()` that is executed when we trap a `ctrl-c`. We will also set another function to quit the program if it traps the `SIGQUIT` signal so we can terminate our program:

```
#include <stdio.h>

void sigproc(void);

void quitproc(void);

main()
{ signal(SIGINT, sigproc);
  signal(SIGQUIT, quitproc);
  printf("ctrl-c disabled use ctrl-\\ to quit \n");
  for(;;); /* infinite loop */ }

void sigproc()
{ signal(SIGINT, sigproc); /* */
  /* NOTE some versions of UNIX will reset signal to default
   after each call. So for portability reset signal each time */
```

```
    printf("you have pressed ctrl-c \n");  
}  
  
void quitproc()  
{ printf("ctrl-\\ pressed to quit\n");  
  exit(0); /* normal exit status */  
}
```

Finally lets write a program that communicates between child and parent processes using `kill()` and `signal()`.

`fork()` creates the child process from the parent. The `pid` can be checked to decide whether it is the child (`== 0`) or the parent (`pid = child process id`).

The parent can then send messages to child using the `pid` and `kill()`.

The child picks up these signals with `signal()` and calls appropriate functions.

An example of communicating process using signals is `sig_talk.c` in Appendix

[-](#).

Dave.Marshall@cm.cf.ac.uk
Wed Sep 14 10:06:31 BST 1994