

CRC Concise Encyclopedia
— of —
MATHEMATICS

CRC Concise Encyclopedia
— of —
MATHEMATICS

Eric W. Weisstein



CRC Press

Boca Raton London New York Washington, D.C.

Library of Congress Cataloging-in-Publication Data

Weisstein, Eric W.

The CRC concise encyclopedia of mathematics / Eric W. Weisstein.

p. cm.

Includes bibliographical references and index.

ISBN 0-8493-9640-9 (alk. paper)

1. Mathematics--Encyclopedias. I. Title.

QA5.W45 1998

510'.3--DC21

98-22385

CIP

This book contains information obtained from authentic and highly regarded sources. Reprinted material is quoted with permission, and sources are indicated. A wide variety of references are listed. Reasonable efforts have been made to publish reliable data and information, but the author and the publisher cannot assume responsibility for the validity of all materials or for the consequences of their use.

Neither this book nor any part may be reproduced or transmitted in any form or by any means, electronic or mechanical, including photocopying, microfilming, and recording, or by any information storage or retrieval system, without prior permission in writing from the publisher.

The consent of CRC Press LLC does not extend to copying for general distribution, for promotion, for creating new works, or for resale. Specific permission must be obtained in writing from CRC Press LLC for such copying.

Direct all inquiries to CRC Press LLC, 2000 Corporate Blvd., N.W., Boca Raton, Florida 33431.

Trademark Notice: Product or corporate names may be trademarks or registered trademarks, and are only used for identification and explanation, without intent to infringe.

© 1999 by CRC Press LLC

No claim to original U.S. Government works

International Standard Book Number 0-8493-9640-9

Library of Congress Card Number 98-22385

Printed in the United States of America 1 2 3 4 5 6 7 8 9 0

Printed on acid-free paper

Introduction

The CRC Concise Encyclopedia of Mathematics is a compendium of mathematical definitions, formulas, figures, tabulations, and references. It is written in an informal style intended to make it accessible to a broad spectrum of readers with a wide range of mathematical backgrounds and interests. Although mathematics is a fascinating subject, it all too frequently is clothed in specialized jargon and dry formal exposition that make many interesting and useful mathematical results inaccessible to laypeople. This problem is often further compounded by the difficulty in locating concrete and easily understood examples. To give perspective to a subject, I find it helpful to learn why it is useful, how it is connected to other areas of mathematics and science, and how it is actually implemented. While a picture may be worth a thousand words, explicit examples are worth at least a few hundred! This work attempts to provide enough details to give the reader a flavor for a subject without getting lost in minutiae. While absolute rigor may suffer somewhat, I hope the improvement in usefulness and readability will more than make up for the deficiencies of this approach.

The format of this work is somewhere between a handbook, a dictionary, and an encyclopedia. It differs from existing dictionaries of mathematics in a number of important ways. First, the entire text and all the equations and figures are available in searchable electronic form on CD-ROM. Second, the entries are extensively cross-linked and cross-referenced, not only to related entries but also to many external sites on the Internet. This makes locating information very convenient. It also provides a highly efficient way to “navigate” from one related concept to another, a feature that is especially powerful in the electronic version. Standard mathematical references, combined with a few popular ones, are also given at the end of most entries to facilitate additional reading and exploration. In the interests of offering abundant examples, this work also contains a large number of explicit formulas and derivations, providing a ready place to locate a particular formula, as well as including the framework for understanding where it comes from.

The selection of topics in this work is more extensive than in most mathematical dictionaries (e.g., Borowski and Borwein’s *HarperCollins Dictionary of Mathematics* and Jeans and Jeans’ *Mathematics Dictionary*). At the same time, the descriptions are more accessible than in “technical” mathematical encyclopedias (e.g., Hazewinkel’s *Encyclopaedia of Mathematics* and Iyanaga’s *Encyclopedic Dictionary of Mathematics*). While the latter remain models of accuracy and rigor, they are not terribly useful to the undergraduate, research scientist, or recreational mathematician. In this work, the most useful, interesting, and entertaining (at least to my mind) aspects of topics are discussed in addition to their technical definitions. For example, in my entry for pi (π), the definition in terms of the diameter and circumference of a circle is supplemented by a great many formulas and series for pi, including some of the amazing discoveries of Ramanujan. These formulas are comprehensible to readers with only minimal mathematical background, and are interesting to both those with and without formal mathematics training. However, they have not previously been collected in a single convenient location. For this reason, I hope that, in addition to serving as a reference source, this work has some of the same flavor and appeal of Martin Gardner’s delightful *Scientific American* columns.

Everything in this work has been compiled by me alone. I am an astronomer by training, but have picked up a fair bit of mathematics along the way. It never ceases to amaze me how mathematical connections weave their way through the physical sciences. It frequently transpires that some piece of recently acquired knowledge turns out to be just what I need to solve some apparently unrelated problem. I have therefore developed the habit of picking up and storing away odd bits of information for future use. This work has provided a mechanism for organizing what has turned out to be a fairly large collection of mathematics. I have also found it very difficult to find clear yet accessible explanations of technical mathematics unless I already have some familiarity with the subject. I hope this encyclopedia will provide jumping-off points for people who are interested in the subjects listed here but who, like me, are not necessarily experts.

The encyclopedia has been compiled over the last 11 years or so, beginning in my college years and continuing during graduate school. The initial document was written in *Microsoft Word*® on a Mac Plus® computer, and had reached about 200 pages by the time I started graduate school in 1990. When Andrew Treverrow made his *OrTeX* program available for the Mac, I began the task of converting all my documents to *TeX*, resulting in a vast improvement in readability. While undertaking the *Word* to *TeX* conversion, I also began cross-referencing entries, anticipating that eventually I would be able to convert the entire document

to hypertext. This hope was realized beginning in 1995, when the Internet explosion was in full swing and I learned of Nikos Drakos's excellent $\text{T}_{\text{E}}\text{X}$ to HTML converter, $\text{L}^{\text{A}}\text{T}_{\text{E}}\text{X}2\text{HTML}$. After some additional effort, I was able to post an HTML version of my encyclopedia to the World Wide Web, currently located at www.astro.virginia.edu/~eww6n/math/.

The selection of topics included in this compendium is not based on any fixed set of criteria, but rather reflects my own random walk through mathematics. In truth, there is no good way of selecting topics in such a work. The mathematician James Sylvester may have summed up the situation most aptly. According to Sylvester (as quoted in the introduction to Ian Stewart's book *From Here to Infinity*), "Mathematics is not a book confined within a cover and bound between brazen clasps, whose contents it needs only patience to ransack; it is not a mine, whose treasures may take long to reduce into possession, but which fill only a limited number of veins and lodes; it is not a soil, whose fertility can be exhausted by the yield of successive harvests; it is not a continent or an ocean, whose area can be mapped out and its contour defined; it is as limitless as that space which it finds too narrow for its aspiration; its possibilities are as infinite as the worlds which are forever crowding in and multiplying upon the astronomer's gaze; it is as incapable of being restricted within assigned boundaries or being reduced to definitions of permanent validity, as the consciousness of life."

Several of Sylvester's points apply particularly to this undertaking. As he points out, mathematics itself cannot be confined to the pages of a book. The results of mathematics, however, are shared and passed on primarily through the printed (and now electronic) medium. While there is no danger of mathematical results being lost through lack of dissemination, many people miss out on fascinating and useful mathematical results simply because they are not aware of them. Not only does collecting many results in one place provide a single starting point for mathematical exploration, but it should also lessen the aggravation of encountering explanations for new concepts which themselves use unfamiliar terminology. In this work, the reader is only a cross-reference (or a mouse click) away from the necessary background material. As to Sylvester's second point, the very fact that the quantity of mathematics is so great means that any attempt to catalog it with any degree of completeness is doomed to failure. This certainly does not mean that it's not worth trying. Strangely, except for relatively small works usually on particular subjects, there do not appear to have been any substantial attempts to collect and display in a place of prominence the treasure trove of mathematical results that have been discovered (invented?) over the years (one notable exception being Sloane and Plouffe's *Encyclopedia of Integer Sequences*). This work, the product of the "gazing" of a single astronomer, attempts to fill that omission.

Finally, a few words about logistics. Because of the alphabetical listing of entries in the encyclopedia, neither table of contents nor index are included. In many cases, a particular entry of interest can be located from a cross-reference (indicated in SMALL CAPS TYPEFACE in the text) in a related article. In addition, most articles are followed by a "see also" list of related entries for quick navigation. This can be particularly useful if you are looking for a specific entry (say, "Zeno's Paradoxes"), but have forgotten the exact name. By examining the "see also" list at bottom of the entry for "Paradox," you will likely recognize Zeno's name and thus quickly locate the desired entry.

The alphabetization of entries contains a few peculiarities which need mentioning. All entries beginning with a numeral are ordered by increasing value and appear before the first entry for "A." In multiple-word entries containing a space or dash, the space or dash is treated as a character which precedes "a," so entries appear in the following order: "Sum," "Sum P. . .," "Sum-P. . .," and "Summary." One exception is that in a series of entries where a trailing "s" appears in some and not others, the trailing "s" is ignored in the alphabetization. Therefore, entries involving Euclid would be alphabetized as follows: "Euclid's Axioms," "Euclid Number," "Euclidean Algorithm." Because of the non-standard nomenclature that ensues from naming mathematical results after their discoverers, an important result such as the "Pythagorean Theorem" is written variously as "Pythagoras's Theorem," the "Pythagoras Theorem," etc. In this encyclopedia, I have endeavored to use the most widely accepted form. I have also tried to consistently give entry titles in the singular (e.g., "Knot" instead of "Knots").

In cases where the same word is applied in different contexts, the context is indicated in parentheses or appended to the end. Examples of the first type are "Crossing Number (Graph)" and "Crossing Number (Link)." Examples of the second type are "Convergent Sequence" and "Convergent Series." In the case of an entry like "Euler Theorem," which may describe one of three or four different formulas, I have taken the liberty of adding descriptive words ("Euler's *Something* Theorem") to all variations, or kept the standard

name for the most commonly used variant and added descriptive words for the others. In cases where specific examples are derived from a general concept, em dashes (—) are used (for example, “Fourier Series,” “Fourier Series—Power Series,” “Fourier Series—Square Wave,” “Fourier Series—Triangle”). The decision to put a possessive ’s at the end of a name or to use a lone trailing apostrophe is based on whether the final “s” is pronounced. “Gauss’s Theorem” is therefore written out, whereas “Archimedes’ Recurrence Formula” is not. Finally, given the absence of a definitive stylistic convention, plurals of numerals are written without an apostrophe (e.g., 1990s instead of 1990’s).

In an endeavor of this magnitude, errors and typographical mistakes are inevitable. The blame for these lies with me alone. Although the current length makes extensive additions in a printed version problematic, I plan to continue updating, correcting, and improving the work.

Eric Weisstein

Charlottesville, Virginia
August 8, 1998

Acknowledgments

Although I alone have compiled and typeset this work, many people have contributed indirectly and directly to its creation. I have not yet had the good fortune to meet Donald Knuth of Stanford University, but he is unquestionably the person most directly responsible for making this work possible. Before his mathematical typesetting program $\mathrm{T}_{\mathrm{E}}\mathrm{X}$, it would have been impossible for a single individual to compile such a work as this. Had Prof. Bateman owned a personal computer equipped with $\mathrm{T}_{\mathrm{E}}\mathrm{X}$, perhaps his shoe box of notes would not have had to await the labors of Erdelyi, Magnus, and Oberhettinger to become a three-volume work on mathematical functions. Andrew Trevorrow's shareware implementation of $\mathrm{T}_{\mathrm{E}}\mathrm{X}$ for the Macintosh, $\mathrm{OzT}_{\mathrm{E}}\mathrm{X}$ (www.kagi.com/authors/akt/oztex.html), was also of fundamental importance. Nikos Drakos and Ross Moore have provided another building block for this work by developing the $\mathrm{L}^{\mathrm{A}}\mathrm{T}_{\mathrm{E}}\mathrm{X}2\mathrm{HTML}$ program (www-dsdl.llnl.gov/files/programs/unix/latex2html/manual/manual.html), which has allowed me to easily maintain and update an on-line version of the encyclopedia long before it existed in book form.

I would like to thank Steven Finch of MathSoft, Inc., for his interesting on-line essays about mathematical constants (www.mathsoft.com/asolve/constant/constant.html), and also for his kind permission to reproduce excerpts from some of these essays. I hope that Steven will someday publish his detailed essays in book form. Thanks also to Neil Sloane and Simon Plouffe for compiling and making available the printed and on-line (www.research.att.com/~njas/sequences/) versions of the *Encyclopedia of Integer Sequences*, an immensely valuable compilation of useful information which represents a truly mind-boggling investment of labor.

Thanks to Robert Dickau, Simon Plouffe, and Richard Schroepel for reading portions of the manuscript and providing a number of helpful suggestions and additions. Thanks also to algebraic topologist Ryan Budney for sharing some of his expertise, to Charles Walkden for his helpful comments about dynamical systems theory, and to Lambros Lambrou for his contributions. Thanks to David W. Wilson for a number of helpful comments and corrections. Thanks to Dale Rolfsen, compiler James Bailey, and artist Ali Roth for permission to reproduce their beautiful knot and link diagrams. Thanks to Gavin Theobald for providing diagrams of his masterful polygonal dissections. Thanks to Wolfram Research, not only for creating an indispensable mathematical tool in *Mathematica*®, but also for permission to include figures from the *Mathematica*® book and *MathSource* repository for the braid, conical spiral, double helix, Enneper's surfaces, Hadamard matrix, helicoid, helix, Henneberg's minimal surface, hyperbolic polyhedra, Klein bottle, Maeder's "owl" minimal surface, Penrose tiles, polyhedron, and Scherk's minimal surfaces entries.

Sincere thanks to Judy Schroeder for her skill and diligence in the monumental task of proofreading the entire document for syntax. Thanks also to Bob Stern, my executive editor from *CRC Press*, for his encouragement, and to Mimi Williams of *CRC Press* for her careful reading of the manuscript for typographical and formatting errors. As this encyclopedia's entry on *PROOFREADING MISTAKES* shows, the number of mistakes that are expected to remain after three independent proofreadings is much lower than the original number, but unfortunately still nonzero. Many thanks to the library staff at the University of Virginia, who have provided invaluable assistance in tracking down many an obscure citation. Finally, I would like to thank the hundreds of people who took the time to e-mail me comments and suggestions while this work was in its formative stages. Your continued comments and feedback are very welcome.

Numerals

0

see ZERO

1

The number one (1) is the first POSITIVE INTEGER. It is an ODD NUMBER. Although the number 1 used to be considered a PRIME NUMBER, it requires special treatment in so many definitions and applications involving primes greater than or equal to 2 that it is usually placed into a class of its own. The number 1 is sometimes also called "unity," so the n th roots of 1 are often called the n th ROOTS OF UNITY. FRACTIONS having 1 as a NUMERATOR are called UNIT FRACTIONS. If only one root, solution, etc., exists to a given problem, the solution is called UNIQUE.

The GENERATING FUNCTION have all COEFFICIENTS 1 is given by

$$\frac{1}{1-x} = 1 + x + x^2 + x^3 + x^4 + \dots$$

see also 2, 3, EXACTLY ONE, ROOT OF UNITY, UNIQUE, UNIT FRACTION, ZERO

2

The number two (2) is the second POSITIVE INTEGER and the first PRIME NUMBER. It is EVEN, and is the only EVEN PRIME (the PRIMES other than 2 are called the ODD PRIMES). The number 2 is also equal to its FACTORIAL since $2! = 2$. A quantity taken to the POWER 2 is said to be SQUARED. The number of times k a given BINARY number $b_n \dots b_2 b_1 b_0$ is divisible by 2 is given by the position of the first $b_k = 1$, counting from the right. For example, $12 = 1100$ is divisible by 2 twice, and $13 = 1101$ is divisible by 2 0 times.

see also 1, BINARY, 3, SQUARED, ZERO

$2x \bmod 1$ Map

Let x_0 be a REAL NUMBER in the CLOSED INTERVAL $[0, 1]$, and generate a SEQUENCE using the MAP

$$x_{n+1} \equiv 2x_n \pmod{1}. \quad (1)$$

Then the number of periodic ORBITS of period p (for p PRIME) is given by

$$N_p = \frac{2^p - 2}{p}. \quad (2)$$

Since a typical ORBIT visits each point with equal probability, the NATURAL INVARIANT is given by

$$\rho(x) = 1. \quad (3)$$

see also TENT MAP

References

Ott, E. *Chaos in Dynamical Systems*. Cambridge: Cambridge University Press, pp. 26-31, 1993.

3

3 is the only INTEGER which is the sum of the preceding POSITIVE INTEGERS ($1 + 2 = 3$) and the only number which is the sum of the FACTORIALS of the preceding POSITIVE INTEGERS ($1! + 2! = 3$). It is also the first ODD PRIME. A quantity taken to the POWER 3 is said to be CUBED.

see also 1, 2, $3x + 1$ MAPPING, CUBED, PERIOD THREE THEOREM, SUPER-3 NUMBER, TERNARY, THREE-COLORABLE, ZERO

$3x + 1$ Mapping

see COLLATZ PROBLEM

10

The number 10 (ten) is the basis for the DECIMAL system of notation. In this system, each "decimal place" consists of a DIGIT 0-9 arranged such that each DIGIT is multiplied by a POWER of 10, decreasing from left to right, and with a decimal place indicating the $10^0 = 1$ s place. For example, the number 1234.56 specifies

$$1 \times 10^3 + 2 \times 10^2 + 3 \times 10^1 + 4 \times 10^0 + 5 \times 10^{-1} + 6 \times 10^{-2}.$$

The decimal places to the left of the decimal point are 1, 10, 100, 1000, 10000, 100000, 1000000, 10000000, ... (Sloane's A011557), called one, ten, HUNDRED, THOUSAND, ten thousand, hundred thousand, MILLION, 10 million, 100 million, and so on. The names of subsequent decimal places for LARGE NUMBERS differ depending on country.

Any POWER of 10 which can be written as the PRODUCT of two numbers not containing 0s must be of the form $2^n \cdot 5^n = 10^n$ for n an INTEGER such that neither 2^n nor 5^n contains any ZEROS. The largest known such number is

$$10^{33} = 2^{33} \cdot 5^{33} \\ = 8,589,934,592 \cdot 116,415,321,826,934,814,453,125.$$

A complete list of known such numbers is

$$\begin{aligned} 10^1 &= 2^1 \cdot 5^1 \\ 10^2 &= 2^2 \cdot 5^2 \\ 10^3 &= 2^3 \cdot 5^3 \\ 10^4 &= 2^4 \cdot 5^4 \\ 10^5 &= 2^5 \cdot 5^5 \\ 10^6 &= 2^6 \cdot 5^6 \\ 10^7 &= 2^7 \cdot 5^7 \\ 10^9 &= 2^9 \cdot 5^9 \\ 10^{18} &= 2^{18} \cdot 5^{18} \\ 10^{33} &= 2^{33} \cdot 5^{33} \end{aligned}$$

(Madachy 1979). Since all POWERS of 2 with exponents $n \leq 4.6 \times 10^7$ contain at least one ZERO (M. Cook), no

other POWER of ten less than 46 million can be written as the PRODUCT of two numbers not containing 0s.

see also BILLION, DECIMAL, HUNDRED, LARGE NUMBER, MILLIARD, MILLION, THOUSAND, TRILLION, ZERO

References

- Madachy, J. S. *Madachy's Mathematical Recreations*. New York: Dover, pp. 127–128, 1979.
 Pickover, C. A. *Keys to Infinity*. New York: W. H. Freeman, p. 135, 1995.
 Sloane, N. J. A. Sequence A011557 in "An On-Line Version of the Encyclopedia of Integer Sequences."

12

One DOZEN, or a twelfth of a GROSS.

see also DOZEN, GROSS

13

A NUMBER traditionally associated with bad luck. A so-called BAKER'S DOZEN is equal to 13. Fear of the number 13 is called TRISKAIDEKAPHOBIA.

see also BAKER'S DOZEN, FRIDAY THE THIRTEENTH, TRISKAIDEKAPHOBIA

15

see 15 PUZZLE, FIFTEEN THEOREM

15 Puzzle

1	2	3	4
5	6	7	8
9	10	11	12
13	14	15	

A puzzle introduced by Sam Loyd in 1878. It consists of 15 squares numbered from 1 to 15 which are placed in a 4×4 box leaving one position out of the 16 empty. The goal is to rearrange the squares from a given arbitrary starting arrangement by sliding them one at a time into the configuration shown above. For some initial arrangements, this rearrangement is possible, but for others, it is not.

To address the solubility of a given initial arrangement, proceed as follows. If the SQUARE containing the number i appears "before" (reading the squares in the box from left to right and top to bottom) n numbers which are less than i , then call it an inversion of order n , and denote it n_i . Then define

$$N \equiv \sum_{i=1}^{15} n_i = \sum_{i=2}^{15} n_i,$$

where the sum need run only from 2 to 15 rather than 1 to 15 since there are no numbers less than 1 (so n_1 must equal 0). If N is EVEN, the position is possible, otherwise it is not. This can be formally proved using ALTERNATING GROUPS. For example, in the following arrangement

2	1	3	4
5	6	7	8
9	10	11	12
13	14	15	

$n_2 = 1$ (2 precedes 1) and all other $n_i = 0$, so $N = 1$ and the puzzle cannot be solved.

References

- Ball, W. W. R. and Coxeter, H. S. M. *Mathematical Recreations and Essays*, 13th ed. New York: Dover, pp. 312–316, 1987.
 Bogomolny, A. "Sam Loyd's Fifteen." <http://www.cut-the-knot.com/pythagoras/fifteen.html>.
 Bogomolny, A. "Sam Loyd's Fifteen [History]." <http://www.cut-the-knot.com/pythagoras/history15.html>.
 Johnson, W. W. "Notes on the '15 Puzzle. I.'" *Amer. J. Math.* **2**, 397–399, 1879.
 Kasner, E. and Newman, J. R. *Mathematics and the Imagination*. Redmond, WA: Tempus Books, pp. 177–180, 1989.
 Kraitichik, M. "The 15 Puzzle." §12.2.1 in *Mathematical Recreations*. New York: W. W. Norton, pp. 302–308, 1942.
 Story, W. E. "Notes on the '15 Puzzle. II.'" *Amer. J. Math.* **2**, 399–404, 1879.

16-Cell

A finite regular 4-D POLYTOPE with SCHLÄFLI SYMBOL $\{3, 3, 4\}$ and VERTICES which are the PERMUTATIONS of $(\pm 1, 0, 0, 0)$.

see also 24-CELL, 120-CELL, 600-CELL, CELL, POLYTOPE

17

17 is a FERMAT PRIME which means that the 17-sided REGULAR POLYGON (the HEPTADECAGON) is CONSTRUCTIBLE using COMPASS and STRAIGHTEDGE (as proved by Gauss).

see also CONSTRUCTIBLE POLYGON, FERMAT PRIME, HEPTADECAGON

References

- Carr, M. "Snow White and the Seven(teen) Dwarfs." <http://www.math.harvard.edu/~hmb/issue2.1/SEVENTEEN/seventeen.html>.
 Fischer, R. "Facts About the Number 17." http://tempo.harvard.edu/~rfischer/hcssim/17_facts/kelly/kelly.html.
 Lefevre, V. "Properties of 17." http://www.ens-lyon.fr/~vlefevre/d17_eng.html.
 Shell Centre for Mathematical Education. "Number 17." <http://acorn.educ.nottingham.ac.uk/ShellCent/Number/Num17.html>.

18-Point Problem

Place a point somewhere on a LINE SEGMENT. Now place a second point and number it 2 so that each of the points is in a different half of the LINE SEGMENT. Continue, placing every N th point so that all N points are on different $(1/N)$ th of the LINE SEGMENT. Formally, for a given N , does there exist a sequence of real numbers x_1, x_2, \dots, x_N such that for every $n \in \{1, \dots, N\}$ and every $k \in \{1, \dots, n\}$, the inequality

$$\frac{k-1}{n} \leq x_k < \frac{k}{n}$$

holds for some $i \in \{1, \dots, n\}$? Surprisingly, it is only possible to place 17 points in this manner (Berlekamp and Graham 1970, Warmus 1976).

Steinhaus (1979) gives a 14-point solution (0.06, 0.55, 0.77, 0.39, 0.96, 0.28, 0.64, 0.13, 0.88, 0.48, 0.19, 0.71, 0.35, 0.82), and Warmus (1976) gives the 17-point solution

$$\begin{aligned} \frac{4}{7} \leq x_1 < \frac{7}{12}, \frac{2}{7} \leq x_2 < \frac{5}{17}, \frac{16}{17} \leq x_3 < 1, \frac{1}{14} \leq x_4 < \frac{1}{13}, \\ \frac{8}{11} \leq x_5 < \frac{11}{15}, \frac{5}{11} \leq x_6 < \frac{6}{13}, \frac{1}{7} \leq x_7 < \frac{2}{13}, \frac{14}{17} \leq x_8 < \frac{5}{6}, \\ \frac{3}{8} \leq x_9 < \frac{5}{13}, \frac{11}{17} \leq x_{10} < \frac{2}{3}, \frac{3}{14} \leq x_{11} < \frac{3}{13}, \\ \frac{15}{17} \leq x_{12} < \frac{11}{12}, \frac{1}{2} \leq x_{12} < \frac{9}{17}, 0 \leq x_{14} < \frac{1}{17}, \\ \frac{13}{17} \leq x_{15} < \frac{4}{5}, \frac{5}{16} \leq x_{16} < \frac{6}{17}, \frac{10}{17} \leq x_{17} < \frac{11}{17}. \end{aligned}$$

Warmus (1976) states that there are 768 patterns of 17-point solutions (counting reversals as equivalent).

see also DISCREPANCY THEOREM, POINT PICKING

References

- Berlekamp, E. R. and Graham, R. L. "Irregularities in the Distributions of Finite Sequences." *J. Number Th.* 2, 152–161, 1970.
- Gardner, M. *The Last Recreations: Hydras, Eggs, and Other Mathematical Mystifications*. New York: Springer-Verlag, pp. 34–36, 1997.
- Steinhaus, H. "Distribution on Numbers" and "Generalization." Problems 6 and 7 in *One Hundred Problems in Elementary Mathematics*. New York: Dover, pp. 12–13, 1979.
- Warmus, M. "A Supplementary Note on the Irregularities of Distributions." *J. Number Th.* 8, 260–263, 1976.

24-Cell

A finite regular 4-D POLYTOPE with SCHLÄFLI SYMBOL $\{3, 4, 3\}$. Coxeter (1969) gives a list of the VERTEX positions. The EVEN coefficients of the D_4 lattice are 1, 24, 24, 96, ... (Sloane's A004011), and the 24 shortest vectors in this lattice form the 24-cell (Coxeter 1973, Conway and Sloane 1993, Sloane and Plouffe 1995).

see also 16-CELL, 120-CELL, 600-CELL, CELL, POLYTOPE

References

- Conway, J. H. and Sloane, N. J. A. *Sphere-Packings, Lattices and Groups*, 2nd ed. New York: Springer-Verlag, 1993.
- Coxeter, H. S. M. *Introduction to Geometry*, 2nd ed. New York: Wiley, p. 404, 1969.
- Coxeter, H. S. M. *Regular Polytopes*, 3rd ed. New York: Dover, 1973.
- Sloane, N. J. A. Sequences A004011/M5140 in "An On-Line Version of the Encyclopedia of Integer Sequences."
- Sloane, N. J. A. and Plouffe, S. Extended entry in *The Encyclopedia of Integer Sequences*. San Diego: Academic Press, 1995.

42

According to Adams, 42 is the ultimate answer to life, the universe, and everything, although it is left as an exercise to the reader to determine the actual question leading to this result.

References

- Adams, D. *The Hitchhiker's Guide to the Galaxy*. New York: Ballantine Books, 1997.

72 Rule

see RULE OF 72

120-Cell

A finite regular 4-D POLYTOPE with SCHLÄFLI SYMBOL $\{5, 3, 3\}$ (Coxeter 1969).

see also 16-CELL, 24-CELL, 600-CELL, CELL, POLYTOPE

References

- Coxeter, H. S. M. *Introduction to Geometry*, 2nd ed. New York: Wiley, p. 404, 1969.

144

A DOZEN DOZEN, also called a GROSS. 144 is a SQUARE NUMBER and a SUM-PRODUCT NUMBER.

see also DOZEN

196-Algorithm

Take any POSITIVE INTEGER of two DIGITS or more, reverse the DIGITS, and add to the original number. Now repeat the procedure with the SUM so obtained. This procedure quickly produces PALINDROMIC NUMBERS for most INTEGERS. For example, starting with the number 5280 produces (5280, 6105, 11121, 23232). The end results of applying the algorithm to 1, 2, 3, ... are 1, 2, 3, 4, 5, 6, 7, 8, 9, 11, 11, 33, 44, 55, 66, 77, 88, 99, 121, ... (Sloane's A033865). The value for 89 is especially large, being 8813200023188.

The first few numbers not known to produce PALINDROMES are 196, 887, 1675, 7436, 13783, ... (Sloane's A006960), which are simply the numbers obtained by iteratively applying the algorithm to the number 196. This number therefore lends itself to the name of the ALGORITHM.

The number of terms $a(n)$ in the iteration sequence required to produce a PALINDROMIC NUMBER from n (i.e., $a(n) = 1$ for a PALINDROMIC NUMBER, $a(n) = 2$ if a PALINDROMIC NUMBER is produced after a single iteration of the 196-algorithm, etc.) for $n = 1, 2, \dots$ are 1, 1, 1, 1, 1, 1, 1, 1, 1, 1, 2, 1, 2, 2, 2, 2, 2, 2, 2, 3, 2, 2, 1, ... (Sloane's A030547). The smallest numbers which require $n = 0, 1, 2, \dots$ iterations to reach a palindrome are 0, 10, 19, 59, 69, 166, 79, 188, ... (Sloane's A023109).

see also ADDITIVE PERSISTENCE, DIGITADITION, MULTIPLICATIVE PERSISTENCE, PALINDROMIC NUMBER, PALINDROMIC NUMBER CONJECTURE, RATS SEQUENCE, RECURRING DIGITAL INVARIANT

References

- Gardner, M. *Mathematical Circus: More Puzzles, Games, Paradoxes and Other Mathematical Entertainments from Scientific American*. New York: Knopf, pp. 242–245, 1979.
- Gruenberger, F. "How to Handle Numbers with Thousands of Digits, and Why One Might Want to." *Sci. Amer.* 250, 19–26, Apr. 1984.
- Sloane, N. J. A. Sequences A023109, A030547, A033865, and A006960/M5410 in "An On-Line Version of the Encyclopedia of Integer Sequences."

239

Some interesting properties (as well as a few arcane ones not reiterated here) of the number 239 are discussed in Beeler *et al.* (1972, Item 63). 239 appears in MACHIN'S FORMULA

$$\frac{1}{4}\pi = 4 \tan\left(\frac{1}{5}\right) - \tan^{-1}\left(\frac{1}{239}\right),$$

which is related to the fact that

$$2 \cdot 13^4 - 1 = 239^2,$$

which is why 239/169 is the 7th CONVERGENT of $\sqrt{2}$. Another pair of INVERSE TANGENT FORMULAS involving 239 is

$$\begin{aligned} \tan^{-1}\left(\frac{1}{239}\right) &= \tan^{-1}\left(\frac{1}{70}\right) - \tan^{-1}\left(\frac{1}{99}\right) \\ &= \tan^{-1}\left(\frac{1}{408}\right) + \tan^{-1}\left(\frac{1}{577}\right). \end{aligned}$$

239 needs 4 SQUARES (the maximum) to express it, 9 CUBES (the maximum, shared only with 23) to express it, and 19 fourth POWERS (the maximum) to express it (see WARING'S PROBLEM). However, 239 doesn't need the maximum number of fifth POWERS (Beeler *et al.* 1972, Item 63).

References

Beeler, M.; Gosper, R. W.; and Schroepel, R. *HAKMEM*. Cambridge, MA: MIT Artificial Intelligence Laboratory, Memo AIM-239, Feb. 1972.

257-gon

257 is a FERMAT PRIME, and the 257-gon is therefore a CONSTRUCTIBLE POLYGON using COMPASS and STRAIGHTEDGE, as proved by Gauss. An illustration of the 257-gon is not included here, since its 257 segments so closely resemble a CIRCLE. Richelot and Schwenkenwein found constructions for the 257-gon in 1832 (Coxeter 1969). De Temple (1991) gives a construction using 150 CIRCLES (24 of which are CARLYLE CIRCLES) which has GEOMETROGRAPHY symbol $94S_1 + 47S_2 + 275C_1 + 0C_2 + 150C_3$ and SIMPLICITY 566.

see also 65537-GON, CONSTRUCTIBLE POLYGON, FERMAT PRIME, HEPTADECAGON, PENTAGON

References

Coxeter, H. S. M. *Introduction to Geometry*, 2nd ed. New York: Wiley, 1969.
De Temple, D. W. "Carlyle Circles and the Lemoine Simplicity of Polygonal Constructions." *Amer. Math. Monthly* **98**, 97-108, 1991.
Dixon, R. *Mathographics*. New York: Dover, p. 53, 1991.
Rademacher, H. *Lectures on Elementary Number Theory*. New York: Blaisdell, 1964.

600-Cell

A finite regular 4-D POLYTOPE with SCHLÄFLI SYMBOL $\{3, 3, 5\}$. For VERTICES, see Coxeter (1969).

see also 16-CELL, 24-CELL, 120-CELL, CELL, POLYTOPE

References

Coxeter, H. S. M. *Introduction to Geometry*, 2nd ed. New York: Wiley, p. 404, 1969.

666

A number known as the BEAST NUMBER appearing in the *Bible* and ascribed various numerological properties.

see also APOCALYPTIC NUMBER, BEAST NUMBER, LEVIATHAN NUMBER

References

Hardy, G. H. *A Mathematician's Apology*, reprinted with a foreword by C. P. Snow. New York: Cambridge University Press, p. 96, 1993.

2187

The digits in the number 2187 form the two VAMPIRE NUMBERS: $21 \times 87 = 1827$ and $2187 = 27 \times 81$.

References

Gardner, M. "Lucky Numbers and 2187." *Math. Intell.* **19**, 26-29, Spring 1997.

65537-gon

65537 is the largest known FERMAT PRIME, and the 65537-gon is therefore a CONSTRUCTIBLE POLYGON using COMPASS and STRAIGHTEDGE, as proved by Gauss. The 65537-gon has so many sides that it is, for all intents and purposes, indistinguishable from a CIRCLE using any reasonable printing or display methods. Hermes spent 10 years on the construction of the 65537-gon at Göttingen around 1900 (Coxeter 1969). De Temple (1991) notes that a GEOMETRIC CONSTRUCTION can be done using 1332 or fewer CARLYLE CIRCLES.

see also 257-GON, CONSTRUCTIBLE POLYGON, HEPTADECAGON, PENTAGON

References

Coxeter, H. S. M. *Introduction to Geometry*, 2nd ed. New York: Wiley, 1969.
De Temple, D. W. "Carlyle Circles and the Lemoine Simplicity of Polygonal Constructions." *Amer. Math. Monthly* **98**, 97-108, 1991.
Dixon, R. *Mathographics*. New York: Dover, p. 53, 1991.

A

A-Integrable

A generalization of the LEBESGUE INTEGRAL. A MEASURABLE FUNCTION $f(x)$ is called A-integrable over the CLOSED INTERVAL $[a, b]$ if

$$m\{x : |f(x)| > n\} = \mathcal{O}(n^{-1}), \quad (1)$$

where m is the LEBESGUE MEASURE, and

$$I = \lim_{n \rightarrow \infty} \int_a^b [f(x)]_n dx \quad (2)$$

exists, where

$$[f(x)]_n = \begin{cases} f(x) & \text{if } |f(x)| \leq n \\ 0 & \text{if } |f(x)| > n. \end{cases} \quad (3)$$

References

Titmarsh, E. G. "On Conjugate Functions." *Proc. London Math. Soc.* **29**, 49–80, 1928.

A-Sequence

N.B. A detailed on-line essay by S. Finch was the starting point for this entry.

An INFINITE SEQUENCE of POSITIVE INTEGERS a_i satisfying

$$1 \leq a_1 < a_2 < a_3 < \dots \quad (1)$$

is an A-sequence if no a_k is the SUM of two or more distinct earlier terms (Guy 1994). Erdős (1962) proved

$$S(A) \equiv \sup_{\text{all } A \text{ sequences}} \sum_{k=1}^{\infty} \frac{1}{a_k} < 103. \quad (2)$$

Any A-sequence satisfies the CHI INEQUALITY (Levine and O'Sullivan 1977), which gives $S(A) < 3.9998$. Abbott (1987) and Zhang (1992) have given a bound from below, so the best result to date is

$$2.0649 < S(A) < 3.9998. \quad (3)$$

Levine and O'Sullivan (1977) conjectured that the sum of RECIPROALS of an A-sequence satisfies

$$S(A) \leq \sum_{k=1}^{\infty} \frac{1}{\chi_k} = 3.01\dots, \quad (4)$$

where χ_i are given by the LEVINE-O'SULLIVAN GREEDY ALGORITHM.

see also B_2 -SEQUENCE, MIAN-CHOWLA SEQUENCE

References

Abbott, H. L. "On Sum-Free Sequences." *Acta Arith.* **48**, 93–96, 1987.

Erdős, P. "Remarks on Number Theory III. Some Problems in Additive Number Theory." *Mat. Lapok* **13**, 28–38, 1962.

Finch, S. "Favorite Mathematical Constants." <http://www.mathsoft.com/asolve/constant/erdos/erdos.html>.

Guy, R. K. " B_2 -Sequences." §E28 in *Unsolved Problems in Number Theory*, 2nd ed. New York: Springer-Verlag, pp. 228–229, 1994.

Levine, E. and O'Sullivan, J. "An Upper Estimate for the Reciprocal Sum of a Sum-Free Sequence." *Acta Arith.* **34**, 9–24, 1977.

Zhang, Z. X. "A Sum-Free Sequence with Larger Reciprocal Sum." Unpublished manuscript, 1992.

AAA Theorem

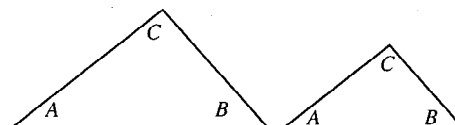

Specifying three ANGLES A , B , and C does not uniquely define a TRIANGLE, but any two TRIANGLES with the same ANGLES are SIMILAR. Specifying two ANGLES of a TRIANGLE automatically gives the third since the sum of ANGLES in a TRIANGLE sums to 180° (π RADIANS), i.e.,

$$C = \pi - A - B.$$

see also AAS THEOREM, ASA THEOREM, ASS THEOREM, SAS THEOREM, SSS THEOREM, TRIANGLE

AAS Theorem



Specifying two angles A and B and a side a uniquely determines a TRIANGLE with AREA

$$K = \frac{a^2 \sin B \sin C}{2 \sin A} = \frac{a^2 \sin B \sin(\pi - A - B)}{2 \sin A}. \quad (1)$$

The third angle is given by

$$C = \pi - A - B, \quad (2)$$

since the sum of angles of a TRIANGLE is 180° (π RADIANS). Solving the LAW OF SINES

$$\frac{a}{\sin A} = \frac{b}{\sin B} \quad (3)$$

for b gives

$$b = a \frac{\sin B}{\sin A}. \quad (4)$$

Finally,

$$c = b \cos A + a \cos B = a(\sin B \cot A + \cos B) \quad (5)$$

$$= a \sin B(\cot A + \cot B). \quad (6)$$

see also AAA THEOREM, ASA THEOREM, ASS THEOREM, SAS THEOREM, SSS THEOREM, TRIANGLE

Abacus

A mechanical counting device consisting of a frame holding a series of parallel rods on each of which beads are strung. Each bead represents a counting unit, and each rod a place value. The primary purpose of the abacus is not to perform actual computations, but to provide a quick means of storing numbers during a calculation. Abaci were used by the Japanese and Chinese, as well as the Romans.

see also ROMAN NUMERAL, SLIDE RULE

References

- Boyer, C. B. and Merzbach, U. C. "The Abacus and Decimal Fractions." *A History of Mathematics*, 2nd ed. New York: Wiley, pp. 199–201, 1991.
- Fernandes, L. "The Abacus: The Art of Calculating with Beads." <http://www.ee.ryerson.ca:8080/~elf/abacus>.
- Gardner, M. "The Abacus." Ch. 18 in *Mathematical Circus: More Puzzles, Games, Paradoxes and Other Mathematical Entertainments from Scientific American*. New York: Knopf, pp. 232–241, 1979.
- Pappas, T. "The Abacus." *The Joy of Mathematics*. San Carlos, CA: Wide World Publ./Tetra, p. 209, 1989.
- Smith, D. E. "Mechanical Aids to Calculation: The Abacus." Ch. 3 §1 in *History of Mathematics*, Vol. 2. New York: Dover, pp. 156–196, 1958.

abc Conjecture

A CONJECTURE due to J. Oesterlé and D. W. Masser. It states that, for any INFINITESIMAL $\epsilon > 0$, there exists a CONSTANT C_ϵ such that for any three RELATIVELY PRIME INTEGERS a, b, c satisfying

$$a + b = c,$$

the INEQUALITY

$$\max\{|a|, |b|, |c|\} \leq C_\epsilon \prod_{p|abc} p^{1+\epsilon}$$

holds, where $p|abc$ indicates that the PRODUCT is over PRIMES p which DIVIDE the PRODUCT abc . If this CONJECTURE were true, it would imply FERMAT'S LAST THEOREM for sufficiently large POWERS (Goldfeld 1996). This is related to the fact that the abc conjecture implies that there are at least $C \ln x$ WIEFERICH PRIMES $\leq x$ for some constant C (Silverman 1988, Vardi 1991). see also FERMAT'S LAST THEOREM, MASON'S THEOREM, WIEFERICH PRIME

References

- Cox, D. A. "Introduction to Fermat's Last Theorem." *Amer. Math. Monthly* **101**, 3–14, 1994.
- Goldfeld, D. "Beyond the Last Theorem." *The Sciences*, 34–40, March/April 1996.
- Guy, R. K. *Unsolved Problems in Number Theory*, 2nd ed. New York: Springer-Verlag, pp. 75–76, 1994.
- Silverman, J. "Wieferich's Criterion and the abc Conjecture." *J. Number Th.* **30**, 226–237, 1988.
- Vardi, I. *Computational Recreations in Mathematics*. Reading, MA: Addison-Wesley, p. 66, 1991.

Abelian

see ABELIAN CATEGORY, ABELIAN DIFFERENTIAL, ABELIAN FUNCTION, ABELIAN GROUP, ABELIAN INTEGRAL, ABELIAN VARIETY, COMMUTATIVE

Abelian Category

An Abelian category is an abstract mathematical CATEGORY which displays some of the characteristic properties of the CATEGORY of all ABELIAN GROUPS.

see also ABELIAN GROUP, CATEGORY

Abel's Curve Theorem

The sum of the values of an INTEGRAL of the "first" or "second" sort

$$\int_{x_0, y_0}^{x_1, y_1} \frac{P dx}{Q} + \dots + \int_{x_0, y_0}^{x_N, y_N} \frac{P dx}{Q} = F(z)$$

and

$$\frac{P(x_1, y_1) dx_1}{Q(x_1, y_1) dz} + \dots + \frac{P(x_N, y_N) dx_N}{Q(x_N, y_N) dz} = \frac{dF}{dz},$$

from a FIXED POINT to the points of intersection with a curve depending rationally upon any number of parameters is a RATIONAL FUNCTION of those parameters.

References

- Coolidge, J. L. *A Treatise on Algebraic Plane Curves*. New York: Dover, p. 277, 1959.

Abelian Differential

An Abelian differential is an ANALYTIC or MEROMORPHIC DIFFERENTIAL on a COMPACT or closed RIEMANN SURFACE.

Abelian Function

An INVERSE FUNCTION of an ABELIAN INTEGRAL. Abelian functions have two variables and four periods. They are a generalization of ELLIPTIC FUNCTIONS, and are also called HYPERELLIPTIC FUNCTIONS.

see also ABELIAN INTEGRAL, ELLIPTIC FUNCTION

References

- Baker, H. F. *Abelian Functions: Abel's Theorem and the Allied Theory, Including the Theory of the Theta Functions*. New York: Cambridge University Press, 1995.
- Baker, H. F. *An Introduction to the Theory of Multiply Periodic Functions*. London: Cambridge University Press, 1907.

Abel's Functional Equation

Let $\text{Li}_2(x)$ denote the DILOGARITHM, defined by

$$\text{Li}_2(x) = \sum_{n=1}^{\infty} \frac{x^n}{n^2},$$

then

$$\begin{aligned} \text{Li}_2(x) + \text{Li}_2(y) + \text{Li}_2(xy) + \text{Li}_2\left(\frac{x(1-y)}{1-xy}\right) \\ + \text{Li}_2\left(\frac{y(1-x)}{1-xy}\right) = 3\text{Li}_2(1). \end{aligned}$$

see also DILOGARITHM, POLYLOGARITHM, RIEMANN ZETA FUNCTION

Abelian Group

N.B. A detailed on-line essay by S. Finch was the starting point for this entry.

A GROUP for which the elements COMMUTE (i.e., $AB = BA$ for all elements A and B) is called an Abelian group. All CYCLIC GROUPS are Abelian, but an Abelian group is not necessarily CYCLIC. All SUBGROUPS of an Abelian group are NORMAL. In an Abelian group, each element is in a CONJUGACY CLASS by itself, and the CHARACTER TABLE involves POWERS of a single element known as a GENERATOR.

No general formula is known for giving the number of nonisomorphic FINITE GROUPS of a given ORDER. However, the number of nonisomorphic Abelian FINITE GROUPS $a(n)$ of any given ORDER n is given by writing n as

$$n = \prod_i p_i^{\alpha_i}, \quad (1)$$

where the p_i are distinct PRIME FACTORS, then

$$a(n) = \prod_i P(\alpha_i), \quad (2)$$

where P is the PARTITION FUNCTION. This gives 1, 1, 1, 2, 1, 1, 1, 3, 2, ... (Sloane's A000688). The smallest orders for which $n = 1, 2, 3, \dots$ nonisomorphic Abelian groups exist are 1, 4, 8, 36, 16, 72, 32, 900, 216, 144, 64, 1800, 0, 288, 128, ... (Sloane's A046056), where 0 denotes an impossible number (i.e., not a product of partition numbers) of nonisomorphic Abelian, groups. The "missing" values are 13, 17, 19, 23, 26, 29, 31, 34, 37, 38, 39, 41, 43, 46, ... (Sloane's A046064). The incrementally largest numbers of Abelian groups as a function of order are 1, 2, 3, 5, 7, 11, 15, 22, 30, 42, 56, 77, 101, ... (Sloane's A046054), which occur for orders 1, 4, 8, 16, 32, 64, 128, 256, 512, 1024, 2048, 4096, 8192, ... (Sloane's A046055).

The KRONECKER DECOMPOSITION THEOREM states that every FINITE Abelian group can be written as a DIRECT PRODUCT of CYCLIC GROUPS of PRIME POWER ORDERS. If the ORDERS of a FINITE GROUP is a PRIME p , then there exists a single Abelian group of order p (denoted Z_p) and no non-Abelian groups. If the ORDERS is a prime squared p^2 , then there are two Abelian groups (denoted Z_{p^2} and $Z_p \otimes Z_p$. If the ORDERS is

a prime cubed p^3 , then there are three Abelian groups (denoted $Z_p \otimes Z_p \otimes Z_p$, $Z_p \otimes Z_{p^2}$, and Z_{p^3}), and five groups total. If the order is a PRODUCT of two primes p and q , then there exists exactly one Abelian group of order pq (denoted $Z_p \otimes Z_q$).

Another interesting result is that if $a(n)$ denotes the number of nonisomorphic Abelian groups of ORDER n , then

$$\sum_{n=1}^{\infty} a(n)n^{-s} = \zeta(s)\zeta(2s)\zeta(3s)\cdots, \quad (3)$$

where $\zeta(s)$ is the RIEMANN ZETA FUNCTION. Srinivasan (1973) has also shown that

$$\sum_{n=1}^N a(n) = A_1 N + A_2 N^{1/2} + A_3 N^{1/3} + \mathcal{O}[x^{105/407}(\ln x)^2], \quad (4)$$

where

$$A_k \equiv \prod_{\substack{j=1 \\ j \neq k}} \zeta\left(\frac{j}{k}\right) = \begin{cases} 2.294856591\dots & \text{for } k=1 \\ -14.6475663\dots & \text{for } k=2 \\ 118.6924619\dots & \text{for } k=3, \end{cases} \quad (5)$$

and ζ is again the RIEMANN ZETA FUNCTION. [Richert (1952) incorrectly gave $A_3 = 114$.] DeKoninck and Ivic (1980) showed that

$$\sum_{n=1}^N \frac{1}{a(n)} = BN + \mathcal{O}[\sqrt{N}(\ln N)^{-1/2}], \quad (6)$$

where

$$B \equiv \prod \left\{ 1 - \sum_{k=2}^{\infty} \left[\frac{1}{P(k-2)} - \frac{1}{P(k)} \right] \frac{1}{p^k} \right\} = 0.752\dots \quad (7)$$

is a product over PRIMES. Bounds for the number of nonisomorphic non-Abelian groups are given by Neumann (1969) and Pyber (1993).

see also FINITE GROUP, GROUP THEORY, KRONECKER DECOMPOSITION THEOREM, PARTITION FUNCTION P , RING

References

- DeKoninck, J.-M. and Ivic, A. *Topics in Arithmetical Functions: Asymptotic Formulae for Sums of Reciprocals of Arithmetical Functions and Related Fields*. Amsterdam, Netherlands: North-Holland, 1980.
- Erdős, P. and Szekeres, G. "Über die Anzahl abelscher Gruppen gegebener Ordnung und über ein verwandtes zahlen-theoretisches Problem." *Acta Sci. Math. (Szeged)* 7, 95–102, 1935.
- Finch, S. "Favorite Mathematical Constants." <http://www.mathsoft.com/asolve/constant/abel/abel.html>.
- Kendall, D. G. and Rankin, R. A. "On the Number of Abelian Groups of a Given Order." *Quart. J. Oxford* 18, 197–208, 1947.
- Kolesnik, G. "On the Number of Abelian Groups of a Given Order." *J. Reine Angew. Math.* 329, 164–175, 1981.

- Neumann, P. M. "An Enumeration Theorem for Finite Groups." *Quart. J. Math. Ser. 2* **20**, 395–401, 1969.
- Pyber, L. "Enumerating Finite Groups of Given Order." *Ann. Math.* **137**, 203–220, 1993.
- Richert, H.-E. "Über die Anzahl abelscher Gruppen gegebener Ordnung I." *Math. Zeitschr.* **56**, 21–32, 1952.
- Sloane, N. J. A. Sequence A000688/M0064 in "An On-Line Version of the Encyclopedia of Integer Sequences."
- Srinivasan, B. R. "On the Number of Abelian Groups of a Given Order." *Acta Arith.* **23**, 195–205, 1973.

Abel's Identity

Given a homogeneous linear SECOND-ORDER ORDINARY DIFFERENTIAL EQUATION,

$$y'' + P(x)y' + Q(x)y = 0, \quad (1)$$

call the two linearly independent solutions $y_1(x)$ and $y_2(x)$. Then

$$y_1''(x) + P(x)y_1'(x) + Q(x)y_1 = 0 \quad (2)$$

$$y_2''(x) + P(x)y_2'(x) + Q(x)y_2 = 0. \quad (3)$$

Now, take $y_1 \times (3) - y_2 \times (2)$,

$$y_1[y_2'' + P(x)y_2' + Q(x)y_2] - y_2[y_1'' + P(x)y_1' + Q(x)y_1] = 0 \quad (4)$$

$$(y_1y_2'' - y_2y_1'') + P(y_1y_2' - y_2y_1') + Q(y_1y_2 - y_2y_1) = 0 \quad (5)$$

$$(y_1y_2'' - y_2y_1'') + P(y_1y_2' - y_2y_1') = 0. \quad (6)$$

Now, use the definition of the WRONSKIAN and take its DERIVATIVE,

$$W = y_1y_2' - y_2y_1' \quad (7)$$

$$\begin{aligned} W' &= (y_1'y_2' + y_1y_2'') - (y_2'y_1' + y_2y_1'') \\ &= y_1y_2'' - y_2y_1''. \end{aligned} \quad (8)$$

Plugging W and W' into (6) gives

$$W' + PW = 0. \quad (9)$$

This can be rearranged to yield

$$\frac{dW}{W} = -P(x) dx \quad (10)$$

which can then be directly integrated to

$$\ln W = -C_1 \int P(x) dx, \quad (11)$$

where $\ln x$ is the NATURAL LOGARITHM. A second integration then yields Abel's identity

$$W(x) = C_2 e^{-\int P(x) dx}, \quad (12)$$

where C_1 is a constant of integration and $C_2 \equiv e^{C_1}$.

see also ORDINARY DIFFERENTIAL EQUATION—SECOND-ORDER

References

- Boyce, W. E. and DiPrima, R. C. *Elementary Differential Equations and Boundary Value Problems*, 4th ed. New York: Wiley, pp. 118, 262, 277, and 355, 1986.

Abel's Impossibility Theorem

In general, POLYNOMIAL equations higher than fourth degree are incapable of algebraic solution in terms of a finite number of ADDITIONS, MULTIPLICATIONS, and ROOT extractions.

see also CUBIC EQUATION, GALOIS'S THEOREM, POLYNOMIAL, QUADRATIC EQUATION, QUARTIC EQUATION, QUINTIC EQUATION

References

- Abel, N. H. "Démonstration de l'impossibilité de la résolution algébrique des équations générales qui dépassent le quatrième degré." *Crelle's J.* **1**, 1826.

Abel's Inequality

Let $\{f_n\}$ and $\{a_n\}$ be SEQUENCES with $f_n \geq f_{n+1} > 0$ for $n = 1, 2, \dots$, then

$$\left| \sum_{n=1}^m a_n f_n \right| \leq A f_1,$$

where

$$A = \max\{|a_1|, |a_1 + a_2|, \dots, |a_1 + a_2 + \dots + a_m|\}.$$

Abelian Integral

An INTEGRAL of the form

$$\int_0^x \frac{dt}{\sqrt{R(t)}},$$

where $R(t)$ is a POLYNOMIAL of degree > 4 . They are also called HYPERELLIPTIC INTEGRALS.

see also ABELIAN FUNCTION, ELLIPTIC INTEGRAL

Abel's Irreducibility Theorem

If one ROOT of the equation $f(x) = 0$, which is irreducible over a FIELD K , is also a ROOT of the equation $F(x) = 0$ in K , then all the ROOTS of the irreducible equation $f(x) = 0$ are ROOTS of $F(x) = 0$. Equivalently, $F(x)$ can be divided by $f(x)$ without a REMAINDER,

$$F(x) = f(x)F_1(x),$$

where $F_1(x)$ is also a POLYNOMIAL over K .

see also ABEL'S LEMMA, KRONECKER'S POLYNOMIAL THEOREM, SCHOENEMANN'S THEOREM

References

- Abel, N. H. "Mémoire sur une classe particulière d'équations résolubles algébriquement." *Crelle's J.* **4**, 1829.
- Dörrie, H. *100 Great Problems of Elementary Mathematics: Their History and Solutions*. New York: Dover, p. 120, 1965.

Abel's Lemma

The pure equation

$$x^p = C$$

of PRIME degree p is irreducible over a FIELD when C is a number of the FIELD but not the p th POWER of an element of the FIELD.

see also ABEL'S IRREDUCIBILITY THEOREM, GAUSS'S POLYNOMIAL THEOREM, KRONECKER'S POLYNOMIAL THEOREM, SCHOENEMANN'S THEOREM

References

Dörrie, H. *100 Great Problems of Elementary Mathematics: Their History and Solutions*. New York: Dover, p. 118, 1965.

Abel's Test

see ABEL'S UNIFORM CONVERGENCE TEST

Abel's Theorem

Given a TAYLOR SERIES

$$F(z) = \sum_{n=0}^{\infty} C_n z^n = \sum_{n=0}^{\infty} C_n r^n e^{in\theta}, \quad (1)$$

where the COMPLEX NUMBER z has been written in the polar form $z = re^{i\theta}$, examine the REAL and IMAGINARY PARTS

$$u(r, \theta) = \sum_{n=0}^{\infty} C_n r^n \cos(n\theta) \quad (2)$$

$$v(r, \theta) = \sum_{n=0}^{\infty} C_n r^n \sin(n\theta). \quad (3)$$

Abel's theorem states that, if $u(1, \theta)$ and $v(1, \theta)$ are CONVERGENT, then

$$u(1, \theta) + iv(1, \theta) = \lim_{r \rightarrow 1} f(re^{i\theta}). \quad (4)$$

Stated in words, Abel's theorem guarantees that, if a REAL POWER SERIES CONVERGES for some POSITIVE value of the argument, the DOMAIN of UNIFORM CONVERGENCE extends at least up to and including this point. Furthermore, the continuity of the sum function extends at least up to and including this point.

References

Arfken, G. *Mathematical Methods for Physicists*, 3rd ed. Orlando, FL: Academic Press, p. 773, 1985.

Abel Transform

The following INTEGRAL TRANSFORM relationship, known as the Abel transform, exists between two functions $f(x)$ and $g(t)$ for $0 < \alpha < 1$,

$$f(x) = \int_0^x \frac{g(t) dt}{(x-t)^\alpha} \quad (1)$$

$$g(t) = -\frac{\sin(\pi\alpha)}{\pi} \frac{d}{dt} \int_0^t \frac{f(x) dx}{(x-t)^{1-\alpha}} \quad (2)$$

$$= -\frac{\sin(\pi\alpha)}{\pi} \left[\int_0^t \frac{df}{dx} \frac{dx}{(t-x)^{1-\alpha}} + \frac{f(0)}{t^{1-\alpha}} \right]. \quad (3)$$

The Abel transform is used in calculating the radial mass distribution of galaxies and inverting planetary radio occultation data to obtain atmospheric information.

References

Arfken, G. *Mathematical Methods for Physicists*, 3rd ed. Orlando, FL: Academic Press, pp. 875–876, 1985.
Binney, J. and Tremaine, S. *Galactic Dynamics*. Princeton, NJ: Princeton University Press, p. 651, 1987.
Bracewell, R. *The Fourier Transform and Its Applications*. New York: McGraw-Hill, pp. 262–266, 1965.

Abel's Uniform Convergence Test

Let $\{u_n(x)\}$ be a SEQUENCE of functions. If

1. $u_n(x)$ can be written $u_n(x) = a_n f_n(x)$,
2. $\sum a_n$ is CONVERGENT,
3. $f_n(x)$ is a MONOTONIC DECREASING SEQUENCE (i.e., $f_{n+1}(x) \leq f_n(x)$) for all n , and
4. $f_n(x)$ is BOUNDED in some region (i.e., $0 \leq f_n(x) \leq M$ for all $x \in [a, b]$)

then, for all $x \in [a, b]$, the SERIES $\sum u_n(x)$ CONVERGES UNIFORMLY.

see also CONVERGENCE TESTS

References

Bromwich, T. J. I'a and MacRobert, T. M. *An Introduction to the Theory of Infinite Series*, 3rd ed. New York: Chelsea, p. 59, 1991.
Whittaker, E. T. and Watson, G. N. *A Course in Modern Analysis*, 4th ed. Cambridge, England: Cambridge University Press, p. 17, 1990.

Abelian Variety

An Abelian variety is an algebraic GROUP which is a complete ALGEBRAIC VARIETY. An Abelian variety of DIMENSION 1 is an ELLIPTIC CURVE.

see also ALBANESE VARIETY

References

Murty, V. K. *Introduction to Abelian Varieties*. Providence, RI: Amer. Math. Soc., 1993.

Abhyankar's Conjecture

For a FINITE GROUP G , let $p(G)$ be the SUBGROUP generated by all the SYLOW p -SUBGROUPS of G . If X is a projective curve in characteristic $p > 0$, and if x_0, \dots, x_t are points of X (for $t > 0$), then a NECESSARY and SUFFICIENT condition that G occur as the GALOIS GROUP of a finite covering Y of X , branched only at the points x_0, \dots, x_t , is that the QUOTIENT GROUP $G/p(G)$ has $2g + t$ generators.

Raynaud (1994) solved the Abhyankar problem in the crucial case of the affine line (i.e., the projective line with a point deleted), and Harbater (1994) proved the full Abhyankar conjecture by building upon this special solution.

see also FINITE GROUP, GALOIS GROUP, QUOTIENT GROUP, SYLOW p -SUBGROUP

References

- Abhyankar, S. "Coverings of Algebraic Curves." *Amer. J. Math.* **79**, 825–856, 1957.
- American Mathematical Society. "Notices of the AMS, April 1995, 1995 Frank Nelson Cole Prize in Algebra." <http://www.ams.org/notices/199504/prize-cole.html>.
- Harbater, D. "Abhyankar's Conjecture on Galois Groups Over Curves." *Invent. Math.* **117**, 1–25, 1994.
- Raynaud, M. "Revêtements de la droite affine en caractéristique $p > 0$ et conjecture d'Abhyankar." *Invent. Math.* **116**, 425–462, 1994.

Ablowitz-Ramani-Segur Conjecture

The Ablowitz-Ramani-Segur conjecture states that a nonlinear PARTIAL DIFFERENTIAL EQUATION is solvable by the INVERSE SCATTERING METHOD only if every nonlinear ORDINARY DIFFERENTIAL EQUATION obtained by exact reduction has the PAINLEVÉ PROPERTY.

see also INVERSE SCATTERING METHOD

References

- Tabor, M. *Chaos and Integrability in Nonlinear Dynamics: An Introduction*. New York: Wiley, p. 351, 1989.

Abscissa

The x - (horizontal) axis of a GRAPH.

see also AXIS, ORDINATE, REAL LINE, x -AXIS, y -AXIS, z -AXIS

Absolute Convergence

A SERIES $\sum_n u_n$ is said to CONVERGE absolutely if the SERIES $\sum_n |u_n|$ CONVERGES, where $|u_n|$ denotes the ABSOLUTE VALUE. If a SERIES is absolutely convergent, then the sum is independent of the order in which terms are summed. Furthermore, if the SERIES is multiplied by another absolutely convergent series, the product series will also converge absolutely.

see also CONDITIONAL CONVERGENCE, CONVERGENT SERIES, RIEMANN SERIES THEOREM

References

- Bromwich, T. J. I'a and MacRobert, T. M. "Absolute Convergence." Ch. 4 in *An Introduction to the Theory of Infinite Series*, 3rd ed. New York: Chelsea, pp. 69–77, 1991.

Absolute Deviation

Let \bar{u} denote the MEAN of a SET of quantities u_i , then the absolute deviation is defined by

$$\Delta u_i \equiv |u_i - \bar{u}|.$$

see also DEVIATION, MEAN DEVIATION, SIGNED DEVIATION, STANDARD DEVIATION

Absolute Error

The DIFFERENCE between the measured or inferred value of a quantity x_0 and its actual value x , given by

$$\Delta x \equiv x_0 - x$$

(sometimes with the ABSOLUTE VALUE taken) is called the absolute error. The absolute error of the SUM or DIFFERENCE of a number of quantities is less than or equal to the SUM of their absolute errors.

see also ERROR PROPAGATION, PERCENTAGE ERROR, RELATIVE ERROR

References

- Abramowitz, M. and Stegun, C. A. (Eds.). *Handbook of Mathematical Functions with Formulas, Graphs, and Mathematical Tables*, 9th printing. New York: Dover, p. 14, 1972.

Absolute Geometry

GEOMETRY which depends only on the first four of EUCLID'S POSTULATES and not on the PARALLEL POSTULATE. Euclid himself used only the first four postulates for the first 28 propositions of the *Elements*, but was forced to invoke the PARALLEL POSTULATE on the 29th.

see also AFFINE GEOMETRY, *Elements*, EUCLID'S POSTULATES, GEOMETRY, ORDERED GEOMETRY, PARALLEL POSTULATE

References

- Hofstadter, D. R. *Gödel, Escher, Bach: An Eternal Golden Braid*. New York: Vintage Books, pp. 90–91, 1989.

Absolute Pseudoprime

see CARMICHAEL NUMBER

Absolute Square

Also known as the squared NORM. The absolute square of a COMPLEX NUMBER z is written $|z|^2$ and is defined as

$$|z|^2 \equiv zz^*, \quad (1)$$

where z^* denotes the COMPLEX CONJUGATE of z . For a REAL NUMBER, (1) simplifies to

$$|z|^2 = z^2. \quad (2)$$

If the COMPLEX NUMBER is written $z = x + iy$, then the absolute square can be written

$$|x + iy|^2 = x^2 + y^2. \quad (3)$$

An important identity involving the absolute square is given by

$$\begin{aligned} |a \pm be^{-i\delta}|^2 &= (a \pm be^{-i\delta})(a \pm be^{i\delta}) \\ &= a^2 + b^2 \pm ab(e^{i\delta} + e^{-i\delta}) \\ &= a^2 + b^2 \pm 2ab \cos \delta. \end{aligned} \quad (4)$$

If $a = 1$, then (4) becomes

$$\begin{aligned} |1 \pm be^{-i\delta}|^2 &= 1 + b^2 \pm 2b \cos \delta \\ &= 1 + b^2 \pm 2b[1 - 2 \sin^2(\tfrac{1}{2}\delta)] \\ &= 1 \pm 2b + b^2 \mp 4b \sin^2(\tfrac{1}{2}\delta) \\ &= (1 \pm b)^2 \mp 4b \sin^2(\tfrac{1}{2}\delta). \end{aligned} \quad (5)$$

If $a = 1$, and $b = 1$, then

$$|1 - e^{-i\delta}|^2 = (1 - 1)^2 + 4 \cdot 1 \sin^2(\tfrac{1}{2}\delta) = 4 \sin^2(\tfrac{1}{2}\delta). \quad (6)$$

Finally,

$$\begin{aligned} |e^{i\phi_1} + e^{i\phi_2}|^2 &= (e^{i\phi_1} + e^{i\phi_2})(e^{-i\phi_1} + e^{-i\phi_2}) \\ &= 2 + e^{i(\phi_2 - \phi_1)} + e^{-i(\phi_2 - \phi_1)} \\ &= 2 + 2 \cos(\phi_2 - \phi_1) = 2[1 + \cos(\phi_2 - \phi_1)] \\ &= 4 \cos^2(\phi_2 - \phi_1). \end{aligned} \quad (7)$$

Absolute Value

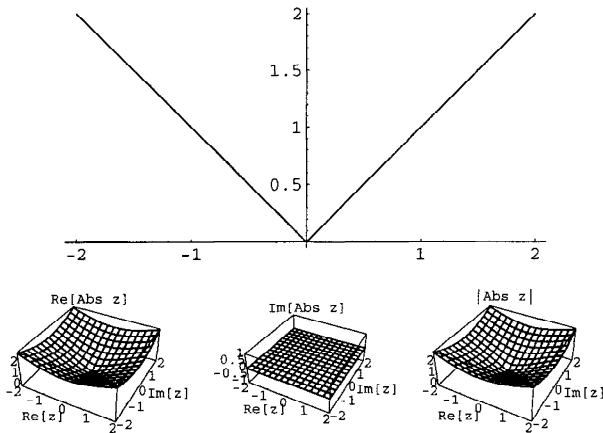

The absolute value of a REAL NUMBER x is denoted $|x|$ and given by

$$|x| = x \operatorname{sgn}(x) = \begin{cases} -x & \text{for } x \leq 0 \\ x & \text{for } x \geq 0, \end{cases}$$

where SGN is the sign function.

The same notation is used to denote the MODULUS of a COMPLEX NUMBER $z = x + iy$, $|z| \equiv \sqrt{x^2 + y^2}$, a p -ADIC absolute value, or a general VALUATION. The NORM of a VECTOR \mathbf{x} is also denoted $|\mathbf{x}|$, although $\|\mathbf{x}\|$ is more commonly used.

Other NOTATIONS similar to the absolute value are the FLOOR FUNCTION $\lfloor x \rfloor$, NINT function $\operatorname{NINT}[x]$, and CEILING FUNCTION $\lceil x \rceil$.

see also ABSOLUTE SQUARE, CEILING FUNCTION, FLOOR FUNCTION, MODULUS (COMPLEX NUMBER), NINT, SGN, TRIANGLE FUNCTION, VALUATION

Absolutely Continuous

Let μ be a POSITIVE MEASURE on a SIGMA ALGEBRA M and let λ be an arbitrary (real or complex) MEASURE on M . Then λ is absolutely continuous with respect to μ , written $\lambda \ll \mu$, if $\lambda(E) = 0$ for every $E \in M$ for which $\mu(E) = 0$.

see also CONCENTRATED, MUTUALLY SINGULAR

References

Rudin, W. *Functional Analysis*. New York: McGraw-Hill, pp. 121–125, 1991.

Absorption Law

The law appearing in the definition of a BOOLEAN ALGEBRA which states

$$a \wedge (a \vee b) = a \vee (a \wedge b) = a$$

for binary operators \vee and \wedge (which most commonly are logical OR and logical AND).

see also BOOLEAN ALGEBRA, LATTICE

References

Birkhoff, G. and Mac Lane, S. *A Survey of Modern Algebra*, 3rd ed. New York: Macmillan, p. 317, 1965.

Abstraction Operator

see LAMBDA CALCULUS

Abundance

The abundance of a number n is the quantity

$$A(n) \equiv \sigma(n) - 2n,$$

where $\sigma(n)$ is the DIVISOR FUNCTION. Kravitz has conjectured that no numbers exist whose abundance is an ODD SQUARE (Guy 1994).

The following table lists special classifications given to a number n based on the value of $A(n)$.

$A(n)$	Number
< 0	deficient number
-1	almost perfect number
0	perfect number
1	quasiperfect number
> 0	abundant number

see also DEFICIENCY

References

Guy, R. K. *Unsolved Problems in Number Theory*, 2nd ed. New York: Springer-Verlag, pp. 45–46, 1994.

Abundant Number

An abundant number is an INTEGER n which is not a PERFECT NUMBER and for which

$$s(n) \equiv \sigma(n) - n > n, \quad (1)$$

where $\sigma(n)$ is the DIVISOR FUNCTION. The quantity $\sigma(n) - 2n$ is sometimes called the ABUNDANCE. The first few abundant numbers are 12, 18, 20, 24, 30, 36, ... (Sloane's A005101). Abundant numbers are sometimes called EXCESSIVE NUMBERS.

There are only 21 abundant numbers less than 100, and they are all EVEN. The first ODD abundant number is

$$945 = 3^3 \cdot 7 \cdot 5. \quad (2)$$

That 945 is abundant can be seen by computing

$$s(945) = 975 > 945. \quad (3)$$

Any multiple of a PERFECT NUMBER or an abundant number is also abundant. Every number greater than 20161 can be expressed as a sum of two abundant numbers.

Define the density function

$$A(x) \equiv \lim_{n \rightarrow \infty} \frac{|\{n : \sigma(n) \geq xn\}|}{n} \quad (4)$$

for a POSITIVE REAL NUMBER x , then Davenport (1933) proved that $A(x)$ exists and is continuous for all x , and Erdős (1934) gave a simplified proof (Finch). Wall (1971) and Wall *et al.* (1977) showed that

$$0.2441 < A(2) < 0.2909, \quad (5)$$

and Deléglise showed that

$$0.2474 < A(2) < 0.2480. \quad (6)$$

A number which is abundant but for which all its PROPER DIVISORS are DEFICIENT is called a PRIMITIVE ABUNDANT NUMBER (Guy 1994, p. 46).

see also ALIQUOT SEQUENCE, DEFICIENT NUMBER, HIGHLY ABUNDANT NUMBER, MULTIAMICABLE NUMBERS, PERFECT NUMBER, PRACTICAL NUMBER, PRIMITIVE ABUNDANT NUMBER, WEIRD NUMBER

References

- Deléglise, M. "Encadrement de la densité des nombres abondants." Submitted.
- Dickson, L. E. *History of the Theory of Numbers, Vol. 1: Divisibility and Primality*. New York: Chelsea, pp. 3-33, 1952.
- Erdős, P. "On the Density of the Abundant Numbers." *J. London Math. Soc.* **9**, 278-282, 1934.
- Finch, S. "Favorite Mathematical Constants." <http://www.mathsoft.com/asolve/constant/abund/abund.html>.
- Guy, R. K. *Unsolved Problems in Number Theory, 2nd ed.* New York: Springer-Verlag, pp. 45-46, 1994.

Singh, S. *Fermat's Enigma: The Epic Quest to Solve the World's Greatest Mathematical Problem*. New York: Walker, pp. 11 and 13, 1997.

Sloane, N. J. A. Sequence A005101/M4825 in "An On-Line Version of the Encyclopedia of Integer Sequences."

Wall, C. R. "Density Bounds for the Sum of Divisors Function." In *The Theory of Arithmetic Functions* (Ed. A. A. Gioia and D. L. Goldsmith). New York: Springer-Verlag, pp. 283-287, 1971.

Wall, C. R.; Crews, P. L.; and Johnson, D. B. "Density Bounds for the Sum of Divisors Function." *Math. Comput.* **26**, 773-777, 1972.

Wall, C. R.; Crews, P. L.; and Johnson, D. B. "Density Bounds for the Sum of Divisors Function." *Math. Comput.* **31**, 616, 1977.

Acceleration

Let a particle travel a distance $s(t)$ as a function of time t (here, s can be thought of as the ARC LENGTH of the curve traced out by the particle). The SPEED (the SCALAR NORM of the VECTOR VELOCITY) is then given by

$$\frac{ds}{dt} = \sqrt{\left(\frac{dx}{dt}\right)^2 + \left(\frac{dy}{dt}\right)^2 + \left(\frac{dz}{dt}\right)^2}. \quad (1)$$

The acceleration is defined as the time DERIVATIVE of the VELOCITY, so the SCALAR acceleration is given by

$$a \equiv \frac{dv}{dt} \quad (2)$$

$$= \frac{d^2s}{dt^2} \quad (3)$$

$$= \frac{\frac{dx}{dt} \frac{d^2x}{dt^2} + \frac{dy}{dt} \frac{d^2y}{dt^2} + \frac{dz}{dt} \frac{d^2z}{dt^2}}{\sqrt{\left(\frac{dx}{dt}\right)^2 + \left(\frac{dy}{dt}\right)^2 + \left(\frac{dz}{dt}\right)^2}} \quad (4)$$

$$= \frac{dx}{ds} \frac{d^2x}{dt^2} + \frac{dy}{ds} \frac{d^2y}{dt^2} + \frac{dz}{ds} \frac{d^2z}{dt^2} \quad (5)$$

$$= \frac{d\mathbf{r}}{ds} \cdot \frac{d^2\mathbf{r}}{dt^2}. \quad (6)$$

The VECTOR acceleration is given by

$$\mathbf{a} \equiv \frac{d\mathbf{v}}{dt} = \frac{d^2\mathbf{r}}{dt^2} = \frac{d^2s}{dt^2} \hat{\mathbf{T}} + \kappa \left(\frac{ds}{dt}\right)^2 \hat{\mathbf{N}}, \quad (7)$$

where $\hat{\mathbf{T}}$ is the UNIT TANGENT VECTOR, κ the CURVATURE, s the ARC LENGTH, and $\hat{\mathbf{N}}$ the UNIT NORMAL VECTOR.

Let a particle move along a straight LINE so that the positions at times t_1 , t_2 , and t_3 are s_1 , s_2 , and s_3 , respectively. Then the particle is uniformly accelerated with acceleration a IFF

$$a \equiv 2 \left[\frac{(s_2 - s_3)t_1 + (s_3 - s_1)t_2 + (s_1 - s_2)t_3}{(t_1 - t_2)(t_2 - t_3)(t_3 - t_1)} \right] \quad (8)$$

is a constant (Klamkin 1995, 1996).

Consider the measurement of acceleration in a rotating reference frame. Apply the ROTATION OPERATOR

$$\tilde{R} \equiv \left(\frac{d}{dt} \right)_{\text{body}} + \omega \times \quad (9)$$

twice to the RADIUS VECTOR \mathbf{r} and suppress the *body* notation,

$$\begin{aligned} \mathbf{a}_{\text{space}} &= \tilde{R}^2 \mathbf{r} = \left(\frac{d}{dt} + \omega \times \right)^2 \mathbf{r} \\ &= \left(\frac{d}{dt} + \omega \times \right) \left(\frac{d\mathbf{r}}{dt} + \omega \times \mathbf{r} \right) \\ &= \frac{d^2 \mathbf{r}}{dt^2} + \frac{d}{dt} (\omega \times \mathbf{r}) + \omega \times \frac{d\mathbf{r}}{dt} + \omega \times (\omega \times \mathbf{r}) \\ &= \frac{d^2 \mathbf{r}}{dt^2} + \omega \times \frac{d\mathbf{r}}{dt} + \mathbf{r} \times \frac{d\omega}{dt} + \omega \times \frac{d\mathbf{r}}{dt} \\ &\quad + \omega \times (\omega \times \mathbf{r}). \end{aligned} \quad (10)$$

Grouping terms and using the definitions of the VELOCITY $\mathbf{v} \equiv d\mathbf{r}/dt$ and ANGULAR VELOCITY $\boldsymbol{\alpha} \equiv d\omega/dt$ give the expression

$$\mathbf{a}_{\text{space}} = \frac{d^2 \mathbf{r}}{dt^2} + 2\omega \times \mathbf{v} + \omega \times (\omega \times \mathbf{r}) + \mathbf{r} \times \boldsymbol{\alpha}. \quad (11)$$

Now, we can identify the expression as consisting of three terms

$$\mathbf{a}_{\text{body}} \equiv \frac{d^2 \mathbf{r}}{dt^2}, \quad (12)$$

$$\mathbf{a}_{\text{Coriolis}} \equiv 2\omega \times \mathbf{v}, \quad (13)$$

$$\mathbf{a}_{\text{centrifugal}} \equiv \omega \times (\omega \times \mathbf{r}), \quad (14)$$

a “body” acceleration, centrifugal acceleration, and Coriolis acceleration. Using these definitions finally gives

$$\mathbf{a}_{\text{space}} = \mathbf{a}_{\text{body}} + \mathbf{a}_{\text{Coriolis}} + \mathbf{a}_{\text{centrifugal}} + \mathbf{r} \times \boldsymbol{\alpha}, \quad (15)$$

where the fourth term will vanish in a uniformly rotating frame of reference (i.e., $\boldsymbol{\alpha} = 0$). The centrifugal acceleration is familiar to riders of merry-go-rounds, and the Coriolis acceleration is responsible for the motions of hurricanes on Earth and necessitates large trajectory corrections for intercontinental ballistic missiles.

see also ANGULAR ACCELERATION, ARC LENGTH, JERK, VELOCITY

References

Klamkin, M. S. “Problem 1481.” *Math. Mag.* **68**, 307, 1995.
Klamkin, M. S. “A Characteristic of Constant Acceleration.”
Solution to Problem 1481. *Math. Mag.* **69**, 308, 1996.

Accidental Cancellation

see ANOMALOUS CANCELLATION

Accumulation Point

An accumulation point is a POINT which is the limit of a SEQUENCE, also called a LIMIT POINT. For some MAPS, periodic orbits give way to CHAOTIC ones beyond a point known as the accumulation point.

see also CHAOS, LOGISTIC MAP, MODE LOCKING, PERIOD DOUBLING

Achilles and the Tortoise Paradox

see ZENO’S PARADOXES

Ackermann Function

The Ackermann function is the simplest example of a well-defined TOTAL FUNCTION which is COMPUTABLE but not PRIMITIVE RECURSIVE, providing a counterexample to the belief in the early 1900s that every COMPUTABLE FUNCTION was also PRIMITIVE RECURSIVE (Dötzel 1991). It grows faster than an exponential function, or even a multiple exponential function. The Ackermann function $A(x, y)$ is defined by

$$A(x, y) \equiv \begin{cases} y + 1 & \text{if } x = 0 \\ A(x - 1, 1) & \text{if } y = 0 \\ A(x - 1, A(x, y - 1)) & \text{otherwise.} \end{cases} \quad (1)$$

Special values for INTEGER x include

$$A(0, y) = y + 1 \quad (2)$$

$$A(1, y) = y + 2 \quad (3)$$

$$A(2, y) = 2y + 3 \quad (4)$$

$$A(3, y) = 2^{y+3} - 3 \quad (5)$$

$$A(4, y) = \underbrace{2^{2^{\dots^2}}}_{y+3} - 3. \quad (6)$$

Expressions of the latter form are sometimes called POWER TOWERS. $A(0, y)$ follows trivially from the definition. $A(1, y)$ can be derived as follows,

$$\begin{aligned} A(1, y) &= A(0, A(1, y - 1)) = A(1, y - 1) + 1 \\ &= A(0, A(1, y - 2)) + 1 = A(1, y - 2) + 2 \\ &= \dots = A(1, 0) + y = A(0, 1) + y = y + 2. \end{aligned} \quad (7)$$

$A(2, y)$ has a similar derivation,

$$\begin{aligned} A(2, y) &= A(1, A(2, y - 1)) = A(2, y - 1) + 2 \\ &= A(1, A(2, y - 2)) + 2 = A(2, y - 2) + 4 = \dots \\ &= A(2, 0) + 2y = A(1, 1) + 2y = 2y + 3. \end{aligned} \quad (8)$$

Buck (1963) defines a related function using the same fundamental RECURRENCE RELATION (with arguments flipped from Buck’s convention)

$$F(x, y) = F(x - 1, F(x, y - 1)), \quad (9)$$

see also ACKERMANN FUNCTION, ARROW NOTATION,
POWER TOWER

$$F(x, 0) = 1 \quad \text{for } x = 3, 4, \dots \quad (13)$$

$$F(4, y) = \underbrace{2^2}_{y^1} \overset{2}{\dots}^2. \quad (17)$$

where $m = \underbrace{2^2}_{65536}^2$, a truly huge number!

Buck, R. C. "Mathematical Induction and Recursive Definitions." *Amer. Math. Monthly* **70**, 128–135, 1963.

Dötzel, G. "A Function to End All Functions." *Algorithm: Recreational Programming* **2.4**, 16–17, 1991.

Kleene, S. C. *Introduction to Metamathematics*. New York: Elsevier, 1971.

Péter, R. *Rekursive Funktionen*. Budapest: Akad. Kiado, 1951.

Reingold, E. H. and Shen, X. "More Nearly Optimal Algorithms for Unbounded Searching, Part I: The Finite Case." *SIAM J. Comput.* **20**, 156–183, 1991.

Rose, H. E. *Subrecursion, Functions, and Hierarchies*. New York: Clarendon Press, 1988.

Sloane, N. J. A. Sequence A001695/M2352 in "An On-Line Version of the Encyclopedia of Integer Sequences."

Smith, H. J. "Ackermann's Function." <http://www.netcom.com/~hjsmith/Ackerman.html>.

Spencer, J. "Large Numbers and Unprovable Theorems." *Amer. Math. Monthly* **90**, 669–675, 1983.

Tarjan, R. E. *Data Structures and Network Algorithms*. Philadelphia PA: SIAM, 1983.

Vardi, I. *Computational Recreations in Mathematics*. Redwood City, CA: Addison-Wesley, pp. 11, 227, and 232, 1991.

A number of the form $n \uparrow \cdots \uparrow n$, where ARROW NOTATION has been used. The first few Ackermann numbers are $1 \uparrow 1 = 1$, $2 \uparrow \uparrow 2 = 4$, and $3 \uparrow \uparrow \uparrow 3 = \underbrace{3^{3^{\cdots^3}}}_{7,625,997,484,987}$.

Ackermann, W. "Zum hilbertschen Aufbau der reellen Zahlen." *Math. Ann.* **99**, 118-133, 1928.

Conway, J. H. and Guy, R. K. *The Book of Numbers*. New York: Springer-Verlag, pp. 60-61, 1996.

Crandall, R. E. "The Challenge of Large Numbers." *Sci. Amer.* **276**, 74-79, Feb. 1997.

Vardi, I. *Computational Recreations in Mathematica*. Redwood City, CA: Addison-Wesley, pp. 11, 227, and 232, 1991.

see also CRUNODE, SPINODE, TACNODE

A term invented by B. Grünbaum in an attempt to promote concrete and precise POLYHEDRON terminology. The word "coptic" derives from the Greek for "to cut," and acoptic polyhedra are defined as POLYHEDRA for which the FACES do not intersect (cut) themselves, making them 2-MANIFOLDS.

see also HONEYCOMB, NOLID, POLYHEDRON, SPONGE

Let $M(X)$ denote the GROUP of all invertible MAPS $X \rightarrow X$ and let G be any GROUP. A HOMOMORPHISM $\theta : G \rightarrow M(X)$ is called an action of G on X . Therefore, θ satisfies

1. For each $g \in G$, $\theta(g)$ is a MAP $X \rightarrow X : x \mapsto \theta(g)x$,
2. $\theta(gh)x = \theta(g)(\theta(h)x)$,
3. $\theta(e)x = x$, where e is the group identity in G ,
4. $\theta(g^{-1})x = \theta(g)^{-1}x$.

see also CASCADE, FLOW, SEMIFLOW

An ANGLE of less than $\pi/2$ RADIANS (90°) is called an acute angle.

see also ANGLE, OBTUSE ANGLE, RIGHT ANGLE,
STRAIGHT ANGLE

Acute Triangle



A TRIANGLE in which all three ANGLES are ACUTE ANGLES. A TRIANGLE which is neither acute nor a RIGHT TRIANGLE (i.e., it has an OBTUSE ANGLE) is called an OBTUSE TRIANGLE. A SQUARE can be dissected into as few as 8 acute triangles.

see also OBTUSE TRIANGLE, RIGHT TRIANGLE

Adams-Bashforth-Moulton Method

see ADAMS' METHOD

Adams' Method

Adams' method is a numerical METHOD for solving linear FIRST-ORDER ORDINARY DIFFERENTIAL EQUATIONS of the form

$$\frac{dy}{dx} = f(x, y). \quad (1)$$

Let

$$h = x_{n+1} - x_n \quad (2)$$

be the step interval, and consider the MACLAURIN SERIES of y about x_n ,

$$y_{n+1} = y_n + \left(\frac{dy}{dx}\right)_n (x - x_n) + \frac{1}{2} \left(\frac{d^2y}{dx^2}\right)_n (x - x_n)^2 + \dots \quad (3)$$

$$\left(\frac{dy}{dx}\right)_{n+1} = \left(\frac{dy}{dx}\right)_n + \left(\frac{d^2y}{dx^2}\right)_n (x - x_n) + \dots \quad (4)$$

Here, the DERIVATIVES of y are given by the BACKWARD DIFFERENCES

$$q_n \equiv \left(\frac{dy}{dx}\right)_n = \frac{\Delta y_n}{x_{n+1} - x_n} = \frac{y_{n+1} - y_n}{h} \quad (5)$$

$$\nabla q_n \equiv \left(\frac{d^2y}{dx^2}\right)_n = q_n - q_{n-1} \quad (6)$$

$$\nabla^2 q_n \equiv \left(\frac{d^3y}{dx^3}\right)_n = \nabla q_n - \nabla q_{n-1}, \quad (7)$$

etc. Note that by (1), q_n is just the value of $f(x_n, y_n)$.

For first-order interpolation, the method proceeds by iterating the expression

$$y_{n+1} = y_n + q_n h \quad (8)$$

where $q_n \equiv f(x_n, y_n)$. The method can then be extended to arbitrary order using the finite difference integration formula from Beyer (1987)

$$\int_0^1 f_p dp = \left(1 + \frac{1}{2} \nabla + \frac{5}{12} \nabla^2 + \frac{3}{8} \nabla^3 + \frac{251}{720} \nabla^4 + \frac{95}{288} \nabla^5 + \frac{19087}{60480} \nabla^6 + \dots\right) f_p \quad (9)$$

to obtain

$$y_{n+1} - y_n = h \left(q_n + \frac{1}{2} \nabla q_{n-1} + \frac{5}{12} \nabla^2 q_{n-2} + \frac{3}{8} \nabla^3 q_{n-3} + \frac{251}{720} \nabla^4 q_{n-4} + \frac{95}{288} \nabla^5 q_{n-5} + \dots \right). \quad (10)$$

Note that von Kármán and Biot (1940) confusingly use the symbol normally used for FORWARD DIFFERENCES Δ to denote BACKWARD DIFFERENCES ∇ .

see also GILL'S METHOD, MILNE'S METHOD, PREDICTOR-CORRECTOR METHODS, RUNGE-KUTTA METHOD

References

- Abramowitz, M. and Stegun, C. A. (Eds.). *Handbook of Mathematical Functions with Formulas, Graphs, and Mathematical Tables*, 9th printing. New York: Dover, p. 896, 1972.
- Beyer, W. H. *CRC Standard Mathematical Tables*, 28th ed. Boca Raton, FL: CRC Press, p. 455, 1987.
- Kármán, T. von and Biot, M. A. *Mathematical Methods in Engineering: An Introduction to the Mathematical Treatment of Engineering Problems*. New York: McGraw-Hill, pp. 14-20, 1940.
- Press, W. H.; Flannery, B. P.; Teukolsky, S. A.; and Vetterling, W. T. *Numerical Recipes in FORTRAN: The Art of Scientific Computing*, 2nd ed. Cambridge, England: Cambridge University Press, p. 741, 1992.

Addend

A quantity to be ADDED to another, also called a SUMMAND. For example, in the expression $a + b + c$, a , b , and c are all addends. The first of several addends, or "the one to which the others are added" (a in the previous example), is sometimes called the AUGEND.

see also ADDITION, AUGEND, PLUS, RADICAND

Addition

$$\begin{array}{r} 1 \ 1 \quad \leftarrow \text{carries} \\ 1 \ 5 \ 8 \quad \leftarrow \text{addend 1} \\ + 2 \ 4 \ 9 \quad \leftarrow \text{addend 2} \\ \hline 4 \ 0 \ 7 \quad \leftarrow \text{sum} \end{array}$$

The combining of two or more quantities using the PLUS operator. The individual numbers being combined are called ADDENDS, and the total is called the SUM. The first of several ADDENDS, or "the one to which the others are added," is sometimes called the AUGEND. The opposite of addition is SUBTRACTION.

While the usual form of adding two n -digit INTEGERS (which consists of summing over the columns right to left and "CARRYING" a 1 to the next column if the sum exceeds 9) requires n operations (plus carries), two n -digit INTEGERS can be added in about $2 \lg n$ steps by n processors using carry-lookahead addition (McGeoch 1993). Here, $\lg x$ is the LG function, the LOGARITHM to the base 2.

see also ADDEND, AMENABLE NUMBER, AUGEND, CARRY, DIFFERENCE, DIVISION, MULTIPLICATION, PLUS, SUBTRACTION, SUM

References

- McGeoch, C. C. "Parallel Addition." *Amer. Math. Monthly* 100, 867-871, 1993.

Addition Chain

An addition chain for a number n is a SEQUENCE $1 = a_0 < a_1 < \dots < a_r = n$, such that each member after a_0 is the SUM of the two earlier (not necessarily distinct) ones. The number r is called the length of the addition chain. For example,

$$1, 1 + 1 = 2, 2 + 2 = 4, 4 + 2 = 6, 6 + 2 = 8, 8 + 6 = 14$$

[illegible]

It is conjectured that the maximum number lacking the DIGIT 1 with persistence 11 is

77777733322222222222222222222222

There is a stronger conjecture that there is a maximum number lacking the DIGIT 1 for each persistence ≥ 2 .

The maximum additive persistence in base 2 is 1. It is conjectured that all powers of $2 > 2^{15}$ contain a 0 in base 3, which would imply that the maximum persistence in base 3 is 3 (Guy, 1994).

see also DIGITADDITION, DIGITAL ROOT, MULTIPLICATIVE PERSISTENCE, NARCISSISTIC NUMBER, RECURRING DIGITAL INVARIANT

References

Guy, R. K. "The Persistence of a Number." §F25 in *Unsolved Problems in Number Theory*, 2nd ed. New York: Springer-Verlag, pp. 262–263, 1994.

Hinden, H. J. "The Additive Persistence of a Number." *J. Recr. Math.* **7**, 134-135, 1974.

Sloane, N. J. A. Sequences A031286 and A006050/M4683 in "An On-Line Version of the Encyclopedia of Integer Sequences."

Sloane, N. J. A. "The Persistence of a Number." *J. Recr. Math.* **6**, 97-98, 1973.

Adèle

An element of an ADÉLE GROUP, sometimes called a REPARTITION in older literature. Adèles arise in both NUMBER FIELDS and FUNCTION FIELDS. The adèles of a NUMBER FIELD are the additive SUBGROUPS of all elements in $\prod k_\nu$, where ν is the PLACE, whose ABSOLUTE VALUE is < 1 at all but finitely many ν s.

Let F be a FUNCTION FIELD of algebraic functions of one variable. Then a MAP r which assigns to every PLACE P of F an element $r(P)$ of F such that there are only a finite number of PLACES P for which $\nu_P(r(P)) < 0$.

see also IDELE

Chevalley, C. C. *Introduction to the Theory of Algebraic Functions of One Variable*. Providence, RI: Amer. Math. Soc., p. 25. 1951.

Adèle Group

The restricted topological DIRECT PRODUCT of the GROUP G_{k_v} with distinct invariant open subgroups G_{0_v} .

Weil, A. *Adèles and Algebraic Groups*. Princeton, NJ: Princeton University Press, 1961.

Adem Relations

Relations in the definition of a STEENROD ALGEBRA which state that, for $i < 2j$,

$$Sq^i \circ Sq^j(x) = \sum_{k=0}^{[i]} \binom{j-k-1}{i-2k} Sq^{i+j-k} \circ Sq^k(x),$$

where $f \circ g$ denotes function COMPOSITION and $[i]$ is the FLOOR FUNCTION.

see also STEENROD ALGEBRA

Adequate Knot

A class of KNOTS containing the class of ALTERNATING KNOTS. Let $c(K)$ be the CROSSING NUMBER. Then for KNOT SUM $K_1 \# K_2$ which is an adequate knot,

$$c(K_1 \# K_2) = c(K_1) + c(K_2).$$

This relationship is postulated to hold true for all KNOTS.

see also ALTERNATING KNOT, CROSSING NUMBER (LINK)

Adiabatic Invariant

A property of motion which is conserved to exponential accuracy in the small parameter representing the typical rate of change of the gross properties of the body.

see also ALGEBRAIC INVARIANT, LYAPUNOV CHARACTERISTIC NUMBER

Adjacency Matrix

The adjacency matrix of a simple GRAPH is a MATRIX with rows and columns labelled by VERTICES, with a 1 or 0 in position (v_i, v_j) according to whether v_i and v_j are ADJACENT or not.

see also INCIDENCE MATRIX

References

Chartrand, G. *Introductory Graph Theory*. New York: Dover, p. 218, 1985.

Adjacency Relation

The SET E of EDGES of a GRAPH (V, E) , being a set of unordered pairs of elements of V , constitutes a RELATION on V . Formally, an adjacency relation is any RELATION which is IRREFLEXIVE and SYMMETRIC.

see also IRREFLEXIVE, RELATION, SYMMETRIC

Adjacent Fraction

Two FRACTIONS are said to be adjacent if their difference has a unit NUMERATOR. For example, $1/3$ and $1/4$ are adjacent since $1/3 - 1/4 = 1/12$, but $1/2$ and $1/5$ are not since $1/2 - 1/5 = 3/10$. Adjacent fractions can be adjacent in a FAREY SEQUENCE.

see also FAREY SEQUENCE, FORD CIRCLE, FRACTION, NUMERATOR

References

Pickover, C. A. *Keys to Infinity*. New York: W. H. Freeman, p. 119, 1995.

Adjacent Value

The value nearest to but still inside an inner FENCE.

References

Tukey, J. W. *Explanatory Data Analysis*. Reading, MA: Addison-Wesley, p. 667, 1977.

Adjacent Vertices

In a GRAPH G , two VERTICES are adjacent if they are joined by an EDGE.

Adjoint Curve

A curve which has at least multiplicity $r_i - 1$ at each point where a given curve (having only ordinary singular points and cusps) has a multiplicity r_i is called the adjoint to the given curve. When the adjoint curve is of order $n - 3$, it is called a special adjoint curve.

References

Coolidge, J. L. *A Treatise on Algebraic Plane Curves*. New York: Dover, p. 30, 1959.

Adjoint Matrix

The adjoint matrix, sometimes also called the ADJUGATE MATRIX, is defined by

$$A^\dagger \equiv (A^T)^*, \quad (1)$$

where the ADJOINT OPERATOR is denoted † and T denotes the TRANSPOSE. If a MATRIX is SELF-ADJOINT, it is said to be HERMITIAN. The adjoint matrix of a MATRIX product is given by

$$(ab)^\dagger_{ij} = [(ab)^T]^\dagger_{ij}. \quad (2)$$

Using the property of transpose products that

$$\begin{aligned} [(ab)^T]^\dagger_{ij} &= (b^T a^T)^\dagger_{ij} = (b_{ik}^T a_{kj}^T)^* = (b^T)^\dagger_{ik} (a^T)^\dagger_{kj} \\ &= b_{ik}^\dagger a_{kj}^\dagger = (b^\dagger a^\dagger)_{ij}, \end{aligned} \quad (3)$$

it follows that

$$(AB)^\dagger = B^\dagger A^\dagger. \quad (4)$$

Adjoint Operator

Given a SECOND-ORDER ORDINARY DIFFERENTIAL EQUATION

$$\tilde{\mathcal{L}}u(x) \equiv p_0 \frac{du^2}{dx^2} + p_1 \frac{du}{dx} + p_2 u, \quad (1)$$

where $p_i \equiv p_i(x)$ and $u \equiv u(x)$, the adjoint operator $\tilde{\mathcal{L}}^\dagger$ is defined by

$$\begin{aligned} \tilde{\mathcal{L}}^\dagger u &\equiv \frac{d}{dx^2}(p_0 u) - \frac{d}{dx}(p_1 u) + p_2 u \\ &= p_0 \frac{d^2 u}{dx^2} + (2p_0' - p_1) \frac{du}{dx} + (p_0'' - p_1' + p_2)u. \end{aligned} \quad (2)$$

Write the two LINEARLY INDEPENDENT solutions as $y_1(x)$ and $y_2(x)$. Then the adjoint operator can also be written

$$\tilde{\mathcal{L}}^{\dagger}u = \int (y_2\tilde{\mathcal{L}}y_1 - y_1\tilde{\mathcal{L}}y_2) dx = \left[\frac{p_1}{p_0}(y_1'y_2 - y_1y_2') \right]. \quad (3)$$

see also SELF-ADJOINT OPERATOR, STURM-LIOUVILLE THEORY

Adjugate Matrix

see ADJOINT MATRIX

Adjunction

If a is an element of a FIELD F over the PRIME FIELD P , then the set of all RATIONAL FUNCTIONS of a with COEFFICIENTS in P is a FIELD derived from P by adjunction of a .

Adleman-Pomerance-Rumely Primality Test

A modified MILLER'S PRIMALITY TEST which gives a guarantee of PRIMALITY or COMPOSITENESS. The ALGORITHM's running time for a number N has been proved to be as $\mathcal{O}((\ln N)^{c \ln \ln \ln N})$ for some $c > 0$. It was simplified by Cohen and Lenstra (1984), implemented by Cohen and Lenstra (1987), and subsequently optimized by Bosma and van der Hulst (1990).

References

- Adleman, L. M.; Pomerance, C.; and Rumely, R. S. "On Distinguishing Prime Numbers from Composite Number." *Ann. Math.* **117**, 173–206, 1983.
- Bosma, W. and van der Hulst, M.-P. "Faster Primality Testing." In *Advances in Cryptology, Proc. Eurocrypt '89, Houthalen, April 10–13, 1989* (Ed. J.-J. Quisquater). New York: Springer-Verlag, 652–656, 1990.
- Brillhart, J.; Lehmer, D. H.; Selfridge, J.; Wagstaff, S. S. Jr.; and Tuckerman, B. *Factorizations of $b^n \pm 1$, $b = 2, 3, 5, 6, 7, 10, 11, 12$ Up to High Powers, rev. ed.* Providence, RI: Amer. Math. Soc., pp. lxxxiv–lxxxv, 1988.
- Cohen, H. and Lenstra, A. K. "Primality Testing and Jacobi Sums." *Math. Comput.* **42**, 297–330, 1984.
- Cohen, H. and Lenstra, A. K. "Implementation of a New Primality Test." *Math. Comput.* **48**, 103–121, 1987.
- Mihailescu, P. "A Primality Test Using Cyclotomic Extensions." In *Applied Algebra, Algebraic Algorithms and Error-Correcting Codes* (Proc. AAEC-6, Rome, July 1988). New York: Springer-Verlag, pp. 310–323, 1989.

Adleman-Rumely Primality Test

see ADLEMAN-POMERANCE-RUMELY PRIMALITY TEST

Admissible

A string or word is said to be admissible if that word appears in a given SEQUENCE. For example, in the SEQUENCE $aabaabaabaabaab \dots$, a , aa , $baab$ are all admissible, but bb is inadmissible.

see also BLOCK GROWTH

Affine Complex Plane

The set \mathbb{A}^2 of all ordered pairs of COMPLEX NUMBERS. see also AFFINE CONNECTION, AFFINE EQUATION, AFFINE GEOMETRY, AFFINE GROUP, AFFINE HULL, AFFINE PLANE, AFFINE SPACE, AFFINE TRANSFORMATION, AFFINITY, COMPLEX PLANE, COMPLEX PROJECTIVE PLANE

Affine Connection

see CONNECTION COEFFICIENT

Affine Equation

A nonhomogeneous LINEAR EQUATION or system of nonhomogeneous LINEAR EQUATIONS is said to be affine.

see also AFFINE COMPLEX PLANE, AFFINE CONNECTION, AFFINE GEOMETRY, AFFINE GROUP, AFFINE HULL, AFFINE PLANE, AFFINE SPACE, AFFINE TRANSFORMATION, AFFINITY

Affine Geometry

A GEOMETRY in which properties are preserved by PARALLEL PROJECTION from one PLANE to another. In an affine geometry, the third and fourth of EUCLID'S POSTULATES become meaningless. This type of GEOMETRY was first studied by Euler.

see also ABSOLUTE GEOMETRY, AFFINE COMPLEX PLANE, AFFINE CONNECTION, AFFINE EQUATION, AFFINE GROUP, AFFINE HULL, AFFINE PLANE, AFFINE SPACE, AFFINE TRANSFORMATION, AFFINITY, ORDERED GEOMETRY

References

- Birkhoff, G. and Mac Lane, S. "Affine Geometry." §9.13 in *A Survey of Modern Algebra*, 3rd ed. New York: Macmillan, pp. 268–275, 1965.

Affine Group

The set of all nonsingular AFFINE TRANSFORMATIONS of a TRANSLATION in SPACE constitutes a GROUP known as the affine group. The affine group contains the full linear group and the group of TRANSLATIONS as SUBGROUPS.

see also AFFINE COMPLEX PLANE, AFFINE CONNECTION, AFFINE EQUATION, AFFINE GEOMETRY, AFFINE HULL, AFFINE PLANE, AFFINE SPACE, AFFINE TRANSFORMATION, AFFINITY

References

- Birkhoff, G. and Mac Lane, S. *A Survey of Modern Algebra*, 3rd ed. New York: Macmillan, p. 237, 1965.

Affine Hull

The IDEAL generated by a SET in a VECTOR SPACE.

see also AFFINE COMPLEX PLANE, AFFINE CONNECTION, AFFINE EQUATION, AFFINE GEOMETRY, AFFINE GROUP, AFFINE PLANE, AFFINE SPACE, AFFINE TRANSFORMATION, AFFINITY, CONVEX HULL, HULL

Affine Plane

A 2-D AFFINE GEOMETRY constructed over a FINITE FIELD. For a FIELD F of size n , the affine plane consists of the set of points which are ordered pairs of elements in F and a set of lines which are themselves a set of points. Adding a POINT AT INFINITY and LINE AT INFINITY allows a PROJECTIVE PLANE to be constructed from an affine plane. An affine plane of order n is a BLOCK DESIGN of the form $(n^2, n, 1)$. An affine plane of order n exists IFF a PROJECTIVE PLANE of order n exists.

see also AFFINE COMPLEX PLANE, AFFINE CONNECTION, AFFINE EQUATION, AFFINE GEOMETRY, AFFINE GROUP, AFFINE HULL, AFFINE SPACE, AFFINE TRANSFORMATION, AFFINITY, PROJECTIVE PLANE

References

Lindner, C. C. and Rodger, C. A. *Design Theory*. Boca Raton, FL: CRC Press, 1997.

Affine Scheme

A technical mathematical object defined as the SPECTRUM $\sigma(A)$ of a set of PRIME IDEALS of a commutative RING A regarded as a local ringed space with a structure sheaf.

see also SCHEME

References

Iyanaga, S. and Kawada, Y. (Eds.). "Schemes." §18E in *Encyclopedic Dictionary of Mathematics*. Cambridge, MA: MIT Press, p. 69, 1980.

Affine Space

Let V be a VECTOR SPACE over a FIELD K , and let A be a nonempty SET. Now define addition $p + a \in A$ for any VECTOR $a \in V$ and element $p \in A$ subject to the conditions

1. $p + 0 = p$,
2. $(p + a) + b = p + (a + b)$,
3. For any $q \in A$, there EXISTS a unique VECTOR $a \in V$ such that $q = p + a$.

Here, $a, b \in V$. Note that (1) is implied by (2) and (3). Then A is an affine space and K is called the COEFFICIENT FIELD.

In an affine space, it is possible to fix a point and coordinate axis such that every point in the SPACE can be represented as an n -tuple of its coordinates. Every ordered pair of points A and B in an affine space is then associated with a VECTOR AB .

see also AFFINE COMPLEX PLANE, AFFINE CONNECTION, AFFINE EQUATION, AFFINE GEOMETRY, AFFINE GROUP, AFFINE HULL, AFFINE PLANE, AFFINE SPACE, AFFINE TRANSFORMATION, AFFINITY

Affine Transformation

Any TRANSFORMATION preserving COLLINEARITY (i.e., all points lying on a LINE initially still lie on a LINE after TRANSFORMATION). An affine transformation is also called an AFFINITY. An affine transformation of \mathbb{R}^n is a MAP $F: \mathbb{R}^n \rightarrow \mathbb{R}^n$ of the form

$$F(p) = Ap + q \quad (1)$$

for all $p \in \mathbb{R}^n$, where A is a linear transformation of \mathbb{R}^n . If $\det(A) = 1$, the transformation is ORIENTATION-PRESERVING; if $\det(A) = -1$, it is ORIENTATION-REVERSING.

DILATION (CONTRACTION, HOMOTHECY), EXPANSION, REFLECTION, ROTATION, and TRANSLATION are all affine transformations, as are their combinations. A particular example combining ROTATION and EXPANSION is the rotation-enlargement transformation

$$\begin{aligned} \begin{bmatrix} x' \\ y' \end{bmatrix} &= s \begin{bmatrix} \cos \alpha & \sin \alpha \\ -\sin \alpha & \cos \alpha \end{bmatrix} \begin{bmatrix} x - x_0 \\ y - y_0 \end{bmatrix} \\ &= s \begin{bmatrix} \cos \alpha (x - x_0) + \sin \alpha (y - y_0) \\ -\sin \alpha (x - x_0) + \cos \alpha (y - y_0) \end{bmatrix}. \end{aligned} \quad (2)$$

Separating the equations,

$$x' = (s \cos \alpha)x + (s \sin \alpha)y - s(x_0 \cos \alpha + y_0 \sin \alpha) \quad (3)$$

$$y' = (-s \sin \alpha)x + (s \cos \alpha)y + s(x_0 \sin \alpha - y_0 \cos \alpha). \quad (4)$$

This can be also written as

$$x' = ax + by + c \quad (5)$$

$$y' = bx + ay + d, \quad (6)$$

where

$$a = s \cos \alpha \quad (7)$$

$$b = -s \sin \alpha. \quad (8)$$

The scale factor s is then defined by

$$s \equiv \sqrt{a^2 + b^2}, \quad (9)$$

and the rotation ANGLE by

$$\alpha = \tan^{-1} \left(-\frac{b}{a} \right). \quad (10)$$

see also AFFINE COMPLEX PLANE, AFFINE CONNECTION, AFFINE EQUATION, AFFINE GEOMETRY, AFFINE GROUP, AFFINE HULL, AFFINE PLANE, AFFINE SPACE, AFFINE TRANSFORMATION, AFFINITY, EQUIAFFINITY, EUCLIDEAN MOTION

References

Gray, A. *Modern Differential Geometry of Curves and Surfaces*. Boca Raton, FL: CRC Press, p. 105, 1993.

Affinity

see AFFINE TRANSFORMATION

Affix

In the archaic terminology of Whittaker and Watson (1990), the COMPLEX NUMBER z representing $x + iy$.

References

Whittaker, E. T. and Watson, G. N. *A Course in Modern Analysis, 4th ed.* Cambridge, England: Cambridge University Press, 1990.

Aggregate

An archaic word for infinite SETS such as those considered by Georg Cantor.

see also CLASS (SET), SET

AGM

see ARITHMETIC-GEOMETRIC MEAN

Agnesi's Witch

see WITCH OF AGNESI

Agnésienne

see WITCH OF AGNESI

Agonic Lines

see SKEW LINES

Ahlfors-Bers Theorem

The RIEMANN'S MODULI SPACE gives the solution to RIEMANN'S MODULI PROBLEM, which requires an ANALYTIC parameterization of the compact RIEMANN SURFACES in a fixed HOMEOMORPHISM.

Airy Differential Equation

Some authors define a general Airy differential equation as

$$y'' \pm k^2 xy = 0. \quad (1)$$

This equation can be solved by series solution using the expansions

$$y = \sum_{n=0}^{\infty} a_n x^n \quad (2)$$

$$\begin{aligned} y' &= \sum_{n=0}^{\infty} n a_n x^{n-1} = \sum_{n=1}^{\infty} n a_n x^{n-1} \\ &= \sum_{n=0}^{\infty} (n+1) a_{n+1} x^n \end{aligned} \quad (3)$$

$$\begin{aligned} y'' &= \sum_{n=0}^{\infty} (n+1) n a_{n+1} x^{n-1} = \sum_{n=1}^{\infty} (n+1) n a_{n+1} x^{n-1} \\ &= \sum_{n=0}^{\infty} (n+2)(n+1) a_{n+2} x^n. \end{aligned} \quad (4)$$

Specializing to the "conventional" Airy differential equation occurs by taking the MINUS SIGN and setting $k^2 = 1$. Then plug (4) into

$$y'' - xy = 0 \quad (5)$$

to obtain

$$\sum_{n=0}^{\infty} (n+2)(n+1) a_{n+2} x^n - x \sum_{n=0}^{\infty} a_n x^n = 0 \quad (6)$$

$$\sum_{n=0}^{\infty} (n+2)(n+1) a_{n+2} x^n - \sum_{n=0}^{\infty} a_n x^{n+1} = 0 \quad (7)$$

$$2a_2 + \sum_{n=1}^{\infty} (n+2)(n+1) a_{n+2} x^n - \sum_{n=1}^{\infty} a_{n-1} x^n = 0 \quad (8)$$

$$2a_2 + \sum_{n=1}^{\infty} [(n+2)(n+1) a_{n+2} - a_{n-1}] x^n = 0. \quad (9)$$

In order for this equality to hold for all x , each term must separately be 0. Therefore,

$$a_2 = 0 \quad (10)$$

$$(n+2)(n+1) a_{n+2} = a_{n-1}. \quad (11)$$

Starting with the $n = 3$ term and using the above RECURRENCE RELATION, we obtain

$$5 \cdot 4 a_5 = 20 a_5 = a_2 = 0. \quad (12)$$

Continuing, it follows by INDUCTION that

$$a_2 = a_5 = a_8 = a_{11} = \dots a_{3n-1} = 0 \quad (13)$$

for $n = 1, 2, \dots$. Now examine terms of the form a_{3n} .

$$a_3 = \frac{a_0}{3 \cdot 2} \quad (14)$$

$$a_6 = \frac{a_3}{6 \cdot 5} = \frac{a_0}{(6 \cdot 5)(3 \cdot 2)} \quad (15)$$

$$a_9 = \frac{a_6}{9 \cdot 8} = \frac{a_0}{(9 \cdot 8)(6 \cdot 5)(3 \cdot 2)}. \quad (16)$$

Again by INDUCTION,

$$a_{3n} = \frac{a_0}{[(3n)(3n-1)][(3n-3)(3n-4)] \dots [6 \cdot 5][3 \cdot 2]} \quad (17)$$

for $n = 1, 2, \dots$. Finally, look at terms of the form a_{3n+1} ,

$$a_4 = \frac{a_1}{4 \cdot 3} \quad (18)$$

$$a_7 = \frac{a_4}{7 \cdot 6} = \frac{a_1}{(7 \cdot 6)(4 \cdot 3)} \quad (19)$$

$$a_{10} = \frac{a_7}{10 \cdot 9} = \frac{a_1}{(10 \cdot 9)(7 \cdot 6)(4 \cdot 3)}. \quad (20)$$

By INDUCTION,

$$a_{3n+1} = \frac{a_1}{[(3n+1)(3n)][(3n-2)(3n-3)] \cdots [7 \cdot 6][4 \cdot 3]} \quad (21)$$

for $n = 1, 2, \dots$. The general solution is therefore

$$y = a_0 \left[1 + \sum_{n=1}^{\infty} \frac{x^{3n}}{(3n)(3n-1)(3n-3)(3n-4) \cdots 3 \cdot 2} \right] + a_1 \left[x + \sum_{n=1}^{\infty} \frac{x^{3n+1}}{(3n+1)(3n)(3n-2)(3n-3) \cdots 4 \cdot 3} \right]. \quad (22)$$

For a general k^2 with a MINUS SIGN, equation (1) is

$$y'' - k^2 xy = 0, \quad (23)$$

and the solution is

$$y(x) = \frac{1}{3} \sqrt{x} \left[AI_{-1/3} \left(\frac{2}{3} kx^{3/2} \right) - BI_{1/3} \left(\frac{2}{3} kx^{3/2} \right) \right], \quad (24)$$

where I is a MODIFIED BESSEL FUNCTION OF THE FIRST KIND. This is usually expressed in terms of the AIRY FUNCTIONS $Ai(x)$ and $Bi(x)$

$$y(x) = A' Ai(k^{2/3}x) + B' Bi(k^{2/3}x). \quad (25)$$

If the PLUS SIGN is present instead, then

$$y'' + k^2 xy = 0 \quad (26)$$

and the solutions are

$$y(x) = \frac{1}{3} \sqrt{x} \left[AJ_{-1/3} \left(\frac{2}{3} kx^{3/2} \right) + BJ_{1/3} \left(\frac{2}{3} kx^{3/2} \right) \right], \quad (27)$$

where $J(z)$ is a BESSEL FUNCTION OF THE FIRST KIND. see also AIRY-FOCK FUNCTIONS, AIRY FUNCTIONS, BESSEL FUNCTION OF THE FIRST KIND, MODIFIED BESSEL FUNCTION OF THE FIRST KIND

Airy-Fock Functions

The three Airy-Fock functions are

$$\nu(z) = \frac{1}{2} \sqrt{\pi} Ai(z) \quad (1)$$

$$w_1(z) = 2e^{i\pi/6} \nu(\omega z) \quad (2)$$

$$w_2(z) = 2e^{-i\pi/6} \nu(\omega^{-1}z), \quad (3)$$

where $Ai(z)$ is an AIRY FUNCTION. These functions satisfy

$$\nu(z) = \frac{w_1(z) - w_2(z)}{2i} \quad (4)$$

$$[w_1(z)]^* = w_2(z^*), \quad (5)$$

where z^* is the COMPLEX CONJUGATE of z .

see also AIRY FUNCTIONS

References

Hazewinkel, M. (Managing Ed.). *Encyclopaedia of Mathematics: An Updated and Annotated Translation of the Soviet "Mathematical Encyclopaedia."* Dordrecht, Netherlands: Reidel, p. 65, 1988.

Airy Functions

Watson's (1966, pp. 188–190) definition of an Airy function is the solution to the AIRY DIFFERENTIAL EQUATION

$$\Phi'' \pm k^2 \Phi x = 0 \quad (1)$$

which is FINITE at the ORIGIN, where Φ' denotes the DERIVATIVE $d\Phi/dx$, $k^2 = 1/3$, and either SIGN is permitted. Call these solutions $(1/\pi)\Phi(\pm k^2, x)$, then

$$\frac{1}{\pi} \Phi(\pm \frac{1}{3}; x) \equiv \int_0^\infty \cos(t^3 \pm xt) dt \quad (2)$$

$$\Phi(\frac{1}{3}; x) = \frac{1}{3} \pi \sqrt{\frac{x}{3}} \left[J_{-1/3} \left(\frac{2x^{3/2}}{3^{3/2}} \right) + J_{1/3} \left(\frac{2x^{3/2}}{3^{3/2}} \right) \right] \quad (3)$$

$$\Phi(-\frac{1}{3}; x) = \frac{1}{3} \pi \sqrt{\frac{x}{3}} \left[I_{-1/3} \left(\frac{2x^{3/2}}{3^{3/2}} \right) - I_{1/3} \left(\frac{2x^{3/2}}{3^{3/2}} \right) \right], \quad (4)$$

where $J(z)$ is a BESSEL FUNCTION OF THE FIRST KIND and $I(z)$ is a MODIFIED BESSEL FUNCTION OF THE FIRST KIND. Using the identity

$$K_n(x) = \frac{\pi I_{-n}(x) - I_n(x)}{2 \sin(n\pi)}, \quad (5)$$

where $K(z)$ is a MODIFIED BESSEL FUNCTION OF THE SECOND KIND, the second case can be re-expressed

$$\Phi(-\frac{1}{3}; x) = \frac{1}{3} \pi \sqrt{\frac{x}{3}} \left(\frac{2}{\pi} \right) \sin \left(\frac{1}{3} \pi \right) K_{1/3} \left(\frac{2x^{3/2}}{3^{3/2}} \right) \quad (6)$$

$$= \frac{\pi}{3} \sqrt{\frac{1}{3}x} \frac{2}{\pi} \frac{\sqrt{3}}{2} K_{1/3} \left(\frac{2x^{3/2}}{3^{3/2}} \right) \quad (7)$$

$$= \frac{1}{3} \sqrt{x} K_{1/3} \left(\frac{2x^{3/2}}{3^{3/2}} \right). \quad (8)$$

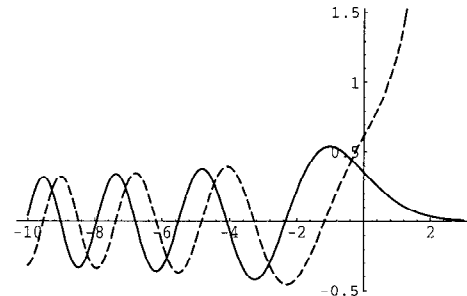

A more commonly used definition of Airy functions is given by Abramowitz and Stegun (1972, pp. 446–447) and illustrated above. This definition identifies the $Ai(x)$ and $Bi(x)$ functions as the two LINEARLY INDEPENDENT solutions to (1) with $k^2 = 1$ and a MINUS SIGN,

$$y'' - yz = 0. \quad (9)$$

The solutions are then written

$$y(z) = A \text{Ai}(z) + B \text{Bi}(z), \quad (10)$$

where

$$\begin{aligned} \text{Ai}(z) &= \frac{1}{\pi} \Phi(-1, z) \\ &= \frac{1}{3} \sqrt{x} [I_{-1/3}(\frac{2}{3}z^{3/2}) - I_{1/3}(\frac{2}{3}z^{3/2})] \\ &= \sqrt{\frac{z}{3\pi}} K_{1/3}(\frac{2}{3}z^{3/2}) \end{aligned} \quad (11)$$

$$\text{Bi}(z) \equiv \sqrt{\frac{z}{3}} [I_{-1/3}(\frac{2}{3}z^{3/2}) + I_{1/3}(\frac{2}{3}z^{3/2})]. \quad (12)$$

In the above plot, $\text{Ai}(z)$ is the solid curve and $\text{Bi}(z)$ is dashed. For zero argument,

$$\text{Ai}(0) = -\frac{3^{-2/3}}{\Gamma(\frac{2}{3})}, \quad (13)$$

where $\Gamma(z)$ is the GAMMA FUNCTION. This means that Watson's expression becomes

$$(3a)^{-1/3} \pi \text{Ai}(\pm(3a)^{-1/3}x) = \int_0^\infty \cos(at^3 \pm xt) dt. \quad (14)$$

A generalization has been constructed by Hardy.

The ASYMPTOTIC SERIES of $\text{Ai}(z)$ has a different form in different QUADRANTS of the COMPLEX PLANE, a fact known as the STOKES PHENOMENON. Functions related to the Airy functions have been defined as

$$\text{Gi}(z) \equiv \frac{1}{\pi} \int_0^\infty \sin(\frac{1}{3}t^3 + zt) dt \quad (15)$$

$$\text{Hi}(z) \equiv \frac{1}{\pi} \int_0^\infty \exp(-\frac{1}{3}t^3 + zt) dt. \quad (16)$$

see also AIRY-FOCK FUNCTIONS

References

- Abramowitz, M. and Stegun, C. A. (Eds.). "Airy Functions." §10.4 in *Handbook of Mathematical Functions with Formulas, Graphs, and Mathematical Tables*, 9th printing. New York: Dover, pp. 446-452, 1972.
- Press, W. H.; Flannery, B. P.; Teukolsky, S. A.; and Vetterling, W. T. "Bessel Functions of Fractional Order, Airy Functions, Spherical Bessel Functions." §6.7 in *Numerical Recipes in FORTRAN: The Art of Scientific Computing*, 2nd ed. Cambridge, England: Cambridge University Press, pp. 234-245, 1992.
- Spanier, J. and Oldham, K. B. "The Airy Functions $\text{Ai}(x)$ and $\text{Bi}(x)$." Ch. 56 in *An Atlas of Functions*. Washington, DC: Hemisphere, pp. 555-562, 1987.
- Watson, G. N. *A Treatise on the Theory of Bessel Functions*, 2nd ed. Cambridge, England: Cambridge University Press, 1966.

Airy Projection

A MAP PROJECTION. The inverse equations for ϕ are computed by iteration. Let the ANGLE of the projection plane be θ_b . Define

$$a = \begin{cases} 0 & \text{for } \theta_b = \frac{1}{2}\pi \\ \frac{\ln[\frac{1}{2} \cos(\frac{1}{2}\pi - \theta_b)]}{\tan[\frac{1}{2}(\frac{1}{2}\pi - \theta_b)]} & \text{otherwise.} \end{cases} \quad (1)$$

For proper convergence, let $x_i = \pi/6$ and compute the initial point by checking

$$x_i = \left| \exp[-(\sqrt{x^2 + y^2} + a \tan x_i) \tan x_i] \right|. \quad (2)$$

As long as $x_i > 1$, take $x_{i+1} = x_i/2$ and iterate again. The first value for which $x_i < 1$ is then the starting point. Then compute

$$x_i = \cos^{-1}\{\exp[-(\sqrt{x^2 + y^2} + a \tan x_i) \tan x_i]\} \quad (3)$$

until the change in x_i between evaluations is smaller than the acceptable tolerance. The (inverse) equations are then given by

$$\phi = \frac{1}{2}\pi - 2x_i \quad (4)$$

$$\lambda = \tan^{-1}\left(-\frac{x}{y}\right). \quad (5)$$

Aitken's δ^2 Process

AN ALGORITHM which extrapolates the partial sums s_n of a SERIES $\sum_n a_n$ whose CONVERGENCE is approximately geometric and accelerates its rate of CONVERGENCE. The extrapolated partial sum is given by

$$s_n' \equiv s_{n+1} - \frac{(s_{n+1} - s_n)^2}{s_{n+1} - 2s_n + s_{n-1}}.$$

see also EULER'S SERIES TRANSFORMATION

References

- Abramowitz, M. and Stegun, C. A. (Eds.). *Handbook of Mathematical Functions with Formulas, Graphs, and Mathematical Tables*, 9th printing. New York: Dover, p. 18, 1972.
- Press, W. H.; Flannery, B. P.; Teukolsky, S. A.; and Vetterling, W. T. *Numerical Recipes in FORTRAN: The Art of Scientific Computing*, 2nd ed. Cambridge, England: Cambridge University Press, p. 160, 1992.

Aitken Interpolation

An algorithm similar to NEVILLE'S ALGORITHM for constructing the LAGRANGE INTERPOLATING POLYNOMIAL. Let $f(x|x_0, x_1, \dots, x_k)$ be the unique POLYNOMIAL of k th ORDER coinciding with $f(x)$ at x_0, \dots, x_k . Then

$$f(x|x_0, x_1) = \frac{1}{x_1 - x_0} \begin{vmatrix} f_0 & x_0 - x \\ f_1 & x_1 - x \end{vmatrix}$$

$$f(x|x_0, x_2) = \frac{1}{x_2 - x_0} \begin{vmatrix} f_0 & x_0 - x \\ f_2 & x_2 - x \end{vmatrix}$$

$$f(x|x_0, x_1, x_2) = \frac{1}{x_2 - x_1} \begin{vmatrix} f(x|x_0, x_1) & x_1 - x \\ f(x|x_0, x_2) & x_2 - x \end{vmatrix}$$

$$f(x|x_0, x_1, x_2, x_3) = \frac{1}{x_3 - x_2} \begin{vmatrix} f(x|x_0, x_1, x_2) & x_2 - x \\ f(x|x_0, x_1, x_3) & x_3 - x \end{vmatrix}.$$

see also LAGRANGE INTERPOLATING POLYNOMIAL

References

- Abramowitz, M. and Stegun, C. A. (Eds.). *Handbook of Mathematical Functions with Formulas, Graphs, and Mathematical Tables*, 9th printing. New York: Dover, p. 879, 1972.
- Acton, F. S. *Numerical Methods That Work*, 2nd printing. Washington, DC: Math. Assoc. Amer., pp. 93-94, 1990.
- Press, W. H.; Flannery, B. P.; Teukolsky, S. A.; and Vetterling, W. T. *Numerical Recipes in FORTRAN: The Art of Scientific Computing*, 2nd ed. Cambridge, England: Cambridge University Press, p. 102, 1992.

Ajima-Malfatti Points

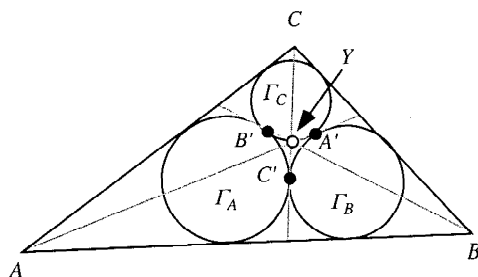

The lines connecting the vertices and corresponding circle-circle intersections in MALFATTI'S TANGENT TRIANGLE PROBLEM coincide in a point Y called the first Ajima-Malfatti point (Kimberling and MacDonald 1990, Kimberling 1994). Similarly, letting A'' , B'' , and C'' be the excenters of ABC , then the lines $A'A''$, $B'B''$, and $C'C''$ are coincident in another point called the second Ajima-Malfatti point. The points are sometimes simply called the MALFATTI POINTS (Kimberling 1994).

References

- Kimberling, C. "Central Points and Central Lines in the Plane of a Triangle." *Math. Mag.* **67**, 163-187, 1994.
- Kimberling, C. "1st and 2nd Ajima-Malfatti Points." <http://www.evansville.edu/~ck6/tcenters/recent/ajmalf.html>.
- Kimberling, C. and MacDonald, I. G. "Problem E 3251 and Solution." *Amer. Math. Monthly* **97**, 612-613, 1990.

Albanese Variety

AN ABELIAN VARIETY which is canonically attached to an ALGEBRAIC VARIETY which is the solution to a certain universal problem. The Albanese variety is dual to the PICARD VARIETY.

References

- Hazewinkel, M. (Managing Ed.). *Encyclopaedia of Mathematics: An Updated and Annotated Translation of the Soviet "Mathematical Encyclopaedia."* Dordrecht, Netherlands: Reidel, pp. 67-68, 1988.

Albers Conic Projection

see ALBERS EQUAL-AREA CONIC PROJECTION

Albers Equal-Area Conic Projection

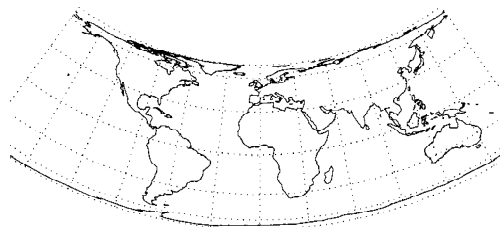

Let ϕ_0 be the LATITUDE for the origin of the CARTESIAN COORDINATES and λ_0 its LONGITUDE. Let ϕ_1 and ϕ_2 be the standard parallels. Then

$$x = \rho \sin \theta \quad (1)$$

$$y = \rho_0 - \rho \cos \theta, \quad (2)$$

where

$$\rho = \frac{\sqrt{C - 2n \sin \phi}}{n} \quad (3)$$

$$\theta = n(\lambda - \lambda_0) \quad (4)$$

$$\rho_0 = \frac{\sqrt{C - 2n \sin \phi_0}}{n} \quad (5)$$

$$C = \cos^2 \phi_1 + 2n \sin \phi_1 \quad (6)$$

$$n = \frac{1}{2}(\sin \phi_1 + \sin \phi_2). \quad (7)$$

The inverse FORMULAS are

$$\phi = \sin^{-1} \left(\frac{C - \rho^2 n^2}{2n} \right) \quad (8)$$

$$\lambda = \lambda_0 + \frac{\theta}{n}, \quad (9)$$

where

$$\rho = \sqrt{x^2 + (\rho_0 - y)^2} \quad (10)$$

$$\theta = \tan^{-1} \left(\frac{x}{\rho_0 - y} \right). \quad (11)$$

References

- Snyder, J. P. *Map Projections—A Working Manual*. U. S. Geological Survey Professional Paper 1395. Washington, DC: U. S. Government Printing Office, pp. 98-103, 1987.

Alcuin's Sequence

The INTEGER SEQUENCE 1, 0, 1, 1, 2, 1, 3, 2, 4, 3, 5, 4, 7, 5, 8, 7, 10, 8, 12, 10, 14, 12, 16, 14, 19, 16, 21, 19, ... (Sloane's A005044) given by the COEFFICIENTS of the MACLAURIN SERIES for $1/(1-x^2)(1-x^3)(1-x^4)$. The number of different TRIANGLES which have INTEGRAL sides and PERIMETER n is given by

$$T(n) = P_3(n) - \sum_{1 \leq j \leq \lfloor n/2 \rfloor} P_2(j) \quad (1)$$

$$= \left\lfloor \frac{n^2}{12} \right\rfloor - \left\lfloor \frac{n}{4} \right\rfloor \left\lfloor \frac{n+2}{4} \right\rfloor \quad (2)$$

$$= \begin{cases} \left\lfloor \frac{n^2}{48} \right\rfloor & \text{for } n \text{ even} \\ \left\lfloor \frac{(n+3)^2}{48} \right\rfloor & \text{for } n \text{ odd,} \end{cases} \quad (3)$$

where $P_2(n)$ and $P_3(n)$ are PARTITION FUNCTIONS, with $P_k(n)$ giving the number of ways of writing n as a sum of k terms, $\lceil x \rceil$ is the NINT function, and $\lfloor x \rfloor$ is the FLOOR FUNCTION (Jordan *et al.* 1979, Andrews 1979, Honsberger 1985). Strangely enough, $T(n)$ for $n = 3, 4, \dots$ is precisely Alcuin's sequence.

see also PARTITION FUNCTION P , TRIANGLE

References

- Andrews, G. "A Note on Partitions and Triangles with Integer Sides." *Amer. Math. Monthly* **86**, 477, 1979.
Honsberger, R. *Mathematical Gems III*. Washington, DC: Math. Assoc. Amer., pp. 39–47, 1985.
Jordan, J. H.; Walch, R.; and Wisner, R. J. "Triangles with Integer Sides." *Amer. Math. Monthly* **86**, 686–689, 1979.
Sloane, N. J. A. Sequence A005044/M0146 in "An On-Line Version of the Encyclopedia of Integer Sequences."

Aleksandrov-Čech Cohomology

A theory which satisfies all the EILENBERG-STEENROD AXIOMS with the possible exception of the LONG EXACT SEQUENCE OF A PAIR AXIOM, as well as a certain additional continuity CONDITION.

References

- Hazewinkel, M. (Managing Ed.). *Encyclopaedia of Mathematics: An Updated and Annotated Translation of the Soviet "Mathematical Encyclopaedia."* Dordrecht, Netherlands: Reidel, p. 68, 1988.

Aleksandrov's Uniqueness Theorem

A convex body in EUCLIDEAN n -space that is centrally symmetric with center at the ORIGIN is determined among all such bodies by its brightness function (the VOLUME of each projection).

see also TOMOGRAPHY

References

- Gardner, R. J. "Geometric Tomography." *Not. Amer. Math. Soc.* **42**, 422–429, 1995.

Aleph

The SET THEORY symbol (\aleph) for the CARDINALITY of an INFINITE SET.

see also ALEPH-0 (\aleph_0), ALEPH-1 (\aleph_1), COUNTABLE SET, COUNTABLY INFINITE SET, FINITE, INFINITE, TRANSFINITE NUMBER, UNCOUNTABLY INFINITE SET

Aleph-0 (\aleph_0)

The SET THEORY symbol for a SET having the same CARDINAL NUMBER as the "small" INFINITE SET of INTEGERS. The ALGEBRAIC NUMBERS also belong to \aleph_0 . Rather surprising properties satisfied by \aleph_0 include

$$\aleph_0^r = \aleph_0 \quad (1)$$

$$r\aleph_0 = \aleph_0 \quad (2)$$

$$\aleph_0 + f = \aleph_0, \quad (3)$$

where f is any FINITE SET. However,

$$\aleph_0^{\aleph_0} = C, \quad (4)$$

where C is the CONTINUUM.

see also ALEPH-1, CARDINAL NUMBER, CONTINUUM, CONTINUUM HYPOTHESIS, COUNTABLY INFINITE SET, FINITE, INFINITE, TRANSFINITE NUMBER, UNCOUNTABLY INFINITE SET

Aleph-1 (\aleph_1)

The SET THEORY symbol for the smallest INFINITE SET larger than ALPHA-0 (\aleph_0). The CONTINUUM HYPOTHESIS asserts that $\aleph_1 = c$, where c is the CARDINALITY of the "large" INFINITE SET of REAL NUMBERS (called the CONTINUUM in SET THEORY). However, the truth of the CONTINUUM HYPOTHESIS depends on the version of SET THEORY you are using and so is UNDECIDABLE.

Curiously enough, n -D SPACE has the same number of points (c) as 1-D SPACE, or any FINITE INTERVAL of 1-D SPACE (a LINE SEGMENT), as was first recognized by Georg Cantor.

see also ALEPH-0 (\aleph_0), CONTINUUM, CONTINUUM HYPOTHESIS, COUNTABLY INFINITE SET, FINITE, INFINITE, TRANSFINITE NUMBER, UNCOUNTABLY INFINITE SET

Alethic

A term in LOGIC meaning pertaining to TRUTH and FALSEHOOD.

see also FALSE, PREDICATE, TRUE

Alexander-Conway Polynomial

see CONWAY POLYNOMIAL

Alexander's Horned Sphere

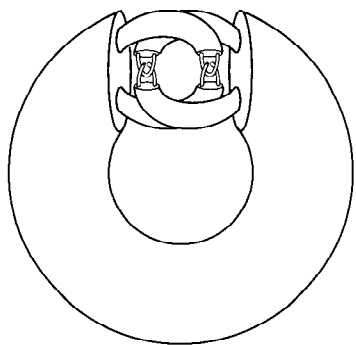

The above solid, composed of a countable UNION of COMPACT SETS, is called Alexander's horned sphere. It is HOMEOMORPHIC with the BALL \mathbb{B}^3 , and its boundary is therefore a SPHERE. It is therefore an example of a wild embedding in \mathbb{E}^3 . The outer complement of the solid is not SIMPLY CONNECTED, and its fundamental GROUP is not finitely generated. Furthermore, the set of nonlocally flat ("bad") points of Alexander's horned sphere is a CANTOR SET.

The complement in \mathbb{R}^3 of the bad points for Alexander's horned sphere is SIMPLY CONNECTED, making it inequivalent to ANTOINE'S HORNED SPHERE. Alexander's horned sphere has an uncountable infinity of WILD POINTS, which are the limits of the sequences of the horned sphere's branch points (roughly, the "ends" of the horns), since any NEIGHBORHOOD of a limit contains a horned complex.

A humorous drawing by Simon Frazer (Guy 1983, Schroeder 1991, Albers 1994) depicts mathematician John H. Conway with Alexander's horned sphere growing from his head.



see also ANTOINE'S HORNED SPHERE

References

- Albers, D. J. Illustration accompanying "The Game of 'Life'." *Math Horizons*, p. 9, Spring 1994.
 Guy, R. "Conway's Prime Producing Machine." *Math. Mag.* **56**, 26–33, 1983.
 Hocking, J. G. and Young, G. S. *Topology*. New York: Dover, 1988.
 Rolfsen, D. *Knots and Links*. Wilmington, DE: Publish or Perish Press, pp. 80–81, 1976.

Schroeder, M. *Fractals, Chaos, Power Law: Minutes from an Infinite Paradise*. New York: W. H. Freeman, p. 58, 1991.

Alexander Ideal

The order IDEAL in Λ , the RING of integral LAURENT POLYNOMIALS, associated with an ALEXANDER MATRIX for a KNOT K . Any generator of a principal Alexander ideal is called an ALEXANDER POLYNOMIAL. Because the ALEXANDER INVARIANT of a TAME KNOT in \mathbb{S}^3 has a SQUARE presentation MATRIX, its Alexander ideal is PRINCIPAL and it has an ALEXANDER POLYNOMIAL $\Delta(t)$.

see also ALEXANDER INVARIANT, ALEXANDER MATRIX, ALEXANDER POLYNOMIAL

References

- Rolfsen, D. *Knots and Links*. Wilmington, DE: Publish or Perish Press, pp. 206–207, 1976.

Alexander Invariant

The Alexander invariant $H_*(\tilde{X})$ of a KNOT K is the HOMOLOGY of the INFINITE cyclic cover of the complement of K , considered as a MODULE over Λ , the RING of integral LAURENT POLYNOMIALS. The Alexander invariant for a classical TAME KNOT is finitely presentable, and only H_1 is significant.

For any KNOT K^n in \mathbb{S}^{n+2} whose complement has the homotopy type of a FINITE COMPLEX, the Alexander invariant is finitely generated and therefore finitely presentable. Because the Alexander invariant of a TAME KNOT in \mathbb{S}^3 has a SQUARE presentation MATRIX, its ALEXANDER IDEAL is PRINCIPAL and it has an ALEXANDER POLYNOMIAL denoted $\Delta(t)$.

see also ALEXANDER IDEAL, ALEXANDER MATRIX, ALEXANDER POLYNOMIAL

References

- Rolfsen, D. *Knots and Links*. Wilmington, DE: Publish or Perish Press, pp. 206–207, 1976.

Alexander Matrix

A presentation matrix for the ALEXANDER INVARIANT $H_1(\tilde{X})$ of a KNOT K . If V is a SEIFERT MATRIX for a TAME KNOT K in \mathbb{S}^3 , then $V^T - tV$ and $V - tV^T$ are Alexander matrices for K , where V^T denotes the MATRIX TRANSPOSE.

see also ALEXANDER IDEAL, ALEXANDER INVARIANT, ALEXANDER POLYNOMIAL, SEIFERT MATRIX

References

- Rolfsen, D. *Knots and Links*. Wilmington, DE: Publish or Perish Press, pp. 206–207, 1976.

Alexander Polynomial

A POLYNOMIAL invariant of a KNOT discovered in 1923 by J. W. Alexander (Alexander 1928). In technical language, the Alexander polynomial arises from the HOMOMORPHISM of the infinitely cyclic cover of a KNOT's complement. Any generator of a PRINCIPAL ALEXANDER IDEAL is called an Alexander polynomial (Rolfsen 1976). Because the ALEXANDER INVARIANT of a TAME KNOT in \mathbb{S}^3 has a SQUARE presentation MATRIX, its ALEXANDER IDEAL is PRINCIPAL and it has an Alexander polynomial denoted $\Delta(t)$.

Let Ψ be the MATRIX PRODUCT of BRAID WORDS of a KNOT, then

$$\frac{\det(I - \Psi)}{1 + t + \dots + t^{n-1}} = \Delta_L, \quad (1)$$

where Δ_L is the Alexander polynomial and \det is the DETERMINANT. The Alexander polynomial of a TAME KNOT in \mathbb{S}^3 satisfies

$$\Delta(t) = \det(V^T - tV), \quad (2)$$

where V is a SEIFERT MATRIX, \det is the DETERMINANT, and V^T denotes the MATRIX TRANSPOSE. The Alexander polynomial also satisfies

$$\Delta(1) = \pm 1. \quad (3)$$

The Alexander polynomial of a splittable link is always 0. Surprisingly, there are known examples of nontrivial KNOTS with Alexander polynomial 1. An example is the $(-3, 5, 7)$ PRETZEL KNOT.

The Alexander polynomial remained the *only* known KNOT POLYNOMIAL until the JONES POLYNOMIAL was discovered in 1984. Unlike the Alexander polynomial, the more powerful JONES POLYNOMIAL *does*, in most cases, distinguish HANDEDNESS. A normalized form of the Alexander polynomial symmetric in t and t^{-1} and satisfying

$$\Delta(\text{unknot}) = 1 \quad (4)$$

was formulated by J. H. Conway and is sometimes denoted ∇_L . The NOTATION $[a + b + c + \dots]$ is an abbreviation for the Conway-normalized Alexander polynomial of a KNOT

$$a + b(x + x^{-1}) + c(x^2 + x^{-2}) + \dots \quad (5)$$

For a description of the NOTATION for LINKS, see Rolfsen (1976, p. 389). Examples of the Conway-Alexander polynomials for common KNOTS include

$$\nabla_{\text{TK}} = [1 - 1 = -x^{-1} + 1 - x] \quad (6)$$

$$\nabla_{\text{FEK}} = [3 - 1 = -x^{-1} + 3 - x] \quad (7)$$

$$\nabla_{\text{SSK}} = [1 - 1 + 1 = x^{-2} - x^{-1} + 1 - x + x^2] \quad (8)$$

for the TREFOIL KNOT, FIGURE-OF-EIGHT KNOT, and SOLOMON'S SEAL KNOT, respectively. Multiplying through to clear the NEGATIVE POWERS gives the usual Alexander polynomial, where the final SIGN is determined by convention.

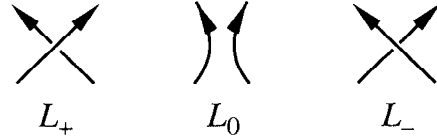

Let an Alexander polynomial be denoted Δ , then there exists a SKEIN RELATIONSHIP (discovered by J. H. Conway)

$$\Delta_{L_+}(t) - \Delta_{L_-}(t) + (t^{-1/2} - t^{1/2})\Delta_{L_0}(t) = 0 \quad (9)$$

corresponding to the above LINK DIAGRAMS (Adams 1994). A slightly different SKEIN RELATIONSHIP convention used by Doll and Hoste (1991) is

$$\nabla_{L_+} - \nabla_{L_-} = z\nabla_{L_0}. \quad (10)$$

These relations allow Alexander polynomials to be constructed for arbitrary knots by building them up as a sequence of over- and undercrossings.

For a KNOT,

$$\Delta_K(-1) \equiv \begin{cases} 1 \pmod{8} & \text{if } \text{Arf}(K) = 0, \\ 5 \pmod{8} & \text{if } \text{Arf}(K) = 1, \end{cases} \quad (11)$$

where Arf is the ARF INVARIANT (Jones 1985). If K is a KNOT and

$$|\Delta_K(i)| > 3, \quad (12)$$

then K cannot be represented as a closed 3-BRAID. Also, if

$$\Delta_K(e^{2\pi i/5}) > \frac{13}{2}, \quad (13)$$

then K cannot be represented as a closed 4-braid (Jones 1985).

The HOMFLY POLYNOMIAL $P(a, z)$ generalizes the Alexander polynomial (as well as the JONES POLYNOMIAL) with

$$\nabla(z) = P(1, z) \quad (14)$$

(Doll and Hoste 1991).

Rolfsen (1976) gives a tabulation of Alexander polynomials for KNOTS up to 10 CROSSINGS and LINKS up to 9 CROSSINGS.

see also BRAID GROUP, JONES POLYNOMIAL, KNOT, KNOT DETERMINANT, LINK, SKEIN RELATIONSHIP

References

- Adams, C. C. *The Knot Book: An Elementary Introduction to the Mathematical Theory of Knots*. New York: W. H. Freeman, pp. 165–169, 1994.
 Alexander, J. W. "Topological Invariants of Knots and Links." *Trans. Amer. Math. Soc.* **30**, 275–306, 1928.

- Alexander, J. W. "A Lemma on a System of Knotted Curves." *Proc. Nat. Acad. Sci. USA* **9**, 93–95, 1923.
- Doll, H. and Hoste, J. "A Tabulation of Oriented Links." *Math. Comput.* **57**, 747–761, 1991.
- Jones, V. "A Polynomial Invariant for Knots via von Neumann Algebras." *Bull. Amer. Math. Soc.* **12**, 103–111, 1985.
- Rolfsen, D. "Table of Knots and Links." Appendix C in *Knots and Links*. Wilmington, DE: Publish or Perish Press, pp. 280–287, 1976.
- Stoimenow, A. "Alexander Polynomials." <http://www.informatik.hu-berlin.de/~stoimeno/ptab/a10.html>.
- Stoimenow, A. "Conway Polynomials." <http://www.informatik.hu-berlin.de/~stoimeno/ptab/c10.html>.

Alexander-Spanier Cohomology

A fundamental result of DE RHAM COHOMOLOGY is that the k th DE RHAM COHOMOLOGY VECTOR SPACE of a MANIFOLD M is canonically isomorphic to the Alexander-Spanier cohomology VECTOR SPACE $H^k(M; \mathbb{R})$ (also called cohomology with compact support). In the case that M is COMPACT, Alexander-Spanier cohomology is exactly "singular" COHOMOLOGY.

Alexander's Theorem

Any LINK can be represented by a closed BRAID.

Algebra

The branch of mathematics dealing with GROUP THEORY and CODING THEORY which studies number systems and operations within them. The word "algebra" is a distortion of the Arabic title of a treatise by Al-Khwarizmi about algebraic methods. Note that mathematicians refer to the "school algebra" generally taught in middle and high school as "ARITHMETIC," reserving the word "algebra" for the more advanced aspects of the subject.

Formally, an algebra is a VECTOR SPACE V , over a FIELD F with a MULTIPLICATION which turns it into a RING defined such that, if $f \in F$ and $x, y \in V$, then

$$f(xy) = (fx)y = x(fy).$$

In addition to the usual algebra of REAL NUMBERS, there are ≈ 1151 additional CONSISTENT algebras which can be formulated by weakening the FIELD AXIOMS, at least 200 of which have been *rigorously* proven to be self-CONSISTENT (Bell 1945).

Algebras which have been investigated and found to be of interest are usually named after one or more of their investigators. This practice leads to exotic-sounding (but unenlightening) names which algebraists frequently use with minimal or nonexistent explanation.

see also ALTERNATE ALGEBRA, ALTERNATING ALGEBRA, B^* -ALGEBRA, BANACH ALGEBRA, BOOLEAN ALGEBRA, BOREL SIGMA ALGEBRA, C^* -ALGEBRA, CAYLEY ALGEBRA, CLIFFORD ALGEBRA, COMMUTATIVE

ALGEBRA, EXTERIOR ALGEBRA, FUNDAMENTAL THEOREM OF ALGEBRA, GRADED ALGEBRA, GRASSMANN ALGEBRA, HECKE ALGEBRA, HEYTING ALGEBRA, HOMOLOGICAL ALGEBRA, HOPF ALGEBRA, JORDAN ALGEBRA, LIE ALGEBRA, LINEAR ALGEBRA, MEASURE ALGEBRA, NONASSOCIATIVE ALGEBRA, QUATERNION, ROBBINS ALGEBRA, SCHUR ALGEBRA, SEMISIMPLE ALGEBRA, SIGMA ALGEBRA, SIMPLE ALGEBRA, STEENROD ALGEBRA, VON NEUMANN ALGEBRA

References

- Artin, M. *Algebra*. Englewood Cliffs, NJ: Prentice-Hall, 1991.
- Bell, E. T. *The Development of Mathematics*, 2nd ed. New York: McGraw-Hill, pp. 35–36, 1945.
- Bhattacharya, P. B.; Jain, S. K.; and Nagpu, S. R. (Eds.). *Basic Algebra*, 2nd ed. New York: Cambridge University Press, 1994.
- Birkhoff, G. and Mac Lane, S. *A Survey of Modern Algebra*, 5th ed. New York: Macmillan, 1996.
- Brown, K. S. "Algebra." <http://www.seanet.com/~ksbrown/ialgebra.htm>.
- Cardano, G. *Ars Magna or The Rules of Algebra*. New York: Dover, 1993.
- Chevalley, C. C. *Introduction to the Theory of Algebraic Functions of One Variable*. Providence, RI: Amer. Math. Soc., 1951.
- Chrystal, G. *Textbook of Algebra*, 2 vols. New York: Dover, 1961.
- Dickson, L. E. *Algebras and Their Arithmetics*. Chicago, IL: University of Chicago Press, 1923.
- Dickson, L. E. *Modern Algebraic Theories*. Chicago, IL: H. Sanborn, 1926.
- Edwards, H. M. *Galois Theory*, corrected 2nd printing. New York: Springer-Verlag, 1993.
- Euler, L. *Elements of Algebra*. New York: Springer-Verlag, 1984.
- Gallian, J. A. *Contemporary Abstract Algebra*, 3rd ed. Lexington, MA: D. C. Heath, 1994.
- Grove, L. *Algebra*. New York: Academic Press, 1983.
- Hall, H. S. and Knight, S. R. *Higher Algebra, A Sequel to Elementary Algebra for Schools*. London: Macmillan, 1960.
- Harrison, M. A. "The Number of Isomorphism Types of Finite Algebras." *Proc. Amer. Math. Soc.* **17**, 735–737, 1966.
- Herstein, I. N. *Noncommutative Rings*. Washington, DC: Math. Assoc. Amer., 1996.
- Herstein, I. N. *Topics in Algebra*, 2nd ed. New York: Wiley, 1975.
- Jacobson, N. *Basic Algebra II*, 2nd ed. New York: W. H. Freeman, 1989.
- Kaplansky, I. *Fields and Rings*, 2nd ed. Chicago, IL: University of Chicago Press, 1995.
- Lang, S. *Undergraduate Algebra*, 2nd ed. New York: Springer-Verlag, 1990.
- Pedersen, J. "Catalogue of Algebraic Systems." <http://tarski.math.usf.edu/algetlg/>.
- Uspensky, J. V. *Theory of Equations*. New York: McGraw-Hill, 1948.
- van der Waerden, B. L. *Algebra*, Vol. 2. New York: Springer-Verlag, 1991.
- van der Waerden, B. L. *Geometry and Algebra in Ancient Civilizations*. New York: Springer-Verlag, 1983.
- van der Waerden, B. L. *A History of Algebra: From Al-Khwarizmi to Emmy Noether*. New York: Springer-Verlag, 1985.
- Varadarajan, V. S. *Algebra in Ancient and Modern Times*. Providence, RI: Amer. Math. Soc., 1998.

Algebraic Closure

The algebraic closure of a FIELD K is the “smallest” FIELD containing K which is algebraically closed. For example, the FIELD of COMPLEX NUMBERS \mathbb{C} is the algebraic closure of the FIELD of REALS \mathbb{R} .

Algebraic Coding Theory

see CODING THEORY

Algebraic Curve

An algebraic curve over a FIELD K is an equation $f(X, Y) = 0$, where $f(X, Y)$ is a POLYNOMIAL in X and Y with COEFFICIENTS in K . A nonsingular algebraic curve is an algebraic curve over K which has no SINGULAR POINTS over K . A point on an algebraic curve is simply a solution of the equation of the curve. A K -RATIONAL POINT is a point (X, Y) on the curve, where X and Y are in the FIELD K .

see also ALGEBRAIC GEOMETRY, ALGEBRAIC VARIETY, CURVE

References

Griffiths, P. A. *Introduction to Algebraic Curves*. Providence, RI: Amer. Math. Soc., 1989.

Algebraic Function

A function which can be constructed using only a finite number of ELEMENTARY FUNCTIONS together with the INVERSES of functions capable of being so constructed.

see also ELEMENTARY FUNCTION, TRANSCENDENTAL FUNCTION

Algebraic Function Field

A finite extension $K = \mathbb{Z}(z)(w)$ of the FIELD $\mathbb{C}(z)$ of RATIONAL FUNCTIONS in the indeterminate z , i.e., w is a ROOT of a POLYNOMIAL $a_0 + a_1\alpha + a_2\alpha^2 + \dots + a_n\alpha^n$, where $a_i \in \mathbb{C}(z)$.

see also ALGEBRAIC NUMBER FIELD, RIEMANN SURFACE

Algebraic Geometry

The study of ALGEBRAIC CURVES, ALGEBRAIC VARIETIES, and their generalization to n -D.

see also ALGEBRAIC CURVE, ALGEBRAIC VARIETY, COMMUTATIVE ALGEBRA, DIFFERENTIAL GEOMETRY, GEOMETRY, PLANE CURVE, SPACE CURVE

References

- Abhyankar, S. S. *Algebraic Geometry for Scientists and Engineers*. Providence, RI: Amer. Math. Soc., 1990.
- Cox, D.; Little, J.; and O'Shea, D. *Ideals, Varieties, and Algorithms: An Introduction to Algebraic Geometry and Commutative Algebra*, 2nd ed. New York: Springer-Verlag, 1996.
- Eisenbud, D. *Commutative Algebra with a View Toward Algebraic Geometry*. New York: Springer-Verlag, 1995.
- Griffiths, P. and Harris, J. *Principles of Algebraic Geometry*. New York: Wiley, 1978.
- Hartshorne, R. *Algebraic Geometry*, rev. ed. New York: Springer-Verlag, 1997.

Lang, S. *Introduction to Algebraic Geometry*. New York: Interscience, 1958.

Pedoe, D. and Hodge, W. V. *Methods of Algebraic Geometry*, Vol. 1. Cambridge, England: Cambridge University Press, 1994.

Pedoe, D. and Hodge, W. V. *Methods of Algebraic Geometry*, Vol. 2. Cambridge, England: Cambridge University Press, 1994.

Pedoe, D. and Hodge, W. V. *Methods of Algebraic Geometry*, Vol. 3. Cambridge, England: Cambridge University Press, 1994.

Seidenberg, A. (Ed.). *Studies in Algebraic Geometry*. Washington, DC: Math. Assoc. Amer., 1980.

Weil, A. *Foundations of Algebraic Geometry*, enl. ed. Providence, RI: Amer. Math. Soc., 1962.

Algebraic Integer

If r is a ROOT of the POLYNOMIAL equation

$$x^n + a_{n-1}x^{n-1} + \dots + a_1x + a_0 = 0,$$

where the a_i s are INTEGERS and r satisfies no similar equation of degree $< n$, then r is an algebraic INTEGER of degree n . An algebraic INTEGER is a special case of an ALGEBRAIC NUMBER, for which the leading COEFFICIENT a_n need not equal 1. RADICAL INTEGERS are a subring of the ALGEBRAIC INTEGERS.

A SUM or PRODUCT of algebraic integers is again an algebraic integer. However, ABEL'S IMPOSSIBILITY THEOREM shows that there are algebraic integers of degree ≥ 5 which are not expressible in terms of ADDITION, SUBTRACTION, MULTIPLICATION, DIVISION, and the extraction of ROOTS on REAL NUMBERS.

The GAUSSIAN INTEGER are algebraic integers of $\mathbb{Q}(\sqrt{-1})$, since $a + bi$ are roots of

$$z^2 - 2az + a^2 + b^2 = 0.$$

see also ALGEBRAIC NUMBER, EUCLIDEAN NUMBER, RADICAL INTEGER

References

- Hancock, H. *Foundations of the Theory of Algebraic Numbers*, Vol. 1: *Introduction to the General Theory*. New York: Macmillan, 1931.
- Hancock, H. *Foundations of the Theory of Algebraic Numbers*, Vol. 2: *The General Theory*. New York: Macmillan, 1932.
- Pohst, M. and Zassenhaus, H. *Algorithmic Algebraic Number Theory*. Cambridge, England: Cambridge University Press, 1989.
- Wagon, S. “Algebraic Numbers.” §10.5 in *Mathematica in Action*. New York: W. H. Freeman, pp. 347–353, 1991.

Algebraic Invariant

A quantity such as a DISCRIMINANT which remains unchanged under a given class of algebraic transformations. Such invariants were originally called HYPERDETERMINANTS by Cayley.

see also DISCRIMINANT (POLYNOMIAL), INVARIANT, QUADRATIC INVARIANT

References

- Grace, J. H. and Young, A. *The Algebra of Invariants*. New York: Chelsea, 1965.
 Gurevich, G. B. *Foundations of the Theory of Algebraic Invariants*. Groningen, Netherlands: P. Noordhoff, 1964.
 Hermann, R. and Ackerman, M. *Hilbert's Invariant Theory Papers*. Rookline, MA: Math Sci Press, 1978.
 Hilbert, D. *Theory of Algebraic Invariants*. Cambridge, England: Cambridge University Press, 1993.
 Mumford, D.; Fogarty, J.; and Kirwan, F. *Geometric Invariant Theory, 3rd enl. ed.* New York: Springer-Verlag, 1994.

Algebraic Knot

A single component ALGEBRAIC LINK.

see also ALGEBRAIC LINK, KNOT, LINK

Algebraic Link

A class of fibered knots and links which arises in ALGEBRAIC GEOMETRY. An algebraic link is formed by connecting the NW and NE strings and the SW and SE strings of an ALGEBRAIC TANGLE (Adams 1994).

see also ALGEBRAIC TANGLE, FIBRATION, TANGLE

References

- Adams, C. C. *The Knot Book: An Elementary Introduction to the Mathematical Theory of Knots*. New York: W. H. Freeman, pp. 48–49, 1994.
 Rolfsen, D. *Knots and Links*. Wilmington, DE: Publish or Perish Press, p. 335, 1976.

Algebraic Number

If r is a ROOT of the POLYNOMIAL equation

$$a_0x^n + a_1x^{n-1} + \dots + a_{n-1}x + a_n = 0, \quad (1)$$

where the a_i s are INTEGERS and r satisfies no similar equation of degree $< n$, then r is an algebraic number of degree n . If r is an algebraic number and $a_0 = 1$, then it is called an ALGEBRAIC INTEGER. It is also true that if the c_i s in

$$c_0x^n + c_1x^{n-1} + \dots + c_{n-1}x + c_n = 0 \quad (2)$$

are algebraic numbers, then any ROOT of this equation is also an algebraic number.

If α is an algebraic number of degree n satisfying the POLYNOMIAL

$$a(x - \alpha)(x - \beta)(x - \gamma) \dots, \quad (3)$$

then there are $n - 1$ other algebraic numbers β, γ, \dots called the conjugates of α . Furthermore, if α satisfies any other algebraic equation, then its conjugates also satisfy the same equation (Conway and Guy 1996).

Any number which is not algebraic is said to be TRANSCENDENTAL.

see also ALGEBRAIC INTEGER, EUCLIDEAN NUMBER, HERMITE-LINDEMANN THEOREM, RADICAL INTEGER, SEMIALGEBRAIC NUMBER, TRANSCENDENTAL NUMBER

References

- Conway, J. H. and Guy, R. K. "Algebraic Numbers." In *The Book of Numbers*. New York: Springer-Verlag, pp. 189–190, 1996.
 Courant, R. and Robbins, H. "Algebraic and Transcendental Numbers." §2.6 in *What is Mathematics?: An Elementary Approach to Ideas and Methods, 2nd ed.* Oxford, England: Oxford University Press, pp. 103–107, 1996.
 Hancock, H. *Foundations of the Theory of Algebraic Numbers. Vol. 1: Introduction to the General Theory*. New York: Macmillan, 1931.
 Hancock, H. *Foundations of the Theory of Algebraic Numbers. Vol. 2: The General Theory*. New York: Macmillan, 1932.
 Wagon, S. "Algebraic Numbers." §10.5 in *Mathematica in Action*. New York: W. H. Freeman, pp. 347–353, 1991.

Algebraic Number Field

see NUMBER FIELD

Algebraic Surface

The set of ROOTS of a POLYNOMIAL $f(x, y, z) = 0$. An algebraic surface is said to be of degree $n = \max(i + j + k)$, where n is the maximum sum of powers of all terms $a_m x^i y^j z^k$. The following table lists the names of algebraic surfaces of a given degree.

Order	Surface
3	cubic surface
4	quartic surface
5	quintic surface
6	sextic surface
7	heptic surface
8	octic surface
9	nonic surface
10	decic surface

see also BARTH DECIC, BARTH SEXTIC, BOY SURFACE, CAYLEY CUBIC, CHAIR, CLEBSCH DIAGONAL CUBIC, CUSHION, DERVISH, ENDRASS OCTIC, HEART SURFACE, KUMMER SURFACE, ORDER (ALGEBRAIC SURFACE), ROMAN SURFACE, SURFACE, TOGLIATTI SURFACE

References

- Fischer, G. (Ed.). *Mathematical Models from the Collections of Universities and Museums*. Braunschweig, Germany: Vieweg, p. 7, 1986.

Algebraic Tangle

Any TANGLE obtained by ADDITIONS and MULTIPLICATIONS of rational TANGLES (Adams 1994).

see also ALGEBRAIC LINK

References

- Adams, C. C. *The Knot Book: An Elementary Introduction to the Mathematical Theory of Knots*. New York: W. H. Freeman, pp. 41–51, 1994.

Algebraic Topology

The study of intrinsic qualitative aspects of spatial objects (e.g., SURFACES, SPHERES, TORI, CIRCLES, KNOTS, LINKS, configuration spaces, etc.) that remain invariant under both-directions continuous ONE-TO-ONE (HOMEOMORPHIC) transformations. The discipline of algebraic topology is popularly known as "RUBBER-SHEET GEOMETRY" and can also be viewed as the study of DISCONNECTIVITIES. Algebraic topology has a great deal of mathematical machinery for studying different kinds of HOLE structures, and it gets the prefix "algebraic" since many HOLE structures are represented best by algebraic objects like GROUPS and RINGS.

A technical way of saying this is that algebraic topology is concerned with FUNCTORS from the topological CATEGORY of GROUPS and HOMOMORPHISMS. Here, the FUNCTORS are a kind of filter, and given an "input" SPACE, they spit out something else in return. The returned object (usually a GROUP or RING) is then a representation of the HOLE structure of the SPACE, in the sense that this algebraic object is a vestige of what the original SPACE was like (i.e., much information is lost, but some sort of "shadow" of the SPACE is retained—just enough of a shadow to understand some aspect of its HOLE-structure, but no more). The idea is that FUNCTORS give much simpler objects to deal with. Because SPACES by themselves are very complicated, they are unmanageable without looking at particular aspects.

COMBINATORIAL TOPOLOGY is a special type of algebraic topology that uses COMBINATORIAL methods.

see also CATEGORY, COMBINATORIAL TOPOLOGY, DIFFERENTIAL TOPOLOGY, FUNCTOR, HOMOTOPY THEORY

References

Dieudonné, J. *A History of Algebraic and Differential Topology: 1900–1960*. Boston, MA: Birkhäuser, 1989.

Algebraic Variety

A generalization to n -D of ALGEBRAIC CURVES. More technically, an algebraic variety is a reduced SCHEME of FINITE type over a FIELD K . An algebraic variety V is defined as the SET of points in the REALS \mathbb{R}^n (or the COMPLEX NUMBERS \mathbb{C}^n) satisfying a system of POLYNOMIAL equations $f_i(x_1, \dots, x_n) = 0$ for $i = 1, 2, \dots$. According to the HILBERT BASIS THEOREM, a FINITE number of equations suffices.

see also ABELIAN VARIETY, ALBANESE VARIETY, BRAUER-SEVERI VARIETY, CHOW VARIETY, PICARD VARIETY

References

Ciliberto, C.; Laura, E.; and Somese, A. J. (Eds.). *Classification of Algebraic Varieties*. Providence, RI: Amer. Math. Soc., 1994.

Algebroidal Function

An ANALYTIC FUNCTION $f(z)$ satisfying the irreducible algebraic equation

$$A_0(z)f^k + A_1(z)f^{k-1} + \dots + A_k(z) = 0$$

with single-valued MEROMORPHIC functions $A_j(z)$ in a COMPLEX DOMAIN G is called a k -algebroidal function in G .

References

Iyanaga, S. and Kawada, Y. (Eds.). "Algebroidal Functions." §19 in *Encyclopedic Dictionary of Mathematics*. Cambridge, MA: MIT Press, pp. 86–88, 1980.

Algorithm

A specific set of instructions for carrying out a procedure or solving a problem, usually with the requirement that the procedure terminate at some point. Specific algorithms sometimes also go by the name METHOD, PROCEDURE, or TECHNIQUE. The word "algorithm" is a distortion of Al-Khwarizmi, an Arab mathematician who wrote an influential treatise about algebraic methods.

see also 196-ALGORITHM, ALGORITHMIC COMPLEXITY, ARCHIMEDES ALGORITHM, BHASKARA-BROUCKNER ALGORITHM, BORCHARDT-PFAFF ALGORITHM, BRELAZ'S HEURISTIC ALGORITHM, BUCHBERGER'S ALGORITHM, BULIRSCH-STOER ALGORITHM, BUMPING ALGORITHM, CLEAN ALGORITHM, COMPUTABLE FUNCTION, CONTINUED FRACTION FACTORIZATION ALGORITHM, DECISION PROBLEM, DIJKSTRA'S ALGORITHM, EUCLIDEAN ALGORITHM, FERGUSON-FORCADE ALGORITHM, FERMAT'S ALGORITHM, FLOYD'S ALGORITHM, GAUSSIAN APPROXIMATION ALGORITHM, GENETIC ALGORITHM, GOSPER'S ALGORITHM, GREEDY ALGORITHM, HASSE'S ALGORITHM, HJLS ALGORITHM, JACOBI ALGORITHM, KRUSKAL'S ALGORITHM, LEVINE-O'SULLIVAN GREEDY ALGORITHM, LLL ALGORITHM, MARKOV ALGORITHM, MILLER'S ALGORITHM, NEVILLE'S ALGORITHM, NEWTON'S METHOD, PRIME FACTORIZATION ALGORITHMS, PRIMITIVE RECURSIVE FUNCTION, PROGRAM, PSLQ ALGORITHM, PSOS ALGORITHM, QUOTIENT-DIFFERENCE ALGORITHM, RISCH ALGORITHM, SCHRAGE'S ALGORITHM, SHANKS' ALGORITHM, SPIGOT ALGORITHM, SYRACUSE ALGORITHM, TOTAL FUNCTION, TURING MACHINE, ZASSENHAUS-BERLEKAMP ALGORITHM, ZEILBERGER'S ALGORITHM

References

Aho, A. V.; Hopcroft, J. E.; and Ullman, J.D. *The Design and Analysis of Computer Algorithms*. Reading, MA: Addison-Wesley, 1974.
 Baase, S. *Computer Algorithms*. Reading, MA: Addison-Wesley, 1988.
 Brassard, G. and Bratley, P. *Fundamentals of Algorithmics*. Englewood Cliffs, NJ: Prentice-Hall, 1995.
 Cormen, T. H.; Leiserson, C. E.; and Rivest, R. L. *Introduction to Algorithms*. Cambridge, MA: MIT Press, 1990.

- Greene, D. H. and Knuth, D. E. *Mathematics for the Analysis of Algorithms*, 3rd ed. Boston: Birkhäuser, 1990.
- Harel, D. *Algorithms: The Spirit of Computing*, 2nd ed. Reading, MA: Addison-Wesley, 1992.
- Knuth, D. E. *The Art of Computer Programming, Vol. 1: Fundamental Algorithms*, 2nd ed. Reading, MA: Addison-Wesley, 1973.
- Knuth, D. E. *The Art of Computer Programming, Vol. 2: Seminumerical Algorithms*, 2nd ed. Reading, MA: Addison-Wesley, 1981.
- Knuth, D. E. *The Art of Computer Programming, Vol. 3: Sorting and Searching*, 2nd ed. Reading, MA: Addison-Wesley, 1973.
- Kozen, D. C. *Design and Analysis of Algorithms*. New York: Springer-Verlag, 1991.
- Shen, A. *Algorithms and Programming*. Boston: Birkhäuser, 1996.
- Skiena, S. S. *The Algorithm Design Manual*. New York: Springer-Verlag, 1997.
- Wilf, H. *Algorithms and Complexity*. Englewood Cliffs, NJ: Prentice Hall, 1986. <http://www.cis.upenn.edu/~wilf/>.

Algorithmic Complexity

see BIT COMPLEXITY, KOLMOGOROV COMPLEXITY

Alhazen's Billiard Problem

In a given CIRCLE, find an ISOSCELES TRIANGLE whose LEGS pass through two given POINTS inside the CIRCLE. This can be restated as: from two POINTS in the PLANE of a CIRCLE, draw LINES meeting at the POINT of the CIRCUMFERENCE and making equal ANGLES with the NORMAL at that POINT.

The problem is called the billiard problem because it corresponds to finding the POINT on the edge of a circular "BILLIARD" table at which a cue ball at a given POINT must be aimed in order to carom once off the edge of the table and strike another ball at a second given POINT. The solution leads to a BIQUADRATIC EQUATION of the form

$$H(x^2 - y^2) - 2Kxy + (x^2 + y^2)(hy - kx) = 0.$$

The problem is equivalent to the determination of the point on a spherical mirror where a ray of light will reflect in order to pass from a given source to an observer. It is also equivalent to the problem of finding, given two points and a CIRCLE such that the points are both inside or outside the CIRCLE, the ELLIPSE whose FOCI are the two points and which is tangent to the given CIRCLE.

The problem was first formulated by Ptolemy in 150 AD, and was named after the Arab scholar Alhazen, who discussed it in his work on optics. It was not until 1997 that Neumann proved the problem to be insoluble using a COMPASS and RULER construction because the solution requires extraction of a CUBE ROOT. This is the same reason that the CUBE DUPLICATION problem is insoluble.

see also BILLIARDS, BILLIARD TABLE PROBLEM, CUBE DUPLICATION

References

- Dörrie, H. "Alhazen's Billiard Problem." §41 in *100 Great Problems of Elementary Mathematics: Their History and Solutions*. New York: Dover, pp. 197–200, 1965.
- Hogendijk, J. P. "Al-Mutaman's Simplified Lemmas for Solving 'Alhazen's Problem'." *From Baghdad to Barcelona/De Bagdad a Barcelona, Vol. I, II (Zaragoza, 1993)*, pp. 59–101, Anu. Filol. Univ. Barc., XIX B-2, Univ. Barcelona, Barcelona, 1996.
- Lohne, J. A. "Alhazens Spiegelproblem." *Nordisk Mat. Tidsskr.* **18**, 5–35, 1970.
- Neumann, P. Submitted to *Amer. Math. Monthly*.
- Riede, H. "Reflexion am Kugelspiegel. Oder: das Problem des Alhazen." *Praxis Math.* **31**, 65–70, 1989.
- Sabra, A. I. "ibn al-Haytham's Lemmas for Solving 'Alhazen's Problem'." *Arch. Hist. Exact Sci.* **26**, 299–324, 1982.

Alhazen's Problem

see ALHAZEN'S BILLIARD PROBLEM

Alias' Paradox

Choose between the following two alternatives:

1. 90% chance of an unknown amount x and a 10% chance of \$1 million, or
2. 89% chance of the same unknown amount x , 10% chance of \$2.5 million, and 1% chance of nothing.

The PARADOX is to determine which choice has the larger expectation value, $0.9x + \$100,000$ or $0.89x + \$250,000$. However, the best choice depends on the unknown amount, even though it is the same in both cases! This appears to violate the INDEPENDENCE AXIOM.

see also INDEPENDENCE AXIOM, MONTY HALL PROBLEM, NEWCOMB'S PARADOX

Aliasing

Given a power spectrum (a plot of power vs. frequency), aliasing is a false translation of power falling in some frequency range $(-f_c, f_c)$ outside the range. Aliasing can be caused by discrete sampling below the NYQUIST FREQUENCY. The sidelobes of any INSTRUMENT FUNCTION (including the simple SINC SQUARED function obtained simply from FINITE sampling) are also a form of aliasing. Although sidelobe contribution at large offsets can be minimized with the use of an APODIZATION FUNCTION, the tradeoff is a widening of the response (i.e., a lowering of the resolution).

see also APODIZATION FUNCTION, NYQUIST FREQUENCY

Aliquant Divisor

A number which does not DIVIDE another exactly. For instance, 4 and 5 are aliquant divisors of 6. A number which is not an aliquant divisor (i.e., one that *does* DIVIDE another exactly) is said to be an ALIQUOT DIVISOR.

see also ALIQUOT DIVISOR, DIVISOR, PROPER DIVISOR

Aliquot Cycle

see SOCIABLE NUMBERS

Aliquot Divisor

A number which DIVIDES another exactly. For instance, 1, 2, 3, and 6 are aliquot divisors of 6. A number which is not an aliquot divisor is said to be an ALIQUANT DIVISOR. The term “aliquot” is frequently used to specifically mean a PROPER DIVISOR, i.e., a DIVISOR of a number other than the number itself.

see also ALIQUANT DIVISOR, DIVISOR, PROPER DIVISOR

Aliquot Sequence

Let

$$s(n) \equiv \sigma(n) - n,$$

where $\sigma(n)$ is the DIVISOR FUNCTION and $s(n)$ is the RESTRICTED DIVISOR FUNCTION. Then the SEQUENCE of numbers

$$s^0(n) \equiv n, s^1(n) = s(n), s^2(n) = s(s(n)), \dots$$

is called an aliquot sequence. If the SEQUENCE for a given n is bounded, it either ends at $s(1) = 0$ or becomes periodic.

1. If the SEQUENCE reaches a constant, the constant is known as a PERFECT NUMBER.
2. If the SEQUENCE reaches an alternating pair, it is called an AMICABLE PAIR.
3. If, after k iterations, the SEQUENCE yields a cycle of minimum length t of the form $s^{k+1}(n)$, $s^{k+2}(n)$, ..., $s^{k+t}(n)$, then these numbers form a group of SOCIABLE NUMBERS of order t .

It has not been proven that all aliquot sequences eventually terminate and become period. The smallest number whose fate is not known is 276, which has been computed up to $s^{487}(276)$ (Guy 1994).

see also 196-ALGORITHM, ADDITIVE PERSISTENCE, AMICABLE NUMBERS, MULTIAMICABLE NUMBERS, MULTIPERFECT NUMBER, MULTIPLICATIVE PERSISTENCE, PERFECT NUMBER, SOCIABLE NUMBERS, UNITARY ALIQUOT SEQUENCE

References

- Guy, R. K. “Aliquot Sequences.” §B6 in *Unsolved Problems in Number Theory*, 2nd ed. New York: Springer-Verlag, pp. 60–62, 1994.
- Guy, R. K. and Selfridge, J. L. “What Drives Aliquot Sequences.” *Math. Comput.* **29**, 101–107, 1975.
- Sloane, N. J. A. Sequences A003023/M0062 in “An On-Line Version of the Encyclopedia of Integer Sequences.”
- Sloane, N. J. A. and Plouffe, S. Extended entry in *The Encyclopedia of Integer Sequences*. San Diego: Academic Press, 1995.

All-Poles Model

see MAXIMUM ENTROPY METHOD

Alladi-Grinstead Constant

N.B. A detailed on-line essay by S. Finch was the starting point for this entry.

Let $N(n)$ be the number of ways in which the FACTORIAL $n!$ can be decomposed into n FACTORS of the form $p_k^{b_k}$ arranged in nondecreasing order. Also define

$$m(n) \equiv \max(p_1^{b_1}), \quad (1)$$

i.e., $m(n)$ is the LEAST PRIME FACTOR raised to its appropriate POWER in the factorization. Then define

$$\alpha(n) \equiv \frac{\ln m(n)}{\ln n} \quad (2)$$

where $\ln(x)$ is the NATURAL LOGARITHM. For instance,

$$\begin{aligned} 9! &= 2 \cdot 2 \cdot 2 \cdot 2 \cdot 2 \cdot 2^2 \cdot 5 \cdot 7 \cdot 3^4 \\ &= 2 \cdot 2 \cdot 2 \cdot 2 \cdot 3 \cdot 5 \cdot 7 \cdot 2^3 \cdot 3^3 \\ &= 2 \cdot 2 \cdot 2 \cdot 2 \cdot 5 \cdot 7 \cdot 2^3 \cdot 3^2 \cdot 3^2 \\ &= 2 \cdot 2 \cdot 2 \cdot 3 \cdot 2^2 \cdot 2^2 \cdot 5 \cdot 7 \cdot 3^3 \\ &= 2 \cdot 2 \cdot 2 \cdot 2^2 \cdot 2^2 \cdot 5 \cdot 7 \cdot 3^2 \cdot 3^2 \\ &= 2 \cdot 2 \cdot 2 \cdot 3 \cdot 3 \cdot 5 \cdot 7 \cdot 3^2 \cdot 2^4 \\ &= 2 \cdot 2 \cdot 3 \cdot 3 \cdot 2^2 \cdot 5 \cdot 7 \cdot 2^3 \cdot 3^2 \\ &= 2 \cdot 2 \cdot 3 \cdot 3 \cdot 3 \cdot 3 \cdot 5 \cdot 7 \cdot 2^5 \\ &= 2 \cdot 3 \cdot 3 \cdot 2^2 \cdot 2^2 \cdot 2^2 \cdot 5 \cdot 7 \cdot 3^2 \\ &= 2 \cdot 3 \cdot 3 \cdot 3 \cdot 3 \cdot 2^2 \cdot 5 \cdot 7 \cdot 2^4 \\ &= 2 \cdot 3 \cdot 3 \cdot 3 \cdot 3 \cdot 5 \cdot 7 \cdot 2^3 \cdot 2^3 \\ &= 3 \cdot 3 \cdot 3 \cdot 3 \cdot 2^2 \cdot 2^2 \cdot 5 \cdot 7 \cdot 2^3, \end{aligned} \quad (3)$$

so

$$\alpha(9) = \frac{\ln 3}{\ln 9} = \frac{\ln 3}{2 \ln 3} = \frac{1}{2}. \quad (4)$$

For large n ,

$$\lim_{n \rightarrow \infty} \alpha(n) = e^{c-1} = 0.809394020534 \dots, \quad (5)$$

where

$$c \equiv \sum_{k=2}^{\infty} \frac{1}{k} \ln \left(\frac{k}{k-1} \right). \quad (6)$$

References

- Alladi, K. and Grinstead, C. “On the Decomposition of $n!$ into Prime Powers.” *J. Number Th.* **9**, 452–458, 1977.
- Finch, S. “Favorite Mathematical Constants.” <http://www.mathsoft.com/asolve/constant/alldgrns/alldgrns.html>.
- Guy, R. K. “Factorial n as the Product of n Large Factors.” §B22 in *Unsolved Problems in Number Theory*, 2nd ed. New York: Springer-Verlag, p. 79, 1994.

Allegory

A technical mathematical object which bears the same resemblance to binary relations as CATEGORIES do to FUNCTIONS and SETS.

see also CATEGORY

References

- Freyd, P. J. and Scedrov, A. *Categories, Allegories*. Amsterdam, Netherlands: North-Holland, 1990.

Allometric

Mathematical growth in which one population grows at a rate PROPORTIONAL to the POWER of another population.

References

Cofrey, W. J. *Geography Towards a General Spatial Systems Approach*. London: Routledge, Chapman & Hall, 1981.

Almost All

Given a property P , if $P(x) \sim x$ as $x \rightarrow \infty$ (so the number of numbers less than x not satisfying the property P is $o(x)$), then P is said to hold true for almost all numbers. For example, almost all positive integers are COMPOSITE NUMBERS (which is not in conflict with the second of EUCLID'S THEOREMS that there are an infinite number of PRIMES).

see also FOR ALL, NORMAL ORDER

References

Hardy, G. H. and Wright, E. M. *An Introduction to the Theory of Numbers*, 5th ed. Oxford, England: Clarendon Press, p. 8, 1979.

Almost Alternating Knot

An ALMOST ALTERNATING LINK with a single component.

Almost Alternating Link

Call a projection of a LINK an almost alternating projection if one crossing change in the projection makes it an alternating projection. Then an almost alternating link is a LINK with an almost alternating projection, but no alternating projection. Every ALTERNATING KNOT has an almost alternating projection. A PRIME KNOT which is almost alternating is either a TORUS KNOT or a HYPERBOLIC KNOT. Therefore, no SATELLITE KNOT is an almost alternating knot.

All nonalternating 9-crossing PRIME KNOTS are almost alternating. Of the 393 nonalternating with 11 or fewer crossings, all but five are known to be nonalternating (3 of these have 11 crossings). The fate of the remaining five is not known. The (2, q), (3, 4), and (3, 5)-TORUS KNOTS are almost alternating.

see also ALTERNATING KNOT, LINK

References

Adams, C. C. *The Knot Book: An Elementary Introduction to the Mathematical Theory of Knots*. New York: W. H. Freeman, pp. 139–146, 1994.

Almost Everywhere

A property of X is said to hold almost everywhere if the SET of points in X where this property fails has MEASURE 0.

see also MEASURE

References

Sansone, G. *Orthogonal Functions*, rev. English ed. New York: Dover, p. 1, 1991.

Almost Integer

A number which is very close to an INTEGER. One surprising example involving both e and π is

$$e^\pi - \pi = 19.999099979 \dots, \quad (1)$$

which can also be written as

$$(\pi + 20)^i = -0.9999999992 - 0.0000388927i \approx -1 \quad (2)$$

$$\cos(\ln(\pi + 20)) \approx -0.9999999992. \quad (3)$$

Applying COSINE a few more times gives

$$\begin{aligned} \cos(\pi \cos(\pi \cos(\ln(\pi + 20)))) \\ \approx -1 + 3.9321609261 \times 10^{-35}. \end{aligned} \quad (4)$$

This curious near-identity was apparently noticed almost simultaneously around 1988 by N. J. A. Sloane, J. H. Conway, and S. Plouffe, but no satisfying explanation as to “why” it has been true has yet been discovered.

An interesting near-identity is given by

$$\begin{aligned} \frac{1}{4} \left[\cos\left(\frac{1}{10}\right) + \cosh\left(\frac{1}{10}\right) + 2 \cos\left(\frac{1}{20}\sqrt{2}\right) \cosh\left(\frac{1}{20}\sqrt{2}\right) \right] \\ = 1 + 2.480 \dots \times 10^{-13} \end{aligned} \quad (5)$$

(W. Dubuque). Other remarkable near-identities are given by

$$\frac{5(1 + \sqrt{5})[\Gamma(\frac{3}{4})]^2}{e^{5\pi/6}\sqrt{\pi}} = 1 + 4.5422 \dots \times 10^{-14}, \quad (6)$$

where $\Gamma(z)$ is the GAMMA FUNCTION (S. Plouffe), and

$$e^6 - \pi^4 - \pi^5 = 0.000017673 \dots \quad (7)$$

(D. Wilson).

A whole class of IRRATIONAL “almost integers” can be found using the theory of MODULAR FUNCTIONS, and a few rather spectacular examples are given by Ramanujan (1913–14). Such approximations were also studied by Hermite (1859), Kronecker (1863), and Smith (1965). They can be generated using some amazing (and very deep) properties of the j -FUNCTION. Some of the numbers which are closest approximations to INTEGERS are $e^{\pi\sqrt{163}}$ (sometimes known as the RAMANUJAN CONSTANT and which corresponds to the field $\mathbb{Q}(\sqrt{-163})$ which has CLASS NUMBER 1 and is the IMAGINARY quadratic field of maximal discriminant), $e^{\pi\sqrt{22}}$, $e^{\pi\sqrt{37}}$, and $e^{\pi\sqrt{58}}$, the latter three of which have CLASS NUMBER 2 and are due to Ramanujan (Berndt 1994, Waldschmidt 1988).

The properties of the j -FUNCTION also give rise to the spectacular identity

$$\left[\frac{\ln(640320^3 + 744)}{\pi} \right]^2 = 163 + 2.32167 \dots \times 10^{-29} \quad (8)$$

(Le Lionnais 1983, p. 152).

The list below gives numbers of the form $x \equiv e^{\pi\sqrt{n}}$ for $n \leq 1000$ for which $[x] - x \leq 0.01$.

$$\begin{aligned} e^{\pi\sqrt{6}} &= 2, 197.990\,869\,543 \dots \\ e^{\pi\sqrt{17}} &= 422, 150.997\,675\,680 \dots \\ e^{\pi\sqrt{18}} &= 614, 551.992\,885\,619 \dots \\ e^{\pi\sqrt{22}} &= 2, 508, 951.998\,257\,553 \dots \\ e^{\pi\sqrt{25}} &= 6, 635, 623.999\,341\,134 \dots \\ e^{\pi\sqrt{37}} &= 199, 148, 647.999\,978\,046\,551 \dots \\ e^{\pi\sqrt{43}} &= 884, 736, 743.999\,777\,466 \dots \\ e^{\pi\sqrt{58}} &= 24, 591, 257, 751.999\,999\,822\,213 \dots \\ e^{\pi\sqrt{59}} &= 30, 197, 683, 486.993\,182\,260 \dots \\ e^{\pi\sqrt{67}} &= 147, 197, 952, 743.999\,998\,662\,454 \dots \\ e^{\pi\sqrt{74}} &= 54, 551, 812, 208.999\,917\,467\,885 \dots \\ e^{\pi\sqrt{149}} &= 45, 116, 546, 012, 289, 599.991\,830\,287 \dots \\ e^{\pi\sqrt{163}} &= 262, 537, 412, 640, 768, 743.999\,999\,999\,999\,250\,072 \dots \\ e^{\pi\sqrt{177}} &= 1, 418, 556, 986, 635, 586, 485.996\,179\,355 \dots \\ e^{\pi\sqrt{232}} &= 604, 729, 957, 825, 300, 084, 759.999\,992\,171\,526 \dots \\ e^{\pi\sqrt{267}} &= 19, 683, 091, 854, 079, 461, 001, 445.992\,737\,040 \dots \\ \\ e^{\pi\sqrt{326}} &= 4, 309, 793, 301, 730, 386, 363, 005, 719.996\,011\,651 \dots \\ e^{\pi\sqrt{386}} &= 639, 355, 180, 631, 208, 421, \dots \\ &\quad \dots 212, 174, 016.997\,669\,832 \dots \\ e^{\pi\sqrt{522}} &= 14, 871, 070, 263, 238, 043, 663, 567, \dots \\ &\quad \dots 627, 879, 007.999\,848\,726 \dots \\ e^{\pi\sqrt{566}} &= 288, 099, 755, 064, 053, 264, 917, 867, \dots \\ &\quad \dots 975, 825, 573.993\,898\,311 \dots \\ e^{\pi\sqrt{638}} &= 28, 994, 858, 898, 043, 231, 996, 779, \dots \\ &\quad \dots 771, 804, 797, 161.992\,372\,939 \dots \\ e^{\pi\sqrt{719}} &= 3, 842, 614, 373, 539, 548, 891, 490, \dots \\ &\quad \dots 294, 277, 805, 829, 192.999\,987\,249 \dots \\ e^{\pi\sqrt{790}} &= 223, 070, 667, 213, 077, 889, 794, 379, \dots \\ &\quad \dots 623, 183, 838, 336, 437.992\,055\,118 \dots \\ e^{\pi\sqrt{792}} &= 249, 433, 117, 287, 892, 229, 255, 125, \dots \\ &\quad \dots 388, 685, 911, 710, 805.996\,097\,323 \dots \\ e^{\pi\sqrt{926}} &= 365, 698, 321, 891, 389, 219, 219, 142, \dots \\ &\quad \dots 531, 076, 638, 716, 362, 775.998\,259\,747 \dots \\ e^{\pi\sqrt{986}} &= 6, 954, 830, 200, 814, 801, 770, 418, 837, \dots \\ &\quad \quad \quad 940, 281, 460, 320, 666, 108.994\,649\,611 \dots \end{aligned}$$

Gosper noted that the expression

$$1 - 262537412640768744e^{-\pi\sqrt{163}} - 196884e^{-2\pi\sqrt{163}} + 103378831900730205293632e^{-3\pi\sqrt{163}}. \quad (9)$$

differs from an INTEGER by a mere 10^{-59} .

see also CLASS NUMBER, j -FUNCTION, PI

References

- Berndt, B. C. *Ramanujan's Notebooks, Part IV*. New York: Springer-Verlag, pp. 90–91, 1994.
- Hermite, C. “Sur la théorie des équations modulaires.” *C. R. Acad. Sci. (Paris)* **48**, 1079–1084 and 1095–1102, 1859.
- Hermite, C. “Sur la théorie des équations modulaires.” *C. R. Acad. Sci. (Paris)* **49**, 16–24, 110–118, and 141–144, 1859.
- Kronecker, L. “Über die Klassenzahl der aus Wurzeln der Einheit gebildeten komplexen Zahlen.” *Monatsber. K. Preuss. Akad. Wiss. Berlin*, 340–345. 1863.
- Le Lionnais, F. *Les nombres remarquables*. Paris: Hermann, 1983.
- Ramanujan, S. “Modular Equations and Approximations to π .” *Quart. J. Pure Appl. Math.* **45**, 350–372, 1913–1914.
- Smith, H. J. S. *Report on the Theory of Numbers*. New York: Chelsea, 1965.
- Waldschmidt, M. “Some Transcendental Aspects of Ramanujan's Work.” In *Ramanujan Revisited: Proceedings of the Centenary Conference* (Ed. G. E. Andrews, B. C. Berndt, and R. A. Rankin). New York: Academic Press, pp. 57–76, 1988.

Almost Perfect Number

A number n for which the DIVISOR FUNCTION satisfies $\sigma(n) = 2n - 1$ is called almost perfect. The only known almost perfect numbers are the POWERS of 2, namely 1, 2, 4, 8, 16, 32, ... (Sloane's A000079). Singh (1997) calls almost perfect numbers SLIGHTLY DEFECTIVE.

see also QUASIPERFECT NUMBER

References

- Guy, R. K. “Almost Perfect, Quasi-Perfect, Pseudoperfect, Harmonic, Weird, Multiperfect and Hyperperfect Numbers.” §B2 in *Unsolved Problems in Number Theory*, 2nd ed. New York: Springer-Verlag, pp. 16 and 45–53, 1994.
- Singh, S. *Fermat's Enigma: The Epic Quest to Solve the World's Greatest Mathematical Problem*. New York: Walker, p. 13, 1997.
- Sloane, N. J. A. Sequence A000079/M1129 in “An On-Line Version of the Encyclopedia of Integer Sequences.”

Almost Prime

A number n with prime factorization

$$n = \prod_{i=1}^r p_i^{a_i}$$

is called k -almost prime when the sum of the POWERS $\sum_{i=1}^r a_i = k$. The set of k -almost primes is denoted P_k .

The PRIMES correspond to the “1-almost prime” numbers 2, 3, 5, 7, 11, ... (Sloane's A000040). The 2-almost prime numbers correspond to SEMIPRIMES 4, 6, 9, 10, 14, 15, 21, 22, ... (Sloane's A001358). The first few 3-almost primes are 8, 12, 18, 20, 27, 28, 30, 42, 44, 45, 50, 52, 63, 66, 68, 70, 75, 76, 78, 92, 98, 99, ... (Sloane's A014612). The first few 4-almost primes are 16, 24, 36, 40, 54, 56, 60, 81, 84, 88, 90, 100, ... (Sloane's A014613). The first few 5-almost primes are 32, 48, 72, 80, ... (Sloane's A014614).

see also CHEN'S THEOREM, PRIME NUMBER, SEMI-PRIME

References

Sloane, N. J. A. Sequences A014612, A014613, A014614, A000040/M0652, and A001358/M3274 in "An On-Line Version of the Encyclopedia of Integer Sequences."

Alpha

A financial measure giving the difference between a fund's actual return and its expected level of performance, given its level of risk (as measured by BETA). A POSITIVE alpha indicates that a fund has performed better than expected based on its BETA, whereas a NEGATIVE alpha indicates poorer performance

see also BETA, SHARPE RATIO

Alpha Function

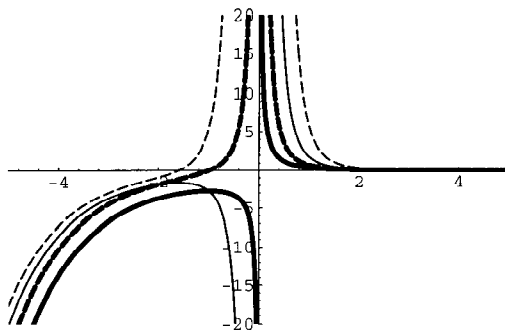

$$\alpha_n(z) \equiv \int_1^{\infty} t^n e^{-zt} dt = n! z^{-(n+1)} e^{-z} \sum_{k=0}^n \frac{z^k}{k!}.$$

The alpha function satisfies the RECURRENCE RELATION

$$z\alpha_n(z) = e^{-z} + n\alpha_{n-1}(z).$$

see also BETA FUNCTION (EXPONENTIAL)

Alpha Value

An alpha value is a number $0 \leq \alpha \leq 1$ such that $P(z \geq z_{\text{observed}}) \leq \alpha$ is considered "SIGNIFICANT," where P is a P -VALUE.

see also CONFIDENCE INTERVAL, P -VALUE, SIGNIFICANCE

Alphabet

A SET (usually of letters) from which a SUBSET is drawn. A sequence of letters is called a WORD, and a set of WORDS is called a CODE.

see also CODE, WORD

Alphamagic Square

A MAGIC SQUARE for which the number of letters in the word for each number generates another MAGIC SQUARE. This definition depends, of course, on the language being used. In English, for example,

5	22	18	4	9	8
28	15	2	11	7	3
12	8	25	6	5	10

where the MAGIC SQUARE on the right corresponds to the number of letters in

five	twenty-two	eighteen
twenty-eight	fifteen	two
twelve	eight	twenty-five

References

Sallows, L. C. F. "Alphamagic Squares." *Abacus* 4, 28–45, 1986.
 Sallows, L. C. F. "Alphamagic Squares. 2." *Abacus* 4, 20–29 and 43, 1987.
 Sallows, L. C. F. "Alpha Magic Squares." In *The Lighter Side of Mathematics* (Ed. R. K. Guy and R. E. Woodrow). Washington, DC: Math. Assoc. Amer., 1994.

Alphabetic

A CRYPTARITHM in which the letters used to represent distinct DIGITS are derived from related words or meaningful phrases. The term was coined by Hunter in 1955 (Madachy 1979, p. 178).

References

Brooke, M. *One Hundred & Fifty Puzzles in Crypt-Arithmetic*. New York: Dover, 1963.
 Hunter, J. A. H. and Madachy, J. S. "Alphametics and the Like." Ch. 9 in *Mathematical Diversions*. New York: Dover, pp. 90–95, 1975.
 Madachy, J. S. "Alphametics." Ch. 7 in *Madachy's Mathematical Recreations*. New York: Dover, pp. 178–200 1979.

Alternate Algebra

Let A denote an \mathbb{R} -ALGEBRA, so that A is a VECTOR SPACE over \mathbb{R} and

$$A \times A \rightarrow A \quad (1)$$

$$(x, y) \mapsto x \cdot y. \quad (2)$$

Then A is said to be alternate if, for all $x, y \in A$,

$$(x \cdot y) \cdot y = x \cdot (y \cdot y) \quad (3)$$

$$(x \cdot x) \cdot y = x \cdot (x \cdot y). \quad (4)$$

Here, VECTOR MULTIPLICATION $x \cdot y$ is assumed to be BILINEAR.

References

Finch, S. "Zero Structures in Real Algebras." <http://www.mathsoft.com/asolve/zerodiv/zerodiv.html>.
 Schafer, R. D. *An Introduction to Non-Associative Algebras*. New York: Dover, 1995.

Alternating Algebra

see EXTERIOR ALGEBRA

Alternating Group

EVEN PERMUTATION GROUPS A_n which are NORMAL SUBGROUPS of the PERMUTATION GROUP of ORDER $n!/2$. They are FINITE analogs of the families of simple LIE GROUPS. The lowest order alternating group is 60. Alternating groups with $n \geq 5$ are non-ABELIAN SIMPLE GROUPS. The number of conjugacy classes in the alternating groups A_n for $n = 2, 3, \dots$ are 1, 3, 4, 5, 7, 9, \dots (Sloane's A000702).

see also PUZZLE, FINITE GROUP, GROUP, LIE GROUP, SIMPLE GROUP, SYMMETRIC GROUP

References

Sloane, N. J. A. Sequence A000702/M2307 in "An On-Line Version of the Encyclopedia of Integer Sequences."
Wilson, R. A. "ATLAS of Finite Group Representation."
<http://for.mat.bham.ac.uk/atlas#alt>.

Alternating Knot

An alternating knot is a KNOT which possesses a knot diagram in which crossings alternate between under- and overpasses. Not all knot diagrams of alternating knots need be alternating diagrams.

The TREFOIL KNOT and FIGURE-OF-EIGHT KNOT are alternating knots. One of TAIT'S KNOT CONJECTURES states that the number of crossings is the same for any diagram of a reduced alternating knot. Furthermore, a reduced alternating projection of a knot has the least number of crossings for any projection of that knot. Both of these facts were proved true by Kauffman (1988), Thistlethwaite (1987), and Murasugi (1987).

If K has a reduced alternating projection of n crossings, then the SPAN of K is $4n$. Let $c(K)$ be the CROSSING NUMBER. Then an alternating knot $K_1 \# K_2$ (a KNOT SUM) satisfies

$$c(K_1 \# K_2) = c(K_1) + c(K_2).$$

In fact, this is true as well for the larger class of ADEQUATE KNOTS and postulated for all KNOTS. The number of PRIME alternating knots of n crossing for $n = 1, 2, \dots$ are 0, 0, 1, 1, 2, 3, 7, 18, 41, 123, 367, \dots (Sloane's A002864).

see also ADEQUATE KNOT, ALMOST ALTERNATING LINK, ALTERNATING LINK, FLYPING CONJECTURE

References

Adams, C. C. *The Knot Book: An Elementary Introduction to the Mathematical Theory of Knots*. New York: W. H. Freeman, pp. 159–164, 1994.
Arnold, B.; Au, M.; Candy, C.; Erdener, K.; Fan, J.; Flynn, R.; Muir, J.; Wu, D.; and Hoste, J. "Tabulating Alternating Knots through 14 Crossings." <ftp://chs.cusd.claremont.edu/pub/knot/paper.TeX.txt> and <ftp://chs.cusd.claremont.edu/pub/knot/AltKnots/>.

Erdener, K. and Flynn, R. "Rolfsen's Table of all Alternating Diagrams through 9 Crossings." <ftp://chs.cusd.claremont.edu/pub/knot/RolfsenTable.final>.

Kauffman, L. "New Invariants in the Theory of Knots." *Amer. Math. Monthly* **95**, 195–242, 1988.

Murasugi, K. "Jones Polynomials and Classical Conjectures in Knot Theory." *Topology* **26**, 297–307, 1987.

Sloane, N. J. A. Sequence A002864/M0847 in "An On-Line Version of the Encyclopedia of Integer Sequences."

Thistlethwaite, M. "A Spanning Tree Expansion for the Jones Polynomial." *Topology* **26**, 297–309, 1987.

Alternating Knot Diagram

A KNOT DIAGRAM which has alternating under- and overcrossings as the KNOT projection is traversed. The first KNOT which does not have an alternating diagram has 8 crossings.

Alternating Link

A LINK which has a LINK DIAGRAM with alternating underpasses and overpasses.

see also ALMOST ALTERNATING LINK

References

Menasco, W. and Thistlethwaite, M. "The Classification of Alternating Links." *Ann. Math.* **138**, 113–171, 1993.

Alternating Permutation

An arrangement of the elements c_1, \dots, c_n such that no element c_i has a magnitude between c_{i-1} and c_{i+1} is called an alternating (or ZIGZAG) permutation. The determination of the number of alternating permutations for the set of the first n INTEGERS $\{1, 2, \dots, n\}$ is known as ANDRÉ'S PROBLEM. An example of an alternating permutation is (1, 3, 2, 5, 4).

As many alternating permutations among n elements begin by rising as by falling. The magnitude of the c_n s does not matter; only the number of them. Let the number of alternating permutations be given by $Z_n = 2A_n$. This quantity can then be computed from

$$2na_n = \sum a_r a_s, \quad (1)$$

where r and s pass through all INTEGRAL numbers such that

$$r + s = n - 1, \quad (2)$$

$a_0 = a_1 = 1$, and

$$A_n = n!a_n. \quad (3)$$

The numbers A_n are sometimes called the EULER ZIGZAG NUMBERS, and the first few are given by 1, 1, 1, 2, 5, 16, 61, 272, \dots (Sloane's A000111). The ODD-numbered A_n s are called EULER NUMBERS, SECANT NUMBERS, or ZIG NUMBERS, and the EVEN-numbered ones are sometimes called TANGENT NUMBERS or ZAG NUMBERS.

Curiously enough, the SECANT and TANGENT MACLAURIN SERIES can be written in terms of the A_n s as

$$\sec x = A_0 + A_2 \frac{x^2}{2!} + A_4 \frac{x^4}{4!} + \dots \quad (4)$$

$$\tan x = A_1 x + A_3 \frac{x^3}{3!} + A_5 \frac{x^5}{5!} + \dots, \quad (5)$$

or combining them,

$$\begin{aligned} \sec x + \tan x \\ = A_0 + A_1 x + A_2 \frac{x^2}{2!} + A_3 \frac{x^3}{3!} + A_4 \frac{x^4}{4!} + A_5 \frac{x^5}{5!} + \dots \end{aligned} \quad (6)$$

see also ENTRINGER NUMBER, EULER NUMBER, EULER ZIGZAG NUMBER, SECANT NUMBER, SEIDEL-ENTRINGER-ARNOLD TRIANGLE, TANGENT NUMBER

References

- André, D. "Developments de $\sec x$ et $\tan x$." *C. R. Acad. Sci. Paris* **88**, 965–967, 1879.
- André, D. "Memoire sur le permutations alternées." *J. Math.* **7**, 167–184, 1881.
- Arnold, V. I. "Bernoulli-Euler Updown Numbers Associated with Function Singularities, Their Combinatorics and Arithmetics." *Duke Math. J.* **63**, 537–555, 1991.
- Arnold, V. I. "Snake Calculus and Combinatorics of Bernoulli, Euler, and Springer Numbers for Coxeter Groups." *Russian Math. Surveys* **47**, 3–45, 1992.
- Bauslaugh, B. and Ruskey, F. "Generating Alternating Permutations Lexicographically." *BIT* **30**, 17–26, 1990.
- Conway, J. H. and Guy, R. K. In *The Book of Numbers*. New York: Springer-Verlag, pp. 110–111, 1996.
- Dörrie, H. "André's Deviation of the Secant and Tangent Series." §16 in *100 Great Problems of Elementary Mathematics: Their History and Solutions*. New York: Dover, pp. 64–69, 1965.
- Honsberger, R. *Mathematical Gems III*. Washington, DC: Math. Assoc. Amer., pp. 69–75, 1985.
- Knuth, D. E. and Buckholtz, T. J. "Computation of Tangent, Euler, and Bernoulli Numbers." *Math. Comput.* **21**, 663–688, 1967.
- Millar, J.; Sloane, N. J. A.; and Young, N. E. "A New Operation on Sequences: The Boustrophedon Transform." *J. Combin. Th. Ser. A* **76**, 44–54, 1996.
- Ruskey, F. "Information of Alternating Permutations." <http://sue.csc.uvic.ca/~cos/inf/perm/Alternating.html>.
- Sloane, N. J. A. Sequence A000111/M1492 in "An On-Line Version of the Encyclopedia of Integer Sequences."

Alternating Series

A SERIES of the form

$$\sum_{k=1}^{\infty} (-1)^{k+1} a_k$$

or

$$\sum_{k=1}^{\infty} (-1)^k a_k.$$

see also SERIES

References

- Arfken, G. "Alternating Series." §5.3 in *Mathematical Methods for Physicists*, 3rd ed. Orlando, FL: Academic Press, pp. 293–294, 1985.
- Bromwich, T. J. Pa and MacRobert, T. M. "Alternating Series." §19 in *An Introduction to the Theory of Infinite Series*, 3rd ed. New York: Chelsea, pp. 55–57, 1991.
- Pinsky, M. A. "Averaging an Alternating Series." *Math. Mag.* **51**, 235–237, 1978.

Alternating Series Test

Also known as the LEIBNIZ CRITERION. An ALTERNATING SERIES CONVERGES if $a_1 \geq a_2 \geq \dots$ and

$$\lim_{k \rightarrow \infty} a_k = 0.$$

see also CONVERGENCE TESTS

Alternative Link

A category of LINK encompassing both ALTERNATING KNOTS and TORUS KNOTS.

see also ALTERNATING KNOT, LINK, TORUS KNOT

References

- Kauffman, L. "Combinatorics and Knot Theory." *Contemp. Math.* **20**, 181–200, 1983.

Altitude

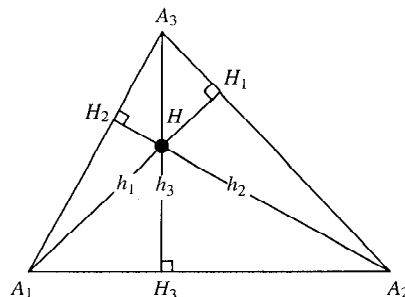

The altitudes of a TRIANGLE are the CEVIANS $A_i H_i$ which are PERPENDICULAR to the LEGS $A_j A_k$ opposite A_i . They have lengths $h_i \equiv \overline{A_i H_i}$ given by

$$h_i = a_{i+1} \sin \alpha_{i+2} = a_{i+2} \sin \alpha_{i+1} \quad (1)$$

$$h_1 = \frac{2\sqrt{s(s-a_1)(s-a_2)(s-a_3)}}{a_1}, \quad (2)$$

where s is the SEMIPERIMETER and $a_i \equiv \overline{A_j A_k}$. Another interesting FORMULA is

$$h_1 h_2 h_3 = 2s\Delta \quad (3)$$

(Johnson 1929, p. 191), where Δ is the AREA of the TRIANGLE. The three altitudes of any TRIANGLE are CONCURRENT at the ORTHOCENTER H . This fundamental fact did not appear anywhere in Euclid's *Elements*.

Other formulas satisfied by the altitude include

$$\frac{1}{h_1} + \frac{1}{h_2} + \frac{1}{h_3} = \frac{1}{r} \quad (4)$$

$$\frac{1}{r_1} = \frac{1}{h_2} + \frac{1}{h_3} - \frac{1}{h_1} \quad (5)$$

$$\frac{1}{r_2} + \frac{1}{r_3} = \frac{1}{r} - \frac{1}{r_1} = \frac{2}{h_1}, \quad (6)$$

where r is the INRADIUS and r_i are the EXRADII (Johnson 1929, p. 189). In addition,

$$HA_1 \cdot HH_1 = HA_2 \cdot HH_2 = HA_3 \cdot HH_3 \quad (7)$$

$$HA_1 \cdot HH_1 = \frac{1}{2}(a_1^2 + a_2^2 + a_3^2) - 4R^2, \quad (8)$$

where R is the CIRCUMRADIUS.

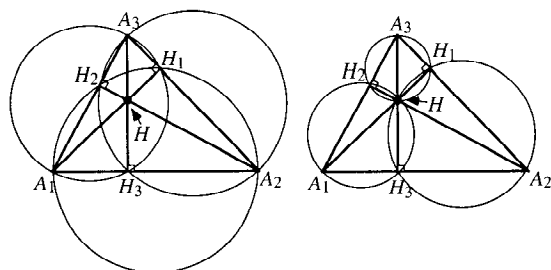

The points A_1, A_3, H_1 , and H_3 (and their permutations with respect to indices) all lie on a CIRCLE, as do the points A_3, H_3, H , and H_1 (and their permutations with respect to indices). TRIANGLES $\Delta A_1 A_2 A_3$ and $\Delta A_1 H_2 H_3$ are inversely similar.

The triangle $H_1 H_2 H_3$ has the minimum PERIMETER of any TRIANGLE inscribed in a given ACUTE TRIANGLE (Johnson 1929, pp. 161–165). The PERIMETER of $\Delta H_1 H_2 H_3$ is $2\Delta/R$ (Johnson 1929, p. 191). Additional properties involving the FEET of the altitudes are given by Johnson (1929, pp. 261–262).

see also CEVIAN, FOOT, ORTHOCENTER, PERPENDICULAR, PERPENDICULAR FOOT

References

- Coxeter, H. S. M. and Greitzer, S. L. *Geometry Revisited*. Washington, DC: Math. Assoc. Amer., pp. 9 and 36–40, 1967.
Johnson, R. A. *Modern Geometry: An Elementary Treatise on the Geometry of the Triangle and the Circle*. Boston, MA: Houghton Mifflin, 1929.

Alysoid

see CATENARY

Ambient Isotopy

An ambient isotopy from an embedding of a MANIFOLD M in N to another is a HOMOTOPY of self DIFFEOMORPHISMS (or ISOMORPHISMS, or piecewise-linear transformations, etc.) of N , starting at the IDENTITY MAP, such that the “last” DIFFEOMORPHISM compounded with the first embedding of M is the second embedding of M . In other words, an ambient isotopy is like an ISOTOPY except that instead of distorting the embedding, the whole ambient SPACE is being stretched and distorted and the embedding is just “coming along for the ride.”

For SMOOTH MANIFOLDS, a MAP is ISOTOPIC IFF it is ambiently isotopic.

For KNOTS, the equivalence of MANIFOLDS under continuous deformation is independent of the embedding SPACE. KNOTS of opposite CHIRALITY have ambient isotopy, but not REGULAR ISOTOPY.

see also ISOTOPY, REGULAR ISOTOPY

References

- Hirsch, M. W. *Differential Topology*. New York: Springer-Verlag, 1988.

Ambiguous

An expression is said to be ambiguous (or poorly defined) if its definition does not assign it a unique interpretation or value. An expression which is *not* ambiguous is said to be WELL-DEFINED.

see also WELL-DEFINED

Ambrose-Kakutani Theorem

For every ergodic FLOW on a nonatomic PROBABILITY SPACE, there is a MEASURABLE SET intersecting almost every orbit in a discrete set.

Amenable Number

A number n which can be built up from INTEGERS a_1, a_2, \dots, a_k by either ADDITION or MULTIPLICATION such that

$$\sum_{i=1}^k a_i = \prod_{i=1}^k a_i = n.$$

The numbers $\{a_1, \dots, a_n\}$ in the SUM are simply a PARTITION of n . The first few amenable numbers are

$$2 + 2 = 2 \times 2 = 4$$

$$1 + 2 + 3 = 1 \times 2 \times 3 = 6$$

$$1 + 1 + 2 + 4 = 1 \times 1 \times 2 \times 4 = 8$$

$$1 + 1 + 2 + 2 + 2 = 1 \times 1 \times 2 \times 2 \times 2 = 8.$$

In fact, all COMPOSITE NUMBERS are amenable.

see also COMPOSITE NUMBER, PARTITION, SUM

References

- Tamvakis, H. “Problem 10454.” *Amer. Math. Monthly* **102**, 463, 1995.

Amicable Numbers

see AMICABLE PAIR, AMICABLE QUADRUPLE, AMICABLE TRIPLE, MULTIAMICABLE NUMBERS

Amicable Pair

An amicable pair consists of two INTEGERS m, n for which the sum of PROPER DIVISORS (the DIVISORS excluding the number itself) of one number equals the other. Amicable pairs are occasionally called FRIENDLY PAIRS, although this nomenclature is to be discouraged since FRIENDLY PAIRS are defined by a different, if related, criterion. Symbolically, amicable pairs satisfy

$$s(m) = n \quad (1)$$

$$s(n) = m, \quad (2)$$

where $s(n)$ is the RESTRICTED DIVISOR FUNCTION or, equivalently,

$$\sigma(m) = \sigma(n) = s(m) + s(n) = m + n, \quad (3)$$

where $\sigma(n)$ is the DIVISOR FUNCTION. The smallest amicable pair is (220, 284) which has factorizations

$$220 = 11 \cdot 5 \cdot 2^2 \quad (4)$$

$$284 = 71 \cdot 2^2 \quad (5)$$

giving RESTRICTED DIVISOR FUNCTIONS

$$\begin{aligned} s(220) &= \sum \{1, 2, 4, 5, 10, 11, 20, 22, 44, 55, 110\} \\ &= 284 \end{aligned} \quad (6)$$

$$\begin{aligned} s(284) &= \sum \{1, 2, 4, 71, 142\} \\ &= 220. \end{aligned} \quad (7)$$

The quantity

$$\sigma(m) = \sigma(n) = s(m) + s(n), \quad (8)$$

in this case, $220 + 284 = 504$, is called the PAIR SUM.

In 1636, Fermat found the pair (17296, 18416) and in 1638, Descartes found (9363584, 9437056). By 1747, Euler had found 30 pairs, a number which he later extended to 60. There were 390 known as of 1946 (Scott 1946). There are a total of 236 amicable pairs below 10^8 (Cohen 1970), 1427 below 10^{10} (te Riele 1986), 3340 less than 10^{11} (Moews and Moews 1993), and less than 2.01×10^{11} (Moews and Moews), and 5001 less than $\approx 3.06 \times 10^{11}$ (Moews and Moews).

The first few amicable pairs are (220, 284), (1184, 1210), (2620, 2924) (5020, 5564), (6232, 6368), (10744, 10856), (12285, 14595), (17296, 18416), (63020, 76084), ... (Sloane's A002025 and A002046). An exhaustive tabulation is maintained by D. Moews.

Let an amicable pair be denoted (m, n) with $m < n$. (m, n) is called a regular amicable pair of type (i, j) if

$$(m, n) = (gM, gN), \quad (9)$$

where $g \equiv \text{GCD}(m, n)$ is the GREATEST COMMON DIVISOR,

$$\text{GCD}(g, M) = \text{GCD}(g, N) = 1, \quad (10)$$

M and N are SQUAREFREE, then the number of PRIME factors of M and N are i and j . Pairs which are not regular are called irregular or exotic (te Riele 1986). There are no regular pairs of type $(1, j)$ for $j \geq 1$. If $m \equiv 0 \pmod{6}$ and

$$n = \sigma(m) - m \quad (11)$$

is EVEN, then (m, n) cannot be an amicable pair (Lee 1969). The minimal and maximal values of m/n found by te Riele (1986) were

$$938304290/1344480478 = 0.697893577... \quad (12)$$

and

$$4000783984/4001351168 = 0.9998582519.... \quad (13)$$

te Riele (1986) also found 37 pairs of amicable pairs having the same PAIR SUM. The first such pair is (609928, 686072) and (643336, 652664), which has the PAIR SUM

$$\sigma(m) = \sigma(n) = m + n = 1,296,000. \quad (14)$$

te Riele (1986) found no amicable n -tuples having the same PAIR SUM for $n > 2$. However, Moews and Moews found a triple in 1993, and te Riele found a quadruple in 1995. In November 1997, a quintuple and sextuple were discovered. The sextuple is (1953433861918, 2216492794082), (1968039941816, 2201886714184), (1981957651366, 2187969004634), (1993501042130, 2176425613870), (2046897812505, 2123028843495), (2068113162038, 2101813493962), all having PAIR SUM 4169926656000. Amazingly, the sextuple is smaller than any known quadruple or quintuple, and is likely smaller than any quintuple.

On October 4, 1997, Mariano Garcia found the largest known amicable pair, each of whose members has 4829 DIGITS. The new pair is

$$N_1 = CM[(P + Q)P^{89} - 1] \quad (15)$$

$$N_2 = CQ[(P - M)P^{89} - 1], \quad (16)$$

where

$$C = 2^{11}P^{89} \quad (17)$$

$$M = 287155430510003638403359267 \quad (18)$$

$$P = 574451143340278962374313859 \quad (19)$$

$$Q = 136272576607912041393307632916794623. \quad (20)$$

$P, Q, (P + Q)P^{89} - 1$, and $(P - M)P^{89} - 1$ are PRIME.

Pomerance (1981) has proved that

$$[\text{amicable numbers} \leq n] < ne^{-[\ln(n)]^{1/3}} \quad (21)$$

for large enough n (Guy 1994). No nonfinite lower bound has been proven.

see also AMICABLE QUADRUPLE, AMICABLE TRIPLE, AUGMENTED AMICABLE PAIR, BREEDER, CROWD, EULER'S RULE, FRIENDLY PAIR, MULTIAMICABLE NUMBERS, PAIR SUM, QUASIAMICABLE PAIR, SOCIABLE NUMBERS, UNITARY AMICABLE PAIR

References

- Alanen, J.; Ore, Ø.; and Stemple, J. "Systematic Computations on Amicable Numbers." *Math. Comput.* **21**, 242–245, 1967.
- Battiato, S. and Borho, W. "Are there Odd Amicable Numbers not Divisible by Three?" *Math. Comput.* **50**, 633–637, 1988.
- Beeler, M.; Gosper, R. W.; and Schroepel, R. Item 62 in *HAKMEM*. Cambridge, MA: MIT Artificial Intelligence Laboratory, Memo AIM-239, Feb. 1972.
- Borho, W. and Hoffmann, H. "Breeding Amicable Numbers in Abundance." *Math. Comput.* **46**, 281–293, 1986.
- Bratley, P.; Lunnon, F.; and McKay, J. "Amicable Numbers and Their Distribution." *Math. Comput.* **24**, 431–432, 1970.
- Cohen, H. "On Amicable and Sociable Numbers." *Math. Comput.* **24**, 423–429, 1970.
- Costello, P. "Amicable Pairs of Euler's First Form." *J. Rec. Math.* **10**, 183–189, 1977–1978.
- Costello, P. "Amicable Pairs of the Form $(i, 1)$." *Math. Comput.* **56**, 859–865, 1991.
- Dickson, L. E. *History of the Theory of Numbers, Vol. 1: Divisibility and Primality*. New York: Chelsea, pp. 38–50, 1952.
- Erdős, P. "On Amicable Numbers." *Publ. Math. Debrecen* **4**, 108–111, 1955–1956.
- Erdős, P. "On Asymptotic Properties of Aliquot Sequences." *Math. Comput.* **30**, 641–645, 1976.
- Gardner, M. "Perfect, Amicable, Sociable." Ch. 12 in *Mathematical Magic Show: More Puzzles, Games, Diversions, Illusions and Other Mathematical Sleight-of-Mind from Scientific American*. New York: Vintage, pp. 160–171, 1978.
- Guy, R. K. "Amicable Numbers." §B4 in *Unsolved Problems in Number Theory, 2nd ed.* New York: Springer-Verlag, pp. 55–59, 1994.
- Lee, E. J. "Amicable Numbers and the Bilinear Diophantine Equation." *Math. Comput.* **22**, 181–197, 1968.
- Lee, E. J. "On Divisibility of the Sums of Even Amicable Pairs." *Math. Comput.* **23**, 545–548, 1969.
- Lee, E. J. and Madachy, J. S. "The History and Discovery of Amicable Numbers, I." *J. Rec. Math.* **5**, 77–93, 1972.
- Lee, E. J. and Madachy, J. S. "The History and Discovery of Amicable Numbers, II." *J. Rec. Math.* **5**, 153–173, 1972.
- Lee, E. J. and Madachy, J. S. "The History and Discovery of Amicable Numbers, III." *J. Rec. Math.* **5**, 231–249, 1972.
- Madachy, J. S. *Madachy's Mathematical Recreations*. New York: Dover, pp. 145 and 155–156, 1979.
- Moews, D. and Moews, P. C. "A Search for Aliquot Cycles and Amicable Pairs." *Math. Comput.* **61**, 935–938, 1993.
- Moews, D. and Moews, P. C. "A List of Amicable Pairs Below 2.01×10^{11} ." Rev. Jan. 8, 1993. <http://xraysgi.ims.uconn.edu:8080/amicable.txt>.
- Moews, D. and Moews, P. C. "A List of the First 5001 Amicable Pairs." Rev. Jan. 7, 1996. <http://xraysgi.ims.uconn.edu:8080/amicable2.txt>.
- Ore, Ø. *Number Theory and Its History*. New York: Dover, pp. 96–100, 1988.
- Pedersen, J. M. "Known Amicable Pairs." <http://www.vejlehs.dk/staff/jmp/aliquot/kwnnap.htm>.
- Pomerance, C. "On the Distribution of Amicable Numbers." *J. reine angew. Math.* **293/294**, 217–222, 1977.
- Pomerance, C. "On the Distribution of Amicable Numbers, II." *J. reine angew. Math.* **325**, 182–188, 1981.
- Scott, E. B. E. "Amicable Numbers." *Scripta Math.* **12**, 61–72, 1946.
- Sloane, N. J. A. Sequences A002025/M5414 and A002046/M5435 in "An On-Line Version of the Encyclopedia of Integer Sequences."
- te Riele, H. J. J. "On Generating New Amicable Pairs from Given Amicable Pairs." *Math. Comput.* **42**, 219–223, 1984.
- te Riele, H. J. J. "Computation of All the Amicable Pairs Below 10^{10} ." *Math. Comput.* **47**, 361–368 and S9–S35, 1986.
- te Riele, H. J. J.; Borho, W.; Battiato, S.; Hoffmann, H.; and Lee, E. J. "Table of Amicable Pairs Between 10^{10} and 10^{52} ." Centrum voor Wiskunde en Informatica, Note NM-N8603. Amsterdam: Stichting Math. Centrum, 1986.
- te Riele, H. J. J. "A New Method for Finding Amicable Pairs." In *Mathematics of Computation 1943–1993: A Half-Century of Computational Mathematics (Vancouver, BC, August 9–13, 1993)* (Ed. W. Gautschi). Providence, RI: Amer. Math. Soc., pp. 577–581, 1994.
- ✱ Weisstein, E. W. "Sociable and Amicable Numbers." <http://www.astro.virginia.edu/~eww6n/math/notebooks/Sociable.m>.

Amicable Quadruple

An amicable quadruple as a QUADRUPLE (a, b, c, d) such that

$$\sigma(a) = \sigma(b) = \sigma(c) = \sigma(d) = a + b + c + d,$$

where $\sigma(n)$ is the DIVISOR FUNCTION.

References

- Guy, R. K. *Unsolved Problems in Number Theory, 2nd ed.* New York: Springer-Verlag, p. 59, 1994.

Amicable Triple

Dickson (1913, 1952) defined an amicable triple to be a TRIPLE of three numbers (l, m, n) such that

$$s(l) = m + n$$

$$s(m) = l + n$$

$$s(n) = l + m,$$

where $s(n)$ is the RESTRICTED DIVISOR FUNCTION (Madachy 1979). Dickson (1913, 1952) found eight sets of amicable triples with two equal numbers, and two sets with distinct numbers. The latter are (123228768, 103340640, 124015008), for which

$$s(12322876) = 103340640 + 124015008 = 227355648$$

$$s(103340640) = 123228768 + 124015008 = 24724377$$

$$s(124015008) = 123228768 + 103340640 = 226569408,$$

and (1945330728960, 2324196638720, 2615631953920), for which

$$\begin{aligned}s(1945330728960) &= 2324196638720 + 2615631953920 \\ &= 4939828592640 \\ s(2324196638720) &= 1945330728960 + 2615631953920 \\ &= 4560962682880 \\ s(2615631953920) &= 1945330728960 + 2324196638720 \\ &= 4269527367680.\end{aligned}$$

A second definition (Guy 1994) defines an amicable triple as a TRIPLE (a, b, c) such that

$$\sigma(a) = \sigma(b) = \sigma(c) = a + b + c,$$

where $\sigma(n)$ is the DIVISOR FUNCTION. An example is $(2^2 3^2 5 \cdot 11, 2^5 3^2 7, 2^2 3^2 71)$.

see also AMICABLE PAIR, AMICABLE QUADRUPLER

References

- Dickson, L. E. "Amicable Number Triples." *Amer. Math. Monthly* **20**, 84–92, 1913.
 Dickson, L. E. *History of the Theory of Numbers, Vol. 1: Divisibility and Primality*. New York: Chelsea, p. 50, 1952.
 Guy, R. K. *Unsolved Problems in Number Theory, 2nd ed.* New York: Springer-Verlag, p. 59, 1994.
 Madachy, J. S. *Madachy's Mathematical Recreations*. New York: Dover, p. 156, 1979.
 Mason, T. E. "On Amicable Numbers and Their Generalizations." *Amer. Math. Monthly* **28**, 195–200, 1921.
 ✱ Weisstein, E. W. "Sociable and Amicable Numbers." <http://www.astro.virginia.edu/~eww6n/math/notebooks/Sociable.m>.

Amortization

The payment of a debt plus accrued INTEREST by regular payments.

Ampersand Curve

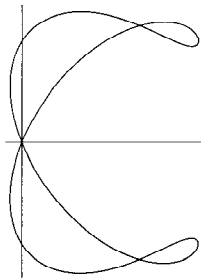

The PLANE CURVE with Cartesian equation

$$(y^2 - x^2)(x - 1)(2x - 3) = 4(x^2 + y^2 - 2x)^2.$$

References

- Cundy, H. and Rollett, A. *Mathematical Models, 3rd ed.* Stradbroke, England: Tarquin Pub., p. 72, 1989.

Amphichiral

An object is amphichiral (also called REFLEXIBLE) if it is superposable with its MIRROR IMAGE (i.e., its image in a plane mirror).

see also AMPHICHIRAL KNOT, CHIRAL, DISYMMETRIC, HANDEDNESS, MIRROR IMAGE

Amphichiral Knot

An amphichiral knot is a KNOT which is capable of being continuously deformed into its own MIRROR IMAGE. The amphichiral knots having ten or fewer crossings are 04_{001} (FIGURE-OF-EIGHT KNOT), 06_{003} , 08_{003} , 08_{009} , 08_{012} , 08_{017} , 08_{018} , 10_{017} , 10_{033} , 10_{037} , 10_{043} , 10_{045} , 10_{079} , 10_{081} , 10_{088} , 10_{099} , 10_{109} , 10_{115} , 10_{118} , and 10_{123} (Jones 1985). The HOMFLY POLYNOMIAL is good at identifying amphichiral knots, but sometimes fails to identify knots which are not. No complete invariant (an invariant which always definitively determines if a KNOT is AMPHICHIRAL) is known.

Let b_+ be the SUM of POSITIVE exponents, and b_- the SUM of NEGATIVE exponents in the BRAID GROUP B_n . If

$$b_+ - 3b_- - n + 1 > 0,$$

then the KNOT corresponding to the closed BRAID b is not amphichiral (Jones 1985).

see also AMPHICHIRAL, BRAID GROUP, INVERTIBLE KNOT, MIRROR IMAGE

References

- Burde, G. and Zieschang, H. *Knots*. Berlin: de Gruyter, pp. 311–319, 1985.
 Jones, V. "A Polynomial Invariant for Knots via von Neumann Algebras." *Bull. Amer. Math. Soc.* **12**, 103–111, 1985.
 Jones, V. "Hecke Algebra Representations of Braid Groups and Link Polynomials." *Ann. Math.* **126**, 335–388, 1987.

Amplitude

The variable ϕ used in ELLIPTIC FUNCTIONS and ELLIPTIC INTEGRALS, which can be defined by

$$\phi = \text{am } u \equiv \int \text{dn } u \, du,$$

where $\text{dn}(u)$ is a JACOBI ELLIPTIC FUNCTION. The term "amplitude" is also used to refer to the maximum offset of a function from its baseline level.

see also ARGUMENT (ELLIPTIC INTEGRAL), CHARACTERISTIC (ELLIPTIC INTEGRAL), DELTA AMPLITUDE, ELLIPTIC FUNCTION, ELLIPTIC INTEGRAL, JACOBI ELLIPTIC FUNCTIONS, MODULAR ANGLE, MODULUS (ELLIPTIC INTEGRAL), NOME, PARAMETER

References

- Abramowitz, M. and Stegun, C. A. (Eds.). *Handbook of Mathematical Functions with Formulas, Graphs, and Mathematical Tables, 9th printing*. New York: Dover, p. 590, 1972.
 Fischer, G. (Ed.). Plate 132 in *Mathematische Modelle/Mathematical Models, Bildband/Photograph Volume*. Braunschweig, Germany: Vieweg, p. 129, 1986.

Anallagmatic Curve

A curve which is invariant under INVERSION. Examples include the CARDIOID, CARTESIAN OVALS, CASSINI OVALS, LIMAÇON, STROPHOID, and MACLAURIN TRISECTRIX.

Anallagmatic Pavement

see HADAMARD MATRIX

Analogy

Inference of the TRUTH of an unknown result obtained by noting its similarity to a result already known to be TRUE. In the hands of a skilled mathematician, analogy can be a very powerful tool for suggesting new and extending old results. However, subtleties can render results obtained by analogy incorrect, so rigorous PROOF is still needed.

see also INDUCTION

Analysis

The study of how continuous mathematical structures (FUNCTIONS) vary around the NEIGHBORHOOD of a point on a SURFACE. Analysis includes CALCULUS, DIFFERENTIAL EQUATIONS, etc.

see also ANALYSIS SITUS, CALCULUS, COMPLEX ANALYSIS, FUNCTIONAL ANALYSIS, NONSTANDARD ANALYSIS, REAL ANALYSIS

References

- Bottazzini, U. *The "Higher Calculus": A History of Real and Complex Analysis from Euler to Weierstraß*. New York: Springer-Verlag, 1986.
- Bressoud, D. M. *A Radical Approach to Real Analysis*. Washington, DC: Math. Assoc. Amer., 1994.
- Ehrlich, P. *Real Numbers, Generalization of the Reals, & Theories of Continua*. Norwell, MA: Kluwer, 1994.
- Hairer, E. and Wanner, G. *Analysis by Its History*. New York: Springer-Verlag, 1996.
- Royden, H. L. *Real Analysis*, 3rd ed. New York: Macmillan, 1988.
- Wheeden, R. L. and Zygmund, A. *Measure and Integral: An Introduction to Real Analysis*. New York: Dekker, 1977.
- Whittaker, E. T. and Watson, G. N. *A Course in Modern Analysis*, 4th ed. Cambridge, England: Cambridge University Press, 1990.

Analysis Situs

An archaic name for TOPOLOGY.

Analytic Continuation

A process of extending the region in which a COMPLEX FUNCTION is defined.

see also MONODROMY THEOREM, PERMANENCE OF ALGEBRAIC FORM, PERMANENCE OF MATHEMATICAL RELATIONS PRINCIPLE

References

- Arfken, G. *Mathematical Methods for Physicists*, 3rd ed. Orlando, FL: Academic Press, pp. 378–380, 1985.
- Morse, P. M. and Feshbach, H. *Methods of Theoretical Physics, Part I*. New York: McGraw-Hill, pp. 389–390 and 392–398, 1953.

Analytic Function

A FUNCTION in the COMPLEX NUMBERS \mathbb{C} is analytic on a region R if it is COMPLEX DIFFERENTIABLE at every point in R . The terms HOLOMORPHIC FUNCTION and REGULAR FUNCTION are sometimes used interchangeably with “analytic function.” If a FUNCTION is analytic, it is infinitely DIFFERENTIABLE.

see also BERGMAN SPACE, COMPLEX DIFFERENTIABLE, DIFFERENTIABLE, PSEUDOANALYTIC FUNCTION, SEMI-ANALYTIC, SUBANALYTIC

References

- Morse, P. M. and Feshbach, H. “Analytic Functions.” §4.2 in *Methods of Theoretical Physics, Part I*. New York: McGraw-Hill, pp. 356–374, 1953.

Analytic Geometry

The study of the GEOMETRY of figures by algebraic representation and manipulation of equations describing their positions, configurations, and separations. Analytic geometry is also called COORDINATE GEOMETRY since the objects are described as n -tuples of points (where $n = 2$ in the PLANE and 3 in SPACE) in some COORDINATE SYSTEM.

see also ARGAND DIAGRAM, CARTESIAN COORDINATES, COMPLEX PLANE, GEOMETRY, PLANE, QUADRANT, SPACE, x -AXIS, y -AXIS, z -AXIS

References

- Courant, R. and Robbins, H. “Remarks on Analytic Geometry.” §2.3 in *What is Mathematics?: An Elementary Approach to Ideas and Methods*, 2nd ed. Oxford, England: Oxford University Press, pp. 72–77, 1996.

Analytic Set

A DEFINABLE SET, also called a SOUSLIN SET.

see also COANALYTIC SET, SOUSLIN SET

Anarboricity

Given a GRAPH G , the anarboricity is the maximum number of line-disjoint nonacyclic SUBGRAPHS whose UNION is G .

see also ARBORICITY

Anchor

An anchor is the BUNDLE MAP ρ from a VECTOR BUNDLE A to the TANGENT BUNDLE TB satisfying

1. $[\rho(X), \rho(Y)] = \rho([X, Y])$ and
2. $[X, \phi Y] = \phi[X, Y] + (\rho(X) \cdot \phi)Y$,

where X and Y are smooth sections of A , ϕ is a smooth function of B , and the bracket is the “Jacobi-Lie bracket” of a VECTOR FIELD.

see also LIE ALGEBROID

References

- Weinstein, A. “Groupoids: Unifying Internal and External Symmetry.” *Not. Amer. Math. Soc.* **43**, 744–752, 1996.

Anchor Ring

An archaic name for the TORUS.

References

- Eisenhart, L. P. *A Treatise on the Differential Geometry of Curves and Surfaces*. New York: Dover, p. 314, 1960.
 Stacey, F. D. *Physics of the Earth*, 2nd ed. New York: Wiley, p. 239, 1977.
 Whittaker, E. T. *A Treatise on the Analytical Dynamics of Particles & Rigid Bodies*, 4th ed. Cambridge, England: Cambridge University Press, p. 21, 1959.

And

A term (PREDICATE) in LOGIC which yields TRUE if one or more conditions are TRUE, and FALSE if any condition is FALSE. A AND B is denoted $A \& B$, $A \wedge B$, or simply AB . The BINARY AND operator has the following TRUTH TABLE:

A	B	$A \wedge B$
F	F	F
F	T	F
T	F	F
T	T	T

A PRODUCT of ANDs (the AND of n conditions) is called a CONJUNCTION, and is denoted

$$\bigwedge_{k=1}^n A_k.$$

Two binary numbers can have the operation AND performed bitwise with 1 representing TRUE and 0 FALSE. Some computer languages denote this operation on A , B , and C as $A \& B \& C$ or $\text{logand}(A, B, C)$.

see also BINARY OPERATOR, INTERSECTION, NOT, OR, PREDICATE, TRUTH TABLE, XOR

Anderson-Darling Statistic

A statistic defined to improve the KOLMOGOROV-SMIRNOV TEST in the TAIL of a distribution.

see also KOLMOGOROV-SMIRNOV TEST, KUIPER STATISTIC

References

- Press, W. H.; Flannery, B. P.; Teukolsky, S. A.; and Vetterling, W. T. *Numerical Recipes in FORTRAN: The Art of Scientific Computing*, 2nd ed. Cambridge, England: Cambridge University Press, p. 621, 1992.

André's Problem

The determination of the number of ALTERNATING PERMUTATIONS having elements $\{1, 2, \dots, n\}$

see also ALTERNATING PERMUTATION

André's Reflection Method

A technique used by André (1887) to provide an elegant solution to the BALLOT PROBLEM (Hilton and Pederson 1991).

References

- André, D. "Solution directe du problème résolu par M. Bertrand." *Comptes Rendus Acad. Sci. Paris* **105**, 436-437, 1887.
 Comtet, L. *Advanced Combinatorics*. Dordrecht, Netherlands: Reidel, p. 22, 1974.
 Hilton, P. and Pederson, J. "Catalan Numbers, Their Generalization, and Their Uses." *Math. Intel.* **13**, 64-75, 1991.
 Vardi, I. *Computational Recreations in Mathematica*. Reading, MA: Addison-Wesley, p. 185, 1991.

Andrew's Sine

The function

$$\psi(z) = \begin{cases} \sin\left(\frac{z}{c}\right) & |z| < c\pi \\ 0, & |z| > c\pi \end{cases}$$

which occurs in estimation theory.

see also SINE

References

- Press, W. H.; Flannery, B. P.; Teukolsky, S. A.; and Vetterling, W. T. *Numerical Recipes in FORTRAN: The Art of Scientific Computing*, 2nd ed. Cambridge, England: Cambridge University Press, p. 697, 1992.

Andrews Cube

see SEMIPERFECT MAGIC CUBE

Andrews-Curtis Link

The LINK of 2-spheres in \mathbb{R}^4 obtained by SPINNING intertwined arcs. The link consists of a knotted 2-sphere and a SPUN TREFOIL KNOT.

see also SPUN KNOT, TREFOIL KNOT

References

- Rolfsen, D. *Knots and Links*. Wilmington, DE: Publish or Perish Press, p. 94, 1976.

Andrews-Schur Identity

$$\begin{aligned} & \sum_{k=0}^n q^{k^2+ak} \begin{bmatrix} 2n-k+a \\ k \end{bmatrix} \\ &= \sum_{k=-\infty}^{\infty} q^{10k^2+(4a-1)k} \begin{bmatrix} 2n+2a+2 \\ n-5k \end{bmatrix} \frac{[10k+2a+2]}{[2n+2a+2]}, \end{aligned} \quad (1)$$

where $[x]$ is a GAUSSIAN POLYNOMIAL. It is a POLYNOMIAL identity for $a = 0, 1$ which implies the ROGERS-RAMANUJAN IDENTITIES by taking $n \rightarrow \infty$ and applying the JACOBI TRIPLE PRODUCT identity. A variant of this equation is

$$\begin{aligned} \sum_{k=-[a/2]}^n q^{k^2+2ak} \begin{bmatrix} n+k+a \\ n-k \end{bmatrix} \\ = \sum_{k=-[(n+2a+2)/5]}^{[n/5]} q^{15k^2+(6a+1)k} \begin{bmatrix} 2n+2a+2 \\ 5-5k \end{bmatrix} \\ \times \frac{[10k+2a+2]}{[2n+2a+2]}, \quad (2) \end{aligned}$$

where the symbol $[x]$ in the SUM limits is the FLOOR FUNCTION (Paule 1994). The RECIPROCAL of the identity is

$$\begin{aligned} \sum_{k=0}^{\infty} \frac{q^{k^2+2ak}}{(q; q)_{2k+a}} \\ = \prod_{j=0}^{\infty} \frac{1}{(1-q^{2j+1})(1-q^{20j+4a+4})(1-q^{20j-4a+16})} \quad (3) \end{aligned}$$

for $a = 0, 1$ (Paule 1994). For $q = 1$, (1) and (2) become

$$\begin{aligned} \sum_{k=-[a/2]}^n \binom{n+k+a}{n-k} \\ = \sum_{k=-[(n+2a+2)/5]}^{[n/5]} \binom{2n+2a+2}{n-5k} \frac{5k+a+1}{n+a+1}. \quad (4) \end{aligned}$$

References

- Andrews, G. E. "A Polynomial Identity which Implies the Rogers-Ramanujan Identities." *Scripta Math.* **28**, 297–305, 1970.
 Paule, P. "Short and Easy Computer Proofs of the Rogers-Ramanujan Identities and of Identities of Similar Type." *Electronic J. Combinatorics* **1**, R10, 1–9, 1994. http://www.combinatorics.org/Volume_1/volume1.html#R10.

Andrica's Conjecture

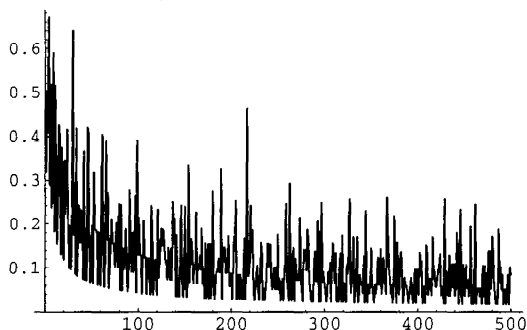

Andrica's conjecture states that, for p_n the n th PRIME NUMBER, the INEQUALITY

$$A_n \equiv \sqrt{p_{n+1}} - \sqrt{p_n} < 1$$

holds, where the discrete function A_n is plotted above. The largest value among the first 1000 PRIMES is for $n = 4$, giving $\sqrt{11} - \sqrt{7} \approx 0.670873$. Since the Andrica function falls asymptotically as n increases so a PRIME GAP of increasing size is needed at large n , it seems likely the CONJECTURE is true. However, it has not yet been proven.

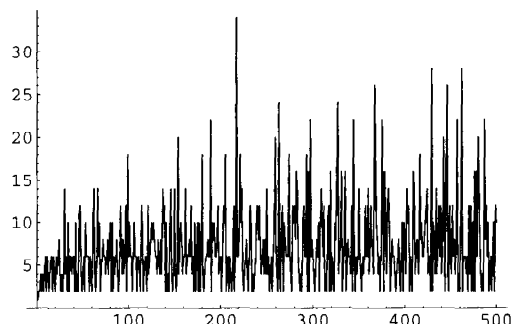

A_n bears a strong resemblance to the PRIME DIFFERENCE FUNCTION, plotted above, the first few values of which are 1, 2, 2, 4, 2, 4, 2, 4, 6, 2, 6, ... (Sloane's A001223).

see also BROCARD'S CONJECTURE, GOOD PRIME, FORTUNATE PRIME, PÓLYA CONJECTURE, PRIME DIFFERENCE FUNCTION, TWIN PEAKS

References

- Golomb, S. W. "Problem E2506: Limits of Differences of Square Roots." *Amer. Math. Monthly* **83**, 60–61, 1976.
 Guy, R. K. *Unsolved Problems in Number Theory*, 2nd ed. New York: Springer-Verlag, p. 21, 1994.
 Rivera, C. "Problems & Puzzles (Conjectures): Andrica's Conjecture." http://www.sci.net.mx/~crivera/ppp/conj_008.htm.
 Sloane, N. J. A. Sequence A001223/M0296 in "An On-Line Version of the Encyclopedia of Integer Sequences."

Anger Function

A generalization of the BESSEL FUNCTION OF THE FIRST KIND defined by

$$\mathcal{J}_\nu(z) \equiv \frac{1}{\pi} \int_0^\pi \cos(\nu\theta - z \sin \theta) d\theta.$$

If ν is an INTEGER n , then $\mathcal{J}_n(z) = J_n(z)$, where $J_n(z)$ is a BESSEL FUNCTION OF THE FIRST KIND. Anger's original function had an upper limit of 2π , but the current NOTATION was standardized by Watson (1966).

see also BESSEL FUNCTION, MODIFIED STRUVE FUNCTION, PARABOLIC CYLINDER FUNCTION, STRUVE FUNCTION, WEBER FUNCTIONS

References

- Abramowitz, M. and Stegun, C. A. (Eds.). "Anger and Weber Functions." §12.3 in *Handbook of Mathematical Functions with Formulas, Graphs, and Mathematical Tables*, 9th printing. New York: Dover, pp. 498–499, 1972.
 Watson, G. N. *A Treatise on the Theory of Bessel Functions*, 2nd ed. Cambridge, England: Cambridge University Press, 1966.

Angle

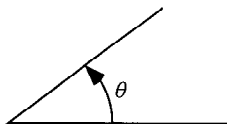

Given two intersecting LINES or LINE SEGMENTS, the amount of ROTATION about the point of intersection (the VERTEX) required to bring one into correspondence with the other is called the angle θ between them. Angles are usually measured in DEGREES (denoted $^\circ$), RADIANs (denoted rad, or without a unit), or sometimes GRADIANS (denoted grad).

One full rotation in these three measures corresponds to 360° , 2π rad, or 400 grad. Half a full ROTATION is called a STRAIGHT ANGLE, and a QUARTER of a full rotation is called a RIGHT ANGLE. An angle less than a RIGHT ANGLE is called an ACUTE ANGLE, and an angle greater than a RIGHT ANGLE is called an OBTUSE ANGLE.

The use of DEGREES to measure angles harks back to the Babylonians, whose SEXAGESIMAL number system was based on the number 60. 360° likely arises from the Babylonian year, which was composed of 360 days (12 months of 30 days each). The DEGREE is further divided into 60 ARC MINUTES, and an ARC MINUTE into 60 ARC SECONDS. A more natural measure of an angle is the RADIAN. It has the property that the ARC LENGTH around a CIRCLE is simply given by the radian angle measure times the CIRCLE RADIUS. The RADIAN is also the most useful angle measure in CALCULUS because the DERIVATIVE of TRIGONOMETRIC functions such as

$$\frac{d}{dx} \sin x = \cos x$$

does not require the insertion of multiplicative constants like $\pi/180$. GRADIANS are sometimes used in surveying (they have the nice property that a RIGHT ANGLE is exactly 100 GRADIANS), but are encountered infrequently, if at all, in mathematics.

The concept of an angle can be generalized from the CIRCLE to the SPHERE. The fraction of a SPHERE subtended by an object is measured in STERADIANS, with the entire SPHERE corresponding to 4π STERADIANS.

A ruled SEMICIRCLE used for measuring and drawing angles is called a PROTRACTOR. A COMPASS can also be used to draw circular ARCS of some angular extent.

see also ACUTE ANGLE, ARC MINUTE, ARC SECOND, CENTRAL ANGLE, COMPLEMENTARY ANGLE, DEGREE, DIHEDRAL ANGLE, DIRECTED ANGLE, EULER ANGLES, GRADIAN, HORN ANGLE, INSCRIBED ANGLE, OBLIQUE ANGLE, OBTUSE ANGLE, PERIGON, PROTRACTOR, RADIAN, RIGHT ANGLE, SOLID ANGLE, STERADIAN, STRAIGHT ANGLE, SUBTEND, SUPPLEMENTARY ANGLE, VERTEX ANGLE

References

Dixon, R. *Mathographics*. New York: Dover, pp. 99–100, 1991.

Angle Bisector

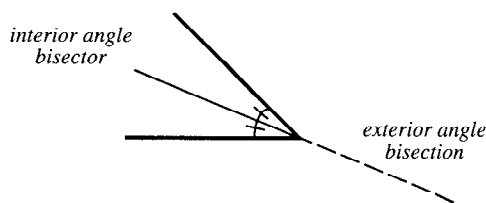

The (interior) bisector of an ANGLE is the LINE or LINE SEGMENT which cuts it into two equal ANGLES on the same "side" as the ANGLE.

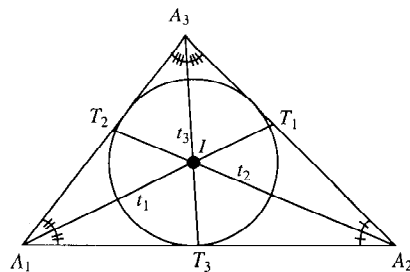

The length of the bisector of ANGLE A_1 in the above TRIANGLE $\Delta A_1 A_2 A_3$ is given by

$$t_1^2 = a_2 a_3 \left[1 - \frac{a_1^2}{(a_2 + a_3)^2} \right],$$

where $t_i \equiv \overline{A_i T_i}$ and $a_i \equiv \overline{A_j A_k}$. The angle bisectors meet at the INCENTER I , which has TRILINEAR COORDINATES 1:1:1.

see also ANGLE BISECTOR THEOREM, CYCLIC QUADRANGLE, EXTERIOR ANGLE BISECTOR, ISODYNAMIC POINTS, ORTHOCENTRIC SYSTEM, STEINER-LEHMUS THEOREM, TRISECTION

References

Coxeter, H. S. M. and Greitzer, S. L. *Geometry Revisited*. Washington, DC: Math. Assoc. Amer., pp. 9–10, 1967.
Dixon, R. *Mathographics*. New York: Dover, p. 19, 1991.
Mackay, J. S. "Properties Concerned with the Angular Bisectors of a Triangle." *Proc. Edinburgh Math. Soc.* **13**, 37–102, 1895.

Angle Bisector Theorem

The ANGLE BISECTOR of an ANGLE in a TRIANGLE divides the opposite side in the same RATIO as the sides adjacent to the ANGLE.

Angle Bracket

The combination of a BRA and KET (bra+ket = bracket) which represents the INNER PRODUCT of two functions or vectors,

$$\langle f|g \rangle = \int f(x)g(x) dx$$

$$\langle \mathbf{v}|\mathbf{w} \rangle = \mathbf{v} \cdot \mathbf{w}.$$

By itself, the BRA is a COVARIANT 1-VECTOR, and the KET is a COVARIANT ONE-FORM. These terms are commonly used in quantum mechanics.

see also BRA, DIFFERENTIAL k -FORM, KET, ONE-FORM

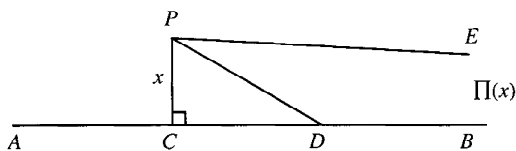
Angle of Parallelism

Given a point P and a LINE AB , draw the PERPENDICULAR through P and call it PC . Let PD be any other line from P which meets CB in D . In a HYPERBOLIC GEOMETRY, as D moves off to infinity along CB , then the line PD approaches the limiting line PE , which is said to be parallel to CB at P . The angle $\angle CPE$ which PE makes with PC is then called the angle of parallelism for perpendicular distance x , and is given by

$$\Pi(x) = 2 \tan^{-1}(e^{-x}).$$

This is known as LOBACHEVSKY'S FORMULA.

see also HYPERBOLIC GEOMETRY, LOBACHEVSKY'S FORMULA

References

Manning, H. P. *Introductory Non-Euclidean Geometry*. New York: Dover, pp. 31–32 and 58, 1963.

Angle Trisection

see TRISECTION

Angular Acceleration

The angular acceleration α is defined as the time DERIVATIVE of the ANGULAR VELOCITY ω ,

$$\alpha \equiv \frac{d\omega}{dt} = \frac{d^2\theta}{dt^2} \hat{z} = \frac{\mathbf{a}}{r}.$$

see also ACCELERATION, ANGULAR DISTANCE, ANGULAR VELOCITY

Angular Defect

The DIFFERENCE between the SUM of face ANGLES A_i at a VERTEX of a POLYHEDRON and 2π ,

$$\delta = 2\pi - \sum_i A_i.$$

see also DESCARTES TOTAL ANGULAR DEFECT, JUMP ANGLE

Angular Distance

The angular distance traveled around a CIRCLE is the number of RADIANS the path subtends,

$$\theta \equiv \frac{\ell}{2\pi r} 2\pi = \frac{\ell}{r}.$$

see also ANGULAR ACCELERATION, ANGULAR VELOCITY

Angular Velocity

The angular velocity ω is the time DERIVATIVE of the ANGULAR DISTANCE θ with direction \hat{z} PERPENDICULAR to the plane of angular motion,

$$\omega \equiv \frac{d\theta}{dt} \hat{z} = \frac{\mathbf{v}}{r}.$$

see also ANGULAR ACCELERATION, ANGULAR DISTANCE

Anharmonic Ratio

see CROSS-RATIO

Anisohedral Tiling

A k -anisohedral tiling is a tiling which permits no n -ISOHEDRAL TILING with $n < k$.

References

Berglund, J. "Is There a k -Anisohedral Tile for $k \geq 5$?" *Amer. Math. Monthly* **100**, 585–588, 1993.

Klee, V. and Wagon, S. *Old and New Unsolved Problems in Plane Geometry and Number Theory*. Washington, DC: Math. Assoc. Amer., 1991.

Annihilator

The term annihilator is used in several different ways in various aspects of mathematics. It is most commonly used to mean the SET of all functions satisfying a given set of conditions which is zero on every member of a given SET.

Annulus

The region in common to two concentric CIRCLES of RADII a and b . The AREA of an annulus is

$$A_{\text{annulus}} = \pi(b^2 - a^2).$$

An interesting identity is as follows. In the figure,

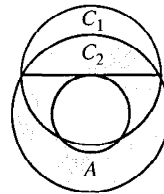

the AREA of the shaded region A is given by

$$A = C_1 + C_2.$$

see also CHORD, CIRCLE, CONCENTRIC CIRCLES, LUNE (PLANE), SPHERICAL SHELL

References

Pappas, T. "The Amazing Trick." *The Joy of Mathematics*. San Carlos, CA: Wide World Publ./Tetra, p. 69, 1989.

Annulus Conjecture

see ANNULUS THEOREM

Annulus Theorem

Let K_1^n and K_2^n be disjoint bicollared knots in \mathbb{R}^{n+1} or S^{n+1} and let U denote the open region between them. Then the closure of U is a closed annulus $S^n \times [0, 1]$. Except for the case $n = 3$, the theorem was proved by Kirby (1969).

References

Kirby, R. C. "Stable Homeomorphisms and the Annulus Conjecture." *Ann. Math.* **89**, 575–582, 1969.
 Rolfsen, D. *Knots and Links*. Wilmington, DE: Publish or Perish Press, p. 38, 1976.

Anomalous Cancellation

The simplification of a FRACTION a/b which gives a correct answer by "canceling" DIGITS of a and b . There are only four such cases for NUMERATOR and DENOMINATORS of two DIGITS in base 10: $64/16 = 4/1 = 4$, $98/49 = 8/4 = 2$, $95/19 = 5/1 = 5$, and $65/26 = 5/2$ (Boas 1979).

The concept of anomalous cancellation can be extended to arbitrary bases. PRIME bases have no solutions, but there is a solution corresponding to each PROPER DIVISOR of a COMPOSITE b . When $b - 1$ is PRIME, this type of solution is the only one. For base 4, for example, the only solution is $32_4/13_4 = 2_4$. Boas gives a table of solutions for $b \leq 39$. The number of solutions is EVEN unless b is an EVEN SQUARE.

b	N	b	N
4	1	26	4
6	2	27	6
8	2	28	10
9	2	30	6
10	4	32	4
12	4	34	6
14	2	35	6
15	6	36	21
16	7	38	2
18	4	39	6
20	4		
21	10		
22	6		
24	6		

see also FRACTION, PRINTER'S ERRORS, REDUCED FRACTION

References

Boas, R. P. "Anomalous Cancellation." Ch. 6 in *Mathematical Plums* (Ed. R. Honsberger). Washington, DC: Math. Assoc. Amer., pp. 113–129, 1979.
 Ogilvy, C. S. and Anderson, J. T. *Excursions in Number Theory*. New York: Dover, pp. 86–87, 1988.

Anomalous Number

see BENFORD'S LAW

Anonymous

A term in SOCIAL CHOICE THEORY meaning invariance of a result under permutation of voters.

see also DUAL VOTING, MONOTONIC VOTING

Anosov Automorphism

A HYPERBOLIC linear map $\mathbb{R}^n \rightarrow \mathbb{R}^n$ with INTEGER entries in the transformation MATRIX and DETERMINANT ± 1 is an ANOSOV DIFFEOMORPHISM of the n -TORUS, called an Anosov automorphism (or HYPERBOLIC AUTOMORPHISM). Here, the term automorphism is used in the GROUP THEORY sense.

Anosov Diffeomorphism

An Anosov diffeomorphism is a C^1 DIFFEOMORPHISM ϕ such that the MANIFOLD M is HYPERBOLIC with respect to ϕ . Very few classes of Anosov diffeomorphisms are known. The best known is ARNOLD'S CAT MAP.

A HYPERBOLIC linear map $\mathbb{R}^n \rightarrow \mathbb{R}^n$ with INTEGER entries in the transformation MATRIX and DETERMINANT ± 1 is an Anosov diffeomorphism of the n -TORUS. Not every MANIFOLD admits an Anosov diffeomorphism. Anosov diffeomorphisms are EXPANSIVE, and there are no Anosov diffeomorphisms on the CIRCLE.

It is conjectured that if $\phi : M \rightarrow M$ is an Anosov diffeomorphism on a COMPACT RIEMANNIAN MANIFOLD and the NONWANDERING SET $\Omega(\phi)$ of ϕ is M , then ϕ is TOPOLOGICALLY CONJUGATE to a FINITE-TO-ONE FACTOR of an ANOSOV AUTOMORPHISM of a NILMANIFOLD. It has been proved that any Anosov diffeomorphism on the n -TORUS is TOPOLOGICALLY CONJUGATE to an ANOSOV AUTOMORPHISM, and also that Anosov diffeomorphisms are C^1 STRUCTURALLY STABLE.

see also ANOSOV AUTOMORPHISM, AXIOM A DIFFEOMORPHISM, DYNAMICAL SYSTEM

References

Anosov, D. V. "Geodesic Flow on Closed Riemannian Manifolds with Negative Curvature." *Proc. Steklov Inst., A. M. S.* 1969.
 Smale, S. "Differentiable Dynamical Systems." *Bull. Amer. Math. Soc.* **73**, 747–817, 1967.

Anosov Flow

A FLOW defined analogously to the ANOSOV DIFFEOMORPHISM, except that instead of splitting the TANGENT BUNDLE into two invariant sub-BUNDLES, they are split into three (one exponentially contracting, one expanding, and one which is 1-dimensional and tangential to the flow direction).

see also DYNAMICAL SYSTEM

Anosov Map

An important example of a ANOSOV DIFFEOMORPHISM.

$$\begin{bmatrix} x_{n+1} \\ y_{n+1} \end{bmatrix} = \begin{bmatrix} 2 & 1 \\ 1 & 1 \end{bmatrix} \begin{bmatrix} x_n \\ y_n \end{bmatrix},$$

where x_{n+1}, y_{n+1} are computed mod 1.

see also ARNOLD'S CAT MAP

ANOVA

"Analysis of Variance." A STATISTICAL TEST for heterogeneity of MEANS by analysis of group VARIANCES. To apply the test, assume random sampling of a variate y with equal VARIANCES, independent errors, and a NORMAL DISTRIBUTION. Let n be the number of REPLICATES (sets of identical observations) within each of K FACTOR LEVELS (treatment groups), and y_{ij} be the j th observation within FACTOR LEVEL i . Also assume that the ANOVA is "balanced" by restricting n to be the same for each FACTOR LEVEL.

Now define the sum of square terms

$$SST \equiv \sum_{i=1}^k \sum_{j=1}^n (y_{ij} - \bar{y})^2 \quad (1)$$

$$= \sum_{i=1}^k \sum_{j=1}^n y_{ij}^2 - \frac{\left(\sum_{i=1}^k \sum_{j=1}^n y_{ij} \right)^2}{Kn} \quad (2)$$

$$SSA \equiv \frac{1}{n} \sum_{i=1}^k \left(\sum_{j=1}^n y_{ij} \right)^2 - \frac{1}{Kn} \left(\sum_{i=1}^k \sum_{j=1}^n y_{ij} \right)^2 \quad (3)$$

$$SSE \equiv \sum_{i=1}^k \sum_{j=1}^n (y_{ij} - \bar{y}_i)^2 \quad (4)$$

$$= SST - SSA, \quad (5)$$

which are the total, treatment, and error sums of squares. Here, \bar{y}_i is the mean of observations within FACTOR LEVEL i , and \bar{y} is the "group" mean (i.e., mean of means). Compute the entries in the following table, obtaining the P -VALUE corresponding to the calculated F -RATIO of the mean squared values

$$F = \frac{MSA}{MSE}. \quad (6)$$

Category	SS	°Freedom	Mean Squared	F -Ratio
treatment	SSA	$K - 1$	$MSA \equiv \frac{SSA}{K-1}$	$\frac{MSA}{MSE}$
error	SSE	$K(n - 1)$	$MSE \equiv \frac{SSE}{K(n-1)}$	
total	SST	$Kn - 1$	$MST \equiv \frac{SST}{Kn-1}$	

If the P -VALUE is small, reject the NULL HYPOTHESIS that all MEANS are the same for the different groups.

see also FACTOR LEVEL, REPLICATE, VARIANCE

Anthropomorphic Polygon

A SIMPLE POLYGON with precisely two EARS and one MOUTH.

References

Toussaint, G. "Anthropomorphic Polygons." *Amer. Math. Monthly* **122**, 31–35, 1991.

Anthyphairetic Ratio

An archaic word for a CONTINUED FRACTION.

References

Fowler, D. H. *The Mathematics of Plato's Academy: A New Reconstruction*. New York: Oxford University Press, 1987.

Antiautomorphism

If a MAP $f : G \rightarrow G'$ from a GROUP G to a GROUP G' satisfies $f(ab) = f(a)f(b)$ for all $a, b \in G$, then f is said to be an antiautomorphism.

see also AUTOMORPHISM

Anticevian Triangle

Given a center $\alpha : \beta : \gamma$, the anticevian triangle is defined as the TRIANGLE with VERTICES $-\alpha : \beta : \gamma$, $\alpha : -\beta : \gamma$, and $\alpha : \beta : -\gamma$. If $A'B'C'$ is the CEVIAN TRIANGLE of X and $A''B''C''$ is an anticevian triangle, then X and A'' are HARMONIC CONJUGATE POINTS with respect to A and A' .

see also CEVIAN TRIANGLE

References

Kimberling, C. "Central Points and Central Lines in the Plane of a Triangle." *Math. Mag.* **67**, 163–187, 1994.

Antichain

Let P be a finite PARTIALLY ORDERED SET. An antichain in P is a set of pairwise incomparable elements (a family of SUBSETS such that, for any two members, one is not the SUBSET of another). The WIDTH of P is the maximum CARDINALITY of an ANTICHAIN in P . For a PARTIAL ORDER, the size of the longest ANTICHAIN is called the WIDTH.

see also CHAIN, DILWORTH'S LEMMA, PARTIALLY ORDERED SET, WIDTH (PARTIAL ORDER)

References

Sloane, N. J. A. Sequence A006826/M2469 in "An On-Line Version of the Encyclopedia of Integer Sequences."

Anticlastic

When the GAUSSIAN CURVATURE K is everywhere NEGATIVE, a SURFACE is called anticlastic and is saddle-shaped. A SURFACE on which K is everywhere POSITIVE is called SYNCLASTIC. A point at which the GAUSSIAN CURVATURE is NEGATIVE is called a HYPERBOLIC POINT.

see also ELLIPTIC POINT, GAUSSIAN QUADRATURE, HYPERBOLIC POINT, PARABOLIC POINT, PLANAR POINT, SYNCLASTIC

Anticommutative

An OPERATOR $*$ for which $a * b = -b * a$ is said to be anticommutative.

see also COMMUTATIVE

Anticommutator

For OPERATORS \tilde{A} and \tilde{B} , the anticommutator is defined by

$$\{\tilde{A}, \tilde{B}\} \equiv \tilde{A}\tilde{B} + \tilde{B}\tilde{A}.$$

see also COMMUTATOR, JORDAN ALGEBRA

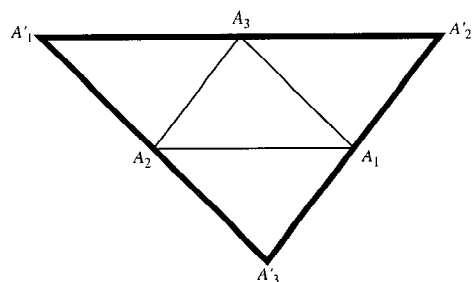
Anticomplementary Triangle

A TRIANGLE $\Delta A'B'C'$ which has a given TRIANGLE ΔABC as its MEDIAL TRIANGLE. The TRILINEAR COORDINATES of the anticomplementary triangle are

$$\begin{aligned} A' &= -a^{-1} : b^{-1} : c^{-1} \\ B' &= a^{-1} : -b^{-1} : c^{-1} \\ C' &= a^{-1} : b^{-1} : -c^{-1}. \end{aligned}$$

see also MEDIAL TRIANGLE

Antiderivative

see INTEGRAL

Antidifferentiation

see INTEGRATION

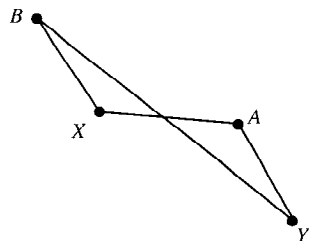
Antigonal Points

Given $\angle AXB + \angle AYB = \pi$ RADIANS in the above figure, then X and Y are said to be antigonal points with respect to A and B .

Antihomography

A CIRCLE-preserving TRANSFORMATION composed of an ODD number of INVERSIONS.

see also HOMOGRAPHY

Antihomologous Points

Two points which are COLLINEAR with respect to a SIMILITUDE CENTER but are not HOMOLOGOUS POINTS. Four interesting theorems from Johnson (1929) follow.

1. Two pairs of antihomologous points form inversely similar triangles with the HOMOTHETIC CENTER.
2. The PRODUCT of distances from a HOMOTHETIC CENTER to two antihomologous points is a constant.
3. Any two pairs of points which are antihomologous with respect to a SIMILITUDE CENTER lie on a CIRCLE.
4. The tangents to two CIRCLES at antihomologous points make equal ANGLES with the LINE through the points.

see also HOMOLOGOUS POINTS, HOMOTHETIC CENTER, SIMILITUDE CENTER

References

Johnson, R. A. *Modern Geometry: An Elementary Treatise on the Geometry of the Triangle and the Circle*. Boston, MA: Houghton Mifflin, pp. 19–21, 1929.

Antilaplacian

The antilaplacian of u with respect to x is a function whose LAPLACIAN with respect to x equals u . The antilaplacian is never unique.

see also LAPLACIAN

Antilinear Operator

An antilinear OPERATOR satisfies the following two properties:

$$\begin{aligned} \tilde{A}[f_1(x) + f_2(x)] &= \tilde{A}f_1(x) + \tilde{A}f_2(x) \\ \tilde{A}cf(x) &= c^* \tilde{A}f(x), \end{aligned}$$

where c^* is the COMPLEX CONJUGATE of c .

see also LINEAR OPERATOR

Antilogarithm

The INVERSE FUNCTION of the LOGARITHM, defined such that

$$\log_b(\text{antilog}_b z) = z = \text{antilog}_b(\log_b z).$$

The antilogarithm in base b of z is therefore b^z .

see also COLOGARITHM, LOGARITHM, POWER

Antimagic Graph

A GRAPH with e EDGES labeled with distinct elements $\{1, 2, \dots, e\}$ so that the SUM of the EDGE labels at each VERTEX differ.

see also MAGIC GRAPH

References

Hartsfield, N. and Ringel, G. *Pearls in Graph Theory: A Comprehensive Introduction*. San Diego, CA: Academic Press, 1990.

Antimagic Square

15	2	12	4
1	14	10	5
8	9	3	16
11	13	6	7

21	18	6	17	4
7	3	13	16	24
5	20	23	11	1
15	8	19	2	25
14	12	9	22	10

10	25	32	13	16	9
22	7	3	24	21	30
20	27	18	26	11	6
1	31	23	33	17	8
19	5	36	12	15	29
34	14	2	4	35	28

14	3	34	21	47	29	22
43	16	13	25	6	26	44
30	48	24	8	12	9	45
10	5	11	38	49	46	19
4	41	37	36	33	27	1
39	17	40	20	7	35	23
31	42	18	32	28	2	15

49	16	50	10	19	28	24	56
42	43	11	15	44	38	55	5
25	21	48	46	9	37	6	63
29	47	8	40	51	30	52	1
45	22	54	23	20	34	2	62
14	59	18	33	41	26	61	13
36	12	58	32	27	64	3	35
17	39	7	57	53	4	60	31

52	19	81	22	29	15	42	31	76
61	10	67	23	54	79	25	33	16
57	9	71	24	38	1	51	47	75
26	78	7	89	66	77	13	27	12
39	21	74	20	37	17	49	55	64
8	65	4	62	50	34	73	41	40
56	68	2	63	14	72	35	44	6
53	30	60	32	36	3	46	43	58
11	70	5	59	48	80	28	45	18

An antimagic square is an $n \times n$ ARRAY of integers from 1 to n^2 such that each row, column, and main diagonal produces a different sum such that these sums form a SEQUENCE of consecutive integers. It is therefore a special case of a HETEROSQUARE.

Antimagic squares of orders one and two are impossible, and it is believed that there are also no antimagic squares of order three. There are 18 families of antimagic squares of order four. Antimagic squares of orders 4–9 are illustrated above (Madachy 1979).

see also HETEROSQUARE, MAGIC SQUARE, TALISMAN SQUARE

References

- Abe, G. "Unsolved Problems on Magic Squares." *Disc. Math.* **127**, 3–13, 1994.
 Madachy, J. S. "Magic and Antimagic Squares." Ch. 4 in *Madachy's Mathematical Recreations*. New York: Dover, pp. 103–113, 1979.
 ✱ Weisstein, E. W. "Magic Squares." <http://www.astro.virginia.edu/~oww6n/math/notebooks/MagicSquares.m>.

Antimorph

A number which can be represented both in the form $x_0^2 - Dy_0^2$ and in the form $Dx_1^2 - y_1^2$. This is only possible when the PELL EQUATION

$$x^2 - Dy^2 = -1$$

is solvable. Then

$$\begin{aligned} x^2 - Dy^2 &= -(x_0 - Dy_0^2)(x_n^2 - Dy_n^2) \\ &= D(x_0y_n - y_0x_n)^2 - (x_0x_n - Dy_0y_n)^2. \end{aligned}$$

see also IDONEAL NUMBER, POLYMORPH

References

- Beiler, A. H. *Recreations in the Theory of Numbers: The Queen of Mathematical Entertains*. New York: Dover, 1964.

Antimorphic Number

see ANTIMORPH

Antinomy

A PARADOX or contradiction.

Antiparallel

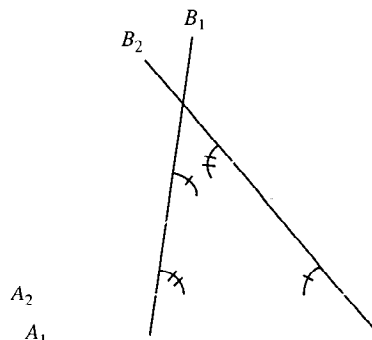

A pair of LINES B_1 , B_2 which make the same ANGLES but in opposite order with two other given LINES A_1 and A_2 , as in the above diagram, are said to be antiparallel to A_1 and A_2 .

see also HYPERPARALLEL, PARALLEL

References

- Phillips, A. W. and Fisher, I. *Elements of Geometry*. New York: American Book Co., 1896.

Antipedal Triangle

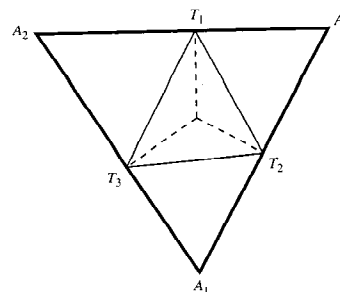

The antipedal triangle A of a given TRIANGLE T is the TRIANGLE of which T is the PEDAL TRIANGLE. For a TRIANGLE with TRILINEAR COORDINATES $\alpha : \beta : \gamma$ and ANGLES A , B , and C , the antipedal triangle has VERTICES with TRILINEAR COORDINATES

$$\begin{aligned} &-(\beta + \alpha \cos C)(\gamma + \alpha \cos B) : (\gamma + \alpha \cos B)(\alpha + \beta \cos C) : \\ &\quad (\beta + \alpha \cos C)(\alpha + \gamma \cos B) \\ &(\gamma + \beta \cos A)(\beta + \alpha \cos C) : -(\gamma + \beta \cos A)(\alpha + \beta \cos C) : \\ &\quad (\alpha + \beta \cos C)(\beta + \gamma \cos A) \\ &(\beta + \gamma \cos A)(\gamma + \alpha \cos B) : (\alpha + \gamma \cos B)(\gamma + \beta \cos A) : \\ &\quad -(\alpha + \gamma \cos B)(\beta + \gamma \cos A). \end{aligned}$$

The ISOGONAL CONJUGATE of the ANTIPEDAL TRIANGLE of a given TRIANGLE is HOMOTHETIC with the original TRIANGLE. Furthermore, the PRODUCT of their AREAS equals the SQUARE of the AREA of the original TRIANGLE (Gallatly 1913).

see also PEDAL TRIANGLE

References

Gallatly, W. *The Modern Geometry of the Triangle*, 2nd ed. London: Hodgson, pp. 56–58, 1913.

Antipersistent Process

A FRACTAL PROCESS for which $H < 1/2$, so $r < 0$.

see also PERSISTENT PROCESS

Antipodal Map

The MAP which takes points on the surface of a SPHERE S^2 to their ANTIPODAL POINTS.

Antipodal Points

Two points are antipodal (i.e., each is the ANTIPODE of the other) if they are diametrically opposite. Examples include endpoints of a LINE SEGMENT, or poles of a SPHERE. Given a point on a SPHERE with LATITUDE δ and LONGITUDE λ , the antipodal point has LATITUDE $-\delta$ and LONGITUDE $\lambda \pm 180^\circ$ (where the sign is taken so that the result is between -180° and $+180^\circ$).

see also ANTIPODE, DIAMETER, GREAT CIRCLE, SPHERE

Antipode

Given a point A , the point B which is the ANTIPODAL POINT of A is said to be the antipode of A .

see also ANTIPODAL POINTS

Antiprism

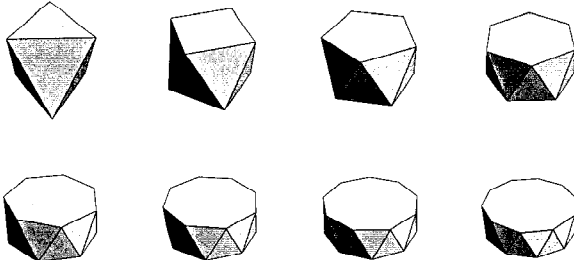

A SEMIREGULAR POLYHEDRON constructed with $2n$ n -gons and $2n$ TRIANGLES. The 3-antiprism is simply the OCTAHEDRON. The DUALS are the TRAPEZOHEDRA. The SURFACE AREA of a n -gonal antiprism is

$$\begin{aligned} S &= 2A_{n\text{-gon}} + 2nA_{\Delta} \\ &= 2 \left[\frac{1}{4}na^2 \cot \left(\frac{\pi}{n} \right) \right] + 2n \left(\frac{1}{4}\sqrt{3}a^2 \right) \\ &= \frac{1}{2}na^2 \left[\cot \left(\frac{\pi}{n} \right) + \sqrt{3} \right]. \end{aligned}$$

see also OCTAHEDRON, PRISM, PRISMOID, TRAPEZOHEDRON

References

Ball, W. W. R. and Coxeter, H. S. M. "Polyhedra." Ch. 5 in *Mathematical Recreations and Essays*, 13th ed. New York: Dover, p. 130, 1987.

Cromwell, P. R. *Polyhedra*. New York: Cambridge University Press, pp. 85–86, 1997.

✱ Weisstein, E. W. "Prisms and Antiprisms." <http://www.astro.virginia.edu/~eww6n/math/notebooks/Prism.m>.

Antiquity

see GEOMETRIC PROBLEMS OF ANTIQUITY

Antisnowflake

see KOCH ANTISNOWFLAKE

Antisquare Number

A number of the form $p^a \cdot A$ is said to be an antisquare if it fails to be a SQUARE NUMBER for the two reasons that a is ODD and A is a nonsquare modulo p .

see also SQUARE NUMBER

Antisymmetric

A quantity which changes SIGN when indices are reversed. For example, $A_{ij} \equiv a_i - a_j$ is antisymmetric since $A_{ij} = -A_{ji}$.

see also ANTISYMMETRIC MATRIX, ANTISYMMETRIC TENSOR, SYMMETRIC

Antisymmetric Matrix

An antisymmetric matrix is a MATRIX which satisfies the identity

$$A = -A^T \quad (1)$$

where A^T is the MATRIX TRANSPOSE. In component notation, this becomes

$$a_{ij} = -a_{ji}. \quad (2)$$

Letting $k = i = j$, the requirement becomes

$$a_{kk} = -a_{kk}, \quad (3)$$

so an antisymmetric matrix must have zeros on its diagonal. The general 3×3 antisymmetric matrix is of the form

$$\begin{bmatrix} 0 & a_{12} & a_{13} \\ -a_{12} & 0 & a_{23} \\ -a_{13} & -a_{23} & 0 \end{bmatrix}. \quad (4)$$

Applying A^{-1} to both sides of the antisymmetry condition gives

$$-A^{-1}A^T = I. \quad (5)$$

Any SQUARE MATRIX can be expressed as the sum of symmetric and antisymmetric parts. Write

$$A = \frac{1}{2}(A + A^T) + \frac{1}{2}(A - A^T). \quad (6)$$

Now

$$A = \begin{bmatrix} a_{11} & a_{12} & \cdots & a_{1n} \\ a_{21} & a_{22} & \cdots & a_{2n} \\ \vdots & \vdots & \ddots & \vdots \\ a_{n1} & a_{n2} & \cdots & a_{nn} \end{bmatrix} \quad (7)$$

$$A^T = \begin{bmatrix} a_{11} & a_{21} & \cdots & a_{n1} \\ a_{12} & a_{22} & \cdots & a_{n2} \\ \vdots & \vdots & \ddots & \vdots \\ a_{1n} & a_{2n} & \cdots & a_{nn} \end{bmatrix}, \quad (8)$$

so

$$A + A^T = \begin{bmatrix} 2a_{11} & a_{12} + a_{21} & \cdots & a_{1n} + a_{n1} \\ a_{12} + a_{21} & 2a_{22} & \cdots & a_{2n} + a_{n2} \\ \vdots & \vdots & \ddots & \vdots \\ a_{1n} + a_{n1} & a_{2n} + a_{n2} & \cdots & 2a_{nn} \end{bmatrix}, \quad (9)$$

which is symmetric, and

$$A - A^T = \begin{bmatrix} 0 & a_{12} - a_{21} & \cdots & a_{1n} - a_{n1} \\ -(a_{12} - a_{21}) & 0 & \cdots & a_{2n} - a_{n2} \\ \vdots & \vdots & \ddots & \vdots \\ -(a_{1n} - a_{n1}) & -(a_{2n} - a_{n2}) & \cdots & 0 \end{bmatrix}, \quad (10)$$

which is antisymmetric.

see also SKEW SYMMETRIC MATRIX, SYMMETRIC MATRIX

Antisymmetric Relation

A RELATION R on a SET S is antisymmetric provided that distinct elements are never both related to one another. In other words xRy and yRx together imply that $x = y$.

Antisymmetric Tensor

An antisymmetric tensor is defined as a TENSOR for which

$$A^{mn} = -A^{nm}. \quad (1)$$

Any TENSOR can be written as a sum of SYMMETRIC and antisymmetric parts as

$$A^{mn} = \frac{1}{2}(A^{mn} + A^{nm}) + \frac{1}{2}(A^{mn} - A^{nm}). \quad (2)$$

The antisymmetric part is sometimes denoted using the special notation

$$A^{[ab]} = \frac{1}{2}(A^{ab} - A^{ba}). \quad (3)$$

For a general TENSOR,

$$A^{[a_1 \cdots a_n]} \equiv \frac{1}{n!} \epsilon_{a_1 \cdots a_n} \sum_{\text{permutations}} A^{a_1 \cdots a_n}, \quad (4)$$

where $\epsilon_{a_1 \cdots a_n}$ is the LEVI-CIVITA SYMBOL, a.k.a. the PERMUTATION SYMBOL.

see also SYMMETRIC TENSOR

Antoine's Horned Sphere

A topological 2-sphere in 3-space whose exterior is not SIMPLY CONNECTED. The outer complement of Antoine's horned sphere is not SIMPLY CONNECTED. Furthermore, the group of the outer complement is not even finitely generated. Antoine's horned sphere is inequivalent to ALEXANDER'S HORNED SPHERE since the complement in \mathbb{R}^3 of the bad points for ALEXANDER'S HORNED SPHERE is SIMPLY CONNECTED.

see also ALEXANDER'S HORNED SPHERE

References

Alexander, J. W. "An Example of a Simply-Connected Surface Bounding a Region which is not Simply-Connected." *Proc. Nat. Acad. Sci.* **10**, 8-10, 1924.
 Rolfsen, D. *Knots and Links*. Wilmington, DE: Publish or Perish Press, pp. 76-79, 1976.

Antoine's Necklace

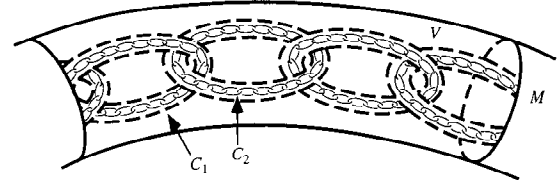

Construct a chain C of $2n$ components in a solid TORUS V . Now form a chain C_1 of $2n$ solid tori in V , where

$$\pi_1(V - C_1) \cong \pi_1(V - C)$$

via inclusion. In each component of C_1 , construct a smaller chain of solid tori embedded in that component. Denote the union of these smaller solid tori C_2 . Continue this process a countable number of times, then the intersection

$$A = \bigcap_{i=1}^{\infty} C_i$$

which is a nonempty compact SUBSET of \mathbb{R}^3 is called Antoine's necklace. Antoine's necklace is HOMEOMORPHIC with the CANTOR SET.

see also ALEXANDER'S HORNED SPHERE, NECKLACE

References

Rolfsen, D. *Knots and Links*. Wilmington, DE: Publish or Perish Press, pp. 73-74, 1976.

Apeirogon

The REGULAR POLYGON essentially equivalent to the CIRCLE having an infinite number of sides and denoted with SCHLÄFLI SYMBOL $\{\infty\}$.

see also CIRCLE, REGULAR POLYGON

References

Coxeter, H. S. M. *Regular Polytopes*, 3rd ed. New York: Dover, 1973.
 Schwartzman, S. *The Words of Mathematics: An Etymological Dictionary of Mathematical Terms Used in English*. Washington, DC: Math. Assoc. Amer., 1994.

Apéry's Constant

N.B. A detailed on-line essay by S. Finch was the starting point for this entry.

Apéry's constant is defined by

$$\zeta(3) = 1.2020569 \dots, \quad (1)$$

(Sloane's A002117) where $\zeta(z)$ is the RIEMANN ZETA FUNCTION. Apéry (1979) proved that $\zeta(3)$ is IRRATIONAL, although it is not known if it is TRANSCENDENTAL. The CONTINUED FRACTION for $\zeta(3)$ is $[1, 4, 1, 18, 1, 1, 1, 4, 1, \dots]$ (Sloane's A013631). The positions at which the numbers 1, 2, ... occur in the continued fraction are 1, 12, 25, 2, 64, 27, 17, 140, 10,

Sums related to $\zeta(3)$ are

$$\zeta(3) = \frac{5}{2} \sum_{n=1}^{\infty} \frac{(-1)^{n-1}}{n^3 \binom{2n}{n}} = \frac{5}{2} \sum_{k=1}^{\infty} \frac{(-1)^{k+1} (k!)^2}{(2k)! k^3} \quad (2)$$

(used by Apéry), and

$$\lambda(3) = \sum_{k=0}^{\infty} \frac{1}{(2k+1)^3} = \frac{7}{8} \zeta(3) \quad (3)$$

$$\sum_{k=0}^{\infty} \frac{1}{(3k+1)^3} = \frac{2\pi^3}{81\sqrt{3}} + \frac{13}{27} \zeta(3) \quad (4)$$

$$\sum_{k=0}^{\infty} \frac{1}{(4k+1)^3} = \frac{\pi^3}{64} + \frac{7}{16} \zeta(3) \quad (5)$$

$$\sum_{k=0}^{\infty} \frac{1}{(6k+1)^3} = \frac{\pi^3}{36\sqrt{3}} + \frac{91}{216} \zeta(3), \quad (6)$$

where $\lambda(z)$ is the DIRICHLET LAMBDA FUNCTION. The above equations are special cases of a general result due to Ramanujan (Berndt 1985). Apéry's proof relied on showing that the sum

$$a(n) \equiv \sum_{k=0}^n \binom{n}{k}^2 \binom{n+k}{k}^2, \quad (7)$$

where $\binom{n}{k}$ is a BINOMIAL COEFFICIENT, satisfies the RECURRENCE RELATION

$$(n+1)^3 a(n+1) - (34n^3 + 51n^2 + 27n + 5) a(n) + n^3 a(n-1) = 0 \quad (8)$$

(van der Poorten 1979, Zeilberger 1991).

Apéry's constant is also given by

$$\zeta(3) = \sum_{n=1}^{\infty} \frac{S_{n,2}}{n!n}, \quad (9)$$

where $S_{n,m}$ is a STIRLING NUMBER OF THE FIRST KIND. This can be rewritten as

$$\sum_{n=1}^{\infty} \frac{H_n}{n^2} = 2\zeta(3), \quad (10)$$

where H_n is the n th HARMONIC NUMBER. Yet another expression for $\zeta(3)$ is

$$\zeta(3) = \frac{1}{2} \sum_{n=1}^{\infty} \frac{1}{n^2} \left(1 + \frac{1}{2} + \dots + \frac{1}{n}\right) \quad (11)$$

(Castellanos 1988).

INTEGRALS for $\zeta(3)$ include

$$\zeta(3) = \frac{1}{2} \int_0^{\infty} \frac{t^2}{e^t - 1} dt \quad (12)$$

$$= \frac{8}{7} \left[\frac{1}{4} \pi^2 \ln 2 + 2 \int_0^{\pi/4} x \ln(\sin x) dx \right]. \quad (13)$$

Gosper (1990) gave

$$\zeta(3) = \frac{1}{4} \sum_{k=1}^{\infty} \frac{30k - 11}{(2k-1)k^3 \binom{2k}{k}^2}. \quad (14)$$

A CONTINUED FRACTION involving Apéry's constant is

$$\frac{6}{\zeta(3)} = 5 - \frac{1^6}{117-} \frac{2^6}{535-} \dots \frac{n^6}{34n^3 + 51n^2 + 27n + 5-} \dots \quad (15)$$

(Apéry 1979, Le Lionnais 1983). Amdeberhan (1996) used WILF-ZEILBERGER PAIRS (F, G) with

$$F(n, k) = \frac{(-1)^k k!^2 (sn - k - 1)!}{(sn + k + 1)! (k + 1)!}, \quad (16)$$

$s = 1$ to obtain

$$\zeta(3) = \frac{5}{2} \sum_{n=1}^{\infty} (-1)^{n-1} \frac{1}{\binom{2n}{n} n^3}. \quad (17)$$

For $s = 2$,

$$\zeta(3) = \frac{1}{4} \sum_{n=1}^{\infty} (-1)^{n-1} \frac{56n^2 - 32 + 5}{(2n-1)^2} \frac{1}{\binom{3n}{n} \binom{2n}{n} n^3} \quad (18)$$

and for $s = 3$,

$$\zeta(3) = \sum_{n=0}^{\infty} \frac{(-1)^n}{72 \binom{4n}{n} \binom{3n}{n}} \times \frac{6120n + 5265n^4 + 13761n^2 + 13878n^3 + 1040}{(4n+1)(4n+3)(n+1)(3n+1)^2(3n+2)^2} \quad (19)$$

(Amdeberhan 1996). The corresponding $G(n, k)$ for $s = 1$ and 2 are

$$G(n, k) = \frac{2(-1)^k k!^2 (n-k)!}{(n+k+1)!(n+1)^2} \quad (20)$$

and

$$G(n, k) = \frac{(-1)^k k!^2 (2n-k)!(3+4n)(4n^2+6n+k+3)}{2(2n+k+2)!(n+1)^2(2n+1)^2}. \quad (21)$$

Gosper (1996) expressed $\zeta(3)$ as the MATRIX PRODUCT

$$\lim_{N \rightarrow \infty} \prod_{n=1}^N M_n = \begin{bmatrix} 0 & \zeta(3) \\ 0 & 1 \end{bmatrix}, \quad (22)$$

where

$$M_n \equiv \begin{bmatrix} \frac{(n+1)^4}{4096(n+\frac{5}{4})^2(n+\frac{7}{4})^2} & \frac{24570n^4 + 64161n^3 + 62152n^2 + 26427n + 4154}{31104(n+\frac{1}{3})(n+\frac{1}{2})(n+\frac{2}{3})} \\ 0 & 1 \end{bmatrix} \quad (23)$$

which gives 12 bits per term. The first few terms are

$$M_1 = \begin{bmatrix} \frac{1}{19600} & \frac{2077}{1728} \\ 0 & 1 \end{bmatrix} \quad (24)$$

$$M_2 = \begin{bmatrix} \frac{1}{9801} & \frac{7561}{4320} \\ 0 & 1 \end{bmatrix} \quad (25)$$

$$M_3 = \begin{bmatrix} \frac{9}{67600} & \frac{50501}{20160} \\ 0 & 1 \end{bmatrix}, \quad (26)$$

which gives

$$\zeta(3) \approx \frac{423203577229}{352066176000} = 1.20205690315732 \dots \quad (27)$$

Given three INTEGERS chosen at random, the probability that no common factor will divide them all is

$$[\zeta(3)]^{-1} \approx 1.202^{-1} = 0.832 \dots \quad (28)$$

B. Haible and T. Papanikolaou computed $\zeta(3)$ to 1,000,000 DIGITS using a WILF-ZEILBERGER PAIR identity with

$$F(n, k) = (-1)^k \frac{n!^6 (2n-k-1)! k!^3}{2(n+k+1)!^2 (2n)!^3}, \quad (29)$$

$s = 1$, and $t = 1$, giving the rapidly converging

$$\zeta(3) = \sum_{n=0}^{\infty} (-1)^n \frac{n!^{10} (205n^2 + 250n + 77)}{64(2n+1)!^5} \quad (30)$$

(Amdeberhan and Zeilberger 1997). The record as of Aug. 1998 was 64 million digits (Plouffe).

see also RIEMANN ZETA FUNCTION, WILF-ZEILBERGER PAIR

References

- Amdeberhan, T. "Faster and Faster Convergent Series for $\zeta(3)$." *Electronic J. Combinatorics* **3**, R13, 1-2, 1996. <http://www.combinatorics.org/Volume3/volume3.html#R13>.
- Amdeberhan, T. and Zeilberger, D. "Hypergeometric Series Acceleration via the WZ Method." *Electronic J. Combinatorics* **4**, No. 2, R3, 1-3, 1997. <http://www.combinatorics.org/Volume4/wilftoc.html#R03>. Also available at <http://www.math.temple.edu/~zeilberg/mamamim/mamamimhtml/accel.html>.
- Apéry, R. "Irrationalité de $\zeta(2)$ et $\zeta(3)$." *Astérisque* **61**, 11-13, 1979.
- Berndt, B. C. *Ramanujan's Notebooks: Part I*. New York: Springer-Verlag, 1985.
- Beukers, F. "A Note on the Irrationality of $\zeta(3)$." *Bull. London Math. Soc.* **11**, 268-272, 1979.
- Borwein, J. M. and Borwein, P. B. *Pi & the AGM: A Study in Analytic Number Theory and Computational Complexity*. New York: Wiley, 1987.
- Castellanos, D. "The Ubiquitous Pi. Part I." *Math. Mag.* **61**, 67-98, 1988.
- Conway, J. H. and Guy, R. K. "The Great Enigma." In *The Book of Numbers*. New York: Springer-Verlag, pp. 261-262, 1996.
- Ewell, J. A. "A New Series Representation for $\zeta(3)$." *Amer. Math. Monthly* **97**, 219-220, 1990.
- Finch, S. "Favorite Mathematical Constants." <http://www.mathsoft.com/asolve/constant/apery/apery.html>.
- Gosper, R. W. "Strip Mining in the Abandoned Orefields of Nineteenth Century Mathematics." In *Computers in Mathematics* (Ed. D. V. Chudnovsky and R. D. Jenks). New York: Marcel Dekker, 1990.
- Haible, B. and Papanikolaou, T. "Fast Multiprecision Evaluation of Series of Rational Numbers." Technical Report TI-97-7. Darmstadt, Germany: Darmstadt University of Technology, Apr. 1997.
- Le Lionnais, F. *Les nombres remarquables*. Paris: Hermann, p. 36, 1983.
- Plouffe, S. "Plouffe's Inverter: Table of Current Records for the Computation of Constants." <http://lacim.uqam.ca/pi/records.html>.
- Plouffe, S. "32,000,279 Digits of Zeta(3)." <http://lacim.uqam.ca/piDATA/Zeta3.txt>.
- Sloane, N. J. A. Sequences A013631 and A002117/M0020 in "An On-Line Version of the Encyclopedia of Integer Sequences."
- van der Poorten, A. "A Proof that Euler Missed... Apéry's Proof of the Irrationality of $\zeta(3)$." *Math. Intel.* **1**, 196-203, 1979.
- Zeilberger, D. "The Method of Creative Telescoping." *J. Symb. Comput.* **11**, 195-204, 1991.

Apoapsis

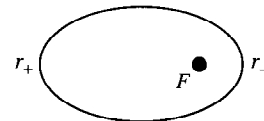

The greatest radial distance of an ELLIPSE as measured from a FOCUS. Taking $v = \pi$ in the equation of an ELLIPSE

$$r = \frac{a(1 - e^2)}{1 + e \cos v}$$

gives the apoapsis distance

$$r_+ = a(1 + e).$$

Apoapsis for an orbit around the Earth is called apogee, and apoapsis for an orbit around the Sun is called aphelion.

see also ECCENTRICITY, ELLIPSE, FOCUS, PERIAPSIS

Apocalypse Number

A number having 666 DIGITS (where 666 is the BEAST NUMBER) is called an apocalypse number. The FIBONACCI NUMBER F_{3184} is an apocalypse number.

see also BEAST NUMBER, LEVIATHAN NUMBER

References

Pickover, C. A. *Keys to Infinity*. New York: Wiley, pp. 97–102, 1995.

Apocalyptic Number

A number of the form 2^n which contains the digits 666 (the BEAST NUMBER) is called an APOCALYPTIC NUMBER. 2^{157} is an apocalyptic number. The first few such powers are 157, 192, 218, 220, ... (Sloane's A007356).

see also APOCALYPSE NUMBER, LEVIATHAN NUMBER

References

Pickover, C. A. *Keys to Infinity*. New York: Wiley, pp. 97–102, 1995.
Sloane, N. J. A. Sequences A007356/M5405 in "An On-Line Version of the Encyclopedia of Integer Sequences."
Sloane, N. J. A. and Plouffe, S. Extended entry in *The Encyclopedia of Integer Sequences*. San Diego: Academic Press, 1995.

Apodization

The application of an APODIZATION FUNCTION.

Apodization Function

A function (also called a TAPERING FUNCTION) used to bring an interferogram smoothly down to zero at the edges of the sampled region. This suppresses sidelobes which would otherwise be produced, but at the expense of widening the lines and therefore decreasing the resolution.

The following are apodization functions for symmetrical (2-sided) interferograms, together with the INSTRUMENT FUNCTIONS (or APPARATUS FUNCTIONS) they produce and a blowup of the INSTRUMENT FUNCTION sidelobes. The INSTRUMENT FUNCTION $I(k)$ corresponding to a given apodization function $A(x)$ can be computed by taking the finite FOURIER COSINE TRANSFORM,

$$I(k) = \int_{-a}^a \cos(2\pi kx) A(x) dx. \quad (1)$$

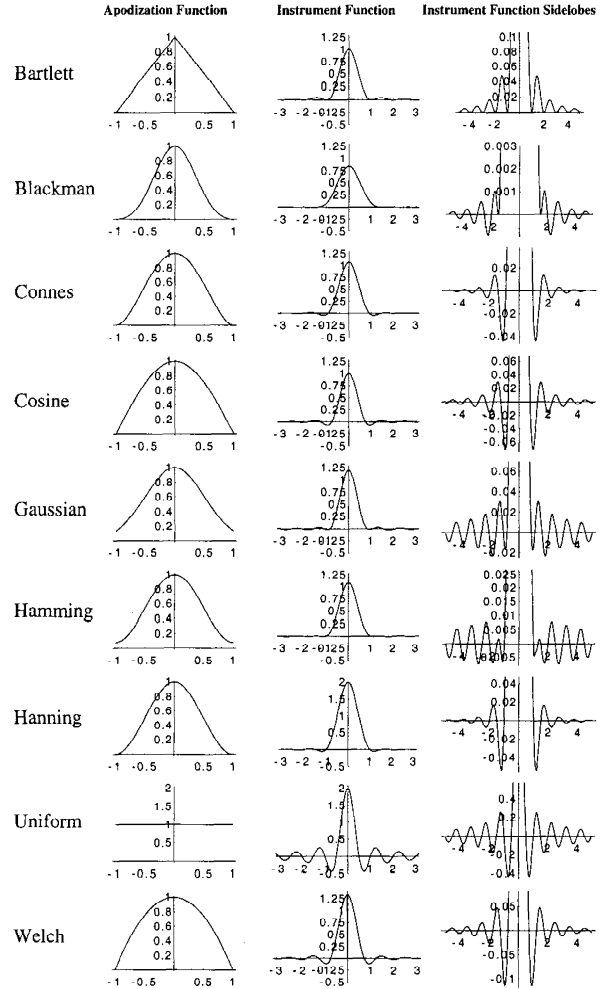

Type	Apodization Function	Instrument Function
Bartlett	$1 - \frac{ x }{a}$	$a \operatorname{sinc}^2(\pi ka)$
Blackman	$B_A(x)$	$B_I(k)$
Connes	$\left(1 - \frac{x^2}{a^2}\right)^2$	$8a\sqrt{2\pi} \frac{J_{5/2}(2\pi ka)}{(2\pi ka)^{5/2}}$
Cosine	$\cos\left(\frac{\pi x}{2a}\right)$	$\frac{4a \cos(2\pi ak)}{\pi(1-16a^2k^2)}$
Gaussian	$e^{-x^2/(2\sigma^2)}$	$2 \int_0^a \cos(2\pi kx) e^{-x^2/(2\sigma^2)} dx$
Hamming	$Hm_A(x)$	$Hm_I(k)$
Hanning	$Hn_A(x)$	$Hn_I(k)$
Uniform	1	$2a \operatorname{sinc}(2\pi ka)$
Welch	$1 - \frac{x^2}{a^2}$	$W_I(k)$

where

$$B_A(x) = 0.42 + 0.5 \cos\left(\frac{\pi x}{a}\right) + 0.08 \cos\left(\frac{2\pi x}{a}\right) \quad (2)$$

$$B_I(k) = \frac{a(0.84 - 0.36a^2k^2 - 2.17 \times 10^{-10}a^4k^4) \operatorname{sinc}(2\pi ak)}{(1 - a^2k^2)(1 - 4a^2k^2)} \quad (3)$$

$$Hm_A(x) = 0.54 + 0.46 \cos\left(\frac{\pi x}{a}\right) \quad (4)$$

$$Hm_I(k) = \frac{a(1.08 - 0.64a^2k^2) \operatorname{sinc}(2\pi ak)}{1 - 4a^2k^2} \quad (5)$$

$$Hn_A(x) = \cos^2 \left(\frac{\pi x}{2a} \right) \quad (6)$$

$$= \frac{1}{2} \left[1 + \cos \left(\frac{\pi x}{a} \right) \right] \quad (7)$$

$$Hn_I(k) = \frac{a \operatorname{sinc}(2\pi ak)}{1 - 4a^2 k^2} \quad (8)$$

$$= a[\operatorname{sinc}(2\pi ka) + \frac{1}{2} \operatorname{sinc}(2\pi ka - \pi) + \frac{1}{2} \operatorname{sinc}(2\pi ka + \pi)] \quad (9)$$

$$W_I(k) = a2\sqrt{2\pi} \frac{J_{3/2}(2\pi ka)}{(2\pi ka)^{3/2}} \quad (10)$$

$$= a \frac{\sin(2\pi ka) - 2\pi ak \cos(2\pi ka)}{2a^3 k^3 \pi^3}. \quad (11)$$

Type	IF FWHM	IF Peak	Peak (-) S.L. Peak	Peak (+) S.L. Peak
Bartlett	1.77179	1	0.00000000	0.0471904
Blackman	2.29880	0.84	-0.00106724	0.00124325
Connes	1.90416	$\frac{16}{15}$	-0.0411049	0.0128926
Cosine	1.63941	$\frac{4}{\pi}$	-0.0708048	0.0292720
Gaussian	—	1	—	—
Hamming	1.81522	1.08	-0.00689132	0.00734934
Hanning	2.00000	1	-0.0267076	0.00843441
Uniform	1.20671	2	-0.217234	0.128375
Welch	1.59044	$\frac{4}{3}$	-0.0861713	0.356044

A general symmetric apodization function $A(x)$ can be written as a FOURIER SERIES

$$A(x) = a_0 + 2 \sum_{n=1}^{\infty} a_n \cos \left(\frac{n\pi x}{b} \right), \quad (12)$$

where the COEFFICIENTS satisfy

$$a_0 + 2 \sum_{n=1}^{\infty} a_n = 1. \quad (13)$$

The corresponding apparatus function is

$$I(t) \equiv \int_{-b}^b A(x) e^{-2\pi i k x} dx = 2b \left\{ a_0 \operatorname{sinc}(2\pi kb) + \sum_{n=1}^{\infty} [\operatorname{sinc}(2\pi kb + n\pi) + \operatorname{sinc}(2\pi kb - n\pi)] \right\}. \quad (14)$$

To obtain an APODIZATION FUNCTION with zero at $ka = 3/4$, use

$$a_0 \operatorname{sinc}(\frac{3}{2}\pi) + a_1 [\operatorname{sinc}(\frac{5}{2}\pi) + \operatorname{sinc}(\frac{1}{2}\pi)] = 0. \quad (15)$$

Plugging in (13),

$$-(1 - 2a_1) \frac{2}{3\pi} + a_1 \left(\frac{2}{5\pi} + \frac{2}{\pi} \right) = -\frac{1}{3}(1 - 2a_1) + a_1 \left(\frac{1}{5} + 1 \right) = 0 \quad (16)$$

$$a_1 \left(\frac{6}{5} + \frac{2}{3} \right) = \frac{1}{3} \quad (17)$$

$$a_1 = \frac{\frac{1}{3}}{\frac{6}{5} + \frac{2}{3}} = \frac{5}{6 \cdot 3 + 2 \cdot 5} = \frac{5}{28} \quad (18)$$

$$a_0 = 1 - 2a_1 = \frac{28 - 2 \cdot 5}{28} = \frac{18}{28} = \frac{9}{14}. \quad (19)$$

The HAMMING FUNCTION is close to the requirement that the APPARATUS FUNCTION goes to 0 at $ka = 5/4$, giving

$$a_0 = \frac{25}{46} \approx 0.5435 \quad (20)$$

$$a_1 = \frac{21}{92} \approx 0.2283. \quad (21)$$

The BLACKMAN FUNCTION is chosen so that the APPARATUS FUNCTION goes to 0 at $ka = 5/4$ and $9/4$, giving

$$a_0 = \frac{3969}{9304} \approx 0.4266 \quad (22)$$

$$a_1 = \frac{1155}{4652} \approx 0.2483 \quad (23)$$

$$a_2 = \frac{715}{18608} \approx 0.0384. \quad (24)$$

see also BARTLETT FUNCTION, BLACKMAN FUNCTION, CONNES FUNCTION, COSINE APODIZATION FUNCTION, FULL WIDTH AT HALF MAXIMUM, GAUSSIAN FUNCTION, HAMMING FUNCTION, HANN FUNCTION, HANNING FUNCTION, MERTZ APODIZATION FUNCTION, PARZEN APODIZATION FUNCTION, UNIFORM APODIZATION FUNCTION, WELCH APODIZATION FUNCTION

References

- Ball, J. A. "The Spectral Resolution in a Correlator System" §4.3.5 in *Methods of Experimental Physics* 12C (Ed. M. L. Meeks). New York: Academic Press, pp. 55-57, 1976.
- Blackman, R. B. and Tukey, J. W. "Particular Pairs of Windows." In *The Measurement of Power Spectra, From the Point of View of Communications Engineering*. New York: Dover, pp. 95-101, 1959.
- Brault, J. W. "Fourier Transform Spectrometry." In *High Resolution in Astronomy: 15th Advanced Course of the Swiss Society of Astronomy and Astrophysics* (Ed. A. Benz, M. Huber, and M. Mayor). Geneva Observatory, Sauverny, Switzerland, pp. 31-32, 1985.
- Harris, F. J. "On the Use of Windows for Harmonic Analysis with the Discrete Fourier Transform." *Proc. IEEE* 66, 51-83, 1978.
- Norton, R. H. and Beer, R. "New Apodizing Functions for Fourier Spectroscopy." *J. Opt. Soc. Amer.* 66, 259-264, 1976.
- Press, W. H.; Flannery, B. P.; Teukolsky, S. A.; and Vetterling, W. T. *Numerical Recipes in FORTRAN: The Art of Scientific Computing*, 2nd ed. Cambridge, England: Cambridge University Press, pp. 547-548, 1992.
- Schnopper, H. W. and Thompson, R. I. "Fourier Spectrometers." In *Methods of Experimental Physics* 12A (Ed. M. L. Meeks). New York: Academic Press, pp. 491-529, 1974.

Apollonius Circles

There are two completely different definitions of the so-called Apollonius circles:

1. The set of all points whose distances from two fixed points are in a constant ratio $1 : \mu$ (Ogilvy 1990).

- The eight CIRCLES (two of which are nondegenerate) which solve APOLLONIUS' PROBLEM for three CIRCLES.

Given one side of a TRIANGLE and the ratio of the lengths of the other two sides, the LOCUS of the third VERTEX is the Apollonius circle (of the first type) whose CENTER is on the extension of the given side. For a given TRIANGLE, there are three circles of Apollonius.

Denote the three Apollonius circles (of the first type) of a TRIANGLE by k_1 , k_2 , and k_3 , and their centers L_1 , L_2 , and L_3 . The center L_1 is the intersection of the side A_2A_3 with the tangent to the CIRCUMCIRCLE at A_1 . L_1 is also the pole of the SYMMEDIAN POINT K with respect to CIRCUMCIRCLE. The centers L_1 , L_2 , and L_3 are COLLINEAR on the POLAR of K with regard to its CIRCUMCIRCLE, called the LEMOINE LINE. The circle of Apollonius k_1 is also the locus of a point whose PEDAL TRIANGLE is ISOSCELES such that $\overline{P_1P_2} = \overline{P_1P_3}$.

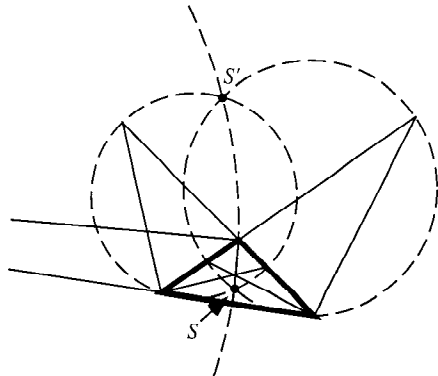

Let U and V be points on the side line BC of a TRIANGLE $\triangle ABC$ met by the interior and exterior ANGLE BISECTORS of ANGLES A . The CIRCLE with DIAMETER UV is called the A -Apollonian circle. Similarly, construct the B - and C -Apollonian circles. The Apollonian circles pass through the VERTICES A , B , and C , and through the two ISODYNAMIC POINTS S and S' . The VERTICES of the D-TRIANGLE lie on the respective Apollonius circles.

see also APOLLONIUS' PROBLEM, APOLLONIUS PURSUIT PROBLEM, CASEY'S THEOREM, HART'S THEOREM, ISODYNAMIC POINTS, SODDY CIRCLES

References

- Johnson, R. A. *Modern Geometry: An Elementary Treatise on the Geometry of the Triangle and the Circle*. Boston, MA: Houghton Mifflin, pp. 40 and 294–299, 1929.
 Ogilvy, C. S. *Excursions in Geometry*. New York: Dover, pp. 14–23, 1990.

Apollonius Point

Consider the EXCIRCLES Γ_A , Γ_B , and Γ_C of a TRIANGLE, and the CIRCLE Γ internally TANGENT to all three. Denote the contact point of Γ and Γ_A by A' , etc. Then

the LINES AA' , BB' , and CC' CONCUR in this point. It has TRIANGLE CENTER FUNCTION

$$\alpha = \sin^2 A \cos^2 \left[\frac{1}{2}(B - C) \right].$$

References

- Kimberling, C. "Apollonius Point." <http://www.evansville.edu/~ck6/tcenters/recent/apollon.html>.
 Kimberling, C. "Central Points and Central Lines in the Plane of a Triangle." *Math. Mag.* **67**, 163–187, 1994.
 Kimberling, C.; Iwata, S.; and Hidetosi, F. "Problem 1091 and Solution." *Cruz Math.* **13**, 128–129 and 217–218, 1987.

Apollonius' Problem

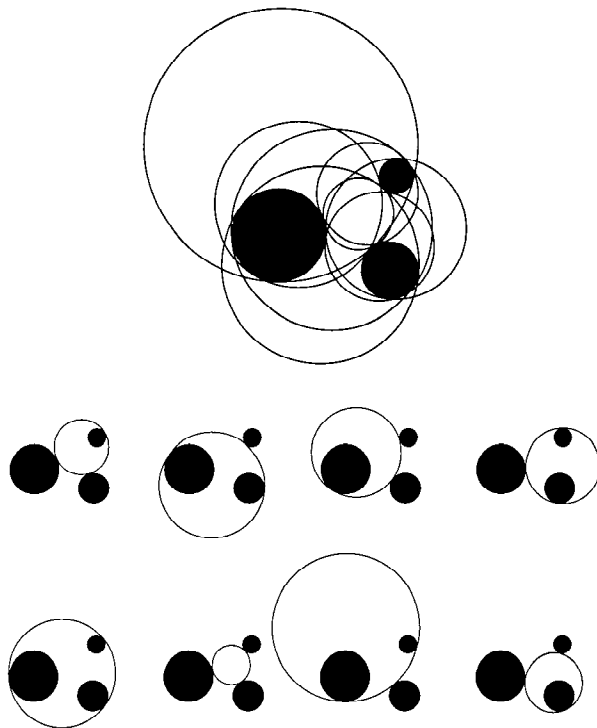

Given three objects, each of which may be a POINT, LINE, or CIRCLE, draw a CIRCLE that is TANGENT to each. There are a total of ten cases. The two easiest involve three points or three LINES, and the hardest involves three CIRCLES. Euclid solved the two easiest cases in his *Elements*, and the others (with the exception of the three CIRCLE problem), appeared in the *Tangencies* of Apollonius which was, however, lost. The general problem is, in principle, solvable by STRAIGHTEDGE and COMPASS alone.

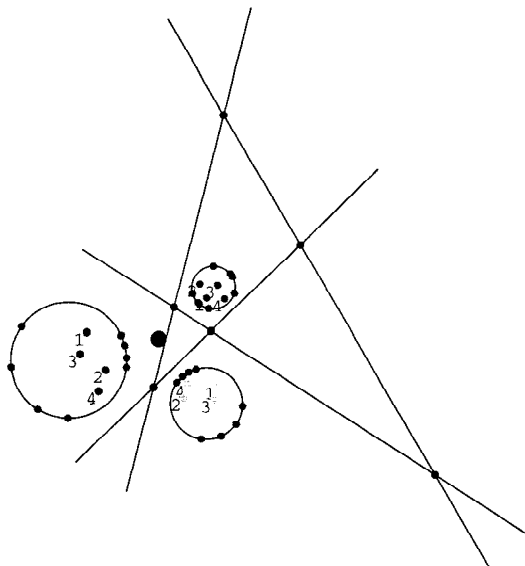

The three-CIRCLE problem was solved by Viète (Boyer 1968), and the solutions are called APOLLONIUS CIRCLES. There are eight total solutions. The simplest solution is obtained by solving the three simultaneous quadratic equations

$$(x - x_1)^2 + (y - y_1)^2 - (r \pm r_1)^2 = 0 \quad (1)$$

$$(x - x_2)^2 + (y - y_2)^2 - (r \pm r_2)^2 = 0 \quad (2)$$

$$(x - x_3)^2 + (y - y_3)^2 - (r \pm r_3)^2 = 0 \quad (3)$$

in the three unknowns x , y , r for the eight triplets of signs (Courant and Robbins 1996). Expanding the equations gives

$$(x^2 + y^2 - r^2) - 2xx_i - 2yy_i \pm 2rr_i + (x_i^2 + y_i^2 - r_i^2) = 0 \quad (4)$$

for $i = 1, 2, 3$. Since the first term is the same for each equation, taking (2) - (1) and (3) - (1) gives

$$ax + by + cr = d \quad (5)$$

$$a'x + b'y + c'r = d', \quad (6)$$

where

$$a = 2(x_1 - x_2) \quad (7)$$

$$b = 2(y_1 - y_2) \quad (8)$$

$$c = \mp 2(r_1 - r_2) \quad (9)$$

$$d = (x_2^2 + y_2^2 - r_2^2) - (x_1^2 + y_1^2 - r_1^2) \quad (10)$$

and similarly for a' , b' , c' and d' (where the 2 subscripts are replaced by 3s). Solving these two simultaneous linear equations gives

$$x = \frac{b'd - bd' - b'cr + bc'r}{ab' - ba'} \quad (11)$$

$$y = \frac{-a'd + ad' + a'cr - ac'r}{ab' - a'b}, \quad (12)$$

which can then be plugged back into the QUADRATIC EQUATION (1) and solved using the QUADRATIC FORMULA.

Perhaps the most elegant solution is due to Gergonne. It proceeds by locating the six HOMOTHETIC CENTERS (three internal and three external) of the three given CIRCLES. These lie three by three on four lines (illustrated above). Determine the POLES of one of these with respect to each of the three CIRCLES and connect the POLES with the RADICAL CENTER of the CIRCLES. If the connectors meet, then the three pairs of intersections are the points of tangency of two of the eight circles (Johnson 1929, Dörrie 1965). To determine which two of the eight Apollonius circles are produced by the three pairs, simply take the two which intersect the original three CIRCLES only in a single point of tangency. The procedure, when repeated, gives the other three pairs of CIRCLES.

If the three CIRCLES are mutually tangent, then the eight solutions collapse to two, known as the SODDY CIRCLES.

see also APOLLONIUS PURSUIT PROBLEM, BEND (CURVATURE), CASEY'S THEOREM, DESCARTES CIRCLE THEOREM, FOUR COINS PROBLEM, HART'S THEOREM, SODDY CIRCLES

References

- Boyer, C. B. *A History of Mathematics*. New York: Wiley, p. 159, 1968.
- Courant, R. and Robbins, H. "Apollonius' Problem." §3.3 in *What is Mathematics?: An Elementary Approach to Ideas and Methods*, 2nd ed. Oxford, England: Oxford University Press, pp. 117 and 125-127, 1996.
- Dörrie, H. "The Tangency Problem of Apollonius." §32 in *100 Great Problems of Elementary Mathematics: Their History and Solutions*. New York: Dover, pp. 154-160, 1965.
- Gauss, C. F. *Werke*, Vol. 4. New York: George Olms, p. 399, 1981.
- Johnson, R. A. *Modern Geometry: An Elementary Treatise on the Geometry of the Triangle and the Circle*. Boston, MA: Houghton Mifflin, pp. 118-121, 1929.
- Ogilvy, C. S. *Excursions in Geometry*. New York: Dover, pp. 48-51, 1990.
- Pappas, T. *The Joy of Mathematics*. San Carlos, CA: Wide World Publ./Tetra, p. 151, 1989.
- Simon, M. *Über die Entwicklung der Elementargeometrie im XIX Jahrhundert*. Berlin, pp. 97-105, 1906.
- ★ Weisstein, E. W. "Plane Geometry." <http://www.astro.virginia.edu/~eww6n/math/notebooks/PlaneGeometry.m>.

Apollonius Pursuit Problem

Given a ship with a known constant direction and speed v , what course should be taken by a chase ship in pursuit (traveling at speed V) in order to intersect the other ship in as short a time as possible? The problem can be solved by finding all points which can be simultaneously reached by both ships, which is an APOLLONIUS CIRCLE with $\mu = v/V$. If the CIRCLE cuts the path of the pursued ship, the intersection is the point towards which

the pursuit ship should steer. If the CIRCLE does not cut the path, then it cannot be caught.

see also APOLLONIUS CIRCLES, APOLLONIUS' PROBLEM, PURSUIT CURVE

References

- Ogilvy, C. S. Solved by M. S. Klamkin. "A Slow Ship Intercepting a Fast Ship." Problem E991. *Amer. Math. Monthly* **59**, 408, 1952.
- Ogilvy, C. S. *Excursions in Geometry*. New York: Dover, p. 17, 1990.
- Steinhaus, H. *Mathematical Snapshots*, 3rd American ed. New York: Oxford University Press, pp. 126–138, 1983.

Apollonius Theorem

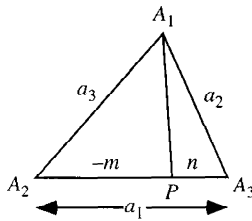

$$ma_2^2 + na_3^2 = (m+n)\overline{A_1P}^2 + m\overline{PA_3}^2 + n\overline{PA_2}^2.$$

Apothem



Given a CIRCLE, the PERPENDICULAR distance a from the MIDPOINT of a CHORD to the CIRCLE's center is called the apothem. It is also equal to the RADIUS r minus the SAGITTA s ,

$$a = r - s.$$

see also CHORD, RADIUS, SAGITTA, SECTOR, SEGMENT

Apparatus Function

see INSTRUMENT FUNCTION

Appell Hypergeometric Function

A formal extension of the HYPERGEOMETRIC FUNCTION to two variables, resulting in four kinds of functions (Appell 1925),

$$F_1(\alpha; \beta, \beta'; \gamma; x, y) = \sum_{m=0}^{\infty} \sum_{n=0}^{\infty} \frac{(\alpha)_{m+n} (\beta)_m (\beta')_n}{m! n! (\gamma)_{m+n}} x^m y^n$$

$$F_2(\alpha; \beta, \beta'; \gamma, \gamma'; x, y) = \sum_{m=0}^{\infty} \sum_{n=0}^{\infty} \frac{(\alpha)_{m+n} (\beta)_m (\beta')_n}{m! n! (\gamma)_m (\gamma')_n} x^m y^n$$

$$F_3(\alpha, \alpha'; \beta, \beta'; \gamma; x, y) = \sum_{m=0}^{\infty} \sum_{n=0}^{\infty} \frac{(\alpha)_m (\alpha')_n (\beta)_m (\beta')_n}{m! n! (\gamma)_{m+n}} x^m y^n$$

$$F_4(\alpha; \beta; \gamma, \gamma'; x, y) = \sum_{m=0}^{\infty} \sum_{n=0}^{\infty} \frac{(\alpha)_{m+n} (\beta)_{m+n}}{m! n! (\gamma)_m (\gamma')_n} x^m y^n.$$

Appell defined the functions in 1880, and Picard showed in 1881 that they may all be expressed by INTEGRALS of the form

$$\int_0^1 u^\alpha (1-u)^\beta (1-xu)^\gamma (1-yu)^\delta du.$$

References

- Appell, P. "Sur les fonctions hypergéométriques de plusieurs variables." In *Mémoire. Sci. Math.* Paris: Gauthier-Villars, 1925.
- Bailey, W. N. *Generalised Hypergeometric Series*. Cambridge, England: Cambridge University Press, p. 73, 1935.
- Iyanaga, S. and Kawada, Y. (Eds.). *Encyclopedic Dictionary of Mathematics*. Cambridge, MA: MIT Press, p. 1461, 1980.

Appell Polynomial

A type of POLYNOMIAL which includes the BERNOULLI POLYNOMIAL, HERMITE POLYNOMIAL, and LAGUERRE POLYNOMIAL as special cases. The series of POLYNOMIALS $\{A_n(z)\}_{n=0}^{\infty}$ is defined by

$$A(t)e^{zt} = \sum_{n=0}^{\infty} A_n(z)t^n,$$

where

$$A(t) = \sum_{k=0}^{\infty} a_k t^k$$

is a formal POWER series with $k = 0, 1, \dots$ and $a_0 \neq 0$.

References

- Hazewinkel, M. (Managing Ed.). *Encyclopaedia of Mathematics: An Updated and Annotated Translation of the Soviet "Mathematical Encyclopaedia."* Dordrecht, Netherlands: Reidel, pp. 209–210, 1988.

Appell Transformation

A HOMOGRAPHIC transformation

$$x_1 = \frac{ax + by + c}{a''x + b''y + c}$$

$$y_1 = \frac{a'x + b'y + c'}{a''x + b''y + c''}$$

with t_1 substituted for t according to

$$k dt_1 = \frac{dt}{(a''x + b''y + c'')^2}.$$

References

- Hazewinkel, M. (Managing Ed.). *Encyclopaedia of Mathematics: An Updated and Annotated Translation of the Soviet "Mathematical Encyclopaedia."* Dordrecht, Netherlands: Reidel, pp. 210–211, 1988.

Apple

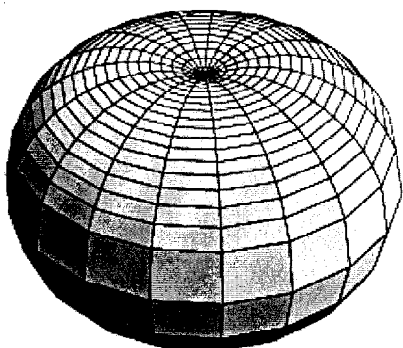

A SURFACE OF REVOLUTION defined by Kepler. It consists of more than half of a circular ARC rotated about an axis passing through the endpoints of the ARC. The equations of the upper and lower boundaries in the x - z PLANE are

$$z_{\pm} = \pm \sqrt{R^2 - (x - r)^2}$$

for $R > r$ and $x \in [-(r + R), r + R]$. It is the outside surface of a SPINDLE TORUS.

see also BUBBLE, LEMON, SPHERE-SPHERE INTERSECTION, SPINDLE TORUS

Approximately Equal

If two quantities A and B are approximately equal, this is written $A \approx B$.

see also DEFINED, EQUAL

Approximation Theory

The mathematical study of how given quantities can be approximated by other (usually simpler) ones under appropriate conditions. Approximation theory also studies the size and properties of the ERROR introduced by approximation. Approximations are often obtained by POWER SERIES expansions in which the higher order terms are dropped.

see also LAGRANGE REMAINDER

References

- Achieser, N. I. and Hyman, C. J. *Theory of Approximation*. New York: Dover, 1993.
- Akheizer, N. I. *Theory of Approximation*. New York: Dover, 1992.
- Cheney, E. W. *Introduction to Approximation Theory*. New York: McGraw-Hill, 1966.
- Golomb, M. *Lectures on Theory of Approximation*. Argonne, IL: Argonne National Laboratory, 1962.
- Jackson, D. *The Theory of Approximation*. New York: Amer. Math. Soc., 1930.
- Natanson, I. P. *Constructive Function Theory, Vol. 1: Uniform Approximation*. New York: Ungar, 1964.
- Petrushev, P. P. and Popov, V. A. *Rational Approximation of Real Functions*. New York: Cambridge University Press, 1987.
- Rivlin, T. J. *An Introduction to the Approximation of Functions*. New York: Dover, 1981.
- Timan, A. F. *Theory of Approximation of Functions of a Real Variable*. New York: Dover, 1994.

Arakelov Theory

A formal mathematical theory which introduces "components at infinity" by defining a new type of divisor class group of INTEGERS of a NUMBER FIELD. The divisor class group is called an "arithmetic surface."

see also ARITHMETIC GEOMETRY

Arbelos

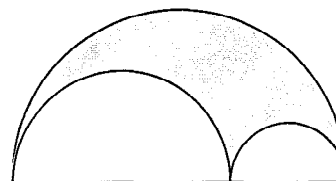

The term "arbelos" means SHOEMAKER'S KNIFE in Greek, and this term is applied to the shaded AREA in the above figure which resembles the blade of a knife used by ancient cobblers (Gardner 1979). Archimedes himself is believed to have been the first mathematician to study the mathematical properties of this figure. The position of the central notch is arbitrary and can be located anywhere along the DIAMETER.

The arbelos satisfies a number of unexpected identities (Gardner 1979).

1. Call the radii of the left and right SEMICIRCLES a and b , respectively, with $a + b \equiv R$. Then the arc length along the bottom of the arbelos is

$$L = 2\pi a + 2\pi b = 2\pi(a + b) = 2\pi R,$$

so the arc lengths along the top and bottom of the arbelos are the same.

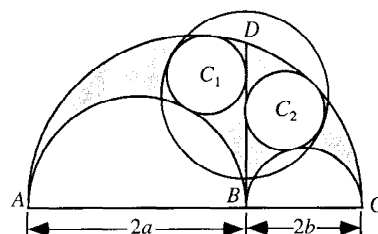

2. Draw the PERPENDICULAR BD from the tangent of the two SEMICIRCLES to the edge of the large CIRCLE. Then the AREA of the arbelos is the same as the AREA of the CIRCLE with DIAMETER BD .
3. The CIRCLES C_1 and C_2 inscribed on each half of BD on the arbelos (called ARCHIMEDES' CIRCLES) each have DIAMETER $(AB)(BC)/(AC)$. Furthermore, the smallest CIRCUMCIRCLE of these two circles has an area equal to that of the arbelos.
4. The line tangent to the semicircles AB and BC contains the point E and F which lie on the lines AD and CD , respectively. Furthermore, BD and EF bisect each other, and the points B , D , E , and F are CONCYCLIC.

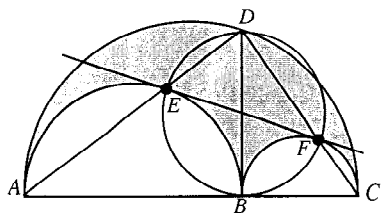

5. In addition to the ARCHIMEDES' CIRCLES C_1 and C_2 in the arbelos figure, there is a third circle C_3 called the BANKOFF CIRCLE which is congruent to these two.

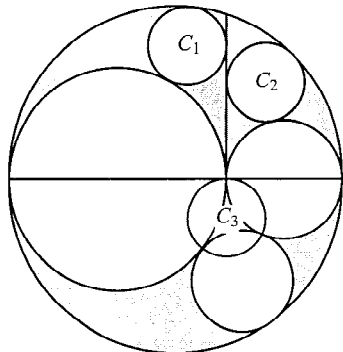

6. Construct a chain of TANGENT CIRCLES starting with the CIRCLE TANGENT to the two small ones and large one. The centers of the CIRCLES lie on an ELLIPSE, and the DIAMETER of the n th CIRCLE C_n is $(1/n)$ th PERPENDICULAR distance to the base of the SEMICIRCLE. This result is most easily proven using INVERSION, but was known to Pappus, who referred to it as an ancient theorem (Hood 1961, Cadwell 1966, Gardner 1979, Bankoff 1981). If $r \equiv AB/AC$, then the radius of the n th circle in the PAPPUS CHAIN is

$$r_n = \frac{(1-r)r}{2[n^2(1-r)^2 + r]}.$$

This general result simplifies to $r_n = 1/(6+n^2)$ for $r = 2/3$ (Gardner 1979). Further special cases when $AC = 1 + AB$ are considered by Gaba (1940).

7. If B divides AC in the GOLDEN RATIO ϕ , then the circles in the chain satisfy a number of other special properties (Bankoff 1955).

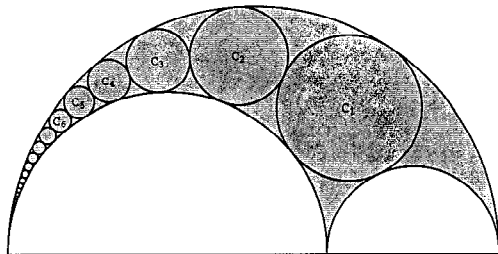

see also ARCHIMEDES' CIRCLES, BANKOFF CIRCLE, COXETER'S LOXODROMIC SEQUENCE OF TANGENT

CIRCLES, GOLDEN RATIO, INVERSION, PAPPUS CHAIN, STEINER CHAIN

References

- Bankoff, L. "The Fibonacci Arbelos." *Scripta Math.* **20**, 218, 1954.
 Bankoff, L. "The Golden Arbelos." *Scripta Math.* **21**, 70-76, 1955.
 Bankoff, L. "Are the Twin Circles of Archimedes Really Twins?" *Math. Mag.* **47**, 214-218, 1974.
 Bankoff, L. "How Did Pappus Do It?" In *The Mathematical Gardner* (Ed. D. Klarner). Boston, MA: Prindle, Weber, and Schmidt, pp. 112-118, 1981.
 Bankoff, L. "The Marvelous Arbelos." In *The Lighter Side of Mathematics* (Ed. R. K. Guy and R. E. Woodrow). Washington, DC: Math. Assoc. Amer., 1994.
 Cadwell, J. H. *Topics in Recreational Mathematics*. Cambridge, England: Cambridge University Press, 1966.
 Gaba, M. G. "On a Generalization of the Arbelos." *Amer. Math. Monthly* **47**, 19-24, 1940.
 Gardner, M. "Mathematical Games: The Diverse Pleasures of Circles that Are Tangent to One Another." *Sci. Amer.* **240**, 18-28, Jan. 1979.
 Heath, T. L. *The Works of Archimedes with the Method of Archimedes*. New York: Dover, 1953.
 Hood, R. T. "A Chain of Circles." *Math. Teacher* **54**, 134-137, 1961.
 Johnson, R. A. *Modern Geometry: An Elementary Treatise on the Geometry of the Triangle and the Circle*. Boston, MA: Houghton Mifflin, pp. 116-117, 1929.
 Ogilvy, C. S. *Excursions in Geometry*. New York: Dover, pp. 54-55, 1990.

Arborescence

A DIGRAPH is called an arborescence if, from a given node x known as the ROOT, there is exactly one elementary path from x to every other node y .

see also ARBORICITY

Arboricity

Given a GRAPH G , the arboricity is the MINIMUM number of line-disjoint acyclic SUBGRAPHS whose UNION is G .

see also ANARBORICITY

Arc

In general, any smooth curve joining two points. In particular, any portion (other than the entire curve) of a CIRCLE or ELLIPSE.

see also APPLE, CIRCLE-CIRCLE INTERSECTION, FIVE DISKS PROBLEM, FLOWER OF LIFE, LEMON, LENS, PIECEWISE CIRCULAR CURVE, REULEAUX POLYGON, REULEAUX TRIANGLE, SALINON, SEED OF LIFE, TRIANGLE ARCS, VENN DIAGRAM, YIN-YANG

Arc Length

Arc length is defined as the length along a curve,

$$s \equiv \int_a^b |d\ell|. \quad (1)$$

Defining the line element $ds^2 \equiv |d\ell|^2$, parameterizing the curve in terms of a parameter t , and noting that

ds/dt is simply the magnitude of the VELOCITY with which the end of the RADIUS VECTOR \mathbf{r} moves gives

$$s = \int_a^b ds = \int_a^b \frac{ds}{dt} dt = \int_a^b |\mathbf{r}'(t)| dt. \quad (2)$$

In POLAR COORDINATES,

$$d\ell = \hat{\mathbf{r}} dr + r\hat{\theta} d\theta = \left(\frac{dr}{d\theta} \hat{\mathbf{r}} + r\hat{\theta} \right) d\theta, \quad (3)$$

so

$$ds = |d\ell| = \sqrt{r^2 + \left(\frac{dr}{d\theta} \right)^2} d\theta \quad (4)$$

$$s = \int_{\theta_1}^{\theta_2} |d\ell| = \int_{\theta_1}^{\theta_2} \sqrt{r^2 + \left(\frac{dr}{d\theta} \right)^2} d\theta. \quad (5)$$

In CARTESIAN COORDINATES,

$$d\ell = x\hat{\mathbf{x}} + y\hat{\mathbf{y}} \quad (6)$$

$$ds = \sqrt{dx^2 + dy^2} = \sqrt{\left(\frac{dy}{dx} \right)^2 + 1} dx. \quad (7)$$

Therefore, if the curve is written

$$\mathbf{r}(x) = x\hat{\mathbf{x}} + f(x)\hat{\mathbf{y}}, \quad (8)$$

then

$$s = \int_a^b \sqrt{1 + f'^2(x)} dx. \quad (9)$$

If the curve is instead written

$$\mathbf{r}(t) = x(t)\hat{\mathbf{x}} + y(t)\hat{\mathbf{y}}, \quad (10)$$

then

$$s = \int_a^b \sqrt{x'^2(t) + y'^2(t)} dt. \quad (11)$$

Or, in three dimensions,

$$\mathbf{r}(t) = x(t)\hat{\mathbf{x}} + y(t)\hat{\mathbf{y}} + z(t)\hat{\mathbf{z}}, \quad (12)$$

so

$$s = \int_a^b \sqrt{x'^2(t) + y'^2(t) + z'^2(t)} dt. \quad (13)$$

see also CURVATURE, GEODESIC, NORMAL VECTOR, RADIUS OF CURVATURE, RADIUS OF TORSION, SPEED, SURFACE AREA, TANGENTIAL ANGLE, TANGENT VECTOR, TORSION (DIFFERENTIAL GEOMETRY), VELOCITY

Arc Minute

A unit of ANGULAR measure equal to 60 ARC SECONDS, or 1/60 of a DEGREE. The arc minute is denoted ' (not to be confused with the symbol for feet).

Arc Second

A unit of ANGULAR measure equal to 1/60 of an ARC MINUTE, or 1/3600 of a DEGREE. The arc second is denoted '' (not to be confused with the symbol for inches).

Arccosecant

see INVERSE COSECANT

Arccosine

see INVERSE COSINE

Arccotangent

see INVERSE COTANGENT

Arch

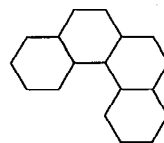

A 4-POLYHEX.

References

Gardner, M. *Mathematical Magic Show: More Puzzles, Games, Diversions, Illusions and Other Mathematical Sleight-of-Mind from Scientific American*. New York: Vintage, p. 147, 1978.

Archimedes Algorithm

Successive application of ARCHIMEDES' RECURRENCE FORMULA gives the Archimedes algorithm, which can be used to provide successive approximations to π (PI). The algorithm is also called the BORCHARDT-PFAFF ALGORITHM. Archimedes obtained the first rigorous approximation of π by CIRCUMSCRIBING and INSCRIBING $n = 6 \cdot 2^k$ -gons on a CIRCLE. From ARCHIMEDES' RECURRENCE FORMULA, the CIRCUMFERENCES a and b of the circumscribed and inscribed POLYGONS are

$$a(n) = 2n \tan\left(\frac{\pi}{n}\right) \quad (1)$$

$$b(n) = 2n \sin\left(\frac{\pi}{n}\right), \quad (2)$$

where

$$b(n) < C = 2\pi r = 2\pi \cdot 1 = 2\pi < a(n). \quad (3)$$

For a HEXAGON, $n = 6$ and

$$a_0 \equiv a(6) = 4\sqrt{3} \quad (4)$$

$$b_0 \equiv b(6) = 6, \quad (5)$$

where $a_k \equiv a(6 \cdot 2^k)$. The first iteration of ARCHIMEDES' RECURRENCE FORMULA then gives

$$a_1 = \frac{2 \cdot 6 \cdot 4\sqrt{3}}{6 + 4\sqrt{3}} = \frac{24\sqrt{3}}{3 + 2\sqrt{3}} = 24(2 - \sqrt{3}) \quad (6)$$

$$\begin{aligned} b_1 &= \sqrt{24(2 - \sqrt{3}) \cdot 6} = 12\sqrt{2 - \sqrt{3}} \\ &= 6(\sqrt{6} - \sqrt{2}). \end{aligned} \quad (7)$$

Additional iterations do not have simple closed forms, but the numerical approximations for $k = 0, 1, 2, 3, 4$ (corresponding to 6-, 12-, 24-, 48-, and 96-gons) are

$$3.00000 < \pi < 3.46410 \quad (8)$$

$$3.10583 < \pi < 3.21539 \quad (9)$$

$$3.13263 < \pi < 3.15966 \quad (10)$$

$$3.13935 < \pi < 3.14609 \quad (11)$$

$$3.14103 < \pi < 3.14271. \quad (12)$$

By taking $k = 4$ (a 96-gon) and using strict inequalities to convert irrational bounds to rational bounds at each step, Archimedes obtained the slightly looser result

$$\frac{223}{71} = 3.14084\dots < \pi < \frac{22}{7} = 3.14285\dots \quad (13)$$

References

- Miel, G. "Of Calculations Past and Present: The Archimedean Algorithm." *Amer. Math. Monthly* **90**, 17–35, 1983.
 Phillips, G. M. "Archimedes in the Complex Plane." *Amer. Math. Monthly* **91**, 108–114, 1984.

Archimedes' Axiom

An AXIOM actually attributed to Eudoxus (Boyer 1968) which states that

$$a/b = c/d$$

IFF the appropriate one of following conditions is satisfied for INTEGERS m and n :

1. If $ma < nb$, then $mc < nd$.
2. If $ma = nb$, then $mc = nd$.
3. If $ma > nb$, then $mc > nd$.

ARCHIMEDES' LEMMA is sometimes also known as Archimedes' axiom.

References

- Boyer, C. B. *A History of Mathematics*. New York: Wiley, p. 99, 1968.

Archimedes' Cattle Problem

Also called the BOVINUM PROBLEMA. It is stated as follows: "The sun god had a herd of cattle consisting of bulls and cows, one part of which was white, a second black, a third spotted, and a fourth brown. Among the bulls, the number of white ones was one half plus one third the number of the black greater than the brown; the number of the black, one quarter plus one fifth the number of the spotted greater than the brown; the number of the spotted, one sixth and one seventh the number of the white greater than the brown. Among the cows, the number of white ones was one third plus one quarter of the total black cattle; the number of the black, one quarter plus one fifth the total of the spotted cattle; the number of spotted, one fifth plus one sixth the total of the brown cattle; the number of the brown, one sixth plus one seventh the total of the white cattle. What was the composition of the herd?"

Solution consists of solving the simultaneous DIOPHANTINE EQUATIONS in INTEGERS W, X, Y, Z (the number of white, black, spotted, and brown bulls) and w, x, y, z (the number of white, black, spotted, and brown cows),

$$W = \frac{5}{6}X + Z \quad (1)$$

$$X = \frac{9}{20}Y + Z \quad (2)$$

$$Y = \frac{13}{42}W + Z \quad (3)$$

$$w = \frac{7}{12}(X + x) \quad (4)$$

$$x = \frac{9}{20}(Y + y) \quad (5)$$

$$y = \frac{11}{30}(Z + z) \quad (6)$$

$$z = \frac{13}{42}(W + w). \quad (7)$$

The smallest solution in INTEGERS is

$$W = 10,366,482 \quad (8)$$

$$X = 7,460,514 \quad (9)$$

$$Y = 7,358,060 \quad (10)$$

$$Z = 4,149,387 \quad (11)$$

$$w = 7,206,360 \quad (12)$$

$$x = 4,893,246 \quad (13)$$

$$y = 3,515,820 \quad (14)$$

$$z = 5,439,213. \quad (15)$$

A more complicated version of the problem requires that $W+X$ be a SQUARE NUMBER and $Y+Z$ a TRIANGULAR NUMBER. The solution to this PROBLEM are numbers with 206544 or 206545 digits.

References

- Amthor, A. and Krumbiegel B. "Das Problema bovinum des Archimedes." *Z. Math. Phys.* **25**, 121–171, 1880.
 Archibald, R. C. "Cattle Problem of Archimedes." *Amer. Math. Monthly* **25**, 411–414, 1918.
 Beiler, A. H. *Recreations in the Theory of Numbers: The Queen of Mathematics Entertains*. New York: Dover, pp. 249–252, 1966.
 Bell, A. H. "Solution to the Celebrated Indeterminate Equation $x^2 - ny^2 = 1$." *Amer. Math. Monthly* **1**, 240, 1894.
 Bell, A. H. "Cattle Problem." By Archimedes 251 BC." *Amer. Math. Monthly* **2**, 140, 1895.
 Bell, A. H. "Cattle Problem of Archimedes." *Math. Mag.* **1**, 163, 1882–1884.
 Calkins, K. G. "Archimedes' Problema Bovinum." <http://www.andrews.edu/~calkins/cattle.html>.
 Dörrie, H. "Archimedes' Problema Bovinum." §1 in *100 Great Problems of Elementary Mathematics: Their History and Solutions*. New York: Dover, pp. 3–7, 1965.
 Grosjean, C. C. and de Meyer, H. E. "A New Contribution to the Mathematical Study of the Cattle-Problem of Archimedes." In *Constantin Carathéodory: An International Tribute, Vols. 1 and 2* (Ed. T. M. Rassias). Teaneck, NJ: World Scientific, pp. 404–453, 1991.
 Merriman, M. "Cattle Problem of Archimedes." *Pop. Sci. Monthly* **67**, 660, 1905.
 Rorres, C. "The Cattle Problem." <http://www.mcs.drexel.edu/~rorres/Archimedes/Cattle/Statement.html>.
 Vardi, I. "Archimedes' Cattle Problem." *Amer. Math. Monthly* **105**, 305–319, 1998.

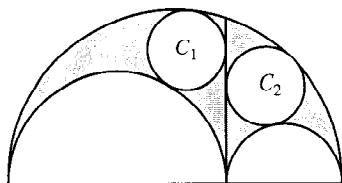
Archimedes' Circles

Draw the PERPENDICULAR LINE from the intersection of the two small SEMICIRCLES in the ARBELOS. The two CIRCLES C_1 and C_2 TANGENT to this line, the large SEMICIRCLE, and each of the two SEMICIRCLES are then congruent and known as Archimedes' circles.

see also ARBELOS, BANKOFF CIRCLE, SEMICIRCLE

Archimedes' Constant

see π

Archimedes' Hat-Box Theorem

Enclose a SPHERE in a CYLINDER and slice PERPENDICULARLY to the CYLINDER's axis. Then the SURFACE AREA of the of SPHERE slice is equal to the SURFACE AREA of the CYLINDER slice.

Archimedes' Lemma

Also known as the continuity axiom, this LEMMA survives in the writings of Eudoxus (Boyer 1968). It states that, given two magnitudes having a ratio, one can find a multiple of either which will exceed the other. This principle was the basis for the EXHAUSTION METHOD which Archimedes invented to solve problems of AREA and VOLUME.

see also CONTINUITY AXIOMS

References

Boyer, C. B. *A History of Mathematics*. New York: Wiley, p. 100, 1968.

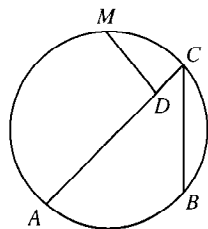
Archimedes' Midpoint Theorem

Let M be the MIDPOINT of the ARC AMB . Pick C at random and pick D such that $MD \perp AC$ (where \perp denotes PERPENDICULAR). Then

$$AD = DC + BC.$$

see also MIDPOINT

References

Honsberger, R. *More Mathematical Morsels*. Washington, DC: Math. Assoc. Amer., pp. 31–32, 1991.

Archimedes' Postulate

see ARCHIMEDES' LEMMA

Archimedes' Problem

Cut a SPHERE by a PLANE in such a way that the VOLUMES of the SPHERICAL SEGMENTS have a given RATIO.

see also SPHERICAL SEGMENT

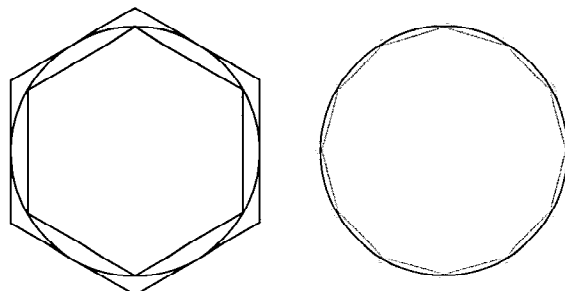
Archimedes' Recurrence Formula

Let a_n and b_n be the PERIMETERS of the CIRCUMSCRIBED and INSCRIBED n -gon and a_{2n} and b_{2n} the PERIMETERS of the CIRCUMSCRIBED and INSCRIBED $2n$ -gon. Then

$$a_{2n} = \frac{2a_nb_n}{a_n + b_n} \quad (1)$$

$$b_{2n} = \sqrt{a_{2n}b_n}. \quad (2)$$

The first follows from the fact that side lengths of the POLYGONS on a CIRCLE of RADIUS $r = 1$ are

$$s_R = 2 \tan \left(\frac{\pi}{n} \right) \quad (3)$$

$$s_r = 2 \sin \left(\frac{\pi}{n} \right), \quad (4)$$

so

$$a_n = 2n \tan \left(\frac{\pi}{n} \right) \quad (5)$$

$$b_n = 2n \sin \left(\frac{\pi}{n} \right). \quad (6)$$

But

$$\begin{aligned} \frac{2a_nb_n}{a_n + b_n} &= \frac{2 \cdot 2n \tan \left(\frac{\pi}{n} \right) \cdot 2n \sin \left(\frac{\pi}{n} \right)}{2n \tan \left(\frac{\pi}{n} \right) + 2n \sin \left(\frac{\pi}{n} \right)} \\ &= 4n \frac{\tan \left(\frac{\pi}{n} \right) \sin \left(\frac{\pi}{n} \right)}{\tan \left(\frac{\pi}{n} \right) + \sin \left(\frac{\pi}{n} \right)}. \end{aligned} \quad (7)$$

Using the identity

$$\tan \left(\frac{1}{2}x \right) = \frac{\tan x \sin x}{\tan x + \sin x} \quad (8)$$

then gives

$$\frac{2a_nb_n}{a_n + b_n} = 4n \tan \left(\frac{\pi}{2n} \right) = a_{2n}. \quad (9)$$

The second follows from

$$\sqrt{a_{2n}b_n} = \sqrt{4n \tan\left(\frac{\pi}{2n}\right) \cdot 2n \sin\left(\frac{\pi}{n}\right)} \quad (10)$$

Using the identity

$$\sin x = 2 \sin\left(\frac{1}{2}x\right) \cos\left(\frac{1}{2}x\right) \quad (11)$$

gives

$$\begin{aligned} \sqrt{a_{2n}b_n} &= 2n \sqrt{2 \tan\left(\frac{\pi}{2n}\right) \cdot 2 \sin\left(\frac{\pi}{2n}\right) \cos\left(\frac{\pi}{2n}\right)} \\ &= 4n \sqrt{\sin^2\left(\frac{\pi}{2n}\right)} = 4n \sin\left(\frac{\pi}{2n}\right) = b_{2n}. \end{aligned} \quad (12)$$

Successive application gives the ARCHIMEDES ALGORITHM, which can be used to provide successive approximations to $\text{PI}(\pi)$.

see also ARCHIMEDES ALGORITHM, PI

References

Dörrie, H. *100 Great Problems of Elementary Mathematics: Their History and Solutions*. New York: Dover, p. 186, 1965.

Archimedean Solid

The Archimedean solids are convex POLYHEDRA which have a similar arrangement of nonintersecting regular plane CONVEX POLYGONS of two or more different types about each VERTEX with all sides the same length. The Archimedean solids are distinguished from the PRISMS, ANTIPRISMS, and ELONGATED SQUARE GYROBICUPOLA by their symmetry group: the Archimedean solids have a spherical symmetry, while the others have “dihedral” symmetry. The Archimedean solids are sometimes also referred to as the SEMIREGULAR POLYHEDRA.

Pugh (1976, p. 25) points out the Archimedean solids are all capable of being circumscribed by a regular TETRAHEDRON so that four of their faces lie on the faces of that TETRAHEDRON. A method of constructing the Archimedean solids using a method known as “expansion” has been enumerated by Stott (Stott 1910; Ball and Coxeter 1987, pp. 139–140).

Let the cyclic sequence $S = (p_1, p_2, \dots, p_q)$ represent the degrees of the faces surrounding a vertex (i.e., S is a list of the number of sides of all polygons surrounding any vertex). Then the definition of an Archimedean solid requires that the sequence must be the same for each vertex to within ROTATION and REFLECTION. Walsh (1972) demonstrates that S represents the degrees of the faces surrounding each vertex of a semiregular convex polyhedron or TESSELLATION of the plane IFF

1. $q \geq 3$ and every member of S is at least 3,
2. $\sum_{i=1}^q \frac{1}{p_i} \geq \frac{1}{2}q - 1$, with equality in the case of a plane TESSELLATION, and

3. for every ODD NUMBER $p \in S$, S contains a subsequence (b, p, b) .

Condition (1) simply says that the figure consists of two or more polygons, each having at least three sides. Condition (2) requires that the sum of interior angles at a vertex must be equal to a full rotation for the figure to lie in the plane, and less than a full rotation for a solid figure to be convex.

The usual way of enumerating the semiregular polyhedra is to eliminate solutions of conditions (1) and (2) using several classes of arguments and then prove that the solutions left are, in fact, semiregular (Kepler 1864, pp. 116–126; Catalan 1865, pp. 25–32; Coxeter 1940, p. 394; Coxeter *et al.* 1954; Lines 1965, pp. 202–203; Walsh 1972). The following table gives all possible regular and semiregular polyhedra and tessellations. In the table, ‘P’ denotes PLATONIC SOLID, ‘M’ denotes a PRISM or ANTIPRISM, ‘A’ denotes an Archimedean solid, and ‘T’ a plane tessellation.

S	Fg.	Solid	Schläfli
(3, 3, 3)	P	tetrahedron	{3, 3}
(3, 4, 4)	M	triangular prism	t{2, 3}
(3, 6, 6)	A	truncated tetrahedron	t{3, 3}
(3, 8, 8)	A	truncated cube	t{4, 3}
(3, 10, 10)	A	truncated dodecahedron	t{5, 3}
(3, 12, 12)	T	(plane tessellation)	t{6, 3}
(4, 4, n)	M	n -gonal Prism	t{2, n }
(4, 4, 4)	P	cube	{4, 3}
(4, 6, 6)	A	truncated octahedron	t{3, 4}
(4, 6, 8)	A	great rhombicuboct.	t{ $\frac{3}{4}$, 3}
(4, 6, 10)	A	great rhombicosidodec.	t{ $\frac{3}{5}$, 3}
(4, 6, 12)	T	(plane tessellation)	t{ $\frac{3}{6}$, 3}
(4, 8, 8)	T	(plane tessellation)	t{4, 4}
(5, 5, 5)	P	dodecahedron	{5, 3}
(5, 6, 6)	A	truncated icosahedron	t{3, 5}
(6, 6, 6)	T	(plane tessellation)	{6, 3}
(3, 3, 3, n)	M	n -gonal antiprism	s{ $\frac{2}{n}$, 3}
(3, 3, 3, 3)	P	octahedron	{3, 4}
(3, 4, 3, 4)	A	cuboctahedron	{ $\frac{3}{4}$, 3}
(3, 5, 3, 5)	A	icosidodecahedron	{ $\frac{5}{3}$, 3}
(3, 6, 3, 6)	T	(plane tessellation)	{ $\frac{3}{6}$, 3}
(3, 4, 4, 4)	A	small rhombicuboct.	r{ $\frac{3}{4}$, 3}
(3, 4, 5, 4)	A	small rhombicosidodec.	r{ $\frac{3}{5}$, 3}
(3, 4, 6, 4)	T	(plane tessellation)	r{ $\frac{3}{6}$, 3}
(4, 4, 4, 4)	T	(plane tessellation)	{4, 4}
(3, 3, 3, 3, 3)	P	icosahedron	{3, 5}
(3, 3, 3, 3, 4)	A	snub cube	s{ $\frac{3}{4}$, 3}
(3, 3, 3, 3, 5)	A	snub dodecahedron	s{ $\frac{3}{5}$, 3}
(3, 3, 3, 3, 6)	T	(plane tessellation)	s{ $\frac{3}{6}$, 3}
(3, 3, 3, 4, 4)	T	(plane tessellation)	—
(3, 3, 4, 3, 4)	T	(plane tessellation)	s{ $\frac{4}{4}$, 3}
(3, 3, 3, 3, 3)	T	(plane tessellation)	{3, 6}

As shown in the above table, there are exactly 13 Archimedean solids (Walsh 1972, Ball and Coxeter 1987).

They are called the CUBOCTAHEDRON, GREAT RHOMBICOSIDODECAHEDRON, GREAT RHOMBICUBOCTAHEDRON, ICOSIDODECAHEDRON, SMALL RHOMBICOSIDODECAHEDRON, SMALL RHOMBICUBOCTAHEDRON, SNUB CUBE, SNUB DODECAHEDRON, TRUNCATED CUBE, TRUNCATED DODECAHEDRON, TRUNCATED ICOSAHE-
DRON (soccer ball), TRUNCATED OCTAHEDRON, and TRUNCATED TETRAHEDRON. The Archimedean solids satisfy

$$(2\pi - \sigma)V = 4\pi,$$

where σ is the sum of face-angles at a vertex and V is the number of vertices (Steinitz and Rademacher 1934, Ball and Coxeter 1987).

Here are the Archimedean solids shown in alphabetical order (left to right, then continuing to the next row).

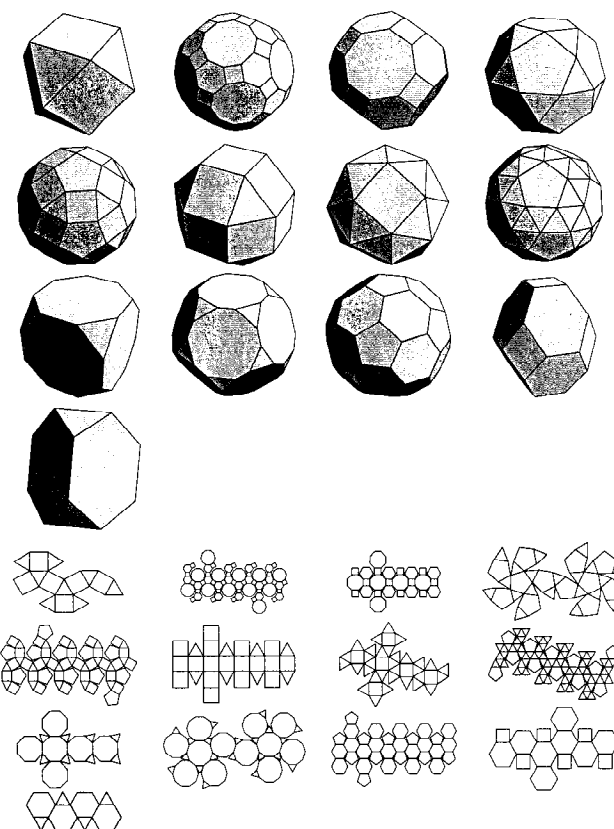

The following table lists the symbol and number of faces of each type for the Archimedean solids (Wenninger 1989, p. 9).

Solid	Schläfli	Wythoff	C&R
cuboctahedron	$\left\{ \begin{smallmatrix} 3 \\ 4 \end{smallmatrix} \right\}$	2 3 4	$(3.4)^2$
great rhombicosidodecahedron	$t \left\{ \begin{smallmatrix} 3 \\ 3 \end{smallmatrix} \right\}$	2 3 5	
great rhombicuboctahedron	$t \left\{ \begin{smallmatrix} 3 \\ 3 \end{smallmatrix} \right\}$	2 3 4	
icosidodecahedron	$\left\{ \begin{smallmatrix} 3 \\ 5 \end{smallmatrix} \right\}$	2 3 5	$(3.5)^2$
small rhombicosidodecahedron	$t \left\{ \begin{smallmatrix} 3 \\ 5 \end{smallmatrix} \right\}$	3 5 2	3.4.5.4
small rhombicuboctahedron	$r \left\{ \begin{smallmatrix} 3 \\ 4 \end{smallmatrix} \right\}$	3 4 2	3.4^3
snub cube	$s \left\{ \begin{smallmatrix} 3 \\ 4 \end{smallmatrix} \right\}$	2 3 4	$3^4.4$
snub dodecahedron	$s \left\{ \begin{smallmatrix} 3 \\ 5 \end{smallmatrix} \right\}$	2 3 5	$3^4.5$
truncated cube	$t\{4, 3\}$	2 3 4	3.8^2
truncated dodecahedron	$t\{5, 3\}$	2 3 5	3.10^2
truncated icosahedron	$t\{3, 5\}$	2 5 3	5.6^2
truncated octahedron	$t\{3, 4\}$	2 4 3	4.6^2
truncated tetrahedron	$t\{3, 3\}$	2 3 3	3.6^2

Solid	v	e	f_3	f_4	f_5	f_6	f_8	f_{10}
cuboctahedron	12	24	8	6				
great rhombicos.	120	180		30		20		12
great rhombicub.	48	72		12		8	6	
icosidodecahedron	30	60	20		12			
small rhombicos.	60	120	20	30	12			
small rhombicub.	24	48	8	18				
snub cube	24	60	32	6				
snub dodecahedron	60	150	80		12			
trunc. cube	24	36	8				6	
trunc. dodec.	60	90	20					12
trunc. icosahedron	60	90			12	20		
trunc. octahedron	24	36		6		8		
trunc. tetrahedron	12	18	4			4		

Let r be the INRADIUS, ρ the MIDRADIUS, and R the CIRCUMRADIUS. The following tables give the analytic and numerical values of r , ρ , and R for the Archimedean solids with EDGES of unit length.

Solid	r
cuboctahedron	$\frac{3}{4}$
great rhombicosidodecahedron	$\frac{1}{241}(105 + 6\sqrt{5})\sqrt{31 + 12\sqrt{5}}$
great rhombicuboctahedron	$\frac{3}{97}(14 + \sqrt{2})\sqrt{13 + 6\sqrt{2}}$
icosidodecahedron	$\frac{1}{8}(5 + 3\sqrt{5})$
small rhombicosidodecahedron	$\frac{1}{41}(15 + 2\sqrt{5})\sqrt{11 + 4\sqrt{5}}$
small rhombicuboctahedron	$\frac{1}{17}(6 + \sqrt{2})\sqrt{5 + 2\sqrt{2}}$
snub cube	*
snub dodecahedron	*
truncated cube	$\frac{1}{17}(5 + 2\sqrt{2})\sqrt{7 + 4\sqrt{2}}$
truncated dodecahedron	$\frac{5}{488}(17\sqrt{2} + 3\sqrt{10})\sqrt{37 + 15\sqrt{5}}$
truncated icosahedron	$\frac{9}{672}(21 + \sqrt{5})\sqrt{58 + 18\sqrt{5}}$
truncated octahedron	$\frac{9}{20}\sqrt{10}$
truncated tetrahedron	$\frac{9}{44}\sqrt{22}$

Solid	ρ	R
cuboctahedron	$\frac{1}{2}\sqrt{3}$	1
great rhombicosidodecahedron	$\frac{1}{2}\sqrt{30+12\sqrt{5}}$	$\frac{1}{2}\sqrt{31+12\sqrt{5}}$
great rhombicuboctahedron	$\frac{1}{2}\sqrt{12+6\sqrt{2}}$	$\frac{1}{2}\sqrt{13+6\sqrt{2}}$
icosidodecahedron	$\frac{1}{2}\sqrt{5+2\sqrt{5}}$	$\frac{1}{2}(1+\sqrt{5})$
small rhombicosidodecahedron	$\frac{1}{2}\sqrt{10+4\sqrt{5}}$	$\frac{1}{2}\sqrt{11+4\sqrt{5}}$
small rhombicuboctahedron	$\frac{1}{2}\sqrt{4+2\sqrt{2}}$	$\frac{1}{2}\sqrt{5+2\sqrt{2}}$
snub cube	*	*
snub dodecahedron	*	*
truncated cube	$\frac{1}{2}(2+\sqrt{2})$	$\frac{1}{2}\sqrt{7+4\sqrt{2}}$
truncated dodecahedron	$\frac{1}{4}(5+3\sqrt{5})$	$\frac{1}{4}\sqrt{74+30\sqrt{5}}$
truncated icosahedron	$\frac{3}{4}(1+\sqrt{5})$	$\frac{1}{4}\sqrt{58+18\sqrt{5}}$
truncated octahedron	$\frac{3}{2}$	$\frac{1}{2}\sqrt{10}$
truncated tetrahedron	$\frac{3}{4}\sqrt{2}$	$\frac{1}{4}\sqrt{22}$

*The complicated analytic expressions for the CIRCUM-RADII of these solids are given in the entries for the SNUB CUBE and SNUB DODECAHEDRON.

Solid	r	ρ	R
cuboctahedron	0.75	0.86603	1
great rhombicosidodecahedron	3.73665	3.76938	3.80239
great rhombicuboctahedron	2.20974	2.26303	2.31761
icosidodecahedron	1.46353	1.53884	1.61803
small rhombicosidodecahedron	2.12099	2.17625	2.23295
small rhombicuboctahedron	1.22026	1.30656	1.39897
snub cube	1.15766	1.24722	1.34371
snub dodecahedron	2.03987	2.09705	2.15583
truncated cube	1.63828	1.70711	1.77882
truncated dodecahedron	2.88526	2.92705	2.96945
truncated icosahedron	2.37713	2.42705	2.47802
truncated octahedron	1.42302	1.5	1.58114
truncated tetrahedron	0.95940	1.06066	1.17260

The DUALS of the Archimedean solids, sometimes called the CATALAN SOLIDS, are given in the following table.

Archimedean Solid	Dual
rhombicosidodecahedron	deltoidal hexecontahedron
small rhombicuboctahedron	deltoidal icositetrahedron
great rhombicuboctahedron	disdyakis dodecahedron
great rhombicosidodecahedron	disdyakis triacontahedron
truncated icosahedron	pentakis dodecahedron
snub dodecahedron (laevo)	pentagonal hexecontahedron (dextro)
snub cube (laevo)	pentagonal icositetrahedron (dextro)
cuboctahedron	rhombic dodecahedron
icosidodecahedron	rhombic triacontahedron
truncated octahedron	tetrakis hexahedron
truncated dodecahedron	triakis icosahedron
truncated cube	triakis octahedron
truncated tetrahedron	triakis tetrahedron

Here are the Archimedean DUALS (Holden 1971, Pearce 1978) displayed in alphabetical order (left to right, then continuing to the next row).

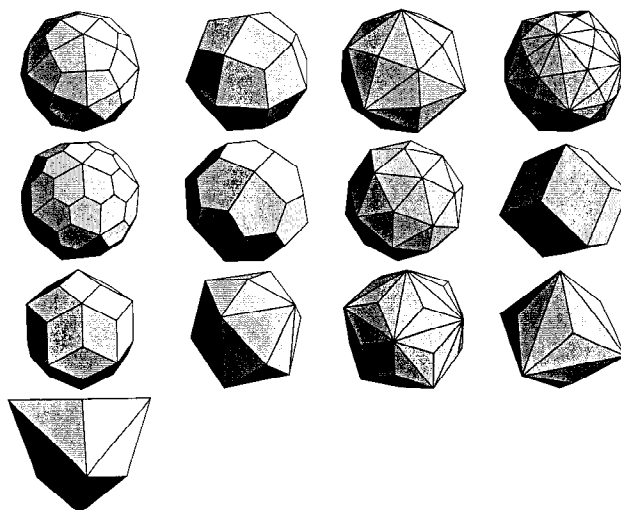

Here are the Archimedean solids paired with their DUALS.

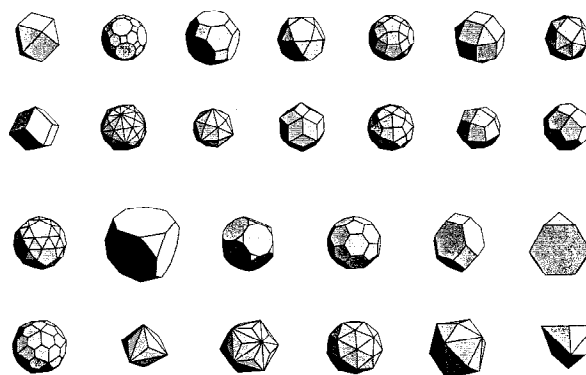

The Archimedean solids and their DUALS are all CANONICAL POLYHEDRA.

see also ARCHIMEDEAN SOLID STELLATION, CATALAN SOLID, DELTAHEDRON, JOHNSON SOLID, KEPLER-POINSOT SOLID, PLATONIC SOLID, SEMIREGULAR POLYHEDRON, UNIFORM POLYHEDRON

References

- Ball, W. W. R. and Coxeter, H. S. M. *Mathematical Recreations and Essays*, 13th ed. New York: Dover, p. 136, 1987.
- Behnke, H.; Bachman, F.; Fladt, K.; and Kunle, H. (Eds.). *Fundamentals of Mathematics*, Vol. 2. Cambridge, MA: MIT Press, pp. 269–286, 1974.
- Catalan, E. "Mémoire sur la Théorie des Polyèdres." *J. l'École Polytechnique (Paris)* 41, 1–71, 1865.
- Coxeter, H. S. M. "The Pure Archimedean Polytopes in Six and Seven Dimensions." *Proc. Cambridge Phil. Soc.* 24, 1–9, 1928.
- Coxeter, H. S. M. "Regular and Semi-Regular Polytopes I." *Math. Z.* 46, 380–407, 1940.
- Coxeter, H. S. M. *Regular Polytopes*, 3rd ed. New York: Dover, 1973.
- Coxeter, H. S. M.; Longuet-Higgins, M. S.; and Miller, J. C. P. "Uniform Polyhedra." *Phil. Trans. Roy. Soc. London Ser. A* 246, 401–450, 1954.
- Critchlow, K. *Order in Space: A Design Source Book*. New York: Viking Press, 1970.

- Cromwell, P. R. *Polyhedra*. New York: Cambridge University Press, pp. 79–86, 1997.
- Cundy, H. and Rollett, A. *Mathematical Models*, 3rd ed. Stradbroke, England: Tarquin Pub., 1989.
- Holden, A. *Shapes, Space, and Symmetry*. New York: Dover, p. 54, 1991.
- Kepler, J. "Harmonice Mundi." *Opera Omnia*, Vol. 5. Frankfurt, pp. 75–334, 1864.
- Kraitchik, M. *Mathematical Recreations*. New York: W. W. Norton, pp. 199–207, 1942.
- Le, Ha. "Archimedean Solids." <http://daisy.uwaterloo.ca/~hqle/archimedean.html>.
- Pearce, P. *Structure in Nature is a Strategy for Design*. Cambridge, MA: MIT Press, pp. 34–35, 1978.
- Pugh, A. *Polyhedra: A Visual Approach*. Berkeley: University of California Press, p. 25, 1976.
- Rawles, B. A. "Platonic and Archimedean Solids—Faces, Edges, Arcs, Vertices, Angles, Volumes, Sphere Ratios." <http://www.intent.com/sg/polyhedra.html>.
- Rorres, C. "Archimedean Solids: Pappus." <http://www.mcs.drexel.edu/~crrorres/Archimedes/Solids/Pappus.html>.
- Steinitz, E. and Rademacher, H. *Vorlesungen über die Theorie der Polyeder*. Berlin, p. 11, 1934.
- Stott, A. B. *Verhandelingen der Koninklijke Akad. Wetenschappen, Amsterdam* 11, 1910.
- Walsh, T. R. S. "Characterizing the Vertex Neighbourhoods of Semi-Regular Polyhedra." *Geometriae Dedicata* 1, 117–123, 1972.
- Wenninger, M. J. *Polyhedron Models*. New York: Cambridge University Press, 1989.

Archimedean Solid Stellation

A large class of POLYHEDRA which includes the DO-DECADODECAHEDRON and GREAT ICOSIDODECAHEDRON. No complete enumeration (even with restrictive uniqueness conditions) has been worked out.

References

- Coxeter, H. S. M.; Longuet-Higgins, M. S.; and Miller, J. C. P. "Uniform Polyhedra." *Phil. Trans. Roy. Soc. London Ser. A* 246, 401–450, 1954.
- Wenninger, M. J. *Polyhedron Models*. New York: Cambridge University Press, pp. 66–72, 1989.

Archimedean Spiral

A SPIRAL with POLAR equation

$$r = a\theta^{1/m},$$

where r is the radial distance, θ is the polar angle, and m is a constant which determines how tightly the spiral is "wrapped." The CURVATURE of an Archimedean spiral is given by

$$\kappa = \frac{n\theta^{1-1/n}(1+n+n^2\theta^2)}{a(1+n^2\theta^2)^{3/2}}.$$

Various special cases are given in the following table.

Name	m
lituus	−2
hyperbolic spiral	−1
Archimedes' spiral	1
Fermat's spiral	2

see also ARCHIMEDES' SPIRAL, DAISY, FERMAT'S SPIRAL, HYPERBOLIC SPIRAL, LITUUS, SPIRAL

References

- Gray, A. *Modern Differential Geometry of Curves and Surfaces*. Boca Raton, FL: CRC Press, pp. 69–70, 1993.
- Lauweirer, H. *Fractals: Endlessly Repeated Geometric Figures*. Princeton, NJ: Princeton University Press, pp. 59–60, 1991.
- Lawrence, J. D. *A Catalog of Special Plane Curves*. New York: Dover, pp. 186 and 189, 1972.
- Lee, X. "Archimedean Spiral." http://www.best.com/~xah/SpecialPlaneCurves_dir/ArchimedeanSpiral_dir/archimedeanSpiral.html.
- Lockwood, E. H. *A Book of Curves*. Cambridge, England: Cambridge University Press, p. 175, 1967.
- MacTutor History of Mathematics Archive. "Spiral of Archimedes." <http://www-groups.dcs.st-and.ac.uk/~history/Curves/Spiral.html>.
- Pappas, T. "The Spiral of Archimedes." *The Joy of Mathematics*. San Carlos, CA: Wide World Publ./Tetra, p. 149, 1989.

Archimedean Spiral Inverse Curve

The INVERSE CURVE of the ARCHIMEDEAN SPIRAL

$$r = a\theta^{1/m}$$

with INVERSION CENTER at the origin and inversion RADIUS k is the ARCHIMEDEAN SPIRAL

$$r = ka\theta^{1/m}.$$

Archimedes' Spiral

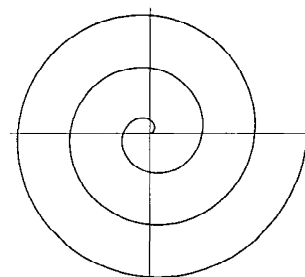

An ARCHIMEDEAN SPIRAL with POLAR equation

$$r = a\theta.$$

This spiral was studied by Conon, and later by Archimedes in *On Spirals* about 225 BC. Archimedes was able to work out the lengths of various tangents to the spiral.

Archimedes' spiral can be used for COMPASS and STRAIGHTEDGE division of an ANGLE into n parts (including ANGLE TRISECTION) and can also be used for CIRCLE SQUARING. In addition, the curve can be used as a cam to convert uniform circular motion into uniform linear motion. The cam consists of one arch of the spiral above the x -AXIS together with its reflection in the x -AXIS. Rotating this with uniform angular velocity about its center will result in uniform linear motion of the point where it crosses the y -AXIS.

see also ARCHIMEDEAN SPIRAL

References

- Gardner, M. *The Unexpected Hanging and Other Mathematical Diversions*. Chicago, IL: Chicago University Press, pp. 106–107, 1991.
 Gray, A. *Modern Differential Geometry of Curves and Surfaces*. Boca Raton, FL: CRC Press, pp. 69–70, 1993.
 Lawrence, J. D. *A Catalog of Special Plane Curves*. New York: Dover, pp. 186–187, 1972.
 Lockwood, E. H. *A Book of Curves*. Cambridge, England: Cambridge University Press, pp. 173–164, 1967.

Archimedes' Spiral Inverse

Taking the ORIGIN as the INVERSION CENTER, ARCHIMEDES' SPIRAL $r = a\theta$ inverts to the HYPERBOLIC SPIRAL $r = a/\theta$.

Archimedean Valuation

A VALUATION for which $|x| \leq 1$ IMPLIES $|1 + x| \leq C$ for the constant $C = 1$ (independent of x). Such a VALUATION does not satisfy the strong TRIANGLE INEQUALITY

$$|x + y| \leq \max(|x|, |y|).$$

Arcsecant

see INVERSE SECANT

Arcsine

see INVERSE SINE

Arctangent

see INVERSE TANGENT

Area

The AREA of a SURFACE is the amount of material needed to “cover” it completely. The AREA of a TRIANGLE is given by

$$A_{\Delta} = \frac{1}{2}lh, \quad (1)$$

where l is the base length and h is the height, or by HERON'S FORMULA

$$A_{\Delta} = \sqrt{s(s-a)(s-b)(s-c)}, \quad (2)$$

where the side lengths are a , b , and c and s the SEMIPERIMETER. The AREA of a RECTANGLE is given by

$$A_{\text{rectangle}} = ab, \quad (3)$$

where the sides are length a and b . This gives the special case of

$$A_{\text{square}} = a^2 \quad (4)$$

for the SQUARE. The AREA of a regular POLYGON with n sides and side length s is given by

$$A_{n\text{-gon}} = \frac{1}{4}ns^2 \cot\left(\frac{\pi}{n}\right). \quad (5)$$

CALCULUS and, in particular, the INTEGRAL, are powerful tools for computing the AREA between a curve $f(x)$ and the x -AXIS over an INTERVAL $[a, b]$, giving

$$A = \int_a^b f(x) dx. \quad (6)$$

The AREA of a POLAR curve with equation $r = r(\theta)$ is

$$A = \frac{1}{2} \int r^2 d\theta. \quad (7)$$

Written in CARTESIAN COORDINATES, this becomes

$$A = \frac{1}{2} \int \left(x \frac{dy}{dt} - y \frac{dx}{dt} \right) dt \quad (8)$$

$$= \frac{1}{2} \int (x dy - y dx). \quad (9)$$

For the AREA of special surfaces or regions, see the entry for that region. The generalization of AREA to 3-D is called VOLUME, and to higher DIMENSIONS is called CONTENT.

see also ARC LENGTH, AREA ELEMENT, CONTENT, SURFACE AREA, VOLUME

References

- Gray, A. “The Intuitive Idea of Area on a Surface.” §13.2 in *Modern Differential Geometry of Curves and Surfaces*. Boca Raton, FL: CRC Press, pp. 259–260, 1993.

Area Element

The area element for a SURFACE with RIEMANNIAN METRIC

$$ds^2 = E du^2 + 2F du dv + G dv^2$$

is

$$dA = \sqrt{EG - F^2} du \wedge dv,$$

where $du \wedge dv$ is the WEDGE PRODUCT.

see also AREA, LINE ELEMENT, RIEMANNIAN METRIC, VOLUME ELEMENT

References

- Gray, A. “The Intuitive Idea of Area on a Surface.” §13.2 in *Modern Differential Geometry of Curves and Surfaces*. Boca Raton, FL: CRC Press, pp. 259–260, 1993.

Area-Preserving Map

A MAP F from \mathbb{R}^n to \mathbb{R}^n is AREA-preserving if

$$m(F(A)) = m(A)$$

for every subregion A of \mathbb{R}^n , where $m(A)$ is the n -D MEASURE of A . A linear transformation is AREA-preserving if its corresponding DETERMINANT is equal to 1.

see also CONFORMAL MAP, SYMPLECTIC MAP

Area Principle

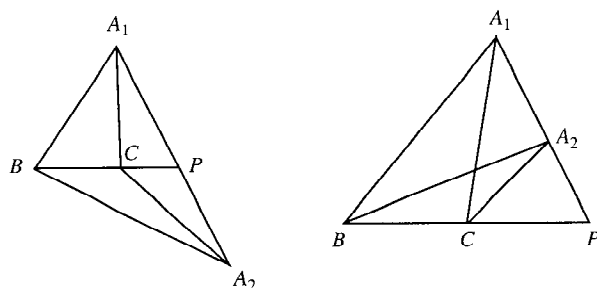

The "AREA principle" states that

$$\frac{|A_1P|}{|A_2P|} = \frac{|A_1BC|}{|A_2BC|}. \quad (1)$$

This can also be written in the form

$$\left[\frac{A_1P}{A_2P} \right] = \left[\frac{A_1BC}{A_2BC} \right], \quad (2)$$

where

$$\left[\frac{AB}{CD} \right] \quad (3)$$

is the ratio of the lengths $[A, B]$ and $[C, D]$ for $AB \parallel CD$ with a PLUS or MINUS SIGN depending on if these segments have the same or opposite directions, and

$$\left[\frac{ABC}{DEFG} \right] \quad (4)$$

is the RATIO of signed AREAS of the TRIANGLES. Grünbaum and Shepard show that CEVA'S THEOREM, HOEHN'S THEOREM, and MENELAUS' THEOREM are the consequences of this result.

see also CEVA'S THEOREM, HOEHN'S THEOREM, MENELAUS' THEOREM, SELF-TRANSVERSALITY THEOREM

References

Grünbaum, B. and Shepard, G. C. "Ceva, Menelaus, and the Area Principle." *Math. Mag.* **68**, 254–268, 1995.

Areal Coordinates

TRILINEAR COORDINATES normalized so that

$$t_1 + t_2 + t_3 = 1.$$

When so normalized, they become the AREAS of the TRIANGLES PA_1A_2 , PA_1A_3 , and PA_2A_3 , where P is the point whose coordinates have been specified.

Arf Invariant

A LINK invariant which always has the value 0 or 1. A KNOT has ARF INVARIANT 0 if the KNOT is "pass equivalent" to the UNKNOT and 1 if it is pass equivalent to the TREFOIL KNOT. If K_+ , K_- , and L are projections which are identical outside the region of the crossing diagram, and K_+ and K_- are KNOTS while L is a 2-component LINK with a nonintersecting crossing

diagram where the two left and right strands belong to the different LINKS, then

$$a(K_+) = a(K_-) + l(L_1, L_2), \quad (1)$$

where l is the LINKING NUMBER of L_1 and L_2 . The Arf invariant can be determined from the ALEXANDER POLYNOMIAL or JONES POLYNOMIAL for a KNOT. For Δ_K the ALEXANDER POLYNOMIAL of K , the Arf invariant is given by

$$\Delta_K(-1) \equiv \begin{cases} 1 \pmod{8} & \text{if } \text{Arf}(K) = 0 \\ 5 \pmod{8} & \text{if } \text{Arf}(K) = 1 \end{cases} \quad (2)$$

(Jones 1985). For the JONES POLYNOMIAL W_K of a KNOT K ,

$$\text{Arf}(K) = W_K(i) \quad (3)$$

(Jones 1985), where i is the IMAGINARY NUMBER.

References

Adams, C. C. *The Knot Book: An Elementary Introduction to the Mathematical Theory of Knots*. New York: W. H. Freeman, pp. 223–231, 1994.

Jones, V. "A Polynomial Invariant for Knots via von Neumann Algebras." *Bull. Amer. Math. Soc.* **12**, 103–111, 1985.

✱ Weisstein, E. W. "Knots." <http://www.astro.virginia.edu/~eww6n/math/notebooks/Knots.m>.

Argand Diagram

A plot of COMPLEX NUMBERS as points

$$z = x + iy$$

using the x -AXIS as the REAL axis and y -AXIS as the IMAGINARY axis. This is also called the COMPLEX PLANE or ARGAND PLANE.

Argand Plane

see ARGAND DIAGRAM

Argoh's Conjecture

Let B_k be the k th BERNOULLI NUMBER. Then does

$$nB_{n-1} \equiv -1 \pmod{n}$$

IFF n is PRIME? For example, for $n = 1, 2, \dots, nB_{n-1} \pmod{n}$ is 0, -1 , -1 , 0, -1 , 0, -1 , 0, -3 , 0, -1 , \dots . There are no counterexamples less than $n = 5,600$. Any counterexample to Argoh's conjecture would be a contradiction to GIUGA'S CONJECTURE, and vice versa.

see also BERNOULLI NUMBER, GIUGA'S CONJECTURE

References

Borwein, D.; Borwein, J. M.; Borwein, P. B.; and Girgensohn, R. "Giuga's Conjecture on Primality." *Amer. Math. Monthly* **103**, 40–50, 1996.

Argument Addition Relation

A mathematical relationship relating $f(x + y)$ to $f(x)$ and $f(y)$.

see also ARGUMENT MULTIPLICATION RELATION, RECURRENCE RELATION, REFLECTION RELATION, TRANSLATION RELATION

Argument (Complex Number)

A COMPLEX NUMBER z may be represented as

$$z \equiv x + iy = |z|e^{i\theta}, \quad (1)$$

where $|z|$ is called the MODULUS of z , and θ is called the argument

$$\arg(x + iy) \equiv \tan^{-1} \left(\frac{y}{x} \right). \quad (2)$$

Therefore,

$$\begin{aligned} \arg(zw) &= \arg(|z|e^{i\theta_z}|w|e^{i\theta_w}) = \arg(e^{i\theta_z}e^{i\theta_w}) \\ &= \arg[e^{i(\theta_z + \theta_w)}] = \arg(z) + \arg(w). \end{aligned} \quad (3)$$

Extending this procedure gives

$$\arg(z^n) = n \arg(z). \quad (4)$$

The argument of a COMPLEX NUMBER is sometimes called the PHASE.

see also AFFIX, COMPLEX NUMBER, DE MOIVRE'S IDENTITY, EULER FORMULA, MODULUS (COMPLEX NUMBER), PHASE, PHASOR

References

Abramowitz, M. and Stegun, C. A. (Eds.). *Handbook of Mathematical Functions with Formulas, Graphs, and Mathematical Tables*, 9th printing. New York: Dover, p. 16, 1972.

Argument (Elliptic Integral)

Given an AMPLITUDE ϕ in an ELLIPTIC INTEGRAL, the argument u is defined by the relation

$$\phi \equiv \operatorname{am} u.$$

see also AMPLITUDE, ELLIPTIC INTEGRAL

Argument (Function)

An argument of a FUNCTION $f(x_1, \dots, x_n)$ is one of the n parameters on which the function's value depends. For example, the SINE $\sin x$ is a one-argument function, the BINOMIAL COEFFICIENT $\binom{n}{m}$ is a two-argument function, and the HYPERGEOMETRIC FUNCTION ${}_2F_1(a, b; c; z)$ is a four-argument function.

Argument Multiplication Relation

A mathematical relationship relating $f(nx)$ to $f(x)$ for INTEGER n .

see also ARGUMENT ADDITION RELATION, RECURRENCE RELATION, REFLECTION RELATION, TRANSLATION RELATION

Argument Principle

If $f(z)$ is MEROMORPHIC in a region R enclosed by a curve γ , let N be the number of COMPLEX ROOTS of $f(z)$ in γ , and P be the number of POLES in γ , then

$$N - P = \frac{1}{2\pi i} \int_{\gamma} \frac{f'(z) dz}{f(z)}.$$

Defining $w \equiv f(z)$ and $\sigma \equiv f(\gamma)$ gives

$$N - P = \frac{1}{2\pi i} \int_{\sigma} \frac{dw}{w}.$$

see also VARIATION OF ARGUMENT

References

Duren, P.; Hengartner, W.; and Laugessen, R. S. "The Argument Principle for Harmonic Functions." *Math. Mag.* **103**, 411-415, 1996.

Argument Variation

see VARIATION OF ARGUMENT

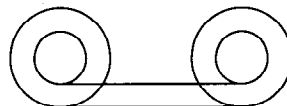
Aristotle's Wheel Paradox

A PARADOX mentioned in the Greek work *Mechanica*, dubiously attributed to Aristotle. Consider the above diagram depicting a wheel consisting of two concentric CIRCLES of different DIAMETERS (a wheel within a wheel). There is a 1:1 correspondence of points on the large CIRCLE with points on the small CIRCLE, so the wheel should travel the same distance regardless of whether it is rolled from left to right on the top straight line or on the bottom one. This seems to imply that the two CIRCUMFERENCES of different sized CIRCLES are equal, which is impossible.

The fallacy lies in the assumption that a 1:1 correspondence of points means that two curves must have the same length. In fact, the CARDINALITIES of points in a LINE SEGMENT of any length (or even an INFINITE LINE, a PLANE, a 3-D SPACE, or an infinite dimensional EUCLIDEAN SPACE) are all the same: \aleph_1 (ALEPH-1), so the points of any of these can be put in a ONE-TO-ONE correspondence with those of any other.

see also ZENO'S PARADOXES

References

- Ballew, D. "The Wheel of Aristotle." *Math. Teacher* **65**, 507-509, 1972.
- Costabel, P. "The Wheel of Aristotle and French Consideration of Galileo's Arguments." *Math. Teacher* **61**, 527-534, 1968.
- Drabkin, I. "Aristotle's Wheel: Notes on the History of the Paradox." *Osiris* **9**, 162-198, 1950.
- Gardner, M. *Wheels, Life, and other Mathematical Amusements*. New York: W. H. Freeman, pp. 2-4, 1983.
- Pappas, T. "The Wheel of Paradox Aristotle." *The Joy of Mathematics*. San Carlos, CA: Wide World Publ./Tetra, p. 202, 1989.
- vos Savant, M. *The World's Most Famous Math Problem*. New York: St. Martin's Press, pp. 48-50, 1993.

Arithmetic

The branch of mathematics dealing with INTEGERS or, more generally, numerical computation. Arithmetical operations include ADDITION, CONGRUENCE calculation, DIVISION, FACTORIZATION, MULTIPLICATION, POWER computation, ROOT extraction, and SUBTRACTION.

The FUNDAMENTAL THEOREM OF ARITHMETIC, also called the UNIQUE FACTORIZATION THEOREM, states that any POSITIVE INTEGER can be represented in exactly one way as a PRODUCT of PRIMES.

The LÖWENHEIMER-SKOLEM THEOREM, which is a fundamental result in MODEL THEORY, establishes the existence of “nonstandard” models of arithmetic.

see also ALGEBRA, CALCULUS, FUNDAMENTAL THEOREM OF ARITHMETIC, GROUP THEORY, HIGHER ARITHMETIC, LINEAR ALGEBRA, LÖWENHEIMER-SKOLEM THEOREM, MODEL THEORY, NUMBER THEORY, TRIGONOMETRY

References

Karpinski, L. C. *The History of Arithmetic*. Chicago, IL: Rand, McNally, & Co., 1925.
Maxfield, J. E. and Maxfield, M. W. *Abstract Algebra and Solution by Radicals*. Philadelphia, PA: Saunders, 1992.
Thompson, J. E. *Arithmetic for the Practical Man*. New York: Van Nostrand Reinhold, 1973.

Arithmetic-Geometric Mean

The arithmetic-geometric mean (AGM) $M(a, b)$ of two numbers a and b is defined by starting with $a_0 \equiv a$ and $b_0 \equiv b$, then iterating

$$a_{n+1} = \frac{1}{2}(a_n + b_n) \quad (1)$$

$$b_{n+1} = \sqrt{a_n b_n} \quad (2)$$

until $a_n = b_n$. a_n and b_n converge towards each other since

$$\begin{aligned} a_{n+1} - b_{n+1} &= \frac{1}{2}(a_n + b_n) - \sqrt{a_n b_n} \\ &= \frac{a_n - 2\sqrt{a_n b_n} + b_n}{2}. \end{aligned} \quad (3)$$

But $\sqrt{b_n} < \sqrt{a_n}$, so

$$2b_n < 2\sqrt{a_n b_n}. \quad (4)$$

Now, add $a_n - b_n - 2\sqrt{a_n b_n}$ to each side

$$a_n + b_n - 2\sqrt{a_n b_n} < a_n - b_n, \quad (5)$$

so

$$a_{n+1} - b_{n+1} < \frac{1}{2}(a_n - b_n). \quad (6)$$

The AGM is very useful in computing the values of complete ELLIPTIC INTEGRALS and can also be used for finding the INVERSE TANGENT. The special value $1/M(1, \sqrt{2})$ is called GAUSS'S CONSTANT.

The AGM has the properties

$$\lambda M(a, b) = M(\lambda a, \lambda b) \quad (7)$$

$$M(a, b) = M\left(\frac{1}{2}(a + b), \sqrt{ab}\right) \quad (8)$$

$$M(1, \sqrt{1 - x^2}) = M(1 + x, 1 - x) \quad (9)$$

$$M(1, b) = \frac{1 + b}{2} M\left(1, \frac{2\sqrt{b}}{1 + b}\right). \quad (10)$$

The Legendre form is given by

$$M(1, x) = \prod_{n=0}^{\infty} \frac{1}{2}(1 + k_n), \quad (11)$$

where $k_0 \equiv x$ and

$$k_{n+1} \equiv \frac{2\sqrt{k_n}}{1 + k_n}. \quad (12)$$

Solutions to the differential equation

$$(x^3 - x) \frac{d^2 y}{dx^2} + (3x^2 - 1) \frac{dy}{dx} + xy = 0 \quad (13)$$

are given by $[M(1 + x, 1 - x)]^{-1}$ and $[M(1, x)]^{-1}$.

A generalization of the ARITHMETIC-GEOMETRIC MEAN is

$$I_p(a, b) = \int_0^{\infty} \frac{x^{p-2} dx}{(x^p + a^p)^{1/p} (x^p + b^p)^{(p-1)/p}}, \quad (14)$$

which is related to solutions of the differential equation

$$x(1 - x^p)Y'' + [1 - (p+1)x^p]Y' - (p-1)x^{p-1}Y = 0. \quad (15)$$

When $p = 2$ or $p = 3$, there is a modular transformation for the solutions of (15) that are bounded as $x \rightarrow 0$. Letting $J_p(x)$ be one of these solutions, the transformation takes the form

$$J_p(\lambda) = \mu J_p(x), \quad (16)$$

where

$$\lambda = \frac{1 - u}{1 + (p-1)u} \quad (17)$$

$$\mu = \frac{1 + (p-1)u}{p} \quad (18)$$

and

$$x^p + u^p = 1. \quad (19)$$

The case $p = 2$ gives the ARITHMETIC-GEOMETRIC MEAN, and $p = 3$ gives a cubic relative discussed by Borwein and Borwein (1990, 1991) and Borwein (1996) in which, for $a, b > 0$ and $I(a, b)$ defined by

$$I(a, b) = \int_0^{\infty} \frac{t dt}{[(a^3 + t^3)(b^3 + t^3)^2]^{1/3}}, \quad (20)$$

$$I(a, b) = I\left(\frac{a+2b}{3}, \left[\frac{b}{3}(a^2 + ab + b^2)\right]\right). \quad (21)$$

For iteration with $a_0 = a$ and $b_0 = b$ and

$$a_{n+1} = \frac{a_n + 2b_n}{3} \quad (22)$$

$$b_{n+1} = \frac{b_n}{3}(a_n^2 + a_nb_n + b_n^2), \quad (23)$$

$$\lim_{n \rightarrow \infty} a_n = \lim_{n \rightarrow \infty} b_n = \frac{I(1, 1)}{I(a, b)}. \quad (24)$$

Modular transformations are known when $p = 4$ and $p = 6$, but they do not give identities for $p = 6$ (Borwein 1996).

see also ARITHMETIC-HARMONIC MEAN

References

- Abramowitz, M. and Stegun, C. A. (Eds.). "The Process of the Arithmetic-Geometric Mean." §17.6 in *Handbook of Mathematical Functions with Formulas, Graphs, and Mathematical Tables*, 9th printing. New York: Dover, pp. 571 ad 598–599, 1972.
- Borwein, J. M. Problem 10281. "A Cubic Relative of the AGM." *Amer. Math. Monthly* **103**, 181–183, 1996.
- Borwein, J. M. and Borwein, P. B. "A Remarkable Cubic Iteration." In *Computational Method & Function Theory: Proc. Conference Held in Valparaiso, Chile, March 13–18, 1989* 387527680 (Ed. A. Dold, B. Eckmann, F. Takens, E. B Saff, S. Ruscheweyh, L. C. Salinas, L. C., and R. S. Varga). New York: Springer-Verlag, 1990.
- Borwein, J. M. and Borwein, P. B. "A Cubic Counterpart of Jacobi's Identity and the AGM." *Trans. Amer. Math. Soc.* **323**, 691–701, 1991.
- Press, W. H.; Flannery, B. P.; Teukolsky, S. A.; and Vetterling, W. T. *Numerical Recipes in FORTRAN: The Art of Scientific Computing*, 2nd ed. Cambridge, England: Cambridge University Press, pp. 906–907, 1992.

Arithmetic Geometry

A vaguely defined branch of mathematics dealing with VARIETIES, the MORDELL CONJECTURE, ARAKELOV THEORY, and ELLIPTIC CURVES.

References

- Cornell, G. and Silverman, J. H. (Eds.). *Arithmetic Geometry*. New York: Springer-Verlag, 1986.
- Lorenzini, D. *An Invitation to Arithmetic Geometry*. Providence, RI: Amer. Math. Soc., 1996.

Arithmetic-Harmonic Mean

Let

$$a_{n+1} = \frac{1}{2}(a_n + b_n) \quad (1)$$

$$b_{n+1} = \frac{2a_nb_n}{a_n + b_n}. \quad (2)$$

Then

$$A(a_0, b_0) = \lim_{n \rightarrow \infty} a_n = \lim_{n \rightarrow \infty} b_n = \sqrt{a_0 b_0}, \quad (3)$$

which is just the GEOMETRIC MEAN.

Arithmetic-Logarithmic-Geometric Mean Inequality

$$\frac{a+b}{2} > \frac{b-a}{\ln b - \ln a} > \sqrt{ab}.$$

see also NAPIER'S INEQUALITY

References

- Nelson, R. B. "Proof without Words: The Arithmetic-Logarithmic-Geometric Mean Inequality." *Math. Mag.* **68**, 305, 1995.

Arithmetic Mean

For a CONTINUOUS DISTRIBUTION function, the arithmetic mean of the population, denoted μ , \bar{x} , $\langle x \rangle$, or $A(x)$, is given by

$$\mu = \langle f(x) \rangle \equiv \int_{-\infty}^{\infty} P(x)f(x) dx, \quad (1)$$

where $\langle x \rangle$ is the EXPECTATION VALUE. For a DISCRETE DISTRIBUTION,

$$\mu = \langle f(x) \rangle \equiv \frac{\sum_{n=0}^N P(x_n)f(x_n)}{\sum_{n=0}^N P(x_n)} = \sum_{n=0}^N P(x_n)f(x_n). \quad (2)$$

The population mean satisfies

$$\langle f(x) + g(x) \rangle = \langle f(x) \rangle + \langle g(x) \rangle \quad (3)$$

$$\langle cf(x) \rangle = c \langle f(x) \rangle, \quad (4)$$

and

$$\langle f(x)g(y) \rangle = \langle f(x) \rangle \langle g(y) \rangle \quad (5)$$

if x and y are INDEPENDENT STATISTICS. The "sample mean," which is the mean estimated from a statistical sample, is an UNBIASED ESTIMATOR for the population mean.

For small samples, the mean is more efficient than the MEDIAN and approximately $\pi/2$ less (Kenney and Keeping 1962, p. 211). A general expression which often holds approximately is

$$\text{mean} - \text{mode} \approx 3(\text{mean} - \text{median}). \quad (6)$$

Given a set of samples $\{x_i\}$, the arithmetic mean is

$$A(x) = \bar{x} = \mu \equiv \langle x \rangle = \frac{1}{N} \sum_{i=1}^N x_i. \quad (7)$$

Hoehn and Niven (1985) show that

$$A(a_1 + c, a_2 + c, \dots, a_n + c) = c + A(a_1, a_2, \dots, a_n) \quad (8)$$

for any POSITIVE constant c . The arithmetic mean satisfies

$$A \geq G \geq H, \quad (9)$$

where G is the GEOMETRIC MEAN and H is the HARMONIC MEAN (Hardy *et al.* 1952; Mitrinović 1970; Beckenbach and Bellman 1983; Bullen *et al.* 1988; Mitrinović *et al.* 1993; Alzer 1996). This can be shown as follows. For $a, b > 0$,

$$\left(\frac{1}{\sqrt{a}} - \frac{1}{\sqrt{b}}\right)^2 \geq 0 \quad (10)$$

$$\frac{1}{a} - \frac{2}{\sqrt{ab}} + \frac{1}{b} \geq 0 \quad (11)$$

$$\frac{1}{a} + \frac{1}{b} \geq \frac{2}{\sqrt{ab}} \quad (12)$$

$$\frac{2}{\frac{1}{a} + \frac{1}{b}} \geq \sqrt{ab} \quad (13)$$

$$H \geq G, \quad (14)$$

with equality IFF $b = a$. To show the second part of the inequality,

$$(\sqrt{a} - \sqrt{b})^2 = a - 2\sqrt{ab} + b \geq 0 \quad (15)$$

$$\frac{a+b}{2} \geq \sqrt{ab} \quad (16)$$

$$A \geq H, \quad (17)$$

with equality IFF $a = b$. Combining (14) and (17) then gives (9).

Given n independent random GAUSSIAN DISTRIBUTED variates x_i , each with population mean $\mu_i = \mu$ and VARIANCE $\sigma_i^2 = \sigma^2$,

$$\bar{x} \equiv \frac{1}{N} \sum_{i=1}^N x_i \quad (18)$$

$$\begin{aligned} \langle \bar{x} \rangle &= \frac{1}{N} \left\langle \sum_{i=1}^N x_i \right\rangle = \frac{1}{N} \sum_{i=1}^N \langle x_i \rangle \\ &= \frac{1}{N} \sum_{i=1}^N \mu = \frac{1}{N} (N\mu) = \mu, \end{aligned} \quad (19)$$

so the sample mean is an UNBIASED ESTIMATOR of population mean. However, the distribution of \bar{x} depends on the sample size. For large samples, \bar{x} is approximately NORMAL. For small samples, STUDENT'S t -DISTRIBUTION should be used.

The VARIANCE of the population mean is independent of the distribution.

$$\begin{aligned} \text{var}(\bar{x}) &= \text{var}\left(\frac{1}{n} \sum_{i=1}^N x_i\right) = \frac{1}{N^2} \text{var}\left(\sum_{i=1}^N x_i\right) \\ &= \frac{1}{N^2} \sum_{i=1}^n \text{var}(x_i) = \left(\frac{1}{N^2}\right) \sum_{i=1}^N \sigma^2 = \frac{\sigma^2}{N}. \end{aligned} \quad (20)$$

From k -STATISTICS for a GAUSSIAN DISTRIBUTION, the UNBIASED ESTIMATOR for the VARIANCE is given by

$$\sigma^2 = \frac{N}{N-1} s^2, \quad (21)$$

where

$$s \equiv \frac{1}{N} \sum_{i=1}^N (x_i - \bar{x})^2, \quad (22)$$

so

$$\text{var}(\bar{x}) = \frac{s^2}{N-1}. \quad (23)$$

The SQUARE ROOT of this,

$$\sigma_x = \frac{s}{\sqrt{N-1}}, \quad (24)$$

is called the STANDARD ERROR.

$$\text{var}(\bar{x}) \equiv \langle \bar{x}^2 \rangle - \langle \bar{x} \rangle^2, \quad (25)$$

so

$$\langle \bar{x}^2 \rangle = \text{var}(\bar{x}) + \langle \bar{x} \rangle^2 = \frac{\sigma^2}{N} + \mu^2. \quad (26)$$

see also ARITHMETIC-GEOMETRIC MEAN, ARITHMETIC-HARMONIC MEAN, CARLEMAN'S INEQUALITY, CUMULANT, GENERALIZED MEAN, GEOMETRIC MEAN, HARMONIC MEAN, HARMONIC-GEOMETRIC MEAN, KURTOSIS, MEAN, MEAN DEVIATION, MEDIAN (STATISTICS), MODE, MOMENT, QUADRATIC MEAN, ROOT-MEAN-SQUARE, SAMPLE VARIANCE, SKEWNESS, STANDARD DEVIATION, TRIMEAN, VARIANCE

References

- Abramowitz, M. and Stegun, C. A. (Eds.). *Handbook of Mathematical Functions with Formulas, Graphs, and Mathematical Tables*, 9th printing. New York: Dover, p. 10, 1972.
- Alzer, H. "A Proof of the Arithmetic Mean-Geometric Mean Inequality." *Amer. Math. Monthly* **103**, 585, 1996.
- Beckenbach, E. F. and Bellman, R. *Inequalities*. New York: Springer-Verlag, 1983.
- Beyer, W. H. *CRC Standard Mathematical Tables*, 28th ed. Boca Raton, FL: CRC Press, p. 471, 1987.
- Bullen, P. S.; Mitrinović, D. S.; and Vasić, P. M. *Means & Their Inequalities*. Dordrecht, Netherlands: Reidel, 1988.
- Hardy, G. H.; Littlewood, J. E.; and Pólya, G. *Inequalities*. Cambridge, England: Cambridge University Press, 1952.
- Hoehn, L. and Niven, I. "Averages on the Move." *Math. Mag.* **58**, 151-156, 1985.
- Kenney, J. F. and Keeping, E. S. *Mathematics of Statistics*, Pt. 1, 3rd ed. Princeton, NJ: Van Nostrand, 1962.
- Mitrinović, D. S.; Pečarić, J. E.; and Fink, A. M. *Classical and New Inequalities in Analysis*. Dordrecht, Netherlands: Kluwer, 1993.
- Vasić, P. M. and Mitrinović, D. S. *Analytic Inequalities*. New York: Springer-Verlag, 1970.

Arithmetic Progression

see ARITHMETIC SERIES

Arithmetic Sequence

A SEQUENCE of n numbers $\{d_0 + kd\}_{k=0}^{n-1}$ such that the differences between successive terms is a constant d .

see also ARITHMETIC SERIES, SEQUENCE

Arithmetic Series

An arithmetic series is the SUM of a SEQUENCE $\{a_k\}$, $k = 1, 2, \dots$, in which each term is computed from the previous one by adding (or subtracting) a constant. Therefore, for $k > 1$,

$$a_k = a_{k-1} + d = a_{k-2} + 2d = \dots = a_1 + d(k-1). \quad (1)$$

The sum of the sequence of the first n terms is then given by

$$\begin{aligned} S_n &= \sum_{k=1}^n a_k = \sum_{k=1}^n [a_1 + (k-1)d] \\ &= na_1 + d \sum_{k=1}^n (k-1) = na_1 + d \sum_{k=2}^n (k-1) \\ &= na_1 + d \sum_{k=1}^{n-1} k \end{aligned} \quad (2)$$

Using the SUM identity

$$\sum_{k=1}^n k = \frac{1}{2}n(n+1) \quad (3)$$

then gives

$$S_n = na_1 + \frac{1}{2}d(n-1) = \frac{1}{2}n[2a_1 + d(n-1)]. \quad (4)$$

Note, however, that

$$a_1 + a_n = a_1 + [a_1 + d(n-1)] = 2a_1 + d(n-1), \quad (5)$$

so

$$S_n = \frac{1}{2}n(a_1 + a_n), \quad (6)$$

or n times the AVERAGE of the first and last terms! This is the trick Gauss used as a schoolboy to solve the problem of summing the INTEGERS from 1 to 100 given as busy-work by his teacher. While his classmates toiled away doing the ADDITION longhand, Gauss wrote a single number, the correct answer

$$\frac{1}{2}(100)(1+100) = 50 \cdot 101 = 5050 \quad (7)$$

on his slate. When the answers were examined, Gauss's proved to be the only correct one.

see also ARITHMETIC SEQUENCE, GEOMETRIC SERIES, HARMONIC SERIES, PRIME ARITHMETIC PROGRESSION

References

Abramowitz, M. and Stegun, C. A. (Eds.). *Handbook of Mathematical Functions with Formulas, Graphs, and*

Mathematical Tables, 9th printing. New York: Dover, p. 10, 1972.

Beyer, W. H. (Ed.). *CRC Standard Mathematical Tables*, 28th ed. Boca Raton, FL: CRC Press, p. 8, 1987.

Courant, R. and Robbins, H. "The Arithmetical Progression." §1.2.2 in *What is Mathematics?: An Elementary Approach to Ideas and Methods*, 2nd ed. Oxford, England: Oxford University Press, pp. 12–13, 1996.

Pappas, T. *The Joy of Mathematics*. San Carlos, CA: Wide World Publ./Tetra, p. 164, 1989.

Armstrong Number

The n -digit numbers equal to sum of n th powers of their digits (a finite sequence), also called PLUS PERFECT NUMBERS. They first few are given by 1, 2, 3, 4, 5, 6, 7, 8, 9, 153, 370, 371, 407, 1634, 8208, 9474, 54748, ... (Sloane's A005188).

see also NARCISSISTIC NUMBER

References

Sloane, N. J. A. Sequence A005188/M0488 in "An On-Line Version of the Encyclopedia of Integer Sequences."

Arnold's Cat Map

The best known example of an ANOSOV DIFFEOMORPHISM. It is given by the TRANSFORMATION

$$\begin{bmatrix} x_{n+1} \\ y_{n+1} \end{bmatrix} = \begin{bmatrix} 1 & 1 \\ 1 & 2 \end{bmatrix} \begin{bmatrix} x_n \\ y_n \end{bmatrix}, \quad (1)$$

where x_{n+1} and y_{n+1} are computed mod 1. The Arnold cat mapping is non-Hamiltonian, nonanalytic, and mixing. However, it is AREA-PRESERVING since the DETERMINANT is 1. The LYAPUNOV CHARACTERISTIC EXPONENTS are given by

$$\begin{vmatrix} 1-\sigma & 1 \\ 1 & 2-\sigma \end{vmatrix} = \sigma^2 - 3\sigma + 1 = 0, \quad (2)$$

so

$$\sigma_{\pm} = \frac{1}{2}(3 \pm \sqrt{5}). \quad (3)$$

The EIGENVECTORS are found by plugging σ_{\pm} into the MATRIX EQUATION

$$\begin{bmatrix} 1-\sigma_{\pm} & 1 \\ 1 & 2-\sigma_{\pm} \end{bmatrix} \begin{bmatrix} x \\ y \end{bmatrix} = \begin{bmatrix} 0 \\ 0 \end{bmatrix}. \quad (4)$$

For σ_+ , the solution is

$$y = \frac{1}{2}(1 + \sqrt{5})x \equiv \phi x, \quad (5)$$

where ϕ is the GOLDEN RATIO, so the unstable (normalized) EIGENVECTOR is

$$\xi_+ = \frac{1}{10}\sqrt{50-10\sqrt{5}} \begin{bmatrix} 1 \\ \frac{1}{2}(1+\sqrt{5}) \end{bmatrix}. \quad (6)$$

Similarly, for σ_- , the solution is

$$y = -\frac{1}{2}(\sqrt{5}-1)x \equiv \phi^{-1}x, \quad (7)$$

so the stable (normalized) EIGENVECTOR is

$$\xi_- = \frac{1}{10}\sqrt{50+10\sqrt{5}} \begin{bmatrix} 1 \\ \frac{1}{2}(1-\sqrt{5}) \end{bmatrix}. \quad (8)$$

see also ANOSOV MAP

Arnold Diffusion

The nonconservation of ADIABATIC INVARIANTS which arises in systems with three or more DEGREES OF FREEDOM.

Arnold Tongue

Consider the CIRCLE MAP. If K is NONZERO, then the motion is periodic in some FINITE region surrounding each rational Ω . This execution of periodic motion in response to an irrational forcing is known as MODE LOCKING. If a plot is made of K versus Ω with the regions of periodic MODE-LOCKED parameter space plotted around rational Ω values (the WINDING NUMBERS), then the regions are seen to widen upward from 0 at $K = 0$ to some FINITE width at $K = 1$. The region surrounding each RATIONAL NUMBER is known as an ARNOLD TONGUE.

At $K = 0$, the Arnold tongues are an isolated set of MEASURE zero. At $K = 1$, they form a general CANTOR SET of dimension $d \approx 0.8700$. In general, an Arnold tongue is defined as a resonance zone emanating out from RATIONAL NUMBERS in a two-dimensional parameter space of variables.

see also CIRCLE MAP

Aronhold Process

The process used to generate an expression for a covariant in the first degree of any one of the equivalent sets of COEFFICIENTS for a curve.

see also CLEBSCH-ARONHOLD NOTATION, JOACHIMSTHAL'S EQUATION

References

Coolidge, J. L. *A Treatise on Algebraic Plane Curves*. New York: Dover, p. 74, 1959.

Aronson's Sequence

The sequence whose definition is: "t is the first, fourth, eleventh, ... letter of this sentence." The first few values are 1, 4, 11, 16, 24, 29, 33, 35, 39, ... (Sloane's A005224).

References

Hofstadter, D. R. *Metamagical Themas: Questing of Mind and Pattern*. New York: BasicBooks, p. 44, 1985.
Sloane, N. J. A. Sequence A005224/M3406 in "An On-Line Version of the Encyclopedia of Integer Sequences."

Arrangement

In general, an arrangement of objects is simply a grouping of them. The number of "arrangements" of n items is given either by a COMBINATION (order is ignored) or PERMUTATION (order is significant).

The division of SPACE into cells by a collection of HYPERPLANES is also called an arrangement.

see also COMBINATION, CUTTING, HYPERPLANE, ORDERING, PERMUTATION

Arrangement Number

see PERMUTATION

Array

An array is a "list of lists" with the length of each level of list the same. The size (sometimes called the "shape") of a d -dimensional array is then indicated as $\underbrace{m \times n \times \cdots \times p}_d$. The most common type of array en-

countered is the 2-D $m \times n$ rectangular array having m columns and n rows. If $m = n$, a square array results. Sometimes, the order of the elements in an array is significant (as in a MATRIX), whereas at other times, arrays which are equivalent modulo reflections (and rotations, in the case of a square array) are considered identical (as in a MAGIC SQUARE or PRIME ARRAY).

In order to exhaustively list the number of distinct arrays of a given shape with each element being one of k possible choices, the naive algorithm of running through each case and checking to see whether it's equivalent to an earlier one is already just about as efficient as can be. The running time must be at least the number of answers, and this is so close to $k^{mn \cdots p}$ that the difference isn't significant.

However, finding the number of possible arrays of a given shape is much easier, and an exact formula can be obtained using the POLYA ENUMERATION THEOREM. For the simple case of an $m \times n$ array, even this proves unnecessary since there are only a few possible symmetry types, allowing the possibilities to be counted explicitly. For example, consider the case of m and n EVEN and distinct, so only reflections need be included. To take a specific case, let $m = 6$ and $n = 4$ so the array looks like

a	b	c		d	e	f
g	h	i		j	k	l
$-$	$-$	$-$	+	$-$	$-$	$-$
m	n	o		p	q	r
s	t	u		v	w	x

where each a, b, \dots, x can take a value from 1 to k . The total number of possible arrangements is k^{24} (k^{mn} in general). The number of arrangements which are equivalent to their left-right mirror images is k^{12} (in general, $k^{mn/2}$), as is the number equal to their up-down mirror images, or their rotations through 180° . There are also k^6 arrangements (in general, $k^{mn/4}$) with full symmetry.

In general, it is therefore true that

$$\begin{cases} k^{mn/4} & \text{with full symmetry} \\ k^{mn/2} - k^{mn/4} & \text{with only left-right reflection} \\ k^{mn/2} - k^{mn/4} & \text{with only up-down reflection} \\ k^{mn/2} - k^{mn/4} & \text{with only } 180^\circ \text{ rotation,} \end{cases}$$

so there are

$$k^{mn} - 3k^{mn/2} + 2k^{mn/4}$$

arrangements with no symmetry. Now dividing by the number of images of each type, the result, for $m \neq n$ with m, n EVEN, is

$$\begin{aligned} N(m, n, k) &= \frac{1}{4}k^{mn} + \left(\frac{1}{2}\right)(3)(k^{mn/2} - k^{mn/4}) \\ &\quad + \frac{1}{4}(k^{mn} - 3k^{mn/2} + 2k^{mn/4}) \\ &= \frac{1}{4}k^{mn} + \frac{3}{4}k^{mn/2} + \frac{1}{2}k^{mn/4}. \end{aligned}$$

The number is therefore of order $\mathcal{O}(k^{mn}/4)$, with "correction" terms of much smaller order.

see also ANTIMAGIC SQUARE, EULER SQUARE, KIRKMAN'S SCHOOLGIRL PROBLEM, LATIN RECTANGLE, LATIN SQUARE, MAGIC SQUARE, MATRIX, MRS. PERKINS' QUILT, MULTIPLICATION TABLE, ORTHOGONAL ARRAY, PERFECT SQUARE, PRIME ARRAY, QUOTIENT-DIFFERENCE TABLE, ROOM SQUARE, STOLARSKY ARRAY, TRUTH TABLE, WYTHOFF ARRAY

Arrow Notation

A NOTATION invented by Knuth (1976) to represent LARGE NUMBERS in which evaluation proceeds from the right (Conway and Guy 1996, p. 60).

$$\begin{array}{ccc} m \uparrow n & \underbrace{m \cdot m \cdots m}_n \\ m \uparrow \uparrow n & \underbrace{m \uparrow m \uparrow \cdots \uparrow m}_n \\ m \uparrow \uparrow \uparrow n & \underbrace{m \uparrow \uparrow m \uparrow \uparrow \cdots \uparrow \uparrow m}_n \end{array}$$

For example,

$$m \uparrow n = m^n \quad (1)$$

$$m \uparrow \uparrow n = \underbrace{m \uparrow \cdots \uparrow m}_n = \underbrace{m^{m \cdots m}}_n$$

$$m \uparrow \uparrow 2 = \underbrace{m \uparrow m}_2 = m \uparrow m = m^m \quad (2)$$

$$\begin{aligned} m \uparrow \uparrow 3 &= \underbrace{m \uparrow m \uparrow m}_3 = m \uparrow (m \uparrow m) \\ &= m \uparrow m^m = m^{m^m} \end{aligned} \quad (3)$$

$$m \uparrow \uparrow \uparrow 2 = \underbrace{m \uparrow \uparrow m}_2 = m \uparrow \uparrow m = \underbrace{m^{m \cdots m}}_m \quad (4)$$

$$\begin{aligned} m \uparrow \uparrow \uparrow 3 &= \underbrace{m \uparrow \uparrow m \uparrow \uparrow m}_3 = m \uparrow \uparrow \underbrace{m^{m \cdots m}}_m \\ &= \underbrace{m \uparrow \cdots \uparrow m}_m = \underbrace{m^{m \cdots m}}_m \\ &\quad \underbrace{m^{m \cdots m}}_m \quad (5) \end{aligned}$$

$m \uparrow \uparrow n$ is sometimes called a POWER TOWER. The values $\underbrace{n \uparrow \cdots \uparrow n}_n$ are called ACKERMANN NUMBERS.

see also ACKERMANN NUMBER, CHAINED ARROW NOTATION, DOWN ARROW NOTATION, LARGE NUMBER, POWER TOWER, STEINHAUS-MOSER NOTATION

References

- Conway, J. H. and Guy, R. K. *The Book of Numbers*. New York: Springer-Verlag, pp. 59–62, 1996.
 Guy, R. K. and Selfridge, J. L. "The Nesting and Roosting Habits of the Laddered Parenthesis." *Amer. Math. Monthly* **80**, 868–876, 1973.
 Knuth, D. E. "Mathematics and Computer Science: Coping with Finiteness. Advances in Our Ability to Compute are Bringing Us Substantially Closer to Ultimate Limitations." *Science* **194**, 1235–1242, 1976.
 Vardi, I. *Computational Recreations in Mathematics*. Redwood City, CA: Addison-Wesley, pp. 11 and 226–229, 1991.

Arrow's Paradox

Perfect democratic voting is, not just in practice but in principle, impossible.

References

- Gardner, M. *Time Travel and Other Mathematical Bewilderments*. New York: W. H. Freeman, p. 56, 1988.

Arrowhead Curve

see SIERPIŃSKI ARROWHEAD CURVE

Art Gallery Theorem

Also called CHVÁTAL'S ART GALLERY THEOREM. If the walls of an art gallery are made up of n straight LINES SEGMENTS, then the entire gallery can always be supervised by $\lfloor n/3 \rfloor$ watchmen placed in corners, where $\lfloor x \rfloor$ is the FLOOR FUNCTION. This theorem was proved by V. Chvátal in 1973. It is conjectured that an art gallery with n walls and h HOLES requires $\lfloor (n+h)/3 \rfloor$ watchmen.

see also ILLUMINATION PROBLEM

References

- Honsberger, R. "Chvátal's Art Gallery Theorem." Ch. 11 in *Mathematical Gems II*. Washington, DC: Math. Assoc. Amer., pp. 104–110, 1976.
 O'Rourke, J. *Art Gallery Theorems and Algorithms*. New York: Oxford University Press, 1987.
 Stewart, I. "How Many Guards in the Gallery?" *Sci. Amer.* **270**, 118–120, May 1994.
 Tucker, A. "The Art Gallery Problem." *Math Horizons*, pp. 24–26, Spring 1994.
 Wagon, S. "The Art Gallery Theorem." §10.3 in *Mathematics in Action*. New York: W. H. Freeman, pp. 333–345, 1991.

Articulation Vertex

A VERTEX whose removal will disconnect a GRAPH, also called a CUT-VERTEX.

see also BRIDGE (GRAPH)

References

- Chartrand, G. "Cut-Vertices and Bridges." §2.4 in *Introductory Graph Theory*. New York: Dover, pp. 45–49, 1985.

Artin Braid Group

see BRAID GROUP

Artin's Conjecture

There are at least two statements which go by the name of Artin's conjecture. The first is the RIEMANN HYPOTHESIS. The second states that every INTEGER not equal to -1 or a SQUARE NUMBER is a primitive root modulo p for infinitely many p and proposes a density for the set of such p which are always rational multiples of a constant known as ARTIN'S CONSTANT. There is an analogous theorem for functions instead of numbers which has been proved by Billharz (Shanks 1993, p. 147).

see also ARTIN'S CONSTANT, RIEMANN HYPOTHESIS

References

Shanks, D. *Solved and Unsolved Problems in Number Theory*, 4th ed. New York: Chelsea, pp. 31, 80–83, and 147, 1993.

Artin's Constant

If $n \neq -1$ and n is not a PERFECT SQUARE, then Artin conjectured that the SET $S(n)$ of all PRIMES for which n is a PRIMITIVE ROOT is infinite. Under the assumption of the EXTENDED RIEMANN HYPOTHESIS, Artin's conjecture was solved in 1967 by C. Hooley. If, in addition, n is not an r th POWER for any $r > 1$, then Artin conjectured that the density of $S(n)$ relative to the PRIMES is C_{Artin} (independent of the choice of n), where

$$C_{\text{Artin}} = \prod_{q \text{ prime}} \left[1 - \frac{1}{q(q-1)} \right] = 0.3739558136 \dots,$$

and the PRODUCT is over PRIMES. The significance of this constant is more easily seen by describing it as the fraction of PRIMES p for which $1/p$ has a maximal DECIMAL EXPANSION (Conway and Guy 1996).

References

- Conway, J. H. and Guy, R. K. *The Book of Numbers*. New York: Springer-Verlag, p. 169, 1996.
- Finch, S. "Favorite Mathematical Constants." <http://www.mathsoft.com/asolve/constant/artin/artin.html>.
- Hooley, C. "On Artin's Conjecture." *J. reine angew. Math.* **225**, 209–220, 1967.
- Ireland, K. and Rosen, M. *A Classical Introduction to Modern Number Theory*, 2nd ed. New York: Springer-Verlag, 1990.
- Ribenboim, P. *The Book of Prime Number Records*. New York: Springer-Verlag, 1989.
- Shanks, D. *Solved and Unsolved Problems in Number Theory*, 4th ed. New York: Chelsea, pp. 80–83, 1993.
- Wrench, J. W. "Evaluation of Artin's Constant and the Twin Prime Constant." *Math. Comput.* **15**, 396–398, 1961.

Artin L-Function

An Artin L -function over the RATIONALS \mathbb{Q} encodes in a GENERATING FUNCTION information about how an irreducible monic POLYNOMIAL over \mathbb{Z} factors when reduced modulo each PRIME. For the POLYNOMIAL $x^2 + 1$, the Artin L -function is

$$L(s, \mathbb{Q}(i)/\mathbb{Q}, \text{sgn}) = \prod_{p \text{ odd prime}} \frac{1}{1 - \left(\frac{-1}{p}\right) p^{-s}},$$

where $(-1/p)$ is a LEGENDRE SYMBOL, which is equivalent to the EULER L -FUNCTION. The definition over arbitrary POLYNOMIALS generalizes the above expression.

see also LANGLANDS RECIPROCITY

References

Knapp, A. W. "Group Representations and Harmonic Analysis, Part II." *Not. Amer. Math. Soc.* **43**, 537–549, 1996.

Artin Reciprocity

see ARTIN'S RECIPROCITY THEOREM

Artin's Reciprocity Theorem

A general RECIPROCITY THEOREM for all orders. If R is a NUMBER FIELD and R' a finite integral extension, then there is a SURJECTION from the group of fractional IDEALS prime to the discriminant, given by the Artin symbol. For some cycle c , the kernel of this SURJECTION contains each PRINCIPAL fractional IDEAL generated by an element congruent to 1 mod c .

see also LANGLANDS PROGRAM

Artinian Group

A GROUP in which any decreasing CHAIN of distinct SUBGROUPS terminates after a FINITE number.

Artinian Ring

A noncommutative SEMISIMPLE RING satisfying the "descending chain condition."

see also GORENSTEIN RING, SEMISIMPLE RING

References

- Artin, E. "Zur Theorie der hyperkomplexer Zahlen." *Hamb. Abh.* **5**, 251–260, 1928.
- Artin, E. "Zur Arithmetik hyperkomplexer Zahlen." *Hamb. Abh.* **5**, 261–289, 1928.

Artistic Series

A SERIES is called artistic if every three consecutive terms have a common three-way ratio

$$P[a_i, a_{i+1}, a_{i+2}] = \frac{(a_i + a_{i+1} + a_{i+2})a_{i+1}}{a_i a_{i+2}}.$$

A SERIES is also artistic IFF its BIAS is a constant. A GEOMETRIC SERIES with RATIO $r > 0$ is an artistic series with

$$P = \frac{1}{r} + 1 + r \geq 3.$$

see also BIAS (SERIES), GEOMETRIC SERIES, MELODIC SERIES

References

Duffin, R. J. "On Seeing Progressions of Constant Cross Ratio." *Amer. Math. Monthly* **100**, 38–47, 1993.

ASA Theorem

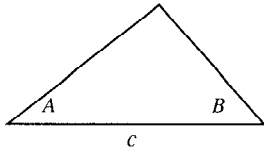

Specifying two adjacent ANGLES A and B and the side between them c uniquely determines a TRIANGLE with AREA

$$K = \frac{c^2}{2(\cot A + \cot B)}. \quad (1)$$

The angle C is given in terms of A and B by

$$C = \pi - A - B, \quad (2)$$

and the sides a and b can be determined by using the LAW OF SINES

$$\frac{a}{\sin A} = \frac{b}{\sin B} = \frac{c}{\sin C} \quad (3)$$

to obtain

$$a = \frac{\sin A}{\sin(\pi - A - B)} c \quad (4)$$

$$b = \frac{\sin B}{\sin(\pi - A - B)} c. \quad (5)$$

see also AAA THEOREM, AAS THEOREM, ASS THEOREM, SAS THEOREM, SSS THEOREM, TRIANGLE

Aschbacher's Component Theorem

Suppose that $E(G)$ (the commuting product of all components of G) is SIMPLE and G contains a SEMISIMPLE INVOLUTION. Then there is some SEMISIMPLE INVOLUTION x such that $C_G(x)$ has a NORMAL SUBGROUP K which is either QUASISIMPLE or ISOMORPHIC to $O^+(4, q)'$ and such that $Q = C_G(K)$ is TIGHTLY EMBEDDED.

see also INVOLUTION (GROUP), ISOMORPHIC GROUPS, NORMAL SUBGROUP, QUASISIMPLE GROUP, SIMPLE GROUP, TIGHTLY EMBEDDED

ASS Theorem

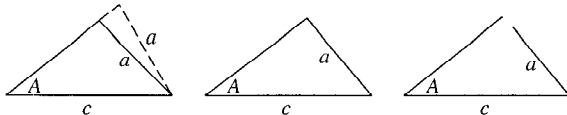

Specifying two adjacent side lengths a and b of a TRIANGLE (taking $a > b$) and one ACUTE ANGLE A opposite a does not, in general, uniquely determine a triangle. If $\sin A < a/c$, there are two possible TRIANGLES satisfying the given conditions. If $\sin A = a/c$, there is one possible TRIANGLE. If $\sin A > a/c$, there are no possible TRIANGLES. Remember: don't try to prove congruence with the ASS theorem or you will make an ASS out of yourself.

see also AAA THEOREM, AAS THEOREM, SAS THEOREM, SSS THEOREM, TRIANGLE

Associative

In simple terms, let x , y , and z be members of an ALGEBRA. Then the ALGEBRA is said to be associative if

$$x \cdot (y \cdot z) = (x \cdot y) \cdot z, \quad (1)$$

where \cdot denotes MULTIPLICATION. More formally, let A denote an \mathbb{R} -algebra, so that A is a VECTOR SPACE over \mathbb{R} and

$$A \times A \rightarrow A \quad (2)$$

$$(x, y) \mapsto x \cdot y. \quad (3)$$

Then A is said to be m -associative if there exists an m -D SUBSPACE S of A such that

$$(y \cdot x) \cdot z = y \cdot (x \cdot z) \quad (4)$$

for all $y, z \in A$ and $x \in S$. Here, VECTOR MULTIPLICATION $x \cdot y$ is assumed to be BILINEAR. An n -D n -associative ALGEBRA is simply said to be "associative."

see also COMMUTATIVE, DISTRIBUTIVE

References

Finch, S. "Zero Structures in Real Algebras." <http://www.mathsoft.com/asolve/zerodiv/zerodiv.html>.

Associative Magic Square

1	15	24	8	17
23	7	16	5	14
20	4	13	22	6
12	21	10	19	3
9	18	2	11	25

An $n \times n$ MAGIC SQUARE for which every pair of numbers symmetrically opposite the center sum to $n^2 + 1$. The LO SHU is associative but not PANMAGIC. Order four squares can be PANMAGIC or associative, but not both. Order five squares are the smallest which can be both associative and PANMAGIC, and 16 distinct associative PANMAGIC SQUARES exist, one of which is illustrated above (Gardner 1988).

see also MAGIC SQUARE, PANMAGIC SQUARE

References

Gardner, M. "Magic Squares and Cubes." Ch. 17 in *Time Travel and Other Mathematical Bewilderments*. New York: W. H. Freeman, 1988.

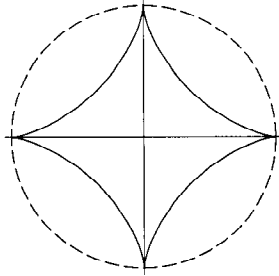
Astroid

A 4-cusped HYPOCYCLOID which is sometimes also called a TETRACUSPID, CUBOCYCLOID, or PARACYCLE. The parametric equations of the astroid can be obtained by plugging in $n \equiv a/b = 4$ or $4/3$ into the equations for a general HYPOCYCLOID, giving

$$x = 3b \cos \phi + b \cos(3\phi) = 4b \cos^3 \phi = a \cos^3 \phi \quad (1)$$

$$y = 3b \sin \phi - b \sin(3\phi) = 4b \sin^3 \phi = a \sin^3 \phi. \quad (2)$$

In CARTESIAN COORDINATES,

$$x^{2/3} + y^{2/3} = a^{2/3}. \quad (3)$$

In PEDAL COORDINATES with the PEDAL POINT at the center, the equation is

$$r^2 + 3p^2 = a^2. \quad (4)$$

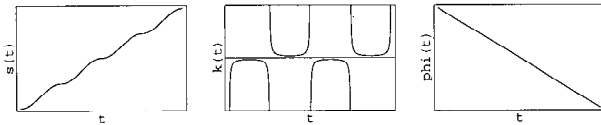

The ARC LENGTH, CURVATURE, and TANGENTIAL ANGLE are

$$s(t) = \frac{3}{2} \int_0^t |\sin(2t')| dt' = \frac{3}{2} \sin^2 t \quad (5)$$

$$\kappa(t) = -\frac{2}{3} \csc(2t) \quad (6)$$

$$\phi(t) = -t. \quad (7)$$

As usual, care must be taken in the evaluation of $s(t)$ for $t > \pi/2$. Since (5) comes from an integral involving the ABSOLUTE VALUE of a function, it must be monotonic increasing. Each QUADRANT can be treated correctly by defining

$$n = \left\lfloor \frac{2t}{\pi} \right\rfloor + 1, \quad (8)$$

where $\lfloor x \rfloor$ is the FLOOR FUNCTION, giving the formula

$$s(t) = (-1)^{1+[n \pmod{2}]} \frac{3}{2} \sin^2 t + 3 \left\lfloor \frac{1}{2} n \right\rfloor. \quad (9)$$

The overall ARC LENGTH of the astroid can be computed from the general HYPOCYCLOID formula

$$s_n = \frac{8a(n-1)}{n} \quad (10)$$

with $n = 4$,

$$s_4 = 6a. \quad (11)$$

The AREA is given by

$$A_n = \frac{(n-1)(n-2)}{n^2} \pi a^2 \quad (12)$$

with $n = 4$,

$$A_4 = \frac{3}{8} \pi a^2. \quad (13)$$

The EVOLUTE of an ELLIPSE is a stretched HYPOCYCLOID. The gradient of the TANGENT T from the point with parameter p is $-\tan p$. The equation of this TANGENT T is

$$x \sin p + y \cos p = \frac{1}{2} a \sin(2p) \quad (14)$$

(MacTutor Archive). Let T cut the x -AXIS and the y -AXIS at X and Y , respectively. Then the length XY is a constant and is equal to a .

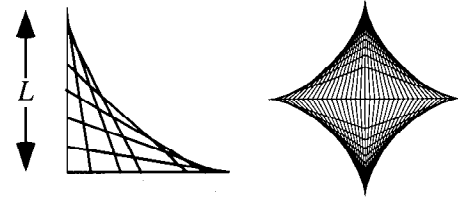

The astroid can also be formed as the ENVELOPE produced when a LINE SEGMENT is moved with each end on one of a pair of PERPENDICULAR axes (e.g., it is the curve enveloped by a ladder sliding against a wall or a garage door with the top corner moving along a vertical track; left figure above). The astroid is therefore a GLISSETTE. To see this, note that for a ladder of length L , the points of contact with the wall and floor are $(x_0, 0)$ and $(0, \sqrt{L^2 - x_0^2})$, respectively. The equation of the LINE made by the ladder with its foot at $(x_0, 0)$ is therefore

$$y - 0 = \frac{\sqrt{L^2 - x_0^2}}{-x_0} (x - x_0) \quad (15)$$

which can be written

$$U(x, y, x_0) = y + \frac{\sqrt{L^2 - x_0^2}}{x_0} (x - x_0). \quad (16)$$

The equation of the ENVELOPE is given by the simultaneous solution of

$$\begin{cases} U(x, y, x_0) = y + \frac{\sqrt{L^2 - x_0^2}}{x_0} (x - x_0) = 0 \\ \frac{\partial U}{\partial x_0} = \frac{x_0^2 - Lx^2}{x_0^2 \sqrt{L^2 - x_0^2}} = 0, \end{cases} \quad (17)$$

which is

$$x = \frac{x_0^3}{L^2} \quad (18)$$

$$y = \frac{(L^2 - x_0^2)^{3/2}}{L^2}. \quad (19)$$

Noting that

$$x^{2/3} = \frac{x_0^2}{L^{4/3}} \quad (20)$$

$$y^{2/3} = \frac{L^2 - x_0^2}{L^{4/3}} \quad (21)$$

allows this to be written implicitly as

$$x^{2/3} + y^{2/3} = L^{2/3}, \quad (22)$$

the equation of the astroid, as promised.

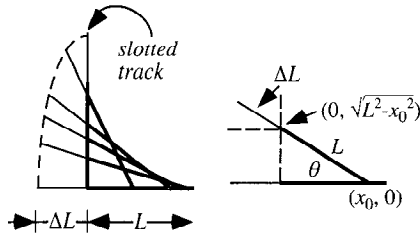

The related problem obtained by having the “garage door” of length L with an “extension” of length ΔL move up and down a slotted track also gives a surprising answer. In this case, the position of the “extended” end for the foot of the door at horizontal position x_0 and ANGLE θ is given by

$$x = -\Delta L \cos \theta \quad (23)$$

$$y = \sqrt{L^2 - x_0^2} + \Delta L \sin \theta. \quad (24)$$

Using

$$x_0 = L \cos \theta \quad (25)$$

then gives

$$x = -\frac{\Delta L}{L} x_0 \quad (26)$$

$$y = \sqrt{L^2 - x_0^2} \left(1 + \frac{\Delta L}{L} \right). \quad (27)$$

Solving (26) for x_0 , plugging into (27) and squaring then gives

$$y^2 = L^2 - \frac{L^2 x^2}{(\Delta L)^2} \left(1 + \frac{\Delta L}{L} \right)^2. \quad (28)$$

Rearranging produces the equation

$$\frac{x^2}{(\Delta L)^2} + \frac{y^2}{(L + \Delta L)^2} = 1, \quad (29)$$

the equation of a (QUADRANT of an) ELLIPSE with SEMIMAJOR and SEMIMINOR AXES of lengths ΔL and $L + \Delta L$.

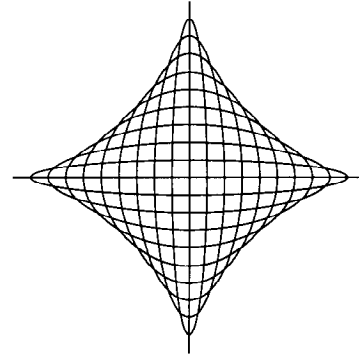

The astroid is also the ENVELOPE of the family of ELLIPSES

$$\frac{x^2}{c^2} + \frac{y^2}{(1-c)^2} - 1 = 0, \quad (30)$$

illustrated above.

see also DELTOID, ELLIPSE ENVELOPE, LAMÉ CURVE, NEPHROID, RANUNCULOID

References

- Lawrence, J. D. *A Catalog of Special Plane Curves*. New York: Dover, pp. 172–175, 1972.
 Lee, X. “Astroid.” http://www.best.com/~xah/SpecialPlaneCurves_dir/Astroid_dir/astroid.html.
 Lockwood, E. H. “The Astroid.” Ch. 6 in *A Book of Curves*. Cambridge, England: Cambridge University Press, pp. 52–61, 1967.
 MacTutor History of Mathematics Archive. “Astroid.” <http://www-groups.dcs.st-and.ac.uk/~history/Curves/Astroid.html>.
 Yates, R. C. “Astroid.” *A Handbook on Curves and Their Properties*. Ann Arbor, MI: J. W. Edwards, pp. 1–3, 1952.

Astroid Evolute

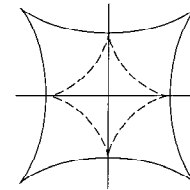

A HYPOCYCLOID EVOLUTE for $n = 4$ is another ASTROID scaled by a factor $n/(n-2) = 4/2 = 2$ and rotated $1/(2 \cdot 4) = 1/8$ of a turn.

Astroid Involute

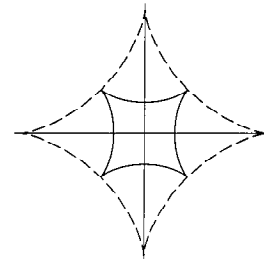

A HYPOCYCLOID INVOLUTE for $n = 4$ is another ASTROID scaled by a factor $(n-2)/2 = 2/4 = 1/2$ and rotated $1/(2 \cdot 4) = 1/8$ of a turn.

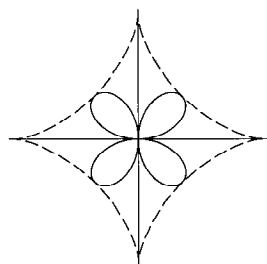
Astroid Pedal Curve

The PEDAL CURVE of an ASTROID with PEDAL POINT at the center is a QUADRIFOLIUM.

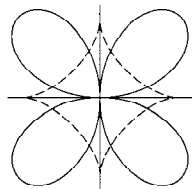
Astroid Radial Curve

The QUADRIFOLIUM

$$\begin{aligned}x &= x_0 + 3a \cos t - 3a \cos(3t) \\y &= y_0 + 3a \sin t + 3a \sin(3t).\end{aligned}$$

Astroidal Ellipsoid

The surface which is the inverse of the ELLIPSOID in the sense that it “goes in” where the ELLIPSOID “goes out.” It is given by the parametric equations

$$\begin{aligned}x &= (a \cos u \cos v)^3 \\y &= (b \sin u \cos v)^3 \\z &= (c \sin v)^3\end{aligned}$$

for $u \in [-\pi/2, \pi/2]$ and $v \in [-\pi, \pi]$. The special case $a = b = c = 1$ corresponds to the HYPERBOLIC OCTAHEDRON.

see also ELLIPSOID, HYPERBOLIC OCTAHEDRON

References

Nordstrand, T. “Astroidal Ellipsoid.” <http://www.uib.no/people/nfytn/asttxt.htm>.

Asymptosy

ASYMPTOTIC behavior. A useful yet endangered word, found rarely outside the captivity of the *Oxford English Dictionary*.

see also ASYMPTOTE, ASYMPTOTIC

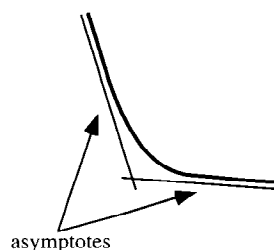
Asymptote

A curve approaching a given curve arbitrarily closely, as illustrated in the above diagram.

see also ASYMPTOSY, ASYMPTOTE, ASYMPTOTIC CURVE

References

Giblin, P. J. “What is an Asymptote?” *Math. Gaz.* **56**, 274–284, 1972.

Asymptotic

Approaching a value or curve arbitrarily closely (i.e., as some sort of LIMIT is taken). A CURVE A which is asymptotic to given CURVE C is called the ASYMPTOTE of C .

see also ASYMPTOSY, ASYMPTOTE, ASYMPTOTIC CURVE, ASYMPTOTIC DIRECTION, ASYMPTOTIC SERIES, LIMIT

Asymptotic Curve

Given a REGULAR SURFACE M , an asymptotic curve is formally defined as a curve $\mathbf{x}(t)$ on M such that the NORMAL CURVATURE is 0 in the direction $\mathbf{x}'(t)$ for all t in the domain of \mathbf{x} . The differential equation for the parametric representation of an asymptotic curve is

$$eu'^2 + 2fu'v' + gv'^2 = 0, \quad (1)$$

where e , f , and g are second FUNDAMENTAL FORMS. The differential equation for asymptotic curves on a MONGE PATCH $(u, v, h(u, v))$ is

$$h_{uu}u'^2 + 2h_{uv}u'v' + h_{vv}v'^2 = 0, \quad (2)$$

and on a polar patch $(r \cos \theta, r \sin \theta, h(r))$ is

$$h''(r)r'^2 + h'(r)r\theta'^2 = 0. \quad (3)$$

The images below show asymptotic curves for the ELLIPTIC HELICOID, FUNNEL, HYPERBOLIC PARABOLOID, and MONKEY SADDLE.

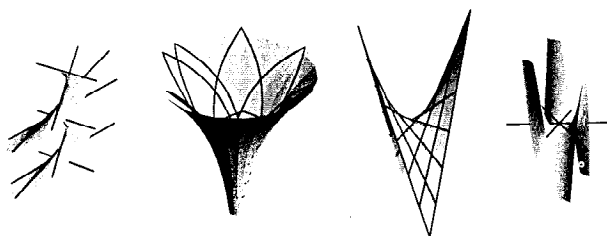

see also RULED SURFACE

References

Gray, A. "Asymptotic Curves," "Examples of Asymptotic Curves," §16.1, 16.2, and 16.3 in *Modern Differential Geometry of Curves and Surfaces*. Boca Raton, FL: CRC Press, pp. 320–331, 1993.

Asymptotic Direction

An asymptotic direction at a point \mathbf{p} of a REGULAR SURFACE $M \in \mathbb{R}^3$ is a direction in which the NORMAL CURVATURE of M vanishes.

1. There are no asymptotic directions at an ELLIPTIC POINT.
2. There are exactly two asymptotic directions at a HYPERBOLIC POINT.
3. There is exactly one asymptotic direction at a PARABOLIC POINT.
4. Every direction is asymptotic at a PLANAR POINT.

see also ASYMPTOTIC CURVE

References

Gray, A. *Modern Differential Geometry of Curves and Surfaces*. Boca Raton, FL: CRC Press, pp. 270 and 320, 1993.

Asymptotic Notation

Let n be a integer variable which tends to infinity and let x be a continuous variable tending to some limit. Also, let $\phi(n)$ or $\phi(x)$ be a positive function and $f(n)$ or $f(x)$ any function. Then Hardy and Wright (1979) define

1. $f = \mathcal{O}(\phi)$ to mean that $|f| < A\phi$ for some constant A and all values of n and x ,
2. $f = o(\phi)$ to mean that $f/\phi \rightarrow 0$,
3. $f \sim \phi$ to mean that $f/\phi \rightarrow 1$,
4. $f \prec \phi$ to mean the same as $f = o(\phi)$,
5. $f \succ \phi$ to mean $f/\phi \rightarrow \infty$, and
6. $f \asymp \phi$ to mean $A_1\phi < f < A_2$ for some positive constants A_1 and A_2 .

$f = o(\phi)$ implies and is stronger than $f = \mathcal{O}(\phi)$.

References

Hardy, G. H. and Wright, E. M. "Some Notation." §1.6 in *An Introduction to the Theory of Numbers*, 5th ed. Oxford, England: Clarendon Press, pp. 7–8, 1979.

Asymptotic Series

An asymptotic series is a SERIES EXPANSION of a FUNCTION in a variable x which may converge or diverge (Erdelyi 1987, p. 1), but whose partial sums can be made an arbitrarily good approximation to a given function for large enough x . To form an asymptotic series $R(x)$ of $f(x)$, written

$$f(x) \sim R(x), \quad (1)$$

take

$$x^n R_n(x) = x^n [f(x) - S_n(x)], \quad (2)$$

where

$$S_n(x) \equiv a_0 + \frac{a_1}{x} + \frac{a_2}{x^2} + \dots + \frac{a_n}{x^n}. \quad (3)$$

The asymptotic series is defined to have the properties

$$\lim_{x \rightarrow \infty} x^n R_n(x) = 0 \quad \text{for fixed } n \quad (4)$$

$$\lim_{n \rightarrow \infty} x^n R_n(x) = \infty \quad \text{for fixed } x. \quad (5)$$

Therefore,

$$f(x) \approx \sum_{n=0}^{\infty} a_n x^{-n} \quad (6)$$

in the limit $x \rightarrow \infty$. If a function has an asymptotic expansion, the expansion is unique. The symbol \sim is also used to mean directly SIMILAR.

References

- Abramowitz, M. and Stegun, C. A. (Eds.). *Handbook of Mathematical Functions with Formulas, Graphs, and Mathematical Tables*, 9th printing. New York: Dover, p. 15, 1972.
- Arfken, G. "Asymptotic of Semiconvergent Series." §5.10 in *Mathematical Methods for Physicists*, 3rd ed. Orlando, FL: Academic Press, pp. 339–346, 1985.
- Bleistein, N. and Handelsman, R. A. *Asymptotic Expansions of Integrals*. New York: Dover, 1986.
- Copson, E. T. *Asymptotic Expansions*. Cambridge, England: Cambridge University Press, 1965.
- de Bruijn, N. G. *Asymptotic Methods in Analysis*, 2nd ed. New York: Dover, 1982.
- Dingle, R. B. *Asymptotic Expansions: Their Derivation and Interpretation*. London: Academic Press, 1973.
- Erdelyi, A. *Asymptotic Expansions*. New York: Dover, 1987.
- Morse, P. M. and Feshbach, H. "Asymptotic Series; Method of Steepest Descent." §4.6 in *Methods of Theoretical Physics, Part I*. New York: McGraw-Hill, pp. 434–443, 1953.
- Olver, F. W. J. *Asymptotics and Special Functions*. New York: Academic Press, 1974.
- Wasow, W. R. *Asymptotic Expansions for Ordinary Differential Equations*. New York: Dover, 1987.

Atiyah-Singer Index Theorem

A theorem which states that the analytic and topological "indices" are equal for any elliptic differential operator on an n -D COMPACT DIFFERENTIABLE \mathbb{C}^∞ boundaryless MANIFOLD.

see also COMPACT MANIFOLD, DIFFERENTIABLE MANIFOLD

References

- Atiyah, M. F. and Singer, I. M. "The Index of Elliptic Operators on Compact Manifolds." *Bull. Amer. Math. Soc.* **69**, 322–433, 1963.
- Atiyah, M. F. and Singer, I. M. "The Index of Elliptic Operators I, II, III." *Ann. Math.* **87**, 484–604, 1968.
- Petkovšek, M.; Wilf, H. S.; and Zeilberger, D. *A=B*. Wellesley, MA: A. K. Peters, p. 4, 1996.

Atkin-Goldwasser-Kilian-Morain Certificate

A recursive PRIMALITY CERTIFICATE for a PRIME p . The certificate consists of a list of

1. A point on an ELLIPTIC CURVE C

$$y^2 = x^3 + g_2x + g_3 \pmod{p}$$

for some numbers g_2 and g_3 .

2. A PRIME q with $q > (p^{1/4} + 1)^2$, such that for some other number k and $m = kq$ with $k \neq 1$, $mC(x, y, g_2, g_3, p)$ is the identity on the curve, but $kC(x, y, g_2, g_3, p)$ is not the identity. This guarantees PRIMALITY of p by a theorem of Goldwasser and Kilian (1986).
3. Each q has its recursive certificate following it. So if the smallest q is known to be PRIME, all the numbers are certified PRIME up the chain.

A PRATT CERTIFICATE is quicker to generate for small numbers. The *Mathematica*® (Wolfram Research, Champaign, IL) task `ProvablePrime[n]` therefore generates an Atkin-Goldwasser-Kilian-Morain certificate only for numbers above a certain limit (10^{10} by default), and a PRATT CERTIFICATE for smaller numbers.

see also ELLIPTIC CURVE PRIMALITY PROVING, ELLIPTIC PSEUDOPRIME, PRATT CERTIFICATE, PRIMALITY CERTIFICATE, WITNESS

References

- Atkin, A. O. L. and Morain, F. "Elliptic Curves and Primality Proving." *Math. Comput.* **61**, 29–68, 1993.
- Bressoud, D. M. *Factorization and Prime Testing*. New York: Springer-Verlag, 1989.
- Goldwasser, S. and Kilian, J. "Almost All Primes Can Be Quickly Certified." *Proc. 18th STOC*. pp. 316–329, 1986.
- Morain, F. "Implementation of the Atkin-Goldwasser-Kilian Primality Testing Algorithm." Rapport de Recherche 911, INRIA, Octobre 1988.
- Schoof, R. "Elliptic Curves over Finite Fields and the Computation of Square Roots mod p ." *Math. Comput.* **44**, 483–494, 1985.
- Wunderlich, M. C. "A Performance Analysis of a Simple Prime-Testing Algorithm." *Math. Comput.* **40**, 709–714, 1983.

Atomic Statement

In LOGIC, a statement which cannot be broken down into smaller statements.

Attraction Basin

see BASIN OF ATTRACTION

Attractor

An attractor is a SET of states (points in the PHASE SPACE), invariant under the dynamics, towards which neighboring states in a given BASIN OF ATTRACTION asymptotically approach in the course of dynamic evolution. An attractor is defined as the smallest unit which cannot be itself decomposed into two or more attractors

with distinct BASINS OF ATTRACTION. This restriction is necessary since a DYNAMICAL SYSTEM may have multiple attractors, each with its own BASIN OF ATTRACTION.

Conservative systems do not have attractors, since the motion is periodic. For dissipative DYNAMICAL SYSTEMS, however, volumes shrink exponentially so attractors have 0 volume in n -D phase space.

A stable FIXED POINT surrounded by a dissipative region is an attractor known as a SINK. Regular attractors (corresponding to 0 LYAPUNOV CHARACTERISTIC EXPONENTS) act as LIMIT CYCLES, in which trajectories circle around a limiting trajectory which they asymptotically approach, but never reach. STRANGE ATTRACTORS are bounded regions of PHASE SPACE (corresponding to POSITIVE LYAPUNOV CHARACTERISTIC EXPONENTS) having zero MEASURE in the embedding PHASE SPACE and a FRACTAL DIMENSION. Trajectories within a STRANGE ATTRACTOR appear to skip around randomly.

see also BARNSEY'S FERN, BASIN OF ATTRACTION, CHAOS GAME, FRACTAL DIMENSION, LIMIT CYCLE, LYAPUNOV CHARACTERISTIC EXPONENT, MEASURE, SINK (MAP), STRANGE ATTRACTOR

Auction

A type of sale in which members of a group of buyers offer ever increasing amounts. The bidder making the last bid (for which no higher bid is subsequently made within a specified time limit: "going once, going twice, sold") must then purchase the item in question at this price. Variants of simple bidding are also possible, as in a VICKERY AUCTION.

see also VICKERY AUCTION

Augend

The first of several ADDENDS, or "the one to which the others are added," is sometimes called the augend. Therefore, while a , b , and c are ADDENDS in $a + b + c$, a is the augend.

see also ADDEND, ADDITION

Augmented Amicable Pair

A PAIR of numbers m and n such that

$$\sigma(m) = \sigma(n) = m + n - 1,$$

where $\sigma(m)$ is the DIVISOR FUNCTION. Beck and Najar (1977) found 11 augmented amicable pairs.

see also AMICABLE PAIR, DIVISOR FUNCTION, QUASI-AMICABLE PAIR

References

- Beck, W. E. and Najar, R. M. "More Reduced Amicable Pairs." *Fib. Quart.* **15**, 331–332, 1977.
- Guy, R. K. *Unsolved Problems in Number Theory*, 2nd ed. New York: Springer-Verlag, p. 59, 1994.

Augmented Dodecahedron

see JOHNSON SOLID

Augmented Hexagonal Prism

see JOHNSON SOLID

Augmented Pentagonal Prism

see JOHNSON SOLID

Augmented Polyhedron

A UNIFORM POLYHEDRON with one or more other solids adjoined.

Augmented Sphenocorona

see JOHNSON SOLID

Augmented Triangular Prism

see JOHNSON SOLID

Augmented Tridiminished Icosahedron

see JOHNSON SOLID

Augmented Truncated Cube

see JOHNSON SOLID

Augmented Truncated Dodecahedron

see JOHNSON SOLID

Augmented Truncated Tetrahedron

see JOHNSON SOLID

Aureum Theorema

Gauss's name for the QUADRATIC RECIPROCITY THEOREM.

Aurifeuillean Factorization

A factorization of the form

$$2^{4n+2} + 1 = (2^{2n+1} - 2^{n+1} + 1)(2^{2n+1} + 2^{n+1} + 1). \quad (1)$$

The factorization for $n = 14$ was discovered by Aurifeuille, and the general form was subsequently discovered by Lucas. The large factors are sometimes written as L and M as follows

$$2^{4k-2} + 1 = (2^{2k-1} - 2^k + 1)(2^{2k-1} + 2^k + 1) \quad (2)$$

$$3^{6k-3} + 1 = (3^{2k-1} + 1)(3^{2k-1} - 3^k + 1)(3^{2k-1} + 3^k + 1), \quad (3)$$

which can be written

$$2^{2h} + 1 = L_{2h}M_{2h} \quad (4)$$

$$3^{3h} + 1 = (3^h + 1)L_{3h}M_{3h} \quad (5)$$

$$5^{5h} - 1 = (5^h - 1)L_{5h}M_{5h}, \quad (6)$$

where $h \equiv 2k - 1$ and

$$L_{2h}, M_{2h} = 2^h + 1 \mp 2^k \quad (7)$$

$$L_{3h}, M_{3h} = 3^h + 1 \mp 3^k \quad (8)$$

$$L_{5h}, M_{5h} = 5^{2h} + 3 \cdot 5^h + 1 \mp 5^k(5^h + 1). \quad (9)$$

see also GAUSS'S FORMULA

References

Brillhart, J.; Lehmer, D. H.; Selfridge, J.; Wagstaff, S. S. Jr.; and Tuckerman, B. *Factorizations of $b^n \pm 1$, $b = 2, 3, 5, 6, 7, 10, 11, 12$ Up to High Powers*, rev. ed. Providence, RI: Amer. Math. Soc., pp. lxviii-lxxii, 1988.
Wagstaff, S. S. Jr. "Aurifeuillean Factorizations and the Period of the Bell Numbers Modulo a Prime." *Math. Comput.* **65**, 383-391, 1996.

Ausdehnungslehre

see EXTERIOR ALGEBRA

Authalic Latitude

AN AUXILIARY LATITUDE which gives a SPHERE equal SURFACE AREA relative to an ELLIPSOID. The authalic latitude is defined by

$$\beta = \sin^{-1} \left(\frac{q}{q_p} \right), \quad (1)$$

where

$$q \equiv (1 - e^2) \left[\frac{\sin \phi}{1 - e^2 \sin^2 \phi} - \frac{1}{2e} \ln \left(\frac{1 - e \sin \phi}{1 + e \sin \phi} \right) \right], \quad (2)$$

and q_p is q evaluated at the north pole ($\phi = 90^\circ$). Let R_q be the RADIUS of the SPHERE having the same SURFACE AREA as the ELLIPSOID, then

$$R_q = a \sqrt{\frac{q_p}{2}}. \quad (3)$$

The series for β is

$$\begin{aligned} \beta = \phi - & \left(\frac{1}{3}e^2 + \frac{31}{180}e^4 + \frac{59}{560}e^6 + \dots \right) \sin(2\phi) \\ & + \left(\frac{17}{360}e^4 + \frac{61}{1260}e^6 + \dots \right) \sin(4\phi) \\ & - \left(\frac{383}{45360}e^6 + \dots \right) \sin(6\phi) + \dots \end{aligned} \quad (4)$$

The inverse FORMULA is found from

$$\Delta\phi = \frac{(1 - e^2 \sin^2 \phi)^2}{2 \cos \phi} \left[\frac{q}{1 - e^2} - \frac{\sin \phi}{1 - e^2 \sin^2 \phi} + \frac{1}{2e} \ln \left(\frac{1 - e \sin \phi}{1 + e \sin \phi} \right) \right], \quad (5)$$

where

$$q = q_p \sin \beta \quad (6)$$

and $\phi_0 = \sin^{-1}(q/2)$. This can be written in series form as

$$\begin{aligned}\phi = & \beta + \left(\frac{1}{3}e^2 + \frac{31}{180}e^4 + \frac{517}{5040}e^6 + \dots\right) \sin(2\beta) \\ & + \left(\frac{23}{360}e^4 + \frac{251}{3780}e^6 + \dots\right) \sin(4\beta) \\ & + \left(\frac{761}{45360}e^6 + \dots\right) \sin(6\beta) + \dots\end{aligned}\quad (7)$$

see also LATITUDE

References

- Adams, O. S. "Latitude Developments Connected with Geodesy and Cartography with Tables, Including a Table for Lambert Equal-Area Meridional Projections." Spec. Pub. No. 67. U. S. Coast and Geodetic Survey, 1921.
Snyder, J. P. *Map Projections—A Working Manual*. U. S. Geological Survey Professional Paper 1395. Washington, DC: U. S. Government Printing Office, p. 16, 1987.

Autocorrelation

The autocorrelation function is defined by

$$C_f(t) \equiv f \star f = f^*(-t) \star f(t) = \int_{-\infty}^{\infty} f^*(\tau) f(t + \tau) d\tau, \quad (1)$$

where \star denotes CONVOLUTION and \star denotes CROSS-CORRELATION. A finite autocorrelation is given by

$$C_f(\tau) \equiv \langle [y(t) - \bar{y}][y(t + \tau) - \bar{y}] \rangle \quad (2)$$

$$= \lim_{T \rightarrow \infty} \int_{-T/2}^{T/2} [y(t) - \bar{y}][y(t + \tau) - \bar{y}] dt. \quad (3)$$

If f is a REAL FUNCTION,

$$f^* = f, \quad (4)$$

and an EVEN FUNCTION so that

$$f(-\tau) = f(\tau), \quad (5)$$

then

$$C_f(t) = \int_{-\infty}^{\infty} f(\tau) f(t + \tau) d\tau. \quad (6)$$

But let $\tau' \equiv -\tau$, so $d\tau' = -d\tau$, then

$$\begin{aligned}C_f(t) &= \int_{\infty}^{-\infty} f(-\tau) f(t - \tau) (-d\tau) \\ &= \int_{-\infty}^{\infty} f(-\tau) f(t - \tau) d\tau \\ &= \int_{-\infty}^{\infty} f(\tau) f(t - \tau) d\tau = f \star f.\end{aligned}\quad (7)$$

The autocorrelation discards phase information, returning only the POWER. It is therefore not reversible.

There is also a somewhat surprising and extremely important relationship between the autocorrelation and

the FOURIER TRANSFORM known as the WIENER-KHINTCHINE THEOREM. Let $\mathcal{F}[f(x)] = F(k)$, and F^* denote the COMPLEX CONJUGATE of F , then the FOURIER TRANSFORM of the ABSOLUTE SQUARE of $F(k)$ is given by

$$\mathcal{F}[|F(k)|^2] = \int_{-\infty}^{\infty} f^*(\tau) f(\tau + x) d\tau. \quad (8)$$

The autocorrelation is a HERMITIAN OPERATOR since $C_f(-t) = C_f^*(t)$. $f \star f$ is MAXIMUM at the ORIGIN. In other words,

$$\int_{-\infty}^{\infty} f(u) f(u + x) du \leq \int_{-\infty}^{\infty} f^2(u) du. \quad (9)$$

To see this, let ϵ be a REAL NUMBER. Then

$$\int_{-\infty}^{\infty} [f(u) + \epsilon f(u + x)]^2 du > 0 \quad (10)$$

$$\begin{aligned}\int_{-\infty}^{\infty} f^2(u) du + 2\epsilon \int_{-\infty}^{\infty} f(u) f(u + x) du \\ + \epsilon^2 \int_{-\infty}^{\infty} f^2(u + x) du > 0\end{aligned}\quad (11)$$

$$\begin{aligned}\int_{-\infty}^{\infty} f^2(u) du + 2\epsilon \int_{-\infty}^{\infty} f(u) f(u + x) du \\ + \epsilon^2 \int_{-\infty}^{\infty} f^2(u) du > 0.\end{aligned}\quad (12)$$

Define

$$a \equiv \int_{-\infty}^{\infty} f^2(u) du \quad (13)$$

$$b \equiv 2 \int_{-\infty}^{\infty} f(u) f(u + x) du. \quad (14)$$

Then plugging into above, we have $ac^2 + bc + c > 0$. This QUADRATIC EQUATION does not have any REAL ROOT, so $b^2 - 4ac \leq 0$, i.e., $b/2 \leq a$. It follows that

$$\int_{-\infty}^{\infty} f(u) f(u + x) du \leq \int_{-\infty}^{\infty} f^2(u) du, \quad (15)$$

with the equality at $x = 0$. This proves that $f \star f$ is MAXIMUM at the ORIGIN.

see also CONVOLUTION, CROSS-CORRELATION, QUANTIZATION EFFICIENCY, WIENER-KHINTCHINE THEOREM

References

- Press, W. H.; Flannery, B. P.; Teukolsky, S. A.; and Vetterling, W. T. "Correlation and Autocorrelation Using the FFT." §13.2 in *Numerical Recipes in FORTRAN: The Art of Scientific Computing*, 2nd ed. Cambridge, England: Cambridge University Press, pp. 538-539, 1992.

Automorphic Function

An automorphic function $f(z)$ of a COMPLEX variable z is one which is analytic (except for POLES) in a domain D and which is invariant under a DENUMERABLY INFINITE group of LINEAR FRACTIONAL TRANSFORMATIONS (also known as MÖBIUS TRANSFORMATIONS)

$$z' = \frac{az + b}{cz + d}.$$

Automorphic functions are generalizations of TRIGONOMETRIC FUNCTIONS and ELLIPTIC FUNCTIONS.

see also MODULAR FUNCTION, MÖBIUS TRANSFORMATIONS, ZETA FUCHSIAN

Automorphic Number

A number k such that nk^2 has its last digits equal to k is called n -automorphic. For example, $1 \cdot 5^2 = 25$ and $1 \cdot 6^2 = 36$ are 1-automorphic and $2 \cdot 8^2 = 128$ and $2 \cdot 88^2 = 15488$ are 2-automorphic. de Guerre and Fairbairn (1968) give a history of automorphic numbers.

The first few 1-automorphic numbers are 1, 5, 6, 25, 76, 376, 625, 9376, 90625, ... (Sloane's A003226, Wells 1986, p. 130). There are two 1-automorphic numbers with a given number of digits, one ending in 5 and one in 6 (except that the 1-digit automorphic numbers include 1), and each of these contains the previous number with a digit prepended. Using this fact, it is possible to construct automorphic numbers having more than 25,000 digits (Madachy 1979). The first few 1-automorphic numbers ending with 5 are 5, 25, 625, 0625, 90625, ... (Sloane's A007185), and the first few ending with 6 are 6, 76, 376, 9376, 09376, ... (Sloane's A016090). The 1-automorphic numbers $a(n)$ ending in 5 are IDEMPOTENT (mod 10^n) since

$$[a(n)]^2 \equiv a(n) \pmod{10^n}$$

(Sloane and Plouffe 1995).

The following table gives the 10-digit n -automorphic numbers.

n	n -Automorphic Numbers	Sloane
1	0000000001, 8212890625, 1787109376	—, A007185, A016090
2	0893554688	A030984
3	6666666667, 7262369792, 9404296875	—, A030985, A030986
4	0446777344	A030987
5	3642578125	A030988
6	3631184896	A030989
7	7142857143, 4548984375, 1683872768	A030990, A030991, A030992
8	0223388672	A030993
9	5754123264, 3134765625, 8888888889	A030994, A030995, —

see also IDEMPOTENT, NARCISSISTIC NUMBER, NUMBER PYRAMID, TRIMORPHIC NUMBER

References

Beeler, M.; Gosper, R. W.; and Schroepel, R. Item 59 in *HAKMEM*. Cambridge, MA: MIT Artificial Intelligence Laboratory, Memo AIM-239, Feb. 1972.

Fairbairn, R. A. "More on Automorphic Numbers." *J. Recr. Math.* **2**, 170–174, 1969.

Fairbairn, R. A. Erratum to "More on Automorphic Numbers." *J. Recr. Math.* **2**, 245, 1969.

de Guerre, V. and Fairbairn, R. A. "Automorphic Numbers." *J. Recr. Math.* **1**, 173–179, 1968.

Hunter, J. A. H. "Two Very Special Numbers." *Fib. Quart.* **2**, 230, 1964.

Hunter, J. A. H. "Some Polyaautomorphic Numbers." *J. Recr. Math.* **5**, 27, 1972.

Kraitchik, M. "Automorphic Numbers." §3.8 in *Mathematical Recreations*. New York: W. W. Norton, pp. 77–78, 1942.

Madachy, J. S. *Madachy's Mathematical Recreations*. New York: Dover, pp. 34–54 and 175–176, 1979.

Sloane, N. J. A. Sequences A016090, A003226/M3752, and A007185/M3940 in "An On-Line Version of the Encyclopedia of Integer Sequences."

Wells, D. *The Penguin Dictionary of Curious and Interesting Numbers*. Middlesex: Penguin Books, pp. 171, 178, 191–192, 1986.

Automorphism

An ISOMORPHISM of a system of objects onto itself.

see also ANOSOV AUTOMORPHISM

Automorphism Group

The GROUP of functions from an object G to itself which preserve the structure of the object, denoted $\text{Aut}(G)$. The automorphism group of a GROUP preserves the MULTIPLICATION table, the automorphism group of a GRAPH the INCIDENCE MATRICES, and that of a FIELD the ADDITION and MULTIPLICATION tables.

see also OUTER AUTOMORPHISM GROUP

Autonomous

A differential equation or system of ORDINARY DIFFERENTIAL EQUATIONS is said to be autonomous if it does not explicitly contain the independent variable (usually denoted t). A second-order autonomous differential equation is of the form $F(y, y', y'') = 0$, where $y' \equiv dy/dt \equiv v$. By the CHAIN RULE, y'' can be expressed as

$$y'' = v' = \frac{dv}{dt} = \frac{dv}{dy} \frac{dy}{dt} = \frac{dv}{dy} v.$$

For an autonomous ODE, the solution is independent of the time at which the initial conditions are applied. This means that all particles pass through a given point in phase space. A nonautonomous system of n first-order ODEs can be written as an autonomous system of $n+1$ ODEs by letting $t \equiv x_{n+1}$ and increasing the dimension of the system by 1 by adding the equation

$$\frac{dx_{n+1}}{dt} = 1.$$

Autoregressive Model

see MAXIMUM ENTROPY METHOD

Auxiliary Circle

The CIRCUMCIRCLE of an ELLIPSE, i.e., the CIRCLE whose center corresponds with that of the ELLIPSE and whose RADIUS is equal to the ELLIPSE's SEMIMAJOR AXIS.

see also CIRCLE, ECCENTRIC ANGLE, ELLIPSE

Auxiliary Latitude

see AUTHALIC LATITUDE, CONFORMAL LATITUDE, GEOCENTRIC LATITUDE, ISOMETRIC LATITUDE, LATITUDE, PARAMETRIC LATITUDE, RECTIFYING LATITUDE, REDUCED LATITUDE

Auxiliary Triangle

see MEDIAL TRIANGLE

Average

see MEAN

Average Absolute Deviation

$$\alpha \equiv \frac{1}{N} \sum_{i=1}^N |x_i - \mu| = \langle |x_i - \mu| \rangle.$$

see also ABSOLUTE DEVIATION, DEVIATION, STANDARD DEVIATION, VARIANCE

Average Function

If f is CONTINUOUS on a CLOSED INTERVAL $[a, b]$, then there is at least one number x^* in $[a, b]$ such that

$$\int_a^b f(x) dx = f(x^*)(b - a).$$

The average value of the FUNCTION (\bar{f}) on this interval is then given by $f(x^*)$.

see MEAN-VALUE THEOREM

Average Seek Time

see POINT-POINT DISTANCE—1-D

Ax-Kochen Isomorphism Theorem

Let P be the SET of PRIMES, and let \mathbb{Q}_p and $Z_p(t)$ be the FIELDS of p -ADIC NUMBERS and formal POWER series over $Z_p = (0, 1, \dots, p-1)$. Further, suppose that D is a “nonprincipal maximal filter” on P . Then $\prod_{p \in P} \mathbb{Q}_p/D$ and $\prod_{p \in P} Z_p(t)/D$ are ISOMORPHIC.

see also HYPERREAL NUMBER, NONSTANDARD ANALYSIS

Axial Vector

see PSEUDOVECTOR

Axiom

A PROPOSITION regarded as self-evidently TRUE without PROOF. The word “axiom” is a slightly archaic synonym for POSTULATE. Compare CONJECTURE or HYPOTHESIS, both of which connote apparently TRUE but not self-evident statements.

see also ARCHIMEDES' AXIOM, AXIOM OF CHOICE, AXIOMATIC SYSTEM, CANTOR-DEDEKIND AXIOM, CONGRUENCE AXIOMS, CONJECTURE, CONTINUITY AXIOMS, COUNTABLE ADDITIVITY PROBABILITY AXIOM, DEDEKIND'S AXIOM, DIMENSION AXIOM, EILENBERG-STEENROD AXIOMS, EUCLID'S AXIOMS, EXCISION AXIOM, FANO'S AXIOM, FIELD AXIOMS, HAUSDORFF AXIOMS, HILBERT'S AXIOMS, HOMOTOPY AXIOM, INACCESSIBLE CARDINALS AXIOM, INCIDENCE AXIOMS, INDEPENDENCE AXIOM, INDUCTION AXIOM, LAW, LEMMA, LONG EXACT SEQUENCE OF A PAIR AXIOM, ORDERING AXIOMS, PARALLEL AXIOM, PASCH'S AXIOM, PEANO'S AXIOMS, PLAYFAIR'S AXIOM, PORISM, POSTULATE, PROBABILITY AXIOMS, PROCLUS' AXIOM, RULE, T2-SEPARATION AXIOM, THEOREM, ZERMELO'S AXIOM OF CHOICE, ZERMELO-FRAENKEL AXIOMS

Axiom A Diffeomorphism

Let $\phi : M \rightarrow M$ be a C^1 DIFFEOMORPHISM on a compact RIEMANNIAN MANIFOLD M . Then ϕ satisfies Axiom A if the NONWANDERING set $\Omega(\phi)$ of ϕ is hyperbolic and the PERIODIC POINTS of ϕ are DENSE in $\Omega(\phi)$. Although it was conjectured that the first of these conditions implies the second, they were shown to be independent in or around 1977. Examples include the ANOSOV DIFFEOMORPHISMS and SMALE HORSESHOE MAP.

In some cases, Axiom A can be replaced by the condition that the DIFFEOMORPHISM is a hyperbolic diffeomorphism on a hyperbolic set (Bowen 1975, Parry and Pollicott 1990).

see also ANOSOV DIFFEOMORPHISM, AXIOM A FLOW, DIFFEOMORPHISM, DYNAMICAL SYSTEM, RIEMANNIAN MANIFOLD, SMALE HORSESHOE MAP

References

- Bowen, R. *Equilibrium States and the Ergodic Theory of Anosov Diffeomorphisms*. New York: Springer-Verlag, 1975.
- Ott, E. *Chaos in Dynamical Systems*. New York: Cambridge University Press, p. 143, 1993.
- Parry, W. and Pollicott, M. “Zeta Functions and the Periodic Orbit Structure of Hyperbolic Dynamics.” *Astérisque* No. 187–188, 1990.
- Smale, S. “Differentiable Dynamical Systems.” *Bull. Amer. Math. Soc.* **73**, 747–817, 1967.

Axiom A Flow

A FLOW defined analogously to the AXIOM A DIFFEOMORPHISM, except that instead of splitting the TANGENT BUNDLE into two invariant sub-BUNDLES, they are split into three (one exponentially contracting, one expanding, and one which is 1-dimensional and tangential to the flow direction).

see also DYNAMICAL SYSTEM

Axiom of Choice

An important and fundamental result in SET THEORY sometimes called ZERMELO'S AXIOM OF CHOICE. It was formulated by Zermelo in 1904 and states that, given any SET of mutually exclusive nonempty SETS, there exists at least one SET that contains exactly one element in common with each of the nonempty SETS.

It is related to HILBERT'S PROBLEM 1B, and was proved to be consistent with other AXIOMS in SET THEORY in 1940 by Gödel. In 1963, Cohen demonstrated that the axiom of choice is independent of the other AXIOMS in Cantorian SET THEORY, so the AXIOM cannot be proved within the system (Boyer and Merzbacher 1991, p. 610).

see also HILBERT'S PROBLEMS, SET THEORY, WELL-ORDERED SET, ZERMELO-FRAENKEL AXIOMS, ZORN'S LEMMA

References

- Boyer, C. B. and Merzbacher, U. C. *A History of Mathematics*, 2nd ed. New York: Wiley, 1991.
- Cohen, P. J. "The Independence of the Continuum Hypothesis." *Proc. Nat. Acad. Sci. U. S. A.* 50, 1143-1148, 1963.
- Cohen, P. J. "The Independence of the Continuum Hypothesis. II." *Proc. Nat. Acad. Sci. U. S. A.* 51, 105-110, 1964.
- Conway, J. H. and Guy, R. K. *The Book of Numbers*. New York: Springer-Verlag, pp. 274-276, 1996.
- Moore, G. H. *Zermelo's Axiom of Choice: Its Origin, Development, and Influence*. New York: Springer-Verlag, 1982.

Axiomatic Set Theory

A version of SET THEORY in which axioms are taken as uninterpreted rather than as formalizations of pre-existing truths.

see also NAIVE SET THEORY, SET THEORY

Axiomatic System

A logical system which possesses an explicitly stated SET of AXIOMS from which THEOREMS can be derived.

see also COMPLETE AXIOMATIC THEORY, CONSISTENCY, MODEL THEORY, THEOREM

Axis

A LINE with respect to which a curve or figure is drawn, measured, rotated, etc. The term is also used to refer to a LINE SEGMENT through a RANGE (Woods 1961).

see also ABSCISSA, ORDINATE, x-AXIS, y-AXIS, z-AXIS

References

- Woods, F. S. *Higher Geometry: An Introduction to Advanced Methods in Analytic Geometry*. New York: Dover, p. 8, 1961.

Axonometry

A METHOD for mapping 3-D figures onto the PLANE.

see also CROSS-SECTION, MAP PROJECTION, POHLKE'S THEOREM, PROJECTION, STEREOLOGY

References

- Coxeter, H. S. M. *Regular Polytopes*, 3rd ed. New York: Dover, p. 313, 1973.

Hazewinkel, M. (Managing Ed.). *Encyclopaedia of Mathematics: An Updated and Annotated Translation of the Soviet "Mathematical Encyclopaedia."* Dordrecht, Netherlands: Reidel, pp. 322-323, 1988.

Azimuthal Equidistant Projection

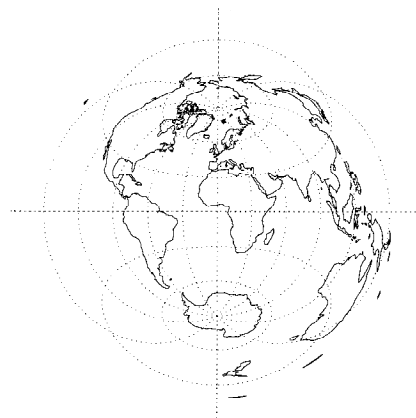

AN AZIMUTHAL PROJECTION which is neither equal-AREA nor CONFORMAL. Let ϕ_1 and λ_0 be the LATITUDE and LONGITUDE of the center of the projection, then the transformation equations are given by

$$x = k' \cos \phi \sin(\lambda - \lambda_0) \quad (1)$$

$$y = k' [\cos \phi_1 \sin \phi - \sin \phi_1 \cos \phi \cos(\lambda - \lambda_0)] \quad (2)$$

Here,

$$k' = \frac{c}{\sin c} \quad (3)$$

and

$$\cos c = \sin \phi_1 \sin \phi + \cos \phi_1 \cos \phi \cos(\lambda - \lambda_0), \quad (4)$$

where c is the angular distance from the center. The inverse FORMULAS are

$$\phi = \sin^{-1} \left(\cos c \sin \phi_1 + \frac{y \sin c \cos \phi_1}{c} \right) \quad (5)$$

and

$$\lambda = \begin{cases} \lambda_0 + \tan^{-1} \left(\frac{x \sin c}{c \cos \phi_1 \cos c - y \sin \phi_1 \sin c} \right) & \text{for } \phi_1 \neq \pm 90^\circ \\ \lambda_0 + \tan^{-1} \left(-\frac{x}{y} \right) & \text{for } \phi_1 = 90^\circ \\ \lambda_0 + \tan^{-1} \left(\frac{x}{y} \right), & \text{for } \phi_1 = -90^\circ, \end{cases} \quad (6)$$

with the angular distance from the center given by

$$c = \sqrt{x^2 + y^2}. \quad (7)$$

References

- Snyder, J. P. *Map Projections—A Working Manual*. U. S. Geological Survey Professional Paper 1395. Washington, DC: U. S. Government Printing Office, pp. 191-202, 1987.

Azimuthal Projection

see AZIMUTHAL EQUIDISTANT PROJECTION, LAMBERT AZIMUTHAL EQUAL-AREA PROJECTION, ORTHOGRAPHIC PROJECTION, STEREOGRAPHIC PROJECTION

B

B^* -Algebra

A BANACH ALGEBRA with an ANTIAUTOMORPHIC INVOLUTION $*$ which satisfies

$$x^{**} = x \quad (1)$$

$$x^*y^* = (yx)^* \quad (2)$$

$$x^* + y^* = (x + y)^* \quad (3)$$

$$(cx)^* = \bar{c}x^* \quad (4)$$

and whose NORM satisfies

$$\|xx^*\| = \|x\|^2. \quad (5)$$

A C^* -ALGEBRA is a special type of B^* -algebra.

see also BANACH ALGEBRA, C^* -ALGEBRA

B_2 -Sequence

N.B. A detailed on-line essay by S. Finch was the starting point for this entry.

Also called a SIDON SEQUENCE. An INFINITE SEQUENCE OF POSITIVE INTEGERS

$$1 \leq b_1 < b_2 < b_3 < \dots \quad (1)$$

such that all pairwise sums

$$b_i + b_j \quad (2)$$

for $i \leq j$ are distinct (Guy 1994). An example is 1, 2, 4, 8, 13, 21, 31, 45, 66, 81, ... (Sloane's A005282).

Zhang (1993, 1994) showed that

$$S(B2) = \sup_{\text{all } B2 \text{ sequences}} \sum_{k=1}^{\infty} \frac{1}{b_k} > 2.1597. \quad (3)$$

The definition can be extended to B_n -sequences (Guy 1994).

see also A-SEQUENCE, MIAN-CHOWLA SEQUENCE

References

- Finch, S. "Favorite Mathematical Constants." <http://www.mathsoft.com/asolve/constant/erdos/erdos.html>.
- Guy, R. K. "Packing Sums of Pairs," "Three-Subsets with Distinct Sums," and " B_2 -Sequences," and B_2 -Sequences Formed by the Greedy Algorithm." §C9, C11, E28, and E32 in *Unsolved Problems in Number Theory*, 2nd ed. New York: Springer-Verlag, pp. 115–118, 121–123, 228–229, and 232–233, 1994.
- Sloane, N. J. A. Sequence A005282/M1094 in "An On-Line Version of the Encyclopedia of Integer Sequences."
- Zhang, Z. X. "A B_2 -Sequence with Larger Reciprocal Sum." *Math. Comput.* **60**, 835–839, 1993.
- Zhang, Z. X. "Finding Finite B_2 -Sequences with Larger $m - a_m^{1/2}$." *Math. Comput.* **63**, 403–414, 1994.

B_p -Theorem

If $O_{p'}(G) = 1$ and if x is a p -element of G , then

$$L_{p'}(C_G(x)) \leq E(C_G(x)),$$

where $L_{p'}$ is the p -LAYER.

B-Spline

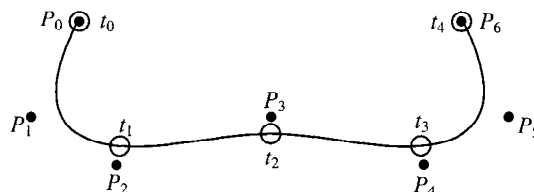

A generalization of the BÉZIER CURVE. Let a vector known as the KNOT VECTOR be defined

$$\mathbf{T} = \{t_0, t_1, \dots, t_m\}, \quad (1)$$

where \mathbf{T} is a nondecreasing SEQUENCE with $t_i \in [0, 1]$, and define control points $\mathbf{P}_0, \dots, \mathbf{P}_n$. Define the degree as

$$p \equiv m - n - 1. \quad (2)$$

The "knots" $t_{p+1}, \dots, t_{m-p-1}$ are called INTERNAL KNOTS.

Define the basis functions as

$$N_{i,0}(t) = \begin{cases} 1 & \text{if } t_i \leq t < t_{i+1} \text{ and } t_i < t_{i+1} \\ 0 & \text{otherwise} \end{cases} \quad (3)$$

$$N_{i,p}(t) = \frac{t - t_i}{t_{i+p} - t_i} N_{i,p-1}(t) + \frac{t_{i+p+1} - t}{t_{i+p+1} - t_{i+1}} N_{i+1,p-1}(t). \quad (4)$$

Then the curve defined by

$$\mathbf{C}(t) = \sum_{i=0}^n \mathbf{P}_i N_{i,p}(t) \quad (5)$$

is a B-spline. Specific types include the nonperiodic B-spline (first $p + 1$ knots equal 0 and last $p + 1$ equal to 1) and uniform B-spline (INTERNAL KNOTS are equally spaced). A B-Spline with no INTERNAL KNOTS is a BÉZIER CURVE.

The degree of a B-spline is independent of the number of control points, so a low order can always be maintained for purposes of numerical stability. Also, a curve is $p - k$ times differentiable at a point where k duplicate knot values occur. The knot values determine the extent of the control of the control points.

A nonperiodic B-spline is a B-spline whose first $p + 1$ knots are equal to 0 and last $p + 1$ knots are equal to 1. A uniform B-spline is a B-spline whose INTERNAL KNOTS are equally spaced.

see also BÉZIER CURVE, NURBS CURVE

B-Tree

B-trees were introduced by Bayer (1972) and McCreight. They are a special *m*-ary balanced tree used in databases because their structure allows records to be inserted, deleted, and retrieved with guaranteed worst-case performance. An *n*-node *B*-tree has height $\mathcal{O}(\lg 2)$, where LG is the LOGARITHM to base 2. The Apple[®] Macintosh[®] (Apple Computer, Cupertino, CA) HFS filing system uses *B*-trees to store disk directories (Benedict 1995). A *B*-tree satisfies the following properties:

1. The ROOT is either a LEAF (TREE) or has at least two CHILDREN.
2. Each node (except the ROOT and LEAVES) has between $\lceil m/2 \rceil$ and *m* CHILDREN, where $\lceil x \rceil$ is the CEILING FUNCTION.
3. Each path from the ROOT to a LEAF (TREE) has the same length.

Every 2-3 TREE is a *B*-tree of order 3. The number of *B*-trees of order *n* = 1, 2, ... are 0, 1, 1, 2, 2, 3, 4, 5, 8, 14, 23, 32, 43, 63, ... (Ruskey, Sloane's A014535).

see also RED-BLACK TREE

References

- Aho, A. V.; Hopcroft, J. E.; and Ullmann, J. D. *Data Structures and Algorithms*. Reading, MA: Addison-Wesley, pp. 369–374, 1987.
- Benedict, B. *Using Norton Utilities for the Macintosh*. Indianapolis, IN: Que, pp. B-17–B-33, 1995.
- Beyer, R. "Symmetric Binary *B*-Trees: Data Structures and Maintenance Algorithms." *Acta Informat.* 1, 290–306, 1972.
- Ruskey, F. "Information on *B*-Trees." <http://sue.csc.uvic.ca/~cos/inf/tree/BTrees.html>.
- Sloane, N. J. A. Sequence A014535 in "An On-Line Version of the Encyclopedia of Integer Sequences."

Baby Monster Group

Also known as FISCHER'S BABY MONSTER GROUP. The SPORADIC GROUP *B*. It has ORDER

$$2^{41} \cdot 3^{13} \cdot 5^6 \cdot 7^2 \cdot 11 \cdot 13 \cdot 17 \cdot 19 \cdot 23 \cdot 31 \cdot 47.$$

see also MONSTER GROUP

References

- Wilson, R. A. "ATLAS of Finite Group Representation." <http://for.mat.bham.ac.uk/atlas/BM.html>.

BAC-CAB Identity

The VECTOR TRIPLE PRODUCT identity

$$\mathbf{A} \times (\mathbf{B} \times \mathbf{C}) = \mathbf{B}(\mathbf{A} \cdot \mathbf{C}) - \mathbf{C}(\mathbf{A} \cdot \mathbf{B}).$$

This identity can be generalized to *n*-D

$$\mathbf{a}_2 \times \cdots \times \mathbf{a}_{n-1} \times (\mathbf{b}_1 \times \cdots \times \mathbf{b}_{n-1}) \\ = (-1)^{n+1} \begin{vmatrix} \mathbf{b}_1 & \cdots & \mathbf{b}_{n-1} \\ \mathbf{a}_2 \cdot \mathbf{b}_1 & \cdots & \mathbf{a}_2 \cdot \mathbf{b}_{n-1} \\ \vdots & \ddots & \vdots \\ \mathbf{a}_{n-1} \cdot \mathbf{b}_1 & \cdots & \mathbf{a}_{n-1} \cdot \mathbf{b}_{n-1} \end{vmatrix}.$$

see also LAGRANGE'S IDENTITY

BAC-CAB Rule

see BAC-CAB IDENTITY

Bachelier Function

see BROWN FUNCTION

Bachet's Conjecture

see LAGRANGE'S FOUR-SQUARE THEOREM

Bachet Equation

The DIOPHANTINE EQUATION

$$x^2 + k = y^3,$$

which is also an ELLIPTIC CURVE. The general equation is still the focus of ongoing study.

Backhouse's Constant

Let $P(x)$ be defined as the POWER series whose *n*th term has a COEFFICIENT equal to the *n*th PRIME,

$$P(x) \equiv \sum_{k=0}^{\infty} p_k x^k = 1 + 2x + 3x^2 + 5x^3 + 7x^4 + 11x^5 + \cdots,$$

and let $Q(x)$ be defined by

$$Q(x) = \frac{1}{P(x)} = \sum_{k=0}^{\infty} q_k x^k.$$

Then N. Backhouse conjectured that

$$\lim_{n \rightarrow \infty} \left| \frac{q_{n+1}}{q_n} \right| = 1.456074948582689671399595351116 \dots$$

The constant was subsequently shown to exist by P. Flajolet.

References

- Finch, S. "Favorite Mathematical Constants." <http://www.mathsoft.com/asolve/constant/backhaus/backhaus.html>.

Bäcklund Transformation

A method for solving classes of nonlinear PARTIAL DIFFERENTIAL EQUATIONS.

see also INVERSE SCATTERING METHOD

References

- Infeld, E. and Rowlands, G. *Nonlinear Waves, Solitons, and Chaos*. Cambridge, England: Cambridge University Press, p. 196, 1990.
- Miura, R. M. (Ed.) *Bäcklund Transformations, the Inverse Scattering Method, Solitons, and Their Applications*. New York: Springer-Verlag, 1974.

Backtracking

A method of drawing FRACTALS by appropriate numbering of the corresponding tree diagram which does not require storage of intermediate results.

Backus-Gilbert Method

A method which can be used to solve some classes of INTEGRAL EQUATIONS and is especially useful in implementing certain types of data inversion. It has been applied to invert seismic data to obtain density profiles in the Earth.

References

- Backus, G. and Gilbert, F. "The Resolving Power of Growth Earth Data." *Geophys. J. Roy. Astron. Soc.* **16**, 169–205, 1968.
- Backus, G. E. and Gilbert, F. "Uniqueness in the Inversion of Inaccurate Gross Earth Data." *Phil. Trans. Roy. Soc. London Ser. A* **266**, 123–192, 1970.
- Loredo, T. J. and Epstein, R. I. "Analyzing Gamma-Ray Burst Spectral Data." *Astrophys. J.* **336**, 896–919, 1989.
- Parker, R. L. "Understanding Inverse Theory." *Ann. Rev. Earth Planet. Sci.* **5**, 35–64, 1977.
- Press, W. H.; Flannery, B. P.; Teukolsky, S. A.; and Vetterling, W. T. "Backus-Gilbert Method." §18.6 in *Numerical Recipes in FORTRAN: The Art of Scientific Computing*, 2nd ed. Cambridge, England: Cambridge University Press, pp. 806–809, 1992.

Backward Difference

The backward difference is a FINITE DIFFERENCE defined by

$$\nabla_p \equiv \nabla f_p \equiv f_p - f_{p-1}. \quad (1)$$

Higher order differences are obtained by repeated operations of the backward difference operator, so

$$\nabla_p^2 = \nabla(\nabla p) = \nabla(f_p - f_{p-1}) = \nabla f_p - \nabla f_{p-1} \quad (2)$$

$$= (f_p - f_{p-1}) - (f_{p-1} - f_{p-2}) \quad (3)$$

$$= f_p - 2f_{p-1} + f_{p-2}$$

In general,

$$\nabla_p^k \equiv \nabla^k f_p \equiv \sum_{m=0}^k (-1)^m \binom{k}{m} f_{p-k+m}, \quad (4)$$

where $\binom{k}{m}$ is a BINOMIAL COEFFICIENT.

NEWTON'S BACKWARD DIFFERENCE FORMULA expresses f_p as the sum of the n th backward differences

$$f_p = f_0 + p\nabla_0 + \frac{1}{2!}p(p+1)\nabla_0^2 + \frac{1}{3!}p(p+1)(p+2)\nabla_0^3 + \dots, \quad (5)$$

where ∇_0^n is the first n th difference computed from the difference table.

see also ADAMS' METHOD, DIFFERENCE EQUATION, DIVIDED DIFFERENCE, FINITE DIFFERENCE, FORWARD DIFFERENCE, NEWTON'S BACKWARD DIFFERENCE FORMULA, RECIPROCAL DIFFERENCE

References

- Beyer, W. H. *CRC Standard Mathematical Tables*, 28th ed. Boca Raton, FL: CRC Press, pp. 429 and 433, 1987.

Bader-Deuffhard Method

A generalization of the BULIRSCH-STOER ALGORITHM for solving ORDINARY DIFFERENTIAL EQUATIONS.

References

- Bader, G. and Deuffhard, P. "A Semi-Implicit Mid-Point Rule for Stiff Systems of Ordinary Differential Equations." *Numer. Math.* **41**, 373–398, 1983.
- Press, W. H.; Flannery, B. P.; Teukolsky, S. A.; and Vetterling, W. T. *Numerical Recipes in FORTRAN: The Art of Scientific Computing*, 2nd ed. Cambridge, England: Cambridge University Press, p. 730, 1992.

Baguenaudier

A PUZZLE involving disentangling a set of rings from a looped double rod (also called CHINESE RINGS). The minimum number of moves needed for n rings is

$$\begin{cases} \frac{1}{3}(2^{n+1} - 2) & n \text{ even} \\ \frac{1}{3}(2^{n+1} - 1) & n \text{ odd.} \end{cases}$$

By simultaneously moving the two end rings, the number of moves can be reduced to

$$\begin{cases} 2^{n-1} - 1 & n \text{ even} \\ 2^{n-1} & n \text{ odd.} \end{cases}$$

The solution of the baguenaudier is intimately related to the theory of GRAY CODES.

References

- Dubrovsky, V. "Nesting Puzzles, Part II: Chinese Rings Produce a Chinese Monster." *Quantum* **6**, 61–65 (Mar.) and 58–59 (Apr.), 1996.
- Gardner, M. "The Binary Gray Code." In *Knotted Doughnuts and Other Mathematical Entertainments*. New York: W. H. Freeman, pp. 15–17, 1986.
- Kraitchik, M. "Chinese Rings." §3.12.3 in *Mathematical Recreations*. New York: W. W. Norton, pp. 89–91, 1942.
- Steinhaus, H. *Mathematical Snapshots*, 3rd American ed. New York: Oxford University Press, p. 268, 1983.

Bailey's Method

see LAMBERT'S METHOD

Bailey's Theorem

Let $\Gamma(z)$ be the GAMMA FUNCTION, then

$$\begin{aligned} & \left[\frac{\Gamma(m + \frac{1}{2})}{\Gamma(m)} \right]^2 \underbrace{\left[\frac{1}{m} + \left(\frac{1}{2} \right)^2 \frac{1}{m+1} + \left(\frac{1 \cdot 3}{2 \cdot 4} \right)^2 \frac{1}{m+2} + \dots \right]}_n \\ &= \left[\frac{\Gamma(n + \frac{1}{2})}{\Gamma(n)} \right]^2 \underbrace{\left[\frac{1}{n} + \left(\frac{1}{2} \right)^2 \frac{1}{n+1} + \left(\frac{1 \cdot 3}{2 \cdot 4} \right)^2 \frac{1}{n+2} + \dots \right]}_m. \end{aligned}$$

Baire Category Theorem

A nonempty complete METRIC SPACE cannot be represented as the UNION of a COUNTABLE family of nowhere DENSE SUBSETS.

Baire Space

A TOPOLOGICAL SPACE X in which each SUBSET of X of the “first category” has an empty interior. A TOPOLOGICAL SPACE which is HOMEOMORPHIC to a complete METRIC SPACE is a Baire space.

Bairstow's Method

A procedure for finding the quadratic factors for the COMPLEX CONJUGATE ROOTS of a POLYNOMIAL $P(x)$ with REAL COEFFICIENTS.

$$\begin{aligned} [x - (a + ib)][x - (a - ib)] \\ = x^2 + 2ax + (a^2 + b^2) \equiv x^2 + Bx + C. \end{aligned} \quad (1)$$

Now write the original POLYNOMIAL as

$$P(x) = (x^2 + Bx + C)Q(x) + Rx + S \quad (2)$$

$$R(B + \delta B, C + \delta C) \approx R(B, C) + \frac{\partial R}{\partial B} \delta B + \frac{\partial R}{\partial C} \delta C \quad (3)$$

$$S(B + \delta B, C + \delta C) \approx S(B, C) + \frac{\partial S}{\partial B} \delta B + \frac{\partial S}{\partial C} \delta C \quad (4)$$

$$\frac{\partial P}{\partial C} = 0 = (x^2 + Bx + C) \frac{\partial Q}{\partial C} + Q(x) + \frac{\partial R}{\partial C} + \frac{\partial S}{\partial C} \quad (5)$$

$$-Q(x) = (x^2 + Bx + C) \frac{\partial Q}{\partial C} + \frac{\partial R}{\partial C} + \frac{\partial S}{\partial C} \quad (6)$$

$$\frac{\partial P}{\partial B} = 0 = (x^2 + Bx + C) \frac{\partial Q}{\partial B} + xQ(x) + \frac{\partial R}{\partial B} + \frac{\partial S}{\partial B} \quad (7)$$

$$-xQ(x) = (x^2 + Bx + C) \frac{\partial Q}{\partial B} + \frac{\partial R}{\partial B} + \frac{\partial S}{\partial B} \quad (8)$$

Now use the 2-D NEWTON'S METHOD to find the simultaneous solutions.

References

Press, W. H.; Flannery, B. P.; Teukolsky, S. A.; and Vetterling, W. T. *Numerical Recipes in C: The Art of Scientific Computing*. Cambridge, England: Cambridge University Press, pp. 277 and 283–284, 1989.

Baker's Dozen

The number 13.

see also 13, DOZEN

Baker's Map

The MAP

$$x_{n+1} = 2\mu x_n, \quad (1)$$

where x is computed modulo 1. A generalized Baker's map can be defined as

$$x_{n+1} = \begin{cases} \lambda_a x_n & y_n < \alpha \\ (1 - \lambda_b) + \lambda_b x_n & y_n > \alpha \end{cases} \quad (2)$$

$$y_{n+1} = \begin{cases} \frac{y_n}{\alpha} & y_n < \alpha \\ \frac{y_n - \alpha}{\beta} & y_n > \alpha, \end{cases} \quad (3)$$

where $\beta \equiv 1 - \alpha$, $\lambda_a + \lambda_b \leq 1$, and x and y are computed mod 1. The $q = 1$ q -DIMENSION is

$$D_1 = 1 + \frac{\alpha \ln\left(\frac{1}{\alpha}\right) + \beta \ln\left(\frac{1}{\beta}\right)}{\alpha \ln\left(\frac{1}{\lambda_a}\right) + \beta \ln\left(\frac{1}{\lambda_b}\right)}. \quad (4)$$

If $\lambda_a = \lambda_b$, then the general q -DIMENSION is

$$D_q = 1 + \frac{1}{q-1} \frac{\ln(\alpha^q + \beta^q)}{\ln \lambda_a}. \quad (5)$$

References

Lichtenberg, A. and Lieberman, M. *Regular and Stochastic Motion*. New York: Springer-Verlag, p. 60, 1983.
Ott, E. *Chaos in Dynamical Systems*. Cambridge, England: Cambridge University Press, pp. 81–82, 1993.
Rasband, S. N. *Chaotic Dynamics of Nonlinear Systems*. New York: Wiley, p. 32, 1990.

Balanced ANOVA

An ANOVA in which the number of REPLICATES (sets of identical observations) is restricted to be the same for each FACTOR LEVEL (treatment group).

see also ANOVA

Balanced Incomplete Block Design

see BLOCK DESIGN

Ball

The n -ball, denoted \mathbb{B}^n , is the interior of a SPHERE \mathbb{S}^{n-1} , and sometimes also called the n -DISK. (Although physicists often use the term “SPHERE” to mean the solid ball, mathematicians definitely do not!) Let $\text{Vol}(\mathbb{B}^n)$ denote the volume of an n -D ball of RADIUS r . Then

$$\sum_{n=0}^{\infty} \text{Vol}(\mathbb{B}^n) = e^{\pi r^2} [1 + \text{erf}(r\sqrt{\pi})],$$

where $\text{erf}(x)$ is the ERF function.

see also ALEXANDER'S HORNED SPHERE, BANACH-TARSKI PARADOX, BING'S THEOREM, BISHOP'S INEQUALITY, BOUNDED, DISK, HYPERSPHERE, SPHERE, WILD POINT

References

Freden, E. Problem 10207. “Summing a Series of Volumes.” *Amer. Math. Monthly* 100, 882, 1993.

Ball Triangle Picking

The determination of the probability for obtaining an OBTUSE TRIANGLE by picking 3 points at random in the unit DISK was generalized by Hall (1982) to the n -D BALL. Buchta (1986) subsequently gave closed form

evaluations for Hall's integrals, with the first few solutions being

$$\begin{aligned}P_2 &= \frac{9}{8} - \frac{4}{\pi^2} \approx 0.72 \\P_3 &= \frac{37}{70} \approx 0.53 \\P_4 &\approx 0.39 \\P_5 &\approx 0.29.\end{aligned}$$

The case P_2 corresponds to the usual DISK case.

see also CUBE TRIANGLE PICKING, OBTUSE TRIANGLE

References

- Buchta, C. "A Note on the Volume of a Random Polytope in a Tetrahedron." *Ill. J. Math.* **30**, 653–659, 1986.
Hall, G. R. "Acute Triangles in the n -Ball." *J. Appl. Prob.* **19**, 712–715, 1982.

Ballantine

see BORROMEAN RINGS

Ballieu's Theorem

For any set $\mu = (\mu_1, \mu_2, \dots, \mu_n)$ of POSITIVE numbers with $\mu_0 = 0$ and

$$M_\mu = \max_{0 \leq k \leq n-1} \frac{\mu_k + \mu_n |b_{n-k}|}{\mu_{k+1}}.$$

Then all the EIGENVALUES λ satisfying $P(\lambda) = 0$, where $P(\lambda)$ is the CHARACTERISTIC POLYNOMIAL, lie on the DISK $|z| \leq M_\mu$.

References

- Gradshteyn, I. S. and Ryzhik, I. M. *Tables of Integrals, Series, and Products*, 5th ed. San Diego, CA: Academic Press, p. 1119, 1979.

Ballot Problem

Suppose A and B are candidates for office and there are $2n$ voters, n voting for A and n for B . In how many ways can the ballots be counted so that A is always ahead of or tied with B ? The solution is a CATALAN NUMBER C_n .

A related problem also called "the" ballot problem is to let A receive a votes and B b votes with $a > b$. This version of the ballot problem then asks for the probability that A stays ahead of B as the votes are counted (Vardi 1991). The solution is $(a - b)/(a + b)$, as first shown by M. Bertrand (Hilton and Pedersen 1991). Another elegant solution was provided by André (1887) using the so-called ANDRÉ'S REFLECTION METHOD.

The problem can also be generalized (Hilton and Pedersen 1991). Furthermore, the TAK FUNCTION is connected with the ballot problem (Vardi 1991).

see also ANDRÉ'S REFLECTION METHOD, CATALAN NUMBER, TAK FUNCTION

References

- André, D. "Solution directe du problème résolu par M. Bertrand." *Comptes Rendus Acad. Sci. Paris* **105**, 436–437, 1887.
Ball, W. W. R. and Coxeter, H. S. M. *Mathematical Recreations and Essays*, 13th ed. New York: Dover, p. 49, 1987.
Carlitz, L. "Solution of Certain Recurrences." *SIAM J. Appl. Math.* **17**, 251–259, 1969.
Comtet, L. *Advanced Combinatorics*. Dordrecht, Netherlands: Reidel, p. 22, 1974.
Feller, W. *An Introduction to Probability Theory and Its Applications*, Vol. 1, 3rd ed. New York: Wiley, pp. 67–97, 1968.
Hilton, P. and Pedersen, J. "The Ballot Problem and Catalan Numbers." *Nieuw Archief voor Wiskunde* **8**, 209–216, 1990.
Hilton, P. and Pedersen, J. "Catalan Numbers, Their Generalization, and Their Uses." *Math. Intel.* **13**, 64–75, 1991.
Kraitchik, M. "The Ballot-Box Problem." §6.13 in *Mathematical Recreations*. New York: W. W. Norton, p. 132, 1942.
Motzkin, T. "Relations Between Hypersurface Cross Ratios, and a Combinatorial Formula for Partitions of a Polygon, for Permanent Preponderance, and for Non-Associative Products." *Bull. Amer. Math. Soc.* **54**, 352–360, 1948.
Vardi, I. *Computational Recreations in Mathematica*. Redwood City, CA: Addison-Wesley, pp. 185–187, 1991.

Banach Algebra

An ALGEBRA A over a FIELD F with a NORM that makes A into a COMPLETE METRIC SPACE, and therefore, a BANACH SPACE. F is frequently taken to be the COMPLEX NUMBERS in order to assure that the SPECTRUM fully characterizes an OPERATOR (i.e., the spectral theorems for normal or compact normal operators do not, in general, hold in the SPECTRUM over the REAL NUMBERS).

see also B^* -ALGEBRA

Banach Fixed Point Theorem

Let f be a contraction mapping from a closed SUBSET F of a BANACH SPACE E into F . Then there exists a unique $z \in F$ such that $f(z) = z$.

see also FIXED POINT THEOREM

References

- Debnath, L. and Mikusiński, P. *Introduction to Hilbert Spaces with Applications*. San Diego, CA: Academic Press, 1990.

Banach-Hausdorff-Tarski Paradox

see BANACH-TARSKI PARADOX

Banach Measure

An "AREA" which can be defined for every set—even those without a true geometric AREA—which is rigid and finitely additive.

Banach Space

A normed linear SPACE which is COMPLETE in the norm-determined METRIC. A HILBERT SPACE is always a Banach space, but the converse need not hold.

see also BESOV SPACE, HILBERT SPACE, SCHAUDER FIXED POINT THEOREM

Banach-Steinhaus Theorem

see UNIFORM BOUNDEDNESS PRINCIPLE

Banach-Tarski Paradox

First stated in 1924, this theorem demonstrates that it is possible to dissect a BALL into six pieces which can be reassembled by rigid motions to form two balls of the same size as the original. The number of pieces was subsequently reduced to five. However, the pieces are extremely complicated. A generalization of this theorem is that any two bodies in \mathbb{R}^3 which do not extend to infinity and each containing a ball of arbitrary size can be dissected into each other (they are EQUIDE-COMPOSABLE).

References

Stromberg, K. "The Banach-Tarski Paradox." *Amer. Math. Monthly* **86**, 3, 1979.

Wagon, S. *The Banach-Tarski Paradox*. New York: Cambridge University Press, 1993.

Bang's Theorem

The lines drawn to the VERTICES of a face of a TETRAHEDRON from the point of contact of the FACE with the INSPIRE form three ANGLES at the point of contact which are the same three ANGLES in each FACE.

References

Brown, B. H. "Theorem of Bang. Isosceles Tetrahedra." *Amer. Math. Monthly* **33**, 224-226, 1926.

Honsberger, R. *Mathematical Gems II*. Washington, DC: Math. Assoc. Amer., p. 93, 1976.

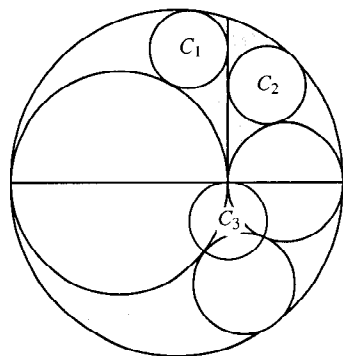
Bankoff Circle

In addition to the ARCHIMEDES' CIRCLES C_1 and C_2 in the ARBELOS figure, there is a third circle C_3 congruent to these two as illustrated in the above figure.

see also ARBELOS

References

Bankoff, L. "Are the Twin Circles of Archimedes Really Twins?" *Math. Mag.* **47**, 214-218, 1974.

Gardner, M. "Mathematical Games: The Diverse Pleasures of Circles that Are Tangent to One Another." *Sci. Amer.* **240**, 18-28, Jan. 1979.

Banzhaf Power Index

The number of ways in which a group of n with weights $\sum_{i=1}^n w_i = 1$ can change a losing coalition (one with $\sum w_i < 1/2$) to a winning one, or vice versa. It was proposed by the lawyer J. F. Banzhaf in 1965.

References

Paulos, J. A. *A Mathematician Reads the Newspaper*. New York: BasicBooks, pp. 9-10, 1995.

Bar (Edge)

The term in rigidity theory for the EDGES of a GRAPH.

see also CONFIGURATION, FRAMEWORK

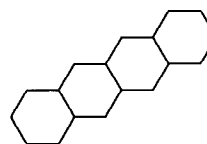
Bar Polyhex

A POLYHEX consisting of HEXAGONS arranged along a line.

see also BAR POLYAMOND

References

Gardner, M. *Mathematical Magic Show: More Puzzles, Games, Diversions, Illusions and Other Mathematical Sleight-of-Mind from Scientific American*. New York: Vintage, p. 147, 1978.

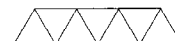
Bar Polyiamond

A POLYIAMOND consisting of EQUILATERAL TRIANGLES arranged along a line.

see also BAR POLYHEX

References

Golomb, S. W. *Polyominoes: Puzzles, Patterns, Problems, and Packings*, 2nd ed. Princeton, NJ: Princeton University Press, p. 92, 1994.

Barber Paradox

A man of Seville is shaved by the Barber of Seville IFF the man does not shave himself. Does the barber shave himself? Proposed by Bertrand Russell.

Barbier's Theorem

All CURVES OF CONSTANT WIDTH of width w have the same PERIMETER πw .

Bare Angle Center

The TRIANGLE CENTER with TRIANGLE CENTER FUNCTION

$$\alpha = A.$$

References

Kimberling, C. "Major Centers of Triangles." *Amer. Math. Monthly* **104**, 431–438, 1997.

Barnes G-Function

see G-FUNCTION

Barnes' Lemma

If a CONTOUR in the COMPLEX PLANE is curved such that it separates the increasing and decreasing sequences of POLES, then

$$\frac{1}{2\pi i} \int_{-i\infty}^{i\infty} \Gamma(\alpha + s)\Gamma(\beta + s)\Gamma(\gamma - s)\Gamma(\delta - s) ds = \frac{\Gamma(\alpha + \gamma)\Gamma(\alpha + \delta)\Gamma(\beta + \gamma)\Gamma(\beta + \delta)}{\Gamma(\alpha + \beta + \gamma + \delta)},$$

where $\Gamma(z)$ is the GAMMA FUNCTION.

Barnes-Wall Lattice

A lattice which can be constructed from the LEECH LATTICE Λ_{24} .

see also COXETER-TODD LATTICE, LATTICE POINT, LEECH LATTICE

References

Barnes, E. S. and Wall, G. E. "Some Extreme Forms Defined in Terms of Abelian Groups." *J. Austral. Math. Soc.* **1**, 47–63, 1959.

Conway, J. H. and Sloane, N. J. A. "The 16-Dimensional Barnes-Wall Lattice Λ_{16} ." §4.10 in *Sphere Packings, Lattices, and Groups*, 2nd ed. New York: Springer-Verlag, pp. 127–129, 1993.

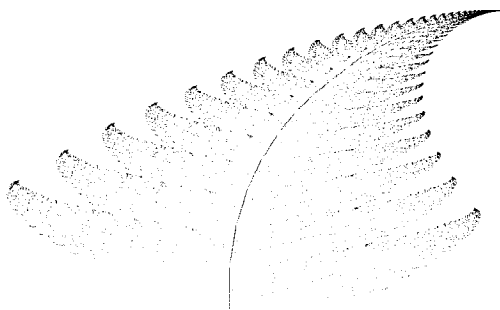
Barnsley's Fern

The ATTRACTOR of the ITERATED FUNCTION SYSTEM given by the set of "fern functions"

$$f_1(x, y) = \begin{bmatrix} 0.85 & 0.04 \\ -0.04 & 0.85 \end{bmatrix} \begin{bmatrix} x \\ y \end{bmatrix} + \begin{bmatrix} 0.00 \\ 1.60 \end{bmatrix} \quad (1)$$

$$f_2(x, y) = \begin{bmatrix} -0.15 & 0.28 \\ 0.26 & 0.24 \end{bmatrix} \begin{bmatrix} x \\ y \end{bmatrix} + \begin{bmatrix} 0.00 \\ 0.44 \end{bmatrix} \quad (2)$$

$$f_3(x, y) = \begin{bmatrix} 0.20 & -0.26 \\ 0.23 & 0.22 \end{bmatrix} \begin{bmatrix} x \\ y \end{bmatrix} + \begin{bmatrix} 0.00 \\ 1.60 \end{bmatrix} \quad (3)$$

$$f_4(x, y) = \begin{bmatrix} 0.00 & 0.00 \\ 0.00 & 0.16 \end{bmatrix} \begin{bmatrix} x \\ y \end{bmatrix} \quad (4)$$

(Barnsley 1993, p. 86; Wagon 1991). These AFFINE TRANSFORMATIONS are contractions. The tip of the fern (which resembles the black spleenwort variety of fern) is the fixed point of f_1 , and the tips of the lowest two branches are the images of the main tip under f_2 and f_3 (Wagon 1991).

see also DYNAMICAL SYSTEM, FRACTAL, ITERATED FUNCTION SYSTEM

References

Barnsley, M. *Fractals Everywhere*, 2nd ed. Boston, MA: Academic Press, pp. 86, 90, 102 and Plate 2, 1993.

Gleick, J. *Chaos: Making a New Science*. New York: Penguin Books, p. 238, 1988.

Wagon, S. "Biasing the Chaos Game: Barnsley's Fern." §5.3 in *Mathematica in Action*. New York: W. H. Freeman, pp. 156–163, 1991.

Barrier

A number n is called a barrier of a number-theoretic function $f(m)$ if, for all $m < n$, $m + f(m) \leq n$. Neither the TOTIENT FUNCTION $\phi(n)$ nor the DIVISOR FUNCTION $\sigma(n)$ has barriers.

References

Guy, R. K. *Unsolved Problems in Number Theory*, 2nd ed. New York: Springer-Verlag, pp. 64–65, 1994.

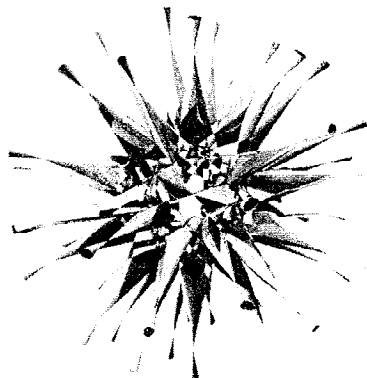
Barth Decic

The Barth decic is a DECIC SURFACE in complex three-dimensional projective space having the maximum possible number of ORDINARY DOUBLE POINTS (345). It is given by the implicit equation

$$8(x^2 - \phi^4 y^2)(y^2 - \phi^4 z^2)(z^2 - \phi^4 x^2) \\ \times (x^4 + y^4 + z^4 - 2x^2 y^2 - 2x^2 z^2 - 2y^2 z^2) \\ + (3 + 5\phi)(x^2 + y^2 + z^2 - w^2)[x^2 + y^2 + z^2 - (2 - \phi)w^2]^2 w^2 \\ = 0,$$

where ϕ is the GOLDEN MEAN and w is a parameter (Endraß, Nordstrand), taken as $w = 1$ in the above plot. The Barth decic is invariant under the ICOSAEDRAL GROUP.

see also ALGEBRAIC SURFACE, BARTH SEXTIC, DECIC SURFACE, ORDINARY DOUBLE POINT

References

- Barth, W. "Two Projective Surfaces with Many Nodes Admitting the Symmetries of the Icosahedron." *J. Alg. Geom.* 5, 173–186, 1996.
- Endraß, S. "Flächen mit vielen Doppelpunkten." *DMV-Mitteilungen* 4, 17–20, 4/1995.
- Endraß, S. "Barth's Decic." <http://www.mathematik.uni-mainz.de/AlgebraischeGeometrie/docs/Ebarthdecic.shtml>.
- Nordstrand, T. "Batch Decic." <http://www.uib.no/people/nfytn/bdectxt.htm>.

Barth Sextic

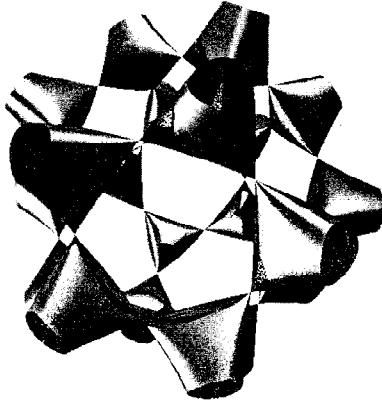

The Barth-sextic is a SEXTIC SURFACE in complex three-dimensional projective space having the maximum possible number of ORDINARY DOUBLE POINTS (65). It is given by the implicit equation

$$4(\phi^2 x^2 - y^2)(\phi^2 y^2 - z^2)(\phi^2 z^2 - x^2) \\ - (1 + 2\phi)(x^2 + y^2 + z^2 - w^2)^2 w^2 = 0.$$

where ϕ is the GOLDEN MEAN, and w is a parameter (Endraß, Nordstrand), taken as $w = 1$ in the above plot. The Barth sextic is invariant under the ICOSAEDRAL GROUP. Under the map

$$(x, y, z, w) \rightarrow (x^2, y^2, z^2, w^2),$$

the surface is the eightfold cover of the CAYLEY CUBIC (Endraß).

see also ALGEBRAIC SURFACE, BARTH DECIC, CAYLEY CUBIC, ORDINARY DOUBLE POINT, SEXTIC SURFACE

References

- Barth, W. "Two Projective Surfaces with Many Nodes Admitting the Symmetries of the Icosahedron." *J. Alg. Geom.* 5, 173–186, 1996.
- Endraß, S. "Flächen mit vielen Doppelpunkten." *DMV-Mitteilungen* 4, 17–20, 4/1995.
- Endraß, S. "Barth's Sextic." <http://www.mathematik.uni-mainz.de/AlgebraischeGeometrie/docs/Ebarthsextic.shtml>.
- Nordstrand, T. "Barth Sextic." <http://www.uib.no/people/nfytn/sexttxt.htm>.

Bartlett Function

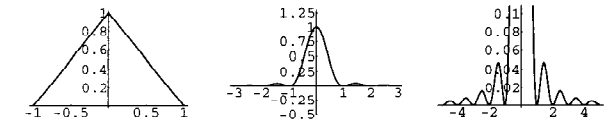

The APODIZATION FUNCTION

$$f(x) = 1 - \frac{|x|}{a} \quad (1)$$

which is a generalization of the one-argument TRIANGLE FUNCTION. Its FULL WIDTH AT HALF MAXIMUM is a . It has INSTRUMENT FUNCTION

$$I(x) = \int_{-a}^a e^{-2\pi i k x} \left(1 - \frac{|x|}{a}\right) dx \\ = \int_{-a}^0 e^{-2\pi i k x} \left(1 + \frac{x}{a}\right) dx \\ + \int_0^a e^{-2\pi i k x} \left(1 - \frac{x}{a}\right) dx. \quad (2)$$

Letting $x' \equiv -x$ in the first part therefore gives

$$\int_{-a}^0 e^{-2\pi i k x} \left(1 + \frac{x}{a}\right) dx = \int_a^0 e^{2\pi i k x'} \left(1 - \frac{x'}{a}\right) (-dx') \\ = \int_0^a e^{2\pi i k x} \left(1 - \frac{x}{a}\right) dx. \quad (3)$$

Rewriting (2) using (3) gives

$$I(x) = (e^{2\pi i k x} + e^{-2\pi i k x}) \left(1 - \frac{x}{a}\right) dx \\ = 2 \int_0^a \cos(2\pi k x) \left(1 - \frac{x}{a}\right) dx. \quad (4)$$

Integrating the first part and using the integral

$$\int x \cos(bx) dx = \frac{1}{b^2} \cos(bx) + \frac{x}{b} \sin(bx) \quad (5)$$

for the second part gives

$$\begin{aligned}
 I(x) &= 2 \left[\frac{\sin(2\pi kx)}{2\pi k} \right. \\
 &\quad \left. - \frac{1}{a} \left\{ \frac{1}{4\pi^2 k^2} \cos(2\pi kx) + \frac{x}{2\pi k} \sin(2\pi kx) \right\} \right]_0^a \\
 &= 2 \left\{ \left[\frac{\sin(2\pi ka)}{2\pi k} - 0 \right] \right. \\
 &\quad \left. - \frac{1}{a} \left[\frac{\cos(2\pi ka) - 1}{4\pi^2 k^2} + \frac{a \sin(2\pi ka)}{2\pi k} \right] \right\} \\
 &= \frac{1}{2\pi^2 a k^2} [\cos(2\pi ka) - 1] = a \frac{\sin^2(\pi ka)}{\pi^2 k^2 a^2} \\
 &= a \operatorname{sinc}^2(\pi ka), \tag{6}
 \end{aligned}$$

where $\operatorname{sinc} x$ is the SINC FUNCTION. The peak (in units of a) is 1. The function $I(x)$ is always positive, so there are no NEGATIVE sidelobes. The extrema are given by letting $\beta \equiv \pi ka$ and solving

$$\frac{d}{d\beta} \left(\frac{\sin \beta}{\beta} \right)^2 = 2 \frac{\sin \beta}{\beta} \frac{\sin \beta - \beta \cos \beta}{\beta^2} = 0 \tag{7}$$

$$\sin \beta (\sin \beta - \beta \cos \beta) = 0 \tag{8}$$

$$\sin \beta - \beta \cos \beta = 0 \tag{9}$$

$$\tan \beta = \beta. \tag{10}$$

Solving this numerically gives $\beta = 4.49341$ for the first maximum, and the peak POSITIVE sidelobe is 0.047190. The full width at half maximum is given by setting $x \equiv \pi ka$ and solving

$$\operatorname{sinc}^2 x = \frac{1}{2} \tag{11}$$

for $x_{1/2}$, yielding

$$x_{1/2} = \pi k_{1/2} a = 1.39156. \tag{12}$$

Therefore, with $L \equiv 2a$,

$$\text{FWHM} = 2k_{1/2} = \frac{0.885895}{a} = \frac{1.77179}{L}. \tag{13}$$

see also APODIZATION FUNCTION, PARZEN APODIZATION FUNCTION, TRIANGLE FUNCTION

References

Bartlett, M. S. "Periodogram Analysis and Continuous Spectra." *Biometrika* **37**, 1-16, 1950.

Barycentric Coordinates

Also known as HOMOGENEOUS COORDINATES or TRILINEAR COORDINATES.

see TRILINEAR COORDINATES

Base Curve

see DIRECTRIX (RULED SURFACE)

Base (Logarithm)

The number used to define a LOGARITHM, which is then written \log_b . The symbol $\log x$ is an abbreviation for $\log_{10} x$, $\ln x$ for $\log_e x$ (the NATURAL LOGARITHM), and $\lg x$ for $\log_2 x$.

see also E, LG, LN, LOGARITHM, NAPIERIAN LOGARITHM, NATURAL LOGARITHM

Base (Neighborhood System)

A base for a neighborhood system of a point x is a collection N of OPEN SETS such that x belongs to every member of N , and any OPEN SET containing x also contains a member of N as a SUBSET.

Base (Number)

A REAL NUMBER x can be represented using any INTEGER number b as a base (sometimes also called a RADIX or SCALE). The choice of a base yields to a representation of numbers known as a NUMBER SYSTEM. In base b , the DIGITS 0, 1, ..., $b - 1$ are used (where, by convention, for bases larger than 10, the symbols A, B, C, ... are generally used as symbols representing the DECIMAL numbers 10, 11, 12, ...).

Base	Name
2	binary
3	ternary
4	quaternary
5	quinary
6	senary
7	septenary
8	octal
9	nonary
10	decimal
11	undenary
12	duodecimal
16	hexadecimal
20	vigesimal
60	sexagesimal

Let the base b representation of a number x be written

$$(a_n a_{n-1} \dots a_0 . a_{-1} \dots)_b, \tag{1}$$

(e.g., 123.456_{10}), then the index of the leading DIGIT needed to represent the number is

$$n \equiv \lfloor \log_b x \rfloor, \tag{2}$$

where $\lfloor x \rfloor$ is the FLOOR FUNCTION. Now, recursively compute the successive DIGITS

$$a_i = \left\lfloor \frac{r_i}{b^i} \right\rfloor, \tag{3}$$

where $r_n \equiv x$ and

$$r_{i-1} = r_i - a_i b^i \tag{4}$$

for $i = n, n-1, \dots, 1, 0, \dots$. This gives the base b representation of x . Note that if x is an INTEGER, then i need only run through 0, and that if x has a fractional part, then the expansion may or may not terminate. For example, the HEXADECIMAL representation of 0.1 (which terminates in DECIMAL notation) is the infinite expression $0.19999\dots_h$.

Some number systems use a mixture of bases for counting. Examples include the Mayan calendar and the old British monetary system (in which ha'pennies, pennies, threepence, sixpence, shillings, half crowns, pounds, and guineas corresponded to units of $1/2, 1, 3, 6, 12, 30, 240$, and 252, respectively).

Knuth has considered using TRANSCENDENTAL bases. This leads to some rather unfamiliar results, such as equating π to 1 in "base π ," $\pi = 1_\pi$.

see also BINARY, DECIMAL, HEREDITARY REPRESENTATION, HEXADECIMAL, OCTAL, QUATERNARY, SEXAGESIMAL, TERNARY, VIGESIMAL

References

- Abramowitz, M. and Stegun, C. A. (Eds.). *Handbook of Mathematical Functions with Formulas, Graphs, and Mathematical Tables*, 9th printing. New York: Dover, p. 28, 1972.
- Bogomolny, A. "Base Converter." <http://www.cut-the-knot.com/binary.html>.
- Lauwerier, H. *Fractals: Endlessly Repeated Geometric Figures*. Princeton, NJ: Princeton University Press, pp. 6–11, 1991.
- ✱ Weisstein, E. W. "Bases." <http://www.astro.virginia.edu/~eww6n/math/notebooks/Bases.m>.

Base Space

The SPACE B of a FIBER BUNDLE given by the MAP $f: E \rightarrow B$, where E is the TOTAL SPACE of the FIBER BUNDLE.

see also FIBER BUNDLE, TOTAL SPACE

Baseball

The numbers 3 and 4 appear prominently in the game of baseball. There are $3 \cdot 3 = 9$ innings in a game, and three strikes are an out. However, 4 balls are needed for a walk. The number of bases can either be regarded as 3 (excluding HOME PLATE) or 4 (including it).

see BASEBALL COVER, HOME PLATE

Baseball Cover

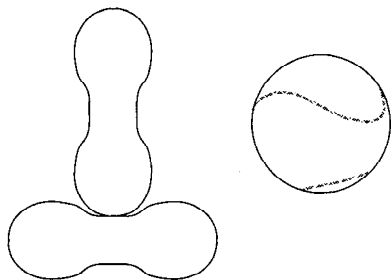

A pair of identical plane regions (mirror symmetric about two perpendicular lines through the center) which can be stitched together to form a baseball (or tennis ball). A baseball has a CIRCUMFERENCE of $9 \frac{1}{8}$ inches. The practical consideration of separating the regions far enough to allow the pitcher a good grip requires that the "neck" distance be about $1 \frac{3}{16}$ inches. The baseball cover was invented by Elias Drake as a boy in the 1840s. (Thompson's attribution of the current design to trial and error development by C. H. Jackson in the 1860s is apparently unsubstantiated, as discovered by George Bart.)

One way to produce a baseball cover is to draw the regions on a SPHERE, then cut them out. However, it is difficult to produce two identical regions in this manner. Thompson (1996) gives mathematical expressions giving baseball cover curves both in the plane and in 3-D. J. H. Conway has humorously proposed the following "baseball curve conjecture:" no two definitions of "the" baseball curve will give the same answer unless their equivalence was obvious from the start.

see also BASEBALL, HOME PLATE, TENNIS BALL THEOREM, YIN-YANG

References

- Thompson, R. B. "Designing a Baseball Cover. 1860's: Patience, Trial, and Error. 1990's: Geometry, Calculus, and Computation." <http://www.mathsoft.com/asolve/baseball/baseball.html>. Rev. March 5, 1996.

Basin of Attraction

The set of points in the space of system variables such that initial conditions chosen in this set dynamically evolve to a particular ATTRACTOR.

see also WADA BASIN

Basis

A (vector) basis is any SET of n LINEARLY INDEPENDENT VECTORS capable of generating an n -dimensional SUBSPACE of \mathbb{R}^n . Given a HYPERPLANE defined by

$$x_1 + x_2 + x_3 + x_4 + x_5 = 0,$$

a basis is found by solving for x_1 in terms of x_2, x_3, x_4 , and x_5 . Carrying out this procedure,

$$x_1 = -x_2 - x_3 - x_4 - x_5,$$

so

$$\begin{bmatrix} x_1 \\ x_2 \\ x_3 \\ x_4 \\ x_5 \end{bmatrix} = x_2 \begin{bmatrix} -1 \\ 1 \\ 0 \\ 0 \\ 0 \end{bmatrix} + x_3 \begin{bmatrix} -1 \\ 0 \\ 1 \\ 0 \\ 0 \end{bmatrix} + x_4 \begin{bmatrix} -1 \\ 0 \\ 0 \\ 1 \\ 0 \end{bmatrix} + x_5 \begin{bmatrix} -1 \\ 0 \\ 0 \\ 0 \\ 1 \end{bmatrix},$$

and the above VECTOR form an (unnormalized) BASIS. Given a MATRIX A with an orthonormal basis, the MATRIX corresponding to a new basis, expressed in terms of the original $\hat{x}_1, \dots, \hat{x}_n$ is

$$A' = [A\hat{x}_1 \quad \dots \quad A\hat{x}_n].$$

see also BILINEAR BASIS, MODULAR SYSTEM BASIS, ORTHONORMAL BASIS, TOPOLOGICAL BASIS

Basis Theorem

see HILBERT BASIS THEOREM

Basler Problem

The problem of analytically finding the value of $\zeta(2)$, where ζ is the RIEMANN ZETA FUNCTION.

References

Castellanos, D. "The Ubiquitous Pi. Part I." *Math. Mag.* **61**, 67-98, 1988.

Basset Function

see MODIFIED BESSEL FUNCTION OF THE SECOND KIND

Batch

A set of values of similar meaning obtained in any manner.

References

Tukey, J. W. *Explanatory Data Analysis*. Reading, MA: Addison-Wesley, p. 667, 1977.

Bateman Function

$$k_\nu(x) \equiv \frac{e^{-x}}{\Gamma(1 + \frac{1}{2}\nu)} U(-\frac{1}{2}\nu, 0, 2x)$$

for $x > 0$, where U is a CONFLUENT HYPERGEOMETRIC FUNCTION OF THE SECOND KIND.

see also CONFLUENT HYPERGEOMETRIC DIFFERENTIAL EQUATION, HYPERGEOMETRIC FUNCTION

Batrachion

A class of CURVE defined at INTEGER values which hops from one value to another. Their name derives from the word *batrachion*, which means "frog-like." Many batrachions are FRACTAL. Examples include the BLANC-MANGE FUNCTION, HOFSTADTER-CONWAY \$10,000 SEQUENCE, HOFSTADTER'S Q-SEQUENCE, and MALLOW'S SEQUENCE.

References

Pickover, C. A. "The Crying of Fractal Batrachion 1,489." Ch. 25 in *Keys to Infinity*. New York: W. H. Freeman, pp. 183-191, 1995.

Bauer's Identical Congruence

Let $t(m)$ denote the set of the $\phi(m)$ numbers less than and RELATIVELY PRIME to m , where $\phi(n)$ is the TOTIENT FUNCTION. Define

$$f_m(x) \equiv \prod_{t(m)} (x - t). \quad (1)$$

A theorem of Lagrange states that

$$f_m(x) \equiv x^{\phi(m)} - 1 \pmod{m}. \quad (2)$$

This can be generalized as follows. Let p be an ODD PRIME DIVISOR of m and p^a the highest POWER which divides m , then

$$f_m(x) \equiv (x^{p-1} - 1)^{\phi(m)/(p-1)} \pmod{p^a} \quad (3)$$

and, in particular,

$$f_{p^a}(x) \equiv (x^{p-1} - 1)^{p^{a-1}} \pmod{p^a}. \quad (4)$$

Furthermore, if $m > 2$ is EVEN and 2^a is the highest POWER of 2 that divides m , then

$$f_m(x) \equiv (x^2 - 1)^{\phi(m)/2} \pmod{2^a} \quad (5)$$

and, in particular,

$$f_{2^a}(x) \equiv (x^2 - 1)^{2^{a-2}} \pmod{2^a}. \quad (6)$$

see also LEUDES DORF THEOREM

References

Hardy, G. H. and Wright, E. M. "Bauer's Identical Congruence." §8.5 in *An Introduction to the Theory of Numbers*, 5th ed. Oxford, England: Clarendon Press, pp. 98-100, 1979.

Bauer's Theorem

see BAUER'S IDENTICAL CONGRUENCE

Bauspiel

A construction for the RHOMBIC DODECAHEDRON.

References

Coxeter, H. S. M. *Regular Polytopes*, 3rd ed. New York: Dover, pp. 26 and 50, 1973.

Bayes' Formula

Let A and B_j be SETS. CONDITIONAL PROBABILITY requires that

$$P(A \cap B_j) = P(A)P(B_j|A), \quad (1)$$

where \cap denotes INTERSECTION ("and"), and also that

$$P(A \cap B_j) = P(B_j \cap A) = P(B_j)P(A|B_j) \quad (2)$$

and

$$P(B_j \cap A) = P(B_j)P(A|B_j). \quad (3)$$

Since (2) and (3) must be equal,

$$P(A \cap B_j) = P(B_j \cap A). \quad (4)$$

From (2) and (3),

$$P(A \cap B_j) = P(B_j)P(A|B_j). \quad (5)$$

Equating (5) with (2) gives

$$P(A)P(B_j|A) = P(B_j)P(A|B_j), \quad (6)$$

so

$$P(B_j|A) = \frac{P(B_j)P(A|B_j)}{P(A)}. \quad (7)$$

Now, let

$$S \equiv \bigcup_{i=1}^N A_i, \quad (8)$$

so A_i is an event in S and $A_i \cap A_j = \emptyset$ for $i \neq j$, then

$$A = A \cap S = A \cap \left(\bigcup_{i=1}^N A_i \right) = \bigcup_{i=1}^N (A \cap A_i) \quad (9)$$

$$P(A) = P\left(\bigcup_{i=1}^N (A \cap A_i)\right) = \sum_{i=1}^N P(A \cap A_i). \quad (10)$$

From (5), this becomes

$$P(A) = \sum_{i=1}^N P(A_i)P(A|A_i), \quad (11)$$

so

$$P(A_i|A) = \frac{P(A_i)P(A|A_i)}{\sum_{j=1}^N P(A_j)P(A|A_j)}. \quad (12)$$

see also CONDITIONAL PROBABILITY, INDEPENDENT STATISTICS

References

Press, W. H.; Flannery, B. P.; Teukolsky, S. A.; and Vetterling, W. T. *Numerical Recipes in FORTRAN: The Art of Scientific Computing*, 2nd ed. Cambridge, England: Cambridge University Press, p. 810, 1992.

Bayes' Theorem

see BAYES' FORMULA

Bayesian Analysis

A statistical procedure which endeavors to estimate parameters of an underlying distribution based on the observed distribution. Begin with a "PRIOR DISTRIBUTION" which may be based on anything, including an assessment of the relative likelihoods of parameters or the results of non-Bayesian observations. In practice, it is common to assume a UNIFORM DISTRIBUTION over the appropriate range of values for the PRIOR DISTRIBUTION.

Given the PRIOR DISTRIBUTION, collect data to obtain the observed distribution. Then calculate the LIKELIHOOD of the observed distribution as a function of parameter values, multiply this likelihood function by the PRIOR DISTRIBUTION, and normalize to obtain a unit probability over all possible values. This is called the POSTERIOR DISTRIBUTION. The MODE of the distribution is then the parameter estimate, and "probability intervals" (the Bayesian analog of CONFIDENCE INTERVALS) can be calculated using the standard procedure. Bayesian analysis is somewhat controversial because the validity of the result depends on how valid the PRIOR DISTRIBUTION is, and this cannot be assessed statistically.

see also MAXIMUM LIKELIHOOD, PRIOR DISTRIBUTION, UNIFORM DISTRIBUTION

References

Hoel, P. G.; Port, S. C.; and Stone, C. J. *Introduction to Statistical Theory*. New York: Houghton Mifflin, pp. 36–42, 1971.
Iversen, G. R. *Bayesian Statistical Inference*. Thousand Oaks, CA: Sage Pub., 1984.
Press, W. H.; Flannery, B. P.; Teukolsky, S. A.; and Vetterling, W. T. *Numerical Recipes in FORTRAN: The Art of Scientific Computing*, 2nd ed. Cambridge, England: Cambridge University Press, pp. 799–806, 1992.
Sivia, D. S. *Data Analysis: A Bayesian Tutorial*. New York: Oxford University Press, 1996.

Bays' Shuffle

A shuffling algorithm used in a class of RANDOM NUMBER generators.

References

Knuth, D. E. §3.2 and 3.3 in *The Art of Computer Programming, Vol. 2: Seminumerical Algorithms*, 2nd ed. Reading, MA: Addison-Wesley, 1981.
Press, W. H.; Flannery, B. P.; Teukolsky, S. A.; and Vetterling, W. T. *Numerical Recipes in FORTRAN: The Art of Scientific Computing*, 2nd ed. Cambridge, England: Cambridge University Press, pp. 270–271, 1992.

Beam Detector

N.B. A detailed on-line essay by S. Finch was the starting point for this entry.

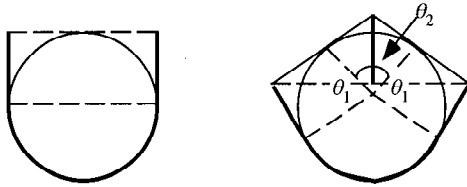

A “beam detector” for a given curve C is defined as a curve (or set of curves) through which every LINE tangent to or intersecting C passes. The shortest 1-arc beam detector, illustrated in the upper left figure, has length $L_1 = \pi + 2$. The shortest known 2-arc beam detector, illustrated in the right figure, has angles

$$\theta_1 \approx 1.286 \text{ rad} \quad (1)$$

$$\theta_2 \approx 1.191 \text{ rad}, \quad (2)$$

given by solving the simultaneous equations

$$2 \cos \theta_1 - \sin(\tfrac{1}{2}\theta_2) = 0 \quad (3)$$

$$\tan(\tfrac{1}{2}\theta_1) \cos(\tfrac{1}{2}\theta_2) + \sin(\tfrac{1}{2}\theta_2)[\sec^2(\tfrac{1}{2}\theta_2) + 1] = 2. \quad (4)$$

The corresponding length is

$$L_2 = 2\pi - 2\theta_1 - \theta_2 + 2 \tan(\tfrac{1}{2}\theta_1) + \sec(\tfrac{1}{2}\theta_2) - \cos(\tfrac{1}{2}\theta_2) + \tan(\tfrac{1}{2}\theta_1) \sin(\tfrac{1}{2}\theta_2) = 4.8189264563 \dots \quad (5)$$

A more complicated expression gives the shortest known 3-arc length $L_3 = 4.799891547 \dots$. Finch defines

$$L = \inf_{n \geq 1} L_n \quad (6)$$

as the beam detection constant, or the TRENCH DIGGERS’ CONSTANT. It is known that $L \geq \pi$.

References

- Croft, H. T.; Falconer, K. J.; and Guy, R. K. §A30 in *Unsolved Problems in Geometry*. New York: Springer-Verlag, 1991.
- Faber, V.; Mycielski, J.; and Pedersen, P. “On the Shortest Curve which Meets All Lines which Meet a Circle.” *Ann. Polon. Math.* **44**, 249–266, 1984.
- Faber, V. and Mycielski, J. “The Shortest Curve that Meets All Lines that Meet a Convex Body.” *Amer. Math. Monthly* **93**, 796–801, 1986.
- Finch, S. “Favorite Mathematical Constants.” <http://www.mathsoft.com/asolve/constant/beam/beam.html>.
- Makai, E. “On a Dual of Tarski’s Plank Problem.” In *Diskrete Geometrie*. 2 Kolloq., Inst. Math. Univ. Salzburg, 127–132, 1980.
- Stewart, I. “The Great Drain Robbery.” *Sci. Amer.*, 206–207, 106, and 125, Sept. 1995, Dec. 1995, and Feb. 1996.

Bean Curve

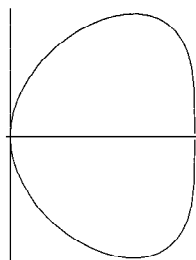

The PLANE CURVE given by the Cartesian equation

$$x^4 + x^2 y^2 + y^4 = x(x^2 + y^2).$$

References

- Cundy, H. and Rollett, A. *Mathematical Models*, 3rd ed. Stradbroke, England: Tarquin Pub., 1989.

Beast Number

The occult “number of the beast” associated in the Bible with the Antichrist. It has figured in many numerological studies. It is mentioned in Revelation 13:13: “Here is wisdom. Let him that hath understanding count the number of the beast: for it is the number of a man; and his number is 666.”

The beast number has several interesting properties which numerologists may find particularly interesting (Keith 1982–83). In particular, the beast number is equal to the sum of the squares of the first 7 PRIMES

$$2^2 + 3^2 + 5^2 + 7^2 + 11^2 + 13^2 + 17^2 = 666, \quad (1)$$

satisfies the identity

$$\phi(666) = 6 \cdot 6 \cdot 6, \quad (2)$$

where ϕ is the TOTIENT FUNCTION, as well as the sum

$$\sum_{i=1}^{6 \cdot 6} i = 666. \quad (3)$$

The number 666 is a sum and difference of the first three 6th POWERS,

$$666 = 1^6 - 2^6 + 3^6 \quad (4)$$

(Keith). Another curious identity is that there are exactly two ways to insert “+” signs into the sequence 123456789 to make the sum 666, and exactly one way for the sequence 987654321,

$$666 = 1 + 2 + 3 + 4 + 567 + 89 = 123 + 456 + 78 + 9 \quad (5)$$

$$666 = 9 + 87 + 6 + 543 + 21 \quad (6)$$

(Keith). 666 is a REPDIGIT, and is also a TRIANGULAR NUMBER

$$T_{6 \cdot 6} = T_{36} = 666. \quad (7)$$

In fact, it is the largest REPDIGIT TRIANGULAR NUMBER (Bellew and Weger 1975–76). 666 is also a SMITH NUMBER. The first 144 DIGITS of $\pi - 3$, where π is P1, add to 666. In addition $144 = (6 + 6) \times (6 + 6)$ (Blatner 1997).

A number of the form 2^i which contains the digits of the beast number “666” is called an APOCALYPTIC NUMBER, and a number having 666 digits is called an APOCALYPSE NUMBER.

see also APOCALYPSE NUMBER, APOCALYPTIC NUMBER, BIMONSTER, MONSTER GROUP

References

- Bellew, D. W. and Weger, R. C. "Repdigit Triangular Numbers." *J. Recr. Math.* **8**, 96–97, 1975–76.
 Blatner, D. *The Joy of Pi*. New York: Walker, back jacket, 1997.
 Castellanos, D. "The Ubiquitous π ." *Math. Mag.* **61**, 153–154, 1988.
 Hardy, G. H. *A Mathematician's Apology*, reprinted with a foreword by C. P. Snow. New York: Cambridge University Press, p. 96, 1993.
 Keith, M. "The Number of the Beast." <http://users.aol.com/s6sj7gt/mike666.htm>.
 Keith, M. "The Number 666." *J. Recr. Math.* **15**, 85–87, 1982–1983.

Beatty Sequence

The Beatty sequence is a SPECTRUM SEQUENCE with an IRRATIONAL base. In other words, the Beatty sequence corresponding to an IRRATIONAL NUMBER θ is given by $[\theta], [2\theta], [3\theta], \dots$, where $[x]$ is the FLOOR FUNCTION. If α and β are POSITIVE IRRATIONAL NUMBERS such that

$$\frac{1}{\alpha} + \frac{1}{\beta} = 1,$$

then the Beatty sequences $[\alpha], [2\alpha], \dots$ and $[\beta], [2\beta], \dots$ together contain all the POSITIVE INTEGERS without repetition.

References

- Gardner, M. *Penrose Tiles and Trapdoor Ciphers... and the Return of Dr. Matrix*, reissue ed. New York: W. H. Freeman, p. 21, 1989.
 Graham, R. L.; Lin, S.; and Lin, C.-S. "Spectra of Numbers." *Math. Mag.* **51**, 174–176, 1978.
 Guy, R. K. *Unsolved Problems in Number Theory*, 2nd ed. New York: Springer-Verlag, p. 227, 1994.
 Sloane, N. J. A. *A Handbook of Integer Sequences*. Boston, MA: Academic Press, pp. 29–30, 1973.

Beauzamy and Dégot's Identity

For P, Q, R , and S POLYNOMIALS in n variables

$$[P \cdot Q, R \cdot S] = \sum_{i_1, \dots, i_n \geq 0} \frac{A}{i_1! \dots i_n!},$$

where

$$A \equiv [R^{(i_1, \dots, i_n)}(D_1, \dots, D_n)Q(x_1, \dots, x_n) \\ \times P^{(i_1, \dots, i_n)}(D_1, \dots, D_n)S(x_1, \dots, x_n)]$$

$D_i = \partial/\partial x_i$ is the DIFFERENTIAL OPERATOR, $[X, Y]$ is the BOMBIERI INNER PRODUCT, and

$$P^{(i_1, \dots, i_n)} = D_1^{i_1} \dots D_n^{i_n} P.$$

see also REZNIK'S IDENTITY

Bee

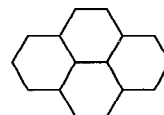

A 4-POLYHEX.

References

- Gardner, M. *Mathematical Magic Show: More Puzzles, Games, Diversions, Illusions and Other Mathematical Sleight-of-Mind from Scientific American*. New York: Vintage, p. 147, 1978.

Behrens-Fisher Test

see FISHER-BEHRENS PROBLEM

Behrmann Cylindrical Equal-Area Projection

A CYLINDRICAL AREA-PRESERVING projection which uses 30° N as the no-distortion parallel.

References

- Dana, P. H. "Map Projections." <http://www.utexas.edu/depts/grg/gcraft/notes/mapproj/mapproj.html>.

Bei

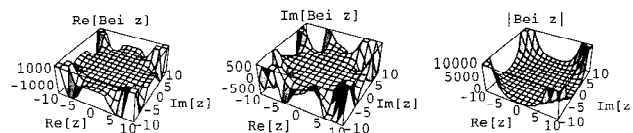
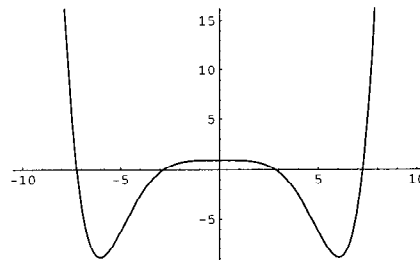

The IMAGINARY PART of

$$J_\nu(xe^{3\pi i/4}) = \text{ber}_\nu(x) + i \text{bei}_\nu(x). \quad (1)$$

The special case $\nu = 0$ gives

$$J_0(i\sqrt{x}) \equiv \text{ber}(x) + i \text{bei}(x), \quad (2)$$

where $J_0(z)$ is the zeroth order BESSEL FUNCTION OF THE FIRST KIND.

$$\text{bei}(x) \equiv \sum_{n=0}^{\infty} \frac{(-1)^n \left(\frac{x}{2}\right)^{4n}}{[(2n)!]^2}. \quad (3)$$

see also BER, BESSEL FUNCTION, KEI, KELVIN FUNCTIONS, KER

References

- Abramowitz, M. and Stegun, C. A. (Eds.). "Kelvin Functions." §9.9 in *Handbook of Mathematical Functions with Formulas, Graphs, and Mathematical Tables*, 9th printing. New York: Dover, pp. 379–381, 1972.
- Spanier, J. and Oldham, K. B. "The Kelvin Functions." Ch. 55 in *An Atlas of Functions*. Washington, DC: Hemisphere, pp. 543–554, 1987.

Bell Curve

see GAUSSIAN DISTRIBUTION, NORMAL DISTRIBUTION

Bell Number

The number of ways a SET of n elements can be PARTITIONED into nonempty SUBSETS is called a BELL NUMBER and is denoted B_n . For example, there are five ways the numbers $\{1, 2, 3\}$ can be partitioned: $\{\{1\}, \{2\}, \{3\}\}$, $\{\{1, 2\}, \{3\}\}$, $\{\{1, 3\}, \{2\}\}$, $\{\{1\}, \{2, 3\}\}$, and $\{\{1, 2, 3\}\}$, so $B_3 = 5$. $B_0 = 1$ and the first few Bell numbers for $n = 1, 2, \dots$ are 1, 2, 5, 15, 52, 203, 877, 4140, 21147, 115975, ... (Sloane's A000110). Bell numbers are closely related to CATALAN NUMBERS.

The diagram below shows the constructions giving $B_3 = 5$ and $B_4 = 15$, with line segments representing elements in the same SUBSET and dots representing subsets containing a single element (Dickau).

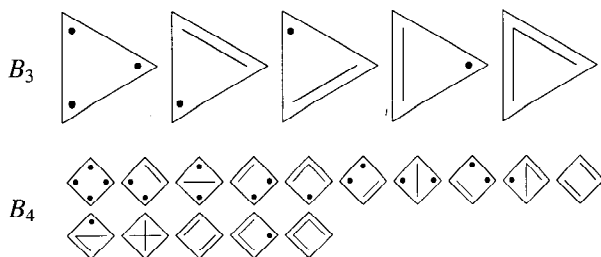

The INTEGERS B_n can be defined by the sum

$$B_n = \sum_{k=1}^n \left\{ \begin{matrix} n \\ k \end{matrix} \right\}, \quad (1)$$

where $S_n^{(k)} = \left\{ \begin{matrix} n \\ k \end{matrix} \right\}$ is a STIRLING NUMBER OF THE SECOND KIND, or by the generating function

$$e^{e^x - 1} = \sum_{n=0}^{\infty} \frac{B_n}{n!} x^n. \quad (2)$$

The Bell numbers can also be generated using the BELL TRIANGLE, using the RECURRENCE RELATION

$$B_{n+1} = \sum_{k=0}^n B_k \binom{n}{k}, \quad (3)$$

where $\binom{a}{b}$ is a BINOMIAL COEFFICIENT, or using the formula of Comtet (1974)

$$B_n = \left\lceil e^{-1} \sum_{m=1}^{2n} \frac{m^n}{m!} \right\rceil, \quad (4)$$

where $\lceil x \rceil$ denotes the CEILING FUNCTION.

The Bell number B_n is also equal to $\phi_n(1)$, where $\phi_n(x)$ is a BELL POLYNOMIAL. DOBIŃSKI'S FORMULA gives the n th Bell number

$$B_n = \frac{1}{e} \sum_{k=0}^{\infty} \frac{k^n}{k!}. \quad (5)$$

Lovász (1993) showed that this formula gives the asymptotic limit

$$B_n \sim n^{-1/2} [\lambda(n)]^{n+1/2} e^{\lambda(n) - n - 1}, \quad (6)$$

where $\lambda(n)$ is defined implicitly by the equation

$$\lambda(n) \log[\lambda(n)] = n. \quad (7)$$

A variation of DOBIŃSKI'S FORMULA gives

$$B_k = \sum_{m=1}^n \frac{m^k}{m!} \sum_{s=0}^{n-m} \frac{(-1)^s}{s} \quad (8)$$

for $1 \leq k \leq n$ (Pitman 1997). de Bruijn (1958) gave the asymptotic formula

$$\frac{\ln B_n}{n} = \ln n - \ln \ln n - 1 + \frac{\ln \ln n}{\ln n} + \frac{1}{\ln n} + \frac{1}{2} \left(\frac{\ln \ln n}{\ln n} \right)^2 + \mathcal{O} \left[\frac{\ln \ln n}{(\ln n)^2} \right]. \quad (9)$$

TOUCHARD'S CONGRUENCE states

$$B_{p+k} \equiv B_k + B_{k+1} \pmod{p}, \quad (10)$$

when p is PRIME. The only PRIME Bell numbers for $n \leq 1000$ are $B_2, B_3, B_7, B_{13}, B_{42}$, and B_{55} . The Bell numbers also have the curious property that

$$\begin{vmatrix} B_0 & B_1 & B_2 & \cdots & B_n \\ B_1 & B_2 & B_3 & \cdots & B_{n+1} \\ \vdots & \vdots & \vdots & \ddots & \vdots \\ B_n & B_{n+1} & B_{n+2} & \cdots & B_{2n} \end{vmatrix} = \prod_{i=1}^n n! \quad (11)$$

(Lenard 1986).

see also BELL POLYNOMIAL, BELL TRIANGLE, DOBIŃSKI'S FORMULA, STIRLING NUMBER OF THE SECOND KIND, TOUCHARD'S CONGRUENCE

References

- Bell, E. T. "Exponential Numbers." *Amer. Math. Monthly* **41**, 411–419, 1934.
- Comtet, L. *Advanced Combinatorics*. Dordrecht, Netherlands: Reidel, 1974.
- Conway, J. H. and Guy, R. K. In *The Book of Numbers*. New York: Springer-Verlag, pp. 91–94, 1996.
- de Bruijn, N. G. *Asymptotic Methods in Analysis*. New York: Dover, pp. 102–109, 1958.
- Dickau, R. M. "Bell Number Diagrams." [http:// forum . swarthmore.edu/advanced/robertd/bell.html](http://forum.swarthmore.edu/advanced/robertd/bell.html).
- Gardner, M. "The Tinkly Temple Bells." Ch. 2 in *Fractal Music, Hypercards, and More Mathematical Recreations from Scientific American Magazine*. New York: W. H. Freeman, 1992.
- Gould, H. W. *Bell & Catalan Numbers: Research Bibliography of Two Special Number Sequences*, 6th ed. Morgantown, WV: Math Monongliae, 1985.
- Lenard, A. In *Fractal Music, Hypercards, and More Mathematical Recreations from Scientific American Magazine*. (M. Gardner). New York: W. H. Freeman, pp. 35–36, 1992.
- Levine, J. and Dalton, R. E. "Minimum Periods, Modulo p , of First Order Bell Exponential Integrals." *Math. Comput.* **16**, 416–423, 1962.
- Lovász, L. *Combinatorial Problems and Exercises*, 2nd ed. Amsterdam, Netherlands: North-Holland, 1993.
- Pitman, J. "Some Probabilistic Aspects of Set Partitions." *Amer. Math. Monthly* **104**, 201–209, 1997.
- Rota, G.-C. "The Number of Partitions of a Set." *Amer. Math. Monthly* **71**, 498–504, 1964.
- Sloane, N. J. A. Sequence A000110/M1484 in "An On-Line Version of the Encyclopedia of Integer Sequences."

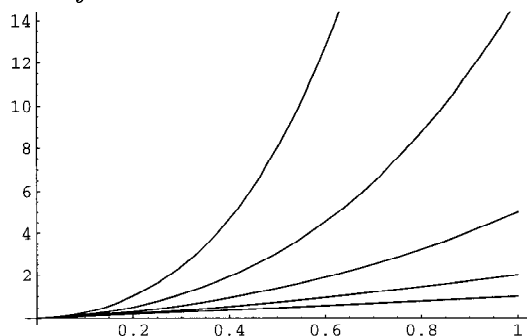
Bell Polynomial

Two different GENERATING FUNCTIONS for the Bell polynomials for $n > 0$ are given by

$$\phi_n(x) = e^{-x} \sum_{k=1}^{\infty} \frac{k^{n-1} x^k}{(k-1)!}$$

or

$$\phi_n(x) = x \sum_{k=1}^{n-1} \binom{n-1}{k-1} \phi_{k-1}(x),$$

where $\binom{n}{k}$ is a BINOMIAL COEFFICIENT.

The Bell polynomials are defined such that $\phi_n(1) = B_n$, where B_n is a BELL NUMBER. The first few Bell polynomials are

$$\begin{aligned}\phi_0(x) &= 1 \\ \phi_1(x) &= x \\ \phi_2(x) &= x + x^2 \\ \phi_3(x) &= x + 3x^2 + x^3 \\ \phi_4(x) &= x + 7x^2 + 6x^3 + x^4 \\ \phi_5(x) &= x + 15x^2 + 25x^3 + 10x^4 + x^5 \\ \phi_6(x) &= x + 31x^2 + 90x^3 + 65x^4 + 15x^5 + x^6.\end{aligned}$$

see also BELL NUMBER

References

- Bell, E. T. "Exponential Polynomials." *Ann. Math.* **35**, 258–277, 1934.

Bell Triangle

1	2	5	15	52	203	877	...
1	3	10	37	151	674	...	
2	7	27	114	523	...		
5	20	87	409	...			
15	67	322	...				
52	255	...					
203	...						
...							

A triangle of numbers which allow the BELL NUMBERS to be computed using the RECURRENCE RELATION

$$B_{n+1} = \sum_{k=0}^n B_k \binom{n}{k}.$$

see also BELL NUMBER, CLARK'S TRIANGLE, LEIBNIZ HARMONIC TRIANGLE, NUMBER TRIANGLE, PASCAL'S TRIANGLE, SEIDEL-ENTRINGER-ARNOLD TRIANGLE

Bellows Conjecture

see FLEXIBLE POLYHEDRON

Beltrami Differential Equation

For a measurable function μ , the Beltrami differential equation is given by

$$f_{z^*} = \mu f_z,$$

where f_z is a PARTIAL DERIVATIVE and z^* denotes the COMPLEX CONJUGATE of z .

see also QUASICONFORMAL MAP

References

- Iyanaga, S. and Kawada, Y. (Eds.). *Encyclopedic Dictionary of Mathematics*. Cambridge, MA: MIT Press, p. 1087, 1980.

Beltrami Field

A VECTOR FIELD \mathbf{u} satisfying the vector identity

$$\mathbf{u} \times (\nabla \times \mathbf{u}) = 0$$

where $\mathbf{A} \times \mathbf{B}$ is the CROSS PRODUCT and $\nabla \times \mathbf{A}$ is the CURL is said to be a Beltrami field.

see also DIVERGENCELESS FIELD, IRROTATIONAL FIELD, SOLENOIDAL FIELD

Beltrami Identity

An identity in CALCULUS OF VARIATIONS discovered in 1868 by Beltrami. The EULER-LAGRANGE DIFFERENTIAL EQUATION is

$$\frac{\partial f}{\partial y} - \frac{d}{dx} \left(\frac{\partial f}{\partial y_x} \right) = 0. \quad (1)$$

Now, examine the DERIVATIVE of x

$$\frac{df}{dx} = \frac{\partial f}{\partial y} y_x + \frac{\partial f}{\partial y_x} y_{xx} + \frac{\partial f}{\partial x}. \quad (2)$$

Solving for the $\partial f / \partial y$ term gives

$$\frac{\partial f}{\partial y} y_x = \frac{df}{dx} - \frac{\partial f}{\partial y_x} y_{xx} - \frac{\partial f}{\partial x}. \quad (3)$$

Now, multiplying (1) by y_x gives

$$y_x \frac{\partial f}{\partial y} - y_x \frac{d}{dx} \left(\frac{\partial f}{\partial y_x} \right) = 0. \quad (4)$$

Substituting (3) into (4) then gives

$$\frac{df}{dx} - \frac{\partial f}{\partial y_x} y_{xx} - \frac{\partial f}{\partial x} - y_x \frac{d}{dx} \left(\frac{\partial f}{\partial y_x} \right) = 0 \quad (5)$$

$$-\frac{\partial f}{\partial x} + \frac{d}{dx} \left(f - y_x \frac{\partial f}{\partial y_x} \right) = 0. \quad (6)$$

This form is especially useful if $f_x = 0$, since in that case

$$\frac{d}{dx} \left(f - y_x \frac{\partial f}{\partial y_x} \right) = 0, \quad (7)$$

which immediately gives

$$f - y_x \frac{\partial f}{\partial y_x} = C, \quad (8)$$

where C is a constant of integration.

The Beltrami identity greatly simplifies the solution for the minimal AREA SURFACE OF REVOLUTION about a given axis between two specified points. It also allows straightforward solution of the BRACHISTOCURVE PROBLEM.

see also BRACHISTOCURVE PROBLEM, CALCULUS OF VARIATIONS, EULER-LAGRANGE DIFFERENTIAL EQUATION, SURFACE OF REVOLUTION

Bend (Curvature)

Given four mutually tangent circles, their bends are defined as the signed CURVATURES of the CIRCLES. If the contacts are all external, the signs are all taken as POSITIVE, whereas if one circle surrounds the other three, the sign of this circle is taken as NEGATIVE (Coxeter 1969).

see also CURVATURE, DESCARTES CIRCLE THEOREM, SODDY CIRCLES

References

Coxeter, H. S. M. *Introduction to Geometry*, 2nd ed. New York: Wiley, pp. 13-14, 1969.

Bend (Knot)

A KNOT used to join the ends of two ropes together to form a longer length.

References

Owen, P. *Knots*. Philadelphia, PA: Courage, p. 49, 1993.

Benford's Law

Also called the FIRST DIGIT LAW, FIRST DIGIT PHENOMENON, or LEADING DIGIT PHENOMENON. In listings, tables of statistics, etc., the DIGIT 1 tends to occur with PROBABILITY $\sim 30\%$, much greater than the expected 10%. This can be observed, for instance, by examining tables of LOGARITHMS and noting that the first pages are much more worn and smudged than later pages. The table below, taken from Benford (1938), shows the distribution of first digits taken from several disparate sources. Of the 54 million real constants in Plouffe's "Inverse Symbolic Calculator" database, 30% begin with the DIGIT 1.

Title	First Digit									#
	1	2	3	4	5	6	7	8	9	
Rivers, Area	31.0	16.4	10.7	11.3	7.2	8.6	5.5	4.2	5.1	335
Population	33.9	20.4	14.2	8.1	7.2	6.2	4.1	3.7	2.2	3259
Constants	41.3	14.4	4.8	8.6	10.6	5.8	1.0	2.9	10.6	104
Newspapers	30.0	18.0	12.0	10.0	8.0	6.0	6.0	5.0	5.0	100
Specific Heat	24.0	18.4	16.2	14.6	10.6	4.1	3.2	4.8	4.1	1389
Pressure	29.6	18.3	12.8	9.8	8.3	6.4	5.7	4.4	4.7	703
H.P. Lost	30.0	18.4	11.9	10.8	8.1	7.0	5.1	5.1	3.6	690
Mol. Wgt.	26.7	25.2	15.4	10.8	6.7	5.1	4.1	2.8	3.2	1800
Drainage	27.1	23.9	13.8	12.6	8.2	5.0	5.0	2.5	1.9	159
Atomic Wgt.	47.2	18.7	5.5	4.4	6.6	4.4	3.3	4.4	5.5	91
n^{-1}, \sqrt{n}	25.7	20.3	9.7	6.8	6.6	6.8	7.2	8.0	8.9	5000
Design	26.8	14.8	14.3	7.5	8.3	8.4	7.0	7.3	5.6	560
Reader's Dig.	33.4	18.5	12.4	7.5	7.1	6.5	5.5	4.9	4.2	308
Cost Data	32.4	18.8	10.1	10.1	9.8	5.5	4.7	5.5	3.1	741
X-Ray Volts	27.9	17.5	14.4	9.0	8.1	7.4	5.1	5.8	4.8	707
Am. League	32.7	17.6	12.6	9.8	7.4	6.4	4.9	5.6	3.0	1458
Blackbody	31.0	17.3	14.1	8.7	6.6	7.0	5.2	4.7	5.4	1165
Addresses	28.9	19.2	12.6	8.8	8.5	6.4	5.6	5.0	5.0	342
$n^1, n^2 \dots n!$	25.3	16.0	12.0	10.0	8.5	8.8	6.8	7.1	5.5	900
Death Rate	27.0	18.6	15.7	9.4	6.7	6.5	7.2	4.8	4.1	418
Average	30.6	18.5	12.4	9.4	8.0	6.4	5.1	4.9	4.7	1011
Prob. Error	0.8	0.4	0.4	0.3	0.2	0.2	0.2	0.2	0.3	

In fact, the first SIGNIFICANT DIGIT seems to follow a LOGARITHMIC DISTRIBUTION, with

$$P(n) \approx \log(n+1) - \log n$$

for $n = 1, \dots, 9$. One explanation uses CENTRAL LIMIT-like theorems for the MANTISSAS of random variables under MULTIPLICATION. As the number of variables increases, the density function approaches that of a LOG-ARITHMIC DISTRIBUTION.

References

- Benford, F. "The Law of Anomalous Numbers." *Proc. Amer. Phil. Soc.* **78**, 551-572, 1938.
- Boyle, J. "An Application of Fourier Series to the Most Significant Digit Problem." *Amer. Math. Monthly* **101**, 879-886, 1994.
- Hill, T. P. "Base-Invariance Implies Benford's Law." *Proc. Amer. Math. Soc.* **12**, 887-895, 1995.
- Hill, T. P. "The Significant-Digit Phenomenon." *Amer. Math. Monthly* **102**, 322-327, 1995.
- Hill, T. P. "A Statistical Derivation of the Significant Digit Law." *Stat. Sci.* **10**, 354-363, 1996.
- Hill, T. P. "The First Digit Phenomenon." *Amer. Sci.* **86**, 358-363, 1998.
- Ley, E. "On the Peculiar Distribution of the U.S. Stock Indices Digits." *Amer. Stat.* **50**, 311-313, 1996.
- Newcomb, S. "Note on the Frequency of the Use of Digits in Natural Numbers." *Amer. J. Math.* **4**, 39-40, 1881.
- Nigrini, M. "A Taxpayer Compliance Application of Benford's Law." *J. Amer. Tax. Assoc.* **18**, 72-91, 1996.
- Plouffe, S. "Inverse Symbolic Calculator." <http://www.cecm.sfu.ca/projects/ISC/>.
- Raimi, R. A. "The Peculiar Distribution of First Digits." *Sci. Amer.* **221**, 109-119, Dec. 1969.
- Raimi, R. A. "The First Digit Phenomenon." *Amer. Math. Monthly* **83**, 521-538, 1976.

Benham's Wheel

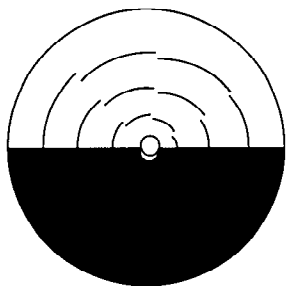

An optical ILLUSION consisting of a spinnable top marked in black with the pattern shown above. When the wheel is spun (especially slowly), the black broken lines appear as green, blue, and red colored bands!

References

- Cohen, J. and Gordon, D. A. "The Prevost-Fechner-Benham Subjective Colors." *Psycholog. Bull.* **46**, 97-136, 1949.
- Festinger, L.; Allyn, M. R.; and White, C. W. "The Perception of Color with Achromatic Stimulation." *Vision Res.* **11**, 591-612, 1971.
- Fineman, M. *The Nature of Visual Illusion*. New York: Dover, pp. 148-151, 1996.
- Trolland, T. L. "The Enigma of Color Vision." *Amer. J. Physiology* **2**, 23-48, 1921.

Bennequin's Conjecture

A BRAID with M strands and R components with P positive crossings and N negative crossings satisfies

$$|P - N| \leq 2U + M - R \leq P + N,$$

where U is the UNKNOTTING NUMBER. While the second part of the INEQUALITY was already known to be true (Boileau and Weber, 1983, 1984) at the time the conjecture was proposed, the proof of the entire conjecture was completed using results of Kronheimer and Mrowka on MILNOR'S CONJECTURE (and, independently, using MENASCO'S THEOREM).

see also BRAID, MENASCO'S THEOREM, MILNOR'S CONJECTURE, UNKNOTTING NUMBER

References

- Bennequin, D. "L'instanton gordien (d'après P. B. Kronheimer et T. S. Mrowka)." *Astérisque* **216**, 233-277, 1993.
- Birman, J. S. and Menasco, W. W. "Studying Links via Closed Braids. II. On a Theorem of Bennequin." *Topology Appl.* **40**, 71-82, 1991.
- Boileau, M. and Weber, C. "Le problème de J. Milnor sur le nombre gordien des nœuds algébriques." *Enseign. Math.* **30**, 173-222, 1984.
- Boileau, M. and Weber, C. "Le problème de J. Milnor sur le nombre gordien des nœuds algébriques." In *Knots, Braids and Singularities (Plans-sur-Bex, 1982)*. Geneva, Switzerland: Monograph. Enseign. Math. Vol. 31, pp. 49-98, 1983.
- Cipra, B. *What's Happening in the Mathematical Sciences, Vol. 2*. Providence, RI: Amer. Math. Soc., pp. 8-13, 1994.
- Kronheimer, P. B. "The Genus-Minimizing Property of Algebraic Curves." *Bull. Amer. Math. Soc.* **29**, 63-69, 1993.
- Kronheimer, P. B. and Mrowka, T. S. "Gauge Theory for Embedded Surfaces. I." *Topology* **32**, 773-826, 1993.
- Kronheimer, P. B. and Mrowka, T. S. "Recurrence Relations and Asymptotics for Four-Manifold Invariants." *Bull. Amer. Math. Soc.* **30**, 215-221, 1994.
- Menasco, W. W. "The Bennequin-Milnor Unknotting Conjectures." *C. R. Acad. Sci. Paris Sér. I Math.* **318**, 831-836, 1994.

Benson's Formula

An equation for a LATTICE SUM with $n = 3$

$$\begin{aligned} -b_3(1) &= \sum'_{i,j,k=-\infty}^{\infty} \frac{(-1)^{i+j+k+1}}{\sqrt{i^2 + j^2 + k^2}} \\ &= 12\pi \sum_{m,n=1,3,\dots}^{\infty} \operatorname{sech}^2\left(\frac{1}{2}\pi\sqrt{m^2 + n^2}\right). \end{aligned}$$

Here, the prime denotes that summation over $(0, 0, 0)$ is excluded. The sum is numerically equal to $-1.74756\dots$, a value known as "the" MADELUNG CONSTANT.

see also MADELUNG CONSTANTS

References

- Borwein, J. M. and Borwein, P. B. *Pi & the AGM: A Study in Analytic Number Theory and Computational Complexity*. New York: Wiley, p. 301, 1987.
- Finch, S. "Favorite Mathematical Constants." <http://www.mathsoft.com/asolve/constant/mdlung/mdlung.html>.

Ber

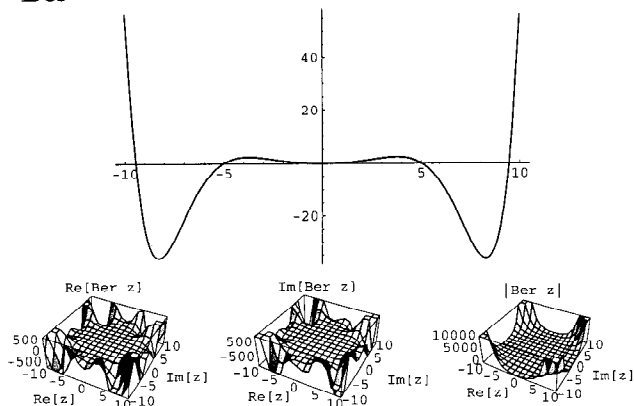

The REAL PART of

$$J_\nu(xe^{3\pi i/4}) = \text{ber}_\nu(x) + i \text{bei}_\nu(x). \quad (1)$$

The special case $\nu = 0$ gives

$$J_0(i\sqrt{x}) \equiv \text{ber}(x) + i \text{bei}(x), \quad (2)$$

where J_0 is the zeroth order BESSEL FUNCTION OF THE FIRST KIND.

$$\text{ber}(x) \equiv \sum_{n=0}^{\infty} \frac{(-1)^n \left(\frac{x}{2}\right)^{2+4n}}{[(2n+1)!]^2}. \quad (3)$$

see also BEI, BESSEL FUNCTION, KEI, KELVIN FUNCTIONS, KER

References

- Abramowitz, M. and Stegun, C. A. (Eds.). "Kelvin Functions." §9.9 in *Handbook of Mathematical Functions with Formulas, Graphs, and Mathematical Tables*, 9th printing. New York: Dover, pp. 379–381, 1972.
- Spanier, J. and Oldham, K. B. "The Kelvin Functions." Ch. 55 in *An Atlas of Functions*. Washington, DC: Hemisphere, pp. 543–554, 1987.

Beraha Constants

The n th Beraha constant is given by

$$\text{Be}_n \equiv 2 + 2 \cos\left(\frac{2\pi}{n}\right).$$

The first few are

$$\begin{aligned} \text{Be}_1 &= 4 \\ \text{Be}_2 &= 0 \\ \text{Be}_3 &= 1 \\ \text{Be}_4 &= 2 \\ \text{Be}_5 &= \frac{1}{2}(3 + \sqrt{5}) \approx 2.618 \\ \text{Be}_6 &= 3 \\ \text{Be}_7 &= 2 + 2 \cos\left(\frac{2}{7}\pi\right) \approx 3.247 \dots \end{aligned}$$

They appear to be ROOTS of the CHROMATIC POLYNOMIALS of planar triangular GRAPHS. Be_4 is $\phi + 1$, where ϕ is the GOLDEN RATIO, and Be_7 is the SILVER CONSTANT.

References

- Le Lionnais, F. *Les nombres remarquables*. Paris: Hermann, p. 143, 1983.

Berger-Kazdan Comparison Theorem

Let M be a compact n -D MANIFOLD with INJECTIVITY radius $\text{inj}(M)$. Then

$$\text{Vol}(M) \geq \frac{c_n \text{inj}(M)}{\pi},$$

with equality IFF M is ISOMETRIC to the standard round SPHERE S^n with RADIUS $\text{inj}(M)$, where $c_n(r)$ is the VOLUME of the standard n -HYPERSPHERE of RADIUS r .

see also BLASCHKE CONJECTURE, HYPERSPHERE, INJECTIVE, ISOMETRY

References

- Chavel, I. *Riemannian Geometry: A Modern Introduction*. New York: Cambridge University Press, 1994.

Bergman Kernel

A Bergman kernel is a function of a COMPLEX VARIABLE with the "reproducing kernel" property defined for any DOMAIN in which there exist NONZERO ANALYTIC FUNCTIONS of class $L_2(D)$ with respect to the LEBESGUE MEASURE dV .

References

- Hazewinkel, M. (Managing Ed.). *Encyclopaedia of Mathematics: An Updated and Annotated Translation of the Soviet "Mathematical Encyclopaedia"*. Dordrecht, Netherlands: Reidel, pp. 356–357, 1988.

Bergman Space

Let G be an open subset of the COMPLEX PLANE \mathbb{C} , and let $L_a^2(G)$ denote the collection of all ANALYTIC FUNCTIONS $f: G \rightarrow \mathbb{C}$ whose MODULUS is square integrable with respect to AREA measure. Then $L_a^2(G)$, sometimes also denoted $A^2(G)$, is called the Bergman space for G . Thus, the Bergman space consists of all the ANALYTIC FUNCTIONS in $L^2(G)$. The Bergman space can also be generalized to $L_a^p(G)$, where $0 < p < \infty$.

Bernoulli Differential Equation

$$\frac{dy}{dx} + p(x)y = q(x)y^n. \quad (1)$$

Let $v \equiv y^{1-n}$ for $n \neq 1$, then

$$\frac{dv}{dx} = (1-n)y^{-n} \frac{dy}{dx}. \quad (2)$$

Rewriting (1) gives

$$y^{-n} \frac{dy}{dx} = q(x) - p(x)y^{1-n} = q(x) - vp(x). \quad (3)$$

Plugging (3) into (2),

$$\frac{dv}{dx} = (1-n)[q(x) - vp(x)]. \quad (4)$$

Now, this is a linear FIRST-ORDER ORDINARY DIFFERENTIAL EQUATION of the form

$$\frac{dv}{dx} + vP(x) = Q(x), \quad (5)$$

where $P(x) \equiv (1-n)p(x)$ and $Q(x) \equiv (1-n)q(x)$. It can therefore be solved analytically using an INTEGRATING FACTOR

$$\begin{aligned} v &= \frac{\int e^{\int P(x) dx} Q(x) dx + C}{e^{\int P(x) dx}} \\ &= \frac{(1-n) \int e^{(1-n) \int p(x) dx} q(x) dx + C}{e^{(1-n) \int p(x) dx}}, \end{aligned} \quad (6)$$

where C is a constant of integration. If $n = 1$, then equation (1) becomes

$$\frac{dy}{dx} = y(q-p) \quad (7)$$

$$\frac{dy}{y} = (q-p) dx \quad (8)$$

$$y = C_2 e^{\int [q(x)-p(x)] dx} \quad (9)$$

The general solution is then, with C_1 and C_2 constants,

$$y = \begin{cases} \left[\frac{(1-n) \int e^{(1-n) \int p(x) dx} q(x) dx + C_1}{e^{(1-n) \int p(x) dx}} \right]^{1/(1-n)} & \text{for } n \neq 1 \\ C_2 e^{\int [q(x)-p(x)] dx} & \text{for } n = 1. \end{cases} \quad (10)$$

Bernoulli Distribution

A DISTRIBUTION given by

$$P(n) = \begin{cases} q \equiv 1-p & \text{for } n = 0 \\ p & \text{for } n = 1 \end{cases} \quad (1)$$

$$= p^n(1-p)^{1-n} \quad \text{for } n = 0, 1. \quad (2)$$

The distribution of heads and tails in COIN TOSsing is a Bernoulli distribution with $p = q = 1/2$. The GENERATING FUNCTION of the Bernoulli distribution is

$$M(t) = \langle e^{tn} \rangle = \sum_{n=0}^1 e^{tn} p^n (1-p)^{1-n} = e^0(1-p) + e^t p, \quad (3)$$

so

$$M(t) = (1-p) + pe^t \quad (4)$$

$$M'(t) = pe^t \quad (5)$$

$$M''(t) = pe^t \quad (6)$$

$$M^{(n)}(t) = pe^t, \quad (7)$$

and the MOMENTS about 0 are

$$\mu'_1 = \mu = M'(0) = p \quad (8)$$

$$\mu'_2 = M''(0) = p \quad (9)$$

$$\mu'_n = M^{(n)}(0) = p. \quad (10)$$

The MOMENTS about the MEAN are

$$\mu_2 = \mu'_2 - (\mu'_1)^2 = p - p^2 = p(1-p) \quad (11)$$

$$\begin{aligned} \mu_3 &= \mu'_3 - 3\mu'_2\mu'_1 + 2(\mu'_1)^3 = p - 3p^2 + 2p^3 \\ &= p(1-p)(1-2p) \end{aligned} \quad (12)$$

$$\begin{aligned} \mu_4 &= \mu'_4 - 4\mu'_3\mu'_1 + 6\mu'_2(\mu'_1)^2 - 3(\mu'_1)^4 \\ &= p - 4p^2 + 6p^3 - 3p^4 \\ &= p(1-p)(3p^2 - 3p + 1). \end{aligned} \quad (13)$$

The MEAN, VARIANCE, SKEWNESS, and KURTOSIS are then

$$\mu = \mu'_1 = p \quad (14)$$

$$\sigma^2 = \mu_2 = p(1-p) \quad (15)$$

$$\begin{aligned} \gamma_1 &= \frac{\mu_3}{\sigma^3} = \frac{p(1-p)(1-2p)}{[p(1-p)]^{3/2}} \\ &= \frac{1-2p}{\sqrt{p(1-p)}} \end{aligned} \quad (16)$$

$$\begin{aligned} \gamma_2 &= \frac{\mu_4}{\sigma^4} - 3 = \frac{p(1-2p)(2p^2 - 2p + 1)}{p^2(1-p)^2} - 3 \\ &= \frac{6p^2 - 6p + 1}{p(1-p)}. \end{aligned} \quad (17)$$

To find an estimator for a population mean,

$$\begin{aligned} \langle p \rangle &= \sum_{Np=0}^N p \binom{N}{Np} \theta^{Np} (1-\theta)^{Nq} \\ &= \theta \sum_{Np=1}^N \binom{N-1}{Np-1} \theta^{Np-1} (1-\theta)^{Nq} \\ &= \theta [\theta + (1-\theta)]^{N-1} = \theta, \end{aligned} \quad (18)$$

so $\langle p \rangle$ is an UNBIASED ESTIMATOR for θ . The probability of Np successes in N trials is then

$$\binom{N}{Np} \theta^{Np} (1-\theta)^{Nq}, \quad (19)$$

where

$$p = \frac{[\text{number of successes}]}{N} \equiv \frac{n}{N}. \quad (20)$$

see also BINOMIAL DISTRIBUTION

Bernoulli Function

see BERNOULLI POLYNOMIAL

Bernoulli Inequality

$$(1+x)^n > 1+nx, \quad (1)$$

where $x \in \mathbb{R} > -1 \neq 0$, $n \in \mathbb{Z} > 1$. This inequality can be proven by taking a MACLAURIN SERIES of $(1+x)^n$,

$$(1+x)^n = 1+nx+\frac{1}{2}n(n-1)x^2+\frac{1}{6}n(n-1)(n-2)x^3+\dots \quad (2)$$

Since the series terminates after a finite number of terms for INTEGRAL n , the Bernoulli inequality for $x > 0$ is obtained by truncating after the first-order term. When $-1 < x < 0$, slightly more finesse is needed. In this case, let $y = |x| = -x > 0$ so that $0 < y < 1$, and take

$$(1-y)^n = 1-ny+\frac{1}{2}n(n-1)y^2-\frac{1}{6}n(n-1)(n-2)y^3+\dots \quad (3)$$

Since each POWER of y multiplies by a number < 1 and since the ABSOLUTE VALUE of the COEFFICIENT of each subsequent term is smaller than the last, it follows that the sum of the third order and subsequent terms is a POSITIVE number. Therefore,

$$(1-y)^n > 1-ny, \quad (4)$$

or

$$(1+x)^n > 1+nx, \quad \text{for } -1 < x < 0, \quad (5)$$

completing the proof of the INEQUALITY over all ranges of parameters.

Bernoulli Lemniscate

see LEMNISCATE

Bernoulli Number

There are two definitions for the Bernoulli numbers. The older one, no longer in widespread use, defines the Bernoulli numbers B_n^* by the equations

$$\begin{aligned} \frac{x}{e^x-1} + \frac{x}{2} - 1 &\equiv \sum_{n=1}^{\infty} \frac{(-1)^{n-1} B_n^* x^{2n}}{(2n)!} \\ &= \frac{B_1^* x^2}{2!} - \frac{B_2^* x^4}{4!} + \frac{B_3^* x^6}{6!} + \dots \quad (1) \end{aligned}$$

for $|x| < 2\pi$, or

$$\begin{aligned} 1 - \frac{x}{2} \cot\left(\frac{x}{2}\right) &\equiv \sum_{n=1}^{\infty} \frac{B_n^* x^{2n}}{(2n)!} \\ &= \frac{B_1^* x^2}{2!} + \frac{B_2^* x^4}{4!} + \frac{B_3^* x^6}{6!} + \dots \quad (2) \end{aligned}$$

for $|x| < \pi$ (Whittaker and Watson 1990, p. 125). Gradshcheyn and Ryzhik (1979) denote these numbers B_n^* , while Bernoulli numbers defined by the newer (National Bureau of Standards) definition are denoted B . The

B_n^* Bernoulli numbers may be calculated from the integral

$$B_n^* = 4n \int_0^{\infty} \frac{t^{2n-1} dt}{e^{2\pi t} - 1}, \quad (3)$$

and analytically from

$$B_n^* = \frac{2(2n)!}{(2\pi)^{2n}} \sum_{p=1}^{\infty} p^{-2n} = \frac{2(2n)!}{(2\pi)^{2n}} \zeta(2n) \quad (4)$$

for $n = 1, 2, \dots$, where $\zeta(z)$ is the RIEMANN ZETA FUNCTION.

The first few Bernoulli numbers B_n^* are

$$\begin{aligned} B_1^* &= \frac{1}{6} \\ B_2^* &= \frac{1}{30} \\ B_3^* &= \frac{1}{42} \\ B_4^* &= \frac{1}{30} \\ B_5^* &= \frac{5}{66} \\ B_6^* &= \frac{691}{2,730} \\ B_7^* &= \frac{7}{6} \\ B_8^* &= \frac{3,617}{510} \\ B_9^* &= \frac{43,867}{798} \\ B_{10}^* &= \frac{174,611}{330} \\ B_{11}^* &= \frac{854,513}{138}. \end{aligned}$$

Bernoulli numbers defined by the modern definition are denoted B_n and also called “EVEN-index” Bernoulli numbers. These are the Bernoulli numbers returned by the *Mathematica*® (Wolfram Research, Champaign, IL) function `BernoulliB[n]`. These Bernoulli numbers are a superset of the archaic ones B_n^* since

$$B_n \equiv \begin{cases} 1 & \text{for } n = 0 \\ -\frac{1}{2} & \text{for } n = 1 \\ (-1)^{(n/2)-1} B_{n/2}^* & \text{for } n \text{ even} \\ 0 & \text{for } n \text{ odd.} \end{cases} \quad (5)$$

The B_n can be defined by the identity

$$\frac{x}{e^x-1} \equiv \sum_{n=0}^{\infty} \frac{B_n x^n}{n!}. \quad (6)$$

These relationships can be derived using the generating function

$$F(x, t) = \sum_{n=0}^{\infty} \frac{B_n(x) t^n}{n!}, \quad (7)$$

which converges uniformly for $|t| < 2\pi$ and all x (Castellanos 1988). Taking the partial derivative gives

$$\frac{\partial F(x, t)}{\partial x} = \sum_{n=0}^{\infty} \frac{B_{n-1}(x) t^n}{(n-1)!} = t \sum_{n=0}^{\infty} \frac{B_n(x) t^n}{n!} = t F(x, t). \quad (8)$$

The solution to this differential equation is

$$F(x, t) = T(t)e^{xt}, \quad (9)$$

so integrating gives

$$\begin{aligned} \int_0^1 F(x, t) dx &= T(t) \int_0^1 e^{xt} dx = T(t) \frac{e^t - 1}{t} \\ &= \sum_{n=0}^{\infty} \frac{t^n}{n!} \int_0^1 B_n(x) dx \\ &= 1 + \sum_{n=1}^{\infty} \frac{t^n}{n!} \int_0^1 B_n(x) dx = 1 \quad (10) \end{aligned}$$

or

$$\frac{te^{xt}}{e^t - 1} = \sum_{n=0}^{\infty} \frac{B_n(x)t^n}{n!} \quad (11)$$

(Castellanos 1988). Setting $x = 0$ and adding $t/2$ to both sides then gives

$$\frac{1}{2}t \coth(\frac{1}{2}t) = \sum_{n=0}^{\infty} \frac{B_{2n}t^{2n}}{(2n)!}. \quad (12)$$

Letting $t = 2ix$ then gives

$$x \cot x = \sum_{n=0}^{\infty} (-1)^n B_{2n} \frac{2x^{2n}}{(2n)!} \quad (13)$$

for $x \in [-\pi, \pi]$. The Bernoulli numbers may also be calculated from the integral

$$B_n = \frac{n!}{2\pi i} \int \frac{z}{e^z - 1} \frac{dz}{z^{n+1}}, \quad (14)$$

or from

$$B_n = \left[\frac{d^n}{dx^n} \frac{x}{e^x - 1} \right]_{x=0}. \quad (15)$$

The Bernoulli numbers satisfy the identity

$$\binom{k+1}{1} B_k + \binom{k+1}{2} B_{k-1} + \dots + \binom{k+1}{k} B_1 + B_0 = 0, \quad (16)$$

where $\binom{n}{k}$ is a BINOMIAL COEFFICIENT. An asymptotic FORMULA is

$$\lim_{n \rightarrow \infty} |B_{2n}| \sim 4\sqrt{\pi n} \left(\frac{n}{\pi e} \right)^{2n}. \quad (17)$$

Bernoulli numbers appear in expressions of the form $\sum_{k=1}^n k^p$, where $p = 1, 2, \dots$. Bernoulli numbers also appear in the series expansions of functions involving $\tan x$, $\cot x$, $\csc x$, $\ln|\sin x|$, $\ln|\cos x|$, $\ln|\tan x|$, $\tanh x$,

$\coth x$, and $\operatorname{csch} x$. An analytic solution exists for EVEN orders,

$$B_{2n} = \frac{(-1)^{n-1} 2(2n)!}{(2\pi)^{2n}} \sum_{p=1}^{\infty} p^{-2n} = \frac{(-1)^{n-1} 2(2n)!}{(2\pi)^{2n}} \zeta(2n) \quad (18)$$

for $n = 1, 2, \dots$, where $\zeta(2n)$ is the RIEMANN ZETA FUNCTION. Another intimate connection with the RIEMANN ZETA FUNCTION is provided by the identity

$$B_n = (-1)^{n+1} n \zeta(1-n). \quad (19)$$

The DENOMINATOR of B_{2k} is given by the VON STAUDT-CLAUSEN THEOREM

$$\operatorname{denom}(B_{2k}) = \prod_{\substack{p \text{ prime} \\ (p-1)|2k}}^{2k+1} p, \quad (20)$$

which also implies that the DENOMINATOR of B_{2k} is SQUAREFREE (Hardy and Wright 1979). Another curious property is that the fraction part of B_n in DECIMAL has a DECIMAL PERIOD which divides n , and there is a single digit before that period (Conway 1996).

$$\begin{aligned} B_0 &= 1 \\ B_1 &= -\frac{1}{2} \\ B_2 &= \frac{1}{6} \\ B_4 &= -\frac{1}{30} \\ B_6 &= \frac{1}{42} \\ B_8 &= -\frac{1}{30} \\ B_{10} &= \frac{5}{66} \\ B_{12} &= -\frac{691}{2,730} \\ B_{14} &= \frac{7}{6} \\ B_{16} &= -\frac{3,617}{510} \\ B_{18} &= \frac{43,867}{798} \\ B_{20} &= -\frac{174,611}{330} \\ B_{22} &= \frac{854,513}{138} \end{aligned}$$

(Sloane's A000367 and A002445). In addition,

$$B_{2n+1} = 0 \quad (21)$$

for $n = 1, 2, \dots$.

Bernoulli first used the Bernoulli numbers while computing $\sum_{k=1}^n k^p$. He used the property of the FIGURATE NUMBER TRIANGLE that

$$\sum_{i=0}^n a_{ij} = \frac{(n+1)a_{nj}}{j+1}, \quad (22)$$

along with a form for a_{nj} which he derived inductively to compute the sums up to $n = 10$ (Boyer 1968, p. 85). For $p \in \mathbb{Z} > 0$, the sum is given by

$$\sum_{k=1}^n k^p = \sum_{k=1}^n \frac{(B + n + 1)^{[p+1]} - B^{p+1}}{p + 1}, \quad (23)$$

where the NOTATION $B^{[k]}$ means the quantity in question is raised to the appropriate POWER k , and all terms of the form B^m are replaced with the corresponding Bernoulli numbers B_m . Written explicitly in terms of a sum of POWERS,

$$\sum_{k=1}^n k^p = \frac{B_k p!}{k!(p - k + 1)!} n^{p-k+1}. \quad (24)$$

It is also true that the COEFFICIENTS of the terms in such an expansion sum to 1 (which Bernoulli stated without proof). Ramanujan gave a number of curious infinite sum identities involving Bernoulli numbers (Berndt 1994).

G. J. Fee and S. Plouffe have computed $B_{200,000}$, which has $\sim 800,000$ DIGITS (Plouffe). Plouffe and collaborators have also calculated B_n for n up to 72,000.

see also ARGONH'S CONJECTURE, BERNOULLI FUNCTION, BERNOULLI POLYNOMIAL, DEBYE FUNCTIONS, EULER-MACLAURIN INTEGRATION FORMULAS, EULER NUMBER, FIGURATE NUMBER TRIANGLE, GENOCCHI NUMBER, PASCAL'S TRIANGLE, RIEMANN ZETA FUNCTION, VON STAUDT-CLAUSEN THEOREM

References

- Abramowitz, M. and Stegun, C. A. (Eds.). "Bernoulli and Euler Polynomials and the Euler-Maclaurin Formula." §23.1 in *Handbook of Mathematical Functions with Formulas, Graphs, and Mathematical Tables*, 9th printing. New York: Dover, pp. 804–806, 1972.
- Arfken, G. "Bernoulli Numbers, Euler-Maclaurin Formula." §5.9 in *Mathematical Methods for Physicists*, 3rd ed. Orlando, FL: Academic Press, pp. 327–338, 1985.
- Ball, W. W. R. and Coxeter, H. S. M. *Mathematical Recreations and Essays*, 13th ed. New York: Dover, p. 71, 1987.
- Berndt, B. C. *Ramanujan's Notebooks, Part IV*. New York: Springer-Verlag, pp. 81–85, 1994.
- Boyer, C. B. *A History of Mathematics*. New York: Wiley, 1968.
- Castellanos, D. "The Ubiquitous Pi. Part I." *Math. Mag.* **61**, 67–98, 1988.
- Conway, J. H. and Guy, R. K. In *The Book of Numbers*. New York: Springer-Verlag, pp. 107–110, 1996.
- Gradshteyn, I. S. and Ryzhik, I. M. *Tables of Integrals, Series, and Products*, 5th ed. San Diego, CA: Academic Press, 1980.
- Hardy, G. H. and Wright, W. M. *An Introduction to the Theory of Numbers*, 5th ed. Oxford, England: Oxford University Press, pp. 91–93, 1979.
- Ireland, K. and Rosen, M. "Bernoulli Numbers." Ch. 15 in *A Classical Introduction to Modern Number Theory*, 2nd ed. New York: Springer-Verlag, pp. 228–248, 1990.
- Knuth, D. E. and Buckholtz, T. J. "Computation of Tangent, Euler, and Bernoulli Numbers." *Math. Comput.* **21**, 663–688, 1967.

Plouffe, S. "Plouffe's Inverter: Table of Current Records for the Computation of Constants." <http://lacim.uqam.ca/pi/records.html>.

Ramanujan, S. "Some Properties of Bernoulli's Numbers." *J. Indian Math. Soc.* **3**, 219–234, 1911.

Sloane, N. J. A. Sequences A000367/M4039 and A002445/M4189 in "An On-Line Version of the Encyclopedia of Integer Sequences."

Spanier, J. and Oldham, K. B. "The Bernoulli Numbers, B_n ." Ch. 4 in *An Atlas of Functions*. Washington, DC: Hemisphere, pp. 35–38, 1987.

Wagstaff, S. S. Jr. "Ramanujan's Paper on Bernoulli Numbers." *J. Indian Math. Soc.* **45**, 49–65, 1981.

Whittaker, E. T. and Watson, G. N. *A Course in Modern Analysis*, 4th ed. Cambridge, England: Cambridge University Press, 1990.

Bernoulli's Paradox

Suppose the HARMONIC SERIES converges to h :

$$\sum_{k=1}^{\infty} \frac{1}{k} = h.$$

Then rearranging the terms in the sum gives

$$h - 1 = h,$$

which is a contradiction.

References

- Boas, R. P. "Some Remarkable Sequences of Integers." Ch. 3 in *Mathematical Plums* (Ed. R. Honsberger). Washington, DC: Math. Assoc. Amer., pp. 39–40, 1979.

Bernoulli Polynomial

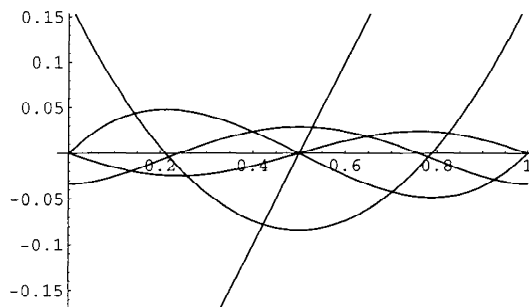

There are two definitions of Bernoulli polynomials in use. The n th Bernoulli polynomial is denoted here by $B_n(x)$, and the archaic Bernoulli polynomial by $B_n^*(x)$. These definitions correspond to the BERNOULLI NUMBERS evaluated at 0,

$$B_n \equiv B_n(0) \quad (1)$$

$$B_n^* \equiv B_n^*(0). \quad (2)$$

They also satisfy

$$B_n(1) = (-1)^n B_n(0) \quad (3)$$

and

$$B_n(1-x) = (-1)^n B_n(x) \quad (4)$$

(Lehmer 1988). The first few Bernoulli POLYNOMIALS are

$$\begin{aligned} B_0(x) &= 1 \\ B_1(x) &= x - \frac{1}{2} \\ B_2(x) &= x^2 - x + \frac{1}{6} \\ B_3(x) &= x^3 - \frac{3}{2}x^2 + \frac{1}{2}x \\ B_4(x) &= x^4 - 2x^3 + x^2 - \frac{1}{30} \\ B_5(x) &= x^5 - \frac{5}{2}x^4 + \frac{5}{3}x^3 - \frac{1}{6}x \\ B_6(x) &= x^6 - 3x^5 + \frac{5}{2}x^4 - \frac{1}{2}x^2 + \frac{1}{42}. \end{aligned}$$

Bernoulli (1713) defined the POLYNOMIALS in terms of sums of the POWERS of consecutive integers,

$$\sum_{k=0}^{m-1} k^{n-1} = \frac{1}{n} [B_n(m) - B_n(0)]. \quad (5)$$

Euler (1738) gave the Bernoulli POLYNOMIALS $B_n(x)$ in terms of the generating function

$$\frac{te^{tx}}{e^t - 1} \equiv \sum_{n=0}^{\infty} B_n(x) \frac{t^n}{n!}. \quad (6)$$

They satisfy recurrence relation

$$\frac{dB_n}{dx} = nB_{n-1}(x) \quad (7)$$

(Appell 1882), and obey the identity

$$B_n(x) = (B + x)^n, \quad (8)$$

where B^k is interpreted here as $B_k(x)$. Hurwitz gave the FOURIER SERIES

$$B_n(x) = -\frac{n!}{(2\pi i)^n} \sum_{k=-\infty}^{\infty} k^{-n} e^{2\pi i k x}, \quad (9)$$

for $0 < x < 1$, and Raabe (1851) found

$$\frac{1}{m} \sum_{k=0}^{m-1} B_n \left(x + \frac{k}{m} \right) = m^{-n} B_n(mx). \quad (10)$$

A sum identity involving the Bernoulli POLYNOMIALS is

$$\begin{aligned} \sum_{k=0}^m \binom{m}{k} B_k(\alpha) B_{m-k}(\beta) \\ = -(m-1) B_m(\alpha + \beta) + m(\alpha + \beta - 1) B_{m-1}(\alpha + \beta) \end{aligned} \quad (11)$$

for an INTEGER m and arbitrary REAL NUMBERS α and β .

see also BERNOULLI NUMBER, EULER-MACLAURIN INTEGRATION FORMULAS, EULER POLYNOMIAL

References

- Abramowitz, M. and Stegun, C. A. (Eds.). "Bernoulli and Euler Polynomials and the Euler-Maclaurin Formula." §23.1 in *Handbook of Mathematical Functions with Formulas, Graphs, and Mathematical Tables*, 9th printing. New York: Dover, pp. 804–806, 1972.
- Appell, P. E. "Sur une classe de polynomes." *Annales d'École Normal Supérieur*, Ser. 2 **9**, 119–144, 1882.
- Arfken, G. *Mathematical Methods for Physicists*, 3rd ed. Orlando, FL: Academic Press, p. 330, 1985.
- Bernoulli, J. *Ars conjectandi*. Basel, Switzerland, p. 97, 1713. Published posthumously.
- Euler, L. "Methodus generalis summandi progressionem." *Comment. Acad. Sci. Petropol.* **6**, 68–97, 1738.
- Lehmer, D. H. "A New Approach to Bernoulli Polynomials." *Amer. Math. Monthly*. **95**, 905–911, 1988.
- Lucas, E. Ch. 14 in *Théorie des Nombres*. Paris, 1891.
- Raabe, J. L. "Zurückführung einiger Summen und bestimmten Integrale auf die Jakob Bernoullische Function." *J. reine angew. Math.* **42**, 348–376, 1851.
- Spanier, J. and Oldham, K. B. "The Bernoulli Polynomial $B_n(x)$." Ch. 19 in *An Atlas of Functions*. Washington, DC: Hemisphere, pp. 167–173, 1987.

Bernoulli's Theorem

see WEAK LAW OF LARGE NUMBERS

Bernoulli Trial

An experiment in which s TRIALS are made of an event, with probability p of success in any given TRIAL.

Bernstein-Bézier Curve

see BÉZIER CURVE

Bernstein's Constant

N.B. A detailed on-line essay by S. Finch was the starting point for this entry.

Let $E_n(f)$ be the error of the best uniform approximation to a REAL function $f(x)$ on the INTERVAL $[-1, 1]$ by REAL POLYNOMIALS of degree at most n . If

$$\alpha(x) = |x|, \quad (1)$$

then Bernstein showed that

$$0.267 \dots < \lim_{n \rightarrow \infty} 2n E_{2n}(\alpha) < 0.286. \quad (2)$$

He conjectured that the lower limit (β) was $\beta = 1/(2\sqrt{\pi})$. However, this was disproven by Varga and Carpenter (1987) and Varga (1990), who computed

$$\beta = 0.2801694990 \dots \quad (3)$$

For rational approximations $p(x)/q(x)$ for p and q of degree m and n , D. J. Newman (1964) proved

$$\frac{1}{2} e^{-9\sqrt{n}} \leq E_{n,n}(\alpha) \leq 3e^{-\sqrt{n}} \quad (4)$$

for $n \geq 4$. Gonchar (1967) and Bulanov (1975) improved the lower bound to

$$e^{-\pi\sqrt{n+1}} \leq E_{n,n}(\alpha) \leq 3e^{-\sqrt{n}}. \quad (5)$$

Vjacheslavo (1975) proved the existence of POSITIVE constants m and M such that

$$m \leq e^{\pi\sqrt{n}} E_{n,n}(\alpha) < M \quad (6)$$

(Petrushev 1987, pp. 105–106). Varga *et al.* (1993) conjectured and Stahl (1993) proved that

$$\lim_{n \rightarrow \infty} e^{\pi\sqrt{2n}} E_{2n,2n}(\alpha) = 8. \quad (7)$$

References

- Bulanov, A. P. "Asymptotics for the Best Rational Approximation of the Function $\text{Sign } x$." *Mat. Sbornik* **96**, 171–178, 1975.
- Finch, S. "Favorite Mathematical Constants." <http://www.mathsoft.com/asolve/constant/brnstrn/brnstrn.html>.
- Gonchar, A. A. "Estimates for the Growth of Rational Functions and their Applications." *Mat. Sbornik* **72**, 489–503, 1967.
- Newman, D. J. "Rational Approximation to $|x|$." *Michigan Math. J.* **11**, 11–14, 1964.
- Petrushev, P. P. and Popov, V. A. *Rational Approximation of Real Functions*. New York: Cambridge University Press, 1987.
- Stahl, H. "Best Uniform Rational Approximation of $|x|$ on $[-1, 1]$." *Russian Acad. Sci. Sb. Math.* **76**, 461–487, 1993.
- Varga, R. S. *Scientific Computations on Mathematical Problems and Conjectures*. Philadelphia, PA: SIAM, 1990.
- Varga, R. S. and Carpenter, A. J. "On a Conjecture of S. Bernstein in Approximation Theory." *Math. USSR Sbornik* **57**, 547–560, 1987.
- Varga, R. S.; Ruttan, A.; and Carpenter, A. J. "Numerical Results on Best Uniform Rational Approximations to $|x|$ on $[-1, +1]$." *Math. USSR Sbornik* **74**, 271–290, 1993.
- Vjacheslavo, N. S. "On the Uniform Approximation of $|x|$ by Rational Functions." *Dokl. Akad. Nauk SSSR* **220**, 512–515, 1975.

Bernstein's Inequality

Let P be a POLYNOMIAL of degree n with derivative P' . Then

$$\|P'\|_{\infty} \leq n\|P\|_{\infty},$$

where

$$\|P\|_{\infty} \equiv \max_{|z|=1} |P(z)|.$$

Bernstein Minimal Surface Theorem

If a MINIMAL SURFACE is given by the equation $z = f(x, y)$ and f has CONTINUOUS first and second PARTIAL DERIVATIVES for all REAL x and y , then f is a PLANE.

References

- Hazewinkel, M. (Managing Ed.). *Encyclopaedia of Mathematics: An Updated and Annotated Translation of the Soviet "Mathematical Encyclopaedia."* Dordrecht, Netherlands: Reidel, p. 369, 1988.

Bernstein Polynomial

The POLYNOMIALS defined by

$$B_{i,n}(t) = \binom{n}{i} t^i (1-t)^{n-i},$$

where $\binom{n}{k}$ is a BINOMIAL COEFFICIENT. The Bernstein polynomials of degree n form a basis for the POWER POLYNOMIALS of degree n .

see also BÉZIER CURVE

Bernstein's Polynomial Theorem

If $g(\theta)$ is a trigonometric POLYNOMIAL of degree m satisfying the condition $|g(\theta)| \leq 1$ where θ is arbitrary and real, then $g'(\theta) \leq m$.

References

- Szegő, G. *Orthogonal Polynomials*, 4th ed. Providence, RI: Amer. Math. Soc., p. 5, 1975.

Bernstein-Szegő Polynomials

The POLYNOMIALS on the interval $[-1, 1]$ associated with the WEIGHT FUNCTIONS

$$\begin{aligned} w(x) &= (1-x^2)^{-1/2} \\ w(x) &= (1-x^2)^{1/2} \\ w(x) &= \sqrt{\frac{1-x}{1+x}}, \end{aligned}$$

also called BERNSTEIN POLYNOMIALS.

References

- Szegő, G. *Orthogonal Polynomials*, 4th ed. Providence, RI: Amer. Math. Soc., pp. 31–33, 1975.

Berry-Osseen Inequality

Gives an estimate of the deviation of a DISTRIBUTION FUNCTION as a SUM of independent RANDOM VARIABLES with a NORMAL DISTRIBUTION.

References

Hazewinkel, M. (Managing Ed.). *Encyclopaedia of Mathematics: An Updated and Annotated Translation of the Soviet "Mathematical Encyclopaedia."* Dordrecht, Netherlands: Reidel, p. 369, 1988.

Berry Paradox

There are several versions of the Berry paradox, the original version of which was published by Bertrand Russell and attributed to Oxford University librarian Mr. G. Berry. In one form, the paradox notes that the number "one million, one hundred thousand, one hundred and twenty one" can be named by the description: "the first number not nameable in under ten words." However, this latter expression has only nine words, so the number *can* be named in under ten words, so there is an inconsistency in naming it in this manner!

References

Chaitin, G. J. "The Berry Paradox." *Complexity* 1, 26–30, 1995.

Bertelsen's Number

An erroneous value of $\pi(10^9)$, where $\pi(x)$ is the PRIME COUNTING FUNCTION. Bertelsen's value of 50,847,478 is 56 lower than the correct value of 50,847,534.

References

Brown, K. S. "Bertelsen's Number." <http://www.seanet.com/~ksbrown/kmath049.htm>.

Bertini's Theorem

The general curve of a system which is LINEARLY INDEPENDENT on a certain number of given irreducible curves will not have a singular point which is not fixed for all the curves of the system.

References

Coolidge, J. L. *A Treatise on Algebraic Plane Curves*. New York: Dover, p. 115, 1959.

Bertrand Curves

Two curves which, at any point, have a common principal NORMAL VECTOR are called Bertrand curves. The product of the TORSIONS of Bertrand curves is a constant.

Bertrand's Paradox

see BERTRAND'S PROBLEM

Bertrand's Postulate

If $n > 3$, there is always at least one PRIME between n and $2n - 2$. Equivalently, if $n > 1$, then there is always at least one PRIME between n and $2n$. It was proved in 1850–51 by Chebyshev, and is therefore sometimes known as CHEBYSHEV'S THEOREM. An elegant proof was later given by Erdős. An extension of this result is that if $n > k$, then there is a number containing a PRIME divisor $> k$ in the sequence $n, n + 1, \dots, n + k - 1$. (The case $n = k + 1$ then corresponds to Bertrand's postulate.) This was first proved by Sylvester, independently by Schur, and a simple proof was given by Erdős.

A related problem is to find the least value of θ so that there exists at least one PRIME between n and $n + \mathcal{O}(n^\theta)$ for sufficiently large n (Berndt 1994). The smallest known value is $\theta = 6/11 + \epsilon$ (Lou and Yao 1992).

see also CHOQUET THEORY, DE POLIGNAC'S CONJECTURE, PRIME NUMBER

References

Berndt, B. C. *Ramanujan's Notebooks, Part IV*. New York: Springer-Verlag, p. 135, 1994.

Erdős, P. "Ramanujan and I." In *Proceedings of the International Ramanujan Centenary Conference held at Anna University, Madras, Dec. 21, 1987*. (Ed. K. Alladi). New York: Springer-Verlag, pp. 1–20, 1989.

Lou, S. and Yau, Q. "A Chebyshev's Type of Prime Number Theorem in a Short Interval (II)." *Hardy-Ramanujan J.* 15, 1–33, 1992.

Bertrand's Problem

What is the PROBABILITY that a CHORD drawn at RANDOM on a CIRCLE of RADIUS r has length $\geq r$? The answer, it turns out, depends on the interpretation of "two points drawn at RANDOM." In the usual interpretation that ANGLES θ_1 and θ_2 are picked at RANDOM on the CIRCUMFERENCE,

$$P = \frac{\pi - \frac{\pi}{3}}{\pi} = \frac{2}{3}.$$

However, if a point is instead placed at RANDOM on a RADIUS of the CIRCLE and a CHORD drawn PERPENDICULAR to it,

$$P = \frac{\frac{\sqrt{3}}{2}r}{r} = \frac{\sqrt{3}}{2}.$$

The latter interpretation is more satisfactory in the sense that the result remains the same for a rotated CIRCLE, a slightly smaller CIRCLE INSCRIBED in the first, or for a CIRCLE of the same size but with its center slightly offset. Jaynes (1983) shows that the interpretation of "RANDOM" as a continuous UNIFORM DISTRIBUTION over the RADIUS is the only one possessing all these three invariances.

References

Bogomolny, A. "Bertrand's Paradox." <http://www.cut-the-knot.com/bertrand.html>.

Jaynes, E. T. *Papers on Probability, Statistics, and Statistical Physics*. Dordrecht, Netherlands: Reidel, 1983.

Pickover, C. A. *Keys to Infinity*. New York: Wiley, pp. 42–45, 1995.

Bertrand's Test

A CONVERGENCE TEST also called DE MORGAN'S AND BERTRAND'S TEST. If the ratio of terms of a SERIES $\{a_n\}_{n=1}^{\infty}$ can be written in the form

$$\frac{a_n}{a_{n+1}} = 1 + \frac{1}{n} + \frac{\rho_n}{n \ln n},$$

then the series converges if $\lim_{n \rightarrow \infty} \rho_n > 1$ and diverges if $\lim_{n \rightarrow \infty} \rho_n < 1$, where $\lim_{n \rightarrow \infty}$ is the LOWER LIMIT and $\lim_{n \rightarrow \infty}$ is the UPPER LIMIT.

see also KUMMER'S TEST

References

Bromwich, T. J. P. and MacRobert, T. M. *An Introduction to the Theory of Infinite Series*, 3rd ed. New York: Chelsea, p. 40, 1991.

Bertrand's Theorem

see BERTRAND'S POSTULATE

Besov Space

A type of abstract SPACE which occurs in SPLINE and RATIONAL FUNCTION approximations. The Besov space $B_{p,q}^{\alpha}$ is a complete quasinormed space which is a BANACH SPACE when $1 \leq p, q \leq \infty$ (Petrushev and Popov 1987).

References

Bergh, J. and Löfström, J. *Interpolation Spaces*. New York: Springer-Verlag, 1976.
Peetre, J. *New Thoughts on Besov Spaces*. Durham, NC: Duke University Press, 1976.
Petrushev, P. P. and Popov, V. A. "Besov Spaces." §7.2 in *Rational Approximation of Real Functions*. New York: Cambridge University Press, pp. 201-203, 1987.
Triebel, H. *Interpolation Theory, Function Spaces, Differential Operators*. New York: Elsevier, 1978.

Bessel's Correction

The factor $(N-1)/N$ in the relationship between the VARIANCE σ and the EXPECTATION VALUES of the SAMPLE VARIANCE,

$$\langle s^2 \rangle = \frac{N-1}{N} \sigma^2, \quad (1)$$

where

$$s^2 \equiv \langle x^2 \rangle - \langle x \rangle^2. \quad (2)$$

For two samples,

$$\hat{\sigma}^2 = \frac{N_1 s_1^2 + N_2 s_2^2}{N_1 + N_2 - 2}. \quad (3)$$

see also SAMPLE VARIANCE, VARIANCE

Bessel Differential Equation

$$x^2 \frac{d^2 y}{dx^2} + x \frac{dy}{dx} + (x^2 - m^2)y = 0. \quad (1)$$

Equivalently, dividing through by x^2 ,

$$\frac{d^2 y}{dx^2} + \frac{1}{x} \frac{dy}{dx} + \left(1 - \frac{m^2}{x^2}\right)y = 0. \quad (2)$$

The solutions to this equation define the BESSEL FUNCTIONS. The equation has a regular SINGULARITY at 0 and an irregular SINGULARITY at ∞ .

A transformed version of the Bessel differential equation given by Bowman (1958) is

$$x^2 \frac{d^2 y}{dx^2} + (2p+1)x \frac{dy}{dx} + (a^2 x^{2r} + \beta^2)y = 0. \quad (3)$$

The solution is

$$y = x^{-p} \left[C_1 J_{q/r} \left(\frac{\alpha}{r} x^r \right) + C_2 Y_{q/r} \left(\frac{\alpha}{r} x^r \right) \right], \quad (4)$$

where

$$q \equiv \sqrt{p^2 - \beta^2}, \quad (5)$$

J and Y are the BESSEL FUNCTIONS OF THE FIRST and SECOND KINDS, and C_1 and C_2 are constants. Another form is given by letting $y = x^{\alpha} J_n(\beta x^{\gamma})$, $\eta = y x^{-\alpha}$, and $\xi = \beta x^{\gamma}$ (Bowman 1958, p. 117), then

$$\frac{d^2 y}{dx^2} - \frac{2\alpha-1}{x} \frac{dy}{dx} + \left(\beta^2 \gamma^2 x^{2\gamma-2} + \frac{\alpha^2 - n^2 \gamma^2}{x^2} \right) y = 0. \quad (6)$$

The solution is

$$y = \begin{cases} x^{\alpha} [A J_n(\beta x^{\gamma}) + B Y_n(\beta x^{\gamma})] & \text{for integral } n \\ A J_n(\beta x^{\gamma}) + B J_{-n}(\beta x^{\gamma}) & \text{for nonintegral } n. \end{cases} \quad (7)$$

see also AIRY FUNCTIONS, ANGER FUNCTION, BEL, BER, BESSEL FUNCTION, BOURGET'S HYPOTHESIS, CATALAN INTEGRALS, CYLINDRICAL FUNCTION, DINI EXPANSION, HANKEL FUNCTION, HANKEL'S INTEGRAL, HEMISPHERICAL FUNCTION, KAPTEYN SERIES, LIPSCHITZ'S INTEGRAL, LOMMEL DIFFERENTIAL EQUATION, LOMMEL FUNCTION, LOMMEL'S INTEGRALS, NEUMANN SERIES (BESSEL FUNCTION), PARSEVAL'S INTEGRAL, POISSON INTEGRAL, RAMANUJAN'S INTEGRAL, RICCATI DIFFERENTIAL EQUATION, SONINE'S INTEGRAL, STRUVE FUNCTION, WEBER FUNCTIONS, WEBER'S DISCONTINUOUS INTEGRALS

References

Bowman, F. *Introduction to Bessel Functions*. New York: Dover, 1958.
Morse, P. M. and Feshbach, H. *Methods of Theoretical Physics, Part I*. New York: McGraw-Hill, p. 550, 1953.

Bessel's Finite Difference Formula

An INTERPOLATION formula also sometimes known as

$$f_p = f_0 + p\delta_{1/2} + B_2(\delta_0^2 + \delta_1^2) + B_3\delta_{1/2}^3 + B_4(\delta_0^4 + \delta_1^4) + B_5\delta_{1/2}^5 + \dots, \quad (1)$$

for $p \in [0, 1]$, where δ is the CENTRAL DIFFERENCE and

$$B_{2n} \equiv \frac{1}{2}G_{2n} \equiv \frac{1}{2}(E_{2n} + F_{2n}) \quad (2)$$

$$B_{2n+1} \equiv G_{2n+1} - \frac{1}{2}G_{2n} \equiv \frac{1}{2}(F_{2n} - E_{2n}) \quad (3)$$

$$E_{2n} \equiv G_{2n} - G_{2n+1} \equiv B_{2n} - B_{2n+1} \quad (4)$$

$$F_{2n} \equiv G_{2n+1} \equiv B_{2n} + B_{2n+1}, \quad (5)$$

where G_k are the COEFFICIENTS from GAUSS'S BACKWARD FORMULA and GAUSS'S FORWARD FORMULA and E_k and F_k are the COEFFICIENTS from EVERETT'S FORMULA. The B_k s also satisfy

$$B_{2n}(p) = B_{2n}(q) \quad (6)$$

$$B_{2n+1}(p) = -B_{2n+1}(q), \quad (7)$$

for

$$q \equiv 1 - p. \quad (8)$$

see also EVERETT'S FORMULA

References

- Abramowitz, M. and Stegun, C. A. (Eds.). *Handbook of Mathematical Functions with Formulas, Graphs, and Mathematical Tables*, 9th printing. New York: Dover, p. 880, 1972.
- Acton, F. S. *Numerical Methods That Work*, 2nd printing. Washington, DC: Math. Assoc. Amer., pp. 90–91, 1990.
- Beyer, W. H. *CRC Standard Mathematical Tables*, 28th ed. Boca Raton, FL: CRC Press, p. 433, 1987.

Bessel's First Integral

$$J_n(x) = \frac{1}{\pi} \int_0^\pi \cos(n\theta - x \sin \theta) d\theta,$$

where $J_n(x)$ is a BESSEL FUNCTION OF THE FIRST KIND.

Bessel's Formula

see BESSEL'S FINITE DIFFERENCE FORMULA, BESSEL'S INTERPOLATION FORMULA, BESSEL'S STATISTICAL FORMULA

Bessel Function

A function $Z(x)$ defined by the RECURRENCE RELATIONS

$$Z_{m+1} + Z_{m-1} = \frac{2m}{x} Z_m$$

and

$$Z_{m+1} - Z_{m-1} = -2 \frac{dZ_m}{dx}.$$

Bessel Function of the First Kind

The Bessel functions are more frequently defined as solutions to the DIFFERENTIAL EQUATION

$$x^2 \frac{d^2 y}{dx^2} + x \frac{dy}{dx} + (x^2 - m^2)y = 0.$$

There are two classes of solution, called the BESSEL FUNCTION OF THE FIRST KIND J and BESSEL FUNCTION OF THE SECOND KIND Y . (A BESSEL FUNCTION OF THE THIRD KIND is a special combination of the first and second kinds.) Several related functions are also defined by slightly modifying the defining equations.

see also BESSEL FUNCTION OF THE FIRST KIND, BESSEL FUNCTION OF THE SECOND KIND, BESSEL FUNCTION OF THE THIRD KIND, CYLINDER FUNCTION, HEMICYLINDRICAL FUNCTION, MODIFIED BESSEL FUNCTION OF THE FIRST KIND, MODIFIED BESSEL FUNCTION OF THE SECOND KIND, SPHERICAL BESSEL FUNCTION OF THE FIRST KIND, SPHERICAL BESSEL FUNCTION OF THE SECOND KIND

References

- Abramowitz, M. and Stegun, C. A. (Eds.). "Bessel Functions of Integer Order," "Bessel Functions of Fractional Order," and "Integrals of Bessel Functions." Chs. 9–11 in *Handbook of Mathematical Functions with Formulas, Graphs, and Mathematical Tables*, 9th printing. New York: Dover, pp. 355–389, 435–456, and 480–491, 1972.
- Arfken, G. "Bessel Functions." Ch. 11 in *Mathematical Methods for Physicists*, 3rd ed. Orlando, FL: Academic Press, pp. 573–636, 1985.
- Bickley, W. G. *Bessel Functions and Formulae*. Cambridge, England: Cambridge University Press, 1957.
- Bowman, F. *Introduction to Bessel Functions*. New York: Dover, 1958.
- Gray, A. and Matthews, G. B. *A Treatise on Bessel Functions and Their Applications to Physics*, 2nd ed. New York: Dover, 1966.
- Luke, Y. L. *Integrals of Bessel Functions*. New York: McGraw-Hill, 1962.
- McLachlan, N. W. *Bessel Functions for Engineers*, 2nd ed. with corrections. Oxford, England: Clarendon Press, 1961.
- Press, W. H.; Flannery, B. P.; Teukolsky, S. A.; and Vetterling, W. T. "Bessel Functions of Integral Order" and "Bessel Functions of Fractional Order, Airy Functions, Spherical Bessel Functions." §6.5 and 6.7 in *Numerical Recipes in FORTRAN: The Art of Scientific Computing*, 2nd ed. Cambridge, England: Cambridge University Press, pp. 223–229 and 234–245, 1992.
- Watson, G. N. *A Treatise on the Theory of Bessel Functions*, 2nd ed. Cambridge, England: Cambridge University Press, 1966.

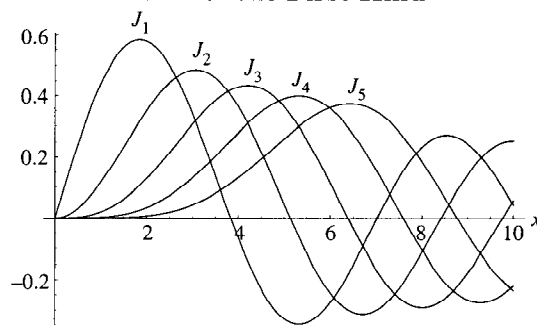
Bessel Function of the First Kind

The Bessel functions of the first kind $J_n(x)$ are defined as the solutions to the BESSEL DIFFERENTIAL EQUATION

$$x^2 \frac{d^2 y}{dx^2} + x \frac{dy}{dx} + (x^2 - m^2)y = 0 \quad (1)$$

which are nonsingular at the origin. They are sometimes also called CYLINDER FUNCTIONS or CYLINDRICAL HARMONICS. The above plot shows $J_n(x)$ for $n = 1, 2, \dots, 5$.

To solve the differential equation, apply FROBENIUS METHOD using a series solution of the form

$$y = x^k \sum_{n=0}^{\infty} a_n x^n = \sum_{n=0}^{\infty} a_n x^{n+k}. \quad (2)$$

Plugging into (1) yields

$$\begin{aligned} x^2 \sum_{n=0}^{\infty} (k+n)(k+n-1) a_n x^{k+n-2} \\ + x \sum_{n=0}^{\infty} (k+n) a_n x^{k+n-1} + x^2 \sum_{n=0}^{\infty} a_n x^{k+n} \\ - m^2 \sum_{n=0}^{\infty} a_n x^{n+k} = 0 \end{aligned} \quad (3)$$

$$\begin{aligned} \sum_{n=0}^{\infty} (k+n)(k+n-1) a_n x^{k+n} + \sum_{n=0}^{\infty} (k+n) a_n x^{k+n} \\ + \sum_{n=2}^{\infty} a_{n-2} x^{k+n} - m^2 \sum_{n=0}^{\infty} a_n x^{n+k} = 0. \end{aligned} \quad (4)$$

The INDICIAL EQUATION, obtained by setting $n = 0$, is

$$a_0[k(k-1) + k - m^2] = a_0(k^2 - m^2) = 0. \quad (5)$$

Since a_0 is defined as the first NONZERO term, $k^2 - m^2 = 0$, so $k = \pm m$. Now, if $k = m$,

$$\begin{aligned} \sum_{n=0}^{\infty} [(m+n)(m+n-1) + (m+n) - m^2] a_n x^{m+n} \\ + \sum_{n=2}^{\infty} a_{n-2} x^{m+n} = 0 \end{aligned} \quad (6)$$

$$\sum_{n=0}^{\infty} [(m+n)^2 - m^2] a_n x^{m+n} + \sum_{n=2}^{\infty} a_{n-2} x^{m+n} = 0 \quad (7)$$

$$\sum_{n=0}^{\infty} n(2m+n) a_n x^{m+n} + \sum_{n=2}^{\infty} a_{n-2} x^{m+n} = 0 \quad (8)$$

$$a_1(2m+1) + \sum_{n=2}^{\infty} [a_n n(2m+n) + a_{n-2}] x^{m+n} = 0. \quad (9)$$

First, look at the special case $m = -1/2$, then (9) becomes

$$\sum_{n=2}^{\infty} [a_n n(n-1) + a_{n-2}] x^{m+n} = 0, \quad (10)$$

so

$$a_n = -\frac{1}{n(n-1)} a_{n-2}. \quad (11)$$

Now let $n = 2l$, where $l = 1, 2, \dots$

$$\begin{aligned} a_{2l} &= -\frac{1}{2l(2l-1)} a_{2l-2} \\ &= \frac{(-1)^l}{[2l(2l-1)][2(l-1)(2l-3)] \dots [2 \cdot 1 \cdot 1]} a_0 \\ &= \frac{(-1)^l}{2^l l! (2l-1)!} a_0, \end{aligned} \quad (12)$$

which, using the identity $2^l l! (2l-1)! = (2l)!$, gives

$$a_{2l} = \frac{(-1)^l}{(2l)!} a_0. \quad (13)$$

Similarly, letting $n = 2l+1$

$$\begin{aligned} a_{2l+1} &= -\frac{1}{(2l+1)(2l)} a_{2l-1} \\ &= \frac{(-1)^l}{[2l(2l+1)][2(l-1)(2l-1)] \dots [2 \cdot 1 \cdot 3][1]} a_1, \end{aligned} \quad (14)$$

which, using the identity $2^l l! (2l+1)! = (2l+1)!$, gives

$$a_{2l+1} = \frac{(-1)^l}{2^l l! (2l+1)!} a_1 = \frac{(-1)^l}{(2l+1)!} a_1. \quad (15)$$

Plugging back into (2) with $k = m = -1/2$ gives

$$\begin{aligned} y &= x^{-1/2} \sum_{n=0}^{\infty} a_n x^n \\ &= x^{-1/2} \left[\sum_{n=1,3,5,\dots}^{\infty} a_n x^n + \sum_{n=0,2,4,\dots}^{\infty} a_n x^n \right] \\ &= x^{-1/2} \left[\sum_{l=0}^{\infty} a_{2l} x^{2l} + \sum_{l=0}^{\infty} a_{2l+1} x^{2l+1} \right] \\ &= x^{-1/2} \left[a_0 \sum_{l=0}^{\infty} \frac{(-1)^l}{(2l)!} x^{2l} + a_1 \sum_{l=0}^{\infty} \frac{(-1)^l}{(2l+1)!} x^{2l+1} \right] \\ &= x^{-1/2} (a_0 \cos x + a_1 \sin x). \end{aligned} \quad (16)$$

The BESSEL FUNCTIONS of order $\pm 1/2$ are therefore defined as

$$J_{-1/2}(x) \equiv \sqrt{\frac{2}{\pi x}} \cos x \quad (17)$$

$$J_{1/2}(x) \equiv \sqrt{\frac{2}{\pi x}} \sin x, \quad (18)$$

so the general solution for $m = \pm 1/2$ is

$$y = a'_0 J_{-1/2}(x) + a'_1 J_{1/2}(x). \quad (19)$$

Now, consider a general $m \neq -1/2$. Equation (9) requires

$$a_1(2m+1) = 0 \quad (20)$$

$$[a_n n(2m+n) + a_{n-2}]x^{m+n} = 0 \quad (21)$$

for $n = 2, 3, \dots$, so

$$a_1 = 0 \quad (22)$$

$$a_n = -\frac{1}{n(2m+n)} a_{n-2} \quad (23)$$

for $n = 2, 3, \dots$. Let $n \equiv 2l+1$, where $l = 1, 2, \dots$, then

$$\begin{aligned} a_{2l+1} &= -\frac{1}{(2l+1)[2(m+1)+1]} a_{2l-1} \\ &= \dots = f(n, m) a_1 = 0, \end{aligned} \quad (24)$$

where $f(n, m)$ is the function of l and m obtained by iterating the recursion relationship down to a_1 . Now let $n \equiv 2l$, where $l = 1, 2, \dots$, so

$$\begin{aligned} a_{2l} &= -\frac{1}{2l(2m+2l)} a_{2l-2} = -\frac{1}{4l(m+l)} a_{2l-2} \\ &= \frac{(-1)^l}{[4l(m+l)][4(l-1)(m+l-1)] \dots [4 \cdot (m+1)]} a_0. \end{aligned} \quad (25)$$

Plugging back into (9),

$$\begin{aligned} y &= \sum_{n=0}^{\infty} a_n x^{n+m} = \sum_{n=1,3,5,\dots}^{\infty} a_n x^{n+m} + \sum_{n=0,2,4,\dots}^{\infty} a_n x^{n+m} \\ &= \sum_{l=0}^{\infty} a_{2l+1} x^{2l+m+1} + \sum_{l=0}^{\infty} a_{2l} x^{2l+m} \\ &= a_0 \sum_{l=0}^{\infty} \frac{(-1)^l}{[4l(m+l)][4(l-1)(m+l-1)] \dots [4 \cdot (m+1)]} x^{2l+m} \\ &= a_0 \sum_{l=0}^{\infty} \frac{[(-1)^l m(m-1) \dots 1] x^{2l+m}}{[4l(m+l)][4(l-1)(m+l-1)] \dots [m(m-1) \dots 1]} \\ &= a_0 \sum_{l=0}^{\infty} \frac{(-1)^l m!}{4^l l! (m+l)!} = a_0 \sum_{l=0}^{\infty} \frac{(-1)^l m!}{2^{2l} l! (m+l)!}. \end{aligned} \quad (26)$$

Now define

$$J_m(x) \equiv \sum_{l=0}^{\infty} \frac{(-1)^l}{2^{2l+m} l! (m+l)!} x^{2l+m}, \quad (27)$$

where the factorials can be generalized to GAMMA FUNCTIONS for nonintegral m . The above equation then becomes

$$y = a_0 2^m m! J_m(x) = a'_0 J_m(x). \quad (28)$$

Returning to equation (5) and examining the case $k = -m$,

$$a_1(1-2m) + \sum_{n=2}^{\infty} [a_n n(n-2m) + a_{n-2}] x^{n-m} = 0. \quad (29)$$

However, the sign of m is arbitrary, so the solutions must be the same for $+m$ and $-m$. We are therefore free to replace $-m$ with $-|m|$, so

$$a_1(1+2|m|) + \sum_{n=2}^{\infty} [a_n n(n+2|m|) + a_{n-2}] x^{|m|+n} = 0, \quad (30)$$

and we obtain the same solutions as before, but with m replaced by $|m|$.

$$J_m(x) = \begin{cases} \sum_{l=0}^{\infty} \frac{(-1)^l}{2^{2l+|m|} l! (|m|+l)!} x^{2l+|m|} & \text{for } |m| \neq -\frac{1}{2} \\ \sqrt{\frac{2}{\pi x}} \cos x & \text{for } m = -\frac{1}{2} \\ \sqrt{\frac{2}{\pi x}} \sin x & \text{for } m = \frac{1}{2}. \end{cases} \quad (31)$$

We can relate J_m and J_{-m} (when m is an INTEGER) by writing

$$J_{-m}(x) = \sum_{l=0}^{\infty} \frac{(-1)^l}{2^{2l-m} l! (l-m)!} x^{2l-m}. \quad (32)$$

Now let $l \equiv l' + m$. Then

$$\begin{aligned} J_{-m}(x) &= \sum_{l'+m=0}^{\infty} \frac{(-1)^{l'+m}}{2^{2l'+m} (l'+m)! l!} x^{2l'+m} \\ &= \sum_{l'=-m}^{-1} \frac{(-1)^{l'+m}}{2^{2l'+m} l'! (l'+m)!} x^{2l'+m} \\ &\quad + \sum_{l'=0}^{\infty} \frac{(-1)^{l'+m}}{2^{2l'+m} l'! (l'+m)!} x^{2l'+m}. \end{aligned} \quad (33)$$

But $l'! = \infty$ for $l' = -m, \dots, -1$, so the DENOMINATOR is infinite and the terms on the right are zero. We therefore have

$$J_{-m}(x) = \sum_{l=0}^{\infty} \frac{(-1)^{l+m}}{2^{2l+m} l! (l+m)!} x^{2l+m} = (-1)^m J_m(x). \quad (34)$$

Note that the BESSEL DIFFERENTIAL EQUATION is second-order, so there must be two linearly independent solutions. We have found both only for $|m| = 1/2$. For a general nonintegral order, the independent solutions are J_m and J_{-m} . When m is an INTEGER, the general (real) solution is of the form

$$Z_m \equiv C_1 J_m(x) + C_2 Y_m(x), \quad (35)$$

where J_m is a Bessel function of the first kind, Y_m (a.k.a. N_m) is the BESSEL FUNCTION OF THE SECOND KIND (a.k.a. NEUMANN FUNCTION or WEBER FUNCTION), and C_1 and C_2 are constants. Complex solutions are given by the HANKEL FUNCTIONS (a.k.a. BESSEL FUNCTIONS OF THE THIRD KIND).

The Bessel functions are ORTHOGONAL in $[0, 1]$ with respect to the weight factor x . Except when $2n$ is a NEGATIVE INTEGER,

$$J_m(z) = \frac{z^{-1/2}}{2^{2m+1/2} i^{m+1/2} \Gamma(m+1)} M_{0,m}(2iz), \quad (36)$$

where $\Gamma(x)$ is the GAMMA FUNCTION and $M_{0,m}$ is a WHITTAKER FUNCTION.

In terms of a CONFLUENT HYPERGEOMETRIC FUNCTION OF THE FIRST KIND, the Bessel function is written

$$J_\nu(z) = \frac{(\frac{1}{2}z)^\nu}{\Gamma(\nu+1)} {}_0F_1(\nu+1; -\frac{1}{4}z^2). \quad (37)$$

A derivative identity for expressing higher order Bessel functions in terms of $J_0(x)$ is

$$J_n(x) = i^n T_n \left(i \frac{d}{dx} \right) J_0(x), \quad (38)$$

where $T_n(x)$ is a CHEBYSHEV POLYNOMIAL OF THE FIRST KIND. Asymptotic forms for the Bessel functions are

$$J_m(x) \approx \frac{1}{\Gamma(m+1)} \left(\frac{x}{2} \right)^m \quad (39)$$

for $x \ll 1$ and

$$J_m(x) \approx \sqrt{\frac{2}{\pi x}} \cos \left(x - \frac{m\pi}{2} - \frac{\pi}{4} \right) \quad (40)$$

for $x \gg 1$. A derivative identity is

$$\frac{d}{dx} [x^m J_m(x)] = x^m J_{m-1}(x). \quad (41)$$

An integral identity is

$$\int_0^u u' J_0(u') du' = u J_1(u). \quad (42)$$

Some sum identities are

$$1 = [J_0(x)]^2 + 2[J_1(x)]^2 + 2[J_2(x)]^2 + \dots \quad (43)$$

$$1 = J_0(x) + 2J_2(x) + 2J_4(x) + \dots \quad (44)$$

and the JACOBI-ANGER EXPANSION

$$e^{iz \cos \theta} = \sum_{n=-\infty}^{\infty} i^n J_n(z) e^{in\theta}, \quad (45)$$

which can also be written

$$e^{iz \cos \theta} = J_0(z) + 2 \sum_{n=1}^{\infty} i^n J_n(z) \cos(n\theta). \quad (46)$$

The Bessel function addition theorem states

$$J_n(y+z) = \sum_{m=-\infty}^{\infty} J_m(y) J_{n-m}(z). \quad (47)$$

ROOTS of the FUNCTION $J_n(x)$ are given in the following table.

zero	$J_0(x)$	$J_1(x)$	$J_2(x)$	$J_3(x)$	$J_4(x)$	$J_5(x)$
1	2.4048	3.8317	5.1336	6.3802	7.5883	8.7715
2	5.5201	7.0156	8.4172	9.7610	11.0647	12.3386
3	8.6537	10.1735	11.6198	13.0152	14.3725	15.7002
4	11.7915	13.3237	14.7960	16.2235	17.6160	18.9801
5	14.9309	16.4706	17.9598	19.4094	20.8269	22.2178

Let x_n be the n th ROOT of the Bessel function $J_0(x)$, then

$$\sum_{n=1}^{\infty} \frac{1}{x_n J_0(x_n)} = 0.38479 \dots \quad (48)$$

(Le Lionnais 1983).

The ROOTS of its DERIVATIVES are given in the following table.

zero	$J_0'(x)$	$J_1'(x)$	$J_2'(x)$	$J_3'(x)$	$J_4'(x)$	$J_5'(x)$
1	3.8317	1.8412	3.0542	4.2012	5.3175	6.4156
2	7.0156	5.3314	6.7061	8.0152	9.2824	10.5199
3	10.1735	8.5363	9.9695	11.3459	12.6819	13.9872
4	13.3237	11.7060	13.1704	14.5858	15.9641	17.3128
5	16.4706	14.8636	16.3475	17.7887	19.1960	20.5755

Various integrals can be expressed in terms of Bessel functions

$$J_0(z) = \frac{1}{2\pi} \int_0^{2\pi} e^{iz \cos \phi} d\phi \quad (49)$$

$$J_n(z) = \frac{1}{\pi} \int_0^\pi \cos(z \sin \theta - n\theta) d\theta, \quad (50)$$

which is BESSEL'S FIRST INTEGRAL,

$$J_n(z) = \frac{i^{-n}}{\pi} \int_0^\pi e^{iz \cos \theta} \cos(n\theta) d\theta \quad (51)$$

$$J_n(z) = \frac{1}{2\pi i^n} \int_0^{2\pi} e^{iz \cos \phi} e^{in\phi} d\phi \quad (52)$$

for $n = 1, 2, \dots$,

$$J_n(z) = \frac{2}{\pi} \frac{x^n}{(2m-1)!!} \int_0^{\pi/2} \sin^{2n} u \cos(x \cos u) du \quad (53)$$

for $n = 1, 2, \dots$,

$$J_n(x) = \frac{1}{2\pi i} \int_\gamma e^{(x/2)(z-1/z)} z^{-n-1} dz \quad (54)$$

for $n > -1/2$. Integrals involving $J_1(x)$ include

$$\int_0^\infty J_1(x) dx = 1 \quad (55)$$

$$\int_0^\infty \left[\frac{J_1(x)}{x} \right]^2 dx = \frac{4}{3\pi} \quad (56)$$

$$\int_0^\infty \left[\frac{J_1(x)}{x} \right]^2 x dx = \frac{1}{2}. \quad (57)$$

see also BESSEL FUNCTION OF THE SECOND KIND, DEBYE'S ASYMPTOTIC REPRESENTATION, DIXON-FERRAR FORMULA, HANSEN-BESSEL FORMULA, KAPTEYN SERIES, KNESER-SOMMERFELD FORMULA, MEHLER'S BESSEL FUNCTION FORMULA, NICHOLSON'S FORMULA, POISSON'S BESSEL FUNCTION FORMULA, SCHLÄFLI'S FORMULA, SCHLÖMILCH'S SERIES, SOMMERFELD'S FORMULA, SONINE-SCHAFHEITLIN FORMULA, WATSON'S FORMULA, WATSON-NICHOLSON FORMULA, WEBER'S DISCONTINUOUS INTEGRALS, WEBER'S FORMULA, WEBER-SONINE FORMULA, WEYRICH'S FORMULA

References

- Abramowitz, M. and Stegun, C. A. (Eds.). "Bessel Functions J and Y ." §9.1 in *Handbook of Mathematical Functions with Formulas, Graphs, and Mathematical Tables*, 9th printing. New York: Dover, pp. 358-364, 1972.
- Arfken, G. "Bessel Functions of the First Kind, $J_\nu(x)$ " and "Orthogonality." §11.1 and 11.2 in *Mathematical Methods for Physicists*, 3rd ed. Orlando, FL: Academic Press, pp. 573-591 and 591-596, 1985.
- Lehmer, D. H. "Arithmetical Periodicities of Bessel Functions." *Ann. Math.* **33**, 143-150, 1932.
- Le Lionnais, F. *Les nombres remarquables*. Paris: Hermann, p. 25, 1983.
- Morse, P. M. and Feshbach, H. *Methods of Theoretical Physics, Part I*. New York: McGraw-Hill, pp. 619-622, 1953.
- Spanier, J. and Oldham, K. B. "The Bessel Coefficients $J_0(x)$ and $J_1(x)$ " and "The Bessel Function $J_\nu(x)$." Chs. 52-53 in *An Atlas of Functions*. Washington, DC: Hemisphere, pp. 509-520 and 521-532, 1987.

Bessel Function Fourier Expansion

Let $n \geq 1/2$ and $\alpha_1, \alpha_2, \dots$ be the POSITIVE ROOTS of $J_n(x) = 0$. An expansion of a function in the interval $(0,1)$ in terms of BESSEL FUNCTIONS OF THE FIRST KIND

$$f(x) = \sum_{l=1}^{\infty} A_l J_n(x\alpha_l), \quad (1)$$

has COEFFICIENTS found as follows:

$$\int_0^1 x f(x) J_n(x\alpha_l) dx = \sum_{r=1}^{\infty} A_r \int_0^1 x J_n(x\alpha_r) J_n(x\alpha_l) dx. \quad (2)$$

But ORTHOGONALITY of BESSEL FUNCTION ROOTS gives

$$\int_0^1 x J_n(x\alpha_l) J_n(x\alpha_r) dx = \frac{1}{2} \delta_{l,r} J_{n+1}^2(\alpha_r) \quad (3)$$

(Bowman 1958, p. 108), so

$$\begin{aligned} \int_0^1 x f(x) J_n(x\alpha_l) dx &= \frac{1}{2} \sum_{r=1}^{\infty} A_r \delta_{l,r} J_{n+1}^2(x\alpha_r) \\ &= \frac{1}{2} A_l J_{n+1}^2(\alpha_l), \end{aligned} \quad (4)$$

and the COEFFICIENTS are given by

$$A_l = \frac{2}{J_{n+1}^2(\alpha_l)} \int_0^1 x f(x) J_n(x\alpha_l) dx. \quad (5)$$

References

- Bowman, F. *Introduction to Bessel Functions*. New York: Dover, 1958.

Bessel Function of the Second Kind

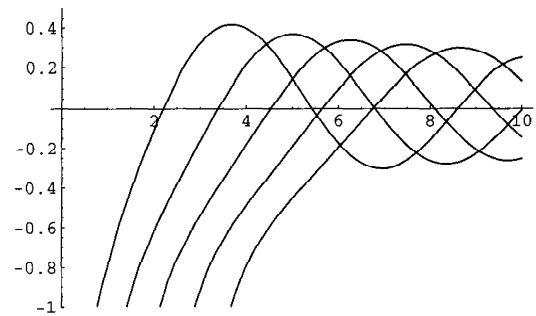

A Bessel function of the second kind $Y_n(x)$ is a solution to the BESSEL DIFFERENTIAL EQUATION which is singular at the origin. Bessel functions of the second kind are also called NEUMANN FUNCTIONS or WEBER FUNCTIONS. The above plot shows $Y_n(x)$ for $n = 1, 2, \dots, 5$.

Let $v \equiv J_n(x)$ be the first solution and u be the other one (since the BESSEL DIFFERENTIAL EQUATION is second-order, there are two LINEARLY INDEPENDENT solutions). Then

$$xu'' + u' + xu = 0 \quad (1)$$

$$xv'' + v' + xv = 0. \quad (2)$$

Take $v \times (1) - u \times (2)$,

$$x(u''v - uv'') + u'v - uv' = 0 \quad (3)$$

$$\frac{d}{dx}[x(u'v - uv')] = 0, \quad (4)$$

so $x(u'v - uv') = B$, where B is a constant. Divide by xv^2 ,

$$\frac{u'v - uv'}{v^2} = \frac{d}{dx} \left(\frac{u}{v} \right) = \frac{B}{xv^2} \quad (5)$$

$$\frac{u}{v} = A + B \int \frac{dx}{xv^2}. \quad (6)$$

Rearranging and using $v \equiv J_m(x)$ gives

$$\begin{aligned} u &= AJ_m(x) + BJ_m(x) \int \frac{dx}{xJ_m^2(x)} \\ &\equiv A'J_m(x) + B'Y_m(x), \end{aligned} \quad (7)$$

where the Bessel function of the second kind is defined by

$$\begin{aligned} Y_m(x) &= \frac{J_m(x) \cos(m\pi) - J_{-m}(x)}{\sin(m\pi)} \\ &= \frac{1}{\pi} \sum_{k=1}^{\infty} \frac{(-1)^k x^{m+2k}}{2^{m+2k} k! (m+k)!} \left[2 \ln \left(\frac{x}{2} \right) + 2\gamma - b_{m+k} - b_k \right] \\ &\quad - \frac{1}{\pi} \sum_{k=0}^{m-1} \frac{x^{-m+2k} (m-k-1)!}{2^{-m+2k} k!} \end{aligned} \quad (8)$$

$m = 0, 1, 2, \dots$, γ is the EULER-MASCHERONI CONSTANT, and

$$b_k \equiv \begin{cases} 0 & k = 0, \\ \sum_{n=0}^k \frac{1}{n} & k \neq 0. \end{cases} \quad (9)$$

The function is given by

$$\begin{aligned} Y_n(z) &= \frac{1}{\pi} \int_0^\pi \sin(z \sin \theta - n\theta) d\theta \\ &\quad - \frac{1}{\pi} \int_0^\infty [e^{nt} + e^{-nt}(-1)^n] e^{-z \sinh t} dt. \end{aligned} \quad (10)$$

Asymptotic equations are

$$Y_m(x) = \begin{cases} \frac{2}{\pi} \left[\ln \left(\frac{1}{2} x \right) + \gamma \right] & m = 0, x \ll 1 \\ -\frac{\Gamma(m)}{\pi} \left(\frac{2}{x} \right)^m & m \neq 0, x \ll 1 \end{cases} \quad (11)$$

$$Y_m(x) = \sqrt{\frac{2}{\pi x}} \sin \left(x - \frac{m\pi}{2} - \frac{\pi}{4} \right) \quad x \gg 1, \quad (12)$$

where $\Gamma(z)$ is a GAMMA FUNCTION.

see also BESSEL FUNCTION OF THE FIRST KIND, BOURGET'S HYPOTHESIS, HANKEL FUNCTION

References

- Abramowitz, M. and Stegun, C. A. (Eds.). "Bessel Functions J and Y ." §9.1 in *Handbook of Mathematical Functions with Formulas, Graphs, and Mathematical Tables*, 9th printing. New York: Dover, pp. 358-364, 1972.
- Arfken, G. "Neumann Functions, Bessel Functions of the Second Kind, $N_\nu(x)$." §11.3 in *Mathematical Methods for Physicists*, 3rd ed. Orlando, FL: Academic Press, pp. 596-604, 1985.
- Morse, P. M. and Feshbach, H. *Methods of Theoretical Physics, Part I*. New York: McGraw-Hill, pp. 625-627, 1953.
- Spanier, J. and Oldham, K. B. "The Neumann Function $Y_\nu(x)$." Ch. 54 in *An Atlas of Functions*. Washington, DC: Hemisphere, pp. 533-542, 1987.

Bessel Function of the Third Kind

see HANKEL FUNCTION

Bessel's Inequality

If $f(x)$ is piecewise CONTINUOUS and has a general FOURIER SERIES

$$\sum_i a_i \phi_i(x) \quad (1)$$

with WEIGHTING FUNCTION $w(x)$, it must be true that

$$\int \left[f(x) - \sum_i a_i \phi_i(x) \right]^2 w(x) dx \geq 0 \quad (2)$$

$$\begin{aligned} \int f^2(x) w(x) dx - 2 \sum_i a_i \int f(x) \phi_i(x) w(x) dx \\ + \sum_i a_i^2 \int \phi_i^2(x) w(x) dx \geq 0. \end{aligned} \quad (3)$$

But the COEFFICIENT of the generalized FOURIER SERIES is given by

$$a_m \equiv \int f(x) \phi_m(x) w(x) dx, \quad (4)$$

so

$$\int f^2(x) w(x) dx - 2 \sum_i a_i^2 + \sum_i a_i^2 \geq 0 \quad (5)$$

$$\int f^2(x) w(x) dx \geq \sum_i a_i^2. \quad (6)$$

Equation (6) is an inequality if the functions ϕ_i are not COMPLETE. If they are COMPLETE, then the inequality (2) becomes an equality, so (6) becomes an equality and is known as PARSEVAL'S THEOREM. If $f(x)$ has a simple FOURIER SERIES expansion with COEFFICIENTS a_0, a_1, \dots, a_n and b_1, \dots, b_n , then

$$\frac{1}{2} a_0^2 + \sum_{k=1}^{\infty} (a_k^2 + b_k^2) \leq \frac{1}{\pi} \int_{-\pi}^{\pi} [f(x)]^2 dx. \quad (7)$$

The inequality can also be derived from SCHWARZ'S INEQUALITY

$$|\langle f|g \rangle|^2 \leq \langle f|f \rangle \langle g|g \rangle \quad (8)$$

by expanding g in a superposition of EIGENFUNCTIONS of f , $g = \sum_i a_i f_i$. Then

$$\langle f|g \rangle = \sum_i a_i \langle f|f_i \rangle \leq \sum_i a_i \quad (9)$$

$$\begin{aligned} |\langle f|g \rangle|^2 &\leq \left| \sum_i a_i \right|^2 = \left(\sum_i a_i \right) \left(\sum_i a_i^* \right) \\ &= \sum_i a_i a_i^* \leq \langle f|f \rangle \langle g|g \rangle. \end{aligned} \quad (10)$$

If g is normalized, then $\langle g|g \rangle = 1$ and

$$\langle f|f \rangle \geq \sum_i a_i a_i^*. \quad (11)$$

see also SCHWARZ'S INEQUALITY, TRIANGLE INEQUALITY

References

Arfken, G. *Mathematical Methods for Physicists*, 3rd ed. Orlando, FL: Academic Press, pp. 526–527, 1985.
Gradshteyn, I. S. and Ryzhik, I. M. *Tables of Integrals, Series, and Products*, 5th ed. San Diego, CA: Academic Press, p. 1102, 1980.

Bessel's Interpolation Formula

see BESSEL'S FINITE DIFFERENCE FORMULA

Bessel Polynomial

see BESSEL FUNCTION

Bessel's Second Integral

see POISSON INTEGRAL

Bessel's Statistical Formula

$$t = \frac{\bar{w} - \omega}{\sigma_w / \sqrt{N}} = \frac{\bar{w} - \omega}{\sqrt{\frac{\sum_{i=1}^N (w_i - \bar{w})^2}{N(N-1)}}}, \quad (1)$$

where

$$\bar{w} \equiv \hat{x}_1 - \bar{x}_2 \quad (2)$$

$$\omega \equiv \mu_{(1)} - \mu_{(2)} \quad (3)$$

$$N \equiv N_1 + N_2. \quad (4)$$

Beta

A financial measure of a fund's sensitivity to market movements which measures the relationship between a fund's excess return over Treasury Bills and the excess return of a benchmark index (which, by definition, has $\beta = 1$). A fund with a beta of β has performed $r = (\beta - 1) \times 100\%$ better (or $|r|$ worse if $r < 0$) than its benchmark index (after deducting the T-bill rate) in up markets and $|r|$ worse (or $|r|$ better if $r < 0$) in down markets.

see also ALPHA, SHARPE RATIO

Beta Distribution

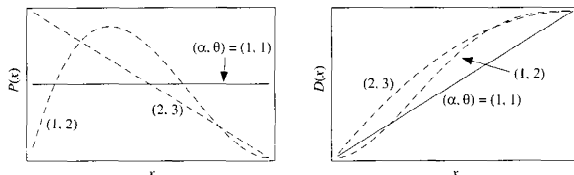

A general type of statistical DISTRIBUTION which is related to the GAMMA DISTRIBUTION. Beta distributions have two free parameters, which are labeled according to one of two notational conventions. The usual definition calls these α and β , and the other uses $\beta' \equiv \beta - 1$ and $\alpha' \equiv \alpha - 1$ (Beyer 1987, p. 534). The above plots are for $(\alpha, \beta) = (1, 1)$ [solid], $(1, 2)$ [dotted], and $(2, 3)$ [dashed]. The probability function $P(x)$ and DISTRIBUTION FUNCTION $D(x)$ are given by

$$\begin{aligned} P(x) &= \frac{(1-x)^{\beta-1} x^{\alpha-1}}{B(\alpha, \beta)} \\ &= \frac{\Gamma(\alpha + \beta)}{\Gamma(\alpha)\Gamma(\beta)} (1-x)^{\beta-1} x^{\alpha-1} \end{aligned} \quad (1)$$

$$D(x) = I(x; a, b), \quad (2)$$

where $B(a, b)$ is the BETA FUNCTION, $I(x; a, b)$ is the REGULARIZED BETA FUNCTION, and $0 < x < 1$ where $\alpha, \beta > 0$. The distribution is normalized since

$$\begin{aligned} \int_0^1 P(x) dx &= \frac{\Gamma(\alpha + \beta)}{\Gamma(\alpha)\Gamma(\beta)} \int_0^1 x^{\alpha-1} (1-x)^{\beta-1} dx \\ &= \frac{\Gamma(\alpha + \beta)}{\Gamma(\alpha)\Gamma(\beta)} B(\alpha, \beta) = 1. \end{aligned} \quad (3)$$

The CHARACTERISTIC FUNCTION is

$$\phi(t) = {}_1F_1(a, a + b, it). \quad (4)$$

The MOMENTS are given by

$$M_r = \int_0^1 (x - \mu)^r dx = \frac{\Gamma(\alpha + \beta)\Gamma(\alpha + r)}{\Gamma(\alpha + \beta + r)\Gamma(\alpha)}. \quad (5)$$

The MEAN is

$$\begin{aligned} \mu &= \frac{\Gamma(\alpha + \beta)}{\Gamma(\alpha)\Gamma(\beta)} \int_0^1 x^{\alpha-1} (1-x)^{\beta-1} x dx \\ &= \frac{\Gamma(\alpha + \beta)}{\Gamma(\alpha)\Gamma(\beta)} B(\alpha + 1, \beta) \\ &= \frac{\Gamma(\alpha + \beta)}{\Gamma(\alpha)\Gamma(\beta)} \frac{\Gamma(\alpha + 1)\Gamma(\beta)}{\Gamma(\alpha + \beta + 1)} = \frac{\alpha}{\alpha + \beta}, \end{aligned} \quad (6)$$

and the VARIANCE, SKEWNESS, and KURTOSIS are

$$\sigma^2 = \frac{\alpha\beta}{(\alpha + \beta)^2(\alpha + \beta + 1)} \quad (7)$$

$$\gamma_1 = \frac{2(\sqrt{\beta} - \sqrt{\alpha})(\sqrt{\alpha} + \sqrt{\beta})\sqrt{1 + \alpha + \beta}}{\sqrt{\alpha\beta}(\alpha + \beta + 2)} \quad (8)$$

$$\gamma_2 = \frac{6(\alpha^2 + \alpha^3 - 4\alpha\beta - 2\alpha^2\beta + \beta^2 - 2\alpha\beta^2 + \beta^3)}{\alpha\beta(\alpha + \beta + 2)(\alpha + \beta + 3)}. \quad (9)$$

The MODE of a variate distributed as $\beta(\alpha, \beta)$ is

$$\hat{x} = \frac{\alpha - 1}{\alpha + \beta - 2}. \quad (10)$$

In "normal" form, the distribution is written

$$f(x) = \frac{\Gamma(\alpha + \beta)}{\Gamma(\alpha)\Gamma(\beta)} x^{\alpha-1} (1-x)^{\beta-1} \quad (11)$$

and the MEAN, VARIANCE, SKEWNESS, and KURTOSIS are

$$\mu = \frac{\alpha}{\alpha + \beta} \quad (12)$$

$$\sigma^2 = \frac{\alpha\beta}{(\alpha + \beta)^2(1 + \alpha + \beta)} \quad (13)$$

$$\gamma_1 = \frac{2(\sqrt{\alpha} - \sqrt{\beta})(\sqrt{\alpha} + \sqrt{\beta})\sqrt{1 + \alpha + \beta}}{\sqrt{\alpha\beta}(\alpha + \beta + 2)} \quad (14)$$

$$\gamma_2 = \frac{3(1 + \alpha + \beta)(2\alpha^2 - 2\alpha\beta + \alpha^2\beta + 2\beta^2 + \alpha\beta^2)}{\alpha\beta(\alpha + \beta + 2)(\alpha + \beta + 3)} \quad (15)$$

see also GAMMA DISTRIBUTION

References

Abramowitz, M. and Stegun, C. A. (Eds.). *Handbook of Mathematical Functions with Formulas, Graphs, and Mathematical Tables*, 9th printing. New York: Dover, pp. 944-945, 1972.
Beyer, W. H. *CRC Standard Mathematical Tables*, 28th ed. Boca Raton, FL: CRC Press, pp. 534-535, 1987.

Beta Function

The beta function is the name used by Legendre and Whittaker and Watson (1990) for the EULERIAN INTEGRAL OF THE SECOND KIND. To derive the integral representation of the beta function, write the product of two FACTORIALS as

$$m!n! = \int_0^\infty e^{-u} u^m du \int_0^\infty e^{-v} v^n dv. \quad (1)$$

Now, let $u \equiv x^2$, $v \equiv y^2$, so

$$\begin{aligned} m!n! &= 4 \int_0^\infty e^{-x^2} x^{2m+1} dx \int_0^\infty e^{-y^2} y^{2n+1} dy \\ &= 4 \int_{-\infty}^\infty \int_{-\infty}^\infty e^{-(x^2+y^2)} x^{2m+1} y^{2n+1} dx dy. \end{aligned} \quad (2)$$

Transforming to POLAR COORDINATES with $x = r \cos \theta$, $y = r \sin \theta$

$$\begin{aligned} m!n! &= 4 \int_0^{\pi/2} \int_0^\infty e^{-r^2} (r \cos \theta)^{2m+1} (r \sin \theta)^{2n+1} r dr d\theta \\ &= 4 \int_0^\infty e^{-r^2} r^{2m+2n+3} dr \int_0^{\pi/2} \cos^{2m+1} \theta \sin^{2n+1} \theta d\theta \\ &= 2(m+n+1)! \int_0^{\pi/2} \cos^{2m+1} \theta \sin^{2n+1} \theta d\theta. \end{aligned} \quad (3)$$

The beta function is then defined by

$$\begin{aligned} B(m+1, n+1) &= B(n+1, m+1) \\ &\equiv 2 \int_0^{\pi/2} \cos^{2m+1} \theta \sin^{2n+1} \theta d\theta = \frac{m!n!}{(m+n+1)!}. \end{aligned} \quad (4)$$

Rewriting the arguments,

$$B(p, q) = \frac{\Gamma(p)\Gamma(q)}{\Gamma(p+q)} = \frac{(p-1)!(q-1)!}{(p+q-1)!}. \quad (5)$$

The general trigonometric form is

$$\int_0^{\pi/2} \sin^n x \cos^m x dx = \frac{1}{2} B(n + \frac{1}{2}, m + \frac{1}{2}). \quad (6)$$

Equation (6) can be transformed to an integral over POLYNOMIALS by letting $u \equiv \cos^2 \theta$,

$$B(m+1, n+1) \equiv \frac{m!n!}{(m+n+1)!} = \int_0^1 u^m (1-u)^n du \quad (7)$$

$$B(m, n) \equiv \frac{\Gamma(m)\Gamma(n)}{\Gamma(m+n)} = \int_0^1 u^{m-1} (1-u)^{n-1} du. \quad (8)$$

To put it in a form which can be used to derive the LEGENDRE DUPLICATION FORMULA, let $x \equiv \sqrt{u}$, so $u = x^2$ and $du = 2x dx$, and

$$\begin{aligned} B(m, n) &= \int_0^1 x^{2(m-1)} (1-x^2)^{n-1} (2x dx) \\ &= 2 \int_0^1 x^{2m-1} (1-x^2)^{n-1} dx. \end{aligned} \quad (9)$$

To put it in a form which can be used to develop integral representations of the BESSEL FUNCTIONS and HYPERGEOMETRIC FUNCTION, let $u \equiv x/(1+x)$, so

$$B(m+1, n+1) = \int_0^\infty \frac{u^m du}{(1+u)^{m+n+2}}. \quad (10)$$

Various identities can be derived using the GAUSS MULTIPLICATION FORMULA

$$\begin{aligned} B(np, nq) &= \frac{\Gamma(np)\Gamma(nq)}{\Gamma[n(p+q)]} \\ &= n^{-nq} \frac{B(p, q)B(p + \frac{1}{n}, q) \cdots B(p + \frac{n-1}{n}, q)}{B(q, q)B(2q, q) \cdots B([n-1]q, q)}. \end{aligned} \quad (11)$$

Additional identities include

$$\begin{aligned} B(p, q+1) &= \frac{\Gamma(p)\Gamma(q+1)}{\Gamma(p+q+1)} = \frac{q}{p} \frac{\Gamma(p+1)\Gamma(q)}{\Gamma([p+1]q)} \\ &= \frac{q}{p} B(p+1, q) \end{aligned} \quad (12)$$

$$B(p, q) = B(p+1, q) + B(p, q+1) \quad (13)$$

$$B(p, q+1) = \frac{q}{p+q} B(p, q). \quad (14)$$

If n is a POSITIVE INTEGER, then

$$B(p, n+1) = \frac{1 \cdot 2 \cdots n}{p(p+1) \cdots (p+n)} \quad (15)$$

$$B(p, p) B(p + \frac{1}{2}, p + \frac{1}{2}) = \frac{\pi}{2^{4p-1} p} \quad (16)$$

$$B(p+q) B(p+q, r) = B(q, r) B(q+r, p). \quad (17)$$

A generalization of the beta function is the incomplete beta function

$$\begin{aligned} B(t; x, y) &\equiv \int_0^t u^{x-1} (1-u)^{y-1} du \\ &= t^p \left[\frac{1}{x} + \frac{1-y}{x+1} t + \dots + \frac{(1-y) \cdots (n-y)}{n!(x+n)} t^n + \dots \right]. \end{aligned} \quad (18)$$

see also CENTRAL BETA FUNCTION, DIRICHLET INTEGRALS, GAMMA FUNCTION, REGULARIZED BETA FUNCTION

References

- Abramowitz, M. and Stegun, C. A. (Eds.). "Beta Function" and "Incomplete Beta Function." §6.2 and 6.6 in *Handbook of Mathematical Functions with Formulas, Graphs, and Mathematical Tables*, 9th printing. New York: Dover, pp. 258 and 263, 1972.
- Arfken, G. "The Beta Function." §10.4 in *Mathematical Methods for Physicists*, 3rd ed. Orlando, FL: Academic Press, pp. 560-565, 1985.
- Morse, P. M. and Feshbach, H. *Methods of Theoretical Physics, Part I*. New York: McGraw-Hill, p. 425, 1953.
- Press, W. H.; Flannery, B. P.; Teukolsky, S. A.; and Vetterling, W. T. "Gamma Function, Beta Function, Factorials, Binomial Coefficients" and "Incomplete Beta Function, Student's Distribution, F-Distribution, Cumulative Binomial Distribution." §6.1 and 6.2 in *Numerical Recipes in FORTRAN: The Art of Scientific Computing*, 2nd ed. Cambridge, England: Cambridge University Press, pp. 206-209 and 219-223, 1992.
- Spanier, J. and Oldham, K. B. "The Incomplete Beta Function $B(\nu; \mu; x)$." Ch. 58 in *An Atlas of Functions*. Washington, DC: Hemisphere, pp. 573-580, 1987.
- Whittaker, E. T. and Watson, G. N. *A Course of Modern Analysis*, 4th ed. Cambridge, England: Cambridge University Press, 1990.

Beta Function (Exponential)

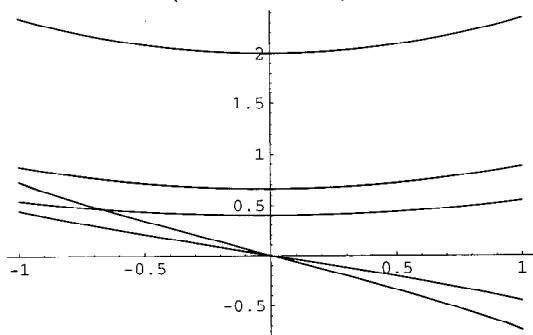

Another "BETA FUNCTION" defined in terms of an integral is the "exponential" beta function, given by

$$\begin{aligned} \beta_n(z) &\equiv \int_{-1}^1 t^n e^{-zt} dt \\ &= n! z^{-(n+1)} \left[e^z \sum_{k=0}^n \frac{(-1)^k z^k}{k!} - e^{-z} \sum_{k=0}^n \frac{z^k}{k!} \right]. \end{aligned} \quad (1)$$

$$(2)$$

The exponential beta function satisfies the RECURRENCE RELATION

$$z\beta_n(z) = (-1)^n e^z - e^{-z} + n\beta_{n-1}(z). \quad (3)$$

The first few integral values are

$$\beta_0(z) = \frac{2 \sinh z}{z} \quad (4)$$

$$\beta_1(z) = \frac{2(\sinh z - z \cosh z)}{z^2} \quad (5)$$

$$\beta_2(z) = \frac{2(2 + z^2) \sinh z - 4z \cosh z}{z^3}. \quad (6)$$

see also ALPHA FUNCTION

Beta Prime Distribution

A distribution with probability function

$$P(x) = \frac{x^{\alpha-1} (1+x)^{-\alpha-\beta}}{B(\alpha, \beta)},$$

where B is a BETA FUNCTION. The MODE of a variate distributed as $\beta'(\alpha, \beta)$ is

$$\hat{x} = \frac{\alpha - 1}{\beta + 1}.$$

If x is a $\beta'(\alpha, \beta)$ variate, then $1/x$ is a $\beta'(\beta, \alpha)$ variate. If x is a $\beta(\alpha, \beta)$ variate, then $(1-x)/x$ and $x/(1-x)$ are $\beta'(\beta, \alpha)$ and $\beta'(\alpha, \beta)$ variates. If x and y are $\gamma(\alpha_1)$ and $\gamma(\alpha_2)$ variates, then x/y is a $\beta'(\alpha_1, \alpha_2)$ variate. If $x^2/2$ and $y^2/2$ are $\gamma(1/2)$ variates, then $z^2 \equiv (x/y)^2$ is a $\beta'(1/2, 1/2)$ variate.

Bethe Lattice

see CAYLEY TREE

Betrothed Numbers

see QUASIAMICABLE PAIR

Betti Group

The free part of the HOMOLOGY GROUP with a domain of COEFFICIENTS in the GROUP of INTEGERS (if this HOMOLOGY GROUP is finitely generated).

References

- Hazewinkel, M. (Managing Ed.). *Encyclopaedia of Mathematics: An Updated and Annotated Translation of the Soviet "Mathematical Encyclopaedia"*. Dordrecht, Netherlands: Reidel, p. 380, 1988.

Betti Number

Betti numbers are topological objects which were proved to be invariants by Poincaré, and used by him to extend the POLYHEDRAL FORMULA to higher dimensional spaces. The n th Betti number is the rank of the n th HOMOLOGY GROUP. Let p_r be the RANK of the HOMOLOGY GROUP H_r of a TOPOLOGICAL SPACE K . For a closed, orientable surface of GENUS g , the Betti numbers are $p_0 = 1$, $p_1 = 2g$, and $p_2 = 1$. For a nonorientable surface with k CROSS-CAPS, the Betti numbers are $p_0 = 1$, $p_1 = k - 1$, and $p_2 = 0$.

see also EULER CHARACTERISTIC, POINCARÉ DUALITY

Bézier Curve

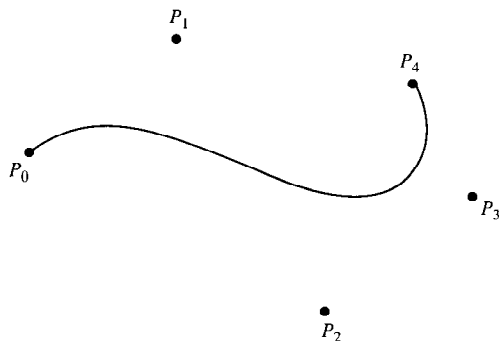

Given a set of n control points, the corresponding Bézier curve (or BERNSTEIN-BÉZIER CURVE) is given by

$$C(t) = \sum_{i=0}^n P_i B_{i,n}(t),$$

where $B_{i,n}(t)$ is a BERNSTEIN POLYNOMIAL and $t \in [0, 1]$.

A "rational" Bézier curve is defined by

$$C(t) = \frac{\sum_{i=0}^n B_{i,p}(t) w_i P_i}{\sum_{i=0}^n B_{i,p}(t) w_i},$$

where p is the order, $B_{i,p}$ are the BERNSTEIN POLYNOMIALS, P_i are control points, and the weight w_i of P_i is the last ordinate of the homogeneous point P_i^w . These curves are closed under perspective transformations, and can represent CONIC SECTIONS exactly.

The Bézier curve always passes through the first and last control points and lies within the CONVEX HULL of the control points. The curve is tangent to $P_1 - P_0$ and $P_n - P_{n-1}$ at the endpoints. The "variation diminishing property" of these curves is that no line can have more intersections with a Bézier curve than with the curve obtained by joining consecutive points with straight line segments. A desirable property of these curves is that the curve can be translated and rotated by performing these operations on the control points.

Undesirable properties of Bézier curves are their numerical instability for large numbers of control points, and

the fact that moving a single control point changes the global shape of the curve. The former is sometimes avoided by smoothly patching together low-order Bézier curves. A generalization of the Bézier curve is the B-SPLINE.

see also B-SPLINE, NURBS CURVE

Bézier Spline

see BÉZIER CURVE, SPLINE

Bezout Numbers

Integers (λ, μ) for a and b such that

$$\lambda a + \mu b = \text{GCD}(a, b).$$

For INTEGERS a_1, \dots, a_n , the Bezout numbers are a set of numbers k_1, \dots, k_n such that

$$k_1 a_1 + k_2 a_2 + \dots + k_n a_n = d,$$

where d is the GREATEST COMMON DIVISOR of a_1, \dots, a_n .

see also GREATEST COMMON DIVISOR

Bezout's Theorem

In general, two algebraic curves of degrees m and n intersect in $m \cdot n$ points and cannot meet in more than $m \cdot n$ points unless they have a component in common (i.e., the equations defining them have a common factor). This can also be stated: if P and Q are two POLYNOMIALS with no roots in common, then there exist two other POLYNOMIALS A and B such that $AP + BQ = 1$. Similarly, given N POLYNOMIAL equations of degrees n_1, n_2, \dots, n_N in N variables, there are in general $n_1 n_2 \dots n_N$ common solutions.

see also POLYNOMIAL

References

Coolidge, J. L. *A Treatise on Algebraic Plane Curves*. New York: Dover, p. 10, 1959.

Bhargava's Theorem

Let the n th composition of a function $f(x)$ be denoted $f^{(n)}(x)$, such that $f^{(0)}(x) = x$ and $f^{(1)}(x) = f(x)$. Denote $f \circ g(x) = f(g(x))$, and define

$$\sum F(a, b, c) = F(a, b, c) + F(b, c, a) + F(c, a, b). \quad (1)$$

Let

$$u \equiv (a, b, c) \quad (2)$$

$$|u| \equiv a + b + c \quad (3)$$

$$||u|| \equiv a^4 + b^4 + c^4, \quad (4)$$

and

$$f(u) = (f_1(u), f_2(u), f_3(u)) \quad (5)$$

$$= (a(b-c), b(c-a), c(a-b)) \quad (6)$$

$$g(u) = (g_1(u), g_2(u), g_3(u)) \\ = \left(\sum a^2 b, \sum ab^2, 3abc \right). \quad (7)$$

Then if $|u| = 0$,

$$\|f^{(m)} \circ g^{(n)}(u)\| = 2(ab + bc + ca)^{2^{m+1}3^n} \\ = \|g^{(n)} \circ f^{(m)}(u)\|, \quad (8)$$

where $m, n \in \{0, 1, \dots\}$ and composition is done in terms of components.

see also DIOPHANTINE EQUATION—QUARTIC, FORD'S THEOREM

References

- Berndt, B. C. *Ramanujan's Notebooks, Part IV*. New York: Springer-Verlag, pp. 97–100, 1994.
 Bhargava, S. "On a Family of Ramanujan's Formulas for Sums of Fourth Powers." *Ganita* **43**, 63–67, 1992.

Bhaskara-Brouckner Algorithm

see SQUARE ROOT

Bi-Connected Component

A maximal SUBGRAPH of an undirected graph such that any two edges in the SUBGRAPH lie on a common simple cycle.

see also STRONGLY CONNECTED COMPONENT

Bianchi Identities

The RIEMANN TENSOR is defined by

$$R_{\lambda\mu\nu\kappa;\eta} = \frac{1}{2} \frac{\partial}{\partial x^\eta} \left(\frac{\partial^2 g_{\lambda\nu}}{\partial x^\kappa \partial x^\mu} - \frac{\partial^2 g_{\mu\nu}}{\partial x^\kappa \partial x^\lambda} - \frac{\partial^2 g_{\lambda\kappa}}{\partial x^\mu \partial x^\nu} + \frac{\partial^2 g_{\mu\kappa}}{\partial x^\nu \partial x^\lambda} \right).$$

Permuting ν , κ , and η (Weinberg 1972, pp. 146–147) gives the Bianchi identities

$$R_{\lambda\mu\nu\kappa;\eta} + R_{\lambda\mu\eta\nu;\kappa} + R_{\lambda\mu\kappa\eta;\nu} = 0.$$

see also BIANCHI IDENTITIES (CONTRACTED), RIEMANN TENSOR

References

- Weinberg, S. *Gravitation and Cosmology: Principles and Applications of the General Theory of Relativity*. New York: Wiley, 1972.

Bianchi Identities (Contracted)

CONTRACTING λ with ν in the BIANCHI IDENTITIES

$$R_{\lambda\mu\nu\kappa;\eta} + R_{\lambda\mu\eta\nu;\kappa} + R_{\lambda\mu\kappa\eta;\nu} = 0 \quad (1)$$

gives

$$R_{\mu\kappa;\eta} - R_{\mu\eta;\kappa} + R^\nu_{\mu\kappa\eta;\nu} = 0. \quad (2)$$

CONTRACTING again,

$$R_{;\eta} - R^\mu_{\eta;\mu} - R^\nu_{\eta;\nu} = 0, \quad (3)$$

or

$$(R^\mu_{\eta} - \frac{1}{2}\delta^\mu_{\eta} R)_{;\mu} = 0, \quad (4)$$

or

$$(R^{\mu\nu} - \frac{1}{2}g^{\mu\nu} R)_{;\mu} = 0. \quad (5)$$

Bias (Estimator)

The bias of an ESTIMATOR $\tilde{\theta}$ is defined as

$$B(\tilde{\theta}) \equiv \langle \tilde{\theta} \rangle - \theta.$$

It is therefore true that

$$\tilde{\theta} - \theta = (\tilde{\theta} - \langle \tilde{\theta} \rangle) + (\langle \tilde{\theta} \rangle - \theta) = (\tilde{\theta} - \langle \tilde{\theta} \rangle) + B(\tilde{\theta}).$$

An ESTIMATOR for which $B = 0$ is said to be UNBIASED.

see also ESTIMATOR, UNBIASED

Bias (Series)

The bias of a SERIES is defined as

$$Q[a_i, a_{i+1}, a_{i+2}] \equiv \frac{a_i a_{i+2} - a_{i+1}^2}{a_i a_{i+1} a_{i+2}}.$$

A SERIES is GEOMETRIC IFF $Q = 0$. A SERIES is ARTISTIC IFF the bias is constant.

see also ARTISTIC SERIES, GEOMETRIC SERIES

References

- Duffin, R. J. "On Seeing Progressions of Constant Cross Ratio." *Amer. Math. Monthly* **100**, 38–47, 1993.

Biased

An ESTIMATOR which exhibits BIAS.

Biaugmented Pentagonal Prism

see JOHNSON SOLID

Biaugmented Triangular Prism

see JOHNSON SOLID

Biaugmented Truncated Cube

see JOHNSON SOLID

BIBD

see BLOCK DESIGN

Bicentric Polygon

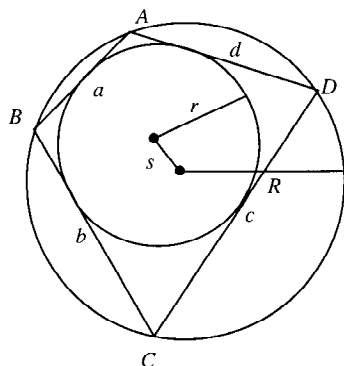

A POLYGON which has both a CIRCUMCIRCLE and an INCIRCLE, both of which touch all VERTICES. All TRIANGLES are bicentric with

$$R^2 - s^2 = 2Rr, \quad (1)$$

where R is the CIRCUMRADIUS, r is the INRADIUS, and s is the separation of centers. In 1798, N. Fuss characterized bicentric POLYGONS of $n = 4, 5, 6, 7$, and 8 sides. For bicentric QUADRILATERALS (FUSS'S PROBLEM), the CIRCLES satisfy

$$2r^2(R^2 - s^2) = (R^2 - s^2)^2 - 4r^2s^2 \quad (2)$$

(Dörrie 1965) and

$$r = \frac{\sqrt{abcd}}{s} \quad (3)$$

$$R = \frac{1}{4} \sqrt{\frac{(ac + bd)(ad + bc)(ab + cd)}{abcd}} \quad (4)$$

(Beyer 1987). In addition,

$$\frac{1}{(R - s)^2} + \frac{1}{(R + s)^2} = \frac{1}{r^2} \quad (5)$$

and

$$a + c = b + d. \quad (6)$$

The AREA of a bicentric quadrilateral is

$$A = \sqrt{abcd}. \quad (7)$$

If the circles permit successive tangents around the INCIRCLE which close the POLYGON for one starting point on the CIRCUMCIRCLE, then they do so for all points on the CIRCUMCIRCLE.

see also PONCELET'S CLOSURE THEOREM

References

- Beyer, W. H. (Ed.) *CRC Standard Mathematical Tables*, 28th ed. Boca Raton, FL: CRC Press, p. 124, 1987.
 Dörrie, H. "Fuss' Problem of the Chord-Tangent Quadrilateral." §39 in *100 Great Problems of Elementary Mathematics: Their History and Solutions*. New York: Dover, pp. 188–193, 1965.

Bicentric Quadrilateral

A 4-sided BICENTRIC POLYGON, also called a CYCLIC-INScriPTABLE QUADRILATERAL.

References

- Beyer, W. H. (Ed.) *CRC Standard Mathematical Tables*, 28th ed. Boca Raton, FL: CRC Press, p. 124, 1987.

Bichromatic Graph

A GRAPH with EDGES of two possible "colors," usually identified as red and blue. For a bichromatic graph with R red EDGES and B blue EDGES,

$$R + B \geq 2.$$

see also BLUE-EMPTY GRAPH, EXTREMAL COLORING, EXTREMAL GRAPH, MONOCHROMATIC FORCED TRIANGLE, RAMSEY NUMBER

Bicollared

A SUBSET $X \subset Y$ is said to be bicollared in Y if there exists an embedding $b : X \times [-1, 1] \rightarrow Y$ such that $b(x, 0) = x$ when $x \in X$. The MAP b or its image is then said to be the bicollar.

References

- Rolfsen, D. *Knots and Links*. Wilmington, DE: Publish or Perish Press, pp. 34–35, 1976.

Bicorn

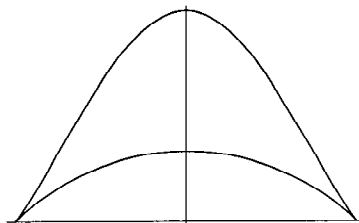

The bicorn is the name of a collection of QUARTIC CURVES studied by Sylvester in 1864 and Cayley in 1867 (MacTutor Archive). The bicorn is given by the parametric equations

$$\begin{aligned} x &= a \sin t \\ y &= \frac{a \cos^2 t (2 + \cos t)}{3 \sin^2 t}. \end{aligned}$$

The graph is similar to that of the COCKED HAT CURVE.

References

- Lawrence, J. D. *A Catalog of Special Plane Curves*. New York: Dover, pp. 147–149, 1972.
 MacTutor History of Mathematics Archive. "Bicorn." <http://www-groups.dcs.st-and.ac.uk/history/Curves/Bicorn.html>.

Bicubic Spline

A bicubic spline is a special case of bicubic interpolation which uses an interpolation function of the form

$$y(x_1, x_2) = \sum_{i=1}^4 \sum_{j=1}^4 c_{ij} t^{i-1} u^{j-1}$$

$$y_{x_1}(x_1, x_2) = \sum_{i=1}^4 \sum_{j=1}^4 (i-1) c_{ij} t^{i-2} u^{j-1}$$

$$y_{x_2}(x_1, x_2) = \sum_{i=1}^4 \sum_{j=1}^4 (j-1) c_{ij} t^{i-1} u^{j-2}$$

$$y_{x_1 x_2} = \sum_{i=1}^4 \sum_{j=1}^4 (i-1)(j-1) c_{ij} t^{i-2} u^{j-2},$$

where c_{ij} are constants and u and t are parameters ranging from 0 to 1. For a bicubic spline, however, the partial derivatives at the grid points are determined globally by 1-D SPLINES.

see also B-SPLINE, SPLINE

References

Press, W. H.; Flannery, B. P.; Teukolsky, S. A.; and Vetterling, W. T. *Numerical Recipes in FORTRAN: The Art of Scientific Computing*, 2nd ed. Cambridge, England: Cambridge University Press, pp. 118–122, 1992.

Bicupola

Two adjoined CUPOLAS.

see also CUPOLA, ELONGATED GYROBICUPOLA, ELONGATED ORTHOBICUPOLA, GYROBICUPOLA, ORTHOBICUPOLA

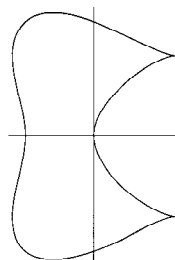
Bicuspid Curve

The PLANE CURVE given by the Cartesian equation

$$(x^2 - a^2)(x - a)^2 + (y^2 - a^2)^2 = 0.$$

Bicylinder

see STEINMETZ SOLID

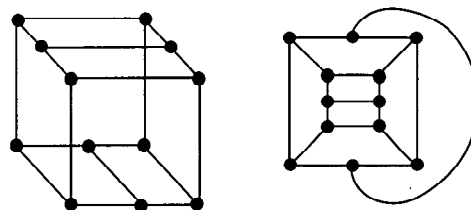
Bidiakis Cube

The 12-VERTEX graph consisting of a CUBE in which two opposite faces (say, top and bottom) have edges drawn across them which connect the centers of opposite sides of the faces in such a way that the orientation of the edges added on top and bottom are PERPENDICULAR to each other.

see also BISLIT CUBE, CUBE, CUBICAL GRAPH

Bieberbach Conjecture

The n th COEFFICIENT in the POWER series of a UNIVALENT FUNCTION should be no greater than n . In other words, if

$$f(z) = a_0 + a_1 z + a_2 z^2 + \dots + a_n z^n + \dots$$

is a conformal transformation of a unit disk on any domain, then $|a_n| \leq n|a_1|$. In more technical terms, “geometric extremality implies metric extremality.” The conjecture had been proven for the first six terms (the cases $n = 2, 3$, and 4 were done by Bieberbach, Lowner, and Shiffer and Garbedjian, respectively), was known to be false for only a finite number of indices (Hayman 1954), and true for a convex or symmetric domain (Le Lionnais 1983). The general case was proved by Louis de Branges (1985). De Branges proved the MILIN CONJECTURE, which established the ROBERTSON CONJECTURE, which in turn established the Bieberbach conjecture (Stewart 1996).

References

- de Branges, L. “A Proof of the Bieberbach Conjecture.” *Acta Math.* **154**, 137–152, 1985.
- Hayman, W. K. *Multivalent Functions*, 2nd ed. Cambridge, England: Cambridge University Press, 1994.
- Hayman, W. K. and Stewart, F. M. “Real Inequalities with Applications to Function Theory.” *Proc. Cambridge Phil. Soc.* **50**, 250–260, 1954.
- Kazarinoff, N. D. “Special Functions and the Bieberbach Conjecture.” *Amer. Math. Monthly* **95**, 689–696, 1988.
- Korevaar, J. “Ludwig Bieberbach’s Conjecture and its Proof.” *Amer. Math. Monthly* **93**, 505–513, 1986.
- Le Lionnais, F. *Les nombres remarquables*. Paris: Hermann, p. 53, 1983.
- Pederson, R. N. “A Proof of the Bieberbach Conjecture for the Sixth Coefficient.” *Arch. Rational Mech. Anal.* **31**, 331–351, 1968/1969.
- Pederson, R. and Schiffer, M. “A Proof of the Bieberbach Conjecture for the Fifth Coefficient.” *Arch. Rational Mech. Anal.* **45**, 161–193, 1972.
- Stewart, I. “The Bieberbach Conjecture.” In *From Here to Infinity: A Guide to Today’s Mathematics*. Oxford, England: Oxford University Press, pp. 164–166, 1996.

Bienaymé-Chebyshev Inequality

see CHEBYSHEV INEQUALITY

Bifoliate

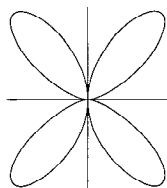

The PLANE CURVE given by the Cartesian equation

$$x^4 + y^4 = 2axy^2.$$

References

Cundy, H. and Rollett, A. *Mathematical Models*, 3rd ed. Stradbroke, England: Tarquin Pub., p. 72, 1989.

Bifolium

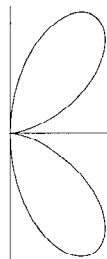

A FOLIUM with $b = 0$. The bifolium is the PEDAL CURVE of the DELTOID, where the PEDAL POINT is the MIDPOINT of one of the three curved sides. The Cartesian equation is

$$(x^2 + y^2)^2 = 4axy^2$$

and the POLAR equation is

$$r = 4a \sin^2 \theta \cos \theta.$$

see also FOLIUM, QUADRIFOLIUM, TRIFOLIUM

References

Lawrence, J. D. *A Catalog of Special Plane Curves*. New York: Dover, pp. 152-153, 1972.
MacTutor History of Mathematics Archive. "Double Folium." <http://www-groups.dcs.st-and.ac.uk/~history/Curves/Double.html>.

Bifurcation

A period doubling, quadrupling, etc., that accompanies the onset of CHAOS. It represents the sudden appearance of a qualitatively different solution for a nonlinear system as some parameter is varied. Bifurcations come in four basic varieties: FLIP BIFURCATION, FOLD BIFURCATION, PITCHFORK BIFURCATION, and TRANSCRITICAL BIFURCATION (Rasband 1990).

see also CODIMENSION, FEIGENBAUM CONSTANT, FEIGENBAUM FUNCTION, FLIP BIFURCATION, HOPF

BIFURCATION, LOGISTIC MAP, PERIOD DOUBLING, PITCHFORK BIFURCATION, TANGENT BIFURCATION, TRANSCRITICAL BIFURCATION

References

Guckenheimer, J. and Holmes, P. "Local Bifurcations." Ch. 3 in *Nonlinear Oscillations, Dynamical Systems, and Bifurcations of Vector Fields*, 2nd pr., rev. corr. New York: Springer-Verlag, pp. 117-165, 1983.
Lichtenberg, A. J. and Lieberman, M. A. "Bifurcation Phenomena and Transition to Chaos in Dissipative Systems." Ch. 7 in *Regular and Chaotic Dynamics*, 2nd ed. New York: Springer-Verlag, pp. 457-569, 1992.
Rasband, S. N. "Asymptotic Sets and Bifurcations." §2.4 in *Chaotic Dynamics of Nonlinear Systems*. New York: Wiley, pp. 25-31, 1990.
Wiggins, S. "Local Bifurcations." Ch. 3 in *Introduction to Applied Nonlinear Dynamical Systems and Chaos*. New York: Springer-Verlag, pp. 253-419, 1990.

Bifurcation Theory

The study of the nature and properties of BIFURCATIONS.

see also CHAOS, DYNAMICAL SYSTEM

Bigraph

see BIPARTITE GRAPH

Bigyrate Diminished Rhombicosidodecahedron

see JOHNSON SOLID

Biharmonic Equation

The differential equation obtained by applying the BIHARMONIC OPERATOR and setting to zero.

$$\nabla^4 \phi = 0. \quad (1)$$

In CARTESIAN COORDINATES, the biharmonic equation is

$$\begin{aligned} \nabla^4 \phi &= \nabla^2(\nabla^2 \phi) \\ &= \left(\frac{\partial^2}{\partial x^2} + \frac{\partial^2}{\partial y^2} + \frac{\partial^2}{\partial z^2} \right) \left(\frac{\partial^2}{\partial x^2} + \frac{\partial^2}{\partial y^2} + \frac{\partial^2}{\partial z^2} \right) \phi \\ &= \frac{\partial^4 \phi}{\partial x^4} + \frac{\partial^4 \phi}{\partial y^4} + \frac{\partial^4 \phi}{\partial z^4} + 2 \frac{\partial^4 \phi}{\partial x^2 \partial y^2} \\ &\quad + 2 \frac{\partial^4 \phi}{\partial y^2 \partial z^2} + 2 \frac{\partial^4 \phi}{\partial x^2 \partial z^2} = 0. \end{aligned} \quad (2)$$

In POLAR COORDINATES (Kaplan 1984, p. 148)

$$\begin{aligned} \nabla^4 \phi &= \phi_{rrrr} + \frac{2}{r^2} \phi_{rr\theta\theta} + \frac{1}{r^4} \phi_{\theta\theta\theta\theta} + \frac{2}{r} \phi_{rrr} \\ &\quad - \frac{2}{r^3} \phi_{r\theta\theta} - \frac{1}{r^2} \phi_{rr} + \frac{4}{r^4} \phi_{\theta\theta} + \frac{1}{r^3} \phi_r = 0. \end{aligned} \quad (3)$$

For a radial function $\phi(r)$, the biharmonic equation becomes

$$\begin{aligned}\nabla^4 \phi &= \frac{1}{r} \frac{d}{dr} \left\{ r \frac{d}{dr} \left[\frac{1}{r} \frac{d}{dr} \left(r \frac{d\phi}{dr} \right) \right] \right\} \\ &= \phi_{rrrr} + \frac{2}{r} \phi_{rrr} - \frac{1}{r^2} \phi_{rr} + \frac{1}{r^3} \phi_r = 0.\end{aligned}\quad (4)$$

Writing the inhomogeneous equation as

$$\nabla^4 \phi = 64\beta, \quad (5)$$

we have

$$64\beta r \, dr = d \left\{ r \frac{d}{dr} \left[\frac{1}{r} \frac{d}{dr} \left(r \frac{d\phi}{dr} \right) \right] \right\} \quad (6)$$

$$32\beta r^2 + C_1 = r \frac{d}{dr} \left[\frac{1}{r} \frac{d}{dr} \left(r \frac{d\phi}{dr} \right) \right] \quad (7)$$

$$\left(32\beta r + \frac{C_1}{r} \right) dr = d \left[\frac{1}{r} \frac{d}{dr} \left(r \frac{d\phi}{dr} \right) \right] \quad (8)$$

$$16\beta r^2 + C_1 \ln r + C_2 = \frac{1}{r} \frac{d}{dr} \left(r \frac{d\phi}{dr} \right) \quad (9)$$

$$(16\beta r^3 + C_1 r \ln r + C_2 r) dr = d \left(r \frac{d\phi}{dr} \right). \quad (10)$$

Now use

$$\int r \ln r \, dr = \frac{1}{2} r^2 \ln r - \frac{1}{4} r^2 \quad (11)$$

to obtain

$$4\beta r^4 + C_1 \left(\frac{1}{2} r^2 \ln r - \frac{1}{4} r^2 \right) + \frac{1}{2} C_2 r^2 + C_3 = r \frac{d\phi}{dr} \quad (12)$$

$$\left(4\beta r^3 + C_1' r \ln r + C_2' r + \frac{C_3}{r} \right) dr = d\phi \quad (13)$$

$$\begin{aligned}\phi(r) &= \beta r^4 + C_1' \left(\frac{1}{2} r^2 \ln r - \frac{1}{4} r^2 \right) \\ &\quad + \frac{1}{2} C_2' r^2 + C_3 \ln r + C_4 \\ &= \beta r^4 + ar^2 + b + (cr^2 + d) \ln \left(\frac{r}{R} \right).\end{aligned}\quad (14)$$

The homogeneous biharmonic equation can be separated and solved in 2-D BIPOLAR COORDINATES.

References

Kaplan, W. *Advanced Calculus*, 4th ed. Reading, MA: Addison-Wesley, 1991.

Biharmonic Operator

Also known as the BILAPLACIAN.

$$\nabla^4 \equiv (\nabla^2)^2.$$

In n -D space,

$$\nabla^4 \left(\frac{1}{r} \right) = \frac{3(15 - 8n + n^2)}{r^5}.$$

see also BIHARMONIC EQUATION

Bijection

A transformation which is ONE-TO-ONE and ONTO.

see also ONE-TO-ONE, ONTO, PERMUTATION

Bilaplacian

see BIHARMONIC OPERATOR

Bilinear

A function of two variables is bilinear if it is linear with respect to each of its variables. The simplest example is $f(x, y) = xy$.

Bilinear Basis

A bilinear basis is a BASIS, which satisfies the conditions

$$(ax + by) \cdot z = a(x \cdot z) + b(y \cdot z)$$

$$z \cdot (ax + by) = a(z \cdot x) + b(z \cdot y).$$

see also BASIS

Billiard Table Problem

Given a billiard table with only corner pockets and sides of INTEGER lengths m and n , a ball sent at a 45° angle from a corner will be pocketed in a corner after $m+n-2$ bounces.

see also ALHAZEN'S BILLIARD PROBLEM, BILLIARDS

Billiards

The game of billiards is played on a RECTANGULAR table (known as a billiard table) upon which balls are placed. One ball (the "cue ball") is then struck with the end of a "cue" stick, causing it to bounce into other balls and REFLECT off the sides of the table. Real billiards can involve spinning the ball so that it does not travel in a straight LINE, but the mathematical study of billiards generally consists of REFLECTIONS in which the reflection and incidence angles are the same. However, strange table shapes such as CIRCLES and ELLIPSES are often considered. Many interesting problems can arise.

For example, ALHAZEN'S BILLIARD PROBLEM seeks to find the point at the edge of a circular "billiards" table at which a cue ball at a given point must be aimed in order to carom once off the edge of the table and strike another ball at a second given point. It was not until 1997 that Neumann proved that the problem is insoluble using a COMPASS and RULER construction.

On an ELLIPTICAL billiard table, the ENVELOPE of a trajectory is a smaller ELLIPSE, a HYPERBOLA, a LINE through the FOCI of the ELLIPSE, or periodic curve (e.g., DIAMOND-shape) (Wagon 1991).

see also ALHAZEN'S BILLIARD PROBLEM, BILLIARD TABLE PROBLEM, REFLECTION PROPERTY

References

- Davis, D.; Ewing, C.; He, Z.; and Shen, T. "The Billiards Simulation." <http://serendip.brynmawr.edu/chaos/home.html>.
- Dullin, H. R.; Richter, P.H.; and Wittek, A. "A Two-Parameter Study of the Extent of Chaos in a Billiard System." *Chaos* **6**, 43–58, 1996.
- Madachy, J. S. "Bouncing Billiard Balls." In *Madachy's Mathematical Recreations*. New York: Dover, pp. 231–241, 1979.
- Neumann, P. Submitted to *Amer. Math. Monthly*.
- Pappas, T. "Mathematics of the Billiard Table." *The Joy of Mathematics*. San Carlos, CA: Wide World Publ./Tetra, p. 43, 1989.
- Peterson, I. "Billiards in the Round." http://www.sciencenews.org/sn_arc97/3_1_97/mathland.htm.
- Wagon, S. "Billiard Paths on Elliptical Tables." §10.2 in *Mathematica in Action*. New York: W. H. Freeman, pp. 330–333, 1991.

Billion

The word billion denotes different numbers in American and British usage. In the American system, one billion equals 10^9 . In the British, French, and German systems, one billion equals 10^{12} .

see also LARGE NUMBER, MILLIARD, MILLION, TRILION

Bilunabirotunda

see JOHNSON SOLID

Bimagic Square

16	41	36	5	27	62	55	18
26	63	54	19	13	44	33	8
1	40	45	12	22	51	58	31
23	50	59	30	4	37	48	9
38	3	10	47	49	24	29	60
52	21	32	57	39	2	11	46
43	14	7	34	64	25	20	53
61	28	17	56	42	15	6	35

If replacing each number by its square in a MAGIC SQUARE produces another MAGIC SQUARE, the square is said to be a bimagic square. The first bimagic square (shown above) has order 8 with magic constant 260 for addition and 11,180 after squaring. Bimagic squares are also called DOUBLY MAGIC SQUARES, and are 2-MULTIMAGIC SQUARES.

see also MAGIC SQUARE, MULTIMAGIC SQUARE, TRIMAGIC SQUARE

References

- Ball, W. W. R. and Coxeter, H. S. M. *Mathematical Recreations and Essays*, 13th ed. New York: Dover, p. 212, 1987.
- Hunter, J. A. H. and Madachy, J. S. "Mystic Arrays." Ch. 3 in *Mathematical Diversions*. New York: Dover, p. 31, 1975.
- Kraitchik, M. "Multimagic Squares." §7.10 in *Mathematical Recreations*. New York: W. W. Norton, pp. 176–178, 1942.

Bimedian

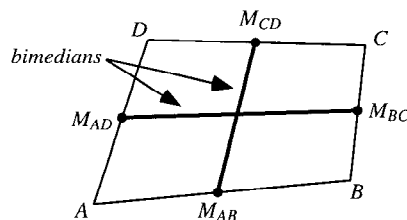

A LINE SEGMENT joining the MIDPOINTS of opposite sides of a QUADRILATERAL.

see also MEDIAN (TRIANGLE), VARIGNON'S THEOREM

Bimodal Distribution

A DISTRIBUTION having two separated peaks.

see also UNIMODAL DISTRIBUTION

Bimonster

The wreathed product of the MONSTER GROUP by Z_2 . The bimonster is a quotient of the COXETER GROUP with the following COXETER-DYNKIN DIAGRAM.

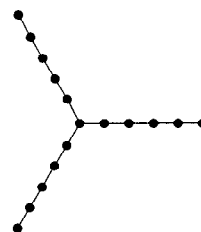

This had been conjectured by Conway, but was proven around 1990 by Ivanov and Norton. If the parameters p, q, r in Coxeter's NOTATION $[3^p, q, r]$ are written side by side, the bimonster can be denoted by the BEAST NUMBER 666.

Bin

An interval into which a given data point does or does not fall.

see also HISTOGRAM

Binary

The BASE 2 method of counting in which only the digits 0 and 1 are used. In this BASE, the number 1011 equals $1 \cdot 2^3 + 0 \cdot 2^2 + 1 \cdot 2^1 + 1 \cdot 2^0 = 11$. This BASE is used in computers, since all numbers can be simply represented as a string of electrically pulsed ons and offs. A NEGATIVE $-n$ is most commonly represented as the complement of the POSITIVE number $n - 1$, so $-11 = 00001011_2$ would be written as the complement of $10 = 00001010_2$, or 11110101. This allows addition to be carried out with the usual carrying and the left-most digit discarded, so $17 - 11 = 6$ gives

$$\begin{array}{r} 00010001 \quad 17 \\ 11110101 \quad -11 \\ \hline 00000110 \quad 6 \end{array}$$

The number of times k a given binary number $b_n \dots b_2 b_1 b_0$ is divisible by 2 is given by the position of the first $b_k = 1$ counting from the right. For example, $12 = 1100$ is divisible by 2 twice, and $13 = 1101$ is divisible by 2 0 times.

Unfortunately, the storage of binary numbers in computers is not entirely standardized. Because computers store information in 8-bit bytes (where a bit is a single binary digit), depending on the "word size" of the machine, numbers requiring more than 8 bits must be stored in multiple bytes. The usual FORTRAN77 integer size is 4 bytes long. However, a number represented as (byte1 byte2 byte3 byte4) in a VAX would be read and interpreted as (byte4 byte3 byte2 byte1) on a Sun. The situation is even worse for floating point (real) numbers, which are represented in binary as a MANTISSA and CHARACTERISTIC, and worse still for long (8-byte) reals!

Binary multiplication of single bit numbers (0 or 1) is equivalent to the AND operation, as can be seen in the following MULTIPLICATION TABLE.

\times	0	1
0	0	0
1	0	1

see also BASE (NUMBER), DECIMAL, HEXADECIMAL, OCTAL, QUATERNARY, TERNARY

References

- Lauwerier, H. *Fractals: Endlessly Repeated Geometric Figures*. Princeton, NJ: Princeton University Press, pp. 6–9, 1991.
- Pappas, T. "Computers, Counting, & Electricity." *The Joy of Mathematics*. San Carlos, CA: Wide World Publ./Tetra, pp. 24–25, 1989.
- Press, W. H.; Flannery, B. P.; Teukolsky, S. A.; and Vetterling, W. T. "Error, Accuracy, and Stability" and "Diagnosing Machine Parameters." §1.2 and §20.1 in *Numerical Recipes in FORTRAN: The Art of Scientific Computing*, 2nd ed. Cambridge, England: Cambridge University Press, pp. 18–21, 276, and 881–886, 1992.
- ✱ Weisstein, E. W. "Bases." <http://www.astro.virginia.edu/~eww6n/math/notebooks/Bases.m>.

Binary Bracketing

A binary bracketing is a BRACKETING built up entirely of binary operations. The number of binary bracketings of n letters (CATALAN'S PROBLEM) are given by the CATALAN NUMBERS C_{n-1} , where

$$C_n \equiv \frac{1}{n+1} \binom{2n}{n} = \frac{1}{n+1} \frac{(2n)!}{n!^2} = \frac{(2n)!}{(n+1)!n!},$$

where $\binom{2n}{n}$ denotes a BINOMIAL COEFFICIENT and $n!$ is the usual FACTORIAL, as first shown by Catalan in 1838. For example, for the four letters a , b , c , and d there are five possibilities: $((ab)c)d$, $(a(bc))d$, $(ab)(cd)$, $a((bc)d)$, and $a(b(cd))$, written in shorthand as $((xx)x)x$, $(x(xx))x$, $(xx)(xx)$, and $x(x(xx))$.

see also BRACKETING, CATALAN NUMBER, CATALAN'S PROBLEM

References

- Schröder, E. "Vier combinatorische Probleme." *Z. Math. Physik* **15**, 361–376, 1870.
- Sloane, N. J. A. Sequences A000108/M1459 in "An On-Line Version of the Encyclopedia of Integer Sequences."
- Sloane, N. J. A. and Plouffe, S. Extended entry in *The Encyclopedia of Integer Sequences*. San Diego: Academic Press, 1995.
- Stanley, R. P. "Hipparchus, Plutarch, Schröder, and Hough." *Amer. Math. Monthly* **104**, 344–350, 1997.

Binary Operator

An OPERATOR which takes two mathematical objects as input and returns a value is called a binary operator. Binary operators are called compositions by Rosenfeld (1968). Sets possessing a binary multiplication operation include the GROUP, GROUPOID, MONOID, QUASIGROUP, and SEMIGROUP. Sets possessing both a binary multiplication and a binary addition operation include the DIVISION ALGEBRA, FIELD, RING, RINGOID, SEMIRING, and UNIT RING.

see also AND, BOOLEAN ALGEBRA, CLOSURE, DIVISION ALGEBRA, FIELD, GROUP, GROUPOID, MONOID, OPERATOR, OR, MONOID, NOT, QUASIGROUP, RING, RINGOID, SEMIGROUP, SEMIRING, XOR, UNIT RING

References

- Rosenfeld, A. *An Introduction to Algebraic Structures*. New York: Holden-Day, 1968.

Binary Quadratic Form

A 2-variable QUADRATIC FORM of the form

$$Q(x, y) = a_{11}x^2 + 2a_{12}xy + a_{22}y^2.$$

see also QUADRATIC FORM, QUADRATIC INVARIANT

Binary Remainder Method

An ALGORITHM for computing a UNIT FRACTION (Stewart 1992).

References

- Stewart, I. "The Riddle of the Vanishing Camel." *Sci. Amer.* **266**, 122–124, June 1992.

Binary Tree

A TREE with two BRANCHES at each FORK and with one or two LEAVES at the end of each BRANCH. (This definition corresponds to what is sometimes known as an "extended" binary tree.) The height of a binary tree is the number of levels within the TREE. For a binary tree of height H with n nodes,

$$H \leq n \leq 2^H - 1.$$

These extremes correspond to a balanced tree (each node except the LEAVES has a left and right CHILD, and all LEAVES are at the same level) and a degenerate tree (each node has only one outgoing BRANCH), respectively. For a search of data organized into a binary tree, the number of search steps $S(n)$ needed to find an item is bounded by

$$\lg n \leq S(n) \leq n.$$

Partial balancing of an arbitrary tree into a so-called AVL binary search tree can improve search speed.

The number of binary trees with n internal nodes is the CATALAN NUMBER C_n (Sloane's A000108), and the number of binary trees of height b is given by Sloane's A001699.

see also B-TREE, QUADTREE, QUATERNARY TREE, RED-BLACK TREE, STERN-BROCOT TREE, WEAKLY BINARY TREE

References

- Lucas, J.; Roelants van Baronaigien, D.; and Ruskey, F. "Generating Binary Trees by Rotations." *J. Algorithms* **15**, 343–366, 1993.
- Ranum, D. L. "On Some Applications of Fibonacci Numbers." *Amer. Math. Monthly* **102**, 640–645, 1995.
- Ruskey, F. "Information on Binary Trees." <http://sue.csc.uvic.ca/~cos/inf/tree/BinaryTrees.html>.
- Ruskey, F. and Proskurowski, A. "Generating Binary Trees by Transpositions." *J. Algorithms* **11**, 68–84, 1990.
- Sloane, N. J. A. Sequences A000108/M1459 and A001699/M3087 in "An On-Line Version of the Encyclopedia of Integer Sequences."

Binet Forms

The two RECURRENCE SEQUENCES

$$U_n = mU_{n-1} + U_{n-2} \quad (1)$$

$$V_n = mV_{n-1} + V_{n-2} \quad (2)$$

with $U_0 = 0$, $U_1 = 1$ and $V_0 = 2$, $V_1 = m$, can be solved for the individual U_n and V_n . They are given by

$$U_n = \frac{\alpha^n - \beta^n}{\Delta} \quad (3)$$

$$V_n = \alpha^n + \beta^n, \quad (4)$$

where

$$\Delta \equiv \sqrt{m^2 + 4} \quad (5)$$

$$\alpha \equiv \frac{m + \Delta}{2} \quad (6)$$

$$\beta \equiv \frac{m - \Delta}{2}. \quad (7)$$

A useful related identity is

$$U_{n-1} + U_{n+1} = V_n. \quad (8)$$

BINET'S FORMULA is a special case of the Binet form for U_n corresponding to $m = 1$.

see also FIBONACCI Q-MATRIX

Binet's Formula

A special case of the U_n BINET FORM with $m = 0$, corresponding to the n th FIBONACCI NUMBER,

$$F_n = \frac{(1 + \sqrt{5})^n - (1 - \sqrt{5})^n}{2^n \sqrt{5}}.$$

It was derived by Binet in 1843, although the result was known to Euler and Daniel Bernoulli more than a century earlier.

see also BINET FORMS, FIBONACCI NUMBER

Bing's Theorem

If M^3 is a closed oriented connected 3-MANIFOLD such that every simple closed curve in M lies interior to a BALL in M , then M is HOMEOMORPHIC with the HYPERSPHERE, S^3 .

see also BALL, HYPERSPHERE

References

- Bing, R. H. "Necessary and Sufficient Conditions that a 3-Manifold be S^3 ." *Ann. Math.* **68**, 17–37, 1958.
- Rolfsen, D. *Knots and Links*. Wilmington, DE: Publish or Perish Press, pp. 251–257, 1976.

Binomial

A POLYNOMIAL with 2 terms.

see also MONOMIAL, POLYNOMIAL, TRINOMIAL

Binomial Coefficient

The number of ways of picking n unordered outcomes from N possibilities. Also known as a COMBINATION. The binomial coefficients form the rows of PASCAL'S TRIANGLE. The symbols ${}_N C_n$ and

$$\binom{N}{n} \equiv \frac{N!}{(N-n)!n!} \quad (1)$$

are used, where the latter is sometimes known as N CHOOSE n . The number of LATTICE PATHS from the ORIGIN $(0, 0)$ to a point (a, b) is the BINOMIAL COEFFICIENT $\binom{a+b}{a}$ (Hilton and Pedersen 1991).

For POSITIVE integer n , the BINOMIAL THEOREM gives

$$(x + a)^n = \sum_{k=0}^n \binom{n}{k} x^k a^{n-k}. \quad (2)$$

The FINITE DIFFERENCE analog of this identity is known as the CHU-VANDERMONDE IDENTITY. A similar formula holds for NEGATIVE INTEGRAL n ,

$$(x + a)^{-n} = \sum_{k=0}^{\infty} \binom{-n}{k} x^k a^{-n-k}. \quad (3)$$

A general identity is given by

$$\frac{(a+b)^n}{a} = \sum_{j=0}^n \binom{n}{j} (a-jc)^{j-1} (b+jc)^{n-j} \quad (4)$$

(Prudnikov *et al.* 1986), which gives the BINOMIAL THEOREM as a special case with $c = 0$.

The binomial coefficients satisfy the identities:

$$\binom{n}{0} = \binom{n}{n} = 1 \quad (5)$$

$$\binom{n}{k} = \binom{n}{n-k} = (-1)^k \binom{k-n-1}{k} \quad (6)$$

$$\binom{n+1}{k} = \binom{n}{k} + \binom{n}{k-1}. \quad (7)$$

Sums of powers include

$$\sum_{k=0}^n \binom{n}{k} = 2^n \quad (8)$$

$$\sum_{k=0}^n (-1)^k \binom{n}{k} = 0 \quad (9)$$

$$\sum_{k=0}^n \binom{n}{k} r^k = (1+r)^n \quad (10)$$

(the BINOMIAL THEOREM), and

$$\begin{aligned} \sum_{n=0}^{\infty} \binom{2n+s}{n} x^n &= {}_2F_1\left(\frac{1}{2}(s+1), \frac{1}{2}(s+2); s+1, 4x\right) \\ &= \frac{2^s}{(\sqrt{1-4x}+1)^s \sqrt{1-4x}}, \quad (11) \end{aligned}$$

where ${}_2F_1(a, b; c; z)$ is a HYPERGEOMETRIC FUNCTION (Abramowitz and Stegun 1972, p. 555; Graham *et al.* 1994, p. 203). For NONNEGATIVE INTEGERS n and r with $r \leq n+1$,

$$\begin{aligned} \sum_{k=0}^n \frac{(-1)^k}{k+1} \binom{n}{k} \left[\sum_{j=0}^{r-1} (-1)^j \binom{n}{j} (r-j)^{n-k} \right. \\ \left. + \sum_{j=0}^{n-r} (-1)^j \binom{n}{j} (n+1-r-j)^{n-k} \right] = n!. \quad (12) \end{aligned}$$

Taking $n = 2r - 1$ gives

$$\sum_{k=0}^n \frac{(-1)^k}{k+1} \binom{n}{k} \sum_{j=0}^{r-1} \binom{n}{j} (r-j)^{n-k} = \frac{1}{2} n!. \quad (13)$$

Another identity is

$$\sum_{k=0}^n \binom{n+k}{k} [x^{n+1}(1-x)^k + (1-x)^{n+1}x^k] = 1 \quad (14)$$

(Beeler *et al.* 1972, Item 42).

RECURRENCE RELATIONS of the sums

$$s_p \equiv \sum_{k=0}^n \binom{n}{k}^p \quad (15)$$

are given by

$$2s_1(n) - s_1(n+1) = 0 \quad (16)$$

$$-2(2n+1)s_2(n) + (n+1)s_2(n) = 0 \quad (17)$$

$$\begin{aligned} -8(n+1)^2 s_3(n) + (-16 - 21n - 7n^2) s_3(n+1) \\ + (n+2)^2 s_3(n+2) = 0 \quad (18) \end{aligned}$$

$$\begin{aligned} -4(n+1)(4n+3)(4n+5)s_4(n) \\ -2(2n+3)(3n^2+9n+7)s_4(n+1) \\ + (n+2)^3 s_4(n+2) = 0. \quad (19) \end{aligned}$$

This sequence for s_3 cannot be expressed as a fixed number of hypergeometric terms (Petkovšek *et al.* 1996, p. 160).

A fascinating series of identities involving binomial coefficients times small powers are

$$\sum_{n=1}^{\infty} \frac{1}{\binom{2n}{n}} = \frac{1}{27} (2\pi\sqrt{3} + 9) = 0.7363998587 \dots \quad (20)$$

$$\sum_{n=1}^{\infty} \frac{1}{n \binom{2n}{n}} = \frac{1}{9} \pi \sqrt{3} = 0.6045997881 \dots \quad (21)$$

$$\sum_{n=1}^{\infty} \frac{1}{n^2 \binom{2n}{n}} = \frac{1}{3} \zeta(2) = \frac{1}{8} \pi^2 \quad (22)$$

$$\sum_{n=1}^{\infty} \frac{1}{n^4 \binom{2n}{n}} = \frac{17}{36} \zeta(4) = \frac{17}{3240} \pi^4 \quad (23)$$

(Comtet 1974, p. 89) and

$$\sum_{n=1}^{\infty} \frac{(-1)^{n-1}}{n^3 \binom{2n}{n}} = \frac{2}{5} \zeta(3), \quad (24)$$

where $\zeta(z)$ is the RIEMANN ZETA FUNCTION (Le Lionnais 1983, pp. 29, 30, 41, 36, and 35; Guy 1994, p. 257).

As shown by Kummer in 1852, the exact POWER of p dividing $\binom{a+b}{a}$ is equal to

$$\epsilon_0 + \epsilon_1 + \dots + \epsilon_t, \quad (25)$$

where this is the number of carries in performing the addition of a and b written in base b (Graham *et al.* 1989, Exercise 5.36; Ribenboim 1989; Vardi 1991, p. 68). Kummer's result can also be stated in the form that the

exponent of a PRIME p dividing $\binom{n}{m}$ is given by the number of integers $j \geq 0$ for which

$$\text{frac}(m/p^j) > \text{frac}(n/p^j), \quad (26)$$

where $\text{frac}(x)$ denotes the FRACTIONAL PART of x . This inequality may be reduced to the study of the exponential sums $\sum_n \Lambda(n)e(x/n)$, where $\Lambda(n)$ is the MANGOLDT FUNCTION. Estimates of these sums are given by Jutila (1974, 1975), but recent improvements have been made by Granville and Ramare (1996).

R. W. Gosper showed that

$$f(n) = \binom{n-1}{\frac{1}{2}(n-1)} \equiv (-1)^{(n-1)/2} \pmod{n} \quad (27)$$

for all PRIMES, and conjectured that it holds *only* for PRIMES. This was disproved when Skiena (1990) found it also holds for the COMPOSITE NUMBER $n = 3 \times 11 \times 179$. Vardi (1991, p. 63) subsequently showed that $n = p^2$ is a solution whenever p is a WIEFERICH PRIME and that if $n = p^k$ with $k > 3$ is a solution, then so is $n = p^{k-1}$. This allowed him to show that the only solutions for COMPOSITE $n < 1.3 \times 10^7$ are 5907, 1093², and 3511², where 1093 and 3511 are WIEFERICH PRIMES.

Consider the binomial coefficients $\binom{2n-1}{n}$, the first few of which are 1, 3, 10, 35, 126, ... (Sloane's A001700). The GENERATING FUNCTION is

$$\frac{1}{2} \left[\frac{1}{\sqrt{1-4x}} - 1 \right] = x + 3x^2 + 10x^3 + 35x^4 + \dots \quad (28)$$

These numbers are SQUAREFREE only for $n = 2, 3, 4, 6, 9, 10, 12, 36, \dots$ (Sloane's A046097), with no others less than $n = 10,000$. Erdős showed that the binomial coefficient $\binom{n}{k}$ is never a POWER of an INTEGER for $n \geq 3$ where $k \neq 0, 1, n-1$, and n (Le Lionnais 1983, p. 48).

The binomial coefficients $\binom{n}{\lfloor n/2 \rfloor}$ are called CENTRAL BINOMIAL COEFFICIENTS, where $\lfloor x \rfloor$ is the FLOOR FUNCTION, although the subset of coefficients $\binom{2n}{n}$ is sometimes also given this name. Erdős and Graham (1980, p. 71) conjectured that the CENTRAL BINOMIAL COEFFICIENT $\binom{2n}{n}$ is *never* SQUAREFREE for $n > 4$, and this is sometimes known as the ERDŐS SQUAREFREE CONJECTURE. SÁRKÖZY'S THEOREM (Sárközy 1985) provides a partial solution which states that the BINOMIAL COEFFICIENT $\binom{2n}{n}$ is never SQUAREFREE for all sufficiently large $n \geq n_0$ (Vardi 1991). Granville and Ramare (1996) proved that the *only* SQUAREFREE values are $n = 2$ and 4. Sander (1992) subsequently showed that $\binom{2n \pm d}{n}$ are also never SQUAREFREE for sufficiently large n as long as d is not "too big."

For p, q , and r distinct PRIMES, then the above function satisfies

$$f(pqr)f(p)f(q)f(r) \equiv f(pq)f(pr)p(qr) \pmod{pqr} \quad (29)$$

(Vardi 1991, p. 66).

The binomial coefficient $\binom{m}{n} \pmod{2}$ can be computed using the XOR operation $n \text{ XOR } m$, making PASCAL'S TRIANGLE mod 2 very easy to construct.

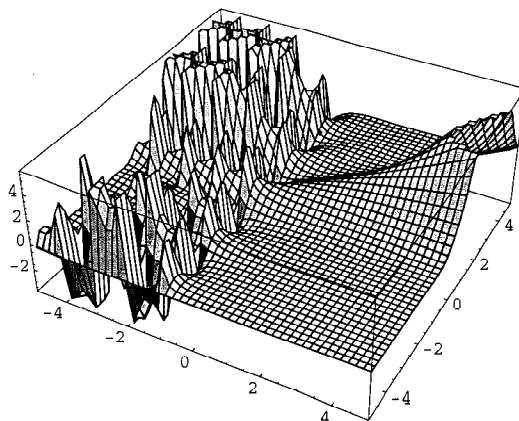

The binomial coefficient "function" can be defined as

$$C(x, y) \equiv \frac{x!}{y!(x-y)!} \quad (30)$$

(Fowler 1996), shown above. It has a very complicated GRAPH for NEGATIVE x and y which is difficult to render using standard plotting programs.

see also BALLOT PROBLEM, BINOMIAL DISTRIBUTION, BINOMIAL THEOREM, CENTRAL BINOMIAL COEFFICIENT, CHU-VANDERMONDE IDENTITY, COMBINATION, DEFICIENCY, ERDŐS SQUAREFREE CONJECTURE, GAUSSIAN COEFFICIENT, GAUSSIAN POLYNOMIAL, KINGS PROBLEM, MULTINOMIAL COEFFICIENT, PERMUTATION, ROMAN COEFFICIENT, SÁRKÖZY'S THEOREM, STREHL IDENTITY, WOLSTENHOLME'S THEOREM

References

- Abramowitz, M. and Stegun, C. A. (Eds.). "Binomial Coefficients." §24.1.1 in *Handbook of Mathematical Functions with Formulas, Graphs, and Mathematical Tables*, 9th printing. New York: Dover, pp. 10 and 822-823, 1972.
- Beeler, M.; Gosper, R. W.; and Schroepel, R. *HAKMEM*. Cambridge, MA: MIT Artificial Intelligence Laboratory, Memo AIM-239, Feb. 1972.
- Comtet, L. *Advanced Combinatorics*. Amsterdam, Netherlands: Kluwer, 1974.
- Conway, J. H. and Guy, R. K. In *The Book of Numbers*. New York: Springer-Verlag, pp. 66-74, 1996.
- Erdős, P.; Graham, R. L.; Nathanson, M. B.; and Jia, X. *Old and New Problems and Results in Combinatorial Number Theory*. New York: Springer-Verlag, 1998.
- Fowler, D. "The Binomial Coefficient Function." *Amer. Math. Monthly* **103**, 1-17, 1996.
- Graham, R. L.; Knuth, D. E.; and Patashnik, O. "Binomial Coefficients." Ch. 5 in *Concrete Mathematics: A Foundation for Computer Science*. Reading, MA: Addison-Wesley, pp. 153-242, 1990.
- Granville, A. and Ramare, O. "Explicit Bounds on Exponential Sums and the Scarcity of Squarefree Binomial Coefficients." *Mathematika* **43**, 73-107, 1996.

- Guy, R. K. "Binomial Coefficients," "Largest Divisor of a Binomial Coefficient," and "Series Associated with the ζ -Function." §B31, B33, and F17 in *Unsolved Problems in Number Theory*, 2nd ed. New York: Springer-Verlag, pp. 84–85, 87–89, and 257–258, 1994.
- Harborth, H. "Number of Odd Binomial Coefficients." *Not. Amer. Math. Soc.* **23**, 4, 1976.
- Hilton, P. and Pedersen, J. "Catalan Numbers, Their Generalization, and Their Uses." *Math. Intel.* **13**, 64–75, 1991.
- Jutila, M. "On Numbers with a Large Prime Factor." *J. Indian Math. Soc.* **37**, 43–53, 1973.
- Jutila, M. "On Numbers with a Large Prime Factor. II." *J. Indian Math. Soc.* **38**, 125–130, 1974.
- Le Lionnais, F. *Les nombres remarquables*. Paris: Hermann, 1983.
- Ogilvy, C. S. "The Binomial Coefficients." *Amer. Math. Monthly* **57**, 551–552, 1950.
- Petkovšek, M.; Wilf, H. S.; and Zeilberger, D. *A=B*. Wellesley, MA: A. K. Peters, 1996.
- Press, W. H.; Flannery, B. P.; Teukolsky, S. A.; and Vetterling, W. T. "Gamma Function, Beta Function, Factorials, Binomial Coefficients." §6.1 in *Numerical Recipes in FORTRAN: The Art of Scientific Computing*, 2nd ed. Cambridge, England: Cambridge University Press, pp. 206–209, 1992.
- Prudnikov, A. P.; Marichev, O. I.; and Brychkow, Yu. A. Formula 41 in *Integrals and Series, Vol. 1: Elementary Functions*. Newark, NJ: Gordon & Breach, p. 611, 1986.
- Ribenboim, P. *The Book of Prime Number Records*, 2nd ed. New York: Springer-Verlag, pp. 23–24, 1989.
- Riordan, J. "Inverse Relations and Combinatorial Identities." *Amer. Math. Monthly* **71**, 485–498, 1964.
- Sander, J. W. "On Prime Divisors of Binomial Coefficients." *Bull. London Math. Soc.* **24**, 140–142, 1992.
- Sárközy, A. "On the Divisors of Binomial Coefficients, I." *J. Number Th.* **20**, 70–80, 1985.
- Skiena, S. *Implementing Discrete Mathematics: Combinatorics and Graph Theory with Mathematica*. Reading, MA: Addison-Wesley, p. 262, 1990.
- Sloane, N. J. A. Sequences A046097 and A001700/M2848 in "An On-Line Version of the Encyclopedia of Integer Sequences."
- Spanier, J. and Oldham, K. B. "The Binomial Coefficients $\binom{n}{m}$." Ch. 6 in *An Atlas of Functions*. Washington, DC: Hemisphere, pp. 43–52, 1987.
- Sved, M. "Counting and Recounting." *Math. Intel.* **5**, 21–26, 1983.
- Vardi, I. "Application to Binomial Coefficients," "Binomial Coefficients," "A Class of Solutions," "Computing Binomial Coefficients," and "Binomials Modulo and Integer." §2.2, 4.1, 4.2, 4.3, and 4.4 in *Computational Recreations in Mathematics*. Redwood City, CA: Addison-Wesley, pp. 25–28 and 63–71, 1991.
- Wolfram, S. "Geometry of Binomial Coefficients." *Amer. Math. Monthly* **91**, 566–571, 1984.

Binomial Distribution

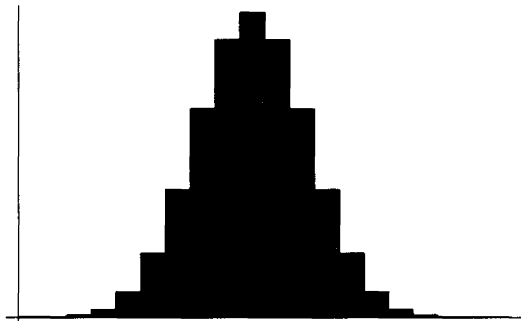

The probability of n successes in N BERNOULLI TRIALS is

$$P(n|N) = \binom{N}{n} p^n (1-p)^{N-n} = \frac{N!}{n!(N-n)!} p^n q^{N-n}. \quad (1)$$

The probability of obtaining more successes than the n observed is

$$P = \sum_{k=n+1}^N \binom{N}{k} p^k (1-p)^{N-k} = I_p(n+1, N-N), \quad (2)$$

where

$$I_x(a, b) \equiv \frac{B(x; a, b)}{B(a, b)}, \quad (3)$$

$B(a, b)$ is the BETA FUNCTION, and $B(x; a, b)$ is the incomplete BETA FUNCTION. The CHARACTERISTIC FUNCTION is

$$\phi(t) = (q + pe^{it})^n. \quad (4)$$

The MOMENT-GENERATING FUNCTION M for the distribution is

$$\begin{aligned} M(t) &= \langle e^{tn} \rangle = \sum_{n=0}^N e^{tn} \binom{N}{n} p^n q^{N-n} \\ &= \sum_{n=0}^N \binom{N}{n} (pe^t)^n (1-p)^{N-n} \\ &= [pe^t + (1-p)]^N \end{aligned} \quad (5)$$

$$M'(t) = N[pe^t + (1-p)]^{N-1} (pe^t) \quad (6)$$

$$\begin{aligned} M''(t) &= N(N-1)[pe^t + (1-p)]^{N-2} (pe^t)^2 \\ &\quad + N[pe^t + (1-p)]^{N-1} (pe^t). \end{aligned} \quad (7)$$

The MEAN is

$$\mu = M'(0) = N(p + 1 - p)p = Np. \quad (8)$$

The MOMENTS about 0 are

$$\mu'_1 = \mu = Np \quad (9)$$

$$\mu'_2 = Np(1-p + Np) \quad (10)$$

$$\mu'_3 = Np(1-3p + 3Np + 2p^2 - 3NP^2 + N^2p^2) \quad (11)$$

$$\begin{aligned} \mu'_4 &= Np(1-7p + 7Np + 12p^2 - 18Np^2 + 6N^2p^2 \\ &\quad - 6p^3 + 11Np^3 - 6N^2p^3 + N^3p^3), \end{aligned} \quad (12)$$

so the MOMENTS about the MEAN are

$$\begin{aligned} \mu_2 &= \sigma^2 = [N(N-1)p^2 + Np] - (Np)^2 \\ &= N^2p^2 - Np^2 + Np - N^2p^2 \\ &= Np(1-p) = Npq \end{aligned} \quad (13)$$

$$\begin{aligned} \mu_3 &= \mu'_3 - 3\mu'_2\mu'_1 + 2(\mu'_1)^3 \\ &= Np(1-p)(1-2p) \end{aligned} \quad (14)$$

$$\begin{aligned} \mu_4 &= \mu'_4 - 4\mu'_3\mu'_1 + 6\mu'_2(\mu'_1)^2 - 3(\mu'_1)^4 \\ &= Np(1-p)[3p^2(2-N) + 3p(N-2) + 1]. \end{aligned} \quad (15)$$

The SKEWNESS and KURTOSIS are

$$\begin{aligned}\gamma_1 &= \frac{\mu_3}{\sigma^3} = \frac{Np(1-p)(1-2p)}{[Np(1-p)]^{3/2}} \\ &= \frac{1-2p}{\sqrt{Np(1-p)}} = \frac{q-p}{\sqrt{Npq}}\end{aligned}\quad (16)$$

$$\gamma_2 = \frac{\mu_4}{\sigma^4} - 3 = \frac{6p^2 - 6p + 1}{Np(1-p)} = \frac{1-6pq}{Npq}.\quad (17)$$

An approximation to the Bernoulli distribution for large N can be obtained by expanding about the value \tilde{n} where $P(n)$ is a maximum, i.e., where $dP/dn = 0$. Since the LOGARITHM function is MONOTONIC, we can instead choose to expand the LOGARITHM. Let $n \equiv \tilde{n} + \eta$, then

$$\ln[P(n)] = \ln[P(\tilde{n})] + B_1\eta + \frac{1}{2}B_2\eta^2 + \frac{1}{3!}B_3\eta^3 + \dots, \quad (18)$$

where

$$B_k \equiv \left[\frac{d^k \ln[P(n)]}{dn^k} \right]_{n=\tilde{n}}. \quad (19)$$

But we are expanding about the maximum, so, by definition,

$$B_1 = \left[\frac{d \ln[P(n)]}{dn} \right]_{n=\tilde{n}} = 0. \quad (20)$$

This also means that B_2 is negative, so we can write $B_2 = -|B_2|$. Now, taking the LOGARITHM of (1) gives

$$\ln[P(n)] = \ln N! - \ln n! - \ln(N-n)! + n \ln p + (N-n) \ln q. \quad (21)$$

For large n and $N-n$ we can use STIRLING'S APPROXIMATION

$$\ln(n!) \approx n \ln n - n, \quad (22)$$

so

$$\frac{d[\ln(n!)]}{dn} \approx (\ln n + 1) - 1 = \ln n \quad (23)$$

$$\begin{aligned}\frac{d[\ln(N-n)!]}{dn} &\approx \frac{d}{dn} [(N-n) \ln(N-n) - (N-n)] \\ &= \left[-\ln(N-n) + (N-n) \frac{-1}{N-n} + 1 \right] \\ &= -\ln(N-n),\end{aligned}\quad (24)$$

and

$$\frac{d \ln[P(n)]}{dn} \approx -\ln n + \ln(N-n) + \ln p - \ln q. \quad (25)$$

To find \tilde{n} , set this expression to 0 and solve for n ,

$$\ln \left(\frac{N-\tilde{n}}{\tilde{n}} \frac{p}{q} \right) = 0 \quad (26)$$

$$\frac{N-\tilde{n}}{\tilde{n}} \frac{p}{q} = 1 \quad (27)$$

$$(N-\tilde{n})p = \tilde{n}q \quad (28)$$

$$\tilde{n}(q+p) = \tilde{n} = Np, \quad (29)$$

since $p+q=1$. We can now find the terms in the expansion

$$\begin{aligned}B_2 &\equiv \left[\frac{d^2 \ln[P(n)]}{dn^2} \right]_{n=\tilde{n}} = -\frac{1}{\tilde{n}} - \frac{1}{N-\tilde{n}} \\ &= -\frac{1}{Np} - \frac{1}{N(1-p)} = -\frac{1}{N} \left(\frac{1}{p} + \frac{1}{q} \right) \\ &= -\frac{1}{N} \left(\frac{p+q}{pq} \right) = -\frac{1}{Npq} = -\frac{1}{N(1-p)}\end{aligned}\quad (30)$$

$$\begin{aligned}B_3 &\equiv \left[\frac{d^3 \ln[P(n)]}{dn^3} \right]_{n=\tilde{n}} = \frac{1}{\tilde{n}^2} - \frac{1}{(N-\tilde{n})^2} \\ &= \frac{1}{N^2 p^2} - \frac{1}{N^2 q^2} = \frac{q^2 - p^2}{N^2 p^2 q^2} \\ &= \frac{(1-2p+p^2) - p^2}{N^2 p^2 (1-p)^2} = \frac{1-2p}{N^2 p^2 (1-p)^2}\end{aligned}\quad (31)$$

$$\begin{aligned}B_4 &\equiv \left[\frac{d^4 \ln[P(n)]}{dn^4} \right]_{n=\tilde{n}} = -\frac{2}{\tilde{n}^3} - \frac{2}{(N-\tilde{n})^3} \\ &= -2 \left(\frac{1}{N^3 p^3} + \frac{1}{N^3 q^3} \right) = \frac{2(p^3 + q^3)}{N^3 p^3 q^3} \\ &= \frac{2(p^2 - pq + q^2)}{N^3 p^3 q^3} \\ &= \frac{2[p^2 - p(1-p) + (1-2p+p^2)]}{N^3 p^3 (1-p^3)} \\ &= \frac{2(3p^2 - 3p + 1)}{N^3 p^3 (1-p^3)}.\end{aligned}\quad (32)$$

Now, treating the distribution as continuous,

$$\lim_{N \rightarrow \infty} \sum_{n=0}^N P(n) \approx \int P(n) dn = \int_{-\infty}^{\infty} P(\tilde{n} + \eta) d\eta = 1. \quad (33)$$

Since each term is of order $1/N \sim 1/\sigma^2$ smaller than the previous, we can ignore terms higher than B_2 , so

$$P(n) = P(\tilde{n}) e^{-|B_2|\eta^2/2}. \quad (34)$$

The probability must be normalized, so

$$\int_{-\infty}^{\infty} P(\tilde{n}) e^{-|B_2|\eta^2/2} d\eta = P(\tilde{n}) \sqrt{\frac{2\pi}{|B_2|}} = 1, \quad (35)$$

and

$$\begin{aligned}P(n) &= \sqrt{\frac{|B_2|}{2\pi}} e^{-|B_2|(n-\tilde{n})^2/2} \\ &= \frac{1}{\sqrt{2\pi Npq}} \exp \left[-\frac{(n-Np)^2}{2Npq} \right].\end{aligned}\quad (36)$$

Defining $\sigma^2 = 2Npq$,

$$P(n) = \frac{1}{\sigma\sqrt{2\pi}} \exp \left[-\frac{(n-\tilde{n})^2}{2\sigma^2} \right], \quad (37)$$

which is a GAUSSIAN DISTRIBUTION. For $p \ll 1$, a different approximation procedure shows that the binomial distribution approaches the POISSON DISTRIBUTION. The first CUMULANT is

$$\kappa_1 = np, \quad (38)$$

and subsequent CUMULANTS are given by the RECURRENCE RELATION

$$\kappa_{r+1} = pq \frac{d\kappa_r}{dp}. \quad (39)$$

Let x and y be independent binomial RANDOM VARIABLES characterized by parameters n, p and m, p . The CONDITIONAL PROBABILITY of x given that $x + y = k$ is

$$\begin{aligned} P(x = i | x + y = k) &= \frac{P(x = i, x + y = k)}{P(x + y = k)} \\ &= \frac{P(x = i, y = k - i)}{P(x + y = k)} = \frac{P(x = i)P(y = k - i)}{P(x + y = k)} \\ &= \frac{\binom{n}{i} p^i (1 - p)^{n-i} \binom{m}{k-i} p^{k-i} (1 - p)^{m-(k-i)}}{\binom{n+m}{k} p^k (1 - p)^{n+m-k}} \\ &= \frac{\binom{n}{i} \binom{m}{k-i}}{\binom{n+m}{k}}. \end{aligned} \quad (40)$$

Note that this is a HYPERGEOMETRIC DISTRIBUTION!

see also DE MOIVRE-LAPLACE THEOREM, HYPERGEOMETRIC DISTRIBUTION, NEGATIVE BINOMIAL DISTRIBUTION

References

- Beyer, W. H. *CRC Standard Mathematical Tables*, 28th ed. Boca Raton, FL: CRC Press, p. 531, 1987.
 Press, W. H.; Flannery, B. P.; Teukolsky, S. A.; and Vetterling, W. T. "Incomplete Beta Function, Student's Distribution, F-Distribution, Cumulative Binomial Distribution." §6.2 in *Numerical Recipes in FORTRAN: The Art of Scientific Computing*, 2nd ed. Cambridge, England: Cambridge University Press, pp. 219–223, 1992.
 Spiegel, M. R. *Theory and Problems of Probability and Statistics*. New York: McGraw-Hill, p. 108–109, 1992.

Binomial Expansion

see BINOMIAL SERIES

Binomial Formula

see BINOMIAL SERIES, BINOMIAL THEOREM

Binomial Number

A number of the form $a^n \pm b^n$, where a, b , and n are INTEGERS. They can be factored algebraically

$$a^n - b^n = (a - b)(a^{n-1} + a^{n-2}b + \dots + ab^{n-2} + b^{n-1}) \quad (1)$$

$$a^n + b^n = (a + b)(a^{n-1} - a^{n-2}b + \dots - ab^{n-2} + b^{n-1}) \quad (2)$$

$$a^{nm} - b^{nm} = (a^m - b^m)[a^{m(n-1)} + a^{m(n-2)}b^m + \dots + b^{m(n-1)}]. \quad (3)$$

In 1770, Euler proved that if $(a, b) = 1$, then every FACTOR of

$$a^{2^n} + b^{2^n} \quad (4)$$

is either 2 or of the form $2^{n+1}K + 1$. If p and q are PRIMES, then

$$\frac{a^{pq} - 1}{(a^p - 1)(a^q - 1)} - 1 \quad (5)$$

is DIVISIBLE by every PRIME FACTOR of a^{p-1} not dividing $a^q - 1$.

see also CUNNINGHAM NUMBER, FERMAT NUMBER, MERSENNE NUMBER, RIESEL NUMBER, SIERPIŃSKI NUMBER OF THE SECOND KIND

References

- Guy, R. K. "When Does $2^a - 2^b$ Divide $n^a - n^b$." §B47 in *Unsolved Problems in Number Theory*, 2nd ed. New York: Springer-Verlag, p. 102, 1994.
 Qi, S and Ming-Zhi, Z. "Pairs where $2^a - a^b$ Divides $n^a - n^b$ for All n ." *Proc. Amer. Math. Soc.* **93**, 218–220, 1985.
 Schinzel, A. "On Primitive Prime Factors of $a^n - b^n$." *Proc. Cambridge Phil. Soc.* **58**, 555–562, 1962.

Binomial Series

For $|x| < 1$,

$$(1 + x)^n = \sum_{k=0}^n \binom{n}{k} x^k \quad (1)$$

$$= \binom{n}{0} x^0 + \binom{n}{1} x^1 + \binom{n}{2} x^2 + \dots \quad (2)$$

$$= 1 + \frac{n!}{1!(n-1)!} x + \frac{n!}{(n-2)!2!} x^2 + \dots \quad (3)$$

$$= 1 + nx + \frac{n(n-1)}{2} x^2 + \dots \quad (4)$$

The binomial series also has the CONTINUED FRACTION representation

$$(1 + x)^n = \frac{1}{1 - \frac{nx}{1 + \frac{1 \cdot (1+n)x}{1 \cdot 2} + \frac{1 \cdot (1-n)x}{2 \cdot 3} + \frac{2(2+n)x}{3 \cdot 4} + \frac{2(2-n)x}{4 \cdot 5} + \frac{3(3+n)x}{5 \cdot 6} + \dots}}. \quad (5)$$

see also BINOMIAL THEOREM, MULTINOMIAL SERIES, NEGATIVE BINOMIAL SERIES

References

- Abramowitz, M. and Stegun, C. A. (Eds.). *Handbook of Mathematical Functions with Formulas, Graphs, and Mathematical Tables*, 9th printing. New York: Dover, pp. 14–15, 1972.
- Pappas, T. "Pascal's Triangle, the Fibonacci Sequence & Binomial Formula." *The Joy of Mathematics*. San Carlos, CA: Wide World Publ./Tetra, pp. 40–41, 1989.

Binomial Theorem

The theorem that, for INTEGRAL POSITIVE n ,

$$(x + a)^n = \sum_{k=0}^n \frac{n!}{k!(n-k)!} x^k a^{n-k} = \sum_{k=0}^n \binom{n}{k} x^k a^{n-k},$$

the so-called BINOMIAL SERIES, where $\binom{n}{k}$ are BINOMIAL COEFFICIENTS. The theorem was known for the case $n = 2$ by Euclid around 300 BC, and stated in its modern form by Pascal in 1665. Newton (1676) showed that a similar formula (with INFINITE upper limit) holds for NEGATIVE INTEGRAL n ,

$$(x + a)^{-n} = \sum_{k=0}^{\infty} \binom{-n}{k} x^k a^{-n-k},$$

the so-called NEGATIVE BINOMIAL SERIES, which converges for $|x| > |a|$.

see also BINOMIAL COEFFICIENT, BINOMIAL SERIES, CAUCHY BINOMIAL THEOREM, CHU-VANDERMONDE IDENTITY, LOGARITHMIC BINOMIAL FORMULA, NEGATIVE BINOMIAL SERIES, q -BINOMIAL THEOREM, RANDOM WALK

References

- Abramowitz, M. and Stegun, C. A. (Eds.). *Handbook of Mathematical Functions with Formulas, Graphs, and Mathematical Tables*, 9th printing. New York: Dover, p. 10, 1972.
- Arfken, G. *Mathematical Methods for Physicists*, 3rd ed. Orlando, FL: Academic Press, pp. 307–308, 1985.
- Conway, J. H. and Guy, R. K. "Choice Numbers Are Binomial Coefficients." In *The Book of Numbers*. New York: Springer-Verlag, pp. 72–74, 1996.
- Coolidge, J. L. "The Story of the Binomial Theorem." *Amer. Math. Monthly* **56**, 147–157, 1949.
- Courant, R. and Robbins, H. "The Binomial Theorem." §1.6 in *What is Mathematics?: An Elementary Approach to Ideas and Methods*, 2nd ed. Oxford, England: Oxford University Press, pp. 16–18, 1996.

Binomial Triangle

see PASCAL'S TRIANGLE

Binormal Developable

A RULED SURFACE M is said to be a binormal developable of a curve \mathbf{y} if M can be parameterized by $\mathbf{x}(u, v) = \mathbf{y}(u) + v\hat{\mathbf{B}}(u)$, where \mathbf{B} is the BINORMAL VECTOR.

see also NORMAL DEVELOPABLE, TANGENT DEVELOPABLE

References

- Gray, A. "Developables." §17.6 in *Modern Differential Geometry of Curves and Surfaces*. Boca Raton, FL: CRC Press, pp. 352–354, 1993.

Binormal Vector

$$\hat{\mathbf{B}} \equiv \hat{\mathbf{T}} \times \hat{\mathbf{N}} \quad (1)$$

$$= \frac{\mathbf{r}' \times \mathbf{r}''}{|\mathbf{r}' \times \mathbf{r}''|}, \quad (2)$$

where the unit TANGENT VECTOR \mathbf{T} and unit "principal" NORMAL VECTOR \mathbf{N} are defined by

$$\hat{\mathbf{T}} \equiv \frac{\mathbf{r}'(s)}{|\mathbf{r}'(s)|} \quad (3)$$

$$\hat{\mathbf{N}} \equiv \frac{\mathbf{r}''(s)}{|\mathbf{r}''(s)|} \quad (4)$$

Here, \mathbf{r} is the RADIUS VECTOR, s is the ARC LENGTH, τ is the TORSION, and κ is the CURVATURE. The binormal vector satisfies the remarkable identity

$$[\dot{\mathbf{B}}, \ddot{\mathbf{B}}, \ddot{\ddot{\mathbf{B}}}] = \tau^5 \frac{d}{ds} \left(\frac{\kappa}{\tau} \right). \quad (5)$$

see also FRENET FORMULAS, NORMAL VECTOR, TANGENT VECTOR

References

- Kreyszig, E. "Binormal. Moving Trihedron of a Curve." §13 in *Differential Geometry*. New York: Dover, p. 36–37, 1991.

Bioche's Theorem

If two complementary PLÜCKER CHARACTERISTICS are equal, then each characteristic is equal to its complement except in four cases where the sum of order and class is 9.

References

- Coolidge, J. L. *A Treatise on Algebraic Plane Curves*. New York: Dover, p. 101, 1959.

Biotic Potential

see LOGISTIC EQUATION

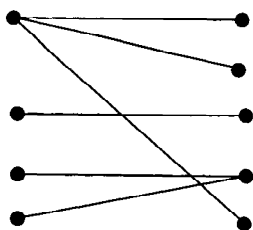
Bipartite Graph

A set of VERTICES decomposed into two disjoint sets such that no two VERTICES within the same set are adjacent. A bigraph is a special case of a k -PARTITE GRAPH with $k = 2$.

see also COMPLETE BIPARTITE GRAPH, k -PARTITE GRAPH, KÖNIG-EGEVÁRY THEOREM

References

- Chartrand, G. *Introductory Graph Theory*. New York: Dover, p. 116, 1985.
 Saaty, T. L. and Kainen, P. C. *The Four-Color Problem: Assaults and Conquest*. New York: Dover, p. 12, 1986.

Biplanar Double Point

see ISOLATED SINGULARITY

Bipolar Coordinates

Bipolar coordinates are a 2-D system of coordinates. There are two commonly defined types of bipolar coordinates, the first of which is defined by

$$x = \frac{a \sinh v}{\cosh v - \cos u} \quad (1)$$

$$y = \frac{a \sin u}{\cosh v - \cos u}, \quad (2)$$

where $u \in [0, 2\pi)$, $v \in (-\infty, \infty)$. The following identities show that curves of constant u and v are CIRCLES in xy -space.

$$x^2 + (y - a \cot u)^2 = a^2 \csc^2 u \quad (3)$$

$$(x - a \coth v)^2 + y^2 = a^2 \operatorname{csch}^2 v. \quad (4)$$

The SCALE FACTORS are

$$h_u = \frac{a}{\cosh v - \cos u} \quad (5)$$

$$h_v = \frac{a}{\cosh v - \cos u}. \quad (6)$$

The LAPLACIAN is

$$\nabla^2 = \frac{(\cosh v - \cos u)^2}{a^2} \left(\frac{\partial^2}{\partial u^2} + \frac{\partial^2}{\partial v^2} \right). \quad (7)$$

LAPLACE'S EQUATION is separable.

Two-center bipolar coordinates are two coordinates giving the distances from two fixed centers r_1 and r_2 , sometimes denoted r and r' . For two-center bipolar coordinates with centers at $(\pm c, 0)$,

$$r_1^2 = (x + c)^2 + y^2 \quad (8)$$

$$r_2^2 = (x - c)^2 + y^2. \quad (9)$$

Combining (8) and (9) gives

$$r_1^2 - r_2^2 = 4cx. \quad (10)$$

Solving for CARTESIAN COORDINATES x and y gives

$$x = \frac{r_1^2 - r_2^2}{4c} \quad (11)$$

$$y = \pm \frac{1}{4c} \sqrt{16c^2 r_1^2 - (r_1^2 - r_2^2 + 4c^2)}. \quad (12)$$

Solving for POLAR COORDINATES gives

$$r = \sqrt{\frac{r_1^2 + r_2^2 - 2c^2}{2}} \quad (13)$$

$$\theta = \tan^{-1} \left[\sqrt{\frac{8c^2(r_1^2 + r_2^2 - 2c^2)}{r_1^2 - r_2^2}} - 1 \right]. \quad (14)$$

References

- Lockwood, E. H. "Bipolar Coordinates." Ch. 25 in *A Book of Curves*. Cambridge, England: Cambridge University Press, pp. 186-190, 1967.

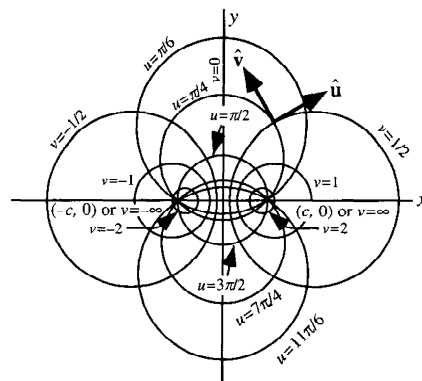
Bipolar Cylindrical Coordinates

A set of CURVILINEAR COORDINATES defined by

$$x = \frac{a \sinh v}{\cosh v - \cos u} \quad (1)$$

$$y = \frac{a \sin u}{\cosh v - \cos u} \quad (2)$$

$$z = z, \quad (3)$$

where $u \in [0, 2\pi)$, $v \in (-\infty, \infty)$, and $z \in (-\infty, \infty)$. There are several notational conventions, and whereas (u, v, z) is used in this work, Arfken (1970) prefers

(η, ξ, z) . The following identities show that curves of constant u and v are CIRCLES in xy -space.

$$x^2 + (y - a \cot u)^2 = a^2 \csc^2 u \tag{4}$$

$$(x - a \coth v)^2 + y^2 = a^2 \operatorname{csch}^2 v. \tag{5}$$

The SCALE FACTORS are

$$h_u = \frac{a}{\cosh v - \cos u} \tag{6}$$

$$h_v = \frac{a}{\cosh v - \cos u} \tag{7}$$

$$h_z = 1. \tag{8}$$

The LAPLACIAN is

$$\nabla^2 = \frac{(\cosh v - \cos u)^2}{a^2} \left(\frac{\partial^2}{\partial u^2} + \frac{\partial^2}{\partial v^2} \right) + \frac{\partial^2}{\partial z^2}. \tag{9}$$

LAPLACE'S EQUATION is not separable in BIPOLAR CYLINDRICAL COORDINATES, but it is in 2-D BIPOLAR COORDINATES.

References

Arfken, G. "Bipolar Coordinates (ξ, η, z) ." §2.9 in *Mathematical Methods for Physicists, 2nd ed.* Orlando, FL: Academic Press, pp. 97–102, 1970.

Biprism

Two slant triangular PRISMS fused together.

see also PRISM, SCHMITT-CONWAY BIPRISM

Bipyramid

see DIPYRAMID

Biquadratfree

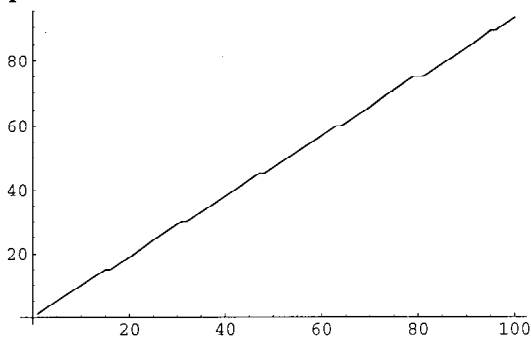

A number is said to be biquadratfree if its PRIME decomposition contains no tripled factors. All PRIMES are therefore trivially biquadratfree. The biquadratfree numbers are 1, 2, 3, 4, 5, 6, 7, 8, 9, 10, 11, 12, 13, 14, 15, 17, ... (Sloane's A046100). The biquadratful numbers (i.e., those that contain at least one biquadrate) are 16, 32, 48, 64, 80, 81, 96, ... (Sloane's A046101). The number of biquadratfree numbers less than 10, 100, 1000, ... are 10, 93, 925, 9240, 92395, 923939, ..., and their asymptotic density is $1/\zeta(4) = 90/\pi^4 \approx 0.923938$, where $\zeta(n)$ is the RIEMANN ZETA FUNCTION.

see also CUBEFREE, PRIME NUMBER, RIEMANN ZETA FUNCTION, SQUAREFREE

References

Sloane, N. J. A. Sequences A046100 and A046101 in "An On-Line Version of the Encyclopedia of Integer Sequences."

Biquadratic Equation

see QUARTIC EQUATION

Biquadratic Number

A biquadratic number is a fourth POWER, n^4 . The first few biquadratic numbers are 1, 16, 81, 256, 625, ... (Sloane's A000583). The minimum number of squares needed to represent the numbers 1, 2, 3, ... are 1, 2, 3, 4, 5, 6, 7, 8, 9, 10, 11, 12, 13, 14, 15, 1, 2, 3, 4, 5, ... (Sloane's A002377), and the number of distinct ways to represent the numbers 1, 2, 3, ... in terms of biquadratic numbers are 1, 1, 1, 1, 1, 1, 1, 1, 1, 1, 1, 1, 1, 1, 2, 2, 2, 2, 2, ... A brute-force algorithm for enumerating the biquadratic permutations of n is repeated application of the GREEDY ALGORITHM.

Every POSITIVE integer is expressible as a SUM of (at most) $g(4) = 19$ biquadratic numbers (WARING'S PROBLEM). Davenport (1939) showed that $G(4) = 16$, meaning that all sufficiently large integers require only 16 biquadratic numbers. The following table gives the first few numbers which require 1, 2, 3, ..., 19 biquadratic numbers to represent them as a sum, with the sequences for 17, 18, and 19 being finite.

#	Sloane	Numbers
1	000290	1, 16, 81, 256, 625, 1296, 2401, 4096, ...
2	003336	2, 17, 32, 82, 97, 162, 257, 272, ...
3	003337	3, 18, 33, 48, 83, 98, 113, 163, ...
4	003338	4, 19, 34, 49, 64, 84, 99, 114, 129, ...
5	003339	5, 20, 35, 50, 65, 80, 85, 100, 115, ...
6	003340	6, 21, 36, 51, 66, 86, 96, 101, 116, ...
7	003341	7, 22, 37, 52, 67, 87, 102, 112, 117, ...
8	003342	8, 23, 38, 53, 68, 88, 103, 118, 128, ...
9	003343	9, 24, 39, 54, 69, 89, 104, 119, 134, ...
10	003344	10, 25, 40, 55, 70, 90, 105, 120, 135, ...
11	003345	11, 26, 41, 56, 71, 91, 106, 121, 136, ...
12	003346	12, 27, 42, 57, 72, 92, 107, 122, 137, ...

The following table gives the numbers which can be represented in n different ways as a sum of k biquadrates.

k	n	Sloane	Numbers
1	1	000290	1, 16, 81, 256, 625, 1296, 2401, 4096, ...
2	2		635318657, 3262811042, 8657437697, ...

The numbers 2, 3, 4, 5, 6, 7, 8, 9, 10, 11, 12, 13, 14, 15, 18, 19, 20, 21, ... (Sloane's A046039) cannot be represented using distinct biquadrates.

see also CUBIC NUMBER, SQUARE NUMBER, WARING'S PROBLEM

References

Davenport, H. "On Waring's Problem for Fourth Powers." *Ann. Math.* 40, 731–747, 1939.

Biquadratic Reciprocity Theorem

$$x^4 \equiv q \pmod{p}. \quad (1)$$

This was solved by Gauss using the GAUSSIAN INTEGERS as

$$\left(\frac{\pi}{\sigma}\right)_4 \left(\frac{\sigma}{\pi}\right)_4 = (-1)^{[(N(\pi)-1)/4][(N(\sigma)-1)/4]}, \quad (2)$$

where π and σ are distinct GAUSSIAN INTEGER PRIMES,

$$N(a + bi) = \sqrt{a^2 + b^2} \quad (3)$$

and N is the norm.

$$\left(\frac{\alpha}{\pi}\right)_4 = \begin{cases} 1 & \text{if } x^4 \equiv \alpha \pmod{\pi} \text{ is solvable} \\ -1, i, \text{ or } -i & \text{otherwise,} \end{cases} \quad (4)$$

where solvable means solvable in terms of GAUSSIAN INTEGERS.

see also RECIPROCITY THEOREM

Biquaternion

A QUATERNION with COMPLEX coefficients. The ALGEBRA of biquaternions is isomorphic to a full matrix ring over the complex number field (van der Waerden 1985).

see also QUATERNION

References

- Clifford, W. K. "Preliminary Sketch of Biquaternions." *Proc. London Math. Soc.* **4**, 381–395, 1873.
 Hamilton, W. R. *Lectures on Quaternions: Containing a Systematic Statement of a New Mathematical Method.* Dublin: Hodges and Smith, 1853.
 Study, E. "Von den Bewegung und Umlegungen." *Math. Ann.* **39**, 441–566, 1891.
 van der Waerden, B. L. *A History of Algebra from al-Khwarizmi to Emmy Noether.* New York: Springer-Verlag, pp. 188–189, 1985.

Birational Transformation

A transformation in which coordinates in two SPACES are expressed rationally in terms of those in another.

see also RIEMANN CURVE THEOREM, WEBER'S THEOREM

Birch Conjecture

see SWINNERTON-DYER CONJECTURE

Birch–Swinerton-Dyer Conjecture

see SWINNERTON-DYER CONJECTURE

Birkhoff's Ergodic Theorem

Let T be an ergodic ENDOMORPHISM of the PROBABILITY SPACE X and let $f : X \rightarrow \mathbb{R}$ be a real-valued MEASURABLE FUNCTION. Then for ALMOST EVERY $x \in X$, we have

$$\frac{1}{n} \sum_{j=1}^n f \circ T^j(x) \rightarrow \int f \, dm$$

as $n \rightarrow \infty$. To illustrate this, take f to be the characteristic function of some SUBSET A of X so that

$$f(x) = \begin{cases} 1 & \text{if } x \in A \\ 0 & \text{if } x \notin A. \end{cases}$$

The left-hand side of (-1) just says how often the orbit of x (that is, the points x, Tx, T^2x, \dots) lies in A , and the right-hand side is just the MEASURE of A . Thus, for an ergodic ENDOMORPHISM, "space-averages = time-averages almost everywhere." Moreover, if T is continuous and uniquely ergodic with BOREL PROBABILITY MEASURE m and f is continuous, then we can replace the ALMOST EVERYWHERE convergence in (-1) to everywhere.

Biotunda

Two adjoined ROTUNDAS.

see also BILUNABIROTUNDA, CUPOLAROTUNDA, ELONGATED GYROCUPOLAROTUNDA, ELONGATED ORTHOCUPOLAROTUNDA, ELONGATED ORTHOBIROTUNDA, GYROCUPOLAROTUNDA, GYROELONGATED ROTUNDA, ORTHOBIROTUNDA, TRIANGULAR HEBESPHENOROTUNDA

Birthday Attack

Birthday attacks are a class of brute-force techniques used in an attempt to solve a class of cryptographic hash function problems. These methods take advantage of functions which, when supplied with a random input, return one of k equally likely values. By repeatedly evaluating the function for different inputs, the same output is expected to be obtained after about $1.2\sqrt{k}$ evaluations.

see also BIRTHDAY PROBLEM

References

- RSA Laboratories. "Question 95. What is a Birthday Attack." <http://www.rsa.com/rsalabs/newfaq/q95.html>.
 "Question 96. How Does the Length of a Hash Value Affect Security?" <http://www.rsa.com/rsalabs/newfaq/q96.html>.
 van Oorschot, P. and Wiener, M. "A Known Plaintext Attack on Two-Key Triple Encryption." In *Advances in Cryptology—Eurocrypt '90*. New York: Springer-Verlag, pp. 366–377, 1991.
 Yuval, G. "How to Swindle Rabin." *Cryptologia* **3**, 187–189, Jul. 1979.

Birthday Problem

Consider the probability $Q_1(n, d)$ that *no two people* out of a group of n will have matching birthdays out of d equally possible birthdays. Start with an arbitrary person's birthday, then note that the probability that the second person's birthday is different is $(d-1)/d$, that the third person's birthday is different from the first two is $[(d-1)/d][(d-2)/d]$, and so on, up through the n th person. Explicitly,

$$Q_1(n, d) = \frac{d-1}{d} \frac{d-2}{d} \dots \frac{d-(n-1)}{d} = \frac{(d-1)(d-2) \dots [d-(n-1)]}{d^n}. \quad (1)$$

But this can be written in terms of FACTORIALS as

$$Q_1(n, d) = \frac{d!}{(d-n)!d^n}, \quad (2)$$

so the probability $P_2(n, 365)$ that two people out of a group of n *do have the same birthday* is therefore

$$P_2(n, d) = 1 - Q_1(n, d) = 1 - \frac{d!}{(d-n)!d^n}. \quad (3)$$

If 365-day years have been assumed, i.e., the existence of leap days is ignored, then the number of people needed for there to be at least a 50% chance that two share birthdays is the smallest n such that $P_2(n, 365) \geq 1/2$. This is given by $n = 23$, since

$$P_2(23, 365) = \frac{38093904702297390785243708291056390518886454060947061}{75091883268515350125426207425223147563269805908203125} \approx 0.507297. \quad (4)$$

The number of people needed to obtain $P_2(n, 365) \geq 1/2$ for $n = 1, 2, \dots$, are 2, 2, 3, 3, 3, 4, 4, 4, 4, 5, ... (Sloane's A033810).

The probability $P_2(n, d)$ can be estimated as

$$P_2(n, d) \approx 1 - e^{-n(n-1)/2d} \quad (5)$$

$$\approx 1 - \left(1 - \frac{n}{2d}\right)^{n-1}, \quad (6)$$

where the latter has error

$$\epsilon < \frac{n^3}{6(d-n+1)^2} \quad (7)$$

(Sayrafiezadeh 1994).

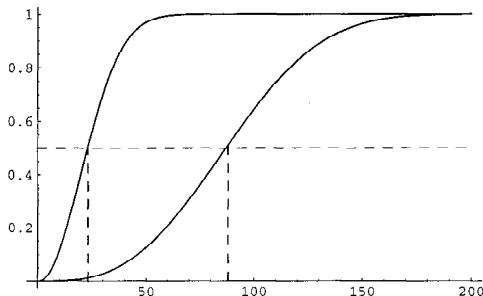

In general, let $Q_i(n, d)$ denote the probability that a birthday is shared by exactly i (and no more) people out of a group of n people. Then the probability that a birthday is shared by k or more people is given by

$$P_k(n, d) = 1 - \sum_{i=1}^{k-1} Q_i(n, d). \quad (8)$$

Q_2 can be computed explicitly as

$$\begin{aligned} Q_2(n, d) &= \frac{n!}{d^n} \sum_{i=1}^{\lfloor n/2 \rfloor} \frac{1}{2^i} \binom{d}{i} \binom{d-i}{n-2i} \\ &= \frac{n!}{d^n} \sum_{i=1}^{\lfloor n/2 \rfloor} \frac{d!}{2^i i! (n-2i)! (d-n+i)!} \\ &= \frac{(-1)^n}{d^n} \left[2^{-n/2} \Gamma(1+n) P_n^{(-d)} \left(\frac{1}{2} \sqrt{2} \right) - \frac{\Gamma(1+d)}{\Gamma(1+d-n)} \right], \end{aligned} \quad (9)$$

where $\binom{n}{m}$ is a BINOMIAL COEFFICIENT, $\Gamma(n)$ is a GAMMA FUNCTION, and $P_n^{(\lambda)}(x)$ is an ULTRASPHERICAL POLYNOMIAL. This gives the explicit formula for $P_3(n, d)$ as

$$\begin{aligned} P_3(n, d) &= 1 - Q_1(n, d) - Q_2(n, d) \\ &= 1 + \frac{(-1)^{n+1} \Gamma(n+1) P_n^{(-d)} (2^{-1/2})}{2^{n/2} d^n}. \end{aligned} \quad (10)$$

$Q_3(n, d)$ cannot be computed in entirely closed form, but a partially reduced form is

$$\begin{aligned} Q_3(n, d) &= \frac{\Gamma(d+1)}{d^n} \left[\frac{(-1)^n F(\frac{9}{8}) - F(-\frac{9}{8})}{\Gamma(d-n+1)} \right. \\ &\quad \left. + (-1)^n \Gamma(1+n) \sum_{i=1}^{\lfloor n/3 \rfloor} \frac{(-3)^{-i} 2^{(i-n)/2} P_{n-3i}^{(-d)} (\frac{1}{2} \sqrt{2})}{\Gamma(d-i+1) \Gamma(i+1)} \right], \end{aligned} \quad (11)$$

where

$$F = F(n, d, a) \equiv 1 - {}_3F_2 \left[\begin{matrix} \frac{1}{3}(1-n), \frac{1}{3}(2-n), -\frac{1}{3} \\ \frac{1}{2}(d-n+1), \frac{1}{2}(d-n+2) \end{matrix}; a \right] \quad (12)$$

and ${}_3F_2(a, b, c; d, e; z)$ is a GENERALIZED HYPERGEOMETRIC FUNCTION.

In general, $Q_k(n, d)$ can be computed using the RECURRENCE RELATION

$$\begin{aligned} Q_k(n, d) &= \sum_{i=1}^{\lfloor n/k \rfloor} \left[\frac{n! d!}{d^{ik} i! (k!)^i (n-ik)! (d-i)!} \right. \\ &\quad \left. \times \sum_{j=1}^{k-1} Q_j(n-k, d-i) \frac{(d-i)^{n-ik}}{d^{n-ik}} \right] \end{aligned} \quad (13)$$

(Finch). However, the time to compute this recursive function grows exponentially with k and so rapidly becomes unwieldy. The minimal number of people to give a 50% probability of having at least n coincident birthdays is 1, 23, 88, 187, 313, 460, 623, 798, 985, 1181, 1385, 1596, 1813, ... (Sloane's A014088; Diaconis and Mosteller 1989).

A good approximation to the number of people n such that $p = P_k(n, d)$ is some given value can be given by solving the equation

$$ne^{-n/(dk)} = \left[d^{k-1} k! \ln \left(\frac{1}{1-p} \right) \left(1 - \frac{n}{d(k+1)} \right) \right]^{1/k} \quad (14)$$

for n and taking $\lceil n \rceil$, where $\lceil n \rceil$ is the CEILING FUNCTION (Diaconis and Mosteller 1989). For $p = 0.5$ and $k = 1, 2, 3, \dots$, this formula gives $n = 1, 23, 88, 187, 313, 459, 722, 797, 983, 1179, 1382, 1592, 1809, \dots$, which differ from the true values by from 0 to 4. A much simpler but also poorer approximation for n such that $p = 0.5$ for $k < 20$ is given by

$$n = 47(k - 1.5)^{3/2} \quad (15)$$

(Diaconis and Mosteller 1989), which gives 86, 185, 307, 448, 606, 778, 965, 1164, 1376, 1599, 1832, ... for $k = 3, 4, \dots$.

The "almost" birthday problem, which asks the number of people needed such that two have a birthday within a day of each other, was considered by Abramson and Moser (1970), who showed that 14 people suffice. An approximation for the minimum number of people needed to get a 50-50 chance that two have a match within k days out of d possible is given by

$$n(k, d) = 1.2 \sqrt{\frac{d}{2k+1}} \quad (16)$$

(Sevast'yanov 1972, Diaconis and Mosteller 1989).

see also BIRTHDAY ATTACK, COINCIDENCE, SMALL WORLD PROBLEM

References

- Abramson, M. and Moser, W. O. J. "More Birthday Surprises." *Amer. Math. Monthly* **77**, 856-858, 1970.
 Ball, W. W. R. and Coxeter, H. S. M. *Mathematical Recreations and Essays*, 13th ed. New York: Dover, pp. 45-46, 1987.
 Bloom, D. M. "A Birthday Problem." *Amer. Math. Monthly* **80**, 1141-1142, 1973.
 Bogomolny, A. "Coincidence." http://www.cut-the-knot.com/do_you_know/coincidence.html.
 Clevenston, M. L. and Watkins, W. "Majorization and the Birthday Inequality." *Math. Mag.* **64**, 183-188, 1991.
 Diaconis, P. and Mosteller, F. "Methods of Studying Coincidences." *J. Amer. Statist. Assoc.* **84**, 853-861, 1989.
 Feller, W. *An Introduction to Probability Theory and Its Applications*, Vol. 1, 3rd ed. New York: Wiley, pp. 31-32, 1968.

- Finch, S. "Puzzle #28 [June 1997]: Coincident Birthdays." <http://www.mathsoft.com/mathcad/library/puzzle/soln28/soln28.html>.
 Gehan, E. A. "Note on the 'Birthday Problem.'" *Amer. Stat.* **22**, 28, Apr. 1968.
 Heuer, G. A. "Estimation in a Certain Probability Problem." *Amer. Math. Monthly* **66**, 704-706, 1959.
 Hocking, R. L. and Schwertman, N. C. "An Extension of the Birthday Problem to Exactly k Matches." *College Math. J.* **17**, 315-321, 1986.
 Hunter, J. A. H. and Madachy, J. S. *Mathematical Diversions*. New York: Dover, pp. 102-103, 1975.
 Klamkin, M. S. and Newman, D. J. "Extensions of the Birthday Surprise." *J. Combin. Th.* **3**, 279-282, 1967.
 Levin, B. "A Representation for Multinomial Cumulative Distribution Functions." *Ann. Statistics* **9**, 1123-1126, 1981.
 McKinney, E. H. "Generalized Birthday Problem." *Amer. Math. Monthly* **73**, 385-387, 1966.
 Mises, R. von. "Über Aufteilungs- und Besetzungswahrscheinlichkeiten." *Revue de la Faculté des Sciences de l'Université d'Istanbul, N. S.* **4**, 145-163, 1939. Reprinted in *Selected Papers of Richard von Mises*, Vol. 2 (Ed. P. Frank, S. Goldstein, M. Kac, W. Prager, G. Szegő, and G. Birkhoff). Providence, RI: Amer. Math. Soc., pp. 313-334, 1964.
 Riesel, H. *Prime Numbers and Computer Methods for Factorization*, 2nd ed. Boston, MA: Birkhäuser, pp. 179-180, 1994.
 Sayrafiezadeh, M. "The Birthday Problem Revisited." *Math. Mag.* **67**, 220-223, 1994.
 Sevast'yanov, B. A. "Poisson Limit Law for a Scheme of Sums of Dependent Random Variables." *Th. Prob. Appl.* **17**, 695-699, 1972.
 Sloane, N. J. A. Sequences A014088 and A033810 in "An On-Line Version of the Encyclopedia of Integer Sequences."
 Stewart, I. "What a Coincidence!" *Sci. Amer.* **278**, 95-96, June 1998.
 Tesler, L. "Not a Coincidence!" <http://www.nomodes.com/coincidence.html>.

Bisected Perimeter Point

see NAGEL POINT

Bisection Procedure

Given an interval $[a, b]$, let a_n and b_n be the endpoints at the n th iteration and r_n be the n th approximate solution. Then, the number of iterations required to obtain an error smaller than ϵ is found as follows.

$$b_n - a_n = \frac{1}{2^{n-1}}(b - a) \quad (1)$$

$$r_n \equiv \frac{1}{2}(a_n + b_n) \quad (2)$$

$$|r_n - r| \leq \frac{1}{2}(b_n - a_n) = 2^{-n}(b - a) < \epsilon \quad (3)$$

$$-n \ln 2 < \ln \epsilon - \ln(b - a), \quad (4)$$

so

$$n > \frac{\ln(b - a) - \ln \epsilon}{\ln 2}. \quad (5)$$

see also ROOT

References

- Arfken, G. *Mathematical Methods for Physicists*, 3rd ed. Orlando, FL: Academic Press, pp. 964-965, 1985.

Press, W. H.; Flannery, B. P.; Teukolsky, S. A.; and Vetterling, W. T. "Bracketing and Bisection." §9.1 in *Numerical Recipes in FORTRAN: The Art of Scientific Computing*, 2nd ed. Cambridge, England: Cambridge University Press, pp. 343–347, 1992.

Bisector

Bisection is the division of a given curve or figure into two equal parts (halves).

see also ANGLE BISECTOR, BISECTION PROCEDURE, EXTERIOR ANGLE BISECTOR, HALF, HEMISPHERE, LINE BISECTOR, PERPENDICULAR BISECTOR, TRISECTION

Bishop's Inequality

Let $V(r)$ be the volume of a BALL of radius r in a complete n -D RIEMANNIAN MANIFOLD with RICCI CURVATURE $\geq (n-1)\kappa$. Then $V(r) \geq V_\kappa(r)$, where V_κ is the volume of a BALL in a space having constant SECTIONAL CURVATURE. In addition, if equality holds for some BALL, then this BALL is ISOMETRIC to the BALL of radius r in the space of constant SECTIONAL CURVATURE κ .

References

Chavel, I. *Riemannian Geometry: A Modern Introduction*. New York: Cambridge University Press, 1994.

Bishops Problem

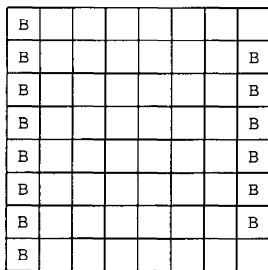

Find the maximum number of bishops $B(n)$ which can be placed on an $n \times n$ CHESSBOARD such that no two attack each other. The answer is $2n-2$ (Dudeney 1970, Madachy 1979), giving the sequence 2, 4, 6, 8, ... (the EVEN NUMBERS) for $n = 2, 3, \dots$. One maximal solution for $n = 8$ is illustrated above. The number of distinct maximal arrangements of bishops for $n = 1, 2, \dots$ are 1, 4, 26, 260, 3368, ... (Sloane's A002465). The number of rotationally and reflectively distinct solutions on an $n \times n$ board for $n \geq 2$ is

$$B(n) = \begin{cases} 2^{(n-4)/2} [2^{(n-2)/2} + 1] & \text{for } n \text{ even} \\ 2^{(n-3)/2} [2^{(n-3)/2} + 1] & \text{for } n \text{ odd} \end{cases}$$

(Dudeney 1970, p. 96; Madachy 1979, p. 45; Pickover 1995). An equivalent formula is

$$B(n) = 2^{n-3} + 2^{\lfloor (n-1)/2 \rfloor - 1},$$

where $\lfloor n \rfloor$ is the FLOOR FUNCTION, giving the sequence for $n = 1, 2, \dots$ as 1, 1, 2, 3, 6, 10, 20, 36, ... (Sloane's A005418).

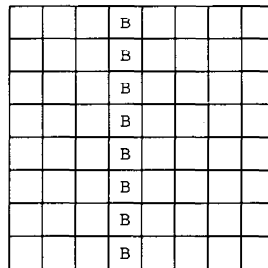

The minimum number of bishops needed to occupy or attack all squares on an $n \times n$ CHESSBOARD is n , arranged as illustrated above.

see also CHESS, KINGS PROBLEM, KNIGHTS PROBLEM, QUEENS PROBLEM, ROOKS PROBLEM

References

Ahrens, W. *Mathematische Unterhaltungen und Spiele*, Vol. 1, 3rd ed. Leipzig, Germany: Teubner, p. 271, 1921.
 Dudeney, H. E. "Bishops—Unguarded" and "Bishops—Guarded." §297 and 298 in *Amusements in Mathematics*. New York: Dover, pp. 88–89, 1970.
 Guy, R. K. "The n Queens Problem." §C18 in *Unsolved Problems in Number Theory*, 2nd ed. New York: Springer-Verlag, pp. 133–135, 1994.
 Madachy, J. *Madachy's Mathematical Recreations*. New York: Dover, pp. 36–46, 1979.
 Pickover, C. A. *Keys to Infinity*. New York: Wiley, pp. 74–75, 1995.
 Sloane, N. J. A. Sequences A002465/M3616 and A005418/M0771 in "An On-Line Version of the Encyclopedia of Integer Sequences."

Bislit Cube

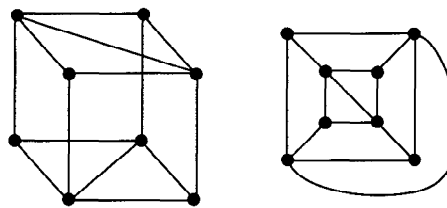

The 8-VERTEX graph consisting of a CUBE in which two opposite faces have DIAGONALS oriented PERPENDICULAR to each other.

see also BIDIAKIS CUBE, CUBE, CUBICAL GRAPH

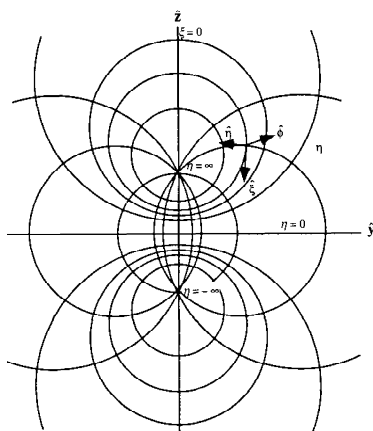
Bispherical Coordinates

A system of CURVILINEAR COORDINATES defined by

$$x = \frac{a \sin \xi \cos \phi}{\cosh \eta - \cos \xi} \quad (1)$$

$$y = \frac{a \sin \xi \sin \phi}{\cosh \eta - \cos \xi} \quad (2)$$

$$z = \frac{a \sinh \eta}{\cosh \eta - \cos \xi} \quad (3)$$

The SCALE FACTORS are

$$h_\xi = \frac{a}{\cos \eta - \cos \xi} \quad (4)$$

$$h_\eta = \frac{a}{\cosh \eta - \cos \xi} \quad (5)$$

$$h_\phi = \frac{a \sin \xi}{\cosh \eta - \cos \xi} \quad (6)$$

The LAPLACIAN is

$$\begin{aligned} \nabla^2 = & \left(\frac{-\cos u \cot^2 u + 3 \cosh v \cot^2 u}{\cosh v - \cos u} \right. \\ & \left. + \frac{-3 \cosh^2 v \cot u \csc u + \cosh^3 v \csc^2 u}{\cosh v - \cos u} \right) \frac{\partial}{\partial \phi^2} \\ & + (\cos u - \cosh v) \sinh v \frac{\partial}{\partial v} + (\cosh^2 v - \cos u)^2 \frac{\partial^2}{\partial v^2} \\ & + (\cosh v - \cos u)(\cosh v \cot u - \sin u - \cos u \cot u) \frac{\partial}{\partial u} \\ & + (\cosh^2 v - \cos u)^2 \frac{\partial^2}{\partial u^2}. \end{aligned} \quad (7)$$

In bispherical coordinates, LAPLACE'S EQUATION is separable, but the HELMHOLTZ DIFFERENTIAL EQUATION is not.

see also LAPLACE'S EQUATION—BISPHERICAL COORDINATES, TOROIDAL COORDINATES

References

- Arfken, G. "Bispherical Coordinates (ξ, η, ϕ). " §2.14 in *Mathematical Methods for Physicists*, 2nd ed. Orlando, FL: Academic Press, pp. 115–117, 1970.
Morse, P. M. and Feshbach, H. *Methods of Theoretical Physics, Part I*. New York: McGraw-Hill, pp. 665–666, 1953.

Bit Complexity

The number of single operations (of ADDITION, SUBTRACTION, and MULTIPLICATION) required to complete an algorithm.

see also STRASSEN FORMULAS

References

- Borodin, A. and Munro, I. *The Computational Complexity of Algebraic and Numeric Problems*. New York: American Elsevier, 1975.

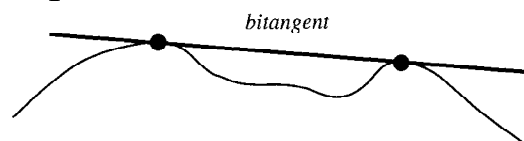
Bitangent

A LINE which is TANGENT to a curve at two distinct points.

see also KLEIN'S EQUATION, PLÜCKER CHARACTERISTICS, SECANT LINE, SOLOMON'S SEAL LINES, TANGENT LINE

Bivariate Distribution

see GAUSSIAN BIVARIATE DISTRIBUTION

Bivector

An antisymmetric TENSOR of second RANK (a.k.a. 2-form).

$$\vec{X} = X_{ab} \omega^a \wedge \omega^b,$$

where \wedge is the WEDGE PRODUCT (or OUTER PRODUCT).

Biweight

see TUKEY'S BIWEIGHT

Black-Scholes Theory

The theory underlying financial derivatives which involves "stochastic calculus" and assumes an uncorrelated LOG NORMAL DISTRIBUTION of continuously varying prices. A simplified "binomial" version of the theory was subsequently developed by Sharpe *et al.* (1995) and Cox *et al.* (1979). It reproduces many results of the full-blown theory, and allows approximation of options for which analytic solutions are not known (Price 1996).

see also GARMAN-KOHLHAGEN FORMULA

References

- Black, F. and Scholes, M. S. "The Pricing of Options and Corporate Liabilities." *J. Political Econ.* 81, 637–659, 1973.
Cox, J. C.; Ross, A.; and Rubenstein, M. "Option Pricing: A Simplified Approach." *J. Financial Economics* 7, 229–263, 1979.
Price, J. F. "Optional Mathematics is Not Optional." *Not. Amer. Math. Soc.* 43, 964–971, 1996.
Sharpe, W. F.; Alexander, G. J.; and Bailey, J. V. *Investments*, 5th ed. Englewood Cliffs, NJ: Prentice-Hall, 1995.

Black Spleenwort Fern

see BARNESLEY'S FERN

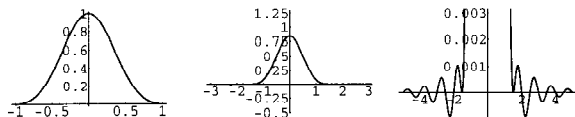
Blackman Function

An APODIZATION FUNCTION given by

$$A(x) = 0.42 + 0.5 \cos\left(\frac{\pi x}{a}\right) + 0.08 \cos\left(\frac{2\pi x}{a}\right). \quad (1)$$

Its FULL WIDTH AT HALF MAXIMUM is 0.810957a. The APPARATUS FUNCTION is

$$I(k) = \frac{a(0.84 - 0.36a^2k^2 - 2.17 \times 10^{-19}a^4k^4) \sin(2\pi ak)}{(1 - a^2k^2)(1 - 4a^2k^2)}. \quad (2)$$

The COEFFICIENTS are approximations to

$$a_0 = \frac{3969}{9304} \quad (3)$$

$$a_1 = \frac{1155}{4652} \quad (4)$$

$$a_2 = \frac{715}{18608}, \quad (5)$$

which would have produced zeros of $I(k)$ at $k = (7/4)a$ and $k = (9/4)a$.

see also APODIZATION FUNCTION

References

Blackman, R. B. and Tukey, J. W. "Particular Pairs of Windows." In *The Measurement of Power Spectra, From the Point of View of Communications Engineering*. New York: Dover, pp. 98-99, 1959.

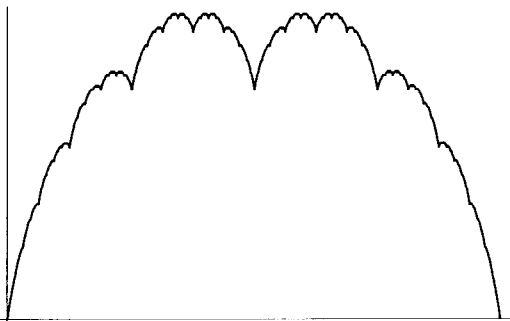
Blancmange Function

A CONTINUOUS FUNCTION which is nowhere DIFFERENTIABLE. The iterations towards the continuous function are BATRACHIONS resembling the HOFSTADTER-CONWAY \$10,000 SEQUENCE. The first six iterations are illustrated below. The d th iteration contains $N + 1$

points, where $N = 2^d$, and can be obtained by setting $b(0) = b(N) = 0$, letting

$$b(m + 2^{n-1}) = 2^n + \frac{1}{2}[b(m) + b(m + 2^n)],$$

and looping over $n = d$ to 1 by steps of -1 and $m = 0$ to $N - 1$ by steps of 2^n .

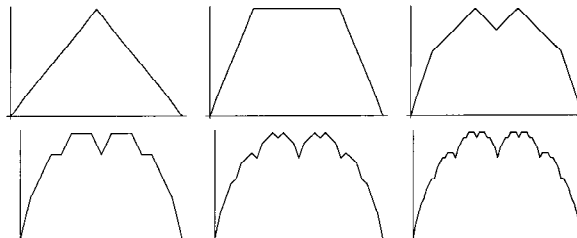

Peitgen and Saupe (1988) refer to this curve as the TAKAGI FRACTAL CURVE.

see also HOFSTADTER-CONWAY \$10,000 SEQUENCE, WEIERSTRAß FUNCTION

References

- Dixon, R. *Mathographics*. New York: Dover, pp. 175-176 and 210, 1991.
- Peitgen, H.-O. and Saupe, D. (Eds.). "Midpoint Displacement and Systematic Fractals: The Takagi Fractal Curve, Its Kin, and the Related Systems." §A.1.2 in *The Science of Fractal Images*. New York: Springer-Verlag, pp. 246-248, 1988.
- Takagi, T. "A Simple Example of the Continuous Function without Derivative." *Proc. Phys. Math. Japan* 1, 176-177, 1903.
- Tall, D. O. "The Blancmange Function, Continuous Everywhere but Differentiable Nowhere." *Math. Gaz.* 66, 11-22, 1982.
- Tall, D. "The Gradient of a Graph." *Math. Teaching* 111, 48-52, 1985.

Blaschke Conjecture

The only WIEDERSEHEN MANIFOLDS are the standard round spheres. The conjecture has been proven by combining the BERGER-KAZDAN COMPARISON THEOREM with A. Weinstein's results for n EVEN and C. T. Yang's for n ODD.

References

Chavel, I. *Riemannian Geometry: A Modern Introduction*. New York: Cambridge University Press, 1994.

Blaschke's Theorem

A convex planar domain in which the minimal length is > 1 always contains a CIRCLE of RADIUS $1/3$.

References

Le Lionnais, F. *Les nombres remarquables*. Paris: Hermann, p. 25, 1983.

Blecksmith-Brillhart-Gerst Theorem

A generalization of SCHRÖTER'S FORMULA.

References

Berndt, B. C. *Ramanujan's Notebooks, Part III*. New York: Springer-Verlag, p. 73, 1985.

Blichfeldt's Lemma

see BLICHFELDT'S THEOREM

Blichfeldt's Theorem

Published in 1914 by Hans Blichfeldt. It states that any bounded planar region with POSITIVE AREA $> A$ placed in any position of the UNIT SQUARE LATTICE can be TRANSLATED so that the number of LATTICE POINTS inside the region will be at least $A + 1$. The theorem can be generalized to n -D.

BLM/Ho Polynomial

A 1-variable unoriented KNOT POLYNOMIAL $Q(x)$. It satisfies

$$Q_{\text{unknot}} = 1 \quad (1)$$

and the SKEIN RELATIONSHIP

$$Q_{L_+} + Q_{L_-} = x(Q_{L_0} + Q_{L_\infty}). \quad (2)$$

It also satisfies

$$Q_{L_1 \# L_2} = Q_{L_1} Q_{L_2}, \quad (3)$$

where $\#$ is the KNOT SUM and

$$Q_{L^*} = Q_L, \quad (4)$$

where L^* is the MIRROR IMAGE of L . The BLM/Ho polynomials of MUTANT KNOTS are also identical. Brandt *et al.* (1986) give a number of interesting properties. For any LINK L with ≥ 2 components, $Q_L - 1$ is divisible by $2(x - 1)$. If L has c components, then the lowest POWER of x in $Q_L(x)$ is $1 - c$, and

$$\lim_{x \rightarrow 0} x^{c-1} Q_L(x) = \lim_{(\ell, m) \rightarrow (1, 0)} (-m)^{c-1} P_L(\ell, m), \quad (5)$$

where P_L is the HOMFLY POLYNOMIAL. Also, the degree of Q_L is less than the CROSSING NUMBER of L . If L is a 2-BRIDGE KNOT, then

$$Q_L(z) = 2z^{-1} V_L(t) V_L(t^{-1} + 1 - 2z^{-1}), \quad (6)$$

where $z \equiv -t - t^{-1}$ (Kanenobu and Sumi 1993).

The POLYNOMIAL was subsequently extended to the 2-variable KAUFFMAN POLYNOMIAL $F(a, z)$, which satisfies

$$Q(x) = F(1, x). \quad (7)$$

Brandt *et al.* (1986) give a listing of Q POLYNOMIALS for KNOTS up to 8 crossings and links up to 6 crossings.

References

- Brandt, R. D.; Lickorish, W. B. R.; and Millett, K. C. "A Polynomial Invariant for Unoriented Knots and Links." *Invent. Math.* **84**, 563–573, 1986.
- Ho, C. F. "A New Polynomial for Knots and Links—Preliminary Report." *Abstracts Amer. Math. Soc.* **6**, 300, 1985.
- Kanenobu, T. and Sumi, T. "Polynomial Invariants of 2-Bridge Knots through 22-Crossings." *Math. Comput.* **60**, 771–778 and S17–S28, 1993.
- Stoimenow, A. "Brandt-Lickorish-Millett-Ho Polynomials." <http://www.informatik.hu-berlin.de/~stoimeno/ptab/blmh10.html>.
- ✱ Weisstein, E. W. "Knots." <http://www.astro.virginia.edu/~eww6n/math/notebooks/Knots.m>.

Bloch Constant

N.B. A detailed on-line essay by S. Finch was the starting point for this entry.

Let F be the set of COMPLEX analytic functions f defined on an open region containing the closure of the unit disk $D = \{z : |z| < 1\}$ satisfying $f(0) = 0$ and $df/dz(0) = 1$. For each f in F , let $b(f)$ be the SUPREMUM of all numbers r such that there is a disk S in D on which f is ONE-TO-ONE and such that $f(S)$ contains a disk of radius r . In 1925, Bloch (Conway 1978) showed that $b(f) \geq 1/72$. Define Bloch's constant by

$$B \equiv \inf\{b(f) : f \in F\}.$$

Ahlfors and Grunsky (1937) derived

$$0.433012701 \dots = \frac{1}{4}\sqrt{3} \leq B \\ < \frac{1}{\sqrt{1+\sqrt{3}}} \frac{\Gamma(\frac{1}{3})\Gamma(\frac{11}{12})}{\Gamma(\frac{1}{4})} < 0.4718617.$$

They also conjectured that the upper limit is actually the value of B ,

$$B = \frac{1}{\sqrt{1+\sqrt{3}}} \frac{\Gamma(\frac{1}{3})\Gamma(\frac{11}{12})}{\Gamma(\frac{1}{4})} \\ = \sqrt{\pi} 2^{1/4} \frac{\Gamma(\frac{1}{3})}{\Gamma(\frac{1}{4})} \sqrt{\frac{\Gamma(\frac{11}{12})}{\Gamma(\frac{1}{12})}} \\ = 0.4718617 \dots$$

(Le Lionnais 1983).

see also LANDAU CONSTANT

References

- Conway, J. B. *Functions of One Complex Variable*, 2nd ed. New York: Springer-Verlag, 1989.
- Finch, S. "Favorite Mathematical Constants." <http://www.mathsoft.com/asolve/constant/bloch/bloch.html>.
- Le Lionnais, F. *Les nombres remarquables*. Paris: Hermann, p. 25, 1983.
- Minda, C. D. "Bloch Constants." *J. d'Analyse Math.* **41**, 54–84, 1982.

Bloch-Landau Constant

see LANDAU CONSTANT

Block

see also BLOCK DESIGN, SQUARE POLYOMINO

Block Design

An incidence system (v, k, λ, r, b) in which a set X of v points is partitioned into a family A of b subsets (blocks) in such a way that any two points determine λ blocks, there are k points in each block, and each point is contained in r different blocks. It is also generally required that $k < v$, which is where the "incomplete" comes from in the formal term most often encountered

for block designs, BALANCED INCOMPLETE BLOCK DESIGNS (BIBD). The five parameters are not independent, but satisfy the two relations

$$vr = bk \quad (1)$$

$$\lambda(v-1) = r(k-1). \quad (2)$$

A BIBD is therefore commonly written as simply (v, k, λ) , since b and r are given in terms of v, k , and λ by

$$b = \frac{v(v-1)\lambda}{k(k-1)} \quad (3)$$

$$r = \frac{\lambda(v-1)}{k-1}. \quad (4)$$

A BIBD is called SYMMETRIC if $b = v$ (or, equivalently, $r = k$).

Writing $X = \{x_i\}_{i=1}^v$ and $A = \{A_j\}_{j=1}^b$, then the INCIDENCE MATRIX of the BIBD is given by the $v \times b$ MATRIX M defined by

$$m_{ij} = \begin{cases} 1 & \text{if } x_i \in A_j \\ 0 & \text{otherwise.} \end{cases} \quad (5)$$

This matrix satisfies the equation

$$MM^T = (r - \lambda)I + \lambda J, \quad (6)$$

where I is a $v \times v$ IDENTITY MATRIX and J is a $v \times v$ matrix of 1s (Dinitz and Stinson 1992).

Examples of BIBDs are given in the following table.

Block Design	(v, k, λ)
affine plane	$(n^2, n, 1)$
Fano plane	$(7, 3, 1)$
Hadamard design	symmetric $(4n+3, 2n+1, n)$
projective plane	symmetric $(n^2+n+1, n+1, 1)$
Steiner triple system	$(v, 3, 1)$
unital	$(q^3+1, q+1, 1)$

see also AFFINE PLANE, DESIGN, FANO PLANE, HADAMARD DESIGN, PARALLEL CLASS, PROJECTIVE PLANE, RESOLUTION, RESOLVABLE, STEINER TRIPLE SYSTEM, SYMMETRIC BLOCK DESIGN, UNITAL

References

- Dinitz, J. H. and Stinson, D. R. "A Brief Introduction to Design Theory." Ch. 1 in *Contemporary Design Theory: A Collection of Surveys* (Ed. J. H. Dinitz and D. R. Stinson). New York: Wiley, pp. 1-12, 1992.
- Ryser, H. J. "The (b, v, r, k, λ) -Configuration." §8.1 in *Combinatorial Mathematics*. Buffalo, NY: Math. Assoc. Amer., pp. 96-102, 1963.

Block Growth

Let $(x_0x_1x_2\ldots)$ be a sequence over a finite ALPHABET A (all the entries are elements of A). Define the block growth function $B(n)$ of a sequence to be the number of ADMISSIBLE words of length n . For example, in the sequence $aabaabaabaabaab\ldots$, the following words are ADMISSIBLE

Length	Admissible Words
1	a, b
2	aa, ab, ba
3	aab, aba, baa
4	$aaba, abaa, baab$

so $B(1) = 2$, $B(2) = 3$, $B(3) = 3$, $B(4) = 3$, and so on. Notice that $B(n) \leq B(n+1)$, so the block growth function is always nondecreasing. This is because any ADMISSIBLE word of length n can be extended rightwards to produce an ADMISSIBLE word of length $n+1$. Moreover, suppose $B(n) = B(n+1)$ for some n . Then each admissible word of length n extends to a *unique* ADMISSIBLE word of length $n+1$.

For a SEQUENCE in which each substring of length n uniquely determines the next symbol in the SEQUENCE, there are only finitely many strings of length n , so the process must eventually cycle and the SEQUENCE must be eventually periodic. This gives us the following theorems:

1. If the SEQUENCE is eventually periodic, with least period p , then $B(n)$ is strictly increasing until it reaches p , and $B(n)$ is constant thereafter.
2. If the SEQUENCE is not eventually periodic, then $B(n)$ is strictly increasing and so $B(n) \geq n+1$ for all n . If a SEQUENCE has the property that $B(n) = n+1$ for all n , then it is said to have minimal block growth, and the SEQUENCE is called a STURMIAN SEQUENCE.

The block growth is also called the GROWTH FUNCTION or the COMPLEXITY of a SEQUENCE.

Block Matrix

A square DIAGONAL MATRIX in which the diagonal elements are SQUARE MATRICES of any size (possibly even 1×1), and the off-diagonal elements are 0.

Block (Set)

One of the disjoint SUBSETS making up a SET PARTITION. A block containing n elements is called an n -block. The partitioning of sets into blocks can be denoted using a RESTRICTED GROWTH STRING.

see also BLOCK DESIGN, RESTRICTED GROWTH STRING, SET PARTITION

Blow-Up

A common mechanism which generates SINGULARITIES from smooth initial conditions.

Blue-Empty Coloring

see BLUE-EMPTY GRAPH

Blue-Empty Graph

AN EXTREMAL GRAPH in which the forced TRIANGLES are all the same color. Call R the number of red MONOCHROMATIC FORCED TRIANGLES and B the number of blue MONOCHROMATIC FORCED TRIANGLES, then a blue-empty graph is an EXTREMAL GRAPH with $B = 0$. For EVEN n , a blue-empty graph can be achieved by coloring red two COMPLETE SUBGRAPHS of $n/2$ points (the RED NET method). There is no blue-empty coloring for ODD n except for $n = 7$ (Lorden 1962).

see also COMPLETE GRAPH, EXTREMAL GRAPH, MONOCHROMATIC FORCED TRIANGLE, RED NET

References

- Lorden, G. "Blue-Empty Chromatic Graphs." *Amer. Math. Monthly* **69**, 114–120, 1962.
 Sauvé, L. "On Chromatic Graphs." *Amer. Math. Monthly* **68**, 107–111, 1961.

Board

A subset of $\mathbf{d} \times \mathbf{d}$, where $\mathbf{d} = \{1, 2, \dots, d\}$.

see also ROOK NUMBER

Boatman's Knot

see CLOVE HITCH

Bochner Identity

For a smooth HARMONIC MAP $u : M \rightarrow N$,

$$\Delta(|\nabla u|^2) = |\nabla(du)|^2 + \langle \text{Ric}_M \nabla u, \nabla u \rangle - \langle \text{Ric}_N(u)(\nabla u, \nabla u) \nabla u, \nabla u \rangle,$$

where ∇ is the GRADIENT, Ric is the RICCI TENSOR, and Riem is the RIEMANN TENSOR.

References

- Eels, J. and Lemaire, L. "A Report on Harmonic Maps." *Bull. London Math. Soc.* **10**, 1–68, 1978.

Bochner's Theorem

Among the continuous functions on \mathbb{R}^n , the POSITIVE DEFINITE FUNCTIONS are those functions which are the FOURIER TRANSFORMS of finite measures.

Bode's Rule

$$\int_{x_1}^{x_5} f(x) dx = \frac{2}{45} h(7f_1 + 32f_2 + 12f_3 + 32f_4 + 7f_5) - \frac{8}{945} h^7 f^{(6)}(\xi).$$

see also HARDY'S RULE, NEWTON-COTES FORMULAS, SIMPSON'S 3/8 RULE, SIMPSON'S RULE, TRAPEZOIDAL RULE, WEDDLE'S RULE

References

- Abramowitz, M. and Stegun, C. A. (Eds.). *Handbook of Mathematical Functions with Formulas, Graphs, and Mathematical Tables*, 9th printing. New York: Dover, p. 886, 1972.

Bogdanov Map

A 2-D MAP which is conjugate to the HÉNON MAP in its nondissipative limit. It is given by

$$\begin{aligned} x' &= x + y' \\ y' &= y + \epsilon y + kx(x - 1) + \mu xy. \end{aligned}$$

see also HÉNON MAP

References

- Arrowsmith, D. K.; Cartwright, J. H. E.; Lansbury, A. N.; and Place, C. M. "The Bogdanov Map: Bifurcations, Mode Locking, and Chaos in a Dissipative System." *Int. J. Bifurcation Chaos* **3**, 803–842, 1993.
 Bogdanov, R. "Bifurcations of a Limit Cycle for a Family of Vector Fields on the Plane." *Selecta Math. Soviet* **1**, 373–388, 1981.

Bogomolov-Miyaoka-Yau Inequality

Relates invariants of a curve defined over the INTEGERS. If this inequality were proven true, then FERMAT'S LAST THEOREM would follow for sufficiently large exponents. Miyaoka claimed to have proven this inequality in 1988, but the proof contained an error.

see also FERMAT'S LAST THEOREM

References

- Cox, D. A. "Introduction to Fermat's Last Theorem." *Amer. Math. Monthly* **101**, 3–14, 1994.

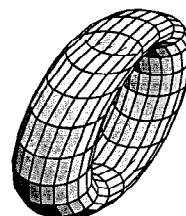
Bohemian Dome

A QUARTIC SURFACE which can be constructed as follows. Given a CIRCLE C and PLANE E PERPENDICULAR to the PLANE of C , move a second CIRCLE K of the same RADIUS as C through space so that its CENTER always lies on C and it remains PARALLEL to E . Then K sweeps out the Bohemian dome. It can be given by the parametric equations

$$\begin{aligned} x &= a \cos u \\ y &= b \cos v + a \sin u \\ z &= c \sin v \end{aligned}$$

where $u, v \in [0, 2\pi)$. In the above plot, $a = 0.5$, $b = 1.5$, and $c = 1$.

see also QUARTIC SURFACE

References

- Fischer, G. (Ed.). *Mathematical Models from the Collections of Universities and Museums*. Braunschweig, Germany: Vieweg, pp. 19–20, 1986.
- Fischer, G. (Ed.). Plate 50 in *Mathematische Modelle/Mathematical Models, Bildband/Photograph Volume*. Braunschweig, Germany: Vieweg, p. 50, 1986.
- Nordstrand, T. "Bohemian Dome." <http://www.uib.no/people/nfytn/bodtxt.htm>.

Bohr-Favard Inequalities

If f has no spectrum in $[-\lambda, \lambda]$, then

$$\|f\|_{\infty} \leq \frac{\pi}{2\lambda} \|f'\|_{\infty}$$

(Bohr 1935). A related inequality states that if A_k is the class of functions such that

$$f(x) = f(x + 2\pi), f(x), f'(x), \dots, f^{(k-1)}(x)$$

are absolutely continuous and $\int_0^{2\pi} f(x) dx = 0$, then

$$\|f\|_{\infty} \leq \frac{4}{\pi} \sum_{\nu=0}^{\infty} \frac{(-1)^{\nu(k+1)}}{(2\nu+1)^{k+1}} \|f^{(k)}(x)\|_{\infty}$$

(Northcott 1939). Further, for each value of k , there is always a function $f(x)$ belonging to A_k and not identically zero, for which the above inequality becomes an inequality (Favard 1936). These inequalities are discussed in Mitrinovic *et al.* (1991).

References

- Bohr, H. "Ein allgemeiner Satz über die Integration eines trigonometrischen Polynoms." *Prace Matem.-Fiz.* **43**, 1935.
- Favard, J. "Application de la formule sommatoire d'Euler à la démonstration de quelques propriétés extrémales des intégrales des fonctions périodiques ou presquepériodiques." *Mat. Tidsskr. B*, 81–94, 1936. [Reviewed in *Zentralblatt f. Math.* **16**, 58–59, 1939.]
- Mitrinovic, D. S.; Pecaric, J. E.; and Fink, A. M. *Inequalities Involving Functions and Their Integrals and Derivatives*. Dordrecht, Netherlands: Kluwer, pp. 71–72, 1991.
- Northcott, D. G. "Some Inequalities Between Periodic Functions and Their Derivatives." *J. London Math. Soc.* **14**, 198–202, 1939.
- Tikhomirov, V. M. "Approximation Theory." In *Analysis II* (Ed. R. V. Gamrelidze). New York: Springer-Verlag, pp. 93–255, 1990.

Bolyai-Gerwein Theorem

see WALLACE-BOLYAI-GERWEIN THEOREM

Bolza Problem

Given the functional

$$U = \int_{t_0}^{t_1} f(y_1, \dots, y_n; y_1', \dots, y_n') dt + G(y_{10}, \dots, y_{nr}; y_{11}, \dots, y_{n1}),$$

find in a class of arcs satisfying p differential and q finite equations

$$\begin{aligned} \phi_{\alpha}(y_1, \dots, y_n; y_1', \dots, y_n') &= 0 & \text{for } \alpha = 1, \dots, p \\ \psi_{\beta}(y_1, \dots, y_n) &= 0 & \text{for } \beta = 1, \dots, q \end{aligned}$$

as well as the r equations on the endpoints

$$\chi_{\gamma}(y_{10}, \dots, y_{nr}; y_{11}, \dots, y_{n1}) = 0 \quad \text{for } \gamma = 1, \dots, r,$$

one which renders U a minimum.

References

- Goldstine, H. H. *A History of the Calculus of Variations from the 17th through the 19th Century*. New York: Springer-Verlag, p. 374, 1980.

Bolzano Theorem

see BOLZANO-WEIERSTRAß THEOREM

Bolzano-Weierstraß Theorem

Every BOUNDED infinite set in \mathbb{R}^n has an ACCUMULATION POINT. For $n = 1$, the theorem can be stated as follows: If a SET in a METRIC SPACE, finite-dimensional EUCLIDEAN SPACE, or FIRST-COUNTABLE SPACE has infinitely many members within a finite interval $x \in [a, b]$, then it has at least one LIMIT POINT x such that $x \in [a, b]$. The theorem can be used to prove the INTERMEDIATE VALUE THEOREM.

Bombieri's Inequality

For HOMOGENEOUS POLYNOMIALS P and Q of degree m and n , then

$$[P \cdot Q]_2 \geq \sqrt{\frac{m!n!}{(m+n)!}} [P]_2 [Q]_2,$$

where $[P \cdot Q]_2$ is the BOMBIERI NORM. If $m = n$, this becomes

$$[P \cdot Q]_2 \geq [P]_2 [Q]_2.$$

see also BEAUZAMY AND DÉGOT'S IDENTITY, REZNIK'S IDENTITY

Bombieri Inner Product

For HOMOGENEOUS POLYNOMIALS P and Q of degree n ,

$$[P, Q] \equiv \sum_{i_1, \dots, i_n \geq 0} (i_1! \cdots i_n!) (a_{i_1, \dots, i_n} b_{i_1, \dots, i_n}).$$

Bombieri Norm

For HOMOGENEOUS POLYNOMIALS P of degree m ,

$$[P]_2 \equiv \sqrt{[P, P]} = \left(\sum_{|\alpha|=m} \frac{\alpha!}{m!} |a_{\alpha}|^2 \right)^{1/2}.$$

see also POLYNOMIAL BAR NORM

Bombieri's Theorem

Define

$$E(x; q, a) \equiv \psi(x; q, a) - \frac{x}{\phi(q)}, \quad (1)$$

where

$$\psi(x; q, a) = \sum_{\substack{n \leq x \\ n \equiv a \pmod{q}}} \Lambda(n) \quad (2)$$

(Davenport 1980, p. 121), $\Lambda(n)$ is the MANGOLDT FUNCTION, and $\phi(q)$ is the TOTIENT FUNCTION. Now define

$$E(x; q) = \max_{(a, q)=1} |E(x; q, a)| \quad (3)$$

where the sum is over a RELATIVELY PRIME to q , $(a, q) = 1$, and

$$E^*(x, q) = \max_{y \leq x} E(y, q). \quad (4)$$

Bombieri's theorem then says that for $A > 0$ fixed,

$$\sum_{q \leq Q} E^*(x, q) \ll \sqrt{x} Q (\ln x)^5, \quad (5)$$

provided that $\sqrt{x} (\ln x)^{-4} \leq Q \leq \sqrt{x}$.

References

- Bombieri, E. "On the Large Sieve." *Mathematika* **12**, 201–225, 1965.
 Davenport, H. "Bombieri's Theorem." Ch. 28 in *Multiplicative Number Theory*, 2nd ed. New York: Springer-Verlag, pp. 161–168, 1980.

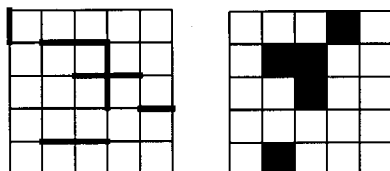
Bond Percolation

bond percolation

site percolation

A PERCOLATION which considers the lattice edges as the relevant entities (left figure).

see also PERCOLATION THEORY, SITE PERCOLATION

Bonferroni Correction

The Bonferroni correction is a multiple-comparison correction used when several independent STATISTICAL TESTS are being performed simultaneously (since while a given ALPHA VALUE α may be appropriate for each individual comparison, it is not for the set of *all* comparisons). In order to avoid a lot of spurious positives, the ALPHA VALUE needs to be lowered to account for the number of comparisons being performed.

The simplest and most conservative approach is the Bonferroni correction, which sets the ALPHA VALUE for the entire *set* of n comparisons equal to α by taking the

ALPHA VALUE for *each* comparison equal to α/n . Explicitly, given n tests T_i for hypotheses H_i ($1 \leq i \leq n$) under the assumption H_0 that all hypotheses H_i are false, and if the individual test critical values are $\leq \alpha/n$, then the experiment-wide critical value is $\leq \alpha$. In equation form, if

$$P(T_i \text{ passes} | H_0) \leq \frac{\alpha}{n}$$

for $1 \leq i \leq n$, then

$$P(\text{some } T_i \text{ passes} | H_0) \leq \alpha,$$

which follows from BONFERRONI'S INEQUALITY.

Another correction instead uses $1 - (1 - \alpha)^{1/n}$. While this choice is applicable for two-sided hypotheses, multivariate normal statistics, and positive orthant dependent statistics, it is not, in general, correct (Shaffer 1995).

see also ALPHA VALUE, HYPOTHESIS TESTING, STATISTICAL TEST

References

- Bonferroni, C. E. "Il calcolo delle assicurazioni su gruppi di teste." In *Studi in Onore del Professore Salvatore Ortu Carboni*. Rome: Italy, pp. 13–60, 1935.
 Bonferroni, C. E. "Teoria statistica delle classi e calcolo delle probabilità." *Pubblicazioni del R Istituto Superiore di Scienze Economiche e Commerciali di Firenze* **8**, 3–62, 1936.
 Dewey, M. "Carlo Emilio Bonferroni: Life and Works." <http://www.nottingham.ac.uk/~mhzmd/life.html>.
 Miller, R. G. Jr. *Simultaneous Statistical Inference*. New York: Springer-Verlag, 1991.
 Perneger, T. V. "What's Wrong with Bonferroni Adjustments." *Brit. Med. J.* **316**, 1236–1238, 1998.
 Shaffer, J. P. "Multiple Hypothesis Testing." *Ann. Rev. Psych.* **46**, 561–584, 1995.

Bonferroni's Inequality

Let $P(E_i)$ be the probability that E_i is true, and $P(\bigcup_{i=1}^n E_i)$ be the probability that E_1, E_2, \dots, E_n are all true. Then

$$P\left(\bigcup_{i=1}^n E_i\right) \leq \sum_{i=1}^n P(E_i).$$

Bonferroni Test

see BONFERRONI CORRECTION

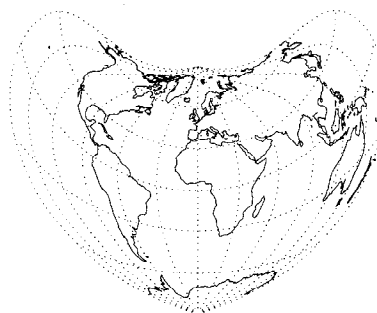
Bonne Projection

A MAP PROJECTION which resembles the shape of a heart. Let ϕ_1 be the standard parallel and λ_0 the central meridian. Then

$$x = \rho \sin E \quad (1)$$

$$y = R \cot \phi_1 - \rho \cos R, \quad (2)$$

where

$$\rho = \cot \phi_1 + \phi_1 - \phi \quad (3)$$

$$E = \frac{(\lambda - \lambda_0) \cos \phi}{\rho}. \quad (4)$$

The inverse FORMULAS are

$$\phi = \cot \phi_1 + \phi_1 - \rho \quad (5)$$

$$\lambda = \lambda_0 + \frac{\rho}{\cos \phi} \tan^{-1} \left(\frac{x}{\cot \phi_1 - y} \right), \quad (6)$$

where

$$\rho = \pm \sqrt{x^2 + (\cot \phi_1 - y)^2}. \quad (7)$$

References

Snyder, J. P. *Map Projections—A Working Manual*. U. S. Geological Survey Professional Paper 1395. Washington, DC: U. S. Government Printing Office, pp. 138–140, 1987.

Book Stacking Problem

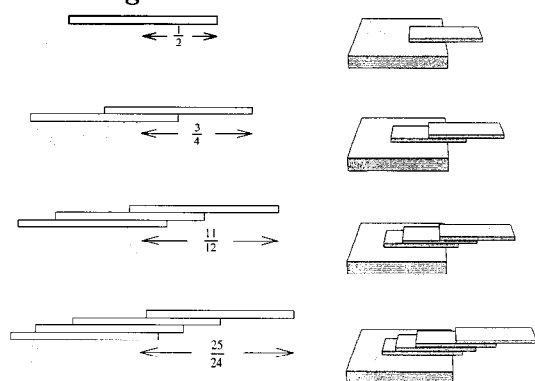

How far can a stack of n books protrude over the edge of a table without the stack falling over? It turns out that the maximum overhang possible d_n for n books (in terms of book lengths) is half the n th partial sum of the HARMONIC SERIES, given explicitly by

$$d_n = \frac{1}{2} \sum_{k=1}^n \frac{1}{k} = \frac{1}{2} [\gamma + \Psi(1+n)]$$

where $\Psi(z)$ is the DIGAMMA FUNCTION and γ is the EULER-MASCHERONI CONSTANT. The first few values are

$$d_1 = \frac{1}{2} = 0.5$$

$$d_2 = \frac{3}{4} = 0.75$$

$$d_3 = \frac{11}{12} \approx 0.91667$$

$$d_4 = \frac{25}{24} \approx 1.04167,$$

(Sloane's A001008 and A002805).

In order to find the number of stacked books required to obtain d book-lengths of overhang, solve the d_n equation for d , and take the CEILING FUNCTION. For $n = 1, 2, \dots$ book-lengths of overhang, 4, 31, 227, 1674, 12367, 91380, 675214, 4989191, 36865412, 272400600, ... (Sloane's A014537) books are needed.

References

Dickau, R. M. "The Book-Stacking Problem." <http://www.prairienet.org/~pops/BookStacking.html>.
 Eisner, L. "Leaning Tower of the Physical Review." *Amer. J. Phys.* **27**, 121, 1959.
 Gardner, M. *Martin Gardner's Sixth Book of Mathematical Games from Scientific American*. New York: Scribner's, p. 167, 1971.
 Graham, R. L.; Knuth, D. E.; and Patashnik, O. *Concrete Mathematics: A Foundation for Computer Science*. Reading, MA: Addison-Wesley, pp. 272–274, 1990.
 Johnson, P. B. "Leaning Tower of Lire." *Amer. J. Phys.* **23**, 240, 1955.
 Sharp, R. T. "Problem 52." *Pi Mu Epsilon J.* **1**, 322, 1953.
 Sharp, R. T. "Problem 52." *Pi Mu Epsilon J.* **2**, 411, 1954.
 Sloane, N. J. A. Sequences A014537, A001008/M2885, and A002805/M1589 in "An On-Line Version of the Encyclopedia of Integer Sequences."

Boole's Inequality

$$P \left(\bigcup_{i=1}^N E_i \right) \leq \sum_{i=1}^N P(E_i).$$

If E_i and E_j are MUTUALLY EXCLUSIVE for all i and j , then the INEQUALITY becomes an equality.

Boolean Algebra

A mathematical object which is similar to a BOOLEAN RING, but which uses the meet and join operators instead of the usual addition and multiplication operators. A Boolean algebra is a set B of elements a, b, \dots with BINARY OPERATORS $+$ and \cdot such that

- 1a. If a and b are in the set B , then $a + b$ is in the set B .
- 1b. If a and b are in the set B , then $a \cdot b$ is in the set B .
- 2a. There is an element Z (zero) such that $a + Z = a$ for every element a .
- 2b. There is an element U (unity) such that $a \cdot U = a$ for every element a .
- 3a. $a + b = b + a$
- 3b. $a \cdot b = b \cdot a$
- 4a. $a + b \cdot c = (a + b)(a + c)$
- 4b. $a \cdot (b + c) = a \cdot b + a \cdot c$
5. For every element a there is an element a' such that $a + a' = U$ and $a \cdot a' = Z$.
6. There are at least two distinct elements in the set B .

(Bell 1937, p. 444).

In more modern terms, a Boolean algebra is a SET B of elements a, b, \dots with the following properties:

1. B has two binary operations, \wedge (WEDGE) and \vee (VEE), which satisfy the IDEMPOTENT laws

$$a \wedge a = a \vee a = a,$$

the COMMUTATIVE laws

$$a \wedge b = b \wedge a$$

$$a \vee b = b \vee a,$$

and the ASSOCIATIVE laws

$$a \wedge (b \wedge c) = (a \wedge b) \wedge c$$

$$a \vee (b \vee c) = (a \vee b) \vee c.$$

2. The operations satisfy the ABSORPTION LAW

$$a \wedge (a \vee b) = a \vee (a \wedge b) = a.$$

3. The operations are mutually distributive

$$a \wedge (b \vee c) = (a \wedge b) \vee (a \wedge c)$$

$$a \vee (b \wedge c) = (a \vee b) \wedge (a \vee c).$$

4. B contains universal bounds O, I which satisfy

$$O \wedge a = O$$

$$O \vee a = a$$

$$I \wedge a = a$$

$$I \vee a = I.$$

5. B has a unary operation $a \rightarrow a'$ of complementation which obeys the laws

$$a \wedge a' = O$$

$$a \vee a' = I$$

(Birkhoff and Mac Lane 1965). Under intersection, union, and complement, the subsets of any set I form a Boolean algebra.

Huntington (1933a, b) presented the following basis for Boolean algebra,

1. Commutivity. $x + y = y + x$.
2. Associativity. $(x + y) + z = x + (y + z)$.
3. HUNTINGTON EQUATION. $n(n(x) + y) + n(n(x) + n(y)) = x$.

H. Robbins then conjectured that the HUNTINGTON EQUATION could be replaced with the simpler ROBBINS EQUATION,

$$n(n(x + y) + n(x + n(y))) = x.$$

The ALGEBRA defined by commutivity, associativity, and the ROBBINS EQUATION is called ROBBINS ALGEBRA. Computer theorem proving demonstrated that every ROBBINS ALGEBRA satisfies the second WINKLER CONDITION, from which it follows immediately that all ROBBINS ALGEBRAS are Boolean.

References

- Bell, E. T. *Men of Mathematics*. New York: Simon and Schuster, 1986.
- Birkhoff, G. and Mac Lane, S. *A Survey of Modern Algebra*, 3rd ed. New York: Macmillan, p. 317, 1965.
- Halmos, P. *Lectures on Boolean Algebras*. Princeton, NJ: Van Nostrand, 1963.
- Huntington, E. V. "New Sets of Independent Postulates for the Algebra of Logic." *Trans. Amer. Math. Soc.* **35**, 274–304, 1933a.
- Huntington, E. V. "Boolean Algebras: A Correction." *Trans. Amer. Math. Soc.* **35**, 557–558, 1933.
- McCune, W. "Robbins Algebras are Boolean." <http://www.mcs.anl.gov/~mccune/papers/robbins/>.

Boolean Connective

One of the LOGIC operators AND \wedge , OR \vee , and NOT \neg .
see also QUANTIFIER

Boolean Function

A Boolean function in n variables is a function

$$f(x_1, \dots, x_n),$$

where each x_i can be 0 or 1 and f is 0 or 1. Determining the number of monotone Boolean functions of n variables is known as DEDEKIND'S PROBLEM. The number of monotonic increasing Boolean functions of n variables is given by 2, 3, 6, 20, 168, 7581, 7828354, ... (Sloane's A000372, Beeler *et al.* 1972, Item 17). The number of inequivalent monotone Boolean functions of n variables is given by 2, 3, 5, 10, 30, ... (Sloane's A003182).

Let $M(n, k)$ denote the number of distinct monotone Boolean functions of n variables with k mincuts. Then

$$M(n, 0) = 1$$

$$M(n, 1) = 2^n$$

$$M(n, 2) = 2^{n-1}(2^n - 1) - 3^n + 2^n$$

$$M(n, 3) = \frac{1}{6}(2^n)(2^n - 1)(2^n - 2) - 6^n + 5^n + 4^n - 3^n.$$

References

- Beeler, M.; Gosper, R. W.; and Schroepel, R. *HAKMEM*. Cambridge, MA: MIT Artificial Intelligence Laboratory, Memo AIM-239, Feb. 1972.
- Sloane, N. J. A. Sequences A003182/M0729 and A000372/M0817 in "An On-Line Version of the Encyclopedia of Integer Sequences."

Boolean Ring

A RING with a unit element in which every element is IDEMPOTENT.

see also BOOLEAN ALGEBRA

Borchardt-Pfaff Algorithm

see ARCHIMEDES ALGORITHM

Border Square

40	1	2	3	42	41	46
38	31	13	14	32	35	12
39	30	26	21	28	20	11
43	33	27	25	23	17	7
6	16	22	29	24	34	44
5	15	37	36	18	19	45
4	49	48	47	8	9	10

31	13	14	32	35
30	26	21	28	20
33	27	25	23	17
16	22	29	24	34
15	37	36	18	19

26	21	28
27	25	23
22	29	24

A MAGIC SQUARE that remains magic when its border is removed. A nested magic square remains magic after the border is successively removed one ring at a time. An example of a nested magic square is the order 7 square illustrated above (i.e., the order 7, 5, and 3 squares obtained from it are all magic).

see also MAGIC SQUARE

References

Kraitchik, M. "Border Squares." §7.7 in *Mathematical Recreations*. New York: W. W. Norton, pp. 167–170, 1942.

Bordism

A relation between COMPACT boundaryless MANIFOLDS (also called closed MANIFOLDS). Two closed MANIFOLDS are bordant IFF their disjoint union is the boundary of a compact $(n+1)$ -MANIFOLD. Roughly, two MANIFOLDS are bordant if together they form the boundary of a MANIFOLD. The word bordism is now used in place of the original term COBORDISM.

References

Budney, R. "The Bordism Project." <http://math.cornell.edu/~rybu/bordism/bordism.html>.

Bordism Group

There are bordism groups, also called COBORDISM GROUPS or COBORDISM RINGS, and there are singular bordism groups. The bordism groups give a framework for getting a grip on the question, "When is a compact boundaryless MANIFOLD the boundary of another MANIFOLD?" The answer is, precisely when all of its STIEFEL-WHITNEY CLASSES are zero. Singular bordism groups give insight into STEENROD'S REALIZATION PROBLEM: "When can homology classes be realized as the image of fundamental classes of manifolds?" That answer is known, too.

The machinery of the bordism group winds up being important for HOMOTOPY THEORY as well.

References

Budney, R. "The Bordism Project." <http://math.cornell.edu/~rybu/bordism/bordism.html>.

Borel-Cantelli Lemma

Let $\{A_n\}_{n=0}^{\infty}$ be a SEQUENCE of events occurring with a certain probability distribution, and let A be the event consisting of the occurrence of a finite number of events A_n , $n = 1, \dots$. Then if

$$\sum_{n=1}^{\infty} P(A_n) < \infty,$$

then

$$P(A) = 1.$$

References

Hazewinkel, M. (Managing Ed.). *Encyclopaedia of Mathematics: An Updated and Annotated Translation of the Soviet "Mathematical Encyclopaedia."* Dordrecht, Netherlands: Reidel, pp. 435–436, 1988.

Borel Determinacy Theorem

Let T be a tree defined on a metric over a set of paths such that the distance between paths p and q is $1/n$, where n is the number of nodes shared by p and q . Let A be a Borel set of paths in the topology induced by this metric. Suppose two players play a game by choosing a path down the tree, so that they alternate and each time choose an immediate successor of the previously chosen point. The first player wins if the chosen path is in A . Then one of the players has a winning STRATEGY in this GAME.

see also GAME THEORY, STRATEGY

Borel's Expansion

Let $\phi(t) = \sum_{n=0}^{\infty} A_n t^n$ be any function for which the integral

$$I(x) \equiv \int_0^{\infty} e^{-tx} t^p \phi(t) dt$$

converges. Then the expansion

$$I(x) = \frac{\Gamma(p+1)}{x^{p+1}} \left[A_0 + (p+1) \frac{A_1}{x} + (p+1)(p+2) \frac{A_2}{x^2} + \dots \right],$$

where $\Gamma(z)$ is the GAMMA FUNCTION, is usually an ASYMPTOTIC SERIES for $I(x)$.

Borel Measure

If F is the BOREL SIGMA ALGEBRA on some TOPOLOGICAL SPACE, then a MEASURE $m : F \rightarrow \mathbb{R}$ is said to be a Borel measure (or BOREL PROBABILITY MEASURE). For a Borel measure, all continuous functions are MEASURABLE.

Borel Probability Measure

see BOREL MEASURE

Borel Set

A DEFINABLE SET derived from the REAL LINE by removing a FINITE number of intervals. Borel sets are measurable and constitute a special type of SIGMA ALGEBRA called a BOREL SIGMA ALGEBRA.

see also STANDARD SPACE

Borel Sigma Algebra

A SIGMA ALGEBRA which is related to the TOPOLOGY of a SET. The Borel *sigma*-algebra is defined to be the SIGMA ALGEBRA generated by the OPEN SETS (or equivalently, by the CLOSED SETS).

see also BOREL MEASURE

Borel Space

A SET equipped with a SIGMA ALGEBRA of SUBSETS.

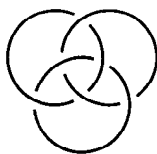
Borromean Rings

Three mutually interlocked rings named after the Italian Renaissance family who used them on their coat of arms. No two rings are linked, so if one of the rings is cut, all three rings fall apart. They are given the LINK symbol 06^2_{03} , and are also called the BALLANTINE. The Borromean rings have BRAID WORD $\sigma_1^{-1}\sigma_2\sigma_1^{-1}\sigma_2\sigma_1^{-1}\sigma_2$ and are also the simplest BRUNNIAN LINK.

References

- Cundy, H. and Rollett, A. *Mathematical Models*, 3rd ed. Stradbroke, England: Tarquin Pub., pp. 58–59, 1989.
 Gardner, M. *The Unexpected Hanging and Other Mathematical Diversions*. Chicago, IL: University of Chicago Press, 1991.
 Jablan, S. "Borromean Triangles." <http://members.tripod.com/~modularity/links.htm>.
 Pappas, T. "Trinity of Rings—A Topological Model." *The Joy of Mathematics*. San Carlos, CA: Wide World Publ./Tetra, p. 31, 1989.

Borrow

$$\begin{array}{r}
 1\ 2\ 3\ 4 \\
 -\ 7\ 8\ 9 \\
 \hline
 4\ 4\ 5
 \end{array}
 \quad
 \begin{array}{r}
 1\ 2\ 3\ 4 \\
 -\ 7\ 8\ 9 \\
 \hline
 4\ 4\ 5
 \end{array}$$

borrows

The procedure used in SUBTRACTION to "borrow" 10 from the next higher DIGIT column in order to obtain a POSITIVE DIFFERENCE in the column in question.

see also CARRY

Borsuk's Conjecture

Borsuk conjectured that it is possible to cut an n -D shape of DIAMETER 1 into $n + 1$ pieces each with diameter smaller than the original. It is true for $n = 2, 3$ and when the boundary is "smooth." However, the minimum number of pieces required has been shown to increase as $\sim 1.1\sqrt{n}$. Since $1.1\sqrt{n} > n + 1$ at $n = 9162$, the conjecture becomes false at high dimensions. In fact, the limit has been pushed back to ~ 2000 .

see also DIAMETER (GENERAL), KELLER'S CONJECTURE, LEBESGUE MINIMAL PROBLEM

References

- Borsuk, K. "Über die Zerlegung einer Euklidischen n -dimensionalen Vollkugel in n Mengen." *Verh. Internat. Math.-Kongr. Zürich* **2**, 192, 1932.
 Borsuk, K. "Drei Sätze über die n -dimensionale euklidische Sphäre." *Fund. Math.* **20**, 177–190, 1933.
 Cipra, B. "If You Can't See It, Don't Believe It..." *Science* **259**, 26–27, 1993.
 Cipra, B. *What's Happening in the Mathematical Sciences, Vol. 1*. Providence, RI: Amer. Math. Soc., pp. 21–25, 1993.
 Grünbaum, B. "Borsuk's Problem and Related Questions." In *Convexity, Proceedings of the Seventh Symposium in Pure Mathematics of the American Mathematical Society, Held at the University of Washington, Seattle, June 13–15, 1961*. Providence, RI: Amer. Math. Soc., pp. 271–284, 1963.
 Kalai, J. K. G. "A Counterexample to Borsuk's Conjecture." *Bull. Amer. Math. Soc.* **329**, 60–62, 1993. Listerik, L. and Schnirelmann, L. *Topological Methods in Variational Problems*. Moscow, 1930.

Borwein Conjectures

Use the definition of the q -SERIES

$$(a; q)_n \equiv \prod_{j=0}^{n-1} (1 - aq^j) \quad (1)$$

and define

$$\left[\begin{matrix} N \\ M \end{matrix} \right] \equiv \frac{(q^{N-M+1}; q)_M}{(q; q)_m}. \quad (2)$$

Then P. Borwein has conjectured that (1) the POLYNOMIALS $A_n(q)$, $B_n(q)$, and $C_n(q)$ defined by

$$(q; q^3)_n (q^2; q^3)_n = A_n(q^3) - qB_n(q^3) - q^2C_n(q^3) \quad (3)$$

have NONNEGATIVE COEFFICIENTS, (2) the POLYNOMIALS $A_n^*(q)$, $B_n^*(q)$, and $C_n^*(q)$ defined by

$$(q; q^3)_n^2 (q^2; q^3)_n^2 = A_n^*(q^3) - qB_n^*(q^3) - q^2C_n^*(q^3) \quad (4)$$

have NONNEGATIVE COEFFICIENTS, (3) the POLYNOMIALS $A_n^*(q)$, $B_n^*(q)$, $C_n^*(q)$, $D_n^*(q)$, and $E_n^*(q)$ defined by

$$(q; q^5)_n (q^2; q^5)_n (q^3; q^5)_n (q^4; q^5)_n = A_n^*(q^5) - qB_n^*(q^5) - q^2C_n^*(q^5) - q^3D_n^*(q^5) - q^4E_n^*(q^5) \quad (5)$$

have NONNEGATIVE COEFFICIENTS, (4) the POLYNOMIALS $A_n^\dagger(m, n, t, q)$, $B_n^\dagger(m, n, t, q)$, and $C_n^\dagger(m, n, t, q)$ defined by

$$(q; q^3)_m (q^2; q^3)_m (zq; q^3)_n (zq^2; q^3)_n \\ = \sum_{t=0}^{2m} z^t [A^\dagger(m, n, t, q^3) - qB^\dagger(m, n, t, q^3) \\ - q^2C^\dagger(m, n, t, q^3)] \quad (6)$$

have NONNEGATIVE COEFFICIENTS, (5) for k ODD and $1 \leq a \leq k/2$, consider the expansion

$$(q^a; q^k)_m (q^{k-a}; q^k)_n \\ = \sum_{\nu=(1-k)/2}^{(k-1)/2} (-1)^\nu q^{k(\nu^2+\nu)/2 - a\nu} F_\nu(q^k) \quad (7)$$

with

$$F_\nu(q) \\ = \sum_{j=-\infty}^{\infty} (-1)^j q^{j(k^2j+2k\nu+k-2a)/2} \begin{bmatrix} m+n \\ m+\nu+kj \end{bmatrix}, \quad (8)$$

then if a is RELATIVELY PRIME to k and $m = n$, the COEFFICIENTS of $F_\nu(q)$ are NONNEGATIVE, and (6) given $\alpha + \beta < 2K$ and $-K + \beta \leq n - m \leq K - \alpha$, consider

$$G(\alpha, \beta, K; q) = \sum_q (-1)^j q^{j[K(\alpha+\beta)j+K(\alpha+\beta)]/2} \\ \times \begin{bmatrix} m+n \\ m+Kj \end{bmatrix}, \quad (9)$$

the GENERATING FUNCTION for partitions inside an $m \times n$ rectangle with hook difference conditions specified by α , β , and K . Let α and β be POSITIVE RATIONAL NUMBERS and $K > 1$ an INTEGER such that αK and βK are integers. Then if $1 \leq \alpha + \beta \leq 2K - 1$ (with strict inequalities for $K = 2$) and $-K + \beta \leq n - m \leq K - \alpha$, then $G(\alpha, \beta, K; q)$ has NONNEGATIVE COEFFICIENTS.

see also q -SERIES

References

- Andrews, G. E. et al. "Partitions with Prescribed Hook Differences." *Europ. J. Combin.* 8, 341-350, 1987.
Bressoud, D. M. "The Borwein Conjecture and Partitions with Prescribed Hook Differences." *Electronic J. Combinatorics* 3, No. 2, R4, 1-14, 1996. http://www.combinatorics.org/Volume_3/volume3_2.html#R4.

Bouligand Dimension

see MINKOWSKI-BOULIGAND DIMENSION

Bound

see GREATEST LOWER BOUND, INFIMUM, LEAST UPPER BOUND, SUPREMUM

Bound Variable

An occurrence of a variable in a LOGIC which is not FREE.

Boundary

The set of points, known as BOUNDARY POINTS, which are members of the CLOSURE of a given set S and the CLOSURE of its complement set. The boundary is sometimes called the FRONTIER.

see also SURGERY

Boundary Conditions

There are several types of boundary conditions commonly encountered in the solution of PARTIAL DIFFERENTIAL EQUATIONS.

1. DIRICHLET BOUNDARY CONDITIONS specify the value of the function on a surface $T = f(\mathbf{r}, t)$.
2. NEUMANN BOUNDARY CONDITIONS specify the normal derivative of the function on a surface,

$$\frac{\partial T}{\partial n} = \hat{\mathbf{n}} \cdot \nabla T = f(\mathbf{r}, y).$$

3. CAUCHY BOUNDARY CONDITIONS specify a weighted average of first and second kinds.
4. ROBIN BOUNDARY CONDITIONS. For an elliptic partial differential equation in a region Ω , Robin boundary conditions specify the sum of αu and the normal derivative of $u = f$ at all points of the boundary of Ω , with α and f being prescribed.

see also BOUNDARY VALUE PROBLEM, DIRICHLET BOUNDARY CONDITIONS, INITIAL VALUE PROBLEM, NEUMANN BOUNDARY CONDITIONS, PARTIAL DIFFERENTIAL EQUATION, ROBIN BOUNDARY CONDITIONS

References

- Arfken, G. *Mathematical Methods for Physicists*, 3rd ed. Orlando, FL: Academic Press, pp. 502-504, 1985.
Morse, P. M. and Feshbach, H. "Boundary Conditions and Eigenfunctions." Ch. 6 in *Methods of Theoretical Physics, Part I*. New York: McGraw-Hill, pp. 495-498 and 676-790, 1953.

Boundary Map

The MAP $H_n(X, A) \rightarrow H_{n-1}(A)$ appearing in the LONG EXACT SEQUENCE OF A PAIR AXIOM.

see also LONG EXACT SEQUENCE OF A PAIR AXIOM

Boundary Point

A point which is a member of the CLOSURE of a given set S and the CLOSURE of its complement set. If A is a subset of \mathbb{R}^n , then a point $\mathbf{x} \in \mathbb{R}^n$ is a boundary point of A if every NEIGHBORHOOD of \mathbf{x} contains at least one point in A and at least one point not in A .

see also BOUNDARY

Boundary Set

A (symmetrical) boundary set of RADIUS r and center \mathbf{x}_0 is the set of all points \mathbf{x} such that

$$|\mathbf{x} - \mathbf{x}_0| = r.$$

Let \mathbf{x}_0 be the ORIGIN. In \mathbb{R}^1 , the boundary set is then the pair of points $x = r$ and $x = -r$. In \mathbb{R}^2 , the boundary set is a CIRCLE. In \mathbb{R}^3 , the boundary set is a SPHERE.

see also CIRCLE, DISK, OPEN SET, SPHERE

Boundary Value Problem

A boundary value problem is a problem, typically an ORDINARY DIFFERENTIAL EQUATION or a PARTIAL DIFFERENTIAL EQUATION, which has values assigned on the physical boundary of the DOMAIN in which the problem is specified. For example,

$$\begin{cases} \frac{\partial^2 u}{\partial t^2} - \nabla^2 u = f & \text{in } \Omega \\ u(0, t) = u_1 & \text{on } \partial\Omega \\ \frac{\partial u}{\partial t}(0, t) = u_2 & \text{on } \partial\Omega, \end{cases}$$

where $\partial\Omega$ denotes the boundary of Ω , is a boundary problem.

see also BOUNDARY CONDITIONS, INITIAL VALUE PROBLEM

References

- Eriksson, K.; Estep, D.; Hansbo, P.; and Johnson, C. *Computational Differential Equations*. Lund: Studentlitteratur, 1996.
- Press, W. H.; Flannery, B. P.; Teukolsky, S. A.; and Vetterling, W. T. "Two Point Boundary Value Problems." Ch. 17 in *Numerical Recipes in FORTRAN: The Art of Scientific Computing*, 2nd ed. Cambridge, England: Cambridge University Press, pp. 745–778, 1992.

Bounded

A SET in a METRIC SPACE (X, d) is bounded if it has a FINITE diameter, i.e., there is an $R < \infty$ such that $d(x, y) \leq R$ for all $x, y \in X$. A SET in \mathbb{R}^n is bounded if it is contained inside some BALL $x_1^2 + \dots + x_n^2 \leq R^2$ of FINITE RADIUS R (Adams 1994).

see also BOUND, FINITE

References

- Adams, R. A. *Calculus: A Complete Course*. Reading, MA: Addison-Wesley, p. 707, 1994.

Bounded Variation

A FUNCTION $f(x)$ is said to have bounded variation if, over the CLOSED INTERVAL $x \in [a, b]$, there exists an M such that

$$|f(x_i) - f(a)| + |f(x_2) - f(x_1)| + \dots + |f(b) - f(x_{n-1})| \leq M$$

for all $a < x_1 < x_2 < \dots < x_{n-1} < b$.

Bourget Function

$$\begin{aligned} J_{n,k}(z) &= \frac{1}{\pi i} \int t^{-n-1} \left(t + \frac{1}{t}\right)^k \exp\left[\frac{1}{2}z\left(t - \frac{1}{t}\right)\right] dt \\ &= \frac{1}{\pi} \int_0^\pi (2 \cos \theta)^k \cos(n\theta - z \sin \theta) d\theta. \end{aligned}$$

see also BESSEL FUNCTION OF THE FIRST KIND

References

- Hazewinkel, M. (Managing Ed.). *Encyclopaedia of Mathematics: An Updated and Annotated Translation of the Soviet "Mathematical Encyclopaedia"*. Dordrecht, Netherlands: Reidel, p. 465, 1988.

Bourget's Hypothesis

When n is an INTEGER ≥ 0 , then $J_n(z)$ and $J_{n+m}(z)$ have no common zeros other than at $z = 0$ for m an INTEGER ≥ 1 , where $J_n(z)$ is a BESSEL FUNCTION OF THE FIRST KIND. The theorem has been proved true for $m=1, 2, 3$, and 4.

References

- Watson, G. N. *A Treatise on the Theory of Bessel Functions*, 2nd ed. Cambridge, England: Cambridge University Press, 1966.

Boustrophedon Transform

The boustrophedon ("ox-plowing") transform \mathbf{b} of a sequence \mathbf{a} is given by

$$b_n = \sum_{k=0}^n \binom{n}{k} a_k E_{n-k} \quad (1)$$

$$a_n = \sum_{k=0}^n (-1)^{n-k} \binom{n}{k} b_k E_{n-k} \quad (2)$$

for $n \geq 0$, where E_n is a SECANT NUMBER or TANGENT NUMBER defined by

$$\sum_{n=0}^{\infty} E_n \frac{x^n}{n!} = \sec x + \tan x. \quad (3)$$

The exponential generating functions of \mathbf{a} and \mathbf{b} are related by

$$\mathcal{B}(x) = (\sec x + \tan x) \mathcal{A}(x), \quad (4)$$

where the exponential generating function is defined by

$$\mathcal{A}(x) = \sum_{n=0}^{\infty} A_n \frac{x^n}{n!}. \quad (5)$$

see also ALTERNATING PERMUTATION, ENTRINGER NUMBER, SECANT NUMBER, SEIDEL-ENTRINGER-ARNOLD TRIANGLE, TANGENT NUMBER

References

- Millar, J.; Sloane, N. J. A.; and Young, N. E. "A New Operation on Sequences: The Boustrophedon Transform." *J. Combin. Th. Ser. A* **76**, 44–54, 1996.

Bovinum Problema

see ARCHIMEDES' CATTLE PROBLEM

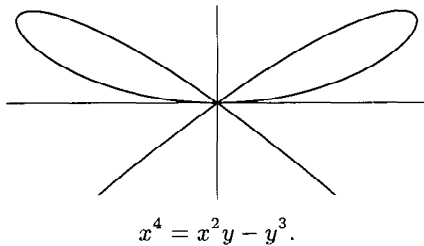
Bow**References**

Cundy, H. and Rollett, A. *Mathematical Models*, 3rd ed. Stradbroke, England: Tarquin Pub., p. 72, 1989.

Bowditch Curve

see LISSAJOUS CURVE

Bowley Index

The statistical INDEX

$$P_B \equiv \frac{1}{2}(P_L + P_P),$$

where P_L is LASPEYRES' INDEX and P_P is PAASCHÉ'S INDEX.

see also INDEX

References

Kenney, J. F. and Keeping, E. S. *Mathematics of Statistics*, Pt. 1, 3rd ed. Princeton, NJ: Van Nostrand, p. 66, 1962.

Bowley Skewness

Also known as QUARTILE SKEWNESS COEFFICIENT,

$$\frac{(Q_3 - Q_2) - (Q_2 - Q_1)}{Q_3 - Q_1} = \frac{Q_1 - 2Q_2 + Q_3}{Q_3 - Q_1},$$

where the Q s denote the INTERQUARTILE RANGES.

see also SKEWNESS

Bowling

Bowling is a game played by rolling a heavy ball down a long narrow track and attempting to knock down ten pins arranged in the form of a TRIANGLE with its vertex oriented towards the bowler. The number 10 is, in fact, the TRIANGULAR NUMBER $T_4 = 4(4+1)/2 = 10$.

Two "bowls" are allowed per "frame." If all the pins are knocked down in the two bowls, the score for that frame is the number of pins knocked down. If some or none of the pins are knocked down on the first bowl, then all the pins knocked down on the second, it is called a "spare," and the number of points tallied is 10 plus the number of pins knocked down on the bowl of the next frame. If all of the pins are knocked down on the first bowl, the number of points tallied is 10 plus the number of

pins knocked down on the next two bowls. Ten frames are bowled, unless the last frame is a strike or spare, in which case an additional bowl is awarded.

The maximum number of points possible, corresponding to knocking down all 10 pins on every bowl, is 300.

References

Cooper, C. N. and Kennedy, R. E. "A Generating Function for the Distribution of the Scores of All Possible Bowling Games." In *The Lighter Side of Mathematics* (Ed. R. K. Guy and R. E. Woodrow). Washington, DC: Math. Assoc. Amer., 1994.

Cooper, C. N. and Kennedy, R. E. "Is the Mean Bowling Score Awful?" In *The Lighter Side of Mathematics* (Ed. R. K. Guy and R. E. Woodrow). Washington, DC: Math. Assoc. Amer., 1994.

Box

see CUBOID

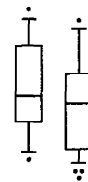
Box-and-Whisker Plot

A HISTOGRAM-like method of displaying data invented by J. Tukey (1977). Draw a box with ends at the QUARTILES Q_1 and Q_3 . Draw the MEDIAN as a horizontal line in the box. Extend the "whiskers" to the farthest points. For every point that is more than $3/2$ times the INTERQUARTILE RANGE from the end of a box, draw a dot on the corresponding top or bottom of the whisker. If two dots have the same value, draw them side by side.

References

Tukey, J. W. *Explanatory Data Analysis*. Reading, MA: Addison-Wesley, pp. 39-41, 1977.

Box Counting Dimension

see CAPACITY DIMENSION

Box Fractal

A FRACTAL which can be constructed using STRING REWRITING by creating a matrix with 3 times as many entries as the current matrix using the rules

```
line 1: "*" -> "*" *, " " -> " "
line 2: "*" -> " * ", " " -> " "
line 3: "*" -> "*" *, " " -> " "
```

Let N_n be the number of black boxes, L_n the length of a side of a white box, and A_n the fractional AREA of black boxes after the n th iteration.

$$N_n = 5^n \quad (1)$$

$$L_n = \left(\frac{1}{3}\right)^n = 3^{-n} \quad (2)$$

$$A_n = L_n^2 N_n = \left(\frac{5}{9}\right)^n. \quad (3)$$

The CAPACITY DIMENSION is therefore

$$\begin{aligned} d_{\text{cap}} &= - \lim_{n \rightarrow \infty} \frac{\ln N_n}{\ln L_n} = - \lim_{n \rightarrow \infty} \frac{\ln(5^n)}{\ln(3^{-n})} \\ &= \frac{\ln 5}{\ln 3} = 1.464973521 \dots \end{aligned} \quad (4)$$

see also CANTOR DUST, SIERPIŃSKI CARPET, SIERPIŃSKI SIEVE

References

★ Weisstein, E. W. "Fractals." <http://www.astro.virginia.edu/~eww6n/math/notebooks/Fractal.m>.

Box-Muller Transformation

A transformation which transforms from a 2-D continuous UNIFORM DISTRIBUTION to a 2-D GAUSSIAN BIVARIATE DISTRIBUTION (or COMPLEX GAUSSIAN DISTRIBUTION). If x_1 and x_2 are uniformly and independently distributed between 0 and 1, then z_1 and z_2 as defined below have a GAUSSIAN DISTRIBUTION with MEAN $\mu = 0$ and VARIANCE $\sigma^2 = 1$.

$$z_1 = \sqrt{-2 \ln x_1} \cos(2\pi x_2) \quad (1)$$

$$z_2 = \sqrt{-2 \ln x_1} \sin(2\pi x_2). \quad (2)$$

This can be verified by solving for x_1 and x_2 ,

$$x_1 = e^{-(z_1^2 + z_2^2)/2} \quad (3)$$

$$x_2 = \frac{1}{2\pi} \tan^{-1} \left(\frac{z_2}{z_1} \right). \quad (4)$$

Taking the JACOBIAN yields

$$\begin{aligned} \frac{\partial(x_1, x_2)}{\partial(z_1, z_2)} &= \begin{vmatrix} \frac{\partial x_1}{\partial z_1} & \frac{\partial x_1}{\partial z_2} \\ \frac{\partial x_2}{\partial z_1} & \frac{\partial x_2}{\partial z_2} \end{vmatrix} \\ &= - \left[\frac{1}{\sqrt{2\pi}} e^{-z_1^2/2} \right] \left[\frac{1}{\sqrt{2\pi}} e^{-z_2^2/2} \right]. \end{aligned} \quad (5)$$

Box-Packing Theorem

The number of "prime" boxes is always finite, where a set of boxes is prime if it cannot be built up from one or more given configurations of boxes.

see also CONWAY PUZZLE, CUBOID, DE BRUIJN'S THEOREM, KLARNER'S THEOREM, SLOTHOUBER-GRAATSMA PUZZLE

References

Honsberger, R. *Mathematical Gems II*. Washington, DC: Math. Assoc. Amer., p. 74, 1976.

Boxcar Function

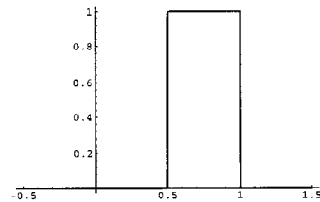

$$y = c[H(x-a) - H(x-b)],$$

where H is the HEAVISIDE STEP FUNCTION.

References

von Seggern, D. *CRC Standard Curves and Surfaces*. Boca Raton, FL: CRC Press, p. 324, 1993.

Boxcars

A roll of two 6s (the highest roll possible) on a pair of 6-sided DICE. The probability of rolling boxcars is $1/36$, or 2.777...%.

see also DICE, DOUBLE SIXES, SNAKE EYES

Boy Surface

A NONORIENTABLE SURFACE which is one of the three possible SURFACES obtained by sewing a MÖBIUS STRIP to the edge of a DISK. The other two are the CROSS-CAP and ROMAN SURFACE. The Boy surface is a model of the PROJECTIVE PLANE without singularities and is a SEXTIC SURFACE.

The Boy surface can be described using the general method for NONORIENTABLE SURFACES, but this was not known until the analytic equations were found by Apéry (1986). Based on the fact that it had been proven impossible to describe the surface using quadratic polynomials, Hopf had conjectured that quartic polynomials were also insufficient (Pinkall 1986). Apéry's IMMERSION proved this conjecture wrong, giving the equations explicitly in terms of the standard form for a NONORIENTABLE SURFACE,

$$\begin{aligned} f_1(x, y, z) &= \frac{1}{2}[(2x^2 - y^2 - z^2)(x^2 + y^2 + z^2) \\ &\quad + 2yz(y^2 - z^2) + zx(x^2 - z^2) \\ &\quad + xy(y^2 - x^2)] \end{aligned} \quad (1)$$

$$\begin{aligned} f_2(x, y, z) &= \frac{1}{2}\sqrt{3}[(y^2 - z^2)(x^2 + y^2 + z^2) \\ &\quad + zx(z^2 - x^2) + xy(y^2 - x^2)] \end{aligned} \quad (2)$$

$$\begin{aligned} f_3(x, y, z) &= \frac{1}{8}(x + y + z)[(x + y + z)^3 \\ &\quad + 4(y - x)(z - y)(x - z)]. \end{aligned} \quad (3)$$



Plugging in

$$x = \cos u \sin v \quad (4)$$

$$y = \sin u \sin v \quad (5)$$

$$z = \cos v \quad (6)$$

and letting $u \in [0, \pi]$ and $v \in [0, \pi]$ then gives the Boy surface, three views of which are shown above.

The \mathbb{R}^3 parameterization can also be written as

$$x = \frac{\sqrt{2} \cos^2 v \cos(2u) + \cos u \sin(2v)}{2 - \sqrt{2} \sin(3u) \sin(2v)} \quad (7)$$

$$y = \frac{\sqrt{2} \cos^2 v \sin(2u) + \cos u \sin(2v)}{2 - \sqrt{2} \sin(3u) \sin(2v)} \quad (8)$$

$$z = \frac{3 \cos^2 v}{2 - \sqrt{2} \sin(3u) \sin(2v)} \quad (9)$$

(Nordstrand) for $u \in [-\pi/2, \pi/2]$ and $v \in [0, \pi]$.

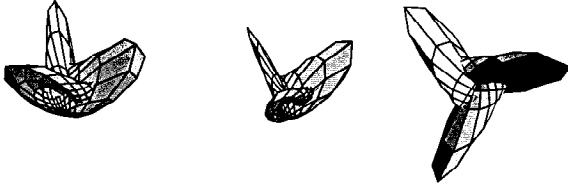

Three views of the surface obtained using this parameterization are shown above.

In fact, a HOMOTOPY (smooth deformation) between the ROMAN SURFACE and Boy surface is given by the equations

$$x(u, v) = \frac{\sqrt{2} \cos(2u) \cos^2 v + \cos u \sin(2v)}{2 - \alpha \sqrt{2} \sin(3u) \sin(2v)} \quad (10)$$

$$y(u, v) = \frac{\sqrt{2} \sin(2u) \cos^2 v - \sin u \sin(2v)}{2 - \alpha \sqrt{2} \sin(3u) \sin(2v)} \quad (11)$$

$$z(u, v) = \frac{3 \cos^2 v}{2 - \alpha \sqrt{2} \sin(3u) \sin(2v)} \quad (12)$$

as α varies from 0 to 1, where $\alpha = 0$ corresponds to the ROMAN SURFACE and $\alpha = 1$ to the Boy surface (Wang), shown below.

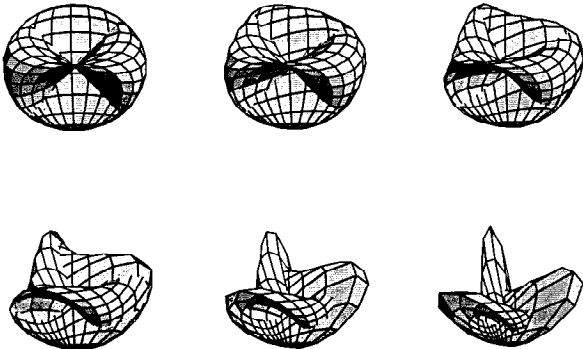

In \mathbb{R}^4 , the parametric representation is

$$x_0 = 3[(u^2 + v^2 + w^2)(u^2 + v^2) - \sqrt{2}vw(3u^2 - v^2)] \quad (13)$$

$$x_1 = \sqrt{2}(u^2 + v^2)(u^2 - v^2 + \sqrt{2}uw) \quad (14)$$

$$x_2 = \sqrt{2}(u^2 + v^2)(2uv - \sqrt{2}vw) \quad (15)$$

$$x_3 = 3(u^2 + v^2)^2, \quad (16)$$

and the algebraic equation is

$$\begin{aligned} 64(x_0 - x_3)^3 x_3^3 - 48(x_0 - x_3)^2 x_3^2 (3x_1^2 + 3x_2^2 + 2x_3^2) \\ + 12(x_0 - x_3)x_3 [27(x_1^2 + x_2^2)^2 - 24x_3^2(x_1^2 + x_2^2) \\ + 36\sqrt{2}x_2x_3(x_2^2 - 3x_1^2) + x_3^4] \\ + (9x_1^2 + 9x_2^2 - 2x_3^2) \\ \times [-81(x_1^2 + x_2^2)^2 - 72x_3^2(x_1^2 + x_2^2) \\ + 108\sqrt{2}x_1x_3(x_1^2 - 3x_2^2) + 4x_3^4] = 0 \end{aligned} \quad (17)$$

(Apéry 1986). Letting

$$x_0 = 1 \quad (18)$$

$$x_1 = x \quad (19)$$

$$x_2 = y \quad (20)$$

$$x_3 = z \quad (21)$$

gives another version of the surface in \mathbb{R}^3 .

see also CROSS-CAP, IMMERSION, MÖBIUS STRIP, NONORIENTABLE SURFACE, REAL PROJECTIVE PLANE, ROMAN SURFACE, SEXTIC SURFACE

References

- Apéry, F. "The Boy Surface." *Adv. Math.* **61**, 185–266, 1986.
 Boy, W. "Über die Curvatura integra und die Topologie geschlossener Flächen." *Math. Ann* **57**, 151–184, 1903.
 Brehm, U. "How to Build Minimal Polyhedral Models of the Boy Surface." *Math. Intell.* **12**, 51–56, 1990.
 Carter, J. S. "On Generalizing Boy Surface—Constructing a Generator of the 3rd Stable Stem." *Trans. Amer. Math. Soc.* **298**, 103–122, 1986.
 Fischer, G. (Ed.). Plates 115–120 in *Mathematische Modelle/Mathematical Models, Bildband/Photograph Volume*. Braunschweig, Germany: Vieweg, pp. 110–115, 1986.
 Geometry Center. "Boy's Surface." <http://www.geom.umn.edu/zoo/toptype/ppplane/boy/>.
 Hilbert, D. and Cohn-Vossen, S. §46–47 in *Geometry and the Imagination*. New York: Chelsea, 1952.
 Nordstrand, T. "Boy's Surface." <http://www.uib.no/people/nfytn/boytxt.htm>.
 Petit, J.-P. and Souriau, J. "Une représentation analytique de la surface de Boy." *C. R. Acad. Sci. Paris Sér. 1 Math* **293**, 269–272, 1981.
 Pinkall, U. *Mathematical Models from the Collections of Universities and Museums* (Ed. G. Fischer). Braunschweig, Germany: Vieweg, pp. 64–65, 1986.
 Stewart, I. *Game, Set and Math*. New York: Viking Penguin, 1991.
 Wang, P. "Renderings." <http://www.ugcs.caltech.edu/~peterw/portfolio/renderings/>.

Bra

A (COVARIANT) 1-VECTOR denoted $\langle\psi|$. The bra is DUAL to the CONTRAVARIANT KET, denoted $|\psi\rangle$. Taken together, the bra and KET form an ANGLE BRACKET (bra+ket = bracket). The bra is commonly encountered in quantum mechanics.

see also ANGLE BRACKET, BRACKET PRODUCT, COVARIANT VECTOR, DIFFERENTIAL k -FORM, KET, ONE-FORM

Brachistochrone Problem

Find the shape of the CURVE down which a bead sliding from rest and ACCELERATED by gravity will slip (without friction) from one point to another in the least time. This was one of the earliest problems posed in the CALCULUS OF VARIATIONS. The solution, a segment of a CYCLOID, was found by Leibniz, L'Hospital, Newton, and the two Bernoullis.

The time to travel from a point P_1 to another point P_2 is given by the INTEGRAL

$$t_{12} = \int_1^2 \frac{ds}{v}. \quad (1)$$

The VELOCITY at any point is given by a simple application of energy conservation equating kinetic energy to gravitational potential energy,

$$\frac{1}{2}mv^2 = mgy, \quad (2)$$

so

$$v = \sqrt{2gy}. \quad (3)$$

Plugging this into (1) then gives

$$t_{12} = \int_1^2 \frac{\sqrt{1+y'^2}}{\sqrt{2gy}} dx = \int_1^2 \sqrt{\frac{1+y'^2}{2gy}} dx. \quad (4)$$

The function to be varied is thus

$$f = (1+y'^2)^{1/2}(2gy)^{-1/2}. \quad (5)$$

To proceed, one would normally have to apply the full-blown EULER-LAGRANGE DIFFERENTIAL EQUATION

$$\frac{\partial f}{\partial y} - \frac{d}{dx} \left(\frac{\partial f}{\partial y'} \right) = 0. \quad (6)$$

However, the function $f(y, y', x)$ is particularly nice since x does not appear explicitly. Therefore, $\partial f / \partial x = 0$, and we can immediately use the BELTRAMI IDENTITY

$$f - y' \frac{\partial f}{\partial y'} = C. \quad (7)$$

Computing

$$\frac{\partial f}{\partial y'} = y'(1+y'^2)^{-1/2}(2gy)^{-1/2}, \quad (8)$$

Brachistochrone Problem

subtracting $y'(\partial f / \partial y')$ from f , and simplifying then gives

$$\frac{1}{\sqrt{2gy}\sqrt{1+y'^2}} = C. \quad (9)$$

Squaring both sides and rearranging slightly results in

$$\left[1 + \left(\frac{dy}{dx} \right)^2 \right] y = \frac{1}{2gC^2} = k^2, \quad (10)$$

where the square of the old constant C has been expressed in terms of a new (POSITIVE) constant k^2 . This equation is solved by the parametric equations

$$x = \frac{1}{2}k^2(\theta - \sin \theta) \quad (11)$$

$$y = \frac{1}{2}k^2(1 - \cos \theta), \quad (12)$$

which are—lo and behold—the equations of a CYCLOID.

If kinetic friction is included, the problem can also be solved analytically, although the solution is significantly messier. In that case, terms corresponding to the normal component of weight and the normal component of the ACCELERATION (present because of path CURVATURE) must be included. Including both terms requires a constrained variational technique (Ashby *et al.* 1975), but including the normal component of weight only gives an elementary solution. The TANGENT and NORMAL VECTORS are

$$\mathbf{T} = \frac{dx}{ds}\hat{\mathbf{x}} + \frac{dy}{ds}\hat{\mathbf{y}} \quad (13)$$

$$\mathbf{N} = -\frac{dy}{ds}\hat{\mathbf{x}} + \frac{dx}{ds}\hat{\mathbf{y}}, \quad (14)$$

gravity and friction are then

$$\mathbf{F}_{\text{gravity}} = mg\hat{\mathbf{y}} \quad (15)$$

$$\mathbf{F}_{\text{friction}} = -\mu(\mathbf{F}_{\text{gravity}}\cdot\hat{\mathbf{N}})\mathbf{T} = -\mu mg \frac{dx}{ds}\mathbf{T}, \quad (16)$$

and the components along the curve are

$$\mathbf{F}_{\text{gravity}}\cdot\hat{\mathbf{T}} = mg \frac{dy}{ds} \quad (17)$$

$$\mathbf{F}_{\text{friction}}\cdot\hat{\mathbf{T}} = -\mu mg \frac{dx}{ds}, \quad (18)$$

so Newton's Second Law gives

$$m \frac{dv}{dt} = mg \frac{dy}{ds} - \mu mg \frac{dx}{ds}. \quad (19)$$

But

$$\frac{dv}{dt} = v \frac{dv}{ds} = \frac{1}{2} \frac{d}{ds}(v^2) \quad (20)$$

$$\frac{1}{2}v^2 = g(y - \mu x) \quad (21)$$

$$v = \sqrt{2g(y - \mu x)}, \quad (22)$$

so

$$t = \int \sqrt{\frac{1 + (y')^2}{2g(y - \mu x)}} dx. \quad (23)$$

Using the EULER-LAGRANGE DIFFERENTIAL EQUATION gives

$$[1 + y'^2](1 + \mu y') + 2(y - \mu x)y'' = 0. \quad (24)$$

This can be reduced to

$$\frac{1 + (y')^2}{(1 + \mu y')^2} = \frac{C}{y - \mu x}. \quad (25)$$

Now letting

$$y' = \cot(\tfrac{1}{2}\theta), \quad (26)$$

the solution is

$$x = \tfrac{1}{2}k^2[(\theta - \sin \theta) + \mu(1 - \cos \theta)] \quad (27)$$

$$y = \tfrac{1}{2}k^2[(1 - \cos \theta) + \mu(\theta + \sin \theta)]. \quad (28)$$

see also CYCLOID, TAUTOCHRONE PROBLEM

References

- Ashby, N.; Brittin, W. E.; Love, W. F.; and Wyss, W. "Brachistochrone with Coulomb Friction." *Amer. J. Phys.* **43**, 902–905, 1975.
- Haws, L. and Kiser, T. "Exploring the Brachistochrone Problem." *Amer. Math. Monthly* **102**, 328–336, 1995.
- Wagon, S. *Mathematica in Action*. New York: W. H. Freeman, pp. 60–66 and 385–389, 1991.

Bracket

see ANGLE BRACKET, BRA, BRACKET POLYNOMIAL, BRACKET PRODUCT, IVERSON BRACKET, KET, LAGRANGE BRACKET, POISSON BRACKET

Bracket Polynomial

A one-variable KNOT POLYNOMIAL related to the JONES POLYNOMIAL. The bracket polynomial, however, is *not* a topological invariant, since it is changed by type I REIDEMEISTER MOVES. However, the SPAN of the bracket polynomial is a knot invariant. The bracket polynomial is occasionally given the grandiose name REGULAR ISOTOPY INVARIANT. It is defined by

$$\langle L \rangle (A, B, d) \equiv \sum_{\sigma} \langle L | \sigma \rangle d^{||\sigma||}, \quad (1)$$

where A and B are the "splitting variables," σ runs through all "states" of L obtained by SPLITTING the LINK, $\langle L | \sigma \rangle$ is the product of "splitting labels" corresponding to σ , and

$$||\sigma|| \equiv N_L - 1, \quad (2)$$

where N_L is the number of loops in σ . Letting

$$B = A^{-1} \quad (3)$$

$$d = -A^2 - A^{-2} \quad (4)$$

gives a KNOT POLYNOMIAL which is invariant under REGULAR ISOTOPY, and normalizing gives the KAUFFMAN POLYNOMIAL X which is invariant under AMBIENT ISOTOPY. The bracket POLYNOMIAL of the UNKNOT is 1. The bracket POLYNOMIAL of the MIRROR IMAGE K^* is the same as for K but with A replaced by A^{-1} . In terms of the one-variable KAUFFMAN POLYNOMIAL X , the two-variable KAUFFMAN POLYNOMIAL F and the JONES POLYNOMIAL V ,

$$X(A) = (-A^3)^{-w(L)} \langle L \rangle, \quad (5)$$

$$\langle L \rangle (A) = F(-A^3, A + A^{-1}) \quad (6)$$

$$\langle L \rangle (A) = V(A^{-4}), \quad (7)$$

where $w(L)$ is the WRITHE of L .

see also SQUARE BRACKET POLYNOMIAL

References

- Adams, C. C. *The Knot Book: An Elementary Introduction to the Mathematical Theory of Knots*. New York: W. H. Freeman, pp. 148–155, 1994.
- Kauffman, L. "New Invariants in the Theory of Knots." *Amer. Math. Monthly* **95**, 195–242, 1988.
- Kauffman, L. *Knots and Physics*. Teaneck, NJ: World Scientific, pp. 26–29, 1991.
- ✱ Weisstein, E. W. "Knots and Links." <http://www.astro.virginia.edu/~eww6n/math/notebooks/Knots.m>.

Bracket Product

The INNER PRODUCT in an L_2 SPACE represented by an ANGLE BRACKET.

see also ANGLE BRACKET, BRA, KET, L_2 SPACE, ONE-FORM

Bracketing

Take x itself to be a bracketing, then recursively define a bracketing as a sequence $B = (B_1, \dots, B_k)$ where $k \geq 2$ and each B_i is a bracketing. A bracketing can be represented as a parenthesized string of x s, with parentheses removed from any single letter x for clarity of notation (Stanley 1997). Bracketings built up of binary operations only are called BINARY BRACKETINGS. For example, four letters have 11 possible bracketings:

$$\begin{array}{cccc} xxxx & (xx)xx & x(xx)x & xx(xx) \\ (xxx)x & x(xxx) & ((xx)x)x & (x(xx))x \\ (xx)(xx) & x((xx)x) & x(x(xx)), & \end{array}$$

the last five of which are binary.

The number of bracketings on n letters is given by the GENERATING FUNCTION

$$\tfrac{1}{4}(1 + x - \sqrt{1 - 6x + x^2}) = x + x^2 + 3x^3 + 11x^4 + 45x^5$$

(Schröder 1870, Stanley 1997) and the RECURRENCE RELATION

$$s_n = \frac{3(2n - 3)s_{n-1} - (n - 3)s_{n-2}}{n}$$

(Sloane), giving the sequence for s_n as 1, 1, 3, 11, 45, 197, 903, ... (Sloane's A001003). The numbers are also given by

$$s_n = \sum_{i_1 + \dots + i_k = n} s(i_1) \cdots s(i_k)$$

for $n \geq 2$ (Stanley 1997).

The first PLUTARCH NUMBER 103,049 is equal to s_{10} (Stanley 1997), suggesting that Plutarch's problem of ten compound propositions is equivalent to the number of bracketings. In addition, Plutarch's second number 310,954 is given by $(s_{10} + s_{11})/2 = 310,954$ (Habsieger *et al.* 1998).

see also BINARY BRACKETING, PLUTARCH NUMBERS

References

- Habsieger, L.; Kazarian, M.; and Lando, S. "On the Second Number of Plutarch." *Amer. Math. Monthly* **105**, 446, 1998.
 Schröder, E. "Vier combinatorische Probleme." *Z. Math. Physik* **15**, 361–376, 1870.
 Sloane, N. J. A. Sequence A001003/M2898 in "An On-Line Version of the Encyclopedia of Integer Sequences."
 Stanley, R. P. "Hipparchus, Plutarch, Schröder, and Hough." *Amer. Math. Monthly* **104**, 344–350, 1997.

Bradley's Theorem

Let

$$S(\alpha, \beta, m; z) \equiv m \sum_{j=0}^{\infty} \frac{\Gamma(m+j(z+1))\Gamma(\beta+1+jz)}{\Gamma(m+jz+1)\Gamma(\alpha+\beta+1+j(z+1))} \frac{(\alpha+j)}{j!}$$

and α be a NEGATIVE INTEGER. Then

$$S(\alpha, \beta, m; z) = \frac{\Gamma(\beta+1-m)}{\Gamma(\alpha+\beta+1-m)},$$

where $\Gamma(z)$ is the GAMMA FUNCTION.

References

- Berndt, B. C. *Ramanujan's Notebooks, Part IV*. New York: Springer-Verlag, pp. 346–348, 1994.
 Bradley, D. "On a Claim by Ramanujan about Certain Hypergeometric Series." *Proc. Amer. Math. Soc.* **121**, 1145–1149, 1994.

Brahmagupta's Formula

For a QUADRILATERAL with sides of length a , b , c , and d , the AREA K is given by

$$K = \sqrt{(s-a)(s-b)(s-c)(s-d) - abcd \cos^2[\frac{1}{2}(A+B)]}, \quad (1)$$

where

$$s \equiv \frac{1}{2}(a+b+c+d) \quad (2)$$

is the SEMIPERIMETER, A is the ANGLE between a and d , and B is the ANGLE between b and c . For a CYCLIC

QUADRILATERAL (i.e., a QUADRILATERAL inscribed in a CIRCLE), $A+B=\pi$, so

$$K = \sqrt{(s-a)(s-b)(s-c)(s-d)} \quad (3)$$

$$= \frac{\sqrt{(bc+ad)(ac+bd)(ab+cd)}}{4R}, \quad (4)$$

where R is the RADIUS of the CIRCUMCIRCLE. If the QUADRILATERAL is INSCRIBED in one CIRCLE and CIRCUMSCRIBED on another, then the AREA FORMULA simplifies to

$$K = \sqrt{abcd}. \quad (5)$$

see also BRETSCHNEIDER'S FORMULA, HERON'S FORMULA

References

- Coxeter, H. S. M. and Greitzer, S. L. *Geometry Revisited*. Washington, DC: Math. Assoc. Amer., pp. 56–60, 1967.
 Johnson, R. A. *Modern Geometry: An Elementary Treatise on the Geometry of the Triangle and the Circle*. Boston, MA: Houghton Mifflin, pp. 81–82, 1929.

Brahmagupta Identity

Let

$$\beta \equiv |B| = x^2 - ty^2,$$

where B is the BRAHMAGUPTA MATRIX, then

$$\det[B(x_1, y_1)B(x_2, y_2)] = \det[B(x_1, y_1)] \det[B(x_2, y_2)] = \beta_1 \beta_2.$$

References

- Suryanarayan, E. R. "The Brahmagupta Polynomials." *Fib. Quart.* **34**, 30–39, 1996.

Brahmagupta Matrix

$$B(x, y) = \begin{bmatrix} x & y \\ \pm ty & \pm x \end{bmatrix}.$$

It satisfies

$$B(x_1, y_1)B(x_2, y_2) = B(x_1x_2 \pm ty_1y_2, x_1y_2 \pm y_1x_2).$$

Powers of the matrix are defined by

$$B^n = \begin{bmatrix} x & y \\ ty & x \end{bmatrix}^n = \begin{bmatrix} x_n & y_n \\ ty_n & x_n \end{bmatrix} \equiv B_n.$$

The x_n and y_n are called BRAHMAGUPTA POLYNOMIALS. The Brahmagupta matrices can be extended to NEGATIVE INTEGERS

$$B^{-n} = \begin{bmatrix} x & y \\ ty & x \end{bmatrix}^{-n} = \begin{bmatrix} x_{-n} & y_{-n} \\ ty_{-n} & x_{-n} \end{bmatrix} \equiv B_{-n}.$$

see also BRAHMAGUPTA IDENTITY

References

- Suryanarayan, E. R. "The Brahmagupta Polynomials." *Fib. Quart.* **34**, 30–39, 1996.

Brahmagupta Polynomial

One of the POLYNOMIALS obtained by taking POWERS of the BRAHMAGUPTA MATRIX. They satisfy the recurrence relation

$$x_{n+1} = xx_n + ty_n \quad (1)$$

$$y_{n+1} = xy_n + yx_n. \quad (2)$$

A list of many others is given by Suryanarayan (1996). Explicitly,

$$x_n = x^n + t \binom{n}{2} x^{n-2} y^2 + t^2 \binom{n}{4} x^{n-4} y^4 + \dots \quad (3)$$

$$y_n = nx^{n-1}y + t \binom{n}{3} x^{n-3} y^3 + t^2 \binom{n}{5} x^{n-5} y^5 + \dots \quad (4)$$

The Brahmagupta POLYNOMIALS satisfy

$$\frac{\partial x_n}{\partial x} = \frac{\partial y_n}{\partial y} = nx_{n-1} \quad (5)$$

$$\frac{\partial x_n}{\partial y} = t \frac{\partial y_n}{\partial y} = nty_{n-1}. \quad (6)$$

The first few POLYNOMIALS are

$$\begin{aligned} x_0 &= 0 \\ x_1 &= x \\ x_2 &= x^2 + ty^2 \\ x_3 &= x^3 + 3txy^2 \\ x_4 &= x^4 + 6tx^2y^2 + t^2y^4 \end{aligned}$$

and

$$\begin{aligned} y_0 &= 0 \\ y_1 &= y \\ y_2 &= 2xy \\ y_3 &= 3x^2y + ty^3 \\ y_4 &= 4x^3y + 4txy^3. \end{aligned}$$

Taking $x = y = 1$ and $t = 2$ gives y_n equal to the PELL NUMBERS and x_n equal to half the Pell-Lucas numbers. The Brahmagupta POLYNOMIALS are related to the MORGAN-VOYCE POLYNOMIALS, but the relationship given by Suryanarayan (1996) is incorrect.

References

Suryanarayan, E. R. "The Brahmagupta Polynomials." *Fib. Quart.* **34**, 30–39, 1996.

Brahmagupta's Problem

Solve the PELL EQUATION

$$x^2 - 92y^2 = 1$$

in INTEGERS. The smallest solution is $x = 1151$, $y = 120$.

see also DIOPHANTINE EQUATION, PELL EQUATION

Braid

An intertwining of strings attached to top and bottom "bars" such that each string never "turns back up." In other words, the path of a braid in something that a falling object could trace out if acted upon only by gravity and horizontal forces.

see also BRAID GROUP

References

Christy, J. "Braids." <http://www.mathsource.com/cgi-bin/MathSource/Applications/Mathematics/0202-228>.

Braid Group

Also called ARTIN BRAID GROUPS. Consider n strings, each oriented vertically from a lower to an upper "bar." If this is the least number of strings needed to make a closed braid representation of a LINK, n is called the BRAID INDEX. Now enumerate the possible braids in a group, denoted B_n . A general n -braid is constructed by iteratively applying the σ_i ($i = 1, \dots, n-1$) operator, which switches the lower endpoints of the i th and $(i+1)$ th strings—keeping the upper endpoints fixed—with the $(i+1)$ th string brought *above* the i th string. If the $(i+1)$ th string passes *below* the i th string, it is denoted σ_i^{-1} .

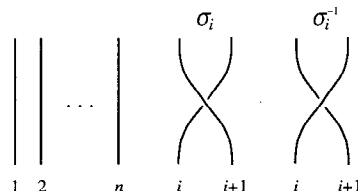

Topological equivalence for different representations of a BRAID WORD $\prod_i \sigma_i$ and $\prod_i \sigma'_i$ is guaranteed by the conditions

$$\begin{cases} \sigma_i \sigma_j = \sigma'_j \sigma'_i & \text{for } |i-j| \geq 2 \\ \sigma_i \sigma_{i+1} \sigma_i = \sigma'_{i+1} \sigma'_i \sigma'_{i+1} & \text{for all } i \end{cases}$$

as first proved by E. Artin. Any n -braid is expressed as a BRAID WORD, e.g., $\sigma_1 \sigma_2 \sigma_3 \sigma_2^{-1} \sigma_1$ is a BRAID WORD for the braid group B_3 . When the opposite ends of the braids are connected by nonintersecting lines, KNOTS are formed which are identified by their braid group and BRAID WORD. The BURAU REPRESENTATION gives a matrix representation of the braid groups.

References

Birman, J. S. "Braids, Links, and the Mapping Class Groups." *Ann. Math. Studies*, No. 82. Princeton, NJ: Princeton University Press, 1976.

Birman, J. S. "Recent Developments in Braid and Link Theory." *Math. Intell.* **13**, 52–60, 1991.

Christy, J. "Braids." <http://www.mathsource.com/cgi-bin/MathSource/Applications/Mathematics/0202-228>.

Jones, V. F. R. "Hecke Algebra Representations of Braid Groups and Link Polynomials." *Ann. Math.* **126**, 335–388, 1987.

✱ Weisstein, E. W. "Knots and Links." <http://www.astro.virginia.edu/~eww6n/math/notebooks/Knots.m>.

Braid Index

The least number of strings needed to make a closed braid representation of a LINK. The braid index is equal to the least number of SEIFERT CIRCLES in any projection of a KNOT (Yamada 1987). Also, for a nonsplittable LINK with CROSSING NUMBER $c(L)$ and braid index $i(L)$,

$$c(L) \geq 2[i(L) - 1]$$

(Ohyama 1993). Let E be the largest and e the smallest POWER of ℓ in the HOMFLY POLYNOMIAL of an oriented LINK, and i be the braid index. Then the MORTON-FRANKS-WILLIAMS INEQUALITY holds,

$$i \geq \frac{1}{2}(E - e) + 1$$

(Franks and Williams 1987). The inequality is sharp for all PRIME KNOTS up to 10 crossings with the exceptions of 09₀₄₂, 09₀₄₉, 10₁₃₂, 10₁₅₀, and 10₁₅₆.

References

- Franks, J. and Williams, R. F. "Braids and the Jones Polynomial." *Trans. Amer. Math. Soc.* **303**, 97–108, 1987.
 Jones, V. F. R. "Hecke Algebra Representations of Braid Groups and Link Polynomials." *Ann. Math.* **126**, 335–388, 1987.
 Ohyama, Y. "On the Minimal Crossing Number and the Braid Index of Links." *Canad. J. Math.* **45**, 117–131, 1993.
 Yamada, S. "The Minimal Number of Seifert Circles Equals the Braid Index of a Link." *Invent. Math.* **89**, 347–356, 1987.

Braid Word

Any n -braid is expressed as a braid word, e.g., $\sigma_1\sigma_2\sigma_3\sigma_2^{-1}\sigma_1$ is a braid word for the BRAID GROUP B_3 . By ALEXANDER'S THEOREM, any LINK is representable by a closed braid, but there is no general procedure for reducing a braid word to its simplest form. However, MARKOV'S THEOREM gives a procedure for identifying different braid words which represent the same LINK.

Let b_+ be the sum of POSITIVE exponents, and b_- the sum of NEGATIVE exponents in the BRAID GROUP B_n . If

$$b_+ - 3b_- - n + 1 > 0,$$

then the closed braid b is not AMPHICHIRAL (Jones 1985).

see also BRAID GROUP

References

- Jones, V. F. R. "A Polynomial Invariant for Knots via von Neumann Algebras." *Bull. Amer. Math. Soc.* **12**, 103–111, 1985.
 Jones, V. F. R. "Hecke Algebra Representations of Braid Groups and Link Polynomials." *Ann. Math.* **126**, 335–388, 1987.

Braikenridge-Maclaurin Construction

The converse of PASCAL'S THEOREM. Let A_1, B_2, C_1, A_2 , and B_1 be the five points on a CONIC. Then the CONIC is the LOCUS of the point

$$C_2 = A_1(z \cdot C_1 A_2) \cdot B_1(z \cdot C_1 B_2),$$

where z is a line through the point $A_1 B_2 \cdot B_1 A_2$.

see also PASCAL'S THEOREM

Branch

The segments of a TREE between the points of connection (FORKS).

see also FORK, LEAF (TREE)

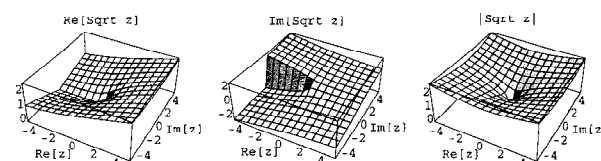
Branch Cut

A line in the COMPLEX PLANE across which a FUNCTION is discontinuous.

function	branch cut(s)
$\cos^{-1} z$	$(-\infty, -1)$ and $(1, \infty)$
\cosh^{-1}	$(-\infty, 1)$
$\cot^{-1} z$	$(-i, i)$
\coth^{-1}	$[-1, 1]$
$\csc^{-1} z$	$(-1, 1)$
csch^{-1}	$(-i, i)$
$\ln z$	$(-\infty, 0]$
$\sec^{-1} z$	$(-1, 1)$
sech^{-1}	$(\infty, 0]$ and $(1, \infty)$
$\sin^{-1} z$	$(-\infty, -1)$ and $(1, \infty)$
\sinh^{-1}	$(-i\infty, -i)$ and $(i, i\infty)$
\sqrt{z}	$(-\infty, 0)$
$\tan^{-1} z$	$(-i\infty, -i)$ and $(i, i\infty)$
\tanh^{-1}	$(-\infty, -1]$ and $[1, \infty)$
$z^n, n \notin \mathbb{Z}$	$(-\infty, 0)$ for $\Re[n] \leq 0$; $(-\infty, 0]$ for $\Re[n] > 0$

see also BRANCH POINT

References

- Morse, P. M. and Feshbach, H. *Methods of Theoretical Physics, Part I*. New York: McGraw-Hill, pp. 399–401, 1953.

Branch Line

see BRANCH CUT

Branch Point

An argument at which identical points in the COMPLEX PLANE are mapped to different points. For example, consider

$$f(z) = z^a.$$

Then $f(e^{0i}) = f(1) = 1$, but $f(e^{2\pi i}) = e^{2\pi ia}$, despite the fact that $e^{i0} = e^{2\pi i}$. PINCH POINTS are also called branch points.

see also BRANCH CUT, PINCH POINT

References

- Arfken, G. *Mathematical Methods for Physicists*, 3rd ed. Orlando, FL: Academic Press, pp. 397–399, 1985.
Morse, P. M. and Feshbach, H. *Methods of Theoretical Physics, Part I*. New York: McGraw-Hill, pp. 391–392 and 399–401, 1953.

Brauer Chain

A Brauer chain is an ADDITION CHAIN in which each member uses the previous member as a summand. A number n for which a shortest chain exists which is a Brauer chain is called a BRAUER NUMBER.

see also ADDITION CHAIN, BRAUER NUMBER, HANSEN CHAIN

References

- Guy, R. K. "Addition Chains. Brauer Chains. Hansen Chains." §C6 in *Unsolved Problems in Number Theory*, 2nd ed. New York: Springer-Verlag, pp. 111–113, 1994.

Brauer Group

The GROUP of classes of finite dimensional central simple ALGEBRAS over k with respect to a certain equivalence.

References

- Hazewinkel, M. (Managing Ed.). *Encyclopaedia of Mathematics: An Updated and Annotated Translation of the Soviet "Mathematical Encyclopaedia."* Dordrecht, Netherlands: Reidel, p. 479, 1988.

Brauer Number

A number n for which a shortest chain exists which is a BRAUER CHAIN is called a Brauer number. There are infinitely many non-Brauer numbers.

see also BRAUER CHAIN, HANSEN NUMBER

References

- Guy, R. K. "Addition Chains. Brauer Chains. Hansen Chains." §C6 in *Unsolved Problems in Number Theory*, 2nd ed. New York: Springer-Verlag, pp. 111–113, 1994.

Brauer-Severi Variety

An ALGEBRAIC VARIETY over a FIELD K that becomes ISOMORPHIC to a PROJECTIVE SPACE.

References

- Hazewinkel, M. (Managing Ed.). *Encyclopaedia of Mathematics: An Updated and Annotated Translation of the Soviet "Mathematical Encyclopaedia."* Dordrecht, Netherlands: Reidel, pp. 480–481, 1988.

Brauer's Theorem

If, in the GERŠGORIN CIRCLE THEOREM for a given m ,

$$|a_{jj} - a_{mm}| > \Lambda_j + \Lambda_m$$

for all $j \neq m$, then exactly one EIGENVALUE of A lies in the DISK Γ_m .

References

- Gradshteyn, I. S. and Ryzhik, I. M. *Tables of Integrals, Series, and Products*, 5th ed. San Diego, CA: Academic Press, p. 1121, 1979.

Braun's Conjecture

Let $B = \{b_1, b_2, \dots\}$ be an INFINITE Abelian SEMI-GROUP with linear order $b_1 < b_2 < \dots$ such that b_1 is the unit element and $a < b$ IMPLIES $ac < bc$ for $a, b, c \in B$. Define a MÖBIUS FUNCTION μ on B by $\mu(b_1) = 1$ and

$$\sum_{b_d | b_n} \mu(b_d) = 0$$

for $n = 2, 3, \dots$. Further suppose that $\mu(b_n) = \mu(n)$ (the true MÖBIUS FUNCTION) for all $n \geq 1$. Then Braun's conjecture states that

$$b_{mn} = b_m b_n$$

for all $m, n \geq 1$.

see also MÖBIUS PROBLEM

References

- Flath, A. and Zulauf, A. "Does the Möbius Function Determine Multiplicative Arithmetic?" *Amer. Math. Monthly* **102**, 354–256, 1995.

Breeder

A pair of POSITIVE INTEGERS (a_1, a_2) such that the equations

$$a_1 + a_2 x = \sigma(a_1) = \sigma(a_2)(x + 1)$$

have a POSITIVE INTEGER solution x , where $\sigma(n)$ is the DIVISOR FUNCTION. If x is PRIME, then $(a_1, a_2 x)$ is an AMICABLE PAIR (te Riele 1986). (a_1, a_2) is a "special" breeder if

$$\begin{aligned} a_1 &= au \\ a_2 &= a, \end{aligned}$$

where a and u are RELATIVELY PRIME, $(a, u) = 1$. If regular amicable pairs of type $(i, 1)$ with $i \geq 2$ are of the form (au, ap) with p PRIME, then (au, a) are special breeders (te Riele 1986).

References

- te Riele, H. J. J. "Computation of All the Amicable Pairs Below 10^{10} ." *Math. Comput.* **47**, 361–368 and S9–S35, 1986.

Brelaz's Heuristic Algorithm

An ALGORITHM which can be used to find a good, but not necessarily minimal, EDGE or VERTEX coloring for a GRAPH.

see also CHROMATIC NUMBER

Brent's Factorization Method

A modification of the POLLARD ρ FACTORIZATION METHOD which uses

$$x_{i+1} = x_i^2 - c \pmod{n}.$$

References

Brent, R. "An Improved Monte Carlo Factorization Algorithm." *Nordisk Tidskrift for Informationsbehandling (BIT)* **20**, 176–184, 1980.

Brent's Method

A ROOT-finding ALGORITHM which combines root bracketing, bisection, and INVERSE QUADRATIC INTERPOLATION. It is sometimes known as the VAN WIJNGAARDEN-DEKER-BRENT METHOD.

Brent's method uses a LAGRANGE INTERPOLATING POLYNOMIAL of degree 2. Brent (1973) claims that this method will always converge as long as the values of the function are computable within a given region containing a ROOT. Given three points x_1 , x_2 , and x_3 , Brent's method fits x as a quadratic function of y , then uses the interpolation formula

$$x = \frac{[y - f(x_1)][y - f(x_2)]x_3}{[f(x_3) - f(x_1)][f(x_3) - f(x_2)]} + \frac{[y - f(x_2)][y - f(x_3)]x_1}{[f(x_1) - f(x_2)][f(x_1) - f(x_3)]} + \frac{[y - f(x_3)][y - f(x_1)]x_2}{[f(x_2) - f(x_3)][f(x_2) - f(x_1)]}. \quad (1)$$

Subsequent root estimates are obtained by setting $y = 0$, giving

$$x = b + \frac{P}{Q}, \quad (2)$$

where

$$P = S[R(R - T)(x_3 - x_2) - (1 - R)(x_2 - x_1)] \quad (3)$$

$$Q = (T - 1)(R - 1)(S - 1) \quad (4)$$

with

$$R \equiv \frac{f(x_2)}{f(x_3)} \quad (5)$$

$$S \equiv \frac{f(x_2)}{f(x_1)} \quad (6)$$

$$T \equiv \frac{f(x_1)}{f(x_3)} \quad (7)$$

(Press et al. 1992).

References

Brent, R. P. Ch. 3–4 in *Algorithms for Minimization Without Derivatives*. Englewood Cliffs, NJ: Prentice-Hall, 1973.
Forsythe, G. E.; Malcolm, M. A.; and Moler, C. B. §7.2 in *Computer Methods for Mathematical Computations*. Englewood Cliffs, NJ: Prentice-Hall, 1977.
Press, W. H.; Flannery, B. P.; Teukolsky, S. A.; and Vetterling, W. T. "Van Wijngaarden-Dekker-Brent Method." §9.3 in *Numerical Recipes in FORTRAN: The Art of Scientific Computing*, 2nd ed. Cambridge, England: Cambridge University Press, pp. 352–355, 1992.

Brent-Salamin Formula

A formula which uses the ARITHMETIC-GEOMETRIC MEAN to compute π . It has quadratic convergence and is also called the GAUSS-SALAMIN FORMULA and SALAMIN FORMULA. Let

$$a_{n+1} = \frac{1}{2}(a_n + b_n) \quad (1)$$

$$b_{n+1} = \sqrt{a_n b_n} \quad (2)$$

$$c_{n+1} = \frac{1}{2}(a_n - b_n) \quad (3)$$

$$d_n \equiv a_n^2 - b_n^2, \quad (4)$$

and define the initial conditions to be $a_0 = 1$, $b_0 = 1/\sqrt{2}$. Then iterating a_n and b_n gives the ARITHMETIC-GEOMETRIC MEAN, and π is given by

$$\pi = \frac{4[M(1, 2^{-1/2})]^2}{1 - \sum_{j=1}^{\infty} 2^{j+1} d_j} \quad (5)$$

$$= \frac{4[M(1, 2^{-1/2})]^2}{1 - \sum_{j=1}^{\infty} 2^{j+1} c_j^2}. \quad (6)$$

King (1924) showed that this formula and the LEGENDRE RELATION are equivalent and that either may be derived from the other.

see also ARITHMETIC-GEOMETRIC MEAN, π

References

Borwein, J. M. and Borwein, P. B. *Pi & the AGM: A Study in Analytic Number Theory and Computational Complexity*. New York: Wiley, pp. 48–51, 1987.
Castellanos, D. "The Ubiquitous Pi. Part II." *Math. Mag.* **61**, 148–163, 1988.
King, L. V. *On the Direct Numerical Calculation of Elliptic Functions and Integrals*. Cambridge, England: Cambridge University Press, 1924.
Lord, N. J. "Recent Calculations of π : The Gauss-Salamin Algorithm." *Math. Gaz.* **76**, 231–242, 1992.
Salamin, E. "Computation of π Using Arithmetic-Geometric Mean." *Math. Comput.* **30**, 565–570, 1976.

Bretschneider's Formula

Given a general QUADRILATERAL with sides of lengths a , b , c , and d (Beyer 1987), the AREA is given by

$$A_{\text{quadrilateral}} = \frac{1}{4} \sqrt{4p^2 q^2 - (b^2 + d^2 - a^2 - c^2)^2},$$

where p and q are the diagonal lengths.

see also BRAHMAGUPTA'S FORMULA, HERON'S FORMULA

References

Beyer, W. H. (Ed.). *CRC Standard Mathematical Tables*, 28th ed. Boca Raton, FL: CRC Press, p. 123, 1987.

Brianchon Point

The point of CONCURRENCE of the joins of the VERTICES of a TRIANGLE and the points of contact of a CONIC SECTION INSCRIBED in the TRIANGLE. A CONIC INSCRIBED in a TRIANGLE has an equation of the form

$$\frac{f}{u} + \frac{g}{v} + \frac{h}{w} = 0,$$

so its Brianchon point has TRILINEAR COORDINATES $(1/f, 1/g, 1/h)$. For KIEPERT'S PARABOLA, the Brianchon point has TRIANGLE CENTER FUNCTION

$$\alpha = \frac{1}{a(b^2 - c^2)},$$

which is the STEINER POINT.

Brianchon's Theorem

The DUAL of PASCAL'S THEOREM. It states that, given a 6-sided POLYGON CIRCUMSCRIBED on a CONIC SECTION, the lines joining opposite VERTICES (DIAGONALS) meet in a single point.

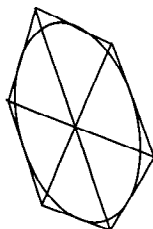

see also DUALITY PRINCIPLE, PASCAL'S THEOREM

References

- Coxeter, H. S. M. and Greitzer, S. L. *Geometry Revisited*. Washington, DC: Math. Assoc. Amer., pp. 77-79, 1967.
Ogilvy, C. S. *Excursions in Geometry*. New York: Dover, p. 110, 1990.

Brick

see EULER BRICK, HARMONIC BRICK, RECTANGULAR PARALLELEPIPED

Bride's Chair

One name for the figure used by Euclid to prove the PYTHAGOREAN THEOREM.

see also PEACOCK'S TAIL, WINDMILL

Bridge Card Game

Bridge is a CARD game played with a normal deck of 52 cards. The number of possible distinct 13-card hands is

$$N = \binom{52}{13} = 635,013,559,600.$$

where $\binom{n}{k}$ is a BINOMIAL COEFFICIENT. While the chances of being dealt a hand of 13 CARDS (out of 52) of the same suit are

$$\frac{4}{\binom{52}{13}} = \frac{1}{158,753,389,900},$$

the chance that one of four players will receive a hand of a single suit is

$$\frac{1}{39,688,347,497}.$$

There are special names for specific types of hands. A ten, jack, queen, king, or ace is called an "honor." Getting the ten, jack, queen, king, and ace of three suits and the ace, king, and queen, and jack of the remaining suit is called 13 top honors. Getting all cards of the same suit is called a 13-card suit. Getting 12 cards of same suit with ace high and the 13th card *not* an ace is called 2-card suit, ace high. Getting *no* honors is called a Yarborough.

The probabilities of being dealt 13-card bridge hands of a given type are given below. As usual, for a hand with probability P , the ODDS against being dealt it are $(1/P) - 1 : 1$.

Hand	Exact	Probability
13 top honors	$\frac{4}{N}$	$\frac{1}{158,753,389,900}$
13-card suit	$\frac{4}{N}$	$\frac{1}{158,753,389,900}$
12-card suit, ace high	$\frac{4 \cdot 12 \cdot 36}{N}$	$\frac{4}{1,469,938,795}$
Yarborough	$\frac{\binom{32}{13}}{N}$	$\frac{5,394}{9,860,459}$
four aces	$\frac{\binom{48}{9}}{N}$	$\frac{11}{4,165}$
nine honors	$\frac{\binom{20}{9} \binom{32}{4}}{N}$	$\frac{888,212}{93,384,347}$

Hand	Probability	Odds
13 top honors	6.30×10^{-12}	158,753,389,899:1
13-card suit	6.30×10^{-12}	158,753,389,899:1
12-card suit, ace high	2.72×10^{-9}	367,484,697.8:1
Yarborough	5.47×10^{-4}	1,827.0:1
four aces	2.64×10^{-3}	377.6:1
nine honors	9.51×10^{-3}	104.1:1

see also CARDS, POKER

References

- Ball, W. W. R. and Coxeter, H. S. M. *Mathematical Recreations and Essays*, 13th ed. New York: Dover, pp. 48-49, 1987.
Kraitchik, M. "Bridge Hands." §6.3 in *Mathematical Recreations*. New York: W. W. Norton, pp. 119-121, 1942.

Bridge (Graph)

The bridges of a GRAPH are the EDGES whose removal disconnects the GRAPH.

see also ARTICULATION VERTEX

References

- Chartrand, G. "Cut-Vertices and Bridges." §2.4 in *Introductory Graph Theory*. New York: Dover, pp. 45-49, 1985.

Bridge Index

A numerical KNOT invariant. For a TAME KNOT K , the bridge index is the least BRIDGE NUMBER of all planar representations of the KNOT. The bridge index of the UNKNOT is defined as 1.

see also BRIDGE NUMBER, CROOKEDNESS

References

- Rolfsen, D. *Knots and Links*. Wilmington, DE: Publish or Perish Press, p. 114, 1976.
 Schubert, H. "Über eine numerische Knotteninvariante." *Math. Z.* **61**, 245–288, 1954.

Bridge of Königsberg

see KÖNIGSBERG BRIDGE PROBLEM

Bridge Knot

An n -bridge knot is a knot with BRIDGE NUMBER n . The set of 2-bridge knots is identical to the set of rational knots. If L is a 2-BRIDGE KNOT, then the BLM/HO POLYNOMIAL Q and JONES POLYNOMIAL V satisfy

$$Q_L(z) = 2z^{-1}V_L(t)V_L(t^{-1} + 1 - 2z^{-1}),$$

where $z \equiv -t - t^{-1}$ (Kanenobu and Sumi 1993). Kanenobu and Sumi also give a table containing the number of distinct 2-bridge knots of n crossings for $n = 10$ to 22, both not counting and counting MIRROR IMAGES as distinct.

n	K_n	$K_n + K_n^*$
3	0	0
4	0	0
5		
6		
7		
8		
9		
10	45	85
11	91	182
12	176	341
13	352	704
14	693	1365
15	1387	2774
16	2752	5461
17	5504	11008
18	10965	21845
19	21931	43862
20	43776	87381
21	87552	175104
22	174933	349525

References

- Kanenobu, T. and Sumi, T. "Polynomial Invariants of 2-Bridge Knots through 22-Crossings." *Math. Comput.* **60**, 771–778 and S17–S28, 1993.
 Schubert, H. "Knotten mit zwei Brücken." *Math. Z.* **65**, 133–170, 1956.

Bridge Number

The least number of unknotted arcs lying above the plane in any projection. The knot 05₀₅ has bridge number 2. Such knots are called 2-BRIDGE KNOTS. There is a one-to-one correspondence between 2-BRIDGE KNOTS and rational knots. The knot 08₀₁₀ is a 3-bridge knot. A knot with bridge number b is an n -EMBEDDABLE KNOT where $n \leq b$.

see also BRIDGE INDEX

References

- Adams, C. C. *The Knot Book: An Elementary Introduction to the Mathematical Theory of Knots*. New York: W. H. Freeman, pp. 64–67, 1994.
 Rolfsen, D. *Knots and Links*. Wilmington, DE: Publish or Perish Press, p. 115, 1976.

Brill-Noether Theorem

If the total group of the canonical series is divided into two parts, the difference between the number of points in each part and the double of the dimension of the complete series to which it belongs is the same.

References

- Coolidge, J. L. *A Treatise on Algebraic Plane Curves*. New York: Dover, p. 263, 1959.

Bring-Jerrard Quintic Form

A TSCHIRNHAUSEN TRANSFORMATION can be used to algebraically transform a general QUINTIC EQUATION to the form

$$z^5 + c_1z + c_0 = 0. \quad (1)$$

In practice, the general quintic is first reduced to the PRINCIPAL QUINTIC FORM

$$y^5 + b_2y^2 + b_1y + b_0 = 0 \quad (2)$$

before the transformation is done. Then, we require that the sum of the third POWERS of the ROOTS vanishes, so $s_3(y_j) = 0$. We assume that the ROOTS z_i of the Bring-Jerrard quintic are related to the ROOTS y_i of the PRINCIPAL QUINTIC FORM by

$$z_i = \alpha y_i^4 + \beta y_i^3 + \gamma y_i^2 + \delta y_i + \epsilon. \quad (3)$$

In a similar manner to the PRINCIPAL QUINTIC FORM transformation, we can express the COEFFICIENTS c_j in terms of the b_j .

see also BRING QUINTIC FORM, PRINCIPAL QUINTIC FORM, QUINTIC EQUATION

Bring Quintic Form

A TSCHIRNHAUSEN TRANSFORMATION can be used to take a general QUINTIC EQUATION to the form

$$x^5 - x - a = 0,$$

where a may be COMPLEX.

see also BRING-JERRARD QUINTIC FORM, QUINTIC EQUATION

References

- Ruppert, W. M. "On the Bring Normal Form of a Quintic in Characteristic 5." *Arch. Math.* **58**, 44–46, 1992.

Brioschi Formula

For a curve with METRIC

$$ds^2 = E du^2 + F du dv + G dv^2, \quad (1)$$

where E , F , and G is the first FUNDAMENTAL FORM, the GAUSSIAN CURVATURE is

$$K = \frac{M_1 + M_2}{(EG - F^2)^2}, \quad (2)$$

where

$$M_1 \equiv \begin{vmatrix} -\frac{1}{2}E_{uv} + F_{uv} - \frac{1}{2}G_{uu} & \frac{1}{2}E_u & F_u - \frac{1}{2}E_v \\ F_v - \frac{1}{2}G_u & E & F \\ \frac{1}{2}G_v & F & G \end{vmatrix} \quad (3)$$

$$M_2 \equiv \begin{vmatrix} 0 & \frac{1}{2}E_v & \frac{1}{2}G_u \\ \frac{1}{2}E_v & E & F \\ \frac{1}{2}G_u & F & G \end{vmatrix}, \quad (4)$$

which can also be written

$$K = -\frac{1}{\sqrt{EG}} \left[\frac{\partial}{\partial u} \left(\frac{1}{\sqrt{E}} \frac{\partial \sqrt{G}}{\partial u} \right) + \frac{\partial}{\partial v} \left(\frac{1}{\sqrt{G}} \frac{\partial \sqrt{E}}{\partial v} \right) \right] \quad (5)$$

$$= -\frac{1}{2\sqrt{EG}} \left[\frac{\partial}{\partial u} \left(\frac{G_u}{\sqrt{EG}} \right) + \frac{\partial}{\partial v} \left(\frac{E_v}{\sqrt{EG}} \right) \right]. \quad (6)$$

see also FUNDAMENTAL FORMS, GAUSSIAN CURVATURE

References

Gray, A. *Modern Differential Geometry of Curves and Surfaces*. Boca Raton, FL: CRC Press, pp. 392–393, 1993.

Briot-Bouquet Equation

An ORDINARY DIFFERENTIAL EQUATION of the form

$$x^m y' = f(x, y),$$

where m is a POSITIVE INTEGER, f is ANALYTIC at $x = y = 0$, $f(0, 0) = 0$, and $f'_y(0, 0) \neq 0$.

References

Hazewinkel, M. (Managing Ed.). *Encyclopaedia of Mathematics: An Updated and Annotated Translation of the Soviet "Mathematical Encyclopaedia."* Dordrecht, Netherlands: Reidel, pp. 481–482, 1988.

Brocard Angle

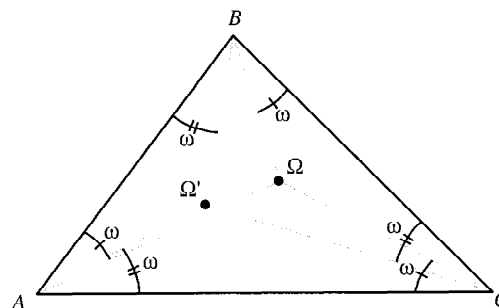

Define the first BROCARD POINT as the interior point Ω of a TRIANGLE for which the ANGLES $\angle\Omega AB$, $\angle\Omega BC$, and $\angle\Omega CA$ are equal. Similarly, define the second BROCARD POINT as the interior point Ω' for which the ANGLES $\angle\Omega' AC$, $\angle\Omega' CB$, and $\angle\Omega' BA$ are equal. Then the ANGLES in both cases are equal, and this angle is called the Brocard angle, denoted ω .

The Brocard angle ω of a TRIANGLE $\triangle ABC$ is given by the formulas

$$\cot \omega = \cot A + \cot B + \cot C \quad (1)$$

$$= \left(\frac{a^2 + b^2 + c^2}{4\Delta} \right) \quad (2)$$

$$= \frac{1 + \cos \alpha_1 \cos \alpha_2 \cos \alpha_3}{\sin \alpha_1 \sin \alpha_2 \sin \alpha_3} \quad (3)$$

$$= \frac{\sin^2 \alpha_1 + \sin^2 \alpha_2 + \sin^2 \alpha_3}{2 \sin \alpha_1 \sin \alpha_2 \sin \alpha_3} \quad (4)$$

$$= \frac{a_1 \sin \alpha_1 + a_2 \sin \alpha_2 + a_3 \sin \alpha_3}{a_1 \cos \alpha_1 + a_2 \cos \alpha_2 + a_3 \cos \alpha_3} \quad (5)$$

$$\csc^2 \omega = \csc^2 \alpha_1 + \csc^2 \alpha_2 + \csc^2 \alpha_3 \quad (6)$$

$$\sin \omega = \frac{2\Delta}{\sqrt{a_1^2 a_2^2 + a_2^2 a_3^2 + a_3^2 a_1^2}}, \quad (7)$$

where Δ is the TRIANGLE AREA, A , B , and C are ANGLES, and a , b , and c are side lengths.

If an ANGLE α of a TRIANGLE is given, the maximum possible Brocard angle is given by

$$\cot \omega = \frac{3}{2} \tan(\frac{1}{2}\alpha) + \frac{1}{2} \cos(\frac{1}{2}\alpha). \quad (8)$$

Let a TRIANGLE have ANGLES A , B , and C . Then

$$\sin A \sin B \sin C \leq k ABC, \quad (9)$$

where

$$k = \left(\frac{3\sqrt{3}}{2\pi} \right)^3 \quad (10)$$

(Le Lionnais 1983). This can be used to prove that

$$8\omega^3 < ABC \quad (11)$$

(Abi-Khuzam 1974).

see also BROCARD CIRCLE, BROCARD LINE, EQUI-BROCARD CENTER, FERMAT POINT, ISOGONIC CENTERS

References

- Abi-Khuzam, F. "Proof of Yff's Conjecture on the Brocard Angle of a Triangle." *Elem. Math.* **29**, 141–142, 1974.
 Johnson, R. A. *Modern Geometry: An Elementary Treatise on the Geometry of the Triangle and the Circle*. Boston, MA: Houghton Mifflin, pp. 263–286 and 289–294, 1929.
 Le Lionnais, F. *Les nombres remarquables*. Paris: Hermann, p. 28, 1983.

Brocard Axis

The LINE KO passing through the LEMOINE POINT K and CIRCUMCENTER O of a TRIANGLE. The distance \overline{OK} is called the BROCARD DIAMETER. The Brocard axis is PERPENDICULAR to the LEMOINE AXIS and is the ISOGONAL CONJUGATE of KIEPERT'S HYPERBOLA. It has equations

$$\sin(B - C)\alpha + \sin(C - A)\beta + \sin(A - B)\gamma = 0$$

$$bc(b^2 - c^2)\alpha + ca(c^2 - a^2)\beta + ab(a^2 - b^2)\gamma = 0.$$

The LEMOINE POINT, CIRCUMCENTER, ISODYNAMIC POINTS, and BROCARD MIDPOINT all lie along the Brocard axis. Note that the Brocard axis is *not* equivalent to the BROCARD LINE.

see also BROCARD CIRCLE, BROCARD DIAMETER, BROCARD LINE

Brocard Circle

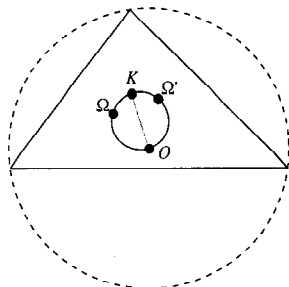

The CIRCLE passing through the first and second BROCARD POINTS Ω and Ω' , the LEMOINE POINT K , and the CIRCUMCENTER O of a given TRIANGLE. The BROCARD POINTS Ω and Ω' are symmetrical about the LINE \overleftrightarrow{KO} , which is called the BROCARD LINE. The LINE SEGMENT \overline{KO} is called the BROCARD DIAMETER, and it has length

$$\overline{OK} = \frac{\overline{O\Omega}}{\cos \omega} = \frac{R\sqrt{1 - 4\sin^2 \omega}}{\cos \omega},$$

where R is the CIRCUMRADIUS and ω is the BROCARD ANGLE. The distance between either of the BROCARD POINTS and the LEMOINE POINT is

$$\overline{\Omega K} = \overline{\Omega' K} = \overline{\Omega O} \tan \omega.$$

see also BROCARD ANGLE, BROCARD DIAMETER, BROCARD POINTS

References

- Johnson, R. A. *Modern Geometry: An Elementary Treatise on the Geometry of the Triangle and the Circle*. Boston, MA: Houghton Mifflin, p. 272, 1929.

Brocard's Conjecture

$$\pi(p_{n+1}^2) - \pi(p_n^2) \geq 4$$

for $n \geq 2$ where π is the PRIME COUNTING FUNCTION.

see also ANDRICA'S CONJECTURE

Brocard Diameter

The LINE SEGMENT \overline{KO} joining the LEMOINE POINT K and CIRCUMCENTER O of a given TRIANGLE. It is the DIAMETER of the TRIANGLE'S BROCARD CIRCLE, and lies along the BROCARD AXIS. The Brocard diameter has length

$$\overline{OK} = \frac{\overline{O\Omega}}{\cos \omega} = \frac{R\sqrt{1 - 4\sin^2 \omega}}{\cos \omega},$$

where Ω is the first BROCARD POINT, R is the CIRCUMRADIUS, and ω is the BROCARD ANGLE.

see also BROCARD AXIS, BROCARD CIRCLE, BROCARD LINE, BROCARD POINTS

Brocard Line

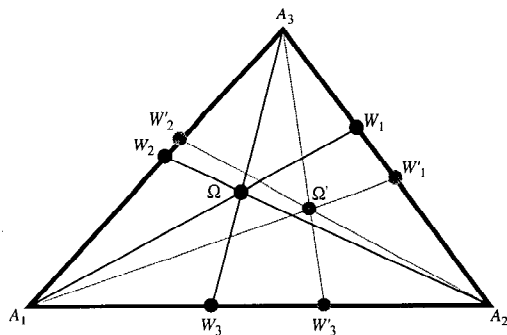

A LINE from any of the VERTICES A_i of a TRIANGLE to the first Ω or second Ω' BROCARD POINT. Let the ANGLE at a VERTEX A_i also be denoted A_i , and denote the intersections of $A_1\Omega$ and $A_1\Omega'$ with A_2A_3 as W_1 and W_2 . Then the ANGLES involving these points are

$$\angle A_1\Omega W_3 = A_1 \quad (1)$$

$$\angle W_3\Omega A_2 = A_3 \quad (2)$$

$$\angle A_2\Omega W_1 = A_2. \quad (3)$$

Distances involving the points W_i and W'_i are given by

$$\overline{A_2\Omega} = \frac{a_3}{\sin A_2} \sin \omega \quad (4)$$

$$\frac{\overline{A_2\Omega}}{\overline{A_3\Omega}} = \frac{a_3^2}{a_1a_2} = \frac{\sin(A_3 - \omega)}{\sin \omega} \quad (5)$$

$$\frac{\overline{W_3A_1}}{\overline{W_3A_2}} = \frac{a_2 \sin \omega}{a_1 \sin(A_3 - \omega)} = \left(\frac{a_2}{a_3}\right)^2, \quad (6)$$

where ω is the BROCARD ANGLE (Johnson 1929, pp. 267–268).

The Brocard line, MEDIAN M , and LEMOINE POINT K are concurrent, with $A_1\Omega_1$, A_2K , and A_3M meeting at a point P . Similarly, $A_1\Omega'$, A_2M , and A_3K meet at a point which is the ISOGONAL CONJUGATE point of P (Johnson 1929, pp. 268–269).

see also BROCARD AXIS, BROCARD DIAMETER, BROCARD POINTS, ISOGONAL CONJUGATE, LEMOINE POINT, MEDIAN (TRIANGLE)

References

Johnson, R. A. *Modern Geometry: An Elementary Treatise on the Geometry of the Triangle and the Circle*. Boston, MA: Houghton Mifflin, pp. 263–286, 1929.

Brocard Midpoint

The MIDPOINT of the BROCARD POINTS. It has TRIANGLE CENTER FUNCTION

$$\alpha = a(b^2 + c^2) = \sin(A + \omega),$$

where ω is the BROCARD ANGLE. It lies on the BROCARD AXIS.

References

Kimberling, C. “Central Points and Central Lines in the Plane of a Triangle.” *Math. Mag.* **67**, 163–187, 1994.

Brocard Points

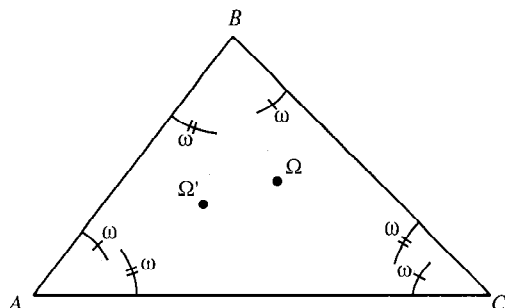

The first Brocard point is the interior point Ω (or τ_1 or Z_1) of a TRIANGLE for which the ANGLES $\angle\Omega AB$, $\angle\Omega BC$, and $\angle\Omega CA$ are equal. The second Brocard point is the interior point Ω' (or τ_2 or Z_2) for which the ANGLES $\angle\Omega' AC$, $\angle\Omega' CB$, and $\angle\Omega' BA$ are equal. The ANGLES in both cases are equal to the BROCARD ANGLE ω ,

$$\begin{aligned} \omega &= \angle\Omega AB = \angle\Omega BC = \angle\Omega CA \\ &= \angle\Omega' AC = \angle\Omega' CB = \angle\Omega' BA. \end{aligned}$$

The first two Brocard points are ISOGONAL CONJUGATES (Johnson 1929, p. 266).

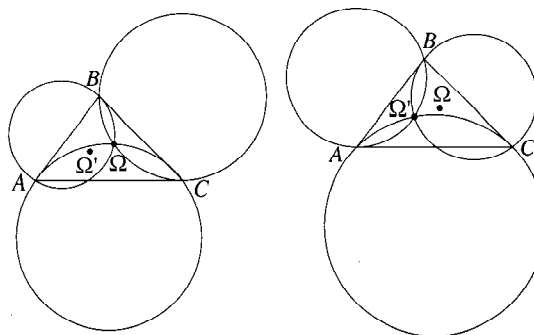

Let C_{BC} be the CIRCLE which passes through the vertices B and C and is TANGENT to the line AC at C , and similarly for C_{AB} and C_{AC} . Then the CIRCLES C_{AB} , C_{BC} , and C_{AC} intersect in the first Brocard point Ω . Similarly, let C'_{BC} be the CIRCLE which passes through the vertices B and C and is TANGENT to the line AB at B , and similarly for C'_{AB} and C'_{AC} . Then the CIRCLES C'_{AB} , C'_{BC} , and C'_{AC} intersect in the second Brocard points Ω' (Johnson 1929, pp. 264–265).

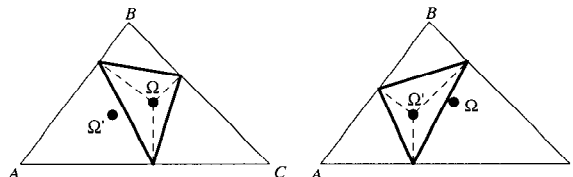

The PEDAL TRIANGLES of Ω and Ω' are congruent, and SIMILAR to the TRIANGLE $\triangle ABC$ (Johnson 1929, p. 269). Lengths involving the Brocard points include

$$\overline{O\Omega} = \overline{O\Omega'} = R\sqrt{1 - 4\sin^2 \omega} \quad (1)$$

$$\overline{\Omega\Omega'} = 2R\sin \omega\sqrt{1 - 4\sin^2 \omega}. \quad (2)$$

Brocard's third point is related to a given TRIANGLE by the TRIANGLE CENTER FUNCTION

$$\alpha = a^{-3} \quad (3)$$

(Casey 1893, Kimberling 1994). The third Brocard point Ω'' (or τ_3 or Z_3) is COLLINEAR with the SPIEKER CENTER and the ISOTOMIC CONJUGATE POINT of its TRIANGLE'S INCENTER.

see also BROCARD ANGLE, BROCARD MIDPOINT, EQUI-BROCARD CENTER, YFF POINTS

References

Casey, J. *A Treatise on the Analytical Geometry of the Point, Line, Circle, and Conic Sections, Containing an Account of Its Most Recent Extensions, with Numerous Examples*, 2nd ed., rev. enl. Dublin: Hodges, Figgis, & Co., p. 66, 1893.

Johnson, R. A. *Modern Geometry: An Elementary Treatise on the Geometry of the Triangle and the Circle*. Boston, MA: Houghton Mifflin, pp. 263–286, 1929.

Kimberling, C. “Central Points and Central Lines in the Plane of a Triangle.” *Math. Mag.* **67**, 163–187, 1994.

Strooker, R. J. “Brocard Points, Circulant Matrices, and Descartes' Folium.” *Math. Mag.* **61**, 172–187, 1988.

Brocard's Problem

Find the values of n for which $n! + 1$ is a SQUARE NUMBER m^2 , where $n!$ is the FACTORIAL (Brocard 1876, 1885). The only known solutions are $n = 4, 5$, and 7 , and there are no other solutions < 1027 . The pairs of numbers (m, n) are called BROWN NUMBERS.

see also BROWN NUMBERS, FACTORIAL, SQUARE NUMBER

References

Brocard, H. Question 166. *Nouv. Corres. Math.* **2**, 287, 1876.

Brocard, H. Question 1532. *Nouv. Ann. Math.* **4**, 391, 1885.

Guy, R. K. *Unsolved Problems in Number Theory*, 2nd ed. New York: Springer-Verlag, p. 193, 1994.

Brocard Triangles

Let the point of intersection of $A_2\Omega$ and $A_3\Omega'$ be B_1 , where Ω and Ω' are the BROCARD POINTS, and similarly define B_2 and B_3 . $B_1B_2B_3$ is the first Brocard triangle, and is inversely similar to $A_1A_2A_3$. It is inscribed in the BROCARD CIRCLE drawn with OK as the DIAMETER. The triangles $B_1A_2A_3$, $B_2A_3A_1$, and $B_3A_1A_2$ are ISOSCELES TRIANGLES with base angles ω , where ω is the BROCARD ANGLE. The sum of the areas of the ISOSCELES TRIANGLES is Δ , the AREA of TRIANGLE $A_1A_2A_3$. The first Brocard triangle is in perspective with the given TRIANGLE, with A_1B_1 , A_2B_2 , and A_3B_3 CONCURRENT. The MEDIAN POINT of the first Brocard triangle is the MEDIAN POINT M of the original triangle. The Brocard triangles are in perspective at M .

Let c_1 , c_2 , and c_3 and c'_1 , c'_2 , and c'_3 be the CIRCLES intersecting in the BROCARD POINTS Ω and Ω' , respectively. Let the two circles c_1 and c'_1 tangent at A_1 to A_1A_2 and A_1A_3 , and passing respectively through A_3 and A_2 , meet again at C_1 . The triangle $C_1C_2C_3$ is the second Brocard triangle. Each VERTEX of the second Brocard triangle lies on the second BROCARD CIRCLE.

The two Brocard triangles are in perspective at M .

see also STEINER POINTS, TARRY POINT

References

Johnson, R. A. *Modern Geometry: An Elementary Treatise on the Geometry of the Triangle and the Circle*. Boston, MA: Houghton Mifflin, pp. 277–281, 1929.

Bromwich Integral

The inverse of the LAPLACE TRANSFORM, given by

$$F(t) = \frac{1}{2\pi i} \int_{\gamma - i\infty}^{\gamma + i\infty} e^{st} f(s) ds,$$

where γ is a vertical CONTOUR in the COMPLEX PLANE chosen so that all singularities of $f(s)$ are to the left of it.

References

Arfken, G. "Inverse Laplace Transformation." §15.12 in *Mathematical Methods for Physicists*, 3rd ed. Orlando, FL: Academic Press, pp. 853–861, 1985.

Brothers

A PAIR of consecutive numbers.

see also PAIR, SMITH BROTHERS, TWINS

Brouwer Fixed Point Theorem

Any continuous FUNCTION $G : D^n \rightarrow D^n$ has a FIXED POINT, where

$$D^n = \{\mathbf{x} \in \mathbb{R}^n : x_1^2 + \dots + x_n^2 \leq 1\}$$

is the unit n -BALL.

see also FIXED POINT THEOREM

References

Milnor, J. W. *Topology from the Differentiable Viewpoint*. Princeton, NJ: Princeton University Press, p. 14, 1965.

Browkin's Theorem

For every POSITIVE INTEGER n , there exists a SQUARE in the plane with exactly n LATTICE POINTS in its interior. This was extended by Schinzel and Kulikowski to all plane figures of a given shape. The generalization of the SQUARE in 2-D to the CUBE in 3-D was also proved by Browkin.

see also CUBE, SCHINZEL'S THEOREM, SQUARE

References

Honsberger, R. *Mathematical Gems I*. Washington, DC: Math. Assoc. Amer., pp. 121–125, 1973.

Brown's Criterion

A SEQUENCE $\{\nu_i\}$ of nondecreasing POSITIVE INTEGERS is COMPLETE IFF

1. $\nu_1 = 1$.
2. For all $k = 2, 3, \dots$,

$$s_{k-1} = \nu_1 + \nu_2 + \dots + \nu_{k-1} \geq \nu_k - 1.$$

A corollary states that a SEQUENCE for which $\nu_1 = 1$ and $\nu_{k+1} \leq 2\nu_k$ is COMPLETE (Honsberger 1985).

see also COMPLETE SEQUENCE

References

Brown, J. L. Jr. "Notes on Complete Sequences of Integers." *Amer. Math. Monthly*, 557–560, 1961.

Honsberger, R. *Mathematical Gems III*. Washington, DC: Math. Assoc. Amer., pp. 123–130, 1985.

Brown Function

For a FRACTAL PROCESS with values $y(t - \Delta t)$ and $y(t + \Delta t)$, the correlation between these two values is given by the Brown function

$$r = 2^{2H-1} - 1,$$

also known as the BACHELIER FUNCTION, LÉVY FUNCTION, or WIENER FUNCTION.

Brown Numbers

Brown numbers are PAIRS (m, n) of INTEGERS satisfying the condition of BROCARD'S PROBLEM, i.e., such that

$$n! + 1 = m^2$$

where $n!$ is the FACTORIAL and m^2 is a SQUARE NUMBER. Only three such PAIRS of numbers are known: (5,4), (11,5), (71,7), and Erdős conjectured that these are the only three such PAIRS. Le Lionnais (1983) points out that there are 3 numbers less than 200,000 for which

$$(n-1)! + 1 \equiv 0 \pmod{n^2},$$

namely 5, 13, and 563.

see also BROCARD'S PROBLEM, FACTORIAL, SQUARE NUMBER

References

- Guy, R. K. *Unsolved Problems in Number Theory*, 2nd ed. New York: Springer-Verlag, p. 193, 1994.
 Le Lionnais, F. *Les nombres remarquables*. Paris: Hermann, p. 56, 1983.
 Pickover, C. A. *Keys to Infinity*. New York: W. H. Freeman, p. 170, 1995.

Broyden's Method

An extension of the secant method of root finding to higher dimensions.

References

- Broyden, C. G. "A Class of Methods for Solving Nonlinear Simultaneous Equations." *Math. Comput.* **19**, 577-593, 1965.
 Press, W. H.; Flannery, B. P.; Teukolsky, S. A.; and Vetterling, W. T. *Numerical Recipes in FORTRAN: The Art of Scientific Computing*, 2nd ed. Cambridge, England: Cambridge University Press, pp. 382-385, 1992.

Bruck-Ryser-Chowla Theorem

If $n \equiv 1, 2 \pmod{4}$, and the SQUAREFREE part of n is divisible by a PRIME $p \equiv 3 \pmod{4}$, then no DIFFERENCE SET of ORDER n exists. Equivalently, if a PROJECTIVE PLANE of order n exists, and $n \equiv 1$ or $2 \pmod{4}$, then n is the sum of two SQUARES.

Dinitz and Stinson (1992) give the theorem in the following form. If a symmetric (v, k, λ) -BLOCK DESIGN exists, then

1. If v is EVEN, then $k - \lambda$ is a SQUARE NUMBER,
2. If v is ODD, the the DIOPHANTINE EQUATION

$$x^2 = (k - \lambda)y^2 + (-1)^{(v-1)/2} \lambda z^2$$

has a solution in integers, not all of which are 0.

see also BLOCK DESIGN, FISHER'S BLOCK DESIGN INEQUALITY

References

- Dinitz, J. H. and Stinson, D. R. "A Brief Introduction to Design Theory." Ch. 1 in *Contemporary Design Theory: A*

Collection of Surveys (Ed. J. H. Dinitz and D. R. Stinson). New York: Wiley, pp. 1-12, 1992.

Gordon, D. M. "The Prime Power Conjecture is True for $n < 2,000,000$." *Electronic J. Combinatorics* **1**, R6, 1-7, 1994. <http://www.combinatorics.org/Volume1/volume1.html#R6>.

Ryser, H. J. *Combinatorial Mathematics*. Buffalo, NY: Math. Assoc. Amer., 1963.

Bruck-Ryser Theorem

see BRUCK-RYSER-CHOWLA THEOREM

Brun's Constant

The number obtained by adding the reciprocals of the TWIN PRIMES,

$$B \equiv \left(\frac{1}{3} + \frac{1}{5}\right) + \left(\frac{1}{5} + \frac{1}{7}\right) + \left(\frac{1}{11} + \frac{1}{13}\right) + \left(\frac{1}{17} + \frac{1}{19}\right) + \cdots, \quad (1)$$

By BRUN'S THEOREM, the constant converges to a definite number as $p \rightarrow \infty$. Any finite sum underestimates B . Shanks and Wrench (1974) used all the TWIN PRIMES among the first 2 million numbers. Brent (1976) calculated all TWIN PRIMES up to 100 billion and obtained (Ribenoim 1989, p. 146)

$$B \approx 1.90216054, \quad (2)$$

assuming the truth of the first HARDY-LITTLEWOOD CONJECTURE. Using TWIN PRIMES up to 10^{14} , Nicely (1996) obtained

$$B \approx 1.9021605778 \pm 2.1 \times 10^{-9} \quad (3)$$

(Cipra 1995, 1996), in the process discovering a bug in Intel's® Pentium™ microprocessor. The value given by Le Lionnais (1983) is incorrect.

see also TWIN PRIMES, TWIN PRIME CONJECTURE, TWIN PRIMES CONSTANT

References

- Ball, W. W. R. and Coxeter, H. S. M. *Mathematical Recreations and Essays*, 13th ed. New York: Dover, p. 64, 1987.
 Brent, R. P. "Tables Concerning Irregularities in the Distribution of Primes and Twin Primes Up to 10^{11} ." *Math. Comput.* **30**, 379, 1976.
 Cipra, B. "How Number Theory Got the Best of the Pentium Chip." *Science* **267**, 175, 1995.
 Cipra, B. "Divide and Conquer." *What's Happening in the Mathematical Sciences, 1995-1996*, Vol. 3. Providence, RI: Amer. Math. Soc., pp. 38-47, 1996.
 Finch, S. "Favorite Mathematical Constants." <http://www.mathsoft.com/asolve/constant/brun/brun.html>.
 Le Lionnais, F. *Les nombres remarquables*. Paris: Hermann, p. 41, 1983.
 Nicely, T. "Enumeration to 10^{14} of the Twin Primes and Brun's Constant." *Virginia J. Sci.* **46**, 195-204, 1996.
 Ribenoim, P. *The Book of Prime Number Records*, 2nd ed. New York: Springer-Verlag, 1989.
 Shanks, D. and Wrench, J. W. "Brun's Constant." *Math. Comput.* **28**, 293-299, 1974.
 Wolf, M. "Generalized Brun's Constants." <http://www.ift.uni.wroc.pl/~mwolf/>.

Brunn-Minkowski Inequality

The n th root of the CONTENT of the set sum of two sets in Euclidean n -space is greater than or equal to the sum of the n th roots of the CONTENTS of the individual sets.

see also TOMOGRAPHY

References

- Cover, T. M. "The Entropy Power Inequality and the Brunn-Minkowski Inequality" §5.10 in *Open Problems in Communications and Computation*. (Ed. T. M. Cover and B. Gopinath). New York: Springer-Verlag, p. 172, 1987.
- Schneider, R. *Convex Bodies: The Brunn-Minkowski Theory*. Cambridge, England: Cambridge University Press, 1993.

Brun's Sum

see BRUN'S CONSTANT

Brun's Theorem

The series producing BRUN'S CONSTANT CONVERGES even if there are an infinite number of TWIN PRIMES. Proved in 1919 by V. Brun.

Brunnian Link

A Brunnian link is a set of n linked loops such that each proper sublink is trivial, so that the removal of any component leaves a set of trivial unlinked UNKNOTS. The BORROMEAN RINGS are the simplest example and have $n = 3$.

see also BORROMEAN RINGS

References

- Rolfsen, D. *Knots and Links*. Wilmington, DE: Publish or Perish Press, 1976.

Brute Force Factorization

see DIRECT SEARCH FACTORIZATION

Bubble

A bubble is a MINIMAL SURFACE of the type that is formed by soap film. The simplest bubble is a single SPHERE. More complicated forms occur when multiple bubbles are joined together. Two outstanding problems involving bubbles are to find the arrangements with the smallest PERIMETER (planar problem) or SURFACE AREA (AREA problem) which enclose and separate n given unit areas or volumes in the plane or in space. For $n = 2$, the problems are called the DOUBLE BUBBLE CONJECTURE and the solution to both problems is known to be the DOUBLE BUBBLE.

see also DOUBLE BUBBLE, MINIMAL SURFACE, PLATEAU'S LAWS, PLATEAU'S PROBLEM

References

- Morgan, F. "Mathematicians, Including Undergraduates, Look at Soap Bubbles." *Amer. Math. Monthly* **101**, 343–351, 1994.
- Pappas, T. "Mathematics & Soap Bubbles." *The Joy of Mathematics*. San Carlos, CA: Wide World Publ./Tetra, p. 219, 1989.

Buchberger's Algorithm

The algorithm for the construction of a GRÖBNER BASIS from an arbitrary ideal basis.

see also GRÖBNER BASIS

References

- Becker, T. and Weispfenning, V. *Gröbner Bases: A Computational Approach to Commutative Algebra*. New York: Springer-Verlag, pp. 213–214, 1993.
- Buchberger, B. "Theoretical Basis for the Reduction of Polynomials to Canonical Forms." *SIGSAM Bull.* **39**, 19–24, Aug. 1976.
- Cox, D.; Little, J.; and O'Shea, D. *Ideals, Varieties, and Algorithms: An Introduction to Algebraic Geometry and Commutative Algebra*, 2nd ed. New York: Springer-Verlag, 1996.

Buckminster Fuller Dome

see GEODESIC DOME

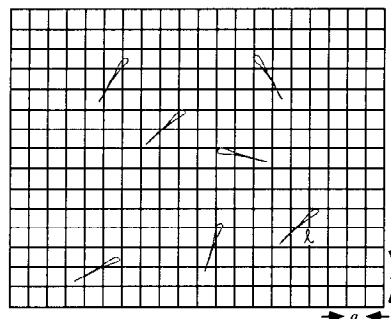
Buffon-Laplace Needle Problem

Find the probability $P(\ell, a, b)$ that a needle of length ℓ will land on a line, given a floor with a grid of equally spaced PARALLEL LINES distances a and b apart, with $\ell > a, b$.

$$P(\ell, a, b) = \frac{2\ell(a+b) - \ell^2}{\pi ab}.$$

see also BUFFON'S NEEDLE PROBLEM

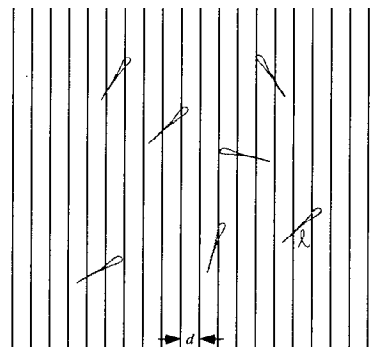
Buffon's Needle Problem

Find the probability $P(\ell, d)$ that a needle of length ℓ will land on a line, given a floor with equally spaced PARALLEL LINES a distance d apart.

$$P(\ell, d) = \int_0^{2\pi} \frac{\ell |\cos \theta|}{d} \frac{d\theta}{2\pi} = \frac{\ell}{2\pi d} 4 \int_0^{\pi/2} \cos \theta d\theta$$

$$= \frac{2\ell}{\pi d} [\sin \theta]_0^{\pi/2} = \frac{2\ell}{\pi d}.$$

Several attempts have been made to experimentally determine π by needle-tossing. For a discussion of the relevant statistics and a critical analysis of one of the more accurate (and least believable) needle-tossings, see Badger (1994).

see also BUFFON-LAPLACE NEEDLE PROBLEM

References

- Badger, L. "Lazzarini's Lucky Approximation of π ." *Math. Mag.* **67**, 83–91, 1994.
- Dörrie, H. "Buffon's Needle Problem." §18 in *100 Great Problems of Elementary Mathematics: Their History and Solutions*. New York: Dover, pp. 73–77, 1965.
- Kraitchik, M. "The Needle Problem." §6.14 in *Mathematical Recreations*. New York: W. W. Norton, p. 132, 1942.
- Wegert, E. and Trefethen, L. N. "From the Buffon Needle Problem to the Kreiss Matrix Theorem." *Amer. Math. Monthly* **101**, 132–139, 1994.

Bulirsch-Stoer Algorithm

An algorithm which finds RATIONAL FUNCTION extrapolations of the form

$$R_{i(i+1)\dots(i+m)} = \frac{P_\mu(x)}{P_\nu(x)} = \frac{p_0 + p_1x + \dots + p_\mu x^\mu}{q_0 + q_1x + \dots + q_\nu x^\nu}$$

and can be used in the solution of ORDINARY DIFFERENTIAL EQUATIONS.

References

- Bulirsch, R. and Stoer, J. §2.2 in *Introduction to Numerical Analysis*. New York: Springer-Verlag, 1991.
- Press, W. H.; Flannery, B. P.; Teukolsky, S. A.; and Vetterling, W. T. "Richardson Extrapolation and the Bulirsch-Stoer Method." §16.4 in *Numerical Recipes in FORTRAN: The Art of Scientific Computing, 2nd ed.* Cambridge, England: Cambridge University Press, pp. 718–725, 1992.

Bullet Nose

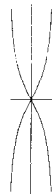

A plane curve with implicit equation

$$\frac{a^2}{x^2} - \frac{b^2}{y^2} = 1. \quad (1)$$

In parametric form,

$$x = a \cos t \quad (2)$$

$$y = b \cot t. \quad (3)$$

The CURVATURE is

$$\kappa = \frac{3ab \cot t \csc t}{(b^2 \csc^4 t + a^2 \sin^2 t)^{3/2}} \quad (4)$$

and the TANGENTIAL ANGLE is

$$\phi = \tan^{-1} \left(\frac{b \csc^3 t}{a} \right). \quad (5)$$

References

- Lawrence, J. D. *A Catalog of Special Plane Curves*. New York: Dover, pp. 127–129, 1972.

Bumping Algorithm

Given a PERMUTATION $\{p_1, p_2, \dots, p_n\}$ of $\{1, \dots, n\}$, the bumping algorithm constructs a standard YOUNG TABLEAU by inserting the p_i one by one into an already constructed YOUNG TABLEAU. To apply the bumping algorithm, start with $\{\{p_1\}\}$, which is a YOUNG TABLEAU. If p_1 through p_k have already been inserted, then in order to insert p_{k+1} , start with the first line of the already constructed YOUNG TABLEAU and search for the first element of this line which is greater than p_{k+1} . If there is no such element, append p_{k+1} to the first line and stop. If there is such an element (say, p_p), exchange p_p for p_{k+1} , search the second line using p_p , and so on.

see also YOUNG TABLEAU

References

- Skiena, S. *Implementing Discrete Mathematics: Combinatorics and Graph Theory with Mathematica*. Reading, MA: Addison-Wesley, 1990.

Bundle

see FIBER BUNDLE

Bureau Representation

Gives a MATRIX representation b_i of a BRAID GROUP in terms of $(n-1) \times (n-1)$ MATRICES. A $-t$ always appears in the (i, i) position.

$$b_1 = \begin{bmatrix} -t & 0 & 0 & \dots & 0 \\ -1 & 1 & 0 & \dots & 0 \\ 0 & 0 & 1 & \dots & 0 \\ \vdots & \vdots & \vdots & \ddots & \vdots \\ 0 & 0 & 1 & \dots & 1 \end{bmatrix} \quad (1)$$

$$b_i = \begin{bmatrix} 1 & \dots & 0 & 0 & \dots & 0 \\ \vdots & \ddots & \vdots & \vdots & \ddots & \vdots \\ 0 & \dots & -t & 0 & \dots & 0 \\ 0 & \dots & -t & 0 & \dots & 0 \\ 0 & \dots & -1 & 1 & \dots & 0 \\ \vdots & \ddots & \vdots & \vdots & \ddots & \vdots \\ 0 & \dots & 0 & 0 & \dots & 1 \end{bmatrix} \quad (2)$$

$$b_{n-1} = \begin{bmatrix} 1 & 0 & \cdots & 0 & 0 \\ 0 & 1 & \cdots & 0 & 0 \\ \vdots & \vdots & \ddots & \vdots & \vdots \\ 0 & 0 & \cdots & 0 & -t \\ 0 & 0 & \cdots & 0 & -t \end{bmatrix}. \quad (3)$$

Let Ψ be the MATRIX PRODUCT of BRAID WORDS, then

$$\frac{\det(I - \Psi)}{1 + t + \cdots + t^{n-1}} = \Delta_L, \quad (4)$$

where Δ_L is the ALEXANDER POLYNOMIAL and \det is the DETERMINANT.

References

- Burau, W. "Über Zopfgruppen und gleichsinnig verdrehte Verkettungen." *Abh. Math. Sem. Hanischen Univ.* **11**, 171–178, 1936.
 Jones, V. "Hecke Algebra Representation of Braid Groups and Link Polynomials." *Ann. Math.* **126**, 335–388, 1987.

Burkhardt Quartic

The VARIETY which is an invariant of degree four and is given by the equation

$$y_0^4 - y_0(y_1^3 + y_2^3 + y_3^3 + y_4^3) + 3y_1y_2y_3y_4 = 0.$$

References

- Burkhardt, H. "Untersuchungen aus dem Gebiet der hyperelliptischen Modulfunctionen. II." *Math. Ann.* **38**, 161–224, 1890.
 Burkhardt, H. "Untersuchungen aus dem Gebiet der hyperelliptischen Modulfunctionen. III." *Math. Ann.* **40**, 313–343, 1892.
 Hunt, B. "The Burkhardt Quartic." Ch. 5 in *The Geometry of Some Special Arithmetic Quotients*. New York: Springer-Verlag, pp. 168–221, 1996.

Burnside's Conjecture

Every non-ABELIAN SIMPLE GROUP has EVEN ORDER.
 see also ABELIAN GROUP, SIMPLE GROUP

Burnside's Lemma

Let J be a FINITE GROUP and the image $R(J)$ be a representation which is a HOMEOMORPHISM of J into a PERMUTATION GROUP $S(X)$, where $S(X)$ is the GROUP of all permutations of a SET X . Define the orbits of $R(J)$ as the equivalence classes under $x \sim y$, which is true if there is some permutation p in $R(J)$ such that $p(x) = y$. Define the fixed points of p as the elements x of X for which $p(x) = x$. Then the AVERAGE number of FIXED POINTS of permutations in $R(J)$ is equal to the number of orbits of $R(J)$.

The LEMMA was apparently known by Cauchy (1845) in obscure form and Frobenius (1887) prior to Burnside's (1900) rediscovery. It was subsequently extended and refined by Pólya (1937) for applications in COMBINATORIAL counting problems. In this form, it is known as PÓLYA ENUMERATION THEOREM.

References

- Pólya, G. "Kombinatorische Anzahlbestimmungen für Gruppen, Graphen, und chemische Verbindungen." *Acta Math.* **68**, 145–254, 1937.

Burnside Problem

A problem originating with W. Burnside (1902), who wrote, "A still undecided point in the theory of discontinuous groups is whether the ORDER of a GROUP may be not finite, while the order of every operation it contains is finite." This question would now be phrased as "Can a finitely generated group be infinite while every element in the group has finite order?" (Vaughan-Lee 1990). This question was answered by Golod (1964) when he constructed finitely generated infinite p -GROUPS. These GROUPS, however, do not have a finite exponent.

Let F_r be the FREE GROUP of RANK r and let N be the SUBGROUP generated by the set of n th POWERS $\{g^n | g \in F_r\}$. Then N is a normal subgroup of F_r . We define $B(r, n) = F_r/N$ to be the QUOTIENT GROUP. We call $B(r, n)$ the r -generator Burnside group of exponent n . It is the largest r -generator group of exponent n , in the sense that every other such group is a HOMEOMORPHIC image of $B(r, n)$. The Burnside problem is usually stated as: "For which values of r and n is $B(r, n)$ a FINITE GROUP?"

An answer is known for the following values. For $r = 1$, $B(1, n)$ is a CYCLIC GROUP of ORDER n . For $n = 2$, $B(r, 2)$ is an elementary ABELIAN 2-group of ORDER 2^n . For $n = 3$, $B(r, 3)$ was proved to be finite by Burnside. The ORDER of the $B(r, 3)$ groups was established by Levi and van der Waerden (1933), namely 3^a where

$$a \equiv r + \binom{r}{2} + \binom{r}{3}, \quad (1)$$

where $\binom{n}{k}$ is a BINOMIAL COEFFICIENT. For $n = 4$, $B(r, 4)$ was proved to be finite by Sanov (1940). Groups of exponent four turn out to be the most complicated for which a POSITIVE solution is known. The precise nilpotency class and derived length are known, as are bounds for the ORDER. For example,

$$|B(2, 4)| = 2^{12} \quad (2)$$

$$|B(3, 4)| = 2^{69} \quad (3)$$

$$|B(4, 4)| = 2^{422} \quad (4)$$

$$|B(5, 4)| = 2^{2728}, \quad (5)$$

while for larger values of r the exact value is not yet known. For $n = 6$, $B(r, 6)$ was proved to be finite by Hall (1958) with ORDER $2^a 3^b$, where

$$a \equiv 1 + (r - 1)3^c \quad (6)$$

$$b \equiv 1 + (r - 1)2^r \quad (7)$$

$$c \equiv r + \binom{r}{2} + \binom{r}{3}. \quad (8)$$

No other Burnside groups are known to be finite. On the other hand, for $r > 2$ and $n \geq 665$, with n ODD,

$B(r, n)$ is infinite (Novikov and Adjan 1968). There is a similar fact for $r > 2$ and n a large POWER of 2.

E. Zelmanov was awarded a FIELDS MEDAL in 1994 for his solution of the “restricted” Burnside problem.

see also FREE GROUP

References

- Burnside, W. “On an Unsettled Question in the Theory of Discontinuous Groups.” *Quart. J. Pure Appl. Math.* **33**, 230–238, 1902.
- Golod, E. S. “On Nil-Algebras and Residually Finite p -Groups.” *Izv. Akad. Nauk SSSR Ser. Mat.* **28**, 273–276, 1964.
- Hall, M. “Solution of the Burnside Problem for Exponent Six.” *Ill. J. Math.* **2**, 764–786, 1958.
- Levi, F. and van der Waerden, B. L. “Über eine besondere Klasse von Gruppen.” *Abh. Math. Sem. Univ. Hamburg* **9**, 154–158, 1933.
- Novikov, P. S. and Adjan, S. I. “Infinite Periodic Groups I, II, III.” *Izv. Akad. Nauk SSSR Ser. Mat.* **32**, 212–244, 251–524, and 709–731, 1968.
- Sanov, I. N. “Solution of Burnside’s problem for exponent four.” *Leningrad State Univ. Ann. Math. Ser.* **10**, 166–170, 1940.
- Vaughan-Lee, M. *The Restricted Burnside Problem*, 2nd ed. New York: Clarendon Press, 1993.

Busemann-Petty Problem

If the section function of a centered convex body in Euclidean n -space ($n \geq 3$) is smaller than that of another such body, is its volume also smaller?

References

- Gardner, R. J. “Geometric Tomography.” *Not. Amer. Math. Soc.* **42**, 422–429, 1995.

Busy Beaver

A busy beaver is an n -state, 2-symbol, 5-tuple TURING MACHINE which writes the maximum possible number $BB(n)$ of 1s on an initially blank tape before halting. For $n = 0, 1, 2, \dots$, $BB(n)$ is given by 0, 1, 4, 6, 13, ≥ 4098 , ≥ 136612 , \dots . The busy beaver sequence is also known as RADO’S SIGMA FUNCTION.

see also HALTING PROBLEM, TURING MACHINE

References

- Chaitin, G. J. “Computing the Busy Beaver Function.” §4.4 in *Open Problems in Communication and Computation* (Ed. T. M. Cover and B. Gopinath). New York: Springer-Verlag, pp. 108–112, 1987.
- Dewdney, A. K. “A Computer Trap for the Busy Beaver, the Hardest-Working Turing Machine.” *Sci. Amer.* **251**, 19–23, Aug. 1984.
- Marxen, H. and Buntrock, J. “Attacking the Busy Beaver 5.” *Bull. EATCS* **40**, 247–251, Feb. 1990.
- Sloane, N. J. A. Sequence A028444 in “An On-Line Version of the Encyclopedia of Integer Sequences.”

Butterfly Catastrophe

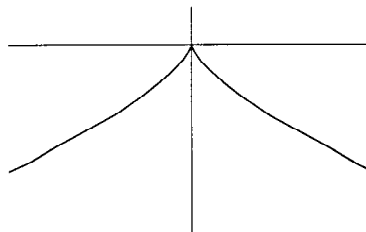

A CATASTROPHE which can occur for four control factors and one behavior axis. The equations

$$\begin{aligned}x &= c(8at^3 + 24t^5) \\ y &= c(-6at^2 - 15t^4)\end{aligned}$$

display such a catastrophe (von Seggern 1993).

References

- von Seggern, D. *CRC Standard Curves and Surfaces*. Boca Raton, FL: CRC Press, p. 94, 1993.

Butterfly Curve

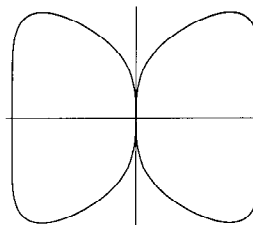

A PLANE CURVE given by the implicit equation

$$y^6 = (x^2 - x^6).$$

see also DUMBBELL CURVE, EIGHT CURVE, PIRIFORM

References

- Cundy, H. and Rollett, A. *Mathematical Models*, 3rd ed. Stradbroke, England: Tarquin Pub., p. 72, 1989.

Butterfly Effect

Due to nonlinearities in weather processes, a butterfly flapping its wings in Tahiti can, in theory, produce a tornado in Kansas. This strong dependence of outcomes on very slightly differing initial conditions is a hallmark of the mathematical behavior known as CHAOS.

see also CHAOS, LORENZ SYSTEM

Butterfly Fractal

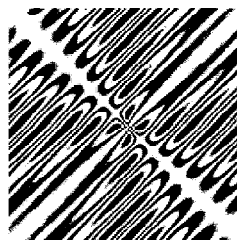

The FRACTAL-like curve generated by the 2-D function

$$f(x, y) = \frac{(x^2 - y^2) \sin\left(\frac{x+y}{a}\right)}{x^2 + y^2}.$$

Butterfly Polyiamond

A 6-POLYIAMOND.

References

Golomb, S. W. *Polyominoes: Puzzles, Patterns, Problems, and Packings*, 2nd ed. Princeton, NJ: Princeton University Press, p. 92, 1994.

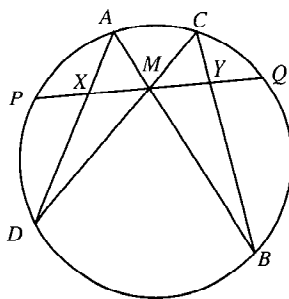
Butterfly Theorem

Given a CHORD PQ of a CIRCLE, draw any other two CHORDS AB and CD passing through its MIDPOINT. Call the points where AD and BC meet PQ X and Y . Then M is the MIDPOINT of XY .

see also CHORD, CIRCLE, MIDPOINT

References

Coxeter, H. S. M. and Greitzer, S. L. *Geometry Revisited*. Washington, DC: Math. Assoc. Amer., pp. 45–46, 1967.

C

C

The FIELD OF COMPLEX NUMBERS, denoted \mathbb{C} .
 see also \mathbb{C}^* , COMPLEX NUMBER, \mathbb{I} , \mathbb{N} , \mathbb{Q} , \mathbb{R} , \mathbb{Z}

\mathbb{C}^*

The RIEMANN SPHERE $\mathbb{C} \cup \{\infty\}$.
 see also \mathbb{C} , COMPLEX NUMBER, \mathbb{Q} , \mathbb{R} , RIEMANN SPHERE, \mathbb{Z}

C^* -Algebra

A special type of B^* -ALGEBRA in which the INVOLUTION is the ADJOINT OPERATOR in a HILBERT SPACE.
 see also B^* -ALGEBRA, k -THEORY

References

Davidson, K. R. *C^* -Algebras by Example*. Providence, RI: Amer. Math. Soc., 1996.

C-Curve

see LÉVY FRACTAL

C-Determinant

A DETERMINANT appearing in PADÉ APPROXIMANT identities:

$$C_{r/s} = \begin{vmatrix} a_{r-s+1} & a_{r-s+2} & \cdots & a_r \\ \vdots & \vdots & \ddots & \vdots \\ a_r & a_{r+1} & \cdots & a_{r+s-1} \end{vmatrix}.$$

see also PADÉ APPROXIMANT

C-Matrix

Any SYMMETRIC MATRIX ($A^T = A$) or SKEW SYMMETRIC MATRIX ($A^T = -A$) C_n with diagonal elements 0 and others ± 1 satisfying

$$CC^T = (n-1)I,$$

where I is the IDENTITY MATRIX, is known as a C -matrix (Ball and Coxeter 1987). Examples include

$$C_4 = \begin{bmatrix} 0 & + & + & + \\ - & 0 & - & + \\ - & + & 0 & - \\ - & - & + & 0 \end{bmatrix}$$

$$C_6 = \begin{bmatrix} 0 & + & + & + & + & + \\ + & 0 & + & - & - & + \\ + & + & 0 & + & + & - \\ + & - & + & 0 & + & - \\ + & - & - & + & 0 & + \\ + & + & - & - & + & 0 \end{bmatrix}.$$

References

Ball, W. W. R. and Coxeter, H. S. M. *Mathematical Recreations and Essays, 13th ed.* New York: Dover, pp. 308–309, 1987.

C-Table

see C-DETERMINANT

Cable Knot

Let K_1 be a TORUS KNOT. Then the SATELLITE KNOT with COMPANION KNOT K_2 is a cable knot on K_2 .

References

Adams, C. C. *The Knot Book: An Elementary Introduction to the Mathematical Theory of Knots*. New York: W. H. Freeman, p. 118, 1994.
 Rolfsen, D. *Knots and Links*. Wilmington, DE: Publish or Perish Press, pp. 112 and 283, 1976.

Cactus Fractal



A MANDELBROT SET-like FRACTAL obtained by iterating the map

$$z_{n+1} = z_n^3 + (z_0 - 1)z_n - z_0.$$

see also FRACTAL, JULIA SET, MANDELBROT SET

Cake Cutting

It is always possible to “fairly” divide a cake among n people using only vertical cuts. Furthermore, it is possible to cut and divide a cake such that each person believes that *everyone* has received $1/n$ of the cake according to his own measure. Finally, if there is some piece on which two people disagree, then there is a way of partitioning and dividing a cake such that each participant believes that he has obtained more than $1/n$ of the cake according to his own measure.

Ignoring the height of the cake, the cake-cutting problem is really a question of fairly dividing a CIRCLE into n equal AREA pieces using cuts in its plane. One method of proving fair cake cutting to always be possible relies on the FROBENIUS-KÖNIG THEOREM.

see also CIRCLE CUTTING, CYLINDER CUTTING, ENVY-FREE, FROBENIUS-KÖNIG THEOREM, HAM SANDWICH THEOREM, PANCAKE THEOREM, PIZZA THEOREM, SQUARE CUTTING, TORUS CUTTING

References

Brams, S. J. and Taylor, A. D. “An Envy-Free Cake Division Protocol.” *Amer. Math. Monthly* **102**, 9–19, 1995.
 Brams, S. J. and Taylor, A. D. *Fair Division: From Cake-Cutting to Dispute Resolution*. New York: Cambridge University Press, 1996.
 Dubbins, L. and Spanier, E. “How to Cut a Cake Fairly.” *Amer. Math. Monthly* **68**, 1–17, 1961.
 Gale, D. “Dividing a Cake.” *Math. Intel.* **15**, 50, 1993.
 Jones, M. L. “A Note on a Cake Cutting Algorithm of Banach and Knaster.” *Amer. Math. Monthly* **104**, 353–355, 1997.
 Rehmman, K. “How to Get (At Least) a Fair Share of the Cake.” In *Mathematical Plums* (Ed. R. Honsberger). Washington, DC: Math. Assoc. Amer., pp. 22–37, 1979.

Steinhaus, H. "Sur la division progmatique." *Ekonometrika (Supp.)* 17, 315–319, 1949.
 Stromquist, W. "How to Cut a Cake Fairly." *Amer. Math. Monthly* 87, 640–644, 1980.

Cal

see WALSH FUNCTION

Calabi's Triangle

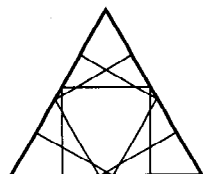

Equilateral Triangle

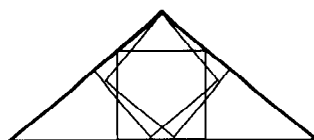

Calabi's Triangle

The one TRIANGLE in addition to the EQUILATERAL TRIANGLE for which the largest inscribed SQUARE can be inscribed in three different ways. The ratio of the sides to that of the base is given by $x = 1.55138752455 \dots$ (Sloane's A046095), where

$$x = \frac{1}{3} + \frac{(-23 + 3i\sqrt{237})^{1/3}}{3 \cdot 2^{2/3}} + \frac{11}{3[2(-23 + 3i\sqrt{237})]^{1/3}}$$

is the largest POSITIVE ROOT of

$$2x^3 - 2x^2 - 3x + 2 = 0,$$

which has CONTINUED FRACTION [1, 1, 1, 4, 2, 1, 2, 1, 5, 2, 1, 3, 1, 1, 390, ...] (Sloane's A046096).

see also GRAHAM'S BIGGEST LITTLE HEXAGON

References

- Conway, J. H. and Guy, R. K. "Calabi's Triangle." In *The Book of Numbers*. New York: Springer-Verlag, p. 206, 1996.
 Sloane, N. J. A. Sequences A046095 and A046096 in "An On-Line Version of the Encyclopedia of Integer Sequences."

Calabi-Yau Space

A structure into which the 6 extra DIMENSIONS of 10-D string theory curl up.

Calculus

In general, "a" calculus is an abstract theory developed in a purely formal way.

"The" calculus, more properly called ANALYSIS (or REAL ANALYSIS or, in older literature, INFINITESIMAL ANALYSIS) is the branch of mathematics studying the rate of change of quantities (which can be interpreted as SLOPES of curves) and the length, AREA, and VOLUME of objects. The CALCULUS is sometimes divided into DIFFERENTIAL and INTEGRAL CALCULUS, concerned with DERIVATIVES

$$\frac{d}{dx}f(x)$$

and INTEGRALS

$$\int f(x) dx,$$

respectively.

While ideas related to calculus had been known for some time (Archimedes' EXHAUSTION METHOD was a form of calculus), it was not until the independent work of Newton and Leibniz that the modern elegant tools and ideas of calculus were developed. Even so, many years elapsed until the subject was put on a mathematically rigorous footing by mathematicians such as Weierstraß.

see also ARC LENGTH, AREA, CALCULUS OF VARIATIONS, CHANGE OF VARIABLES THEOREM, DERIVATIVE, DIFFERENTIAL CALCULUS, ELLIPSOIDAL CALCULUS, EXTENSIONS CALCULUS, FLUENT, FLUXION, FRACTIONAL CALCULUS, FUNCTIONAL CALCULUS, FUNDAMENTAL THEOREMS OF CALCULUS, HEAVISIDE CALCULUS, INTEGRAL, INTEGRAL CALCULUS, JACOBIAN, LAMBDA CALCULUS, KIRBY CALCULUS, MALLI-AVIN CALCULUS, PREDICATE CALCULUS, PROPOSITIONAL CALCULUS, SLOPE, TENSOR CALCULUS, UMBRAL CALCULUS, VOLUME

References

- Anton, H. *Calculus with Analytic Geometry*, 5th ed. New York: Wiley, 1995.
 Apostol, T. M. *Calculus*, 2nd ed., Vol. 1: *One-Variable Calculus, with an Introduction to Linear Algebra*. Waltham, MA: Blaisdell, 1967.
 Apostol, T. M. *Calculus*, 2nd ed., Vol. 2: *Multi-Variable Calculus and Linear Algebra, with Applications to Differential Equations and Probability*. Waltham, MA: Blaisdell, 1969.
 Apostol, T. M. *A Century of Calculus*, 2 vols. Pt. 1: 1894–1968. Pt. 2: 1969–1991. Washington, DC: Math. Assoc. Amer., 1992.
 Ayres, F. Jr. and Mendelson, E. *Schaum's Outline of Theory and Problems of Differential and Integral Calculus*, 3rd ed. New York: McGraw-Hill, 1990.
 Borden, R. S. *A Course in Advanced Calculus*. New York: Dover, 1998.
 Boyer, C. B. *A History of the Calculus and Its Conceptual Development*. New York: Dover, 1989.
 Brown, K. S. "Calculus and Differential Equations." <http://www.seanet.com/~ksbrown/icalculu.htm>.
 Courant, R. and John, F. *Introduction to Calculus and Analysis*, Vol. 1. New York: Springer-Verlag, 1990.
 Courant, R. and John, F. *Introduction to Calculus and Analysis*, Vol. 2. New York: Springer-Verlag, 1990.
 Hahn, A. *Basic Calculus: From Archimedes to Newton to Its Role in Science*. New York: Springer-Verlag, 1998.
 Kaplan, W. *Advanced Calculus*, 4th ed. Reading, MA: Addison-Wesley, 1992.
 Marsden, J. E. and Tromba, A. J. *Vector Calculus*, 4th ed. New York: W. H. Freeman, 1996.
 Strang, G. *Calculus*. Wellesley, MA: Wellesley-Cambridge Press, 1991.

Calculus of Variations

A branch of mathematics which is a sort of generalization of CALCULUS. Calculus of variations seeks to find the path, curve, surface, etc., for which a given FUNCTION has a STATIONARY VALUE (which, in physical

problems, is usually a MINIMUM or MAXIMUM). Mathematically, this involves finding STATIONARY VALUES of integrals of the form

$$I = \int_b^a f(y, \dot{y}, x) dx. \quad (1)$$

I has an extremum only if the EULER-LAGRANGE DIFFERENTIAL EQUATION is satisfied, i.e., if

$$\frac{\partial f}{\partial y} - \frac{d}{dx} \left(\frac{\partial f}{\partial \dot{y}} \right) = 0. \quad (2)$$

The FUNDAMENTAL LEMMA OF CALCULUS OF VARIATIONS states that, if

$$\int_a^b M(x)h(x) dx = 0 \quad (3)$$

for all $h(x)$ with CONTINUOUS second PARTIAL DERIVATIVES, then

$$M(x) = 0 \quad (4)$$

on (a, b) .

see also BELTRAMI IDENTITY, BOLZA PROBLEM, BRACHISTOCURVE PROBLEM, CATENARY, ENVELOPE THEOREM, EULER-LAGRANGE DIFFERENTIAL EQUATION, ISOPERIMETRIC PROBLEM, ISOVOLUME PROBLEM, LINDELOF'S THEOREM, PLATEAU'S PROBLEM, POINT-POINT DISTANCE—2-D, POINT-POINT DISTANCE—3-D, ROULETTE, SKEW QUADRILATERAL, SPHERE WITH TUNNEL, UNDULOID, WEIERSTRASS-ERDMAN CORNER CONDITION

References

- Arfken, G. "Calculus of Variations." Ch. 17 in *Mathematical Methods for Physicists*, 3rd ed. Orlando, FL: Academic Press, pp. 925–962, 1985.
- Bliss, G. A. *Calculus of Variations*. Chicago, IL: Open Court, 1925.
- Forsyth, A. R. *Calculus of Variations*. New York: Dover, 1960.
- Fox, C. *An Introduction to the Calculus of Variations*. New York: Dover, 1988.
- Isenberg, C. *The Science of Soap Films and Soap Bubbles*. New York: Dover, 1992.
- Menger, K. "What is the Calculus of Variations and What are Its Applications?" In *The World of Mathematics* (Ed. K. Newman). Redmond, WA: Microsoft Press, pp. 886–890, 1988.
- Sagan, H. *Introduction to the Calculus of Variations*. New York: Dover, 1992.
- Todhunter, I. *History of the Calculus of Variations During the Nineteenth Century*. New York: Chelsea, 1962.
- Weinstock, R. *Calculus of Variations, with Applications to Physics and Engineering*. New York: Dover, 1974.

Calculus

$$1 \text{ calculus} \equiv \frac{1}{2304}.$$

see also HALF, QUARTER, SCRUPLE, UNCIA, UNIT FRACTION

Calderón's Formula

$$f(x) = C_\psi \int_{-\infty}^{\infty} \int_{-\infty}^{\infty} \langle f, \psi^{a,b} \rangle \psi^{a,b}(x) a^{-2} da db,$$

where

$$\psi^{a,b}(x) = |a|^{-1/2} \psi\left(\frac{x-b}{a}\right).$$

This result was originally derived using HARMONIC ANALYSIS, but also follows from a WAVELETS viewpoint.

Caliban Puzzle

A puzzle in LOGIC in which one or more facts must be inferred from a set of given facts.

Calvary Cross

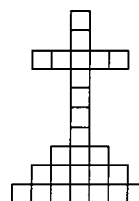

see also CROSS

Cameron's Sum-Free Set Constant

A set of POSITIVE INTEGERS S is sum-free if the equation $x + y = z$ has no solutions $x, y, z \in S$. The probability that a random sum-free set S consists entirely of ODD INTEGERS satisfies

$$0.21759 \leq c \leq 0.21862.$$

References

- Cameron, P. J. "Cyclic Automorphisms of a Countable Graph and Random Sum-Free Sets." *Graphs and Combinatorics* 1, 129–135, 1985.
- Cameron, P. J. "Portrait of a Typical Sum-Free Set." In *Surveys in Combinatorics 1987* (Ed. C. Whitehead). New York: Cambridge University Press, 13–42, 1987.
- Finch, S. "Favorite Mathematical Constants." <http://www.mathsoft.com/asolve/constant/cameron/cameron.html>.

Cancellation

see ANOMALOUS CANCELLATION

Cancellation Law

If $bc \equiv bd \pmod{a}$ and $(b, a) = 1$ (i.e., a and b are RELATIVELY PRIME), then $c \equiv d \pmod{a}$.

see also CONGRUENCE

References

- Courant, R. and Robbins, H. *What is Mathematics?: An Elementary Approach to Ideas and Methods*, 2nd ed. Oxford, England: Oxford University Press, p. 36, 1996.
- Shanks, D. *Solved and Unsolved Problems in Number Theory*, 4th ed. New York: Chelsea, p. 56, 1993.

Cannonball Problem

Find a way to stack a SQUARE of cannonballs laid out on the ground into a SQUARE PYRAMID (i.e., find a SQUARE NUMBER which is also SQUARE PYRAMIDAL). This corresponds to solving the DIOPHANTINE EQUATION

$$\sum_{i=1}^k i^2 = \frac{1}{6}k(1+k)(1+2k) = N^2$$

for some pyramid height k . The only solution is $k = 24$, $N = 70$, corresponding to 4900 cannonballs (Ball and Coxeter 1987, Dickson 1952), as conjectured by Lucas (1875, 1876) and proved by Watson (1918).

see also SPHERE PACKING, SQUARE NUMBER, SQUARE PYRAMID, SQUARE PYRAMIDAL NUMBER

References

- Ball, W. W. R. and Coxeter, H. S. M. *Mathematical Recreations and Essays*, 13th ed. New York: Dover, p. 59, 1987.
 Dickson, L. E. *History of the Theory of Numbers*, Vol. 2: *Diophantine Analysis*. New York: Chelsea, p. 25, 1952.
 Lucas, É. Question 1180. *Nouvelles Ann. Math. Ser. 2* **14**, 336, 1875.
 Lucas, É. Solution de Question 1180. *Nouvelles Ann. Math. Ser. 2* **15**, 429–432, 1876.
 Ogilvy, C. S. and Anderson, J. T. *Excursions in Number Theory*. New York: Dover, pp. 77 and 152, 1988.
 Pappas, T. "Cannon Balls & Pyramids." *The Joy of Mathematics*. San Carlos, CA: Wide World Publ./Tetra, p. 93, 1989.
 Watson, G. N. "The Problem of the Square Pyramid." *Messenger. Math.* **48**, 1–22, 1918.

Canonical Form

A clear-cut way of describing every object in a class in a ONE-TO-ONE manner.

see also NORMAL FORM, ONE-TO-ONE

References

- Petkovšek, M.; Wilf, H. S.; and Zeilberger, D. *A=B*. Wellesley, MA: A. K. Peters, p. 7, 1996.

Canonical Polyhedron

A POLYHEDRON is said to be canonical if all its EDGES touch a SPHERE and the center of gravity of their contact points is the center of that SPHERE. Each combinatorial type of (GENUS zero) polyhedron contains just one canonical version. The ARCHIMEDEAN SOLIDS and their DUALS are all canonical.

References

- Conway, J. H. "Re: polyhedra database." Posting to geometry.forum.newsgroup, Aug. 31, 1995.

Canonical Transformation

see SYMPLECTIC DIFFEOMORPHISM

Cantor Comb

see CANTOR SET

Cantor-Dedekind Axiom

The points on a line can be put into a ONE-TO-ONE correspondence with the REAL NUMBERS.

see also CARDINAL NUMBER, CONTINUUM HYPOTHESIS, DEDEKIND CUT

Cantor Diagonal Slash

A clever and rather abstract technique used by Georg Cantor to show that the INTEGERS and REALS cannot be put into a ONE-TO-ONE correspondence (i.e., the INFINITY of REAL NUMBERS is "larger" than the INFINITY of INTEGERS). It proceeds by constructing a new member S' of a SET from already known members S by arranging its n th term to differ from the n th term of the n th member of S . The tricky part is that this is done in such a way that the SET including the new member has a larger CARDINALITY than the original SET S .

see also CARDINALITY, CONTINUUM HYPOTHESIS, DENUMERABLE SET

References

- Courant, R. and Robbins, H. *What is Mathematics?: An Elementary Approach to Ideas and Methods*, 2nd ed. Oxford, England: Oxford University Press, pp. 81–83, 1996.
 Penrose, R. *The Emperor's New Mind: Concerning Computers, Minds, and the Laws of Physics*. Oxford, England: Oxford University Press, pp. 84–85, 1989.

Cantor Dust

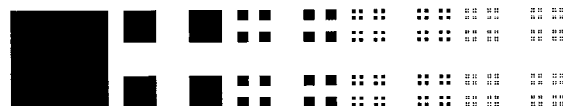

A FRACTAL which can be constructed using STRING REWRITING by creating a matrix three times the size of the current matrix using the rules

```
line 1: "*" -> "*" *, " " -> " "
line 2: "*" -> " " , " " -> " "
line 3: "*" -> "*" *, " " -> " "
```

Let N_n be the number of black boxes, L_n the length of a side of a white box, and A_n the fractional AREA of black boxes after the n th iteration.

$$N_n = 5^n \quad (1)$$

$$L_n = \left(\frac{1}{3}\right)^n = 3^{-n} \quad (2)$$

$$A_n = L_n^2 N_n = \left(\frac{5}{9}\right)^n. \quad (3)$$

The CAPACITY DIMENSION is therefore

$$\begin{aligned} d_{\text{cap}} &= -\lim_{n \rightarrow \infty} \frac{\ln N_n}{\ln L_n} = -\lim_{n \rightarrow \infty} \frac{\ln(5^n)}{\ln(3^{-n})} \\ &= \frac{\ln 5}{\ln 3} = 1.464973521 \dots \end{aligned} \quad (4)$$

see also BOX FRACTAL, SIERPIŃSKI CARPET, SIERPIŃSKI SIEVE

References

- Dickau, R. M. "Cantor Dust." <http://forum.swarthmore.edu/advanced/robertd/cantor.html>.
 Ott, E. *Chaos in Dynamical Systems*. New York: Cambridge University Press, pp. 103-104, 1993.
 ✱ Weisstein, E. W. "Fractals." <http://www.astro.virginia.edu/~eww6n/math/notebooks/Fractal.m>.

Cantor's Equation

$$\omega^\epsilon = \epsilon,$$

where ω is an ORDINAL NUMBER and ϵ is an INACCESSIBLE CARDINAL.

see also INACCESSIBLE CARDINAL, ORDINAL NUMBER

References

- Conway, J. H. and Guy, R. K. *The Book of Numbers*. New York: Springer-Verlag, p. 274, 1996.

Cantor Function

The function whose values are

$$\frac{1}{2} \left(\frac{c_1}{2} + \dots + \frac{c_{m-1}}{2^{m-1}} + \frac{2}{2^m} \right)$$

for any number between

$$a \equiv \frac{c_1}{3} + \dots + \frac{c_{m-1}}{3^{m-1}} + \frac{1}{3^m}$$

and

$$b \equiv \frac{c_1}{3} + \dots + \frac{c_{m-1}}{3^{m-1}} + \frac{2}{3^m}.$$

Chalice (1991) shows that any real-values function $F(x)$ on $[0, 1]$ which is MONOTONE INCREASING and satisfies

1. $F(0) = 0$,
2. $F(x/3) = F(x)/2$,
3. $F(1-x) = 1 - F(x)$

is the Cantor function.

see also CANTOR SET, DEVIL'S STAIRCASE

References

- Chalice, D. R. "A Characterization of the Cantor Function." *Amer. Math. Monthly* **98**, 255-258, 1991.
 Wagon, S. "The Cantor Function" and "Complex Cantor Sets." §4.2 and 5.1 in *Mathematica in Action*. New York: W. H. Freeman, pp. 102-108 and 143-149, 1991.

Cantor's Paradox

The SET of all SETS is its own POWER SET. Therefore, the CARDINALITY of the SET of all SETS must be bigger than itself.

see also CANTOR'S THEOREM, POWER SET

Cantor Set

The Cantor set (T_∞) is given by taking the interval $[0,1]$ (set T_0), removing the middle third (T_1), removing the middle third of each of the two remaining pieces (T_2), and continuing this procedure ad infinitum. It is therefore the set of points in the INTERVAL $[0,1]$ whose ternary expansions do not contain 1, illustrated below.

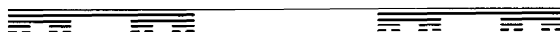

This produces the SET of REAL NUMBERS $\{x\}$ such that

$$x = \frac{c_1}{3} + \dots + \frac{c_n}{3^n} + \dots, \quad (1)$$

where c_n may equal 0 or 2 for each n . This is an infinite, PERFECT SET. The total length of the LINE SEGMENTS in the n th iteration is

$$\ell_n = \left(\frac{2}{3}\right)^n, \quad (2)$$

and the number of LINE SEGMENTS is $N_n = 2^n$, so the length of each element is

$$\epsilon_n \equiv \frac{\ell}{N} = \left(\frac{1}{3}\right)^n \quad (3)$$

and the CAPACITY DIMENSION is

$$\begin{aligned} d_{\text{cap}} &\equiv - \lim_{\epsilon \rightarrow 0^+} \frac{\ln N}{\ln \epsilon} = - \lim_{n \rightarrow \infty} \frac{n \ln 2}{-n \ln 3} \\ &= \frac{\ln 2}{\ln 3} = 0.630929\dots \end{aligned} \quad (4)$$

The Cantor set is nowhere DENSE, so it has LEBESGUE MEASURE 0.

A general Cantor set is a CLOSED SET consisting entirely of BOUNDARY POINTS. Such sets are UNCOUNTABLE and may have 0 or POSITIVE LEBESGUE MEASURE. The Cantor set is the only totally disconnected, perfect, COMPACT METRIC SPACE up to a HOMEOMORPHISM (Willard 1970).

see also ALEXANDER'S HORNED SPHERE, ANTOINE'S NECKLACE, CANTOR FUNCTION

References

- Boas, R. P. Jr. *A Primer of Real Functions*. Washington, DC: Amer. Math. Soc., 1996.
 Lauwerier, H. *Fractals: Endlessly Repeated Geometric Figures*. Princeton, NJ: Princeton University Press, pp. 15-20, 1991.
 Willard, S. §30.4 in *General Topology*. Reading, MA: Addison-Wesley, 1970.

Cantor Square Fractal

A FRACTAL which can be constructed using STRING REWRITING by creating a matrix three times the size of the current matrix using the rules

line 1: "*"-">"***", " ">" "
 line 2: "*"-">"* *", " ">" "
 line 3: "*"-">"***", " ">" "

The first few steps are illustrated above.

The size of the unit element after the n th iteration is

$$L_n = \left(\frac{1}{3}\right)^n$$

and the number of elements is given by the RECURRENT RELATION

$$N_n = 4N_{n-1} + 5(9^n)$$

where $N_1 \equiv 5$, and the first few numbers of elements are 5, 65, 665, 6305, Expanding out gives

$$N_n = 5 \sum_{k=0}^n 4^{n-k} 9^{k-1} = 9^n - 4^n.$$

The CAPACITY DIMENSION is therefore

$$\begin{aligned} D &= - \lim_{n \rightarrow \infty} \frac{\ln N_n}{\ln L_n} = - \lim_{n \rightarrow \infty} \frac{\ln(9^n - 4^n)}{\ln(3^{-n})} \\ &= - \lim_{n \rightarrow \infty} \frac{\ln(9^n)}{\ln(3^{-n})} = \frac{\ln 9}{\ln 3} = \frac{2 \ln 3}{\ln 3} = 2. \end{aligned}$$

Since the DIMENSION of the filled part is 2 (i.e., the SQUARE is completely filled), Cantor's square fractal is not a true FRACTAL.

see also BOX FRACTAL, CANTOR DUST

References

Lauwerier, H. *Fractals: Endlessly Repeated Geometric Figures*. Princeton, NJ: Princeton University Press, pp. 82–83, 1991.

✱ Weisstein, E. W. "Fractals." <http://www.astro.virginia.edu/~eww6n/math/notebooks/Fractal.m>.

Cantor's Theorem

The CARDINAL NUMBER of any set is lower than the CARDINAL NUMBER of the set of all its subsets. A COROLLARY is that there is no highest \aleph (ALEPH).

see also CANTOR'S PARADOX

Cap

see CROSS-CAP, SPHERICAL CAP

Capacity

see TRANSFINITE DIAMETER

Capacity Dimension

A DIMENSION also called the FRACTAL DIMENSION, HAUSDORFF DIMENSION, and HAUSDORFF-BESICOVITCH DIMENSION in which nonintegral values are permitted. Objects whose capacity dimension is different from their TOPOLOGICAL DIMENSION are called FRACTALS. The capacity dimension of a compact METRIC SPACE X is a REAL NUMBER d_{capacity} such that if $n(\epsilon)$ denotes the minimum number of open sets of diameter less than or equal to ϵ , then $n(\epsilon)$ is proportional to ϵ^{-D} as $\epsilon \rightarrow 0$. Explicitly,

$$d_{\text{capacity}} \equiv - \lim_{\epsilon \rightarrow 0^+} \frac{\ln N}{\ln \epsilon}$$

(if the limit exists), where N is the number of elements forming a finite COVER of the relevant METRIC SPACE and ϵ is a bound on the diameter of the sets involved (informally, ϵ is the size of each element used to cover the set, which is taken to approach 0). If each element of a FRACTAL is equally likely to be visited, then $d_{\text{capacity}} = d_{\text{information}}$, where $d_{\text{information}}$ is the INFORMATION DIMENSION. The capacity dimension satisfies

$$d_{\text{correlation}} \leq d_{\text{information}} \leq d_{\text{capacity}}$$

where $d_{\text{correlation}}$ is the CORRELATION DIMENSION, and is conjectured to be equal to the LYAPUNOV DIMENSION. see also CORRELATION EXPONENT, DIMENSION, HAUSDORFF DIMENSION, KAPLAN-YORKE DIMENSION

References

Nayfeh, A. H. and Balachandran, B. *Applied Nonlinear Dynamics: Analytical, Computational, and Experimental Methods*. New York: Wiley, pp. 538–541, 1995.

Peitgen, H.-O. and Richter, D. H. *The Beauty of Fractals: Images of Complex Dynamical Systems*. New York: Springer-Verlag, 1986.

Wheeden, R. L. and Zygmund, A. *Measure and Integral: An Introduction to Real Analysis*. New York: M. Dekker, 1977.

Carathéodory Derivative

A function f is Carathéodory differentiable at a if there exists a function ϕ which is CONTINUOUS at a such that

$$f(x) - f(a) = \phi(x)(x - a).$$

Every function which is Carathéodory differentiable is also FRÉCHET DIFFERENTIABLE.

see also DERIVATIVE, FRÉCHET DERIVATIVE

Carathéodory's Fundamental Theorem

Each point in the CONVEX HULL of a set S in \mathbb{R}^n is in the convex combination of $n + 1$ or fewer points of S .

see also CONVEX HULL, HELLY'S THEOREM

Cardano's Formula

see CUBIC EQUATION

Cardinal Number

In informal usage, a cardinal number is a number used in counting (a COUNTING NUMBER), such as 1, 2, 3, . . .

Formally, a cardinal number is a type of number defined in such a way that any method of counting SETS using it gives the same result. (This is not true for the ORDINAL NUMBERS.) In fact, the cardinal numbers are obtained by collecting all ORDINAL NUMBERS which are obtainable by counting a given set. A set has \aleph_0 (ALEPH-0) members if it can be put into a ONE-TO-ONE correspondence with the finite ORDINAL NUMBERS.

Two sets are said to have the same cardinal number if all the elements in the sets can be paired off ONE-TO-ONE. An INACCESSIBLE CARDINAL cannot be expressed in terms of a smaller number of smaller cardinals.

see also ALEPH, ALEPH-0 (\aleph_0), ALEPH-1 (\aleph_1), CANTOR-DEDEKIND AXIOM, CANTOR DIAGONAL SLASH, CONTINUUM, CONTINUUM HYPOTHESIS, EQUIPOLLENT, INACCESSIBLE CARDINALS AXIOM, INFINITY, ORDINAL NUMBER, POWER SET, SURREAL NUMBER, UNCOUNTABLE SET

References

- Cantor, G. *Über unendliche, lineare Punktmannigfaltigkeiten, Arbeiten zur Mengenlehre aus dem Jahren 1872–1884*. Leipzig, Germany: Teubner, 1884.
- Conway, J. H. and Guy, R. K. "Cardinal Numbers." In *The Book of Numbers*. New York: Springer-Verlag, pp. 277–282, 1996.
- Courant, R. and Robbins, H. "Cantor's 'Cardinal Numbers.'" §2.4.3 in *What is Mathematics?: An Elementary Approach to Ideas and Methods*, 2nd ed. Oxford, England: Oxford University Press, pp. 83–86, 1996.

Cardinality

see CARDINAL NUMBER

Cardioid

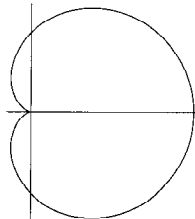

The curve given by the POLAR equation

$$r = a(1 + \cos \theta), \quad (1)$$

sometimes also written

$$r = 2b(1 + \cos \theta), \quad (2)$$

where $b \equiv a/2$, the CARTESIAN equation

$$(x^2 + y^2 - ax)^2 = a^2(x^2 + y^2), \quad (3)$$

and the parametric equations

$$x = a \cos t(1 + \cos t) \quad (4)$$

$$y = a \sin t(1 + \cos t). \quad (5)$$

The cardioid is a degenerate case of the LIMAÇON. It is also a 1-CUSPED EPICYCLOID (with $r = R$) and is the CAUSTIC formed by rays originating at a point on the circumference of a CIRCLE and reflected by the CIRCLE.

The name cardioid was first used by de Castillon in *Philosophical Transactions of the Royal Society* in 1741. Its ARC LENGTH was found by La Hire in 1708. There are exactly three PARALLEL TANGENTS to the cardioid with any given gradient. Also, the TANGENTS at the ends of any CHORD through the CUSP point are at RIGHT ANGLES. The length of any CHORD through the CUSP point is $2a$.

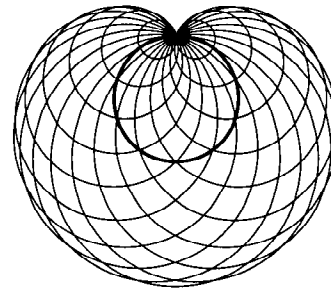

The cardioid may also be generated as follows. Draw a CIRCLE C and fix a point A on it. Now draw a set of CIRCLES centered on the CIRCUMFERENCE of C and passing through A . The ENVELOPE of these CIRCLES is then a cardioid (Pedoe 1995). Let the CIRCLE C be centered at the origin and have RADIUS 1, and let the fixed point be $A = (1, 0)$. Then the RADIUS of a CIRCLE centered at an ANGLE θ from $(1, 0)$ is

$$\begin{aligned} r^2 &= (0 - \cos \theta)^2 + (1 - \sin \theta)^2 \\ &= \cos^2 \theta + 1 - 2 \sin \theta + \sin^2 \theta \\ &= 2(1 - \sin \theta). \end{aligned} \quad (6)$$

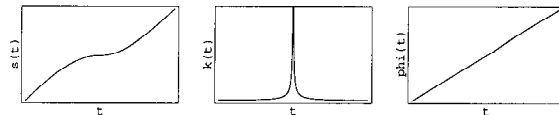

The ARC LENGTH, CURVATURE, and TANGENTIAL ANGLE are

$$s = \int_0^t 2|\cos(\frac{1}{2}t)| dt = 4a \sin(\frac{1}{2}\theta) \quad (7)$$

$$\kappa = \frac{3|\sec(\frac{1}{2}\theta)|}{4a} \quad (8)$$

$$\phi = \frac{3}{2}\theta. \quad (9)$$

As usual, care must be taken in the evaluation of $s(t)$ for $t > \pi$. Since (7) comes from an integral involving the

ABSOLUTE VALUE of a function, it must be monotonic increasing. Each QUADRANT can be treated correctly by defining

$$n = \left\lfloor \frac{t}{\pi} \right\rfloor + 1, \quad (10)$$

where $\lfloor x \rfloor$ is the FLOOR FUNCTION, giving the formula

$$s(t) = (-1)^{1+[n \pmod{2}]} 4 \sin(\tfrac{1}{2}t) + 8 \lfloor \tfrac{1}{2}n \rfloor. \quad (11)$$

The PERIMETER of the curve is

$$\begin{aligned} L &= \int_0^{2\pi} |2a \cos(\tfrac{1}{2}\theta)| d\theta = 4a \int_0^\pi \cos(\tfrac{1}{2}\theta) d\theta \\ &= 4a \int_0^{\pi/2} \cos \phi (2 d\phi) = 8a \int_0^{\pi/2} \cos \phi d\phi \\ &= 8a [\sin \phi]_0^{\pi/2} = 8a. \end{aligned} \quad (12)$$

The AREA is

$$\begin{aligned} A &= \tfrac{1}{2} \int_0^{2\pi} r^2 d\theta = \tfrac{1}{2} a^2 \int_0^{2\pi} (1 + 2 \cos \theta + \cos^2 \theta) d\theta \\ &= \tfrac{1}{2} a^2 \int_0^{2\pi} \{1 + 2 \cos \theta + \tfrac{1}{2}[1 + \cos(2\theta)]\} d\theta \\ &= \tfrac{1}{2} a^2 \int_0^{2\pi} [\tfrac{3}{2} + 2 \cos \theta + \tfrac{1}{2} \cos(2\theta)] d\theta \\ &= \tfrac{1}{2} a^2 [\tfrac{3}{2}\theta + 2 \sin \theta + \tfrac{1}{4} \sin(2\theta)]_0^{2\pi} = \tfrac{3}{2} \pi a^2. \end{aligned} \quad (13)$$

see also CIRCLE, CISSOID, CONCHOID, EQUIANGULAR SPIRAL, LEMNISCATE, LIMAÇON, MANDELBROT SET

References

- Gray, A. "Cardioids." §3.3 in *Modern Differential Geometry of Curves and Surfaces*. Boca Raton, FL: CRC Press, pp. 41–42, 1993.
- Lawrence, J. D. *A Catalog of Special Plane Curves*. New York: Dover, pp. 118–121, 1972.
- Lee, X. "Cardioid." http://www.best.com/~xah/SpecialPlaneCurves_dir/Cardioid_dir/cardioid.html.
- Lee, X. "Cardioid." http://www.best.com/~xah/SpecialPlaneCurves_dir/Cardioid_dir/cardioidGG.html.
- Lockwood, E. H. "The Cardioid." Ch. 4 in *A Book of Curves*. Cambridge, England: Cambridge University Press, pp. 34–43, 1967.
- MacTutor History of Mathematics Archive. "Cardioid." <http://www-groups.dcs.st-and.ac.uk/~history/Curves/Cardioid.html>.
- Pedoe, D. *Circles: A Mathematical View*, rev. ed. Washington, DC: Math. Assoc. Amer., pp. xxvi–xxvii, 1995.
- Yates, R. C. "The Cardioid." *Math. Teacher* **52**, 10–14, 1959.
- Yates, R. C. "Cardioid." *A Handbook on Curves and Their Properties*. Ann Arbor, MI: J. W. Edwards, pp. 4–7, 1952.

Cardioid Caustic

The CATACAUSTIC of a CARDIOID for a RADIANT POINT at the CUSP is a NEPHROID. The CATACAUSTIC for PARALLEL rays crossing a CIRCLE is a CARDIOID.

Cardioid Evolute

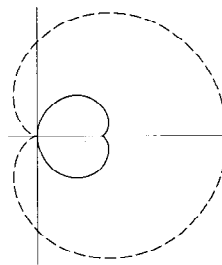

$$\begin{aligned} x &= \tfrac{2}{3}a + \tfrac{1}{3}a \cos \theta (1 - \cos \theta) \\ y &= \tfrac{1}{3}a \sin \theta (1 - \cos \theta). \end{aligned}$$

This is a mirror-image CARDIOID with $a' = a/3$.

Cardioid Inverse Curve

If the CUSP of the cardioid is taken as the INVERSION CENTER, the cardioid inverts to a PARABOLA.

Cardioid Involute

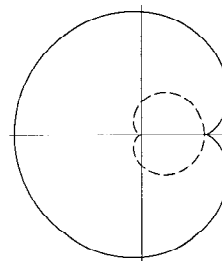

$$\begin{aligned} x &= 2a + 3a \cos \theta (1 - \cos \theta) \\ y &= 3a \sin \theta (1 - \cos \theta). \end{aligned}$$

This is a mirror-image CARDIOID with $a' = 3a$.

Cardioid Pedal Curve

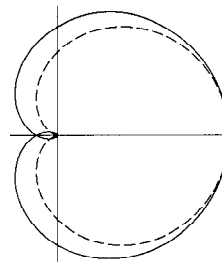

The PEDAL CURVE of the CARDIOID where the PEDAL POINT is the CUSP is CAYLEY'S SEXTIC.

Cards

Cards are a set of n rectangular pieces of cardboard with markings on one side and a uniform pattern on the other. The collection of all cards is called a "deck," and a normal deck of cards consists of 52 cards of four different "suits." The suits are called clubs (♣), diamonds (♦), hearts (♥), and spades (♠). Spades and clubs are

colored black, while hearts and diamonds are colored red. The cards of each suit are numbered 1 through 13, where the special terms ace (1), jack (11), queen (12), and king (13) are used instead of numbers 1 and 11–13.

The randomization of the order of cards in a deck is called SHUFFLING. Cards are used in many gambling games (such as POKER), and the investigation of the probabilities of various outcomes in card games was one of the original motivations for the development of modern PROBABILITY theory.

see also BRIDGE CARD GAME, CLOCK SOLITAIRE, COIN, COIN TOSSING, DICE, POKER, SHUFFLE

Carleman's Inequality

Let $\{a_i\}_{i=1}^n$ be a SET of POSITIVE numbers. Then the GEOMETRIC MEAN and ARITHMETIC MEAN satisfy

$$\sum_{i=1}^n (a_1 a_2 \cdots a_i)^{1/i} \leq \frac{e}{n} \sum_{i=1}^n a_i.$$

Here, the constant e is the best possible, in the sense that counterexamples can be constructed for any stricter INEQUALITY which uses a smaller constant.

see also ARITHMETIC MEAN, e , GEOMETRIC MEAN

References

- Gradshteyn, I. S. and Ryzhik, I. M. *Tables of Integrals, Series, and Products*, 5th ed. San Diego, CA: Academic Press, p. 1094, 1979.
 Hardy, G. H.; Littlewood, J. E.; and Pólya, G. *Inequalities*, 2nd ed. Cambridge, England: Cambridge University Press, pp. 249–250, 1988.

Carlson-Levin Constant

N.B. A detailed on-line essay by S. Finch was the starting point for this entry.

Assume that f is a NONNEGATIVE REAL function on $[0, \infty)$ and that the two integrals

$$\int_0^\infty x^{p-1-\lambda} [f(x)]^p dx \quad (1)$$

$$\int_0^\infty x^{q-1+\mu} [f(x)]^q dx \quad (2)$$

exist and are FINITE. If $p = q = 2$ and $\lambda = \mu = 1$, Carlson (1934) determined

$$\int_0^\infty f(x) dx \leq \sqrt{\pi} \left(\int_0^\infty [f(x)]^2 dx \right)^{1/4} \times \left(\int_0^\infty x^2 [f(x)]^2 dx \right)^{1/4} \quad (3)$$

and showed that $\sqrt{\pi}$ is the best constant (in the sense that counterexamples can be constructed for any stricter

INEQUALITY which uses a smaller constant). For the general case

$$\int_0^\infty f(x) dx \leq C \left(\int_0^\infty x^{p-1-\lambda} [f(x)]^p dx \right)^s \times \left(\int_0^\infty x^{q-1+\mu} [f(x)]^q dx \right)^t, \quad (4)$$

and Levin (1948) showed that the best constant

$$C = \frac{1}{(ps)^s (qt)^t} \left[\frac{\Gamma\left(\frac{s}{\alpha}\right) \Gamma\left(\frac{t}{\alpha}\right)}{(\lambda + \mu) \Gamma\left(\frac{s+t}{\alpha}\right)} \right]^\alpha, \quad (5)$$

where

$$s \equiv \frac{\mu}{p\mu + q\lambda} \quad (6)$$

$$t \equiv \frac{\lambda}{p\mu + q\lambda} \quad (7)$$

$$\alpha \equiv 1 - s - t \quad (8)$$

and $\Gamma(z)$ is the GAMMA FUNCTION.

References

- Beckenbach, E. F.; and Bellman, R. *Inequalities*. New York: Springer-Verlag, 1983.
 Boas, R. P. Jr. Review of Levin, V. I. "Exact Constants in Inequalities of the Carlson Type." *Math. Rev.* **9**, 415, 1948.
 Finch, S. "Favorite Mathematical Constants." <http://www.mathsoft.com/asolve/constant/crlslvn/crlslvn.html>.
 Levin, V. I. "Exact Constants in Inequalities of the Carlson Type." *Doklady Akad. Nauk. SSSR (N. S.)* **59**, 635–638, 1948. English review in Boas (1948).
 Mitrinovic, D. S.; Pecaric, J. E.; and Fink, A. M. *Inequalities Involving Functions and Their Integrals and Derivatives*. Kluwer, 1991.

Carlson's Theorem

If $f(z)$ is regular and of the form $\mathcal{O}(e^{k|z|})$ where $k < \pi$, for $\Re[z] \geq 0$, and if $f(z) = 0$ for $z = 0, 1, \dots$, then $f(z)$ is identically zero.

see also GENERALIZED HYPERGEOMETRIC FUNCTION

References

- Bailey, W. N. "Carlson's Theorem." §5.3 in *Generalised Hypergeometric Series*. Cambridge, England: Cambridge University Press, pp. 36–40, 1935.

Carlyle Circle

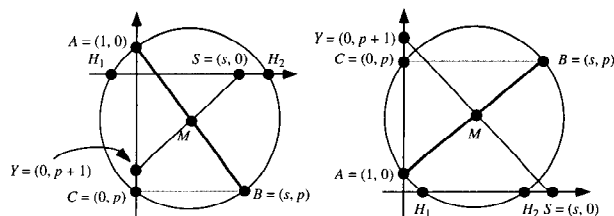

Consider a QUADRATIC EQUATION $x^2 - sx + p = 0$ where s and p denote signed lengths. The CIRCLE which has

the points $A = (0, 1)$ and $B = (s, p)$ as a DIAMETER is then called the Carlyle circle $C_{s,p}$ of the equation. The CENTER of $C_{s,p}$ is then at the MIDPOINT of AB , $M = (s/2, (1+p)/2)$, which is also the MIDPOINT of $S = (s, 0)$ and $Y = (0, 1+p)$. Call the points at which $C_{s,p}$ crosses the x -AXIS $H_1 = (x_1, 0)$ and $H_2 = (x_2, 0)$ (with $x_1 \geq x_2$). Then

$$s = x_1 + x_2$$

$$p = x_1 x_2$$

$$(x - x_1)(x - x_2) = x^2 - sx + p,$$

so x_1 and x_2 are the ROOTS of the quadratic equation. see also 257-GON, 65537-GON, HEPTADECAGON, PENTAGON

References

- De Temple, D. W. "Carlyle Circles and the Lemoine Simplicity of Polygonal Constructions." *Amer. Math. Monthly* **98**, 97–108, 1991.
 Eves, H. *An Introduction to the History of Mathematics*, 6th ed. Philadelphia, PA: Saunders, 1990.
 Leslie, J. *Elements of Geometry and Plane Trigonometry with an Appendix and Very Copious Notes and Illustrations*, 4th ed., improved and exp. Edinburgh: W. & G. Tait, 1820.

Carmichael Condition

A number n satisfies the Carmichael condition IFF $(p-1)|(n/p-1)$ for all PRIME DIVISORS p of n . This is equivalent to the condition $(p-1)|(n-1)$ for all PRIME DIVISORS p of n .

see also CARMICHAEL NUMBER

References

- Borwein, D.; Borwein, J. M.; Borwein, P. B.; and Girgensohn, R. "Giuga's Conjecture on Primality." *Amer. Math. Monthly* **103**, 40–50, 1996.

Carmichael's Conjecture

Carmichael's conjecture asserts that there are an INFINITE number of CARMICHAEL NUMBERS. This was proven by Alford *et al.* (1994).

see also CARMICHAEL NUMBER, CARMICHAEL'S TOTIENT FUNCTION CONJECTURE

References

- Alford, W. R.; Granville, A.; and Pomerance, C. "There Are Infinitely Many Carmichael Numbers." *Ann. Math.* **139**, 703–722, 1994.
 Cipra, B. *What's Happening in the Mathematical Sciences*, Vol. 1. Providence, RI: Amer. Math. Soc., 1993.
 Guy, R. K. "Carmichael's Conjecture." §B39 in *Unsolved Problems in Number Theory*, 2nd ed. New York: Springer-Verlag, p. 94, 1994.
 Pomerance, C.; Selfridge, J. L.; and Wagstaff, S. S. Jr. "The Pseudoprimes to $25 \cdot 10^9$." *Math. Comput.* **35**, 1003–1026, 1980.
 Ribenboim, P. *The Book of Prime Number Records*, 2nd ed. New York: Springer-Verlag, pp. 29–31, 1989.
 Schiaffly, A. and Wagon, S. "Carmichael's Conjecture on the Euler Function is Valid Below $10^{10,000,000}$." *Math. Comput.* **63**, 415–419, 1994.

Carmichael Function

$\lambda(n)$ is the LEAST COMMON MULTIPLE (LCM) of all the FACTORS of the TOTIENT FUNCTION $\phi(n)$, except that if $8|n$, then $2^{\alpha-2}$ is a FACTOR instead of $2^{\alpha-1}$.

$$\lambda(n) = \begin{cases} \phi(n) & \text{for } n = p^\alpha, p = 2 \text{ and } \alpha \leq 2, \text{ or } p \geq 3 \\ \frac{1}{2}\phi(n) & \text{for } n = 2^\alpha \text{ and } \alpha \geq 3 \\ \text{LCM}[\lambda(p_i^{\alpha_i})]_i & \text{for } n = \prod_i p_i^{\alpha_i}. \end{cases}$$

Some special values are

$$\lambda(1) = 1$$

$$\lambda(2) = 1$$

$$\lambda(4) = 2$$

$$\lambda(2^r) = 2^{r-2}$$

for $r \geq 3$, and

$$\lambda(p^r) = \phi(p^r)$$

for p an ODD PRIME and $r \geq 1$. The ORDER of $a \pmod n$ is at most $\lambda(n)$ (Ribenboim 1989). The values of $\lambda(n)$ for the first few n are 1, 1, 2, 2, 2, 4, 2, 6, 4, 10, 2, 12, ... (Sloane's A011773).

see also MODULO MULTIPLICATION GROUP

References

- Ribenboim, P. *The Book of Prime Number Records*, 2nd ed. New York: Springer-Verlag, p. 27, 1989.
 Riesel, H. "Carmichael's Function." *Prime Numbers and Computer Methods for Factorization*, 2nd ed. Boston, MA: Birkhäuser, pp. 273–275, 1994.
 Sloane, N. J. A. Sequence A011773 in "An On-Line Version of the Encyclopedia of Integer Sequences."
 Vardi, I. *Computational Recreations in Mathematica*. Redwood City, CA: Addison-Wesley, p. 226, 1991.

Carmichael Number

A Carmichael number is an ODD COMPOSITE NUMBER n which satisfies FERMAT'S LITTLE THEOREM

$$a^{n-1} - 1 \equiv 0 \pmod n$$

for every choice of a satisfying $(a, n) = 1$ (i.e., a and n are RELATIVELY PRIME) with $1 < a < n$. A Carmichael number is therefore a PSEUDOPRIME to any base. Carmichael numbers therefore cannot be found to be COMPOSITE using FERMAT'S LITTLE THEOREM. However, if $(a, n) \neq 1$, the congruence of FERMAT'S LITTLE THEOREM is sometimes NONZERO, thus identifying a Carmichael number n as COMPOSITES.

Carmichael numbers are sometimes called ABSOLUTE PSEUDOPRIMES and also satisfy KORSALT'S CRITERION. R. D. Carmichael first noted the existence of such numbers in 1910, computed 15 examples, and conjectured that there were infinitely many (a fact finally proved by Alford *et al.* 1994).

The first few Carmichael numbers are 561, 1105, 1729, 2465, 2821, 6601, 8911, 10585, 15841, 29341, ... (Sloane's A002997). Carmichael numbers have at least three PRIME FACTORS. For Carmichael numbers with exactly three PRIME FACTORS, once one of the PRIMES has been specified, there are only a finite number of Carmichael numbers which can be constructed. Numbers of the form $(6k+1)(12k+1)(18k+1)$ are Carmichael numbers if each of the factors is PRIME (Korselt 1899, Ore 1988, Guy 1994). This can be seen since for

$$N \equiv (6k+1)(12k+1)(18k+1) = 1296k^3 + 396k^2 + 36k + 1,$$

$N - 1$ is a multiple of $36k$ and the LEAST COMMON MULTIPLE of $6k$, $12k$, and $18k$ is $36k$, so $a^{N-1} \equiv 1$ modulo each of the PRIMES $6k+1$, $12k+1$, and $18k+1$, hence $a^{N-1} \equiv 1$ modulo their product. The first few such Carmichael numbers correspond to $k = 1, 6, 35, 45, 51, 55, 56, \dots$ and are 1729, 294409, 56052361, 118901521, ... (Sloane's A046025). The largest known Carmichael number of this form was found by H. Dubner in 1996 and has 1025 digits.

The smallest Carmichael numbers having 3, 4, ... factors are $561 = 3 \times 11 \times 17$, $41041 = 7 \times 11 \times 13 \times 41$, 825265 , 321197185 , ... (Sloane's A006931). In total, there are only 43 Carmichael numbers $< 10^6$, $2163 \leq 2.5 \times 10^{10}$, $105,212 \leq 10^{15}$, and $246,683 \leq 10^{16}$ (Pinch 1993). Let $C(n)$ denote the number of Carmichael numbers less than n . Then, for sufficiently large n ($n \sim 10^7$ from numerical evidence),

$$C(n) \sim n^{2/7}$$

(Alford *et al.* 1994).

The Carmichael numbers have the following properties:

1. If a PRIME p divides the Carmichael number n , then $n \equiv 1 \pmod{p-1}$ implies that $n \equiv p \pmod{p(p-1)}$.
2. Every Carmichael number is SQUAREFREE.
3. An ODD COMPOSITE SQUAREFREE number n is a Carmichael number IFF n divides the DENOMINATOR of the BERNOULLI NUMBER B_{n-1} .

see also CARMICHAEL CONDITION, PSEUDOPRIME

References

- Alford, W. R.; Granville, A.; and Pomerance, C. "There are Infinitely Many Carmichael Numbers." *Ann. Math.* **139**, 703–722, 1994.
- Beyer, W. H. *CRC Standard Mathematical Tables*, 28th ed. Boca Raton, FL: CRC Press, p. 87, 1987.
- Guy, R. K. "Carmichael Numbers." §A13 in *Unsolved Problems in Number Theory*, 2nd ed. New York: Springer-Verlag, pp. 30–32, 1994.
- Korselt, A. "Problème chinois." *L'intermédiaire math.* **6**, 143–143, 1899.
- Ore, Ø. *Number Theory and Its History*. New York: Dover, 1988.
- Pinch, R. G. E. "The Carmichael Numbers up to 10^{15} ." *Math. Comput.* **55**, 381–391, 1993.

Pinch, R. G. E. <ftp://emu.pmms.cam.ac.uk/pub/Carmichael/>.

Pomerance, C.; Selfridge, J. L.; and Wagstaff, S. S. Jr. "The Pseudoprimes to $25 \cdot 10^9$." *Math. Comput.* **35**, 1003–1026, 1980.

Riesel, H. *Prime Numbers and Computer Methods for Factorization*, 2nd ed. Basel: Birkhäuser, pp. 89–90 and 94–95, 1994.

Shanks, D. *Solved and Unsolved Problems in Number Theory*, 4th ed. New York: Chelsea, p. 116, 1993.

Sloane, N. J. A. Sequences A002997/M5462 and A006931/M5463 in "An On-Line Version of the Encyclopedia of Integer Sequences."

Carmichael Sequence

A FINITE, INCREASING SEQUENCE of INTEGERS $\{a_1, \dots, a_m\}$ such that

$$(a_i - 1) | (a_1 \cdots a_{i-1})$$

for $i = 1, \dots, m$, where $m|n$ indicates that m DIVIDES n . A Carmichael sequence has exclusive EVEN or ODD elements. There are infinitely many Carmichael sequences for every order.

see also GIUGA SEQUENCE

References

- Borwein, D.; Borwein, J. M.; Borwein, P. B.; and Girgensohn, R. "Giuga's Conjecture on Primality." *Amer. Math. Monthly* **103**, 40–50, 1996.

Carmichael's Theorem

If a and n are RELATIVELY PRIME so that the GREATEST COMMON DENOMINATOR $\text{GCD}(a, n) = 1$, then

$$a^{\lambda(n)} \equiv 1 \pmod{n},$$

where λ is the CARMICHAEL FUNCTION.

Carmichael's Totient Function Conjecture

It is thought that the TOTIENT VALENCE FUNCTION $N_\phi(m) \geq 2$ (i.e., the TOTIENT VALENCE FUNCTION never takes the value 1). This assertion is called Carmichael's totient function conjecture and is equivalent to the statement that there exists an $m \neq n$ such that $\phi(n) = \phi(m)$ (Ribenoim 1996, pp. 39–40). Any counterexample to the conjecture must have more than 10,000 DIGITS (Conway and Guy 1996). Recently, the conjecture was reportedly proven by F. Saidak in November, 1997 with a proof short enough to fit on a postcard.

see also TOTIENT FUNCTION, TOTIENT VALENCE FUNCTION

References

- Conway, J. H. and Guy, R. K. *The Book of Numbers*. New York: Springer-Verlag, p. 155, 1996.
- Ribenoim, P. *The New Book of Prime Number Records*. New York: Springer-Verlag, 1996.

Carnot's Polygon Theorem

If P_1, P_2, \dots , are the VERTICES of a finite POLYGON with no "minimal sides" and the side $P_i P_j$ meets a curve in the POINTS P_{ij1} and P_{ij2} , then

$$\frac{\prod_i \overline{P_1 P_{12i}} \prod_i \overline{P_2 P_{23i}} \cdots \prod_i \overline{P_N P_{N1i}}}{\prod_i \overline{P_N P_{N1i}} \cdots \prod_i \overline{P_2 P_{21i}}} = 1,$$

where \overline{AB} denotes the DISTANCE from POINT A to B .

References

Coolidge, J. L. *A Treatise on Algebraic Plane Curves*. New York: Dover, p. 190, 1959.

Carnot's Theorem

Given any TRIANGLE $A_1 A_2 A_3$, the signed sum of PERPENDICULAR distances from the CIRCUMCENTER O to the sides is

$$OO_1 + OO_2 + OO_3 = R + r,$$

where r is the INRADIUS and R is the CIRCUMRADIUS. The sign of the distance is chosen to be POSITIVE IFF the entire segment OO_i lies outside the TRIANGLE.

see also JAPANESE TRIANGULATION THEOREM

References

Eves, H. W. *A Survey of Geometry*, rev. ed. Boston, MA: Allyn and Bacon, pp. 256 and 262, 1972.
Honsberger, R. *Mathematical Gems III*. Washington, DC: Math. Assoc. Amer., p. 25, 1985.

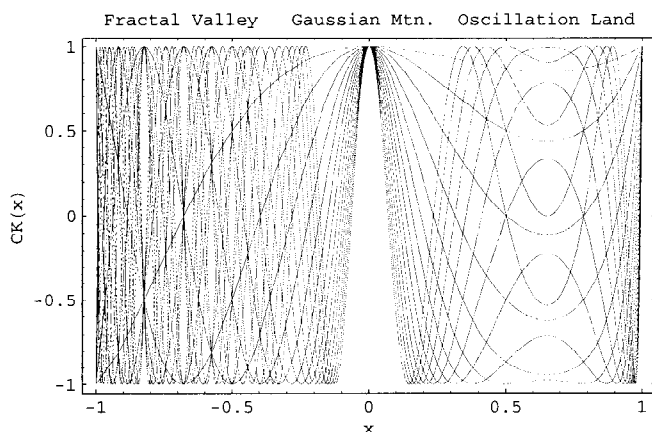
Carotid-Kundalini Fractal

A fractal-like structure is produced for $x < 0$ by superposing plots of CAROTID-KUNDALINI FUNCTIONS CK_n of different orders n . The region $-1 < x < 0$ is called FRACTAL LAND by Pickover (1995), the central region the GAUSSIAN MOUNTAIN RANGE, and the region $x > 0$ OSCILLATION LAND. The plot above shows $n = 1$ to 25. Gaps in FRACTAL LAND occur whenever

$$x \cos^{-1} x = 2\pi \frac{p}{q}$$

for p and q RELATIVELY PRIME INTEGERS. At such points x , the functions assume the $[(q+1)/2]$ values

$\cos(2\pi r/q)$ for $r = 0, 1, \dots, [q/2]$, where $[z]$ is the CEILING FUNCTION and $\lfloor z \rfloor$ is the FLOOR FUNCTION.

References

Pickover, C. A. "Are Infinite Carotid-Kundalini Functions Fractal?" Ch. 24 in *Keys to Infinity*. New York: W. H. Freeman, pp. 179–181, 1995.

Carotid-Kundalini Function

The FUNCTION given by

$$CK_n(x) \equiv \cos(nx \cos^{-1} x),$$

where n is an INTEGER and $-1 < x < 1$.

see also CAROTID-KUNDALINI FRACTAL

Carry

$$\begin{array}{r} 1 \ 1 \quad \leftarrow \text{carries} \\ 1 \ 5 \ 8 \quad \leftarrow \text{addend 1} \\ + 2 \ 4 \ 9 \quad \leftarrow \text{addend 2} \\ \hline 4 \ 0 \ 7 \quad \leftarrow \text{sum} \end{array}$$

The operating of shifting the leading DIGITS of an ADDITION into the next column to the left when the SUM of that column exceeds a single DIGIT (i.e., 9 in base 10).

see also ADDEND, ADDITION, BORROW

Carrying Capacity

see LOGISTIC GROWTH CURVE

Cartan Matrix

A MATRIX used in the presentation of a LIE ALGEBRA.

References

Jacobson, N. *Lie Algebras*. New York: Dover, p. 121, 1979.

Cartan Relation

The relationship $Sq^i(x \smile y) = \sum_{j+k=i} Sq^j(x) \smile Sq^k(y)$ encountered in the definition of the STEENROD ALGEBRA.

Cartan Subgroup

A type of maximal Abelian SUBGROUP.

References

Knapp, A. W. "Group Representations and Harmonic Analysis, Part II." *Not. Amer. Math. Soc.* **43**, 537–549, 1996.

Cartan Torsion Coefficient

The ANTISYMMETRIC parts of the CONNECTION COEFFICIENT $\Gamma^\lambda_{\mu\nu}$.

Cartesian Coordinates

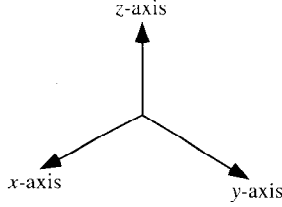

Cartesian coordinates are rectilinear 2-D or 3-D coordinates (and therefore a special case of CURVILINEAR COORDINATES) which are also called RECTANGULAR COORDINATES. The three axes of 3-D Cartesian coordinates, conventionally denoted the x -, y -, and z -AXES (a NOTATION due to Descartes) are chosen to be linear and mutually PERPENDICULAR. In 3-D, the coordinates x , y , and z may lie anywhere in the INTERVAL $(-\infty, \infty)$.

The SCALE FACTORS of Cartesian coordinates are all unity, $h_i = 1$. The LINE ELEMENT is given by

$$ds = dx \hat{\mathbf{x}} + dy \hat{\mathbf{y}} + dz \hat{\mathbf{z}}, \quad (1)$$

and the VOLUME ELEMENT by

$$dV = dx dy dz. \quad (2)$$

The GRADIENT has a particularly simple form,

$$\nabla \equiv \hat{\mathbf{x}} \frac{\partial}{\partial x} + \hat{\mathbf{y}} \frac{\partial}{\partial y} + \hat{\mathbf{z}} \frac{\partial}{\partial z}, \quad (3)$$

as does the LAPLACIAN

$$\nabla^2 \equiv \frac{\partial^2}{\partial x^2} + \frac{\partial^2}{\partial y^2} + \frac{\partial^2}{\partial z^2}. \quad (4)$$

The LAPLACIAN is

$$\begin{aligned} \nabla^2 \mathbf{F} &\equiv \nabla \cdot (\nabla \mathbf{F}) = \frac{\partial^2 \mathbf{F}}{\partial x^2} + \frac{\partial^2 \mathbf{F}}{\partial y^2} + \frac{\partial^2 \mathbf{F}}{\partial z^2} \\ &= \hat{\mathbf{x}} \left(\frac{\partial^2 F_x}{\partial x^2} + \frac{\partial^2 F_x}{\partial y^2} + \frac{\partial^2 F_x}{\partial z^2} \right) \\ &\quad + \hat{\mathbf{y}} \left(\frac{\partial^2 F_y}{\partial x^2} + \frac{\partial^2 F_y}{\partial y^2} + \frac{\partial^2 F_y}{\partial z^2} \right) \\ &\quad + \hat{\mathbf{z}} \left(\frac{\partial^2 F_z}{\partial x^2} + \frac{\partial^2 F_z}{\partial y^2} + \frac{\partial^2 F_z}{\partial z^2} \right). \end{aligned} \quad (5)$$

The DIVERGENCE is

$$\nabla \cdot \mathbf{F} = \frac{\partial F_x}{\partial x} + \frac{\partial F_y}{\partial y} + \frac{\partial F_z}{\partial z}, \quad (6)$$

and the CURL is

$$\begin{aligned} \nabla \times \mathbf{F} &= \begin{vmatrix} \hat{\mathbf{x}} & \hat{\mathbf{y}} & \hat{\mathbf{z}} \\ \frac{\partial}{\partial x} & \frac{\partial}{\partial y} & \frac{\partial}{\partial z} \\ F_x & F_y & F_z \end{vmatrix} \\ &= \left(\frac{\partial F_z}{\partial y} - \frac{\partial F_y}{\partial z} \right) \hat{\mathbf{x}} + \left(\frac{\partial F_x}{\partial z} - \frac{\partial F_z}{\partial x} \right) \hat{\mathbf{y}} \\ &\quad + \left(\frac{\partial F_y}{\partial x} - \frac{\partial F_x}{\partial y} \right) \hat{\mathbf{z}}. \end{aligned} \quad (7)$$

The GRADIENT of the DIVERGENCE is

$$\begin{aligned} \nabla(\nabla \cdot \mathbf{u}) &= \begin{bmatrix} \frac{\partial}{\partial x} \left(\frac{\partial u_x}{\partial x} + \frac{\partial u_y}{\partial y} + \frac{\partial u_z}{\partial z} \right) \\ \frac{\partial}{\partial y} \left(\frac{\partial u_x}{\partial x} + \frac{\partial u_y}{\partial y} + \frac{\partial u_z}{\partial z} \right) \\ \frac{\partial}{\partial z} \left(\frac{\partial u_x}{\partial x} + \frac{\partial u_y}{\partial y} + \frac{\partial u_z}{\partial z} \right) \end{bmatrix} \\ &= \begin{bmatrix} \frac{\partial}{\partial x} \\ \frac{\partial}{\partial y} \\ \frac{\partial}{\partial z} \end{bmatrix} \left(\frac{\partial u_x}{\partial x} + \frac{\partial u_y}{\partial y} + \frac{\partial u_z}{\partial z} \right). \end{aligned} \quad (8)$$

LAPLACE'S EQUATION is separable in Cartesian coordinates.

see also COORDINATES, HELMHOLTZ DIFFERENTIAL EQUATION—CARTESIAN COORDINATES

References

Arfken, G. "Special Coordinate Systems—Rectangular Cartesian Coordinates." §2.3 in *Mathematical Methods for Physicists*, 3rd ed. Orlando, FL: Academic Press, pp. 94–95, 1985.

Morse, P. M. and Feshbach, H. *Methods of Theoretical Physics, Part I*. New York: McGraw-Hill, p. 656, 1953.

Cartesian Ovals

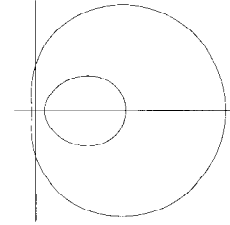

A curve consisting of two ovals which was first studied by Descartes in 1637. It is the locus of a point P whose distances from two FOCI F_1 and F_2 in two-center BIPOLEAR COORDINATES satisfy

$$mr \pm nr' = k, \quad (1)$$

where m, n are POSITIVE INTEGERS, k is a POSITIVE real, and r and r' are the distances from F_1 and F_2 . If $m = n$, the oval becomes an an ELLIPSE. In CARTESIAN COORDINATES, the Cartesian ovals can be written

$$m\sqrt{(x-a)^2 + y^2} + n\sqrt{(x+a)^2 + y^2} = k^2 \quad (2)$$

$$\begin{aligned} (x^2 + y^2 + a^2)(m^2 - n^2) - 2ax(m^2 + n^2) - k^2 \\ = -2n\sqrt{(x+a)^2 + y^2}, \end{aligned} \quad (3)$$

$$\begin{aligned} [(m^2 - n^2)(x^2 + y^2 + a^2) - 2ax(m^2 + n^2)]^2 \\ = 2(m^2 + n^2)(n^2 + y^2 + a^2) - 4ax(m^2 - n^2) - k^2. \end{aligned} \quad (4)$$

Now define

$$b \equiv m^2 - n^2 \quad (5)$$

$$c \equiv m^2 + n^2, \quad (6)$$

and set $a = 1$. Then

$$[b(x^2 + y^2) - 2cx + b]^2 + 4bx + k^2 - 2c = 2c(x^2 + y^2). \quad (7)$$

If c' is the distance between F_1 and F_2 , and the equation

$$r + mr' = a \quad (8)$$

is used instead, an alternate form is

$$[(1-m^2)(x^2+y^2)+2m^2c'x+a'^2-m^2c'^2]^2 = 4a'^2(x^2+y^2). \quad (9)$$

The curves possess three FOCI. If $m = 1$, one Cartesian oval is a central CONIC, while if $m = a/c$, then the curve is a LIMAÇON and the inside oval touches the outside one. Cartesian ovals are ANALLAGMATIC CURVES.

References

- Cundy, H. and Rollett, A. *Mathematical Models*, 3rd ed. Stradbroke, England: Tarquin Pub., p. 35, 1989.
 Lawrence, J. D. *A Catalog of Special Plane Curves*. New York: Dover, pp. 155–157, 1972.
 Lockwood, E. H. *A Book of Curves*. Cambridge, England: Cambridge University Press, p. 188, 1967.
 MacTutor History of Mathematics Archive. “Cartesian Oval.” <http://www-groups.dcs.st-and.ac.uk/~history/Curves/Cartesian.html>.

Cartesian Product

see DIRECT PRODUCT (SET)

Cartesian Trident

see TRIDENT OF DESCARTES

Cartography

The study of MAP PROJECTIONS and the making of geographical maps.

see also MAP PROJECTION

Cascade

A \mathbb{Z} -ACTION or \mathbb{N} -ACTION. A cascade and a single MAP $X \rightarrow X$ are essentially the same, but the term “cascade” is preferred by many Russian authors.

see also ACTION, FLOW

Casey's Theorem

Four CIRCLES are TANGENT to a fifth CIRCLE or a straight LINE IFF

$$t_{12}t_{34} \pm t_{13}t_{42} \pm t_{14}t_{23} = 0,$$

where t_{ij} is a common TANGENT to CIRCLES i and j .

see also PURSER'S THEOREM

References

- Johnson, R. A. *Modern Geometry: An Elementary Treatise on the Geometry of the Triangle and the Circle*. Boston, MA: Houghton Mifflin, pp. 121–127, 1929.

Casimir Operator

An OPERATOR

$$\Gamma = \sum_{i=1}^m e_i^R u^{iR}$$

on a representation R of a LIE ALGEBRA.

References

- Jacobson, N. *Lie Algebras*. New York: Dover, p. 78, 1979.

Cassini Ellipses

see CASSINI OVALS

Cassini's Identity

For F_n the n th FIBONACCI NUMBER,

$$F_{n-1}F_{n+1} - F_n^2 = (-1)^n.$$

see also FIBONACCI NUMBER

References

- Petkovšek, M.; Wilf, H. S.; and Zeilberger, D. *A=B*. Wellesley, MA: A. K. Peters, p. 12, 1996.

Cassini Ovals

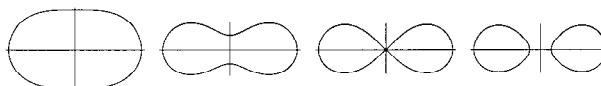

The curves, also called CASSINI ELLIPSES, described by a point such that the product of its distances from two fixed points a distance $2a$ apart is a constant b^2 . The shape of the curve depends on b/a . If $a < b$, the curve is a single loop with an OVAL (left figure above) or dog bone (second figure) shape. The case $a = b$ produces a LEMNISCATE (third figure). If $a > b$, then the curve consists of two loops (right figure). The curve was first investigated by Cassini in 1680 when he was studying the relative motions of the Earth and the Sun. Cassini believed that the Sun traveled around the Earth on one of these ovals, with the Earth at one FOCUS of the oval.

Cassini ovals are ANALLAGMATIC CURVES. The Cassini ovals are defined in two-center BIPOLAR COORDINATES by the equation

$$r_1 r_2 = b^2, \quad (1)$$

with the origin at a FOCUS. Even more incredible curves are produced by the locus of a point the product of whose distances from 3 or more fixed points is a constant.

The Cassini ovals have the CARTESIAN equation

$$[(x-a)^2 + y^2][(x+a)^2 + y^2] = b^4 \quad (2)$$

or the equivalent form

$$(x^2 + y^2 + a^2)^2 - 4a^2 x^2 = b^4 \quad (3)$$

and the polar equation

$$r^4 + a^4 - 2a^2 r^2 \cos(2\theta) = b^4. \quad (4)$$

Solving for r^2 using the QUADRATIC EQUATION gives

$$\begin{aligned} r^2 &= \frac{2a^2 \cos(2\theta) + \sqrt{4a^4 \cos^2(2\theta) - 4(a^4 - b^4)}}{2} \\ &= a^2 \cos(2\theta) + \sqrt{a^4 \cos^2(2\theta) + b^4 - a^4} \\ &= a^2 \cos(2\theta) + \sqrt{a^4 [\cos^2(2\theta) - 1] + b^4} \\ &= a^2 \cos(2\theta) + \sqrt{b^4 - a^4 \sin^2(2\theta)} \\ &= a^2 \left[\cos(2\theta) + \sqrt{\left(\frac{b}{a}\right)^4 - \sin^2(2\theta)} \right]. \end{aligned} \quad (5)$$

If $a < b$, the curve has AREA

$$A = \frac{1}{2} r^2 d\theta = 2\left(\frac{1}{2}\right) \int_{-\pi/4}^{\pi/4} r^2 d\theta = a^2 + b^2 E\left(\frac{a^4}{b^4}\right), \quad (6)$$

where the integral has been done over half the curve and then multiplied by two and $E(x)$ is the complete ELLIPTIC INTEGRAL OF THE SECOND KIND. If $a = b$, the curve becomes

$$r^2 = a^2 [\cos(2\theta) + \sqrt{1 - \sin^2 \theta}] = 2a^2 \cos(2\theta), \quad (7)$$

which is a LEMNISCATE having AREA

$$A = 2a^2 \quad (8)$$

(two loops of a curve $\sqrt{2}$ the linear scale of the usual lemniscate $r^2 = a^2 \cos(2\theta)$, which has area $A = a^2/2$ for each loop). If $a > b$, the curve becomes two disjoint ovals with equations

$$r = \pm a \sqrt{\cos(2\theta) \pm \sqrt{\left(\frac{b}{a}\right)^4 - \sin^2(2\theta)}}, \quad (9)$$

where $\theta \in [-\theta_0, \theta_0]$ and

$$\theta_0 \equiv \frac{1}{2} \sin^{-1} \left[\left(\frac{b}{a}\right)^2 \right]. \quad (10)$$

see also CASSINI SURFACE, LEMNISCATE, MANDELBROT SET, OVAL

References

- Gray, A. "Cassinian Ovals." §4.2 in *Modern Differential Geometry of Curves and Surfaces*. Boca Raton, FL: CRC Press, pp. 63–65, 1993.
- Lawrence, J. D. *A Catalog of Special Plane Curves*. New York: Dover, pp. 153–155, 1972.
- Lee, X. "Cassinian Oval." http://www.best.com/~xah/SpecialPlaneCurves_dir/CassinianOval_dir/cassinianOval.html.
- Lockwood, E. H. *A Book of Curves*. Cambridge, England: Cambridge University Press, pp. 187–188, 1967.
- MacTutor History of Mathematics Archive. "Cassinian Ovals." <http://www-groups.dcs.st-and.ac.uk/~history/Curves/Cassinian.html>.
- Yates, R. C. "Cassinian Curves." *A Handbook on Curves and Their Properties*. Ann Arbor, MI: J. W. Edwards, pp. 8–11, 1952.

Cassini Projection

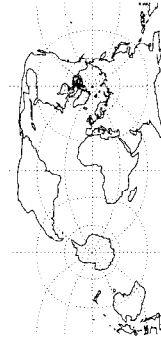

A MAP PROJECTION.

$$x = \sin^{-1} B \quad (1)$$

$$y = \tan^{-1} \left[\frac{\tan \phi}{\cos(\lambda - \lambda_0)} \right], \quad (2)$$

where

$$B = \cos \phi \sin(\lambda - \lambda_0). \quad (3)$$

The inverse FORMULAS are

$$\phi = \sin^{-1}(\sin D \cos x) \quad (4)$$

$$\lambda = \lambda_0 + \tan^{-1} \left(\frac{\tan x}{\cos D} \right), \quad (5)$$

where

$$D = y + \phi_0. \quad (6)$$

References

- Snyder, J. P. *Map Projections—A Working Manual*. U. S. Geological Survey Professional Paper 1395. Washington, DC: U. S. Government Printing Office, pp. 92–95, 1987.

Cassini Surface

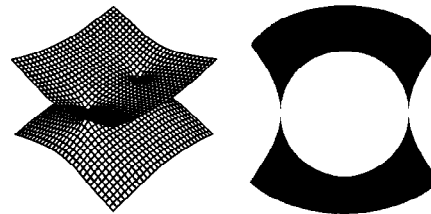

The QUARTIC SURFACE obtained by replacing the constant c in the equation of the CASSINI OVALS

$$[(x - a)^2 + y^2][(x + a)^2 + y^2] = c^2 \quad (1)$$

by $c = z^2$, obtaining

$$[(x - a)^2 + y^2][(x + a)^2 + y^2] = z^4. \quad (2)$$

As can be seen by letting $y = 0$ to obtain

$$(x^2 - a^2)^2 = z^4 \quad (3)$$

$$x^2 + z^2 = a^2, \quad (4)$$

Catalan's Constant

A constant which appears in estimates of combinatorial functions. It is usually denoted K , $\beta(2)$, or G . It is not known if K is IRRATIONAL. Numerically,

$$K = 0.915965594177 \dots \quad (1)$$

(Sloane's A006752). The CONTINUED FRACTION for K is $[0, 1, 10, 1, 8, 1, 88, 4, 1, 1, \dots]$ (Sloane's A014538). K can be given analytically by the following expressions,

$$K \equiv \beta(2) \quad (2)$$

$$= \sum_{k=0}^{\infty} \frac{(-1)^k}{(2k+1)^2} = \frac{1}{1^2} - \frac{1}{3^2} + \frac{1}{5^2} - \dots \quad (3)$$

$$= 1 + \sum_{n=1}^{\infty} \frac{1}{(4n+1)^2} - \frac{1}{9} - \sum_{n=1}^{\infty} \frac{1}{(4n+3)^2} \quad (4)$$

$$= \int_0^1 \frac{\tan^{-1} x \, dx}{x} \quad (5)$$

$$= - \int_0^1 \frac{\ln x \, dx}{1+x^2}, \quad (6)$$

where $\beta(z)$ is the DIRICHLET BETA FUNCTION. In terms of the POLYGAMMA FUNCTION $\Psi_1(x)$,

$$K = \frac{1}{16} \Psi_1\left(\frac{1}{4}\right) - \frac{1}{16} \Psi_1\left(\frac{3}{4}\right) \quad (7)$$

$$= \frac{1}{80} \Psi_1\left(\frac{5}{12}\right) + \frac{1}{80} \Psi_1\left(\frac{1}{12}\right) - \frac{1}{10} \pi^2 \quad (8)$$

$$= \frac{1}{32} \Psi_1\left(\frac{1}{8}\right) - \frac{1}{32} \Psi_1\left(\frac{3}{8}\right) - \frac{1}{16} \sqrt{2}. \quad (9)$$

Applying CONVERGENCE IMPROVEMENT to (3) gives

$$K = \frac{1}{16} \sum_{m=1}^{\infty} (m+1) \frac{3^m - 1}{4^m} \zeta(m+2), \quad (10)$$

where $\zeta(z)$ is the RIEMANN ZETA FUNCTION and the identity

$$\frac{1}{(1-3z)^2} - \frac{1}{(1-z)^2} = \sum_{m=1}^{\infty} (m+1) \frac{3^m - 1}{4^m} z^m \quad (11)$$

has been used (Flajolet and Vardi 1996). The Flajolet and Vardi algorithm also gives

$$K = \frac{1}{\sqrt{2}} \prod_{k=1}^{\infty} \left[\left(1 - \frac{1}{2^{2k}}\right) \frac{\zeta(2k)}{\beta(2k)} \right]^{1/(2^{k+1})}, \quad (12)$$

where $\beta(z)$ is the DIRICHLET BETA FUNCTION. Glaisher (1913) gave

$$K = 1 - \sum_{n=1}^{\infty} \frac{n \zeta(2n+1)}{16^n} \quad (13)$$

(Vardi 1991, p. 159). W. Gosper used the related FORMULA

$$K = \frac{1}{\sqrt{2}} \left[\frac{1}{\Psi(2) - 1} \right]^{2^{1/2}} \prod_{k=2}^{\infty} \left[\frac{1}{-\Psi(2^k) - 1} \right]^{1/(2^{k+1})}, \quad (14)$$

where

$$\Psi(m) = \frac{m \psi_{m-1}\left(\frac{1}{4}\right)}{\pi^m (2^m - 1) 4^{m-1} B_m}, \quad (15)$$

where B_n is a BERNOULLI NUMBER and $\psi(x)$ is a POLY-GAMMA FUNCTION (Finch). The Catalan constant may also be defined by

$$K \equiv \frac{1}{2} \int_0^1 K(k) \, dk, \quad (16)$$

where $K(k)$ (not to be confused with Catalan's constant itself, denoted K) is a complete ELLIPTIC INTEGRAL OF THE FIRST KIND.

$$K = \frac{\pi \ln 2}{8} + \sum_{i=1}^{\infty} \frac{a_i}{2^{\lfloor (i+1)/2 \rfloor} i^2}, \quad (17)$$

where

$$\{a_i\} = \{1, 1, 1, 0, -1, -1, -1, 0\} \quad (18)$$

is given by the periodic sequence obtained by appending copies of $\{1, 1, 1, 0, -1, -1, -1, 0\}$ (in other words, $a_i \equiv a_{[(i-1) \bmod 8] + 1}$ for $i > 8$) and $\lfloor x \rfloor$ is the FLOOR FUNCTION (Nielsen 1909).

see also DIRICHLET BETA FUNCTION

References

- Abramowitz, M. and Stegun, C. A. (Eds.). *Handbook of Mathematical Functions with Formulas, Graphs, and Mathematical Tables*, 9th printing. New York: Dover, pp. 807–808, 1972.
- Adamchik, V. "32 Representations for Catalan's Constant." <http://www.wolfram.com/-victor/articles/catalan/catalan.html>.
- Arfken, G. *Mathematical Methods for Physicists*, 3rd ed. Orlando, FL: Academic Press, pp. 551–552, 1985.
- Fee, G. J. "Computation of Catalan's Constant using Ramanujan's Formula." *ISAAC '90. Proc. Internat. Symp. Symbolic Algebraic Comp.*, Aug. 1990. Reading, MA: Addison-Wesley, 1990.
- Finch, S. "Favorite Mathematical Constants." <http://www.mathsoft.com/asolve/constant/catalan/catalan.html>.
- Flajolet, P. and Vardi, I. "Zeta Function Expansions of Classical Constants." Unpublished manuscript. 1996. <http://pauillac.inria.fr/algo/flajolet/Publications/landau.ps>.
- Glaisher, J. W. L. "Numerical Values of the Series $1 - 1/3^n + 1/5^n - 1/7^n + 1/9^n - \dots$ for $n = 2, 4, 6$." *Messenger Math.* **42**, 35–58, 1913.
- Gosper, R. W. "A Calculus of Series Rearrangements." In *Algorithms and Complexity: New Directions and Recent Results* (Ed. J. F. Traub). New York: Academic Press, 1976.
- Nielsen, N. *Der Eulersche Dilogarithmus*. Leipzig, Germany: Halle, pp. 105 and 151, 1909.

- Plouffe, S. "Plouffe's Inverter: Table of Current Records for the Computation of Constants." <http://lacim.uqam.ca/pi/records.html>.
- Sloane, N. J. A. Sequences A014538 and A006752/M4593 in "An On-Line Version of the Encyclopedia of Integer Sequences."
- Srivastava, H. M. and Miller, E. A. "A Simple Reducible Case of Double Hypergeometric Series involving Catalan's Constant and Riemann's Zeta Function." *Int. J. Math. Educ. Sci. Technol.* **21**, 375-377, 1990.
- Vardi, I. *Computational Recreations in Mathematica*. Reading, MA: Addison-Wesley, p. 159, 1991.
- Yang, S. "Some Properties of Catalan's Constant G ." *Int. J. Math. Educ. Sci. Technol.* **23**, 549-556, 1992.

Catalan's Diophantine Problem

Find consecutive POWERS, i.e., solutions to

$$a^b - c^d = 1,$$

excluding 0 and 1. CATALAN'S CONJECTURE is that the only solution is $3^2 - 2^3 = 1$, so 8 and 9 (2^3 and 3^2) are the only consecutive POWERS (again excluding 0 and 1).

see also CATALAN'S CONJECTURE

References

- Cassels, J. W. S. "On the Equation $a^x - b^y = 1$. II." *Proc. Cambridge Phil. Soc.* **56**, 97-103, 1960.
- Inkeri, K. "On Catalan's Problem." *Acta Arith.* **9**, 285-290, 1964.

Catalan Integrals

Special cases of general FORMULAS due to Bessel.

$$J_0(\sqrt{z^2 - y^2}) = \frac{1}{\pi} \int_0^\pi e^{y \cos \theta} \cos(z \sin \theta) d\theta,$$

where J_0 is a BESSEL FUNCTION OF THE FIRST KIND. Now, let $z \equiv 1 - z'$ and $y \equiv 1 + z'$. Then

$$J_0(2i\sqrt{z}) = \frac{1}{\pi} \int_0^\pi e^{(1+z) \cos \theta} \cos[(1-z) \sin \theta] d\theta.$$

Catalan Number

The Catalan numbers are an INTEGER SEQUENCE $\{C_n\}$ which appears in TREE enumeration problems of the type, "In how many ways can a regular n -gon be divided into $n - 2$ TRIANGLES if different orientations are counted separately?" (EULER'S POLYGON DIVISION PROBLEM). The solution is the Catalan number C_{n-2} (Dörrie 1965, Honsberger 1973), as graphically illustrated below (Dickau).

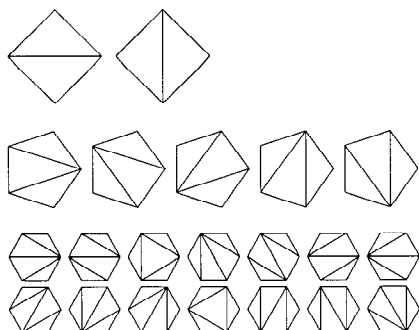

The first few Catalan numbers are 1, 2, 5, 14, 42, 132, 429, 1430, 4862, 16796, ... (Sloane's A000108). The only ODD Catalan numbers are those of the form c_{2k-1} , and the last DIGIT is five for $k = 9$ to 15. The only PRIME Catalan numbers for $n \leq 2^{15} - 1$ are $C_2 = 2$ and $C_3 = 5$.

The Catalan numbers turn up in many other related types of problems. For instance, the Catalan number C_{n-1} gives the number of BINARY BRACKETINGS of n letters (CATALAN'S PROBLEM). The Catalan numbers also give the solution to the BALLOT PROBLEM, the number of trivalent PLANTED PLANAR TREES (Dickau),

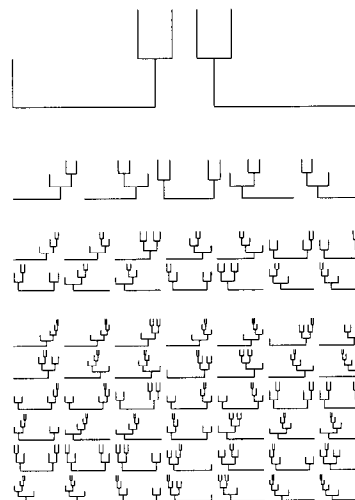

the number of states possible in an n -FLEXAGON, the number of different diagonals possible in a FRIEZE PATTERN with $n + 1$ rows, the number of ways of forming an n -fold exponential, the number of rooted planar binary trees with n internal nodes, the number of rooted plane bushes with n EDGES, the number of extended BINARY TREES with n internal nodes, the number of mountains which can be drawn with n upstrokes and n downstrokes, the number of noncrossing handshakes possible across a round table between n pairs of people (Conway and Guy 1996), and the number of SEQUENCES with NONNEGATIVE PARTIAL SUMS which can be formed from n 1s and $n - 1$ s (Bailey 1996, Buraldi 1992)!

An explicit formula for C_n is given by

$$C_n \equiv \frac{1}{n+1} \binom{2n}{n} = \frac{1}{n+1} \frac{(2n)!}{n!^2} = \frac{(2n)!}{(n+1)!n!}, \quad (1)$$

where $\binom{2n}{n}$ denotes a BINOMIAL COEFFICIENT and $n!$ is the usual FACTORIAL. A RECURRENCE RELATION for C_n is obtained from

$$\begin{aligned} \frac{C_{n+1}}{C_n} &= \frac{(2n+2)!}{(n+2)[(n+1)!]^2} \frac{(n+1)(n!)^2}{(2n)!} \\ &= \frac{(2n+2)(2n+1)(n+1)}{(n+2)(n+1)^2} \\ &= \frac{2(2n+1)(n+1)^2}{(n+1)^2(n+2)} = \frac{2(2n+1)}{n+2}, \end{aligned} \quad (2)$$

so

$$C_{n+1} = \frac{2(2n+1)}{n+2} C_n. \quad (3)$$

Other forms include

$$C_n = \frac{2 \cdot 6 \cdot 10 \cdots (4n-2)}{(n+1)!} \quad (4)$$

$$= \frac{2^n (2n-1)!!}{(n+1)!} \quad (5)$$

$$= \frac{(2n)!}{n!(n+1)!}. \quad (6)$$

SEGNER'S RECURRENCE FORMULA, given by Segner in 1758, gives the solution to EULER'S POLYGON DIVISION PROBLEM

$$E_n = E_2 E_{n-1} + E_3 E_{n-2} + \cdots + E_{n-1} E_2. \quad (7)$$

With $E_1 = E_2 = 1$, the above RECURRENCE RELATION gives the Catalan number $C_{n-2} = E_n$.

The GENERATING FUNCTION for the Catalan numbers is given by

$$\frac{1 - \sqrt{1-4x}}{2x} = \sum_{n=0}^{\infty} C_n x^n = 1 + x + 2x^2 + 5x^3 + \dots \quad (8)$$

The asymptotic form for the Catalan numbers is

$$C_k \sim \frac{4^k}{\sqrt{\pi} k^{3/2}} \quad (9)$$

(Vardi 1991, Graham *et al.* 1994).

A generalization of the Catalan numbers is defined by

$${}_p d_k = \frac{1}{k} \binom{pk}{k-1} = \frac{1}{(p-1)k+1} \binom{pk}{k} \quad (10)$$

for $k \geq 1$ (Klarner 1970, Hilton and Pederson 1991). The usual Catalan numbers $C_k = {}_2 d_k$ are a special case with $p = 2$. ${}_p d_k$ gives the number of p -ary TREES with k source-nodes, the number of ways of associating k applications of a given p -ary OPERATOR, the number of ways of dividing a convex POLYGON into k disjoint $(p+1)$ -gons with nonintersecting DIAGONALS, and the number of p -GOOD PATHS from $(0, -1)$ to $(k, (p-1)k-1)$ (Hilton and Pederson 1991).

A further generalization is obtained as follows. Let p be an INTEGER > 1 , let $P_k = (k, (p-1)k-1)$ with $k \geq 0$, and $q \leq p-1$. Then define ${}_p d_{q0} = 1$ and let ${}_p d_{qk}$ be the number of p -GOOD PATHS from $(1, q-1)$ to P_k (Hilton and Pederson 1991). Formulas for ${}_p d_{qi}$ include the generalized JONAH FORMULA

$$\binom{n-q}{k-1} = \sum_{i=1}^k {}_p d_{qi} \binom{n-pi}{k-i} \quad (11)$$

and the explicit formula

$${}_p d_{qk} = \frac{p-q}{pk-q} \binom{pk-q}{k-1}. \quad (12)$$

A RECURRENCE RELATION is given by

$${}_p d_{qk} = \sum_{i,j} {}_p d_{p-r,i} {}_p d_{q+r,j} \quad (13)$$

where $i, j, r \geq 1$, $k \geq 1$, $q < p-r$, and $i+j = k+1$ (Hilton and Pederson 1991).

see also BALLOT PROBLEM, BINARY BRACKETING, BINARY TREE, CATALAN'S PROBLEM, CATALAN'S TRIANGLE, DELANNOY NUMBER, EULER'S POLYGON DIVISION PROBLEM, FLEXAGON, FRIEZE PATTERN, MOTZKIN NUMBER, p -GOOD PATH, PLANTED PLANAR TREE, SCHRÖDER NUMBER, SUPER CATALAN NUMBER

References

- Alter, R. "Some Remarks and Results on Catalan Numbers." *Proc. 2nd Louisiana Conf. Comb., Graph Th., and Comput.*, 109-132, 1971.
- Alter, R. and Kubota, K. K. "Prime and Prime Power Divisibility of Catalan Numbers." *J. Combin. Th.* **15**, 243-256, 1973.
- Bailey, D. F. "Counting Arrangements of 1's and -1's." *Math. Mag.* **69**, 128-131, 1996.
- Brualdi, R. A. *Introductory Combinatorics*, 3rd ed. New York: Elsevier, 1997.
- Campbell, D. "The Computation of Catalan Numbers." *Math. Mag.* **57**, 195-208, 1984.
- Chorneyko, I. Z. and Mohanty, S. G. "On the Enumeration of Certain Sets of Planted Trees." *J. Combin. Th. Ser. B* **18**, 209-221, 1975.
- Chu, W. "A New Combinatorial Interpretation for Generalized Catalan Numbers." *Disc. Math.* **65**, 91-94, 1987.
- Conway, J. H. and Guy, R. K. In *The Book of Numbers*. New York: Springer-Verlag, pp. 96-106, 1996.
- Dershowitz, N. and Zaks, S. "Enumeration of Ordered Trees." *Disc. Math.* **31**, 9-28, 1980.
- Dickau, R. M. "Catalan Numbers." <http://forum.swarthmore.edu/advanced/robertd/catalan.html>.
- Dörrie, H. "Euler's Problem of Polygon Division." §7 in *100 Great Problems of Elementary Mathematics: Their History and Solutions*. New York: Dover, pp. 21-27, 1965.
- Eggleton, R. B. and Guy, R. K. "Catalan Strikes Again! How Likely is a Function to be Convex?" *Math. Mag.* **61**, 211-219, 1988.
- Gardner, M. "Catalan Numbers." Ch. 20 in *Time Travel and Other Mathematical Bewilderments*. New York: W. H. Freeman, 1988.
- Gardner, M. "Catalan Numbers: An Integer Sequence that Materializes in Unexpected Places." *Sci. Amer.* **234**, 120-125, June 1976.
- Gould, H. W. *Bell & Catalan Numbers: Research Bibliography of Two Special Number Sequences*, 6th ed. Morgantown, WV: Math Monongliae, 1985.
- Graham, R. L.; Knuth, D. E.; and Patashnik, O. Exercise 9.8 in *Concrete Mathematics: A Foundation for Computer Science*, 2nd ed. Reading, MA: Addison-Wesley, 1994.
- Guy, R. K. "Dissecting a Polygon Into Triangles." *Bull. Malayan Math. Soc.* **5**, 57-60, 1958.
- Hilton, P. and Pederson, J. "Catalan Numbers, Their Generalization, and Their Uses." *Math. Int.* **13**, 64-75, 1991.
- Honsberger, R. *Mathematical Gems I*. Washington, DC: Math. Assoc. Amer., pp. 130-134, 1973.

- Honsberger, R. *Mathematical Gems III*. Washington, DC: Math. Assoc. Amer., pp. 146–150, 1985.
- Klarner, D. A. "Correspondences Between Plane Trees and Binary Sequences." *J. Comb. Th.* **9**, 401–411, 1970.
- Rogers, D. G. "Pascal Triangles, Catalan Numbers and Renewal Arrays." *Disc. Math.* **22**, 301–310, 1978.
- Sands, A. D. "On Generalized Catalan Numbers." *Disc. Math.* **21**, 218–221, 1978.
- Singmaster, D. "An Elementary Evaluation of the Catalan Numbers." *Amer. Math. Monthly* **85**, 366–368, 1978.
- Sloane, N. J. A. *A Handbook of Integer Sequences*. Boston, MA: Academic Press, pp. 18–20, 1973.
- Sloane, N. J. A. Sequences A000108/M1459 in "An On-Line Version of the Encyclopedia of Integer Sequences."
- Sloane, N. J. A. and Plouffe, S. Extended entry in *The Encyclopedia of Integer Sequences*. San Diego: Academic Press, 1995.
- Vardi, I. *Computational Recreations in Mathematics*. Redwood City, CA: Addison-Wesley, pp. 187–188 and 198–199, 1991.
- Wells, D. G. *The Penguin Dictionary of Curious and Interesting Numbers*. London: Penguin, pp. 121–122, 1986.

Catalan's Problem

The problem of finding the number of different ways in which a PRODUCT of n different ordered FACTORS can be calculated by pairs (i.e., the number of BINARY BRACKETINGS of n letters). For example, for the four FACTORS a, b, c , and d , there are five possibilities: $((ab)c)d$, $(a(bc))d$, $(ab)(cd)$, $a((bc)d)$, and $a(b(cd))$. The solution was given by Catalan in 1838 as

$$C'_n = \frac{2 \cdot 6 \cdot 10 \cdot (4n - 6)}{n!}$$

and is equal to the CATALAN NUMBER $C_{n-1} = C'_n$.

see also BINARY BRACKETING, CATALAN'S DIOPHANTINE PROBLEM, EULER'S POLYGON DIVISION PROBLEM

References

- Dörrie, H. *100 Great Problems of Elementary Mathematics: Their History and Solutions*. New York: Dover, p. 23, 1965.

Catalan Solid

The DUAL POLYHEDRA of the ARCHIMEDEAN SOLIDS, given in the following table.

Archimedean Solid	Dual
rhombicosidodecahedron	deltoidal hexecontahedron
small rhombicuboctahedron	deltoidal icositetrahedron
great rhombicuboctahedron	disdyakis dodecahedron
great rhombicosidodecahedron	disdyakis triacontahedron
truncated icosahedron	pentakis dodecahedron
snub dodecahedron	pentagonal hexecontahedron
(laevo)	(dextro)
snub cube	pentagonal icositetrahedron
(laevo)	(dextro)
cuboctahedron	rhombic dodecahedron
icosidodecahedron	rhombic triacontahedron
truncated octahedron	tetrakis hexahedron
truncated dodecahedron	triakis icosahedron
truncated cube	triakis octahedron
truncated tetrahedron	triakis tetrahedron

Here are the ARCHIMEDEAN DUALS (Holden 1971, Pearce 1978) displayed in alphabetical order (left to right, then continuing to the next row).

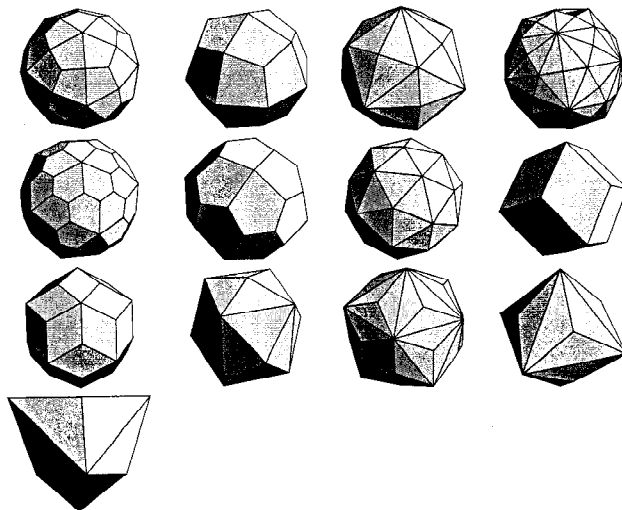

Here are the Archimedean solids paired with the corresponding Catalan solids.

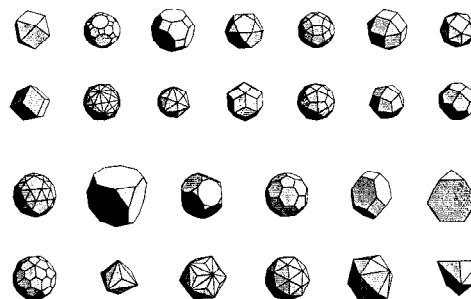

see also ARCHIMEDEAN SOLID, DUAL POLYHEDRON, SEMIREGULAR POLYHEDRON

References

- Catalan, E. "Mémoire sur la Théorie des Polyèdres." *J. l'École Polytechnique (Paris)* **41**, 1–71, 1865.
- Holden, A. *Shapes, Space, and Symmetry*. New York: Dover, 1991.

Catalan's Surface

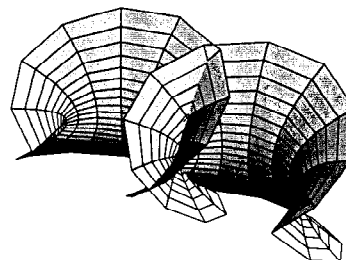

A MINIMAL SURFACE given by the parametric equations

$$x(u, v) = u - \sin u \cosh v \quad (1)$$

$$y(u, v) = 1 - \cos u \cosh v \quad (2)$$

$$z(u, v) = 4 \sin\left(\frac{1}{2}u\right) \sinh\left(\frac{1}{2}v\right) \quad (3)$$

(Gray 1993), or

$$x(r, \phi) = a \sin(2\phi) - 2a\phi + \frac{1}{2}av^2 \cos(2\phi) \quad (4)$$

$$y(r, \phi) = -a \cos(2\phi) - \frac{1}{2}av^2 \cos(2\phi) \quad (5)$$

$$z(r, \phi) = 2av \sin \phi, \quad (6)$$

where

$$v = -r + \frac{1}{r} \quad (7)$$

(do Carmo 1986).

References

- Catalan, E. "Mémoire sur les surfaces dont les rayons de courbure en chaque point, sont égaux et des signes contraires." *C. R. Acad. Sci. Paris* **41**, 1019–1023, 1855.
- do Carmo, M. P. "Catalan's Surface" §3.5D in *Mathematical Models from the Collections of Universities and Museums* (Ed. G. Fischer). Braunschweig, Germany: Vieweg, pp. 45–46, 1986.
- Fischer, G. (Ed.). Plates 94–95 in *Mathematische Modelle/Mathematical Models, Bildband/Photograph Volume*. Braunschweig, Germany: Vieweg, pp. 90–91, 1986.
- Gray, A. *Modern Differential Geometry of Curves and Surfaces*. Boca Raton, FL: CRC Press, pp. 448–449, 1993.

Catalan's Triangle

A triangle of numbers with entries given by

$$c_{nm} = \frac{(n+m)!(n-m+1)}{m!(n+1)!}$$

for $0 \leq m \leq n$, where each element is equal to the one above plus the one to the left. Furthermore, the sum of each row is equal to the last element of the next row and also equal to the CATALAN NUMBER C_n .

1						
1	1					
1	2	2				
1	3	5	5			
1	4	9	14	14		
1	5	14	28	42	42	
1	6	20	48	90	132	132

(Sloane's A009766).

see also BELL TRIANGLE, CLARK'S TRIANGLE, EULER'S TRIANGLE, LEIBNIZ HARMONIC TRIANGLE, NUMBER TRIANGLE, PASCAL'S TRIANGLE, PRIME TRIANGLE, SEIDEL-ENTRINGER-ARNOLD TRIANGLE

References

- Sloane, N. J. A. Sequence A009766 in "An On-Line Version of the Encyclopedia of Integer Sequences."

Catalan's Trisectrix

see TSCHIRNHAUSEN CUBIC

Catastrophe

see BUTTERFLY CATASTROPHE, CATASTROPHE THEORY, CUSP CATASTROPHE, ELLIPTIC UMBILIC CATASTROPHE, FOLD CATASTROPHE, HYPERBOLIC UMBILIC CATASTROPHE, PARABOLIC UMBILIC CATASTROPHE, SWALLOWTAIL CATASTROPHE

Catastrophe Theory

Catastrophe theory studies how the qualitative nature of equation solutions depends on the parameters that appear in the equations. Subspecializations include bifurcation theory, nonequilibrium thermodynamics, singularity theory, synergetics, and topological dynamics. For any system that seeks to minimize a function, only seven different local forms of catastrophe "typically" occur for four or fewer variables: (1) FOLD CATASTROPHE, (2) CUSP CATASTROPHE, (3) SWALLOWTAIL CATASTROPHE, (4) BUTTERFLY CATASTROPHE, (5) ELLIPTIC UMBILIC CATASTROPHE, (6) HYPERBOLIC UMBILIC CATASTROPHE, (7) PARABOLIC UMBILIC CATASTROPHE.

More specifically, for any system with fewer than five control factors and fewer than three behavior axes, these are the only seven catastrophes possible. The following tables gives the possible catastrophes as a function of control factors and behavior axes (Goetz).

Control Factors	1 Behavior Axis	2 Behavior Axes
1	fold	—
2	cusp	—
3	swallowtail	hyperbolic umbilic, elliptic umbilic
4	butterfly	parabolic umbilic

References

- Arnold, V. I. *Catastrophe Theory*, 3rd ed. Berlin: Springer-Verlag, 1992.
- Gilmore, R. *Catastrophe Theory for Scientists and Engineers*. New York: Dover, 1993.
- Goetz, P. "Phil's Good Enough Complexity Dictionary." <http://www.cs.buffalo.edu/~goetz/dict.html>.
- Saunders, P. T. *An Introduction to Catastrophe Theory*. Cambridge, England: Cambridge University Press, 1980.
- Stewart, I. *The Problems of Mathematics*, 2nd ed. Oxford, England: Oxford University Press, p. 211, 1987.
- Thom, R. *Structural Stability and Morphogenesis: An Outline of a General Theory of Models*. Reading, MA: Reading, MA: Addison-Wesley, 1993.
- Thompson, J. M. T. *Instabilities and Catastrophes in Science and Engineering*. New York: Wiley, 1982.
- Woodcock, A. E. R. and Davis, M. *Catastrophe Theory*. New York: E. P. Dutton, 1978.
- Zeeman, E. C. *Catastrophe Theory—Selected Papers 1972–1977*. Reading, MA: Addison-Wesley, 1977.

Categorical Game

A GAME in which no draw is possible.

Categorical Variable

A variable which belongs to exactly one of a finite number of CATEGORIES.

Category

A category consists of two things: an OBJECT and a MORPHISM (sometimes called an "arrow"). An OBJECT is some mathematical structure (e.g., a GROUP, VECTOR SPACE, or DIFFERENTIABLE MANIFOLD) and a MORPHISM is a MAP between two OBJECTS. The MORPHISMS are then required to satisfy some fairly natural conditions; for instance, the IDENTITY MAP between any object and itself is always a MORPHISM, and the composition of two MORPHISMS (if defined) is always a MORPHISM.

One usually requires the MORPHISMS to preserve the mathematical structure of the objects. So if the objects are all groups, a good choice for a MORPHISM would be a group HOMOMORPHISM. Similarly, for vector spaces, one would choose linear maps, and for differentiable manifolds, one would choose differentiable maps.

In the category of TOPOLOGICAL SPACES, homomorphisms are usually continuous maps between topological spaces. However, there are also other category structures having TOPOLOGICAL SPACES as objects, but they are not nearly as important as the "standard" category of TOPOLOGICAL SPACES and continuous maps.

see also ABELIAN CATEGORY, ALLEGORY, EILENBERG-STEENROD AXIOMS, GROUPOID, HOLONOMY, LOGOS, MONODROMY, TOPOS

References

Freyd, P. J. and Scedrov, A. *Categories, Allegories*. Amsterdam, Netherlands: North-Holland, 1990.

Category Theory

The branch of mathematics which formalizes a number of algebraic properties of collections of transformations between mathematical objects (such as binary relations, groups, sets, topological spaces, etc.) of the same type, subject to the constraint that the collections contain the identity mapping and are closed with respect to compositions of mappings. The objects studied in category theory are called CATEGORIES.

see also CATEGORY

Catenary

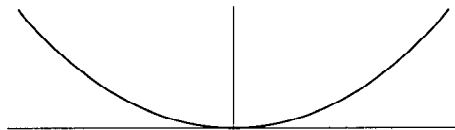

The curve a hanging flexible wire or chain assumes when supported at its ends and acted upon by a uniform gravitational force. The word catenary is derived from the Latin word for "chain." In 1669, Jungius disproved Galileo's claim that the curve of a chain hanging under gravity would be a PARABOLA (MacTutor Archive). The curve is also called the ALYSOID and CHAINETTE. The equation was obtained by Leibniz, Huygens, and Johann Bernoulli in 1691 in response to a challenge by Jakob Bernoulli.

Huygens was the first to use the term catenary in a letter to Leibniz in 1690, and David Gregory wrote a treatise on the catenary in 1690 (MacTutor Archive). If you roll a PARABOLA along a straight line, its FOCUS traces out a catenary. As proved by Euler in 1744, the catenary is also the curve which, when rotated, gives the surface of minimum SURFACE AREA (the CATENOID) for the given bounding CIRCLE.

The CARTESIAN equation for the catenary is given by

$$y = \frac{1}{2}a(e^{x/a} + e^{-x/a}) = a \cosh\left(\frac{x}{a}\right), \quad (1)$$

and the CESÀRO EQUATION is

$$(s^2 + a^2)\kappa = -a. \quad (2)$$

The catenary gives the shape of the road over which a regular polygonal "wheel" can travel smoothly. For a regular n -gon, the corresponding catenary is

$$y = -A \cosh\left(\frac{x}{A}\right), \quad (3)$$

where

$$A \equiv R \cos\left(\frac{\pi}{n}\right). \quad (4)$$

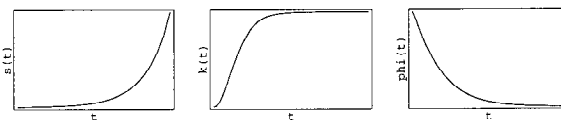

The ARC LENGTH, CURVATURE, and TANGENTIAL ANGLE are

$$s = a \sinh\left(\frac{t}{a}\right), \quad (5)$$

$$\kappa = -\frac{1}{a} \operatorname{sech}^2\left(\frac{t}{a}\right), \quad (6)$$

$$\phi = -2 \tan^{-1}\left[\tanh\left(\frac{t}{2a}\right)\right]. \quad (7)$$

The slope is proportional to the ARC LENGTH as measured from the center of symmetry.

see also CALCULUS OF VARIATIONS, CATENOID, LINDELOF'S THEOREM, SURFACE OF REVOLUTION

References

- Geometry Center. "The Catenary." <http://www.geom.umn.edu/zoo/diffgeom/surfspace/catenoid/catenary.html>.
- Gray, A. "The Evolute of a Tractrix is a Catenary." §5.3 in *Modern Differential Geometry of Curves and Surfaces*. Boca Raton, FL: CRC Press, pp. 80–81, 1993.
- Lawrence, J. D. *A Catalog of Special Plane Curves*. New York: Dover, pp. 195 and 199–200, 1972.
- Lockwood, E. H. "The Tractrix and Catenary." Ch. 13 in *A Book of Curves*. Cambridge, England: Cambridge University Press, pp. 118–124, 1967.
- MacTutor History of Mathematics Archive. "Catenary." <http://www-groups.dcs.st-and.ac.uk/~history/Curves/Catenary.html>.
- Pappas, T. "The Catenary & the Parabolic Curves." *The Joy of Mathematics*. San Carlos, CA: Wide World Publ./Tetra, p. 34, 1989.
- Yates, R. C. "Catenary." *A Handbook on Curves and Their Properties*. Ann Arbor, MI: J. W. Edwards, pp. 12–14, 1952.

Catenary Evolute

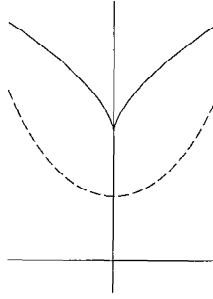

$$x = a[x - \frac{1}{2} \sinh(2t)]$$

$$y = 2a \cosh t.$$

Catenary Involute

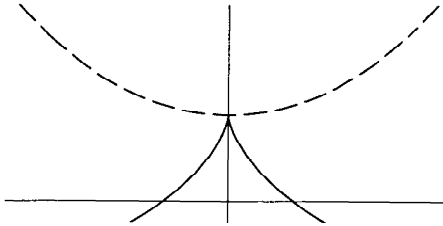

The parametric equation for a CATENARY is

$$\mathbf{r}(t) = a \begin{bmatrix} t \\ \cosh t \end{bmatrix}, \quad (1)$$

so

$$\frac{d\mathbf{r}}{dt} = a \begin{bmatrix} 1 \\ \sinh t \end{bmatrix} \quad (2)$$

$$\left| \frac{d\mathbf{r}}{dt} \right| = a\sqrt{1 + \sinh^2 t} = a \cosh t \quad (3)$$

and

$$\hat{\mathbf{T}} = \frac{\frac{d\mathbf{r}}{dt}}{\left| \frac{d\mathbf{r}}{dt} \right|} = \begin{bmatrix} \operatorname{sech} t \\ \tanh t \end{bmatrix} \quad (4)$$

$$ds^2 = |d\mathbf{r}|^2 = a^2(1 + \sinh^2 t) dt^2 = a^2 \cosh^2 t dt^2 \quad (5)$$

$$\frac{ds}{dt} = a \cosh t. \quad (6)$$

Therefore,

$$s = a \int \cosh t dt = a \sinh t \quad (7)$$

and the equation of the INVOLUTE is

$$x = a(t - \tanh t) \quad (8)$$

$$y = a \operatorname{sech} t. \quad (9)$$

This curve is called a TRACTRIX.

Catenary Radial Curve



The KAMPYLE OF EUDOXUS.

Catenoid

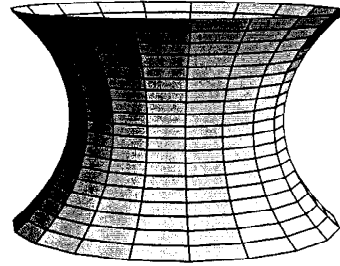

A CATENARY of REVOLUTION. The catenoid and PLANE are the only SURFACES OF REVOLUTION which are also MINIMAL SURFACES. The catenoid can be given by the parametric equations

$$x = c \cosh \left(\frac{v}{c} \right) \cos u \quad (1)$$

$$y = c \cosh \left(\frac{v}{c} \right) \sin u \quad (2)$$

$$z = v, \quad (3)$$

where $u \in [0, 2\pi)$. The differentials are

$$dx = \sinh \left(\frac{v}{c} \right) \cos u dv - \cosh \left(\frac{v}{c} \right) \sin u du \quad (4)$$

$$dy = \sinh \left(\frac{v}{c} \right) \sin u dv + \cosh \left(\frac{v}{c} \right) \cos u du \quad (5)$$

$$dz = dv, \quad (6)$$

so the LINE ELEMENT is

$$ds^2 = dx^2 + dy^2 + dz^2$$

$$= \left[\sinh^2 \left(\frac{v}{c} \right) + 1 \right] dv^2 + \cosh^2 \left(\frac{v}{c} \right) du^2$$

$$= \cosh^2 \left(\frac{v}{c} \right) dv^2 + \cosh^2 \left(\frac{v}{c} \right) du^2. \quad (7)$$

The PRINCIPAL CURVATURES are

$$\kappa_1 = -\frac{1}{c} \operatorname{sech}^2 \left(\frac{v}{c} \right) \quad (8)$$

$$\kappa_2 = \frac{1}{c} \operatorname{sech}^2 \left(\frac{v}{c} \right). \quad (9)$$

The MEAN CURVATURE of the catenoid is

$$H = 0 \quad (10)$$

and the GAUSSIAN CURVATURE is

$$K = -\frac{1}{c^2} \operatorname{sech}^4 \left(\frac{v}{c} \right). \quad (11)$$

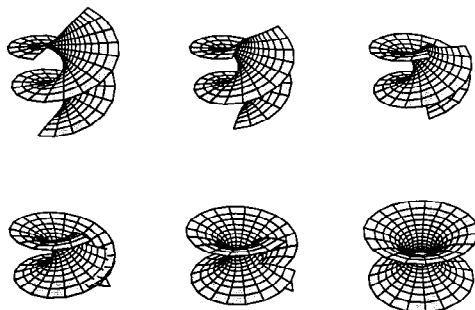

The HELICOID can be continuously deformed into a catenoid with $c = 1$ by the transformation

$$x(u, v) = \cos \alpha \sinh v \sin u + \sin \alpha \cosh v \cos u \quad (12)$$

$$y(u, v) = -\cos \alpha \sinh v \cos u + \sin \alpha \cosh v \sin u \quad (13)$$

$$z(u, v) = u \cos \alpha + v \sin \alpha, \quad (14)$$

where $\alpha = 0$ corresponds to a HELICOID and $\alpha = \pi/2$ to a catenoid.

see also CATENARY, COSTA MINIMAL SURFACE, HELICOID, MINIMAL SURFACE, SURFACE OF REVOLUTION

References

- do Carmo, M. P. "The Catenoid." §3.5A in *Mathematical Models from the Collections of Universities and Museums* (Ed. G. Fischer). Braunschweig, Germany: Vieweg, p. 43, 1986.
- Fischer, G. (Ed.). Plate 90 in *Mathematische Modelle/Mathematical Models, Bildband/Photograph Volume*. Braunschweig, Germany: Vieweg, p. 86, 1986.
- Geometry Center. "The Catenoid." <http://www.geom.umn.edu/zoo/diffgeom/surfspace/catenoid/>.
- Gray, A. "The Catenoid." §18.4 *Modern Differential Geometry of Curves and Surfaces*. Boca Raton, FL: CRC Press, pp. 367–369, 1993.
- Meusnier, J. B. "Mémoire sur la courbure des surfaces." *Mém. des savans étrangers* 10 (lu 1776), 477–510, 1785.

Caterpillar Graph

A TREE with every NODE on a central stalk or only one EDGE away from the stalk.

References

- Gardner, M. *Wheels, Life, and other Mathematical Amusements*. New York: W. H. Freeman, p. 160, 1983.

Cattle Problem of Archimedes

see ARCHIMEDES' CATTLE PROBLEM

Cauchy Binomial Theorem

$$\sum_{m=0}^n y^m q^{m(m+1)/2} \binom{n}{m}_q = \prod_{k=1}^n (1 + yq^k),$$

where $\binom{n}{m}_q$ is a GAUSSIAN COEFFICIENT.

see also q -BINOMIAL THEOREM

Cauchy Boundary Conditions

BOUNDARY CONDITIONS of a PARTIAL DIFFERENTIAL EQUATION which are a weighted AVERAGE of DIRICHLET BOUNDARY CONDITIONS (which specify the value of the function on a surface) and NEUMANN BOUNDARY CONDITIONS (which specify the normal derivative of the function on a surface).

see also BOUNDARY CONDITIONS, CAUCHY PROBLEM, DIRICHLET BOUNDARY CONDITIONS, NEUMANN BOUNDARY CONDITIONS

References

- Morse, P. M. and Feshbach, H. *Methods of Theoretical Physics, Part I*. New York: McGraw-Hill, pp. 678–679, 1953.

Cauchy's Cosine Integral Formula

$$\int_{-\pi/2}^{\pi/2} \cos^{\mu+\nu-2} \theta e^{i\theta(\mu-\nu+2\xi)} d\theta = \frac{\pi \Gamma(\mu+\nu-1)}{2^{\mu+\nu-2} \Gamma(\mu+\xi) \Gamma(\nu-\xi)},$$

where $\Gamma(z)$ is the GAMMA FUNCTION.

Cauchy Criterion

A NECESSARY and SUFFICIENT condition for a SEQUENCE S_i to CONVERGE. The Cauchy criterion is satisfied when, for all $\epsilon > 0$, there is a fixed number N such that $|S_j - S_i| < \epsilon$ for all $i, j > N$.

Cauchy Distribution

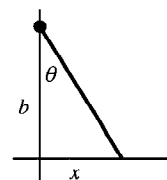

The Cauchy distribution, also called the LORENTZIAN DISTRIBUTION, describes resonance behavior. It also describes the distribution of horizontal distances at which a LINE SEGMENT tilted at a random ANGLE cuts the x -AXIS. Let θ represent the ANGLE that a line, with fixed point of rotation, makes with the vertical axis, as shown above. Then

$$\tan \theta = \frac{x}{b} \quad (1)$$

$$\theta = \tan^{-1} \left(\frac{x}{b} \right) \quad (2)$$

$$d\theta = -\frac{1}{1 + \frac{x^2}{b^2}} \frac{dx}{b} = -\frac{b dx}{b^2 + x^2}, \quad (3)$$

so the distribution of ANGLE θ is given by

$$\frac{d\theta}{\pi} = -\frac{1}{\pi} \frac{b dx}{b^2 + x^2}. \quad (4)$$

This is normalized over all angles, since

$$\int_{-\pi/2}^{\pi/2} \frac{d\theta}{\pi} = 1 \quad (5)$$

and

$$\begin{aligned} -\int_{-\infty}^{\infty} \frac{1}{\pi} \frac{b dx}{b^2 + x^2} &= \frac{1}{\pi} \left[\tan^{-1} \left(\frac{b}{x} \right) \right]_{-\infty}^{\infty} \\ &= \frac{1}{\pi} \left[\frac{1}{2}\pi - \left(-\frac{1}{2}\pi \right) \right] = 1. \end{aligned} \quad (6)$$

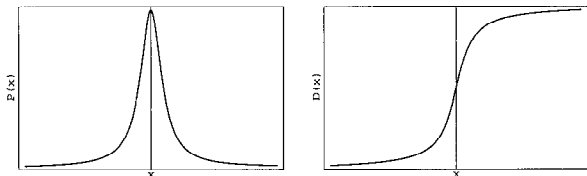

The general Cauchy distribution and its cumulative distribution can be written as

$$P(x) = \frac{1}{\pi} \frac{\frac{1}{2}\Gamma}{(x - \mu)^2 + (\frac{1}{2}\Gamma)^2} \quad (7)$$

$$D(x) = \frac{1}{2} + \frac{1}{\pi} \tan^{-1} \left(\frac{x - \mu}{b} \right), \quad (8)$$

where Γ is the FULL WIDTH AT HALF MAXIMUM ($\Gamma = 2b$ in the above example) and μ is the MEAN ($\mu = 0$ in the above example). The CHARACTERISTIC FUNCTION is

$$\begin{aligned} \phi(t) &= \frac{1}{\pi} \int_{-\infty}^{\infty} \frac{e^{it(\Gamma x/2 - \mu)}}{1 + x^2} dx \\ &= \frac{e^{-i\mu t}}{\pi} \int_{-\infty}^{\infty} \frac{\cos(\Gamma t x/2)}{1 + (\Gamma x/2)^2} dx \\ &= e^{-i\mu t - \Gamma|t|/2}. \end{aligned} \quad (9)$$

The MOMENTS are given by

$$\mu_2 = \sigma^2 = \infty \quad (10)$$

$$\mu_3 = \begin{cases} 0 & \text{for } \mu = 0 \\ \infty & \text{for } \mu \neq 0 \end{cases} \quad (11)$$

$$\mu_4 = \infty, \quad (12)$$

and the STANDARD DEVIATION, SKEWNESS, and KURTOSIS by

$$\sigma^2 = \infty \quad (13)$$

$$\gamma_1 = \begin{cases} 0 & \text{for } \mu = 0 \\ \infty & \text{for } \mu \neq 0 \end{cases} \quad (14)$$

$$\gamma_2 = \infty. \quad (15)$$

If X and Y are variates with a NORMAL DISTRIBUTION, then $Z \equiv X/Y$ has a Cauchy distribution with MEAN $\mu = 0$ and full width

$$\Gamma = \frac{2\sigma_y}{\sigma_x}. \quad (16)$$

see also GAUSSIAN DISTRIBUTION, NORMAL DISTRIBUTION

References

Spiegel, M. R. *Theory and Problems of Probability and Statistics*. New York: McGraw-Hill, pp. 114–115, 1992.

Cauchy Equation

see EULER EQUATION

Cauchy's Formula

The GEOMETRIC MEAN is smaller than the ARITHMETIC MEAN,

$$\left(\prod_{i=1}^N n_i \right)^{1/N} < \frac{\sum_{i=1}^N n_i}{N}.$$

Cauchy Functional Equation

The fifth of HILBERT'S PROBLEMS is a generalization of this equation.

Cauchy-Hadamard Theorem

The RADIUS OF CONVERGENCE of the TAYLOR SERIES

$$a_0 + a_1 z + a_2 z^2 + \dots$$

is

$$r = \frac{1}{\lim_{n \rightarrow \infty} (|a_n|)^{1/n}}.$$

see also RADIUS OF CONVERGENCE, TAYLOR SERIES

Cauchy Inequality

A special case of the HÖLDER SUM INEQUALITY with $p = q = 2$,

$$\left(\sum_{k=1}^n a_k b_k \right)^2 \leq \left(\sum_{k=1}^n a_k^2 \right) \left(\sum_{k=1}^n b_k^2 \right), \quad (1)$$

where equality holds for $a_k = c b_k$. In 2-D, it becomes

$$(a^2 + b^2)(c^2 + a^2) \geq (ac + bd)^2. \quad (2)$$

It can be proven by writing

$$\sum_{i=1}^n (a_i x + b_i)^2 = \sum_{i=1}^n a_i^2 \left(x + \frac{b_i}{a_i} \right)^2 = 0. \quad (3)$$

If b_i/a_i is a constant c , then $x = -c$. If it is not a constant, then all terms cannot simultaneously vanish for REAL x , so the solution is COMPLEX and can be found using the QUADRATIC EQUATION

$$x = \frac{-2 \sum a_i b_i \pm \sqrt{4 \left(\sum a_i b_i \right)^2 - 4 \sum a_i^2 \sum b_i^2}}{2 \sum a_i^2}. \quad (4)$$

In order for this to be COMPLEX, it must be true that

$$\left(\sum_i a_i b_i\right)^2 \leq \left(\sum_i a_i^2\right) \left(\sum_i b_i^2\right), \quad (5)$$

with equality when b_i/a_i is a constant. The VECTOR derivation is much simpler,

$$(\mathbf{a} \cdot \mathbf{b})^2 = a^2 b^2 \cos^2 \theta \leq a^2 b^2, \quad (6)$$

where

$$a^2 \equiv \mathbf{a} \cdot \mathbf{a} = \sum_i a_i^2, \quad (7)$$

and similarly for b .

see also CHERYSHEV INEQUALITY, HÖLDER SUM INEQUALITY

References

Abramowitz, M. and Stegun, C. A. (Eds.). *Handbook of Mathematical Functions with Formulas, Graphs, and Mathematical Tables*, 9th printing. New York: Dover, p. 11, 1972.

Cauchy Integral Formula

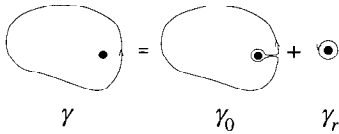

Given a CONTOUR INTEGRAL of the form

$$\int_{\gamma} \frac{f(z) dz}{z - z_0}, \quad (1)$$

define a path γ_0 as an infinitesimal CIRCLE around the point z_0 (the dot in the above illustration). Define the path γ_r as an arbitrary loop with a cut line (on which the forward and reverse contributions cancel each other out) so as to go around z_0 .

The total path is then

$$\gamma = \gamma_0 + \gamma_r, \quad (2)$$

so

$$\int_{\gamma} \frac{f(z) dz}{z - z_0} = \int_{\gamma_0} \frac{f(z) dz}{z - z_0} + \int_{\gamma_r} \frac{f(z) dz}{z - z_0}. \quad (3)$$

From the CAUCHY INTEGRAL THEOREM, the CONTOUR INTEGRAL along any path not enclosing a POLE is 0. Therefore, the first term in the above equation is 0 since γ_0 does not enclose the POLE, and we are left with

$$\int_{\gamma} \frac{f(z) dz}{z - z_0} = \int_{\gamma_r} \frac{f(z) dz}{z - z_0}. \quad (4)$$

Now, let $z = z_0 + re^{i\theta}$, so $dz = ire^{i\theta} d\theta$. Then

$$\begin{aligned} \int_{\gamma} \frac{f(z) dz}{z - z_0} &= \int_{\gamma_r} \frac{f(z_0 + re^{i\theta})}{re^{i\theta}} ire^{i\theta} d\theta \\ &= \int_{\gamma_r} f(z_0 + re^{i\theta}) i d\theta. \end{aligned} \quad (5)$$

But we are free to allow the radius r to shrink to 0, so

$$\begin{aligned} \int_{\gamma} \frac{f(z) dz}{z - z_0} &= \lim_{r \rightarrow 0} \int_{\gamma_r} f(z_0 + re^{i\theta}) i d\theta = \int_{\gamma_r} f(z_0) i d\theta \\ &= if(z_0) \int_{\gamma_r} d\theta = 2\pi i f(z_0), \end{aligned} \quad (6)$$

and

$$f(z_0) = \frac{1}{2\pi i} \int_{\gamma} \frac{f(z) dz}{z - z_0}. \quad (7)$$

If multiple loops are made around the POLE, then equation (7) becomes

$$n(\gamma, z_0) f(z_0) = \frac{1}{2\pi i} \int_{\gamma} \frac{f(z) dz}{z - z_0}, \quad (8)$$

where $n(\gamma, z_0)$ is the WINDING NUMBER.

A similar formula holds for the derivatives of $f(z)$,

$$\begin{aligned} f'(z_0) &= \lim_{h \rightarrow 0} \frac{f(z_0 + h) - f(z_0)}{h} \\ &= \lim_{h \rightarrow 0} \frac{1}{2\pi i h} \left(\int_{\gamma} \frac{f(z) dz}{z - z_0 - h} - \int_{\gamma} \frac{f(z) dz}{z - z_0} \right) \\ &= \lim_{h \rightarrow 0} \frac{1}{2\pi i h} \int_{\gamma} \frac{f(z)[(z - z_0) - (z - z_0 - h)] dz}{(z - z_0 - h)(z - z_0)} \\ &= \lim_{h \rightarrow 0} \frac{1}{2\pi i h} \int_{\gamma} \frac{hf(z) dz}{(z - z_0 - h)(z - z_0)} \\ &= \frac{1}{2\pi i} \int_{\gamma} \frac{f(z) dz}{(z - z_0)^2}. \end{aligned} \quad (9)$$

Iterating again,

$$f''(z_0) = \frac{2}{2\pi i} \int_{\gamma} \frac{f(z) dz}{(z - z_0)^3}. \quad (10)$$

Continuing the process and adding the WINDING NUMBER n ,

$$n(\gamma, z_0) f^{(r)}(z_0) = \frac{r!}{2\pi i} \int_{\gamma} \frac{f(z) dz}{(z - z_0)^{r+1}}. \quad (11)$$

see also MORERA'S THEOREM

References

Arfken, G. "Cauchy's Integral Formula." §6.4 in *Mathematical Methods for Physicists*, 3rd ed. Orlando, FL: Academic Press, pp. 371-376, 1985.
Morse, P. M. and Feshbach, H. *Methods of Theoretical Physics, Part I*. New York: McGraw-Hill, pp. 367-372, 1953.

Cauchy Integral Test

see INTEGRAL TEST

Cauchy Integral Theorem

If f is continuous and finite on a simply connected region R and has only finitely many points of nondifferentiability in R , then

$$\oint_{\gamma} f(z) dz = 0 \quad (1)$$

for any closed CONTOUR γ completely contained in R . Writing z as

$$z \equiv x + iy \quad (2)$$

and $f(z)$ as

$$f(z) \equiv u + iv \quad (3)$$

then gives

$$\begin{aligned} \oint_{\gamma} f(z) dz &= \int_{\gamma} (u + iv)(dx + i dy) \\ &= \int_{\gamma} u dx - v dy + i \int_{\gamma} v dx + u dy. \end{aligned} \quad (4)$$

From GREEN'S THEOREM,

$$\int_{\gamma} f(x, y) dx - g(x, y) dy = - \iint \left(\frac{\partial g}{\partial x} + \frac{\partial f}{\partial y} \right) dx dy, \quad (5)$$

$$\int_{\gamma} f(x, y) dx + g(x, y) dy = \iint \left(\frac{\partial g}{\partial x} - \frac{\partial f}{\partial y} \right) dx dy \quad (6)$$

so (4) becomes

$$\begin{aligned} \oint_{\gamma} f(z) dz &= - \iint \left(\frac{\partial v}{\partial x} + \frac{\partial u}{\partial y} \right) dx dy \\ &\quad + i \iint \left(\frac{\partial u}{\partial x} - \frac{\partial v}{\partial y} \right) dx dy. \end{aligned} \quad (7)$$

But the CAUCHY-RIEMANN EQUATIONS require that

$$\frac{\partial u}{\partial x} = \frac{\partial v}{\partial y} \quad (8)$$

$$\frac{\partial u}{\partial y} = - \frac{\partial v}{\partial x}, \quad (9)$$

so

$$\oint_{\gamma} f(z) dz = 0, \quad (10)$$

Q. E. D.

For a MULTIPLY CONNECTED region,

$$\int_{C_1} f(z) dz = \int_{C_2} f(z) dz. \quad (11)$$

see also CAUCHY INTEGRAL THEOREM, MORERA'S THEOREM, RESIDUE THEOREM (COMPLEX ANALYSIS)

References

- Arfken, G. "Cauchy's Integral Theorem." §6.3 in *Mathematical Methods for Physicists*, 3rd ed. Orlando, FL: Academic Press, pp. 365–371, 1985.
Morse, P. M. and Feshbach, H. *Methods of Theoretical Physics, Part I*. New York: McGraw-Hill, pp. 363–367, 1953.

Cauchy-Kovalevskaya Theorem

The theorem which proves the existence and uniqueness of solutions to the CAUCHY PROBLEM.

see also CAUCHY PROBLEM

Cauchy-Lagrange Identity

$$\begin{aligned} (a_1^2 + a_2^2 + \dots + a_n^2)(b_1^2 + b_2^2 + \dots + b_n^2) \\ = (a_1 b_2 - a_2 b_1)^2 + (a_1 b_3 - a_3 b_1)^2 + \dots \\ + (a_{n-1} b_n - a_n b_{n-1})^2. \end{aligned}$$

From this identity, the n -D CAUCHY INEQUALITY follows.

Cauchy-Maclaurin Theorem

see MACLAURIN-CAUCHY THEOREM

Cauchy Mean Theorem

For numbers > 0 , the GEOMETRIC MEAN $<$ the ARITHMETIC MEAN.

Cauchy Principal Value

$$\begin{aligned} PV \int_{-\infty}^{\infty} f(x) dx &\equiv \lim_{R \rightarrow \infty} \int_{-R}^R f(x) dx \\ PV \int_a^b f(x) dx &\equiv \lim_{\epsilon \rightarrow 0} \left[\int_a^{c-\epsilon} f(x) dx + \int_{c+\epsilon}^b f(x) dx \right], \end{aligned}$$

where $\epsilon > 0$ and $a \leq c \leq b$.

References

- Arfken, G. *Mathematical Methods for Physicists*, 3rd ed. Orlando, FL: Academic Press, pp. 401–403, 1985.
Sansone, G. *Orthogonal Functions*, rev. English ed. New York: Dover, p. 158, 1991.

Cauchy Problem

If $f(x, y)$ is an ANALYTIC FUNCTION in a NEIGHBORHOOD of the point (x_0, y_0) (i.e., it can be expanded in a series of NONNEGATIVE INTEGER POWERS of $(x - x_0)$ and $(y - y_0)$), find a solution $y(x)$ of the DIFFERENTIAL EQUATION

$$\frac{dy}{dx} = f(x),$$

with initial conditions $y = y_0$ and $x = x_0$. The existence and uniqueness of the solution were proven by Cauchy and Kovalevskaya in the CAUCHY-KOVALEVSKAYA THEOREM. The Cauchy problem amounts to determining the shape of the boundary and type of equation which yield unique and reasonable solutions for the CAUCHY BOUNDARY CONDITIONS.

see also CAUCHY BOUNDARY CONDITIONS

Cauchy Ratio Test

see RATIO TEST

Cauchy Remainder Form

The remainder of n terms of a TAYLOR SERIES is given by

$$R_n = \frac{(x-c)^{n-1}(x-a)}{(n-1)!} f^{(n)}(c),$$

where $a \leq c \leq x$.

Cauchy-Riemann Equations

Let

$$f(x, y) = u(x, y) + iv(x, y), \quad (1)$$

where

$$z \equiv x + iy, \quad (2)$$

so

$$dz = dx + i dy. \quad (3)$$

The total derivative of f with respect to z may then be computed as follows.

$$y = \frac{z-x}{i} \quad (4)$$

$$x = z - iy, \quad (5)$$

so

$$\frac{\partial y}{\partial z} = \frac{1}{i} = -i \quad (6)$$

$$\frac{\partial x}{\partial z} = 1, \quad (7)$$

and

$$\frac{df}{dz} = \frac{\partial f}{\partial x} \frac{\partial x}{\partial z} + \frac{\partial f}{\partial y} \frac{\partial y}{\partial z} = \frac{\partial f}{\partial x} - i \frac{\partial f}{\partial y}. \quad (8)$$

In terms of u and v , (8) becomes

$$\begin{aligned} \frac{df}{dz} &= \left(\frac{\partial u}{\partial x} + i \frac{\partial v}{\partial x} \right) - i \left(\frac{\partial u}{\partial y} + i \frac{\partial v}{\partial y} \right) \\ &= \left(\frac{\partial u}{\partial x} + i \frac{\partial v}{\partial x} \right) + \left(-i \frac{\partial u}{\partial y} + \frac{\partial v}{\partial y} \right). \end{aligned} \quad (9)$$

Along the real, or x -AXIS, $\partial f / \partial y = 0$, so

$$\frac{df}{dz} = \frac{\partial u}{\partial x} + i \frac{\partial v}{\partial x}. \quad (10)$$

Along the imaginary, or y -axis, $\partial f / \partial x = 0$, so

$$\frac{df}{dz} = -i \frac{\partial u}{\partial y} + \frac{\partial v}{\partial y}. \quad (11)$$

If f is COMPLEX DIFFERENTIABLE, then the value of the derivative must be the same for a given dz , regardless of its orientation. Therefore, (10) must equal (11), which requires that

$$\frac{\partial u}{\partial x} = \frac{\partial v}{\partial y} \quad (12)$$

and

$$\frac{\partial v}{\partial x} = -\frac{\partial u}{\partial y}. \quad (13)$$

These are known as the Cauchy-Riemann equations. They lead to the condition

$$\frac{\partial^2 u}{\partial x \partial y} = -\frac{\partial^2 v}{\partial x \partial y}. \quad (14)$$

The Cauchy-Riemann equations may be concisely written as

$$\begin{aligned} \frac{df}{dz^*} &= \frac{\partial f}{\partial x} + i \frac{\partial f}{\partial y} = \left(\frac{\partial u}{\partial x} + i \frac{\partial v}{\partial x} \right) + i \left(\frac{\partial u}{\partial y} + i \frac{\partial v}{\partial y} \right) \\ &= \left(\frac{\partial u}{\partial x} - \frac{\partial v}{\partial y} \right) + i \left(\frac{\partial u}{\partial y} + \frac{\partial v}{\partial x} \right) = 0. \end{aligned} \quad (15)$$

In POLAR COORDINATES,

$$f(re^{i\theta}) \equiv R(r, \theta)e^{i\Theta(r, \theta)}, \quad (16)$$

so the Cauchy-Riemann equations become

$$\frac{\partial R}{\partial r} = \frac{R}{r} \frac{\partial \Theta}{\partial \theta} \quad (17)$$

$$\frac{1}{r} \frac{\partial R}{\partial \theta} = -R \frac{\partial \Theta}{\partial r}. \quad (18)$$

If u and v satisfy the Cauchy-Riemann equations, they also satisfy LAPLACE'S EQUATION in 2-D, since

$$\frac{\partial^2 u}{\partial x^2} + \frac{\partial^2 u}{\partial y^2} = \frac{\partial}{\partial x} \left(\frac{\partial v}{\partial y} \right) + \frac{\partial}{\partial y} \left(-\frac{\partial v}{\partial x} \right) = 0 \quad (19)$$

$$\frac{\partial^2 v}{\partial x^2} + \frac{\partial^2 v}{\partial y^2} = \frac{\partial}{\partial x} \left(-\frac{\partial u}{\partial y} \right) + \frac{\partial}{\partial y} \left(\frac{\partial u}{\partial x} \right) = 0. \quad (20)$$

By picking an arbitrary $f(z)$, solutions can be found which automatically satisfy the Cauchy-Riemann equations and LAPLACE'S EQUATION. This fact is used to find so-called CONFORMAL SOLUTIONS to physical problems involving scalar potentials such as fluid flow and electrostatics.

see also CAUCHY INTEGRAL THEOREM, CONFORMAL SOLUTION, MONOGENIC FUNCTION, POLYGENIC FUNCTION

References

- Abramowitz, M. and Stegun, C. A. (Eds.). *Handbook of Mathematical Functions with Formulas, Graphs, and Mathematical Tables*, 9th printing. New York: Dover, p. 17, 1972.
- Arfken, G. "Cauchy-Riemann Conditions." §6.2 in *Mathematical Methods for Physicists*, 3rd ed. Orlando, FL: Academic Press, pp. 3560-365, 1985.

Cauchy's Rigidity Theorem

see RIGIDITY THEOREM

Cauchy Root Test

see ROOT TEST

Cauchy-Schwarz Integral Inequality

Let $f(x)$ and $g(x)$ be any two REAL integrable functions of $[a, b]$, then

$$\left[\int_a^b f(x)g(x) dx \right]^2 \leq \left[\int_a^b f^2(x) dx \right] \left[\int_a^b g^2(x) dx \right],$$

with equality IFF $f(x) = kg(x)$ with k real.

References

Gradshteyn, I. S. and Ryzhik, I. M. *Tables of Integrals, Series, and Products*, 5th ed. San Diego, CA: Academic Press, p. 1099, 1993.

Cauchy-Schwarz Sum Inequality

$$|\mathbf{a} \cdot \mathbf{b}| \leq |\mathbf{a}| |\mathbf{b}|.$$

$$\left(\sum_{k=1}^n a_k b_k \right)^2 \leq \left(\sum_{k=1}^n a_k^2 \right) \left(\sum_{k=1}^n b_k^2 \right).$$

Equality holds IFF the sequences a_1, a_2, \dots and b_1, b_2, \dots are proportional.

see also FIBONACCI IDENTITY

References

Gradshteyn, I. S. and Ryzhik, I. M. *Tables of Integrals, Series, and Products*, 5th ed. San Diego, CA: Academic Press, p. 1092, 1979.

Cauchy Sequence

A SEQUENCE a_1, a_2, \dots such that the METRIC $d(a_m, a_n)$ satisfies

$$\lim_{\min(m,n) \rightarrow \infty} d(a_m, a_n) = 0.$$

Cauchy sequences in the rationals do not necessarily CONVERGE, but they do CONVERGE in the REALS.

REAL NUMBERS can be defined using either DEDEKIND CUTS or Cauchy sequences.

see also DEDEKIND CUT

Cauchy Test

see RATIO TEST

Caustic

The curve which is the ENVELOPE of reflected (CAT-ACAUSTIC) or refracted (DIACAUSTIC) rays of a given curve for a light source at a given point (known as the RADIANT POINT). The caustic is the EVOLUTE of the ORTHOTOMIC.

References

Lawrence, J. D. *A Catalog of Special Plane Curves*. New York: Dover, p. 60, 1972.

Lee, X. "Caustics." http://www.best.com/~xah/SpecialPlaneCurves_dir/Caustics_dir/caustics.html.

Lockwood, E. H. "Caustic Curves." Ch. 24 in *A Book of Curves*. Cambridge, England: Cambridge University Press, pp. 182–185, 1967.

Yates, R. C. "Caustics." *A Handbook on Curves and Their Properties*. Ann Arbor, MI: J. W. Edwards, pp. 15–20, 1952.

Cavalieri's Principle

1. If the lengths of every one-dimensional slice are equal for two regions, then the regions have equal AREAS.
2. If the AREAS of every two-dimensional slice (CROSS-SECTION) are equal for two SOLIDS, then the SOLIDS have equal VOLUMES.

see also CROSS-SECTION, PAPPUS'S CENTROID THEOREM

References

Beyer, W. H. (Ed.) *CRC Standard Mathematical Tables*, 28th ed. Boca Raton, FL: CRC Press, p. 126 and 132, 1987.

Cayley Algebra

The only NONASSOCIATIVE DIVISION ALGEBRA with REAL SCALARS. There is an 8-square identity corresponding to this algebra. The elements of a Cayley algebra are called CAYLEY NUMBERS or OCTONIONS.

References

Kurosh, A. G. *General Algebra*. New York: Chelsea, pp. 226–28, 1963.

Cayley-Bacharach Theorem

Let $X_1, X_2 \subset \mathbb{P}^2$ be CUBIC plane curves meeting in nine points p_1, \dots, p_9 . If $X \subset \mathbb{P}^2$ is any CUBIC containing p_1, \dots, p_8 , then X contains p_9 as well. It is related to GORENSTEIN RINGS, and is a generalization of PAPPUS'S HEXAGON THEOREM and PASCAL'S THEOREM.

References

Eisenbud, D.; Green, M.; and Harris, J. "Cayley-Bacharach Theorems and Conjectures." *Bull. Amer. Math. Soc.* **33**, 295–324, 1996.

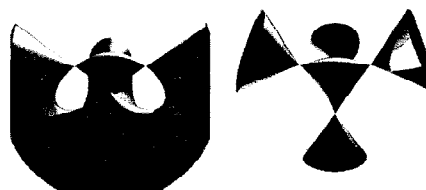
Cayley Cubic

A CUBIC RULED SURFACE (Fischer 1986) in which the director line meets the director CONIC SECTION. Cayley's surface is the unique cubic surface having four ORDINARY DOUBLE POINTS (Hunt), the maximum possible for CUBIC SURFACE (Endraß). The Cayley cubic is invariant under the TETRAHEDRAL GROUP and contains exactly nine lines, six of which connect the four nodes pairwise and the other three of which are coplanar (Endraß).

If the ORDINARY DOUBLE POINTS in projective 3-space are taken as $(1, 0, 0, 0)$, $(0, 1, 0, 0)$, $(0, 0, 1, 0)$, $(0, 0, 0, 1)$, then the equation of the surface in projective coordinates is

$$\frac{1}{x_0} + \frac{1}{x_1} + \frac{1}{x_2} + \frac{1}{x_3} = 0$$

(Hunt). Defining “affine” coordinates with plane at infinity $v = x_0 + x_1 + x_2 + 2x_3$ and

$$\begin{aligned}x &= \frac{x_0}{v} \\y &= \frac{x_1}{v} \\z &= \frac{x_2}{v}\end{aligned}$$

then gives the equation

$$-5(x^2y + x^2z + y^2x + y^2z + z^2y + z^2x) + 2(xy + xz + yz) = 0$$

plotted in the left figure above (Hunt). The slightly different form

$$4(x^3 + y^3 + z^3 + w^3) - (x + y + z + w)^3 = 0$$

is given by Endraß which, when rewritten in TETRAHEDRAL COORDINATES, becomes

$$x^2 + y^2 - x^2z + y^2z + z^2 - 1 = 0,$$

plotted in the right figure above.

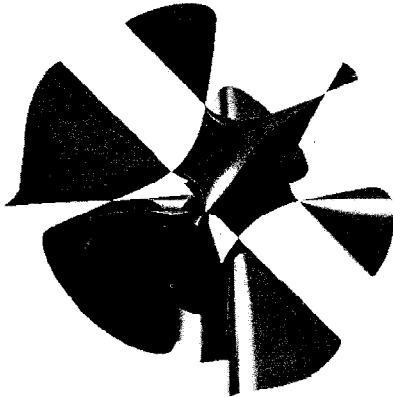

The Hessian of the Cayley cubic is given by

$$\begin{aligned}0 &= x_0^2(x_1x_2 + x_1x_3 + x_2x_3) + x_1^2(x_0x_2 + x_0x_3 + x_2x_3) \\ &\quad + x_2^2(x_0x_1 + x_0x_3 + x_1x_3) + x_3^2(x_0x_1 + x_0x_2 + x_1x_2).\end{aligned}$$

in homogeneous coordinates x_0, x_1, x_2 , and x_3 . Taking the plane at infinity as $v = 5(x_0 + x_1 + x_2 + 2x_3)/2$ and setting x, y , and z as above gives the equation

$$\begin{aligned}25[x^3(y+z) + y^3(x+z) + z^3(x+y)] + 50(x^2y^2 + x^2z^2 + y^2z^2) \\ - 125(x^2yz + y^2xz + z^2xy) + 60xyz - 4(xy + xz + yz) = 0,\end{aligned}$$

plotted above (Hunt). The Hessian of the Cayley cubic has 14 ORDINARY DOUBLE POINTS, four more than a the general Hessian of a smooth CUBIC SURFACE (Hunt).

References

Endraß, S. “Flächen mit vielen Doppelpunkten.” *DMV-Mitteilungen* 4, 17–20, Apr. 1995.

Endraß, S. “The Cayley Cubic.” <http://www.mathematik.uni-mainz.de/AlgebraischeGeometrie/docs/Ecayley.shtml>.

Fischer, G. (Ed.). *Mathematical Models from the Collections of Universities and Museums*. Braunschweig, Germany: Vieweg, p. 14, 1986.

Fischer, G. (Ed.). Plate 33 in *Mathematische Modelle/Mathematical Models, Bildband/Photograph Volume*. Braunschweig, Germany: Vieweg, p. 33, 1986.

Hunt, B. “Algebraic Surfaces.” <http://www.mathematik.uni-kl.de/~wwwagag/Galerie.html>.

Hunt, B. *The Geometry of Some Special Arithmetic Quotients*. New York: Springer-Verlag, pp. 115–122, 1996.

Nordstrand, T. “The Cayley Cubic.” <http://www.uib.no/people/nfytn/cleytxt.htm>.

Cayley Graph

The representation of a GROUP as a network of directed segments, where the vertices correspond to elements and the segments to multiplication by group generators and their inverses.

see also CAYLEY TREE

References

Grossman, I. and Magnus, W. *Groups and Their Graphs*. New York: Random House, p. 45, 1964.

Cayley’s Group Theorem

Every FINITE GROUP of order n can be represented as a PERMUTATION GROUP on n letters, as first proved by Cayley in 1878 (Rotman 1995).

see also FINITE GROUP, PERMUTATION GROUP

References

Rotman, J. J. *An Introduction to the Theory of Groups*, 4th ed. New York: Springer-Verlag, p. 52, 1995.

Cayley-Hamilton Theorem

Given

$$\begin{vmatrix} a_{11} - x & a_{12} & \cdots & a_{1m} \\ a_{21} & a_{22} - x & \cdots & a_{2m} \\ \vdots & \vdots & \ddots & \vdots \\ a_{m1} & a_{m2} & \cdots & a_{mm} - x \end{vmatrix} = x^m + c_{m-1}x^{m-1} + \cdots + c_0, \quad (1)$$

then

$$A^m + c_{m-1}A^{m-1} + \cdots + c_0I = 0, \quad (2)$$

where I is the IDENTITY MATRIX. Cayley verified this identity for $m = 2$ and 3 and postulated that it was true for all m . For $m = 2$, direct verification gives

$$\begin{vmatrix} a - x & b \\ c & d - x \end{vmatrix} = (a - x)(d - x) - bc = x^2 - (a + d)x + (ad - bc) \equiv x^2 + c_1x + c_2 \quad (3)$$

$$A = \begin{bmatrix} a & b \\ c & d \end{bmatrix} \quad (4)$$

$$A^2 = \begin{bmatrix} a & b \\ c & d \end{bmatrix} \begin{bmatrix} a & b \\ c & d \end{bmatrix} = \begin{bmatrix} a^2 + bc & ab + bd \\ ac + cd & bc + d^2 \end{bmatrix} \quad (5)$$

$$-(a+d)A = \begin{bmatrix} -a^2 - ad & -ab - bd \\ -ac - dc & -ad - d^2 \end{bmatrix} \quad (6)$$

$$(ad - bc)I = \begin{bmatrix} ad - bc & 0 \\ 0 & ad - bc \end{bmatrix}, \quad (7)$$

so

$$A^2 - (a+d)A + (ad - bc)I = \begin{bmatrix} 0 & 0 \\ 0 & 0 \end{bmatrix}. \quad (8)$$

The Cayley-Hamilton theorem states that a $n \times n$ MATRIX A is annihilated by its CHARACTERISTIC POLYNOMIAL $\det(xI - A)$, which is monic of degree n .

References

Gradshteyn, I. S. and Ryzhik, I. M. *Tables of Integrals, Series, and Products*, 5th ed. San Diego, CA: Academic Press, p. 1117, 1979.

Segercrantz, J. "Improving the Cayley-Hamilton Equation for Low-Rank Transformations." *Amer. Math. Monthly* **99**, 42-44, 1992.

Cayley's Hypergeometric Function Theorem

If

$$(1 - z)^{a+b-c} {}_2F_1(2a, 2b; 2c; z) = \sum_{n=0}^{\infty} a_n z^n,$$

then

$${}_2F_1(a, b; c + \tfrac{1}{2}; z) {}_2F_1(c - a, c - b; c; \tfrac{1}{2}z) = \sum_{n=0}^{\infty} \frac{(c)_n}{(c + \tfrac{1}{2})^n} a_n z^n,$$

where ${}_2F_1(a, b; c; z)$ is a HYPERGEOMETRIC FUNCTION. see also HYPERGEOMETRIC FUNCTION

Cayley-Klein Parameters

The parameters α , β , γ , and δ which, like the three EULER ANGLES, provide a way to uniquely characterize the orientation of a solid body. These parameters satisfy the identities

$$\alpha\alpha^* + \gamma\gamma^* = 1 \quad (1)$$

$$\alpha\alpha^* + \beta\beta^* = 1 \quad (2)$$

$$\beta\beta^* + \delta\delta^* = 1 \quad (3)$$

$$\alpha^*\beta + \gamma^*\delta = 0 \quad (4)$$

$$\alpha\delta - \beta\gamma = 1 \quad (5)$$

and

$$\beta = -\gamma^* \quad (6)$$

$$\delta = \alpha^*, \quad (7)$$

where z^* denotes the COMPLEX CONJUGATE. In terms of the EULER ANGLES θ , ϕ , and ψ , the Cayley-Klein parameters are given by

$$\alpha = e^{i(\psi+\phi)/2} \cos(\tfrac{1}{2}\theta) \quad (8)$$

$$\beta = ie^{i(\psi-\phi)/2} \sin(\tfrac{1}{2}\theta) \quad (9)$$

$$\gamma = ie^{-i(\psi-\phi)/2} \sin(\tfrac{1}{2}\theta) \quad (10)$$

$$\delta = e^{-(\psi+\phi)/2} \cos(\tfrac{1}{2}\theta) \quad (11)$$

(Goldstein 1960, p. 155).

The transformation matrix is given in terms of the Cayley-Klein parameters by

$$A = \begin{bmatrix} \tfrac{1}{2}(\alpha^2 - \gamma^2 + \delta^2 - \beta^2) & \tfrac{1}{2}i(\gamma^2 - \alpha^2 + \delta^2 - \beta^2) & \gamma\delta - \alpha\beta \\ \tfrac{1}{2}i(\alpha^2 + \gamma^2 - \beta^2 - \delta^2) & \tfrac{1}{2}(\alpha^2 + \gamma^2 + \beta^2 + \delta^2) & -i(\alpha\beta + \gamma\delta) \\ \beta\delta - \alpha\gamma & i(\alpha\gamma + \beta\delta) & \alpha\delta + \beta\gamma \end{bmatrix} \quad (12)$$

(Goldstein 1960, p. 153).

The Cayley-Klein parameters may be viewed as parameters of a matrix (denoted Q for its close relationship with QUATERNIONS)

$$Q = \begin{bmatrix} \alpha & \beta \\ \gamma & \delta \end{bmatrix} \quad (13)$$

which characterizes the transformations

$$u' = \alpha u + \beta v \quad (14)$$

$$v' = \gamma u + \delta v. \quad (15)$$

of a linear space having complex axes. This matrix satisfies

$$Q^\dagger Q = QQ^\dagger = I, \quad (16)$$

where I is the IDENTITY MATRIX and A^\dagger the MATRIX TRANSPOSE, as well as

$$|Q|^*|Q| = 1. \quad (17)$$

In terms of the EULER PARAMETERS e_i and the PAULI MATRICES σ_i , the Q -matrix can be written as

$$Q = e_0 I + i(e_1 \sigma_1 + e_2 \sigma_2 + e_3 \sigma_3) \quad (18)$$

(Goldstein 1980, p. 156).

see also EULER ANGLES, EULER PARAMETERS, PAULI MATRICES, QUATERNION

References

Goldstein, H. "The Cayley-Klein Parameters and Related Quantities." §4-5 in *Classical Mechanics*, 2nd ed. Reading, MA: Addison-Wesley, pp. 148-158, 1980.

Cayley-Klein-Hilbert Metric

The METRIC of Felix Klein's model for HYPERBOLIC GEOMETRY,

$$g_{11} = \frac{a^2(1 - x_2^2)}{(1 - x_1^2 - x_2^2)^2}$$

$$g_{12} = \frac{a^2 x_1 x_2}{(1 - x_1^2 - x_2^2)^2}$$

$$g_{22} = \frac{a^2(1 - x_1^2)}{(1 - x_1^2 - x_2^2)^2}.$$

see also HYPERBOLIC GEOMETRY

Cayley Number

There are two completely different definitions of Cayley numbers. The first type Cayley numbers is one of the eight elements in a CAYLEY ALGEBRA, also known as an OCTONION. A typical Cayley number is of the form

$$a + bi_0 + ci_1 + di_2 + ei_3 + fi_4 + gi_5 + hi_6,$$

where each of the triples (i_0, i_1, i_3) , (i_1, i_2, i_4) , (i_2, i_3, i_5) , (i_3, i_4, i_6) , (i_4, i_5, i_0) , (i_5, i_6, i_1) , (i_6, i_0, i_2) behaves like the QUATERNIONS (i, j, k) . Cayley numbers are *not* ASSOCIATIVE. They have been used in the study of 7- and 8-D space, and a general rotation in 8-D space can be written

$$x' \rightarrow ((((((x_{c1})c_2)c_3)c_4)c_5)c_6)c_7).$$

The second type of Cayley number is a quantity which describes a DEL PEZZO SURFACE.

see also COMPLEX NUMBER, DEL PEZZO SURFACE, QUATERNION, REAL NUMBER

References

Conway, J. H. and Guy, R. K. "Cayley Numbers." In *The Book of Numbers*. New York: Springer-Verlag, pp. 234–235, 1996.

Okubo, S. *Introduction to Octonion and Other Non-Associative Algebras in Physics*. New York: Cambridge University Press, 1995.

Cayley's Ruled Surface

see CAYLEY CUBIC

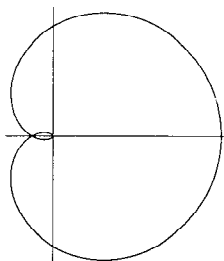
Cayley's Sextic

A plane curve discovered by Maclaurin but first studied in detail by Cayley. The name Cayley's sextic is due to R. C. Archibald, who attempted to classify curves in a paper published in Strasbourg in 1900 (MacTutor Archive). Cayley's sextic is given in POLAR COORDINATES by

$$r = a \cos^3\left(\frac{1}{3}\theta\right), \quad (1)$$

or

$$r = 4b \cos^3\left(\frac{1}{3}\theta\right), \quad (2)$$

where $b \equiv a/4$. In the latter case, the CARTESIAN equation is

$$4(x^2 + y^2 - bx)^3 = 27a^2(x^2 + y^2)^2. \quad (3)$$

The parametric equations are

$$x(t) = 4a \cos^4\left(\frac{1}{2}t\right)(2 \cos t - 1) \quad (4)$$

$$y(t) = 4a \cos^3\left(\frac{1}{2}t\right) \sin\left(\frac{3}{2}t\right). \quad (5)$$

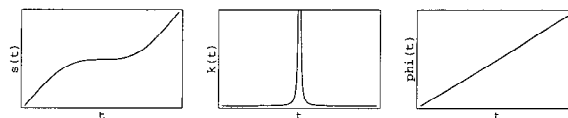

The ARC LENGTH, CURVATURE, and TANGENTIAL ANGLE are

$$s(t) = 3(t + \sin t), \quad (6)$$

$$\kappa(t) = \frac{1}{3} \sec^2\left(\frac{1}{2}t\right), \quad (7)$$

$$\phi(t) = 2t. \quad (8)$$

References

Lawrence, J. D. *A Catalog of Special Plane Curves*. New York: Dover, pp. 178 and 180, 1972.

MacTutor History of Mathematics Archive. "Cayley's Sextic." <http://www-groups.dcs.st-and.ac.uk/~history/Curves/Cayleys.html>.

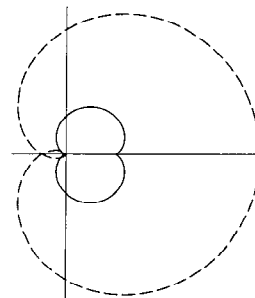
Cayley's Sextic Evolute

The EVOLUTE of Cayley's sextic is

$$x = \frac{1}{8}a + \frac{1}{16}a[3 \cos\left(\frac{2}{3}t\right) - \cos(2t)]$$

$$y = \frac{1}{16}a[3 \sin\left(\frac{2}{3}t\right) - \sin(2t)],$$

which is a NEPHROID.

Cayley Tree

A TREE in which each NODE has a constant number of branches. The PERCOLATION THRESHOLD for a Cayley tree having z branches is

$$p_c = \frac{1}{z-1}.$$

see also CAYLEY GRAPH

Cayleyian Curve

The ENVELOPE of the lines connecting corresponding points on the JACOBIAN CURVE and STEINERIAN CURVE. The Cayleyian curve of a net of curves of order n has the same GENUS (CURVE) as the JACOBIAN CURVE and STEINERIAN CURVE and, in general, the class $3n(n-1)$.

References

Coolidge, J. L. *A Treatise on Algebraic Plane Curves*. New York: Dover, p. 150, 1959.

Čech Cohomology

The direct limit of the COHOMOLOGY groups with COEFFICIENTS in an ABELIAN GROUP of certain coverings of a TOPOLOGICAL SPACE.

Ceiling Function

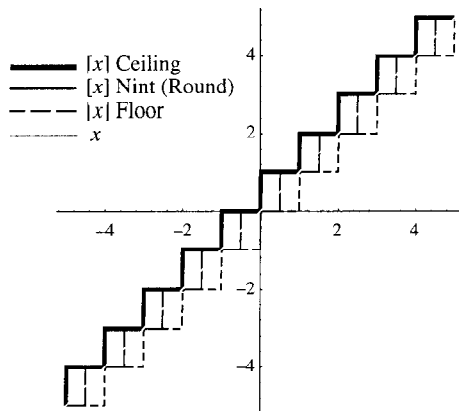

The function $\lceil x \rceil$ which gives the smallest INTEGER $\geq x$, shown as the thick curve in the above plot. Schroeder (1991) calls the ceiling function symbols the "GALLOWS" because of the similarity in appearance to the structure used for hangings. The name and symbol for the ceiling function were coined by K. E. Iverson (Graham *et al.* 1990). It can be implemented as $\text{ceil}(x) = -\text{int}(-x)$, where $\text{int}(x)$ is the INTEGER PART of x .

see also FLOOR FUNCTION, INTEGER PART, NINT

References

Graham, R. L.; Knuth, D. E.; and Patashnik, O. "Integer Functions." Ch. 3 in *Concrete Mathematics: A Foundation for Computer Science*. Reading, MA: Addison-Wesley, pp. 67–101, 1990.
Iverson, K. E. *A Programming Language*. New York: Wiley, p. 12, 1962.
Schroeder, M. *Fractals, Chaos, Power Laws: Minutes from an Infinite Paradise*. New York: W. H. Freeman, p. 57, 1991.

Cell

A finite regular POLYTOPE.

see also 16-CELL, 24-CELL, 120-CELL, 600-CELL

Cellular Automaton

A grid (possibly 1-D) of cells which evolves according to a set of rules based on the states of surrounding cells. von Neumann was one of the first people to consider such a model, and incorporated a cellular model into his "universal constructor." von Neumann proved that an automaton consisting of cells with four orthogonal neighbors and 29 possible states would be capable of simulating a TURING MACHINE for some configuration of about 200,000 cells (Gardner 1983, p. 227).

1-D automata are called "elementary" and are represented by a row of pixels with states either 0 or 1. These can be represented with an 8-bit binary number, as shown by Stephen Wolfram. Wolfram further restricted the number from $2^8 = 256$ to 32 by requiring certain symmetry conditions.

The most well-known cellular automaton is Conway's game of LIFE, popularized in Martin Gardner's *Scientific American* columns. Although the computation of successive LIFE generations was originally done by hand, the computer revolution soon arrived and allowed more extensive patterns to be studied and propagated.

see LIFE, LANGTON'S ANT

References

Adami, C. *Artificial Life*. Cambridge, MA: MIT Press, 1998.
Buchi, J. R. and Siefkes, D. (Eds.). *Finite Automata, Their Algebras and Grammars: Towards a Theory of Formal Expressions*. New York: Springer-Verlag, 1989.
Burks, A. W. (Ed.). *Essays on Cellular Automata*. Urbana-Champaign, IL: University of Illinois Press, 1970.
Cipra, B. "Cellular Automata Offer New Outlook on Life, the Universe, and Everything." In *What's Happening in the Mathematical Sciences, 1995-1996, Vol. 3*. Providence, RI: Amer. Math. Soc., pp. 70–81, 1996.
Dewdney, A. K. *The Armchair Universe: An Exploration of Computer Worlds*. New York: W. H. Freeman, 1988.
Gardner, M. "The Game of Life, Parts I-III." Chs. 20–22 in *Wheels, Life, and Other Mathematical Amusements*. New York: W. H. Freeman, pp. 219 and 222, 1983.
Gutowitz, H. (Ed.). *Cellular Automata: Theory and Experiment*. Cambridge, MA: MIT Press, 1991.
Levy, S. *Artificial Life: A Report from the Frontier Where Computers Meet Biology*. New York: Vintage, 1993.
Martin, O.; Odlyzko, A.; and Wolfram, S. "Algebraic Aspects of Cellular Automata." *Communications in Mathematical Physics* **93**, 219–258, 1984.
McIntosh, H. V. "Cellular Automata." <http://www.cs.cinvestav.mx/mcintosh/cellular.html>.
Preston, K. Jr. and Duff, M. B. *Modern Cellular Automata: Theory and Applications*. New York: Plenum, 1985.
Sigmund, K. *Games of Life: Explorations in Ecology, Evolution and Behaviour*. New York: Penguin, 1995.
Sloane, N. J. A. Sequences A006977/M2497 in "An On-Line Version of the Encyclopedia of Integer Sequences."
Sloane, N. J. A. and Plouffe, S. Extended entry in *The Encyclopedia of Integer Sequences*. San Diego: Academic Press, 1995.

Toffoli, T. and Margolus, N. *Cellular Automata Machines: A New Environment for Modeling*. Cambridge, MA: MIT Press, 1987.

Wolfram, S. "Statistical Mechanics of Cellular Automata." *Rev. Mod. Phys.* **55**, 601–644, 1983.

Wolfram, S. (Ed.). *Theory and Application of Cellular Automata*. Reading, MA: Addison-Wesley, 1986.

Wolfram, S. *Cellular Automata and Complexity: Collected Papers*. Reading, MA: Addison-Wesley, 1994.

Wuensche, A. and Lesser, M. *The Global Dynamics of Cellular Automata: An Atlas of Basin of Attraction Fields of One-Dimensional Cellular Automata*. Reading, MA: Addison-Wesley, 1992.

Cellular Space

A HAUSDORFF SPACE which has the structure of a so-called CW-COMPLEX.

Center

A special POINT which usually has some symmetric placement with respect to points on a curve or in a SOLID. The center of a CIRCLE is equidistant from all points on the CIRCLE and is the intersection of any two distinct DIAMETERS. The same holds true for the center of a SPHERE.

see also CENTER (GROUP), CENTER OF MASS, CIRCUMCENTER, CURVATURE CENTER, ELLIPSE, EQUIBROCARD CENTER, EXCENTER, HOMOTHETIC CENTER, INCENTER, INVERSION CENTER, ISOGONIC CENTERS, MAJOR TRIANGLE CENTER, NINE-POINT CENTER, ORTHOCENTER, PERSPECTIVE CENTER, POINT, RADICAL CENTER, SIMILITUDE CENTER, SPHERE, SPIEKER CENTER, TAYLOR CENTER, TRIANGLE CENTER, TRIANGLE CENTER FUNCTION, YFF CENTER OF CONGRUENCE

Center Function

see TRIANGLE CENTER FUNCTION

Center of Gravity

see CENTER OF MASS

Center (Group)

The center of a GROUP is the set of elements which commute with every member of the GROUP. It is equal to the intersection of the CENTRALIZERS of the GROUP elements.

see also ISOCLINIC GROUPS, NILPOTENT GROUP

Center of Mass

see CENTROID (GEOMETRIC)

Centered Cube Number

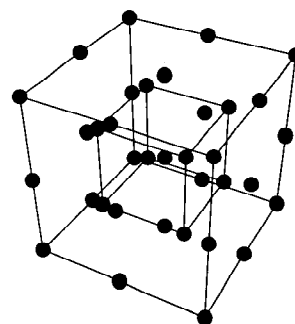

A FIGURATE NUMBER of the form,

$$CCub_n = n^3 + (n-1)^3 = (2n-1)(n^2 - n + 1).$$

The first few are 1, 9, 35, 91, 189, 341, ... (Sloane's A005898). The GENERATING FUNCTION for the centered cube numbers is

$$\frac{x(x^3 + 5x^2 + 5x + 1)}{(x-1)^4} = x + 9x^2 + 35x^3 + 91x^4 + \dots$$

see also CUBIC NUMBER

References

Conway, J. H. and Guy, R. K. *The Book of Numbers*. New York: Springer-Verlag, p. 51, 1996.

Sloane, N. J. A. Sequence A005898/M4616 in "An On-Line Version of the Encyclopedia of Integer Sequences."

Centered Hexagonal Number

see HEX NUMBER

Centered Pentagonal Number

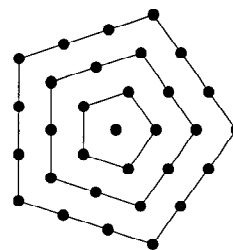

A CENTERED POLYGONAL NUMBER consisting of a central dot with five dots around it, and then additional dots in the gaps between adjacent dots. The general term is $(5n^2 - 5n + 2)/2$, and the first few such numbers are 1, 6, 16, 31, 51, 76, ... (Sloane's A005891). The GENERATING FUNCTION of the centered pentagonal numbers is

$$\frac{x(x^2 + 3x + 1)}{(x-1)^3} = x + 6x^2 + 16x^3 + 31x^4 + \dots$$

see also CENTERED SQUARE NUMBER, CENTERED TRIANGULAR NUMBER

References

Sloane, N. J. A. Sequence A005891/M4112 in "An On-Line Version of the Encyclopedia of Integer Sequences."

Centered Polygonal Number

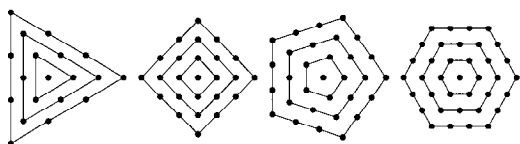

A FIGURATE NUMBER in which layers of POLYGONS are drawn centered about a point instead of with the point at a VERTEX.

see also CENTERED PENTAGONAL NUMBER, CENTERED SQUARE NUMBER, CENTERED TRIANGULAR NUMBER

References

Sloane, N. J. A. and Plouffe, S. Extended entry for sequence M3826 in *The Encyclopedia of Integer Sequences*. San Diego, CA: Academic Press, 1995.

Centered Square Number

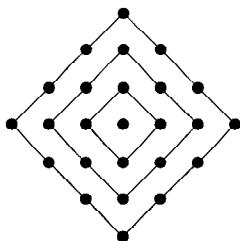

A CENTERED POLYGONAL NUMBER consisting of a central dot with four dots around it, and then additional dots in the gaps between adjacent dots. The general term is $n^2 + (n-1)^2$, and the first few such numbers are 1, 5, 13, 25, 41, ... (Sloane's A001844). Centered square numbers are the sum of two consecutive SQUARE NUMBERS and are congruent to 1 (mod 4). The GENERATING FUNCTION giving the centered square numbers is

$$\frac{x(x+1)^2}{(1-x)^3} = x + 5x^2 + 13x^3 + 25x^4 + \dots$$

see also CENTERED PENTAGONAL NUMBER, CENTERED POLYGONAL NUMBER, CENTERED TRIANGULAR NUMBER, SQUARE NUMBER

References

Conway, J. H. and Guy, R. K. *The Book of Numbers*. New York: Springer-Verlag, p. 41, 1996.
Sloane, N. J. A. Sequence A001844/M3826 in "An On-Line Version of the Encyclopedia of Integer Sequences."

Centered Triangular Number

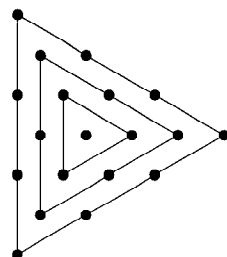

A CENTERED POLYGONAL NUMBER consisting of a central dot with three dots around it, and then additional

dots in the gaps between adjacent dots. The general term is $(3n^2 - 3n + 2)/2$, and the first few such numbers are 1, 4, 10, 19, 31, 46, 64, ... (Sloane's A005448). The GENERATING FUNCTION giving the centered triangular numbers is

$$\frac{x(x^2 + x + 1)}{(1-x)^3} = x + 4x^2 + 10x^3 + 19x^4 + \dots$$

see also CENTERED PENTAGONAL NUMBER, CENTERED SQUARE NUMBER

References

Sloane, N. J. A. Sequence A005448/M3378 in "An On-Line Version of the Encyclopedia of Integer Sequences."

Centillion

In the American system, 10^{303} .

see also LARGE NUMBER

Central Angle

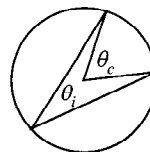

An ANGLE having its VERTEX at a CIRCLE's center which is formed by two points on the CIRCLE's CIRCUMFERENCE. For angles with the same endpoints,

$$\theta_c = 2\theta_i,$$

where θ_i is the INSCRIBED ANGLE.

References

Pedoe, D. *Circles: A Mathematical View*, rev. ed. Washington, DC: Math. Assoc. Amer., pp. xxi-xxii, 1995.

Central Beta Function

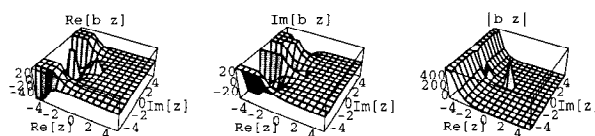
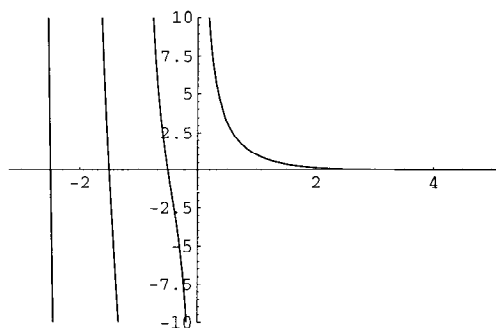

The central beta function is defined by

$$\beta(p) \equiv B(p, p), \quad (1)$$

where $B(p, q)$ is the BETA FUNCTION. It satisfies the identities

$$\beta(p) = 2^{1-2p} B(p, \tfrac{1}{2}) \quad (2)$$

$$= 2^{1-2p} \cos(\pi p) B(\tfrac{1}{2} - p, p) \quad (3)$$

$$= \int_0^1 \frac{t^p dt}{(1+t)^{2p}} \quad (4)$$

$$= \frac{2}{p} \prod_{n=1}^{\infty} \frac{n(n+2p)}{(n+p)(n+p)} \quad (5)$$

With $p = 1/2$, the latter gives the WALLIS FORMULA. When $p = a/b$,

$$b\beta(a/b) = 2^{1-2a/b} J(a, b), \quad (6)$$

where

$$J(a, b) \equiv \int_0^1 \frac{t^{a-1} dt}{\sqrt{1-t^b}}. \quad (7)$$

The central beta function satisfies

$$(2+4x)\beta(1+x) = x\beta(x) \quad (8)$$

$$(1-2x)\beta(1-x)\beta(x) = 2\pi \cot(\pi x) \quad (9)$$

$$\beta(\tfrac{1}{2} - x) = 2^{4x-1} \tan(\pi x) \beta(x) \quad (10)$$

$$\beta(x)\beta(x + \tfrac{1}{2}) = 2^{4x+1} \pi \beta(2x)\beta(2x + \tfrac{1}{2}). \quad (11)$$

For p an ODD POSITIVE INTEGER, the central beta function satisfies the identity

$$\beta(px) = \frac{1}{\sqrt{p}} \prod_{k=1}^{(p-1)/2} \frac{2x + \frac{2k-1}{p}}{2\pi} \prod_{k=0}^{p-1} \beta\left(x + \frac{k}{p}\right). \quad (12)$$

see also BETA FUNCTION, REGULARIZED BETA FUNCTION

References

Borwein, J. M. and Zucker, I. J. "Elliptic Integral Evaluation of the Gamma Function at Rational Values of Small Denominators." *IMA J. Numerical Analysis* **12**, 519–526, 1992.

Central Binomial Coefficient

The n th central binomial coefficient is defined as $\binom{n}{\lfloor n/2 \rfloor}$, where $\binom{n}{k}$ is a BINOMIAL COEFFICIENT and $\lfloor n \rfloor$ is the FLOOR FUNCTION. The first few values are 1, 2, 3, 6, 10, 20, 35, 70, 126, 252, ... (Sloane's A001405). The central binomial coefficients have GENERATING FUNCTION

$$\frac{1-4x^2-\sqrt{1-4x^2}}{2(2x^3-x^2)} = 1 + 2x + 3x^2 + 6x^3 + 10x^4 + \dots$$

The central binomial coefficients are SQUAREFREE only for $n = 1, 2, 3, 4, 5, 7, 8, 11, 17, 19, 23, 71, \dots$ (Sloane's A046098), with no others less than 1500.

The above coefficients are a superset of the alternative "central" binomial coefficients

$$\binom{2n}{n} = \frac{(2n)!}{(n!)^2},$$

which have GENERATING FUNCTION

$$\frac{1}{\sqrt{1-4x}} = 1 + 2x + 6x^2 + 20x^3 + 70x^4 + \dots$$

The first few values are 2, 6, 20, 70, 252, 924, 3432, 12870, 48620, 184756, ... (Sloane's A000984).

Erdős and Graham (1980, p. 71) conjectured that the central binomial coefficient $\binom{2n}{n}$ is *never* SQUAREFREE for $n > 4$, and this is sometimes known as the ERDŐS SQUAREFREE CONJECTURE. SÁRKÖZY'S THEOREM (Sárközy 1985) provides a partial solution which states that the BINOMIAL COEFFICIENT $\binom{2n}{n}$ is never SQUAREFREE for all sufficiently large $n \geq n_0$ (Vardi 1991). Granville and Ramare (1996) proved that the *only* SQUAREFREE values are $n = 2$ and 4. Sander (1992) subsequently showed that $\binom{2n \pm d}{n}$ are also never SQUAREFREE for sufficiently large n as long as d is not "too big."

see also BINOMIAL COEFFICIENT, CENTRAL TRINOMIAL COEFFICIENT, ERDŐS SQUAREFREE CONJECTURE, SÁRKÖZY'S THEOREM, QUOTA SYSTEM

References

Granville, A. and Ramare, O. "Explicit Bounds on Exponential Sums and the Scarcity of Squarefree Binomial Coefficients." *Mathematika* **43**, 73–107, 1996.

Sander, J. W. "On Prime Divisors of Binomial Coefficients." *Bull. London Math. Soc.* **24**, 140–142, 1992.

Sárközy, A. "On Divisors of Binomial Coefficients. I." *J. Number Th.* **20**, 70–80, 1985.

Sloane, N. J. A. Sequences A046098, A000984/M1645, and A001405/M0769 in "An On-Line Version of the Encyclopedia of Integer Sequences."

Vardi, I. "Application to Binomial Coefficients," "Binomial Coefficients," "A Class of Solutions," "Computing Binomial Coefficients," and "Binomials Modulo and Integer." §2.2, 4.1, 4.2, 4.3, and 4.4 in *Computational Recreations in Mathematics*. Redwood City, CA: Addison-Wesley, pp. 25–28 and 63–71, 1991.

Central Conic

An ELLIPSE or HYPERBOLA.

see also CONIC SECTION

References

Coxeter, H. S. M. and Greitzer, S. L. *Geometry Revisited*. Washington, DC: Math. Assoc. Amer., pp. 146–150, 1967.

Ogilvy, C. S. *Excursions in Geometry*. New York: Dover, p. 77, 1990.

Central Difference

The central difference for a function tabulated at equal intervals f_i is defined by

$$\delta(f_{n+1/2}) = \delta_{n+1/2} = \delta_{n+1/2}^1 \equiv f_{n+1} - f_n. \quad (1)$$

Higher order differences may be computed for EVEN and ODD powers,

$$\delta_{n+1/2}^{2k} = \sum_{j=0}^{2k} (-1)^j \binom{2k}{j} f_{n+k-j} \quad (2)$$

$$\delta_{n+1/2}^{2k+1} = \sum_{j=0}^{2k+1} (-1)^j \binom{2k+1}{j} f_{n+k+1-j}. \quad (3)$$

see also BACKWARD DIFFERENCE, DIVIDED DIFFERENCE, FORWARD DIFFERENCE

References

Abramowitz, M. and Stegun, C. A. (Eds.). "Differences." §25.1 in *Handbook of Mathematical Functions with Formulas, Graphs, and Mathematical Tables*, 9th printing. New York: Dover, pp. 877-878, 1972.

Central Limit Theorem

Let x_1, x_2, \dots, x_N be a set of N INDEPENDENT random variates and each x_i have an *arbitrary* probability distribution $P(x_1, \dots, x_N)$ with MEAN μ_i and a finite VARIANCE σ_i^2 . Then the normal form variate

$$X_{\text{norm}} \equiv \frac{\sum_{i=1}^N x_i - \sum_{i=1}^N \mu_i}{\sqrt{\sum_{i=1}^N \sigma_i^2}} \quad (1)$$

has a limiting distribution which is NORMAL (GAUSSIAN) with MEAN $\mu = 0$ and VARIANCE $\sigma^2 = 1$. If conversion to normal form is not performed, then the variate

$$X \equiv \frac{1}{N} \sum_{i=1}^N x_i \quad (2)$$

is NORMALLY DISTRIBUTED with $\mu_X = \mu_x$ and $\sigma_X = \sigma_x/\sqrt{N}$. To prove this, consider the INVERSE FOURIER TRANSFORM of $P_X(f)$.

$$\begin{aligned} \mathcal{F}^{-1}[P_X(f)] &\equiv \int_{-\infty}^{\infty} e^{2\pi i f X} p(X) dX \\ &= \int_{-\infty}^{\infty} \sum_{n=0}^{\infty} \frac{(2\pi i f X)^n}{n!} p(X) dX \\ &= \sum_{n=0}^{\infty} \frac{(2\pi i f)^n}{n!} \int_{-\infty}^{\infty} X^n p(X) dx \\ &= \sum_{n=0}^{\infty} \frac{(2\pi i f)^n}{n!} \langle x \rangle^n. \end{aligned} \quad (3)$$

Now write

$$\begin{aligned} \langle X^n \rangle &= \langle N^{-n} (x_1 + x_2 + \dots + x_N)^n \rangle \\ &= \int_{-\infty}^{\infty} N^{-n} (x_1 + \dots + x_N)^n p(x_1) \dots p(x_N) dx_1 \dots dx_N, \end{aligned} \quad (4)$$

so we have

$$\begin{aligned} \mathcal{F}^{-1}[P_X(f)] &= \sum_{n=0}^{\infty} \frac{(2\pi i f)^n}{n!} \langle X^n \rangle \\ &= \sum_{n=0}^{\infty} \frac{(2\pi i f)^n}{n!} \int_{-\infty}^{\infty} N^{-n} (x_1 + \dots + x_N)^n \\ &\quad \times p(x_1) \dots p(x_N) dx_1 \dots dx_N \\ &= \int_{-\infty}^{\infty} \sum_{n=0}^{\infty} \left[\frac{2\pi i f (x_1 + \dots + x_N)}{N} \right]^n \frac{1}{n!} \\ &\quad \times p(x_1) \dots p(x_N) dx_1 \dots dx_N \\ &= \int_{-\infty}^{\infty} e^{2\pi i f (x_1 + \dots + x_N)/N} p(x_1) \dots p(x_N) dx_1 \dots dx_N \\ &= \left[\int_{-\infty}^{\infty} e^{2\pi i f x_1/N} p(x_1) dx_1 \right] \\ &\quad \times \dots \times \left[\int_{-\infty}^{\infty} e^{2\pi i f x_N/N} p(x_N) dx_N \right] \\ &= \left[\int_{-\infty}^{\infty} e^{2\pi i f x/N} p(x) dx \right]^N \\ &= \left\{ \int_{-\infty}^{\infty} \left[1 + \left(\frac{2\pi i f}{N} \right) x + \frac{1}{2} \left(\frac{2\pi i f}{N} \right)^2 x^2 + \dots \right] p(x) dx \right\}^N \\ &= \left[\int_{-\infty}^{\infty} p(x) dx + \frac{2\pi i f}{N} \int_{-\infty}^{\infty} x p(x) dx \right. \\ &\quad \left. - \frac{(2\pi f)^2}{2N^2} \int_{-\infty}^{\infty} x^2 p(x) dx + \mathcal{O}(N^{-3}) \right]^N \\ &= \left[1 + \frac{2\pi i f}{N} \langle x \rangle - \frac{(2\pi f)^2}{2N^2} \langle x^2 \rangle + \mathcal{O}(N^{-3}) \right]^N \\ &= \exp \left\{ N \ln \left[1 + \frac{2\pi i f}{N} \langle x \rangle - \frac{(2\pi f)^2}{2N^2} \langle x^2 \rangle + \mathcal{O}(N^{-3}) \right] \right\}. \end{aligned} \quad (5)$$

Now expand

$$\ln(1+x) = x - \frac{1}{2}x^2 + \frac{1}{3}x^3 + \dots, \quad (6)$$

so

$$\begin{aligned} \mathcal{F}^{-1}[P_X(f)] &\approx \exp \left\{ N \left[\frac{2\pi i f}{N} \langle x \rangle - \frac{(2\pi f)^2}{2N^2} \langle x^2 \rangle \right. \right. \\ &\quad \left. \left. + \frac{1}{2} \frac{(2\pi i f)^2}{N^2} \langle x \rangle^2 + \mathcal{O}(N^{-3}) \right] \right\} \\ &= \exp \left[2\pi i f \langle x \rangle - \frac{(2\pi f)^2 \langle x^2 \rangle - \langle x \rangle^2}{2N} + \mathcal{O}(N^{-2}) \right] \\ &\approx \exp \left[2\pi i f \mu_x - \frac{(2\pi f)^2 \sigma_x^2}{2N} \right], \end{aligned} \quad (7)$$

since

$$\mu_x \equiv \langle x \rangle \quad (8)$$

$$\sigma_x^2 \equiv \langle x^2 \rangle - \langle x \rangle^2. \quad (9)$$

Taking the FOURIER TRANSFORM,

$$\begin{aligned} P_X &\equiv \int_{-\infty}^{\infty} e^{-2\pi i f x} \mathcal{F}^{-1}[P_X(f)] df \\ &= \int_{-\infty}^{\infty} e^{2\pi i f(\mu_x - x) - (2\pi f)^2 \sigma_x^2 / 2N} df. \end{aligned} \quad (10)$$

This is of the form

$$\int_{-\infty}^{\infty} e^{iaf - bf^2} df, \quad (11)$$

where $a \equiv 2\pi(\mu_x - x)$ and $b \equiv (2\pi\sigma_x)^2/2N$. But, from Abramowitz and Stegun (1972, p. 302, equation 7.4.6),

$$\int_{-\infty}^{\infty} e^{iaf - bf^2} df = e^{-a^2/4b} \sqrt{\frac{\pi}{b}}. \quad (12)$$

Therefore,

$$\begin{aligned} P_X &= \sqrt{\frac{\pi}{\frac{(2\pi\sigma_x)^2}{2N}}} \exp \left\{ -\frac{[2\pi(\mu_x - x)]^2}{4 \frac{(2\pi\sigma_x)^2}{2N}} \right\} \\ &= \sqrt{\frac{2\pi N}{4\pi^2 \sigma_x^2}} \exp \left[-\frac{4\pi^2 (\mu_x - x)^2 2N}{4 \cdot 4\pi^2 \sigma_x^2} \right] \\ &= \frac{\sqrt{N}}{\sigma_x \sqrt{2\pi}} e^{-(\mu_x - x)^2 N / 2\sigma_x^2}. \end{aligned} \quad (13)$$

But $\sigma_X = \sigma_x / \sqrt{N}$ and $\mu_X = \mu_x$, so

$$P_X = \frac{1}{\sigma_X \sqrt{2\pi}} e^{-(\mu_X - x)^2 / 2\sigma_X^2}. \quad (14)$$

The “fuzzy” central limit theorem says that data which are influenced by many small and unrelated random effects are approximately NORMALLY DISTRIBUTED.

see also LINDBERG CONDITION, LINDBERG-FELLER CENTRAL LIMIT THEOREM, LYAPUNOV CONDITION

References

- Abramowitz, M. and Stegun, C. A. (Eds.). *Handbook of Mathematical Functions with Formulas, Graphs, and Mathematical Tables*, 9th printing. New York: Dover, 1972.
- Spiegel, M. R. *Theory and Problems of Probability and Statistics*. New York: McGraw-Hill, pp. 112–113, 1992.
- Zabell, S. L. “Alan Turing and the Central Limit Theorem.” *Amer. Math. Monthly* **102**, 483–494, 1995.

Central Trinomial Coefficient

The n th central binomial coefficient is defined as the coefficient of x^n in the expansion of $(1+x+x^2)^n$. The first few are 1, 3, 7, 19, 51, 141, 393, ... (Sloane's A002426). This sequence cannot be expressed as a fixed number of hypergeometric terms (Petkovšek *et al.* 1996, p. 160). The GENERATING FUNCTION is given by

$$f(x) = \frac{1}{\sqrt{(1+x)(1-3x)}} = 1 + x + 3x^2 + 7x^3 + \dots$$

see also CENTRAL BINOMIAL COEFFICIENT

References

- Petkovšek, M.; Wilf, H. S.; and Zeilberger, D. *A=B*. Wellesley, MA: A. K. Peters, 1996.
- Sloane, N. J. A. Sequence A002426/M2673 in “An On-Line Version of the Encyclopedia of Integer Sequences.”

Centralizer

The centralizer of a FINITE non-ABELIAN SIMPLE GROUP G is an element z of order 2 such that

$$C_G(z) = \{g \in G : gz = zg\}.$$

see also CENTER (GROUP), NORMALIZER

Centrode

$$\mathbf{C} \equiv \tau \mathbf{T} + \kappa \mathbf{B},$$

where τ is the TORSION, κ is the CURVATURE, \mathbf{T} is the TANGENT VECTOR, and \mathbf{B} is the BINORMAL VECTOR.

Centroid (Function)

By analogy with the GEOMETRIC CENTROID, the centroid of an arbitrary function $f(x)$ is defined as

$$\langle x \rangle = \frac{\int_{-\infty}^{\infty} x f(x) dx}{\int_{-\infty}^{\infty} f(x) dx}.$$

References

- Bracewell, R. *The Fourier Transform and Its Applications*. New York: McGraw-Hill, pp. 139–140 and 156, 1965.

Centroid (Geometric)

The CENTER OF MASS of a 2-D planar LAMINA or a 3-D solid. The mass of a LAMINA with surface density function $\sigma(x, y)$ is

$$M = \iint \sigma(x, y) dA. \quad (1)$$

The coordinates of the centroid (also called the CENTER OF GRAVITY) are

$$\bar{x} = \frac{\iint x \sigma(x, y) dA}{M} \quad (2)$$

$$\bar{y} = \frac{\iint y \sigma(x, y) dA}{M}. \quad (3)$$

The centroids of several common laminas along the non-symmetrical axis are summarized in the following table.

Figure	\bar{y}
parabolic segment	$\frac{3}{5}h$
semicircle	$\frac{4r}{3\pi}$

In 3-D, the mass of a solid with density function $\rho(x, y, z)$ is

$$M = \iiint \rho(x, y, z) dV, \quad (4)$$

and the coordinates of the center of mass are

$$\bar{x} = \frac{\iiint x \rho(x, y, z) dV}{M} \quad (5)$$

$$\bar{y} = \frac{\iiint y \rho(x, y, z) dV}{M} \quad (6)$$

$$\bar{z} = \frac{\iiint z \rho(x, y, z) dV}{M}. \quad (7)$$

Figure	\bar{z}
cone	$\frac{1}{4}h$
conical frustum	$\frac{h(R_1^2 + 2R_1R_2 + 3R_2^2)}{4(R_1^2 + R_1R_2 + R_2^2)}$
hemisphere	$\frac{3}{8}R$
paraboloid	$\frac{2}{3}h$
pyramid	$\frac{1}{4}h$

see also PAPPUS'S CENTROID THEOREM

References

- Beyer, W. H. *CRC Standard Mathematical Tables*, 28th ed. Boca Raton, FL: CRC Press, p. 132, 1987.
 McLean, W. G. and Nelson, E. W. "First Moments and Centroids." Ch. 9 in *Schaum's Outline of Theory and Problems of Engineering Mechanics: Statics and Dynamics*, 4th ed. New York: McGraw-Hill, pp. 134–162, 1988.

Centroid (Orthocentric System)

The centroid of the four points constituting an ORTHOCENTRIC SYSTEM is the center of the common NINE-POINT CIRCLE (Johnson 1929, p. 249). This fact automatically guarantees that the centroid of the INCENTER and EXCENTERS of a TRIANGLE is located at the CIRCUMCENTER.

References

- Johnson, R. A. *Modern Geometry: An Elementary Treatise on the Geometry of the Triangle and the Circle*. Boston, MA: Houghton Mifflin, 1929.

Centroid (Triangle)

The centroid (CENTER OF MASS) of the VERTICES of a TRIANGLE is the point M (or G) of intersection of the TRIANGLE'S three MEDIANS, also called the MEDIAN POINT (Johnson 1929, p. 249). The centroid is always in the interior of the TRIANGLE, and has TRILINEAR COORDINATES

$$\frac{1}{a} : \frac{1}{b} : \frac{1}{c}, \quad (1)$$

or

$$\csc A : \csc B : \csc C. \quad (2)$$

If the sides of a TRIANGLE are divided so that

$$\frac{\overline{A_2P_1}}{\overline{P_1A_3}} = \frac{\overline{A_3P_2}}{\overline{P_2A_1}} = \frac{\overline{A_1P_3}}{\overline{P_3A_2}} = \frac{p}{q}, \quad (3)$$

the centroid of the TRIANGLE $\Delta P_1P_2P_3$ is M (Johnson 1929, p. 250).

Pick an interior point X . The TRIANGLES BXC , CXA , and AXB have equal areas IFF X corresponds to the centroid. The centroid is located one third of the way from each VERTEX to the MIDPOINT of the opposite side. Each median divides the triangle into two equal areas; all the medians together divide it into six equal parts, and the lines from the MEDIAN POINT to the VERTICES divide the whole into three equivalent TRIANGLES. In general, for any line in the plane of a TRIANGLE ABC ,

$$d = \frac{1}{3}(d_A + d_B + d_C), \quad (4)$$

where d , d_A , d_B , and d_C are the distances from the centroid and VERTICES to the line. A TRIANGLE will balance at the centroid, and along any line passing through the centroid. The TRILINEAR POLAR of the centroid is called the LEMOINE AXIS. The PERPENDICULARS from the centroid are proportional to s_i^{-1} ,

$$a_1p_2 = a_2p_2 = a_3p_3 = \frac{2}{3}\Delta, \quad (5)$$

where Δ is the AREA of the TRIANGLE. Let P be an arbitrary point, the VERTICES be A_1 , A_2 , and A_3 , and the centroid M . Then

$$\overline{PA_1}^2 + \overline{PA_2}^2 + \overline{PA_3}^2 = \overline{MA_1}^2 + \overline{MA_2}^2 + \overline{MA_3}^2 + 3\overline{PM}^2. \quad (6)$$

If O is the CIRCUMCENTER of the triangle's centroid, then

$$\overline{OM}^2 = R^2 - \frac{1}{9}(a^2 + b^2 + c^2). \quad (7)$$

The centroid lies on the EULER LINE.

The centroid of the PERIMETER of a TRIANGLE is the triangle's SPIEKER CENTER (Johnson 1929, p. 249).

see also CIRCUMCENTER, EULER LINE, EXMEDIAN POINT, INCENTER, ORTHOCENTER

References

- Carr, G. S. *Formulas and Theorems in Pure Mathematics*, 2nd ed. New York: Chelsea, p. 622, 1970.

- Coxeter, H. S. M. and Greitzer, S. L. *Geometry Revisited*. Washington, DC: Math. Assoc. Amer., p. 7, 1967.
 Dixon, R. *Mathographics*. New York: Dover, pp. 55–57, 1991.
 Johnson, R. A. *Modern Geometry: An Elementary Treatise on the Geometry of the Triangle and the Circle*. Boston, MA: Houghton Mifflin, pp. 173–176 and 249, 1929.
 Kimberling, C. “Central Points and Central Lines in the Plane of a Triangle.” *Math. Mag.* **67**, 163–187, 1994.
 Kimberling, C. “Centroid.” <http://www.evansville.edu/~ck6/tcenters/class/centroid.html>.

Certificate of Compositeness

see COMPOSITENESS CERTIFICATE

Certificate of Primality

see PRIMALITY CERTIFICATE

Cesàro Equation

An INTRINSIC EQUATION which expresses a curve in terms of its ARC LENGTH s and RADIUS OF CURVATURE R (or equivalently, the CURVATURE κ).

see also ARC LENGTH, INTRINSIC EQUATION, NATURAL EQUATION, RADIUS OF CURVATURE, WHEWELL EQUATION

References

- Yates, R. C. “Intrinsic Equations.” *A Handbook on Curves and Their Properties*. Ann Arbor, MI: J. W. Edwards, pp. 123–126, 1952.

Cesàro Fractal

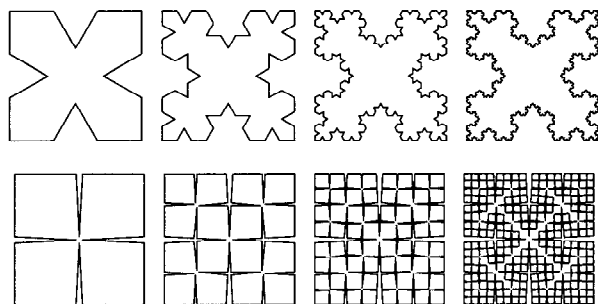

A FRACTAL also known as the TORN SQUARE FRACTAL. The base curves and motifs for the two fractals illustrated above are shown below.

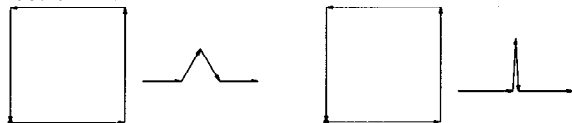

see also FRACTAL, KOCH SNOWFLAKE

References

- Lauwerier, H. *Fractals: Endlessly Repeated Geometric Figures*. Princeton, NJ: Princeton University Press, p. 43, 1991.
 Pappas, T. *The Joy of Mathematics*. San Carlos, CA: Wide World Publ./Tetra, p. 79, 1989.
 Weisstein, E. W. “Fractals.” <http://www.astro.virginia.edu/~eww6n/math/notebooks/Fractal.m>.

Cesàro Mean

see FEJES TÓTH'S INTEGRAL

Ceva's Theorem

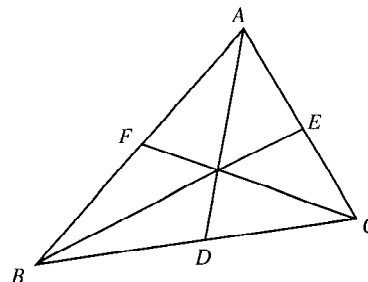

Given a TRIANGLE with VERTICES A , B , and C and points along the sides D , E , and F , a NECESSARY and SUFFICIENT condition for the CEVIANS AD , BE , and CF to be CONCURRENT (intersect in a single point) is that

$$BD \cdot CE \cdot AF = DC \cdot EA \cdot FB. \quad (1)$$

Let $P = [V_1, \dots, V_n]$ be an arbitrary n -gon, C a given point, and k a POSITIVE INTEGER such that $1 \leq k \leq n/2$. For $i = 1, \dots, n$, let W_i be the intersection of the lines CV_i and $V_{i-k}V_{i+k}$, then

$$\prod_{i=1}^n \left[\frac{V_{i-k}W_i}{W_iV_{i+k}} \right] = 1. \quad (2)$$

Here, $AB||CD$ and

$$\left[\frac{AB}{CD} \right] \quad (3)$$

is the RATIO of the lengths $[A, B]$ and $[C, D]$ with a plus or minus sign depending on whether these segments have the same or opposite directions (Grünbaum and Shepard 1995).

Another form of the theorem is that three CONCURRENT lines from the VERTICES of a TRIANGLE divide the opposite sides in such fashion that the product of three nonadjacent segments equals the product of the other three (Johnson 1929, p. 147).

see also HOEHN'S THEOREM, MENELAUS' THEOREM

References

- Beyer, W. H. (Ed.) *CRC Standard Mathematical Tables*, 28th ed. Boca Raton, FL: CRC Press, p. 122, 1987.
 Coxeter, H. S. M. and Greitzer, S. L. *Geometry Revisited*. Washington, DC: Math. Assoc. Amer., pp. 4–5, 1967.
 Grünbaum, B. and Shepard, G. C. “Ceva, Menelaus, and the Area Principle.” *Math. Mag.* **68**, 254–268, 1995.
 Johnson, R. A. *Modern Geometry: An Elementary Treatise on the Geometry of the Triangle and the Circle*. Boston, MA: Houghton Mifflin, pp. 145–151, 1929.
 Pedoe, D. *Circles: A Mathematical View*, rev. ed. Washington, DC: Math. Assoc. Amer., p. xx, 1995.

Cevian

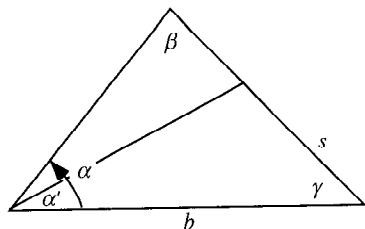

A line segment which joins a VERTEX of a TRIANGLE with a point on the opposite side (or its extension). In the above figure,

$$s = \frac{b \sin \alpha'}{\sin(\gamma + \alpha')}.$$

References

Thébault, V. "On the Cevians of a Triangle." *Amer. Math. Monthly* **60**, 167–173, 1953.

Cevian Conjugate Point

see ISOTOMIC CONJUGATE POINT

Cevian Transform

Vandeghen's (1965) name for the transformation taking points to their ISOTOMIC CONJUGATE POINTS.

see also ISOTOMIC CONJUGATE POINT

References

Vandeghen, A. "Some Remarks on the Isogonal and Cevian Transforms. Alignments of Remarkable Points of a Triangle." *Amer. Math. Monthly* **72**, 1091–1094, 1965.

Cevian Triangle

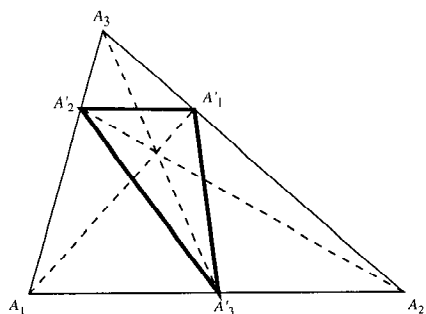

Given a center $\alpha : \beta : \gamma$, the cevian triangle is defined as that with VERTICES $0 : \beta : \gamma$, $\alpha : 0 : \gamma$, and $\alpha : \beta : 0$. If $A'B'C'$ is the CEVIAN TRIANGLE of X and $A''B''C''$ is the ANTICEVIAN TRIANGLE, then X and A'' are HARMONIC CONJUGATE POINTS with respect to A and A' .

see also ANTICEVIAN TRIANGLE

Chain

Let P be a finite PARTIALLY ORDERED SET. A chain in P is a set of pairwise comparable elements (i.e., a TOTALLY ORDERED subset). The WIDTH of P is the maximum CARDINALITY of an ANTICHAIN in P . For a PARTIAL ORDER, the size of the longest CHAIN is called the WIDTH.

see also ADDITION CHAIN, ANTICHAIN, BRAUER CHAIN, CHAIN (GRAPH), DILWORTH'S LEMMA, HANSEN CHAIN

Chain Fraction

see CONTINUED FRACTION

Chain (Graph)

A chain of a GRAPH is a SEQUENCE $\{x_1, x_2, \dots, x_n\}$ such that $(x_1, x_2), (x_2, x_3), \dots, (x_{n-1}, x_n)$ are EDGES of the GRAPH.

Chain Rule

If $g(x)$ is DIFFERENTIABLE at the point x and $f(x)$ is DIFFERENTIABLE at the point $g(x)$, then $f \circ g$ is DIFFERENTIABLE at x . Furthermore, let $y = f(g(x))$ and $u = g(x)$, then

$$\frac{dy}{dx} = \frac{dy}{du} \cdot \frac{du}{dx}. \quad (1)$$

There are a number of related results which also go under the name of "chain rules." For example, if $z = f(x, y)$, $x = g(t)$, and $y = h(t)$, then

$$\frac{dz}{dt} = \frac{\partial z}{\partial x} \frac{dx}{dt} + \frac{\partial z}{\partial y} \frac{dy}{dt}. \quad (2)$$

The "general" chain rule applies to two sets of functions

$$y_1 = f_1(u_1, \dots, u_p)$$

$$\vdots (3)$$

$$y_m = f_m(u_1, \dots, u_p)$$

and

$$u_1 = g_1(x_1, \dots, x_n)$$

$$\vdots (4)$$

$$u_p = g_p(x_1, \dots, x_n).$$

Defining the $m \times n$ JACOBI MATRIX by

$$\left(\frac{\partial y_i}{\partial x_j} \right) = \begin{bmatrix} \frac{\partial y_1}{\partial x_1} & \frac{\partial y_1}{\partial x_2} & \cdots & \frac{\partial y_1}{\partial x_n} \\ \vdots & \vdots & \ddots & \vdots \\ \frac{\partial y_m}{\partial x_1} & \frac{\partial y_m}{\partial x_2} & \cdots & \frac{\partial y_m}{\partial x_n} \end{bmatrix}, \quad (5)$$

and similarly for $(\partial y_i / \partial u_j)$ and $(\partial u_i / \partial x_j)$ then gives

$$\left(\frac{\partial y_i}{\partial x_j} \right) = \left(\frac{\partial y_i}{\partial u_j} \right) \left(\frac{\partial u_i}{\partial x_j} \right). \quad (6)$$

In differential form, this becomes

$$dy_1 = \left(\frac{\partial y_1}{\partial u_1} \frac{\partial u_1}{\partial x_1} + \dots + \frac{\partial y_1}{\partial u_p} \frac{\partial u_p}{\partial x_1} \right) dx_1 \\ + \left(\frac{\partial y_1}{\partial u_1} \frac{\partial u_1}{\partial x_2} + \dots + \frac{\partial y_1}{\partial u_p} \frac{\partial u_p}{\partial x_2} \right) dx_2 + \dots \quad (7)$$

(Kaplan 1984).

see also DERIVATIVE, JACOBIAN, POWER RULE, PRODUCT RULE

References

- Anton, H. *Calculus with Analytic Geometry, 2nd ed.* New York: Wiley, p. 165, 1984.
 Kaplan, W. "Derivatives and Differentials of Composite Functions" and "The General Chain Rule." §2.8 and 2.9 in *Advanced Calculus, 3rd ed.* Reading, MA: Addison-Wesley, pp. 101–105 and 106–110, 1984.

Chained Arrow Notation

A NOTATION which generalizes ARROW NOTATION and is defined as

$$\underbrace{a \uparrow \dots \uparrow b}_c \equiv a \rightarrow b \rightarrow c.$$

see also ARROW NOTATION

References

- Conway, J. H. and Guy, R. K. *The Book of Numbers.* New York: Springer-Verlag, p. 61, 1996.

Chainette

see CATENARY

Chair

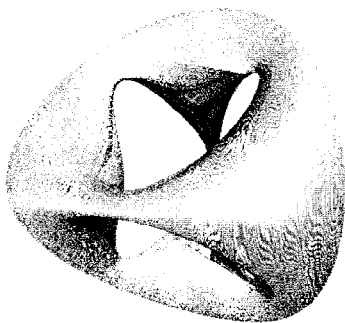

A SURFACE with tetrahedral symmetry which, according to Nordstrand, looks like an inflatable chair from the 1970s. It is given by the implicit equation

$$(x^2 + y^2 + z^2 - ak^2)^2 - b[(z - k)^2 - 2x^2][(z + k)^2 - 2y^2] = 0.$$

see also BRIDE'S CHAIR

References

- Nordstrand, T. "Chair." <http://www.uib.no/people/nfytn/chairtxt.htm>.

Chaitin's Constant

AN IRRATIONAL NUMBER Ω which gives the probability that for any set of instructions, a UNIVERSAL TURING MACHINE will halt. The digits in Ω are random and cannot be computed ahead of time.

see also HALTING PROBLEM, TURING MACHINE, UNIVERSAL TURING MACHINE

References

- Finch, S. "Favorite Mathematical Constants." <http://www.mathsoft.com/asolve/constant/chaitin/chaitin.html>.
 Gardner, M. "The Random Number Ω Bids Fair to Hold the Mysteries of the Universe." *Sci. Amer.* **241**, 20–34, Nov. 1979.
 Gardner, M. "Chaitin's Omega." Ch. 21 in *Fractal Music, Hypercards, and More Mathematical Recreations from Scientific American Magazine*. New York: W. H. Freeman, 1992.
 Kobayashi, K. "Sigma(N)O-Complete Properties of Programs and Lartin-Lof Randomness." *Information Proc. Let.* **46**, 37–42, 1993.

Chaitin's Number

see CHAITIN'S CONSTANT

Chaitin's Omega

see CHAITIN'S CONSTANT

Champernowne Constant

Champernowne's number 0.1234567891011... (Sloane's A033307) is the decimal obtained by concatenating the POSITIVE INTEGERS. It is NORMAL in base 10. In 1961, Mahler showed it to also be TRANSCENDENTAL.

The CONTINUED FRACTION of the Champernowne constant is [0, 8, 9, 1, 149083, 1, 1, 1, 4, 1, 1, 1, 3, 4, 1, 1, 1, 15,

457540111391031076483646628242956118599603939...
 710457555000662004393090262659256314937953207...
 747128656313864120937550355209460718308998457...
 5801469863148833592141783010987,

6, 1, 1, 21, 1, 9, 1, 1, 2, 3, 1, 7, 2, 1, 83, 1, 156, 4, 58, 8, 54, ...] (Sloane's A030167). The next term of the CONTINUED FRACTION is huge, having 2504 digits. In fact, the coefficients eventually become unbounded, making the continued fraction difficult to calculate for too many more terms. Large terms greater than 10^5 occur at positions 5, 19, 41, 102, 163, 247, 358, 460, ... and have 6, 166, 2504, 140, 33102, 109, 2468, 136, ... digits (Plouffe). Interestingly, the COPELAND-ERDŐS CONSTANT, which is the decimal obtained by concatenating the PRIMES, has a well-behaved CONTINUED FRACTION which does not show the "large term" phenomenon.

see also COPELAND-ERDŐS CONSTANT, SMARANDACHE SEQUENCES

References

- Champernowne, D. G. "The Construction of Decimals Normal in the Scale of Ten." *J. London Math. Soc.* **8**, 1933.
 Finch, S. "Favorite Mathematical Constants." <http://www.mathsoft.com/asolve/constant/cntfrc/cntfrc.html>.
 Sloane, N. J. A. Sequences A030167 and A033307 in "An On-Line Version of the Encyclopedia of Integer Sequences."

Change of Variables Theorem

A theorem which effectively describes how lengths, areas, volumes, and generalized n -dimensional volumes (CONTENTS) are distorted by DIFFERENTIABLE FUNCTIONS. In particular, the change of variables theorem reduces the whole problem of figuring out the distortion of the content to understanding the infinitesimal distortion, i.e., the distortion of the DERIVATIVE (a linear MAP), which is given by the linear MAP's DETERMINANT. So $f: \mathbb{R}^n \rightarrow \mathbb{R}^n$ is an AREA-PRESERVING linear MAP IFF $|\det(f)| = 1$, and in more generality, if S is any subset of \mathbb{R}^n , the CONTENT of its image is given by $|\det(f)|$ times the CONTENT of the original. The change of variables theorem takes this infinitesimal knowledge, and applies CALCULUS by breaking up the DOMAIN into small pieces and adds up the change in AREA, bit by bit.

The change of variable formula persists to the generality of DIFFERENTIAL FORMS on MANIFOLDS, giving the formula

$$\int_M (f^* \omega) = \int_W (\omega)$$

under the conditions that M and W are compact connected oriented MANIFOLDS with nonempty boundaries, $f: M \rightarrow W$ is a smooth map which is an orientation-preserving DIFFEOMORPHISM of the boundaries.

In 2-D, the explicit statement of the theorem is

$$\begin{aligned} \int_R f(x, y) dx dy \\ = \int_{R^*} f[x(u, v), y(u, v)] \left| \frac{\partial(x, y)}{\partial(u, v)} \right| du dv \end{aligned}$$

and in 3-D, it is

$$\begin{aligned} \int_R f(x, y, z) dx dy dz \\ = \int_{R^*} f[x(u, v, w), y(u, v, w), z(u, v, w)] \left| \frac{\partial(x, y, z)}{\partial(u, v, w)} \right| du dv dw, \end{aligned}$$

where $R = f(R^*)$ is the image of the original region R^* ,

$$\left| \frac{\partial(x, y, z)}{\partial(u, v, w)} \right|$$

is the JACOBIAN, and f is a global orientation-preserving DIFFEOMORPHISM of R and R^* (which are open subsets of \mathbb{R}^n).

The change of variables theorem is a simple consequence of the CURL THEOREM and a little DE RHAM COHOMOLOGY. The generalization to n -D requires no additional assumptions other than the regularity conditions on the boundary.

see also IMPLICIT FUNCTION THEOREM, JACOBIAN

References

- Kaplan, W. "Change of Variables in Integrals." §4.6 in *Advanced Calculus*, 3rd ed. Reading, MA: Addison-Wesley, pp. 238–245, 1984.

Chaos

A DYNAMICAL SYSTEM is chaotic if it

1. Has a DENSE collection of points with periodic orbits,
2. Is sensitive to the initial condition of the system (so that initially nearby points can evolve quickly into very different states), and
3. Is TOPOLOGICALLY TRANSITIVE.

Chaotic systems exhibit irregular, unpredictable behavior (the BUTTERFLY EFFECT). The boundary between linear and chaotic behavior is characterized by PERIOD DOUBLING, following by quadrupling, etc.

An example of a simple physical system which displays chaotic behavior is the motion of a magnetic pendulum over a plane containing two or more attractive magnets. The magnet over which the pendulum ultimately comes to rest (due to frictional damping) is highly dependent on the starting position and velocity of the pendulum (Dickau). Another such system is a double pendulum (a pendulum with another pendulum attached to its end).

see also ACCUMULATION POINT, ATTRACTOR, BASIN OF ATTRACTION, BUTTERFLY EFFECT, CHAOS GAME, FEIGENBAUM CONSTANT, FRACTAL DIMENSION, GINGERBREADMAN MAP, HÉNON-HEILES EQUATION, HÉNON MAP, LIMIT CYCLE, LOGISTIC EQUATION, LYAPUNOV CHARACTERISTIC EXPONENT, PERIOD THREE THEOREM, PHASE SPACE, QUANTUM CHAOS, RESONANCE OVERLAP METHOD, ŠARKOVSKII'S THEOREM, SHADOWING THEOREM, SINK (MAP), STRANGE ATTRACTOR

References

- Bai-Lin, H. *Chaos*. Singapore: World Scientific, 1984.
 Baker, G. L. and Gollub, J. B. *Chaotic Dynamics: An Introduction*, 2nd ed. Cambridge: Cambridge University Press, 1996.
 Cvitanovic, P. *Universality in Chaos: A Reprint Selection*, 2nd ed. Bristol: Adam Hilger, 1989.
 Dickau, R. M. "Magnetic Pendulum." <http://forum.swarthmore.edu/advanced/robertd/magneticpendulum.html>.
 Drazin, P. G. *Nonlinear Systems*. Cambridge, England: Cambridge University Press, 1992.
 Field, M. and Golubitsky, M. *Symmetry in Chaos: A Search for Pattern in Mathematics, Art and Nature*. Oxford, England: Oxford University Press, 1992.
 Gleick, J. *Chaos: Making a New Science*. New York: Penguin, 1988.

- Guckenheimer, J. and Holmes, P. *Nonlinear Oscillations, Dynamical Systems, and Bifurcations of Vector Fields*, 3rd ed. New York: Springer-Verlag, 1997.
- Lichtenberg, A. and Lieberman, M. *Regular and Stochastic Motion*, 2nd ed. New York: Springer-Verlag, 1994.
- Lorenz, E. N. *The Essence of Chaos*. Seattle, WA: University of Washington Press, 1996.
- Ott, E. *Chaos in Dynamical Systems*. New York: Cambridge University Press, 1993.
- Ott, E.; Sauer, T.; and Yorke, J. A. *Coping with Chaos: Analysis of Chaotic Data and the Exploitation of Chaotic Systems*. New York: Wiley, 1994.
- Peitgen, H.-O.; Jürgens, H.; and Saupe, D. *Chaos and Fractals: New Frontiers of Science*. New York: Springer-Verlag, 1992.
- Poon, L. "Chaos at Maryland." <http://www-chaos.umd.edu>.
- Rasband, S. N. *Chaotic Dynamics of Nonlinear Systems*. New York: Wiley, 1990.
- Strogatz, S. H. *Nonlinear Dynamics and Chaos, with Applications to Physics, Biology, Chemistry, and Engineering*. Reading, MA: Addison-Wesley, 1994.
- Tabor, M. *Chaos and Integrability in Nonlinear Dynamics: An Introduction*. New York: Wiley, 1989.
- Tuillaro, N.; Abbott, T. R.; and Reilly, J. *An Experimental Approach to Nonlinear Dynamics and Chaos*. Redwood City, CA: Addison-Wesley, 1992.
- Wiggins, S. *Global Bifurcations and Chaos: Analytical Methods*. New York: Springer-Verlag, 1988.
- Wiggins, S. *Introduction to Applied Nonlinear Dynamical Systems and Chaos*. New York: Springer-Verlag, 1990.

Chaos Game

Pick a point at random inside a regular n -gon. Then draw the next point a fraction r of the distance between it and a VERTEX picked at random. Continue the process (after throwing out the first few points). The result of this "chaos game" is sometimes, but not always, a FRACTAL. The case $(n, r) = (4, 1/2)$ gives the interior of a SQUARE with all points visited with equal probability.

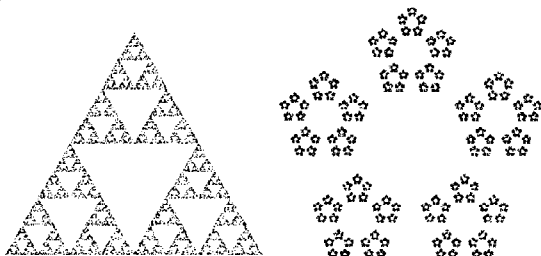

(3, 1/2)

(5, 1/3)

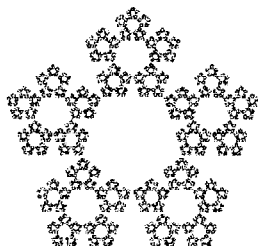

(5, 3/8)

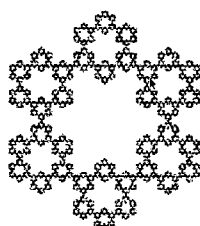

(6, 1/3)

see also BARNSEY'S FERN

References

- Barnsley, M. F. and Rising, H. *Fractals Everywhere*, 2nd ed. Boston, MA: Academic Press, 1993.
- Dickau, R. M. "The Chaos Game." [http:// forum . swarthmore.edu/advanced/robertd/chaos_game.html](http://forum.swarthmore.edu/advanced/robertd/chaos_game.html).
- Wagon, S. *Mathematica in Action*. New York: W. H. Freeman, pp. 149–163, 1991.
- ✱ Weisstein, E. W. "Fractals." <http://www.astro.virginia.edu/~eww6n/math/notebooks/Fractal.m>.

Character (Group)

The GROUP THEORY term for what is known to physicists as the TRACE. All members of the same CONJUGACY CLASS in the same representation have the same character. Members of other CONJUGACY CLASSES may also have the same character, however. An (abstract) GROUP can be uniquely identified by a listing of the characters of its various representations, known as a CHARACTER TABLE. Some of the SCHÖNFLIES SYMBOLS denote different sets of symmetry operations but correspond to the same abstract GROUP and so have the same CHARACTER TABLES.

Character (Multiplicative)

A continuous HOMEOMORPHISM of a GROUP into the NONZERO COMPLEX NUMBERS. A multiplicative character ω gives a REPRESENTATION on the 1-D SPACE \mathbb{C} of COMPLEX NUMBERS, where the REPRESENTATION action by $g \in G$ is multiplication by $\omega(g)$. A multiplicative character is UNITARY if it has ABSOLUTE VALUE 1 everywhere.

References

- Knapp, A. W. "Group Representations and Harmonic Analysis, Part II." *Not. Amer. Math. Soc.* **43**, 537–549, 1996.

Character (Number Theory)

A number theoretic function $\chi_k(n)$ for POSITIVE integral n is a character modulo k if

$$\begin{aligned}\chi_k(1) &= 1 \\ \chi_k(n) &= \chi_k(n+k) \\ \chi_k(m)\chi_k(n) &= \chi_k(mn)\end{aligned}$$

for all m, n , and

$$\chi_k(n) = 0$$

if $(k, n) \neq 1$. χ_k can only assume values which are $\phi(k)$ ROOTS OF UNITY, where ϕ is the TOTIENT FUNCTION. see also DIRICHLET L -SERIES

Character Table

C_1	E
A	1

C_s	E	σ_h		
A	1	1	x, y, R_z	x^2, y^2, z^2, xy
B	1	-1	z, R_x, R_y	yz, xz

Character Table

C_i	E	i		
A_g	1	1	R_x, R_y, R_z	$x^2, y^2, z^2, xy, xz, yz$
A_u	1	-1	x, y, z	

C_2	E	C_2		
A	1	1	z, R_z	x^2, y^2, z^2, xy
B	1	-1	x, y, R_x, R_y	yz, xz

C_3	E	C_3	C_3^2		$\epsilon = \exp(2\pi i/3)$
A	1	1	1	z, R_z	x^2, y^2, z^2, xy
E	$\begin{Bmatrix} 1 & \epsilon & \epsilon^* \\ 1 & \epsilon^* & \epsilon \end{Bmatrix}$			$(x, y)(R_x, R_y)$	$(x^2 - y^2, xy)(yz, xz)$

C_4	E	C_3	C_2	C_4^3		
A	1	1	1	1	z, R_z	$x^2 + y^2, z^2$
B	1	-1	1	-1		$x^2 - y^2, xy$
E	$\begin{Bmatrix} 1 & i & -1 & -i \\ 1 & -i & 1 & i \end{Bmatrix}$				$(x, y)(R_x, R_y)$	(yz, xz)

C_5	E	C_5	C_5^2	C_5^3	C_5^4		$\epsilon = \exp(2\pi i/5)$
A	1	1	1	1	1	z, R_z	$x^2 + y^2, z^2$
E_1	$\begin{Bmatrix} 1 & \epsilon & \epsilon^2 & \epsilon^{2*} & \epsilon^* \\ 1 & \epsilon^* & \epsilon^{2*} & \epsilon^2 & \epsilon \end{Bmatrix}$					$(x, y)(R_x, R_y)$	(yz, xz)
E_2	$\begin{Bmatrix} 1 & \epsilon^2 & \epsilon^* & \epsilon & \epsilon^{2*} \\ 1 & \epsilon^{2*} & \epsilon & \epsilon^* & \epsilon^2 \end{Bmatrix}$						$(x^2 - y^2, xy)$

C_6	E	C_6	C_3	C_2	C_3^2	C_6^5		$\epsilon = \exp(2\pi i/6)$
A	1	1	1	1	1	1	z, R_z	$x^2 + y^2, z^2$
B	1	-1	1	-1	1	-1		
E_1	$\begin{Bmatrix} 1 & \epsilon & -\epsilon^* & -1 & -\epsilon & \epsilon^* \\ 1 & \epsilon^* & -\epsilon & -1 & -\epsilon^* & \epsilon \end{Bmatrix}$						$(x, y)(R_x, R_y)$	(yz, xz)
E_2	$\begin{Bmatrix} 1 & -\epsilon & -\epsilon & 1 & -\epsilon^* & -\epsilon \\ 1 & -\epsilon^* & -\epsilon^* & 1 & -\epsilon & \epsilon^* \end{Bmatrix}$							$(x^2 - y^2, xy)$

D_2	E	$C_2(z)$	$C_2(y)$	$C_2(x)$		
A_1	1	1	1	1		$x^2 + y^2, z^2$
B_1	1	1	-1	-1	z, R_z	xy
B_2	1	-1	1	-1	y, R_y	xz
B_3	1	-1	-1	1	z, R_z	yz

D_3	E	$2C_3$	$3C_2$		
A_1	1	1	1		$x^2 + y^2, z^2$
A_2	1	1	-1	z, R_z	xy
E	2	-1	0	$(x, y)(R_x, R_y)$	$(x^2 - y^2, xy)(xz, yz)$

D_4	E	$2C_4$	C_2	$2C_2'$	$2C_2''$		
A_1	1	1	1	1	1		$x^2 + y^2, z^2$
A_2	1	1	1	-1	-1	z, R_z	
B_1	1	-1	1	1	-1		$x^2 - y^2$
B_2	1	-1	1	-1	1		xy
E	2	0	-2	0	0	$(x, y)(R_x, R_y)$	(xz, yz)

D_5	E	$2C_5$	$2C_5^2$	$5C_2$		
A_1	1	1	1	1		$x^2 + y^2, z^2$
B_1	1	1	1	-1	z, R_z	
B_2	2	$2 \cos 72^\circ$	$2 \cos 144^\circ$	0	$(x, y)(R_x, R_y)$	(xz, yz)
B_3	2	$2 \cos 144^\circ$	$2 \cos 72^\circ$	0		$(x^2 - y^2, xy)$

Character Table 227

D_6	E	$2C_6$	$2C_3$	C_2	$3C_2'$	$3C_2''$		
A_1	1	1	1	1	1	1		$x^2 + y^2, z^2$
A_2	1	1	1	1	-1	-1	z, R_z	
B_1	1	-1	1	-1	1	-1		
B_2	1	-1	1	-1	-1	1	$(x, y)(R_x, R_y)$	
E_1	2	1	-1	-2	0	0		(xz, yz)
E_2	2	-1	-1	2	0	0		$(x^2 - y^2, xy)$

C_{2v}	E	C_2	$\sigma_v(xz)$	$\sigma_v'(yz)$		
A_1	1	1	1	1	z	x^2, y^2, z^2
A_2	1	1	-1	-1	R_z	xy
B_1	1	-1	1	-1	x, R_y	xz
B_2	1	-1	-1	1	y, R_x	yz

C_{3v}	E	$2C_3$	$3\sigma_v$		
A_1	1	1	1	z	$x^2 + y^2, z^2$
A_2	1	1	-1	R_z	
E	2	-1	0	$(x, y)(R_x, R_y)$	$(x^2 - y^2, xy)(xz, yz)$

C_{4v}	E	$2C_4$	C_2	$2\sigma_v$	$2\sigma_d$		
A_1	1	1	1	1	1	z	$x^2 + y^2, z^2$
A_2	1	1	1	-1	-1	R_z	
B_1	1	-1	1	1	-1		$x^2 - y^2$
B_2	1	-1	1	-1	1		xy
E	2	0	-2	0	0	$(x, y)(R_x, R_y)$	(xz, yz)

C_{5v}	E	$2C_5$	$2C_5^2$	$5\sigma_v$		
A_1	1	1	1	1	z	$x^2 + y^2, z^2$
B_1	1	1	1	-1	R_z	
B_2	2	$2 \cos 72^\circ$	$2 \cos 144^\circ$	0	$(x, y)(R_x, R_y)$	(xz, yz)
B_3	2	$2 \cos 144^\circ$	$2 \cos 72^\circ$	0		$(x^2 - y^2, xy)$

C_{6v}	E	$2C_6$	$2C_3$	C_2	$3\sigma_v$	$3\sigma_d$		
A_1	1	1	1	1	1	1	z	$x^2 + y^2, z^2$
A_2	1	1	1	1	-1	-1	R_z	
B_1	1	-1	1	-1	1	-1		
B_2	1	-1	1	-1	-1	1		
E_1	2	1	-1	-2	0	0	$(x, y)(R_x, R_y)$	(xz, yz)
E_2	2	-1	-1	2	0	0		$(x^2 - y^2, xy)$

$C_{\infty v}$	E	C_{∞}^+	\dots	$\infty\sigma_v$		
$A_1 \equiv \Sigma^+$	1	1	\dots	1	z	$x^2 + y^2, z^2$
$A_2 \equiv \Sigma^-$	1	1	\dots	-1	R_z	
$E_1 \equiv \Pi$	2	$2 \cos \Phi$	\dots	0	$(x, y); (R_x, R_y)$	(xz, yz)
$E_2 \equiv \Delta$	2	$2 \cos 2\Phi$	\dots	0		$(x^2 - y^2, xy)$
$E_3 \equiv \Phi$	2	$2 \cos 3\Phi$	\dots	0		
\vdots	\vdots	\vdots	\ddots	\vdots		

References

- Bishop, D. M. "Character Tables." Appendix 1 in *Group Theory and Chemistry*. New York: Dover, pp. 279-288, 1993.
- Cotton, F. A. *Chemical Applications of Group Theory*, 3rd ed. New York: Wiley, 1990.
- Iyanaga, S. and Kawada, Y. (Eds.). "Characters of Finite Groups." Appendix B, Table 5 in *Encyclopedic Dictionary of Mathematics*. Cambridge, MA: MIT Press, pp. 1496-1503, 1980.

Characteristic Class

Characteristic classes are COHOMOLOGY classes in the BASE SPACE of a VECTOR BUNDLE, defined through OBSTRUCTION theory, which are (perhaps partial) obstructions to the existence of k everywhere linearly independent vector FIELDS on the VECTOR BUNDLE. The most common examples of characteristic classes are the CHERN, PONTRYAGIN, and STIEFEL-WHITNEY CLASSES.

Characteristic (Elliptic Integral)

A parameter n used to specify an ELLIPTIC INTEGRAL OF THE THIRD KIND.

see also AMPLITUDE, ELLIPTIC INTEGRAL, MODULAR ANGLE, MODULUS (ELLIPTIC INTEGRAL), NOME, PARAMETER

References

Abramowitz, M. and Stegun, C. A. (Eds.). *Handbook of Mathematical Functions with Formulas, Graphs, and Mathematical Tables*, 9th printing. New York: Dover, p. 590, 1972.

Characteristic Equation

The equation which is solved to find a MATRIX's EIGENVALUES, also called the CHARACTERISTIC POLYNOMIAL. Given a 2×2 system of equations with MATRIX

$$M \equiv \begin{bmatrix} a & b \\ c & d \end{bmatrix}, \quad (1)$$

the MATRIX EQUATION is

$$\begin{bmatrix} a & b \\ c & d \end{bmatrix} \begin{bmatrix} x \\ y \end{bmatrix} = t \begin{bmatrix} x \\ y \end{bmatrix}, \quad (2)$$

which can be rewritten

$$\begin{bmatrix} a-t & b \\ c & d-t \end{bmatrix} \begin{bmatrix} x \\ y \end{bmatrix} = t \begin{bmatrix} 0 \\ 0 \end{bmatrix}. \quad (3)$$

M can have no MATRIX INVERSE, since otherwise

$$\begin{bmatrix} x \\ y \end{bmatrix} = M^{-1} \begin{bmatrix} 0 \\ 0 \end{bmatrix} = \begin{bmatrix} 0 \\ 0 \end{bmatrix}, \quad (4)$$

which contradicts our ability to pick arbitrary x and y . Therefore, M has no inverse, so its DETERMINANT is 0. This gives the characteristic equation

$$\begin{vmatrix} a-t & b \\ c & d-t \end{vmatrix} = 0, \quad (5)$$

where $|A|$ denotes the DETERMINANT of A . For a general $k \times k$ MATRIX

$$\begin{bmatrix} a_{11} & a_{12} & \dots & a_{1k} \\ a_{21} & a_{22} & \dots & a_{2k} \\ \vdots & \vdots & \ddots & \vdots \\ a_{k1} & a_{k2} & \dots & a_{kk} \end{bmatrix}, \quad (6)$$

the characteristic equation is

$$\begin{vmatrix} a_{11}-t & a_{12} & \dots & a_{1k} \\ a_{21} & a_{22}-t & \dots & a_{2k} \\ \vdots & \vdots & \ddots & \vdots \\ a_{k1} & a_{k2} & \dots & a_{kk}-t \end{vmatrix} = 0. \quad (7)$$

see also BALLIEU'S THEOREM, CAYLEY-HAMILTON THEOREM, PARODI'S THEOREM, ROUTH-HURWITZ THEOREM

References

Gradshteyn, I. S. and Ryzhik, I. M. *Tables of Integrals, Series, and Products*, 5th ed. San Diego, CA: Academic Press, pp. 1117-1119, 1979.

Characteristic (Euler)

see EULER CHARACTERISTIC

Characteristic Factor

A characteristic factor is a factor in a particular factorization of the TOTIENT FUNCTION $\phi(n)$ such that the product of characteristic factors gives the representation of a corresponding abstract GROUP as a DIRECT PRODUCT. By computing the characteristic factors, any ABELIAN GROUP can be expressed as a DIRECT PRODUCT of CYCLIC SUBGROUPS, for example, $Z_2 \otimes Z_4$ or $Z_2 \otimes Z_2 \otimes Z_2$. There is a simple algorithm for determining the characteristic factors of MODULO MULTIPLICATION GROUPS.

see also CYCLIC GROUP, DIRECT PRODUCT (GROUP), MODULO MULTIPLICATION GROUP, TOTIENT FUNCTION

References

Shanks, D. *Solved and Unsolved Problems in Number Theory*, 4th ed. New York: Chelsea, p. 94, 1993.

Characteristic (Field)

For a FIELD K with multiplicative identity 1, consider the numbers $2 = 1 + 1$, $3 = 1 + 1 + 1$, $4 = 1 + 1 + 1 + 1$, etc. Either these numbers are all different, in which case we say that K has characteristic 0, or two of them will be equal. In this case, it is straightforward to show that, for some number p , we have $\underbrace{1 + 1 + \dots + 1}_{p \text{ times}} = 0$.

If p is chosen to be as small as possible, then p will be a PRIME, and we say that K has characteristic p . The FIELDS \mathbb{Q} , \mathbb{R} , \mathbb{C} , and the p -ADIC NUMBERS \mathbb{Q}_p have characteristic 0. For p a PRIME, the GALOIS FIELD $\text{GF}(p^n)$ has characteristic p .

If H is a SUBFIELD of K , then H and K have the same characteristic.

see also FIELD, SUBFIELD

Characteristic Function

The characteristic function $\phi(t)$ is defined as the FOURIER TRANSFORM of the PROBABILITY DENSITY FUNCTION,

$$\phi(t) = \mathcal{F}[P(x)] = \int_{-\infty}^{\infty} e^{itx} P(x) dx \quad (1)$$

$$= \int_{-\infty}^{\infty} P(x) dx + it \int_{-\infty}^{\infty} x P(x) dx + \frac{1}{2}(it)^2 \int_{-\infty}^{\infty} x^2 P(x) dx + \dots \quad (2)$$

$$= \sum_{k=0}^{\infty} \frac{(it)^k}{k!} \mu'_k \quad (3)$$

$$= 1 + it\mu'_1 - \frac{1}{2}t^2\mu'_2 - \frac{1}{3!}it^3\mu'_3 + \frac{1}{4!}t^4\mu'_4 + \dots, \quad (4)$$

where μ'_n (sometimes also denoted ν_n) is the n th MOMENT about 0 and $\mu'_0 \equiv 1$. The characteristic function can therefore be used to generate MOMENTS about 0,

$$\phi^{(n)}(0) \equiv \left[\frac{d^n \phi}{dt^n} \right]_{t=0} = i^n \mu'_n \quad (5)$$

or the CUMULANTS κ_n ,

$$\ln \phi(t) \equiv \sum_{n=0}^{\infty} \kappa_n \frac{(it)^n}{n!}. \quad (6)$$

A DISTRIBUTION is not uniquely specified by its MOMENTS, but is uniquely specified by its characteristic function.

see also CUMULANT, MOMENT, MOMENT-GENERATING FUNCTION, PROBABILITY DENSITY FUNCTION

References

- Abramowitz, M. and Stegun, C. A. (Eds.). *Handbook of Mathematical Functions with Formulas, Graphs, and Mathematical Tables*, 9th printing. New York: Dover, p. 928, 1972.
- Kenney, J. F. and Keeping, E. S. "Moment-Generating and Characteristic Functions," "Some Examples of Moment-Generating Functions," and "Uniqueness Theorem for Characteristic Functions." §4.6–4.8 in *Mathematics of Statistics*, Pt. 2, 2nd ed. Princeton, NJ: Van Nostrand, pp. 72–77, 1951.

Characteristic (Partial Differential Equation)

Paths in a 2-D plane used to transform PARTIAL DIFFERENTIAL EQUATIONS into systems of ORDINARY DIFFERENTIAL EQUATIONS. They were invented by Riemann. For an example of the use of characteristics, consider the equation

$$u_t - 6uu_x = 0.$$

Now let $u(s) = u(x(s), t(s))$. Since

$$\frac{du}{ds} = \frac{dx}{ds} u_x + \frac{dt}{ds} u_t,$$

it follows that $dt/ds = 1$, $dx/ds = -6u$, and $du/ds = 0$. Integrating gives $t(s) = s$, $x(s) = -6su_0(x)$, and $u(s) = u_0(x)$, where the constants of integration are 0 and $u_0(x) = u(x, 0)$.

Characteristic Polynomial

The expanded form of the CHARACTERISTIC EQUATION.

$$\det(xI - A),$$

where A is an $n \times n$ MATRIX and I is the IDENTITY MATRIX.

see also CAYLEY-HAMILTON THEOREM

Characteristic (Real Number)

For a REAL NUMBER x , $[x] = \text{int}(x)$ is called the characteristic. Here, $[x]$ is the FLOOR FUNCTION.

see also MANTISSA, SCIENTIFIC NOTATION

Charlier's Check

A check which can be used to verify correct computation of MOMENTS.

Chasles-Cayley-Brill Formula

The number of coincidences of a (ν, ν') correspondence of value γ on a curve of GENUS p is given by

$$\nu + \nu' + 2p\gamma.$$

see also ZEUTHEN'S THEOREM

References

- Coolidge, J. L. *A Treatise on Algebraic Plane Curves*. New York: Dover, p. 129, 1959.

Chasles's Contact Theorem

If a one-parameter family of curves has index N and class M , the number tangent to a curve of order n_1 and class m_1 in general position is

$$m_1 N + n_1 M.$$

References

- Coolidge, J. L. *A Treatise on Algebraic Plane Curves*. New York: Dover, p. 436, 1959.

Chasles's Polars Theorem

If the TRILINEAR POLARS of the VERTICES of a TRIANGLE are distinct from the respectively opposite sides, they meet the sides in three COLLINEAR points.

see also COLLINEAR, TRIANGLE, TRILINEAR POLAR

Chasles's Theorem

If two projective PENCILS of curves of orders n and n' have no common curve, the LOCUS of the intersections of corresponding curves of the two is a curve of order $n+n'$ through all the centers of either PENCIL. Conversely, if a curve of order $n+n'$ contains all centers of a PENCIL of order n to the multiplicity demanded by NOETHER'S FUNDAMENTAL THEOREM, then it is the LOCUS of the intersections of corresponding curves of this PENCIL and one of order n' projective therewith.

see also NOETHER'S FUNDAMENTAL THEOREM, PENCIL

References

Coolidge, J. L. *A Treatise on Algebraic Plane Curves*. New York: Dover, p. 33, 1959.

Chebyshev Approximation Formula

Using a CHEBYSHEV POLYNOMIAL OF THE FIRST KIND T , define

$$c_j \equiv \frac{2}{N} \sum_{k=1}^N f(x_k) T_j(x_k) \\ = \frac{2}{N} \sum_{k=1}^N f \left[\cos \left\{ \frac{\pi(k-\frac{1}{2})}{N} \right\} \right] \cos \left\{ \frac{\pi j(k-\frac{1}{2})}{N} \right\}.$$

Then

$$f(x) \approx \sum_{k=0}^{N-1} c_k T_k(x) - \frac{1}{2} c_0.$$

It is exact for the N zeros of $T_N(x)$. This type of approximation is important because, when truncated, the error is spread smoothly over $[-1, 1]$. The Chebyshev approximation formula is very close to the MINIMAX POLYNOMIAL.

References

Press, W. H.; Flannery, B. P.; Teukolsky, S. A.; and Vetterling, W. T. "Chebyshev Approximation," "Derivatives or Integrals of a Chebyshev-Approximated Function," and "Polynomial Approximation from Chebyshev Coefficients." §5.8, 5.9, and 5.10 in *Numerical Recipes in FORTRAN: The Art of Scientific Computing*, 2nd ed. Cambridge, England: Cambridge University Press, pp. 184–188, 189–190, and 191–192, 1992.

Chebyshev Constants

N.B. A detailed on-line essay by S. Finch was the starting point for this entry.

The constants

$$\lambda_{m,n} = \inf_{r \in R_{m,n}} \sup_{x \geq 0} |e^{-x} - r(x)|,$$

where

$$r(x) = \frac{p(x)}{q(x)},$$

p and q are m th and n th order POLYNOMIALS, and $R_{m,n}$ is the set all RATIONAL FUNCTIONS with REAL coefficients.

see also ONE-NINTH CONSTANT, RATIONAL FUNCTION

References

Finch, S. "Favorite Mathematical Constants." <http://www.mathsoft.com/asolve/constant/onenin/onenin.html>.
Petrushev, P. P. and Popov, V. A. *Rational Approximation of Real Functions*. New York: Cambridge University Press, 1987.
Varga, R. S. *Scientific Computations on Mathematical Problems and Conjectures*. Philadelphia, PA: SIAM, 1990.
Philadelphia, PA: SIAM, 1990.

Chebyshev Deviation

$$\max_{a \leq x \leq b} \{|f(x) - \rho(x)|w(x)\}.$$

References

Szegő, G. *Orthogonal Polynomials*, 4th ed. Providence, RI: Amer. Math. Soc., p. 41, 1975.

Chebyshev Differential Equation

$$(1-x^2) \frac{d^2 y}{dx^2} - x \frac{dy}{dx} + m^2 y = 0 \quad (1)$$

for $|x| < 1$. The Chebyshev differential equation has regular SINGULARITIES at -1 , 1 , and ∞ . It can be solved by series solution using the expansions

$$y = \sum_{n=0}^{\infty} a_n x^n \quad (2)$$

$$y' = \sum_{n=0}^{\infty} n a_n x^{n-1} = \sum_{n=1}^{\infty} n a_n x^{n-1} \\ = \sum_{n=0}^{\infty} (n+1) a_{n+1} x^n \quad (3)$$

$$y'' = \sum_{n=0}^{\infty} (n+1) n a_{n+1} x^{n-1} = \sum_{n=1}^{\infty} (n+1) n a_{n+1} x^{n-1} \\ = \sum_{n=0}^{\infty} (n+2)(n+1) a_{n+2} x^n. \quad (4)$$

Now, plug (2-4) into the original equation (1) to obtain

$$(1-x^2) \sum_{n=0}^{\infty} (n+2)(n+1) a_{n+2} x^n \\ - x \sum_{n=0}^{\infty} (n+1) n a_{n+1} x^{n-1} + m^2 \sum_{n=0}^{\infty} a_n x^n = 0 \quad (5)$$

$$\sum_{n=0}^{\infty} (n+2)(n+1) a_{n+2} x^n - \sum_{n=0}^{\infty} (n+2)(n+1) a_{n+2} x^{n+2} \\ - \sum_{n=0}^{\infty} (n+1) a_{n+1} x^{n+1} + m^2 \sum_{n=0}^{\infty} a_n x^n = 0 \quad (6)$$

$$\sum_{n=0}^{\infty} (n+2)(n+1)a_{n+2}x^n - \sum_{n=2}^{\infty} n(n-1)a_nx^{n+2} - \sum_{n=1}^{\infty} na_nx^n + m^2 \sum_{n=0}^{\infty} a_nx^n = 0 \quad (7)$$

$$2 \cdot 1a_2 + 3 \cdot 2a_3x - 1 \cdot ax + m^2a_0 + m^2a_1x + \sum_{n=2}^{\infty} [(n+2)(n+1)a_{n+2} - n(n-1)a_n - na_n + m^2a_n]x^n = 0 \quad (8)$$

$$(2a_2 + m^2a_0) + [(m^2 - 1)a_1 + 6a_3]x + \sum_{n=2}^{\infty} [(n+2)(n+1)a_{n+2} + (m^2 - n^2)a_n]x^n = 0, \quad (9)$$

so

$$2a_2 + m^2a_0 = 0 \quad (10)$$

$$(m^2 - 1)a_1 + 6a_3 = 0 \quad (11)$$

$$a_{n+2} = \frac{n^2 - m^2}{(n+1)(n+2)}a_n \quad \text{for } n = 2, 3, \dots \quad (12)$$

The first two are special cases of the third, so the general recurrence relation is

$$a_{n+2} = \frac{n^2 - m^2}{(n+1)(n+2)}a_n \quad \text{for } n = 0, 1, \dots \quad (13)$$

From this, we obtain for the EVEN COEFFICIENTS

$$a_2 = -\frac{1}{2}m^2a_0 \quad (14)$$

$$a_4 = \frac{2^2 - m^2}{3 \cdot 4}a_2 = \frac{(2^2 - m^2)(-m^2)}{1 \cdot 2 \cdot 3 \cdot 4}a_0 \quad (15)$$

$$a_{2n} = \frac{[(2n)^2 - m^2][(2n-2)^2 - m^2] \cdots [1^2 - m^2]}{(2n)!}a_0, \quad (16)$$

and for the ODD COEFFICIENTS

$$a_3 = \frac{1 - m^2}{6}a_1 \quad (17)$$

$$a_5 = \frac{3^2 - m^2}{4 \cdot 5}a_3 = \frac{(3^2 - m^2)(1^2 - m^2)}{5!}a_1 \quad (18)$$

$$a_{2n-1} = \frac{[(2n-1)^2 - m^2][(2n-3)^2 - m^2] \cdots [1^2 - m^2]}{(2n+1)!}a_1. \quad (19)$$

So the general solution is

$$y = a_0 \left[1 + \sum_{k=2,4,\dots}^{\infty} \frac{[k^2 - m^2][(k-2)^2 - m^2] \cdots [-m^2]}{k!} x^k \right] + a_1 \left[x + \sum_{k=3,5,\dots}^{\infty} \frac{[(k-2)^2 - m^2][(k-2)^2 - m^2] \cdots [1^2 - m^2]}{k!} x^k \right] \quad (20)$$

If n is EVEN, then y_1 terminates and is a POLYNOMIAL solution, whereas if n is ODD, then y_2 terminates and is a POLYNOMIAL solution. The POLYNOMIAL solutions defined here are known as CHEBYSHEV POLYNOMIALS OF THE FIRST KIND. The definition of the CHEBYSHEV POLYNOMIAL OF THE SECOND KIND gives a similar, but distinct, recurrence relation

$$a'_{n+2} = \frac{(n+1)^2 - m^2}{(n+2)(n+3)}a'_n \quad \text{for } n = 0, 1, \dots \quad (21)$$

Chebyshev Function

$$\theta(x) \equiv \sum_{p \leq x} \ln p,$$

where the sum is over PRIMES p , so

$$\lim_{x \rightarrow \infty} \frac{x}{\theta(x)} = 1.$$

Chebyshev-Gauss Quadrature

Also called CHEBYSHEV QUADRATURE. A GAUSSIAN QUADRATURE over the interval $[-1, 1]$ with WEIGHTING FUNCTION $W(x) = 1/\sqrt{1-x^2}$. The ABSCISSAS for quadrature order n are given by the roots of the CHEBYSHEV POLYNOMIAL OF THE FIRST KIND $T_n(x)$, which occur symmetrically about 0. The WEIGHTS are

$$w_i = -\frac{A_{n+1}\gamma_n}{A_n T'_n(x_i) T_{n+1}(x_i)} = \frac{A_n}{A_{n-1}} \frac{\gamma_{n-1}}{T_{n-1}(x_i) T'_n(x_i)}, \quad (1)$$

where A_n is the COEFFICIENT of x^n in $T_n(x)$. For HERMITE POLYNOMIALS,

$$A_n = 2^{n-1}, \quad (2)$$

so

$$\frac{A_{n+1}}{A_n} = 2. \quad (3)$$

Additionally,

$$\gamma_n = \frac{1}{2}\pi, \quad (4)$$

so

$$w_i = -\frac{\pi}{T_{n+1}(x_i) T'_n(x_i)}. \quad (5)$$

Since

$$T_n(x) = \cos(n \cos^{-1} x), \quad (6)$$

the ABSCISSAS are given explicitly by

$$x_i = \cos \left[\frac{(2i-1)\pi}{2n} \right]. \quad (7)$$

Since

$$T'_n(x_i) = \frac{(-1)^{i+1}n}{\alpha_i} \quad (8)$$

$$T_{n+1}(x_i) = (-1)^i \sin \alpha_i, \quad (9)$$

where

$$\alpha_i = \frac{(2i-1)\pi}{2n}, \quad (10)$$

all the WEIGHTS are

$$w_i = \frac{\pi}{n}. \quad (11)$$

The explicit FORMULA is then

$$\begin{aligned} & \int_{-1}^1 \frac{f(x) dx}{\sqrt{1-x^2}} \\ &= \frac{\pi}{n} \sum_{k=1}^n f \left[\cos \left(\frac{(2k-1)\pi}{2n} \right) \right] + \frac{2\pi}{2^{2n}(2n)!} f^{(2n)}(\xi). \end{aligned} \quad (12)$$

n	x_i	w_i
2	± 0.707107	1.5708
3	0	1.0472
	± 0.866025	1.0472
4	± 0.382683	0.785398
	± 0.92388	0.785398
5	0	0.628319
	± 0.587785	0.628319
	± 0.951057	0.628319

References

Hildebrand, F. B. *Introduction to Numerical Analysis*. New York: McGraw-Hill, pp. 330–331, 1956.

Chebyshev Inequality

Apply MARKOV'S INEQUALITY with $a \equiv k^2$ to obtain

$$P[(x - \mu)^2 \geq k^2] \leq \frac{\langle (x - \mu)^2 \rangle}{k^2} = \frac{\sigma^2}{k^2}. \quad (1)$$

Therefore, if a RANDOM VARIABLE x has a finite MEAN μ and finite VARIANCE σ^2 , then $\forall k \geq 0$,

$$P(|x - \mu| \geq k) \leq \frac{\sigma^2}{k^2} \quad (2)$$

$$P(|x - \mu| \geq k\sigma) \leq \frac{1}{k^2}. \quad (3)$$

References

Abramowitz, M. and Stegun, C. A. (Eds.). *Handbook of Mathematical Functions with Formulas, Graphs, and Mathematical Tables*, 9th printing. New York: Dover, p. 11, 1972.

Chebyshev Integral

$$\int x^p (1-x)^q dx.$$

Chebyshev Integral Inequality

$$\begin{aligned} & \int_a^b f_1(x) dx \int_a^b f_2(x) dx \cdots \int_a^b f_n(x) dx \\ & \leq (b-a)^{n-1} \int_a^b f(x_1) f(x_2) \cdots f(x_n) dx, \end{aligned}$$

where f_1, f_2, \dots, f_n are NONNEGATIVE integrable functions on $[a, b]$ which are monotonic increasing or decreasing.

References

Gradshteyn, I. S. and Ryzhik, I. M. *Tables of Integrals, Series, and Products*, 5th ed. San Diego, CA: Academic Press, p. 1092, 1979.

Chebyshev Phenomenon

see PRIME QUADRATIC EFFECT

Chebyshev Polynomial of the First Kind

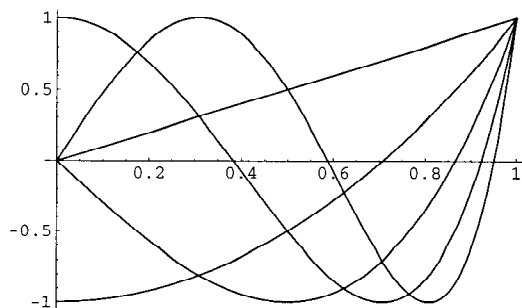

A set of ORTHOGONAL POLYNOMIALS defined as the solutions to the CHEBYSHEV DIFFERENTIAL EQUATION and denoted $T_n(x)$. They are used as an approximation to a LEAST SQUARES FIT, and are a special case of the ULTRASPHERICAL POLYNOMIAL with $\alpha = 0$. The Chebyshev polynomials of the first kind $T_n(x)$ are illustrated above for $x \in [0, 1]$ and $n = 1, 2, \dots, 5$.

The Chebyshev polynomials of the first kind can be obtained from the generating functions

$$g_1(t, x) \equiv \frac{1-t^2}{1-2xt+t^2} = T_0(x) + 2 \sum_{n=1}^{\infty} T_n(x) t^n \quad (1)$$

and

$$g_2(t, x) \equiv \frac{1-xt}{1-2xt+t^2} = \sum_{n=0}^{\infty} T_n(x) t^n \quad (2)$$

for $|x| \leq 1$ and $|t| < 1$ (Beeler *et al.* 1972, Item 15). (A closely related GENERATING FUNCTION is the basis for the definition of CHEBYSHEV POLYNOMIAL OF THE SECOND KIND.) They are normalized such that $T_n(1) = 1$. They can also be written

$$T_n(x) = \frac{n}{2} \sum_{r=0}^{\lfloor n/2 \rfloor} \frac{(-1)^r}{n-r} \binom{n-r}{r} (2x)^{n-2r}, \quad (3)$$

or in terms of a DETERMINANT

$$T_n = \begin{vmatrix} x & 1 & 0 & 0 & \cdots & 0 & 0 \\ 1 & 2x & 1 & 0 & \cdots & 0 & 0 \\ 0 & 1 & 2x & 1 & \cdots & 0 & 0 \\ 0 & 0 & 1 & 2x & \cdots & 0 & 0 \\ \vdots & \vdots & \vdots & \vdots & \ddots & \vdots & \vdots \\ 0 & 0 & 0 & 0 & \cdots & 1 & 2x \end{vmatrix}. \quad (4)$$

In closed form,

$$T_n(x) = \cos(n \cos^{-1} x) = \sum_{m=0}^{\lfloor n/2 \rfloor} \binom{n}{2m} x^{n-2m} (x^2 - 1)^m, \quad (5)$$

where $\binom{n}{k}$ is a BINOMIAL COEFFICIENT and $\lfloor x \rfloor$ is the FLOOR FUNCTION. Therefore, zeros occur when

$$x = \cos \left[\frac{\pi(k - \frac{1}{2})}{n} \right] \quad (6)$$

for $k = 1, 2, \dots, n$. Extrema occur for

$$x = \cos \left(\frac{\pi k}{n} \right), \quad (7)$$

where $k = 0, 1, \dots, n$. At maximum, $T_n(x) = 1$, and at minimum, $T_n(x) = -1$. The Chebyshev POLYNOMIALS are ORTHONORMAL with respect to the WEIGHTING FUNCTION $(1 - x^2)^{-1/2}$

$$\int_{-1}^1 \frac{T_m(x) T_n(x) dx}{\sqrt{1 - x^2}} = \begin{cases} \frac{1}{2} \pi \delta_{nm} & \text{for } m \neq 0, n \neq 0 \\ \pi & \text{for } m = n = 0, \end{cases} \quad (8)$$

where δ_{mn} is the KRONECKER DELTA. Chebyshev polynomials of the first kind satisfy the additional discrete identity

$$\sum_{k=1}^m T_i(x_k) T_j(x_k) = \begin{cases} \frac{1}{2} m \delta_{ij} & \text{for } i \neq 0, j \neq 0 \\ m & \text{for } i = j = 0, \end{cases} \quad (9)$$

where x_k for $k = 1, \dots, m$ are the m zeros of $T_m(x)$. They also satisfy the RECURRENCE RELATIONS

$$T_{n+1}(x) = 2xT_n(x) - T_{n-1}(x) \quad (10)$$

$$T_{n+1}(x) = xT_n(x) - \sqrt{(1 - x^2)\{1 - [T_n(x)]^2\}} \quad (11)$$

for $n \geq 1$. They have a COMPLEX integral representation

$$T_n(x) = \frac{1}{4\pi i} \int_{\gamma} \frac{(1 - z^2) z^{-n-1} dz}{1 - 2xz + z^2} \quad (12)$$

and a Rodrigues representation

$$T_n(x) = \frac{(-1)^n \sqrt{\pi} (1 - x^2)^{1/2}}{2n(n - \frac{1}{2})!} \frac{d^n}{dx^n} [(1 - x^2)^{n-1/2}]. \quad (13)$$

Using a FAST FIBONACCI TRANSFORM with multiplication law

$$(A, B)(C, D) = (AD + BC + 2xAC, BD - AC) \quad (14)$$

gives

$$(T_{n+1}(x), -T_n(x)) = (T_1(x), -T_0(x))(1, 0)^n. \quad (15)$$

Using GRAM-SCHMIDT ORTHONORMALIZATION in the range $(-1, 1)$ with WEIGHTING FUNCTION $(1 - x^2)^{(-1/2)}$ gives

$$p_0(x) = 1 \quad (16)$$

$$p_1(x) = \left[x - \frac{\int_{-1}^1 x(1 - x^2)^{-1/2} dx}{\int_{-1}^1 (1 - x^2)^{-1/2} dx} \right] = x - \frac{[-(1 - x^2)^{1/2}]_{-1}^1}{[\sin^{-1} x]_{-1}^1} = x \quad (17)$$

$$p_2(x) = \left[x - \frac{\int_{-1}^1 x^3(1 - x^2)^{-1/2} dx}{\int_{-1}^1 x^2(1 - x^2)^{-1/2} dx} \right] x - \left[\frac{\int_{-1}^1 x^2(1 - x^2)^{-1/2} dx}{\int_{-1}^1 (1 - x^2)^{-1/2} dx} \right] \cdot 1 = [x - 0]x - \frac{\pi}{2} = x^2 - \frac{1}{2}, \quad (18)$$

etc. Normalizing such that $T_n(1) = 1$ gives

$$\begin{aligned} T_0(x) &= 1 \\ T_1(x) &= x \\ T_2(x) &= 2x^2 - 1 \\ T_3(x) &= 4x^3 - 3x \\ T_4(x) &= 8x^4 - 8x^2 + 1 \\ T_5(x) &= 16x^5 - 20x^3 + 5x \\ T_6(x) &= 32x^6 - 48x^4 + 18x^2 - 1. \end{aligned}$$

The Chebyshev polynomial of the first kind is related to the BESSEL FUNCTION OF THE FIRST KIND $J_n(x)$ and MODIFIED BESSEL FUNCTION OF THE FIRST KIND $I_n(x)$ by the relations

$$J_n(x) = i^n T_n \left(i \frac{d}{dx} \right) J_0(x) \quad (19)$$

$$I_n(x) = T_n \left(\frac{d}{dx} \right) I_0(x). \quad (20)$$

Letting $x \equiv \cos \theta$ allows the Chebyshev polynomials of the first kind to be written as

$$T_n(x) = \cos(n\theta) = \cos(n \cos^{-1} x). \quad (21)$$

The second linearly dependent solution to the transformed differential equation

$$\frac{d^2 T_n}{d\theta^2} + n^2 T_n = 0 \quad (22)$$

is then given by

$$V_n(x) = \sin(n\theta) = \sin(n \cos^{-1} x), \quad (23)$$

which can also be written

$$V_n(x) = \sqrt{1-x^2} U_{n-1}(x), \quad (24)$$

where U_n is a CHEBYSHEV POLYNOMIAL OF THE SECOND KIND. Note that $V_n(x)$ is therefore *not* a POLYNOMIAL.

The POLYNOMIAL

$$x^n - 2^{1-n} T_n(x) \quad (25)$$

(of degree $n-2$) is the POLYNOMIAL of degree $< n$ which stays closest to x^n in the interval $(-1, 1)$. The maximum deviation is 2^{1-n} at the $n+1$ points where

$$x = \cos\left(\frac{k\pi}{n}\right), \quad (26)$$

for $k = 0, 1, \dots, n$ (Beeler *et al.* 1972, Item 15).

see also CHEBYSHEV APPROXIMATION FORMULA, CHEBYSHEV POLYNOMIAL OF THE SECOND KIND

References

- Abramowitz, M. and Stegun, C. A. (Eds.). "Orthogonal Polynomials." Ch. 22 in *Handbook of Mathematical Functions with Formulas, Graphs, and Mathematical Tables*, 9th printing. New York: Dover, pp. 771-802, 1972.
- Arfken, G. "Chebyshev (Tschebyscheff) Polynomials" and "Chebyshev Polynomials—Numerical Applications." §13.3 and 13.4 in *Mathematical Methods for Physicists*, 3rd ed. Orlando, FL: Academic Press, pp. 731-748, 1985.
- Beeler, M.; Gosper, R. W.; and Schroepel, R. *HAKMEM*. Cambridge, MA: MIT Artificial Intelligence Laboratory, Memo AIM-239, Feb. 1972.
- Iyanaga, S. and Kawada, Y. (Eds.). "Čebyšev (Tschebyscheff) Polynomials." Appendix A, Table 20.II in *Encyclopedic Dictionary of Mathematics*. Cambridge, MA: MIT Press, pp. 1478-1479, 1980.
- Rivlin, T. J. *Chebyshev Polynomials*. New York: Wiley, 1990.
- Spanier, J. and Oldham, K. B. "The Chebyshev Polynomials $T_n(x)$ and $U_n(x)$." Ch. 22 in *An Atlas of Functions*. Washington, DC: Hemisphere, pp. 193-207, 1987.

Chebyshev Polynomial of the Second Kind

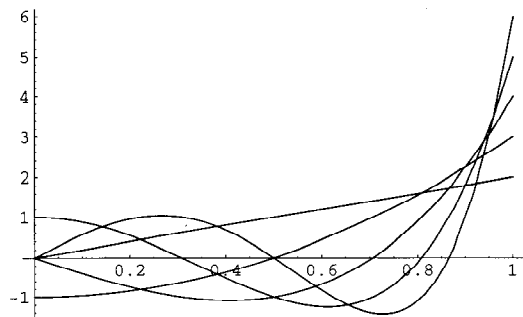

A modified set of Chebyshev POLYNOMIALS defined by a slightly different GENERATING FUNCTION. Used to develop four-dimensional SPHERICAL HARMONICS in angular momentum theory. They are also a special case of the ULTRASPHERICAL POLYNOMIAL with $\alpha = 1$. The Chebyshev polynomials of the second kind $U_n(x)$ are illustrated above for $x \in [0, 1]$ and $n = 1, 2, \dots, 5$.

The defining GENERATING FUNCTION of the Chebyshev polynomials of the second kind is

$$g_2(t, x) = \frac{1}{1-2xt+t^2} = \sum_{n=0}^{\infty} U_n(x) t^n \quad (1)$$

for $|x| < 1$ and $|t| < 1$. To see the relationship to a CHEBYSHEV POLYNOMIAL OF THE FIRST KIND (T), take $\partial g / \partial t$,

$$\begin{aligned} \frac{\partial g}{\partial t} &= -(1-2xt+t^2)^{-2}(-2x+2t) \\ &= 2(t-x)(1-2xt+t^2)^{-2} \\ &= \sum_{n=0}^{\infty} n U_n(x) t^{n-1}. \end{aligned} \quad (2)$$

Multiply (2) by t ,

$$(2t^2-2xt)(1-2xt+t^2)^{-2} = \sum_{n=0}^{\infty} n U_n(x) t^n \quad (3)$$

and take (3)-(2),

$$\begin{aligned} \frac{(2t^2-2tx)-(1-2xt+t^2)}{(1-2xt+t^2)^2} &= \frac{t^2-1}{(1-2xt+t^2)^2} \\ &= \sum_{n=0}^{\infty} (n-1) U_n(x) t^n. \end{aligned} \quad (4)$$

The Rodrigues representation is

$$U_n(x) = \frac{(-1)^n (n+1) \sqrt{\pi}}{2^{n+1} (n+\frac{1}{2})! (1-x^2)^{1/2}} \frac{d^n}{dx^n} [(1-x^2)^{n+1/2}]. \quad (5)$$

The polynomials can also be written

$$\begin{aligned} U_n(x) &= \sum_{r=0}^{\lfloor n/2 \rfloor} (-1)^r \binom{n-r}{r} (2x)^{n-2r} \\ &= \sum_{m=0}^{\lfloor n/2 \rfloor} \binom{n+1}{2m+1} x^{n-2m} (x^2-1)^m, \end{aligned} \quad (6)$$

where $\lfloor x \rfloor$ is the FLOOR FUNCTION and $\lceil x \rceil$ is the CEILING FUNCTION, or in terms of a DETERMINANT

$$U_n = \begin{vmatrix} 2x & 1 & 0 & 0 & \cdots & 0 & 0 \\ 0 & 2x & 1 & 0 & \cdots & 0 & 0 \\ 0 & 1 & 2x & 1 & \cdots & 0 & 0 \\ \vdots & \vdots & \ddots & \ddots & \ddots & \ddots & \vdots \\ 0 & 0 & 0 & 0 & \cdots & 1 & 2x \end{vmatrix}. \quad (7)$$

The first few POLYNOMIALS are

$$\begin{aligned} U_0(x) &= 1 \\ U_1(x) &= 2x \\ U_2(x) &= 4x^2 - 1 \\ U_3(x) &= 8x^3 - 4x \\ U_4(x) &= 16x^4 - 12x^2 + 1 \\ U_5(x) &= 32x^5 - 32x^3 + 6x \\ U_6(x) &= 64x^6 - 80x^4 + 24x^2 - 1. \end{aligned}$$

Letting $x \equiv \cos \theta$ allows the Chebyshev polynomials of the second kind to be written as

$$U_n(x) = \frac{\sin[(n+1)\theta]}{\sin \theta}. \quad (8)$$

The second linearly dependent solution to the transformed differential equation is then given by

$$W_n(x) = \frac{\cos[(n+1)\theta]}{\sin \theta}, \quad (9)$$

which can also be written

$$W_n(x) = (1-x^2)^{-1/2} T_{n+1}(x), \quad (10)$$

where T_n is a CHEBYSHEV POLYNOMIAL OF THE FIRST KIND. Note that $W_n(x)$ is therefore *not* a POLYNOMIAL. *see also* CHEBYSHEV APPROXIMATION FORMULA, CHEBYSHEV POLYNOMIAL OF THE FIRST KIND, ULTRA-SPHERICAL POLYNOMIAL

References

- Abramowitz, M. and Stegun, C. A. (Eds.). "Orthogonal Polynomials." Ch. 22 in *Handbook of Mathematical Functions with Formulas, Graphs, and Mathematical Tables*, 9th printing. New York: Dover, pp. 771-802, 1972.
- Arfken, G. "Chebyshev (Tshebyscheff) Polynomials" and "Chebyshev Polynomials—Numerical Applications." §13.3 and 13.4 in *Mathematical Methods for Physicists*, 3rd ed. Orlando, FL: Academic Press, pp. 731-748, 1985.
- Rivlin, T. J. *Chebyshev Polynomials*. New York: Wiley, 1990.
- Spanier, J. and Oldham, K. B. "The Chebyshev Polynomials $T_n(x)$ and $U_n(x)$." Ch. 22 in *An Atlas of Functions*. Washington, DC: Hemisphere, pp. 193-207, 1987.

Chebyshev Quadrature

A GAUSSIAN QUADRATURE-like FORMULA for numerical estimation of integrals. It uses WEIGHTING FUNCTION $W(x) = 1$ in the interval $[-1, 1]$ and forces all the weights to be equal. The general FORMULA is

$$\int_{-1}^1 f(x) dx = \frac{2}{n} \sum_{i=1}^n f(x_i).$$

The ABSCISSAS are found by taking terms up to y^n in the MACLAURIN SERIES of

$$s_n(y) = \exp \left\{ \frac{1}{2}n \left[-2 + \ln(1-y) \left(1 - \frac{1}{y} \right) + \ln(1+y) \left(1 + \frac{1}{y} \right) \right] \right\},$$

and then defining

$$G_n(x) \equiv x^n s_n \left(\frac{1}{x} \right).$$

The ROOTS of $G_n(x)$ then give the ABSCISSAS. The first few values are

$$\begin{aligned} G_0(x) &= 1 \\ G_1(x) &= x \\ G_2(x) &= \frac{1}{3}(3x^2 - 1) \\ G_3(x) &= \frac{1}{2}(2x^3 - x) \\ G_4(x) &= \frac{1}{45}(45x^4 - 30x^2 + 1) \\ G_5(x) &= \frac{1}{72}(72x^5 - 60x^3 + 7x) \\ G_6(x) &= \frac{1}{105}(105x^6 - 105x^4 + 21x^2 - 1) \\ G_7(x) &= \frac{1}{6480}(6480x^7 - 7560x^5 + 2142x^3 - 149x) \\ G_8(x) &= \frac{1}{42525}(42525x^8 - 56700x^6 + 20790x^4 - 2220x^2 - 43) \\ G_9(x) &= \frac{1}{22400}(22400x^9 - 33600x^7 + 15120x^5 - 2280x^3 + 53x). \end{aligned}$$

Because the ROOTS are all REAL for $n \leq 7$ and $n = 9$ only (Hildebrand 1956), these are the only permissible orders for Chebyshev quadrature. The error term is

$$E_n = \begin{cases} c_n \frac{f^{(n+1)}(\xi)}{(n+1)!} & n \text{ odd} \\ c_n \frac{f^{(n+2)}(\xi)}{(n+2)!} & n \text{ even,} \end{cases}$$

where

$$c_n = \begin{cases} \int_{-1}^1 x G_n(x) dx & n \text{ odd} \\ \int_{-1}^1 x^2 G_n(x) dx & n \text{ even.} \end{cases}$$

The first few values of c_n are 2/3, 8/45, 1/15, 32/945, 13/756, and 16/1575 (Hildebrand 1956). Beyer (1987) gives abscissas up to $n = 7$ and Hildebrand (1956) up to $n = 9$.

n	x_i
2	± 0.57735
3	0 ± 0.707107
4	± 0.187592 ± 0.794654
5	0 ± 0.374541 ± 0.832497
6	± 0.266635 ± 0.422519 ± 0.866247
7	0 ± 0.323912 ± 0.529657 ± 0.883862
9	0 ± 0.167906 ± 0.528762 ± 0.601019 ± 0.911589

The ABSCISSAS and weights can be computed analytically for small n .

n	x_i
2	$\pm \frac{1}{3}\sqrt{3}$
3	0 $\pm \frac{1}{2}\sqrt{2}$
4	$\pm \sqrt{\frac{\sqrt{5}-2}{3\sqrt{5}}}$ $\pm \sqrt{\frac{\sqrt{5}+2}{3\sqrt{5}}}$
5	0 $\pm \frac{1}{2}\sqrt{\frac{5-\sqrt{11}}{3}}$ $\pm \frac{1}{2}\sqrt{\frac{5+\sqrt{11}}{3}}$

see also CHEBYSHEV QUADRATURE, LOBATTO QUADRATURE

References

- Beyer, W. H. *CRC Standard Mathematical Tables*, 28th ed. Boca Raton, FL: CRC Press, p. 466, 1987.
Hildebrand, F. B. *Introduction to Numerical Analysis*. New York: McGraw-Hill, pp. 345-351, 1956.

Chebyshev-Radau Quadrature

A GAUSSIAN QUADRATURE-like FORMULA over the interval $[-1, 1]$ which has WEIGHTING FUNCTION $W(x) = x$. The general FORMULA is

$$\int_{-1}^1 xf(x) dx = \sum_{i=1}^n w_i [f(x_i) - f(-x_i)].$$

n	x_i	w_i
1	0.7745967	0.4303315
2	0.5002990	0.2393715
	0.8922365	0.2393715
3	0.4429861	0.1599145
	0.7121545	0.1599145
	0.9293066	0.1599145
4	0.3549416	0.1223363
	0.6433097	0.1223363
	0.7783202	0.1223363
	0.9481574	0.1223363

References

- Beyer, W. H. *CRC Standard Mathematical Tables*, 28th ed. Boca Raton, FL: CRC Press, p. 466, 1987.

Chebyshev Sum Inequality

If

$$a_1 \geq a_2 \geq \dots \geq a_n$$

$$b_1 \geq b_2 \geq \dots \geq b_n,$$

then

$$n \sum_{k=1}^n a_k b_k \geq \left(\sum_{k=1}^n a_k \right) \left(\sum_{k=1}^n b_k \right).$$

This is true for *any* distribution.

see also CAUCHY INEQUALITY, HÖLDER SUM INEQUALITY

References

- Gradshteyn, I. S. and Ryzhik, I. M. *Tables of Integrals, Series, and Products*, 5th ed. San Diego, CA: Academic Press, p. 1092, 1979.
Hardy, G. H.; Littlewood, J. E.; and Pólya, G. *Inequalities*, 2nd ed. Cambridge, England: Cambridge University Press, pp. 43-44, 1988.

Chebyshev-Sylvester Constant

In 1891, Chebyshev and Sylvester showed that for sufficiently large x , there exists at least one prime number p satisfying

$$x < p < (1 + \alpha)x,$$

where $\alpha = 0.092\dots$. Since the PRIME NUMBER THEOREM shows the above inequality is true for all $\alpha > 0$ for sufficiently large x , this constant is only of historical interest.

References

- Le Lionnais, F. *Les nombres remarquables*. Paris: Hermann, p. 22, 1983.

Chebyshev's Theorem

see BERTRAND'S POSTULATE

Checker-Jumping Problem

Seeks the minimum number of checkers placed on a board required to allow pieces to move by a sequence of horizontal or vertical jumps (removing the piece jumped over) n rows beyond the forward-most initial checker. The first few cases are 2, 4, 8, 20. It is, however, impossible to reach level 5.

References

Honsberger, R. *Mathematical Gems II*. Washington, DC: Math. Assoc. Amer., pp. 23–28, 1976.

Checkerboard

see CHESSBOARD

Checkers

Beeler *et al.* (1972, Item 93) estimated that there are about 10^{12} possible positions. However, this disagrees with the estimate of Jon Schaeffer of 5×10^{20} plausible positions, with 10^{18} reachable under the rules of the game. Because “solving” checkers may require only the SQUARE ROOT of the number of positions in the search space (i.e., 10^9), so there is hope that some day checkers may be solved (i.e., it may be possible to guarantee a win for the first player to move before the game is even started; Dubuque 1996).

Depending on how they are counted, the number of EULERIAN CIRCUITS on an $n \times n$ checkerboard are either 1, 40, 793, 12800, 193721, ... (Sloane's A006240) or 1, 13, 108, 793, 5611, 39312, ... (Sloane's A006239).

see also CHECKERBOARD, CHECKER-JUMPING PROBLEM

References

- Beeler, M.; Gosper, R. W.; and Schroepel, R. *HAKMEM*. Cambridge, MA: MIT Artificial Intelligence Laboratory, Memo AIM-239, Feb. 1972.
- Dubuque, W. “Re: number of legal chess positions.” math-fun@cs.arizona.edu posting, Aug 15, 1996.
- Kraitchik, M. “Chess and Checkers” and “Checkers (Draughts).” §12.1.1 and 12.1.10 in *Mathematical Recreations*. New York: W. W. Norton, pp. 267–276 and 284–287, 1942.
- Schaeffer, J. *One Jump Ahead: Challenging Human Supremacy in Checkers*. New York: Springer-Verlag, 1997.
- Sloane, N. J. A. Sequences A006239/M4909 and A006240/M5271 in “An On-Line Version of the Encyclopedia of Integer Sequences.”

Checksum

A sum of the digits in a given transmission modulo some number. The simplest form of checksum is a parity bit appended on to 7-bit numbers (e.g., ASCII characters) such that the total number of 1s is always EVEN (“even parity”) or ODD (“odd parity”). A significantly more sophisticated checksum is the CYCLIC REDUNDANCY CHECK (or CRC), which is based on the algebra of polynomials over the integers (mod 2). It is substantially more reliable in detecting transmission errors, and is one common error-checking protocol used in modems.

see also CYCLIC REDUNDANCY CHECK, ERROR-CORRECTING CODE

References

Press, W. H.; Flannery, B. P.; Teukolsky, S. A.; and Vetterling, W. T. “Cyclic Redundancy and Other Checksums.” Ch. 20.3 in *Numerical Recipes in FORTRAN: The Art of Scientific Computing*, 2nd ed. Cambridge, England: Cambridge University Press, pp. 888–895, 1992.

Cheeger's Finiteness Theorem

Consider the set of compact n -RIEMANNIAN MANIFOLDS M with $\text{diameter}(M) \leq d$, $\text{Volume}(M) \geq V$, and $|\mathcal{K}| \leq \kappa$ where κ is the SECTIONAL CURVATURE. Then there is a bound on the number of DIFFEOMORPHISMS classes of this set in terms of the constants n , d , V , and κ .

References

Chavel, I. *Riemannian Geometry: A Modern Introduction*. New York: Cambridge University Press, 1994.

Chefalo Knot

A fake KNOT created by tying a SQUARE KNOT, then looping one end twice through the KNOT such that when both ends are pulled, the KNOT vanishes.

Chen's Theorem

Every “large” EVEN INTEGER may be written as $2n = p + m$ where p is a PRIME and $m \in P_2$ is the SET of SEMIPRIMES (i.e., 2-ALMOST PRIMES).

see also ALMOST PRIME, PRIME NUMBER, SEMIPRIME

References

Rivera, C. “Problems & Puzzles (Conjectures): Chen's Conjecture.” http://www.sci.net.mx/~crivera/ppp/conj_002.htm.

Chern Class

A GADGET defined for COMPLEX VECTOR BUNDLES. The Chern classes of a COMPLEX MANIFOLD are the Chern classes of its TANGENT BUNDLE. The i th Chern class is an OBSTRUCTION to the existence of $(n - i + 1)$ everywhere COMPLEX linearly independent VECTOR FIELDS on that VECTOR BUNDLE. The i th Chern class is in the $(2i)$ th cohomology group of the base SPACE.

see also OBSTRUCTION, PONTRYAGIN CLASS, STIEFEL-WHITNEY CLASS

Chern Number

The Chern number is defined in terms of the CHERN CLASS of a MANIFOLD as follows. For any collection CHERN CLASSES such that their cup product has the same DIMENSION as the MANIFOLD, this cup product can be evaluated on the MANIFOLD's FUNDAMENTAL CLASS. The resulting number is called the Chern number for that combination of Chern classes. The most important aspect of Chern numbers is that they are COBORDISM invariant.

see also PONTRYAGIN NUMBER, STIEFEL-WHITNEY NUMBER

Chernoff Face

A way to display n variables on a 2-D surface. For instance, let x be eyebrow slant, y be eye size, z be nose length, etc.

References

Gonick, L. and Smith, W. *The Cartoon Guide to Statistics*. New York: Harper Perennial, p. 212, 1993.

Chess

Chess is a game played on an 8×8 board, called a CHESSBOARD, of alternating black and white squares. Pieces with different types of allowed moves are placed on the board, a set of black pieces in the first two rows and a set of white pieces in the last two rows. The pieces are called the bishop (2), king (1), knight (2), pawn (8), queen (1), and rook (2). The object of the game is to capture the opponent's king. It is believed that chess was played in India as early as the sixth century AD.

In a game of 40 moves, the number of possible board positions is at least 10^{120} according to Peterson (1996). However, this value does not agree with the 10^{40} possible positions given by Beeler *et al.* (1972, Item 95). This value was obtained by estimating the number of pawn positions (in the no-captures situation, this is 15^8), times all pieces in all positions, dividing by 2 for each of the (rook, knight) which are interchangeable, dividing by 2 for each pair of bishops (since half the positions will have the bishops on the same color squares). There are more positions with one or two captures, since the pawns can then switch columns (Schroeppel 1996). Shannon (1950) gave the value

$$P(40) \approx \frac{64!}{32!(8!)^2(2!)^6} \approx 10^{43}.$$

The number of chess games which end in exactly n plies (including games that mate in fewer than n plies) for $n = 1, 2, 3, \dots$ are 20, 400, 8902, 197742, 4897256, 119060679, 3195913043, ... (K. Thompson, Sloane's A007545). Rex Stout's fictional detective Nero Wolfe quotes the number of possible games after ten moves as follows: "Wolfe grunted. One hundred and sixty-nine million, five hundred and eighteen thousand, eight hundred and twenty-nine followed by twenty-one ciphers. The number of ways the first ten moves, both sides, may be played" (Stout 1983). The number of chess positions after n moves for $n = 1, 2, \dots$ are 20, 400, 5362, 71852, 809896?, 9132484?, ... (Schwarzkopf 1994, Sloane's A019319).

Cunningham (1889) incorrectly found 197,299 games and 71,782 positions after the fourth move. C. Flye St. Marie was the first to find the correct number of positions after four moves: 71,852. Dawson (1946) gives the source as *Intermediare des Mathematiques* (1895), but K. Fabel writes that Flye St. Marie corrected the number 71,870 (which he found in 1895) to 71,852 in

1903. The history of the determination of the chess sequences is discussed in Schwarzkopf (1994).

Two problems in recreational mathematics ask

1. How many pieces of a given type can be placed on a CHESSBOARD without any two attacking.
2. What is the smallest number of pieces needed to occupy or attack every square.

The answers are given in the following table (Madachy 1979).

Piece	Max.	Min.
bishops	14	8
kings	16	9
knight	32	12
queens	8	5
rooks	8	8

see also BISHOPS PROBLEM, CHECKERBOARD, CHECKERS, FAIRY CHESS, GO, GOMORY'S THEOREM, HARD HEXAGON ENTROPY CONSTANT, KINGS PROBLEM, KNIGHT'S TOUR, MAGIC TOUR, QUEENS PROBLEM, ROOKS PROBLEM, TOUR

References

- Ball, W. W. R. and Coxeter, H. S. M. *Mathematical Recreations and Essays*, 13th ed. New York: Dover, pp. 124–127, 1987.
- Beeler, M.; Gosper, R. W.; and Schroeppel, R. *HAKMEM*. Cambridge, MA: MIT Artificial Intelligence Laboratory, Memo AIM-239, Feb. 1972.
- Dawson, T. R. "A Surprise Correction." *The Fairy Chess Review* 6, 44, 1946.
- Dickins, A. "A Guide to Fairy Chess." p. 28, 1967/1969/1971.
- Dudeney, H. E. "Chessboard Problems." *Amusements in Mathematics*. New York: Dover, pp. 84–109, 1970.
- Fabel, K. "Nüsse." *Die Schwalbe* 84, 196, 1934.
- Fabel, K. "Weihnachtsnüsse." *Die Schwalbe* 100, 97, 1947.
- Fabel, K. "Weihnachtsnüsse." *Die Schwalbe* 195, 14, 1948.
- Fabel, K. "Eröffnungen." *Am Rande des Schachbretts*, 34–35, 1947.
- Fabel, K. "Die ersten Schritte." *Rund um das Schachbrett*, 107–109, 1955.
- Fabel, K. "Eröffnungen." *Schach und Zahl* 8, 1966/1971.
- Hunter, J. A. H. and Madachy, J. S. *Mathematical Diversions*. New York: Dover, pp. 86–89, 1975.
- Kraitchik, M. "Chess and Checkers." §12.1.1 in *Mathematical Recreations*. New York: W. W. Norton, pp. 267–276, 1942.
- Madachy, J. S. "Chessboard Placement Problems." Ch. 2 in *Madachy's Mathematical Recreations*. New York: Dover, pp. 34–54, 1979.
- Peterson, I. "The Soul of a Chess Machine: Lessons Learned from a Contest Pitting Man Against Computer." *Sci. News* 149, 200–201, Mar. 30, 1996.
- Petković, M. *Mathematics and Chess*. New York: Dover, 1997.
- Schroeppel, R. "Reprise: Number of legal chess positions." tech-news@cs.arizona.edu posting, Aug. 18, 1996.
- Schwarzkopf, B. "Die ersten Züge." *Problemkiste*, 142–143, No. 92, Apr. 1994.
- Shannon, C. "Programming a Computer for Playing Chess." *Phil. Mag.* 41, 256–275, 1950.
- Sloane, N. J. A. Sequences A019319 and A007545/M5100 in "An On-Line Version of the Encyclopedia of Integer Sequences."

Stout, R. "Gambit." In *Seven Complete Nero Wolfe Novels*. New York: Avenic Books, p. 475, 1983.

Chessboard

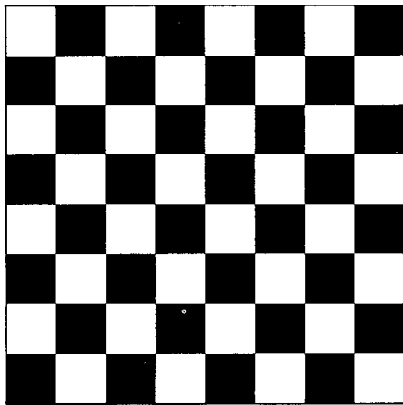

A board containing 8×8 squares alternating in color between black and white on which the game of CHESS is played. The checkerboard is identical to the chessboard except that chess's black and white squares are colored red and white in CHECKERS. It is impossible to cover a chessboard from which two opposite corners have been removed with DOMINOES.

see also CHECKERS, CHESS, DOMINO, GOMORY'S THEOREM, WHEAT AND CHESSBOARD PROBLEM

References

Pappas, T. "The Checkerboard." *The Joy of Mathematics*. San Carlos, CA: Wide World Publ./Tetra, pp. 136 and 232, 1989.

Chevalley Groups

Finite SIMPLE GROUPS of LIE-TYPE. They include four families of linear SIMPLE GROUPS: $PSL(n, q)$, $PSU(n, q)$, $PSp(2n, q)$, or $P\Omega^\epsilon(n, q)$.

see also TWISTED CHEVALLEY GROUPS

References

Wilson, R. A. "ATLAS of Finite Group Representation." <http://for.mat.bham.ac.uk/atlas#chev>.

Chevalley's Theorem

Let $f(x)$ be a member of a FINITE FIELD $F[x_1, x_2, \dots, x_n]$ and suppose $f(0, 0, \dots, 0) = 0$ and n is greater than the degree of f , then f has at least two zeros in $A^n(F)$.

References

Chevalley, C. "Démonstration d'une hypothèse de M. Artin." *Abhand. Math. Sem. Hamburg* 11, 73–75, 1936.
Ireland, K. and Rosen, M. "Chevalley's Theorem." §10.2 in *A Classical Introduction to Modern Number Theory*, 2nd ed. New York: Springer-Verlag, pp. 143–144, 1990.

Chevron

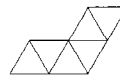

A 6-POLYIAMOND.

References

Golomb, S. W. *Polyominoes: Puzzles, Patterns, Problems, and Packings*, 2nd ed. Princeton, NJ: Princeton University Press, p. 92, 1994.

Chi

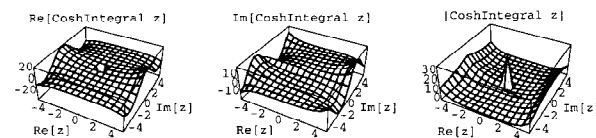
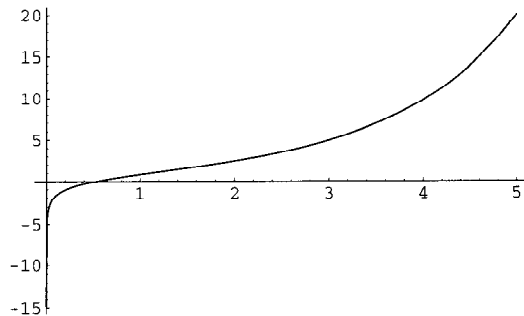

$$\text{Chi}(z) = \gamma + \ln z + \int_0^z \frac{\cosh t - 1}{t} dt,$$

where γ is the EULER-MASCHERONI CONSTANT. The function is given by the *Mathematica*® (Wolfram Research, Champaign, IL) command `CoshIntegral[z]`.

see also COSINE INTEGRAL, SHI, SINE INTEGRAL

References

Abramowitz, M. and Stegun, C. A. (Eds.). "Sine and Cosine Integrals." §5.2 in *Handbook of Mathematical Functions with Formulas, Graphs, and Mathematical Tables*, 9th printing. New York: Dover, pp. 231–233, 1972.

Chi Distribution

The probability density function and cumulative distribution function are

$$P_n(x) = \frac{2^{1-n/2} x^{n-1} e^{-x^2/2}}{\Gamma(\frac{1}{2}n)} \quad (1)$$

$$D_n(x) = Q(\frac{1}{2}n, \frac{1}{2}x^2), \quad (2)$$

where Q is the REGULARIZED GAMMA FUNCTION.

$$\mu = \frac{\sqrt{2}\Gamma(\frac{1}{2}(n+1))}{\Gamma(\frac{1}{2}n)} \quad (3)$$

$$\sigma^2 = \frac{2[\Gamma(\frac{1}{2}n)\Gamma(1+\frac{1}{2}n) - \Gamma^2(\frac{1}{2}(n+1))]}{\Gamma^2(\frac{1}{2}n)} \quad (4)$$

$$\gamma_1 = \frac{2\Gamma^3(\frac{1}{2}(n+1)) - 3\Gamma(\frac{1}{2}n)\Gamma(\frac{1}{2}(n+1))\Gamma(1+\frac{1}{2}n)}{[\Gamma(\frac{1}{2}n)\Gamma(1+\frac{1}{2}n) - \Gamma^2(\frac{1}{2}(n+1))]^{3/2}}$$

$$\begin{aligned}
& + \frac{\Gamma^2(\frac{1}{2}n)\Gamma(\frac{3+n}{2})}{[\Gamma(\frac{1}{2}n)\Gamma(1+\frac{1}{2}n) - \Gamma^2(\frac{1}{2}(n+1))]^{3/2}} \quad (5) \\
\gamma_2 = & \frac{-3\Gamma^4(\frac{1}{2}(n+1)) + 6\Gamma(\frac{1}{2}n) + \Gamma^2(\frac{1}{2}(n+1))\Gamma(1+\frac{1}{2}n)}{[\Gamma(\frac{1}{2}n)\Gamma(\frac{2+n}{2}) - \Gamma^2(\frac{1}{2}(n+1))]^2} \\
& + \frac{-4\Gamma^2(\frac{1}{2}n)\Gamma(\frac{1}{2}(n+1))\Gamma(\frac{3+n}{2}) + \Gamma^3(\frac{1}{2}n)\Gamma(\frac{4+n}{2})}{[\Gamma(\frac{1}{2}n)\Gamma(\frac{2+n}{2}) - \Gamma^2(\frac{1}{2}(n+1))]^2}, \quad (6)
\end{aligned}$$

where μ is the MEAN, σ^2 the VARIANCE, γ_1 the SKEWNESS, and γ_2 the KURTOSIS. For $n = 1$, the χ distribution is a HALF-NORMAL DISTRIBUTION with $\theta = 1$. For $n = 2$, it is a RAYLEIGH DISTRIBUTION with $\sigma = 1$.

see also CHI-SQUARED DISTRIBUTION, HALF-NORMAL DISTRIBUTION, RAYLEIGH DISTRIBUTION

Chi Inequality

The inequality

$$(j+1)a_j + a_i \geq (j+1)i,$$

which is satisfied by all *A*-SEQUENCES.

References

Levine, E. and O'Sullivan, J. "An Upper Estimate for the Reciprocal Sum of a Sum-Free Sequence." *Acta Arith.* **34**, 9-24, 1977.

Chi-Squared Distribution

A χ^2 distribution is a GAMMA DISTRIBUTION with $\theta \equiv 2$ and $\alpha \equiv r/2$, where r is the number of DEGREES OF FREEDOM. If Y_i have NORMAL INDEPENDENT distributions with MEAN 0 and VARIANCE 1, then

$$\chi^2 \equiv \sum_{i=1}^n Y_i^2 \quad (1)$$

is distributed as χ^2 with n DEGREES OF FREEDOM. If χ_i^2 are independently distributed according to a χ^2 distribution with n_1, n_2, \dots, n_k DEGREES OF FREEDOM, then

$$\sum_{j=1}^k \chi_j^2 \quad (2)$$

is distributed according to χ^2 with $n \equiv \sum_{j=1}^n n_j$ DEGREES OF FREEDOM.

$$P_n(x) = \begin{cases} \frac{x^{r/2-1}e^{-x/2}}{\Gamma(\frac{1}{2}r)2^{r/2}} & \text{for } 0 \leq x < \infty \\ 0 & \text{for } x < 0. \end{cases} \quad (3)$$

The cumulative distribution function is then

$$\begin{aligned}
D_n(\chi^2) &= \int_0^{\chi^2} \frac{t^{r/2-1}e^{-t/2} dt}{\Gamma(\frac{1}{2}r)2^{r/2}} \\
&= \frac{\gamma(\frac{1}{2}n, \frac{1}{2}\chi^2)}{\Gamma(\frac{1}{2}n)} = P(\frac{1}{2}n, \frac{1}{2}\chi^2), \quad (4)
\end{aligned}$$

where $P(a, z)$ is a REGULARIZED GAMMA FUNCTION. The CONFIDENCE INTERVALS can be found by finding the value of x for which $D_n(x)$ equals a given value. The MOMENT-GENERATING FUNCTION of the χ^2 distribution is

$$M(t) = (1 - 2t)^{-r/2} \quad (5)$$

$$R(t) \equiv \ln M(t) = -\frac{1}{2}r \ln(1 - 2t) \quad (6)$$

$$R'(t) = \frac{r}{1 - 2t} \quad (7)$$

$$R''(t) = \frac{2r}{(1 - 2t)^2}, \quad (8)$$

so

$$\mu = R'(0) = r \quad (9)$$

$$\sigma^2 = R''(0) = 2r \quad (10)$$

$$\gamma_1 = 2\sqrt{\frac{2}{r}} \quad (11)$$

$$\gamma_2 = \frac{12}{r}. \quad (12)$$

The n th MOMENT about zero for a distribution with n DEGREES OF FREEDOM is

$$m'_n = 2^n \frac{\Gamma(n + \frac{1}{2}r)}{\Gamma(\frac{1}{2}r)} = r(r+2) \cdots (r+2n-2), \quad (13)$$

and the moments about the MEAN are

$$\mu_2 = 2r \quad (14)$$

$$\mu_3 = 8r \quad (15)$$

$$\mu_4 = 12n^2 + 48n. \quad (16)$$

The n th CUMULANT is

$$\kappa_n = 2^n \Gamma(n)(\frac{1}{2}r) = 2^{n-1}(n-1)!r. \quad (17)$$

The MOMENT-GENERATING FUNCTION is

$$\begin{aligned}
M(t) &= e^{rt/\sqrt{2r}} \left(1 - \frac{2t}{\sqrt{2r}}\right)^{-r/2} \\
&= \left[e^{t\sqrt{2/r}} \left(1 - \sqrt{\frac{2}{r}}t\right) \right]^{-r/2} \\
&= \left[1 - \frac{t^2}{r} - \frac{1}{3} \left(\frac{2}{r}\right)^{3/2} t^3 - \dots \right]^{-r/2}. \quad (18)
\end{aligned}$$

As $r \rightarrow \infty$,

$$\lim_{r \rightarrow \infty} M(t) = e^{t^2/2}, \quad (19)$$

so for large r ,

$$\sqrt{2\chi^2} = \sqrt{\sum_i \frac{(x_i - \mu_i)^2}{\sigma_i^2}} \quad (20)$$

is approximately a GAUSSIAN DISTRIBUTION with MEAN $\sqrt{2r}$ and VARIANCE $\sigma^2 = 1$. Fisher showed that

$$\frac{\chi^2 - r}{\sqrt{2r - 1}} \quad (21)$$

is an improved estimate for moderate r . Wilson and Hilferty showed that

$$\left(\frac{\chi^2}{r}\right)^{1/3} \quad (22)$$

is a nearly GAUSSIAN DISTRIBUTION with MEAN $\mu = 1 - 2/(9r)$ and VARIANCE $\sigma^2 = 2/(9r)$.

In a GAUSSIAN DISTRIBUTION,

$$P(x) dx = \frac{1}{\sigma\sqrt{2\pi}} e^{-(x-\mu)^2/2\sigma^2} dx, \quad (23)$$

let

$$z \equiv (x - \mu)^2 / \sigma^2. \quad (24)$$

Then

$$dz = \frac{2(x - \mu)}{\sigma^2} dx = \frac{2\sqrt{z}}{\sigma} dx \quad (25)$$

so

$$dx = \frac{\sigma}{2\sqrt{z}} dz. \quad (26)$$

But

$$P(z) dz = 2P(x) dx, \quad (27)$$

so

$$P(x) dx = 2 \frac{1}{\sigma\sqrt{2\pi}} e^{-z/2} dz = \frac{1}{\sigma\sqrt{\pi}} e^{-z/2} dz. \quad (28)$$

This is a χ^2 distribution with $r = 1$, since

$$P(z) dz = \frac{z^{1/2-1} e^{-z/2}}{\Gamma(\frac{1}{2})2^{1/2}} dz = \frac{x^{-1/2} e^{-1/2}}{\sqrt{2\pi}} dz. \quad (29)$$

If X_i are independent variates with a NORMAL DISTRIBUTION having MEANS μ_i and VARIANCES σ_i^2 for $i = 1, \dots, n$, then

$$\frac{1}{2}\chi^2 \equiv \sum_{i=1}^n \frac{(x_i - \mu_i)^2}{2\sigma_i^2} \quad (30)$$

is a GAMMA DISTRIBUTION variate with $\alpha = n/2$,

$$P(\frac{1}{2}\chi^2) d(\frac{1}{2}\chi^2) = \frac{1}{\Gamma(\frac{1}{2}n)} e^{-\chi^2/2} (\frac{1}{2}\chi^2)^{(n/2)-1} d(\frac{1}{2}\chi^2). \quad (31)$$

The noncentral chi-squared distribution is given by

$$P(x) = 2^{-n/2} e^{-(\lambda+x)/2} x^{n/2-1} F(\frac{1}{2}n, \frac{1}{4}\lambda x), \quad (32)$$

where

$$F(a, z) \equiv \frac{{}_0F_1(; a; z)}{\Gamma(a)}, \quad (33)$$

${}_0F_1$ is the CONFLUENT HYPERGEOMETRIC LIMIT FUNCTION and Γ is the GAMMA FUNCTION. The MEAN, VARIANCE, SKEWNESS, and KURTOSIS are

$$\mu = \lambda + n \quad (34)$$

$$\sigma^2 = 2(2\lambda + n) \quad (35)$$

$$\gamma_1 = \frac{2\sqrt{2}(3\lambda + n)}{(2\lambda + n)^{3/2}} \quad (36)$$

$$\gamma_2 = \frac{12(4\lambda + n)}{(2\lambda + n)^2}. \quad (37)$$

see also CHI DISTRIBUTION, SNEDECOR'S F -DISTRIBUTION

References

- Abramowitz, M. and Stegun, C. A. (Eds.). *Handbook of Mathematical Functions with Formulas, Graphs, and Mathematical Tables*, 9th printing. New York: Dover, pp. 940-943, 1972.
- Beyer, W. H. *CRC Standard Mathematical Tables*, 28th ed. Boca Raton, FL: CRC Press, p. 535, 1987.
- Press, W. H.; Flannery, B. P.; Teukolsky, S. A.; and Vetterling, W. T. "Incomplete Gamma Function, Error Function, Chi-Square Probability Function, Cumulative Poisson Function." §6.2 in *Numerical Recipes in FORTRAN: The Art of Scientific Computing*, 2nd ed. Cambridge, England: Cambridge University Press, pp. 209-214, 1992.
- Spiegel, M. R. *Theory and Problems of Probability and Statistics*. New York: McGraw-Hill, pp. 115-116, 1992.

Chi-Squared Test

Let the probabilities of various classes in a distribution be p_1, p_2, \dots, p_k . The expected frequency

$$\chi_s^2 = \sum_{i=1}^k \frac{(m_i - Np_i)^2}{Np_i}$$

is a measure of the deviation of a sample from expectation. Karl Pearson proved that the limiting distribution of χ_s^2 is χ^2 (Kenney and Keeping 1951, pp. 114-116).

$$\begin{aligned} \Pr(\chi^2 \geq \chi_s^2) &= \int_{\chi_s^2}^{\infty} f(\chi^2) d(\chi^2) \\ &= \frac{1}{2} \int_{\chi_s^2}^{\infty} \frac{\left(\frac{\chi^2}{2}\right)^{(k-3)/2}}{\Gamma\left(\frac{k-1}{2}\right)} e^{-\chi^2/2} d(\chi^2) \\ &= 1 - \frac{\Gamma\left(\frac{1}{2}\chi_s^2, \frac{k-1}{2}\right)}{\Gamma\left(\frac{k-1}{2}\right)} \\ &= 1 - I\left(\frac{\chi_s^2}{\sqrt{2(k-1)}}, \frac{k-3}{2}\right), \end{aligned}$$

where $I(x, n)$ is PEARSON'S FUNCTION. There are some subtleties involved in using the χ^2 test to fit curves (Kenney and Keeping 1951, pp. 118-119).

When fitting a one-parameter solution using χ^2 , the best-fit parameter value can be found by calculating χ^2

at three points, plotting against the parameter values of these points, then finding the minimum of a PARABOLA fit through the points (Cuzzi 1972, pp. 162–168).

References

- Cuzzi, J. *The Subsurface Nature of Mercury and Mars from Thermal Microwave Emission*. Ph.D. Thesis. Pasadena, CA: California Institute of Technology, 1972.
 Kenney, J. F. and Keeping, E. S. *Mathematics of Statistics*, Pt. 2, 2nd ed. Princeton, NJ: Van Nostrand, 1951.

Child

A node which is one EDGE further away from a given EDGE in a ROOTED TREE.

see also ROOT (TREE), ROOTED TREE, SIBLING

Chinese Hypothesis

A PRIME p always satisfies the condition that $2^p - 2$ is divisible by p . However, this condition is not true *exclusively* for PRIME (e.g., $2^{341} - 2$ is divisible by $341 = 11 \cdot 31$). COMPOSITE NUMBERS n (such as 341) for which $2^n - 2$ is divisible by n are called POULET NUMBERS, and are a special class of FERMAT PSEUDOPRIMES. The Chinese hypothesis is a special case of FERMAT'S LITTLE THEOREM.

see also CARMICHAEL NUMBER, EULER'S THEOREM, FERMAT'S LITTLE THEOREM, FERMAT PSEUDOPRIME, POULET NUMBER, PSEUDOPRIME

References

- Shanks, D. *Solved and Unsolved Problems in Number Theory*, 4th ed. New York: Chelsea, pp. 19–20, 1993.

Chinese Remainder Theorem

Let r and s be POSITIVE INTEGERS which are RELATIVELY PRIME and let a and b be any two INTEGERS. Then there is an INTEGER N such that

$$N \equiv a \pmod{r} \quad (1)$$

and

$$N \equiv b \pmod{s}. \quad (2)$$

Moreover, N is uniquely determined modulo rs . An equivalent statement is that if $(r, s) = 1$, then every pair of RESIDUE CLASSES modulo r and s corresponds to a simple RESIDUE CLASS modulo rs .

The theorem can also be generalized as follows. Given a set of simultaneous CONGRUENCES

$$x \equiv a_i \pmod{m_i} \quad (3)$$

for $i = 1, \dots, r$ and for which the m_i are pairwise RELATIVELY PRIME, the solution of the set of CONGRUENCES is

$$x = a_1 b_1 \frac{M}{m_1} + \dots + a_r b_r \frac{M}{m_r} \pmod{M}, \quad (4)$$

where

$$M \equiv m_1 m_2 \cdots m_r \quad (5)$$

and the b_i are determined from

$$b_i \frac{M}{m_i} \equiv 1 \pmod{m_i}. \quad (6)$$

References

- Ireland, K. and Rosen, M. "The Chinese Remainder Theorem." §3.4 in *A Classical Introduction to Modern Number Theory*, 2nd ed. New York: Springer-Verlag, pp. 34–38, 1990.
 Uspensky, J. V. and Heaslet, M. A. *Elementary Number Theory*. New York: McGraw-Hill, pp. 189–191, 1939.
 Wagon, S. "The Chinese Remainder Theorem." §8.4 in *Mathematics in Action*. New York: W. H. Freeman, pp. 260–263, 1991.

Chinese Rings

see BAGUENAUDIER

Chiral

Having forms of different HANDEDNESS which are not mirror-symmetric.

see also DISYMMETRIC, ENANTIOMER, HANDEDNESS, MIRROR IMAGE, REFLEXIBLE

Choice Axiom

see AXIOM OF CHOICE

Choice Number

see COMBINATION

Cholesky Decomposition

Given a symmetric POSITIVE DEFINITE MATRIX A , the Cholesky decomposition is an upper TRIANGULAR MATRIX U such that

$$A = U^T U.$$

see also LU DECOMPOSITION, QR DECOMPOSITION

References

- Nash, J. C. "The Choleski Decomposition." Ch. 7 in *Compact Numerical Methods for Computers: Linear Algebra and Function Minimisation*, 2nd ed. Bristol, England: Adam Hilger, pp. 84–93, 1990.
 Press, W. H.; Flannery, B. P.; Teukolsky, S. A.; and Vetterling, W. T. "Cholesky Decomposition." §2.9 in *Numerical Recipes in FORTRAN: The Art of Scientific Computing*, 2nd ed. Cambridge, England: Cambridge University Press, pp. 89–91, 1992.

Choose

An alternative term for a BINOMIAL COEFFICIENT, in which $\binom{n}{k}$ is read as " n choose k ." R. K. Guy suggested this pronunciation around 1950, when the notations nC_r and ${}_nC_r$ were commonly used. Leo Moser liked the pronunciation and he and others spread it around. It got the final seal of approval from Donald Knuth when he incorporated it into the TeX mathematical typesetting language as `{n\choose k}`.

Choquet Theory

Erdős proved that there exist at least one PRIME of the form $4k + 1$ and at least one PRIME of the form $4k + 3$ between n and $2n$ for all $n > 6$.

see also EQUINUMEROUS, PRIME NUMBER

Chord

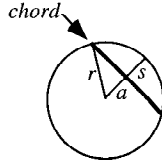

The LINE SEGMENT joining two points on a curve. The term is often used to describe a LINE SEGMENT whose ends lie on a CIRCLE. In the above figure, r is the RADIUS of the CIRCLE, a is called the APOTHEM, and s the SAGITTA.

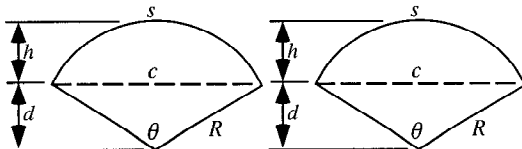

The shaded region in the left figure is called a SECTOR, and the shaded region in the right figure is called a SEGMENT.

All ANGLES inscribed in a CIRCLE and subtended by the same chord are equal. The converse is also true: The LOCUS of all points from which a given segment subtends equal ANGLES is a CIRCLE.

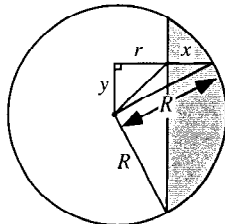

Let a CIRCLE of RADIUS R have a CHORD at distance r . The AREA enclosed by the CHORD, shown as the shaded region in the above figure, is then

$$A = 2 \int_0^{\sqrt{R^2 - r^2}} x(y) dy. \quad (1)$$

But

$$y^2 + (r + x)^2 = R^2, \quad (2)$$

so

$$x(y) = \sqrt{R^2 - y^2} - r \quad (3)$$

and

$$\begin{aligned} A &= 2 \int_0^{\sqrt{R^2 - r^2}} (\sqrt{R^2 - y^2} - r) dy \\ &= \left[y\sqrt{R^2 - y^2} + R^2 \tan^{-1} \left(\frac{y}{\sqrt{R^2 - y^2}} \right) - 2ry \right]_0^{\sqrt{R^2 - r^2}} \\ &= r\sqrt{R^2 - r^2} + R^2 \tan^{-1} \left[\left(\frac{R}{r} \right)^2 - 1 \right] - 2r\sqrt{R^2 - r^2} \\ &= R^2 \tan^{-1} \left[\left(\frac{R}{r} \right)^2 - 1 \right] - r\sqrt{R^2 - r^2}. \end{aligned} \quad (4)$$

Checking the limits, when $r = R$, $A = 0$ and when $r \rightarrow 0$,

$$A = \frac{1}{2} \pi R^2, \quad (5)$$

see also ANNULUS, APOTHEM, BERTRAND'S PROBLEM, CONCENTRIC CIRCLES, RADIUS, SAGITTA, SECTOR, SEGMENT

Chordal

see RADICAL AXIS

Chordal Theorem

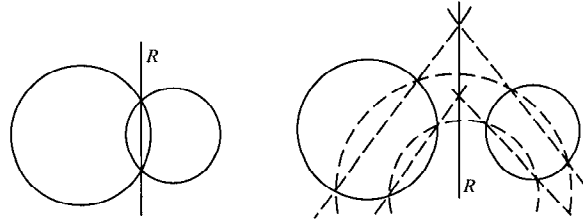

The LOCUS of the point at which two given CIRCLES possess the same POWER is a straight line PERPENDICULAR to the line joining the MIDPOINTS of the CIRCLE and is known as the chordal (or RADICAL AXIS) of the two CIRCLES.

References

Dörrie, H. *100 Great Problems of Elementary Mathematics: Their History and Solutions*. New York: Dover, p. 153, 1965.

Chow Coordinates

A generalization of GRASSMANN COORDINATES to m -D varieties of degree d in P^n , where P^n is an n -D projective space. To define the Chow coordinates, take the intersection of a m -D VARIETY Z of degree d by an $(n - m)$ -D SUBSPACE U of P^n . Then the coordinates of the d points of intersection are algebraic functions of the GRASSMANN COORDINATES of U , and by taking a symmetric function of the algebraic functions, a hHOMOGENEOUS POLYNOMIAL known as the Chow form of Z is obtained. The Chow coordinates are then

the COEFFICIENTS of the Chow form. Chow coordinates can generate the smallest field of definition of a divisor.

References

- Chow, W.-L. and van der Waerden., B. L. "Zur algebraische Geometrie IX." *Math. Ann.* **113**, 692–704, 1937.
 Wilson, W. S.; Chern, S. S.; Abhyankar, S. S.; Lang, S.; and Igusa, J.-I. "Wei-Liang Chow." *Not. Amer. Math. Soc.* **43**, 1117–1124, 1996.

Chow Ring

The intersection product for classes of rational equivalence between cycles on an ALGEBRAIC VARIETY.

References

- Chow, W.-L. "On Equivalence Classes of Cycles in an Algebraic Variety." *Ann. Math.* **64**, 450–479, 1956.
 Wilson, W. S.; Chern, S. S.; Abhyankar, S. S.; Lang, S.; and Igusa, J.-I. "Wei-Liang Chow." *Not. Amer. Math. Soc.* **43**, 1117–1124, 1996.

Chow Variety

The set $C_{n,m,d}$ of all m -D varieties of degree d in an n -D projective space P^n into an M -D projective space P^M .

References

- Wilson, W. S.; Chern, S. S.; Abhyankar, S. S.; Lang, S.; and Igusa, J.-I. "Wei-Liang Chow." *Not. Amer. Math. Soc.* **43**, 1117–1124, 1996.

Christoffel-Darboux Formula

For three consecutive ORTHOGONAL POLYNOMIALS

$$p_n(x) = (A_n x + B_n)p_{n-1}(x) - C_n p_{n-2}(x) \quad (1)$$

for $n = 2, 3, \dots$, where $A_n > 0$, B_n , and $C_n > 0$ are constants. Denoting the highest COEFFICIENT of $p_n(x)$ by k_n ,

$$A_n = \frac{k_n}{k_{n-1}} \quad (2)$$

$$C_n = \frac{A_n}{A_{n-1}} = \frac{k_n k_{n-2}}{k_{n-1}^2}. \quad (3)$$

Then

$$\begin{aligned} p_0(x)p_0(y) + \dots + p_n(x)p_n(y) \\ = \frac{k_n}{k_{n+1}} \frac{p_{n+1}(x)p_n(y) - p_n(x)p_{n+1}(y)}{x - y}. \end{aligned} \quad (4)$$

In the special case of $x = y$, (4) gives

$$\begin{aligned} [p_0(x)]^2 + \dots + [p_n(x)]^2 \\ = \frac{k_n}{k_{n+1}} [p'_{n+1}(x)p_n(x) - p'_n(x)p_{n+1}(x)]. \end{aligned} \quad (5)$$

References

- Abramowitz, M. and Stegun, C. A. (Eds.). *Handbook of Mathematical Functions with Formulas, Graphs, and Mathematical Tables*, 9th printing. New York: Dover, p. 785, 1972.
 Szegő, G. *Orthogonal Polynomials*, 4th ed. Providence, RI: Amer. Math. Soc., pp. 42–44, 1975.

Christoffel-Darboux Identity

$$\sum_{k=0}^{\infty} \frac{\phi_k(x)\phi_k(y)}{\gamma_k} = \frac{\phi_{m+1}(x)\phi_m(y) - \phi_m(x)\phi_{m+1}(y)}{a_m \gamma_m (x - y)}, \quad (1)$$

where $\phi_k(x)$ are ORTHOGONAL POLYNOMIALS with WEIGHTING FUNCTION $W(x)$,

$$\gamma_m \equiv \int [\phi_m(x)]^2 W(x) dx, \quad (2)$$

and

$$a_k \equiv \frac{A_{k+1}}{A_k} \quad (3)$$

where A_k is the COEFFICIENT of x^k in $\phi_k(x)$.

References

- Hildebrand, F. B. *Introduction to Numerical Analysis*. New York: McGraw-Hill, p. 322, 1956.

Christoffel Formula

Let $\{p_n(x)\}$ be orthogonal POLYNOMIALS associated with the distribution $d\alpha(x)$ on the interval $[a, b]$. Also let

$$\rho \equiv c(x - x_1)(x - x_2) \cdots (x - x_l)$$

(for $c \neq 0$) be a POLYNOMIAL of order l which is NONNEGATIVE in this interval. Then the orthogonal POLYNOMIALS $\{q(x)\}$ associated with the distribution $\rho(x) d\alpha(x)$ can be represented in terms of the POLYNOMIALS $p_n(x)$ as

$$\rho(x)q_n(x) = \begin{vmatrix} p_n(x) & p_{n+1}(x) & \cdots & p_{n+l}(x) \\ p_n(x_1) & p_{n+1}(x_1) & \cdots & p_{n+l}(x_1) \\ \vdots & \vdots & \ddots & \vdots \\ p_n(x_l) & p_{n+1}(x_l) & \cdots & p_{n+l}(x_l) \end{vmatrix}.$$

In the case of a zero x_k of multiplicity $m > 1$, we replace the corresponding rows by the derivatives of order 0, 1, 2, \dots , $m - 1$ of the POLYNOMIALS $p_n(x_1), \dots, p_{n+l}(x_l)$ at $x = x_k$.

References

- Szegő, G. *Orthogonal Polynomials*, 4th ed. Providence, RI: Amer. Math. Soc., pp. 29–30, 1975.

Christoffel Number

One of the quantities λ_i appearing in the GAUSS-JACOBI MECHANICAL QUADRATURE. They satisfy

$$\lambda_1 + \lambda_2 + \dots + \lambda_n = \int_a^b d\alpha(x) = \alpha(b) - \alpha(a) \quad (1)$$

and are given by

$$\lambda_\nu = \int_a^b \left[\frac{p_n(x)}{p'_n(x_\nu)(x - x_\nu)} \right]^2 d\alpha(x) \quad (2)$$

$$\lambda_\nu = -\frac{k_{n+1}}{k_n} \frac{1}{p_{n+1}(x_\nu)p'_n(x_\nu)} \quad (3)$$

$$= \frac{k_n}{k_{n-1}} \frac{1}{p_{n-1}(x_\nu)P'_n(x_\nu)} \quad (4)$$

$$(\lambda_\nu)^{-1} = [p_0(x_\nu)]^2 + \dots + [p_n(x_\nu)]^2, \quad (5)$$

where k_n is the higher COEFFICIENT of $p_n(x)$.

References

Szegő, G. *Orthogonal Polynomials*, 4th ed. Providence, RI: Amer. Math. Soc., pp. 47–48, 1975.

Christoffel Symbol of the First Kind

Variously denoted $[ij, k]$, $\begin{bmatrix} i & j \\ k \end{bmatrix}$, Γ_{abc} , or $\{ab, c\}$.

$$[ij, k] = \begin{bmatrix} i & j \\ k \end{bmatrix} \equiv g_{mk} \Gamma_{ij}^m = g_{mk} \vec{e}^m \cdot \frac{\partial \vec{e}_i}{\partial q^j} = \vec{e}_k \cdot \frac{\partial \vec{e}_i}{\partial q^j}, \quad (1)$$

where g_{mk} is the METRIC TENSOR and

$$\vec{e}_i \equiv \frac{\partial \vec{r}}{\partial q^i} = h_i \hat{e}_i. \quad (2)$$

But

$$\begin{aligned} \frac{\partial g_{ij}}{\partial q^k} &= \frac{\partial}{\partial q^k} (\vec{e}_i \cdot \vec{e}_j) = \frac{\partial \vec{e}_i}{\partial q^k} \cdot \vec{e}_j + \vec{e}_i \cdot \frac{\partial \vec{e}_j}{\partial q^k} \\ &= [ik, j] + [jk, i], \end{aligned} \quad (3)$$

so

$$[ab, c] = \frac{1}{2} (g_{ac,b} + g_{bc,a} - g_{ab,c}). \quad (4)$$

References

Arfken, G. *Mathematical Methods for Physicists*, 3rd ed. Orlando, FL: Academic Press, pp. 160–167, 1985.

Christoffel Symbol of the Second Kind

Variously denoted $\begin{Bmatrix} m \\ i & j \end{Bmatrix}$ or Γ_{ij}^m .

$$\begin{aligned} \begin{Bmatrix} m \\ i & j \end{Bmatrix} &\equiv \Gamma_{ij}^m = \vec{e}^m \cdot \frac{\partial \vec{e}_i}{\partial q^j} = g^{km} [ij, k] \\ &= \frac{1}{2} g^{km} \left(\frac{\partial g_{ik}}{\partial q^j} + \frac{\partial g_{jk}}{\partial q^i} - \frac{\partial g_{ij}}{\partial q^k} \right), \end{aligned} \quad (1)$$

where Γ_{ij}^m is a CONNECTION COEFFICIENT and $\{bc, d\}$ is a CHRISTOFFEL SYMBOL OF THE FIRST KIND.

$$\begin{Bmatrix} a \\ b & c \end{Bmatrix} = g_{ad} \{bc, d\}. \quad (2)$$

The Christoffel symbols are given in terms of the first FUNDAMENTAL FORM E , F , and G by

$$\Gamma_{11}^1 = \frac{GE_u - 2FF_u + FE_v}{2(EG - F^2)} \quad (3)$$

$$\Gamma_{12}^1 = \frac{GE_v - FG_u}{2(EG - F^2)} \quad (4)$$

$$\Gamma_{22}^1 = \frac{2GF_v - GG_u - FG_v}{2(EG - F^2)} \quad (5)$$

$$\Gamma_{11}^2 = \frac{2EF_u - EE_v - FE_u}{2(EG - F^2)} \quad (6)$$

$$\Gamma_{12}^2 = \frac{EG_u - FE_v}{2(EG - F^2)} \quad (7)$$

$$\Gamma_{22}^2 = \frac{EG_v - 2FF_v + FG_u}{2(EG - F^2)}, \quad (8)$$

and $\Gamma_{21}^1 = \Gamma_{12}^1$ and $\Gamma_{21}^2 = \Gamma_{12}^2$. If $F = 0$, the Christoffel symbols of the second kind simplify to

$$\Gamma_{11}^1 = \frac{E_u}{2E} \quad (9)$$

$$\Gamma_{12}^1 = \frac{E_v}{2E} \quad (10)$$

$$\Gamma_{22}^1 = -\frac{G_u}{2E} \quad (11)$$

$$\Gamma_{11}^2 = -\frac{E_v}{2G} \quad (12)$$

$$\Gamma_{12}^2 = \frac{G_u}{2G} \quad (13)$$

$$\Gamma_{22}^2 = \frac{G_v}{2G} \quad (14)$$

(Gray 1993).

The following relationships hold between the Christoffel symbols of the second kind and coefficients of the first FUNDAMENTAL FORM,

$$\Gamma_{11}^1 E + \Gamma_{11}^2 F = \frac{1}{2} E_u \quad (15)$$

$$\Gamma_{12}^1 E + \Gamma_{12}^2 F = \frac{1}{2} E_v \quad (16)$$

$$\Gamma_{22}^1 E + \Gamma_{22}^2 F = F_v - \frac{1}{2} G_u \quad (17)$$

$$\Gamma_{11}^1 F + \Gamma_{11}^2 G = F_u - \frac{1}{2} E_v \quad (18)$$

$$\Gamma_{12}^1 F + \Gamma_{12}^2 G = \frac{1}{2} G_u \quad (19)$$

$$\Gamma_{22}^1 F + \Gamma_{22}^2 G = \frac{1}{2} G_v \quad (20)$$

$$\Gamma_{11}^1 + \Gamma_{12}^2 = (\ln \sqrt{EG - F^2})_u \quad (21)$$

$$\Gamma_{12}^1 + \Gamma_{22}^2 = (\ln \sqrt{EG - F^2})_v \quad (22)$$

(Gray 1993).

For a surface given in MONGE'S FORM $z = F(x, y)$,

$$\Gamma_{ij}^k = \frac{z_{ij} z_k}{1 + z_1^2 + z_2^2}. \quad (23)$$

see also CHRISTOFFEL SYMBOL OF THE FIRST KIND, CONNECTION COEFFICIENT, GAUSS EQUATIONS

References

- Arfken, G. *Mathematical Methods for Physicists*, 3rd ed. Orlando, FL: Academic Press, pp. 160–167, 1985.
- Gray, A. “Christoffel Symbols.” §20.3 in *Modern Differential Geometry of Curves and Surfaces*. Boca Raton, FL: CRC Press, pp. 397–400, 1993.
- Morse, P. M. and Feshbach, H. *Methods of Theoretical Physics, Part I*. New York: McGraw-Hill, pp. 47–48, 1953.

Chromatic Number

The fewest number of colors $\gamma(G)$ necessary to color a GRAPH or surface. The chromatic number of a surface of GENUS g is given by the HEAWOOD CONJECTURE,

$$\gamma(g) = \left\lfloor \frac{1}{2}(7 + \sqrt{48g + 1}) \right\rfloor,$$

where $\lfloor x \rfloor$ is the FLOOR FUNCTION. $\gamma(g)$ is sometimes also denoted $\chi(g)$. For $g = 0, 1, \dots$, the first few values of $\chi(g)$ are 4, 7, 8, 9, 10, 11, 12, 12, 13, 13, 14, 15, 15, 16, ... (Sloane's A000934).

The fewest number of colors necessary to color each EDGE of a GRAPH so that no two EDGES incident on the same VERTEX have the same color is called the “EDGE chromatic number.”

see also BRELAZ'S HEURISTIC ALGORITHM, CHROMATIC POLYNOMIAL, EDGE-COLORING, EULER CHARACTERISTIC, HEAWOOD CONJECTURE, MAP COLORING, TORUS COLORING

References

- Chartrand, G. “A Scheduling Problem: An Introduction to Chromatic Numbers.” §9.2 in *Introductory Graph Theory*. New York: Dover, pp. 202–209, 1985.
- Eppstein, D. “The Chromatic Number of the Plane.” <http://www.ics.uci.edu/~eppstein/junkyard/plane-color/>.
- Sloane, N. J. A. Sequence A000934/M3292 in “An On-Line Version of the Encyclopedia of Integer Sequences.”

Chromatic Polynomial

A POLYNOMIAL $P(z)$ of a graph g which counts the number of ways to color g with exactly z colors. Tutte (1970) showed that the chromatic POLYNOMIALS of planar triangular graphs possess a ROOT close to $\phi^2 = 2.618033\dots$, where ϕ is the GOLDEN MEAN. More precisely, if n is the number of VERTICES of G , then

$$P_G(\phi^2) \leq \phi^{5-n}$$

(Le Lionnais 1983).

References

- Le Lionnais, F. *Les nombres remarquables*. Paris: Hermann, p. 46, 1983.
- Tutte, W. T. “On Chromatic Polynomials and the Golden Ratio.” *J. Combin. Th.* **9**, 289–296, 1970.

Chu Identity

see CHU-VANDERMONDE IDENTITY

Chu Space

A Chu space is a binary relation from a SET A to an antiset X which is defined as a SET which transforms via converse functions.

References

- Stanford Concurrency Group. “Guide to Papers on Chu Spaces.” <http://boole.stanford.edu/chuguide.html>.

Chu-Vandermonde Identity

$$(x + a)_n = \sum_{k=0}^{\infty} \binom{n}{k} (a)_k (x)_{n-k}$$

where $\binom{n}{k}$ is a BINOMIAL COEFFICIENT and $(a)_n \equiv a(a-1)\cdots(a-n+1)$ is the POCHHAMMER SYMBOL. A special case gives the identity

$$\sum_{l=0}^{\max(k,n)} \binom{m}{k-l} \binom{n}{l} = \binom{m+n}{k}.$$

see also BINOMIAL THEOREM, UMBRAL CALCULUS

References

- Petkovšek, M.; Wilf, H. S.; and Zeilberger, D. *A=B*. Wellesley, MA: A. K. Peters, pp. 130 and 181–182, 1996.

Church's Theorem

No decision procedure exists for ARITHMETIC.

Church's Thesis

see CHURCH-TURING THESIS

Church-Turing Thesis

The TURING MACHINE concept defines what is meant mathematically by an algorithmic procedure. Stated another way, a function f is effectively COMPUTABLE IFF it can be computed by a TURING MACHINE.

see also ALGORITHM, COMPUTABLE FUNCTION, TURING MACHINE

References

- Penrose, R. *The Emperor's New Mind: Concerning Computers, Minds, and the Laws of Physics*. Oxford, England: Oxford University Press, pp. 47–49, 1989.

Chvátal's Art Gallery Theorem

see ART GALLERY THEOREM

Chvátal's Theorem

Let the GRAPH G have VERTICES with VALENCES $d_1 \leq \dots \leq d_m$. If for every $i < n/2$ we have either $d_i \geq i+1$ or $d_{n-i} \geq n-i$, then the GRAPH is HAMILTONIAN.

ci

see COSINE INTEGRAL

Ci

see COSINE INTEGRAL

Cigarettes

It is possible to place 7 cigarettes in such a way that each touches the other if $l/d > 7\sqrt{3}/2$ (Gardner 1959, p. 115).

References

Gardner, M. *The Scientific American Book of Mathematical Puzzles & Diversions*. New York: Simon and Schuster, 1959.

Cin

see COSINE INTEGRAL

Circle

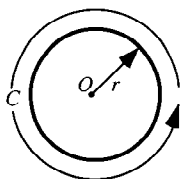

A circle is the set of points equidistant from a given point O . The distance r from the CENTER is called the RADIUS, and the point O is called the CENTER. Twice the RADIUS is known as the DIAMETER $d = 2r$. The PERIMETER C of a circle is called the CIRCUMFERENCE, and is given by

$$C = \pi d = 2\pi r. \quad (1)$$

The circle is a CONIC SECTION obtained by the intersection of a CONE with a PLANE PERPENDICULAR to the CONE's symmetry axis. A circle is the degenerate case of an ELLIPSE with equal semimajor and semiminor axes (i.e., with ECCENTRICITY 0). The interior of a circle is called a DISK. The generalization of a circle to 3-D is called a SPHERE, and to n -D for $n \geq 4$ a HYPERSPHERE.

The region of intersection of two circles is called a LENS. The region of intersection of three symmetrically placed circles (as in a VENN DIAGRAM), in the special case of the center of each being located at the intersection of the other two, is called a REULEAUX TRIANGLE.

The parametric equations for a circle of RADIUS a are

$$x = a \cos t \quad (2)$$

$$y = a \sin t. \quad (3)$$

For a body moving uniformly around the circle,

$$x' = -a \sin t \quad (4)$$

$$y' = a \cos t, \quad (5)$$

and

$$x'' = -a \cos t \quad (6)$$

$$y'' = -a \sin t. \quad (7)$$

When normalized, the former gives the equation for the unit TANGENT VECTOR of the circle, $(-\sin t, \cos t)$. The circle can also be parameterized by the rational functions

$$x = \frac{1-t^2}{t(1+t)} \quad (8)$$

$$y = \frac{2t}{1+t^2}, \quad (9)$$

but an ELLIPTIC CURVE cannot. The following plots show a sequence of NORMAL and TANGENT VECTORS for the circle.

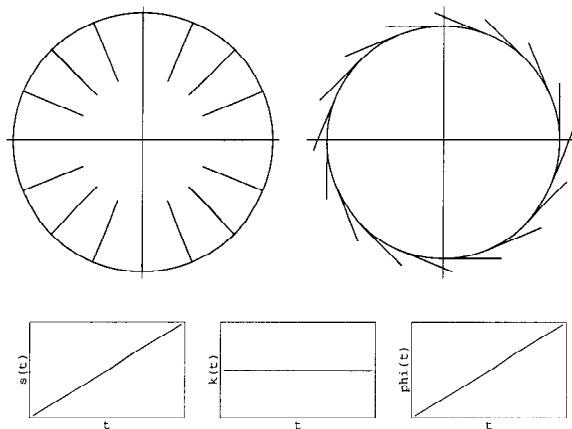

The ARC LENGTH s , CURVATURE κ , and TANGENTIAL ANGLE ϕ of the circle are

$$s(t) = \int ds = \int \sqrt{x'^2 + y'^2} dt = at \quad (10)$$

$$\kappa(t) = \frac{x'y'' - y'x''}{(x'^2 + y'^2)^{3/2}} = \frac{1}{a} \quad (11)$$

$$\phi(t) = \int \kappa(t) dt = \frac{t}{a}. \quad (12)$$

The CESÀRO EQUATION is

$$\kappa = \frac{1}{a}. \quad (13)$$

In POLAR COORDINATES, the equation of the circle has a particularly simple form.

$$r = a \quad (14)$$

is a circle of RADIUS a centered at ORIGIN,

$$r = 2a \cos \theta \quad (15)$$

is circle of RADIUS a centered at $(a, 0)$, and

$$r = 2a \sin \theta \quad (16)$$

is a circle of RADIUS a centered on $(0, a)$. In CARTESIAN COORDINATES, the equation of a circle of RADIUS a centered on (x_0, y_0) is

$$(x - x_0)^2 + (y - y_0)^2 = a^2. \quad (17)$$

In PEDAL COORDINATES with the PEDAL POINT at the center, the equation is

$$pa = r^2. \quad (18)$$

The circle having P_1P_2 as a diameter is given by

$$(x - x_1)(x - x_2) + (y - y_1)(y - y_2) = 0. \quad (19)$$

The equation of a circle passing through the three points (x_i, y_i) for $i = 1, 2, 3$ (the CIRCUMCIRCLE of the TRIANGLE determined by the points) is

$$\begin{vmatrix} x^2 + y^2 & x & y & 1 \\ x_1^2 + y_1^2 & x_1 & y_1 & 1 \\ x_2^2 + y_2^2 & x_2 & y_2 & 1 \\ x_3^2 + y_3^2 & x_3 & y_3 & 1 \end{vmatrix} = 0. \quad (20)$$

The CENTER and RADIUS of this circle can be identified by assigning coefficients of a QUADRATIC CURVE

$$ax^2 + cy^2 + dx + ey + f = 0, \quad (21)$$

where $a = c$ and $b = 0$ (since there is no xy cross term). COMPLETING THE SQUARE gives

$$a \left(x + \frac{d}{2a} \right)^2 + a \left(y + \frac{e}{2a} \right)^2 + f - \frac{d^2 + e^2}{4a} = 0. \quad (22)$$

The CENTER can then be identified as

$$x_0 = -\frac{d}{2a} \quad (23)$$

$$y_0 = -\frac{e}{2a} \quad (24)$$

and the RADIUS as

$$r = \sqrt{\frac{d^2 + e^2}{4a^2} - \frac{f}{a}}, \quad (25)$$

where

$$a = \begin{vmatrix} x_1 & y_1 & 1 \\ x_2 & y_2 & 1 \\ x_3 & y_3 & 1 \end{vmatrix} \quad (26)$$

$$d = -\begin{vmatrix} x_1^2 + y_1^2 & y_1 & 1 \\ x_2^2 + y_2^2 & y_2 & 1 \\ x_3^2 + y_3^2 & y_3 & 1 \end{vmatrix} \quad (27)$$

$$e = \begin{vmatrix} x_1^2 + y_1^2 & x_1 & 1 \\ x_2^2 + y_2^2 & x_2 & 1 \\ x_3^2 + y_3^2 & x_3 & 1 \end{vmatrix} \quad (28)$$

$$f = -\begin{vmatrix} x_1^2 + y_1^2 & x_1 & y_1 \\ x_2^2 + y_2^2 & x_2 & y_2 \\ x_3^2 + y_3^2 & x_3 & y_3 \end{vmatrix}. \quad (29)$$

Four or more points which lie on a circle are said to be CONCYCLIC. Three points are trivially concyclic since three noncollinear points determine a circle.

The CIRCUMFERENCE-to-DIAMETER ratio C/d for a circle is constant as the size of the circle is changed (as it must be since scaling a plane figure by a factor s increases its PERIMETER by s), and d also scales by s . This ratio is denoted π (Pi), and has been proved TRANSCENDENTAL. With d the DIAMETER and r the RADIUS,

$$C = \pi d = 2\pi r. \quad (30)$$

Knowing C/d , we can then compute the AREA of the circle either geometrically or using CALCULUS. From CALCULUS,

$$A = \int_0^{2\pi} d\theta \int_0^r r dr = (2\pi) \left(\frac{1}{2} r^2 \right) = \pi r^2. \quad (31)$$

Now for a few geometrical derivations. Using concentric strips, we have

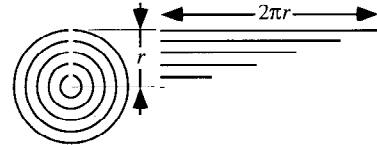

As the number of strips increases to infinity, we are left with a TRIANGLE on the right, so

$$A = \frac{1}{2} (2\pi r) r = \pi r^2. \quad (32)$$

This derivation was first recorded by Archimedes in *Measurement of a Circle* (ca. 225 BC). If we cut the circle instead into wedges,

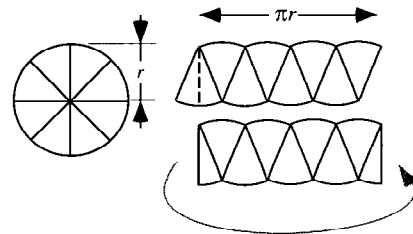

As the number of wedges increases to infinity, we are left with a RECTANGLE, so

$$A = (\pi r) r = \pi r^2. \quad (33)$$

see also ARC, BLASCHKE'S THEOREM, BRAHMGUPTA'S FORMULA, BROCARD CIRCLE, CASEY'S THEOREM, CHORD, CIRCUMCIRCLE, CIRCUMFERENCE, CLIFFORD'S CIRCLE THEOREM, CLOSED DISK, CONCENTRIC CIRCLES, COSINE CIRCLE, COTES CIRCLE PROPERTY, DIAMETER, DISK, DROZ-FARNY CIRCLES, EULER TRIANGLE FORMULA, EXCIRCLE, FEUERBACH'S THEOREM,

FIVE DISKS PROBLEM, FLOWER OF LIFE, FORD CIRCLE, FUHRMANN CIRCLE, GERŠGORIN CIRCLE THEOREM, HOPF CIRCLE, INCIRCLE, INVERSE DISTANCE, JOHNSON CIRCLE, KINNEY'S SET, LEMOINE CIRCLE, LENS, MAGIC CIRCLES, MALFATTI CIRCLES, MCCAY CIRCLE, MIDCIRCLE, MONGE'S THEOREM, MOSER'S CIRCLE PROBLEM, NEUBERG CIRCLES, NINE-POINT CIRCLE, OPEN DISK, P -CIRCLE, PARRY CIRCLE, Π , POLAR CIRCLE, POWER (CIRCLE), PRIME CIRCLE, PTOLEMY'S THEOREM, PURSER'S THEOREM, RADICAL AXIS, RADIUS, REULEAUX TRIANGLE, SEED OF LIFE, SEIFERT CIRCLE, SEMICIRCLE, SODDY CIRCLES, SPHERE, TAYLOR CIRCLE, TRIANGLE INSCRIBING IN A CIRCLE, TRIPPLICATE-RATIO CIRCLE, TUCKER CIRCLES, UNIT CIRCLE, VENN DIAGRAM, VILLARCEAU CIRCLES, YIN-YANG

References

- Beyer, W. H. *CRC Standard Mathematical Tables*, 28th ed. Boca Raton, FL: CRC Press, pp. 125 and 197, 1987.
- Casey, J. "The Circle." Ch. 3 in *A Treatise on the Analytical Geometry of the Point, Line, Circle, and Conic Sections, Containing an Account of Its Most Recent Extensions, with Numerous Examples*, 2nd ed., rev. enl. Dublin: Hodges, Figgis, & Co., pp. 96–150, 1893.
- Courant, R. and Robbins, H. *What is Mathematics?: An Elementary Approach to Ideas and Methods*, 2nd ed. Oxford, England: Oxford University Press, pp. 74–75, 1996.
- Dunham, W. "Archimedes' Determination of Circular Area." Ch. 4 in *Journey Through Genius: The Great Theorems of Mathematics*. New York: Wiley, pp. 84–112, 1990.
- Eppstein, D. "Circles and Spheres." <http://www.ics.uci.edu/~eppstein/junkyard/sphere.html>.
- Lawrence, J. D. *A Catalog of Special Plane Curves*. New York: Dover, pp. 65–66, 1972.
- MacTutor History of Mathematics Archive. "Circle." <http://www-groups.dcs.st-and.ac.uk/~history/Curves/Circle.html>.
- Pappas, T. "Infinity & the Circle" and "Japanese Calculus." *The Joy of Mathematics*. San Carlos, CA: Wide World Publ./Tetra, pp. 68 and 139, 1989.
- Pedoe, D. *Circles: A Mathematical View*, rev. ed. Washington, DC: Math. Assoc. Amer., 1995.
- Yates, R. C. "The Circle." *A Handbook on Curves and Their Properties*. Ann Arbor, MI: J. W. Edwards, pp. 21–25, 1952.

Circles-and-Squares Fractal

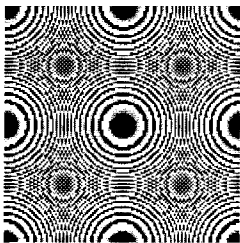

A FRACTAL produced by iteration of the equation

$$z_{n+1} = z_n^2 \pmod{m}$$

which results in a MÛIRÉ-like pattern.

see also FRACTAL, MÛIRÉ PATTERN

Circle Caustic

Consider a point light source located at a point $(\mu, 0)$. The CATACAUSTIC of a unit CIRCLE for the light at $\mu = \infty$ is the NEPHROID

$$x = \frac{1}{4}[3 \cos t - \cos(3t)] \quad (1)$$

$$y = \frac{1}{4}[3 \sin t - \sin(3t)]. \quad (2)$$

The CATACAUSTIC for the light at a finite distance $\mu > 1$ is the curve

$$x = \frac{\mu(1 - 3\mu \cos t + 2\mu \cos^3 t)}{-(1 + 2\mu^2) + 3\mu \cos t} \quad (3)$$

$$y = \frac{2\mu^2 \sin^3 t}{1 + 2\mu^2 - 3\mu \cos t}, \quad (4)$$

and for the light on the CIRCUMFERENCE of the CIRCLE $\mu = 1$ is the CARDIROID

$$x = \frac{2}{3} \cos t(1 + \cos t) - \frac{1}{3} \quad (5)$$

$$y = \frac{2}{3} \sin t(1 + \cos t). \quad (6)$$

If the point is inside the circle, the catacaustic is a discontinuous two-part curve. These four cases are illustrated below.

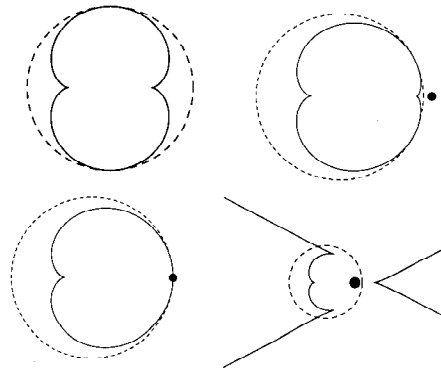

The CATACAUSTIC for PARALLEL rays crossing a CIRCLE is a CARDIROID.

see also CATACAUSTIC, CAUSTIC

Circle-Circle Intersection

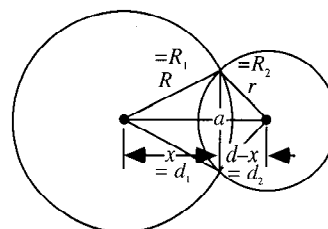

Let two CIRCLES of RADII R and r and centered at $(0, 0)$ and $(d, 0)$ intersect in a LENS-shaped region. The equations of the two circles are

$$x^2 + y^2 = R^2 \quad (1)$$

$$(x - d)^2 + y^2 = r^2. \quad (2)$$

Combining (1) and (2) gives

$$(x - d)^2 + (R^2 - x^2) = r^2. \quad (3)$$

Multiplying through and rearranging gives

$$x^2 - 2dx + d^2 - x^2 = r^2 - R^2. \quad (4)$$

Solving for x results in

$$x = \frac{d^2 - r^2 + R^2}{2d}. \quad (5)$$

The line connecting the cusps of the LENS therefore has half-length given by plugging x back in to obtain

$$\begin{aligned} y^2 &= R^2 - x^2 = R^2 - \left(\frac{d^2 - r^2 + R^2}{2d} \right)^2 \\ &= \frac{4d^2 R^2 - (d^2 - r^2 + R^2)^2}{4d^2}, \end{aligned} \quad (6)$$

giving a length of

$$\begin{aligned} a &= \frac{1}{d} \sqrt{4d^2 R^2 - (d^2 - r^2 + R^2)^2} \\ &= \frac{1}{d} [(-d + r - R)(-d - r + R) \\ &\quad \times [(-d + r + R)(d + r + R)]^{1/2}. \end{aligned} \quad (7)$$

This same formulation applies directly to the SPHERE-SPHERE INTERSECTION problem.

To find the AREA of the asymmetric "LENS" in which the CIRCLES intersect, simply use the formula for the circular SEGMENT of radius R' and triangular height d'

$$A(R', d') = R'^2 \cos^{-1} \left(\frac{d'}{R'} \right) - d' \sqrt{R'^2 - d'^2} \quad (8)$$

twice, one for each half of the "LENS." Noting that the heights of the two segment triangles are

$$d_1 = x = \frac{d^2 - r^2 + R^2}{2d} \quad (9)$$

$$d_2 = d - x = \frac{d^2 + r^2 - R^2}{2d}. \quad (10)$$

The result is

$$\begin{aligned} A &= A(R_1, d_1) + A(R_2, d_2) \\ &= r^2 \cos^{-1} \left(\frac{d^2 + r^2 - R^2}{2dr} \right) \\ &\quad + R^2 \cos^{-1} \left(\frac{d^2 + R^2 - r^2}{2dR} \right) \\ &\quad - \frac{1}{2} \sqrt{(d - r - R)(d + r - R)(d - r + R)(d + r + R)}. \end{aligned} \quad (11)$$

The limiting cases of this expression can be checked to give 0 when $d = R + r$ and

$$A = 2R^2 \cos^{-1} \left(\frac{d}{2R} \right) - \frac{1}{2} d \sqrt{4R^2 - d^2} \quad (12)$$

$$= 2A(\frac{1}{2}d, R) \quad (13)$$

when $r = R$, as expected. In order for half the area of two UNIT DISKS ($R = 1$) to overlap, set $A = \pi R^2/2 = \pi/2$ in the above equation

$$\frac{1}{2}\pi = 2 \cos^{-1}(\frac{1}{2}d) - \frac{1}{2}d\sqrt{4 - d^2} \quad (14)$$

and solve numerically, yielding $d \approx 0.807946$.

see also LENS, SEGMENT, SPHERE-SPHERE INTERSECTION

Circle Cutting

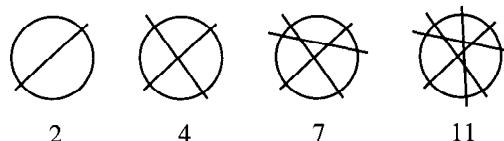

Determining the maximum number of pieces in which it is possible to divide a CIRCLE for a given number of cuts is called the circle cutting, or sometimes PANCAKE CUTTING, problem. The minimum number is always $n + 1$, where n is the number of cuts, and it is always possible to obtain any number of pieces between the minimum and maximum. The first cut creates 2 regions, and the n th cut creates n new regions, so

$$f(1) = 2 \quad (1)$$

$$f(2) = 2 + f(1) \quad (2)$$

$$f(n) = n + f(n - 1). \quad (3)$$

Therefore,

$$\begin{aligned} f(n) &= n + [(n - 1) + f(n - 2)] \\ &= n + (n - 1) + \dots + 2 + f(1) = \sum_{k=2}^n kf(1) \\ &= \sum_{k=1}^n k - 1 + f(1) = \frac{1}{2}n(n + 1) - 1 + 2 \\ &= \frac{1}{2}(n^2 + n + 2). \end{aligned} \quad (4)$$

Evaluating for $n = 1, 2, \dots$ gives 2, 4, 7, 11, 16, 22, ... (Sloane's A000124).

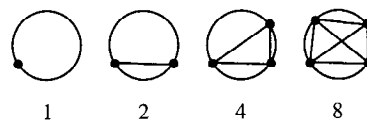

A related problem, sometimes called MOSER'S CIRCLE PROBLEM, is to find the number of pieces into which a CIRCLE is divided if n points on its CIRCUMFERENCE

are joined by CHORDS with no three CONCURRENT. The answer is

$$g(n) = \binom{n}{4} + \binom{n}{2} + 1 \quad (5)$$

$$= \frac{1}{24}(n^4 - 6n^3 + 23n^2 - 18n + 24), \quad (6)$$

(Yaglom and Yaglom 1987, Guy 1988, Conway and Guy 1996, Noy 1996), where $\binom{n}{m}$ is a BINOMIAL COEFFICIENT. The first few values are 1, 2, 4, 8, 16, 31, 57, 99, 163, 256, ... (Sloane's A000127). This sequence and problem are an example of the danger in making assumptions based on limited trials. While the series starts off like 2^{n-1} , it begins differing from this GEOMETRIC SERIES at $n = 6$.

see also CAKE CUTTING, CYLINDER CUTTING, HAM SANDWICH THEOREM, PANCAKE THEOREM, PIZZA THEOREM, SQUARE CUTTING, TORUS CUTTING

References

- Conway, J. H. and Guy, R. K. "How Many Regions." In *The Book of Numbers*. New York: Springer-Verlag, pp. 76–79, 1996.
- Guy, R. K. "The Strong Law of Small Numbers." *Amer. Math. Monthly* **95**, 697–712, 1988.
- Noy, M. "A Short Solution of a Problem in Combinatorial Geometry." *Math. Mag.* **69**, 52–53, 1996.
- Sloane, N. J. A. Sequences A000124/M1041 and A000127/M1119 in "An On-Line Version of the Encyclopedia of Integer Sequences."
- Yaglom, A. M. and Yaglom, I. M. Problem 47. *Challenging Mathematical Problems with Elementary Solutions*, Vol. 1. New York: Dover, 1987.

Circle Evolute

$$x = \cos t \quad x' = -\sin t \quad x'' = -\cos t \quad (1)$$

$$y = \sin t \quad y' = \cos t \quad y'' = -\sin t, \quad (2)$$

so the RADIUS OF CURVATURE is

$$R = \frac{(x'^2 + y'^2)^{3/2}}{y''x' - x''y'} = \frac{(\sin^2 t + \cos^2 t)^{3/2}}{(-\sin t)(-\sin t) - (-\cos t)\cos t} = 1, \quad (3)$$

and the TANGENT VECTOR is

$$\hat{\mathbf{T}} = \begin{bmatrix} -\sin t \\ \cos t \end{bmatrix}. \quad (4)$$

Therefore,

$$\cos \tau = \hat{\mathbf{T}} \cdot \hat{\mathbf{x}} = -\sin t \quad (5)$$

$$\sin \tau = \hat{\mathbf{T}} \cdot \hat{\mathbf{y}} = \cos t, \quad (6)$$

so

$$\xi(t) = x - R \sin \tau = \cos t - 1 \cdot \cos t = 0 \quad (7)$$

$$\eta(t) = y + R \cos \tau = \sin t + 1 \cdot (-\sin t) = 0, \quad (8)$$

and the EVOLUTE degenerates to a POINT at the ORIGIN.

see also CIRCLE INVOLUTE

References

- Gray, A. *Modern Differential Geometry of Curves and Surfaces*. Boca Raton, FL: CRC Press, p. 77, 1993.
- Lauwerier, H. *Fractals: Endlessly Repeated Geometric Figures*. Princeton, NJ: Princeton University Press, pp. 55–59, 1991.

Circle Inscribing

If r is the RADIUS of a CIRCLE inscribed in a RIGHT TRIANGLE with sides a and b and HYPOTENUSE c , then

$$r = \frac{1}{2}(a + b - c).$$

see INSCRIBED, POLYGON

Circle Involute

First studied by Huygens when he was considering clocks without pendula for use on ships at sea. He used the circle involute in his first pendulum clock in an attempt to force the pendulum to swing in the path of a CYCLOID.

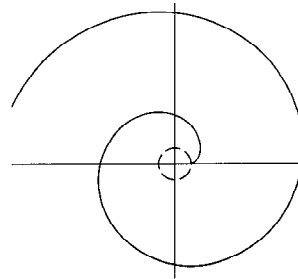

For a CIRCLE with $a = 1$, the parametric equations of the circle and their derivatives are given by

$$x = \cos t \quad x' = -\sin t \quad x'' = -\cos t \quad (1)$$

$$y = \sin t \quad y' = \cos t \quad y'' = -\sin t. \quad (2)$$

The TANGENT VECTOR is

$$\hat{\mathbf{T}} = \begin{bmatrix} -\sin t \\ \cos t \end{bmatrix} \quad (3)$$

and the ARC LENGTH along the circle is

$$s = \int \sqrt{x'^2 + y'^2} dt = \int dt = t, \quad (4)$$

so the involute is given by

$$\mathbf{r}_i = \mathbf{r} - s\hat{\mathbf{T}} = \begin{bmatrix} \cos t \\ \sin t \end{bmatrix} - t \begin{bmatrix} -\sin t \\ \cos t \end{bmatrix} = \begin{bmatrix} \cos t + t \sin t \\ \sin t - t \cos t \end{bmatrix}, \quad (5)$$

or

$$x = a(\cos t + t \sin t) \quad (6)$$

$$y = a(\sin t - t \cos t). \quad (7)$$

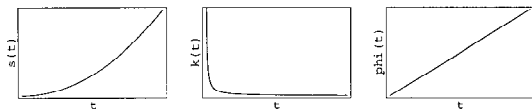

The ARC LENGTH, CURVATURE, and TANGENTIAL ANGLE are

$$s = \int ds = \int \sqrt{x'^2 + y'^2} dt = \frac{1}{2}at^2 \quad (8)$$

$$\kappa = \frac{1}{at} \quad (9)$$

$$\phi = t. \quad (10)$$

The CESÀRO EQUATION is

$$\kappa = \frac{1}{\sqrt{as}}. \quad (11)$$

see also CIRCLE, CIRCLE EVOLUTE, ELLIPSE INVOLUTE, INVOLUTE

References

- Gray, A. *Modern Differential Geometry of Curves and Surfaces*. Boca Raton, FL: CRC Press, p. 83, 1993.
 Lawrence, J. D. *A Catalog of Special Plane Curves*. New York: Dover, pp. 190–191, 1972.
 MacTutor History of Mathematics Archive. "Involute of a Circle." <http://www-groups.dcs.st-and.ac.uk/~history/Curves/Involute.html>.

Circle Involute Pedal Curve

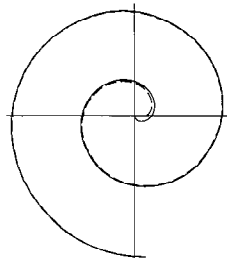

The PEDAL CURVE of CIRCLE INVOLUTE

$$f = \cos t + t \sin t$$

$$g = \sin t - t \cos t$$

with the center as the PEDAL POINT is the ARCHIMEDES' SPIRAL

$$x = t \sin t$$

$$y = -t \cos t.$$

Circle Lattice Points

For every POSITIVE INTEGER n , there exists a CIRCLE which contains exactly n lattice points in its interior. H. Steinhaus proved that for every POSITIVE INTEGER n , there exists a CIRCLE of AREA n which contains exactly n lattice points in its interior.

Circle Lattice Points

SCHINZEL'S THEOREM shows that for every POSITIVE INTEGER n , there exists a CIRCLE in the PLANE having exactly n LATTICE POINTS on its CIRCUMFERENCE. The theorem also explicitly identifies such "SCHINZEL CIRCLES" as

$$\begin{cases} (x - \frac{1}{2})^2 + y^2 = \frac{1}{4}5^{k-1} & \text{for } n = 2k \\ (x - \frac{1}{3})^2 + y^2 = \frac{1}{9}5^{2k} & \text{for } n = 2k + 1. \end{cases} \quad (1)$$

Note, however, that these solutions do not necessarily have the smallest possible RADIUS. For example, while the SCHINZEL CIRCLE centered at $(1/3, 0)$ and with RADIUS $625/3$ has nine lattice points on its CIRCUMFERENCE, so does the CIRCLE centered at $(1/3, 0)$ with RADIUS $65/3$.

Let r be the smallest INTEGER RADIUS of a CIRCLE centered at the ORIGIN $(0, 0)$ with $L(r)$ LATTICE POINTS. In order to find the number of lattice points of the CIRCLE, it is only necessary to find the number in the first octant, i.e., those with $0 \leq y \leq \lfloor r/\sqrt{2} \rfloor$, where $\lfloor z \rfloor$ is the FLOOR FUNCTION. Calling this $N(r)$, then for $r \geq 1$, $L(r) = 8N(r) - 4$, so $L(r) \equiv 4 \pmod{8}$. The multiplication by eight counts all octants, and the subtraction by four eliminates points on the axes which the multiplication counts twice. (Since $\sqrt{2}$ is IRRATIONAL, the MIDPOINT of a arc is never a LATTICE POINT.)

GAUSS'S CIRCLE PROBLEM asks for the number of lattice points *within* a CIRCLE of RADIUS r

$$N(r) = 1 + 4 \lfloor r \rfloor + 4 \sum_{i=1}^{\lfloor r \rfloor} \left\lfloor \sqrt{r^2 - i^2} \right\rfloor. \quad (2)$$

Gauss showed that

$$N(r) = \pi r^2 + E(r), \quad (3)$$

where

$$|E(r)| \leq 2\sqrt{2}\pi r. \quad (4)$$

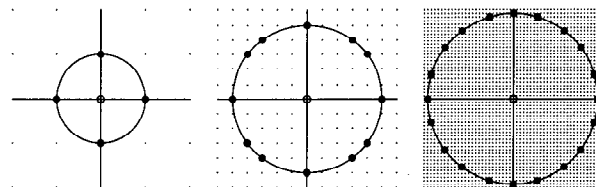

The number of lattice points on the CIRCUMFERENCE of circles centered at $(0, 0)$ with radii $0, 1, 2, \dots$ are $1, 4, 4, 4, 12, 4, 4, 4, 12, 4, 4, \dots$ (Sloane's A046109). The following table gives the smallest RADIUS $r \leq 111,000$ for a circle centered at $(0, 0)$ having a given number of LATTICE POINTS $L(r)$. Note that the high water mark radii are always multiples of five.

$L(r)$	r
1	0
4	1
12	5
20	25
28	125
36	65
44	3,125
52	15,625
60	325
68	$\leq 390,625$
76	$\leq 1,953,125$
84	1,625
92	$\leq 48,828,125$
100	4,225
108	1,105
132	40,625
140	21,125
180	5,525
252	27,625
300	71,825
324	32,045

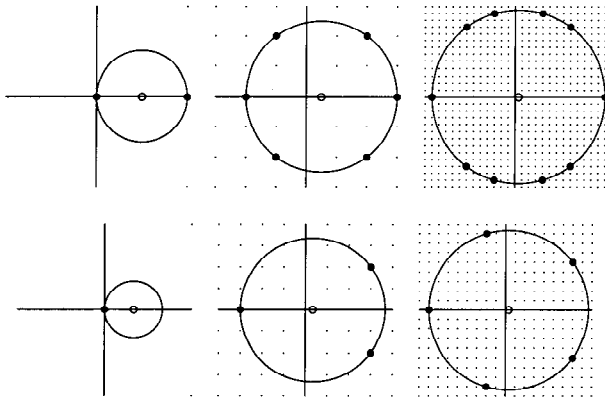

If the CIRCLE is instead centered at $(1/2, 0)$, then the CIRCLES of RADII $1/2, 3/2, 5/2, \dots$ have 2, 2, 6, 2, 2, 2, 6, 6, 2, 2, 2, 10, 2, ... (Sloane's A046110) on their CIRCUMFERENCES. If the CIRCLE is instead centered at $(1/3, 0)$, then the number of lattice points on the CIRCUMFERENCE of the CIRCLES of RADIUS $1/3, 2/3, 4/3, 5/3, 7/3, 8/3, \dots$ are 1, 1, 1, 3, 1, 1, 3, 1, 3, 1, 1, 3, 1, 3, 1, 1, 5, 3, ... (Sloane's A046111).

Let

1. a_n be the RADIUS of the CIRCLE centered at $(0, 0)$ having $8n + 4$ lattice points on its CIRCUMFERENCE,
2. $b_n/2$ be the RADIUS of the CIRCLE centered at $(1/2, 0)$ having $4n + 2$ lattice points on its CIRCUMFERENCE,
3. $c_n/3$ be the RADIUS of CIRCLE centered at $(1/3, 0)$ having $2n + 1$ lattice points on its CIRCUMFERENCE.

Then the sequences $\{a_n\}$, $\{b_n\}$, and $\{c_n\}$ are equal, with the exception that $b_n = 0$ if $2|n$ and $c_n = 0$ if $3|n$. However, the sequences of *smallest* radii having the above numbers of lattice points are equal in the three cases

and given by 1, 5, 25, 125, 65, 3125, 15625, 325, ... (Sloane's A046112).

KULIKOWSKI'S THEOREM states that for every POSITIVE INTEGER n , there exists a 3-D SPHERE which has exactly n LATTICE POINTS on its surface. The SPHERE is given by the equation

$$(x - a)^2 + (y - b)^2 + (z - \sqrt{2})^2 = c^2 + 2,$$

where a and b are the coordinates of the center of the so-called SCHINZEL CIRCLE and c is its RADIUS (Honsberger 1973).

see also CIRCLE, CIRCUMFERENCE, GAUSS'S CIRCLE PROBLEM, KULIKOWSKI'S THEOREM, LATTICE POINT, SCHINZEL CIRCLE, SCHINZEL'S THEOREM

References

- Honsberger, R. "Circles, Squares, and Lattice Points." Ch. 11 in *Mathematical Gems I*. Washington, DC: Math. Assoc. Amer., pp. 117–127, 1973.
- Kulikowski, T. "Sur l'existence d'une sphère passant par un nombre donné aux coordonnées entières." *L'Enseignement Math. Ser. 2* 5, 89–90, 1959.
- Schinzel, A. "Sur l'existence d'un cercle passant par un nombre donné de points aux coordonnées entières." *L'Enseignement Math. Ser. 2* 4, 71–72, 1958.
- Sierpiński, W. "Sur quelques problèmes concernant les points aux coordonnées entières." *L'Enseignement Math. Ser. 2* 4, 25–31, 1958.
- Sierpiński, W. "Sur un problème de H. Steinhaus concernant les ensembles de points sur le plan." *Fund. Math.* 46, 191–194, 1959.
- Sierpiński, W. *A Selection of Problems in the Theory of Numbers*. New York: Pergamon Press, 1964.
- ✱ Weisstein, E. W. "Circle Lattice Points." <http://www.astro.virginia.edu/~eww6n/math/notebooks/CircleLatticePoints.m>.

Circle Lattice Theorem

see GAUSS'S CIRCLE PROBLEM

Circle Map

A 1-D MAP which maps a CIRCLE onto itself

$$\theta_{n+1} = \theta_n + \Omega - \frac{K}{2\pi} \sin(2\pi\theta_n), \quad (1)$$

where θ_{n+1} is computed mod 1. Note that the circle map has two parameters: Ω and K . Ω can be interpreted as an externally applied frequency, and K as a strength of nonlinearity. The 1-D JACOBIAN is

$$\frac{\partial \theta_{n+1}}{\partial \theta_n} = 1 - K \cos(2\pi\theta_n), \quad (2)$$

so the circle map is not AREA-PRESERVING. It is related to the STANDARD MAP

$$I_{n+1} = I_n + \frac{K}{2\pi} \sin(2\pi\theta_n) \quad (3)$$

$$\theta_{n+1} = \theta_n + I_{n+1}, \quad (4)$$

for I and θ computed mod 1. Writing θ_{n+1} as

$$\theta_{n+1} = \theta_n + I_n + \frac{K}{2\pi} \sin(2\pi\theta_n) \quad (5)$$

gives the circle map with $I_n = \Omega$ and $K = -K$. The unperturbed circle map has the form

$$\theta_{n+1} = \theta_n + \Omega. \quad (6)$$

If Ω is RATIONAL, then it is known as the map WINDING NUMBER, defined by

$$\Omega = W \equiv \frac{p}{q}, \quad (7)$$

and implies a periodic trajectory, since θ_n will return to the same point (at most) every q ORBITS. If Ω is IRRATIONAL, then the motion is quasiperiodic. If K is NONZERO, then the motion may be periodic in some finite region surrounding each RATIONAL Ω . This execution of periodic motion in response to an IRRATIONAL forcing is known as MODE LOCKING.

If a plot is made of K vs. Ω with the regions of periodic MODE-LOCKED parameter space plotted around RATIONAL Ω values (WINDING NUMBERS), then the regions are seen to widen upward from 0 at $K = 0$ to some finite width at $K = 1$. The region surrounding each RATIONAL NUMBER is known as an ARNOLD TONGUE. At $K = 0$, the ARNOLD TONGUES are an isolated set of MEASURE zero. At $K = 1$, they form a CANTOR SET of DIMENSION $d \approx 0.08700$. For $K > 1$, the tongues overlap, and the circle map becomes noninvertible. The circle map has a FEIGENBAUM CONSTANT

$$\delta \equiv \lim_{n \rightarrow \infty} \frac{\theta_n - \theta_{n-1}}{\theta_{n+1} - \theta_n} = 2.833. \quad (8)$$

see also ARNOLD TONGUE, DEVIL'S STAIRCASE, MODE LOCKING, WINDING NUMBER (MAP)

Circle Method

see PARTITION FUNCTION P

Circle Negative Pedal Curve

The NEGATIVE PEDAL CURVE of a circle is an ELLIPSE if the PEDAL POINT is inside the CIRCLE, and a HYPERBOLA if the PEDAL POINT is outside the CIRCLE.

Circle Notation

A NOTATION for LARGE NUMBERS due to Steinhaus (1983) in which \textcircled{n} is defined in terms of STEINHAUS-MOSER NOTATION as n in n SQUARES. The particular number known as the MEGA is then defined as follows.

$$\textcircled{2} = \boxed{4} = \boxed{\triangle 2} = \boxed{\triangle 2^2} = \boxed{4^4} = \boxed{256}$$

see also MEGA, MEGISTRON, STEINHAUS-MOSER NOTATION

References

Steinhaus, H. *Mathematical Snapshots*, 3rd American ed. New York: Oxford University Press, pp. 28–29, 1983.

Circle Order

A POSET P is a circle order if it is ISOMORPHIC to a SET of DISKS ordered by containment.

see also ISOMORPHIC POSETS, PARTIALLY ORDERED SET

Circle Orthotomic

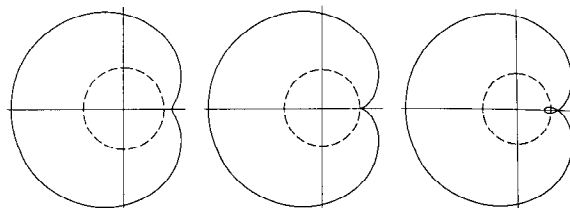

The ORTHOTOMIC of the CIRCLE represented by

$$x = \cos t \quad (1)$$

$$y = \sin t \quad (2)$$

with a source at (x, y) is

$$x = x \cos(2t) - y \sin(2t) + 2 \sin t \quad (3)$$

$$y = -x \sin(2t) - y \cos(2t) + 2 \cos t. \quad (4)$$

Circle Packing

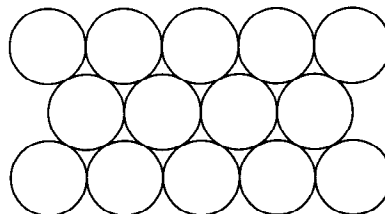

The densest packing of spheres in the PLANE is the hexagonal lattice of the bee's honeycomb (illustrated above), which has a PACKING DENSITY of

$$\eta = \frac{\pi}{2\sqrt{3}} = 0.9068996821\dots$$

Gauss proved that the hexagonal lattice is the densest plane *lattice* packing, and in 1940, L. Fejes Tóth proved that the hexagonal lattice is indeed the densest of *all* possible plane packings.

Solutions for the smallest diameter CIRCLES into which n UNIT CIRCLES can be packed have been proved optimal for $n = 1$ through 10 (Kravitz 1967). The best known results are summarized in the following table.

n	d exact	d approx.
1	1	1.00000
2	2	2.00000
3	$1 + \frac{2}{3}\sqrt{3}$	2.15470...
4	$1 + \sqrt{2}$	2.41421...
5	$1 + \sqrt{2(1 + 1/\sqrt{5})}$	2.70130...
6	3	3.00000
7	3	3.00000
8	$1 + \csc(\pi/7)$	3.30476...
9	$1 + \sqrt{2(2 + \sqrt{2})}$	3.61312...
10		3.82...
11		
12		4.02...

For CIRCLE packing inside a SQUARE, proofs are known only for $n = 1$ to 9.

n	d exact	d approx.
1	1	1.000
2		0.58...
3		0.500...
4	$\frac{1}{2}$	0.500
5		0.41...
6		0.37...
7		0.348...
8		0.341...
9	$\frac{1}{3}$	0.333...
10		0.148204...

The smallest SQUARE into which two UNIT CIRCLES, one of which is split into two pieces by a chord, can be packed is not known (Goldberg 1968, Ogilvy 1990).

see also HYPERSPHERE PACKING, MALFATTI'S RIGHT TRIANGLE PROBLEM, MERGELYAN-WESLER THEOREM, SPHERE PACKING

References

- Conway, J. H. and Sloane, N. J. A. *Sphere Packings, Lattices, and Groups*, 2nd ed. New York: Springer-Verlag, 1992.
- Eppstein, D. "Covering and Packing." <http://www.ics.uci.edu/~eppstein/junkyard/cover.html>.
- Folkman, J. H. and Graham, R. "A Packing Inequality for Compact Convex Subsets of the Plane." *Canad. Math. Bull.* **12**, 745–752, 1969.
- Gardner, M. "Mathematical Games: The Diverse Pleasures of Circles that Are Tangent to One Another." *Sci. Amer.* **240**, 18–28, Jan. 1979.
- Gardner, M. "Tangent Circles." Ch. 10 in *Fractal Music, Hypercards, and More Mathematical Recreations from Scientific American Magazine*. New York: W. H. Freeman, 1992.
- Goldberg, M. "Problem E1924." *Amer. Math. Monthly* **75**, 195, 1968.
- Goldberg, M. "The Packing of Equal Circles in a Square." *Math. Mag.* **43**, 24–30, 1970.
- Goldberg, M. "Packing of 14, 16, 17, and 20 Circles in a Circle." *Math. Mag.* **44**, 134–139, 1971.
- Graham, R. L. and Lubachevsky, B. D. "Repeated Patterns of Dense Packings of Equal Disks in a Square." *Electronic J. Combinatorics* **3**, R16, 1–17, 1996. <http://www.combinatorics.org/Volume3/volume3.html#R16>.
- Kravitz, S. "Packing Cylinders into Cylindrical Containers." *Math. Mag.* **40**, 65–70, 1967.

- McCaughan, F. "Circle Packings." <http://www.pmms.cam.ac.uk/~gjm11/cpacking/info.html>.
- Molland, M. and Payan, Charles. "A Better Packing of Ten Equal Circles in a Square." *Discrete Math.* **84**, 303–305, 1990.
- Ogilvy, C. S. *Excursions in Geometry*. New York: Dover, p. 145, 1990.
- Reis, G. F. "Dense Packing of Equal Circle within a Circle." *Math. Mag.* **48**, 33–37, 1975.
- Schaer, J. "The Densest Packing of Nine Circles in a Square." *Can. Math. Bul.* **8**, 273–277, 1965.
- Schaer, J. "The Densest Packing of Ten Equal Circles in a Square." *Math. Mag.* **44**, 139–140, 1971.
- Valette, G. "A Better Packing of Ten Equal Circles in a Square." *Discrete Math.* **76**, 57–59, 1989.

Circle Pedal Curve

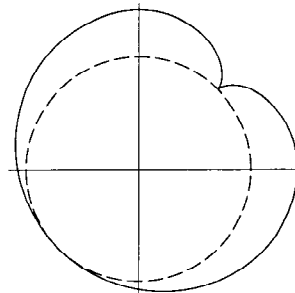

The PEDAL CURVE of a CIRCLE is a CARDIOID if the PEDAL POINT is taken on the CIRCUMFERENCE,

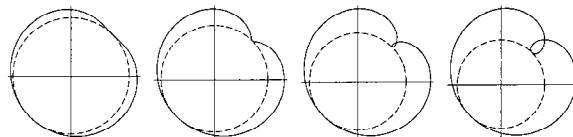

and otherwise a LIMAÇON.

Circle-Point Midpoint Theorem

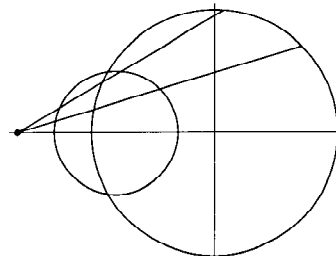

Taking the locus of MIDPOINTS from a fixed point to a circle of radius r results in a circle of radius $r/2$. This follows trivially from

$$\begin{aligned} \mathbf{r}(\theta) &= \begin{bmatrix} -x \\ 0 \end{bmatrix} + \frac{1}{2} \left(\begin{bmatrix} r \cos \theta \\ r \sin \theta \end{bmatrix} - \begin{bmatrix} -x \\ 0 \end{bmatrix} \right) \\ &= \begin{bmatrix} \frac{1}{2} r \cos \theta - \frac{1}{2} x \\ \frac{1}{2} r \sin \theta \end{bmatrix}. \end{aligned}$$

References

- Johnson, R. A. *Modern Geometry: An Elementary Treatise on the Geometry of the Triangle and the Circle*. Boston, MA: Houghton Mifflin, p. 17, 1929.

Circle Radial Curve

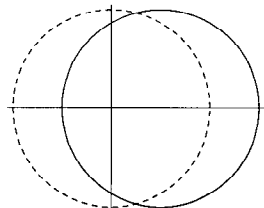

The RADIAL CURVE of a unit CIRCLE from a RADIAL POINT $(x, 0)$ is another CIRCLE with parametric equations

$$\begin{aligned}x(t) &= x - \cos t \\y(t) &= -\sin t.\end{aligned}$$

Circle Squaring

Construct a SQUARE equal in AREA to a CIRCLE using only a STRAIGHTEDGE and COMPASS. This was one of the three GEOMETRIC PROBLEMS OF ANTIQUITY, and was perhaps first attempted by Anaxagoras. It was finally proved to be an impossible problem when PI was proven to be TRANSCENDENTAL by Lindemann in 1882.

However, approximations to circle squaring are given by constructing lengths close to $\pi = 3.1415926\dots$ Ramanujan (1913–14) and Olds (1963) give geometric constructions for $355/113 = 3.1415929\dots$ Gardner (1966, pp. 92–93) gives a geometric construction for $3 + 16/113 = 3.1415929\dots$ Dixon (1991) gives constructions for $6/5(1 + \phi) = 3.141640\dots$ and $\sqrt{4 + [3 - \tan(30^\circ)]} = 3.141533\dots$

While the circle cannot be squared in EUCLIDEAN SPACE, it *can* in GAUSS-BOLYAI-LOBACHEVSKY SPACE (Gray 1989).

see also GEOMETRIC CONSTRUCTION, QUADRATURE, SQUARING

References

- Conway, J. H. and Guy, R. K. *The Book of Numbers*. New York: Springer-Verlag, pp. 190–191, 1996.
- Dixon, R. *Mathographics*. New York: Dover, pp. 44–49 and 52–53, 1991.
- Dunham, W. “Hippocrates’ Quadrature of the Lune.” Ch. 1 in *Journey Through Genius: The Great Theorems of Mathematics*. New York: Wiley, pp. 20–26, 1990.
- Gardner, M. “The Transcendental Number Pi.” Ch. 8 in *Martin Gardner’s New Mathematical Diversions from Scientific American*. New York: Simon and Schuster, 1966.
- Gray, J. *Ideas of Space*. Oxford, England: Oxford University Press, 1989.
- Meyers, L. F. “Update on William Wernick’s ‘Triangle Constructions with Three Located Points.’” *Math. Mag.* **69**, 46–49, 1996.
- Olds, C. D. *Continued Fractions*. New York: Random House, pp. 59–60, 1963.
- Ramanujan, S. “Modular Equations and Approximations to π .” *Quart. J. Pure. Appl. Math.* **45**, 350–372, 1913–1914.

Circle Strophoid

The STROPHOID of a CIRCLE with pole at the center and fixed point on the CIRCUMFERENCE is a FREETH’S NEPHROID.

Circle Tangents

There are four CIRCLES that touch all the sides of a given TRIANGLE. These are all touched by the CIRCLE through the intersection of the ANGLE BISECTORS of the TRIANGLE, known as the NINE-POINT CIRCLE.

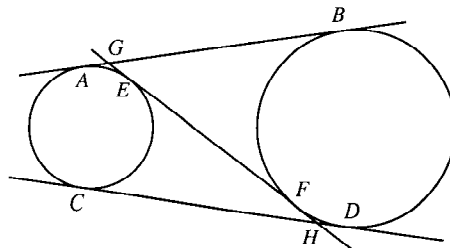

Given the above figure, $GE = FH$, since

$$\begin{aligned}AB &= AG + GB = GE + GF = GE + (GE + EF) \\&= 2G + EF\end{aligned}$$

$$\begin{aligned}CD &= CH + HD = EH + FH = FH + (FH + EF) \\&= EF + 2FH.\end{aligned}$$

Because $AB = CD$, it follows that $GE = FH$.

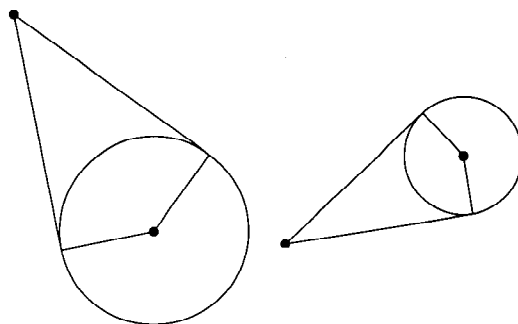

The line tangent to a CIRCLE of RADIUS a centered at (x, y)

$$\begin{aligned}x' &= x + a \cos t \\y' &= y + a \sin t\end{aligned}$$

through $(0, 0)$ can be found by solving the equation

$$\begin{bmatrix} x + a \cos t \\ y + a \sin t \end{bmatrix} \cdot \begin{bmatrix} a \cos t \\ a \sin t \end{bmatrix} = 0,$$

giving

$$t = \pm \cos^{-1} \left(\frac{-ax \pm y \sqrt{x^2 + y^2 - a^2}}{x^2 + y^2} \right).$$

Two of these four solutions give tangent lines, as illustrated above.

see also KISSING CIRCLES PROBLEM, MIQUEL POINT, MONGE'S PROBLEM, PEDAL CIRCLE, TANGENT LINE, TRIANGLE

References

Dixon, R. *Mathographics*. New York: Dover, p. 21, 1991.
Honsberger, R. *More Mathematical Morsels*. Washington, DC: Math. Assoc. Amer., pp. 4-5, 1991.

Circuit

see CYCLE (GRAPH)

Circuit Rank

Also known as the CYCLOMATIC NUMBER. The circuit rank is the smallest number of EDGES γ which must be removed from a GRAPH of N EDGES and n nodes such that no CIRCUIT remains.

$$\gamma = N - n + 1.$$

Circulant Determinant

Gradshteyn and Ryzhik (1970) define circulants by

$$\begin{vmatrix} x_1 & x_2 & x_3 & \cdots & x_n \\ x_n & x_1 & x_2 & \cdots & x_{n-1} \\ x_{n-1} & x_n & x_1 & \cdots & x_{n-2} \\ \vdots & \vdots & \vdots & \ddots & \vdots \\ x_2 & x_3 & x_4 & \cdots & x_1 \end{vmatrix} = \prod_{j=1}^n (x_1 + x_2 \omega_j + x_3 \omega_j^2 + \cdots + x_n \omega_j^{n-1}), \quad (1)$$

where ω_j is the n th ROOT OF UNITY. The second-order circulant determinant is

$$\begin{vmatrix} x_1 & x_2 \\ x_2 & x_1 \end{vmatrix} = (x_1 + x_2)(x_1 - x_2), \quad (2)$$

and the third order is

$$\begin{vmatrix} x_1 & x_2 & x_3 \\ x_3 & x_1 & x_2 \\ x_2 & x_3 & x_1 \end{vmatrix} = (x_1 + x_2 + x_3)(x_1 + \omega x_2 + \omega^2 x_3)(x_1 + \omega^2 x_2 + \omega x_3), \quad (3)$$

where ω and ω^2 are the COMPLEX CUBE ROOTS of UNITY.

The EIGENVALUES λ of the corresponding $n \times n$ circulant matrix are

$$\lambda_j = x_1 + x_2 \omega_j + x_3 \omega_j^2 + \cdots + x_n \omega_j^{n-1}. \quad (4)$$

see also CIRCULANT MATRIX

References

Gradshteyn, I. S. and Ryzhik, I. M. *Tables of Integrals, Series, and Products*, 5th ed. San Diego, CA: Academic Press, pp. 1111-1112, 1979.
Vardi, I. *Computational Recreations in Mathematica*. Reading, MA: Addison-Wesley, p. 114, 1991.

Circulant Graph

A GRAPH of n VERTICES in which the i th VERTEX is adjacent to the $(i + j)$ th and $(i - j)$ th VERTICES for each j in a list l .

Circulant Matrix

An $n \times n$ MATRIX C defined as follows,

$$C = \begin{bmatrix} 1 & \binom{n}{1} & \binom{n}{2} & \cdots & \binom{n}{n-1} \\ \binom{n}{n-1} & 1 & \binom{n}{1} & \cdots & \binom{n}{n-2} \\ \vdots & \vdots & \vdots & \ddots & \vdots \\ \binom{n}{1} & \binom{n}{2} & \binom{n}{3} & \cdots & 1 \end{bmatrix}$$

$$C = \prod_{j=0}^{n-1} [(1 + \omega_j)^n - 1],$$

where $\omega_0 \equiv 1$, $\omega_1, \dots, \omega_{n-1}$ are the n th ROOTS OF UNITY. Circulant matrices are examples of LATIN SQUARES.

see also CIRCULANT DETERMINANT

References

Davis, P. J. *Circulant Matrices*, 2nd ed. New York: Chelsea, 1994.
Strooker, R. J. "Brocard Points, Circulant Matrices, and Descartes' Folium." *Math. Mag.* **61**, 172-187, 1988.
Vardi, I. *Computational Recreations in Mathematica*. Reading, MA: Addison-Wesley, p. 114, 1991.

Circular Cylindrical Coordinates

see CYLINDRICAL COORDINATES

Circular Functions

The functions describing the horizontal and vertical positions of a point on a CIRCLE as a function of ANGLE (COSINE and SINE) and those functions derived from them:

$$\cot x \equiv \frac{1}{\tan x} = \frac{\cos x}{\sin x} \quad (1)$$

$$\csc x \equiv \frac{1}{\sin x} \quad (2)$$

$$\sec x \equiv \frac{1}{\cos x} \quad (3)$$

$$\tan x \equiv \frac{\sin x}{\cos x}. \quad (4)$$

The study of circular functions is called TRIGONOMETRY.

see also COSECANT, COSINE, COTANGENT, ELLIPTIC FUNCTION, GENERALIZED HYPERBOLIC FUNCTIONS, HYPERBOLIC FUNCTIONS, SECANT, SINE, TANGENT, TRIGONOMETRY

References

Abramowitz, M. and Stegun, C. A. (Eds.). "Circular Functions." §4.3 in *Handbook of Mathematical Functions with Formulas, Graphs, and Mathematical Tables*, 9th printing. New York: Dover, pp. 71-79, 1972.

Circular Permutation

The number of ways to arrange n distinct objects along a CIRCLE is

$$P_n = (n-1)!.$$

The number is $(n-1)!$ instead of the usual FACTORIAL $n!$ since all CYCLIC PERMUTATIONS of objects are equivalent because the CIRCLE can be rotated.

see also PERMUTATION, PRIME CIRCLE

Circumcenter

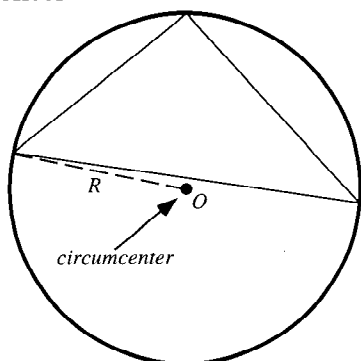

The center O of a TRIANGLE'S CIRCUMCIRCLE. It can be found as the intersection of the PERPENDICULAR BISECTORS. If the TRIANGLE is ACUTE, the circumcenter is in the interior of the TRIANGLE. In a RIGHT TRIANGLE, the circumcenter is the MIDPOINT of the HYPOTENUSE.

$$\overline{OO_1} + \overline{OO_2} + \overline{OO_3} = R + r, \quad (1)$$

where O_i are the MIDPOINTS of sides A_i , R is the CIRCUMRADIUS, and r is the INRADIUS (Johnson 1929, p. 190). The TRILINEAR COORDINATES of the circumcenter are

$$\cos A : \cos B : \cos C, \quad (2)$$

and the exact trilinears are therefore

$$R \cos A : R \cos B : R \cos C. \quad (3)$$

The AREAL COORDINATES are

$$\left(\frac{1}{2}a \cot A, \frac{1}{2}b \cot B, \frac{1}{2}c \cot C\right). \quad (4)$$

The distance between the INCENTER and circumcenter is $\sqrt{R(R-2r)}$. Given an interior point, the distances to the VERTICES are equal IFF this point is the circumcenter. It lies on the BROCARD AXIS.

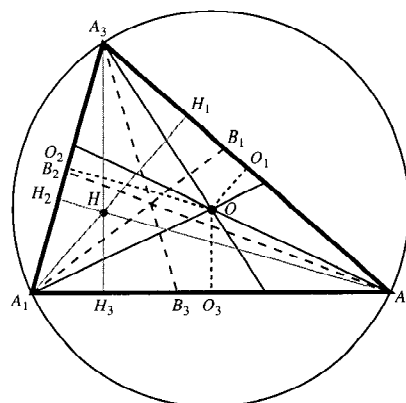

The circumcenter O and ORTHOCENTER H are ISOGONAL CONJUGATES.

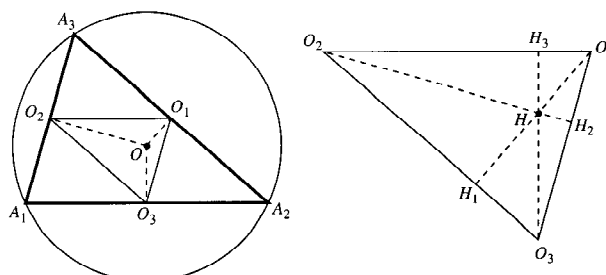

The ORTHOCENTER H of the PEDAL TRIANGLE $\Delta O_1O_2O_3$ formed by the CIRCUMCENTER O concurs with the circumcenter O itself, as illustrated above. The circumcenter also lies on the EULER LINE.

see also BROCARD DIAMETER, CARNOT'S THEOREM, CENTROID (TRIANGLE), CIRCLE, EULER LINE, INCENTER, ORTHOCENTER

References

- Carr, G. S. *Formulas and Theorems in Pure Mathematics*, 2nd ed. New York: Chelsea, p. 623, 1970.
 Dixon, R. *Mathographics*. New York: Dover, p. 55, 1991.
 Eppstein, D. "Circumcenters of Triangles." <http://www.ics.uci.edu/~eppstein/junkyard/circumcenter.html>.
 Johnson, R. A. *Modern Geometry: An Elementary Treatise on the Geometry of the Triangle and the Circle*. Boston, MA: Houghton Mifflin, 1929.
 Kimberling, C. "Central Points and Central Lines in the Plane of a Triangle." *Math. Mag.* **67**, 163–187, 1994.
 Kimberling, C. "Circumcenter." <http://www.evansville.edu/~ck6/tcenters/class/ccenter.html>.

Circumcircle

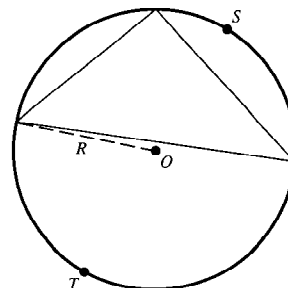

A TRIANGLE's circumscribed circle. Its center O is called the CIRCUMCENTER, and its RADIUS R the CIRCUMRADIUS. The circumcircle can be specified using TRILINEAR COORDINATES as

$$\beta\gamma a + \gamma\alpha b + \alpha\beta c = 0. \quad (1)$$

The STEINER POINT S and TARRY POINT T lie on the circumcircle.

A GEOMETRIC CONSTRUCTION for the circumcircle is given by Pedoe (1995, pp. xii–xiii). The equation for the circumcircle of the TRIANGLE with VERTICES (x_i, y_i) for $i = 1, 2, 3$ is

$$\begin{vmatrix} x^2 + y^2 & x & y & 1 \\ x_1^2 + y_1^2 & x_1 & y_1 & 1 \\ x_2^2 + y_2^2 & x_2 & y_2 & 1 \\ x_3^2 + y_3^2 & x_3 & y_3 & 1 \end{vmatrix} = 0. \quad (2)$$

Expanding the DETERMINANT,

$$a(x^2 + y^2) + 2dx + 2fy + g = 0, \quad (3)$$

where

$$a = \begin{vmatrix} x_1 & y_1 & 1 \\ x_2 & y_2 & 1 \\ x_3 & y_3 & 1 \end{vmatrix} \quad (4)$$

$$d = -\frac{1}{2} \begin{vmatrix} x_1^2 + y_1^2 & y_1 & 1 \\ x_2^2 + y_2^2 & y_2 & 1 \\ x_3^2 + y_3^2 & y_3 & 1 \end{vmatrix} \quad (5)$$

$$f = \frac{1}{2} \begin{vmatrix} x_1^2 + y_1^2 & x_1 & 1 \\ x_2^2 + y_2^2 & x_2 & 1 \\ x_3^2 + y_3^2 & x_3 & 1 \end{vmatrix} \quad (6)$$

$$g = - \begin{vmatrix} x_1^2 + y_1^2 & x_1 & y_1 \\ x_2^2 + y_2^2 & x_2 & y_2 \\ x_3^2 + y_3^2 & x_3 & y_3 \end{vmatrix}. \quad (7)$$

COMPLETING THE SQUARE gives

$$a \left(x + \frac{d}{a} \right)^2 + a \left(y + \frac{f}{a} \right)^2 - \frac{d^2}{a} - \frac{f^2}{a} + g = 0 \quad (8)$$

which is a CIRCLE of the form

$$(x - x_0)^2 + (y - y_0)^2 = r^2, \quad (9)$$

with CIRCUMCENTER

$$x_0 = -\frac{d}{a} \quad (10)$$

$$y_0 = -\frac{f}{a} \quad (11)$$

and CIRCUMRADIUS

$$r = \sqrt{\frac{f^2 + d^2}{a^2} - \frac{g}{a}}. \quad (12)$$

see also CIRCLE, CIRCUMCENTER, CIRCUMRADIUS, EX-CIRCLE, INCIRCLE, PARRY POINT, PURSER'S THEOREM, STEINER POINTS, TARRY POINT

References

Pedoe, D. *Circles: A Mathematical View*, rev. ed. Washington, DC: Math. Assoc. Amer., 1995.

Circumference

The PERIMETER of a CIRCLE. For RADIUS r or DIAMETER $d = 2r$,

$$C = 2\pi r = \pi d,$$

where π is PI.

see also CIRCLE, DIAMETER, PERIMETER, PI, RADIUS

Circuminscribed

Given two closed curves, the circuminscribed curve is simultaneously INSCRIBED in the outer one and CIRCUMSCRIBED on the inner one.

see also PONCELET'S CLOSURE THEOREM

Circumradius

The radius of a TRIANGLE's CIRCUMCIRCLE or of a POLYHEDRON's CIRCUMSPHERE, denoted R . For a TRIANGLE,

$$R = \frac{abc}{\sqrt{(a+b+c)(b+c-a)(c+a-b)(a+b-c)}}, \quad (1)$$

where the side lengths of the TRIANGLE are a , b , and c .

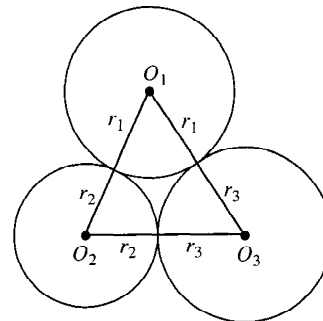

This equation can also be expressed in terms of the RADII of the three mutually tangent CIRCLES centered at the TRIANGLE's VERTICES. Relabeling the diagram for the SODDY CIRCLES with VERTICES O_1 , O_2 , and O_3 and the radii r_1 , r_2 , and r_3 , and using

$$a = r_1 + r_2 \quad (2)$$

$$b = r_2 + r_3 \quad (3)$$

$$c = r_1 + r_3 \quad (4)$$

then gives

$$R = \frac{(r_1 + r_2)(r_1 + r_3)(r_2 + r_3)}{4\sqrt{r_1 r_2 r_3 (r_1 + r_2 + r_3)}}. \quad (5)$$

If O is the CIRCUMCENTER and M is the triangle CENTROID, then

$$\overline{OM}^2 = R^2 - \frac{1}{9}(a^2 + b^2 + c^2). \quad (6)$$

$$Rr = \frac{a_1 a_2 a_3}{4s} \quad (7)$$

$$\cos \alpha_1 + \cos \alpha_2 + \cos \alpha_3 = 1 + \frac{r}{R} \quad (8)$$

$$r = 2R \cos \alpha_1 \cos \alpha_2 \cos \alpha_3 \quad (9)$$

$$a_1^2 + a_2^2 + a_3^2 = 4rR + 8R^2 \quad (10)$$

(Johnson 1929, pp. 189–191). Let d be the distance between INRADIUS r and circumradius R , $d = \overline{rR}$. Then

$$R^2 - d^2 = 2Rr \quad (11)$$

$$\frac{1}{R-d} + \frac{1}{R+d} = \frac{1}{r} \quad (12)$$

(Mackay 1886–87). These and many other identities are given in Johnson (1929, pp. 186–190).

For an ARCHIMEDEAN SOLID, expressing the circumradius in terms of the INRADIUS r and MIDRADIUS ρ gives

$$R = \frac{1}{2}(r + \sqrt{r^2 + a^2}) \quad (13)$$

$$= \sqrt{\rho^2 + \frac{1}{4}a^2} \quad (14)$$

for an ARCHIMEDEAN SOLID.

see also CARNOT'S THEOREM, CIRCUMCIRCLE, CIRCUMSPHERE

References

- Johnson, R. A. *Modern Geometry: An Elementary Treatise on the Geometry of the Triangle and the Circle*. Boston, MA: Houghton Mifflin, 1929.
- Mackay, J. S. "Historical Notes on a Geometrical Theorem and its Developments [18th Century]." *Proc. Edinburgh Math. Soc.* **5**, 62–78, 1886–1887.

Circumscribed

A geometric figure which touches only the VERTICES (or other extremities) of another figure.

see also CIRCUMCENTER, CIRCUMCIRCLE, CIRCUMINSCRIBED, CIRCUMRADIUS, INSCRIBED

Circumsphere

A SPHERE circumscribed in a given solid. Its radius is called the CIRCUMRADIUS.

see also INSPHERE

Cis

$$\text{Cis } x \equiv e^{ix} = \cos x + i \sin x.$$

Cissoïd

Given two curves C_1 and C_2 and a fixed point O , let a line from O cut C_1 at Q and C_2 at R . Then the LOCUS of a point P such that $OP = QR$ is the cissoïd. The word cissoïd means "ivy shaped."

Curve 1	Curve 2	Pole	Cissoïd
line	parallel line	any point	line
line	circle	center	conchoid of Nicomedes
circle	tangent line	on C	oblique cissoïd
circle	tangent line	on C opp. tangent	cissoïd of Diocles
circle	radial line	on C	strophoid
circle	concentric circle	center	circle
circle	same circle	$(a\sqrt{2}, 0)$	lemniscate

see also CISSOID OF DIOCLES

References

- Lawrence, J. D. *A Catalog of Special Plane Curves*. New York: Dover, pp. 53–56 and 205, 1972.
- Lee, X. "Cissoïd." http://www.best.com/~xah/SpecialPlaneCurves_dir/Cissoïd_dir/cissoïd.html.
- Lockwood, E. H. "Cissoïds." Ch. 15 in *A Book of Curves*. Cambridge, England: Cambridge University Press, pp. 130–133, 1967.
- Yates, R. C. "Cissoïd." *A Handbook on Curves and Their Properties*. Ann Arbor, MI: J. W. Edwards, pp. 26–30, 1952.

Cissoïd of Diocles

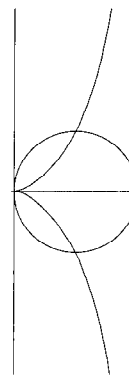

A curve invented by Diocles in about 180 BC in connection with his attempt to duplicate the cube by geometrical methods. The name "cissoïd" first appears in the work of Geminus about 100 years later. Fermat and Roberval constructed the tangent in 1634. Huygens and Wallis found, in 1658, that the AREA between the curve and its asymptote was $3a$ (MacTutor Archive). From a given point there are either one or three TANGENTS to the cissoïd.

Given an origin O and a point P on the curve, let S be the point where the extension of the line OP intersects the line $x = 2a$ and R be the intersection of the CIRCLE of RADIUS a and center $(a, 0)$ with the extension of OP . Then the cissoïd of Diocles is the curve which satisfies $OP = RS$.

The cissoïd of Diocles is the ROULETTE of the VERTEX of a PARABOLA rolling on an equal PARABOLA. Newton gave a method of drawing the cissoïd of Diocles using two line segments of equal length at RIGHT ANGLES. If they are moved so that one line always passes through a fixed point and the end of the other line segment slides along a straight line, then the MIDPOINT of the sliding line segment traces out a cissoïd of Diocles.

The cissoïd of Diocles is given by the parametric equations

$$x = 2a \sin^2 \theta \quad (1)$$

$$y = \frac{2a \sin^3 \theta}{\cos \theta}. \quad (2)$$

Converting these to POLAR COORDINATES gives

$$\begin{aligned} r^2 = x^2 + y^2 &= 4a^2 \left(\sin^4 \theta + \frac{\sin^6 \theta}{\cos^2 \theta} \right) \\ &= 4a^2 \sin^4 \theta (1 + \tan^2 \theta) = 4a^2 \sin^4 \theta \sec^2 \theta, \end{aligned} \quad (3)$$

so

$$r = 2a \sin^2 \theta \sec \theta = 2a \sin \theta \tan \theta. \quad (4)$$

In CARTESIAN COORDINATES,

$$\begin{aligned} \frac{x^3}{2a - x} &= \frac{8a^3 \sin^6 \theta}{2a - 2a \sin^2 \theta} = 4a^2 \frac{\sin^6 \theta}{1 - \sin^2 \theta} \\ &= 4a^2 \frac{\sin^6 \theta}{\cos^2 \theta} = y^2. \end{aligned} \quad (5)$$

An equivalent form is

$$x(x^2 + y^2) = 2ay^2. \quad (6)$$

Using the alternative parametric form

$$x(t) = \frac{2at^2}{1+t^2} \quad (7)$$

$$y(t) = \frac{2at^3}{1+t^2} \quad (8)$$

(Gray 1993), gives the CURVATURE as

$$\kappa(t) = \frac{3}{a|t|(t^2 + 4)^{3/2}}. \quad (9)$$

References

- Gray, A. "The Cissoïd of Diocles." §3.4 in *Modern Differential Geometry of Curves and Surfaces*. Boca Raton, FL: CRC Press, pp. 43–46, 1993.
- Lawrence, J. D. *A Catalog of Special Plane Curves*. New York: Dover, pp. 98–100, 1972.
- Lee, X. "Cissoïd of Diocles." <http://www.best.com/~xah/SpecialPlaneCurves.dir/CissoïdOfDiocles.dir/cissoïdOfDiocles.html>.
- Lockwood, E. H. *A Book of Curves*. Cambridge, England: Cambridge University Press, pp. 130–133, 1967.
- MacTutor History of Mathematics Archive. "Cissoïd of Diocles." <http://www-groups.dcs.st-and.ac.uk/~history/Curves/Cissoïd.html>.
- Yates, R. C. "Cissoïd." *A Handbook on Curves and Their Properties*. Ann Arbor, MI: J. W. Edwards, pp. 26–30, 1952.

Cissoïd of Diocles Caustic

The CAUSTIC of the cissoïd where the RADIANT POINT is taken as $(8a, 0)$ is a CARDIOID.

Cissoïd of Diocles Inverse Curve

If the cusp of the CISSOÏD OF DIOCLES is taken as the INVERSION CENTER, then the cissoïd inverts to a PARABOLA.

Cissoïd of Diocles Pedal Curve

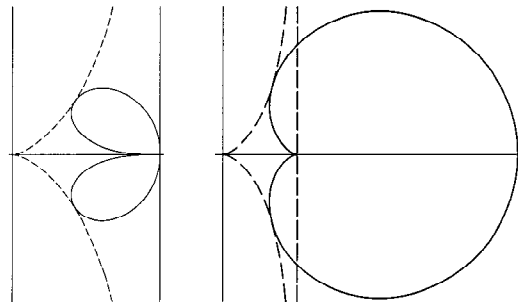

The PEDAL CURVE of the cissoïd, when the PEDAL POINT is on the axis beyond the ASYMPTOTE at a distance from the cusp which is four times that of the ASYMPTOTE is a CARDIOID.

Clairaut's Differential Equation

$$y = x \frac{dy}{dx} + f\left(\frac{dy}{dx}\right)$$

or

$$y = px + f(p),$$

where f is a FUNCTION of one variable and $p \equiv dy/dx$. The general solution is $y = cx + f(c)$. The singular solution ENVELOPES are $x = -f'(c)$ and $y = f(c) - cf'(c)$.

see also D'ALEMBERT'S EQUATION

References

- Boyer, C. B. *A History of Mathematics*. New York: Wiley, p. 494, 1968.

Clarity

The RATIO of a measure of the size of a "fit" to the size of a "residual."

References

- Tukey, J. W. *Explanatory Data Analysis*. Reading, MA: Addison-Wesley, p. 667, 1977.

Clark's Triangle

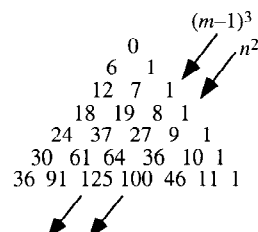

A NUMBER TRIANGLE created by setting the VERTEX equal to 0, filling one diagonal with 1s, the other diagonal with multiples of an INTEGER f , and filling in the remaining entries by summing the elements on either side from one row above. Call the first column $n = 0$ and the last column $m = n$ so that

$$c(m, 0) = fm \quad (1)$$

$$c(m, m) = 1, \quad (2)$$

then use the RECURRENCE RELATION

$$c(m, n) = c(m-1, n-1) + c(m-1, n) \quad (3)$$

to compute the rest of the entries. For $n = 1$, we have

$$c(m, 1) = c(m-1, 0) + c(m-1, 1) \quad (4)$$

$$c(m, 1) - c(m-1, 1) = c(m-1, 0) = f(m-1). \quad (5)$$

For arbitrary m , the value can be computed by SUMMING this RECURRENCE,

$$c(m, 1) = f \left(\sum_{k=1}^{m-1} k \right) + 1 = \frac{1}{2}fm(m-1) + 1. \quad (6)$$

Now, for $n = 2$ we have

$$c(m, 2) = c(m-1, 1) + c(m-1, 2) \quad (7)$$

$$c(m, 2) - c(m-1, 2) = c(m-1, 1) = \frac{1}{2}f(m-1)m+1, \quad (8)$$

so SUMMING the RECURRENCE gives

$$\begin{aligned} c(m, 2) &= \sum_{k=1}^m [\frac{1}{2}fk(k-1) + 1] = \sum_{k=1}^m (\frac{1}{2}fk^2 - \frac{1}{2}fk + 1) \\ &= \frac{1}{2}f[\frac{1}{6}m(m+1)(2m+1)] - \frac{1}{2}f[\frac{1}{2}m(m+1)] + m \\ &= \frac{1}{6}(m-1)(fm^2 - 2fm + 6). \end{aligned} \quad (9)$$

Similarly, for $n = 3$ we have

$$\begin{aligned} c(m, 3) - c(m-1, 3) &= c(m-1, 2) \\ &= \frac{1}{6}fm^3 - fm^2 + (\frac{11}{6}f + 1)m - (f + 2). \end{aligned} \quad (10)$$

Taking the SUM,

$$c(m, 3) = \sum_{k=2}^m \frac{1}{6}fk^3 - fk^2 + (\frac{11}{6}f + 1)k - (f + 2). \quad (11)$$

Evaluating the SUM gives

$$c(m, 3) = \frac{1}{24}(m-1)(m-2)(fm^2 - 3fm + 12). \quad (12)$$

So far, this has just been relatively boring ALGEBRA. But the amazing part is that if $f = 6$ is chosen as the INTEGER, then $c(m, 2)$ and $c(m, 3)$ simplify to

$$\begin{aligned} c(m, 2) &= \frac{1}{6}(m-1)(6m^2 - 12m + 6) \\ &= (m-1)^3 \end{aligned} \quad (13)$$

$$c(m, 3) = \frac{1}{4}(m-1)^2(m-2)^2, \quad (14)$$

which are consecutive CUBES $(m-1)^3$ and nonconsecutive SQUARES $n^2 = [(m-1)(m-2)/2]^2$.

see also BELL TRIANGLE, CATALAN'S TRIANGLE, EULER'S TRIANGLE, LEIBNIZ HARMONIC TRIANGLE, NUMBER TRIANGLE, PASCAL'S TRIANGLE, SEIDEL-ENTRINGER-ARNOLD TRIANGLE, SUM

References

Clark, J. E. "Clark's Triangle." *Math. Student* **26**, No. 2, p. 4, Nov. 1978.

Class

see CHARACTERISTIC CLASS, CLASS INTERVAL, CLASS (MULTIPLY PERFECT NUMBER), CLASS NUMBER, CLASS (SET), CONJUGACY CLASS

Class (Group)

see CONJUGACY CLASS

Class Interval

The constant bin size in a HISTOGRAM.

see also SHEPPARD'S CORRECTION

Class (Map)

A MAP $u: \mathbb{R}^n \rightarrow \mathbb{R}^n$ from a DOMAIN G is called a map of class C^r if each component of

$$u(x) = (u_1(x_1, \dots, x_n), \dots, u_m(x_1, \dots, x_n))$$

is of class C^r ($0 \leq r \leq \infty$ or $r = \omega$) in G , where C^d denotes a continuous function which is differentiable d times.

Class (Multiply Perfect Number)

The number k in the expression $s(n) = kn$ for a MULTIPLY PERFECT NUMBER is called its class.

Class Number

For any IDEAL I , there is an IDEAL I_i such that

$$II_i = z, \quad (1)$$

where z is a PRINCIPAL IDEAL, (i.e., an IDEAL of rank 1). Moreover, there is a finite list of ideals I_i such that this equation may be satisfied for every I . The size of this list is known as the class number. When the class number is 1, the RING corresponding to a given IDEAL has unique factorization and, in a sense, the class

number is a measure of the failure of unique factorization in the original number ring.

A finite series giving exactly the class number of a RING is known as a CLASS NUMBER FORMULA. A CLASS NUMBER FORMULA is known for the full ring of cyclotomic integers, as well as for any subring of the cyclotomic integers. Finding the class number is a computationally difficult problem.

Let $h(d)$ denote the class number of a quadratic ring, corresponding to the BINARY QUADRATIC FORM

$$ax^2 + bxy + cy^2, \quad (2)$$

with DISCRIMINANT

$$d \equiv b^2 - 4ac. \quad (3)$$

Then the class number $h(d)$ for DISCRIMINANT d gives the number of possible factorizations of $ax^2 + bxy + cy^2$ in the QUADRATIC FIELD $\mathbb{Q}(\sqrt{d})$. Here, the factors are of the form $x + y\sqrt{d}$, with x and y half INTEGERS.

Some fairly sophisticated mathematics shows that the class number for discriminant d can be given by the CLASS NUMBER FORMULA

$$h(d) \equiv \begin{cases} -\frac{1}{2 \ln \eta} \sum_{r=1}^{d-1} (d|r) \ln \sin\left(\frac{\pi r}{d}\right) & \text{for } d > 0 \\ -\frac{w(d)}{2|d|} \sum_{r=1}^{|d|-1} (d|r) r & \text{for } d < 0, \end{cases} \quad (4)$$

where $(d|r)$ is the KRONECKER SYMBOL, $\eta(d)$ is the FUNDAMENTAL UNIT, $w(d)$ is the number of substitutions which leave the BINARY QUADRATIC FORM unchanged

$$w(d) = \begin{cases} 6 & \text{for } d = -3 \\ 4 & \text{for } d = -4 \\ 2 & \text{otherwise,} \end{cases} \quad (5)$$

and the sums are taken over all terms where the KRONECKER SYMBOL is defined (Cohn 1980). The class number for $d > 0$ can also be written

$$\eta^{2h(d)} = \prod_{r=1}^{d-1} \sin^{-(d|r)}\left(\frac{\pi r}{d}\right) \quad (6)$$

for $d > 0$, where the PRODUCT is taken over terms for which the KRONECKER SYMBOL is defined.

The class number is related to the DIRICHLET L -SERIES by

$$h(d) = \frac{L_d(1)}{\kappa(d)}, \quad (7)$$

where $\kappa(d)$ is the DIRICHLET STRUCTURE CONSTANT.

Wagner (1996) shows that class number $h(-d)$ satisfies the INEQUALITY

$$h(-d) > \frac{1}{55} \prod_{p|d}^* \left(1 - \frac{|2\sqrt{p}|}{p+1}\right) \ln d, \quad (8)$$

for $-d < 0$, where $\lfloor x \rfloor$ is the FLOOR FUNCTION, the product is over PRIMES dividing d , and the $*$ indicates that the GREATEST PRIME FACTOR of d is omitted from the product.

The *Mathematica*® (Wolfram Research, Champaign, IL) function `NumberTheory`NumberTheoryFunctions`ClassNumber[n]` gives the class number $h(d)$ for d a NEGATIVE SQUAREFREE number of the form $4k+1$.

GAUSS'S CLASS NUMBER PROBLEM asks to determine a complete list of fundamental DISCRIMINANTS $-d$ such that the CLASS NUMBER is given by $h(-d) = m$ for a given m . This problem has been solved for $n \leq 7$ and ODD $n \leq 23$. Gauss conjectured that the class number $h(-d)$ of an IMAGINARY quadratic field with DISCRIMINANT $-d$ tends to infinity with d , an assertion now known as GAUSS'S CLASS NUMBER CONJECTURE.

The discriminants d having $h(-d) = 1, 2, 3, 4, 5, \dots$ are Sloane's A014602 (Cohen 1993, p. 229; Cox 1997, p. 271), Sloane's A014603 (Cohen 1993, p. 229), Sloane's A006203 (Cohen 1993, p. 504), Sloane's A013658 (Cohen 1993, p. 229), Sloane's A046002, Sloane's A046003, The complete set of negative discriminants having class numbers 1–5 and ODD 7–23 are known. Buell (1977) gives the smallest and largest fundamental class numbers for $d < 4,000,000$, partitioned into EVEN discriminants, discriminants 1 (mod 8), and discriminants 5 (mod 8). Arno *et al.* (1993) give complete lists of values of d with $h(-d) = k$ for ODD $k = 5, 7, 9, \dots, 23$. Wagner gives complete lists of values for $k = 5, 6$, and 7.

Lists of NEGATIVE discriminants corresponding to IMAGINARY QUADRATIC FIELDS $\mathbb{Q}(\sqrt{-d(n)})$ having small class numbers $h(-d)$ are given in the table below. In the table, N is the number of "fundamental" values of $-d$ with a given class number $h(-d)$, where "fundamental" means that $-d$ is not divisible by any SQUARE NUMBER s^2 such that $h(-d/s^2) < h(-d)$. For example, although $h(-63) = 2$, -63 is not a fundamental discriminant since $63 = 3^2 \cdot 7$ and $h(-63/3^2) = h(-7) = 1 < h(-63)$. EVEN values $8 \leq h(-d) \leq 18$ have been computed by Weisstein. The number of negative discriminants having class number 1, 2, 3, ... are 9, 18, 16, 54, 25, 51, 31, ... (Sloane's A046125). The largest negative discriminants having class numbers 1, 2, 3, ... are 163, 427, 907, 1555, 2683, ... (Sloane's A038552).

The following table lists the numbers with small class numbers ≤ 11 . Lists including larger class numbers are given by Weisstein.

$h(-d)$	N	d
1	9	3, 4, 7, 8, 11, 19, 43, 67, 163
2	18	15, 20, 24, 35, 40, 51, 52, 88, 91, 115, 123, 148, 187, 232, 235, 267, 403, 427
3	16	23, 31, 59, 83, 107, 139, 211, 283, 307, 331, 379, 499, 547, 643, 883, 907

$h(-d)$	N	d
4	54	39, 55, 56, 68, 84, 120, 132, 136, 155, 168, 184, 195, 203, 219, 228, 259, 280, 291, 292, 312, 323, 328, 340, 355, 372, 388, 408, 435, 483, 520, 532, 555, 568, 595, 627, 667, 708, 715, 723, 760, 763, 772, 795, 955, 1003, 1012, 1027, 1227, 1243, 1387, 1411, 1435, 1507, 1555
5	25	47, 79, 103, 127, 131, 179, 227, 347, 443, 523, 571, 619, 683, 691, 739, 787, 947, 1051, 1123, 1723, 1747, 1867, 2203, 2347, 2683
6	51	87, 104, 116, 152, 212, 244, 247, 339, 411, 424, 436, 451, 472, 515, 628, 707, 771, 808, 835, 843, 856, 1048, 1059, 1099, 1108, 1147, 1192, 1203, 1219, 1267, 1315, 1347, 1363, 1432, 1563, 1588, 1603, 1843, 1915, 1963, 2227, 2283, 2443, 2515, 2563, 2787, 2923, 3235, 3427, 3523, 3763
7	31	71, 151, 223, 251, 463, 467, 487, 587, 811, 827, 859, 1163, 1171, 1483, 1523, 1627, 1787, 1987, 2011, 2083, 2179, 2251, 2467, 2707, 3019, 3067, 3187, 3907, 4603, 5107, 5923
8	131	95, 111, 164, 183, 248, 260, 264, 276, 295, 299, 308, 371, 376, 395, 420, 452, 456, 548, 552, 564, 579, 580, 583, 616, 632, 651, 660, 712, 820, 840, 852, 868, 904, 915, 939, 952, 979, 987, 995, 1032, 1043, 1060, 1092, 1128, 1131, 1155, 1195, 1204, 1240, 1252, 1288, 1299, 1320, 1339, 1348, 1380, 1428, 1443, 1528, 1540, 1635, 1651, 1659, 1672, 1731, 1752, 1768, 1771, 1780, 1795, 1803, 1828, 1848, 1864, 1912, 1939, 1947, 1992, 1995, 2020, 2035, 2059, 2067, 2139, 2163, 2212, 2248, 2307, 2308, 2323, 2392, 2395, 2419, 2451, 2587, 2611, 2632, 2667, 2715, 2755, 2788, 2827, 2947, 2968, 2995, 3003, 3172, 3243, 3315, 3355, 3403, 3448, 3507, 3595, 3787, 3883, 3963, 4123, 4195, 4267, 4323, 4387, 4747, 4843, 4867, 5083, 5467, 5587, 5707, 5947, 6307
9	34	199, 367, 419, 491, 563, 823, 1087, 1187, 1291, 1423, 1579, 2003, 2803, 3163, 3259, 3307, 3547, 3643, 4027, 4243, 4363, 4483, 4723, 4987, 5443, 6043, 6427, 6763, 6883, 7723, 8563, 8803, 9067, 10627
10	87	119, 143, 159, 296, 303, 319, 344, 415, 488, 611, 635, 664, 699, 724, 779, 788, 803, 851, 872, 916, 923, 1115, 1268, 1384, 1492, 1576, 1643, 1684, 1688, 1707, 1779, 1819, 1835, 1891, 1923, 2152, 2164,

$h(-d)$	N	d
		2363, 2452, 2643, 2776, 2836, 2899, 3028, 3091, 3139, 3147, 3291, 3412, 3508, 3635, 3667, 3683, 3811, 3859, 3928, 4083, 4227, 4372, 4435, 4579, 4627, 4852, 4915, 5131, 5163, 5272, 5515, 5611, 5667, 5803, 6115, 6259, 6403, 6667, 7123, 7363, 7387, 7435, 7483, 7627, 8227, 8947, 9307, 10147, 10483, 13843
11	41	167, 271, 659, 967, 1283, 1303, 1307, 1459, 1531, 1699, 2027, 2267, 2539, 2731, 2851, 2971, 3203, 3347, 3499, 3739, 3931, 4051, 5179, 5683, 6163, 6547, 7027, 7507, 7603, 7867, 8443, 9283, 9403, 9643, 9787, 10987, 13003, 13267, 14107, 14683, 15667

The table below gives lists of POSITIVE fundamental discriminants d having small class numbers $h(d)$, corresponding to REAL quadratic fields. All POSITIVE SQUAREFREE values of $d \leq 97$ (for which the KRON-ECKER SYMBOL is defined) are included.

$h(d)$	d
1	5, 13, 17, 21, 29, 37, 41, 53, 57, 61, 69, 73, 77
2	65

The POSITIVE d for which $h(d) = 1$ is given by Sloane's A014539.

see also CLASS NUMBER FORMULA, DIRICHLET L -SERIES, DISCRIMINANT (BINARY QUADRATIC FORM), GAUSS'S CLASS NUMBER CONJECTURE, GAUSS'S CLASS NUMBER PROBLEM, HEEGNER NUMBER, IDEAL, j -FUNCTION

References

- Arno, S. "The Imaginary Quadratic Fields of Class Number 4." *Acta Arith.* **40**, 321–334, 1992.
- Arno, S.; Robinson, M. L.; and Wheeler, F. S. "Imaginary Quadratic Fields with Small Odd Class Number." <http://www.math.uiuc.edu/Algebraic-Number-Theory/0009/>.
- Buell, D. A. "Small Class Numbers and Extreme Values of L -Functions of Quadratic Fields." *Math. Comput.* **139**, 786–796, 1977.
- Cohen, H. *A Course in Computational Algebraic Number Theory*. New York: Springer-Verlag, 1993.
- Cohn, H. *Advanced Number Theory*. New York: Dover, pp. 163 and 234, 1980.
- Cox, D. A. *Primes of the Form $x^2 + ny^2$: Fermat, Class Field Theory and Complex Multiplication*. New York: Wiley, 1997.
- Davenport, H. "Dirichlet's Class Number Formula." Ch. 6 in *Multiplicative Number Theory*, 2nd ed. New York: Springer-Verlag, pp. 43–53, 1980.
- Iyanaga, S. and Kawada, Y. (Eds.). "Class Numbers of Algebraic Number Fields." Appendix B, Table 4 in *Encyclopedic Dictionary of Mathematics*. Cambridge, MA: MIT Press, pp. 1494–1496, 1980.
- Montgomery, H. and Weinberger, P. "Notes on Small Class Numbers." *Acta Arith.* **24**, 529–542, 1974.
- Sloane, N. J. A. Sequences A014539, A038552, A046125, and A003657/M2332 in "An On-Line Version of the Encyclopedia of Integer Sequences."

Stark, H. M. "A Complete Determination of the Complex Quadratic Fields of Class Number One." *Michigan Math. J.* **14**, 1–27, 1967.

Stark, H. M. "On Complex Quadratic Fields with Class Number Two." *Math. Comput.* **29**, 289–302, 1975.

Wagner, C. "Class Number 5, 6, and 7." *Math. Comput.* **65**, 785–800, 1996.

✱ Weisstein, E. W. "Class Numbers." <http://www.astro.virginia.edu/~eww6n/math/notebooks/ClassNumbers.m>.

Class Number Formula

A class number formula is a finite series giving exactly the CLASS NUMBER of a RING. For a RING of quadratic integers, the class number is denoted $h(d)$, where d is the discriminant. A class number formula is known for the full ring of cyclotomic integers, as well as for any subring of the cyclotomic integers. This formula includes the quadratic case as well as many cubic and higher-order rings.

see also CLASS NUMBER

Class Representative

A set of class representatives is a SUBSET of X which contains exactly one element from each EQUIVALENCE CLASS.

Class (Set)

A class is a special kind of SET invented to get around RUSSELL'S PARADOX while retaining the arbitrary criteria for membership which leads to difficulty for SETS. The members of classes are SETS, but it is possible to have the class C of "all SETS which are not members of themselves" without producing a paradox (since C is a proper class (and not a SET), it is not a candidate for membership in C).

see also AGGREGATE, RUSSELL'S PARADOX, SET

Classical Groups

The four following types of GROUPS,

1. LINEAR GROUPS,
2. ORTHOGONAL GROUPS,
3. SYMPLECTIC GROUPS, and
4. UNITARY GROUPS,

which were studied before more exotic types of groups (such as the SPORADIC GROUPS) were discovered.

see also GROUP, LINEAR GROUP, ORTHOGONAL GROUP, SYMPLECTIC GROUP, UNITARY GROUP

Classification

The classification of a collection of objects generally means that a list has been constructed with exactly one member from each ISOMORPHISM type among the objects, and that tools and techniques can effectively be used to identify any combinatorially given object with its unique representative in the list. Examples of mathematical objects which have been classified include the finite SIMPLE GROUPS and 2-MANIFOLDS but not, for example, KNOTS.

Classification Theorem

The classification theorem of FINITE SIMPLE GROUPS, also known as the ENORMOUS THEOREM, which states that the FINITE SIMPLE GROUPS can be classified completely into

1. CYCLIC GROUPS \mathbb{Z}_p of PRIME ORDER,
2. ALTERNATING GROUPS A_n of degree at least five,
3. LIE-TYPE CHEVALLEY GROUPS $PSL(n, q)$, $PSU(n, q)$, $PsP(2n, q)$, and $P\Omega^\epsilon(n, q)$,
4. LIE-TYPE (TWISTED CHEVALLEY GROUPS or the TITS GROUP) ${}^3D_4(q)$, $E_6(q)$, $E_7(q)$, $E_8(q)$, $F_4(q)$, ${}^2F_4(2^n)'$, $G_2(q)$, ${}^2G_2(3^n)$, ${}^2B(2^n)$,
5. SPORADIC GROUPS M_{11} , M_{12} , M_{22} , M_{23} , M_{24} , $J_2 = HJ$, Suz , HS , McL , Co_3 , Co_2 , Co_1 , He , Fi_{22} , Fi_{23} , Fi'_{24} , HN , Th , B , M , J_1 , $O'N$, J_3 , Ly , Ru , J_4 .

The "PROOF" of this theorem is spread throughout the mathematical literature and is estimated to be approximately 15,000 pages in length.

see also FINITE GROUP, GROUP, j -FUNCTION, SIMPLE GROUP

References

- Cartwright, M. "Ten Thousand Pages to Prove Simplicity." *New Scientist* **109**, 26–30, 1985.
- Cipra, B. "Are Group Theorists Simpleminded?" *What's Happening in the Mathematical Sciences, 1995–1996*, Vol. 3. Providence, RI: Amer. Math. Soc., pp. 82–99, 1996.
- Cipra, B. "Slimming an Outsized Theorem." *Science* **267**, 794–795, 1995.
- Gorenstein, D. "The Enormous Theorem." *Sci. Amer.* **253**, 104–115, Dec. 1985.
- Solomon, R. "On Finite Simple Groups and Their Classification." *Not. Amer. Math. Soc.* **42**, 231–239, 1995.

Clausen Formula

Clausen's ${}_4F_3$ identity

$${}_4F_3 \left[\begin{matrix} a & b & c & d \\ e & f & g \end{matrix} ; 1 \right] = \frac{(2a)_{|d|} (a+b)_{|d|} (2b)_{|d|}}{(2a+2b)_{|d|} a_{|d|} b_{|d|}},$$

holds for $a+b+c-d=1/2$, $e=a+b+1/2$, $a+f=d+1=b+g$, d a nonpositive integer, and $(a)_n$ is the POCHHAMMER SYMBOL (Petkovšek *et al.* 1996).

Another identity ascribed to Clausen which involves the HYPERGEOMETRIC FUNCTION ${}_2F_1(a, b; c; z)$ and the GENERALIZED HYPERGEOMETRIC FUNCTION ${}_3F_2(a, b, c; d, e; z)$ is given by

$$\left[{}_2F_1 \left(\begin{matrix} a, b \\ a+b+\frac{1}{2} \end{matrix} ; x \right) \right]^2 = {}_3F_2 \left(\begin{matrix} 2a, a+b, 2b \\ a+b+\frac{1}{2}, 2a+2b \end{matrix} ; x \right).$$

see also GENERALIZED HYPERGEOMETRIC FUNCTION, HYPERGEOMETRIC FUNCTION

References

- Petkovšek, M.; Wilf, H. S.; and Zeilberger, D. $A=B$. Wellesley, MA: A. K. Peters, pp. 43 and 127, 1996.

Clausen Function

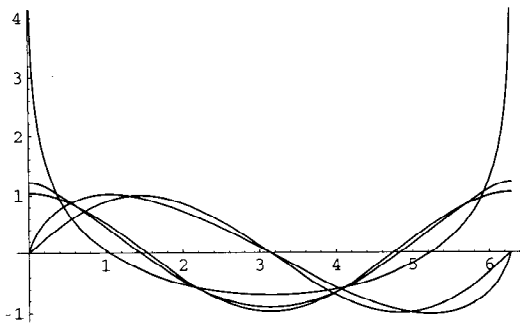

Define

$$S_n(x) \equiv \sum_{k=1}^{\infty} \frac{\sin(kx)}{k^n} \quad (1)$$

$$C_n(x) \equiv \sum_{k=1}^{\infty} \frac{\cos(kx)}{k^n}, \quad (2)$$

and write

$$\text{Cl}_n(x) \equiv \begin{cases} S_n(x) = \sum_{k=1}^{\infty} \frac{\sin(kx)}{k^n} & n \text{ even} \\ C_n(x) = \sum_{k=1}^{\infty} \frac{\cos(kx)}{k^n} & n \text{ odd.} \end{cases} \quad (3)$$

Then the Clausen function $\text{Cl}_n(x)$ can be given symbolically in terms of the POLYLOGARITHM as

$$\text{Cl}_n(x) = \begin{cases} \frac{1}{2}i[\text{Li}_n(e^{-ix}) - \text{Li}_n(e^{ix})] & n \text{ even} \\ \frac{1}{2}[\text{Li}_n(e^{-ix}) + \text{Li}_n(e^{ix})] & n \text{ odd.} \end{cases}$$

For $n = 1$, the function takes on the special form

$$\text{Cl}_1(x) = C_1(x) = -\ln |2 \sin(\frac{1}{2}x)| \quad (4)$$

and for $n = 2$, it becomes CLAUSEN'S INTEGRAL

$$\text{Cl}_2(x) = S_2(x) = -\int_0^x \ln[2 \sin(\frac{1}{2}t)] dt. \quad (5)$$

The symbolic sums of opposite parity are summable symbolically, and the first few are given by

$$C_2(x) = \frac{1}{6}\pi^2 - \frac{1}{2}\pi x + \frac{1}{4}x^2 \quad (6)$$

$$C_4(x) = \frac{1}{90} - \frac{1}{12}\pi^2 x^2 + \frac{1}{12}\pi x^3 - \frac{1}{48}x^4 \quad (7)$$

$$S_1(x) = \frac{1}{2}(\pi - x) \quad (8)$$

$$S_3(x) = \frac{1}{6}\pi^2 x - \frac{1}{4}\pi x^2 + \frac{1}{12}x^3 \quad (9)$$

$$S_5(x) = \frac{1}{90}\pi^4 x - \frac{1}{36}\pi^2 x^3 + \frac{1}{48}\pi x^4 - \frac{1}{240}x^5 \quad (10)$$

for $0 \leq x \leq 2\pi$ (Abramowitz and Stegun 1972).

see also CLAUSEN'S INTEGRAL, POLYGAMMA FUNCTION, POLYLOGARITHM

References

- Abramowitz, M. and Stegun, C. A. (Eds.). "Clausen's Integral and Related Summations" §27.8 in *Handbook of Mathematical Functions with Formulas, Graphs, and Mathematical Tables*, 9th printing. New York: Dover, pp. 1005–1006, 1972.
- Arfken, G. *Mathematical Methods for Physicists*, 3rd ed. Orlando, FL: Academic Press, p. 783, 1985.
- Clausen, R. "Über die Zerlegung reeller gebrochener Funktionen." *J. reine angew. Math.* **8**, 298–300, 1832.
- Grosjean, C. C. "Formulae Concerning the Computation of the Clausen Integral $\text{Cl}_2(\alpha)$." *J. Comput. Appl. Math.* **11**, 331–342, 1984.
- Jolley, L. B. W. *Summation of Series*. London: Chapman, 1925.
- Wheeler, A. D. *A Short Table of Summable Series*. Report No. SM-14642. Santa Monica, CA: Douglas Aircraft Co., 1953.

Clausen's Integral

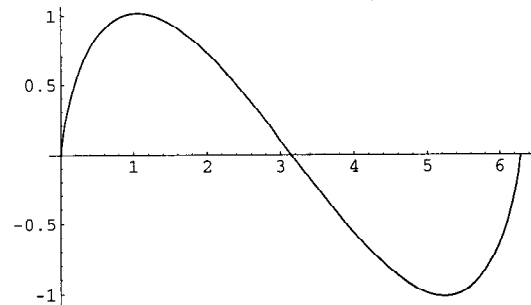

The CLAUSEN FUNCTION

$$\text{Cl}_2(\theta) = -\int_0^\theta \ln[2 \sin(\frac{1}{2}t)] dt.$$

see also CLAUSEN FUNCTION

References

- Abramowitz, M. and Stegun, C. A. (Eds.). *Handbook of Mathematical Functions with Formulas, Graphs, and Mathematical Tables*, 9th printing. New York: Dover, pp. 1005–1006, 1972.
- Ashour, A. and Sabri, A. "Tabulation of the Function $\psi(\theta) = \sum_{n=1}^{\infty} \frac{\sin(n\theta)}{n^2}$." *Math. Tables Aids Comp.* **10**, 54 and 57–65, 1956.
- Clausen, R. "Über die Zerlegung reeller gebrochener Funktionen." *J. reine angew. Math.* **8**, 298–300, 1832.

CLEAN Algorithm

An iterative algorithm which DECONVOLVES a sampling function (the "DIRTY BEAM") from an observed brightness ("DIRTY MAP") of a radio source. This algorithm is of fundamental importance in radio astronomy, where it is used to create images of astronomical sources which are observed using arrays of radio telescopes ("synthesis imaging"). As a result of the algorithm's importance to synthesis imaging, a great deal of effort has gone into optimizing and adjusting the ALGORITHM. CLEAN is a nonlinear algorithm, since linear DECONVOLUTION algorithms such as WIENER FILTERING and inverse filtering

are inapplicable to applications with invisible distributions (i.e., incomplete sampling of the spatial frequency plane) such as map obtained in synthesis imaging.

The basic CLEAN method was developed by Högbom (1974). It was originally designed for point sources, but it has been found to work well for extended sources as well when given a reasonable starting model. The Högbom CLEAN constructs discrete approximations I_n to the CLEAN MAP in the (ξ, η) plane from the CONVOLUTION equation

$$b' * I = I', \quad (1)$$

where b' is the DIRTY BEAM, I' is the DIRTY MAP (both in the (ξ, η) PLANE), and $f * g$ denotes a CONVOLUTION.

The CLEAN algorithm starts with an initial approximation $I_0 = 0$. At the n th iteration, it then searches for the largest value in the residual map

$$I_n = I' - b' * I_{n-1}. \quad (2)$$

A DELTA FUNCTION is then centered at the location of the largest residual flux and given an amplitude μ (the so-called "LOOP GAIN") times this value. An antenna's response to the DELTA FUNCTION, the DIRTY BEAM, is then subtracted from I_{n-1} to yield I_n . Iteration continues until a specified iteration limit N is reached, or until the peak residual or ROOT-MEAN-SQUARE residual decreases to some level. The resulting final map is denoted I_N , and the position of each DELTA FUNCTION is saved in a "CLEAN component" table in the CLEAN MAP file. At the point where component subtraction is stopped, it is assumed that the residual brightness distribution consists mainly of NOISE.

To diminish high spatial frequency features which may be spuriously extrapolated from the measured data, each CLEAN component is convolved with the so-called CLEAN BEAM b , which is simply a suitably smoothed version of the sampling function ("DIRTY BEAM"). Usually, a GAUSSIAN is used. A good CLEAN BEAM should:

1. Have a unity FOURIER TRANSFORM inside the sampled region of (u, v) space,
2. Have a FOURIER TRANSFORM which tends to 0 outside the sampled (u, v) region as quickly as possible, and
3. Not have any effects produced by NEGATIVE side-lobes larger than the NOISE level.

A CLEAN MAP is produced when the final residual map is added to the approximate solution,

$$[\text{clean map}] = I_N * b + [I' - b' * I_N] \quad (3)$$

in order to include the NOISE.

CLEAN will always converge to one (of possibly many) solutions if the following three conditions are satisfied (Schwarz 1978):

1. The beam must be symmetric.
2. The FOURIER TRANSFORM of the DIRTY BEAM is NONNEGATIVE (positive definite or positive semidefinite).
3. There must be no spatial frequencies present in the dirty image which are not also present in the DIRTY BEAM.

These conditions are almost always satisfied in practice. If the number of CLEAN components does not exceed the number of independent (u, v) points, CLEAN converges to a solution which is the least squares fit of the FOURIER TRANSFORMS of the DELTA FUNCTION components to the measured visibility (Thompson *et al.* 1986, p. 347). Schwarz claims that the CLEAN algorithm is equivalent to a least squares fitting of cosine and sine parts in the (u, v) plane of the visibility data. Schwab has produced a NOISE analysis of the CLEAN algorithm in the case of least squares minimization of a noiseless image which involves an $N \times M$ MATRIX. However, no NOISE analysis has been performed for a REAL image.

Poor modulation of short spacings results in an underestimation of the flux, which is manifested in a bowl of negative surface brightness surrounding an object. Providing an estimate of the "zero spacing" flux (the total flux of the source, which cannot be directly measured by an interferometer) can considerably reduce this effect. Modulations or stripes can occur at spatial frequencies corresponding to undersampled parts of the (u, v) plane. This can result in a golf ball-like mottling for disk sources such as planets, or a corrugated pattern of parallel lines of peaks and troughs ("stripes"). A more accurate model can be used to suppress the "golf ball" modulations, but may not eliminate the corrugations. A tapering function which deemphasizes data near $(u, v) = (0, 0)$ can also be used. Stripes can sometimes be eliminated using the Cornwell smoothness-stabilized CLEAN (a.k.a. Prussian helmet algorithm; Thompson *et al.* 1986). CLEANing part way, then restarting the CLEAN also seems to eliminate the stripes, although this fact is more disturbing than reassuring. Stability of the CLEAN algorithm is discussed by Tan (1986).

In order to CLEAN a map of a given dimension, it is necessary to have a beam pattern twice as large so a point source can be subtracted from any point in the map. Because the CLEAN algorithm uses a FAST FOURIER TRANSFORM, the size must also be a POWER of 2.

There are many variants of the basic Högbom CLEAN which extend the method to achieve greater speed and produce more realistic maps. Alternate nonlinear DECONVOLUTION methods, such as the MAXIMUM ENTROPY METHOD, may also be used, but are generally slower than the CLEAN technique. The Astronomical Image Processing Software (AIPS) of the National Radio Astronomical Observatory includes 2-D

DECONVOLUTION algorithms in the tasks DCONV and UVMAP. Among the variants of the basic Högbom CLEAN are Clark, Cornwell smoothness stabilized (Prussian helmet), Cotton-Schwab, Gerchberg-Saxton (Fienup), Steer, Steer-Dewdney-Ito, and van Cittert iteration.

In the Clark (1980) modification, CLEAN picks out only the largest residual points, and subtracts approximate point source responses in the (ξ, η) plane during minor (Högbom CLEAN) cycles. It only occasionally (during major cycles) computes the full I_n residual map by subtracting the identified point source responses in the (u, v) plane using a FAST FOURIER TRANSFORM for the CONVOLUTION. The ALGORITHM then returns to a minor cycle. This algorithm modifies the Högbom method to take advantage of the array processor (although it also works without one). It is therefore a factor of 2–10 faster than the simple Högbom routine. It is implemented as the AIPS task **APCLN**.

The Cornwell smoothness stabilized variant was developed because, when dealing with two-dimensional extended structures, CLEAN can produce artifacts in the form of low-level high frequency stripes running through the brighter structure. These stripes derive from poor interpolations into unsampled or poorly sampled regions of the (u, v) plane. When dealing with quasi-one-dimensional sources (i.e., jets), the artifacts resemble knots (which may not be so readily recognized as spurious). **APCLN** can invoke a modification of CLEAN that is intended to bias it toward generating smoother solutions to the deconvolution problem while preserving the requirement that the transform of the CLEAN components list fits the data. The mechanism for introducing this bias is the addition to the DIRTY BEAM of a DELTA FUNCTION (or “spike”) of small amplitude (**PHAT**) while searching for the CLEAN components. The beam used for the deconvolution resembles the helmet worn by German military officers in World War I, hence the name “Prussian helmet” CLEAN.

The theory underlying the Cornwell smoothness stabilized algorithm is given by Cornwell (1982, 1983), where it is described as the smoothness stabilized CLEAN. It is implemented in the AIPS tasks **APCLN** and **MX**. The spike performs a NEGATIVE feedback into the dirty image, thus suppressing features not required by the data. Spike heights of a few percent and lower than usual loop gains are usually needed. Also according to the **MX** documentation,

$$\text{PHAT} \approx \frac{(\text{noise})^2}{2(\text{signal})^2} = \frac{1}{2(\text{SNR})^2}.$$

Unfortunately, the addition of a Prussian helmet generally has “limited success,” so resorting to another deconvolution method such as the MAXIMUM ENTROPY METHOD is sometimes required.

The Cotton-Schwab uses the Clark method, but the major cycle subtractions of CLEAN components are performed on ungridded visibility data. The Cotton-Schwab technique is often faster than the Clark variant. It is also capable of including the w baseline term, thus removing distortions from noncoplanar baselines. It is often faster than the Clark method. The Cotton-Schwab technique is implemented as the AIPS task **MX**.

The Gerchberg-Saxton variant, also called the Fienup variant, is a technique originally introduced for solving the phase problem in electron microscopy. It was subsequently adapted for visibility amplitude measurements only. A Gerchberg-Saxton map is constrained to be NONZERO, and positive. Data and image plane constraints are imposed alternately while transforming to and from the image plane. If the boxes to CLEAN are chosen to surround the source snugly, then the algorithm will converge faster and will have more chance of finding a unique image. The algorithm is slow, but should be comparable to the Clark technique (**APCLN**) if the map contains many picture elements. However, the resolution is data dependent and varies across the map. It is implemented as the AIPS task **APGS** (Pearson 1984).

The Steer variant is a modification of the Clark variant (Cornwell 1982). It is slow, but should be comparable to the Clark algorithm if the map contains many picture elements. The algorithm used in the program is due to David Steer. The principle is similar to Barry Clark’s CLEAN except that in the minor cycle only points above the (trim level) \times (peak in the residual map) are selected. In the major cycle these are removed using a FAST FOURIER TRANSFORM. If boxes are chosen to surround the source snugly, then the algorithm will converge faster and will have more chance of finding a unique image. It is implemented in AIPS as the experimental program **STEER** and as the Steer-Dewdney-Ito variant combined with the Clark algorithm as **SDCLN**.

The Steer-Dewdney-Ito variant is similar to the Clark variant, but the components are taken as all pixels having residual flux greater than a cutoff value times the current peak residual. This method should avoid the “ripples” produced by the standard CLEAN on extended emission. The AIPS task **SDCLN** does an AP-based CLEAN of the the Clark type, but differs from **APCLN** in that it offers the option to switch to the Steer-Dewdney-Ito method.

Finally, van Cittert iteration consists of two steps:

1. Estimate a correction to add to the current map estimate by multiplying the residuals by some weight. In the classical van Cittert algorithm, this weight is a constant, where as in CLEAN the weight is zero everywhere except at the peak of the residuals.
2. Add the step to the current estimate, and subtract the estimate, convolved with the DIRTY BEAM, from the residuals.

Though it is a simple algorithm, it works well (if slowly) for cases where the DIRTY BEAM is positive semidefinite (as it is in astronomical observations). The basic idea is that the DIRTY MAP is a reasonably good estimate of the deconvolved map. The different iterations vary only in the weight to apply to each residual in determining the correction step. van Cittert iteration is implemented as the AIPS task **APVC**, which is a rather experimental and ad hoc procedure. In some limiting cases, it reduces to the standard CLEAN algorithm (though it would be impractically slow).

see also CLEAN BEAM, CLEAN MAP, DIRTY BEAM, DIRTY MAP

References

- Christiansen, W. N. and Högbom, J. A. *Radiotelescopes, 2nd ed.* Cambridge, England: Cambridge University Press, pp. 214–216, 1985.
- Clark, B. G. "An Efficient Implementation of the Algorithm 'CLEAN'." *Astron. Astrophys.* **89**, 377–378, 1980.
- Cornwell, T. J. "Can CLEAN be Improved?" VLA Scientific Memorandum No. 141, 1982.
- Cornwell, T. J. "Image Restoration (and the CLEAN Technique)." Lecture 9. NRAO VLA Workshop on Synthesis Mapping, p. 113, 1982.
- Cornwell, T. J. "A Method of Stabilizing the CLEAN Algorithm." *Astron. Astrophys.* **121**, 281–285, 1983.
- Cornwell, T. and Braun, R. "Deconvolution." Ch. 8 in *Synthesis Imaging in Radio Astronomy: Third NRAO Summer School, 1988* (Ed. R. A. Perley, F. R. Schwab, and A. H. Bridle). San Francisco, CA: Astronomical Society of the Pacific, pp. 178–179, 1989.
- Högbom, J. A. "Aperture Synthesis with a Non-Regular Distribution of Interferometric Baselines." *Astron. Astrophys. Supp.* **15**, 417–426, 1974.
- National Radio Astronomical Observatory. Astronomical Image Processing Software (AIPS) software package. **APCLN**, **MX**, and **UVMAP** tasks.
- Pearson, T. J. and Readhead, A. C. S. "Image Formation by Self-Calibration in Radio Astronomy." *Ann. Rev. Astron. Astrophys.* **22**, 97–130, 1984.
- Schwarz, U. J. "Mathematical-Statistical Description of the Iterative Beam Removing Technique (Method CLEAN)." *Astron. Astrophys.* **65**, 345–356, 1978.
- Tan, S. M. "An Analysis of the Properties of CLEAN and Smoothness Stabilized CLEAN. Some Warnings." *Mon. Not. Royal Astron. Soc.* **220**, 971–1001, 1986.
- Thompson, A. R.; Moran, J. M.; and Swenson, G. W. Jr. *Interferometry and Synthesis in Radio Astronomy*. New York: Wiley, p. 348, 1986.

CLEAN Beam

An ELLIPTICAL GAUSSIAN fit to the DIRTY BEAM in order to remove sidelobes. The CLEAN beam is convolved with the final CLEAN iteration to diminish spurious high spatial frequencies.

see also CLEAN ALGORITHM, CLEAN MAP, DECONVOLUTION, DIRTY BEAM, DIRTY MAP

CLEAN Map

The deconvolved map extracted from a finitely sampled DIRTY MAP by the CLEAN ALGORITHM, MAXIMUM ENTROPY METHOD, or any other DECONVOLUTION procedure.

see also CLEAN ALGORITHM, CLEAN BEAM, DECONVOLUTION, DIRTY BEAM, DIRTY MAP

Clebsch-Aronhold Notation

A notation used to describe curves. The fundamental principle of Clebsch-Aronhold notation states that if each of a number of forms be replaced by a POWER of a linear form in the same number of variables equal to the order of the given form, and if a sufficient number of equivalent symbols are introduced by the ARONHOLD PROCESS so that no actual COEFFICIENT appears except to the first degree, then every identical relation holding for the new specialized forms holds for the general ones.

References

- Coolidge, J. L. *A Treatise on Algebraic Plane Curves*. New York: Dover, p. 79, 1959.

Clebsch Diagonal Cubic



A CUBIC ALGEBRAIC SURFACE given by the equation

$$x_0^3 + x_1^3 + x_2^3 + x_3^3 + x_4^3 = 0, \quad (1)$$

with the added constraint

$$x_0 + x_1 + x_2 + x_3 + x_4 = 0. \quad (2)$$

The implicit equation obtained by taking the plane at infinity as $x_0 + x_1 + x_2 + x_3/2$ is

$$\begin{aligned} 81(x^3 + y^3 + z^3) - 189(x^2y + x^2z + y^2x + y^2z + z^2x + z^2y) \\ + 54xyz + 126(xy + xz + yz) - 9(x^2 + y^2 + z^2) \\ - 9(x + y + z) + 1 = 0 \end{aligned} \quad (3)$$

(Hunt, Nordstrand). On Clebsch's diagonal surface, all 27 of the complex lines (SOLOMON'S SEAL LINES) present on a general smooth CUBIC SURFACE are real. In addition, there are 10 points on the surface where 3 of the 27 lines meet. These points are called ECKARDT POINTS (Fischer 1986, Hunt), and the Clebsch diagonal surface is the unique CUBIC SURFACE containing 10 such points (Hunt).

If one of the variables describing Clebsch's diagonal surface is dropped, leaving the equations

$$x_0^3 + x_1^3 + x_2^3 + x_3^3 = 0, \quad (4)$$

$$x_0 + x_1 + x_2 + x_3 = 0, \quad (5)$$

the equations degenerate into two intersecting PLANES given by the equation

$$(x + y)(x + z)(y + z) = 0. \quad (6)$$

see also CUBIC SURFACE, ECKARDT POINT

References

- Fischer, G. (Ed.). *Mathematical Models from the Collections of Universities and Museums*. Braunschweig, Germany: Vieweg, pp. 9–11, 1986.
 Fischer, G. (Ed.). Plates 10–12 in *Mathematische Modelle/Mathematical Models, Bildband/Photograph Volume*. Braunschweig, Germany: Vieweg, pp. 13–15, 1986.
 Hunt, B. *The Geometry of Some Special Arithmetic Quotients*. New York: Springer-Verlag, pp. 122–128, 1996.
 Nordstrand, T. "Clebsch Diagonal Surface." <http://www.uib.no/people/nfytn/clebtxt.htm>.

Clebsch-Gordon Coefficient

A mathematical symbol used to integrate products of three SPHERICAL HARMONICS. Clebsch-Gordon coefficients commonly arise in applications involving the addition of angular momentum in quantum mechanics. If products of more than three SPHERICAL HARMONICS are desired, then a generalization known as WIGNER 6j-SYMBOLS or WIGNER 9j-SYMBOLS is used. The Clebsch-Gordon coefficients are written

$$C_{m_1 m_2}^j = (j_1 j_2 m_1 m_2 | j_1 j_2 j m) \quad (1)$$

and are defined by

$$\Psi_{JM} = \sum_{M=M_1+M_2} C_{M_1 M_2}^J \Psi_{M_1 M_2}, \quad (2)$$

where $J \equiv J_1 + J_2$. The Clebsch-Gordon coefficients are sometimes expressed using the related RACAH V-COEFFICIENTS

$$V(j_1 j_2 j; m_1 m_2 m) \quad (3)$$

or WIGNER 3j-SYMBOLS. Connections among the three are

$$(j_1 j_2 m_1 m_2 | j_1 j_2 j m) = (-1)^{-j_1+j_2-m} \sqrt{2j+1} \begin{pmatrix} j_1 & j_2 & j \\ m_1 & m_2 & -m \end{pmatrix} \quad (4)$$

$$(j_1 j_2 m_1 m_2 | j_1 j_2 j m) = (-1)^{j+m} \sqrt{2j+1} V(j_1 j_2 j; m_1 m_2 -m) \quad (5)$$

$$V(j_1 j_2 j; m_1 m_2 m) = (-1)^{-j_1+j_2+j} \begin{pmatrix} j_1 & j_2 & j_1 \\ m_2 & m_1 & m_2 \end{pmatrix}. \quad (6)$$

They have the symmetry

$$(j_1 j_2 m_1 m_2 | j_1 j_2 j m) = (-1)^{j_1+j_2-j} (j_2 j_1 m_2 m_1 | j_2 j_1 j m), \quad (7)$$

and obey the orthogonality relationships

$$\sum_{j,m} (j_1 j_2 m_1 m_2 | j_1 j_2 j m) (j_1 j_2 j m | j_1 j_2 m'_1 m'_2) = \delta_{m_1 m'_1} \delta_{m_2 m'_2} \quad (8)$$

$$\sum_{m_1, m_2} (j_1 j_2 m_1 m_2 | j_1 j_2 j m) (j_1 j_2 j' m' | j_1 j_2 m_1 m_2) = \delta_{jj'} \delta_{mm'}. \quad (9)$$

see also RACAH V-COEFFICIENT, RACAH W-COEFFICIENT, WIGNER 3j-SYMBOL, WIGNER 6j-SYMBOL, WIGNER 9j-SYMBOL

References

- Abramowitz, M. and Stegun, C. A. (Eds.). "Vector-Addition Coefficients." §27.9 in *Handbook of Mathematical Functions with Formulas, Graphs, and Mathematical Tables, 9th printing*. New York: Dover, pp. 1006–1010, 1972.
 Cohen-Tannoudji, C.; Diu, B.; and Laloë, F. "Clebsch-Gordon Coefficients." Complement B_x in *Quantum Mechanics, Vol. 2*. New York: Wiley, pp. 1035–1047, 1977.
 Condon, E. U. and Shortley, G. §3.6–3.14 in *The Theory of Atomic Spectra*. Cambridge, England: Cambridge University Press, pp. 56–78, 1951.
 Fano, U. and Fano, L. *Basic Physics of Atoms and Molecules*. New York: Wiley, p. 240, 1959.
 Messiah, A. "Clebsch-Gordon (C.-G.) Coefficients and '3j' Symbols." Appendix C.I in *Quantum Mechanics, Vol. 2*. Amsterdam, Netherlands: North-Holland, pp. 1054–1060, 1962.
 Shore, B. W. and Menzel, D. H. "Coupling and Clebsch-Gordon Coefficients." §6.2 in *Principles of Atomic Spectra*. New York: Wiley, pp. 268–276, 1968.
 Sobel'man, I. I. "Angular Momenta." Ch. 4 in *Atomic Spectra and Radiative Transitions, 2nd ed.* Berlin: Springer-Verlag, 1992.

Clement Matrix

see KAC MATRIX

Clenshaw Recurrence Formula

The downward Clenshaw recurrence formula evaluates a sum of products of indexed COEFFICIENTS by functions which obey a recurrence relation. If

$$f(x) = \sum_{k=0}^N c_k F_k(x)$$

and

$$F_{n+1}(x) = \alpha(n, x) F_n(x) + \beta(n, x) F_{n-1}(x),$$

where the c_k s are known, then define

$$y_{N+2} = y_{N+1} = 0$$

$$y_k = \alpha(k, x)y_{k+1} + \beta(k+1, x)y_{k+2} + c_k$$

for $k = N, N-1, \dots$ and solve backwards to obtain y_2 and y_1 .

$$c_k = y_k - \alpha(k, x)y_{k+1} - \beta(k+1, x)y_{k+2}$$

$$f(x) = \sum_{k=0}^N c_k F_k(x)$$

$$= c_0 F_0(x) + [y_1 - \alpha(1, x)y_2 - \beta(2, x)y_3]F_1(x)$$

$$+ [y_2 - \alpha(2, x)y_3 - \beta(3, x)y_4]F_2(x)$$

$$+ [y_3 - \alpha(3, x)y_4 - \beta(4, x)y_5]F_3(x)$$

$$+ [y_4 - \alpha(4, x)y_5 - \beta(5, x)y_6]F_4(x) + \dots$$

$$= c_0 F_0(x) + y_1 F_1(x) + y_2 [F_2(x) - \alpha(1, x)F_1(x)]$$

$$+ y_3 [F_3(x) - \alpha(2, x)F_2(x) - \beta(2, x)]$$

$$+ y_4 [F_4(x) - \alpha(3, x)F_3(x) - \beta(3, x)] + \dots$$

$$= c_0 F_0(x) + y_2 [\{\alpha(1, x)F_1(x) + \beta(1, x)F_0(x)\}$$

$$- \alpha(1, x)F_1(x)] + y_1 F_1(x)$$

$$= c_0 F_0(x) + y_1 F_1(x) + \beta(1, x)F_0(x)y_2.$$

The upward Clenshaw recurrence formula is

$$y_{-2} = y_{-1} = 0$$

$$y_k = \frac{1}{\beta(k+1, x)} [y_{k-2} - \alpha(k, x)y_{k-1} - c_k]$$

for $k = 0, 1, \dots, N-1$.

$$f(x) = c_N F_N(x) - \beta(N, x)F_{N-1}(x)y_{N-1} - F_N(x)y_{N-2}.$$

References

Press, W. H.; Flannery, B. P.; Teukolsky, S. A.; and Vetterling, W. T. "Recurrence Relations and Clenshaw's Recurrence Formula." §5.5 in *Numerical Recipes in FORTRAN: The Art of Scientific Computing*, 2nd ed. Cambridge, England: Cambridge University Press, pp. 172-178, 1992.

Cliff Random Number Generator

A RANDOM NUMBER generator produced by iterating

$$X_{n+1} = |100 \ln X_n \pmod{1}|$$

for a SEED $X_0 = 0.1$. This simple generator passes the NOISE SPHERE test for randomness by showing no structure.

see also RANDOM NUMBER, SEED

References

Pickover, C. A. "Computers, Randomness, Mind, and Infinity." Ch. 31 in *Keys to Infinity*. New York: W. H. Freeman, pp. 233-247, 1995.

Clifford Algebra

Let V be an n -D linear SPACE over a FIELD K , and let Q be a QUADRATIC FORM on V . A Clifford algebra is then defined over the $T(V)/I(Q)$, where $T(V)$ is the tensor algebra over V and I is a particular IDEAL of $T(V)$.

References

Iyanaga, S. and Kawada, Y. (Eds.). "Clifford Algebras." §64 in *Encyclopedic Dictionary of Mathematics*. Cambridge, MA: MIT Press, pp. 220-222, 1980.
Lounesto, P. "Counterexamples to Theorems Published and Proved in Recent Literature on Clifford Algebras, Spinors, Spin Groups, and the Exterior Algebra." <http://www.hit.fi/~lounesto/counterexamples.htm>.

Clifford's Circle Theorem

Let C_1, C_2, C_3 , and C_4 be four CIRCLES of GENERAL POSITION through a point P . Let P_{ij} be the second intersection of the CIRCLES C_i and C_j . Let C_{ijk} be the CIRCLE $P_{ij}P_{ik}P_{jk}$. Then the four CIRCLES $P_{234}, P_{134}, P_{124}$, and P_{123} all pass through the point P_{1234} . Similarly, let C_5 be a fifth CIRCLE through P . Then the five points $P_{2345}, P_{1345}, P_{1245}, P_{1235}$ and P_{1234} all lie on one CIRCLE C_{12345} . And so on.

see also CIRCLE, COX'S THEOREM

Clifford's Curve Theorem

The dimension of a special series can never exceed half its order.

References

Coolidge, J. L. *A Treatise on Algebraic Plane Curves*. New York: Dover, p. 263, 1959.

Clique

In a GRAPH of N VERTICES, a subset of pairwise adjacent VERTICES is known as a clique. A clique is a fully connected subgraph of a given graph. The problem of finding the size of a clique for a given GRAPH is an NP-COMplete PROBLEM. The number of graphs on n nodes having 3 cliques are 0, 0, 1, 4, 12, 31, 67, ... (Sloane's A005289).

see also CLIQUE NUMBER, MAXIMUM CLIQUE PROBLEM, RAMSEY NUMBER, TURÁN'S THEOREM

References

Sloane, N. J. A. Sequence A005289/M3440 in "An On-Line Version of the Encyclopedia of Integer Sequences."

Clique Number

The number of VERTICES in the largest CLIQUE of G , denoted $\omega(G)$. For an arbitrary GRAPH,

$$\omega(G) \geq \sum_{i=1}^n \frac{1}{n - d_i},$$

where d_i is the DEGREE of VERTEX i .

References

Aigner, M. "Turán's Graph Theorem." *Amer. Math. Monthly* **102**, 808-816, 1995.

Clock Solitaire

A solitaire game played with CARDS. The chance of winning is $1/13$, and the AVERAGE number of CARDS turned up is 42.4.

References

Gardner, M. *Mathematical Magic Show: More Puzzles, Games, Diversions, Illusions and Other Mathematical Sleight-of-Mind from Scientific American*. New York: Vintage, pp. 244–247, 1978.

Close Packing

see SPHERE PACKING

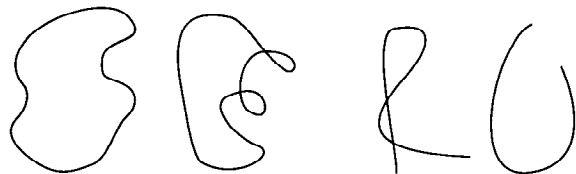
Closed Curve

closed curves

open curves

A CURVE with no endpoints which completely encloses an AREA. A closed curve is formally defined as the continuous IMAGE of a CLOSED SET.

see also SIMPLE CURVE

Closed Curve Problem

Find NECESSARY and SUFFICIENT conditions that determine when the integral curve of two periodic functions $\kappa(s)$ and $\tau(s)$ with the same period L is a CLOSED CURVE.

Closed Disk

An n -D closed disk of RADIUS r is the collection of points of distance $\leq r$ from a fixed point in EUCLIDEAN n -space.

see also DISK, OPEN DISK

Closed Form

A discrete FUNCTION $A(n, k)$ is called closed form (or sometimes “hypergeometric”) in two variables if the ratios $A(n+1, k)/A(n, k)$ and $A(n, k+1)/A(n, k)$ are both RATIONAL FUNCTIONS. A pair of closed form functions (F, G) is said to be a WILF-ZEILBERGER PAIR if

$$F(n+1, k) - F(n, k) = G(n, k+1) - G(n, k).$$

see also RATIONAL FUNCTION, WILF-ZEILBERGER PAIR

References

Petkovšek, M.; Wilf, H. S.; and Zeilberger, D. *A=B*. Wellesley, MA: A. K. Peters, p. 141, 1996.
Zeilberger, D. “Closed Form (Pun Intended!).” *Contemporary Math.* **143**, 579–607, 1993.

Closed Graph Theorem

A linear OPERATOR between two BANACH SPACES is continuous IFF it has a “closed” GRAPH.

see also BANACH SPACE

References

Zeidler, E. *Applied Functional Analysis: Applications to Mathematical Physics*. New York: Springer-Verlag, 1995.

Closed Interval

An INTERVAL which includes its LIMIT POINTS. If the endpoints of the interval are FINITE numbers a and b , then the INTERVAL is denoted $[a, b]$. If one of the endpoints is $\pm\infty$, then the interval still contains all of its LIMIT POINTS, so $[a, \infty)$ and $(-\infty, b]$ are also closed intervals.

see also HALF-CLOSED INTERVAL, OPEN INTERVAL

Closed Set

There are several equivalent definitions of a closed SET. A SET S is closed if

1. The COMPLEMENT of S is an OPEN SET,
2. S is its own CLOSURE,
3. Sequences/nets/filters in S which converge do so within S ,
4. Every point outside S has a NEIGHBORHOOD disjoint from S .

The POINT-SET TOPOLOGICAL definition of a closed set is a set which contains all of its LIMIT POINTS. Therefore, a closed set C is one for which, whatever point x is picked outside of C , x can always be isolated in some OPEN SET which doesn’t touch C .

see also CLOSED INTERVAL

Closure

A SET S and a BINARY OPERATOR $*$ are said to exhibit closure if applying the BINARY OPERATOR to two elements S returns a value which is itself a member of S .

The term “closure” is also used to refer to a “closed” version of a given set. The closure of a SET can be defined in several equivalent ways, including

1. The SET plus its LIMIT POINTS, also called “boundary” points, the union of which is also called the “frontier,”
2. The unique smallest CLOSED SET containing the given SET,
3. The COMPLEMENT of the interior of the COMPLEMENT of the set,
4. The collection of all points such that every NEIGHBORHOOD of them intersects the original SET in a nonempty SET.

In topologies where the T2-SEPARATION AXIOM is assumed, the closure of a finite SET S is S itself.

see also BINARY OPERATOR, EXISTENTIAL CLOSURE, REFLEXIVE CLOSURE, TIGHT CLOSURE, TRANSITIVE CLOSURE

Clothoid

see also CORNU SPIRAL

Clove Hitch

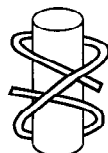

A HITCH also called the BOATMAN'S KNOT or PEG KNOT.

References

Owen, P. *Knots*. Philadelphia, PA: Courage, pp. 24–27, 1993.

Clump

see RUN

Cluster

Given a lattice, a cluster is a group of filled cells which are all connected to their neighbors vertically or horizontally.

see also CLUSTER PERIMETER, PERCOLATION THEORY, s-CLUSTER, s-RUN

References

Stauffer, D. and Aharony, A. *Introduction to Percolation Theory*, 2nd ed. London: Taylor & Francis, 1992.

Cluster Perimeter

The number of empty neighbors of a CLUSTER.

see also PERIMETER POLYNOMIAL

Coanalytic Set

A DEFINABLE SET which is the complement of an ANALYTIC SET.

see also ANALYTIC SET

Coastline Paradox

Determining the length of a country's coastline is not as simple as it first appears, as first considered by L. F. Richardson (1881–1953). In fact, the answer depends on the length of the RULER you use for the measurements. A shorter RULER measures more of the sinuosity of bays and inlets than a larger one, so the estimated length continues to increase as the RULER length decreases.

In fact, a coastline is an example of a FRACTAL, and plotting the length of the RULER versus the measured length of the coastline on a log-log plot gives a straight line, the slope of which is the FRACTAL DIMENSION of the coastline (and will be a number between 1 and 2).

References

Lauwerier, H. *Fractals: Endlessly Repeated Geometric Figures*. Princeton, NJ: Princeton University Press, pp. 29–31, 1991.

Coates-Wiles Theorem

In 1976, Coates and Wiles showed that ELLIPTIC CURVES with COMPLEX MULTIPLICATION having an infinite number of solutions have L -functions which are zero at the relevant fixed point. This is a special case of the SWINNERTON-DYER CONJECTURE.

References

Cipra, B. "Fermat Prover Points to Next Challenges." *Science* 271, 1668–1669, 1996.

Coaxial Circles

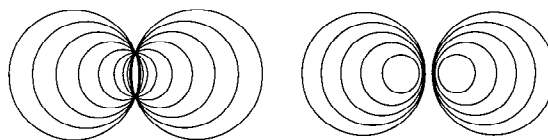

CIRCLES which share a RADICAL LINE with a given circle are said to be coaxial. The centers of coaxial circles are COLLINEAR. It is possible to combine the two types of coaxial systems illustrated above such that the sets are orthogonal.

see also CIRCLE, COAXALOID SYSTEM, GAUSS-BODENMILLER THEOREM, RADICAL LINE

References

Coxeter, H. S. M. and Greitzer, S. L. *Geometry Revisited*. Washington, DC: Math. Assoc. Amer., pp. 35–36 and 122, 1967.

Dixon, R. *Mathographics*. New York: Dover, pp. 68–72, 1991.
Johnson, R. A. *Modern Geometry: An Elementary Treatise on the Geometry of the Triangle and the Circle*. Boston, MA: Houghton Mifflin, pp. 34–37, 199, and 279, 1929.

Coaxial System

A system of COAXIAL CIRCLES.

Coaxaloid System

A system of circles obtained by multiplying each RADIUS in a COAXAL SYSTEM by a constant.

References

Johnson, R. A. *Modern Geometry: An Elementary Treatise on the Geometry of the Triangle and the Circle*. Boston, MA: Houghton Mifflin, pp. 276–277, 1929.

Cobordant Manifold

Two open MANIFOLDS M and M' are cobordant if there exists a MANIFOLD with boundary W^{n+1} such that an acceptable restrictive relationship holds.

see also COBORDISM, h -COBORDISM THEOREM, MORSE THEORY

Cobordism

see BORDISM, h -COBORDISM

Cobordism Group

see BORDISM GROUP

Cobordism Ring

see BORDISM GROUP

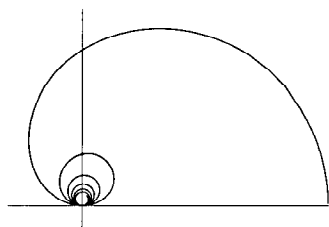
Cochleoid

The cochleoid, whose name means “snail-form” in Latin, was first discussed by J. Peck in 1700 (MacTutor Archive). The points of contact of PARALLEL TANGENTS to the cochleoid lie on a STROPHOID.

In POLAR COORDINATES,

$$r = \frac{a \sin \theta}{\theta}. \quad (1)$$

In CARTESIAN COORDINATES,

$$(x^2 + y^2) \tan^{-1} \left(\frac{y}{x} \right) = ay. \quad (2)$$

The CURVATURE is

$$\kappa = \frac{2\sqrt{2} \theta^3 [2\theta - \sin(2\theta)]}{[1 + 2\theta^2 - \cos(2\theta) - 2\theta \sin(2\theta)]^{3/2}}. \quad (3)$$

see also QUADRATRIX OF HIPPIAS

References

Lawrence, J. D. *A Catalog of Special Plane Curves*. New York: Dover, pp. 192 and 196, 1972.
MacTutor History of Mathematics Archive. “Cochleoid.”
<http://www-groups.dcs.st-and.ac.uk/~history/Curves/Cochleoid.html>.

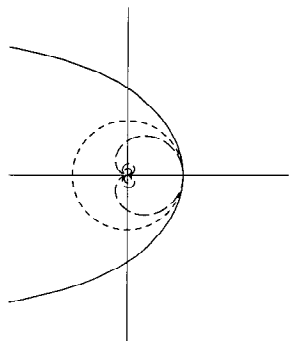
Cochleoid Inverse Curve

The INVERSE CURVE of the COCHLEOID

$$r = \frac{\sin \theta}{\theta} \quad (1)$$

with INVERSION CENTER at the ORIGIN and inversion radius k is the QUADRATRIX OF HIPPIAS.

$$x = kt \cot \theta \quad (2)$$

$$y = kt. \quad (3)$$

Cochloid

see CONCHOID OF NICOMEDES

Cochran's Theorem

The converse of FISHER'S THEOREM.

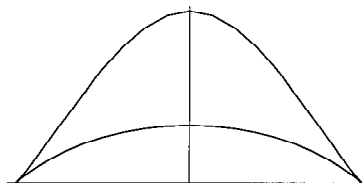
Cocked Hat Curve

The PLANE CURVE

$$(x^2 + 2ay - a^2)^2 = y^2(a^2 - x^2),$$

which is similar to the BICORN.

References

Cundy, H. and Rollett, A. *Mathematical Models*, 3rd ed. Stradbroke, England: Tarquin Pub., p. 72, 1989.

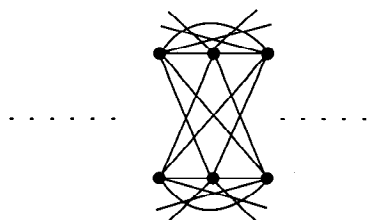
Cocktail Party Graph

A GRAPH consisting of two rows of paired nodes in which all nodes but the paired ones are connected with an EDGE. It is the complement of the LADDER GRAPH.

Coconut

see MONKEY AND COCONUT PROBLEM

Codazzi Equations

see MAINARDI-CODAZZI EQUATIONS

Code

A code is a set of n -tuples of elements (“WORDS”) taken from an ALPHABET.

see also ALPHABET, CODING THEORY, ENCODING, ERROR-CORRECTING CODE, GRAY CODE, HUFFMAN CODING, ISBN, LINEAR CODE, WORD

Codimension

The minimum number of parameters needed to fully describe all possible behaviors near a nonstructurally stable element.

see also BIFURCATION

Coding Theory

Coding theory, sometimes called ALGEBRAIC CODING THEORY, deals with the design of ERROR-CORRECTING CODES for the reliable transmission of information across noisy channels. It makes use of classical and modern algebraic techniques involving FINITE FIELDS, GROUP THEORY, and polynomial algebra. It has connections with other areas of DISCRETE MATHEMATICS, especially NUMBER THEORY and the theory of experimental designs.

see also ENCODING, ERROR-CORRECTING CODE, GALLOIS FIELD, HADAMARD MATRIX

References

- Alexander, B. "At the Dawn of the Theory of Codes." *Math. Intel.* 15, 20–26, 1993.
- Golomb, S. W.; Peile, R. E.; and Scholtz, R. A. *Basic Concepts in Information Theory and Coding: The Adventures of Secret Agent 00111*. New York: Plenum, 1994.
- Humphreys, O. F. and Prest, M. Y. *Numbers, Groups, and Codes*. New York: Cambridge University Press, 1990.
- MacWilliams, F. J. and Sloane, N. J. A. *The Theory of Error-Correcting Codes*. New York: Elsevier, 1978.
- Roman, S. *Coding and Information Theory*. New York: Springer-Verlag, 1992.

Coefficient

A multiplicative factor (usually indexed) such as one of the constants a_i in the POLYNOMIAL $a_n x^n + a_{n-1} x^{n-1} + \dots + a_2 x^2 + a_1 x + a_0$.

see also BINOMIAL COEFFICIENT, CARTAN TORSION COEFFICIENT, CENTRAL BINOMIAL COEFFICIENT, CLEBSCH-GORDON COEFFICIENT, COEFFICIENT FIELD, COMMUTATION COEFFICIENT, CONNECTION COEFFICIENT, CORRELATION COEFFICIENT, CROSS-CORRELATION COEFFICIENT, EXCESS COEFFICIENT, GAUSSIAN COEFFICIENT, LAGRANGIAN COEFFICIENT, MULTINOMIAL COEFFICIENT, PEARSON'S SKEWNESS COEFFICIENTS, PRODUCT-MOMENT COEFFICIENT OF CORRELATION, QUARTILE SKEWNESS COEFFICIENT, QUARTILE VARIATION COEFFICIENT, RACAH V-COEFFICIENT, RACAH W-COEFFICIENT, REGRESSION COEFFICIENT, ROMAN COEFFICIENT, TRIANGLE COEFFICIENT, UNDETERMINED COEFFICIENTS METHOD, VARIATION COEFFICIENT

Coefficient Field

Let V be a VECTOR SPACE over a FIELD K , and let A be a nonempty SET. For an appropriately defined AFFINE SPACE A , K is called the COEFFICIENT field.

Coercive Functional

A bilinear FUNCTIONAL ϕ on a normed SPACE E is called coercive (or sometimes ELLIPTIC) if there exists a POSITIVE constant K such that

$$\phi(x, x) \geq K \|x\|^2$$

for all $x \in E$.

see also LAX-MILGRAM THEOREM

References

- Debnath, L. and Mikusiński, P. *Introduction to Hilbert Spaces with Applications*. San Diego, CA: Academic Press, 1990.

Cofactor

The MINOR of a DETERMINANT is another DETERMINANT $|C|$ formed by omitting the i th row and j th column of the original DETERMINANT $|M|$.

$$C_{ij} \equiv (-1)^{i+j} a_i M_{ij}.$$

see also DETERMINANT EXPANSION BY MINORS, MINOR

Cohen-Kung Theorem

Guarantees that the trajectory of LANGTON'S ANT is unbounded.

Cohomology

Cohomology is an invariant of a TOPOLOGICAL SPACE, formally "dual" to HOMOLOGY, and so it detects "holes" in a SPACE. Cohomology has more algebraic structure than HOMOLOGY, making it into a graded ring (multiplication given by "cup product"), whereas HOMOLOGY is just a graded ABELIAN GROUP invariant of a SPACE.

A generalized homology or cohomology theory must satisfy all of the EILENBERG-STEENROD AXIOMS with the exception of the dimension axiom.

see also ALEKSANDROV-ČECH COHOMOLOGY, ALEXANDER-SPANIER COHOMOLOGY, ČECH COHOMOLOGY, DE RHAM COHOMOLOGY, HOMOLOGY (TOPOLOGY)

Cohomotopy Group

Cohomotopy groups are similar to HOMOTOPY GROUPS. A cohomotopy group is a GROUP related to the HOMOTOPY classes of MAPS from a SPACE X into a SPHERE S^n .

see also HOMOTOPY GROUP

Coin

A flat disk which acts as a two-sided DIE.

see BERNOULLI TRIAL, CARDS, COIN PARADOX, COIN TOSSING, DICE, FELLER'S COIN-TOSSING CONSTANTS, FOUR COINS PROBLEM, GAMBLER'S RUIN

References

- Brooke, M. *Fun for the Money*. New York: Scribner's, 1963.

Coin Flipping

see COIN TOSSING

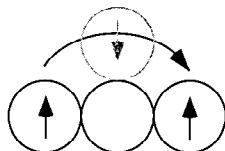
Coin Paradox

After a half rotation of the coin on the left around the central coin (of the same RADIUS), the coin undergoes a complete rotation.

References

Pappas, T. "The Coin Paradox." *The Joy of Mathematics*. San Carlos, CA: Wide World Publ./Tetra, p. 220, 1989.

Coin Problem

Let there be $n \geq 2$ INTEGERS $0 < a_1 < \dots < a_n$ with $(a_1, a_2, \dots, a_n) = 1$ (all RELATIVELY PRIME). For large enough $N = \sum_{i=1}^n a_i x_i$, there is a solution in NONNEGATIVE INTEGERS x_i . The greatest $N = g(a_1, a_2, \dots, a_n)$ for which there is no solution is called the coin problem. Sylvester showed

$$g(a_1, a_2) = (a_1 - 1)(a_2 - 1) - 1,$$

and an explicit solution is known for $n = 3$, but no closed form solution is known for larger N .

References

Guy, R. K. "The Money-Changing Problem." §C7 in *Unsolved Problems in Number Theory*, 2nd ed. New York: Springer-Verlag, pp. 113–114, 1994.

Coin Tossing

An idealized coin consists of a circular disk of zero thickness which, when thrown in the air and allowed to fall, will rest with either side face up ("heads" H or "tails" T) with equal probability. A coin is therefore a two-sided DIE. A coin toss corresponds to a BERNOULLI DISTRIBUTION with $p = 1/2$. Despite slight differences between the sides and NONZERO thickness of actual coins, the distribution of their tosses makes a good approximation to a $p = 1/2$ BERNOULLI DISTRIBUTION.

There are, however, some rather counterintuitive properties of coin tossing. For example, it is twice as likely that the triple *TTH* will be encountered before *THT* than after it, and three times as likely that *THH* will precede *HTT*. Furthermore, it is six times as likely that *HTT* will be the first of *HTT*, *TTH*, and *TTT* to occur (Honsberger 1979). More amazingly still, *spinning* a penny instead of tossing it results in heads only about 30% of the time (Paulos 1995).

Let $w(n)$ be the probability that no RUN of three consecutive heads appears in n independent tosses of a COIN. The following table gives the first few values of $w(n)$.

n	$w(n)$
0	1
1	1
2	1
3	$\frac{7}{8}$
4	$\frac{13}{16}$
5	$\frac{9}{4}$

Feller (1968, pp. 278–279) proved that

$$\lim_{n \rightarrow \infty} w(n) \alpha^{n+1} = \beta, \quad (1)$$

where

$$\alpha = \frac{1}{3}[(136 + 24\sqrt{33})^{1/3} - 8(136 + 24\sqrt{33})^{-1/3} - 2] \\ = 1.087378025 \dots \quad (2)$$

and

$$\beta = \frac{2 - \alpha}{4 - 3\alpha} = 1.236839845 \dots \quad (3)$$

The corresponding constants for a RUN of $k > 1$ heads are α_k , the smallest POSITIVE ROOT of

$$1 - x + (\frac{1}{2}x)^{k+1} = 0, \quad (4)$$

and

$$\beta_k = \frac{2 - \alpha}{k + 1 - k\alpha_k}. \quad (5)$$

These are modified for unfair coins with $P(H) = p$ and $P(T) = q = 1 - p$ to α'_k , the smallest POSITIVE ROOT of

$$1 - x + qp^k x^{k+1} = 0, \quad (6)$$

and

$$\beta'_k = \frac{1 - p\alpha'_k}{(k + 1 - k\alpha'_k)p} \quad (7)$$

(Feller 1968, pp. 322–325).

see also BERNOULLI DISTRIBUTION, CARDS, COIN, DICE, GAMBLER'S RUIN, MARTINGALE, RUN, SAINT PETERSBURG PARADOX

References

- Feller, W. *An Introduction to Probability Theory and Its Application*, Vol. 1, 3rd ed. New York: Wiley, 1968.
- Finch, S. "Favorite Mathematical Constants." <http://www.mathsoft.com/asolve/constant/feller/feller.html>.
- Ford, J. "How Random is a Coin Toss?" *Physics Today* **36**, 40–47, 1983.
- Honsberger, R. "Some Surprises in Probability." Ch. 5 in *Mathematical Plums* (Ed. R. Honsberger). Washington, DC: Math. Assoc. Amer., pp. 100–103, 1979.
- Keller, J. B. "The Probability of Heads." *Amer. Math. Monthly* **93**, 191–197, 1986.
- Paulos, J. A. *A Mathematician Reads the Newspaper*. New York: BasicBooks, p. 75, 1995.
- Peterson, I. *Islands of Truth: A Mathematical Mystery Cruise*. New York: W. H. Freeman, pp. 238–239, 1990.
- Spencer, J. "Combinatorics by Coin Flipping." *Coll. Math. J.*, **17**, 407–412, 1986.

Coincidence

A coincidence is a surprising concurrence of events, perceived as meaningfully related, with no apparent causal connection (Diaconis and Mosteller 1989).

see also BIRTHDAY PROBLEM, LAW OF TRULY LARGE NUMBERS, ODDS, PROBABILITY, RANDOM NUMBER

References

- Bogomolny, A. "Coincidence." http://www.cut-the-knot.com/do_you_know/coincidence.html.
 Falk, R. "On Coincidences." *Skeptical Inquirer* 6, 18–31, 1981–82.
 Falk, R. "The Judgment of Coincidences: Mine Versus Yours." *Amer. J. Psych.* 102, 477–493, 1989.
 Falk, R. and MacGregor, D. "The Surprisingness of Coincidences." In *Analysing and Aiding Decision Processes* (Ed. P. Humphreys, O. Svenson, and A. Vári). New York: Elsevier, pp. 489–502, 1984.
 Diaconis, P. and Mosteller, F. "Methods of Studying Coincidences." *J. Amer. Statist. Assoc.* 84, 853–861, 1989.
 Jung, C. G. *Synchronicity: An Acausal Connecting Principle*. Princeton, NJ: Princeton University Press, 1973.
 Kammerer, P. *Das Gesetz der Serie: Eine Lehre von den Wiederholungen im Lebens—und im Weltgeschehen*. Stuttgart, Germany: Deutsche Verlags-Anstalt, 1919.
 Stewart, I. "What a Coincidence!" *Sci. Amer.* 278, 95–96, June 1998.

Colatitude

The polar angle on a SPHERE measured from the North Pole instead of the equator. The angle ϕ in SPHERICAL COORDINATES is the COLATITUDE. It is related to the LATITUDE δ by $\phi = 90^\circ - \delta$.

see also LATITUDE, LONGITUDE, SPHERICAL COORDINATES

Colinear

see COLLINEAR

Collatz Problem

A problem posed by L. Collatz in 1937, also called the $3x + 1$ MAPPING, HASSE'S ALGORITHM, KAKUTANI'S PROBLEM, SYRACUSE ALGORITHM, SYRACUSE PROBLEM, THWAITES CONJECTURE, and ULAM'S PROBLEM (Lagarias 1985). Thwaites (1996) has offered a £1000 reward for resolving the CONJECTURE. Let n be an INTEGER. Then the Collatz problem asks if iterating

$$f(n) = \begin{cases} \frac{1}{2}n & \text{for } n \text{ even} \\ 3n + 1 & \text{for } n \text{ odd} \end{cases} \quad (1)$$

always returns to 1 for POSITIVE n . This question has been tested and found to be true for all numbers $< 5.6 \times 10^{13}$ (Leavens and Vermeulen 1992), and more recently, 10^{15} (Vardi 1991, p. 129). The members of the SEQUENCE produced by the Collatz are sometimes known as HAILSTONE NUMBERS. Because of the difficulty in solving this problem, Erdős commented that "mathematics is not yet ready for such problems" (Lagarias 1985). If NEGATIVE numbers are included, there are four known cycles (excluding the trivial 0 cycle): (4,

2, 1), (−2, −1), (−5, −7, −10), and (−17, −25, −37, −55, −82, −41, −61, −91, −136, −68, −34). The number of tripling steps needed to reach 1 for $n = 1, 2, \dots$ are 0, 0, 2, 0, 1, 2, 5, 0, 6, \dots (Sloane's A006667).

The Collatz problem was modified by Terras (1976, 1979), who asked if iterating

$$T(x) = \begin{cases} \frac{1}{2}x & \text{for } x \text{ even} \\ \frac{1}{2}(3x + 1) & \text{for } x \text{ odd} \end{cases} \quad (2)$$

always returns to 1. If NEGATIVE numbers are included, there are 4 known cycles: (1, 2), (−1), (−5, −7, −10), and (−17, −25, −37, −55, −82, −41, −61, −91, −136, −68, −34). It is a special case of the "generalized Collatz problem" with $d = 2$, $m_0 = 1$, $m_1 = 3$, $r_0 = 0$, and $r_1 = -1$. Terras (1976, 1979) also proved that the set of INTEGERS $S_k \equiv \{n : n \text{ has stopping time } \leq k\}$ has a limiting asymptotic density $F(k)$, so the limit

$$F(k) = \lim_{x \rightarrow \infty} \frac{1}{x}, \quad (3)$$

for $\{n : n \leq x \text{ and } \sigma(n) \leq k\}$ exists. Furthermore, $F(k) \rightarrow 1$ as $k \rightarrow \infty$, so almost all INTEGERS have a finite stopping time. Finally, for all $k \geq 1$,

$$1 - F(k) = \lim_{x \rightarrow \infty} \frac{1}{x} \leq 2^{-\eta k}, \quad (4)$$

where

$$\eta = 1 - H(\theta) = 0.05004 \dots \quad (5)$$

$$H(x) = -x \lg x - (1 - x) \lg(1 - x) \quad (6)$$

$$\theta = \frac{1}{\lg 3} \quad (7)$$

(Lagarias 1985).

Conway proved that the original Collatz problem has no nontrivial cycles of length < 400 . Lagarias (1985) showed that there are no nontrivial cycles with length $< 275,000$. Conway (1972) also proved that Collatz-type problems can be formally UNDECIDABLE.

A generalization of the COLLATZ PROBLEM lets $d \geq 2$ be a POSITIVE INTEGER and m_0, \dots, m_{d-1} be NONZERO INTEGERS. Also let $r_i \in \mathbb{Z}$ satisfy

$$r_i \equiv im_i \pmod{d}. \quad (8)$$

Then

$$T(x) = \frac{m_i x - r_i}{d} \quad (9)$$

for $x \equiv i \pmod{d}$ defines a generalized Collatz mapping. An equivalent form is

$$T(x) = \left\lfloor \frac{m_i x}{d} \right\rfloor + X_i \quad (10)$$

for $x \equiv i \pmod{d}$ where X_0, \dots, X_{d-1} are INTEGERS and $\lfloor r \rfloor$ is the FLOOR FUNCTION. The problem is connected with ERGODIC THEORY and MARKOV CHAINS (Matthews 1995). Matthews (1995) obtained the following table for the mapping

$$T_k(x) = \begin{cases} \frac{1}{2}x & \text{for } x \equiv 0 \pmod{2} \\ \frac{1}{2}(3x + k) & \text{for } x \equiv 1 \pmod{2}, \end{cases} \quad (11)$$

where $k = T_{5^k}$.

k	# Cycles	Max. Cycle Length
0	5	27
1	10	34
2	13	118
3	17	118
4	19	118
5	21	165
6	23	433

Matthews and Watts (1984) proposed the following conjectures.

1. If $|m_0 \dots m_{d-1}| < d^d$, then all trajectories $\{T^K(n)\}$ for $n \in \mathbb{Z}$ eventually cycle.
2. If $|m_0 \dots m_{d-1}| > d^d$, then almost all trajectories $\{T^K(n)\}$ for $n \in \mathbb{Z}$ are divergent, except for an exceptional set of INTEGERS n satisfying

$$\#\{n \in S \mid -X \leq n < X\} = o(X).$$

3. The number of cycles is finite.
4. If the trajectory $\{T^K(n)\}$ for $n \in \mathbb{Z}$ is not eventually cyclic, then the iterates are uniformly distribution mod d^α for each $\alpha \geq 1$, with

$$\lim_{N \rightarrow \infty} \frac{1}{N+1} \text{card}\{K \leq N \mid T^K(n) \equiv j \pmod{d^\alpha}\} = d^{-\alpha} \quad (12)$$

for $0 \leq j \leq d^\alpha - 1$.

Matthews believes that the map

$$T(x) = \begin{cases} 7x + 3 & \text{for } x \equiv 0 \pmod{3} \\ \frac{1}{3}(7x + 2) & \text{for } x \equiv 1 \pmod{3} \\ \frac{1}{3}(x - 2) & \text{for } x \equiv 2 \pmod{3} \end{cases} \quad (13)$$

will either reach $0 \pmod{3}$ or will enter one of the cycles (-1) or $(-2, -4)$, and offers a \$100 (Australian?) prize for a proof.

see also HAILSTONE NUMBER

References

- Applegate, D. and Lagarias, J. C. "Density Bounds for the $3x + 1$ Problem 1. Tree-Search Method." *Math. Comput.* **64**, 411–426, 1995.
- Applegate, D. and Lagarias, J. C. "Density Bounds for the $3x + 1$ Problem 2. Krasikov Inequalities." *Math. Comput.* **64**, 427–438, 1995.

Beeler, M.; Gosper, R. W.; and Schroepel, R. *HAKMEM*. Cambridge, MA: MIT Artificial Intelligence Laboratory, Memo AIM-239, Feb. 1972.

Burckel, S. "Functional Equations Associated with Congruential Functions." *Theor. Comp. Sci.* **123**, 397–406, 1994.

Conway, J. H. "Unpredictable Iterations." *Proc. 1972 Number Th. Conf.*, University of Colorado, Boulder, Colorado, pp. 49–52, 1972.

Crandall, R. "On the ' $3x + 1$ ' Problem." *Math. Comput.* **32**, 1281–1292, 1978.

Everett, C. "Iteration of the Number Theoretic Function $f(2n) = n$, $f(2n + 1) = f(3n + 2)$." *Adv. Math.* **25**, 42–45, 1977.

Guy, R. K. "Collatz's Sequence." §E16 in *Unsolved Problems in Number Theory*, 2nd ed. New York: Springer-Verlag, pp. 215–218, 1994.

Lagarias, J. C. "The $3x + 1$ Problem and Its Generalizations." *Amer. Math. Monthly* **92**, 3–23, 1985. <http://www.cec.sfu.ca/organics/papers/lagarias/>.

Leavens, G. T. and Vermeulen, M. " $3x + 1$ Search Programs." *Comput. Math. Appl.* **24**, 79–99, 1992.

Matthews, K. R. "The Generalized $3x + 1$ Mapping." <http://www.maths.uq.oz.au/~krm/survey.dvi>. Rev. Sept. 10, 1995.

Matthews, K. R. "A Generalized $3x + 1$ Conjecture." [\$100 Reward for a Proof.] <ftp://www.maths.uq.edu.au/pub/krm/gnubc/challenge>.

Matthews, K. R. and Watts, A. M. "A Generalization of Hasset's Generalization of the Syracuse Algorithm." *Acta Arith.* **43**, 167–175, 1984.

Sloane, N. J. A. Sequence A006667/M0019 in "An On-Line Version of the Encyclopedia of Integer Sequences."

Terras, R. "A Stopping Time Problem on the Positive Integers." *Acta Arith.* **30**, 241–252, 1976.

Terras, R. "On the Existence of a Density." *Acta Arith.* **35**, 101–102, 1979.

Thwaites, B. "Two Conjectures, or How to win £1100." *Math. Gaz.* **80**, 35–36, 1996.

Vardi, I. "The $3x + 1$ Problem." Ch. 7 in *Computational Recreations in Mathematics*. Redwood City, CA: Addison-Wesley, pp. 129–137, 1991.

Collinear

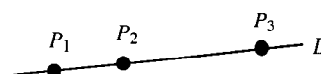

Three or more points P_1, P_2, P_3, \dots , are said to be collinear if they lie on a single straight LINE L . (Two points are always collinear.) This will be true IFF the ratios of distances satisfy

$$x_2 - x_1 : y_2 - y_1 : z_2 - z_1 = x_3 - x_1 : y_3 - y_1 : z_3 - z_1.$$

Two points are trivially collinear since two points determine a LINE.

see also CONCYCLIC, DIRECTED ANGLE, N-CLUSTER, SYLVESTER'S LINE PROBLEM

Collineation

A transformation of the plane which transforms COLLINEAR points into COLLINEAR points. A projective collineation transforms every 1-D form projectively, and a perspective collineation is a collineation which leaves all lines through a point and points through a line invariant. In an ELATION, the center and axis are incident; in

a HOMOLOGY they are not. For further discussion, see Coxeter (1969, p. 248).

see also AFFINITY, CORRELATION, ELATION, EQUI-AFFINITY, HOMOLOGY (GEOMETRY), PERSPECTIVE COLLINEATION, PROJECTIVE COLLINEATION

References

Coxeter, H. S. M. "Collineations and Correlations." §14.6 in *Introduction to Geometry*, 2nd ed. New York: Wiley, pp. 247–251, 1969.

Cologarithm

The LOGARITHM of the RECIPROCAL of a number, equal to the NEGATIVE of the LOGARITHM of the number itself,

$$\text{colog } x \equiv \log \left(\frac{1}{x} \right) = -\log x.$$

see also ANTILOGARITHM, LOGARITHM

Colon Product

Let **AB** and **CD** be DYADS. Their colon product is defined by

$$\mathbf{AB} : \mathbf{CD} \equiv \mathbf{C} \cdot \mathbf{AB} \cdot \mathbf{D} = (\mathbf{A} \cdot \mathbf{C})(\mathbf{B} \cdot \mathbf{D}).$$

Colorable

Color each segment of a KNOT DIAGRAM using one of three colors. If

1. at any crossing, either the colors are all different or all the same, and
2. at least two colors are used,

then a KNOT is said to be colorable (or more specifically, THREE-COLORABLE). Colorability is invariant under REIDEMEISTER MOVES, and can be generalized. For instance, for five colors 0, 1, 2, 3, and 4, a KNOT is five-colorable if

1. at any crossing, three segments meet. If the overpass is numbered a and the two underpasses B and C , then $2a \equiv b + c \pmod{5}$, and
2. at least two colors are used.

Colorability cannot always distinguish HANDEDNESS. For instance, three-colorability can distinguish the mirror images of the TREFOIL KNOT but not the FIGURE-OF-EIGHT KNOT. Five-colorability, on the other hand, distinguishes the MIRROR IMAGES of the FIGURE-OF-EIGHT KNOT but not the TREFOIL KNOT.

see also COLORING, THREE-COLORABLE

Coloring

A coloring of plane regions, LINK segments, etc., is an assignment of a distinct labelling (which could be a number, letter, color, etc.) to each component. Coloring problems generally involve TOPOLOGICAL considerations (i.e., they depend on the abstract study of the arrangement of objects), and theorems about colorings,

such as the famous FOUR-COLOR THEOREM, can be extremely difficult to prove.

see also COLORABLE, EDGE-COLORING, FOUR-COLOR THEOREM, k -COLORING, POLYHEDRON COLORING, SIX-COLOR THEOREM, THREE-COLORABLE, VERTEX COLORING

References

Eppstein, D. "Coloring." <http://www.ics.uci.edu/~eppstein/junkyard/color.html>.

Saaty, T. L. and Kainen, P. C. *The Four-Color Problem: Assaults and Conquest*. New York: Dover, 1986.

Columbian Number

see SELF NUMBER

Colunar Triangle

Given a SCHWARZ TRIANGLE ($p \ q \ r$), replacing each VERTEX with its antipodes gives the three colunar SPHERICAL TRIANGLES

$$(p \ q' \ r'), (p' \ q \ r'), (p' \ q' \ r),$$

where

$$\frac{1}{p} + \frac{1}{p'} = 1$$

$$\frac{1}{q} + \frac{1}{q'} = 1$$

$$\frac{1}{r} + \frac{1}{r'} = 1.$$

see also SCHWARZ TRIANGLE, SPHERICAL TRIANGLE

References

Coxeter, H. S. M. *Regular Polytopes*, 3rd ed. New York: Dover, p. 112, 1973.

Comb Function

see SHAH FUNCTION

Combination

The number of ways of picking r unordered outcomes from n possibilities. Also known as the BINOMIAL COEFFICIENT or CHOICE NUMBER and read " n choose r ."

$${}_nC_r \equiv \binom{n}{r} \equiv \frac{n!}{r!(n-r)!},$$

where $n!$ is a FACTORIAL.

see also BINOMIAL COEFFICIENT, DERANGEMENT, FACTORIAL, PERMUTATION, SUBFACTORIAL

References

Conway, J. H. and Guy, R. K. "Choice Numbers." In *The Book of Numbers*. New York: Springer-Verlag, pp. 67–68, 1996.

Ruskey, F. "Information on Combinations of a Set." <http://sue.csc.uvic.ca/~cos/inf/comb/CombinationsInfo.html>.

Combination Lock

Let a combination of n buttons be a SEQUENCE of disjoint nonempty SUBSETS of the SET $\{1, 2, \dots, n\}$. If the number of possible combinations is denoted a_n , then a_n satisfies the RECURRENCE RELATION

$$a_n = \sum_{i=0}^{n-1} \binom{n}{n-i} a_i, \quad (1)$$

with $a_0 = 1$. This can also be written

$$a_n = \frac{d^n}{dx^n} \left(\frac{1}{2 - e^x} \right) \Big|_{x=0} = \frac{1}{2} \sum_{k=0}^{\infty} \frac{k^n}{2^k}, \quad (2)$$

where the definition $0^0 = 1$ has been used. Furthermore,

$$a_n = \sum_{k=1}^n A_{n,k} 2^{n-k} = \sum_{k=1}^n A_{n,k} 2^{k-1}, \quad (3)$$

where $A_{n,k}$ are EULERIAN NUMBERS. In terms of the STIRLING NUMBERS OF THE SECOND KIND $s(n, k)$,

$$a_n = \sum_{k=1}^n k! s(n, k). \quad (4)$$

a_n can also be given in closed form as

$$a_n = \frac{1}{2} \text{Li}_{-n}\left(\frac{1}{2}\right), \quad (5)$$

where $\text{Li}_n(z)$ is the POLYLOGARITHM. The first few values of a_n for $n = 1, 2, \dots$ are 1, 3, 13, 75, 541, 4683, 47293, 545835, 7087261, 102247563, ... (Sloane's A000670).

The quantity

$$b_n \equiv \frac{a_n}{n!} \quad (6)$$

satisfies the inequality

$$\frac{1}{2(\ln 2)^n} \leq b_n \leq \frac{1}{(\ln 2)^n}. \quad (7)$$

References

- Sloane, N. J. A. Sequence A000670/M2952 in "An On-Line Version of the Encyclopedia of Integer Sequences."
 Velleman, D. J. and Call, G. S. "Permutations and Combination Locks." *Math. Mag.* **68**, 243–253, 1995.

Combinatorial Species

see SPECIES

Combinatorial Topology

Combinatorial topology is a special type of ALGEBRAIC TOPOLOGY that uses COMBINATORIAL methods. For example, SIMPLICIAL HOMOLOGY is a combinatorial construction in ALGEBRAIC TOPOLOGY, so it belongs to combinatorial topology.

see also ALGEBRAIC TOPOLOGY, SIMPLICIAL HOMOLOGY, TOPOLOGY

Combinatorics

The branch of mathematics studying the enumeration, combination, and permutation of sets of elements and the mathematical relations which characterize these properties.

see also ANTICHAIN, CHAIN, DILWORTH'S LEMMA, DIVERSITY CONDITION, ERDŐS-SZEKERES THEOREM, INCLUSION-EXCLUSION PRINCIPLE, KIRKMAN'S SCHOOLGIRL PROBLEM, KIRKMAN TRIPLE SYSTEM, LENGTH (PARTIAL ORDER), PARTIAL ORDER, PIGEONHOLE PRINCIPLE, RAMSEY'S THEOREM, SCHRÖDER-BERNSTEIN THEOREM, SCHUR'S LEMMA, SPERNER'S THEOREM, TOTAL ORDER, VAN DER WAERDEN'S THEOREM, WIDTH (PARTIAL ORDER)

References

- Abramowitz, M. and Stegun, C. A. (Eds.). "Combinatorial Analysis." Ch. 24 in *Handbook of Mathematical Functions with Formulas, Graphs, and Mathematical Tables*, 9th printing. New York: Dover, pp. 821–8827, 1972.
 Aigner, M. *Combinatorial Theory*. New York: Springer-Verlag, 1997.
 Bellman, R. and Hall, M. *Combinatorial Analysis*. Amer. Math. Soc., 1979.
 Biggs, N. L. "The Roots of Combinatorics." *Historia Mathematica* **6**, 109–136, 1979.
 Bose, R. C. and Manvel, B. *Introduction to Combinatorial Theory*. New York: Wiley, 1984.
 Brown, K. S. "Combinatorics." <http://www.seanet.com/~ksbrown/icomina.htm>.
 Cameron, P. J. *Combinatorics: Topics, Techniques, Algorithms*. New York: Cambridge University Press, 1994.
 Cohen, D. *Basic Techniques of Combinatorial Theory*. New York: Wiley, 1978.
 Cohen, D. E. *Combinatorial Group Theory: A Topological Approach*. New York: Cambridge University Press, 1989.
 Colbourn, C. J. and Dinitz, J. H. *CRC Handbook of Combinatorial Designs*. Boca Raton, FL: CRC Press, 1996.
 Comtet, L. *Advanced Combinatorics*. Dordrecht, Netherlands: Reidel, 1974.
 Coolsaet, K. "Index of Combinatorial Objects." <http://www.hogent.be/~kc/ico/>.
 Dinitz, J. H. and Stinson, D. R. (Eds.). *Contemporary Design Theory: A Collection of Surveys*. New York: Wiley, 1992.
Electronic Journal of Combinatorics. http://www.combinatorics.org/previous_volumes.html.
 Eppstein, D. "Combinatorial Geometry." <http://www.ics.uci.edu/~eppstein/junkyard/combinatorial.html>.
 Erickson, M. J. *Introduction to Combinatorics*. New York: Wiley, 1996.
 Fields, J. "On-Line Dictionary of Combinatorics." <http://math.uic.edu/~fields/dic/>.
 Godsil, C. D. "Problems in Algebraic Combinatorics." *Electronic J. Combinatorics* **2**, F1, 1–20, 1995. <http://www.combinatorics.org/Volume2/volume2.html#F1>.
 Graham, R. L.; Grötschel, M.; and Lovász, L. (Eds.). *Handbook of Combinatorics*, 2 vols. Cambridge, MA: MIT Press, 1996.
 Graham, R. L.; Knuth, D. E.; and Patashnik, O. *Concrete Mathematics: A Foundation for Computer Science*, 2nd ed. Reading, MA: Addison-Wesley, 1994.
 Hall, M. Jr. *Combinatorial Theory*, 2nd ed. New York: Wiley, 1986.
 Knuth, D. E. (Ed.). *Stable Marriage and Its Relation to Other Combinatorial Problems*. Providence, RI: Amer. Math. Soc., 1997.

- Kučera, L. *Combinatorial Algorithms*. Bristol, England: Adam Hilger, 1989.
- Liu, C. L. *Introduction to Combinatorial Mathematics*. New York: McGraw-Hill, 1968.
- MacMahon, P. A. *Combinatory Analysis*. New York: Chelsea, 1960.
- Nijenhuis, A. and Wilf, H. *Combinatorial Algorithms for Computers and Calculators, 2nd ed.* New York: Academic Press, 1978.
- Riordan, J. *Combinatorial Identities, reprint ed. with corrections*. Huntington, NY: Krieger, 1979.
- Riordan, J. *An Introduction to Combinatorial Analysis*. New York: Wiley, 1980.
- Roberts, F. S. *Applied Combinatorics*. Englewood Cliffs, NJ: Prentice-Hall, 1984.
- Rota, G.-C. (Ed.). *Studies in Combinatorics*. Providence, RI: Math. Assoc. Amer., 1978.
- Ruskey, F. "The (Combinatorial) Object Server." <http://sue.csc.uvic.ca/~cos>.
- Ryser, H. J. *Combinatorial Mathematics*. Buffalo, NY: Math. Assoc. Amer., 1963.
- Skiena, S. S. *Implementing Discrete Mathematics: Combinatorics and Graph Theory with Mathematica*. Reading, MA: Addison-Wesley, 1990.
- Sloane, N. J. A. "An On-Line Version of the Encyclopedia of Integer Sequences." <http://www.research.att.com/~njas/sequences/eisonline.html>.
- Sloane, N. J. A. and Plouffe, S. *The Encyclopedia of Integer Sequences*. San Diego, CA: Academic Press, 1995.
- Street, A. P. and Wallis, W. D. *Combinatorial Theory: An Introduction*. Winnipeg, Manitoba: Charles Babbage Research Center, 1977.
- Tucker, A. *Applied Combinatorics, 3rd ed.* New York: Wiley, 1995.
- van Lint, J. H. and Wilson, R. M. *A Course in Combinatorics*. New York: Cambridge University Press, 1992.
- Wilf, H. S. *Combinatorial Algorithms: An Update*. Philadelphia, PA: SIAM, 1989.

Comma Derivative

$$A_{,k} \equiv \frac{\partial A}{\partial x^k} \equiv \partial_k A$$

$$A^k_{,k} \equiv \frac{1}{g_k} \frac{\partial A^k}{\partial x^k} \equiv \partial_k A^k.$$

see also COVARIANT DERIVATIVE, SEMICOLON DERIVATIVE

Comma of Didymus

The musical interval by which four fifths exceed a seventeenth (i.e., two octaves and a major third),

$$\frac{\left(\frac{3}{2}\right)^4}{2^2\left(\frac{5}{4}\right)} = \frac{3^4}{2^4 \cdot 5} = \frac{81}{80} = 1.0125,$$

also called a SYNTONIC COMMA.

see also COMMA OF PYTHAGORAS, DIESIS, SCHISMA

Comma of Pythagoras

The musical interval by which twelve fifths exceed seven octaves,

$$\frac{\left(\frac{3}{2}\right)^{12}}{2^7} = \frac{3^{12}}{2^{19}} = \frac{531441}{524288} = 1.013643265.$$

Successive CONTINUED FRACTION CONVERGENTS to $\log 2 / \log(3/2)$ give increasingly close approximations m/n of m fifths by n octaves as 1, 2, 5/3, 12/7, 41/24, 53/31, 306/179, 665/389, ... (Sloane's A005664 and A046102; Jeans 1968, p. 188), shown in **bold** in the table below. All near-equalities of m fifths and n octaves having

$$R \equiv \frac{\left(\frac{3}{2}\right)^m}{2^n} = \frac{3^m}{2^{m+n}}$$

with $|R - 1| < 0.02$ are given in the following table.

m	n	Ratio	m	n	Ratio
12	7	1.013643265	265	155	1.010495356
41	24	0.9886025477	294	172	0.9855324037
53	31	1.002090314	306	179	0.9989782832
65	38	1.015762098	318	186	1.012607608
94	55	0.9906690375	347	203	0.9875924759
106	62	1.004184997	359	210	1.001066462
118	69	1.017885359	371	217	1.014724276
147	86	0.9927398469	400	234	0.9896568543
159	93	1.006284059	412	241	1.003159005
188	110	0.9814251419	424	248	1.016845369
200	117	0.994814985	453	265	0.9917255479
212	124	1.008387509	465	272	1.005255922
241	141	0.9834766286	477	279	1.018970895
253	148	0.9968944607	494	289	0.9804224033

see also COMMA OF DIDYMUS, DIESIS, SCHISMA

References

- Conway, J. H. and Guy, R. K. *The Book of Numbers*. New York: Springer-Verlag, p. 257, 1995.
- Guy, R. K. "Small Differences Between Powers of 2 and 3." §F23 in *Unsolved Problems in Number Theory, 2nd ed.* New York: Springer-Verlag, p. 261, 1994.
- Sloane, N. J. A. Sequences A005664 and A046102 in "An On-Line Version of the Encyclopedia of Integer Sequences."

Common Cycloid

see CYCLOID

Common Residue

The value of b , where $a \equiv b \pmod{m}$, taken to be NON-NEGATIVE and smaller than m .

see also MINIMAL RESIDUE, RESIDUE (CONGRUENCE)

Commutation Coefficient

A coefficient which gives the difference between partial derivatives of two coordinates with respect to the other coordinate,

$$c_{\alpha\beta}^{\mu} \vec{e}_{\mu} = [\vec{e}_{\alpha}, \vec{e}_{\beta}] = \nabla_{\alpha} \vec{e}_{\beta} - \nabla_{\beta} \vec{e}_{\alpha}.$$

see also CONNECTION COEFFICIENT

Commutative

Let A denote an \mathbb{R} -algebra, so that A is a VECTOR SPACE over \mathbb{R} and

$$A \times A \rightarrow A$$

$$(x, y) \mapsto x \cdot y.$$

Now define

$$Z \equiv \{x \in A : x \cdot y \text{ for some } y \in A \neq 0\},$$

where $0 \in Z$. An ASSOCIATIVE \mathbb{R} -algebra is commutative if $x \cdot y = y \cdot x$ for all $x, y \in A$. Similarly, a RING is commutative if the MULTIPLICATION operation is commutative, and a LIE ALGEBRA is commutative if the COMMUTATOR $[A, B]$ is 0 for every A and B in the LIE ALGEBRA.

see also ABELIAN, ASSOCIATIVE, TRANSITIVE

References

- Finch, S. "Zero Structures in Real Algebras." <http://www.mathsoft.com/asolve/zerodiv/zerodiv.html>.
MacDonald, I. G. and Atiyah, M. F. *Introduction to Commutative Algebra*. Reading, MA: Addison-Wesley, 1969.

Commutative Algebra

An ALGEBRA in which the $+$ operators and \times are COMMUTATIVE.

see also ALGEBRAIC GEOMETRY, GRÖBNER BASIS

References

- MacDonald, I. G. and Atiyah, M. F. *Introduction to Commutative Algebra*. Reading, MA: Addison-Wesley, 1969.
Cox, D.; Little, J.; and O'Shea, D. *Ideals, Varieties, and Algorithms: An Introduction to Algebraic Geometry and Commutative Algebra*, 2nd ed. New York: Springer-Verlag, 1996.
Samuel, P. and Zariski, O. *Commutative Algebra*, Vol. 2. New York: Springer-Verlag, 1997.

Commutator

Let $\tilde{A}, \tilde{B}, \dots$ be OPERATORS. Then the commutator of \tilde{A} and \tilde{B} is defined as

$$[\tilde{A}, \tilde{B}] \equiv \tilde{A}\tilde{B} - \tilde{B}\tilde{A}. \quad (1)$$

Let a, b, \dots be constants. Identities include

$$[f(x), x] = 0 \quad (2)$$

$$[\tilde{A}, \tilde{A}] = 0 \quad (3)$$

$$[\tilde{A}, \tilde{B}] = -[\tilde{B}, \tilde{A}] \quad (4)$$

$$[\tilde{A}, \tilde{B}\tilde{C}] = [\tilde{A}, \tilde{B}]\tilde{C} + \tilde{B}[\tilde{A}, \tilde{C}] \quad (5)$$

$$[\tilde{A}\tilde{B}, \tilde{C}] = [\tilde{A}, \tilde{C}]\tilde{B} + \tilde{A}[\tilde{B}, \tilde{C}] \quad (6)$$

$$[a + \tilde{A}, b + \tilde{B}] = [\tilde{A}, \tilde{B}] \quad (7)$$

$$[\tilde{A} + \tilde{B}, \tilde{C} + \tilde{D}] = [\tilde{A}, \tilde{C}] + [\tilde{A}, \tilde{D}] + [\tilde{B}, \tilde{C}] + [\tilde{B}, \tilde{D}]. \quad (8)$$

The commutator can be interpreted as the "infinitesimal" of the commutator of a LIE GROUP.

Let A and B be TENSORS. Then

$$[A, B] \equiv \nabla_A B - \nabla_B A. \quad (9)$$

see also ANTICOMMUTATOR, JACOBI IDENTITIES

Compact Group

If the parameters of a LIE GROUP vary over a CLOSED INTERVAL, the GROUP is compact. Every representation of a compact group is equivalent to a UNITARY representation.

Compact Manifold

A MANIFOLD which can be "charted" with finitely many EUCLIDEAN SPACE charts. The CIRCLE is the only compact 1-D MANIFOLD. The SPHERE and n -TORUS are the only compact 2-D MANIFOLDS. It is an open question if the known compact MANIFOLDS in 3-D are complete, and it is not even known what a complete list in 4-D should look like. The following terse table therefore summarizes current knowledge about the number of compact manifolds $N(D)$ of D dimensions.

D	$N(D)$
1	1
2	2

see also TYCHONOV COMPACTNESS THEOREM

Compact Set

The SET S is compact if, from any SEQUENCE of elements X_1, X_2, \dots of S , a subsequence can always be extracted which tends to some limit element X of S . Compact sets are therefore closed and bounded.

Compact Space

A TOPOLOGICAL SPACE is compact if every open cover of X has a finite subcover. In other words, if X is the union of a family of open sets, there is a finite subfamily whose union is X . A subset A of a TOPOLOGICAL SPACE X is compact if it is compact as a TOPOLOGICAL SPACE with the relative topology (i.e., every family of open sets of X whose union contains A has a finite subfamily whose union contains A).

Compact Surface

A surface with a finite number of TRIANGLES in its TRIANGULATION. The SPHERE and TORUS are compact, but the PLANE and TORUS minus a DISK are not.

Compactness Theorem

Inside a BALL B in \mathbb{R}^3 ,

$$\{ \text{rectifiable currents } S \text{ in } BL \text{ AREA } S \leq c, \text{ length } \partial S \leq c \}$$

is compact under the FLAT NORM.

References

- Morgan, F. "What Is a Surface?" *Amer. Math. Monthly* **103**, 369–376, 1996.

Companion Knot

Let K_1 be a knot inside a TORUS. Now knot the TORUS in the shape of a second knot (called the companion knot) K_2 . Then the new knot resulting from K_1 is called the SATELLITE KNOT K_3 .

References

Adams, C. C. *The Knot Book: An Elementary Introduction to the Mathematical Theory of Knots*. New York: W. H. Freeman, pp. 115–118, 1994.

Comparability Graph

The comparability graph of a POSET $P = (X, \leq)$ is the GRAPH with vertex set X for which vertices x and y are adjacent IFF either $x \leq y$ or $y \leq x$ in P .

see also INTERVAL GRAPH, PARTIALLY ORDERED SET

Comparison Test

Let $\sum a_k$ and $\sum b_k$ be a SERIES with POSITIVE terms and suppose $a_1 \leq b_1$, $a_2 \leq b_2$, ...

1. If the bigger series CONVERGES, then the smaller series also CONVERGES.
2. If the smaller series DIVERGES, then the bigger series also DIVERGES.

see also CONVERGENCE TESTS

References

Arfken, G. *Mathematical Methods for Physicists*, 3rd ed. Orlando, FL: Academic Press, pp. 280–281, 1985.

Compass

A tool with two arms joined at their ends which can be used to draw CIRCLES. In GEOMETRIC CONSTRUCTIONS, the classical Greek rules stipulate that the compass cannot be used to mark off distances, so it must “collapse” whenever one of its arms is removed from the page. This results in significant complication in the complexity of GEOMETRIC CONSTRUCTIONS.

see also CONSTRUCTIBLE POLYGON, GEOMETRIC CONSTRUCTION, GEOMETROGRAPHY, MASCHERONI CONSTRUCTION, PLANE GEOMETRY, POLYGON, PONCELET-STEINER THEOREM, RULER, SIMPLICITY, STEINER CONSTRUCTION, STRAIGHTEDGE

References

Dixon, R. “Compass Drawings.” Ch. 1 in *Mathographics*. New York: Dover, pp. 1–78, 1991.

Compatible

Let $\|A\|$ be the MATRIX NORM associated with the MATRIX A and $\|x\|$ be the VECTOR NORM associated with a VECTOR x . Let the product Ax be defined, then $\|A\|$ and $\|x\|$ are said to be compatible if

$$\|Ax\| \leq \|A\| \|x\|.$$

References

Gradshteyn, I. S. and Ryzhik, I. M. *Tables of Integrals, Series, and Products*, 5th ed. San Diego, CA: Academic Press, p. 1115, 1980.

Complement Graph

The complement GRAPH \bar{G} of G has the same VERTICES as G but contains precisely those two-element SUBSETS which are not in G .

Complement Knot

see KNOT COMPLEMENT

Complement Set

Given a set S with a subset E , the complement of E is defined as

$$E' \equiv \{F : F \in S, F \notin E\}. \quad (1)$$

If $E = S$, then

$$E' \equiv S' = \emptyset, \quad (2)$$

where \emptyset is the EMPTY SET. Given a single SET, the second PROBABILITY AXIOM gives

$$1 = P(S) = P(E \cup E'). \quad (3)$$

Using the fact that $E \cap E' = \emptyset$,

$$1 = P(E) + P(E') \quad (4)$$

$$P(E') = 1 - P(E). \quad (5)$$

This demonstrates that

$$P(S') = P(\emptyset) = 1 - P(S) = 1 - 1 = 0. \quad (6)$$

Given two SETS,

$$P(E \cap F') = P(E) - P(E \cap F) \quad (7)$$

$$P(E' \cap F') = 1 - P(E) - P(F) + P(E \cap F). \quad (8)$$

Complementary Angle

Two ANGLES α and $\pi/2 - \alpha$ are said to be complementary.

see also ANGLE, SUPPLEMENTARY ANGLE

Complete

see COMPLETE AXIOMATIC THEORY, COMPLETE BGRAPH, COMPLETE FUNCTIONS, COMPLETE GRAPH, COMPLETE QUADRANGLE, COMPLETE QUADRILATERAL, COMPLETE SEQUENCE, COMPLETE SPACE, COMPLETENESS PROPERTY, WEAKLY COMPLETE SEQUENCE

Complete Axiomatic Theory

An axiomatic theory (such as a GEOMETRY) is said to be complete if each valid statement in the theory is capable of being proven true or false.

see also CONSISTENCY

Complete Bigraph

see COMPLETE BIPARTITE GRAPH

Complete Bipartite Graph

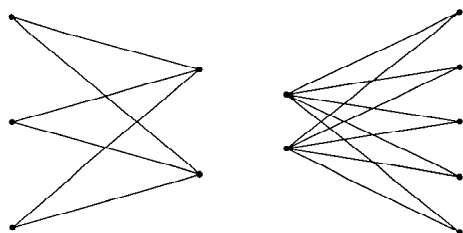

A BIPARTITE GRAPH (i.e., a set of VERTICES decomposed into two disjoint sets such that there are no two VERTICES within the same set are adjacent) such that every pair of VERTICES in the two sets are adjacent. If there are p and q VERTICES in the two sets, the complete bipartite graph (sometimes also called a COMPLETE BIGRAPH) is denoted $K_{p,q}$. The above figures show $K_{3,2}$ and $K_{2,5}$.

see also BIPARTITE GRAPH, COMPLETE GRAPH, COMPLETE k -PARTITE GRAPH, k -PARTITE GRAPH, THOMASSEN GRAPH, UTILITY GRAPH

References

Saaty, T. L. and Kainen, P. C. *The Four-Color Problem: Assaults and Conquest*. New York: Dover, p. 12, 1986.

Complete Functions

A set of ORTHONORMAL FUNCTIONS $\phi_n(x)$ is termed complete in the CLOSED INTERVAL $x \in [a, b]$ if, for every piecewise CONTINUOUS FUNCTION $f(x)$ in the interval, the minimum square error

$$E_n \equiv \|f - (c_1\phi_1 + \dots + c_n\phi_n)\|^2$$

(where $\|$ denotes the NORM) converges to zero as n becomes infinite. Symbolically, a set of functions is complete if

$$\lim_{m \rightarrow \infty} \int_a^b \left[f(x) - \sum_{n=0}^m a_n \phi_n(x) \right]^2 w(x) dx = 0,$$

where $w(x)$ is a WEIGHTING FUNCTION and the above is a LEBESGUE INTEGRAL.

see also BESSEL'S INEQUALITY, HILBERT SPACE

References

Arfken, G. "Completeness of Eigenfunctions." §9.4 in *Mathematical Methods for Physicists*, 3rd ed. Orlando, FL: Academic Press, pp. 523–538, 1985.

Complete Graph

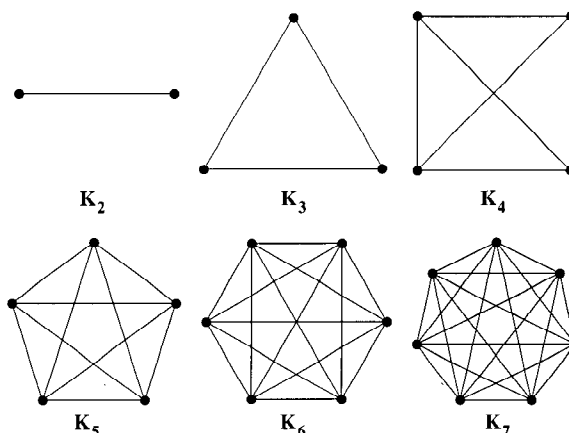

A GRAPH in which each pair of VERTICES is connected by an EDGE. The complete graph with n VERTICES is denoted K_n . In older literature, complete GRAPHS are called UNIVERSAL GRAPHS.

K_4 is the TETRAHEDRAL GRAPH and is therefore a PLANAR GRAPH. K_5 is nonplanar. Conway and Gordon (1983) proved that every embedding of K_6 is INTRINSICALLY LINKED with at least one pair of linked triangles. They also showed that any embedding of K_7 contains a knotted HAMILTONIAN CYCLE.

The number of EDGES in K_v is $v(v-1)/2$, and the GENUS is $(v-3)(v-4)/12$ for $v \geq 3$. The number of distinct variations for K_n (GRAPHS which cannot be transformed into each other without passing nodes through an EDGE or another node) for $n = 1, 2, \dots$ are 1, 1, 1, 1, 6, 3, 411, 37, The ADJACENCY MATRIX of the complete graph takes the particularly simple form of all 1s with 0s on the diagonal.

It is not known in general if a set of TREES with 1, 2, ..., $n-1$ EDGES can always be packed into K_n . However, if the choice of TREES is restricted to either the path or star from each family, then the packing can always be done (Zaks and Liu 1977, Honsberger 1985).

References

Chartrand, G. *Introductory Graph Theory*. New York: Dover, pp. 29–30, 1985.
 Conway, J. H. and Gordon, C. M. "Knots and Links in Spatial Graphs." *J. Graph Th.* 7, 445–453, 1983.
 Honsberger, R. *Mathematical Gems III*. Washington, DC: Math. Assoc. Amer., pp. 60–63, 1985.
 Saaty, T. L. and Kainen, P. C. *The Four-Color Problem: Assaults and Conquest*. New York: Dover, p. 12, 1986.
 Zaks, S. and Liu, C. L. "Decomposition of Graphs into Trees." *Proc. Eighth Southeastern Conference on Combinatorics, Graph Theory, and Computing*. pp. 643–654, 1977.

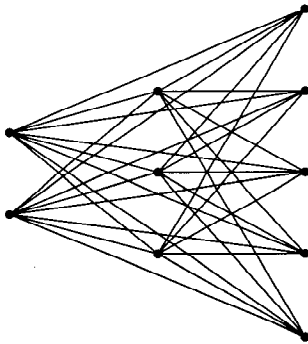
Complete k -Partite Graph

A k -PARTITE GRAPH (i.e., a set of VERTICES decomposed into k disjoint sets such that no two VERTICES within the same set are adjacent) such that every pair of VERTICES in the k sets are adjacent. If there are p, q, \dots, r VERTICES in the k sets, the complete k -partite graph is denoted $K_{p,q,\dots,r}$. The above figure shows $K_{2,3,5}$.

see also COMPLETE GRAPH, COMPLETE k -PARTITE GRAPH, k -PARTITE GRAPH

References

Saaty, T. L. and Kainen, P. C. *The Four-Color Problem: Assaults and Conquest*. New York: Dover, p. 12, 1986.

Complete Metric Space

A complete metric space is a METRIC SPACE in which every CAUCHY SEQUENCE is CONVERGENT. Examples include the REAL NUMBERS with the usual metric and the p -ADIC NUMBERS.

Complete Permutation

see DERANGEMENT

Complete Quadrangle

If the four points making up a QUADRILATERAL are joined pairwise by six distinct lines, a figure known as a complete quadrangle results. Note that a complete quadrilateral is defined differently from a COMPLETE QUADRANGLE.

The midpoints of the sides of any complete quadrangle and the three diagonal points all lie on a CONIC known as the NINE-POINT CONIC. If it is an ORTHOCENTRIC QUADRILATERAL, the CONIC reduces to a CIRCLE. The ORTHOCENTERS of the four TRIANGLES of a complete quadrangle are COLLINEAR on the RADICAL LINE of the CIRCLES on the diameters of a QUADRILATERAL.

see also COMPLETE QUADRANGLE, PTOLEMY'S THEOREM

References

Coxeter, H. S. M. *Introduction to Geometry*, 2nd ed. New York: Wiley, pp. 230–231, 1969.

Demir, H. "The Compleat [sic] Cyclic Quadrilateral." *Amer. Math. Monthly* **79**, 777–778, 1972.

Johnson, R. A. *Modern Geometry: An Elementary Treatise on the Geometry of the Triangle and the Circle*. Boston, MA: Houghton Mifflin, pp. 61–62, 1929.

Ogilvy, C. S. *Excursions in Geometry*. New York: Dover, pp. 101–104, 1990.

Complete Quadrilateral

The figure determined by four lines and their six points of intersection (Johnson 1929, pp. 61–62). Note that this is different from a COMPLETE QUADRANGLE. The midpoints of the diagonals of a complete quadrilateral are COLLINEAR (Johnson 1929, pp. 152–153).

A theorem due to Steiner (Mention 1862, Johnson 1929, Steiner 1971) states that in a complete quadrilateral, the bisectors of angles are CONCURRENT at 16 points which are the incenters and EXCENTERS of the four TRIANGLES. Furthermore, these points are the intersections of two sets of four CIRCLES each of which is a member of a conjugate coaxial system. The axes of these systems intersect at the point common to the CIRCUMCIRCLES of the quadrilateral.

see also COMPLETE QUADRANGLE, GAUSS-BODENMILLER THEOREM, POLAR CIRCLE

References

Coxeter, H. S. M. *Introduction to Geometry*, 2nd ed. New York: Wiley, pp. 230–231, 1969.

Johnson, R. A. *Modern Geometry: An Elementary Treatise on the Geometry of the Triangle and the Circle*. Boston, MA: Houghton Mifflin, pp. 61–62, 149, 152–153, and 255–256, 1929.

Mention, M. J. "Démonstration d'un Théorème de M. Steiner." *Nouv. Ann. Math.*, 2nd Ser. **1**, 16–20, 1862.

Mention, M. J. "Démonstration d'un Théorème de M. Steiner." *Nouv. Ann. Math.*, 2nd Ser. **1**, 65–67, 1862.

Steiner, J. *Gesammelte Werke*, 2nd ed, Vol. 1. New York: Chelsea, p. 223, 1971.

Complete Residue System

A set of numbers $a_0, a_1, \dots, a_{m-1} \pmod{m}$ form a complete set of residues if they satisfy

$$a_i \equiv i \pmod{m}$$

for $i = 0, 1, \dots, m - 1$. In other words, a complete system of residues is formed by a base and a modulus if the residues r_i in $b^i \equiv r_i \pmod{m}$ for $i = 1, \dots, m - 1$ run through the values $1, 2, \dots, m - 1$.

see also HAUPT-EXPONENT

Complete Sequence

A SEQUENCE of numbers $V = \{\nu_n\}$ is complete if every POSITIVE INTEGER n is the sum of some subsequence of V , i.e., there exist $a_i = 0$ or 1 such that

$$n = \sum_{i=1}^{\infty} a_i \nu_i$$

(Honsberger 1985, pp. 123–126). The FIBONACCI NUMBERS are complete. In fact, dropping one number still

leaves a complete sequence, although dropping two numbers does not (Honsberger 1985, pp. 123 and 126). The SEQUENCE of PRIMES with the element {1} prepended,

$$\{1, 2, 3, 5, 7, 11, 13, 17, 19, 23, \dots\}$$

is complete, even if any number of PRIMES each > 7 are dropped, as long as the dropped terms do not include two consecutive PRIMES (Honsberger 1985, pp. 127–128). This is a consequence of BERTRAND'S POSTULATE.

see also BERTRAND'S POSTULATE, BROWN'S CRITERION, FIBONACCI DUAL THEOREM, GREEDY ALGORITHM, WEAKLY COMPLETE SEQUENCE, ZECKENDORF'S THEOREM

References

- Brown, J. L. Jr. "Unique Representations of Integers as Sums of Distinct Lucas Numbers." *Fib. Quart.* **7**, 243–252, 1969.
Hoggatt, V. E. Jr.; Cox, N.; and Bicknell, M. "A Primer for Fibonacci Numbers. XII." *Fib. Quart.* **11**, 317–331, 1973.
Honsberger, R. *Mathematical Gems III*. Washington, DC: Math. Assoc. Amer., 1985.

Complete Space

A SPACE of COMPLETE FUNCTIONS.

see also COMPLETE METRIC SPACE

Completely Regular Graph

A POLYHEDRAL GRAPH is completely regular if the DUAL GRAPH is also REGULAR. There are only five types. Let ρ be the number of EDGES at each node, ρ^* the number of EDGES at each node of the DUAL GRAPH, V the number of VERTICES, E the number of EDGES, and F the number of faces in the PLATONIC SOLID corresponding to the given graph. The following table summarizes the completely regular graphs.

Type	ρ	ρ^*	V	E	F
Tetrahedral	3	3	4	6	4
Cubical	3	4	8	12	6
Dodecahedral	3	5	20	39	12
Octahedral	4	3	6	12	8
Icosahedral	5	3	12	30	20

Completeness Property

All lengths can be expressed as REAL NUMBERS.

Completing the Square

The conversion of an equation of the form $ax^2 + bx + c$ to the form

$$a \left(x + \frac{b}{2a} \right)^2 + \left(c - \frac{b^2}{4a} \right),$$

which, defining $B \equiv b/2a$ and $C \equiv c - b^2/4a$, simplifies to

$$a(x + B)^2 + C.$$

Complex

A finite SET of SIMPLEXES such that no two have a common point. A 1-D complex is called a GRAPH.

see also CW-COMPLEX, SIMPLICIAL COMPLEX

Complex Analysis

The study of COMPLEX NUMBERS, their DERIVATIVES, manipulation, and other properties. Complex analysis is an extremely powerful tool with an unexpectedly large number of practical applications to the solution of physical problems. CONTOUR INTEGRATION, for example, provides a method of computing difficult INTEGRALS by investigating the singularities of the function in regions of the COMPLEX PLANE near and between the limits of integration.

The most fundamental result of complex analysis is the CAUCHY-RIEMANN EQUATIONS, which give the conditions a FUNCTION must satisfy in order for a complex generalization of the DERIVATIVE, the so-called COMPLEX DERIVATIVE, to exist. When the COMPLEX DERIVATIVE is defined "everywhere," the function is said to be ANALYTIC. A single example of the unexpected power of complex analysis is PICARD'S THEOREM, which states that an ANALYTIC FUNCTION assumes every COMPLEX NUMBER, with possibly one exception, infinitely often in any NEIGHBORHOOD of an ESSENTIAL SINGULARITY!

see also ANALYTIC CONTINUATION, BRANCH CUT, BRANCH POINT, CAUCHY INTEGRAL FORMULA, CAUCHY INTEGRAL THEOREM, CAUCHY PRINCIPAL VALUE, CAUCHY-RIEMANN EQUATIONS, COMPLEX NUMBER, CONFORMAL MAP, CONTOUR INTEGRATION, DE MOIVRE'S IDENTITY, EULER FORMULA, INSIDE-OUTSIDE THEOREM, JORDAN'S LEMMA, LAURENT SERIES, LIOUVILLE'S CONFORMALITY THEOREM, MONOGENIC FUNCTION, MORERA'S THEOREM, PERMANENCE OF ALGEBRAIC FORM, PICARD'S THEOREM, POLE, POLYGENIC FUNCTION, RESIDUE (COMPLEX ANALYSIS)

References

- Arfken, G. "Functions of a Complex Variable I: Analytic Properties, Mapping" and "Functions of a Complex Variable II: Calculus of Residues." Chs. 6–7 in *Mathematical Methods for Physicists*, 3rd ed. Orlando, FL: Academic Press, pp. 352–395 and 396–436, 1985.
Boas, R. P. *Invitation to Complex Analysis*. New York: Random House, 1987.
Churchill, R. V. and Brown, J. W. *Complex Variables and Applications*, 6th ed. New York: McGraw-Hill, 1995.
Conway, J. B. *Functions of One Complex Variable*, 2nd ed. New York: Springer-Verlag, 1995.
Forsyth, A. R. *Theory of Functions of a Complex Variable*, 3rd ed. Cambridge, England: Cambridge University Press, 1918.
Lang, S. *Complex Analysis*, 3rd ed. New York: Springer-Verlag, 1993.
Morse, P. M. and Feshbach, H. "Functions of a Complex Variable" and "Tabulation of Properties of Functions of Complex Variables." Ch. 4 in *Methods of Theoretical Physics, Part I*. New York: McGraw-Hill, pp. 348–491 and 480–485, 1953.

Complex Conjugate

The complex conjugate of a COMPLEX NUMBER $z \equiv a+bi$ is defined to be $z^* \equiv a-bi$. The complex conjugate is ASSOCIATIVE, $(z_1 + z_2)^* = z_1^* + z_2^*$, since

$$\begin{aligned}(a_1 + b_1i)^* + (a_2 + b_2i)^* &= a_1 - ib_1 + a_2 - ib_2 \\ &= (a_1 - ib_1) + (a_2 - ib_2) \\ &= (a_1 + b_1)^* + (a_2 + b_2)^*,\end{aligned}$$

and DISTRIBUTIVE, $(z_1 z_2)^* = z_1^* z_2^*$, since

$$\begin{aligned}[(a_1 + b_1i)(a_2 + b_2i)]^* &= [(a_1 a_2 - b_1 b_2) + i(a_1 b_2 + a_2 b_1)]^* \\ &= (a_1 a_2 - b_1 b_2) - i(a_1 b_2 + a_2 b_1) \\ &= (a_1 - ib_1)(a_2 - ib_2) \\ &= (a_1 + ib_1)^*(a_2 + ib_2)^*.\end{aligned}$$

References

Abramowitz, M. and Stegun, C. A. (Eds.). *Handbook of Mathematical Functions with Formulas, Graphs, and Mathematical Tables*, 9th printing. New York: Dover, p. 16, 1972.

Complex Derivative

A DERIVATIVE of a COMPLEX function, which must satisfy the CAUCHY-RIEMANN EQUATIONS in order to be COMPLEX DIFFERENTIABLE.

see also CAUCHY-RIEMANN EQUATIONS, COMPLEX DIFFERENTIABLE, DERIVATIVE

Complex Differentiable

If the CAUCHY-RIEMANN EQUATIONS are satisfied for a function $f(x) = u(x) + iv(x)$ and the PARTIAL DERIVATIVES of $u(x)$ and $v(x)$ are CONTINUOUS, then the COMPLEX DERIVATIVE df/dz exists.

see also ANALYTIC FUNCTION, CAUCHY-RIEMANN EQUATIONS, COMPLEX DERIVATIVE, PSEUDOANALYTIC FUNCTION

Complex Function

A FUNCTION whose RANGE is in the COMPLEX NUMBERS is said to be a complex function.

see also REAL FUNCTION, SCALAR FUNCTION, VECTOR FUNCTION

Complex Matrix

A MATRIX whose elements may contain COMPLEX NUMBERS. The MATRIX PRODUCT of two 2×2 complex matrices is given by

$$\begin{bmatrix} x_{11} + y_{11}i & x_{12} + y_{12}i \\ x_{21} + y_{21}i & x_{22} + y_{22}i \end{bmatrix} \begin{bmatrix} u_{11} + v_{11}i & u_{12} + v_{12}i \\ u_{21} + v_{21}i & u_{22} + v_{22}i \end{bmatrix} \\ = \begin{bmatrix} R_{11} & R_{12} \\ R_{21} & R_{22} \end{bmatrix} + i \begin{bmatrix} I_{11} & I_{12} \\ I_{21} & I_{22} \end{bmatrix},$$

where

$$\begin{aligned}R_{11} &= u_{11}x_{11} + u_{21}x_{12} - v_{11}y_{11} - v_{21}y_{12} \\ R_{12} &= u_{12}x_{11} + u_{22}x_{12} - v_{12}y_{11} - v_{22}y_{12} \\ R_{21} &= u_{11}x_{21} + u_{21}x_{22} - v_{11}y_{21} - v_{21}y_{22} \\ R_{22} &= u_{12}x_{21} + u_{22}x_{22} - v_{12}y_{21} - v_{22}y_{22} \\ I_{11} &= v_{11}x_{11} + v_{21}x_{12} + u_{11}y_{11} + u_{21}y_{12} \\ I_{12} &= v_{12}x_{11} + v_{22}x_{12} + u_{12}y_{11} + u_{22}y_{12} \\ I_{21} &= v_{11}x_{21} + v_{21}x_{22} + u_{11}y_{21} + u_{21}y_{22} \\ I_{22} &= v_{12}x_{21} + v_{22}x_{22} + u_{12}y_{21} + u_{22}y_{22}.\end{aligned}$$

see also REAL MATRIX

Complex Multiplication

TWO COMPLEX NUMBERS $x = a + ib$ and $y = c + id$ are multiplied as follows:

$$\begin{aligned}xy &= (a + ib)(c + id) = ac + ibc + iad - bd \\ &= (ac - bd) + i(ad + bc).\end{aligned}$$

However, the multiplication can be carried out using only three REAL multiplications, ac , bd , and $(a+b)(c+d)$ as

$$\begin{aligned}\Re[(a + ib)(c + id)] &= ac - bd \\ \Im[(a + ib)(c + id)] &= (a + b)(c + d) - ac - bd.\end{aligned}$$

Complex multiplication has a special meaning for ELLIPTIC CURVES.

see also COMPLEX NUMBER, ELLIPTIC CURVE, IMAGINARY PART, MULTIPLICATION, REAL PART

References

Cox, D. A. *Primes of the Form $x^2 + ny^2$: Fermat, Class Field Theory and Complex Multiplication*. New York: Wiley, 1997.

Complex Number

The complex numbers are the FIELD \mathbb{C} of numbers of the form $x + iy$, where x and y are REAL NUMBERS and i is the IMAGINARY NUMBER equal to $\sqrt{-1}$. When a single letter $z = x + iy$ is used to denote a complex number, it is sometimes called an "AFFIX." The FIELD of complex numbers includes the FIELD of REAL NUMBERS as a SUBFIELD.

Through the EULER FORMULA, a complex number

$$z = x + iy \quad (1)$$

may be written in "PHASOR" form

$$z = |z|(\cos \theta + i \sin \theta) = |z|e^{i\theta}. \quad (2)$$

Here, $|z|$ is known as the MODULUS and θ is known as the ARGUMENT or PHASE. The ABSOLUTE SQUARE of

z is defined by $|z|^2 = zz^*$, and the argument may be computed from

$$\arg(z) = \theta = \tan^{-1} \left(\frac{y}{x} \right). \quad (3)$$

DE MOIVRE'S IDENTITY relates POWERS of complex numbers

$$z^n = |z|^n [\cos(n\theta) + i \sin(n\theta)]. \quad (4)$$

Finally, the REAL $\Re(z)$ and IMAGINARY PARTS $\Im(z)$ are given by

$$\Re(z) = \frac{1}{2}(z + z^*) \quad (5)$$

$$\Im(z) = \frac{z - z^*}{2i} = -\frac{1}{2}i(z - z^*) = \frac{1}{2}i(z^* - z). \quad (6)$$

The POWERS of complex numbers can be written in closed form as follows:

$$z^n = \left[x^n - \binom{n}{2} x^{n-2} y^2 + \binom{n}{4} x^{n-4} y^4 - \dots \right] + i \left[\binom{n}{1} x^{n-1} y - \binom{n}{3} x^{n-3} y^3 + \dots \right]. \quad (7)$$

The first few are explicitly

$$z^2 = (x^2 - y^2) + i(2xy) \quad (8)$$

$$z^3 = (x^3 - 3xy^2) + i(3x^2y - y^3) \quad (9)$$

$$z^4 = (x^4 - 6x^2y^2 + y^4) + i(4x^3y - 4xy^3) \quad (10)$$

$$z^5 = (x^5 - 10x^3y^2 + 5xy^4) + i(5x^4y - 10x^2y^3 + y^5) \quad (11)$$

(Abramowitz and Stegun 1972).

see also ABSOLUTE SQUARE, ARGUMENT (COMPLEX NUMBER), COMPLEX PLANE, i , IMAGINARY NUMBER, MODULUS, PHASE, PHASOR, REAL NUMBER, SURREAL NUMBER

References

- Abramowitz, M. and Stegun, C. A. (Eds.). *Handbook of Mathematical Functions with Formulas, Graphs, and Mathematical Tables*, 9th printing. New York: Dover, pp. 16–17, 1972.
- Arfken, G. *Mathematical Methods for Physicists*, 3rd ed. Orlando, FL: Academic Press, pp. 353–357, 1985.
- Courant, R. and Robbins, H. "Complex Numbers." §2.5 in *What is Mathematics?: An Elementary Approach to Ideas and Methods*, 2nd ed. Oxford, England: Oxford University Press, pp. 88–103, 1996.
- Morse, P. M. and Feshbach, H. "Complex Numbers and Variables." §4.1 in *Methods of Theoretical Physics, Part I*. New York: McGraw-Hill, pp. 349–356, 1953.
- Press, W. H.; Flannery, B. P.; Teukolsky, S. A.; and Vetterling, W. T. "Complex Arithmetic." §5.4 in *Numerical Recipes in FORTRAN: The Art of Scientific Computing*, 2nd ed. Cambridge, England: Cambridge University Press, pp. 171–172, 1992.

Complex Plane

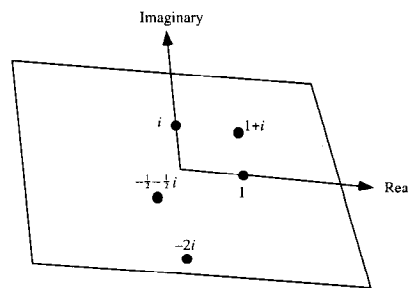

The plane of COMPLEX NUMBERS spanned by the vectors 1 and i , where i is the IMAGINARY NUMBER. Every COMPLEX NUMBER corresponds to a unique POINT in the complex plane. The LINE in the plane with $i = 0$ is the REAL LINE. The complex plane is sometimes called the ARGAND PLANE or GAUSS PLANE, and a plot of COMPLEX NUMBERS in the plane is sometimes called an ARGAND DIAGRAM.

see also AFFINE COMPLEX PLANE, ARGAND DIAGRAM, ARGAND PLANE, BERGMAN SPACE, COMPLEX PROJECTIVE PLANE

References

- Courant, R. and Robbins, H. "The Geometric Interpretation of Complex Numbers." §5.2 in *What is Mathematics?: An Elementary Approach to Ideas and Methods*, 2nd ed. Oxford, England: Oxford University Press, pp. 92–97, 1996.

Complex Projective Plane

The set \mathbb{P}^2 is the set of all EQUIVALENCE CLASSES $[a, b, c]$ of ordered triples $(a, b, c) \in \mathbb{C}^3 \setminus (0, 0, 0)$ under the equivalence relation $(a, b, c) \sim (a', b', c')$ if $(a, b, c) = (\lambda a', \lambda b', \lambda c')$ for some NONZERO COMPLEX NUMBER λ .

Complex Representation

see PHASOR

Complex Structure

The complex structure of a point $\mathbf{x} = x_1, x_2$ in the PLANE is defined by the linear MAP $J : \mathbb{R}^2 \rightarrow \mathbb{R}^2$

$$J(x_1, x_2) = (-x_2, x_1),$$

and corresponds to a clockwise rotation by $\pi/2$. This map satisfies

$$\begin{aligned} J^2 &= -I \\ (J\mathbf{x}) \cdot (J\mathbf{y}) &= \mathbf{x} \cdot \mathbf{y} \\ (J\mathbf{x}) \cdot \mathbf{x} &= 0, \end{aligned}$$

where I is the IDENTITY MAP.

More generally, if V is a 2-D VECTOR SPACE, a linear map $J : V \rightarrow V$ such that $J^2 = -I$ is called a complex structure on V . If $V = \mathbb{R}^2$, this collapses to the previous definition.

References

- Gray, A. *Modern Differential Geometry of Curves and Surfaces*. Boca Raton, FL: CRC Press, pp. 3 and 229, 1993.

Complexity (Number)

The number of 1s needed to represent an INTEGER using only additions, multiplications, and parentheses are called the integer's complexity. For example,

$$\begin{aligned}
 1 &= 1 \\
 2 &= 1 + 1 \\
 3 &= 1 + 1 + 1 \\
 4 &= (1 + 1)(1 + 1) = 1 + 1 + 1 + 1 \\
 5 &= (1 + 1)(1 + 1) + 1 = 1 + 1 + 1 + 1 + 1 \\
 6 &= (1 + 1)(1 + 1 + 1) \\
 7 &= (1 + 1)(1 + 1 + 1) + 1 \\
 8 &= (1 + 1)(1 + 1)(1 + 1) \\
 9 &= (1 + 1 + 1)(1 + 1 + 1) \\
 10 &= (1 + 1 + 1)(1 + 1 + 1) + 1 \\
 &= (1 + 1)(1 + 1 + 1 + 1 + 1)
 \end{aligned}$$

So, for the first few n , the complexity is 1, 2, 3, 4, 5, 5, 6, 6, 6, 7, 8, 7, 8, ... (Sloane's A005245).

References

- Guy, R. K. "Expressing Numbers Using Just Ones." §F26 in *Unsolved Problems in Number Theory*, 2nd ed. New York: Springer-Verlag, p. 263, 1994.
- Guy, R. K. "Some Suspiciously Simple Sequences." *Amer. Math. Monthly* **93**, 186–190, 1986.
- Guy, R. K. "Monthly Unsolved Problems, 1969–1987." *Amer. Math. Monthly* **94**, 961–970, 1987.
- Guy, R. K. "Unsolved Problems Come of Age." *Amer. Math. Monthly* **96**, 903–909, 1989.
- Rawsthorne, D. A. "How Many 1's are Needed?" *Fib. Quart.* **27**, 14–17, 1989.
- Sloane, N. J. A. Sequence A005245/M0457 in "An On-Line Version of the Encyclopedia of Integer Sequences."

Complexity (Sequence)

see BLOCK GROWTH

Complexity Theory

Divides problems into "easy" and "hard" categories. A problem is easy and assigned to the P-PROBLEM (POLYNOMIAL time) class if the number of steps needed to solve it is bounded by some POWER of the problem's size. A problem is hard and assigned to the NP-PROBLEM (nondeterministic POLYNOMIAL time) class if the number of steps is not bounded and may grow exponentially.

However, if a solution is known to an NP-PROBLEM, it can be reduced to a single period verification. A problem is NP-COMPLETE if an ALGORITHM for solving it can be translated into one for solving any other NP-PROBLEM. Examples of NP-COMPLETE PROBLEMS include the HAMILTONIAN CYCLE and TRAVELING SALESMAN PROBLEMS. LINEAR PROGRAMMING, thought to be an NP-PROBLEM, was shown to actually be a P-PROBLEM by L. Khachian in 1979. It is not known if all apparently NP-PROBLEMS are actually P-PROBLEMS.

see also BIT COMPLEXITY, NP-COMPLETE PROBLEM, NP-PROBLEM, P-PROBLEM

References

- Brigdes, D. S. *Computability*. New York: Springer-Verlag, 1994.
- Brookshear, J. G. *Theory of Computation: Formal Languages, Automata, and Complexity*. Redwood City, CA: Benjamin/Cummings, 1989.
- Cooper, S. B.; Slaman, T. A.; and Wainer, S. S. (Eds.). *Computability, Enumerability, Unsolvability: Directions in Recursion Theory*. New York: Cambridge University Press, 1996.
- Garey, M. R. and Johnson, D. S. *Computers and Intractability: A Guide to the Theory of NP-Completeness*. New York: W. H. Freeman, 1983.
- Goetz, P. "Phil Goetz's Complexity Dictionary." <http://www.cs.buffalo.edu/~goetz/dict.html>.
- Hopcroft, J. E. and Ullman, J. D. *Introduction to Automated Theory, Languages, and Computation*. Reading, MA: Addison-Wesley, 1979.
- Lewis, H. R. and Papadimitriou, C. H. *Elements of the Theory of Computation*, 2nd ed. Englewood Cliffs, NJ: Prentice-Hall, 1997.
- Sudkamp, T. A. *Language and Machines: An Introduction to the Theory of Computer Science*, 2nd ed. Reading, MA: Addison-Wesley, 1996.
- Welsh, D. J. A. *Complexity: Knots, Colourings and Counting*. New York: Cambridge University Press, 1993.

Component

A GROUP L is a component of H if L is a QUASISIMPLE GROUP which is a SUBNORMAL SUBGROUP of H .

see also GROUP, QUASISIMPLE GROUP, SUBGROUP, SUBNORMAL

Composite Knot

A KNOT which is not a PRIME KNOT. Composite knots are special cases of SATELLITE KNOTS.

see also KNOT, PRIME KNOT, SATELLITE KNOT

Composite Number

A POSITIVE INTEGER which is not PRIME (i.e., which has FACTORS other than 1 and itself).

A composite number C can always be written as a PRODUCT in at least two ways (since $1 \cdot C$ is always possible). Call these two products

$$C = ab = cd, \quad (1)$$

then it is obviously the case that $C|ab$ (C divides ab). Set

$$c = mn, \quad (2)$$

where m is the part of C which divides a , and n the part of C which divides n . Then there are p and q such that

$$a = mp \quad (3)$$

$$b = nq. \quad (4)$$

Solving $ab = cd$ for d gives

$$d = \frac{ab}{c} = \frac{(mp)(nq)}{mn} = pq. \quad (5)$$

It then follows that

$$\begin{aligned} S &\equiv a^2 + b^2 + c^2 + d^2 \\ &= m^2 p^2 + n^2 q^2 + m^2 n^2 + p^2 q^2 \\ &= (m^2 + q^2)(n^2 + p^2). \end{aligned} \quad (6)$$

It therefore follows that $a^2 + b^2 + c^2 + d^2$ is never PRIME! In fact, the more general result that

$$S \equiv a^k + b^k + c^k + d^k \quad (7)$$

is never PRIME for k an INTEGER ≥ 0 also holds (Honsberger 1991).

There are infinitely many integers of the form $\lfloor (3/2)^n \rfloor$ and $\lfloor (4/3)^n \rfloor$ which are composite, where $\lfloor x \rfloor$ is the FLOOR FUNCTION (Forman and Shapiro, 1967; Guy 1994, p. 220). The first few composite $\lfloor (3/2)^n \rfloor$ occur for $n = 8, 9, 10, 11, 12, 13, 14, 15, 16, 17, 18, 19, 20, 23, \dots$, and the few composite $\lfloor (4/3)^n \rfloor$ occur for $n = 5, 8, 13, 14, 15, 16, 17, 18, 19, 20, 21, 22, \dots$

see also AMENABLE NUMBER, GRIMM'S CONJECTURE, HIGHLY COMPOSITE NUMBER, PRIME FACTORIZATION PRIME GAPS, PRIME NUMBER

References

- Forman, W. and Shapiro, H. N. "An Arithmetic Property of Certain Rational Powers." *Comm. Pure Appl. Math.* **20**, 561–573, 1967.
 Guy, R. K. *Unsolved Problems in Number Theory*, 2nd ed. New York: Springer-Verlag, 1994.
 Honsberger, R. *More Mathematical Morsels*. Washington, DC: Math. Assoc. Amer., pp. 19–20, 1991.
 Sloane, N. J. A. Sequence A002808/M3272 in "An On-Line Version of the Encyclopedia of Integer Sequences."

Composite Runs

see PRIME GAPS

Compositeness Certificate

A compositeness certificate is a piece of information which guarantees that a given number p is COMPOSITE. Possible certificates consist of a FACTOR of a number (which, in general, is much quicker to check by direct division than to determine initially), or of the determination that either

$$a^{p-1} \not\equiv 1 \pmod{p},$$

(i.e., p violates FERMAT'S LITTLE THEOREM), or

$$a \not\equiv -1, 1 \text{ and } a^2 \equiv 1 \pmod{p}.$$

A quantity a satisfying either property is said to be a WITNESS to p 's compositeness.

see also ADLEMAN-POMERANCE-RUMELY PRIMALITY TEST, FERMAT'S LITTLE THEOREM, MILLER'S PRIMALITY TEST, PRIMALITY CERTIFICATE, WITNESS

Compositeness Test

A test which always identifies PRIME numbers correctly, but may incorrectly identify a COMPOSITE NUMBER as a PRIME.

see also PRIMALITY TEST

Composition

The combination of two FUNCTIONS to form a single new OPERATOR. The composition of two functions f and g is denoted $f \circ g$ and is defined by

$$f \circ g = f(g(x))$$

when f and g are both functions of x .

An operation called composition is also defined on BINARY QUADRATIC FORMS. For two numbers represented by two forms, the product can then be represented by the composition. For example, the composition of the forms $2x^2 + 15y^2$ and $3x^2 + 10y^2$ is given by $6x^2 + 5y^2$, and in this case, the product of 17 and 13 would be represented as $(6 \cdot 36 + 5 \cdot 1 = 221)$. There are several algorithms for computing binary quadratic form composition, which is the basis for some factoring methods.

see also ADEM RELATIONS, BINARY OPERATOR, BINARY QUADRATIC FORM

Composition Series

Every FINITE GROUP G of order greater than one possesses a finite series of SUBGROUPS, called a composition series, such that

$$I \subset H_s \subset \dots \subset H_2 \subset H_1 \subset G,$$

where H_{i+1} is a maximal subgroup of H_i . The QUOTIENT GROUPS $G/H_1, H_1/H_2, \dots, H_{s-1}/H_s, H_s$ are called composition quotient groups.

see also FINITE GROUP, JORDAN-HÖLDER THEOREM, QUOTIENT GROUP, SUBGROUP

References

- Lomont, J. S. *Applications of Finite Groups*. New York: Dover, p. 26, 1993.

Composition Theorem

Let

$$Q(x, y) \equiv x^2 + y^2.$$

Then

$$Q(x, y)Q(x', y') = Q(xx' - yy', x'y + xy'),$$

since

$$\begin{aligned} (x^2 + y^2)(x'^2 + y'^2) &= (xx' - yy')^2 + (x'y + x'y')^2 \\ &= x^2 x'^2 + y^2 y'^2 + x'^2 y^2 + x^2 y'^2. \end{aligned}$$

see also GENUS THEOREM

Compound Interest

Let P be the PRINCIPAL (initial investment), r be the annual compounded rate, $i^{(n)}$ the “nominal rate,” n be the number of times INTEREST is compounded per year (i.e., the year is divided into n CONVERSION PERIODS), and t be the number of years (the “term”). The INTEREST rate per CONVERSION PERIOD is then

$$r \equiv \frac{i^{(n)}}{n}. \quad (1)$$

If interest is compounded n times at an annual rate of r (where, for example, 10% corresponds to $r = 0.10$), then the effective rate over $1/n$ the time (what an investor would earn if he did not redeposit his interest after each compounding) is

$$(1 + r)^{1/n}. \quad (2)$$

The total amount of holdings A after a time t when interest is re-invested is then

$$A = P \left(1 + \frac{i^{(n)}}{n} \right)^{nt} = P(1 + r)^{nt}. \quad (3)$$

Note that even if interest is compounded continuously, the return is still finite since

$$\lim_{n \rightarrow \infty} \left(1 + \frac{1}{n} \right)^n = e, \quad (4)$$

where e is the base of the NATURAL LOGARITHM.

The time required for a given PRINCIPAL to double (assuming $n = 1$ CONVERSION PERIOD) is given by solving

$$2P = P(1 + r)^t, \quad (5)$$

or

$$t = \frac{\ln 2}{\ln(1 + r)}, \quad (6)$$

where LN is the NATURAL LOGARITHM. This function can be approximated by the so-called RULE OF 72:

$$t \approx \frac{0.72}{r}. \quad (7)$$

see also e , INTEREST, LN, NATURAL LOGARITHM, PRINCIPAL, RULE OF 72, SIMPLE INTEREST

References

- Kellison, S. G. *The Theory of Interest*, 2nd ed. Burr Ridge, IL: Richard D. Irwin, pp. 14–16, 1991.
 Milanfar, P. “A Persian Folk Method of Figuring Interest.” *Math. Mag.* **69**, 376, 1996.

Compound Polyhedron

see POLYHEDRON COMPOUND

Computability

see COMPLEXITY THEORY

Computable Function

Any computable function can be incorporated into a PROGRAM using while-loops (i.e., “while something is true, do something else”). For-loops (which have a fixed iteration limit) are a special case of while-loops, so computable functions could also be coded using a combination of for- and while-loops. The ACKERMANN FUNCTION is the simplest example of a well-defined TOTAL FUNCTION which is computable but not PRIMITIVE RECURSIVE, providing a counterexample to the belief in the early 1900s that every computable function was also primitive recursive (Dötzel 1991).

see also ACKERMANN FUNCTION, CHURCH’S THESIS, COMPUTABLE NUMBER, PRIMITIVE RECURSIVE FUNCTION, TURING MACHINE

References

- Dötzel, G. “A Function to End All Functions.” *Algorithm: Recreational Programming* **2**, 16–17, 1991.

Computable Number

A number which can be computed to any number of DIGITS desired by a TURING MACHINE. Surprisingly, most IRRATIONALS are not computable numbers!

References

- Penrose, R. *The Emperor’s New Mind: Concerning Computers, Minds, and the Laws of Physics*. Oxford, England: Oxford University Press, 1989.

Computational Complexity

see COMPLEXITY THEORY

Concatenated Number Sequences

see CONSECUTIVE NUMBER SEQUENCES

Concatenation

The concatenation of two strings a and b is the string ab formed by joining a and b . Thus the concatenation of the strings “book” and “case” is the string “bookcase”. The concatenation of two strings a and b is often denoted ab , $a||b$, or (in *Mathematica*® (Wolfram Research, Champaign, IL)) $a <> b$. Concatenation is an associative operation, so that the concatenation of three or more strings, for example abc , $abcd$, etc., is well-defined.

The concatenation of two or more numbers is the number formed by concatenating their numerals. For example, the concatenation of 1, 234, and 5678 is 12345678. The value of the result depends on the numeric base, which is typically understood from context.

The formula for the concatenation of numbers p and q in base b is

$$p||q = pb^{l(q)} + q,$$

where

$$l(q) = \lfloor \log_b q \rfloor + 1$$

is the LENGTH of q in base b and $\lfloor x \rfloor$ is the FLOOR FUNCTION.

see also CONSECUTIVE NUMBER SEQUENCES, LENGTH (NUMBER), SMARANDACHE SEQUENCES

Concave

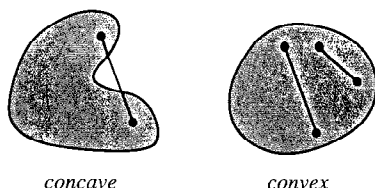

A SET in \mathbb{R}^d is concave if it *does not* contain all the LINE SEGMENTS connecting any pair of its points. If the SET *does* contain all the LINE SEGMENTS, it is called CONVEX.

see also CONNECTED SET, CONVEX FUNCTION, CONVEX HULL, CONVEX OPTIMIZATION THEORY, CONVEX POLYGON, DELAUNAY TRIANGULATION, SIMPLY CONNECTED

Concave Function

A function $f(x)$ is said to be concave on an interval $[a, b]$ if, for any points x_1 and x_2 in $[a, b]$, the function $-f(x)$ is CONVEX on that interval. If the second DERIVATIVE of f

$$f''(x) > 0,$$

on an open interval (a, b) (where $f''(x)$ is the second DERIVATIVE), then f is concave up on the interval. If

$$f''(x) < 0$$

on the interval, then f is concave down on it.

References

Gradshteyn, I. S. and Ryzhik, I. M. *Tables of Integrals, Series, and Products*, 5th ed. San Diego, CA: Academic Press, p. 1100, 1980.

Concentrated

Let μ be a POSITIVE MEASURE on a SIGMA ALGEBRA M , and let λ be an arbitrary (real or complex) MEASURE on M . If there is a SET $A \in M$ such that $\lambda(E) = \lambda(A \cap E)$ for every $E \in M$, then λ is said to be concentrated on A . This is equivalent to requiring that $\lambda(E) = 0$ whenever $E \cap A = \emptyset$.

see also ABSOLUTELY CONTINUOUS, MUTUALLY SINGULAR

References

Rudin, W. *Functional Analysis*. New York: McGraw-Hill, p. 121, 1991.

Concentric

Two geometric figures are said to be concentric if their CENTERS coincide. The region between two concentric CIRCLES is called an ANNULUS.

see also ANNULUS, CONCENTRIC CIRCLES, CONCYCLIC, ECCENTRIC

Concentric Circles

The region between two CONCENTRIC circles of different RADII is called an ANNULUS.

Given two concentric circles with RADII R and $2R$, what is the probability that a chord chosen at random from the outer circle will cut across the inner circle? Depending on how the "random" CHORD is chosen, $1/2$, $1/3$, or $1/4$ could all be correct answers.

1. Picking any two points on the outer circle and connecting them gives $1/3$.
2. Picking any random point on a diagonal and then picking the CHORD that perpendicularly bisects it gives $1/2$.
3. Picking any point on the large circle, drawing a line to the center, and then drawing the perpendicularly bisected CHORD gives $1/4$.

So some care is obviously needed in specifying what is meant by "random" in this problem.

Given an arbitrary CHORD BB' to the larger of two concentric CIRCLES centered on O , the distance between inner and outer intersections is equal on both sides ($AB = A'B'$). To prove this, take the PERPENDICULAR to BB' passing through O and crossing at P . By symmetry, it must be true that PA and PA' are equal. Similarly, PB and PB' must be equal. Therefore, $PB - PA = AB$ equals $PB' - PA' = A'B'$. Incidentally, this is also true for HOMEOWDS, but the proof is nontrivial.

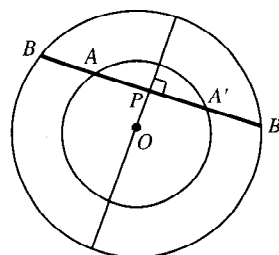

see also ANNULUS

Concho-Spiral

The SPACE CURVE with parametric equations

$$\begin{aligned} r &= \mu^u a \\ \theta &= u \\ z &= \mu^u c. \end{aligned}$$

see also CONICAL SPIRAL, SPIRAL

Conchoid

A curve whose name means "shell form." Let C be a curve and O a fixed point. Let P and P' be points on a line from O to C meeting it at Q , where $P'Q = QP = k$, with k a given constant. For example, if C is a CIRCLE and O is on C , then the conchoid is a LIMAÇON, while in the special case that k is the DIAMETER of C ,

then the conchoid is a CARDIOID. The equation for a parametrically represented curve $(f(t), g(t))$ with $O = (x_0, y_0)$ is

$$x = f \pm \frac{k(f - x_0)}{\sqrt{(f - x_0)^2 + (g - y_0)^2}}$$

$$y = g \pm \frac{k(g - y_0)}{\sqrt{(f - x_0)^2 + (g - y_0)^2}}.$$

see also CONCHO-SPIRAL, CONCHOID OF DE SLUZE, CONCHOID OF NICOMEDES, CONICAL SPIRAL, DÜRER'S CONCHOID

References

- Lawrence, J. D. *A Catalog of Special Plane Curves*. New York: Dover, pp. 49–51, 1972.
 Lee, X. "Conchoid." http://www.best.com/~xah/SpecialPlaneCurves_dir/Conchoid_dir/conchoid.html.
 Lockwood, E. H. "Conchoids." Ch. 14 in *A Book of Curves*. Cambridge, England: Cambridge University Press, pp. 126–129, 1967.
 Yates, R. C. "Conchoid." *A Handbook on Curves and Their Properties*. Ann Arbor, MI: J. W. Edwards, pp. 31–33, 1952.

Conchoid of de Sluze

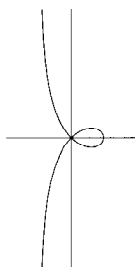

A curve first constructed by René de Sluze in 1662. In CARTESIAN COORDINATES,

$$a(x - a)(x^2 + y^2) = k^2 x^2,$$

and in POLAR COORDINATES,

$$r = \frac{k^2 \cos \theta}{a} + a \sec \theta.$$

The above curve has $k^2/a = 1$, $a = -0.5$.

Conchoid of Nicomedes

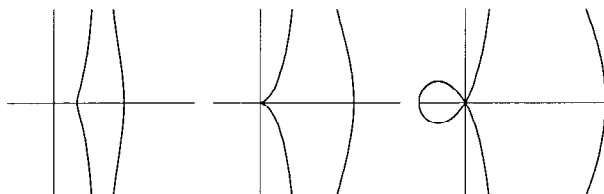

A curve studied by the Greek mathematician Nicomedes in about 200 BC, also called the COCHLOID. It is the LOCUS of points a fixed distance away from a line as measured along a line from the FOCUS point (MacTutor Archive). Nicomedes recognized the three distinct forms

seen in this family. This curve was a favorite with 17th century mathematicians and could be used to solve the problems of CUBE DUPLICATION and ANGLE TRISECTION.

In POLAR COORDINATES,

$$r = b + a \sec \theta. \quad (1)$$

In CARTESIAN COORDINATES,

$$(x - a)^2(x^2 + y^2) = b^2 x^2. \quad (2)$$

The conchoid has $x = a$ as an asymptote and the AREA between either branch and the ASYMPTOTE is infinite. The AREA of the loop is

$$A = a\sqrt{b^2 - a^2} - 2ab \ln \left(\frac{b + \sqrt{b^2 - a^2}}{a} \right) + b^2 \cos^{-1} \left(\frac{a}{b} \right). \quad (3)$$

see also CONCHOID

References

- Lawrence, J. D. *A Catalog of Special Plane Curves*. New York: Dover, pp. 135–139, 1972.
 Lee, X. "Conchoid of Nicomedes." http://www.best.com/~xah/SpecialPlaneCurves_dir/ConchoidOfNicomedes_dir/conchoidOfNicomedes.html.
 MacTutor History of Mathematics Archive. "Conchoid." <http://www-groups.dcs.st-and.ac.uk/~history/Curves/Conchoid.html>.
 Pappas, T. "Conchoid of Nicomedes." *The Joy of Mathematics*. San Carlos, CA: Wide World Publ./Tetra, pp. 94–95, 1989.
 Yates, R. C. "Conchoid." *A Handbook on Curves and Their Properties*. Ann Arbor, MI: J. W. Edwards, pp. 31–33, 1952.

Concordant Form

A concordant form is an integer TRIPLE (a, b, N) where

$$\begin{cases} a^2 + b^2 = c^2 \\ a^2 + Nb^2 = d^2 \end{cases}$$

with c and d integers. Examples include

$$\begin{cases} 14663^2 + 111384^2 = 112345^2 \\ 14663^2 + 47 \cdot 111384^2 = 763751^2 \\ 1141^2 + 13260^2 = 13309^2 \\ 1141^2 + 53 \cdot 13260^2 = 96541^2 \\ 2873161^2 + 2401080^2 = 3744361^2 \\ 2873161^2 + 83 \cdot 2401080^2 = 22062761^2 \end{cases}$$

Dickson (1962) states that C. H. Brooks and S. Watson found in *The Ladies' and Gentlemen's Diary* (1857) that $x^2 + y^2$ and $x^2 + Ny^2$ can be simultaneously squares for $N < 100$ only for 1, 7, 10, 11, 17, 20, 22, 23, 24, 27, 30, 31, 34, 41, 42, 45, 49, 50, 52, 57, 58, 59, 60, 61, 68, 71, 72, 74, 76, 77, 79, 82, 85, 86, 90, 92, 93, 94, 97,

99, and 100 (which evidently omits 47, 53, and 83 from above). The list of concordant primes less than 1000 is now complete with the possible exception of the 16 primes 103, 131, 191, 223, 271, 311, 431, 439, 443, 593, 607, 641, 743, 821, 929, and 971 (Brown).

see also CONGRUUM

References

- Brown, K. S. "Concordant Forms." <http://www.seanet.com/~ksbrown/kmath286.htm>.
 Dickson, L. E. *History of the Theory of Numbers, Vol. 1: Divisibility and Primality*. New York: Chelsea, p. 475, 1952.

Concur

Two or more lines which intersect in a POINT are said to concur.

see also CONCURRENT

Concurrent

Two or more LINES are said to be concurrent if they intersect in a single point. Two LINES concur if their TRILINEAR COORDINATES satisfy

$$\begin{vmatrix} l_1 & m_1 & n_1 \\ l_2 & m_2 & n_2 \\ l_3 & m_3 & n_3 \end{vmatrix} = 0. \quad (1)$$

Three LINES concur if their TRILINEAR COORDINATES satisfy

$$l_1\alpha + m_1\beta + n_1\gamma = 0 \quad (2)$$

$$l_2\alpha + m_2\beta + n_2\gamma = 0 \quad (3)$$

$$l_3\alpha + m_3\beta + n_3\gamma = 0, \quad (4)$$

in which case the point is

$$m_2n_3 - n_2m_3 : n_2l_3 - l_2n_3 : l_2m_3 - m_2l_3. \quad (5)$$

Three lines

$$A_1x + B_1y + C_1 = 0 \quad (6)$$

$$A_2x + B_2y + C_2 = 0 \quad (7)$$

$$A_3x + B_3y + C_3 = 0. \quad (8)$$

are concurrent if their COEFFICIENTS satisfy

$$\begin{vmatrix} A_1 & B_1 & C_1 \\ A_2 & B_2 & C_2 \\ A_3 & B_3 & C_3 \end{vmatrix} = 0. \quad (9)$$

see also CONCYCLIC, POINT

Concyclic

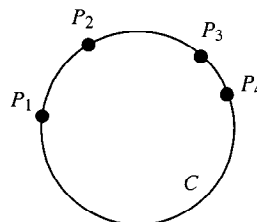

Four or more points $P_1, P_2, P_3, P_4, \dots$ which lie on a CIRCLE C are said to be concyclic. Three points are trivially concyclic since three noncollinear points determine a CIRCLE. The number of the n^2 LATTICE POINTS $x, y \in [1, n]$ which can be picked with no four concyclic is $\mathcal{O}(n^{2/3} - \epsilon)$ (Guy 1994).

A theorem states that if any four consecutive points of a POLYGON are not concyclic, then its AREA can be increased by making them concyclic. This fact arises in some PROOFS that the solution to the ISOPERIMETRIC PROBLEM is the CIRCLE.

see also CIRCLE, COLLINEAR, CONCENTRIC, CYCLIC HEXAGON, CYCLIC PENTAGON, CYCLIC QUADRILATERAL, ECCENTRIC, N-CLUSTER

References

- Guy, R. K. "Lattice Points, No Four on a Circle." §F3 in *Unsolved Problems in Number Theory, 2nd ed.* New York: Springer-Verlag, p. 241, 1994.

Condition

A requirement NECESSARY for a given statement or theorem to hold. Also called a CRITERION.

see also BOUNDARY CONDITIONS, CARMICHAEL CONDITION, CAUCHY BOUNDARY CONDITIONS, CONDITION NUMBER, DIRICHLET BOUNDARY CONDITIONS, DIVERSITY CONDITION, FELLER-LÉVY CONDITION, HÖLDER CONDITION, LICHNEROWICZ CONDITIONS, LINDBERGH CONDITION, LIPSCHITZ CONDITION, LYAPUNOV CONDITION, NEUMANN BOUNDARY CONDITIONS, ROBERTSON CONDITION, ROBIN BOUNDARY CONDITIONS, TAYLOR'S CONDITION, TRIANGLE CONDITION, WEIERSTRASS-ERDMAN CORNER CONDITION, WINKLER CONDITIONS

Condition Number

The ratio of the largest to smallest SINGULAR VALUE of a system. A system is said to be singular if the condition number is INFINITE, and ill-conditioned if it is too large.

Conditional Convergence

If the SERIES

$$\sum_{n=0}^{\infty} u_n$$

CONVERGES, but

$$\sum_{n=0}^{\infty} |u_n|$$

does not, where $|x|$ is the ABSOLUTE VALUE, then the SERIES is said to be conditionally CONVERGENT.

see also ABSOLUTE CONVERGENCE, CONVERGENCE TESTS, RIEMANN SERIES THEOREM, SERIES

Conditional Probability

The conditional probability of A given that B has occurred, denoted $P(A|B)$, equals

$$P(A|B) = \frac{P(A \cap B)}{P(B)}, \quad (1)$$

which can be proven directly using a VENN DIAGRAM. Multiplying through, this becomes

$$P(A|B)P(B) = P(A \cap B), \quad (2)$$

which can be generalized to

$$P(A \cup B \cup C) = P(A)P(B|A)P(C|A \cup B). \quad (3)$$

Rearranging (1) gives

$$P(B|A) = \frac{P(B \cap A)}{P(A)}. \quad (4)$$

Solving (4) for $P(B \cap A) = P(A \cap B)$ and plugging in to (1) gives

$$P(A|B) = \frac{P(A)P(B|A)}{P(B)}. \quad (5)$$

see also BAYES' FORMULA

Condom Problem

see GLOVE PROBLEM

Condon-Shortley Phase

The $(-1)^m$ phase factor in some definitions of the SPHERICAL HARMONICS and associated LEGENDRE POLYNOMIALS. Using the Condon-Shortley convention gives

$$Y_n^m(\theta, \phi) = (-1)^m \sqrt{\frac{2n+1}{4\pi} \frac{(n-m)!}{(n+m)!}} P_n^m(\cos \theta) e^{im\phi}.$$

see also LEGENDRE POLYNOMIAL, SPHERICAL HARMONIC

References

- Arfken, G. *Mathematical Methods for Physicists*, 3rd ed. Orlando, FL: Academic Press, pp. 682 and 692, 1985.
 Condon, E. U. and Shortley, G. *The Theory of Atomic Spectra*. Cambridge, England: Cambridge University Press, 1951.
 Shore, B. W. and Menzel, D. H. *Principles of Atomic Spectra*. New York: Wiley, p. 158, 1968.

Conductor

see j -CONDUCTOR

Cone

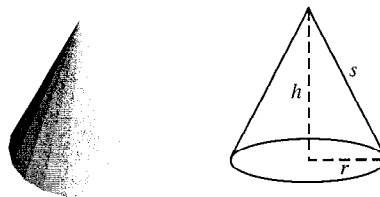

A cone is a PYRAMID with a circular CROSS-SECTION. A right cone is a cone with its vertex above the center of its base. A right cone of height h can be described by the parametric equations

$$x = r(h - z) \cos \theta \quad (1)$$

$$y = r(h - z) \sin \theta \quad (2)$$

$$z = z \quad (3)$$

for $z \in [0, h]$ and $\theta \in [0, 2\pi)$. The VOLUME of a cone is therefore

$$V = \frac{1}{3} A_b h, \quad (4)$$

where A_b is the base AREA and h is the height. If the base is circular, then

$$V = \frac{1}{3} \pi r^2 h. \quad (5)$$

This amazing fact was first discovered by Eudoxus, and other proofs were subsequently found by Archimedes in *On the Sphere and Cylinder* (ca. 225 BC) and Euclid in Proposition XII.10 of his *Elements* (Dunham 1990).

The CENTROID can be obtained by setting $R_2 = 0$ in the equation for the centroid of the CONICAL FRUSTUM,

$$\bar{z} = \frac{\langle z \rangle}{V} = \frac{h(R_1^2 + R_1 R_2 + R_2^2)}{4(R_1^2 + 2R_1 R_2 + 3R_2^2)}, \quad (6)$$

(Beyer 1987, p. 133) yielding

$$\bar{z} = \frac{1}{4} h. \quad (7)$$

For a right circular cone, the SLANT HEIGHT s is

$$s = \sqrt{r^2 + h^2} \quad (8)$$

and the surface AREA (not including the base) is

$$S = \pi r s = \pi r \sqrt{r^2 + h^2}. \quad (9)$$

In discussions of CONIC SECTIONS, the word cone is often used to refer to two similar cones placed apex to apex. This allows the HYPERBOLA to be defined as the

intersection of a PLANE with both NAPPES (pieces) of the cone.

The LOCUS of the apex of a variable cone containing an ELLIPSE fixed in 3-space is a HYPERBOLA through the FOCI of the ELLIPSE. In addition, the LOCUS of the apex of a cone containing that HYPERBOLA is the original ELLIPSE. Furthermore, the ECCENTRICITIES of the ELLIPSE and HYPERBOLA are reciprocals.

see also CONIC SECTION, CONICAL FRUSTUM, CYLINDER, NAPPE, PYRAMID, SPHERE

References

- Beyer, W. H. (Ed.) *CRC Standard Mathematical Tables*, 28th ed. Boca Raton, FL: CRC Press, pp. 129 and 133, 1987.
 Dunham, W. *Journey Through Genius: The Great Theorems of Mathematics*. New York: Wiley, pp. 76–77, 1990.
 Yates, R. C. "Cones." *A Handbook on Curves and Their Properties*. Ann Arbor, MI: J. W. Edwards, pp. 34–35, 1952.

Cone Graph

A GRAPH $C_n + \overline{K_m}$, where C_n is a CYCLIC GRAPH and K_m is a COMPLETE GRAPH.

Cone Net

The mapping of a grid of regularly ruled squares onto a CONE with no overlap or misalignment. Cone nets are possible for vertex angles of 90° , 180° , and 270° , and are beautifully illustrated by Steinhaus (1983).

References

- Steinhaus, H. *Mathematical Snapshots*, 3rd American ed. New York: Oxford University Press, pp. 224–228, 1983.

Cone (Space)

The JOIN of a TOPOLOGICAL SPACE X and a point P , $C(X) = X * P$.

References

- Rolfsen, D. *Knots and Links*. Wilmington, DE: Publish or Perish Press, p. 6, 1976.

Cone-Sphere Intersection

Let a CONE of opening parameter c and vertex at $(0, 0, 0)$ intersect a SPHERE of RADIUS r centered at (x_0, y_0, z_0) , with the CONE oriented such that its axis does not pass through the center of the SPHERE. Then the equations of the curve of intersection are

$$\frac{x^2 + y^2}{c^2} = z^2 \quad (1)$$

$$(x - x_0)^2 + (y - y_0)^2 + (z - z_0)^2 = r^2. \quad (2)$$

Combining (1) and (2) gives

$$(x - x_0)^2 + (y - y_0)^2 + \frac{x^2 + y^2}{c^2} - \frac{2z_0}{c} \sqrt{x^2 + y^2} + z_0^2 = r^2 \quad (3)$$

$$x^2 \left(1 + \frac{1}{c^2}\right) - 2x_0x + y^2 \left(1 + \frac{1}{c^2}\right) - 2y_0y + (x_0^2 + y_0^2 + z_0^2 - r^2) - \frac{2z_0}{c} \sqrt{x^2 + y^2} = 0. \quad (4)$$

Therefore, x and y are connected by a complicated QUARTIC EQUATION, and x , y , and z by a QUADRATIC EQUATION.

If the CONE-SPHERE intersection is *on-axis* so that a CONE of opening parameter c and vertex at $(0, 0, z_0)$ is oriented with its AXIS along a radial of the SPHERE of radius r centered at $(0, 0, 0)$, then the equations of the curve of intersection are

$$(z - z_0)^2 = \frac{x^2 + y^2}{c^2} \quad (5)$$

$$x^2 + y^2 + z^2 = r^2. \quad (6)$$

Combining (5) and (6) gives

$$c^2(z - z_0)^2 + z^2 = r^2 \quad (7)$$

$$c^2(z^2 - 2z_0z + z_0^2) + z^2 = r^2 \quad (8)$$

$$z^2(c^2 + 1) - 2c^2z_0z + (z_0^2c^2 - r^2) = 0. \quad (9)$$

Using the QUADRATIC EQUATION gives

$$z = \frac{2c^2z_0 \pm \sqrt{4c^4z_0^2 - 4(c^2 + 1)(z_0^2c^2 - r^2)}}{2(c^2 + 1)} \\ = \frac{c^2z_0 \pm \sqrt{c^2(r^2 - z_0^2) + r^2}}{c^2 + 1}. \quad (10)$$

So the curve of intersection is planar. Plugging (10) into (5) shows that the curve is actually a CIRCLE, with RADIUS given by

$$a = \sqrt{r^2 - z^2}. \quad (11)$$

Confidence Interval

The probability that a measurement will fall within a given CLOSED INTERVAL $[a, b]$. For a continuous distribution,

$$CI(a, b) \equiv \int_a^b P(x) dx, \quad (1)$$

where $P(x)$ is the PROBABILITY DISTRIBUTION FUNCTION. Usually, the confidence interval of interest is symmetrically placed around the mean, so

$$CI(x) \equiv CI(\mu - x, \mu + x) = \int_{\mu-x}^{\mu+x} P(x) dx, \quad (2)$$

where μ is the MEAN. For a GAUSSIAN DISTRIBUTION, the probability that a measurement falls within $n\sigma$ of the mean μ is

$$\begin{aligned} \text{CI}(n\sigma) &\equiv \frac{1}{\sigma\sqrt{2\pi}} \int_{\mu-n\sigma}^{\mu+n\sigma} e^{-(x-\mu)^2/2\sigma^2} dx \\ &= \frac{2}{\sigma\sqrt{2\pi}} \int_0^{\mu+n\sigma} e^{-(x-\mu)^2/2\sigma^2} dx. \end{aligned} \quad (3)$$

Now let $u \equiv (x - \mu)/\sqrt{2}\sigma$, so $du = dx/\sqrt{2}\sigma$. Then

$$\begin{aligned} \text{CI}(n\sigma) &= \frac{2}{\sigma\sqrt{2\pi}} \sqrt{2}\sigma \int_0^{n/\sqrt{2}} e^{-u^2} du \\ &= \frac{2}{\sqrt{\pi}} \int_0^{n/\sqrt{2}} e^{-u^2} du = \text{erf}\left(\frac{n}{\sqrt{2}}\right), \end{aligned} \quad (4)$$

where $\text{erf}(x)$ is the so-called ERF function. The variate value producing a confidence interval CI is often denoted x_{CI} , so

$$x_{\text{CI}} = \sqrt{2} \text{erf}^{-1}(\text{CI}). \quad (5)$$

range	CI
σ	0.6826895
2σ	0.9544997
3σ	0.9973002
4σ	0.9999366
5σ	0.9999994

To find the standard deviation range corresponding to a given confidence interval, solve (4) for n .

$$n = \sqrt{2} \text{erf}^{-1}(\text{CI}) \quad (6)$$

CI	range
0.800	$\pm 1.28155\sigma$
0.900	$\pm 1.64485\sigma$
0.950	$\pm 1.95996\sigma$
0.990	$\pm 2.57583\sigma$
0.995	$\pm 2.80703\sigma$
0.999	$\pm 3.29053\sigma$

Configuration

A finite collection of points $p = (p_1, \dots, p_n)$, $p_i \in \mathbb{R}^d$, where \mathbb{R}^d is a EUCLIDEAN SPACE.

see also BAR (EDGE), EUCLIDEAN SPACE, FRAMEWORK, RIGID

Confluent Hypergeometric Differential Equation

$$xy'' + (b-x)y' - ay = 0, \quad (1)$$

where $y' \equiv dy/dx$ and with boundary conditions

$${}_1F_1(a; b; 0) = 1 \quad (2)$$

$$\left[\frac{\partial}{\partial x} {}_1F_1(a; b; x) \right]_{x=0} = \frac{a}{b}. \quad (3)$$

The equation has a REGULAR SINGULAR POINT at 0 and an irregular singularity at ∞ . The solutions are called CONFLUENT HYPERGEOMETRIC FUNCTION OF THE FIRST or SECOND KINDS. Solutions of the first kind are denoted ${}_1F_1(a; b; x)$ or $M(a, b, x)$.

see also HYPERGEOMETRIC DIFFERENTIAL EQUATION, WHITTAKER DIFFERENTIAL EQUATION

References

- Abramowitz, M. and Stegun, C. A. (Eds.). *Handbook of Mathematical Functions with Formulas, Graphs, and Mathematical Tables*, 9th printing. New York: Dover, p. 504, 1972.
 Arfken, G. "Confluent Hypergeometric Functions." §13.6 in *Mathematical Methods for Physicists*, 3rd ed. Orlando, FL: Academic Press, pp. 753-758, 1985.
 Morse, P. M. and Feshbach, H. *Methods of Theoretical Physics, Part I*. New York: McGraw-Hill, pp. 551-555, 1953.

Confluent Hypergeometric Function

see CONFLUENT HYPERGEOMETRIC FUNCTION OF THE FIRST KIND, CONFLUENT HYPERGEOMETRIC FUNCTION OF THE SECOND KIND

Confluent Hypergeometric Function of the First Kind

The confluent hypergeometric function a degenerate form the HYPERGEOMETRIC FUNCTION ${}_2F_1(a, b; c; z)$ which arises as a solution the the CONFLUENT HYPERGEOMETRIC DIFFERENTIAL EQUATION. It is commonly denoted ${}_1F_1(a; b; z)$, $M(a, b, z)$, or $\Phi(a; b; z)$, and is also known as KUMMER'S FUNCTION of the first kind. An alternate form of the solution to the Confluent Hypergeometric Differential Equation is known as the WHITTAKER FUNCTION.

The confluent hypergeometric function has a HYPERGEOMETRIC SERIES given by

$${}_1F_1(a; b; z) = 1 + \frac{a}{b}z + \frac{a(a+1)}{b(b+1)} \frac{z^2}{2!} + \dots = \sum_{k=0}^{\infty} \frac{(a)_k}{(b)_k} \frac{z^k}{k!}, \quad (1)$$

where $(a)_k$ and $(b)_k$ are POCHHAMMER SYMBOLS. If a and b are INTEGERS, $a < 0$, and either $b > 0$ or $b < a$, then the series yields a POLYNOMIAL with a finite number of terms. If b is an INTEGER ≤ 0 , then ${}_1F_1(a; b; z)$ is undefined. The confluent hypergeometric function also has an integral representation

$${}_1F_1(a; b; z) = \frac{\Gamma(b)}{\Gamma(b-a)\Gamma(a)} \int_0^1 e^{zt} t^{a-1} (1-t)^{b-a-1} dt \quad (2)$$

(Abramowitz and Stegun 1972, p. 505).

BESSEL FUNCTIONS, the ERROR FUNCTION, the incomplete GAMMA FUNCTION, HERMITE POLYNOMIAL, LAGUERRE POLYNOMIAL, as well as other are all special

cases of this function (Abramowitz and Stegun 1972, p. 509).

KUMMER'S SECOND FORMULA gives

$${}_1F_1\left(\frac{1}{2} + m; 2m + 1; z\right) = M_{0,m}(z) = z^{m+1/2} \times \left[1 + \sum_{p=1}^{\infty} \frac{z^{2p}}{2^{4p} p! (m+1)(m+2) \cdots (m+p)} \right], \quad (3)$$

where ${}_1F_1$ is the CONFLUENT HYPERGEOMETRIC FUNCTION and $m \neq -1/2, -1, -3/2, \dots$

see also CONFLUENT HYPERGEOMETRIC DIFFERENTIAL EQUATION, CONFLUENT HYPERGEOMETRIC FUNCTION OF THE SECOND KIND, CONFLUENT HYPERGEOMETRIC LIMIT FUNCTION, GENERALIZED HYPERGEOMETRIC FUNCTION, HEINE HYPERGEOMETRIC SERIES, HYPERGEOMETRIC FUNCTION, HYPERGEOMETRIC SERIES, KUMMER'S FORMULAS, WEBER-SONINE FORMULA, WHITTAKER FUNCTION

References

- Abramowitz, M. and Stegun, C. A. (Eds.). "Confluent Hypergeometric Functions." Ch. 13 in *Handbook of Mathematical Functions with Formulas, Graphs, and Mathematical Tables*, 9th printing. New York: Dover, pp. 503–515, 1972.
- Arfken, G. "Confluent Hypergeometric Functions." §13.6 in *Mathematical Methods for Physicists*, 3rd ed. Orlando, FL: Academic Press, pp. 753–758, 1985.
- Iyanaga, S. and Kawada, Y. (Eds.). "Hypergeometric Function of Confluent Type." Appendix A, Table 19.I in *Encyclopedic Dictionary of Mathematics*. Cambridge, MA: MIT Press, p. 1469, 1980.
- Morse, P. M. and Feshbach, H. *Methods of Theoretical Physics, Part I*. New York: McGraw-Hill, pp. 551–554 and 604–605, 1953.
- Slater, L. J. *Confluent Hypergeometric Functions*. Cambridge, England: Cambridge University Press, 1960.
- Spanier, J. and Oldham, K. B. "The Kummer Function $M(a; c; x)$." Ch. 47 in *An Atlas of Functions*. Washington, DC: Hemisphere, pp. 459–469, 1987.

Confluent Hypergeometric Function of the Second Kind

Gives the second linearly independent solution to the CONFLUENT HYPERGEOMETRIC DIFFERENTIAL EQUATION. It is also known as the KUMMER'S FUNCTION of the second kind, the TRICOMI FUNCTION, or the GORDON FUNCTION. It is denoted $U(a, b, z)$ and has an integral representation

$$U(a, b, z) = \frac{1}{\Gamma(a)} \int_0^\infty e^{-zt} t^{a-1} (1+t)^{b-a-1} dt$$

(Abramowitz and Stegun 1972, p. 505). The WHITTAKER FUNCTIONS give an alternative form of the solution. For small z , the function behaves as z^{1-b} .

see also BATEMAN FUNCTION, CONFLUENT HYPERGEOMETRIC FUNCTION OF THE FIRST KIND, CONFLUENT HYPERGEOMETRIC LIMIT FUNCTION, COULOMB WAVE FUNCTION, CUNNINGHAM FUNCTION, GORDON

FUNCTION, HYPERGEOMETRIC FUNCTION, POISSON-CHARLIER POLYNOMIAL, TORONTO FUNCTION, WEBER FUNCTIONS, WHITTAKER FUNCTION

References

- Abramowitz, M. and Stegun, C. A. (Eds.). "Confluent Hypergeometric Functions." Ch. 13 in *Handbook of Mathematical Functions with Formulas, Graphs, and Mathematical Tables*, 9th printing. New York: Dover, pp. 503–515, 1972.
- Arfken, G. "Confluent Hypergeometric Functions." §13.6 in *Mathematical Methods for Physicists*, 3rd ed. Orlando, FL: Academic Press, pp. 753–758, 1985.
- Morse, P. M. and Feshbach, H. *Methods of Theoretical Physics, Part I*. New York: McGraw-Hill, pp. 671–672, 1953.
- Spanier, J. and Oldham, K. B. "The Tricomi Function $U(a; c; x)$." Ch. 48 in *An Atlas of Functions*. Washington, DC: Hemisphere, pp. 471–477, 1987.

Confluent Hypergeometric Limit Function

$${}_0F_1(; a; z) \equiv \lim_{q \rightarrow \infty} {}_1F_1\left(q; a; \frac{z}{q}\right). \quad (1)$$

It has a series expansion

$${}_0F_1(; a; z) = \sum_{n=0}^{\infty} \frac{z^n}{(a)_n n!} \quad (2)$$

and satisfies

$$z \frac{d^2 y}{dz^2} + a \frac{dy}{dz} - y = 0. \quad (3)$$

A BESSEL FUNCTION OF THE FIRST KIND can be expressed in terms of this function by

$$J_n(x) = \frac{(\frac{1}{2}x)^n}{n!} {}_0F_1(; n+1; -\frac{1}{4}x^2) \quad (4)$$

(Petkovšek *et al.* 1996).

see also CONFLUENT HYPERGEOMETRIC FUNCTION, GENERALIZED HYPERGEOMETRIC FUNCTION, HYPERGEOMETRIC FUNCTION

References

- Petkovšek, M.; Wilf, H. S.; and Zeilberger, D. *A=B*. Wellesley, MA: A. K. Peters, p. 38, 1996.

Confocal Conics

Confocal conics are CONIC SECTIONS sharing a common FOCUS. Any two confocal CENTRAL CONICS are orthogonal (Ogilvy 1990, p. 77).

see also CONIC SECTION, FOCUS

References

- Ogilvy, C. S. *Excursions in Geometry*. New York: Dover, pp. 77–78, 1990.

Confocal Ellipsoidal Coordinates

The confocal ellipsoidal coordinates (called simply ellipsoidal coordinates by Morse and Feshbach 1953) are given by the equations

$$\frac{x^2}{a^2 + \xi} + \frac{y^2}{b^2 + \xi} + \frac{z^2}{c^2 + \xi} = 1 \quad (1)$$

$$\frac{x^2}{a^2 + \eta} + \frac{y^2}{b^2 + \eta} + \frac{z^2}{c^2 + \eta} = 1 \quad (2)$$

$$\frac{x^2}{a^2 + \zeta} + \frac{y^2}{b^2 + \zeta} + \frac{z^2}{c^2 + \zeta} = 1, \quad (3)$$

where $-c^2 < \xi < \infty$, $-b^2 < \eta < -c^2$, and $-a^2 < \zeta < -b^2$. Surfaces of constant ξ are confocal ELLIPSOIDS, surfaces of constant η are one-sheeted HYPERBOLOIDS, and surfaces of constant ζ are two-sheeted HYPERBOLOIDS. For every (x, y, z) , there is a unique set of ellipsoidal coordinates. However, (ξ, η, ζ) specifies eight points symmetrically located in octants. Solving for x , y , and z gives

$$x^2 = \frac{(a^2 + \xi)(a^2 + \eta)(a^2 + \zeta)}{(b^2 - a^2)(c^2 - a^2)} \quad (4)$$

$$y^2 = \frac{(b^2 + \xi)(b^2 + \eta)(b^2 + \zeta)}{(a^2 - b^2)(c^2 - b^2)} \quad (5)$$

$$z^2 = \frac{(c^2 + \xi)(c^2 + \eta)(c^2 + \zeta)}{(a^2 - c^2)(b^2 - c^2)}. \quad (6)$$

The LAPLACIAN is

$$\begin{aligned} \nabla^2 \Psi = & (\eta - \zeta) f(\xi) \frac{\partial}{\partial \xi} \left[f(\xi) \frac{\partial \Psi}{\partial \xi} \right] \\ & + (\zeta - \xi) f(\eta) \frac{\partial}{\partial \eta} \left[f(\eta) \frac{\partial \Psi}{\partial \eta} \right] + (\xi - \eta) f(\zeta) \frac{\partial}{\partial \zeta} \left[f(\zeta) \frac{\partial \Psi}{\partial \zeta} \right], \end{aligned} \quad (7)$$

where

$$f(x) \equiv \sqrt{(x + a^2)(x + b^2)(x + c^2)}. \quad (8)$$

Another definition is

$$\frac{x^2}{a^2 - \lambda} + \frac{y^2}{b^2 - \lambda} + \frac{z^2}{c^2 - \lambda} = 1 \quad (9)$$

$$\frac{x^2}{a^2 - \mu} + \frac{y^2}{b^2 - \mu} + \frac{z^2}{c^2 - \mu} = 1 \quad (10)$$

$$\frac{x^2}{a^2 - \nu} + \frac{y^2}{b^2 - \nu} + \frac{z^2}{c^2 - \nu} = 1, \quad (11)$$

where

$$\lambda < c^2 < \mu < b^2 < \nu < a^2 \quad (12)$$

(Arfken 1970, pp. 117–118). Byerly (1959, p. 251) uses a slightly different definition in which the Greek variables are replaced by their squares, and $a = 0$. Equation (9) represents an ELLIPSOID, (10) represents a one-sheeted

HYPERBOLOID, and (11) represents a two-sheeted HYPERBOLOID. In terms of CARTESIAN COORDINATES,

$$x^2 = \frac{(a^2 - \lambda)(a^2 - \mu)(a^2 - \nu)}{(a^2 - b^2)(a^2 - c^2)} \quad (13)$$

$$y^2 = \frac{(b^2 - \lambda)(b^2 - \mu)(b^2 - \nu)}{(b^2 - a^2)(b^2 - c^2)} \quad (14)$$

$$z^2 = \frac{(c^2 - \lambda)(c^2 - \mu)(c^2 - \nu)}{(c^2 - a^2)(c^2 - b^2)}. \quad (15)$$

The SCALE FACTORS are

$$h_\lambda = \sqrt{\frac{(\mu - \lambda)(\nu - \lambda)}{4(a^2 - \lambda)(b^2 - \lambda)(c^2 - \lambda)}} \quad (16)$$

$$h_\mu = \sqrt{\frac{(\nu - \mu)(\lambda - \mu)}{4(a^2 - \mu)(b^2 - \mu)(c^2 - \mu)}} \quad (17)$$

$$h_\nu = \sqrt{\frac{(\lambda - \nu)(\mu - \nu)}{4(a^2 - \nu)(b^2 - \nu)(c^2 - \nu)}}. \quad (18)$$

The LAPLACIAN is

$$\begin{aligned} \nabla^2 = & 2 \frac{a^2 b^2 + a^2 c^2 + b^2 c^2 - 2\nu(a^2 + b^2 + c^2) + 3\nu^2}{(\mu - \nu)(\nu - \lambda)} \frac{\partial}{\partial \nu} \\ & + \frac{4(a^2 - \nu)(b^2 - \nu)(c^2 - \nu)}{(\mu - \nu)(\nu - \lambda)} \frac{\partial^2}{\partial \nu^2} \\ & + 2 \frac{a^2 b^2 + a^2 c^2 + b^2 c^2 - 2\mu(a^2 + b^2 + c^2) + 3\mu^2}{(\nu - \mu)(\mu - \lambda)} \frac{\partial}{\partial \mu} \\ & + \frac{4(a^2 - \mu)(b^2 - \mu)(c^2 - \mu)}{(\mu - \lambda)(\nu - \mu)} \frac{\partial^2}{\partial \mu^2} \\ & + 2 \frac{a^2 b^2 + a^2 c^2 + b^2 c^2 + 2\lambda(a^2 + b^2 + c^2) - 3\lambda^2}{(\mu - \lambda)(\nu - \lambda)} \frac{\partial}{\partial \lambda} \\ & + \frac{4(a^2 - \lambda)(b^2 - \lambda)(c^2 - \lambda)}{(\mu - \lambda)(\nu - \lambda)} \frac{\partial^2}{\partial \lambda^2}. \end{aligned} \quad (19)$$

Using the NOTATION of Byerly (1959, pp. 252–253), this can be reduced to

$$\nabla^2 = (\mu^2 - \nu^2) \frac{\partial^2}{\partial \alpha^2} + (\lambda^2 - \nu^2) \frac{\partial^2}{\partial \beta^2} + (\lambda^2 - \mu^2) \frac{\partial^2}{\partial \gamma^2}, \quad (20)$$

where

$$\begin{aligned} \alpha &= c \int_c^\lambda \frac{d\lambda}{\sqrt{(\lambda^2 - b^2)(\lambda^2 - c^2)}} \\ &= F\left(\frac{b}{c}, \frac{\pi}{2}\right) - F\left(\frac{b}{c}, \sin^{-1}\left(\frac{c}{\lambda}\right)\right) \end{aligned} \quad (21)$$

$$\begin{aligned} \beta &= c \int_b^\mu \frac{d\mu}{\sqrt{(c^2 - \mu^2)(\mu^2 - b^2)}} \\ &= F\left[\sqrt{1 - \frac{b^2}{c^2}}, \sin^{-1}\left(\sqrt{\frac{1 - \frac{b^2}{\mu^2}}{1 - \frac{b^2}{c^2}}}\right)\right] \end{aligned} \quad (22)$$

$$\begin{aligned} \gamma &= c \int_0^\nu \frac{d\nu}{\sqrt{(b^2 - \nu^2)(c^2 - \nu^2)}} \\ &= F\left(\frac{b}{c}, \sin^{-1}\left(\frac{\nu}{b}\right)\right). \end{aligned} \quad (23)$$

Here, F is an ELLIPTIC INTEGRAL OF THE FIRST KIND. In terms of α , β , and γ ,

$$\lambda = c \operatorname{dc} \left(\alpha, \frac{b}{c} \right) \quad (24)$$

$$\mu = b \operatorname{nd} \left(\beta, \sqrt{1 - \frac{b^2}{c^2}} \right) \quad (25)$$

$$\nu = b \operatorname{sn} \left(\gamma, \frac{b}{c} \right), \quad (26)$$

where dc , nd and sn are JACOBI ELLIPTIC FUNCTIONS. The HELMHOLTZ DIFFERENTIAL EQUATION is separable in confocal ellipsoidal coordinates.

see also HELMHOLTZ DIFFERENTIAL EQUATION—CONFOCAL ELLIPSOIDAL COORDINATES

References

- Abramowitz, M. and Stegun, C. A. (Eds.). "Definition of Elliptical Coordinates." §21.1 in *Handbook of Mathematical Functions with Formulas, Graphs, and Mathematical Tables*, 9th printing. New York: Dover, p. 752, 1972.
- Arfken, G. "Confocal Ellipsoidal Coordinates (ξ_1, ξ_2, ξ_3)." §2.15 in *Mathematical Methods for Physicists*, 2nd ed. New York: Academic Press, pp. 117–118, 1970.
- Byerly, W. E. *An Elementary Treatise on Fourier's Series, and Spherical, Cylindrical, and Ellipsoidal Harmonics, with Applications to Problems in Mathematical Physics*. New York: Dover, 1959.
- Morse, P. M. and Feshbach, H. *Methods of Theoretical Physics, Part I*. New York: McGraw-Hill, p. 663, 1953.

Confocal Parabolic Coordinates

see CONFOCAL PARABOLOIDAL COORDINATES

Confocal Paraboloidal Coordinates

$$\frac{x^2}{a^2 - \lambda} + \frac{y^2}{b^2 - \lambda} = z - \lambda \quad (1)$$

$$\frac{x^2}{a^2 - \mu} + \frac{y^2}{b^2 - \mu} = z - \mu \quad (2)$$

$$\frac{x^2}{a^2 - \nu} + \frac{y^2}{b^2 - \nu} = z - \nu, \quad (3)$$

where $\lambda \in (-\infty, b^2)$, $\mu \in (b^2, a^2)$, and $\nu \in (a^2, \infty)$.

$$x^2 = \frac{(a^2 - \lambda)(a^2 - \mu)(a^2 - \nu)}{(b^2 - a^2)} \quad (4)$$

$$y^2 = \frac{(b^2 - \lambda)(b^2 - \mu)(b^2 - \nu)}{(a^2 - b^2)} \quad (5)$$

$$z = \lambda + \mu + \nu - a^2 - b^2. \quad (6)$$

The SCALE FACTORS are

$$h_\lambda = \sqrt{\frac{(\mu - \lambda)(\nu - \lambda)}{4(a^2 - \lambda)(b^2 - \lambda)}} \quad (7)$$

$$h_\mu = \sqrt{\frac{(\nu - \mu)(\lambda - \mu)}{4(a^2 - \mu)(b^2 - \mu)}} \quad (8)$$

$$h_\nu = \sqrt{\frac{(\lambda - \nu)(\mu - \nu)}{16(a^2 - \nu)(b^2 - \nu)}}. \quad (9)$$

The LAPLACIAN is

$$\begin{aligned} \nabla^2 = & \frac{2(a^2 + b^2 - 2\nu)}{(\mu - \nu)(\nu - \lambda)} \frac{\partial}{\partial \nu} + \frac{4(a^2 - \nu)(\nu - b^2)}{(\mu - \nu)(\nu - \lambda)} \frac{\partial^2}{\nu^2} \\ & + \frac{2(a^2 + b^2 - 2\mu)}{(\mu - \lambda)(\nu - \mu)} \frac{\partial}{\partial \mu} + \frac{4(a^2 - \mu)(\mu - b^2)}{(\mu - \lambda)(\nu - \mu)} \frac{\partial^2}{\partial \mu^2} \\ & + \frac{2(2\lambda - a^2 - b^2)}{(\mu - \lambda)(\nu - \lambda)} \frac{\partial}{\partial \lambda} + \frac{4(\lambda - a^2)(\lambda - b^2)}{(\mu - \lambda)(\nu - \lambda)} \frac{\partial^2}{\partial \lambda^2}. \end{aligned} \quad (10)$$

The HELMHOLTZ DIFFERENTIAL EQUATION is SEPARABLE.

see also HELMHOLTZ DIFFERENTIAL EQUATION—CONFOCAL PARABOLOIDAL COORDINATES

References

- Arfken, G. "Confocal Parabolic Coordinates (ξ_1, ξ_2, ξ_3)." §2.17 in *Mathematical Methods for Physicists*, 2nd ed. Orlando, FL: Academic Press, pp. 119–120, 1970.
- Morse, P. M. and Feshbach, H. *Methods of Theoretical Physics, Part I*. New York: McGraw-Hill, p. 664, 1953.

Conformal Latitude

An AUXILIARY LATITUDE defined by

$$\begin{aligned} \chi & \equiv 2 \tan^{-1} \left\{ \tan\left(\frac{1}{4}\pi + \frac{1}{2}\phi\right) \left[\frac{1 - e \sin \phi}{1 + e \sin \phi} \right]^{e/2} \right\} - \frac{1}{2}\pi \\ & = 2 \tan^{-1} \left[\frac{1 + \sin \phi}{1 - \sin \phi} \left(\frac{1 - e \sin \phi}{1 + e \sin \phi} \right)^e \right]^{1/2} - \frac{1}{2}\pi \\ & = \phi - \left(\frac{1}{2}e^2 + \frac{5}{24}e^4 + \frac{3}{32}e^6 + \frac{281}{5760}e^8 + \dots\right) \sin(2\phi) \\ & \quad + \left(\frac{5}{48}e^4 + \frac{7}{80}e^6 + \frac{697}{11520}e^8 + \dots\right) \sin(4\phi) \\ & \quad - \left(\frac{13}{480}e^6 + \frac{461}{13440} + \dots\right) \sin(6\phi) \\ & \quad + \left(\frac{1237}{161280}e^8 + \dots\right) \sin(8\phi) + \dots \end{aligned}$$

The inverse is obtained by iterating the equation

$$\phi = 2 \tan^{-1} \left[\tan\left(\frac{1}{4}\pi + \frac{1}{2}\chi\right) \left(\frac{1 + e \sin \phi}{1 - e \sin \phi} \right)^{e/2} \right] - \frac{1}{2}\pi$$

using $\phi = \chi$ as the first trial. A series form is

$$\begin{aligned} \phi = \chi & + \left(\frac{1}{2}e^2 + \frac{5}{24}e^4 + \frac{1}{12}e^6 + \frac{13}{360}e^8 + \dots\right) \sin(2\chi) \\ & + \left(\frac{7}{48}e^4 + \frac{29}{240}e^6 + \frac{811}{11520}e^8 + \dots\right) \sin(4\chi) \\ & + \left(\frac{7}{120}e^6 + \frac{81}{1120}e^8 + \dots\right) \sin(6\chi) \\ & + \left(\frac{4279}{161280}e^8 + \dots\right) \sin(8\chi) + \dots \end{aligned}$$

The conformal latitude was called the ISOMETRIC LATITUDE by Adams (1921), but this term is now used to refer to a different quantity.

see also AUXILIARY LATITUDE, LATITUDE

References

- Adams, O. S. "Latitude Developments Connected with Geodesy and Cartography with Tables, Including a Table for Lambert Equal-Area Meridional Projections." Spec. Pub. No. 67. U. S. Coast and Geodetic Survey, pp. 18 and 84–85, 1921.
- Snyder, J. P. *Map Projections—A Working Manual*. U. S. Geological Survey Professional Paper 1395. Washington, DC: U. S. Government Printing Office, pp. 15–16, 1987.

Conformal Map

A TRANSFORMATION which preserves ANGLES is known as conformal. For a transformation to be conformal, it must be an ANALYTIC FUNCTION and have a NONZERO DERIVATIVE. Let θ and ϕ be the tangents to the curves γ and $f(\gamma)$ at z_0 and w_0 ,

$$w - w_0 \equiv f(z) - f(z_0) = \frac{f(z) - f(z_0)}{z - z_0}(z - z_0) \quad (1)$$

$$\arg(w - w_0) = \arg \left[\frac{f(z) - f(z_0)}{z - z_0} \right] + \arg(z - z_0). \quad (2)$$

Then as $w \rightarrow w_0$ and $z \rightarrow z_0$,

$$\phi = \arg f'(z_0) + \theta \quad (3)$$

$$|w| = |f'(z_0)| |z|. \quad (4)$$

see also ANALYTIC FUNCTION, HARMONIC FUNCTION, MÖBIUS TRANSFORMATION, QUASICONFORMAL MAP, SIMILAR

References

- Arfken, G. "Conformal Mapping." §6.7 in *Mathematical Methods for Physicists*, 3rd ed. Orlando, FL: Academic Press, pp. 392–394, 1985.
 Bergman, S. *The Kernel Function and Conformal Mapping*. New York: Amer. Math. Soc., 1950.
 Katznelson, Y. *An Introduction to Harmonic Analysis*. New York: Dover, 1976.
 Morse, P. M. and Feshbach, H. "Conformal Mapping." §4.7 in *Methods of Theoretical Physics, Part I*. New York: McGraw-Hill, pp. 358–362 and 443–453, 1953.
 Nehari, Z. *Conformal Map*. New York: Dover, 1982.

Conformal Solution

By letting $w \equiv f(z)$, the REAL and IMAGINARY PARTS of w must satisfy the CAUCHY-RIEMANN EQUATIONS and LAPLACE'S EQUATION, so they automatically provide a scalar POTENTIAL and a so-called stream function. If a physical problem can be found for which the solution is valid, we obtain a solution—which may have been very difficult to obtain directly—by working backwards. Let

$$Az^n = Ar^n e^{in\theta}, \quad (1)$$

the REAL and IMAGINARY PARTS then give

$$\phi = Ar^n \cos(n\theta) \quad (2)$$

$$\psi = Ar^n \sin(n\theta). \quad (3)$$

For $n = -2$,

$$\phi = \frac{A}{r^2} \cos(2\theta) \quad (4)$$

$$\psi = -\frac{A}{r^2} \sin(2\theta), \quad (5)$$

which is a double system of LEMNISCATES (Lamb 1945, p. 69). For $n = -1$,

$$\phi = \frac{A}{r} \cos \theta \quad (6)$$

$$\psi = -\frac{A}{r} \sin \theta. \quad (7)$$

This solution consists of two systems of CIRCLES, and ϕ is the POTENTIAL FUNCTION for two PARALLEL opposite charged line charges (Feynman *et al.* 1989, §7-5; Lamb 1945, p. 69). For $n = 1/2$,

$$\phi = Ar^{1/2} \cos \left(\frac{\theta}{2} \right) = A \sqrt{\frac{\sqrt{x^2 + y^2} + x}{2}} \quad (8)$$

$$\psi = Ar^{1/2} \sin \left(\frac{\theta}{2} \right) = A \sqrt{\frac{\sqrt{x^2 + y^2} - x}{2}}. \quad (9)$$

ϕ gives the field near the edge of a thin plate (Feynman *et al.* 1989, §7-5). For $n = 1$,

$$\phi = Ar \cos \theta = Ax \quad (10)$$

$$\psi = Ar \sin \theta = Ay. \quad (11)$$

This is two straight lines (Lamb 1945, p. 68). For $n = 3/2$,

$$w = Ar^{3/2} e^{3i\theta/2}. \quad (12)$$

ϕ gives the field near the outside of a rectangular corner (Feynman *et al.* 1989, §7-5). For $n = 2$,

$$w = A(x + iy)^2 = A[(x^2 - y^2) + 2ixy] \quad (13)$$

$$\phi = A(x^2 - y^2) = Ar^2 \cos(2\theta) \quad (14)$$

$$\psi = 2Axy = Ar^2 \sin(2\theta). \quad (15)$$

These are two PERPENDICULAR HYPERBOLAS, and ϕ is the POTENTIAL FUNCTION near the middle of two point charges or the field on the opening side of a charged RIGHT ANGLE conductor (Feynman 1989, §7-3).

see also CAUCHY-RIEMANN EQUATIONS, CONFORMAL MAP, LAPLACE'S EQUATION

References

- Feynman, R. P.; Leighton, R. B.; and Sands, M. *The Feynman Lectures on Physics, Vol. 1*. Redwood City, CA: Addison-Wesley, 1989.
 Lamb, H. *Hydrodynamics*, 6th ed. New York: Dover, 1945.

Conformal Tensor

see WEYL TENSOR

Conformal Transformation

see CONFORMAL MAP

Congruence

If $b - c$ is integrally divisible by a , then b and c are said to be congruent with MODULUS a . This is written mathematically as $b \equiv c \pmod{a}$. If $b - c$ is *not* divisible by a , then we say $b \not\equiv c \pmod{a}$. The \pmod{a} is sometimes omitted when the MODULUS a is understood for a given computation, so care must be taken not to confuse the symbol \equiv with that for an EQUIVALENCE. The quantity b is called the RESIDUE or REMAINDER. The COMMON RESIDUE is taken to be NONNEGATIVE and smaller than m , and the MINIMAL RESIDUE is b or $b - m$, whichever is smaller in ABSOLUTE VALUE. In many computer languages (such as FORTRAN or *Mathematica*[®]), the COMMON RESIDUE of $c \pmod{a}$ is written $\text{mod}(c, a)$.

Congruence arithmetic is perhaps most familiar as a generalization of the arithmetic of the clock: 40 minutes past the hour plus 35 minutes gives $40 + 35 \equiv 15 \pmod{60}$, or 15 minutes past the hour, and 10 o'clock a.m. plus five hours gives $10 + 5 \equiv 3 \pmod{12}$, or 3 o'clock p.m. Congruences satisfy a number of important properties, and are extremely useful in many areas of NUMBER THEORY. Using congruences, simple DIVISIBILITY TESTS to check whether a given number is divisible by another number can sometimes be derived. For example, if the sum of a number's digits is divisible by 3 (9), then the original number is divisible by 3 (9).

Congruences also have their limitations. For example, if $a \equiv b$ and $c \equiv d \pmod{n}$, then it follows that $a^x \equiv b^x$, but usually not that $x^c \equiv x^d$ or $a^c \equiv b^d$. In addition, by "rolling over," congruences discard absolute information. For example, knowing the number of minutes past the hour is useful, but knowing the hour the minutes are past is often more useful still.

Let $a \equiv a' \pmod{m}$ and $b \equiv b' \pmod{m}$, then important properties of congruences include the following, where \Rightarrow means "IMPLIES":

1. Equivalence: $a \equiv b \pmod{0} \Rightarrow a = b$.
2. Determination: either $a \equiv b \pmod{m}$ or $a \not\equiv b \pmod{m}$.
3. Reflexivity: $a \equiv a \pmod{m}$.
4. Symmetry: $a \equiv b \pmod{m} \Rightarrow b \equiv a \pmod{m}$.
5. Transitivity: $a \equiv b \pmod{m}$ and $b \equiv c \pmod{m} \Rightarrow a \equiv c \pmod{m}$.
6. $a + b \equiv a' + b' \pmod{m}$.
7. $a - b \equiv a' - b' \pmod{m}$.
8. $ab \equiv a'b' \pmod{m}$.
9. $a \equiv b \pmod{m} \Rightarrow ka \equiv kb \pmod{m}$.
10. $a \equiv b \pmod{m} \Rightarrow a^n \equiv b^n \pmod{m}$.
11. $a \equiv b \pmod{m_1}$ and $a \equiv b \pmod{m_2} \Rightarrow a \equiv b \pmod{[m_1, m_2]}$, where $[m_1, m_2]$ is the LEAST COMMON MULTIPLE.
12. $ak \equiv bk \pmod{m} \Rightarrow a \equiv b \pmod{\frac{m}{(k, m)}}$, where (k, m) is the GREATEST COMMON DIVISOR.

13. If $a \equiv b \pmod{m}$, then $P(a) \equiv P(b) \pmod{m}$, for $P(x)$ a POLYNOMIAL.

Properties (6–8) can be proved simply by defining

$$a \equiv a' + rd \quad (1)$$

$$b \equiv b' + sd, \quad (2)$$

where r and s are INTEGERS. Then

$$a + b \equiv a' + b' + (r + s)d \quad (3)$$

$$a - b \equiv a' - b' + (r - s)d \quad (4)$$

$$ab \equiv a'b' + (a's + b'r + rsd)d, \quad (5)$$

so the properties are true.

Congruences also apply to FRACTIONS. For example, note that $\pmod{7}$

$$2 \times 4 \equiv 1 \quad 3 \times 3 \equiv 2 \quad 6 \times 6 \equiv 1 \pmod{7}, \quad (6)$$

so

$$\frac{1}{2} \equiv 4 \quad \frac{1}{4} \equiv 2 \quad \frac{2}{3} \equiv 3 \quad \frac{1}{6} \equiv 6 \pmod{7}. \quad (7)$$

To find $p/q \pmod{m}$, use an ALGORITHM similar to the GREEDY ALGORITHM. Let $q_0 \equiv q$ and find

$$p_0 = \left\lceil \frac{m}{q_0} \right\rceil, \quad (8)$$

where $\lceil x \rceil$ is the CEILING FUNCTION, then compute

$$q_1 \equiv q_0 p_0 \pmod{m}. \quad (9)$$

Iterate until $q_n = 1$, then

$$\frac{p}{q} \equiv p \prod_{i=0}^{n-1} p_i \pmod{m}. \quad (10)$$

This method always works for m PRIME, and sometimes even for m COMPOSITE. However, for a COMPOSITE m , the method can fail by reaching 0 (Conway and Guy 1996).

A LINEAR CONGRUENCE

$$ax \equiv b \pmod{m} \quad (11)$$

is solvable IFF the congruence

$$b \equiv 0 \pmod{(a, m)} \quad (12)$$

is solvable, where $d \equiv (a, m)$ is the GREATEST COMMON DIVISOR, in which case the solutions are $x_0, x_0 + m/d, x_0 + 2m/d, \dots, x_0 + (d - 1)m/d$, where $x_0 < m/d$. If $d = 1$, then there is only one solution.

A general QUADRATIC CONGRUENCE

$$a_2x^2 + a_1x + a_0 \equiv 0 \pmod{n} \quad (13)$$

can be reduced to the congruence

$$x^2 \equiv q \pmod{p} \quad (14)$$

and can be solved using EXCLUDENTS. Solution of the general polynomial congruence

$$a_mx^m + \dots + a_2x^2 + a_1x + a_0 \equiv 0 \pmod{n} \quad (15)$$

is intractable. Any polynomial congruence will give congruent results when congruent values are substituted.

Two simultaneous congruences

$$x \equiv a \pmod{m} \quad (16)$$

$$x \equiv b \pmod{n} \quad (17)$$

are solvable only when $x \equiv b \pmod{(m,n)}$, and the single solution is

$$x \equiv x_0 \pmod{[m,n]}, \quad (18)$$

where $x_0 < m/d$.

see also CANCELLATION LAW, CHINESE REMAINDER THEOREM, COMMON RESIDUE, CONGRUENCE AXIOMS, DIVISIBILITY TESTS, GREATEST COMMON DIVISOR, LEAST COMMON MULTIPLE, MINIMAL RESIDUE, MODULUS (CONGRUENCE), QUADRATIC RECIPROCITY LAW, RESIDUE (CONGRUENCE)

References

- Conway, J. H. and Guy, R. K. "Arithmetic Modulo p ." In *The Book of Numbers*. New York: Springer-Verlag, pp. 130–132, 1996.
- Courant, R. and Robbins, H. "Congruences." §2 in Supplement to Ch. 1 in *What is Mathematics?: An Elementary Approach to Ideas and Methods*, 2nd ed. Oxford, England: Oxford University Press, pp. 31–40, 1996.
- Shanks, D. *Solved and Unsolved Problems in Number Theory*, 4th ed. New York: Chelsea, p. 55, 1993.
- ✱ Weisstein, E. W. "Fractional Congruences." <http://www.astro.virginia.edu/~eww6n/math/notebooks/ModFraction.m>.

Congruence Axioms

The five of HILBERT'S AXIOMS which concern geometric equivalence.

see also CONGRUENCE AXIOMS, CONTINUITY AXIOMS, HILBERT'S AXIOMS, INCIDENCE AXIOMS, ORDERING AXIOMS, PARALLEL POSTULATE

References

- Hilbert, D. *The Foundations of Geometry*, 2nd ed. Chicago, IL: Open Court, 1980.
- Iyanaga, S. and Kawada, Y. (Eds.). "Hilbert's System of Axioms." §163B in *Encyclopedic Dictionary of Mathematics*. Cambridge, MA: MIT Press, pp. 544–545, 1980.

Congruence (Geometric)

Two geometric figures are said to be congruent if they are equivalent to within a ROTATION. This relationship is written $A \cong B$. (Unfortunately, this symbol is also used to denote ISOMORPHIC GROUPS.)

see also SIMILAR

Congruence Transformation

A transformation of the form $g = D^T \eta D$, where $\det(D) \neq 0$ and $\det(D)$ is the DETERMINANT.

see also SYLVESTER'S INERTIA LAW

Congruent

A number a is said to be congruent to b modulo m if $m|a - b$ (m DIVIDES $a - b$).

Congruent Incircles Point

The point Y for which TRIANGLES BYC , CYA , and AYB have congruent INCIRCLES. It is a special case of an ELKIES POINT.

References

- Kimberling, C. "Central Points and Central Lines in the Plane of a Triangle." *Math. Mag.* **67**, 163–187, 1994.

Congruent Isoscelizers Point

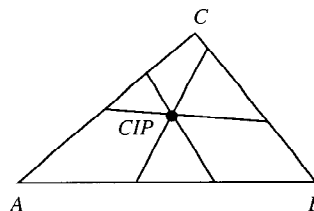

In 1989, P. Yff proved there is a unique configuration of ISOSCELIZERS for a given TRIANGLE such that all three have the same length. Furthermore, these ISOSCELIZERS meet in a point called the congruent isoscelizers point, which has TRIANGLE CENTER FUNCTION

$$\alpha = \cos(\tfrac{1}{2}B) + \cos(\tfrac{1}{2}C) - \cos(\tfrac{1}{2}A).$$

see also CONGRUENT ISOSCELIZERS POINT, ISOSCELIZER

References

- Kimberling, C. "Congruent Isoscelizers Point." <http://www.evansville.edu/~ck6/tcenters/recent/conisos.html>.

Congruent Numbers

A set of numbers (a, x, y, t) such that

$$\begin{cases} x^2 + ay^2 = z^2 \\ x^2 - ay^2 = t^2. \end{cases}$$

They are a generalization of the CONGRUUM PROBLEM, which is the case $y = 1$. For $a = 101$, the smallest solution is

$$\begin{aligned}x &= 2015242462949760001961 \\y &= 118171431852779451900 \\z &= 2339148435306225006961 \\t &= 1628124370727269996961.\end{aligned}$$

see also CONGRUUM

References

Guy, R. K. "Congruent Number." §D76 in *Unsolved Problems in Number Theory*, 2nd ed. New York: Springer-Verlag, pp. 195–197, 1994.

Congruum

A number h which satisfies the conditions of the CONGRUUM PROBLEM:

$$x^2 + h = a^2$$

and

$$x^2 - h = b^2.$$

see also CONCORDANT FORM, CONGRUUM PROBLEM

Congruum Problem

Find a SQUARE NUMBER x^2 such that, when a given number h is added or subtracted, new SQUARE NUMBERS are obtained so that

$$x^2 + h = a^2 \quad (1)$$

and

$$x^2 - h = b^2. \quad (2)$$

This problem was posed by the mathematicians Théodore and Jean de Palerma in a mathematical tournament organized by Frederick II in Pisa in 1225. The solution (Ore 1988, pp. 188–191) is

$$x = m^2 + n^2 \quad (3)$$

$$h = 4mn(m^2 - n^2), \quad (4)$$

where m and n are INTEGERS. Fibonacci proved that all numbers h (the CONGRUA) are divisible by 24. FERMAT'S RIGHT TRIANGLE THEOREM is equivalent to the result that a congruum cannot be a SQUARE NUMBER. A table for small m and n is given in Ore (1988, p. 191), and a larger one (for $h \leq 1000$) by Lagrange (1977).

m	n	h	x
2	1	24	5
3	1	96	10
3	2	120	13
4	1	240	17
4	3	336	25

see also CONCORDANT FORM, CONGRUENT NUMBERS, SQUARE NUMBER

References

- Alter, R. and Curtz, T. B. "A Note on Congruent Numbers." *Math. Comput.* **28**, 303–305, 1974.
- Alter, R.; Curtz, T. B.; and Kubota, K. K. "Remarks and Results on Congruent Numbers." In *Proc. Third South-eastern Conference on Combinatorics, Graph Theory, and Computing, 1972, Boca Raton, FL*. Boca Raton, FL: Florida Atlantic University, pp. 27–35, 1972.
- Bastien, L. "Nombres congruents." *Interméd. des Math.* **22**, 231–232, 1915.
- Gérardin, A. "Nombres congruents." *Interméd. des Math.* **22**, 52–53, 1915.
- Lagrange, J. "Construction d'une table de nombres congruents." *Calculateurs en Math.*, *Bull. Soc. math. France.*, Mémoire 49–50, 125–130, 1977.
- Ore, Ø. *Number Theory and Its History*. New York: Dover, 1988.

Conic

see CONIC SECTION

Conic Constant

$$K \equiv -e^2,$$

where e is the ECCENTRICITY of a CONIC SECTION.

see also CONIC SECTION, ECCENTRICITY

Conic Double Point

see ISOLATED SINGULARITY

Conic Equidistant Projection

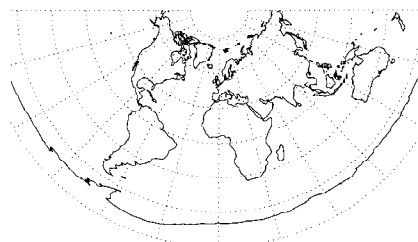

A MAP PROJECTION with transformation equations

$$x = \rho \sin \theta \quad (1)$$

$$y = \rho_0 - \rho \cos \theta, \quad (2)$$

where

$$\rho = (G - \phi) \quad (3)$$

$$\theta = n(\lambda - \lambda_0) \quad (4)$$

$$\rho_0 = (G - \theta_0) \quad (5)$$

$$G = \frac{\cos \phi_1}{n} + \phi_1 \quad (6)$$

$$n = \frac{\cos \phi_1 - \cos \phi_2}{\phi_2 - \phi_1}. \quad (7)$$

The inverse FORMULAS are given by

$$\phi = G - \rho \quad (8)$$

$$\lambda = \lambda_0 + \frac{\theta}{n}, \quad (9)$$

where

$$\rho = \operatorname{sgn}(n) \sqrt{x^2 + (\rho_0 - y)^2} \quad (10)$$

$$\theta = \tan^{-1} \left(\frac{x}{\rho_0 - y} \right). \quad (11)$$

Conic Projection

see ALBERS EQUAL-AREA CONIC PROJECTION, CONIC EQUIDISTANT PROJECTION, LAMBERT AZIMUTHAL EQUAL-AREA PROJECTION, POLYCONIC PROJECTION

Conic Section

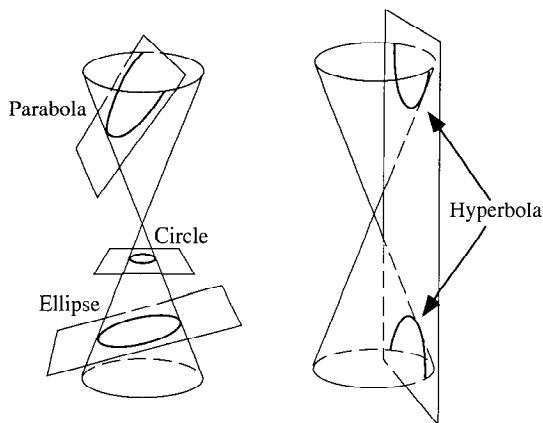

The conic sections are the nondegenerate curves generated by the intersections of a PLANE with one or two NAPPES of a CONE. For a PLANE parallel to a CROSS-SECTION, a CIRCLE is produced. The closed curve produced by the intersection of a single NAPPE with an inclined PLANE is an ELLIPSE or PARABOLA. The curve produced by a PLANE intersecting both NAPPES is a HYPERBOLA. The ELLIPSE and HYPERBOLA are known as CENTRAL CONICS.

Because of this simple geometric interpretation, the conic sections were studied by the Greeks long before their application to inverse square law orbits was known. Apollonius wrote the classic ancient work on the subject entitled *On Conics*. Kepler was the first to notice that planetary orbits were ELLIPSES, and Newton was then able to derive the shape of orbits mathematically using CALCULUS, under the assumption that gravitational force goes as the inverse square of distance. Depending on the energy of the orbiting body, orbit shapes which are any of the four types of conic sections are possible.

A conic section may more formally be defined as the locus of a point P that moves in the PLANE of a fixed point F called the FOCUS and a fixed line d called the

DIRECTRIX (with F not on d) such that the ratio of the distance of P from F to its distance from d is a constant e called the ECCENTRICITY. For a FOCUS $(0,0)$ and DIRECTRIX $x = -a$, the equation is

$$x^2 + y^2 = e^2(x + a)^2.$$

If $e = 1$, the conic is a PARABOLA, if $e < 1$, the conic is an ELLIPSE, and if $e > 1$, it is a HYPERBOLA.

In standard form, a conic section is written

$$y^2 = 2Rx - (1 - e^2)x^2,$$

where R is the RADIUS OF CURVATURE and e is the ECCENTRICITY. Five points in a plane determine a conic (Le Lionnais 1983, p. 56).

see also BRIANCHON'S THEOREM, CENTRAL CONIC, CIRCLE, CONE, ECCENTRICITY, ELLIPSE, FERMAT CONIC, HYPERBOLA, NAPPE, PARABOLA, PASCAL'S THEOREM, QUADRATIC CURVE, SEYDEWITZ'S THEOREM, SKEW CONIC, STEINER'S THEOREM

References

- Besant, W. H. *Conic Sections, Treated Geometrically*, 8th ed. rev. Cambridge, England: Deighton, Bell, 1890.
- Casey, J. "Special Relations of Conic Sections" and "Invariant Theory of Conics." Chs. 9 and 15 in *A Treatise on the Analytical Geometry of the Point, Line, Circle, and Conic Sections, Containing an Account of Its Most Recent Extensions, with Numerous Examples*, 2nd ed., rev. enl. Dublin: Hodges, Figgis, & Co., pp. 307-332 and 462-545, 1893.
- Coolidge, J. L. *A History of the Conic Sections and Quadric Surfaces*. New York: Dover, 1968.
- Coxeter, H. S. M. and Greitzer, S. L. *Geometry Revisited*. Washington, DC: Math. Assoc. Amer., pp. 138-141, 1967.
- Downs, J. W. *Conic Sections*. Dale Seymour Pub., 1993.
- Iyanaga, S. and Kawada, Y. (Eds.). "Conic Sections." §80 in *Encyclopedic Dictionary of Mathematics*. Cambridge, MA: MIT Press, pp. 271-276, 1980.
- Le Lionnais, F. *Les nombres remarquables*. Paris: Hermann, p. 56, 1983.
- Lee, X. "Conic Sections." http://www.best.com/~rah/SpecialPlaneCurves_dir/ConicSections_dir/conicSections.html.
- Ogilvy, C. S. "The Conic Sections." Ch. 6 in *Excursions in Geometry*. New York: Dover, pp. 73-85, 1990.
- Pappas, T. "Conic Sections." *The Joy of Mathematics*. San Carlos, CA: Wide World Publ./Tetra, pp. 196-197, 1989.
- Salmon, G. *Conic Sections*, 6th ed. New York: Chelsea, 1954.
- Smith, C. *Geometric Conics*. London: MacMillan, 1894.
- Sommerville, D. M. Y. *Analytical Conics*, 3rd ed. London: G. Bell and Sons, 1961.
- Yates, R. C. "Conics." *A Handbook on Curves and Their Properties*. Ann Arbor, MI: J. W. Edwards, pp. 36-56, 1952.

Conic Section Tangent

Given a CONIC SECTION

$$x^2 + y^2 + 2gx + 2fy + c = 0,$$

the tangent at (x_1, y_1) is given by the equation

$$xx_1 + yy_1 + g(x + x_1) + f(y + y_1) + c = 0.$$

Conical Coordinates

Arfken (1970) and Morse and Feshbach (1953) use slightly different definitions of these coordinates. The system used in *Mathematica*[®] (Wolfram Research, Inc., Champaign, Illinois) is

$$x = \frac{\lambda\mu\nu}{ab} \quad (1)$$

$$y = \frac{\lambda}{a} \sqrt{\frac{(\mu^2 - a^2)(\nu^2 - a^2)}{a^2 - b^2}} \quad (2)$$

$$z = \frac{\lambda}{b} \sqrt{\frac{(\mu^2 - b^2)(\nu^2 - b^2)}{b^2 - a^2}}, \quad (3)$$

where $b^2 > \mu^2 > c^2 > \nu^2$. The NOTATION of Byerly replaces λ with r , and a and b with b and c . The above equations give

$$x^2 + y^2 + z^2 = \lambda^2 \quad (4)$$

$$\frac{x^2}{\mu^2} + \frac{y^2}{\mu^2 - a^2} + \frac{z^2}{\mu^2 - b^2} = 0 \quad (5)$$

$$\frac{x^2}{\nu^2} + \frac{y^2}{\nu^2 - a^2} + \frac{z^2}{\nu^2 - b^2} = 0. \quad (6)$$

The SCALE FACTORS are

$$h_\lambda = 1 \quad (7)$$

$$h_\mu = \sqrt{\frac{\lambda^2(\mu^2 - \nu^2)}{(\mu^2 - a^2)(b^2 - \mu^2)}} \quad (8)$$

$$h_\nu = \sqrt{\frac{\lambda^2(\mu^2 - \nu^2)}{(\nu^2 - a^2)(\nu^2 - b^2)}}. \quad (9)$$

The LAPLACIAN is

$$\begin{aligned} \nabla^2 = & \frac{\nu(2\nu^2 - a^2 - b^2)}{(\mu - \nu)(\mu + \nu)\lambda^2} \frac{\partial}{\partial \nu} \\ & + \frac{(a - \nu)(a + \nu)(\nu - b)(\nu + b)}{(\nu - \mu)(\nu + \mu)\lambda^2} \frac{\partial^2}{\partial \nu^2} \\ & + \frac{\mu(2\mu^2 - a^2 - b^2)}{(\nu - \mu)(\nu + \mu)\lambda^2} \frac{\partial}{\partial \mu} \\ & + \frac{(\mu - b)(\mu + b)(\mu - a)(\mu + a)}{(\nu - \mu)(\nu + \mu)\lambda^2} \frac{\partial^2}{\partial \mu^2} \\ & + \frac{2}{\lambda} \frac{\partial}{\partial \lambda} + \frac{\partial^2}{\partial \lambda^2}. \end{aligned} \quad (10)$$

The HELMHOLTZ DIFFERENTIAL EQUATION is separable in conical coordinates.

see also HELMHOLTZ DIFFERENTIAL EQUATION—CONICAL COORDINATES

References

- Arfken, G. "Conical Coordinates (ξ_1, ξ_2, ξ_3).” §2.16 in *Mathematical Methods for Physicists*, 2nd ed. Orlando, FL: Academic Press, pp. 118–119, 1970.
- Byerly, W. E. *An Elementary Treatise on Fourier's Series, and Spherical, Cylindrical, and Ellipsoidal Harmonics, with Applications to Problems in Mathematical Physics*. New York: Dover, p. 263, 1959.
- Morse, P. M. and Feshbach, H. *Methods of Theoretical Physics, Part I*. New York: McGraw-Hill, p. 659, 1953.
- Spence, R. D. "Angular Momentum in Sphero-Conal Coordinates." *Amer. J. Phys.* **27**, 329–335, 1959.

Conical Frustum

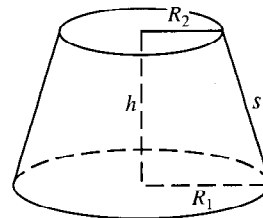

A conical frustum is a FRUSTUM created by slicing the top off a CONE (with the cut made parallel to the base). For a right circular CONE, let s be the slant height and R_1 and R_2 the top and bottom RADII. Then

$$s = \sqrt{(R_1 - R_2)^2 + h^2}. \quad (1)$$

The SURFACE AREA, not including the top and bottom CIRCLES, is

$$A = \pi(R_1 + R_2)s = \pi(R_1 + R_2)\sqrt{(R_1 - R_2)^2 + h^2}. \quad (2)$$

The VOLUME of the frustum is given by

$$V = \pi \int_0^h [r(z)]^2 dz. \quad (3)$$

But

$$r(z) = R_1 + (R_2 - R_1)\frac{z}{h}, \quad (4)$$

so

$$\begin{aligned} V &= \pi \int_0^h \left[R_1 + (R_2 - R_1)\frac{z}{h} \right]^2 dz \\ &= \frac{1}{3}\pi h(R_1^2 + R_1R_2 + R_2^2). \end{aligned} \quad (5)$$

This formula can be generalized to any PYRAMID by letting A_1 be the base AREAS of the top and bottom of the frustum. Then the VOLUME can be written as

$$V = \frac{1}{3}h(A_1 + A_2 + \sqrt{A_1A_2}). \quad (6)$$

The weighted mean of z over the frustum is

$$\langle z \rangle = \pi \int_0^h z[r(z)]^2 dz = \frac{1}{12}h^2(R_1^2 + 2R_1R_2 + 3R_2^2). \quad (7)$$

The CENTROID is then given by

$$\bar{z} = \frac{\langle z \rangle}{V} = \frac{h(R_1^2 + R_1R_2 + R_2^2)}{4(R_1^2 + 2R_1R_2 + 3R_2^2)} \quad (8)$$

(Beyer 1987, p. 133). The special case of the CONE is given by taking $R_2 = 0$, yielding $\bar{z} = h/4$.

see also CONE, FRUSTUM, PYRAMIDAL FRUSTUM, SPHERICAL SEGMENT

References

- Beyer, W. H. (Ed.) *CRC Standard Mathematical Tables*, 28th ed. Boca Raton, FL: CRC Press, pp. 129–130 and 133, 1987.

Conical Function

Functions which can be expressed in terms of LEGENDRE FUNCTIONS OF THE FIRST and SECOND KINDS. See Abramowitz and Stegun (1972, p. 337).

$$\begin{aligned}
 P_{-1/2+ip}^{\mu}(\cos \theta) &= 1 + \frac{4p^2 + 1^2}{2^2} \sin^2(\tfrac{1}{2}\theta) \\
 &\quad + \frac{(4p^2 + 1^2)(4p^2 + 3^2)}{2^2 4^2} \sin^4(\tfrac{1}{2}\theta) + \dots \\
 &= \frac{2}{\pi} \int_0^{\theta} \frac{\cosh(pt) dt}{\sqrt{2(\cos t - \cos \theta)}} \\
 Q_{-1/2 \mp ip}^{\mu}(\cos \theta) &= \pm i \sinh(p\pi) \int_0^{\infty} \frac{\cos(pt) dt}{\sqrt{2(\cosh t + \cos \theta)}} \\
 &\quad + \int_0^{\infty} \frac{\cosh(pt) dt}{\sqrt{2(\cos t - \cos \theta)}}.
 \end{aligned}$$

see also TOROIDAL FUNCTION

References

- Abramowitz, M. and Stegun, C. A. (Eds.). "Conical Functions." §8.12 in *Handbook of Mathematical Functions with Formulas, Graphs, and Mathematical Tables*, 9th printing. New York: Dover, p. 337, 1972.
- Iyanaga, S. and Kawada, Y. (Eds.). *Encyclopedic Dictionary of Mathematics*. Cambridge, MA: MIT Press, p. 1464, 1980.

Conical Spiral

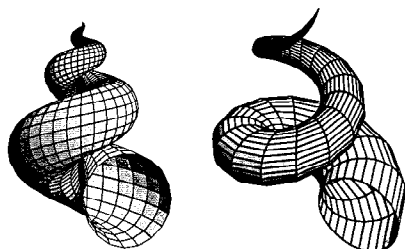

A surface modeled after the shape of a SEASHELL. One parameterization (left figure) is given by

$$x = 2[1 - e^{u/(6\pi)}] \cos u \cos^2(\tfrac{1}{2}v) \quad (1)$$

$$y = 2[-1 + e^{u/(6\pi)}] \cos^2(\tfrac{1}{2}v) \sin u \quad (2)$$

$$z = 1 - e^{u/(3\pi)} - \sin v + e^{u/(6\pi)} \sin v, \quad (3)$$

where $v \in [0, 2\pi)$, and $u \in [0, 6\pi)$ (Wolfram). Nordstrand gives the parameterization

$$x = \left[\left(1 - \frac{v}{2\pi} \right) (1 + \cos u) + c \right] \cos(nv) \quad (4)$$

$$y = \left[\left(1 - \frac{v}{2\pi} \right) (1 + \cos u) + c \right] \sin(nv) \quad (5)$$

$$z = \frac{bv}{2\pi} + a \sin u \left(1 - \frac{v}{2\pi} \right) \quad (6)$$

for $u, v \in [0, 2\pi]$ (right figure with $a = 0.2$, $b = 1$, $c = 0.1$, and $n = 2$).

References

- Gray, A. "Sea Shells." §11.6 in *Modern Differential Geometry of Curves and Surfaces*. Boca Raton, FL: CRC Press, pp. 223–223, 1993.
- Nordstrand, T. "Conic Spiral or Seashell." <http://www.uib.no/people/nfytn/shelltxt.htm>.
- Wolfram Research "Mathematica Version 2.0 Graphics Gallery." <http://www.mathsource.com/cgi-bin/MathSource/Applications/Graphics/3D/0207-155>.

Conical Wedge

The SURFACE also called the CONOCUNEUS OF WALLIS and given by the parametric equation

$$\begin{aligned}
 x &= u \cos v \\
 y &= u \sin v \\
 z &= c(1 - 2 \cos^2 v).
 \end{aligned}$$

see also CYLINDRICAL WEDGE, WEDGE

References

- von Seggern, D. *CRC Standard Curves and Surfaces*. Boca Raton, FL: CRC Press, p. 302, 1993.

Conjecture

A proposition which is consistent with known data, but has neither been verified nor shown to be false. It is synonymous with HYPOTHESIS.

see also ABC CONJECTURE, ABHYANKAR'S CONJECTURE, ABLOWITZ-RAMANI-SEGUR CONJECTURE, ANDRICA'S CONJECTURE, ANNULUS CONJECTURE, ARGONH'S CONJECTURE, ARTIN'S CONJECTURE, AXIOM, BACHET'S CONJECTURE, BENNEQUIN'S CONJECTURE, BIEBERBACH CONJECTURE, BIRCH CONJECTURE, BLASCHKE CONJECTURE, BORSUK'S CONJECTURE, BORWEIN CONJECTURES, BRAUN'S CONJECTURE, BROCARD'S CONJECTURE, BURNSIDE'S CONJECTURE, CARMICHAEL'S CONJECTURE, CATALAN'S CONJECTURE, CRAMÉR CONJECTURE, DE POLIGNAC'S CONJECTURE, DIESIS, DODECAHEDRAL CONJECTURE, DOUBLE BUBBLE CONJECTURE, EBERHART'S CONJECTURE, EULER'S CONJECTURE, EULER POWER CONJECTURE, EULER QUARTIC CONJECTURE, FEIT-THOMPSON CONJECTURE, FERMAT'S CONJECTURE, FLYPING CONJECTURE, GILBREATH'S CONJECTURE, GIUGA'S CONJECTURE, GOLDBACH CONJECTURE, GRIMM'S CONJECTURE, GUY'S CONJECTURE, HARDY-LITTLEWOOD CONJECTURES, HASSE'S CONJECTURE, HEAWOOD CONJECTURE, HYPOTHESIS, JACOBIAN CONJECTURE, KAPLAN-YORKE CONJECTURE, KELLER'S CONJECTURE, KELVIN'S CONJECTURE, KEPLER CONJECTURE, KREISEL CONJECTURE, KUMMER'S CONJECTURE, LEMMA, LOCAL DENSITY CONJECTURE, MERTENS CONJECTURE, MILIN CONJECTURE, MILNOR'S CONJECTURE, MORDELL CONJECTURE, NETTO'S CONJECTURE, NIRENBERG'S CONJECTURE, ORE'S CONJECTURE, PADÉ CONJECTURE,

PALINDROMIC NUMBER CONJECTURE, PILLAI'S CONJECTURE, POINCARÉ CONJECTURE, PÓLYA CONJECTURE, PORISM, PRIME k -TUPLES CONJECTURE, PRIME PATTERNS CONJECTURE, PRIME POWER CONJECTURE, PROOF, QUILLEN-LICHTENBAUM CONJECTURE, RAMANUJAN-PETERSSON CONJECTURE, ROBERTSON CONJECTURE, SAFAREVICH CONJECTURE, SAUSAGE CONJECTURE, SCHANUEL'S CONJECTURE, SCHISMA, SCHOLZ CONJECTURE, SEIFERT CONJECTURE, SELFRIDGE'S CONJECTURE, SHANKS' CONJECTURE, SMITH CONJECTURE, SWINNERTON-DYER CONJECTURE, SZPIRO'S CONJECTURE, TAIT'S HAMILTONIAN GRAPH CONJECTURE, TAIT'S KNOT CONJECTURES, TANIYAMA-SHIMURA CONJECTURE, TAU CONJECTURE, THEOREM, THURSTON'S GEOMETRIZATION CONJECTURE, THWAITES CONJECTURE, VOTTA'S CONJECTURE, WANG'S CONJECTURE, WARING'S PRIME CONJECTURE, WARING'S SUM CONJECTURE, ZARANKIEWICZ'S CONJECTURE

References

Rivera, C. "Problems & Puzzles (Conjectures)." <http://www.sci.net.mx/~crivera/ppp/conjectures.htm>.

Conjugacy Class

A complete set of mutually conjugate GROUP elements. Each element in a GROUP belongs to exactly one class, and the identity ($I = 1$) element is always in its own class. The ORDERS of all classes must be integral FACTORS of the ORDER of the GROUP. From the last two statements, a GROUP of PRIME order has one class for each element. More generally, in an ABELIAN GROUP, each element is in a conjugacy class by itself. Two operations belong to the same class when one may be replaced by the other in a new COORDINATE SYSTEM which is accessible by a symmetry operation (Cotton 1990, p. 52). These sets correspond directly to the sets of equivalent operation.

Let G be a FINITE GROUP of ORDER $|G|$. If $|G|$ is ODD, then

$$|G| \equiv s \pmod{16}$$

(Burnside 1955, p. 295). Furthermore, if every PRIME p_i DIVIDING $|G|$ satisfies $p_i \equiv 1 \pmod{4}$, then

$$|G| \equiv s \pmod{32}$$

(Burnside 1955, p. 320). Poonen (1995) showed that if every PRIME p_i DIVIDING $|G|$ satisfies $p_i \equiv 1 \pmod{m}$ for $m \geq 2$, then

$$|G| \equiv s \pmod{2m^2}.$$

References

Burnside, W. *Theory of Groups of Finite Order*, 2nd ed. New York: Dover, 1955.
Cotton, F. A. *Chemical Applications of Group Theory*, 3rd ed. New York: Wiley, 1990.
Poonen, B. "Congruences Relating the Order of a Group to the Number of Conjugacy Classes." *Amer. Math. Monthly* 102, 440–442, 1995.

Conjugate Element

Given a GROUP with elements A and X , there must be an element B which is a SIMILARITY TRANSFORMATION of A , $B = X^{-1}AX$ so A and B are conjugate with respect to X . Conjugate elements have the following properties:

1. Every element is conjugate with itself.
2. If A is conjugate with B with respect to X , then B is conjugate to A with respect to X .
3. If A is conjugate with B and C , then B and C are conjugate with each other.

see also CONJUGACY CLASS, CONJUGATE SUBGROUP

Conjugate Gradient Method

An ALGORITHM for calculating the GRADIENT $\nabla f(\mathbf{P})$ of a function at an n -D point \mathbf{P} . It is more robust than the simpler STEEPEST DESCENT METHOD.

References

Press, W. H.; Flannery, B. P.; Teukolsky, S. A.; and Vetterling, W. T. *Numerical Recipes in FORTRAN: The Art of Scientific Computing*, 2nd ed. Cambridge, England: Cambridge University Press, pp. 413–417, 1992.

Conjugate Points

see HARMONIC CONJUGATE POINTS, ISOGONAL CONJUGATE, ISOTOMIC CONJUGATE POINT

Conjugate Subgroup

A SUBGROUP H of an original GROUP G has elements h_i . Let x be a fixed element of the original GROUP G which is not a member of H . Then the transformation xh_ix^{-1} , ($i = 1, 2, \dots$) generates a conjugate SUBGROUP xHx^{-1} . If, for all x , $xHx^{-1} = H$, then H is a SELF-CONJUGATE (also called INVARIANT or NORMAL) SUBGROUP. All SUBGROUPS of an ABELIAN GROUP are invariant.

Conjugation

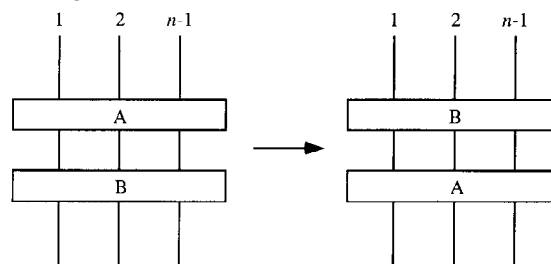

A type I MARKOV MOVE.

see also MARKOV MOVES, STABILIZATION

Conjunction

A product of ANDs, denoted

$$\bigwedge_{k=1}^n A_k.$$

see also AND, DISJUNCTION

Connected Graph

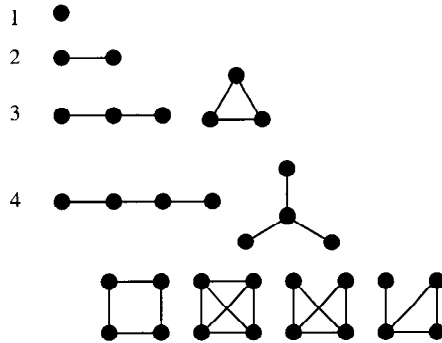

A GRAPH which is connected (as a TOPOLOGICAL SPACE), i.e., there is a path from any point to any other point in the GRAPH. The number of n -VERTEX (unlabeled) connected graphs for $n = 1, 2, \dots$ are 1, 1, 2, 6, 21, 112, 853, 11117, ... (Sloane's A001349).

References

- Chartrand, G. "Connected Graphs." §2.3 in *Introductory Graph Theory*. New York: Dover, pp. 41–45, 1985.
 Sloane, N. J. A. Sequence A001349/M1657 in "An On-Line Version of the Encyclopedia of Integer Sequences."

Connected Set

A connected set is a SET which cannot be partitioned into two nonempty SUBSETS which are open in the relative topology induced on the SET. Equivalently, it is a SET which cannot be partitioned into two nonempty SUBSETS such that each SUBSET has no points in common with the closure of the other.

The REAL NUMBERS are a connected set.

see also CLOSED SET, EMPTY SET, OPEN SET, SET, SUBSET

Connected Space

A SPACE D is connected if any two points in D can be connected by a curve lying wholly within D . A SPACE is 0-connected (a.k.a. PATHWISE-CONNECTED) if every MAP from a 0-SPHERE to the SPACE extends continuously to the 1-DISK. Since the 0-SPHERE is the two endpoints of an interval (1-DISK), every two points have a path between them. A space is 1-connected (a.k.a. SIMPLY CONNECTED) if it is 0-connected and if every MAP from the 1-SPHERE to it extends continuously to a MAP from the 2-DISK. In other words, every loop in the SPACE is contractible. A SPACE is n -MULTIPLY CONNECTED if it is $(n - 1)$ -connected and if every MAP from the n -SPHERE into it extends continuously over the $(n + 1)$ -DISK.

A theorem of Whitehead says that a SPACE is infinitely connected IFF it is contractible.

see also CONNECTIVITY, LOCALLY PATHWISE-CONNECTED SPACE, MULTIPLY CONNECTED, PATHWISE-CONNECTED, SIMPLY CONNECTED

Connected Sum

The connected sum $M_1 \# M_2$ of n -manifolds M_1 and M_2 is formed by deleting the interiors of n -BALLS B_i^n in M_i^n and attaching the resulting punctured MANIFOLDS $M_i - \dot{B}_i$ to each other by a HOMEOMORPHISM $h : \partial B_2 \rightarrow \partial B_1$, so

$$M_1 \# M_2 = (M_1 - \dot{B}_1) \bigcup_h (M_2 - \dot{B}_2).$$

B_i is required to be interior to M_i and ∂B_i bicollared in M_i to ensure that the connected sum is a MANIFOLD.

The connected sum of two KNOTS is called a KNOT SUM.
 see also KNOT SUM

References

- Rolfsen, D. *Knots and Links*. Wilmington, DE: Publish or Perish Press, p. 39, 1976.

Connected Sum Decomposition

Every COMPACT 3-MANIFOLD is the CONNECTED SUM of a unique collection of PRIME 3-MANIFOLDS.

see also JACO-SHALEN-JOHANNSSON TORUS DECOMPOSITION

Connection

see CONNECTION COEFFICIENT, GAUSS-MANIN CONNECTION

Connection Coefficient

A quantity also known as a CHRISTOFFEL SYMBOL OF THE SECOND KIND. Connection COEFFICIENTS are defined by

$$\Gamma_{\vec{e}_\beta \vec{e}_\gamma}^{\vec{e}_\alpha} \equiv \vec{e}^\alpha \cdot (\nabla_{\vec{e}_\gamma} \vec{e}_\beta) \quad (1)$$

(long form) or

$$\Gamma_{\beta\gamma}^\alpha \equiv \vec{e}^\alpha \cdot (\nabla_\gamma \vec{e}_\beta), \quad (2)$$

(abbreviated form), and satisfy

$$\nabla_{\vec{e}_\gamma} \vec{e}_\beta = \Gamma_{\vec{e}_\beta \vec{e}_\gamma}^{\vec{e}_\alpha} \vec{e}_\alpha \quad (3)$$

(long form) and

$$\nabla_\gamma \vec{e}_\beta = \Gamma_{\beta\gamma}^\alpha \vec{e}_\alpha \quad (4)$$

(abbreviated form).

Connection COEFFICIENTS are not TENSORS, but have TENSOR-like CONTRAVARIANT and COVARIANT indices. A fully COVARIANT connection COEFFICIENT is given by

$$\Gamma_{\alpha\beta\gamma} \equiv \frac{1}{2}(g_{\alpha\beta,\gamma} + g_{\alpha\gamma,\beta} + c_{\alpha\beta\gamma} + c_{\alpha\gamma\beta} - c_{\beta\gamma\alpha}), \quad (5)$$

where the g s are the METRIC TENSORS, the c s are COMMUTATION COEFFICIENTS, and the commas indicate the

COMMA DERIVATIVE. In an ORTHONORMAL BASIS, $g_{\alpha\beta,\gamma} = 0$ and $g_{\mu\gamma} = \delta_{\mu\gamma}$, so

$$\Gamma_{\alpha\beta\gamma} = \Gamma_{\alpha\beta}^{\mu} g_{\mu\gamma} = \Gamma_{\alpha\beta}^{\mu} = \frac{1}{2}(c_{\alpha\beta\gamma} + c_{\alpha\gamma\beta} - c_{\beta\gamma\alpha}) \quad (6)$$

and

$$\Gamma_{ijk} = 0 \quad \text{for } i \neq j \neq k \quad (7)$$

$$\Gamma_{iik} = -\frac{1}{2} \frac{\partial g_{ii}}{\partial x^k} \quad \text{for } i \neq k \quad (8)$$

$$\Gamma_{iji} = \Gamma_{jii} = \frac{1}{2} \frac{\partial g_{ii}}{\partial x^j} \quad (9)$$

$$\Gamma_{ij}^k = 0 \quad \text{for } i \neq j \neq k \quad (10)$$

$$\Gamma_{ii}^k = -\frac{1}{2g_{kk}} \frac{\partial g_{ii}}{\partial x^k} \quad \text{for } i \neq k \quad (11)$$

$$\Gamma_{ij}^i = \Gamma_{jii}^i = \frac{1}{2g_{ii}} \frac{\partial g_{ii}}{\partial x^j} = \frac{1}{2} \frac{\partial \ln g_{ii}}{\partial x^j}. \quad (12)$$

For TENSORS of RANK 3, the connection COEFFICIENTS may be concisely summarized in MATRIX form:

$$\Gamma^{\theta} \equiv \begin{bmatrix} \Gamma_{rr}^{\theta} & \Gamma_{r\theta}^{\theta} & \Gamma_{r\phi}^{\theta} \\ \Gamma_{\theta r}^{\theta} & \Gamma_{\theta\theta}^{\theta} & \Gamma_{\theta\phi}^{\theta} \\ \Gamma_{\phi r}^{\theta} & \Gamma_{\phi\theta}^{\theta} & \Gamma_{\phi\phi}^{\theta} \end{bmatrix}. \quad (13)$$

Connection COEFFICIENTS arise in the computation of GEODESICS. The GEODESIC EQUATION of free motion is

$$d\tau^2 = -\eta_{\alpha\beta} d\xi^{\alpha} d\xi^{\beta}, \quad (14)$$

or

$$\frac{d^2 \xi^{\alpha}}{d\tau^2} = 0. \quad (15)$$

Expanding,

$$\frac{d}{d\tau} \left(\frac{\partial \xi^{\alpha}}{\partial x^{\mu}} \frac{dx^{\mu}}{d\tau} \right) = \frac{\partial \xi^{\alpha}}{\partial x^{\mu}} \frac{d^2 x^{\mu}}{d\tau^2} + \frac{\partial^2 \xi^{\alpha}}{\partial x^{\mu} \partial x^{\nu}} \frac{dx^{\mu}}{d\tau} \frac{dx^{\nu}}{d\tau} = 0 \quad (16)$$

$$\frac{\partial \xi^{\alpha}}{\partial x^{\mu}} \frac{d^2 x^{\mu}}{d\tau^2} \frac{\partial x^{\lambda}}{\partial \xi^{\alpha}} + \frac{\partial^2 \xi^{\alpha}}{\partial x^{\mu} \partial x^{\nu}} \frac{dx^{\mu}}{d\tau} \frac{dx^{\nu}}{d\tau} \frac{\partial x^{\lambda}}{\partial \xi^{\alpha}} = 0. \quad (17)$$

But

$$\frac{\partial \xi^{\alpha}}{\partial x^{\nu}} \frac{\partial x^{\lambda}}{\partial \xi^{\alpha}} = \delta_{\nu}^{\lambda}, \quad (18)$$

so

$$\begin{aligned} \delta_{\mu}^{\lambda} \frac{d^2 x^{\mu}}{d\tau^2} + \left[\frac{\partial^2 \xi^{\alpha}}{\partial x^{\mu} \partial x^{\nu}} \frac{\partial x^{\lambda}}{\partial \xi^{\alpha}} \right] \frac{dx^{\mu}}{d\tau} \frac{dx^{\nu}}{d\tau} \\ = \frac{d^2 x^{\lambda}}{d\tau^2} + \Gamma_{\mu\nu}^{\lambda} \frac{dx^{\mu}}{d\tau} \frac{dx^{\nu}}{d\tau}, \end{aligned} \quad (19)$$

where

$$\Gamma_{\mu\nu}^{\lambda} \equiv \frac{\partial^2 \xi^{\alpha}}{\partial x^{\mu} \partial x^{\nu}} \frac{\partial x^{\lambda}}{\partial \xi^{\alpha}}. \quad (20)$$

see also CARTAN TORSION COEFFICIENT, CHRISTOFFEL SYMBOL OF THE FIRST KIND, CHRISTOFFEL SYMBOL OF THE SECOND KIND, COMMA DERIVATIVE, COMMUTATION COEFFICIENT, CURVILINEAR COORDINATES, SEMICOLON DERIVATIVE, TENSOR

Connectivity

see CONNECTED SPACE, EDGE CONNECTIVITY, VERTEX CONNECTIVITY

Connes Function

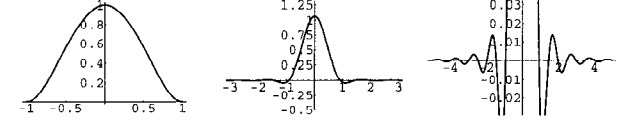

The APODIZATION FUNCTION

$$A(x) = \left(1 - \frac{x^2}{a^2}\right)^2.$$

Its FULL WIDTH AT HALF MAXIMUM is $\sqrt{4 - 2\sqrt{2}} a$, and its INSTRUMENT FUNCTION is

$$I(x) = 8a\sqrt{2\pi} \frac{J_{5/2}(2\pi ka)}{(2\pi ka)^{5/2}},$$

where $J_n(z)$ is a BESSEL FUNCTION OF THE FIRST KIND.

see also APODIZATION FUNCTION

Conocuneus of Wallis

see CONICAL WEDGE

Conoid

see PLÜCKER'S CONOID, RIGHT CONOID

Consecutive Number Sequences

Consecutive number sequences are sequences constructed by concatenating numbers of a given type. Many of these sequences were considered by Smarandache, so they are sometimes known as SMARANDACHE SEQUENCES.

The n th term of the consecutive integer sequence consists of the concatenation of the first n POSITIVE integers: 1, 12, 123, 1234, ... (Sloane's A007908; Smarandache 1993, Dumitrescu and Seleacu 1994, sequence 1; Mudge 1995; Stephen 1998). This sequence gives the digits of the CHAMPERNOWNE CONSTANT and contains no PRIMES in the first 4,470 terms (Weisstein). This is roughly consistent with simple arguments based on the distribution of prime which suggest that only a single prime is expected in the first 15,000 or so terms. The number of digits of the n term can be computed by noticing the pattern in the following table, where $d = \lfloor \log_{10} n \rfloor + 1$ is the number of digits in n .

d	n Range	Digits
1	1–9	n
2	10–99	$9 + 2(n - 9)$
3	100–999	$9 + 90 \cdot 2 + 3(n - 99)$
4	1000–9999	$9 + 90 \cdot 2 + 900 \cdot 3 + 4(n - 999)$

Therefore, the number of digits $D(n)$ in the n th term can be written

$$\begin{aligned} D(n) &= d(n+1 - 10^{d-1}) + \sum_{k=1}^{d-1} 9k \cdot 10^{k-1} \\ &= (n+1)d - \frac{10^d - 1}{9}, \end{aligned}$$

where the second term is the REPUNIT R_d .

The n th term of the reverse integer sequence consists of the concatenation of the first n POSITIVE integers written backwards: 1, 21, 321, 4321, ... (Sloane's A000422; Smarandache 1993, Dumitrescu and Seleacu 1994, Stephen 1998). The only PRIME in the first 3,576 terms (Weisstein) of this sequence is the 82nd term 828180...321 (Stephen 1998), which has 155 digits. This is roughly consistent with simple arguments based on the distribution of prime which suggest that a single prime is expected in the first 15,000 or so terms. The terms of the reverse integer sequence have the same number of digits as do the consecutive integer sequence.

The concatenation of the first n PRIMES gives 2, 23, 235, 2357, 235711, ... (Sloane's A019518; Smith 1996, Mudge 1997). This sequence converges to the digits of the COPELAND-ERDŐS CONSTANT and is PRIME for terms 1, 2, 4, 128, 174, 342, 435, 1429, ... (Sloane's A046035; Ibstedt 1998, pp. 78–79), with no others less than 2,305 (Weisstein).

The concatenation of the first n ODD NUMBERS gives 1, 13, 135, 1357, 13579, ... (Sloane's A019519; Smith 1996, Marimutha 1997, Mudge 1997). This sequence is PRIME for terms 2, 10, 16, 34, 49, 2570, ... (Sloane's A046036; Weisstein, Ibstedt 1998, pp. 75–76), with no others less than 2,650 (Weisstein). The 2570th term, given by 1 3 5 7...5137 5139, has 9725 digits and was discovered by Weisstein in Aug. 1998.

The concatenation of the first n EVEN NUMBERS gives 2, 24, 246, 2468, 246810, ... (Sloane's A019520; Smith 1996; Marimutha 1997; Mudge 1997; Ibstedt 1998, pp. 77–78).

The concatenation of the first n SQUARE NUMBERS gives 1, 14, 149, 14916, ... (Sloane's A019521; Marimutha 1997). The only PRIME in the first 2,090 terms is the third term, 149, (Weisstein).

The concatenation of the first n CUBIC NUMBERS gives 1, 18, 1827, 182764, ... (Sloane's A019522; Marimutha 1997). There are no PRIMES in the first 1,830 terms (Weisstein).

see also CHAMPERNOWNE CONSTANT, CONCATENATION, COPELAND-ERDŐS CONSTANT, CUBIC NUMBER, DEMLO NUMBER, EVEN NUMBER, ODD NUMBER, SMARANDACHE SEQUENCES, SQUARE NUMBER

References

- Dumitrescu, C. and Seleacu, V. (Ed.). *Some Notions and Questions in Number Theory*. Glendale, AZ: Erhus University Press, 1994.
- Ibstedt, H. "Smarandache Concatenated Sequences." Ch. 5 in *Computer Analysis of Number Sequences*. Lupton, AZ: American Research Press, pp. 75–79, 1998.
- Marimutha, H. "Smarandache Concatenate Type Sequences." *Bull. Pure Appl. Sci.* **16E**, 225–226, 1997.
- Mudge, M. "Top of the Class." *Personal Computer World*, 674–675, June 1995.
- Mudge, M. "Not Numerology but Numeralogy!" *Personal Computer World*, 279–280, 1997.
- Smarandache, F. *Only Problems, Not Solutions!*, 4th ed. Phoenix, AZ: Xiquan, 1993.
- Smith, S. "A Set of Conjectures on Smarandache Sequences." *Bull. Pure Appl. Sci.* **15E**, 101–107, 1996.
- Stephen, R. W. "Factors and Primes in Two Smarandache Sequences." *Smarandache Notions J.* **9**, 4–10, 1998. <http://www.tmt.de/~stephen/sm.ps.gz>.

Conservation of Number Principle

A generalization of Poncelet's PERMANENCE OF MATHEMATICAL RELATIONS PRINCIPLE made by H. Schubert in 1874–79. The conservation of number principle asserts that the number of solutions of any determinate algebraic problem in any number of parameters under variation of the parameters is invariant in such a manner that no solutions become INFINITE. Schubert called the application of this technique the CALCULUS of ENUMERATIVE GEOMETRY.

see also DUALITY PRINCIPLE, HILBERT'S PROBLEMS, PERMANENCE OF MATHEMATICAL RELATIONS PRINCIPLE

References

- Bell, E. T. *The Development of Mathematics*, 2nd ed. New York: McGraw-Hill, p. 340, 1945.

Conservative Field

The following conditions are equivalent for a conservative VECTOR FIELD:

1. For any oriented simple closed curve C , the LINE INTEGRAL $\oint_C \mathbf{F} \cdot d\mathbf{s} = 0$.
2. For any two oriented simple curves C_1 and C_2 with the same endpoints, $\int_{C_1} \mathbf{F} \cdot d\mathbf{s} = \int_{C_2} \mathbf{F} \cdot d\mathbf{s}$.
3. There exists a SCALAR POTENTIAL FUNCTION f such that $\mathbf{F} = \nabla f$, where ∇ is the GRADIENT.
4. The CURL $\nabla \times \mathbf{F} = \mathbf{0}$.

see also CURL, GRADIENT, LINE INTEGRAL, POTENTIAL FUNCTION, VECTOR FIELD

Consistency

The absence of contradiction (i.e., the ability to prove that a statement and its NEGATIVE are both true) in an AXIOMATIC THEORY is known as consistency.

see also COMPLETE AXIOMATIC THEORY, CONSISTENCY STRENGTH

Consistency Strength

If the CONSISTENCY of one of two propositions implies the CONSISTENCY of the other, the first is said to have greater consistency strength.

Constant

Any REAL NUMBER which is “significant” (or interesting) in some way. In this work, the term “constant” is generally reserved for REAL nonintegral numbers of interest, while “NUMBER” is reserved for interesting INTEGERS (e.g., BRUN’S CONSTANT, but BEAST NUMBER).

Certain constants are known to many DECIMAL DIGITS and recur throughout many diverse areas of mathematics, often in unexpected and surprising places (e.g., π , e , and to some extent, the EULER-MASCHERONI CONSTANT γ). Other constants are more specialized and may be known to only a few DIGITS. S. Plouffe maintains a site about the computation and identification of numerical constants. Plouffe’s site also contains a page giving the largest number of DIGITS computed for the most common constants. S. Finch maintains a delightful, more expository site containing detailed essays and references on constants both common and obscure.

see also ABUNDANT NUMBER, ALLADI-GRINSTEAD CONSTANT, APÉRY’S CONSTANT, ARCHIMEDES’ CONSTANT, ARTIN’S CONSTANT, BACKHOUSE’S CONSTANT, BERAHA CONSTANTS, BERNSTEIN’S CONSTANT, BLOCH CONSTANT, BRUN’S CONSTANT, CAMERON’S SUM-FREE SET CONSTANT, CARLSON-LEVIN CONSTANT, CATALAN’S CONSTANT, CHAITIN’S CONSTANT, CHAMPERNOWNE CONSTANT, CHEBYSHEV CONSTANTS, CHEBYSHEV-SYLVESTER CONSTANT, COMMA OF DIDYMUS, COMMA OF PYTHAGORAS, CONIC CONSTANT, CONSTANT FUNCTION, CONSTANT PROBLEM, CONTINUED FRACTION CONSTANT, CONWAY’S CONSTANT, COPELAND-ERDŐS CONSTANT, COPSON-DE BRUIJN CONSTANT, DE BRUIJN-NEWMAN CONSTANT, DELIAN CONSTANT, DIESIS, DU BOIS RAYMOND CONSTANTS, e , ELLISON-MENDÈS-FRANCE CONSTANT, ERDŐS RECIPROCAL SUM CONSTANTS, EULER-MASCHERONI CONSTANT, EXTREME VALUE DISTRIBUTION, FAVARD CONSTANTS, FELLER’S COIN-TOSSING CONSTANTS, FRANSÉN-ROBINSON CONSTANT, FREIMAN’S CONSTANT, GAUSS’S CIRCLE PROBLEM, GAUSS’S CONSTANT, GAUSS-KUZMIN-WIRSING CONSTANT, GELFOND-SCHNEIDER CONSTANT, GEOMETRIC PROBABILITY CONSTANTS, GIBBS CONSTANT, GLAISHER-KINKELIN CONSTANT, GOLDEN MEAN, GOLOMB CONSTANT, GOLOMB-DICKMAN CONSTANT, GOMPERTZ CONSTANT, GROSSMAN’S CONSTANT, GROTHENDIECK’S MAJORANT, HADAMARD-VALLÉE POUSSIN CONSTANTS, HAFNER-SARNAK-MCCURLEY CONSTANT, HALPHEN CONSTANT, HARD SQUARE ENTROPY CONSTANT, HARDY-LITTLEWOOD CONSTANTS, HERMITE CONSTANTS, HILBERT’S CONSTANTS, INFINITE PRODUCT, ITERATED EXPONENTIAL CONSTANTS,

KHINTCHINE’S CONSTANT, KHINTCHINE-LÉVY CONSTANT, KOEBE’S CONSTANT, KOLMOGOROV CONSTANT, LAL’S CONSTANT, LANDAU CONSTANT, LANDAU-KOLMOGOROV CONSTANTS, LANDAU-RAMANUJAN CONSTANT, LEBESGUE CONSTANTS (FOURIER SERIES), LEBESGUE CONSTANTS (LAGRANGE INTERPOLATION), LEGENDRE’S CONSTANT, LEHMER’S CONSTANT, LENGUEL’S CONSTANT, LÉVY CONSTANT, LINNIK’S CONSTANT, LIOUVILLE’S CONSTANT, LIOUVILLE-ROTH CONSTANT, LUDOLPH’S CONSTANT, MADELUNG CONSTANTS, MAGIC CONSTANT, MAGIC GEOMETRIC CONSTANTS, MASSER-GRAMAIN CONSTANT, MERTENS CONSTANT, MILLS’ CONSTANT, MOVING SOFA CONSTANT, NAPIER’S CONSTANT, NIELSEN-RAMANUJAN CONSTANTS, NIVEN’S CONSTANT, OMEGA CONSTANT, ONE-NINTH CONSTANT, OTTER’S TREE ENUMERATION CONSTANTS, PARITY CONSTANT, π , PISOT-VIJAYARAGHAVAN CONSTANTS, PLASTIC CONSTANT, PLOUFFE’S CONSTANT, POLYGON CIRCUMSCRIBING CONSTANT, POLYGON INSCRIBING CONSTANT, PORTER’S CONSTANT, PYTHAGORAS’S CONSTANT, QUADRATIC RECURRENCE, QUADTREE, RABBIT CONSTANT, RAMANUJAN CONSTANT, RANDOM WALK, RÉNYI’S PARKING CONSTANTS, ROBBIN CONSTANT, SALEM CONSTANTS, SELF-AVOIDING WALK, SHAH-WILSON CONSTANT, SHALLIT CONSTANT, SHAPIRO’S CYCLIC SUM CONSTANT, SIERPIŃSKI CONSTANT, SILVER CONSTANT, SILVERMAN CONSTANT, SMARANDACHE CONSTANTS, SOLDNER’S CONSTANT, SPHERE PACKING, STIELTJES CONSTANTS, STOLARSKY-HARBORTH CONSTANT, SYLVESTER’S SEQUENCE, THUE CONSTANT, THUE-MORSE CONSTANT, TOTIENT FUNCTION CONSTANTS, TRAVELING SALESMAN CONSTANTS, TREE SEARCHING, TWIN PRIMES CONSTANT, VARGA’S CONSTANT, W2-CONSTANT, WEIERSTRASS CONSTANT, WHITNEY-MIKHLIN EXTENSION CONSTANTS, WILBRAHAM-GIBBS CONSTANT, WIRTINGER-SOBOLEV ISOPERIMETRIC CONSTANTS

References

- Borwein, J. and Borwein, P. *A Dictionary of Real Numbers*. London: Chapman & Hall, 1990.
- Finch, S. “Favorite Mathematical Constants.” <http://www.mathsoft.com/asolve/constant/constant.html>.
- Le Lionnais, F. *Les nombres remarquables*. Paris: Hermann, 1983.
- Plouffe, S. “Inverse Symbolic Calculator Table of Constants.” <http://www.cecm.sfu.ca/projects/ISC/I.d.html>.
- Plouffe, S. “Plouffe’s Inverter.” <http://www.lacim.uqam.ca/pi/>.
- Plouffe, S. “Plouffe’s Inverter: Table of Current Records for the Computation of Constants.” <http://lacim.uqam.ca/pi/records.html>.
- Wells, D. W. *The Penguin Dictionary of Curious and Interesting Numbers*. Harmondsworth, England: Penguin Books, 1986.

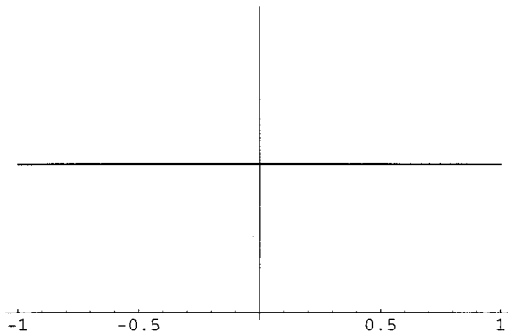
Constant Function

A FUNCTION $f(x) = c$ which does not change as its parameters vary. The GRAPH of a 1-D constant FUNCTION is a straight LINE. The DERIVATIVE of a constant FUNCTION c is

$$\frac{d}{dx} c = 0, \quad (1)$$

and the INTEGRAL is

$$\int c \, dx = cx. \quad (2)$$

The FOURIER TRANSFORM of the constant function $f(x) = 1$ is given by

$$\mathcal{F}[1] = \int_{-\infty}^{\infty} e^{-2\pi i k x} \, dx = \delta(k), \quad (3)$$

where $\delta(k)$ is the DELTA FUNCTION.

see also FOURIER TRANSFORM—1

References

Spanier, J. and Oldham, K. B. "The Constant Function c ." Ch. 1 in *An Atlas of Functions*. Washington, DC: Hemisphere, pp. 11–14, 1987.

Constant Precession Curve

see CURVE OF CONSTANT PRECESSION

Constant Problem

Given an expression involving known constants, integration in finite terms, computation of limits, etc., determine if the expression is equal to ZERO. The constant problem is a very difficult unsolved problem in TRANSCENDENTAL NUMBER theory. However, it is known that the problem is UNDECIDABLE if the expression involves oscillatory functions such as SINE. However, the FERGUSON-FORCADE ALGORITHM is a practical algorithm for determining if there exist integers a_i for given real numbers x_i such that

$$a_1 x_1 + a_2 x_2 + \dots + a_n x_n = 0,$$

or else establish bounds within which no relation can exist (Bailey 1988).

see also FERGUSON-FORCADE ALGORITHM, INTEGER RELATION, SCHANUEL'S CONJECTURE

References

Bailey, D. H. "Numerical Results on the Transcendence of Constants Involving π , e , and Euler's Constant." *Math. Comput.* **50**, 275–281, 1988.
Sackell, J. "Zero-Equivalence in Function Fields Defined by Algebraic Differential Equations." *Trans. Amer. Math. Soc.* **336**, 151–171, 1993.

Constant Width Curve

see CURVE OF CONSTANT WIDTH

Constructible Number

A number which can be represented by a FINITE number of ADDITIONS, SUBTRACTIONS, MULTIPLICATIONS, DIVISIONS, and FINITE SQUARE ROOT extractions of integers. Such numbers correspond to LINE SEGMENTS which can be constructed using only STRAIGHTEDGE and COMPASS.

All RATIONAL NUMBERS are constructible, and all constructible numbers are ALGEBRAIC NUMBERS (Courant and Robbins 1996, p. 133). If a CUBIC EQUATION with rational coefficients has no rational root, then none of its roots is constructible (Courant and Robbins, p. 136).

In particular, let F_0 be the FIELD of RATIONAL NUMBERS. Now construct an extension field F_1 of constructible numbers by the adjunction of $\sqrt{k_0}$, where k_0 is in F_0 , but $\sqrt{k_0}$ is not, consisting of all numbers of the form $a_0 + b_0 \sqrt{k_0}$, where $a_0, b_0 \in F_0$. Next, construct an extension field F_2 of F_1 by the adjunction of $\sqrt{k_1}$, defined as the numbers $a_1 + b_1 \sqrt{k_1}$, where $a_1, b_1 \in F_1$, and k_1 is a number in F_1 for which $\sqrt{k_1}$ does not lie in F_1 . Continue the process n times. Then constructible numbers are precisely those which can be reached by such a sequence of extension fields F_n , where n is a measure of the "complexity" of the construction (Courant and Robbins 1996).

see also ALGEBRAIC NUMBER, COMPASS, CONSTRUCTIBLE POLYGON, EUCLIDEAN NUMBER, RATIONAL NUMBER, STRAIGHTEDGE

References

Courant, R. and Robbins, H. "Constructible Numbers and Number Fields." §3.2 in *What is Mathematics?: An Elementary Approach to Ideas and Methods*, 2nd ed. Oxford, England: Oxford University Press, pp. 127–134, 1996.

Constructible Polygon

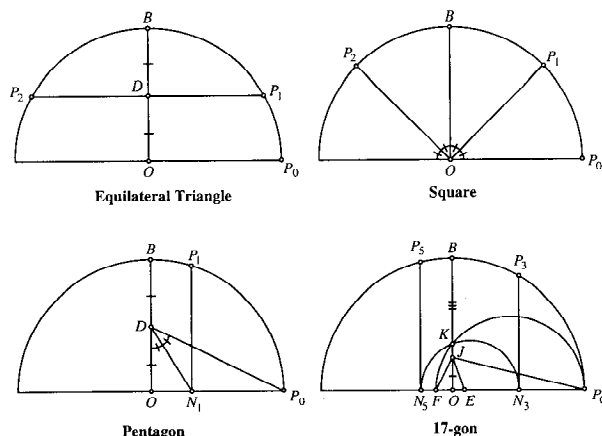

COMPASS and STRAIGHTEDGE constructions dating back to Euclid were capable of inscribing regular polygons of 3, 4, 5, 6, 8, 10, 12, 16, 20, 24, 32, 40, 48, 64, ..., sides. However, this listing is not a complete enumeration of "constructible" polygons. A regular n -gon ($n \geq 3$) can be constructed by STRAIGHTEDGE and COMPASS IFF

$$n = 2^k p_1 p_2 \cdots p_s,$$

where k is in INTEGER ≥ 0 and the p_i are distinct FERMAT PRIMES. FERMAT NUMBERS are of the form

$$F_m = 2^{2^m} + 1,$$

where m is an INTEGER ≥ 0 . The only known PRIMES of this form are 3, 5, 17, 257, and 65537. The fact that this condition was SUFFICIENT was first proved by Gauss in 1796 when he was 19 years old. That this condition was also NECESSARY was not explicitly proven by Gauss, and the first proof of this fact is credited to Wantzel (1836).

see also COMPASS, CONSTRUCTIBLE NUMBER, GEOMETRIC CONSTRUCTION, GEOMETROGRAPHY, HEP-TADECAGON, HEXAGON, OCTAGON, PENTAGON, POLY-GON, SQUARE, STRAIGHTEDGE, TRIANGLE

References

- Ball, W. W. R. and Coxeter, H. S. M. *Mathematical Recreations and Essays*, 13th ed. New York: Dover, pp. 94–96, 1987.
- Courant, R. and Robbins, H. *What is Mathematics?: An Elementary Approach to Ideas and Methods*, 2nd ed. Oxford, England: Oxford University Press, p. 119, 1996.
- De Temple, D. W. "Carlyle Circles and the Lemoine Simplicity of Polygonal Constructions." *Amer. Math. Monthly* **98**, 97–108, 1991.
- Dixon, R. "Compass Drawings." Ch. 1 in *Mathographics*. New York: Dover, pp. 1–78, 1991.
- Gauss, C. F. §365 and 366 in *Disquisitiones Arithmeticae*. Leipzig, Germany, 1801. Translated by A. A. Clarke. New Haven, CT: Yale University Press, 1965.
- Kazarinoff, N. D. "On Who First Proved the Impossibility of Constructing Certain Regular Polygons with Ruler and Compass Alone." *Amer. Math. Monthly* **75**, 647–648, 1968.
- Ogilvy, C. S. *Excursions in Geometry*. New York: Dover, pp. 137–138, 1990.

Wantzel, P. L. "Recherches sur les moyens de reconnaître si un Problème de Géométrie peut se résoudre avec la règle et le compas." *J. Math. pures appliq.* **1**, 366–372, 1836.

Construction

see GEOMETRIC CONSTRUCTION

Constructive Dilemma

A formal argument in LOGIC in which it is stated that (1) $P \Rightarrow Q$ and $R \Rightarrow S$ (where \Rightarrow means "IMPLIES"), and (2) either P or R is true, from which two statements it follows that either Q or S is true.

see also DESTRUCTIVE DILEMMA, DILEMMA

Contact Angle

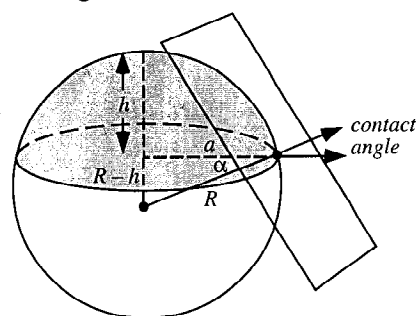

The ANGLE α between the normal vector of a SPHERE (or other geometric object) at a point where a PLANE is tangent to it and the normal vector of the plane. In the above figure,

$$\begin{aligned}\alpha &= \cos^{-1} \left(\frac{a}{R} \right) \\ &= \sin^{-1} \left(\frac{R-h}{R} \right).\end{aligned}$$

see also SPHERICAL CAP

Contact Number

see KISSING NUMBER

Contact Triangle

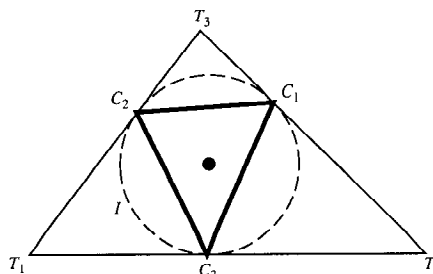

The TRIANGLE formed by the points of intersection of a TRIANGLE T 's INCIRCLE with T . This is the PEDAL TRIANGLE of T with the INCENTER as the PEDAL POINT (c.f., TANGENTIAL TRIANGLE). The contact triangle

and TANGENTIAL TRIANGLE are perspective from the GERGONNE POINT.

see also GERGONNE POINT, PEDAL TRIANGLE, TANGENTIAL TRIANGLE

References

Oldknow, A. "The Euler-Gergonne-Soddy Triangle of a Triangle." *Amer. Math. Monthly* **103**, 319–329, 1996.

Content

The generalized VOLUME for an n -D object (the "HYPERVOLUME").

see also VOLUME

Contiguous Function

A HYPERGEOMETRIC FUNCTION in which one parameter changes by $+1$ or -1 is said to be contiguous. There are 26 functions contiguous to ${}_2F_1(a, b, c; x)$ taking one pair at a time. There are 325 taking two or more pairs at a time. See Abramowitz and Stegun (1972, pp. 557–558).

see also HYPERGEOMETRIC FUNCTION

References

Abramowitz, M. and Stegun, C. A. (Eds.). *Handbook of Mathematical Functions with Formulas, Graphs, and Mathematical Tables*, 9th printing. New York: Dover, 1972.

Continued Fraction

A "general" continued fraction representation of a REAL NUMBER x is of the form

$$x = b_0 + \frac{a_1}{b_1 + \frac{a_2}{b_2 + \frac{a_3}{b_3 + \dots}}}, \quad (1)$$

which can be written

$$x = b_0 + \frac{a_1}{b_1 +} \frac{a_2}{b_2 +} \dots \quad (2)$$

The SIMPLE CONTINUED FRACTION representation of x (which is usually what is meant when the term "continued fraction" is used without qualification) of a number is given by

$$x = a_0 + \frac{1}{a_1 + \frac{1}{a_2 + \frac{1}{a_3 + \dots}}}, \quad (3)$$

which can be written in a compact abbreviated NOTATION as

$$x = [a_0, a_1, a_2, a_3, \dots]. \quad (4)$$

Here,

$$a_0 = [x] \quad (5)$$

is the integral part of σ (where $[x]$ is the FLOOR FUNCTION),

$$a_1 = \left\lfloor \frac{1}{x - a_0} \right\rfloor \quad (6)$$

is the integral part of the RECIPROCAL of $x - a_0$, a_2 is the integral part of the reciprocal of the remainder, etc. The quantities a_i are called PARTIAL QUOTIENTS. An archaic word for a continued fraction is ANTHYPHAIRETIC RATIO.

Continued fractions provide, in some sense, a series of "best" estimates for an IRRATIONAL NUMBER. Functions can also be written as continued fractions, providing a series of better and better rational approximations. Continued fractions have also proved useful in the proof of certain properties of numbers such as e and π (PI). Because irrationals which are square roots of RATIONAL NUMBERS have periodic continued fractions, an exact representation for a tabulated numerical value (i.e., 1.414... for PYTHAGORAS'S CONSTANT, $\sqrt{2}$) can sometimes be found.

Continued fractions are also useful for finding near commensurabilities between events with different periods. For example, the Metonic cycle used for calendrical purposes by the Greeks consists of 235 lunar months which very nearly equal 19 solar years, and $235/19$ is the sixth CONVERGENT of the ratio of the lunar phase (synodic) period and solar period ($365.2425/29.53059$). Continued fractions can also be used to calculate gear ratios, and were used for this purpose by the ancient Greeks (Guy 1990).

If only the first few terms of a continued fraction are kept, the result is called a CONVERGENT. Let P_n/Q_n be convergents of a nonsimple continued fraction. Then

$$P_{-1} \equiv 1 \quad Q_{-1} \equiv 0 \quad (7)$$

$$P_0 \equiv b_0 \quad Q_0 \equiv 1 \quad (8)$$

and subsequent terms are calculated from the RECURRENT RELATIONS

$$P_j = b_j P_{j-1} + a_j P_{j-2} \quad (9)$$

$$Q_j = b_j Q_{j-1} + a_j Q_{j-2} \quad (10)$$

for $j = 1, 2, \dots, n$. It is also true that

$$P_n Q_{n-1} - P_{n-1} Q_n = (-1)^{n-1} \prod_{k=1}^n a_k. \quad (11)$$

The error in approximating a number by a given CONVERGENT is roughly the MULTIPLICATIVE INVERSE of the square of the DENOMINATOR of the first neglected term.

A *finite simple* continued fraction representation terminates after a finite number of terms. To "round" a continued fraction, truncate the last term unless it is ± 1 ,

in which case it should be added to the previous term (Beeler *et al.* 1972, Item 101A). To take one over a continued fraction, add (or possibly delete) an initial 0 term. To negate, take the NEGATIVE of all terms, optionally using the identity

$$[-a, -b, -c, -d, \dots] = [-a - 1, 1, b - 1, c, d, \dots]. \quad (12)$$

A particularly beautiful identity involving the terms of the continued fraction is

$$\frac{[a_0, a_1, \dots, a_n]}{[a_0, a_1, \dots, a_{n-1}]} = \frac{[a_n, a_{n-1}, \dots, a_1, a_0]}{[a_n, a_{n-1}, \dots, a_1]}. \quad (13)$$

Finite simple fractions represent rational numbers and all rational numbers are represented by finite continued fractions. There are two possible representations for a finite simple fraction:

$$[a_1, \dots, a_n] = \begin{cases} [a_1, \dots, a_{n-1}, a_n - 1, 1] & \text{for } a_n > 1 \\ [a_1, \dots, a_{n-2}, a_{n-1} + 1] & \text{for } a_n = 1. \end{cases} \quad (14)$$

On the other hand, an infinite simple fraction represents a unique IRRATIONAL NUMBER, and each IRRATIONAL NUMBER has a unique infinite continued fraction.

Consider the CONVERGENTS p_n/q_n of a *simple* continued fraction, and define

$$p_{-1} \equiv 0 \quad q_{-1} \equiv 1 \quad (15)$$

$$p_0 \equiv 1 \quad q_0 \equiv 0 \quad (16)$$

$$p_1 \equiv a_1 \quad q_1 \equiv 1. \quad (17)$$

Then subsequent terms can be calculated from the RECURRENCE RELATIONS

$$p_i = a_i p_{i-1} + p_{i-2} \quad (18)$$

$$q_i = a_i q_{i-1} + q_{i-2}. \quad (19)$$

The CONTINUED FRACTION FUNDAMENTAL RECURRENCE RELATION for *simple* continued fractions is

$$p_n q_{n-1} - p_{n-1} q_n = (-1)^n. \quad (20)$$

It is also true that if $a_1 \neq 0$,

$$\frac{p_n}{p_{n-1}} = [a_n, a_{n-1}, \dots, a_1] \quad (21)$$

$$\frac{q_n}{q_{n-1}} = [a_n, \dots, a_2]. \quad (22)$$

Furthermore,

$$\frac{p_n}{q_n} = \frac{p_{n+1} - p_{n-1}}{q_{n+1} - q_{n-1}} \quad (23)$$

$$p_n = (n-1)p_{n-1} + (n-1)p_{n-2} + (n-2)p_{n-3} + \dots + 3p_2 + 2p_1 + p_1 + 1. \quad (24)$$

Also, if $p/q > 1$ and

$$\frac{p}{q} = [a_1, a_2, \dots, a_n], \quad (25)$$

then

$$\frac{q}{p} = [0, a_1, \dots, a_n]. \quad (26)$$

Similarly, if $p/q < 1$ so

$$\frac{p}{q} = [0, a_1, \dots, a_n], \quad (27)$$

then

$$\frac{q}{p} = [a_1, \dots, a_n]. \quad (28)$$

The convergents also satisfy

$$c_n - c_{n-1} = \frac{(-1)^n}{q_n q_{n-1}} \quad (29)$$

$$c_n - c_{n-2} = \frac{a_n (-1)^{n-1}}{q_n q_{n-2}}. \quad (30)$$

The ODD convergents c_{2n+1} of an infinite simple continued fraction form an INCREASING SEQUENCE, and the EVEN convergents c_{2n} form a DECREASING SEQUENCE (so any ODD convergent is less than any EVEN convergent). Summarizing,

$$c_1 < c_3 < c_5 < \dots < c_{2n+1} < \dots < c_{2n} < \dots < c_6 < c_4 < c_2. \quad (31)$$

Furthermore, each convergent for $n \geq 3$ lies between the two preceding ones. Each convergent is nearer to the value of the infinite continued fraction than the previous one. Let p_n/q_n be the n th continued fraction representation. Then

$$\frac{1}{(a_{n+1} + 2)q_n^2} < \left| \sigma - \frac{p_n}{q_n} \right| < \frac{1}{a_{n+1}q_n^2}. \quad (32)$$

The SQUARE ROOT of a SQUAREFREE INTEGER has a periodic continued fraction of the form

$$\sqrt{n} = [a_1, \overline{a_2, \dots, a_n, 2a_1}] \quad (33)$$

(Rose 1994, p. 130). Furthermore, if D is not a SQUARE NUMBER, then the terms of the continued fraction of \sqrt{D} satisfy

$$0 < a_n < 2\sqrt{D}. \quad (34)$$

In particular,

$$[\bar{a}] = \frac{a + \sqrt{a^2 + 4}}{2} \quad (35)$$

$$[1, \bar{a}] = \frac{-1 + \sqrt{1 + 4a}}{2} \quad (36)$$

$$[a, 2a] = \sqrt{a^2 + 1} \quad (37)$$

$$[\overline{ac}, \bar{a}] = \frac{b + \sqrt{b^2 + 4c}}{2} \quad (38)$$

$$\begin{aligned} & [a_1, \dots, a_n] \\ &= \frac{-(q_{n-1} - p_n) + \sqrt{(q_{n-1} - p_n)^2 + 4q_n p_{n-1}}}{2q_n} \end{aligned} \quad (39)$$

$$[a_1, \overline{b_1, \dots, b_n}] = a_1 + \frac{1}{[b_1, \dots, b_n]} \quad (40)$$

$$[\overline{b_1, \dots, b_n}] = \frac{[b_1, \dots, b_n]p_n + p_{n-1}}{[b_1, \dots, b_n]q_n + q_{n-1}}. \quad (41)$$

The first follows from

$$\begin{aligned} \alpha &= n + \frac{1}{n + \frac{1}{n + \frac{1}{n + \dots}}} \\ &= n + \frac{1}{n + \left(\frac{1}{n + \frac{1}{n + \dots}} \right)}. \end{aligned} \quad (42)$$

Therefore,

$$\alpha - n = \frac{1}{n + \frac{1}{n + \frac{1}{n + \dots}}}, \quad (43)$$

so plugging (43) into (42) gives

$$\alpha = n + \frac{1}{n + (\alpha - n)} = n + \frac{1}{\alpha}. \quad (44)$$

Expanding

$$\alpha^2 - n\alpha - 1 = 0, \quad (45)$$

and solving using the QUADRATIC FORMULA gives

$$\alpha = \frac{n + \sqrt{n^2 + 4}}{2}. \quad (46)$$

The analog of this treatment in the general case gives

$$\alpha = \frac{\alpha p_n + p_{n-1}}{\alpha q_n + q_{n-1}}. \quad (47)$$

The following table gives the repeating simple continued fractions for the square roots of the first few integers (excluding the trivial SQUARE NUMBERS).

N	$\alpha_{\sqrt{N}}$	N	$\alpha_{\sqrt{N}}$
2	$[1, \overline{2}]$	22	$[4, \overline{1, 2, 4, 2, 1, 8}]$
3	$[1, \overline{1, 2}]$	23	$[4, \overline{1, 3, 1, 8}]$
5	$[2, \overline{4}]$	24	$[4, \overline{1, 8}]$
6	$[2, \overline{2, 4}]$	26	$[5, \overline{10}]$
7	$[2, \overline{1, 1, 4}]$	27	$[5, \overline{5, 10}]$
8	$[2, \overline{1, 4}]$	28	$[5, \overline{3, 2, 3, 10}]$
10	$[3, \overline{6}]$	29	$[5, \overline{2, 1, 1, 2, 10}]$
11	$[3, \overline{3, 6}]$	30	$[5, \overline{2, 10}]$
12	$[3, \overline{2, 6}]$	31	$[5, \overline{1, 1, 3, 5, 3, 1, 1, 10}]$
13	$[3, \overline{1, 1, 1, 1, 6}]$	32	$[5, \overline{1, 1, 1, 10}]$
14	$[3, \overline{1, 2, 1, 6}]$	33	$[5, \overline{1, 2, 1, 10}]$
15	$[3, \overline{1, 6}]$	34	$[5, \overline{1, 4, 1, 10}]$
17	$[4, \overline{8}]$	35	$[5, \overline{1, 10}]$
18	$[4, \overline{4, 8}]$	37	$[6, \overline{12}]$
19	$[4, \overline{2, 1, 3, 1, 2, 8}]$	38	$[6, \overline{6, 12}]$
20	$[4, \overline{2, 8}]$	39	$[6, \overline{4, 12}]$
21	$[4, \overline{1, 1, 2, 1, 1, 8}]$	40	$[6, \overline{3, 12}]$

The periods of the continued fractions of the square roots of the first few nonsquare integers 2, 3, 5, 6, 7, 8, 10, 11, 12, 13, ... (Sloane's A000037) are 1, 2, 1, 2, 4, 2, 1, 2, 2, 5, ... (Sloane's A013943; Williams 1981, Jacobson *et al.* 1995). An upper bound for the length is roughly $\mathcal{O}(\ln D\sqrt{D})$.

An even stronger result is that a continued fraction is periodic IFF it is a ROOT of a quadratic POLYNOMIAL. Calling the portion of a number x remaining after a given convergent the "tail," it must be true that the relationship between the number x and terms in its tail is of the form

$$x = \frac{ax + b}{cd + d}, \quad (48)$$

which can only lead to a QUADRATIC EQUATION.

LOGARITHMS $\log_{b_0} b_1$ can be computed by defining b_2 , ... and the POSITIVE INTEGER n_1, \dots such that

$$b_1^{n_1} < b_0 < b_1^{n_1+1} \quad b_2 = \frac{b_0}{b_1^{n_1}} \quad (49)$$

$$b_2^{n_2} < b_1 < b_2^{n_2+1} \quad b_3 = \frac{b_1}{b_2^{n_2}} \quad (50)$$

and so on. Then

$$\log_{b_0} b_1 = [n_1, n_2, n_3, \dots]. \quad (51)$$

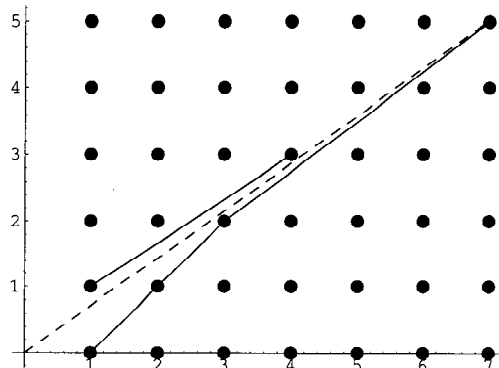

A geometric interpretation for a reduced FRACTION y/x consists of a string through a LATTICE of points with ends at $(1, 0)$ and (x, y) (Klein 1907, 1932; Steinhaus 1983; Ball and Coxeter 1987, pp. 86–87; Davenport 1992). This interpretation is closely related to a similar one for the GREATEST COMMON DIVISOR. The pegs it presses against (x_i, y_i) give alternate CONVERGENTS y_i/x_i , while the other CONVERGENTS are obtained from the pegs it presses against with the initial end at $(0, 1)$. The above plot is for $e - 2$, which has convergents 0, 1, 2/3, 3/4, 5/7, ...

Let the continued fraction for x be written $[a_1, a_2, \dots, a_n]$. Then the limiting value is *almost always* KHINTCHINE'S CONSTANT

$$K \equiv \lim_{n \rightarrow \infty} (a_1 a_2 \cdots a_n)^{1/n} = 2.68545 \dots \quad (52)$$

Continued fractions can be used to express the POSITIVE ROOTS of any POLYNOMIAL equation. Continued fractions can also be used to solve linear DIOPHANTINE EQUATIONS and the PELL EQUATION. Euler showed that if a CONVERGENT SERIES can be written in the form

$$c_1 + c_1 c_2 + c_1 c_2 c_3 + \dots, \quad (53)$$

then it is equal to the continued fraction

$$1 - \frac{c_1}{1 - \frac{c_2}{1 + c_2 - \frac{c_3}{1 + c_3 - \dots}}} \quad (54)$$

Gosper has invented an ALGORITHM for performing analytic ADDITION, SUBTRACTION, MULTIPLICATION, and DIVISION using continued fractions. It requires keeping track of eight INTEGERS which are conceptually arranged at the VERTICES of a CUBE. The ALGORITHM has not, however, appeared in print (Gosper 1996).

An algorithm for computing the continued fraction for $(ax + b)/(cx + d)$ from the continued fraction for x is given by Beeler *et al.* (1972, Item 101), Knuth (1981, Exercise 4.5.3.15, pp. 360 and 601), and Fowler (1991). (In line 9 of Knuth's solution, $X_k \leftarrow \lfloor A/C \rfloor$ should be replaced by $X_k \leftarrow \min(\lfloor A/C \rfloor, \lfloor (A+B)/(C+D) \rfloor)$.) Beeler *et al.* (1972) and Knuth (1981) also mention the bivariate case $(axy + bx + cy + d)/(Axy + Bx + Cy + D)$. *see also* GAUSSIAN BRACKETS, HURWITZ'S IRRATIONAL NUMBER THEOREM, KHINTCHINE'S CONSTANT, LAGRANGE'S CONTINUED FRACTION THEOREM, LAMÉ'S THEOREM, LÉVY CONSTANT, PADÉ APPROXIMANT, PARTIAL QUOTIENT, PI, QUADRATIC IRRATIONAL NUMBER, QUOTIENT-DIFFERENCE ALGORITHM, SEGRE'S THEOREM

References

- Abramowitz, M. and Stegun, C. A. (Eds.). *Handbook of Mathematical Functions with Formulas, Graphs, and*
Mathematical Tables, 9th printing. New York: Dover, p. 19, 1972.
- Acton, F. S. "Power Series, Continued Fractions, and Rational Approximations." Ch. 11 in *Numerical Methods That Work, 2nd printing.* Washington, DC: Math. Assoc. Amer., 1990.
- Ball, W. W. R. and Coxeter, H. S. M. *Mathematical Recreations and Essays, 13th ed.* New York: Dover, pp. 54–57 and 86–87, 1987.
- Beeler, M.; Gosper, R. W.; and Schroepel, R. *HAKMEM.* Cambridge, MA: MIT Artificial Intelligence Laboratory, Memo AIM-239, pp. 36–44, Feb. 1972.
- Beskin, N. M. *Fascinating Fractions.* Moscow: Mir Publishers, 1980.
- Brezinski, C. *History of Continued Fractions and Padé Approximants.* New York: Springer-Verlag, 1980.
- Conway, J. H. and Guy, R. K. "Continued Fractions." In *The Book of Numbers.* New York: Springer-Verlag, pp. 176–179, 1996.
- Courant, R. and Robbins, H. "Continued Fractions. Diophantine Equations." §2.4 in Supplement to Ch. 1 in *What is Mathematics?: An Elementary Approach to Ideas and Methods, 2nd ed.* Oxford, England: Oxford University Press, pp. 49–51, 1996.
- Davenport, H. §IV.12 in *The Higher Arithmetic: An Introduction to the Theory of Numbers, 6th ed.* New York: Cambridge University Press, 1992.
- Euler, L. *Introduction to Analysis of the Infinite, Book I.* New York: Springer-Verlag, 1980.
- Fowler, D. H. *The Mathematics of Plato's Academy.* Oxford, England: Oxford University Press, 1991.
- Guy, R. K. "Continued Fractions" §F20 in *Unsolved Problems in Number Theory, 2nd ed.* New York: Springer-Verlag, p. 259, 1994.
- Jacobson, M. J. Jr.; Lukes, R. F.; and Williams, H. C. "An Investigation of Bounds for the Regulator of Quadratic Fields." *Experiment. Math.* 4, 211–225, 1995.
- Khinchin, A. Ya. *Continued Fractions.* New York: Dover, 1997.
- Kimberling, C. "Continued Fractions." <http://www.evansville.edu/~ck6/integer/contfr.html>.
- Klein, F. *Ausgewählte Kapitel der Zahlentheorie.* Germany: Teubner, 1907.
- Klein, F. *Elementary Number Theory.* New York, p. 44, 1932.
- Kline, M. *Mathematical Thought from Ancient to Modern Times.* New York: Oxford University Press, 1972.
- Knuth, D. E. *The Art of Computer Programming, Vol. 2: Seminumerical Algorithms, 2nd ed.* Reading, MA: Addison-Wesley, p. 316, 1981.
- Moore, C. D. *An Introduction to Continued Fractions.* Washington, DC: National Council of Teachers of Mathematics, 1964.
- Olds, C. D. *Continued Fractions.* New York: Random House, 1963.
- Pettoufrezzo, A. J. and Bykrit, D. R. *Elements of Number Theory.* Englewood Cliffs, NJ: Prentice-Hall, 1970.
- Press, W. H.; Flannery, B. P.; Teukolsky, S. A.; and Vetterling, W. T. "Evaluation of Continued Fractions." §5.2 in *Numerical Recipes in FORTRAN: The Art of Scientific Computing, 2nd ed.* Cambridge, England: Cambridge University Press, pp. 163–167, 1992.
- Rose, H. E. *A Course in Number Theory, 2nd ed.* Oxford, England: Oxford University Press, 1994.
- Rosen, K. H. *Elementary Number Theory and Its Applications.* New York: Addison-Wesley, 1980.
- Sloane, N. J. A. Sequences A013943 and A000037/M0613 in "An On-Line Version of the Encyclopedia of Integer Sequences."
- Steinhaus, H. *Mathematical Snapshots, 3rd American ed.* New York: Oxford University Press, pp. 39–42, 1983.

- Van Tuyl, A. L. "Continued Fractions." <http://www.calvin.edu/academic/math/confrac/>.
- Wagon, S. "Continued Fractions." §8.5 in *Mathematica in Action*. New York: W. H. Freeman, pp. 263–271, 1991.
- Wall, H. S. *Analytic Theory of Continued Fractions*. New York: Chelsea, 1948.
- Williams, H. C. "A Numerical Investigation into the Length of the Period of the Continued Fraction Expansion of \sqrt{D} ." *Math. Comp.* **36**, 593–601, 1981.

Continued Fraction Constant

A continued fraction with partial quotients which increase in ARITHMETIC PROGRESSION is

$$[A + D, A + 2D, A + 3D, \dots] = \frac{I_{A/D} \left(\frac{2}{D} \right)}{I_{1+A/D} \left(\frac{2}{D} \right)},$$

where $I_n(x)$ is a MODIFIED BESSEL FUNCTION OF THE FIRST KIND (Beeler *et al.* 1972, Item 99). A special case is

$$C = 0 + \frac{1}{1 + \frac{1}{2 + \frac{1}{3 + \frac{1}{4 + \frac{1}{5 + \dots}}}}},$$

which has the value

$$C = \frac{I_1(2)}{I_0(2)} = 0.697774658 \dots$$

(Lehmer 1973, Rabinowitz 1990).

see also *e*, GOLDEN MEAN, MODIFIED BESSEL FUNCTION OF THE FIRST KIND, PI, RABBIT CONSTANT, THUE-MORSE CONSTANT

References

- Beeler, M.; Gosper, R. W.; and Schroepel, R. *HAKMEM*. Cambridge, MA: MIT Artificial Intelligence Laboratory, Memo AIM-239, Feb. 1972.
- Finch, S. "Favorite Mathematical Constants." <http://www.mathsoft.com/asolve/constant/cntfrc/cntfrc.html>.
- Guy, R. K. "Review: The Mathematics of Plato's Academy." *Amer. Math. Monthly* **97**, 440–443, 1990.
- Lehmer, D. H. "Continued Fractions Containing Arithmetic Progressions." *Scripta Math.* **29**, 17–24, 1973.
- Rabinowitz, S. Problem E3264. "Asymptotic Estimates from Convergents of a Continued Fraction." *Amer. Math. Monthly* **97**, 157–159, 1990.

Continued Fraction Factorization Algorithm

A PRIME FACTORIZATION ALGORITHM which uses RESIDUES produced in the CONTINUED FRACTION of \sqrt{mN} for some suitably chosen m to obtain a SQUARE NUMBER. The ALGORITHM solves

$$x^2 \equiv y^2 \pmod{n}$$

by finding an m for which $m^2 \pmod{n}$ has the smallest upper bound. The method requires (by conjecture) about $\exp(\sqrt{2 \log n \log \log n})$ steps, and was the fastest PRIME FACTORIZATION ALGORITHM in use before the

QUADRATIC SIEVE FACTORIZATION METHOD, which eliminates the 2 under the SQUARE ROOT (Pomerance 1996), was developed.

see also EXPONENT VECTOR, PRIME FACTORIZATION ALGORITHMS

References

- Morrison, M. A. and Brillhart, J. "A Method of Factoring and the Factorization of F_7 ." *Math. Comput.* **29**, 183–205, 1975.
- Pomerance, C. "A Tale of Two Sieves." *Not. Amer. Math. Soc.* **43**, 1473–1485, 1996.

Continued Fraction Fundamental

Recurrence Relation

For a SIMPLE CONTINUED FRACTION $\sigma = [a_0, a_1, \dots]$ with CONVERGENTS p_n/q_n , the fundamental RECURRENCE RELATION is given by

$$p_n q_{n-1} - p_{n-1} q_n = (-1)^n.$$

References

- Olds, C. D. *Continued Fractions*. New York: Random House, p. 27, 1963.

Continued Fraction Map

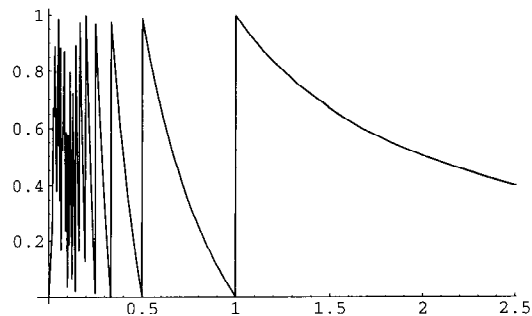

$$f(x) = \frac{1}{x} - \left\lfloor \frac{1}{x} \right\rfloor$$

for $x \in [0, 1]$, where $\lfloor x \rfloor$ is the FLOOR FUNCTION. The INVARIANT DENSITY of the map is

$$\rho(y) = \frac{1}{(1+y) \ln 2}.$$

References

- Beck, C. and Schlögl, F. *Thermodynamics of Chaotic Systems*. Cambridge, England: Cambridge University Press, pp. 194–195, 1995.

Continued Fraction Unit Fraction Algorithm

An algorithm for computing a UNIT FRACTION, called the FAREY SEQUENCE method by Bleicher (1972).

References

- Bleicher, M. N. "A New Algorithm for the Expansion of Continued Fractions." *J. Number Th.* **4**, 342–382, 1972.

Continued Square Root

Expressions of the form

$$\lim_{k \rightarrow \infty} x_0 + \sqrt{x_1 + \sqrt{x_2 + \sqrt{\dots + x_k}}}.$$

Herschfeld (1935) proved that a continued square root of REAL NONNEGATIVE terms converges IFF $(x_n)^{2^{-n}}$ is bounded. He extended this result to arbitrary POWERS (which include continued square roots and CONTINUED FRACTIONS as well), which is known as HERSCHELD'S CONVERGENCE THEOREM.

see also CONTINUED FRACTION, HERSCHELD'S CONVERGENCE THEOREM, SQUARE ROOT

References

- Herschfeld, A. "On Infinite Radicals." *Amer. Math. Monthly* **42**, 419–429, 1935.
 Pólya, G. and Szegő, G. *Problems and Theorems in Analysis, Vol. 1*. New York: Springer-Verlag, 1997.
 Sizer, W. S. "Continued Roots." *Math. Mag.* **59**, 23–27, 1986.

Continued Vector Product

see VECTOR TRIPLE PRODUCT

Continuity

The property of being CONTINUOUS.

see also CONTINUITY AXIOMS, CONTINUITY CORRECTION, CONTINUITY PRINCIPLE, CONTINUOUS DISTRIBUTION, CONTINUOUS FUNCTION, CONTINUOUS SPACE, FUNDAMENTAL CONTINUITY THEOREM

Continuity Axioms

"The" continuity axiom is an additional AXIOM which must be added to those of Euclid's *Elements* in order to guarantee that two equal CIRCLES of RADIUS r intersect each other if the separation of their centers is less than $2r$ (Dunham 1990). The continuity *axioms* are the three of HILBERT'S AXIOMS which concern geometric equivalence.

ARCHIMEDES' LEMMA is sometimes also known as "the continuity axiom."

see also CONGRUENCE AXIOMS, HILBERT'S AXIOMS, INCIDENCE AXIOMS, ORDERING AXIOMS, PARALLEL POSTULATE

References

- Dunham, W. *Journey Through Genius: The Great Theorems of Mathematics*. New York: Wiley, p. 38, 1990.
 Hilbert, D. *The Foundations of Geometry*. Chicago, IL: Open Court, 1980.
 Iyanaga, S. and Kawada, Y. (Eds.). "Hilbert's System of Axioms." §163B in *Encyclopedic Dictionary of Mathematics*. Cambridge, MA: MIT Press, pp. 544–545, 1980.

Continuity Correction

A correction to a discrete BINOMIAL DISTRIBUTION to approximate a continuous distribution.

$$P(a \leq X \leq b)$$

$$\approx P\left(\frac{a - \frac{1}{2} - np}{\sqrt{np(1-p)}} \leq z \leq \frac{b - \frac{1}{2} - np}{\sqrt{np(1-p)}}\right),$$

where

$$z \equiv \frac{(x - \mu)}{\sigma}$$

is a continuous variate with a NORMAL DISTRIBUTION and X is a variate of a BINOMIAL DISTRIBUTION.

see also BINOMIAL DISTRIBUTION, NORMAL DISTRIBUTION

Continuity Principle

see PERMANENCE OF MATHEMATICAL RELATIONS PRINCIPLE

Continuous

A general mathematical property obeyed by mathematical objects in which all elements are within a NEIGHBORHOOD of nearby points.

see also ABSOLUTELY CONTINUOUS, CONTINUOUS DISTRIBUTION, CONTINUOUS FUNCTION, CONTINUOUS SPACE, JUMP

Continuous Distribution

A DISTRIBUTION for which the variables may take on a continuous range of values. Abramowitz and Stegun (1972, p. 930) give a table of the parameters of most common discrete distributions.

see also BETA DISTRIBUTION, BIVARIATE DISTRIBUTION, CAUCHY DISTRIBUTION, CHI DISTRIBUTION, CHI-SQUARED DISTRIBUTION, CORRELATION COEFFICIENT, DISCRETE DISTRIBUTION, DOUBLE EXPONENTIAL DISTRIBUTION, EQUALLY LIKELY OUTCOMES DISTRIBUTION, EXPONENTIAL DISTRIBUTION, EXTREME VALUE DISTRIBUTION, F -DISTRIBUTION, FERMI-DIRAC DISTRIBUTION, FISHER'S z -DISTRIBUTION, FISHER-TIPPETT DISTRIBUTION, GAMMA DISTRIBUTION, GAUSSIAN DISTRIBUTION, HALF-NORMAL DISTRIBUTION, LAPLACE DISTRIBUTION, LATTICE DISTRIBUTION, LÉVY DISTRIBUTION, LOGARITHMIC DISTRIBUTION, LOG-SERIES DISTRIBUTION, LOGISTIC DISTRIBUTION, LORENTZIAN DISTRIBUTION, MAXWELL DISTRIBUTION, NORMAL DISTRIBUTION, PARETO DISTRIBUTION, PASCAL DISTRIBUTION, PEARSON TYPE III DISTRIBUTION, POISSON DISTRIBUTION, PÓLYA DISTRIBUTION, RATIO DISTRIBUTION, RAYLEIGH DISTRIBUTION, RICE DISTRIBUTION, SNEDECOR'S F -DISTRIBUTION, STUDENT'S t -DISTRIBUTION, STUDENT'S z -DISTRIBUTION, UNIFORM DISTRIBUTION, WEIBULL DISTRIBUTION

References

Abramowitz, M. and Stegun, C. A. (Eds.). *Handbook of Mathematical Functions with Formulas, Graphs, and Mathematical Tables*, 9th printing. New York: Dover, pp. 927 and 930, 1972.

Continuous Function

A continuous function is a FUNCTION $f: X \rightarrow Y$ where the pre-image of every OPEN SET in Y is OPEN in X . A function $f(x)$ in a single variable x is said to be continuous at point x_0 if

1. $f(x_0)$ is defined, so x_0 is the DOMAIN of f .
2. $\lim_{x \rightarrow x_0} f(x)$ exists.
3. $\lim_{x \rightarrow x_0} f(x) = f(x_0)$,

where \lim denotes a LIMIT. If f is DIFFERENTIABLE at point x_0 , then it is also continuous at x_0 . If f and g are continuous at x_0 , then

1. $f + g$ is continuous at x_0 .
2. $f - g$ is continuous at x_0 .
3. $f \times g$ is continuous at x_0 .
4. $f \div g$ is continuous at x_0 if $g(x_0) \neq 0$ and is discontinuous at x_0 if $g(x_0) = 0$.
5. $f \circ g$ is continuous, where \circ denotes using g as the argument to f .

see also CRITICAL POINT, DIFFERENTIABLE, LIMIT, NEIGHBORHOOD, STATIONARY POINT

Continuous Space

A TOPOLOGICAL SPACE.

see also NET

Continuum

The nondenumerable set of REAL NUMBERS, denoted C . It satisfies

$$\aleph_0 + C = C \quad (1)$$

and

$$C^r = C, \quad (2)$$

where \aleph_0 is \aleph_0 (ALEPH-0). It is also true that

$$\aleph_0^{\aleph_0} = C. \quad (3)$$

However,

$$C^C = F \quad (4)$$

is a SET larger than the continuum. Paradoxically, there are exactly as many points C on a LINE (or LINE SEGMENT) as in a PLANE, a 3-D SPACE, or finite HYPER-SPACE, since all these SETS can be put into a ONE-TO-ONE correspondence with each other.

The CONTINUUM HYPOTHESIS, first proposed by Georg Cantor, holds that the CARDINAL NUMBER of the continuum is the same as that of \aleph_1 . The surprising truth is that this proposition is UNDECIDABLE, since neither it nor its converse contradicts the tenets of SET THEORY.

see also ALEPH-0 (\aleph_0), ALEPH-1 (\aleph_1), CONTINUUM HYPOTHESIS, DENUMERABLE SET

Continuum Hypothesis

The proposal originally made by Georg Cantor that there is no infinite SET with a CARDINAL NUMBER between that of the "small" infinite SET of INTEGERS \aleph_0 and the "large" infinite set of REAL NUMBERS C (the "CONTINUUM"). Symbolically, the continuum hypothesis is that $\aleph_1 = C$. Gödel showed that no contradiction would arise if the continuum hypothesis was added to conventional ZERMELO-FRAENKEL SET THEORY. However, using a technique called FORCING, Paul Cohen (1963, 1964) proved that no contradiction would arise if the *negation* of the continuum hypothesis was added to SET THEORY. Together, Gödel's and Cohen's results established that the validity of the continuum hypothesis depends on the version of SET THEORY being used, and is therefore UNDECIDABLE (assuming the ZERMELO-FRAENKEL AXIOMS together with the AXIOM OF CHOICE).

Conway and Guy (1996) give a generalized version of the Continuum Hypothesis which is also UNDECIDABLE: is $2^{\aleph_\alpha} = \aleph_{\alpha+1}$ for every α ?

see also ALEPH-0 (\aleph_0), ALEPH-1 (\aleph_1), AXIOM OF CHOICE, CARDINAL NUMBER, CONTINUUM, DENUMERABLE SET, FORCING, HILBERT'S PROBLEMS, LEBESGUE MEASURABILITY PROBLEM, UNDECIDABLE, ZERMELO-FRAENKEL AXIOMS, ZERMELO-FRAENKEL SET THEORY

References

Cohen, P. J. "The Independence of the Continuum Hypothesis." *Proc. Nat. Acad. Sci. U. S. A.* **50**, 1143-1148, 1963.
 Cohen, P. J. "The Independence of the Continuum Hypothesis. II." *Proc. Nat. Acad. Sci. U. S. A.* **51**, 105-110, 1964.
 Cohen, P. J. *Set Theory and the Continuum Hypothesis*. New York: W. A. Benjamin, 1966.
 Conway, J. H. and Guy, R. K. *The Book of Numbers*. New York: Springer-Verlag, p. 282, 1996.
 Gödel, K. *The Consistency of the Continuum-Hypothesis*. Princeton, NJ: Princeton University Press, 1940.
 McGough, N. "The Continuum Hypothesis." <http://www.jazzie.com/ii/math/ch> and <http://www.best.com/-ii/math/ch/>.

Contour

A path in the COMPLEX PLANE over which CONTOUR INTEGRATION is performed.

see also CONTOUR INTEGRATION

Contour Integral

see CONTOUR INTEGRATION

Contour Integration

Let $P(x)$ and $Q(x)$ be POLYNOMIALS of DEGREES n and m with COEFFICIENTS b_n, \dots, b_0 and c_m, \dots, c_0 . Take the contour in the upper half-plane, replace x by z , and write $z \equiv Re^{i\theta}$. Then

$$\int_{-\infty}^{\infty} \frac{P(z) dz}{Q(z)} = \lim_{R \rightarrow \infty} \int_{-R}^R \frac{P(z) dz}{Q(z)}. \quad (1)$$

Define a path γ_R which is straight along the REAL axis from $-R$ to R and makes a circular arc to connect the two ends in the upper half of the COMPLEX PLANE. The RESIDUE THEOREM then gives

$$\begin{aligned} \lim_{R \rightarrow \infty} \int_{\gamma_R} \frac{P(z) dz}{Q(z)} \\ = \lim_{R \rightarrow \infty} \int_{-R}^R \frac{P(z) dz}{Q(z)} + \lim_{R \rightarrow \infty} \int_0^\pi \frac{P(Re^{i\theta})}{Q(Re^{i\theta})} iRe^{i\theta} d\theta \\ = 2\pi i \sum_{\Im[z] > 0} \text{Res} \left[\frac{P(z)}{Q(z)} \right], \quad (2) \end{aligned}$$

where Res denotes the RESIDUES. Solving,

$$\begin{aligned} \lim_{R \rightarrow \infty} \int_{-R}^R \frac{P(z) dz}{Q(z)} \\ = 2\pi i \sum_{\Im[z] > 0} \text{Res} \frac{P(z)}{Q(z)} - \lim_{R \rightarrow \infty} \int_0^\pi \frac{P(Re^{i\theta})}{Q(Re^{i\theta})} iRe^{i\theta} d\theta. \quad (3) \end{aligned}$$

Define

$$\begin{aligned} I_r &\equiv \lim_{R \rightarrow \infty} \int_0^\pi \frac{P(Re^{i\theta})}{Q(Re^{i\theta})} iRe^{i\theta} d\theta \\ &= \lim_{R \rightarrow \infty} \int_0^\pi \frac{b_n(Re^{i\theta})^n + b_{n-1}(Re^{i\theta})^{n-1} + \dots + b_0}{c_m(Re^{i\theta})^m + c_{m-1}(Re^{i\theta})^{m-1} + \dots + c_0} iR d\theta \\ &= \lim_{R \rightarrow \infty} \int_0^\pi \frac{b_n}{c_m} (Re^{i\theta})^{n-m} iR d\theta \\ &= \lim_{R \rightarrow \infty} \int_0^\pi \frac{b_n}{c_m} R^{n+1-m} i(e^{i\theta})^{n-m} d\theta \quad (4) \end{aligned}$$

and set

$$\epsilon \equiv -(n+1-m), \quad (5)$$

then equation (4) becomes

$$I_r \equiv \lim_{R \rightarrow \infty} \frac{i}{R^\epsilon} \frac{b_n}{c_m} \int_0^\pi e^{i(n-m)\theta} d\theta. \quad (6)$$

Now,

$$\lim_{R \rightarrow \infty} R^{-\epsilon} = 0 \quad (7)$$

for $\epsilon > 0$. That means that for $-n-1+m \geq 1$, or $m \geq n+2$, $I_r = 0$, so

$$\int_{-\infty}^{\infty} \frac{P(z) dz}{Q(z)} = 2\pi i \sum_{\Im[z] > 0} \text{Res} \left[\frac{P(z)}{Q(z)} \right] \quad (8)$$

for $m \geq n+2$. Apply JORDAN'S LEMMA with $f(x) \equiv P(x)/Q(x)$. We must have

$$\lim_{x \rightarrow \infty} f(x) = 0, \quad (9)$$

so we require $m \geq n+1$. Then

$$\int_{-\infty}^{\infty} \frac{P(z)}{Q(z)} e^{iaz} dz = 2\pi i \sum_{\Im[z] > 0} \text{Res} \left[\frac{P(z)}{Q(z)} e^{iaz} \right] \quad (10)$$

for $m \geq n+1$.

Since this must hold separately for REAL and IMAGINARY PARTS, this result can be extended to

$$\int_{-\infty}^{\infty} \frac{P(x)}{Q(x)} \cos(ax) dx = 2\pi \Re \left\{ \sum_{\Im[z] > 0} \text{Res} \left[\frac{P(z)}{Q(z)} e^{iaz} \right] \right\} \quad (11)$$

$$\int_{-\infty}^{\infty} \frac{P(x)}{Q(x)} \sin(ax) dx = 2\pi \Im \left\{ \sum_{\Im[z] > 0} \text{Res} \left[\frac{P(z)}{Q(z)} e^{iaz} \right] \right\}. \quad (12)$$

It is also true that

$$\int_{-\infty}^{\infty} \frac{P(z)}{Q(z)} \ln(az) dz = 0. \quad (13)$$

see also CAUCHY INTEGRAL FORMULA, CAUCHY INTEGRAL THEOREM, INSIDE-OUTSIDE THEOREM, JORDAN'S LEMMA, RESIDUE (COMPLEX ANALYSIS), SINE INTEGRAL

References

Morse, P. M. and Feshbach, H. *Methods of Theoretical Physics, Part I*. New York: McGraw-Hill, pp. 353-356, 1953.

Contracted Cycloid

see CURTATE CYCLOID

Contraction

see DILATION

Contraction (Graph)

The merging of nodes in a GRAPH by eliminating segments between two nodes.

Contraction (Tensor)

The contraction of a TENSOR is obtained by setting unlike indices equal and summing according to the EINSTEIN SUMMATION convention. Contraction reduces the RANK of a TENSOR by 2. For a second RANK TENSOR,

$$\text{contr}(B_j^{i'}) \equiv B_i^{i'}$$

$$B_i^{i'} = \frac{\partial x_{i'}}{\partial x_k} \frac{\partial x_l}{\partial x_i} B_l^k = \frac{\partial x_l}{\partial x_k} B_l^k = \delta_k^l B_l^k = B_k^k.$$

Therefore, the contraction is invariant, and must be a SCALAR. In fact, this SCALAR is known as the TRACE of a MATRIX in MATRIX theory.

References

Arfken, G. "Contraction, Direct Product." §3.2 in *Mathematical Methods for Physicists*, 3rd ed. Orlando, FL: Academic Press, pp. 124-126, 1985.

Contradiction Law

No A is not- A .

see also NOT

Contravariant Tensor

A contravariant tensor is a TENSOR having specific transformation properties (c.f., a COVARIANT TENSOR). To examine the transformation properties of a contravariant tensor, first consider a TENSOR of RANK 1 (a VECTOR)

$$d\mathbf{r} = dx_1\hat{\mathbf{x}}_1 + dx_2\hat{\mathbf{x}}_2 + dx_3\hat{\mathbf{x}}_3, \quad (1)$$

for which

$$dx'_i = \frac{\partial x'_i}{\partial x_j} dx_j. \quad (2)$$

Now let $A_i \equiv dx_i$, then any set of quantities A_j which transform according to

$$A'_i = \frac{\partial x'_i}{\partial x_j} A_j, \quad (3)$$

or, defining

$$a_{ij} \equiv \frac{\partial x'_i}{\partial x_j}, \quad (4)$$

according to

$$A'_i = a_{ij} A_j \quad (5)$$

is a contravariant tensor. Contravariant tensors are indicated with raised indices, i.e., a^μ .

COVARIANT TENSORS are a type of TENSOR with differing transformation properties, denoted a_ν . However, in 3-D CARTESIAN COORDINATES,

$$\frac{\partial x_j}{\partial x'_i} = \frac{\partial x'_i}{\partial x_j} \equiv a_{ij} \quad (6)$$

for $i, j = 1, 2, 3$, meaning that contravariant and covariant tensors are equivalent. The two types of tensors do differ in higher dimensions, however. Contravariant FOUR-VECTORS satisfy

$$a^\mu = \Lambda^\mu_\nu a^\nu, \quad (7)$$

where Λ is a LORENTZ TENSOR.

To turn a COVARIANT TENSOR into a contravariant tensor, use the METRIC TENSOR $g^{\mu\nu}$ to write

$$a^\mu \equiv g^{\mu\nu} a_\nu. \quad (8)$$

Covariant and contravariant indices can be used simultaneously in a MIXED TENSOR.

see also COVARIANT TENSOR, FOUR-VECTOR, LORENTZ TENSOR, METRIC TENSOR, MIXED TENSOR, TENSOR

References

- Arfken, G. "Noncartesian Tensors, Covariant Differentiation." §3.8 in *Mathematical Methods for Physicists*, 3rd ed. Orlando, FL: Academic Press, pp. 158–164, 1985.
Morse, P. M. and Feshbach, H. *Methods of Theoretical Physics, Part I*. New York: McGraw-Hill, pp. 44–46, 1953.

Contravariant Vector

A CONTRAVARIANT TENSOR of RANK 1.

see also CONTRAVARIANT TENSOR, VECTOR

Control Theory

The mathematical study of how to manipulate the parameters affecting the behavior of a system to produce the desired or optimal outcome.

see also KALMAN FILTER, LINEAR ALGEBRA, PONTYRAGIN MAXIMUM PRINCIPLE

References

- Zabczyk, J. *Mathematical Control Theory: An Introduction*. Boston, MA: Birkhäuser, 1993.

Convective Acceleration

The acceleration of an element of fluid, given by the CONVECTIVE DERIVATIVE of the VELOCITY \mathbf{v} ,

$$\frac{D\mathbf{v}}{Dt} = \frac{\partial \mathbf{v}}{\partial t} + \mathbf{v} \cdot \nabla \mathbf{v},$$

where ∇ is the GRADIENT operator.

see also ACCELERATION, CONVECTIVE DERIVATIVE, CONVECTIVE OPERATOR

References

- Batchelor, G K. *An Introduction to Fluid Dynamics*. Cambridge, England: Cambridge University Press, p. 73, 1977.

Convective Derivative

A DERIVATIVE taken with respect to a moving coordinate system, also called a LAGRANGIAN DERIVATIVE. It is given by

$$\frac{D}{Dt} = \frac{\partial}{\partial t} + \mathbf{v} \cdot \nabla,$$

where ∇ is the GRADIENT operator and \mathbf{v} is the VELOCITY of the fluid. This type of derivative is especially useful in the study of fluid mechanics. When applied to \mathbf{v} ,

$$\frac{D\mathbf{v}}{Dt} = \frac{\partial \mathbf{v}}{\partial t} + (\nabla \times \mathbf{v}) \times \mathbf{v} + \nabla(\frac{1}{2}\mathbf{v}^2).$$

see also CONVECTIVE OPERATOR, DERIVATIVE, VELOCITY

References

- Batchelor, G K. *An Introduction to Fluid Dynamics*. Cambridge, England: Cambridge University Press, p. 73, 1977.

Convective Operator

Defined for a VECTOR FIELD \mathbf{A} by $(\mathbf{A} \cdot \nabla)$, where ∇ is the GRADIENT operator.

Applied in arbitrary orthogonal 3-D coordinates to a VECTOR FIELD \mathbf{B} , the convective operator becomes

$$[(\mathbf{A} \cdot \nabla)\mathbf{B}]_j = \sum_{k=1}^3 \left[\frac{A_k}{h_k} \frac{\partial B_j}{\partial q_k} + \frac{B_k}{h_k h_j} \left(A_j \frac{\partial h_j}{\partial q_k} - A_k \frac{\partial h_k}{\partial q_j} \right) \right], \quad (1)$$

where the h_i s are related to the METRIC TENSORS by $h_i = \sqrt{g_{ii}}$. In CARTESIAN COORDINATES,

$$\begin{aligned} (\mathbf{A} \cdot \nabla) \mathbf{B} = & \left(A_x \frac{\partial B_x}{\partial x} + A_y \frac{\partial B_x}{\partial y} + A_z \frac{\partial B_x}{\partial z} \right) \hat{\mathbf{x}} \\ & + \left(A_x \frac{\partial B_y}{\partial x} + A_y \frac{\partial B_y}{\partial y} + A_z \frac{\partial B_y}{\partial z} \right) \hat{\mathbf{y}} \\ & + \left(A_x \frac{\partial B_z}{\partial x} + A_y \frac{\partial B_z}{\partial y} + A_z \frac{\partial B_z}{\partial z} \right) \hat{\mathbf{z}}. \quad (2) \end{aligned}$$

In CYLINDRICAL COORDINATES,

$$\begin{aligned} (\mathbf{A} \cdot \nabla) \mathbf{B} = & \left(A_r \frac{\partial B_r}{\partial r} + \frac{A_\phi}{r} \frac{\partial B_r}{\partial \phi} + A_z \frac{\partial B_r}{\partial z} - \frac{A_\phi B_\phi}{r} \right) \hat{\mathbf{r}} \\ & + \left(A_r \frac{\partial B_\phi}{\partial r} + \frac{A_\phi}{r} \frac{\partial B_\phi}{\partial \phi} + A_z \frac{\partial B_\phi}{\partial z} + \frac{A_\phi B_r}{r} \right) \hat{\boldsymbol{\phi}} \\ & + \left(A_r \frac{\partial B_z}{\partial r} + \frac{A_\phi}{r} \frac{\partial B_z}{\partial \phi} + A_z \frac{\partial B_z}{\partial z} \right) \hat{\mathbf{z}}. \quad (3) \end{aligned}$$

In SPHERICAL COORDINATES,

$$\begin{aligned} (\mathbf{A} \cdot \nabla) \mathbf{B} = & \left(A_r \frac{\partial B_r}{\partial r} + \frac{A_\theta}{r} \frac{\partial B_r}{\partial \theta} + \frac{A_\phi}{r \sin \theta} \frac{\partial B_r}{\partial \phi} - \frac{A_\theta B_\theta + A_\phi B_\phi}{r} \right) \hat{\mathbf{r}} \\ & + \left(A_r \frac{\partial B_\theta}{\partial r} + \frac{A_\theta}{r} \frac{\partial B_\theta}{\partial \theta} + \frac{A_\phi}{r \sin \theta} \frac{\partial B_\theta}{\partial \phi} + \frac{A_\theta B_r}{r} - \frac{A_\phi B_\phi \cot \theta}{r} \right) \hat{\boldsymbol{\theta}} \\ & + \left(A_r \frac{\partial B_\phi}{\partial r} + \frac{A_\theta}{r} \frac{\partial B_\phi}{\partial \theta} + \frac{A_\phi}{r \sin \theta} \frac{\partial B_\phi}{\partial \phi} + \frac{A_\phi B_r}{r} + \frac{A_\theta B_\theta \cot \theta}{r} \right) \hat{\boldsymbol{\phi}}. \quad (4) \end{aligned}$$

see also CONVECTIVE ACCELERATION, CONVECTIVE DERIVATIVE, CURVILINEAR COORDINATES, GRADIENT

Convergence Acceleration

see CONVERGENCE IMPROVEMENT

Convergence Improvement

The improvement of the convergence properties of a SERIES, also called CONVERGENCE ACCELERATION, such that a SERIES reaches its limit to within some accuracy with fewer terms than required before. Convergence improvement can be effected by forming a linear combination with a SERIES whose sum is known. Useful sums include

$$\sum_{n=1}^{\infty} \frac{1}{n(n+1)} = 1 \quad (1)$$

$$\sum_{n=1}^{\infty} \frac{1}{n(n+1)(n+2)} = \frac{1}{4} \quad (2)$$

$$\sum_{n=1}^{\infty} \frac{1}{n(n+1)(n+2)(n+3)} = \frac{1}{18} \quad (3)$$

$$\sum_{n=1}^{\infty} \frac{1}{n(n+1) \cdots (n+p)} = \frac{1}{p \cdot p!}. \quad (4)$$

Convergence Improvement

Kummer's transformation takes a convergent series

$$s = \sum_{k=0}^{\infty} a_k \quad (5)$$

and another convergent series

$$c = \sum_{k=0}^{\infty} c_k \quad (6)$$

with known c such that

$$\lim_{k \rightarrow \infty} \frac{a_k}{c_k} = \lambda \neq 0. \quad (7)$$

Then a series with more rapid convergence to the same value is given by

$$s = \lambda c + \sum_{k=0}^{\infty} \left(1 - \lambda \frac{c_k}{a_k} \right) a_k \quad (8)$$

(Abramowitz and Stegun 1972).

EULER'S TRANSFORM takes a convergent alternating series

$$\sum_{k=0}^{\infty} (-1)^k a_k = a_0 - a_1 + a_2 - \dots \quad (9)$$

into a series with more rapid convergence to the same value to

$$s = \sum_{k=0}^{\infty} \frac{(-1)^k \Delta^k a_0}{2^{k+1}}, \quad (10)$$

where

$$\Delta^k a_0 = \sum_{m=0}^k (-1)^m \binom{k}{m} a_{k-m} \quad (11)$$

(Abramowitz and Stegun 1972; Beeler *et al.* 1972, Item 120).

Given a series of the form

$$S = \sum_{n=1}^{\infty} f\left(\frac{1}{n}\right), \quad (12)$$

where $f(z)$ is an ANALYTIC at 0 and on the closed unit DISK, and

$$f(z)|_{z \rightarrow 0} = \mathcal{O}(z^2), \quad (13)$$

then the series can be rearranged to

$$\begin{aligned} S &= \sum_{n=1}^{\infty} \sum_{m=2}^{\infty} f_m \left(\frac{1}{n} \right)^m \\ &= \sum_{m=2}^{\infty} \sum_{n=1}^{\infty} f_m \left(\frac{1}{n} \right)^m = \sum_{m=2}^{\infty} f_m \zeta(m), \quad (14) \end{aligned}$$

where

$$f(z) = \sum_{m=2}^{\infty} f_m z^m \quad (15)$$

is the MACLAURIN SERIES of f and $\zeta(z)$ is the RIEMANN ZETA FUNCTION (Flajolet and Vardi 1996). The transformed series exhibits geometric convergence. Similarly, if $f(z)$ is ANALYTIC in $|z| \leq 1/n_0$ for some POSITIVE INTEGER n_0 , then

$$S = \sum_{n=1}^{n_0-1} f\left(\frac{1}{n}\right) + \sum_{m=2}^{\infty} f_m \left[\zeta(m) - \frac{1}{1^m} - \dots - \frac{1}{(n_0-1)^m} \right], \quad (16)$$

which converges geometrically (Flajolet and Vardi 1996). (16) can also be used to further accelerate the convergence of series (14).

see also EULER'S TRANSFORM, WILF-ZEILBERGER PAIR

References

- Abramowitz, M. and Stegun, C. A. (Eds.). *Handbook of Mathematical Functions with Formulas, Graphs, and Mathematical Tables*, 9th printing. New York: Dover, p. 16, 1972.
- Arfken, G. *Mathematical Methods for Physicists*, 3rd ed. Orlando, FL: Academic Press, pp. 288–289, 1985.
- Beeler, M.; Gosper, R. W.; and Schroepel, R. *HAKMEM*. Cambridge, MA: MIT Artificial Intelligence Laboratory, Memo AIM-239, Feb. 1972.
- Flajolet, P. and Vardi, I. "Zeta Function Expansions of Classical Constants." Unpublished manuscript. 1996. <http://pauillac.inria.fr/algo/flajolet/Publications/landau.ps>.

Convergence Tests

A test to determine if a given SERIES CONVERGES or DIVERGES.

see also ABEL'S UNIFORM CONVERGENCE TEST, BERTRAND'S TEST, D'ALEMBERT RATIO TEST, DIVERGENCE TESTS, ERMAKOFF'S TEST, GAUSS'S TEST, INTEGRAL TEST, KUMMER'S TEST, RAABE'S TEST, RATIO TEST, RIEMANN SERIES THEOREM, ROOT TEST

References

- Arfken, G. "Convergence Tests." §5.2 in *Mathematical Methods for Physicists*, 3rd ed. Orlando, FL: Academic Press, pp. 280–293, 1985.
- Bromwich, T. J. I'a and MacRobert, T. M. *An Introduction to the Theory of Infinite Series*, 3rd ed. New York: Chelsea, pp. 55–57, 1991.

Convergent

The RATIONAL NUMBER obtained by keeping only a limited number of terms in a CONTINUED FRACTION is called a convergent. For example, in the SIMPLE CONTINUED FRACTION for the GOLDEN RATIO,

$$\phi = 1 + \frac{1}{1 + \frac{1}{1 + \dots}}$$

the convergents are

$$1, 1 + \frac{1}{1} = \frac{3}{2}, 1 + \frac{1}{1 + \frac{1}{1}} = \frac{5}{3}, \dots$$

The word convergent is also used to describe a CONVERGENT SEQUENCE or CONVERGENT SERIES.

see also CONTINUED FRACTION, CONVERGENT SEQUENCE, CONVERGENT SERIES, PARTIAL QUOTIENT, SIMPLE CONTINUED FRACTION

Convergent Sequence

A SEQUENCE S_n converges to the limit S

$$\lim_{n \rightarrow \infty} S_n = S$$

if, for any $\epsilon > 0$, there exists an N such that $|S_n - S| < \epsilon$ for $n > N$. If S_n does not converge, it is said to DIVERGE. Every bounded MONOTONIC SEQUENCE converges. Every unbounded SEQUENCE diverges. This condition can also be written as

$$\overline{\lim}_{n \rightarrow \infty} S_n = \lim_{n \rightarrow \infty} S_n = S.$$

see also CONDITIONAL CONVERGENCE, STRONG CONVERGENCE, WEAK CONVERGENCE

Convergent Series

The infinite SERIES $\sum_{n=1}^{\infty} a_n$ is convergent if the SEQUENCE of partial sums

$$S_n = \sum_{k=1}^n a_k$$

is convergent. Conversely, a SERIES is divergent if the SEQUENCE of partial sums is divergent. If $\sum u_k$ and $\sum v_k$ are convergent SERIES, then $\sum(u_k + v_k)$ and $\sum(u_k - v_k)$ are convergent. If $c \neq 0$, then $\sum u_k$ and $c \sum u_k$ both converge or both diverge. Convergence and divergence are unaffected by deleting a finite number of terms from the beginning of a series. Constant terms in the denominator of a sequence can usually be deleted without affecting convergence. All but the highest POWER terms in POLYNOMIALS can usually be deleted in both NUMERATOR and DENOMINATOR of a SERIES without affecting convergence. If a SERIES converges absolutely, then it converges.

see also CONVERGENCE TESTS, RADIUS OF CONVERGENCE

References

- Bromwich, T. J. I'a. and MacRobert, T. M. *An Introduction to the Theory of Infinite Series*, 3rd ed. New York: Chelsea, 1991.

Conversion Period

The period of time between INTEREST payments.

see also COMPOUND INTEREST, INTEREST, SIMPLE INTEREST

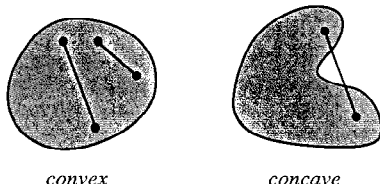
Convex

A SET in EUCLIDEAN SPACE \mathbb{R}^d is convex if it contains *all* the LINE SEGMENTS connecting any pair of its points. If the SET does not contain all the LINE SEGMENTS, it is called CONCAVE.

see also CONNECTED SET, CONVEX FUNCTION, CONVEX HULL, CONVEX OPTIMIZATION THEORY, CONVEX POLYGON, DELAUNAY TRIANGULATION, MINKOWSKI CONVEX BODY THEOREM, SIMPLY CONNECTED

References

Croft, H. T.; Falconer, K. J.; and Guy, R. K. "Convexity." Ch. A in *Unsolved Problems in Geometry*. New York: Springer-Verlag, pp. 6–47, 1994.

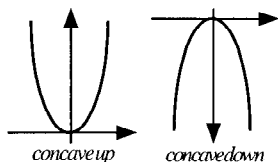
Convex Function

A function whose value at the MIDPOINT of every INTERVAL in its DOMAIN does not exceed the AVERAGE of its values at the ends of the INTERVAL. In other words, a function $f(x)$ is convex on an INTERVAL $[a, b]$ if for any two points x_1 and x_2 in $[a, b]$,

$$f\left[\frac{1}{2}(x_1 + x_2)\right] \leq \frac{1}{2}[f(x_1) + f(x_2)].$$

If $f(x)$ has a second DERIVATIVE in $[a, b]$, then a NECESSARY and SUFFICIENT condition for it to be convex on that INTERVAL is that the second DERIVATIVE $f''(x) > 0$ for all x in $[a, b]$.

see also CONCAVE FUNCTION, LOGARITHMICALLY CONVEX FUNCTION

References

Eggleton, R. B. and Guy, R. K. "Catalan Strikes Again! How Likely is a Function to be Convex?" *Math. Mag.* **61**, 211–219, 1988.
 Gradshteyn, I. S. and Ryzhik, I. M. *Tables of Integrals, Series, and Products*, 5th ed. San Diego, CA: Academic Press, p. 1100, 1980.

Convex Hull

The convex hull of a set of points S is the INTERSECTION of all convex sets containing S . For N points p_1, \dots, p_N , the convex hull C is then given by the expression

$$C \equiv \left\{ \sum_{j=1}^N \lambda_j p_j : \lambda_j \geq 0 \text{ for all } j \text{ and } \sum_{j=1}^N \lambda_j = 1 \right\}.$$

see also CARATHÉODORY'S FUNDAMENTAL THEOREM, CROSS POLYTOPE, GROEMER PACKING, GROEMER THEOREM, SAUSAGE CONJECTURE, SYLVESTER'S FOUR-POINT PROBLEM

References

Santaló, L. A. *Integral Geometry and Geometric Probability*. Reading, MA: Addison-Wesley, 1976.

Convex Optimization Theory

The problem of maximizing a linear function over a convex polyhedron, also known as OPERATIONS RESEARCH or OPTIMIZATION THEORY. The general problem of convex optimization is to find the minimum of a convex (or quasiconvex) function f on a FINITE-dimensional convex body A . Methods of solution include Levin's algorithm and the method of circumscribed ELLIPSOIDS, also called the Nemirovsky-Yudin-Shor method.

References

Tokhomirov, V. M. "The Evolution of Methods of Convex Optimization." *Amer. Math. Monthly* **103**, 65–71, 1996.

Convex Polygon

A POLYGON is CONVEX if it contains *all* the LINE SEGMENTS connecting any pair of its points. Let $f(n)$ be the smallest number such that when W is a set of more than $f(n)$ points in GENERAL POSITION (with no three points COLLINEAR) in the plane, all of the VERTICES of some convex n -gon are contained in W . The answers for $n = 2, 3$, and 4 are 2, 4, and 8. It is conjectured that $f(n) = 2^{n-2}$, but only proven that

$$2^{n-2} \leq f(n) \leq \binom{2n-4}{n-2},$$

where $\binom{n}{k}$ is a BINOMIAL COEFFICIENT.

Convex Polyhedron

A POLYHEDRON for which a line connecting any two (noncoplanar) points on the surface always lies in the interior of the polyhedron. The 92 convex polyhedra having only REGULAR POLYGONS as faces are called the JOHNSON SOLIDS, which include the PLATONIC SOLIDS and ARCHIMEDEAN SOLIDS. No method is known for computing the VOLUME of a general convex polyhedron (Ogilvy 1990, p. 173).

see also ARCHIMEDEAN SOLID, DELTAHEDRON, JOHNSON SOLID, KEPLER-POINOT SOLID, PLATONIC SOLID, REGULAR POLYGON

References

Ogilvy, C. S. *Excursions in Geometry*. New York: Dover, 1990.

Convolution

A convolution is an integral which expresses the amount of overlap of one function $g(t)$ as it is shifted over another function $f(t)$. It therefore “blends” one function with another. For example, in synthesis imaging, the measured DIRTY MAP is a convolution of the “true” CLEAN MAP with the DIRTY BEAM (the FOURIER TRANSFORM of the sampling distribution). The convolution is sometimes also known by its German name, FALTUNG (“folding”). A convolution over a finite range $[0, t]$ is given by

$$f(t) * g(t) \equiv \int_0^t f(\tau)g(t-\tau) d\tau, \quad (1)$$

where the symbol $f * g$ (occasionally also written as $f \otimes g$) denotes convolution of f and g . Convolution is more often taken over an infinite range,

$$f(t) * g(t) \equiv \int_{-\infty}^{\infty} f(\tau)g(t-\tau) d\tau = \int_{-\infty}^{\infty} g(\tau)f(t-\tau) d\tau. \quad (2)$$

Let f , g , and h be arbitrary functions and a a constant. Convolution has the following properties:

$$f * g = g * f \quad (3)$$

$$f * (g * h) = (f * g) * h \quad (4)$$

$$f * (g + h) = (f * g) + (f * h) \quad (5)$$

$$a(f * g) = (af) * g = f * (ag). \quad (6)$$

The INTEGRAL identity

$$\int_a^x \int_a^x f(t) dt dx = \int_a^x (x-t)f(t) dt \quad (7)$$

also gives a convolution. Taking the DERIVATIVE of a convolution gives

$$\frac{d}{dx}(f * g) = \frac{df}{dx} * g = f * \frac{dg}{dx}. \quad (8)$$

The AREA under a convolution is the product of areas under the factors,

$$\begin{aligned} \int_{-\infty}^{\infty} (f * g) dx &= \int_{-\infty}^{\infty} \left[\int_{-\infty}^{\infty} f(u)g(x-u) du \right] dx \\ &= \int_{-\infty}^{\infty} f(u) \left[\int_{-\infty}^{\infty} g(x-u) dx \right] du \\ &= \left[\int_{-\infty}^{\infty} f(u) du \right] \left[\int_{-\infty}^{\infty} g(x) dx \right]. \quad (9) \end{aligned}$$

The horizontal CENTROIDS add

$$\int_{-\infty}^{\infty} \langle x(f * g) \rangle dx = \langle xf \rangle + \langle xg \rangle, \quad (10)$$

as do the VARIANCES

$$\int_{-\infty}^{\infty} \langle x^2(f * g) \rangle dx = \langle x^2 f \rangle + \langle x^2 g \rangle, \quad (11)$$

where

$$\langle x^n f \rangle \equiv \frac{\int_{-\infty}^{\infty} x^n f(x) dx}{\int_{-\infty}^{\infty} f(x) dx}. \quad (12)$$

see also AUTOCORRELATION, CONVOLUTION THEOREM, CROSS-CORRELATION, WIENER-KHINTCHINE THEOREM

References

- Bracewell, R. “Convolution.” Ch. 3 in *The Fourier Transform and Its Applications*. New York: McGraw-Hill, pp. 25–50, 1965.
- Hirschman, I. I. and Widder, D. V. *The Convolution Transform*. Princeton, NJ: Princeton University Press, 1955.
- Morse, P. M. and Feshbach, H. *Methods of Theoretical Physics, Part I*. New York: McGraw-Hill, pp. 464–465, 1953.
- Press, W. H.; Flannery, B. P.; Teukolsky, S. A.; and Vetterling, W. T. “Convolution and Deconvolution Using the FFT.” §13.1 in *Numerical Recipes in FORTRAN: The Art of Scientific Computing, 2nd ed.* Cambridge, England: Cambridge University Press, pp. 531–537, 1992.

Convolution Theorem

Let $f(t)$ and $f(t)$ be arbitrary functions of time t with FOURIER TRANSFORMS. Take

$$f(t) = \mathcal{F}^{-1}[F(\nu)] = \int_{-\infty}^{\infty} F(\nu)e^{2\pi i \nu t} d\nu \quad (1)$$

$$g(t) = \mathcal{F}^{-1}[G(\nu)] = \int_{-\infty}^{\infty} G(\nu)e^{2\pi i \nu t} d\nu, \quad (2)$$

where \mathcal{F}^{-1} denotes the inverse FOURIER TRANSFORM (where the transform pair is defined to have constants $A = 1$ and $B = -2\pi$). Then the CONVOLUTION is

$$\begin{aligned} f * g &\equiv \int_{-\infty}^{\infty} g(t')f(t-t')dt' \\ &= \int_{-\infty}^{\infty} g(t') \left[\int_{-\infty}^{\infty} F(\nu)e^{2\pi i \nu(t-t')} d\nu \right] dt'. \quad (3) \end{aligned}$$

Interchange the order of integration,

$$\begin{aligned} f * g &= \int_{-\infty}^{\infty} F(\nu) \left[\int_{-\infty}^{\infty} g(t')e^{-2\pi i \nu t'} dt' \right] e^{2\pi i \nu t} d\nu \\ &= \int_{-\infty}^{\infty} F(\nu)G(\nu)e^{2\pi i \nu t} d\nu \\ &= \mathcal{F}^{-1}[F(\nu)G(\nu)]. \quad (4) \end{aligned}$$

So, applying a FOURIER TRANSFORM to each side, we have

$$\mathcal{F}[f * g] = \mathcal{F}[f]\mathcal{F}[g]. \quad (5)$$

The convolution theorem also takes the alternate forms

$$\mathcal{F}[fg] = \mathcal{F}[f] * \mathcal{F}[g] \quad (6)$$

$$\mathcal{F}(\mathcal{F}[f]\mathcal{F}[g]) = f * g \quad (7)$$

$$\mathcal{F}(\mathcal{F}[f] * \mathcal{F}[g]) = fg. \quad (8)$$

see also AUTOCORRELATION, CONVOLUTION, FOURIER TRANSFORM, WIENER-KHINTCHINE THEOREM

References

- Arfken, G. "Convolution Theorem." §15.5 in *Mathematical Methods for Physicists*, 3rd ed. Orlando, FL: Academic Press, pp. 810–814, 1985.
 Bracewell, R. "Convolution Theorem." *The Fourier Transform and Its Applications*. New York: McGraw-Hill, pp. 108–112, 1965.

Conway-Alexander Polynomial

see ALEXANDER POLYNOMIAL

Conway's Constant

The constant

$$\lambda = 1.303577269034296\dots$$

(Sloane's A014715) giving the asymptotic rate of growth $C\lambda^k$ of the number of DIGITS in the k th term of the LOOK AND SAY SEQUENCE. λ is given by the largest ROOT of the POLYNOMIAL

$$\begin{aligned} 0 = & x^{71} \\ & - x^{69} - 2x^{68} - x^{67} + 2x^{66} + 2x^{65} + x^{64} - x^{63} - x^{62} - x^{61} \\ & - x^{60} - x^{59} + 2x^{58} + 5x^{57} + 3x^{56} - 2x^{55} - 10x^{54} \\ & - 3x^{53} - 2x^{52} + 6x^{51} + 6x^{50} + x^{49} + 9x^{48} - 3x^{47} \\ & - 7x^{46} - 8x^{45} - 8x^{44} + 10x^{43} + 6x^{42} + 8x^{41} - 4x^{40} \\ & - 12x^{39} + 7x^{38} - 7x^{37} + 7x^{36} + x^{35} - 3x^{34} + 10x^{33} \\ & + x^{32} - 6x^{31} - 2x^{30} - 10x^{29} - 3x^{28} + 2x^{27} + 9x^{26} \\ & - 3x^{25} + 14x^{24} - 8x^{23} - 7x^{21} + 9x^{20} - 3x^{19} - 4x^{18} \\ & - 10x^{17} - 7x^{16} + 12x^{15} + 7x^{14} + 2x^{13} - 12x^{12} \\ & - 4x^{11} - 2x^{10} - 5x^9 + x^7 - 7x^6 \\ & + 7x^5 - 4x^4 + 12x^3 - 6x^2 + 3x - 6. \end{aligned}$$

The POLYNOMIAL given in Conway (1987, p. 188) contains a misprint. The CONTINUED FRACTION for λ is 1, 3, 3, 2, 2, 54, 5, 2, 1, 16, 1, 30, 1, 1, 1, 2, 2, 1, 14, 1, ... (Sloane's A014967).

see also CONWAY SEQUENCE, COSMOLOGICAL THEOREM, LOOK AND SAY SEQUENCE

References

- Conway, J. H. "The Weird and Wonderful Chemistry of Audioactive Decay." §5.11 in *Open Problems in Communications and Computation* (Ed. T. M. Cover and B. Gopinath). New York: Springer-Verlag, pp. 173–188, 1987.
 Conway, J. H. and Guy, R. K. "The Look and Say Sequence." In *The Book of Numbers*. New York: Springer-Verlag, pp. 208–209, 1996.

Finch, S. "Favorite Mathematical Constants." <http://www.mathsoft.com/asolve/constant/cnwy/cnwy.html>.

Sloane, N. J. A. Sequence A014967 in "An On-Line Version of the Encyclopedia of Integer Sequences."

Vardi, I. *Computational Recreations in Mathematica*. Reading, MA: Addison-Wesley, pp. 13–14, 1991.

Conway's Game of Life

see LIFE

Conway Groups

The AUTOMORPHISM GROUP Co_1 of the LEECH LATTICE modulo a center of order two is called "the" Conway group. There are 15 exceptional CONJUGACY CLASSES of the Conway group. This group, combined with the GROUPS Co_2 and Co_3 obtained similarly from the LEECH LATTICE by stabilization of the 1-D and 2-D sublattices, are collectively called Conway groups. The Conway groups are SPORADIC GROUPS.

see also LEECH LATTICE, SPORADIC GROUP

References

- Wilson, R. A. "ATLAS of Finite Group Representation." <http://for.mat.bham.ac.uk/atlas/Co1.html>, [Co2.html](http://for.mat.bham.ac.uk/atlas/Co2.html), [Co3.html](http://for.mat.bham.ac.uk/atlas/Co3.html).

Conway's Knot

The KNOT with BRAID WORD

$$\sigma_2^3 \sigma_1 \sigma_3^{-1} \sigma_2^{-2} \sigma_1 \sigma_2^{-1} \sigma_1 \sigma_3^{-1}.$$

The JONES POLYNOMIAL of Conway's knot is

$$t^{-4}(-1 + 2t - 2t^2 + 2t^3 + t^6 - 2t^7 + 2t^8 - 2t^9 + t^{10}),$$

the same as for the KINOSHITA-TERASAKA KNOT.

Conway's Knot Notation

A concise NOTATION based on the concept of the TANGLE used by Conway (1967) to enumerate KNOTS up to 11 crossings. An ALGEBRAIC KNOT containing no NEGATIVE signs in its Conway knot NOTATION is an ALTERNATING KNOT.

References

- Conway, J. H. "An Enumeration of Knots and Links, and Some of Their Algebraic Properties." In *Computation Problems in Abstract Algebra* (Ed. J. Leech). Oxford, England: Pergamon Press, pp. 329–358, 1967.

Conway's Life

see LIFE

Conway Notation

see CONWAY'S KNOT NOTATION, CONWAY POLYHEDRON NOTATION

Conway Polyhedron Notation

A NOTATION for POLYHEDRA which begins by specifying a “seed” polyhedron using a capital letter. The PLATONIC SOLIDS are denoted T (TETRAHEDRON), O (OCTAHEDRON), C (CUBE), I (ICOSAHEDRON), and D (DODECAHEDRON), according to their first letter. Other polyhedra include the PRISMS, P_n , ANTIPRISMS, A_n , and PYRAMIDS, Y_n , where $n \geq 3$ specifies the number of sides of the polyhedron’s base.

Operations to be performed on the polyhedron are then specified with lower-case letters preceding the capital letter.

see also POLYHEDRON, SCHLÄFLI SYMBOL, WYTHOFF SYMBOL

References

Hart, G. “Conway Notation for Polyhedra.” <http://www.li.net/~george/virtual-polyhedra/conway.notation.html>.

Conway Polynomial

see ALEXANDER POLYNOMIAL

Conway Puzzle

Construct a $5 \times 5 \times 5$ cube from 13 $1 \times 2 \times 4$ blocks, 1 $2 \times 2 \times 2$ block, 1 $1 \times 2 \times 2$ and 3 $1 \times 1 \times 3$ blocks.

see also BOX-PACKING THEOREM, CUBE DISSECTION, DE BRUIJN’S THEOREM, KLARNER’S THEOREM, POLY-CUBE, SLOTHOUBER-GRAATSMa PUZZLE

References

Honsberger, R. *Mathematical Gems II*. Washington, DC: Math. Assoc. Amer., pp. 77–80, 1976.

Conway Sequence

The LOOK AND SAY SEQUENCE generated from a starting DIGIT of 3, as given by Vardi (1991).

see also CONWAY’S CONSTANT, LOOK AND SAY SEQUENCE

References

Vardi, I. *Computational Recreations in Mathematica*. Reading, MA: Addison-Wesley, pp. 13–14, 1991.

Conway Sphere

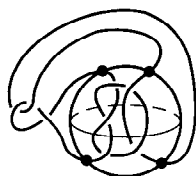

A sphere with four punctures occurring where a KNOT passes through the surface.

References

Adams, C. C. *The Knot Book: An Elementary Introduction to the Mathematical Theory of Knots*. New York: W. H. Freeman, p. 94, 1994.

Coordinate Geometry

see ANALYTIC GEOMETRY

Coordinate System

A system of COORDINATES.

Coordinates

A set of n variables which fix a geometric object. If the coordinates are distances measured along PERPENDICULAR axes, they are known as CARTESIAN COORDINATES. The study of GEOMETRY using one or more coordinate systems is known as ANALYTIC GEOMETRY.

see also AREAL COORDINATES, BARYCENTRIC COORDINATES, BIPOLAR COORDINATES, BIPOLAR CYLINDRICAL COORDINATES, BISPHERICAL COORDINATES, CARTESIAN COORDINATES, CHOW COORDINATES, CIRCULAR CYLINDRICAL COORDINATES, CONFOCAL ELLIPSOIDAL COORDINATES, CONFOCAL PARABOLOIDAL COORDINATES, CONICAL COORDINATES, CURVILINEAR COORDINATES, CYCLIDIC COORDINATES, CYLINDRICAL COORDINATES, ELLIPSOIDAL COORDINATES, ELLIPTIC CYLINDRICAL COORDINATES, GAUSSIAN COORDINATE SYSTEM, GRASSMANN COORDINATES, HARMONIC COORDINATES, HOMOGENEOUS COORDINATES, OBLATE SPHEROIDAL COORDINATES, ORTHOCENTRIC COORDINATES, PARABOLIC COORDINATES, PARABOLIC CYLINDRICAL COORDINATES, PARABOLOIDAL COORDINATES, PEDAL COORDINATES, POLAR COORDINATES, PROLATE SPHEROIDAL COORDINATES, QUADRIPLANAR COORDINATES, RECTANGULAR COORDINATES, SPHERICAL COORDINATES, TOROIDAL COORDINATES, TRILINEAR COORDINATES

References

Arfken, G. “Coordinate Systems.” Ch. 2 in *Mathematical Methods for Physicists*, 3rd ed. Orlando, FL: Academic Press, pp. 85–117, 1985.
Woods, F. S. *Higher Geometry: An Introduction to Advanced Methods in Analytic Geometry*. New York: Dover, p. 1, 1961.

Coordination Number

see KISSING NUMBER

Copeland-Erdős Constant

The decimal 0.23571113171923... (Sloane’s A033308) obtained by concatenating the PRIMES: 2, 23, 235, 2357, 235711, ... (Sloane’s A033308; one of the SMARNDACHE SEQUENCES). In 1945, Copeland and Erdős showed that it is a NORMAL NUMBER. The first few digits of the CONTINUED FRACTION of the Copeland-Erdős are 0, 4, 4, 8, 16, 18, 5, 1, ... (Sloane’s A030168). The positions of the first occurrence of n in the CONTINUED FRACTION are 8, 16, 20, 2, 7, 15, 12, 4, 17, 254, ... (Sloane’s A033309). The incrementally largest terms are 1, 27, 154, 1601, 2135, ... (Sloane’s A033310), which occur at positions 2, 5, 11, 19, 1801, ... (Sloane’s A033311).

see also CHAMPERNOWNE CONSTANT, PRIME NUMBER

References

Sloane, N. J. A. Sequences A030168, A033308, A033309, A033310, and A033311 in "An On-Line Version of the Encyclopedia of Integer Sequences."

Coplanar

Three noncollinear points determine a plane and so are trivially coplanar. Four points are coplanar IFF the volume of the TETRAHEDRON defined by them is 0,

$$\begin{vmatrix} x_1 & y_1 & z_1 & 0 \\ x_2 & y_2 & z_2 & 0 \\ x_3 & y_3 & z_3 & 0 \\ x_4 & y_4 & z_4 & 0 \end{vmatrix}.$$

Coprime

see RELATIVELY PRIME

Copson-de Bruijn Constant

see DE BRUIJN CONSTANT

Copson's Inequality

Let $\{a_n\}$ be a NONNEGATIVE SEQUENCE and $f(x)$ a NONNEGATIVE integrable function. Define

$$A_n = \sum_{k=1}^n a_k \quad (1)$$

$$B_n = \sum_{k=n}^{\infty} a_k \quad (2)$$

and

$$F(x) = \int_0^x f(t) dt \quad (3)$$

$$G(x) = \int_x^{\infty} f(t) dt, \quad (4)$$

and take $0 < p < 1$. For integrals,

$$\int_0^{\infty} \left[\frac{G(x)}{x} \right]^p dx > \left(\frac{p}{p-1} \right)^p \int_0^{\infty} [f(x)]^p dx \quad (5)$$

(unless f is identically 0). For sums,

$$\left(1 + \frac{1}{p-1} \right) B_1^p + \sum_{n=2}^{\infty} \left(\frac{B_n}{n} \right)^p > \left(\frac{p}{p-1} \right)^p \sum_{n=1}^{\infty} a_n^p \quad (6)$$

(unless all $a_n = 0$).

References

- Beesack, P. R. "On Some Integral Inequalities of E. T. Copson." In *General Inequalities 2* (Ed. E. F. Beckenbach). Basel: Birkhäuser, 1980.
- Copson, E. T. "Some Integral Inequalities." *Proc. Royal Soc. Edinburgh* **75A**, 157–164, 1975–1976.
- Hardy, G. H.; Littlewood, J. E.; and Pólya, G. Theorems 326–327, 337–338, and 345 in *Inequalities*. Cambridge, England: Cambridge University Press, 1934.
- Mitrinovic, D. S.; Pecaric, J. E.; and Fink, A. M. *Inequalities Involving Functions and Their Integrals and Derivatives*. Dordrecht, Netherlands: Kluwer, 1991.

Copula

A function that joins univariate distribution functions to form multivariate distribution functions. A 2-D copula is a function $C: I^2 \rightarrow I$ such that

$$C(0, t) = C(t, 0) = 0$$

and

$$C(1, t) = C(t, 1) = t$$

for all $t \in I$, and

$$C(u_2, v_2) - C(u_1, v_2) - C(u_2, v_1) + C(u_1, v_1) \geq 0$$

for all $u_1, u_2, v_1, v_2 \in I$ such that $u_1 \leq u_2$ and $v_1 \leq v_2$.

see also SKLAR'S THEOREM

Cork Plug

A 3-D SOLID which can stopper a SQUARE, TRIANGULAR, or CIRCULAR HOLE. There is an infinite family of such shapes. The one with smallest VOLUME has TRIANGULAR CROSS-SECTIONS and $V = \pi r^3$; that with the largest VOLUME is made using two cuts from the top diameter to the EDGE and has VOLUME $V = 4\pi r^3/3$.

see also STEREOLOGY, TRIP-LET

Corkscrew Surface



A surface also called the TWISTED SPHERE.

References

- Gray, A. *Modern Differential Geometry of Curves and Surfaces*. Boca Raton, FL: CRC Press, pp. 493–494, 1993.

Cornish-Fisher Asymptotic Expansion

$$y \approx m + \sigma w,$$

where

$$\begin{aligned} w = & x + [\gamma_1 h_1(x)] + [\gamma_2 h_2(x) + \gamma_1^2 h_{11}(x)] \\ & + [\gamma_3 h_3(x) + \gamma_1 \gamma_2 h_{12}(x) + \gamma_1^3 h_{111}(x)] \\ & + [\gamma_4 h_4(x) + \gamma_2^2 h_{22}(x) + \gamma_1 \gamma_3 h_{13}(x) \\ & + \gamma_1^2 \gamma_2 h_{112}(x) + \gamma_1^4 h_{1111}(x)] + \dots, \end{aligned}$$

where

$$\begin{aligned}
 h_1(x) &= \frac{1}{6} \text{He}_2(x) \\
 h_2(x) &= \frac{1}{24} \text{He}_3(x) \\
 h_{11}(x) &= -\frac{1}{36} [2 \text{He}_3(x) + \text{He}_1(x)] \\
 h_3(x) &= \frac{1}{120} \text{He}_4(x) \\
 h_{12}(x) &= -\frac{1}{24} [\text{He}_4(x) + \text{He}_2(x)] \\
 h_{111}(x) &= \frac{1}{324} [12 \text{He}_4(x) + 19 \text{He}_2(x)] \\
 h_4(x) &= \frac{1}{720} \text{He}_5(x) \\
 h_{22}(x) &= -\frac{1}{384} [3 \text{He}_5(x) + 6 \text{He}_3(x) + 2 \text{He}_1(x)] \\
 h_{13}(x) &= -\frac{1}{180} [2 \text{He}_5(x) + 3 \text{He}_3(x)] \\
 h_{112}(x) &= \frac{1}{288} [14 \text{He}_5(x) + 37 \text{He}_3(x) + 8 \text{He}_1(x)] \\
 h_{1111}(x) &= -\frac{1}{7776} [252 \text{He}_5(x) + 832 \text{He}_3(x) + 227 \text{He}_1(x)].
 \end{aligned}$$

see also EDGEWORTH SERIES, GRAM-CHARLIER SERIES

References

Abramowitz, M. and Stegun, C. A. (Eds.). *Handbook of Mathematical Functions with Formulas, Graphs, and Mathematical Tables*, 9th printing. New York: Dover, p. 935, 1972.

Cornu Spiral

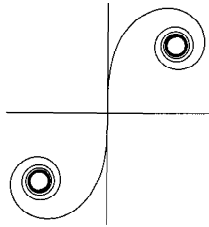

A plot in the COMPLEX PLANE of the points

$$B(z) = C(t) + iS(t) = \int_0^t e^{i\pi x^2/2} dx, \quad (1)$$

where $C(z)$ and $S(z)$ are the FRESNEL INTEGRALS. The Cornu spiral is also known as the CLOTHOID or EULER'S SPIRAL. A Cornu spiral describes diffraction from the edge of a half-plane.

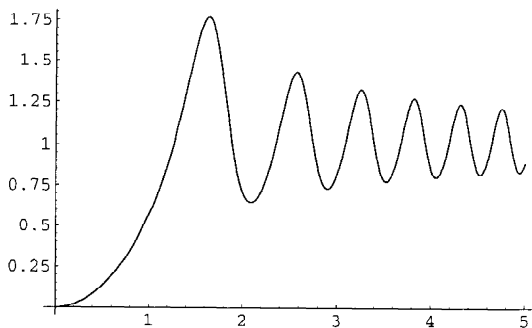

The SLOPE of the Cornu spiral

$$m(t) = \frac{S(t)}{C(t)} \quad (2)$$

is plotted above.

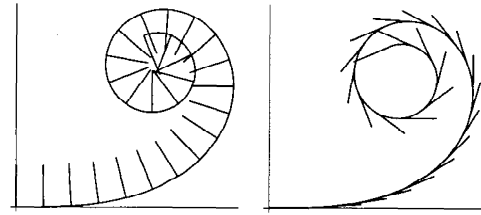

The SLOPE of the curve's TANGENT VECTOR (above right figure) is

$$m_T(t) = \frac{S'(t)}{C'(t)} = \tan(\tfrac{1}{2}\pi t^2), \quad (3)$$

plotted below.

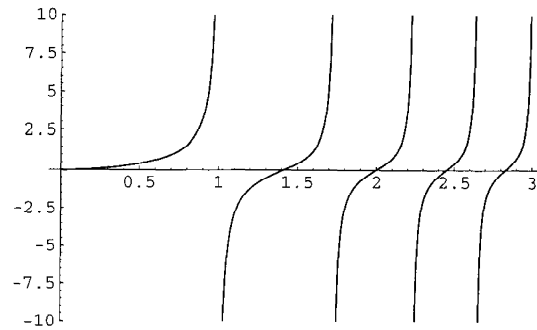

The CESÀRO EQUATION for a Cornu spiral is $\rho = c^2/s$, where ρ is the RADIUS OF CURVATURE and s the ARC LENGTH. The TORSION is $\tau = 0$.

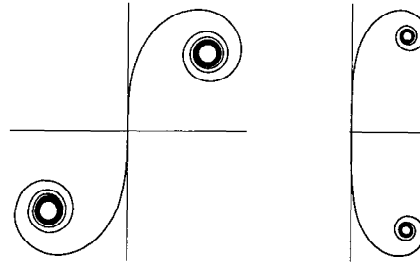

Gray (1993) defines a generalization of the Cornu spiral given by parametric equations

$$x(t) = a \int_0^t \sin\left(\frac{u^{n+1}}{n+1}\right) du \quad (4)$$

$$y(t) = a \int_0^t \cos\left(\frac{u^{n+1}}{n+1}\right) du. \quad (5)$$

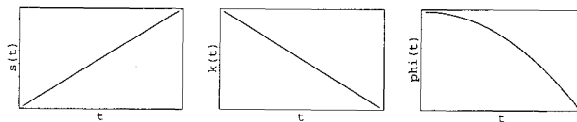

The ARC LENGTH, CURVATURE, and TANGENTIAL ANGLE of this curve are

$$s(t) = at \quad (3)$$

$$\kappa(t) = -\frac{t^n}{a} \quad (4)$$

$$\phi(t) = -\frac{t^{n+1}}{n+1}. \quad (5)$$

The CESÀRO EQUATION is

$$\kappa = -\frac{a}{s^n}. \quad (6)$$

Dillen (1990) describes a class of “polynomial spirals” for which the CURVATURE is a polynomial function of the ARC LENGTH. These spirals are a further generalization of the Cornu spiral.

see also FRESNEL INTEGRALS, NIELSEN’S SPIRAL

References

- Dillen, F. “The Classification of Hypersurfaces of a Euclidean Space with Parallel Higher Fundamental Form.” *Math. Z.* **203**, 635–643, 1990.
- Gray, A. “Clothoids.” §3.6 in *Modern Differential Geometry of Curves and Surfaces*. Boca Raton, FL: CRC Press, pp. 50–52, 1993.
- Lawrence, J. D. *A Catalog of Special Plane Curves*. New York: Dover, pp. 190–191, 1972.

Cornucopia

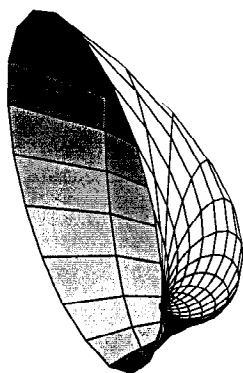

The SURFACE given by the parametric equations

$$x = e^{bv} \cos v + e^{av} \cos u \cos v$$

$$y = e^{bv} \sin v + e^{av} \cos u \sin v$$

$$z = e^{av} \sin u.$$

References

- von Seggern, D. *CRC Standard Curves and Surfaces*. Boca Raton, FL: CRC Press, p. 304, 1993.

Corollary

An immediate consequence of a result already proved. Corollaries usually state more complicated THEOREMS in a language simpler to use and apply.

see also LEMMA, PORISM, THEOREM

Corona (Polyhedron)

see AUGMENTED SPHENOCORONA, HEBESPHENOMEGACORONA, SPHENOCORONA, SPHENOMEGACORONA

Corona (Tiling)

The first corona of a TILE is the set of all tiles that have a common boundary point with that tile (including the original tile itself). The second corona is the set of tiles that share a point with something in the first corona, and so on.

References

- Eppstein, D. “Heesch’s Problem.” <http://www.ics.uci.edu/~eppstein/junkyard/heesch>.

Correlation

see AUTOCORRELATION, CORRELATION COEFFICIENT, CORRELATION (GEOMETRIC), CORRELATION (STATISTICAL), CROSS-CORRELATION

Correlation Coefficient

The correlation coefficient is a quantity which gives the quality of a LEAST SQUARES FITTING to the original data. To define the correlation coefficient, first consider the sum of squared values ss_{xx} , ss_{xy} , and ss_{yy} of a set of n data points (x_i, y_i) about their respective means,

$$\begin{aligned} ss_{xx} &\equiv \Sigma(x_i - \bar{x})^2 = \Sigma x^2 - 2\bar{x}\Sigma x + \Sigma \bar{x}^2 \\ &= \Sigma x^2 - 2n\bar{x}^2 + n\bar{x}^2 = \Sigma x^2 - n\bar{x}^2 \end{aligned} \quad (1)$$

$$\begin{aligned} ss_{yy} &\equiv \Sigma(y_i - \bar{y})^2 = \Sigma y^2 - 2\bar{y}\Sigma y + \Sigma \bar{y}^2 \\ &= \Sigma y^2 - 2n\bar{y}^2 + n\bar{y}^2 = \Sigma y^2 - n\bar{y}^2 \end{aligned} \quad (2)$$

$$\begin{aligned} ss_{xy} &\equiv \Sigma(x_i - \bar{x})(y_i - \bar{y}) = \Sigma(x_i y_i - \bar{x} y_i - x_i \bar{y} + \bar{x} \bar{y}) \\ &= \Sigma x y - n\bar{x}\bar{y} - n\bar{x}\bar{y} + n\bar{x}\bar{y} = \Sigma x y - n\bar{x}\bar{y}. \end{aligned} \quad (3)$$

For linear LEAST SQUARES FITTING, the COEFFICIENT b in

$$y = a + bx \quad (4)$$

is given by

$$b = \frac{n \sum xy - \sum x \sum y}{n \sum x^2 - (\sum x)^2} = \frac{ss_{xy}}{ss_{xx}}, \quad (5)$$

and the COEFFICIENT b' in

$$x = a' + b'y \quad (6)$$

is given by

$$b' = \frac{n \sum xy - \sum x \sum y}{n \sum y^2 - (\sum y)^2}. \quad (7)$$

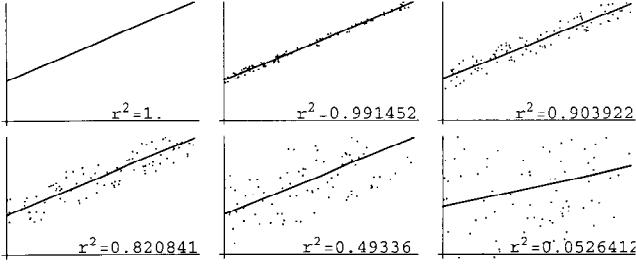

The correlation coefficient r^2 (sometimes also denoted R^2) is then defined by

$$r \equiv \sqrt{bb'} = \frac{n \sum xy - \sum x \sum y}{\sqrt{[n \sum x^2 - (\sum x)^2][n \sum y^2 - (\sum y)^2]}}, \quad (8)$$

which can be written more simply as

$$r^2 = \frac{SS_{xy}^2}{SS_{xx}SS_{yy}}. \quad (9)$$

The correlation coefficient is also known as the PRODUCT-MOMENT COEFFICIENT OF CORRELATION or PEARSON'S CORRELATION. The correlation coefficients for linear fits to increasingly noisy data are shown above.

The correlation coefficient has an important physical interpretation. To see this, define

$$A \equiv (\sum x^2 - n\bar{x}^2)^{-1} \quad (10)$$

and denote the "expected" value for y_i as \hat{y}_i . Sums of \hat{y}_i are then

$$\begin{aligned} \hat{y}_i &= a + bx_i = \bar{y} - b\bar{x} + bx_i = \bar{x} + b(x_i - \bar{x}) \\ &= A(\bar{y}\sum x^2 - \bar{x}\sum xy + x_i\sum xy - n\bar{x}\bar{y}x_i) \\ &= A[\bar{y}\sum x^2 + (x_i - \bar{x})\sum xy - n\bar{x}\bar{y}x_i] \end{aligned} \quad (11)$$

$$\sum \hat{y}_i = A(n\bar{y}\sum x^2 - n^2\bar{x}^2\bar{y}) \quad (12)$$

$$\begin{aligned} \sum \hat{y}_i^2 &= A^2[n\bar{y}^2(\sum x^2)^2 - n^2\bar{x}^2\bar{y}^2(\sum x^2) \\ &\quad - 2n\bar{x}\bar{y}(\sum xy)(\sum x^2) + 2n^2\bar{x}^3\bar{y}(\sum xy) \\ &\quad + (\sum x^2)(\sum xy)^2 - n\bar{x}^2(\sum xy)] \end{aligned} \quad (13)$$

$$\begin{aligned} \sum y_i \hat{y}_i &= A\sum[y_i\bar{y}\sum x^2 + y_i(x_i - \bar{x})\sum xy - n\bar{x}\bar{y}x_i y_i] \\ &= A[n\bar{y}^2\sum x^2 + (\sum xy)^2 - n\bar{x}\bar{y}\sum xy - n\bar{x}\bar{y}(\sum xy)] \\ &= A[n\bar{y}^2\sum x^2 + (\sum xy)^2 - 2n\bar{x}\bar{y}\sum xy]. \end{aligned} \quad (14)$$

The sum of squared residuals is then

$$\begin{aligned} SSR &\equiv \sum (\hat{y}_i - \bar{y})^2 = \sum (\hat{y}_i^2 - 2\bar{y}\hat{y}_i + \bar{y}^2) \\ &= A^2(\sum xy - n\bar{x}\bar{y})^2(\sum x^2 - n\bar{x}^2) = \frac{(\sum xy - n\bar{x}\bar{y})^2}{\sum x^2 - n\bar{x}^2} \\ &= bSS_{xy} = \frac{SS_{xy}^2}{SS_{xx}} = SS_{yy}r^2 = b^2SS_{xx}, \end{aligned} \quad (15)$$

and the sum of squared errors is

$$\begin{aligned} SSE &\equiv \sum (y_i - \hat{y}_i)^2 = \sum (y_i - \bar{y} + b\bar{x} - bx_i)^2 \\ &= \sum [y_i - \bar{y} - b(x_i - \bar{x})]^2 \\ &= \sum (y_i - \bar{y})^2 + b^2\sum (x_i - \bar{x})^2 - 2b\sum (x_i - \bar{x})(y_i - \bar{y}) \\ &= SS_{yy} + b^2SS_{xx} - 2bSS_{xy}. \end{aligned} \quad (16)$$

But

$$b = \frac{SS_{xy}}{SS_{xx}} \quad (17)$$

$$r^2 = \frac{SS_{xy}^2}{SS_{xx}SS_{yy}}, \quad (18)$$

so

$$\begin{aligned} SSE &= SS_{yy} + \frac{SS_{xy}^2}{SS_{xx}^2}SS_{xx} - 2\frac{SS_{xy}}{SS_{xx}}SS_{xy} \\ &= SS_{yy} - \frac{SS_{xy}^2}{SS_{xx}} \end{aligned} \quad (19)$$

$$\begin{aligned} &= SS_{yy} \left(1 - \frac{SS_{xy}^2}{SS_{xx}^2}\right) = SS_{yy}(1 - r^2) \\ &= s_y^2 - s_{\hat{y}}^2, \end{aligned} \quad (20)$$

and

$$SSE + SSR = SS_{yy}(1 - r^2) + SS_{yy}r^2 = SS_{yy}. \quad (21)$$

The square of the correlation coefficient r^2 is therefore given by

$$r^2 \equiv \frac{SSR}{SS_{yy}} = \frac{SS_{xy}^2}{SS_{xx}SS_{yy}} = \frac{(\sum xy - n\bar{x}\bar{y})^2}{(\sum x^2 - n\bar{x}^2)(\sum y^2 - n\bar{y}^2)}. \quad (22)$$

In other words, r^2 is the proportion of SS_{yy} which is accounted for by the regression.

If there is complete correlation, then the lines obtained by solving for best-fit (a, b) and (a', b') coincide (since all data points lie on them), so solving (6) for y and equating to (4) gives

$$y = -\frac{a'}{b'} + \frac{x}{b'} = a + bx. \quad (23)$$

Therefore, $a = -a'/b'$ and $b = 1/b'$, giving

$$r^2 = bb' = 1. \quad (24)$$

The correlation coefficient is independent of both origin and scale, so

$$r(u, v) = r(x, y), \quad (25)$$

where

$$u \equiv \frac{x - x_0}{h} \quad (26)$$

$$v \equiv \frac{y - y_0}{h}. \quad (27)$$

see also CORRELATION INDEX, CORRELATION COEFFICIENT—GAUSSIAN BIVARIATE DISTRIBUTION, CORRELATION RATIO, LEAST SQUARES FITTING, REGRESSION COEFFICIENT

References

- Acton, F. S. *Analysis of Straight-Line Data*. New York: Dover, 1966.
- Kenney, J. F. and Keeping, E. S. "Linear Regression and Correlation." Ch. 15 in *Mathematics of Statistics, Pt. 1, 3rd ed.* Princeton, NJ: Van Nostrand, pp. 252–285, 1962.
- Gonick, L. and Smith, W. *The Cartoon Guide to Statistics*. New York: Harper Perennial, 1993.
- Press, W. H.; Flannery, B. P.; Teukolsky, S. A.; and Vetterling, W. T. "Linear Correlation." §14.5 in *Numerical Recipes in FORTRAN: The Art of Scientific Computing, 2nd ed.* Cambridge, England: Cambridge University Press, pp. 630–633, 1992.

Correlation Coefficient—Gaussian Bivariate Distribution

For a GAUSSIAN BIVARIATE DISTRIBUTION, the distribution of correlation COEFFICIENTS is given by

$$\begin{aligned}
 P(r) &= \frac{1}{\pi} (N-2) (1-r^2)^{(N-4)/2} (1-\rho^2)^{(N-1)/2} \\
 &\quad \times \int_0^\infty \frac{d\beta}{(\cosh \beta - \rho r)^{N-1}} \\
 &= \frac{1}{\pi} (N-2) (1-r^2)^{(N-4)/2} (1-\rho^2)^{(N-1)/2} \sqrt{\frac{\pi}{2}} \frac{\Gamma(N-1)}{\Gamma(N-\frac{1}{2})} \\
 &\quad \times (1-\rho r)^{-(N-3/2)} {}_2F_1\left(\frac{1}{2}, \frac{1}{2}, \frac{2N-1}{2}, \frac{\rho r+1}{2}\right) \\
 &= \frac{(N-2)\Gamma(N-1)(1-\rho^2)^{(N-1)/2}(1-r^2)^{(N-4)/2}}{\sqrt{2\pi}\Gamma(N-\frac{1}{2})(1-\rho r)^{N-3/2}} \\
 &\quad \times \left[1 + \frac{1}{4} \frac{\rho r+1}{2N-1} + \frac{9}{16} \frac{(\rho r+1)^2}{(2N-1)(2N+1)} + \dots\right], \quad (1)
 \end{aligned}$$

where ρ is the population correlation COEFFICIENT, ${}_2F_1(a, b; c; x)$ is a HYPERGEOMETRIC FUNCTION, and $\Gamma(z)$ is the GAMMA FUNCTION (Kenney and Keeping 1951, pp. 217–221). The MOMENTS are

$$\langle r \rangle = \rho - \frac{\rho(1-\rho^2)}{2n} \quad (2)$$

$$\text{var}(r) = \frac{(1-\rho^2)^2}{n} \left(1 + \frac{11\rho^2}{2n} + \dots\right) \quad (3)$$

$$\gamma_1 = \frac{6\rho}{\sqrt{n}} \left(1 + \frac{77\rho^2 - 30}{12n} + \dots\right)$$

$$\gamma_2 = \frac{6}{n} (12\rho^2 - 1) + \dots, \quad (4)$$

where $n \equiv N-1$. If the variates are uncorrelated, then $\rho = 0$ and

$$\begin{aligned}
 {}_2F_1\left(\frac{1}{2}, \frac{1}{2}, \frac{2N-1}{2}, \frac{\rho r+1}{2}\right) &= {}_2F_1\left(\frac{1}{2}, \frac{1}{2}, \frac{2N-1}{2}, \frac{1}{2}\right) \\
 &= \frac{\Gamma(N-\frac{1}{2})2^{3/2-N}\sqrt{\pi}}{[\Gamma(\frac{N}{2})]^2}, \quad (5)
 \end{aligned}$$

so

$$\begin{aligned}
 P(r) &= \frac{(N-2)\Gamma(N-1)}{\sqrt{2\pi}\Gamma(N-\frac{1}{2})} (1-r^2)^{(N-4)/2} \\
 &\quad \times \frac{\Gamma(N-\frac{1}{2})2^{3/2-N}\sqrt{\pi}}{[\Gamma(\frac{N}{2})]^2} \\
 &= \frac{2^{1-N}(N-2)\Gamma(N-1)}{[\Gamma(\frac{N}{2})]^2} (1-r^2)^{(N-4)/2}. \quad (6)
 \end{aligned}$$

But from the LEGENDRE DUPLICATION FORMULA,

$$\sqrt{\pi}\Gamma(N-1) = 2^{N-2}\Gamma(\frac{N}{2})\Gamma(\frac{N-1}{2}), \quad (7)$$

so

$$\begin{aligned}
 P(r) &= \frac{(2^{1-N})(2^{N-2})(N-2)\Gamma(\frac{N}{2})\Gamma(\frac{N-1}{2})}{\sqrt{\pi}[\Gamma(\frac{N}{2})]^2} (1-r^2)^{(N-4)/2} \\
 &= \frac{(N-2)\Gamma(\frac{N-1}{2})}{2\sqrt{\pi}\Gamma(\frac{N}{2})} (1-r^2)^{(N-4)/2} \\
 &= \frac{1}{\sqrt{\pi}} \frac{\frac{\nu}{2}\Gamma(\frac{\nu+1}{2})}{\Gamma(\frac{\nu}{2}+1)} (1-r^2)^{(\nu-2)/2} \\
 &= \frac{1}{\sqrt{\pi}} \frac{\Gamma(\frac{\nu+1}{2})}{\Gamma(\frac{\nu}{2})} (1-r^2)^{(\nu-2)/2}. \quad (8)
 \end{aligned}$$

The uncorrelated case can be derived more simply by letting β be the true slope, so that $\eta = \alpha + \beta x$. Then

$$t \equiv (b-\beta) \frac{s_x}{s_y} \sqrt{\frac{N-2}{1-r^2}} = \frac{(b-\beta)r}{b} \sqrt{\frac{N-2}{1-r^2}} \quad (9)$$

is distributed as STUDENT'S t with $\nu \equiv N-2$ DEGREES OF FREEDOM. Let the population regression COEFFICIENT ρ be 0, then $\beta = 0$, so

$$t = r \sqrt{\frac{\nu}{1-r^2}}, \quad (10)$$

and the distribution is

$$P(t) dt = \frac{1}{\sqrt{\nu\pi}} \frac{\Gamma(\frac{\nu+1}{2})}{\Gamma(\frac{\nu}{2}) (1+\frac{t^2}{\nu})^{(\nu+1)/2}} dt. \quad (11)$$

Plugging in for t and using

$$\begin{aligned}
 dt &= \sqrt{\nu} \left[\frac{\sqrt{1-r^2} - r(\frac{1}{2})(-2r)(1-r^2)^{-1/2}}{1-r^2} \right] dr \\
 &= \sqrt{\frac{\nu}{1-r^2}} \left(\frac{1-r^2+r^2}{1-r^2} \right) dr \\
 &= \sqrt{\frac{\nu}{(1-r)^3}} dr \quad (12)
 \end{aligned}$$

gives

$$\begin{aligned}
 P(t) dt &= \frac{1}{\sqrt{\nu\pi}} \frac{\Gamma(\frac{\nu+1}{2})}{\Gamma(\frac{\nu}{2}) \left[1 + \frac{r^2\nu}{(1-r^2)\nu}\right]^{(\nu+1)/2}} \sqrt{\frac{\nu}{(1-r)^3}} dr \\
 &= \frac{(1-r^2)^{-3/2}}{\sqrt{\pi}} \frac{\Gamma(\frac{\nu+1}{2})}{\Gamma(\frac{\nu}{2}) \left(\frac{1}{1-r^2}\right)^{(\nu+1)/2}} dr \\
 &= \frac{1}{\sqrt{\pi}} \frac{\Gamma(\frac{\nu+1}{2})}{\Gamma(\frac{\nu}{2})} (1-r^2)^{-3/2} (1-r^2)^{(\nu+1)/2} dr \\
 &= \frac{1}{\sqrt{\pi}} \frac{\Gamma(\frac{\nu+1}{2})}{\Gamma(\frac{\nu}{2})} (1-r^2)^{(\nu-2)/2} dr, \quad (13)
 \end{aligned}$$

so

$$P(r) = \frac{1}{\sqrt{\pi}} \frac{\Gamma(\frac{\nu+1}{2})}{\Gamma(\frac{\nu}{2})} (1-r^2)^{(\nu-2)/2} \quad (14)$$

as before. See Bevington (1969, pp. 122–123) or Pugh and Winslow (1966, §12-8). If we are interested instead in the probability that a correlation COEFFICIENT would be obtained $\geq |r|$, where r is the observed COEFFICIENT, then

$$\begin{aligned}
 P_c(r, N) &= 2 \int_{|r|}^1 P(r', N) dr' = 1 - 2 \int_0^{|r|} P(r', N) dr' \\
 &= 1 - \frac{2}{\sqrt{\pi}} \frac{\Gamma(\frac{\nu+1}{2})}{\Gamma(\frac{\nu}{2})} \int_0^{|r|} (1-r'^2)^{(\nu-2)/2} dr'. \quad (15)
 \end{aligned}$$

Let $I \equiv \frac{1}{2}(\nu - 2)$. For EVEN ν , the exponent I is an INTEGER so, by the BINOMIAL THEOREM,

$$(1-r^2)^I = \sum_{k=0}^I \binom{I}{k} (-r^2)^k \quad (16)$$

and

$$\begin{aligned}
 P_c(r) &= 1 - \frac{2}{\sqrt{\pi}} \frac{\Gamma(\frac{\nu+1}{2})}{\Gamma(\frac{\nu}{2})} (-1)^k \frac{I!}{(I-k)!k!} \int_0^{|r|} \sum_{k=0}^I r'^{2k} dr' \\
 &= 1 - \frac{2}{\sqrt{\pi}} \frac{\Gamma(\frac{\nu+1}{2})}{\Gamma(\frac{\nu}{2})} \sum_{k=0}^I \left[(-1)^k \frac{I!}{(I-k)!k!} \frac{|r|^{2k+1}}{2k+1} \right]. \quad (17)
 \end{aligned}$$

For ODD ν , the integral is

$$\begin{aligned}
 P_c(r) &= 1 - 2 \int_0^{|r|} P(r') dr' \\
 &= 1 - \frac{2}{\sqrt{\pi}} \frac{\Gamma(\frac{\nu+1}{2})}{\Gamma(\frac{\nu}{2})} \int_0^{|r|} (\sqrt{1-r'^2})^{\nu-2} dr'. \quad (18)
 \end{aligned}$$

Let $r \equiv \sin x$ so $dr = \cos x dx$, then

$$\begin{aligned}
 P_c(r) &= 1 - \frac{2}{\sqrt{\pi}} \frac{\Gamma(\frac{\nu+1}{2})}{\Gamma(\frac{\nu}{2})} \int_0^{\sin^{-1}|r|} \cos^{\nu-2} x \cos x dx \\
 &= 1 - \frac{2}{\sqrt{\pi}} \frac{\Gamma(\frac{\nu+1}{2})}{\Gamma(\frac{\nu}{2})} + \int_0^{\sin^{-1}|r|} \cos^{\nu-1} x dx. \quad (19)
 \end{aligned}$$

But ν is ODD, so $\nu - 1 \equiv 2n$ is EVEN. Therefore

$$\begin{aligned}
 \frac{2}{\sqrt{\pi}} \frac{\Gamma(\frac{\nu+1}{2})}{\Gamma(\frac{\nu}{2})} &= \frac{2}{\sqrt{\pi}} \frac{\Gamma(n+1)}{\Gamma(n+\frac{1}{2})} = \frac{2}{\sqrt{\pi}} \frac{n!}{\frac{(2n-1)!!}{2^n} \sqrt{\pi}} \\
 &= \frac{2}{\pi} \frac{2^n n!}{(2n-1)!!} = \frac{2}{\pi} \frac{(2n)!!}{(2n-1)!!}. \quad (20)
 \end{aligned}$$

Combining with the result from the COSINE INTEGRAL gives

$$\begin{aligned}
 P_c(r) &= 1 - \frac{2}{\pi} \frac{(2n)!!(2n-1)!!}{(2n-1)!!(2n)!!} \\
 &\times \left[\sin x \sum_{k=0}^{n-1} \frac{(2k)!!}{(2k+1)!!} \cos^{2k+1} x + x \right]_0^{\sin^{-1}|r|}. \quad (21)
 \end{aligned}$$

Use

$$\cos^{2k-1} x = (1-r^2)^{(2k-1)/2} = (1-r^2)^{(k-1/2)}, \quad (22)$$

and define $J \equiv n - 1 = (\nu - 3)/2$, then

$$\begin{aligned}
 P_c(r) &= 1 - \frac{2}{\pi} \left[\sin^{-1}|r| + |r| \sum_{k=0}^J \frac{(2k)!!}{(2k+1)!!} (1-r^2)^{k+1/2} \right]. \quad (23)
 \end{aligned}$$

(In Bevington 1969, this is given incorrectly.) Combining the correct solutions

$$P_c(r) = \begin{cases} 1 - \frac{2}{\sqrt{\pi}} \frac{\Gamma[(\nu+1)/2]}{\Gamma(\nu/2)} \sum_{k=0}^I \left[(-1)^k \frac{I!}{(I-k)!k!} \frac{|r|^{2k+1}}{2k+1} \right] & \text{for } \nu \text{ even} \\ 1 - \frac{2}{\pi} \left[\sin^{-1}|r| + |r| \sum_{k=0}^J \frac{(2k)!!}{(2k+1)!!} (1-r^2)^{k+1/2} \right] & \text{for } \nu \text{ odd} \end{cases} \quad (24)$$

If $\rho \neq 0$, a skew distribution is obtained, but the variable z defined by

$$z \equiv \tanh^{-1} r \quad (25)$$

is approximately normal with

$$\mu_z = \tanh^{-1} \rho \quad (26)$$

$$\sigma_z^2 = \frac{1}{N-3} \quad (27)$$

(Kenney and Keeping 1962, p. 266).

Let b_j be the slope of a best-fit line, then the multiple correlation COEFFICIENT is

$$R^2 = \sum_{j=1}^n \left(b_j \frac{s_{jy}}{s_y^2} \right)^2 = \sum_{j=1}^n \left(b_j \frac{s_j}{s_y} r_{jy} \right)^2, \quad (28)$$

where s_{jy} is the sample VARIANCE.

On the surface of a SPHERE,

$$r \equiv \frac{\int f g d\Omega}{\int f d\Omega \int g d\Omega}, \quad (29)$$

where $d\Omega$ is a differential SOLID ANGLE. This definition guarantees that $-1 < r < 1$. If f and g are expanded in REAL SPHERICAL HARMONICS,

$$f(\theta, \phi) \equiv \sum_{l=0}^{\infty} \sum_{m=0}^l [C_l^m Y_l^{m,c}(\theta, \phi) \sin(m\phi) + S_l^m Y_l^{m,s}(\theta, \phi)] \quad (30)$$

$$g(\theta, \phi) \equiv \sum_{l=0}^{\infty} \sum_{m=0}^l [A_l^m Y_l^{m,c}(\theta, \phi) \sin(m\phi) + B_l^m Y_l^{m,s}(\theta, \phi)]. \quad (31)$$

Then

$$r_l = \frac{\sum_{m=0}^l (C_l^m A_l^m + S_l^m B_l^m)}{\sqrt{\sum_{m=0}^l (C_l^{m2} + S_l^{m2})} \sqrt{\sum_{m=0}^l (A_l^{m2} + B_l^{m2})}}. \quad (32)$$

The confidence levels are then given by

$$\begin{aligned} G_1(r) &= r \\ G_2(r) &= r(1 + \frac{1}{2}s^2) = \frac{1}{2}r(3 - r^2) \\ G_3(r) &= r[1 + \frac{1}{2}s^2(1 + \frac{3}{4}s^2)] = \frac{1}{8}r(15 - 10r^2 + 3r^4) \\ G_4(r) &= r\{1 + \frac{1}{2}s^2[1 + \frac{3}{4}s^2(1 + \frac{5}{6}s^2)]\} \\ &= \frac{1}{16}r(35 - 35r^2 + 21r^4 - 5r^6), \end{aligned}$$

where

$$s \equiv \sqrt{1 - r^2} \quad (33)$$

(Eckhardt 1984).

see also FISHER'S z' -TRANSFORMATION, SPEARMAN RANK CORRELATION, SPHERICAL HARMONIC

References

- Bevington, P. R. *Data Reduction and Error Analysis for the Physical Sciences*. New York: McGraw-Hill, 1969.
Eckhardt, D. H. "Correlations Between Global Features of Terrestrial Fields." *Math. Geology* **16**, 155-171, 1984.
Kenney, J. F. and Keeping, E. S. *Mathematics of Statistics*, Pt. 1, 3rd ed. Princeton, NJ: Van Nostrand, 1962.
Kenney, J. F. and Keeping, E. S. *Mathematics of Statistics*, Pt. 2, 2nd ed. Princeton, NJ: Van Nostrand, 1951.
Pugh, E. M. and Winslow, G. H. *The Analysis of Physical Measurements*. Reading, MA: Addison-Wesley, 1966.

Correlation Dimension

Define the correlation integral as

$$C(\epsilon) \equiv \lim_{n \rightarrow \infty} \frac{1}{N^2} \sum_{\substack{i,j=1 \\ i \neq j}}^{\infty} H(\epsilon - ||x_i - x_j||), \quad (1)$$

where H is the HEAVISIDE STEP FUNCTION. When the below limit exists, the correlation dimension is then defined as

$$D_2 \equiv d_{cor} \equiv \lim_{\epsilon, \epsilon' \rightarrow 0^+} \frac{\ln \left[\frac{C(\epsilon)}{C(\epsilon')} \right]}{\ln \left(\frac{\epsilon}{\epsilon'} \right)}. \quad (2)$$

If ν is the CORRELATION EXPONENT, then

$$\lim_{\epsilon \rightarrow 0} \nu \rightarrow D_2. \quad (3)$$

It satisfies

$$d_{cor} \leq d_{inf} \leq d_{cap} \stackrel{?}{=} d_{LYA}. \quad (4)$$

To estimate the correlation dimension of an M -dimensional system with accuracy $(1-Q)$ requires N_{min} data points, where

$$N_{min} \geq \left[\frac{R(2-Q)}{2(1-Q)} \right]^M, \quad (5)$$

where $R \geq 1$ is the length of the "plateau region." If an ATTRACTOR exists, then an estimate of D_2 saturates above some M given by

$$M \geq 2D + 1, \quad (6)$$

which is sometimes known as the fractal Whitney embedding prevalence theorem.

see also CORRELATION EXPONENT, q -DIMENSION

References

- Nayfeh, A. H. and Balachandran, B. *Applied Nonlinear Dynamics: Analytical, Computational, and Experimental Methods*. New York: Wiley, pp. 547-548, 1995.

Correlation Exponent

A measure ν of a STRANGE ATTRACTOR which allows the presence of CHAOS to be distinguished from random noise. It is related to the CAPACITY DIMENSION D and INFORMATION DIMENSION σ , satisfying

$$\nu \leq \sigma \leq D. \quad (1)$$

It satisfies

$$\nu \leq D_{KY}, \quad (2)$$

where D_{KY} is the KAPLAN-YORKE DIMENSION. As the cell size goes to zero,

$$\lim_{\epsilon \rightarrow 0} \nu \rightarrow D_2, \quad (3)$$

where D_2 is the CORRELATION DIMENSION.

References

- Grassberger, P. and Procaccia, I. "Measuring the Strangeness of Strange Attractors." *Physica D* **9**, 189-208, 1983.

Correlation (Geometric)

A point-to-line and line-to-point TRANSFORMATION which transforms points A into lines a' and lines b into points B' such that a' passes through B' IFF A' lies on b .

see also POLARITY

Correlation Index

$$r_c \equiv \frac{s_y \hat{y}}{s_y s_{\hat{y}}}$$

$$r_c^2 = \frac{s_{\hat{y}}^2}{s_y^2} = 1 - \frac{\text{SSE}}{s_y^2}.$$

see also CORRELATION COEFFICIENT

Correlation Integral

Consider a set of points \mathbf{X}_i on an ATTRACTOR, then the correlation integral is

$$C(l) \equiv \lim_{N \rightarrow \infty} \frac{1}{N^2} f,$$

where f is the number of pairs (i, j) whose distance $|\mathbf{X}_i - \mathbf{X}_j| < l$. For small l ,

$$C(l) \sim l^\nu,$$

where ν is the CORRELATION EXPONENT.

References

Grassberger, P. and Procaccia, I. "Measuring the Strangeness of Strange Attractors." *Physica D* 9, 189-208, 1983.

Correlation Ratio

Let there be N_i observations of the i th phenomenon, where $i = 1, \dots, p$ and

$$N \equiv \sum N_i \quad (1)$$

$$\bar{y}_i \equiv \frac{1}{N_i} \sum_{\alpha} y_{i\alpha} \quad (2)$$

$$\bar{y} \equiv \frac{1}{N} \sum_i \sum_{\alpha} y_{i\alpha}. \quad (3)$$

Then

$$E_{y^2} \equiv \frac{\sum_i N_i (y_i - \bar{y})^2}{\sum_i \sum_{\alpha} (y_{i\alpha} - \bar{y})^2}. \quad (4)$$

Let η_{yx} be the population correlation ratio. If $N_i = N_j$ for $i \neq j$, then

$$f(E^2) = \frac{e^{-\lambda} (E^2)^{a-1} (1 - E^2)^{b-1} {}_1F_1(a, b; \lambda E^2)}{B(a, b)}, \quad (5)$$

where

$$\lambda \equiv \frac{N\eta^2}{2(1 - \eta^2)} \quad (6)$$

$$a \equiv \frac{n_1}{2} \quad (7)$$

$$b \equiv \frac{n_2}{2}, \quad (8)$$

and ${}_1F_1(a, b; z)$ is the CONFLUENT HYPERGEOMETRIC LIMIT FUNCTION. If $\lambda = 0$, then

$$f(E^2) = \beta(a, b) \quad (9)$$

(Kenney and Keeping 1951, pp. 323-324).

see also CORRELATION COEFFICIENT, REGRESSION COEFFICIENT

References

Kenney, J. F. and Keeping, E. S. *Mathematics of Statistics*, Pt. 2, 2nd ed. Princeton, NJ: Van Nostrand, 1951.

Correlation (Statistical)

For two variables x and y ,

$$\text{cor}(x, y) \equiv \frac{\text{cov}(x, y)}{\sigma_x \sigma_y}, \quad (1)$$

where σ_x denotes STANDARD DEVIATION and $\text{cov}(x, y)$ is the COVARIANCE of these two variables. For the general case of variables x_i and x_j , where $i, j = 1, 2, \dots, n$,

$$\text{cor}(x_i, x_j) = \frac{\text{cov}(x_i, x_j)}{\sqrt{V_{ii} V_{jj}}}, \quad (2)$$

where V_{ii} are elements of the COVARIANCE MATRIX. In general, a correlation gives the strength of the relationship between variables. The variance of any quantity is always NONNEGATIVE by definition, so

$$\text{var} \left(\frac{x}{\sigma_x} + \frac{y}{\sigma_y} \right) \geq 0. \quad (3)$$

From a property of VARIANCES, the sum can be expanded

$$\text{var} \left(\frac{x}{\sigma_x} \right) + \text{var} \left(\frac{y}{\sigma_y} \right) + 2 \text{cov} \left(\frac{x}{\sigma_x}, \frac{y}{\sigma_y} \right) \geq 0 \quad (4)$$

$$\frac{1}{\sigma_x^2} \text{var}(x) + \frac{1}{\sigma_y^2} \text{var}(y) + \frac{2}{\sigma_x \sigma_y} \text{cov}(x, y) \geq 0 \quad (5)$$

$$1 + 1 + \frac{2}{\sigma_x \sigma_y} \text{cov}(x, y) = 2 + \frac{2}{\sigma_x \sigma_y} \text{cov}(x, y) \geq 0. \quad (6)$$

Therefore,

$$\text{cor}(x, y) = \frac{\text{cov}(x, y)}{\sigma_x \sigma_y} \geq -1. \quad (7)$$

Similarly,

$$\text{var}\left(\frac{x}{\sigma_x}\right) - \left(\frac{y}{\sigma_y}\right) \geq 0 \quad (8)$$

$$\text{var}\left(\frac{x}{\sigma_x}\right) + \text{var}\left(-\frac{y}{\sigma_y}\right) + 2\text{cov}\left(\frac{x}{\sigma_x}, -\frac{y}{\sigma_y}\right) \geq 0 \quad (9)$$

$$\frac{1}{\sigma_x^2} \text{var}(x) + \frac{1}{\sigma_y^2} \text{var}(y) - \frac{2}{\sigma_x \sigma_y} \text{cov}(x, y) \geq 0 \quad (10)$$

$$1 + 1 - \frac{2}{\sigma_x \sigma_y} \text{cov}(x, y) = 2 - \frac{2}{\sigma_x \sigma_y} \text{cov}(x, y) \geq 0. \quad (11)$$

Therefore,

$$\text{cor}(x, y) = \frac{\text{cov}(x, y)}{\sigma_x \sigma_y} \leq 1, \quad (12)$$

so $-1 \leq \text{cor}(x, y) \leq 1$. For a linear combination of two variables,

$$\begin{aligned} \text{var}(y - bx) &= \text{var}(y) + \text{var}(-bx) + 2\text{cov}(y, -bx) \\ &= \text{var}(y) + b^2 \text{var}(x) - 2b \text{cov}(x, y) \\ &= \sigma_y^2 + \sigma_x^2 - 2b \text{cov}(x, y). \end{aligned} \quad (13)$$

Examine the cases where $\text{cor}(x, y) = \pm 1$,

$$\text{cor}(x, y) \equiv \frac{\text{cov}(x, y)}{\sigma_x \sigma_y} = \pm 1 \quad (14)$$

$$\text{var}(y - bx) = b^2 \sigma_x^2 + \sigma_y^2 \mp 2b \sigma_x \sigma_y = (b \sigma_x \mp \sigma_y)^2. \quad (15)$$

The VARIANCE will be zero if $b \equiv \pm \sigma_y / \sigma_x$, which requires that the argument of the VARIANCE is a constant. Therefore, $y - bx = a$, so $y = a + bx$. If $\text{cor}(x, y) = \pm 1$, y is either perfectly correlated ($b > 0$) or perfectly anti-correlated ($b < 0$) with x .

see also COVARIANCE, COVARIANCE MATRIX, VARIANCE

Cosecant

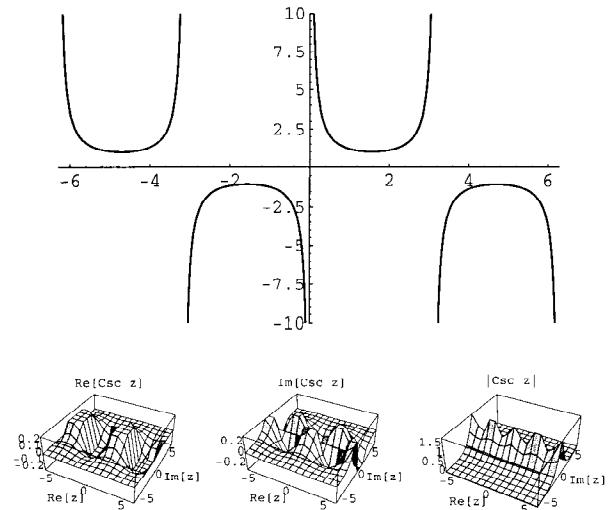

The function defined by $\csc x \equiv 1/\sin x$, where $\sin x$ is the SINE. The MACLAURIN SERIES of the cosecant function is

$$\begin{aligned} \csc x &= \frac{1}{x} + \frac{1}{6}x + \frac{7}{360}x^3 + \frac{31}{15120}x^5 + \dots \\ &+ \frac{(-1)^{n+1} 2(2^{2n-1} - 1) B_{2n}}{(2n)!} x^{2n-1} + \dots, \end{aligned}$$

where B_{2n} is a BERNOULLI NUMBER.

see also INVERSE COSECANT, SECANT, SINE

References

Abramowitz, M. and Stegun, C. A. (Eds.). "Circular Functions." §4.3 in *Handbook of Mathematical Functions with Formulas, Graphs, and Mathematical Tables*, 9th printing. New York: Dover, pp. 71-79, 1972.
Spanier, J. and Oldham, K. B. "The Secant $\sec(x)$ and Cosecant $\csc(x)$ Functions." Ch. 33 in *An Atlas of Functions*. Washington, DC: Hemisphere, pp. 311-318, 1987.

Coset

Consider a countable SUBGROUP H with ELEMENTS h_i and an element x not in H , then

$$xh_i \quad (1)$$

$$h_i x \quad (2)$$

for $i = 1, 2, \dots$ are left and right cosets of the SUBGROUP H with respect to x . The coset of a SUBGROUP has the same number of ELEMENTS as the SUBGROUP. The ORDER of any SUBGROUP is a divisor of the ORDER of the GROUP. The original GROUP can be represented by

$$G = H + x_1 H + x_2 H + \dots \quad (3)$$

For G a not necessarily FINITE GROUP with H a SUBGROUP of G , define an EQUIVALENCE RELATION $x \sim y$ if $x = hy$ for some h in H . Then the EQUIVALENCE CLASSES are the left (or right, depending on convention) cosets of H in G , namely the sets

$$\{x \in G : x = ha \text{ for some } h \text{ in } H\}, \quad (4)$$

where a is an element of G .

see also EQUIVALENCE CLASS, GROUP, SUBGROUP

Cosh

see HYPERBOLIC COSINE

Cosine

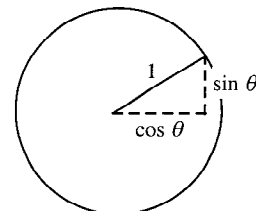

Let θ be an ANGLE measured counterclockwise from the x -axis along the arc of the unit CIRCLE. Then $\cos \theta$ is the horizontal coordinate of the arc endpoint. As a result of this definition, the cosine function is periodic with period 2π .

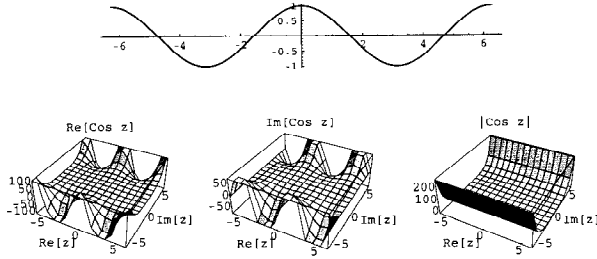

The cosine function has a FIXED POINT at 0.739085.

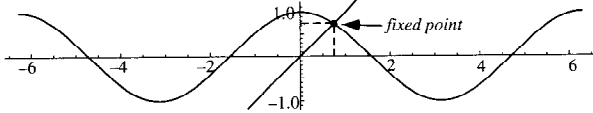

The cosine function can be defined algebraically using the infinite sum

$$\cos x \equiv \sum_{n=0}^{\infty} \frac{(-1)^n x^{2n}}{(2n)!} = 1 - \frac{x^2}{2!} + \frac{x^4}{4!} - \frac{x^6}{6!} + \dots, \quad (1)$$

or the INFINITE PRODUCT

$$\cos x = \prod_{n=1}^{\infty} \left[1 - \frac{4x^2}{\pi^2(2n-1)^2} \right]. \quad (2)$$

A close approximation to $\cos(x)$ for $x \in [0, \pi/2]$ is

$$\cos\left(\frac{\pi}{2}x\right) \approx 1 - \frac{x^2}{x + (1-x)\sqrt{\frac{2-x}{3}}} \quad (3)$$

(Hardy 1959). The difference between $\cos x$ and Hardy's approximation is plotted below.

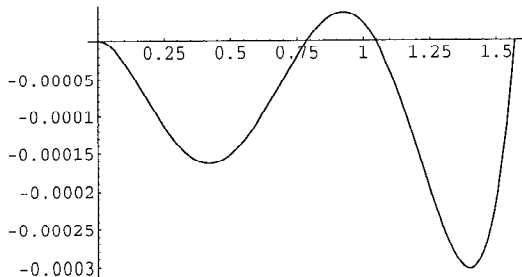

The FOURIER TRANSFORM of $\cos(2\pi k_0 x)$ is given by

$$\begin{aligned} \mathcal{F}[\cos(2\pi k_0 x)] &= \int_{-\infty}^{\infty} e^{-2\pi i k x} \cos(2\pi k_0 x) dx \\ &= \frac{1}{2} [\delta(k - k_0) + \delta(k + k_0)], \end{aligned} \quad (4)$$

where $\delta(k)$ is the DELTA FUNCTION.

The cosine sum rule gives an expansion of the COSINE function of a multiple ANGLE in terms of a sum of POWERS of sines and cosines,

$$\begin{aligned} \cos(n\theta) &= 2 \cos \theta \cos[(n-1)\theta] - \cos[(n-2)\theta] \\ &= \cos^n \theta - \binom{n}{2} \cos^{n-2} \theta \sin^2 \theta \\ &\quad + \binom{n}{4} \cos^{n-4} \theta \sin^4 \theta - \dots \end{aligned} \quad (5)$$

Summing the COSINE of a multiple angle from $n = 0$ to $N - 1$ can be done in closed form using

$$\sum_{n=0}^{N-1} \cos(nx) = \Re \left[\sum_{n=0}^{N-1} e^{inx} \right]. \quad (6)$$

The EXPONENTIAL SUM FORMULAS give

$$\begin{aligned} \sum_{n=0}^{N-1} \cos(nx) &= \Re \left[\frac{\sin(\frac{1}{2}Nx)}{\sin(\frac{1}{2}x)} e^{i(N-1)x/2} \right] \\ &= \frac{\sin(\frac{1}{2}Nx)}{\sin(\frac{1}{2}x)} \cos[\frac{1}{2}x(N-1)]. \end{aligned} \quad (7)$$

Similarly,

$$\sum_{n=0}^{\infty} p^n \cos(nx) = \Re \left[\sum_{n=0}^{\infty} p^n e^{inx} \right], \quad (8)$$

where $|p| < 1$. The EXPONENTIAL SUM FORMULA gives

$$\begin{aligned} \sum_{n=0}^{\infty} p^n \cos(nx) &= \Re \left[\frac{1 - pe^{-ix}}{1 - 2p \cos x + p^2} \right] \\ &= \frac{1 - p \cos x}{1 - 2p \cos x + p^2}. \end{aligned} \quad (9)$$

Cvijović and Klinowski (1995) note that the following series

$$C_\nu(\alpha) = \sum_{k=0}^{\infty} \frac{\cos(2k+1)\alpha}{(2k+1)^\nu} \quad (10)$$

has closed form for $\nu = 2n$,

$$C_{2n}(\alpha) = \frac{(-1)^n}{4(2n-1)!} \pi^{2n} E_{2n-1}\left(\frac{\alpha}{\pi}\right), \quad (11)$$

where $E_n(x)$ is an EULER POLYNOMIAL.

see also EULER POLYNOMIAL, EXPONENTIAL SUM FORMULAS, FOURIER TRANSFORM—COSINE, HYPERBOLIC COSINE, SINE, TANGENT, TRIGONOMETRIC FUNCTIONS

References

Abramowitz, M. and Stegun, C. A. (Eds.). "Circular Functions." §4.3 in *Handbook of Mathematical Functions with*

Formulas, Graphs, and Mathematical Tables, 9th printing. New York: Dover, pp. 71–79, 1972.

Hardy, G. H. *Ramanujan: Twelve Lectures on Subjects Suggested by His Life and Work*, 3rd ed. New York: Chelsea, p. 68, 1959.

Cvijović, D. and Klinowski, J. "Closed-Form Summation of Some Trigonometric Series." *Math. Comput.* **64**, 205–210, 1995.

Hansen, E. R. *A Table of Series and Products*. Englewood Cliffs, NJ: Prentice-Hall, 1975.

Project Mathematics! *Sines and Cosines, Parts I–III*. Videotapes (28, 30, and 30 minutes). California Institute of Technology. Available from the Math. Assoc. Amer.

Spanier, J. and Oldham, K. B. "The Sine $\sin(x)$ and Cosine $\cos(x)$ Functions." Ch. 32 in *An Atlas of Functions*. Washington, DC: Hemisphere, pp. 295–310, 1987.

Cosine Apodization Function

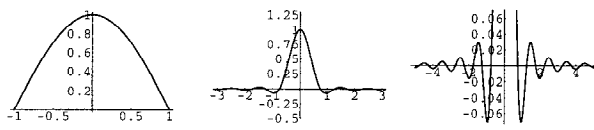

The APODIZATION FUNCTION

$$A(x) = \cos\left(\frac{\pi x}{2a}\right).$$

Its FULL WIDTH AT HALF MAXIMUM is $4a/3$. Its INSTRUMENT FUNCTION is

$$I(k) = \frac{4a \cos(2\pi ak)}{\pi(1 - 16a^2 k^2)}.$$

see also APODIZATION FUNCTION

Cosine Circle

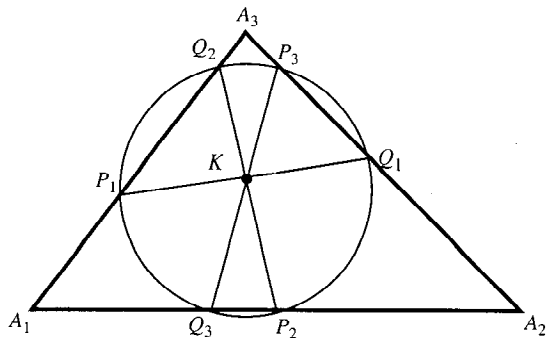

Also called the second LEMOINE CIRCLE. Draw lines through the LEMOINE POINT K and PARALLEL to the sides of the TRIANGLES. The points where the antiparallel lines intersect the sides then lie on a CIRCLE known as the cosine circle with center at K . The CHORDS P_2Q_3 , P_3Q_1 , and P_1Q_2 are proportional to the COSINES of the ANGLES of $\Delta A_1A_2A_3$, giving the circle its name.

TRIANGLES $P_1P_2P_3$ and $\Delta A_1A_2A_3$ are directly similar, and TRIANGLES $\Delta Q_1Q_2Q_3$ and $A_1A_2A_3$ are similar. The MIQUEL POINT of $\Delta P_1P_2P_3$ is at the BROCARD POINT Ω of $\Delta P_1P_2P_3$.

see also BROCARD POINTS, LEMOINE CIRCLE, MIQUEL POINT, TUCKER CIRCLES

References

Johnson, R. A. *Modern Geometry: An Elementary Treatise on the Geometry of the Triangle and the Circle*. Boston, MA: Houghton Mifflin, pp. 271–273, 1929.

Cosine Integral

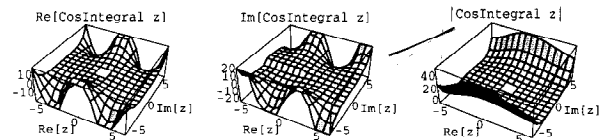
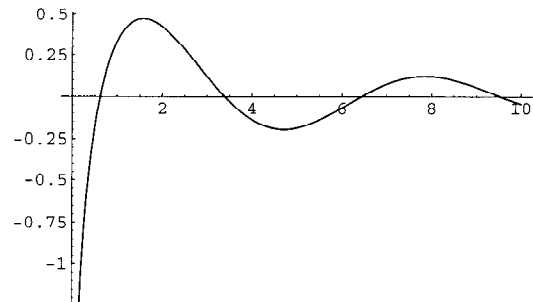

There are (at least) three types of "cosine integrals," denoted $\text{ci}(x)$, $\text{Ci}(x)$, and $\text{Cin}(x)$:

$$\text{ci}(x) \equiv - \int_x^\infty \frac{\cos t}{t} dt \quad (1)$$

$$= \frac{1}{2} [\text{ei}(ix) + \text{ei}(-ix)] \quad (2)$$

$$= -\frac{1}{2} [\text{E}_1(ix) + \text{E}_1(-ix)], \quad (3)$$

$$\text{Ci}(x) \equiv \gamma + \ln x + \int_0^x \frac{\cos t - 1}{t} dt \quad (4)$$

$$\text{Cin}(x) \equiv \int_0^x \frac{(1 - \cos t)}{t} dt \quad (5)$$

$$= -\text{Ci}(x) + \ln x + \gamma. \quad (6)$$

Here, $\text{ei}(x)$ is the EXPONENTIAL INTEGRAL, $\text{E}_n(x)$ is the E_n -FUNCTION, and γ is the EULER-MASCHERONI CONSTANT. $\text{ci}(x)$ is the function returned by the *Mathematica*® (Wolfram Research, Champaign, IL) command `CosIntegral[x]` and displayed above.

To compute the integral of an EVEN power times a cosine,

$$I \equiv \int x^{2n} \cos(mx) dx, \quad (7)$$

use INTEGRATION BY PARTS. Let

$$u = x^{2n} \quad dv = \cos(mx) dx \quad (8)$$

$$du = 2nx^{2n-1} dx \quad v = \frac{1}{m} \sin(mx), \quad (9)$$

so

$$I = \frac{1}{m} x^{2n} \sin(mx) - \frac{2n}{m} \int x^{2n-1} \sin(mx) dx. \quad (10)$$

Using INTEGRATION BY PARTS again,

$$u = x^{2n-1} \quad dv = \sin(mx) dx \quad (11)$$

$$du = (2n-1)x^{2n-2} dx \quad v = -\frac{1}{m} \cos(mx), \quad (12)$$

and

$$\begin{aligned} \int x^{2n} \cos(mx) dx &= \frac{1}{m} x^{2n} \sin(mx) - \frac{2n}{m} \left[-\frac{1}{m} x^{2n-1} \cos(mx) \right. \\ &\quad \left. + \frac{2n-1}{m} \int x^{2n-2} \cos(mx) dx \right] \\ &= \frac{1}{m} x^{2n} \sin(mx) + \frac{2n}{m^2} x^{2n-1} \cos(mx) \\ &\quad - \frac{(2n)(2n-1)}{m^2} \int x^{2n-2} \cos(mx) dx \\ &= \frac{1}{m} x^{2n} \sin(mx) + \frac{2n}{m^2} x^{2n-1} \cos(mx) \\ &\quad + \dots + \frac{(2n)!}{m^{2n}} \int x^0 \cos(mx) dx \\ &= \frac{1}{m} x^{2n} \sin(mx) + \frac{2n}{m^2} x^{2n-1} \cos(mx) \\ &\quad + \dots + \frac{(2n)!}{m^{2n+1}} \sin(mx) \\ &= \sin(mx) \sum_{k=0}^n (-1)^{k+1} \frac{(2n)!}{(2n-2k)! m^{2k+1}} x^{2n-2k} \\ &\quad + \cos(mx) \sum_{k=1}^n (-1)^{k+1} \frac{(2n)!}{(2k-2n-1)! m^{2k}} x^{2n-2k+1}. \end{aligned} \quad (13)$$

Letting $k' \equiv n-k$,

$$\begin{aligned} \int x^{2n} \cos(mx) dx &= \sin(mx) \sum_{k=0}^n (-1)^{n-k+1} \frac{(2n)!}{(2k)! m^{2n-2k+1}} x^{2k} \\ &\quad + \cos(mx) \sum_{k=0}^{n-1} (-1)^{n-k+1} \frac{(2n)!}{(2k-1)! m^{2n-2k}} x^{2k+1} \\ &= (-1)^{n+1} (2n)! \left[\sin(mx) \sum_{k=0}^n \frac{(-1)^k}{(2k)! m^{2n-2k+1}} x^{2k} \right. \\ &\quad \left. + \cos(mx) \sum_{k=1}^n \frac{(-1)^{k+1}}{(2k-3)! m^{2n-2k+2}} x^{2k-1} \right]. \end{aligned} \quad (14)$$

To find a closed form for an integral power of a cosine function,

$$I \equiv \int \cos^m x dx, \quad (15)$$

perform an INTEGRATION BY PARTS so that

$$u = \cos^{m-1} x \quad dv = \cos x dx \quad (16)$$

$$du = -(m-1) \cos^{m-2} x \sin x dx \quad v = \sin x. \quad (17)$$

Therefore

$$\begin{aligned} I &= \sin x \cos^{m-1} x + (m-1) \int \cos^{m-2} x \sin^2 x dx \\ &= \sin x \cos^{m-1} x \\ &\quad + (m-1) \left[\int \cos^{m-2} x dx - \int \cos^m x dx \right] \\ &= \sin x \cos^{m-1} x + (m-1) \left[\int \cos^{m-2} x dx - I \right], \end{aligned} \quad (18)$$

so

$$I[1 + (m-1)] = \sin x \cos^{m-1} x + (m-1) \int \cos^{m-2} x dx \quad (19)$$

$$\begin{aligned} I &= \int \cos^m x dx \\ &= \frac{\sin x \cos^{m-1} x}{m} + \frac{m-1}{m} \int \cos^{m-2} x dx. \end{aligned} \quad (20)$$

Now, if m is EVEN so $m \equiv 2n$, then

$$\begin{aligned} \int \cos^{2n} x dx &= \frac{\sin x \cos^{2n-1} x}{2n} + \frac{2n-1}{2n} \int \cos^{2n-2} x dx \\ &= \frac{\sin x \cos^{2n-1} x}{2n} + \frac{2n-1}{n} \left[\frac{\sin x \cos^{2n-3} x}{2n-2} \right. \\ &\quad \left. + \frac{2n-3}{2n-2} \int \cos^{2n-4} x dx \right] \\ &= \sin x \left[\frac{1}{2n} \cos^{2n-1} x + \frac{2n-1}{(2n)(2n-2)} \cos^{2n-3} x \right] \\ &\quad + \frac{(2n-1)(2n-3)}{(2n)(2n-2)} \int \cos^{2n-4} x dx \\ &= \sin x \left[\frac{1}{2n} \cos^{2n-1} x \right. \\ &\quad \left. + \frac{2n-1}{(2n)(2n-2)} \cos^{2n-3} x + \dots \right] \\ &\quad + \frac{(2n-1)(2n-3) \dots 1}{(2n)(2n-2) \dots 2} \int \cos^0 x dx \\ &= \sin x \sum_{k=1}^n \frac{(2n-2k)!!}{(2n)!!} \frac{(2n-1)!!}{(2n-2k+1)!!} \cos^{2n-2k+1} x \\ &\quad + \frac{(2n-1)!!}{(2n)!!} x. \end{aligned} \quad (21)$$

Now let $k' \equiv n - k + 1$, so $n - k = k' - 1$,

$$\begin{aligned} & \int \cos^{2n} x \, dx \\ &= \sin x \sum_{k=1}^n \frac{(2k-2)!!}{(2n)!!} \frac{(2n-1)!!}{(2k-1)!!} \cos^{2k-1} x + \frac{(2n-1)!!}{(2n)!!} x \\ &= \frac{(2n-1)!!}{(2n)!!} \left[\sin x \sum_{k=0}^{n-1} \frac{(2k)!!}{(2k+1)!!} \cos^{2k+1} x + x \right]. \end{aligned} \quad (22)$$

Now if m is ODD so $m \equiv 2n + 1$, then

$$\begin{aligned} & \int \cos^{2n+1} x \, dx \\ &= \frac{\sin x \cos^{2n} x}{2n+1} + \frac{2n}{2n+1} \int \cos^{2n-1} x \, dx \\ &= \frac{\sin x \cos^{2n} x}{2n+1} + \frac{2n}{2n+1} \left[\frac{\sin x \cos^{2n-2} x}{2n-1} \right. \\ & \quad \left. + \frac{2n-2}{2n-1} \int \cos^{2n-3} x \, dx \right] \\ &= \sin x \left[\frac{1}{2n+1} \cos^{2n} x + \frac{2n}{(2n+1)(2n-1)} \cos^{2n-2} x \right] \\ & \quad + \frac{(2n)(2n-2)}{(2n+1)(2n-1)} \int \cos^{2n-3} x \, dx \\ &= \sin x \left[\frac{1}{2n+1} \cos^{2n} x \right. \\ & \quad \left. + \frac{2n}{(2n+1)(2n-1)} \cos^{2n-2} x + \dots \right] \\ & \quad + \frac{(2n)(2n-2) \cdots 2}{(2n+1)(2n-1) \cdots 3} \int \cos x \, dx \\ &= \sin x \sum_{k=0}^n \frac{(2n-2k-1)!!}{(2n+1)!!} \frac{(2n)!!}{(2n-2k)!!} \cos^{2n-2k} x. \end{aligned} \quad (23)$$

Now let $k' \equiv n - k$,

$$\int \cos^{2n} x \, dx = \frac{(2n)!!}{(2n+1)!!} \sin x \sum_{k=0}^n \frac{(2k-1)!!}{(2k)!!} \cos^{2k} x. \quad (24)$$

The general result is then

$$\int \cos^m x \, dx = \begin{cases} \frac{(2n-1)!!}{(2n)!!} \left[\sin x \sum_{k=0}^{n-1} \frac{(2k)!!}{(2k+1)!!} \cos^{2k+1} x + x \right] & \text{for } m = 2n \\ \frac{(2n)!!}{(2n+1)!!} \sin x \sum_{k=0}^n \frac{(2k-1)!!}{(2k)!!} \cos^{2k} x & \text{for } m = 2n+1. \end{cases} \quad (25)$$

The infinite integral of a cosine times a Gaussian can also be done in closed form,

$$\int_{-\infty}^{\infty} e^{-ax^2} \cos(kx) \, dx = \sqrt{\frac{\pi}{a}} e^{-k^2/4a}. \quad (26)$$

see also CHI, DAMPED EXPONENTIAL COSINE INTEGRAL, NIELSEN'S SPIRAL, SHI, SICI SPIRAL, SINE INTEGRAL

References

- Abramowitz, M. and Stegun, C. A. (Eds.). "Sine and Cosine Integrals." §5.2 in *Handbook of Mathematical Functions with Formulas, Graphs, and Mathematical Tables*, 9th printing. New York: Dover, pp. 231-233, 1972.
- Arfken, G. *Mathematical Methods for Physicists*, 3rd ed. Orlando, FL: Academic Press, pp. 342-343, 1985.
- Press, W. H.; Flannery, B. P.; Teukolsky, S. A.; and Vetterling, W. T. "Fresnel Integrals, Cosine and Sine Integrals." §6.79 in *Numerical Recipes in FORTRAN: The Art of Scientific Computing*, 2nd ed. Cambridge, England: Cambridge University Press, pp. 248-252, 1992.
- Spanier, J. and Oldham, K. B. "The Cosine and Sine Integrals." Ch. 38 in *An Atlas of Functions*. Washington, DC: Hemisphere, pp. 361-372, 1987.

Cosines Law

see LAW OF COSINES

Cosmic Figure

see PLATONIC SOLID

Cosmological Theorem

There exists an INTEGER N such that every string in the LOOK AND SAY SEQUENCE "decays" in at most N days to a compound of "common" and "transuranic elements."

The table below gives the periodic table of atoms associated with the LOOK AND SAY SEQUENCE as named by Conway (1987). The "abundance" is the average number of occurrences for long strings out of every million atoms. The asymptotic abundances are zero for transuranic elements, and 27.246... for arsenic (As), the next rarest element. The most common element is hydrogen (H), having an abundance of 91,970.383.... The starting element is U, represented by the string "3," and subsequent terms are those giving a description of the current term: one three (13); one one, one three (1113); three ones, one three (3113), etc.

Abundance	n	E_n	E_n is the derivate of E_{n+1}
102.56285249	92	U	3
9883.5986392	91	Pa	12
7581.9047125	90	Th	1113
6926.9352045	89	Ac	3113
5313.7894999	88	Ra	132113
4076.3134078	87	Fr	1113122113
3127.0209328	86	Rn	311311222113
2398.7998311	85	At	Ho.1322113
1840.1669683	84	Po	1113222113
1411.6286100	83	Bi	3113322113
1082.8883285	82	Pb	Pm.123222113
830.70513293	81	Tl	111213322113
637.25039755	80	Hg	31121123222113
488.84742982	79	Au	132112211213322113
375.00456738	78	Pt	111312212221121123222113
287.67344775	77	Ir	3113112211322112211213322113
220.68001229	76	Os	1321132122211322212221121123222113
169.28801808	75	Re	11312211312113221133211322112211213322113
315.56655252	74	W	Ge.Ca.312211322212221121123222113
242.07736666	73	Ta	1311222113321132211221121213322113
2669.0970363	72	Hf	11132.Pa.H.Ca.W
2047.5173200	71	Lu	311312
1570.6911808	70	Yb	1321131112
1204.9083841	69	Tm	11131221133112
1098.5955997	68	Er	311311222.Ca.Co
47987.529438	67	Ho	1321132.Pm
36812.186418	66	Dy	111312211312
28239.358949	65	Tb	3113112221131112
21662.972821	64	Gd	Ho.13221133112
20085.668709	63	Eu	1113222.Ca.Co
15408.115182	62	Sm	311332
29820.456167	61	Pm	132.Ca.Zn
22875.863883	60	Nd	111312
17548.529287	59	Pr	31131112
13461.825166	58	Ce	1321133112
10326.833312	57	La	11131.H.Ca.Co
7921.9188284	56	Ba	311311
6077.0611889	55	Cs	13211321
4661.8342720	54	Xe	11131221131211
3576.1856107	53	I	311311222113111221
2743.3629718	52	Te	Ho.1322113312211
2104.4881933	51	Sb	Eu.Ca.3112221
1614.3946687	50	Sn	Pm.13211
1238.4341972	49	In	11131221
950.02745646	48	Cd	3113112211
728.78492056	47	Ag	132113212221
559.06537946	46	Pd	111312211312113211
428.87015041	45	Rh	311311222113111221131221
328.99480576	44	Ru	Ho.132211331222113112211
386.07704943	43	Tc	Eu.Ca.311322113212221
296.16736852	42	Mo	13211322211312113211
227.19586752	41	Nb	1113122113322113111221131221
174.28645997	40	Zr	Er.12322211331222113112211
133.69860315	39	Y	1112133.II.Ca.Tc
102.56285249	38	Sr	3112112.U
78.678000089	37	Rb	1321122112
60.355455682	36	Kr	11131221222112
46.299868152	35	Br	3113112211322112

Abundance	n	E_n	E_n is the derivate of E_{n+1}
35.517547944	34	Se	13211321222113222112
27.246216076	33	As	11131221131211322113322112
1887.4372276	32	Ge	31131122211311122113222.Na
1447.8905642	31	Ga	Ho.13221133122211332
23571.391336	30	Zn	Eu.Ca.Ac.H.Ca.312
18082.082203	29	Cu	131112
13871.123200	28	Ni	11133112
45645.877256	27	Co	Zn.32112
35015.858546	26	Fe	13122112
26861.360180	25	Mn	111311222112
20605.882611	24	Cr	31132.Si
15807.181592	23	V	13211312
12126.002783	22	Ti	11131221131112
9302.0974443	21	Sc	3113112221133112
56072.543129	20	Ca	Ho.Pa.H.12.Ca
43014.360913	19	K	1112
32997.170122	18	Ar	3112
25312.784218	17	Cl	132112
19417.939250	16	S	1113122112
14895.886658	15	P	311311222112
32032.812960	14	Si	Ho.1322112
24573.006696	13	Al	1113222112
18850.441228	12	Mg	3113322112
14481.448773	11	Na	Pm.123222112
11109.006696	10	Ne	111213322112
8521.9396539	9	F	31121123222112
6537.3490750	8	O	132112211213322112
5014.9302464	7	N	111312212221121123222112
3847.0525419	6	C	3113112211322112211213322112
2951.1503716	5	B	1321132122211322212221121123222112
2263.8860325	4	Be	111312211312113221133211322112211213322112
4220.0665982	3	Li	Ge.Ca.312211322212221121123222122
3237.2968588	2	He	13112221133211322112211213322112
91790.383216	1	H	Hf.Pa.22.Ca.Li

see also CONWAY'S CONSTANT, LOOK AND SAY SEQUENCE

References

- Conway, J. H. "The Weird and Wonderful Chemistry of Audioactive Decay." §5.11 in *Open Problems in Communication and Computation* (Ed. T. M. Cover and B. Gopinath). New York: Springer-Verlag, pp. 173–188, 1987.
- Conway, J. H. "The Weird and Wonderful Chemistry of Audioactive Decay." *Eureka*, 5–18, 1985.
- Ekhad, S. B. and Zeilberger, D. "Proof of Conway's Lost Cosmological Theorem." *Electronic Research Announcement of the Amer. Math. Soc.* **3**, 78–82, 1997. <http://www.math temple.edu/~zeilberg/mamarim/mamarimhtml/horton.html>.

Costa-Hoffman-Meeks Minimal Surface

see COSTA MINIMAL SURFACE

Costa Minimal Surface

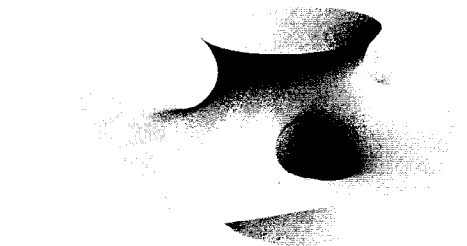

A complete embedded MINIMAL SURFACE of finite topology. It has no BOUNDARY and does not intersect itself. It can be represented parametrically by

$$\begin{aligned} x &= \frac{1}{2} \Re \left\{ -\zeta(u + iv) + \pi u + \frac{\pi^2}{4e_1} \right. \\ &\quad \left. + \frac{\pi}{2e_1} [\zeta(u + iv - \tfrac{1}{2}) - \zeta(u + iv - \tfrac{1}{2}i)] \right\} \\ y &= \frac{1}{2} \Re \left\{ -i\zeta(u + iv) + \pi v + \frac{\pi^2}{4e_1} \right. \\ &\quad \left. - \frac{\pi}{2e_1} [i\zeta(u + iv - \tfrac{1}{2}) - i\zeta(u + iv - \tfrac{1}{2}i)] \right\} \\ z &= \frac{1}{4} \sqrt{2\pi} \ln \left| \frac{\wp(u + iv) - e_1}{\wp(u + iv) + e_1} \right|, \end{aligned}$$

where $\zeta(z)$ is the WEIERSTRASS ZETA FUNCTION, $\wp(g_2, g_3; z)$ is the WEIERSTRASS ELLIPTIC FUNCTION, $c = 189.07272$, $e_1 = 6.87519$, and the invariants are given by $g_2 = c$ and $g_3 = 0$.

References

- Costa, A. "Examples of a Complete Minimal Immersion in R^3 of Genus One and Three Embedded Ends." *Bil. Soc. Bras. Mat.* 15, 47–54, 1984.
- do Carmo, M. P. *Mathematical Models from the Collections of Universities and Museums* (Ed. G. Fischer). Braunschweig, Germany: Vieweg, p. 43, 1986.
- Gray, A. *Modern Differential Geometry of Curves and Surfaces*. Boca Raton, FL: CRC Press, 1993.
- Gray, A. Images of the Costa surface. <ftp://bianchi.umd.edu/pub/COSTAPS/>.
- Nordstrand, T. "Costa-Hoffman-Meeks Minimal Surface." <http://www.uib.no/people/nfytn/costatxt.htm>.
- Peterson, I. "The Song in the Stone: Developing the Art of Telecarving a Minimal Surface." *Sci. News* 149, 110–111, Feb. 17, 1996.

Cosymmedian Triangles

Extend the SYMMEDIAN LINES of a TRIANGLE $\Delta A_1 A_2 A_3$ to meet the CIRCUMCIRCLE at P_1, P_2, P_3 . Then the LEMOINE POINT K of $\Delta A_1 A_2 A_3$ is also the LEMOINE POINT of $\Delta P_1 P_2 P_3$. The TRIANGLES $\Delta A_1 A_2 A_3$ and $\Delta P_1 P_2 P_3$ are cosymmedian triangles, and have the same BROCARD CIRCLE, second BROCARD TRIANGLE, BROCARD ANGLE, BROCARD POINTS, and CIRCUMCIRCLE.

see also BROCARD ANGLE, BROCARD CIRCLE, BROCARD POINTS, BROCARD TRIANGLES, CIRCUMCIRCLE, LEMOINE POINT, SYMMEDIAN LINE

Cotangent

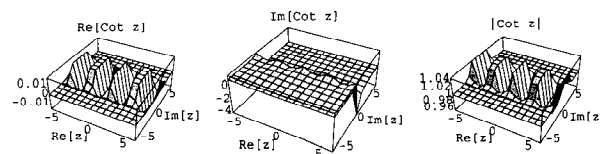
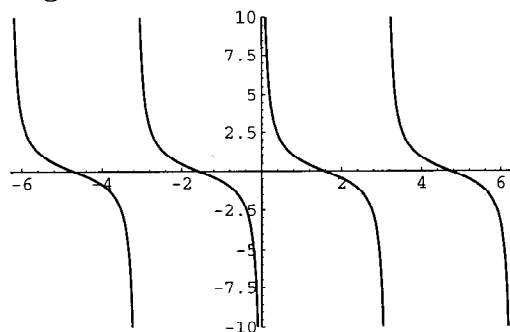

The function defined by $\cot x \equiv 1/\tan x$, where $\tan x$ is the TANGENT. The MACLAURIN SERIES for $\cot x$ is

$$\begin{aligned} \cot x &= \frac{1}{x} - \frac{1}{3}x - \frac{1}{45}x^3 - \frac{2}{945}x^5 - \frac{1}{4725}x^7 - \dots \\ &\quad - \frac{(-1)^{n+1} 2^{2n} B_{2n}}{(2n)!} - \dots, \end{aligned}$$

where B_n is a BERNOULLI NUMBER.

$$\pi \cot(\pi x) = \frac{1}{x} + 2x \sum_{n=1}^{\infty} \frac{1}{x^2 - n^2}.$$

It is known that, for $n \geq 3$, $\cot(\pi/n)$ is rational only for $n = 4$.

see also HYPERBOLIC COTANGENT, INVERSE COTANGENT, LEHMER'S CONSTANT, TANGENT

References

- Abramowitz, M. and Stegun, C. A. (Eds.). "Circular Functions." §4.3 in *Handbook of Mathematical Functions with Formulas, Graphs, and Mathematical Tables*, 9th printing. New York: Dover, pp. 71–79, 1972.
- Spanier, J. and Oldham, K. B. "The Tangent $\tan(x)$ and Cotangent $\cot(x)$ Functions." Ch. 34 in *An Atlas of Functions*. Washington, DC: Hemisphere, pp. 319–330, 1987.

Cotangent Bundle

The cotangent bundle of a MANIFOLD is similar to the TANGENT BUNDLE, except that it is the set (x, f) where $x \in M$ and f is a dual vector in the TANGENT SPACE to $x \in M$. The cotangent bundle is denoted by T^*M .

see also TANGENT BUNDLE

Cotes Circle Property

$$x^{2n} + 1 = \left[x^2 - 2x \cos \left(\frac{\pi}{2n} \right) + 1 \right] \\ \times \left[x^2 - 2x \cos \left(\frac{3\pi}{2n} \right) + 1 \right] \times \cdots \times \\ \times \left[x^2 - 2x \cos \left(\frac{(2n-1)\pi}{2n} \right) + 1 \right].$$

Cotes Number

The numbers $\lambda_{\nu n}$ in the GAUSSIAN QUADRATURE formula

$$Q_n(f) = \sum_{\nu=1}^n \lambda_{\nu n} f(x_{\nu n}).$$

see also GAUSSIAN QUADRATURE

References

Cajori, F. *A History of Mathematical Notations*, Vols. 1-2. New York: Dover, p. 42, 1993.

Cotes' Spiral

The planar orbit of a particle under a r^{-3} force field. It is an EPISPIRAL.

Coth

see HYPERBOLIC COTANGENT.

Coulomb Wave Function

A special case of the CONFLUENT HYPERGEOMETRIC FUNCTION OF THE FIRST KIND. It gives the solution to the radial Schrödinger equation in the Coulomb potential ($1/r$) of a point nucleus

$$\frac{d^2 W}{d\rho^2} + \left[1 - \frac{2\eta}{\rho} - \frac{L(L+1)}{\rho^2} \right] W = 0. \quad (1)$$

The complete solution is

$$W = C_1 F_L(\eta, \rho) + C_2 G_L(\eta, \rho). \quad (2)$$

The Coulomb function of the first kind is

$$F_L(\eta, \rho) = C_L(\eta) \rho^{L+1} e^{-i\rho} {}_1F_1(L+1-i\eta; 2L+2; 2i\rho), \quad (3)$$

where

$$C_L(\eta) \equiv \frac{2^L e^{-\pi\eta/2} |\Gamma(L+1+i\eta)|}{\Gamma(2L+2)}, \quad (4)$$

${}_1F_1(a; b; z)$ is the CONFLUENT HYPERGEOMETRIC FUNCTION, $\Gamma(z)$ is the GAMMA FUNCTION, and the Coulomb function of the second kind is

$$G_L(\eta, \rho) = \frac{2\eta}{C_0^2(\eta)} F_L(\eta, \rho) \left[\ln(2\rho) + \frac{q_L(\eta)}{p_L(\eta)} \right] \\ + \frac{1}{(2L+1)C_L(\eta)} \rho^{-L} \sum_{K=-L}^{\infty} a_K^L(\eta) \rho^{K+L}, \quad (5)$$

where q_L , p_L , and a_K^L are defined in Abramowitz and Stegun (1972, p. 538).

References

Abramowitz, M. and Stegun, C. A. (Eds.). "Coulomb Wave Functions." Ch. 14 in *Handbook of Mathematical Functions with Formulas, Graphs, and Mathematical Tables*, 9th printing. New York: Dover, pp. 537-544, 1972.

Morse, P. M. and Feshbach, H. *Methods of Theoretical Physics, Part I*. New York: McGraw-Hill, pp. 631-633, 1953.

Count

The largest n such that $|z_n| < 4$ in a MANDELBROT SET. Points of different count are often assigned different colors.

Countable Additivity Probability Axiom

For a COUNTABLE SET of n disjoint events E_1, E_2, \dots, E_n

$$P \left(\bigcup_{i=1}^n E_i \right) = \sum_{i=1}^n P(E_i).$$

see also COUNTABLE SET

Countable Set

A SET which is either FINITE or COUNTABLY INFINITE.

see also ALEPH-0, ALEPH-1, COUNTABLY INFINITE SET, FINITE, INFINITE, UNCOUNTABLY INFINITE SET

Countable Space

see FIRST-COUNTABLE SPACE

Countably Infinite Set

Any SET which can be put in a ONE-TO-ONE correspondence with the NATURAL NUMBERS (or INTEGERS), and so has CARDINAL NUMBER \aleph_0 . Examples of countable sets include the INTEGERS and ALGEBRAIC NUMBERS. Georg Cantor showed that the number of REAL NUMBERS is rigorously larger than a countably infinite set, and the postulate that this number, the "CONTINUUM," is equal to \aleph_1 is called the CONTINUUM HYPOTHESIS.

see also ALEPH-0, ALEPH-1, CANTOR DIAGONAL SLASH, CARDINAL NUMBER, CONTINUUM HYPOTHESIS, COUNTABLE SET,

Counting Generalized Principle

If r experiments are performed with n_i possible outcomes for each experiment $i = 1, 2, \dots, r$, then there are a total of $\prod_{i=1}^r n_i$ possible outcomes.

Counting Number

A POSITIVE INTEGER: 1, 2, 3, 4, ... (Sloane's A000027), also called a NATURAL NUMBER. However, 0 is sometimes also included in the list of counting numbers. Due to lack of standard terminology, the following terms are recommended in preference to "counting number," "NATURAL NUMBER," and "WHOLE NUMBER."

Set	Name	Symbol
$\dots, -2, -1, 0, 1, 2, \dots$	integers	\mathbb{Z}
$1, 2, 3, 4, \dots$	positive integers	\mathbb{Z}^+
$0, 1, 2, 3, 4, \dots$	nonnegative integers	\mathbb{Z}^*
$-1, -2, -3, -4, \dots$	negative integers	\mathbb{Z}^-

see also NATURAL NUMBER, WHOLE NUMBER, \mathbb{Z} , \mathbb{Z}^- , \mathbb{Z}^+ , \mathbb{Z}^*

References

Sloane, N. J. A. Sequence A000027/M0472 in "An On-Line Version of the Encyclopedia of Integer Sequences."

Coupon Collector's Problem

Let n objects be picked repeatedly with probability p_i that object i is picked on a given try, with

$$\sum_i p_i = 1.$$

Find the earliest time at which all n objects have been picked at least once.

References

Hildebrand, M. V. "The Birthday Problem." *Amer. Math. Monthly* 100, 643, 1993.

Covariance

Given n sets of variates denoted $\{x_1\}, \dots, \{x_n\}$, a quantity called the COVARIANCE MATRIX is defined by

$$V_{ij} = \text{cov}(x_i, x_j) \quad (1)$$

$$\equiv \langle (x_i - \mu_i)(x_j - \mu_j) \rangle \quad (2)$$

$$= \langle x_i x_j \rangle - \langle x_i \rangle \langle x_j \rangle, \quad (3)$$

where $\mu_i = \langle x_i \rangle$ and $\mu_j = \langle x_j \rangle$ are the MEANS of x_i and x_j , respectively. An individual element V_{ij} of the COVARIANCE MATRIX is called the covariance of the two variates x_i and x_j , and provides a measure of how strongly correlated these variables are. In fact, the derived quantity

$$\text{cor}(x_i, x_j) \equiv \frac{\text{cov}(x_i, x_j)}{\sigma_i \sigma_j}, \quad (4)$$

where σ_i, σ_j are the STANDARD DEVIATIONS, is called the CORRELATION of x_i and x_j . Note that if x_i and x_j are taken from the same set of variates (say, x), then

$$\text{cov}(x, x) = \langle x^2 \rangle - \langle x \rangle^2 = \text{var}(x), \quad (5)$$

giving the usual VARIANCE $\text{var}(x)$. The covariance is also symmetric since

$$\text{cov}(x, y) = \text{cov}(y, x). \quad (6)$$

For two variables, the covariance is related to the VARIANCE by

$$\text{var}(x + y) = \text{var}(x) + \text{var}(y) + 2 \text{cov}(x, y). \quad (7)$$

For two independent variates $x = x_i$ and $y = x_j$,

$$\text{cov}(x, y) = \langle xy \rangle - \mu_x \mu_y = \langle x \rangle \langle y \rangle - \mu_x \mu_y = 0, \quad (8)$$

so the covariance is zero. However, if the variables are correlated in some way, then their covariance will be NONZERO. In fact, if $\text{cov}(x, y) > 0$, then y tends to increase as x increases. If $\text{cov}(x, y) < 0$, then y tends to decrease as x increases.

The covariance obeys the identity

$$\begin{aligned} \text{cov}(x + z, y) &= \langle (x + z)y - \langle x + z \rangle \langle y \rangle \rangle \\ &= \langle xy \rangle + \langle zy \rangle - (\langle x \rangle + \langle z \rangle) \langle y \rangle \\ &= \langle xy \rangle - \langle x \rangle \langle y \rangle + \langle zy \rangle - \langle z \rangle \langle y \rangle \\ &= \text{cov}(x, y) + \text{cov}(z, y). \end{aligned} \quad (9)$$

By induction, it therefore follows that

$$\text{cov} \left(\sum_{i=1}^n x_i, y \right) = \sum_{i=1}^n \text{cov}(x_i, y) \quad (10)$$

$$\text{cov} \left(\sum_{i=1}^n x_i, \sum_{j=1}^m y_j \right) = \sum_{i=1}^n \text{cov} \left(x_i, \sum_{j=1}^m y_j \right) \quad (11)$$

$$= \sum_{i=1}^n \text{cov} \left(\sum_{j=1}^m y_j, x_i \right) \quad (12)$$

$$= \sum_{i=1}^n \sum_{j=1}^m \text{cov}(y_j, x_i) \quad (13)$$

$$= \sum_{i=1}^n \sum_{j=1}^m \text{cov}(x_i, y_j). \quad (14)$$

see also CORRELATION (STATISTICAL), COVARIANCE MATRIX, VARIANCE

Covariance Matrix

Given n sets of variates denoted $\{x_1\}, \dots, \{x_n\}$, the first-order covariance matrix is defined by

$$V_{ij} = \text{cov}(x_i, x_j) \equiv \langle (x_i - \mu_i)(x_j - \mu_j) \rangle,$$

where μ_i is the MEAN. Higher order matrices are given by

$$V_{ij}^{mn} = \langle (x_i - \mu_i)^m (x_j - \mu_j)^n \rangle.$$

An individual matrix element $V_{ij} = \text{cov}(x_i, x_j)$ is called the COVARIANCE of x_i and x_j .

see also CORRELATION (STATISTICAL), COVARIANCE, VARIANCE

Covariant Derivative

The covariant derivative of a TENSOR A^α (also called the SEMICOLON DERIVATIVE since its symbol is a semicolon)

$$A^\alpha{}_{;\alpha} = \nabla \cdot \mathbf{A} = A^k{}_{,k} + \Gamma^k_{jk} A^j, \quad (1)$$

and of A_j is

$$A_{j;k} = \frac{1}{g^{kk}} \frac{\partial A_j}{\partial x_k} - \Gamma^i_{jk} A_i, \quad (2)$$

where Γ is a CONNECTION COEFFICIENT.

see also CONNECTION COEFFICIENT, COVARIANT TENSOR, DIVERGENCE

References

Morse, P. M. and Feshbach, H. *Methods of Theoretical Physics, Part I*. New York: McGraw-Hill, pp. 48–50, 1953.

Covariant Tensor

A covariant tensor is a TENSOR having specific transformation properties (c.f., a CONTRAVARIANT TENSOR). To examine the transformation properties of a covariant tensor, first consider the GRADIENT

$$\nabla \phi \equiv \frac{\partial \phi}{\partial x_1} \hat{\mathbf{x}}_1 + \frac{\partial \phi}{\partial x_2} \hat{\mathbf{x}}_2 + \frac{\partial \phi}{\partial x_3} \hat{\mathbf{x}}_3, \quad (1)$$

for which

$$\frac{\partial \phi'}{\partial x'_i} = \frac{\partial \phi}{\partial x_j} \frac{\partial x_j}{\partial x'_i}, \quad (2)$$

where $\phi(x_1, x_2, x_3) = \phi'(x'_1, x'_2, x'_3)$. Now let

$$A_i \equiv \frac{\partial \phi}{\partial x_i}, \quad (3)$$

then any set of quantities A_j which transform according to

$$A'_i = \frac{\partial x_j}{\partial x'_i} A'_j \quad (4)$$

or, defining

$$a_{ij} \equiv \frac{\partial x_j}{\partial x'_i}, \quad (5)$$

according to

$$A_i = a_{ij} A'_j \quad (6)$$

is a covariant tensor. Covariant tensors are indicated with lowered indices, i.e., a_μ .

CONTRAVARIANT TENSORS are a type of TENSOR with differing transformation properties, denoted a^ν . However, in 3-D CARTESIAN COORDINATES,

$$\frac{\partial x_j}{\partial x'_i} = \frac{\partial x'_i}{\partial x_j} \equiv a_{ij} \quad (7)$$

for $i, j = 1, 2, 3$, meaning that contravariant and covariant tensors are equivalent. The two types of tensors do

differ in higher dimensions, however. Covariant FOUR-VECTORS satisfy

$$a_\mu = \Lambda^\nu_\mu a_\nu, \quad (8)$$

where Λ is a LORENTZ TENSOR.

To turn a CONTRAVARIANT TENSOR into a covariant tensor, use the METRIC TENSOR $g_{\mu\nu}$ to write

$$a_\mu \equiv g_{\mu\nu} a^\nu. \quad (9)$$

Covariant and contravariant indices can be used simultaneously in a MIXED TENSOR.

see also CONTRAVARIANT TENSOR, FOUR-VECTOR, LORENTZ TENSOR, METRIC TENSOR, MIXED TENSOR, TENSOR

References

Arfken, G. "Noncartesian Tensors, Covariant Differentiation." §3.8 in *Mathematical Methods for Physicists*, 3rd ed. Orlando, FL: Academic Press, pp. 158–164, 1985.
Morse, P. M. and Feshbach, H. *Methods of Theoretical Physics, Part I*. New York: McGraw-Hill, pp. 44–46, 1953.

Covariant Vector

A COVARIANT TENSOR of RANK 1.

Cover

A group C of SUBSETS of X whose UNION contains the given set X ($\cup\{S : S \in C\} = X$) is called a cover (or a COVERING). A MINIMAL COVER is a cover for which removal of one member destroys the covering property. There are various types of specialized covers, including proper covers, antichain covers, minimal covers, k -covers, and k^* -covers. The number of possible covers for a set of N elements is

$$|C(N)| = \frac{1}{2} \sum_{k=0}^N (-1)^k \binom{N}{k} 2^{2^{N-k}},$$

the first few of which are 1, 5, 109, 32297, 2147321017, 9223372023970362989, ... (Sloane's A003465). The number of proper covers for a set of N elements is

$$\begin{aligned} |C'(N)| &= |C(N)| - \frac{1}{4} 2^{2^N} \\ &= \frac{1}{2} \sum_{k=0}^N (-1)^k \binom{N}{k} 2^{2^{N-k}} - \frac{2^{2^N}}{4}, \end{aligned}$$

the first few of which are 0, 1, 45, 15913, 1073579193, ... (Sloane's A007537).

see also MINIMAL COVER

References

Eppstein, D. "Covering and Packing." <http://www.ics.uci.edu/~eppstein/junkyard/cover.html>.
Macula, A. J. "Covers of a Finite Set." *Math. Mag.* **67**, 141–144, 1994.
Sloane, N. J. A. Sequences A003465/M4024 and A007537/M5287 in "An On-Line Version of the Encyclopedia of Integer Sequences."

Cover Relation

The transitive reflexive reduction of a PARTIAL ORDER. An element z of a POSET (X, \leq) covers another element x provided that there exists no third element y in the poset for which $x \leq y \leq z$. In this case, z is called an "upper cover" of x and x a "lower cover" of z .

Covering

see COVER

Covering Dimension

see LEBESGUE COVERING DIMENSION

Covering System

A system of congruences $a_i \bmod n_i$ with $1 \leq i \leq k$ is called a covering system if every INTEGER y satisfies $y \equiv a_i \pmod{n_i}$ for at least one value of i .

see also EXACT COVERING SYSTEM

References

Guy, R. K. "Covering Systems of Congruences." §F13 in *Unsolved Problems in Number Theory*, 2nd ed. New York: Springer-Verlag, pp. 251–253, 1994.

Coversine

$$\text{covers } A \equiv 1 - \sin A,$$

where $\sin A$ is the SINE.

see also EXSECANT, HAVERSINE, SINE, VERSINE

References

Abramowitz, M. and Stegun, C. A. (Eds.). *Handbook of Mathematical Functions with Formulas, Graphs, and Mathematical Tables*, 9th printing. New York: Dover, p. 78, 1972.

Cox's Theorem

Let $\sigma_1, \dots, \sigma_4$ be four PLANES in GENERAL POSITION through a point P and let P_{ij} be a point on the LINE $\sigma_i \cdot \sigma_j$. Let σ_{ijk} denote the PLANE $P_{ij}P_{ik}P_{jk}$. Then the four PLANES $\sigma_{234}, \sigma_{134}, \sigma_{124}, \sigma_{123}$ all pass through one point P_{1234} . Similarly, let $\sigma_1, \dots, \sigma_5$ be five PLANES in GENERAL POSITION through P . Then the five points $P_{2345}, P_{1345}, P_{1245}, P_{1235}$, and P_{1234} all lie in one PLANE. And so on.

see also CLIFFORD'S CIRCLE THEOREM

Coxeter Diagram

see COXETER-DYNKIN DIAGRAM

Coxeter-Dynkin Diagram

A labeled graph whose nodes are indexed by the generators of a COXETER GROUP having (P_i, P_j) as an EDGE labeled by M_{ij} whenever $M_{ij} > 2$, where M_{ij} is an element of the COXETER MATRIX. Coxeter-Dynkin diagrams are used to visualize COXETER GROUPS. A Coxeter-Dynkin diagram is associated with each RATIONAL DOUBLE POINT (Fischer 1986).

see also COXETER GROUP, DYNKIN DIAGRAM, RATIONAL DOUBLE POINT

References

Arnold, V. I. "Critical Points of Smooth Functions." *Proc. Int. Congr. Math.* 1, 19–39, 1974.
Fischer, G. (Ed.). *Mathematical Models from the Collections of Universities and Museums*. Braunschweig, Germany: Vieweg, pp. 12–13, 1986.

Coxeter Graph

see COXETER-DYNKIN DIAGRAM

Coxeter Group

A group generated by the elements P_i for $i = 1, \dots, n$ subject to

$$(P_i P_j)^{M_{ij}} = 1,$$

where M_{ij} are the elements of a COXETER MATRIX. Coxeter used the NOTATION $[3^{p,q,r}]$ for the Coxeter group generated by the nodes of a Y-shaped COXETER-DYNKIN DIAGRAM whose three arms have p , q , and r EDGES. A Coxeter group of this form is finite IFF

$$\frac{1}{p+q} + \frac{1}{q+1} + \frac{1}{r+1} > 1.$$

see also BIMONSTER

References

Arnold, V. I. "Snake Calculus and Combinatorics of Bernoulli, Euler, and Springer Numbers for Coxeter Groups." *Russian Math. Surveys* 47, 3–45, 1992.

Coxeter's Loxodromic Sequence of Tangent Circles

An infinite sequence of CIRCLES such that every four consecutive CIRCLES are mutually tangent, and the CIRCLES' RADII $\dots, R_{-n}, \dots, R_{-1}, R_0, R_1, R_2, R_3, R_4, \dots, R_n, R_n + 1, \dots$, are in GEOMETRIC PROGRESSION with ratio

$$k \equiv \frac{R_{n+1}}{R_n} = \phi + \sqrt{\phi},$$

where ϕ is the GOLDEN RATIO (Gardner 1979ab). Coxeter (1968) generalized the sequence to SPHERES.

see also ARBELOS, GOLDEN RATIO, HEXLET, PAPPUS CHAIN, STEINER CHAIN

References

Coxeter, D. "Coxeter on 'Firmament.'" <http://www.bangor.ac.uk/SculMath/image/donald.htm>.
Coxeter, H. S. M. "Loxodromic Sequences of Tangent Spheres." *Aequationes Math.* 1, 112–117, 1968.

- Gardner, M. "Mathematical Games: The Diverse Pleasures of Circles that Are Tangent to One Another." *Sci. Amer.* **240**, 18-28, Jan. 1979a.
- Gardner, M. "Mathematical Games: How to be a Psychic, Even if You are a Horse or Some Other Animal." *Sci. Amer.* **240**, 18-25, May 1979b.

Coxeter Matrix

An $n \times n$ SQUARE MATRIX M with

$$M_{ii} = 1$$

$$M_{ij} = M_{ji} > 1$$

for all $i, j = 1, \dots, n$.

see also COXETER GROUP

Coxeter-Todd Lattice

The complex LATTICE Λ_6^ω corresponding to real lattice K_{12} having the densest HYPERSPHERE PACKING (KISSING NUMBER) in 12-D. The associated AUTOMORPHISM GROUP G_0 was discovered by Mitchell (1914). The order of G_0 is given by

$$|\text{Aut}(\Lambda_6^\omega)| = 2^9 \cdot 3^7 \cdot 5 \cdot 7 = 39,191,040.$$

The order of the AUTOMORPHISM GROUP of K_{12} is given by

$$|\text{Aut}(K_{12})| = 2^{10} \cdot 3^7 \cdot 5 \cdot 7$$

(Conway and Sloane 1983).

see also BARNES-WALL LATTICE, LEECH LATTICE

References

- Conway, J. H. and Sloane, N. J. A. "The Coxeter-Todd Lattice, the Mitchell Group and Related Sphere Packings." *Math. Proc. Camb. Phil. Soc.* **93**, 421-440, 1983.
- Conway, J. H. and Sloane, N. J. A. "The 12-Dimensional Coxeter-Todd Lattice K_{12} ." §4.9 in *Sphere Packings, Lattices, and Groups*, 2nd ed. New York: Springer-Verlag, pp. 127-129, 1993.
- Coxeter, H. S. M. and Todd, J. A. "As Extreme Duodenary Form." *Canad. J. Math.* **5**, 384-392, 1953.
- Mitchell, H. H. "Determination of All Primitive Collineation Groups in More than Four Variables." *Amer. J. Math.* **36**, 1-12, 1914.
- Todd, J. A. "The Characters of a Collineation Group in Five Dimensions." *Proc. Roy. Soc. London Ser. A* **200**, 320-336, 1950.

Cramér Conjecture

An unproven CONJECTURE that

$$\lim_{n \rightarrow \infty} \frac{p_{n+1} - p_n}{(\ln p_n)^2} = 1,$$

where p_n is the n th PRIME.

References

- Cramér, H. "On the Order of Magnitude of the Difference Between Consecutive Prime Numbers." *Acta Arith.* **2**, 23-46, 1936.
- Guy, R. K. *Unsolved Problems in Number Theory*, 2nd ed. New York: Springer-Verlag, p. 7, 1994.
- Riesel, H. "The Cramér Conjecture." *Prime Numbers and Computer Methods for Factorization*, 2nd ed. Boston, MA: Birkhäuser, pp. 79-82, 1994.
- Rivera, C. "Problems & Puzzles (Conjectures): Cramer's Conjecture." http://www.sci.net.mx/~crivera/ppp/conj_007.htm.

Cramér-Euler Paradox

A curve of order n is generally determined by $n(n+3)/2$ points. So a CONIC SECTION is determined by five points and a CUBIC CURVE should require nine. But the MACLAURIN-BEZOUT THEOREM says that two curves of degree n intersect in n^2 points, so two CUBICS intersect in nine points. This means that $n(n+3)/2$ points do not always uniquely determine a single curve of order n . The paradox was publicized by Stirling, and explained by Plücker.

see also CUBIC CURVE, MACLAURIN-BEZOUT THEOREM

Cramer's Rule

Given a set of linear equations

$$\begin{cases} a_1x + b_1y + c_1z = d_1 \\ a_2x + b_2y + c_2z = d_2 \\ a_3x + b_3y + c_3z = d_3, \end{cases} \quad (1)$$

consider the DETERMINANT

$$D \equiv \begin{vmatrix} a_1 & b_1 & c_1 \\ a_2 & b_2 & c_2 \\ a_3 & b_3 & c_3 \end{vmatrix}. \quad (2)$$

Now multiply D by x , and use the property of DETERMINANTS that MULTIPLICATION by a constant is equivalent to MULTIPLICATION of each entry in a given row by that constant

$$x \begin{vmatrix} a_1 & b_1 & c_1 \\ a_2 & b_2 & c_2 \\ a_3 & b_3 & c_3 \end{vmatrix} = \begin{vmatrix} a_1x & b_1 & c_1 \\ a_2x & b_2 & c_2 \\ a_3x & b_3 & c_3 \end{vmatrix}. \quad (3)$$

Another property of DETERMINANTS enables us to add a constant times any column to any column and obtain the same DETERMINANT, so add y times column 2 and z times column 3 to column 1,

$$xD = \begin{vmatrix} a_1x + b_1y + c_1z & b_1 & c_1 \\ a_2x + b_2y + c_2z & b_2 & c_2 \\ a_3x + b_3y + c_3z & b_3 & c_3 \end{vmatrix} = \begin{vmatrix} d_1 & b_1 & c_1 \\ d_2 & b_2 & c_2 \\ d_3 & b_3 & c_3 \end{vmatrix}. \quad (4)$$

If $\mathbf{d} = \mathbf{0}$, then (4) reduces to $xD = 0$, so the system has nondegenerate solutions (i.e., solutions other than $(0, 0, 0)$) only if $D = 0$ (in which case there is a family of solutions). If $\mathbf{d} \neq \mathbf{0}$ and $D = 0$, the system has no unique solution. If instead $\mathbf{d} \neq \mathbf{0}$ and $D \neq 0$, then solutions are given by

$$x = \frac{\begin{vmatrix} d_1 & b_1 & c_1 \\ d_2 & b_2 & c_2 \\ d_3 & b_3 & c_3 \end{vmatrix}}{D}, \quad (5)$$

and similarly for

$$y = \frac{\begin{vmatrix} a_1 & d_1 & c_1 \\ a_2 & d_2 & c_2 \\ a_3 & d_3 & c_3 \end{vmatrix}}{D} \quad (6)$$

$$z = \frac{\begin{vmatrix} a_1 & b_1 & d_1 \\ a_2 & b_2 & d_2 \\ a_3 & b_3 & d_3 \end{vmatrix}}{D}. \quad (7)$$

This procedure can be generalized to a set of n equations so, given a system of n linear equations

$$\begin{bmatrix} a_{11} & a_{12} & \cdots & a_{1n} \\ \vdots & \vdots & \ddots & \vdots \\ a_{1n1} & a_{n2} & \cdots & a_{nn} \end{bmatrix} \begin{bmatrix} x_1 \\ \vdots \\ x_n \end{bmatrix} = \begin{bmatrix} d_1 \\ \vdots \\ d_n \end{bmatrix}, \quad (8)$$

let

$$D \equiv \begin{vmatrix} a_{11} & a_{12} & \cdots & a_{1n} \\ \vdots & \vdots & \ddots & \vdots \\ a_{1n1} & a_{n2} & \cdots & a_{nn} \end{vmatrix}. \quad (9)$$

If $\mathbf{d} = \mathbf{0}$, then nondegenerate solutions exist only if $D = 0$. If $\mathbf{d} \neq \mathbf{0}$ and $D = 0$, the system has no unique solution. Otherwise, compute

$$D_k \equiv \begin{vmatrix} a_{11} & \cdots & a_{1(k-1)} & d_1 & a_{1(k+1)} & \cdots & a_{1n} \\ \vdots & \ddots & \vdots & \vdots & \vdots & \ddots & \vdots \\ a_{n1} & \cdots & a_{n(k-1)} & d_n & a_{n(k+1)} & \cdots & a_{nn} \end{vmatrix}. \quad (10)$$

Then $x_k = D_k/D$ for $1 \leq k \leq n$. In the 3-D case, the VECTOR analog of Cramer's rule is

$$(\mathbf{A} \times \mathbf{B}) \times (\mathbf{C} \times \mathbf{D}) = (\mathbf{A} \cdot \mathbf{B} \times \mathbf{D})\mathbf{C} - (\mathbf{A} \cdot \mathbf{B} \times \mathbf{C})\mathbf{D}. \quad (11)$$

see also DETERMINANT, LINEAR ALGEBRA, MATRIX, SYSTEM OF EQUATIONS, VECTOR

Cramér's Theorem

If X and Y are INDEPENDENT variates and $X + Y$ is a GAUSSIAN DISTRIBUTION, then both X and Y must have GAUSSIAN DISTRIBUTIONS. This was proved by Cramér in 1936.

Craps

A game played with two DICE. If the total is 7 or 11 (a "natural"), the thrower wins and retains the DICE for another throw. If the total is 2, 3, or 12 ("craps"), the thrower loses but retains the DICE. If the total is any other number (called the thrower's "point"), the thrower must continue throwing and roll the "point" value again before throwing a 7. If he succeeds, he wins and retains the DICE, but if a 7 appears first, the player loses and passes the dice. The probability of winning is $244/495 \approx 0.493$ (Kraitchik 1942).

References

- Kenney, J. F. and Keeping, E. S. *Mathematics of Statistics*, Pt. 2, 2nd ed. Princeton, NJ: Van Nostrand, pp. 12–13, 1951.
- Kraitchik, M. "Craps." §6.5 in *Mathematical Recreations*. New York: W. W. Norton, pp. 123–126, 1942.

CRC

see CYCLIC REDUNDANCY CHECK

Creative Telescoping

see TELESCOPING SUM, ZEILBERGER'S ALGORITHM

Cremona Transformation

An entire Cremona transformation is a BIRATIONAL TRANSFORMATION of the PLANE. Cremona transformations are MAPS of the form

$$x_{i+1} = f(x_i, y_i)$$

$$y_{i+1} = g(x_i, y_i),$$

in which f and g are POLYNOMIALS. A quadratic Cremona transformation is always factorable.

see also NOETHER'S TRANSFORMATION THEOREM

References

- Coolidge, J. L. *A Treatise on Algebraic Plane Curves*. New York: Dover, pp. 203–204, 1959.

Cribbage

Cribbage is a game in which each of two players is dealt a hand of six CARDS. Each player then discards two of his six cards to a four-card "crib" which alternates between players. After the discard, the top card in the remaining deck is turned up. Cards are then alternating played out by the two players, with points being scored for pairs, runs, cumulative total of 15 and 31, and playing the last possible card ("go") not giving a total over 31. All face cards are counted as 10 for the purpose of playing out, but the normal values of Jack = 11, Queen = 12, King = 13 are used to determine runs. Aces are always low (ace = 1). After all cards have been played, each player counts the four cards in his hand taken in conjunction with the single top card. Points are awarded for pairs, flushes, runs, and combinations of cards giving 15. A Jack having the same suit as a top card is awarded an additional point for "nobbs." The crib is then also counted and scored. The winner is the first person to "peg" a certain score, as recorded on a "cribbage board."

The best possible score in a hand is 29, corresponding to three 5s and a Jack with a top 5 the same suit as the Jack. Hands with scores of 25, 26, and 27 are not possible.

see also BRIDGE CARD GAME, CARDS, POKER

Criss-Cross Method

A standard form of the LINEAR PROGRAMMING problem of maximizing a linear function over a CONVEX POLYHEDRON is to maximize $\mathbf{c} \cdot \mathbf{x}$ subject to $\mathbf{m}\mathbf{x} \leq \mathbf{b}$ and $\mathbf{x} \geq \mathbf{0}$, where \mathbf{m} is a given $s \times d$ matrix, \mathbf{c} and \mathbf{b} are given d -vector and s -vectors, respectively. The Criss-cross method always finds a VERTEX solution if an optimal solution exists.

see also CONVEX POLYHEDRON, LINEAR PROGRAMMING, VERTEX (POLYHEDRON)

Criterion

A requirement NECESSARY for a given statement or theorem to hold. Also called a CONDITION.

see also BROWN'S CRITERION, CAUCHY CRITERION, EULER'S CRITERION, GAUSS'S CRITERION, KORSELT'S CRITERION, LEIBNIZ CRITERION, POCKLINGTON'S CRITERION, VANDIVER'S CRITERIA, WEYL'S CRITERION

Critical Line

The LINE $\Re(s) = 1/2$ in the COMPLEX PLANE on which the RIEMANN HYPOTHESIS asserts that all nontrivial (COMPLEX) ROOTS of the RIEMANN ZETA FUNCTION $\zeta(s)$ lie. Although it is known that an INFINITE number of zeros lie on the critical line and that these comprise at least 40% of all zeros, the RIEMANN HYPOTHESIS is still unproven.

see also RIEMANN HYPOTHESIS, RIEMANN ZETA FUNCTION

References

Vardi, I. *Computational Recreations in Mathematics*. Reading, MA: Addison-Wesley, p. 142, 1991.

Critical Point

A FUNCTION $y = f(x)$ has critical points at all points x_0 where $f'(x_0) = 0$ or $f(x)$ is not DIFFERENTIABLE. A FUNCTION $z = f(x, y)$ has critical points where the GRADIENT $\nabla f = 0$ or $\partial f / \partial x$ or the PARTIAL DERIVATIVE $\partial f / \partial y$ is not defined.

see also FIXED POINT, INFLECTION POINT, ONLY CRITICAL POINT IN TOWN TEST, STATIONARY POINT

Critical Strip

see CRITICAL LINE

Crook



A 6-POLYAMOND.

References

Golomb, S. W. *Polyominoes: Puzzles, Patterns, Problems, and Packings*, 2nd ed. Princeton, NJ: Princeton University Press, p. 92, 1994.

Crookedness

Let a KNOT K be parameterized by a VECTOR FUNCTION $\mathbf{v}(t)$ with $t \in \mathbb{S}^1$, and let \mathbf{w} be a fixed UNIT VECTOR in \mathbb{R}^3 . Count the number of RELATIVE MINIMA of the projection function $\mathbf{w} \cdot \mathbf{v}(t)$. Then the MINIMUM such number over all directions \mathbf{w} and all K of the given type is called the crookedness $\mu(K)$. Milnor (1950) showed that $2\pi\mu(K)$ is the INFIMUM of the total curvature of K . For any TAME KNOT K in \mathbb{R}^3 , $\mu(K) = b(K)$ where $b(K)$ is the BRIDGE INDEX.

see also BRIDGE INDEX

References

Milnor, J. W. "On the Total Curvature of Knots." *Ann. Math.* **52**, 248–257, 1950.
Rolfesen, D. *Knots and Links*. Wilmington, DE: Publish or Perish Press, p. 115, 1976.

Cross

In general, a cross is a figure formed by two intersecting LINE SEGMENTS. In LINEAR ALGEBRA, a cross is defined as a set of n mutually PERPENDICULAR pairs of VECTORS of equal magnitude from a fixed origin in EUCLIDEAN n -SPACE.

The word "cross" is also used to denote the operation of the CROSS PRODUCT, so $\mathbf{a} \times \mathbf{b}$ would be pronounced "a cross b."

see also CROSS PRODUCT, DOT, EUTACTIC STAR, GAULLIST CROSS, GREEK CROSS, LATIN CROSS, MALTESE CROSS, PAPAL CROSS, SAINT ANDREW'S CROSS, SAINT ANTHONY'S CROSS, STAR

Cross-Cap



The self-intersection of a one-sided SURFACE. It can be described as a circular HOLE which, when entered, exits from its opposite point (from a topological viewpoint, both singular points on the cross-cap are equivalent). The cross-cap has a segment of double points which terminates at two "PINCH POINTS" known as WHITNEY SINGULARITIES.

The cross-cap can be generated using the general method for NONORIENTABLE SURFACES using the polynomial function

$$\mathbf{f}(x, y, z) = (xz, yz, \frac{1}{2}(z^2 - x^2)) \quad (1)$$

(Pinkall 1986). Transforming to SPHERICAL COORDINATES gives

$$x(u, v) = \frac{1}{2} \cos u \sin(2v) \quad (2)$$

$$y(u, v) = \frac{1}{2} \sin u \sin(2v) \quad (3)$$

$$z(u, v) = \frac{1}{2} (\cos^2 v - \cos^2 u \sin^2 v) \quad (4)$$

for $u \in [0, 2\pi)$ and $v \in [0, \pi/2]$. To make the equations slightly simpler, all three equations are normally multiplied by a factor of 2 to clear the arbitrary scaling constant. Three views of the cross-cap generated using this equation are shown above. Note that the middle one looks suspiciously like MAEDER'S OWL MINIMAL SURFACE.

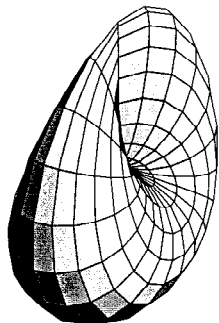

Another representation is

$$f(x, y, z) = (yz, 2xy, x^2 - y^2), \quad (5)$$

(Gray 1993), giving parametric equations

$$x = \frac{1}{2} \sin u \sin(2v) \quad (6)$$

$$y = \sin(2u) \sin^2 v \quad (7)$$

$$z = \cos(2u) \sin^2 v, \quad (8)$$

(Geometry Center) where, for aesthetic reasons, the y - and z -coordinates have been multiplied by 2 to produce a squashed, but topologically equivalent, surface. Nordstrand gives the implicit equation

$$4x^2(x^2 + y^2 + z^2 + z) + y^2(y^2 + z^2 - 1) = 0 \quad (9)$$

which can be solved for z to yield

$$z = \frac{-2x^2 \pm \sqrt{(y^2 + 2x^2)(1 - 4x^2 - y^2)}}{4x^2 + y^2}. \quad (10)$$

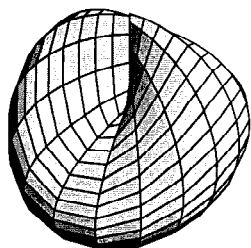

Taking the inversion of a cross-cap such that $(0, 0, -1/2)$ is sent to ∞ gives a CYLINDROID, shown above (Pinkall 1986).

The cross-cap is one of the three possible SURFACES obtained by sewing a MÖBIUS STRIP to the edge of a DISK. The other two are the BOY SURFACE and ROMAN SURFACE.

see also BOY SURFACE, MÖBIUS STRIP, NONORIENTABLE SURFACE, PROJECTIVE PLANE, ROMAN SURFACE

References

- Fischer, G. (Ed.). Plate 107 in *Mathematische Modelle/Mathematical Models, Bildband/Photograph Volume*. Braunschweig, Germany: Vieweg, p. 108, 1986.
 Geometry Center. "The Crosscap." <http://www.geom.umn.edu/zoo/toptype/plane/cap/>.
 Pinkall, U. *Mathematical Models from the Collections of Universities and Museums* (Ed. G. Fischer). Braunschweig, Germany: Vieweg, p. 64, 1986.

Cross-Correlation

Let \star denote cross-correlation. Then the cross-correlation of two functions $f(t)$ and $g(t)$ of a real variable t is defined by

$$f \star g \equiv f^*(-t) * g(t), \quad (1)$$

where $*$ denotes CONVOLUTION and $f^*(t)$ is the COMPLEX CONJUGATE of $f(t)$. The CONVOLUTION is defined by

$$f(t) * g(t) = \int_{-\infty}^{\infty} f(\tau)g(t - \tau)d\tau, \quad (2)$$

therefore

$$f \star g \equiv \int_{-\infty}^{\infty} f^*(-\tau)g(t - \tau)d\tau. \quad (3)$$

Let $\tau' \equiv -\tau$, so $d\tau' = -d\tau$ and

$$\begin{aligned} f \star g &= \int_{\infty}^{-\infty} f^*(\tau')g(t + \tau')(-d\tau') \\ &= \int_{-\infty}^{\infty} f^*(\tau)g(t + \tau)d\tau. \end{aligned} \quad (4)$$

The cross-correlation satisfies the identity

$$(g \star h) \star (g \star h) = (g \star g) \star (h \star h). \quad (5)$$

If f or g is EVEN, then

$$f \star g = f * g, \quad (6)$$

where $*$ denotes CONVOLUTION.

see also AUTOCORRELATION, CONVOLUTION, CROSS-CORRELATION THEOREM

Cross-Correlation Coefficient

The COEFFICIENT ρ in a GAUSSIAN BIVARIATE DISTRIBUTION.

Cross-Correlation Theorem

Let $f \star g$ denote the CROSS-CORRELATION of functions $f(t)$ and $g(t)$. Then

$$\begin{aligned} f \star g &= \int_{-\infty}^{\infty} f^*(\tau)g(t + \tau)d\tau \\ &= \int_{-\infty}^{\infty} \left[\int_{-\infty}^{\infty} F^*(\nu)e^{2\pi i\nu\tau}d\nu \int_{-\infty}^{\infty} G(\nu')e^{-2\pi i\nu'(t+\tau)}d\nu' \right] d\tau \\ &= \int_{-\infty}^{\infty} \int_{-\infty}^{\infty} \int_{-\infty}^{\infty} F^*(\nu)G(\nu')e^{-2\pi i\tau(\nu'-\nu)}e^{-2\pi i\nu't}d\tau d\nu d\nu' \\ &= \int_{-\infty}^{\infty} \int_{-\infty}^{\infty} F^*(\nu)G(\nu')e^{-2\pi i\nu't} \left[\int_{-\infty}^{\infty} e^{-2\pi i\tau(\nu'-\nu)}d\tau \right] d\nu d\nu' \\ &= \int_{-\infty}^{\infty} \int_{-\infty}^{\infty} F^*(\nu)G(\nu')e^{-2\pi i\nu't}\delta(\nu' - \nu)d\nu' d\nu \\ &= \int_{-\infty}^{\infty} F^*(\nu)G(\nu)e^{-2\pi i\nu't}d\nu \\ &= \mathcal{F}[F^*(\nu)G(\nu)], \end{aligned} \quad (1)$$

where \mathcal{F} denotes the FOURIER TRANSFORM and

$$f(t) \equiv \mathcal{F}[F(\nu)] = \int_{-\infty}^{\infty} F(\nu) e^{-2\pi i \nu t} dt \quad (2)$$

$$g(t) \equiv \mathcal{F}[G(\nu)] = \int_{-\infty}^{\infty} G(\nu) e^{-2\pi i \nu t} dt. \quad (3)$$

Applying a FOURIER TRANSFORM on each side gives the cross-correlation theorem,

$$f \star g = \mathcal{F}[F^*(\nu)G(\nu)]. \quad (4)$$

If $F = G$, then the cross-correlation theorem reduces to the WIENER-KHINTCHINE THEOREM.

see also FOURIER TRANSFORM, WIENER-KHINTCHINE THEOREM

Cross Curve

see CRUCIFORM

Cross Fractal

see CANTOR SQUARE FRACTAL

Cross of Lorraine

see GAULLIST CROSS

Cross Polytope

A regular POLYTOPE in n -D (generally assumed to satisfy $n \geq 5$) corresponding to the CONVEX HULL of the points formed by permuting the coordinates $(\pm 1, 0, 0, \dots, 0)$. It is denoted β_n and has SCHLÄFLI SYMBOL $\{3^{n-2}, 4\}$. In 3-D, the cross polytope is the OCTAHEDRON.

see also MEASURE POLYTOPE, SIMPLEX

Cross Product

For VECTORS \mathbf{u} and \mathbf{v} ,

$$\mathbf{u} \times \mathbf{v} = \hat{\mathbf{x}}(u_y v_z - u_z v_y) - \hat{\mathbf{y}}(u_x v_z - u_z v_x) + \hat{\mathbf{z}}(u_x v_y - u_y v_x). \quad (1)$$

This can be written in a shorthand NOTATION which takes the form of a DETERMINANT

$$\mathbf{u} \times \mathbf{v} = \begin{vmatrix} \hat{\mathbf{x}} & \hat{\mathbf{y}} & \hat{\mathbf{z}} \\ u_x & u_y & u_z \\ v_x & v_y & v_z \end{vmatrix}. \quad (2)$$

It is also true that

$$|\mathbf{u} \times \mathbf{v}| = |\mathbf{u}| |\mathbf{v}| \sin \theta, \quad (3)$$

$$= |\mathbf{u}| |\mathbf{v}| \sqrt{1 - (\hat{\mathbf{u}} \cdot \hat{\mathbf{v}})^2}, \quad (4)$$

where θ is the angle between \mathbf{u} and \mathbf{v} , given by the DOT PRODUCT

$$\cos \theta \equiv \hat{\mathbf{u}} \cdot \hat{\mathbf{v}}. \quad (5)$$

Identities involving the cross product include

$$\frac{d}{dt} [\mathbf{r}_1(t) \times \mathbf{r}_2(t)] = \mathbf{r}_1(t) \times \frac{d\mathbf{r}_2}{dt} + \frac{d\mathbf{r}_1}{dt} \times \mathbf{r}_2(t) \quad (6)$$

$$\mathbf{A} \times \mathbf{B} = -\mathbf{B} \times \mathbf{A} \quad (7)$$

$$\mathbf{A} \times (\mathbf{B} + \mathbf{C}) = \mathbf{A} \times \mathbf{B} + \mathbf{A} \times \mathbf{C} \quad (8)$$

$$(t\mathbf{A}) \times \mathbf{B} = t(\mathbf{A} \times \mathbf{B}). \quad (9)$$

For a proof that $\mathbf{A} \times \mathbf{B}$ is a PSEUDOVECTOR, see Arfken (1985, pp. 22-23). In TENSOR notation,

$$\mathbf{A} \times \mathbf{B} = \epsilon_{ijk} A^j B^k, \quad (10)$$

where ϵ_{ijk} is the LEVI-CIVITA TENSOR.

see also DOT PRODUCT, SCALAR TRIPLE PRODUCT

References

Arfken, G. "Vector or Cross Product." §1.4 in *Mathematical Methods for Physicists*, 3rd ed. Orlando, FL: Academic Press, pp. 18-26, 1985.

Cross-Ratio

$$[a, b, c, d] \equiv \frac{(a-b)(c-d)}{(a-d)(c-b)}. \quad (1)$$

For a MÖBIUS TRANSFORMATION f ,

$$[a, b, c, d] = [f(a), f(b), f(c), f(d)]. \quad (2)$$

There are six different values which the cross-ratio may take, depending on the order in which the points are chosen. Let $\lambda \equiv [a, b, c, d]$. Possible values of the cross-ratio are then λ , $1 - \lambda$, $1/\lambda$, $(\lambda - 1)/\lambda$, $1/(1 - \lambda)$, and $\lambda/(\lambda - 1)$.

Given lines a , b , c , and d which intersect in a point O , let the lines be cut by a line l , and denote the points of intersection of l with each line by A , B , C , and D . Let the distance between points A and B be denoted AB , etc. Then the cross-ratio

$$[AB, CD] \equiv \frac{(AB)(CD)}{(BC)(AD)} \quad (3)$$

is the same for any position of the l (Coxeter and Greitzer 1967). Note that the definitions $(AB/AD)/(BC/CD)$ and $(CA/CB)/(DA/DB)$ are used instead by Kline (1990) and Courant and Robbins (1966), respectively. The identity

$$[AD, BC] + [AB, DC] = 1 \quad (4)$$

holds IFF $AC//BD$, where $//$ denotes SEPARATION.

The cross-ratio of four points on a radial line of an INVERSION CIRCLE is preserved under INVERSION (Ogilvy 1990, p. 40).

see also MÖBIUS TRANSFORMATION, SEPARATION

Crossing Number (Graph)

Given a "good" GRAPH (i.e., one for which all intersecting EDGES intersect in a single point and arise from four distinct VERTICES), the crossing number is the minimum possible number of crossings with which the GRAPH can be drawn. A GRAPH with crossing number 0 is a PLANAR GRAPH. Garey and Johnson (1983) showed that determining the crossing number is an NP-COMplete PROBLEM. GUY'S CONJECTURE suggests that the crossing number for the COMPLETE GRAPH K_n is

which can be rewritten

The first few predicted and known values are given in the following table (Sloane's A000241).

Order	Predicted	Known
1	0	0
2	0	0
3	0	0
4	0	0
5	1	1
6	3	3
7	9	9
8	18	18
9	36	36
10	60	60
11	100	
12	150	
13	225	
14	315	
15	441	
16	588	

ZARANKIEWICZ'S CONJECTURE asserts that the crossing number for a COMPLETE BIGRAPH is

$$\left\lfloor \frac{n}{2} \right\rfloor \left\lfloor \frac{n-1}{2} \right\rfloor \left\lfloor \frac{m}{2} \right\rfloor \left\lfloor \frac{m-1}{2} \right\rfloor. \quad (3)$$

It has been checked up to $m, n = 7$, and Zarankiewicz has shown that, in general, the FORMULA provides an upper bound to the actual number. The table below gives known results. When the number is not known exactly, the prediction of ZARANKIEWICZ'S CONJECTURE is given in parentheses.

	1	2	3	4	5	6	7
1	0	0	0	0	0	0	0
2		0	0	0	0	0	0
3			1	2	4	6	9
4				4	8	12	18
5					16	24	36
6						36	54
7							77, 79, or (81)

354 Cross-Section

Cross-Section

The cross-section of a SOLID is a LAMINA obtained by its intersection with a PLANE. The cross-section of an object therefore represents an infinitesimal “slice” of a solid, and may be different depending on the orientation of the slicing plane. While the cross-section of a SPHERE is always a DISK, the cross-section of a CUBE may be a SQUARE, HEXAGON, or other shape.

see also AXONOMETRY, CAVALIERI'S PRINCIPLE, LAMINA, PLANE, PROJECTION, RADON TRANSFORM, STEREOLOGY

Crossed Ladders Problem

Given two crossed LADDERS resting against two buildings, what is the distance between the buildings? Let the height at which they cross be c and the lengths of the LADDERS a and b . The height at which b touches the building k is then obtained by solving

$$k^4 - 2ck^3 + k^2(a^2 - b^2) - 2ck(a^2 - b^2) + c^2(a^2 - b^2) = 0.$$

Call the horizontal distance from the top of a to the crossing u , and the distance from the top of b , v . Call the height at which a touches the building h . There are solutions in which a , b , h , k , u , and v are all INTEGERS. One is $a = 119$, $b = 70$, $c = 30$, and $u + v = 56$.

see also LADDER

References

Gardner, M. *Mathematical Circus: More Puzzles, Games, Paradoxes and Other Mathematical Entertainments from Scientific American*. New York: Knopf, pp. 62–64, 1979.

Crossed Trough

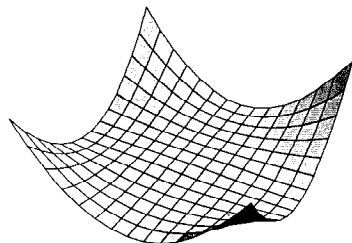

The SURFACE

$$z = cx^2y^2.$$

see also MONKEY SADDLE

References

von Seggern, D. *CRC Standard Curves and Surfaces*. Boca Raton, FL: CRC Press, p. 286, 1993.

Consider the crossing number for a rectilinear GRAPH G which may have only straight EDGES, denoted $\bar{\nu}(G)$. For a COMPLETE GRAPH of order $n \geq 10$, the rectilinear crossing number is always larger than the general graph crossing number. The first few values for COMPLETE GRAPHS are 0, 0, 0, 0, 1, 3, 9, 19, 36, 61 or 62, ... (Sloane's A014540). The $n = 10$ lower limit is from Singer (1986), who proved that

$$\bar{\nu}(K_n) \leq \frac{1}{312}(5n^4 - 39n^3 + 91n^2 - 57n). \quad (4)$$

Jensen (1971) has shown that

$$\bar{\nu}(K_n) \leq \frac{7}{432}n^4 + \mathcal{O}(n^3). \quad (5)$$

Consider the crossing number for a toroidal GRAPH. For a COMPLETE GRAPH, the first few are 0, 0, 0, 0, 0, 0, 0, 4, 9, 23, 42, 70, 105, 154, 226, 326, ... (Sloane's A014543). The toroidal crossing numbers for a COMPLETE BIGRAPH are given in the following table.

	1	2	3	4	5	6	7
1	0	0	0	0	0	0	
2		0	0	0	0	0	
3			0	0	0	0	
4					2		
5					5	8	
6						12	
7							

see also GUY'S CONJECTURE, ZARANKIEWICZ'S CONJECTURE

References

- Gardner, M. "Crossing Numbers." Ch. 11 in *Knotted Doughnuts and Other Mathematical Entertainments*. New York: W. H. Freeman, pp. 133-144, 1986.
- Garey, M. R. and Johnson, D. S. "Crossing Number is NP-Complete." *SIAM J. Alg. Discr. Meth.* **4**, 312-316, 1983.
- Guy, R. K. "Latest Results on Crossing Numbers." In *Recent Trends in Graph Theory, Proc. New York City Graph Theory Conference, 1st, 1970*. (Ed. New York City Graph Theory Conference Staff). New York: Springer-Verlag, 1971.
- Guy, R. K. and Jenkyns, T. "The Toroidal Crossing Number of $K_{m,n}$." *J. Comb. Th.* **6**, 235-250, 1969.
- Guy, R. K.; Jenkyns, T.; and Schaer, J. "Toroidal Crossing Number of the Complete Graph." *J. Comb. Th.* **4**, 376-390, 1968.
- Jensen, H. F. "An Upper Bound for the Rectilinear Crossing Number of the Complete Graph." *J. Comb. Th. Ser. B* **10**, 212-216, 1971.
- Kleitman, D. J. "The Crossing Number of $K_{5,n}$." *J. Comb. Th.* **9**, 315-323, 1970.
- Singer, D. Unpublished manuscript "The Rectilinear Crossing Number of Certain Graphs," 1971. Quoted in Gardner, M. *Knotted Doughnuts and Other Mathematical Entertainments*. New York: W. H. Freeman, 1986.
- Sloane, N. J. A. Sequences A014540, A014543, and A000241/M2772 in "An On-Line Version of the Encyclopedia of Integer Sequences."
- Tutte, W. T. "Toward a Theory of Crossing Numbers." *J. Comb. Th.* **8**, 45-53, 1970.

Crossing Number (Link)

The least number of crossings that occur in any projection of a LINK. In general, it is difficult to find the crossing number of a given LINK.

References

- Adams, C. C. *The Knot Book: An Elementary Introduction to the Mathematical Theory of Knots*. New York: W. H. Freeman, pp. 67-69, 1994.

Crout's Method

A ROOT finding technique used in LU DECOMPOSITION. It solves the N^2 equations

$$\begin{aligned} i < j & \quad \alpha_{i1}\beta_{1j} + \alpha_{i2}\beta_{2j} + \dots + \alpha_{ii}\beta_{ij} = a_{ij} \\ i = j & \quad \alpha_{i1}\beta_{1j} + \alpha_{i2}\beta_{2j} + \dots + \alpha_{ii}\beta_{jj} = a_{ij} \\ i > j & \quad \alpha_{i1}\beta_{1j} + \alpha_{i2}\beta_{2j} + \dots + \alpha_{ij}\beta_{jj} = a_{ij} \end{aligned}$$

for the $N^2 + N$ unknowns α_{ij} and β_{ij} .

see also LU DECOMPOSITION

References

- Press, W. H.; Flannery, B. P.; Teukolsky, S. A.; and Vetterling, W. T. *Numerical Recipes in FORTRAN: The Art of Scientific Computing, 2nd ed.* Cambridge, England: Cambridge University Press, pp. 36-38, 1992.

Crowd

A group of SOCIABLE NUMBERS of order 3.

Crown



A 6-POLYIAMOND.

References

- Golomb, S. W. *Polyominoes: Puzzles, Patterns, Problems, and Packings, 2nd ed.* Princeton, NJ: Princeton University Press, p. 92, 1994.

Crucial Point

The HOMOTHETIC CENTER of the ORTHIC TRIANGLE and the triangular hull of the three EXCIRCLES. It has TRIANGLE CENTER FUNCTION

$$\alpha = \tan A = \sin(2B) + \sin(2C) - \sin(2A).$$

References

- Kimberling, C. "Central Points and Central Lines in the Plane of a Triangle." *Math. Mag.* **67**, 163-187, 1994.
- Lyness, R. and Veldkamp, G. R. Problem 682 and Solution. *Cruz Math.* **9**, 23-24, 1983.

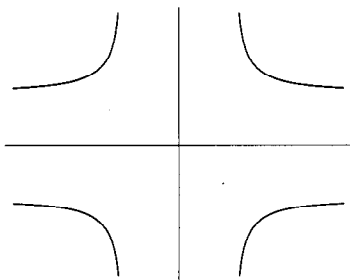
Cruciform

A plane curve also called the CROSS CURVE and POLICEMAN ON POINT DUTY CURVE (Cundy and Rollett 1989). It is given by the equation

$$x^2 y^2 - a^2 x^2 - a^2 y^2 = 0, \quad (1)$$

which is equivalent to

$$1 - \frac{a^2}{y^2} - \frac{a^2}{x^2} = 0 \quad (2)$$

$$\frac{a^2}{x^2} + \frac{b^2}{y^2} = 1, \quad (3)$$

or, rewriting,

$$y^2 = \frac{a^2 x^2}{x^2 - a^2}. \quad (4)$$

In parametric form,

$$x = a \sec t \quad (5)$$

$$y = b \csc t. \quad (6)$$

The CURVATURE is

$$\kappa = \frac{3ab \csc^2 t \sec^2 t}{(b^2 \cos^2 t \csc^2 t + a^2 \sec^2 t \tan^2 t)^{3/2}}. \quad (7)$$

References

- Cundy, H. and Rollett, A. *Mathematical Models*, 3rd ed. Stradbroke, England: Tarquin Pub., p. 71, 1989.
Lawrence, J. D. *A Catalog of Special Plane Curves*. New York: Dover, pp. 127 and 130–131, 1972.

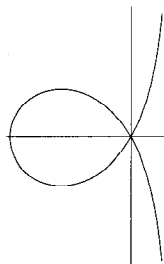
Crunode

A point where a curve intersects itself so that two branches of the curve have distinct tangent lines. The MACLAURIN TRISECTRIX, shown above, has a crunode at the origin.

see also ACNODE, SPINODE, TACNODE

Cryptarithm

see CRYPTARITHMETIC

Cryptarithmic

A number PUZZLE in which a group of arithmetical operations has some or all of its DIGITS replaced by letters or symbols, and where the original DIGITS must be found. In such a puzzle, each letter represents a unique digit.

see also ALPHAMETIC, DIGIMETIC, SKELETON DIVISION

References

- Bogomolny, A. "Cryptarithms." <http://www.cut-the-knot.com/st.crypto.html>.
Brooke, M. *One Hundred & Fifty Puzzles in Crypt-Arithmetic*. New York: Dover, 1963.
Kraitchik, M. "Cryptarithmic." §3.11 in *Mathematical Recreations*. New York: W. W. Norton, pp. 79–83, 1942.
Marks, R. W. *The New Mathematics Dictionary and Handbook*. New York: Bantam Books, 1964.

Cryptography

The science and mathematics of encoding and decoding information.

see also CRYPTARITHM, KNAPSACK PROBLEM, PUBLIC-KEY CRYPTOGRAPHY

References

- Davies, D. W. *The Security of Data in Networks*. Los Angeles, CA: IEEE Computer Soc., 1981.
Diffie, W. and Hellman, M. "New Directions in Cryptography." *IEEE Trans. Info. Th.* **22**, 644–654, 1976.
Honsberger, R. "Four Clever Schemes in Cryptography." Ch. 10 in *Mathematical Gems III*. Washington, DC: Math. Assoc. Amer., pp. 151–173, 1985.
Simmons, G. J. "Cryptology, The Mathematics of Secure Communications." *Math. Intel.* **1**, 233–246, 1979.

Crystallography Restriction

If a discrete GROUP of displacements in the plane has more than one center of rotation, then the only rotations that can occur are by 2, 3, 4, and 6. This can be shown as follows. It must be true that the sum of the interior angles divided by the number of sides is a divisor of 360° .

$$\frac{180^\circ(n-2)}{n} = \frac{360^\circ}{m},$$

where m is an INTEGER. Therefore, symmetry will be possible only for

$$\frac{2n}{n-2} = m,$$

where m is an INTEGER. This will hold for 1-, 2-, 3-, 4-, and 6-fold symmetry. That it does not hold for $n > 6$ is seen by noting that $n = 6$ corresponds to $m = 3$. The $m = 2$ case requires that $n = n - 2$ (impossible), and the $m = 1$ case requires that $n = -2$ (also impossible).

see also POINT GROUPS, SYMMETRY

Császár Polyhedron

A POLYHEDRON topologically equivalent to a TORUS discovered in the late 1940s. It has 7 VERTICES, 14 faces, and 21 EDGES, and is the DUAL POLYHEDRON of the SZILASSI POLYHEDRON. Its SKELETON is ISOMORPHIC to the COMPLETE GRAPH K_7 .

see also SZILASSI POLYHEDRON, TOROIDAL POLYHEDRON

References

- Császár, Á. "A Polyhedron without Diagonals." *Acta Sci. Math.* **13**, 140–142, 1949–1950.
 Gardner, M. "The Császár Polyhedron." Ch. 11 in *Time Travel and Other Mathematical Bewilderments*. New York: W. H. Freeman, 1988.
 Gardner, M. *Fractal Music, Hypercards, and More: Mathematical Recreations from Scientific American Magazine*. New York: W. H. Freeman, pp. 118–120, 1992.
 Hart, G. "Toroidal Polyhedra." <http://www.li.net/~george/virtual-polyhedra/toroidal.html>.

Csch

see HYPERBOLIC COSECANT

Cube

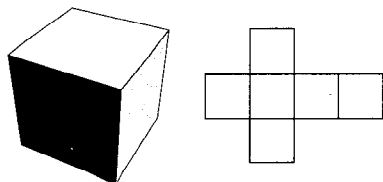

The three-dimensional PLATONIC SOLID (P_3) which is also called the HEXAHEDRON. The cube is composed of six SQUARE faces $6\{4\}$ which meet each other at RIGHT ANGLES, and has 8 VERTICES and 12 EDGES. It is described by the SCHLÄFLI SYMBOL $\{4, 3\}$. It is a ZONOHEDRON. It is also the UNIFORM POLYHEDRON U_6 with WYTHOFF SYMBOL $3|24$. It has the O_h OCTAHEDRAL GROUP of symmetries. The DUAL POLYHEDRON of the cube is the OCTAHEDRON.

Because the VOLUME of a cube of side length n is given by n^3 , a number of the form n^3 is called a CUBIC NUMBER (or sometimes simply "a cube"). Similarly, the operation of taking a number to the third POWER is called CUBING.

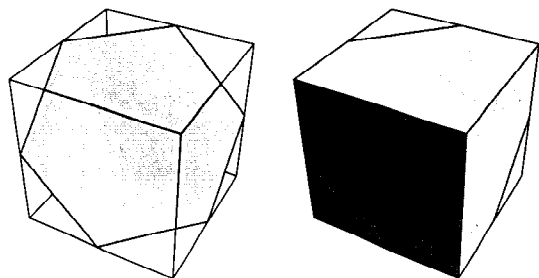

The cube cannot be STELLATED. A PLANE passing through the MIDPOINTS of opposite sides (perpendicular to a C_3 axis) cuts the cube in a regular HEXAGONAL CROSS-SECTION (Gardner 1960; Steinhaus 1983, p. 170; Cundy and Rollett 1989, p. 157; Holden 1991, pp. 22–23). Since there are four such axes, there are four possibly hexagonal cross-sections. If the vertices of the cube are $(\pm 1, \pm 1, \pm 1)$, then the vertices of the inscribed HEXAGON are $(0, -1, -1)$, $(1, 0, -1)$, $(1, 1, 0)$, $(0, 1, 1)$, $(-1, 0, 1)$, and $(-1, -1, 0)$. The largest SQUARE which will fit inside a cube of side a has each corner a distance $1/4$ from a corner of a cube. The resulting SQUARE has side length $3\sqrt{2}a/4$, and the cube containing that side is called PRINCE RUPERT'S CUBE.

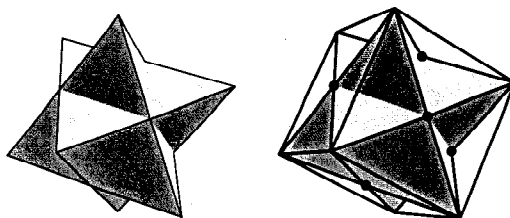

The solid formed by the faces having the sides of the STELLA OCTANGULA (left figure) as DIAGONALS is a cube (right figure; Ball and Coxeter 1987).

The VERTICES of a cube of side length 2 with face-centered axes are given by $(\pm 1, \pm 1, \pm 1)$. If the cube is oriented with a space diagonal along the z -axis, the coordinates are $(0, 0, \sqrt{3})$, $(0, 2\sqrt{2}/3, 1/\sqrt{3})$, $(\sqrt{2}, \sqrt{2}/3, -1/\sqrt{3})$, $(\sqrt{2}, -\sqrt{2}/3, 1/\sqrt{3})$, $(0, -2\sqrt{2}/3, -1/\sqrt{3})$, $(-\sqrt{2}, -\sqrt{2}/3, 1/\sqrt{3})$, $(-\sqrt{2}, \sqrt{2}/3, -1/\sqrt{3})$, and the negatives of these vectors. A FACETED version is the GREAT CUBICUBOCTAHEDRON.

A cube of side length 1 has INRADIUS, MIDRADIUS, and CIRCUMRADIUS of

$$r = \frac{1}{2} = 0.5 \quad (1)$$

$$\rho = \frac{1}{2}\sqrt{2} \approx 0.70710 \quad (2)$$

$$R = \frac{1}{2}\sqrt{3} \approx 0.86602. \quad (3)$$

The cube has a DIHEDRAL ANGLE of

$$\alpha = \frac{1}{2}\pi. \quad (4)$$

The SURFACE AREA and VOLUME of the cube are

$$S = 6a^2 \quad (5)$$

$$V = a^3. \quad (6)$$

see also AUGMENTED TRUNCATED CUBE, BIAUGMENTED TRUNCATED CUBE, BIDIakis CUBE, BISLIT CUBE, BROWKIN'S THEOREM, CUBE DISSECTION, CUBE DOVETAILING PROBLEM, CUBE DUPLICATION, CUBIC NUMBER, CUBICAL GRAPH, HADWIGER PROBLEM, HYPERCUBE, KELLER'S CONJECTURE, PRINCE

RUPERT'S CUBE, RUBIK'S CUBE, SOMA CUBE, STELLA OCTANGULA, TESSERACT

References

- Beyer, W. H. (Ed.) *CRC Standard Mathematical Tables*, 28th ed. Boca Raton, FL: CRC Press, p. 127, 1987.
 Cundy, H. and Rollett, A. "Hexagonal Section of a Cube." §3.15.1 in *Mathematical Models*, 3rd ed. Stradbroke, England: Tarquin Pub., p. 157, 1989.
 Davie, T. "The Cube (Hexahedron)." <http://www.dcs.st-and.ac.uk/~d/mathrecs/polyhedra/cube.html>.
 Eppstein, D. "Rectilinear Geometry." <http://www.ics.uci.edu/~eppstein/junkyard/rect.html>.
 Gardner, M. "Mathematical Games: More About the Shapes that Can Be Made with Complex Dominoes." *Sci. Amer.* **203**, 186–198, Nov. 1960.
 Holden, A. *Shapes, Space, and Symmetry*. New York: Dover, 1991.
 Steinhaus, H. *Mathematical Snapshots*, 3rd American ed. New York: Oxford University Press, 1983.

Cube 2-Compound

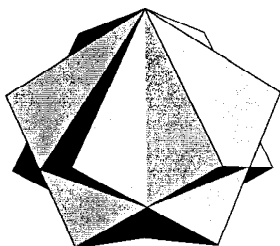

A POLYHEDRON COMPOUND obtained by allowing two CUBES to share opposite VERTICES, then rotating one a sixth of a turn (Holden 1971, p. 34).

see also CUBE, CUBE 3-COMPOUND, CUBE 4-COMPOUND, CUBE 5-COMPOUND, POLYHEDRON COMPOUND

References

- Holden, A. *Shapes, Space, and Symmetry*. New York: Dover, 1991.

Cube 3-Compound

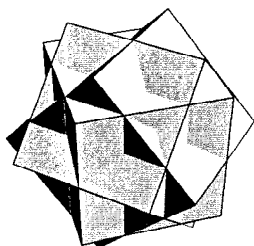

A compound with the symmetry of the CUBE which arises by joining three CUBES such that each shares two C_2 axes (Holden 1971, p. 35).

see also CUBE, CUBE 2-COMPOUND, CUBE 4-COMPOUND, CUBE 5-COMPOUND, POLYHEDRON COMPOUND

References

- Holden, A. *Shapes, Space, and Symmetry*. New York: Dover, 1991.

Cube 4-Compound

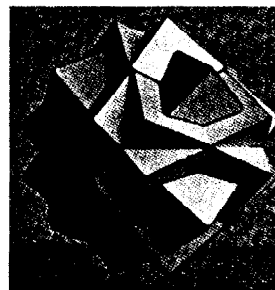

A compound with the symmetry of the CUBE which arises by joining four CUBES such that each C_3 axis falls along the C_3 axis of one of the other CUBES (Holden 1971, p. 35).

see also CUBE, CUBE 2-COMPOUND, CUBE 3-COMPOUND, CUBE 5-COMPOUND, POLYHEDRON COMPOUND

References

- Holden, A. *Shapes, Space, and Symmetry*. New York: Dover, 1991.

Cube 5-Compound

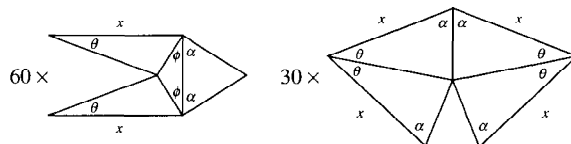
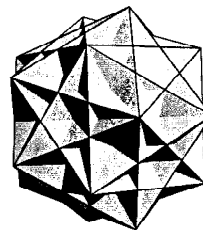

A POLYHEDRON COMPOUND consisting of the arrangement of five CUBES in the VERTICES of a DODECAHEDRON. In the above figure, let a be the length of a CUBE EDGE. Then

$$\begin{aligned} x &= \frac{1}{2}a(3 - \sqrt{5}) \\ \theta &= \tan^{-1} \left(\frac{3 - \sqrt{5}}{2} \right) \approx 20^\circ 54' \\ \phi &= \tan^{-1} \left(\frac{\sqrt{5} - 1}{2} \right) \approx 31^\circ 43' \\ \psi &= 90^\circ - \phi \approx 58^\circ 17' \\ \alpha &= 90^\circ - \theta \approx 69^\circ 6'. \end{aligned}$$

The compound is most easily constructed using pieces like the ones in the above line diagram. The cube 5-compound has the 30 facial planes of the RHOMBIC TRIACONTAHEDRON (Ball and Coxeter 1987).

see also CUBE, CUBE 2-COMPOUND, CUBE 3-COMPOUND, CUBE 4-COMPOUND, DODECAHEDRON,

POLYHEDRON COMPOUND, RHOMBIC TRIACONTAHE-
DRON

References

- Ball, W. W. R. and Coxeter, H. S. M. *Mathematical Recreations and Essays*, 13th ed. New York: Dover, pp. 135 and 137, 1987.
Cundy, H. and Rollett, A. *Mathematical Models*, 3rd ed. Stradbroke, England: Tarquin Pub., pp. 135–136, 1989.

Cube Dissection

A CUBE can be divided into n subcubes for only $n = 1, 8, 15, 20, 22, 27, 29, 34, 36, 38, 39, 41, 43, 45, 46$, and $n \geq 48$ (Sloane's A014544).

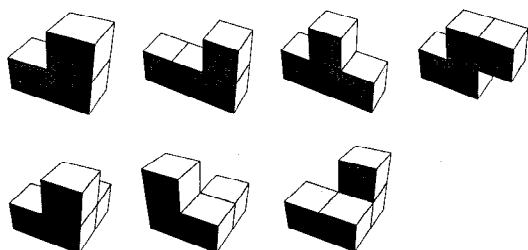

The seven pieces used to construct the $3 \times 3 \times 3$ cube dissection known as the SOMA CUBE are one 3-POLYCUBE and six 4-POLYCUBES ($1 \cdot 3 + 6 \cdot 4 = 27$), illustrated above.

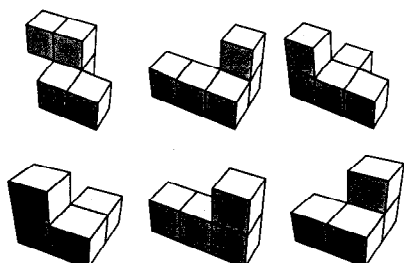

Another $3 \times 3 \times 3$ cube dissection due to Steinhaus uses three 5-POLYCUBES and three 4-POLYCUBES ($3 \cdot 5 + 3 \cdot 4 = 27$), illustrated above.

It is possible to cut a 1×3 RECTANGLE into two identical pieces which will form a CUBE (without overlapping) when folded and joined. In fact, an INFINITE number of solutions to this problem were discovered by C. L. Baker (Hunter and Madachy 1975).

see also CONWAY PUZZLE, DISSECTION, HADWIGER PROBLEM, POLYCUBE, SLOTHOUBER-GRAATSMA PUZZLE, SOMA CUBE

References

- Ball, W. W. R. and Coxeter, H. S. M. *Mathematical Recreations and Essays*, 13th ed. New York: Dover, pp. 112–113, 1987.
Cundy, H. and Rollett, A. *Mathematical Models*, 3rd ed. Stradbroke, England: Tarquin Pub., pp. 203–205, 1989.
Gardner, M. "Block Packing." Ch. 18 in *Time Travel and Other Mathematical Bewilderments*. New York: W. H. Freeman, pp. 227–239, 1988.

- Gardner, M. *Fractal Music, Hypercards, and More: Mathematical Recreations from Scientific American Magazine*. New York: W. H. Freeman, pp. 297–298, 1992.
Honsberger, R. *Mathematical Gems II*. Washington, DC: Math. Assoc. Amer., pp. 75–80, 1976.
Hunter, J. A. H. and Madachy, J. S. *Mathematical Diversions*. New York: Dover, pp. 69–70, 1975.
Sloane, N. J. A. Sequence A014544 in "An On-Line Version of the Encyclopedia of Integer Sequences."

Cube Dovetailing Problem

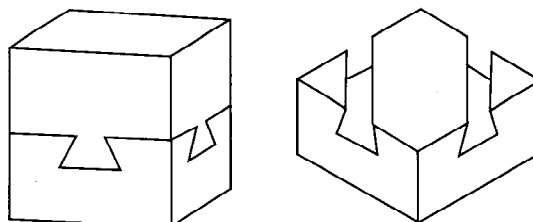

Given the figure on the left (without looking at the solution on the right), determine how to disengage the two slotted CUBE halves without cutting, breaking, or distorting.

References

- Dudeney, H. E. *Amusements in Mathematics*. New York: Dover, pp. 145 and 249, 1958.
Ogilvy, C. S. *Excursions in Mathematics*. New York: Dover, pp. 57, 59, and 143, 1994.

Cube Duplication

Also called the DELIAN PROBLEM or DUPLICATION OF THE CUBE. A classical problem of antiquity which, given the EDGE of a CUBE, requires a second CUBE to be constructed having double the VOLUME of the first using only a STRAIGHTEDGE and COMPASS.

Under these restrictions, the problem cannot be solved because the DELIAN CONSTANT $2^{1/3}$ (the required RATIO of sides of the original CUBE and that to be constructed) is not a EUCLIDEAN NUMBER. The problem can be solved, however, using a NEUSIS CONSTRUCTION.

see also ALHAZEN'S BILLIARD PROBLEM, COMPASS, CUBE, DELIAN CONSTANT, GEOMETRIC PROBLEMS OF ANTIQUITY, NEUSIS CONSTRUCTION, STRAIGHTEDGE

References

- Ball, W. W. R. and Coxeter, H. S. M. *Mathematical Recreations and Essays*, 13th ed. New York: Dover, pp. 93–94, 1987.
Conway, J. H. and Guy, R. K. *The Book of Numbers*. New York: Springer-Verlag, pp. 190–191, 1996.
Courant, R. and Robbins, H. "Doubling the Cube" and "A Classical Construction for Doubling the Cube." §3.3.1 and 3.5.1 in *What is Mathematics?: An Elementary Approach to Ideas and Methods*, 2nd ed. Oxford, England: Oxford University Press, pp. 134–135 and 146, 1996.
Dörrie, H. "The Delian Cube-Doubling Problem." §35 in *100 Great Problems of Elementary Mathematics: Their History and Solutions*. New York: Dover, pp. 170–172, 1965.

Cube-Octahedron Compound

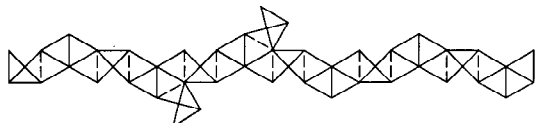
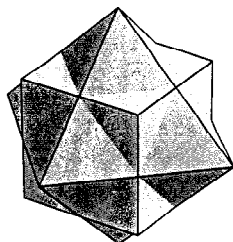

A POLYHEDRON COMPOUND composed of a CUBE and its DUAL POLYHEDRON, the OCTAHEDRON. The 14 vertices are given by $(\pm 1, \pm 1, \pm 1)$, $(\pm 2, 0, 0)$, $(0, \pm 2, 0)$, $(0, 0, \pm 2)$.

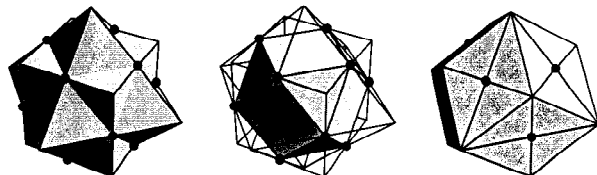

The solid common to both the CUBE and OCTAHEDRON (left figure) in a cube-octahedron compound is a CUB-OCTAHEDRON (middle figure). The edges intersecting in the points plotted above are the diagonals of RHOMBUSES, and the 12 RHOMBUSES form a RHOMBIC DO-DECAHEDRON (right figure; Ball and Coxeter 1987).

see also CUBE, CUBOCTAHEDRON, OCTAHEDRON, POLYHEDRON COMPOUND

References

- Ball, W. W. R. and Coxeter, H. S. M. *Mathematical Recreations and Essays*, 13th ed. New York: Dover, p. 137, 1987.
 Coxeter, H. S. M. *Introduction to Geometry*, 2nd ed. New York: Wiley, p. 158, 1969.
 Cundy, H. and Rollett, A. *Mathematical Models*, 3rd ed. Stradbroke, England: Tarquin Pub., p. 130, 1989.

Cube Point Picking

N.B. A detailed on-line essay by S. Finch was the starting point for this entry.

Let two points be picked randomly from a unit n -D HYPERCUBE. The expected distance between the points $\Delta(N)$ is then

$$\begin{aligned}\Delta(1) &= \frac{1}{3} \\ \Delta(2) &= \frac{1}{15}[\sqrt{2} + 2 + 5 \ln(1 + \sqrt{2})] = 0.521405433 \dots \\ \Delta(3) &= \frac{1}{105}[4 + 17\sqrt{2} - 6\sqrt{3} + 21 \ln(1 + \sqrt{2}) \\ &\quad + 42 \ln(2 + \sqrt{3}) - 7\pi] = 0.661707182 \dots \\ \Delta(4) &= 0.77766 \dots \\ \Delta(5) &= 0.87852 \dots\end{aligned}$$

$$\Delta(6) = 0.96895 \dots$$

$$\Delta(7) = 1.05159 \dots$$

$$\Delta(8) = 1.12817 \dots$$

The function $\Delta(n)$ satisfies

$$\frac{1}{3}n^{1/2} \leq \Delta(n) \leq (\frac{1}{6}n)^{1/2} \sqrt{\frac{1}{3} \left[1 + 2 \left(1 - \frac{3}{5n} \right)^{1/2} \right]}$$

(Anderssen *et al.* 1976).

Pick N points p_1, \dots, p_N randomly in a unit n -cube. Let C be the CONVEX HULL, so

$$C \equiv \left\{ \sum_{j=1}^N \lambda_j p_j : \lambda_j \geq 0 \text{ for all } j \text{ and } \sum_{j=1}^N \lambda_j = 1 \right\}.$$

Let $V(n, N)$ be the expected n -D VOLUME (the CONTENT) of C , $S(n, N)$ be the expected $(n-1)$ -D SURFACE AREA of C , and $P(n, N)$ the expected number of VERTICES on the POLYGONAL boundary of C . Then

$$\begin{aligned}\lim_{N \rightarrow \infty} \frac{N[1 - V(2, N)]}{\ln N} &= \frac{8}{3} \\ \lim_{N \rightarrow \infty} \sqrt{N}[4 - S(2, N)] &= \sqrt{2\pi} \left[2 - \int_0^1 (\sqrt{1+t^2} - 1)t^{-3/2} dt \right] \\ &= 4.2472965 \dots,\end{aligned}$$

and

$$\begin{aligned}\lim_{N \rightarrow \infty} P(2, N) - \frac{8}{3} \ln N &= \frac{8}{3}(\gamma - \ln 2) \\ &= -0.309150708 \dots\end{aligned}$$

(Rényi and Sulanke 1963, 1964). The average DISTANCE between two points chosen at random inside a unit cube is

$$\frac{1}{105}(4 + 17\sqrt{2} - 6\sqrt{3} + 21 \ln(1 + \sqrt{2}) + 42 \ln(2 + \sqrt{3}) - 7\pi)$$

(Robbins 1978, Le Lionnais 1983).

Pick n points on a CUBE, and space them as far apart as possible. The best value known for the minimum straight LINE distance between any two points is given in the following table.

n	$d(n)$
5	1.1180339887498
6	1.0606601482100
7	1
8	1
9	0.86602540378463
10	0.74999998333331
11	0.70961617562351
12	0.70710678118660
13	0.70710678118660
14	0.70710678118660
15	0.625

see also CUBE TRIANGLE PICKING, DISCREPANCY THEOREM, POINT PICKING

References

- Anderssen, R. S.; Brent, R. P.; Daley, D. J.; and Moran, A. P. "Concerning $\int_0^1 \cdots \int_0^1 \sqrt{x_1^2 + \cdots + x_k^2} dx_1 \cdots dx_k$ and a Taylor Series Method." *SIAM J. Appl. Math.* **30**, 22–30, 1976.
- Bolis, T. S. Solution to Problem E2629. "Average Distance Between Two Points in a Box." *Amer. Math. Monthly* **85**, 277–278, 1978.
- Finch, S. "Favorite Mathematical Constants." <http://www.mathsoft.com/asolve/constant/geom/geom.html>.
- Ghosh, B. "Random Distances within a Rectangle and Between Two Rectangles." *Bull. Calcutta Math. Soc.* **43**, 17–24, 1951.
- Holshouser, A. L.; King, L. R.; and Klein, B. G. Solution to Problem E3217, "Minimum Average Distance Between Points in a Rectangle." *Amer. Math. Monthly* **96**, 64–65, 1989.
- Le Lionnais, F. *Les nombres remarquables*. Paris: Hermann, p. 30, 1983.
- Rényi, A. and Sulanke, R. "Über die konvexe Hülle von n zufällig gewählten Punkten, I." *Z. Wahrscheinlichkeits* **2**, 75–84, 1963.
- Rényi, A. and Sulanke, R. "Über die konvexe Hülle von n zufällig gewählten Punkten, II." *Z. Wahrscheinlichkeits* **3**, 138–147, 1964.
- Robbins, D. "Average Distance Between Two Points in a Box." *Amer. Math. Monthly* **85**, 278, 1978.
- Santaló, L. A. *Integral Geometry and Geometric Probability*. Reading, MA: Addison-Wesley, 1976.

Cube Power

A number raised to the third POWER. x^3 is read as "x cubed."

see also CUBIC NUMBER

Cube Root

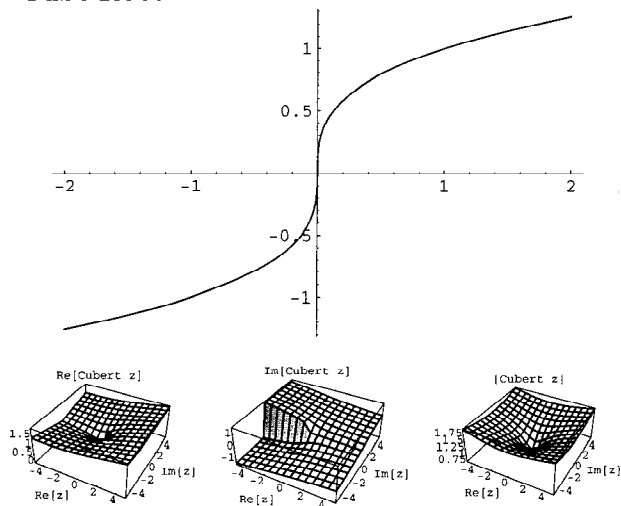

Given a number z , the cube root of z , denoted $\sqrt[3]{z}$ or $z^{1/3}$ (z to the 1/3 POWER), is a number a such that $a^3 = z$. There are three (not necessarily distinct) cube roots for any number.

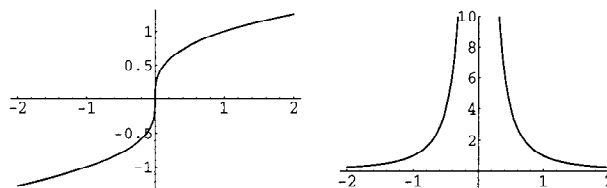

For real arguments, the cube root is an INCREASING FUNCTION, although the usual derivative test cannot be used to establish this fact at the ORIGIN since the derivative approaches infinity there (as illustrated above).

see also CUBE DUPLICATION, CUBED, DELIAN CONSTANT, GEOMETRIC PROBLEMS OF ANTIQUITY, k -MATRIX, SQUARE ROOT

Cube Triangle Picking

Pick 3 points at random in the unit n -HYPERCUBE. Denote the probability that the three points form an OBTUSE TRIANGLE $\Pi(n)$. Langford (1969) proved

$$\Pi(2) = \frac{97}{150} + \frac{1}{40}\pi = 0.725206483 \dots$$

see also BALL TRIANGLE PICKING, CUBE POINT PICKING

References

- Finch, S. "Favorite Mathematical Constants." <http://www.mathsoft.com/asolve/constant/geom/geom.html>.
- Langford, E. "The Probability that a Random Triangle is Obtuse." *Biometrika* **56**, 689–690, 1969.
- Santaló, L. A. *Integral Geometry and Geometric Probability*. Reading, MA: Addison-Wesley, 1976.

Cubed

A number to the POWER 3 is said to be cubed, so that x^3 is called "x cubed."

see also CUBE ROOT, SQUARED

Cubefree

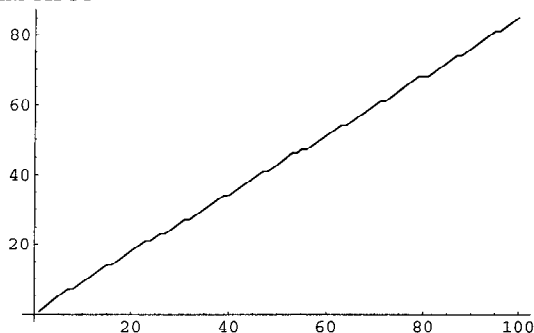

A number is said to be cubefree if its PRIME decomposition contains no tripled factors. All PRIMES are therefore trivially cubefree. The cubefree numbers are 1, 2, 3, 4, 5, 6, 7, 9, 10, 11, 12, 13, 14, 15, 17, ... (Sloane's A004709). The cubeful numbers (i.e., those that contain at least one cube) are 8, 16, 24, 27, 32, 40, 48, 54, ... (Sloane's A046099). The number of cubefree numbers less than 10, 100, 1000, ... are 9, 85, 833,

8319, 83190, 831910, ..., and their asymptotic density is $1/\zeta(3) \approx 0.831907$, where $\zeta(n)$ is the RIEMANN ZETA FUNCTION.

see also BIQUADRATEFREE, PRIME NUMBER, RIEMANN ZETA FUNCTION, SQUAREFREE

References

Sloane, N. J. A. Sequences A004709 and A046099 in "An On-Line Version of the Encyclopedia of Integer Sequences."

Cubic Curve

A cubic curve is an ALGEBRAIC CURVE of degree 3. An algebraic curve over a FIELD K is an equation $f(X, Y) = 0$, where $f(X, Y)$ is a POLYNOMIAL in X and Y with COEFFICIENTS in K , and the degree of f is the MAXIMUM degree of each of its terms (MONOMIALS).

Newton showed that all cubics can be generated by the projection of the five divergent cubic parabolas. Newton's classification of cubic curves appeared in the chapter "Curves" in *Lexicon Technicum* by John Harris published in London in 1710. Newton also classified all cubics into 72 types, missing six of them. In addition, he showed that any cubic can be obtained by a suitable projection of the ELLIPTIC CURVE

$$y^2 = ax^3 + bx^2 + cx + d, \quad (1)$$

where the projection is a BIRATIONAL TRANSFORMATION, and the general cubic can also be written as

$$y^2 = x^3 + ax + b. \quad (2)$$

Newton's first class is equations of the form

$$xy^2 + ey = ax^3 + bx^2 + cx + d. \quad (3)$$

This is the hardest case and includes the SERPENTINE CURVE as one of the subcases. The third class was

$$ay^2 = x(x^2 - 2bx + c), \quad (4)$$

which is called NEWTON'S DIVERGING PARABOLAS. Newton's 66th curve was the TRIDENT OF NEWTON. Newton's classification of cubics was criticized by Euler because it lacked generality. Plücker later gave a more detailed classification with 219 types.

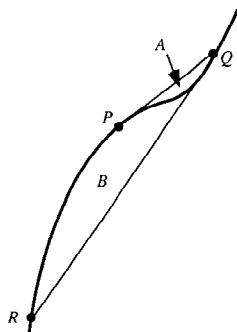

Pick a point P , and draw the tangent to the curve at P . Call the point where this tangent intersects the curve Q . Draw another tangent and call the point of intersection with the curve R . Every curve of third degree has the property that, with the areas in the above labeled figure,

$$B = 16A \quad (5)$$

(Honsberger 1991).

see also CAYLEY-BACHARACH THEOREM, CUBIC EQUATION

References

Honsberger, R. *More Mathematical Morsels*. Washington, DC: Math. Assoc. Amer., pp. 114–118, 1991.
 Newton, I. *Mathematical Works*, Vol. 2. New York: Johnson Reprint Corp., pp. 135–161, 1967.
 Wall, C. T. C. "Affine Cubic Functions III." *Math. Proc. Cambridge Phil. Soc.* **87**, 1–14, 1980.
 Westfall, R. S. *Never at Rest: A Biography of Isaac Newton*. New York: Cambridge University Press, 1988.
 Yates, R. C. "Cubic Parabola." *A Handbook on Curves and Their Properties*. Ann Arbor, MI: J. W. Edwards, pp. 56–59, 1952.

Cubic Equation

A cubic equation is a POLYNOMIAL equation of degree three. Given a general cubic equation

$$z^3 + a_2z^2 + a_1z + a_0 = 0 \quad (1)$$

(the COEFFICIENT a_3 of z^3 may be taken as 1 without loss of generality by dividing the entire equation through by a_3), first attempt to eliminate the a_2 term by making a substitution of the form

$$z \equiv x - \lambda. \quad (2)$$

Then

$$(x - \lambda)^3 + a_2(x - \lambda)^2 + a_1(x - \lambda) + a_0 = 0 \quad (3)$$

$$(x^3 - 3\lambda x^2 + 3\lambda^2 x - \lambda^3) + a_2(x^2 - 2\lambda x + \lambda^2) + a_1(x - \lambda) + a_0 = 0 \quad (4)$$

$$x^3 + x^2(a_2 - 3\lambda) + x(a_1 - 2a_2\lambda + 3\lambda^2) + (a_0 - a_1\lambda + a_2\lambda^2 - \lambda^3) = 0. \quad (5)$$

The x^2 is eliminated by letting $\lambda = a_2/3$, so

$$z \equiv x - \frac{1}{3}a_2. \quad (6)$$

Then

$$z^3 = (x - \frac{1}{3}a_2)^3 = x^3 - a_2x^2 + \frac{1}{3}a_2^2x - \frac{1}{27}a_2^3 \quad (7)$$

$$a_2z^2 = a_2(x - \frac{1}{3}a_2)^2 = a_2x^2 - \frac{2}{3}a_2^2x + \frac{1}{9}a_2^3 \quad (8)$$

$$a_1z = a_1(x - \frac{1}{3}a_2) = a_1x - \frac{1}{3}a_1a_2, \quad (9)$$

so equation (1) becomes

$$x^3 + (-a_2 + a_2)x^2 + (\frac{1}{3}a_2^2 - \frac{2}{3}a_2^2 + a_1)x - (\frac{1}{27}a_2^3 - \frac{1}{9}a_2^3 + \frac{1}{3}a_1a_2 - a_0) = 0 \quad (10)$$

$$x^3 + (a_1 - \frac{1}{3}a_2^2)x - (\frac{1}{3}a_1a_2 - \frac{2}{27}a_2^3 - a_0) = 0 \quad (11)$$

$$x^3 + 3 \cdot \frac{3a_1 - a_2^2}{9}x - 2 \cdot \frac{9a_1a_2 - 27a_0 - 2a_2^3}{54} = 0. \quad (12)$$

Defining

$$p \equiv \frac{3a_1 - a_2^2}{3} \quad (13)$$

$$q \equiv \frac{9a_1a_2 - 27a_0 - 2a_2^3}{27} \quad (14)$$

then allows (12) to be written in the standard form

$$x^3 + px = q. \quad (15)$$

The simplest way to proceed is to make VIETA'S SUBSTITUTION

$$x = w - \frac{p}{3w}, \quad (16)$$

which reduces the cubic to the equation

$$w^3 - \frac{p^3}{27w^3} - q = 0, \quad (17)$$

which is easily turned into a QUADRATIC EQUATION in w^3 by multiplying through by w^3 to obtain

$$(w^3)^2 - q(w^3) - \frac{1}{27}p^3 = 0 \quad (18)$$

(Birkhoff and Mac Lane 1965, p. 106). The result from the QUADRATIC EQUATION is

$$\begin{aligned} w^3 &= \frac{1}{2} \left(q \pm \sqrt{q^2 + \frac{4}{27}p^3} \right) = \frac{1}{2}q \pm \sqrt{\frac{1}{4}q^2 + \frac{1}{27}p^3} \\ &= R \pm \sqrt{R^2 + Q^3}, \end{aligned} \quad (19)$$

where Q and R are sometimes more useful to deal with than are p and q . There are therefore six solutions for w (two corresponding to each sign for each ROOT of w^3). Plugging w back in to (17) gives three pairs of solutions, but each pair is equal, so there are three solutions to the cubic equation.

Equation (12) may also be explicitly factored by attempting to pull out a term of the form $(x - B)$ from the cubic equation, leaving behind a quadratic equation which can then be factored using the QUADRATIC FORMULA. This process is equivalent to making Vieta's substitution, but does a slightly better job of motivating Vieta's "magic" substitution, and also at producing the explicit formulas for the solutions. First, define the intermediate variables

$$Q \equiv \frac{3a_1 - a_2^2}{9} \quad (20)$$

$$R \equiv \frac{9a_1a_2 - 27a_0 - 2a_2^3}{54} \quad (21)$$

(which are identical to p and q up to a constant factor). The general cubic equation (12) then becomes

$$x^3 + 3Qx - 2R = 0. \quad (22)$$

Let B and C be, for the moment, arbitrary constants. An identity satisfied by PERFECT CUBIC equations is that

$$x^3 - B^3 = (x - B)(x^2 + Bx + B^2). \quad (23)$$

The general cubic would therefore be directly factorable if it did not have an x term (i.e., if $Q = 0$). However, since in general $Q \neq 0$, add a multiple of $(x - B)$ —say $C(x - B)$ —to both sides of (23) to give the slightly messy identity

$$(x^3 - B^3) + C(x - B) = (x - B)(x^2 + Bx + B^2 + C) = 0, \quad (24)$$

which, after regrouping terms, is

$$x^3 + Cx - (B^3 + BC) = (x - B)[x^2 + Bx + (B^2 + C)] = 0. \quad (25)$$

We would now like to match the COEFFICIENTS C and $-(B^3 + BC)$ with those of equation (22), so we must have

$$C = 3Q \quad (26)$$

$$B^3 + BC = 2R. \quad (27)$$

Plugging the former into the latter then gives

$$B^3 + 3QB = 2R. \quad (28)$$

Therefore, if we can find a value of B satisfying the above identity, we have factored a linear term from the cubic, thus reducing it to a QUADRATIC EQUATION. The trial solution accomplishing this miracle turns out to be the symmetrical expression

$$B = [R + \sqrt{Q^3 + R^2}]^{1/3} + [R - \sqrt{Q^3 + R^2}]^{1/3}. \quad (29)$$

Taking the second and third POWERS of B gives

$$\begin{aligned} B^2 &= [R + \sqrt{Q^3 + R^2}]^{2/3} + 2[R^2 - (Q^3 + R^2)]^{1/3} \\ &\quad + [R - \sqrt{Q^3 + R^2}]^{2/3} \\ &= [R + \sqrt{Q^3 + R^2}]^{2/3} + [R - \sqrt{Q^3 + R^2}]^{2/3} - 2Q \end{aligned} \quad (30)$$

$$\begin{aligned} B^3 &= -2QB + \left\{ [R + \sqrt{Q^3 + R^2}]^{1/3} + [R - \sqrt{Q^3 + R^2}]^{1/3} \right\} \\ &\quad \times \left\{ [R + \sqrt{Q^3 + R^2}]^{2/3} + [R - \sqrt{Q^3 + R^2}]^{2/3} \right\} \\ &= [R + \sqrt{Q^3 + R^2}] + [R - \sqrt{Q^3 + R^2}] \\ &\quad + [R - \sqrt{Q^3 + R^2}]^{1/3}[R - \sqrt{Q^3 + R^2}]^{2/3} \\ &\quad + [R - \sqrt{Q^3 + R^2}]^{2/3}[R - \sqrt{Q^3 + R^2}]^{1/3} - 2QB \\ &= -2QB + 2R + [R^2 - (Q^3 + R^2)]^{1/3} \\ &\quad \times \left[\left(R + \sqrt{Q^3 + R^2} \right)^{1/3} + \left(R - \sqrt{Q^3 + R^2} \right)^{1/3} \right] \\ &= -2QB + 2R - QB = -3QB + 2R. \end{aligned} \quad (31)$$

Plugging B^3 and B into the left side of (28) gives

$$(-3QB + 2R) + 3QB = 2R, \quad (32)$$

so we have indeed found the factor $(x - B)$ of (22), and we need now only factor the quadratic part. Plugging $C = 3Q$ into the quadratic part of (25) and solving the resulting

$$x^2 + Bx + (B^2 + 3Q) = 0 \quad (33)$$

then gives the solutions

$$\begin{aligned} x &= \frac{1}{2}[-B \pm \sqrt{B^2 - 4(B^2 + 3Q)}] \\ &= -\frac{1}{2}B \pm \frac{1}{2}\sqrt{-3B^2 - 12Q} \\ &= -\frac{1}{2}B \pm \frac{1}{2}\sqrt{3}i\sqrt{B^2 + 4Q}. \end{aligned} \quad (34)$$

These can be simplified by defining

$$\begin{aligned} A &\equiv [R + \sqrt{Q^3 + R^2}]^{1/3} - [R - \sqrt{Q^3 + R^2}]^{1/3} \quad (35) \\ A^2 &= [R + \sqrt{Q^3 + R^2}]^{2/3} - 2[R^2 - (Q^3 + R^2)]^{1/3} \\ &\quad + [R - \sqrt{Q^3 + R^2}]^{2/3} \\ &= [R + \sqrt{Q^3 + R^2}]^{2/3} + [R - \sqrt{Q^3 + R^2}]^{2/3} + 2Q \\ &= B^2 + 4Q, \end{aligned} \quad (36)$$

so that the solutions to the quadratic part can be written

$$x = -\frac{1}{2}B \pm \frac{1}{2}\sqrt{3}iA. \quad (37)$$

Defining

$$D \equiv Q^3 + R^2 \quad (38)$$

$$S \equiv \sqrt[3]{R + \sqrt{D}} \quad (39)$$

$$T \equiv \sqrt[3]{R - \sqrt{D}}, \quad (40)$$

where D is the DISCRIMINANT (which is defined slightly differently, including the opposite SIGN, by Birkhoff and Mac Lane 1965) then gives very simple expressions for A and B , namely

$$B = S + T \quad (41)$$

$$A = S - T. \quad (42)$$

Therefore, at last, the ROOTS of the original equation in z are then given by

$$z_1 = -\frac{1}{3}a_2 + (S + T) \quad (43)$$

$$z_2 = -\frac{1}{3}a_2 - \frac{1}{2}(S + T) + \frac{1}{2}i\sqrt{3}(S - T) \quad (44)$$

$$z_3 = -\frac{1}{3}a_2 - \frac{1}{2}(S + T) - \frac{1}{2}i\sqrt{3}(S - T), \quad (45)$$

with a_2 the COEFFICIENT of z^2 in the original equation, and S and T as defined above. These three equations

giving the three ROOTS of the cubic equation are sometimes known as CARDANO'S FORMULA. Note that if the equation is in the standard form of Vieta

$$x^3 + px = q, \quad (46)$$

in the variable x , then $a_2 = 0$, $a_1 = p$, and $a_0 = -q$, and the intermediate variables have the simple form (c.f. Beyer 1987)

$$Q = \frac{1}{3}p \quad (47)$$

$$R = \frac{1}{2}q \quad (48)$$

$$D \equiv Q^3 + R^2 = \left(\frac{p}{3}\right)^3 + \left(\frac{q}{2}\right)^2. \quad (49)$$

The equation for z_1 in CARDANO'S FORMULA does not have an i appearing in it explicitly while z_2 and z_3 do, but this does not say anything about the number of REAL and COMPLEX ROOTS (since S and T are themselves, in general, COMPLEX). However, determining which ROOTS are REAL and which are COMPLEX can be accomplished by noting that if the DISCRIMINANT $D > 0$, one ROOT is REAL and two are COMPLEX CONJUGATES; if $D = 0$, all ROOTS are REAL and at least two are equal; and if $D < 0$, all ROOTS are REAL and unequal. If $D < 0$, define

$$\theta \equiv \cos^{-1} \left(\frac{R}{\sqrt{-Q^3}} \right). \quad (50)$$

Then the REAL solutions are of the form

$$z_1 = 2\sqrt{-Q} \cos \left(\frac{\theta}{3} \right) - \frac{1}{3}a_2 \quad (51)$$

$$z_2 = 2\sqrt{-Q} \cos \left(\frac{\theta + 2\pi}{3} \right) - \frac{1}{3}a_2 \quad (52)$$

$$z_3 = 2\sqrt{-Q} \cos \left(\frac{\theta + 4\pi}{3} \right) - \frac{1}{3}a_2. \quad (53)$$

This procedure can be generalized to find the REAL ROOTS for any equation in the standard form (46) by using the identity

$$\sin^3 \theta - \frac{3}{4} \sin \theta + \frac{1}{4} \sin(3\theta) = 0 \quad (54)$$

(Dickson 1914) and setting

$$x \equiv \sqrt{\frac{4|p|}{3}} y \quad (55)$$

(Birkhoff and Mac Lane 1965, pp. 90-91), then

$$\left(\frac{4|p|}{3} \right)^{3/2} y^3 + p \sqrt{\frac{4|p|}{3}} y = q \quad (56)$$

$$y^3 + \frac{3}{4} \frac{p}{|p|} y = \left(\frac{3}{4|p|} \right)^{3/2} q \quad (57)$$

$$4y^3 + 3 \operatorname{sgn}(p)y = \frac{1}{2}q \left(\frac{3}{|p|} \right)^{3/2} \equiv C. \quad (58)$$

If $p > 0$, then use

$$\sinh(3\theta) = 4 \sinh^3 \theta + 3 \sinh \theta \quad (59)$$

to obtain

$$y = \sinh\left(\frac{1}{3} \sinh^{-1} C\right). \quad (60)$$

If $p < 0$ and $|C| \geq 1$, use

$$\cosh(3\theta) = 4 \cosh^3 \theta - 3 \cosh \theta, \quad (61)$$

and if $p < 0$ and $|C| \leq 1$, use

$$\cos(3\theta) = 4 \cos^3 \theta - 3 \cos \theta, \quad (62)$$

to obtain

$$y = \begin{cases} \cosh\left(\frac{1}{3} \cosh^{-1} C\right) & \text{for } C \geq 1 \\ -\cosh\left(\frac{1}{3} \cosh^{-1} |C|\right) & \text{for } C \leq -1 \\ \cos\left(\frac{1}{3} \cos^{-1} C\right) \text{ [three solutions]} & \text{for } |C| < 1. \end{cases} \quad (63)$$

The solutions to the original equation are then

$$x_i = 2\sqrt{\frac{|p|}{3}} y_i - \frac{1}{3}a_2. \quad (64)$$

An alternate approach to solving the cubic equation is to use LAGRANGE RESOLVENTS. Let $\omega \equiv e^{2\pi i/3}$, define

$$(1, x_1) = x_1 + x_2 + x_3 \quad (65)$$

$$(\omega, x_1) = x_1 + \omega x_2 + \omega^2 x_3 \quad (66)$$

$$(\omega^2, x_1) = x_1 + \omega^2 x_2 + \omega x_3, \quad (67)$$

where x_i are the ROOTS of

$$x^3 + px + q = 0, \quad (68)$$

and consider the equation

$$[x - (u_1 + u_2)][x - (\omega u_1 + \omega^2 u_2)][x - (\omega^2 u_1 + \omega u_2)] = 0, \quad (69)$$

where u_1 and u_2 are COMPLEX NUMBERS. The ROOTS are then

$$x_j = \omega^j u_1 + \omega^{2j} u_2 \quad (70)$$

for $j = 0, 1, 2$. Multiplying through gives

$$x^3 - 3u_1 u_2 x - (u_1^3 + u_2^3) = 0, \quad (71)$$

or

$$x^3 + px + q = 0, \quad (72)$$

where

$$u_1^3 + u_2^3 = -q \quad (73)$$

$$u_1^3 u_2^3 = -\left(\frac{1}{3}\right)^3. \quad (74)$$

The solutions satisfy NEWTON'S IDENTITIES

$$z_1 + z_2 + z_3 = -a_2 \quad (75)$$

$$z_1 z_2 + z_2 z_3 + z_1 z_3 = a_1 \quad (76)$$

$$z_1 z_2 z_3 = -a_0. \quad (77)$$

In standard form, $a_2 = 0$, $a_1 = p$, and $a_0 = -q$, so we have the identities

$$p = z_1 z_2 - z_3^2 \quad (78)$$

$$(z_1 - z_2)^2 = -(4p - 3z_3^2) \quad (79)$$

$$z_1^2 + z_2^2 + z_3^2 = -2p. \quad (80)$$

Some curious identities involving the roots of a cubic equation due to Ramanujan are given by Berndt (1994).

see also QUADRATIC EQUATION, QUARTIC EQUATION, QUINTIC EQUATION, SEXTIC EQUATION

References

- Abramowitz, M. and Stegun, C. A. (Eds.). *Handbook of Mathematical Functions with Formulas, Graphs, and Mathematical Tables*, 9th printing. New York: Dover, p. 17, 1972.
- Berger, M. §16.4.1–16.4.11.1 in *Geometry I*. New York: Springer-Verlag, 1994.
- Berndt, B. C. *Ramanujan's Notebooks, Part IV*. New York: Springer-Verlag, pp. 22–23, 1994.
- Beyer, W. H. *CRC Standard Mathematical Tables*, 28th ed. Boca Raton, FL: CRC Press, pp. 9–11, 1987.
- Birkhoff, G. and Mac Lane, S. *A Survey of Modern Algebra*, 3rd ed. New York: Macmillan, pp. 90–91, 106–107, and 414–417, 1965.
- Dickson, L. E. "A New Solution of the Cubic Equation." *Amer. Math. Monthly* **5**, 38–39, 1898.
- Dickson, L. E. *Elementary Theory of Equations*. New York: Wiley, pp. 36–37, 1914.
- Dunham, W. "Cardano and the Solution of the Cubic." Ch. 6 in *Journey Through Genius: The Great Theorems of Mathematics*. New York: Wiley, pp. 133–154, 1990.
- Ehrlich, G. §4.16 in *Fundamental Concepts of Abstract Algebra*. Boston, MA: PWS-Kent, 1991.
- Jones, J. "Omar Khayyám and a Geometric Solution of the Cubic." http://jwilson.coe.uga.edu/emt669/Student_Folders/Jones/June/omar/omarpaper.html.
- Kennedy, E. C. "A Note on the Roots of a Cubic." *Amer. Math. Monthly* **40**, 411–412, 1933.
- King, R. B. *Beyond the Quartic Equation*. Boston, MA: Birkhäuser, 1996.
- Press, W. H.; Flannery, B. P.; Teukolsky, S. A.; and Vetterling, W. T. "Quadratic and Cubic Equations." §5.6 in *Numerical Recipes in FORTRAN: The Art of Scientific Computing*, 2nd ed. Cambridge, England: Cambridge University Press, pp. 178–180, 1992.
- Spanier, J. and Oldham, K. B. "The Cubic Function $x^3 + ax^2 + bx + c$ and Higher Polynomials." Ch. 17 in *An Atlas of Functions*. Washington, DC: Hemisphere, pp. 131–147, 1987.
- van der Waerden, B. L. §64 in *Algebra*. New York: Frederick Ungar, 1970.

Cubic Number

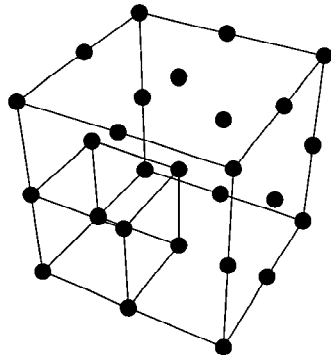

A FIGURATE NUMBER of the form n^3 , for n a POSITIVE INTEGER. The first few are 1, 8, 27, 64, ... (Sloane's A000578). The GENERATING FUNCTION giving the cubic numbers is

$$\frac{x(x^2 + 4x + 1)}{(x - 1)^4} = x + 8x^2 + 27x^3 + \dots \quad (1)$$

The HEX PYRAMIDAL NUMBERS are equivalent to the cubic numbers (Conway and Guy 1996).

The number of *positive* cubes needed to represent the numbers 1, 2, 3, ... are 1, 2, 3, 4, 5, 6, 7, 1, 2, 3, 4, 5, 6, 7, 8, 2, ... (Sloane's A02376), and the number of distinct ways to represent the numbers 1, 2, 3, ... in terms of positive cubes are 1, 1, 1, 1, 1, 1, 1, 2, 2, 2, 2, 2, 2, 2, 3, 3, 3, 3, 3, 3, 3, 3, 4, 4, 4, 5, 5, 5, 5, ... (Sloane's A003108). In the early twentieth century, Dickson, Pillai, and Niven proved that every POSITIVE INTEGER is the sum of not more than nine CUBES (so $g(3) = 9$ in WARING'S PROBLEM).

In 1939, Dickson proved that the only INTEGERS requiring nine CUBES are 23 and 239. Wieferich proved that only 15 INTEGERS require eight CUBES: 15, 22, 50, 114, 167, 175, 186, 212, 213, 238, 303, 364, 420, 428, and 454 (Sloane's A018889). The quantity $G(3)$ in WARING'S PROBLEM therefore satisfies $G(3) \leq 7$, and the largest number known requiring seven cubes is 8042. The following table gives the first few numbers which require at least $N = 1, 2, 3, \dots, 9$ (positive) cubes to represent them as a sum.

N	Sloane	Numbers
1	000578	1, 8, 27, 64, 125, 216, 343, 512, ...
2	003325	2, 9, 16, 28, 35, 54, 65, 72, 91, ...
3	003072	3, 10, 17, 24, 29, 36, 43, 55, 62, ...
4	003327	4, 11, 18, 25, 30, 32, 37, 44, 51, ...
5	003328	5, 12, 19, 26, 31, 33, 38, 40, 45, ...
6		6, 13, 20, 34, 39, 41, 46, 48, 53, ...
7	018890	7, 14, 21, 42, 47, 49, 61, 77, ...
8	018889	15, 22, 50, 114, 167, 175, 186, ...,
9	—	23, 239

There is a finite set of numbers which cannot be expressed as the sum of *distinct* cubes: 2, 3, 4, 5, 6, 7, 10,

11, 12, 13, 14, 15, 16, 17, 18, 19, 20, 21, 22, 23, 24, 25, 26, ... (Sloane's A001476). The following table gives the numbers which can be represented in W different ways as a sum of N positive cubes. For example,

$$157 = 4^3 + 4^3 + 3^3 + 1^3 + 1^3 = 5^3 + 2^3 + 2^3 + 2^3 + 2^3 \quad (2)$$

can be represented in $W = 2$ ways by $N = 5$ cubes. The smallest number representable in $W = 2$ ways as a sum of $N = 2$ cubes,

$$1729 = 1^3 + 12^3 = 9^3 + 10^3, \quad (3)$$

is called the HARDY-RAMANUJAN NUMBER and has special significance in the history of mathematics as a result of a story told by Hardy about Ramanujan. Sloane's A001235 is defined as the sequence of numbers which are the sum of cubes in two *or more* ways, and so appears identical in the first few terms.

N	W	Sloane	Numbers
1	1	000578	1, 8, 27, 64, 125, 216, 343, 512, ...
2	1	025403	2, 9, 16, 28, 35, 54, 65, 72, 91, ...
2	2		1729, 4104, 13832, 20683, 32832, ...
2	3	003825	87539319, 119824488, 143604279, ...
2	4	003826	6963472309248, 12625136269928, ...
2	5		48988659276962496, ...
2	6		8230545258248091551205888, ...
3	1	025395	3, 10, 17, 24, 29, 36, 43, 55, 62, ...

It is believed to be possible to express any number as a SUM of four (positive or negative) cubes, although this has not been proved for numbers of the form $9n \pm 4$. In fact, all numbers *not* of the form $9n \pm 4$ are known to be expressible as the SUM of *three* (positive or negative) cubes except 30, 33, 42, 52, 74, 110, 114, 156, 165, 195, 290, 318, 366, 390, 420, 435, 444, 452, 462, 478, 501, 530, 534, 564, 579, 588, 600, 606, 609, 618, 627, 633, 732, 735, 758, 767, 786, 789, 795, 830, 834, 861, 894, 903, 906, 912, 921, 933, 948, 964, 969, and 975 (Guy 1994, p. 151).

The following table gives the possible residues (mod n) for cubic numbers for $n = 1$ to 20, as well as the number of distinct residues $s(n)$.

n	$s(n)$	$x^3 \pmod n$
2	2	0, 1
3	3	0, 1, 2
4	3	0, 1, 3
5	5	0, 1, 2, 3, 4
6	6	0, 1, 2, 3, 4, 5
7	3	0, 1, 6
8	5	0, 1, 3, 5, 7
9	3	0, 1, 8
10	10	0, 1, 2, 3, 4, 5, 6, 7, 8, 9
11	11	0, 1, 2, 3, 4, 5, 6, 7, 8, 9, 10
12	9	0, 1, 3, 4, 5, 7, 8, 9, 11
13	5	0, 1, 5, 8, 12
14	6	0, 1, 6, 7, 8, 13
15	15	0, 1, 2, 3, 4, 5, 6, 7, 8, 9, 10, 11, 12, 13, 14
16	10	0, 1, 3, 5, 7, 8, 9, 11, 13, 15
17	17	0, 1, 2, 3, 4, 5, 6, 7, 8, 9, 10, 11, 12, 13, 14, 15, 16
18	6	0, 1, 8, 9, 10, 17
19	7	0, 1, 7, 8, 11, 12, 18
20	15	0, 1, 3, 4, 5, 7, 8, 9, 11, 12, 13, 15, 16, 17, 19

Dudeney found two RATIONAL NUMBERS other than 1 and 2 whose cubes sum to 9,

$$\frac{415280564497}{348671682660} \text{ and } \frac{676702467503}{348671682660} \quad (4)$$

The problem of finding two RATIONAL NUMBERS whose cubes sum to six was "proved" impossible by Legendre. However, Dudeney found the simple solutions 17/21 and 37/21.

The only three consecutive INTEGERS whose cubes sum to a cube are given by the DIOPHANTINE EQUATION

$$3^3 + 4^3 + 5^3 = 6^3. \quad (5)$$

CATALAN'S CONJECTURE states that 8 and 9 (2^3 and 3^2) are the only consecutive POWERS (excluding 0 and 1), i.e., the only solution to CATALAN'S DIOPHANTINE PROBLEM. This CONJECTURE has not yet been proved or refuted, although R. Tijdeman has proved that there can be only a finite number of exceptions should the CONJECTURE not hold. It is also known that 8 and 9 are the only consecutive cubic and SQUARE NUMBERS (in either order).

There are six POSITIVE INTEGERS equal to the sum of the DIGITS of their cubes: 1, 8, 17, 18, 26, and 27 (Moret Blanc 1879). There are four POSITIVE INTEGERS equal to the sums of the cubes of their digits:

$$153 = 1^3 + 5^3 + 3^3 \quad (6)$$

$$370 = 3^3 + 7^3 + 0^3 \quad (7)$$

$$371 = 3^3 + 7^3 + 1^3 \quad (8)$$

$$407 = 4^3 + 0^3 + 7^3 \quad (9)$$

(Ball and Coxeter 1987). There are two SQUARE NUMBERS of the form $n^3 - 4$: $4 = 2^3 - 4$ and $121 = 5^3 - 4$ (Le Lionnais 1983). A cube cannot be the concatenation of two cubes, since if c^3 is the concatenation of a^3 and b^3 ,

then $c^3 = 10^k a^3 + b^3$, where k is the number of digits in b^3 . After shifting any powers of 1000 in 10^k into a^3 , the original problem is equivalent to finding a solution to one of the DIOPHANTINE EQUATIONS

$$c^3 - b^3 = a^3 \quad (10)$$

$$c^3 - b^3 = 10a^3 \quad (11)$$

$$c^3 - b^3 = 100a^3. \quad (12)$$

None of these have solutions in integers, as proved independently by Sylvester, Lucas, and Pepin (Dickson 1966, pp. 572–578).

see also BIQUADRATIC NUMBER, CENTERED CUBE NUMBER, CLARK'S TRIANGLE, DIOPHANTINE EQUATION—CUBIC, HARDY-RAMANUJAN NUMBER, PARTITION, SQUARE NUMBER

References

- Ball, W. W. R. and Coxeter, H. S. M. *Mathematical Recreations and Essays*, 13th ed. New York: Dover, p. 14, 1987.
- Conway, J. H. and Guy, R. K. *The Book of Numbers*. New York: Springer-Verlag, pp. 42–44, 1996.
- Davenport, H. "On Waring's Problem for Cubes." *Acta Math.* **71**, 123–143, 1939.
- Dickson, L. E. *History of the Theory of Numbers*, Vol. 2: *Diophantine Analysis*. New York: Chelsea, 1966.
- Guy, R. K. "Sum of Four Cubes." §D5 in *Unsolved Problems in Number Theory*, 2nd ed. New York: Springer-Verlag, pp. 151–152, 1994.
- Le Lionnais, F. *Les nombres remarquables*. Paris: Hermann, p. 53, 1983.
- Sloane, N. J. A. Sequences A000578/M4499, A02376/M0466, and A003108/M0209 in "An On-Line Version of the Encyclopedia of Integer Sequences."

Cubic Reciprocity Theorem

A RECIPROCITY THEOREM for the case $n = 3$ solved by Gauss using "INTEGERS" of the form $a + b\rho$, when ρ is a root of $x^2 + x + 1 = 0$ and a, b are INTEGERS.

see also RECIPROCITY THEOREM

References

- Ireland, K. and Rosen, M. "Cubic and Biquadratic Reciprocity." Ch. 9 in *A Classical Introduction to Modern Number Theory*, 2nd ed. New York: Springer-Verlag, pp. 108–137, 1990.

Cubic Spline

A cubic spline is a SPLINE constructed of piecewise third-order POLYNOMIALS which pass through a set of control points. The second DERIVATIVE of each POLYNOMIAL is zero at the endpoints.

References

- Burden, R. L.; Faires, J. D.; and Reynolds, A. C. *Numerical Analysis*, 6th ed. Boston, MA: Brooks/Cole, pp. 120–121, 1997.
- Press, W. H.; Flannery, B. P.; Teukolsky, S. A.; and Vetterling, W. T. "Cubic Spline Interpolation." §3.3 in *Numerical Recipes in FORTRAN: The Art of Scientific Computing*, 2nd ed. Cambridge, England: Cambridge University Press, pp. 107–110, 1992.

Cubic Surface

An ALGEBRAIC SURFACE of ORDER 3. Schläfli and Cayley classified the singular cubic surfaces. On the general cubic, there exists a curious geometrical structure called DOUBLE SIXES, and also a particular arrangement of 27 (possibly complex) lines, as discovered by Schläfli (Salmon 1965, Fischer 1986) and sometimes called SOLOMON'S SEAL LINES. A nonregular cubic surface can contain 3, 7, 15, or 27 real lines (Segre 1942, Le Lionnais 1983). The CLEBSCH DIAGONAL CUBIC contains all possible 27. The maximum number of ORDINARY DOUBLE POINTS on a cubic surface is four, and the unique cubic surface having four ORDINARY DOUBLE POINTS is the CAYLEY CUBIC.

Schoutte (1910) showed that the 27 lines can be put into a ONE-TO-ONE correspondence with the vertices of a particular POLYTOPE in 6-D space in such a manner that all incidence relations between the lines are mirrored in the connectivity of the POLYTOPE and conversely (Du Val 1931). A similar correspondence can be made between the 28 bitangents of the general plane QUARTIC CURVE and a 7-D POLYTOPE (Coxeter 1928) and between the tritangent planes of the canonical curve of genus 4 and an 8-D POLYTOPE (Du Val 1933).

A smooth cubic surface contains 45 TRITANGENTS (Hunt). The Hessian of smooth cubic surface contains at least 10 ORDINARY DOUBLE POINTS, although the Hessian of the CAYLEY CUBIC contains 14 (Hunt).

see also CAYLEY CUBIC, CLEBSCH DIAGONAL CUBIC, DOUBLE SIXES, ECKARDT POINT, ISOLATED SINGULARITY, NORDSTRAND'S WEIRD SURFACE, SOLOMON'S SEAL LINES, TRITANGENT

References

- Bruce, J. and Wall, C. T. C. "On the Classification of Cubic Surfaces." *J. London Math. Soc.* **19**, 245–256, 1979.
- Cayley, A. "A Memoir on Cubic Surfaces." *Phil. Trans. Roy. Soc.* **159**, 231–326, 1869.
- Coxeter, H. S. M. "The Pure Archimedean Polytopes in Six and Seven Dimensions." *Proc. Cambridge Phil. Soc.* **24**, 7–9, 1928.
- Du Val, P. "On the Directrices of a Set of Points in a Plane." *Proc. London Math. Soc. Ser. 2* **35**, 23–74, 1933.
- Fischer, G. (Ed.). *Mathematical Models from the Collections of Universities and Museums*. Braunschweig, Germany: Vieweg, pp. 9–14, 1986.
- Fladt, K. and Baur, A. *Analytische Geometrie spezieller Flächen und Raumkurven*. Braunschweig, Germany: Vieweg, pp. 248–255, 1975.
- Hunt, B. "Algebraic Surfaces." <http://www.mathematik.uni-kl.de/~wwwag/Galerie.html>.
- Hunt, B. "The 27 Lines on a Cubic Surface" and "Cubic Surfaces." Ch. 4 and Appendix B.4 in *The Geometry of Some Special Arithmetic Quotients*. New York: Springer-Verlag, pp. 108–167 and 302–310, 1996.
- Le Lionnais, F. *Les nombres remarquables*. Paris: Hermann, p. 49, 1983.
- Rodenberg, C. "Zur Classification der Flächen dritter Ordnung." *Math. Ann.* **14**, 46–110, 1878.
- Salmon, G. *Analytic Geometry of Three Dimensions*. New York: Chelsea, 1965.
- Schläfli, L. "On the Distribution of Surface of Third Order into Species." *Phil. Trans. Roy. Soc.* **153**, 193–247, 1864.

- Schoutte, P. H. "On the Relation Between the Vertices of a Definite Sixdimensional Polytope and the Lines of a Cubic Surface." *Proc. Roy. Acad. Amsterdam* **13**, 375–383, 1910.
- Segre, B. *The Nonsingular Cubic Surface*. Oxford, England: Clarendon Press, 1942.

Cubical Conic Section

see CUBICAL ELLIPSE, CUBICAL HYPERBOLA, CUBICAL PARABOLA, SKEW CONIC

Cubical Ellipse

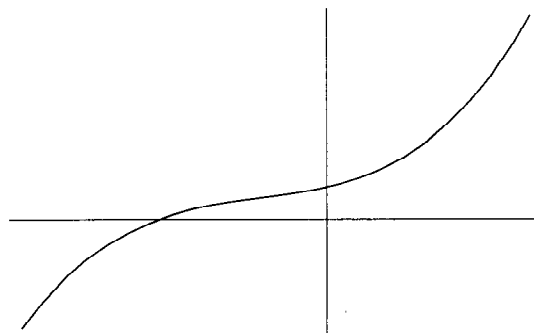

An equation of the form

$$y = ax^3 + bx^2 + cx + d$$

where only one ROOT is real.

see also CUBICAL CONIC SECTION, CUBICAL HYPERBOLA, CUBICAL PARABOLA, CUBICAL PARABOLIC HYPERBOLA, ELLIPSE, SKEW CONIC

Cubical Graph

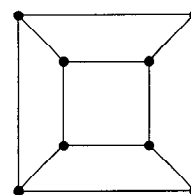

An 8-vertex POLYHEDRAL GRAPH.

see also BIDIAKIS CUBE, BISLIT CUBE, DODECAHEDRAL GRAPH, ICOSAHEDRAL GRAPH, OCTAHEDRAL GRAPH, TETRAHEDRAL GRAPH

Cubical Hyperbola

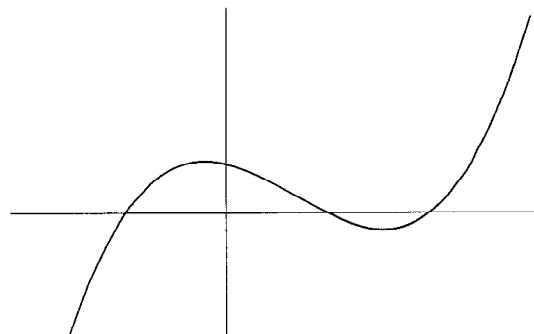

An equation of the form

$$y = ax^3 + bx^2 + cx + d,$$

where the three ROOTS are REAL and distinct, i.e.,

$$\begin{aligned} y &= a(x - r_1)(x - r_2)(x - r_3) \\ &= a[x^3 - (r_1 + r_2 + r_3)x^2 + (r_1r_2 + r_1r_3 + r_2r_3)x \\ &\quad - r_1r_2r_3]. \end{aligned}$$

see also CUBICAL CONIC SECTION, CUBICAL ELLIPSE, CUBICAL HYPERBOLA, CUBICAL PARABOLA, HYPERBOLA

Cubical Parabola

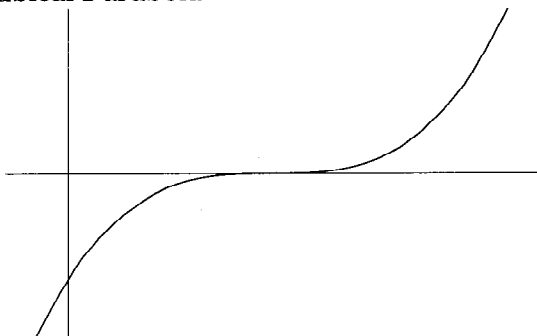

An equation of the form

$$y = ax^3 + bx^2 + cx + d,$$

where the three ROOTS of the equation coincide (and are therefore real), i.e.,

$$y = a(x - r)^3 = a(x^3 - 3rx^2 - 3r^2x - r^3).$$

see also CUBICAL CONIC SECTION, CUBICAL ELLIPSE, CUBICAL HYPERBOLA, CUBICAL PARABOLIC HYPERBOLA, PARABOLA, SEMICUBICAL PARABOLA

Cubical Parabolic Hyperbola

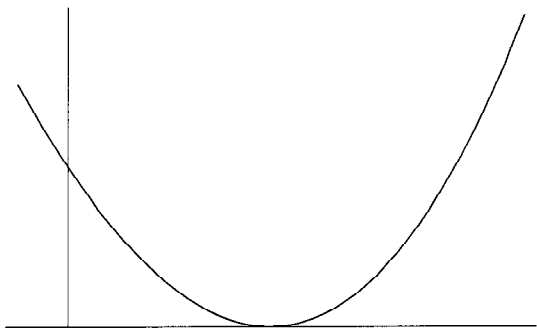

An equation of the form

$$y = ax^3 + bx^2 + cx + d,$$

where two of the ROOTS of the equation coincide (and all three are therefore real), i.e.,

$$\begin{aligned} y &= a(x - r_1)^2(x - r_2) \\ &= a[x^3 - (2r_1 + r_2)x^2 + r_1(r_1 + 2r_2)x - r_1^2r_2]. \end{aligned}$$

see also CUBICAL CONIC SECTION, CUBICAL ELLIPSE, CUBICAL HYPERBOLA, CUBICAL PARABOLA, HYPERBOLA

Cubicuboctahedron

see GREAT CUBICUBOCTAHEDRON, SMALL CUBICUBOCTAHEDRON

Cubique d'Agnesi

see WITCH OF AGNESI

Cubitruncated Cuboctahedron

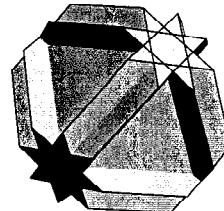

The UNIFORM POLYHEDRON U_{16} whose DUAL is the TETRADYAKIS HEXAHEDRON. It has WYTHOFF SYMBOL $3 \frac{4}{3} 4$. Its faces are $8\{6\} + 6\{8\} + 6\{\frac{8}{3}\}$. It is a FACETED OCTAHEDRON. The CIRCUMRADIUS for a cubitruncated cuboctahedron of unit edge length is

$$R = \frac{1}{2}\sqrt{7}.$$

References

Wenninger, M. J. *Polyhedron Models*. Cambridge, England: Cambridge University Press, pp. 113–114, 1971.

Cuboctahedron

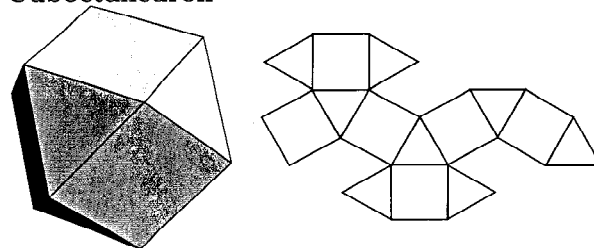

An ARCHIMEDEAN SOLID (also called the DYMAXION or HEPTAPARALLELOHEDRON) whose DUAL is the RHOMBIC DODECAHEDRON. It is one of the two convex QUASIREGULAR POLYHEDRA and has SCHLÄFLI SYMBOL $\{3\}_4$. It is also UNIFORM POLYHEDRON U_7 and has WYTHOFF SYMBOL $2|34$. Its faces are $\{3\} + 6\{4\}$. It has the O_h OCTAHEDRAL GROUP of symmetries.

The VERTICES of a cuboctahedron with EDGE length of $\sqrt{2}$ are $(0, \pm 1, \pm 1)$, $(\pm 1, 0, \pm 1)$, and $(\pm 1, \pm 1, 0)$. The INRADIUS, MIDRADIUS, and CIRCUMRADIUS for $a = 1$ are

$$\begin{aligned} r &= \frac{3}{4} = 0.75 \\ \rho &= \frac{1}{2}\sqrt{3} \approx 0.86602 \\ R &= 1. \end{aligned}$$

FACETED versions include the CUBOHEMIOCTAHEDRON and OCTAHEMIOCTAHEDRON.

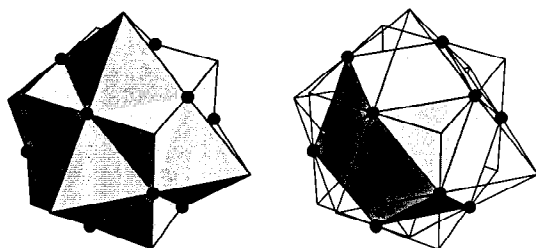

The solid common to both the CUBE and OCTAHEDRON (left figure) in a CUBE-OCTAHEDRON COMPOUND is a CUBOCTAHEDRON (right figure; Ball and Coxeter 1987). *see also* ARCHIMEDEAN SOLID, CUBE, CUBE-OCTAHEDRON COMPOUND, CUBOHEMIOCTAHEDRON, OCTAHEDRON, OCTAHEMIOCTAHEDRON, QUASIREGULAR POLYHEDRON, RHOMBIC DODECAHEDRON, RHOMBUS

References

- Ball, W. W. R. and Coxeter, H. S. M. *Mathematical Recreations and Essays*, 13th ed. New York: Dover, p. 137, 1987.
Ghyka, M. *The Geometry of Art and Life*. New York: Dover, p. 54, 1977.

Cuboctatruncated Cuboctahedron

see CUBITRUNCATED CUBOCTAHEDRON

Cubocycloid

see ASTROID

Cubohemioctahedron

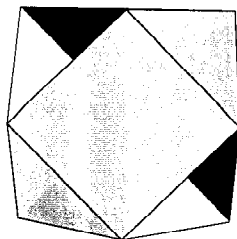

The UNIFORM POLYHEDRON U_{15} whose DUAL is the HEXAHEMIOCTAHEDRON. It has WYTHOFF SYMBOL $\frac{4}{3} 4 | 3$. Its faces are $4\{6\} + 6\{4\}$. It is a FACETED version of the CUBOCTAHEDRON. Its CIRCUMRADIUS for unit edge length is

$$R = 1.$$

References

- Wenninger, M. J. *Polyhedron Models*. Cambridge, England: Cambridge University Press, pp. 121-122, 1971.

Cuboid

A rectangular PARALLELEPIPED.

see also EULER BRICK, PARALLELEPIPED, SPIDER AND FLY PROBLEM

Cullen Number

A number of the form

$$C_n = 2^n n + 1.$$

The first few are 3, 9, 25, 65, 161, 385, ... (Sloane's A002064). The only Cullen numbers C_n for $n < 300,000$ which are PRIME are for $n = 1, 141, 4713, 5795, 6611, 18496, 32292, 32469, 59656, 90825, 262419, \dots$ (Sloane's A005849; Ballinger). Cullen numbers are DIVISIBLE by $p = 2n - 1$ if p is a PRIME of the form $8k \pm 3$.

see also CUNNINGHAM NUMBER, FERMAT NUMBER, SIERPIŃSKI NUMBER OF THE FIRST KIND, WOODALL NUMBER

References

- Ballinger, R. "Cullen Primes: Definition and Status." <http://ballingerr.xray.ufl.edu/proths/cullen.html>.
Guy, R. K. "Cullen Numbers." §B20 in *Unsolved Problems in Number Theory*, 2nd ed. New York: Springer-Verlag, p. 77, 1994.
Keller, W. "New Cullen Primes." *Math. Comput.* **64**, 1733-1741, 1995.
Leyland, P. <ftp://sable.ox.ac.uk/pub/math/factors/cullen>.
Ribenboim, P. *The New Book of Prime Number Records*. New York: Springer-Verlag, pp. 360-361, 1996.
Sloane, N. J. A. Sequences A002064/M2795 and A005849/M5401 in "An On-Line Version of the Encyclopedia of Integer Sequences."

Cumulant

Let $\phi(t)$ be the CHARACTERISTIC FUNCTION, defined as the FOURIER TRANSFORM of the PROBABILITY DENSITY FUNCTION,

$$\phi(t) = \mathcal{F}[P(x)] = \int_{-\infty}^{\infty} e^{itx} P(x) dx. \quad (1)$$

Then the cumulants κ_n are defined by

$$\ln \phi(t) \equiv \sum_{n=0}^{\infty} \kappa_n \frac{(it)^n}{n!}. \quad (2)$$

Taking the MACLAURIN SERIES gives

$$\begin{aligned} \ln \phi(t) &= (it)\mu'_1 + \frac{1}{2}(it)^2(\mu'_2 - \mu_1'^2) \\ &\quad + \frac{1}{3!}(it)^3(2\mu_1'^3 - 3\mu_1'\mu'_2 + \mu_3') \\ &\quad + \frac{1}{4!}(it)^4(-6\mu_1'^4 + 12\mu_1'^2\mu'_2 - 3\mu_2'^2 - 4\mu_1'\mu'_3 + \mu_4') \\ &\quad + \frac{1}{5!}(it)^5[-24\mu_1'^5 + 60\mu_1'^3\mu'_2 + 20\mu_1'^2\mu'_3 + 10\mu_2'\mu'_3 \\ &\quad + 5\mu_1'(6\mu_2'^2 - \mu_4') + \mu_5'] + \dots, \quad (3) \end{aligned}$$

where μ'_n are MOMENTS about 0, so

$$\kappa_1 = \mu'_1 \quad (4)$$

$$\kappa_2 = \mu'_2 - \mu_1'^2 \quad (5)$$

$$\kappa_3 = 2\mu_1'^3 - 3\mu_1'\mu_2' + \mu_3' \quad (6)$$

$$\kappa_4 = -6\mu_1'^4 + 12\mu_1'^2\mu_2' - 3\mu_2'^2 - 4\mu_1'\mu_3' + \mu_4' \quad (7)$$

$$\kappa_5 = -24\mu_1'^5 + 60\mu_1'^3\mu_2' + 20\mu_1'^2\mu_3' + 10\mu_2'\mu_3' + 5\mu_1'(6\mu_2'^2 - \mu_4') + \mu_5'. \quad (8)$$

In terms of the MOMENTS μ_n about the MEAN,

$$\kappa_1 = \mu \quad (9)$$

$$\kappa_2 = \mu_2 = \sigma^2 \quad (10)$$

$$\kappa_3 = \mu_3 \quad (11)$$

$$\kappa_4 = \mu_4 - 3\mu_2^2 \quad (12)$$

$$\kappa_5 = \mu_5 - 10\mu_2\mu_3, \quad (13)$$

where μ is the MEAN and $\sigma^2 \equiv \mu_2$ is the VARIANCE.

The k -STATISTICS are UNBIASED ESTIMATORS of the cumulants.

see also CHARACTERISTIC FUNCTION, CUMULANT-GENERATING FUNCTION, k -STATISTIC, KURTOSIS, MEAN, MOMENT, SHEPPARD'S CORRECTION, SKEWNESS, VARIANCE

References

- Abramowitz, M. and Stegun, C. A. (Eds.). *Handbook of Mathematical Functions with Formulas, Graphs, and Mathematical Tables*, 9th printing. New York: Dover, p. 928, 1972.
- Kenney, J. F. and Keeping, E. S. "Cumulants and the Cumulant-Generating Function," "Additive Property of Cumulants," and "Sheppard's Correction." §4.10–4.12 in *Mathematics of Statistics*, Pt. 2, 2nd ed. Princeton, NJ: Van Nostrand, pp. 77–82, 1951.

Cumulant-Generating Function

Let $M(h)$ be the MOMENT-GENERATING FUNCTION. Then

$$K(h) \equiv \ln M(h) = \kappa_1 h + \frac{1}{2!} h^2 \kappa_2 + \frac{1}{3!} h^3 \kappa_3 + \dots$$

If

$$L = \sum_{j=1}^M c_j x_j$$

is a function of N independent variables, the cumulant generating function for L is then

$$K(h) = \sum_{j=1}^N K_j(c_j h).$$

see also CUMULANT, MOMENT-GENERATING FUNCTION

References

- Abramowitz, M. and Stegun, C. A. (Eds.). *Handbook of Mathematical Functions with Formulas, Graphs, and*

Mathematical Tables, 9th printing. New York: Dover, p. 928, 1972.

Kenney, J. F. and Keeping, E. S. "Cumulants and the Cumulant-Generating Function" and "Additive Property of Cumulants." §4.10–4.11 in *Mathematics of Statistics*, Pt. 2, 2nd ed. Princeton, NJ: Van Nostrand, pp. 77–80, 1951.

Cumulative Distribution Function

see DISTRIBUTION FUNCTION

Cundy and Rollett's Egg

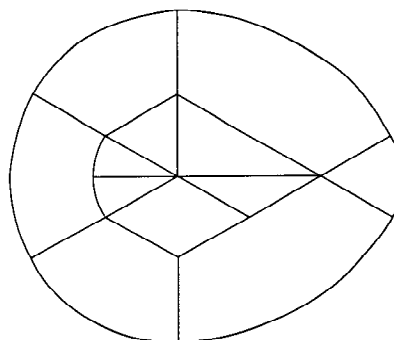

An OVAL dissected into pieces which are to be used to create pictures. The resulting figures resemble those constructed out of TANGRAMS.

see also DISSECTION, EGG, OVAL, TANGRAM

References

- Cundy, H. and Rollett, A. *Mathematical Models*, 3rd ed. Stradbroke, England: Tarquin Pub., pp. 19–21, 1989.
- Dixon, R. *Mathographics*. New York: Dover, p. 11, 1991.

Cunningham Chain

A SEQUENCE of PRIMES $q_1 < q_2 < \dots < q_k$ is a Cunningham chain of the first kind (second kind) of length k if $q_{i+1} = 2q_i + 1$ ($q_{i+1} = 2q_i - 1$) for $i = 1, \dots, k-1$. Cunningham PRIMES of the first kind are SOPHIE GERMAIN PRIMES.

The two largest known Cunningham chains (of the first kind) of length three are $(384205437 \cdot 2^{4000} - 1, 384205437 \cdot 2^{4001} - 1, 384205437 \cdot 2^{4002} - 1)$ and $(651358155 \cdot 2^{3291} - 1, 651358155 \cdot 2^{3292} - 1, 651358155 \cdot 2^{3293} - 1)$, both discovered by W. Roonguthai in 1998.

see also PRIME ARITHMETIC PROGRESSION, PRIME CLUSTER

References

- Guy, R. K. "Cunningham Chains." §A7 in *Unsolved Problems in Number Theory*, 2nd ed. New York: Springer-Verlag, pp. 18–19, 1994.
- Ribenboim, P. *The New Book of Prime Number Records*. New York: Springer-Verlag, p. 333, 1996.
- Roonguthai, W. "Yves Gallot's Proth and Cunningham Chains." <http://ksc9.th.com/warut/cunningham.html>.

Cunningham Function

Sometimes also called the PEARSON-CUNNINGHAM FUNCTION. It can be expressed using WHITTAKER FUNCTIONS (Whittaker and Watson 1990, p. 353).

$$\omega_{n,m}(x) \equiv \frac{e^{\pi i(m/2-n)+x}}{\Gamma(1+n-\frac{1}{2}m)} U(\frac{1}{2}m-n, 1+m, x),$$

where U is a CONFLUENT HYPERGEOMETRIC FUNCTION OF THE SECOND KIND (Abramowitz and Stegun 1972, p. 510).

see also CONFLUENT HYPERGEOMETRIC FUNCTION OF THE SECOND KIND, WHITTAKER FUNCTION

References

- Abramowitz, M. and Stegun, C. A. (Eds.). *Handbook of Mathematical Functions with Formulas, Graphs, and Mathematical Tables*, 9th printing. New York: Dover, 1972.
- Whittaker, E. T. and Watson, G. N. *A Course in Modern Analysis*, 4th ed. Cambridge, England: Cambridge University Press, 1990.

Cunningham Number

A BINOMIAL NUMBER of the form $C^\pm(b, n) \equiv b^n \pm 1$. Bases b^k which are themselves powers need not be considered since they correspond to $(b^k)^n \pm 1 = b^{kn} \pm 1$. PRIME NUMBERS of the form $C^\pm(b, n)$ are very rare.

A NECESSARY (but not SUFFICIENT) condition for $C^+(2, n) = 2^n + 1$ to be PRIME is that n be of the form $n = 2^m$. Numbers of the form $F_m = C^+(2, 2^m) = 2^{2^m} + 1$ are called FERMAT NUMBERS, and the only known PRIMES occur for $C^+(2, 1) = 3$, $C^+(2, 2) = 5$, $C^+(2, 4) = 17$, $C^+(2, 8) = 257$, and $C^+(2, 16) = 65537$ (i.e., $n = 0, 1, 2, 3, 4$). The only other PRIMES $C^+(b, n)$ for nontrivial $b \leq 11$ and $2 \leq n \leq 1000$ are $C^+(6, 2) = 37$, $C^+(6, 4) = 1297$, and $C^+(10, 2) = 101$.

PRIMES of the form $C^-(b, n)$ are also very rare. The MERSENNE NUMBERS $M_n = C^-(2, n) = 2^n - 1$ are known to be prime only for 37 values, the first few of which are $n = 2, 3, 5, 7, 13, 17, 19, \dots$ (Sloane's A000043). There are no other PRIMES $C^-(b, n)$ for nontrivial $b \leq 20$ and $2 \leq n \leq 1000$.

In 1925, Cunningham and Woodall (1925) gathered together all that was known about the PRIMALITY and factorization of the numbers $C^\pm(b, n)$ and published a small book of tables. These tables collected from scattered sources the known prime factors for the bases 2 and 10 and also presented the authors' results of 30 years' work with these and other bases.

Since 1925, many people have worked on filling in these tables. D. H. Lehmer, a well-known mathematician who died in 1991, was for many years a leader of these efforts. Lehmer was a mathematician who was at the forefront of computing as modern electronic computers became a reality. He was also known as the inventor of some

ingenious pre-electronic computing devices specifically designed for factoring numbers.

Updated factorizations were published in Brillhart *et al.* (1988). The current archive of Cunningham number factorizations for $b = 1, \dots, \pm 12$ is kept on <ftp://sable.ox.ac.uk/pub/math/cunningham>. The tables have been extended by Brent and te Riele (1992) to $b = 13, \dots, 100$ with $m < 255$ for $b < 30$ and $m < 100$ for $b \geq 30$. All numbers with exponent 58 and smaller, and all composites with ≤ 90 digits have now been factored.

see also BINOMIAL NUMBER, CULLEN NUMBER, FERMAT NUMBER, MERSENNE NUMBER, REPUNIT, RIESEL NUMBER, SIERPIŃSKI NUMBER OF THE FIRST KIND, WOODALL NUMBER

References

- Brent, R. P. and te Riele, H. J. J. "Factorizations of $a^n \pm 1$, $13 \leq a < 100$." Report NM-R9212, *Centrum voor Wiskunde en Informatica*. Amsterdam, June 1992. The text is available electronically at <ftp://sable.ox.ac.uk/pub/math/factors/BMtR.13-99.dvi>, and the files at [BMtR.13-99.update1](ftp://sable.ox.ac.uk/pub/math/factors/BMtR.13-99.update1) (94-09-01) and [BMtR.13-99.update2](ftp://sable.ox.ac.uk/pub/math/factors/BMtR.13-99.update2) (95-06-01).
- Brillhart, J.; Lehmer, D. H.; Selfridge, J.; Wagstaff, S. S. Jr.; and Tuckerman, B. *Factorizations of $b^n \pm 1$, $b = 2, 3, 5, 6, 7, 10, 11, 12$ Up to High Powers*, rev. ed. Providence, RI: Amer. Math. Soc., 1988. Updates are available electronically from <ftp://sable.ox.ac.uk/pub/math/cunningham/>.
- Cunningham, A. J. C. and Woodall, H. J. *Factorisation of $y^n \mp 1$, $y = 2, 3, 5, 6, 7, 10, 11, 12$ Up to High Powers (n)* . London: Hodgson, 1925.
- Mudge, M. "Not Numerology but Numeralogy!" *Personal Computer World*, 279-280, 1997.
- Ribenboim, P. "Numbers $k \times 2^n \pm 1$." §5.7 in *The New Book of Prime Number Records*. New York: Springer-Verlag, pp. 355-360, 1996.
- Sloane, N. J. A. Sequence A000043/M0672 in "An On-Line Version of the Encyclopedia of Integer Sequences."

Cunningham Project

see CUNNINGHAM NUMBER

Cupola



An n -gonal cupola Q_n (possible for only $n = 3, 4, 5$) is a POLYHEDRON having n TRIANGULAR and n SQUARE faces separating an $\{n\}$ and a $\{2n\}$ REGULAR POLYGON. The coordinates of the base VERTICES are

$$\left(R \cos \left[\frac{\pi(2k+1)}{2n} \right], R \sin \left[\frac{\pi(2k+1)}{2n} \right], 0 \right), \quad (1)$$

and the coordinates of the top VERTICES are

$$\left(r \cos \left[\frac{2k\pi}{n} \right], r \sin \left[\frac{2k\pi}{n} \right], z \right), \quad (2)$$

where R and r are the CIRCUMRADII of the base and top

$$R = \frac{1}{2}a \csc\left(\frac{\pi}{2n}\right) \quad (3)$$

$$r = \frac{1}{2}a \csc\left(\frac{\pi}{n}\right), \quad (4)$$

and z is the height, obtained by letting $k = 0$ in the equations (1) and (2) to obtain the coordinates of neighboring bottom and top VERTICES,

$$\mathbf{b} = \begin{bmatrix} R \cos\left(\frac{\pi}{2n}\right) \\ R \sin\left(\frac{\pi}{2n}\right) \\ 0 \end{bmatrix} \quad (5)$$

$$\mathbf{t} = \begin{bmatrix} r \\ 0 \\ z \end{bmatrix}. \quad (6)$$

Since all side lengths are a ,

$$|\mathbf{b} - \mathbf{t}|^2 = a^2. \quad (7)$$

Solving for z then gives

$$\left[R \cos\left(\frac{\pi}{2n}\right) - r\right]^2 + R^2 \sin^2\left(\frac{\pi}{2n}\right) + z^2 = a^2 \quad (8)$$

$$z^2 + R^2 + r^2 - 2rR \cos\left(\frac{\pi}{2n}\right) = a^2 \quad (9)$$

$$\begin{aligned} z &= \sqrt{a^2 - 2rR \cos\left(\frac{\pi}{2n}\right) - r^2 - R^2} \\ &= a \sqrt{1 - \frac{1}{4} \csc^2\left(\frac{\pi}{n}\right)}. \end{aligned} \quad (10)$$

see also BICUPOLA, ELONGATED CUPOLA, GYRO-ELONGATED CUPOLA, PENTAGONAL CUPOLA, SQUARE CUPOLA, TRIANGULAR CUPOLA

References

Johnson, N. W. "Convex Polyhedra with Regular Faces." *Canad. J. Math.* **18**, 169–200, 1966.

Cupolarotunda

A CUPOLA adjoined to a ROTUNDA.

see also GYROCUPOLAROTUNDA, ORTHOCUPOLAROTUNDA

Curl

The curl of a TENSOR field is given by

$$(\nabla \times A)^\alpha = \epsilon^{\alpha\mu\nu} A_{\nu;\mu}, \quad (1)$$

where ϵ_{ijk} is the LEVI-CIVITA TENSOR and “;” is the COVARIANT DERIVATIVE. For a VECTOR FIELD, the curl is denoted

$$\text{curl}(\mathbf{F}) \equiv \nabla \times \mathbf{F}, \quad (2)$$

and $\nabla \times \mathbf{F}$ is normal to the PLANE in which the “circulation” is MAXIMUM. Its magnitude is the limiting value of circulation per unit AREA,

$$(\nabla \times \mathbf{F}) \cdot \hat{\mathbf{n}} \equiv \lim_{A \rightarrow 0} \frac{\oint_C \mathbf{F} \cdot d\mathbf{s}}{A}. \quad (3)$$

Let

$$\mathbf{F} \equiv F_1 \hat{\mathbf{u}}_1 + F_2 \hat{\mathbf{u}}_2 + F_3 \hat{\mathbf{u}}_3 \quad (4)$$

and

$$h_i \equiv \left| \frac{\partial \mathbf{r}}{\partial u_i} \right|, \quad (5)$$

then

$$\begin{aligned} \nabla \times \mathbf{F} &\equiv \frac{1}{h_1 h_2 h_3} \begin{vmatrix} h_1 \hat{\mathbf{u}}_1 & h_2 \hat{\mathbf{u}}_2 & h_3 \hat{\mathbf{u}}_3 \\ \frac{\partial}{\partial u_1} & \frac{\partial}{\partial u_2} & \frac{\partial}{\partial u_3} \\ h_1 F_1 & h_2 F_2 & h_3 F_3 \end{vmatrix} \\ &= \frac{1}{h_2 h_3} \left[\frac{\partial}{\partial u_2} (h_3 F_3) - \frac{\partial}{\partial u_3} (h_2 F_2) \right] \hat{\mathbf{u}}_1 \\ &\quad + \frac{1}{h_1 h_3} \left[\frac{\partial}{\partial u_3} (h_1 F_1) - \frac{\partial}{\partial u_1} (h_3 F_3) \right] \hat{\mathbf{u}}_2 \\ &\quad + \frac{1}{h_1 h_2} \left[\frac{\partial}{\partial u_1} (h_2 F_2) - \frac{\partial}{\partial u_2} (h_1 F_1) \right] \hat{\mathbf{u}}_3. \end{aligned} \quad (6)$$

Special cases of the curl formulas above can be given for CURVILINEAR COORDINATES.

see also CURL THEOREM, DIVERGENCE, GRADIENT, VECTOR DERIVATIVE

References

Arfken, G. “Curl, $\nabla \times$.” §1.8 in *Mathematical Methods for Physicists*, 3rd ed. Orlando, FL: Academic Press, pp. 42–47, 1985.

Curl Theorem

A special case of STOKES’ THEOREM in which F is a VECTOR FIELD and M is an oriented, compact embedded 2-MANIFOLD with boundary in \mathbb{R}^3 , given by

$$\int_S (\nabla \times \mathbf{F}) \cdot d\mathbf{a} = \int_{\partial S} \mathbf{F} \cdot d\mathbf{s}. \quad (1)$$

There are also alternate forms. If

$$\mathbf{F} \equiv \mathbf{c}F, \quad (2)$$

then

$$\int_S d\mathbf{a} \times \nabla F = \int_C F d\mathbf{s}. \quad (3)$$

and if

$$\mathbf{F} \equiv \mathbf{c} \times \mathbf{P}, \quad (4)$$

then

$$\int_S (d\mathbf{a} \times \nabla) \times \mathbf{P} = \int_C d\mathbf{s} \times \mathbf{P}. \quad (5)$$

see also CHANGE OF VARIABLES THEOREM, CURL, STOKES’ THEOREM

References

Arfken, G. “Stokes’s Theorem.” §1.12 in *Mathematical Methods for Physicists*, 3rd ed. Orlando, FL: Academic Press, pp. 61–64, 1985.

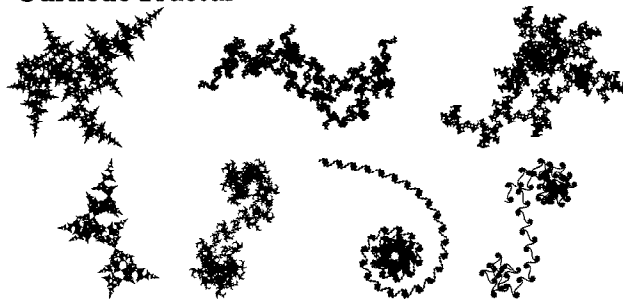
Curlicue Fractal

The curlicue fractal is a figure obtained by the following procedure. Let s be an IRRATIONAL NUMBER. Begin with a line segment of unit length, which makes an ANGLE $\phi_0 \equiv 0$ to the horizontal. Then define θ_n iteratively by

$$\theta_{n+1} = (\theta_n + 2\pi s) \pmod{2\pi},$$

with $\theta_0 = 0$. To the end of the previous line segment, draw a line segment of unit length which makes an angle

$$\phi_{n+1} = \theta_n + \phi_n \pmod{2\pi},$$

to the horizontal (Pickover 1995). The result is a FRAC-TAL, and the above figures correspond to the curlicue fractals with 10,000 points for the GOLDEN RATIO ϕ , $\ln 2$, e , $\sqrt{2}$, the EULER-MASCHERONI CONSTANT γ , π , and FEIGENBAUM CONSTANT δ .

The TEMPERATURE of these curves is given in the following table.

Constant	Temperature
golden ratio ϕ	46
$\ln 2$	51
e	58
$\sqrt{2}$	58
Euler-Mascheroni constant γ	63
π	90
Feigenbaum constant δ	92

References

- Berry, M. and Goldberg, J. "Renormalization of Curlicues." *Nonlinearity* 1, 1-26, 1988.
 Moore, R. and van der Poorten, A. "On the Thermodynamics of Curves and Other Curlicues." *McQuarie Univ. Math. Rep.* 89-0031, April 1989.
 Pickover, C. A. "The Fractal Golden Curlicue is Cool." Ch. 21 in *Keys to Infinity*. New York: W. H. Freeman, pp. 163-167, 1995.
 Pickover, C. A. *Mazes for the Mind: Computers and the Unexpected*. New York: St. Martin's Press, 1993.
 Sedgewick, R. *Algorithms*. Reading, MA: Addison-Wesley, 1988.
 Stewart, I. *Another Fine Math You've Got Me Into...* New York: W. H. Freeman, 1992.

Current

A linear FUNCTIONAL on a smooth differential form.

see also FLAT NORM, INTEGRAL CURRENT, RECTIFI-
 ABLE CURRENT

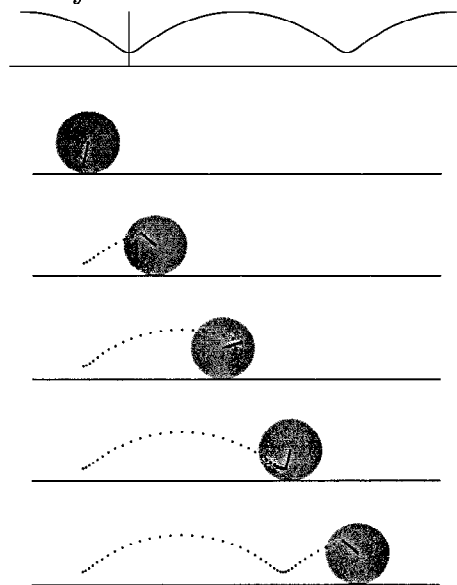
Curtate Cycloid

The path traced out by a fixed point at a RADIUS $b < a$, where a is the RADIUS of a rolling CIRCLE, sometimes also called a CONTRACTED CYCLOID.

$$x = a\phi - b \sin \phi \quad (1)$$

$$y = a - b \cos \phi. \quad (2)$$

The ARC LENGTH from $\phi = 0$ is

$$s = 2(a + b)E(u), \quad (3)$$

where

$$\sin(\frac{1}{2}\phi) = \operatorname{sn} u \quad (4)$$

$$k^2 = \frac{4ab}{(a + c)^2}, \quad (5)$$

and $E(u)$ is a complete ELLIPTIC INTEGRAL OF THE SECOND KIND and $\operatorname{sn} u$ is a JACOBI ELLIPTIC FUNCTION.

see also CYCLOID, PROLATE CYCLOID

References

- Cundy, H. and Rollett, A. *Mathematical Models*, 3rd ed. Stradbroke, England: Tarquin Pub., 1989.
 Wagon, S. *Mathematica in Action*. New York: W. H. Freeman, pp. 46-50, 1991.

Curtate Cycloid Evolute

The EVOLUTE of the CURTATE CYCLOID

$$x = a\phi - b \sin \phi \quad (1)$$

$$y = a - b \cos \phi. \quad (2)$$

is given by

$$x = \frac{a[-2b\phi + 2a\phi \cos \phi - 2a \sin \phi + b \sin(2\phi)]}{2(a \cos \phi - b)} \quad (3)$$

$$y = \frac{a(a - b \cos \phi)^2}{b(a \cos \phi - b)}. \quad (4)$$

Curvature

In general, there are two important types of curvature: **EXTRINSIC CURVATURE** and **INTRINSIC CURVATURE**. The **EXTRINSIC CURVATURE** of curves in 2- and 3-space was the first type of curvature to be studied historically, culminating in the **FRENET FORMULAS**, which describe a **SPACE CURVE** entirely in terms of its “curvature,” **TORSION**, and the initial starting point and direction.

After the curvature of 2- and 3-D curves was studied, attention turned to the curvature of surfaces in 3-space. The main curvatures which emerged from this scrutiny are the **MEAN CURVATURE**, **GAUSSIAN CURVATURE**, and the **WEINGARTEN MAP**. **MEAN CURVATURE** was the most important for applications at the time and was the most studied, but Gauss was the first to recognize the importance of the **GAUSSIAN CURVATURE**.

Because **GAUSSIAN CURVATURE** is “intrinsic,” it is detectable to 2-dimensional “inhabitants” of the surface, whereas **MEAN CURVATURE** and the **WEINGARTEN MAP** are not detectable to someone who can’t study the 3-dimensional space surrounding the surface on which he resides. The importance of **GAUSSIAN CURVATURE** to an inhabitant is that it controls the surface **AREA** of **SPHERES** around the inhabitant.

Riemann and many others generalized the concept of curvature to **SECTIONAL CURVATURE**, **SCALAR CURVATURE**, the **RIEMANN TENSOR**, **RICCI CURVATURE**, and a host of other **INTRINSIC** and **EXTRINSIC CURVATURES**. General curvatures no longer need to be numbers, and can take the form of a **MAP**, **GROUP**, **GROUPOID**, tensor field, etc.

The simplest form of curvature and that usually first encountered in **CALCULUS** is an **EXTRINSIC CURVATURE**. In 2-D, let a **PLANE CURVE** be given by **CARTESIAN** parametric equations $x = x(t)$ and $y = y(t)$. Then the curvature κ is defined by

$$\kappa \equiv \frac{d\phi}{ds} = \frac{\frac{d\phi}{dt}}{\frac{ds}{dt}} = \frac{\frac{d\phi}{dt}}{\sqrt{\left(\frac{dx}{dt}\right)^2 + \left(\frac{dy}{dt}\right)^2}} = \frac{\frac{d\phi}{dt}}{\sqrt{x'^2 + y'^2}}, \quad (1)$$

where ϕ is the **POLAR ANGLE** and s is the **ARC LENGTH**. As can readily be seen from the definition, curvature therefore has units of inverse distance. The $d\phi/dt$ derivative in the above equation can be eliminated by using the identity

$$\tan \phi = \frac{dy}{dx} = \frac{dy/dt}{dx/dt} = \frac{y'}{x'}, \quad (2)$$

so

$$\frac{d}{dt}(\tan \phi) = \sec^2 \phi \frac{d\phi}{dt} = \frac{x'y'' - y'x''}{x'^2} \quad (3)$$

and

$$\begin{aligned} \frac{d\phi}{dt} &= \frac{1}{1 + \tan^2 \phi} \frac{x'y'' - y'x''}{x'^2} \\ &= \frac{1}{\frac{y'^2}{x'^2}} \frac{x'y'' - y'x''}{x'^2} = \frac{x'y'' - y'x''}{x'^2 + y'^2}. \end{aligned} \quad (4)$$

Combining (2) and (4) gives

$$\kappa = \frac{x'y'' - y'x''}{(x'^2 + y'^2)^{3/2}}. \quad (5)$$

For a 2-D curve written in the form $y = f(x)$, the equation of curvature becomes

$$\kappa = \frac{\frac{d^2y}{dx^2}}{\left[1 + \left(\frac{dy}{dx}\right)^2\right]^{3/2}}. \quad (6)$$

If the 2-D curve is instead parameterized in **POLAR COORDINATES**, then

$$\kappa = \frac{r^2 + 2r_\theta^2 - rr_{\theta\theta}}{(r^2 + r_\theta^2)^{3/2}}, \quad (7)$$

where $r_\theta \equiv \partial r / \partial \theta$ (Gray 1993). In **PEDAL COORDINATES**, the curvature is given by

$$\kappa = \frac{1}{r} \frac{dp}{dr}. \quad (8)$$

The curvature for a 2-D curve given implicitly by $g(x, y) = 0$ is given by

$$\kappa = \frac{g_{xx}g_y^2 - 2g_{xy}g_xg_y + g_{yy}g_x^2}{(g_x^2 + g_y^2)^{3/2}} \quad (9)$$

(Gray 1993).

Now consider a parameterized **SPACE CURVE** $\mathbf{r}(t)$ in 3-D for which the **TANGENT VECTOR** $\hat{\mathbf{T}}$ is defined as

$$\hat{\mathbf{T}} \equiv \frac{\frac{d\mathbf{r}}{dt}}{\left|\frac{d\mathbf{r}}{dt}\right|} = \frac{\frac{d\mathbf{r}}{dt}}{\frac{ds}{dt}}. \quad (10)$$

Therefore,

$$\frac{d\mathbf{r}}{dt} = \frac{ds}{dt} \hat{\mathbf{T}} \quad (11)$$

$$\frac{d^2\mathbf{r}}{dt^2} = \frac{d^2s}{dt^2} \hat{\mathbf{T}} + \frac{ds}{dt} \frac{d\hat{\mathbf{T}}}{dt} = \frac{ds^2}{dt^2} \hat{\mathbf{T}} + \kappa \hat{\mathbf{N}} \left(\frac{ds}{dt}\right)^2, \quad (12)$$

where $\hat{\mathbf{N}}$ is the **NORMAL VECTOR**. But

$$\begin{aligned} \frac{d\mathbf{r}}{dt} \times \frac{d^2\mathbf{r}}{dt^2} &= \frac{ds}{dt} \frac{d^2s}{dt^2} (\hat{\mathbf{T}} \times \hat{\mathbf{T}}) + \kappa \left(\frac{ds}{dt}\right)^3 (\hat{\mathbf{T}} \times \hat{\mathbf{N}}) \\ &= \kappa \left(\frac{ds}{dt}\right)^3 (\hat{\mathbf{T}} \times \hat{\mathbf{N}}) \end{aligned} \quad (13)$$

$$\left| \frac{d\mathbf{r}}{dt} \times \frac{d^2\mathbf{r}}{dt^2} \right| = \kappa \left(\frac{ds}{dt} \right)^3 = \kappa \left| \frac{d\mathbf{r}}{dt} \right|^3, \quad (14)$$

so

$$\kappa = \left| \frac{d\hat{\mathbf{T}}}{ds} \right| = \frac{\left| \frac{d\mathbf{r}}{dt} \times \frac{d^2\mathbf{r}}{dt^2} \right|}{\left| \frac{d\mathbf{r}}{dt} \right|^3}. \quad (15)$$

The curvature of a 2-D curve is related to the RADIUS OF CURVATURE of the curve's OSCULATING CIRCLE. Consider a CIRCLE specified parametrically by

$$x = a \cos t \quad (16)$$

$$y = a \sin t \quad (17)$$

which is tangent to the curve at a given point. The curvature is then

$$\kappa = \frac{x'y'' - y'x''}{(x'^2 + y'^2)^{3/2}} = \frac{a^2}{a^3} = \frac{1}{a}, \quad (18)$$

or one over the RADIUS OF CURVATURE. The curvature of a CIRCLE can also be repeated in vector notation. For the CIRCLE with $0 \leq t < 2\pi$, the ARC LENGTH is

$$\begin{aligned} s(t) &= \int_0^t \sqrt{\left(\frac{dx}{dt}\right)^2 + \left(\frac{dy}{dt}\right)^2} dt \\ &= \int_0^t \sqrt{a^2 \cos^2 t + a^2 \sin^2 t} dt = at, \end{aligned} \quad (19)$$

so $t = s/a$ and the equations of the CIRCLE can be rewritten as

$$x = a \cos \left(\frac{s}{a} \right) \quad (20)$$

$$y = a \sin \left(\frac{s}{a} \right). \quad (21)$$

The POSITION VECTOR is then given by

$$\mathbf{r}(s) = a \cos \left(\frac{s}{a} \right) \hat{\mathbf{x}} + a \sin \left(\frac{s}{a} \right) \hat{\mathbf{y}}, \quad (22)$$

and the TANGENT VECTOR is

$$\hat{\mathbf{T}} = \frac{d\mathbf{r}}{ds} = -\sin \left(\frac{s}{a} \right) \hat{\mathbf{x}} + \cos \left(\frac{s}{a} \right) \hat{\mathbf{y}}, \quad (23)$$

so the curvature is related to the RADIUS OF CURVATURE a by

$$\begin{aligned} \kappa &= \left| \frac{d\hat{\mathbf{T}}}{ds} \right| = \left| -\frac{1}{a} \cos \left(\frac{s}{a} \right) \hat{\mathbf{x}} - \frac{1}{a} \sin \left(\frac{s}{a} \right) \hat{\mathbf{y}} \right| \\ &= \sqrt{\frac{\cos^2 \left(\frac{s}{a} \right) + \sin^2 \left(\frac{s}{a} \right)}{a^2}} = \frac{1}{a}, \end{aligned} \quad (24)$$

as expected.

Four very important derivative relations in differential geometry related to the FRENET FORMULAS are

$$\dot{\mathbf{r}} = \mathbf{T} \quad (25)$$

$$\ddot{\mathbf{r}} = \kappa \mathbf{N} \quad (26)$$

$$\ddot{\mathbf{r}} = \kappa \mathbf{N} + \kappa(\tau \mathbf{B} - \kappa \mathbf{T}) \quad (27)$$

$$[\dot{\mathbf{r}}, \ddot{\mathbf{r}}, \ddot{\mathbf{r}}] = \kappa^2 \tau, \quad (28)$$

where \mathbf{T} is the TANGENT VECTOR, \mathbf{N} is the NORMAL VECTOR, \mathbf{B} is the BINORMAL VECTOR, and τ is the TORSION (Coxeter 1969, p. 322).

The curvature at a point on a surface takes on a variety of values as the PLANE through the normal varies. As κ varies, it achieves a minimum and a maximum (which are in perpendicular directions) known as the PRINCIPAL CURVATURES. As shown in Coxeter (1969, pp. 352–353),

$$\kappa^2 - \sum b_i^i \kappa + \det(b_i^j) = 0 \quad (29)$$

$$\kappa^2 - 2H\kappa + K = 0, \quad (30)$$

where K is the GAUSSIAN CURVATURE, H is the MEAN CURVATURE, and \det denotes the DETERMINANT.

The curvature κ is sometimes called the FIRST CURVATURE and the TORSION τ the SECOND CURVATURE. In addition, a THIRD CURVATURE (sometimes called TOTAL CURVATURE)

$$\sqrt{ds_T^2 + ds_B^2} \quad (31)$$

is also defined. A signed version of the curvature of a CIRCLE appearing in the DESCARTES CIRCLE THEOREM for the radius of the fourth of four mutually tangent circles is called the BEND.

see also BEND (CURVATURE), CURVATURE CENTER, CURVATURE SCALAR, EXTRINSIC CURVATURE, FIRST CURVATURE, FOUR-VERTEX THEOREM, GAUSSIAN CURVATURE, INTRINSIC CURVATURE, LANCRET EQUATION, LINE OF CURVATURE, MEAN CURVATURE, NORMAL CURVATURE, PRINCIPAL CURVATURES, RADIUS OF CURVATURE, RICCI CURVATURE, RIEMANN TENSOR, SECOND CURVATURE, SECTIONAL CURVATURE, SODDY CIRCLES, THIRD CURVATURE, TORSION (DIFFERENTIAL GEOMETRY), WEINGARTEN MAP

References

- Coxeter, H. S. M. *Introduction to Geometry*, 2nd ed. New York: Wiley, 1969.
- Fischer, G. (Ed.). Plates 79–85 in *Mathematische Modelle/Mathematical Models, Bildband/Photograph Volume*. Braunschweig, Germany: Vieweg, pp. 74–81, 1986.
- Gray, A. "Curvature of Curves in the Plane," "Drawing Plane Curves with Assigned Curvature," and "Drawing Space Curves with Assigned Curvature." §1.5, 6.4, and 7.8 in *Modern Differential Geometry of Curves and Surfaces*. Boca Raton, FL: CRC Press, pp. 11–13, 68–69, 113–118, and 145–147, 1993.
- Kreyszig, E. "Principal Normal, Curvature, Osculating Circle." §12 in *Differential Geometry*. New York: Dover, pp. 34–36, 1991.
- Yates, R. C. "Curvature." *A Handbook on Curves and Their Properties*. Ann Arbor, MI: J. W. Edwards, pp. 60–64, 1952.

Curvature Center

The point on the POSITIVE RAY of the NORMAL VECTOR at a distance $\rho(s)$, where ρ is the RADIUS OF CURVATURE. It is given by

$$\mathbf{z} = \mathbf{x} + \rho \mathbf{N} = \mathbf{x} + \rho^2 \frac{\mathbf{T}}{ds}, \quad (1)$$

where \mathbf{N} is the NORMAL VECTOR and \mathbf{T} is the TANGENT VECTOR. It can be written in terms of \mathbf{x} explicitly as

$$\mathbf{z} = \mathbf{x} + \frac{\mathbf{x}''(\mathbf{x}' \cdot \mathbf{x}')^2 - \mathbf{x}'(\mathbf{x}' \cdot \mathbf{x}')(\mathbf{x}' \cdot \mathbf{x}'')}{(\mathbf{x}' \cdot \mathbf{x}')(\mathbf{x}'' \cdot \mathbf{x}'') - (\mathbf{x}' \cdot \mathbf{x}'')^2}. \quad (2)$$

For a CURVE represented parametrically by $(f(t), g(t))$,

$$\alpha = f - \frac{(f'^2 - g'^2)g'}{f'g'' - f''g'} \quad (3)$$

$$\beta = g + \frac{(f'^2 - g'^2)f'}{f'g'' - f''g'}. \quad (4)$$

References

Gray, A. *Modern Differential Geometry of Curves and Surfaces*. Boca Raton, FL: CRC Press, 1993.

Curvature Scalar

The curvature scalar is given by

$$R \equiv g^{\mu\kappa} R_{\mu\kappa},$$

where $g^{\mu\kappa}$ is the METRIC TENSOR and $R_{\mu\kappa}$ is the RICCI TENSOR.

see also CURVATURE, GAUSSIAN CURVATURE, MEAN CURVATURE, METRIC TENSOR, RADIUS OF CURVATURE, RICCI TENSOR, RIEMANN-CHRISTOFFEL TENSOR

Curvature Vector

$$\mathbf{K} \equiv \frac{d\mathbf{T}}{ds},$$

where \mathbf{T} is the TANGENT VECTOR defined by

$$\mathbf{T} \equiv \frac{\frac{d\mathbf{x}}{ds}}{\left| \frac{d\mathbf{x}}{ds} \right|}.$$

Curve

A CONTINUOUS MAP from a 1-D SPACE to an n -D SPACE. Loosely speaking, the word "curve" is often used to mean the GRAPH of a 2- or 3-D curve. The simplest curves can be represented parametrically in n -D SPACE as

$$\begin{aligned} x_1 &= f_1(t) \\ x_2 &= f_2(t) \\ &\vdots \\ x_n &= f_n(t). \end{aligned}$$

Other simple curves can be simply defined only implicitly, i.e., in the form

$$f(x_1, x_2, \dots) = 0.$$

see also ARCHIMEDEAN SPIRAL, ASTROID, ASYMPTOTIC CURVE, BASEBALL COVER, BATRACHION, BICORN, BIFOLIUM, BOW, BULLET NOSE, BUTTERFLY CURVE, CARDIOID, CASSINI OVALS, CATALAN'S TRISECTRIX, CATENARY, CAUSTIC, CAYLEY'S SEXTIC, CESÀRO EQUATION, CIRCLE, CIRCLE INVOLUTE, CIS-ROID, CISOID OF DIOCLES, COCHLEOID, CONCHOID, CONCHOID OF NICOMEDES, CROSS CURVE, CRUCIFORM, CUBICAL PARABOLA, CURVE OF CONSTANT PRECESSION, CURVE OF CONSTANT WIDTH, CURTATE CYCLOID, CYCLOID, DELTA CURVE, DELTOID, DEVIL'S CURVE, DEVIL ON TWO STICKS, DUMBBELL CURVE, DÜRER'S CONCHOID, EIGHT CURVE, ELECTRIC MOTOR CURVE, ELLIPSE, ELLIPSE INVOLUTE, ELLIPTIC CURVE, ENVELOPE, EPICYCLOID, EQUIPOTENTIAL CURVE, EUDOXUS'S KAMPYLE, EVOLUTE, EXPONENTIAL RAMP, FERMAT CONIC, FOLIUM OF DESCARTES, FREETH'S NEPHROID, FREY CURVE, GAUSSIAN FUNCTION, GERONO LEMNISCATE, GLISSETTE, GUDERMANNIAN FUNCTION, GUTSCHOVEN'S CURVE, HIPPOPEDE, HORSE FETTER, HYPERBOLA, HYPERELIPSE, HYPOCYCLOID, HYPOELLIPSE, INVOLUTE, ISOPTIC CURVE, KAPPA CURVE, KERATOID CUSP, KNOT CURVE, LAMÉ CURVE, LEMNISCATE, L'HOSPITAL'S CUBIC, LIMAÇON, LINKS CURVE, LISSAJOUS CURVE, LITUUS, LOGARITHMIC SPIRAL, MACLAURIN TRISECTRIX, MALTESE CROSS, MILL, NATURAL EQUATION, NEGATIVE PEDAL CURVE, NEPHROID, NIELSEN'S SPIRAL, ORTHOPTIC CURVE, PARABOLA, PEAR CURVE, PEAR-SHAPED CURVE, PEARLS OF SLUZE, PEDAL CURVE, PEG TOP, PIRIFORM, PLATEAU CURVES, POLICEMAN ON POINT DUTY CURVE, PROLATE CYCLOID, PURSUIT CURVE, QUADRATRIX OF HIPPIAS, RADIAL CURVE, RHODONEA, ROSE, ROULETTE, SEMICUBICAL PARABOLA, SERPENTINE CURVE, SICI SPIRAL, SIGMOID CURVE, SINUSOIDAL SPIRAL, SPACE CURVE, STROPHOID, SUPERELLIPSE, SWASTIKA, SWEEP SIGNAL, TALBOT'S CURVE, TEARDROP CURVE, TRACTRIX, TRIDENT, TRIDENT OF DESCARTES, TRIDENT OF NEWTON, TROCHOID, TSCHIRNHAUSEN CUBIC, VERSIERA, WATT'S CURVE, WHEWELL EQUATION, WITCH OF AGNESI

References

Cundy, H. and Rollett, A. *Mathematical Models*, 3rd ed. Stradbroke, England: Tarquin Pub., pp. 71–75, 1989.
 "Geometry." *The New Encyclopædia Britannica*, 15th ed. 19, pp. 946–951, 1990.
 Gray, A. "Famous Plane Curves." Ch. 3 in *Modern Differential Geometry of Curves and Surfaces*. Boca Raton, FL: CRC Press, pp. 37–55, 1993.
 Lawrence, J. D. *A Catalog of Special Plane Curves*. New York: Dover, 1972.
 Lee, X. "A Catalog of Special Plane Curves." http://www.best.com/~xah/SpecialPlaneCurves_dir/specialPlaneCurves.html.

Lockwood, E. H. *A Book of Curves*. Cambridge, England: Cambridge University Press, 1961.

MacTutor History of Mathematics Archive. <http://www-groups.dcs.st-and.ac.uk/~history/Curves/Curves.html>.

Oakley, C. O. *Analytic Geometry*. New York: Barnes and Noble, 1957.

Shikin, E. V. *Handbook and Atlas of Curves*. Boca Raton, FL: CRC Press, 1995.

Smith, P. F.; Gale, A. S.; and Neelley, J. H. *New Analytic Geometry, Alternate Edition*. Boston, MA: Ginn and Company, 1938.

von Seggern, D. *CRC Standard Curves and Surfaces*. Boca Raton, FL: CRC Press, 1993.

Walker, R. J. *Algebraic Curves*. New York: Springer-Verlag, 1978.

✱ Weisstein, E. W. "Plane Curves." <http://www.astro.virginia.edu/~eww6n/math/notebooks/Curves.m>.

Yates, R. C. *A Handbook on Curves and Their Properties*. Ann Arbor, MI: J. W. Edwards, 1947.

Yates, R. C. *The Trisection Problem*. Reston, VA: National Council of Teachers of Mathematics, 1971.

Zwillinger, D. (Ed.). "Algebraic Curves." §8.1 in *CRC Standard Mathematical Tables and Formulae, 3rd ed.* Boca Raton, FL: CRC Press, 1996. <http://www.geom.umn.edu/docs/reference/CRC-formulas/node33.html>.

Curve of Constant Breadth

see CURVE OF CONSTANT WIDTH

Curve of Constant Precession

A curve whose CENTRODE revolves about a fixed axis with constant ANGLE and SPEED when the curve is traversed with unit SPEED. The TANGENT INDICATRIX of a curve of constant precession is a SPHERICAL HELIX. An ARC LENGTH parameterization of a curve of constant precession with NATURAL EQUATIONS

$$\kappa(s) = -\omega \sin(\mu s) \quad (1)$$

$$\tau(s) = \omega \cos(\mu s) \quad (2)$$

is

$$x(s) = \frac{\alpha + \mu \sin[(\alpha - \mu)s]}{2\alpha} - \frac{\alpha - \mu \sin[(\alpha + \mu)s]}{2\alpha} \quad (3)$$

$$y(s) = -\frac{\alpha + \mu \cos[(\alpha - \mu)s]}{2\alpha} + \frac{\alpha - \mu \cos[(\alpha + \mu)s]}{2\alpha} \quad (4)$$

$$z(s) = \frac{\omega}{\mu\alpha} \sin(\mu s), \quad (5)$$

where

$$\alpha \equiv \sqrt{\omega^2 + \mu^2} \quad (6)$$

and ω , and μ are constant. This curve lies on a circular one-sheeted HYPERBOLOID

$$x^2 + y^2 - \frac{\mu^2}{\omega^2} z^2 = \frac{4\mu^2}{\omega^4}. \quad (7)$$

The curve is closed IFF μ/α is RATIONAL.

References

Scofield, P. D. "Curves of Constant Precession." *Amer. Math. Monthly* **102**, 531–537, 1995.

Curve of Constant Slope

see GENERALIZED HELIX

Curve of Constant Width

Curves which, when rotated in a square, make contact with all four sides. The "width" of a closed convex curve is defined as the distance between parallel lines bounding it ("supporting lines"). Every curve of constant width is convex. Curves of constant width have the same "width" regardless of their orientation between the parallel lines. In fact, they also share the same PERIMETER (BARBIER'S THEOREM). Examples include the CIRCLE (with largest AREA), and REULEAUX TRIANGLE (with smallest AREA) but there are an infinite number. A curve of constant width can be used in a special drill chuck to cut square "HOLES."

A generalization gives solids of constant width. These do not have the same surface AREA for a given width, but their shadows are curves of constant width with the same width!

see also DELTA CURVE, KAKEYA NEEDLE PROBLEM, REULEAUX TRIANGLE

References

Bogomolny, A. "Shapes of Constant Width." http://www.cut-the-knot.com/do_you_know/cwidth.html.

Böhm, J. "Convex Bodies of Constant Width." Ch. 4 in *Mathematical Models from the Collections of Universities and Museums* (Ed. G. Fischer). Braunschweig, Germany: Vieweg, pp. 96–100, 1986.

Fischer, G. (Ed.). Plates 98–102 in *Mathematische Modelle/Mathematical Models, Bildband/Photograph Volume*. Braunschweig, Germany: Vieweg, pp. 89 and 96, 1986.

Gardner, M. Ch. 18 in *The Unexpected Hanging and Other Mathematical Diversions*. Chicago, IL: Chicago University Press, 1991.

Goldberg, M. "Circular-Arc Rotors in Regular Polygons." *Amer. Math. Monthly* **55**, 393–402, 1948.

Kelly, P. *Convex Figures*. New York: Harcourt Brace, 1995.

Rademacher, H. and Toeplitz, O. *The Enjoyment of Mathematics: Selections from Mathematics for the Amateur*. Princeton, NJ: Princeton University Press, 1957.

Yaglom, I. M. and Boltyanski, V. G. *Convex Figures*. New York: Holt, Rinehart, and Winston, 1961.

Curvilinear Coordinates

A general METRIC $g_{\mu\nu}$ has a LINE ELEMENT

$$ds^2 = g_{\mu\nu} du^\mu du^\nu, \quad (1)$$

where EINSTEIN SUMMATION is being used. Curvilinear coordinates are defined as those with a diagonal METRIC so that

$$g_{\mu\nu} \equiv \delta_\nu^\mu h_\mu^2, \quad (2)$$

where δ_ν^μ is the KRONECKER DELTA. Curvilinear coordinates therefore have a simple LINE ELEMENT

$$ds^2 = \delta_\nu^\mu h_\mu^2 du^\mu du^\nu = h_\mu^2 du^{\mu^2}, \quad (3)$$

which is just the PYTHAGOREAN THEOREM, so the differential VECTOR is

$$d\mathbf{r} = h_\mu du_\mu \hat{\mathbf{u}}_\mu, \quad (4)$$

or

$$d\mathbf{r} = \frac{\partial \mathbf{r}}{\partial u_1} du_1 + \frac{\partial \mathbf{r}}{\partial u_2} du_2 + \frac{\partial \mathbf{r}}{\partial u_3} du_3, \quad (5)$$

where the SCALE FACTORS are

$$h_i = \left| \frac{\partial \mathbf{r}}{\partial u_i} \right| \quad (6)$$

and

$$\hat{\mathbf{u}}_i \equiv \frac{\frac{\partial \mathbf{r}}{\partial u_i}}{\left| \frac{\partial \mathbf{r}}{\partial u_i} \right|} = \frac{1}{h_i} \frac{\partial \mathbf{r}}{\partial u_i}. \quad (7)$$

Equation (5) may therefore be re-expressed as

$$d\mathbf{r} = h_1 du_1 \hat{\mathbf{u}}_1 + h_2 du_2 \hat{\mathbf{u}}_2 + h_3 du_3 \hat{\mathbf{u}}_3. \quad (8)$$

The GRADIENT is

$$\text{grad}(\phi) \equiv \nabla \phi = \frac{1}{h_1} \frac{\partial \phi}{\partial u_1} \hat{\mathbf{u}}_1 + \frac{1}{h_2} \frac{\partial \phi}{\partial u_2} \hat{\mathbf{u}}_2 + \frac{1}{h_3} \frac{\partial \phi}{\partial u_3} \hat{\mathbf{u}}_3, \quad (9)$$

the DIVERGENCE is

$$\text{div}(\mathbf{F}) \equiv \nabla \cdot \mathbf{F} \equiv \frac{1}{h_1 h_2 h_3} \left[\frac{\partial}{\partial u_1} (h_2 h_3 F_1) + \frac{\partial}{\partial u_2} (h_3 h_1 F_2) + \frac{\partial}{\partial u_3} (h_1 h_2 F_3) \right], \quad (10)$$

and the CURL is

$$\begin{aligned} \nabla \times \mathbf{F} &\equiv \frac{1}{h_1 h_2 h_3} \begin{vmatrix} h_1 \hat{\mathbf{u}}_1 & h_2 \hat{\mathbf{u}}_2 & h_3 \hat{\mathbf{u}}_3 \\ \frac{\partial}{\partial u_1} & \frac{\partial}{\partial u_2} & \frac{\partial}{\partial u_3} \\ h_1 F_1 & h_2 F_2 & h_3 F_3 \end{vmatrix} \\ &= \frac{1}{h_2 h_3} \left[\frac{\partial}{\partial u_2} (h_3 F_3) - \frac{\partial}{\partial u_3} (h_2 F_2) \right] \hat{\mathbf{u}}_1 \\ &\quad + \frac{1}{h_1 h_3} \left[\frac{\partial}{\partial u_3} (h_1 F_1) - \frac{\partial}{\partial u_1} (h_3 F_3) \right] \hat{\mathbf{u}}_2 \\ &\quad + \frac{1}{h_1 h_2} \left[\frac{\partial}{\partial u_1} (h_2 F_2) - \frac{\partial}{\partial u_2} (h_1 F_1) \right] \hat{\mathbf{u}}_3. \end{aligned} \quad (11)$$

Orthogonal curvilinear coordinates satisfy the additional constraint that

$$\hat{\mathbf{u}}_i \cdot \hat{\mathbf{u}}_j = \delta_{ij}. \quad (12)$$

Therefore, the LINE ELEMENT is

$$ds^2 = d\mathbf{r} \cdot d\mathbf{r} = h_1^2 du_1^2 + h_2^2 du_2^2 + h_3^2 du_3^2 \quad (13)$$

and the VOLUME ELEMENT is

$$\begin{aligned} dV &= |(h_1 \hat{\mathbf{u}}_1 du_1) \cdot (h_2 \hat{\mathbf{u}}_2 du_2) \times (h_3 \hat{\mathbf{u}}_3 du_3)| \\ &= h_1 h_2 h_3 du_1 du_2 du_3 \\ &= \left| \frac{\partial \mathbf{r}}{\partial u_1} \cdot \frac{\partial \mathbf{r}}{\partial u_2} \times \frac{\partial \mathbf{r}}{\partial u_3} \right| du_1 du_2 du_3 \\ &= \begin{vmatrix} \frac{\partial x}{\partial u_1} & \frac{\partial x}{\partial u_2} & \frac{\partial x}{\partial u_3} \\ \frac{\partial y}{\partial u_1} & \frac{\partial y}{\partial u_2} & \frac{\partial y}{\partial u_3} \\ \frac{\partial z}{\partial u_1} & \frac{\partial z}{\partial u_2} & \frac{\partial z}{\partial u_3} \end{vmatrix} du_1 du_2 du_3 \\ &= \left| \frac{\partial(x, y, z)}{\partial(u_1, u_2, u_3)} \right| du_1 du_2 du_3, \end{aligned} \quad (14)$$

where the latter is the JACOBIAN.

Orthogonal curvilinear coordinate systems include BIPOLAR CYLINDRICAL COORDINATES, BISPHERICAL COORDINATES, CARTESIAN COORDINATES, CONFOCAL ELLIPSOIDAL COORDINATES, CONFOCAL PARABOLOIDAL COORDINATES, CONICAL COORDINATES, CYCLIDIC COORDINATES, CYLINDRICAL COORDINATES, ELLIPSOIDAL COORDINATES, ELLIPTIC CYLINDRICAL COORDINATES, OBLATE SPHEROIDAL COORDINATES, PARABOLIC COORDINATES, PARABOLIC CYLINDRICAL COORDINATES, PARABOLOIDAL COORDINATES, POLAR COORDINATES, PROLATE SPHEROIDAL COORDINATES, SPHERICAL COORDINATES, and TOROIDAL COORDINATES. These are degenerate cases of the CONFOCAL ELLIPSOIDAL COORDINATES.

see also CHANGE OF VARIABLES THEOREM, CURL, DIVERGENCE, GRADIENT, JACOBIAN, LAPLACIAN

References

- Arfken, G. "Curvilinear Coordinates" and "Differential Vector Operators." §2.1 and 2.2 in *Mathematical Methods for Physicists*, 3rd ed. Orlando, FL: Academic Press, pp. 86-90 and 90-94, 1985.
- Gradshteyn, I. S. and Ryzhik, I. M. *Tables of Integrals, Series, and Products*, 5th ed. San Diego, CA: Academic Press, pp. 1084-1088, 1980.
- Morse, P. M. and Feshbach, H. "Curvilinear Coordinates" and "Table of Properties of Curvilinear Coordinates." §1.3 in *Methods of Theoretical Physics, Part I*. New York: McGraw-Hill, pp. 21-31 and 115-117, 1953.

Cushion

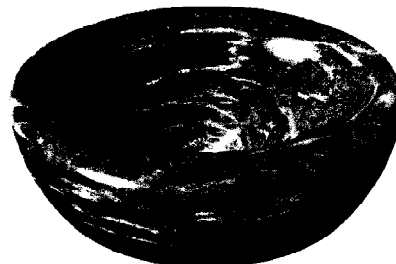

The QUARTIC SURFACE resembling a squashed round cushion on a barroom stool and given by the equation

$$\begin{aligned} z^2 x^2 - z^4 - 2zx^2 + 2z^3 + x^2 - z^2 \\ - (x^2 - z)^2 - y^4 - 2x^2 y^2 - y^2 z^2 + 2y^2 z + y^2 = 0. \end{aligned}$$

see also QUARTIC SURFACE

References

Nordstrand, T. "Surfaces." <http://www.uib.no/people/nfytn/surfaces.htm>.

Cusp

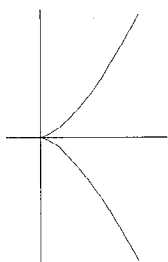

A function $f(x)$ has a cusp (also called a SPINODE) at a point x_0 if $f(x)$ is CONTINUOUS at x_0 and

$$\lim_{x \rightarrow x_0} f'(x) = \infty$$

from one side while

$$\lim_{x \rightarrow x_0} f'(x) = -\infty$$

from the other side, so the curve is CONTINUOUS but the DERIVATIVE is not. A cusp is a type of DOUBLE POINT. The above plot shows the curve $x^3 - y^2 = 0$, which has a cusp at the ORIGIN.

see also DOUBLE CUSP, DOUBLE POINT, ORDINARY DOUBLE POINT, RAMPHOID CUSP, SALIENT POINT

References

Walker, R. J. *Algebraic Curves*. New York: Springer-Verlag, pp. 57–58, 1978.

Cusp Catastrophe

A CATASTROPHE which can occur for two control factors and one behavior axis. The equation $y = x^{2/3}$ has a cusp catastrophe.

see also CATASTROPHE

References

von Seggern, D. *CRC Standard Curves and Surfaces*. Boca Raton, FL: CRC Press, p. 28, 1993.

Cusp Form

A cusp form on $\Gamma_0(N)$, the group of INTEGER matrices with determinant 1 which are upper triangular mod N , is an ANALYTIC FUNCTION on the upper half-plane consisting of the COMPLEX NUMBERS with POSITIVE IMAGINARY PART. Weight n cusp forms satisfy

$$f\left(\frac{az+b}{cz+d}\right) = (cz+d)^n f(z)$$

for all matrices

$$\begin{bmatrix} a & b \\ c & d \end{bmatrix} \in \Gamma_0(N).$$

see also MODULAR FORM

Cusp Map

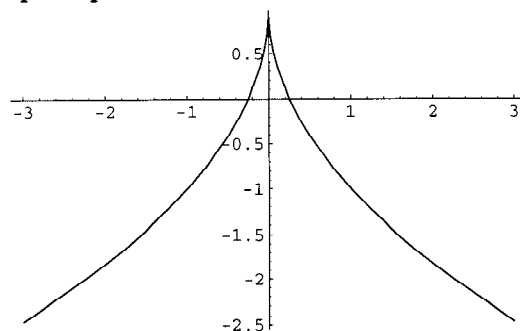

The function

$$f(x) = 1 - 2|x|^{1/2}$$

for $x \in [-1, 1]$. The INVARIANT DENSITY is

$$\rho(y) = \frac{1}{2}(1 - y).$$

References

Beck, C. and Schlögl, F. *Thermodynamics of Chaotic Systems*. Cambridge, England: Cambridge University Press, p. 195, 1995.

Cusp Point

see CUSP

Cut-Vertex

see ARTICULATION VERTEX

Cutting

see ARRANGEMENT, CAKE CUTTING, CIRCLE CUTTING, CYLINDER CUTTING, PANCAKE CUTTING, PIE CUTTING, SQUARE CUTTING, TORUS CUTTING

CW-Approximation Theorem

If X is any SPACE, then there is a CW-COMPLEX Y and a MAP $f : Y \rightarrow X$ inducing ISOMORPHISMS on all HOMOTOPY, HOMOLOGY, and COHOMOLOGY groups.

CW-Complex

A CW-complex is a homotopy-theoretic generalization of the notion of a SIMPLICIAL COMPLEX. A CW-complex is any SPACE X which can be built by starting off with a discrete collection of points called X^0 , then attaching 1-D DISKS D^1 to X^0 along their boundaries S^0 , writing X^1 for the object obtained by attaching the D^1 s to X^0 , then attaching 2-D DISKS D^2 to X^1 along their boundaries S^1 , writing X^2 for the new SPACE, and so on, giving spaces X^n for every n . A CW-complex is any SPACE that has this sort of decomposition into SUBSPACES X^n built up in such a hierarchical fashion (so the X^n s must exhaust all of X). In particular, X^n may be built from X^{n-1} by attaching infinitely many n -DISKS, and the attaching MAPS $S^{n-1} \rightarrow X^{n-1}$ may be any continuous MAPS.

The main importance of CW-complexes is that, for the sake of HOMOTOPY, HOMOLOGY, and COHOMOLOGY groups, every SPACE is a CW-complex. This is called the CW-APPROXIMATION THEOREM. Another is WHITEHEAD'S THEOREM, which says that MAPS between CW-complexes that induce ISOMORPHISMS on all HOMOTOPY GROUPS are actually HOMOTOPY equivalences.

see also COHOMOLOGY, CW-APPROXIMATION THEOREM, HOMOLOGY GROUP, HOMOTOPY GROUP, SIMPLICIAL COMPLEX, SPACE, SUBSPACE, WHITEHEAD'S THEOREM

Cycle (Circle)

A CIRCLE with an arrow indicating a direction.

Cycle (Graph)

A subset of the EDGE-set of a graph that forms a CHAIN (GRAPH), the first node of which is also the last (also called a CIRCUIT).

see also CYCLIC GRAPH, HAMILTONIAN CYCLE, WALK

Cycle Graph

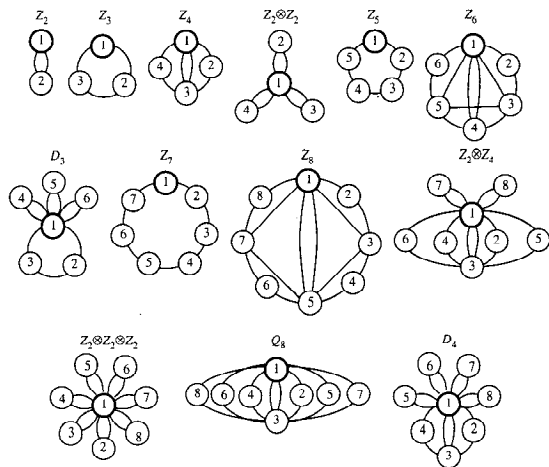

A cycle graph is a GRAPH which shows cycles of a GROUP as well as the connectivity between the cycles. Several examples are shown above. For Z_4 , the group elements A_i satisfy $A_i^4 = 1$, where 1 is the IDENTITY ELEMENT, and two elements satisfy $A_1^2 = A_3^2 = 1$.

For a CYCLIC GROUP of COMPOSITE ORDER n (e.g., Z_4 , Z_6 , Z_8), the degenerate subcycles corresponding to factors dividing n are often not shown explicitly since their presence is implied.

see also CHARACTERISTIC FACTOR, CYCLIC GROUP

References

Shanks, D. *Solved and Unsolved Problems in Number Theory*, 4th ed. New York: Chelsea, pp. 83–98, 1993.

Cycle (Map)

An n -cycle is a finite sequence of points Y_0, \dots, Y_{n-1} such that, under a MAP G ,

$$Y_1 = G(Y_0)$$

$$Y_2 = G(Y_1)$$

$$Y_{n-1} = G(Y_{n-2})$$

$$Y_0 = G(Y_{n-1}).$$

In other words, it is a periodic trajectory which comes back to the same point after n iterations of the cycle. Every point Y_j of the cycle satisfies $Y_j = G^n(Y_j)$ and is therefore a FIXED POINT of the mapping G^n . A fixed point of G is simply a CYCLE of period 1.

Cycle (Permutation)

A SUBSET of a PERMUTATION whose elements trade places with one another. A cycle decomposition of a PERMUTATION can therefore be viewed as a CLASS of a PERMUTATION GROUP. For example, in the PERMUTATION GROUP $\{4, 2, 1, 3\}$, $\{1, 3, 4\}$ is a 3-cycle ($1 \rightarrow 3, 3 \rightarrow 4$, and $4 \rightarrow 1$) and $\{2\}$ is a 1-cycle ($2 \rightarrow 2$). Every PERMUTATION GROUP on n symbols can be uniquely expressed as a product of disjoint cycles. The cyclic decomposition of a PERMUTATION can be computed in *Mathematica*[®] (Wolfram Research, Champaign, IL) with the function `ToCycles` and the PERMUTATION corresponding to a cyclic decomposition can be computed with `FromCycles`. According to Vardi (1991), the *Mathematica* code for `ToCycles` is one of the most obscure ever written.

To find the number $N(m, n)$ of m cycles in a PERMUTATION GROUP of order n , take

$$N(n, m) = (-1)^{n-m} S_1(n, m),$$

where S_1 is the STIRLING NUMBER OF THE FIRST KIND.

see also GOLOMB-DICKMAN CONSTANT, PERMUTATION, PERMUTATION GROUP, SUBSET

References

Skiena, S. *Implementing Discrete Mathematics: Combinatorics and Graph Theory with Mathematica*. Reading, MA: Addison-Wesley, p. 20, 1990.

Vardi, I. *Computational Recreations in Mathematica*. Redwood City, CA: Addison-Wesley, p. 223, 1991.

Cyclic Graph

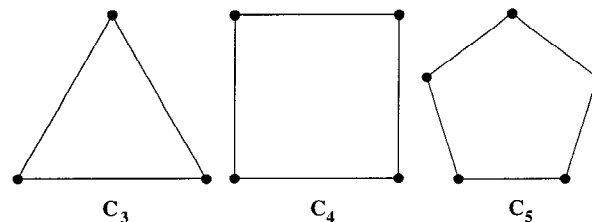

A GRAPH of n nodes and n edges such that node i is connected to the two adjacent nodes $i+1$ and $i-1 \pmod{n}$, where the nodes are numbered $0, 1, \dots, n-1$.

see also CYCLE (GRAPH), CYCLE GRAPH, STAR GRAPH, WHEEL GRAPH

Cyclic Group

A cyclic group Z_n of ORDER n is a GROUP defined by the element X (the GENERATOR) and its n POWERS up to

$$X^n = I,$$

where I is the IDENTITY ELEMENT. Cyclic groups are both ABELIAN and SIMPLE. There exists a unique cyclic group of every order $n \geq 2$, so cyclic groups of the same order are always isomorphic (Shanks 1993, p. 74), and all GROUPS of PRIME ORDER are cyclic.

Examples of cyclic groups include Z_2 , Z_3 , Z_4 , and the MODULO MULTIPLICATION GROUPS M_m such that $m = 2, 4, p^n$, or $2p^n$, for p an ODD PRIME and $n \geq 1$ (Shanks 1993, p. 92). By computing the CHARACTERISTIC FACTORS, any ABELIAN GROUP can be expressed as a DIRECT PRODUCT of cyclic SUBGROUPS, for example, $Z_2 \otimes Z_4$ or $Z_2 \otimes Z_2 \otimes Z_2$.

see also ABELIAN GROUP, CHARACTERISTIC FACTOR, FINITE GROUP— Z_2 , FINITE GROUP— Z_3 , FINITE GROUP— Z_2 , FINITE GROUP— Z_5 , FINITE GROUP— Z_6 , MODULO MULTIPLICATION GROUP, SIMPLE GROUP

References

- Lomont, J. S. "Cyclic Groups." §3.10.A in *Applications of Finite Groups*. New York: Dover, p. 78, 1987.
Shanks, D. *Solved and Unsolved Problems in Number Theory*, 4th ed. New York: Chelsea, 1993.

Cyclic Hexagon

A hexagon (not necessarily regular) on whose VERTICES a CIRCLE may be CIRCUMSCRIBED. Let

$$\sigma_i \equiv \sum_{i,j,\dots,n=1} a_i^2 a_j^2 \dots a_n^2, \quad (1)$$

where the sum runs over all distinct permutations of the SQUARES of the six side lengths, so

$$\sigma_1 = a_1^2 + a_2^2 + a_3^2 + a_4^2 + a_5^2 + a_6^2 \quad (2)$$

$$\begin{aligned} \sigma_2 = & a_1^2 a_2^2 + a_1^2 a_3^2 + a_1^2 a_4^2 + a_1^2 a_5^2 + a_1^2 a_6^2 \\ & + a_2^2 a_3^2 + a_2^2 a_4^2 + a_2^2 a_5^2 + a_2^2 a_6^2 \\ & + a_3^2 a_4^2 + a_3^2 a_5^2 + a_3^2 a_6^2 \\ & + a_4^2 a_5^2 + a_4^2 a_6^2 + a_5^2 a_6^2 \end{aligned} \quad (3)$$

$$\begin{aligned} \sigma_3 = & a_1^2 a_2^2 a_3^2 + a_1^2 a_2^2 a_4^2 + a_1^2 a_2^2 a_5^2 + a_1^2 a_2^2 a_6^2 \\ & + a_2^2 a_3^2 a_4^2 + a_2^2 a_3^2 a_5^2 + a_2^2 a_3^2 a_6^2 \\ & + a_3^2 a_4^2 a_5^2 + a_3^2 a_4^2 a_6^2 + a_4^2 a_5^2 a_6^2 \end{aligned} \quad (4)$$

$$\begin{aligned} \sigma_4 = & a_1^2 a_2^2 a_3^2 a_4^2 + a_1^2 a_2^2 a_3^2 a_5^2 + a_1^2 a_2^2 a_3^2 a_6^2 \\ & + a_1^2 a_3^2 a_4^2 a_5^2 + a_1^2 a_3^2 a_4^2 a_6^2 \\ & + a_1^2 a_3^2 a_5^2 a_6^2 + a_1^2 a_4^2 a_5^2 a_6^2 \\ & + a_2^2 a_3^2 a_4^2 a_5^2 + a_2^2 a_3^2 a_4^2 a_6^2 + a_2^2 a_3^2 a_5^2 a_6^2 \\ & + a_2^2 a_4^2 a_5^2 a_6^2 + a_3^2 a_4^2 a_5^2 a_6^2 \end{aligned} \quad (5)$$

$$\begin{aligned} \sigma_5 = & a_1^2 a_2^2 a_3^2 a_4^2 a_5^2 + a_1^2 a_2^2 a_3^2 a_4^2 a_6^2 \\ & + a_1^2 a_2^2 a_3^2 a_5^2 a_6^2 + a_1^2 a_2^2 a_4^2 a_5^2 a_6^2 \\ & + a_1^2 a_3^2 a_4^2 a_5^2 a_6^2 + a_2^2 a_3^2 a_4^2 a_5^2 a_6^2 \end{aligned} \quad (6)$$

$$\sigma_6 = a_1^2 a_2^2 a_3^2 a_4^2 a_5^2 a_6^2. \quad (7)$$

Then define

$$t_2 = u - 4\sigma_2 + \sigma_1^2 \quad (8)$$

$$t_3 = 8\sigma_3 + \sigma_1 t_2 - 16\sqrt{\sigma_6} \quad (9)$$

$$t_4 = t_2^2 - 64\sigma_4 + 64\sigma_1\sqrt{\sigma_6} \quad (10)$$

$$t_5 = 128\sigma_5 + 32t_2\sqrt{\sigma_6} \quad (11)$$

$$u = 16K^2. \quad (12)$$

The AREA of the hexagon then satisfies

$$ut_4^3 + t_3^2 t_4^2 - 16t_3^3 t_5 - 18ut_3 t_4 t_5 - 27u^2 t_5^2 = 0, \quad (13)$$

or this equation with $\sqrt{\sigma_6}$ replaced by $-\sqrt{\sigma_6}$, a seventh order POLYNOMIAL in u . This is $1/(4u^2)$ times the DISCRIMINANT of the CUBIC EQUATION

$$z^3 + 2t_3 z^2 - ut_4 z + 2y^2 t_5. \quad (14)$$

see also CONCYCLIC, CYCLIC PENTAGON, CYCLIC POLYGON, FUHRMANN'S THEOREM

References

- Robbins, D. P. "Areas of Polygons Inscribed in a Circle." *Discr. Comput. Geom.* **12**, 223–236, 1994.
Robbins, D. P. "Areas of Polygons Inscribed in a Circle." *Amer. Math. Monthly* **102**, 523–530, 1995.

Cyclic-Inscriptable Quadrilateral

see BICENTRIC QUADRILATERAL

Cyclic Number

A number having $n-1$ DIGITS which, when MULTIPLIED by 1, 2, 3, ..., $n-1$, produces the same digits in a different order. Cyclic numbers are generated by the UNIT FRACTIONS $1/n$ which have maximal period DECIMAL EXPANSIONS (which means n must be PRIME). The first few numbers which generate cyclic numbers are 7, 17, 19, 23, 29, 47, 59, 61, 97, ... (Sloane's A001913). A much larger generator is 17389.

It has been conjectured, but not yet proven, that an INFINITE number of cyclic numbers exist. In fact, the FRACTION of PRIMES which generate cyclic numbers seems to be approximately $3/8$. See Yates (1973) for a table of PRIME period lengths for PRIMES $< 1,370,471$. When a cyclic number is multiplied by its generator, the result is a string of 9s. This is a special case of MIDY'S THEOREM.

07 = 0.142857
17 = 0.0588235294117647
19 = 0.052631578947368421
23 = 0.0434782608695652173913
29 = 0.0344827586206896551724137931
47 = 0.021276595744680851063829787234042553191...
...4893617
59 = 0.016949152542372881355932203389830508474...
...5762711864406779661
61 = 0.016393442622950819672131147540983606557...

...377049180327868852459
 97 = 0.010309278350515463917525773195876288659...
 ...79381443298969072164948453608247422680412...
 ...3711340206185567

see also DECIMAL EXPANSION, MIDY'S THEOREM

References

- Gardner, M. Ch. 10 in *Mathematical Circus: More Puzzles, Games, Paradoxes and Other Mathematical Entertainments from Scientific American*. New York: Knopf, 1979.
- Guttman, S. "On Cyclic Numbers." *Amer. Math. Monthly* **44**, 159–166, 1934.
- Kraitchik, M. "Cyclic Numbers." §3.7 in *Mathematical Recreations*. New York: W. W. Norton, pp. 75–76, 1942.
- Rao, K. S. "A Note on the Recurring Period of the Reciprocal of an Odd Number." *Amer. Math. Monthly* **62**, 484–487, 1955.
- Sloane, N. J. A. Sequence A001913/M4353 in "An On-Line Version of the Encyclopedia of Integer Sequences."
- Yates, S. *Primes with Given Period Length*. Trondheim, Norway: Universitetsforlaget, 1973.

Cyclic Pentagon

A cyclic pentagon is a not necessarily regular PENTAGON on whose VERTICES a CIRCLE may be CIRCUMSCRIBED. Let

$$\sigma_i \equiv \sum_{i,j,\dots,n=1} a_i^2 a_j^2 \cdots a_n^2, \quad (1)$$

where the SUM runs over all distinct PERMUTATIONS of the SQUARES of the 5 side lengths, so

$$\sigma_1 = a_1^2 + a_2^2 + a_3^2 + a_4^2 + a_5^2 \quad (2)$$

$$\begin{aligned} \sigma_2 = & a_1^2 a_2^2 + a_1^2 a_3^2 + a_1^2 a_4^2 + a_1^2 a_5^2 + a_2^2 a_3^2 \\ & + a_2^2 a_4^2 + a_2^2 a_5^2 + a_3^2 a_4^2 + a_3^2 a_5^2 \\ & + a_4^2 a_5^2 \end{aligned} \quad (3)$$

$$\begin{aligned} \sigma_3 = & a_1^2 a_2^2 a_3^2 + a_1^2 a_2^2 a_4^2 + a_1^2 a_2^2 a_5^2 \\ & + a_2^2 a_3^2 a_4^2 + a_2^2 a_3^2 a_5^2 + a_3^2 a_4^2 a_5^2 \end{aligned} \quad (4)$$

$$\begin{aligned} \sigma_4 = & a_1^2 a_2^2 a_3^2 a_4^2 + a_1^2 a_2^2 a_3^2 a_5^2 + a_1^2 a_3^2 a_4^2 a_5^2 \\ & + a_2^2 a_3^2 a_4^2 a_5^2 \end{aligned} \quad (5)$$

$$\sigma_5 = a_1^2 a_2^2 a_3^2 a_4^2 a_5^2. \quad (6)$$

Then define

$$t_2 = u - 4\sigma_2 + \sigma_1^2 \quad (7)$$

$$t_3 = 8\sigma_3 + \sigma_1 t_2 \quad (8)$$

$$t_4 = -64\sigma_4 + t_2^2 \quad (9)$$

$$t_5 = 128\sigma_5 \quad (10)$$

$$u = 16K^2. \quad (11)$$

The AREA of the pentagon then satisfies

$$ut_4^3 + t_3^2 t_4^2 - 16t_3^3 t_5 - 18ut_3 t_4 t_5 - 27u^2 t_5^2 = 0, \quad (12)$$

a seventh order POLYNOMIAL in u . This is $1/(4u^2)$ times the DISCRIMINANT of the CUBIC EQUATION

$$z^3 + 2t_3 z^2 - ut_4 z + 2y^2 t_5. \quad (13)$$

see also CONCYCLIC, CYCLIC HEXAGON, CYCLIC POLYGON

References

- Robbins, D. P. "Areas of Polygons Inscribed in a Circle." *Discr. Comput. Geom.* **12**, 223–236, 1994.
- Robbins, D. P. "Areas of Polygons Inscribed in a Circle." *Amer. Math. Monthly* **102**, 523–530, 1995.

Cyclic Permutation

A PERMUTATION which shifts all elements of a SET by a fixed offset, with the elements shifted off the end inserted back at the beginning. For a SET with elements a_0, a_1, \dots, a_{n-1} , this can be written $a_i \rightarrow a_{i+k \pmod n}$ for a shift of k .

see also PERMUTATION

Cyclic Polygon

A cyclic polygon is a POLYGON with VERTICES upon which a CIRCLE can be CIRCUMSCRIBED. Since every TRIANGLE has a CIRCUMCIRCLE, every TRIANGLE is cyclic. It is conjectured that for a cyclic polygon of $2m+1$ sides, $16K^2$ (where K is the AREA) satisfies a MONIC POLYNOMIAL of degree Δ_m , where

$$\Delta_m \equiv \sum_{k=0}^{m-1} (m-k) \binom{2m+1}{k} \quad (1)$$

$$= \frac{1}{2} \left[(2m+1) \binom{2m}{m} - 2^{2m} \right] \quad (2)$$

(Robbins 1995). It is also conjectured that a cyclic polygon with $2m+2$ sides satisfies one of two POLYNOMIALS of degree Δ_m . The first few values of Δ_m are 1, 7, 38, 187, 874, ... (Sloane's A000531).

For TRIANGLES ($n = 3 = 2 \cdot 1 + 1$), the POLYNOMIAL is HERON'S FORMULA, which may be written

$$16K^2 = 2a^2 b^2 + 2a^2 c^2 + 2b^2 c^2 - a^4 - b^4 - c^4, \quad (3)$$

and which is of order $\Delta_1 = 1$ in $16K^2$. For a CYCLIC QUADRILATERAL, the POLYNOMIAL is BRAHMACUPTA'S FORMULA, which may be written

$$\begin{aligned} 16K^2 = & -a^4 + 2a^2 b^2 - b^4 + 2a^2 c^2 + 2b^2 c^2 - c^4 \\ & + 8abcd + 2a^2 d^2 + 2b^2 d^2 + 2c^2 d^2 - d^4, \end{aligned} \quad (4)$$

which is of order $\Delta_1 = 1$ in $16K^2$. Robbins (1995) gives the corresponding FORMULAS for the CYCLIC PENTAGON and CYCLIC HEXAGON.

see also CONCYCLIC, CYCLIC HEXAGON, CYCLIC PENTAGON, CYCLIC QUADRANGLE, CYCLIC QUADRILATERAL

References

- Robbins, D. P. "Areas of Polygons Inscribed in a Circle." *Discr. Comput. Geom.* **12**, 223–236, 1994.
- Robbins, D. P. "Areas of Polygons Inscribed in a Circle." *Amer. Math. Monthly* **102**, 523–530, 1995.
- Sloane, N. J. A. Sequence A000531 in "An On-Line Version of the Encyclopedia of Integer Sequences."

Cyclic Quadrangle

Let A_1, A_2, A_3 , and A_4 be four POINTS on a CIRCLE, and H_1, H_2, H_3, H_4 the ORTHOCENTERS of TRIANGLES $\Delta A_2 A_3 A_4$, etc. If, from the eight POINTS, four with different subscripts are chosen such that three are from one set and the fourth from the other, these POINTS form an ORTHOCENTRIC SYSTEM. There are eight such systems, which are analogous to the six sets of ORTHOCENTRIC SYSTEMS obtained using the feet of the ANGLE BISECTORS, ORTHOCENTER, and VERTICES of a generic TRIANGLE.

On the other hand, if all the POINTS are chosen from one set, or two from each set, with all different subscripts, the four POINTS lie on a CIRCLE. There are four pairs of such CIRCLES, and eight POINTS lie by fours on eight equal CIRCLES.

The SIMSON LINE of A_4 with regard to TRIANGLE $\Delta A_1 A_2 A_3$ is the same as that of H_4 with regard to the TRIANGLE $\Delta H_1 A_2 A_3$.

see also ANGLE BISECTOR, CONCYCLIC, CYCLIC POLYGON, CYCLIC QUADRILATERAL, ORTHOCENTRIC SYSTEM

References

Johnson, R. A. *Modern Geometry: An Elementary Treatise on the Geometry of the Triangle and the Circle*. Boston, MA: Houghton Mifflin, pp. 251-253, 1929.

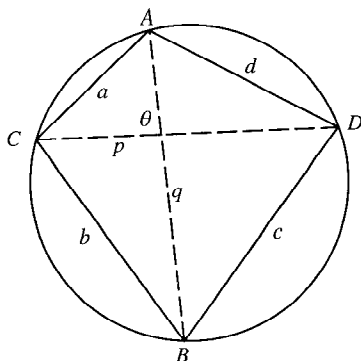
Cyclic Quadrilateral

A QUADRILATERAL for which a CIRCLE can be circumscribed so that it touches each VERTEX. The AREA is then given by a special case of BRETSCHNEIDER'S FORMULA. Let the sides have lengths a, b, c , and d , let s be the SEMIPERIMETER

$$s = \frac{1}{2}(a + b + c + d), \quad (1)$$

and let R be the CIRCUMRADIUS. Then

$$A = \sqrt{(s-a)(s-b)(s-c)(s-d)} \quad (2)$$

$$= \frac{\sqrt{(ac+bd)(ad+bc)(ab+cd)}}{4R}. \quad (3)$$

Solving for the CIRCUMRADIUS gives

$$R = \frac{1}{4} \sqrt{\frac{(ac+bd)(ad+bc)(ab+cd)}{(s-a)(s-b)(s-c)(s-d)}}. \quad (4)$$

The DIAGONALS of a cyclic quadrilateral have lengths

$$p = \sqrt{\frac{(ab+cd)(ac+bd)}{ad+bc}} \quad (5)$$

$$q = \sqrt{\frac{(ac+bd)(ad+bc)}{ab+cd}}, \quad (6)$$

so that $pq = ac + bd$. In general, there are three essentially distinct cyclic quadrilaterals (modulo ROTATION and REFLECTION) whose edges are permutations of the lengths a, b, c , and d . Of the six corresponding DIAGONAL lengths, three are distinct. In addition to p and q , there is therefore a "third" DIAGONAL which can be denoted r . It is given by the equation

$$r = \sqrt{\frac{(ad+bc)(ab+cd)}{ac+bd}}. \quad (7)$$

This allows the AREA formula to be written in the particularly beautiful and simple form

$$A = \frac{pqr}{4R}. \quad (8)$$

The DIAGONALS are sometimes also denoted p, q , and r .

The AREA of a cyclic quadrilateral is the MAXIMUM possible for any QUADRILATERAL with the given side lengths. Also, the opposite ANGLES of a cyclic quadrilateral sum to π RADIANS (Dunham 1990).

A cyclic quadrilateral with RATIONAL sides a, b, c , and d , DIAGONALS p and q , CIRCUMRADIUS R , and AREA A is given by $a = 25, b = 33, c = 39, d = 65, p = 60, q = 52, R = 65/2$, and $A = 1344$.

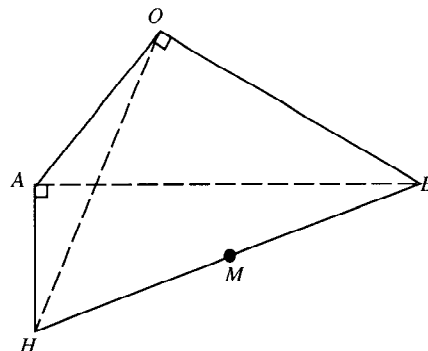

Let $AHBO$ be a QUADRILATERAL such that the angles $\angle HAB$ and $\angle HOB$ are RIGHT ANGLES, then $AHBO$ is a cyclic quadrilateral (Dunham 1990). This is a COROLLARY of the theorem that, in a RIGHT TRIANGLE, the MIDPOINT of the HYPOTENUSE is equidistant from the

three VERTICES. Since M is the MIDPOINT of both RIGHT TRIANGLES $\triangle AHB$ and $\triangle BOH$, it is equidistant from all four VERTICES, so a CIRCLE centered at M may be drawn through them. This theorem is one of the building blocks of Heron's derivation of HERON'S FORMULA.

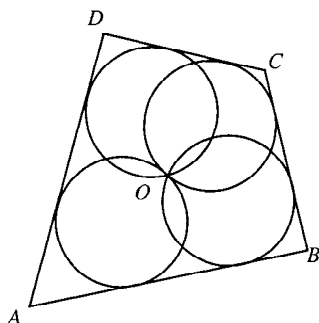

Place four equal CIRCLES so that they intersect in a point. The quadrilateral $ABCD$ is then a cyclic quadrilateral (Honsberger 1991). For a CONVEX cyclic quadrilateral Q , consider the set of CONVEX cyclic quadrilaterals $Q_{||}$ whose sides are PARALLEL to Q . Then the $Q_{||}$ of maximal AREA is the one whose DIAGONALS are PERPENDICULAR (Gürel 1996).

see also BRETSCHNEIDER'S FORMULA, CONCYCLIC, CYCLIC POLYGON, CYCLIC QUADRANGLE, EULER BRICK, HERON'S FORMULA, PTOLEMY'S THEOREM, QUADRILATERAL

References

- Beyer, W. H. *CRC Standard Mathematical Tables*, 28th ed. Boca Raton, FL: CRC Press, p. 123, 1987.
 Dunham, W. *Journey Through Genius: The Great Theorems of Mathematics*. New York: Wiley, p. 121, 1990.
 Gürel, E. Solution to Problem 1472. "Maximal Area of Quadrilaterals." *Math. Mag.* **69**, 149, 1996.
 Honsberger, R. *More Mathematical Morsels*. Washington, DC: Math. Assoc. Amer., pp. 36-37, 1991.

Cyclic Redundancy Check

A sophisticated CHECKSUM (often abbreviated CRC), which is based on the algebra of polynomials over the integers (mod 2). It is substantially more reliable in detecting transmission errors, and is one common error-checking protocol used in modems.

see also CHECKSUM, ERROR-CORRECTING CODE

References

- Press, W. H.; Flannery, B. P.; Teukolsky, S. A.; and Vetterling, W. T. "Cyclic Redundancy and Other Checksums." Ch. 20.3 in *Numerical Recipes in FORTRAN: The Art of Scientific Computing*, 2nd ed. Cambridge, England: Cambridge University Press, pp. 888-895, 1992.

Cyclid

see CYCLIDE

Cyclide

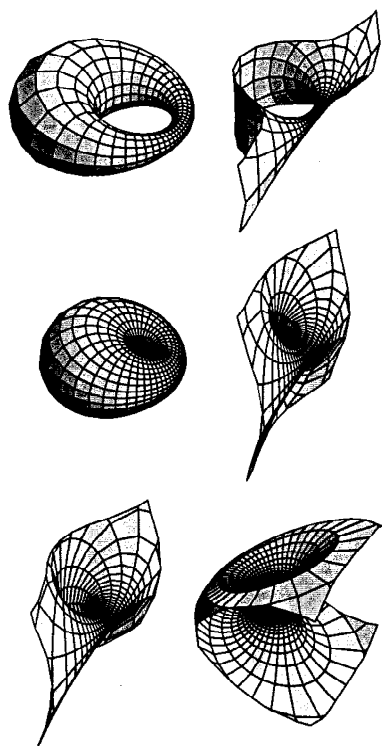

A pair of focal conics which are the envelopes of two one-parameter families of spheres, sometimes also called a CYCLID. The cyclide is a QUARTIC SURFACE, and the lines of curvature on a cyclide are all straight lines or circular arcs (Pinkall 1986). The STANDARD TORI and their inversions in a SPHERE S centered at a point \mathbf{x}_0 and of RADIUS r , given by

$$I(\mathbf{x}_0, r) = \mathbf{x}_0 + \frac{\mathbf{x} - \mathbf{x}_0 r^2}{|\mathbf{x} - \mathbf{x}_0|^2},$$

are both cyclides (Pinkall 1986). Illustrated above are RING CYCLIDES, HORN CYCLIDES, and SPINDLE CYCLIDES. The figures on the right correspond to \mathbf{x}_0 lying on the torus itself, and are called the PARABOLIC RING CYCLIDE, PARABOLIC HORN CYCLIDE, and PARABOLIC SPINDLE CYCLIDE, respectively.

see also CYCLIDIC COORDINATES, HORN CYCLIDE, PARABOLIC HORN CYCLIDE, PARABOLIC RING CYCLIDE, RING CYCLIDE, SPINDLE CYCLIDE, STANDARD TORI

References

- Bierschneider-Jakobs, A. "Cyclides." <http://www.mi.uni-erlangen.de/~biersch/cyclides.html>.
 Byerly, W. E. *An Elementary Treatise on Fourier's Series, and Spherical, Cylindrical, and Ellipsoidal Harmonics, with Applications to Problems in Mathematical Physics*. New York: Dover, p. 273, 1959.
 Eisenhart, L. P. "Cyclides of Dupin." §133 in *A Treatise on the Differential Geometry of Curves and Surfaces*. New York: Dover, pp. 312-314, 1960.

Fischer, G. (Ed.). Plates 71–77 in *Mathematische Modelle/Mathematical Models, Bildband/Photograph Volume*. Braunschweig, Germany: Vieweg, pp. 66–72, 1986.

Nordstrand, T. "Dupin Cyclide." <http://www.uib.no/people/nfytn/dupintxt.htm>.

Pinkall, U. "Cyclides of Dupin." §3.3 in *Mathematical Models from the Collections of Universities and Museums* (Ed. G. Fischer). Braunschweig, Germany: Vieweg, pp. 28–30, 1986.

Salmon, G. *Analytic Geometry of Three Dimensions*. New York: Chelsea, p. 527, 1979.

Cyclidic Coordinates

A general system of CURVILINEAR COORDINATES based on the CYCLIDE in which LAPLACE'S EQUATION is SEPARABLE.

References

Byerly, W. E. *An Elementary Treatise on Fourier's Series, and Spherical, Cylindrical, and Ellipsoidal Harmonics, with Applications to Problems in Mathematical Physics*. New York: Dover, p. 273, 1959.

Cycloid

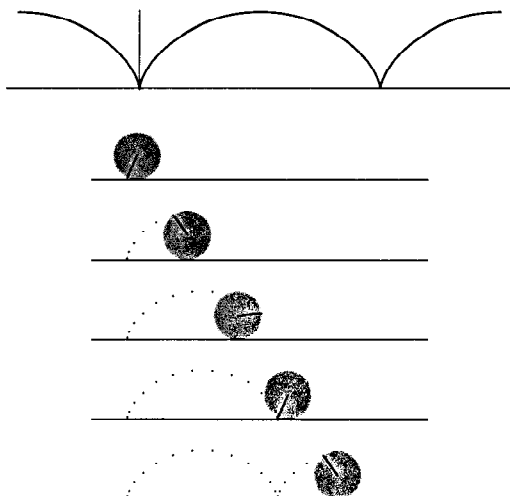

The cycloid is the locus of a point on the rim of a CIRCLE of RADIUS a rolling along a straight LINE. It was studied and named by Galileo in 1599. Galileo attempted to find the AREA by weighing pieces of metal cut into the shape of the cycloid. Torricelli, Fermat, and Descartes all found the AREA. The cycloid was also studied by Roberval in 1634, Wren in 1658, Huygens in 1673, and Johann Bernoulli in 1696. Roberval and Wren found the ARC LENGTH (MacTutor Archive). Gear teeth were also made out of cycloids, as first proposed by Desargues in the 1630s (Cundy and Rollett 1989).

In 1696, Johann Bernoulli challenged other mathematicians to find the curve which solves the BRACHISTOCHRON PROBLEM, knowing the solution to be a cycloid. Leibniz, Newton, Jakob Bernoulli and L'Hospital all solved Bernoulli's challenge. The cycloid also solves the TAUTOCHRON PROBLEM. Because of the frequency with which it provoked quarrels among mathematicians

in the 17th century, the cycloid became known as the "Helen of Geometers" (Boyer 1968, p. 389).

The cycloid is the CATACAUSTIC of a CIRCLE for a RADIANT POINT on the circumference, as shown by Jakob and Johann Bernoulli in 1692. The CAUSTIC of the cycloid when the rays are parallel to the y -axis is a cycloid with twice as many arches. The RADIAL CURVE of a CYCLOID is a CIRCLE. The EVOLUTE and INVOLUTE of a cycloid are identical cycloids.

If the cycloid has a CUSP at the ORIGIN, its equation in CARTESIAN COORDINATES is

$$x = a \cos^{-1} \left(\frac{a-y}{a} \right) \mp \sqrt{2ay - y^2}. \quad (1)$$

In parametric form, this becomes

$$x = a(t - \sin t) \quad (2)$$

$$y = a(1 - \cos t). \quad (3)$$

If the cycloid is upside-down with a cusp at $(0, a)$, (2) and (3) become

$$x = 2a \sin^{-1} \left(\frac{y}{2a} \right) + \sqrt{2ay - y^2} \quad (4)$$

or

$$x = a(t + \sin t) \quad (5)$$

$$y = a(1 - \cos t) \quad (6)$$

(sign of $\sin t$ flipped for x).

The DERIVATIVES of the parametric representation (2) and (3) are

$$x' = a(1 - \cos t) \quad (7)$$

$$y' = a \sin t \quad (8)$$

$$\begin{aligned} \frac{dy}{dx} &= \frac{y'}{x'} = \frac{a \sin t}{a(1 - \cos t)} = \frac{\sin t}{1 - \cos t} \\ &= \frac{2 \sin(\frac{1}{2}t) \cos(\frac{1}{2}t)}{2 \sin^2(\frac{1}{2}t)} = \cot(\frac{1}{2}t). \end{aligned} \quad (9)$$

The squares of the derivatives are

$$x'^2 = a^2(1 - 2 \cos t + \cos^2 t) \quad (10)$$

$$y'^2 = a^2 \sin^2 t, \quad (11)$$

so the ARC LENGTH of a single cycle is

$$\begin{aligned} L &= \int ds = \int_0^{2\pi} \sqrt{x'^2 + y'^2} dt \\ &= a \int_0^{2\pi} \sqrt{(1 - 2 \cos t + \cos^2 t) + \sin^2 t} dt \\ &= a\sqrt{2} \int_0^{2\pi} \sqrt{1 - \cos t} dt = 2a \int_0^{2\pi} \sqrt{\frac{1 - \cos t}{2}} dt \\ &= 2a \int_0^{2\pi} |\sin(\frac{1}{2}t)| dt. \end{aligned} \quad (12)$$

Now let $u \equiv t/2$ so $du = dt/2$. Then

$$\begin{aligned} L &= 4a \int_0^\pi \sin u \, du = 4a[-\cos u]_0^\pi \\ &= -4a[(-1) - 1] = 8a. \end{aligned} \quad (13)$$

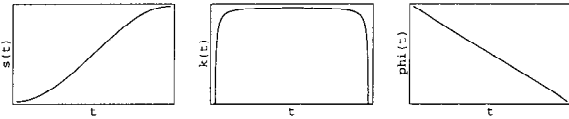

The ARC LENGTH, CURVATURE, and TANGENTIAL ANGLE are

$$s = 8a \sin^2(\tfrac{1}{4}t) \quad (14)$$

$$\kappa = -\tfrac{1}{4}a \csc(\tfrac{1}{2}t) \quad (15)$$

$$\phi = -\tfrac{1}{2}at. \quad (16)$$

The AREA under a single cycle is

$$\begin{aligned} A &= \int_0^{2\pi} y \, dx = a^2 \int_0^{2\pi} (1 - \cos \phi)(1 - \cos \phi) \, d\phi \\ &= a^2 \int_0^{2\pi} (1 - \cos \phi)^2 \, d\phi \\ &= a^2 \int_0^{2\pi} (1 - 2\cos \phi + \cos^2 \phi) \, d\phi \\ &= a^2 \int_0^{2\pi} \{1 - 2\cos \phi + \tfrac{1}{2}[1 + \cos(2\phi)]\} \, d\phi \\ &= a^2 \int_0^{2\pi} [\tfrac{3}{2} - 2\cos \phi + \tfrac{1}{2}\cos(2\phi)] \, d\phi \\ &= a^2 [\tfrac{3}{2}\phi - 2\sin \phi + \tfrac{1}{4}\sin(2\phi)]_0^{2\pi} \\ &= a^2 \tfrac{3}{2}2\pi = 3\pi a^2. \end{aligned} \quad (17)$$

The NORMAL is

$$\hat{\mathbf{T}} = \frac{1}{\sqrt{2 - 2\cos t}} \begin{bmatrix} 1 - \cos t \\ \sin t \end{bmatrix}. \quad (18)$$

see also CURTATE CYCLOID, CYCLIDE, CYCLOID EVOLUTE, CYCLOID INVOLUTE, EPICYCLOID, HYPOCYCLOID, PROLATE CYCLOID, TROCHOID

References

- Bogomolny, A. "Cycloids." <http://www.cut-the-knot.com/pythagoras/cycloids.html>.
 Boyer, C. B. *A History of Mathematics*. New York: Wiley, 1968.
 Cundy, H. and Rollett, A. *Mathematical Models*, 3rd ed. Stradbroke, England: Tarquin Pub., 1989.
 Gray, A. "Cycloids." §3.1 in *Modern Differential Geometry of Curves and Surfaces*. Boca Raton, FL: CRC Press, pp. 37–39, 1993.
 Lawrence, J. D. *A Catalog of Special Plane Curves*. New York: Dover, pp. 192 and 197, 1972.
 Lee, X. "Cycloid." http://www.best.com/~zah/SpecialPlaneCurves_dir/Cycloid_dir/cycloid.html.

Lockwood, E. H. "The Cycloid." Ch. 9 in *A Book of Curves*. Cambridge, England: Cambridge University Press, pp. 80–89, 1967.

MacTutor History of Mathematics Archive. "Cycloid." <http://www-groups.dcs.st-and.ac.uk/~history/Curves/Cycloid.html>.

Muterspaugh, J.; Driver, T.; and Dick, J. E. "The Cycloid and Tautochronism." <http://ezinfo.ucs.indiana.edu/~jedick/project/intro.html>.

Pappas, T. "The Cycloid—The Helen of Geometry." *The Joy of Mathematics*. San Carlos, CA: Wide World Publ./Tetra, pp. 6–8, 1989.

Wagon, S. "Rolling Circles." Ch. 2 in *Mathematica in Action*. New York: W. H. Freeman, pp. 39–66, 1991.

Yates, R. C. "Cycloid." *A Handbook on Curves and Their Properties*. Ann Arbor, MI: J. W. Edwards, pp. 65–70, 1952.

Cycloid Evolute

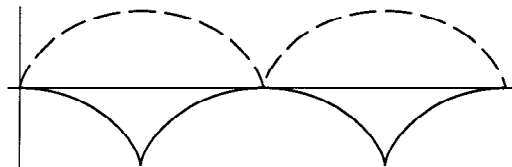

The EVOLUTE of the CYCLOID

$$x(t) = a(t - \sin t)$$

$$y(t) = a(1 - \cos t)$$

is given by

$$x(t) = a(t + \sin t)$$

$$y(t) = a(\cos t - 1).$$

As can be seen in the above figure, the EVOLUTE is simply a shifted copy of the original CYCLOID, so the CYCLOID is its own EVOLUTE.

Cycloid Involute



The INVOLUTE of the CYCLOID

$$x(t) = a(t - \sin t)$$

$$y(t) = a(1 - \cos t)$$

is given by

$$x(t) = a(t + \sin t)$$

$$y(t) = a(3 + \cos t).$$

As can be seen in the above figure, the INVOLUTE is simply a shifted copy of the original CYCLOID, so the CYCLOID is its own INVOLUTE!

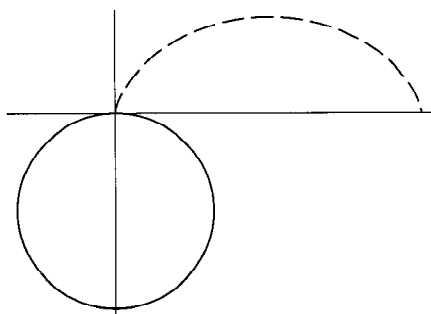
Cycloid Radial Curve

The RADIAL CURVE of the CYCLOID is the CIRCLE

$$\begin{aligned}x &= x_0 + 2a \sin \phi \\ y &= -2a + y_0 + 2a \cos \phi.\end{aligned}$$

Cyclomatic Number

see CIRCUIT RANK

Cyclotomic Equation

The equation

$$x^p = 1,$$

where solutions $\zeta_k = e^{2\pi i k/p}$ are the ROOTS OF UNITY sometimes called DE MOIVRE NUMBERS. Gauss showed that the cyclotomic equation can be reduced to solving a series of QUADRATIC EQUATIONS whenever p is a FERMAT PRIME. Wantzel (1836) subsequently showed that this condition is not only SUFFICIENT, but also NECESSARY. An “irreducible” cyclotomic equation is an expression of the form

$$\frac{x^p - 1}{x - 1} = x^{p-1} + x^{p-2} + \dots + 1 = 0,$$

where p is PRIME. Its ROOTS z_i satisfy $|z_i| = 1$.

see also CYCLOTOMIC POLYNOMIAL, DE MOIVRE NUMBER, POLYGON, PRIMITIVE ROOT OF UNITY

References

- Courant, R. and Robbins, H. *What is Mathematics?: An Elementary Approach to Ideas and Methods*, 2nd ed. Oxford, England: Oxford University Press, pp. 99–100, 1996.
- Scott, C. A. “The Binomial Equation $x^p - 1 = 0$.” *Amer. J. Math.* **8**, 261–264, 1886.
- Wantzel, P. L. “Recherches sur les moyens de reconnaître si un Problème de Géométrie peut se résoudre avec la règle et le compas.” *J. Math. pures appliq.* **1**, 366–372, 1836.

Cyclotomic Factorization

$$z^p - y^p = (z - y)(z - \zeta y) \cdots (z - \zeta^{p-1} y),$$

where $\zeta \equiv e^{2\pi i/p}$ (a DE MOIVRE NUMBER) and p is a PRIME.

Cyclotomic Field

The smallest field containing $m \in \mathbb{Z} \geq 1$ with ζ a PRIME ROOT OF UNITY is denoted $\mathbb{R}_m(\zeta)$.

$$x^p + y^p = \prod_{k=1}^p (x + \zeta^k y).$$

Specific cases are

$$\begin{aligned}\mathbb{R}_3 &= \mathbb{Q}(\sqrt{-3}) \\ \mathbb{R}_4 &= \mathbb{Q}(\sqrt{-1}) \\ \mathbb{R}_6 &= \mathbb{Q}(\sqrt{-3}),\end{aligned}$$

where \mathbb{Q} denotes a QUADRATIC FIELD.

Cyclotomic Integer

A number of the form

$$a_0 + a_1 \zeta + \dots + a_{p-1} \zeta^{p-1},$$

where

$$\zeta \equiv e^{2\pi i/p}$$

is a DE MOIVRE NUMBER and p is a PRIME number. Unique factorizations of cyclotomic INTEGERS fail for $p > 23$.

Cyclotomic Invariant

Let p be an ODD PRIME and F_n the CYCLOTOMIC FIELD of p^{n+1} th ROOTS of unity over the rational FIELD. Now let $p^{e(n)}$ be the POWER of p which divides the CLASS NUMBER h_n of F_n . Then there exist INTEGERS $\mu_p, \lambda_p \geq 0$ and ν_p such that

$$e(n) = \mu_p p^n + \lambda_p n + \nu_p$$

for all sufficiently large n . For REGULAR PRIMES, $\mu_p = \lambda_p = \nu_p = 0$.

References

- Johnson, W. “Irregular Primes and Cyclotomic Invariants.” *Math. Comput.* **29**, 113–120, 1975.

Cyclotomic Number

see DE MOIVRE NUMBER, SYLVESTER CYCLOTOMIC NUMBER

Cyclotomic Polynomial

A polynomial given by

$$\Phi_d(x) = \prod_{k=1}^d (x - \zeta_k), \quad (1)$$

where ζ_i are the primitive d th ROOTS OF UNITY in \mathbb{C} given by $\zeta_k = e^{2\pi i k/d}$. The numbers ζ_k are sometimes called DE MOIVRE NUMBERS. $\Phi_d(x)$ is an irreducible

POLYNOMIAL in $\mathbb{Z}[x]$ with degree $\phi(d)$, where ϕ is the TOTIENT FUNCTION. For d PRIME,

$$\Phi_p = \sum_{k=0}^{p-1} x^k, \quad (2)$$

i.e., the coefficients are all 1. Φ_{105} has coefficients of -2 for x^7 and x^{41} , making it the first cyclotomic polynomial to have a coefficient other than ± 1 and 0. This is true because 105 is the first number to have three distinct ODD PRIME factors, i.e., $105 = 3 \cdot 5 \cdot 7$ (McClellan and Rader 1979, Schroeder 1997). Migotti (1883) showed that COEFFICIENTS of Φ_{pq} for p and q distinct PRIMES can be only 0, ± 1 . Lam and Leung (1996) considered

$$\Phi_{pq} \equiv \sum_{k=0}^{pq-1} a_k x^k \quad (3)$$

for p, q PRIME. Write the TOTIENT FUNCTION as

$$\phi(pq) = (p-1)(q-1) = rp + sq \quad (4)$$

and let

$$0 \leq k \leq (p-1)(q-1), \quad (5)$$

then

1. $a_k = 1$ IFF $k = ip + jq$ for some $i \in [0, r]$ and $j \in [0, s]$,
2. $a_k = -1$ IFF $k + pq = ip + jq$ for $i \in [r+1, q-1]$ and $j \in [s+1, p-1]$,
3. otherwise $a_k = 0$.

The number of terms having $a_k = 1$ is $(r+1)(s+1)$, and the number of terms having $a_k = -1$ is $(p-s-1)(q-r-1)$. Furthermore, assume $q > p$, then the middle COEFFICIENT of Φ_{pq} is $(-1)^r$.

The LOGARITHM of the cyclotomic polynomial

$$\Phi_n(x) = \prod_{d|n} (1 - x^{n/d})^{\mu(d)} \quad (6)$$

is the MÖBIUS INVERSION FORMULA (Vardi 1991, p. 225).

The first few cyclotomic POLYNOMIALS are

$$\begin{aligned} \Phi_1(x) &= x - 1 \\ \Phi_2(x) &= x + 1 \\ \Phi_3(x) &= x^2 + x + 1 \\ \Phi_4(x) &= x^2 + 1 \\ \Phi_5(x) &= x^4 + x^3 + x^2 + x + 1 \\ \Phi_6(x) &= x^2 - x + 1 \\ \Phi_7(x) &= x^6 + x^5 + x^4 + x^3 + x^2 + x + 1 \\ \Phi_8(x) &= x^4 + 1 \\ \Phi_9(x) &= x^6 + x^3 + 1 \\ \Phi_{10}(x) &= x^4 - x^3 + x^2 - x + 1. \end{aligned}$$

The smallest values of n for which Φ_n has one or more coefficients $\pm 1, \pm 2, \pm 3, \dots$ are 0, 105, 385, 1365, 1785, 2805, 3135, 6545, 6545, 10465, 10465, 10465, 10465, 10465, 11305, \dots (Sloane's A013594).

The POLYNOMIAL $x^n - 1$ can be factored as

$$x^n - 1 = \prod_{d|n} \Phi_d(x), \quad (7)$$

where $\Phi_d(x)$ is a CYCLOTOMIC POLYNOMIAL. Furthermore,

$$x^n + 1 = \frac{x^{2n-1}}{x^n - 1} = \frac{\prod_{d|2n} \Phi_d(x)}{\prod_{d|n} \Phi_d(x)} = \prod_{d|m} \Phi_{2^t d}(x). \quad (8)$$

The COEFFICIENTS of the inverse of the cyclotomic POLYNOMIAL

$$\begin{aligned} \frac{1}{1+x+x^2} &= 1 - x + x^3 - x^4 + x^6 - x^7 + x^9 - x^{10} + \dots \\ &= \sum_{n=0}^{\infty} c_n x^n \end{aligned} \quad (9)$$

can also be computed from

$$c_n = 1 - 2 \left\lfloor \frac{1}{3}(n+2) \right\rfloor + \left\lfloor \frac{1}{3}(n+1) \right\rfloor + \left\lfloor \frac{1}{3}n \right\rfloor, \quad (10)$$

where $\lfloor x \rfloor$ is the FLOOR FUNCTION.

see also AURIFEUILLEAN FACTORIZATION, MÖBIUS INVERSION FORMULA

References

- Beiter, M. "The Midterm Coefficient of the Cyclotomic Polynomial $F_{pq}(x)$." *Amer. Math. Monthly* **71**, 769-770, 1964.
- Beiter, M. "Magnitude of the Coefficients of the Cyclotomic Polynomial F_{pq} ." *Amer. Math. Monthly* **75**, 370-372, 1968.
- Bloom, D. M. "On the Coefficients of the Cyclotomic Polynomials." *Amer. Math. Monthly* **75**, 372-377, 1968.
- Carlitz, L. "The Number of Terms in the Cyclotomic Polynomial $F_{pq}(x)$." *Amer. Math. Monthly* **73**, 979-981, 1966.
- Conway, J. H. and Guy, R. K. *The Book of Numbers*. New York: Springer-Verlag, 1996.
- de Bruijn, N. G. "On the Factorization of Cyclic Groups." *Indag. Math.* **15**, 370-377, 1953.
- Lam, T. Y. and Leung, K. H. "On the Cyclotomic Polynomial $\Phi_{pq}(X)$." *Amer. Math. Monthly* **103**, 562-564, 1996.
- Lehmer, E. "On the Magnitude of Coefficients of the Cyclotomic Polynomials." *Bull. Amer. Math. Soc.* **42**, 389-392, 1936.
- McClellan, J. H. and Rader, C. *Number Theory in Digital Signal Processing*. Englewood Cliffs, NJ: Prentice-Hall, 1979.
- Migotti, A. "Zur Theorie der Kreisteilungsgleichung." *Sitzber. Math.-Naturwiss. Classe der Kaiser. Akad. der Wiss., Wien* **87**, 7-14, 1883.
- Schroeder, M. R. *Number Theory in Science and Communication, with Applications in Cryptography, Physics, Digital Information, Computing, and Self-Similarity*, 3rd ed. New York: Springer-Verlag, p. 245, 1997.
- Sloane, N. J. A. Sequence A013594 in "An On-Line Version of the Encyclopedia of Integer Sequences."
- Vardi, I. *Computational Recreations in Mathematica*. Redwood City, CA: Addison-Wesley, pp. 8 and 224-225, 1991.

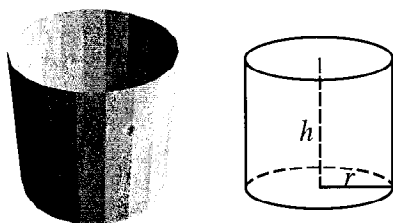
Cylinder

A cylinder is a solid of circular CROSS-SECTION in which the centers of the CIRCLES all lie on a single LINE. The cylinder was extensively studied by Archimedes in his 2-volume work *On the Sphere and Cylinder* in ca. 225 BC.

A cylinder is called a right cylinder if it is “straight” in the sense that its cross-sections lie directly on top of each other; otherwise, the cylinder is called oblique. The surface of a cylinder of height h and RADIUS r can be described parametrically by

$$x = r \cos \theta \quad (1)$$

$$y = r \sin \theta \quad (2)$$

$$z = z, \quad (3)$$

for $z \in [0, h]$ and $\theta \in [0, 2\pi)$. These are the basis for CYLINDRICAL COORDINATES. The SURFACE AREA (of the sides) and VOLUME of the cylinder of height h and RADIUS r are

$$S = 2\pi r h \quad (4)$$

$$V = \pi r^2 h. \quad (5)$$

Therefore, if top and bottom caps are added, the volume-to-surface area ratio for a cylindrical container is

$$\frac{V}{S} = \frac{\pi r^2 h}{2\pi r h + 2\pi r^2} = \frac{1}{2} \left(\frac{1}{r} + \frac{1}{h} \right)^{-1}, \quad (6)$$

which is related to the HARMONIC MEAN of the radius r and height h .

see also CONE, CYLINDER-SPHERE INTERSECTION, CYLINDRICAL SEGMENT, ELLIPTIC CYLINDER, GENERALIZED CYLINDER, SPHERE, STEINMETZ SOLID, VIVIANI'S CURVE

References

Beyer, W. H. (Ed.) *CRC Standard Mathematical Tables*, 28th ed. Boca Raton, FL: CRC Press, p. 129, 1987.

Cylinder Cutting

The maximum number of pieces into which a cylinder can be divided by n oblique cuts is given by

$$f(n) = \binom{n+1}{3} + n + 1 = \frac{1}{6}(n+2)(n+3),$$

where $\binom{a}{b}$ is a BINOMIAL COEFFICIENT. This problem is sometimes also called CAKE CUTTING or PIE CUTTING. For $n = 1, 2, \dots$ cuts, the maximum number of pieces is 2, 4, 8, 15, 26, 42, \dots (Sloane's A000125).

see also CIRCLE CUTTING, HAM SANDWICH THEOREM, PANCAKE THEOREM, TORUS CUTTING

References

Bogomolny, A. “Can You Cut a Cake into 8 Pieces with Three Movements.” http://www.cut-the-knot.com/do_you_know/cake.html.

Sloane, N. J. A. Sequence A000125/M1100 in “An On-Line Version of the Encyclopedia of Integer Sequences.”

Cylinder-Cylinder Intersection

see STEINMETZ SOLID

Cylinder Function

The cylinder function is defined as

$$C(x, y) \equiv \begin{cases} 1 & \text{for } \sqrt{x^2 + y^2} \leq a \\ 0 & \text{for } \sqrt{x^2 + y^2} > a. \end{cases} \quad (1)$$

The BESSEL FUNCTIONS are sometimes also called cylinder functions. To find the FOURIER TRANSFORM of the cylinder function, let

$$k_x = k \cos \alpha \quad (2)$$

$$k_y = k \sin \alpha \quad (3)$$

$$x = r \cos \theta \quad (4)$$

$$y = r \sin \theta. \quad (5)$$

Then

$$\begin{aligned} F(k, a) &= \mathcal{F}(C(x, y)) \\ &= \int_0^{2\pi} \int_0^a e^{i(k \cos \alpha r \cos \theta + k \sin \alpha r \sin \theta)} r dr d\theta \\ &= \int_0^{2\pi} \int_0^a e^{i k r \cos(\theta - \alpha)} r dr d\theta. \end{aligned} \quad (6)$$

Let $b = \theta - \alpha$, so $db = d\theta$. Then

$$\begin{aligned} F(k, a) &= \int_{-\alpha}^{2\pi - \alpha} \int_0^a e^{i k r \cos b} r dr db \\ &= \int_0^{2\pi} \int_0^a e^{i k r \cos b} r dr db \\ &= 2\pi \int_0^a J_0(kr) r dr, \end{aligned} \quad (7)$$

where J_0 is a zeroth order BESSEL FUNCTION OF THE FIRST KIND. Let $u \equiv kr$, so $du = k dr$, then

$$\begin{aligned} F(k, a) &= \frac{2\pi}{k^2} \int_0^{ka} J_0(u) u du = \frac{2\pi}{k^2} [u J_1(u)]_0^{ka} \\ &= \frac{2\pi a}{k} J_1(ka) = 2\pi a^2 \frac{J_1(ka)}{ka}. \end{aligned} \quad (8)$$

As defined by Watson (1966), a "cylinder function" is any function which satisfies the RECURRENCE RELATIONS

$$C_{\nu-1}(z) + C_{\nu+1}(z) = \frac{2\nu}{z} C_{\nu}(z) \quad (9)$$

$$C_{\nu-1}(z) - C_{\nu+1}(z) = 2C'_{\nu}(z). \quad (10)$$

This class of functions can be expressed in terms of BESSEL FUNCTIONS.

see also BESSEL FUNCTION OF THE FIRST KIND, CYLINDER FUNCTION, CYLINDRICAL FUNCTION, HEMISPHERICAL FUNCTION

References

Watson, G. N. *A Treatise on the Theory of Bessel Functions*, 2nd ed. Cambridge, England: Cambridge University Press, 1966.

Cylinder-Sphere Intersection

see VIVIANI'S CURVE

Cylindrical Coordinates

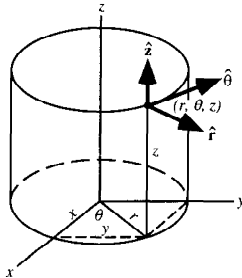

Cylindrical coordinates are a generalization of 2-D POLAR COORDINATES to 3-D by superposing a height (z) axis. Unfortunately, there are a number of different notations used for the other two coordinates. Either r or ρ is used to refer to the radial coordinate and either ϕ or θ to the azimuthal coordinates. Arfken (1985), for instance, uses (ρ, ϕ, z) , while Beyer (1987) uses (r, θ, z) . In this work, the NOTATION (r, θ, z) is used.

$$r = \sqrt{x^2 + y^2} \quad (1)$$

$$\theta = \tan^{-1} \left(\frac{y}{x} \right) \quad (2)$$

$$z = z, \quad (3)$$

where $r \in [0, \infty)$, $\theta \in [0, 2\pi)$, and $z \in (-\infty, \infty)$. In terms of x , y , and z

$$x = r \cos \theta \quad (4)$$

$$y = r \sin \theta \quad (5)$$

$$z = z. \quad (6)$$

Morse and Feshbach (1953) define the cylindrical coordinates by

$$x = \xi_1 \xi_2 \quad (7)$$

$$y = \xi_1 \sqrt{1 - \xi_2^2} \quad (8)$$

$$z = \xi_3, \quad (9)$$

where $\xi_1 = r$ and $\xi_2 = \cos \theta$. The METRIC elements of the cylindrical coordinates are

$$g_{rr} = 1 \quad (10)$$

$$g_{\theta\theta} = r^2 \quad (11)$$

$$g_{zz} = 1, \quad (12)$$

so the SCALE FACTORS are

$$g_r = 1 \quad (13)$$

$$g_{\theta} = r \quad (14)$$

$$g_z = 1. \quad (15)$$

The LINE ELEMENT is

$$ds = dr \hat{\mathbf{r}} + r d\theta \hat{\boldsymbol{\theta}} + dz \hat{\mathbf{z}}, \quad (16)$$

and the VOLUME ELEMENT is

$$dV = r dr d\theta dz. \quad (17)$$

The JACOBIAN is

$$\left| \frac{\partial(x, y, z)}{\partial(r, \theta, z)} \right| = r. \quad (18)$$

A CARTESIAN VECTOR is given in CYLINDRICAL COORDINATES by

$$\mathbf{r} = \begin{bmatrix} r \cos \theta \\ r \sin \theta \\ z \end{bmatrix}. \quad (19)$$

To find the UNIT VECTORS,

$$\hat{\mathbf{r}} \equiv \frac{\frac{d\mathbf{r}}{dr}}{\left| \frac{d\mathbf{r}}{dr} \right|} = \begin{bmatrix} \cos \theta \\ \sin \theta \\ 0 \end{bmatrix} \quad (20)$$

$$\hat{\boldsymbol{\theta}} \equiv \frac{\frac{d\mathbf{r}}{d\theta}}{\left| \frac{d\mathbf{r}}{d\theta} \right|} = \begin{bmatrix} -\sin \theta \\ \cos \theta \\ 0 \end{bmatrix} \quad (21)$$

$$\hat{\mathbf{z}} \equiv \frac{\frac{d\mathbf{r}}{dz}}{\left| \frac{d\mathbf{r}}{dz} \right|} = \begin{bmatrix} 0 \\ 0 \\ 1 \end{bmatrix}. \quad (22)$$

Derivatives of unit VECTORS with respect to the coordinates are

$$\frac{\partial \hat{\mathbf{r}}}{\partial r} = \mathbf{0} \quad (23)$$

$$\frac{\partial \hat{\mathbf{r}}}{\partial \theta} = \begin{bmatrix} -\sin \theta \\ \cos \theta \\ 0 \end{bmatrix} = \hat{\boldsymbol{\theta}} \quad (24)$$

$$\frac{\partial \hat{\mathbf{r}}}{\partial z} = \mathbf{0} \quad (25)$$

$$\frac{\partial \hat{\boldsymbol{\theta}}}{\partial r} = \mathbf{0} \quad (26)$$

$$\frac{\partial \hat{\boldsymbol{\theta}}}{\partial \theta} = \begin{bmatrix} -\cos \theta \\ -\sin \theta \\ 0 \end{bmatrix} = -\hat{\mathbf{r}} \quad (27)$$

$$\frac{\partial \hat{\boldsymbol{\theta}}}{\partial z} = \mathbf{0} \quad (28)$$

$$\frac{\partial \hat{\mathbf{z}}}{\partial r} = \mathbf{0} \quad (29)$$

$$\frac{\partial \hat{\mathbf{z}}}{\partial \theta} = \mathbf{0} \quad (30)$$

$$\frac{\partial \hat{\mathbf{z}}}{\partial z} = \mathbf{0}. \quad (31)$$

The GRADIENT of a VECTOR FIELD in cylindrical coordinates is given by

$$\nabla \equiv \hat{\mathbf{r}} \frac{\partial}{\partial r} + \hat{\boldsymbol{\theta}} \frac{1}{r} \frac{\partial}{\partial \theta} + \hat{\mathbf{z}} \frac{\partial}{\partial z}, \quad (32)$$

so the GRADIENT components become

$$\nabla_r \hat{\mathbf{r}} = \mathbf{0} \quad (33)$$

$$\nabla_\theta \hat{\mathbf{r}} = \frac{1}{r} \hat{\boldsymbol{\theta}} \quad (34)$$

$$\nabla_z \hat{\mathbf{r}} = \mathbf{0} \quad (35)$$

$$\nabla_r \hat{\boldsymbol{\theta}} = \mathbf{0} \quad (36)$$

$$\nabla_\theta \hat{\boldsymbol{\theta}} = -\frac{1}{r} \hat{\mathbf{r}} \quad (37)$$

$$\nabla_z \hat{\boldsymbol{\theta}} = \mathbf{0} \quad (38)$$

$$\nabla_r \hat{\mathbf{z}} = \mathbf{0} \quad (39)$$

$$\nabla_\theta \hat{\mathbf{z}} = \mathbf{0} \quad (40)$$

$$\nabla_z \hat{\mathbf{z}} = \mathbf{0}. \quad (41)$$

Now, since the CONNECTION COEFFICIENTS are defined by

$$\Gamma_{jk}^i = \hat{\mathbf{x}}_i \cdot (\nabla_k \hat{\mathbf{x}}_j), \quad (42)$$

$$\Gamma^r = \begin{bmatrix} 0 & 0 & 0 \\ 0 & -\frac{1}{r} & 0 \\ 0 & 0 & 0 \end{bmatrix} \quad (43)$$

$$\Gamma^\theta = \begin{bmatrix} 0 & \frac{1}{r} & 0 \\ 0 & 0 & 0 \\ 0 & 0 & 0 \end{bmatrix} \quad (44)$$

$$\Gamma^z = \begin{bmatrix} 0 & 0 & 0 \\ 0 & 0 & 0 \\ 0 & 0 & 0 \end{bmatrix}. \quad (45)$$

The COVARIANT DERIVATIVES, given by

$$A_{j;k} = \frac{1}{g^{kk}} \frac{\partial A_j}{\partial x_k} - \Gamma_{jk}^i A_i, \quad (46)$$

are

$$A_{r;r} = \frac{\partial A_r}{\partial r} - \Gamma_{rr}^i A_i = \frac{\partial A_r}{\partial r} \quad (47)$$

$$\begin{aligned} A_{r;\theta} &= \frac{1}{r} \frac{\partial A_r}{\partial \theta} - \Gamma_{r\theta}^i A_i = \frac{1}{r} \frac{\partial A_r}{\partial \theta} - \Gamma_{r\theta}^\theta A_\theta \\ &= \frac{1}{r} \frac{\partial A_r}{\partial \theta} - \frac{A_\theta}{r} \end{aligned} \quad (48)$$

$$A_{r;z} = \frac{\partial A_r}{\partial z} - \Gamma_{rz}^i A_i = \frac{\partial A_r}{\partial z} \quad (49)$$

$$A_{\theta;r} = \frac{\partial A_\theta}{\partial r} \Gamma_{\theta r}^i A_i = \frac{\partial A_\theta}{\partial r} \quad (50)$$

$$\begin{aligned} A_{\theta;\theta} &= \frac{1}{r} \frac{\partial A_\theta}{\partial \theta} - \Gamma_{\theta\theta}^i A_i = \frac{1}{r} \frac{\partial A_\theta}{\partial \theta} - \Gamma_{\theta\theta}^r A_r \\ &= \frac{1}{r} \frac{\partial A_\theta}{\partial \theta} + \frac{A_r}{r} \end{aligned} \quad (51)$$

$$A_{\theta;z} = \frac{\partial A_\theta}{\partial z} - \Gamma_{\theta z}^i A_i = \frac{\partial A_\theta}{\partial z} \quad (52)$$

$$A_{z;r} = \frac{\partial A_z}{\partial r} - \Gamma_{zr}^i A_i = \frac{\partial A_z}{\partial r} \quad (53)$$

$$A_{z;\theta} = \frac{1}{r} \frac{\partial A_z}{\partial \theta} - \Gamma_{z\theta}^i A_i = \frac{1}{r} \frac{\partial A_z}{\partial \theta} \quad (54)$$

$$A_{z;z} = \frac{\partial A_z}{\partial z} - \Gamma_{zz}^i A_i = \frac{\partial A_z}{\partial z}. \quad (55)$$

CROSS PRODUCTS of the coordinate axes are

$$\hat{\mathbf{r}} \times \hat{\mathbf{z}} = -\hat{\boldsymbol{\theta}} \quad (56)$$

$$\hat{\boldsymbol{\theta}} \times \hat{\mathbf{z}} = \hat{\mathbf{r}} \quad (57)$$

$$\hat{\mathbf{r}} \times \hat{\boldsymbol{\theta}} = \hat{\mathbf{z}}. \quad (58)$$

The COMMUTATION COEFFICIENTS are given by

$$c_{\alpha\beta}^\mu \vec{e}_\mu = [\vec{e}_\alpha, \vec{e}_\beta] = \nabla_\alpha \vec{e}_\beta - \nabla_\beta \vec{e}_\alpha, \quad (59)$$

But

$$[\hat{\mathbf{r}}, \hat{\mathbf{r}}] = [\hat{\boldsymbol{\theta}}, \hat{\boldsymbol{\theta}}] = [\hat{\boldsymbol{\phi}}, \hat{\boldsymbol{\phi}}] = \mathbf{0}, \quad (60)$$

so $c_{rr}^\alpha = c_{\theta\theta}^\alpha = c_{\phi\phi}^\alpha = 0$, where $\alpha = r, \theta, \phi$. Also

$$[\hat{\mathbf{r}}, \hat{\boldsymbol{\theta}}] = -[\hat{\boldsymbol{\theta}}, \hat{\mathbf{r}}] = \nabla_r \hat{\boldsymbol{\theta}} - \nabla_\theta \hat{\mathbf{r}} = \mathbf{0} - \frac{1}{r} \hat{\boldsymbol{\theta}} = -\frac{1}{r} \hat{\boldsymbol{\theta}}, \quad (61)$$

so $c_{r\theta}^\theta = -c_{\theta r}^\theta = -\frac{1}{r}$, $c_{r\theta}^r = c_{\theta r}^r = 0$. Finally,

$$[\hat{\mathbf{r}}, \hat{\boldsymbol{\phi}}] = [\hat{\boldsymbol{\theta}}, \hat{\boldsymbol{\phi}}] = \mathbf{0}. \quad (62)$$

Summarizing,

$$c^r = \begin{bmatrix} 0 & 0 & 0 \\ 0 & 0 & 0 \\ 0 & 0 & 0 \end{bmatrix} \quad (63)$$

$$c^\theta = \begin{bmatrix} 0 & -\frac{1}{r} & 0 \\ \frac{1}{r} & 0 & 0 \\ 0 & 0 & 0 \end{bmatrix} \quad (64)$$

$$c^\phi = \begin{bmatrix} 0 & 0 & 0 \\ 0 & 0 & 0 \\ 0 & 0 & 0 \end{bmatrix}. \quad (65)$$

Time DERIVATIVES of the VECTOR are

$$\dot{\mathbf{r}} = \begin{bmatrix} \cos \theta \dot{r} - r \sin \theta \dot{\theta} \\ \sin \theta \dot{r} + r \cos \theta \dot{\theta} \\ \dot{z} \end{bmatrix} = \dot{r} \hat{\mathbf{r}} + r \dot{\theta} \hat{\boldsymbol{\theta}} + \dot{z} \hat{\mathbf{z}} \quad (66)$$

$$\begin{aligned} \ddot{\mathbf{r}} &= \begin{bmatrix} -\sin \theta \dot{r} \dot{\theta} + \cos \theta \ddot{r} - \sin \theta \ddot{\theta} - r \cos \theta \dot{\theta}^2 - r \sin \theta \ddot{\theta} \\ \cos \theta \dot{r} \dot{\theta} + \sin \theta \ddot{r} + \cos \theta \ddot{\theta} - r \sin \theta \dot{\theta}^2 + r \cos \theta \ddot{\theta} \\ \ddot{z} \end{bmatrix} \\ &= \begin{bmatrix} -2 \sin \theta \dot{r} \dot{\theta} + \cos \theta \ddot{r} - r \cos \theta \dot{\theta}^2 - r \sin \theta \ddot{\theta} \\ 2 \cos \theta \dot{r} \dot{\theta} + \sin \theta \ddot{r} - r \sin \theta \dot{\theta}^2 + r \cos \theta \ddot{\theta} \\ \ddot{z} \end{bmatrix} \\ &= (\ddot{r} - r \dot{\theta}^2) \hat{\mathbf{r}} + (2 \dot{r} \dot{\theta} + r \ddot{\theta}) \hat{\boldsymbol{\theta}} + \ddot{z} \hat{\mathbf{z}}. \end{aligned} \quad (67)$$

SPEED is given by

$$v \equiv |\dot{\mathbf{r}}| = \sqrt{\dot{r}^2 + r^2 \dot{\theta}^2 + \dot{z}^2}. \quad (68)$$

Time derivatives of the unit VECTORS are

$$\dot{\hat{\mathbf{r}}} = \begin{bmatrix} -\sin \theta \dot{\theta} \\ \cos \theta \dot{\theta} \\ 0 \end{bmatrix} = \dot{\theta} \hat{\boldsymbol{\theta}} \quad (69)$$

$$\dot{\hat{\boldsymbol{\theta}}} = \begin{bmatrix} -\cos \theta \dot{\theta} \\ -\sin \theta \dot{\theta} \\ 0 \end{bmatrix} = -\dot{\theta} \hat{\mathbf{r}} \quad (70)$$

$$\dot{\hat{\mathbf{z}}} = \begin{bmatrix} 0 \\ 0 \\ 0 \end{bmatrix} = \mathbf{0}. \quad (71)$$

CROSS PRODUCTS of the axes are

$$\hat{\mathbf{r}} \times \hat{\mathbf{z}} = -\hat{\boldsymbol{\theta}} \quad (72)$$

$$\hat{\boldsymbol{\theta}} \times \hat{\mathbf{z}} = \hat{\mathbf{r}} \quad (73)$$

$$\hat{\mathbf{r}} \times \hat{\boldsymbol{\theta}} = \hat{\mathbf{z}}. \quad (74)$$

The CONVECTIVE DERIVATIVE is

$$\frac{D\mathbf{r}}{Dt} \equiv \left(\frac{\partial}{\partial t} + \dot{\mathbf{r}} \cdot \nabla \right) \mathbf{r} = \frac{\partial \mathbf{r}}{\partial t} + \dot{\mathbf{r}} \cdot \nabla \mathbf{r}. \quad (75)$$

To rewrite this, use the identity

$$\nabla(\mathbf{A} \cdot \mathbf{B}) = \mathbf{A} \times (\nabla \times \mathbf{B}) + \mathbf{B} \times (\nabla \times \mathbf{A}) + (\mathbf{A} \cdot \nabla) \mathbf{B} + (\mathbf{B} \cdot \nabla) \mathbf{A} \quad (76)$$

and set $\mathbf{A} = \mathbf{B}$, to obtain

$$\nabla(\mathbf{A} \cdot \mathbf{A}) = 2\mathbf{A} \times (\nabla \times \mathbf{A}) + 2(\mathbf{A} \cdot \nabla) \mathbf{A}, \quad (77)$$

so

$$(\mathbf{A} \cdot \nabla) \mathbf{A} = \nabla(\frac{1}{2} \mathbf{A}^2) - \mathbf{A} \times (\nabla \times \mathbf{A}). \quad (78)$$

Then

$$\frac{D\mathbf{r}}{Dt} = \ddot{\mathbf{r}} + \nabla(\frac{1}{2} \dot{\mathbf{r}}^2) - \dot{\mathbf{r}} \times (\nabla \times \dot{\mathbf{r}}) = \ddot{\mathbf{r}} + (\nabla \times \dot{\mathbf{r}}) \times \dot{\mathbf{r}} + \nabla(\frac{1}{2} \dot{\mathbf{r}}^2). \quad (79)$$

The CURL in the above expression gives

$$\nabla \times \dot{\mathbf{r}} = \frac{1}{r} \frac{\partial}{\partial r} (r^2 \dot{\boldsymbol{\theta}}) \hat{\mathbf{z}} = 2\dot{\boldsymbol{\theta}} \hat{\mathbf{z}}, \quad (80)$$

so

$$\begin{aligned} -\dot{\mathbf{r}} \times (\nabla \times \dot{\mathbf{r}}) &= -2\dot{\boldsymbol{\theta}} (\dot{\mathbf{r}} \times \hat{\mathbf{z}} + r\dot{\boldsymbol{\theta}} \hat{\boldsymbol{\theta}} \times \hat{\mathbf{z}}) \\ &= -2\dot{\boldsymbol{\theta}} (-\dot{\mathbf{r}} \hat{\boldsymbol{\theta}} + r\dot{\boldsymbol{\theta}} \hat{\mathbf{r}}) = 2\dot{\mathbf{r}} \dot{\boldsymbol{\theta}} \hat{\boldsymbol{\theta}} - 2r\dot{\boldsymbol{\theta}}^2 \hat{\mathbf{r}}. \end{aligned} \quad (81)$$

We expect the gradient term to vanish since SPEED does not depend on position. Check this using the identity $\nabla(f^2) = 2f\nabla f$,

$$\nabla(\frac{1}{2} \dot{\mathbf{r}}^2) = \frac{1}{2} \nabla(\dot{\mathbf{r}}^2 + r^2 \dot{\boldsymbol{\theta}}^2 + \dot{\mathbf{z}}^2) = \dot{\mathbf{r}} \nabla \dot{\mathbf{r}} + r\dot{\boldsymbol{\theta}} \nabla(r\dot{\boldsymbol{\theta}}) + \dot{\mathbf{z}} \nabla \dot{\mathbf{z}}. \quad (82)$$

Examining this term by term,

$$\dot{\mathbf{r}} \nabla \dot{\mathbf{r}} = \dot{\mathbf{r}} \frac{\partial}{\partial t} \nabla r = \dot{\mathbf{r}} \frac{\partial}{\partial t} \hat{\mathbf{r}} = \dot{\mathbf{r}} \hat{\boldsymbol{\theta}} = \dot{\mathbf{r}} \hat{\boldsymbol{\theta}} \quad (83)$$

$$\begin{aligned} r\dot{\boldsymbol{\theta}} \nabla(r\dot{\boldsymbol{\theta}}) &= r\dot{\boldsymbol{\theta}} \left[r \frac{\partial}{\partial t} \nabla \boldsymbol{\theta} + \dot{\boldsymbol{\theta}} \nabla r \right] = r\dot{\boldsymbol{\theta}} \left[r \frac{\partial}{\partial t} \left(\frac{1}{r} \hat{\boldsymbol{\theta}} \right) + \dot{\boldsymbol{\theta}} \hat{\mathbf{r}} \right] \\ &= r\dot{\boldsymbol{\theta}} \left[r \left(-\frac{1}{r^2} \dot{\mathbf{r}} \hat{\boldsymbol{\theta}} + \frac{1}{r} \dot{\boldsymbol{\theta}} \right) + \dot{\boldsymbol{\theta}} \hat{\mathbf{r}} \right] \\ &= -\dot{\boldsymbol{\theta}} \hat{\boldsymbol{\theta}} + r\dot{\boldsymbol{\theta}} (-\dot{\boldsymbol{\theta}} \hat{\mathbf{r}}) + r\dot{\boldsymbol{\theta}}^2 \hat{\mathbf{r}} = -\dot{\boldsymbol{\theta}} \hat{\boldsymbol{\theta}} \end{aligned} \quad (84)$$

$$\dot{\mathbf{z}} \nabla \dot{\mathbf{z}} = \dot{\mathbf{z}} \frac{\partial}{\partial t} \nabla z = \dot{\mathbf{z}} \frac{\partial}{\partial t} \hat{\mathbf{z}} = \dot{\mathbf{z}} \hat{\mathbf{z}} = \mathbf{0}, \quad (85)$$

so, as expected,

$$\nabla(\frac{1}{2} \dot{\mathbf{r}}^2) = \mathbf{0}. \quad (86)$$

We have already computed $\ddot{\mathbf{r}}$, so combining all three pieces gives

$$\begin{aligned} \frac{D\mathbf{r}}{Dt} &= (\ddot{r} - r\dot{\boldsymbol{\theta}}^2 - 2r\dot{\boldsymbol{\theta}}\dot{\boldsymbol{\theta}}) \hat{\mathbf{r}} + (2\dot{r}\dot{\boldsymbol{\theta}} + 2\dot{\mathbf{r}}\dot{\boldsymbol{\theta}} + r\ddot{\boldsymbol{\theta}}) \hat{\boldsymbol{\theta}} + \ddot{\mathbf{z}} \hat{\mathbf{z}} \\ &= (\ddot{r} - 3r\dot{\boldsymbol{\theta}}^2) \hat{\mathbf{r}} + (4\dot{r}\dot{\boldsymbol{\theta}} + r\ddot{\boldsymbol{\theta}}) \hat{\boldsymbol{\theta}} + \ddot{\mathbf{z}} \hat{\mathbf{z}}. \end{aligned} \quad (87)$$

The DIVERGENCE is

$$\begin{aligned} \nabla \cdot \mathbf{A} &= A_{r,r}^r = A_{r,r}^r + (\Gamma_{rr}^r A^r + \Gamma_{\theta r}^r A^\theta + \Gamma_{zr}^r A^z) + A_{,\theta}^\theta \\ &\quad + (\Gamma_{r\theta}^\theta A^r + \Gamma_{\theta\theta}^\theta A^\theta + \Gamma_{z\theta}^\theta A^z) \\ &\quad + A_{,z}^z + (\Gamma_{rz}^z A^r + \Gamma_{\theta z}^z A^\theta + \Gamma_{zz}^z A^z) \\ &= A_{r,r}^r + A_{,\theta}^\theta + A_{,z}^z + (0 + 0 + 0) + \left(\frac{1}{r} + 0 + 0 \right) \\ &\quad + (0 + 0 + 0) \\ &= \frac{1}{r} \frac{\partial}{\partial r} A^r + \frac{1}{r} \frac{\partial}{\partial \theta} A^\theta + \frac{1}{r} \frac{\partial}{\partial z} A^z + \frac{1}{r} A^r \\ &= \left(\frac{\partial}{\partial r} + \frac{1}{r} \right) A^r + \frac{1}{r} \frac{\partial}{\partial \theta} A^\theta + \frac{\partial}{\partial z} A^z, \end{aligned} \quad (88)$$

or, in VECTOR notation

$$\nabla \cdot \mathbf{F} = \frac{1}{r} \frac{\partial}{\partial r} (r F_r) + \frac{1}{r} \frac{\partial F_\theta}{\partial \theta} + \frac{\partial F_z}{\partial z}. \quad (89)$$

The CROSS PRODUCT is

$$\begin{aligned} \nabla \times \mathbf{F} &= \left(\frac{1}{r} \frac{\partial F_z}{\partial \theta} - \frac{\partial F_\theta}{\partial z} \right) \hat{\mathbf{r}} + \left(\frac{\partial F_r}{\partial z} - \frac{\partial F_z}{\partial r} \right) \hat{\boldsymbol{\theta}} \\ &\quad + \frac{1}{r} \left[\frac{\partial}{\partial r} (r F_\theta) - \frac{\partial F_r}{\partial \theta} \right] \hat{\mathbf{z}}, \end{aligned} \quad (90)$$

and the LAPLACIAN is

$$\begin{aligned} \nabla^2 f &\equiv \frac{1}{r} \frac{\partial}{\partial r} \left(r \frac{\partial f}{\partial r} \right) + \frac{1}{r^2} \frac{\partial^2 f}{\partial \theta^2} + \frac{\partial^2 f}{\partial z^2} \\ &= \frac{\partial^2 f}{\partial r^2} + \frac{1}{r} \frac{\partial f}{\partial r} + \frac{1}{r^2} \frac{\partial^2 f}{\partial \theta^2} + \frac{\partial^2 f}{\partial z^2}. \end{aligned} \quad (91)$$

The vector LAPLACIAN is

$$\nabla^2 \mathbf{v} = \left[\begin{aligned} &\frac{\partial^2 v_r}{\partial r^2} + \frac{1}{r^2} \frac{\partial^2 v_r}{\partial \phi^2} + \frac{\partial^2 v_r}{\partial z^2} + \frac{1}{r} \frac{\partial v_r}{\partial r} - \frac{2}{r^2} \frac{\partial v_\phi}{\partial \theta} - \frac{v_r}{r^2} \\ &\frac{\partial^2}{\partial r^2} + \frac{1}{r^2} \frac{\partial^2 v_\phi}{\partial \phi^2} + \frac{\partial^2 v_\phi}{\partial z^2} + \frac{1}{r} \frac{\partial v_\phi}{\partial r} + \frac{2}{r^2} \frac{\partial v_r}{\partial \theta} - \frac{v_\phi}{r^2} \\ &\frac{\partial^2 v_z}{\partial r^2} + \frac{1}{r^2} \frac{\partial^2 v_z}{\partial \phi^2} + \frac{\partial^2 v_z}{\partial z^2} + \frac{1}{r} \frac{\partial v_z}{\partial r} \end{aligned} \right]. \quad (92)$$

The HELMHOLTZ DIFFERENTIAL EQUATION is separable in cylindrical coordinates and has STÄCKEL DETERMINANT $S = 1$ (for r, θ, z) or $S = 1/(1 - \xi_2^2)$ (for Morse and Feshbach's ξ_1, ξ_2, ξ_3).

see also ELLIPTIC CYLINDRICAL COORDINATES, HELMHOLTZ DIFFERENTIAL EQUATION—CIRCULAR CYLINDRICAL COORDINATES, POLAR COORDINATES, SPHERICAL COORDINATES

References

- Arfken, G. "Circular Cylindrical Coordinates." §2.4 in *Mathematical Methods for Physicists*, 3rd ed. Orlando, FL: Academic Press, pp. 95–101, 1985.
- Beyer, W. H. *CRC Standard Mathematical Tables*, 28th ed. Boca Raton, FL: CRC Press, p. 212, 1987.
- Morse, P. M. and Feshbach, H. *Methods of Theoretical Physics, Part I*. New York: McGraw-Hill, p. 657, 1953.

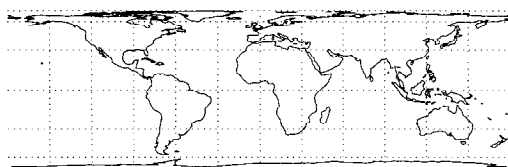
Cylindrical Equal-Area Projection

The MAP PROJECTION having transformation equations,

$$x = (\lambda - \lambda_0) \cos \phi_s \quad (1)$$

$$y = \frac{\sin \phi}{\cos \phi_s} \quad (2)$$

for the normal aspect, and inverse transformation equations

$$\phi = \sin^{-1}(y \cos \phi_s) \quad (3)$$

$$\lambda = \frac{x}{\cos \phi_s} + \lambda_0. \quad (4)$$

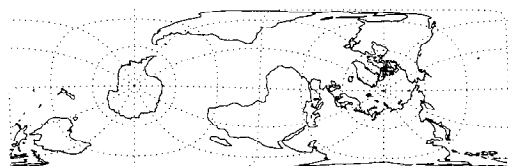

An oblique form of the cylindrical equal-area projection is given by the equations

$$\lambda_p = \tan^{-1} \left(\frac{\cos \phi_1 \sin \phi_2 \cos \lambda_1 - \sin \phi_1 \cos \phi_2 \cos \lambda_2}{\sin \phi_1 \cos \phi_2 \sin \lambda_2 - \cos \phi_1 \sin \phi_2 \sin \lambda_1} \right) \quad (5)$$

$$\phi_p = \tan^{-1} \left[-\frac{\cos(\lambda_p - \lambda_1)}{\tan \phi_1} \right], \quad (6)$$

and the inverse FORMULAS are

$$\phi = \sin^{-1}(y \sin \phi_p + \sqrt{1 - y^2} \cos \phi_p \sin x) \quad (7)$$

$$\lambda = \lambda_0 + \tan^{-1} \left(\frac{\sqrt{1 - y^2} \sin \phi_p \sin x - y \cos \phi_p}{\sqrt{1 - y^2} \cos x} \right). \quad (8)$$

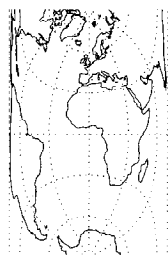

A transverse form of the cylindrical equal-area projection is given by the equations

$$x = \cos \phi \sin(\lambda - \lambda_0) \quad (9)$$

$$y = \tan^{-1} \left[\frac{\tan \phi}{\cos(\lambda - \lambda_0)} \right] - \phi_0, \quad (10)$$

and the inverse FORMULAS are

$$\phi = \sin^{-1}[\sqrt{1 - x^2} \sin(y + \phi_0)] \quad (11)$$

$$\lambda = \lambda_0 + \tan^{-1} \left[\frac{x}{\sqrt{1 - x^2}} \cos(y + \phi_0) \right]. \quad (12)$$

References

Snyder, J. P. *Map Projections—A Working Manual*. U. S. Geological Survey Professional Paper 1395. Washington, DC: U. S. Government Printing Office, pp. 76–85, 1987.

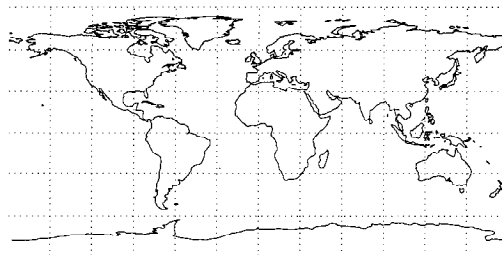
Cylindrical Equidistant Projection

The MAP PROJECTION having transformation equations

$$x = (\lambda - \lambda_0) \cos \phi_1 \quad (1)$$

$$y = \phi, \quad (2)$$

and the inverse FORMULAS are

$$\phi = y \quad (3)$$

$$\lambda = \lambda_0 + \frac{x}{\cos \phi_1}. \quad (4)$$

References

Snyder, J. P. *Map Projections—A Working Manual*. U. S. Geological Survey Professional Paper 1395. Washington, DC: U. S. Government Printing Office, pp. 90–91, 1987.

Cylindrical Function

$$R_m(x, y) \equiv \frac{J'_m(x)Y'_m(y) - J'_m(y)Y'_m(x)}{J_m(x)Y'_m(y) - J'_m(y)Y_m(x)}$$

$$S_m(x, y) \equiv \frac{J'_m(x)Y_m(y) - J_m(y)Y'_m(x)}{J_m(x)Y_m(y) - J_m(y)Y_m(x)}.$$

see also CYLINDER FUNCTION, HEMISPHERICAL FUNCTION

Cylindrical Harmonics

see BESSEL FUNCTION OF THE FIRST KIND

Cylindrical Hoof

see CYLINDRICAL WEDGE

Cylindrical Projection

see BEHRMANN CYLINDRICAL EQUAL-AREA PROJECTION, CYLINDRICAL EQUAL-AREA PROJECTION, CYLINDRICAL EQUIDISTANT PROJECTION, GALL'S STEREOGRAPHIC PROJECTION, MERCATOR PROJECTION, MILLER CYLINDRICAL PROJECTION, PETERS PROJECTION, PSEUDOCYLINDRICAL PROJECTION

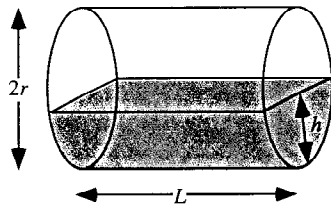
Cylindrical Segment

The solid portion of a CYLINDER below a cutting PLANE which is oriented PARALLEL to the CYLINDER's axis of symmetry. For a CYLINDER of RADIUS r and length L , the VOLUME of the cylindrical segment is given by multiplying the AREA of a circular SEGMENT of height h by L ,

$$V = Lr^2 \cos^{-1} \left(\frac{r-h}{r} \right) - (r-h)L\sqrt{2rh-h^2}.$$

see also CYLINDRICAL WEDGE, SECTOR, SEGMENT, SPHERICAL SEGMENT

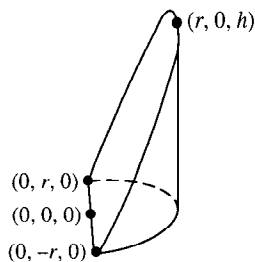
Cylindrical Wedge

The solid cut from a CYLINDER by a tilted PLANE passing through a DIAMETER of the base. It is also called a CYLINDRICAL HOOF. Let the height of the wedge be h and the radius of the CYLINDER from which it is cut r . Then plugging the points $(0, -r, 0)$, $(0, r, 0)$, and $(r, 0, h)$ into the 3-point equation for a PLANE gives the equation for the plane as

$$hx - rz = 0. \quad (1)$$

Combining with the equation of the CIRCLE which describes the curved part remaining of the cylinder (and

writing $t = x$) then gives the parametric equations of the "tongue" of the wedge as

$$x = t \quad (2)$$

$$y = \pm \sqrt{r^2 - t^2} \quad (3)$$

$$z = \frac{ht}{r} \quad (4)$$

for $t \in [0, r]$. To examine the form of the tongue, it needs to be rotated into a convenient plane. This can be accomplished by first rotating the plane of the curve by 90° about the x -AXIS using the ROTATION MATRIX $R_x(90^\circ)$ and then by the ANGLE

$$\theta = \tan^{-1} \left(\frac{h}{r} \right) \quad (5)$$

above the z -AXIS. The transformed plane now rests in the xz -plane and has parametric equations

$$x = \frac{t\sqrt{h^2 + r^2}}{r} \quad (6)$$

$$z = \pm \sqrt{r^2 - t^2} \quad (7)$$

and is shown below.

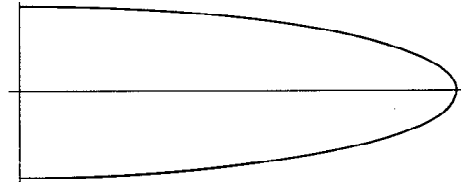

The length of the tongue (measured down its middle) is obtained by plugging $t = r$ into the above equation for x , which becomes

$$L = \sqrt{h^2 + r^2} \quad (8)$$

(and which follows immediately from the PYTHAGOREAN THEOREM). The VOLUME of the wedge is given by

$$V = \frac{2}{3}r^2h. \quad (9)$$

see also CONICAL WEDGE, CYLINDRICAL SEGMENT

Cylindroid

see PLÜCKER'S CONOID

D

d'Alembert's Equation

The ORDINARY DIFFERENTIAL EQUATION

$$y = xf(y') + g(y'),$$

where $y' \equiv dy/dx$ and f and g are given functions.

d'Alembert Ratio Test

see RATIO TEST

d'Alembert's Solution

A method of solving the 1-D WAVE EQUATION.

see also WAVE EQUATION

d'Alembert's Theorem

If three CIRCLES A , B , and C are taken in pairs, the external similarity points of the three pairs lie on a straight line. Similarly, the external similarity point of one pair and the two internal similarity points of the other two pairs lie upon a straight line, forming a similarity axis of the three CIRCLES.

References

Dörrie, H. *100 Great Problems of Elementary Mathematics: Their History and Solutions*. New York: Dover, p. 155, 1965.

d'Alembertian Operator

Written in the NOTATION of PARTIAL DERIVATIVES,

$$\square^2 \equiv \nabla^2 - \frac{1}{c^2} \frac{\partial^2}{\partial t^2},$$

where c is the speed of light. Writing in TENSOR notation

$$\square^2 \phi \equiv (g^{\lambda\kappa} \phi_{;\lambda})_{;\kappa} = g^{\lambda\kappa} \frac{\partial^2 \phi}{\partial x^\lambda \partial x^\kappa} - \Gamma^\lambda \frac{\partial \phi}{\partial x^\lambda}.$$

see also HARMONIC COORDINATES

d-Analog

The d -analog of INFINITY FACTORIAL is given by

$$[\infty!]_d = \prod_{n=3}^{\infty} \left(1 - \frac{2^d}{n^d}\right).$$

This INFINITE PRODUCT can be evaluated in closed form for small POSITIVE integral $d \geq 2$.

see also q -ANALOG

References

Finch, S. "Favorite Mathematical Constants." <http://www.mathsoft.com/asolve/constant/infprd/infprd.html>.

D-Number

A NATURAL NUMBER $n > 3$ such that

$$n|(a^{n-2} - a)$$

whenever $(a, n) = 1$ (a and n are RELATIVELY PRIME) and $a \leq n$. There are an infinite number of such numbers, the first few being 9, 15, 21, 33, 39, 51, ... (Sloane's A033553).

see also KNÖDEL NUMBERS

References

Makowski, A. "Generalization of Morrow's D -Numbers." *Simon Stevin* **36**, 71, 1962/1963.

Sloane, N. J. A. Sequence A033553 in "An On-Line Version of the Encyclopedia of Integer Sequences."

D-Statistic

see KOLMOGOROV-SMIRNOV TEST

D-Triangle

Let the circles c_2 and c'_3 used in the construction of the BROCARD POINTS which are tangent to A_2A_3 at A_2 and A_3 , respectively, meet again at D_1 . The points $D_1D_2D_3$ then define the D-triangle. The VERTICES of the D-triangle lie on the respective APOLLONIUS CIRCLES.

see also APOLLONIUS CIRCLES, BROCARD POINTS

References

Johnson, R. A. *Modern Geometry: An Elementary Treatise on the Geometry of the Triangle and the Circle*. Boston, MA: Houghton Mifflin, pp. 284-285, 296 and 307, 1929.

Daisy

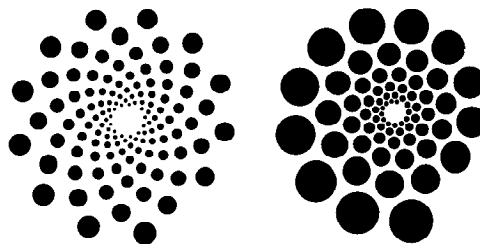

A figure resembling a daisy or sunflower in which copies of a geometric figure of increasing size are placed at regular intervals along a spiral. The resulting figure appears to have multiple spirals spreading out from the center.

see also PHYLLOTAXIS, SPIRAL, SWIRL, WHIRL

References

Dixon, R. "On Drawing a Daisy." §5.1 in *Mathographics*. New York: Dover, pp. 122-143, 1991.

Damped Exponential Cosine Integral

$$\int_0^{\infty} e^{-\omega T} \cos(\omega t) d\omega. \quad (1)$$

Integrate by parts with

$$u \equiv e^{-\omega T} \quad dv = \cos(\omega t) d\omega \quad (2)$$

$$du = -Te^{-\omega T} d\omega \quad v = \frac{1}{t} \sin(\omega t), \quad (3)$$

so

$$\begin{aligned} \int e^{-\omega T} \cos(\omega t) d\omega \\ = \frac{1}{t} e^{-\omega t} \sin(\omega t) + \frac{T}{t} \int e^{-\omega T} \sin(\omega t) d\omega. \end{aligned} \quad (4)$$

Now integrate

$$\int e^{-\omega T} \sin(\omega t) d\omega \quad (5)$$

by parts. Let

$$v = e^{-\omega T} \quad dv = \sin(\omega t) d\omega \quad (6)$$

$$du = -Te^{-\omega T} d\omega \quad v = -\frac{1}{t} \cos(\omega t), \quad (7)$$

so

$$\int e^{-\omega t} \sin(\omega t) d\omega = -\frac{1}{t} \cos(\omega t) - \frac{T}{t} \int e^{-\omega T} \cos(\omega t) d\omega \quad (8)$$

and

$$\begin{aligned} \int e^{\omega T} \cos(\omega t) d\omega &= \frac{1}{t} e^{-\omega t} \sin(\omega t) \\ &- \frac{T}{t^2} e^{-\omega t} \cos(\omega t) - \frac{T^2}{t^2} \int e^{-\omega T} \cos(\omega t) d\omega \end{aligned} \quad (9)$$

$$\begin{aligned} \left(1 + \frac{T^2}{t^2}\right) \int e^{-\omega T} \cos(\omega t) d\omega \\ = e^{-\omega T} \left[\frac{1}{t} \sin(\omega t) - \frac{T}{t^2} \cos(\omega t) \right] \end{aligned} \quad (10)$$

$$\begin{aligned} \frac{t^2 + T^2}{t^2} \int e^{-\omega T} \cos(\omega t) d\omega \\ = \frac{e^{-\omega t}}{t^2} [t \sin(\omega T) - T \cos(\omega t)] \end{aligned} \quad (11)$$

$$\int e^{-\omega T} \cos(\omega t) d\omega = \frac{e^{-\omega T}}{t^2 + T^2} [t \sin(\omega t) - T \cos(\omega T)]. \quad (12)$$

Therefore,

$$\int_0^{\infty} e^{-\omega T} \cos(\omega t) d\omega = 0 + \frac{T}{t^2 + T^2} = \frac{T}{t^2 + T^2}. \quad (13)$$

see also COSINE INTEGRAL, FOURIER TRANSFORM—LORENTZIAN FUNCTION, LORENTZIAN FUNCTION

Dandelin Spheres

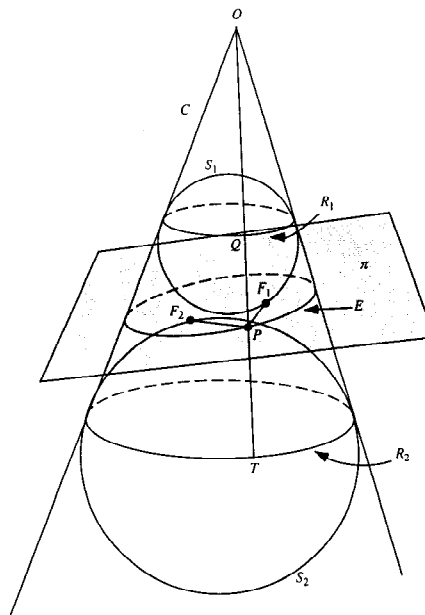

The inner and outer SPHERES TANGENT internally to a CONE and also to a PLANE intersecting the CONE are called Dandelin spheres.

The SPHERES can be used to show that the intersection of the PLANE with the CONE is an ELLIPSE. Let π be a PLANE intersecting a right circular CONE with vertex O in the curve E . Call the SPHERES TANGENT to the CONE and the PLANE S_1 and S_2 , and the CIRCLES on which the CIRCLES are TANGENT to the CONE R_1 and R_2 . Pick a line along the CONE which intersects R_1 at Q , E at P , and R_2 at T . Call the points on the PLANE where the CIRCLES are TANGENT F_1 and F_2 . Because intersecting tangents have the same length,

$$F_1P = QP$$

$$F_2P = TP.$$

Therefore,

$$PF_1 + PF_2 = QP + PT = QT,$$

which is a constant independent of P , so E is an ELLIPSE with $a = QT/2$.

see also CONE, SPHERE

References

- Honsberger, R. "Kepler's Conics." Ch. 9 in *Mathematical Plums* (Ed. R. Honsberger). Washington, DC: Math. Assoc. Amer., p. 170, 1979.
- Honsberger, R. *More Mathematical Morsels*. Washington, DC: Math. Assoc. Amer., pp. 40–44, 1991.
- Ogilvy, C. S. *Excursions in Geometry*. New York: Dover, pp. 80–81, 1990.
- Ogilvy, C. S. *Excursions in Mathematics*. New York: Dover, pp. 68–69, 1994.

Danielson-Lanczos Lemma

The DISCRETE FOURIER TRANSFORM of length N (where N is EVEN) can be rewritten as the sum of two DISCRETE FOURIER TRANSFORMS, each of length $N/2$. One is formed from the EVEN numbered points; the other from the ODD numbered points. Denote the k th point of the DISCRETE FOURIER TRANSFORM by F_n . Then

$$\begin{aligned} F_n &= \sum_{k=0}^{N-1} f_k e^{-2\pi i k n / N} \\ &= \sum_{k=0}^{N/2-1} e^{-2\pi i k n / (N/2)} f_{2k} + W^n \sum_{k=0}^{N/2-1} e^{-2\pi i k n / (N/2)} f_{2k+1} \\ &= F_n^e + W^n F_n^o, \end{aligned}$$

where $W \equiv e^{-2\pi i / N}$ and $n = 0, \dots, N$. This procedure can be applied recursively to break up the $N/2$ even and ODD points to their $N/4$ EVEN and ODD points. If N is a POWER of 2, this procedure breaks up the original transform into $\lg N$ transforms of length 1. Each transform of an individual point has $F_n^{eeo\dots} = f_k$ for some k . By reversing the patterns of evens and odds, then letting $e = 0$ and $o = 1$, the value of k in BINARY is produced. This is the basis for the FAST FOURIER TRANSFORM.

see also DISCRETE FOURIER TRANSFORM, FAST FOURIER TRANSFORM, FOURIER TRANSFORM

References

Press, W. H.; Flannery, B. P.; Teukolsky, S. A.; and Vetterling, W. T. *Numerical Recipes in C: The Art of Scientific Computing*. Cambridge, England: Cambridge University Press, pp. 407–411, 1989.

Darboux Integral

A variant of the RIEMANN INTEGRAL defined when the UPPER and LOWER INTEGRALS, taken as limits of the LOWER SUM

$$L(f; \phi; N) = \sum_{r=1}^n m(f; \delta_r) - \phi(x_{r-1})$$

and UPPER SUM

$$U(f; \phi; N) = \sum_{r=1}^n M(f; \delta_r) - \phi(x_{r-1}),$$

are equal. Here, $f(x)$ is a REAL FUNCTION, $\phi(x)$ is a monotonic increasing function with respect to which the sum is taken, $m(f; S)$ denotes the lower bound of $f(x)$ over the interval S , and $M(f; S)$ denotes the upper bound.

see also LOWER INTEGRAL, LOWER SUM, RIEMANN INTEGRAL, UPPER INTEGRAL, UPPER SUM

References

Kestelman, H. *Modern Theories of Integration*, 2nd rev. ed. New York: Dover, p. 250, 1960.

Darboux-Stieltjes Integral

see DARBOUX INTEGRAL

Darboux Vector

The rotation VECTOR of the TRIHEDRON of a curve with CURVATURE $\kappa \neq 0$ when a point moves along a curve with unit SPEED. It is given by

$$\mathbf{D} = \tau \mathbf{T} + \kappa \mathbf{B}, \quad (1)$$

where τ is the TORSION, \mathbf{T} the TANGENT VECTOR, and \mathbf{B} the BINORMAL VECTOR. The Darboux vector field satisfies

$$\dot{\mathbf{T}} = \mathbf{D} \times \mathbf{T} \quad (2)$$

$$\dot{\mathbf{N}} = \mathbf{D} \times \mathbf{N} \quad (3)$$

$$\dot{\mathbf{B}} = \mathbf{D} \times \mathbf{B}. \quad (4)$$

see also BINORMAL VECTOR, CURVATURE, TANGENT VECTOR, TORSION (DIFFERENTIAL GEOMETRY)

References

Gray, A. *Modern Differential Geometry of Curves and Surfaces*. Boca Raton, FL: CRC Press, p. 151, 1993.

Darling's Products

A generalization of the HYPERGEOMETRIC FUNCTION identity

$$\begin{aligned} {}_2F_1(\alpha, \beta; \gamma; z) {}_2F_1(1-\alpha, 1-\beta; 2-\gamma; z) \\ = {}_2F_1(\alpha+1-\gamma, \beta+1-\gamma; 2-\gamma; z) {}_2F_1(\gamma-\alpha, \gamma-\beta; \gamma; z) \end{aligned} \quad (1)$$

to the GENERALIZED HYPERGEOMETRIC FUNCTION ${}_3F_2(a, b, c; d, e; x)$. Darling's products are

$$\begin{aligned} {}_3F_2 \left[\begin{matrix} \alpha, \beta, \gamma; z \\ \delta, \epsilon \end{matrix} \right] {}_3F_2 \left[\begin{matrix} 1-\alpha, 1-\beta, 1-\gamma; z \\ 2-\delta, 2-\epsilon \end{matrix} \right] \\ = \frac{\epsilon-1}{\epsilon-\delta} {}_3F_2 \left[\begin{matrix} \alpha+1-\delta, \beta+1-\delta, \gamma+1-\delta; z \\ 2-\delta, \epsilon+1-\delta \end{matrix} \right] \\ \quad \times {}_3F_2 \left[\begin{matrix} \delta-\alpha, \delta-\beta, \delta-\gamma; z \\ \delta, \delta+1-\epsilon \end{matrix} \right] \\ + \frac{\delta-1}{\delta-\epsilon} {}_3F_2 \left[\begin{matrix} \alpha+1-\epsilon, \beta+1-\epsilon, \gamma+1-\epsilon; z \\ 2-\epsilon, \delta+1-\epsilon \end{matrix} \right] \\ \quad \times {}_3F_2 \left[\begin{matrix} \epsilon-\alpha, \epsilon-\beta, \epsilon-\gamma; z \\ \epsilon, \epsilon+1-\delta \end{matrix} \right] \end{aligned} \quad (2)$$

and

$$\begin{aligned} (1-z)^{\alpha+\beta+\gamma-\delta-\epsilon} {}_3F_2 \left[\begin{matrix} \alpha, \beta, \gamma; z \\ \delta, \epsilon \end{matrix} \right] \\ = \frac{\epsilon-1}{\epsilon-\delta} {}_3F_2 \left[\begin{matrix} \delta-\alpha, \delta-\beta, \delta-\gamma; z \\ \delta, \delta+1-\epsilon \end{matrix} \right] \\ \quad \times {}_3F_2 \left[\begin{matrix} \epsilon-\alpha, \epsilon-\beta, \epsilon-\gamma; z \\ \epsilon-1, \epsilon+1-\delta \end{matrix} \right] \\ + \frac{\delta-1}{\delta-\epsilon} {}_3F_2 \left[\begin{matrix} \epsilon-\alpha, \epsilon-\beta, \epsilon-\gamma; z \\ \epsilon, \epsilon+1-\delta \end{matrix} \right] \\ \quad \times {}_3F_2 \left[\begin{matrix} \delta-\alpha, \delta-\beta, \delta-\gamma; z \\ \delta-1, \delta+1-\epsilon \end{matrix} \right], \end{aligned} \quad (3)$$

which reduce to (1) when $\gamma = \epsilon \rightarrow \infty$.

References

Bailey, W. N. "Darling's Theorems of Products." §10.3 in *Generalised Hypergeometric Series*. Cambridge, England: Cambridge University Press, pp. 88–92, 1935.

Dart

see PENROSE TILES

Darwin-de Sitter Spheroid

A SURFACE OF REVOLUTION of the form

$$r(\phi) = a[1 - e \sin^2 \phi - (\frac{3}{8}e^2 + k) \sin^2(2\phi)],$$

where k is a second-order correction to the figure of a rotating fluid.

see also OBLATE SPHEROID, PROLATE SPHEROID, SPHEROID

References

Zharkov, V. N. and Trubitsyn, V. P. *Physics of Planetary Interiors*. Tucson, AZ: Pachart Publ. House, 1978.

Darwin's Expansions

Series expansions of the PARABOLIC CYLINDER FUNCTION $U(a, x)$ and $W(a, x)$. The formulas can be found in Abramowitz and Stegun (1972).

References

Abramowitz, M. and Stegun, C. A. (Eds.). *Handbook of Mathematical Functions with Formulas, Graphs, and Mathematical Tables*, 9th printing. New York: Dover, pp. 689–690 and 694–695, 1972.

Data Structure

A formal structure for the organization of information. Examples of data structures include the LIST, QUEUE, STACK, and TREE.

Database

A database can be roughly defined as a structure consisting of

1. A collection of information (the data),
2. A collection of queries that can be submitted, and
3. A collection of algorithms by which the structure responds to queries, searches the data, and returns the results.

References

Petkovšek, M.; Wilf, H. S.; and Zeilberger, D. $A=B$. Wellesley, MA: A. K. Peters, p. 48, 1996.

Daubechies Wavelet Filter

A WAVELET used for filtering signals. Daubechies (1988, p. 980) has tabulated the numerical values up to order $p = 10$.

References

Daubechies, I. "Orthonormal Bases of Compactly Supported Wavelets." *Comm. Pure Appl. Math.* **41**, 909–996, 1988.
Press, W. H.; Flannery, B. P.; Teukolsky, S. A.; and Vetterling, W. T. "Interpolation and Extrapolation." Ch. 3 in *Numerical Recipes in FORTRAN: The Art of Scientific Computing*, 2nd ed. Cambridge, England: Cambridge University Press, pp. 584–586, 1992.

Davenport-Schinzel Sequence

Form a sequence from an ALPHABET of letters $[1, n]$ such that there are no consecutive letters and no alternating subsequences of length greater than d . Then the sequence is a Davenport-Schinzel sequence if it has maximal length $N_d(n)$. The value of $N_1(n)$ is the trivial sequence of 1s: 1, 1, 1, ... (Sloane's A000012). The values of $N_2(n)$ are the POSITIVE INTEGERS 1, 2, 3, 4, ... (Sloane's A000027). The values of $N_3(n)$ are the ODD INTEGERS 1, 3, 5, 7, ... (Sloane's A005408). The first nontrivial Davenport-Schinzel sequence $N_4(n)$ is given by 1, 4, 8, 12, 17, 22, 27, 32, ... (Sloane's A002004). Additional sequences are given by Guy (1994, p. 221) and Sloane.

References

Davenport, H. and Schinzel, A. "A Combinatorial Problem Connected with Differential Equations." *Amer. J. Math.* **87**, 684–690, 1965.
Guy, R. K. "Davenport-Schinzel Sequences." §E20 in *Unsolved Problems in Number Theory*, 2nd ed. New York: Springer-Verlag, pp. 220–222, 1994.
Roselle, D. P. and Stanton, R. G. "Results of Davenport-Schinzel Sequences." In *Proc. Louisiana Conference on Combinatorics, Graph Theory, and Computing*. Louisiana State University, Baton Rouge, March 1–5, 1970 (Ed. R. C. Mullin, K. B. Reid, and D. P. Roselle). Winnipeg, Manitoba: Utilitas Mathematica, pp. 249–267, 1960.
Sharir, M. and Agarwal, P. *Davenport-Schinzel Sequences and Their Geometric Applications*. New York: Cambridge University Press, 1995.
Sloane, N. J. A. Sequences A000012/M0003, A000027/M0472, A002004/M3328, and A005408/M2400 in "An On-Line Version of the Encyclopedia of Integer Sequences."

Dawson's Integral

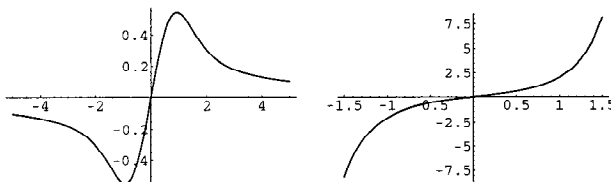

An INTEGRAL which arises in computation of the Voigt lineshape:

$$D(x) \equiv e^{-x^2} \int_0^x e^{y^2} dy. \quad (1)$$

It is sometimes generalized such that

$$D_{\pm}(x) \equiv e^{\mp x^2} \int_0^x e^{\pm y^2} dy, \quad (2)$$

giving

$$D_+(x) = \frac{1}{2} \sqrt{\pi} e^{-x^2} \operatorname{erfi}(x) \quad (3)$$

$$D_-(x) = \frac{1}{2} \sqrt{\pi} e^{x^2} \operatorname{erf}(x), \quad (4)$$

where $\operatorname{erf}(z)$ is the ERF function and $\operatorname{erfi}(z)$ is the imaginary error function ERFI. $D_+(x)$ is illustrated in the left figure above, and $D_-(x)$ in the right figure. D_+ has a maximum at $D'_+(x) = 0$, or

$$1 - \sqrt{\pi} e^{-x^2} x^2 \operatorname{erfi}(x) = 0, \quad (5)$$

giving

$$D_+(0.9241388730) = 0.5410442246, \quad (6)$$

and an inflection at $D''_+(x) = 0$, or

$$-2x + \sqrt{\pi} e^{-x^2} (2x^2 - 1) \operatorname{erfi}(x) = 0, \quad (7)$$

giving

$$D_+(1.5019752683) = 0.4276866160. \quad (8)$$

References

- Abramowitz, M. and Stegun, C. A. (Eds.). *Handbook of Mathematical Functions with Formulas, Graphs, and Mathematical Tables*, 9th printing. New York: Dover, p. 298, 1972.
- Press, W. H.; Flannery, B. P.; Teukolsky, S. A.; and Vetterling, W. T. "Dawson's Integrals." §6.10 in *Numerical Recipes in FORTRAN: The Art of Scientific Computing*, 2nd ed. Cambridge, England: Cambridge University Press, pp. 252–254, 1992.
- Spanier, J. and Oldham, K. B. "Dawson's Integral." Ch. 42 in *An Atlas of Functions*. Washington, DC: Hemisphere, pp. 405–410, 1987.

Day of Week

see FRIDAY THE THIRTEENTH, WEEKDAY

de Bruijn Constant

Also called the COPSON-DE BRUIJN CONSTANT. It is defined by

$$\sum_{n=1}^{\infty} a_n \leq c \sum_{n=1}^{\infty} \sqrt{\frac{a_n^2 + a_{n+1}^2 + a_{n+2}^2 + \dots}{n}}.$$

where

$$c = 1.0164957714 \dots$$

References

- Copson, E. T. "Note on Series of Positive Terms." *J. London Math. Soc.* **2**, 9–12, 1927.
- Copson, E. T. "Note on Series of Positive Terms." *J. London Math. Soc.* **3**, 49–51, 1928.
- de Bruijn, N. G. *Asymptotic Methods in Analysis*. New York: Dover, 1981.
- Finch, S. "Favorite Mathematical Constants." <http://www.mathsoft.com/asolve/constant/copson/copson.html>.

de Bruijn Diagram

see DE BRUIJN GRAPH

de Bruijn Graph

A graph whose nodes are sequences of symbols from some ALPHABET and whose edges indicate the sequences which might overlap.

References

- Golomb, S. W. *Shift Register Sequences*. San Francisco, CA: Holden-Day, 1967.
- Ralston, A. "de Bruijn Sequences—A Model Example of the Interaction of Discrete Mathematics and Computer Science." *Math. Mag.* **55**, 131–143, 1982.

de Bruijn-Newman Constant

N.B. A detailed on-line essay by S. Finch was the starting point for this entry.

Let Ξ be the XI FUNCTION defined by

$$\Xi(iz) = \frac{1}{2} (z^2 - \frac{1}{4}) \pi^{-z/2 - \frac{1}{4}} \Gamma(\frac{1}{2}z + \frac{1}{4}) \zeta(z + \frac{1}{2}). \quad (1)$$

$\Xi(z/2)/8$ can be viewed as the FOURIER TRANSFORM of the signal

$$\Phi(t) = \sum_{n=1}^{\infty} (2\pi^2 n^4 e^{9t} - 3\pi n^2 e^{5t}) e^{-\pi n^2 e^{4t}} \quad (2)$$

for $t \in \mathbb{R} \geq 0$. Then denote the FOURIER TRANSFORM of $\Phi(t)e^{\lambda t^2}$ as $H(\lambda, z)$,

$$\mathcal{F}[\Phi(t)e^{\lambda t^2}] = H(\lambda, z). \quad (3)$$

de Bruijn (1950) proved that H has only REAL zeros for $\lambda \geq 1/2$. C. M. Newman (1976) proved that there exists a constant Λ such that H has only REAL zeros IFF $\lambda \geq \Lambda$. The best current lower bound (Csordas *et al.* 1993, 1994) is $\Lambda > -5.895 \times 10^{-9}$. The RIEMANN HYPOTHESIS is equivalent to the conjecture that $\Lambda \leq 0$.

References

- Csordas, G.; Odlyzko, A.; Smith, W.; and Varga, R. S. "A New Lehmer Pair of Zeros and a New Lower Bound for the de Bruijn-Newman Constant." *Elec. Trans. Numer. Analysis* **1**, 104–111, 1993.
- Csordas, G.; Smith, W.; and Varga, R. S. "Lehmer Pairs of Zeros, the de Bruijn-Newman Constant and the Riemann Hypothesis." *Constr. Approx.* **10**, 107–129, 1994.
- de Bruijn, N. G. "The Roots of Trigonometric Integrals." *Duke Math. J.* **17**, 197–226, 1950.
- Finch, S. "Favorite Mathematical Constants." <http://www.mathsoft.com/asolve/constant/dbnwm/dbnwm.html>.
- Newman, C. M. "Fourier Transforms with only Real Zeros." *Proc. Amer. Math. Soc.* **61**, 245–251, 1976.

de Bruijn Sequence

The shortest sequence such that every string of length n on the ALPHABET a occurs as a contiguous subrange of the sequence described by a . Every de Bruijn sequence corresponds to an EULERIAN CYCLE on a "DE BRUIJN GRAPH." Surprisingly, it turns out that the lexicographic sequence of LYNDON WORDS of lengths DIVISIBLE by n gives the lexicographically smallest de Bruijn sequence (Ruskey).

References

Ruskey, F. "Information on Necklaces, Lyndon Words, de Bruijn Sequences." <http://sue.csc.uvic.ca/~cos/inf/neck/NecklaceInfo.html>.

de Bruijn's Theorem

A box can be packed with a HARMONIC BRICK $a \times ab \times abc$ IFF the box has dimensions $ap \times abq \times abcr$ for some natural numbers p, q, r (i.e., the box is a multiple of the brick).

see also BOX-PACKING THEOREM, CONWAY PUZZLE, DE BRUIJN'S THEOREM, KLARNER'S THEOREM

References

Honsberger, R. *Mathematical Gems II*. Washington, DC: Math. Assoc. Amer., pp. 69–72, 1976.

de Jonquières Theorem

The total number of groups of a g_N^* consisting in a point of multiplicity k_1 , one of multiplicity k_2, \dots , one of multiplicity k_p , where

$$\sum k_i = N \quad (1)$$

$$\sum (k_i - 1) = r, \quad (2)$$

and where α_1 points have one multiplicity, α_2 another, etc., and

$$\Pi = k_1 k_2 \cdots k_p \quad (3)$$

is

$$\frac{\Pi p(p-1) \cdots (p-\rho)}{\alpha_1! \alpha_2! \cdots} \left[\frac{\Pi}{p-\rho} - \frac{\sum_i \frac{\partial \Pi}{\partial k_i}}{p-\rho+1} + \frac{\sum_{ij} \frac{\partial^2 \Pi}{\partial k_i \partial k_j}}{p-\rho+2} + \cdots \right]. \quad (4)$$

References

Coolidge, J. L. *A Treatise on Algebraic Plane Curves*. New York: Dover, p. 288, 1959.

de Jonquières Transformation

A transformation which is of the same type as its inverse. A de Jonquières transformation is always factorable.

References

Coolidge, J. L. *A Treatise on Algebraic Plane Curves*. New York: Dover, pp. 203–204, 1959.

de la Loubere's Method

A method for constructing MAGIC SQUARES of ODD order, also called the SIAMESE METHOD.

see also MAGIC SQUARE

de Longchamps Point

The reflection of the ORTHOCENTER about the CIRCUMCENTER. This point is also the ORTHOCENTER of the ANTICOMPLEMENTARY TRIANGLE. It has TRIANGLE CENTER FUNCTION

$$\alpha = \cos A - \cos B \cos C.$$

It lies on the EULER LINE.

References

Altshiller-Court, N. "On the de Longchamps Circle of the Triangle." *Amer. Math. Monthly* **33**, 368–375, 1926.

Kimberling, C. "Central Points and Central Lines in the Plane of a Triangle." *Math. Mag.* **67**, 163–187, 1994.

Vandeghen, A. "Soddy's Circles and the de Longchamps Point of a Triangle." *Amer. Math. Monthly* **71**, 176–179, 1964.

de Mere's Problem

The probability of getting at least one "6" in four rolls of a single 6-sided DIE is

$$1 - \left(\frac{5}{6}\right)^4 = 0.518 \dots, \quad (1)$$

which is slightly higher than the probability of at least one double 6 in 24 throws,

$$1 - \left(\frac{35}{36}\right)^{24} = 0.491 \dots \quad (2)$$

de Mere suspected that (1) was higher than (2). He posed the question to Pascal, who solved the problem and proved de Mere correct.

see also DICE

References

Kraitchik, M. "A Dice Problem." §6.2 in *Mathematical Recreations*. New York: W. W. Norton, pp. 118–119, 1942.

de Moivre's Identity

$$e^{i(n\theta)} = (e^{i\theta})^n. \quad (1)$$

From the EULER FORMULA it follows that

$$\cos(n\theta) + i \sin(n\theta) = (\cos \theta + i \sin \theta)^n. \quad (2)$$

A similar identity holds for the HYPERBOLIC FUNCTIONS,

$$(\cosh z + \sinh z)^n = \cosh(nz) + \sinh(nz). \quad (3)$$

References

Arfken, G. *Mathematical Methods for Physicists*, 3rd ed. Orlando, FL: Academic Press, pp. 356–357, 1985.

Courant, R. and Robbins, H. *What is Mathematics?: An Elementary Approach to Ideas and Methods*, 2nd ed. Oxford, England: Oxford University Press, pp. 96–100, 1996.

de Moivre Number

A solution $\zeta_k = e^{2\pi i k/d}$ to the CYCLOTOMIC EQUATION

$$x^d = 1.$$

The de Moivre numbers give the coordinates in the COMPLEX PLANE of the VERTICES of a regular POLYGON with d sides and unit RADIUS.

n	de Moivre Numbers
2	± 1
3	$1, \frac{1}{2}(-1 \pm i\sqrt{3})$
4	$\pm 1, \pm i$
5	$1, \frac{1}{4} \left(-1 + \sqrt{5} \pm (1 + \sqrt{5}) \sqrt{\frac{5-5\sqrt{5}}{2}} i \right),$ $-\frac{1+\sqrt{5}}{4} \pm \frac{\sqrt{5-\sqrt{5}}}{2\sqrt{2}} i$
6	$\pm 1, \pm \frac{1}{2}(\pm 1 + i\sqrt{3})$

see also CYCLOTOMIC EQUATION, CYCLOTOMIC POLYNOMIAL, EUCLIDEAN NUMBER

References

Conway, J. H. and Guy, R. K. *The Book of Numbers*. New York: Springer-Verlag, 1996.

de Moivre-Laplace Theorem

The sum of those terms of the BINOMIAL SERIES of $(p+q)^s$ for which the number of successes x falls between d_1 and d_2 is approximately

$$Q \approx \frac{1}{\sqrt{2\pi}} \int_{t_1}^{t_2} e^{-t^2/2} dt, \quad (1)$$

where

$$t_1 \equiv \frac{d_1 - \frac{1}{2} - sp}{\sigma} \quad (2)$$

$$t_2 \equiv \frac{d_2 + \frac{1}{2} - sp}{\sigma} \quad (3)$$

$$\sigma \equiv \sqrt{spq}. \quad (4)$$

Uspensky (1937) has shown that

$$Q = \frac{1}{\sqrt{2\pi}} \int_{t_1}^{t_2} e^{-t^2/2} dt + \frac{q-p}{6\sigma} \left[(1-t^2) \frac{1}{2\pi} e^{-t^2/2} \right]_{t_1}^{t_2} + \Omega, \quad (5)$$

where

$$|\Omega| < \frac{0.12 + 0.18|p-q|}{\sigma^2} + e^{-3\sigma/2} \quad (6)$$

for $\sigma \geq 5$.

A COROLLARY states that the probability that x successes in s trials will differ from the expected value sp by more than d is

$$P_\delta \approx 1 - 2 \int_0^\delta \phi(t) dt, \quad (7)$$

where

$$\delta \equiv \frac{d + \frac{1}{2}}{\sigma}. \quad (8)$$

Uspensky (1937) showed that

$$Q_{\delta_1} \equiv P(|x - sp| \leq d) = 2 \int_0^{\delta_1} \phi(t) dt + \frac{1 - \theta_1 - \theta_2}{\sigma} \phi(\delta_1) + \Omega_1, \quad (9)$$

where

$$\delta_1 \equiv \frac{d}{\sigma} \quad (10)$$

$$\theta_1 \equiv (sq + d) - [sq + d] \quad (11)$$

$$\theta_2 \equiv (sp + d) - [sp + d] \quad (12)$$

and

$$|\Omega_1| < \frac{0.20 + 0.25|p-q|}{\sigma^2} + e^{-3\sigma/2}, \quad (13)$$

for $\sigma \geq 5$.

References

Uspensky, J. V. *Introduction to Mathematical Probability*. New York: McGraw-Hill, 1937.

de Moivre's Quintic

$$x^5 + ax^3 + \frac{1}{5}a^2x + b = 0.$$

see also QUINTIC EQUATION

de Morgan's and Bertrand's Test

see BERTRAND'S TEST

de Morgan's Duality Law

For every proposition involving logical addition and multiplication ("or" and "and"), there is a corresponding proposition in which the words "addition" and "multiplication" are interchanged.

de Morgan's Laws

Let \cup represent "or", \cap represent "and", and $'$ represent "not." Then, for two logical units E and F ,

$$(E \cup F)' = E' \cap F'$$

$$(E \cap F)' = E' \cup F'.$$

de Polignac's Conjecture

Every EVEN NUMBER is the difference of two consecutive PRIMES in infinitely many ways. If true, taking the difference 2, this conjecture implies that there are infinitely many TWIN PRIMES (Ball and Coxeter 1987). The CONJECTURE has never been proven true or refuted.

see also EVEN NUMBER, TWIN PRIMES

References

Ball, W. W. R. and Coxeter, H. S. M. *Mathematical Recreations and Essays*, 13th ed. New York: Dover, p. 64, 1987.
de Polignac, A. "Six propositions arithmologiques déduites de crible d'Ératosthène." *Nouv. Ann. Math.* 8, 423-429, 1849.

de Rham Cohomology

de Rham cohomology is a formal set-up for the analytic problem: If you have a DIFFERENTIAL k -FORM ω on a MANIFOLD M , is it the EXTERIOR DERIVATIVE of another DIFFERENTIAL k -FORM ω' ? Formally, if $\omega = d\omega'$ then $d\omega = 0$. This is more commonly stated as $d \circ d = 0$, meaning that if ω is to be the EXTERIOR DERIVATIVE of a DIFFERENTIAL k -FORM, a NECESSARY condition that ω must satisfy is that its EXTERIOR DERIVATIVE is zero.

de Rham cohomology gives a formalism that aims to answer the question, "Are all differential k -forms on a MANIFOLD with zero EXTERIOR DERIVATIVE the EXTERIOR DERIVATIVES of $(k+1)$ -forms?" In particular, the k th de Rham cohomology vector space is defined to be the space of all k -forms with EXTERIOR DERIVATIVE 0, modulo the space of all boundaries of $(k+1)$ -forms. This is the trivial VECTOR SPACE IFF the answer to our question is yes.

The fundamental result about de Rham cohomology is that it is a topological invariant of the MANIFOLD, namely: the k th de Rham cohomology VECTOR SPACE of a MANIFOLD M is canonically isomorphic to the ALEXANDER-SPANIER COHOMOLOGY VECTOR SPACE $H^k(M; \mathbb{R})$ (also called cohomology with compact support). In the case that M is compact, ALEXANDER-SPANIER COHOMOLOGY is exactly singular cohomology. *see also* ALEXANDER-SPANIER COHOMOLOGY, CHANGE OF VARIABLES THEOREM, DIFFERENTIAL k -FORM, EXTERIOR DERIVATIVE, VECTOR SPACE

de Sluze Conchoid

see CONCHOID OF DE SLUZE

de Sluze Pearls

see PEARLS OF SLUZE

Debye's Asymptotic Representation

An asymptotic expansion for a HANKEL FUNCTION OF THE FIRST KIND

$$H_\nu^{(1)}(x) \sim \frac{1}{\sqrt{\pi}} \exp\{ix[\cos \alpha + (\alpha - \pi/2) \sin \alpha]\} \\ \times \left[\frac{e^{i\pi/4}}{X} + \left(\frac{1}{8} + \frac{5}{24} \tan^2 \alpha\right) \frac{3e^{3\pi i/4}}{2X^3} \right. \\ \left. + \left(\frac{3}{128} + \frac{77}{576} \tan^2 \alpha + \frac{385}{3456} \tan^4 \alpha\right) \frac{3 \cdot e^{5\pi i/4}}{2^2 X^5} + \dots \right],$$

where

$$\frac{\nu}{x} = \sin \alpha, \\ 1 - \frac{\nu}{x} > \frac{3}{x} \nu^{1/2},$$

and

$$X \equiv \sqrt{-x \cos(\frac{1}{2}\alpha)}.$$

see also HANKEL FUNCTION OF THE FIRST KIND

References

Iyanaga, S. and Kawada, Y. (Eds.). *Encyclopedic Dictionary of Mathematics*. Cambridge, MA: MIT Press, p. 1475, 1980.

Debye Functions

$$\int_0^x \frac{t^n dt}{e^t - 1} = x^n \left[\frac{1}{n} - \frac{x}{2(n+1)} + \sum_{k=1}^{\infty} \frac{B_{2k} x^{2k}}{(2k+n)(2k!)} \right], \quad (1)$$

where $|x| < 2\pi$ and B_n are BERNOULLI NUMBERS.

$$\int_x^{\infty} \frac{t^n dt}{e^t - 1} = \sum_{k=1}^{\infty} e^{-kx} \left[\frac{x^n}{k} + \frac{nx^{n-1}}{k^2} \right. \\ \left. + \frac{n(n-1)x^{n-2}}{k^3} + \dots + \frac{n!}{k^{n+1}} \right], \quad (2)$$

where $x > 0$. The sum of these two integrals is

$$\int_0^{\infty} \frac{t^n dt}{e^t - 1} = n! \zeta(n+1), \quad (3)$$

where $\zeta(z)$ is the RIEMANN ZETA FUNCTION.

References

Abramowitz, M. and Stegun, C. A. (Eds.). "Debye Functions." §27.1 in *Handbook of Mathematical Functions with Formulas, Graphs, and Mathematical Tables*, 9th printing. New York: Dover, pp. 998, 1972.

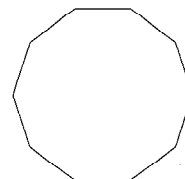
Decagon

The constructible regular 10-sided POLYGON with SCHLÄFLI SYMBOL {10}. The INRADIUS r , CIRCUMRADIUS R , and AREA can be computed directly from the formulas for a general regular POLYGON with side length s and $n = 10$ sides,

$$r = \frac{1}{2} s \cot \left(\frac{\pi}{10} \right) = \frac{1}{2} \sqrt{25 - 10\sqrt{5}} s \quad (1)$$

$$R = \frac{1}{2} s \csc \left(\frac{\pi}{10} \right) = \frac{1}{2} (1 + \sqrt{5}) s = \phi s \quad (2)$$

$$A = \frac{1}{4} n s^2 \cot \left(\frac{\pi}{10} \right) = \frac{5}{2} \sqrt{5 + 2\sqrt{5}} s^2. \quad (3)$$

Here, ϕ is the GOLDEN MEAN.

see also DECAGRAM, DODECAGON, TRIGONOMETRY VALUES— $\pi/10$, UNDECAGON

References

Dixon, R. *Mathographics*. New York: Dover, p. 18, 1991.

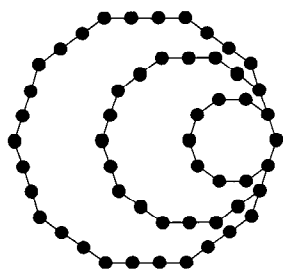
Decagonal Number

A FIGURATE NUMBER of the form $4n^2 - 3n$. The first few are 1, 10, 27, 52, 85, ... (Sloane's A001107). The GENERATING FUNCTION giving the decagonal numbers is

$$\frac{x(7x+1)}{(1-x)^3} = x + 10x^2 + 27x^3 + 52x^4 + \dots$$

References

Sloane, N. J. A. Sequence A001107/M4690 in "An On-Line Version of the Encyclopedia of Integer Sequences."

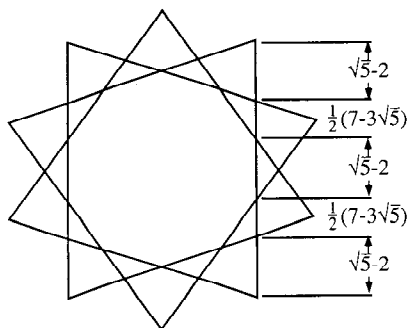
Decagram

The STAR POLYGON $\left\{ \frac{10}{3} \right\}$.

see also DECAGON, STAR POLYGON

Decic Surface

A SURFACE which can be represented implicitly by a POLYNOMIAL of degree 10 in x , y , and z . An example is the BARTH DECIC.

see also BARTH DECIC, CUBIC SURFACE, QUADRATIC SURFACE, QUARTIC SURFACE

Decidable

A "theory" in LOGIC is decidable if there is an ALGORITHM that will decide on input ϕ whether or not ϕ is a SENTENCE true of the FIELD of REAL NUMBERS \mathbb{R} .

see also CHURCH'S THESIS, GÖDEL'S COMPLETENESS THEOREM, GÖDEL'S INCOMPLETENESS THEOREM, KREISEL CONJECTURE, TARSKI'S THEOREM, UNDECIDABLE, UNIVERSAL STATEMENT

References

Kemeny, J. G. "Undecidable Problems of Elementary Number Theory." *Math. Ann.* **135**, 160-169, 1958.

Decillion

In the American system, 10^{33} .

see also LARGE NUMBER

Decimal

The base 10 notational system for representing REAL NUMBERS.

see also 10, BASE (NUMBER), BINARY, HEXADECIMAL, OCTAL

References

Pappas, T. "The Evolution of Base Ten." *The Joy of Mathematics*. San Carlos, CA: Wide World Publ./Tetra, pp. 2-3, 1989.

✳ Weisstein, E. W. "Bases." <http://www.astro.virginia.edu/~eww6n/math/notebooks/Bases.m>.

Decimal Expansion

The decimal expansion of a number is its representation in base 10. For example, the decimal expansion of 25^2 is 625, of π is 3.14159..., and of $1/9$ is 0.1111....

If $r \equiv p/q$ has a finite decimal expansion, then

$$\begin{aligned} r &= \frac{a_1}{10} + \frac{a_2}{10^2} + \dots + \frac{a_n}{10^n} \\ &= \frac{a_1 10^{n-1} + a_2 10^{n-2} + \dots + a_n}{10^n} \\ &= \frac{a_1 10^{n-1} + a_2 10^{n-2} + \dots + a_n}{2^n 5^n}. \end{aligned} \quad (1)$$

FACTORING possible common multiples gives

$$r = \frac{p}{2^\alpha 5^\beta}, \quad (2)$$

where $p \not\equiv 0 \pmod{2, 5}$. Therefore, the numbers with finite decimal expansions are fractions of this form. The number of decimals is given by $\max(\alpha, \beta)$. Numbers which have a finite decimal expansion are called REGULAR NUMBERS.

Any NONREGULAR fraction m/n is periodic, and has a period $\lambda(n)$ independent of m , which is at most $n-1$ DIGITS long. If n is RELATIVELY PRIME to 10, then the period of m/n is a divisor of $\phi(n)$ and has at most $\phi(n)$ DIGITS, where ϕ is the TOTIENT FUNCTION. When a rational number m/n with $(m, n) = 1$ is expanded, the period begins after s terms and has length t , where s and t are the smallest numbers satisfying

$$10^2 \equiv 10^{s+t} \pmod{n}. \quad (3)$$

When $n \not\equiv 0 \pmod{2, 5}$, $s = 0$, and this becomes a purely periodic decimal with

$$10^t \equiv 1 \pmod{n}. \quad (4)$$

As an example, consider $n = 84$.

$$\begin{aligned} 10^0 &\equiv 1 & 10^1 &\equiv 10 & 10^2 &\equiv 16 & 10^3 &\equiv -8 \\ 10^4 &\equiv 4 & 10^5 &\equiv 40 & 10^6 &\equiv -20 & 10^7 &\equiv -32, \\ 10^8 &\equiv 16 \end{aligned}$$

so $s = 2$, $t = 6$. The decimal representation is $1/84 = 0.0119047\bar{6}$. When the DENOMINATOR of a fraction m/n has the form $n = n_0 2^\alpha 5^\beta$ with $(n_0, 10) = 1$, then the period begins after $\max(\alpha, \beta)$ terms and the length of the period is the exponent to which 10 belongs (mod n_0), i.e., the number x such that $10^x \equiv 1 \pmod{n_0}$. If q is PRIME and $\lambda(q)$ is EVEN, then breaking the repeating DIGITS into two equal halves and adding gives all 9s. For example, $1/7 = 0.14285\bar{7}$, and $142 + 857 = 999$. For $1/q$ with a PRIME DENOMINATOR other than 2 or 5, all cycles n/q have the same length (Conway and Guy 1996).

If n is a PRIME and 10 is a PRIMITIVE ROOT of n , then the period $\lambda(n)$ of the repeating decimal $1/n$ is given by

$$\lambda(n) = \phi(n), \quad (5)$$

where $\phi(n)$ is the TOTIENT FUNCTION. Furthermore, the decimal expansions for p/n , with $p = 1, 2, \dots, n-1$ have periods of length $n-1$ and differ only by a cyclic permutation. Such numbers are called LONG PRIMES by Conway and Guy (1996). An equivalent definition is that

$$10^i \equiv 1 \pmod{n} \quad (6)$$

for $i = n-1$ and no i less than this. In other words, a NECESSARY (but not SUFFICIENT) condition is that the number $9R_{n-1}$ (where R_n is a REPUNIT) is DIVISIBLE by n , which means that R_n is DIVISIBLE by n .

The first few numbers with maximal decimal expansions, called FULL REPTEND PRIMES, are 7, 17, 19, 23, 29, 47, 59, 61, 97, 109, 113, 131, 149, 167, ... (Sloane's A001913). The decimals corresponding to these are called CYCLIC NUMBERS. No general method is known for finding FULL REPTEND PRIMES. Artin conjectured that ARTIN'S CONSTANT $C = 0.3739558136\dots$ is the fraction of PRIMES p for which $1/p$ has decimal maximal period (Conway and Guy 1996). D. Lehmer has generalized this conjecture to other bases, obtaining values which are small rational multiples of C .

To find DENOMINATORS with short periods, note that

$$\begin{aligned} 10^1 - 1 &= 3^2 \\ 10^2 - 1 &= 3^2 \cdot 11 \\ 10^3 - 1 &= 3^3 \cdot 37 \\ 10^4 - 1 &= 3^2 \cdot 11 \cdot 101 \\ 10^5 - 1 &= 3^2 \cdot 41 \cdot 271 \\ 10^6 - 1 &= 3^3 \cdot 7 \cdot 11 \cdot 13 \cdot 37 \\ 10^7 - 1 &= 3^2 \cdot 239 \cdot 4649 \\ 10^8 - 1 &= 3^2 \cdot 11 \cdot 73 \cdot 101 \cdot 137 \\ 10^9 - 1 &= 3^4 \cdot 37 \cdot 333667 \\ 10^{10} - 1 &= 3^2 \cdot 11 \cdot 41 \cdot 271 \cdot 9091 \\ 10^{11} - 1 &= 3^2 \cdot 21649 \cdot 513239 \\ 10^{12} - 1 &= 3^3 \cdot 7 \cdot 11 \cdot 13 \cdot 37 \cdot 101 \cdot 9901. \end{aligned}$$

The period of a fraction with DENOMINATOR equal to a PRIME FACTOR above is therefore the POWER of 10 in which the factor first appears. For example, 37 appears in the factorization of $10^3 - 1$ and $10^9 - 1$, so its period is 3. Multiplication of any FACTOR by a $2^\alpha 5^\beta$ still gives the same period as the FACTOR alone. A DENOMINATOR obtained by a multiplication of two FACTORS has a period equal to the first POWER of 10 in which both FACTORS appear. The following table gives the PRIMES having small periods (Sloane's A046106, A046107, and A046108; Ogilvy and Anderson 1988).

period	primes
1	3
2	11
3	37
4	101
5	41, 271
6	7, 13
7	239, 4649
8	73, 137
9	333667
10	9091
11	21649, 513239
12	9901
13	53, 79, 265371653
14	909091
15	31, 2906161
16	17, 5882353
17	2071723, 5363222357
18	19, 52579
19	111111111111111111
20	3541, 27961

A table of the periods e of small PRIMES other than the special $p = 5$, for which the decimal expansion is not periodic, follows (Sloane's A002371).

p	e	p	e	p	e
3	1	31	15	67	33
7	6	37	3	71	35
11	2	41	5	73	8
13	6	43	21	79	13
17	16	47	46	83	41
19	18	53	13	89	44
23	22	59	58	97	96
29	28	61	60	101	4

Shanks (1873ab) computed the periods for all PRIMES up to 120,000 and published those up to 29,989.

see also FRACTION, MIDY'S THEOREM, REPEATING DECIMAL

References

- Conway, J. H. and Guy, R. K. "Fractions Cycle into Decimals." In *The Book of Numbers*. New York: Springer-Verlag, pp. 157-163 and 166-171, 1996.
- Das, R. C. "On Bose Numbers." *Amer. Math. Monthly* **56**, 87-89, 1949.
- Dickson, L. E. *History of the Theory of Numbers, Vol. 1: Divisibility and Primality*. New York: Chelsea, pp. 159-179, 1952.

- Lehmer, D. H. "A Note on Primitive Roots." *Scripta Math.* **26**, 117–119, 1963.
- Ogilvy, C. S. and Anderson, J. T. *Excursions in Number Theory*. New York: Dover, p. 60, 1988.
- Rademacher, H. and Toeplitz, O. *The Enjoyment of Mathematics: Selections from Mathematics for the Amateur*. Princeton, NJ: Princeton University Press, pp. 147–163, 1957.
- Rao, K. S. "A Note on the Recurring Period of the Reciprocal of an Odd Number." *Amer. Math. Monthly* **62**, 484–487, 1955.
- Shanks, W. "On the Number of Figures in the Period of the Reciprocal of Every Prime Number Below 20,000." *Proc. Roy. Soc. London* **22**, 200, 1873a.
- Shanks, W. "On the Number of Figures in the Period of the Reciprocal of Every Prime Number Between 20,000 and 30,000." *Proc. Roy. Soc. London* **22**, 384, 1873b.
- Shiller, J. K. "A Theorem in the Decimal Representation of Rationals." *Amer. Math. Monthly* **66**, 797–798, 1959.
- Sloane, N. J. A. Sequences A001913/M4353 and A002371/M4050 in "An On-Line Version of the Encyclopedia of Integer Sequences."

Decimal Period

see DECIMAL EXPANSION

Decision Problem

Does there exist an ALGORITHM for deciding whether or not a specific mathematical assertion does or does not have a proof? The decision problem is also known as the ENTSCHEIDUNGSPROBLEM (which, not so coincidentally, is German for "decision problem"). Using the concept of the TURING MACHINE, Turing showed the answer to be NEGATIVE for elementary NUMBER THEORY. J. Robinson and Tarski showed the decision problem is undecidable for arbitrary FIELDS.

Decision Theory

A branch of GAME THEORY dealing with strategies to maximize the outcome of a given process in the face of uncertain conditions.

see also NEWCOMB'S PARADOX, OPERATIONS RESEARCH, PRISONER'S DILEMMA

Decomposition

A rewriting of a given quantity (e.g., a MATRIX) in terms of a combination of "simpler" quantities.

see also CHOLESKY DECOMPOSITION, CONNECTED SUM DECOMPOSITION, JACO-SHALEN-JOHANNSSON TORUS DECOMPOSITION, LU DECOMPOSITION, QR DECOMPOSITION, SINGULAR VALUE DECOMPOSITION

Deconvolution

The inversion of a CONVOLUTION equation, i.e., the solution for f of an equation of the form

$$f * g = h + \epsilon,$$

given g and h , where ϵ is the NOISE and $*$ denotes the CONVOLUTION. Deconvolution is ill-posed and will usually not have a unique solution even in the absence of NOISE.

Linear deconvolution ALGORITHMS include INVERSE FILTERING and WIENER FILTERING. Nonlinear ALGORITHMS include the CLEAN ALGORITHM, MAXIMUM ENTROPY METHOD, and LUCY.

see also CLEAN ALGORITHM, CONVOLUTION, LUCY, MAXIMUM ENTROPY METHOD, WIENER FILTER

References

- Cornwell, T. and Braun, R. "Deconvolution." Ch. 8 in *Synthesis Imaging in Radio Astronomy: Third NRAO Summer School, 1988* (Ed. R. A. Perley, F. R. Schwab, and A. H. Bridle). San Francisco, CA: Astronomical Society of the Pacific, pp. 167–183, 1989.
- Press, W. H.; Flannery, B. P.; Teukolsky, S. A.; and Vetterling, W. T. "Convolution and Deconvolution Using the FFT." §13.1 in *Numerical Recipes in FORTRAN: The Art of Scientific Computing*, 2nd ed. Cambridge, England: Cambridge University Press, pp. 531–537, 1992.

Decreasing Function

A function $f(x)$ decreases on an INTERVAL I if $f(b) < f(a)$ for all $b > a$, where $a, b \in I$. Conversely, a function $f(x)$ increases on an INTERVAL I if $f(b) > f(a)$ for all $b > a$ with $a, b \in I$.

If the DERIVATIVE $f'(x)$ of a CONTINUOUS FUNCTION $f(x)$ satisfies $f'(x) < 0$ on an OPEN INTERVAL (a, b) , then $f(x)$ is decreasing on (a, b) . However, a function may decrease on an interval without having a derivative defined at all points. For example, the function $-x^{1/3}$ is decreasing everywhere, including the origin $x = 0$, despite the fact that the DERIVATIVE is not defined at that point.

see also DERIVATIVE, INCREASING FUNCTION, NONDECREASING FUNCTION, NONINCREASING FUNCTION

Decreasing Sequence

A SEQUENCE $\{a_1, a_2, \dots\}$ for which $a_1 \geq a_2 \geq \dots$

see also INCREASING SEQUENCE

Decreasing Series

A SERIES s_1, s_2, \dots for which $s_1 \geq s_2 \geq \dots$

Dedekind's Axiom

For every partition of all the points on a line into two nonempty SETS such that no point of either lies between two points of the other, there is a point of one SET which lies between every other point of that SET and every point of the other SET.

Dedekind Cut

A set partition of the RATIONAL NUMBERS into two nonempty subsets S_1 and S_2 such that all members of S_1 are less than those of S_2 and such that S_1 has no greatest member. REAL NUMBERS can be defined using either Dedekind cuts or CAUCHY SEQUENCES.

see also CANTOR-DEDEKIND AXIOM, CAUCHY SEQUENCE

References

Courant, R. and Robbins, H. "Alternative Methods of Defining Irrational Numbers. Dedekind Cuts." §2.2.6 in *What is Mathematics?: An Elementary Approach to Ideas and Methods*, 2nd ed. Oxford, England: Oxford University Press, pp. 71–72, 1996.

Dedekind Eta Function

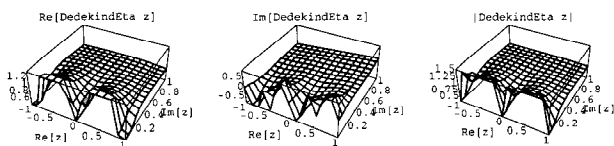

Let

$$q = e^{2\pi iz}, \quad (1)$$

then the Dedekind eta function is defined by

$$\eta(z) \equiv q^{1/24} \prod_{n=1}^{\infty} (1 - q^n), \quad (2)$$

which can be written as

$$\eta(z) = q^{1/24} \left\{ 1 + \sum_{n=1}^{\infty} (-1)^n [q^{n(3n-1)/2} + q^{n(3n+1)/2}] \right\} \quad (3)$$

(Weber 1902, pp. 85 and 112; Atkin and Morain 1993). η is a MODULAR FORM. Letting $\zeta_{24} = 2^{2\pi i/24}$ be a ROOT OF UNITY, $\eta(z)$ satisfies

$$\eta(z+1) = \zeta_{24} \eta(z) \quad (4)$$

$$\eta\left(-\frac{1}{z}\right) = -\sqrt{z}i \eta(z) \quad (5)$$

(Weber 1902, p. 113; Atkin and Morain 1993).

see also DIRICHLET ETA FUNCTION, THETA FUNCTION, WEBER FUNCTIONS

References

Atkin, A. O. L. and Morain, F. "Elliptic Curves and Primality Proving." *Math. Comput.* **61**, 29–68, 1993.
Weber, H. *Lehrbuch der Algebra*, Vols. I–II. New York: Chelsea, 1902.

Dedekind Function

$$\psi(n) = n \prod_{\substack{\text{distinct prime} \\ \text{factors } p \text{ of } n}} (1 + p^{-1}),$$

where the PRODUCT is over the distinct PRIME FACTORS of n . The first few values are 1, 3, 4, 6, 6, 12, 8, 12, 12, 18, ... (Sloane's A001615).

see also DEDEKIND ETA FUNCTION, EULER PRODUCT, TOTIENT FUNCTION

References

Cox, D. A. *Primes of the Form $x^2 + ny^2$: Fermat, Class Field Theory and Complex Multiplication*. New York: Wiley, p. 228, 1997.
Guy, R. K. *Unsolved Problems in Number Theory*, 2nd ed. New York: Springer-Verlag, p. 96, 1994.
Sloane, N. J. A. Sequence A001615/M2315 in "An On-Line Version of the Encyclopedia of Integer Sequences."

Dedekind's Problem

The determination of the number of monotone BOOLEAN FUNCTIONS of n variables is called Dedekind's problem.

Dedekind Ring

A abstract commutative RING in which every NONZERO IDEAL is a unique product of PRIME IDEALS.

Dedekind Sum

Given RELATIVELY PRIME INTEGERS p and q , the Dedekind sum is defined by

$$s(p, q) \equiv \sum_{i=1}^q \left(\left(\frac{i}{q} \right) \right) \left(\left(\frac{pi}{q} \right) \right), \quad (1)$$

where

$$((x)) \equiv \begin{cases} x - [x] - \frac{1}{2} & x \in \mathbb{Z} \\ 0 & x \notin \mathbb{Z}. \end{cases} \quad (2)$$

Dedekind sums obey 2-term

$$s(p, q) + s(q, p) = -\frac{1}{4} + \frac{1}{12} \left(\frac{p}{q} + \frac{q}{p} + \frac{1}{pq} \right), \quad (3)$$

and 3-term

$$s(bc', a) + s(ca', b) + s(ab', c) = -\frac{1}{4} + \frac{1}{12} \left(\frac{a}{bc} + \frac{b}{ca} + \frac{c}{ab} \right) \quad (4)$$

reciprocity laws, where a, b, c are pairwise COPRIME and

$$aa' \equiv 1 \pmod{b} \quad (5)$$

$$bb' \equiv 1 \pmod{c} \quad (6)$$

$$cc' \equiv 1 \pmod{a}. \quad (7)$$

Let $p, q, u, v \in \mathbb{N}$ with $(p, q) = (u, v) = 1$ (i.e., are pairwise RELATIVELY PRIME), then the Dedekind sums also satisfy

$$s(p, q) + s(u, v) = s(pu' - qv', pv + qu) - \frac{1}{4} + \frac{1}{12} \left(\frac{q}{vt} + \frac{v}{tq} + \frac{t}{qv} \right), \quad (8)$$

where $t = pv + qu$, and u', v' are any INTEGERS such that $uu' + vv' = 1$ (Pommersheim 1993).

References

Pommersheim, J. "Toric Varieties, Lattice Points, and Dedekind Sums." *Math. Ann.* **295**, 1–24, 1993.

Deducible

If q is logically deducible from p , this is written $p \vdash q$.

Deep Theorem

Qualitatively, a deep theorem is a theorem whose proof is long, complicated, difficult, or appears to involve branches of mathematics which are not obviously related to the theorem itself (Shanks 1993). Shanks (1993) cites the QUADRATIC RECIPROCITY THEOREM as an example of a deep theorem.

see also THEOREM

References

Shanks, D. "Is the Quadratic Reciprocity Law a Deep Theorem?" §2.25 in *Solved and Unsolved Problems in Number Theory*, 4th ed. New York: Chelsea, pp. 64–66, 1993.

Defective Matrix

A MATRIX whose EIGENVECTORS are not COMPLETE.

Defective Number

see DEFICIENT NUMBER

Deficiency

The deficiency of a BINOMIAL COEFFICIENT $\binom{n+k}{k}$ with $k \leq n$ as the number of i for which $b_i = 1$, where

$$n + i = a_i b_i,$$

$1 \leq i \leq k$, the PRIME factors of b_i are $> k$, and $\prod a_i = k!$, where $k!$ is the FACTORIAL.

see also ABUNDANCE

References

Guy, R. K. *Unsolved Problems in Number Theory*, 2nd ed. New York: Springer-Verlag, pp. 84–85, 1994.

Deficient Number

Numbers which are not PERFECT and for which

$$s(N) \equiv \sigma(N) - N < N,$$

or equivalently

$$\sigma(n) < 2n,$$

where $\sigma(N)$ is the DIVISOR FUNCTION. Deficient numbers are sometimes called DEFECTIVE NUMBERS (Singh 1997). PRIMES, POWERS of PRIMES, and any divisors of a PERFECT or deficient number are all deficient. The first few deficient numbers are 1, 2, 3, 4, 5, 7, 8, 9, 10, 11, 13, 14, 15, 16, 17, 19, 21, 22, 23, ... (Sloane's A002855). see also ABUNDANT NUMBER, LEAST DEFICIENT NUMBER, PERFECT NUMBER

References

Dickson, L. E. *History of the Theory of Numbers*, Vol. 1: *Divisibility and Primality*. New York: Chelsea, pp. 3–33, 1952.
Guy, R. K. *Unsolved Problems in Number Theory*, 2nd ed. New York: Springer-Verlag, p. 45, 1994.
Singh, S. *Fermat's Enigma: The Epic Quest to Solve the World's Greatest Mathematical Problem*. New York: Walker, p. 11, 1997.
Sloane, N. J. A. Sequence A002855/M0514 in "An On-Line Version of the Encyclopedia of Integer Sequences."

Definable Set

An ANALYTIC, BOREL, or COANALYTIC SET.

Defined

If A and B are equal by definition (i.e., A is defined as B), then this is written symbolically as $A \equiv B$ or $A := B$.

Definite Integral

An INTEGRAL

$$\int_a^b f(x) dx$$

with upper and lower limits. The first FUNDAMENTAL THEOREM OF CALCULUS allows definite integrals to be computed in terms of INDEFINITE INTEGRALS, since if F is the INDEFINITE INTEGRAL for $f(x)$, then

$$\int_a^b f(x) dx = F(b) - F(a).$$

see also CALCULUS, FUNDAMENTAL THEOREMS OF CALCULUS, INDEFINITE INTEGRAL, INTEGRAL

Degenerate

A limiting case in which a class of object changes its nature so as to belong to another, usually simpler, class. For example, the POINT is a degenerate case of the CIRCLE as the RADIUS approaches 0, and the CIRCLE is a degenerate form of an ELLIPSE as the ECCENTRICITY approaches 0. Another example is the two identical ROOTS of the second-order POLYNOMIAL $(x-1)^2$. Since the n ROOTS of an n th degree POLYNOMIAL are usually distinct, ROOTS which coincide are said to be degenerate. Degenerate cases often require special treatment in numerical and analytical solutions. For example, a simple search for both ROOTS of the above equation would find only a single one: 1

The word degenerate also has several very specific and technical meanings in different branches of mathematics.

References

Arfken, G. *Mathematical Methods for Physicists*, 3rd ed. Orlando, FL: Academic Press, pp. 513–514, 1985.

Degree

The word “degree” has many meanings in mathematics. The most common meaning is the unit of ANGLE measure defined such that an entire rotation is 360° . This unit harks back to the Babylonians, who used a base 60 number system. 360° likely arises from the Babylonian year, which was composed of 360 days (12 months of 30 days each). The degree is subdivided into 60 MINUTES per degree, and 60 SECONDS per MINUTE.

see also ARC MINUTE, ARC SECOND, DEGREE OF FREEDOM, DEGREE (MAP), DEGREE (POLYNOMIAL), DEGREE (VERTEX), INDEGREE, LOCAL DEGREE, OUT-DEGREE

Degree (Algebraic Surface)

see ORDER (ALGEBRAIC SURFACE)

Degree of Freedom

The number of degrees of freedom in a problem, distribution, etc., is the number of parameters which may be independently varied.

see also LIKELIHOOD RATIO

Degree (Map)

Let $f : M \mapsto N$ be a MAP between two compact, connected, oriented n -D MANIFOLDS without boundary. Then f induces a HOMEOMORPHISM f_* from the HOMOLOGY GROUPS $H_n(M)$ to $H_n(N)$, both canonically isomorphic to the INTEGERS, and so f_* can be thought of as a HOMEOMORPHISM of the INTEGERS. The INTEGER $d(f)$ to which the number 1 gets sent is called the degree of the MAP f .

There is an easy way to compute $d(f)$ if the MANIFOLDS involved are smooth. Let $x \in N$, and approximate f by a smooth map HOMOTOPIC to f such that x is a “regular value” of f (which exist and are everywhere by

SARD’S THEOREM). By the IMPLICIT FUNCTION THEOREM, each point in $f^{-1}(x)$ has a NEIGHBORHOOD such that f restricted to it is a DIFFEOMORPHISM. If the DIFFEOMORPHISM is orientation preserving, assign it the number +1, and if it is orientation reversing, assign it the number –1. Add up all the numbers for all the points in $f^{-1}(x)$, and that is the $d(f)$, the degree of f . One reason why the degree of a map is important is because it is a HOMOTOPY invariant. A sharper result states that two self-maps of the n -sphere are homotopic IFF they have the same degree. This is equivalent to the result that the n th HOMOTOPY GROUP of the n -SPHERE is the set \mathbb{Z} of INTEGERS. The ISOMORPHISM is given by taking the degree of any representation.

One important application of the degree concept is that homotopy classes of maps from n -spheres to n -spheres are classified by their degree (there is exactly one homotopy class of maps for every INTEGER n , and n is the degree of those maps).

Degree (Polynomial)

see ORDER (POLYNOMIAL)

Degree Sequence

Given an (undirected) GRAPH, a degree sequence is a monotonic nonincreasing sequence of the degrees of its VERTICES. A degree sequence is said to be k -connected if there exists some k -CONNECTED GRAPH corresponding to the degree sequence. For example, while the degree sequence $\{1, 2, 1\}$ is 1- but not 2-connected, $\{2, 2, 2\}$ is 2-connected. The number of degree sequences for $n = 1, 2, \dots$ is given by 1, 2, 4, 11, 31, 102, ... (Sloane’s A004251).

see also GRAPHICAL PARTITION

References

Ruskey, F. “Information on Degree Sequences.” <http://sue.csc.uvic.ca/~cos/inf/nump/DegreeSequences.html>.

Ruskey, F.; Cohen, R.; Eades, P.; and Scott, A. “Alley CATs in Search of Good Homes.” *Congres. Numer.* **102**, 97–110, 1994.

Sloane, N. J. A. Sequence A004251/M1250 in “An On-Line Version of the Encyclopedia of Integer Sequences.”

Degree (Vertex)

see VERTEX DEGREE

Dehn Invariant

An invariant defined using the angles of a 3-D POLYHEDRON. It remains constant under solid DISSECTION and reassembly. However, solids with the same volume can have different Dehn invariants. Two POLYHEDRA can be dissected into each other only if they have the same volume and the same Dehn invariant.

see also DISSECTION, EHRHART POLYNOMIAL

Dehn's Lemma

If you have an embedding of a 1-SPHERE in a 3-MANIFOLD which exists continuously over the 2-DISK, then it also extends over the DISK as an embedding. It was proposed by Dehn in 1910, but a correct proof was not obtained until the work of Papakyriakopoulos (1957ab).

References

- Hempel, J. *3-Manifolds*. Princeton, NJ: Princeton University Press, 1976.
 Papakyriakopoulos, C. D. "On Dehn's Lemma and the Asphericity of Knots." *Proc. Nat. Acad. Sci. USA* **43**, 169–172, 1957a.
 Papakyriakopoulos, C. D. "On Dehn's Lemma and the Asphericity of Knots." *Ann. Math.* **66**, 1–26, 1957.
 Rolfsen, D. *Knots and Links*. Wilmington, DE: Publish or Perish Press, pp. 100–101, 1976.

Dehn Surgery

The operation of drilling a tubular NEIGHBORHOOD of a KNOT K in \mathbb{S}^3 and then gluing in a solid TORUS so that its meridian curve goes to a (p, q) -curve on the TORUS boundary of the KNOT exterior. Every compact connected 3-MANIFOLD comes from Dehn surgery on a LINK in \mathbb{S}^3 .

see also KIRBY CALCULUS

References

- Adams, C. C. *The Knot Book: An Elementary Introduction to the Mathematical Theory of Knots*. New York: W. H. Freeman, p. 260, 1994.

Del

see GRADIENT

Del Pezzo Surface

A SURFACE which is related to CAYLEY NUMBERS.

References

- Coxeter, H. S. M. *Regular Polytopes*, 3rd ed. New York: Dover, p. 211, 1973.
 Hunt, B. "Del Pezzo Surfaces." §4.1.4 in *The Geometry of Some Special Arithmetic Quotients*. New York: Springer-Verlag, pp. 128–129, 1996.

Delannoy Number

The Delannoy numbers are defined by

$$D(a, b) = D(a - 1, b) + D(a, b - 1) + D(a - 1, b - 1),$$

where $D(0, 0) = 1$. They are the number of lattice paths from $(0, 0)$ to (b, a) in which only east $(1, 0)$, north $(0, 1)$, and northeast $(1, 1)$ steps are allowed (i.e., \rightarrow , \uparrow , and \nearrow).

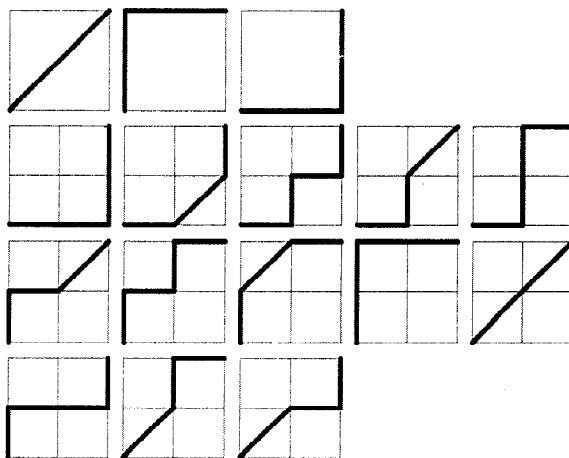

For $n \equiv a = b$, the Delannoy numbers are the number of "king walks"

$$D(n, n) = P_n(3),$$

where $P_n(x)$ is a LEGENDRE POLYNOMIAL (Moser 1955, Vardi 1991). Another expression is

$$D(n, n) = \sum_{k=0}^n \binom{n}{k} \binom{n+k}{k} = {}_2F_1(-n, n+1; 1; -1),$$

where $\binom{a}{b}$ is a BINOMIAL COEFFICIENT and ${}_2F_1(a, b; c; z)$ is a HYPERGEOMETRIC FUNCTION. The values of $D(n, n)$ for $n = 1, 2, \dots$ are 3, 13, 63, 321, 1683, 8989, 48639, ... (Sloane's A001850).

The SCHRÖDER NUMBERS bear the same relation to the Delannoy numbers as the CATALAN NUMBERS do to the BINOMIAL COEFFICIENTS.

see also BINOMIAL COEFFICIENT, CATALAN NUMBER, MOTZKIN NUMBER, SCHRÖDER NUMBER

References

- Sloane, N. J. A. Sequence A001850/M2942 in "An On-Line Version of the Encyclopedia of Integer Sequences."

Delaunay Triangulation

The NERVE of the cells in a VORONOI DIAGRAM, which is the triangular of the CONVEX HULL of the points in the diagram. The Delaunay triangulation of a VORONOI DIAGRAM in \mathbb{R}^2 is the diagram's planar dual.

see also TRIANGULATION

Delian Constant

The number $2^{1/3}$ (the CUBE ROOT of 2) which is to be constructed in the CUBE DUPLICATION problem. This number is not a EUCLIDEAN NUMBER although it is an ALGEBRAIC of third degree.

References

- Conway, J. H. and Guy, R. K. "Three Greek Problems." In *The Book of Numbers*. New York: Springer-Verlag, pp. 192–194, 1996.

Delian Problem

see CUBE DUPLICATION

Delta Amplitude

Given an AMPLITUDE ϕ and a MODULUS m in an ELLIPTIC INTEGRAL,

$$\Delta(\phi) \equiv \sqrt{1 - m \sin^2 \phi}.$$

see also AMPLITUDE, ELLIPTIC INTEGRAL, MODULUS (ELLIPTIC INTEGRAL)

Delta Curve

A curve which can be turned continuously inside an EQUILATERAL TRIANGLE. There are an infinite number of delta curves, but the simplest are the CIRCLE and lens-shaped Δ -biangle. All the Δ curves of height h have the same PERIMETER $2\pi h/3$. Also, at each position of a Δ curve turning in an EQUILATERAL TRIANGLE, the perpendiculars to the sides at the points of contact are CONCURRENT at the instantaneous center of rotation.

see also REULEAUX TRIANGLE

References

Honsberger, R. *Mathematical Gems I*. Washington, DC: Math. Assoc. Amer., pp. 56–59, 1973.

Delta Function

Defined as the limit of a class of DELTA SEQUENCES. Sometimes called the IMPULSE SYMBOL. The most commonly used (equivalent) definitions are

$$\delta(x) \equiv \lim_{n \rightarrow \infty} \frac{1}{2\pi} \frac{\sin[(n + \frac{1}{2})x]}{\sin(\frac{1}{2}x)} \quad (1)$$

(the so-called DIRICHLET KERNEL) and

$$\delta(x) \equiv \lim_{n \rightarrow \infty} \frac{\sin(nx)}{\pi x} \quad (2)$$

$$= \frac{1}{2\pi} \int_{-\infty}^{\infty} e^{-ikx} dk \quad (3)$$

$$= \frac{1}{2\pi} \int_{-\infty}^{\infty} e^{-ikx} dk \quad (4)$$

$$= \mathcal{F}[1], \quad (5)$$

where \mathcal{F} is the FOURIER TRANSFORM. Some identities include

$$\delta(x - a) = 0 \quad (6)$$

for $x \neq a$,

$$\int_{a-\epsilon}^{a+\epsilon} \delta(x - a) dx = 1, \quad (7)$$

where ϵ is any POSITIVE number, and

$$\int_{-\infty}^{\infty} f(x) \delta(x - a) dx = f(a) \quad (8)$$

$$\int_{-\infty}^{\infty} f(x) \delta'(x - a) dx = -f'(a) \quad (9)$$

$$x \int f(x) \delta(x - x_0) dx = x_0 \int f(x) \delta(x - x_0) dx \quad (10)$$

$$\delta' * f = \int_{-\infty}^{\infty} \delta'(a - x) f(x) dx = f'(x) \quad (11)$$

$$\int_{-\infty}^{\infty} |\delta'(x)| dx = \infty \quad (12)$$

$$x^2 \delta'(x) = 0 \quad (13)$$

$$\delta'(-x) = -\delta'(x) \quad (14)$$

$$x \delta'(x) = -\delta(x). \quad (15)$$

(15) can be established using INTEGRATION BY PARTS as follows:

$$\begin{aligned} \int f(x) x \delta'(x) dx &= - \int \delta(x) \frac{d}{dx} [x f(x)] dx \\ &= - \int \delta[f(x) + x f'(x)] dx \\ &= - \int f(x) \delta(x) dx. \end{aligned} \quad (16)$$

Additional identities are

$$\delta(ax) = \frac{1}{a} \delta(x) \quad (17)$$

$$\delta(x^2 - a^2) = \frac{1}{2a} [\delta(x + a) + \delta(x - a)] \quad (18)$$

$$\delta[g(x)] = \sum_i \frac{\delta(x - x_i)}{|g'(x_i)|}, \quad (19)$$

where the x_i s are the ROOTS of g . For example, examine

$$\delta(x^2 + x - 2) = \delta[(x - 1)(x + 2)]. \quad (20)$$

Then $g'(x) = 2x + 1$, so $g'(x_1) = g'(1) = 3$ and $g'(x_2) = g'(-2) = -3$, and we have

$$\delta(x^2 + x - 2) = \frac{1}{3} \delta(x - 1) + \frac{1}{3} \delta(x + 2). \quad (21)$$

A FOURIER SERIES expansion of $\delta(x - a)$ gives

$$a_n = \frac{1}{\pi} \int_{-\pi}^{\pi} \delta(x - a) \cos(nx) dx = \frac{1}{\pi} \cos(na) \quad (22)$$

$$b_n = \frac{1}{\pi} \int_{-\pi}^{\pi} \delta(x - a) \sin(nx) dx = \frac{1}{\pi} \sin(na), \quad (23)$$

so

$$\begin{aligned} \delta(x - a) &= \frac{1}{2\pi} + \frac{1}{\pi} \sum_{n=1}^{\infty} [\cos(na) \cos(nx) + \sin(na) \sin(nx)] \\ &= \frac{1}{2\pi} + \frac{1}{\pi} \sum_{n=1}^{\infty} \cos[n(x - a)]. \end{aligned} \quad (24)$$

The FOURIER TRANSFORM of the delta function is

$$\mathcal{F}[\delta(x - x_0)] = \int_{-\infty}^{\infty} e^{-2\pi i k x} \delta(x - x_0) dx = e^{-2\pi i k x_0}. \quad (25)$$

Delta functions can also be defined in 2-D, so that in 2-D CARTESIAN COORDINATES

$$\delta^2(x - x_0, y - y_0) = \delta(x - x_0)\delta(y - y_0), \quad (26)$$

and in 3-D, so that in 3-D CARTESIAN COORDINATES

$$\delta^3(x - x_0, y - y_0, z - z_0) = \delta(x - x_0)\delta(y - y_0)\delta(z - z_0), \quad (27)$$

in CYLINDRICAL COORDINATES

$$\delta^3(r, \theta, z) = \frac{\delta(r)\delta(z)}{\pi r}, \quad (28)$$

and in SPHERICAL COORDINATES,

$$\delta^3(r, \theta, \phi) = \frac{\delta(r)}{2\pi r^2}. \quad (29)$$

A series expansion in CYLINDRICAL COORDINATES gives

$$\begin{aligned} \delta^3(\mathbf{r}_1 - \mathbf{r}_2) &= \frac{1}{r_1} \delta(r_1 - r_2) \delta(\phi_1 - \phi_2) \delta(z_1 - z_2) \\ &= \frac{1}{r_1} \delta(r_1 - r_2) \frac{1}{2\pi} \sum_{m=-\infty}^{\infty} e^{im(\phi_1 - \phi_2)} \frac{1}{2\pi} \int_{-\infty}^{\infty} e^{ik(z_1 - z_2)} dk. \end{aligned} \quad (30)$$

The delta function also obeys the so-called SIFTING PROPERTY

$$\int f(\mathbf{y}) \delta(\mathbf{x} - \mathbf{y}) d\mathbf{y} = f(\mathbf{x}). \quad (31)$$

see also DELTA SEQUENCE, DOUBLET FUNCTION, FOURIER TRANSFORM—DELTA FUNCTION

References

Arfken, G. *Mathematical Methods for Physicists*, 3rd ed. Orlando, FL: Academic Press, pp. 481–485, 1985.
Spanier, J. and Oldham, K. B. "The Dirac Delta Function $\delta(x - a)$." Ch. 10 in *An Atlas of Functions*. Washington, DC: Hemisphere, pp. 79–82, 1987.

Delta Sequence

A SEQUENCE of strongly peaked functions for which

$$\lim_{n \rightarrow \infty} \int_{-\infty}^{\infty} \delta_n(x) f(x) dx = f(n) \quad (1)$$

so that in the limit as $n \rightarrow \infty$, the sequences become DELTA FUNCTIONS. Examples include

$$\delta_n(x) = \begin{cases} 0 & x < -\frac{1}{2n} \\ n & -\frac{1}{2n} < x < \frac{1}{2n} \\ 0 & x > \frac{1}{2n} \end{cases} \quad (2)$$

$$= \frac{n}{\sqrt{\pi}} e^{-n^2 x^2} \quad (3)$$

$$= \frac{n}{\pi} \text{sinc}(ax) \equiv \frac{\sin(nx)}{\pi x} \quad (4)$$

$$= \frac{1}{\pi x} \frac{e^{inx} - e^{-inx}}{2i} \quad (5)$$

$$= \frac{1}{2\pi i x} [e^{ixt}]_{-n}^n \quad (6)$$

$$= \frac{1}{2\pi} \int_{-n}^n e^{ixt} dt \quad (7)$$

$$= \frac{1}{2\pi} \frac{\sin[(n + \frac{1}{2})x]}{\sin(\frac{1}{2}x)}, \quad (8)$$

where (8) is known as the DIRICHLET KERNEL.

Delta Variation

see VARIATION

Deltahedron

A semiregular POLYHEDRON whose faces are all EQUILATERAL TRIANGLES. There are an infinite number of deltahedra, but only eight convex ones (Freudenthal and van der Waerden 1947). They have 4, 6, 8, 10, 12, 14, 16, and 20 faces. These are summarized in the table below, and illustrated in the following figures.

n	Name
4	tetrahedron
6	triangular dipyramid
8	octahedron
10	pentagonal dipyramid
12	snub disphenoid
14	triaugmented triangular prism
16	gyroelongated square dipyramid
20	icosahedron

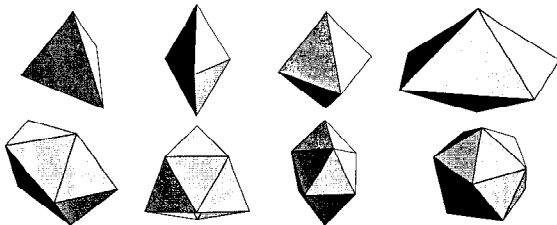

The STELLA OCTANGULA is a concave deltahedron with 24 sides:

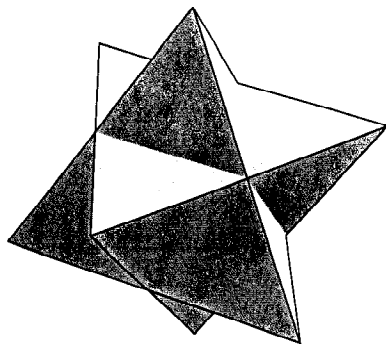

Another with 60 faces is a “caved in” DODECAHEDRON which is ICOSAHDRON STELLATION I_{20} .



Cundy (1952) identifies 17 concave deltahedra with two kinds of VERTICES.

see also GYROELONGATED SQUARE DIPYRAMID, ICOSAHDRON, OCTAHEDRON, PENTAGONAL DIPYRAMID, SNUB DISPHENOID TETRAHEDRON, TRIANGULAR DIPYRAMID, TRIAUGMENTED TRIANGULAR PRISM

References

- Cundy, H. M. “Deltahedra.” *Math. Gaz.* **36**, 263–266, 1952.
 Freudenthal, H. and van der Waerden, B. L. “On an Assertion of Euclid.” *Simon Stevin* **25**, 115–121, 1947.
 Gardner, M. *Fractal Music, Hypercards, and More: Mathematical Recreations from Scientific American Magazine*. New York: W. H. Freeman, pp. 40, 53, and 58–60, 1992.
 Pugh, A. *Polyhedra: A Visual Approach*. Berkeley, CA: University of California Press, pp. 35–36, 1976.

Deltoid

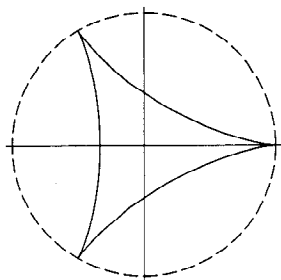

A 3-cusped HYPOCYCLOID, also called a TRICUSPOID, which has $n \equiv a/b = 3$ or $3/2$, where a is the RADIUS of the large fixed CIRCLE and b is the RADIUS of the small rolling CIRCLE. The deltoid was first considered by Euler in 1745 in connection with an optical problem. It was also investigated by Steiner in 1856 and is sometimes called STEINER’S HYPOCYCLOID (MacTutor Archive). The equation of the deltoid is obtained

by setting $n = 3$ in the equation of the HYPOCYCLOID, yielding the parametric equations

$$x = \left[\frac{2}{3} \cos \phi - \frac{1}{3} \cos(2\phi) \right] a = 2b \cos \phi + b \cos(2\phi) \quad (1)$$

$$y = \left[\frac{2}{3} \sin \phi + \frac{1}{3} \sin(2\phi) \right] a = 2b \sin \phi - b \sin(2\phi). \quad (2)$$

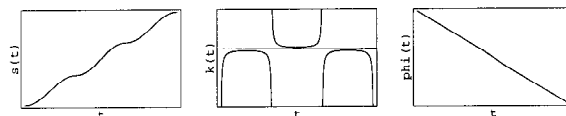

The ARC LENGTH, CURVATURE, and TANGENTIAL ANGLE are

$$s(t) = 4 \int_0^t \left| \sin\left(\frac{3}{2}t'\right) \right| dt' = \frac{16}{3} \sin^2\left(\frac{3}{4}t\right) \quad (3)$$

$$\kappa(t) = -\frac{1}{8} \csc\left(\frac{3}{2}t\right) \quad (4)$$

$$\phi(t) = -\frac{1}{2}t. \quad (5)$$

As usual, care must be taken in the evaluation of $s(t)$ for $t > 2\pi/3$. Since the form given above comes from an integral involving the ABSOLUTE VALUE of a function, it must be monotonic increasing. Each branch can be treated correctly by defining

$$n = \left\lfloor \frac{3t}{2\pi} \right\rfloor + 1, \quad (6)$$

where $\lfloor x \rfloor$ is the FLOOR FUNCTION, giving the formula

$$s(t) = (-1)^{1+[n \pmod{2}]} \frac{16}{3} \sin^2\left(\frac{3}{4}t\right) + \frac{32}{3} \left\lfloor \frac{1}{2}n \right\rfloor. \quad (7)$$

The total ARC LENGTH is computed from the general HYPOCYCLOID equation

$$s_n = \frac{8a(n-1)}{n}. \quad (8)$$

With $n = 3$, this gives

$$s_3 = \frac{16}{3}a. \quad (9)$$

The AREA is given by

$$A_n = \frac{(n-1)(n-2)}{n^2} \pi a^2 \quad (10)$$

with $n = 3$,

$$A_3 = \frac{2}{9} \pi a^2. \quad (11)$$

The length of the tangent to the tricuspoid, measured between the two points P, Q in which it cuts the curve again, is constant and equal to $4a$. If you draw TANGENTS at P and Q , they are at RIGHT ANGLES.

References

- Gray, A. *Modern Differential Geometry of Curves and Surfaces*. Boca Raton, FL: CRC Press, p. 53, 1993.
 Lawrence, J. D. *A Catalog of Special Plane Curves*. New York: Dover, pp. 131–135, 1972.

Lee, X. "Deltoid." http://www.best.com/~xah/SpecialPlaneCurves_dir/Deltoid_dir/deltoid.html.

Lockwood, E. H. "The Deltoid." Ch. 8 in *A Book of Curves*. Cambridge, England: Cambridge University Press, pp. 72–79, 1967.

Macbeth, A. M. "The Deltoid, I." *Eureka* 10, 20–23, 1948.

Macbeth, A. M. "The Deltoid, II." *Eureka* 11, 26–29, 1949.

Macbeth, A. M. "The Deltoid, III." *Eureka* 12, 5–6, 1950.

MacTutor History of Mathematics Archive. "Tricuspid." <http://www-groups.dcs.st-and.ac.uk/~history/Curves/Tricuspid.html>.

Yates, R. C. "Deltoid." *A Handbook on Curves and Their Properties*. Ann Arbor, MI: J. W. Edwards, pp. 71–74, 1952.

Deltoid Caustic

The caustic of the DELTOID when the rays are PARALLEL in any direction is an ASTROID.

Deltoid Evolute

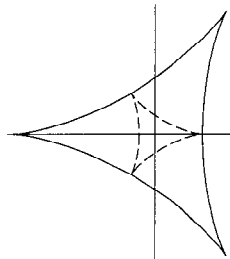

A HYPOCYCLOID EVOLUTE for $n = 3$ is another DELTOID scaled by a factor $n/(n-2) = 3/1 = 3$ and rotated $1/(2 \cdot 3) = 1/6$ of a turn.

Deltoid Involute

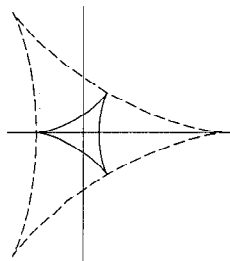

A HYPOCYCLOID INVOLUTE for $n = 3$ is another DELTOID scaled by a factor $(n-2)/n = 1/3$ and rotated $1/(2 \cdot 3) = 1/6$ of a turn.

Deltoid Pedal Curve

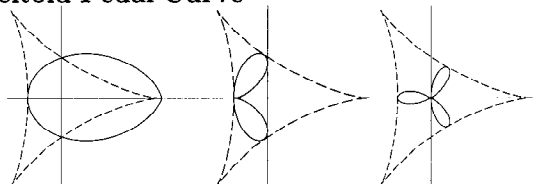

The PEDAL CURVE for a DELTOID with the PEDAL POINT at the CUSP is a FOLIUM. For the PEDAL POINT at the CUSP (NEGATIVE x -intercept), it is a BIFOLIUM. At the center, or anywhere on the inscribed EQUILATERAL TRIANGLE, it is a TRIFOLIUM.

Deltoid Radial Curve

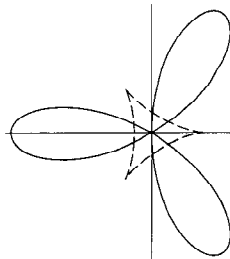

The TRIFOLIUM

$$x = x_0 + 4a \cos \phi - 4a \cos(2\phi)$$

$$y = y_0 + 4a \sin \phi + 4a \sin(2\phi).$$

Deltoidal Hexecontahedron

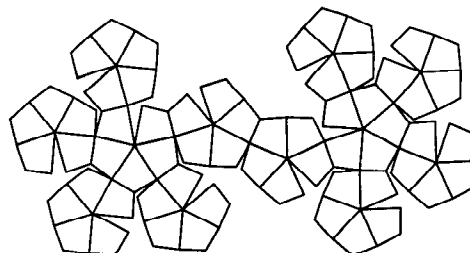
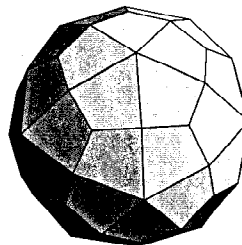

The DUAL POLYHEDRON of the RHOMBICOSIDODECAHEDRON.

Deltoidal Icositetrahedron

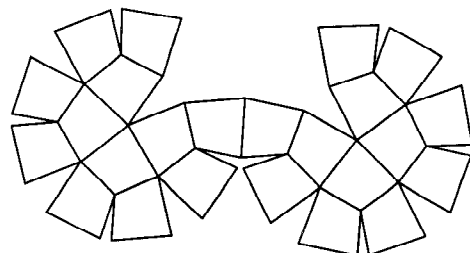
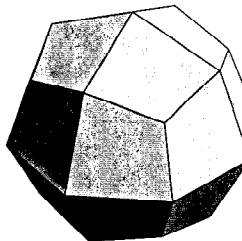

The DUAL POLYHEDRON of the SMALL RHOMBICUB-OCTAHEDRON. It is also called the TRAPEZOIDAL ICOSITETRAHEDRON.

Demlo Number

The initially PALINDROMIC NUMBERS 1, 121, 12321, 1234321, 123454321, ... (Sloane's A002477). For the first through ninth terms, the sequence is given by the GENERATING FUNCTION

$$\frac{10x + 1}{(x-1)(10x-1)(100x-1)} \\ = 1 + 121x + 12321x^2 + 1234321x^3 + \dots$$

(Plouffe 1992, Sloane and Plouffe 1995). The definition of this sequence is slightly ambiguous from the tenth term on.

see also CONSECUTIVE NUMBER SEQUENCES, PALINDROMIC NUMBER

References

- Kaprekar, D. R. "On Wonderful Demlo Numbers." *Math. Student* 6, 68–70, 1938.
- Plouffe, S. "Approximations de Séries Génératrices et quelques conjectures." Montréal, Canada: Université du Québec à Montréal, Mémoire de Maîtrise, UQAM, 1992.
- Sloane, N. J. A. Sequence A002477/M5386 in "An On-Line Version of the Encyclopedia of Integer Sequences."

Dendrite Fractal

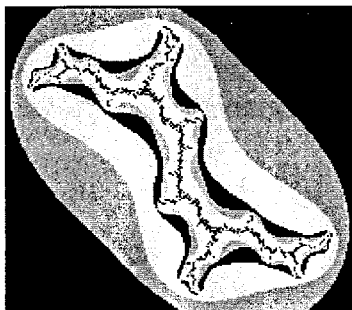

A JULIA SET with $c = i$.

Denjoy Integral

A type of INTEGRAL which is an extension of both the RIEMANN INTEGRAL and the LEBESGUE INTEGRAL. The original Denjoy integral is now called a Denjoy integral "in the restricted sense," and a more general type is now called a Denjoy integral "in the wider sense." The independently discovered PERON INTEGRAL turns out to be equivalent to the Denjoy integral "in the restricted sense."

see also INTEGRAL, LEBESGUE INTEGRAL, PERON INTEGRAL, RIEMANN INTEGRAL

References

- Iyanaga, S. and Kawada, Y. (Eds.). "Denjoy Integrals." §103 in *Encyclopedic Dictionary of Mathematics*. Cambridge, MA: MIT Press, pp. 337–340, 1980.
- Kestelman, H. "General Denjoy Integral." §9.2 in *Modern Theories of Integration*, 2nd rev. ed. New York: Dover, pp. 217–227, 1960.

Denominator

The number q in a FRACTION p/q .

see also FRACTION, NUMERATOR, RATIO, RATIONAL NUMBER

Dense

A set A in a FIRST-COUNTABLE SPACE is dense in B if $B = A \cup L$, where L is the limit of sequences of elements of A . For example, the rational numbers are dense in the reals. In general, a SUBSET A of X is dense if its CLOSURE $\text{cl}(A) = X$.

see also CLOSURE, DENSITY, DERIVED SET, PERFECT SET

Density

see DENSITY (POLYGON), DENSITY (SEQUENCE), NATURAL DENSITY

Density (Polygon)

The number q in a STAR POLYGON $\{\frac{p}{q}\}$.

see also STAR POLYGON

Density (Sequence)

Let a SEQUENCE $\{a_i\}_{i=1}^{\infty}$ be strictly increasing and composed of NONNEGATIVE INTEGERS. Call $A(x)$ the number of terms not exceeding x . Then the density is given by $\lim_{x \rightarrow \infty} A(x)/x$ if the LIMIT exists.

References

- Guy, R. K. *Unsolved Problems in Number Theory*, 2nd ed. New York: Springer-Verlag, p. 199, 1994.

Denumerable Set

A SET is denumerable if a prescription can be given for identifying its members one at a time. Such a set is said to have CARDINAL NUMBER \aleph_0 . Examples of denumerable sets include ALGEBRAIC NUMBERS, INTEGERS, and RATIONAL NUMBERS. Once one denumerable set S is given, any other set which can be put into a ONE-TO-ONE correspondence with S is also denumerable. Examples of nondenumerable sets include the REAL, COMPLEX, IRRATIONAL, and TRANSCENDENTAL NUMBERS.

see also ALEPH-0, ALEPH-1, CANTOR DIAGONAL SLASH, CONTINUUM, HILBERT HOTEL

References

- Courant, R. and Robbins, H. "The Denumerability of the Rational Number and the Non-Denumerability of the Continuum." §2.4.2 in *What is Mathematics?: An Elementary Approach to Ideas and Methods*, 2nd ed. Oxford, England: Oxford University Press, pp. 79–83, 1996.

Denumerably Infinite

see DENUMERABLE SET

Depth (Graph)

The depth $E(G)$ of a GRAPH G is the minimum number of PLANAR GRAPHS P_i needed such that the union $\cup_i P_i = G$.

see also PLANAR GRAPH

Depth (Size)

The depth of a box is the horizontal DISTANCE from front to back (usually not necessarily defined to be smaller than the WIDTH, the horizontal DISTANCE from side to side).

see also HEIGHT, WIDTH (SIZE)

Depth (Statistics)

The smallest RANK (either up or down) of a set of data.

References

Tukey, J. W. *Explanatory Data Analysis*. Reading, MA: Addison-Wesley, p. 30, 1977.

Depth (Tree)

The depth of a RESOLVING TREE is the number of levels of links, not including the top. The depth of the link is the minimal depth for any RESOLVING TREE of that link. The only links of length 0 are the trivial links. A KNOT of length 1 is always a trivial KNOT and links of depth one are always HOPF LINKS, possibly with a few additional trivial components (Bleiler and Scharlemann). The LINKS of depth two have also been classified (Thompson and Scharlemann).

References

Adams, C. C. *The Knot Book: An Elementary Introduction to the Mathematical Theory of Knots*. New York: W. H. Freeman, p. 169, 1994.

Derangement

A PERMUTATION of n ordered objects in which none of the objects appears in its natural place. The function giving this quantity is the SUBFACTORIAL $!n$, defined by

$$!n \equiv n! \sum_{k=0}^n \frac{(-1)^k}{k!} \quad (1)$$

or

$$!n \equiv \left[\frac{n!}{e} \right], \quad (2)$$

where $k!$ is the usual FACTORIAL and $[x]$ is the NINT function. These are also called RENCONTRES NUMBERS (named after rencontres solitaire), or COMPLETE PERMUTATIONS, or derangements. The number of derangements $!n = d(n)$ of length n satisfy the RECURRENCE RELATIONS

$$d(n) = (n-1)[d(n-1) + d(n-2)] \quad (3)$$

and

$$d(n) = nd(n-1) + (-1)^n, \quad (4)$$

with $d(1) = 0$ and $d(2) = 1$. The first few are 0, 1, 2, 9, 44, 265, 1854, ... (Sloane's A000166). This sequence cannot be expressed as a fixed number of hypergeometric terms (Petkovšek *et al.* 1996, pp. 157–160).

see also MARRIED COUPLES PROBLEM, PERMUTATION, ROOT, SUBFACTORIAL

References

Aitken, A. C. *Determinants and Matrices*. Westport, CT: Greenwood Pub., p. 135, 1983.
 Ball, W. W. R. and Coxeter, H. S. M. *Mathematical Recreations and Essays, 13th ed.* New York: Dover, pp. 46–47, 1987.
 Coolidge, J. L. *An Introduction to Mathematical Probability*. Oxford, England: Oxford University Press, p. 24, 1925.
 Courant, R. and Robbins, H. *What is Mathematics?: An Elementary Approach to Ideas and Methods, 2nd ed.* Oxford, England: Oxford University Press, pp. 115–116, 1996.
 de Montmort, P. R. *Essai d'analyse sur les jeux de hasard*. Paris, p. 132, 1713.
 Dickau, R. M. "Derangements." <http://forum.swarthmore.edu/advanced/robertd/derangements.html>.
 Durell, C. V. and Robson, A. *Advanced Algebra*. London, p. 459, 1937.
 Petkovšek, M.; Wilf, H. S.; and Zeilberger, D. *A=B*. Wellesley, MA: A. K. Peters, 1996.
 Roberts, F. S. *Applied Combinatorics*. Englewood Cliffs, NJ: Prentice-Hall, 1984.
 Ruskey, F. "Information on Derangements." <http://sue.csc.uvic.ca/~cos/inf/perm/Derangements.html>.
 Sloane, N. J. A. Sequence A000166/M1937 in "An On-Line Version of the Encyclopedia of Integer Sequences."
 Stanley, R. P. *Enumerative Combinatorics, Vol. 1*. New York: Cambridge University Press, p. 67, 1986.
 Vardi, I. *Computational Recreations in Mathematica*. Reading, MA: Addison-Wesley, p. 123, 1991.

Derivative

The derivative of a FUNCTION represents an infinitesimal change in the function with respect to whatever parameters it may have. The "simple" derivative of a function f with respect to x is denoted either $f'(x)$ or $\frac{df}{dx}$ (and often written in-line as df/dx). When derivatives are taken with respect to time, they are often denoted using Newton's FLUXION notation, $\frac{dx}{dt} = \dot{x}$. The derivative of a function $f(x)$ with respect to the variable x is defined as

$$f'(x) \equiv \lim_{h \rightarrow 0} \frac{f(x+h) - f(x)}{h}. \quad (1)$$

Note that in order for the limit to exist, both $\lim_{h \rightarrow 0+}$ and $\lim_{h \rightarrow 0-}$ must exist and be equal, so the FUNCTION must be continuous. However, continuity is a NECESSARY but *not* SUFFICIENT condition for differentiability. Since some DISCONTINUOUS functions can be integrated, in a sense there are "more" functions which can be integrated than differentiated. In a letter to Stieltjes, Hermite wrote, "I recoil with dismay and horror at this lamentable plague of functions which do not have derivatives."

A 3-D generalization of the derivative to an arbitrary direction is known as the DIRECTIONAL DERIVATIVE.

In general, derivatives are mathematical objects which exist between smooth functions on manifolds. In this formalism, derivatives are usually assembled into "TANGENT MAPS."

Simple derivatives of some simple functions follow.

$$\frac{d}{dx} x^n = nx^{n-1} \quad (2)$$

$$\frac{d}{dx} \ln |x| = \frac{1}{x} \quad (3)$$

$$\frac{d}{dx} \sin x = \cos x \quad (4)$$

$$\frac{d}{dx} \cos x = -\sin x \quad (5)$$

$$\begin{aligned} \frac{d}{dx} \tan x &= \frac{d}{dx} \left(\frac{\sin x}{\cos x} \right) = \frac{\cos x \cos x - \sin x(-\sin x)}{\cos^2 x} \\ &= \frac{1}{\cos^2 x} = \sec^2 x \end{aligned} \quad (6)$$

$$\begin{aligned} \frac{d}{dx} \csc x &= \frac{d}{dx} (\sin x)^{-1} = -(\sin x)^{-2} \cos x = -\frac{\cos x}{\sin^2 x} \\ &= -\csc x \cot x \end{aligned} \quad (7)$$

$$\begin{aligned} \frac{d}{dx} \sec x &= \frac{d}{dx} (\cos x)^{-1} = -(\cos x)^{-2} (-\sin x) = \frac{\sin x}{\cos^2 x} \\ &= \sec x \tan x \end{aligned} \quad (8)$$

$$\begin{aligned} \frac{d}{dx} \cot x &= \frac{d}{dx} \left(\frac{\cos x}{\sin x} \right) = \frac{\sin x(-\sin x) - \cos x \cos x}{\cos^2 x} \\ &= -\frac{1}{\cos^2 x} = -\csc^2 x \end{aligned} \quad (9)$$

$$\frac{d}{dx} e^x = e^x \quad (10)$$

$$\begin{aligned} \frac{d}{dx} a^x &= \frac{d}{dx} e^{x \ln a} = \frac{d}{dx} e^{x \ln a} \\ &= (\ln a) e^{x \ln a} = (\ln a) a^x \end{aligned} \quad (11)$$

$$\frac{d}{dx} \sin^{-1} x = \frac{1}{\sqrt{1-x^2}} \quad (12)$$

$$\frac{d}{dx} \cos^{-1} x = -\frac{1}{\sqrt{1-x^2}} \quad (13)$$

$$\frac{d}{dx} \tan^{-1} x = \frac{1}{1+x^2} \quad (14)$$

$$\frac{d}{dx} \cot^{-1} x = -\frac{1}{1+x^2} \quad (15)$$

$$\frac{d}{dx} \sec^{-1} x = \frac{1}{x\sqrt{x^2-1}} \quad (16)$$

$$\frac{d}{dx} \csc^{-1} x = -\frac{1}{x\sqrt{x^2-1}} \quad (17)$$

$$\frac{d}{dx} \sinh x = \cosh x \quad (18)$$

$$\frac{d}{dx} \cosh x = \sinh x \quad (19)$$

$$\frac{d}{dx} \tanh x = \operatorname{sech}^2 x \quad (20)$$

$$\frac{d}{dx} \coth x = -\operatorname{csch}^2 x \quad (21)$$

$$\frac{d}{dx} \operatorname{sech} x = -\operatorname{sech} x \tanh x \quad (22)$$

$$\frac{d}{dx} \operatorname{csch} x = -\operatorname{csch} x \coth x \quad (23)$$

$$\frac{d}{dx} \operatorname{sn} x = \operatorname{cn} x \operatorname{dn} x \quad (24)$$

$$\frac{d}{dx} \operatorname{cn} x = -\operatorname{sn} x \operatorname{dn} x \quad (25)$$

$$\frac{d}{dx} \operatorname{dn} x = -k^2 \operatorname{sn} x \operatorname{cn} x. \quad (26)$$

Derivatives of sums are equal to the sum of derivatives so that

$$[f(x) + \dots + h(x)]' = f'(x) + \dots + h'(x). \quad (27)$$

In addition, if c is a constant,

$$\frac{d}{dx} [cf(x)] = cf'(x). \quad (28)$$

Furthermore,

$$\frac{d}{dx} [f(x)g(x)] = f(x)g'(x) + f'(x)g(x), \quad (29)$$

where f' denotes the DERIVATIVE of f with respect to x . This derivative rule can be applied iteratively to yield derivate rules for products of three or more functions, for example,

$$\begin{aligned} [fgh]' &= (fg)h' + (fg)'h = fgh' + (f'g + fg')h \\ &= f'gh + fg'h + fgh'. \end{aligned} \quad (30)$$

Other rules involving derivatives include the CHAIN RULE, POWER RULE, PRODUCT RULE, and QUOTIENT RULE. Miscellaneous other derivative identities include

$$\frac{dy}{dx} = \frac{\frac{dy}{dt}}{\frac{dx}{dt}} \quad (31)$$

$$\frac{dy}{dx} = \frac{1}{\frac{dx}{dy}}. \quad (32)$$

If $F(x, y) = C$, where C is a constant, then

$$dF = \frac{\partial F}{\partial y} dy + \frac{\partial F}{\partial x} dx = 0, \quad (33)$$

so

$$\frac{dy}{dx} = -\frac{\frac{\partial F}{\partial x}}{\frac{\partial F}{\partial y}}. \quad (34)$$

A vector derivative of a vector function

$$\mathbf{X}(t) \equiv \begin{bmatrix} x_1(t) \\ x_2(t) \\ \vdots \\ x_k(t) \end{bmatrix} \quad (35)$$

can be defined by

$$\frac{d\mathbf{X}}{dt} = \begin{bmatrix} \frac{dx_1}{dt} \\ \frac{dx_2}{dt} \\ \vdots \\ \frac{dx_k}{dt} \end{bmatrix} \quad (36)$$

see also BLANCMANGE FUNCTION, CARATHÉODORY DERIVATIVE, COMMA DERIVATIVE, CONVECTIVE DERIVATIVE, COVARIANT DERIVATIVE, DIRECTIONAL DERIVATIVE, EULER-LAGRANGE DERIVATIVE, FLUXION, FRACTIONAL CALCULUS, FRÉCHET DERIVATIVE, LAGRANGIAN DERIVATIVE, LIE DERIVATIVE, POWER RULE, SCHWARZIAN DERIVATIVE, SEMICOLON DERIVATIVE, WEIERSTRASS FUNCTION

References

- Abramowitz, M. and Stegun, C. A. (Eds.). *Handbook of Mathematical Functions with Formulas, Graphs, and Mathematical Tables*, 9th printing. New York: Dover, p. 11, 1972.
- Anton, H. *Calculus with Analytic Geometry*, 5th ed. New York: Wiley, 1987.
- Beyer, W. H. "Derivatives." *CRC Standard Mathematical Tables*, 28th ed. Boca Raton, FL: CRC Press, pp. 229–232, 1987.

Derivative Test

see FIRST DERIVATIVE TEST, SECOND DERIVATIVE TEST

Derived Set

The LIMIT POINTS of a SET P , denoted P' .

see also DENSE, LIMIT POINT, PERFECT SET

Dervish

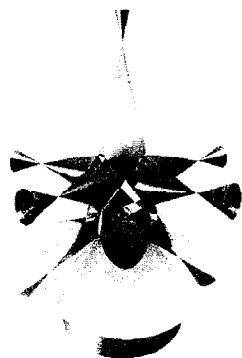

A QUINTIC SURFACE having the maximum possible number of ORDINARY DOUBLE POINTS (31), which was constructed by W. Barth in 1994 (Endraß). The implicit equation of the surface is

$$\begin{aligned} &64(x-w)[x^4 - 4x^3w - 10x^2y^2 - 4x^2w^2 \\ &\quad + 16xw^3 - 20xy^2w + 5y^4 + 16w^4 - 20y^2w^2] \\ &\quad - 5\sqrt{5 - \sqrt{5}}(2z - \sqrt{5 - \sqrt{5}}w) \\ &\quad \times [4(x^2 + y^2 + z^2) + (1 + 3\sqrt{5})w^2]^2, \end{aligned}$$

where w is a parameter (Endraß). The surface can also be described by the equation

$$aF + q = 0, \quad (1)$$

where

$$F = h_1h_2h_3h_4h_5, \quad (2)$$

$$h_1 = x - z \quad (3)$$

$$h_2 = \cos\left(\frac{2\pi}{5}\right)x - \sin\left(\frac{2\pi}{5}\right)y - z \quad (4)$$

$$h_3 = \cos\left(\frac{4\pi}{5}\right)x - \sin\left(\frac{4\pi}{5}\right)y - z \quad (5)$$

$$h_4 = \cos\left(\frac{6\pi}{5}\right)x - \sin\left(\frac{6\pi}{5}\right)y - z \quad (6)$$

$$h_5 = \cos\left(\frac{8\pi}{5}\right)x - \sin\left(\frac{8\pi}{5}\right)y - z \quad (7)$$

$$q = (1 - cz)(x^2 + y^2 - 1 + rz^2)^2, \quad (8)$$

and

$$r = \frac{1}{4}(1 + \sqrt{5}) \quad (9)$$

$$a = -\frac{8}{5}\left(1 + \frac{1}{\sqrt{5}}\right)\sqrt{5 - \sqrt{5}} \quad (10)$$

$$c = \frac{1}{2}\sqrt{5 - \sqrt{5}} \quad (11)$$

(Nordstrand).

The dervish is invariant under the GROUP D_5 and contains exactly 15 lines. Five of these are the intersection of the surface with a D_5 -invariant cone containing 16 nodes, five are the intersection of the surface with a D_5 -invariant plane containing 10 nodes, and the last five are the intersection of the surface with a second D_5 -invariant plane containing no nodes (Endraß).

References

- Endraß, S. "Togliatti Surfaces." <http://www.mathematik.uni-mainz.de/AlgebraischeGeometrie/docs/Etogliatti.shtml>.
- Endraß, S. "Flächen mit vielen Doppelpunkten." *DMV-Mitteilungen* 4, 17–20, 4/1995.
- Endraß, S. *Symmetrische Fläche mit vielen gewöhnlichen Doppelpunkten*. Ph.D. thesis. Erlangen, Germany, 1996.
- Nordstrand, T. "Dervish." <http://www.uib.no/people/nfytndervtxt.htm>.

Desargues' Theorem

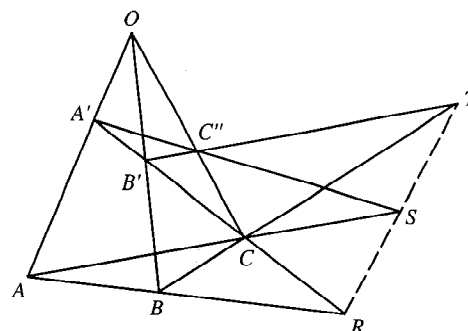

If the three straight LINES joining the corresponding VERTICES of two TRIANGLES ABC and $A'B'C'$ all meet in a point (the PERSPECTIVE CENTER), then the three intersections of pairs of corresponding sides lie on a straight LINE (the PERSPECTIVE AXIS). Equivalently, if two TRIANGLES are PERSPECTIVE from a POINT, they are PERSPECTIVE from a LINE.

Desargues' theorem is essentially its own dual according to the DUALITY PRINCIPLE of PROJECTIVE GEOMETRY.

see also DUALITY PRINCIPLE, PAPPUS'S HEXAGON THEOREM, PASCAL LINE, PASCAL'S THEOREM, PERSPECTIVE AXIS, PERSPECTIVE CENTER, PERSPECTIVE TRIANGLES

References

- Coxeter, H. S. M. and Greitzer, S. L. *Geometry Revisited*. Washington, DC: Math. Assoc. Amer., pp. 70–72, 1967.
 Ogilvy, C. S. *Excursions in Geometry*. New York: Dover, pp. 89–92, 1990.

Descartes Circle Theorem

A special case of APOLLONIUS' PROBLEM requiring the determination of a CIRCLE touching three mutually tangent CIRCLES (also called the KISSING CIRCLES PROBLEM). There are two solutions: a small circle surrounded by the three original CIRCLES, and a large circle surrounding the original three. Frederick Soddy gave the FORMULA for finding the RADIUS of the so-called inner and outer SODDY CIRCLES given the RADII of the other three. The relationship is

$$2(\kappa_1^2 + \kappa_2^2 + \kappa_3^2 + \kappa_4^2) = (\kappa_1 + \kappa_2 + \kappa_3 + \kappa_4)^2,$$

where κ_i are the CURVATURES of the CIRCLES. Here, the NEGATIVE solution corresponds to the outer SODDY CIRCLE and the POSITIVE solution to the inner SODDY CIRCLE. This formula was known to Descartes and Viète (Boyer and Merzbach 1991, p. 159), but Soddy extended it to SPHERES. In n -D space, $n + 2$ mutually touching n -SPHERES can always be found, and the relationship of their CURVATURES is

$$n \left(\sum_{i=1}^{n+2} \kappa_i^2 \right) = \left(\sum_{i=1}^{n+2} \kappa_i \right)^2.$$

see also APOLLONIUS' PROBLEM, FOUR COINS PROBLEM, SODDY CIRCLES, SPHERE PACKING

References

- Boyer, C. B. and Merzbach, U. C. *A History of Mathematics*, 2nd ed. New York: Wiley, 1991.
 Coxeter, H. S. M. *Introduction to Geometry*, 2nd ed. New York: Wiley, pp. 13–16, 1969.
 Wilker, J. B. "Four Proofs of a Generalization of the Descartes Circle Theorem." *Amer. Math. Monthly* **76**, 278–282, 1969.

Descartes-Euler Polyhedral Formula

see POLYHEDRAL FORMULA

Descartes Folium

see FOLIUM OF DESCARTES

Descartes' Formula

see DESCARTES TOTAL ANGULAR DEFECT

Descartes Ovals

see CARTESIAN OVALS

Descartes' Sign Rule

A method of determining the maximum number of POSITIVE and NEGATIVE REAL ROOTS of a POLYNOMIAL.

For POSITIVE ROOTS, start with the SIGN of COEFFICIENT of the lowest (or highest) POWER. Count the number of SIGN changes n as you proceed from the lowest to the highest POWER (ignoring POWERS which do not appear). Then n is the *maximum* number of POSITIVE ROOTS. Furthermore, the number of allowable ROOTS is $n, n - 2, n - 4, \dots$. For example, consider the POLYNOMIAL

$$f(x) = x^7 + x^6 - x^4 - x^3 - x^2 + x - 1.$$

Since there are three SIGN changes, there are a maximum of three possible POSITIVE ROOTS.

For NEGATIVE ROOTS, starting with a POLYNOMIAL $f(x)$, write a new POLYNOMIAL $g(x)$ with the SIGNS of all ODD POWERS reversed, while leaving the SIGNS of the EVEN POWERS unchanged. Then proceed as before to count the number of SIGN changes n . Then n is the *maximum* number of NEGATIVE ROOTS. For example, consider the POLYNOMIAL

$$f(x) = x^7 + x^6 - x^4 - x^3 - x^2 + x - 1,$$

and compute the new POLYNOMIAL

$$g(x) = -x^7 + x^6 - x^4 + x^3 - x^2 - x - 1.$$

There are four SIGN changes, so there are a maximum of four NEGATIVE ROOTS.

see also BOUND, STURM FUNCTION

References

- Anderson, B.; Jackson, J.; and Sitharam, M. "Descartes' Rule of Signs Revisited." *Amer. Math. Monthly* **105**, 447–451, 1998.
 Hall, H. S. and Knight, S. R. *Higher Algebra: A Sequel to Elementary Algebra for Schools*. London: Macmillan, pp. 459–460, 1950.
 Struik, D. J. (Ed.). *A Source Book in Mathematics 1200–1800*. Princeton, NJ: Princeton University Press, pp. 89–93, 1986.

Descartes Total Angular Defect

The total angular defect is the sum of the ANGULAR DEFECTS over all VERTICES of a POLYHEDRON, where the ANGULAR DEFECT δ at a given VERTEX is the difference between the sum of face angles and 2π . For any convex POLYHEDRON, the Descartes total angular defect is

$$\Delta = \sum_i \delta_i = 4\pi. \quad (1)$$

This is equivalent to the POLYHEDRAL FORMULA for a closed rectilinear surface, which satisfies

$$\Delta = 2\pi(V - E + F). \quad (2)$$

A POLYHEDRON with N_0 equivalent VERTICES is called a PLATONIC SOLID and can be assigned a SCHLÄFLI SYMBOL $\{p, q\}$. It then satisfies

$$N_0 = \frac{4\pi}{\delta} \quad (3)$$

and

$$\delta = 2\pi - q \left(1 - \frac{2}{p}\right) \pi, \quad (4)$$

so

$$N_0 = \frac{4p}{2p + 2q - pq}. \quad (5)$$

see also ANGULAR DEFECT, PLATONIC SOLID, POLYHEDRAL FORMULA, POLYHEDRON

Descriptive Set Theory

The study of DEFINABLE SETS and functions in POLISH SPACES.

References

Becker, H. and Kechris, A. S. *The Descriptive Set Theory of Polish Group Actions*. New York: Cambridge University Press, 1996.

Design

A formal description of the constraints on the possible configurations of an experiment which is subject to given conditions. A design is sometimes called an EXPERIMENTAL DESIGN.

see also BLOCK DESIGN, COMBINATORICS, DESIGN THEORY, HADAMARD DESIGN, HOWELL DESIGN, SPHERICAL DESIGN, SYMMETRIC BLOCK DESIGN, TRANSVERSAL DESIGN

Design Theory

The study of DESIGNS and, in particular, NECESSARY and SUFFICIENT conditions for the existence of a BLOCK DESIGN.

see also BRUCK-RYSER-CHOWLA THEOREM, FISHER'S BLOCK DESIGN INEQUALITY

References

Assmus, E. F. Jr. and Key, J. D. *Designs and Their Codes*. New York: Cambridge University Press, 1993.
Colbourn, C. J. and Dinitz, J. H. *CRC Handbook of Combinatorial Designs*. Boca Raton, FL: CRC Press, 1996.
Dinitz, J. H. and Stinson, D. R. (Eds.). "A Brief Introduction to Design Theory." Ch. 1 in *Contemporary Design Theory: A Collection of Surveys*. New York: Wiley, pp. 1–12, 1992.

Desmic Surface

Let Δ_1 , Δ_2 , and Δ_3 be tetrahedra in projective 3-space \mathbb{P}^3 . Then the tetrahedra are said to be desmically related if there exist constants α , β , and γ such that

$$\alpha\Delta_1 + \beta\Delta_2 + \gamma\Delta_3 = 0.$$

A desmic surface is then defined as a QUARTIC SURFACE which can be written as

$$a\Delta_1 + b\Delta_2 + c\Delta_3 = 0$$

for desmically related tetrahedra Δ_1 , Δ_2 , and Δ_3 . Desmic surfaces have 12 ORDINARY DOUBLE POINTS, which are the vertices of three tetrahedra in 3-space (Hunt).

see also QUARTIC SURFACE

References

Hunt, B. "Desmic Surfaces." §B.5.2 in *The Geometry of Some Special Arithmetic Quotients*. New York: Springer-Verlag, pp. 311–315, 1996.
Jessop, C. §13 in *Quartic Surfaces with Singular Points*. Cambridge, England: Cambridge University Press, 1916.

Destructive Dilemma

A formal argument in LOGIC in which it is stated that

1. $P \Rightarrow Q$ and $R \Rightarrow S$ (where \Rightarrow means "IMPLIES"), and
2. Either not- Q or not- S is true, from which two statements it follows that either not- P or not- R is true.

see also CONSTRUCTIVE DILEMMA, DILEMMA

Determinant

Determinants are mathematical objects which are very useful in the analysis and solution of systems of linear equations. As shown in CRAMER'S RULE, a nonhomogeneous system of linear equations has a nontrivial solution IFF the determinant of the system's MATRIX is NONZERO (so that the MATRIX is nonsingular). A 2×2 determinant is defined to be

$$\det \begin{bmatrix} a & b \\ c & d \end{bmatrix} \equiv \begin{vmatrix} a & b \\ c & d \end{vmatrix} \equiv ad - bc. \quad (1)$$

A $k \times k$ determinant can be expanded by MINORS to obtain

$$\begin{vmatrix} a_{11} & a_{12} & a_{13} & \cdots & a_{1k} \\ a_{21} & a_{22} & a_{23} & \cdots & a_{2k} \\ \vdots & \vdots & \vdots & \ddots & \vdots \\ a_{k1} & a_{k2} & a_{k3} & \cdots & a_{kk} \end{vmatrix} \\ = a_{11} \begin{vmatrix} a_{22} & a_{23} & \cdots & a_{2k} \\ \vdots & \vdots & \ddots & \vdots \\ a_{k2} & a_{k3} & \cdots & a_{kk} \end{vmatrix} - a_{12} \begin{vmatrix} a_{21} & a_{23} & \cdots & a_{2k} \\ \vdots & \vdots & \ddots & \vdots \\ a_{k1} & a_{k3} & \cdots & a_{kk} \end{vmatrix} \\ + \cdots \pm a_{1k} \begin{vmatrix} a_{21} & a_{22} & \cdots & a_{2(k-1)} \\ \vdots & \vdots & \ddots & \vdots \\ a_{k1} & a_{k2} & \cdots & a_{k(k-1)} \end{vmatrix}. \quad (2)$$

A general determinant for a MATRIX A has a value

$$|A| = \sum_i a_{ij} a^{ij}, \quad (3)$$

with no implied summation over i and where a^{ij} is the COFACTOR of a_{ij} defined by

$$a^{ij} \equiv (-1)^{i+j} C_{ij}. \quad (4)$$

Here, C is the $(n-1) \times (n-1)$ MATRIX formed by eliminating row i and column j from A , i.e., by DETERMINANT EXPANSION BY MINORS.

Given an $n \times n$ determinant, the additive inverse is

$$|-A| = (-1)^n |A|. \quad (5)$$

Determinants are also DISTRIBUTIVE, so

$$|AB| = |A| |B|. \quad (6)$$

This means that the determinant of a MATRIX INVERSE can be found as follows:

$$|| = |AA^{-1}| = |A| |A^{-1}| = 1, \quad (7)$$

where I is the IDENTITY MATRIX, so

$$|A| = \frac{1}{|A^{-1}|}. \quad (8)$$

Determinants are MULTILINEAR in rows and columns, since

$$\begin{vmatrix} a_1 & a_2 & a_3 \\ a_4 & a_5 & a_6 \\ a_7 & a_8 & a_9 \end{vmatrix} = \begin{vmatrix} a_1 & 0 & 0 \\ a_4 & a_5 & a_6 \\ a_7 & a_8 & a_9 \end{vmatrix} \\ + \begin{vmatrix} 0 & a_2 & 0 \\ a_4 & a_5 & a_6 \\ a_7 & a_8 & a_9 \end{vmatrix} + \begin{vmatrix} 0 & 0 & a_3 \\ a_4 & a_5 & a_6 \\ a_7 & a_8 & a_9 \end{vmatrix} \quad (9)$$

and

$$\begin{vmatrix} a_1 & a_2 & a_3 \\ a_4 & a_5 & a_6 \\ a_7 & a_8 & a_9 \end{vmatrix} = \begin{vmatrix} a_1 & a_2 & a_3 \\ 0 & a_5 & a_6 \\ 0 & a_8 & a_9 \end{vmatrix} \\ + \begin{vmatrix} 0 & a_2 & a_3 \\ a_4 & a_5 & a_6 \\ 0 & a_8 & a_9 \end{vmatrix} + \begin{vmatrix} 0 & a_2 & a_3 \\ 0 & a_5 & a_6 \\ a_7 & a_8 & a_9 \end{vmatrix}. \quad (10)$$

The determinant of the SIMILARITY TRANSFORMATION of a matrix is equal to the determinant of the original MATRIX

$$|BAB^{-1}| = |B| |A| |B^{-1}| = |B| |A| \frac{1}{|B^{-1}|} = |A|. \quad (11)$$

The determinant of a similarity transformation minus a multiple of the unit MATRIX is given by

$$|B^{-1}AB - \lambda I| = |B^{-1}AB - B^{-1}\lambda B| = |B^{-1}(A - \lambda I)B| \\ = |B^{-1}| |A - \lambda I| |B| = |A - \lambda I|. \quad (12)$$

The determinant of a MATRIX TRANSPOSE equals the determinant of the original MATRIX,

$$|A| = |A^T|, \quad (13)$$

and the determinant of a COMPLEX CONJUGATE is equal to the COMPLEX CONJUGATE of the determinant

$$|A^*| = |A|^*. \quad (14)$$

Let ϵ be a small number. Then

$$|I + \epsilon A| = 1 + \epsilon \text{Tr}(A) + \mathcal{O}(\epsilon^2), \quad (15)$$

where $\text{Tr}(A)$ is the trace of A . The determinant takes on a particularly simple form for a TRIANGULAR MATRIX

$$\begin{vmatrix} a_{11} & a_{12} & \cdots & a_{1k} \\ 0 & a_{22} & \cdots & a_{2k} \\ \vdots & \vdots & \ddots & \vdots \\ 0 & 0 & \cdots & a_{kk} \end{vmatrix} = \prod_{n=1}^k a_{nn}. \quad (16)$$

Important properties of the determinant include the following.

1. Switching two rows or columns changes the sign.
2. Scalars can be factored out from rows and columns.
3. Multiples of rows and columns can be added together without changing the determinant's value.
4. Scalar multiplication of a row by a constant c multiplies the determinant by c .
5. A determinant with a row or column of zeros has value 0.
6. Any determinant with two rows or columns equal has value 0.

Property 1 can be established by induction. For a 2×2 MATRIX, the determinant is

$$\begin{vmatrix} a_1 & b_1 \\ a_2 & b_2 \end{vmatrix} = a_1 b_2 - b_1 a_2 = -(b_1 a_2 - a_1 b_2) \\ = - \begin{vmatrix} b_1 & a_1 \\ b_2 & a_2 \end{vmatrix} \quad (17)$$

For a 3×3 MATRIX, the determinant is

$$\begin{vmatrix} a_1 & b_1 & c_1 \\ a_2 & b_2 & c_2 \\ a_3 & b_3 & c_3 \end{vmatrix} \\ = a_1 \begin{vmatrix} b_2 & c_2 \\ b_3 & c_3 \end{vmatrix} - b_1 \begin{vmatrix} a_2 & c_2 \\ a_3 & c_3 \end{vmatrix} + c_1 \begin{vmatrix} a_2 & b_2 \\ a_3 & b_3 \end{vmatrix} \\ = - \left(a_1 \begin{vmatrix} c_2 & b_2 \\ c_3 & b_3 \end{vmatrix} + b_1 \begin{vmatrix} c_2 & a_2 \\ c_3 & a_3 \end{vmatrix} - c_1 \begin{vmatrix} a_2 & b_2 \\ a_3 & b_3 \end{vmatrix} \right) \\ = - \begin{vmatrix} a_1 & c_1 & b_1 \\ a_2 & c_2 & b_2 \\ a_3 & c_3 & b_3 \end{vmatrix} \\ = - \left(-a_1 \begin{vmatrix} b_2 & c_2 \\ b_3 & c_3 \end{vmatrix} + b_1 \begin{vmatrix} a_2 & c_2 \\ a_3 & c_3 \end{vmatrix} + c_1 \begin{vmatrix} b_2 & a_2 \\ b_3 & a_3 \end{vmatrix} \right) \\ = - \begin{vmatrix} b_1 & a_1 & c_1 \\ b_2 & a_2 & c_2 \\ b_3 & a_3 & c_3 \end{vmatrix} \\ = - \left(-a_1 \begin{vmatrix} c_2 & b_2 \\ c_3 & b_3 \end{vmatrix} - b_1 \begin{vmatrix} a_2 & c_2 \\ a_3 & c_3 \end{vmatrix} + c_1 \begin{vmatrix} b_2 & a_2 \\ b_3 & a_3 \end{vmatrix} \right) \\ = - \begin{vmatrix} c_1 & b_1 & a_1 \\ c_2 & b_2 & a_2 \\ c_3 & b_3 & a_3 \end{vmatrix}. \quad (18)$$

Property 2 follows likewise. For 2×2 and 3×3 matrices,

$$\begin{vmatrix} ka_1 & b_1 \\ ka_2 & b_2 \end{vmatrix} = k(a_1 b_2) - k(b_1 a_2) = k \begin{vmatrix} a_1 & b_1 \\ a_2 & b_2 \end{vmatrix} \quad (19)$$

and

$$\begin{vmatrix} ka_1 & b_1 & c_1 \\ ka_2 & b_2 & c_2 \\ ka_3 & b_3 & c_3 \end{vmatrix} = ka_1 \begin{vmatrix} b_2 & c_2 \\ b_3 & c_3 \end{vmatrix} - b_1 \begin{vmatrix} ka_2 & c_2 \\ ka_3 & c_3 \end{vmatrix} \\ + c_1 \begin{vmatrix} ka_2 & b_2 \\ ka_3 & b_3 \end{vmatrix} = k \begin{vmatrix} a_1 & b_1 & c_1 \\ a_2 & b_2 & c_2 \\ a_3 & b_3 & c_3 \end{vmatrix}. \quad (20)$$

Property 3 follows from the identity

$$\begin{vmatrix} a_1 + kb_1 & b_1 & c_1 \\ a_2 + kb_2 & b_2 & c_2 \\ a_3 + kb_3 & b_3 & c_3 \end{vmatrix} = (a_1 + kb_1) \begin{vmatrix} b_2 & c_2 \\ b_3 & c_3 \end{vmatrix} \\ - b_1 \begin{vmatrix} a_2 + kb_2 & c_2 \\ a_3 + kb_3 & c_3 \end{vmatrix} + c_1 \begin{vmatrix} a_2 + kb_2 & b_2 \\ a_3 + kb_3 & b_3 \end{vmatrix}. \quad (21)$$

If a_{ij} is an $n \times n$ MATRIX with a_{ij} REAL NUMBERS, then $\det[a_{ij}]$ has the interpretation as the oriented n -dimensional CONTENT of the PARALLELEPIPED spanned

by the column vectors $[a_{i,1}], \dots, [a_{i,n}]$ in \mathbb{R}^n . Here, “oriented” means that, up to a change of $+$ or $-$ SIGN, the number is the n -dimensional CONTENT, but the SIGN depends on the “orientation” of the column vectors involved. If they agree with the standard orientation, there is a $+$ SIGN; if not, there is a $-$ SIGN. The PARALLELEPIPED spanned by the n -D vectors \mathbf{v}_1 through \mathbf{v}_i is the collection of points

$$t_1 \mathbf{v}_1 + \dots + t_i \mathbf{v}_i, \quad (22)$$

where t_j is a REAL NUMBER in the CLOSED INTERVAL $[0,1]$.

There are an infinite number of 3×3 determinants with no 0 or ± 1 entries having unity determinant. One parametric family is

$$\begin{vmatrix} -8n^2 - 8n & 2n + 1 & 4n \\ -4n^2 - 4n & n + 1 & 2n + 1 \\ -4n^2 - 4n - 1 & n & 2n - 1 \end{vmatrix}. \quad (23)$$

Specific examples having small entries include

$$\begin{vmatrix} 2 & 3 & 2 \\ 4 & 2 & 3 \\ 9 & 6 & 7 \end{vmatrix}, \begin{vmatrix} 2 & 3 & 5 \\ 3 & 2 & 3 \\ 9 & 5 & 7 \end{vmatrix}, \begin{vmatrix} 2 & 3 & 6 \\ 3 & 2 & 3 \\ 17 & 11 & 16 \end{vmatrix}, \dots \quad (24)$$

(Guy 1989, 1994).

see also CIRCULANT DETERMINANT, COFACTOR, HESSIAN DETERMINANT, HYPERDETERMINANT, IMMANANT, JACOBIAN, KNOT DETERMINANT, MATRIX, MINOR, PERMANENT, VANDERMONDE DETERMINANT, WRONSKIAN

References

- Arfken, G. “Determinants.” §4.1 in *Mathematical Methods for Physicists*, 3rd ed. Orlando, FL: Academic Press, pp. 168–176, 1985.
 Guy, R. K. “Unsolved Problems Come of Age.” *Amer. Math. Monthly* **96**, 903–909, 1989.
 Guy, R. K. “A Determinant of Value One.” §F28 in *Unsolved Problems in Number Theory*, 2nd ed. New York: Springer-Verlag, pp. 265–266, 1994.

Determinant (Binary Quadratic Form)

The determinant of a BINARY QUADRATIC FORM

$$Au^2 + 2Buv + Cv^2$$

is

$$D \equiv B^2 - AC.$$

It is equal to 1/4 of the corresponding DISCRIMINANT.

Determinant Expansion by Minors

Also known as LAPLACIAN DETERMINANT EXPANSION BY MINORS. Let $|M|$ denote the DETERMINANT of a MATRIX M , then

$$|M| = \sum_{i=1}^k (-1)^{i+j} a_i M_{ij},$$

where M_{ij} is called a MINOR,

$$|M| = \sum_{i=1}^k a_i C_{ij},$$

where C_{ij} is called a COFACTOR.

see also COFACTOR, DETERMINANT

References

Arfken, G. *Mathematical Methods for Physicists*, 3rd ed. Orlando, FL: Academic Press, pp. 169–170, 1985.

Determinant (Knot)

see KNOT DETERMINANT

Determinant Theorem

Given a MATRIX m , the following are equivalent:

1. $|m| \neq 0$.
2. The columns of m are linearly independent.
3. The rows of m are linearly independent.
4. $\text{Range}(m) = \mathbb{R}^n$.
5. $\text{Null}(m) = \{0\}$.
6. m has a MATRIX INVERSE.

see also DETERMINANT, MATRIX INVERSE, NULLSPACE, RANGE (IMAGE)

Developable Surface

A surface on which the GAUSSIAN CURVATURE K is everywhere 0.

see also BINORMAL DEVELOPABLE, NORMAL DEVELOPABLE, SYNCLASTIC, TANGENT DEVELOPABLE

Deviation

The DIFFERENCE of a quantity from some fixed value, usually the “correct” or “expected” one.

see ABSOLUTE DEVIATION, AVERAGE ABSOLUTE DEVIATION, DIFFERENCE, DISPERSION (STATISTICS), MEAN DEVIATION, SIGNED DEVIATION, STANDARD DEVIATION

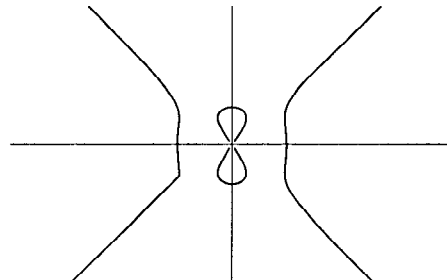
Devil's Curve

The devil's curve was studied by G. Cramer in 1750 and Lacroix in 1810 (MacTutor Archive). It appeared in *Nouvelles Annales* in 1858. The Cartesian equation is

$$y^4 - a^2 y^2 = x^4 - b^2 x^2, \quad (1)$$

equivalent to

$$y^2(y^2 - a^2) = x^2(x^2 - b^2), \quad (2)$$

the polar equation is

$$r^2(\sin^2 \theta - \cos^2 \theta) = a^2 \sin^2 \theta - b^2 \cos^2 \theta, \quad (3)$$

and the parametric equations are

$$x = \cos t \sqrt{\frac{a^2 \sin^2 t - b^2 \cos^2 t}{\sin^2 t - \cos^2 t}} \quad (4)$$

$$y = \sin t \sqrt{\frac{a^2 \sin^2 t - b^2 \cos^2 t}{\sin^2 t - \cos^2 t}}. \quad (5)$$

A special case of the Devil's curve is the so-called ELECTRIC MOTOR CURVE:

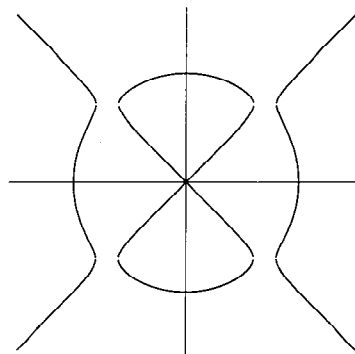

$$y^2(y^2 - 96) = x^2(x^2 - 100) \quad (6)$$

(Cundy and Rollett 1989).

see also ELECTRIC MOTOR CURVE

References

- Cundy, H. and Rollett, A. *Mathematical Models*, 3rd ed. Stradbroke, England: Tarquin Pub., p. 71, 1989.
- Gray, A. *Modern Differential Geometry of Curves and Surfaces*. Boca Raton, FL: CRC Press, p. 71, 1993.
- Lawrence, J. D. *A Catalog of Special Plane Curves*. New York: Dover, pp. 151–152, 1972.
- MacTutor History of Mathematics Archive. “Devil's Curve.” <http://www-groups.dcs.st-and.ac.uk/~history/Curves/Devils.html>.

Devil's Staircase

A plot of the WINDING NUMBER W resulting from MODE LOCKING as a function of Ω for the CIRCLE MAP with $K = 1$. At each value of Ω , the WINDING NUMBER is some RATIONAL NUMBER. The result is a monotonic increasing "staircase" for which the simplest RATIONAL NUMBERS have the largest steps. For $K = 1$, the MEASURE of quasiperiodic states (Ω IRRATIONAL) on the Ω -axis has become zero, and the measure of MODE-LOCKED state has become 1. The DIMENSION of the Devil's staircase $\approx 0.8700 \pm 3.7 \times 10^{-4}$.

see also CANTOR FUNCTION

References

- Mandelbrot, B. B. *The Fractal Geometry of Nature*. New York: W. H. Freeman, 1983.
 Ott, E. *Chaos in Dynamical Systems*. New York: Cambridge University Press, 1993.
 Rasband, S. N. *Chaotic Dynamics of Nonlinear Systems*. New York: Wiley, p. 132, 1990.

Devil on Two Sticks

see DEVIL'S CURVE

Diabolical Cube

A 6-piece POLYCUBE DISSECTION of the 3×3 CUBE.

see also CUBE DISSECTION, SOMA CUBE

References

- Gardner, M. "Polycubes." Ch. 3 in *Knotted Doughnuts and Other Mathematical Entertainments*. New York: W. H. Freeman, pp. 29–30, 1986.

Diabolical Square

see PANMAGIC SQUARE

Diabolo

A 2-POLYABOLO.

Diacaustic

The ENVELOPE of refracted rays for a given curve.

see also CATACAUSTIC, CAUSTIC

References

- Lawrence, J. D. *A Catalog of Special Plane Curves*. New York: Dover, p. 60, 1972.

Diagonal Matrix

A diagonal matrix is a MATRIX A of the form

$$a_{ij} = c_i \delta_{ij}, \quad (1)$$

where δ is the KRONECKER DELTA, c_i are constants, and there is no summation over indices. The general diagonal matrix is therefore SQUARE and of the form

$$\begin{bmatrix} c_1 & 0 & \cdots & 0 \\ 0 & c_2 & \cdots & 0 \\ \vdots & \vdots & \ddots & \vdots \\ 0 & 0 & \cdots & c_n \end{bmatrix}. \quad (2)$$

Given a MATRIX equation of the form

$$\begin{bmatrix} a_{11} & \cdots & a_{1n} \\ \vdots & \ddots & \vdots \\ a_{n1} & \cdots & a_{nn} \end{bmatrix} \begin{bmatrix} \lambda_1 & \cdots & 0 \\ \vdots & \ddots & \vdots \\ 0 & \cdots & \lambda_n \end{bmatrix} = \begin{bmatrix} \lambda_1 & \cdots & 0 \\ \vdots & \ddots & \vdots \\ 0 & \cdots & \lambda_n \end{bmatrix} \begin{bmatrix} a_{11} & \cdots & a_{1n} \\ \vdots & \ddots & \vdots \\ a_{n1} & \cdots & a_{nn} \end{bmatrix}, \quad (3)$$

multiply through to obtain

$$\begin{bmatrix} a_{11}\lambda_1 & \cdots & a_{1n}\lambda_n \\ \vdots & \ddots & \vdots \\ a_{n1}\lambda_1 & \cdots & a_{nn}\lambda_n \end{bmatrix} = \begin{bmatrix} a_{11}\lambda_1 & \cdots & a_{1n}\lambda_1 \\ \vdots & \ddots & \vdots \\ a_{n1}\lambda_n & \cdots & a_{nn}\lambda_n \end{bmatrix}. \quad (4)$$

Since in general, $\lambda_i \neq \lambda_j$ for $i \neq j$, this can be true only if off-diagonal components vanish. Therefore, A must be diagonal.

Given a diagonal matrix T ,

$$T^n = \begin{bmatrix} t_1 & 0 & \cdots & 0 \\ 0 & t_2 & \cdots & 0 \\ \vdots & \vdots & \ddots & \vdots \\ 0 & 0 & \cdots & t_k \end{bmatrix}^n = \begin{bmatrix} t_1^n & 0 & \cdots & 0 \\ 0 & t_2^n & \cdots & 0 \\ \vdots & \vdots & \ddots & \vdots \\ 0 & 0 & \cdots & t_k^n \end{bmatrix}. \quad (5)$$

see also MATRIX, TRIANGULAR MATRIX, TRIDIAGONAL MATRIX

References

- Arfken, G. *Mathematical Methods for Physicists, 3rd ed.* Orlando, FL: Academic Press, pp. 181–184 and 217–229, 1985.

Diagonal Metric

A METRIC g_{ij} which is zero for $i \neq j$.

see also METRIC

Diagonal (Polygon)

A LINE SEGMENT connecting two nonadjacent VERTICES of a POLYGON. The number of ways a fixed convex n -gon can be divided into TRIANGLES by nonintersecting diagonals is C_{n-2} (with C_{n-3} diagonals), where C_n is a CATALAN NUMBER. This is EULER'S POLYGON DIVISION PROBLEM. Counting the number of regions determined by drawing the diagonals of a regular n -gon is a more difficult problem, as is determining the number of n -tuples of CONCURRENT diagonals (Beller *et al.* 1972, Item 2).

The number of regions which the diagonals of a CONVEX POLYGON divide its center if no three are concurrent in its interior is

$$N = \binom{n}{4} + \binom{n-1}{2} = \frac{1}{24}(n-1)(n-2)(n^2-3n+12).$$

The first few values are 0, 0, 1, 4, 11, 25, 50, 91, 154, 246, ... (Sloane's A006522).

see also CATALAN NUMBER, DIAGONAL (POLYHEDRON), EULER'S POLYGON DIVISION PROBLEM, POLYGON, VERTEX (POLYGON)

References

Beeler, M.; Gosper, R. W.; and Schroepel, R. *HAKMEM*. Cambridge, MA: MIT Artificial Intelligence Laboratory, Memo AIM-239, Feb. 1972.
Sloane, N. J. A. Sequence A006522/M3413 in "An On-Line Version of the Encyclopedia of Integer Sequences."

Diagonal (Polyhedron)

A LINE SEGMENT connecting two nonadjacent sides of a POLYHEDRON. The only simple POLYHEDRON with no diagonals is the TETRAHEDRON. The only known TOROIDAL POLYHEDRON with no diagonals is the CSÁSZÁR POLYHEDRON.

see also DIAGONAL (POLYGON), EULER BRICK, POLYHEDRON, SPACE DIAGONAL

Diagonal Ramsey Number

A RAMSEY NUMBER of the form $R(k, k; 2)$.

see also RAMSEY NUMBER

Diagonal Slash

see CANTOR DIAGONAL SLASH

Diagonal (Solidus)

see SOLIDUS

Diagonalization

see MATRIX DIAGONALIZATION

Diagonals Problem

see EULER BRICK

Diagram

A schematic mathematical illustration showing the relationships between or properties of mathematical objects.

see also ALTERNATING KNOT DIAGRAM, ARGAND DIAGRAM, COXETER-DYNKIN DIAGRAM, DE BRUIJN DIAGRAM, DYNKIN DIAGRAM, FERRERS DIAGRAM, HASSE DIAGRAM, HEEGAARD DIAGRAM, KNOT DIAGRAM, LINK DIAGRAM, STEM-AND-LEAF DIAGRAM, VENN DIAGRAM, VORONOI DIAGRAM, YOUNG DIAGRAM

Diameter

The diameter of a CIRCLE is the DISTANCE from a point on the CIRCLE to point π RADIANS away. If r is the RADIUS, $d = 2r$.

see also BROCARD DIAMETER, CIRCUMFERENCE, DIAMETER (GENERAL), DIAMETER (GRAPH), PI, RADIUS, TRANSFINITE DIAMETER

Diameter (General)

The farthest DISTANCE between two points on the boundary of a closed figure.

see also BORSUK'S CONJECTURE

References

Eppstein, D. "Width, Diameter, and Geometric Inequalities." <http://www.ics.uci.edu/~eppstein/junkyard/diam.html>.

Diameter (Graph)

The length of the "longest shortest path" between two VERTICES of a GRAPH. In other words, a graph's diameter is the largest number of vertices which must be traversed in order to travel from one vertex to another when paths which backtrack, detour, or loop are excluded from consideration.

Diamond

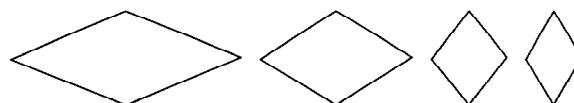

A convex QUADRILATERAL having sides of equal length and PERPENDICULAR PLANES of symmetry passing through opposite pairs of VERTICES. The LOZENGE is a special case of a diamond.

see also KITE, LOZENGE, PARALLELOGRAM, QUADRILATERAL, RHOMBUS

Dice

A die (plural "dice") is a SOLID with markings on each of its faces. The faces are usually all the same shape, making PLATONIC SOLIDS and ARCHIMEDEAN SOLID DUALS the obvious choices. The die can be "rolled" by throwing it in the air and allowing it to come to rest on one of its faces. Dice are used in many games of chance as a way of picking RANDOM NUMBERS on which to bet, and are used in board or roll-playing games to determine the number of spaces to move, results of a conflict, etc. A COIN can be viewed as a degenerate 2-sided case of a die.

The most common type of die is a six-sided CUBE with the numbers 1–6 placed on the faces. The value of the roll is indicated by the number of "spots" showing on the top. For the six-sided die, opposite faces are arranged to always sum to seven. This gives two possible MIRROR IMAGE arrangements in which the numbers 1, 2, and 3 may be arranged in a clockwise or counterclockwise order about a corner. Commercial dice may, in fact, have either orientation. The illustrations below show 6-sided dice with counterclockwise and clockwise arrangements, respectively.

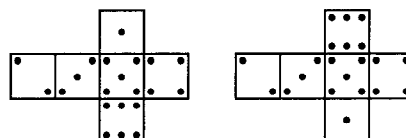

The CUBE has the nice property that there is an upward-pointing face opposite the bottom face from which the value of the "roll" can easily be read. This would not be true, for instance, for a TETRAHEDRAL die, which would have to be picked up and turned over to reveal the number underneath (although it could be determined by noting which number 1-4 was *not* visible on one of the upper three faces). The arrangement of spots $\cdot\cdot$ corresponding to a roll of 5 on a six-sided die is called the QUINCUNX. There are also special names for certain rolls of two six-sided dice: two 1s are called SNAKE EYES and two 6s are called BOXCARS.

Shapes of dice other than the usual 6-sided CUBE are commercially available from companies such as Dice & Games, Ltd.[®]

Diaconis and Keller (1989) show that there exist "fair" dice other than the usual PLATONIC SOLIDS and duals of the ARCHIMEDEAN SOLIDS, where a fair die is one for which its symmetry group acts transitively on its faces. However, they did not explicitly provide any examples.

The probability of obtaining p points (a roll of p) on n s -sided dice can be computed as follows. The number of ways in which p can be obtained is the COEFFICIENT of x^p in

$$f(x) = (x + x^2 + \dots + x^s)^n, \quad (1)$$

since each possible arrangement contributes one term. $f(x)$ can be written as a MULTINOMIAL SERIES

$$f(x) = x^n \left(\sum_{i=0}^{s-1} x^i \right)^n = x^n \left(\frac{1-x^s}{1-x} \right)^n, \quad (2)$$

so the desired number c is the COEFFICIENT of x^p in

$$x^n (1-x^s)^n (1-x)^{-n}. \quad (3)$$

Expanding,

$$x^n \sum_{k=0}^n (-1)^k \binom{n}{k} x^{sk} \sum_{l=0}^{\infty} \binom{n+l-1}{l} x^l, \quad (4)$$

so in order to get the COEFFICIENT of x^p , include all terms with

$$p = n + sk + l. \quad (5)$$

c is therefore

$$c = \sum_{k=0}^n (-1)^k \binom{n}{k} \binom{p-sk-1}{p-sk-n}. \quad (6)$$

But $p-sk-n > 0$ only when $k < (p-n)/s$, so the other terms do not contribute. Furthermore,

$$\binom{p-sk-1}{p-sk-n} = \binom{p-sk-1}{n-1}, \quad (7)$$

so

$$c = \sum_{k=0}^{\lfloor (p-n)/s \rfloor} (-1)^k \binom{n}{k} \binom{p-sk-1}{n-1}, \quad (8)$$

where $\lfloor x \rfloor$ is the FLOOR FUNCTION, and

$$P(p, n, s) = \frac{1}{s^n} \sum_{k=0}^{\lfloor (p-n)/s \rfloor} (-1)^k \binom{n}{k} \binom{p-sk-1}{n-1}. \quad (9)$$

Consider now $s = 6$. For $n = 2$ six-sided dice,

$$k_{\max} \equiv \left\lfloor \frac{p-2}{6} \right\rfloor = \begin{cases} 0 & \text{for } 2 \leq p \leq 7 \\ 1 & \text{for } 12 \leq p \leq 8, \end{cases} \quad (10)$$

and

$$\begin{aligned} P(p, 2, 6) &= \frac{1}{6^2} \sum_{k=0}^{k_{\max}} (-1)^k \binom{2}{k} \binom{p-6k-1}{1} \\ &= \frac{1}{6^2} \sum_{k=0}^{k_{\max}} (-1)^k \frac{2!}{k!(2-k)!} (p-6k-1) \\ &= \frac{1}{36} \sum_{k=0}^{k_{\max}} (1-2k)(k+1)(p-6k-1) \\ &= \frac{1}{36} \begin{cases} p-1 & \text{for } 2 \leq p \leq 7 \\ 13-p & \text{for } 8 \leq p \leq 12 \end{cases} \\ &= \frac{6-|p-7|}{36} \quad \text{for } 2 \leq p \leq 12. \end{aligned} \quad (11)$$

The most common roll is therefore seen to be a 7, with probability $6/36 = 1/6$, and the least common rolls are 2 and 12, both with probability $1/36$.

For $n = 3$ six-sided dice,

$$k_{\max} = \left\lfloor \frac{p-3}{6} \right\rfloor = \begin{cases} 0 & \text{for } 3 \leq p \leq 8 \\ 1 & \text{for } 9 \leq p \leq 14 \\ 2 & \text{for } 15 \leq p \leq 18, \end{cases} \quad (12)$$

and

$$\begin{aligned} P(p, 3, 6) &= \frac{1}{6^3} \sum_{k=0}^{k_{\max}} (-1)^k \binom{3}{k} \binom{p-6k-1}{2} \\ &= \frac{1}{6^3} \sum_{k=0}^{k_{\max}} (-1)^k \frac{3!}{k!(3-k)!} \frac{(p-6k-1)(p-6k-2)}{2} \\ &= \frac{1}{216} \begin{cases} \frac{(p-1)(p-2)}{2} & \text{for } 3 \leq p \leq 8 \\ \frac{(p-1)(p-2)}{2} - 3 \frac{(p-7)(p-8)}{2} & \text{for } 9 \leq p \leq 14 \\ \frac{(p-1)(p-2)}{2} - 3 \frac{(p-7)(p-8)}{2} + 3 \frac{(p-13)(p-14)}{2} & \text{for } 15 \leq p \leq 18 \end{cases} \\ &= \frac{1}{216} \begin{cases} \frac{1}{2}(p-1)(p-2) & \text{for } 3 \leq p \leq 8 \\ -p^2 + 21p - 83 & \text{for } 9 \leq p \leq 14 \\ \frac{1}{2}(19-p)(20-p) & \text{for } 15 \leq p \leq 18. \end{cases} \end{aligned} \quad (13)$$

For three six-sided dice, the most common rolls are 10 and 11, both with probability $1/8$; and the least common rolls are 3 and 18, both with probability $1/216$.

For four six-sided dice, the most common roll is 14, with probability 73/648; and the least common rolls are 4 and 24, both with probability 1/1296.

In general, the likeliest roll p_L for n s -sided dice is given by

$$p_L(n, s) = \left\lfloor \frac{1}{2}n(s+1) \right\rfloor, \quad (14)$$

which can be written explicitly as

$$p_L(n, s) = \begin{cases} \frac{1}{2}n(s+1) & \text{for } n \text{ even} \\ \frac{1}{2}[n(s+1) - 1] & \text{for } n \text{ odd, } s \text{ even} \\ \frac{1}{2}n(s+1) & \text{for } n \text{ odd, } s \text{ odd.} \end{cases} \quad (15)$$

For 6-sided dice, the likeliest rolls are given by

$$p_L(n, 6) = \left\lfloor \frac{7}{2}n \right\rfloor = \begin{cases} \frac{7}{2}n & \text{for } n \text{ even} \\ \frac{7}{2}(7n-1) & \text{for } n \text{ odd, } s \text{ even} \\ \frac{7}{2}n & \text{for } n \text{ odd, } s \text{ odd,} \end{cases} \quad (16)$$

or 7, 10, 14, 17, 21, 24, 28, 31, 35, ... for $n = 2, 3, \dots$ (Sloane's A030123) dice. The probabilities corresponding to the most likely rolls can be computed by plugging $p = p_L$ into the general formula together with

$$k_L(n, s) = \begin{cases} \frac{1}{2}n & \text{for } n \text{ even} \\ \left\lfloor \frac{n(s-1)-1}{2s} \right\rfloor & \text{for } n \text{ odd, } s \text{ even} \\ \left\lfloor \frac{n(s-1)}{2s} \right\rfloor & \text{for } n \text{ odd, } s \text{ odd.} \end{cases} \quad (17)$$

Unfortunately, $P(p_L, n, s)$ does not have a simple closed-form expression in terms of s and n . However, the probabilities of obtaining the likeliest roll totals can be found explicitly for a particular s . For n 6-sided dice, the probabilities are 1/6, 1/8, 73/648, 65/648, 361/3888, 24017/279936, 7553/93312, ... for $n = 2, 3, \dots$

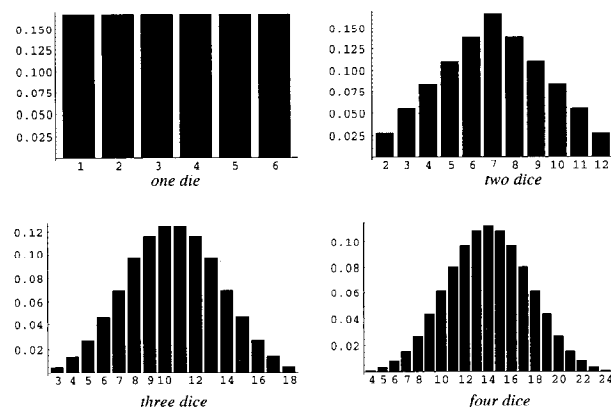

The probabilities for obtaining a given total using n 6-sided dice are shown above for $n = 1, 2, 3$, and 4 dice. They can be seen to approach a GAUSSIAN DISTRIBUTION as the number of dice is increased.

see also BOXCARS, COIN TOSSING, CRAPS, DE MERE'S PROBLEM, EFRON'S DICE, POKER, QUINCUNX, SICHERMAN DICE, SNAKE EYES

References

- Diaconis, P. and Keller, J. B. "Fair Dice." *Amer. Math. Monthly* **96**, 337-339, 1989.
- Dice & Games, Ltd. "Dice & Games Hobby Games Accessories." <http://www.dice.co.uk/hob.htm>.
- Gardner, M. "Dice." Ch. 18 in *Mathematical Magic Show: More Puzzles, Games, Diversions, Illusions and Other Mathematical Sleight-of-Mind from Scientific American*. New York: Vintage, pp. 251-262, 1978.
- Robertson, L. C.; Shortt, R. M.; Landry, S. G. "Dice with Fair Sums." *Amer. Math. Monthly* **95**, 316-328, 1988.
- Sloane, N. J. A. Sequence A030123 in "An On-Line Version of the Encyclopedia of Integer Sequences."

Dichroic Polynomial

A POLYNOMIAL $Z_G(q, v)$ in two variables for abstract GRAPHS. A GRAPH with one VERTEX has $Z = q$. Adding a VERTEX not attached by any EDGES multiplies the Z by q . Picking a particular EDGE of a GRAPH G , the POLYNOMIAL for G is defined by adding the POLYNOMIAL of the GRAPH with that EDGE deleted to v times the POLYNOMIAL of the graph with that EDGE collapsed to a point. Setting $v = -1$ gives the number of distinct VERTEX colorings of the GRAPH. The dichroic POLYNOMIAL of a PLANAR GRAPH can be expressed as the SQUARE BRACKET POLYNOMIAL of the corresponding ALTERNATING LINK by

$$Z_G(q, v) = q^{N/2} B_{L(G)},$$

where N is the number of VERTICES in G . Dichroic POLYNOMIALS for some simple GRAPHS are

$$\begin{aligned} Z_{K_1} &= q \\ Z_{K_2} &= q^2 + vq \\ Z_{K_3} &= q^3 + 3vq^2 + 3v^2q + v^3q. \end{aligned}$$

References

- Adams, C. C. *The Knot Book: An Elementary Introduction to the Mathematical Theory of Knots*. New York: W. H. Freeman, pp. 231-235, 1994.

Dido's Problem

Find the figure bounded by a line which has the maximum AREA for a given PERIMETER. The solution is a SEMICIRCLE.

see also ISOPERIMETRIC PROBLEM, ISOVOLUME PROBLEM, PERIMETER, SEMICIRCLE

Diesis

The musical interval by which an octave exceeds three major thirds,

$$\frac{2}{(\frac{5}{4})^3} = \frac{2^7}{5^3} = \frac{128}{125} = 1.024.$$

Taking CONTINUED FRACTION CONVERGENTS of $\log(5/4)/\log(2)$ gives the increasing accurate approximations m/n of m octaves and n major thirds: 1/3,

9/28, 19/59, 47/146, 207/643, 1289/4004, ... (Sloane's A046103 and A046104). Other near equalities of m octaves and n major thirds having

$$R \equiv \frac{2^m}{\left(\frac{5}{4}\right)^n} = \frac{2^{m+2n}}{5^n}$$

with $|R - 1| < 0.02$ are given in the following table.

m	n	Ratio	m	n	Ratio
9	28	0.9903520314	104	323	1.012011267
10	31	1.01412048	113	351	1.002247414
18	56	0.9807971462	122	379	0.9925777621
19	59	1.004336278	123	382	1.016399628
28	87	0.9946464728	131	407	0.983001403
29	90	1.018517988	132	410	1.006593437
37	115	0.9850501549	141	438	0.9968818549
38	118	1.008691359	150	466	0.9872639701
47	146	0.9989595361	151	469	1.010958305
56	174	0.9893216059	160	497	1.001204611
57	177	1.013065324	169	525	0.9915450208
66	205	1.003291302	170	528	1.015342101
75	233	0.9936115791	178	553	0.9819786256
76	236	1.017458257	179	556	1.005546113
84	261	0.9840252458	188	584	0.9958446353
85	264	1.007641852	189	587	1.019744907
94	292	0.9979201548	197	612	0.9862367575
103	320	0.9882922525	198	615	1.00990644

see also COMMA OF DIDYMUS, COMMA OF PYTHAGORAS, SCHISMA

References

Sloane, N. J. A. Sequences A046103 and A046104 in "An On-Line Version of the Encyclopedia of Integer Sequences."

Diffeomorphism

A diffeomorphism is a MAP between MANIFOLDS which is DIFFERENTIABLE and has a DIFFERENTIABLE inverse.

see also ANOSOV DIFFEOMORPHISM, AXIOM A DIFFEOMORPHISM, SYMPLECTIC DIFFEOMORPHISM, TANGENT MAP

Difference

The difference of two numbers n_1 and n_2 is $n_1 - n_2$, where the MINUS sign denotes SUBTRACTION.

see also BACKWARD DIFFERENCE, FINITE DIFFERENCE, FORWARD DIFFERENCE

Difference Equation

A difference equation is the discrete analogue of a DIFFERENTIAL EQUATION. A difference equation involves a FUNCTION with INTEGER-valued arguments $f(n)$ in a form like

$$f(n) - f(n-1) = g(n), \quad (1)$$

where g is some FUNCTION. The above equation is the discrete analog of the first-order ORDINARY DIFFERENTIAL EQUATION

$$f'(x) = g(x). \quad (2)$$

Examples of difference equations often arise in DYNAMICAL SYSTEMS. Examples include the iteration involved in the MANDELBROT and JULIA SET definitions,

$$f(n+1) = f(n)^2 + c, \quad (3)$$

with c a constant, as well as the LOGISTIC EQUATION

$$f(n+1) = rf(n)[1 - f(n)], \quad (4)$$

with r a constant.

see also FINITE DIFFERENCE, RECURRENCE RELATION

References

Batchelder, P. M. *An Introduction to Linear Difference Equations*. New York: Dover, 1967.
 Bellman, R. E. and Cooke, K. L. *Differential-Difference Equations*. New York: Academic Press, 1963.
 Beyer, W. H. "Finite Differences." *CRC Standard Mathematical Tables, 28th ed.* Boca Raton, FL: CRC Press, pp. 429-460, 1988.
 Brand, L. *Differential and Difference Equations*. New York: Wiley, 1966.
 Goldberg, S. *Introduction to Difference Equations, with Illustrative Examples from Economics, Psychology, and Sociology*. New York: Dover, 1986.
 Levy, H. and Lessman, F. *Finite Difference Equations*. New York: Dover, 1992.
 Richtmyer, R. D. and Morton, K. W. *Difference Methods for Initial-Value Problems, 2nd ed.* New York: Interscience Publishers, 1967.

Difference Operator

see BACKWARD DIFFERENCE, FORWARD DIFFERENCE

Difference Quotient

$$\Delta_h f(x) \equiv \frac{f(x+h) - f(x)}{h} = \frac{\Delta f}{h}.$$

It gives the slope of the SECANT LINE passing through $f(x)$ and $f(x+h)$. In the limit $h \rightarrow 0$, the difference quotient becomes the PARTIAL DERIVATIVE

$$\lim_{h \rightarrow 0} \Delta_{x(h)} f(x, y) = \frac{\partial f}{\partial x}.$$

Difference Set

Let G be a GROUP of ORDER h and D be a set of k elements of G . If the set of differences $d_i - d_j$ contains every NONZERO element of G exactly λ times, then D is a (h, k, λ) -difference set in G of ORDER $n = k - \lambda$. If $\lambda = 1$, the difference set is called planar. The quadratic residues in the GALOIS FIELD $GF(11)$ form a difference set. If there is a difference set of size k in a group G , then $2\binom{k}{2}$ must be a multiple of $|G| - 1$, where $\binom{k}{2}$ is a BINOMIAL COEFFICIENT.

see also BRUCK-RYSER-CHOWLA THEOREM, FIRST MULTIPLIER THEOREM, PRIME POWER CONJECTURE

References

Gordon, D. M. "The Prime Power Conjecture is True for $n < 2,000,000$." *Electronic J. Combinatorics* 1, R6, 1-7, 1994. <http://www.combinatorics.org/Volume1/volume1.html#R6>.

Difference of Successes

If x_1/n_1 and x_2/n_2 are the observed proportions from standard NORMALLY DISTRIBUTED samples with proportion of success θ , then the probability that

$$w \equiv \frac{x_1}{n_1} - \frac{x_2}{n_2} \quad (1)$$

will be as great as observed is

$$P_\delta = 1 - 2 \int_0^{|\delta|} \phi(t) dt, \quad (2)$$

where

$$\delta \equiv \frac{w}{\sigma_w} \quad (3)$$

$$\sigma_w \equiv \sqrt{\hat{\theta}(1-\hat{\theta}) \left(\frac{1}{n_1} + \frac{1}{n_2} \right)} \quad (4)$$

$$\hat{\theta} \equiv \frac{x_1 + x_2}{n_1 + n_2}. \quad (5)$$

Here, $\hat{\theta}$ is the UNBIASED ESTIMATOR. The SKEWNESS and KURTOSIS of this distribution are

$$\gamma_1^2 = \frac{(n_1 - n_2)^2}{n_1 n_2 (n_1 + n_2)} \frac{1 - 4\hat{\theta}(1-\hat{\theta})}{\hat{\theta}(1-\hat{\theta})} \quad (6)$$

$$\gamma_2 = \frac{n_1^2 - n_1 n_2 + n_2^2}{n_1 n_2 (n_1 + n_2)} \frac{1 - 6\hat{\theta}(1-\hat{\theta})}{\hat{\theta}(1-\hat{\theta})}. \quad (7)$$

Difference Table

A table made by subtracting adjacent entries in a sequence, then repeating the process with those numbers.

see also FINITE DIFFERENCE, QUOTIENT-DIFFERENCE TABLE

Different

Two quantities are said to be different (or "unequal") if they are not EQUAL.

The term "different" also has a technical usage related to MODULES. Let a MODULE M in an INTEGRAL DOMAIN D_1 for $R(\sqrt{D})$ be expressed using a two-element basis as

$$M = [\xi_1, \xi_2],$$

where ξ_1 and ξ_2 are in D_1 . Then the different of the MODULE is defined as

$$\Delta = \Delta(M) = \begin{vmatrix} \xi_1 & \xi_2 \\ \xi_1' & \xi_2' \end{vmatrix} = \xi_1 \xi_2' - \xi_1' \xi_2.$$

The different $\Delta \neq 0$ IFF ξ_1 and ξ_2 are linearly independent. The DISCRIMINANT is defined as the square of the different.

see also DISCRIMINANT (MODULE), EQUAL, MODULE

References

Cohn, H. *Advanced Number Theory*. New York: Dover, pp. 72-73, 1980.

Different Prime Factors

see DISTINCT PRIME FACTORS

Differentiable

A FUNCTION is said to be differentiable at a point if its DERIVATIVE exists at that point. Let $z = x + iy$ and $f(z) = u(x, y) + iv(x, y)$ on some region G containing the point z_0 . If $f(z)$ satisfies the CAUCHY-RIEMANN EQUATIONS and has continuous first PARTIAL DERIVATIVES at z_0 , then $f'(z_0)$ exists and is given by

$$f'(z_0) = \lim_{z \rightarrow z_0} \frac{f(z) - f(z_0)}{z - z_0},$$

and the function is said to be COMPLEX DIFFERENTIABLE. Amazingly, there exist CONTINUOUS FUNCTIONS which are nowhere differentiable. Two examples are the BLANCMANGE FUNCTION and WEIERSTRASS FUNCTION.

see also BLANCMANGE FUNCTION, CAUCHY-RIEMANN EQUATIONS, COMPLEX DIFFERENTIABLE, CONTINUOUS FUNCTION, DERIVATIVE, PARTIAL DERIVATIVE, WEIERSTRASS FUNCTION

Differentiable Manifold

see SMOOTH MANIFOLD

Differential

A DIFFERENTIAL 1-FORM.

see also EXACT DIFFERENTIAL, INEXACT DIFFERENTIAL

Differential Calculus

That portion of "the" CALCULUS dealing with DERIVATIVES.

see also INTEGRAL CALCULUS

Differential Equation

An equation which involves the DERIVATIVES of a function as well as the function itself. If PARTIAL DERIVATIVES are involved, the equation is called a PARTIAL DIFFERENTIAL EQUATION; if only ordinary DERIVATIVES are present, the equation is called an ORDINARY DIFFERENTIAL EQUATION. Differential equations play an extremely important and useful role in applied math, engineering, and physics, and much mathematical and numerical machinery has been developed for the solution of differential equations.

see also INTEGRAL EQUATION, ORDINARY DIFFERENTIAL EQUATION, PARTIAL DIFFERENTIAL EQUATION

References

Arfken, G. "Differential Equations." Ch. 8 in *Mathematical Methods for Physicists*, 3rd ed. Orlando, FL: Academic Press, pp. 437-496, 1985.
Dormand, J. R. *Numerical Methods for Differential Equations: A Computational Approach*. Boca Raton, FL: CRC Press, 1996.

Differential Form

see DIFFERENTIAL k -FORM

Differential Geometry

Differential geometry is the study of RIEMANNIAN MANIFOLDS. Differential geometry deals with metrical notions on MANIFOLDS, while DIFFERENTIAL TOPOLOGY deals with those nonmetrical notions of MANIFOLDS.

see also DIFFERENTIAL TOPOLOGY

References

- Eisenhart, L. P. *A Treatise on the Differential Geometry of Curves and Surfaces*. New York: Dover, 1960.
 Gray, A. *Modern Differential Geometry of Curves and Surfaces*. Boca Raton, FL: CRC Press, 1993.
 Kreyszig, E. *Differential Geometry*. New York: Dover, 1991.
 Lipschutz, M. M. *Theory and Problems of Differential Geometry*. New York: McGraw-Hill, 1969.
 Spivak, M. *A Comprehensive Introduction to Differential Geometry*, 2nd ed, 5 vols. Berkeley, CA: Publish or Perish Press, 1979.
 Struik, D. J. *Lectures on Classical Differential Geometry*. New York: Dover, 1988.
 Weatherburn, C. E. *Differential Geometry of Three Dimensions*, 2 vols. Cambridge, England: Cambridge University Press, 1961.

Differential k -Form

A differential k -form is a TENSOR of RANK k which is antisymmetric under exchange of any pair of indices. The number of algebraically independent components in n -D is $\binom{n}{k}$, where this is a BINOMIAL COEFFICIENT. In particular, a 1-form (often simply called a "differential") is a quantity

$$\omega^1 = b_1 dx_1 + b_2 dx_2, \quad (1)$$

where $b_1 = b_1(x_1, x_2)$ and $b_2 = b_2(x_1, x_2)$ are the components of a COVARIANT TENSOR. Changing variables from \mathbf{x} to \mathbf{y} gives

$$\omega^1 = \sum_{i=1}^2 b_i dx_i = \sum_{i=1}^2 \sum_{j=1}^2 b_i \frac{\partial x_i}{\partial y_j} = \sum_{j=1}^2 \bar{b}_j dy_j, \quad (2)$$

where

$$\bar{b}_j \equiv \sum_{i=1}^2 b_i \frac{\partial x_i}{\partial y_j}, \quad (3)$$

which is the covariant transformation law. 2-forms can be constructed from the WEDGE PRODUCT of 1-forms. Let

$$\theta_1 \equiv b_1 dx_1 + b_2 dx_2 \quad (4)$$

$$\theta_2 \equiv c_1 dx_1 + c_2 dx_2, \quad (5)$$

then $\theta_1 \wedge \theta_2$ is a 2-form denoted ω^2 . Changing variables $x_1(y_1, y_2)$ to $x_2(y_1, y_2)$ gives

$$dx_1 = \frac{\partial x_1}{\partial y_1} dy_1 + \frac{\partial x_1}{\partial y_2} dy_2 \quad (6)$$

$$dx_2 = \frac{\partial x_2}{\partial y_1} dy_1 + \frac{\partial x_2}{\partial y_2} dy_2, \quad (7)$$

so

$$\begin{aligned} dx_1 \wedge dx_2 &= \left(\frac{\partial x_1}{\partial y_1} \frac{\partial x_2}{\partial y_2} - \frac{\partial x_1}{\partial y_2} \frac{\partial x_2}{\partial y_1} \right) dy_1 \wedge dy_2 \\ &= \frac{\partial(x_1, x_2)}{\partial(y_1, y_2)} dy_1 \wedge dy_2. \end{aligned} \quad (8)$$

Similarly, a 4-form can be constructed from WEDGE PRODUCTS of two 2-forms or four 1-forms

$$\omega^4 = \omega_1^2 \wedge \omega_2^2 = (\omega_1^1 \wedge \omega_2^1) \wedge (\omega_3^1 \wedge \omega_4^1). \quad (9)$$

see also ANGLE BRACKET, BRA, EXTERIOR DERIVATIVE, KET, ONE-FORM, SYMPLECTIC FORM, WEDGE PRODUCT

References

- Weintraub, S. H. *Differential Forms: A Complement to Vector Calculus*. San Diego, CA: Academic Press, 1996.

Differential Operator

The OPERATOR representing the computation of a DERIVATIVE,

$$\tilde{D} = \frac{d}{dx}.$$

The second derivative is then denoted \tilde{D}^2 , the third \tilde{D}^3 , etc. The INTEGRAL is denoted \tilde{D}^{-1} .

see also CONVECTIVE DERIVATIVE, DERIVATIVE, FRACTIONAL DERIVATIVE, GRADIENT

Differential Structure

see EXOTIC R4, EXOTIC SPHERE

Differential Topology

The motivating force of TOPOLOGY, consisting of the study of smooth (differentiable) MANIFOLDS. Differential topology deals with nonmetrical notions of MANIFOLDS, while DIFFERENTIAL GEOMETRY deals with metrical notions of MANIFOLDS.

see also DIFFERENTIAL GEOMETRY

References

- Dieudonné, J. *A History of Algebraic and Differential Topology: 1900–1960*. Boston, MA: Birkhäuser, 1989.
 Munkres, J. R. *Elementary Differential Topology*. Princeton, NJ: Princeton University Press, 1963.

Differentiation

The computation of a DERIVATIVE.

see also CALCULUS, DERIVATIVE, INTEGRAL, INTEGRATION

Digamma Function

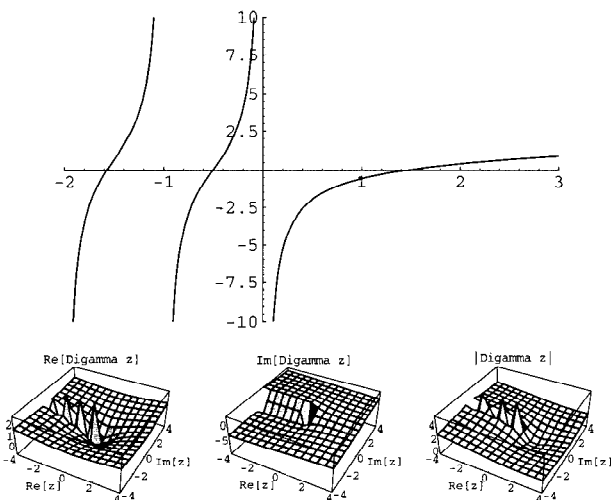

Two notations are used for the digamma function. The $\Psi(z)$ digamma function is defined by

$$\Psi(z) \equiv \frac{d}{dz} \ln \Gamma(z) = \frac{\Gamma'(z)}{\Gamma(z)}, \quad (1)$$

where Γ is the GAMMA FUNCTION, and is the function returned by the function `PolyGamma[z]` in *Mathematica*[®] (Wolfram Research, Champaign, IL). The F digamma function is defined by

$$F(z) \equiv \frac{d}{dz} \ln z! \quad (2)$$

and is equal to

$$F(z) = \Psi(z+1). \quad (3)$$

From a series expansion of the FACTORIAL function,

$$\begin{aligned} F(z) &= \frac{d}{dz} \lim_{n \rightarrow \infty} [\ln n! + z \ln n \\ &\quad - \ln(z+1) - \ln(z+2) - \dots - \ln(z+n)] \quad (4) \\ &= \lim_{n \rightarrow \infty} \left(\ln n - \frac{1}{z+1} - \frac{1}{z+2} - \dots - \frac{1}{z+n} \right) \quad (5) \end{aligned}$$

$$= -\gamma - \sum_{n=1}^{\infty} \left(\frac{1}{z+n} - \frac{1}{n} \right) \quad (6)$$

$$= -\gamma + \sum_{n=1}^{\infty} \frac{z}{n(n+z)} \quad (7)$$

$$= \ln z + \frac{1}{2z} - \sum_{n=1}^{\infty} \frac{B_{2n}}{2nz^{2n}}, \quad (8)$$

where γ is the EULER-MASCHERONI CONSTANT and B_{2n} are BERNOULLI NUMBERS.

The n th DERIVATIVE of $\Psi(z)$ is called the POLYGAMMA FUNCTION and is denoted $\psi_n(z)$. Since the digamma

function is the zeroth derivative of $\Psi(z)$ (i.e., the function itself), it is also denoted $\psi_0(z)$.

The digamma function satisfies

$$\Psi(z) = \int_0^{\infty} \left(\frac{e^{-t}}{t} - \frac{e^{-zt}}{1-e^{-t}} \right) dt. \quad (9)$$

For integral $z \equiv n$,

$$\Psi(n) = -\gamma + \sum_{k=1}^{n-1} \frac{1}{k} = -\gamma + H_{n-1}, \quad (10)$$

where γ is the EULER-MASCHERONI CONSTANT and H_n is a HARMONIC NUMBER. Other identities include

$$\frac{d\Psi}{dz} = \sum_{n=0}^{\infty} \frac{1}{(z+n)^2} \quad (11)$$

$$\Psi(1-z) - \Psi(z) = \pi \cot(\pi z) \quad (12)$$

$$\Psi(z+1) = \Psi(z) + \frac{1}{z} \quad (13)$$

$$\Psi(2z) = \frac{1}{2}\Psi(z) + \frac{1}{2}\Psi\left(z + \frac{1}{2}\right) + \ln 2. \quad (14)$$

Special values are

$$\Psi\left(\frac{1}{2}\right) = -\gamma - 2 \ln 2 \quad (15)$$

$$\Psi(1) = -\gamma. \quad (16)$$

At integral values,

$$\psi_0(n+1) = -\gamma + \sum_{k=1}^n \frac{1}{k}, \quad (17)$$

and at half-integral values,

$$\psi_0\left(\frac{1}{2} \pm n\right) = -\ln(4\gamma) + 2 \sum_{k=1}^n \frac{1}{2k-1}. \quad (18)$$

At rational arguments, $\psi_0(p/q)$ is given by the explicit equation

$$\begin{aligned} \psi_0\left(\frac{p}{q}\right) &= -\gamma - \ln(2q) - \frac{1}{2}\pi \cot\left(\frac{p}{q}\pi\right) \\ &\quad + 2 \sum_{k=1}^{\lceil q/2 \rceil - 1} \cos\left(\frac{2\pi pk}{q}\right) \ln\left[\sin\left(\frac{\pi k}{q}\right)\right] \quad (19) \end{aligned}$$

for $0 < p < q$ (Knuth 1973). These give the special values

$$\psi_0\left(\frac{1}{2}\right) = -\gamma - 2 \ln 2 \quad (20)$$

$$\psi_0\left(\frac{1}{3}\right) = \frac{1}{6}(-6\gamma - \pi\sqrt{3} - 9 \ln 3) \quad (21)$$

$$\psi_0\left(\frac{2}{3}\right) = \frac{1}{6}(-6\gamma + \pi\sqrt{3} - 9 \ln 3) \quad (22)$$

$$\psi_0\left(\frac{1}{4}\right) = -\gamma - \frac{1}{2}\pi - 3 \ln 2 \quad (23)$$

$$\psi_0\left(\frac{3}{4}\right) = \frac{1}{2}(-2\gamma + \pi - 6 \ln 2) \quad (24)$$

$$\psi_0(1) = -\gamma, \quad (25)$$

where γ is the EULER-MASCHERONI CONSTANT. Sums and differences of $\psi_1(r/s)$ for small integral r and s can be expressed in terms of CATALAN'S CONSTANT and π .

see also GAMMA FUNCTION, HARMONIC NUMBER, HURWITZ ZETA FUNCTION, POLYGAMMA FUNCTION

References

- Abramowitz, M. and Stegun, C. A. (Eds.). "Psi (Digamma) Function." §6.3 in *Handbook of Mathematical Functions with Formulas, Graphs, and Mathematical Tables*, 9th printing. New York: Dover, pp. 258–259, 1972.
- Arfken, G. "Digamma and Polygamma Functions." §10.2 in *Mathematical Methods for Physicists*, 3rd ed. Orlando, FL: Academic Press, pp. 549–555, 1985.
- Knuth, D. E. *The Art of Computer Programming, Vol. 1: Fundamental Algorithms*, 2nd ed. Reading, MA: Addison-Wesley, p. 94, 1973.
- Spanier, J. and Oldham, K. B. "The Digamma Function $\psi(x)$." Ch. 44 in *An Atlas of Functions*. Washington, DC: Hemisphere, pp. 423–434, 1987.

Digimetic

A CRYPTARITHM in which DIGITS are used to represent other DIGITS.

Digit

The number of digits D in an INTEGER n is the number of numbers in some base (usually 10) required to represent it. The numbers 1 to 9 are therefore single digits, while the numbers 10 to 99 are double digits. Terms such as "double-digit inflation" are occasionally encountered, although this particular usage has thankfully not been needed in the U.S. for some time. The number of (base 10) digits in a number n can be calculated as

$$D = \lfloor \log_{10} n + 1 \rfloor,$$

where $\lfloor x \rfloor$ is the FLOOR FUNCTION.

see also 196-ALGORITHM, ADDITIVE PERSISTENCE, DIGITADITION, DIGITAL ROOT, FACTORION, FIGURES, LENGTH (NUMBER), MULTIPLICATIVE PERSISTENCE, NARCISSISTIC NUMBER, SCIENTIFIC NOTATION, SIGNIFICANT DIGITS, SMITH NUMBER

Digitadition

Start with an INTEGER n , known as the GENERATOR. Add the SUM of the GENERATOR's digits to the GENERATOR to obtain the digitadition n' . A number can have more than one GENERATOR. If a number has no GENERATOR, it is called a SELF NUMBER. The sum of all numbers in a digitadition series is given by the last term minus the first plus the sum of the DIGITS of the last.

If the digitadition process is performed on n' to yield its digitadition n'' , on n'' to yield n''' , etc., a single-digit number, known as the DIGITAL ROOT of n , is eventually obtained. The digital roots of the first few integers are 1, 2, 3, 4, 5, 6, 7, 8, 9, 1, 2, 3, 4, 5, 6, 7, 9, 1, ... (Sloane's A010888).

If the process is generalized so that the k th (instead of first) powers of the digits of a number are repeatedly added, a periodic sequence of numbers is eventually obtained for any given starting number n . If the original number n is equal to the sum of the k th powers of its digits, it is called a NARCISSISTIC NUMBER. If the original number is the smallest number in the eventually periodic sequence of numbers in the repeated k -digitaditions, it is called a RECURRING DIGITAL INVARIANT. Both NARCISSISTIC NUMBERS and RECURRING DIGITAL INVARIANTS are relatively rare.

The only possible periods for repeated 2-digitaditions are 1 and 8, and the periods of the first few positive integers are 1, 8, 8, 8, 8, 8, 1, 8, 8, 1, ... The possible periods p for n -digitaditions are summarized in the following table, together with digitaditions for the first few integers and the corresponding sequence numbers.

n	Sloane	ps	n -Digitaditions
2	031176	1, 8	1, 8, 8, 8, 8, 8, 1, 8, 8, ...
3	031178	1, 2, 3	1, 1, 1, 3, 1, 1, 1, 1, ...
4	031182	1, 2, 7	1, 7, 7, 7, 7, 7, 7, ...
5	031186	1, 2, 4, 6, 10, 12, 22, 28	1, 12, 22, 4, 10, 22, 28, 10, 22, 1, ...
6	031195	1, 2, 3, 4, 10, 30	1, 10, 30, 30, 30, 10, 10, 10, 3, 1, 10, ...
7	031200	1, 2, 3, 6, 12, 14, 21, 27, 30, 56, 92	1, 92, 14, 30, 92, 56, 6, 92, 56, 1, 92, 27, ...
8	031211	1, 25, 154	1, 25, 154, 154, 154, 154, 25, 154, 154, 1, 25, ...
9	031212	1, 2, 3, 4, 8, 10, 19, 24, 28, 30, 80, 93	1, 30, 93, 1, 19, 80, 4, 30, 80, 1, 30, 93, 4, 10, ...
10	031212	1, 6, 7, 17, 81, 123	1, 30, 93, 1, 19, 80, 4, 30, 80, 1, 30, 93, 4, 10, ...

The numbers having period-1 2-digitated sequences are also called HAPPY NUMBERS. The first few numbers having period p n -digitaditions are summarized in the following table, together with their sequence numbers.

<i>n</i>	<i>p</i>	Sloane	Members
2	1	007770	1, 7, 10, 13, 19, 23, 28, 31, 32, ...
2	8	031177	2, 3, 4, 5, 6, 8, 9, 11, 12, 14, 15, ...
3	1	031179	1, 2, 3, 5, 6, 7, 8, 9, 10, 11, 12, ...
3	2	031180	49, 94, 136, 163, 199, 244, 316, ...
3	3	031181	4, 13, 16, 22, 25, 28, 31, 40, 46, ...
4	1	031183	1, 10, 12, 17, 21, 46, 64, 71, 100, ...
4	2	031184	66, 127, 172, 217, 228, 271, 282, ...
4	7	031185	2, 3, 4, 5, 6, 7, 8, 9, 11, 13, 14, ...
5	1	031187	1, 10, 100, 145, 154, 247, 274, ...
5	2	031188	133, 139, 193, 199, 226, 262, ...
5	4	031189	4, 37, 40, 55, 73, 124, 142, ...
5	6	031190	16, 61, 106, 160, 601, 610, 778, ...
5	10	031191	5, 8, 17, 26, 35, 44, 47, 50, 53, ...
5	12	031192	2, 11, 14, 20, 23, 29, 32, 38, 41, ...
5	22	031193	3, 6, 9, 12, 15, 18, 21, 24, 27, ...
5	28	031194	7, 13, 19, 22, 25, 28, 31, 34, 43, ...
6	1	011557	1, 10, 100, 1000, 10000, 100000, ...
6	2	031357	3468, 3486, 3648, 3684, 3846, ...
6	3	031196	9, 13, 31, 37, 39, 49, 57, 73, 75, ...
6	4	031197	255, 466, 525, 552, 646, 664, ...
6	10	031198	2, 6, 7, 8, 11, 12, 14, 15, 17, 19, ...
6	30	031199	3, 4, 5, 16, 18, 22, 29, 30, 33, ...
7	1	031201	1, 10, 100, 1000, 1259, 1295, ...
7	2	031202	22, 202, 220, 256, 265, 526, 562, ...
7	3	031203	124, 142, 148, 184, 214, 241, 259, ...
7	6		7, 70, 700, 7000, 70000, 700000, ...
7	12	031204	17, 26, 47, 59, 62, 71, 74, 77, 89, ...
7	14	031205	3, 30, 111, 156, 165, 249, 294, ...
7	21	031206	19, 34, 43, 91, 109, 127, 172, 190, ...
7	27	031207	12, 18, 21, 24, 39, 42, 45, 54, 78, ...
7	30	031208	4, 13, 16, 25, 28, 31, 37, 40, 46, ...
7	56	031209	6, 9, 15, 27, 33, 36, 48, 51, 57, ...
7	92	031210	2, 5, 8, 11, 14, 20, 23, 29, 32, 35, ...
8	1		1, 10, 14, 17, 29, 37, 41, 71, 73, ...
8	25		2, 7, 11, 15, 16, 20, 23, 27, 32, ...
8	154		3, 4, 5, 6, 8, 9, 12, 13, 18, 19, ...
9	1		1, 4, 10, 40, 100, 400, 1000, 1111, ...
9	2		127, 172, 217, 235, 253, 271, 325, ...
9	3		444, 4044, 4404, 4440, 4558, ...
9	4		7, 13, 31, 67, 70, 76, 103, 130, ...
9	8		22, 28, 34, 37, 43, 55, 58, 73, 79, ...
9	10		14, 38, 41, 44, 83, 104, 128, 140, ...
9	19		5, 26, 50, 62, 89, 98, 155, 206, ...
9	24		16, 61, 106, 160, 337, 373, 445, ...
9	28		19, 25, 46, 49, 52, 64, 91, 94, ...
9	30		2, 8, 11, 17, 20, 23, 29, 32, 35, ...
9	80		6, 9, 15, 18, 24, 33, 42, 48, 51, ...
9	93		3, 12, 21, 27, 30, 36, 39, 45, 54, ...
10	1	011557	1, 10, 100, 1000, 10000, 100000, ...
10	6		266, 626, 662, 1159, 1195, 1519, ...
10	7		46, 58, 64, 85, 122, 123, 132, ...
10	17		2, 4, 5, 11, 13, 20, 31, 38, 40, ...
10	81		17, 18, 37, 71, 73, 81, 107, 108, ...
10	123		3, 6, 7, 8, 9, 12, 14, 15, 16, 19, ...

see also 196-ALGORITHM, ADDITIVE PERSISTENCE, DIGIT, DIGITAL ROOT, MULTIPLICATIVE PERSISTENCE,

NARCISSISTIC NUMBER, RECURRING DIGITAL INVARIANT

Digital Root

Consider the process of taking a number, adding its DIGITS, then adding the DIGITS of numbers derived from it, etc., until the remaining number has only one DIGIT. The number of additions required to obtain a single DIGIT from a number n is called the ADDITIVE PERSISTENCE of n , and the DIGIT obtained is called the digital root of n .

For example, the sequence obtained from the starting number 9876 is (9876, 30, 3), so 9876 has an ADDITIVE PERSISTENCE of 2 and a digital root of 3. The digital roots of the first few integers are 1, 2, 3, 4, 5, 6, 7, 8, 9, 1, 2, 3, 4, 5, 6, 7, 9, 1, ... (Sloane's A010888). The digital root of an INTEGER n can therefore be computed without actually performing the iteration using the simple congruence formula

$$\begin{cases} n \pmod{9} & n \not\equiv 0 \pmod{9} \\ 9 & n \equiv 0 \pmod{9}. \end{cases}$$

see also ADDITIVE PERSISTENCE, DIGITADDITION, KAPREKAR NUMBER, MULTIPLICATIVE DIGITAL ROOT, MULTIPLICATIVE PERSISTENCE, NARCISSISTIC NUMBER, RECURRING DIGITAL INVARIANT, SELF NUMBER

References

Sloane, N. J. A. Sequences A010888 and A007612/M1114 in "An On-Line Version of the Encyclopedia of Integer Sequences."

Digon

The DEGENERATE POLYGON (corresponding to a LINE SEGMENT) with SCHLÄFLI SYMBOL {2}.

see also LINE SEGMENT, POLYGON, TRIGONOMETRY VALUES— $\pi/2$

Digraph

see DIRECTED GRAPH

Dihedral Angle

The ANGLE between two PLANES. The dihedral angle between the planes

$$A_1x + B_1y + C_1z + D_1 = 0 \quad (1)$$

$$A_2x + B_2y + C_2z + D_2 = 0 \quad (2)$$

is

$$\cos \theta = \frac{A_1A_2 + B_1B_2 + C_1C_2}{\sqrt{A_1^2 + B_1^2 + C_1^2} \sqrt{A_2^2 + B_2^2 + C_2^2}}. \quad (3)$$

see also ANGLE, PLANE, VERTEX ANGLE

Dihedral Group

A GROUP of symmetries for an n -sided REGULAR POLYGON, denoted D_n . The ORDER of D_n is $2n$.

see also FINITE GROUP— D_3 , FINITE GROUP— D_4

References

- Arfken, G. "Dihedral Groups, D_n ." *Mathematical Methods for Physicists*, 3rd ed. Orlando, FL: Academic Press, p. 248, 1985.
Lomont, J. S. "Dihedral Groups." §3.10.B in *Applications of Finite Groups*. New York: Dover, pp. 78–80, 1987.

Dijkstra's Algorithm

An ALGORITHM for finding the shortest path between two VERTICES.

see also FLOYD'S ALGORITHM

Dijkstra Tree

The shortest path-spanning TREE from a VERTEX of a GRAPH.

Dilation

An AFFINE TRANSFORMATION in which the scale is reduced. A dilation is also known as a CONTRACTION or HOMOTHECY. Any dilation which is not a simple translation has a unique FIXED POINT. The opposite of a dilation is an EXPANSION.

see also AFFINE TRANSFORMATION, EXPANSION, HOMOTHECY

References

- Coxeter, H. S. M. and Greitzer, S. L. *Geometry Revisited*. Washington, DC: Math. Assoc. Amer., pp. 94–95, 1967.

Dilemma

Informally, a situation in which a decision must be made from several alternatives, none of which is obviously the optimal one. In formal LOGIC, a dilemma is a specific type of argument using two conditional statements which may take the form of a CONSTRUCTIVE DILEMMA or a DESTRUCTIVE DILEMMA.

see also CONSTRUCTIVE DILEMMA, DESTRUCTIVE DILEMMA, MONTY HALL PROBLEM, PARADOX, PRISONER'S DILEMMA

Dilogarithm

A special case of the POLYLOGARITHM $\text{Li}_n(z)$ for $n = 2$. It is denoted $\text{Li}_2(z)$, or sometimes $L_2(z)$, and is defined by the sum

$$\text{Li}_2(z) = \sum_{k=1}^{\infty} \frac{z^k}{k^2}$$

or the integral

$$\text{Li}_2(z) \equiv \int_z^0 \frac{\ln(1-t) dt}{t}.$$

There are several remarkable identities involving the POLYLOGARITHM function.

see also ABEL'S FUNCTIONAL EQUATION, POLYLOGARITHM, SPENCE'S INTEGRAL

References

- Abramowitz, M. and Stegun, C. A. (Eds.). "Dilogarithm." §27.7 in *Handbook of Mathematical Functions with Formulas, Graphs, and Mathematical Tables*, 9th printing. New York: Dover, pp. 1004–1005, 1972.

Dilworth's Lemma

The WIDTH of a set P is equal to the minimum number of CHAINS needed to COVER P . Equivalently, if a set P of $ab + 1$ elements is PARTIALLY ORDERED, then P contains a CHAIN of size $a + 1$ or an ANTICHAIN of size $b + 1$. Letting N be the CARDINALITY of P , W the WIDTH, and L the LENGTH, this last statement says $N \leq LW$. Dilworth's lemma is a generalization of the ERDŐS-SZEKERES THEOREM. RAMSEY'S THEOREM generalizes Dilworth's Lemma.

see also COMBINATORICS, ERDŐS-SZEKERES THEOREM, RAMSEY'S THEOREM

Dilworth's Theorem

see DILWORTH'S LEMMA

Dimension

The notion of dimension is important in mathematics because it gives a precise parameterization of the conceptual or visual complexity of any geometric object. In fact, the concept can even be applied to abstract objects which cannot be directly visualized. For example, the notion of time can be considered as one-dimensional, since it can be thought of as consisting of only "now," "before" and "after." Since "before" and "after," regardless of how far back or how far into the future they are, are extensions, time is like a line, a 1-dimensional object.

To see how lower and higher dimensions relate to each other, take any geometric object (like a POINT, LINE, CIRCLE, PLANE, etc.), and "drag" it in an opposing direction (drag a POINT to trace out a LINE, a LINE to trace out a box, a CIRCLE to trace out a CYLINDER, a DISK to a solid CYLINDER, etc.). The result is an object which is qualitatively "larger" than the previous object, "qualitative" in the sense that, regardless of how you drag the original object, you always trace out an object of the same "qualitative size." The POINT could be made into a straight LINE, a CIRCLE, a HELIX, or some other CURVE, but all of these objects are qualitatively of the same dimension. The notion of dimension was invented for the purpose of measuring this "qualitative" topological property.

Making things a bit more formal, finite collections of objects (e.g., points in space) are considered 0-dimensional. Objects that are "dragged" versions of 0-dimensional objects are then called 1-dimensional. Similarly, objects which are dragged 1-dimensional objects are 2-dimensional, and so on. Dimension is formalized in

mathematics as the intrinsic dimension of a TOPOLOGICAL SPACE. This dimension is called the LEBESGUE COVERING DIMENSION (also known simply as the TOPOLOGICAL DIMENSION). The archetypal example is EUCLIDEAN n -space \mathbb{R}^n , which has topological dimension n . The basic ideas leading up to this result (including the DIMENSION INVARIANCE THEOREM, DOMAIN INVARIANCE THEOREM, and LEBESGUE COVERING DIMENSION) were developed by Poincaré, Brouwer, Lebesgue, Urysohn, and Menger.

There are several branchings and extensions of the notion of topological dimension. Implicit in the notion of the LEBESGUE COVERING DIMENSION is that dimension, in a sense, is a measure of how an object fills space. If it takes up a lot of room, it is higher dimensional, and if it takes up less room, it is lower dimensional. HAUSDORFF DIMENSION (also called FRACTAL DIMENSION) is a fine tuning of this definition that allows notions of objects with dimensions other than INTEGERS. FRACTALS are objects whose HAUSDORFF DIMENSION is different from their TOPOLOGICAL DIMENSION.

The concept of dimension is also used in ALGEBRA, primarily as the dimension of a VECTOR SPACE over a FIELD. This usage stems from the fact that VECTOR SPACES over the reals were the first VECTOR SPACES to be studied, and for them, their topological dimension can be calculated by purely algebraic means as the CARDINALITY of a maximal linearly independent subset. In particular, the dimension of a SUBSPACE of \mathbb{R}^n is equal to the number of LINEARLY INDEPENDENT VECTORS needed to generate it (i.e., the number of VECTORS in its BASIS). Given a transformation A of \mathbb{R}^n ,

$$\dim[\text{Range}(A)] + \dim[\text{Null}(A)] = \dim(\mathbb{R}^n).$$

see also CAPACITY DIMENSION, CODIMENSION, CORRELATION DIMENSION, EXTERIOR DIMENSION, FRACTAL DIMENSION, HAUSDORFF DIMENSION, HAUSDORFF-BESICOVITCH DIMENSION, KAPLAN-YORKE DIMENSION, KRULL DIMENSION, LEBESGUE COVERING DIMENSION, LEBESGUE DIMENSION, LYAPUNOV DIMENSION, POSET DIMENSION, q -DIMENSION, SIMILARITY DIMENSION, TOPOLOGICAL DIMENSION

References

- Abbott, E. A. *Flatland: A Romance of Many Dimensions*. New York: Dover, 1992.
- Hinton, C. H. *The Fourth Dimension*. Pomeroy, WA: Health Research, 1993.
- Manning, H. *The Fourth Dimension Simply Explained*. Magnolia, MA: Peter Smith, 1990.
- Manning, H. *Geometry of Four Dimensions*. New York: Dover, 1956.
- Neville, E. H. *The Fourth Dimension*. Cambridge, England: Cambridge University Press, 1921.
- Rucker, R. von Bitter. *The Fourth Dimension: A Guided Tour of the Higher Universes*. Boston, MA: Houghton Mifflin, 1984.
- Sommerville, D. M. Y. *An Introduction to the Geometry of n Dimensions*. New York: Dover, 1958.

Dimension Axiom

One of the EILENBERG-STEENROD AXIOMS. Let X be a single point space. $H_n(X) = 0$ unless $n = 0$, in which case $H_0(X) = G$ where G are some GROUPS. The H_0 are called the COEFFICIENTS of the HOMOLOGY THEORY $H(\cdot)$.

see also EILENBERG-STEENROD AXIOMS, HOMOLOGY (TOPOLOGY)

Dimension Invariance Theorem

\mathbb{R}^n is HOMEOMORPHIC to \mathbb{R}^m IFF $n = m$. This theorem was first proved by Brouwer.

see also DOMAIN INVARIANCE THEOREM

Dimensionality Theorem

For a finite GROUP of h elements with an n_i th dimensional i th irreducible representation,

$$\sum_i n_i^2 = h.$$

Diminished Polyhedron

A UNIFORM POLYHEDRON with pieces removed.

Diminished Rhombicosidodecahedron

see JOHNSON SOLID

Dini Expansion

An expansion based on the ROOTS of

$$x^{-n}[xJ'_n(x) + HJ_n(x)] = 0,$$

where $J_n(x)$ is a BESSEL FUNCTION OF THE FIRST KIND, is called a Dini expansion.

see also BESSEL FUNCTION FOURIER EXPANSION

References

- Bowman, F. *Introduction to Bessel Functions*. New York: Dover, p. 109, 1958.

Dini's Surface

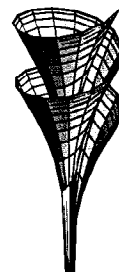

A surface of constant NEGATIVE CURVATURE obtained by twisting a PSEUDOSPHERE and given by the parametric equations

$$x = a \cos u \sin v \quad (1)$$

$$y = a \sin u \sin v \quad (2)$$

$$z = a\{\cos v + \ln[\tan(\frac{1}{2}v)]\} + bu. \quad (3)$$

The above figure corresponds to $a = 1$, $b = 0.2$, $u \in [0, 4\pi]$, and $v \in (0, 2]$.

see also PSEUDOSPHERE

References

- Geometry Center. "Dini's Surface." <http://www.geom.umn.edu/zoo/diffgeom/surfspace/dini/>.
 Gray, A. *Modern Differential Geometry of Curves and Surfaces*. Boca Raton, FL: CRC Press, pp. 494–495, 1993.
 Nordstrand, T. "Dini's Surface." <http://www.uib.no/people/nfytndintxt.htm>.

Dini's Test

A test for the convergence of FOURIER SERIES. Let

$$\phi_x(t) \equiv f(x+t) + f(x-t) - 2f(x),$$

then if

$$\int_0^\pi \frac{|\phi_x(t)|}{t} dt$$

is FINITE, the FOURIER SERIES converges to $f(x)$ at x .

see also FOURIER SERIES

References

- Sansone, G. *Orthogonal Functions*, rev. English ed. New York: Dover, pp. 65–68, 1991.

Dinitz Problem

Given any assignment of n -element sets to the n^2 locations of a square $n \times n$ array, is it always possible to find a PARTIAL LATIN SQUARE? The fact that such a PARTIAL LATIN SQUARE can always be found for a 2×2 array can be proven analytically, and techniques were developed which also proved the existence for 4×4 and 6×6 arrays. However, the general problem eluded solution until it was answered in the affirmative by Galvin in 1993 using results of Janssen (1993ab) and F. Maffray.

see also PARTIAL LATIN SQUARE

References

- Chetwynd, A. and Häggkvist, R. "A Note on List-Colorings." *J. Graph Th.* **13**, 87–95, 1989.
 Cipra, B. "Quite Easily Done." In *What's Happening in the Mathematical Sciences* **2**, pp. 41–46, 1994.
 Erdős, P.; Rubin, A.; and Taylor, H. "Choosability in Graphs." *Congr. Numer.* **26**, 125–157, 1979.
 Häggkvist, R. "Towards a Solution of the Dinitz Problem?" *Disc. Math.* **75**, 247–251, 1989.
 Janssen, J. C. M. "The Dinitz Problem Solved for Rectangles." *Bull. Amer. Math. Soc.* **29**, 243–249, 1993a.
 Janssen, J. C. M. *Even and Odd Latin Squares*. Ph.D. thesis. Lehigh University, 1993b.
 Kahn, J. "Recent Results on Some Not-So-Recent Hypergraph Matching and Covering Problems." *Proceedings of the Conference on Extremal Problems for Finite Sets*. Visegrád, Hungary, 1991.
 Kahn, J. "Coloring Nearly-Disjoint Hypergraphs with $n + o(n)$ Colors." *J. Combin. Th. Ser. A* **59**, 31–39, 1992.

Diocles's Cissoid

see CISSOID OF DIOCLES

Diophantine Equation

An equation in which only INTEGER solutions are allowed. HILBERT'S 10TH PROBLEM asked if a technique for solving a general Diophantine existed. A general method exists for the solution of first degree Diophantine equations. However, the impossibility of obtaining a general solution was proven by Julia Robinson and Martin Davis in 1970, following proof of the result that the equation $n = F_{2m}$ (where F_{2m} is a FIBONACCI NUMBER) is Diophantine by Yuri Matijasevič (Matijasevič 1970, Davis 1973, Davis and Hersch 1973, Matijasevič 1993).

No general method is known for quadratic or higher Diophantine equations. Jones and Matijasevič (1982) proved that no ALGORITHMS can exist to determine if an arbitrary Diophantine equation in nine variables has solutions. Ogilvy and Anderson (1988) give a number of Diophantine equations with known and unknown solutions.

D. Wilson has compiled a list of the smallest n th POWERS which are the sums of n distinct smaller n th POWERS. The first few are 3, 5, 6, 15, 12, 25, 40, ... (Sloane's A030052):

$$3^1 = 1^1 + 2^1$$

$$5^2 = 3^2 + 4^2$$

$$6^3 = 3^3 + 4^3 + 5^3$$

$$15^4 = 4^4 + 6^4 + 8^4 + 9^4 + 14^4$$

$$12^5 = 4^5 + 5^5 + 6^5 + 7^5 + 9^5 + 11^5$$

$$25^6 = 1^6 + 2^6 + 3^6 + 5^6 + 6^6 + 7^6 + 8^6 + 9^6 + 10^6 + 12^6 + 13^6 + 15^6 + 16^6 + 17^6 + 18^6 + 23^6$$

$$40^7 = 1^7 + 3^7 + 5^7 + 9^7 + 12^7 + 14^7 + 16^7 + 17^7 + 18^7 + 20^7 + 21^7 + 22^7 + 25^7 + 28^7 + 39^7$$

$$84^8 = 1^8 + 2^8 + 3^8 + 5^8 + 7^8 + 9^8 + 10^8 + 11^8 + 12^8 + 13^8 + 14^8 + 15^8 + 16^8 + 17^8 + 18^8 + 19^8 + 21^8 + 23^8 + 24^8 + 25^8 + 26^8 + 27^8 + 29^8 + 32^8 + 33^8 + 35^8 + 37^8 + 38^8 + 39^8 + 41^8 + 42^8 + 43^8 + 45^8 + 46^8 + 47^8 + 48^8 + 49^8 + 51^8 + 52^8 + 53^8 + 57^8 + 58^8 + 59^8 + 61^8 + 63^8 + 69^8 + 73^8$$

$$47^9 = 1^9 + 2^9 + 4^9 + 7^9 + 11^9 + 14^9 + 15^9 + 18^9 + 26^9 + 27^9 + 30^9 + 31^9 + 32^9 + 33^9 + 36^9 + 38^9 + 39^9 + 43^9$$

$$63^{10} = 1^{10} + 2^{10} + 4^{10} + 5^{10} + 6^{10} + 8^{10} + 12^{10} + 15^{10} + 16^{10} + 17^{10} + 20^{10} + 21^{10} + 25^{10} + 26^{10} + 27^{10} + 28^{10} + 30^{10} + 36^{10} + 37^{10} + 38^{10} + 40^{10} + 51^{10} + 62^{10}.$$

see also ABC CONJECTURE, ARCHIMEDES' CATTLE PROBLEM, BACHET EQUATION, BRAHMAGUPTA'S

PROBLEM, CANNONBALL PROBLEM, CATALAN'S PROBLEM, DIOPHANTINE EQUATION—LINEAR, DIOPHANTINE EQUATION—QUADRATIC, DIOPHANTINE EQUATION—CUBIC, DIOPHANTINE EQUATION—QUARTIC, DIOPHANTINE EQUATION—5TH POWERS, DIOPHANTINE EQUATION—6TH POWERS, DIOPHANTINE EQUATION—7TH POWERS, DIOPHANTINE EQUATION—8TH POWERS, DIOPHANTINE EQUATION—9TH POWERS, DIOPHANTINE EQUATION—10TH POWERS, DIOPHANTINE EQUATION— n TH POWERS, DIOPHANTUS PROPERTY, EULER BRICK, EULER QUARTIC CONJECTURE, FERMAT'S LAST THEOREM, FERMAT SUM THEOREM, GENUS THEOREM, HURWITZ EQUATION, MARKOV NUMBER, MONKEY AND COCONUT PROBLEM, MULTI-GRADE EQUATION, p -ADIC NUMBER, PELL EQUATION, PYTHAGOREAN QUADRUPLE, PYTHAGOREAN TRIPLE

References

- Beiler, A. H. *Recreations in the Theory of Numbers: The Queen of Mathematics Entertains*. New York: Dover, 1966.
- Carmichael, R. D. *The Theory of Numbers, and Diophantine Analysis*. New York: Dover, 1959.
- Chen, S. "Equal Sums of Like Powers: On the Integer Solution of the Diophantine System." <http://www.nease.net/~chin/eslp/>.
- Chen, S. "References." <http://www.nease.net/~chin/eslp/referenc.htm>
- Davis, M. "Hilbert's Tenth Problem is Unsolvable." *Amer. Math. Monthly* **80**, 233–269, 1973.
- Davis, M. and Hersh, R. "Hilbert's 10th Problem." *Sci. Amer.*, pp. 84–91, Nov. 1973.
- Dörrie, H. "The Fermat-Gauss Impossibility Theorem." §21 in *100 Great Problems of Elementary Mathematics: Their History and Solutions*. New York: Dover, pp. 96–104, 1965.
- Guy, R. K. "Diophantine Equations." Ch. D in *Unsolved Problems in Number Theory*, 2nd ed. New York: Springer-Verlag, pp. 139–198, 1994.
- Hardy, G. H. and Wright, E. M. *An Introduction to the Theory of Numbers*, 5th ed. Oxford, England: Clarendon Press, 1979.
- Hunter, J. A. H. and Madachy, J. S. "Diophantos and All That." Ch. 6 in *Mathematical Diversions*. New York: Dover, pp. 52–64, 1975.
- Ireland, K. and Rosen, M. "Diophantine Equations." Ch. 17 in *A Classical Introduction to Modern Number Theory*, 2nd ed. New York: Springer-Verlag, pp. 269–296, 1990.
- Jones, J. P. and Matijasevič, Yu. V. "Exponential Diophantine Representation of Recursively Enumerable Sets." *Proceedings of the Herbrand Symposium, Marseilles, 1981*. Amsterdam, Netherlands: North-Holland, pp. 159–177, 1982.
- Lang, S. *Introduction to Diophantine Approximations*, 2nd ed. New York: Springer-Verlag, 1995.
- Matijasevič, Yu. V. "Solution to of the Tenth Problem of Hilbert." *Mat. Lapok* **21**, 83–87, 1970.
- Matijasevič, Yu. V. *Hilbert's Tenth Problem*. Cambridge, MA: MIT Press, 1993.
- Mordell, L. J. *Diophantine Equations*. New York: Academic Press, 1969.
- Nagel, T. *Introduction to Number Theory*. New York: Wiley, 1951.
- Ogilvy, C. S. and Anderson, J. T. "Diophantine Equations." Ch. 6 in *Excursions in Number Theory*. New York: Dover, pp. 65–83, 1988.
- Sloane, N. J. A. Sequence A030052 in "An On-Line Version of the Encyclopedia of Integer Sequences."

Diophantine Equation—5th Powers

The 2-1 fifth-order Diophantine equation

$$A^5 + B^5 = C^5 \quad (1)$$

is a special case of FERMAT'S LAST THEOREM with $n = 5$, and so has no solution. No solutions to the 2-2 equation

$$A^5 + B^5 = C^5 + D^5 \quad (2)$$

are known, despite the fact that sums up to 1.02×10^{26} have been checked (Guy 1994, p. 140), improving on the results on Lander *et al.* (1967), who checked up to 2.8×10^{14} . (In fact, no solutions are known for POWERS of 6 or 7 either.)

No solutions to the 3-1 equation

$$A^5 + B^5 + C^5 = D^5 \quad (3)$$

are known (Lander *et al.* 1967), nor are any 3-2 solutions up to 8×10^{12} (Lander *et al.* 1967).

Parametric solutions are known for the 3-3 (Guy 1994, pp. 140 and 142). Swinnerton-Dyer (1952) gave two parametric solutions to the 3-3 equation but, forty years later, W. Gosper discovered that the second scheme has an unfixable bug. The smallest primitive 3-3 solutions are

$$24^5 + 28^5 + 67^5 = 3^5 + 54^5 + 62^5 \quad (4)$$

$$18^5 + 44^5 + 66^5 = 13^5 + 51^5 + 64^5 \quad (5)$$

$$21^5 + 43^5 + 76^5 = 8^5 + 62^5 + 68^5 \quad (6)$$

$$56^5 + 67^5 + 83^5 = 53^5 + 72^5 + 81^5 \quad (7)$$

$$49^5 + 75^5 + 107^5 = 39^5 + 92^5 + 100^5 \quad (8)$$

(Moessner 1939, Moessner 1948, Lander *et al.* 1967).

For 4 fifth POWERS, we have the 4-1 equation

$$27^5 + 84^5 + 110^5 + 133^5 = 144^5 \quad (9)$$

(Lander and Parkin 1967, Lander *et al.* 1967), but it is not known if there is a parametric solution (Guy 1994, p. 140). Sastry's (1934) 5-1 solution gives some 4-2 solutions. The smallest primitive 4-2 solutions are

$$4^5 + 10^5 + 20^5 + 28^5 = 3^5 + 29^5 \quad (10)$$

$$5^5 + 13^5 + 25^5 + 37^5 = 12^5 + 38^5 \quad (11)$$

$$26^5 + 29^5 + 35^5 + 50^5 = 28^5 + 52^5 \quad (12)$$

$$5^5 + 25^5 + 62^5 + 63^5 = 61^5 + 64^5 \quad (13)$$

$$6^5 + 50^5 + 53^5 + 82^5 = 16^5 + 85^5 \quad (14)$$

$$56^5 + 63^5 + 72^5 + 86^5 = 31^5 + 96^5 \quad (15)$$

$$44^5 + 58^5 + 67^5 + 94^5 = 14^5 + 99^5 \quad (16)$$

$$11^5 + 13^5 + 37^5 + 99^5 = 63^5 + 97^5 \quad (17)$$

$$48^5 + 57^5 + 76^5 + 100^5 = 25^5 + 106^5 \quad (18)$$

$$58^5 + 76^5 + 79^5 + 102^5 = 54^5 + 111^5 \quad (19)$$

(Rao 1934, Moessner 1948, Lander *et al.* 1967).

A two-parameter solution to the 4-3 equation was given by Xeroudakes and Moessner (1958). Gloden (1949) also gave a parametric solution. The smallest solution is

$$1^5 + 8^5 + 14^5 + 27^5 = 3^5 + 22^5 + 25^5 \quad (20)$$

(Rao 1934, Lander *et al.* 1967). Several parametric solutions to the 4-4 equation were found by Xeroudakes and Moessner (1958). The smallest 4-4 solution is

$$5^5 + 6^5 + 6^5 + 8^5 = 4^5 + 7^5 + 7^5 + 7^5 \quad (21)$$

(Rao 1934, Lander *et al.* 1967). The first 4-4-4 equation is

$$3^5 + 48^5 + 52^5 + 61^5 = 13^5 + 36^5 + 51^5 + 64^5 \\ = 18^5 + 36^5 + 44^5 + 66^5 \quad (22)$$

(Lander *et al.* 1967).

Sastry (1934) found a 2-parameter solution for 5-1 equations

$$(75v^5 - u^5)^5 + (u^5 + 25v^5)^5 + (u^5 - 25v^5)^5 \\ + (10u^3v^2)^5 + (50uv^4)^5 = (u^5 + 75v^5)^5 \quad (23)$$

(quoted in Lander and Parkin 1967), and Lander and Parkin (1967) found the smallest numerical solutions. Lander *et al.* (1967) give a list of the smallest solutions, the first few being

$$19^5 + 43^5 + 46^5 + 47^5 + 67^5 = 72^5 \quad (24)$$

$$21^5 + 23^5 + 37^5 + 79^5 + 84^5 = 94^5 \quad (25)$$

$$7^5 + 43^5 + 57^5 + 80^5 + 100^5 = 107^5 \quad (26)$$

$$8^5 + 120^5 + 191^5 + 259^5 + 347^5 = 365^5 \quad (27)$$

$$79^5 + 202^5 + 258^5 + 261^5 + 395^5 = 415^5 \quad (28)$$

$$4^5 + 26^5 + 139^5 + 296^5 + 412^5 = 427^5 \quad (29)$$

$$31^5 + 105^5 + 139^5 + 314^5 + 416^5 = 435^5 \quad (30)$$

$$54^5 + 91^5 + 101^5 + 404^5 + 430^5 = 480^5 \quad (31)$$

$$19^5 + 201^5 + 347^5 + 388^5 + 448^5 = 503^5 \quad (32)$$

$$159^5 + 172^5 + 200^5 + 356^5 + 513^5 = 530^5 \quad (33)$$

$$218^5 + 276^5 + 385^5 + 409^5 + 495^5 = 553^5 \quad (34)$$

$$2^5 + 298^5 + 351^5 + 474^5 + 500^5 = 575^5 \quad (35)$$

(Lander and Parkin 1967, Lander *et al.* 1967).

The smallest primitive 5-2 solutions are

$$4^5 + 5^5 + 7^5 + 16^5 + 21^5 = 1^5 + 22^5 \quad (36)$$

$$9^5 + 11^5 + 14^5 + 18^5 + 30^5 = 23^5 + 29^5 \quad (37)$$

$$10^5 + 14^5 + 26^5 + 31^5 + 33^5 = 16^5 + 38^5 \quad (38)$$

$$4^5 + 22^5 + 29^5 + 35^5 + 36^5 = 24^5 + 42^5 \quad (39)$$

$$8^5 + 15^5 + 17^5 + 19^5 + 45^5 = 30^5 + 44^5 \quad (40)$$

$$5^5 + 6^5 + 26^5 + 27^5 + 44^5 = 36^5 + 42^5 \quad (41)$$

(Rao 1934, Lander *et al.* 1967).

The 6-1 equation has solutions

$$4^5 + 5^5 + 6^5 + 7^5 + 9^5 + 11^5 = 12^5 \quad (42)$$

$$5^5 + 10^5 + 11^5 + 16^5 + 19^5 + 29^5 = 30^5 \quad (43)$$

$$15^5 + 16^5 + 17^5 + 22^5 + 24^5 + 28^5 = 32^5 \quad (44)$$

$$13^5 + 18^5 + 23^5 + 31^5 + 36^5 + 66^5 = 67^5 \quad (45)$$

$$7^5 + 20^5 + 29^5 + 31^5 + 34^5 + 66^5 = 67^5 \quad (46)$$

$$22^5 + 35^5 + 48^5 + 58^5 + 61^5 + 64^5 = 78^5 \quad (47)$$

$$4^5 + 13^5 + 19^5 + 20^5 + 67^5 + 96^5 = 99^5 \quad (48)$$

$$6^5 + 17^5 + 60^5 + 64^5 + 73^5 + 89^5 = 99^5 \quad (49)$$

(Martin 1887, 1888, Lander and Parkin 1967, Lander *et al.* 1967).

The smallest 7-1 solution is

$$1^5 + 7^5 + 8^5 + 14^5 + 15^5 + 18^5 + 20^5 = 23^5 \quad (50)$$

(Lander *et al.* 1967).

References

- Berndt, B. C. *Ramanujan's Notebooks, Part IV*. New York: Springer-Verlag, p. 95, 1994.
- Gloden, A. "Über mehrgeradige Gleichungen." *Arch. Math.* **1**, 482-483, 1949.
- Guy, R. K. "Sums of Like Powers. Euler's Conjecture." §D1 in *Unsolved Problems in Number Theory, 2nd ed.* New York: Springer-Verlag, pp. 139-144, 1994.
- Lander, L. J. and Parkin, T. R. "A Counterexample to Euler's Sum of Powers Conjecture." *Math. Comput.* **21**, 101-103, 1967.
- Lander, L. J.; Parkin, T. R.; and Selfridge, J. L. "A Survey of Equal Sums of Like Powers." *Math. Comput.* **21**, 446-459, 1967.
- Martin, A. "Methods of Finding n th-Power Numbers Whose Sum is an n th Power; With Examples." *Bull. Philos. Soc. Washington* **10**, 107-110, 1887.
- Martin, A. *Smithsonian Misc. Coll.* **33**, 1888.
- Martin, A. "About Fifth-Power Numbers whose Sum is a Fifth Power." *Math. Mag.* **2**, 201-208, 1896.
- Moessner, A. "Einige numerische Identitäten." *Proc. Indian Acad. Sci. Sect. A* **10**, 296-306, 1939.
- Moessner, A. "Alcune ricerche di teoria dei numeri e problemi diofantei." *Bol. Soc. Mat. Mexicana* **2**, 36-39, 1948.
- Rao, K. S. "On Sums of Fifth Powers." *J. London Math. Soc.* **9**, 170-171, 1934.
- Sastry, S. "On Sums of Powers." *J. London Math. Soc.* **9**, 242-246, 1934.
- Swinnerton-Dyer, H. P. F. "A Solution of $A^5 + B^5 + C^5 = D^5 + E^5 + F^5$." *Proc. Cambridge Phil. Soc.* **48**, 516-518, 1952.
- Xeroudakes, G. and Moessner, A. "On Equal Sums of Like Powers." *Proc. Indian Acad. Sci. Sect. A* **48**, 245-255, 1958.

Diophantine Equation—6th Powers

The 2-1 equation

$$A^6 + B^6 = C^6 \quad (D1)$$

is a special case of FERMAT'S LAST THEOREM with $n = 6$, and so has no solution. Ekl (1996) has searched and found no solutions to the 2-2

$$A^6 + B^6 = C^6 + D^6 \quad (2)$$

with sums less than 7.25×10^{26} .

No solutions are known to the 3-1 or 3-2 equations. However, parametric solutions are known for the 3-3 equation

$$A^6 + B^6 + C^6 = D^6 + E^6 + F^6 \quad (3)$$

(Guy 1994, pp. 140 and 142). Known solutions are

$$3^6 + 19^6 + 22^6 = 10^6 + 15^6 + 23^6 \quad (4)$$

$$36^6 + 37^6 + 67^6 = 15^6 + 52^6 + 65^6 \quad (5)$$

$$33^6 + 47^6 + 74^6 = 23^6 + 54^6 + 73^6 \quad (6)$$

$$32^6 + 43^6 + 81^6 = 3^6 + 55^6 + 80^6 \quad (7)$$

$$37^6 + 50^6 + 81^6 = 11^6 + 65^6 + 78^6 \quad (8)$$

$$25^6 + 62^6 + 138^6 = 82^6 + 92^6 + 135^6 \quad (9)$$

$$51^6 + 113^6 + 136^6 = 40^6 + 125^6 + 129^6 \quad (10)$$

$$71^6 + 92^6 + 147^6 = 1^6 + 132^6 + 133^6 \quad (11)$$

$$111^6 + 121^6 + 230^6 = 26^6 + 169^6 + 225^6 \quad (12)$$

$$75^6 + 142^6 + 245^6 = 14^6 + 163^6 + 243^6 \quad (13)$$

(Rao 1934, Lander *et al.* 1967).

No solutions are known to the 4-1 or 4-2 equations. The smallest primitive 4-3 solutions are

$$41^6 + 58^6 + 73^6 = 15^6 + 32^6 + 65^6 + 70^6 \quad (14)$$

$$61^6 + 62^6 + 85^6 = 52^6 + 56^6 + 69^6 + 83^6 \quad (15)$$

$$61^6 + 74^6 + 85^6 = 26^6 + 56^6 + 71^6 + 87^6 \quad (16)$$

$$11^6 + 88^6 + 90^6 = 21^6 + 74^6 + 78^6 + 92^6 \quad (17)$$

$$26^6 + 83^6 + 95^6 = 23^6 + 24^6 + 28^6 + 101^6 \quad (18)$$

(Lander *et al.* 1967). Moessner (1947) gave three parametric solutions to the 4-4 equation. The smallest 4-4 solution is

$$2^6 + 2^6 + 9^6 + 9^6 = 3^6 + 5^6 + 6^6 + 10^6 \quad (19)$$

(Rao 1934, Lander *et al.* 1967). The smallest 4-4-4 solution is

$$\begin{aligned} 1^6 + 34^6 + 49^6 + 111^6 &= 7^6 + 43^6 + 69^6 + 110^6 \\ &= 18^6 + 25^6 + 77^6 + 109^6 \end{aligned} \quad (20)$$

(Lander *et al.* 1967).

No n -1 solutions are known for $n \leq 6$ (Lander *et al.* 1967). No solution to the 5-1 equation is known (Guy 1994, p. 140) or the 5-2 equation.

No solutions are known to the 6-1 or 6-2 equations.

The smallest 7-1 solution is

$$74^6 + 234^6 + 402^6 + 474^6 + 702^6 + 894^6 + 1077^6 = 1141^6 \quad (21)$$

(Lander *et al.* 1967). The smallest 7-2 solution is

$$18^6 + 22^6 + 36^6 + 58^6 + 69^6 + 78^6 + 78^6 = 56^6 + 91^6 \quad (22)$$

(Lander *et al.* 1967).

The smallest primitive 8-1 solutions are

$$\begin{aligned} 8^6 + 12^6 + 30^6 + 78^6 + 102^6 \\ + 138^6 + 165^6 + 246^6 = 251^6 \end{aligned} \quad (23)$$

$$\begin{aligned} 48^6 + 111^6 + 156^6 + 186^6 + 188^6 \\ + 228^6 + 240^6 + 426^6 = 431^6 \end{aligned} \quad (24)$$

$$\begin{aligned} 93^6 + 93^6 + 195^6 + 197^6 + 303^6 \\ + 303^6 + 303^6 + 411^6 = 440^6 \end{aligned} \quad (25)$$

$$\begin{aligned} 219^6 + 255^6 + 261^6 + 267^6 + 289^6 \\ + 351^6 + 351^6 + 351^6 = 440^6 \end{aligned} \quad (26)$$

$$\begin{aligned} 12^6 + 66^6 + 138^6 + 174^6 + 212^6 \\ + 288^6 + 306^6 + 441^6 = 455^6 \end{aligned} \quad (27)$$

$$\begin{aligned} 12^6 + 48^6 + 222^6 + 236^6 + 333^6 \\ + 384^6 + 390^6 + 426^6 = 493^6 \end{aligned} \quad (28)$$

$$\begin{aligned} 66^6 + 78^6 + 144^6 + 228^6 + 256^6 \\ + 288^6 + 435^6 + 444^6 = 499^6 \end{aligned} \quad (29)$$

$$\begin{aligned} 16^6 + 24^6 + 60^6 + 156^6 + 204^6 \\ + 276^6 + 330^6 + 492^6 = 502^6 \end{aligned} \quad (30)$$

$$\begin{aligned} 61^6 + 96^6 + 156^6 + 228^6 + 276^6 \\ + 318^6 + 354^6 + 534^6 = 547^6 \end{aligned} \quad (31)$$

$$\begin{aligned} 170^6 + 177^6 + 276^6 + 312^6 + 312^6 \\ + 408^6 + 450^6 + 498^6 = 559^6 \end{aligned} \quad (32)$$

$$\begin{aligned} 60^6 + 102^6 + 126^6 + 261^6 + 270^6 \\ + 338^6 + 354^6 + 570^6 = 581^6 \end{aligned} \quad (33)$$

$$\begin{aligned} 57^6 + 146^6 + 150^6 + 360^6 + 390^6 \\ + 402^6 + 444^6 + 528^6 = 583^6 \end{aligned} \quad (34)$$

$$\begin{aligned} 33^6 + 72^6 + 122^6 + 192^6 + 204^6 \\ + 390^6 + 534^6 + 534^6 = 607^6 \end{aligned} \quad (35)$$

$$\begin{aligned} 12^6 + 90^6 + 114^6 + 114^6 + 273^6 \\ + 306^6 + 492^6 + 592^6 = 623^6 \end{aligned} \quad (36)$$

(Lander *et al.* 1967). The smallest 8-2 solution is

$$8^6 + 10^6 + 12^6 + 15^6 + 24^6 + 30^6 + 33^6 + 36^6 = 35^6 + 37^6 \quad (37)$$

(Lander *et al.* 1967).

The smallest 9-1 solution is

$$1^6 + 17^6 + 19^6 + 22^6 + 31^6 + 37^6 + 37^6 + 41^6 + 49^6 = 54^6 \quad (38)$$

(Lander *et al.* 1967). The smallest 9-2 solution is

$$1^6 + 5^6 + 5^6 + 7^6 + 13^6 + 13^6 + 13^6 + 17^6 + 19^6 = 6^6 + 21^6 \quad (39)$$

(Lander *et al.* 1967).

The smallest 10-1 solution is

$$2^6 + 4^6 + 7^6 + 14^6 + 16^6 + 26^6 + 26^6 + 30^6 + 32^6 + 32^6 = 39^6 \quad (40)$$

(Lander *et al.* 1967). The smallest 10-2 solution is

$$1^6 + 1^6 + 1^6 + 4^6 + 4^6 + 7^6 + 9^6 + 11^6 + 11^6 + 11^6 = 12^6 + 12^6 \quad (41)$$

(Lander *et al.* 1967).

The smallest 11-1 solution is

$$2^6 + 5^6 + 5^6 + 5^6 + 7^6 + 7^6 + 9^6 + 9^6 + 10^6 + 14^6 + 17^6 = 18^6 \quad (42)$$

(Lander *et al.* 1967).

There is also at least one 16-1 identity,

$$1^6 + 2^6 + 4^6 + 5^6 + 6^6 + 7^6 + 9^6 + 12^6 + 13^6 + 15^6 + 16^6 + 18^6 + 20^6 + 21^6 + 22^6 + 23^6 = 28^6 \quad (43)$$

(Martin 1893). Moessner (1959) gave solutions for 16-1, 18-1, 20-1, and 23-1.

References

- Ekl, R. L. "Equal Sums of Four Seventh Powers." *Math. Comput.* **65**, 1755–1756, 1996.
- Guy, R. K. "Sums of Like Powers. Euler's Conjecture." §D1 in *Unsolved Problems in Number Theory*, 2nd ed. New York: Springer-Verlag, pp. 139–144, 1994.
- Lander, L. J.; Parkin, T. R.; and Selfridge, J. L. "A Survey of Equal Sums of Like Powers." *Math. Comput.* **21**, 446–459, 1967.
- Martin, A. "On Powers of Numbers Whose Sum is the Same Power of Some Number." *Quart. J. Math.* **26**, 225–227, 1893.
- Moessner, A. "On Equal Sums of Like Powers." *Math. Student* **15**, 83–88, 1947.
- Moessner, A. "Einige zahlentheoretische Untersuchungen und diophantische Probleme." *Glasnik Mat.-Fiz. Astron. Društvo Mat. Fiz. Hrvatske Ser. 2* **14**, 177–182, 1959.
- Rao, S. K. "On Sums of Sixth Powers." *J. London Math. Soc.* **9**, 172–173, 1934.

Diophantine Equation—7th Powers

The 2-1 equation

$$A^7 + B^7 = C^7 \quad (1)$$

is a special case of FERMAT'S LAST THEOREM with $n = 7$, and so has no solution. No solutions to the 2-2 equation

$$A^7 + B^7 = C^7 + D^7 \quad (2)$$

are known

No solutions to the 3-1 or 3-2 equations are known, neither are solutions to the 3-3 equation

$$A^7 + B^7 + C^7 = D^7 + E^7 + F^7 \quad (3)$$

(Ekl 1996).

No 4-1, 4-2, or 4-3 solutions are known. Guy (1994, p. 140) asked if a 4-4 equation exists for 7th POWERS. An affirmative answer was provided by (Ekl 1996),

$$149^7 + 123^7 + 14^7 + 10^7 = 146^7 + 129^7 + 90^7 + 15^7 \quad (4)$$

$$194^7 + 150^7 + 105^7 + 23^7 = 192^7 + 152^7 + 132^7 + 38^7. \quad (5)$$

A 4-5 solution is known.

No 5-1, 5-2, or 5-3 solutions are known. Numerical solutions to the 5-4 equation are given by Gloden (1948). The smallest 5-4 solution is

$$3^7 + 11^7 + 26^7 + 29^7 + 52^7 = 12^7 + 16^7 + 43^7 + 50^7 \quad (6)$$

(Lander *et al.* 1967). Gloden (1949) gives parametric solutions to the 5-5 equation. The first few 5-5 solutions are

$$8^7 + 8^7 + 13^7 + 16^7 + 19^7 = 2^7 + 12^7 + 15^7 + 17^7 + 18^7 \quad (7)$$

$$4^7 + 8^7 + 14^7 + 16^7 + 23^7 = 7^7 + 7^7 + 9^7 + 20^7 + 22^7 \quad (8)$$

$$11^7 + 12^7 + 18^7 + 21^7 + 26^7 = 9^7 + 10^7 + 22^7 + 23^7 + 24^7 \quad (9)$$

$$6^7 + 12^7 + 20^7 + 22^7 + 27^7 = 10^7 + 13^7 + 13^7 + 25^7 + 26^7 \quad (10)$$

$$3^7 + 13^7 + 17^7 + 24^7 + 38^7 = 14^7 + 26^7 + 32^7 + 32^7 + 33^7 \quad (11)$$

(Lander *et al.* 1967).

No 6-1, 6-2, or 6-3 solutions are known. A parametric solution to the 6-6 equation was given by Sastry and Rai (1948). The smallest is

$$2^7 + 3^7 + 6^7 + 6^7 + 10^7 + 13^7 = 1^7 + 1^7 + 7^7 + 7^7 + 12^7 + 12^7 \quad (12)$$

(Lander *et al.* 1967).

There are no known solutions to the 7-1 equation (Guy 1994, p. 140). A 7²-2 solution is

$$\begin{aligned} 2^7 + 26^7 \\ = 4^7 + 8^7 + 13^7 + 14^7 + 14^7 + 16^7 + 18^7 + 22^7 + 23^7 + 23^7 \\ = 7^7 + 7^7 + 9^7 + 13^7 + 14^7 + 18^7 + 20^7 + 22^7 + 22^7 + 23^7 \end{aligned} \quad (13)$$

(Lander *et al.* 1967). The smallest 7-3 solution is

$$7^7 + 7^7 + 12^7 + 16^7 + 27^7 + 28^7 + 31^7 = 26^7 + 30^7 + 30^7 \quad (14)$$

(Lander *et al.* 1967).

The smallest 8-1 solution is

$$12^8 + 35^8 + 53^8 + 58^8 + 64^8 + 83^8 + 85^8 + 90^8 = 102^8 \quad (15)$$

(Lander *et al.* 1967). The smallest 8-2 solution is

$$5^7 + 6^7 + 7^7 + 15^7 + 15^7 + 20^7 + 28^7 + 31^7 = 10^7 + 33^7 \quad (16)$$

(Lander *et al.* 1967).

The smallest 9-1 solution is

$$6^7 + 14^7 + 20^7 + 22^7 + 27^7 + 33^7 + 41^7 + 50^7 + 59^7 = 62^7 \quad (17)$$

(Lander *et al.* 1967).

References

- Ekl, R. L. "Equal Sums of Four Seventh Powers." *Math. Comput.* **65**, 1755–1756, 1996.
 Gloden, A. "Zwei Parameterlösungen einer mehrgeradigen Gleichung." *Arch. Math.* **1**, 480–482, 1949.
 Guy, R. K. "Sums of Like Powers. Euler's Conjecture." §D1 in *Unsolved Problems in Number Theory*, 2nd ed. New York: Springer-Verlag, pp. 139–144, 1994.
 Lander, L. J.; Parkin, T. R.; and Selfridge, J. L. "A Survey of Equal Sums of Like Powers." *Math. Comput.* **21**, 446–459, 1967.
 Sastry, S. and Rai, T. "On Equal Sums of Like Powers." *Math. Student* **16**, 18–19, 1948.

Diophantine Equation—8th Powers

The 2-1 equation

$$A^8 + B^8 = C^8 \quad (1)$$

is a special case of FERMAT'S LAST THEOREM with $n = 8$, and so has no solution. No 2-2 solutions are known.

No 3-1, 3-2, or 3-3 solutions are known.

No 4-1, 4-2, 4-3, or 4-4 solutions are known.

No 5-1, 5-2, 5-3, or 5-4 solutions are known, but Letac (1942) found a solution to the 5-5 equation. The smallest 5-5 solution is

$$1^8 + 10^8 + 11^8 + 20^8 + 43^8 = 5^8 + 28^8 + 32^8 + 35^8 + 41^8 \quad (2)$$

(Lander *et al.* 1967).

No 6-1, 6-2, 6-3, or 6-4 solutions are known. Moessner and Gloden (1944) found solutions to the 6-6 equation. The smallest 6-6 solution is

$$3^8 + 6^8 + 8^8 + 10^8 + 15^8 + 23^8 = 5^8 + 9^8 + 9^8 + 12^8 + 20^8 + 22^8 \quad (3)$$

(Lander *et al.* 1967).

No 7-1, 7-2, or 7-3 solutions are known. The smallest 7-4 solution is

$$7^8 + 9^8 + 16^8 + 22^8 + 22^8 + 28^8 + 34^8 = 6^8 + 11^8 + 20^8 + 35^8 \quad (4)$$

(Lander *et al.* 1967). Moessner and Gloden (1944) found solutions to the 7-6 equation. Parametric solutions to the 7-7 equation were given by Moessner (1947) and Gloden (1948). The smallest 7-7 solution is

$$1^8 + 3^8 + 5^8 + 6^8 + 6^8 + 8^8 + 13^8 = 4^8 + 7^8 + 9^8 + 9^8 + 10^8 + 11^8 + 12^8 \quad (5)$$

(Lander *et al.* 1967).

No 8-1 or 8-2 solutions are known. The smallest 8-3 solution is

$$6^8 + 12^8 + 16^8 + 16^8 + 38^8 + 38^8 + 40^8 + 47^8 = 8^8 + 17^8 + 50^8 \quad (6)$$

(Lander *et al.* 1967). Sastry (1934) used the smallest 17-1 solution to give a parametric 8-8 solution. The smallest 8-8 solution is

$$1^8 + 3^8 + 7^8 + 7^8 + 7^8 + 10^8 + 10^8 + 12^8 = 4^8 + 5^8 + 5^8 + 6^8 + 6^8 + 11^8 + 11^8 + 11^8 \quad (7)$$

(Lander *et al.* 1967).

No solutions to the 9-1 equation is known. The smallest 9-2 solution is

$$2^8 + 7^8 + 8^8 + 16^8 + 17^8 + 20^8 + 20^8 + 24^8 + 24^8 = 11^8 + 27^8 \quad (8)$$

(Lander *et al.* 1967). Letac (1942) found solutions to the 9-9 equation.

No solutions to the 10-1 equation are known.

The smallest 11-1 solution is

$$14^8 + 18^8 + 2 \cdot 44^8 + 66^8 + 70^8 + 92^8 + 93^8 + 96^8 + 106^8 + 112^8 = 125^8 \quad (9)$$

(Lander *et al.* 1967).

The smallest 12-1 solution is

$$2 \cdot 8^8 + 10^8 + 3 \cdot 24^8 + 26^8 + 30^8 + 34^8 + 44^8 + 52^8 + 63^8 = 65^8 \quad (10)$$

(Lander *et al.* 1967).

The general identity

$$(2^{8k+4} + 1)^8 = (2^{8k+4} - 1)^8 + (2^{7k+4})^8 + (2^{k+1})^8 + 7[(2^{5k+3})^8 + (2^{3k+2})^8] \quad (11)$$

gives a solution to the 17-1 equation (Lander *et al.* 1967).

References

- Gloden, A. "Parametric Solutions of Two Multi-Degreed Equalities." *Amer. Math. Monthly* **55**, 86–88, 1948.
- Lander, L. J.; Parkin, T. R.; and Selfridge, J. L. "A Survey of Equal Sums of Like Powers." *Math. Comput.* **21**, 446–459, 1967.
- Letac, A. *Gazetta Mathematica* **48**, 68–69, 1942.
- Moessner, A. "On Equal Sums of Like Powers." *Math. Student* **15**, 83–88, 1947.
- Moessner, A. and Gloden, A. "Einige Zahlentheoretische Untersuchungen und Resultate." *Bull. Sci. École Polytech. de Timisoara* **11**, 196–219, 1944.
- Sastry, S. "On Sums of Powers." *J. London Math. Soc.* **9**, 242–246, 1934.

Diophantine Equation—9th Powers

The 2-1 equation

$$A^9 + B^9 = C^9 \quad (1)$$

is a special case of FERMAT'S LAST THEOREM with $n = 9$, and so has no solution. There is no known 2-2 solution.

There are no known 3-1, 3-2, or 3-3 solutions.

There are no known 4-1, 4-2, 4-3, or 4-4 solutions.

There are no known 5-1, 5-2, 5-3, 5-4, or 5-5 solutions.

There are no known 6-1, 6-2, 6-3, 6-4, or 6-5 solutions. The smallest 6-6 solution is

$$1^9 + 13^9 + 13^9 + 14^9 + 18^9 + 23^9 = 5^9 + 9^9 + 10^9 + 15^9 + 21^9 + 22^9 \quad (2)$$

(Lander *et al.* 1967).

There are no known 7-1, 7-2, 7-3, 7-4, or 7-5 solutions.

There are no known 8-1, 8-2, 8-3, 8-4, or 8-5 solutions.

There are no known 9-1, 9-2, 9-3, 9-4, or 9-5 solutions.

There are no known 10-1, 10-2, or 10-3 solutions. The smallest 10-4 solution is

$$2^9 + 6^9 + 6^9 + 9^9 + 10^9 + 11^9 + 14^9 + 18^9 + 2 \cdot 19^9 = 5^9 + 12^9 + 16^9 + 21^9 \quad (3)$$

(Lander *et al.* 1967). No 10-5 solution is known. Moessner (1947) gives a parametric solution to the 10-10 equation.

There are no known 11-1 or 11-2 solutions. The smallest 11-3 solution is

$$2^9 + 3^9 + 6^9 + 7^9 + 9^9 + 9^9 + 19^9 + 19^9 + 21^9 + 25^9 + 29^9 = 13^9 + 16^9 + 30^9 \quad (4)$$

(Lander *et al.* 1967). The smallest 11-5 solution is

$$3^9 + 5^9 + 5^9 + 9^9 + 9^9 + 12^9 + 15^9 + 15^9 + 16^9 + 21^9 + 21^9 = 7^9 + 8^9 + 14^9 + 20^9 + 22^9 \quad (5)$$

(Lander *et al.* 1967). Palamá (1953) gave a solution to the 11-11 equation.

There is no known 12-1 solution. The smallest 12-2 solution is

$$4 \cdot 2^9 + 2 \cdot 3^9 + 4^9 + 7^9 + 16^9 + 17^9 + 2 \cdot 19^9 = 15^9 + 21^9 \quad (6)$$

(Lander *et al.* 1967).

There are no known 13-1 or 14-1 solutions. The smallest 15-1 solution is

$$2^9 + 2^9 + 4^9 + 6^9 + 6^9 + 7^9 + 9^9 + 9^9 + 10^9 + 15^9 + 18^9 + 21^9 + 21^9 + 23^9 + 23^9 = 26^9 \quad (7)$$

(Lander *et al.* 1967).

References

- Lander, L. J.; Parkin, T. R.; and Selfridge, J. L. "A Survey of Equal Sums of Like Powers." *Math. Comput.* **21**, 446–459, 1967.
- Moessner, A. "On Equal Sums of Like Powers." *Math. Student* **15**, 83–88, 1947.
- Palamá, G. "Diophantine Systems of the Type $\sum_{i=1}^p a_i^k = \sum_{i=1}^p b_i^k$ ($k = 1, 2, \dots, n, n+2, n+4, \dots, n+2r$)." *Scripta Math.* **19**, 132–134, 1953.

Diophantine Equation—10th Powers

The 2-1 equation

$$A^{10} + B^{10} = C^{10} \quad (1)$$

is a special case of FERMAT'S LAST THEOREM with $n = 10$, and so has no solution. The smallest values for which $n-1$, $n-2$, etc., have solutions are 23, 19, 24, 23, 16, 27, and 7, corresponding to

$$5 \cdot 1^{10} + 2^{10} + 3^{10} + 6^{10} + 6 \cdot 7^{10} + 4 \cdot 9^{10} + 10^{10} + 2 \cdot 12^{10} + 13^{10} + 14^{10} = 15^{10} \quad (2)$$

$$5 \cdot 2^{10} + 5^{10} + 6^{10} + 10^{10} + 6 \cdot 11^{10} + 2 \cdot 12^{10} + 3 \cdot 15^{10} = 9^{10} + 17^{10} \quad (3)$$

$$1^{10} + 2^{10} + 3^{10} + 10 \cdot 4^{10} + 7^{10} + 7 \cdot 8^{10} + 10^{10} + 12^{10} + 16^{10} = 11^{10} + 2 \cdot 15^{10} \quad (4)$$

$$5 \cdot 1^{10} + 2 \cdot 2^{10} + 3 \cdot 3^{10} + 4^{10} + 4 \cdot 6^{10} + 3 \cdot 7^{10} + 8^{10} + 2 \cdot 10^{10} + 2 \cdot 14^{10} + 15^{10} = 3 \cdot 11^{10} + 16^{10} \quad (5)$$

$$4 \cdot 1^{10} + 2^{10} + 2 \cdot 4^{10} + 6^{10} + 2 \cdot 12^{10} + 5 \cdot 13^{10} + 15^{10} = 2 \cdot 3^{10} + 8^{10} + 14^{10} + 16^{10} \quad (6)$$

$$1^{10} + 4 \cdot 3^{10} + 2 \cdot 4^{10} + 2 \cdot 5^{10} + 7 \cdot 6^{10} + 9 \cdot 7^{10} + 10^{10} + 13^{10} = 2 \cdot 2^{10} + 8^{10} + 11^{10} + 2 \cdot 12^{10} \quad (7)$$

$$1^{10} + 28^{10} + 31^{10} + 32^{10} + 55^{10} + 61^{10} + 68^{10} = 17^{10} + 20^{10} + 23^{10} + 44^{10} + 49^{10} + 64^{10} + 67^{10} \quad (8)$$

(Lander *et al.* 1967).

References

Lander, L. J.; Parkin, T. R.; and Selfridge, J. L. "A Survey of Equal Sums of Like Powers." *Math. Comput.* **21**, 446–459, 1967.

Diophantine Equation—Cubic

The 2-1 equation

$$A^3 + B^3 = C^3 \quad (1)$$

is a case of FERMAT'S LAST THEOREM with $n = 3$. In fact, this particular case was known not to have any solutions long before the general validity of FERMAT'S LAST THEOREM was established. The 2-2 equation

$$A^3 + B^3 = C^3 + D^3 \quad (2)$$

has a known parametric solution (Dickson 1966, pp. 550–554; Guy 1994, p. 140), and 10 solutions with sum $< 10^5$,

$$1729 = 1^3 + 12^3 = 9^3 + 10^3 \quad (3)$$

$$4104 = 2^3 + 16^3 = 9^3 + 15^3 \quad (4)$$

$$13832 = 2^3 + 24^3 = 18^3 + 20^3 \quad (5)$$

$$20683 = 10^3 + 27^3 = 19^3 + 24^3 \quad (6)$$

$$32832 = 4^3 + 32^3 = 18^3 + 30^3 \quad (7)$$

$$39312 = 2^3 + 34^3 = 15^3 + 33^3 \quad (8)$$

$$40033 = 9^3 + 34^3 = 16^3 + 33^3 \quad (9)$$

$$46683 = 3^3 + 36^3 = 16^3 + 33^3 \quad (10)$$

$$64232 = 17^3 + 39^3 = 26^3 + 36^3 \quad (11)$$

$$65728 = 12^3 + 40^3 = 31^3 + 33^3 \quad (12)$$

(Sloane's A001235; Moreau 1898). The first number (Madachy 1979, pp. 124 and 141) in this sequence, the so-called HARDY-RAMANUJAN NUMBER, is associated with a story told about Ramanujan by G. H. Hardy, but was known as early as 1657 (Berndt and Bhargava 1993). The smallest number representable in n ways as a sum of cubes is called the n th TAXICAB NUMBER.

Ramanujan gave a general solution to the 2-2 equation as

$$(\alpha + \lambda^2 \gamma)^3 + (\lambda \beta + \gamma)^3 = (\lambda \alpha + \gamma)^3 + (\beta + \lambda^2 \gamma)^3 \quad (13)$$

where

$$\alpha^2 + \alpha \beta + \beta^2 = 3 \lambda \gamma^2 \quad (14)$$

(Berndt 1994, p. 107). Another form due to Ramanujan is

$$(A^2 + 7AB - 9B^2)^3 + (2A^2 - 4AB + 12B^2)^3 = (2A^2 + 10B^2)^3 + (A^2 - 9AB - B^2)^3. \quad (15)$$

Hardy and Wright (1979, Theorem 412) prove that there are numbers that are expressible as the sum of two cubes in n ways for any n (Guy 1994, pp. 140–141). The proof is constructive, providing a method for computing such numbers: given RATIONALS NUMBERS r and s , compute

$$t = \frac{r(r^3 + 2s^3)}{r^3 - s^3} \quad (16)$$

$$u = \frac{s(2r^3 + s^3)}{r^3 - s^3} \quad (17)$$

$$v = \frac{t(t^3 - 2u^3)}{t^3 + u^3} \quad (18)$$

$$w = \frac{u(2t^3 - u^3)}{t^3 + u^3}. \quad (19)$$

Then

$$r^3 + s^3 = t^3 - u^3 = v^3 + w^3 \quad (20)$$

The DENOMINATORS can now be cleared to produce an integer solution. If r/s is picked to be large enough, the v and w will be POSITIVE. If r/s is still larger, the v/w will be large enough for v and w to be used as the inputs to produce a third pair, etc. However, the resulting integers may be quite large, even for $n = 2$. E.g., starting with $3^3 + 1^3 = 28$, the algorithm finds

$$28 = \left(\frac{28340511}{21446828}\right)^3 + \left(\frac{63284705}{21446828}\right)^3, \quad (21)$$

giving

$$28 \cdot 21446828^3 = (3 \cdot 21446828)^3 + 21446828^3 \quad (22)$$

$$= 28340511^3 + 63284705^3. \quad (23)$$

The numbers representable in three ways as a sum of two cubes (a 2-2-2 equation) are

$$87539319 = 167^3 + 436^3 = 228^3 + 423^3 = 255^3 + 414^3 \quad (24)$$

$$119824488 = 11^3 + 493^3 = 90^3 + 492^3 = 346^3 + 428^3 \quad (25)$$

$$143604279 = 111^3 + 522^3 = 359^3 + 460^3 = 408^3 + 423^3 \quad (26)$$

$$175959000 = 70^3 + 560^3 = 198^3 + 552^3 = 315^3 + 525^3 \quad (27)$$

$$327763000 = 300^3 + 670^3 = 339^3 + 661^3 = 510^3 + 580^3 \quad (28)$$

(Guy 1994, Sloane's A003825). Wilson (1997) found 32 numbers representable in four ways as the sum of two cubes (a 2-2-2-2 equation). The first is

$$6963472309248 = 2421^2 + 19083^2 = 5436^2 + 18948^2 \\ = 102020^3 + 18072^2 = 13322^3 + 15530^3. \quad (29)$$

The smallest known numbers so representable are 6963472309248, 12625136269928, 21131226514944, 26059452841000, ... (Sloane's A003826). Wilson also found six five-way sums,

$$48988659276962496 = 38787^3 + 365757^3 \\ = 107839^3 + 362753^3 \\ = 205292^3 + 342952^3 \\ = 221424^3 + 336588^3 \\ = 231518^3 + 331954^3 \quad (30)$$

$$490593422681271000 = 48369^3 + 788631^3 \\ = 233775^3 + 781785^3 \\ = 285120^3 + 776070^3 \\ = 543145^3 + 691295^3 \\ = 579240^3 + 666630^3 \quad (31)$$

$$6355491080314102272 = 103113^3 + 1852215^3 \\ = 580488^3 + 1833120^3 \\ = 788724^3 + 1803372^3 \\ = 1150792^3 + 1690544^3 \\ = 1462050^3 + 1478238^3 \quad (32)$$

$$27365551142421413376 = 167751^3 + 3013305^3 \\ = 265392^3 + 3012792^3 \\ = 944376^3 + 2982240^3 \\ = 1283148^3 + 2933844^3 \\ = 1872184^3 + 2750288^3 \quad (33)$$

$$1199962860219870469632 = 591543^3 + 10625865^3 \\ = 935856^3 + 10624056^3 \\ = 3330168^3 + 10516320^3 \\ = 6601912^3 + 9698384^3 \\ = 8387550^3 + 8480418^3 \quad (34)$$

$$111549833098123426841016 = 1074073^3 + 48137999^3 \\ = 8787870^3 + 48040356^3 \\ = 13950972^3 + 47744382^3 \\ = 24450192^3 + 45936462^3 \\ = 33784478^3 + 41791204^3, \quad (35)$$

and a single six-way sum

$$8230545258248091551205888 \\ = 11239317^3 + 201891435^3 \\ = 17781264^3 + 201857064^3 \\ = 63273192^3 + 199810080^3 \\ = 85970916^3 + 196567548^3 \\ = 125436328^3 + 184269296^3 \\ = 159363450^3 + 161127942^3. \quad (36)$$

The first rational solution to the 3-1 equation

$$A^3 + B^3 + C^3 = D^3 \quad (37)$$

was found by Euler and Vieta (Dickson 1966, pp. 550–554). Hardy and Wright (1979, pp. 199–201) give a solution which can be based on the identities

$$a^3(a^3 + b^3)^3 = b^3(a^3 + b^3)^3 + a^3(a^3 - 2b^3)^3 \\ + b^3(2a^3 - b^3)^3 \quad (38)$$

$$a^3(a^3 + 2b^3)^3 = a^3(a^3 - b^3)^3 + b^3(a^3 - b^3)^3 \\ + b^3(2a^3 + b^3)^3. \quad (39)$$

This is equivalent to the general 2-2 solution found by Ramanujan (Berndt 1994, pp. 54 and 107). The smallest integral solutions are

$$3^3 + 4^3 + 5^3 = 6^3 \quad (40)$$

$$1^3 + 6^3 + 8^3 = 9^3 \quad (41)$$

$$7^3 + 14^3 + 17^3 = 20^3 \quad (42)$$

$$11^3 + 15^3 + 27^3 = 29^3 \quad (43)$$

$$28^3 + 53^3 + 75^3 = 84^3 \quad (44)$$

$$26^3 + 55^3 + 78^3 = 87^3 \quad (45)$$

$$33^3 + 70^3 + 92^3 = 105^3 \quad (46)$$

(Beeler *et al.* 1972; Madachy 1979, pp. 124 and 141). Other general solutions have been found by Binet (1841) and Schwering (1902), although Ramanujan's formulation is the simplest. No general solution giving *all* POSITIVE integral solutions is known (Dickson 1966, pp. 550–561).

4-1 equations include

$$11^3 + 12^3 + 13^3 + 14^3 = 20^3 \quad (47)$$

$$5^3 + 7^3 + 9^3 + 10^3 = 13^3. \quad (48)$$

A solution to the 4-4 equation is

$$2^3 + 3^3 + 10^3 + 11^3 = 1^3 + 5^3 + 8^3 + 12^3 \quad (49)$$

(Madachy 1979, pp. 118 and 133).

5-1 equations

$$1^3 + 3^3 + 4^3 + 5^3 + 8^3 = 9^3 \quad (50)$$

$$3^3 + 4^3 + 5^3 + 8^3 + 10^3 = 12^3, \quad (51)$$

and a 6-1 equation is given by

$$1^3 + 5^3 + 6^3 + 7^3 + 8^3 + 10^3 = 13^3. \quad (52)$$

A 6-6 equation also exists:

$$1^3 + 2^3 + 4^3 + 8^3 + 9^3 + 12^3 = 3^3 + 5^3 + 6^3 + 7^3 + 10^3 + 11^3 \quad (53)$$

(Madachy 1979, p. 142).

Euler gave the general solution to

$$A^3 + B^3 = C^2 \quad (54)$$

as

$$A = 3n^3 + 6n^2 - n \quad (55)$$

$$B = -3n^3 + 6n^2 + n \quad (56)$$

$$C = 6n^2(3n^2 + 1). \quad (57)$$

see also CANNONBALL PROBLEM, HARDY-RAMANUJAN NUMBER, SUPER-3 NUMBER, TAXICAB NUMBER, TRIMORPHIC NUMBER

References

- Beeler, M.; Gosper, R. W.; and Schroepfel, R. Item 58 in *HAKMEM*. Cambridge, MA: MIT Artificial Intelligence Laboratory, Memo AIM-239, Feb. 1972.
- Berndt, B. C. *Ramanujan's Notebooks, Part IV*. New York: Springer-Verlag, 1994.
- Berndt, B. C. and Bhargava, S. "Ramanujan—For Low-brows." *Amer. Math. Monthly* **100**, 645–656, 1993.
- Binet, J. P. M. "Note sur une question relative à la théorie des nombres." *C. R. Acad. Sci. (Paris)* **12**, 248–250, 1841.
- Dickson, L. E. *History of the Theory of Numbers, Vol. 2: Diophantine Analysis*. New York: Chelsea, 1966.
- Guy, R. K. "Sums of Like Powers. Euler's Conjecture." §D1 in *Unsolved Problems in Number Theory, 2nd ed.* New York: Springer-Verlag, pp. 139–144, 1994.
- Hardy, G. H. *Ramanujan: Twelve Lectures on Subjects Suggested by His Life and Work, 3rd ed.* New York: Chelsea, p. 68, 1959.
- Hardy, G. H. and Wright, E. M. *An Introduction to the Theory of Numbers, 5th ed.* Oxford, England: Clarendon Press, 1979.
- Madachy, J. S. *Madachy's Mathematical Recreations*. New York: Dover, 1979.
- Moreau, C. "Plus petit nombre égal à la somme de deux cubes de deux façons." *L'Intermédiaire Math.* **5**, 66, 1898.
- Schwering, K. "Vereinfachte Lösungen des Eulerschen Aufgabs: $x^3 + y^3 + z^3 + v^3 = 0$." *Arch. Math. Phys.* **2**, 280–284, 1902.
- Shanks, D. *Solved and Unsolved Problems in Number Theory, 4th ed.* New York: Chelsea, p. 157, 1993.
- Sloane, N. J. A. Sequences A001235 and A003825 in "An On-Line Version of the Encyclopedia of Integer Sequences."
- Wilson, D. Personal communication, Apr. 17, 1997.

Diophantine Equation—Linear

A linear Diophantine equation (in two variables) is an equation of the general form

$$ax + by = c, \quad (1)$$

where solutions are sought with a , b , and c INTEGERS. Such equations can be solved completely, and the first known solution was constructed by Brahmagupta. Consider the equation

$$ax + by = 1. \quad (2)$$

Now use a variation of the EUCLIDEAN ALGORITHM, letting $a = r_1$ and $b = r_2$

$$r_1 = q_1 r_2 + r_3 \quad (3)$$

$$r_2 = q_2 r_3 + r_4 \quad (4)$$

$$r_{n-3} = q_{n-3} r_{n-2} + r_{n-1} \quad (5)$$

$$r_{n-2} = q_{n-2} r_{n-1} + 1. \quad (6)$$

Starting from the bottom gives

$$1 = r_{n-2} - q_{n-2} r_{n-1} \quad (7)$$

$$r_{n-1} = r_{n-3} - q_{n-3} r_{n-2}, \quad (8)$$

so

$$\begin{aligned} 1 &= r_{n-2} - q_{n-2}(r_{n-3} - q_{n-3} r_{n-2}) \\ &= -q_{n-2} r_{n-3} + (1 - q_{n-2} q_{n-3}) r_{n-2}. \end{aligned} \quad (9)$$

Continue this procedure all the way back to the top.

Take as an example the equation

$$1027x + 712y = 1. \quad (10)$$

Proceed as follows.

$$\begin{array}{ll} 1027 = 712 \cdot 1 + 315 & | \quad 1 = -165 \cdot 1027 + 238 \cdot 712 \uparrow \\ 712 = 315 \cdot 2 + 82 & | \quad 1 = 73 \cdot 712 - 165 \cdot 315 \uparrow \\ 315 = 82 \cdot 3 + 69 & | \quad 1 = -19 \cdot 315 + 73 \cdot 82 \uparrow \\ 82 = 69 \cdot 1 + 13 & | \quad 1 = 16 \cdot 82 - 19 \cdot 69 \uparrow \\ 69 = 13 \cdot 5 + 4 & | \quad 1 = -3 \cdot 69 + 16 \cdot 13 \uparrow \\ 13 = 4 \cdot 3 + 1 \downarrow & | \quad 1 = 1 \cdot 13 - 3 \cdot 4 \uparrow \\ & | \quad 1 = 0 \cdot 4 + 1 \cdot 1, \end{array}$$

The solution is therefore $x = -165$, $y = 238$. The above procedure can be simplified by noting that the two left-most columns are offset by one entry and alternate signs, as they must since

$$1 = -A_{i+1} r_i + A_i r_{i+1} \quad (11)$$

$$r_{i+1} = r_{i-1} - r_i q_{i-1} \quad (12)$$

$$1 = A_i r_{i-1} - (A_i q_{i-1} + A_{i+1}), \quad (13)$$

so the COEFFICIENTS of r_{i-1} and r_{i+1} are the same and

$$A_{i-1} = -(A_i q_{i-1} + A_{i+1}). \quad (14)$$

Repeating the above example using this information therefore gives

$$\begin{array}{llll} 1027 = 712 \cdot 1 + 315 & | & (-) & 165 \cdot 1 + 73 = 238 \uparrow \\ 712 = 315 \cdot 2 + 82 & | & (+) & 73 \cdot 2 + 19 = 165 \uparrow \\ 315 = 82 \cdot 3 + 69 & | & (-) & 19 \cdot 3 + 16 = 73 \uparrow \\ 82 = 69 \cdot 1 + 13 & | & (+) & 16 \cdot 1 + 3 = 19 \uparrow \\ 69 = 13 \cdot 5 + 4 & | & (-) & 3 \cdot 5 + 1 = 16 \uparrow \\ 13 = 4 \cdot 3 + 1 \downarrow & | & (+) & 1 \cdot 3 + 0 = 3 \uparrow \\ & | & (-) & 0 \cdot 1 + 1 = 1 \uparrow \end{array}$$

and we recover the above solution.

Call the solutions to

$$ax + by = 1 \quad (15)$$

x_0 and y_0 . If the signs in front of ax or by are NEGATIVE, then solve the above equation and take the signs of the solutions from the following table:

equation	x	y
$ax + by = 1$	x_0	y_0
$ax - by = 1$	x_0	$-y_0$
$-ax + by = 1$	$-x_0$	y_0
$-ax - by = 1$	$-x_0$	$-y_0$

In fact, the solution to the equation

$$ax - by = 1 \quad (16)$$

is equivalent to finding the CONTINUED FRACTION for a/b , with a and b RELATIVELY PRIME (Olds 1963). If there are n terms in the fraction, take the $(n-1)$ th convergent p_{n-1}/q_{n-1} . But

$$p_n q_{n-1} - p_{n-1} q_n = (-1)^n, \quad (17)$$

so one solution is $x_0 = (-1)^n q_{n-1}$, $y_0 = (-1)^n p_{n-1}$, with a general solution

$$x = x_0 + kb \quad (18)$$

$$y = y_0 + ka \quad (19)$$

with k an arbitrary INTEGER. The solution in terms of smallest POSITIVE INTEGERS is given by choosing an appropriate k .

Now consider the general first-order equation of the form

$$ax + by = c. \quad (20)$$

The GREATEST COMMON DIVISOR $d \equiv \text{GCD}(a, b)$ can be divided through yielding

$$a'x + b'y = c', \quad (21)$$

where $a' \equiv a/d$, $b' \equiv b/d$, and $c' \equiv c/d$. If $d \nmid c$, then c' is not an INTEGER and the equation cannot have a solution in INTEGERS. A necessary and sufficient condition for the general first-order equation to have solutions in INTEGERS is therefore that $d \mid c$. If this is the case, then solve

$$a'x + b'y = 1 \quad (22)$$

and multiply the solutions by c' , since

$$a'(c'x) + b'(c'y) = c'. \quad (23)$$

References

- Courant, R. and Robbins, H. "Continued Fractions. Diophantine Equations." §2.4 in Supplement to Ch. 1 in *What is Mathematics?: An Elementary Approach to Ideas and Methods*, 2nd ed. Oxford, England: Oxford University Press, pp. 49–51, 1996.
- Dickson, L. E. "Linear Diophantine Equations and Congruences." Ch. 2 in *History of the Theory of Numbers*, Vol. 2: *Diophantine Analysis*. New York: Chelsea, pp. 41–99, 1952.
- Olds, C. D. Ch. 2 in *Continued Fractions*. New York: Random House, 1963.

Diophantine Equation— n th Powers

The 2-1 equation

$$A^n + B^n = C^n \quad (1)$$

is a special case of FERMAT'S LAST THEOREM and so has no solutions for $n \geq 3$. Lander *et al.* (1967) give a table showing the smallest n for which a solution to

$$x_1^k + x_2^k + \dots + x_m^k = y_1^k + y_2^k + \dots + y_n^k,$$

with $1 \leq m \leq n$ is known.

m	k									
	2	3	4	5	6	7	8	9	10	
1	2	3	3	4	7	8	11	15	23	
2	2	2	2	4	7	8	9	12	19	
3				3	3	7	8	11	24	
4						4	7	10	23	
5						5	5	11	16	
6								6	27	
7									7	

Take the results from the RAMANUJAN 6-10-8 IDENTITY that for $ad = bc$, with

$$\begin{aligned} F_{2m}(a, b, c, d) &= (a + b + c)^{2m} + (b + c + d)^{2m} \\ &- (c + d + a)^{2m} - (d + a + b)^{2m} + (a - d)^{2m} - (b - c)^{2m} \end{aligned} \quad (2)$$

and

$$\begin{aligned} f_{2m}(x, y) &= (1 + x + y)^{2m} + (x + y + xy)^{2m} \\ &- (y + xy + 1)^{2m} - (xy + 1 + x)^{2m} + (1 - xy)^{2m} - (x - y)^{2m}, \end{aligned} \quad (3)$$

then

$$F_{2m}(a, b, c, d) = a^{2m} f_{2m}(x, y). \quad (4)$$

Using

$$f_2(x, y) = 0 \quad (5)$$

$$f_4(x, y) = 0 \quad (6)$$

now gives

$$\begin{aligned} (a + b + c)^n + (b + c + d)^n + (a - d)^n \\ = (c + d + a)^n + (d + a + b)^n + (b - c)^n \end{aligned} \quad (7)$$

for $n = 2$ or 4 .

see also RAMANUJAN 6-10-8 IDENTITY

References

- Berndt, B. C. *Ramanujan's Notebooks, Part IV*. New York: Springer-Verlag, p. 101, 1994.
- Berndt, B. C. and Bhargava, S. "Ramanujan—For Low-brows." *Amer. Math. Monthly* **100**, 644–656, 1993.
- Dickson, L. E. *History of the Theory of Numbers*, Vol. 2: *Diophantine Analysis*. New York: Chelsea, pp. 653–657, 1966.

Gloden, A. *Mehrgradige Gleichungen*. Groningen, Netherlands: P. Noordhoff, 1944.

Guy, R. K. *Unsolved Problems in Number Theory*, 2nd ed. New York: Springer-Verlag, 1994.

Lander, L. J.; Parkin, T. R.; and Selfridge, J. L. "A Survey of Equal Sums of Like Powers." *Math. Comput.* **21**, 446–459, 1967.

Reznick, B. "Sums of Even Powers of Real Linear Forms." *Mem. Amer. Math. Soc.* No. 463, **96**. Providence, RI: Amer. Math. Soc., 1992.

Diophantine Equation—Quadratic

An equation of the form

$$x^2 - Dy^2 = 1, \quad (1)$$

where D is an INTEGER is called a PELL EQUATION. Pell equations, as well as the analogous equation with a minus sign on the right, can be solved by finding the CONTINUED FRACTION for \sqrt{D} . (The trivial solution $x = 1, y = 0$ is ignored in all subsequent discussion.) Let p_n/q_n denote the n th CONVERGENT $[a_1, a_2, \dots, a_n]$, then we are looking for a convergent which obeys the identity

$$p_n^2 - Dq_n^2 = (-1)^n, \quad (2)$$

which turns out to always be possible since the CONTINUED FRACTION of a QUADRATIC SURD always becomes periodic at some term a_{r+1} , where $a_{r+1} = 2a_1$, i.e.,

$$\sqrt{D} = [a_1, \overline{a_2, \dots, a_r, 2a_1}]. \quad (3)$$

Writing $n = rk$ gives

$$p_{rk}^2 - Dq_{rk}^2 = (-1)^{rk}, \quad (4)$$

for k a POSITIVE INTEGER. If r is ODD, solutions to

$$x^2 - Dy^2 = \pm 1 \quad (5)$$

can be obtained if k is chosen to be EVEN or ODD, but if r is EVEN, there are no values of k which can make the exponent ODD.

If r is EVEN, then $(-1)^r$ is POSITIVE and the solution in terms of smallest INTEGERS is $x = p_r$ and $y = q_r$, where p_r/q_r is the r th CONVERGENT. If r is ODD, then $(-1)^r$ is NEGATIVE, but we can take $k = 2$ in this case, to obtain

$$p_{2r}^2 - Dq_{2r}^2 = 1, \quad (6)$$

so the solution in smallest INTEGERS is $x = p_{2r}, y = q_{2r}$. Summarizing,

$$(x, y) = \begin{cases} (p_r, q_r) & \text{for } r \text{ even} \\ (p_{2r}, q_{2r}) & \text{for } r \text{ odd.} \end{cases} \quad (7)$$

The more complicated equation

$$x^2 - Dy^2 = \pm c \quad (8)$$

can also be solved for certain values of c and D , but the procedure is more complicated (Chrystal 1961). However, if a single solution to the above equation is known, other solutions can be found. Let p and q be solutions to (8), and r and s solutions to the "unit" form". Then

$$(p^2 - Dq^2)(r^2 - Ds^2) = \pm c \quad (9)$$

$$(pr \pm Dqs)^2 - D(ps \pm qr)^2 = \pm c. \quad (10)$$

Call a Diophantine equation consisting of finding m POWERS equal to a sum of n equal POWERS an " $m - n$ equation." The 2-1 equation

$$A^2 = B^2 + C^2, \quad (11)$$

which corresponds to finding a PYTHAGOREAN TRIPLE (A, B, C) has a well-known general solution (Dickson 1966, pp. 165-170). To solve the equation, note that every PRIME of the form $4x + 1$ can be expressed as the sum of two RELATIVELY PRIME squares in exactly one way. To find in how many ways a general number m can be expressed as a sum of two squares, factor it as follows

$$m = 2^{a_0} p_1^{2a_1} \dots p_n^{2a_n} q_1^{b_1} \dots q_r^{b_r}, \quad (12)$$

where the p s are primes of the form $4x - 1$ and the q s are primes of the form $x + 1$. If the a s are integral, then define

$$B \equiv (2b_1 + 1)(2b_2 + 1) \dots (2b_r + 1) - 1. \quad (13)$$

Then m is a sum of two *unequal* squares in

$$N(m) = \begin{cases} 0 & \text{for any } a_i \text{ half-integral} \\ \frac{1}{2}(b_1 + 1)(b_2 + 1) \dots (b_r + 1) & \text{for all } a_i \text{ integral, } B \text{ odd} \\ \frac{1}{2}(b_1 + 1)(b_2 + 1) \dots (b_r + 1) - \frac{1}{2} & \text{for all } a_i \text{ integral, } B \text{ even.} \end{cases} \quad (14)$$

If zero is counted as a square, both POSITIVE and NEGATIVE numbers are included, and the order of the two squares is distinguished, Jacobi showed that the number of ways a number can be written as the sum of two squares is four times the excess of the number of DIVISORS of the form $4x + 1$ over the number of DIVISORS of the form $4x - 1$.

A set of INTEGERS satisfying the 3-1 equation

$$A^2 + B^2 + C^2 = D^2 \quad (15)$$

is called a PYTHAGOREAN QUADRUPLE. Parametric solutions to the 2-2 equation

$$A^2 + B^2 = C^2 + D^2 \quad (16)$$

are known (Dickson 1966; Guy 1994, p. 140).

Solutions to an equation of the form

$$(A^2 + B^2)(C^2 + D^2) = E^2 + F^2 \quad (17)$$

are given by the FIBONACCI IDENTITY

$$(a^2 + b^2)(c^2 + d^2) = (ac \pm bd)^2 + (bc \mp ad)^2 \equiv e^2 + f^2. \quad (18)$$

Another similar identity is the EULER FOUR-SQUARE IDENTITY

$$(a_1^2 + a_2^2)(b_1^2 + b_2^2)(c_1^2 + c_2^2)(d_1^2 + d_2^2) = e_1^2 + e_2^2 + e_3^2 + e_4^2 \quad (19)$$

$$\begin{aligned} (a_1^2 + a_2^2 + a_3^2 + a_4^2)(b_1^2 + b_2^2 + b_3^2 + b_4^2) \\ = (a_1b_1 - a_2b_2 - a_3b_3 - a_4b_4)^2 \\ + (a_1b_2 + a_2b_1 + a_3b_4 - a_4b_3)^2 \\ + (a_1b_3 - a_2b_4 + a_3b_1 + a_4b_2)^2 \\ + (a_1b_4 + a_2b_3 - a_3b_2 + a_4b_1)^2. \end{aligned} \quad (20)$$

Degen's eight-square identity holds for eight squares, but no other number, as proved by Cayley. The two-square identity underlies much of TRIGONOMETRY, the four-square identity some of QUATERNIONS, and the eight-square identity, the CAYLEY ALGEBRA (a noncommutative nonassociative algebra; Bell 1945).

RAMANUJAN'S SQUARE EQUATION

$$2^n - 7 = x^2 \quad (21)$$

has been proved to have only solutions $n = 3, 4, 5, 7$, and 15 (Beeler *et al.* 1972, Item 31).

see also ALGEBRA, CANNONBALL PROBLEM, CONTINUED FRACTION, FERMAT DIFFERENCE EQUATION, LAGRANGE NUMBER (DIOPHANTINE EQUATION), PELL EQUATION, PYTHAGOREAN QUADRUPLE, PYTHAGOREAN TRIPLE, QUADRATIC RESIDUE

References

- Beeler, M.; Gosper, R. W.; and Schroepel, R. *HAKMEM*. Cambridge, MA: MIT Artificial Intelligence Laboratory, Memo AIM-239, Feb. 1972.
- Beiler, A. H. "The Pellian." Ch. 22 in *Recreations in the Theory of Numbers: The Queen of Mathematics Entertains*. New York: Dover, pp. 248–268, 1966.
- Bell, E. T. *The Development of Mathematics*, 2nd ed. New York: McGraw-Hill, p. 159, 1945.
- Chrystal, G. *Textbook of Algebra*, 2 vols. New York: Chelsea, 1961.
- Degan, C. F. *Canon Pellianus*. Copenhagen, Denmark, 1817.
- Dickson, L. E. "Number of Representations as a Sum of 5, 6, 7, or 8 Squares." Ch. 13 in *Studies in the Theory of Numbers*. Chicago, IL: University of Chicago Press, 1930.
- Dickson, L. E. *History of the Theory of Numbers*, Vol. 2: *Diophantine Analysis*. New York: Chelsea, 1966.
- Guy, R. K. *Unsolved Problems in Number Theory*, 2nd ed. New York: Springer-Verlag, 1994.
- Lam, T. Y. *The Algebraic Theory of Quadratic Forms*. Reading, MA: W. A. Benjamin, 1973.

Rajwade, A. R. *Squares*. Cambridge, England: Cambridge University Press, 1993.

Scharlau, W. *Quadratic and Hermitian Forms*. Berlin: Springer-Verlag, 1985.

Shapiro, D. B. "Products of Sums and Squares." *Expo. Math.* 2, 235–261, 1984.

Smarandache, F. "Un metodo de resolucioe de la ecuacion diofantica." *Gaz. Math.* 1, 151–157, 1988.

Smarandache, F. "Method to Solve the Diophantine Equation $ax^2 - by^2 + c = 0$." In *Collected Papers*, Vol. 1. Bucharest, Romania: Tempus, 1996.

Taussky, O. "Sums of Squares." *Amer. Math. Monthly* 77, 805–830, 1970.

Whitford, E. E. *Pell Equation*. New York: Columbia University Press, 1912.

Diophantine Equation—Quartic

Call an equation involving quartics m - n if a sum of m quartics is equal to a sum of n fourth POWERS. The 2-1 equation

$$A^4 + B^4 = C^4 \quad (1)$$

is a case of FERMAT'S LAST THEOREM with $n = 4$ and therefore has no solutions. In fact, the equations

$$A^4 \pm B^4 = C^2 \quad (2)$$

also have no solutions in INTEGERS.

Parametric solutions to the 2-2 equation

$$A^4 + B^4 = C^4 + D^4 \quad (3)$$

are known (Euler 1802; Géradin 1917; Guy 1994, pp. 140–141). A few specific solutions are

$$59^4 + 158^4 = 133^4 + 134^4 = 635,318,657 \quad (4)$$

$$7^4 + 239^4 = 157^4 + 227^4 = 3,262,811,042 \quad (5)$$

$$193^4 + 292^4 = 256^4 + 257^4 = 8,657,437,697 \quad (6)$$

$$298^4 + 497^4 = 271^4 + 502^4 = 68,899,596,497 \quad (7)$$

$$514^4 + 359^4 = 103^4 + 542^4 = 86,409,838,577 \quad (8)$$

$$222^4 + 631^4 = 503^4 + 558^4 = 160,961,094,577 \quad (9)$$

$$21^4 + 717^4 = 471^4 + 681^4 = 264,287,694,402 \quad (10)$$

$$76^4 + 1203^4 = 653^4 + 1176^4 = 2,094,447,251,857 \quad (11)$$

$$997^4 + 1342^4 = 878^4 + 1381^4 = 4,231,525,221,377 \quad (12)$$

$$27^4 + 2379^4 = 577^4 + 728^4 = 32,031,536,780,322 \quad (13)$$

(Sloane's A001235; Richmond 1920, Leech 1957), the smallest of which is due to Euler. Lander *et al.* (1967) give a list of 25 primitive 2-2 solutions. General (but incomplete) solutions are given by

$$x = a + b \quad (14)$$

$$y = c - d \quad (15)$$

$$u = a - b \quad (16)$$

$$v = c + d, \quad (17)$$

where

$$a = n(m^2 + n^2)(-m^4 + 18m^2n^2 - n^4) \quad (18)$$

$$b = 2m(m^6 + 10m^4n^2 + m^2n^4 + 4n^6) \quad (19)$$

$$c = 2n(4m^6 + m^4n^2 + 10m^2n^4 + n^6) \quad (20)$$

$$d = m(m^2 + n^2)(-m^4 + 18m^2n^2 - n^4) \quad (21)$$

(Hardy and Wright 1979).

In 1772, Euler proposed that the 3-1 equation

$$A^4 + B^4 + C^4 = D^4 \quad (22)$$

had no solutions in INTEGERS (Lander *et al.* 1967). This assertion is known as the EULER QUARTIC CONJECTURE. Ward (1948) showed there were no solutions for $D \leq 10,000$, which was subsequently improved to $D \leq 220,000$ by Lander *et al.* (1967). However, the EULER QUARTIC CONJECTURE was disproved in 1987 by Noam D. Elkies, who, using a geometric construction, found

$$2,682,440^4 + 15,365,639^4 + 18,796,760^4 = 20,615,673^4 \quad (23)$$

and showed that infinitely many solutions existed (Guy 1994, p. 140). In 1988, Roger Frye found

$$95,800^4 + 217,519^4 + 414,560^4 = 422,481^4 \quad (24)$$

and proved that there are no solutions in smaller INTEGERS (Guy 1994, p. 140). Another solution was found by Allan MacLeod in 1997,

$$638,523,249^4 = 630,662,624^4 + 275,156,240^4 + 219,076,465^4. \quad (25)$$

It is not known if there is a parametric solution.

In contrast, there are many solutions to the 3-1 equation

$$A^4 + B^4 + C^4 = 2D^4 \quad (26)$$

(see below).

Parametric solutions to the 3-2 equation

$$A^4 + B^4 = C^4 + D^4 + E^4 \quad (27)$$

are known (Gérardin 1910, Ferrari 1913). The smallest 3-2 solution is

$$3^4 + 5^4 + 8^4 = 7^4 + 7^4 \quad (28)$$

(Lander *et al.* 1967).

Ramanujan gave the 3-3 equations

$$2^4 + 4^4 + 7^4 = 3^4 + 6^4 + 6^4 \quad (29)$$

$$3^4 + 7^4 + 8^4 = 1^4 + 2^4 + 9^4 \quad (30)$$

$$6^4 + 9^4 + 12^4 = 2^4 + 2^4 + 13^4 \quad (31)$$

(Berndt 1994, p. 101). Similar examples can be found in Martin (1896). Parametric solutions were given by Gérardin (1911).

Ramanujan also gave the general expression

$$3^4 + (2x^4 - 1)^4 + (4x^5 + x)^4 = (4x^4 + 1)^4 + (6x^4 - 3)^4 + (4x^5 - 5x)^4 \quad (32)$$

(Berndt 1994, p. 106). Dickson (1966, pp. 653–655) cites several FORMULAS giving solutions to the 3-3 equation, and Haldeman (1904) gives a general FORMULA.

The 4-1 equation

$$A^4 + B^4 + C^4 + D^4 = E^4 \quad (33)$$

has solutions

$$30^4 + 120^4 + 272^4 + 315^4 = 353^4 \quad (34)$$

$$240^4 + 340^4 + 430^4 + 599^4 = 651^4 \quad (35)$$

$$435^4 + 710^4 + 1384^4 + 2420^4 = 2487^4 \quad (36)$$

$$1130^4 + 1190^4 + 1432^4 + 2365^4 = 2501^4 \quad (37)$$

$$850^4 + 1010^4 + 1546^4 + 2745^4 = 2829^4 \quad (38)$$

$$2270^4 + 2345^4 + 2460^4 + 3152^4 = 3723^4 \quad (39)$$

$$350^4 + 1652^4 + 3230^4 + 3395^4 = 3973^4 \quad (40)$$

$$205^4 + 1060^4 + 2650^4 + 4094^4 = 4267^4 \quad (41)$$

$$1394^4 + 1750^4 + 3545^4 + 3670^4 = 4333^4 \quad (42)$$

$$699^4 + 700^4 + 2840^4 + 4250^4 = 4449^4 \quad (43)$$

$$380^4 + 1660^4 + 1880^4 + 4907^4 = 4949^4 \quad (44)$$

$$1000^4 + 1120^4 + 3233^4 + 5080^4 = 5281^4 \quad (45)$$

$$410^4 + 1412^4 + 3910^4 + 5055^4 = 5463^4 \quad (46)$$

$$955^4 + 1770^4 + 2634^4 + 5400^4 = 5491^4 \quad (47)$$

$$30^4 + 1680^4 + 3043^4 + 5400^4 = 5543^4 \quad (48)$$

$$1354^4 + 1810^4 + 4355^4 + 5150^4 = 5729^4 \quad (49)$$

$$542^4 + 2770^4 + 4280^4 + 5695^4 = 6167^4 \quad (50)$$

$$50^4 + 885^4 + 5000^4 + 5984^4 = 6609^4 \quad (51)$$

$$1490^4 + 3468^4 + 4790^4 + 6185^4 = 6801^4 \quad (52)$$

$$1390^4 + 2850^4 + 5365^4 + 6368^4 = 7101^4 \quad (53)$$

$$160^4 + 1345^4 + 2790^4 + 7166^4 = 7209^4 \quad (54)$$

$$800^4 + 3052^4 + 5440^4 + 6635^4 = 7339^4 \quad (55)$$

$$2230^4 + 3196^4 + 5620^4 + 6995^4 = 7703^4 \quad (56)$$

(Norrie 1911, Patterson 1942, Leech 1958, Brudno 1964, Lander *et al.* 1967), but it is not known if there is a parametric solution (Guy 1994, p. 139).

Ramanujan gave the 4-2 equation

$$3^4 + 9^4 = 5^4 + 5^4 + 6^4 + 6^4, \quad (57)$$

and the 4-3 identities

$$2^4 + 2^4 + 7^4 = 4^4 + 4^4 + 5^4 + 6^4 \quad (58)$$

$$3^4 + 9^4 + 14^4 = 7^4 + 8^4 + 10^4 + 13^4 \quad (59)$$

$$7^4 + 10^4 + 13^4 = 5^4 + 5^4 + 6^4 + 14^4 \quad (60)$$

(Berndt 1994, p. 101). Haldeman (1904) gives general FORMULAS for 4-2 and 4-3 equations.

There are an infinite number of solutions to the 5-1 equation

$$A^4 + B^4 + C^4 + D^4 + E^4 = F^4. \quad (61)$$

Some of the smallest are

$$2^4 + 2^4 + 3^4 + 4^2 + 4^2 = 5^4 \quad (62)$$

$$4^4 + 6^4 + 8^4 + 9^4 + 14^4 = 15^4 \quad (63)$$

$$4^4 + 21^4 + 22^4 + 26^4 + 28^4 = 35^4 \quad (64)$$

$$1^4 + 2^4 + 12^4 + 24^4 + 44^4 = 45^4 \quad (65)$$

$$1^4 + 8^4 + 12^4 + 32^4 + 64^4 = 65^4 \quad (66)$$

$$2^4 + 39^4 + 44^4 + 46^4 + 52^4 = 65^4 \quad (67)$$

$$22^4 + 52^4 + 57^4 + 74^4 + 76^4 = 95^4 \quad (68)$$

$$22^4 + 28^4 + 63^4 + 72^4 + 94^4 = 105^4 \quad (69)$$

(Berndt 1994). Berndt and Bhargava (1993) and Berndt (1994, pp. 94–96) give Ramanujan's solutions for arbitrary s, t, m , and n ,

$$\begin{aligned} (8s^2 + 40st - 24t^2)^4 + (6s^2 - 44st - 18t^2)^4 \\ + (14s^2 - 4st - 42t^2)^4 + (9s^2 + 27t^2)^4 + (4s^2 + 12t^2)^4 \\ = (15s^2 + 45t^2)^4, \quad (70) \end{aligned}$$

and

$$\begin{aligned} (4m^2 - 12n^2)^4 + (3m^2 + 9n^2)^4 + (2m^2 - 12mn - 6n^2)^4 \\ + (4m^2 + 12n^2)^4 + (2m^2 + 12mn - 6n^2)^4 = (5m^2 + 15n^2)^4. \quad (71) \end{aligned}$$

These are also given by Dickson (1966, p. 649), and two general FORMULAS are given by Beiler (1966, p. 290). Other solutions are given by Fauquembergue (1898), Haldeman (1904), and Martin (1910).

Ramanujan gave

$$2(ab + ac + bc)^2 = a^4 + b^4 + c^4 \quad (72)$$

$$2(ab + ac + bc)^4 = a^4(b - c)^4 + b^4(c - a)^4 + c^4(a - b)^4 \quad (73)$$

$$\begin{aligned} 2(ab + ac + bc)^6 = (a^2b + b^2c + c^2a)^4 \\ + (ab^2 + bc^2 + ca^2)^4 + (3abc)^4 \quad (74) \end{aligned}$$

$$\begin{aligned} 2(ab + ac + bc)^8 = (a^3 + 2abc)^4(b - c)^4 \\ + (b^3 + 2abc)^4(c - a)^4 + (c^3 + 2abc)^4(a - b)^4, \quad (75) \end{aligned}$$

where

$$a + b + c = 0 \quad (76)$$

(Berndt 1994, pp. 96–97). FORMULA (73) is equivalent to FERRARI'S IDENTITY

$$\begin{aligned} (a^2 + 2ac - 2bc - b^2)^4 + (b^2 - 2ab - 2ac - c^2)^4 \\ + (c^2 + 2ab + 2bc - a^2)^4 = 2(a^2 + b^2 + c^2 - ab + ac + bc)^4. \quad (77) \end{aligned}$$

BHARGAVA'S THEOREM is a general identity which gives the above equations as a special case, and may have been the route by which Ramanujan proceeded. Another identity due to Ramanujan is

$$\begin{aligned} (a + b + c)^4 + (b + c + d)^4 + (a - d)^4 \\ = (c + d + a)^4 + (d + a + b)^4 + (b - c)^4, \quad (78) \end{aligned}$$

where $a/b = c/d$, and 4 may also be replaced by 2 (Ramanujan 1957, Hirschhorn 1998).

V. Kyratas noticed that $a = 3, b = 7, c = 20, d = 25, e = 38$, and $f = 39$ satisfy

$$\frac{a^4 + b^4 + c^4}{d^4 + e^4 + f^4} = \frac{a + b + c}{d + e + f} \quad (79)$$

and asks if there are any other distinct integer solutions.

The first few numbers n which are a sum of two or more fourth POWERS ($m - 1$ equations) are 353, 651, 2487, 2501, 2829, ... (Sloane's A003294). The only number of the form

$$4x^4 + y^4 \quad (80)$$

which is PRIME is 5 (Baudran 1885, Le Lionnais 1983).

see also BHARGAVA'S THEOREM, FORD'S THEOREM

References

- Barbette, E. *Les sommes de p-ièmes puissances distinctes égales à une p-ième puissance*. Doctoral Dissertation, Liege, Belgium. Paris: Gauthier-Villars, 1910.
- Beiler, A. H. *Recreations in the Theory of Numbers: The Queen of Mathematics Entertains*. New York: Dover, 1966.
- Berndt, B. C. *Ramanujan's Notebooks, Part IV*. New York: Springer-Verlag, 1994.
- Berndt, B. C. and Bhargava, S. "Ramanujan—For Low-brows." *Am. Math. Monthly* **100**, 645–656, 1993.
- Bhargava, S. "On a Family of Ramanujan's Formulas for Sums of Fourth Powers." *Ganita* **43**, 63–67, 1992.
- Brudno, S. "A Further Example of $A^4 + B^4 + C^4 + D^4 = E^4$." *Proc. Cambridge Phil. Soc.* **60**, 1027–1028, 1964.
- Dickson, L. E. *History of the Theory of Numbers, Vol. 2: Diophantine Analysis*. New York: Chelsea, 1966.
- Euler, L. *Nova Acta Acad. Petrop. as annos 1795–1796* **13**, 45, 1802.
- Fauquembergue, E. *L'intermédiaire des Math.* **5**, 33, 1898.
- Ferrari, F. *L'intermédiaire des Math.* **20**, 105–106, 1913.
- Guy, R. K. "Sums of Like Powers. Euler's Conjecture" and "Some Quartic Equations." §D1 and D23 in *Unsolved Problems in Number Theory, 2nd ed.* New York: Springer-Verlag, pp. 139–144 and 192–193, 1994.

- Haldeman, C. B. "On Biquadrate Numbers." *Math. Mag.* **2**, 285–296, 1904.
- Hardy, G. H. and Wright, E. M. §13.7 in *An Introduction to the Theory of Numbers*, 5th ed. Oxford, England: Clarendon Press, 1979.
- Hirschhorn, M. D. "Two or Three Identities of Ramanujan." *Amer. Math. Monthly* **105**, 52–55, 1998.
- Lander, L. J.; Parkin, T. R.; and Selfridge, J. L. "A Survey of Equal Sums of Like Powers." *Math. Comput.* **21**, 446–459, 1967.
- Le Lionnais, F. *Les nombres remarquables*. Paris: Hermann, p. 56, 1983.
- Leech, J. "Some Solutions of Diophantine Equations." *Proc. Cambridge Phil. Soc.* **53**, 778–780, 1957.
- Leech, J. "On $A^4 + B^4 + C^4 + D^4 = E^4$." *Proc. Cambridge Phil. Soc.* **54**, 554–555, 1958.
- Martin, A. "About Biquadrate Numbers whose Sum is a Biquadrate." *Math. Mag.* **2**, 173–184, 1896.
- Martin, A. "About Biquadrate Numbers whose Sum is a Biquadrate—II." *Math. Mag.* **2**, 325–352, 1904.
- Norrie, R. *University of St. Andrews 500th Anniversary Memorial Volume*. Edinburgh, Scotland: pp. 87–89, 1911.
- Patterson, J. O. "A Note on the Diophantine Problem of Finding Four Biquadrates whose Sum is a Biquadrate." *Bull. Amer. Math. Soc.* **48**, 736–737, 1942.
- Ramanujan, S. *Notebooks*. New York: Springer-Verlag, pp. 385–386, 1987.
- Richmond, H. W. "On Integers Which Satisfy the Equation $t^3 \pm x^3 \pm y^3 \pm z^3 = 0$." *Trans. Cambridge Phil. Soc.* **22**, 389–403, 1920.
- Sloane, N. J. A. Sequences A001235 and A003294/M5446 in "An On-Line Version of the Encyclopedia of Integer Sequences."
- Ward, M. "Euler's Problem on Sums of Three Fourth Powers." *Duke Math. J.* **15**, 827–837, 1948.

Diophantine Quadruple

see DIOPHANTINE SET

Diophantine Set

A set S of POSITIVE integers is said to be Diophantine IFF there exists a POLYNOMIAL Q with integral coefficients in $m \geq 1$ indeterminates such that

$$S = \{Q(x_1, \dots, x_m) \geq 1 : x_1 \geq 1, \dots, x_m \geq 1\}.$$

It has been proved that the set of PRIME numbers is a Diophantine set.

References

- Ribenboim, P. *The New Book of Prime Number Records*. New York: Springer-Verlag, pp. 189–192, 1995.

Diophantus Property

A set of POSITIVE INTEGERS $S = \{a_1, \dots, a_m\}$ satisfies the Diophantus property $D(n)$ of order n if, for all $i, j = 1, \dots, m$ with $i \neq j$,

$$a_i a_j + n = b_{ij}^2, \quad (1)$$

where n and b_{ij} are INTEGERS. The set S is called a Diophantine n -tuple. Fermat found the first $D(1)$ quadruple: $\{1, 3, 8, 120\}$. General $D(1)$ quadruples are

$$\{F_{2n}, F_{2n+2}, F_{2n+4}, 4F_{2n+1}F_{2n+2}F_{2n+3}\} \quad (2)$$

where F_n are FIBONACCI NUMBERS, and

$$\{n, n+2, 4n+4, 4(n+1)(2n+1)(2n+3)\}. \quad (3)$$

The quadruplet

$$\{2F_{n-1}, 2F_{n+1}, 2F_n^3 F_{n+1} F_{n+2}, 2F_{n+1} F_{n+2} F_{n+3} (2F_{n+1}^2 - F_n^2)\} \quad (4)$$

is $D(F_n^2)$ (Dujella 1996). Dujella (1993) showed there exist no Diophantine quadruples $D(4k+2)$.

References

- Aleksandriiskii, D. *Arifmetika i kniga o mnogougol'nyh chislakh*. Moscow: Nauka, 1974.
- Brown, E. "Sets in Which $xy+k$ is Always a Square." *Math. Comput.* **45**, 613–620, 1985.
- Davenport, H. and Baker, A. "The Equations $3x^2 - 2 = y^2$ and $8x^2 - 7 = z^2$." *Quart. J. Math. (Oxford) Ser. 2* **20**, 129–137, 1969.
- Dujella, A. "Generalization of a Problem of Diophantus." *Acta Arithm.* **65**, 15–27, 1993.
- Dujella, A. "Diophantine Quadruples for Squares of Fibonacci and Lucas Numbers." *Portugaliae Math.* **52**, 305–318, 1995.
- Dujella, A. "Generalized Fibonacci Numbers and the Problem of Diophantus." *Fib. Quart.* **34**, 164–175, 1996.
- Hoggatt, V. E. Jr. and Bergum, G. E. "A Problem of Fermat and the Fibonacci Sequence." *Fib. Quart.* **15**, 323–330, 1977.
- Jones, B. W. "A Variation of a Problem of Davenport and Diophantus." *Quart. J. Math. (Oxford) Ser. (2)* **27**, 349–353, 1976.

Diophantus' Riddle

"Diophantus' youth lasts $1/6$ of his life. He grew a beard after $1/12$ more of his life. After $1/7$ more of his life, Diophantus married. Five years later, he had a son. The son lived exactly half as long as his father, and Diophantus died just four years after his son's death. All of this totals the years Diophantus lived."

Let D be the number of years Diophantus lived, and let S be the number of years his son lived. Then the above word problem gives the two equations

$$\begin{aligned} D &= \left(\frac{1}{6} + \frac{1}{12} + \frac{1}{7}\right)D + 5 + S + 4 \\ S &= \frac{1}{2}D. \end{aligned}$$

Solving this simultaneously gives $S = 42$ as the age of the son and $D = 84$ as the age of Diophantus.

References

- Pappas, T. "Diophantus' Riddle." *The Joy of Mathematics*. San Carlos, CA: Wide World Publ./Tetra, pp. 123 and 232, 1989.

Dipyramid

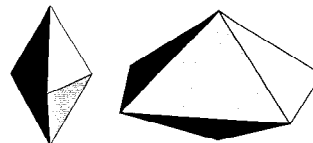

Two PYRAMIDS symmetrically placed base-to-base, also called a DIPYRAMID. They are the DUALS of the Archimedean PRISMS.

see also ELONGATED DIPYRAMID, PENTAGONAL DIPYRAMID, PRISM, PYRAMID, TRAPEZOHEDRON, TRIANGULAR DIPYRAMID, TRIGONAL DIPYRAMID

References

Cundy, H. and Rollett, A. *Mathematical Models*, 3rd ed. Stradbroke, England: Tarquin Pub., p. 117, 1989.

Dirac Delta Function

see DELTA FUNCTION

Dirac Matrices

Define the 4×4 matrices

$$\sigma_i = \mathbf{I} \otimes \sigma_i, \text{ Pauli} \quad (1)$$

$$\rho_i = \sigma_i, \text{ Pauli} \otimes \mathbf{I}, \quad (2)$$

where $\sigma_i, \text{ Pauli}$ are the PAULI MATRICES, \mathbf{I} is the IDENTITY MATRIX, $i = 1, 2, 3$, and $A \otimes B$ is the matrix DIRECT PRODUCT. Explicitly,

$$\mathbf{I} = \begin{bmatrix} 1 & 0 & 0 & 0 \\ 0 & 1 & 0 & 0 \\ 0 & 0 & 1 & 0 \\ 0 & 0 & 0 & 1 \end{bmatrix} \quad (3)$$

$$\sigma_1 = \begin{bmatrix} 0 & 1 & 0 & 0 \\ 1 & 0 & 0 & 0 \\ 0 & 0 & 0 & 1 \\ 0 & 0 & 1 & 0 \end{bmatrix} \quad (4)$$

$$\sigma_2 = \begin{bmatrix} 0 & -i & 0 & 0 \\ i & 0 & 0 & 0 \\ 0 & 0 & 0 & -i \\ 0 & 0 & i & 0 \end{bmatrix} \quad (5)$$

$$\sigma_3 = \begin{bmatrix} 1 & 0 & 0 & 0 \\ 0 & -1 & 0 & 0 \\ 0 & 0 & 1 & 0 \\ 0 & 0 & 0 & -1 \end{bmatrix} \quad (6)$$

$$\rho_1 = \begin{bmatrix} 0 & 0 & 1 & 0 \\ 0 & 0 & 0 & 1 \\ 1 & 0 & 0 & 0 \\ 0 & 1 & 0 & 0 \end{bmatrix} \quad (7)$$

$$\rho_2 = \begin{bmatrix} 0 & 0 & -i & 0 \\ 0 & 0 & 0 & -i \\ i & 0 & 0 & 0 \\ 0 & i & 0 & 0 \end{bmatrix} \quad (8)$$

$$\rho_3 = \begin{bmatrix} 1 & 0 & 0 & 0 \\ 0 & 1 & 0 & 0 \\ 0 & 0 & -1 & 0 \\ 0 & 0 & 0 & -1 \end{bmatrix} \quad (9)$$

These matrices satisfy the anticommutation identities

$$\sigma_i \sigma_j + \sigma_j \sigma_i = 2\delta_{ij} \mathbf{I} \quad (10)$$

$$\rho_i \rho_j + \rho_j \rho_i = 2\delta_{ij} \mathbf{I}, \quad (11)$$

where δ_{ij} is the KRONECKER DELTA, the commutation identity

$$[\sigma_i, \rho_j] = \sigma_i \rho_j - \rho_j \sigma_i = 0, \quad (12)$$

and are cyclic under permutations of indices

$$\sigma_i \sigma_j = i \sigma_k \quad (13)$$

$$\rho_i \rho_j = i \rho_k. \quad (14)$$

A total of 16 Dirac matrices can be defined via

$$\mathbf{E}_{ij} = \rho_i \sigma_j \quad (15)$$

for $i, j = 0, 1, 2, 3$ and where $\sigma_0 = \rho_0 \equiv \mathbf{I}$. These matrix satisfy

1. $|\mathbf{E}_{ij}| = 1$, where $|A|$ is the DETERMINANT,
2. $\mathbf{E}_{ij}^2 = \mathbf{I}$,
3. $\mathbf{E}_{ij} = \mathbf{E}_{ij}^\dagger$, making them Hermitian, and therefore unitary,
4. $\text{tr}(\mathbf{E}_{ij}) = 0$, except $\text{tr}(\mathbf{E}_{00}) = 4$,
5. Any two \mathbf{E}_{ij} multiplied together yield a Dirac matrix to within a multiplicative factor of $-i$ or $\pm i$,
6. The \mathbf{E}_{ij} are linearly independent,
7. The \mathbf{E}_{ij} form a complete set, i.e., any 4×4 constant matrix may be written as

$$A = \sum_{i,j=0}^3 c_{ij} \mathbf{E}_{ij}, \quad (16)$$

where the c_{ij} are real or complex and are given by

$$c_{mn} = \frac{1}{4} \text{tr}(A \mathbf{E}_{mn}) \quad (17)$$

(Arfken 1985).

Dirac's original matrices were written α_i and were defined by

$$\alpha_i = \mathbf{E}_{1i} = \rho_1 \sigma_i \quad (18)$$

$$\alpha_4 = \mathbf{E}_{30} = \rho_3, \quad (19)$$

for $i = 1, 2, 3$, giving

$$\alpha_1 = \mathbf{E}_{1i} = \begin{bmatrix} 0 & 0 & 0 & 1 \\ 0 & 0 & 1 & 0 \\ 0 & 1 & 0 & 0 \\ 1 & 0 & 0 & 0 \end{bmatrix} \quad (20)$$

$$\alpha_2 = \mathbf{E}_{2i} = \begin{bmatrix} 0 & 0 & 0 & -i \\ 0 & 0 & i & 0 \\ 0 & -i & 0 & 0 \\ i & 0 & 0 & 0 \end{bmatrix} \quad (21)$$

$$\alpha_3 = \mathbf{E}_{3i} = \begin{bmatrix} 0 & 0 & 1 & 0 \\ 0 & 0 & 0 & -1 \\ 1 & 0 & 0 & 0 \\ 0 & -1 & 0 & 0 \end{bmatrix} \quad (22)$$

$$\alpha_4 = \mathbf{E}_{30} = \begin{bmatrix} 1 & 0 & 0 & 0 \\ 0 & 1 & 0 & 0 \\ 0 & 0 & -1 & 0 \\ 0 & 0 & 0 & -1 \end{bmatrix}. \quad (23)$$

The additional matrix

$$\alpha_5 = E_{20} = \rho_2 = \begin{bmatrix} 0 & 0 & -i & 0 \\ 0 & 0 & 0 & -i \\ i & 0 & 0 & 0 \\ 0 & i & 0 & 0 \end{bmatrix} \quad (24)$$

is sometimes defined. Other sets of Dirac matrices are sometimes defined as

$$y_i = E_{2i} \quad (25)$$

$$y_4 = E_{30} \quad (26)$$

$$y_5 = -E_{10} \quad (27)$$

and

$$\delta_i = E_{3i} \quad (28)$$

for $i = 1, 2, 3$ (Arfken 1985) and

$$\gamma_i = \begin{bmatrix} 0 & \sigma_i \\ -\sigma_i & 0 \end{bmatrix} \quad (29)$$

$$\gamma_4 = \begin{bmatrix} 1 & 0 \\ 2I & -1 \end{bmatrix} \quad (30)$$

for $i = 1, 2, 3$ (Goldstein 1980).

Any of the 15 Dirac matrices (excluding the identity matrix) commute with eight Dirac matrices and anticommute with the other eight. Let $M \equiv \frac{1}{2}(1 + E_{ij})$, then

$$M^2 = M. \quad (31)$$

In addition

$$\begin{bmatrix} \alpha_1 \\ \alpha_2 \\ \alpha_3 \end{bmatrix} \times \begin{bmatrix} \alpha_1 \\ \alpha_2 \\ \alpha_3 \end{bmatrix} = 2i\sigma. \quad (32)$$

The products of α_i and y_i satisfy

$$\alpha_1 \alpha_2 \alpha_3 \alpha_4 \alpha_5 = 1 \quad (33)$$

$$y_1 y_2 y_3 y_4 y_5 = 1. \quad (34)$$

The 16 Dirac matrices form six anticommuting sets of five matrices each:

1. $\alpha_1, \alpha_2, \alpha_3, \alpha_4, \alpha_5$,
2. y_1, y_2, y_3, y_4, y_5 ,
3. $\delta_1, \delta_2, \delta_3, \rho_1, \rho_2$,
4. $\alpha_1, y_1, \delta_1, \sigma_2, \sigma_3$,
5. $\alpha_2, y_2, \delta_2, \sigma_1, \sigma_3$,
6. $\alpha_3, y_3, \delta_3, \sigma_1, \sigma_2$.

see also PAULI MATRICES

References

- Arfken, G. *Mathematical Methods for Physicists*, 3rd ed. Orlando, FL: Academic Press, pp. 211–213, 1985.
Goldstein, H. *Classical Mechanics*, 2nd ed. Reading, MA: Addison-Wesley, p. 580, 1980.

Dirac's Theorem

A GRAPH with $n \geq 3$ VERTICES in which each VERTEX has VALENCY $\geq n/2$ has a HAMILTONIAN CIRCUIT.

see also HAMILTONIAN CIRCUIT

Direct Product (Group)

The expression of a GROUP as a product of SUBGROUPS. The CHARACTERS of the representations of a direct product are equal to the products of the CHARACTERS of the representations based on the individual sets of functions. For R_1 and R_2 ,

$$\chi(R_1 \otimes R_2) = \chi(R_1)\chi(R_2).$$

The representation of a direct product Γ_{AB} will contain the totally symmetric representation only if the irreducible Γ_A equals the irreducible Γ_B .

Direct Product (Matrix)

Given two $n \times m$ MATRICES, their direct product $C = A \otimes B$ is an $(mn) \times (nm)$ MATRIX with elements defined by

$$C_{\alpha\beta} = A_{ij}B_{kl}, \quad (1)$$

where

$$\alpha \equiv n(i-1) + k \quad (2)$$

$$\beta \equiv n(j-1) + l. \quad (3)$$

For a 2×2 MATRIX,

$$A \otimes B = \begin{bmatrix} a_{11}B & a_{12}B \\ a_{21}B & a_{22}B \end{bmatrix} \quad (4)$$

$$= \begin{bmatrix} a_{11}b_{11} & a_{11}b_{12} & a_{12}b_{11} & a_{12}b_{12} \\ a_{11}b_{21} & a_{11}b_{22} & a_{12}b_{21} & a_{12}b_{22} \\ a_{21}b_{11} & a_{21}b_{12} & a_{22}b_{11} & a_{22}b_{12} \\ a_{21}b_{21} & a_{21}b_{22} & a_{22}b_{21} & a_{22}b_{22} \end{bmatrix}. \quad (5)$$

Direct Product (Set)

The direct product of two sets A and B is defined to be the set of all points (a, b) where $a \in A$ and $b \in B$. The direct product is denoted $A \times B$ or $A \otimes B$ and is also called the CARTESIAN PRODUCT, since it originated in Descartes' formulation of analytic geometry. In the Cartesian view, points in the plane are specified by their vertical and horizontal coordinates, with points on a line being specified by just one coordinate. The main examples of direct products are EUCLIDEAN 3-space ($\mathbb{R} \otimes \mathbb{R} \otimes \mathbb{R}$, where \mathbb{R} are the REAL NUMBERS), and the plane ($\mathbb{R} \times \mathbb{R}$).

Direct Product (Tensor)

For a first-RANK TENSOR (i.e., a VECTOR),

$$a'_i b'^j = \frac{\partial x_k}{\partial x'_i} a_k \frac{\partial x'_j}{\partial x_l} b^l = \frac{\partial x_k}{\partial x'_i} \frac{\partial x'_j}{\partial x_l} (a_k b^l), \quad (1)$$

which is a second-RANK TENSOR. The CONTRACTION of a direct product of first-RANK TENSORS is the SCALAR

$$\text{contr}(a'_i b'^j) = a'_i b'^i = a_k b^k. \quad (2)$$

For a second-RANK TENSOR,

$$A_j B_{kl} = C_j^{ikl} \quad (3)$$

$$C_j^{ikl} = \frac{\partial x'_i}{\partial x_m} \frac{\partial x_n}{\partial x'_j} \frac{\partial x'_k}{\partial x_p} \frac{\partial x'_l}{\partial x_q} C_n^{mpq}. \quad (4)$$

For a general TENSOR, the direct product of two TENSORS is a TENSOR of RANK equal to the sum of the two initial RANKS. The direct product is ASSOCIATIVE, but not COMMUTATIVE.

References

Arfken, G. "Contraction, Direct Product." §3.2 in *Mathematical Methods for Physicists*, 3rd ed. Orlando, FL: Academic Press, pp. 124–126, 1985.

Direct Search Factorization

Direct search factorization is the simplest PRIME FACTORIZATION ALGORITHM. It consists of searching for factors of a number by systematically performing TRIAL DIVISIONS, usually using a sequence of increasing numbers. Multiples of small PRIMES are commonly excluded to reduce the number of trial DIVISORS, but just including them is sometimes faster than the time required to exclude them. This approach is very inefficient, and can be used only with fairly small numbers.

When using this method on a number n , only DIVISORS up to $\lfloor \sqrt{n} \rfloor$ (where $\lfloor x \rfloor$ is the FLOOR FUNCTION) need to be tested. This is true since if all INTEGERS less than this had been tried, then

$$\frac{n}{\lfloor \sqrt{n} \rfloor + 1} < \sqrt{n}. \quad (1)$$

In other words, all possible FACTORS have had their COFACTORS already tested. It is also true that, when the smallest PRIME FACTOR p of n is $> \sqrt[3]{n}$, then its COFACTOR m (such that $n = pm$) must be PRIME. To prove this, suppose that the smallest p is $> \sqrt[3]{n}$. If $m = ab$, then the smallest value a and b could assume is p . But then

$$n = pm = pab = p^3 > n, \quad (2)$$

which cannot be true. Therefore, m must be PRIME, so

$$n = p_1 p_2. \quad (3)$$

see also PRIME FACTORIZATION ALGORITHMS, TRIAL DIVISION

Direct Sum (Module)

The direct sum of two MODULES V and W over the same RING R is given by $V \otimes W$ with MODULE operations defined by

$$r \cdot (v, w) = (rv, rw)$$

$$(v, w) \oplus (y, z) = (v + y, w + z).$$

The direct sum of an arbitrary family of MODULES over the same RING is also defined. If J is the indexing set for the family of MODULES, then the direct sum is represented by the collection of functions with finite support from J to the union of all these MODULES such that the function sends $j \in J$ to an element in the MODULE indexed by j .

The dimension of a direct sum is the product of the dimensions of the quantities summed. The significant property of the direct sum is that it is the coproduct in the category of MODULES. This general definition gives as a consequence the definition of the direct sum of ABELIAN GROUPS (since they are MODULES over the INTEGERS) and the direct sum of VECTOR SPACES (since they are MODULES over a FIELD).

Directed Angle

The symbol $\angle ABC$ denotes the directed angle from AB to BC , which is the signed angle through which AB must be rotated about B to coincide with BC . Four points $ABCD$ lie on a CIRCLE (i.e., are CONCYCLIC) IFF $\angle ABC = \angle ADC$. It is also true that

$$\angle l_1 l_2 + \angle l_2 l_1 = 0^\circ \text{ or } 180^\circ.$$

Three points A , B , and C are COLLINEAR IFF $\angle ABC = 0$. For any four points, A , B , C , and D ,

$$\angle ABC + \angle CDA = \angle BAD + \angle DCB.$$

see also ANGLE, COLLINEAR, CONCYCLIC, MIQUEL EQUATION

References

Johnson, R. A. *Modern Geometry: An Elementary Treatise on the Geometry of the Triangle and the Circle*. Boston, MA: Houghton Mifflin, pp. 11–15, 1929.

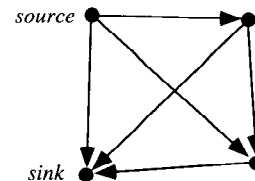
Directed Graph

A GRAPH in which each EDGE is replaced by a directed EDGE, also called a DIGRAPH or REFLEXIVE GRAPH. A COMPLETE directed graph is called a TOURNAMENT. If G is an undirected connected GRAPH, then one can

always direct the circuit EDGES of G and leave the SEPARATING EDGES undirected so that there is a directed path from any node to another. Such a GRAPH is said to be transitive if the adjacency relation is transitive. The number of directed graphs of n nodes for $n = 1, 2, \dots$ are 1, 1, 3, 16, 218, 9608, ... (Sloane's A000273).

see also ARBORESCENCE, CAYLEY GRAPH, INDEGREE, NETWORK, OUTDEGREE, SINK (DIRECTED GRAPH), SOURCE, TOURNAMENT

References

Sloane, N. J. A. Sequence A000273/M3032 in "An On-Line Version of the Encyclopedia of Integer Sequences."

Direction Cosine

Let a be the ANGLE between \mathbf{v} and \mathbf{x} , b the ANGLE between \mathbf{v} and \mathbf{y} , and c the ANGLE between \mathbf{v} and \mathbf{z} . Then the direction cosines are equivalent to the (x, y, z) coordinates of a UNIT VECTOR $\hat{\mathbf{v}}$,

$$\alpha \equiv \cos a \equiv \frac{\mathbf{v} \cdot \hat{\mathbf{x}}}{|\mathbf{v}|} \quad (1)$$

$$\beta \equiv \cos b \equiv \frac{\mathbf{v} \cdot \hat{\mathbf{y}}}{|\mathbf{v}|} \quad (2)$$

$$\gamma \equiv \cos c \equiv \frac{\mathbf{v} \cdot \hat{\mathbf{z}}}{|\mathbf{v}|}. \quad (3)$$

From these definitions, it follows that

$$\alpha^2 + \beta^2 + \gamma^2 = 1. \quad (4)$$

To find the JACOBIAN when performing integrals over direction cosines, use

$$\theta = \sin^{-1} \left(\sqrt{\alpha^2 + \beta^2} \right) \quad (5)$$

$$\phi = \tan^{-1} \left(\frac{\beta}{\alpha} \right) \quad (6)$$

$$\gamma = \sqrt{1 - \alpha^2 - \beta^2}. \quad (7)$$

The JACOBIAN is

$$\left| \frac{\partial(\theta, \phi)}{\partial(\alpha, \beta)} \right| = \left| \begin{array}{cc} \frac{\partial \theta}{\partial \alpha} & \frac{\partial \theta}{\partial \beta} \\ \frac{\partial \phi}{\partial \alpha} & \frac{\partial \phi}{\partial \beta} \end{array} \right|. \quad (8)$$

Using

$$\frac{d}{dx} (\sin^{-1} x) = \frac{1}{\sqrt{1-x^2}} \quad (9)$$

$$\frac{d}{dx} (\tan^{-1} x) = \frac{1}{1+x^2}, \quad (10)$$

$$\begin{aligned} \left| \frac{\partial(\theta, \phi)}{\partial(\alpha, \beta)} \right| &= \left| \begin{array}{cc} \frac{\frac{1}{2}(\alpha^2 + \beta^2)^{-1/2} 2\alpha}{\sqrt{1-\alpha^2-\beta^2}} & \frac{\frac{1}{2}(\alpha^2 + \beta^2)^{-1/2} 2\beta}{\sqrt{1-\alpha^2-\beta^2}} \\ \frac{-\alpha^{-2}\beta}{1+\frac{\beta^2}{\alpha^2}} & \frac{\alpha^{-1}}{1+\frac{\beta^2}{\alpha^2}} \end{array} \right| \\ &= \frac{1}{\sqrt{1-\alpha^2-\beta^2}} \frac{(\alpha^2 + \beta^2)^{-1/2}}{1+\frac{\beta^2}{\alpha^2}} \left(1 + \frac{\beta^2}{\alpha^2} \right) \\ &= \frac{1}{\sqrt{(\alpha^2 + \beta^2)(1-\alpha^2-\beta^2)}}, \end{aligned} \quad (11)$$

so

$$\begin{aligned} d\Omega &= \sin \theta \, d\phi \, d\theta = \sqrt{\alpha^2 + \beta^2} \left| \frac{\partial(\theta, \phi)}{\partial(\alpha, \beta)} \right| d\alpha \, d\beta \\ &= \frac{d\alpha \, d\beta}{\sqrt{1-\alpha^2-\beta^2}} = \frac{d\alpha \, d\beta}{\gamma}. \end{aligned} \quad (12)$$

Direction cosines can also be defined between two sets of CARTESIAN COORDINATES,

$$\alpha_1 \equiv \hat{\mathbf{x}}' \cdot \hat{\mathbf{x}} \quad (13)$$

$$\alpha_2 \equiv \hat{\mathbf{x}}' \cdot \hat{\mathbf{y}} \quad (14)$$

$$\alpha_3 \equiv \hat{\mathbf{x}}' \cdot \hat{\mathbf{z}} \quad (15)$$

$$\beta_1 \equiv \hat{\mathbf{y}}' \cdot \hat{\mathbf{x}} \quad (16)$$

$$\beta_2 \equiv \hat{\mathbf{y}}' \cdot \hat{\mathbf{y}} \quad (17)$$

$$\beta_3 \equiv \hat{\mathbf{y}}' \cdot \hat{\mathbf{z}} \quad (18)$$

$$\gamma_1 \equiv \hat{\mathbf{z}}' \cdot \hat{\mathbf{x}} \quad (19)$$

$$\gamma_2 \equiv \hat{\mathbf{z}}' \cdot \hat{\mathbf{y}} \quad (20)$$

$$\gamma_3 \equiv \hat{\mathbf{z}}' \cdot \hat{\mathbf{z}}. \quad (21)$$

Projections of the unprimed coordinates onto the primed coordinates yield

$$\hat{\mathbf{x}}' = (\hat{\mathbf{x}}' \cdot \hat{\mathbf{x}})\hat{\mathbf{x}} + (\hat{\mathbf{x}}' \cdot \hat{\mathbf{y}})\hat{\mathbf{y}} + (\hat{\mathbf{x}}' \cdot \hat{\mathbf{z}})\hat{\mathbf{z}} = \alpha_1 \hat{\mathbf{x}} + \alpha_2 \hat{\mathbf{y}} + \alpha_3 \hat{\mathbf{z}} \quad (22)$$

$$\hat{\mathbf{y}}' = (\hat{\mathbf{y}}' \cdot \hat{\mathbf{x}})\hat{\mathbf{x}} + (\hat{\mathbf{y}}' \cdot \hat{\mathbf{y}})\hat{\mathbf{y}} + (\hat{\mathbf{y}}' \cdot \hat{\mathbf{z}})\hat{\mathbf{z}} = \beta_1 \hat{\mathbf{x}} + \beta_2 \hat{\mathbf{y}} + \beta_3 \hat{\mathbf{z}} \quad (23)$$

$$\hat{\mathbf{z}}' = (\hat{\mathbf{z}}' \cdot \hat{\mathbf{x}})\hat{\mathbf{x}} + (\hat{\mathbf{z}}' \cdot \hat{\mathbf{y}})\hat{\mathbf{y}} + (\hat{\mathbf{z}}' \cdot \hat{\mathbf{z}})\hat{\mathbf{z}} = \gamma_1 \hat{\mathbf{x}} + \gamma_2 \hat{\mathbf{y}} + \gamma_3 \hat{\mathbf{z}}, \quad (24)$$

and

$$x' = \mathbf{r} \cdot \hat{\mathbf{x}}' = \alpha_1 x + \alpha_2 y + \alpha_3 z \quad (25)$$

$$y' = \mathbf{r} \cdot \hat{\mathbf{y}}' = \beta_1 x + \beta_2 y + \beta_3 z \quad (26)$$

$$z' = \mathbf{r} \cdot \hat{\mathbf{z}}' = \gamma_1 x + \gamma_2 y + \gamma_3 z. \quad (27)$$

Projections of the primed coordinates onto the unprimed coordinates yield

$$\begin{aligned} \hat{\mathbf{x}} &= (\hat{\mathbf{x}} \cdot \hat{\mathbf{x}}')\hat{\mathbf{x}}' + (\hat{\mathbf{x}} \cdot \hat{\mathbf{y}}')\hat{\mathbf{y}}' + (\hat{\mathbf{x}} \cdot \hat{\mathbf{z}}')\hat{\mathbf{z}}' \\ &= \alpha_1 \hat{\mathbf{x}}' + \beta_1 \hat{\mathbf{y}}' + \gamma_1 \hat{\mathbf{z}}' \end{aligned} \quad (28)$$

$$\begin{aligned} \hat{\mathbf{y}} &= (\hat{\mathbf{y}} \cdot \hat{\mathbf{x}}')\hat{\mathbf{x}}' + (\hat{\mathbf{y}} \cdot \hat{\mathbf{y}}')\hat{\mathbf{y}}' + (\hat{\mathbf{y}} \cdot \hat{\mathbf{z}}')\hat{\mathbf{z}}' \\ &= \alpha_2 \hat{\mathbf{x}}' + \beta_2 \hat{\mathbf{y}}' + \gamma_2 \hat{\mathbf{z}}' \end{aligned} \quad (29)$$

$$\begin{aligned} \hat{\mathbf{z}} &= (\hat{\mathbf{z}} \cdot \hat{\mathbf{x}}')\hat{\mathbf{x}}' + (\hat{\mathbf{z}} \cdot \hat{\mathbf{y}}')\hat{\mathbf{y}}' + (\hat{\mathbf{z}} \cdot \hat{\mathbf{z}}')\hat{\mathbf{z}}' \\ &= \alpha_3 \hat{\mathbf{x}}' + \beta_3 \hat{\mathbf{y}}' + \gamma_3 \hat{\mathbf{z}}', \end{aligned} \quad (30)$$

and

$$x = \mathbf{r} \cdot \hat{\mathbf{x}} = \alpha_1 x + \beta_1 y + \gamma_1 z \quad (31)$$

$$y = \mathbf{r} \cdot \hat{\mathbf{y}} = \alpha_2 x + \beta_2 y + \gamma_2 z \quad (32)$$

$$z = \mathbf{r} \cdot \hat{\mathbf{z}} = \alpha_3 x + \beta_3 y + \gamma_3 z. \quad (33)$$

Using the orthogonality of the coordinate system, it must be true that

$$\hat{\mathbf{x}} \cdot \hat{\mathbf{y}} = \hat{\mathbf{y}} \cdot \hat{\mathbf{z}} = \hat{\mathbf{z}} \cdot \hat{\mathbf{x}} = 0 \quad (34)$$

$$\hat{\mathbf{x}} \cdot \hat{\mathbf{x}} = \hat{\mathbf{y}} \cdot \hat{\mathbf{y}} = \hat{\mathbf{z}} \cdot \hat{\mathbf{z}} = 1, \quad (35)$$

giving the identities

$$\alpha_l \alpha_m + \beta_l \beta_m + \gamma_l \gamma_m = 0 \quad (36)$$

for $l, m = 1, 2, 3$ and $l \neq m$, and

$$\alpha_l^2 + \beta_l^2 + \gamma_l^2 = 1 \quad (37)$$

for $l = 1, 2, 3$. These two identities may be combined into the single identity

$$\alpha_l \alpha_m + \beta_l \beta_m + \gamma_l \gamma_m = \delta_{lm}, \quad (38)$$

where δ_{lm} is the KRONECKER DELTA.

Directional Derivative

$$\nabla_{\mathbf{u}} f \equiv \nabla f \cdot \frac{\mathbf{u}}{|\mathbf{u}|} \propto \lim_{h \rightarrow 0} \frac{f(\mathbf{x} + h\mathbf{u}) - f(\mathbf{x})}{h}. \quad (1)$$

$\nabla_{\mathbf{u}} f(x_0, y_0, z_0)$ is the rate at which the function $w = f(x, y, z)$ changes at (x_0, y_0, z_0) in the direction \mathbf{u} . Let \mathbf{u} be a UNIT VECTOR in CARTESIAN COORDINATES, so

$$|\mathbf{u}| = \sqrt{u_x^2 + u_y^2 + u_z^2} = 1, \quad (2)$$

then

$$\nabla_{\mathbf{u}} f = \frac{\partial f}{\partial x} u_x + \frac{\partial f}{\partial y} u_y + \frac{\partial f}{\partial z} u_z. \quad (3)$$

The directional derivative is often written in the notation

$$\frac{d}{ds} \equiv \hat{\mathbf{s}} \cdot \nabla = s_x \frac{\partial}{\partial x} + s_y \frac{\partial}{\partial y} + s_z \frac{\partial}{\partial z}. \quad (4)$$

Directly Similar

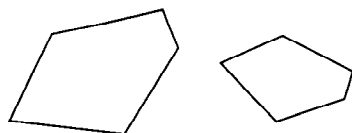

directly similar

Two figures are said to be SIMILAR when all corresponding ANGLES are equal, and are directly similar when all corresponding ANGLES are equal and described in the same rotational sense.

see also FUNDAMENTAL THEOREM OF DIRECTLY SIMILAR FIGURES, INVERSELY SIMILAR, SIMILAR

Director Curve

The curve $\mathbf{d}(u)$ in the RULED SURFACE parameterization

$$\mathbf{x}(u, v) = \mathbf{b}(u) + v\mathbf{d}(u).$$

see also DIRECTRIX (RULED SURFACE), RULED SURFACE, RULING

References

Gray, A. *Modern Differential Geometry of Curves and Surfaces*. Boca Raton, FL: CRC Press, p. 333, 1993.

Directrix (Conic Section)

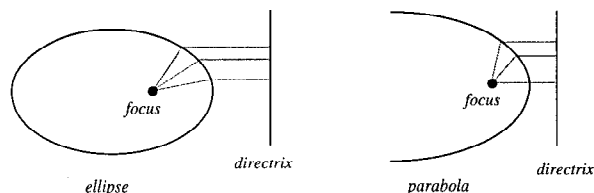

The LINE which, together with the point known as the FOCUS, serves to define a CONIC SECTION.

see also CONIC SECTION, ELLIPSE, FOCUS, HYPERBOLA, PARABOLA

References

Coxeter, H. S. M. *Introduction to Geometry*, 2nd ed. New York: Wiley, pp. 115–116, 1969.
Coxeter, H. S. M. and Greitzer, S. L. *Geometry Revisited*. Washington, DC: Math. Assoc. Amer., pp. 141–144, 1967.

Directrix (Graph)

A CYCLE.

Directrix (Ruled Surface)

The curve $\mathbf{b}(u)$ in the RULED SURFACE parameterization

$$\mathbf{x}(u, v) = \mathbf{b}(u) + v\mathbf{d}(u)$$

is called the directrix (or BASE CURVE).

see also DIRECTOR CURVE, RULED SURFACE

References

Gray, A. *Modern Differential Geometry of Curves and Surfaces*. Boca Raton, FL: CRC Press, p. 333, 1993.

Dirichlet Beta Function

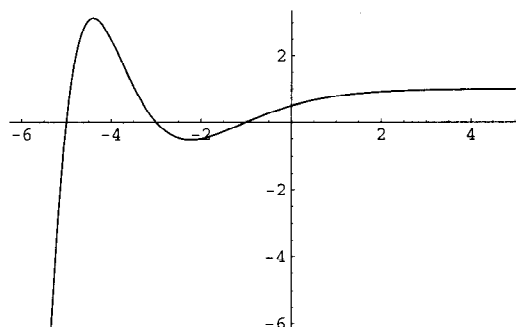

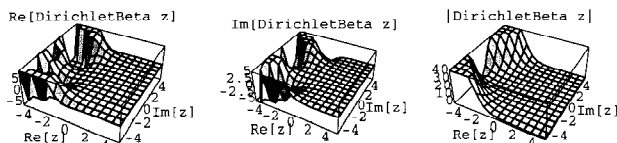

$$\beta(x) \equiv \sum_{n=0}^{\infty} (-1)^n (2n+1)^{-x} \quad (1)$$

$$\beta(x) = 2^{-x} \Phi(-1, x, \frac{1}{2}), \quad (2)$$

where Φ is the LERCH TRANSCENDENT. The beta function can be written in terms of the HURWITZ ZETA FUNCTION $\zeta(x, a)$ by

$$\beta(x) = \frac{1}{4^x} [\zeta(x, \frac{1}{4}) - \zeta(x, \frac{3}{4})]. \quad (3)$$

The beta function can be evaluated directly for POSITIVE ODD x as

$$\beta(2k+1) = \frac{(-1)^k E_{2k}}{2(2k)!} \left(\frac{1}{2}\pi\right)^{2k+1}, \quad (4)$$

where E_n is an EULER NUMBER. The beta function can be defined over the whole COMPLEX PLANE using ANALYTIC CONTINUATION,

$$\beta(1-z) = \left(\frac{2}{\pi}\right)^z \sin(\frac{1}{2}\pi z) \Gamma(z) \beta(z), \quad (5)$$

where $\Gamma(z)$ is the GAMMA FUNCTION.

Particular values for β are

$$\beta(1) = \frac{1}{4}\pi \quad (6)$$

$$\beta(2) \equiv K \quad (7)$$

$$\beta(3) = \frac{1}{32}\pi^3, \quad (8)$$

where K is CATALAN'S CONSTANT.

see also CATALAN'S CONSTANT, DIRICHLET ETA FUNCTION, DIRICHLET LAMBDA FUNCTION, HURWITZ ZETA FUNCTION, LERCH TRANSCENDENT, RIEMANN ZETA FUNCTION, ZETA FUNCTION

References

Abramowitz, M. and Stegun, C. A. (Eds.). *Handbook of Mathematical Functions with Formulas, Graphs, and Mathematical Tables*, 9th printing. New York: Dover, pp. 807–808, 1972.

Spanier, J. and Oldham, K. B. "The Zeta Numbers and Related Functions." Ch. 3 in *An Atlas of Functions*. Washington, DC: Hemisphere, pp. 25–33, 1987.

Dirichlet Boundary Conditions

PARTIAL DIFFERENTIAL EQUATION BOUNDARY CONDITIONS which give the value of the function on a surface, e.g., $T = f(\mathbf{r}, t)$.

see also BOUNDARY CONDITIONS, CAUCHY BOUNDARY CONDITIONS

References

Morse, P. M. and Feshbach, H. *Methods of Theoretical Physics, Part I*. New York: McGraw-Hill, p. 679, 1953.

Dirichlet's Box Principle

A.k.a. the PIGEONHOLE PRINCIPLE. Given n boxes and $m > n$ objects, at least one box must contain more than one object. This statement has important applications in number theory and was first stated by Dirichlet in 1834.

see also FUBINI PRINCIPLE

References

Chartrand, G. *Introductory Graph Theory*. New York: Dover, p. 38, 1985.

Shanks, D. *Solved and Unsolved Problems in Number Theory*, 4th ed. New York: Chelsea, pp. 161, 1993.

Dirichlet's Boxing-In Principle

see DIRICHLET'S BOX PRINCIPLE

Dirichlet Conditions

see DIRICHLET BOUNDARY CONDITIONS, DIRICHLET FOURIER SERIES CONDITIONS

Dirichlet Divisor Problem

Let $d(n) = \nu(n) = \sigma_0(n)$ be the number of DIVISORS of n (including n itself). For a PRIME p , $\nu(p) = 2$. In general,

$$\sum_{k=1}^n \nu(k) = n \ln n + (2\gamma - 1)n + \mathcal{O}(n^\theta),$$

where γ is the EULER-MASCHERONI CONSTANT. Dirichlet originally gave $\theta \approx 1/2$. As of 1988, this had been reduced to $\theta \approx 7/22$.

see also DIVISOR FUNCTION

Dirichlet Energy

Let h be a real-valued HARMONIC FUNCTION on a bounded DOMAIN Ω , then the Dirichlet energy is defined as $\int_{\Omega} |\nabla h|^2 dx$, where ∇ is the GRADIENT.

see also ENERGY

Dirichlet Eta Function

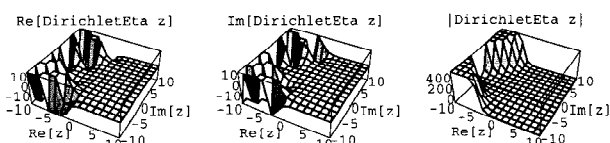
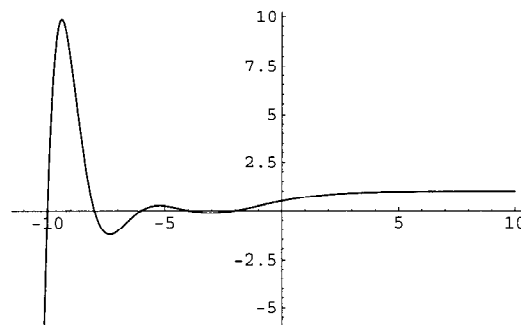

$$\eta(x) \equiv \sum_{n=1}^{\infty} (-1)^{n-1} n^{-x} = (1 - 2^{1-x})\zeta(x), \quad (1)$$

where $n = 1, 2, \dots$, and $\zeta(x)$ is the RIEMANN ZETA FUNCTION. Particular values are given in Abramowitz and Stegun (1972, p. 811). The eta function is related to the RIEMANN ZETA FUNCTION and DIRICHLET LAMBDA FUNCTION by

$$\frac{\zeta(\nu)}{2^\nu} = \frac{\lambda(\nu)}{2^\nu - 1} = \frac{\eta(\nu)}{2^\nu - 2} \quad (2)$$

and

$$\zeta(\nu) + \eta(\nu) = 2\lambda(\nu) \quad (3)$$

(Spanier and Oldham 1987). The value $\eta(1)$ may be computed by noting that the MACLAURIN SERIES for $\ln(1+x)$ for $-1 < x \leq 1$ is

$$\ln(1+x) = x - \frac{1}{2}x^2 + \frac{1}{3}x^3 - \frac{1}{4}x^4 + \dots \quad (4)$$

Therefore,

$$\begin{aligned} \ln 2 &= \ln(1+1) = 1 - \frac{1}{2} + \frac{1}{3} - \frac{1}{4} + \dots \\ &= \sum_{n=1}^{\infty} \frac{(-1)^{n-1}}{n} = \eta(1). \end{aligned} \quad (5)$$

Values for EVEN INTEGERS are related to the analytical values of the RIEMANN ZETA FUNCTION. $\eta(0)$ is defined to be $\frac{1}{2}$.

$$\begin{aligned} \eta(0) &= \frac{1}{2} \\ \eta(1) &= \ln 2 \\ \eta(2) &= \frac{\pi^2}{12} \\ \eta(3) &= 0.90154\dots \\ \eta(4) &= \frac{7\pi^4}{720}. \end{aligned}$$

see also DEDEKIND ETA FUNCTION, DIRICHLET BETA FUNCTION, DIRICHLET LAMBDA FUNCTION, RIEMANN ZETA FUNCTION, ZETA FUNCTION

References

- Abramowitz, M. and Stegun, C. A. (Eds.). *Handbook of Mathematical Functions with Formulas, Graphs, and Mathematical Tables*, 9th printing. New York: Dover, pp. 807–808, 1972.
- Spanier, J. and Oldham, K. B. "The Zeta Numbers and Related Functions." Ch. 3 in *An Atlas of Functions*. Washington, DC: Hemisphere, pp. 25–33, 1987.

Dirichlet's Formula

If g is continuous and $\mu, \nu > 0$, then

$$\begin{aligned} \int_0^t (t-\xi)^{\mu-1} d\xi \int_0^\xi (\xi-x)^{\nu-1} g(\xi, x) dx \\ = \int_0^t dx \int_x^t (t-\xi)^{\mu-1} (\xi-x)^{\nu-1} g(\xi, x) d\xi. \end{aligned}$$

Dirichlet Fourier Series Conditions

A piecewise regular function which

1. Has a finite number of finite discontinuities and
2. Has a finite number of extrema

can be expanded in a FOURIER SERIES which converges to the function at continuous points and the mean of the POSITIVE and NEGATIVE limits at points of discontinuity.

see also FOURIER SERIES

Dirichlet Function

Let c and $d \neq c$ be REAL NUMBERS (usually taken as $c = 1$ and $d = 0$). The Dirichlet function is defined by

$$D(x) = \begin{cases} c & \text{for } x \text{ rational} \\ d & \text{for } x \text{ irrational.} \end{cases}$$

The function is CONTINUOUS at IRRATIONAL x and discontinuous at RATIONAL points. The function can be written analytically as

$$D(x) = \lim_{m,n \rightarrow \infty} \cos[(m! \pi x)^n].$$

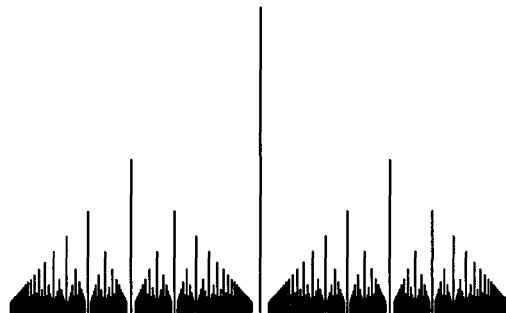

Because the Dirichlet function cannot be plotted without producing a solid blend of lines, a modified version can be defined as

$$D_M(x) = \begin{cases} 0 & \text{for } x \text{ rational} \\ b & \text{for } x = a/b \text{ with } a/b \text{ a reduced fraction} \end{cases}$$

(Dixon 1991), illustrated above.

see also CONTINUOUS FUNCTION, IRRATIONAL NUMBER, RATIONAL NUMBER

References

- Dixon, R. *Mathographics*. New York: Dover, pp. 177 and 184–186, 1991.
- Tall, D. "The Gradient of a Graph." *Math. Teaching* 111, 48–52, 1985.

Dirichlet Integrals

There are several types of integrals which go under the name of a "Dirichlet integral." The integral

$$D[u] = \int_{\Omega} |\nabla u|^2 dV \quad (1)$$

appears in DIRICHLET'S PRINCIPLE.

The integral

$$\frac{1}{2\pi} \int_{-\pi}^{\pi} f(x) \frac{\sin[(n + \frac{1}{2})x]}{\sin(\frac{1}{2}x)} dx, \quad (2)$$

where the kernel is the DIRICHLET KERNEL, gives the n th partial sum of the FOURIER SERIES.

Another integral is denoted

$$\delta_k \equiv \frac{1}{\pi} \int_{-\infty}^{\infty} \frac{\sin \alpha_k \rho_k}{\rho_k} e^{i \rho_k \gamma_k} d\rho_k = \begin{cases} 0 & \text{for } |\gamma_k| > \alpha_k \\ 1 & \text{for } |\gamma_k| < \alpha_k \end{cases} \quad (3)$$

for $k = 1, \dots, n$.

There are two types of Dirichlet integrals which are denoted using the letters C , D , I , and J . The type 1 Dirichlet integrals are denoted I , J , and IJ , and the type 2 Dirichlet integrals are denoted C , D , and CD .

The type 1 integrals are given by

$$\begin{aligned} I &\equiv \iint \dots \int f(t_1 + t_2 + \dots + t_n) \\ &\quad \times t_1^{\alpha_1-1} t_2^{\alpha_2-1} \dots t_n^{\alpha_n-1} dt_1 dt_2 \dots dt_n \\ &= \frac{\Gamma(\alpha_1)\Gamma(\alpha_2)\dots\Gamma(\alpha_n)}{\Gamma(\sum_n \alpha_n)} \int_0^1 f(\tau) \tau^{(\sum_n \alpha_n)-1} d\tau, \end{aligned} \quad (4)$$

where $\Gamma(z)$ is the GAMMA FUNCTION. In the case $n = 2$,

$$I = \iint_T x^p y^q dx dy = \frac{p!q!}{(p+q+2)!} = \frac{B(p+1, q+1)}{p+q+2}, \quad (5)$$

where the integration is over the TRIANGLE T bounded by the x -axis, y -axis, and line $x + y = 1$ and $B(x, y)$ is the BETA FUNCTION.

The type 2 integrals are given for b -D vectors \mathbf{a} and \mathbf{r} , and $0 \leq c \leq b$,

$$\begin{aligned} C_{\mathbf{a}}^{(b)}(\mathbf{r}, m) &= \frac{\Gamma(m+R)}{\Gamma(m) \prod_{i=1}^b \Gamma(r_i)} \\ &\quad \times \int_0^{a_1} \dots \int_0^{a_b} \frac{\prod_{i=1}^b x_i^{r_i-1} dx_i}{\left(1 + \sum_{i=1}^b x_i\right)^{m+R}} \end{aligned} \quad (6)$$

$$\begin{aligned} D_{\mathbf{a}}^{(b)}(\mathbf{r}, m) &= \frac{\Gamma(m+R)}{\Gamma(m) \prod_{i=1}^b \Gamma(r_i)} \\ &\quad \times \int_{a_1}^{\infty} \dots \int_{a_b}^{\infty} \frac{\prod_{i=1}^b x_i^{r_i-1} dx_i}{\left(1 + \sum_{i=1}^b x_i\right)^{m+R}} \end{aligned} \quad (7)$$

$$\begin{aligned} CD_{\mathbf{a}}^{(c, d-c)}(\mathbf{r}, m) &= \frac{\Gamma(m+R)}{\Gamma(m) \prod_{i=1}^b \Gamma(r_i)} \\ &\quad \times \int_0^{a_c} \int_{a_{c+1}}^{\infty} \dots \int_{a_b}^{\infty} \frac{\prod_{i=1}^b x_i^{r_i-1} dx_i}{\left(1 + \sum_{i=1}^b x_i\right)^{m+R}}, \end{aligned} \quad (8)$$

where

$$R \equiv \sum_{i=1}^k r_i \quad (9)$$

$$a_i \equiv \frac{p_i}{1 - \sum_{i=1}^k p_i}, \quad (10)$$

and p_i are the cell probabilities. For equal probabilities, $a_i = 1$. The Dirichlet D integral can be expanded as a MULTINOMIAL SERIES as

$$\begin{aligned} D_{\mathbf{a}}^{(b)}(\mathbf{r}, m) &= \frac{1}{\left(1 + \sum_{i=1}^b\right)^m} \\ &\quad \times \sum_{x_1 < r_1} \dots \sum_{x_b < r_b} \binom{m-1 + \sum_{a=1}^b x_a}{m-1, x_1, \dots, x_b} \\ &\quad \times \prod_{i=1}^b b \left(\frac{a_i}{1 + \sum_{k=1}^b a_k} \right)^{x_i}. \end{aligned} \quad (11)$$

For small b , C and D can be expressed analytically either partially or fully for general arguments and $a_i = 1$.

$$C_1^{(1)}(r_2; r_1) = \frac{\Gamma(r_1 + r_2) {}_2F_1(r_2, r_1 + r_2; 1 + r_2; -1)}{r_2 \Gamma(r_1) \Gamma(r_2)} \quad (12)$$

$$\begin{aligned} C_1^{(2)}(r_2, r_3; r_1) &= \frac{\Gamma(r_1 + r_2 + r_3)}{r_2 \Gamma(r_1) \Gamma(r_2) \Gamma(r_3)} \\ &\quad \times \int_0^1 {}_2F_1 y^{r_3-1} (1+y)^{-(r_1+r_2+r_3)} dy, \end{aligned} \quad (13)$$

where

$${}_2F_1 \equiv {}_2F_1(r_2, r_1 + r_2 + r_3; 1 + r_2, -(1+y)^{-1}) \quad (14)$$

is a HYPERGEOMETRIC FUNCTION.

$$D_1^{(1)}(r_2; r_1) = \frac{\Gamma(r_1 + r_2) {}_2F_1(r_1, r_1 + r_2; 1 + r_1; -1)}{r_1 \Gamma(r_1) \Gamma(r_2)} \quad (15)$$

$$\begin{aligned} D_1^{(2)}(r_2, r_3; r_1) &= \frac{\Gamma(r_1 + r_2 + r_3)}{(r_1 + r_3) \Gamma(r_1) \Gamma(r_2) \Gamma(r_3)} \\ &\quad \times \int_1^{\infty} {}_2F_1 y^{r_3-1} dy, \end{aligned} \quad (16)$$

where

$${}_2F_1 \equiv {}_2F_1(r_1 + r_3, r_1 + r_2 + r_3; 1 + r_1 + r_3; -1-y). \quad (17)$$

References

- Sobel, M.; Uppuluri, R. R.; and Frankowski, K. *Selected Tables in Mathematical Statistics, Vol. 4: Dirichlet Distribution—Type 1*. Providence, RI: Amer. Math. Soc., 1977.
- Sobel, M.; Uppuluri, R. R.; and Frankowski, K. *Selected Tables in Mathematical Statistics, Vol. 9: Dirichlet Integrals of Type 2 and Their Applications*. Providence, RI: Amer. Math. Soc., 1985.
- ✱ Weisstein, E. W. "Dirichlet Integrals." <http://www.astro.virginia.edu/~eww6n/math/notebooks/DirichletIntegrals.m>.

Dirichlet Kernel

The Dirichlet kernel D_n^M is obtained by integrating the CHARACTER $e^{i(\xi, x)}$ over the BALL $|\xi| \leq M$,

$$D_n^M = -\frac{1}{2\pi r} \frac{d}{dr} D_{n-2}^M.$$

The Dirichlet kernel of a DELTA SEQUENCE is given by

$$\delta_n(x) \equiv \frac{1}{2\pi} \frac{\sin[(n + \frac{1}{2})x]}{\sin(\frac{1}{2}x)}.$$

The integral of this kernel is called the DIRICHLET INTEGRAL $D[u]$.

see also DELTA SEQUENCE, DIRICHLET INTEGRALS, DIRICHLET'S LEMMA

Dirichlet L -Series

Series of the form

$$L_k(s, \chi) \equiv \sum_{n=1}^{\infty} \chi_k(n) n^{-s}, \quad (1)$$

where the CHARACTER (NUMBER THEORY) $\chi_k(n)$ is an INTEGER function with period m . These series appear in number theory (they were used, for instance, to prove DIRICHLET'S THEOREM) and can be written as sums of LERCH TRANSCENDENTS with z a POWER of $e^{2\pi i/m}$. The DIRICHLET ETA FUNCTION

$$\eta(s) \equiv \sum_{n=1}^{\infty} \frac{(-1)^{n+1}}{n^s} = (1 - 2^{1-s})\zeta(s) \quad (2)$$

(for $s \neq 1$) and DIRICHLET BETA FUNCTION

$$L_{-4}(s) = \beta(s) \equiv \sum_{n=0}^{\infty} \frac{(-1)^n}{(2n+1)^s} \quad (3)$$

and RIEMANN ZETA FUNCTION

$$L_{+1}(s) = \zeta(s) \quad (4)$$

are Dirichlet series (Borwein and Borwein 1987, p. 289). χ_k is called primitive if the CONDUCTOR $f(\chi) = k$. Otherwise, χ_k is imprimitive. A primitive L -series modulo k is then defined as one for which $\chi_k(n)$ is primitive. All imprimitive L -series can be expressed in terms of primitive L -series.

Let $P = 1$ or $P = \prod_{i=1}^t p_i$, where p_i are distinct ODD PRIMES. Then there are three possible types of primitive L -series with REAL COEFFICIENTS. The requirement of REAL COEFFICIENTS restricts the CHARACTER to $\chi_k(n) = \pm 1$ for all k and n . The three type are then

1. If $k = P$ (e.g., $k = 1, 3, 5, \dots$) or $k = 4P$ (e.g., $k = 4, 12, 20, \dots$), there is exactly one primitive L -series.

2. If $k = 8P$ (e.g., $k = 8, 24, \dots$), there are two primitive L -series.

3. If $k = 2P, Pp_i$, or $2^\alpha P$ where $\alpha > 3$ (e.g., $k = 2, 6, 9, \dots$), there are no primitive L -series

(Zucker and Robertson 1976). All primitive L -series are algebraically independent and divide into two types according to

$$\chi_k(k-1) = \pm 1. \quad (5)$$

Primitive L -series of these types are denoted L_+ . For a primitive L -series with REAL CHARACTER (NUMBER THEORY), if $k = P$, then

$$L_k = \begin{cases} L_{-k} & \text{if } P \equiv 3 \pmod{4} \\ L_k & \text{if } P \equiv 1 \pmod{4}. \end{cases} \quad (6)$$

If $k = 4P$, then

$$L_k = \begin{cases} L_{-k} & \text{if } P \equiv 1 \pmod{4} \\ L_k & \text{if } P \equiv 3 \pmod{4}, \end{cases} \quad (7)$$

and if $k = 8P$, then there is a primitive function of each type (Zucker and Robertson 1976).

The first few primitive NEGATIVE L -series are $L_{-3}, L_{-4}, L_{-7}, L_{-8}, L_{-11}, L_{-15}, L_{-19}, L_{-20}, L_{-23}, L_{-24}, L_{-31}, L_{-35}, L_{-39}, L_{-40}, L_{-43}, L_{-47}, L_{-51}, L_{-52}, L_{-55}, L_{-56}, L_{-59}, L_{-67}, L_{-68}, L_{-71}, L_{-79}, L_{-83}, L_{-84}, L_{-87}, L_{-88}, L_{-91}, L_{-95}, \dots$ (Sloane's A003657), corresponding to the negated discriminants of imaginary quadratic fields. The first few primitive POSITIVE L -series are $L_{+1}, L_{+5}, L_{+8}, L_{+12}, L_{+13}, L_{+17}, L_{+21}, L_{+24}, L_{+28}, L_{+29}, L_{+33}, L_{+37}, L_{+40}, L_{+41}, L_{+44}, L_{+53}, L_{+56}, L_{+57}, L_{+60}, L_{+61}, L_{+65}, L_{+69}, L_{+73}, L_{+76}, L_{+77}, L_{+85}, L_{+88}, L_{+89}, L_{+92}, L_{+93}, L_{+97}, \dots$ (Sloane's A046113).

The KRONECKER SYMBOL is a REAL CHARACTER modulo k , and is in fact essentially the only type of REAL primitive CHARACTER (Ayoub 1963). Therefore,

$$L_{+d}(s) = \sum_{n=1}^{\infty} (d|n) n^{-s} \quad (8)$$

$$L_{-d}(s) = \sum_{n=1}^{\infty} (-d|n) n^{-s}, \quad (9)$$

where $(d|n)$ is the KRONECKER SYMBOL. The functional equations for L_{\pm} are

$$L_{-k}(s) = 2^s \pi^{s-1} k^{-s+1/2} \Gamma(1-s) \cos(\frac{1}{2}s\pi) L_{-k}(1-s) \quad (10)$$

$$L_{+k}(s) = 2^s \pi^{s-1} k^{-s+1/2} \Gamma(1-s) \sin(\frac{1}{2}s\pi) L_{+k}(1-s). \quad (11)$$

For m a POSITIVE INTEGER

$$L_{+k}(-2m) = 0 \quad (12)$$

$$L_{-k}(1-2m) = 0 \quad (13)$$

$$L_{+k}(2m) = Rk^{-1/2}\pi^{2m} \quad (14)$$

$$L_{-k}(2m-1) = R'k^{-1/2}\pi^{2m-1} \quad (15)$$

$$L_{+k}(1-2m) = \frac{(-1)^m(2m-1)!R}{(2k)^{2m-1}} \quad (16)$$

$$L_{-k}(-2k) = \frac{(-1)^m R'(2m)!}{(2k)^{2m}}, \quad (17)$$

where R and R' are RATIONAL NUMBERS. $L_{+k}(1)$ can be expressed in terms of transcendentals by

$$L_d(1) = h(d)\kappa(d), \quad (18)$$

where $h(d)$ is the CLASS NUMBER and $\kappa(d)$ is the DIRICHLET STRUCTURE CONSTANT. Some specific values of primitive L -series are

$$L_{-15}(1) = \frac{2\pi}{\sqrt{15}}$$

$$L_{-11}(1) = \frac{\pi}{\sqrt{11}}$$

$$L_{-8}(1) = \frac{\pi}{2\sqrt{2}}$$

$$L_{-7}(1) = \frac{\pi}{\sqrt{7}}$$

$$L_{-4}(1) = \frac{1}{4}\pi$$

$$L_{-3}(1) = \frac{\pi}{3\sqrt{3}}$$

$$L_{+5}(1) = \frac{2}{\sqrt{5}} \ln \left(\frac{1+\sqrt{5}}{2} \right)$$

$$L_{+8}(1) =$$

$$L_{+12}(1) = \frac{\ln(2+\sqrt{3})}{\sqrt{3}}$$

$$L_{+13}(1) = \frac{2}{\sqrt{13}} \ln \left(\frac{3+\sqrt{13}}{2} \right)$$

$$L_{+17}(1) = \frac{2}{\sqrt{17}} \ln(4+\sqrt{17})$$

$$L_{+21}(1) = \frac{2}{\sqrt{21}} \ln \left(\frac{5+\sqrt{21}}{2} \right)$$

$$L_{+24}(1) = \frac{\ln(5+2\sqrt{6})}{\sqrt{6}}.$$

No general forms are known for $L_{-k}(2m)$ and $L_{+k}(2m-1)$ in terms of known transcendentals. For example,

$$L_{-4}(2) = \beta(2) \equiv K, \quad (19)$$

where K is defined as CATALAN'S CONSTANT.

see also DIRICHLET BETA FUNCTION, DIRICHLET ETA FUNCTION

References

- Ayoub, R. G. *An Introduction to the Analytic Theory of Numbers*. Providence, RI: Amer. Math. Soc., 1963.
- Borwein, J. M. and Borwein, P. B. *Pi & the AGM: A Study in Analytic Number Theory and Computational Complexity*. New York: Wiley, 1987.
- Buell, D. A. "Small Class Numbers and Extreme Values of L -Functions of Quadratic Fields." *Math. Comput.* **139**, 786-796, 1977.
- Ireland, K. and Rosen, M. "Dirichlet L -Functions." Ch. 16 in *A Classical Introduction to Modern Number Theory*, 2nd ed. New York: Springer-Verlag, pp. 249-268, 1990.
- Sloane, N. J. A. Sequences A046113 and A003657/M2332 in "An On-Line Version of the Encyclopedia of Integer Sequences."
- ✱ Weisstein, E. W. "Class Numbers." <http://www.astro.virginia.edu/~eww6n/math/notebooks/ClassNumbers.m>.
- Zucker, I. J. and Robertson, M. M. "Some Properties of Dirichlet L -Series." *J. Phys. A: Math. Gen.* **9**, 1207-1214, 1976.

Dirichlet Lambda Function

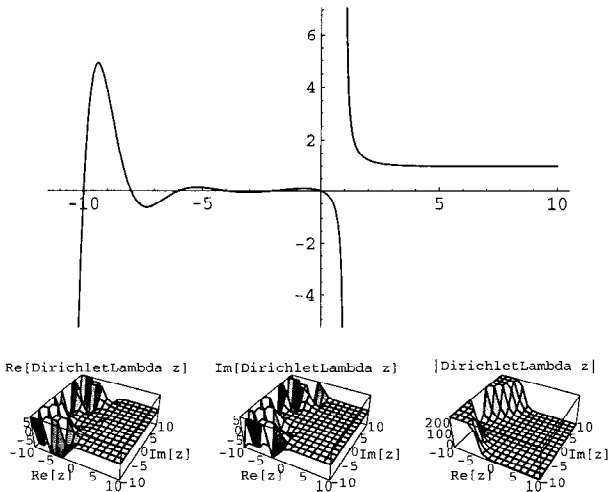

$$\lambda(x) \equiv \sum_{n=0}^{\infty} (2n+1)^{-x} = (1-2^{-x})\zeta(x) \quad (1)$$

for $x = 2, 3, \dots$, where $\zeta(x)$ is the RIEMANN ZETA FUNCTION. The function is undefined at $x = 1$. It can be computed in closed form where $\zeta(x)$ can, that is for EVEN POSITIVE n . It is related to the RIEMANN ZETA FUNCTION and DIRICHLET ETA FUNCTION by

$$\frac{\zeta(\nu)}{2^\nu} = \frac{\lambda(\nu)}{2^\nu - 1} = \frac{\eta(\nu)}{2^\nu - 2} \quad (2)$$

and

$$\zeta(\nu) + \eta(\nu) = 2\lambda(\nu) \quad (3)$$

(Spanier and Oldham 1987). Special values of $\lambda(n)$ include

$$\lambda(2) = \frac{\pi^2}{8} \quad (4)$$

$$\lambda(4) = \frac{\pi^4}{96}. \quad (5)$$

see also DIRICHLET BETA FUNCTION, DIRICHLET ETA FUNCTION, RIEMANN ZETA FUNCTION, ZETA FUNCTION

References

- Abramowitz, M. and Stegun, C. A. (Eds.). *Handbook of Mathematical Functions with Formulas, Graphs, and Mathematical Tables*, 9th printing. New York: Dover, pp. 807–808, 1972.
- Spanier, J. and Oldham, K. B. "The Zeta Numbers and Related Functions." Ch. 3 in *An Atlas of Functions*. Washington, DC: Hemisphere, pp. 25–33, 1987.

Dirichlet's Lemma

$$\int_0^\pi \frac{\sin[(n + \frac{1}{2})x]}{2 \sin(\frac{1}{2}x)} dx = \frac{1}{2}\pi,$$

where the KERNEL is the DIRICHLET KERNEL.

References

- Cohn, H. *Advanced Number Theory*. New York: Dover, p. 37, 1980.
- Gradshteyn, I. S. and Ryzhik, I. M. *Tables of Integrals, Series, and Products*, 5th ed. San Diego, CA: Academic Press, p. 1101, 1979.

Dirichlet's Principle

Also known as THOMSON'S PRINCIPLE. There exists a function u that minimizes the functional

$$D[u] = \int_{\Omega} |\nabla u|^2 dV$$

(called the DIRICHLET INTEGRAL) for $\Omega \subset \mathbb{R}^2$ or \mathbb{R}^3 among all the functions $u \in C^{(1)}(\Omega) \cap C^{(0)}(\bar{\Omega})$ which take on given values f on the boundary $\partial\Omega$ of Ω , and that function u satisfies $\nabla^2 = 0$ in Ω , $u|_{\partial\Omega} = f$, $u \in C^{(2)}(\Omega) \cap C^{(0)}(\bar{\Omega})$. Weierstraß showed that Dirichlet's argument contained a subtle fallacy. As a result, it can be claimed only that there exists a lower bound to which $D[u]$ comes arbitrarily close without being forced to actually reach it. Kneser, however, obtained a valid proof of Dirichlet's principle.

see also DIRICHLET'S BOX PRINCIPLE, DIRICHLET INTEGRALS

Dirichlet Region

see VORONOI POLYGON

Dirichlet Series

A sum $\sum a_n e^{\lambda_n z}$, where a_n and z are COMPLEX and λ_n is REAL and MONOTONIC increasing.

see also DIRICHLET L-SERIES

Dirichlet Structure Constant

$$\kappa(d) = \begin{cases} \frac{2 \ln \eta(d)}{\sqrt{d}} & \text{for } d > 0 \\ \frac{2\pi}{w(d)\sqrt{|d|}} & \text{for } d < 0, \end{cases}$$

where $\eta(d)$ is the FUNDAMENTAL UNIT and $w(d)$ is the number of substitutions which leave the binary quadratic form unchanged

$$w(d) = \begin{cases} 6 & \text{for } d = -3 \\ 4 & \text{for } d = -4 \\ 2 & \text{otherwise.} \end{cases}$$

see also CLASS NUMBER, DIRICHLET L-SERIES

References

- ✱ Weisstein, E. W. "Class Numbers." <http://www.astro.virginia.edu/~eww6n/math/notebooks/ClassNumbers.m>.

Dirichlet Tessellation

see VORONOI DIAGRAM

Dirichlet's Test

Let

$$\left| \sum_{n=1}^p a_n \right| < K,$$

where K is independent of p . Then if $f_n \geq f_{n+1} > 0$ and

$$\lim_{n \rightarrow \infty} f_n = 0,$$

it follows that

$$\sum_{n=1}^{\infty} a_n f_n$$

CONVERGES.

see also CONVERGENCE TESTS

Dirichlet's Theorem

Given an ARITHMETIC SERIES of terms $an+b$, for $n = 1, 2, \dots$, the series contains an infinite number of PRIMES if a and b are RELATIVELY PRIME, i.e., $(a, b) = 1$. Dirichlet proved this theorem using DIRICHLET L-SERIES.

see also PRIME ARITHMETIC PROGRESSION, PRIME PATTERNS CONJECTURE, RELATIVELY PRIME, SIERPIŃSKI'S PRIME SEQUENCE THEOREM

References

- Courant, R. and Robbins, H. "Primes in Arithmetical Progressions." §1.2b in Supplement to Ch. 1 in *What is Mathematics?: An Elementary Approach to Ideas and Methods*, 2nd ed. Oxford, England: Oxford University Press, pp. 26–27, 1996.
- Shanks, D. *Solved and Unsolved Problems in Number Theory*, 4th ed. New York: Chelsea, pp. 22–23, 1993.

Dirty Beam

The FOURIER TRANSFORM of the (u, v) sampling distribution in synthesis imaging

$$b' = \mathcal{F}^{-1}(S), \quad (1)$$

also called the SYNTHESIZED BEAM. It is called a "beam" by way of analogy with the DIRTY MAP

$$\begin{aligned} I' &= \mathcal{F}^{-1}(VS) = \mathcal{F}^{-1}[V] * \mathcal{F}^{-1}[S] \\ &= I * \mathcal{F}^{-1}(S) \equiv I * b', \end{aligned} \quad (2)$$

where $*$ denotes CONVOLUTION. Here, I' is the intensity which would be observed for an extended source by an antenna with response pattern b_1 ,

$$I' = b_1(\theta'') * I(\theta''). \quad (3)$$

The dirty beam is often a complicated function. In order to avoid introducing any high spatial frequency features when CLEANing, an elliptical Gaussian is usually fit to the dirty beam, producing a CLEAN BEAM which is CONVOLVED with the final iteration.

see also CLEAN ALGORITHM, CLEAN MAP, DIRTY MAP

Dirty Map

From the van Cittert-Zernicke theorem, the relationship between observed visibility function $V(u, v)$ and source brightness $I(\xi, \eta)$ in synthesis imaging is given by

$$\begin{aligned} I(\xi, \eta) &= \int_{-\infty}^{\infty} \int_{-\infty}^{\infty} V(u, v) e^{2\pi i(\xi u + \eta v)} du dv \\ &= \mathcal{F}^{-1}[V(u, v)]. \end{aligned} \quad (1)$$

But the visibility function is sampled only at discrete points $S(u, v)$ (finite sampling), so only an approximation to I , called the "dirty map" and denoted I' , is measured. It is given by

$$\begin{aligned} I'(\xi, \eta) &= \int_{-\infty}^{\infty} \int_{-\infty}^{\infty} S(u, v) V(u, v) e^{2\pi i(\xi u + \eta v)} du dv \\ &= \mathcal{F}^{-1}[VS], \end{aligned} \quad (2)$$

where $S(u, v)$ is the sampling function and $V(u, v)$ is the observed visibility function. Let $*$ denote CONVOLUTION and rearrange the CONVOLUTION THEOREM,

$$\mathcal{F}[f * g] = \mathcal{F}[f]\mathcal{F}[g] \quad (3)$$

into the form

$$\mathcal{F}[\mathcal{F}^{-1}[f] * \mathcal{F}^{-1}[g]] = fg, \quad (4)$$

from which it follows that

$$\mathcal{F}^{-1}[f] * \mathcal{F}^{-1}[g] = \mathcal{F}^{-1}[fg]. \quad (5)$$

Now note that

$$I = \mathcal{F}^{-1}[V] \quad (6)$$

is the CLEAN MAP, and define the "DIRTY BEAM" as the inverse FOURIER TRANSFORM of the sampling function,

$$b' \equiv \mathcal{F}^{-1}[S]. \quad (7)$$

The dirty map is then given by

$$I' = \mathcal{F}^{-1}[VS] = \mathcal{F}^{-1}[V] * \mathcal{F}^{-1}[S] = I * b'. \quad (8)$$

In order to deconvolve the desired CLEAN MAP I from the measured dirty map I' and the known DIRTY BEAM b' , the CLEAN ALGORITHM is often used.

see also CLEAN ALGORITHM, CLEAN MAP, DIRTY BEAM

Disc

see DISK

Disconnected Form

A FORM which is the sum of two FORMS involving separate sets of variables.

Disconnectivity

Disconnectivities are mathematical entities which stand in the way of a SPACE being contractible (i.e., shrunk to a point, where the shrinking takes place inside the SPACE itself). When dealing with TOPOLOGICAL SPACES, a disconnectivity is interpreted as a "HOLE" in the space. Disconnectivities in SPACE are studied through the EXTENSION PROBLEM or the LIFTING PROBLEM.

see also EXTENSION PROBLEM, HOLE, LIFTING PROBLEM

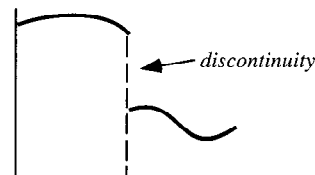
Discontinuity

A point at which a mathematical object is DISCONTINUOUS.

Discontinuous

Not CONTINUOUS. A point at which a function is discontinuous is called a DISCONTINUITY, or sometimes a JUMP.

References

Yates, R. C. "Functions with Discontinuous Properties." *A Handbook on Curves and Their Properties*. Ann Arbor, MI: J. W. Edwards, pp. 100–107, 1952.

Discordant Permutation

see MARRIED COUPLES PROBLEM

Discrepancy Theorem

Let s_1, s_2, \dots be an infinite series of real numbers lying between 0 and 1. Then corresponding to any arbitrarily large K , there exists a positive integer n and two subintervals of equal length such that the number of s_ν with $\nu = 1, 2, \dots, n$ which lie in one of the subintervals differs from the number of such s_ν that lie in the other subinterval by more than K (van der Corput 1935ab, van Aardenne-Ehrenfest 1945, 1949, Roth 1954).

This statement can be refined as follows. Let N be a large integer and s_1, s_2, \dots, s_N be a sequence of N real numbers lying between 0 and 1. Then for any integer $1 \leq n \leq N$ and any real number α satisfying $0 < \alpha < 1$, let $D_n(\alpha)$ denote the number of s_ν with $\nu = 1, 2, \dots, n$ that satisfy $0 \leq s_\nu < \alpha$. Then there exist n and α such that

$$|D_n(\alpha) - n\alpha| > c_1 \frac{\ln \ln N}{\ln \ln \ln N}$$

where c_1 is a positive constant.

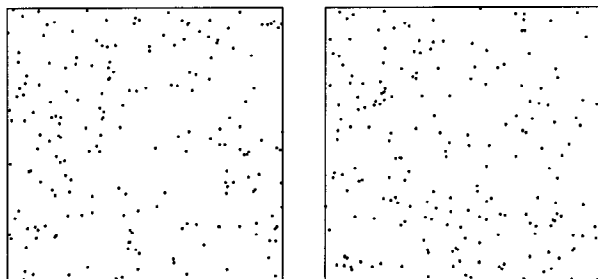

This result can be further strengthened, which is most easily done by reformulating the problem. Let $N > 1$ be an integer and P_1, P_2, \dots, P_N be N (not necessarily distinct) points in the square $0 \leq x \leq 1, 0 \leq y \leq 1$. Then

$$\int_0^1 \int_0^1 [S(x, y) - Nxy]^2 dx dy > c_2 \ln N,$$

where c_2 is a positive constant and $S(u, v)$ is the number of points in the rectangle $0 \leq x < u, 0 \leq y < v$ (Roth 1954). Therefore,

$$|S(x, y) - Nxy| > c_3 \sqrt{\ln N},$$

and the original result can be stated as the fact that there exist n and α such that

$$|D_n(\alpha) - n\alpha| > c_4 \sqrt{\ln N}.$$

The randomly distributed points shown in the above squares have $|S(x, y) - Nxy|^2 = 6.40$ and 9.11 , respectively.

Similarly, the discrepancy of a set of N points in a unit d -HYPERCUBE satisfies

$$|S(x, y) - Nxy| > c(\ln N)^{(d-1)/2}$$

(Roth 1954, 1976, 1979, 1980).

see also 18-POINT PROBLEM, CUBE POINT PICKING

References

- Berlekamp, E. R. and Graham, R. L. "Irregularities in the Distributions of Finite Sequences." *J. Number Th.* **2**, 152–161, 1970.
 Roth, K. F. "On Irregularities of Distribution." *Mathematika* **1**, 73–79, 1954.
 Roth, K. F. "On Irregularities of Distribution. II." *Comm. Pure Appl. Math.* **29**, 739–744, 1976.
 Roth, K. F. "On Irregularities of Distribution. III." *Acta Arith.* **35**, 373–384, 1979.
 Roth, K. F. "On Irregularities of Distribution. IV." *Acta Arith.* **37**, 67–75, 1980.
 van Aardenne-Ehrenfest, T. "Proof of the Impossibility of a Just Distribution of an Infinite Sequence Over an Interval." *Proc. Kon. Ned. Akad. Wetensch.* **48**, 3–8, 1945.
 van Aardenne-Ehrenfest, T. *Proc. Kon. Ned. Akad. Wetensch.* **52**, 734–739, 1949.
 van der Corput, J. G. *Proc. Kon. Ned. Akad. Wetensch.* **38**, 813–821, 1935a.
 van der Corput, J. G. *Proc. Kon. Ned. Akad. Wetensch.* **38**, 1058–1066, 1935b.

Discrete Distribution

A DISTRIBUTION whose variables can take on only discrete values. Abramowitz and Stegun (1972, p. 929) give a table of the parameters of most common discrete distributions.

see also BERNOULLI DISTRIBUTION, BINOMIAL DISTRIBUTION, CONTINUOUS DISTRIBUTION, DISTRIBUTION, GEOMETRIC DISTRIBUTION, HYPERGEOMETRIC DISTRIBUTION, NEGATIVE BINOMIAL DISTRIBUTION, POISSON DISTRIBUTION, PROBABILITY, STATISTICS, UNIFORM DISTRIBUTION

References

- Abramowitz, M. and Stegun, C. A. (Eds.). *Handbook of Mathematical Functions with Formulas, Graphs, and Mathematical Tables*, 9th printing. New York: Dover, pp. 927 and 929, 1972.

Discrete Fourier Transform

The FOURIER TRANSFORM is defined as

$$f(\nu) = \mathcal{F}[f(t)] = \int_{-\infty}^{\infty} f(t) e^{-2\pi i \nu t} dt. \quad (1)$$

Now consider generalization to the case of a discrete function, $f(t) \rightarrow f(t_k)$ by letting $f_k \equiv f(t_k)$, where $t_k \equiv k\Delta$, with $k = 0, \dots, N-1$. Choose the frequency step such that

$$\nu_n = \frac{n}{N\Delta}, \quad (2)$$

with $n = -N/2, \dots, 0, \dots, N/2$. There are $N+1$ values of n , so there is one relationship between the frequency components. Writing this out as per Press *et al.* (1989)

$$\mathcal{F}[f(t)] = \sum_{k=0}^{N-1} f_k e^{-2\pi i (n/N\Delta) k \Delta} \Delta = \Delta \sum_{k=0}^{N-1} f_k e^{-2\pi i n k / N}, \quad (3)$$

and

$$F_n \equiv \sum_{k=0}^{N-1} f_k e^{-2\pi i n k / N}. \quad (4)$$

The inverse transform is

$$f_k = \frac{1}{N} \sum_{n=0}^{N-1} F_n e^{2\pi i n k / N}. \quad (5)$$

Note that $F_{-n} = F_{N-n}$, $n = 1, 2, \dots$, so an alternate formulation is

$$\nu_n = \frac{n}{N\Delta}, \quad (6)$$

where the NEGATIVE frequencies $-\nu_c < \nu < 0$ have $N/2 + 1 \leq n \leq N - 1$, POSITIVE frequencies $0 < \nu < \nu_c$ have $1 \leq n \leq N/2 - 1$, with zero frequency $n = 0$. $n = N/2$ corresponds to both $\nu = \nu_c$ and $\nu = -\nu_c$. The discrete Fourier transform can be computed using a FAST FOURIER TRANSFORM.

The discrete Fourier transform is a special case of the z -TRANSFORM.

see also FAST FOURIER TRANSFORM, FOURIER TRANSFORM, HARTLEY TRANSFORM, WINOGRAD TRANSFORM, z -TRANSFORM

References

- Arfken, G. "Discrete Orthogonality—Discrete Fourier Transform." §14.6 in *Mathematical Methods for Physicists*, 3rd ed. Orlando, FL: Academic Press, pp. 787–792, 1985.
 Press, W. H.; Flannery, B. P.; Teukolsky, S. A.; and Vetterling, W. T. "Fourier Transform of Discretely Sampled Data." §12.1 in *Numerical Recipes in C: The Art of Scientific Computing*. Cambridge, England: Cambridge University Press, pp. 494–498, 1989.

Discrete Mathematics

The branch of mathematics dealing with objects which can assume only certain "discrete" values. Discrete objects can be characterized by INTEGERS (or RATIONAL NUMBERS), whereas continuous objects require REAL NUMBERS. The study of how discrete objects combine with one another and the probabilities of various outcomes is known as COMBINATORICS.

see also COMBINATORICS

References

- Balakrishnan, V. K. *Introductory Discrete Mathematics*. New York: Dover, 1997.
 Bobrow, L. S. and Arbib, M. A. *Discrete Mathematics: Applied Algebra for Computer and Information Science*. Philadelphia, PA: Saunders, 1974.
 Dossey, J. A.; Otto, A. D.; Spence, L.; and Eynden, C. V. *Discrete Mathematics*, 3rd ed. Reading, MA: Addison-Wesley, 1997.
 Skiena, S. S. *Implementing Discrete Mathematics*. Reading, MA: Addison-Wesley, 1990.

Discrete Set

A finite SET or an infinitely COUNTABLE SET of elements.

Discrete Uniform Distribution

see EQUALLY LIKELY OUTCOMES DISTRIBUTION

Discriminant

A discriminant is a quantity (usually invariant under certain classes of transformations) which characterizes certain properties of a quantity's ROOTS. The concept of the discriminant is used for BINARY QUADRATIC FORMS, ELLIPTIC CURVES, METRICS, MODULES, POLYNOMIALS, QUADRATIC CURVES, QUADRATIC FIELDS, QUADRATIC FORMS, and in the SECOND DERIVATIVE TEST.

Discriminant (Binary Quadratic Form)

The discriminant of a BINARY QUADRATIC FORM

$$au^2 + buv + cv^2$$

is defined by

$$d \equiv b^2 - 4ac.$$

It is equal to four times the corresponding DETERMINANT.

see also CLASS NUMBER

Discriminant (Elliptic Curve)

AN ELLIPTIC CURVE is of the form

$$y^2 = x^3 + a_2x^2 + a_1x + a_0.$$

Let the ROOTS of y^2 be r_1 , r_2 , and r_3 . The discriminant is then defined as

$$\Delta = k(r_1 - r_2)^2(r_1 - r_3)^2(r_2 - r_3)^2.$$

see also FREY CURVE, MINIMAL DISCRIMINANT

Discriminant (Metric)

Given a METRIC $g_{\alpha\beta}$, the discriminant is defined by

$$g \equiv \det(g_{\alpha\beta}) = \begin{vmatrix} g_{11} & g_{12} \\ g_{21} & g_{22} \end{vmatrix} = g_{11}g_{22} - (g_{12})^2. \quad (1)$$

Let g be the discriminant and \bar{g} the transformed discriminant, then

$$\bar{g} = D^2 g \quad (2)$$

$$g = \bar{D}^2 \bar{g}, \quad (3)$$

where

$$D \equiv \frac{\partial(u^1, u^2)}{\partial(\bar{u}^1, \bar{u}^2)} = \begin{vmatrix} \frac{\partial u^1}{\partial \bar{u}^1} & \frac{\partial u^1}{\partial \bar{u}^2} \\ \frac{\partial u^2}{\partial \bar{u}^1} & \frac{\partial u^2}{\partial \bar{u}^2} \end{vmatrix} \quad (4)$$

$$\bar{D} \equiv \frac{\partial(\bar{u}^1, \bar{u}^2)}{\partial(u^1, u^2)} = \begin{vmatrix} \frac{\partial \bar{u}^1}{\partial u^1} & \frac{\partial \bar{u}^1}{\partial u^2} \\ \frac{\partial \bar{u}^2}{\partial u^1} & \frac{\partial \bar{u}^2}{\partial u^2} \end{vmatrix}. \quad (5)$$

Discriminant (Module)

Let a MODULE M in an INTEGRAL DOMAIN D_1 for $R(\sqrt{D})$ be expressed using a two-element basis as

$$M = [\xi_1, \xi_2],$$

where ξ_1 and ξ_2 are in D_1 . Then the DIFFERENT of the MODULE is defined as

$$\Delta = \Delta(M) = \begin{vmatrix} \xi_1 & \xi_2 \\ \xi'_1 & \xi'_2 \end{vmatrix} = \xi_1 \xi'_2 - \xi'_1 \xi_2$$

and the discriminant is defined as the square of the DIFFERENT (Cohn 1980).

For IMAGINARY QUADRATIC FIELDS $\mathbb{Q}(\sqrt{n})$ (with $n < 0$), the discriminants are given in the following table.

-1	-2 ²	-33	-2 ² · 3 · 11	-67	-67
-2	-2 ³	-34	-2 ³ · 17	-69	-2 ² · 3 · 23
-3	-3	-35	-5 · 7	-70	-2 ³ · 5 · 7
-5	-2 ² · 5	-37	-2 ² · 37	-71	-71
-6	-2 ³ · 3	-39	-3 · 13	-73	-2 ² · 73
-7	-7	-41	-2 ² · 41	-74	-2 ³ · 37
-10	-2 ³ · 5	-42	-2 ³ · 3 · 7	-77	-2 ² · 7 · 11
-11	-11	-43	-43	-78	-2 ³ · 3 · 13
-13	-2 ² · 13	-46	-2 ³ · 23	-79	-79
-14	-2 ³ · 7	-47	-47	-82	-2 ³ · 41
-15	-3 · 5	-51	-3 · 17	-83	-83
-17	-2 ² · 17	-53	-2 ² · 53	-85	-2 ² · 5 · 17
-19	-19	-55	-5 · 11	-86	-2 ³ · 43
-21	-2 ² · 3 · 7	-57	-2 ² · 3 · 19	-87	-3 · 29
-22	-2 ³ · 11	-58	-2 ³ · 29	-89	-2 ² · 89
-23	-23	-59	-59	-91	-7 · 13
-26	-2 ³ · 13	-61	-2 ² · 61	-93	-2 ² · 3 · 31
-29	-2 ² · 29	-62	-2 ³ · 31	-94	-2 ³ · 47
-30	-2 ³ · 3 · 5	-65	-2 ² · 5 · 13	-95	-5 · 19
-31	-31	-66	-2 ³ · 3 · 11	-97	-2 ² · 97

The discriminants of REAL QUADRATIC FIELDS $\mathbb{Q}(\sqrt{n})$ ($n > 0$) are given in the following table.

2	2 ³	34	2 ³ · 17	67	67 · 2 ²
3	3 · 2 ²	35	7 · 2 ² · 5	69	3 · 23
5	5	37	37	70	7 · 2 ³ · 5
6	3 · 2 ³	38	19 · 2 ³	71	71 · 2 ²
7	7 · 2 ²	39	3 · 2 ² · 13	73	73
10	2 ³ · 5	41	41	74	2 ³ · 37
11	11 · 2 ²	42	3 · 2 ³ · 7	77	7 · 11
13	13	43	43 · 2 ²	78	3 · 2 ³ · 13
14	7 · 2 ³	46	23 · 2 ³	79	79 · 2 ²
15	3 · 2 ² · 5	47	47 · 2 ²	82	2 ³ · 41
17	17	51	3 · 2 ² · 17	83	83 · 2 ²
19	19 · 2 ²	53	53	85	5 · 17
21	3 · 7	55	11 · 2 ² · 5	86	43 · 2 ³
22	11 · 2 ³	57	3 · 19	87	3 · 2 ² · 13
23	23 · 2 ²	58	2 ³ · 29	89	89
26	2 ³ · 13	59	59 · 2 ²	91	7 · 2 ² · 13
29	29	61	61	93	3 · 31
30	3 · 2 ³ · 5	62	31 · 2 ³	94	47 · 2 ³
31	31 · 2 ²	65	5 · 13	95	19 · 2 ² · 5
33	3 · 11	66	3 · 2 ³ · 11	97	97

see also DIFFERENT, FUNDAMENTAL DISCRIMINANT, MODULE

References

Cohn, H. *Advanced Number Theory*. New York: Dover, pp. 72-73 and 261-274, 1980.

Discriminant (Polynomial)

The PRODUCT of the SQUARES of the differences of the POLYNOMIAL ROOTS x_i . For a POLYNOMIAL of degree n ,

$$D_n \equiv \prod_{\substack{i,j \\ i < j}}^n (x_i - x_j)^2. \quad (1)$$

The discriminant of the QUADRATIC EQUATION

$$ax^2 + bx + c = 0 \quad (2)$$

is usually taken as

$$D = b^2 - 4ac. \quad (3)$$

However, using the general definition of the POLYNOMIAL DISCRIMINANT gives

$$D \equiv \prod_{i < j} (z_i - z_j)^2 = \frac{b^2 - 4ac}{a^2}, \quad (4)$$

where z_i are the ROOTS.

The discriminant of the CUBIC EQUATION

$$z^3 + a_2 z^2 + a_1 z + a_0 = 0 \quad (5)$$

is commonly defined as

$$D \equiv Q^3 + R^2, \quad (6)$$

where

$$Q \equiv \frac{3a_1 - a_2^2}{9} \quad (7)$$

$$R \equiv \frac{9a_2 a_1 - 27a_0 - 2a_2^3}{54}. \quad (8)$$

However, using the general definition of the polynomial discriminant for the standard form CUBIC EQUATION

$$z^3 + pz = q \quad (9)$$

gives

$$D \equiv \prod_{i < j} (z_i - z_j)^2 = P^2 = -4p^3 - 27q^2, \quad (10)$$

where z_i are the ROOTS and

$$P = (z_1 - z_2)(z_2 - z_3)(z_1 - z_3). \quad (11)$$

The discriminant of a QUARTIC EQUATION

$$x^4 + a_3x^3 + a_2x^2 + a_1x + a_0 = 0 \quad (12)$$

is

$$\begin{aligned} & -27a_1^4 + 18a_3a_2a_1^3 - 4a_3^3a_1^3 - 4a_2^3a_1^2 + a_3^2a_2^2a_1^2 \\ & + a_0(144a_2a_1^2 - 6a_3^2a_1^2 - 80a_3a_2^2a_1 + 18a_3^3a_2a_1 + 16a_2^4 \\ & - 4a_3^2a_2^3) + a_0^2(-192a_3a_1 - 128a_2^2 + 144a_3^2a_2 - 27a_3^4) \\ & - 256a_0^3 \quad (13) \end{aligned}$$

(Beeler *et al.* 1972, Item 4).

see also RESULTANT

References

Beeler, M.; Gosper, R. W.; and Schroepel, R. *HAKMEM*.
Cambridge, MA: MIT Artificial Intelligence Laboratory,
Memo AIM-239, Feb. 1972.

Discriminant (Quadratic Curve)

Given a general QUADRATIC CURVE

$$Ax^2 + Bxy + Cy^2 + Dx + Ey + F = 0, \quad (1)$$

the quantity X is known as the discriminant, where

$$X \equiv B^2 - 4AC, \quad (2)$$

and is invariant under ROTATION. Using the COEFFICIENTS from QUADRATIC EQUATIONS for a rotation by an angle θ ,

$$\begin{aligned} A' &= \frac{1}{2}A[1 + \cos(2\theta)] + \frac{1}{2}B \sin(2\theta) + \frac{1}{2}C[1 - \cos(2\theta)] \\ &= \frac{A+C}{2} + \frac{B}{2} \sin(2\theta) + \frac{A-C}{2} \cos(2\theta) \quad (3) \end{aligned}$$

$$B' = G \cos\left(2\theta + \delta - \frac{\pi}{2}\right) = G \sin(2\theta + \delta) \quad (4)$$

$$\begin{aligned} C' &= \frac{1}{2}A[1 - \cos(2\theta)] - \frac{1}{2}B \sin(2\theta) + \frac{1}{2}C[1 + \cos(2\theta)] \\ &= \frac{A+C}{2} - \frac{B}{2} \sin(2\theta) + \frac{C-A}{2} \cos(2\theta). \quad (5) \end{aligned}$$

Now let

$$G \equiv \sqrt{B^2 + (A-C)^2} \quad (6)$$

$$\delta \equiv \tan^{-1}\left(\frac{B}{C-A}\right) \quad (7)$$

$$\delta_2 \equiv \tan^{-1}\left(\frac{A-C}{B}\right) = -\cot^{-1}\left(\frac{B}{C-A}\right), \quad (8)$$

and use

$$\cot^{-1}(x) = \frac{1}{2}\pi - \tan^{-1}(x) \quad (9)$$

$$\delta_2 = \delta - \frac{1}{2}\pi \quad (10)$$

to rewrite the primed variables

$$A' = \frac{A+C}{2} + \frac{1}{2}G \cos(2\theta + \delta) \quad (11)$$

$$B' = B \cos(2\theta) + (C-A) \sin(2\theta) = G \cos(2\theta + \delta_2) \quad (12)$$

$$C' = \frac{A+C}{2} - \frac{1}{2}G \cos(2\theta + \delta). \quad (13)$$

From (11) and (13), it follows that

$$4A'C' = (A+C)^2 - G^2 \cos(2\theta + \delta). \quad (14)$$

Combining with (12) yields, for an arbitrary θ

$$\begin{aligned} X &\equiv B'^2 - 4A'C' \\ &= G^2 \sin^2(2\theta + \delta) + G^2 \cos^2(2\theta + \delta) - (A+C)^2 \\ &= G^2 - (A+C)^2 = B^2 + (A-C)^2 - (A+C)^2 \\ &= B^2 - 4AC, \quad (15) \end{aligned}$$

which is therefore invariant under rotation. This invariant therefore provides a useful shortcut to determining the shape represented by a QUADRATIC CURVE. Choosing θ to make $B' = 0$ (see QUADRATIC EQUATION), the curve takes on the form

$$A'x^2 + C'y^2 + D'x + E'y + F = 0. \quad (16)$$

COMPLETING THE SQUARE and defining new variables gives

$$A'x'^2 + C'y'^2 = H. \quad (17)$$

Without loss of generality, take the sign of H to be positive. The discriminant is

$$X = B'^2 - 4A'C' = -4A'C'. \quad (18)$$

Now, if $-4A'C' < 0$, then A' and C' both have the same sign, and the equation has the general form of an ELLIPSE (if A' and B' are positive). If $-4A'C' > 0$, then A' and C' have opposite signs, and the equation has the general form of a HYPERBOLA. If $-4A'C' = 0$, then either A' or C' is zero, and the equation has the general form of a PARABOLA (if the NONZERO A' or C' is positive). Since the discriminant is invariant, these conclusions will also hold for an arbitrary choice of θ , so they also hold when $-4A'C'$ is replaced by the original $B^2 - 4AC$. The general result is

1. If $B^2 - 4AC < 0$, the equation represents an ELLIPSE, a CIRCLE (degenerate ELLIPSE), a POINT (degenerate CIRCLE), or has no graph.
2. If $B^2 - 4AC > 0$, the equation represents a HYPERBOLA or pair of intersecting lines (degenerate HYPERBOLA).
3. If $B^2 - 4AC = 0$, the equation represents a PARABOLA, a LINE (degenerate PARABOLA), a pair of PARALLEL lines (degenerate PARABOLA), or has no graph.

Discriminant (Quadratic Form)

see DISCRIMINANT (BINARY QUADRATIC FORM)

Discriminant (Second Derivative Test)

$$D \equiv f_{xx}f_{yy} - f_{xy}f_{yx} = f_{xx}f_{yy} - f_{xy}^2,$$

where f_{ij} are PARTIAL DERIVATIVES.

see also SECOND DERIVATIVE TEST

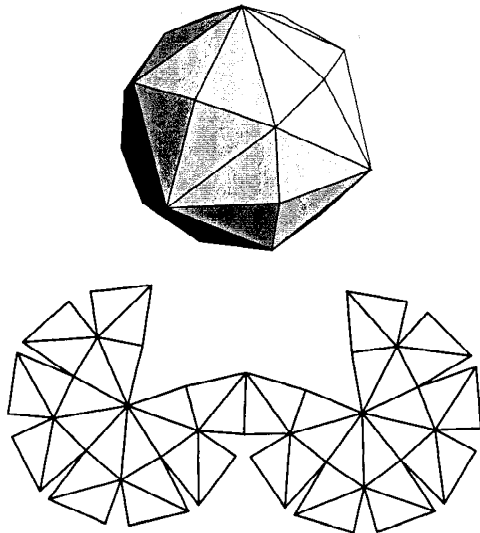
Disdyakis Dodecahedron

The DUAL POLYHEDRON of the ARCHIMEDEAN GREAT RHOMBICUBOCTAHEDRON, also called the HEXAKIS OCTAHEDRON.

see also GREAT DISDYAKIS DODECAHEDRON

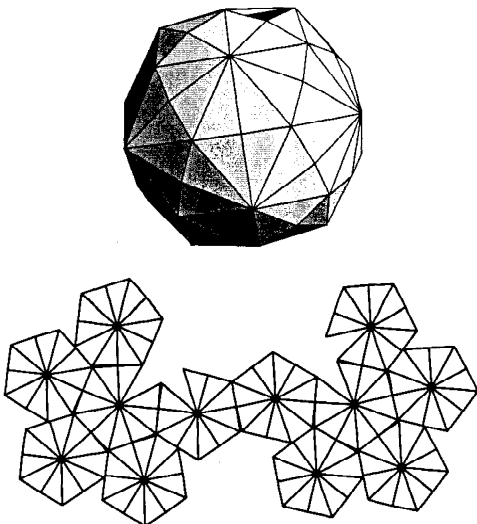
Disdyakis Triacontahedron

The DUAL POLYHEDRON of the ARCHIMEDEAN GREAT RHOMBICOSIDODECAHEDRON. It is also called the HEXAKIS ICOSAHEDRON.

Disjoint

see MUTUALLY EXCLUSIVE

Disjunction

A product of ORs, denoted

$$\bigvee_{k=1}^n A_k.$$

see also CONJUNCTION, OR

Disjunctive Game

see NIM-HEAP

Disk

An n -D disk (or DISC) of RADIUS r is the collection of points of distance $\leq r$ (CLOSED DISK) or $< r$ (OPEN DISK) from a fixed point in EUCLIDEAN n -space. A disk is the SHADOW of a BALL on a PLANE PERPENDICULAR to the BALL-RADIANT POINT line.

The n -disk for $n \geq 3$ is called a BALL, and the boundary of the n -disk is a $(n-1)$ -HYPERSPHERE. The standard n -disk, denoted \mathbb{D}^n (or \mathbb{B}^n), has its center at the ORIGIN and has RADIUS $r = 1$.

see also BALL, CLOSED DISK, DISK COVERING PROBLEM, FIVE DISKS PROBLEM, HYPERSPHERE, MERGELYAN-WESLER THEOREM, OPEN DISK, POLYDISK, SPHERE, UNIT DISK

Disk Covering Problem

N.B. A detailed on-line essay by S. Finch was the starting point for this entry.

Given a UNIT DISK, find the smallest RADIUS $r(n)$ required for n equal disks to completely cover the UNIT DISK. For a symmetrical arrangement with $n = 5$ (the FIVE DISKS PROBLEM), $r(5) = \phi - 1 = 1/\phi = 0.6180340\dots$, where ϕ is the GOLDEN RATIO. However, the radius can be reduced in the general disk covering problem where symmetry is not required. The first few such values are

$$r(1) = 1$$

$$r(2) = 1$$

$$r(3) = \frac{1}{2}\sqrt{3}$$

$$r(4) = \frac{1}{2}\sqrt{2}$$

$$r(5) = 0.609382864\dots$$

$$r(6) = 0.555$$

$$r(7) = \frac{1}{2}$$

$$r(8) = 0.437$$

$$r(9) = 0.422$$

$$r(10) = 0.398.$$

Here, values for $n = 6, 8, 9, 10$ were obtained using computer experimentation by Zahn (1962). The value $r(5)$ is equal to $\cos(\theta + \phi/2)$, where θ and ϕ are solutions to

$$2 \sin \theta - \sin(\theta + \frac{1}{2}\phi + \psi) - \sin(\psi - \theta - \frac{1}{2}\phi) = 0 \quad (1)$$

$$2 \sin \phi - \sin(\theta + \frac{1}{2}\phi + \chi) - \sin(\chi - \theta - \frac{1}{2}\phi) = 0 \quad (2)$$

$$2 \sin \theta + \sin(\chi + \theta) - \sin(\chi - \theta) - \sin(\psi + \phi) - \sin(\psi - \phi) - 2 \sin(\psi - 2\theta) = 0 \quad (3)$$

$$\cos(2\psi - \chi + \phi) - \cos(2\psi + \chi - \phi) - 2 \cos \chi + \cos(2\psi + \chi - 2\theta) + \cos(2\psi - \chi - 2\theta) = 0 \quad (4)$$

(Neville 1915). It is also given by $1/x$, where x is the largest real root of

$$a(y)x^6 - b(y)x^5 + c(y)x^4 - d(y)x^3 + e(y)x^2 - f(y)x + g(y) = 0 \quad (5)$$

maximized over all y , subject to the constraints

$$\sqrt{2} < x < 2y + 1 \quad (6)$$

$$-1 < y < 1, \quad (7)$$

and with

$$a(y) = 80y^2 + 64y \quad (8)$$

$$b(y) = 416y^3 + 384y^2 + 64y \quad (9)$$

$$c(y) = 848y^4 + 928y^3 + 352y^2 + 32y \quad (10)$$

$$d(y) = 768y^5 + 992y^4 + 736y^3 + 288y^2 + 96y$$

$$e(y) = 256y^6 + 384y^5 + 592y^4 + 480y^3 + 336y^2 + 96y + 16 \quad (11)$$

$$f(y) = 128y^5 + 192y^4 + 256y^3 + 160y^2 + 96y + 32 \quad (12)$$

$$g(y) = 64y^2 + 64y + 16 \quad (13)$$

(Bezdek 1983, 1984).

Letting $N(\epsilon)$ be the smallest number of DISKS of RADIUS ϵ needed to cover a disk D , the limit of the ratio of the AREA of D to the AREA of the disks is given by

$$\lim_{\epsilon \rightarrow 0^+} \frac{1}{\epsilon^2 N(\epsilon)} = \frac{3\sqrt{3}}{2\pi} \quad (14)$$

(Kershner 1939, Verblunsky 1949).

see also FIVE DISKS PROBLEM

References

- Ball, W. W. R. and Coxeter, H. S. M. "The Five-Disk Problem." In *Mathematical Recreations and Essays*, 13th ed. New York: Dover, pp. 97–99, 1987.
- Bezdek, K. "Über einige Kreisüberdeckungen." *Beiträge Algebra Geom.* **14**, 7–13, 1983.
- Bezdek, K. "Über einige optimale Konfigurationen von Kreisen." *Ann. Univ. Sci. Budapest Eötvös Sect. Math.* **27**, 141–151, 1984.

Finch, S. "Favorite Mathematical Constants." <http://www.mathsoft.com/asolve/constant/circle/circle.html>.

Kershner, R. "The Number of Circles Covering a Set." *Amer. J. Math.* **61**, 665–671, 1939.

Neville, E. H. "On the Solution of Numerical Functional Equations, Illustrated by an Account of a Popular Puzzle and of its Solution." *Proc. London Math. Soc.* **14**, 308–326, 1915.

Verblunsky, S. "On the Least Number of Unit Circles which Can Cover a Square." *J. London Math. Soc.* **24**, 164–170, 1949.

Zahn, C. T. "Black Box Maximization of Circular Coverage." *J. Res. Nat. Bur. Stand. B* **66**, 181–216, 1962.

Disk Lattice Points

see GAUSS'S CIRCLE PROBLEM

Dispersion Numbers

see MAGIC GEOMETRIC CONSTANTS

Dispersion Relation

Any pair of equations giving the REAL PART of a function as an integral of its IMAGINARY PART and the IMAGINARY PART as an integral of its REAL PART. Dispersion relationships imply causality in physics. Let

$$f(x_0) \equiv u(x_0) + iv(x_0), \quad (1)$$

then

$$u(x_0) = \frac{1}{\pi} PV \int_{-\infty}^{\infty} \frac{v(x) dx}{x - x_0} \quad (2)$$

$$v(x_0) = -\frac{1}{\pi} PV \int_{-\infty}^{\infty} \frac{u(x) dx}{x - x_0}, \quad (3)$$

where PV denotes the CAUCHY PRINCIPAL VALUE and $u(x_0)$ and $v(x_0)$ are HILBERT TRANSFORMS of each other. If the COMPLEX function is symmetric such that $f(-x) = f^*(x)$, then

$$u(x_0) = \frac{2}{\pi} PV \int_0^{\infty} \frac{xv(x) dx}{x^2 - x_0^2} \quad (4)$$

$$v(x_0) = -\frac{2}{\pi} PV \int_0^{\infty} \frac{xu(x) dx}{x^2 - x_0^2}. \quad (5)$$

Dispersion (Sequence)

An array $B = b_{ij}$, $i, j \geq 1$ of POSITIVE INTEGERS is called a dispersion if

1. The first column of B is a strictly increasing sequence, and there exists a strictly increasing sequence $\{s_k\}$ such that
2. $b_{12} = s_1 \geq 2$,
3. The complement of the SET $\{b_{1i} : i \geq 1\}$ is the SET $\{s_k\}$,
4. $b_{ij} = s_{b_{i,j-1}}$ for all $j \geq 3$ for $i = 1$ and for all $g \geq 2$ for all $i \geq 2$.

If an array $B = b_{ij}$ is a dispersion, then it is an INTERSPERSION.

see also INTERSPERSION

References

Kimberling, C. "Interspersion and Dispersions." *Proc. Amer. Math. Soc.* **117**, 313–321, 1993.

Dispersion (Statistics)

$$(\Delta u)_i^2 \equiv (u_i - \bar{u})^2.$$

see also ABSOLUTE DEVIATION, SIGNED DEVIATION, VARIANCE

Disphenocingulum

see JOHNSON SOLID

Disphenoid

A TETRAHEDRON with identical ISOSCELES or SCALENE faces.

Dissection

Any two rectilinear figures with equal AREA can be dissected into a finite number of pieces to form each other. This is the WALLACE-BOLYAI-GERWEIN THEOREM. For minimal dissections of a TRIANGLE, PENTAGON, and OCTAGON into a SQUARE, see Stewart (1987, pp. 169–170) and Ball and Coxeter (1987, pp. 89–91). The TRIANGLE to SQUARE dissection (HABERDASHER'S PROBLEM) is particularly interesting because it can be built from hinged pieces which can be folded and unfolded to yield the two shapes (Gardner 1961; Stewart 1987, p. 169; Pappas 1989).

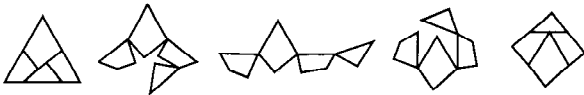

Laczkovich (1988) proved that the CIRCLE can be squared in a finite number of dissections ($\sim 10^{50}$). Furthermore, any shape whose boundary is composed of smoothly curving pieces can be dissected into a SQUARE.

The situation becomes considerably more difficult moving from 2-D to 3-D. In general, a POLYHEDRON cannot be dissected into other POLYHEDRA of a specified type. A CUBE can be dissected into n^3 CUBES, where n is any INTEGER. In 1900, Dehn proved that not every PRISM cannot be dissected into a TETRAHEDRON (Lenhard 1962, Ball and Coxeter 1987) The third of HILBERT'S PROBLEMS asks for the determination of two TETRAHEDRA which cannot be decomposed into congruent TETRAHEDRA directly or by adjoining congruent TETRAHEDRA. Max Dehn showed this could not be done in 1902, and W. F. Kagon obtained the same result independently in 1903. A quantity growing out of Dehn's work which can be used to analyze the possibility of performing a given solid dissection is the DEHN INVARIANT.

The table below is an updated version of the one given in Gardner (1991, p. 50). Many of the improvements are due to G. Theobald (Frederickson 1997). The minimum number of pieces known to dissect a regular n -gon (where n is a number in the first column) into a k -gon (where k is a number in the bottom row) is read off by the intersection of the corresponding row and column. In the table, $\{n\}$ denotes a regular n -gon, GR a GOLDEN RECTANGLE, GC a GREEK CROSS, LC a LATIN CROSS, MC a MALTESE CROSS, SW a SWASTIKA, $\{5/2\}$ a five-point star (solid PENTAGRAM), $\{6/2\}$ a six-point star (i.e., HEXAGRAM or solid STAR OF DAVID), and $\{8/3\}$ the solid OCTAGRAM.

{4}	4									
{5}	6	6								
{6}	5	5	7							
{7}	8	7	9	8						
{8}	7	5	9	8	11					
{9}	8	9	12	11	14	13				
{10}	7	7	10	9	11	10	13			
{12}	8	6	10	6	11	10	14	12		
GR	4	3	6	5	7	6	9	6	7	
GC	5	4	7	7	9	9	12	10	6	
LC	5	5	8	6	8	8	11	10	7	
MC		7		14						
SW		6		12						
{5/2}	7	7	9	9	11	10	14	6	12	
{6/2}	5	5	8	6	9	8	11	9	9	
{8/3}	8	8	9	9	12	6	13	12	12	
	{3}	{4}	{5}	{6}	{7}	{8}	{9}	{10}	{12}	

GC	5								
LC	5	7							
MC		8							
SW		8	9						
{5/2}	7	12	10	10					
{6/2}	5	8	8				11		
{8/3}	7	10	11				13	10	
	GR	GC	LC	MC	SW	{5/2}	{6/2}		

The best-known dissections of one regular convex n -gon into another are shown for $n = 3, 4, 5, 6, 7, 8, 9, 10$, and 12 in the following illustrations due to Theobald.

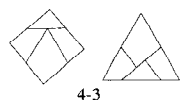

4-3

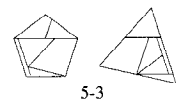

5-3

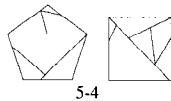

5-4

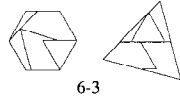

6-3

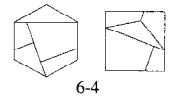

6-4

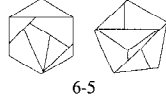

6-5

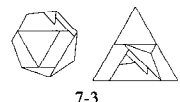

7-3

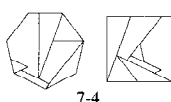

7-4

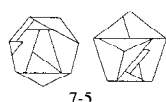

7-5

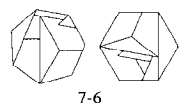

7-6

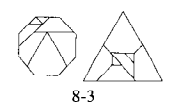

8-3

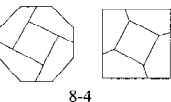

8-4

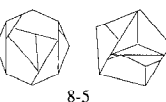

8-5

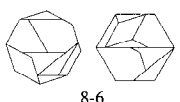

8-6

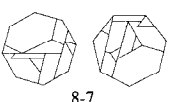

8-7

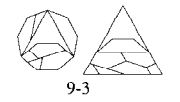

9-3

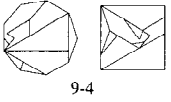

9-4

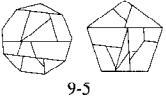

9-5

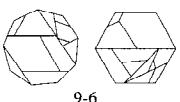

9-6

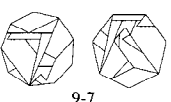

9-7

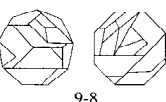

9-8

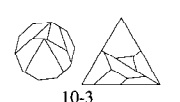

10-3

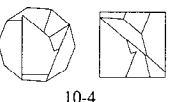

10-4



10-5



10-9

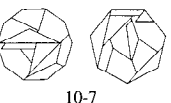

10-7

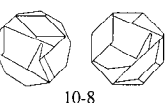

10-8

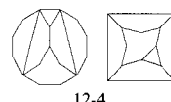

12-4

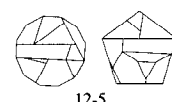

12-5

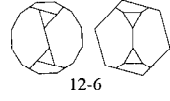

12-6

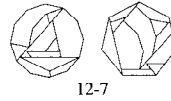

12-7

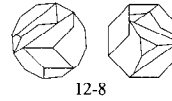

12-8

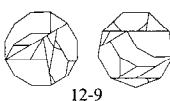

12-9

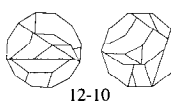

12-10

The best-known dissections of regular concave polygons are illustrated below for $\{5/2\}$, $\{6/2\}$, and $\{8/3\}$ (Theobald).

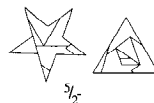
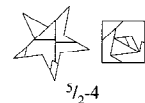
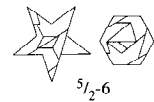
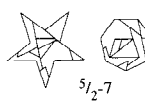
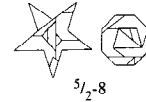
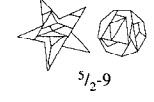
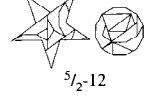
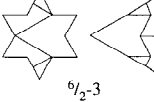
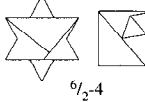
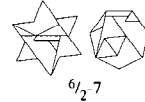
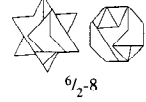
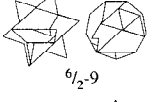
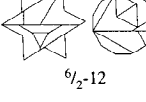
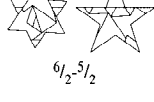
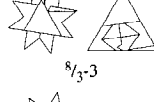
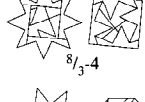
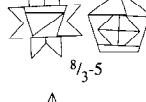
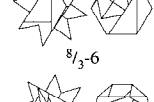
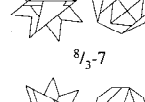
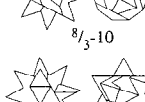
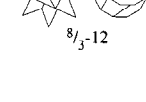
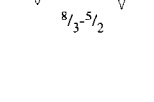
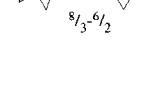
 $5/2-3$  $5/2-4$  $5/2-5$  $5/2-6$  $5/2-7$  $5/2-8$  $5/2-9$  $5/2-12$  $6/2-3$  $6/2-4$  $6/2-7$  $6/2-8$  $6/2-9$  $6/2-12$  $6/2-5/2$  $8/3-3$  $8/3-4$  $8/3-5$  $8/3-6$  $8/3-7$  $8/3-8$  $8/3-9$  $8/3-10$  $8/3-12$  $8/3-5/2$  $8/3-6/2$

The best-known dissections of various crosses are illustrated below (Theobald).

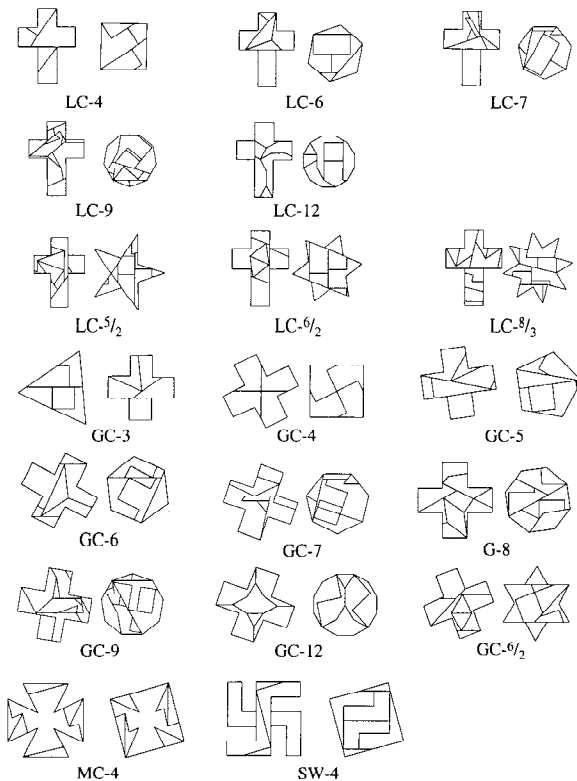

The best-known dissections of the GOLDEN RECTANGLE are illustrated below (Theobald).

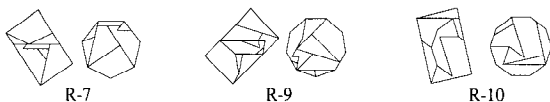

see also BANACH-TARSKI PARADOX, CUNDY AND ROLLETT'S EGG, DECAHEDRON, DEHN INVARIANT, DIABOLICAL CUBE, DISSECTION PUZZLES, DODECAHEDRON, EHRHART POLYNOMIAL, EQUIDECOMPOSABLE, EQUILATERAL TRIANGLE, GOLDEN RECTANGLE, HEPTAGON, HEXAGON, HEXAGRAM, HILBERT'S PROBLEMS, LATIN CROSS, MALTESE CROSS, NONAGON, OCTAGON, OCTAGRAM, PENTAGON, PENTAGRAM, POLYHEDRON DISSECTION, PYTHAGOREAN SQUARE PUZZLE, PYTHAGOREAN THEOREM, REP-TILE, SOMA CUBE, SQUARE, STAR OF LAKSHMI, SWASTIKA, T-PUZZLE, TANGRAM, WALLACE-BOLYAI-GERWEIN THEOREM

References

- Ball, W. W. R. and Coxeter, H. S. M. *Mathematical Recreations and Essays*, 13th ed. New York: Dover, pp. 87–94, 1987.
- Coffin, S. T. *The Puzzling World of Polyhedral Dissections*. New York: Oxford University Press, 1990.
- Cundy, H. and Rollett, A. Ch. 2 in *Mathematical Models*, 3rd ed. Stradbroke, England: Tarquin Pub., 1989.
- Eppstein, D. "Dissection." <http://www.ics.uci.edu/~eppstein/junkyard/dissect.html>.
- Eppstein, D. "Dissection Tiling." <http://www.ics.uci.edu/~eppstein/junkyard/distile>.

- Eriksson, K. "Splitting a Polygon into Two Congruent Pieces." *Amer. Math. Monthly* **103**, 393–400, 1996.
- Frederickson, G. *Dissections: Plane and Fancy*. New York: Cambridge University Press, 1997.
- Gardner, M. *The Second Scientific American Book of Mathematical Puzzles & Diversions: A New Selection*. New York: Simon and Schuster, 1961.
- Gardner, M. "Paper Cutting." Ch. 5 in *Martin Gardner's New Mathematical Diversions from Scientific American*. New York: Simon and Schuster, 1966.
- Gardner, M. *The Unexpected Hanging and Other Mathematical Diversions*. Chicago, IL: Chicago University Press, 1991.
- Hunter, J. A. H. and Madachy, J. S. *Mathematical Diversions*. New York: Dover, pp. 65–67, 1975.
- Kraitchik, M. "Dissection of Plane Figures." §8.1 in *Mathematical Recreations*. New York: W. W. Norton, pp. 193–198, 1942.
- Laczkovich, M. "Von Neumann's Paradox with Translation." *Fund. Math.* **131**, 1–12, 1988.
- Lenhard, H.-C. "Über fünf neue Tetraeder, die einem Würfel äquivalent sind." *Elemente Math.* **17**, 108–109, 1962.
- Lindgren, H. "Geometric Dissections." *Austral. Math. Teacher* **7**, 7–10, 1951.
- Lindgren, H. "Geometric Dissections." *Austral. Math. Teacher* **9**, 17–21, 1953.
- Lindgren, H. "Going One Better in Geometric Dissections." *Math. Gaz.* **45**, 94–97, 1961.
- Lindgren, H. *Recreational Problems in Geometric Dissection and How to Solve Them*. New York: Dover, 1972.
- Madachy, J. S. "Geometric Dissection." Ch. 1 in *Madachy's Mathematical Recreations*. New York: Dover, pp. 15–33, 1979.
- Pappas, T. "A Triangle to a Square." *The Joy of Mathematics*. San Carlos, CA: Wide World Publ./Tetra, pp. 9 and 230, 1989.
- Stewart, I. *The Problems of Mathematics*, 2nd ed. Oxford, England: Oxford University Press, 1987.

Dissection Puzzles

A puzzle in which one object is to be converted to another by making a finite number of cuts and reassembling it. The cuts are often, but not always, restricted to straight lines. Sometimes, a given puzzle is pre-cut and is to be re-assembled into two or more given shapes.

see also CUNDY AND ROLLETT'S EGG, PYTHAGOREAN SQUARE PUZZLE, T-PUZZLE, TANGRAM

Dissipative System

A system in which the phase space volume contracts along a trajectory. This means that the generalized DIVERGENCE is less than zero,

$$\frac{\partial f_i}{\partial x_i} < 0,$$

where EINSTEIN SUMMATION has been used.

Distance

Let $\gamma(t)$ be a smooth curve in a MANIFOLD M from x to y with $\gamma(0) = x$ and $\gamma(1) = y$. Then $\gamma'(t) \in T_{\gamma(t)}$, where

T_x is the TANGENT SPACE of M at x . The LENGTH of γ with respect to the Riemannian structure is given by

$$\int_0^1 \|\gamma'(t)\|_{\gamma(t)} dt, \quad (1)$$

and the distance $d(x, y)$ between x and y is the shortest distance between x and y given by

$$d(x, y) = \inf_{\gamma: x \text{ to } y} \int \|\gamma'(t)\|_{\gamma(t)} dt. \quad (2)$$

In order to specify the relative distances of $n > 1$ points in the plane, $1+2(n-2) = 2n-3$ coordinates are needed, since the first can always be taken as $(0, 0)$ and the second as $(x, 0)$, which defines the x -AXIS. The remaining $n-2$ points need two coordinates each. However, the total number of distances is

$$\binom{n}{2} = \frac{n!}{2!(n-2)!} = \frac{1}{2}n(n-1), \quad (3)$$

where $\binom{n}{k}$ is a BINOMIAL COEFFICIENT. The distances between $n > 1$ points are therefore subject to m relationships, where

$$m \equiv \frac{1}{2}n(n-1) - (2n-3) = \frac{1}{2}(n-2)(n-3). \quad (4)$$

For $n = 1, 2, \dots$, this gives 0, 0, 0, 1, 3, 6, 10, 15, 21, 28, ... (Sloane's A000217) relationships, and the number of relationships between n points is the TRIANGULAR NUMBER T_{n-3} .

Although there are no relationships for $n = 2$ and $n = 3$ points, for $n = 4$ (a QUADRILATERAL), there is one (Weinberg 1972):

$$\begin{aligned} 0 = & d_{12}^4 d_{34}^2 + d_{13}^4 d_{24}^2 + d_{14}^4 d_{23}^2 + d_{23}^4 d_{14}^2 \\ & + d_{24}^4 d_{13}^2 + d_{34}^4 d_{12}^2 \\ & + d_{12}^2 d_{23}^2 d_{31}^2 + d_{12}^2 d_{24}^2 d_{41}^2 + d_{12}^2 d_{34}^2 d_{41}^2 \\ & + d_{23}^2 d_{34}^2 d_{42}^2 - d_{12}^2 d_{23}^2 d_{34}^2 - d_{13}^2 d_{32}^2 d_{24}^2 \\ & - d_{12}^2 d_{24}^2 d_{43}^2 - d_{14}^2 d_{42}^2 d_{23}^2 - d_{13}^2 d_{34}^2 d_{42}^2 \\ & - d_{14}^2 d_{43}^2 d_{32}^2 - d_{23}^2 d_{31}^2 d_{14}^2 - d_{21}^2 d_{13}^2 d_{34}^2 \\ & - d_{24}^2 d_{41}^2 d_{13}^2 - d_{21}^2 d_{14}^2 d_{43}^2 - d_{31}^2 d_{12}^2 d_{24}^2 \\ & - d_{32}^2 d_{21}^2 d_{14}^2. \end{aligned} \quad (5)$$

This equation can be derived by writing

$$d_{ij} \equiv \sqrt{(x_i - x_j)^2 + (y_i - y_j)^2} \quad (6)$$

and eliminating x_i and y_j from the equations for d_{12} , d_{13} , d_{14} , d_{23} , d_{24} , and d_{34} .

see also ARC LENGTH, CUBE POINT PICKING, EXPANSIVE, LENGTH (CURVE), METRIC, PLANAR DISTANCE, POINT-LINE DISTANCE—2-D, POINT-LINE

DISTANCE—3-D, POINT-PLANE DISTANCE, POINT-POINT DISTANCE—1-D, POINT-POINT DISTANCE—2-D, POINT-POINT DISTANCE—3-D, SPACE DISTANCE, SPHERE

References

- Gray, A. "The Intuitive Idea of Distance on a Surface." §13.1 in *Modern Differential Geometry of Curves and Surfaces*. Boca Raton, FL: CRC Press, pp. 251–255, 1993.
Sloane, N. J. A. Sequence A000217/M2535 in "An On-Line Version of the Encyclopedia of Integer Sequences."
Weinberg, S. *Gravitation and Cosmology: Principles and Applications of the General Theory of Relativity*. New York: Wiley, p. 7, 1972.

Distinct Prime Factors

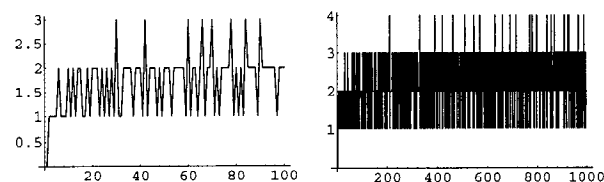

The number of distinct prime factors of a number n is denoted $\omega(n)$. The first few values for $n = 1, 2, \dots$ are 0, 1, 1, 1, 1, 2, 1, 1, 1, 2, 1, 2, 1, 2, 2, 1, 1, 2, 1, 2, ... (Sloane's A001221). The first few values of the SUMMATORY FUNCTION

$$\sum_{k=2}^n \omega(k)$$

are 1, 2, 3, 4, 6, 7, 8, 9, 11, 12, 14, 15, 17, 19, 20, 21, ... (Sloane's A013939), and the asymptotic value is

$$\sum_{k=2}^n \omega(k) = n \ln \ln n + B_1 n + o(n),$$

where B_1 is MERTENS CONSTANT. In addition,

$$\sum_{k=2}^n [\omega(k)]^2 = n(\ln \ln n)^2 + O(n \ln \ln n).$$

see also DIVISOR FUNCTION, GREATEST PRIME FACTOR, HARDY-RAMANUJAN THEOREM, HETEROGENEOUS NUMBERS, LEAST PRIME FACTOR, MERTENS CONSTANT, PRIME FACTORS

References

- Hardy, G. H. and Wright, E. M. "The Number of Prime Factors of n " and "The Normal Order of $\omega(n)$ and $\Omega(n)$." §22.10 and 22.11 in *An Introduction to the Theory of Numbers*, 5th ed. Oxford, England: Clarendon Press, pp. 354–358, 1979.
Sloane, N. J. A. Sequences A013939 and A001221/M0056 in "An On-Line Version of the Encyclopedia of Integer Sequences."

Distribution

The distribution of a variable is a description of the relative numbers of times each possible outcome will occur in a number of trials. The function describing the distribution is called the PROBABILITY FUNCTION, and the function describing the probability that a given value or any value smaller than it will occur is called the DISTRIBUTION FUNCTION.

Formally, a distribution can be defined as a normalized MEASURE, and the distribution of a RANDOM VARIABLE x is the MEASURE P_x on S' defined by setting

$$P_x(A') = P\{s \in S : x(s) \in A'\},$$

where (S, \mathbb{S}, P) is a PROBABILITY SPACE, (S, \mathbb{S}) is a MEASURABLE SPACE, and P a MEASURE on \mathbb{S} with $P(S) = 1$.

see also CONTINUOUS DISTRIBUTION, DISCRETE DISTRIBUTION, DISTRIBUTION FUNCTION, MEASURABLE SPACE, MEASURE, PROBABILITY, PROBABILITY DENSITY FUNCTION, RANDOM VARIABLE, STATISTICS

References

Doob, J. L. "The Development of Rigor in Mathematical Probability (1900–1950)." *Amer. Math. Monthly* **103**, 586–595, 1996.

Distribution Function

The distribution function $D(x)$, sometimes also called the PROBABILITY DISTRIBUTION FUNCTION, describes the probability that a trial X takes on a value less than or equal to a number x . The distribution function is therefore related to a continuous PROBABILITY DENSITY FUNCTION $P(x)$ by

$$D(x) = P(X \leq x) \equiv \int_{-\infty}^x P(x') dx', \quad (1)$$

so $P(x)$ (when it exists), is simply the derivative of the distribution function

$$P(x) = D'(x) = [P(x')]_{-\infty}^x = P(x) - P(-\infty). \quad (2)$$

Similarly, the distribution function is related to a discrete probability $P(x)$ by

$$D(x) = P(X \leq x) = \sum_{X \leq x} P(x). \quad (3)$$

In general, there exist distributions which are neither continuous nor discrete.

A JOINT DISTRIBUTION FUNCTION can be defined if outcomes are dependent on two parameters:

$$D(x, y) \equiv P(X \leq x, Y \leq y) \quad (4)$$

$$D_x(x) \equiv D(x, \infty) \quad (5)$$

$$D_y(y) \equiv D(\infty, y). \quad (6)$$

Similarly, a multiple distribution function can be defined if outcomes depend on n parameters:

$$D(a_1, \dots, a_n) \equiv P(x_1 \leq a_1, \dots, x_n \leq a_n). \quad (7)$$

Given a continuous $P(x)$, assume you wish to generate numbers distributed as $P(x)$ using a random number generator. If the random number generator yields a uniformly distributed value y_i in $[0, 1]$ for each trial i , then compute

$$D(x) \equiv \int_{-\infty}^x P(x') dx'. \quad (8)$$

The FORMULA connecting y_i with a variable distributed as $P(x)$ is then

$$x_i = D^{-1}(y_i), \quad (9)$$

where $D^{-1}(x)$ is the inverse function of $D(x)$. For example, if $P(x)$ were a GAUSSIAN DISTRIBUTION so that

$$D(x) = \frac{1}{2} \left[1 + \operatorname{erf} \left(\frac{x - \mu}{\sigma\sqrt{2}} \right) \right], \quad (10)$$

then

$$x_i = \sigma\sqrt{2} \operatorname{erf}^{-1}(2y_i - 1) + \mu. \quad (11)$$

If $P(x) = Cx^n$ for $x \in (x_{\min}, x_{\max})$, then normalization gives

$$\int_{x_{\min}}^{x_{\max}} P(x) dx = C \frac{[x^{n+1}]_{x_{\min}}^{x_{\max}}}{n+1} = 1, \quad (12)$$

so

$$C = \frac{n+1}{x_{\max}^{n+1} - x_{\min}^{n+1}}. \quad (13)$$

Let y be a uniformly distributed variate on $[0, 1]$. Then

$$\begin{aligned} D(x) &= \int_{x_{\min}}^x P(x) dx = C \int_{x_{\min}}^x x^n dx \\ &= \frac{C}{n+1} (x^{n+1} - x_{\min}^{n+1}) \equiv y, \end{aligned} \quad (14)$$

and the variate given by

$$\begin{aligned} x &= \left(\frac{n+1}{C} y + x_{\min}^{n+1} \right)^{1/(n+1)} \\ &= [(x_{\max}^{n+1} - x_{\min}^{n+1})y + x_{\min}^{n+1}]^{1/(n+1)} \end{aligned} \quad (15)$$

is distributed as $P(x)$.

A distribution with constant VARIANCE of y for all values of x is known as a HOMOSCEDASTIC distribution. The method of finding the value at which the distribution is a maximum is known as the MAXIMUM LIKELIHOOD method.

see also BERNOULLI DISTRIBUTION, BETA DISTRIBUTION, BINOMIAL DISTRIBUTION, BIVARIATE DISTRIBUTION, CAUCHY DISTRIBUTION, CHI DISTRIBUTION, CHI-SQUARED DISTRIBUTION, CORNISH-FISHER

ASYMPTOTIC EXPANSION, CORRELATION COEFFICIENT, DISTRIBUTION, DOUBLE EXPONENTIAL DISTRIBUTION, EQUALLY LIKELY OUTCOMES DISTRIBUTION, EXPONENTIAL DISTRIBUTION, EXTREME VALUE DISTRIBUTION, *F*-DISTRIBUTION, FERMI-DIRAC DISTRIBUTION, FISHER'S *z*-DISTRIBUTION, FISHER-TIPPETT DISTRIBUTION, GAMMA DISTRIBUTION, GAUSSIAN DISTRIBUTION, GEOMETRIC DISTRIBUTION, HALF-NORMAL DISTRIBUTION, HYPERGEOMETRIC DISTRIBUTION, JOINT DISTRIBUTION FUNCTION, LAPLACE DISTRIBUTION, LATTICE DISTRIBUTION, LÉVY DISTRIBUTION, LOGARITHMIC DISTRIBUTION, LOG-SERIES DISTRIBUTION, LOGISTIC DISTRIBUTION, LORENTZIAN DISTRIBUTION, MAXWELL DISTRIBUTION, NEGATIVE BINOMIAL DISTRIBUTION, NORMAL DISTRIBUTION, PARETO DISTRIBUTION, PASCAL DISTRIBUTION, PEARSON TYPE III DISTRIBUTION, POISSON DISTRIBUTION, PÓLYA DISTRIBUTION, RATIO DISTRIBUTION, RAYLEIGH DISTRIBUTION, RICE DISTRIBUTION, SNEDECOR'S *F*-DISTRIBUTION, STUDENT'S *t*-DISTRIBUTION, STUDENT'S *z*-DISTRIBUTION, UNIFORM DISTRIBUTION, WEIBULL DISTRIBUTION

References

- Abramowitz, M. and Stegun, C. A. (Eds.). "Probability Functions." Ch. 26 in *Handbook of Mathematical Functions with Formulas, Graphs, and Mathematical Tables*, 9th printing. New York: Dover, pp. 925–964, 1972.
- Iyanaga, S. and Kawada, Y. (Eds.). "Distribution of Typical Random Variables." Appendix A, Table 22 in *Encyclopedic Dictionary of Mathematics*. Cambridge, MA: MIT Press, pp. 1483–1486, 1980.

Distribution (Functional)

A functional distribution, also called a GENERALIZED FUNCTION, is a generalization of the concept of a function. Functional distributions are defined as continuous linear FUNCTIONALS over a SPACE of infinitely differentiable functions such that all continuous functions have SCHWARZIAN DERIVATIVES which are themselves distributions. The most commonly encountered functional distribution is the DELTA FUNCTION.

see also DELTA FUNCTION, GENERALIZED FUNCTION, SCHWARZIAN DERIVATIVE

References

- Friedlander, F. G. *Introduction to the Theory of Distributions*. Cambridge, England: Cambridge University Press, 1982.
- Gel'fand, I. M. and Shilov, G. E. *Generalized Functions*, Vol. 1: *Properties and Operations*. New York: Harcourt Brace, 1977.
- Gel'fand, I. M. and Shilov, G. E. *Generalized Functions*, Vol. 2: *Spaces of Fundamental and Generalized Functions*. New York: Harcourt Brace, 1977.
- Gel'fand, I. M. and Shilov, G. E. *Generalized Functions*, Vol. 3: *Theory of Differential Equations*. New York: Harcourt Brace, 1977.
- Gel'fand, I. M. and Vilenkin, N. Ya. *Generalized Functions*, Vol. 4: *Applications of Harmonic Analysis*. New York: Harcourt Brace, 1977.
- Gel'fand, I. M.; Graev, M. I.; and Vilenkin, N. Ya. *Generalized Functions*, Vol. 5: *Integral Geometry and Representation Theory*. New York: Harcourt Brace, 1977.

Griffel, D. H. *Applied Functional Analysis*. Englewood Cliffs, NJ: Prentice-Hall, 1984.

Halperin, I. and Schwartz, L. *Introduction to the Theory of Distributions, Based on the Lectures Given by Laurent Schwarz*. Toronto, Canada: University of Toronto Press, 1952.

Lighthill, M. J. *Introduction to Fourier Analysis and Generalised Functions*. Cambridge, England: Cambridge University Press, 1958.

Richards, I. and Young, H. *The Theory of Distributions: A Nontechnical Introduction*. New York: Cambridge University Press, 1995.

Rudin, W. *Functional Analysis*, 2nd ed. New York: McGraw-Hill, 1991.

Strichartz, R. *Fourier Transforms and Distribution Theory*. Boca Raton, FL: CRC Press, 1993.

Zemanian, A. H. *Distribution Theory and Transform Analysis: An Introduction to Generalized Functions, with Applications*. New York: Dover, 1987.

Distribution Parameter

The distribution parameter of a NONCYLINDRICAL RULED SURFACE parameterized by

$$\mathbf{x}(u, v) = \boldsymbol{\sigma}(u) + v\boldsymbol{\delta}(u), \quad (1)$$

where $\boldsymbol{\sigma}$ is the STRICTION CURVE and $\boldsymbol{\delta}$ the DIRECTOR CURVE, is the function p defined by

$$p = \frac{\det(\boldsymbol{\sigma}'\boldsymbol{\delta}\boldsymbol{\delta}')}{\boldsymbol{\delta}' \cdot \boldsymbol{\delta}'} \quad (2)$$

The GAUSSIAN CURVATURE of a RULED SURFACE is given in terms of its distribution parameter by

$$K = -\frac{[p(u)]^2}{\{[p(u)]^2 + v^2\}^2} \quad (3)$$

see also NONCYLINDRICAL RULED SURFACE, STRICTION CURVE

References

- Gray, A. *Modern Differential Geometry of Curves and Surfaces*. Boca Raton, FL: CRC Press, pp. 347–348, 1993.

Distribution (Statistical)

The set of probabilities for each possible event.

see DISTRIBUTION FUNCTION

Distributive

Elements of an ALGEBRA which obey the identity

$$A(B + C) = AB + AC$$

are said to be distributive over the operation $+$.

see also ASSOCIATIVE, COMMUTATIVE, TRANSITIVE

Distributive Lattice

A LATTICE which satisfies the identities

$$(x \wedge y) \vee (x \wedge z) = x \wedge (y \vee z)$$

$$(x \vee y) \wedge (x \vee z) = x \vee (y \wedge z)$$

is said to be distributive.

see also LATTICE, MODULAR LATTICE

References

Grätzer, G. *Lattice Theory: First Concepts and Distributive Lattices*. San Francisco, CA: W. H. Freeman, pp. 35–36, 1971.

Disymmetric

An object which is not superimposable on its MIRROR IMAGE is said to be disymmetric. All asymmetric objects are disymmetric, and an object with no IMPROPER ROTATION (rotoinversion) axis must also be disymmetric.

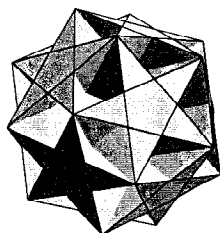
Ditrigonal Dodecadodecahedron

The UNIFORM POLYHEDRON U_{41} , also called the DITRIGONAL DODECAHEDRON, whose DUAL POLYHEDRON is the MEDIAL TRIAMBIC ICOSAEDRON. It has WYTHOFF SYMBOL $3 | \frac{5}{3} 5$. Its faces are $12\{\frac{5}{2}\} + 12\{5\}$. It is a FACETED version of the SMALL DITRIGONAL ICOSIDODECAHEDRON. The CIRCUMRADIUS for unit edge length is

$$R = \frac{1}{2}\sqrt{3}.$$

References

Wenninger, M. J. *Polyhedron Models*. Cambridge, England: Cambridge University Press, pp. 123–124, 1989.

Ditrigonal Dodecahedron

see DITRIGONAL DODECADODECAHEDRON

Divergence

The divergence of a VECTOR FIELD \mathbf{F} is given by

$$\text{div}(\mathbf{F}) \equiv \nabla \cdot \mathbf{F} \equiv \lim_{V \rightarrow 0} \frac{\oint_S \mathbf{F} \cdot d\mathbf{a}}{V}. \quad (1)$$

Define

$$\mathbf{F} \equiv F_1 \hat{\mathbf{u}}_1 + F_2 \hat{\mathbf{u}}_2 + F_3 \hat{\mathbf{u}}_3. \quad (2)$$

Then in arbitrary orthogonal CURVILINEAR COORDINATES,

$$\text{div}(\mathbf{F}) \equiv \nabla \cdot \mathbf{F} \equiv \frac{1}{h_1 h_2 h_3} \left[\frac{\partial}{\partial u_1} (h_2 h_3 F_1) + \frac{\partial}{\partial u_2} (h_3 h_1 F_2) + \frac{\partial}{\partial u_3} (h_1 h_2 F_3) \right]. \quad (3)$$

If $\nabla \cdot \mathbf{F} = 0$, then the field is said to be a DIVERGENCELESS FIELD. For divergence in individual coordinate systems, see CURVILINEAR COORDINATES.

$$\nabla \cdot \frac{\mathbf{Ax}}{|\mathbf{x}|} = \frac{\text{Tr}(\mathbf{A})}{|\mathbf{x}|} - \frac{\mathbf{x}^T (\mathbf{Ax})}{|\mathbf{x}|^3}. \quad (4)$$

The divergence of a TENSOR A is

$$\nabla \cdot A \equiv A_{;\alpha}^\alpha = A_{,k}^k + \Gamma_{jk}^k A^j, \quad (5)$$

where ; is the COVARIANT DERIVATIVE. Expanding the terms gives

$$\begin{aligned} A_{;\alpha}^\alpha &= A_{,\alpha}^\alpha + (\Gamma_{\alpha\alpha}^\alpha A^\alpha + \Gamma_{\beta\alpha}^\alpha A^\beta + \Gamma_{\gamma\alpha}^\alpha A^\gamma) \\ &+ A_{,\beta}^\beta + (\Gamma_{\alpha\beta}^\beta A^\alpha + \Gamma_{\beta\beta}^\beta A^\beta + \Gamma_{\gamma\beta}^\beta A^\gamma) \\ &+ A_{,\gamma}^\gamma + (\Gamma_{\alpha\gamma}^\gamma A^\alpha + \Gamma_{\beta\gamma}^\gamma A^\beta + \Gamma_{\gamma\gamma}^\gamma A^\gamma). \end{aligned} \quad (6)$$

see also CURL, CURL THEOREM, GRADIENT, GREEN'S THEOREM, DIVERGENCE THEOREM, VECTOR DERIVATIVE

References

Arfken, G. "Divergence, $\nabla \cdot$." §1.7 in *Mathematical Methods for Physicists*, 3rd ed. Orlando, FL: Academic Press, pp. 37–42, 1985.

Divergence Tests

If

$$\lim_{k \rightarrow \infty} u_k \neq 0,$$

then the series $\{u_n\}$ diverges.

see also CONVERGENCE TESTS, CONVERGENT SERIES, DINI'S TEST, SERIES

Divergence Theorem

A.k.a. GAUSS'S THEOREM. Let V be a region in space with boundary ∂V . Then

$$\int_V (\nabla \cdot \mathbf{F}) dV = \int_{\partial V} \mathbf{F} \cdot d\mathbf{a}. \quad (1)$$

Let S be a region in the plane with boundary ∂S .

$$\int_S \nabla \cdot \mathbf{F} dA = \int_{\partial S} \mathbf{F} \cdot \mathbf{n} ds. \quad (2)$$

If the VECTOR FIELD \mathbf{F} satisfies certain constraints, simplified forms can be used. If $\mathbf{F}(x, y, z) = v(x, y, z)\mathbf{c}$ where \mathbf{c} is a constant vector $\neq \mathbf{0}$, then

$$\int_S \mathbf{F} \cdot d\mathbf{a} = \mathbf{c} \cdot \int_S v d\mathbf{a}. \quad (3)$$

But

$$\nabla \cdot (f\mathbf{v}) = (\nabla f) \cdot \mathbf{v} + f(\nabla \cdot \mathbf{v}), \quad (4)$$

so

$$\int_V \nabla \cdot (c\mathbf{v}) dV = \mathbf{c} \cdot \int_V (\nabla \mathbf{v} + \mathbf{v} \nabla \cdot \mathbf{c}) dV = \mathbf{c} \cdot \int_V \nabla \mathbf{v} dV \quad (5)$$

$$\mathbf{c} \cdot \left(\int_S v d\mathbf{a} - \int_V \nabla v dV \right) = 0. \quad (6)$$

But $\mathbf{c} \neq \mathbf{0}$, and $\mathbf{c} \cdot \mathbf{f}(v)$ must vary with v so that $\mathbf{c} \cdot \mathbf{f}(v)$ cannot always equal zero. Therefore,

$$\int_S v d\mathbf{a} = \int_V \nabla v dV. \quad (7)$$

If $\mathbf{F}(x, y, z) = \mathbf{c} \times P(x, y, z)$, where \mathbf{c} is a constant vector $\neq \mathbf{0}$, then

$$\int_S d\mathbf{a} \times \mathbf{P} = \int_V \nabla \times \mathbf{P} dV. \quad (8)$$

see also CURL THEOREM, GRADIENT, GREEN'S THEOREM

References

Arfken, G. "Gauss's Theorem." §1.11 in *Mathematical Methods for Physicists*, 3rd ed. Orlando, FL: Academic Press, pp. 57–61, 1985.

Divergenceless Field

A divergenceless field, also called a SOLENOIDAL FIELD, is a FIELD for which $\nabla \cdot \mathbf{F} = 0$. Therefore, there exists a \mathbf{G} such that $\mathbf{F} = \nabla \times \mathbf{G}$. Furthermore, \mathbf{F} can be written as

$$\mathbf{F} = \nabla \times (T\mathbf{r}) + \nabla^2(S\mathbf{r}) \equiv \mathbf{T} + \mathbf{S},$$

where

$$\begin{aligned} \mathbf{T} &\equiv \nabla \times (T\mathbf{r}) = -\mathbf{r} \times (\nabla T) \\ \mathbf{S} &\equiv \nabla^2(S\mathbf{r}) = \nabla \left[\frac{\partial}{\partial r}(rS) \right] - \mathbf{r} \nabla^2 S. \end{aligned}$$

Following Lamb, \mathbf{T} and \mathbf{S} are called TOROIDAL FIELD and POLOIDAL FIELD.

see also BELTRAMI FIELD, IRROTATIONAL FIELD, POLOIDAL FIELD, SOLENOIDAL FIELD, TOROIDAL FIELD

Divergent Sequence

A divergent sequence is a SEQUENCE for which the LIMIT exists but is not CONVERGENT.

see also CONVERGENT SEQUENCE, DIVERGENT SERIES

Divergent Series

A SERIES which is not CONVERGENT. Series may diverge by marching off to infinity or by oscillating.

see also CONVERGENT SERIES, DIVERGENT SEQUENCE

References

Bromwich, T. J. I'a and MacRobert, T. M. *An Introduction to the Theory of Infinite Series*, 3rd ed. New York: Chelsea, 1991.

Diversity Condition

For any group of k men out of N , there must be at least k jobs for which they are collectively qualified.

Divide

To divide is to perform the operation of DIVISION, i.e., to see how many time a DIVISOR d goes into another number n . n divided by d is written n/d or $n \div d$. The result need not be an INTEGER, but if it is, some additional terminology is used. $d|n$ is read " d divides n " and means that d is a PROPER DIVISOR of n . In this case, n is said to be DIVISIBLE by d . Clearly, $1|n$ and $n|n$. By convention, $n|0$ for every n except 0 (Hardy and Wright 1979). The "divided" operation satisfies

$$\begin{aligned} b|a \text{ and } c|b &\Rightarrow c|a \\ b|a &\Rightarrow bc|ac \\ c|a \text{ and } c|b &\Rightarrow c|(ma + nb). \end{aligned}$$

$d'|n$ is read " d' does not divide n " and means that d' is not a PROPER DIVISOR of n . $a^k||b$ means a^k divides b exactly.

see also CONGRUENCE, DIVISIBLE, DIVISION, DIVISOR

References

Hardy, G. H. and Wright, E. M. *An Introduction to the Theory of Numbers*, 5th ed. Oxford, England: Clarendon Press, p. 1, 1979.

Divided Difference

The divided difference $f[x_1, x_2, \dots, x_n]$ on n points x_1, x_2, \dots, x_n of a function $f(x)$ is defined by $f[x_1] \equiv f(x_1)$ and

$$f[x_1, x_2, \dots, x_n] = \frac{f[x_1, \dots, x_n] - f[x_2, \dots, x_n]}{x_1 - x_n} \quad (1)$$

for $n \geq 2$. The first few differences are

$$[x_0, x_1] = \frac{f_0 - f_1}{x_0 - x_1} \quad (2)$$

$$[x_0, x_1, x_2] = \frac{[x_0, x_1] - [x_1, x_2]}{x_0 - x_2} \quad (3)$$

$$[x_0, x_1, \dots, x_n] = \frac{[x_0, \dots, x_{n-1}] - [x_1, \dots, x_n]}{x_0 - x_n}. \quad (4)$$

Defining

$$\pi_n(x) \equiv (x - x_0)(x - x_1) \cdots (x - x_n) \quad (5)$$

and taking the DERIVATIVE

$$\pi'_n(x_k) = (x_k - x_0) \cdots (x_k - x_{k-1})(x_k - x_{k+1}) \cdots (x_k - x_n) \quad (6)$$

gives the identity

$$[x_0, x_1, \dots, x_n] = \sum_{k=0}^n \frac{f_k}{\pi'_n(x_k)}. \quad (7)$$

Consider the following question: does the property

$$f[x_1, x_2, \dots, x_n] = h(x_1 + x_2 + \dots + x_n) \quad (8)$$

for $n \geq 2$ and $h(x)$ a given function guarantee that $f(x)$ is a POLYNOMIAL of degree $\leq n$? Aczél (1985) showed that the answer is “yes” for $n = 2$, and Bailey (1992) showed it to be true for $n = 3$ with differentiable $f(x)$. Schwaiger (1994) and Andersen (1996) subsequently showed the answer to be “yes” for all $n \geq 3$ with restrictions on $f(x)$ or $h(x)$.

see also NEWTON'S DIVIDED DIFFERENCE INTERPOLATION FORMULA, RECIPROCAL DIFFERENCE

References

- Abramowitz, M. and Stegun, C. A. (Eds.). *Handbook of Mathematical Functions with Formulas, Graphs, and Mathematical Tables*, 9th printing. New York: Dover, pp. 877–878, 1972.
- Aczél, J. “A Mean Value Property of the Derivative of Quadratic Polynomials—Without Mean Values and Derivatives.” *Math. Mag.* **58**, 42–45, 1985.
- Andersen, K. M. “A Characterization of Polynomials.” *Math. Mag.* **69**, 137–142, 1996.
- Bailey, D. F. “A Mean-Value Property of Cubic Polynomials—Without Mean Values.” *Math. Mag.* **65**, 123–124, 1992.
- Beyer, W. H. (Ed.) *CRC Standard Mathematical Tables*, 28th ed. Boca Raton, FL: CRC Press, pp. 439–440, 1987.
- Schwaiger, J. “On a Characterization of Polynomials by Divided Differences.” *Aequationes Math.* **48**, 317–323, 1994.

Divine Proportion

see GOLDEN RATIO

Divisibility Tests

Write a decimal number a out digit by digit in the form $a_n \dots a_3 a_2 a_1 a_0$. It is always true that $10^0 = 1 \equiv 1$ for any base.

- 2 $10^1 \equiv 0$, so $10^n \equiv 0$ for $n \geq 1$. Therefore, if the last digit a_0 is divisible by 2 (i.e., is EVEN), then so is a .
- 3 $10^1 \equiv 1$, $10^2 \equiv 1$, \dots , $10^n \equiv 1$. Therefore, if $\sum_{i=1}^n a_i$ is divisible by 3, so is a .
- 4 $10^1 \equiv 2$, $10^2 \equiv 0$, \dots , $10^n \equiv 0$. So if the last two digits are divisible by 4, more specifically if $r \equiv a_0 + 2a_1$ is, then so is a .
- 5 $10^1 \equiv 0$, so $10^n \equiv 0$ for $n \geq 1$. Therefore, if the last digit a_0 is divisible by 5 (i.e., is 5 or 0), then so is a .
- 6 $10^1 \equiv -2$, $10^2 \equiv -2$, so $10^n \equiv -2$. Therefore, if $r \equiv a_0 - 2 \sum_{i=1}^n a_i$ is divisible by 6, so is a . If a is divisible by 3 and is EVEN, it is also divisible by 6.
- 7 $10^1 \equiv 3$, $10^2 \equiv 2$, $10^3 \equiv -1$, $10^4 \equiv -3$, $10^5 \equiv -2$, $10^6 \equiv 1$, and the sequence then repeats. Therefore, if $r \equiv (a_0 + 3a_1 + 2a_2 - a_3 - 3a_4 - 2a_5) + (a_6 + 3a_7 + \dots) + \dots$ is divisible by 7, so is a .

8 $10^1 \equiv 2$, $10^2 \equiv 4$, $10^3 \equiv 0$, \dots , $10^n \equiv 0$. Therefore, if the last three digits are divisible by 8, more specifically if $r \equiv a_0 + 2a_1 + 4a_2$ is, then so is a .

9 $10^1 \equiv 1$, $10^2 \equiv 1$, \dots , $10^3 \equiv 1$. Therefore, if $\sum_{i=1}^n a_i$ is divisible by 9, so is a .

10 $10^1 \equiv 0$, so if the last digit is 0, then a is divisible by 10.

11 $10^1 \equiv -1$, $10^2 \equiv 1$, $10^3 \equiv -1$, $10^4 \equiv 1$, \dots . Therefore, if $r \equiv a_0 - a_1 + a_2 - a_3 + \dots$ is divisible by 11, then so is a .

12 $10^1 \equiv -2$, $10^2 \equiv 4$, $10^3 \equiv 4$, \dots . Therefore, if $r \equiv a_0 - 2a_1 + 4(a_2 + a_3 + \dots)$ is divisible by 12, then so is a . Divisibility by 12 can also be checked by seeing if a is divisible by 3 and 4.

13 $10^1 \equiv -3$, $10^2 \equiv -4$, $10^3 \equiv -1$, $10^4 \equiv 3$, $10^5 \equiv 4$, $10^6 \equiv 1$, and the pattern repeats. Therefore, if $r \equiv (a_0 - 3a_1 - 4a_2 - a_3 + 3a_4 + 4a_5) + (a_6 - 3a_7 + \dots) + \dots$ is divisible by 13, so is a .

For additional tests for 13, see Gardner (1991).

References

- Dickson, L. E. *History of the Theory of Numbers*, Vol. 1: *Divisibility and Primality*. New York: Chelsea, pp. 337–346, 1952.
- Gardner, M. Ch. 14 in *The Unexpected Hanging and Other Mathematical Diversions*. Chicago, IL: Chicago University Press, 1991.

Divisible

A number n is said to be divisible by d if d is a PROPER DIVISOR of n . The sum of any n consecutive INTEGERS is divisible by $n!$, where $n!$ is the FACTORIAL.

see also DIVIDE, DIVISOR, DIVISOR FUNCTION

References

- Guy, R. K. “Divisibility.” Ch. B in *Unsolved Problems in Number Theory*, 2nd ed. New York: Springer-Verlag, pp. 44–104, 1994.

Division

Taking the RATIO x/y of two numbers x and y , also written $x \div y$. Here, y is called the DIVISOR. The symbol “/” is called a SOLIDUS (or DIAGONAL), and the symbol “÷” is called the OBELUS. Division in which the fractional (remainder) is discarded is called INTEGER DIVISION, and is sometimes denoted using a backslash, \.

see also ADDITION, DIVIDE, INTEGER DIVISION, LONG DIVISION, MULTIPLICATION, OBELUS, ODDS, RATIO, SKELETON DIVISION, SOLIDUS, SUBTRACTION, TRIAL DIVISION

Division Algebra

A division algebra, also called a DIVISION RING or SKEW FIELD, is a RING in which every NONZERO element has a multiplicative inverse, but multiplication is not COMMUTATIVE. Explicitly, a division algebra is a set together with two BINARY OPERATORS $S(+, *)$ satisfying the following conditions:

1. Additive associativity: For all $a, b, c \in S$, $(a+b)+c = a+(b+c)$,
2. Additive commutativity: For all $a, b \in S$, $a+b = b+a$,
3. Additive identity: There exists an element $0 \in S$ such that for all $a \in S$, $0+a = a+0 = a$,
4. Additive inverse: For every $a \in S$ there exists a $-a \in S$ such that $a+(-a) = (-a)+a = 0$,
5. Multiplicative associativity: For all $a, b, c \in S$, $(a*b)*c = a*(b*c)$,
6. Multiplicative identity: There exists an element $1 \in S$ not equal to 0 such that for all $a \in S$, $1*a = a*1 = a$,
7. Multiplicative inverse: For every $a \in S$ not equal to 0 , there exists $a^{-1} \in S$, $a*a^{-1} = a^{-1}*a = 1$,
8. Left and right distributivity: For all $a, b, c \in S$, $a*(b+c) = (a*b)+(a*c)$ and $(b+c)*a = (b*a)+(c*a)$.

Thus a division algebra $(S, +, *)$ is a UNIT RING for which $(S - \{0\}, *)$ is a GROUP. A division algebra must contain at least two elements. A COMMUTATIVE division algebra is called a FIELD.

In 1878 and 1880, Frobenius and Peirce proved that the only associative REAL division algebras are real numbers, COMPLEX NUMBERS, and QUATERNIONS. The CAYLEY ALGEBRA is the only NONASSOCIATIVE DIVISION ALGEBRA. Hurwitz (1898) proved that the ALGEBRAS of REAL NUMBERS, COMPLEX NUMBERS, QUATERNIONS, and CAYLEY NUMBERS are the only ones where multiplication by unit "vectors" is distance-preserving. Adams (1956) proved that n -D vectors form an ALGEBRA in which division (except by 0) is always possible only for $n = 1, 2, 4$, and 8 .

see also CAYLEY NUMBER, FIELD, GROUP, NONASSOCIATIVE ALGEBRA, QUATERNION, UNIT RING

References

- Dickson, L. E. *Algebras and Their Arithmetics*. Chicago, IL: University of Chicago Press, 1923.
- Dixon, G. M. *Division Algebras: Octonions, Quaternions, Complex Numbers and the Algebraic Design of Physics*. Dordrecht, Netherlands: Kluwer, 1994.
- Herstein, I. N. *Topics in Algebra*, 2nd ed. New York: Wiley, pp. 326-329, 1975.
- Hurwitz, A. "Ueber die Composition der quadratischen Formen von beliebig vielen Variablen." *Nachr. Gesell. Wiss. Göttingen, Math.-Phys. Klasse*, 309-316, 1898.
- Kurosh, A. G. *General Algebra*. New York: Chelsea, pp. 221-243, 1963.
- Petro, J. "Real Division Algebras of Dimension > 1 contain \mathbb{C} ." *Amer. Math. Monthly* **94**, 445-449, 1987.

Division Lemma

When ac is DIVISIBLE by a number b that is RELATIVELY PRIME to a , then c must be DIVISIBLE by b .

Division Ring

see DIVISION ALGEBRA

Divisor

A divisor of a number N is a number d which DIVIDES N , also called a FACTOR. The total number of divisors for a given number N can be found as follows. Write a number in terms of its PRIME FACTORIZATION

$$N = p_1^{\alpha_1} p_2^{\alpha_2} \cdots p_r^{\alpha_r}. \quad (1)$$

For any divisor d of N , $N = dd'$ where

$$d = p_1^{\delta_1} p_2^{\delta_2} \cdots p_r^{\delta_r}, \quad (2)$$

so

$$d' = p_1^{\alpha_1 - \delta_1} p_2^{\alpha_2 - \delta_2} \cdots p_r^{\alpha_r - \delta_r}. \quad (3)$$

Now, $\delta_1 = 0, 1, \dots, \alpha_1$, so there are $\alpha_1 + 1$ possible values. Similarly, for δ_n , there are $\alpha_n + 1$ possible values, so the total number of divisors $\nu(N)$ of N is given by

$$\nu(N) = \prod_{n=1}^r (\alpha_n + 1). \quad (4)$$

The function $\nu(N)$ is also sometimes denoted $d(N)$ or $\sigma_0(N)$. The product of divisors can be found by writing the number N in terms of all possible products

$$N = \begin{pmatrix} d^{(1)} d'^{(1)} \\ \vdots \\ d^{(\nu)} d'^{(\nu)} \end{pmatrix}, \quad (5)$$

so

$$\begin{aligned} N^{\nu(N)} &= [d^{(1)} \cdots d^{(\nu)}] [d'^{(1)} d'^{(\nu)}] \\ &= \prod_{i=1}^{\nu} d_i \prod_{i=1}^{\nu} d'_i = \left(\prod d \right)^2, \end{aligned} \quad (6)$$

and

$$\prod d = N^{\nu(N)/2}. \quad (7)$$

The GEOMETRIC MEAN of divisors is

$$G = \left(\prod d \right)^{\nu(N)/2} = [N^{\nu(N)/2}]^{1/\nu(N)} = \sqrt{N}. \quad (8)$$

The sum of the divisors can be found as follows. Let $N \equiv ab$ with $a \neq b$ and $(a, b) = 1$. For any divisor d of N , $d = a_i b_i$, where a_i is a divisor of a and b_i is a divisor of b . The divisors of a are $1, a_1, a_2, \dots$, and a . The divisors of b are $1, b_1, b_2, \dots$, b . The sums of the divisors are then

$$\sigma(a) = 1 + a_1 + a_2 + \dots + a \quad (9)$$

$$\sigma(b) = 1 + b_1 + b_2 + \dots + b. \quad (10)$$

For a given a_i ,

$$a_i(1 + b_1 + b_2 + \dots + b) = a_i \sigma(b). \quad (11)$$

Summing over all a_i ,

$$(1 + a_1 + a_2 + \dots + a) \sigma(b) = \sigma(a) \sigma(b), \quad (12)$$

so $\sigma(N) = \sigma(ab) = \sigma(a) \sigma(b)$. Splitting a and b into prime factors,

$$\sigma(N) = \sigma(p_1^{\alpha_1}) \sigma(p_2^{\alpha_2}) \dots \sigma(p_r^{\alpha_r}). \quad (13)$$

For a prime POWER $p_i^{\alpha_i}$, the divisors are $1, p_i, p_i^2, \dots, p_i^{\alpha_i}$, so

$$\sigma(p_i^{\alpha_i}) = 1 + p_i + p_i^2 + \dots + p_i^{\alpha_i} = \frac{p_i^{\alpha_i+1} - 1}{p_i - 1}. \quad (14)$$

For N , therefore,

$$\sigma(N) = \prod_{i=1}^r \frac{p_i^{\alpha_i+1} - 1}{p_i - 1}. \quad (15)$$

For the special case of N a PRIME, (15) simplifies to

$$\sigma(p) = \frac{p^2 - 1}{p - 1} = p + 1. \quad (16)$$

For N a POWER of two, (15) simplifies to

$$\sigma(2^\alpha) = \frac{2^{\alpha+1} - 1}{2 - 1} = 2^{\alpha+1} - 1. \quad (17)$$

The ARITHMETIC MEAN is

$$A(N) \equiv \frac{\sigma(N)}{\nu(N)}. \quad (18)$$

The HARMONIC MEAN is

$$\frac{1}{H} \equiv \frac{1}{n} \left(\sum \frac{1}{d} \right). \quad (19)$$

But $N = dd'$, so $\frac{1}{\nu(N)} = \frac{d'}{N}$ and

$$\sum \frac{1}{d} = \frac{1}{N} \sum d' = \frac{1}{N} \sum d = \frac{\sigma(N)}{N}, \quad (20)$$

and we have

$$\frac{1}{H(N)} = \frac{1}{N(\nu)} \frac{\sigma(N)}{N} = \frac{A(N)}{N} \quad (21)$$

$$N = A(N)H(N). \quad (22)$$

Given three INTEGERS chosen at random, the probability that no common factor will divide them all is

$$[\zeta(3)]^{-1} \approx 1.202^{-1} = 0.832 \dots, \quad (23)$$

where $\zeta(3)$ is APÉRY'S CONSTANT.

Let $f(n)$ be the number of elements in the greatest subset of $[1, n]$ such that none of its elements are divisible by two others. For n sufficiently large,

$$0.6725 \dots \leq \frac{f(n)}{n} \leq 0.673 \dots \quad (24)$$

(Le Lionnais 1983, Lebensold 1976/1977).

see also ALIQUANT DIVISOR, ALIQUOT DIVISOR, ALIQUOT SEQUENCE, DIRICHLET DIVISOR PROBLEM, DIVISOR FUNCTION, e-DIVISOR, EXPONENTIAL DIVISOR, GREATEST COMMON DIVISOR, INFINARY DIVISOR, k-ARY DIVISOR, PERFECT NUMBER, PROPER DIVISOR, UNITARY DIVISOR

References

- Guy, R. K. "Solutions of $d(n) = d(n+1)$." §B18 in *Unsolved Problems in Number Theory*, 2nd ed. New York: Springer-Verlag, pp. 73-75, 1994.
 Le Lionnais, F. *Les nombres remarquables*. Paris: Hermann, p. 43, 1983.
 Lebensold, K. "A Divisibility Problem." *Studies Appl. Math.* **56**, 291-294, 1976/1977.

Divisor Function

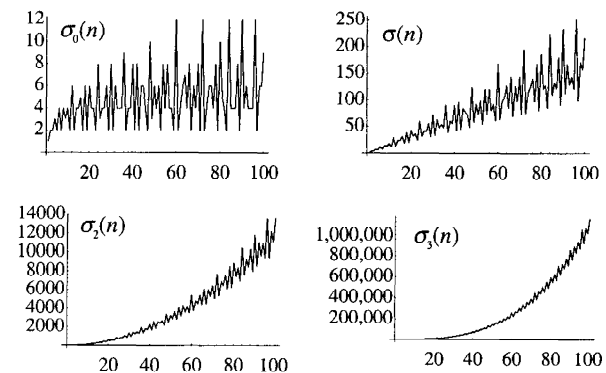

$\sigma_k(n)$ is defined as the sum of the k th POWERS of the DIVISORS of n . The function $\sigma_0(n)$ gives the total number of DIVISORS of n and is often denoted $d(n)$, $\nu(n)$, $\tau(n)$, or $\Omega(n)$ (Hardy and Wright 1979, pp. 354-355). The first few values of $\sigma_0(n)$ are 1, 2, 2, 3, 2, 4, 2, 4, 3, 4, 2, 6, ... (Sloane's A000005). The function $\sigma_1(n)$ is equal to the sum of DIVISORS of n and is often denoted $\sigma(n)$. The first few values of $\sigma(n)$ are 1, 3, 4, 7, 6, 12, 8, 15, 13, 18, ... (Sloane's A000203). The first few values of $\sigma_2(n)$ are 1, 5, 10, 21, 26, 50, 50, 85, 91, 130, ... (Sloane's A001157). The first few values of $\sigma_3(n)$ are 1, 9, 28, 73, 126, 252, 344, 585, 757, 1134, ... (Sloane's A001158).

The sum of the DIVISORS of n excluding n itself (i.e., the PROPER DIVISORS of n) is called the RESTRICTED DIVISOR FUNCTION and is denoted $s(n)$. The first few values are 0, 1, 1, 3, 1, 6, 1, 7, 4, 8, 1, 16, ... (Sloane's A001065).

As an illustrative example, consider the number 140, which has DIVISORS $d_i = 1, 2, 4, 5, 7, 10, 14, 20, 28, 35, 70$, and 140 (for a total of $N = 12$ of them). Therefore,

$$d(140) = N = 12 \quad (1)$$

$$\sigma(140) = \sum_i^N d_i = 336 \quad (2)$$

$$\sigma_2(140) = \sum_i^N d_i^2 = 27,300 \quad (3)$$

$$\sigma_3(140) = \sum_i^N d_i^3 = 3,164,112. \quad (4)$$

The $\sigma(n)$ function has the series expansion

$$\sigma(n) = \frac{1}{6}\pi^2 n \left[1 + \frac{(-1)^n}{2^2} + \frac{2\cos(\frac{2}{3}n\pi)}{3^2} + \frac{2\cos(\frac{1}{2}n\pi)}{4^2} + \frac{2[\cos(\frac{2}{5}n\pi) + \cos(\frac{4}{5}n\pi)]}{5^2} + \dots \right] \quad (5)$$

(Hardy 1959). It also satisfies the INEQUALITY

$$\frac{\sigma(n)}{n \ln \ln n} \leq e^\gamma + \frac{2(1 - \sqrt{2}) + \gamma - \ln(4\pi)}{\sqrt{\ln n} \ln \ln n} + \mathcal{O}\left(\frac{1}{\sqrt{\ln n} (\ln \ln n)^2}\right), \quad (6)$$

where γ is the EULER-MASCHERONI CONSTANT (Robin 1984, Erdős 1989).

Let a number n have PRIME factorization

$$n = \prod_{j=1}^r p_j^{\alpha_j}, \quad (7)$$

then

$$\sigma(n) = \prod_{j=1}^r \frac{p_j^{\alpha_j+1} - 1}{p_j - 1} \quad (8)$$

(Berndt 1985). GRONWALL'S THEOREM states that

$$\lim_{n \rightarrow \infty} \frac{\sigma(n)}{n \ln \ln n} = e^\gamma, \quad (9)$$

where γ is the EULER-MASCHERONI CONSTANT.

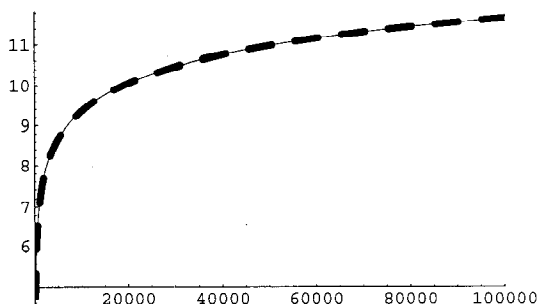

In general,

$$\sigma_k(n) \equiv \sum_{d|n} d^k. \quad (10)$$

In 1838, Dirichlet showed that the average number of DIVISORS of all numbers from 1 to n is asymptotic to

$$\frac{\sum_{i=1}^n \sigma_0(i)}{n} \sim \ln n + 2\gamma - 1 \quad (11)$$

(Conway and Guy 1996), as illustrated above, where the thin solid curve plots the actual values and the thick dashed curve plots the asymptotic function.

A curious identity derived using MODULAR FORM theory is given by

$$\sigma_7(n) = \sigma_3(n) + 120 \sum_{k=1}^{n-1} \sigma_3(k) \sigma_3(n-k). \quad (12)$$

The asymptotic SUMMATORY FUNCTION of $\sigma_0(n) = \Omega(n)$ is given by

$$\sum_{k=2}^n \Omega(k) = n \ln \ln n + B_2 + o(n), \quad (13)$$

where

$$B_2 = \gamma + \sum_{p \text{ prime}} \left[\ln(1 - p^{-1}) + \frac{1}{p-1} \right] \approx 1.034653 \quad (14)$$

(Hardy and Wright 1979, p. 355). This is related to the DIRICHLET DIVISOR PROBLEM. The SUMMATORY FUNCTIONS for σ_a with $a > 1$ are

$$\sum_{k=1}^n \sigma_a(k) = \frac{\zeta(a+1)}{a+1} n^{a+1} + \mathcal{O}(n^a). \quad (15)$$

For $a = 1$,

$$\sum_{k=1}^n \sigma_1(k) = \frac{\pi^2}{12} n^2 + \mathcal{O}(n \ln n). \quad (16)$$

The divisor function is ODD IFF n is a SQUARE NUMBER or twice a SQUARE NUMBER. The divisor function satisfies the CONGRUENCE

$$n\sigma(n) \equiv 2 \pmod{\phi(n)}, \quad (17)$$

for all PRIMES and no COMPOSITE NUMBERS with the exception of 4, 6, and 22 (Subbarao 1974). $\tau(n)$ is PRIME whenever $\sigma(n)$ is (Honsberger 1991). Factorizations of $\sigma(p^a)$ for PRIME p are given by Sorli.

see also DIRICHLET DIVISOR PROBLEM, DIVISOR, FACTOR, GREATEST PRIME FACTOR, GRONWALL'S THEOREM, LEAST PRIME FACTOR, MULTIPLY PERFECT

NUMBER, ORE'S CONJECTURE, PERFECT NUMBER, $r(n)$, RESTRICTED DIVISOR FUNCTION, SILVERMAN CONSTANT, TAU FUNCTION, TOTIENT FUNCTION, TOTIENT VALENCE FUNCTION, TWIN PEAKS

References

- Abramowitz, M. and Stegun, C. A. (Eds.). "Divisor Functions." §24.3.3 in *Handbook of Mathematical Functions with Formulas, Graphs, and Mathematical Tables*, 9th printing. New York: Dover, p. 827, 1972.
- Berndt, B. C. *Ramanujan's Notebooks: Part I*. New York: Springer-Verlag, p. 94, 1985.
- Conway, J. H. and Guy, R. K. *The Book of Numbers*. New York: Springer-Verlag, pp. 260–261, 1996.
- Dickson, L. E. *History of the Theory of Numbers, Vol. 1: Divisibility and Primality*. New York: Chelsea, pp. 279–325, 1952.
- Dirichlet, G. L. "Sur l'usage des séries infinies dans la théorie des nombres." *J. reine angew. Math.* **18**, 259–274, 1838.
- Erdős, P. "Ramanujan and I." In *Proceedings of the International Ramanujan Centenary Conference held at Anna University, Madras, Dec. 21, 1987*. (Ed. K. Alladi). New York: Springer-Verlag, pp. 1–20, 1989.
- Guy, R. K. "Solutions of $m\sigma(m) = n\sigma(n)$," "Analogues with $d(n)$, $\sigma_k(n)$," "Solutions of $\sigma(n) = \sigma(n+1)$," and "Solutions of $\sigma(q) + \sigma(r) = \sigma(q+r)$." §B11, B12, B13 and B15 in *Unsolved Problems in Number Theory*, 2nd ed. New York: Springer-Verlag, pp. 67–70, 1994.
- Hardy, G. H. *Ramanujan: Twelve Lectures on Subjects Suggested by His Life and Work*, 3rd ed. New York: Chelsea, p. 141, 1959.
- Hardy, G. H. and Weight, E. M. *An Introduction to the Theory of Numbers*, 5th ed. Oxford, England: Oxford University Press, pp. 354–355, 1979.
- Honsberger, R. *More Mathematical Morsels*. Washington, DC: Math. Assoc. Amer., pp. 250–251, 1991.
- Robin, G. "Grandes valeurs de la fonction somme des diviseurs et hypothèse de Riemann." *J. Math. Pures Appl.* **63**, 187–213, 1984.
- Sloane, N. J. A. Sequences A000005/M0246, A000203/M2329, A001065/M2226, A001157/M3799, A001158/M4605 in "An On-Line Version of the Encyclopedia of Integer Sequences."
- Sorli, R. "Factorization Tables." <http://www.maths.uts.edu.au/staff/ron/fact/fact.html>.
- Subbarao, M. V. "On Two Congruences for Primality." *Pacific J. Math.* **52**, 261–268, 1974.

Divisor Theory

A generalization by Kronecker of Kummer's theory of PRIME IDEAL factors. A divisor on a full subcategory C of $\text{mod}(A)$ is an additive mapping χ on C with values in a SEMIGROUP of IDEALS on A .

see also IDEAL, IDEAL NUMBER, PRIME IDEAL, SEMIGROUP

References

- Edwards, H. M. *Divisor Theory*. Boston, MA: Birkhäuser, 1989.
- Vasconcelos, W. V. *Divisor Theory in Module Categories*. Amsterdam, Netherlands: North-Holland, pp. 63–64, 1974.

Dixon's Factorization Method

In order to find INTEGERS x and y such that

$$x^2 \equiv y^2 \pmod{n} \quad (1)$$

(a modified form of FERMAT'S FACTORIZATION METHOD), in which case there is a 50% chance that $\text{GCD}(n, x - y)$ is a FACTOR of n , choose a RANDOM INTEGER r_i , compute

$$g(r_i) \equiv r_i^2 \pmod{n}, \quad (2)$$

and try to factor $g(r_i)$. If $g(r_i)$ is not easily factorable (up to some small trial divisor d), try another r_i . In practice, the trial r s are usually taken to be $\lfloor \sqrt{n} \rfloor + k$, with $k = 1, 2, \dots$, which allows the QUADRATIC SIEVE FACTORIZATION METHOD to be used. Continue finding and factoring $g(r_i)$ s until $N \equiv \pi d$ are found, where π is the PRIME COUNTING FUNCTION. Now for each $g(r_i)$, write

$$g(r_i) = p_1^{a_{1i}} p_2^{a_{2i}} \dots p_{N_i}^{a_{N_i}}, \quad (3)$$

and form the EXPONENT VECTOR

$$\mathbf{v}(r_i) = \begin{bmatrix} a_{1i} \\ a_{2i} \\ \vdots \\ a_{N_i} \end{bmatrix}. \quad (4)$$

Now, if a_{ki} are even for any k , then $g(r_i)$ is a SQUARE NUMBER and we have found a solution to (1). If not, look for a linear combination $\sum_i c_i \mathbf{v}(r_i)$ such that the elements are all even, i.e.,

$$c_1 \begin{bmatrix} a_{11} \\ a_{21} \\ \vdots \\ a_{N1} \end{bmatrix} + c_2 \begin{bmatrix} a_{12} \\ a_{22} \\ \vdots \\ a_{N2} \end{bmatrix} + \dots + c_N \begin{bmatrix} a_{1N} \\ a_{2N} \\ \vdots \\ a_{NN} \end{bmatrix} = \begin{bmatrix} 0 \\ 0 \\ \vdots \\ 0 \end{bmatrix} \pmod{2} \quad (5)$$

$$\begin{bmatrix} a_{11} & a_{12} & \dots & a_{1N} \\ a_{21} & a_{22} & \dots & a_{2N} \\ \vdots & \vdots & \ddots & \vdots \\ a_{N1} & a_{N2} & \dots & a_{NN} \end{bmatrix} \begin{bmatrix} c_1 \\ c_2 \\ \vdots \\ c_N \end{bmatrix} = \begin{bmatrix} 0 \\ 0 \\ \vdots \\ 0 \end{bmatrix} \pmod{2}. \quad (6)$$

Since this must be solved only mod 2, the problem can be simplified by replacing the a_{ij} s with

$$b_{ij} = \begin{cases} 0 & \text{for } a_{ij} \text{ even} \\ 1 & \text{for } a_{ij} \text{ odd.} \end{cases} \quad (7)$$

GAUSSIAN ELIMINATION can then be used to solve

$$\mathbf{bc} = \mathbf{z} \quad (8)$$

for \mathbf{c} , where \mathbf{z} is a VECTOR equal to $\mathbf{0} \pmod{2}$. Once \mathbf{c} is known, then we have

$$\prod_k g(r_k) \equiv \prod_k r_k^2 \pmod{n}, \quad (9)$$

where the products are taken over all k for which $c_k = 1$. Both sides are PERFECT SQUARES, so we have a 50% chance that this yields a nontrivial factor of n . If it does not, then we proceed to a different z and repeat the procedure. There is no guarantee that this method will yield a factor, but in practice it produces factors faster than any method using trial divisors. It is especially amenable to parallel processing, since each processor can work on a different value of r .

References

- Bressoud, D. M. *Factorization and Prime Testing*. New York: Springer-Verlag, pp. 102–104, 1989.
 Dixon, J. D. "Asymptotically Fast Factorization of Integers." *Math. Comput.* **36**, 255–260, 1981.
 Lenstra, A. K. and Lenstra, H. W. Jr. "Algorithms in Number Theory." In *Handbook of Theoretical Computer Science, Volume A: Algorithms and Complexity* (Ed. J. van Leeuwen). New York: Elsevier, pp. 673–715, 1990.
 Pomerance, C. "A Tale of Two Sieves." *Not. Amer. Math. Soc.* **43**, 1473–1485, 1996.

Dixon-Ferrar Formula

Let $J_\nu(z)$ be a BESSEL FUNCTION OF THE FIRST KIND, $Y_\nu(z)$ a BESSEL FUNCTION OF THE SECOND KIND, and $K_\nu(z)$ a MODIFIED BESSEL FUNCTION OF THE FIRST KIND. Also let $\Re[z] > 0$ and $|\Re[z]| < 1/2$. Then

$$J_\nu^2(z) + Y_\nu^2(z) = \frac{8 \cos(\nu\pi)}{\pi^2} \int_0^\infty K_{2\nu}(2z \sinh t) dt.$$

see also NICHOLSON'S FORMULA, WATSON'S FORMULA

References

- Gradshteyn, I. S. and Ryzhik, I. M. Eqn. 6.518 in *Tables of Integrals, Series, and Products*, 5th ed. San Diego, CA: Academic Press, p. 671, 1979.
 Iyanaga, S. and Kawada, Y. (Eds.). *Encyclopedic Dictionary of Mathematics*. Cambridge, MA: MIT Press, p. 1476, 1980.

Dixon's Random Squares Factorization Method

see DIXON'S FACTORIZATION METHOD

Dixon's Theorem

$${}_3F_2 \left[\begin{matrix} n, -x, -y \\ x+n+1, y+n+1 \end{matrix} \right] \\ = \Gamma(x+n+1)\Gamma(y+n+1)\Gamma(\tfrac{1}{2}n+1)\Gamma(x+y+\tfrac{1}{2}n+1) \\ \times \Gamma(n+1)\Gamma(x+y+n+1)\Gamma(x+\tfrac{1}{2}n+1)\Gamma(y+\tfrac{1}{2}n+1),$$

where ${}_3F_2(a, b, c; d, e; z)$ is a GENERALIZED HYPERGEOMETRIC FUNCTION and $\Gamma(z)$ is the GAMMA FUNCTION. It can be derived from the DOUGALL-RAMANUJAN IDENTITY. It can be written more symmetrically as

$${}_3F_2(a, b, c; d, e; 1) = \frac{(\tfrac{1}{2}a)!(a-b)!(a-c)!(\tfrac{1}{2}a-b-c)!}{a!(\tfrac{1}{2}a-b)!(\tfrac{1}{2}a-c)!(a-b-c)!},$$

where $1 + a/2 - b - c$ has a positive REAL PART, $d = a - b + 1$, and $e = a - c + 1$. The identity can also be written as the beautiful symmetric sum

$$\sum_k (-1)^k \binom{a+b}{a+k} \binom{a+c}{c+k} \binom{b+c}{b+k} = \frac{(a+b+c)!}{a!b!c!}$$

(Petkovšek 1996).

see also DOUGALL-RAMANUJAN IDENTITY, GENERALIZED HYPERGEOMETRIC FUNCTION

References

- Bailey, W. N. *Generalised Hypergeometric Series*. Cambridge, England: Cambridge University Press, 1935.
 Cartier, P. and Foata, D. *Problèmes combinatoires de commutation et réarrangements*. New York: Springer-Verlag, 1969.
 Knuth, D. E. *The Art of Computer Programming, Vol. 1: Fundamental Algorithms*, 2nd ed. Reading, MA: Addison-Wesley, 1973.
 Petkovšek, M.; Wilf, H. S.; and Zeilberger, D. *A=B*. Wellesley, MA: A. K. Peters, p. 43, 1996.
 Zeilberger, D. and Bressoud, D. "A Proof of Andrew's q -Dyson Conjecture." *Disc. Math.* **54**, 201–224, 1985.

Dobiński's Formula

Gives the n th BELL NUMBER,

$$B_n = \frac{1}{e} \sum_{k=0}^{\infty} \frac{k^n}{k!}. \quad (1)$$

It can be derived by dividing the formula for a STIRLING NUMBER OF THE SECOND KIND by $m!$, yielding

$$\frac{m^n}{m!} = \sum_{k=1}^m \left\{ \begin{matrix} n \\ k \end{matrix} \right\} \frac{1}{(m-k)!}. \quad (2)$$

Then

$$\sum_{m=1}^{\infty} \frac{m^n}{m!} \lambda^m = \left(\sum_{k=1}^n \left\{ \begin{matrix} n \\ k \end{matrix} \right\} \lambda^k \right) \left(\sum_{j=0}^{\infty} \frac{\lambda^j}{j!} \right), \quad (3)$$

and

$$\sum_{k=1}^n \left\{ \begin{matrix} n \\ k \end{matrix} \right\} \lambda^k = e^{-\lambda} \sum_{m=1}^{\infty} \frac{m^n}{m!} \lambda^m. \quad (4)$$

Now setting $\lambda = 1$ gives the identity (Dobiński 1877; Rota 1964; Berge 1971, p. 44; Comtet 1974, p. 211; Roman 1984, p. 66; Lupas 1988; Wilf 1990, p. 106; Chen and Yeh 1994; Pitman 1997).

References

- Berge, C. *Principles of Combinatorics*. New York: Academic Press, 1971.
 Chen, B. and Yeh, Y.-N. "Some Explanations of Dobiński's Formula." *Studies Appl. Math.* **92**, 191–199, 1994.
 Comtet, L. *Advanced Combinatorics*. Boston, MA: Reidel, 1974.
 Dobiński, G. "Summierung der Reihe $\sum n^m/n!$ für $m = 1, 2, 3, 4, 5, \dots$ " *Grunert Archiv (Arch. Math. Phys.)* **61**, 333–336, 1877.

Foata, D. *La série génératrice exponentielle dans les problèmes d'énumération*. Vol. 54 of *Séminaire de Mathématiques supérieures*. Montréal, Canada: Presses de l'Université de Montréal, 1974.

Lupas, A. "Dobiński-Type Formula for Binomial Polynomials." *Stud. Univ. Babeş-Bolyai Math.* **33**, 30–44, 1988.

Pitman, J. "Some Probabilistic Aspects of Set Partitions." *Amer. Math. Monthly* **104**, 201–209, 1997.

Roman, S. *The Umbral Calculus*. New York: Academic Press, 1984.

Rota, G.-C. "The Number of Partitions of a Set." *Amer. Math. Monthly* **71**, 498–504, 1964.

Wilf, H. *Generatingfunctionology*, 2nd ed. San Diego, CA: Academic Press, 1990.

Dodecadodecahedron

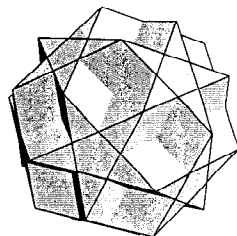

The UNIFORM POLYHEDRON U_{36} whose DUAL POLYHEDRON is the MEDIAL RHOMBIC TRIACONTAHEDRON. The solid is also called the GREAT DODECADODECAHEDRON, and its DUAL POLYHEDRON is also called the SMALL STELLATED TRIACONTAHEDRON. It can be obtained by TRUNCATING a GREAT DODECAHEDRON or FACETING a ICOSIDODECAHEDRON with PENTAGONS and covering remaining open spaces with PENTAGRAMS (Holden 1991, p. 103). A FACETED version is the GREAT DODECAHEMICOSAHEDRON. The dodecadodecahedron is an ARCHIMEDEAN SOLID STELLATION. The dodecadodecahedron has SCHLÄFLI SYMBOL $\{\frac{5}{2}, 5\}$ and WYTHOFF SYMBOL $2 | \frac{5}{2} 5$. Its faces are $12\{\frac{5}{2}\} + 12\{5\}$, and its CIRCUMRADIUS for unit edge length is

$$R = 1.$$

References

- Cundy, H. and Rollett, A. *Mathematical Models*, 3rd ed. Stradbroke, England: Tarquin Pub., p. 123, 1989.
 Holden, A. *Shapes, Space, and Symmetry*. New York: Dover, 1991.
 Wenninger, M. J. *Polyhedron Models*. Cambridge, England: Cambridge University Press, p. 112, 1989.

Dodecagon

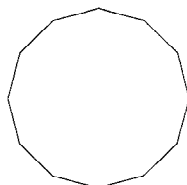

The constructible regular 12-sided POLYGON with SCHLÄFLI SYMBOL $\{12\}$. The INRADIUS r , CIRCUMRADIUS R , and AREA A can be computed directly from

the formulas for a general regular POLYGON with side length s and $n = 12$ sides,

$$r = \frac{1}{2}s \cot\left(\frac{\pi}{12}\right) = \frac{1}{2}(2 + \sqrt{3})s \quad (1)$$

$$R = \frac{1}{2}s \cot\left(\frac{\pi}{12}\right) = \frac{1}{2}(\sqrt{2} + \sqrt{6})s \quad (2)$$

$$A = \frac{1}{4}ns^2 \cot\left(\frac{\pi}{12}\right) = 3(2 + \sqrt{3})s^2. \quad (3)$$

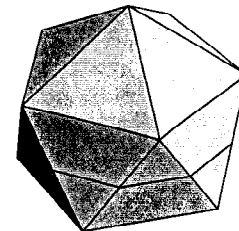
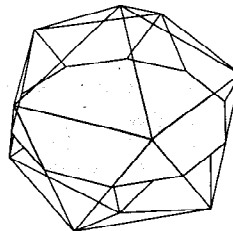
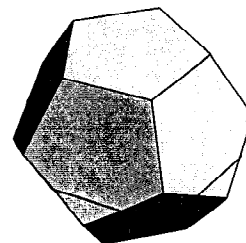
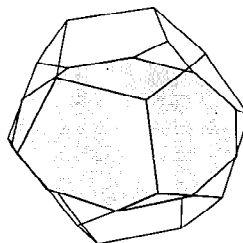

A PLANE PERPENDICULAR to a C_5 axis of a DODECAHEDRON or ICOSAHEDRON cuts the solid in a regular DECAGONAL CROSS-SECTION (Holden 1991, pp. 24–25).

The GREEK, LATIN, and MALTESE CROSSES are all irregular dodecagons.

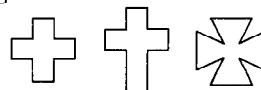

see also DECAGON, DODECAGRAM, DODECAHEDRON, GREEK CROSS, LATIN CROSS, MALTESE CROSS, TRIGONOMETRY VALUES— $\pi/12$, UNDECAGON

References

- Holden, A. *Shapes, Space, and Symmetry*. New York: Dover, 1991.

Dodecagram

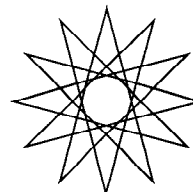

The STAR POLYGON $\{\frac{12}{5}\}$.

see also STAR POLYGON, TRIGONOMETRY VALUES— $\pi/12$

Dodecahedral Conjecture

In any unit SPHERE PACKING, the volume of any VORONOI CELL around any sphere is at least as large as a regular DODECAHEDRON of INRADIUS 1. If true, this would provide a bound on the densest possible sphere packing greater than any currently known. It would not, however, be sufficient to establish the KEPLER CONJECTURE.

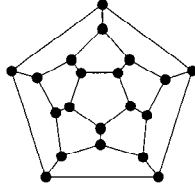
Dodecahedral Graph

A POLYHEDRAL GRAPH.

see also CUBICAL GRAPH, ICOSAHERAL GRAPH, OCTAHEDRAL GRAPH, TETRAHEDRAL GRAPH

Dodecahedral Space

see POINCARÉ MANIFOLD

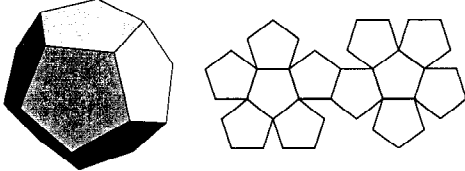
Dodecahedron

The regular dodecahedron is the PLATONIC SOLID (P_4) composed of 20 VERTICES, 30 EDGES, and 12 PENTAGONAL FACES. It is given by the symbol $12\{5\}$, the SCHLÄFLI SYMBOL $\{5, 3\}$. It is also UNIFORM POLYHEDRON U_{23} and has WYTHOFF SYMBOL $3|25$. The dodecahedron has the ICOSAHERAL GROUP I_h of symmetries.

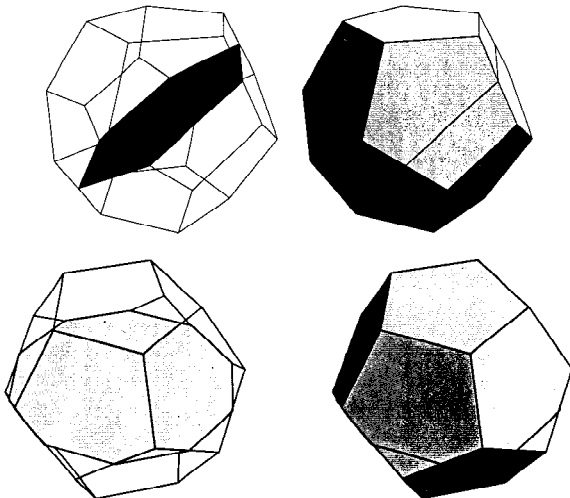

A PLANE PERPENDICULAR to a C_3 axis of a dodecahedron cuts the solid in a regular HEXAGONAL CROSS-SECTION (Holden 1991, p. 27). A PLANE PERPENDICULAR to a C_5 axis of a dodecahedron cuts the solid in a regular DECAGONAL CROSS-SECTION (Holden 1991, p. 24).

The DUAL POLYHEDRON of the dodecahedron is the ICOSAHERON.

When the dodecahedron with edge length $\sqrt{10 - 2\sqrt{5}}$ is oriented with two opposite faces parallel to the xy -PLANE, the vertices of the top and bottom faces lie at $z = \pm(\phi + 1)$ and the other VERTICES lie at $z = \pm(\phi - 1)$, where ϕ is the GOLDEN RATIO. The explicit coordinates are

$$\pm \left(2 \cos\left(\frac{2}{5}\pi i\right), 2 \sin\left(\frac{2}{5}\pi i\right), \phi + 1 \right) \quad (1)$$

$$\pm \left(2\phi \cos\left(\frac{2}{5}\pi i\right), 2\phi \sin\left(\frac{2}{5}\pi i\right), \phi - 1 \right) \quad (2)$$

with $i = 0, 1, \dots, 4$, where ϕ is the GOLDEN RATIO. Explicitly, these coordinates are

$$\mathbf{x}_{10}^{\pm} = \pm(2, 0, \frac{1}{2}(3 + \sqrt{5})) \quad (3)$$

$$\mathbf{x}_{11}^{\pm} = \pm(\frac{1}{2}(\sqrt{5} - 1), \frac{1}{2}\sqrt{10 + 2\sqrt{5}}, \frac{1}{2}(3 + \sqrt{5})) \quad (4)$$

$$\mathbf{x}_{12}^{\pm} = \pm(-\frac{1}{2}(1 + \sqrt{5}), \frac{1}{2}\sqrt{10 - 2\sqrt{5}}, \frac{1}{2}(3 + \sqrt{5})) \quad (5)$$

$$\mathbf{x}_{13}^{\pm} = \pm(-\frac{1}{2}(1 + \sqrt{5}), -\frac{1}{2}\sqrt{10 - 2\sqrt{5}}, \frac{1}{2}(3 + \sqrt{5})) \quad (6)$$

$$\mathbf{x}_{14}^{\pm} = \pm(\frac{1}{2}(\sqrt{5} - 1), -\frac{1}{2}\sqrt{10 + 2\sqrt{5}}, \frac{1}{2}(3 + \sqrt{5})) \quad (7)$$

$$\mathbf{x}_{20}^{\pm} = \pm(1 + \sqrt{5}, 0, \frac{1}{2}(\sqrt{5} - 1)) \quad (8)$$

$$\mathbf{x}_{21}^{\pm} = \pm(1, \sqrt{5 + 2\sqrt{5}}, \frac{1}{2}(\sqrt{5} - 1)) \quad (9)$$

$$\mathbf{x}_{22}^{\pm} = \pm(-\frac{1}{2}(3 + \sqrt{5}), \frac{1}{2}\sqrt{10 + 2\sqrt{5}}, \frac{1}{2}(\sqrt{5} - 1)) \quad (10)$$

$$\mathbf{x}_{23}^{\pm} = \pm(-\frac{1}{2}(3 + \sqrt{5}), -\frac{1}{2}\sqrt{10 + 2\sqrt{5}}, \frac{1}{2}(\sqrt{5} - 1)) \quad (11)$$

$$\mathbf{x}_{24}^{\pm} = \pm(1, -\sqrt{5 + 2\sqrt{5}}, \frac{1}{2}(\sqrt{5} - 1)), \quad (12)$$

where \mathbf{x}_{1i}^+ are the top vertices, \mathbf{x}_{2i}^+ are the vertices above the mid-plane, \mathbf{x}_{2i}^- are the vertices below the mid-plane, and \mathbf{x}_{2i}^- are the bottom vertices. The VERTICES of a dodecahedron can be given in a simple form for a dodecahedron of side length $a = \sqrt{5} - 1$ by $(0, \pm\phi^{-1}, \pm\phi)$, $(\pm\phi, 0, \pm\phi^{-1})$, $(\pm\phi^{-1}, \pm\phi, 0)$, and $(\pm 1, \pm 1, \pm 1)$.

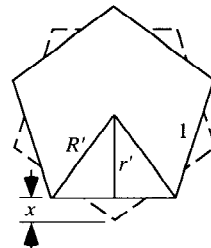

For a dodecahedron of unit edge length $a = 1$, the CIRCUMRADIUS R' and INRADIUS r' of a PENTAGONAL FACE are

$$R' = \frac{1}{10} \sqrt{50 + 10\sqrt{5}} \quad (13)$$

$$r' = \frac{1}{10} \sqrt{25 + 10\sqrt{5}}. \quad (14)$$

The SAGITTA x is then given by

$$x \equiv R' - r' = \frac{1}{10} \sqrt{125 - 10\sqrt{5}}. \quad (15)$$

Now consider the following figure.

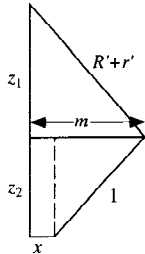

Using the PYTHAGOREAN THEOREM on the figure then gives

$$z_1^2 + m^2 = (R' + r')^2 \quad (16)$$

$$z_2^2 + (m - x)^2 = 1 \quad (17)$$

$$\left(\frac{z_1 + z_2}{2}\right)^2 + R'^2 = \left(\frac{z_1 - z_2}{2}\right)^2 + (m + r')^2. \quad (18)$$

Equation (18) can be written

$$z_1 z_2 + r^2 = (m + r')^2. \quad (19)$$

Solving (16), (17), and (19) simultaneously gives

$$m = r' = \frac{1}{10} \sqrt{25 + 10\sqrt{5}} \quad (20)$$

$$z_1 = 2r' = \frac{1}{5} \sqrt{25 + 10\sqrt{5}} \quad (21)$$

$$z_2 = R' = \frac{1}{10} \sqrt{50 + 10\sqrt{5}}. \quad (22)$$

The INRADIUS of the dodecahedron is then given by

$$r = \frac{1}{2}(z_1 + z_2), \quad (23)$$

so

$$\begin{aligned} r^2 &= \frac{1}{4} \left(\frac{1}{10} \sqrt{50 + 10\sqrt{5}} + \frac{1}{5} \sqrt{25 + 10\sqrt{5}} \right)^2 \\ &= \frac{1}{40} (25 + 11\sqrt{5}), \end{aligned} \quad (24)$$

and

$$r = \sqrt{\frac{25 + 11\sqrt{5}}{40}} = \frac{1}{20} \sqrt{250 + 110\sqrt{5}} = 1.11351\dots \quad (25)$$

Now,

$$\begin{aligned} R^2 &= R'^2 + r^2 = \left[\frac{1}{100} (50 + 10\sqrt{5}) + \frac{1}{400} (250 + 110\sqrt{5}) \right] \\ &= \frac{3}{8} (3 + \sqrt{5}), \end{aligned} \quad (26)$$

and the CIRCUMRADIUS is

$$R = a \sqrt{\frac{3}{8} (3 + \sqrt{5})} = \frac{1}{4} (\sqrt{15} + \sqrt{3}) = 1.40125\dots \quad (27)$$

The INTERRADIUS is given by

$$\begin{aligned} \rho^2 &= r'^2 + r^2 = \left[\frac{1}{100} (25 + 10\sqrt{5}) + \frac{1}{400} (250 + 110\sqrt{5}) \right] \\ &= \frac{1}{8} (7 + 3\sqrt{5}), \end{aligned} \quad (28)$$

so

$$\rho = \frac{1}{4} (3 + \sqrt{5}) = 1.30901\dots \quad (29)$$

The AREA of a single FACE is the AREA of a PENTAGON,

$$A = \frac{1}{4} \sqrt{25 + 10\sqrt{5}}. \quad (30)$$

The VOLUME of the dodecahedron can be computed by summing the volume of the 12 constituent PENTAGONAL PYRAMIDS,

$$\begin{aligned} V &= 12 \left(\frac{1}{3} Ar \right) \\ &= 12 \left(\frac{1}{3} \right) \left(\frac{1}{4} \sqrt{25 + 10\sqrt{5}} \right) \left(\frac{1}{20} \sqrt{250 + 110\sqrt{5}} \right) \\ &= \frac{1}{20} (75 + 35\sqrt{5}) = \frac{1}{4} (15 + 7\sqrt{5}). \end{aligned} \quad (31)$$

Apollonius showed that the VOLUME V and SURFACE AREA A of the dodecahedron and its DUAL the ICOSAHEDRON are related by

$$\frac{V_{\text{icosahedron}}}{V_{\text{dodecahedron}}} = \frac{A_{\text{icosahedron}}}{A_{\text{dodecahedron}}} \quad (32)$$

The HEXAGONAL SCALENOHEDRON is an irregular dodecahedron.

see also AUGMENTED DODECAHEDRON, AUGMENTED TRUNCATED DODECAHEDRON, DODECAGON, DODECAHEDRON-ICOSAHEDRON COMPOUND, ELONGATED DODECAHEDRON, GREAT DODECAHEDRON, GREAT STELLATED DODECAHEDRON, HYPERBOLIC DODECAHEDRON, ICOSAHEDRON, METABIAUGMENTED DODECAHEDRON, METABIAUGMENTED TRUNCATED DODECAHEDRON, PARABIAUGMENTED DODECAHEDRON, PARABIAUGMENTED TRUNCATED DODECAHEDRON, PYRITOHEDRON, RHOMBIC DODECAHEDRON, SMALL STELLATED DODECAHEDRON, TRIAUGMENTED DODECAHEDRON, TRIAUGMENTED TRUNCATED DODECAHEDRON, TRIGONAL DODECAHEDRON, TRIGONOMETRY VALUES— $\pi/5$ TRUNCATED DODECAHEDRON

References

- Cundy, H. and Rollett, A. *Mathematical Models*, 3rd ed. Stradbroke, England: Tarquin Pub., 1989.
 Davie, T. "The Dodecahedron." <http://www.dcs.st-and.ac.uk/~ad/mathrecs/polyhedra/dodecahedron.html>.
 Holden, A. *Shapes, Space, and Symmetry*. New York: Dover, 1991.

Dodecahedron-Icosahedron Compound

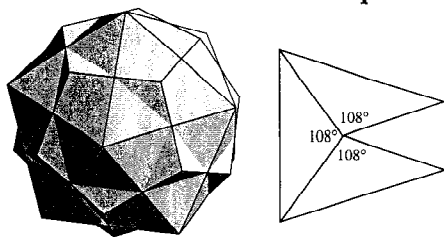

A POLYHEDRON COMPOUND of a DODECAHEDRON and ICOSAHEDRON which is most easily constructed by adding 20 triangular PYRAMIDS, constructed as above, to an ICOSAHEDRON. In the compound, the DODECAHEDRON and ICOSAHEDRON are rotated $\pi/5$ radians with respect to each other, and the ratio of the ICOSAHEDRON to DODECAHEDRON edges lengths are the GOLDEN RATIO ϕ .

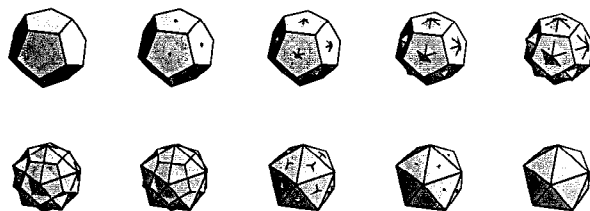

The above figure shows compounds composed of a DODECAHEDRON of unit edge length and ICOSAHEDRON having edge lengths varying from $\sqrt{5}/2$ (inscribed in the dodecahedron) to 2 (circumscribed about the dodecahedron).

The intersecting edges of the compound form the DIAGONALS of 30 RHOMBUSES comprising the TRIACONTAHEDRON, which is the DUAL POLYHEDRON of the ICOSIDODECAHEDRON (Ball and Coxeter 1987). The dodecahedron-icosahedron is the first STELLATION of the ICOSIDODECAHEDRON.

see also DODECAHEDRON, ICOSAHEDRON, ICOSIDODECAHEDRON, POLYHEDRON COMPOUND

References

Cundy, H. and Rollett, A. *Mathematical Models*, 2nd ed. Stradbroke, England: Tarquin Pub., p. 131, 1989.
 Wenninger, M. J. *Polyhedron Models*. Cambridge, England: Cambridge University Press, p. 76, 1989.

Dodecahedron Stellations

The dodecahedron has three STELLATIONS: the GREAT DODECAHEDRON, GREAT STELLATED DODECAHEDRON, and SMALL STELLATED DODECAHEDRON. The only STELLATIONS of PLATONIC SOLIDS which are UNIFORM POLYHEDRA are these three and one ICOSAHEDRON STELLATION. Bulatov has produced 270 stellations of a deformed dodecahedron.

see also ICOSAHEDRON STELLATIONS, STELLATED POLYHEDRON, STELLATION

References

Bulatov, V.v "270 Stellations of Deformed Dodecahedron."
<http://www.physics.orst.edu/~bulatov/polyhedra/dodeca270/>.

Dodecahedron 2-Compound

A compound of two dodecahedra with the symmetry of the CUBE arises by combining the two dodecahedra rotated 90° with respect to each other about a common C_2 axis (Holden 1991, p. 37).

see also POLYHEDRON COMPOUND

References

Holden, A. *Shapes, Space, and Symmetry*. New York: Dover, 1991.

Domain

A connected OPEN SET. The term domain is also used to describe the set of values D for which a FUNCTION is defined. The set of values to which D is sent by the function (MAP) is then called the RANGE.

see also MAP, ONE-TO-ONE, ONTO, RANGE (IMAGE), REINHARDT DOMAIN

Domain Invariance Theorem

The Invariance of Domain Theorem is that if $f : A \rightarrow \mathbb{R}^n$ is a ONE-TO-ONE continuous MAP from A , a compact subset of \mathbb{R}^n , then the interior of A is mapped to the interior of $f(A)$.

see also DIMENSION INVARIANCE THEOREM

Dome

see BOHEMIAN DOME, GEODESIC DOME, HEMISPHERE, SPHERICAL CAP, TORISPHERICAL DOME, VAULT

Dominance

The dominance RELATION on a SET of points in EUCLIDEAN n -space is the INTERSECTION of the n coordinate-wise orderings. A point p dominates a point q provided that every coordinate of p is at least as large as the corresponding coordinate of q .

The dominance orders in \mathbb{R}^n are precisely the POSETS of DIMENSION at most n .

see also PARTIALLY ORDERED SET, REALIZER

Domino



The unique 2-POLYOMINO consisting of two equal squares connected along a complete EDGE.

The FIBONACCI NUMBER F_{n+1} gives the number of ways for 2×1 dominoes to cover a $2 \times n$ CHECKERBOARD, as illustrated in the following diagrams (Dickau).

